

# HPARCHIVE

This vintage Hewlett Packard document was  
preserved and distributed by

[www.hparchive.com](http://www.hparchive.com)

Please visit us on the web!

Scanned by on-line curator: Jack Hudler

**\*\* For FREE Distribution Only \*\***



**HEWLETT  
PACKARD**

**1988**

# TEST AND MEASUREMENT CATALOG



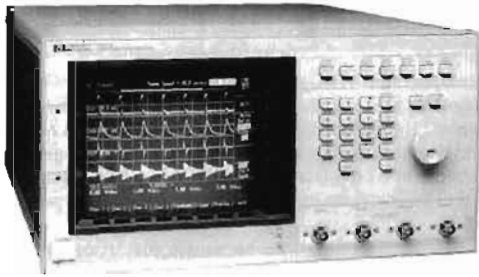

#### HP 54112D Digitizing Oscilloscope

The HP 54112D is a four-channel deep-memory (64k memory per channel) oscilloscope. With its 400 megasample-per-second digitizing rate the HP 54112D is ideal for working in TTL and CMOS design. The 100-MHz bandwidth is suitable for work in ATE, robotics, communications and electro-mechanical systems.

The HP 54112D offers extensive capabilities that include automatic measurements, autoscaling, digital storage, color display and state and pattern triggering. See page 59.



#### HP 54120T Digitizing Oscilloscope

With 10 ps time-interval accuracy and 0.4% vertical accuracy, the HP 54120T Digitizing Oscilloscope offers uncompromising performance for designers who are pushing back the state-of-the-art. A 20-GHz bandwidth, four channels, time domain reflectometry, and histograms are just a few of the performance contributions this oscilloscope makes. See page 60.



#### HP 5185T Precision Digitizing Oscilloscope

Analyze time and frequency domains with the HP 5185T, HP's highest-performance precision digitizing oscilloscope. The HP 5185T adds the data acquisition features of the HP 5185A waveform recorder to a waveform analyzer. Bench-top control, a high-quality display, and flexible analysis capability in the waveform analyzer use and display the precision needed with 8 bits of data. The 250-megasample/second sample rate provides useful 2-channel information beyond the 110-MHz bandwidth.

Once a signal has been digitized, the HP 5185T can complete up to four separate signal analysis functions. The touch-sensitive display guides the user through menus for analysis, cursor control, display setup, measurement setup and control, and plotting or disc operation. Waveform measurements and instrument setups can be transferred directly from the HP 5185T to storage on the optional internal disc drive. See page 64.

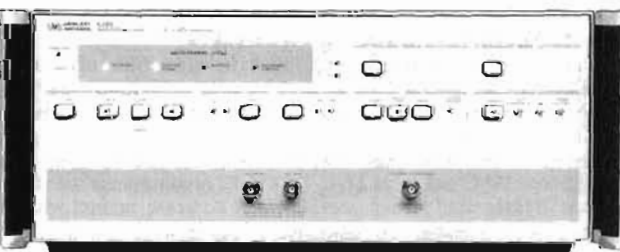

#### HP 5185A Waveform Recorder

Use the HP 5185A's precision voltage and fine timing resolution to capture details in signals that frustrate most oscilloscope users. Dual, adjustable 250-megasample/second A/D conversion results in fine timing resolution of 4 ns, and the 8 bits of the A/D conversions provide precision voltage resolution of approximately 0.4 mV on the  $\pm 50$  mV range. Whether you need flexible triggering or long memory to capture a signal, the HP 5185T provides the solution. Enhanced triggering such as variable hysteresis, bittrigger and drop-out trigger ensure that you don't miss an event or trigger falsely on the wrong event. Signals with long durations are recorded with the 65,536 samples in each channel. Software supplied with the HP 5185A includes instrument setup and data-transfer routines in BASIC for use with HP 9000 Series 200/300 Computers, or with the HP Vectra PC with the HP 82300A BASIC Language Processor. See page 65.



#### HP 71210A Microwave Spectrum Analyzer

The latest addition to the HP 70000 Modular Spectrum Analyzer family offers state-of-the-art performance with all the benefits of modularity. The HP 71210A Microwave Spectrum Analyzer has a unique front-end architecture and fundamental mixing from 100 Hz to 22 GHz. This results in superior sensitivity, amplitude accuracy, and measurement speed. Typical sensitivity is greater than  $-137$  dBm at 20 GHz, and frequency response is  $\pm 2$  dB from 2.7 to 22 GHz. In addition, full sweeps from 100 Hz to 22 GHz are possible. The instrument also offers continuously-peaked preselection.

If you are performing spur search, third order intermodulation, harmonic distortion, or any other measurement in which sensitivity, amplitude accuracy, and measurement speed are important, the HP 71210A will provide you with the highest performance available today. See page 110.

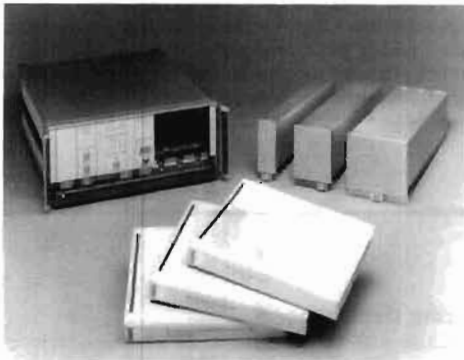

#### HP 70595A Design Guides, HP 7059XA Module Part Kits

HP 70595A Design Guides and HP 7059XA Module Part Kits provide the vehicle for incorporating your custom designs into the HP 70000 Modular Measurement System. The design guides provide direction for the development of custom modular products, and part kits supply hardware for  $1/8$ -,  $3/8$ -, and  $1/2$ -width modules.

Use of this family of Module Development Products enables many custom functions to be incorporated into an HP 70000 system. Custom modules can use the power, cooling, and clean EMI environment provided by the HP 70000 Modular Measurement System. Computer control of custom modules is available via HP-IB. See page 110.

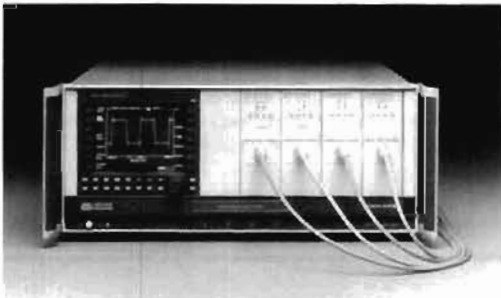

#### HP 70700A Digitizer

The HP 70700A Digitizer is a new addition to the expanding HP 70000 Modular Measurement System product family. This module offers 20 Msample/second, 10-bit resolution, and 256K of memory. It can be used either to enhance the performance of an HP 70000 modular spectrum analyzer or act as a stand-alone, multi-channel waveform recorder.

Added to an HP 70000 analyzer, the digitizer allows sweeps as fast as 80  $\mu$ s in the time domain and 15 ms in the frequency domain. This improvement in digitizing speed is especially useful in the analysis of pulsed RF signals. As a stand-alone instrument, the digitizer can be configured as a multi-channel waveform-analysis system. A system of up to eight channels can be assembled in a single HP 70001 mainframe. See page 110.



#### HP 8562A and 8562B Portable Microwave Spectrum Analyzers

HP has expanded its line of portable spectrum analyzers with two MIL-rugged units that each cover the 1 kHz to 22 GHz range plus millimeter frequencies. The HP 8562A has tracking preselection up to 22 GHz, while the unpreselected HP 8562B is intended for applications in which most measurements are made below 2.9 GHz.

These analyzers are designed for harsh field conditions. They feature a 5-minute warm-up time in ambient temperatures from  $-10$  to  $+55^{\circ}\text{C}$  and meet MIL-T-28800C requirements for vibration, pulse shock, and transit drop. Synthesized tuning provides fast, accurate tuning, while a built-in frequency counter makes precise frequency measurements even in wide-span displays. Both analyzers have a speaker and AM/FM demodulation for listening to signals of interest.

The HP 8562A/B are suitable for such diverse uses as the maintenance of terrestrial and satellite microwave links, radar systems, AM/FM/TV broadcast equipment, telecom systems, and avionics; component testing; signal surveillance; and EMI diagnostic testing. See page 131.



**HP 5371A Frequency and Time Interval Analyzer**

The HP 5371A Frequency and Time Interval Analyzer uses HP's new continuous measurement technology for characterizing frequency, phase, time interval and jitter. Unlike traditional counters that are limited by very slow measurement rates, the HP 5371A can measure dynamic and transient signal conditions. The HP 5371A offers new measurement solutions for applications in digital communications, radar/EW, electro-mechanical processes, data storage, modulation analysis and basic research.

With continuous measurement technology, there is no measurement dead time for sampling intervals as short as 100 ns, so you can now directly measure time-interval frequency or phase phenomena on signals up to 500 MHz without missing information. Built-in graphic display and data-reduction features give you processed results such as histograms, statistics and time-profiles quickly and easily. This reduces the need for external processors and test-code development. See page 184.



**HP 5316B, 5334B Universal Counters**

Modernized components and simplified designs make it possible to offer B models of the HP 5334A and 5316A Universal Counters at prices that are reduced significantly from the A models. Frequency and time measurement capabilities have not been sacrificed to achieve these lower prices. Ideal for the budget-conscious ATE engineer, the HP 5316B has a full set of universal counter capabilities and HP-IB is standard.

For the next step up in performance, the HP 5334B provides the high resolution frequency and time measurements necessary for designing, building, and maintaining today's sophisticated communications and navigation systems. The HP 5334B's breadth of measurements and excellent reliability make it an invaluable general-purpose tool for the ATE systems designer. See pages 196 (HP 5316B) and 190 (HP 5334B).

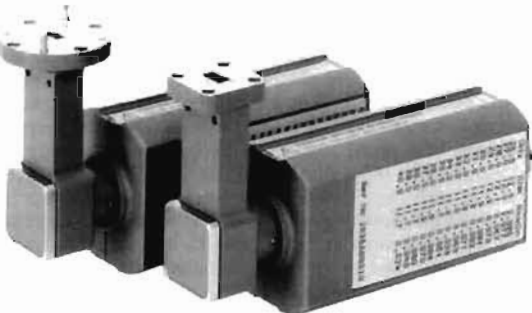

**HP R/Q 347B Waveguide Noise Sources**

Two new waveguide noise sources extend the measuring range for component and system noise figure measurements from 26.5 to 50 GHz. They are fully compatible with the recently-introduced HP 8970B Noise Figure Meter (10 to 1500 MHz) and the HP 8970S/T Microwave Noise Figure Measurement System (10 MHz to 18 GHz). Particular design attention was focused on minimizing ENR variations with time and temperature by providing better heat sinking of the avalanche diode source.

As operational microwave systems move into the millimeter-wave frequency ranges, engineering and design of the front-end semiconductor devices such as mixers and GasFET amplifiers require characterization of noise figure and gain. These new noise sources provide the precision input signal for such component and system testing. See page 211.



#### HP 4195A Network/Spectrum Analyzer

The HP 4195A is a high-performance, cost-effective and intelligent analyzer with combined vector network and spectrum analysis capabilities. It covers frequencies from 10 Hz to 500 MHz with an excellent 0.001 Hz resolution for audio, baseband, HF, VHF and IF applications. It directly measures amplitude ratio, phase, group delay and spectrum level needed for characterizing linear/non-linear analog circuits or components used in communication, telecommunications, consumer electronics and other equipment.

The HP 4195A's excellent accuracy and resolution meets the exacting measurement standards that are required for developing advanced equipment. A color display allows you to readily differentiate between multiple traces. Convenient softkey operation and marker functions make deriving device parameters quick and easy. Measurement results can be directly copied to a printer or plotter without an external computer. Furthermore, the HP 4195A offers software functions for user computing and self-control. User program, user define function and user math functions allow you to customize quickly the setups most suited to your application. A built-in 3.5 inch disc drive can save the instrument state, data and user functions. See page 226.



#### HP 8510B Microwave Network Analyzer

The HP 8510B Network Analyzer provides high-performance magnitude and phase measurements of components and devices in the 45-MHz to 100-GHz frequency range. With a built-in high-speed computer, the HP 8510B can provide the highest quality measurement results by using powerful error-correction techniques. Built-in data processing also allows the HP 8510B to display device response as a function of time, providing further insight into its behavior.

The HP 8510B incorporates second-generation features and performance to keep pace with the demands of high frequency component testing. New capabilities allow the HP 8510B to be tailored, without compromise, to address diverse measurement applications such as characterizing microwave semiconductor wafers and ICs, frequency translation devices (e.g., mixers), and far-field antenna patterns. See page 243.

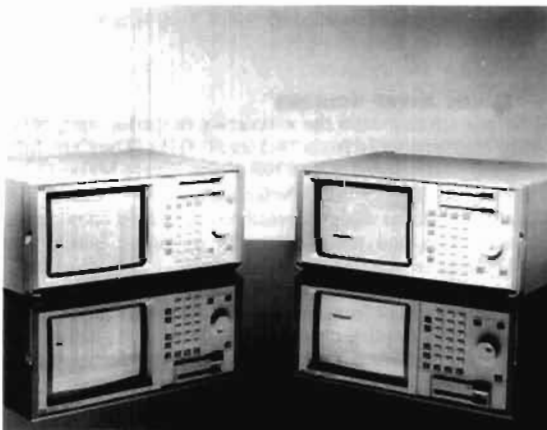

#### HP 1650A, 1651A Logic Analyzers

The HP 1650A and 1651A are today's best values in general-purpose logic analyzers. The HP 1650A provides 80 channels and the HP 1651A provides 32 channels of 25-MHz state or 100-MHz timing. Lengthen your timing window with transitional timing and capture elusive glitches on all channels. Configure the HP 1650A or 1651A in one of four ways: as a state analyzer, a timing analyzer, two state analyzers, or as a state analyzer and a timing analyzer. Generate report-quality documentation with pushbutton ease. Program either analyzer with easily understood commands through the built-in RS-232C interface. Make measurements quickly with the simplified user interface and connect to your circuit with new light-weight passive probes and flexible cables. You can also hook up quickly to today's most popular 8-, 16-, and 32-bit microprocessors with HP's preprocessors and store and recall configurations from built-in disc drives for fast setup. And, at only 22 pounds, the HP 1650A or 1651A can be easily carried. See page 255.



### HP 16500A Logic Analysis System

With up to 400 channels of general-purpose logic analysis, 80 channels of 1-GHz timing analysis, 204 channels of 50 megabit/second pattern generation, and an 8-channel 400-megasample/second digitizing oscilloscope, the HP 16500A Logic Analysis System can provide solutions customized to your needs. Make time-correlated measurements and define complex trigger conditions across state, timing and analog domains. Link your stimulus response system into models of HP's electronic design systems. Improve the efficiency of measurements with a color display and easy-to-use knob, touchscreen and mouse controls. Debug even complex multiple 8-, 16-, and 32-bit microprocessors. Store and recall configurations from two built-in disc drives for fast setup and generate report-quality documentation with push-button ease. See page 258.

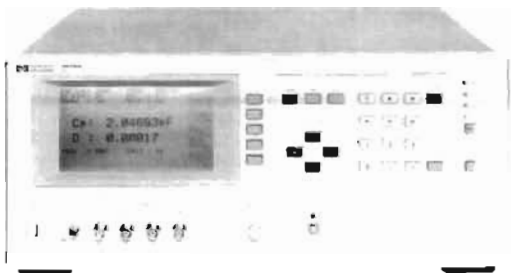

### HP 4279A 1 MHz C-V Meter

The HP 4279A 1 MHz C-V Meter offers the optimum solution for increasing quality and throughput when measuring the capacitance versus bias voltage characteristics of semiconductors. The HP 4279A measures capacitance over a range of 0.00001 pF to 1280.00 pF with a basic accuracy of 0.1% and a 6-digit display resolution, while sweeping the dc bias voltage. An internal, programmable dc bias sweep source with a 0.1% voltage accuracy throughout the  $\pm 38$ -V range ensures very low measurement error due to bias voltage uncertainty. It makes the HP 4279A ideal for the precise characterization and testing of varactor diodes, MOS diodes, etc. Measurement time can be selected from three modes of 10 ms, 20 ms and 30 ms to maximize productivity. The HP 4279A's very fast ranging and high-speed HP-IB data transfer capabilities reduce test time. The automatic bias polarity control feature allows quick selection of the correct polarity bias voltage for the device under test. This new function eases manual testing of samples in incoming/outgoing inspection and provides a simple method of polarity control for automatic test systems. See page 292.

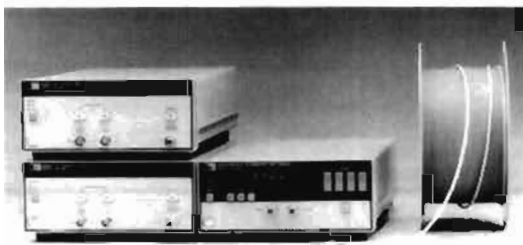

### Fiber Optic Products

Additions in the 850-, 1300- and 1550-nm ranges expand HP's line of long-wavelength measurement equipment. In the 850-nm range, additions include an attenuator, optical head, optical power splitter, and LED source. Two laser diode sources, one for 1300 nm and one for 1550 nm, plus a 1300/1550-nm single-mode attenuator round out the expansion. See pages 305 and 306.



### HP 8145A Optical Time Domain Reflectometer

The HP 8145A is a rugged, portable instrument for field maintenance and bench applications. A special data-correlation technique increases dynamic range to more than 28 dB at 1,300 nm single-mode and enables the HP 8145A to measure up to 150 times faster than conventional instruments. The instrument also features softkey-driven operation, full HP-IB programming, waveform storage, and it can hold two laser modules. See page 308.



#### HP 5527A Laser Position Transducer Enhancements

A number of new products enhance the performance of the HP 5527A and HP 5501A Laser Position Transducer systems. These products can be retrofitted to existing systems and increase their accuracy, stability, repeatability, slew rate and number of axes.

Using innovative optics to track index of refraction changes in air directly, the HP 10717A Wavelength Tracker provides exceptional accuracy for HP laser position transducer systems. The HP 10946B Automatic Compensation Board receives the output of the HP 10717A and uses it to correct automatically the HP 5527A laser measurements for these changes. The new HP 5517B Laser Head is half the size of the HP 5517A Laser Head for space-critical applications. When used with the HP 5527A Laser Position Transducer System, it provides a 25% greater slew rate than the HP 5517A, and can also improve the slew rate of the HP 5501A system.

The new, more-sensitive HP 10780B Receiver will increase the reliability and flexibility of your laser transducer system by allowing you to add additional axes to your HP 5527A or HP 5501A. The new HP 1076B High Stability Plane Mirror Interferometer, a direct replacement for the HP 10706A, improves measurement stability during optics temperature changes by reducing measurement drift to  $1/3$  the value typically achieved by conventional plane-mirror interferometers. See page 342.

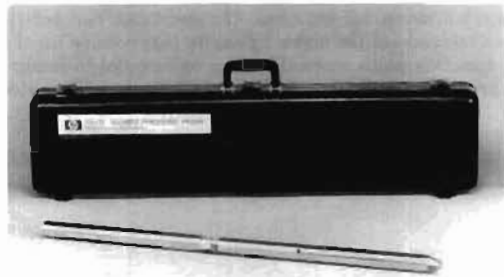

#### HP 2813E Pressure Probe

An improved version of the widely accepted HP 2813B/C Pressure Probes now makes pressure measurements at a faster rate. The new HP 2813E Pressure Probe does this through a newly-designed mechanical package. The improved thermal response behavior minimizes pressure errors for environmental temperature changes (more than 4 times faster than the HP 2813C and more than 10 times faster than the HP 2813B). The HP 2813E features the following improvements: new steel housing resistant to caustic fluids, shock mounting of internal parts, increased bending moment and axial strengths, 12k psi differential pressure hold-off, and a double buffer tube section that offers more protection for the sensor crystal. See page 344.



#### HP 8904A Multifunction Synthesizer

Using advanced digital chip technology, the HP 8904A Multi-function Synthesizer creates complex signals from six simple waveforms. It begins with a synthesizer that creates accurate sine, square, triangle, ramp, noise and dc signals at a single output. Option 001 then adds three more synthesizers or channels that either can modulate the first synthesizer or be summed to the output. Option 002 adds a second output for two-signal applications. Frequency, amplitude, waveform and phase can be independently set for each synthesizer. Choose AM, FM,  $\phi$ M, DSBSC or pulse modulation. With all this versatility, generate precise signals for VOR, FM stereo and communications signalling. See page 398.



### HP 6632A, 6633A, 6634A System DC Power Supplies

HP has expanded its family of highly controllable system power supplies with the addition of three new single-output, high-performance models: the HP 6632A, 6633A and 6634A. This system power supply family has features that meet the needs of ATE and programmable power supply applications now and well into the future.

These three new HP-IB-programmable power supplies offer significant systems-design advantages over currently available alternatives. Each integrates the functions of a power supply, IEEE-488 isolated D/A programmers, a DVM, and precision current-monitor shunt into one compact package. This one-box approach yields substantial savings in system-integration time, rack space, and design and documentation costs over alternatives that use individual IEEE-488 programmers, DVMs and power supply modules.

Each power supply has an extensive HP-IB interface with many talker/listener functions, including remote programming of voltage and current and readback of actual measured output values using the internal DVM and precision current shunt. This feature eliminates the need for a separate DVM to monitor power supply output levels. See page 436.



### HP 3787B Digital Data Test Set

The HP 3787B Digital Data Test Set offers comprehensive error measurement capability for the digital transmission hierarchy at the DS1C (3.152 Mbit/s), DS1 (1.544 Mbit/s) and DSO (64 kbit/s) levels. At DS1 and DS1C, it allows on-line, non-intrusive monitoring of live digital traffic as well as out-of-service testing. The unit is designed to monitor DS1 and DS1C signals for line code (AMI and B8ZS), frame word errors (SF, ESF, T1DM and Ft bits only), cyclic redundancy check code and logic (binary) errors and offers comprehensive error analysis features. Jitter performance is optional. For testing leased services such as T1 (1.544 Mbit/s) and the Digital Data System (2.4k, 4.8k, 9.6k and 56 kbit/s), the HP 3787B provides a wide range of standard and user-definable test patterns and loopback codes. See page 479.

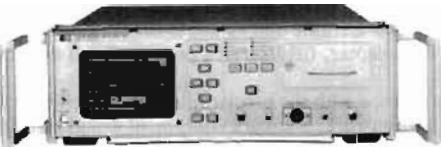

### HP 3789A/B DS3 Transmission Test Sets

The HP 3789A and HP 3789B are new DS3 test sets that allow you to select the measurement capability needed to match your test requirements. The HP 3789A has the basic pattern generation and error measurement capability required for the installation, commissioning and maintenance of DS3 transmission systems. The integrated package is easy to use manually and has HP-IB and RS-232C ports for automated test or monitoring applications. Its capability can be extended with the optional built-in printer and 24- or 48-volt dc operation.

The HP 3789B is a more sophisticated test set that offers extraordinary troubleshooting capability. In addition to having all the power of the HP 3789A, it can measure both DS3 and DS1 signals from a DS3 access. Optional enhancements include jitter measurements at DS1 and DS3, the ability to perform and display any two measurements simultaneously, dc operation, and a choice of built-in printer or disc drive for data logging. See page 478.



### HP 3709B Constellation Analyzer

Designed for in-service performance assessments of digital microwave radio systems, the HP 3709B takes advantage of a technique called constellation pattern analysis to identify noise, amplitude, phase and non-linear distortions of radio signals. An examination of the displayed constellation pattern allows impairments to be pinpointed. Measurements of the constellation pattern quantify the effect of impairments, providing data for reports and a guide to adjustments. For convenience, a printout of the constellation pattern and measurements can be produced on a ThinkJet printer. The HP 3709B can be used alone or coupled to a computer to permit a more in-depth analysis of radio performance. See page 489.





#### HP 4954A Protocol Analyzer

The HP 4954A is a high-speed, multi-protocol, expandable protocol analyzer for designing datacom products and analyzing network performance. A high-speed state-of-the-art multiprocessor design guarantees reliable, sophisticated analysis and simulation of full-duplex bit-oriented protocols to 72 kilobits/second and data capture of bit-oriented protocols at lower line utilizations up to 256 kilobits/second. Other features include multi-protocol testing capabilities and mass storage on an integral 20-Mbyte hard disc and 613-Kbyte 3.5-inch flexible disc. The HP 4954A is expandable through application software to address specific needs such as SNA product development and X.25 network performance analysis. See page 494.



#### HP 4972A LAN Protocol Analyzer

The HP 4972A is HP's new portable, high-performance protocol analyzer for managing and maintaining local area networks (LAN). Designed for end users, field-service managers and R&D engineers, the HP 4972A features powerful testing capabilities for IEEE 802.3/Ethernet networks. Users of the HP 4972A can monitor, capture and analyze data frames on the network; create and measure network loading; and analyze network-, node-, and connection-level performance. The HP 4972A enables you to characterize network traffic and evaluate network performance. For troubleshooting in the field or in the data center, field-service personnel can collect accurate statistical or frame data quickly.

The softkey-guided programming language can be used with the precise filtering capabilities of the HP 4972A to analyze events as they occur on the network. Network equipment designers can use versatile traffic generator and troubleshooting features for scenario analysis. In addition, the full-feature remote capability of the HP 4972A allows users to test and analyze the operation of a LAN at a distant location. See page 495.



#### HP 9480 Analog LSI Test System

Your mixed signal device testing demands high-speed, advanced tester resources that can accommodate rapid advances in state-of-the-art linear integrated circuits. The HP 9480 Analog LSI Test System offers exceptional performance for testing mixed signal devices up to a 128-MHz rate. The HP 9480 system emphasizes high speed, flexibility, and cost-effectiveness. System hardware makes possible highly accurate, high-resolution measurements for greater dependability in test results. The HP 9480 is simple to operate and program, which minimizes operating costs and increases engineering productivity. See page 508.



#### HP 4062C Semiconductor Parametric Test System

To improve IC yield and quality, and increase efficiency during new process development, the HP 4062C performs precise dc voltage, current and capacitance, and conductance measurements at a wafer test station. The HP 4062C includes a system rack, the HP 4142B Modular DC Source/Monitor, the HP 4280A 1 MHz C Meter/C-V Plotter, and a switching matrix subsystem. Precise 20 fA, 4  $\mu$ V and 1 fF measurements to  $\pm 200$  V and  $\pm 1$  A are possible through the 4062C's low-noise, reliable switching matrix, which you can configure with up to 48 DUT pins. And the new dc subsystem allows you to test  $V_{th}/hFE$  in just 25 ms (typical results).

A new optional software package, Test Management Shell, supports a complete menu-driven interface to minimize programming requirements. Optional relational data base software provides you with maximum data flexibility. See page 512.



#### HP 4142B Modular DC Source/Monitor

The HP 4142B Modular DC Source/Monitor provides high accuracy, high resolution, high throughput, and a wide measurement range. It offers exceptional performance for device characterization and development, process monitoring, and process development. Eight plug-in module slots can accommodate any combination of the four presently-available modules, and as new modules become available, you can upgrade your measurement capabilities with ease. With the 20 mA and 4  $\mu$ V resolution, you can easily evaluate low-level voltage and current characteristics such as resistivity, source resistance and leakage current. Use the  $\pm 200$  V or  $\pm 1$  A output to test GaAs devices, power MOSFETs, and bipolar transistors. You can even minimize thermal drift with the HP 4142B's pulsed output capability. See page 507.



#### HP 3065ST Standard Technologies Board Test System

The newest member of the HP 3065 Board Test Family, the HP 3065ST, is a complete, low-cost board test system that includes a test station, controller, two terminals, repair message printer, and automatic, easy-to-use software. The HP 3065ST performs analog in-circuit and analog functional testing. It also provides digital in-circuit testing, using HP's Safeguard In-Circuit analysis to minimize device degradation during backdriving. HP's digital library consists of over 400 digital device tests for SSI, MSI, LSI, and VLSI devices, including the 68000 and 80286 microprocessors. Our HP JPC-II second-generation in-circuit program generator automatically generates both analog and digital test from board entry data. The HP 3065ST is an automatic, easy-to-program test system with powerful test capabilities and excellent reliability. See page 529.

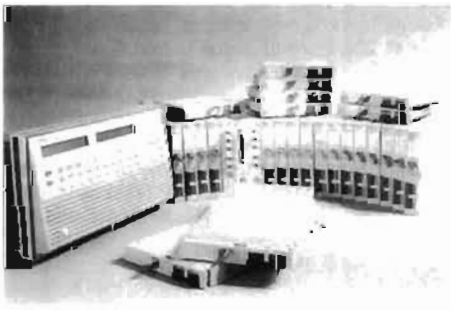

#### HP 3852A Data Acquisition/Control Unit Enhancements

A new multi-tasking operating system with real-time interrupt capability gives the user complete control over front panel, HP-IB, interrupt, and subroutine execution in the HP 3852A. Timeslicing and user-definable priorities allow apparently simultaneous task executions while the user maintains complete control of program flow. The new HP 44714A 3-Channel Stepper Motor Controller provides all of the signals necessary to control three stepper motors in one plug-in module. Output can be a continuous stream or a fixed number of pulses. Acceleration and deceleration are independently programmable and quadrature counters provide position feedback. The new HP 44723A High-Speed Digital Sense/Control module has 16 channels of input and 16 channels of output. Both have data rates of over 100,000 16-bit words per second and both can be externally triggered. Interrupts can be generated on any transition of any input or from a user-defined 165-bit pattern. See page 560.



#### HP Temperature and Vibration Transducers

Now temperature and vibration measurements are easier than ever with transducers available from HP. The HP 40650 series includes two hammer kits and eight accelerometer kits that contain everything you need for modal analysis or shock and vibration monitoring with HP analyzers. The HP 40652, 40653 and 40654 series temperature transducers include rugged and inexpensive thermocouples, fast response thermistors and accurate RTDs. See pages 567 and 568.



#### HP 3235A Switch/Test Unit Enhancements

The HP 3235A Switch/Test Unit now provides a better solution for your functional test system requirements by increasing switching, functionality, and PC board interfacing capability. Additional switching modules are available including a 75-ohm 1.3 GHz multiplexer, 10-ampere actuator, 64 two-wire (128 one-wire) armature relay mux/matrix, and microwave switching up to 18 and 26.5 GHz. Accurate temperature measurement is now possible using thermocouple-compensated multiplexers. Two types of source modules are available. The AC/DC source module can generate arbitrary, sine and square waveforms up to 1 MHz with triangle waves up to 100 KHz. The other source module has four D/A converters with isolated outputs. The HP SimPlate Board Test Fixture allows easy interfacing to PC boards using a "bed-of-nails" fixture.

The HP 3235A Switch/Test Unit reduces development (time of HP-IB systems and improves their throughput by providing off-the-shelf switching and interfacing. Under HP-IB control, the HP 3235A routes signals between your device-under-test (DUT) and the test equipment. For additional flexibility and convenience, an optional quick-interconnect fixture adapts the HP 3235A to a variety of DUTs. See page 570.



#### HP 6954A Multiprogrammer

The HP 6954A Multiprogrammer is the latest and most powerful addition to HP's family of computer-aided test products. It integrates the test measurement and control capability of the HP 6944A Multiprogrammer with the power of the HP 9000 Model 310 Computer, as well as a rugged 20-Mbyte hard-disk memory, into a single unit. Eight plug-in slots for HP Multiprogrammer Series II I/O cards are provided. The cards offer a wide spectrum of capabilities, including high-speed burst data acquisition at 500 k-words/second, scanning, high-speed memory I/O, counter-timer functions, digital I/O and a host of other test and measurement functions. The HP 6954A can capture and transfer data continuously at 200 k-words/second. Additional plug-in cards allow event triggering and burst data capture of up to 1 megawords of data within the multiprogrammer.

This Multiprogrammer supports the full line of DIO cards and software for the HP 9000 Series 200/300 family of computers. This allows it to be highly leveraged with the very powerful HP 9000 Series 200/300 architecture and provides a growth path from the intelligent stand-alone unit to a larger automated system. The HP 6954A comes standard with an HP 9000 Model 310 single-board computer, which has built-in 1-Mbyte RAM, HP-IB, HP-HIL keyboard and RS-232 interfaces. See page 578.



#### Lotus Measure™

Lotus Measure now provides an accurate and efficient way to collect data with HP's HP-IB instruments and to store it in Lotus 1-2-3® for analysis, display and archiving. Lotus Measure runs on the HP Vectra PC and works from within Lotus 1-2-3 to control both collection of the data via the HP-IB interface bus and distribution of the data into specified cells of a Lotus 1-2-3 worksheet. See page 591.



**HP Data Acquisition Manager (DACQ/PC)**

HP DACQ/PC is a general-purpose data acquisition manager for the HP Vectra Technical Computer. A companion product to HP DACQ/300 for the HP 9000 Series 200/300 Computers, it reduces your software development time and performs up to 90% of your software tasks. Run DACQ/PC on the HP BASIC Language Processor for the HP Vectra to give you access to the HP BASIC programming environment. Add DACQ/PC subroutines to your mainline HP BASIC program to retrieve data from any HP-IB instrument. Use DACQ/PC to create a data base, store data, and analyze, print or plot the data. DACQ/PC can create both plots and real-time strip charts. Analyze the data (FFTs and inverse FFTs, scaling, limit checks, and statistics) or convert the data (thermocouple, thermistor RTD and strain conversions) to engineering units, regardless of data source. See page 592.



**HP Emulation and Analysis Subsystems Support MC68020 Processors**

A new emulator and an integrated analyzer support MC68020 32-bit microprocessors. The HP 64416A/B MC68020 Emulation Subsystem provides real-time 20-MHz emulation support of the Motorola MC68020 in the HP 64000-UX Microprocessor Development Environment.

The HP MC68020 development solution includes the HP 64416A/B with either 256 kbytes or 512 kbytes of emulation memory, an HP 64411A MC68020 Analysis Bus Generator Board, and an HP 64404A/64405A Integrated Analysis Board. The tools provide an environment for design, test, and integration of hardware and software. See page 616.



**HP Teamwork Software Specification and Design Environment**

HP Teamwork Software Specification and Design Environment improves software development and reduces maintenance costs. HP Teamwork/SA,SD,RT, and HP Access provide tools for structured analysis with real-time extensions, structured design and integration of the resulting data base with other software development tools. These products help reduce the costs of software development by allowing rapid capture and maintenance for software applications including embedded microprocessor systems, measurement automation, instrument control and general scientific uses. See page 619.



**Model PC-308 HP BASIC Controller**

Based on the IBM PC-compatible HP Vectra, with an HP BASIC Language Processor plug-in card, the HP PC-308 workstations are ideally suited to applications that demand both the high performance of HP BASIC and PC compatibility. The HP PC-308 offers the productivity and performance of HP BASIC as well as access to all of the PC-DOS software of the HP Vectra. See page 635.



#### HP 9000 Model 318M Monochrome Workstation

Utilizing the same 16.6-MHz CPU board as the Model 330, the Model 318M is a low-cost, restricted-configuration, 2-board computer system. It includes an MC68881 floating point coprocessor, 4-Mb RAM, 32-bit memory bus, and 1024 x 768 bit-mapped monochrome display. Also featured are an IEEE-488 HP-IB interface, an RS-232C serial interface, an IEEE 802.3/Ethernet LAN interface with ThinMAU and "T" connector, HP-HIL, and a two-channel DMA controller. See page 635.



#### HP 9000 Model 330 Technical Workstation

The Model 330 is a 2 MIPS computer based on the Motorola 16.67-MHz MC68020 processor, MC68881 floating point coprocessor, and MC 68851 Paged Memory Management Unit. Maximum system performance is ensured by operating 4 Mbytes of on-board RAM synchronously with the MC68020 processor. The Model 330 features a 32-bit memory bus, 32-bit DIO-II bus, and the same system interface board as the HP Model 350. Two system slots are available for adding a RAM board, a video board or a 2-slot DIO backplane for accessories. Typical applications include data manipulation and general computation, microprocessor system development, schematic design capture, 2D mechanical design, personal productivity, computer-aided software engineering and data acquisition/analysis. See page 633.



#### HP 9000 Model 350 Technical Workstation

Based on the 25-MHz MC68020 processor with a 20-MHz MC68881 floating point coprocessor, the Model 350 delivers up to 4 MIPS and the capability to address up to four Gbytes of virtual memory. The Model 350 SPU contains four system slots. Three slots are used by the system processor board, an 8-Mbyte RAM board, and a standard system interface board. The interface board includes LAN, a two-channel DMA controller, a high-speed disc interface, an HP-IB interface, an RS-232 interface and an HP-HIL interface. The fourth system slot is available for installing a video board, display system interface board or a 2-slot DIO backplane. The 350 features a full 32-bit I/O bus (DIO-II) and a dedicated 32-bit memory bus.

The full potential of the 25-MHz 68020 is realized by the use of a 32-Kbyte cache with 32-bit-wide entries operating at a 120-ns cycle time. The custom memory management unit translates virtual memory addresses into physical memory addresses in parallel with cache-miss detection. Maximum throughput is maintained for very large HP-UX programs and multiple concurrent processes. See page 633.



#### HP 9000 Model 350CH High-Performance 2D Color Workstation

The 350CH couples high-power computation with industry-leading 2D graphics for applications such as printed circuit board and VLSI design, 2D mechanical design, 2D mapping and architectural and engineering construction. It features the HP 98562B SPU, HP 98784A 19-inch color monitor, an 8-plane frame buffer memory, and 2 overlay planes. Also included are the HP 98550A 1280 x 1024 resolution Color Video Board, HP 46021A Keyboard, HP 46060A HP-HIL 2-button mouse, HP 46081A HP-HIL extension with audio, HP 46084A HP-HIL ID module, HP 98515A option 022 HP-UX Application Execution Environment, and HP 50952B option 022 NS-ARPA Networking Services. See page 634.



**HP 9000 Model 850S Superminicomputer**

HP's Model 850S Superminicomputer is the most powerful engineering, manufacturing and scientific computer in Hewlett-Packard history. It is the fastest member of the new HP Precision Architecture family of RISC-based computers, outperforming other superminis in its price class with a relative estimated throughput of 7.2 MIPS. The Model 850S offers 60% better CPU performance and greater expandability than the HP 9000 Model 840S. The computer is based on HP's proprietary VLSI NMOS III technology, but runs under the HP-UX operating system, which conforms to UNIX™ operating system standards. While the new supermini extends both the HP 1000 and HP 9000 computer lines, it also has been designed with compatibility in mind. All Series 800 computers are object-code-compatible with one another. In addition, the Model 850S is highly compatible with HP 9000 Series 500, 300 and 200 products at the source code level. See page 630.



**HP 9000 Model 825S Minicomputer**

The new HP 9000 Model 825S is the low-end member of Hewlett-Packard's Series 800 line of computers based on HP Precision Architecture. Running under the HP-UX operating system, the Model 825S offers 0.5 to 0.7 times the supermini throughput of the HP 9000 Model 840S. The Model 825S is object-code-compatible with the Model 840S and 850S HP Precision Architecture systems so applications are completely portable. The Model 825S offers 1.5 to 2 times the performance of the HP 1000 A900 and HP 9000 Model 350. The Model 825S is a logical, high-capacity, high-performance extension of both the HP 1000 and HP 9000 product lines. HP-UX is the real-time implementation of the UNIX™ operating system and contains PORT/HP-UX facilities for application migration from HP 1000 systems. The HP-UX-based HP 9000 Series 500, 300, and 200 systems are source-code-compatible with the Model 825S so application migration and data exchange is virtually effortless among HP 9000 systems. See page 631.



**HP 9000 Model 825SRX Superworkstation**

The Model 825SRX is a superworkstation that combines high performance computation with state-of-the-art 3D graphics. This combination provides the ability to perform real-time design of complex assemblies. You can enter design parameters, view the object in realistic terms, and simulate the performance of the part - all on the same workstation.

With earlier systems, there was always a tradeoff between the simple user interface of the workstation and the computer power needed for simulation. The Model 825SRX gives you both. The system processor performs over eight times faster than the Digital Equipment VAX 11/780, while the 3D graphics system can perform 180,000 3D transforms per second. See page 632.



**X Window System**

The X Window system provides HP's Series 300 and HP 825 engineering workstation products with a network-compatible "windowing" system that allows interconnection between HP workstations and workstations from other vendors. With the X Window system, you can create multiple windows on your workstation display that allow you to interact with programs running on your workstation, another HP workstation, or even workstations from other vendors that are connected to your system over a network. Programs that are compiled on another vendor's workstation to use X ("clients") can use the X windowing software on HP workstations ("servers") for their input and output - and the reverse. See page 647.

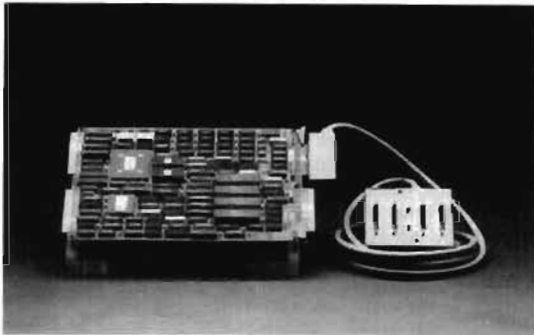

#### HP 1000 A400 Real-Time Minicomputer

The HP 1000 A400 Real-Time Minicomputer features a complete HP 1000 A-Series CPU, 0.5 megabyte of memory, and a four-port serial I/O multiplexer on one card. This new minicomputer delivers full A-Series functionality to OEMs or system designers for monitoring and control, data acquisition, telecommunications, or other applications in which low-cost, compact, real-time solutions are required. The A400 is supported under the RTE-A real-time executive operating system and is completely compatible with all other members of the A-Series family. The A400 is available as a single-board computer for embedded control applications, in 6-, 14-, and 20-slot box computers, and in a 14-slot system processor unit. See page 654.

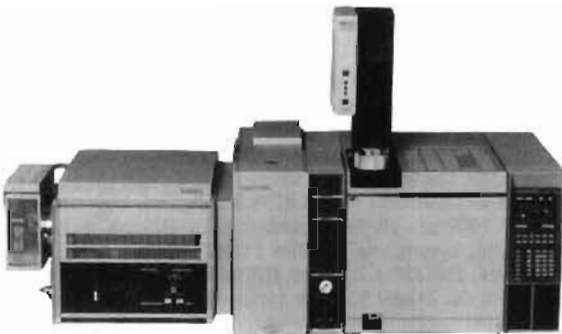

#### Analytical Chemistry Systems

Measurement techniques in life sciences, drug testing and environmental disciplines are becoming increasingly important. Hewlett-Packard's GC/FTIR/MSD System (shown here) helps scientists separate, quantify and identify substances in all these fields. HP AminoQuant, an amino acid analyzer, quantitates primary and secondary amino acids, at sub-picomole levels, helping to advance biochemical research. And HP's gas chromatography-based water analysis system is specifically tailored to meet the newest EPA reporting requirements. For information on all of HP's systems for analytical laboratories, see page 662.



#### Vectra Publisher PC

Vectra Publisher PC conveniently bundles the best hardware and software components needed for desktop publishing. The heart of the system is the Vectra PC with either a monochrome or enhanced color monitor, and PageMaker®, the leading page composition software. The system comes preassembled for easy ordering and set-up. When combined with an HP LaserJet printer and HP ScanJet scanner, you'll have a complete, fully supported desktop publishing workstation. See page 674.



#### HP Portable Vectra CS Personal Computer

A personal computer that gives you the functionality of a desktop computer in a battery-powered portable package, the HP Portable Vectra CS PC can also communicate with desktop and main-frame computers. Now you can take your office with you when you travel, without sacrificing the features you use most in a PC. With the Portable Vectra, you get the flexibility and power you need to meet your needs today, without restricting your options for the future. The Portable Vectra is fully compatible with the IBM PC/XT, so you can choose from many popular software programs. See page 678.





**HP-28C Scientific Professional Calculator**

The HP-28C, for professionals and students in science and engineering, is believed to incorporate more built-in functions and calculating power than any other handheld product. Use the basic four functions, or see how easily you can perform calculations in algebra, calculus, matrix math, complex numbers and binary integers. The HP-28C also has extensive capabilities in statistics, programming, functions and data plotting, a built-in table of 126 unit conversion factors, and an equation solver. Menus and softkeys make using this calculator fast and easy. See page 684.



**MICRO 3000 Computer**

The new MICRO 3000 is a complete entry-level business system for small-to-medium businesses or for large companies that have branch office and departmental applications. It brings the power of concurrent transaction processing, word processing, batch processing and data management to the office environment. The MICRO 3000 has a friendly menu-driven user interface that simplifies the operation and use of the system. In addition to its stand-alone capabilities, the MICRO 3000 can operate as a node in a network of computers. Two versions of the MICRO 3000 are available: the Entry Level System provides a powerful yet inexpensive solution for small businesses; the Full Size System, with increased memory and disc capacity, is designed for branch office and departmental applications. Software compatibility preserves your software investment by providing a smooth and conversion-free growth path to larger HP systems. See page 692.



**MICRO 3000XE Computer**

The MICRO 3000XE is an entry-level computer system with mid-range configurability in a package designed for the office environment. Aimed at large branch offices, departments, and businesses, the MICRO 3000XE offers the same functionality and ease of use as the MICRO 3000 with the power and expandability to support up to 56 users. As with all HP 3000 computer systems, the MICRO 3000 XE protects your software investment with compatible software that provides an easy growth path to larger HP 3000 systems. In addition to its stand-alone capabilities, the MICRO 3000XE can operate as a node in a network of computers. See page 692.

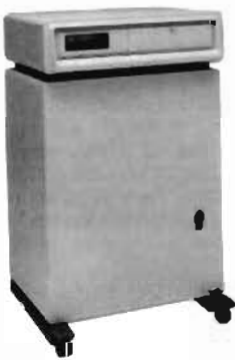

**HP 3000 Series 52 Computer**

The Series 52 is a mid-range member of the HP 3000 family of compatible, interactive business systems, supporting up to 92 users. Designed as a departmental computer system, the Series 52 can also meet a small company's data processing needs. On-line transaction processing, program development, batch processing, office applications, and data communications can all take place concurrently. In addition to its stand-alone capabilities, the Series 52 can operate as a node in a network of computers. See page 692.



#### HP 3000 Series 930 Computer

The Series 930 is the first member of the HP 3000 computer family to use the RISC-based HP Precision Architecture. Using the enhanced MPE XL operating system, the Series 930 provides high performance in multi-user, multi-tasking interactive and batch environments. As a new member of the proven HP 3000 family, the Series 930 provides a powerful extension to the highly-regarded networking and data management capabilities for which the HP 3000 systems are known. In addition to enhanced support for data base applications, the Series 930 also excels in computationally-intensive EDP environments.

Applications software packages are available to support a wide variety of financial, manufacturing and office applications on HP 3000 systems. With these capabilities, the Series 930 provides a true high-performance, general-purpose business computing solution. See page 692.

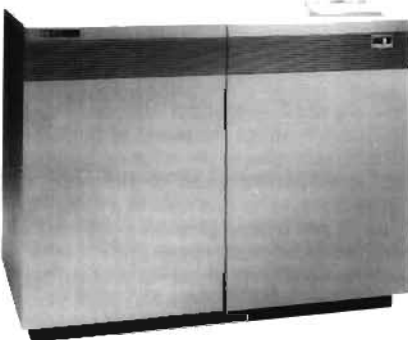

#### HP 3000 Series 950 Computer

The Series 950, the highest-performance member of the HP 3000 computer family, is the first HP 3000 to utilize Hewlett-Packard's proprietary NMOS III VLSI technology. Use of this state-of-the-art VLSI technology in conjunction with HP's Precision Architecture for the 900 Series of HP 3000 computers results in 7 MIPS processor performance. The entire central processor unit is contained on a single NMOS III chip, resulting in higher reliability and a simpler design. The Series 950 was designed to provide an easy upgrade path from the HP 3000 Series 70 and Series 930 systems. See page 692.



#### ALLBASE/XL Data Base Management System

ALLBASE/XL is a new data base management system for the HP 3000 Series 900 business computer systems. It combines HPIMAGE, a functionally complete network model interface, with HP SQL, a relational model interface. With HPIMAGE, relationships between data sets are predefined as part of the data base structure. These predetermined relationships provide application programs with the fastest data access ALLBASE/XL has to offer. HP SQL features a full implementation of the de facto standard SQL (structured query language) relational language. HP SQL can be accessed using HP Visor, an interface that allows end users to perform ad hoc queries and generate customized reports. See page 692.



#### HP 700 Display Terminal Family

The HP 700 family of display terminals offers an impressive selection of compatibility features for users of HP and non-HP computer systems. The HP 700/92 and HP 700/94 are designed for HP systems, replacing the HP 2392A and HP 2394A terminals. The HP 700/41 provides ASCII compatibility, the HP 700/22 provides ANSI compatibility, and the HP 700/71 provides IBM compatibility. Each terminal is equipped with a 14-inch screen in your choice of phosphor color, compatible keyboard and many other features to make your work easier. See page 698.



#### HP 3082A Industrial Touch Terminal

HP Industrial Touch is a compact, rugged terminal that is plug-compatible with HP 2392 and DEC VT100/52 terminals. It is designed specifically for factory-floor use in planning, production, control and maintenance applications. HP Industrial Touch features a full 28-by-80-character screen with alphanumeric and character graphics capabilities, a built-in sealed alphanumeric keypad, screen-labeled function keys, a variable-volume beeper and firmware-based screen editors. HP Industrial Touch is also available with optional touchscreen and internal decoding for barcode wands, slot readers and laser scanners.

HP Industrial Touch can be mounted close to the user in almost any factory situation. A multi-purpose mounting bracket allows it to be secured to benches, walls, poles, I-beams, cabinet doors, and factory machines. The terminal requires no additional enclosures for harsh environments, is sealed to meet NEMA 4, 4X, 12 and 13 specifications (excluding freezing), and contains no fans or filters. Easy to use and install, HP Industrial Touch is highly reliable. The combination of features and benefits significantly reduce the cost of ownership and increase operator productivity on the factory floor. See page 702.



#### HP 9666A Operator Interface Unit (Rugged Terminal)

Specifically designed for the harsh factory floor, the HP 9666A Operator Interface Unit can withstand temperatures from 0 to 60 degrees Celsius. Incorporated in a compact dust- and drip-protected NEMA 12 enclosure, the 12-inch, high-resolution color display and state-of-the-art interactive touchscreen can be used in alpha-numeric as well as graphics applications.

With the HP-HIL interface, the user can connect input and hard-copy devices at the same time. The Unit allows the user to daisy chain up to three input devices to the keyboard. The system port offers both RS-232C and RS-422 capabilities at data transmission rates up to 19.2 kbps with handshaking. For additional flexibility, a second port offers another RS-232C serial interface. The OIU also provides a subset of ANSI X3.64 standard for users requiring a device-independent environment. Additionally, the OIU can execute many DEC VT100 and VT52 control sequences. See page 704.

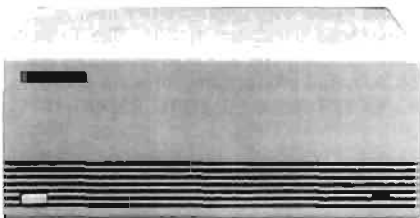

#### HP 7957A, 7958A Disc Drives

High performance levels previously found only in HP's 8- and 14-inch disc drive products are now designed into the 5 1/4-inch HP 7957 and HP 7958 disc drives. These 81- and 130-megabyte drives provide high reliability, low monthly support costs, and entry-level pricing. With a 52-dBA sound power level, the drives are barely audible in an office environment. These mid-range disc drives are also compact, making them suitable for engineering workstations and multi-user technical systems. They're supported on the HP 3000, HP 1000, and HP 9000 computer systems, as well as on the HP 260 Business Computer System and HP 64000 Logic Development System. See page 708.

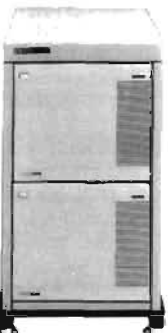

#### HP 7936, 7937 Disc Drives

Designed for a wide range of multi-user computer systems, the HP 7936 (307 megabyte) and HP 7937 (571 megabyte) disc drives provide high reliability and performance at a low per-megabyte cost. Their compact size and modular design allow optimal floorspace use and flexible cabinet configurations. Power consumption remains low even when multiple units are installed in one area. Average seek time for both disc drive models is 20.5 ms, and data can be transferred instantaneously at up to 2.35 megabytes per second. Disc controller cache is available as an enhancement for both disc drives. The two megabytes of read cache and four kilobytes of non-volatile write cache provide high-speed response without the overhead of mechanical movements. The disc drives are supported on HP 3000, HP 1000, and HP 9000 HP-UX computer systems. See page 709.



#### HP 7980A, 7979A 1/2-Inch Tape Drives

The HP 7980A is a 1/2-inch, 6250GCR/1600PE, reel-to-reel streaming tape drive designed for systems with disc backup requirements greater than 400 megabytes. The HP 7979A is also a 1/2-inch reel-to-reel streaming tape drive but employs the 1600PE format only and is therefore best suited to systems requiring between 100 and 500 megabytes of disc backup. Both drives are horizontally-mounted and feature autoloader capabilities and industry-leading reliability. See page 710.



#### HP RuggedWriter 480 Printer (HP 2235 Series)

The new HP RuggedWriter 480 Printer offers top-quality 24-wire printing that's fast - 480-cps draft and 240-cps letter-quality printing. And it's rugged - designed for unlimited printing with excellent reliability (20,000 hours MTBF). Three independent paper paths accommodate hand-fed paper, tractor-fed paper and the sheet feeder accessory. The RuggedWriter 480 Printer works both as a shared printer in multi-application work areas and as a dedicated printer. See page 716.

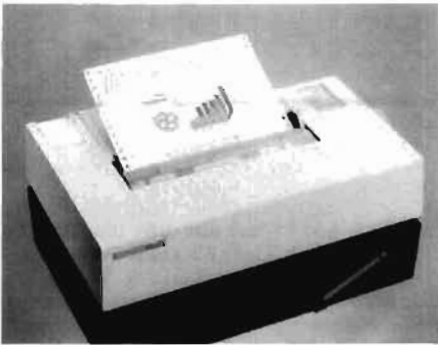

#### HP PaintJet Color Graphics Printer (HP 3630A)

The HP PaintJet is a versatile printer designed to provide both high-resolution color graphics and fast near-letter-quality text. The PaintJet printer offers crisp, dark text; merged text and graphics for reports or schedules; and full-page color graphics on either paper or transparency film.

The HP PaintJet printer's two disposable print cartridges hold four specially-formulated inks. A total of 330 colors are available in graphics mode with appropriate software. The same print cartridges work on both paper and overhead transparency film. The PaintJet printer is compatible with nearly every leading personal computer and is supported by many leading business graphics, word processing, PC-CAD, and productivity software packages. Three interface options are available: RS-232C/CCITT V.24, HP-IB (IEEE 488-1978), and Centronics Parallel. See page 714.



#### LaserJet Series II Printer

The LaserJet Series II printer replaces the original LaserJet and LaserJet PLUS printers, adding many improvements at a lower cost. Printing at 8 pages per minute, the LaserJet Series II is 36% lighter, has a 200-sheet input paper bin, 100-sheet correct-order output bin, two LaserJet font cartridge slots, and is compatible with LaserJet PLUS printer software and fonts. The front control panel allows you to select features such as number of copies, interface configuration, primary font, and number of lines per page.

The easy-to-replace toner cartridge lasts for 4,000 pages and provides rich, black images at a low cost. The LaserJet Series II handles overhead transparency film, labels, and even envelopes and heavy paper using the manual feed mode. An envelope cassette is also available for automatic envelope printing. Paper sizes include letter, legal, executive, and European A4.

A memory slot is provided for adding 1, 2 or 4 megabytes to the 512K internal printer memory. Added memory allows more downloadable fonts and full-page graphics at 300 x 300 dots per inch for applications such as desktop publishing and computer-aided design. See page 715.



**LaserJet 2000 Printer**

At print speeds up to 20 pages per minute, the LaserJet 2000 printer is an excellent departmental printer for minicomputer systems and PC networks. The printer delivers publication-quality text and graphics at a resolution of 300 x 300 dots per inch. Six paper sizes, including letter, legal, ledger, executive and European A4 and A3, are supported.

The LaserJet 2000 is compatible with the LaserJet PLUS, so it operates with over 600 software packages and works with LaserJet font cartridges and soft fonts. The printer is shipped with 34 resident fonts and has 3 slots for LaserJet font cartridges. Designed to handle up to 70,000 pages per month, it handles high volumes of output with little operator intervention. Two standard 250-sheet input paper trays and an optional 2000-sheet input paper deck allow printing for hours without paper reloading. The LaserJet 2000 is shipped with 1.5 megabytes of memory, which can be expanded to 5.5 megabytes (in 1-megabyte increments). A duplex model is also available for printing two-sided documents, adding flexibility and saving paper for departments with high-volume output. See page 716.

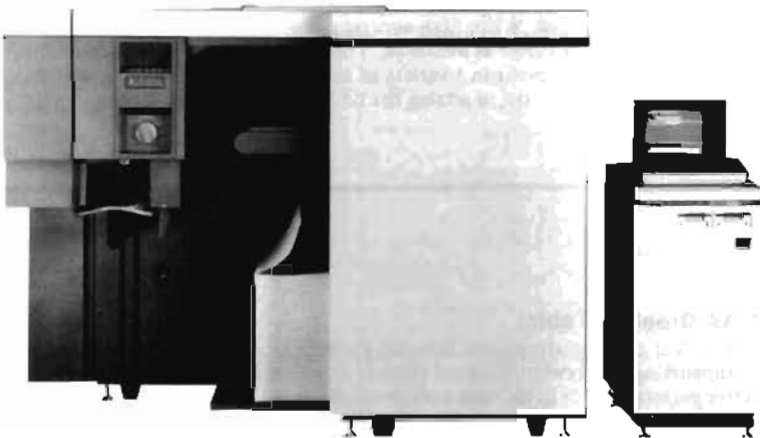

**HP 2685C Laser Print Station**

The HP 2685C is a stand-alone, local or remote laser print station that replaces the discontinued HP 2685B. The station consists of an HP 2680A Laser Printer, disc and tape drives, a console terminal and a system controller. One of the improvements in the HP 2685C is a new choice of system controller options - either a Micro/3000 or a Micro/3000XE can now be selected. New disc and tape drive options are also available with the HP 2685C. See page 716.



**HP DraftMaster I and II Plotters (HP 7595A, 7596A)**

The HP DraftMaster I and II plotters are high-performance drafting plotters designed for CAD professionals. The plotters have extensive software support and an HP 758X software emulation mode allows users to use any existing HP 758X software with no loss in performance.

A new adjustable eight-pen carousel accepts all supported pen types: drafting, fiber-tip and roller-ball pens. Both plotter models handle A- through E-size vellum, bond, and polyester film media, as well as transparency film and glossy paper. The pen sorting function of the plotters trims plotting time by minimizing pen changes and the bi-directional plotting feature further increases drawing efficiency by automatically starting the next line segment at its nearest endpoint. Both HP DraftMaster plotters come with RS-232C, RS-422-A, and HP-IB interfaces. See page 724.

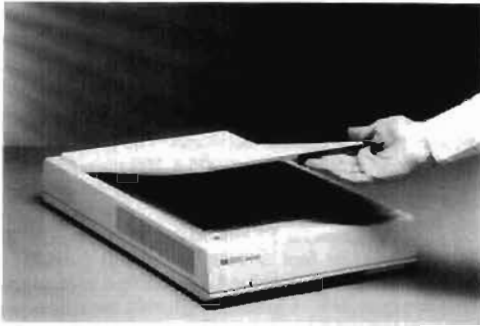

#### HP 9190A ScanJet Desktop Scanner

The new HP ScanJet desktop scanner improves the look of your laser-printed documents by providing an easy way to include photographs, line art, and graphics from a broad range of original sources. This flatbed design, 300 dots-per-inch monochrome scanner captures and stores images for use in desktop publishing applications in 20 seconds or less. The HP ScanJet also has text input capabilities via a popular third-party OCR software package. See page 711.

#### HP 7080A SketchPro Digitizing Tablet

The HP SketchPro tablet is a high-performance, low-cost graphics tablet designed for tasks such as menu picks, graphics placement, drawing and tracing. The SketchPro tablet uses an RS-232C interface to connect to computers such as the HP Vectra, IBM PC/XT/AT or compatibles. By offering four different operating modes the tablet provides convenient and accurate input with interactive graphics applications, including CAD/CAM, presentation graphics, computer art and desktop publishing.

With the tablet's stylus you can make fast movements and create complex drawings as easily as with a pencil and paper. When high accuracy is needed for tasks such as tracing existing drawings, an optional cursor is available. You can use the HP SketchPro tablet's programmable function keys to perform a variety of special functions, including stretching and shrinking, changing aspect ratio, or setting the tablet mode. See page 712.



#### HP 45911A Graphics Tablet

The HP 45911A is a high-performance, low-cost graphics tablet. When it is installed on a computer supporting the Hewlett-Packard Human Interface Link (HP-HIL), you have a very effective pointing device to increase your productivity with interactive graphics applications such as CAD/CAM, presentation graphics and computer art. The HP 45911A is suitable for tasks such as menu picks, graphics placement, drawing and tracing. The tablet has very high resolution, up to 1200 lines per inch. Its fast response time and high accuracy make it easy to use. See page 713.



#### HP 37212B Modem

The HP 37212B modem provides high-speed error-free communication over both dial-up or unconditioned 2-wire leased lines. It also offers fallback speeds of 1200 bps or 300 bps. A comprehensive range of sophisticated features make it an excellent general-purpose modem suitable for a wide range of applications. Special flow-control options allow both HP and non-HP computers to use the MNP error-correcting feature without degrading throughput. An alternative control channel is available to allow automatic control of the modem even if the primary data channel is incapable of outputting dialing information (as in DS applications). A host of convenience features ensure maximum ease-of-use.

The HP 37212B complies with most modulation standards, and includes compatibility with the Hayes "AT" command set. Unlike most modems, the HP 37212B is suitable for use in many countries throughout the world. See page 705.

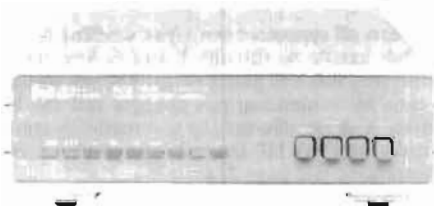

## HP in Profile

Hewlett-Packard Company develops, manufactures and markets measurement and computation products and systems used by people in science, engineering, business, industry, education, and medicine. These products are known for their high quality, reliability and advanced technology and include calculators, computers and peripherals, electronic instruments, instruments for chemical analysis, medical instrumentation, and electronic components.

Headquartered in Palo Alto, California, Hewlett-Packard employs approximately 82,000 people worldwide, of whom some 55,000 work in the U.S.A. Product research and manufacturing activity is highly decentralized, with facilities in the U.S.A., the UK, Europe, Japan, Southeast Asia, Latin America and Canada. The worldwide sales organization includes more than 100 sales and support offices in the U.S.A., and some 275 sales and support offices and distributorships in 76 other countries.

With a 1986 revenue of 7.1 billion dollars, HP is ranked in the top 51 U.S. industrial corporations. Approximately 50 percent of this revenue was generated outside the United States.

## HP Test and Measurement

Hewlett-Packard's first product, developed in 1939, was an audio oscillator based on a new and innovative design. In the company's first 20 years, this oscillator was the foundation for an ever-broadening line of test and measurement instruments used primarily by engineers and scientists. The first HP catalog, published in 1943, used 24 pages to describe a total product offering of 12 instruments. This 1988 edition has more than 750 pages on which are detailed some 1,700 instruments, computers and accessories out of the company's total offering of more than 10,000 products. Customers use HP instruments to evaluate the performance of their own electrical equipment, in developing products, in controlling quality and manufacturing processes, and in field service applications.

In addition to the electronics industry, major markets for HP test and measurement equipment include



Microwave component manufacturers are constantly demanding more performance and capability for their test equipment. The HP 8510B network analyzer, the next generation of the industry-standard HP 8510A network analyzer, addresses many previously difficult microwave measurement problems. These include direct measurement of devices and circuits in fixtures, frequency translation device measurements, and characterization of antenna performance.

telecommunications, aerospace, aviation, and scientific research. In fact, HP instruments are used in almost every industry where precise testing, measurement and control are required.

## HP Computers

HP's first computer was introduced in 1966. Its purpose was to gather and analyze the data produced by HP electronic instruments. Today, HP computers, computer systems, and peripheral devices account for a substantial portion of the company's product line. This broad range of computation products and systems offers solutions for many different applications.

HP's strength in engineering, scientific and manufacturing applications has enabled it to make major contributions in key technical computer markets. Advanced data communications technology allows instrument systems to be linked with computers, giving customers tools for acquiring, analyzing, managing, and transmitting data. HP also is an important business computer manufac-

turer. Offerings include portable computers, personal computers, and minicomputers. The company's minicomputer line is the second most widely installed general-purpose business computer in the world, with more than 26,000 machines in use. Our strong support of industry networking standards and open systems makes multi-vendor connectivity possible and gives us the flexibility to solve customer problems using a variety of approaches, including software application packages developed by third parties.

In 1986, HP introduced the first in a series of new, high-performance computers based on HP Precision Architecture. The simplicity of the new architecture ensures ease of manufacture while providing both business and technical customers with superior price/performance compared with conventional designs. More important, HP Precision Architecture promises future performance capabilities many times greater than today's computer systems and allows the company to develop a range of

compatible computer systems, including personal computers, engineering workstations, and minicomputers. The unified architecture enables customers to leverage their software investments, since the same application can run on a wide range of machines within the same family.

### HP Test and Measurement Systems

The impact of increasingly scarce and costly technical manpower has accelerated the need for measurement systems, with their higher speed, accuracy, repeatability and productivity. HP instruments and computers are designed with systems in mind.

In 1965 HP created its own internal standard for linking HP instruments and computers. That standard became a worldwide standard, IEEE-488, and today it is used by several hundred manufacturers in more than 14 countries. We call this standard HP-IB, the Hewlett-Packard Interface Bus. In this catalog, system-ready products are marked with the symbol



In all cases, the goal of HP systems is to provide essential information in a useful form and in the most efficient and timely manner. The result is that customers can improve the productivity of their processes and organizations.

### Other HP Products

In addition to electronic measurement and computation products, HP manufactures a number of other product lines, all of them related by basic electronics technology. Among these are electronic components such as microwave semiconductor and optoelectronic devices. Other important fields of interest include medicine and analytical chemistry. Today, hospitals and clinics use HP equipment for patient monitoring, diagnosis and therapy, and data man-



Engineers and scientists who need fast, easy-to-use computer-aided test and measurement software have traditionally relied on HP BASIC, HP's advanced instrument-control language. Previously available only on HP 9000 Series 200/300 computers, HP BASIC is now offered for industry-standard MS-DOS systems. The HP BASIC Language Processor consists of an HP Vectra PC plug-in card with HP-IB interface, HP BASIC 5.0 and support software. The Language Processor card is an IBM PC/AT-size board with a Motorola 68000 processor and up to 4M bytes of RAM (512K bytes standard). Accessories include a GPIO and Shared Resource Manager interface cards.

agement. Analytical instruments are widely used in the chemical, energy, pharmaceutical and food industries, as well as in medical and chemical research programs for government and industry.

### HP Innovation

HP's continuing growth is based on a strong commitment to research and development. Each year the company invests about ten percent of its net revenue in R&D (\$824 million in 1986). This heavy investment enables HP to remain at the forefront of technological development and to maintain a steady flow of new and useful products. Well over half of the company's 1986 orders were for products introduced during the previous three years, a clear indication of the importance of HP's product-development efforts.

Each of HP's 55 divisions has the primary responsibility for developing its own products. Together, the divisions account for close to 85 percent of the company's annual R&D budget. The remaining 15 percent is invested in more basic, higher risk, longer term research undertak-

en by HP Laboratories, the central source of technical support for the divisions. Through endeavors in various areas of science and technology, the corporate laboratories also help the company develop new areas of business. Customers benefit through access to computers and instruments that are at the forefront of technology.

### HP Support

HP's commitment to engineering excellence is equaled by its commitment to providing customers with high-quality support services. Hewlett-Packard's support organization consists of a worldwide sales and service network staffed by highly trained engineers and technicians. Our support starts before you purchase an HP product and continues long after the product has been delivered.

Before you purchase a product or system, HP sales representatives are available to help you assess your needs and choose the product or system that meets your immediate and longer term requirements.



If your needs are best filled by an instrument system, we offer applications and training support to help you obtain full use of your system, hardware support to help maximize system up time, and software support to keep your system software current and productive.

To help you plan your system and its use, we offer the consulting and training expertise of experienced systems engineers. For the installation and maintenance of your system and its components, we offer the services of customer engineers. And for the long-term support of your system, HP offers an extensive menu of services. The menu includes contract or as-needed calibration and repair with on-site and at-HP options, as appropriate. Update services are available for both software and hardware, as is training for your own service personnel.

HP's worldwide support network ensures prompt availability of replacement parts throughout the service life of products and beyond. Replacement parts services also include parts stocking recommendations based on extensive component reliability histories and the numbers and mix of HP products to be supported.

For products requiring consumable supplies, such as recording paper, ribbons and magnetic media, we offer fast, convenient service from well-stocked supply centers. These centers also offer personal computers and software, peripherals and terminals, cables and connectors, workstation furniture, books and learning aids.

HP's comprehensive support extends to information services, including excellent hardware and software manuals and a wide variety of no-charge publications. These publications help you choose the HP products that best fill your needs, allow you to benefit from applications knowledge acquired by users inside

and outside of HP, and help you maintain your HP products. This literature includes new-product announcements, catalogs, product family brochures and single-product data sheets, application notes, programming aids, service notes, and maintenance periodicals.

The support services outlined above are described in more detail in the back sections of this catalog. Your nearest HP office can either supply the support services you need or help you obtain them. The locations of HP offices are listed on the back pages of this catalog.

#### **The HP Catalog**

This catalog is divided into sections that are based on nine broad product groups, including sources and analyzers, design automation and technical computers, semiconductor test and board test, etc. Many of the sections are prefaced by descriptions of basic kinds of measurements and the techniques of measurement that are associated with the featured products.

Products described in this catalog are indexed four ways. There is a general index with product type or application and a broad product group index. Products are also indexed alphabetically, by type, application, and name; and numerically by HP model number. The general and product group indexes are located inside the front cover. The product group index is color-keyed to blue page tabs for each product group section to allow you to locate readily the sections in which you are most interested. The alphabetical index begins on page 24, and the numerical index begins on page 35.

A description is provided for each product, but for some products you'll want to refer to a data sheet for a full set of specifications. Data sheets are available on request at local HP sales offices.

#### **Contacting HP**

Locations of HP sales and service offices are listed on the back pages of this catalog. The listing also indicates the types of products normally available through each office (not all offices handle the full line of HP products).

Calls to your local HP office will be routed to the person best qualified to assist you. Give the operator your specific product interest: test and measurement, computers, medical, analytical, or components.

Our sales force is made up of specialists in each of these five major product areas. Staff engineers are always available during business hours. Our sales representatives are supported by the HP systems engineering organization, which has specialists in measurement and computation systems.

Information on product availability, prices, and order status is immediately available through our worldwide order processing network.

#### **Suggestions Welcomed**

The purpose of this catalog is to give you useful information about Hewlett-Packard products, along with some company background that may help you reach decisions on products and systems that will fill your needs. The catalog emphasizes test and measurement products and systems and includes representatives of HP's other product categories. Literature describing the other products in detail is available through your local sales office.

If you have any comments and suggestions about how we can make this catalog more useful to you, please let us know by writing to:

Hewlett-Packard Company  
Steve Duer  
Catalog Manager  
3200 Hillview Avenue  
Palo Alto, CA 94304  
U.S.A.

## A

- AC  
 Digital Voltmeters ..... 88-101  
 Probes ..... 101  
 True RMS Voltmeters ..... 88-100
- Accelerometers ..... 568
- Access and Test System ..... 491
- Accessories  
 Adapters ..... 245, 307, 338, 339, 730, 731  
 Cabinet ..... 738  
 Cables/Connectors ..... 220, 241, 245, 249, 307, 549, 730  
 Computer ..... 758  
 Connectors, Adapters ..... 307, 339, 730, 731  
 EMI Measurement ..... 127  
 Fiber-Optic Lenses ..... 307  
 Fixtures, Board Test System ..... 531  
 HP Touch ..... 670, 672  
 Logic Analyzer ..... 264  
 Network Analyzer ..... 220, 233, 237, 240-252, 271  
 Operating Cases ..... 736  
 Optical ..... 307  
 Oscilloscope ..... 60, 75-77  
 PC Instruments ..... 603  
 Personal Computer Networking ..... 682  
 Pulse Generator ..... 428  
 Signal Generator ..... 363  
 SLMS ..... 481  
 Spectrum Analyzer ..... 125-127, 141, 142, 228  
 Transit Cases ..... 732  
 Voltmeter ..... 101  
 Waveguide ..... 247, 332, 335, 337, 339-341
- Active Probes ..... 76, 273
- Adapters  
 2.4mm ..... 338  
 50-75Ω ..... 241, 363, 731  
 Acculink ..... 683  
 APC-3.5 ..... 730  
 APC-7® ..... 730  
 Optical ..... 307  
 Quasi-Peak ..... 126  
 Waveguide ..... 339
- A/D Converters ..... 48, 62-72, 78, 583, 586, 589, 652
- AdvanceLink ..... 683
- AdvanceNet ..... 682
- Agile Upconverter ..... 368
- Air Line Extensions ..... 340
- Alphanumeric LED Displays ..... 660
- AM/FM Signal Generators ..... 349-362, 366, 369, 371-374
- AM/FM/φM Modulation Analyzers ..... 160, 319
- AM/FM/φM Signal Generators ..... 320, 351-359
- AM/FM Test Source ..... 162
- Ammeters ..... 88-101, 522
- Amplifiers  
 Broadband Power ..... 394  
 Broadband Preamp ..... 394  
 Distribution ..... 468  
 Power Supply ..... 456  
 Microwave ..... 393, 394  
 RF ..... 395
- Analog  
 Circuit Test Systems ..... 528  
 Converters, A-D ..... 48, 62-72, 78, 583, 586, 589, 652  
 Input/Output Cards For HP-1000 A-Series ..... 589  
 Voltmeter ..... 100
- Analyzers  
 Amino Acid ..... 662  
 Audio ..... 163, 485  
 Audio Spectrum ..... 106, 143-152, 226  
 Automatic Network ..... 243  
 Automatic Scalar Network ..... 215  
 Automatic Spectrum ..... 106, 110-136, 139, 143-153  
 Customer Support ..... 746-759  
 Data ..... 310, 313  
 Data Error ..... 499  
 Data Line ..... 474  
 Digital Transmission ..... 319, 476  
 Distortion ..... 163-166  
 Fourier (FFT) ..... 144-152  
 Frequency and Time Domain ..... 62-69  
 Frequency and Time Interval ..... 184  
 Frequency Stability ..... 153-155, 184  
 Gain-Phase ..... 230, 235, 278  
 Impedance ..... 226, 276-285  
 Impedance/Gain-Phase ..... 226, 278, 280  
 Jitter ..... 184  
 LAN Protocol ..... 495  
 Logic ..... 254-269, 616  
 Microwave Link ..... 486  
 Microwave Modulation ..... 319  
 Modulation ..... 160, 184, 319  
 Network ..... 148, 212-253, 278  
 Phase ..... 184  
 Phase Noise ..... 153-155  
 Phase Noise, Side Band ..... 153-155  
 Primary Multiplex ..... 474  
 Protocol ..... 492-495  
 RF Impedance ..... 282  
 RF Signal Modulation ..... 160  
 Scalar Network ..... 215-225  
 Selective Level ..... 109, 167, 481-485  
 Semiconductor Parameter ..... 520  
 Spectrum ..... 106, 110-154, 226  
 Signature ..... 270-272  
 Time and Frequency Domain ..... 62-69  
 Time Interval ..... 184  
 Training ..... 748  
 Vector Modulation ..... 319  
 Vibration ..... 145-148  
 Wave ..... 109, 167, 404, 405, 482, 485  
 Waveform ..... 48-78, 110-116, 145, 148, 151, 184, 319
- APC-3.5 series Adapters ..... 730
- APC-7® series Adapters ..... 730
- Arbitrary Waveform Generators ..... 70, 311, 364, 406, 413
- Arbitrary Waveform Synthesizer ..... 364
- Artificial Intelligence ..... 648
- ASIC Test System ..... 510
- Atomic Clock/Frequency Standard ..... 462
- Attenuators  
 Coaxial ..... 328-331  
 Coaxial, Microwave, OEM ..... 328  
 Optical ..... 306  
 Test System ..... 158  
 Waveguide ..... 332
- Audio Synthesizer ..... 398
- Automatic Test Systems ..... 588

## B

- Balanced 2/4 Wire Audio Channel Selector ..... 474
- Bar Code  
 Printers ..... 716

\*A registered trademark of the Bunker Ramo Corporation

Readers ..... 661  
Terminal ..... 702  
Wand ..... 679  
Bar Graph Array, LED ..... 660  
Battery Operated  
Calculators/Computer ..... 676-679, 684-689  
Counters ..... 179, 196-199  
Disc Drive ..... 706  
DMM ..... 98-100  
Microwave Power Meter ..... 203  
Printers ..... 715  
Beam Lead Diodes ..... 661  
Bias Networks ..... 246  
Bias Supply, Transistor ..... 246  
Bit Error Rate Test Sets ..... 475, 476, 499  
Bipolar Transistors ..... 661  
BNC Series Adapters ..... 730  
Board Test Fixtures ..... 531  
Board Testers ..... 528, 529  
Breadboard Cards, Multiprogrammer ..... 583, 586  
Breadboard, PC Instruments ..... 601  
Bridges, Directional ..... 218, 219, 333  
Broadband Amplifiers ..... 393-395  
Business Computer Systems ..... 690-697

**C**  
Cabinet Accessories ..... 738  
Cabinet Identification ..... 738, 742  
Cable Assemblies ..... 220, 241, 245, 249, 307, 549, 730  
Cable Kit, Scalar Analyzer ..... 220  
Cables/Connectors ..... 730  
Cables, HP-IB ..... 549  
Cables, Network Analyzer ..... 220, 241, 245, 249  
Cables, Optical ..... 307  
CAD Software ..... 611, 612, 613, 620, 622  
CAE Software ..... 613  
Calculators, Handheld Computers & Peripherals  
Business ..... 684  
Card Reader ..... 685  
Cassette Drive ..... 686  
Catalogs ..... 758  
Financial Programmable ..... 684  
I/O Module ..... 685  
Memory Modules ..... 685  
Optical Wand ..... 685  
Printer/Plotter ..... 714, 718  
Scientific Programmables ..... 684  
Calibration Data, Attenuators ..... 328  
Calibration Kits (Network Analyzer) ..... 220, 242, 244, 245, 249  
Calibration Service ..... 754  
Calibrators  
AM/FM (HP 8901A/B) ..... 162  
Power Meter, for HP 432 Series ..... 206  
Range, for HP 435B Power Meter ..... 203  
Scalar, for HP 8756A & 8757A ..... 221  
Time Interval ..... 182  
Cardiology/Cardiovascular Instrumentation ..... 664  
Capacitance Meters ..... 288-294, 524  
Capacitor Sets ..... 297  
Carrier Testing ..... 318, 480  
Carts, Instrumentation ..... 77  
CASE ..... 616  
Cases, Combining ..... 742  
Cases, Transit ..... 732  
Catalog, Computer Users Supplies and Accessories ..... 758  
Catalog, Test and Measurement Accessories ..... 758  
Catalog, Technical Software ..... 612

Cavity Frequency Meters ..... 335  
Cellular Radio Test System ..... 322  
Cesium Beam Frequency Standard ..... 463  
ChemStations ..... 662  
Chromatographs, Gas ..... 662  
Chromatographs, Liquid ..... 662  
Circuit Test Systems ..... 528-531  
Circuit Testers, Digital ..... 270-275, 528-531  
Clip, Logic ..... 274  
Clock, Atomic ..... 463  
Clock, Digital ..... 550  
C Meters ..... 288-294, 524  
C Meter/C-V Plotter ..... 524  
Coaxial  
Accessories ..... 326-341, 730  
Adapters ..... 339, 731  
Air Lines ..... 341  
Attenuators ..... 328-330  
Crystal Detectors ..... 336  
Directional Couplers ..... 334  
Dual Directional Coupler ..... 334  
Fixed Attenuators ..... 328, 329  
Frequency Meters ..... 335  
Low-Pass Filters ..... 220  
Noise Sources ..... 211  
Pad Attenuators ..... 328, 329  
Power Sensors ..... 204, 207  
Shorts ..... 338, 341  
Sliding Loads ..... 341  
Step Attenuators ..... 330  
Switches ..... 327, 571  
Terminations ..... 338, 340, 341  
Thermistor Mounts ..... 207  
Thermocouple Mounts ..... 204  
Waveguide Adapters ..... 338, 339  
Comb Generator ..... 142  
Combining Cases ..... 742  
Communications, Data ..... 184, 492-501, 668, 670, 673, 676, 682, 683, 690, 693, 694, 752  
Communications, Signalling ..... 398  
Communications Test Equipment ..... 62, 109, 167, 318-325, 398, 472-501  
Comparator, Logic ..... 274  
Comparator, Phase ..... 235, 464  
Component & Semiconductor Measurement  
Digital IC Test System ..... 510, 520  
Digital IC Testers ..... 313, 510, 520  
Impedance, LCR Meters ..... 276-297  
Semiconductor Parametric Test ..... 508, 512-527  
Components, Solid State ..... 660, 661  
Computer-Aided Design (CAD) ..... 608-625, 712, 719-725  
Computer-Aided Engineering (CAE) ..... 608-625, 712, 719-725  
Computer-Aided Software Engineering (CASE) ..... 616-619  
Computer-Aided Test ..... 569  
Computers & Peripherals  
Artificial Intelligence ..... 648  
Automatic Test Systems ..... 528, 588  
Board Computers ..... 654  
Business Computer Systems ..... 690-697  
Color Computers ..... 629-638, 649  
Common Lisp Development Environment ..... 640, 648  
Computer Users Catalog ..... 758  
Controllers ..... 534-537, 626  
Digitizing Tablets ..... 712, 713  
Disc Drives ..... 706-709  
Disc/Tape Drives ..... 710  
Display Boards ..... 636, 649

- DOS Coprocessor ..... 636, 653  
 Engineering Workstations ..... 611, 626  
 Flexible Disc Drives ..... 706  
 Graphics ..... 649, 714-725  
 Handheld Computers ..... 679, 685  
 HP-IL Peripherals ..... 685, 686  
 Interfacing Summary ..... 652  
 Modems ..... 683, 705  
 Monitors ..... 701  
 Networking and Data Communications ..... 530, 611, 613,  
     642, 645, 669, 670, 673, 675, 682  
 Network Support ..... 751  
 Personal Computers ..... 668-689  
 Plotters ..... 718-727  
 Portable Computers ..... 639, 676-679, 685  
 Printers ..... 714-717  
 Real-Time Systems ..... 654  
 Scanner ..... 711  
 Supplies and Accessories ..... 727, 758  
 Support ..... 746  
 Tablets ..... 712  
 Tape Drives ..... 708, 710  
 Technical Computers ..... 534, 626-657, 674  
 Technical Software Catalogs ..... 612  
 Terminals ..... 698-700, 702, 704  
 X-Window Software ..... 647  
 Connector Adapters ..... 730  
 Connectors, Microwave Precision ..... 730  
 Connectors, Optical ..... 307  
 Constellation Analyzer ..... 319, 489  
 Controllers ..... 534-537, 626  
 Converters  
   A-to-D ..... 48, 62-72, 78, 583, 586, 589, 652  
   D-to-A ..... 447, 550, 559, 583, 586, 589, 598  
 Counters, Electronic  
   Counter/Analyzer ..... 184  
   Counter/Timers ..... 181, 188-199  
   Counter/Tracking Generator ..... 137, 138  
   Digital Multimeter/Counters ..... 270, 554, 555, 558, 559  
   DVM/DMMs ..... 192-195  
   Low Cost ..... 179, 199  
   Microwave ..... 170-180  
   Multiprogrammer Card ..... 583  
   PC Instruments Universal Counter ..... 599  
   Portable, Battery Operated ..... 179, 196-199  
   Pulsed RF ..... 176  
   Reciprocal ..... 170-180, 188-194, 196-198,  
     554, 558  
   Time Interval ..... 181-186, 188-199  
   Time Interval Probes ..... 187  
   Universal ..... 181, 188-199  
 Counter/Totalizer Cards ..... 559, 583, 586  
 Couplers, Directional (Coax and Waveguide) ..... 334, 335  
 CRT Displays ..... 698-703  
 Crystal Detectors ..... 336, 337  
 Crystal Oscillator ..... 467  
 Current Tracer, Digital ..... 273  
 Custom Products for Handheld Computers ..... 687  
 Customer Support ..... 746-759  
**D**  
 D/A Converters ..... 447, 550, 559, 583, 586, 589, 598  
 D/A Converter Cards, Multiprogrammer ..... 559, 583, 586  
 Data  
   Acquisition Systems ..... 50, 62, 72, 78, 552-568  
   Acquisition System Training ..... 748  
   Analyzer ..... 310, 313  
   Communications ..... 184, 492-501, 668, 670, 673, 676,  
     682, 683, 690, 693, 694, 752  
   Error Analyzer ..... 499  
   Generators ..... 263, 310, 313  
   Time Interval Analyzer ..... 184  
   Transmission Test Set ..... 499  
 Data Acquisition  
   Measurement and Control Unit ..... 556  
   PC Instruments Data Logging Package ..... 604  
   PC Instruments Data Acquisition Software ..... 604  
   Systems ..... 50, 62, 72, 78, 552-568  
   System Training ..... 748  
   Voltmeters/Counters ..... 88-101, 184, 188-196, 552-566  
 Datacommunications Test Equipment  
   Bit Error Rate Test Sets ..... 475, 476, 499  
   Data Line Analyzers ..... 475  
   General Information ..... 492, 496  
   LAN Protocol Analyzer ..... 495  
   Network Circuit Access Test Set ..... 501  
   Protocol Analyzers ..... 492-495  
   Selective Level Meter ..... 109, 482  
   Spectrum Analyzers ..... 102-167  
   Time Interval Analyzer ..... 184  
   Transmission Impairment Test Sets ..... 496-501  
   Vector Modulation Generator/Analyzer ..... 490  
   Waveform Analyzer ..... 62  
 DC Source/Monitor ..... 518  
 DC Voltmeters ..... 88-101, 192-195, 554, 555, 558-566  
 DC Power Supplies  
   Amplifier/Power Supply ..... 456  
   Autoranging ..... 440, 445, 450  
   Condensed Listing ..... 430-434  
   Constant-Current Sources ..... 461  
   Digitally Controlled ..... 446  
   Dual Tracking ..... 438, 448, 457  
   General Information ..... 430  
   General Purpose: 10-30 W Output ..... 457  
   General Purpose: 25-200 W Output ..... 448  
   General Purpose: 100-2000 W Output ..... 450, 452  
   General Purpose: 300-11,000 W Output ..... 454  
   HP-IB Programmable ..... 431, 432, 436-441  
   PC Instruments 20V ..... 601  
   PC Instruments 50V ..... 601  
   Precision Voltage Sources ..... 446, 460  
   Programmable ..... 430, 431, 432, 436-441  
   Source/Monitors ..... 518  
   Specifications, Definitions ..... 435  
   Transistor Bias ..... 246  
 Decade Capacitor ..... 297  
 Degaussers ..... 87, 464  
 Delay Generators ..... 416-429  
 Design Automation  
   Computers ..... 611, 626  
   Electronic Design System ..... 613  
   Overview ..... 608  
   Selection Guide ..... 608  
   Technical Computing Environment ..... 611  
   Third-Party Software ..... 612  
 Design Interfaces ..... 613  
 DesignCenter Products ..... 608-625  
 Detectors  
   Adapter ..... 218  
   Coaxial, Microwave, OEM ..... 336  
   Crystal, Coaxial and Waveguide ..... 336, 337  
   Diode Array ..... 663  
   Error ..... 475  
   Scalar ..... 218, 219

Development Systems, Logic	616
Dial-Up Modem	705
Digital	
AC Voltmeters	88-101
Analyzer, Logic	616
Analyzers, Signature	270-272
Audio Synthesizer	398
Bar Code Wand	679
Board Testers	528-531
Capacitance Meters	288-294, 524
Cassette Drive	686
Circuit Test	270-275, 528-531
Communications Generator/Analyzer	318
Constellation Analyzer	319, 489
Current Tracer	273
DC Voltmeters	88-101, 192-195, 554, 555, 558-566
DC Voltmeter/Counters	192-195
IC Testers	270-275, 313, 508, 510, 522, 528-531
IC Test Systems	508-517
Impedance Analyzers	276-285
In-Circuit Board Test Systems	528-531
Input Cards, Multiprogrammer	583, 586
I/O for PC Instruments	597
LCR Meters	286-294
Microprocessor Troubleshooting	270-272, 616
Modulation Analyzer	319
Modulation Signal Generator	320
Multimeters	88-101
Multimeters, Multiprogrammer	582
Multimeters, Signature	270
Noise Figure Meter	209, 210
Oscilloscopes	48-71
PC Board Test Systems	528-531
Power Meters	201, 202
Pressure Gauge	344
Programmable Power Supplies	430-432, 436-441
Signal Analyzers	319
Signal Generators	263, 313, 320
Signature Analyzers	270-272
Stimuli	310-317, 416-429
Thermometers	345, 554, 558
Time Interval Analyzer	184
D/A Current Converter Cards	558, 582, 586
D/A Voltage Converter Cards	558, 582, 586
Transmission Analyzer	476
Troubleshooting	270-275
Voltmeters	88-101
Digital-to-Analog Converters	447, 550, 559, 583, 586, 589, 598
Digital Data Test Set	479
Digitizer Module	110, 116
Digitizing Tablets	712, 713
Digitizing Oscilloscopes	48-71
Dimensional Measurements	342, 343
Diodes	661
Diode Array Spectrophotometers	663
Directional Bridges	218, 219, 333
Disc Drives	706-709
Disc/Tape Drives	710
Distortion Analyzers	163-166
Distribution Amplifier	468
DOS Coprocessor	636, 653
Double Balanced Mixer	337
Doubler, Frequency	363, 388, 389
Down Converters	141, 363, 486
Drafting, Mechanical Engineering	624
Drafting Plotters	718-725

DS3 Transmission Test Set	478
Dual Arbitrary Waveform Generator	311, 406
Dual Tracking Power Supplies	438, 448, 457, 458
Dual VHF Switch Module	574, 602
Dual Voltage DAC for PC Instruments	598
Dynamic Signal Analyzers	144, 145, 148

**E**

Eight-Pen Plotters	718, 720-725
Electrical Engineering (EE) DesignCenter	608
Electronic Counters	168-199
Electronic Mail	696
EMI Measurement Software and Accessories	125-127
EMI Measurement Systems	124
Emulators, Microprocessor	617
Engineering Graphics	620, 622
Engineering Workstations	611, 626, 629-633
Error Rate Measurements	475, 476
Extenders, HP-IB	551

**F**

Factory Floor Terminal	702
FDM Measurement Systems	482, 491
FDM Network Monitoring Systems	480, 482, 491
Fiber Optics	
Adapters	307
Attenuators	306
Average Power Meter	304
Cables	307, 660
Connectors	307, 660
Heads	302, 304
Laser Diode Source	305
LED Source	305
Optical Time Domain Reflectometer	308
Pulse Power Meter	302
Receiver	303
Signal Sources	301, 305
Switch	303
Test Equipment	300-309
Transmitters/Receivers	660
Filters	
High Pass	220
Low Pass	135, 220, 340
Fixtures, Board Test System	531
Fourier Analyzers	144, 145, 148, 151
FM Modulation Analyzers	160, 184
FM Signal Generators	320, 366, 369, 371-374
Frequency	
Analyzer	184
Counters	94-96, 168-199, 554, 599
Counter/Tracking Generator	137, 138
Doubblers	363, 388, 389
Meters, Coaxial and Waveguide	335
Stability Analyzer	153-155, 184
Synthesizers	320, 349-359, 368-374, 378, 400-405, 482
Frequency and Time Domain Analyzers	62-71
Frequency and Time Standards	462-469
Cesium	463
Distribution Amplifier	468
General Information	462
Quartz	467
Rubidium	465
Standby Power Supplies	469
Frequency Selective Meter and Tracking Oscillator	109, 167, 482, 485
Function Generators	396-415
Function Generator for PC Instruments	599

## ALPHABETICAL INDEX

## G

Gas Chromatographs	662
GC/FTIR Systems	663
GC/Mass Spectrometer Systems	662
Generators	
Arbitrary Waveform	70, 311, 364, 368, 398, 406, 413
Data	263, 310-317
Delay	416-429
Digital Modulation	320
Function	396-415
Jitter	477
Noise	211, 398
Optical, Pulse/Function	301
Pattern	310-317, 475-477
PRBS	311, 317
Pulse	396, 412, 413, 416-429
Pulse/Function	396-403, 406-415, 417
Signal	318-321, 348-375, 378, 379
Square Wave	396-415
Sweep	354, 369, 371, 372, 376-392, 400-405, 412, 413, 482
Timing	429
Tracking	116, 137, 404, 482
Vector	311, 319
Vector Modulation	319
Waveform	70, 311, 364, 368, 398
Word	311, 315, 317, 428, 479
Graphics	
Displays	649, 700
Plotters	72, 78, 718-727
Printers	714-717
Software	79, 612, 622, 650, 697
Supplies	727
Tablets	712
Technical Computers	534, 608, 611, 626-657, 674
Terminals	700, 704

## H

Hammer Kits	568
Handheld Calculators & Computers	679, 684-689, 758
Hardware Support	754
Harmonic Mixers (Coaxial and Waveguide)	141, 337
Hewlett-Packard Interface Bus (HP-IB)	538
Hewlett-Packard Interface Loop (HP-IL)	688, 689
HP-IB	
Attenuator/Switch Driver	330
Cables	549
Channel Selector	474
Computers	534-537, 626-641
Digital Clock	550
Digital-to-Analog Converter	70
Digitizer	110, 116
Extenders	551
Frequency Counters	168-196
General Information	538-542
Logic Analyzers	254
Oscilloscopes	48, 261
Power Meters	201, 202
Relay Actuators	330, 550, 558, 570, 574
Spectrum Analyzers	106, 110-136, 139, 144-152, 226
Switches	481, 550, 570, 574
Switch Controller	481
Switch/Control Unit	330, 481, 574
Switch Driver	330
Switch Test Unit	570
Time Synthesizer	429
Training	747
VHF Switches	550, 570, 574

HP-IL	688, 689
HP-HIL	670

## I

IC Design Analysis Software	526
IC Design Verification System	510
IC Testers, Digital	270-275, 313, 508, 510, 522, 528-531
IC Test Systems, Analog	509
IC Test Systems, Digital	508-517
Impedance Analyzers	226, 276-285
Impedance/Gain-Phase Analyzer	226, 278, 280
Impedance Meter	284
Impedance Transformers (50-75 $\Omega$ )	142
Indicators, LED	660
Industrial Touch Terminal	702
Infrared Detector	663
InkJet Printers	714-717
Integral, The	639
Integrators	663
Interface Bus (HP-IB)	538-551
Interface Cards for Technical Computers	652
Interface Cards & Software for PC Instruments	603-605
Interface Loop (HP-IL)	688, 689
Interface Kits	
HP-IL	686
IBM Disc/Tape	706
Multiprogrammer	581, 585
Interfacing Summary for Computers	652
Interference & Noise Test Set	489
Interrupt Card, Multiprogrammer	583, 586
Interferometers, Laser	342
Isolators, Optical	660
Isolators, Waveguide	335

## J

Jitter Generator & Receiver	477
Jitter, Time Interval Analyzer	184

## K

Kits, Accelerometer and Hammer	568
Kits, Fiber Optic Link	660
Kits, Interface	581, 585, 686, 706
Kits, Rack Mounting	738, 739, 742

## L

Laboratory Automation Systems	663
LAN Protocol Analyzer	495
Laser	
Calibrator System	343
Diode Source	305
Interferometers	342
Position Transducer	342
Printers	715-717
Transducer System	343
LC/MS Systems	662
LCR Meters	286-294
LCZ Meters	290
LED Displays	660
LED Indicators	660
LED Source	305
LF Impedance Analyzer	280
Light Bar Modules, LED	660
Light Emitting Diodes	660
Limiters	142
Liquid Chromatographs	662
Local Area Networks	642, 645, 682, 693-697
Logic	
Analyzer, Development Systems	616

- Analyzer Training Courses ..... 747  
 Analyzers ..... 254-269, 616  
 Clip ..... 274  
 Comparator ..... 274  
 Current Tracer ..... 273  
 Development System ..... 616  
 Pattern Generator ..... 263  
 Probes ..... 262, 263, 269, 273  
 Pulsar ..... 273  
 Signal Sources ..... 310, 396, 416  
 Troubleshooting Kits ..... 275
- M**  
 Magnetic Tape Recorders, Analog ..... 85  
 Mail, Electronic ..... 696  
 Mass Selective Detectors ..... 662  
 Mass Spectrometers ..... 662  
 Matrix Switch (HP-1B) ..... 327, 519, 570-575  
 Measurement and Control Cards,  
 HP-1000 A-Series ..... 589  
 Measurement Graphics Software ..... 73, 79  
 Measurement Plotting System ..... 72, 78  
 Measuring Receiver ..... 156  
 Mechanical Engineering  
 Design ..... 624  
 DesignCenter ..... 624  
 Drafting ..... 624  
 Drafting Plotters ..... 722-725  
 Modal Analysis ..... 624  
 Solids Modeling ..... 624, 632, 649  
 Test ..... 624  
 Medical Instrumentation ..... 664  
 Memory Card, Multiprogrammer ..... 582  
 Memory Modules, HP-41 and HP-71 ..... 685  
 Meters  
 AC ..... 88-101  
 Capacitance ..... 286-294, 524  
 Carrier Noise ..... 155  
 Digital Multimeter ..... 88-101  
 Distortion ..... 163-166, 485  
 Frequency ..... 94, 168-199, 335, 554, 599  
 High Resistance ..... 296  
 Impedance ..... 226, 276-285  
 LCR ..... 286-294  
 LCZ ..... 290  
 Low Resistance ..... 92, 296  
 Modulation ..... 160, 319  
 Multifunction ..... 88-101  
 Noise Figure ..... 209  
 Ohmmeter ..... 88-101, 296  
 PC Instruments Digital Multimeter ..... 598  
 Peak Power ..... 207  
 Phase ..... 144, 148, 184, 230, 238  
 Picoampere ..... 522  
 Power ..... 156, 201-207, 302, 304  
 Q ..... 295  
 Signature ..... 270-272  
 Standing-Wave-Ratio (SWR) ..... 253  
 Susceptance ..... 278, 280, 282, 286  
 Time Interval ..... 181, 184, 188-199  
 True RMS ..... 88-100  
 Vector Impedance ..... 284  
 Microprocessor  
 Bus Analyzer ..... 616  
 Development Environment ..... 616  
 Development Station ..... 616  
 Emulation ..... 616  
 PROM Programming ..... 616  
 Software Analyzer ..... 616  
 Troubleshooting ..... 270-272, 618  
 Microwave  
 Amplifiers ..... 393, 394  
 Attenuator Calibration ..... 158  
 Counters ..... 170-180  
 Diodes ..... 661  
 Down-Converter ..... 158  
 Link Analyzers ..... 486  
 Measurement System ..... 158  
 Modulators ..... 158, 318  
 Network Analyzers ..... 212-253  
 Noise Figure Meter ..... 209  
 Noise Figure Test Set ..... 209  
 Oscilloscope/TDR ..... 60  
 Power Measuring Equipment ..... 156, 200-207  
 Radio Testing ..... 318, 322, 480  
 Semiconductors ..... 661  
 Signal Generators ..... 348  
 Signal Generator Calibration ..... 159  
 Spectrum Analyzers ..... 110-120, 124, 131-139, 320  
 Sweep Oscillators ..... 376-392  
 Synthesizers ..... 351-359, 370-374  
 TDR/Oscilloscopes ..... 60  
 Test Equipment ..... 326-341  
 Transistors ..... 661  
 Millimetre Wave Instrumentation  
 Adapters ..... 339  
 Attenuators ..... 332  
 Bends ..... 339  
 Counters ..... 170, 176  
 Detectors ..... 337  
 Directional Couplers ..... 335  
 Frequency Meters ..... 335  
 General Information ..... 326  
 Harmonic Mixers ..... 141, 337  
 Isolators ..... 335  
 Network Analyzer ..... 247  
 Power Sensors ..... 204  
 Shorts ..... 341  
 Spectrum Analyzers ..... 111, 113, 117, 119, 131, 139  
 Straight Sections ..... 339  
 Sweep Oscillator ..... 380  
 Synthesized Sweeper ..... 372, 380  
 Terminations ..... 341  
 Twists ..... 339  
 Milliohmmeters ..... 92, 296  
 Miniature Fiber Optic Link ..... 660  
 Mixers, Double-Balanced ..... 337  
 Mixers, Coaxial and Waveguide ..... 141, 337  
 Modems ..... 683, 705  
 Modular Measurement System ..... 110-116  
 Modulation Analyzers ..... 160, 184, 319  
 Modulator/Demodulator ..... 486, 683  
 Modulators, Absorptive ..... 221, 375  
 Modulators, PIN ..... 375  
 Modulation Test Source ..... 162, 320  
 Modules (HP-41, HP-71) ..... 685  
 Monitors ..... 701  
 Multimeters ..... 88-101, 270  
 Multimeter, Signature ..... 270  
 Multiplex (Primary) Analyzer ..... 474  
 Multiplexers ..... 94-96, 554-566, 570-575, 597, 602  
 Multipoint HP-1B Extender ..... 551  
 Multiprogrammers ..... 576-587
- N**  
 Network Analysis, General Information ..... 212-214

## ALPHABETICAL INDEX

- Network Analyzers ..... 144, 148, 151, 212-253, 278  
   Automatic ..... 144, 148, 230, 243  
   Automatic Scalar ..... 215  
   Impedance/Gain-Phase ..... 278  
   Millimeter-Wave ..... 247  
   Scalar ..... 215-225  
   Vector ..... 144, 148, 226-252, 278  
 Network Circuit Test Set ..... 501  
 Networking  
   Board Test Systems ..... 530  
   Business Computers ..... 693  
   Computer Integrated Manufacturing ..... 645  
   Personal Computers ..... 669, 670, 673, 675, 676, 678, 682  
   Support ..... 751  
   Technical Computers ..... 642  
 Noise  
   Figure Meter ..... 209  
   Generator ..... 398  
   Measurements ..... 153, 155, 208, 489  
   Microwave Noise Figure Test Set ..... 210  
   Sources ..... 210  
 Noise and Interference Test Set ..... 489  
**O**  
 Obstetrical and Neonatal Instrumentation ..... 664  
**OEM**  
   Computers ..... 626, 654  
   Displays, CRT ..... 649, 698-704  
   Graphics Plotters ..... 718-724  
   HP-IL Interface Kit ..... 686  
   Measurement Plotting System ..... 72, 78  
   Microwave Attenuators ..... 328, 330  
   Microwave Components ..... 661  
   Microwave Crystal Detectors ..... 336, 337  
   Microwave Switches ..... 327  
   Optoelectronic Components ..... 660  
   Power Supplies ..... 430  
   Printers ..... 714-717  
 Ohmmeters ..... 88-101, 296  
 Operating Cases ..... 736  
**Optical**  
   Accessories ..... 307  
   Adapters ..... 307  
   Attenuator ..... 306  
   Average Power Meter ..... 304  
   Cables ..... 307  
   Connectors ..... 307  
   Heads ..... 302, 304  
   Laser Diode Source ..... 305  
   LED Source ..... 305  
   Pulse Power Meter ..... 302  
   Receiver ..... 303  
   Signal Source ..... 301, 305  
   Switch ..... 303  
   Time Domain Reflectometer ..... 308  
 Optocouplers ..... 660  
 Optoelectronics ..... 660  
 OR Monitors ..... 665  
**Oscillators**  
   Function ..... 396-415  
   General Information ..... 396  
   Low Frequency ..... 398-403, 412, 482  
   Sinewave ..... 398-405, 482-484  
   Squarewave ..... 396-415  
   Sweep ..... 163, 354, 369, 371, 372, 376-392,  
     400-405, 412, 413, 482  
   Synthesized Sweep ..... 368-373, 378, 400-405, 482-484  
 Oscilloscopes ..... 48  
   Accessories ..... 75-77  
   Digital Waveform Storage ..... 52-59  
   Digitizing ..... 48-64, 66, 600  
   PC Instruments Digitizing Oscilloscope ..... 600  
   Precision ..... 62-71  
   Spectrum Analyzer Plug-In ..... 110-116, 137  
   Testmobiles ..... 77  
**P**  
   pA Meter/DC Voltage Source ..... 522  
   Pad, Coaxial Attenuator ..... 328  
   Parameter Extraction Software ..... 526  
   Parts Libraries, Electronic Design System ..... 613  
   Patient Monitors ..... 665  
   Pattern Generator, Digital ..... 263, 311  
   Pattern Generator/Error Detector ..... 475, 476  
   PC Board Design/Test Link ..... 620  
   PC Board Testers ..... 528-531  
   PC Instruments ..... 596-605  
   PCM Test Equipment ..... 472-479  
   Peak Power Meters ..... 207  
   Peripherals, Computer ..... 685, 698-727  
   Personal Calculators & Handheld Computers ..... 668-689  
   Personal Computers ..... 668-683  
   Personal Computer (PC) Instruments ..... 596-605, 668  
   Personal Productivity Center ..... 694-697  
   Phase Comparator ..... 235, 464  
   Phase Meters ..... 144, 148, 184, 230, 238  
   Phase Modulation Analyzers ..... 160, 184, 319  
   Phase Noise Measurement ..... 153-155  
   PIN Diodes ..... 661  
   PIN Modulators, Microwave ..... 375  
   Plotter Accessories and Supplies ..... 727  
   Plotters, Drafting ..... 722-725  
   Plotters, Graphics ..... 72, 78, 718-727  
   Portable PLUS, The ..... 676  
   Portable Spectrum Analyzers ..... 128-134  
   Portable Vectra CS ..... 678  
   Position Measurement, Laser ..... 342  
   Power Amplifiers ..... 393-395  
   Power Dividers ..... 221, 307, 333  
   Power Meter Calibrators ..... 203, 206  
   Power Meter/Measuring Receiver ..... 156  
   Power Meter, Optical ..... 302, 304  
   Power Meters, RF & Microwave ..... 156, 200-207  
   Power Sensors, RF & Microwave ..... 157, 204, 207  
   Power Splitters, Coaxial ..... 221, 333  
   Power Splitters, Optical ..... 307  
   Power Supplies  
     Amplifier/Power Supplies ..... 456  
     Atomic Clock ..... 469  
     Condensed Listing ..... 430-434  
     Constant Current Sources ..... 461  
     Digitally Controlled ..... 436-447  
     Dual Tracking ..... 438, 448, 457, 458  
     Frequency Standards ..... 469  
     HP-IB Programmable ..... 436-447  
     Laboratory ..... 448-461  
     Multiprogrammer Control ..... 432-434  
     Precision Current, Voltage Sources ..... 460, 461  
     Programmable ..... 436-447  
     Specifications, Definitions ..... 435  
     Standby ..... 469  
   Power Supply/Amplifier ..... 456  
   PRBS Generators ..... 311, 317  
   Preamplifiers ..... 142, 187  
   Precision Coaxial Connectors ..... 338, 730  
   Precision Digitizing Oscilloscopes ..... 62-71



Precision Frequency Reference ..... 116  
Precision Frequency Sources ..... 462-469  
Precision Oscillator ..... 467  
Precision Time Interval Counters ..... 181, 184  
Preprocessor, Logic State Development System ..... 618  
Preprocessors, Logic Analyzer ..... 264  
Preselectors ..... 116, 126  
Pressure Probes, Quartz ..... 344  
Primary Multiplex Analyzer ..... 474  
Printed Circuit Design ..... 620  
Printers  
  Bar Code ..... 716  
  Color ..... 714  
  Daisywheel ..... 715  
  Desktop Publishing ..... 715, 716  
  Dot Matrix ..... 715-717  
  Graphics ..... 714-717  
  Impact ..... 715, 716  
  InkJet ..... 714, 715  
  Laser ..... 715-717  
  Line ..... 716  
  Page ..... 715-717  
  Personal ..... 715  
  Supplies ..... 758  
  Tempest ..... 716  
  Thermal ..... 715  
Probes  
  Accessories ..... 101, 273  
  Close-Field ..... 127, 142  
  Digital Multimeter ..... 101  
  High Frequency ..... 101  
  High Voltage ..... 101  
  Impedance ..... 278  
  Logic ..... 262, 263, 269, 273  
  Oscilloscope ..... 61, 75, 76  
  Pressure ..... 344  
  RTD ..... 567  
  Temperature ..... 345  
  Time Interval ..... 187  
  Voltage Divider ..... 101  
Programming Development Aids, HP-41 & HP-71 ..... 687  
Protocol Analyzers ..... 492-495  
Pulse Adder, Splitter, Inverter ..... 428  
Pulse Generators ..... 396, 412-415, 416-429  
  Configurable ..... 428  
  High Power ..... 423  
  Programmable ..... 413, 418-422  
Pulse/Function Generators ..... 396-403, 406-415, 417  
Pulse/Function Generator, Optical ..... 301  
Pulse Width/Duty Cycle Analyzer ..... 184  
Pulsers, Logic ..... 273  
**Q**  
Q Meter ..... 295  
Quartz Frequency Standard ..... 467  
Quasi-Peak Adapter ..... 126  
Quartz Pressure Probe ..... 344  
Quartz Pressure Set ..... 344  
Quartz Thermometer ..... 345  
**R**  
Rack Mount Kits ..... 738, 739, 742  
Rack Shelf for PC Instruments ..... 604  
Rack Slides ..... 739, 740, 742, 743  
Radio System Testing ..... 488  
Radio Test Systems ..... 322, 491  
Range Calibrator (for HP 435B Power Meter) ..... 203  
Readers, Card (HP-41 CV/CX) ..... 685, 686

Receiver, Measuring ..... 156  
Receiver, Optical ..... 303  
Recorders  
  Instrumentation Tape ..... 85  
  Measurement Plotting System ..... 72, 78-81  
  Waveform ..... 62-72, 78-81, 110, 116  
  X-Y ..... 72, 78-84  
Reflection/Transmission Test Sets ..... 233, 240, 250, 251, 252  
Reflectometer, Optical Time Domain ..... 308  
Relay Actuators (HP-IB) ..... 330, 550, 558, 570, 574  
Relay Actuator for PC Instruments ..... 597  
Relay Output Card, Multiprogrammer ..... 583, 586  
Remote Access & Test System ..... 491  
Remote Terminal Unit ..... 556  
Resistance Meters ..... 88-101, 296  
Resuscitation Instrumentation ..... 665  
**RF**  
  Amplifiers ..... 395  
  Counters ..... 169  
  Impedance Analyzer ..... 239, 282  
  Network Analyzer ..... 236, 239  
  Preselector ..... 126  
  Signal Generators ..... 348  
  Spectrum Analyzers ..... 104, 226  
  Switch ..... 327, 570, 602  
  Time and Frequency Analyzers ..... 62-71  
  Tracking Generator Module ..... 116  
  Transceiver Test Systems ..... 322  
RMS Voltmeters ..... 88-100  
ROMs, for Portable PLUS ..... 677  
Rotary Vane Attenuators, Waveguide ..... 332  
RTD Probes ..... 567  
Rubidium Frequency Standard ..... 465  
**S**  
S-Parameter Test Sets ..... 240, 250, 252  
Scalar Network Analyzers ..... 215-225  
Scanners ..... 519, 583, 586, 711  
Scanner Cards, Multiprogrammer ..... 583, 586  
Schottky Diodes ..... 661  
Selective Level Measuring Set ..... 481, 482  
Selective Level Voltmeters ..... 109, 167, 481, 482, 485  
Semiconductor/Component Test Systems ..... 510-521  
Semiconductor Parameter Analysis System ..... 516  
Semiconductor Parameter Analyzer ..... 522  
Semiconductor Parameter Extraction Software ..... 526  
Semiconductor Parametric Test System ..... 515  
Sensor Module ..... 157  
Sensors, Power ..... 157, 204, 207  
Service ..... 758  
Shorts, Coaxial ..... 341  
Shorts, Waveguide ..... 341  
Signal Analyzers  
  Audio ..... 106, 143-152, 163, 167, 485  
  Distortion ..... 163-166  
  Frequency and Time Interval ..... 184  
  General Information ..... 102  
  Modulation ..... 160, 184, 319  
  Phase Noise ..... 153-155  
  Spectrum ..... 106, 110-154, 226  
  Time Interval ..... 184  
  Waveform ..... 48-78, 110-116, 145, 148, 151, 319  
Signal Generators  
  Accessories ..... 363  
  Avionics ..... 360  
  Calibration ..... 159  
  General Information ..... 348  
  Generator/Recorder ..... 70

## ALPHABETICAL INDEX

- HF, VHF, UHF, SHF ..... 318-321, 349-362, 366-374  
 Microwave ..... 366-374  
 Programmable ..... 349-359, 368-374  
 Pulse Modulator ..... 375  
 Service Kits ..... 353, 356, 367, 373, 374  
 Sweep ..... 354, 369, 371, 372, 376-392,  
     400-405, 412, 413, 482  
 Synthesized ..... 349-359, 368-374, 378, 396-415, 482  
 VOR Modulator ..... 398  
 Signal Monitoring Software ..... 123  
 Signal Simulation System ..... 364, 368  
 Signal Sources ..... 310-318, 348-392, 396-429  
 Signal Sources, Optical ..... 301, 305  
 Signal Sources, Programmable .. 310-318, 349-359, 368-374,  
     378-388, 398-410, 413, 418-422, 482  
 Signature Analysis ..... 270-272  
 Signature Analyzer, Digital ..... 272  
 Signature Multimeter, Digital ..... 270  
 SimPlate Fixture Series ..... 531  
 Simulation, Signal ..... 364, 368  
 Single Sideband Phase Noise Test System ..... 153  
 Single Sideband Phase Noise Test Set ..... 155  
 Slides for Rack Mounting ..... 739, 740, 742, 743  
 Sliding Loads (Coaxial and Waveguide) ..... 341  
 SMA, SMB, SMC Series Adapters ..... 730  
 Software  
   Active Device Measurement ..... 246  
   Applications Solutions ..... 608-625, 688, 690, 692, 694, 696  
   Attenuator Test ..... 158  
   Basic Network Measurement ..... 245  
   Business ..... 690-697  
   Cellular Radio Test ..... 323  
   CAD ..... 608-625, 672  
   CAE ..... 613  
   CAE Link ..... 511  
   Data Acquisition ..... 592  
   Data Base Management ..... 680, 692, 697  
   Datacom ..... 673, 676, 680, 693, 696  
   Electronic Design ..... 608, 613  
   EMI Measurement ..... 125  
   Engineering Documentation ..... 622  
   Engineering Graphics Systems (EGS) ..... 622  
   Functional Test ..... 594  
   Graphics ..... 79, 612, 622, 650, 697  
   HP-41 ..... 688  
   HP-71 ..... 688  
   HP-94 ..... 679  
   IC Design Verification System ..... 511  
   IGES Translator ..... 623  
   Mechanical Design & Drafting ..... 624  
   Mechanical Engineering ..... 624  
   Microprocessor Development ..... 616  
   NC Drill ..... 623  
   Network Measurement ..... 234  
   Operating System (for HP 3000) ..... 692  
   Parameter Extraction (TECAP) ..... 526  
   PC Instruments Data Acquisition ..... 603  
   Photoplotter/NC Drill ..... 623  
   Portable PLUS Personal Computer ..... 676  
   Portable Vectra CS Personal Computer ..... 678  
   Printed Circuit Design ..... 620  
   Scalar Network Analyzer ..... 224  
   Signal Generator Test ..... 159  
   Signal Monitoring ..... 123  
   Spectrum Analyzer System ..... 118, 123, 125  
   Spreadsheets ..... 681, 697  
   Support ..... 753  
   Technical Documentation ..... 623  
   Technical Software Solutions ..... 608, 612  
   Terminal Emulation ..... 676, 683, 690, 696  
   Test ..... 594  
   The Integral ..... 639  
   Touchscreen II Personal Computer ..... 671  
   Transceiver Test ..... 323  
   Translator (IGES) ..... 623  
   Transmission Line Test System ..... 225  
   Vectra Personal Computer ..... 673  
   Vector Network Analyzer ..... 245, 246  
   Waveform Measurement ..... 69  
   Waveform Generator ..... 71, 364  
   Word Processing ..... 681, 697  
 Solid State  
   Displays, Lamps, Optocouplers, Fiber Optics ..... 660  
   Diodes, Transistors, Integrated Products ..... 661  
 Solids Modeling ..... 632, 633, 649  
 Source, AM/FM Test ..... 162  
 Sources, Optical ..... 301, 305  
 Sources, Signal ..... 310-318, 348-392, 396-429  
 Spectrophotometer, Diode Array ..... 662  
 Spectrum Analyzers, General Information ..... 102, 103  
 Spectrum Analyzers ..... 110-154, 226  
 Spectrum Analyzer Preselector ..... 116, 126  
 Stability Analyzer, Frequency ..... 153-155, 184  
 Standard Capacitor Sets ..... 297  
 Standards, Frequency and Time ..... 462-469  
 Standby Power Supply ..... 469  
 Standing Wave Ratio (SWR) Meter ..... 253  
 Step Attenuators, Coaxial ..... 330  
 Stepping Motor Control Card (Multiprogrammer) ..... 586  
 Storage-Normalizer ..... 253  
 Supplies, Plotter & Printer ..... 727  
 Support, Customer ..... 746  
 Sweep Oscillators, General Information ..... 376  
 Sweep Oscillators ..... 163, 354, 369, 371, 372, 376-392,  
     400-405, 412, 413, 482  
 Sweep Signal Generators ..... 354, 369, 371, 372, 376-392,  
     400-405, 412, 413, 482  
 Sweeper Synthesizers ..... 369, 378, 400, 402, 404, 405  
 Switch Controller, HP-IB ..... 330, 481, 574  
 Switches  
   AC Power Controller ..... 560-566  
   Access, Distribution and Bidirectional ..... 481  
   Actuators ..... 94, 330, 481, 554, 560, 570, 574  
   HP-IB Driver ..... 330  
   Coaxial, Five-Port ..... 327, 554  
   Coaxial, Microwave OEM ..... 327  
   Matrix Microwave ..... 327  
   Matrix (HP-IB) ..... 519, 570, 574  
   Optical ..... 303  
   Relay Multiplexer for PC Instruments ..... 597  
   Switch/Test Unit ..... 570  
   SPDT ..... 327  
   VHF, HP-IB ..... 550, 570, 574  
   VHF, PC Instruments ..... 602  
 Switching Matrix ..... 519  
 Synthesized Function Generators ..... 398, 400, 413  
 Synthesized Signal Generators ..... 349-359, 368-374, 378,  
     396-415, 482  
 Synthesized Signal Sources ..... 368-374, 378, 398,  
     400-405, 482  
 Synthesized Sweep Oscillators ..... 378, 400-405  
 Synthesizer, Audio Complex ..... 398  
 Synthesizer, Arbitrary Waveform ..... 364, 368, 413  
 Synthesizer, Time ..... 429

Synthesizers, Frequency ..... 368-374, 378, 400, 402, 404, 482

Systems

- Attenuator Calibration ..... 158, 200
- Automatic Test ..... 588
- Board Test ..... 528-531
- CAD ..... 620, 624
- CAE ..... 613
- Computer-Aided Engineering ..... 608-625
- Computer-Aided Software Engineering (CASE) ..... 616
- Data Acquisition ..... 552-568
- Digital IC Test ..... 510
- IC Design Verification ..... 510
- Laser Measurement ..... 343
- Logic Analysis ..... 258
- LSI Test ..... 508
- Microprocessor Development ..... 616
- Modular Measurement ..... 110-116
- Network Analysis ..... 234
- Phase Noise Measurement ..... 153, 155
- Power Sensor Calibration ..... 200
- Real-Time Computer ..... 654
- Remote Access & Test ..... 491
- Semiconductor Test ..... 508-517
- Signal Generator Calibration ..... 159
- Spectrum Analyzer/EMI Measurement ..... 124
- Transceiver Test ..... 322
- Transmission Line Test ..... 225
- Waveform Generation ..... 71, 364, 368
- Waveform Measurement ..... 68

System I, System II Cabinets ..... 738, 742

**T**

- Tablets ..... 712
- Tape Degausser ..... 87
- Tape Drives ..... 708, 710
- Tape Recorders, Analog Magnetic ..... 85
- TECAP Parameter Extraction Software ..... 526
- Technical Computers and Peripherals ..... 534, 611-657
  - Artificial Intelligence ..... 648
  - Computers ..... 534, 626-657, 674
  - Computing Overview ..... 626
  - Controllers ..... 534-537
  - Disc Drives ..... 706-709
  - DOS Coprocessor ..... 636, 653
  - Engineering Workstations ..... 611, 626
  - Graphics ..... 649
  - HP-IB Interface ..... 646, 652
  - Integral, The ..... 639
  - I/O Expander ..... 652
  - Interfacing Summary ..... 652
  - Multiprogrammer: I/O Expander & Converter ..... 576
  - Network Support ..... 751
  - Networking ..... 642, 645
  - Operating Systems ..... 640
  - Parallel Asynchronous FIFO Interface ..... 630, 652
  - Peripherals ..... 651
  - Plotters ..... 718-727
  - Printers ..... 714-717
  - Real-Time Systems ..... 654
  - Selection Guide ..... 627
  - Software Catalog ..... 612
- Technical Documentation Software ..... 623
- Telecommunications Test Equipment ..... 106, 109, 167, 230, 308, 472-491
  - Access Switch ..... 481
  - Audio Channel Selector: HP-IB Controlled ..... 474
  - Balanced 2/4-wire Audio Channel Selector ..... 474
  - Bidirectional Switch ..... 481

- Carrier Testing ..... 319, 480
- Cellular Radio Test Equipment ..... 322
- Constellation Analyzer ..... 319, 489
- Controller, Switch ..... 330, 481
- Customer Support ..... 746
- Digital Data Test Set ..... 479
- Digital Modulation Generator/Analyzer ..... 320
- Digital Transmission Analyzer ..... 476
- Digitizing Oscilloscopes ..... 48-68
- Down Converter ..... 486
- DS3 Transmission Test Set ..... 478
- Error Rate Measurements ..... 475, 476
- FDM Measurements ..... 480-484, 491
- FDM Surveillance Software ..... 491
- Frequency Analyzer ..... 184
- HP-IB Controlled Channel Selector ..... 474
- Jitter Generator & Receiver ..... 477
- Jitter, Time Interval Analyzer ..... 184
- Microwave Counters ..... 170-180
- Microwave Link Analyzers ..... 486
- Microwave Network Analyzers ..... 243-252
- Microwave Radio Testing ..... 480
- Microwave Upconverter ..... 486, 487
- Modulation Analyzers ..... 156-162, 184, 319
- Modulator/Demodulator ..... 486
- Noise and Interference Test Set ..... 489
- Optical Time Domain Reflectometer ..... 308
- Pattern Generator/Error Detector ..... 476
- PCM Terminal Test Set ..... 474
- PCM Testing ..... 184, 472-479
- Power Meters ..... 158, 200-207
- Primary Multiplex Analyzer ..... 474
- Remote Access and Test System ..... 491
- Remote Automatic Surveillance Systems ..... 491
- RF Radio Testing ..... 322
- Selective Level Measuring Sets ..... 481
- Selective Level Meters ..... 109, 167, 481, 482, 485
- SLMS Accessories ..... 481
- Spectrum Analyzers ..... 106-154, 226
- Support ..... 746
- Switch, Access ..... 481
- Switch Controller ..... 330, 481
- Time Interval Analyzer ..... 184
- Transmission Impairment Measuring Sets ..... 497-501
- Transmission Line Test Sets ..... 225
- Vector Modulation Generator/Analyzer ..... 318
- Voice & Data Testing ..... 496
- Waveform Analyzers ..... 62-71
- Temperature Measurement ..... 345, 554, 558, 561, 582
- Terminal Emulation ..... 676, 683, 696
- Terminals, Display ..... 698-704
- Termination Panel, Multiprogrammer ..... 585
- Terminations, Coaxial and Waveguide ..... 338, 340, 341
- Test and Measurement Accessories Catalog ..... 758
- Test Head ..... 511
- Testmobiles ..... 77
- Test Set, Signal Generator ..... 159
- Test Systems, Automatic ..... 588
- Test System, LSI ..... 508
- Test System, Digital IC ..... 510
- Thermistor Assemblies ..... 567
- Thermistor Sensors, Coaxial and Waveguide ..... 207
- Thermocouple Power Meters ..... 201-205
- Thermocouple Power Sensors ..... 204
- Thermocouple Scanning Cards ..... 554, 558-566, 582
- Thermocouple Wire ..... 567
- Thermometer, Quartz ..... 345

# ALPHABETICAL INDEX

- Time Base Card, Multiprogrammer ..... 582  
 Time, Frequency Domain Analyzers ..... 62-71  
 Time Interval Analyzer ..... 184  
 Time Interval Calibrator ..... 182  
 Time Interval Counters ..... 181-186, 188-199  
 Time Module, HP-41 ..... 685  
 Time Standards ..... 462-469  
 Time Synthesizer ..... 429  
 Timer/Pacer Cards, Multiprogrammer ..... 583, 586  
 Timing Analyzer ..... 184  
 Timing Generator, HP-1B ..... 429  
 TNC Adapters ..... 730  
 Touchscreen II ..... 670  
 Touch Accessory, HP ..... 672, 701  
 Tracer, Current ..... 273  
 Tracking Generators ..... 116, 137, 404, 482  
 Tracking Generator Module ..... 116  
 Training Support ..... 747  
 Transceiver Modulation Analyzer ..... 160  
 Transceiver Test Systems ..... 322, 323  
 Transducer, Laser Position ..... 342  
 Transfer Function Analyzer ..... 144  
 Transient Digitizers ..... 52-71  
 Transient Generators ..... 70, 364  
 Transient Recorders ..... 52-71  
 Transmission Impairment Measuring Sets ..... 497-501  
 Transmission Line Test Software ..... 224  
 Transmission Line Test System ..... 225  
 Transmission Test Sets ..... 500, 501  
 Transistor Bias Supply ..... 246  
 Transistor Test Fixtures ..... 246, 250, 252  
 Transistors, Bipolar ..... 661  
 Transit Cases ..... 732  
 Troubleshooter Kits, IC ..... 275  
 True RMS Voltmeters ..... 88-100  
 Type N Series Adapters ..... 730  
 Type N Short ..... 341
- U**  
 UHF Signal Generators ..... 320, 351-359  
 Ultrasound Imaging ..... 664  
 Upconverter ..... 368
- V**  
 Vector Analyzer ..... 319  
 Vector Generator ..... 311, 319  
 Vector Impedance Meter ..... 284  
 Vector Modulation Generator/Analyzer ..... 318
- Vector Network Analyzers ..... 144, 148, 226-252, 278  
 Vector Voltmeter ..... 238  
 Vectra PC ..... 638, 672  
 Verification Kits (Network Analyzer) ..... 245  
 VHF Signal Generators ..... 349-362  
 VHF Switch Module ..... 550, 571  
 VHF Switch for PC Instruments ..... 602  
 Vibration Analyzers ..... 144-148  
 Voice/Data Testing ..... 496  
 Voltmeters ..... 88-101  
   Analog ..... 100  
   Digital ..... 90-100
- W**  
 Wand, Handheld ..... 679  
 Waveform  
   Analyzers ..... 48-78, 110-116, 145, 148, 151, 184, 319  
   Digitizers ..... 48-71, 110-116, 261  
   Generator, Arbitrary ..... 70, 311, 364, 368, 398, 406, 413  
   Recorders ..... 62-72, 78-81, 110, 116  
   Synthesizer, Arbitrary ..... 364, 368, 413  
   Synthesizer, Complex ..... 398  
 Waveguide  
   Adapters ..... 339  
   Attenuators ..... 332  
   Calibration Kits ..... 247  
   Coaxial Adapters ..... 339  
   Detectors ..... 337  
   Directional Couplers ..... 335  
   Frequency Meters ..... 335  
   Harmonic Mixers ..... 141, 337  
   Holders ..... 340  
   Low-Pass Filters ..... 340  
   Movable Shorts ..... 341  
   Sliding Loads ..... 341  
   Sliding Shorts ..... 341  
   Stand ..... 340  
   Terminations ..... 341  
   Thermistor Mounts ..... 207  
   Variable Attenuators ..... 332  
 Wideband Amplifiers ..... 393-395  
 Wire, Thermocouple ..... 567  
 Word Generators ..... 311, 315, 317, 428, 479
- X**  
 X-Ray Systems, Scientific & Industrial ..... 666  
 X-Y Recorders ..... 72, 78-84  
 X Window Software ..... 647

<b>D1001A HP Portable 3 Personal Computer</b> .....	678
<b>D1002A 1200 bps Asynchronous Modem</b> .....	678
<b>D1003A 2400 bps Synchronous/Asynchronous Modem</b> .....	678
<b>D1004A Dual-Serial/EMS Adapter, Opt. 001</b> .....	678
<b>D1004A Dual-Serial/EMS Adapter, Opt. 002</b> .....	678
<b>D1006A Technical Reference Manual</b> .....	678
<b>D1007A Software</b> .....	678
<b>D1008A 1 Mbyte EMS RAM Kit</b> .....	678
<b>HP-11C Programmable Scientific Calculator</b> .....	684
<b>HP-12C Programmable Financial Calculator</b> .....	684
<b>HP-15C Programmable Scientific Calculator with Matrices</b> .....	684
<b>HP-16C Programmable Calculator for Computer Science</b> .....	684
<b>HP-18C Business Consultant Professional Calculator</b> .....	684
<b>HP-28C Professional Scientific Calculator</b> .....	684
<b>HP-41CV/CX Advanced Programmable Calculators</b> .....	685
<b>HP-41 CV/CX Opt. 001 Custom Calculator</b> .....	687
<b>HP-71B Handheld Computer</b> .....	685
<b>HP-94D 64K-Byte Handheld Computer</b> .....	679
<b>HP-94E 128K-Byte Handheld Computer</b> .....	679
<b>HP-94F 246K-Byte Handheld Computer</b> .....	679

<b>100</b>	
<b>105B Quartz Oscillator</b> .....	467
<b>110 The Portable PLUS</b> .....	676
<b>141T System Spectrum Analyzers</b> .....	137
<b>141T Spectrum Analyzer Mainframe</b> .....	137

<b>200</b>	
<b>214B Pulse Generator</b> .....	423
<b>260 Series 30 &amp; 401 Business Computer Systems</b> .....	690
<b>281 Series Coaxial-Waveguide Adapters</b> .....	339
<b>292 Series Waveguide-Waveguide Adapters</b> .....	339

<b>300</b>	
<b>334A Distortion Analyzer</b> .....	166
<b>339A Distortion Measuring Set</b> .....	165
<b>346A/B/C Noise Sources</b> .....	211
<b>347B Series Waveguide Noise Sources</b> .....	211
<b>355 Series Coaxial Step Attenuators</b> .....	330
<b>362A Series Waveguide Low-pass Filters</b> .....	340
<b>365 Series mm-Wave Waveguide Isolators</b> .....	335
<b>370 Series mm-Wave Fixed Attenuators</b> .....	332
<b>382 Series Waveguide Precision Variable Attenuators</b> .....	332

<b>400</b>	
<b>415E SWR Meter</b> .....	253
<b>422A/C Series Waveguide Crystal Detectors</b> .....	337
<b>423B Coaxial Crystal Detectors</b> .....	336
<b>432 Series Power Meters</b> .....	206
<b>435B Power Meter</b> .....	203
<b>436A Power Meter</b> .....	202
<b>436A-E40 Power Sensor Calibration System</b> .....	200
<b>438A Dual Power Meter</b> .....	201
<b>438A Option 700 MATE - Programmed Power Meter</b> .....	201
<b>478A Coaxial Thermistor Mount</b> .....	207
<b>486A Series Waveguide Thermistor Mounts</b> .....	207

<b>500</b>	
<b>532 Series Waveguide Frequency Meters</b> .....	335
<b>537A Coaxial Frequency Meter</b> .....	335
<b>545A Logic Probe</b> .....	273
<b>546A Logic Pulser</b> .....	273
<b>547A Current Tracer</b> .....	273
<b>548A Logic Clip</b> .....	274

<b>700</b>	
<b>700/22 Display Terminal</b> .....	699
<b>700/41 Display Terminal</b> .....	699
<b>700/71 Display Terminal</b> .....	699
<b>700/92 Display Terminal</b> .....	698
<b>700/94 Display Terminal</b> .....	698
<b>752 Series Waveguide Directional Couplers</b> .....	335

<b>774-777D Coaxial Dual Directional Couplers</b> .....	334
<b>778D Coaxial Dual Directional Coupler</b> .....	334
<b>779D Coaxial Directional Coupler</b> .....	334

<b>800</b>	
<b>853A Spectrum Analyzer Display</b> .....	135
<b>896 Series Waveguide Precision Straights</b> .....	339
<b>897 Series E-, H-Plane Waveguide Bends</b> .....	339
<b>898 Series Waveguide Twists</b> .....	339
<b>899 Series Waveguide Straight Sections</b> .....	339

<b>900</b>	
<b>905A Coaxial Sliding Load</b> .....	341
<b>908A Coaxial 50-Ohm Termination</b> .....	340
<b>909A/C/D/E/F Coaxial 50-Ohm Terminations</b> .....	340
<b>910 Series Waveguide Terminations</b> .....	341
<b>911C Coaxial Sliding Loads</b> .....	341
<b>914 Series Waveguide Sliding Loads</b> .....	341
<b>920 Series Waveguide Moving Shorts</b> .....	341
<b>921 Waveguide Fixed Shorts</b> .....	341

<b>1000</b>	
<b>1000 Computers and Systems</b> .....	654
<b>1000/26 Computer System</b> .....	655
<b>1000/27 Computer System</b> .....	655
<b>1000/29 Computer System</b> .....	655
<b>1008A Testmobile</b> .....	77
<b>1040A Diode-Array Detector</b> .....	662
<b>1046A Fluorescence Detector</b> .....	662
<b>1051A &amp; 1052A Combining Cases</b> .....	742
<b>1090 Liquid Chromatograph Systems</b> .....	662
<b>1122A Probe Power Supply</b> .....	76
<b>1124A Active Divider Probe</b> .....	76
<b>1133A TV Video Sync Pod</b> .....	77
<b>1631A/D Logic Analyzers</b> .....	257
<b>1645A Data Error Analyzer</b> .....	499
<b>1650A 80-Channel Logic Analyzer</b> .....	255
<b>1651A 32-Channel Logic Analyzer</b> .....	255

<b>2000</b>	
<b>2106BK Board Computer</b> .....	657
<b>2137A Computer</b> .....	657
<b>2139A Computer</b> .....	657
<b>2156B Computer</b> .....	657
<b>2196C/D Model 26 Computer Systems</b> .....	654
<b>2197C/D Model 27 Computer Systems</b> .....	654
<b>2199C/D Model 29 Computer Systems</b> .....	654
<b>2225A/B/C/D/P ThinkJet Personal Printer</b> .....	715
<b>2227A/B QuietJet PLUS Printer</b> .....	715
<b>2228A QuietJet Printer</b> .....	715
<b>2235A/B/C/D RuggedWriter 480 Printer</b> .....	716
<b>2393A Graphics Terminal</b> .....	700
<b>2397A Color Graphics Terminal</b> .....	700
<b>2424A Micro 14 Computer</b> .....	654
<b>2426E/F Micro 16 Computers</b> .....	654
<b>2434A Micro 24 Computer</b> .....	654
<b>2436A/E Micro 26 Computer</b> .....	654
<b>2437A Micro 27 Computer</b> .....	654
<b>2439A Micro 29 Computer</b> .....	654
<b>2484A Micro 24 Computer</b> .....	654
<b>2486A Micro 26 Computer System</b> .....	654
<b>2487A Micro 27 Computer System</b> .....	654
<b>2489A Micro 29 Computer System</b> .....	654
<b>2563B Line Printer</b> .....	716
<b>2564B Line Printer</b> .....	716
<b>2566B Line Printer</b> .....	716
<b>2567B Line Printer</b> .....	716
<b>2603A Daisywheel Printer</b> .....	715
<b>2680A Laser Printing System</b> .....	716
<b>2684A LaserJet 2000 Printer</b> .....	716
<b>2685B Laser Print Station</b> .....	716
<b>2685C Laser Print Station</b> .....	716
<b>2686D LaserJet 500 PLUS Printer</b> .....	715

# MODEL NUMBER INDEX

New product listings are printed in bold face type

2689A Laser Printing System.....	717	3781A Pattern Generator (CEPT, CCITT).....	475
2804A Quartz Thermometer.....	345	3781B Pattern Generator (BELL Compatible).....	475
2813D Quartz Pressure Set.....	344	3782A Error Detector (CEPT and CCITT Compatible).....	475
<b>2813E Quartz Pressure Probe</b> .....	344	3782B Error Detector (BELL Compatible).....	475
2816A Pressure Signal Processor.....	344	3785A Jitter Generator & Receiver (CEPT).....	477
2932A General Purpose Printer.....	716	3785B Jitter Generator & Receiver (Bell).....	477
2934A Business Printer.....	716	<b>3787B Digital Data Test Set</b> .....	479
		<b>3789A DS3 Transmission Test Set</b> .....	478
		<b>3789B DS3 Transmission Test Set</b> .....	478
		<b>3852A Data Acquisition/Control Unit</b> .....	560
		3852S Data Acquisition/Control System.....	560
		3964A Instrumentation Tape Recorder.....	86
		3968A Instrumentation Tape Recorder.....	86
<b>3000</b>		<b>4000</b>	
<b>3000 Micro 3000, Micro 3000XE, Series 52, 58, 70, 930, 950</b>		4061A Semiconductor/Component Test System.....	517
<b>Business Computer Systems</b> .....	691	4062B Semiconductor Parametric Test System.....	514
3048A Phase Noise Measurement System.....	153	<b>4062C Semiconductor Parametric Test System</b> .....	512
3060A/3061A/3062A User's Course.....	748	4063A Semiconductor Parameter Analysis System.....	516
3065 Board Test Family (HP-IB).....	528	4085M Switching Matrix.....	519
3065C + 24D Board Test System User Training.....	748	4140B pA Meter/DC Voltage Source.....	522
<b>3065ST Standard Technologies Board Test System</b> .....	529	4141B DC Source/Monitor.....	518
<b>3082A Industrial Touch Terminal</b> .....	702	<b>4142B Modular DC Source/Monitor</b> .....	507
<b>3235A Switch/Test Unit</b> .....	570	4145B Semiconductor Parameter Analyzer.....	520
3312A Function Generator.....	412	4191A RF Impedance Analyzer.....	282
3314A Function Generator.....	414	4192A LF Impedance Analyzer.....	280
3325A Function Generator/Frequency Synthesizer/Sweeper.....	400	4193A Vector Impedance Meter.....	284
3326A Two-Channel Synthesizer (HP-IB).....	402	4194A Impedance/Gain - Phase Analyzer.....	278
3335A Frequency Synthesizer.....	404	<b>4195A Network/Spectrum Analyzer</b> .....	226
3336A/B/C Synthesizer/Level Generators.....	405, 482	4261A Digital LCR Meter.....	293
3390 Series Integrators.....	663	4262A Digital LCR Meter.....	293
3400A RMS Voltmeter.....	100	4274A Multifrequency LCR Meter.....	286
3421A Data Acquisition/Control Unit.....	554	4275A Multifrequency LCR Meter.....	286
3437A System Voltmeter.....	97	4276A LCZ Meter.....	290
3455A Digital Voltmeter.....	97	4277A LCZ Meter.....	290
3456A Systems DVM.....	92	4278A 1 kHz/1 MHz Capacitance Meter.....	288
3457A Multimeter.....	94	<b>4279A 1 MHz C-V Meter</b> .....	292
3466A 4½ Digit Autoranging DMM.....	100	4280A 1 MHz C Meter/C-V Plotter.....	524
3468A/B 5½ Digit Multimeter (HP-IL).....	98	4328A Milliohmeter.....	296
3478A 5½ Digit Multimeter (HP-IB).....	90	4329A High Resistance Meter.....	296
3488A Switch Control Unit (HP-IB).....	574	4342A Q Meter.....	295
3497A Data Acquisition/Control Unit.....	558	4440B Decade Capacitor.....	297
3498A Extender.....	559	<b>4765A Cardiology Instrumentation</b> .....	664
3551A Transmission Test Set.....	500	4925B Bit Error Rate Test Set.....	499
3552A Transmission Test Set.....	500	4935A Transmission Impairment Measuring Set.....	500
3561A Dynamic Signal Analyzer (HP-IB).....	145	4936A Transmission Impairment Measuring Set.....	500
3562A Dynamic Signal Analyzer (HP-IB).....	148	4937A Transmission Impairment Measuring Set.....	501
3575A Gain/Phase Meter.....	235	4938A Network Circuit Access Test Set.....	501
3577A Network Analyzer (HP-IB).....	230	4945A Transmission Impairment Measuring Set.....	497
3577S Network Analyzer System.....	234	4947A Transmission Impairment Measuring Set.....	497
3580A Spectrum Analyzer.....	143	4948A In-Service Transmission Impairment Measuring Set.....	498
3581A Wave Analyzer.....	167	4951C Protocol Analyzer.....	493
3581C Selective Voltmeter.....	485	4952A Protocol Analyzer.....	493
3582A Spectrum Analyzer.....	144	<b>4954A Protocol Analyzer</b> .....	494
3585A Spectrum Analyzer.....	106	4955A Protocol Analyzer.....	495
3586A/B Selective Level Meter.....	482	<b>4972A LAN Protocol Analyzer</b> .....	495
3586C Selective Level Meter.....	109		
<b>3630A PaintJet Color Graphics Printer</b> .....	714		
3708A Noise and Interference Test Set.....	489		
<b>3709B Constellation Analyzer</b> .....	489		
3711A IF/BB Transmitter (70/140 MHz IF).....	486		
3712A IF/BB Receiver (70/140 MHz IF).....	486		
3717A 70 MHz Modulator/Demodulator.....	486		
3730B Down Converter: RF to IF.....	486		
3736B RF Module (1.7 to 4.2 GHz).....	486		
3737B RF Module (3.7 to 8.5 GHz).....	486		
3738B RF Module (5.9 to 11.7 GHz).....	486		
3739B RF Module (10.7 to 14.5 GHz).....	486		
3746A Selective Level Measuring Set (32 MHz).....	481		
3754A Access Switch.....	481		
3755A Switch Controller.....	481		
3756A 90 MHz Bi-directional Switch.....	481		
3757A 8.5 MHz Access Switch.....	481		
3764A Digital Transmission Analyzer.....	476		
3776A PCM Terminal Test Set.....	474		
3776B PCM Terminal Test Set.....	474		
3777A HP-IB-Controlled Channel Selector.....	474		
3779C Primary Multiplex Analyzer (CEPT).....	474		
3779D Primary Multiplex Analyzer (Bell).....	474		
3780A Pattern Generator/Error Detector.....	476		
		<b>5000</b>	
		5005B Signature Multimeter.....	270
		5006A Signature Analyzer.....	272
		5011T Logic Troubleshooting Kit.....	275
		5021A Logic Troubleshooting Kit.....	275
		5022A Logic Troubleshooting Kit.....	275
		5023A Logic Troubleshooting Kit.....	275
		5024A Logic Troubleshooting Kit.....	275
		5061B Cesium Beam Frequency Standard.....	463
		E21-5061B Flying Clock (Cesium).....	463
		5065A Rubidium Frequency Standard.....	465
		E21-5065A Portable Rubidium Time Standard.....	465
		5087A Distribution Amplifier.....	468
		5089A Standby Power Supply.....	469
		5180A Waveform Recorder.....	68
		5180S Waveform Measurement System.....	69
		5180T.U Precision Digitizing Oscilloscopes.....	62-71

5182A Waveform Recorder/Generator..... 70  
5182S Waveform Generation System..... 71  
5183A Waveform Recorder..... 67  
5183T,U Precision Digitizing Oscilloscopes..... 66  
**5185A Waveform Recorder**..... 65  
**5185T Precision Digitizing Oscilloscopes**..... 64  
5314A Universal Counter..... 199  
5315A Universal Counters..... 196  
**5316B Universal Counter**..... 196  
5328B Universal Counter..... 195  
**5334B Universal Counter**..... 190  
5335A Universal Counter..... 192  
5340A Microwave Frequency Counter..... 175  
5342A Microwave Frequency Counter..... 173  
5343A Microwave Frequency Counter..... 173  
5345A Electronic Counter..... 176, 188  
5350B Microwave Frequency Counter..... 170  
5351B Microwave Frequency Counter..... 170  
5352B Microwave Frequency Counter..... 170  
5355A Automatic Frequency Converter..... 176  
5356A, B, C, D Frequency Converter Heads..... 176  
5359A Time Synthesizer..... 429  
5363B Time Interval Probes..... 187  
5370B Universal Time Interval Counter..... 181  
**5371A Frequency & Time Interval Analyzer**..... 184  
5384A Frequency Counter..... 179  
5385A Frequency Counter..... 179  
5386A Frequency Counter..... 179  
5501A Laser Transducer System..... 343  
**5517A Laser Head**..... 342  
**5517B High Slew Rate Laser Head**..... 342  
**5527A Laser Position Transducer**..... 342  
5528A Laser Measurement System..... 343  
5880A Gas Chromatograph..... 662  
5890A Gas Chromatograph..... 662  
5965A Infrared Detector..... 663  
5970B Mass Selective Detector..... 662, 663  
5988A GC/Mass Spectrometer..... 662  
5988A LC/Mass Spectrometer..... 662  
5995C GC/Mass Spectrometer..... 662

**6000**

6002A Autoranging DC Power Supply..... 445  
6010A 1000 Watt Autoranging Power Supply..... 450  
6011A 1000 Watt Autoranging Power Supply..... 450  
6012B 200 Watt Autoranging Power Supply..... 450  
6023A 200 Watt Autoranging Power Supply..... 450  
6024A 200 Watt Autoranging DC Power Supply..... 450  
6030A 1000 Watt Autoranging System Power Supply..... 440  
6031A 1000 Watt Autoranging System Power Supply..... 440  
6032A 1000 Watt Autoranging System Power Supply..... 440  
6033A 200 Watt Autoranging System Power Supply..... 440  
6038A 200 Watt Autoranging System Power Supply..... 440  
6114A & 6115A Precision DC Power Supplies..... 460  
6129C-6131C Digitally Controlled Voltage Sources..... 446  
6140A Digital Current Source..... 446  
6177C Precision DC Current Source..... 461  
6181C Precision DC Current Source..... 461  
6186C Precision DC Current Source..... 461  
6200B-6209B DC Power Supplies..... 457-459  
6212C-6218C DC Power Supplies..... 457-459  
6227B Dual Tracking DC Power Supply..... 448  
6228B Dual Tracking DC Power Supply..... 448  
6234A Dual Output Power Supply..... 457-459  
6235A Triple Output Power Supply..... 458  
6236B Triple Output DC Power Supply..... 458  
6237B Triple Output DC Power Supply..... 458  
6253A Dual Output DC Power Supply..... 448  
6255A Dual Output DC Power Supply..... 448  
6259B DC Power Supply..... 452  
6260B DC Power Supply..... 452  
6261B DC Power Supply..... 452  
6263B DC Power Supply..... 452  
6264B DC Power Supply..... 452  
6266B DC Power Supply..... 452

6267B DC Power Supply..... 452  
6268B DC Power Supply..... 452  
6269B DC Power Supply..... 452  
6274B DC Power Supply..... 452  
6281A DC Power Supply..... 448  
6282A DC Power Supply..... 448  
6284A DC Power Supply..... 448  
6286A DC Power Supply..... 448  
6289A DC Power Supply..... 448  
6291A DC Power Supply..... 448  
6294A DC Power Supply..... 448  
6296A DC Power Supply..... 448  
6299A DC Power Supply..... 448  
6434B DC Power Supply..... 454  
6443B DC Power Supply..... 454  
6448B DC Power Supply..... 454  
6453A DC Power Supply..... 454  
6456B DC Power Supply..... 454  
6459A DC Power Supply..... 454  
6464C DC Power Supply..... 454  
6466C DC Power Supply..... 454  
6469C DC Power Supply..... 454  
6472C DC Power Supply..... 454  
6475C DC Power Supply..... 454  
6477C DC Power Supply..... 454  
6479C DC Power Supply..... 454  
6483C DC Power Supply..... 454  
6621A System Power Supply..... 438  
6622A System Power Supply..... 438  
6623A System Power Supply..... 438  
6624A System Power Supply..... 438  
**6632A System Power Supply**..... 436  
**6633A System Power Supply**..... 436  
**6634A System Power Supply**..... 436  
6824A DC Power Supply/Amplifier..... 456  
6825A DC Power Supply/Amplifier..... 456  
6826A DC Power Supply/Amplifier..... 456  
6827A DC Power Supply/Amplifier..... 456  
6940B Multiprogrammer..... 585  
6941B Multiprogrammer Extender..... 585  
6942A Multiprogrammer..... 581  
6943A Multiprogrammer Extender..... 581  
6944A Multiprogrammer..... 580  
6944A + 24D Multiprogrammer's User Course..... 747  
**6954A Multiprogrammer**..... 578

**7000**

**7060A Graphics Tablet**..... 713  
7090A Measurement Plotting System..... 72, 78  
7440A ColorPro Plotter..... 718  
7475A 6-Pen Graphics Plotter..... 719  
7550A 8-Pen Graphics Plotter..... 720  
7570A DraftPro Plotter..... 722  
**7595A DraftMaster I Plotter**..... 724  
**7596A DraftMaster II Rollfeed Plotter**..... 724  
7907A Disc/Tape Drive..... 707  
7935H/XP Disc Drives..... 707  
**7936H/XP Disc Drive**..... 709  
**7937H/XP Disc Drive**..... 709  
7942A Disc/Tape Drive..... 708  
7946A Disc/Tape Drive..... 708  
**7957A Disc Drive**..... 708  
**7958A Disc Drive**..... 708  
**7979A 1/2" Tape Drive**..... 710  
**7980A 1/2" Tape Drive**..... 710

**8000**

8005B Pulse Generator..... 424  
8011A Pulse Generator..... 424  
8012B Pulse Generator..... 425  
8013B Pulse Generator..... 425  
8015A Pulse Generator..... 426  
8016A Word Generator..... 315  
8018A Serial Data Generator..... 317

# MODEL NUMBER INDEX

New product listings are printed in bold face type

8080A Mainframe.....	428	8553B Spectrum Analyzer, Tuning Section.....	137
8081A Repetition Rate Generator, 300 MHz.....	428	8555A Spectrum Analyzer, Tuning Section.....	137
8082A Pulse Generator.....	427	8559A Spectrum Analyzer.....	135
8083A Output Amplifier, 300 MHz.....	428	<b>8562A Portable Spectrum Analyzer.....</b>	131
8084A Word Generator, 300 MHz.....	428	<b>8562B Portable Spectrum Analyzer.....</b>	131
8091A Repetition Rate Generator, 1 GHz.....	428	8566B Spectrum Analyzer.....	117, 119
8092A Delay Generator/Frequency Divider.....	428	8566A + 24D Spectrum Analyzer Programming.....	118, 748
8093A Output Amplifier, 1 GHz.....	428	8566S Automatic Spectrum Analyzer.....	118
8111A 1 Hz-20 MHz Pulse/Function Generator.....	411	8567A Spectrum Analyzer.....	117, 121
8112A Programmable Pulse Generator.....	418	8568A + 24D Spectrum Analyzer Programming.....	118, 748
8116A Pulse/Function Generator.....	409	8568B Spectrum Analyzer.....	117, 121
<b>8145A Optical Time Domain Reflectometer.....</b>	308	8568S Automatic Spectrum Analyzer.....	118
8150A Optical Signal Source.....	301	8569B Spectrum Analyzer.....	139
8151A Optical Pulse Power Meter.....	302	8570A Spectrum Analyzer.....	139
8152A Optical Average Power Meter.....	304	8573A CISPR EMI Receiver.....	124
8154B LED Source 1300 nm.....	305	8574A CISPR EMI Receiver.....	124
<b>8155A LD Source.....</b>	305	8590A Portable RF Spectrum Analyzer.....	128
<b>8157A Optical Attenuator.....</b>	306	8620C Sweep Oscillator Family.....	390-392
8158B Optical Attenuator.....	306	8640B AM/FM Signal Generator.....	360
8159A Optical Switch.....	303	8640B Option 004, Avionics Signal Generator.....	362
8160A Programmable Pulse Generator.....	420	8642A/B Synthesized Signal Generators.....	351
8161A Programmable Pulse Generator.....	420	8656B Synthesized Signal Generator.....	349
8165A Programmable Signal Source.....	408	<b>8660D Synthesized Signal Generator.....</b>	357
8170A Logic Pattern Generator.....	316	8662A Synthesized Signal Generator.....	354
8175A Digital Signal Generator.....	311, 406	8663A Synthesized Signal Generator.....	354
8180A/B Data Generator.....	313, 510	8671B Synthesized CW Generator.....	370
8180A + 24A Operating & Programming Techniques Course.....	748	8672A Synthesized Signal Generator (2 to 18 GHz).....	374
8181A Data Generator Extender.....	313, 510	8672S MW Synthesized Generator (0.1 to 18 GHz).....	374
8182A Data Analyzer.....	313, 510	8673B Synthesized Generator (2 to 26.5 GHz).....	372
8328A/S Transmission Line Test Set.....	225	8673C/D Synthesized Signal Generators (0.1 to 18/26 GHz).....	372
8340B Synthesized Sweeper.....	369, 378	8673E Synthesized Signal Generator (2 to 18 GHz).....	371
8341B Synthesized Sweeper.....	369, 378	8683B/D Signal Generators.....	366
8349B Microwave Amplifier.....	394	8684B/D Signal Generators.....	366
8350B Sweep Oscillator Family.....	380-389	8717B Transistor Bias Supply.....	246
8403A Modulator.....	375	8721A Coaxial Directional Bridge.....	333
8405A Vector Voltmeter.....	238	8731-8734 series PIN Modulators.....	375
8406A Comb Generator.....	142	8743B Reflection/Transmission Test Unit.....	251
8410C Network Analyzer Mainframe.....	249	8745A S-Parameter Test Set.....	250
8410S Series Network Analyzers.....	248	8746B S-Parameter Test Set.....	252
8411A Harmonic Frequency Converter.....	249	8750A Storage-Normalizer.....	253
8412B Phase-Magnitude Display.....	249	8753A Network Analyzer.....	239
8414B Polar Display.....	249	8754A Network Analyzer.....	236
8418B Auxiliary Display Holder.....	249	8756A Scalar Network Analyzer.....	223
8443A Tracking Generator-Counter.....	137	8757A Scalar Network Analyzer.....	217
8444A Tracking Generator.....	137	8757S Automatic Scalar Network Analyzer System.....	215
8444A Option 059 Tracking Generator.....	137	8761A,B Coaxial Switches.....	327
8445B Automatic Preselector.....	137	8770A Arbitrary Waveform Synthesizer.....	364
8447 Series Amplifiers.....	395	8770S Signal Simulator System.....	364
8451A Diode Array Spectrophotometer.....	663	8780A Vector Signal Generator.....	320, 368, 490
8452A Diode Array Spectrophotometer.....	663	8900C/D Peak Power Meters.....	207
8470B Coaxial Crystal Detectors.....	336	8901A Modulation Analyzer.....	160
8472B Coaxial Crystal Detector.....	336	8901B Modulation Analyzer.....	160
8473B/C/D/E Coaxial Crystal Detectors.....	336	8902A Measuring Receiver.....	156
8477A Power Meter Calibrator.....	206	8902S Microwave Measurement System.....	158
8478B Coaxial Thermistor Mount.....	207	8903B Audio Analyzer.....	163
8481A/B/H Power Sensors.....	204	8903E Distortion Analyzer.....	163
8482A/B/H Power Sensors.....	204	<b>8904A Multifunction Synthesizer.....</b>	398
8483A Power Sensor.....	204	8952A Signal Generator Test Set.....	159
8484A Power Sensor.....	204	8953A Transceiver Test Set.....	322
8485A Power Sensor.....	204	8954A Transceiver Interface.....	325
8486A mm-Wave Power Sensors.....	205	8955A RF Test System.....	322
<b>8490D 2.4mm Coaxial Fixed Attenuator.....</b>	328	8956A System Interface.....	325
8491A/B Coaxial Fixed Attenuators.....	328	8957S Cellular Radio Test System.....	322
8492A Coaxial Fixed Attenuator.....	328	8958A Cellular Radio Interface.....	325
8493A/B/C Coaxial Fixed Attenuators.....	328	8970B Noise Figure Meter.....	209
8494A/B/G/H Coaxial Step Attenuators.....	330	8970S/T Microwave Noise Figure Measurement System.....	210
8495A/B/D/G/H/K Coaxial Step Attenuators.....	330	8971B Microwave Noise Figure Test Set.....	210
8496A/B/G/H Coaxial Step Attenuators.....	330	8980A Vector Analyzer.....	319, 490
8497K Coaxial Step Attenuator.....	330		
8498A Coaxial Fixed Attenuator.....	328		
<b>8510B Network Analyzer.....</b>	243		
8511A Frequency Converter.....	243		
8514B S-Parameter Test Set (500 MHz-18 GHz).....	243		
8515A S-Parameter Test Set (45 MHz-26.5 GHz).....	243		
8552B Spectrum Analyzer—IF Section.....	137		
		<b>9000</b>	
		9000 Controllers.....	626
		9000 Engineering Workstations.....	611, 626
		9000 Operating Systems.....	640



9000 Technical Computer Systems..... 626  
9000 Model 216S Computer..... 637  
9000 Model 220A Modular Computer..... 637  
9000 Model 220S Modular Computer..... 637  
9000 Model 226A Controller/Computer..... 637  
9000 Model 226S Controller/Computer..... 637  
9000 Model 236CU Color Computer..... 637  
9000 Model 236U Computer/Workstation..... 637  
9000 Series 300 Computers..... 633  
**9000 Model PC-308 HP BASIC Controller**..... 635  
9000 Model 310 Technical Computer & Controller..... 634  
9000 Model 310C Low-Cost Color Workstation..... 635  
9000 Model 310M Measurement Automation Workstation..... 635  
**9000 Model 318M Monochrome Workstation**..... 635  
9000 Model 320 Technical Computer System..... 633  
**9000 Model 330 Technical Computer System**..... 634  
9000 Model 330C Color Workstation..... 635  
9000 Model 330CMA Color Instrument Controller..... 635  
9000 Model 330M Monochrome Workstation..... 635  
9000 Model 330MMA Monochrome Instrument  
Controller..... 635  
**9000 Model 350 Technical Computer System**..... 633  
9000 Model 350C Color Workstation..... 634  
**9000 Model 350CH High-Performance 2D Color  
Workstation**..... 634  
9000 Model 350M Monochrome Workstation..... 635  
9000 Model 350SRX Solid Modeling Workstation..... 634  
**9000 Model 825S Minicomputer**..... 631  
**9000 Model 825SRX Superworkstation**..... 632  
9000 Model 840S Minicomputer..... 629  
**9000 Model 850S Superminicomputer**..... 630  
9114B Double-Sided 3½" Disc Drive..... 706  
9122D/S 3½" Microfloppy Disc Drive..... 706  
9123D Dual 3½" Drive (for HP Touchscreen II)..... 671, 706  
9127A Single-Sided 5¼" Flexible Disc Drive..... 706  
9133L 40 Mbyte Winchester/3½" Microfloppy..... 706  
9134L 40 Mbyte Winchester Hard Disc..... 706  
9142A ¼" Tape Subsystem..... 706  
9144A ¼" High Performance Tape Subsystem..... 710  
9153A 10 Mbyte Winchester/3½" Microfloppy..... 671, 706  
**9153B 20 Mbyte Winchester 3½" Microfloppy**..... 671, 706  
9154A 10 Mbyte Winchester Hard Disc..... 706  
**9154B 20 Mbyte Winchester Hard Disc**..... 706  
**9190A HP ScanJet Desktop Scanner**..... 711  
**9480 Analog LSI Test System**..... 508  
**9666A Rugged Terminal, Operator Interface Unit**..... 704  
9807A The Integral Personal Computer..... 639  
9888A Bus Expander..... 652

**10000**

10002A 50:1 Passive Oscilloscope Probe..... 76  
10020A Resistive Divider Probe Kit..... 76  
10021A PC Instruments Oscilloscope Probe..... 603  
10024A IC Test Clip..... 76  
10040A PC Instruments Oscilloscope Probe..... 603  
10062A Protective Cover..... 312  
10100C 50-ohm BNC Feedthrough..... 76  
10110B BNC Male to Dual Banana Plug..... 730  
10229A Hook Tip Adapter..... 76  
10269C GP Probe Interface..... 264  
10275A PDP-11 UNIBUS Interface..... 269  
10276A LSI-11 Interface..... 269  
10342B/G Bus Preprocessor..... 264  
10345A 8 Channel ECL Differential Driver Pod..... 269  
10346A 8 Channel TTL Tristate Buffer..... 269  
10387A Interface, Type 303 Modems (HP 1645A)..... 499  
10388A Interface, CCITT V.35 (HP 1645A)..... 499  
10389A Interface, Breakout Box (RS-232C/V.24)  
(HP 1645A)..... 499  
10390A System Performance Analysis..... 269  
10391A Inverse Assembler Development Package..... 269  
10430A 10:1 Passive Oscilloscope Probe..... 75  
10431A 10:1 Passive Oscilloscope Probe..... 75  
10432A 10:1 Passive Oscilloscope Probe..... 75  
10433A 10:1 Passive Oscilloscope Probe..... 75

10434A 10:1 Passive Oscilloscope Probe..... 75  
10435A 10:1 Passive Oscilloscope Probe..... 75  
10436A 10:1 Passive Oscilloscope Probe..... 75  
10437A 50 Ohm Probe..... 75  
10438A 1:1 Passive Oscilloscope Probe..... 75  
10439A 1:1 Passive Oscilloscope Probe..... 75  
10440A 100:1 Passive Oscilloscope Probe..... 75  
10501A Cable Assembly..... 730  
10502A Cable Assembly..... 730  
10503A Cable Assembly..... 730  
10514A Double-Balanced Mixer..... 337  
10529A Logic Comparator..... 274  
10534A Double-Balanced Mixer..... 337  
10541A Reference Boards..... 274  
10541B Preprogrammed Reference Boards..... 274  
10595A Board Extender Kit (HP 5345A)..... 189  
10638A Degausser..... 464  
10715A Differential Interferometer..... 342  
10717A Wavelength Tracker..... 342  
10821A Probe Accessory Kit (HP 5363B)..... 187  
10833A/B/C/D HP-IB Cables..... 549  
10834A HP-IB Cable Adapter..... 549  
10842A Extender Board Kit (HP 5342/5343/5344S)..... 174  
10855A Broadband Preamplifier..... 187  
10870A Service Kit (HP 5370B)..... 183  
10871A Service Kit (HP 5180A)..... 69  
10873A Rack Mount Kit..... 69  
10874A Slide Mount Kit..... 69  
10875A/B DMA Cables..... 69

**11000**

11002A Test Leads..... 730  
11003A Test Leads..... 730  
11096B High Frequency Probe..... 101  
11340A/B/C HP-IL Cable Assemblies..... 555  
11500 Series Cable Assemblies..... 730  
11501A Cable Assembly..... 730  
11509A Fusholder..... 363  
11511A Coaxial Short..... 341  
11512A Coaxial Short..... 341  
11515A Waveguide Adapter..... 339  
11516A Waveguide Adapter..... 339  
11517A Mixer..... 141  
11518A-11520A Waveguide Taper Sections..... 141  
11524A APC-7 to N (female) Adapter..... 730  
11525A APC-7 to N (male) Adapter..... 730  
11533A APC-7 to SMA (male) Adapter..... 730  
11534A APC-7 to SMA (female) Adapter..... 730  
11536A Probe Tee for HP 8405A..... 238  
11540A Waveguide Stand..... 340  
11545A-11548A Waveguide Holders..... 340  
11549A Power Splitter for HP 8405A..... 238  
11565A Coaxial Short..... 341  
11566A Air Line Extension..... 340  
11567A Air Line Extension..... 340  
11570A Accessory Kit for HP 8405A..... 238  
11581A Attenuator Set..... 328  
11582A Attenuator Set..... 328  
11583A/C Attenuator Sets..... 328  
11590B Bias Network..... 246  
11600B Transistor Fixture..... 250  
11602B Transistor Fixture..... 250  
11605A Flexible Arm for HP 8743A..... 251  
11608A Transistor Fixture..... 252  
11609A Cable Kit for HP 8410S..... 249  
11610B Test Port Extension Cable..... 251  
11612A Bias Network..... 246  
11613B Calibrator for HP 8756A, 8757A..... 221  
11614A Firmware Enhancement for HP 8757A..... 220  
11635A Bias Decoupling Network..... 246  
11636A/B Power Dividers..... 221, 333  
11643A Series Millimeter-Wave Test Set Kits..... 247  
11644A Series Millimeter-Wave Calibration Kits..... 247  
11650A Accessory Kit for HP 8410S..... 249  
11661B Frequency Extension Module..... 357

# MODEL NUMBER INDEX

New product listings are printed in bold face type

11664A/D/E Detector for HP 8755, 8756 and 8757 .....	218	<b>12000</b>	
11664C Detector Adapter for HP 8755, 8756 and 8757 .....	218	12060B 8-Channel Analog Input Card .....	589
11665B Modulator for HP 8755, 8756 and 8757 .....	221	12061A 32-Channel Analog Input Expansion Card .....	589
11667A/B Power Splitters .....	221, 333	12062A 4-Channel Analog Output Card .....	589
11668A High Pass Filter for HP 8755, 8756, 8757 .....	220	12063A 32-Channel Digital Multifunction Card .....	589
11672A Service Accessory Kit for HP 8660A/C .....	359	<b>12100A A400 Single-Board Computer</b> .....	657
11675B Leveling Cable Assembly for HP 784C .....	487	<b>12103K 2MB Parity Memory Array Card</b> .....	657
11678A Low Pass Filter Kit .....	220	<b>12103L 4MB Parity Memory Array Card</b> .....	657
11679A/B Extension Cables for HP 8755, 8756 and 8757 .....	220	<b>12103M 8MB Parity Memory Array Card</b> .....	657
11683A Range Calibrator .....	203	12111B 1MB ECC Memory Array Card .....	657
11684/5/6/8/9A Low Pass Filters .....	220	12111C 2MB ECC Memory Array Card .....	657
11687A Adapter, 50 to 75Ω .....	363	12154A Battery Backup for Micro 24, 26, 27, 29 .....	657
11690A Frequency Doubler .....	363	12157B A-Series Battery Backup System .....	657
11691D Coaxial Directional Coupler .....	334	<b>12221B 8MB ECC Memory Array Card</b> .....	657
11692D Coaxial Dual Directional Coupler .....	334		
11693A Limiter .....	142	<b>13000</b>	
11694A Matching Transformer, 50-75 Ω .....	142	13064A Tape Degausser .....	86
11707A Test Plug-in .....	359		
11708A Attenuator (for Calibrating HP 8484A) .....	204	<b>14000</b>	
11710B Down Converter .....	363	14513A Rack Kit (for one unit, 3½ in. H) .....	449, 459
11712A Service Support Kit		14515A Rack Kit (for one unit, 5¼ in. H) .....	449
(for HP 8671A, 8672A/S) .....	374	14521C Rack Kit (for Bench Series) .....	459
11713A Attenuator/Switch Driver .....	330	14523A Rack Kit (for two units, 3½ in. H) .....	449, 459
11714A Service Support Kit (for HP 8662A, 8663A) .....	356	14525A Rack Kit (for two units, 5¼ in. H) .....	449
11715A AM/FM Test Source .....	162	14533B Pocket Programmer .....	446
11716A/B Interconnection Kits .....	330	14534A Pocket Programmer Cable .....	446
11717A Attenuator/Switch Rack Mount Kit .....	330	14535A Interface Kit, DCPS-to-HP 1000 Computers .....	446
11720A Pulse Modulator .....	375	14536A Chaining Cable .....	446
11721A Frequency Doubler .....	363	14540A 1000 Cable Assembly, Multiprogrammer-to	
11722A Sensor Module .....	157	HP 1000 Computers .....	585
11726A Support Kit for HP 8673B/C/D .....	373	14541A Chaining Cable, HP 6940B	
11729C Carrier Noise Test Set .....	155	or 6941B to HP 6941B .....	585
11731A Frequency Extension Retrofit Kit .....	374	14550B Interface Kit, Multiprogrammer-to	
11732A Frequency Extension Retrofit Kit .....	374	HP 1000 Computers .....	585
11736A/B I-Q Tutor Training Kit .....	490	14551A Multiprogrammer Service Kit .....	585
11742A Coaxial Blocking Capacitor .....	340	14555A Connector Kit .....	585
11776A Waveform Generation Software .....	364	14556A Software Library for HP 9825A .....	585
11790A/B Software Application Pac for		14557A Power Supply Interconnect Cable .....	585
HP 8953A & 9816S, 9826S, 9836S .....	323	14558A Termination Panel .....	585
11792A Sensor Module .....	158	14560A Cable Assembly .....	585
11793A Microwave Converter .....	158	14561A Cable Assembly .....	585
11794A Software Pac for HP 8902S .....	158	14562A Cable Assembly .....	585
11795A Software Pac for HP 8902S .....	158	14753A Computer Aided Test Programming Package .....	580, 584
11798A Software Application Pac for Cellular Radio Test .....	324	14753R Right to Reproduce CAT Program Pkg .....	580, 584
11799A Signaling Unit .....	325	14801A PC Instruments Rack Shelf .....	603
11801A/B/C On-Site Service Kits for HP 8642A/B .....	353	14802A PC Instruments Terminal Block .....	603
11805A Software Application Pac for HP 8953A .....	323	14855A PC Instruments Data Acquisition System .....	603
11806A Attenuator Calibration Software for HP 8902S,		14856A PC Instruments Data Acquisition System .....	603
8952S .....	158		
<b>11816A Retrofit Kit for HP 8904A Opt. 001</b> .....	399	<b>15000</b>	
<b>11817A Retrofit Kit for HP 8904A Opt. 002</b> .....	399	15104A Pulse Adder/Splitter .....	428
<b>11818A Retrofit Kit for HP 8904A Opt. 003</b> .....	399	15115A Pulse Splitter/Inverter .....	428
11848A Phase Noise Interface .....	153	15116A Pulse Inverter .....	428
11850C/D Power Splitters .....	242, 333	15179A Rack Adapter Frame .....	425
11851B RF Cable Kit .....	242	15408A-15411A HP 8175A Accessories .....	312
11852B 50-75 Ω Minimum Loss Pad .....	242	15415A Plug-on Miniprobe .....	312
11853A 50 Ω Type N Accessory Kit .....	242	15425A Test Head .....	511
11854A 50 Ω BNC Accessory Kit .....	242	15429A Solder-in Receptacles .....	312
11855A 75 Ω Type N Accessory Kit .....	242	15430A Cable for Master-Slave Operation .....	312
11856A 75 Ω BNC Accessory Kit .....	242	15453A-15458A HP 8170A Accessories .....	316
11857B/D Test Port Extension Cables		15461A ECL Pod .....	312
for HP 85046A & B .....	242	15462A TTL/CMOS Pod .....	312
11858A Transistor Fixture Adapter .....	242	15463A Trigger Pod .....	312
11866A APC-7 Calibration Kit .....	249	15464A TTL Pod .....	312
11867A RF Limiter .....	142	15466A Test Head .....	511
11869A Adapter for		15475A Optical Cleaning Kit .....	301, 307
HP 86200 Series Sweeper Plug-ins .....	390	15512A Cable .....	474
11870A Low Pass Filter .....	135	15513A Cable .....	474
11900 Series 2.4 mm Coaxial Adapters .....	338, 731	15515B Loop Holding Unit .....	474
11940A Close-Field Probe .....	127, 142	15518A/B/C Loop Holding Accessories .....	474
<b>11941A Close-Field Probe</b> .....	127, 142	15580A 20 MHz High-Impedance Active Probe .....	481
<b>11945A Close-Field Probe Set</b> .....	127, 142	15581B 25 MHz High-Impedance Passive Probe .....	481
11970 Series Harmonic Mixers .....	141, 337	15582A Return Loss Kit .....	481
11971 Series Harmonic Mixers .....	141, 337	15589A Instrument Cart .....	481
11975A Microwave Power Amplifier .....	393		

**16000**

16005A Probe ..... 296

16006A Probe ..... 296

16007A/B Test Leads ..... 296

16008A Resistivity Cell ..... 296

16014A Series Loss Test Adapter ..... 295

16023B DC Bias Controller ..... 287

16034A/B/E Test Fixture for Chip Components ..... 277

16047A Direct Coupled Test Fixture ..... 277

16047B Test Fixture with Safety Cover ..... 277

16047C Test Fixture for High Frequencies ..... 277

16047D Direct Coupled Test Fixture ..... 277

16048A Test Leads, BNC ..... 277

16048B Test Leads, RF Miniature ..... 277

16048C Test Leads, Alligator Clips ..... 277

16048D Test Leads, BNC (2m) ..... 277

16053A Test Leads ..... 523

16054A Connection Selector ..... 523

16055A Test Fixture ..... 523

16056A Current Divider ..... 523

16058A Test Fixture ..... 518, 521

16061A Test Fixture ..... 277

16062A Test Leads ..... 277

16063A Test Leads ..... 277

16064A Retrofit Kit for Comparator ..... 291

16065A External DC Bias Test Fixture ..... 277

16066A Test Fixture Adapter ..... 513

16067A 24-pin DIP Low Leakage Fixture ..... 513

16068A 48-pin DIP Low Leakage Fixture ..... 513

16069A Universal Low Leakage Fixture ..... 513

16070A General Purpose DIP Fixture ..... 513

16071A Universal Fixture ..... 513

16072A Personality Board ..... 513

16075A Relay Test Adapter ..... 513

16076A System Test Module ..... 513

16077A Extension Cable Fixture ..... 513

16080A Direct Coupled Test Fixture ..... 525

16081A Test Leads ..... 525

16082A Test Leads ..... 525

16083A Pulse Bias Noise Clipper ..... 525

16085A Terminal Adapter ..... 277

16091A Coaxial Fixture Set ..... 277

16092A Spring Clip Fixture ..... 277

16093A/B Binding Post Fixture ..... 277

16094A Probe Fixture ..... 277

16095A Probe Fixture ..... 277

16096A 2-Port Component Test Fixture ..... 277

16097A Accessory Kit ..... 281

16099A Test Fixture Adapter ..... 285

16117A Low Noise Test Leads ..... 296

16143A Probe Cable ..... 296

16269A Process Test Manager ..... 516

16320B Pin Board ..... 513

16334A Test Fixture for Chip Components ..... 277

16380A/C Standard Capacitor Sets ..... 297

16451A Dielectric Test Adapter ..... 295

16462A Auxiliary Capacitor ..... 295

16470A/B/C Reference Inductors ..... 295

**16500A Logic Analysis System** ..... 258

16510A 80 Channel 25 MHz State/Timing Card ..... 260

16515A 1 GHz Timing Card ..... 262

16516A 1 GHz Timing Card ..... 262

16520A 50 Mb Pattern Generator Master Card ..... 263

16521A 50 Mb Pattern Generator Expansion Card ..... 263

16530A 400 Msample Digitizing Oscilloscope Card ..... 261

16531A 400 Msample Digitizing Oscilloscope Card ..... 261

**17000**

17090B Measurement Graphics Software ..... 73, 79

**18000**

18107A External Oscillator (HP 2804A) ..... 345

18110A Laboratory Probe and Cal Module,  
26 mm (1 in.) (HP 2804A) ..... 345

18111A Laboratory Probe and Cal Module,  
232 mm (9.1 in.) (HP 2804A) ..... 345

18132A Rack Mount ..... 501

18134A Carrying Case ..... 501

18174A RS-449/422A/423A ..... 493

18176A Rack Mount Kit ..... 497

18177A V.35 Interface Pod ..... 493

18179A RS-232C/V.24 Interface Pod ..... 493

18180A RS-232C/V.24, RS-449/422A/423A Interface ..... 493

18183A RS-232C/V.24 Interface ..... 499

18184A V.35 Interface ..... 499

18185A 115V Power Module ..... 499

18190A Soft Vinyl Carrying Case ..... 493

18191A Rack Mount ..... 499

18192A Carrying Case ..... 499

18194A 220V Power Module ..... 499

18263A 3270 Installation, Maintenance Software ..... 493

18264A X.25, SNA Link Level Analysis ..... 493

18265A DDCMP Analysis ..... 493

18331D SNA Analysis DDCMP X.25 Analysis/Simulation ..... 493

18332D 3270 Tester ..... 493

18352A X.21 State Simulator ..... 494

18353A Password Security ..... 494

18355A CCITT #7/CCS7 Analysis ..... 494

18360A SNA Emulation Language ..... 494

18361A 3270 Device Exerciser ..... 494

18362A LU6.2 Node Exerciser ..... 494

18370A X.25 Network Performance Analysis ..... 494

**19000**

19746A I/O Expander ..... 629

19748A Additional 8MB of RAM ..... 629

19749A Cable Management System ..... 629, 630

**20000**

27110B HP-IB Interface ..... 630, 652

27112A General-Purpose Interface ..... 652

27114A Parallel Async AFI Interface ..... 630, 652

27116A HP-CIO Extender Card ..... 652

27122A RJE/500 Interface ..... 652

27125B LAN/9000 Series 500 Link ..... 652

27130B Eight-Channel Multiplex Card ..... 652

27140A Six-Channel Modem Multiplexer Interface ..... 652

**27505A HP/Word PC** ..... 681

27506F AdvanceWrite I ..... 681

27507F AdvanceWrite II ..... 681

**27534A AdvanceMail** ..... 680

**27535F AdvanceMail** ..... 680

**27536F HP Word/PC** ..... 681

**27546F AdvanceWrite PLUS** ..... 681

**30000**

33300 Series Coaxial Step Attenuators ..... 332

33311B/C Coaxial Switches ..... 327

33312B/C Coaxial Switches ..... 327

33313B/C Coaxial Switches ..... 327

33320 Series Coaxial Step Attenuators ..... 332

33330B/C/D/E Coaxial Crystal Detectors ..... 336

33340A/B/C DEM Coaxial Attenuators ..... 328

**33440A LaserJet Series II Printer** ..... 715

34110A Carrying Case ..... 101

34111A High Voltage Probe ..... 101

34112A Touch-Hold Probe ..... 101

34118A Test Lead Kit ..... 101

34119A High Voltage Probe ..... 101

34800/80) Functional Test Manager/300 ..... 594

35151D The Calendar ..... 681

35152D The List Manager ..... 681

35153D The Writer ..... 681

35154D The Speller ..... 681

35155D The Planner ..... 681

35156D The Personal Correspondence Pack ..... 681

35157D The Personal Organizer Pack ..... 681

35177M JetStart (for HP ThinkJet) ..... 680

# MODEL NUMBER INDEX

New product listings are printed in bold face type

35178M LaserStart (for HP LaserJet).....	680
35184A Sideways (for Touchscreen PC, ThinkJet printer).....	681
35188A Laser Plotter.....	681
35190J LaserControl 100 (for Vectra PC, LaserJet).....	681
35401A ¼" Cartridge Tape Drive.....	710
35675A Accuracy Enhancement Software.....	233
35676A/B 50/75 Ohm Reflection/Transmission Test Kit.....	233
35677A/B 50/75 Ohm S-Parameter Test Set.....	233
35678A/B 50/75 Ohm Type N Calibration Kit.....	234
35679A/B 50/75 Ohm Type N Port Extension Cables.....	234
35723A HP Touch Accessory.....	671, 701
35731A/B Monochrome Monitor.....	701
<b>35731D 12-Inch Monochrome Plus Video Display</b> .....	<b>675</b>
<b>35732A Monochrome Plus Video Adapter</b> .....	<b>675</b>
35741A/B Color Monitor.....	701
35743A/B Enhanced Graphics Display.....	701
<b>35743A 13-Inch HP Enhanced Graphics Display</b> .....	<b>675</b>
<b>35745A 13-Inch Industrial Enhanced Graphics Display</b> .....	<b>675</b>
36568A HPMessage.....	680
36569E HPMessage.....	680
36890F Print Central.....	681
36898A HP Access.....	680
36898F HP Access.....	680
37050S FDM Network Monitoring System.....	491
37051S FDM Measurement System.....	491
37100S Remote Access and Test System.....	491
37201A HP-IB Extender.....	551
37204A Multipoint HP-IB Extender.....	551
<b>37204B Multipoint HP-IB Extender</b> .....	<b>551</b>
<b>37212B Dial-Up Modem</b> .....	<b>705</b>
39961D Smart Wand.....	679
39963D Smart Wand.....	679
39965D Smart Wand.....	679
<b>40000</b>	
<b>40651 Hammer and Accelerometer Kits</b> .....	<b>568</b>
<b>40652 Thermocouple Wires</b> .....	<b>567</b>
<b>40653 Thermistor Assemblies</b> .....	<b>567</b>
<b>40654A RTD Probe</b> .....	<b>567</b>
<b>40654B RTD</b> .....	<b>567</b>
41941A/B Impedance Probe Kits.....	278
41951A Impedance Test Kit.....	228
43730 Flash X-Ray Systems.....	667
43850 Cabinet X-Ray Systems.....	666
44203C/D/L/S SimPlate Fixtures.....	531
<b>44458A/B Data Acquisition Manager</b> .....	<b>592</b>
<b>44459A/B Data Acquisition Manager</b> .....	<b>554</b>
<b>44460A/B Lotus Measure Software</b> .....	<b>591</b>
44461A HP-IB Interface.....	555
44462A 10 Channel Multiplexer Assembly.....	554
44463A Extra Connector Block.....	555
44464A Breadboard Assembly.....	555
44465A 8-Bit In, 8-Bit Out Digital I/O Assembly.....	555
44466A Extra Connector Block for HP 44465A.....	555
44469A Seven 10:1 Dividers.....	555
44582A BTL PLUS Software for HP 3061, 3062 Systems.....	530
44670C/L/X NS/3065 Software for HP 3065 Family.....	530
44671C/L/X PR PLUS Software.....	530
44672A Q-STATS II Software.....	530
45070A HP 260 Series 30 SPU.....	690
45071A I/O Extender.....	690
45072A HP 260 Series 40 SPU.....	690
45310A BASIC Programmer's Library.....	680
45311A ICON Design System.....	680
45411A Drawing Gallery.....	681
45412A VT100 Terminal Emulator.....	680
45418A Executive MemoMaker.....	681
45419C Programmer's Tools.....	680
45421A Executive Card Manager.....	680
45427D WordStar Professional®.....	681
45431A Advancelink.....	680
45433A Gallery Picture Library Vol. II.....	681
45435A Touchscreen Programmer's Tools.....	680
45437A The Gallery Collection.....	681
45441D Executive Card Manager: Templates.....	680
45443A Forms Master.....	680
45444A ExecuDesk.....	680
45445D BASIC by Microsoft*.....	680
45446D Compiled BASIC by Microsoft.....	680
45447D Pascal by Microsoft.....	680
45448A COBOL by Microsoft.....	680
45449D FORTRAN by Microsoft.....	680
45450D GW™ BASIC by Microsoft.....	680
45452D Lattice® C Compiler.....	680
45474D MicroSoft WORD.....	681
45482A 1-2-3® from Lotus®.....	681
45498A Symphony® from Lotus.....	680
45504K MemoMaker/Time Management, Opt. 400.....	681
45513A Charting Gallery.....	681
45549K Microsoft® WORD, Opt. 400.....	681
45554K MultiMate™, Opt. 400.....	681
45555K Executive Card Manager, Opt. 400.....	680
45563A R:Base 5000.....	680
45568A Office Activities Portfolio.....	681
45569A Chemical/Petrochemical Portfolio.....	681
45570A Business Management Portfolio.....	681
45571A HPDraw Figures Portfolio.....	681
45624A Touchscreen MS-DOS User's Guide.....	671
45625A Touchscreen Technical Reference Manual.....	671
<b>45632A 384K-Byte Memory Board</b> .....	<b>671</b>
45640A Touchscreen Internal Modem.....	680
45641B Touchscreen 3278 Emulation Accessory with File Transfer.....	680
45711E Portable PLUS PC (256K RAM).....	677
45711F Portable PLUS PC (without built-in modem).....	677
<b>45811A 360K-Byte Flexible Disc Drive</b> .....	<b>675</b>
<b>45812A 1.2M-Byte Flexible Disc Drive</b> .....	<b>675</b>
45816A 20M-byte Internal Disc Subsystem.....	675
45816M 20M-byte Internal Hard-Disc Drive.....	675
45817A 40M-byte Internal Disc Subsystem.....	675
45817M 40M-byte Internal Hard-Disc Drive.....	675
45850A Touchscreen II CPU with Terminal Kit.....	671
45851A Touchscreen II CPU with PC Kit.....	671
45885A 8087 Co-Processor Accessory (for Touchscreen II).....	671
<b>45890A 512K-Byte Expanded Memory Board</b> .....	<b>671</b>
<b>45896A 20M-Byte Hard Disc Subsystem</b> .....	<b>675</b>
<b>45897B 40M-Byte Hard Disc Subsystem</b> .....	<b>675</b>
<b>45911B HP SketchPro Digitizing Tablet</b> .....	<b>712</b>
<b>45938A ROM Upgrade Kit</b> .....	<b>675</b>
<b>45951C Vectra MS-DOS 3.2 (3.5-Inch Media)</b> .....	<b>679</b>
45953C MS-Macro Assembler 4.0.....	671
45973A ½M-Byte Extended Memory Card.....	675
45974A 1M-Byte Extended Memory Card.....	675
45987A Numeric Coprocessor.....	675
46021A HP-HIL Keyboard.....	636, 643
46060A HP-HIL Mouse.....	264, 636, 675
46080A-46089A HP 9000 Series 300 HP-HIL Devices.....	636
46094A, 46095A HP 9000 Series 300 HP-HIL Devices.....	636
48000 Remote Terminal Unit.....	556
<b>50000</b>	
50011C HP-IB Instrument Control Using Series 200/300 BASIC.....	747
50950A HP LAN Network Services for VAX.....	643
50952B HP LAN Network/ARPA Services, HP 9000 Series 300.....	643
50954A/R HP LAN Network/ARPA Services, HP 9000 Series 500.....	643
51409A Basics of HP-IB Theory Course.....	747
51412A HP-IB with MS-DOS Course.....	747
51820A Waveform Generation Software.....	71
52126A Intel Multibus Interface.....	269
54001A 1-GHz Miniature Active Probe Pod.....	56
54002A 50Ω BNC Input Pod.....	56
54003A 1-MΩ Probe Pod.....	56
54006A Resistive Divider Probe Kit.....	61
54007A Low Loss Measurements Kit.....	61
54100A 1-GHz Digitizing Oscilloscope.....	56
54100D 1-GHz Logic Triggering Digitizing Oscilloscope.....	56
54100M MATE Digitizing Oscilloscope.....	55

54110D 1-GHz Color Digitizing Oscilloscope..... 56  
54111D 500-MHz Logic Triggering Digitizing Oscilloscope..... 58  
54112D 100-MHz, 4-Channel Digitizing Oscilloscope..... 59  
54120T 20 GHz Digitizing Oscilloscope..... 60  
54200A 50-MHz Digitizing Oscilloscope..... 52  
54200D 50-MHz Logic Triggering Digitizing Oscilloscope..... 52  
54201A 300-MHz Digitizing Oscilloscope..... 52  
54201D 300-MHz Logic Triggering Digitizing Oscilloscope..... 52  
54300A Probe Multiplexer..... 74  
59306A HP-IB Relay Actuator..... 550  
59307A HP-IB VHF Switch..... 550  
59309A HP-IB Digital Clock..... 550  
59401A Bus System Analyzer..... 549  
59500A Multiprogrammer HP-IB Interface..... 585  
59501B HP-IB Power Supply Programmer..... 447, 550  
59991A-K34 Broadband Linear Phase Comparator..... 464  
59992A-J06 Time Interval Calibrator..... 182  
59992A-K70 Rack Mount Adapter Kit (HP 5342A, 5343A)..... 174

**60000**

61001A PC Instruments System Power Unit..... 603  
61010A PC Instruments Digital I/O..... 597  
61011A PC Instruments Relay Multiplexer..... 597  
61012A PC Instruments Dual Voltage DAC..... 598  
61013A PC Instruments Digital Multimeter..... 598  
61014A PC Instruments Function Generator..... 599  
61015A PC Instruments Universal Counter..... 599  
61016A PC Instruments Digitizing Oscilloscope..... 600  
61017A PC Instruments Relay Actuator..... 601  
61018A PC Instruments Breadboard..... 601  
61019A PC Instruments 20-Volt Power Supply..... 601  
61020A PC Instruments VHF Multiplexer..... 602  
61025A PC Instruments 50-Volt Power Supply..... 601  
61061C PC Instruments Interface for HP Vectra PC, IBM PC and AT&T PC 6300..... 604  
64000 Logic Development System..... 616  
64000-UX Microprocessor Development Environment..... 617  
64100A HP 64000-UX Microprocessor Development Environment, Development Station..... 617  
64100A+24D Logic Development Concepts and Measurements Course..... 747  
64110A HP 64000-UX, Transportable Development System..... 616  
64131S Bundled Emulation Systems..... 619  
64132S Bundled Emulation Systems..... 619  
642XXS HP 64000-UX, Emulation Subsystems..... 618  
64276X HP 64000-UX, Microprogram Development Subsystem..... 618  
64302A HP 64000-UX, Emulation Bus Analyzer..... 618  
64310A HP 64000-UX, Software Performance Analyzer..... 618  
64310A + 24D Software Performance Analysis Training..... 747  
64320S 25MHz Logic State Software Analyzer..... 618  
64330 High-Level Software Analyzer..... 618  
64340 Real-Time, High-Level Software Analyzer..... 618  
6434XX Real-Time, High-Level Software Analyzer..... 618  
64500S HP 64000-UX PROM Programming Subsystem..... 618  
64600 Series Preprocessors..... 618  
64600S + 24D State/Software Analysis Training..... 747  
64610S HP 64000-UX High-Speed Timing/State..... 618  
64620S HP 64000-UX Logic State/Software..... 618  
64620S + 24D State/Software Analysis Course..... 747  
647XX HP Teamwork SA/SD/RT Access..... 619  
64800 Series Cross Assemblers/Compilers..... 617  
68324F Office Activities Portfolio..... 681  
68325F Chemical/Petrochemical Portfolio..... 681  
68326F Business Management Portfolio..... 681  
68327F HPDraw Figures Portfolio..... 681  
68328F R:Base System V..... 680  
68330F Executive MemoMaker..... 681  
68330F Executive Memo Manager, Opt. 003..... 681  
68331F Executive Card Manager..... 680  
68331F Executive Card Manager, Opt. 003..... 680  
68332F Executive Spreadsheet..... 681

68333F AdvanceLink..... 680  
68333F AdvanceLink, Opt. 003..... 680  
68335F Executive Card Manager: Templates..... 680  
68336F R:Base 5000..... 680  
68339F Symphony from Lotus..... 680  
68340F 1-2-3 from Lotus..... 681  
68340F 1-2-3 from Lotus, Opt. 003..... 681  
68342F WordStar 2000 Plus..... 681  
68350F Charting Gallery..... 681  
68351F Drawing Gallery..... 681  
68352F Gallery Collection..... 681  
68352F Gallery Collection, Opt. 003..... 681  
69280A Breadboard Card..... 586  
69321B D/A Voltage Converter..... 586  
69322A Quad D/A Voltage Converter Card..... 586  
69331B Digital Output Card..... 586  
69332A Open Collector Output Card..... 586  
69335A Stepping Motor Control Card..... 586  
69336B High Speed Scanner Card..... 586  
69351C Voltage Regulator Card..... 586  
69370A D/A Current Converter Card..... 586  
69380A Breadboard Output Card..... 586  
69422A High Speed A/D Converter Card..... 586  
69423A Low Level A/D Converter Card..... 586  
69430A Isolated Digital Input Card..... 586  
69431A Digital Input Card..... 586  
69433A Relay Output With Readback Card..... 586  
69434A Event Sense Card..... 586  
69435A Pulse Counter Card..... 586  
69436A Process Interrupt Card..... 586  
69480A Breadboard Input Card..... 586  
69500A Unloaded Resistance Output Card..... 586  
69501A-69513A Power Supply Control Cards..... 586  
69520A Power Supply Programming Card..... 586  
69602B Timer/Pacer Card..... 586  
69700A-69706A Resistance Output Cards..... 583  
69709A Power Supply Control Card..... 583  
69720A D/A Voltage Converter Card..... 583  
69721A Digital-to-Analog Current Converter Card..... 583  
69730A Relay Output Card..... 583  
69731B Digital Output Card..... 583  
69734A Timebase Card..... 583  
69735A Pulse Train Output/Stepping Motor Control Card..... 583  
69736A Timer/Pacer Card..... 583  
69750A Scan Control/Pacer Card..... 583  
69751A Analog-to-Digital Converter Card..... 583  
69752A 64 Channel FET Scanner Card..... 583  
69753A 16 Channel Temperature Scanner Card..... 583  
69754A 32 Channel Relay Scanner Card..... 583  
69755A 16 Channel FET Scanner Card..... 583  
69759A 500 kHz A/D Converter Card..... 583  
69761A Integrating Digital Multimeter Card..... 583  
69770A Isolated Digital Input Card..... 583  
69771A Digital Input/Analog Comparator Card..... 583  
69774A Counter Card..... 583  
69775A Counter/Totalizer Card..... 583  
69776A Interrupt Card..... 583  
69790B Memory Card..... 583  
69791A/69792A 1 Megaword Memory System..... 583  
69793A Breadboard Card..... 583

**70000**

70000 Modular Measurement System..... 110  
70001A Modular Measurement System Mainframe..... 116  
70205A Graphics Display Module..... 112, 116  
70206A System Graphics Display..... 112, 116  
70300A Tracking Generator Module..... 116  
70310A Precision Frequency Reference Module..... 116  
70591A 1/4-Width Module Part Kit..... 110, 116  
70592A 1/4-Width Module Part Kit..... 110, 116  
70593A 3/4-Width Module Part Kit..... 110, 116  
70595A Module Design Guides..... 110, 116  
70600A Presclector..... 116

# MODEL NUMBER INDEX

New product listings are printed in bold face type

70700A Digitizer	110, 116
70900A Local Oscillator Module	116
70902A IF Section Module (Res BW 10 Hz - 300 kHz)	116
70903A IF Section Module (Res BW 100 kHz - 3 MHz)	116
70904A RF Section Module (100 Hz - 2.9 GHz)	116
70905A/B RF Section Modules (50 kHz - 22 GHz)	116
70906A RF Section Module (50 kHz - 26.5 GHz)	116
70907A External Mixer Interface Module	116
70908A RF Section Module	110, 116
71000S Spectrum Analyzer System Reference	113
71100A RF Spectrum Analyzer (100 Hz - 2.9 GHz)	113
71200A Microwave Spectrum Analyzer (50 kHz - 22/26.5 GHz)	113
71201A Preselected Microwave Spectrum Analyzer	113
71210A Fundamentally-Mixed Microwave Spectrum Analyzer	110, 113
71300A Millimeter Spectrum Analyzer	113
72425A Vectra PC Model 25	673
72445A Vectra PC Model 45	673
72450A Vectra PC Model 50	673
72458A Vectra 3000 Monochrome Model 58	673
72459A Vectra 3000 EGA Model 59	673
72460A Vectra PC Model 60	673
72468A Vectra/StarLAN Monochrome PC Model 68	675
72469A Vectra/StarLAN EGA PC Model 69	675
72496A Vectra Publisher PC Monochrome Model 96	674
72497A Vectra Publisher PC Monochrome Model 97	674
74210A Design Capture System for HP 9000 Series 300	615
74230A Design Verification Interface for HILO-3	615
74230B HILO-3 Logic Simulator	615
74230C HILO-3 Simulator Models	615
74230D HILO-3 Fault Simulator	615
74250A HP Design Interface for SCICARDS	615
74250B HP Design Interface for Calay	615
74250E HP Design Interface for Racal/Redac	615
74250G HP Design Interface for Computervision	615
74260A TTL Parts Library	615
74260B MDS Parts Library	615
74260C ECL Parts Library	615
74260D $\mu$ P Parts Library	615
74260E PLD Parts Library	615
74305A/R HP EGS, Engineering Graphics System Software	622
74306A HP EGS, Add-on Modules	622
74307A/R Hybrid Circuit Design Module	623
74308A/R High Performance HP EGS	623
74231A HICHP Hardware Modeling System	615
74241A EDS/3065 Test Program Generator	615
74400A/R HP Printed Circuit Design System	621
74401A/R HP Printed Circuit Design System, Design Module	621
74402A/R HP Printed Circuit Design System, Autorouter Module	621
74403A/R HP Printed Circuit Design System, Library Module	621
74661A R,L,C Parts Library	615
74661B Semiconductor Parts Library	615
74836A ME Series 30 Solids Modeling	624
79232U HP PROLOG Artificial Intelligence Language	648
<b>80000</b>	
81000AS Optical Power Splitter, 600 - 1200 nm	307
81000BS Optical Power Splitter, 1200 - 1650 nm	307
81511A Optical Head, 550 - 950 nm	302, 307
81512A Optical Head, 900 - 1725 nm	302, 307
81519A Optical Receiver	303, 307
81520A Optical Head, 450 - 1020 nm	304, 307
81521B Optical Head, 900 - 1700 nm	304, 307
81810S Digital IC Test System	510
82104A Card Reader (HP-41CV/CX)	685
82153A Optical Wand (HP-41CV/CX)	685
82160A HP-IL Module (HP-41CV/CX)	685
82161A Digital Cassette Drive	686
82162A Printer/Plotter	686
82164A HP-IL/RS-232C Interface	686
82165A HP-IL/GPIO Interface	686
82166C HP-IL Interface Kit	686
82169A HP-IL/HP-IB Interface	686
82180A Extended Functions/Memory Module (HP-41CV)	686
82181A Extended Memory Module	686
82182A Time Module (HP-41CV)	686
82183A Extended I/O Module	686
82240A Infrared Printer	685
82314A Vectra HP BASIC Controller, Monochrome	674
82315A Vectra HP BASIC Controller, Color	674
82400A Card Reader (HP-71B)	686
82401A HP-IL Interface (HP-71B)	686
82402A Dual HP-IL Adapter	686
82420A 4K Memory Module (HP-71B)	686
82440A Software Development Utility (HP-71B)	687
82477A HP-IL Link	687
82478A FORTH Assembly/Debugger	687
82479A Data Acquisition Pac (HP-71/HP 3421A)	688
82491-82494A/B Custom Modules (HP-71B)	687
82508A/B Custom Modules (HP-41)	687
82509A/B Custom Modules (HP-41)	687
82520A Software Development System (HP-94)	679
82821A Data Comm Pack for HP Integral PC	643
82862K BASIC by Microsoft, Opt. 400	680
82863K REFLECTION 1 <sup>TM</sup> , Opt. 400	680
82866KD Localization, German—Opt. 400	681
82866KF Localization, French—Opt. 400	681
82866KZ Localization, Italian—Opt. 400	681
82867K YTERM 3278 Emulation, Opt. 630	680
82870K AdvanceMail, Opt. 400	680
82938A HP-IL/Series 80 Interface	686
82959S Tilt/Swivel Base for HP Enhanced Graphics Display	675
82964E Vectra CAD/CAE System	674
82965A High-Speed Numeric Coprocessor	675
82973A HP-IL Interface Card	686
83522A 0.01-2.4 GHz RF Plug-in for HP 8350B	385
83525A/B 0.01-8.4 GHz RF Plug-ins for HP 8350B	385
83540A/B 2-8.4 GHz RF Plug-ins for HP 8350B	386
83545A 5.9-12.4 GHz RF Plug-in for HP 8350B	386
83550A 8-20 GHz RF Plug-in for HP 8350B	386
83554A 26.5-40 GHz Millimeter-Wave Source Module	388
83555A 33-50 GHz Millimeter-Wave Source Module	388
83556A 40-60 GHz Millimeter-Wave Source Module	388
83570A 18-26.5 GHz RF Plug-in for HP 8350B	387
83572A/B 26.5-40 GHz RF Plug-in for HP 8350B	387
83590A 2-20 GHz RF Plug-in for HP 8350B	383
83592A/B/C 0.01-20 GHz RF Plug-in for HP 8350B	383
83594A 2-26.5 GHz RF Plug-in for HP 8350B	383
83595A 0.01-26.5 GHz RF Plug-in for HP 8350B	383
84811A Peak Power Sensor	207
85014B Active Device Measurements Application Pac (HP 8510A/B)	246
85015B System Software for HP 8756S and 8757S	224
85016B Transmission Line Test Software for HP 8756S and 8757S	224
85020A/B RF Directional Bridges for HP 8755, 8756, 8757	218
85022A System Cable Kit for HP 8756S and 8757S	220
85023A/B/C/D System Verification Kit for HP 8756S and 8757S	220
85025A/B AC/DC Detector for HP 8757A	218
85025C Detector Adapter for HP 8757A	218
85026A Waveguide Detectors for HP 8757A	218
85027A/B/C/E Microwave Directional Bridges for HP 8755, 8756, 8757	218
85028A Directivity Verification Standards	220
85029A 7mm Verification Kit	242
85031B APC-7 Calibration Kit for HP 8753A	242
85032B 50 $\Omega$ Type-N Calibration Kit	242
85033C 3.5mm Calibration Kit	242
85036B 75 $\Omega$ Type-N Calibration Kit	242
85041A Transistor Test Fixture Kit	246
85043A System Rack Kit	245

85043B System Rack Kit.....	242
85044A/B Transmission/Reflection Test Set.....	242
85046A/B S-Parameter Test Sets for HP 8753A.....	242
85050B/C/D 7mm Calibration Kit.....	244
85051B 7mm Verification Kit.....	245
85052B/E 3.5mm Calibration Kit.....	244
85053B 3.5mm Verification Kit.....	245
85054B Type N Calibration Kit.....	244
85055A Type N Verification Kit.....	245
85100A LO/IF Kit for mm-Wave 8510.....	247
85130B Special 3.5mm to 7mm Adapter Kit.....	245
85131C/D 3.5mm Test Port Return Cables.....	245
85132C/D 7mm Test Port Return Cables.....	245
85138A/B 2.4mm 50 Ω Terminations.....	338, 341
85140A/B 2.4mm Short Circuits.....	338, 341
85141A/B 2.4mm Open Circuits.....	338, 341
85160A Measurement Automation Software for HP 8753A.....	242
85161A Measurement Automation Software for HP 8510B.....	245
85650A Quasi-Peak Adapter.....	126
85685A RF Preselector.....	126
85863B System Software for HP 8566B, 8567A, 8568B.....	118
85864C EMI Measurement Software for HP 8566A/B or 8568A/B.....	125
85865B Signal Monitoring Software for HP 8566A/B or 8568A/B.....	123
85867A EMI Receiver Functions.....	126
85870A Open-Site EMI Measurement System Software.....	125
86200 Series RF Plug-ins for HP 8620C, 8350B.....	390
86222A/B RF Plug-ins for HP 8620C, 8350B.....	390
86235A RF Plug-in for HP 8620C, 8350B.....	390
86240A/B/C RF Plug-ins for HP 8620C, 8350B.....	390
86241A 3.2-6.5 GHz RF Plug-in for HP 8620C, 8350B.....	390
86242D 5.9-9 GHz RF Plug-in for HP 8620C, 8350B.....	390
86245A 5.9-12.4 GHz RF Plug-in for HP 8620C, 8350B.....	390
86250D 8-12.4 GHz RF Plug-in for HP 8620C, 8350B.....	390
86251A 7.5-18.6 GHz RF Plug-in for HP 8620C, 8350B.....	390
86260A 12.4-18 GHz RF Plug-in for HP 8620C, 8350B.....	390
86260B 10-15.5 GHz RF Plug-in for HP 8620C, 8350B.....	390
86260C 17-22 GHz RF Plug-in for HP 8620C, 8350B.....	390
86290B/C RF Plug-ins for HP 8620C, 8350B.....	390
86601A 0.01-110 MHz RF Section.....	358
86602B 1-1300 MHz RF Section.....	358
86603A 1-2600 MHz RF Section.....	358
86631B Auxiliary Section.....	359
86632B AM/FM Modulation Section.....	359
86633B AM/FM Modulation Section.....	359
86634A FM Modulation Section.....	359
86635A FM/FM Modulation Section.....	359
86720A Frequency Extension Unit.....	374
86792A Agile Upconverter.....	368
88500A IBM Disc/Tape Interface.....	706

## 90000

91290A 5/8" HP Qualified Media.....	706
91781A RJE/1000-II.....	646
91782A MRJE/1000.....	646
91786A LAN/9000 Series 800 Link.....	631, 643, 644
91787A NS/9000 Series 800 Software.....	631, 643, 644
91788A LAN/850 Link.....	643, 644
91789A/R NS850.....	643, 644
92192A 3/2" Doublesided Microfloppy Discs.....	706
92223A/C Repeater Kit.....	644, 646
92242L 60.0 Mbyte Tape (for HP 9142A).....	706
92242S 15.0 Mbyte Tape (for HP 9142A).....	706
92430A HP Fortran 77/HP-UX.....	629
92431A HP Pascal/HP-UX.....	629
92433A HP Simplex (Kanji Font).....	629, 630
92436A Starbase Graphics Library.....	629
92437A DGL, AGP, Starbase Graphics Libraries.....	629
92438A Development System Bundle.....	629
92439A Native Language I/O (Kanji).....	629, 630
92440A HPtoday Developer Pack.....	629

92441A HPtoday Run Time Environment.....	629
92442A ALLBASE/HP-UX, HPtoday Developer Pack.....	629
92443A HP FORTRAN 77/HP-UX.....	631
92444A HP Pascal/HP-UX.....	631
92445A/R Starbase Graphics Library.....	631, 650
92446A DGL/AGP, Starbase Graphics Library.....	631, 650
92447A Development System Bundle.....	631
92455A Unlimited HP-UX License.....	629, 630
92459A ALLBASE/HP-UX, HPtoday Developer Pack.....	631
92460A ALLBASE/HP-UX.....	631
92461A HP FORTRAN 77/HP-UX.....	630
92462A HP Pascal/HP-UX.....	630
92463A Starbase/HP-UX Graphics Library.....	630
92464A HP DGL/AGP/HP-UX Graphics Library.....	630
92468A ALLBASE/HP-UX, HPtoday Developer Pack/HP-UX.....	630
92469A ALLBASE/HP-UX.....	630
92522A/R Starbase Display List.....	650
92524A X Window System.....	647
92529A HP GKS.....	630
92533A HPVISOR HPSQL Interface.....	631
92535A HP Visor.....	630
92916A Bar Code Reader.....	636
98053A Versatec Hardcopy Support (Series 300).....	650
98194A LAN/9000 Series 800 Link.....	629, 643, 644, 646, 652
98195A/R NS/9000 Series 800 Software.....	629, 644, 646
98203C HP-HIL Keyboard.....	636
98242A/B I/O Card Cage Upgrade Kits.....	636
98243B HP Series 300 Processor Upgrade Kit.....	636
98250A Series 300 DGL, AGP.....	650
98253A EPROM Programmer Interface.....	652
98255A EPROM Card.....	652
98256A 256-Kbyte RAM.....	636, 652
98257A/P 1-Mbyte RAM Cards.....	636, 652
98258A 4 Mb RAM Controller.....	636
98258B 4 Mb RAM Add-on.....	636
98258C 12 Mb RAM Add-on.....	636
98259A Bubble Memory Interface.....	652
98262A High Speed Disc Interface.....	636
98286A DOS Coprocessor Interface Card.....	652, 653
98286S DOS Coprocessor System.....	636, 653
98286T HP Series 300 DOS/Memory Enhancement Kit.....	653
98287A Series 300/98700H Interface.....	652
98310A/R HP EGS Photoplotter/NC Drill Utility, Right-to-Copy.....	623
98311A/R HP EGS, IGES Translator, Right-to-Copy.....	623
98358A VME Bus Software Drivers.....	636
98363A ME Series 5 (Pascal).....	625
98364A ME Series 5 (HP-UX).....	625
98365A ME Series 10 (Pascal).....	625
98366A ME Series 10 (HP-UX).....	625
98515A HP-UX 5.1 Application Execution Environment.....	641
98517A HP-UX 5.1 Programming Environment.....	641
98518A HP-UX FORTRAN 77 Compiler.....	641
98519A HP-UX Pascal Compiler.....	641
98520A HP-UX DGL/AGP Graphics Library.....	641
98531A HP 9000 Series 300 DOS Coprocessor Software.....	653
98542A Monochrome Video Board.....	636, 649
98543A Color Video Board.....	636, 649
98544B Monochrome Video Board.....	636, 649
98546B Monochrome Alpha/Graphics Video Board.....	636, 649
98547A Color Video Board.....	636, 649
98550A High Resolution Color Graphics Board.....	636, 649
98563A Monochrome Workstation.....	635
98567A Rackmount Kit for HP 35731A.....	636
98567B Rackmount Kit for HP 35741A.....	636
98568A Eight-Slot I/O Expander.....	636, 652
98569A Rackmount Kit for SPU.....	636
98570A DIO-II Expander.....	636
98580A Measurement Automation Workstation.....	635
98580M Monochrome Instrument Controller.....	635
98581A Low-Cost Color Workstation.....	635
98581M Color Instrument Controller.....	635
98582C/M Monochrome Workstations.....	635
98583L Color Workstation.....	635

**MODEL NUMBER INDEX**

New product listings are printed in bold face type

98584A/B Model 320/350 Monochrome AI Workstations .....	648	98701A Additional Graphics Memory for HP 98700H.....	649, 652
98585A/B Model 320/350 Color AI Development Systems.....	648	98710A Graphics Accelerator.....	649, 652
98595A HP-UX Application Execution Environment (1-16 Users).....	641	98720A Graphics Subsystem .....	629, 636, 649
98596A HP-UX Programming Environment (1-32 Users).....	641	98721A Graphics Accelerator.....	629, 636, 649
98597A HP-UX Programming Environment (1-16 Users).....	641	98722A 8-Plane Frame Buffer Memory.....	629
98598A HP-UX FORTRAN 77 Compiler .....	641	98751A 19-Inch Color Monitor .....	636
98599A HP-UX Pascal Compiler .....	641	98752A 19-Inch Color Monitor .....	636
98600A HP-UX DGL/AGP Graphics Library (Series 500).....	641, 650	98764A Starbase Display List (Series 300) .....	650
98601A BASIC 2.0 Language System .....	641	98785A 16-Inch Color Monitor (60 Hz).....	636
98602A BASIC 2.0 Plus Extensions.....	641	98786A 17-Inch Monochrome Monitor.....	636
98603A BASIC 4.0 Language System .....	641	98789A 16-Inch Color Monitor (50 Hz).....	636
98604A HPL 2.0 Language System .....	641	98791B HP 2392A/VT100 Terminal Emulator .....	644, 646
98605A BASIC 5.0 ROM Card .....	652	98797/98A RJE Software for HP-UX.....	641
98613A/B RAM-Based BASIC Language Systems .....	641	98819A HP TechWriter Software.....	623
98614A RAM-Based HPL 2.0 Language System .....	641		
98615B/C RAM-Based Pascal Language Systems .....	641	D1001-60009 Battery Module .....	679
98616A RAM-Based BASIC 5.0 Language System .....	641	00041-15042 Automatic Start and Cassette Duplication Module (HP-41CV/CX) .....	685
98617A RAM-Based Pascal 3.2 Language System .....	641	00041-15043 HP-IL Development Module (HP-41CV/CX).....	685
98618A BASIC 5.0 Compiler.....	641	00071-90068 Vol. I: Detailed Design Description.....	687
98620B Two Channel DMA Controller .....	652	00071-90069 Vol. II: Entry Point and Poll Interfaces .....	687
98622A GPIO Interface.....	652	00071-90070 Vol. III: Operating System Source Listings.....	687
98623A BCD Interface .....	652	00071-90071 Hardware Design Specifications .....	687
98624A HP-IB Interface.....	646, 652	00071-90104 Vol. II: Entry Point and Poll Interfaces .....	687
98625B High-Speed HP-IB Disc Interface .....	652	00071-90105 Vol. III: Operating System Source Listings.....	687
98626A RS-232C Serial Interface.....	644, 652	0960-0054 SMA-Female Short (50 Ohm) .....	341
98627A RGB Color Video Interface .....	652	0960-0055 SMA-Male Short (50 Ohm).....	341
98628A Datacomm Interface.....	644, 652	1250-XXXX Series Adapters and Connectors .....	730
98630A Breadboard Interface .....	652	1250-1530 N(m) Short.....	341
98633A HP 6944A Multiprogrammer Interface .....	580, 652	1250-1531 N(f) Short .....	341
98635A Floating Point Math Board.....	652	1251-2277 Dual Banana Plug to BNC Female .....	730
98640A ADC Card .....	652	1251-2816 Dual Banana Plug (for Cable).....	730
98641A RJE Interface (Series 500) .....	644, 646, 652	1460-XXXX Series Cabinet Parts.....	741
98642A Four-Channel Multiplexer .....	644, 646, 652	1490-XXXX Series Slide Kits, Casters .....	743
98643A HP LAN/300 Link .....	643, 644, 646, 652	1494-XXXX Series Slide Kits .....	740
98644A RS-232C Asynchronous Serial Interface.....	644, 652	5040-XXXX Series Rack Frames.....	742
98646A VMEbus Interface.....	636, 652	5060-XXXX Control Panel Covers .....	742
98647A PC Instruments Interface .....	652	5060-XXXX Filler Panels.....	742
98672A GKS Graphics Library (Series 300).....	650	5060-XXXX Rack Adapter Frames.....	742
98673A GKS Graphics Library (Series 500).....	650	5060-XXXX Rack Mounting Kits.....	742
98678A HP Development Environment for Common LISP.....	648	5060-XXXX Series Racking Accessories, Covers.....	743
98679B Execution License for Common LISP.....	648	5061-XXXX Series System II Cabinet Parts.....	738, 739
98683X DGL Skeleton Device Handler .....	650	8120-18XX Cables and Adapters .....	730
98684X DGL Skeleton Device Handler .....	650	9211-XXXX Series Operating Cases .....	736
98690A PDI Development Package for HP 98691A .....	644, 646, 652	9211-XXXX Series Transit Cases .....	732
98691A Programmable Datacomm Interface .....	644, 646, 652	11000-XXXXX Series Cables .....	730
98693A SRM Access for HP-UX.....	641	82401-90023 Internal Design Specifications, HP-IL (HP-71) .....	687
98700H Color Graphics Subsystem.....	649, 652		



## **ANALYZERS & METERS**

<b>Oscilloscopes &amp; Waveform Analyzers.....</b>	<b>48</b>
<b>Plotters &amp; Recorders.....</b>	<b>78</b>
<b>Digital Multimeters.....</b>	<b>88</b>
<b>Signal Analyzers.....</b>	<b>102</b>
<b>Electronic Counters.....</b>	<b>168</b>
<b>Power Meters.....</b>	<b>200</b>
<b>Noise Figure Meter.....</b>	<b>208</b>
<b>Network Analyzers.....</b>	<b>212</b>
<b>Logic Analyzers.....</b>	<b>254</b>
<b>Digital Circuit Testers.....</b>	<b>270</b>
<b>Component Measurement.....</b>	<b>276</b>

Hewlett-Packard offers a wide variety of test and measurement products that receive a signal, analyze it and display the results. Included in this category are products ranging from digital multimeters, counters, and digitizing oscilloscopes to noise figure meters and network and spectrum analyzers. They are used in both standalone and system applications.

# OSCILLOSCOPES & WAVEFORM ANALYZERS

## HP Digitizing Oscilloscopes

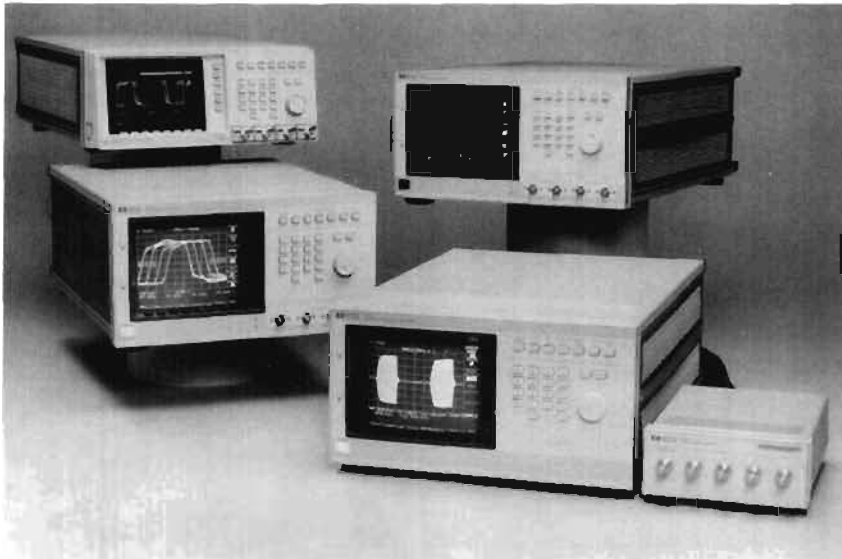

The HP 54100 and HP 54200 Series Digitizing Oscilloscopes... combining high bandwidth with high digitizing rates makes these general-purpose oscilloscopes useful for both analog and digital measurements.

### Choose the Right Scope for Your Application

Selecting a digitizing oscilloscope is similar to selecting a conventional one; it involves asking whether the instrument can capture the waveform of interest, and, after storage, whether the data can be recalled and analyzed in the desired way.

#### Selection Criteria

**Digitizing rate:** for single-shot transient capture, digitizing rate is the key criteria for determining whether the oscilloscope can capture a one-time event. It is suggested that your scope have a digitizing rate of at least

two and a half to four times the bandwidth of the waveform you wish to capture for single-shot measurements. For repetitive waveforms, some scopes use repetitive sampling, for which digitizing rate is a less important criterion than bandwidth and vertical resolution.

**Bandwidth:** bandwidth is another fundamental selection criterion. It affects the accuracy of amplitude and timing measurements.

The bandwidth of an oscilloscope should exceed that of the signal; how much it exceeds it depends on the measurement accuracy needed. In general, the instrument's bandwidth should be three times the highest frequency component of the signal.

For pulse applications, the rise time is related to the maximum frequency content by:

$$\text{frequency} = 0.35/\text{rise time}$$

This guideline suggests that you should choose an oscilloscope with a rise time less than one-third the rise time of your signals.

**Resolution:** voltage resolution and timing resolution are also important criteria when choosing an oscilloscope. Your particular application helps determine how much resolution you need. For single-shot acquisition, there is an inherent trade-off between timing resolution and vertical resolution. Obtaining higher vertical resolution means sacrificing digitizing rate.

The timing resolution of the scope is more important to the digital designer who measures propagation delay and setup and hold times.

If, however, the signal being measured is a complex, modulated-analog signal where frequency-domain analysis is desired in addition to time-domain analysis, then increased voltage resolution results in greater signal-to-noise measurement capability. A guideline is 6 dB signal-to-noise measurement capability per bit of resolution (ten bits gives you 60 dB). Bits of resolution are related to percentage resolution by:

$$\% = 100/2^n$$

where  $n$  is the number of bits.

**Memory:** the fourth selection criterion is the memory length of the oscilloscope. Memory length simply describes how long an event (i.e., how many samples can be captured, although there are a variety of techniques to capture long waveforms or non-continuous events using burst timebase or adaptive sample rate.

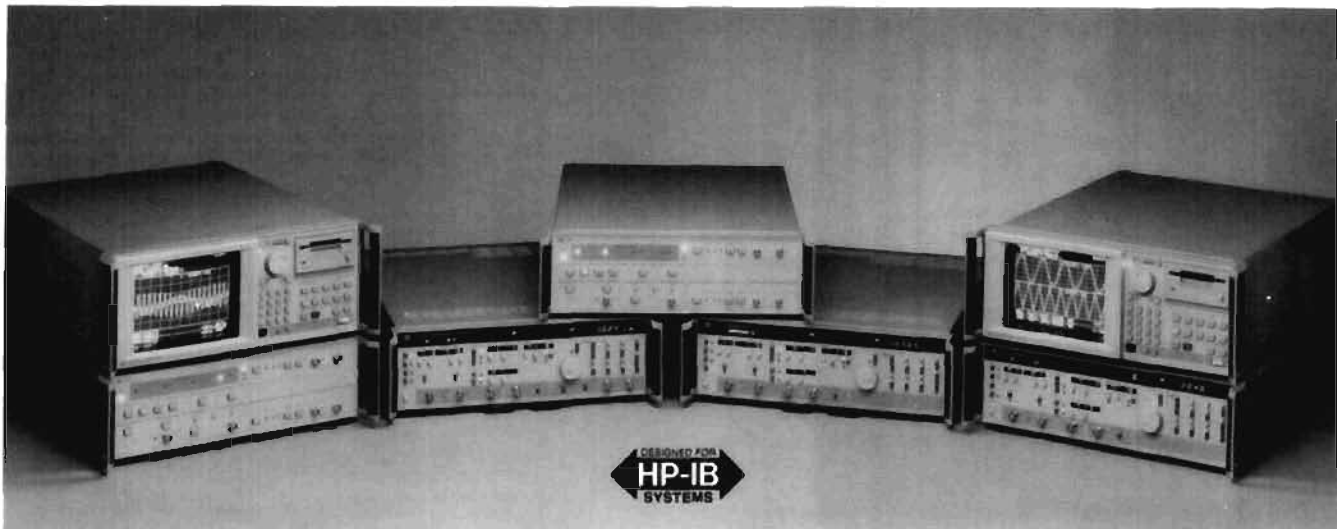

The HP 5180/83 Series Precision Digitizing Oscilloscopes... exceptional resolution and dynamic range plus built-in analysis features allow complete characterization of complex modulated signals.

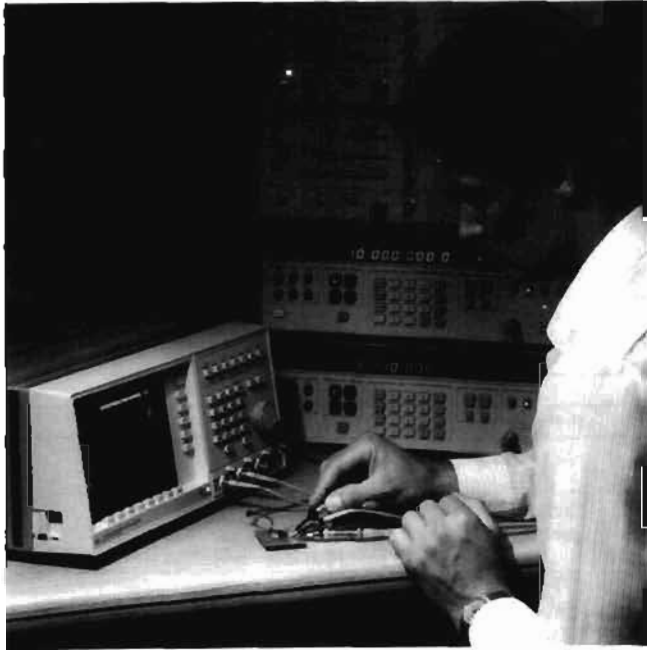

### Triggering on Complex Digital Waveforms

- Logic pattern triggering allows you to trigger on the complex events found in typical digital systems.
- Trigger holdoff can be specified by events or by time for stable triggering on long, complex sequences of events.
- Independent trigger threshold adjustments for each channel. No need to reset the trigger level each time you switch from one trigger source to another.



### Digital Storage

- Bright, stable display of low duty-cycle signals.
- Retain waveforms as long as desired for worst-case analysis.
- Fade-free, non-blooming display.
- Store as many waveforms as needed for comparison or reference.
- Make measurements after signal is acquired. This is especially useful on single-shot signals or infrequent error conditions.
- Waveform data available over the HP-IB.
- Signal averaging for noise rejection and increased resolution.

### Automatic Measurements

- Automatic edge finders save time, eliminate uncertainty, and reduce operator error in time-interval measurements.
- Measure pulse parameters automatically, without a controller.
- Markers indicate where the measurement was made, providing confidence in measurement results.

### Pre-trigger Display

- Find causes of events.
- Displayed time can be any time before or after the trigger, and is not limited to one screen width before the trigger. Time intervals can be measured with a resolution of parts per million, before and after the trigger.

### Store Waveforms for Comparison and Reference

- Pixel memories for overlaying multiple waveforms.
- Waveform memories for measurements and comparison of stored signals.

### Easy-to-Use

- Pressing the Auto-Scale button automatically sets up the time base, sensitivity, offset, and trigger for a stable display over a wide range of input signals.
- Save up to ten front panel setups in non-volatile memory; simplify a sequence of repeated measurements quickly.
- Instant hardcopy with either a pen plotter or a graphics printer eliminates time-consuming, expensive photography.
- ECL and TTL presets scale the vertical gain, offset, and trigger levels for the selected logic family. This saves time in setting up for a measurement.

### Simplified Programming

- Simple, logical, structured programming mnemonics make programs easy to edit, easy to understand, and easy to modify for new applications.
- Measurement-oriented, English-like mnemonics.

### Document Results

Active as well as stored waveforms, setup conditions, and measurement results can be printed or plotted for instant, low-cost documentation. HP printers provide report-quality hardcopy for articles or printed reports at minimal cost, and without the delay of photographic reproduction.

### Color as a Measurement Tool

The addition of color to an oscilloscope can make productivity improvements in applications performed manually as well as those involving automated measurements. Color can be combined with intensity, line types, and modulation to create easier, faster measurements with fewer errors than with a monochrome oscilloscope.

The HP 54110/111D/112D/120T can display a high-resolution, flicker-free color representation of rapidly changing data. With the nine-inch raster display, the user can work with as many as nine colors at one time, selecting these nine from a total of 4096 available. For convenience, a default nine-color palette was designed to provide optimum viewing for users in standard laboratory environments.

Adding color to an instrument such as an oscilloscope aids the user in four ways.

- it helps in differentiating between overlapping, superimposed, or similar waveforms;
- it helps in associating displayed information with corresponding data or waveforms;
- it can be used to emphasize displayed information; and
- the user can choose colors and their use to compensate for color blindness, ambient conditions, or special test requirements.

# OSCILLOSCOPES & WAVEFORM ANALYZERS

## HP Digitizing Oscilloscopes (cont'd)

HP Model #	54200A/D	54201A/D	54100A/D & 54110D	54111D	54112D
Bandwidth -Repetitive -Single-shot	50 MHz 50 MHz	300 MHz 50 MHz	1 GHz 4 MHz**	500 MHz 250 MHz	100 MHz 100 MHz
Time (rep) Interval (s-s) Accuracy	N/A 2 ns	200ps 2 ns	100 ps 300 ps	100 ps 300 ps	300 ps 300 ps
Channels	2	2	2	2	4
Digitizing Rate	200Msa/s	200Msa/s	40 Msa/s	1 Gsa/s	400Msa/s
Memory/Channel	1k sa	1k sa	1k sa	8k sa	64k sa
Vertical Resolution	6 bits, 8 with avg	6 bits, 8 with avg	7 bits, 10 with avg	8 bits to 25 MHz 7 bits to 100MHz 6 bits to 500 MHz	6 bits
Input Voltage Ranges	Cont. Var. 40mV-40V full scale	Cont. Var. 40mV-16V full scale	7 ranges 80mV-8V full scale	Cont. Var 8mV-40V full scale	Cont. Var 40mV-40V full scale
Input Coupling	1 M <sup>+</sup> /ac,dc	1M, 50, ac,dc internal	50,10K 1M pods	ac,dc, 50,1M internal	ac,dc, 50,1M internal
Effective Bits	-	-	-	-	-
Pulse Parameter Measurements	yes	yes	yes	yes	yes
Waveform Math	-	A+B, A-B,	A+B, A-B AvsB, Invert	A+B, A-B Invert	A+B, A-B Invert
Other Analysis Functions	Accumulate, Envelope, Averaging	Accumulate, Envelope, Averaging	Infinite Pers. Avg., Magnify	Infinite Pers. Avg.	Infinite Pers. Avg.
Waveform Storage	4 Waveforms	4 Waveforms	2 Pixel, 4 Waveform	2 Pixel 4 Repet. WH 4 SS WH	2 Pixel 4 Repet WH 4 SS WH
Trigger Enhancements	27 bit state Trigger, Missing/ Bit, Digital Delay	27Bit state Trigger, Missing/Extra bit, Digital Delay	Edge, Pattern State, Digital Delay by Event and Time, Time Qualified Pattern	Edge, Pattern State, Digital Delay by Event and Time, Time Qualified Pattern	Edge, Pattern State, Digital Delay by Event and Time Time Qualified
Timebase Enhancements					
Instant Hardcopy & Disc Support	HP Printers HP Plotters				
Other	-	-	Color Display	Color Display	Color Display
Price	\$5900/\$9800	\$7900/9800	\$12,900 \$17,600 \$21,100	\$23,900	\$22,900
Page Reference	52	52	55	57	59

\* D Models only

\*\* 10 pps per period without reconstruction

**Compare the Features . . .**

Whether you need pinpoint vertical resolution or lightning-fast signal capture, Hewlett-Packard's digitizing oscilloscopes provide a powerful set of features and capabilities in an easy-to-use interface.

Here's a look at how the various models compare in terms of features, capabilities, and price.

HP Model #	54120T	5180T/U	5183T/U	5185T	70700A
<b>Bandwidth</b> -Repetitive -Single-shot	20 GHz N/A	10 MHz 10 MHz	1 MHz 1 MHz	110 MHz 110 MHz	10 MHz 10 MHz
<b>Time (rep)</b> <b>Interval (s-s)</b> <b>Accuracy</b>	10 ps N/A	50 ns 50 ns	250 ns 250 ns	4 ns 4 ns	50 ns 50 ns
<b>Channels</b>	4	2/4	2/4	2	1-8
<b>Digitizing Rate</b>	N/A	20 MSa/s	4 MSa/s	250 MSa/s	20 MSa/s
<b>Memory/Channel</b>	1K sa	8k sa	64k sa 256k sa option	64k sa	256 ksa
<b>Vertical Resolution</b>	12 bits, 14 bits with avg	10 bits	12 bits	8 bits	10 bits
<b>Input Voltage Ranges</b>	Cont. Var 8mV-640mV full scale	7 ranges 100 mV-10V full scale	9 ranges 100 mV-50V full scale	9 ranges 50mV-20V full scale	4 ranges 600 mV-20V full scale
<b>Input Coupling</b>	50 ohm	ac, dc, 1M 50 aux. ch.	ac, dc 1 Mohm	ac, dc 50 ohm 1 Mohm	ac, dc 1 Megohm, dc 50 ohm
<b>Effective Bits</b>	-	7.8 eff bits 60 dB	10.0 eff bits 72 dB	6.8 eff bits 48 dB	7.0 eff bits
<b>Pulse Parameter Measurements</b>	yes	yes	yes	yes	yes
<b>Waveforms Math</b>	A+B, A-B, AvsB, Invert, Only, Max, Min	A+B, A-B, Integration, Differentiation A*B, A+Const, A-Const, A*Const			A+B, A-B, A*B A vs B, Invert
<b>Other Analysis Functions</b>	Infinite Persistence, Averaging, Histograms, TDR, TDT	Event crossings, Min/Max hold, FFT, Voltmeter, Freq counter	Event crossing, Min/Max Hold, FFT, Voltmeter, Freq counter, Inverse ASR	Event crossing Min/Max Hold FFT, Voltmeter, Freq counter	Averaging, Magnity, FFT Random Event Capture  4 Waveforms
<b>Waveform Storage</b>	2 Pixel, 4 Waveform	250-1k Wfm to optional built-in Floppy Disc			
<b>Trigger Enhancements</b>	Edge, Delay by Time	Digital Trigger Variable sensitivity, Bi-trigger, Trig Out	Digital Trig, Var sens, Bi-trig, Dropout Trig, High Freq Trig, Delay Trigger Trig Out	Var Sens, Bi-trig, pos/neg, Dropout trig, Delay trig Trig Out	Interpolated digital trigger, Edge, Level, Range
<b>Timebase Enhancements</b>		External Encode	External Encode, External Timebase	External Encode External Timebase Gated Timebase	
<b>Instant Hardcopy &amp; Disc Support</b>	HP Printers HP Plotters	HP 9122 Discs and HP plotters			HP Plotters HP Printers
<b>Other</b>	Color Display	Optional Built-in Floppy Disc			Modular
<b>Price</b>	\$27.850	\$29.100/ \$47.700	\$19.900/ \$29.900	\$40.000	\$7500/Channel plus Mainframe
<b>Page Reference</b>	60	68	66	64	110

# OSCILLOSCOPES & WAVEFORM ANALYZERS

## 200 Megasample/Second Digitizing Oscilloscopes

Models 54200A/D, 54201A/D

- Dual 200 megasample/second digitizers, allowing 50 MHz single-shot capture
- Pre-trigger viewing
- Automatic waveform measurements
- Up to 27 channels of state triggering
- Infinite variable persistence
- Instant hardcopy output
- 300 MHz repetitive bandwidth (HP 54201A/D only)

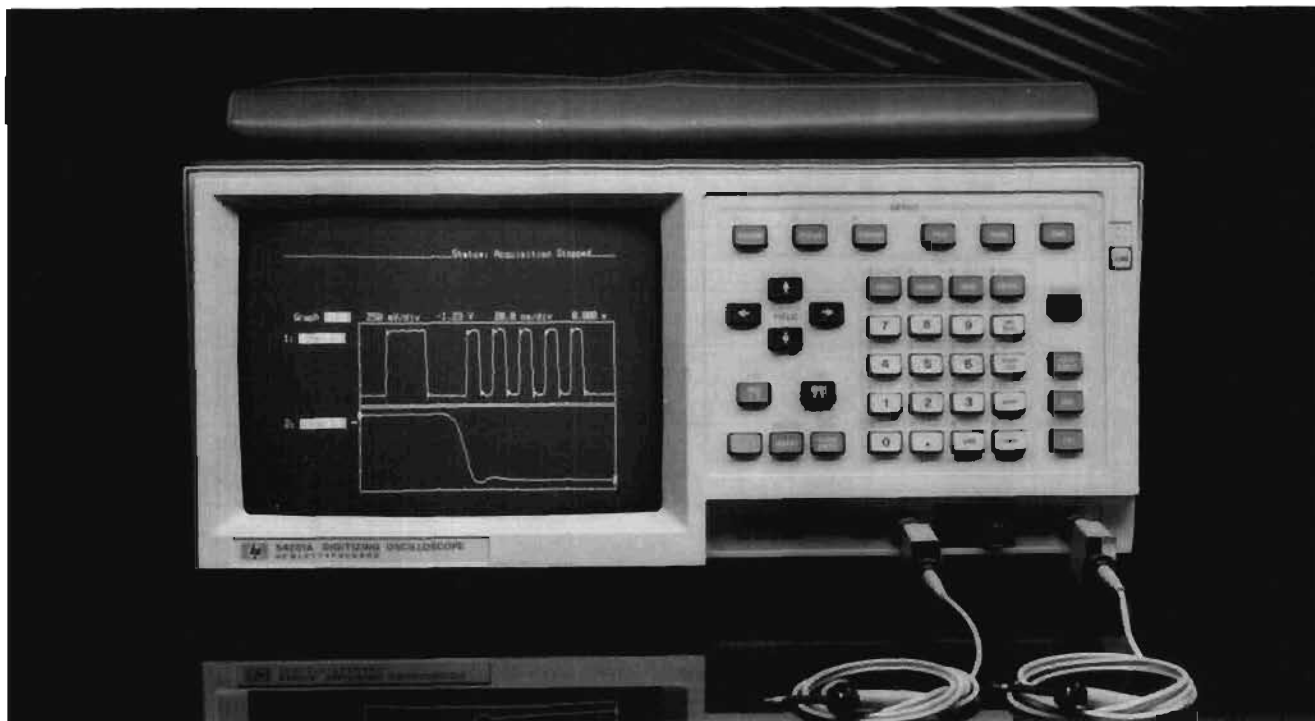

### HP 54200A/D

- Dual 200 megasample/second digitizers
- 50 MHz bandwidth
- Pre-trigger display
- Auto-scaling of input signal
- Automatic measurements of waveform parameters
- Infinite persistence display, plus envelope and average display modes
- The HP 54200D model adds:
  - Up to 27 channels of state triggering
  - Missing bit triggering mode
  - Extra bit triggering mode

### HP 54201A/D

- 300 MHz repetitive bandwidth
- Dual 200 megasample/second digitizers
- 50 MHz single-shot bandwidth
- Pre-trigger display
- Auto-scaling of input signal
- Automatic measurements of waveform parameters
- Infinite persistence display, plus envelope and average display modes
- The HP 54201D model adds:
  - Up to 27 channels of state triggering
  - Missing bit triggering mode
  - Extra bit triggering mode

### Simplify Waveform Capture and Analysis

#### Easy Instrument Setup

- Pressing the Auto-Scale button automatically provides a scaled display of a wide range of input signals.
- Save and recall your front panel setups for quick return to previous measurements.
- ECL and TTL preset keys automatically set up vertical range, offset, and trigger levels for viewing digital signals.
- Input and memory labels aid in signal and setup identification.
- "Configuration" menu gives instrument status in a single display to aid in instrument setup and measurement documentation.
- Built-in 50 ohm switchable inputs eliminate the need for external termination devices (HP 54201A/D only).

#### Digital Storage

- Bright, fade-free, non-blooming displays.
- Waveforms can be stored for comparison or analysis. Stored waveforms can be displayed concurrently with live waveforms and can be output directly to a printer or plotter.
- Time/voltage cursors enable measurements on or between live and stored waveforms.
- Average mode improves signal-to-noise ratio on repetitive signals.
- Envelope mode saves maximum and minimum values of repetitive events for worst-case analysis.
- Accumulate mode displays multi-valued waveforms.
- Connect-the-dots mode aids signal interpretation (HP 54201A/D).

**Specifications**

Channels 1 and 2 (Vertical)	HP 54200A/D		HP 54201A/D			
<b>Acquisition Method</b>	Real-time sampling		Real-time sampling		Repetitive sampling	
<b>Bandwidth (-3 dB)</b> dc-coupled ac-coupled	dc - 50 MHz 10 Hz - 50 MHz		dc - 50 MHz 10 Hz - 50 MHz		dc - 300 MHz 10 Hz - 300 MHz	
<b>Transition Time</b> (10-90%, calculated from: bandwidth X trans. time = 0.35)	7 ns		7 ns		1.2 ns	
<b>Range</b> (fs calibrated with 2-digit resolution)	40 mV to 40 V		40 mV to 16 V			
<b>Gain Accuracy</b>	±2% of full-scale*					
<b>A/D Conversion (ADC) Accuracy</b>	±1.6% of full-scale					
<b>Dc Offset Acc. Chan. Range</b> 40 mV to 390 mV 400 mV to 40 V 40 mV to 790 mV 800 mV to 16 V	±1% (offset) ±5mV ±1% (offset) ±50mV		±1% of offset ±5mV ±1% of offset ±100mV			
<b>Voltage Meas. Accuracy (dc)</b> Single cursor (X or 0) Dual cursor (X to 0 on same waveform)	Gain accuracy + ADC accuracy + offset accuracy Gain accuracy + 2 (ADC accuracy)					
<b>Input Coupling</b>	ac, dc					
<b>Input Resist. (Nominal)</b>	1 MΩ		1 MΩ; 50Ω dc coupling			
<b>Input Cap. (Nominal)</b>	14 pF		10 pF			
<b>Maximum Safe Input Voltage</b>	±40V (dc+pk ac)		1 MΩ: ±40V (dc+peak ac) 50Ω: 5 Vrms or ±40V (dc + peak ac), whichever is less			
<b>Input (dc + pk ac) Operating Range</b> Channel range 40 mV to 390 mV 400 mV to 40 V 40 mV to 16 V	±2 V ±20 V		±1 vertical range from center			
<b>Dc Offset Range/ resolution</b>	Channel Range	Offset Range	Offset Res.	Channel Range	Offset Range	Offset Res.
	40 mV/ 390 mV	±2 V	~1.2 mV	40 mV/ 790 mV	±1.5 V	1 mV
	400 mV/ 40 V	±20 V	~12 mV	800 mV/ 16 V	±30 V	20 mV

\* Specifications apply within ±10° C of auto-calibration temperature.  
 \*\* Dual-cursor specs apply for measurements made on the same or simultaneously-acquired waveforms.  
 \*\*\* Provides 10:1, 1MΩ input at HP 10017A or HP 10018A probe tip.  
 Notes: specifications apply after a 30-minute warmup period. Single-shot reconstruction uncertainty equals ±1 ns (applies for time ranges of 50 ns through 2 μs).

Time Base (Horizontal)	HP 54200A/D		HP 54201A/D			
<b>Acquisition Method</b>	Real-time sampling		Real-time sampling		Repetitive sampling	
<b>Range</b> (10 div.), 1-2.5 sequence	50 ns - 10 s full-scale					10 ns - 20 μs full-scale
<b>Time Base Accuracy</b> single/dual cursors	±2 ns or ±0.2% of time range, whichever is greater.**					±200 ps or ±2% of time range, whichever is greater.**
<b>Delay (Time Offset)</b> Pre/Post-trigger range	Time Range	Pre-trigger Range	Post-trigger Range	Time Range	Pre-trigger Range	Post-trigger Range
	50 ns to 5μs	up to 5μs	up to 1 ms	Real-time Sampling Mode		
	10μs to 10s	up to 1 screen diameter	up to 260 screen diameters	50 ns to 5μs	up to 10μs	at least 200 screen dia
				Repetitive Sampling Mode		
				10ns to 20μs	up to at 2 screen diameters	at least 200 screen diameters
<b>Pre/Post-trigger resolution</b>	Adjustable in steps of 0.1 (coarse) and 0.004 (fine) screen diameters, or the LSB digit, whichever is greater.			Adjustable in steps of 0.1 (coarse) and 0.001 (fine) screen diameters, or the LSB digit, whichever is greater.		

Trigger (Analog)	HP 54200A/D		HP 54201A/D			
<b>Acquisition Method</b>	Real-time sampling		Real-time sampling		Repetitive sampling	
<b>Sources</b>	Chan. 1, chan. 2, external trig. input		Chan. 1, chan. 2		External trigger input	
<b>Sensitivity</b>	1/8 of full-scale (dc - 50 MHz)		1/8 of full-scale (dc-250MHz)		50Ω: 60 mV - 250 MHz 2MΩ: 1V (dc/ 100 MHz)***	
<b>Trig. Range</b> Chan. range 40 mV - 390 mV 400 mV - 40 V 40 mV - 16 V	±2 V ±20 V		±1.5 x fs		±2 V	
<b>Resolution</b> Chan. range 40 mV - 390 mV 400 mV - 40 V 40 mV - 16 V	~2.4 mV ~24 mV		.02 x fs		20 mV	
<b>Level Acc.</b> Chan. range 40 mV - 390 mV 400 mV - 40 V 40 mV - 790 mV 800 mV - 16 V	±2% ±5 mV ±2% ±50 mV		±*3% ±5 mV ±3% ±100 mV		±3% ±30 mV	
<b>External Trig. Input</b>	HP 54200A/D		HP 54201A/D			
<b>Acquisition Method</b>	Real-time sampling		Real-time sampling		Repetitive sampling	
<b>Input Resist. (Nominal)</b>	1 MΩ		50 Ω		2M Ω***	
<b>Input Coupling</b>	ac, dlc		dc		dc	
<b>Maximum Safe Input Voltage</b>	±40V (dc+peak ac)		5 Vrms or ±40V (dc+pk ac), whichever is less.		±40V (dc + peak ac)	
<b>Input Oper. Range</b>	Same as chan. 1 and chan. 2 inputs		±5 V (dc + peak ac)			

# OSCILLOSCOPES & WAVEFORM ANALYZERS

## 200 Megasample/Second Digitizing Oscilloscopes (cont'd)

Models 54200A/D, 54201A/D

### State Trigger Mode

(HP 54200D and HP 54201D only)

### Clock Repetition Rate

Single phase: 25 MHz max. with single clock and single edge; 20 MHz max. with any ORed combination of clocks and edges. Multiplexed: master/slave clock timing; master clock must follow slave clock by at least 10 ns and precede next slave clock by 50 ns or more.

**Minimum Clock Pulse Width:** 20 ns at threshold

**Minimum Setup Time:** 20 ns, the time data must be present before the clock transition.

**Minimum Hold Time:** 0 seconds, the time data must be present after the clock transition.

### Probes (HP 10271A)

**Input RC:** 100 k $\Omega$   $\pm$  2% shunted by  $\sim$ 5 pF at the probe body.

**Minimum Input:** 600 mV peak-to-peak

**Minimum Input Overdrive:** 250 mV or 30% of input amplitude, whichever is greater.

**Maximum Safe Input Voltage:**  $\pm$ 40 V peak

**Threshold Range:** -9.9 V to +9.9 V in 0.1 V increments

**Threshold Accuracy:**  $\pm$ 2.5%  $\pm$  120 mV

**Dynamic Range:**  $\pm$ 10 V about threshold

### Digitizer

#### Digitizing Technique

Real-time digitizing: all data points are acquired on a single acquisition.

Random repetitive digitizing (HP 54201A/D): data points are acquired on multiple acquisitions.

**Resolution:** 6 bits; 1 part in 64. Effective resolution can be extended up to  $\sim$ 7 bits by using data filtering and averaging.

**Acquisition Record Length:** 1001 samples (1000 intervals).

#### Display

**Data Display Formats:** one, two, or four waveforms can be displayed at the same time. They can be live waveforms (channel 1 or 2 display) or stored waveforms (from waveform memories 0, 1, 2, or 3) in any combination.

#### Display/Store Modes

Normal: the display is repetitively updated with each new waveform acquisition.

Accumulate: all successive waveform acquisitions are displayed until crased. Erasure modes are manual, slow (after 64 acquisitions), and fast (after 16 acquisitions).

Envelope: provides a display of the running maximum and minimum voltage at each sample point for a repetitive input waveform.

Average: provides a display of the average voltage at each sample point for 4, 16, 64, or 256 user-defined waveform acquisitions. On each acquisition 1/n times, the new data is added to (n-1)/n of the previous value at each time coordinate. Operates in a continuous mode.

**Connect-The-Dots (HP 54201A/D):** provides a display of the sample points connected by straight lines.

### Measurement Aids

**Automatic Measurements:** the following waveform measurements can be performed automatically on live or stored waveforms. The standard measurement thresholds are the 10%, 50%, and 90% points of the waveform. In the user-defined mode, voltages, percentages, or ECL/TTL presets can be used to define the upper and lower thresholds. Measurements are continuously updated with each new acquisition.

Frequency	Duty Cycle
Period	Delay
+ Pulse Width	Delay [Ave], [Max],
- Pulse Width	[Min], [Last] (HP 54201A/D)
Rise Time	V <sub>ampl</sub>
Fall Time	V <sub>max</sub>
	V <sub>min</sub>
	V <sub>rms</sub>

### Setup Aids

**Auto-Scale:** pressing the Auto-Scale key sets the vertical and horizontal ranges, offset, and trigger level to display the input signals. Period, positive pulse, negative pulse, rising edge, or falling edge may be selected as the horizontal display criterion. Requires a duty cycle of  $>$  1%, frequency  $>$  50 Hz, and amplitude  $>$  20 mV peak. Vertical, horizontal, and trigger auto-scaling functions may be selectively enabled or disabled. The HP 54201A/D requires a frequency between 50 Hz and 200 MHz.

**Presets:** scales the vertical range, offset, and trigger level to predetermined values for displaying ECL or TTL waveforms.

**Setup Memories:** four front-panel setups (0 through 3) may be saved in non-volatile memory. Labels may be assigned to each setup.

### Ordering Information

	Price
HP 54200A 50 MHz digitizing oscilloscope	\$5950
HP 54200D 50 MHz, logic triggering digitizing oscilloscope	\$10,100
HP 54201A 300 MHz digitizing oscilloscope	\$7950
HP 54201D 300 MHz, logic triggering digitizing oscilloscope	\$9950



- 1 GHz bandwidth
- Auto pulse parameter and time interval measurements
- Digital storage
- Available with color or monochrome display
- Pre-trigger viewing
- Logic triggering capability



HP 54110D



### HP 54100A/D and HP 54110D

As the speeds of analog and digital logic continue to increase, board and system designers need to pay even closer attention to high-frequency and transmission-line characteristics of their circuits. Design requirements are rigorous. Subnanosecond technology creates narrow and elusive pulses.

#### High Bandwidth

The HP 54100/110D unite a powerful 1 GHz bandwidth with a random repetitive sampling technique for viewing rarely occurring narrow waveforms. With a 40 megasample/second single-shot digitizing rate and an effective digitizing rate of 100 gigasamples/second, these oscilloscopes yield 0.002% time base accuracy, 50 ps aperture jitter, and 10 ps resolution for confident measurements of critical timing parameters in high-speed circuitry.

With random repetitive sampling, you can capture waveforms that occur thousands of screen diameters before the trigger event. This gives an effective memory depth of millions of bytes for finding causes of failures that occur long before the trigger.

#### High Resolution

Analyze perturbations within a waveform with high resolution. With vertical magnification and waveform averaging, small signal details can be viewed and measured with 10 bits of effective resolution.

#### Flexible Analysis

Only the HP 54100A/D and HP 54110D allow the display of either vertical channel versus the other. The 1 GHz bandwidth makes this feature valuable in measuring high-speed I-V device characteristics and transfer functions high-speed converters.

#### The HP 54100A/D

When a monochrome display is preferred, for example in a totally automatic test application, choose the HP 54100A or HP 54100D

oscilloscope. These units require less rack height (7") than the HP 54110D (8.75") and have all of the same measurement features and specifications. The HP 54100A has one external trigger input, while the HP 54100D and HP 54110D have two.

#### The HP 54100M

In non-commercial applications when compatibility with the U.S. Air Force MATE (Modular Automatic Test Equipment) program is needed, contact Hewlett-Packard for information concerning the HP 54100M oscilloscope. The HP 54100M implements automatic test features of the HP 54100A through an internal TMA (Test Module Adapter). The HP 54100M is CILL (Control Interface Intermediate Language) compatible and includes most of the same features as the HP 54100A.

#### A Choice of Input Pods and Probes

The HP 54100/110 inputs are configured with removable pods that can be chosen according to the application. Pods can be changed quickly and easily, and they occupy a minimum of storage space.

- 50 ohm inputs and probes for a wide variety of environments, without the expense of amplifier plug-ins.
- 1 GHz miniature active probes for densely packed, high-speed logic circuits.
- 1 Mohm probes for circuits sensitive to resistive loading.
- 50 ohm BNC inputs for measurements where terminated lines are important.
- 100:1 probes for extended dynamic range.

For more information on the HP 54100/110's probing system, please refer to page 75.

# OSCILLOSCOPES & WAVEFORM ANALYZERS

## Digitizing Oscilloscopes (cont'd)

Models 54100A/D, 54110D

### Specifications - HP 54100A/D, HP 54110D

#### Inputs

	HP 54002A	HP 54001A	HP 54003A
	50 $\Omega$ input	1 GHz miniature active probe	1 M $\Omega$ input, with 10:1 probe attached
<b>Maximum input voltage</b>	5 V rms	20 V peak	20 V peak
<b>Coupling</b>	dc	dc	dc
<b>Input capacitance (nominal)</b>	N/A	2 pF	8 pF
<b>Input resistance (nominal)</b>	50 $\Omega$	10 k $\Omega$	1 M $\Omega$
<b>Bandwidth (-3dB)</b>	dc to 1 GHz	dc to 1 GHz	dc to 300 MHz
<b>Transition time (10% to 90%)</b>	$\leq 350$ ps	$\leq 350$ ps	$\leq 1.2$ ns
<b>System bandwidth with HP 54100A/D, 54110D (-3 dB)</b>	dc to 1 GHz	dc to 700 MHz	dc to 300 MHz
<b>System transition time with HP 54100A/D, 54110D (10% to 90%)</b>	$\leq 350$ ps	$\leq 400$ ps	$\leq 1.2$ ns
<b>Division ratio</b>	1:1	10:1 $\pm 3\%$	10:1 $\pm 3\%$

#### Vertical (Voltage)

The following apply when the HP 54100A/D is used with the HP 54002A 50 ohm input pod.

**Bandwidth (-3 dB):** dc to 1 GHz; these specifications apply over ambient temperature range of +15° C to +35° C.

**Transition time (10% to 90%):**  $\leq 350$  ps

**Deflection factor (full-scale=8 divisions):** 10 mV/div to 1 V/div in 1-2.5 steps.

**DC accuracy, single voltage marker:**  $\pm 3\%$  of full-scale  $\pm 2\%$  of offset; when driven from a 50 ohm source.

**DC delta voltage accuracy using voltage markers on the same channel:**  $\pm 1\%$  of full-scale  $\pm 3\%$  of reading, when driven from a 50 ohm source.

#### DC Offset

**Range:**  $\pm 1.5 \times$  full-scale (referenced to center screen).

**Magnifier:** expands displayed signal vertically from 1 to 16 times; adjustable in 0.5% steps

**Inputs:** two inputs, configurable with HP 54000-series pods

#### Horizontal (Time)

**Deflection Factor (full-scale is 10 divisions):** 100 ps/div to 1 sec/div.

#### Delay (Time Offset)

**Pre-trigger range:** up to -200 ms or -10 divisions, whichever is greater.

**Post-trigger range:** up to +1 second or +10 divisions, whichever is greater.

#### Time Base Accuracy

**Single-channel:**  $(100 \text{ ps} \pm 2 \times 10^{-5} \times \text{delta T reading})$

**Channel-to-channel:**  $(200 \text{ ps} \pm 2 \times 10^{-5} \times \text{delta T reading})$

**RMS Jitter:**  $(50 \text{ ps} + 5 \times 10^{-7} \times \text{delay setting})$

#### Trigger

The following apply when the HP 54100A/D, 54100D is used with the HP 54002A 50 ohm input pod.

Trigger Source	Vertical Channel 1 or 2	Trigger Input 3 (HP 54100D, 54110D; Trig In 3 or 4)
<b>Trigger level range</b>	$\pm 2 \times$ full-scale	$\pm 2$ V
<b>Trigger sensitivity</b> dc to 100 MHz 100 to 500 MHz	0.12 $\times$ full-scale 0.24 $\times$ full-scale	40 mV 50 mV

**Trigger Source:** channel 1, channel 2, trigger 3 input (HP 54100D/54110D, trigger 4 input).

**Trigger 3 input (HP 54100D, 54110D, trigger 4 input):** configurable with HP 54000-series pods.

### Operating Characteristics

#### Digitizer

**Resolution:** 7 bits (1 part in 128).

Effective resolution can be extended up to approx 10 bits by using magnification and averaging.

**Digitizing rate:** up to 40 megasamples/s. Vertical

**Input protection:** a relay opens when applied voltage exceeds rated input for input pod in use (see "Inputs").

#### Horizontal

**Delay between channels:** difference in delay between channels can be nulled out in 10 ps steps up to 10 ns to compensate for differences in input cables or probe length.

**Reference location:** the reference point can be located at the left edge, center, or right edge of the display. The reference point is that point where the time is offset from the trigger by the delay time.

#### Display

**Data display resolution:** 500 points horizontally by 256 points vertically

#### Data display formats

Split screen: each channel display is four divisions high.

Full screen: the 2 channels are overlaid. Each channel display is eight div high.

#### Display modes

Variable persistence: the time that each data point is retained on the display can be varied from 200 ms to 10 seconds, or it can be displayed indefinitely.

Averaging: the number of averages can be varied from 1 to 2048 in powers of 2. On each acquisition, 1/n times the new data is added to (n-1)/n of the previous value at each time coordinate. Averaging operates continuously; the average does not converge to a final value after n acquisitions.

**Graticules:** full grid, axes with tic marks, or frame with tic marks.

**Display colors (HP 54110D):** a default color selection is set up in the instrument. Different colors are used for display background, channel 1/ function 1, channel 2/ function 2, background and highlighted text, advisories, markers, and memories. If desired, the user may change the colors used from the front panel or over the HP-IB.

#### Ordering Information

HP 54100A

HP 54100D

HP 54110D color display

#### Price

\$12,900

\$17,600

\$21,900

#### Input Pods And Probes

HP 54001A 1 GHz miniature active probe pod

HP 54002A 50 ohm BNC input pod

HP 54003A 1-megohm, 10:1 probe pod

\$765

\$130

\$665



- 1 Ggasample/second digitizing rate
- 500 MHz repetitive bandwidth
- 8k memory depth



The HP 54111D features a 1 ggasample/second digitizing rate and a 500 MHz bandwidth.

#### HP 54111D: High-speed General-Purpose Scope

The HP 54111D is a 1 ggasample/second, two-channel digitizing oscilloscope with a memory depth of 8k samples per channel. The HP 54111D retains all of the key features and user friendliness of the HP 54100/110 oscilloscopes . . . such as automatic measurements, auto-scaling, cursors, and a functional color display. Plus, the HP 54111D adds features necessary for controlling and managing the added memory depth, such as scroll, zoom, and memory bar.

#### Key Contributions

- 1 ggasample/second digitizing rate (maximum)
- 500 MHz repetitive bandwidth
- 250 MHz single-shot bandwidth
- 8k memory per channel
- Up to eight bits of vertical resolution with bandwidth limits
- Two channels of simultaneous capture at the full digitizing rate
- Pre-trigger information
- Automatic measurements
- Fully HP-IB programmable with HP's oscilloscope language (HP-OL)
- Complex triggering capabilities
- Instant hardcopy output
- Flexible display modes

#### General-purpose to Special Applications

With a 1 ggasample/second digitizing rate, the HP 54111D gives you the fastest sampling rate available in a general-purpose digitizing oscilloscope. However, the HP 54111D is much more than an instrument for capturing fast single-shot transients. With random repetitive sampling, this instrument provides a bandwidth of 500 MHz for high-speed circuit design and test.

In addition to its single-shot and repetitive capabilities, the HP 54111D provides flexible input coupling with a side dynamic range for viewing and analyzing a variety of signals. Use this scope for just about any general-purpose application from very slow to very high-speed repetitive or non-repetitive waveforms.

#### Memory Bar Simplifies Data Viewing

The HP 54111D provides 8k samples of memory per channel. This results in 16 screens of waveform information in each real-time or

single-shot acquisition cycle. To simplify management of all this data, the HP 54111D displays a memory bar. The memory bar is displayed along the top edge of the graticule and shows the portion of memory being viewed relative to the entire memory record. In addition, the trigger point is also shown along the memory bar.

#### Ultra High Digitizing Rate

No longer do you need a manual analog storage oscilloscope to capture high-speed single-shot phenomena found in:

- high-speed pulse analysis
- nuclear test studies
- plasma discharge
- high voltage arcing
- high frequency bursts

All these single-shot events can be captured easily with two simultaneous digitizers running at 1 GHz, with 8  $\mu$ s of data stored for review and analysis.

#### High-speed ECL Design

Non-repetitive glitches appearing on the clock signal can be captured easily with the 250 MHz single-shot performance of the HP 54111D. Eight  $\mu$ s of pre-trigger data is invaluable for determining the cause of the glitch.

#### High-speed Semiconductor Design

Single-shot performance of 250 MHz permits you to measure the outputs from latches (i.e., one-time events for multiple clock periods in ECL circuits).

#### Laser and High Energy Research

Photo detector pulses can be measured via single-shot capture using the 1 GHz sampling rate and built-in automatic pulse parameters measurements. Infinite persistence can also be used to show and measure maximum variations of the waveform to 500 MHz repetitive bandwidth.

The HP 54111D's two simultaneous 1 ggasample/second channels give you the single-shot performance of the most advanced analog storage oscilloscopes, but with all the advantages and ease of use of a digitizing oscilloscope. And with a staggered over-sampling technique, the HP 54111D provides this single-shot performance with up to eight bits of non-blooming vertical resolution.

# OSCILLOSCOPES & WAVEFORM ANALYZERS

## Digitizing Oscilloscopes (cont'd)

Models 54100A/D, 54110D



With its 1 gigasample/second digitizing rate, the HP 54111D was able to capture this laser pulse single-shot.

### Data Communications

Combine 1 gigasample/second digitizing rate with eight kbytes of memory depth per channel, and you have an invaluable tool for analyzing high-speed serial waveforms such as data communications or radar testing.

### High Bandwidth Applications

Not only is the HP 54111D digitizing oscilloscope useful for single-shot phenomena, but it also samples repetitively, giving you 500 MHz bandwidth with high signal fidelity. Use this scope for just about any general-purpose application from very slow to very high-speed repetitive or non-repetitive waveforms.

### Computer-aided Test

The HP 54111D has many features that make it an excellent tool in computer-aided test. Its repetitive bandwidth and digitizing rate allow it to cover a wide range of automatic measurement applications. In addition, this instrument has many features that enhance test throughput time, such as built-in automatic measurements, fast acquisition cycles, and deep memory.

### Input Range and Conditioning

The HP 54111D has the widest input dynamic range and coupling capabilities of any of our digitizing oscilloscopes. The input sensitivity can be set from 1 mV/div to 5 V/div. In addition, all input coupling is internal and programmable. The selections include: ac, dc, 1 megohm, 50 ohms, and GND. These input signal conditioning features make the HP 54111D more general-purpose for the circuit designer and test engineer.

## HP 54111D Specifications

### Vertical (Voltage)

Channels: 2

Bandwidth:

dc-coupled

ac-coupled

Transition Time  
(10% to 90%)

Deflection Factor  
(full scale=8 div.)

Resolution

Single-shot

dc to 250 MHz

10 Hz to 250 MHz

1.4 ns\*\*\*\*

Repetitive

dc to 500 MHz

10 Hz to 500 MHz

700 ps

1 mV/div to 5 V/div continuous\*

8 bits to 25 MHz,

7 bits to 100 MHz,

100 MHz, 6 bits to

250 MHz

6 bits, 8 bits

with averaging

to 500 MHz

**Gain Accuracy:**  $\pm 2\%$  of full-scale\*\*

**Dc Offset Accuracy:**  $\pm 1.5\%$  of setting

### Measurement Accuracy

Single data point:  $\pm$ gain acc  $\pm$  offset acc  $\pm$  resolution

Between data points on the same waveform:  $\pm$ gain acc  $\pm 2 \times$  resolution

**Dc Offset Range:**  $\pm 200$  mV (1 mV/div to 4.9 mV/div)

$\pm 1$  V (5 mV/div to 49 mV/div)

$\pm 10$  V (50 mV/div to .49 V/div)

$\pm 100$  V (.5 V/div to 5 V/div)

**Input Coupling:** ac/dc/dc-50 ohms/Gnd

**Input Impedance:** 1 Mohm at 6.5 pF or 50 ohm (dc)

**Maximum Safe Input Voltage:**  $\pm 40$  V at 1 Mohm (dc + peak ac), 5 V rms at 50 ohms

### Horizontal (Time)

**Digitizing Rate:** 1 gigasamples/second to 50 samples/second

**Deflection Factor:** 500 ps/div to 1 s/div

**Memory Depth Per Channel:** 8k (8  $\mu$ s at 1 gigasample/second), single-shot only.

**Pre-trigger Delay Range:**  $-8 \mu$ s at timebase settings 50  $\mu$ s/div and less, increasing to  $-160$  seconds at 1 s/div.

**Post-trigger Delay Range:** .16 seconds at timebase settings .5  $\mu$ s/div and less, increasing to 10k seconds at 1 s/div.

Time Measurement Accuracy	Single-shot	Repetitive
single channel	$\pm 300$ ps	$\pm 100$ ps
dual channel	$\pm .03\%$ of reading $\pm 600$ ps $\pm .03\%$ of reading	$\pm .03\%$ of reading $\pm 200$ ps $\pm .03\%$ of reading
<b>Triggering Sources</b>	Internal Chan 1,2	Ext. Inputs 3,4
<b>Sensitivity</b>		
single-shot	0.1 of full scale, dc to 200 MHz***	15 mV (1:1), dc to 200 MHz
repetitive	0.2 of full scale, 200 MHz to 500 MHz***	45 mV (1:1), 200 MHz to 500 MHz
<b>Trigger Level Range</b>	$\pm 3 \times$ full scale	$\pm 1$ V (1:1)
<b>Input Resistance</b>	NA	1 Mohm
<b>Maximum Input Safe Voltage</b>	NA	$\pm 10$ V, dc + peak ac
<b>Input Operating Range</b>	NA	$\pm 1$ V(1:1), dc + peak ac

\*Bandwidth for settings 1 mV/div to 4.9 mV/div is reduced to 150 MHz.

\*\*When calibrated to probe tip using front panel calibration source. Applies to major ranges (5 mV/div, 10 mV/div, 20 mV/div, 50 mV/div, 100 mV/div, 200 mV/div, 500 mV/div, 1 V/div, and 2 V/div). All continuous settings between these ranges are  $\pm 3\%$  of full-scale.

\*\*\*Applies to settings 5 mV/div only.

\*\*\*\*1.4 ns calculated by measuring a 1.4 ns risetime source. In the 6-bit glitter mode, a 1.4 ns input risetime is measured as  $2.0 \text{ ns} = \sqrt{(1.4)^2 + (1.4)^2}$

### Ordering Information

HP 54111D 1 gigasample/second digitizing oscilloscope

Price

\$23,900

- 64k memory depth per channel
- Quad 400 megasamples per second digitizers
- Four channels.

- 100 MHz bandwidth (single-shot and repetitive)



HP 54112D



#### HP 54112D Specifications

##### Vertical (Voltage)

Channels	4	
Bandwidth	Single-shot	Repetitive
dc-coupled	dc to 100 MHz	dc to 100 MHz
ac-coupled	10 Hz to 100 MHz	10 Hz to 100 MHz
Transition Time (10% to 90%)	3.5 ns (nominal)	
Deflection Factor (full scale=8 div)	5 mV/div to 5 V/div continuous	
Resolution	6 bits	6 bits, 8 bits with averaging

**Gain Accuracy:**  $\pm 2\%$  of full-scale\*

**Dc Offset Accuracy:**  $\pm 1.5\%$  of setting

##### Measurement Accuracy

single data point:  $\pm \text{gain acc} \pm \text{offset acc} \pm \text{resolution}$ .  
between data points on same waveform:  $\pm \text{gain acc} \pm 2 \times \text{resolution}$ .

**Dc Offset Range:**  $\pm 1 \text{ V}$  (5 mV/div to 49 mV/div)  
 $\pm 10 \text{ V}$  (50 mV/div to .49 V/div)  
 $\pm 40 \text{ V}$  (.5 V/div to 5 V/div)

**Input Coupling:** ac/dc/dc-50 ohms

**Input Impedance:** 1 Mohms at 6.5 pF or 50 ohms

**Maximum Safe Input Voltage:**  $\pm 40 \text{ V}$  at 1 Mohm (dc + peak ac)  
5 V rms at 50 ohms

\* When calibrated to probe tip using front panel calibration source. Applies to major ranges (5 mV, 10 mV, 20 mV, 50 mV, 100 mV, 200 mV, 500 mV, 1 V and 2 V). All continuous settings between these ranges are  $\pm 3\%$  of full scale.

##### Horizontal (Time)

**Digitizing Rate:** 400 Megasamples/second to 50 samples/second.

**Memory Depth Per Channel:** selectable either 64k or 8k in single-shot only

**Pre-trigger Delay Range:**  $-160 \mu\text{sec}$  at timebase settings of 125 ns/div and less, increasing to  $-1200$  seconds at 1 second/div.

**Post-trigger Delay Range:** .16 sec at timebase settings .5  $\mu\text{sec}/\text{div}$  and less, increasing to 10,000 seconds at 1 s/div.

Time Measurement Accuracy	
single channel	$\pm 500 \text{ ps} \pm .002\%$ of reading
dual channel	$\pm 1 \text{ ns} \pm .002\%$ of reading

##### Triggering

**Sources:** internal chan. 1,2,3,4 and external input.

##### Sensitivity

**Internal:** 0.1 of full-scale

**External:** 10 mV (1:1)

##### Trigger level range:

**Internal:**  $\pm 3 \times$  full scale

**External:**  $\pm 5 \text{ V}$  (1:1)

##### External trigger input

**Input resistance:** 200k ohms

**Maximum input safe voltage:**  $\pm 40 \text{ V}$  dc + peak ac.

**Input operating range:**  $\pm 5 \text{ V}$  (1:1) dc + peak ac.

#### HP 54112D: Four Channel Deep Memory Scope

The HP 54112D is a 400 megasample per second, four channel digitizing oscilloscope with 64k samples of memory depth per channel. The HP 54112D retains all the key features and the user friendliness of the HP 54100 series scopes. These features include automatic measurements, autoscaling, cursors, functional color display, scroll, zoom, and memory bar.

#### Key Contributions

- 400 megasamples per second digitizing rate
- 100 MHz repetitive and single-shot bandwidth
- 64k memory per channel
- Four channels of simultaneous capture at the full digitizing rate
- 160 useconds of pre- or post-trigger information minimum
- Automatic measurements
- Fully programmable
- Complex triggering capabilities
- Instant hardcopy output

#### Automatic Test Environment

The English-like commands and logical structure of HPOL (Hewlett-Packard Oscilloscope Language) make programming the 54100 series scopes in computer aided test a much easier task. The learning curve is greatly reduced.

The four channels, built-in automatic measurements and very deep memory of the 54112D improve the throughput of ATE systems. Data that used to take many acquisitions passes can now be captured in one.

#### General Purpose Inputs

The fully programmable input impedance and coupling of the four channels allow the user to choose 1 megohm impedance AC or DC coupled or 50 ohm DC coupled on each channel.

#### Ordering Information

HP 54112D 4 channel 64k memory/channel digitizing oscilloscope

#### Price

\$22,900

# OSCILLOSCOPES & WAVEFORM ANALYZERS

## Digitizing Oscilloscopes (cont'd)

### Model 54120T

- 20 GHz Bandwidth
- 10 ps Accuracy
- Histograms
- TDR

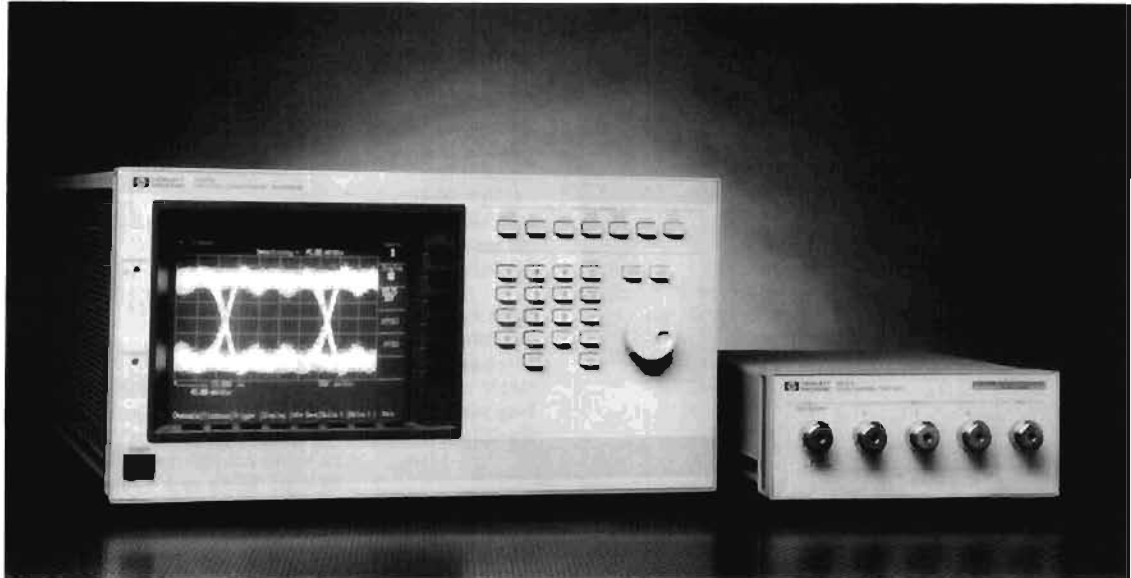

HP 54120T



### HP 54120T-20 GHz Bandwidth, 10 ps Time Interval Accuracy

The HP 54120T Digitizing Oscilloscope combines a 20 GHz bandwidth, a time domain reflectometer, four input channels and superb stability in an easy-to-use, fully-programmable instrument. Whether your application involves high-speed device and circuit characterization, microwave and RF measurements, or high-speed datacom analysis, this new instrument will give you a new confidence in state-of-the-art measurements.

#### Key Contributions

- dc-20 GHz bandwidth
- 17.5 ps risetime
- 10 ps time interval accuracy
- 0.25 ps time interval resolution
- 10 ps/div-1 s/div timebase
- 0.4% vertical accuracy
- 32  $\mu$ V resolution
- 1 mV/div-80 mV/div vertical sensitivity
- Automatic pulse-parameter measurements
- Fully programmable
- Pushbutton hardcopy documentation
- Four input channels
- Step generator with 35 ps risetime and 1% flatness
- Reflection (TDR)/Transmission (TDT) normalization<sup>1</sup>
- Time and voltage histograms

#### Picosecond Measurements

The HP 54120T's 0.25 ps time interval resolution and 10 ps time interval accuracy reduce the scope's contribution to errors in digital timing measurements in semi-conductors and computers.

#### Quantify Noise and Jitter

Time and Voltage histograms, which quantify jitter and noise measurements, characterize the eye pattern in data communications applications. Eye height and width, location of the one or zero, are all easily found with histograms.

#### Eliminate Reflections With TDR

Ringings and waveform distortion can be eliminated by using time domain reflectometry to locate and remove discontinuities in transmission line systems.

#### Probe The Inaccessible-The HP 54006A

##### Resistive Divider Probe Kit

The HP 54006A, 10:1 50 ohm and 20:1 1 kohm, 6 GHz resistive divider probe kit gives access to signal points that previously avoided inspection. Now designers can see what the waveform looks like at the input to a GaAs gate, instead of having to settle for what it looks like at the end of a 50 ohm cable.

#### Precision Low-loss Measurements-

##### The HP 54007A Accessory Kit

The HP 54007A Accessory Kit provides an assortment of parts with APC-3.5 connectors for low loss measurements. This kit is highly recommended for low loss reflection/transmission measurements. The kit includes low loss 50 ohm coaxial cables, coaxial shorts, coaxial 50 ohm terminations, 7.5 cm airline, 6 dB and 40 dB attenuators, and a power splitter.

<sup>1</sup> Normalization utilizes the Bracewell transform which is under license from Stanford University.

**HP 54120T Specifications**  
**Channels (Vertical)**

	20 GHz Bandwidth Mode (Available in average display mode only)	12.4 GHz Bandwidth Mode (Available in either average or persistence display modes)
Bandwidth (-3 dB)	dc to 20 GHz, Chs 2, 3, & 4 (Ch 1 is -3.5 dB @ 20 GHz) dc to 18 GHz, Ch 1	dc to 12.4 GHz
Transition Time (10% to 90%) (calculated from $T_r = .35/BW$ )	$\leq 17.5$ ps, Chs 2, 3, 4 $\leq 19.4$ ps, Ch 1	$\leq 28.2$ ps
Scale Factor (full-scale is 8 divisions)		
Minimum		1 mV/div
Maximum		80 mV/div
dc Accuracy, Single Voltage Marker	Average mode: $\pm 0.4\%$ of full-scale $\pm 2$ mV Persistence mode: $\pm 0.4\%$ of full-scale $\pm 2$ mV $\pm 3.0\%$ of (reading ch offset)	
dc Difference Voltage Accuracy Using Two Voltage Markers On The Same Channel	Average mode: $\pm 0.8\%$ of full-scale Persistence mode: $\pm 0.8\%$ of full-scale $\pm 3.0\%$ of reading	
Programmable dc Offset	Channel offset: $\pm 500$ mV	
Inputs:		
Number	Four	
Dynamic Range	$\pm 320$ mV relative to channel offset	
Maximum Safe Input voltage	$\pm 2$ V dc + ac peak, (16 dBm)	
Nominal Impedance	50 ohms	
Percent Reflection	$\leq 5\%$ for 30 ps risetime	
Connectors	3.5 mm (m)	

**TDR System**

	Combined Oscilloscope and TDR Performance	Normalized Characteristics
Risetime	$\leq 45$ ps*	Adjustable; allowable values based on timebase setting Minimum: 10 ps or $0.8 \times \text{Time/div}$ , whichever is greater Maximum: $5 \times \text{Time/div}$
Flatness	$\leq 1\%$ after 1 ns from edge: $\leq +5\%$ , $-2\%$ to 1 ns from edge	$\leq 0.1\%$
Step generator levels		
Low	0 V $\pm 2$ mV	0 V $\pm 2$ mV
High	+200 mV $\pm 2$ mV	+200 mV $\pm 2$ mV

\*The risetime of the generator is less than 35 ps, as calculated by  $(T_r \text{ system})^2 = (T_r \text{ generator})^2 + (T_r \text{ scope})^2$

**Timebase (Horizontal)**

Scale Factor (Full-scale is 10 divisions)	
Minimum	10 ps/div
Maximum	1 s/div
Delay (Time offset relative to trigger)	
Minimum	16 ns
Maximum	1000 screen diameters or 10 seconds, whichever is smaller.
Time Interval Accuracy (Dual marker measurement)	10 ps $\pm 0.1\%$ of reading
Time Interval Resolution	0.25 ps or 0.02 division, whichever is larger

**Trigger-External Input Only**

Sensitivity	
dc-100 MHz	40 mV peak-to-peak
100 MHz to 500 MHz	100 mV peak-to-peak
Pulse Width	1 ns $\geq 80$ mV
Trigger Level Range	$\pm 1$ V
Jitter (Trigger and timebase combined) (one standard deviation)	$\leq 5$ ps + $5E-5 \times \text{delay setting}$
Trigger Input:	
Maximum Safe Input Voltage	$\pm 2$ V dc + ac peak, (16 dBm)
Nominal Impedance	50 ohms
Percent Reflection	$\leq 10\%$ for 100 ps risetime
Connector	3.5 mm (m)

**Ordering Information**

- HP 54120T 20 GHz Digitizing Oscilloscope**  
The HP 54120T 20 GHz Digitizing Oscilloscope consists of an HP 54120A Digitizing Oscilloscope Mainframe and an HP 54121A Four Channel Test Set. The HP 54120T may be ordered or the HP 54120A and HP 54121A may be ordered separately. Only one HP 54121A may be connected to an HP 54120A mainframe at a time.
- HP 54120A** includes:  
Color mainframe, interface cable, operating and programming manual for the HP 54120A and HP 54121A, and a U.S. power cord.
- HP 54121A** includes:  
Four vertical channels; switchable step generator; and a trigger input; five adapters, APC-3.5 (f-f); five coaxial shorts, SMA (m); one anti-static mat with wrist strap; and RF accessories. RF accessories include: Five 20 dB attenuators, APC-3.5 (f-m); three 50 ohm cables, SMA (m-m); two SMA (m) to BNC (f) adapters; one 50 ohm termination, SMA (m); One 50 ohm termination, SMA (f); One coaxial short, SMA (f).
- |  |          |
|--|----------|
| <b>HP 54120T</b> Digitizing Oscilloscope           | \$27,850 |
| <b>Opt 090</b> Deletes RF accessories              | -\$1,800 |
| <b>Opt 908</b> Rackmount kits                      | \$89     |
| <b>Opt 910</b> Extra Manual                        | \$120    |
| <b>HP 54120A</b> Digitizing Oscilloscope Mainframe | \$11,525 |
| <b>Opt 908</b> Rackmount kit                       | \$40     |
| <b>Opt 910</b> Extra Manual                        | \$120    |
| <b>HP 54121A</b> Four Channel Test Set             | \$16,325 |
| <b>Opt 090</b> Deletes RF accessories              | -\$1,800 |
| <b>Opt 908</b> Rackmount kit                       | \$49     |
| <b>Accessories</b>                                 |          |
| <b>HP 54006A</b> 6 GHz resistive divider probe kit | \$895    |
| <b>HP 54007A</b> Accessory kit                     | \$5225   |

# OSCILLOSCOPES & WAVEFORM ANALYZERS

## Precision Digitizing Oscilloscopes

Models 5180T/U, 5183T/U, & 5185T

- HP: 5185T: 8-bit resolution, 250 Msamples/s, 64-ksample/channel memory
- HP 5183T/U: 12-bit resolution, 4 Msamples/s, up to 512-ksample memory
- HP 5180T/U: 10-bit resolution, 20 Msamples/s, 16-ksample memory
- 2 channel operation (4 channels for HP 5183U and HP 5180U)
- Dual domain analysis
- High-quality 2048 x 2048-point vector display
- Complete HP-IB programmability
- 48 dB, 60 dB or 72 dB of dynamic range



HP 5183T (5183U, 4 channels—not shown), see page 66 for more information.



HP 5185T, see page 64 for more information.



HP 5180U (5180T, 2 channels—not shown), see page 68 for more information.



### Precision Digitizing Oscilloscope

The oscilloscope has been one of the fundamental engineering tools for many decades. It is a general purpose instrument, which provides the same measurement answers as racks of instrumentation. Voltage, frequency, phase and many more parameters can be measured using an oscilloscope, but it usually involves laborious human intervention to count graticules and interpret data. Also, until the storage scope, most transient measurements could not be performed.

With the advent of digitizing oscilloscopes, the tedium involved in taking data from a waveform has been vanquished. The production line no longer needs the single, dedicated instruments, customized to take a voltage or time measurement. The digitizing scope can "capture" the waveform, and preprocess the signal to provide single number answers so that the technician or computer can make simple "go" or "no go" decisions. Waveforms can be stored enabling characterization and correlation between runs.

Accuracy unrealized by oscilloscopes is obtained by this new series of precision digitizing oscilloscopes. Measurements with standard analog oscilloscopes produce approximately 30 dB of dynamic range; the HP 5183T/U, 5180T/U, and 5185T precision digitizing oscilloscopes have 72 dB, 60 dB, and 48dB of dynamic range respectively.

### Built-in Analysis Package

HP precision digitizing oscilloscopes provide many analysis features. These features give the designer or technician the information he needs in real time without resorting to the use of sophisticated external software to manipulate the data.

### Precision Pulse Measurements

These oscilloscopes provide pulse measurements according to the IEEE-194 standard. The designers can also define their own pulse characterization environment. Risettime or falltime are provided with the touch of a finger in the analysis menu. Positive and negative

pulse widths along with duty cycle and amplitude are other statistics available. Also included at a single touch are overshoot and undershoot.

### Real Time Conversion to Frequency Domain

With the introduction of the precision digitizing oscilloscope, the designer can now do some frequency domain analysis with the same instrument that does the time domain analysis. Both domains can be observed and characterized simultaneously. An FFT is performed on the time record using either a Hann, Uniform, Flat Top or user defined window. The magnitude and the phase spectrums can then be computed and displayed independently using the flexibility of the instruments.

### Waveform Math and Calculus

Two waveforms can be manipulated mathematically by adding, subtracting or multiplying them together. This gives the designer the ability to experiment quickly with modulation, performing experiments on raw data before breadboarding is done. Afterwards, the data can be gathered from the actual circuit and compared against the theoretical data. All this is accomplished without the aid of external computational equipment.

Incoming signals, or waveforms in memory can be integrated or differentiated, resulting in a waveform that lets the designer bypass special purpose hardware or computer programming. The DC drift of a circuit is easily quantifiable using integration in the analysis feature set. High frequency components of a signal are easily identifiable by integrating an incoming signal and placing it either underneath the signal, or combining the two traces into one display.

### Waveform Reconstruction means Readable Displays

A common complaint when using digitizing oscilloscopes, is that the representation of the data is not always optimum. The following two figures show the same waveform; the top waveform has used the waveform reconstruction algorithm, built into the HP 5183T/U, 5180T/U, and 5185T, and the bottom waveform shows the data with the recon-



struction feature turned off. The top graph is also the representation that would be viewed on a storage oscilloscope.

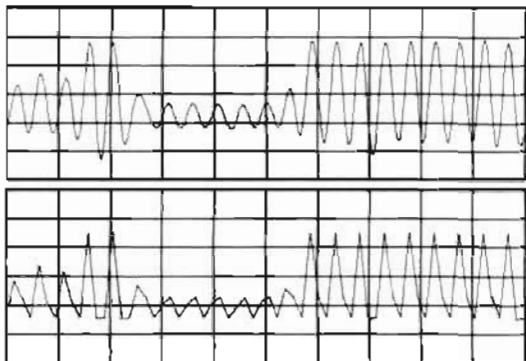

Reconstruction gives designers a truer representation of the data, allowing them to continue thinking in the analog time domain.

### Flexibility in Data Presentation

These digitizing oscilloscopes are extremely friendly as bench top instruments. One to four traces can be displayed, with the designer determining what the traces consist of and how they are displayed. As with analog oscilloscopes, continuous or single-shot waveforms can be displayed. Here the similarity with analog scopes ends; the precision digitizing oscilloscope can also display waveforms stored in memory, or signals that have been processed using the analysis functions inside the scope. These oscilloscopes can display analyzed data and the original measurement continuously as the signals are digitized. Once the waveform has been digitized, the display can be manipulated by zooming in on an interesting section, or changing the gain and offset to show more fine details.

### Permanent Copies of Waveforms

The HP 5183T/U, 5180T/U, and 5185T provide two ways to create permanent copies of waveforms or processed signals. With the

optional internal floppy disc, up to 250 1K records can be stored. In addition to storing captured and processed waveforms, the entire state of the instrument can be stored so that complex series of instrument setups can be recalled at a touch, leaving the designer or technician to concentrate on the device under test, and not setting up instruments. The waveforms are formatted in Hewlett-Packard's LIF directory, permitting the recorded disc to be used with any of the HP 9000 series 200 and 300 computers. In addition to storing the binary waveform, each file is time stamped.

Hardcopies of the display can also be created without the aid of a controller. This series of precision digitizing oscilloscopes operates most HP plotters (see the data sheet for a complete list of the supported plotters).

### Precision Measurements with Cursors

Two cursors are provided for making accurate measurements. A reference level, settable by the operator, is used to make voltage measurements; timing measurements are taken with respect to the trigger point. The difference between two cursors is also available for voltage, timing, frequency and decibels. Measurements using the delta cursors feature can be made on a single trace, or between two different traces being displayed.

Quick timing, frequency, voltage and power analysis can be accomplished using a single cursor. Once the cursor is placed on the desired waveform, the minimum and maximum can be determined with a single touch. A single keystroke places the cursor on the next minimum, maximum, or zero crossing which reveals waveform details without the user having to perform a tedious search.

### Battery Backed up Instrument Settings

Four instrument settings may be stored, but five can be recalled. The fifth memory location contains the instrument environment that was present before the last recall, which means that a complex instrument setting won't be overwritten by accident. This gives the designer or technician the ability to determine the exact instrument settings, and then auto-sequence through five different test setups. The ram that stores the front panel settings along with the internal clock is backed up by a lithium battery.

## Common Analysis Features

### Pulse characterization

Rise time, fall time, baseline, topline  
+ width, - width, overshoot, period  
frequency and duty cycle

### Voltmeter

Peak to peak, rms and period rms

### Frequency Domain

Power spectrum, phase spectrum and magnitude spectrum

### Available windows

Uniform, Hann and Flat Top

### Waveform math

Add, subtract and multiply

### Calculus

Integrate and differentiate

### Frequency Counter

Average frequency and event crossing

### Miscellaneous functions

Minimum hold, maximum hold and extract

### Cursor functions

Waveform maximum, waveform minimum, next maximum, next minimum, next crossing, next positive crossing and next negative crossing

### Display functions

X zoom, X position, Y gain, Y offset,  
reconstruction and dot or line mode

### Plotting

Plot waveforms with most HP plotters

### Mass storage

Using 3.5 inch floppy discs, when option 035 is installed

See next two pages for more information on the HP 5185A/T.  
See pages 66 and 67 for more information on the 5183A/T/U.  
See page 68 and 69 for more information on the HP 5180T/U.

# OSCILLOSCOPES & WAVEFORM ANALYZERS

## Precision Digitizing Oscilloscope (cont'd)

Model 5185T

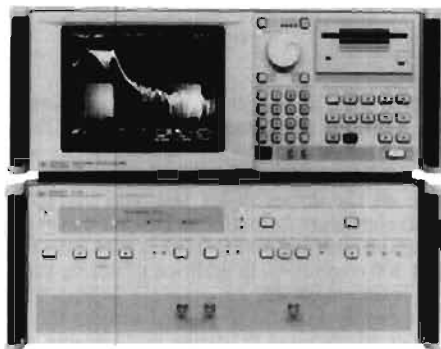

HP 5185T

### High-speed Precision Digitizing Oscilloscope

The HP 5185T provides uncompromised voltage resolution along with its high digitizing speed. In-depth dual domain analysis is now possible at 110 MHz bandwidth. The HP 5185T is one of HP's most powerful single-shot measurement tools because the power of a high-speed waveform recorder (the HP 5185A) is coupled with the multi-talented display section. The display section consists of a high-quality 2048 x 2048-point vector display, a precision analysis package, and a flexible user and computer interface.

### Capture Your Most Elusive Signals

Triggering on the correct signal is one of the more important features that must be considered when purchasing an oscilloscope. With the correct trigger, less memory is needed because you can trigger on exactly the event of interest. Otherwise, you must record much more than you need and hope the event is buried in your recording. The HP 5185T provides flexible triggering via variable sensitivity (hysteresis), delay trigger, bi-trigger, posneg trigger, drop-out trigger, and pre- and post-triggering.

### Record the Details That Most Oscilloscope Users Miss

HP builds the HP 5185T with a separate high performance ADC (analog-to-digital-converters) for each of the two channels, allowing simultaneous two channel recording at the maximum speed. The two ADCs are bipolar flash converters, which provide a lower noise-floor than CCDs (charge-coupled-devices), a commonly used technology for high-speed ADCs. The 8-bit ADCs ensure 48 dB<sup>1</sup> of dynamic range, and HP specifications guarantee its usefulness.

Recording high-fidelity information at a 250 Msample/sec rate is a key performance specification for the HP 5185T, but this would be useless if signal conditioning was ignored. The HP 5185T provides nine ranges that can optimize your signal whether it's 50 mV or 20 V peak-to-peak. Standard scope features are supplied, such as 1M $\Omega$ /50 $\Omega$  termination and ac/dc coupling, along with uncommon features such as the wideband input and switchable 6-pole anti-alias filter.

### Turn Those Details Into Answers with Characterized Analysis

The HP 5185T emulates a rack of instrumentation because of the built-in analysis package (see the previous page for a list of the analysis functions). The HP 5185T can emulate a spectrum analyzer, a voltmeter, and a frequency counter for the analysis of single-shot or repetitive signals. Real-time analysis is possible as with dedicated instruments, but one of the real strengths of the precision digitizing oscilloscope, is that it can do post-processing and delimited analysis.

The three graphs show a sample of the measurement characteristics that are in the datasheet. Since the HP 5185T supports delimited analysis, the characteristics for the voltmeter and the frequency counter are graphed as a function of the number of periods.

- 4 ns minimum sample interval
- 8-bits of resolution
- 64 ksample per channel
- Characterized Analysis Results
- Optional high-stability timebase
- Enhanced triggering and timebase

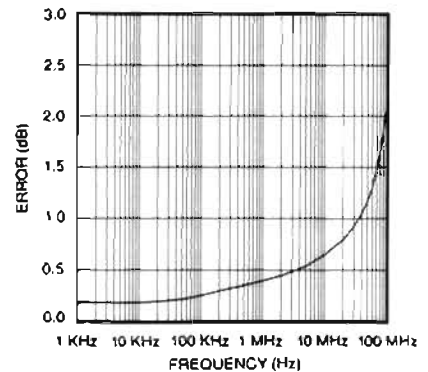

The spectrum plot shows that the error as the frequency goes up is due to the roll-off in the signal conditioning.

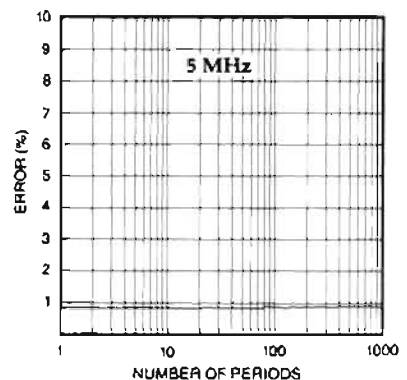

The periodic-rms voltage function ensures that you take the rms voltage of full periods only.

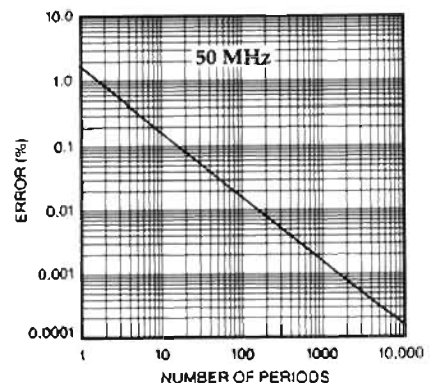

Increasing the number of periods for the frequency counter function improves the resolution. Option 010 ensures that today's measurements match tomorrow's because of the best aging rate available in a digitizing oscilloscope.

<sup>1</sup>Resolution can be determined as approximately 6 dB/bit.

See page 65 for specifications and ordering information.

# OSCILLOSCOPES & WAVEFORM ANALYZERS

## Waveform Recorder and Ordering Information

Models 5185A/T

65

- 250 Msamples per second
- 8 bits of resolution
- 64 ksamples per channel
- Includes powerful HP BASIC drivers
- 12 input ranges
- Enhanced triggering and timebase

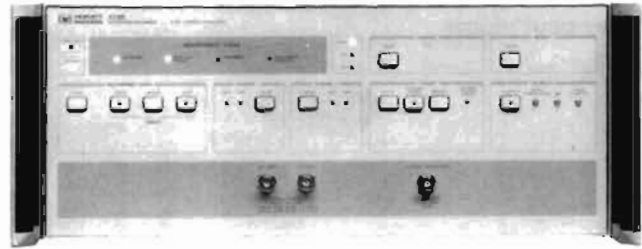

HP 5185A

### HP 5185A Waveform Recorder

For those applications that require high timing resolution coupled with the 48 db of dynamic range of the HP 5185T, but not the characterized analysis, real time control or custom display, the HP 5185A is the optimum solution.

### Powerful Data Acquisition with HP BASIC

The interface language of choice with instrumentation is HP BASIC because of rapid program development and easy control of complex instruments. The HP 5185A comes standard with BASIC software drivers for the HP 9000 series 200/300 computers to create an unparalleled data acquisition system. Raw data is transferred across the HP-IB bus at rates of 300 kbytes/second when the DMA card is installed in the computer.

### Lower Cost Solutions with PCs

When system throughput is not the critical factor, and an installed software base must be used for analysis, an IBM-PC compatible, such as the HP Vectra, can control the HP 5185A. This is accomplished with the standard software drivers when the PC has the HP 82300A BASIC language processor card installed.

### HP 5185A/T Condensed Specifications<sup>1</sup>

#### Channel 1 and 2 inputs

- Input attenuator ranges:**  $\pm 50$  mV to  $\pm 20$  V (full scale).
- Input offset voltage:**  $\pm 1.35$  V below 1 V range,  $\pm 20$  V on the 1 V range and above.
- Input Bandwidth ( $-3$  dB):**  $> 110$  MHz (nominal 125 MHz), with anti-alias filter (6-pole)  $< 70$  MHz (nominal 60 MHz).
- Input Impedance (nominal):** 1 M $\Omega$  switchable 15 pf or 50  $\Omega$ .
- Input coupling:** ac, dc.
- Damage level (50  $\Omega$  input):** 5 Vdc or rms all ranges.  
(1 M $\Omega$  input):  $\pm 30$  Vdc all ranges, 6.6 Vrms for input ranges below 1 volt, 30 Vrms for input ranges 1 volt and above.

#### Dynamic Performance after Calibration

- Harmonic and spurious distortion:**  $-46$  dBc @ 5 MHz,  
 $-36$  dBc @ 50 MHz.

- Effective bits:** 6.8 bits @ 5 MHz,  
6.5 bits @ 50 MHz.

#### Triggering

- Internal trigger:** level and sensitivity selectable over input voltage range.
- External trigger:** level selectable over  $\pm 2.5$  V.
- External source:** + and -.
- Internal source:** channel 1, channel 2, delay.
- Settable:** level, hysteresis, position, drop-out delay, delay from external trigger.
- Internal slope:**  $\pm$ , bi-trigger, posneg, and dropout.
- Trigger position:**  $-99\%$  to  $> 1600\%$  of record length.

#### Timebase

- Internal timebase:** 250 MHz internal timebase allows sample intervals of 4 ns, and 8 ns to 490 us in 8 ns multiples.

#### Internal reference:

- Timebase reference:** 10 MHz.
- Aging rate:**  $\pm 3 \times 10^{-6}$ /year after 10 days power.
- Temperature:**  $\pm 5 \times 10^{-6}$ , 0 to 50°C.
- External reference input:** 1, 2, 5, or 10 MHz.
- External encode:** variable from dc to 250 MHz. External encode signal can be divided down using internal timebase divide chain.
- Gated timebase:** Either the internal timebase or the external encode can be gated on and off with the external trigger.

### HP 5185T Condensed Specifications<sup>1</sup>

#### Measurement Control

- Triggering:** Auto, normal, single, and manual.
- Enhancements:** Capture, auto-advance, and loop-advance.
- Averaging:** Average from 1 to 100 records.

#### Memory

- Standard:** 65,536 samples per channel.
- Record size:** 1k samples to 64k samples in powers of two.

#### Timebase

- High stability frequency reference (Option 010)**
- Timebase reference:** 10 MHz
- Aging rate:**  $2 \times 10^{-7}$ /year after 10 days of power
- Temperature:**  $7 \times 10^{-9}$ , 0 to 50°C.

### HP 5185A<sup>1</sup>

#### Operating System Environment

BASIC software drivers operate under BASIC 4.0 on the HP 9000 series 200/300, and HP Vectra with HP 82300A.

#### Measurement Control

- Triggering:** Single and auto.
- Sweep delay:**  $10^{-2}$  seconds to  $10^5$  seconds (time until a trigger is forced for auto-trigger).

#### Memory

- Standard:** 65,536 samples per channel.
- Record size:** 64 samples to 64k samples per channel.

#### Ordering Information

**HP 5185A** Waveform Recorder 2-channel (includes an interconnect cable, software for control and data transfer on the HP series 200 and 300 computers, and one day of consulting).

**Price**  
\$28,200

#### Option for the HP 5185A

- Option W30** Two additional years of "return to HP" service and support add \$740

**HP 5185T** Digitizing Oscilloscope 2-channel (includes waveform analyzer, 2-channel recorder section, characterized analysis package, interconnect cables, and one day of consulting).

\$40,000

#### Options for the HP 5185T

- Opt 010** Oven Oscillator add \$1,200
- Opt 035** Floppy Disc Drive add \$1,000
- Opt W30** Two additional years of "return to HP" service and support add \$1,050

<sup>1</sup>See the HP 5185A/T Datasheet (Pub 02-5852-7883) for more information.

# OSCILLOSCOPES & WAVEFORM ANALYZERS

## Precision Digitizing Oscilloscope

Model 5183T/U

- Differential inputs
- Adaptive Sample Rate
- Dropout trigger
- 256K word per channel optional memory
- Complete calibration to probe tip
- Configurable as two or four channels



HP 5183T



### Unbeatable measurement resolution & accuracy

The HP 5183T/U provides many features unavailable from any other digitizing oscilloscope. Trigger features allow data acquisition that was previously either impossible, or required complex external trigger circuitry. The optional 512K word memory allows long continuous records to be acquired. In one channel operation, channel one can be configured to have 512K samples with option 512 installed. Adaptive Sample Rate gives the benefit of catching glitches that would ordinarily escape detection. The burst timebase feature allows samples to be gathered in packets of samples as small as 1 sample per trigger point. Calibration is now possible out to the probe tip providing greater absolute accuracy.

### Enhanced trigger capability

As with the other Hewlett-Packard waveform recorders, post- and pre-triggering are available. This permits viewing of the trigger point, the events leading up to the trigger point, or events that occur long after the trigger has occurred. Dropout trigger provides the capability to trigger on the absence of a signal. This means that the HP 5183T/U can be used to monitor a signal source such as a power main. The recorder can be configured with auto advance to capture up to 256 1K records showing dropouts, when Option 512 is installed.

Delay trigger is used in the following manner. A trigger event occurs at the external trigger input. Then, when a user defined delay elapses, the recorder will wait for the proper internal trigger and record in the operator defined environment. This can be used for recording signals such as a specific sector on a magnetic disc, using the index pulse as the external trigger, and the approximate delay to the proper sector.

Trigger-on-all allows the trigger circuitry to be or'ed together internally. This trigger scheme is also available in four channel operation, with two recorder sections being used together. This allows the designer to set up triggering conditions for the channels, and whichever event occurs first, will cause synchronous triggering and sampling in all channels.

High frequency trigger will cause the recorder to trigger on a glitch of sufficient amplitude or other large high frequency components in the waveform. This is only available with the optional Adaptive Sample Rate.

### Adaptive Sample Rate (ASR)

ASR provides rapid sampling only when it is needed. With this option, the recorder will sample at a slow speed until high frequency energy is detected. As this occurs, the timebase will speed up to capture the high frequency signal, returning to the slower speed when the high frequency ceases. This means that for many input signals, the memory can appear to be up to 30 Mbytes, when the optional 512K word memory is used.

### HP 5183T/U Specifications\*

#### Channel 1 and 2 inputs

**Maximum sensitivity (nominal):** 50  $\mu$ V.  
**Input attenuator ranges:** 100 mV to 50 V (Full scale).  
**Input offset voltage:**  $\pm$ 200% of input attenuator range.  
**Input bandwidth (nominal):** (-1 dB) 1 MHz, (-2 dB) 3 MHz with filter (10 pole), (-4 dB) 1 MHz, (-65 dB) 3 MHz.  
**Input impedance (nominal):** 1 M $\Omega$  in parallel with 45 pF.  
**CMRR at 10 kHz:** 60 dB on 100 mV to 1 V ranges.  
**Damage level:**  $\pm$ 5 V dc plus peak ac on 100 mV to 1 V ranges 400% of range dc plus peak ac or 2 V to 50 V ranges.

#### Dynamic performance after calibration

**Harmonic and spurious distortion:**  $\leq$ -65 dBc.  
**Effective bits:** 10.0 bits.

#### Triggering

**Internal trigger:** level and sensitivity selectable over input voltage range.

**External trigger:** level selectable over  $\pm$ 5 V.

**Internal source:** channel 1, channel 2, drop-out, delay, trigger-on-all, or high frequency trigger (with Option 301).

**Measurement control:** auto, normal, single, manual trigger.

**Settable:** level, hysteresis, position, drop out delay, delay from external trigger (sequential trigger).

**Slope:**  $\pm$  and bittrigger (internal only).

**Trigger position:** - 100% to + 6400% of record length

#### Timebase

**Internal timebase:** 4 MHz reference, sample intervals are between 250 ns and 4 s, in 250 ns increments.

**Ageing rate:**  $\pm$ 3  $\times$  10<sup>-6</sup>/year after 10 days of power.

**Temperature:**  $\pm$ 2  $\times$  10<sup>-6</sup>, 0 to 50 C.

**External timebase:** 1, 4 or 10 MHz.

**External encode:** dc to 2.1 MHz, or 1.9 MHz to 4 MHz.

#### Option 010

**Timebase:** 4 MHz is locked to high-stability 10 MHz reference.

**Ageing rate:** 2  $\times$  10<sup>-7</sup>/year after 10 days of power.

**Temperature:** 7  $\times$  10<sup>-9</sup>, 0 to 50°C.

#### Memory

**Size:** 65,536 words per channel, or 262,144 words per channel when Option 512 is installed.

**Segmentation:** memory can be configured as a single 131,072 word record for channel A, or between 1 to 64 equal length records for channel A and B.

When Option 512 is installed, memory can be configured as a single 524,288 word record for channel A, or between 1 and 256 equal length records for channel A and B.

**ASR (Adaptive Sample Rate):** Slows timebase by a 1:64 rate when high frequency energy is not present; Option 301.

\* See HP 5183T/U Data Sheet for more information. See page 67 for ordering information.

# OSCILLOSCOPES & WAVEFORM ANALYZERS

## Waveform Recorder and Ordering Information

Models 5183A/T/U

- Flexibility in signal conditioning
- 72 dB of dynamic range for analysis
- Includes BASIC and Pascal software drivers



HP 5183A

### HP 5183A Waveform Recorder

For those applications that require the superb fidelity of the HP 5183T, but not the packaged analysis routines, real time control or display, the HP 5183A is the ideal solution. It comes standard with software that enables control and data transfer in either BASIC or Pascal with the HP 200 and 300 series computer.

### HP 5183A Condensed Specifications\*

#### Channel 1 and 2 inputs

**Maximum sensitivity (nominal):** 50  $\mu$ V  
**Input attenuator ranges:**  $\pm$  100 mV to  $\pm$  50 V (full scale).  
**Input offset voltage:**  $\pm$  200% of input attenuator range.  
**Input bandwidth (nominal):** (-1 dB) 1 MHz, (-2 dB) 3 MHz with filter (10 pole), (-4 dB) 1 MHz, (-65 dB) 3 MHz.  
**Input impedance (nominal):** 1M $\Omega$  in parallel with 45 pF.  
**CMRR at 10 kHz:** 60 dB on 100 mV to 1 V ranges.  
**Damage level:**  $\pm$  5 V dc plus peak ac on 100 mV to 1 V ranges 400% of range dc plus peak ac or 2 V to 50 V ranges.

#### Dynamic Performance after Calibration

**Harmonic and spurious distortion:**  $\leq$  -65 dBc.  
**Effective bits:** 10.0 bits.

#### Triggering

**Internal trigger:** level and sensitivity selectable over input voltage range.  
**External trigger:** level selectable over  $\pm$  5V.  
**Internal source:** Channel 1, Channel 2.  
**Measurement control:** auto, normal, single, manual trigger.  
**Settable:** level, hysteresis, position.  
**Slope:**  $\pm$  and bi-trigger (internal only).  
**Trigger position:** -100% to +6400% of record length.

\*See HP 5183A Recorder Data Sheet (Pub 5952-7824D) for more information.

#### Time Base

**Internal time base:** 4 MHz internal time base allows sample rates between 250 ns and 4 s, in 250 ns increments.  
**External time base:** 1, 4 or 10 MHz.  
**External encoder:** dc to 2.1 MHz or 1.9 MHz to 4 MHz.

#### Memory

**Size:** 65,536 words per channel, or 262,144 words per channel when Option 512 is installed.

### Ordering Information

Price

<b>HP 5183A</b> Waveform Recorder 2-Channel (includes an interconnect cable and software for control and data transfer on the HP 200 and 300 series computers)	\$ 12,000
<b>HP 5183T</b> Digitizing Oscilloscope 2-Channel (includes waveform analyzer, 2-channel recorder section, and interconnect cables)	\$ 19,900
<b>HP 5183U</b> Digitizing Oscilloscope 4-Channel includes waveform analyzer, 2 two-channel recorder sections, and interconnect cables.	\$ 29,900
<b>Options for HP 5183T</b>	
Opt 010 Oven Oscillator	+\$1,200
Opt 035 Floppy Disc Drive	+\$1,000
Opt 301 Adaptive Sample Rate	+\$3,100
Opt 512 512K Word Memory	+\$5,200
<b>Options for HP 5183U</b>	
Opt 010 Oven Oscillator	+\$1,200
Opt 035 Floppy Disc Drive	+\$1,000
Opt 301 Adaptive Sample Rate	+\$6,200
Opt 512 512K Word Memory	+\$10,400

# OSCILLOSCOPES & WAVEFORM ANALYZERS

## Digitizing Oscilloscope and Waveform Recorder/Measurement System

Models 5180T/U, 5180A, 5180S, 51800A

- High quality display
- Built-in analysis provides answer and raw data
- Utilizes the HP 5180A for quality digitization
- 16K memory records up to 32 waveforms
- High-speed signal acquisition
- Accurately digitizes transient signals
- Up to 1 million words/s data transfer



HP 5180T (HP 5180U not shown)

### HP 5180T/U

#### Automatic Analysis

The HP 5180T/U delivers answers normally associated with other instruments such as time interval counters, voltmeters, spectrum analyzers, and storage oscilloscopes. Unlike other instruments, these digitizing oscilloscopes require only one waveform capture to get results. After you capture your signal, you can view it as you would with a storage oscilloscope; you can zoom in to view details, analyze pulses, view its frequency spectrum, and measure its rms or peak-to-peak amplitude - all using the same signal.

#### Dynamic Performance

Dynamic (ac) performance can mean the difference between just looking at a waveform or completely analyzing it. To help you analyze your signals thoroughly, the HP 5180T/U provides 10-bit resolution for waveform data while delivering fully specified, high-fidelity dynamic performance.

#### Automatic Setup

The display provides many convenient features that enhance the system's waveform capture. For example, the AUTOSCOPE function acquires repetitive waveforms and automatically sets the input amplifier, trigger level, and time base to the appropriate values for optimum signal viewing. Existing front-panel settings are automatically saved in non-volatile RAM when AUTOSCOPE is pressed. You can also save up to four additional front-panel setups for recall at your convenience. An optional built-in floppy disc, which is compatible with those for the HP 9000 Series 200 and 300 Computers, lets you store both front-panel settings and captured waveforms. See page 69 for condensed specifications and ordering information.

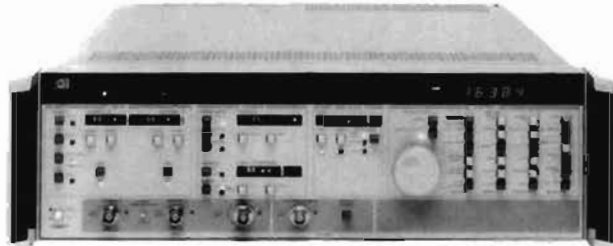

HP 5180A

### HP 5180A

#### High Quality Samples Every 50 Nanoseconds

Signal processing requires high quality input data. Hewlett-Packard's 5180A Waveform Recorder digitizes and stores single-shot or repetitive signals. Voltage waveforms are digitized at sampling rates up to 20 M sa/s (50 ns/sample). Each voltage sample is encoded into a 10-bit word and stored into the memory. These precise voltages (and times) can be read from the front panel with cursors.

Excellent dynamic performance (please read HP Product Note 5180-2) means the ADC does not break up for higher input frequencies. Therefore, your signal is accurately represented for analysis (and replay; see the next pages for description of the HP 5182A Waveform Recorder/Generator).

**Accurately Digitize Transients** - The shape of fast attack and decay single-shot waveforms is preserved because the higher frequency components are accurately digitized. The digital trigger is precisely settable ensuring reliable triggering with no drift. Selectable hysteresis eliminates false triggering due to noise.

#### View Single-shot or Repetitive Signals Quickly

The HP 5180A controls external XYZ displays and hardcopy devices to show the contents of memory records without the need for a computer. Zoom and Gain features expand displayed waveforms horizontally or vertically to look in detail at a selected portion of a waveform. Dual trace capability puts two waveforms on an external display for visual comparison. Digital plotters and printers are controlled by HP-IB. There are two methods of transferring data from the HP 5180A to a computer for analysis: HP-IB and DMA. Direct Memory Access (DMA) can transfer data at a rate up to 1 million words/second, depending on the computer.

The HP 5180A can begin recording a signal at one sampling rate and then switch to another. The switch point is selectable. Set one timebase at a faster sample rate to record more detail, and set the other at a slower rate to conserve memory space. Two transients may be recorded simultaneously using the HP 5180A's input CHOP mode.

The HP 5180A is fully programmable over HP-IB for automated operations. See page 69 for condensed specifications and ordering information.

- Automatic measurements
- Universal measurement solutions
- Modular software



HP 5180S

## HP 5180S and HP 51800A

### Automatic Time Domain Measurements

Make time domain measurements on single-shot or repetitive waveforms with the HP Model 51800A Waveform Measurement Library. The library is a collection of programs designed to make measurements on signals captured by the HP 5180A Waveform Recorder and HP 5182A Waveform Recorder/Generator. Instruments are controlled by sub-programs. All you do is chain them together to make the measurements you need.

### Realize the Power of a Waveform Recorder by Interfacing It to an HP Series 200 or 300 Technical Computer

The HP 5180S Waveform Measurement System allows you to configure a computer-controlled system based on the HP 5180A Waveform Controller. Because the signal has been digitized and stored, it can now be sent to a computer for analysis and then to a disc for permanent storage. Frequency, Period, Pulse Width, Rise/Fall Time, Volts rms and Volts p-p are some of the many standard measurement programs.

### HP 5180A/T/U Specifications

See HP 5180A Waveform Recorder or HP 5180 T/U Digitizing Oscilloscope Data Sheet (Pub 5952-7722D & 5952-7835D) for more information.

#### Channel A and B Inputs

**Maximum sensitivity:** 200  $\mu$ V.

**Input attenuator range:**  $\pm$ 100 mV to  $\pm$ 10 V (full scale).

**Input offset voltage:**  $\pm$  selected Voltage Range.

**Amplifier bandwidth (-3 dB):** dc to 40 MHz (dc coupling).  
10 Hz to 40 MHz (ac coupling).

**Input impedance (NOMINAL):** 1 M $\Omega$  || 40 pF (10 V range).  
1 M $\Omega$  || 35 pF (other ranges).

**Damage level:**  $\pm$ 12 V above 1 kHz.

#### Dynamic Performance (at 1 MHz)

**Harmonic and spurious distortion:** -50 dBc

**Effective bits:** 7.8

#### Triggering

**Internal trigger:** level and sensitivity selectable over input voltage range.

**External trigger:** level selectable over  $\pm$ 2.5 V range.

**Trigger position:** -100% to +9999% of memory.

#### Timebase

**Internal timebase:** 20 MHz internal timebase allows sample rates between 50 ns and 50 ms in a 1-2-5 sequence.

**External timebase:** external timebase signals between 1 MHz and 20 MHz may be used. Internal divide ratio between 1 and  $10^6$  in a 1, 2, 5 sequence.

- Increase test design productivity
- Choose standard measurements
- Add custom tests

#### Memory

**Size:** 16,384 10-bit words.

**Segmentation:** memory may be divided into 1, 2, 4, 8, 16, or 32 equal-length records.

#### Outputs

**XYZ CRT monitor outputs:** X, Y deflection voltages (NOMINAL) -1 to 0V into 50  $\Omega$ . X requires 1 MHz bandwidth input; Y requires 5 MHz bandwidth input. Z voltage (NOMINAL) is 0 to 2 V into 1 k $\Omega$  (0 to 1V into 50  $\Omega$ ), selectable positive or negative going blanking pulse. Z requires 1.25 MHz bandwidth input.

**HP-IB:** all front panel function values selectable via HP-IB. Data I/O in ASCII or binary; maximum 3 Kbyte/second rate, depending on controller. "Talk only" to HP-GL plotters available even if no controller is used.

**DMA:** direct memory access allows fast parallel data transfer; maximum 1M word/second, depending on controller.

#### General

**Operating temperature:** 0°C to 55°C.

**Power requirements:** 100/120/220/240 volts  $\pm$ 5%, -10%; 48 to 66 Hz. Max power dissipation 500 VA.

**Weight:** 22 kg (48 lb) net; 25 kg (53 lb) shipping.

**Size:** 142 mm H x 426 mm W x 574 mm D (5 $\frac{1}{2}$ " x 16 $\frac{1}{2}$ " x 23").

### Ordering Information

HP 5180A Waveform Recorder

\$19,600

HP 5180S Waveform Measurement System

N/C

To ensure coordination of shipments and compatibility of instruments, computers and software, use the system model number when ordering the individual components, including peripherals such as printers and plotters. Obtain an HP 51800A Data Sheet and HP 5180S Ordering Guide from your local sales office.

HP 51800A Waveform Measurement Library

\$1,200

HP 5180T Digitizing Oscilloscope (2 Channel) includes waveform analyzer, two-channel recorder section, and interconnect cables

\$29,900

HP 5180U Digitizing Oscilloscope (4 Channel) includes waveform analyzer, 2 two-channel recorder sections, and interconnect cables

\$49,600

#### Accessories for HP 5180A

HP 10871B Service Kit

\$4,500

HP 10873A Rack Mount Kit

\$140

HP 10874A Slide Mount Kit

\$190

HP 10875A 4.8 m DMA Cable

\$180

HP 10875B 1.0 m DMA Cable

\$180

Opt 910 Additional Manuals

+\$170

#### Option for HP 5180T/U

Opt 035 Floppy Disc

+\$1,000

#### Accessories for HP 5180U

HP 1008A Testmobile

\$950

Opt 002 Storage Shelf and Lower Cabinet

+\$115

To ensure coordination of shipments and compatibility of instruments and peripherals such as printers, plotters, and disc drives, it is important that you request the appropriate Data Sheets and Ordering Guides from your local sales office.

# OSCILLOSCOPES & WAVEFORM ANALYZERS

## Waveform Recorder/Generator, 20 MHz, 10 Bits, 16K Word Memory

### Model 5182A

- 16K nonvolatile waveform memory
- Fully programmable via HP-IB
- Quickly transfer waveforms to/from computer
- Easily simulate complex, real signals
- Record single-shot, replay repetitively



### Duplicate Infrequent Waveforms Whenever You Need Them

Get an "instant replay" of your single shot signal when you buy a HP 5182A Waveform Recorder/Generator. Also create repetitive signals by playing back a single recording over and over again with no time gap between replays.

Now you can test your circuits with the actual signal you record rather than a theoretical one. "What if" testing can be done by adding a computer to modify and store the waveforms. An HP Series 200/300 Technical Computer, HP 9111A Graphics Tablet and an HP 5182A comprise the HP 5182S Waveform Generation System.

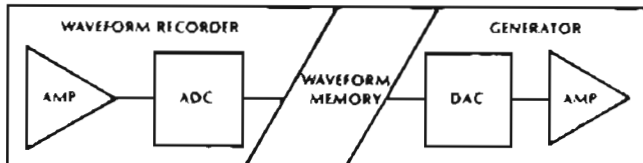

### A Waveform Recorder/Generator is a High Speed Digital "Tape" Recorder

The "tape" is silicon memory. At 20 M samples per second, it can store 819  $\mu$ s, 819 seconds at 20 samples per second. This digitized waveform can be played back once, or over and over again with no time gap. For example, you can accurately store 16 separate lines of video, or a single sector of data from a floppy disc drive. The video signal can generate color bar patterns to test video circuits. The disc signal can be used to test read-recovery circuits.



### Capture and Save in the Field, Replay on the Bench

Continuous (battery backed up) waveform memory allows you to record up to 32 waveforms on site. Remove the power and carry the HP 5182A back to the lab. Now you can play them back to test your circuits or for further analysis. Attach the HP 5182A to an HP Series 200/300 Technical Computer and you can store the waveforms on disc, process them further and modify them for "what if" testing.

### Simulate Expensive, Single-Shot Experiments

Some experiments can be very time consuming and expensive to repeat, for example: biomedical experiments, measurements of explosions, and propagation experiments such as radar and sonar. With the HP 5182A you can capture the signal accurately, when it occurs. Then, switch to generator mode, and you're ready to replay it, any time you need it.

A sync pulse is generated once per playback cycle for synchronizing other equipment.

### Generator Section Specifications

For accessories and specifications of the recorder section, please see page 69.

#### Peak output voltage (for full-scale waveform) into 50 ohms

Range	Vernier Range	Min	Max	Vernier Step Size
5.12 V	520 mV	5.12 V	40 mV	
512 mV	52 mV	512 mV	4 mV	
51.2 mV	5.2 mV	51.2 mV	0.4 mV	

Max. output voltage into open circuit: 10 V (NOMINAL).

Output offset:  $-5.12$  V to  $+5.11$  V in 10 mV steps into 50 ohms.

AC Performance: Noise:  $-65$  dBc.

Harmonic distortion (dc to 1 MHz):  $-48$  dBc.

Spurious (sample rate related):  $-40$  dBc TYPICAL.

Output risetime: 100 ns max. (10% to 90%).

Amplifier bandwidth ( $-3$ dB): 10 MHz (NOMINAL)

DC performance (10 bits resolution per sample)

Differential nonlinearity:  $<1$  LSB (Monotonic).

Integral nonlinearity:  $<3$  LSB.

Offset accuracy: 100 mV (20-30°C).

Absolute accuracy: 1% of p-p full scale range (20-30°C).

Internal trigger: Output automatically triggered when armed

External trigger: Slope, level, hysteresis, width, impedance, coupling and maximum input same as for Recorder. (See page 69).

Insertion delay: 250 ns max

#### Time base modes

**Main only:** Available in Single, Auto, and Normal Sweep Arm modes.

**Mixed (main, delay):** Available in Single and Normal Sweep Arm modes.

**Memory size:** 16384 10-bit words; Segmentation: 1,2,4,8,16 or 32 equal length blocks. Generation: Data may be generated from any memory block. Within any one block, a portion of the waveform may be generated by setting the starting point and stopping point. An even number of points is always output.

**Sync output:** Voltage: 0 to  $-0.75$  V NOMINAL into 50 ohms. Pulse Width: One sample interval with the falling (first) edge active (or approximately 100  $\mu$ s when the sync pulse is past the stop position, and Sweep Arm is Single or Normal). Position: Settable from first point in the record to the last point. If the sync position is set outside the limits of the Start and Stop Position markers, the output record is extended to include the Sync Position by assigning a dc voltage (equal to the nearest Start/Stop Position marker) to the waveform between the Start/Stop Position marker and the sync position.

#### Ordering Information

HP 5182A Waveform Recorder/Generator

\$23,900



- Save time storing and recalling waveforms
- Quickly modify and utilize waveforms
- Save time when generating arbitrary waveforms
- No programming necessary

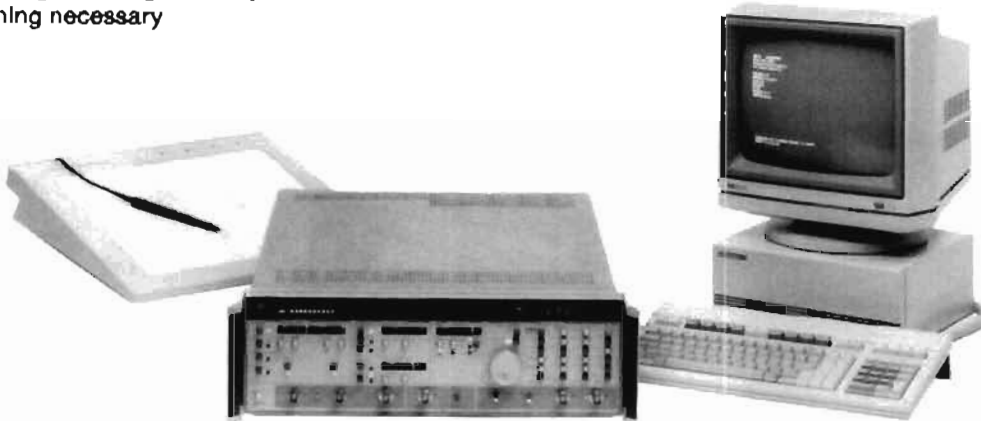

The 5182S waveform capture and playback system.

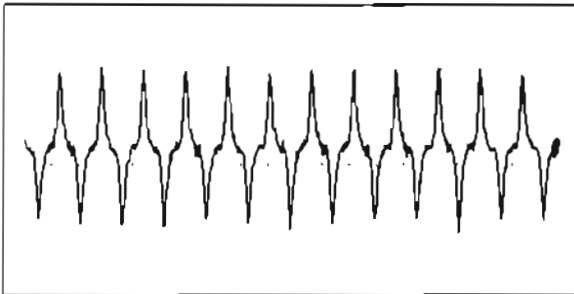

This signal was recorded from a floppy disc read head.

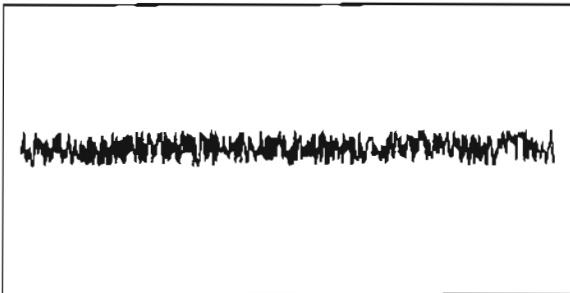

Combined with noise generated from built-in function . . .

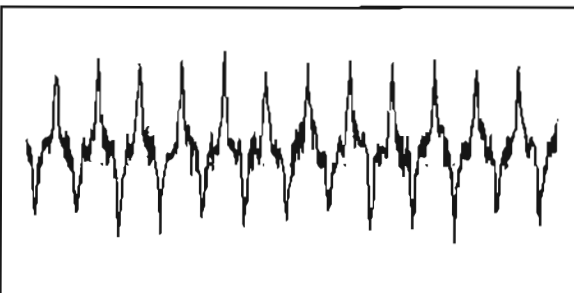

It is used to test the sensitivity of read recovery circuits.

### Save Time Generating Specialized Waveforms

The HP 51820A Software is a powerful set of tools for creating specialized waveforms. Modify captured waveforms or define new ones with the HP 46087A graphics tablet (part of the HP 5182S system). Simply press a SOFTKEY to send waveforms to the HP 5182A for replay or disc for storage. Since the HP 51820A is a complete package (no programming is required), you are productive immediately.

The software is driven by a main menu and three submenus: draw, process and I/O. Because it's only two levels deep, you won't get lost in multiple levels of menus.

### Waveform Capture, Modification and Playback

Modify waveforms you've captured and play them back into the device you are testing. Rather than waiting for a glitch to occur randomly, you can draw one and see the circuit response immediately.

Waveforms can also be modified by processing. Simple functions like offset and gain are built into the SOFTKEY MENU. There are also SOFTKEYS for adding or multiplying two waveforms together.

More complicated processing like calculus and convolution can be accomplished by modifying the user-equation subroutines. Four SOFTKEYS are reserved for your own equations. The Software comes with the equations programmed to generate sine waves, triangle waves, square waves and random noise.

### Arbitrary Waveform Generation

There are three ways to create the waveforms you need. You can recall waveforms from the library, including sine waves, square waves,  $SIN(X)/X$ , Gaussian pulses, exponentials and more. You can calculate waveform samples with equations. Third, you can draw or trace waveforms with the graphics tablet. Choose the method that will get you the signal you need in the shortest time.

### Ordering Information

HP 5182S Waveform Generation System

Price  
N/C

To ensure coordination of shipments and compatibility of instruments, computers and software, use the system model number when ordering individual components including peripherals such as printers and plotters. Obtain HP 51820A and HP 51800A Data Sheets and a HP 5182S Ordering Guide from your local sales office. See page 760.

HP 51820A Waveform Generation Software

\$1,200

# OSCILLOSCOPES & WAVEFORM ANALYZERS

## Three-Channel Recorder to 3 kHz, 12 Bits, 33.3 kHz Sample Rate

### Model 7090A

- DC to 3 kHz bandwidth, 33.3 kHz sampling rate
- 3 Channels with simultaneous sampling
- 12-bit resolution, 1 k buffer/channel
- 6 trigger modes with up to 100% pre-trigger capture
- Full HP-IB programmability
- Annotation of set-up and trigger conditions and data points



The HP 7090A is designed for low-frequency (< 3 kHz) measurement, analysis, and documentation. The HP 7090A merges several technologies - waveform recording, digital plotting, analog recording, and automated measurement - to provide a powerful solution to a broad range of measurement applications. It significantly increases the ability to measure and display low-frequency phenomena and substantially improves real-time recording and digital plotting ... all in one low-cost system.

#### Signal Capture

Simultaneous sampling on each of three channels, 12-bit resolution, bandwidth of dc to 3 kHz (33.3 k samples/s maximum), and 1000 word memory per channel allow high resolution measurement, storage, and display.

#### Flexible Triggering

The HP 7090A has six trigger modes which allow virtually any signal change to initiate signal capture, even decaying repetitive signals such as faults in a power line voltage, or in a transducer's carrier. Combined with pre-trigger capability, these trigger modes make the HP 7090A ideal for turn-on/off characterization, fault monitoring and mechanical motion analysis.

#### A System Component

All panel functions are programmable via the HP-IB interface. Data can be transferred from the internal 1 k-buffers or streamed in real time from the analog-to-digital converters at up to 500 points/s. In addition, the menu-driven HP 17090B Measurement Graphics Software package is available for HP 9000 Series 200 computers (BASIC 3.0 only). The software allows easy data manipulation, storage and retrieval, and system integration.

#### Versatile Capabilities

Uniquely, the HP 7090A is also a high performance analog/digital plotter. It is ideal for a graphics dump from a smart instrument or as part of an HP-IB system; you can also use the HP 7090A to take an X-Y dump from an analog instrument. With the HP 7090A, hand annotation is unnecessary. The 7090A annotates setup conditions, date and time, selected data points from memory, and trigger information. It draws user-defined axes and grids, eliminating the need for

pre-printed graph paper. The HP 7090A even lets you plot overhead transparencies for technical presentations using your current spreadsheet/graphics software.

#### Applications

**Capturing Low Frequency Electrical Transients:** General diagnostic monitoring (such as looking for relative timing sequences) and fault monitoring (capturing pre-trigger data for intermittent failure analysis) are natural applications for the HP 7090A.

**Measuring Phase Relationships:** The simultaneous sampling on all channels is ideal for measuring current/voltage phase relationships in power systems.

**Analog Instrument/Digital System Link:** The HP 7090A can integrate an analog instrument into an HP-IB system: the HP 7090A, with a controller can digitize output voltages from analog instruments for HP-IB system data entry.

**Mechanical and Electromechanical Testing:** Applications in which transducers convert velocity, acceleration, force, temperature or torque to voltage are a good fit for the HP 7090A. These applications have a maximum output frequency below 3 kHz. The HP 7090A's flexible trigger capabilities make it useful for one-shot electromechanical events such as clutch and mechanism engagements.

**Electromechanical Control Systems:** The HP 7090A can measure the response of a system to a stimulus; a typical use would be exciting the system with a step function and using the measured response to determine damping ratio and the natural frequency of the control system.

**Material Testing:** The HP 7090A can record classic stress-strain curves, particularly those obtained from destructive testing. The data is stored in a buffer, so even though the sample has been destroyed, the data can be viewed and rescaled in several different ways.

**Automatic Test:** When linked to an HP 9000 Series 200 computer, the HP 7090A is a good, inexpensive learning tool for small companies considering automatic test systems. Applications include environmental and production line testing and proof of performance records.



**Measurement Graphics Software**

HP 17090 Measurement Graphics Software is designed to access the full capabilities of the HP 7090A Measurement Plotting System and integrate it into computer system applications. This software is compatible with properly configured Series 200 and Series 300 computers. The computer system must have ten softkeys, a knob, and separate displays for alpha characters and graphics. The main user interface with this software is through 10 softkeys on the computer's keyboard and a knob.

**Program Capabilities:** There are six main functional areas of Measurement Graphics Software: measurement setup, measurement, display, annotation, storage and retrieval, and data manipulation.

Measurement Graphics Software helps you use the HP 7090A's features easily and efficiently, and it provides storage, annotation and data transformation capabilities not available on the HP 7090A Unit alone.

**Friendly, Menu-driven Interface:** Each menu allows the user to view several parameters simultaneously. Series 200 and 300 softkeys and cursor-control knob minimize keyboard input, and the "help" softkey displays the available choices and ranges for each parameter setting.

**System Requirements**

The following table lists the operating system, memory, and equipment that are needed to use the software with the HP 7090.

HP 17090 Version	Operating System	Available Memory <sup>1</sup>		Applicable HP 9000 Models
		Minimum	Optimum	
A	BASIC 2.0	235K	470K	HP 216 HP 226 HP 236 HP 220 <sup>2</sup>
B	BASIC 3.0	216K	433K	HP 216 HP 226 HP 236 HP 220 <sup>2</sup>
C	BASIC 4.0/4.03	245K	470K	HP 216 HP 217 <sup>3</sup> HP 226 HP 236 HP 220 <sup>3</sup> HP 237 <sup>1</sup> Series 300 <sup>4,5,6</sup>

<sup>1</sup>Memory required after loading BASIC and all necessary binary files. With minimum RAM, short delays will be encountered when software subsystems are swapped in memory.

<sup>2</sup>Applicable when equipped with an HP 98203A/B Keyboard.

<sup>3</sup>Applicable when equipped with BASIC 4.03 and an HP 98203C Keyboard. The HP 220 may also be used with BASIC 4.0 and an HP 98203A/B Keyboard.

<sup>4</sup>BASIC 4.03 is required when the computer is equipped with an HP 98203C Keyboard.

<sup>5</sup>The HP 46083A Knob is required when the computer is equipped with either an HP 46020A or 46021A Keyboard.

<sup>6</sup>The HP 98546A Display Compatibility Interface is required when the computer is equipped with a single-plane monochrome bit-mapped display.

**Summary of HP 7090A Specifications\***

**Inputs**

- Number of channels: 3
- Input alternator range: ±5 mV to ±100 V (full scale)
- Input offset voltage: ±2 full scale or ±100 V maximum
- Amplifier bandwidth (≥ 3 dB): dc to 3 kHz for all full scale ranges ≥ 20 mV, 2.6 kHz for all full scale ranges ≤ 20 mV
- Input impedance: 1 Mohm, shunted by 45 pf (Nominal)
- CMRR: 140 dBdc; 100 dBac @ 60 Hz with 1 kohm unbalance in LOW terminal and most sensitive range (at 25°C)

**Dynamic Performance**

- Slewing speed (Nominal)
  - Direct mode: 127 cm/s (50 in/s)
  - Plotting mode: 75 cm/s (30 in/s)
- Acceleration (Nominal): 2 g constant
- Peak capture: 250 μs at fastest timebase range

**Triggering**

- Internal trigger:
  - Inside or outside window
  - Above or below level, selectable over the full-scale range in 1.0% increments (Nominal)
  - Source: channel 1
- External trigger:
  - BNC connector, TTL level or contact closure to ground
- Manual trigger:
  - Available from front panel controls
- Display: Up to 100% pre-trigger; up to 24 hour post-trigger delay after trigger before measurement start

**Timebase**

- Range:
  - Buffer mode: 30 milliseconds to 24 hours
  - Direct record mode: 1 second to 24 hours
- Accuracy: ±0.1%

**Memory**

- Size: 1 K per channel
- Resolution: 12 bits

**Supplemental Characteristics**

**Analog to Digital**

- Maximum sampling rate: 33.3 k samples/s
- Maximum streaming rate over HP-IB:

	ASCII	Binary
1 channel	167/s	500/s
1 channel plus trigger	143/s	333/s
3 channels	59/s	167/s
3 channels plus trigger	59/s	167/s

**Writing System**

- 6-pen carousel with automatic pen capping
- Fiber-tip pens for paper or transparencies

**Ordering Information**

- HP 10833A HP-IB (IEEE-488) 1-meter cable \$81 ☛
- HP 10833B HP-IB (IEEE-488) 2-meter cable \$91 ☛
- HP 17090 Measurement Graphics Software A/B/C
  - Option 630 (3.5 in. disc size) \$700
  - Option 655 (5.25 in. disc size) \$700
- HP 7090A Measurement Plotting System \$4,900

\*Refer to page 81 for complete specifications.

☛ Fast-Ship product—see page 758

# OSCILLOSCOPES & WAVEFORM ANALYZERS

## Probe Multiplexer

Models 54300A, 54001A, 54002A, 54003A

- Expand Input Capability Of 50 $\Omega$  Instrumentation
- Your choice 50 $\Omega$ , 10k $\Omega$  & 1 M $\Omega$  Input Pods

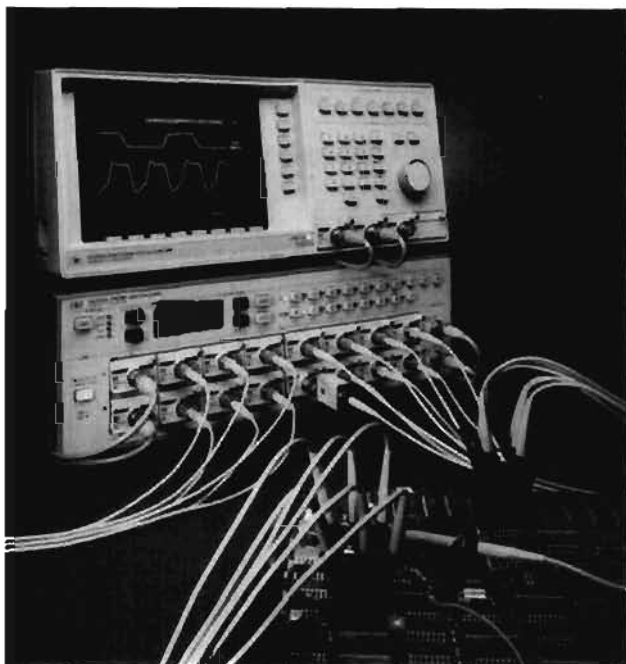

The HP 54300A probe multiplexer expands the input capability of the HP 54100A/D digitizing oscilloscope, or any 50 $\Omega$  Input Instrument, simplifying delicate high-frequency connections.

### The Multi-input Tool For 50 $\Omega$ Instrumentation

The HP 54300A is a programmable, dual eight-to-one probe multiplexer designed to expand the input capability of instrumentation with 50 $\Omega$  inputs. The unique strength of this multiplexer is its configurability. The user may select from three different input pods: two high-frequency, high-impedance probes, or a 50 $\Omega$  BNC input for terminated line applications.

The HP 54300A features full HP-IB programmability as well as simple front-panel control. It has internal non-volatile memory for storing lists of switching steps. Switch lists can be advanced step-by-step from a front-panel button, over the HP-IB (i.e., IEEE-488) or for data logging applications, through a TTL pulse entered at the rear panel.

### Automate Complex Measurements

The HP 54300A is ideal for delicate situations where high frequency connections must be maintained and probes cannot be conveniently moved from one connection to another. Complex measurements can be automated by using the multiplexer's 16 inputs, switching one or two of them at a time into the test instrument, under computer control. In situations requiring more than 16 inputs, HP 54300A multiplexers may be cascaded in series to give a total of 128 inputs.

### Your Choice Of Inputs

Configurable input is one of the HP 54300A's strongest contributions. It accepts all of the input pods designed for the HP 54100/110 1 GHz digitizing oscilloscope.

- Fully HP-IB Programmable, Plus Convenient Front-panel Control
- Internal Non-volatile Memory

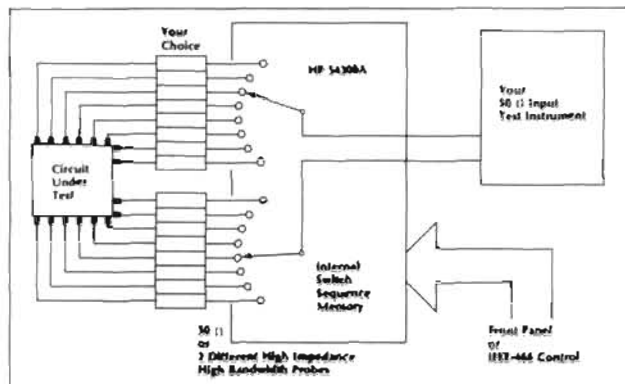

The HP 54300A's configurable inputs and HP-IB programmability make it a powerful addition to your bench or ATE system.

### HP 54001A 1 GHz Active Mini-probe Pod

This pod, with its built-in probe, offers 1 GHz bandwidth with 10k $\Omega$ /2 pF input loading. It uses HP's mini-tip probe for easy access in compact circuits, and features both high-bandwidth and high-impedance at the probe tip. This probe is ideal for making high-speed logic measurements, where high bandwidth is needed and probe capacitance is a significant factor in loading the test circuit.

### HP 54002A 50 $\Omega$ BNC Pod

This pod should be used with terminated 50 $\Omega$  systems. Output from the multiplexer using this pod is <2 dB down at >1 GHz. The 54002A is also useful with divider probes such as the HP 10020A.

### HP 54003A 300 MHz 1 M $\Omega$ Probe Pod

This pod, with a 10:1 detachable mini-tip probe, has 1 M $\Omega$  resistive and 8 pF capacitive loading. It is valuable when resistance is a more significant loading factor than capacitance, such as in operational amplifier measurements. If desired, the probe may be removed from its pod to provide a 1 M $\Omega$  approximately 10 pF BNC input.

### Fully Programmable For Automated Testing

All functions that can be controlled from the HP 54300A front panel can also be controlled over the HP-IB. Simple, English-like commands are used with an optional format that is compatible with the command language of the HP 3488A switch/control unit.

The HP 54300A command set is simple, but complete. Even information such as the type of input pod that is being used or the total number of switch closures that have occurred on a given switch pole may be obtained over the bus. This information is useful in determining whether the correct pods have been inserted for a particular automatic program, or to indicate when switch replacement is due. The HP 54300A is a powerful complement to other HP programmable instruments and HP computers for automated testing of high-frequency circuits.

### Ordering Information

	Price
<b>HP 54300A</b> dual 8:1 probe multiplexer	\$7900
Includes one operating and programming manual. Each HP 54300 accepts up to 16 input pods in any combination. Pods must be ordered separately.	
<b>Opt. 908</b> Rackmount flange kit	\$35
<b>HP 54001A</b> 1 GHz miniature active probe pod	\$765
<b>HP 54002A</b> 50 $\Omega$ BNC input pod	\$130
<b>HP 54003A</b> 1M $\Omega$ 10:1 probe pod	\$665

For information on other probes and probing accessories, please refer to the section on the HP 54100/110 digitizing oscilloscope, page 75.

- Modular construction
- Improved electrical performance
- New accessories

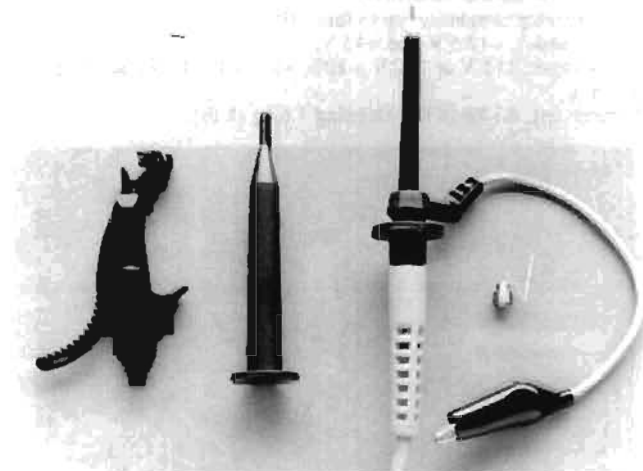

### The HP 10400A Miniature Probe Family

The HP 10400A miniature probe family offers modular construction, improved reliability, and superior electrical performance over our previous mini-probes. Modular construction allows individual replacement of probe tips, cables, and chassis assemblies cutting down on probe replacement and repair costs. Improved cable and strain relief design increase reliability. Electrical performance is also improved by reducing the probe shunt capacitance and increasing the input resistance that load the circuit under test.

The HP 10400A mini-probe family also features new accessories (see below) including a new ground lead utilizing a ferrite bead for reduced ringing on pulse tops, and a new IC grabber that allows easy connection of a single probe to many IC packages without fear of shorting adjacent pins.

### OSCILLOSCOPE/MINIATURE PROBE COMPATIBILITY AND PROBE CHARACTERISTICS

HP Oscilloscope/ Logic Analyzer	HP Probe Model No.	Approx Overall Length in Metres (ft)	Division Ratio	Input R	Approx Shunt Capacitance	Compensates Oscilloscope Input	Max dc Volts	Price	
Same as 10431A but without probe indent	10430A	1m (3.3)	10:1	10MΩ	6.5 pF	1MΩ 6-9 pF	450	\$115	☞
54111A	10431A*	1m (3.3)	10:1	10MΩ	6.5 pF	1MΩ 6-9 pF	450	\$120	☞
1631A/D, 1715/22/25/26/27 1805/09, 54200/201	10432A**	1m (3.3)	10:1	10MΩ	7.5 pF	1MΩ 10-16 pF	450	\$105	☞
1631A/D, 16530/31 54003A, 54200/201	10433A	2m (6.5)	10:1	10MΩ	10 pF	1MΩ 10-16 pF	450	\$105	☞
1740/41/42/43/44/45/46	10434A	1m (3.3)	10:1	10MΩ	8 pF	1MΩ 18-22 pF	450	\$105	☞
1631A/D, 1715/22/25/26/27 1805/09, 54200/201	10435A	1m (3.3)	10:1	1MΩ	7.5 pF	1MΩ 10-16 pF	450	\$115	☞
1740/41/42/43/44/45/46	10436A	2m (6.5)	10:1	10MΩ	11 pF	1MΩ 18-22 pF	450	\$110	☞
For oscilloscopes with 50 inputs	10437A	2m (6.6)	1:1	50Ω				\$80	☞
All scopes with high Z inputs (may reduce bandwidth)	10438A	1m (3.3)	1:1		40 pF		450	\$85	☞
	10439A	2m (6.6)	1:1		64 pF		450	\$90	☞
1631A/D, 1715/22/25/26/27 1805/09, 1950A 54003A, 54111D, 54200/201	10440A	2m (6.6)	100:1	10MΩ	2.5 pF	1MΩ 6-14 pF	450	\$115	☞

Note 1. Maximum input voltage may be limited by scope input maximum voltage.

\*Has probe identification pin.

\*\*The 54201A/D use the HP 10432A probe for the vertical inputs and the HP 10435A probe for the trigger inputs.

☞ Fast Ship Product—see page 758.

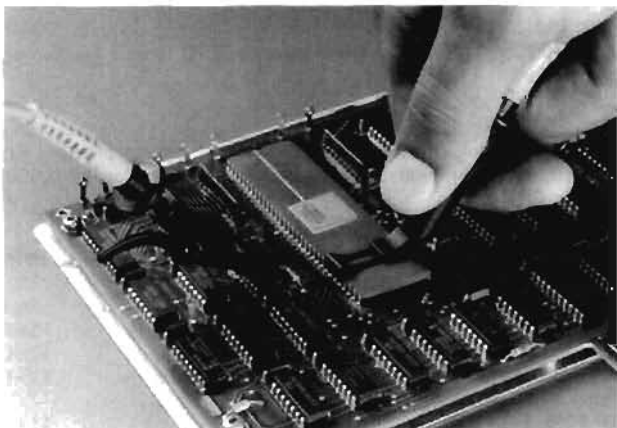

### HP 10400A Family Accessories

Each 10400A family probe is shipped with one general purpose grabber, one IC grabber, and one ground lead. An accessory package is also included which contains 4 grounding spanners (for close grounds at the probe tip), 1 probe barrel insulator, 1 adjustment screwdriver, and 8 colored cable markers.

The photo at left illustrates use of the IC grabber. This device fits DIPs with 0.1 inch pin spacing (standard) and up to 0.9 inch package width. It is handy for connecting the mini-probe tip to a single DIP pin. Construction prevents shorting adjacent pins during hook-up. For applications where several adjacent DIP pins must be probed, the 10024A accessory can be used (see next page).

# OSCILLOSCOPES & WAVEFORM ANALYZERS

## Probes and Other Oscilloscope Accessories (cont'd)

### HP 10002A 1000V 50:1 Voltage Divider Probe

The HP 10002A voltage divider probe is a general purpose probe for use with instruments that have a bandwidth of less than 40 MHz with an input impedance of 1 megohm shunted by approximately 15 to 55 pF. The probe is rated at 1000V peak.

### HP 10020A Resistive Divider Probe Kit

The HP 10020A Resistive Divider Kit is a signal probing system for measuring fast transition signals in high impedance systems. It is designed for use with 50 ohm input oscilloscopes, but may be used with other than 50 ohm systems if a 50 ohm feedthrough termination (HP 10100C) is used. The extremely low input RC of the 10020A provides high fidelity measurements of fast transition signals.

### HP 10020A Resistive Dividers

Division Ratio	Input R* (ohms)	Division Accuracy	Max V** (rms)	Input C (pF)
1:1	50	—	6	—
5:1	250	±3%	9	<0.7
10:1	500	±3%	12	<0.7
20:1	1000	±3%	15	<0.7
50:1	2500	±3%	25	<0.7
100:1	5000	±3%	35	<0.7

\*When terminated in 50 ohms.

\*\*Limited by power dissipation of resistive element.

**Probe length (overall):** 1.2 m (4 ft).

**Weight:** net, 0.45 kg (1 lb); shipping, 1.4 kg (3 lb).

**Accessories supplied:** blocking capacitor, BNC adapter tip, 6-32 adapter tip, alligator tip, probe handle, cable assy's 5.1 cm (2 in) & 15.2 cm (6 in) ground, spanner tip, insulating caps, colored sleeves

### HP 1124A 100 MHz Active Divider Probe

The HP 1124A active divider probe provides high voltage, general-purpose probing capabilities for instruments having 50 ohm inputs without selectable high impedance inputs. This 10 Mohm 10 pF probe allows direct measurements of 100 V, in the 100:1 division ratio mode, from dc to 100 MHz. In the 10:1 division ratio mode, input voltage range is ±10 V. Power is supplied by instruments with probe power jacks or the HP 1122A probe power supply.

### HP 1124A Specifications

(Measured when connected to a 50 ohm load)

**Bandwidth:** (measured from a terminated 50 ohm source) dc-coupled, dc to 100 MHz; ac-coupled, 2 Hz to 100 MHz.

**Pulse response:** (measured from a terminated 50 ohm source) transition time, <3.5 ns; perturbations, 5% p-p. Measured with pulse transition time of >2.5 ns.

**Attenuation ratio:** 10:1 ±5%; 100:1 ±5%.

**Dynamic range:** x10, ±10 V; x100, ±100 V.

**Input RC:** 10 Mohm shunted by ≈ 10 pF.

**Maximum safe input**

dc-coupled: x10, ±300 V (dc + peak ac) ≤ 100 MHz; x100, ±500 V (dc + peak ac) ≤ 100 MHz.

ac-coupled: x10, ±300 V (dc + peak ac) ≤ 100 MHz; dc component must not exceed ±200 V; x100, ±500 V (dc + peak ac) ≤ 100 MHz; dc component must not exceed ±200 V.

**Accessories supplied:** one 20.3 cm (8 in) ground lead, one retractable hook tip, and two probe tip insulating caps.

**Power:** supplied by instruments with probe power jacks or the HP 1122A probe power supply.

**Weight:** net, 0.2 kg (5 oz); shipping, 0.91 kg (2 lb).

**Length:** 1.5 m (5 ft) overall.

### Ordering Information

HP 10002A 1000V 50:1 Voltage Divider Probe

HP 10020A resistive divider probe kit

HP 1124A 100 MHz active probe

### Price

\$195

\$435

\$350

### HP 1122A Probe Power Supply

The HP 1122A is a regulated power supply that provides all power requirements for simultaneous operation of up to four active probes.

### HP 1122A Specifications

**Probe driving capability:** up to four HP active probes.

**Power output:** -12.6 V and +15 V, ±3%.

**Power input:** 115 V or 230 V ±10%, 48 to 440 Hz, 40 W (with four probes).

**Weight:** net, 2.7 kg (6 lb); shipping 3.6 kg (8 lb).

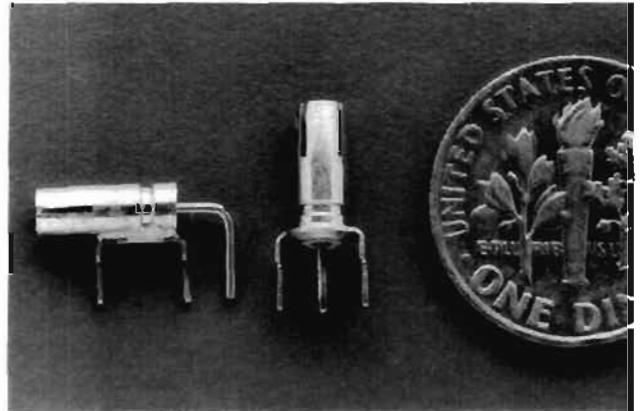

### HP 1250-1737 PC Board Mini Probe Socket

The HP 1250-1737 PC board mini probe socket is ideal for breadboard circuit applications where it is desirable to make a reliable circuit connection between the mini probe tip and a test circuit (Soldering the tip itself into place is not recommended.) The HP 1250-1737 is also useful in production PC board applications as an oscilloscope test point. The probe plugs into the socket parallel to the PC board.

### HP 1250-1918 PC Board Vertical Mini Probe Socket

The HP 1250-1918 is similar to the 1250-1737 (above) except that it is designed for attaching the probe vertically to the board rather than horizontally.

### HP 10024A IC Test Clip

The HP 10024A IC test clip provides easy probing of dual in-line packages and includes four insulated circuit interface pins. Additional circuit interface pins are available (see Ordering Information) in packages of twelve pins. Each pin has a tip on each end so that probes such as those on HP logic analyzers can be connected for fast, functional checks of circuit operation.

### Probe Accessories

#### Terminations

HP 10100C: 50 ohm ±1% BNC male to BNC female feedthrough termination.

#### Standard Probe Tip Adapters

HP 10229A hook tip adapter: retractable pincer tip provides firm connection to circuit nodes. Recommended accessory for HP 10020A resistive divider kit.

#### Ordering Information

HP 1122A probe power supply

HP 1250-1737 PC board mini probe socket

HP 1250-1918 PC board mini probe socket (vertical)

HP 10024A IC test clip (with 4 circuit interface pins)

HP 10024-69501 interface pin kit for HP 10024A; includes 12 interface pins.

HP 1250-1454 BNC-10-mini probe adapter

HP 10229A retractable hook tip adapter

HP 10100C 50 ohm feedthrough termination

### Price

\$1030.00

\$6.75

\$8.75

\$20.00

\$39.00

\$13.50

\$20.00

\$40.00

## Testmobile

The HP 1008A provides a sturdy, lightweight, stable platform for your oscilloscope or instrumentation system (see specification chart). Large angled wheels with a wide track move quietly and smoothly over most surfaces. The top tray is table height and can be tilted to a convenient viewing angle between 30 degrees above and 30 degrees below the horizontal position with a total of seven detent positions in 10 degree increments. The caps on each side rail are designed to hold three probes to reduce the possibility of damaging probes not in use. A 01007-60017 power strip (U.S.) is included with each HP 1008A.

HP 1008A Option 006 adds a storage cabinet with a shelf on top and a drawer in the lower position to the basic HP 1008A. Load limit is 18 kg (40 lb) each on the shelf and in the cabinet, 11 kg (25 lb) in the drawer.

## HP 1008A Specifications

HP 1008A	
Height	930 mm (36 1/2 in)
Overall width	759 mm (29 7/8 in)
Width of tray	473 mm (18 5/8 in)
Tilt tray angle	±30°
Weight	net 13 kg (28 lb)
	shipping 22 kg (48 lb)
Max load on tilt tray	45 kg (100 lb)
Max load below tilt tray	see option description



**Basic Testmobile**

**Opt 006:** storage cabinet with shelf on top and drawer in lower position; load limit 18 (40 lb) each on shelf and in cabinet, 11 kg (25 lb) in drawer.

## Ordering Information

HP 1008A testmobile \$970.00  
 HP 1008A Opt 006 Added shelf and cabinet for 1008A \$270.00

## HP 1133A TV/Video Sync Pod

- Clamped or unclamped video output.
- Trigger output for line and frame.
- For most standard broadcast composite video systems
- Compatible with most analog & digitizing scopes

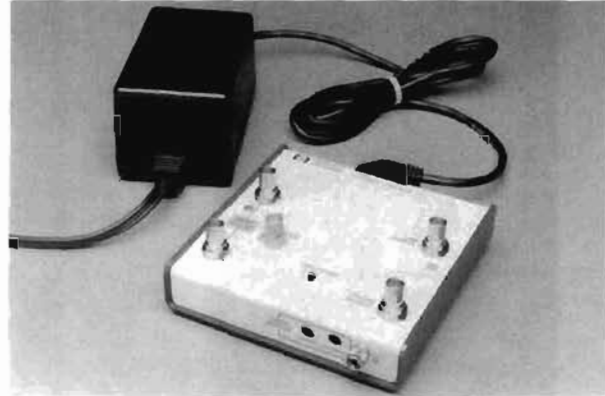

The HP 1133A TV/Video Sync Pod is an accessory that provides users with TV sync triggering for most analog or digitizing oscilloscopes. It features clamped or unclamped video outputs that can be viewed on the oscilloscope's vertical channels and trigger outputs that can synchronize the oscilloscope to video frame and individual lines.

The pod itself is packaged in a case approximately 14x14x4.5 cm (5.5x5.5x1.75") and is powered by a separate ac power module. The pod features a loop-thru input (two female BNC) which can be driven from a 75 ohm source, or for probing high impedance circuits, from a 1-10 megohm probe. The loop-thru feature allows 75 ohm signal to be looped through the TV/Video pod then connected to a video monitor or other 75 ohm device. Clamped or unclamped video outputs are designed to drive a high impedance probe (1-10 megohm) connected to the oscilloscope input.

The HP 1133A is compatible with broadcast standards M, N, C, B, G, H, I, D, K, K1, and L systems.

## Characteristics

Video input: AC coupled with an RC of 1 megohm shunted by approximately 10 pF.

Bandwidth: Approximately 10 MHz

Maximum input voltage: 40 Volts (DC plus peak AC)

Frame output is phase locked to the leading edge of the third field synchronizing pulse on field one, to the leading edge of the second pulse on field two. Frame output goes high on field one, and low on field two.

A switch is provided for positive or negative sync pulse polarity.

A gain control is provided to adjust for signal amplitude at BNC input.

Gain from input BNC to unclamped output is approximately 2.5 to 50.

## Ordering Information

Note: The 1133A must be ordered with a power supply option.

HP 1133A TV/Video Sync Pod \$275.00

**Opt ABA** Power supply for U.S.A., 120V, nema 515P plug N/C

**Opt ABB** Power supply for Europe, 220V CEE7-VII plug N/C

**Opt ABJ** Power supply for Japan, 100V nema 515P plug N/C

**Opt ABU** Power supply for United Kingdom, 240V BS1363 plug N/C

# PLOTTERS & RECORDERS

## Measurement Plotting System

Model 7090A

- Floating and guarded inputs
- DC to 3 kHz bandwidth, 33.3 kHz sampling rate
- 3 channels with simultaneous sampling
- 12-bit resolution, 1 k buffer/channel
- 6 trigger modes with up to 100% pre-trigger capture
- Full programmability and data transfer over HP-IB



HP 7090A

The HP 7090A is designed for low-frequency (< 3 kHz) measurement, analysis, and documentation. The 7090A merges several technologies - waveform recording, digital plotting, analog recording, and automated measurement - to provide a powerful solution to a broad range of measurement applications. It significantly increases the ability to measure and display low-frequency phenomena and substantially improves real-time recording and digital plotting . . . all in one low-cost system.

### Signal Capture

Simultaneous sampling on each of three channels, 12-bit resolution, bandwidth of dc to 3 kHz (33.3 k samples/s maximum), and 1000 word memory per channel allow high resolution measurement, storage, and display.

### Flexible Triggering

The HP 7090A has six trigger modes which allow virtually any signal change to initiate signal capture, even decaying repetitive signals such as faults in a power line voltage, or in a transducer's carrier. Combined with pre-trigger capability, these trigger modes make the HP 7090A Measurement Plotting System ideal for turn-on/off characterization, fault monitoring and mechanical motion analysis.

### A System Component

All panel functions are programmable via the HP-IB interface. Data can be transferred from the internal 1 k-buffers or streamed in real time from the analog-to-digital converters at up to 500 points/s. In addition, the menu-driven HP 17090B Measurement Graphics Software package is available for HP 9000 Series 200

computers (BASIC 3.0 only). The software allows easy data manipulation, storage and retrieval, and system integration.

### Versatile Capabilities

As the name implies, the HP 7090A Measurement Plotting System is also a high performance digital plotter. It is ideal for a graphics dump from a smart instrument (e.g. from an HP 8569B Spectrum Analyzer) or as part of an HP-IB system; you can also use the HP 7090A to take an X-Y dump from an analog instrument (e.g. from an HP 141T Spectrum Analyzer System). With the HP 7090A, hand annotation is unnecessary. The 7090A annotates setup conditions, date and time, selected data points from memory, and trigger information. It draws user-defined axes and grids, eliminating the need for pre-printed graph paper. The HP 7090A even lets you plot overhead transparencies for technical presentations.

### Applications

**Analog Recording:** Electrical, chemical, mechanical and medical fields all benefit from recording real-time X-Y and Y-T relationships. As an analog recorder, the HP 7090A has sensitivity to 5 mV full scale and 41,000 calibrated ranges for easy and quick calibration to measurement units. The HP 7090A's superior dynamic performance and high sensitivity provide users the versatility and accuracy required in laboratory environments.

**Capturing Low Frequency Electrical Transients:** General diagnostic monitoring (such as looking for relative timing sequences) and fault monitoring (capturing pre-trigger data for intermittent



failure analysis) are natural applications for the HP 7090A. **Measuring Phase Relationships:** The simultaneous sampling on all channels is ideal for measuring current/voltage phase relationships in power systems.

**Analog Instrument/Digital System Link:** The HP 7090A can integrate an analog instrument into an HP-IB system; the HP 7090A, with a controller can digitize output voltages from analog instruments for HP-IB system data entry.

**Mechanical and Electromechanical Testing:** Applications in which transducers convert velocity, acceleration, force, temperature or torque to voltage are a good fit for the HP 7090A. These applications have a maximum output frequency below 3 kHz. The HP 7090A's flexible trigger capabilities make it useful for one-shot electromechanical events such as clutch and mechanism engagements.

**Electromechanical Control Systems:** The HP 7090A can measure the response of a system to a stimulus; a typical use would be exciting the system with a step function and using the measured response to determine damping ratio and the natural frequency of the control system.

**Material Testing:** The HP 7090A can record classic stress-strain curves, particularly those obtained from destructive testing. The data is stored in a buffer, so even though the sample has been destroyed, the data can be viewed and rescaled in several different ways.

**Automatic Test:** When linked to an HP 9000 Series 200 computer, the HP 7090A is a good, inexpensive learning tool for small companies considering automatic test systems. Applications include environmental and production line testing and proof of performance records.

**Measurement Graphics Software**

HP 17090 Measurement Graphics Software is designed to access the full capabilities of the HP 7090A Measurement Plotting System and integrate it into computer system applications. This software is compatible with properly configured Series 200 and Series 300 computers. The computer system must have ten softkeys, a knob, and separate displays for alpha characters and graphics. The main user interface with this software is through 10 softkeys on the computer's keyboard and a knob.

**Program Capabilities:** There are six main functional areas of Measurement Graphics Software:

- measurement setup
- measurement
- display
- annotation
- storage and retrieval
- data manipulation

Measurement Graphics Software helps you use the HP 7090A's features easily and efficiently, and it provides storage, annotation and data transformation capabilities not available on the HP 7090A unit alone.

**Friendly, Menu-driven Interface:** Each menu allows the user to view several parameters simultaneously. Series 200 and 300 softkeys and cursor-control knob minimize keyboard input, and the "help" softkey displays the available choices and ranges for each parameter setting.

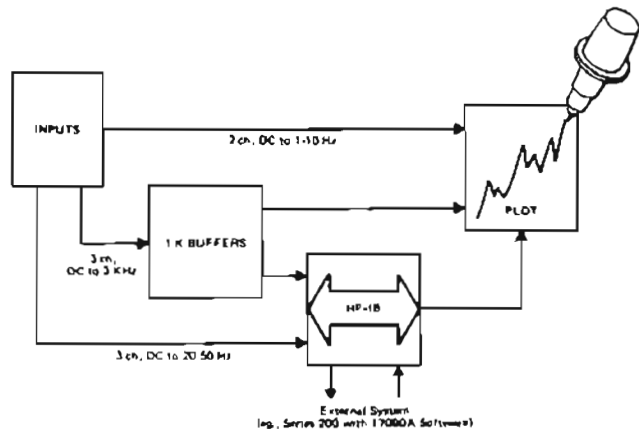

Possible data flow paths for the HP 7090A Measurement Plotting System.

**System Requirements**

The following table lists the operating system, memory, and equipment that are needed to use the software with the HP 7090.

HP 17090 Version	Operating System	Available Memory <sup>1</sup>		Applicable HP 9000 Models
		Minimum	Optimum	
A	BASIC 2.0	235K	470K	HP 216 HP 226 HP 236 HP 220 <sup>2</sup>
B	BASIC 3.0	216K	433K	HP 216 HP 226 HP 236 HP 220 <sup>2</sup>
C	BASIC 4.0/4.03	245K	470K	HP 216 HP 217 <sup>3</sup> HP 226 HP 236 HP 220 <sup>2</sup> HP 237 <sup>4</sup> Series 300 <sup>5,6</sup>

<sup>1</sup> Memory required after loading BASIC and all necessary binary files. With minimum RAM, short delays will be encountered when software subsystems are swapped in memory.  
<sup>2</sup> Applicable when equipped with an HP 98203A/B Keyboard.  
<sup>3</sup> Applicable when equipped with BASIC 4.03 and an HP 98203C Keyboard. The HP 220 may also be used with BASIC 4.0 and an HP 98203A/B Keyboard.  
<sup>4</sup> BASIC 4.03 is required when the computer is equipped with an HP 98203C Keyboard.  
<sup>5</sup> The HP 46083A Knob is required when the computer is equipped with either an HP 46020A or 46021A Keyboard.  
<sup>6</sup> The HP 98548A Display Compatibility Interface is required when the computer is equipped with a single-plane monochrome bit-mapped display.

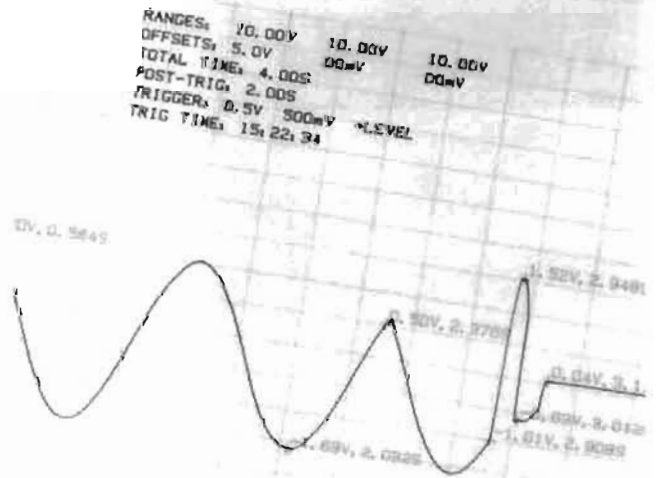

# PLOTTERS & RECORDERS

## Measurement Plotting System (cont'd)

Model 7090A

### HP 7090A Panel Controls



Easy-to-read controls provide accurate feedback of recording conditions.



Annotation capability eliminates errors from hand annotation, and creates accurate hardcopy records.



Controls allow the easy selection and movement of pens. Scaling capability allows you to design graphs to fit custom formats.

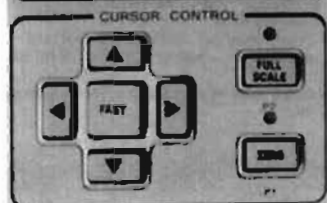

Ten thousand possible ranges eliminate guessing about exact set-up parameters. Ability to store set-up conditions decreases set-up time for repeated experiments.

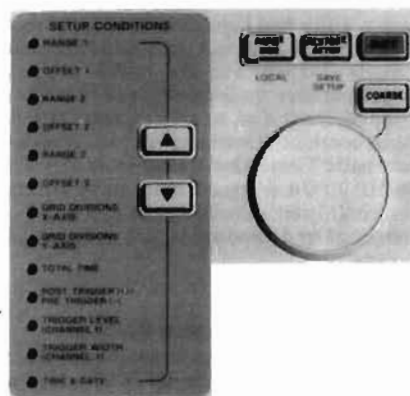

Multiple trigger modes make viewing transient and pre-trigger data easy; eliminates the search through strip chart/oscillographic output for an event.



Three output channels allow you to measure and view low-frequency phenomena at a much lower cost than a traditional waveform recorder.

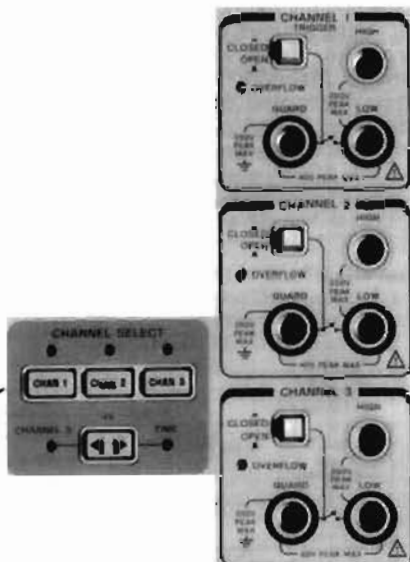

Data display capability allows you to scan the buffer, displaying current values on LCD or labeling datapoints on graph.



External connectors provide flexibility for configuring experiments to meet your varied measurement needs.

**Specifications**

**Inputs**

Number of channels	3
Type of input	floating, guarded
Sensitivity	5 mV to 100 V full scale
Sensitivity ranges	41,000
Zero offset	±2 full scale or ±100 V maximum
Zero offset ranges	approximately 5% or range steps
Input impedance	1 Mohm, shunted by 45 pf (Nominal)
Maximum input voltage	200 V, dc or peak
Maximum source resistance	10 kohm
Common mode rejection ratio	140 dB dc; 100 dB ac @ 60 Hz with 1 kohm unbalance in LOW terminal and most sensitive range (at 25 C)

**Electrical accuracy (@ 25 C, ±1 scale offset maximum):**

Constant inaccuracy	
1 V to 100 V range	±0.15% of range
5 mV to 500 mV range	increases from ±0.15% of range @ 500 mV to ±0.26% of range @ 5 mV
Reading inaccuracy	±0.055% of reading
Temperature coefficient	
Constant inaccuracy	
1 V to 100 V range	±0.012% of range/degree C
5 mV to 500 V range	increases from ±0.012% or range/degree C @ 500 mV to ±0.044% of range/degree C @ 5 mV
Reading inaccuracy	±0.01% of reading/degree C

**Timebase**

Buffer mode	
Range	30 milliseconds to 24 hours
Number of ranges	4,700
Direct mode	
Range	1 second to 24 hours
Number of ranges	3,700
Accuracy	±0.1%

**Dynamic Performance**

Slewing Speed (Nominal)	
Direct mode	127 cm/s (50 in./s)
Plotting mode	75 cm/s (30 in./s)
Acceleration (Nominal)	2 g constant
Bandwidth (≥3dB)	3 kHz for all full scale ranges ≥ 20 mV 2.6 kHz for all full-scale ranges < 20 mV
Peak capture	250 μs at fastest timebase range

**Memory per Channel**

Size	1000 words
Resolution	12-bits

**Trigger Characteristics**

Internal Trigger	Inside or outside window to capture decaying repetitive signals, inside resets with each reverse transition; Above or below level, selectable over the full-scale range in 1.0% of range increments (NOMINAL); Source, channel 1
External Trigger	BNC connector, TTL level or contact closure to ground
Manual Trigger	Available from front-panel controls
Display	Up to 100% pre-trigger capture, up to 24 hour post-trigger delay before measurement start

**Supplemental Characteristics**

Writing System	6-pen carousel with automatic pen capping Fiber-tip pens for paper or transparencies
Digital Plotting	Intelligence: over 40 HP-GL instructions; five built in character sets including ANSI ASCII, HP 9825, French/German, Scandinavian,

Media	Spanish/Latin America Front-panel controls: P1, P2; pen position cursors; pen selection Interface modes (user selectable): listen only; listen/talk Types: paper, overhead transparency film Sizes (switch-selectable): A4/A (210 x 297 mm, 8.5 x 11 in.); A3/B (297 x 420 mm, 11 x 17 in.)															
Programming	HP-IB control of all recorder and plotter functions Software lockable front panel															
Scope Output	Allows use of X-Y oscilloscope to preview buffer contents Connectors: 2 BNC, vertical and horizontal Output: -10 V to 10 V (0 V corresponds to origin on chart); refreshed every 15 ms Resolution: 10-bit															
Digital Voltmeter (DVM) Mode	Allows panel display of dc voltage levels on selected channel input Sampling rate: 1/sec (NOMINAL)															
Pen Position Data Display	Allows cursor to move pen along plotted buffer data on selected channel, value shown on display, and coordinate pair can be printed at selected points.															
External Pen Lift Control	BNC connector, TTL level or contact closure to ground															
Analog-to-digital	Max. sampling rate: 33.3 k samples/s Max. streaming rate over HP-IB:															
	<table border="0"> <tr><td></td><td>ASCII</td><td>Binary</td></tr> <tr><td>1 channel</td><td>167/s</td><td>500/s</td></tr> <tr><td>1 channel plus trigger</td><td>143/s</td><td>333/s</td></tr> <tr><td>3 channels</td><td>59/s</td><td>167/s</td></tr> <tr><td>3 channels plus trigger</td><td>59/s</td><td>167/s</td></tr> </table>		ASCII	Binary	1 channel	167/s	500/s	1 channel plus trigger	143/s	333/s	3 channels	59/s	167/s	3 channels plus trigger	59/s	167/s
	ASCII	Binary														
1 channel	167/s	500/s														
1 channel plus trigger	143/s	333/s														
3 channels	59/s	167/s														
3 channels plus trigger	59/s	167/s														
Real-time Clock	Functions: second, minute, hour, day, year Controls: front-panel set, battery (lithium) backup Accuracy: ±4 sec/day @ 25 C Operating temperature: 0-55 C Source: 100, 120, 220, 240 V ac -10%, +5% Frequency: 48-66 Hz Consumption: 140 W Height: 205.5 mm (8.1 in.) Weight: 575.0 (22.6 in.) Depth: 465.0 (18.3 in.) Net: 15.7 kg (34.5 lbs) Shipping: 23.6 kg (18.3 lbs)															
Environmental Power Requirement																
Size																
Weight																

**Accessories Supplied**

Interfacing and Programming Manual	07090-90001
Operator's Manual	07090-90002
Pocket Guide	07090-90004

An assortment of pens and media are also shipped with each HP 7090A unit sold. Paper size and power cord are determined by destination.

**Ordering Information**

HP 10833A or 45529A HP-1B (IEEE-488) 1-meter cable	\$80.00
HP 10833B or 45529B HP-1B (IEEE-488) 2-meter cable	\$90.00
HP 7090A Measurement Plotting System	\$4900.00
Option 910 (duplicate set of manuals)	\$100.00
HP 17090A/B/C Measurement Graphics Software	
Option 630 (3.5 in. disc size)	\$700.00
Option 655 (5.25 in. disc size)	\$700.00

# PLOTTERS & RECORDERS

## Recorder/Plotter Selection Guide

The following pages list recommended graphics output devices for over 100 HP instruments. HP instruments designed with microprocessors can control plotting from front-panel buttons or menu-driven softkeys. If your instrument has this capability, it will be listed with a "direct to plotter" output capability.

Other HP instruments require the appropriate controller and software in order to send graphics output to the plotter. These devices are indicated by "indirect to plotter" output capability. If the system includes or requires a particular controller, that controller is indicated. Voltage and penlift for instruments with analog output are also listed.

(To order the ColorPro plotter ask for the HP 7440A.)

HP Instrument	Output Capability*	Plotter Software Support	X-Y Recorder Outputs		Recommended HP Models
			Voltage	Penlift	
PC Instruments	Indirect to plotter	Data Acquisition Software: HP 150, HP 14855A, IBM PC, HP 14856A			7475A ColorPro
141T Spectrum Analyzer System	Direct to recorder		X -5 to 5 V Y 0 to -8 V	YES (14 V pen up, 0 V pen down)	7090A
415E SWR Meter	Direct to recorder		Y 0 to 1 V	NO	7090A
432A/B/C 436A/438A Power Meters	Direct to recorder		Y 0 to 1 V	NO	7090A
853A Spectrum Analyzer Display	Direct to recorder  Direct to plotter (LO)	Front-panel controls graticule and/or trace (no annotation)	X -5 to 5 V Y 0 to .8 V	YES (15 V pen up, 0 V pen down)	7090A 7475A 7550A ColorPro
1040A UV/VIS LC Detector	Indirect to plotter	HP 1040A opt. 631 software available			7475A 7550A ColorPro
1090A Liquid Chromatograph	Indirect to plotter System includes HP 85B	HP software included			7475A 7550A ColorPro
3046A/B/S Selective Level Measuring Systems	Indirect to plotter	Customer software required			7090A 7475A ColorPro
3047A/S Spectrum Analyzer Systems	Indirect to plotter	HP software included with 3047S			7475A 7550A
3054A/C/DL/S Data Acquisition Systems	Indirect to plotter	Customer software required for 3054C/DL			7475 7550 ColorPro
3314A Function Generator	Direct to recorder		X -5 to 5 V	YES	7090A
3325A Synthesizer/Function Generator	Direct to recorder		X 0 to 10 V	YES TTL	7090A
3326A Two Channel Synthesizer	Direct to recorder		X 0 to 10 V	YES-TTL	7090A
3335A Synthesizer/Level Generator	Direct to recorder		X 0 to 10 V	NO	7090A
3336A/B/C Synthesizer/Level Generator	Direct to recorder		X 0 to 10 V	YES-TTL	7090A
3350A/3357A/B Lab Automation System	Indirect to plotter System includes HP 1000	HP 19135C C/PLOT/3350 software available			7475A 7550A
3421A Data Acquisition/ Control Unit	Indirect to plotter	Customer software required			7475A ColorPro
3497A/S Data Acquisition/ Control System	Indirect to plotter	Customer software required			7475A ColorPro
3561A/62A/65S Dynamic Signal Analyzer	Direct to plotter (05) or Indirect to plotter	Front-panel control duplicates screen image to plotter. Software similar to 3577, also adds annotation			7090A 7475A 7550A ColorPro
3575A Gain/Phase Meter	Direct to recorder		Y1 10 mV/degree Y2 10 mV/dB	NO	7090A
3577A Network Analyzer	Direct to plotter (LO) or indirect to plotter	Front-panel control duplicates screen image to plotter. Menu-driven software provides selectable graticule, trace, annotation, pen number, line type.			7090A 7475A 7550A ColorPro
3580A Spectrum Analyzer	Direct to recorder		X 0 to 5 V Y 0 to 5 V	YES Contact closure to ground during sweep	7090A
3581A Wave Analyzer 3581C Selective Voltmeter	Direct to recorder		X 0 to 5 V Y 0 to 5 V	YES Contact closure to ground during sweep	7090A
3582A/S Spectrum Analyzer	Direct to recorder  Indirect to plotter	Customer software required	X 0 to 5.25 V Y 0 to 5.25 V	YES Contact closure during sweep	7090A 7475A ColorPro
3585A Spectrum Analyzer	Direct to recorder  Indirect to plotter	HP software available	X 0 to 10 V Y 0 to 10 V	YES TTL	7090A 7475A ColorPro
3586A/B/C Selective Level Meter	Indirect to plotter	Customer software required			7475A ColorPro
3708S Noise and Interference Test System	Indirect to plotter	HP software available (HP 3708D A/B/C/R)			7475A 7090A ColorPro

\*"Indirect to plotter" requires an appropriate controller and software. "Direct to plotter" may require an address of 05 or LO (listen only).

HP Instrument	Output Capability. "Indirect to plotter" requires an appropriate controller and software.	Plotter Software Support	X-Y Recorder Outputs		Recom- mended HP Models
			Volts	Pen/Ink	
3712A MLA Receiver	Direct to recorder		X -5 to 5 V Y -5 to 5 V	YES	7090A
3770B Telephone Analyzer	Direct to recorder (Special graph paper available)		X 0 to 5 V Y -5 to 5 V	NO	7090A
3776A/B PCM Terminal Test Set	Direct to recorder or Direct to plotter (LO)				7090A 7475A 7550A ColorPro
3780A Error Measuring Set	Direct to recorder		Y 0 to 1 mA into 10Kohm max	NO	7090A
3852A Data Acquisition/Control Unit	Indirect to plotter	HP 44458A software available			7475A
4061A/S Semiconductor Component Test System	Indirect to plotter	HP software included with 4061S			7475A ColorPro
4062B/S Semiconductor Parametric Test System	Indirect to plotter	Customer software required			7475A ColorPro
4063A/S Semiconductor Parametric Analysis System	Indirect to plotter	HP software included			7475A 7550A ColorPro
4064A/S DLTS Analysis System	Indirect to plotter	HP software included			7475A 7550A ColorPro
4140B $\mu$ A Meter/DC Voltage Source	Direct to recorder Indirect to plotter	Customer software required	X -10 to 10 V Y -5 to 5 V	YES	7090A 7475A ColorPro
4145A Semiconductor Parameter Analyzer	Direct to plotter (LO)	Front-panel controls select trace and/or graticule, fixed characters			7475A 7550A ColorPro
4191A RF Impedance Analyzer (with Option 004)	Direct to recorder  Indirect to plotter	Customer software required	X 0 to 1 V Y1 0 to 1 V Y2 0 to 1 V	NO	7090A 7475A ColorPro
(Option 004 not required)					
4192A LF Impedance Analyzer	Direct to recorder Indirect to plotter	Customer software required	X -1 to 1 V Y -1 to 1 V	YES TTL (low level at pen down)	7090A 7475A ColorPro
4193A Vector Impedance Meter	Direct to recorder Indirect to plotter	Customer software required	X 0 to 1 V Y1 0 to 1 V Y2 -1 to 1 V	YES	7090A 7475A ColorPro
4194A Impedance Gain-Phase Analyzer	Direct to plotter	Front-panel control duplicates screen image to plotter. Graticule, traces are selectable			7475A 7550A ColorPro
4290A 1 MHz C Meter/C-V Plotter	Direct to recorder Indirect to plotter	HP software available	X -10 to 10 V Y -10 to 10 V	YES	7090A 7475A ColorPro
5180A Waveform Recorder 5182A Waveform Recorder Generator	Direct to recorder Direct to plotter (LO) or Indirect to plotter	Front panel controls provide fixed graticule, trace, annotation; 51800A Waveform Measurement Library also available.	X -1 to 0 V Y -1 to 0 V	YES (0 V and 5 V)	7090A 7475A 7550A
5180T/U 5183T/U Waveform Recorders	Direct to plotter Indirect to plotter	Front panel controls provide user selectable graticule, trace, and annotation. Waveform measurement library also available.			7090A 7475A 7550A ColorPro
5390A Frequency Stability Analyzer	Indirect to plotter	HP software provides graticule, trace, and characters			7475A
54100A/D, 54110C 6 Hz Digitizing Oscilloscope 54120A/D, 54201A/D Digitizing Oscilloscope	Direct to plotter				7090A 7475A 7550A ColorPro
5427A Digital Vibration Test Control System	Direct to plotter (05)	Front-panel controls select fixed-format graticule, trace, and/or characters			7090A 7475A 7550A
5528B3/88S Dimensional Metrology Analysis Systems	Indirect to plotter. System includes HP 85	Menu-driven software provides fixed-format plots with graticule and characters, selectable traces, title block, and vertical scale			7475A ColorPro
5965A Infrared Detector	Indirect to plotter	HP 59965A software available for series 300.			7475A 7550A ColorPro
5987A/5970B/85C/87A/88A GCMS Systems	Indirect to plotter. System includes HP 1000, Series 200 or Series 300.	59872A software available			7475A 7550A ColorPro
6901S Measurement and Analysis System	Direct to plotter (05)	Menu-driven software provides fixed-format plots with graticule and characters, selectable trace			7475A
6940B/42A Multiprogrammers	Indirect to plotter	Customer software required			7475A ColorPro
6942S Computer Aided Test System	Indirect to plotter	Customer software required			7475A ColorPro
6944A/S Multiprogrammer	Indirect to plotter	Customer software required			7475A ColorPro
71000 Series Modular Spectrum Analyzers	Direct to plotter				7475A 7550A ColorPro
8116A Pulse/Function Generator (with Option 001)	Direct to recorder		X 0 to 10 V (1.5 V/decade)	YES TTL	7090A
8165A Programmable Signal Source (with Option 002)	Direct to recorder		X 0 to 2.99 V (1 V/decade)	NO	7090A
8340A Synthesized Sweeper	Direct to recorder		X 0 to 10 V	YES	7090A

# PLOTTERS & RECORDERS

## Recorder/Plotter Selection Guide (cont'd)

HP Instrument	Output Capability "Indirect to plotter" requires an appropriate controller and software.	Plotter Software Support	X-Y Recorder Outputs		Recom- mended HP Models
			Voltage	Pen/Ink	
8350B Sweep Oscillator	Direct to recorder		X 0 to 10 V	YES	7090A
8405A Vector Voltmeter	Direct to recorder		Y1 0 to 1 V Y2 -5 to 5 V	NO	7090A
8410B Network Analyzer System — The following plugins are part of the 8410B system:					
8412A Phase-Magnitude Display	Direct to recorder		Y1 50 mV/dB Y2 10 mV/degree	NO	7090A
8414A Polar Display	Direct to recorder		X -2.5 to 2.5 V Y -2.5 to 2.5 V	NO	7090A
8408B/S Automatic Network Analyzer	Indirect to plotter	HP software duplicates screen image onto plotter			7475A 7550A ColorPro
8450/51A/52A Diode Array Spectrophotometers	Direct to plotter	Selectable graticule, trace, and characters			7475A 7550A
8452A Diode Array Spectrophotometer	Direct to plotter	Selectable graticule, trace, and characters.			7475A 7550A ColorPro
8505A Network Analyzer	Direct to recorder Indirect to plotter	HP software provides graticule, trace, and characters	X 0 to 7.5 V Y -1.25 to 1.25V	YES 200 mA current sink	7090A 7475A 7550A ColorPro
8507D/S Automatic RF Network Analyzer System	Indirect to plotter	HP software provides graticule, trace, and characters			7475A 7550A ColorPro
8510A Network Analyzer	Direct to plotter	Front-panel controls select graticule, trace characters, pen and quadrant			7475A 7550A ColorPro
8557A/58B/59A Spectrum Analyzers With 853A Display	Direct to recorder Direct to plotter		X -5 to 5 V Y 0 to .8 V (with 853A and 180 mainframes)	YES (15 V pen up, 0 V pen down)	7090A 7475A
8565A Spectrum Analyzer	Direct to recorder		X -5 to 5 V Y 0 to .8 V	YES (15 V pen up, 0 V pen down)	7090A ColorPro
8566B/S/68B/S Spectrum Analyzers	Direct to recorder Direct to plotter	HP 85862/63 software packages available	X 0 to 10 V Y 0 to 10 V	YES (15 V pen up, 0 V pen down)	7090A 7475A ColorPro
8569B/8570A Spectrum Analyzers	Direct to recorder Direct to plotter	Front-panel controls select graticule, trace, and/or characters	X -5 to 5 V Y 0 to .8 V	YES (15 V pen up, 0 V pen down)	7090A 7475A 7550A ColorPro
8620C Sweep Oscillator	Direct to recorder		X 0 to 10 V	YES (5 V pen up)	7090A
8642A/B Synthesized Signal Generator	Direct to recorder		X 0 to 10 V	YES-TTL	7090A
8660C Synthesized Signal Generator	Direct to recorder		X 0 to 8 V	YES (with Option H24)	7090A
8682A/63A/73B/C/D Synthesized Signal Generators	Direct to recorder		X 0 to 10 V	YES-TTL	7090A
8683A/B/D/84A/B/D Signal Generators	Direct to recorder		X 0 to 10 V	NO	7090A
8750A Storage-Normalizer	Direct to recorder		X 0 to 1 V Y -4 to 4 V	YES (open collector driver, 20 V max)	7090A
8753A Network Analyzer	Direct to plotter				7475A 7550A 7090A ColorPro
8754A Network Analyzer	Direct to recorder		X 0 to 1 V Y -4 to .4 V	YES (5 V pen up, 0 V pen down)	7090A
8755S Scalar Network Analyzer System	Direct to recorder		Y -4 to 4 V X 0 to 10 V	YES (open collector driver, 20 V max)	7090A
8757A/S Automatic Scalar Network Analyzer	Direct to plotter	HP 8757A has softkeys with custom plot capability. HP 8757S has menu-driven software.			7090A 7475A 7550A ColorPro
8756A/S Automatic Scalar Network Analyzer	Direct to plotter	8756A provides menu-driven softkeys. 8756S has menu-driven software to select graticule, trace, and/or characters (rev. 1 does not include 7550A in ID table)			7475A 7550A ColorPro
8900C/D Peak Power Meter	Direct to recorder		Y 0 to 1 V	NO	7090A
8903B Audio Analyzer	Direct to recorder Indirect to plotter	Customer software required*	X 0 to 10 V Y 0 to 10 V	YES	7090A 7475A ColorPro
8953A/S Transceiver Test System	Indirect to plotter	Customer software required*			7475A ColorPro
8995A/S RF Test System	Indirect to plotter	Customer software required*			7475A
8970A Noise Figure Meter	Direct to recorder Indirect to plotter	Customer software required*	X 0 to 6 V Y 0 to 6 V	YES TTL	7090A 7475A ColorPro



## Introduction

Instrumentation tape recorders (ITRs) are used to record, store, and reproduce test data for many and varied applications. The main reasons for using ITRs are economy, accurate data recording and reproduction, and long-term data storage. ITRs manufactured by Hewlett-Packard are 4 or 8-channel recorders using  $\frac{1}{4}$ -inch tape. They are designed specifically for applications under 64 kHz. ITR recording provides nondestructive reproduction so data can be reproduced repeatedly without degrading the quality, and time-base can be contracted or expanded. Data is contracted by using faster tape speeds to reproduce slow-speed data or expanded by doing the reverse to produce, for example, lower frequency data for use on a graphics recorder.

## ITR Characteristics

**Direct record/reproduce electronics:** direct electronics accept frequencies above 100 Hz (approximate) and record the amplitude of the input signal on the tape as a proportional magnetic flux intensity. Because direct electronics require a "linear" relationship, changing tape type generally necessitates the re-equalization of each direct channel. Direct electronics also require that each recorded tape be degaussed (erased) fully before being reused.

**FM record/reproduce electronics:** FM electronics accept very low frequencies, including dc. In FM, the amplitude of the input signal is recorded as a frequency deviation from a "center" frequency, the maximum input amplitude being recorded as a 40% deviation. Because amplitude is converted to a frequency, FM tends to be insensitive to tape drop-outs, but sensitive to speed irregularities such as flutter. With FM, tape types can be changed without re-equalizing the channel. Since FM records to saturation, tape can be reused without degaussing with only a small (10 to 15 dB) loss in signal-to-noise ratio.

**Common frequency range:** FM and direct have a common segment of the frequency range in which either type of electronics can function. On Hewlett-Packard's ITRs this range is approximately 100 Hz to 5 kHz. The advantages of using direct electronics in this range are high frequency response at slow tape speeds and a general insensitivity to flutter. The advantages of FM are dc response and a general insensitivity to tape drop-outs.

**Tape speed control:** the tape speed is usually controlled by a phase-lock servo system in one of two ways. The more common method uses the servo system to control the

rotational speed of the tape capstan, employing a tachometer mounted on the capstan's shaft to monitor the speed. With this method, tape speed control is limited to approximately  $\pm 0.2\%$ , because of capstan irregularities, tape slippage, and tape stretching. The less common but more precise method uses a frequency reference placed on one track during recording as the speed reference for the phase-lock servo during reproduce. Tape servo generates a reproduce speed that is virtually identical to the record speed; the time difference between events in record and reproduce is indicated by the time base error specification (which assumes continuous phase-lock operation). The time base error figure represents a short-term specification, because drop-outs, etc., may cause momentary loss of phase lock.

**Flutter:** this is a short-term tape speed variation. It produces time base perturbations in direct electronics and noise in FM.

**Signal-to-noise ratio:** this is the ratio of maximum to minimum recordable amplitude expressed as a voltage ratio in dB. Basically, it represents the usable dynamic range.

**Tape selection:** it is recommended that instrumentation tape such as Ampex 797 always be used. Use of other quality tape may adversely affect head wear, signal-to-noise ratio, etc.

# PLOTTERS & RECORDERS

## Instrumentation Tape Recorders and Degausser

Models 3964A, 3968A, and 13064A Degausser

- Continuing savings by recording on 1/4-inch tape
- Choice of 4 or 8-channel recorders
- Selection of FM or direct electronics
- Six tape speeds, including 15/32 ips
- Remote control (TTL or optional HP-IB)
- Switch selection of tach or tape servo



HP 3968A

HP 3964A

### HP 3964A and 3968A ITRs, HP 13064A Degausser

The 4-channel HP 3964A and 8-channel HP 3968A are quality instrumentation tape recorders (ITRs) that provide cost-saving operation by using 1/4-inch tape for a wide variety of recordings. Medical versions of the HP 3964A and 3968A (Options 009 and 010) are available. These versions include a UL 544 medical listing making them useful in hospitals, medical offices, and research facilities.

The HP 13064A bulk tape degausser erases a complete roll of tape cleanly in seconds. A thoroughly clean tape is necessary to obtain maximum signal-to-noise ratio.

Both the HP 3964A and the HP 3968A are precision-built ITRs with features that cut costs, enhance the usefulness of the units, and simplify recording tasks in laboratory, medical, production, and field use.

### HP 3964A, 3968A Features

**Cost-saving 1/4-inch tape:** provides continuing savings for the life of the recorder. By using 1/4-inch tape, rather than 1/2-inch tape, users can save over 50 percent on tape costs.

**AC/DC calibrator:** provides an internal voltage source that simplifies the set up of input and output levels for each data channel. Six voltages, ac or dc, can be pushbutton selected, applied, and monitored to check out each channel. In addition, there is an external connector to allow the use of scopes or other monitoring devices.

**Tach or tape servo control:** tach-servo and tape-servo systems are switch selectable.

**Flutter compensation:** improves the signal-to-noise ratio in FM by up to 12 dB in a vibrating environment. When switched on, flutter-generated noise introduced during record and reproduce is subtracted from all FM data channels during reproduce to improve performance. One FM channel is used for flutter compensation; this same channel can also be used for tape servo control, saving a data channel for recording when both flutter compensation and tape servo are required.

**Voice capability:** provides voice annotation capability on the fourth channel of the HP 3964A or the eighth channel of the HP 3968A, using the press-to-talk microphone. The voice channel accepts data only, voice only, or data with a voice interrupt. Microphone, speaker, and headphone jack are provided with both recorders.

**FM electronics-to-electronics (e-e) mode:** transfers the input signal automatically to output, bypassing the record/reproduce heads. This occurs when tape is below record/reproduce speed or in Fast Forward, Rewind, or Stop mode. E-E allows the unit to be set and calibrated without using tape.

### Instrumentation Tape Recorder Notes

These technical application notes are available, at no charge, from your Hewlett-Packard sales office:

Topic	Application Note No.	HP Part Number
Dropouts	213-1	5952-2841
Crosstalk	213-2	5952-2844
Interchannel Time Displacement Error	213-3	5952-2848
Magnetic Tape Recording Handbook	89	5952-2820

### HP 3964A, 3968A Transport Specifications

**Tape width:** 1/4 inch (6.3 mm)

**Reel size:** standard 7-inch (18 cm) plastic reel, totally enclosed by reel cover

#### Heads

**HP 3964A:** One 4-track record and one 4-track reproduce

**HP 3968A:** One 8-track record and one 8-track reproduce

Tape Speed* (ips)	15	7 1/2	3 3/4	1 7/8	1 5/16	1 5/32
Flutter (% p-p)	0.35	0.35	0.40	0.50	0.70	1.5
Time base error ( $\mu$ s)*	$\pm 4$	$\pm 5$	$\pm 7.5$	$\pm 15$	$\pm 25$	$\pm 50$
Start time (s) (typical)	3	1.5	0.9	0.5	0.5	0.5
Tape speed accuracy $\pm$ %	0.2	0.2	0.2	0.2	0.2	0.2

\*Tape servo operation

**Tape motion controls:** pushbutton selectable Forward Record, Reverse Record, Forward Play, Reverse Play, Fast Forward, Fast Rewind, and Stop

**EOT sensing:** tape drive stops automatically at the end of tape (EOT)

**Reel revolution counter:** 4-digit counter with pushbutton reset



### FM Record/Reproduce Specifications<sup>1</sup>

Tape Speed (ips)	Passband <sup>2</sup> (Hz)	Signal-to-noise <sup>3</sup> Ratio	
		HP 3964A	HP 3968A
15	dc-5000	48	46
7 1/2	dc-2500	48	46
3 3/4	dc-1250	48	46
1 7/8	dc-625	46	46
1 1/16	dc-312	44	44
1 1/32	dc-156	40	40

- Based on use of Ampex 797 tape or equivalent
- Frequency response over passband is  $\pm 1.0$  dB referenced to 10% of upper band edge frequency
- Signal measured with carrier deviation  $\pm 40\%$  of upper passband without flutter compensation. Output filters of reproduce amplifiers selected for constant amplitude response. May also be selected for linear phase (transient) response

**Flutter compensation:** can improve signal-to-noise by up to 4 dB under static conditions and as much as 12 dB under conditions of vibration. Selected by rear panel switch.

**Distortion:** total harmonic distortion  $< 1.2\%$  @ 15 to 1 1/8 ips,  $< 2\%$  @ 1 1/16 to 1 1/32 ips.

**Linearity:**  $\pm 1.0\%$  of peak-to-peak output for best straight line through zero at  $\pm 40\%$  deviation

**DC drift:**  $\pm 0.1\%$  (max) of full scale output per  $^{\circ}\text{C}$

**Input level:** 1 V to 30 V (peak-to-peak); continuously adjustable

**Input impedance:** 100 k $\Omega$  nominal, shunted by  $< 100$  pF single-ended

**Output level:** 1 to 5 V (peak-to-peak); continuously adjustable

**Load impedance:** minimum load impedance 660  $\Omega$

### Direct Record/Reproduce Specifications<sup>1</sup>

Tape Speed (ips)	Passband ( $\pm 3$ dB) <sup>2</sup>		S/N Ratio (dB) <sup>3</sup>	
	HP 3964A	HP 3968A	HP 3964A	HP 3968A
15	70-64000 Hz	500-64000 Hz	38	36
7 1/2	50-32000 Hz	250-32000 Hz	38	36
3 3/4	50-16000 Hz	100-16000 Hz	38	36
1 7/8	50-8000 Hz	100-8000 Hz	38	36
1 1/16	50-4000 Hz	100-4000 Hz	38	35
1 1/32	50-2010 Hz	100-2000 Hz	37	35

- Based on the use of Ampex 797 tape or equivalent
- Reference to 10% of upper band edge
- Referenced to a 500 Hz sine wave with a maximum of 1% third harmonic distortion when reproduced at 3 3/4 ips

**Input level:** 1 V to 30 V (p-p); continuously adjustable

**Input impedance:** 100 k $\Omega$  nominal, single-ended

**Output level:** 0.5 to 5 V (p-p); continuously adjustable

**Load impedance:** minimum load impedance 600  $\Omega$

**Calibrator:** internal signal source, peak ac and  $\pm$ dc levels of 0, 1.0, 1.414, 2.5, 5.0, and 10.0 volts  $\pm 2\%$

**Meter modes:** peak ac or dc, input or output

### HP 3964A, 3968A General Specifications

**Size**

**HP 3964A:** 400 H x 427 W x 256 mm D (15.7" x 16.8" x 10.1")

**HP 3968A:** 445 H x 427 W x 256 mm D (17.5" x 16.8" x 10.1")

**Weight:** HP 3964A, 29.5 kg (65 lb); HP 3968A, 31.3 kg (69 lb)

**Power requirements:** 100, 120, 220, or 240 V,  $\pm 5\%$ ,  $-10\%$ , 48-66 Hz; 110 W average

**Temperature:** storage,  $-40^{\circ}\text{C}$  to  $75^{\circ}\text{C}$ ; operating,  $0^{\circ}\text{C}$  to  $55^{\circ}\text{C}$ ; tape limit,  $10^{\circ}\text{C}$  to  $40^{\circ}\text{C}$

**Altitude:** storage, 15240 m (50000 ft); operating, 4500 m (15000 ft)

**Humidity:** the system, excluding tape limitations, will operate from 10% to 95% RH ( $25^{\circ}\text{C}$  to  $40^{\circ}\text{C}$ ), non-condensing

**Shock:** 30 g maximum (11 ms) non-operating  
**Mounting:** rack mounting kit for equipment racks, 19-inch



HP 13064A

### HP 13064A Tape Degausser Specifications

**Tape size:** 1/2-inch (6.33 mm) tape on reels up to 10 1/2 inch (266 mm) in diameter

**Erase:** 60 dB minimum

**Duty cycle:** one minute ON, three minutes OFF

**Size:** 67 H x 133 W x 171 mm D (2.6" x 5.25" x 6.75")

**Weight:** approximately 4.3 kg (9.5 lb)

**Power requirements:** 115 V ac  $\pm 10\%$ , 50-60 Hz (Opt 001); 230 V ac  $\pm 10\%$ , 50-60 Hz (Opt 002)

### HP 3964A, 3968A Options

#### Record/Reproduce Channel Data Card Options

Option provides one data card. Specify one option for each channel, up to 4 for HP 3964A, up to 8 for HP 3968A.

**001** FM data card, standard

**030** FM data card, medical (must order Opt 009 or 010)

**002** Direct data card, standard

**031** Direct data card, medical (must order Opt 009 or 010)

#### Medical ITR Options

**009** Medical version with white paint

**010** Medical version with standard paint

#### Other Options

Specify no more than one of each option per mainframe

**003** Rear panel with BNC input/output connectors for each channel.

**HP 3964A**

**HP 3968A**

**004** Locking knob set (screwdriver adjustable)

**005** Metric speed annotation on pushbuttons

**007** HP-1B remote control of speeds and mode

**024** Loop adapter (accommodates 5 to 30-ft loop)

**028** Slides for 19 in. racks

**027** Slides for HP cabinets

**041** IRIG servo reference frequency

**070** Overlap. For two units. Provides automatic play/record commands for second recorder when first unit tape is low

### Ordering Information

**HP 3964A** 4-channel instrumentation tape recorder

**HP 3968A** 8-channel instrumentation tape recorder

**HP 13064A** Tape degausser (specify Option 00) for

115 V ac or 002 for 230 Vac, N/C for options)

**HP 13107A** Transit case for HP 3964A

**HP 13106A** Transit case for HP 3968A

### Price

\$9,670

\$10,370

\$155

\$480

\$480

# DIGITAL MULTIMETERS

## General Information



Hewlett-Packard offers a wide range of Digital Multimeters (DMMs) to meet your measurement requirements. HP offers both high performance DMMs and a full product line of system DMMs.

HP has DMMs ideally suited for many applications, including design and development, production testing, and data acquisition. Measurement-driven applications in R&D and calibration labs need the accuracy and stability of HP's 3456A or 3457A. Many bench measurement problems are easily handled by the HP 3468A/B, a high performance  $5\frac{1}{2}$  digit five function DMM.

Production testing requires a wide variety of functions, resolutions, and speeds; the HP 3457A fits those needs. Data acquisition applications may demand the high speed of the HP 3437A or the sensitivity and resolution of the HP 3456A or HP 3457A.

For low-cost HP-IB systems, the  $3\frac{1}{2}$  to  $5\frac{1}{2}$  digit HP 3478A provides five measurement functions—DC Volts, AC Volts, DC Current, AC Current, and Resistance—with the performance to meet many system requirements without putting a big dent in your instrumentation budget.

When selecting a DMM, besides considering the functions, resolution, accuracy, speed, and price desired, look at the quality, reliability, cost of ownership, system throughput, and flexibility of HP's DMMs.

### Optimized for Your Measurements

In some system applications, measurement speed is the most important requirement. Other applications demand high accuracy, high resolution, and excellent noise rejection. Often your requirements are somewhere in between. HP's innovative integration technique used in almost all of its DMMs can trade speed for resolution which adds measurement flexibility.

HP's integrating DMMs offer the fastest reading rates available with powerline-related noise rejection. Integration selection (number of powerline cycles) is the key to performance tradeoffs in HP's system DMMs. For example, reading rates are maximized by decreasing resolution and the number of powerline cycles. Conversely, accuracy and resolution are improved by increasing the number of powerline cycles. In short, HP allows you to choose the resolution, accuracy, and noise rejection needed, while maximizing measurement speed.

Offering  $3\frac{1}{2}$  to  $7\frac{1}{2}$  digit resolution and excellent long term DC accuracy, the HP 3457A offers you choices between high speed, low resolution (1350  $3\frac{1}{2}$  digit readings/sec) or low speed, high resolution (one  $7\frac{1}{2}$  digit reading every two seconds with more than 160 dB effective common mode rejection) measurements.

### High Throughput Reduces Test Time

For system applications, you can increase throughput using DMMs like the HP 3456A. This system DMM is HP's throughput leader when you need to change functions and ranges often to obtain all of your measurements. The ability to change functions and ranges fast while taking measurements is an excellent way of viewing measurement throughput. All of HP's system multimeters share this common strength to help you improve your throughput, and your profits.

Most of HP's system DMMs have a "Voltmeter Complete" pulse output for incrementing channels on external scanners or switches, without the delay of a computer command. An external trigger input is ideal for synchronizing your DMM to your measurement. Interrupt capability allows your system to run more efficiently, since your computer need only provide control when requested by the DMM.

Features such as Pass/Fail Limit testing in the HP 3457A, program memory and reading storage minimize the computer interaction with the DMM. These features are examples of how HP can help you speed-up your system.

### Low Cost of Ownership

HP's DMMs have quality and reliability built-in, plus an optional hardware support feature to prove it.

From concept to implementation, every phase of designing and manufacturing DMMs such as the HP 3468A/B and the HP 3478A have resulted in extremely reliable products.

These field-proven DMMs have lived up to their design expectations. In keeping with the precedent set by the HP 3468A/B and HP 3478A, the HP 3457A Multimeter emphasizes quality and reliability while offering you performance and convenience rivaling that of competitive DMMs costing twice as much. Reliability of our products is so good that we now offer three years of hardware support for the HP 3456A, 3457A, and 3468A/B. This option, called W30, has a surprisingly low incremental price. HP's 3468A/B, 3478A, and 3457A DMM's have electronic, "no pots," calibration. Designed-in modularity, and self-test capabilities keep repair time and costs to a minimum. As a result of HP's commitment to quality, you can benefit by reducing your total cost of ownership when purchasing HP DMMs.



### SYSTEM DMMs

### BENCH DMMs

HP Model	3457A p.94	3456A p.92	3478A p.90	3468A/B p.98
<b>GENERAL INFORMATION</b>				
Digits of Resolution	3½ to 6½	3½ to 6½	3½ to 5½	3½ to 5½
Base Price	\$2800	\$4100	\$1095	\$750
<b>A/D CONVERSION METHOD</b>				
	Multislope Integration	Multislope Integration	Multislope Integration	Multislope Integration True RMS
<b>STANDARD FEATURES</b>				
	7 Functions Math, Electronic Calibration,	3 Functions Math, Ratio,	5 Functions, Electronic Calibration	4-Wire Ohms, Electronic Calibration, Auto/Manual Current Ranging HP-IL
<b>OPTIONAL FEATURES</b>				
	Plug-in Multiplexers, 3 Yr. Hardware Support CIL Language	Enhanced AC Accuracy, 3 Yr. Hardware Support	3 Yr. Hardware Support	Rechargeable Battery 3 Yr Hardware Support
<b>DC VOLTAGE</b>				
Ranges	30 mV to 300 V	100 mV to 1000 V	30 mV to 300 V	300 mV to 300 V
Sensitivity	10 nV	100 nV	100 nV	1 µV
90 Day/1 Yr Best Full Scale Accuracy	0.0019%/0.0027%	0.0017%/0.0025%	0.0047%/0.0067%	0.019%
Max Readings Per Sec 60Hz/50Hz Modes				32
at 3½ digits	1350/1350	330/290	90/85	
at 4½ digits	1250/1250	330/290	35/30	
at 5½ digits	360/312	210/180	4.4/3.7	
at 6½ digits	53/45	48/40	—	
<b>AC VOLTAGE</b>				
Ranges	30 mV to 300 V	1 V to 1000 V	300 mV to 300 V	300 mV to 300 V
<b>RESISTANCE</b>				
Ranges	30 Ω to 3 GΩ	100 Ω to 1 GΩ	30 Ω to 30 MΩ	300 Ω to 30 MΩ
<b>CURRENT</b>				
DC Ranges Min/Max	300 µA to 1.5 A	—	300 mA to 3 A	3 A
AC Ranges	30 mA to 1.0 A	—	300 mA to 3 A	300mA to 3A

# DIGITAL MULTIMETERS

## Low Cost 3½ to 5½ Digit HP-IB Multimeter

Model 3478A

- 5 measurement functions
- Up to 90 readings/s
- Electronic calibration
- 100 nanovolt resolution



HP 3478A

### Description

The HP 3478A provides a low cost, full function, reliable DMM for system measurements. Selectable 3½ to 5½ digit resolution and 5 autoranging functions offer flexibility in automated testing. The HP 3478A can measure DCV, true RMS ACV, 2- and 4-wire ohms, and dc and ac current. Simple, fast electronic calibration eliminates all adjustments to provide a lower cost of ownership.

### Low Cost of Ownership

The combination of an extremely reliable DMM with features like complete electronic calibration and self-test gives you the lowest cost of ownership. We're so sure of the HP 3478A's reliability that you can get additional hardware service for less than 2% of the DMMs price per year.

### Performance

Selectable speed and resolution provide the right capability for your measurement. The HP 3478A can perform production tests or acquire experimental data at 90 readings/s with 3½ digit resolution, or take 35 readings/s with 130 dB of noise rejection using 4½ digits. The 5½ digit mode offers 100 nVdc and 100 µΩ resolution for precise measurements. True RMS with 300 kHz bandwidth and 4:1 crest factor provides reliable measurements of ac signals. Fast autoranging makes the first reading useful and accurate.

### Designed for Systems

Switchable front/rear inputs permit flexible system connections. The Voltmeter Complete output and External Trigger input allow synchronization of the HP 3478A with a scanner for fast multiplexed measurements without the delay of software commands. The test program can write prompt messages or results on the alphanumeric display. The operator can respond by pressing the HP 3478A's SRQ key to interrupt the controller and start the next test. Built-in self-test capability assures proper operation.

### Electronic Calibration

Complete calibration of the HP 3478A is accomplished without any internal adjustment or removing the instrument's covers. The simple and fast electronic calibration procedure lowers the cost of ownership. You only need to connect standards to the HP 3478A and store calibration constants in the HP 3478A's non-volatile memory.

Calibration can be done manually from the front panel or automatically using HP-IB.

### Specifications

#### DC Voltage

##### Input Characteristics

Range	Maximum Reading (5½ digit)	Resolution		
		5½ digit	4½ digit	3½ digit
30 mV	±30.3099 mV	100 nV	1 µV	10 µV
300 mV	±303.099 mV	1 µV	10 µV	100 µV
3 V	±3.03099 V	10 µV	100 µV	1 mV
30 V	±30.3099 V	100 µV	1 mV	10 mV
300 V	±303.099 V	1 mV	10 mV	100 mV

**Input resistance:** 30 mV, 300 mV, 3 V ranges:  $>10^{10} \Omega$   
30 V, 300 V ranges:  $10 \text{ M}\Omega \pm 1\%$

**Maximum input voltage (non-destructive):** Hi to Lo: 303 Vrms or 450 V peak; Hi or Lo to Earth Ground:  $\pm 500 \text{ V peak}$

**Measurement accuracy:**  $\pm(\%$  of reading + number of counts). Auto zero ON.

#### 5½ Digit Mode

Range	$T_{\text{Cal}} \pm 1^\circ \text{C}$		$T_{\text{Cal}} \pm 5^\circ \text{C}$	
	24 Hour	90 Day	90 Day	1 Year
30 mV	0.025 + 40	0.0275 + 40	0.035 + 40	0.035 + 40
300 mV	0.004 + 4	0.005 + 5	0.007 + 5	0.007 + 5
3 V	0.003 + 2	0.004 + 2	0.006 + 2	0.006 + 2
30 V	0.004 + 3	0.005 + 4	0.007 + 4	0.007 + 4
300 V	0.004 + 2	0.005 + 2	0.007 + 2	0.007 + 2

$T_{\text{Cal}}$  is the temperature of the environment where the HP 3478A was calibrated. Calibration should be performed with the temperature of the environment between 20°C and 30°C. 24 hour accuracy relative to calibration standards.

**4½ and 3½ digit mode:** accuracy is the same as 5½ digit mode for % of reading; use 1 count for number of counts on all ranges except 30 mV, use 4 counts.

**Temperature coefficient:** 0° to 55°C, 5½ digits, auto zero ON. ±(% of reading + number of counts)/°C

Range	Temperature Coefficient
30 mV	0.0028 + 5.0
300 mV	0.0005 + 0.5
3 V	0.0004 + 0.05
30 V	0.0006 + 0.5
300 V	0.0004 + 0.05

**Noise rejection:** in dB with 1 kΩ imbalance in Lo lead. AC rejection for 50, 60 Hz ± 0.1%. Auto zero ON.

Display	AC NMR	AC ECMR	DC CMR
5½ digits	80	150	140
4½ digits	59	130	140
3½ digits	0	70	140

**Maximum Reading Rates (readings/s.)**

Line Frequency	Auto Zero and Display	Resolution		
		3½ digits	4½ digits	5½ digits
60 Hz	Off	90	35	4.4
	On	60	20	2.3
50 Hz	Off	85	30	3.7
	On	50	17	1.9

**AC Voltage (true rms)**

**Input Characteristics**

Range	Maximum Reading (5½ Digit)	Resolution		
		5½ Digit	4½ Digit	3½ Digit
300 mV	303.099 mV	1 µV	10 µV	100 µV
3 V	3.03099 V	10 µV	100 µV	1 mV
30 V	30.3099 V	100 µV	1 mV	10 mV
300 V	303.009 V	1 mV	10 mV	100 mV

**Input impedance:** 1 MΩ ± 1% shunted by <60 pF

**Maximum input voltage (non-destructive):**

Hi to Lo: 303 Vrms or 450 V peak

Hi or Lo to Earth Ground: ±500 V peak

**Measurement accuracy:** ±(% of reading + number of counts).

Auto zero ON. 5½ digit display. Accuracy is specified for sinewave inputs only, > 10% full scale.

**1 Year, T<sub>Cal</sub> ± 5°C**

Frequency	Ranges		
	300 mV	3 V, 30 V	300 V
20-50 Hz	1.14 + 163	1.14 + 102	1.18 + 102
50-100 Hz	0.46 + 163	0.46 + 103	0.50 + 102
100 Hz-20 kHz	0.20 + 120	0.20 + 70	0.24 + 70
20-50 kHz	0.38 + 205	0.26 + 140	0.42 + 140
50-100 kHz	1.20 + 840	0.87 + 780	0.98 + 780
100-300 kHz	10.1 + 3720 (30 V range only)		

**Crest factor:** > 4:1 at full scale

**Common mode rejection:** with 1 kΩ imbalance in Lo lead, > 70 dB, at 60 Hz

**Maximum reading rates:** 3½ or 4½ digits, 1.4 readings/s; 5½ digits, 1.0 readings/s. First reading is correct within 70 counts of final value when triggered coincident with step input. Add 0.6 seconds for each range change.

**Resistance (2-wire Ω, 4-wire Ω)**

**Input Characteristics**

Range	Maximum Reading (5½ Digit)	Resolution		
		5½ Digit	4½ Digit	3½ Digit
30 Ω	30.3099 Ω	100 µΩ	1 mΩ	10 mΩ
300 Ω	303.099 Ω	1 mΩ	10 mΩ	100 mΩ
3 kΩ	3.03099 kΩ	10 mΩ	100 mΩ	1 Ω
30 kΩ	30.3099 kΩ	100 mΩ	1 Ω	10 Ω
300 kΩ	303.099 kΩ	1 Ω	10 Ω	100 Ω
3 MΩ	3.03099 MΩ	10 Ω	100 Ω	1 kΩ
30 MΩ	30.3099 MΩ	100 Ω	1 kΩ	10 kΩ

**Input protection (non destructive):** Hi to Lo: ±350 V peak; Hi or Lo to Earth Ground: ±500 V peak.

**Measurement accuracy:** ±(% of reading + number of counts). Auto zero ON. 5½ digit display. 4-wire ohms.

Range	T <sub>Cal</sub> ± 1°C			T <sub>Cal</sub> ± 5°C		
	24 Hour	90 Day	1 Year	24 Hour	90 Day	1 Year
30 Ω	0.023 + 35	0.027 + 41	0.034 + 41	0.023 + 35	0.027 + 41	0.034 + 41
300 Ω	0.0045 + 4	0.012 + 5	0.017 + 5	0.0045 + 4	0.012 + 5	0.017 + 5
3 k-300 kΩ	0.0035 + 2	0.011 + 2	0.016 + 2	0.0035 + 2	0.011 + 2	0.016 + 2
3 MΩ	0.0052 + 2	0.011 + 2	0.016 + 2	0.0052 + 2	0.011 + 2	0.016 + 2
30 MΩ	0.036 + 2	0.066 + 2	0.078 + 2	0.036 + 2	0.066 + 2	0.078 + 2

**Current Through Unknown**

Range	30 Ω	300 Ω	3 kΩ	30 kΩ	300 kΩ	3 MΩ	30 MΩ
Current	1 mA	1 mA	1 mA	100 µA	10 µA	1 µA	100 nA

**DC Current**

**Input Characteristics**

Range	Maximum Reading (5½ Digit)	Resolution		
		5½ Digit	4½ Digit	3½ Digit
300 mA	± 303.099 mA	1 µA	10 µA	100 µA
3 A	± 3.03099 A	10 µA	100 µA	1 mA

**Maximum input (non-destructive):** 3 A from <250 V source; fuse protected.

**Measurement accuracy:** ±(% of reading + number of counts). Auto zero ON. 5½ digit display.

Range	T <sub>Cal</sub> ± 5°C	
	90 Days	1 Year
300 mA	0.11 + 40	0.15 + 40
3 A (<1 A)	0.14 + 6	0.17 + 6
3 A (>1 A)	1.0 + 30	1.0 + 30

**Maximum burden at full scale:** 1 V (3 A range), 0.1 V (0.3 A range)

**AC Current (true rms responding)**

**Input Characteristics**

Range	Maximum Reading (5½ Digit)	Resolution		
		5½ Digit	4½ Digit	3½ Digit
300 mA	303.099 mA	1 µA	10 µA	100 µA
3 A	3.03099 A	10 µA	100 µA	1 mA

**Maximum input (non-destructive):** 3 A from <250 V source; fuse protected.

**Measurement accuracy:** ±(% of reading + number of counts). Auto zero ON. 5½ digit display. Accuracy is specified for sinewave inputs only, > 10% of full scale.

**1 Year, T<sub>Cal</sub> ± 5°C**

Frequency	Ranges	
	300 mA	3 A
20-50 Hz	1.54 + 163	2.24 + 163
50-1 kHz	0.81 + 163	1.50 + 163
1 k-10 kHz	0.72 + 163	1.42 + 163
10 k-20 kHz	0.86 + 163	1.56 + 163

**Maximum burden at full scale:** 1 V RMS (3A range)

**General**

**Operating temperature:** 0 to 55°C

**Humidity range:** 95% R.H., 0 to 40°C

**Power:** ac line 48 to 440 Hz; 86 to 250 V, 25 VA max.

**Size:** 102 mm H x 215 mm W x 356 mm D (4" x 8" x 14"); 3½ in. H without feet.

**Weight:** 3 kg (6.5 lb)

**HP-IB Interface Functions:** SH1, AH1, T5, TE0, L4, LE0, SR1, RL1, PPO, DC1, DT1, C0

**Ordering Information**

**Price**

- Choose one N/C power option:
- Opt 315:** 100 V, 50 Hz; **Opt 335:** 220 V, 50 Hz
- Opt 318:** 100 V, 60 Hz; **Opt 338:** 220 V, 60 Hz
- Opt 325:** 120 V, 50 Hz; **Opt 345:** 240 V, 50 Hz
- Opt 328:** 120 V, 60 Hz; **Opt 348:** 240 V, 60 Hz
- Opt W30:** Three year extended hardware support \$35.00
- Opt 907:** Front Handle Kit (HP P/N 5061-0088) \$51.00
- Opt 908:** Rack Mount Kit (HP P/N 5061-0072) \$54.00
- Opt 910:** Extra Manuals (HP P/N 03478-90005 and (HP P/N 03478-90006) \$22.00

**HP 3478A Multimeter**

**\$1,095.00**

Fast Ship Product—see page 758.

# DIGITAL MULTIMETERS

## 6½ to 3½ Digit HP-IB DMM with High Stability

Model 3456A

- Up to 330 readings per second
- 100 nanovolt resolution
- Transfer standard performance
- 100 micro-ohm to 1.0 gigaohm measurement capability
- Offset compensated ohms (OC Ω)
- Fast AC

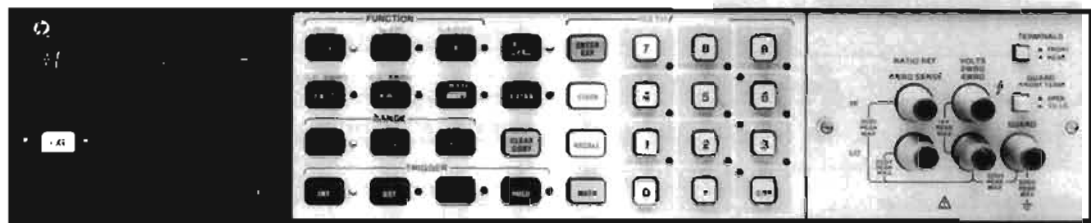

HP 3456A



### Description

This microprocessor-based, fully guarded, integrating Digital Multimeter is designed for bench or systems. The HP Model 3456A measures DC, true RMS AC voltage and resistance.

Measurement speed and accuracy can be enhanced for a specific application, using the HP 3456A's selectable integration time (up to 100 power line cycles). An operator can select up to 330 readings/second for high speed bursts or one reading every fifteen minutes for periodic measurements. Resolution of 100 nanovolts at 48 readings/second (6½ digits) to 10 microvolt resolution at 330 readings per second (3½ or 4½ digits) can be selected.

Transfer standard performance is assured with the HP 3456A. With good repeatability and 100 nanovolt sensitivity, accuracy on the 100 volt range is  $\pm 0.0008\% + 2$  counts over a 24-hour period at 23°C  $\pm 1^\circ\text{C}$ .

Four full-scale, true RMS AC voltage ranges are provided, with reading speeds up to 12 readings per second over a 10 Hz to 250 kHz frequency range. Best accuracy is 0.05%. Crest factor is greater than seven at full scale.

### System DMM

Full programmability over HP-IB is standard on the HP 3456A. The front panel indicators on the HP 3456A display range, function and HP-IB status during remote operation. Also on the front panel is a SRQ (Service Request) button which can be used to flag or interrupt a computer. With the HP 3456A's program memory and reading storage capability, the HP 3456A can take measurements and store them while a computer performs some other task.

Another system feature of the HP 3456A is its hardware scanner advance capability for scanned or multiplexed system applications. As soon as the HP 3456A's measurement cycle is complete, a TTL signal is available to trigger a variety of switching instruments like the HP 3497A Data Acquisition/Control Unit to advance to their next channel. Up to 330 channels can be scanned per second without computer interaction.

### Bench DMM

With a 2 ppm stability, the HP 3456A is a true transfer standard offering either 100 nanovolt sensitivity or 0.001% accuracy. Other standard features include fast autorange and easy-to-use math functions. The user can scale, limit test, null and make measurements in percent error, dB and dBm, as well as convert thermistor readings to degrees F and C. A statistics function key (STAT) enables the operator to improve the HP 3456A's sensitivity, resolution and accuracy by averaging. Averaging reduces random noise fluctuations and improves sensitivity by a factor of the square root of the number of measurements. For example, for low level signals after 100 measurements, the actual sensitivity of the HP 3456A is approximately 10 nanovolts instead of 100 nanovolts. In addition, STAT enables the

operator to recall the maximum (upper), minimum (lower), and variance.

Calibration of the HP 3456A is fast and convenient since all routine adjustments are accessible from a concealed door in the front panel. Should service be necessary, built-in diagnostics and PC Board modules make the HP 3456A easy to service.

### Specifications

#### DC Voltage

##### Input Characteristics

RANGE	MAXIMUM READING (5½ digit)	6½ digit	RESOLUTION (5½ digit)	4½ digit	INPUT RESISTANCE	MAXIMUM INPUT VOLTAGE
0.1 V	0.19999 V	100 nV	1 µV	10 µV	$>10^{10} \Omega$	$\pm 1000$ V peak
1.0 V	1.19999 V	1 µV	10 µV	100 µV	$>10^{10} \Omega$	
10.0 V	11.9999 V	10 µV	100 µV	1 mV	$>10^{10} \Omega$	
100.0 V	119.999 V	100 µV	1 mV	10 mV	10 MΩ $\pm 5\%$	
1000.0 V	1000.00 V	1 mV	10 mV	100 mV	10 MΩ $\pm 5\%$	

Guard to chassis:  $\pm 500$  V peak

Guard to low:  $\pm 200$  V peak

Measurement accuracy:  $\pm$  (% of reading + number of counts). Auto-zero on and filter off.

RANGE	24 hour: 23°C $\pm 1^\circ\text{C}$		90 days: 23°C $\pm 5^\circ\text{C}$		1 year: 23°C $\pm 5^\circ\text{C}$	
	6½ digit ( $\geq 10$ PLC)	6½ digit (1 PLC)	6½ digit ( $\geq 10$ PLC)	6½ digit (1 PLC)	6½ digit ( $\geq 10$ PLC)	6½ digit (1 PLC)
0.1 V	0.0022 + 24	0.0024 + 32	0.0026 + 24	0.0027 + 32	0.0034 + 24	0.0035 + 32
1.0 V	0.0009 + 4	0.0012 + 5	0.0016 + 4	0.0017 + 5	0.0024 + 4	0.0025 + 5
10.0 V	0.0008 + 2	0.0011 + 3	0.0015 + 2	0.0016 + 3	0.0023 + 2	0.0024 + 3
100.0 V	0.0011 + 3	0.0014 + 4	0.0018 + 3	0.0019 + 4	0.0026 + 3	0.0027 + 4
1000.0 V	0.0011 + 2	0.0013 + 3	0.0016 + 2	0.0017 + 3	0.0024 + 2	0.0025 + 3

\*Add .02  $\left( \frac{\text{Input Voltage}}{1000} \right)$  % to % of reading.

Filter ON: rejection is  $>60$  dB at 50 Hz. Add 2 µV to uncertainty for .1 V, 1.0 V and 10 V range and 200 µV for 100 V and 1000 V range.

#### Response Time

Filter OFF: for preprogrammed settling times (0.0 seconds), error is  $<0.0005\%$  of input voltage step.

Filter ON: for preprogrammed settling times (.65 seconds), error is  $<.01\%$  of input voltage step.

#### NOISE REJECTION (dB) (1 kΩ unbalance in Lo)

	AC' NMR	AC' ECMR	DC ECMR
.01 PLC or .1 PLC	0	90	140
$\geq 1$ PLC	60	150	140
$\geq 1$ PLC with filter	120	160	140

\*For 50, 60 Hz (depending on option)  $\pm 0.09\%$

**AC RMS Voltage (AC, AC + DC)**

**Input Characteristics**

RANGE	MAXIMUM READING (5 1/2 digit)			RESOLUTION			INPUT IMPEDANCE	MAXIMUM INPUT VOLTAGE
	6 1/2 digit	5 1/2 digit	4 1/2 digit	5 1/2 digit	4 1/2 digit	4 1/2 digit		
1.0 V	1 19999 V	1 μV	10 μV	100 μV	1 MΩ ± 5% shunted by <90 pF	± 1000 V peak (700 V rms) 10 <sup>8</sup> VHZ		
10.0 V	11 9999 V	10 μV	100 μV	1 mV				
100.00 V	119 999 V	100 μV	1 mV	10 mV				
1000.0 V	700.00 V	1 mV	10 mV	100 mV				

**Measurement accuracy:** ±(% of reading + number of counts). Auto-zero on, > 1% of scale, and dc component < 10% of AC component.

90 days: 23°C ± 5°C

Integration Time In Power Line Cycles	Frequency in Hz					
	10 to 20	Filter Off— 20 to 30	400-20k 30-20k	20k to 50k 20k to 50k	50k to 100k 50k to 100k	100k to 250k 100k to 250k
> 1~ (6 Digit) <sup>1</sup>	.47 + 450	.35 + 500	.07 + 730	.17 + 1700	.55 ± 2900	5.0 + 6500
.1~ (5 Digit)	.48 + 90	.36 + 53	.08 + 73	.18 + 173	.56 ± 293	5.0 + 653
.01~ (4 Digit)	.56 + 10	.41 + 7	.13 + 9	.23 + 19	.61 + 31	5.1 + 67

<sup>1</sup>Frequencies > 100 kHz are specified for 1.0 V and 10 V ranges only.

<sup>2</sup>Integration Time in Power Line Cycles (PLC). For 5 1/2 digits, multiply counts by 0.1. For 4 1/2 digits, multiply counts by 0.01.

**Guard to chassis:** ±500 V peak

**Guard to low:** ±200 V peak

**DC component > 10% of ac component:** (5 1/2 digit) Add ±(0.05% of Reading + 50 counts) to accuracy. For 6 1/2 digit, multiply counts by 10. For 4 1/2 digit, multiply counts by .1. For signals with no AC component, use the 1 kHz ac spec.

**Crest factor:** > 7:1 at full scale.

**Common mode rejection (1 kΩ Lo unbalance):** > 90dB DC to 60 Hz.

**Auto-zero OFF:** for stable environment ±1°C no accuracy change.

**Response time:** for preprogrammed settling times, error is < .1% of input voltage step.

**Filter OFF:** 0.06 seconds

**Filter ON:** .80 seconds

**Resistance (2 WΩ, 4 WΩ, 2 WOCΩ, 4 WOCΩ)**

**Input Characteristics**

RANGE	MAXIMUM READING (5 1/2 digit)			RESOLUTION			CURRENT THROUGH UNKNOWN
	6 1/2 digit	5 1/2 digit	4 1/2 digit	5 1/2 digit	4 1/2 digit	4 1/2 digit	
100 Ω	119.999 Ω	100 μΩ	1 mΩ	10 mΩ	10 mΩ	1 mA	
1 kΩ	1199.99 Ω	1 mΩ	10 mΩ	100 mΩ	100 mΩ	1 mA	
10 kΩ	11.9999 kΩ	10 mΩ	100 mΩ	1 Ω	100 μA		
100 kΩ	119.999 kΩ	100 mΩ	1 Ω	10 Ω	50 μA		
1 MΩ	1199.99 kΩ	1 Ω	10 Ω	100 Ω	5 μA		
10 MΩ	11.9999 MΩ	10 Ω	100 Ω	1 kΩ	500 nA		
100 MΩ	119.999 MΩ	100 Ω	1 kΩ	10 kΩ	≤ 500 nA <sup>1</sup>		
1 GΩ	1000.00 MΩ	1 kΩ	10 kΩ	100 kΩ	≤ 500 nA <sup>1</sup>		

<sup>1</sup>Ohms source is a 500 nA current source in parallel with a 10 MΩ resistance.

**Non-destructive overload:** 350 V peak

**Measurement accuracy:** ± (% of reading + number of counts). Auto-zero on, filter off, and 4-wire ohms.

RANGE	24 hour: 23°C ± 5°C		90 days: 23°C ± 5°C	
	6 1/2 digit (≥ 10 PLC)	6 1/2 digit (1 PLC)	6 1/2 digit (≥ 10 PLC)	6 1/2 digit (1 PLC)
100 Ω	0.003 + 24	0.003 + 32	0.004 + 24	0.004 + 32
1 kΩ	0.002 + 4	0.003 + 5	0.003 + 4	0.004 + 5
10 kΩ	0.002 + 4	0.003 + 5	0.003 + 4	0.004 + 5
100 kΩ	0.002 + 2	0.003 + 3	0.003 + 2	0.004 + 3
1 MΩ	0.006 + 2	0.006 + 3	0.007 + 2	0.007 + 3
10 MΩ	0.041 + 2	0.041 + 3	0.042 + 2	0.042 + 3
100 MΩ	1.3 + 1	1.3 + 1	1.8 + 1	1.8 + 1
1 GΩ	11 + 1	11 + 1	16 + 1	16 + 1

**Ratio**

**Type:** DC/DC, AC/DC, or (AC + DC)/DC

**Method:** 4-wire with Volts Lo input common

$$\text{Ratio} = \frac{\text{Signal Voltage}}{\text{Ref. Hi Voltage} - \text{Ref. Lo Voltage}}$$

**Signal measurement:** Same as DC Volts, AC Volts, or AC + DC Volts

**Reference measurement:** automatically selects .1 V, 1 V, or 10 V DC. Volts range and a 0.0 ms. settling time. Filter is off.

**Maximum Reference Voltages**

Ref. Hi: ±12 V

Ref. Lo: ±9% of Ref. Hi

Ref. Hi-Ref. Lo: ±11.9999 V

Protection: ±340 V peak

**Accuracy:** total % signal error + total % reference error (same as .1 V, 1 V, or 10 V DC volts)

**Reading Rate**

Reading rates are with autorange, math, display and filter off. Output is to internal memory using internal trigger and packed mode. Packed output in place of internal memory adds 0.35 ms; ASCII output adds 2.3 ms per reading.

**Rates vs. integration time and auto-zero:** DC volts and 100 Ω thru 10 kΩ ranges with preprogrammed settling times (-0.0 s.). Also, AC or AC + DC volts and 100 kΩ thru 10 kΩ ranges with 0.0 s delay.

INTEGRATION TIME IN POWER LINE CYCLES (PLC)	RATES (rdgs/second)			
	Auto Zero OFF		Auto Zero ON	
	60 Hz	50 Hz	60 Hz	50 Hz
0.01 (4 1/2 digit)	330	290	210	180
0.10 (5 1/2 digit)	210	180	120	100
1.00 (6 1/2 digit)	48	40	25	20
10.00 (6 1/2 digit)	5.8	4.8	2.9	2.4
100.00 (6 1/2 digit)	.57	.47	.29	.24

**Memory**

**Reading store:** Store up to 350 readings. These readings can be recalled from HP-IB interface or front panel

**Program memory:** can execute an internal program which controls instrument configuration and measurement sequence. Program is input from the HP-IB interface with up to 1400 ASCII characters.

**Memory size:** total size is 1400 bytes. Memory used is 1 byte per ASCII character + 4 bytes per reading stored.

**General**

**Operating temperature:** 0 to 50°C

**Warmup time:** one hour to meet all specifications

**Humidity range:** 95% R.H., 0 to 40°C

**Storage temperature:** -40 to +75°C

**Power:** 100/120/220/240 V +5%, -10%, 48 Hz to 400 Hz line operation, 45 VA max.

**Size:** 88.9 mm H x 425.5 mm W x 527.1 mm D (3 1/2" x 16 1/4" x 20 1/4")

**Weight:** net, 10.49 kg (23.13 lb.); shipping, 13.35 kg (29.38 lb.)

**Ordering Information**

	Price
<b>Opt 050:</b> Noise rejection for 50 Hz	N/C
<b>Opt 060:</b> Noise rejection for 60 Hz	N/C
<b>Opt 907:</b> Front handle kit, P/N 5061-1666	+ \$51 ☞
<b>Opt 908:</b> Rack flange kit, P/N 5061-9674	+ \$31 ☞
<b>Opt 909:</b> Rack flange and front handle kit, HP P/N 5061-9675	+ \$74 ☞
<b>Opt 910:</b> Extra operating & service manual	+ \$78
<b>Opt H01:</b> Enhanced AC accuracy	+ \$200
<b>Opt W30:</b> 3 year hardware support	+ \$120
<b>HP 3456A Digital Voltmeter</b>	4180

☞ Fast-Ship Product — see page 758

# DIGITAL MULTIMETERS

## 3 $\frac{1}{2}$ to 6 $\frac{1}{2}$ Digit DMM with Extended Resolution to 7 $\frac{1}{2}$ Digits

### HP Model 3457A

- Over 1350 Readings/sec at 3 $\frac{1}{2}$  Digits
- Seven Functions—DCV, ACV, DCI, ACI, Ohms, Frequency and Period
- Two Plug-In Multiplexer Options
- DC Sensitivity to 10 Nanovolts
- Outstanding Combination of Performance and Price

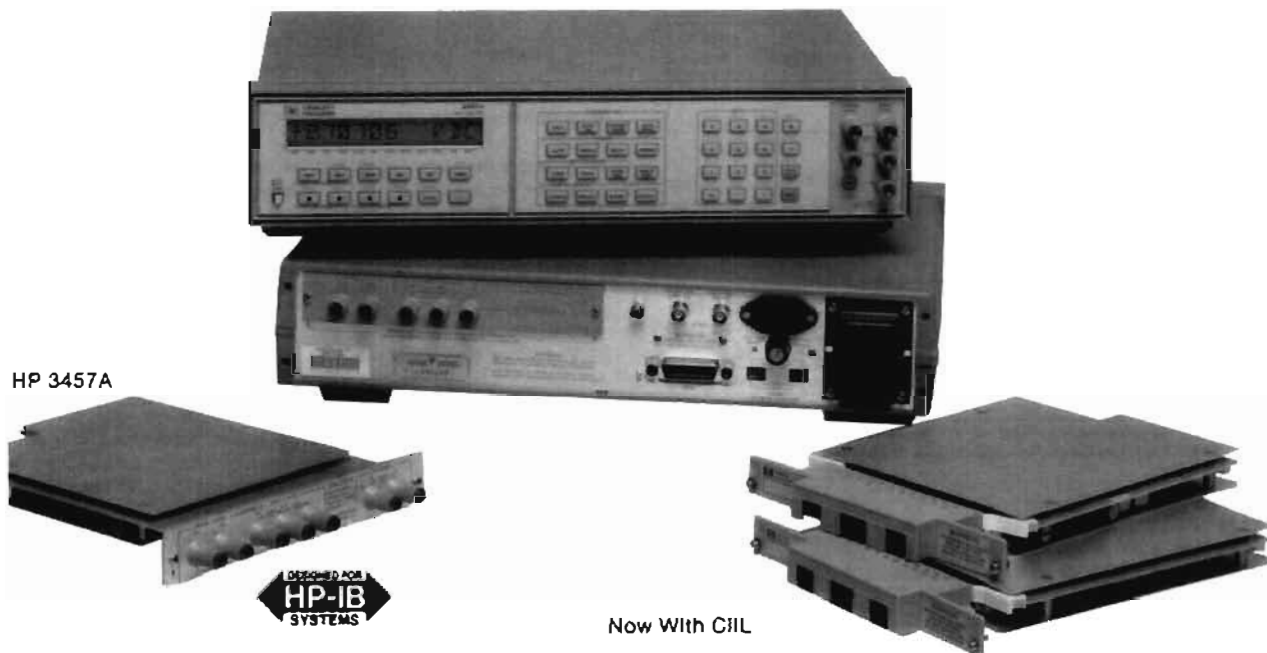

### Description

The HP 3457A has seven functions with 3 $\frac{1}{2}$  to 6 $\frac{1}{2}$  digits of resolution extendable to 7 $\frac{1}{2}$  digits at reading rates from 1 reading every 2 seconds to 1350 rds/s and basic DC volts accuracy as good as 5 ppm. In addition, the input of the HP 3457A can be expanded up to ten channels with either of the optional plug-in multiplexer assemblies. On the bench, the front panel operation is extremely flexible and comprehensive. In systems, the Hewlett-Packard Interface Bus (HP-IB) is standard.

### Powerful Measurement Management

The HP 3457A combines superb analog measuring capability with equally powerful measurement management. More than 1000 readings or whole measurement sequences can be stored in the HP 3457A for convenient and fast measurement throughput. The present dmm setup can be stored in the non-volatile state memory for convenient reconfiguration of the dmm.

Additional power from math functions can be obtained by using PASS/FAIL limit testing, NULL, SCALE, THERMISTOR linearization, and others. The power of total electronic calibration, including AC volts, makes it easy to maintain instrument performance.

### System Features

Keeping with HP's long tradition of systems oriented digital multimeters, the HP 3457A has all the systems features you've come to expect plus more to make interfacing to your computer even easier—features like flexible formatting of ASCII, 16 bit binary, or 32 bit binary data and buffer memory so that you can take measurements with the HP 3457A at its highest speed. In addition, you'll find the VOLTMETER COMPLETE output and EXTERNAL TRIGGER input signals ideal for synchronizing other instrumentation with the HP 3457A. Finally, programmable front-rear terminal switching lets you measure two separate inputs without a scanner.

### Hewlett-Packard Multimeter Language (HPML)

Another first for the HP 3457A DMM is an easy-to-use dmm language—HPML. Designed so that software written for today's multimeter will fit tomorrow's, HPML only asks you to define the parameters necessary to accomplish your measurement. For example, if you want to make a measurement on a 9 volt DC signal with 0.01% resolution, the command sequence is "DCV,9,.01".

### Control Interface Intermediate Language (CIIIL) Option

With Option 700, the HP 3457A responds to standardized DMM CIIIL commands via HP-IB. Physically and functionally identical to the standard HP 3457A, Option 700 adds the CIIIL command set with a built-in Test Module Adapter (TMA) to the DMM's standard HPML. The HP 3457A is further enhanced by adding the functions of AC and DC current measurement through CIIIL through HP-IB.

### Three Rear Panel Plug-in Options

Either one of three different optional assemblies may be used with the HP 3457A for different measurement capabilities. Using the multiplexer assemblies will enable up to ten signal channels to be scanned either sequentially or randomly. All of the functional capability offered through the normal front and rear input terminals is available for multiple inputs. Using the high voltage assembly allows single channel measurement of either AC or DC voltages at the rear panel.

For measurement flexibility, the HP 44491A Armature Relay Multiplexer Assembly offers eight two-wire channels and two current/actuator channels. Under software control, the eight two-wire channels can be reconfigured to four 4-wire ohm channels. The two current channels offer automatic make-before-break switching so that the path for current as high as 1.5 A is never broken. In addition, these two channels can be used as external device actuator channels. Each channel can switch up to 150 V. The general purpose multiplexer can close a channel and make a measurement at a maximum rate of 33 channels per second.

For higher speed scanning, the HP 44492A Reed Relay Multiplexer Assembly offers ten two-wire channels. The HP 44492A is useful for switching dcV, acV, ac+dcV, two wire ohms, frequency and period measurement signals with a maximum amplitude of 125 V. The Reed Relay Multiplexer can close a relay and make a measurement at a maximum rate of 300 channels per second.

For measurement of voltages up to 1414 V peak, the HP 44497A High Voltage Assembly offers a 1000:1 attenuator input (channel 1) for the high voltage measurements. In addition, the other rear terminal input (channel 0) can be utilized to perform conventional VDC, VAC, Two-wire and Four-wire Ohms, Period, Frequency, DCI, and ACI measurements. Using the HP 44497A with HP 3457A in the 6 $\frac{1}{2}$  digit mode will yield a resolution of 1 mV for a 1000 V input. Implementing the MATH Scale function will have the HP 3457A LCD display the measurement results in the correct units of kilovolts.



# DIGITAL MULTIMETERS

## System Digital Multimeters

HP Model 3437A, 3455A

97

- 5½/6½-Digit DVM with Auto Cal
- High Speed 3½ Digit System Voltmeter



HP 3437A

HP 3455A

### HP 3437A Description

The Hewlett-Packard 3437A System Voltmeter is designed for systems. It is a 3½-digit, high-speed dc voltmeter with sample and hold. The standard unit measures dc volts, provides trigger delay, burst reading capability and Hewlett-Packard Interface Bus (HP-IB).

There are three dc floating input ranges: 0.1V, 1.0V and 10.0V full scale with a maximum display of "1998." Sample and Hold allow the HP 3437A to be an instantaneous reading voltmeter. The trigger delay can be set from 0.1µs to 1.0 second and the number of readings can be set from 0 to 9999 readings.

### Performance

**Static Accuracy (90 days, 23°C ±5°C)**

**10 V range:** ±(0.05% of reading + 1.6 counts).

**Static accuracy temperature coefficient (0°C–50°C):** ±(0.002% reading + 0.05 counts) / °C

### Input Characteristics

**10 V range:** R = 1 MΩ ±20%; C < 75 pF.

**Maximum input voltage high to low on all ranges:** < ±30 V peak.

**Maximum voltage low to chassis:** ±42 V peak.

**Maximum reading rate (remote, N Rdgs. > 1, and a zero delay listener)**

**ASCH:** 3600 readings/s.

**Packed:** 5700 readings/s.

**Input Bandwidth (3 dB)**

**1 V and 10 V range:** 1.0 MHz.

### General

**Operating temperature:** 0 to 55°C.

**Storage temperature:** -40°C to 75°C.

**Humidity range:** < 95% R.H., 0°C to 40°C.

**Power:** 100 V, 120 V, 220 V, 240 V ±5%, -10%, 48 Hz to 440 Hz line operation, < 42 VA.

**Size:** 88.9 mm H x 212.7 mm W x 527.1 mm D (3½" x 8½" x 20¾").

**Weight:** net, 5.6 kg (12 lb 4 oz). Shipping, 7.6 kg (16 lb 12 oz).

### HP 3437A System Voltmeter

**\$3370**

**Option W30:** extended warranty

**\$95**

### HP 3455A Description

Hewlett-Packard's 3455A Digital Voltmeter is a microprocessor controlled 5½- or 6½-digit integrating voltmeter for bench or systems applications. The standard instrument measures dc volts, ac volts, and resistance. HP-IB and auto or manual ranging are also standard.

### Measuring Speed

The HP 3455A is fully guarded and has greater than 60 dB normal mode noise rejection at reading rates of up to 24 readings per second on all dc ranges. Ohms reading rates are up to 12 readings/second and an ac fast mode gives reading rates of up to 13 readings/second at

frequencies above 300 Hz. (Readings/second given for 60 Hz operation and high resolution off.)

### Performance

DC measurements can be made with up to 1µV sensitivity. Ohms measurements are made with either a 2-wire and 4-wire mode. The High Resolution (6½-digit) mode gives dc and ohms measurements with greater than 1 part per million resolution. The standard true rms ac to dc converter measures sinusoid and complex signals with crest factors up to 7:1 at full scale from 30 Hz to 1 MHz.

### Specifications

**Accuracy ± (% of reading + counts)**

24 hrs: 23°C ± 1°C		
Range	24 Hrs.	90 Days
1 V	0.003 + 4	0.006 + 4
10 V	0.002 + 3	0.005 + 3
100 & 1000 V	0.004 + 3	0.007 + 3

**Input resistance:** 0.1 V through 10 V range: > 10<sup>10</sup> ohms. 100 V and 1000 V range: 10 megohm ±0.1% with Auto Cal. "off."

**Maximum Input Voltage: High to low input terminals:** ±1000 V peak; **Guard to chassis:** ±500 V peak; **Guard to low terminal:** ±200 V peak

**NMR at 50 or 60 Hz ±0.1%:** > 60 dB.

**ECMR with 1 kΩ Unbalance in Lo at DC:** > 160dB;

### AC Voltage (rms converter)

#### Input Impedance

**Front terminals:** 2 MΩ ±1% shunted by less than 105 pf.

**Rear terminals:** 2 MΩ ±1% shunted by less than 90 pf.

#### Maximum Input Voltage

**High to low terminals:** ±1400 volts peak; 10<sup>7</sup> V/Hz max.

**Guard to chassis:** ±500 V peak; **Guard to low terminal:** ±200 V peak.

**Crest factor:** 7:1 at full scale.

### Performance (rms converter)

**Accuracy:** [± % of reading + counts] (ac coupled)

Fast ACV	300 Hz to 20 kHz	20 kHz to 100 kHz	100 kHz to 250 kHz	250 kHz to 500 kHz	500 kHz to 1 MHz
	30 Hz to 20 kHz	100 kHz	250 kHz	500 kHz	1 MHz
ACV					
90 days					
23°C ± 5°C	0.05 + 50	0.50 + 100	2.00 + 250	5.00 + 500	6.00 + 3100

**Accuracy ± (% of reading + counts) 4-wire kΩ**

24 hours: 23°C ± 1°C		
Range	24 Hours	90 Days
1 kΩ	0.0025 + 4	0.0035 + 5
10 kΩ	0.0045 + 4	0.0060 + 5
100 kΩ	0.0020 + 5	0.0035 + 6
1000 kΩ	0.0120 + 4	0.0135 + 5
10,000 kΩ	0.1000 + 4	0.1000 + 5

### Maximum Reading Rates for Remote Operations. (Rdgs/s)

Function	50 Hz	60 Hz
DCV	22	24
Ohms	11	12
ACV (rms)	1.1	1.3
Fast ACV (rms)	12	13

### General

**Power:** 100 V, 120 V, 240 V ±5% -10%, 48-400 Hz; < 60 VA.

**Size:** 88.9 H x 425.5 W x 527.1 mm D (3.5" x 16.75" x 20.75").

**Weight:** net, 9.38 kg (20.7 lb); shipping, 11.8 kg (26 lb).

### Options

**001:** average converter

**Price**

less \$100

### HP 3455A Digital Voltmeter

**\$5710**

**Option W30:** extended warranty

**\$95**

# DIGITAL MULTIMETERS

## 3 1/2 to 6 1/2 Digit DMM with Extended Resolution to 7 1/2 Digits (cont'd)

### HP Model 3457A

#### General Specifications

**Operating Temperature:** 0 to 55° C

**Warmup Time:** one hour to all specifications except where noted

**Humidity Range:** 95% R.H., 0 to 40° C

**Storage Temperature:** -40 to +75° C

**Power:** 100/120/220/240 V  $\pm$ 10%, 48 Hz - 66 Hz, 220 V,  $\pm$ 10%, 48 Hz to 66 Hz. Fused at .2A (115 V) or 0.08 A (230 V). <30 VA.

**Size:** 89 mm H (without removable feet) x 425mm W x 292mm D (3.5" x 16.75" x 11.5"). Height (with removable feet): 100 mm (4"). Allow 76mm (3") additional depth for wiring.

**Net Weight:** 5.05 kgm (11.1 lbs)

**Shipping Weight:** 9.3 kgm (20.5 lbs)

#### Plug-in Options

##### HP 44491A Armature Relay Multiplexer Assembly Input Characteristics:

Eight two-wire armature relay channels and two current/actuator channels. Maximum voltage (terminal-to-terminal or terminal to chassis) 250 Vrms. Maximum current (per channel) - 1.0 A DC or AC. Thermal Offset - 3  $\mu$  V. Closed channel resistance (end of relay life) - <2 Ohms. Maximum switching and measurement speed - 33 channels/second.

##### HP 44492A Reed Relay Multiplexer Assembly Input Characteristics:

Ten two-wire reed relay channels. Maximum voltage (terminal-to-terminal or terminal-to-chassis) - 125 V peak. Thermal offset - 3  $\mu$  V. Closed channel resistance (end of relay life) - <4 Ohms. Specified for <100 kHz ac volts and frequency operation. Maximum switching and measurement speed - 300 channels/second.

Armature Relay (44491A)

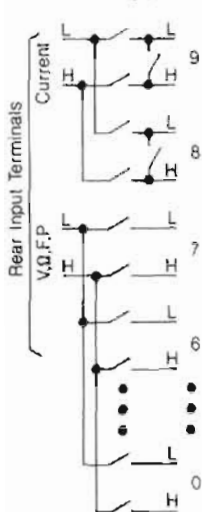

Reed Relay (44492A)

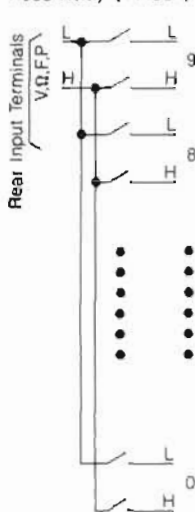

**HP 44497A High Voltage Attenuator Assembly Input Characteristics:** Two relay channels, channel 1 devoted to high voltage measurements. Maximum High-to-Low voltage of 1000 Volts DC or AC rms. Maximum Low-to-Earth voltage of 350 V Peak Non-destructive Overload voltage of 1700 V Peak, 1200 Volts DC. Attenuator accuracy to be added to HP 3457A range and function accuracy for total accuracy.

DC	0.030% of reading
20 Hz - 1 KHz	2.8% of reading
1 KHz - 10 KHz	10.0% of reading

Note: One year accuracy applies to Tcal = 5%, NPLC=1 or greater. Specifications are for low-to-earth voltage less than 0.1 times the High-to-Earth voltage.



#### Model 3457A Multimeter

**Price**  
**\$2900**

*HP 44491A Armature Relay Multiplexer Assembly	\$460
*HP 44492A Reed Relay Multiplexer Assembly	\$460
*HP 44497A High Voltage Attenuator Assembly	\$385
Option 401: Side Handle Kit (P/N 5061-1171)	\$20
Option 700: CII Language	\$970
Option 907: Front Handle Kit (P/N 5061-1170)	\$51
Option 908: Rack Flange Kit (P/N 5061-1168)	\$31
Option 909: Rack Flange and Front Handle Kit (P/N 5061-1169)	\$73
Option 910: Extra Operating and Service Manual	\$106
Option W30: Two years of additional hardware support	\$80
<b>Accessories:</b>	
HP 44490A Rack Slide Kit for 30 inch depth racks	\$229
HP 44493A Screw Terminal Connector for HP 44491A includes strain relief and housing	\$61
HP 44494A Screw Terminal Connector for HP 44492A includes strain relief and housing	\$61
HP 34118A Test Lead Kit	\$26
HP 11096B RF Probe, detects AC voltage up to 700 MHz	\$200
HP 34111A High Voltage Probe, 1000 to 1, DC high voltage divider for up to 40 kVDC	\$210
HP 34119A High Voltage Probe, 1000:1, AC & DC Voltage Divider for up to 5000V	\$127
HP 44414A: Four Thermistor Pack	\$61
03457-10085 Calibration Software (85B Computer)	\$100
03457-10200 Calibration Software (200 Series Computer)	\$100

\*Plug-in options may be ordered and shipped separately without a HP 3457A mainframe. Unless otherwise specified, the optional plug-in accessories will be shipped with the HP 3457A mainframe.

## Abbreviated Technical Specifications

### 90 day, Tcal ± 5 deg. C

#### DC Voltage

Range	Maximum Reading	Best 6 1/2 Digit Accuracy <sup>1</sup> ± (% Rdg + Cnts)		Input Resistance
		% of Reading	Count Error	
30 mV	30.03000 mV	0.0040	365	10 GΩ
300 mV	303.0000 mV	0.0025	39	10 GΩ
3.0 V	3.030000 V	0.0017	6	10 GΩ
30.0 V	30.30000 V	0.0035	19	10 MΩ
300.0 V	303.0000 V	0.0050	6	10 MΩ

1. After 1 hr warm-up, integration time 100 PLC. Tcal is the temperature of the calibration environment between 18 and 28 deg C.

#### DC Current

Range	Maximum Reading	Best 6 1/2 Digit Accuracy <sup>1</sup> ± (% Rdg + Cnts)		Input Resistance
		% of Reading	Count Error	
300 μA	303.0000 μA	0.02	104	10000
3 mA	3.030000 mA	0.02	104	1000
30 mA	30.30000 mA	0.02	104	100
300 mA	303.0000 mA	0.07	204	10
1.0A	1.000000 A	0.07	604	0.1Ω

1. After 1 hr warm-up, integration time 100 PLC. Tcal is the temperature of the calibration environment between 18 and 28 deg C.

#### Resistance (2 and 4 wire ohms)<sup>2</sup>

Range	Maximum Reading	Best 6 1/2 Digit Accuracy <sup>1</sup> ± (% Rdg + Cnts)		
		% of Reading	Count Error	Current Output
30 Ohm	30.30000 Ohm	0.0065	315	1 mA
300 Ohm	303.0000 Ohm	0.0045	34	1 mA
3 kOhm	3.030000 kOhm	0.0035	6	1 mA
30 kOhm	30.30000 kOhm	0.0035	6	100 μA
300 kOhm	303.0000 kOhm	0.0040	7	10 μA
3 MOhm	3.030000 MOhm	0.0055	12	1 μA
30 MOhm	30.30000 MOhm	0.0250	80	100nA
300 MOhm <sup>2</sup>	303.0000 MOhm	1.6	1000	100nA
3.0 GOhm <sup>2</sup>	3.030000 GOhm	16.0	1000	100nA

- After 1 hr warm up, integration time 100 PLC. Tcal is the temperature of the calibration environment between 18 and 28 deg C.
- For two-wire ohms, add 200m Ohms to count error specifications.
- For two-wire ohms only, Accuracy is specified following autocal (ACAL), under stable conditions (±1 deg C).

#### Maximum Reading Rates (DCV, DCI, and Resistance up to 30 kOhm)<sup>2</sup>

Power Line Cycles <sup>2</sup>	Maximum # of Digits	Readings per Second—60Hz (50Hz)		
		Auto Zero On	Auto Zero Off	NMR
.0005	3 1/2	300	1350	0
.005	4 1/2	280	1250	0
.1	5 1/2	140 (128)	360 (312)	0
1.0	6 1/2	26 (22)	53 (45)	60dB
10	7 1/2	2.5 (2.0)	4.8 (4.0)	80dB
100	7 3/4	25 (0.2)	0.5 (0.4)	90dB

- Using Math HIRE mode.
- Reading rates are specified with zero delay, fixed range, display off, and front panel off. The output is to internal reading memory using single integer format and internal timer.
- Integration Time in Power Line Cycles (PLC).

**Common Mode Rejection (dB):** (1 kOhm unbalance in low lead) DC ECMR 140 dB; AC ECMR: <1 PLC, 76 dB; AC ECMR >1 PLC 156 dB, for 50, 60 Hz ±.08%.

#### True RMS ACV and (AC+DC)V

**Bandwidth:** 20 Hz to 1 MHz  
**Crest Factor:** 3.5 to 1 at full scale

**Common Mode Rejection:** (1 kOhm unbalance in LO): >76 dB, DC to 60 Hz

**Accuracy:** (90 day)

Accuracy specified for sine wave inputs, >10% of range. DC component <10% of AC component after 1 hr warm-up and within one week of autocal. Integration time = 10 PLC. AC Band set to <400 Hz. DC coupled mode requires 2 hour warm-up.

Range	Maximum Reading	(100 Hz to 20 kHz) Best 5 1/2 Digit Accuracy ± (% Rdg + Cnts)				Input Impedance
		AC Coupled % of Reading	Count Error	DC Coupled % of Reading	Count Error	
30mV	32.50000mV	0.13	116	0.17	364	1MΩ ±1% shunted by <90pf
300mV	325.0000mV	0.13	116	0.17	364	
3.0V	3.250000 V	0.13	116	0.17	364	
30.V	32.50000 V	0.13	116	0.17	364	
300V	303.0000 V	0.19	116	0.23	364	

#### True RMS ACI and (AC+DC)

**Bandwidth:** 20 Hz to 100 kHz Crest Factor: 3.5 to full scale

**Accuracy:** (90 day)

Accuracy specified for sine wave inputs, >10% of range. DC component <10% of AC component after 1 hr warm-up and within one week of autocal. Integration time = 10 PLC. AC Band set to <400 Hz. DC coupled mode requires 2 hour warm-up.

Range	Maximum Reading	(100 Hz to 20 kHz) Best 5 1/2 Digit Accuracy ± (% Rdg + Cnts)			
		AC Coupled		DC Coupled	
		% of Reading	Count Error	% of Reading	Count Error
30mA	32.50000mA	0.25	290	0.3	1600
300mA	325.0000mA	0.25	290	0.3	1600
1.0A	1.000000 A	0.35	290	0.4	1600

#### Reading Rates (ACV and ACI)<sup>1</sup>

Power Line Cycles	Maximum # of Digits	Readings per Second .60 Hz (50 Hz)	
		Input <400 Hz (Slow Response)	Input >400 Hz (Fast Response)
.0005	3 1/2	1	9.5
.005	4 1/2	1	9.5
.1	5 1/2	1 (1)	9.25 (9.2)
1	6 1/2	1 (1)	7.25 (6.9)
10	6 3/4	0.7 (0.65)	2.0 (1.7)
100	6 7/8	0.2 (0.17)	0.25 (0.2)

1. Reading rates are specified with preprogrammed delays, fixed range, and Auto Zero on.

**Frequency and Period:** Measures the frequency or period of the ac component of the ac or dc coupled voltage or current input. The counter uses a reciprocal counting technique to give constant resolution independent of input frequency.

**Input Impedance:** Refer to AC voltage and current specifications.

**Frequency Range:** 10 Hz to 1.5 MHz (voltage input)

10 Hz to 100 KHz (current input)

**Period Range:** .1 s to 667 ns (voltage input)

.1 s to 3.33 us (current input)

**Sensitivity:** 10 mV or 100 μA (sinewave)

**Triggering:** Triggers and counts on zero crossings

**Accuracy:** (1 year)

Frequency	Period	± % of Reading
10 Hz to 400 Hz	1 s to 0.25 s	0.05
400 Hz to 1.5 MHz	0.25 s to 667 ns	0.01

**Maximum Reading Rate:** 2.0 rdgs/s for integration time of 1 PLC. AC Band >400 Hz, delay zero and math off, and fixed range.

**Memory:** 2139 available bytes that can be partitioned into 3 segments, one devoted to storing measurements, one devoted to storing measurement subprograms, and one devoted to storing instrument states.

**Math Functions:** The HP 3457A performs the following math functions on the measurements—NULL, SCALE, OFFSET, RMS FILTER, SINGLE POLE FILTER, THERMISTOR LINEARIZATION, DB, DBM, % ERROR, PASS/FAIL LIMIT TESTING, and STATISTICS. Two math functions may be used at one time.

# DIGITAL MULTIMETERS

## High Performance 5½ to 3½ Digit Bench DMM

HP Models 3468A/B

- Five functions
- Electronic calibration
- 5½ to 3½ digits

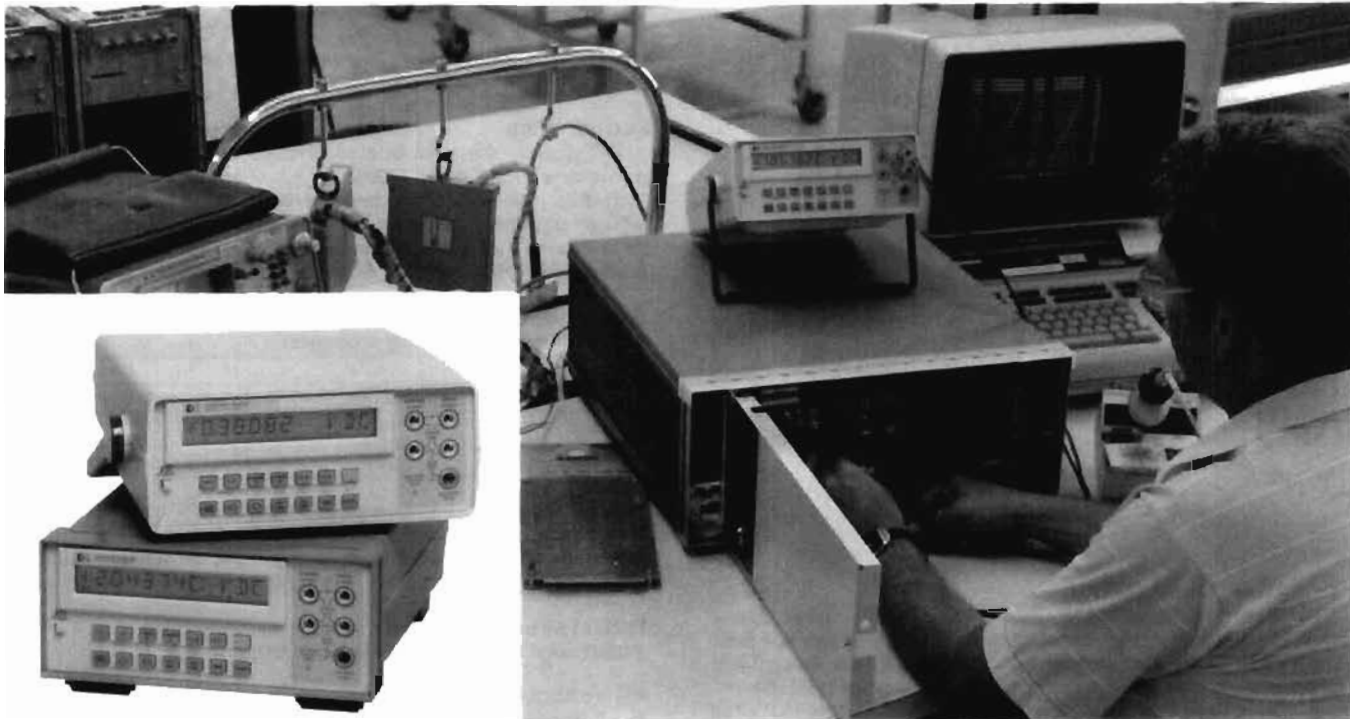

HP 3468A/B

### Description

The HP Models 3468A/B are autoranging 5½ to 3½ digit DMMs, with the five functions of dc volts, true RMS ac volts, 2- and 4-wire ohms, dc current and true RMS ac current. They are low-cost, highly reliable DMMs which can be completely calibrated electronically, either manually from the front panel or remotely in an automatic calibration system. Remote calibration is made possible by the built-in HP-IL (Hewlett-Packard Interface Loop) interface which provides complete programmability of functions, ranges and modifiers.

The HP 3468A comes in a streamlined portable package with a handle for convenient carrying, whereas the HP 3468B comes in a plastic system case for easy rack mounting. Both are available with a rechargeable battery and battery charging circuitry for portable measurements.

### High Performance

The HP 3468A/B have 5 functions with selectable 5½, 4½ or 3½ digit resolution. DC and true RMS ac voltage measurements are provided from 0.3 volt full scale range with 1 µV sensitivity up to 300 volts. The bandwidth of the true RMS ac converter is from 20 Hz to 100 kHz on all ranges and up to 300 kHz on the 30 V range. Either 2 or 4-wire ohms measurements can be selected with a maximum range of 30 MΩ. Both dc and true RMS ac current capability is provided up to 3 A. All functions on the HP 3468A/B incorporate fast autoranging. The HP 3468A/B use an integrating analog to digital conversion technique for high noise rejection. The selectable 3½, 4½ or 5½ digits of resolution allows flexibility for choosing speed or noise rejection.

### Electronic Calibration

Complete calibration of the HP 3468A/B is done electronically, either manually from the front panel or remotely in an automatic calibration system. There are no internal adjustments necessary. Complete calibration of all functions is done without removal of the instrument's covers, thus saving valuable time and reducing cost. The calibration procedure for the HP 3468A/B involves connecting a calibration standard to the input, then pressing three keystrokes to store one calibration constant in CMOS RAM for each range and function. When the HP 3468A/B make a measurement, each reading is corrected according to the calibration constants that have been stored. The internal CMOS RAM used in the HP 3468A/B is powered by a

lithium battery to create a non-volatile memory capable of holding the calibration constants for more than ten years.

### HP-IL

The HP Models 3468A/B are fully programmable with HP-IL, a two-wire serial interface, and the HP-41C/CV handheld calculators or the more powerful HP Series 80 computers. HP-IL provides automatic measurements and adds computational power to these bench DMMs.

### Battery

The optional battery pack includes a rechargeable battery and the battery charger circuitry for up to five hours of continuous measurements.

### DC Voltage

#### Input Characteristics

Range	Maximum Reading (5½ digit)	Resolution		
		5½ digit	4½ digit	3½ digit
0.3 V	±0.301000 V	1 µV	10 µV	100 µV
3 V	± 3.010000 V	10 µV	100 µV	1 mV
30 V	± 30.0000 V	100 µV	1 mV	10 mV
300 V	± 301.0000 V	1 mV	10 mV	100 mV

**Input resistance:** 0.3 V, 3 V ranges:  $> 10^{10} \Omega$   
30 V, 300 V ranges:  $10 \text{ M}\Omega \pm 1\%$

**Maximum Input Voltage (non-destructive)**

Hi to Lo: 301 Vrms or 450 V peak

Hi or Lo to Earth Ground: ±500 V peak

**Measurement accuracy:**  $\pm(\% \text{ of reading} + \text{number of counts})$ .

Auto zero ON, 5½ digits.

Range	T <sub>Cal</sub> ± 0.1°C 24 Hour	T <sub>Cal</sub> ± 0.5°C	
		90 Day	1 Year
0.3 V	0.005 + 4	0.009 + 5	0.02 + 5
3 V	0.0035 + 2	0.0072 + 2	0.0150 + 2
30 V	0.005 + 3	0.009 + 3	0.02 + 3
300 V	0.0055 + 2	0.009 + 2	0.02 + 2

\*T<sub>Cal</sub> is the temperature of the environment where the 3468A/B was calibrated. Calibration should be performed with the temperature of the environment between 20°C and 30°C.

**Temperature coefficient:** 0°C to 55°C, 5½ digits, auto zero ON, ± (% of reading + number of counts)/°C.

Range	Temperature Coefficient
0.3 V, 30 V	0.0008 + 0.5
3 V, 300 V	0.0007 + .05

**Noise rejection:** in dB, with 1 kΩ imbalance in Lo lead. AC rejection for 50, 60 Hz ±0.1%. Auto zero ON.

Display	AC NMR	AC ECRM	DC CMR
5½ digits	80	150	140
4½ digits	59	130	140
3½ digits	0	70	140

**Maximum reading rate with HP-85:** 32 readings/second.

**Maximum reading rate with HP-41CV:** 2 readings/second.

**Resistance** (2-wire Ω, 4-wire Ω)

**Input Characteristics**

Range	Maximum Reading (5½ digit)	Resolution		
		5½ digit	4½ digit	3½ digit
300 Ω	301.000 Ω	1 mΩ	10 mΩ	100 mΩ
3 kΩ	3.01000 kΩ	10 mΩ	100 mΩ	1 Ω
30 kΩ	30.1000 kΩ	100 mΩ	1 Ω	10 Ω
300 kΩ	301.000 kΩ	1 Ω	10 Ω	100 Ω
3 MΩ	3.01000 MΩ	10 Ω	100 Ω	1 kΩ
30 MΩ	30.1000 MΩ	100 Ω	1 kΩ	10 kΩ

**Input protection** (non-destructive): ± 350 V peak.

**Measurement accuracy:** ± (% of reading + number of counts). Auto zero ON. 5½ digit display. 4-wire ohms.

Range	TCal ±1°C 24 Hour	TCal ±5°C	
		90 Day	1 Year
300 Ω	.0045 + 4	.012 + 5	.017 + 5
3 kΩ-300 kΩ	.0035 + 2	.011 + 2	.016 + 2
3 MΩ	.0052 + 2	.011 + 2	.016 + 2
30 MΩ	.036 + 2	.066 + 2	.078 + 2

**Current Through Unknown**

Range	300 Ω	3 kΩ	30 kΩ	300 kΩ	3 MΩ	30 MΩ
Current	1 mA	1 mA	100 μA	10 μA	1 μA	100 nA

**Maximum open circuit voltage:** 6.5 V

**AC Voltage** (true RMS responding)

**Input Characteristics**

Range	Maximum Reading (5½ digit)	Resolution		
		5½ digit	4½ digit	3½ digit
0.3 V	0.301000 V	1 μV	10 μV	100 μV
3 V	3.010000 V	10 μV	100 μV	1 mV
30 V	30.1000 V	100 μV	1 mV	10 mV
300 V	301.000 V	1 mV	10 mV	100 mV

**Input impedance:** 1 MΩ ±1% shunted by <60 pF.

**Maximum input voltage** (non-destructive): 301 Vrms or 450 V peak.

**Measurement accuracy:** ± (% of reading + number of counts) Auto zero ON. 5½ digit display. Accuracy is specified for sinewave inputs only, >10% of full scale.

**1 Year, TCal ±5°C**

Frequency	Ranges		
	0.3V	3 V, 30 V	300 V
20-50 Hz	1.14 + 163	1.14 + 102	1.18 + 102
50-100 Hz	0.46 + 163	0.46 + 103	0.5 + 102
100 Hz-20 kHz	0.29 + 163	0.26 + 102	0.33 + 102
20-50 kHz	0.56 + 247	0.41 + 180	0.55 + 180
50-100 kHz	1.74 + 882	1.05 + 825	1.26 + 825
100 k-300 kHz		10.1 + 3720 (30 V range only)	

**Crest factor:** >4:1 at full scale.

**DC Current**

**Input Characteristics**

Range	Maximum Reading (5½ digit)	Resolution		
		5½ digit	4½ digit	3½ digit
3 A	± 3.01000 A	10 μA	100 μA	1 mA

**Maximum input** (non-destructive): 3 A from <250 V source; fuse protected.

**Measurement accuracy:** ± (% of reading + number of counts). Auto zero ON. 5½ digit display.

Range	TCal ±5°C	
	90 Days	1 Year
3 A, <1 A input	0.14 + 6	0.17 + 6
3 A, >1 A input	1.0 + 30	1.0 + 30

**AC Current** (true RMS responding)

**Input Characteristics**

Range	Maximum Reading (5½ digit)	Resolution		
		5½ digit	4½ digit	3½ digit
3 A	0.301000 A	1 μA	10 μA	100 μA
3 A	3.01000 A	10 μA	100 μA	1 mA

**Maximum input** (non-destructive): 3 A from <250 V source; fuse protected.

**Measurement accuracy:** ± (% of reading + number of counts). Auto zero ON. 5½ digit display. Accuracy specified for sinewave inputs only, >10% of full scale.

**1 Year, TCal ±5°C**

Frequency	Ranges	
	0.3 A	3 A
20-50 Hz	1.77 + 163	2.5 + 163
50-1 kHz	1.3 + 163	1.8 + 163
1 k-10 kHz	1.0 + 163	1.7 + 163
10 k-20 kHz	1.14 + 163	1.84 + 163

**General Information**

**Operating temperature:** 0 to 55°C

**Humidity range:** 95% R.H., 0 to 40°C

**Power:** AC line 48 to 440 Hz, 86 to 250 V, (see configuration)

**Battery:** (Opt 001) Rechargeable lead-acid; minimum continuous operation for 5 hours at 25°C; recharge time is 16 hours with HP 3468A/B off and 36 hours with HP 3468A/B on.

**Size:** HP 3468A: 98.4 mm H x 238.1 mm W x 276.2 mm D (3.88 in. H x 9.38 in. W x 10.88 in. D). 3468B: 89 mm H x 213 mm W x 275 mm D (without feet), 3.5 in. H x 8.38 in. W x 10.83 in. D.

**Weight:** HP 3468A/B—2.1 kg (4.63 lb); HP 3468A/B with Opt 001—3.1 kg (6.83 lb).

**Configuration:** order one power and frequency option at no charge from below.

**Opt 315:** 100 V, 50 Hz; **Opt 335:** 220 V, 50 Hz

**Opt 318:** 100 V, 60 Hz; **Opt 338:** 220 V, 60 Hz

**Opt 325:** 120 V, 50 Hz; **Opt 345:** 240 V, 50 Hz

**Opt 328:** 120 V, 60 Hz; **Opt 348:** 240 V, 60 Hz

**Ordering Information**

HP 3468A DMM in Streamlined Portable Case with HP-IL and test probes. **Price** \$750 ☎

HP 3468B DMM in Rack and Stack Case with HP-IL and test probes. **Price** \$750 ☎

**Options and Accessories**

HP 3468A/B Option W30, add 3 year Extended Hardware Support \$25

HP 3468A/B Option 001, add Rechargeable Battery Pack \$150

HP 3468B Option 401, add Side Handle Kit \$20

(HP P/N 5061-1171)

HP 3468B Option 907, add Front Handle Kit \$51

(HP P/N 5061-1170)

HP 3468B Option 908, add Rack Mount Kit for a Single Instrument (HP P/N 5060-0173) \$54

HP P/N 5060-0174 Rack Mount Kit for rack mounting two instruments side-by-side \$82.50

☎ Fast-Ship product - See page 758

# DIGITAL MULTIMETERS

## Bench, General Purpose and Wide Bandwidth

### HP Models 3466A/3400A



HP 3466A

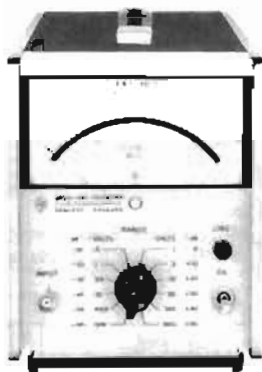

HP 3400A

#### HP Model 3466A

The HP 3466A is a 4 1/2 digit autoranging multimeter offering six functions ACV, DCV, ACI, DCI, Ohms, and Diode Test. ACV and ACI measurements are true rms with selectable ac or dc coupling. Available with rechargeable batteries or ac power only, it offers 1  $\mu$ volt and 1 mOhm sensitivity with zero adjustment on the lowest ranges to compensate for external offsets.

#### Specifications

##### Voltage

##### DC V

Range	Maximum Display	Accuracy: 1 year. 15 to 30 deg. C $\pm$ (% of reading + # of counts)
20 mV	$\pm$ 19.999	0.05 + 3
200 mV	$\pm$ 199.99	0.04 + 2
2 V	$\pm$ 1.9999	0.03 + 1
20 V	$\pm$ 19.999	0.03 + 1
200 V	$\pm$ 199.99	0.035 + 1
1200 V	$\pm$ 1199.9	0.035 + 1, <700 V input
1200 V	$\pm$ 1199.9	0.055 + 1 >700 V input

##### AC V (true-rms responding, true-rms calibrated)

Frequency Range	Accuracy: 1 year. 15 to 30 deg. C $\pm$ (% of reading + # counts)
20 to 30 Hz	2 + 50
30 to 50 Hz	1 + 30
50 Hz to 10 kHz	0.3 + 20
10 to 20 kHz	1 + 40
20 to 100 kHz	2 + 150

**Maximum Input:** (ac+dc)V:  $\pm$  1200 Vdc, 1700 V (dc + peak ac).  
acV:  $\pm$ 600 V dc, 1700V(peak ac + dc);  $10^7$  volt-Hz max.

**Crest Factor:** 4:1 at full scale.

##### Resistance

**Ranges:** 20 Ohm to 20 MOhm in 7 ranges

**Input Protection:** 250V or 350V (dc + peak ac).

Range	Accuracy: 1 year. 15 to 30 deg. C $\pm$ (% of reading + # counts)
20 to 200 Ohm	0.08 + 2
200 Ohm to 200 kOhm	0.03 + 1
2000 kOhm	0.04 + 1
20 MOhm	0.15 + 1

##### Current

**Maximum Input:** current: 2 A (fused protected). Voltage: 250 V

##### DC I

Range	Accuracy: 1 year. 15 to 30 deg. C $\pm$ (% reading + # counts)
200 $\mu$ A, 2mA, 20mA	0.07 + 2
200 mA	0.15 + 2
2000 mA	0.5 + 2

##### AC I

Range	Frequency	Accuracy: 1 year. 15 to 30 deg.C $\pm$ (% reading + # counts)
200 $\mu$ A to 200 mA	20 to 30 Hz	2.0 + 50
	30 Hz to 10 kHz	0.9 + 35
2000 mA	20 to 30 Hz	2.0 + 50
	30 Hz to 10 kHz	1.2 + 20

#### Ordering Information

HP 3466A Opt. 001, streamlined portable case, ac line power only

Price

\$75

HP 3466A Opt. 002, Rack and Stack case, ac line power only. (Rack mount kit not included.)

\$10

**HP 3466A Digital Multimeter.** Standard configuration in a streamlined portable case with handle, ac line power, batteries and charger, and test leads.

\$1220

Fast-Ship product - See page 758

#### HP Model 3400A

The HP 3400A is a true rms analog voltmeter. Six-decade frequency coverage makes the HP 3400A extremely flexible for audio and RF measurements up to 10 MHz and permits the measurement of broadband noise and fast risetime pulses.

Pulses or other non-sinusoids with crest factors up to 10:1 can be measured full scale. Plots of measured data and higher resolution measurements can be produced by connecting a dmm to the convenient rear-panel dc output which produces a linear 0 to 1 volt output proportional to the meter deflection.

#### Specifications

**Voltage Range:** 1 mV to 300 V full scale, 12 ranges.

**dB Range:** -72 to +52 dBm (0 dBm = 1 mW into 600 Ohm).

**Frequency range:** 10 Hz to 10 MHz.

**Response:** responds the rms value (heating value) of the input signal for all waveforms.

**Meter accuracy:** % of full scale (20 to 30 deg. C)\*

10 Hz	50 Hz	1 MHz	2 MHz	3 MHz	10 MHz
5%	1%	2%	3%	5%	

**AC to DC converter accuracy:** % of full scale (20 to 30 deg. C)

10 Hz	50 Hz	1 MHz	2 MHz	3 MHz	10 MHz
5%	0.75%	2%	3%	5%	

\* TC: 0.1% from 0 to 20 and 30 to 55 deg.C

**Crest Factor:** (ratio of peak to rms amplitude of input signal): 10:1 at full scale.

**Input Impedance:** from 0.001 to 0.3V range: 10 MOhm shunted by <50 pF. 1.0 to 300 V range: 10 MOhm shunted by < 20 pF, ac coupled input.

**Output:** negative 1 V dc into open circuit at full scale deflection, proportional to meter deflection from 10 to 100% of full scale. 1 mA maximum; nominal source impedance is 1 kOhm. Output noise is < 1 mV rms.

**Accessories furnished:** 10110A adapter, BNC to dual banana jack.

#### Ordering Information

HP 3400A Opt. 001 expands the dB scale by placing it on the top of the meter.

Price

\$41

Rear terminals in parallel with front terminals and linear log scale uppermost on the meter face are available on special order.

**HP 3400A RMS Voltmeter**

\$1790



HP 11096B



HP 34118A



HP 34119A



HP 34110A



HP 34111A

#### HP 11096B High Frequency Probe

Converts dc voltmeter with 10 MΩ input to peak-responding high-frequency ac voltmeter. Works with any dc voltmeter with 10 MΩ input impedance.

#### HP 11096B Specifications

**Voltage range:** 0.25 to 30 Vrms.

**Transfer Accuracy (when used with 10 MΩ ± 10% dc voltmeter):**

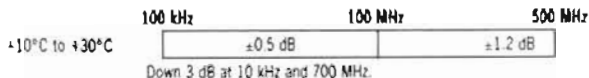

**Input Impedance:** 4 MΩ shunted by 3 pF.

**Maximum input:** 30 V rms ac; 200 V dc.

#### HP 34111A DC Hi-Voltage Probe

1000:1 divider will accept up to 40 kV. Input Z = 10<sup>9</sup> Ω. Divider accuracy meets specifications when connected to 10 MΩ input resistance instrument.

#### Division Ratio Accuracy

0–20 kV	<4%
30–40 kV	<4%
20–30 kV	<2%

Divider has interchangeable hook and pointed tip

#### HP 34119A High Voltage Probe

This 1000:1 divider probe will accept either 5000 Vdc or 5000 Vac rms. Input Z=500 MΩ at 3 pF. It can be used with DMM's having an input resistance of 10 MΩ for dc, and 1 MΩ for ac, selectable through a switch on the probe. Supplied with the probe is a domed tip, a hook tip, and a trimmer tool for ac voltage compensation.

#### HP 34119A Specifications

**AC Voltage Input Derating:** 5 kV at frequencies less than 350 kHz, 2.5 kV at frequencies from 250 kHz to 1 MHz.

**Operating Modes DC (10M):** DMM Input Resistance must be 10 MΩ ±1%. ac (1M): DMM input resistance must be 1 MΩ ±1%.

**DC Division Ratio Accuracy:** 1.5% of reading.

**AC Division Ratio Accuracy:** ±1.5% of reading at frequencies less than 100 kHz, ±2.5% of reading at frequencies from 100 kHz to 1 MHz.

#### Ordering Information

#### Price

HP 34110A Carrying Case for 1/2 Rack Size Instruments	\$46
HP 34111A DC Hi-Voltage Probe	\$210
HP 34118A Test Lead Kit	\$26
HP 34119A High Voltage Probe	\$127

# SIGNAL ANALYZERS

Wave, Distortion, Modulation, Spectrum, and Fourier Analyzers

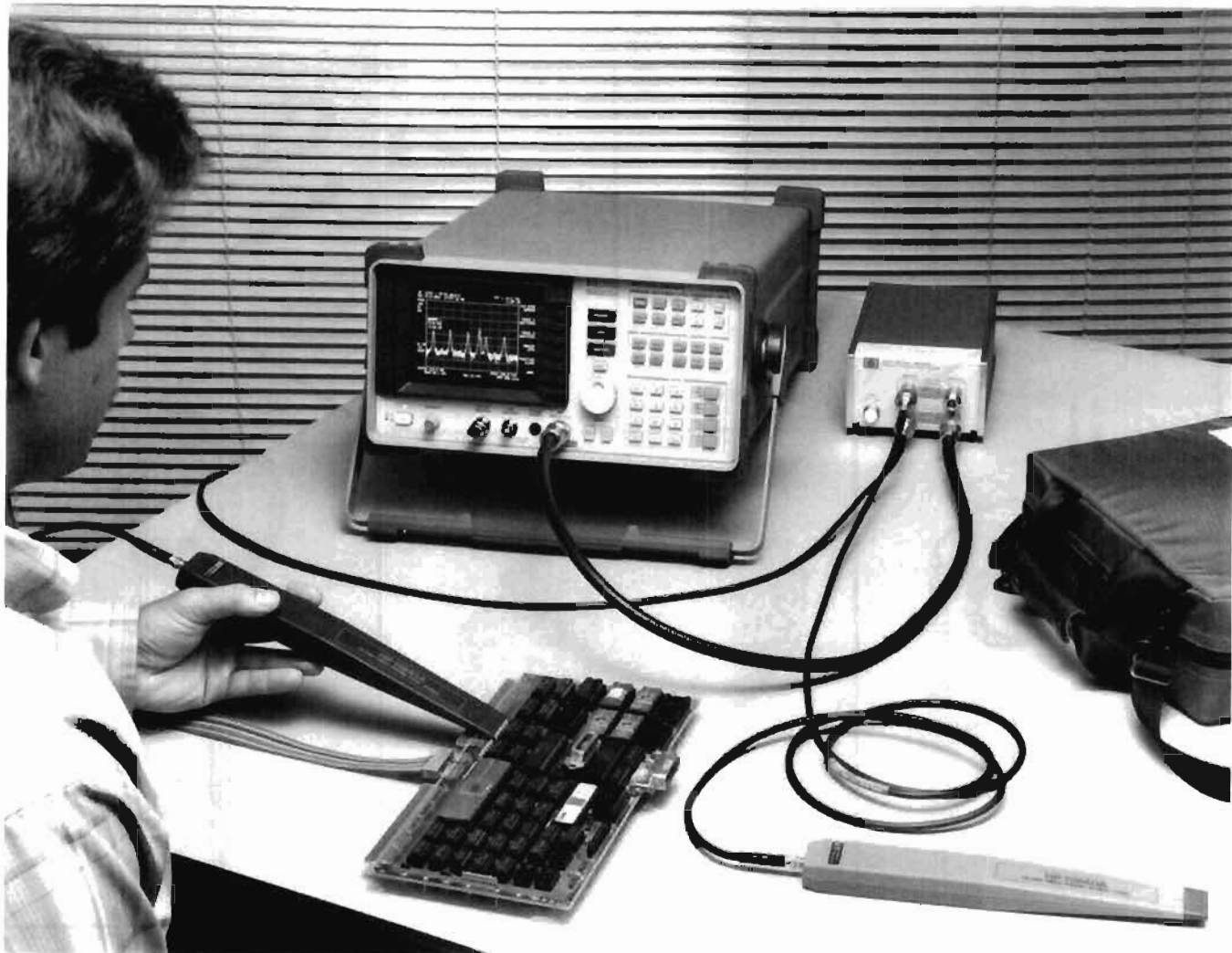

## Signal Analyzers

Several different types of signal analyzers provide frequency domain measurement capability. Spectrum analyzers, distortion analyzers, audio analyzers, modulation analyzers, and measuring receivers are all offered by HP. Each of these instruments has capabilities that make it the preferred instrument for particular measurement applications.

The spectrum analyzer is a swept-tuned, superheterodyne receiver that provides a CRT display of amplitude versus frequency. It is essentially a frequency-selective, peak-responding voltmeter calibrated to display the RMS value of a sine wave. The spectrum analyzer can show the individual frequency components that make up a complex signal. (It does not provide phase information about a signal, however). The swept receiver technique used in Hewlett-Packard spectrum analyzers enables frequency domain measurements to be made over a large dynamic range and a wide frequency range of 5 Hz to 325 GHz.

The Fourier analyzer uses digital sampling and mathematical transformation techniques to form a Fourier spectrum of a signal. This

method is presently useful for measuring signals from a few  $\mu$ Hz to 100 kHz and provides frequency, amplitude, and phase information. Like the spectrum analyzer, all information is presented on a CRT display. With its real-time signal analysis capability, the Fourier analyzer is able to capture periodic as well as random and transient events.

The wave analyzer uses a tunable filter, which can be visualized as a movable frequency window, to measure both the amplitude and frequency of individual spectral components. This measurement technique essentially makes the instrument a frequency-selective voltmeter. The wave analyzer employs meters and digital displays to show both the amplitude and frequency of the signal within the window. HP wave analyzers provide accurate results from 15 Hz to 32.5 MHz.

Distortion analyzers and audio analyzers employ broadband detectors and notch filters to measure signal properties such as total harmonic distortion. These tunable filters enable the analyzer to selectively display the level and frequency of harmonic and distortion products. Measurement results are shown on a meter or digital display. Audio analyzers include a signal source, making

possible measurements such as SINAD that include signal and distortion levels. The frequency range covered by HP distortion and audio analyzers extends from 5 Hz to 600 kHz.

Modulation analyzers are designed to capture and analyze a fundamental signal and its entire modulation envelope. These analyzers use independent AM and FM detection circuits for simultaneous analysis of complex modulated signals. When a modulation analyzer is combined with a measuring receiver, accurate measurements of frequency, power, and modulation characteristics can be made on signals from 150 kHz to 26.5 GHz. All measurement results are presented on a digital display.

## Spectrum Analyzers

Spectrum analyzers take advantage of the frequency-conversion properties of the swept-tuned heterodyne receiver to make significant contributions to frequency-domain signal analysis. The following are some of the measurements that can be made with spectrum analyzers:

- 1) Absolute and relative frequency.
- 2) Absolute and relative amplitude.



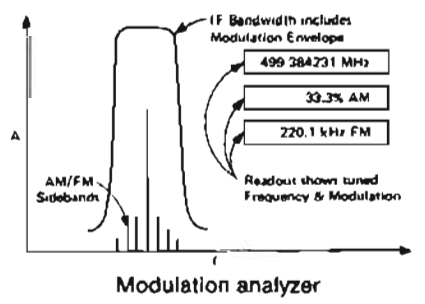
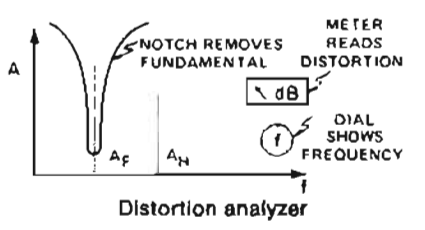
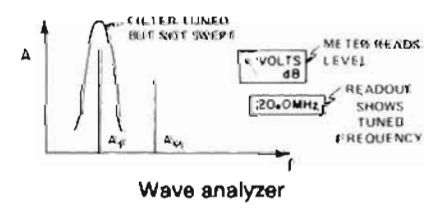
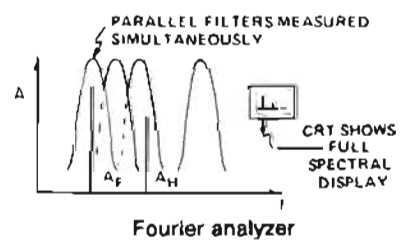
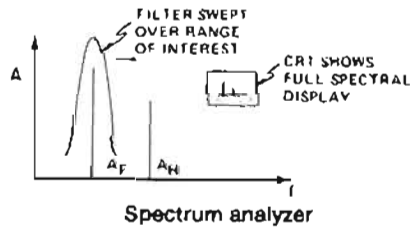
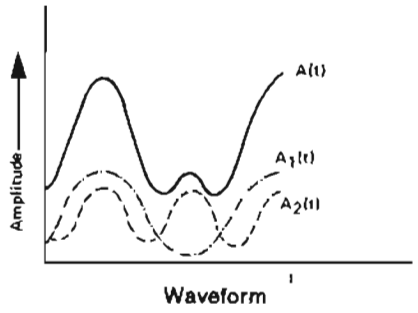

These measurements are possible because spectrum analyzers have the following characteristics:

- 1) Broad frequency coverage from 5 Hz to 325 GHz.
- 2) Wide amplitude range from  $-138$  dBm to  $+30$  dBm.
- 3) Excellent sensitivity for low-signal detection.
- 4) Excellent frequency stability.
- 5) High resolution of frequency and amplitude.

These capabilities allow spectrum analyzers to provide frequency-domain signal analysis for numerous applications, including the manufacture and maintenance of microwave communication links, radar, telecom equipment, CATV systems, and broadcast equipment; EMI diagnostic testing; and signal surveillance.

In addition to the swept-tuned frequency mode, spectrum analyzers can also be used in the fixed-tuned mode (zero span) to provide time-domain measurement capability much like that of an oscilloscope.

With the addition of desktop technical computers, the capability of spectrum analyzers can be greatly enhanced. Computers can be used to directly control the operation of spectrum analyzers over HP-IB. Computers can also be used to develop downloadable programs (DLPs) for those spectrum analyzers with the capability to store such programs in non-volatile memory. These custom measurement routines are then as easy to use as any of the standard instrument features.

In addition, spectrum analyzers with HP-IB capability can directly control a plotter or printer, enabling a hard copy of the CRT display to be made without the use of a computer. Application areas that require accurate, high speed, repetitive routines; physical separation of the operator and the analyzer; unattended operation or operation by personnel with limited technical skills—all are candidates for automation.

Areas that benefit significantly from automated spectrum analysis include

- 1) EMC testing.
- 2) frequency spectrum monitoring.
- 3) production testing of RF or microwave components, subsystems, or systems, and
- 4) remote site testing.

The basic measurement capabilities of the spectrum analyzer, combined with its ability to automate and to interface with other HP-IB instruments and peripherals, make this instrument ideal for many general-purpose and specialized applications.

**Fourier Analyzers**

Fourier analyzers offer fast, high-resolution spectrum and network analysis. Unlike conventional swept analyzers, Fourier-based analyzers can measure dynamic signals because they measure all frequencies simultaneously, not one at a time.

Fourier analyzers characterize signals using digital signal processing techniques based on the Discrete Fourier Transform. For a complete description of these techniques, see Application Note 243, "The Fundamentals of Signal Analysis."

Fourier analyzers are especially useful on low frequency signals ( $<100$  kHz) or where very fast measurements are desired. They can improve measurement speed by a factor of 10 to 100 and allow accurate measurements on frequencies as low as a few microHertz. Signal components as closely spaced as 20 microHertz can be clearly resolved and accurately measured.

Since both magnitude and phase of each frequency component are measured, the Fourier analyzer can measure the statistical properties of signals or the joint properties or relationships of two or more signals. Applications include acoustic, modal, vibration or rotating machine analysis. In addition, various types of modulation can be detected and measured.

Simultaneous measurement of magnitude and phase on two or more channels provides high quality network measurements. Transfer functions or frequency response can be easily measured and the use of band-limited or band-translated random noise as the stimulus allows the entire frequency span of interest to be measured at once. Measurement of the coherence function can provide an indication of the validity of many network measurements.

**Wave Analyzers/SLMs**

Wave analyzers are known by several different names: frequency selective voltmeters, carrier frequency voltmeters, and selective level meters. A wave analyzer can be thought of as a finite bandwidth filter which can be tuned throughout a particular frequency range. Signals will be selectively measured as they are isolated within the bandwidth of the filter. For a particular signal, the wave analyzer will indicate both its frequency and amplitude.

The uses of wave analyzers can be categorized into three broad areas: 1) amplitude measurement of a single component of a complex frequency system, 2) amplitude measurement in the presence of noise and interfering signals, and 3) measurement of signal energy appearing in a specified, well-defined bandwidth.

Wave analyzers are most commonly used in communication systems and have input configurations and measurement bandwidths optimized for these applications. Both balanced and unbalanced inputs are available and impedances range from 50 Ohms to 600 Ohms.

**Distortion, Audio Analyzers**

The Hewlett-Packard distortion and audio analyzers consist of a narrow band rejection filter and broadband detector. Before the fundamental is rejected, the analyzer first measures the amplitude of the fundamental, all the harmonic components, and noise. Then the rejection filter is employed to remove the fundamental. The ratio of the two measurements is total harmonic distortion plus noise.

- 3) Noise.
- 4) Distortion products.
- 5) AM, FM & pulsed RF modulation.
- 6) Stimulus response.
- 7) Electromagnetic compatibility (EMC).

# SIGNAL ANALYZERS

## Wave, Distortion, Modulation, Spectrum and Fourier Analyzers (cont'd)

### Audio Analyzers

The audio analyzer performs several basic low frequency measurements in addition to distortion, making it a general purpose audio test set. The audio analyzer includes the SINAD function for testing mobile radio receiver sensitivity. It contains a low distortion audio oscillator for stimulus response testing in combination with its distortion analyzer. It contains a true rms voltmeter and dc voltmeter for accurate measurement of complex waveform levels. Swept ac level and swept distortion measurements can be made using the internal source and rms voltmeter. A reciprocal frequency counter is also included that continuously counts the frequency of the input signal.

### True Harmonic Distortion Measurements

Computer-controlled spectrum analyzers provide a rapid means of measuring true harmonic distortion levels. The fundamental and its harmonic components are rapidly measured one at a time and the distortion is computed and either stored or printed.

### Modulation Analyzers/Measuring Receivers

A modulation analyzer is a precision receiver designed to detect the entire modulation envelope of a signal under test. It can

measure and display the carrier characteristics of RF frequency and power as well as AM, FM and phase modulation characteristics such as AM depth, peak deviation, residual modulation, and various ratios associated with them. The modulation analyzer faithfully recovers the actual modulation signal for further analysis such as distortion testing.

In addition to all the capabilities of the modulation analyzer, the measuring receiver can measure power down to  $-127$  dBm. With very high accuracy, the measuring receiver can look at signals up to millimeter-wave frequencies. This makes it ideal for calibration of signal generators and attenuators.

### Microwave Modulation Analyzers

Most modern microwave communication and radar/EW system designs are now turning to the use of complex modulations to improve performance and make them less susceptible to signal environments. This typically involves the use of quadrature or "vector" modulation formats, such as QPSK, 16QAM, etc., in the case of communication systems and complex, coded formats in the case of radar/EW systems.

In all of these receivers, the signal processing is not handled in the traditional one-

channel, amplitude-only mode, but instead is demodulated into in-phase and quadrature signals that provide dynamic phase and amplitude information about the carrier's modulation, and thus enhance system performance.

The high bandwidth requirements of those modulations combined with the need to measure and characterize both the amplitude and phase of the signals has led to the introduction of the HP 8980A Vector Analyzer. Essentially a matched, dual-channel, sampling oscilloscope with dc to 350 MHz baseband capability, the HP 8980A also features powerful measuring routines for measuring parameters such as quadrature error, lock angle and closure.

The Vector Analyzer is used in conjunction with user-configured vector down-converters for processing the microwave or IF signal down to the quadrature baseband. Extensive application information is available in the form of Application Notes 343-1 and 343-3 as well as Product Note 8980A-1. The Vector Analyzer itself is fully described in the Vector Modulation section of this catalog.

## Signal Analyzers Selection Guide

### Spectrum Analyzers

Frequency Range	Amplitude Calibration Range	Bandwidths		HP Model Description	HP Companion Instruments	Page
		Min	Max			
0.02 Hz-25.6 kHz	-120 to +30 dBV	0.02 Hz	363 Hz	3582A Spectrum Analyzer		144
0.02 Hz-40 MHz (Offset from Carrier) 5 MHz to 18 GHz (Carrier Range)	-170 dBc	0.02 Hz	30 kHz	3048A Phase Noise Measurement System	8662A/8663A Synthesized Signal Generator 8642A/B Synthesized Signal Generator 11729B Carrier Noise Test Set	153
5 Hz-50 kHz	-150 to +30 dBm	1 Hz	300 Hz	3580A Spectrum Analyzer		143
20 Hz to 40.1 MHz	-137 dB to +30 dBm	3 Hz	30 kHz	3585A Spectrum Analyzer		106
1 kHz-110 MHz	-140 to +10 dBm	10 Hz	300 kHz	8553B Tuning Section Plug-In	8443A Tracking Generator	137
10 kHz-1.5 GHz	-113 to +30 dBm	1 kHz	3 MHz	8590A Spectrum Analyzer		128
100 Hz-1.5 GHz	-135 dBm to +30 dBm	10 Hz	3 MHz	8568B Spectrum Analyzer and 8568S Automatic Spectrum Analyzer	8444A Opt. 059 Tracking Generator 85650A Quasi-Peak Adapter, 85865A RF Preselector	117 118
10 kHz-1.5 GHz	-115 dBm to +30 dBm	1 kHz	3 MHz	8567A Spectrum Analyzer	85650A Quasi-Peak Adapter, 85865A RF Preselector	117
10 MHz-21 GHz	-111 dBm to +30 dBm	1 kHz	3 MHz	8559A Spectrum Analyzer		135
100 Hz-2.9 GHz	-134 dBm to +30 dBm	10 Hz	3 MHz	71100A Modular Spectrum Analyzer	70300A Tracking Generator, 70310A Precision Frequency Reference, 70700A Digitizer	113
1 kHz-22 GHz <sup>2</sup> (Extendable to 325 GHz)	-121 to +30 dBm	100 Hz	3 MHz	8562A/B Spectrum Analyzer	85629A Test and Adjustment Module	131
100 Hz-22 GHz <sup>1</sup> (Extendable to 325 GHz)	-134 dBm to +30 dBm	10 Hz	3 MHz	8566B Spectrum Analyzer and 8566S Automatic Spectrum Analyzer	85650A Quasi-Peak Adapter, 85865A RF Preselector 11970K/A/Q/U/V/W Harmonic Mixers	117 118
50 Hz-26.5 GHz	-132 dBm to +30 dBm	10 Hz	3 MHz	71200A Modular Spectrum Analyzer	70300A Tracking Generator	113
50 kHz-22 GHz	-130 to +30 dBm	10 Hz	3 MHz	71201A Modular Spectrum Analyzer	70300A Tracking Generator, 70310A Precision Frequency Reference, 70700A Digitizer	113
100 Hz-22 GHz	-138 to +30 dBm	10 Hz	3 MHz	71210A Modular Spectrum Analyzer	70300A Tracking Generator, 70700A Digitizer	110
10 MHz-22 GHz <sup>2</sup> (Extendable to 115 GHz and above)	-123 to +30 dBm	100 Hz	3 MHz	8569B Spectrum Analyzer	8444A Opt. 059 Tracking Generator 11971K/A/Q/U/V Harmonic Mixers	139
10 MHz-22 GHz	-110 to +30 dBm	1 kHz	3 MHz	8570A Spectrum Analyzer		139
10 MHz-18 GHz (Extendable to 40 GHz and above)	-127 to +10 dBm	100 Hz	300 kHz	8555A Tuning Section Plug-In	8444A Opt. 059 Tracking Generator 8445B Automatic Preselector (10 MHz-18 GHz) 11517A Harmonic Mixer	137
18 GHz-110 GHz (Extendable from 2.7 to 325 GHz)	-130 dBm to -1 dBm	10 Hz	3 MHz	71300A Modular Spectrum Analyzer	11970K/A/Q/U/V/W Harmonic Mixers, 70310A Precision Frequency Reference, 70700A Digitizer	113

NOTE 1: For use in display mainframe HP 141T with 8552B IF section plug-in (page 137).

NOTE 2: For use in display mainframe HP 853A.

NOTE 3: Frequency range extendable to 110 GHz through the use of the HP 11970 series Harmonic Mixers. For higher frequency coverage, other external mixers are commercially available.

NOTE 4: Frequency range extendable to 71 GHz through the use of the HP 11971 series Harmonic Mixers. For higher frequency coverage, other external mixers are commercially available.

**Modulation Analyzers/Measuring Receivers**

Frequency Range	Modulation Measurements	Amplitude Measurement Range	Audio Frequency Count + Distortion Measurement	HP Model Number	Page
dc to 350 MHz	Baseband AM, FM	5mV to 5V	No	8980A	319
150 kHz-1300 MHz	AM, FM, FM	+30 to 0 dBm	No	8901A	160
150 kHz-1300 MHz	AM, FM, FM	+30 to -20 dBm	Yes	8901B	160
150 kHz-1300 MHz	AM, FM, FM	+30 to -127 dBm	Yes	8902A	158
150 kHz - 18 GHz or 26.5 GHz	AM, FM, FM	+30 to -100 dBm	Yes	8902S	158

**Dynamic Signal Analyzers**

Frequency Range	Amplitude Calibration Range	Resolution Points	HP Model Description	Functions Available		Page
		Max				
0.02 Hz-25.6 kHz	9 steps from 3 mV to 30 V RMS	256 VS 128 TF	3582A Spectrum Analyzer	Voltage Spectrum (VS) Phase Spectrum Transfer Function (TF)	Coherence Function Digital Averaging	144
0.0001 Hz - 100 kHz	78 steps from 3 mV to 22 V RMS	400	3561A Dynamic Signal Analyzer	Voltage Spectrum Phase Spectrum	1/3 V and 1/1 Octave Spectrum Time Domain Waveform	145
64 μHz to 100 kHz	78 steps from +3.972 mV to +31.547 V	801	3562A Dynamic Signal Analyzer	Power Spectrum Linear Spectrum Frequency Response Coherence Function Histogram Correlation	Impulse Response Waveform Recording Data Throughput Demodulation Vector Averaging Orbit Diagram	148

**Distortion/Audio Analyzers**

Fundamental Frequency Range	Minimum Distortion	Auto Set Level	Auto Nulling	True RMS	AM Detector	Filters	HP Model No.	Internal Source	HP-IB	Page
5 Hz to 600 kHz	0.03% (-70 dB)		•	•	•	•	334A			168
10 Hz-110 kHz	0.0018% (-95 dB)	•	•	•	•	•	334A Opt 002			168
20 Hz-100 kHz	0.01% (-80 dB)	•	•	•	Note I	•	8903B*	•	•	163
20 Hz-100 kHz	0.01% (-80dB)	•	•	•	Note I	•	8903E**		•	163

\*The HP 8903B also performs Frequency Count, Signal/Noise, SINAD, watts, ac/dc voltage measurements.  
NOTE 1: The HP 8901A Modulation Analyzer (page 160) provides complete demodulation of AM, FM, and FM signals. \*\* The HP 8903E also performs Frequency Count, SINAD, and ac/dc voltage measurements.

**Wave Analyzers/Selective Level Meters**

Frequency Range	Selective Bandpass	Dynamic Range		Freq. Readouts	Type of Inputs	Type of Outputs	Modes of Operation	HP Model Number	Page
		Absolute	Relative						
15 Hz to 50 kHz	3 Hz 10 Hz 30 Hz 100 Hz 300 Hz	0.1 μV-300 V full scale	>85 dB	5-place digital	Banana Jacks	rec: 5 V full scale, with pen fit BFO, Local Oscillator, tuning loudspeaker, and headphone jack	AFC, normal, BFO	3581A/ 3581C	167 485
50 Hz to 32.5 MHz	20 Hz 400 Hz 3100 Hz	-130 to +20 dBm	>80 dB	LED, 0.1 Hz Resolution	50/75 Ω BNC 600 Ω Banana Jacks	Tracking Generator Audio/Loud Speaker 1 MHz Ref.	Wideband Selective USB/LSB	3586C (3336C*)	109 405
50 Hz to 32.5 MHz	20 Hz 400 Hz 1740/2000 Hz Optional 3100 Hz WTD	-130 to +20 dBm	>70 dB	LED 0.1 Hz Resolution	75 Ω BNC/WECO 124 Ω WECO 135 Ω WECO 150 Ω Siemens 600 Ω WECO/ Siemens	Tracking Generator Audio/Loud Speaker 1 MHz Ref.	Wideband Selective SSB	3586A/B (3336A/B*) (3335A)	482 482 404

\*Tracking Synthesizers.

**Carrier Phase Noise Analysis**

Frequency Range	HP Model Number	Maximum Sensitivity dBc/Hz (depends on offset & method)	Functions Available	Page
5 MHz-18 GHz	3048A Phase Noise Measurement System	-170 dBc/Hz (Requires external reference source of equivalent performance)	Fully documented Software with specified Phase Detector, Frequency Discriminator, AM and Two Port Measurements	153
5 MHz-18 GHz	11729C Carrier Noise Test Set	-126 dBc/Hz (Including HP 8662A Reference Source)	Phase Detector Mode Frequency Discriminator Mode AM Noise Option, Pulsed Carrier	155

# SIGNAL ANALYZERS

## 20 Hz to 40 MHz Spectrum Analyzer

### Model 3585A

- 80 dB dynamic range
- 3 Hz resolution bandwidth
- $\pm 0.4$  dB amplitude accuracy
- $1001 \times 1024$  Digital Storage Display

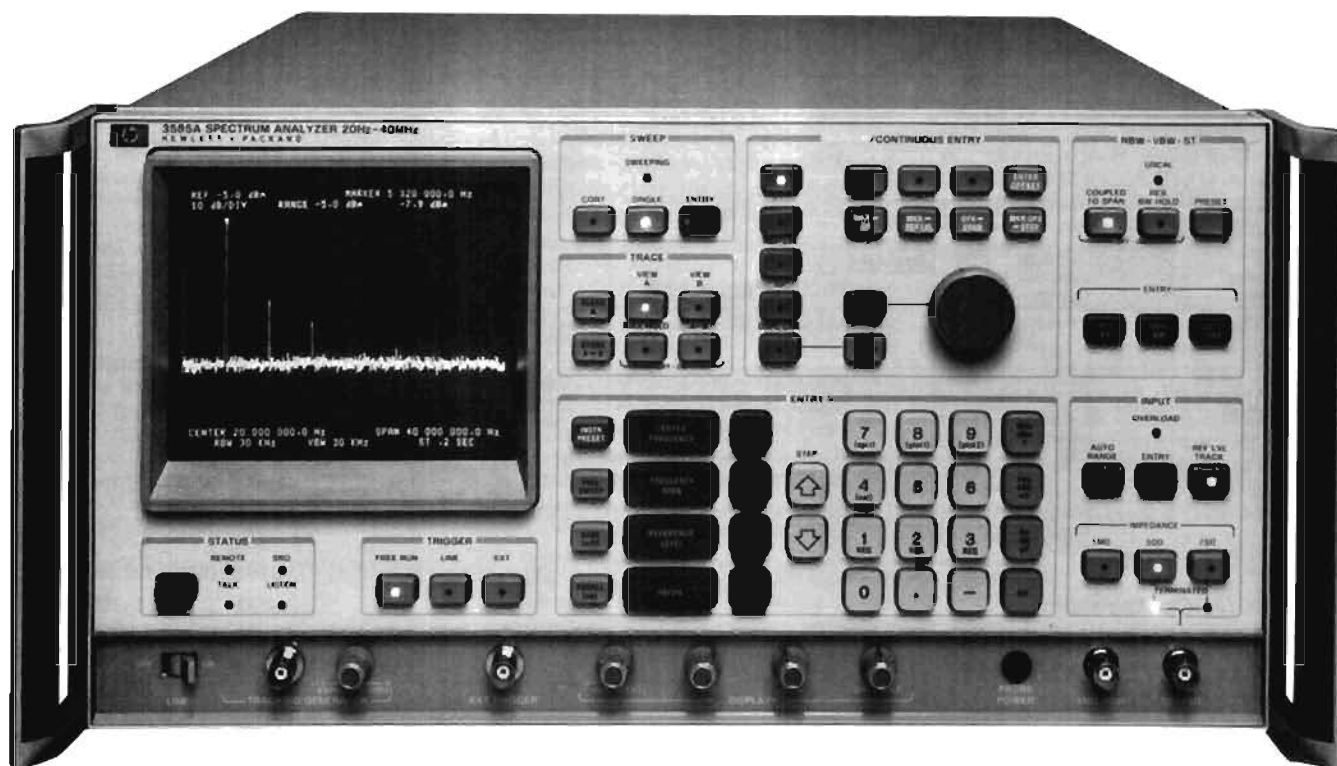

HP 3585A  
(Shown with Opt. 907)



#### Uncompromising Baseband Signal Analysis

The HP 3585A Spectrum Analyzer delivers high performance where it counts - at baseband frequencies. With unmatched accuracy, resolution, and dynamic range, the 3585A is HP's best solution for signal analysis at the critical frequencies comprising voice, picture, or digital information.

In today's high speed, high density information processing systems, maintaining the integrity of data signals requires more measurement performance than ever before. The 3585A provides 80 dB of spurious-free dynamic range, a sharp 3 Hz resolution bandwidth, and fully synthesized tuning. Its 20 Hz - 40.1 MHz frequency range is more than adequate to cover most information bandwidths.

Measurement performance is critically important at baseband frequencies, because signal degradation occurring here is typically not recoverable elsewhere in the system. As a result, test requirements for baseband signals and circuits often demand a level of performance that only a high-performance, low-frequency signal analyzer such as the HP 3585A can provide.

#### Inside the HP 3585A

The HP 3585A is a swept heterodyne, triple conversion circuit with several major improvements. Frequency tuning is accomplished by a fully synthesized, phase continuous local oscillator, assuring excellent frequency stability for narrowband analysis across the entire frequency range. Internal microprocessors manage several functions including front panel operation, 1001-point digital vector storage display,

and periodic calibration of amplitude and frequency offsets. An accurate internal narrowband frequency counter can discriminate between the frequencies of closely spaced sinusoids with 0.1 Hz resolution. Finally, the HP 3585A contains fast-settling narrow resolution bandwidth filters that are among the best in the industry.

#### Fast, Flexible Frequency Sweeps

Well-designed filters and the phase-continuous, synthesized local oscillator team up to give the HP 3585A very fast sweep speeds. A 40-MHz sweep using the 30-kHz resolution bandwidth takes only 200 milliseconds, fast enough for high-resolution spectrum surveillance. A 1-MHz sweep using a 1-kHz bandwidth takes only 2 seconds.

Sweep width can be set to any arbitrary span between 0 and 40.1 MHz, or adjusted from 100 Hz to 40 MHz in a 1.25 step format. Resolution bandwidth and sweep time automatically track the selected frequency span to ensure optimum performance, or can be manually controlled.

#### 1001 $\times$ 1024 Digital Storage Display

The high performance of the HP 3585A is further complemented by a built-in 1001  $\times$  1024-point display. Measured analog signals are converted to 1001 digital data points prior to storage and display, allowing each point to be accessed individually using the display marker.

**Front Panel Convenience**

The HP 3585A's microprocessor-controlled front panel and CRT readout simplify complicated measurements. Frequency and amplitude settings may be entered directly using the keypad, incrementally stepped, or varied continuously using the rotary pulse generator.

An autoranging input attenuator eliminates the task of manually adjusting attenuation to achieve the correct mixer level. The input Range can also be manually adjusted from -25 dBm to +30 dBm in 5-dB steps.

With its primary marker set to a signal peak or other point of interest, the HP 3585A displays amplitude and frequency numerically on the CRT. A second marker numerically displays amplitude and frequency offsets between the two markers. Programmable Offset Step allows an operator to move easily between harmonically-related signals or evenly-spaced communication channels.

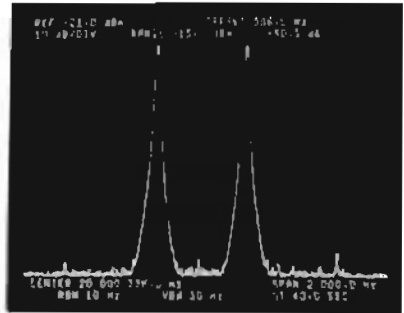

Offset Marker indicates a spurious sideband at -90.3 dBc, 506.0 Hz away from the carrier.

**Versatile Noise and Distortion Analysis**

Quiet and rock-stable, the HP 3585A excels as a noise and distortion analyzer. Its own uncompromising sensitivity and spectral purity are assured by its advanced front end design, synthesized local oscillator and built-in, oven-stabilized reference.

The HP 3585A can measure spurious, harmonic, and intermodulation products at levels typically 100 dB or more below the fundamental. Using its 3 Hz resolution bandwidth, power line sidebands below -95 dBc can typically be measured at frequency offsets of only 50 or 60 Hz. Total harmonic distortion and intermodulation distortion measurements can be automated using HPIB programming.

A built-in noise level key displays RMS noise density normalized to a 1 Hz bandwidth at the marker position, allowing easy comparison of measurements made with different resolution bandwidths.

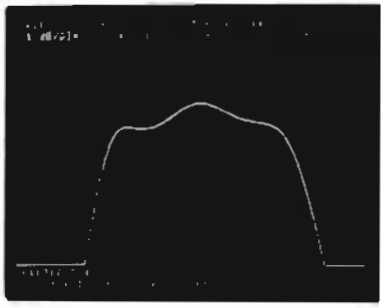

1 dB/div. frequency response for a bandpass amplifier centered at 3.442 MHz. Because this 2 MHz sweep takes only 0.2 seconds, the operator can observe circuit adjustments almost instantly.

**Frequency Response Measurements**

With its built-in tracking generator, digital trace storage, and narrowband frequency counter, the HP 3585A Spectrum Analyzer can accurately measure the frequency response of crystals, filters, and amplifiers. Small amplitude variations are resolved to 0.01 dB using the marker readout and the 1 dB/division expanded amplitude scale. Unwanted effects of test fixtures and cables are removed simply by storing the frequency response of the test setup in Trace B and subtracting it from measured data in Trace A.

With its wide dynamic range capability and high-resolution display, the HP 3585A is ideal for measuring and viewing the analog portions of 14 or 16-bit digital audio systems. It can also measure the frequency response of digital modem filters with better than ± 0.4 dB accuracy.

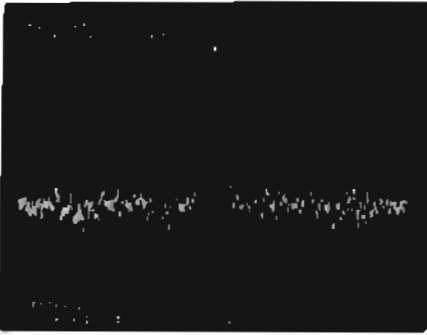

Built-in counter allows a 27 MHz carrier to be displayed with 0.1 Hz resolution and  $1 \times 10^{-7}$  / mo. stability.

**HF Radio Applications**

In addition to its many uses as a baseband signal analyzer, the HP 3585A finds a home in HF radio applications as well. Synthesized tuning and high-resolution display make wideband surveillance of the entire 30-MHz HF radio spectrum easy. Fast-settling resolution bandwidth filters speed the analysis of modulated HF carriers.

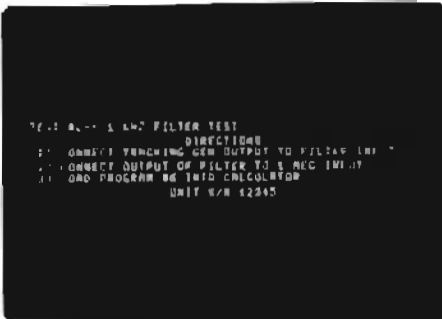

HP 3585A displays detailed instructions for an automatic filter test downloaded from an external computer.

# SIGNAL ANALYZERS

## 20 Hz to 40 MHz Spectrum Analyzer (cont'd)

### Specifications

#### Frequency

**Measurement range:** 20 Hz to 40.1 MHz

#### Displayed Frequency Span

**Range:** 0 Hz to 40.1 MHz variable with 0.1 Hz resolution or 10 Hz to 40 MHz in 1, 2, 5 steps

**Accuracy:**  $-0\% + 0.2\%$  of frequency span setting

#### Displayed Center, Start/Stop, and Manual Frequency

**Range:** 0 Hz to 40.1 MHz with 0.1 Hz resolution

**Accuracy:**  $1 \times 10^{-7}$ /month of frequency

#### Marker

**Readout accuracy:**  $\pm 0.2\%$  of frequency span  $\pm$  resolution bandwidth

**Counter accuracy:**  $\pm 0.3$  Hz  $\pm 1 \times 10^{-7}$ /month of counted frequency for a signal 20 dB greater than other signals and noise in the resolution bandwidth setting

#### Resolution Bandwidths

**Range:** 3 dB bandwidths of 3 Hz to 30 kHz in a 1, 3, 10 sequence

**Accuracy:**  $\pm 20\%$  at the 3 dB points

**Selectivity:** 60 dB/3 dB  $< 11:1$

#### Amplitude

##### Measurement range:

1 M $\Omega$  input:  $-31$  nVrms to  $+7.08$  Vrms

50/75  $\Omega$  input:  $-137$  dBm to  $+30$  dBm

All receiver inputs can be overdriven by up to 12.3 dB above the range setting, with some degradation in distortion performance.

##### Displayed Range

**Scale:** 10 division CRT vertical axis with Reference Level at the top graticule line

**Calibration:** 10, 5, 2 and 1 dB/division from the Reference Level

**Input range:**  $-25$  dBm to  $+30$  dBm in 5 dB steps

**Reference Level Range (relative to input range):**  $-100$  dB to  $+10$  dB

**Reference level accuracy (using 1 or 2 dB/div., at midscreen with sweep rate reduced by 4 or at the manual frequency)**

##### 50/75 $\Omega$ Input

+10 dB      -50 dB      -70 dB      -90 dB

$\pm 0.4$  dB     $\pm 0.7$  dB     $\pm 1.5$  dB

1 M $\Omega$  Input - add to above

20 Hz      10 MHz      40.1 MHz

$\pm 0.7$  dB     $\pm 1.5$  dB

##### Amplitude Linearity (referred to reference level)

0 dB      -20 dB      -50 dB      -80 dB      -95 dB

$\pm 0.3$  dB     $\pm 0.6$  dB     $\pm 1.0$  dB     $\pm 2.0$  dB

##### Frequency Response (referred to center of span)

50/75  $\Omega$  input:  $\pm 0.5$  dB

1 M $\Omega$  input

20 Hz      10 MHz      40.1 MHz

$\pm 0.7$  dB     $\pm 1.5$  dB

##### Marker Amplitude Accuracy

**Midscreen at the reference level:** use Reference Level accuracy from  $+30$  dBm to  $-115$  dBm, add Amplitude Linearity below  $-115$  dBm.

**Anywhere on screen:** add Reference Level Accuracy, Amplitude Linearity and Frequency Response.

##### Dynamic Range

**Spurious Responses (image, out of band, and harmonic distortion)**

50/75  $\Omega$  input:  $< -80$  dB referred to a single signal equal to or less than Input Range

1 M $\Omega$  input:  $< -80$  dB except second harmonic distortion  $< -70$  dB

##### Intermodulation Distortion

50/75  $\Omega$  input:  $< -80$  dB referred to the larger of two signals each  $\geq 6$  dB below Input Range except 2nd order IM from 10 MHz to 40 MHz  $< -70$  dB

1 M $\Omega$  input:  $< -70$  dB

**Residual responses (no signal at input):**  $< -120$  dBm using  $-25$  dBm range

**Residual phase noise (typical at 40 MHz,  $-10$  dBm input):**

5 KHz offset:  $-112$  dBc/Hz

100 KHz offset:  $-120$  dBc/Hz

##### Average Noise Level

50/75  $\Omega$  Input

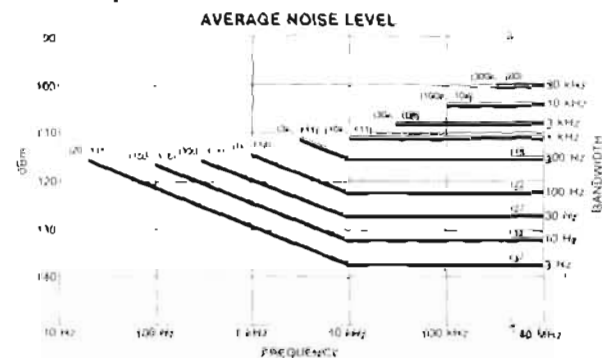

1 M $\Omega$  input: Below 500 kHz add 12 dB to above

##### Sweep

**Modes:** continuous, single or manual

**Trigger:** free Run, Line, or External

**Time:** 0.2 s full sweep to 200 s/Hz of Frequency Span (swept time excluding auto calibration cycles)

##### Input

###### Signal Inputs

50/75  $\Omega$ :  $> 26$  dB return loss, BNC connector

1 M $\Omega$ :  $\pm 3\%$  shunted by  $< 30$  pF, BNC connector

###### Maximum Input Level

50/75  $\Omega$ : 13 V peak ac plus dc relay protected against overloads to 42 V peak.

1 M $\Omega$  input: 42 V peak ac plus dc (derate by factor of two for each octave above 5 MHz).

**External trigger input:** negative going TTL level or contact closure required to initiate sweep.

**External reference input:** 10 MHz (or subharmonic to 1 MHz), 0 dBm minimum level

##### Output

###### Tracking Generator

**Level:** 0 dBm to  $-11$  dBm with a single turn knob

**Frequency accuracy:**  $\pm 1$  Hz relative to analyzer tuning

**Frequency response:**  $\pm 0.7$  dB

**Impedance:** 50  $\Omega$ ;  $> 14$  dB return loss

**Probe power:**  $+15$  Vdc,  $-12.6$  Vdc; 150 mA max.

**IF:** 350 kHz,  $-11$  dBV to  $-15$  dBV at the reference level

**Video:** 10 V at the reference level

**Frequency reference:** 10.000 MHz  $\pm 1 \times 10^{-7}$ /month,  $+10$  dBm into 50  $\Omega$

##### HP-IB Interface Functions

Sh1, An1, T6, L4, SR1, RL1, TP0, DC1, DT1, C0

##### General

###### Environmental

**Temperature:** operating  $0^\circ\text{C}$  to  $55^\circ\text{C}$

**Humidity:**  $< 95\%$  RH except 300 Hz BW  $< 40\%$  RH

**Warm-up time:** 20 minutes at ambient temperature

**Power requirements:** 115 V ( $+11\%$   $-25\%$ ), 48-440 Hz

230V ( $+11\%$   $-18\%$ ), 48-66 Hz

180 watts 3A max

**Weight:** 39.9 kg (88 lb)

**Size:** 229 mm (9") H  $\times$  426 mm (16.75") W  $\times$  635 mm (25") D

##### Ordering Information

Opt. 907: Front Handle Kit

\$77

Opt. 908: Rack Flange Kit

\$41

Opt. 909: Combined Opt. 907 and 908

\$107

Opt. 910: Extra Manuals

\$204

Opt. W30: Extended Warranty

\$350

HP 3585A Signal Analyzer

\$24,200

## 50 Hz to 32.5 MHz Selective Level Meter

Model 3586C

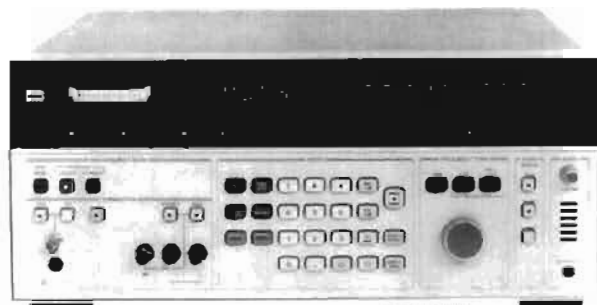

HP 3586C



### DESCRIPTION

The HP 3586C Selective Level Meter is designed for general purpose wave analysis applications in the design, manufacture, and maintenance of electronic systems. It's companion products, the HP 3586A and HP 3586B are optimized for measurements in Frequency Division Multiplex (FDM) systems. The HP 3586C is fully HP-IB programmable and covers the frequency range of 50 Hz to 32.5 MHz, allowing measurement of audio, sonar and other low frequency systems, as well as high frequency communications and subsystems. Input impedances of 50, 75, and 600 Ohms are provided with 10kOhm bridging for maximum measurement flexibility in a wide variety of applications. Signal levels are measured with up to  $\pm 0.2$  dB accuracy down to  $-80$  dBm with 0.01 dB resolution and bandwidth choices of 20, 400, or 3100 Hz. The built-in counter and narrow resolution bandwidths allow harmonic and intermodulation measurements to be made with ease. Frequency can be set or measured with 0.1 Hz resolution and  $\pm \times 10^{-5}$  stability ( $\pm 2 \times 10^{-7}$  optional).

Also included is a tracking output for frequency response measurements of high-Q filters and other selective networks

### HP 3586C Specifications (abbreviated)

#### Frequency

**Frequency range:** 50/75  $\Omega$  unbalanced input, 50 Hz to 32.5 MHz; 600  $\Omega$  Balanced Input, 50 Hz to 108 kHz

**Frequency resolution:** 0.1 Hz

**Center frequency accuracy:**  $\pm 1 \times 10^{-4}$ /year, ( $\pm 2 \times 10^{-7}$ /year with option 004).

**Counter accuracy:**  $\pm 1.0$  Hz in addition to center frequency accuracy for signals within the 60 dB bandwidth of the IF filter chosen or greater than  $-100$  dBm (largest signal is measured).

#### Selectivity

**3 dB bandwidth,\***  $\pm 10\%$ : 20 Hz, 400 Hz, 3100 Hz

\*Noise bandwidth is the same as the 3 dB bandwidth

**60 dB bandwidth:** 3100 Hz BW,  $\pm 1.850$  Hz; 400 Hz BW,  $\pm 1100$  Hz; 20 Hz BW,  $\pm 90$  Hz

**Passband flatness**  $\pm 0.3$  dB

#### Amplitude

**Measurement range:**  $+20$  to  $-120$  dBm

**Amplitude resolution:** .01 dB

**Level accuracy:** 10 dB auto range, low distortion mode, after calibration, signal at  $\pm 1$  Hz from center frequency.

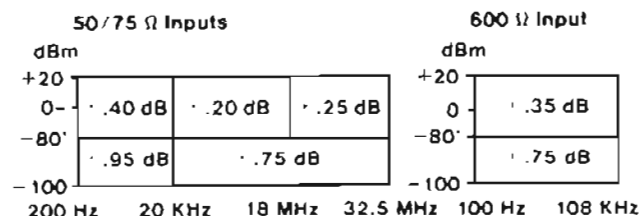

\*20 Hz & 400 Hz BW below  $-90$  dBm

**Wideband power accuracy:** after calibration, 100 dB range, average on,  $-45$  to  $+20$  dBm.

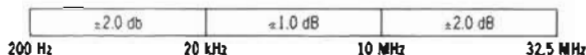

#### Dynamic Range

##### Spurious Responses

$-110$  dBm maximum or the following, whichever is greater:

**Image rejection (100-132 MHz):**  $-80$  dBc

**IF rejection:** 15625 Hz,  $-80$  dBc; 50 MHz,  $-60$  dBc

**Spurious signals:**  $> 1600$  Hz offset,  $> -80$  dBc; 300 Hz to 1600 Hz,  $> -75$  dBc

**Residual spurious:**  $-110$  dBm maximum;  $< 350$  Hz,  $-95$  dBm

##### Distortion

**Harmonic distortion:**  $-75$  dB below full scale, low distortion mode, above 4 kHz.

**Intermodulation distortion:** two-tone second and third order, separation 10 kHz to 1 MHz,  $-78$  dB below full scale. Either tone  $\geq 10$  MHz,  $-70$  dB.

##### Noise Floor (full scale setting $-35$ to $-120$ dBm)

Frequency	Bandwidth	Noise Level
100 kHz to 32.5 MHz	3100	$-114$ dBm
	20 Hz, 400 Hz	$-120$ dBm
2 kHz to 100 kHz	All	$-105$ dBm

The noise floor for full scale settings of  $-30$  to  $+25$  dBm will be 75 dB below full scale for  $> 100$  kHz, or 55 dB below full scale for  $< 100$  kHz.

#### Signal Inputs

Impedance	Frequency	Mating Connector	Return Loss
50/75 ohms unbalanced	50 Hz to 32.5 MHz	BNC	30dB
600 ohms balanced	50 Hz to 108 kHz	Dual Banana Plug 0.75 inch Spacing	25dB

**Balance:** 600  $\Omega$ ; 40 dB

#### Demodulated Audio Output

**Output level:** 0 dBm into a 600  $\Omega$  load

#### Auxiliary Signal Inputs/Outputs

**Tracking output:** 0 dBm rear panel tracking output

**Ext. reference input:** 1 MHz to 10 MHz or sub-harmonic input.

**Reference output:** 10 MHz at 8 dBm output (also 10 MHz oven oscillator on instruments with option 004).

**Probe power:** front panel dc output for HP active high impedance accessory probes, (+15,  $-12$  Vdc)

**Additional outputs:** audio, phase jitter and meter output.

#### Options

**Option 004: High stability frequency reference:** 10 MHz oven stabilized reference oscillator improves frequency stability to  $\pm 2 \times 10^{-7}$ /year.

#### General

##### Operating Environment

**Temperature:**  $0^\circ$  to  $55^\circ$  C

**Relative humidity:** 95%,  $0^\circ$  to  $40^\circ$  C

**Altitude:**  $\leq 15,000$  ft.,  $\leq 4600$  metres

**Storage environment temperature:**  $-40^\circ$  C to  $75^\circ$  C

**Storage altitude:**  $\leq 50,000$  ft.,  $\leq 15,240$  metres

**Power:** 100/120/220/240 V,  $\pm 5\%$ ,  $-10\%$ , 48 to 66 Hz, 150 VA

**Weight:** 23 kg. (50 lb) net; 30 kg. (65 lb) shipping

**Size:** 177 mm H x 425.5 mm W x 475.5 mm D (7" x 16.75" x 16.75")

##### HP 3586C Selective Level Meter\*

**\$10,900**

**Opt 004:** High Stability Frequency Reference \$750

**Opt 907:** Front Panel Handles \$66

**Opt 908:** Rack Flange Kit \$36

**Opt 909:** Rack Flange & Handle Combination Kit \$92

**Opt W30:** Extended Warranty \$310

##### Accessories

**HP 1124A:** High Impedance Probe \$350

\*HP-IB cables not supplied. See page 549.

# SIGNAL ANALYZERS

## HP 70000 Modular Measurement System

- New additions to modular spectrum analyzer family
- Fundamental mixing from 100 Hz to 22 GHz
- Unmatched sensitivity, frequency response, and dynamic range

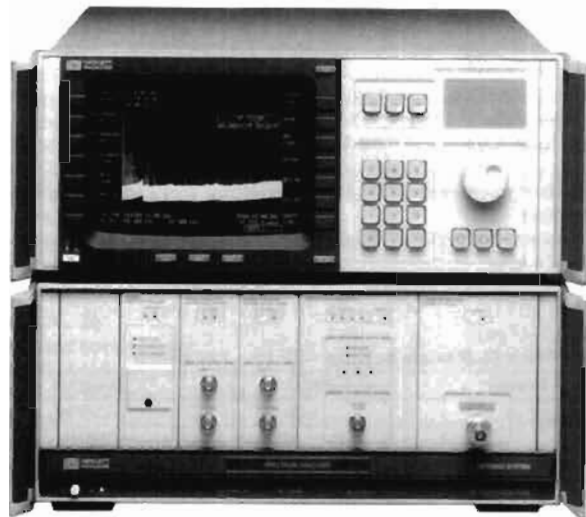

HP 71210A



### HP 71210A Microwave Spectrum Analyzer: 100 Hz - 22 GHz

The HP 71210A Microwave Spectrum Analyzer is the latest addition to the growing HP 70000 Modular Spectrum Analyzer family. This instrument offers state-of-the-art performance in addition to the benefits of modularity. The HP 71210A offers unsurpassed sensitivity, frequency response, and dynamic range made possible by the new, fundamentally mixed HP 70908A RF Section. And automatic, continuous preselector peaking eliminates the need to use time-consuming preselector peak functions.

The HP 71210A comes complete with a large system display, two IF sections, and the Precision Frequency Reference Module. This configuration provides outstanding performance yet still reserves 1/3 of the mainframe for future expansion.

Sensitivity is specified as  $-133$  dBm from 2.7 to 22 GHz. This outstanding performance translates into measurement speeds as much as 10,000 times faster than those of other microwave analyzers, due to the relationship between sensitivity, resolution bandwidth, and sweep time. Frequency-response standards have also been raised by the HP 71210A, which is specified at  $\pm 2$  dB from 2.7 to 22 GHz.

The superior performance of the HP 71210A makes it ideal for applications such as spur searching, surveillance, third order intermodulation, and harmonic distortion measurements.

The new HP 70908A RF Section is the key module in the HP 71210A. It has a unique architecture and RF design that result in new levels of spectrum analyzer performance. This module provides fundamental mixing to 22 GHz, continuous YIG tuned preselector peaking, and fast band switching.

As with any component of the HP 70000 Modular Measurement System, the HP 70908A RF Section can be ordered separately. The addition of this module will upgrade your current HP 70000 system with the latest in technology and the highest in performance. For more information on this new system see pages 113 and 116, or contact your local HP sales office for complete specifications and details.

- Digitizer module for waveform-analysis capability
- Module Development Products for design of custom modules

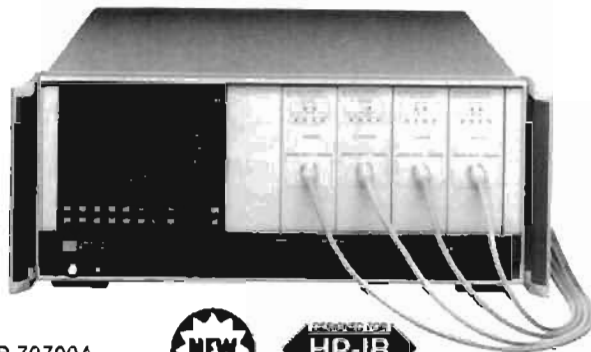

HP 70700A



### HP 70700A Digitizer

The HP 70700A Digitizer is a new addition to the HP 70000 Modular Measurement System. This 1/2-width module offers 20 Msample/sec, 10-bit resolution, and 256K of memory. The digitizer can be used to either enhance the performance of an HP 70000 Modular Spectrum Analyzer or act as a stand-alone instrument.

Used in conjunction with any HP 70000 spectrum analyzer, the digitizer improves both the time-domain (zero span) and frequency-domain performance of the instrument. Sweeps as fast as 15 msec in the frequency domain and 80  $\mu$ sec in zero span are possible. This improvement in digitizing speed is especially useful for the analysis of pulsed RF signals.

Configured as a stand-alone instrument within an HP 70000 system, the HP 70700A can be used as a waveform recorder, transient analyzer, or digitizing oscilloscope. Features such as random event capture, pre- and post-trigger data, FFT, detection sampling modes, and multi-channel capability make the HP 70700A Digitizer a versatile addition to any HP 70000 Modular Spectrum Analyzer.

For parallel, multi-channel waveform analysis an eight-channel system can be configured within a single HP 70001A mainframe. In addition, up to 64 channels can be synchronously sampled with the aid of external circuitry. All modules share the same clock for true synchronous detection. All features are controllable by computer, making the digitizer ideal for automatic data acquisition applications. See page 116, or contact your local HP sales office for complete specifications and application details.

### Module Development Products

The HP 70595A Design Guides and the HP 70593A Module Part Kits provide the vehicle for incorporating your custom designs into the HP 70000 Modular Measurement System. The design guides provide direction for the development of custom modular products, and part kits supply hardware for 1/4, 1/2, and 3/4-width modules.

Use of this family of Module Development Products enables many custom functions to be incorporated into an HP 70000 system. Custom modules can use the power, cooling, and clean EMI environment provided by the HP 70000 Modular Measurement System. Computer control of custom modules is available via HP-IB.

The HP 70595A Design Guides are a set of three books covering various aspects of electrical, mechanical, and EMC design. Topics discussed include power supply design; EMC considerations and testing; electrical and mechanical interfacing; and module layout guidelines. This information helps reduce the time and money spent on adapting new or existing designs into the HP 70000 system environment.

The HP 70591A, 70592A, and 70593A Module Part Kits provide all necessary hardware for 1/4, 1/2, and 3/4-width modules. Parts included are housing components, latch mechanisms, connectors, and common hardware. When assembled, these parts house the custom product, connect it to the mainframe, provide EMI shielding, and enable the mainframe's power supply and forced air cooling to be used. See page 116 for more information, or contact your local HP sales office for complete details and specifications.



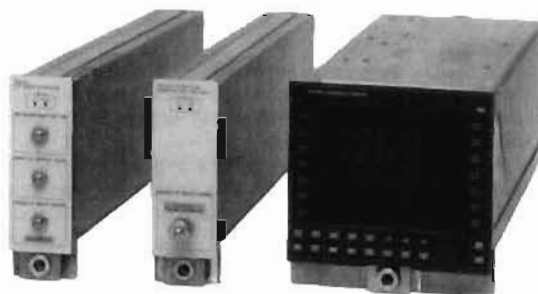

### HP 70000 Modular Spectrum Analyzers

The HP 70000 Modular Measurement System offers state-of-the-art spectrum analysis capability with all the benefits of modularity. Standard or custom systems can be ordered to meet your measurement requirements. As your needs change or as new modules are developed, you can expand or upgrade your system economically by simply adding new or different modules. Keep your up-time high with on-site repair by replacing modules. Use downloadable programs (DLPs) to increase productivity. Automated systems can be configured with the addition of a wide variety of HP technical computers and peripherals. You can also design your own modules for use in the HP 70000 system.

### Choose Small or Large, Standard or Custom Systems

A rugged, reliable mainframe and two high-performance display/control units form the core of the HP 70000 Spectrum Analyzers. These system components combine with an expanding variety of modules to create the measurement system that's right for your application.

You can choose from five standard, factory configured spectrum analyzer systems or fashion your own custom system from available system components. Either way, a factory assembled and tested system will be delivered ready for use. You can also order individual system components, including mainframes and displays.

The five standard HP 70000 Modular Spectrum Analyzers cover frequency ranges from RF to millimeter. (See pages 113-115 for configurations and specifications.) You can also add options to modify your system or extend the warranty.

Custom systems give you the flexibility to configure just the capability you need. The basic elements required to construct a spectrum analyzer are a display, an HP 70900A Local Oscillator, an RF or external mixer interface module, and an IF section. For certain automated systems a display may not be required.

### Expand Your Measurement Capabilities

A growing variety of new modules makes it easy to increase or modify your measurement capability. Stimulus-response measurements can be made with the addition of the HP 70300A Tracking Generator. Automatic signal monitoring/surveillance capability can be obtained by using a controller and the HP 85865B Signal Monitoring Software. (See page 123 for details.) You can increase frequency

accuracy with the addition of the HP 70310A Precision Frequency Reference or add the HP 70700A Digitizer to both enhance spectrum analyzer time domain measurements and provide a stand-alone, programmable waveform recorder. Additional mainframes can be added as your system expands, with system control residing in a single display.

### Module Development Product Family

Benefit from the years of engineering R & D on the HP 70000 modular system in designing your own speciality modules. With the assistance of the HP 70595A Design Guides and the HP 7059XA (1/8, 3/8, and 1/2-width) Part Kits, you can more readily utilize the power, cooling, and EMI shielding of the HP 70000 Modular Measurement System environment. Design guides include information on electrical, mechanical, and EMC design that will shorten your development cycle.

### Create Custom Softkeys

Specific measurement routines can be created and stored in the HP 70000 Modular Spectrum Analyzers. These custom routines (DLPs) become as easy to retrieve and use as any other function of the analyzer. Using custom DLPs that are executable with a single softkey, you can make the analyzer more efficient for a specific measurement requirement.

### Product Support

In addition to the standard one-year, return-to-HP warranty, an optional two-year warranty is offered on every standard or custom system, for total coverage of three years. A one-year standard and two-year optional warranty is also offered on all system components purchased individually.

The HP 11990A software package provides complete electrical test capability to data sheet specifications and is available for any standard or custom system.

A one-day, lab-intensive HP 70000 user's course is offered to help you use the HP 70000 more effectively and more efficiently. You will learn how to connect and configure modules, become familiar with the menus that control system operation, and learn how to use some of the unique features of the HP 70000 system. (See pages 114 and 748.)

# SIGNAL ANALYZERS

## HP 70000 Modular Measurement System (cont'd)

### Adapts to Meet Your Needs

#### Just the Capability You Need

The HP 70000 Modular Spectrum Analyzer family lets you choose the right capability for an application without paying for features you don't need. Get the frequency range you need with one of five RF Sections or with the External Mixer Interface Module and HP 11970 mixers. Choose from two IF Sections to get the frequency resolution you want, and choose from two display/control units to suit your needs.

#### Expandable

As your needs change, expand your HP 70000 Modular Spectrum Analyzer by adding modules instead of replacing the entire system. A standard system can be upgraded at any time with the addition of selected modules.

The HP 70000 product line continues to grow with new modules and capabilities added every year. This expanding product offering promises to meet your long-term measurement requirements. With its easy system upgrade path, the HP 70000 has inherent longevity, eliminating many of the "hidden" costs of replacing an instrument: operator and service retraining time, reprogramming, documentation, and installation time.

#### Centralized System Control

One HP 70000 Modular Measurement System can contain many spectrum analyzers, all controlled by a single HP 70205A or 70206A Display. This central display can present the outputs from up to four instruments simultaneously.

Like individual instruments, the HP 70206A System Display can be physically separated from the spectrum analyzer by up to two kilometers while linked via the HP 70000 Modular System Interface Bus (MSIB). The display can be at a location that is convenient for the operator, and the analyzer can be placed at the measurement site.

#### Easy to Use

Three keys on the display (USER, MENU, and DISPLAY) let you control all instrument functions. These "hardkeys" access "softkey" menus on the display. Softkeys allow control of every command and function of the HP 70000 system.

The most frequently-used softkeys are displayed by simply pressing the USER key. This calls up such keys as CENTER FREQ, SPAN, MARKER DELTA, HIGHEST PEAK, and NEXT PEAK.

#### Customized Softkeys

You can replace the softkeys found under the USER key with any of over 200 available softkeys to create a customized keyboard. This makes your HP 70000 more efficient for specific measurements.

#### Downloadable Programming

For complex measurements that are made routinely, "one-button" solutions can be developed that make the system easy for anyone to operate. Using the downloadable programming capability of the HP 70000, a measurement routine is created on a computer and downloaded into the non-volatile memory of the analyzer, where it can be executed either manually or remotely.

Any function of the spectrum analyzer can be used in a downloadable program (DLP). And you can place the DLP under the control of a specific softkey, which can be labelled for identification.

A DLP for spur searching appears in the plot at right. This program directs the HP 70000 to make the calculations, take measurements, and display the results in a usable form.

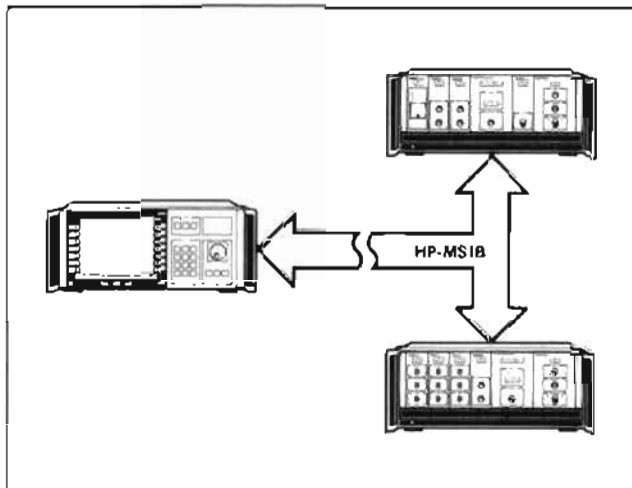

A single display can control multiple instruments separated by up to 2 kilometers.

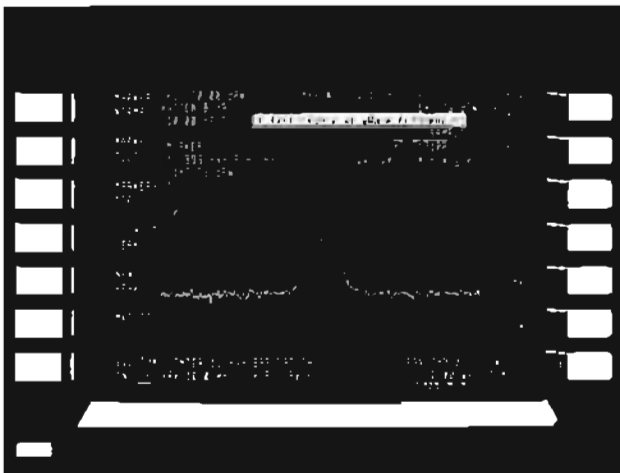

The fourteen most frequently-used functions appear when the USER key is pressed.

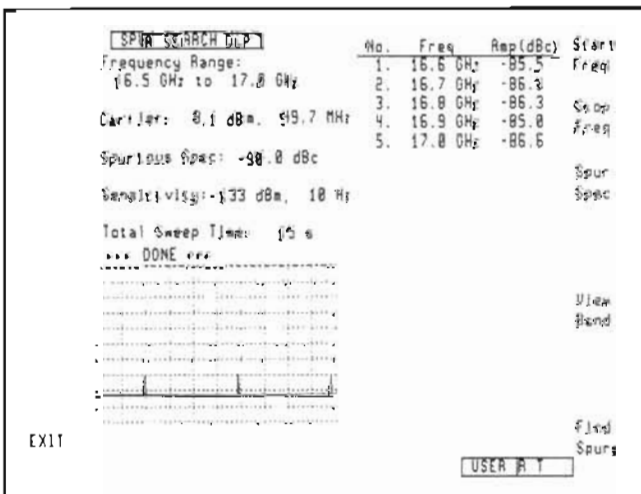

A one-button solution can be created to execute a complex measurement routine such as spur searching.



**HP 70000 Standard Spectrum Analyzer Systems**

Five standard, factory-configured systems are offered in RF, microwave, and millimeter frequency ranges. Each system is completely assembled and tested at the factory, and is shipped ready to use. A one-year, return-to-HP warranty is included with any standard or custom system. See page 114 for specification summaries.

**HP 71100A RF Spectrum Analyzer**

System Components (7/8 mainframe occupied)

HP 70001A Mainframe

HP 70205A Graphics Display

HP 70900A Local Oscillator

HP 70902A IF Section

HP 70904A RF Section

Price  
\$33,700

**HP 71200A Microwave Spectrum Analyzer**

System Components (7/8 mainframe occupied)

HP 70001A Mainframe

HP 70205A Graphics Display

HP 70900A Local Oscillator

HP 70902A IF Section

HP 70905A RF Section

\$36,750

**HP 71201A Microwave Spectrum Analyzer**

System Components (8/8 mainframe occupied)

HP 70001A Mainframe

HP 70205A Graphics Display

HP 70900A Local Oscillator

HP 70902A IF Section

HP 70905B RF Section

HP 70600A Preselector

\$45,950

**HP 71210A Microwave Spectrum Analyzer**

System Components (7/8 mainframe occupied)

HP 70001A Mainframe

HP 70206A System Graphics Display

HP 70900A Local Oscillator

HP 70902A IF Section

HP 70903A IF Section

HP 70908A RF Section

HP 70310A Precision Frequency Reference

**HP 71300A Millimeter Spectrum Analyzer**

System Components (7/8 mainframe occupied)

HP 70001A Mainframe

HP 70205A Graphics Display

HP 70900A Local Oscillator

HP 70902A IF Section

HP 70907A External Mixer Interface

\$34,700

**System Options**

Except as noted, the options below apply to all standard systems.

- Option 001 Delete HP 70905A RF Section, add HP 70906A RF Section (HP 71200A only) +\$1,650
- Option 002 Delete HP 70205A Graphics Display, add HP 70206A System Graphics Display (all models except HP 71210A) +\$1,800
- Option 004 Add HP 70903A IF Section (all models except HP 71210A) +\$2,650
- Option 005 Delete HP 70902A IF Section, add HP 70903A IF Section (all models except HP 71210A) -\$700

- Option 400 Add 400 Hz Power Line Frequency Operation to the mainframe +\$750
- Option 401 Add 400 Hz Power Line Frequency Operation to the mainframe and HP 70206A System Graphics Display +\$1850
- Option 655 Delete 3 1/2" Operation Verification software disks, add 5 1/4" disks \$0
- Option 908 Rack Flange Kit for mainframe or HP 70206A Display without handles +\$35
- Option 913 Rack Flange Kit for mainframe or HP 70206A Display with handles +\$40
- Option 010 Rack Mount Slide Kit for mainframe +\$450
- Option 011 Rack Mount Slide Kit for display +\$200
- Option 910 Extra Manual Set +\$250

**System Support Options**

Option W30 provides an additional, two year return-to-HP warranty:

- HP 71100A Option W30 \$690
- HP 71200A Option W30 \$780
- HP 71201A Option W30 \$950
- HP 71210A Option W30 \$950
- HP 71300A Option W30 \$730

The HP 11990A System Performance Test Software Package provides complete test capability of system specifications (Use of external test equipment required):

- HP 11990A (required for any HP 70000 system) \$1,000
- Option 100 For HP 71100A \$300
- Option 200 For HP 71200A \$300
- Option 201 For HP 71201A \$300
- Option 210 For HP 71210A \$300
- Option 300 For HP 71300A \$300
- Option 655 Delete 3 1/2" disks, add 5 1/4" disks \$0

The HP 70050AX Modular Spectrum Analyzer User Course is a one-day, hands-on, lab-intensive course designed to help you use the HP 70000 Spectrum Analyzer more effectively and more efficiently. You will learn how to connect and configure modules, become familiar with the multiple menus that operate the system, and learn how to use some of the unique features of the HP 70000.

HP 70050AX Utilizes customer-supplied equipment and facilities \$2,000/class

**HP 70000 Custom Spectrum Analyzer Systems**

Custom systems can be made up in several ways. You can choose to start with a standard system and then add modules, accessories, and options as desired. You can also build a system by selecting system components individually.

Factory-configured, custom systems can be ordered using the HP 71000S product number. This product number ensures factory assembly and test, and delivery of a system ready to use. System automation can be added under the HP 71000S product number with the selection of series 200 or 300 computers and peripherals. When individual modules are ordered, all necessary cables are included to allow connection into any system configuration.

# SIGNAL ANALYZERS

## HP 70000 Modular Measurement System (cont'd)

### HP 70000 Specification Summary

	HP 71100A	HP 71200A
Frequency Range tunable in <1 Hz increments	100 Hz - 2.9 GHz	50 kHz - 22 GHz 50 kHz - 26.5 GHz (Opt. 001)
Total Amplitude Range	-134 to +30 dBm	-132 to +30 dBm
Displayed Avg. Noise Level (dBm) (10 Hz Res. BW, 0 dB attn)	1 kHz - 30 kHz <-85 300 kHz - 1 MHz <-118 1 MHz - 2.9 GHz <-128	1 MHz - 10 MHz <-118 10 MHz - 6.2 GHz <-129 19.7 GHz - 22 GHz <-116
Frequency Response (10 dB input attn)	100 Hz - 2.5 GHz $\pm$ 1 dB 100 Hz - 2.9 GHz $\pm$ 1.5 dB	50 kHz - 2.9 GHz $\pm$ 2.3 dB 2.7 GHz - 12.7 GHz $\pm$ 1.5 dB
Scale Fidelity (Log, 10 Hz Res BW, 0-90 dB)	$\pm$ 0.5 dB	$\pm$ 0.5 dB
Frequency Accuracy After cal One year after cal (At 1 GHz, 0 Hz Span, 0-55°C)	$\pm$ 10 kHz ( $\pm$ 17 Hz)* $\pm$ 13 kHz ( $\pm$ 117 Hz)*	$\pm$ 10 kHz ( $\pm$ 17 Hz)* $\pm$ 13 kHz ( $\pm$ 117 Hz)*
Resolution Bandwidths (-3 dB) adjustable in 1,3,10 sequence & 10% increments (except 3 kHz - 10 kHz)	10 Hz - 300 kHz 10 Hz - 3 MHz (opt. 004)	10 Hz - 300 kHz 10 Hz - 3 MHz (Opt. 004)
Phase Noise 1 GHz, 30 kHz offset	-97 dBc/Hz	-97 dBc/Hz
Dynamic Range (@ 1 GHz) 2nd Harmonic Distortion Third Order Intermod Distortion	<-70 dBc <-70 dBc	<-70 dBc <-74 dBc
Frequency Span - Range (adj. 0.5% of displayed span)	1 Hz to 2.9 GHz Plus 0 Hz	1 Hz to 22/26.5 GHz Plus 0 Hz
Sweep Time	50 msec to 1,000 sec; or 15 msec to 335 sec in swept freq. mode & 80 $\mu$ sec to 335 sec in fixed freq. mode (0 span) with HP 70700A	
Weight kg (lb)	30.9 (68.1)	30.6 (67.5)

\*with HP 70310A Precision Frequency Reference

### General Specifications

#### Environmental

**Temperature:** Operation 0 to +55° C; Storage -40 to +75° C

**Humidity:** Operation 0 to 95% Relative Humidity at 40° C

**EMI:** Conducted & radiated interference is within the requirements of MIL-STD-461B, RE02/part7, CISPR pub. 11, and FTZ 526/1979

#### Power Requirements

**HP 70001A Mainframe:** 100, 120, 220, or 240 VAC ( $\pm$ 10%) 47-66 Hz or 400 Hz with option 400

**Modules:** All power supplied by mainframe

**HP 70206A Display:** 100, 120, 220, or 240 VAC ( $\pm$ 10%) 47-66 Hz or 400 Hz with option 401

#### Warm-up Time

One hour from cold start (0-55° C)

#### Size in mm (Inches)

**HP 70001A Mainframe:** 177.0 (6.97) H, 425.4 (16.75) W, 526.0 (20.7) L

**HP 70206A Display:** 177.0 (6.97) H, 425.4 (16.75) W, 502.0 (19.75) L

### Available System Inputs/Outputs (F=front panel, R=rear panel)

**HP 70205A & 70206A Displays:** Composite video out (BNC R)

**HP 70900A LO Section:** 300 MHz Cal out (BNC F), Ext Freq Ref in (SMB R), Sweep out (SMB R), Tune+Span out (SMB R), HSWP out/in (SMB R)

**HP 70902A IF Section:** Aux video out (BNC F), 3 MHz IF out (BNC F), 21.4 MHz Aux IF out (SMB R), 3 MHz limited IF out (SMB R)

**HP 70903A IF Section:** Aux video out (BNC F), 21.4 MHz IF out (BNC F), 21.4 MHz Log IF out (SMB R)

**HP 70904A RF Section:** RF in (Type N F), 1st LO aux out (SMA R), Probe power out (F)

**HP 70905A RF Section:** RF in (Type N F), 321.4 MHz IF in/out (SMB R), 1st LO aux out (SMA R)

**HP 70906B RF Section:** 321.4 MHz IF in/out (SMB R), 1st LO aux out (SMA R)

**HP 70000 Specification Summary (cont)**

HP 71201A	HP 71210A	HP 71300A
50 kHz · 22GHz	100 Hz · 22 GHz	18-110 GHz w/HP 11970 mixers 2.7-325 GHz w/other mixers
-130 to +30 dBm	-138 to +30 dBm	-130 to -1 dBm
1 MHz · 10 MHz 10 MHz · 6.2 GHz 19.7 GHz · 22 GHz	1 MHz · 10 MHz <-118 10 MHz · 2 GHz <-138 2 GHz · 22 GHz <-133	with HP 11970 mixers 18-40 GHz <-128 33-60 GHz <-124 50-75 GHz <-112
50 kHz · 2.9 GHz 2.7 GHz · 12.7 GHz	100 Hz · 2.9 GHz ±1.5 dB 2.7 GHz · 22 GHz ±2.0 dB	with HP 11970 mixers 18 GHz · 60 GHz ±2.3 dB 50 GHz · 75 GHz ±2.5 dB
±0.5 dB	±0.5 dB	±0.5 dB
±10 kHz (±17 Hz)* ±13 kHz (±117 Hz)*	±17 Hz ±117 Hz	All 100 GHz ±1 MHz (±710 Hz)* ±1.3 MHz (±10.7 kHz)*
10 Hz · 300 kHz 10 Hz · 3 MHz (opt. 004)	10 Hz · 3 MHz	10 Hz · 300 kHz 10 Hz · 3 MHz (Opt. 004)
-97 dBc/Hz	-97 dBc/Hz	18 · 26.5 GHz -81 dBc/Hz
bypass/filtered <-70/<-76 dBc <-74/<-66 dBc	<-70 dBc <-70 dBc	depends on external mixer used
1 Hz to 22 GHz Plus 0 Hz	1 Hz to 22 GHz Plus 0 Hz	1 Hz to 110/325 GHz Plus 0 Hz
50 msec to 1,000 sec; or 15 msec to 335 sec in swept freq. mode & 80 µsec to 335 sec in fixed freq. mode (0 span) with HP 70700A		
30.2 (66.6)	50.1 (110)	30.5 (67.2)

**Available System Inputs/Outputs (con't)**

- HP 70906A RF Section:** RF in (APC-3.5 F), 321.4 MHz IF in/out (SMB R), 1st LO aux out (SMA R)
- HP 70908A RF Section:** RF in (Type N F), 321.4 MHz IF out (SMB R), 1st LO aux out (SMA R)
- HP 70907A EMIM:** IF in (SMA F), LO out (SMA F), Mixer bias out (SMA F), 1st LO aux out (SMA R), 300 MHz 2nd LO in/out (SMB R)
- HP 70600A Preselector:** RF in (Type N F), Tune+Span in (SMB R)
- HP 70300A Tracking Generator:** RF out (Type N F), Ext ALC in (BNC F), AM in (BNC F), 300 MHz out (SMB R), 21.4 MHz in/out (SMB R), 1st LO aux out (SMA R)
- HP 70310A PFR:** Ext Ref in (SMB R), 10 MHz & 100 MHz Ref out (SMB R)
- HP 70700A Digitizer:** Video in (BNC F), Video in (SMB R), Sync out (SMB R)

**Accessory Module Specification Summaries**

- HP 70300A Tracking Generator**
- Frequency Range:** 20 Hz - 2.9 GHz swept and CW
- Resolution:** <1 Hz
- Output Amplitude:** -10 dBm to -21 dBm, or -10 dBm to -91 dBm with Option 001
- Level Flatness:** ±0.5 dB from 10 MHz - 2.9 GHz (relative to 300 MHz); -0.7dB, +1.2 dB from 20 Hz - 10 MHz (relative to 1 MHz)
- AM Rates:** Internal, 400 Hz & 1 kHz; External, 20 Hz - 20 kHz
- HP 70310A Precision Frequency Reference**
- Aging:** <5×10<sup>-10</sup>/day (7-day average); <1×10<sup>-7</sup>/year
- Temperature Stability:** <7×10<sup>-9</sup> over 0 to 55° C (25° C reference)
- Output Power 10 MHz & 100 MHz:** 0 dBm (typical)
- Input Power 1, 2, 5, or 10 MHz:** -5 to +21 dBm
- HP 70700A Digitizer**
- Maximum Sampling Rate:** 20 MSa/sec
- Amplitude Resolution:** 10 bits
- Waveform memory:** 256K 10-bit words
- Gain Accuracy:** ±1%
- Offset Accuracy:** ±1%
- Input Voltage Ranges:** ±0.3V, ±1V, ±3V, ±10V

# SIGNAL ANALYZERS

## HP 70000 Modular Measurement System (cont'd)

### Components Of The HP 70000 Measurement System

The HP 70000 Modular Spectrum Analyzer family includes the components listed below. These components can be ordered individually to create or supplement a spectrum analyzer. A mainframe, local oscillator, RF or external mixer interface, and an IF section are the minimum required to form a spectrum analyzer. (See page 113 for standard HP 70000 Modular Spectrum Analyzer Systems.)

<b>HP 70001 System Mainframe</b>		<b>Price</b>	
The HP 70001A System Mainframe provides all necessary power, cooling, digital interfacing, and EMI shielding for any width module. The mainframe fits standard EIA racks and holds a maximum of eight 1/2-width modules. Modules are automatically connected to power, digital interface, and forced-air cooling when installed.		\$4,200	
<b>HP 70206A System Graphics Display</b>		\$6,100	
The HP 70206A System Graphics Display is a full-width, stand-alone, menu-driven human interface for the HP 70000 spectrum analyzer. It displays measurement results and configuration information; and it has high-resolution-graphic, trace, text, and marker capability. Display includes a 9-inch CRT, data and control keys, and an analog control knob. The display can be stacked or racked with the HP 70001A Mainframe or located up to 2 km away from the analyzer.			
<b>HP 70205A Graphics Display</b>		\$4,300	
The HP 70205A Graphics Display is a 1/2-width module that provides all the capabilities of the HP 70206A System Graphics Display in a modular form.			
<b>HP 70900A Local Oscillator</b>		\$14,400	
The HP 70900A Local Oscillator is a 1/2-width module that provides a swept LO signal, processes video signals, and acts as the master controller for the spectrum analyzer. The swept LO of 3.0 to 6.6 GHz is sent to RF modules and any other modules that require it. The LO contains the system firmware, enabling it to control and coordinate measurements and to output data to a display or computer. It also has a minimum of 32K bytes of memory for DLPs.			
<b>HP 70902A IF Section (Res BW 10 Hz - 300 kHz)</b>		\$3,350	
<b>HP 70903A IF Section (Res BW 100 kHz - 3 MHz)</b>		\$2,650	
The HP 70902A and HP 70903A IF Sections are 1/2-width modules that process a 21.4 MHz IF signal received from an RF or external mixer interface module. A detected video signal is produced and routed to the video processor in the LO. Both IF modules contain resolution bandwidth filters, log amplifiers, detection circuitry, and video filters. Both sections can be used in a single system to provide Res BWs of 10 Hz to 3 MHz.			
<b>HP 70904A RF Section (100 Hz - 2.9 GHz)</b>		\$7,450	
<b>HP 70905A RF Section (50 kHz - 22 GHz)</b>		\$10,500	
<b>HP 70905B RF Section (50 kHz - 22 GHz, no attenuator)</b>		\$9,550	
<b>HP 70906A RF Section (50 kHz - 26.5 GHz)</b>		\$12,150	
The HP 70904A, 70905A, 70905B, and 70906A RF Sections are 1/2-width modules that serve as front ends for RF and microwave spectrum analyzer systems. The HP 70905B does not have an input attenuator and is intended for use with the HP 70600A Preselector. The other three RF Sections contain input attenuators. All modules convert the incoming RF signal to a 21.4 MHz IF. All four RF Sections are unpreselected.			
<b>HP 70908A RF Section (100 Hz - 22 GHz)</b>		\$35,200	
The HP 70908A RF Section is a 1/2-width module that serves as a preselected front end for microwave spectrum analyzers. This module has fundamental mixing and continuous preselector peaking from 100 Hz to 22 GHz. The module contains an input attenuator and converts input signals to a 21.4 MHz IF.			
<b>HP 70907A External Mixer Interface</b>			\$8,450
The HP 70907A External Mixer Interface is a 1/2-width module that provides the interface between external mixers and spectrum analyzer systems. The module contains an LO amplifier, mixer bias supply, and down-conversion circuitry to convert the 321.4 MHz input IF to a 21.4 MHz IF signal. The frequency range is 18 GHz to 110 GHz using HP 11970 mixers, and 2.7 GHz to 325 GHz using mixers from other manufacturers.			
<b>HP 70600A Preselector</b>			\$10,150
The HP 70600A is a 1/2-width module used in conjunction with the HP 70905A and 70905B RF Sections to provide tracking preselection from 2.7 to 22 GHz and low pass filtering below 2.9 GHz. Preselection eliminates confusing multiple responses caused by the multi-band spectrum analyzer and makes microwave measurements easier and faster. For measurements where preselection is not desirable, the HP 70600A can easily be bypassed.			
<b>HP 70300A Tracking Generator</b>			\$10,150
<b>Option 001 Add 70 dB Attenuator</b>			+\$1,200
The HP 70300A Tracking Generator is a 1/2-width module whose output signal tracks the tuned frequency of the spectrum analyzer. Stimulus-response measurements with a dynamic range of 125 dB can be made using the HP 70300A in conjunction with an HP 70000 Spectrum Analyzer. Frequency range of the module is 20 Hz to 2.9 GHz.			
<b>HP 70310A Precision Frequency Reference</b>			\$4,300
<b>Option 001 Add Distribution Amplifier</b>			+\$1,500
<b>Option 002 Delete Ovenized Oscillator and External Power Pak</b>			-\$2,400
The HP 70310A is a 1/2-width module that provides precision reference signals at 10 MHz and 100 MHz for HP 70000 systems and other instruments. Signals are phase-locked to an internal ovenized oscillator, improving the HP 70000 frequency reference accuracy (after one year) from 3 ppm to 0.1 ppm. An external reference input allows the use of house standards or other external references at 1, 2, 5, or 10 MHz.			
<b>Option 001</b>			
adds two distribution amplifiers, each with three outputs and one input. <b>Option 002</b> deletes the ovenized oscillator and external power pak but retains the external reference input capability.			
<b>HP 70700A Digitizer</b>			\$7,500
The HP 70700A is a 1/2-width module that adds precision digitizing capability to the HP 70000 instruments. With a sampling rate of 20M-sample/sec, 10 bits/sample, and 256K words of memory, the HP 70700A improves the analyzer's ability to characterize signals in the time domain.			
An improvement in digitizing rate by a factor of 1000 allows faster start-to-stop frequency sweeps and improves the resolution of signals such as pulsed RF. Sweep times as fast as 80 $\mu$ sec can be made in zero span (time domain).			
The HP 70700A can also be used as a stand-alone, programmable waveform recorder, transient analyzer, or digitizing oscilloscope. For multi-channel applications, up to eight HP 70700A Digitizers will operate synchronously in a single HP 70001A mainframe.			
<b>HP 70000 Module Development Products</b>			
<b>HP 70595A Set of Module Development Design Guides</b>			\$3,000
<b>HP 70591A 1/2-width Module Part Kit</b>			\$750
<b>HP 70592A 1/2-width Module Part Kit</b>			\$800
<b>HP 70593A 1/2-width Module Part Kit</b>			\$1,400
The HP 70595A Module Design Guides and the HP 7059XA Module Part Kits enable you to take advantage of the cooling, power, and EMI shielding offered by the HP 70000 Modular Measurement System environment. Design guides include electrical, mechanical, and EMC information to aid you in the design and fabrication of modules to meet your specific needs. Module part kits include base, front and rear frames and panels, connector, cover, and associated hardware necessary for their assembly.			
<b>HP 11970 Harmonic Mixers</b> (See page 141.)			

# SIGNAL ANALYZERS

## Spectrum Analyzers, 100 Hz to 325 GHz

Models 8566B, 8567A & 8588B

117

- 100 Hz to 325 GHz coverage with synthesizer accuracy
- 10 kHz to 1.5 GHz coverage at a lower price
- 100 Hz to 1.5 GHz coverage with counter accuracy

- 2 to 22 GHz preselected range
- Trace markers with amplitude and frequency readout
- 16K bytes of user RAM for trace data or custom routines



HP 8566B



HP 8568B

The HP 8566B, HP 8567A, and HP 8568B are high-performance spectrum analyzers for bench and ATE system use. The HP 8566B is the highest performance analyzer of the three, with extendable frequency range from 100 Hz to 325 GHz. The HP 8567A is identical to the HP 8568B in many respects, but has reduced performance in some areas and a lower price. See pages 118, 120, and 122 for specification summaries on all three analyzers.

Each analyzer is designed around its own internal bus and controlled by its own microcomputer to yield significant improvements in operational and data processing features, as well as flexibility under computer control. Each analyzer has 16K bytes of user RAM for storing trace data, instrument states, or custom downloadable programs (DLPs).

### Performance

The exceptional frequency stability of both the HP 8566B and the HP 8568B makes measurements with 10 Hz resolution bandwidths possible. This narrow resolution bandwidth yields sensitivities to  $-135$  dBm in both instruments. Excellent frequency stability, sensitivity, and frequency-reference accuracy combine to allow very accurate measurement of small signals in the presence of large ones.

For applications that don't require the high performance of the HP 8568B, the HP 8567A offers the same speed, versatility, and automatic operation capability at a lower price. Resolution bandwidths as narrow as 1 kHz yield sensitivities as low as  $-115$  dBm.

### Usability

The instrument control settings are conveniently notated on the CRT for easy reference. Functions are activated by pressing a front-panel key, then selecting the function value using the knob, step keys, or numeric keyboard. To maintain a calibrated display, certain functions are automatically coupled in the analyzer. For example, resolution bandwidth, video bandwidth, and sweep time are automatically adjusted by the instrument when the frequency span is reduced.

Up to four tunable display markers are available to aid in measuring and analyzing signals. Two markers can be used to make relative measurements by displaying their amplitude and frequency difference. Marker information allows you to step between evenly spaced portions of a spectral display (such as signal harmonics) or "zoom-in" on a selected portion of the spectrum.

Analyzer control settings can also be saved in the non-volatile memory of the analyzer. Different operators can recall these settings to make consistent, repeatable measurements.

### Versatile CRT Display and Plotting Capabilities

All displayed information resides in the analyzer's digital memory, which refreshes the CRT at a flicker-free rate. Multiple traces can be displayed to measure residual FM or drift, or to conduct real-time surveillance over a wide frequency range.

By adding an HP-IB plotter, a hardcopy of all information on the display of the analyzer can be made for analysis, documentation, or presentation. Plots can be produced directly or with the aid of a controller.

### Custom Programming of Softkeys

Custom measurement routines can be created to meet your specific requirements. These programs can be created on an external controller or from the front-panel controls of the instrument and then stored in the non-volatile memory of the analyzer. Custom programming allows you to create complex measurement routines that can be stored and executed using a single softkey. This capability makes the analyzer a custom instrument that is more efficient for your specific tasks.

# SIGNAL ANALYZERS

## Spectrum Analyzers, 100 Hz to 325 GHz (cont'd)

### Models 8566B, 8567A & 8568B

#### Specification Summary

	8566B	8567A	8568B
Frequency Range	100Hz-22GHz 18.6-110GHz w/HP11970 Mixers 110-325GHz w/other mixers	10kHz-1500MHz	100Hz-1500MHz
Total Amplitude Range	-134 to +30dBm	-115 to +30dBm	-135 to +30dBm
Displayed Ave Noise Level (dBm) (10Hz Res BW, 0dB attn)	1MHz-2.5GHz <-134 2.5-8GHz <-132 5.8-12.5GHz <-125 12.5-18.6GHz <-119 18.6-22GHz <-114	50kHz-1MHz <-92' 1MHz-1500MHz <-115'	500Hz-1MHz <-112 1MHz-1500MHz <-135
Frequency Accuracy One year after cal (At 1GHz, 0Hz Span 5-55°C)	±267Hz	±15kHz	±267Hz
Resolution Bandwidths (-3dB) adj in 1,3,10 sequence	10Hz to 3MHz	1kHz to 3MHz	10Hz to 3MHz
Frequency Response (10dB input attn)	2-12.5GHz ±1.7dB 12.5-20GHz ±2.2dB	10kHz-500MHz ±1dB	100Hz-500MHz ±1dB 100Hz-1500MHz ±1.5dB
Weight	50kg (112 lb)	45kg (100 lb)	45kg (100 lb)
Price	\$57,650	\$27,550	\$35,300

'1kHz Res BW



HP 8566S

#### HP 8566S, 8567S & 8568S

The HP 8566S, 8567S, and 8568S Automatic Spectrum Analyzers are systems based upon the HP 8566B, 8567A and 8568B Spectrum Analyzers, respectively. Each system has an HP 9000 Series 200 or 300 Desktop Computer with system software available in BASIC language. A wide variety of compatible HP-IB printers and plotters can be used to tailor the system to your specific needs. Operator training is also available for the HP 8566S and 8568S systems. This intensive hands-on course will teach you the basic programming techniques needed for remote operation of these two spectrum analyzer systems.

#### System Software

System software is available for the HP 8566B, 8567A, and 8568B in BASIC. This software package provides the system programmer with high-level routines to aid in the development of custom programs for specific measurement applications. Capabilities include automatic computation and setting of analyzer functions to insure optimum measurement performance.

The system software comes on a 5 1/4-inch disk (3 1/2-inch also available) for use with HP Series 200 or 300 computers. Also included is a manual which provides extensive documentation and line-by-line annotation of each program.

#### Ordering Information

HP 8566S (HP 8566B based system)  
 HP 8567S (HP 8567A based system)  
 HP 8568S (HP 8568B based system)  
 HP 8566A+24D (HP 8566B based) Operation Training Course  
 HP 8568A+24D (HP 8568B based) Operation Training Course  
 HP 85863B System Software for HP 8566B, 8567A and 8568B

For complete details on prices, options, and ordering information contact your local HP sales office.



# SIGNAL ANALYZERS

## Spectrum Analyzer, 100 Hz to 325 GHz

### Model 8566B

119

- 100 Hz to 22 GHz, external mixing to 325 GHz
- Synthesizer frequency accuracy
- Direct plot capability

- Expanded firmware feature set
- Enhanced signal-processing power
- 16K bytes of user RAM

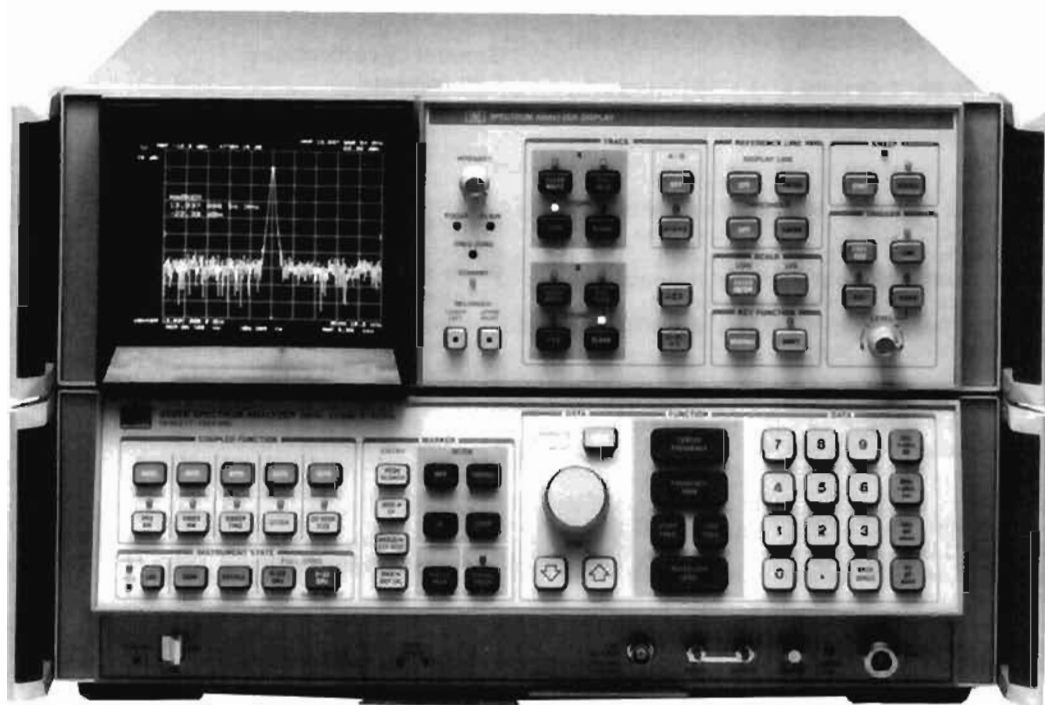

HP 8566B



The HP 8566B Microwave Spectrum Analyzer is a high-performance instrument, ideal for bench or ATE applications. The frequency range of 100 Hz to 22 GHz, using internal mixing, can be extended to 110 GHz with HP 11970 external mixers (see page 141), or to 325 GHz with mixers from other suppliers. A synthesized local oscillator produces counter-like accuracy at microwave and millimeter-wave frequencies. A 10-Hz resolution bandwidth and excellent frequency stability allow difficult measurements such as line-related sideband characterization at 22 GHz.

The HP 8566B offers 16K bytes of RAM for user-defined routines, which can be developed for complex measurements that are made routinely. Using the downloadable programming capability of the HP 8566B, measurement routines can be created on a computer and then downloaded into the non-volatile memory of the analyzer. Custom routines can also be defined and saved using the front-panel controls of the analyzer.

The ability to create and store downloadable programs (DLPs) makes the instrument more efficient for your specific measurement tasks. Custom DLPs can be executed via the HP-IB or user-defined front panel softkeys. Instrument settings can also be saved for future recall to insure that repeatable measurements can be made by different operators. You can control other HP-IB devices such as plotters, printers, signal generators, and power meters with user-defined softkeys on the HP 8566B. And CRT information can be plotted directly without the use of a controller.

All HP 8566B functions are remotely programmable via HP-IB. Many high-level functions are available that produce results instead of just more data. This enables the controller to move on to other tasks, thereby reducing the total execution time. Friendly programming codes and easily recognizable mnemonics facilitate learning the analyzer's language.

A unique, integrated preselector/mixer provides high sensitivity with preselection from 2 GHz to 22 GHz. Coupled functions insure that a calibrated display and a specific input-mixer-drive level are maintained. Functions can be uncoupled and set manually if you wish.

Automatic spectrum analyzer systems can be purchased via the HP 8566S model number. Systems are designed around the HP 8566B analyzer, HP 9000 Series 200 or 300 Desktop Computers, and a variety of peripherals and software packages. System software is available for the HP 8566B in BASIC language for maximum flexibility. Automated signal monitoring and surveillance capabilities can be added with the HP 85865B Signal Monitoring Software. (See page 123 for details.) Operator training is available through the HP 8566A+24D Spectrum Analyzer Operator Course. This four-day, hands-on course teaches programming techniques for remote operation of the spectrum analyzer. (See Customer Education for course details.)

# SIGNAL ANALYZERS

## Spectrum Analyzer, 100 Hz to 325 GHz (cont'd)

Model 8566B

### HP 8566B Specification Summary

#### Frequency

**Frequency Range:** 100 Hz to 22 GHz with internal mixer; extendable to 110 GHz with HP 11970 external mixers and to 325 GHz with mixers from other suppliers

**Frequency Span:** 0 to 2.5 GHz, 2 to 22 GHz, plus 0 Hz (zero span)

**Frequency Reference Accuracy:** Aging rate:  $< 1 \times 10^{-6}$ /day,  $< 2.5 \times 10^{-7}$ /year

**Temperature Stability:**  $< 7 \times 10^{-4}$ , 0 to 55° C

**Resolution Bandwidth:** 3 dB bandwidths of 10 Hz to 3 MHz in a 1, 3, 10 sequence

**Bandwidth Selectivity, 60 dB/3 dB ratio:**  $< 11:1$ , 30 Hz to 3 kHz;  $< 13:1$ , 10 kHz & 30 kHz;  $< 15:1$ , 100 kHz to 3 MHz

**Bandwidth Shape:** synchronously tuned, 4- or 5-pole filters, approximately Gaussian shape

**Video Bandwidth:** 1 Hz to 3 MHz in a 1, 3, 10 sequence

**Residual FM (typical peak to peak, fundamental mixing mode):**  $< 0.2$  Hz, frequency span  $< 5$  kHz;  $< 5$  Hz, frequency span  $< 100$  kHz;  $< 200$  Hz, frequency span  $< 5$  MHz

**Drift (typical, after one hour warm-up at stabilized temperature):**  $< 10$  Hz/minute of sweep time, frequency span  $\leq 100$  kHz;  $< 500$  Hz/minute of sweep time, frequency span 100 kHz to 5 MHz;  $< 5$  kHz/minute of sweep time, frequency span  $\geq 5$  MHz

#### Spectral Purity

**Noise sidebands (center frequency 100 Hz to 5.8 GHz):** 320 Hz offset,  $< -80$  dBc/Hz; 1 kHz offset,  $< -85$  dBc/Hz; 10 kHz offset,  $< -90$  dBc/Hz; 100 kHz offset,  $< -105$  dBc/Hz

#### Amplitude

**Amplitude Range (dBm):**  $-134$  to  $+30$ , 1 MHz-2.5 GHz;  $-132$  to  $+30$ , 2.5-5.8 GHz;  $-125$  to  $+30$ , 5.8-12.5 GHz;  $-119$  to  $+30$ , 12.5-18.6 GHz;  $-114$  to  $+30$ , 18.6-22 GHz

**Log Display Range:** 1, 2, 5, or 10 dB/division for 10, 20, 50, & 90 dB displays, respectively

**Scale Fidelity:**  $\pm 0.1$  dB/dB over 0 to 80 dB display;  $\pm 1.0$  dB max over 0 to 80 dB display;  $\pm 1.5$  dB max over 0 to 90 dB display

**Calibrator Uncertainty:**  $\pm 0.3$  dB

**Frequency Response (10 dB input atten):** 100 Hz to 2.5 GHz,  $\pm 0.6$  dB; 2 to 12.5 GHz,  $\pm 1.7$  dB; 12.5 to 20 GHz,  $\pm 2.2$  dB; 20 to 22 GHz,  $\pm 3.0$  dB

#### Dynamic Range

**Spurious Responses:**  $< -70$  dBc for mixer levels  $< -40$  dBm

#### Second Harmonic Distortion

**Unpreselected, mixer levels  $\leq -40$  dBm:**  $< -70$  dBc, 100 Hz to 2.5 GHz;  $< -80$  dBc, 50 to 700 MHz

**Preselected, mixer levels  $\leq -10$  dBm:**  $< -100$  dBc, 2 to 22 GHz

**Third Order Intercept (TOI):**  $> +5$  dBm, 100 Hz to 5 MHz;  $> +7$  dBm, 5 MHz to 5.8 GHz;  $> +5$  dBm, 5.8 to 18.6 GHz

**Image Responses:**  $< -70$  dBc, 100 Hz to 18.6 GHz;  $< -60$  dBc, 18.6 to 22 GHz

**Multiple Responses:**  $< -70$  dBc, 100 Hz to 22 GHz

**Out-Of-Band Responses:**  $< -60$  dBc, 2 to 22 GHz

**Residual Responses (0 dB input atten, no input signal):**  $\leq -100$  dBm, 100 Hz to 5.8 GHz;  $\leq -95$  dBm, 5.8 to 12.5 GHz;  $\leq -85$  dBm, 12.5 to 18.6 GHz;  $\leq -80$  dBm, 18.6 to 22 GHz

**Gain Compression ( $\leq -5$  dBm at mixer):**  $< 1.0$  dB, 100 Hz to 22 GHz

**Displayed Average Noise Level (0 dB input atten, 10 Hz Res BW)**

**Unpreselected:**  $< -95$  dBm, 100 Hz to 50 kHz;  $< -112$  dBm, 50 kHz to 1 MHz;  $< -134$  dBm, 1 MHz to 2.5 GHz

**Preselected:**  $< -132$  dBm, 2 to 5.8 GHz;  $< -125$ , 5.8 to 12.5 GHz;  $< -119$  dBm, 12.5 to 18.6 GHz;  $< -114$  dBm, 18.6 to 22 GHz

#### Sweep time

**Zero Span:** 1  $\mu$ sec to 1500 seconds

**Swept:** 20 msec to 1500 seconds

**Accuracy:**  $\pm 10\%$   $\leq 200$  second sweep times;  $\pm 30\%$   $> 200$  second sweep times

**Trigger:** Free run, line, video, external, continuous, and single

### General Specifications

#### Environmental

**Temperature:** Operation: 0 to 55° C Storage:  $-40$  to  $+75$ ° C

**Humidity:** Operating  $< 95\%$  R.H. 0 to 40° C

**EMI:** Conducted and radiated interference is within the requirements of MIL-STD-461B, CEO3/part 2, and REO2/part 7, and the requirements of CISPR pub. 11, and FTZ 526/1979

**Power Requirements:** 100, 120, 220, or 240 VAC ( $\pm 5\%$ ,  $-10\%$ ), 50 to 60 Hz or 400 Hz with Option 400

**Warm-up Time Operation:** 30 minutes from cold start (0 to 55° C)

**Frequency Reference:** frequency within  $1 \times 10^{-8}$  of final stab frequency within 30 minutes

**Size (w/out handles), mm (inches):** 279.2 (11) H, 425.5 (16.75) W, 598.5 (23.56) L

**Weight:** 50 kg (112 lb)

#### Inputs

RF in (Type N), Ext Freq Ref in, Ext Sweep Trig in

**Quasi-Peak:** Video in, IF in

#### Outputs

Cal out, 1st LO out, IF out, Sweep + Tune out, Display X, Y, Z out, Horiz Sweep out, Video out, Penlift out, 21.4 MHz IF out, Freq Ref, 10 MHz

**Quasi-Peak:** Video out, IF out

### Ordering Information

	Price
HP 8566B Spectrum Analyzer	\$57,650
Option 016: Installed EMI receiver functions	+\$250
Option 400: 400 Hz power-line frequency operation	+\$400
Option W30: Two additional years return-to-HP warranty	+\$950
Option 462: Impulse bandwidths for EMI measurements	+\$2,000
Option 655: 5.25" operation verification disks instead of 3.5" disks	50
Option 010: Rack mount slide kit	+\$450
Option 908: Rack flange kit (instrument w/out handles)	+\$65
Option 913: Rack flange kit (instrument w/handles)	+\$70
Option 910: Extra operating and test and adjustment manuals	+\$350
Option 915: Troubleshooting and repair manual	+\$200
Option 080: Information card in Japanese	50
Option 081: Information card in French	50

# SIGNAL ANALYZERS

## Spectrum Analyzers, 100 Hz to 1500 MHz

### Models 8568B & 8567A

- 100 Hz or 10 kHz to 1500 MHz frequency range
- Powerful firmware feature set
- Direct plot capability
- 16K bytes of user RAM for custom routines

- Powerful signal- and trace-processing functions
- EMI measurement capability
- Stimulus-response test capability
- Frequency counter accuracy

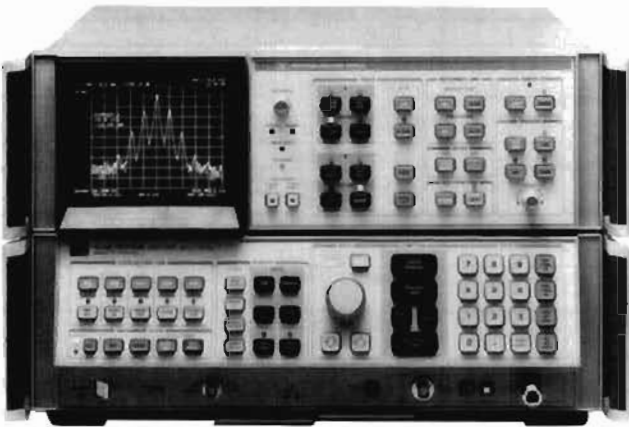

HP 8568B

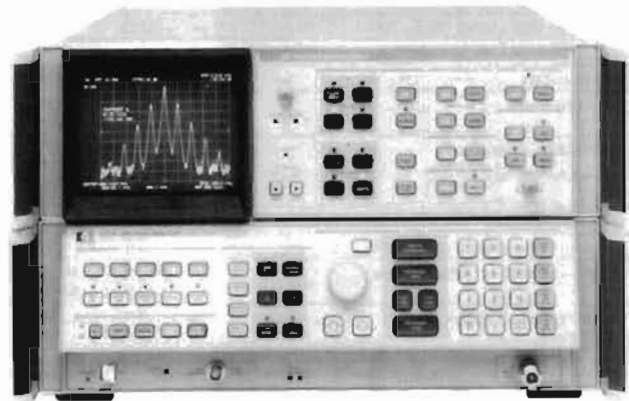

HP 8567A



The HP 8568B and HP 8567A RF Spectrum Analyzers offer a choice in high performance instruments for bench and ATE use. The HP 8568B covers the 100 Hz to 1500 MHz frequency range while the HP 8567A goes from 10 kHz to 1500 MHz. The HP 8568B has superior performance in several areas, including better frequency accuracy, narrower resolution bandwidths, and greater sensitivity (see following page for specification summary). If the higher performance of the HP 8568B is not required, the HP 8567A offers the same powerful feature set and capabilities at a very cost-effective price.

Both instruments offer 16K bytes of RAM for custom user-defined measurement routines. Custom measurement programs can be created, either on an external controller or using the front-panel controls of the spectrum analyzer, and then stored in the non-volatile memory of the instrument. These stored programs can be executed with a single softkey, making them as easy to use as any other function of the analyzer. This capability facilitates customization of either the HP 8568B or the HP 8567A to better suit your particular measurement requirements. In addition, instrument control settings can also be saved for future recall, to insure repeatable measurements even by different operators.

The HP 8568B and 8567A fit into many RF application areas including EMI testing, component stimulus-response testing, and broadband signal surveillance. Add the HP 85650A Quasi-Peak Adapter, HP 85685A RF Preselector, and HP EMI Measurement Software for complete CISPR and MIL-STD EMI measurement capability. (See page 124 for EMI system details.) Stimulus-response measurement capability can be obtained at a minimal cost with the addition of the HP 8444A Option 059 Tracking Generator. If you need automatic broadband surveillance capability, use the HP 85865B Signal Monitoring Software with either analyzer. (See page 123 for Signal Monitoring System details.)

Automatic spectrum analyzer systems can be purchased via the HP 8568S or 8567S model numbers. Systems are designed around the HP 8568B or the HP 8567A RF Spectrum Analyzers, HP 9000 Series 200 or 300 Desktop Computers, and a variety of peripherals and software packages. System software is available in BASIC language for maximum flexibility. (See page 118 for details and ordering information on automatic systems.) Operator training is also available for HP 8568B-based systems. The four-day HP 8568A-24D Spectrum Analyzer Operator Course is designed to teach you programming techniques for remote operation of the HP 8568B. (See Customer Education for course details.)

# SIGNAL ANALYZERS

## Spectrum Analyzers, 100 Hz to 1500 MHz (cont'd)

Models 8568B & 8567A

### Specification Summary

FREQUENCY	8568B	8567A
Frequency Range	100Hz - 1500MHz - DC coupled 100kHz - 1500MHz - AC coupled	10kHz - 1500MHz
Frequency Span	100Hz to 1500MHz + zero span	100Hz to 1500MHz + zero span
Frequency Reference Accuracy		
Aging Rate	$< 2.5 \times 10^{-7}$ /year	$< 5 \times 10^{-7}$ /year
Temperature Stability	$< 7 \times 10^{-7}$ (0-55°C)	$< 1 \times 10^{-6}$ (5-55°C)
Resolution Bandwidth (-3dB)	10Hz - 3MHz in 1,3,10 sequence	1kHz - 3MHz in 1,3,10 sequence
Video Bandwidth	1Hz - 3MHz in 1,3,10 sequence	1Hz - 3MHz in 1,3,10 sequence
Residual FM (pk to pk, <100kHz span)	$< 3$ Hz (Res BW = 30Hz)	$< 100$ Hz (Res BW 1kHz)
Drift (per minute of sweeptime) (after one hour warm-up)	$< 10$ Hz (freq span $\leq 100$ kHz)	$< 100$ Hz (freq span $\leq 100$ kHz)
Phase Noise (30kHz offset, 1Hz Res BW)	-107dBc	-105dBc
<b>AMPLITUDE</b>		
Amplitude Range	-135 to +30dBm	-115 to +30dBm
Log Display Range	1,2.5, or 10dB/div for 10,20,50 or 90dB display	1,2.5, or 10dB/div for 10,20,50 or 90dB display
Scale Fidelity - incremental cumulative (20-30°C)	$\pm 0.1$ dB/dB, 0-90dB $\leq \pm 1.0$ dB, 0-80dB $\leq \pm 1.5$ dB, 0-90dB	$\pm 0.1$ dB/dB, 0-80dB $\leq \pm 1.0$ dB, 0-80dB $\leq \pm 1.5$ dB, 0-90dB
Calibrator Uncertainty	$\pm 0.3$ dB	$\pm 0.3$ dB
Frequency Response (input atten $\geq 10$ dB)	$\pm 1.5$ dB, 100Hz - 1500MHz	$\pm 1$ dB, 10kHz - 1500MHz
Spurious Responses ( $< -40$ dBm at mixer)	$< -70$ dBc ( $< 10$ MHz input sig) $< -75$ dBc ( $> 10$ MHz input sig)	$< -70$ dBc
Second Harmonic Distortion (-30dBm at mixer)	$< -70$ dBc (sig $\geq 10$ MHz) $< -60$ dBc (sig $< 10$ MHz)	$< -70$ dBc (sig $\geq 10$ MHz) $< -60$ dBc (sig $< 10$ MHz)
Third Order Intercept (TOI)	+10dBm (sig $> 10$ MHz)	+10dBm (sig $> 10$ MHz)
Residual Responses (at 1MHz) (0dB attn, no input signal)	$< -105$ dBm	$< -100$ dBm
Gain Compression ( $\leq 10$ dBm at mixer)	$< 0.5$ dB	$< 1.0$ dB
Displayed Average Noise Level (0dB attn, 1Hz Video BW)	$< -112$ dBm, 500Hz-1MHz (10Hz Res BW) $< -135$ dBm, $> 1$ MHz (10Hz Res BW)	$< -92$ dBm, 50kHz-1MHz (1kHz Res BW) $< -115$ dBm, $> 1$ MHz (1kHz Res BW)
Sweep - Zero Span	1 $\mu$ sec to 1500 sec	1 $\mu$ sec to 1500 sec
Sweep	20 msec to 1500 sec	20 msec to 1500 sec

### General Specifications (Pertain to both 8568B and 8567A unless noted)

#### Environmental

**Temperature:** Operation, 8568B, 0 to 55° C; 8567A, 5° to 55° C  
Storage, -40° to +75° C

**EMI:** Conducted and radiated interference is within the requirements of MIL-STD-461B, CE03/part 2 and RE02/part 7, and the requirements of CISPR pub. 11 and FTZ 526/1979

**Power Requirements:** 100, 120, 220, or 240 VAC (+ 5%, - 10%), 50-60 Hz or 400 Hz with Option 400

#### Warm-up Time

**Operation:** 30 minutes from cold start

#### Frequency Reference

**8568B:** frequency within  $1 \times 10^{-2}$  of final stab freq within 30 minutes

**8567A:** frequency within  $5 \times 10^{-2}$  of final stab freq within 30 minutes

**Size (w/out handles), mm (inches):** 279.2 (11) H, 425.5 (16.75) W, 558.8 (22) L

**Weight:** 45 kg (100 lb)

#### Inputs

RF in (Type N), RF in (BNC, 8568B only), Ext Freq Ref in, Ext Sweep Trig in

**Quasi-Peak:** Video in, IF in

#### Outputs

Cal out, Display X, Y, & Z out, Horiz Sweep out, Video out, Penlift out, 21.4 MHz IF, 1st LO, Freq Ref, Probe Power out (8568B only)

**Quasi-Peak:** Video out, IF out

### Ordering Information

HP 8568B Spectrum Analyzer	\$35,300
HP 8567A Spectrum Analyzer	\$27,550
Option 001: 75 ohm (BNC) RF input	+ \$200
Option 018: Installed EMI receiver functions	+ \$250
Option 044: Add HP 8444A Opt 059 Tracking Generator (8567A only)	+ \$4,760
Option W30: Two additional years return-to-HP warranty	
8568B	+ \$690
8567A	+ \$540
Option 400: 400 Hz power line frequency operation	+ \$400
8568B	+ \$700
8567A	\$0
Option 855: 5.25" operation verification disks instead of 3.5" disks	
Option 010: Rack mount slide kit	+ \$450
Option 908: Rack flange kit (instrument w/out handles)	
8568B	+ \$65
8567A	+ \$150
Option 913: Rack flange kit (instrument w/handles)	
8568B	+ \$70
8567A	+ \$150
Option 910: Extra operating and test and adjustment manuals	+ \$350
Option 915: Troubleshooting and repair manual	
8568B	+ \$200
8567A	+ \$220
Option 462: Impulse bandwidths for EMI measurements (8568B only)	+ \$2,000
Option 080: 8568B information card in Japanese	\$0
Option 081: 8568B information card in French	\$0

- Automates the HP 8566B, 8567A, 8568B, 71000 Modular Series, and 8562A Portable Spectrum Analyzers for
- Operator-controlled or unattended long-term signal monitoring
  - Broadband surveillance and signal intelligence
  - Communication system testing and maintenance



Typical system configuration using HP 85865B Signal Monitoring Software



Increase the power and flexibility of your HP 8566B, 8567A, 8568B, 71000 Modular Series, or 8562A Portable Spectrum Analyzer for signal monitoring and broadband surveillance. The HP 85865B Signal Monitoring Software automates your system for site surveillance applications and long-term attended or unattended monitoring operations. Menu options allow you to store command sequences and set the time of program execution. Monitor up to 128 frequency bands of interest and measure percent occupancy using the software's frequency histogram display. A multiband display option lets you view four selected bands at one time on the analyzer's CRT, and you can easily obtain hard copy of statistical information on band usage and transmission length using your system's printer or plotter. Signal data, collected continuously or at intervals over long periods of time, are stored with date and time included to provide comprehensive reports on ambient signal activity.

### Diverse Applications

The HP 85865B Signal Monitoring Software offers advantages in areas requiring long-term monitoring of signal environments. For example, to maintain quality over the lifetime of a communication system, the program provides information on current band usage for management of the frequency spectrum, and on signal parameters to assure that transmissions meet specified tolerances. A "task scheduler" directs the spectrum analyzer to execute a file of commands at a given time, enabling completely automatic, unattended testing. Large blocks of data are stored and retrieved easily with a Hewlett-Packard Winchester disc drive.

For surveillance operations, the software's run-mode options permit the spectrum analyzer to automatically "search" a defined band, tune to a signal, measure frequency and amplitude, and determine modulation format. Data can be reported selectively: set an "alarm" to notify you when signals meet pre-determined characteristics, or construct a "signal mask" to prevent unwanted signals from being reported. Adding the HP 5180A Waveform Recorder to your system lets you measure pulse parameters including pulse width, pulse repetition interval, peak power, and average power for use in radar detection and system testing.

### Powerful Graphics

Powerful display formats transform your system's console into an effective tool to analyze and manipulate data. View multiple bands—up to four at one time—in the frequency as well as the time domain. A "parameter summary" displays such measured signal parameters as pulse width, modulation format, pulse repetition interval, amplitude, and frequency. For a time profile of a particular band, use the three dimensional "raster" display of frequency, amplitude, and time. The "histogram" options provide information on band usage, and the "timegram" reports signal data as a function of time. The "timegram summary" displays statistics on percent occupancy, maximum frequency and amplitude, and average message length of two-way communication signals at specific frequencies. Transfer all display formats directly to an HP-IB plotter or printer for customized hard-copy output.

The HP 85865B Signal Monitoring Software, written in Pascal 3.1, requires an HP 8566B (100 Hz to 22 GHz), HP 8567A (10kHz to 1.5 GHz), HP 8568B (100 Hz to 1.5 GHz), 71000 Modular Series, or 8562A (1kHz to 22 GHz) Spectrum Analyzers and a compatible computer. For pulse analysis, a waveform recorder must be added to the system, and it is recommended that your computer contain at least 2.5 Mbytes of memory. Contact your nearest HP field representative for a complete list of accessories, including mass-storage devices, printers, and plotters. Hardware can be ordered as a single shipment using the "S" system. See page 118.

### Ordering Information

	<b>Price</b>
<b>HP 85865B</b> Signal Monitoring Software	
Option 630 (3 1/2 inch discs)	\$5100
Option 655 (5 1/4 inch discs)	5100
Option 700 (1/2 inch tape cartridge)	5100
Remote Options:	
Option 001 (3 1/2 inch discs)	add 2100
Option 002 (5 1/4 inch discs)	add 2100
Option 701 (1/2 inch tape cartridge)	add 2100

# SIGNAL ANALYZERS

## CISPR EMI Receivers, 9kHz to 1.5GHz

Models 8573A, 8574A

- Meets CISPR Publication 16\* requirements
- Performs VDE and FCC Compliance Tests

- Makes diagnostic EMI measurements
- Automates VDE, FCC, and MIL-STD EMI tests

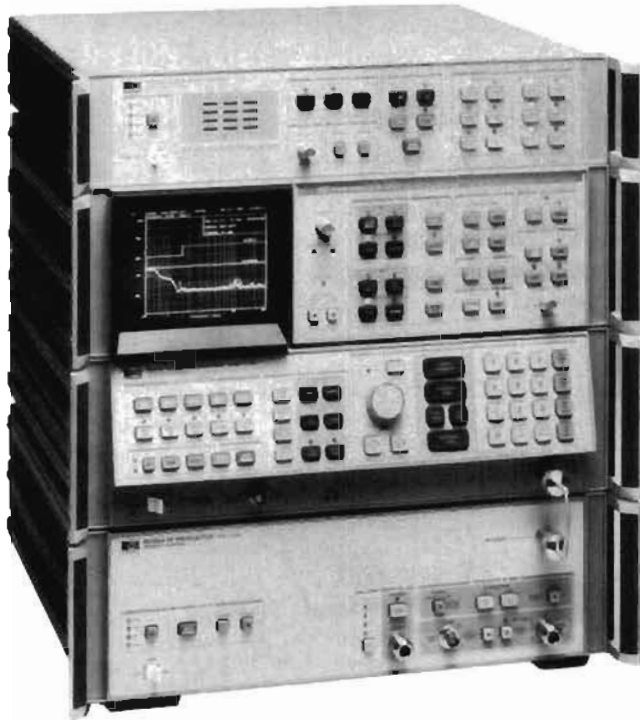

Typical HP 8573A Configuration with additional Controller



The HP 8573A and 8574A EMI Receivers are designed for making fast, accurate EMI measurements. With improved sensitivity and overload protection, these powerful receivers meet CISPR Publication 16\* recommendations as well as requirements of the FCC, VDE, and VCCI. And, because a versatile HP 8567A or 8568B Spectrum Analyzer forms the heart of each system, full EMI diagnostic capabilities aid you throughout a product's evolution, from design stages to completion of final commercial and MIL-STD qualification tests.

### CISPR/EMI Receiver Features and More

To meet CISPR Publication 16 specifications, the HP 85650A Quasi-Peak Adapter provides the CISPR EMI Receivers with required bandwidths and quasi-peak detection. Each system comes with the HP 85867A EMI Receiver Functions, a set of downloaded programs that make possible speedy "one-button" manual quasi-peak measurements. The HP 85685A RF Preselector adds input overload protection and increased measurement sensitivity, and its built-in absolute amplitude calibration ensures  $\pm 2$ dB amplitude accuracy. The preselector automatically tracks the spectrum analyzer during manual and remote operation. A low-frequency RF input withstands large impulses and Line Impedance Stabilization Network (LISN) transients. Both the low-frequency and high-frequency inputs allow the use of CISPR calibration pulses.

### Automatic Control for Remote Operations

The HP 8573A and 8574A CISPR EMI Receivers let you automate emission measurements via the HP-IB for conducted or radiated tests using a variety of compatible system controllers, EMI

accessories, and peripherals. You can write your own programs or elect HP software: the HP 85864C EMI Measurement software or HP 85870A Open-Site EMI Measurement System Software. Both feature easy-to-use menu structures that lead you through EMI measurements from initial setup to final results. Choose from libraries of FCC, and VDE emission tests, or design your own. Results can be annotated and notes generated as part of your test documentation, and subroutines can be added to the software for automatic control of your EMI accessories.

EMI accessories available for FCC, VDE, and MIL-STD tests feature a LISN for commercial conducted measurements and current probes for MIL-STD conducted emission requirements. Transducer kits contain magnetic and electric field antennas for radiated emission testing from 9 kHz to 10 GHz. Other EMI accessories include preamplifiers, printers, plotters, and a system cabinet. See page 127.

### Ordering Information

	Price
HP 8573A CISPR EMI Receiver	\$53,000
HP 8574A CISPR EMI Receiver	\$60,770
Option 001 HP 85900 System Cabinet (includes Option 913)	add \$2,900
Option 908 Rack mounting kit without handles	add \$122.50
Option 910 Extra set of operating manuals	add \$410
Option 913 Rack mounting kit with handles	add \$135

\*CISPR Publication 16 is the Comite International Special des Perturbations Radioelectrique specification for radio interference measuring apparatus and measurement methods.

- Locate EMI "hot spots" quickly
- Increase EMI measurement repeatability
- Utilize powerful analysis aids



### HP 85870A Open-Site EMI Measurement System Software

The HP 85870A Open-site EMI Measurement System (OEMS) Software is specially designed to automate and simplify commercial EMI, radiated-emission compliance measurements. EMI measurements made at open sites, due to ambient signals present in the measurement environment, are inherently more complex than measurements made in shielded enclosures. The HP 85870A helps EMI engineers and technicians quickly obtain repeatable, accurate, and completely documented measurement results using the HP 8573A and 8574A EMI Receivers.

#### Identify and record ambients

The OEMS Software allows you to identify and categorize ambients by automatically (or manually) generating a list of the frequencies and amplitudes of ambient signals that are present when the equipment under test (EUT) is off. The ambient list is incorporated into a user-defined frequency-band table, which allows you to segment the entire range of interest and categorize the ambients in each band. For example, you can specify and label the 6-meter ham, FM radio, and land mobile bands in the frequency-band table. Methods are provided to generate and maintain complex ambient signal lists for repeated use. The spectrum analyzer screen is marked where the ambient signals occur for simplified identification of suspect EUT emissions.

#### Identify and maximize EUT emissions

With a complete ambient list and a remote AC power switch, the software can automatically turn on the EUT and find suspect emissions, even in the presence of impulsive or noisy environments. The EMC engineer or technician can then select from a number of features such as Tune & Listen, EUT On/Off, and Zoom Local to determine which signals are coming from the EUT. Confirmed emissions are assigned to a final list of signals. Each emission's amplitude is then determined by automatically controlling a turntable and antenna mast using a signal characterization routine of your choice. EUT emissions can be manually maximized using the SIG PEAK function, which controls an HP-1B antenna mast and turntable or allows manual positioning. The OEMS software records information on each signal such as frequency and amplitude deviation from the limit, as well as the antenna height, turntable position, and user comments.

#### Generate complete reports in desired formats

Complete measurement results are documented in the format of your choice using the OEMS Software Report Generator. You can design your own test report using combinations of fixed text and

- Begin testing at system turn-on
- Test to standard or internal limits
- Automatically correct data for transducer and system gain/loss

updateable variable fields for the date and time of test, equipment name and serial number, or any other information. Ambient, suspect, or final signal lists and log frequency plots of the final data can be integrated with your text for concise, professional-looking reports. A library is provided to store these report formats. CRT data and signal lists can also be sent to a printer or plotter from virtually any point in the software.

### HP 85864C EMI Measurement Software

The HP 85864C EMI Measurement Software is a general-purpose program for making automatic commercial and military emission measurements using an HP 8566B, 8567A, or 8568B Spectrum Analyzer. The friendly menu structure of the program leads you through an EMI measurement from initial setup to the final plotting of the test results. The HP 85864C has an easy start-up procedure, so you are "ready to run" even if you have never programmed before.

#### Automate MIL-STD and commercial EMI measurements

The HP 85864C EMI Measurement Software automates military and commercial EMI emission measurements. It is designed to automate EMI measurements made in a shielded enclosure. The HP 85864C takes advantage of the spectrum analyzer's ability to quickly measure wide frequency spans and locate EMI "hot spots" using peak detection. For commercial measurements, quasi-peak data need be taken only at these "hot spots." Save time and effort in your MIL-STD measurements by letting the software take narrowband and broadband data in the same test.

#### Design your own tests

Design your own tests or choose from the examples given in the software. These examples reside in the test library and include MIL-STD, FCC, and VDE/FTZ emission tests. Transducer factors, test limits, and receiver parameters are easily changed and stored in libraries. Once your test is designed, it is stored away and can be executed repeatedly at the push of a key.

#### Compatibility

The HP 85864C and 85870A are compatible with the following equipment:

<b>Spectrum Analyzer*</b>	HP 8566B, 8567A, 8568B
<b>RF Preselector</b>	HP 85685A
<b>Quasi-Peak Adapter</b>	HP 85650A
<b>EMI Receiver</b>	HP 8573A, 8574A
<b>Computer*</b>	HP 9000 Series 300 Model 310, 320, 330 (medium-resolution monitor only) HP 9000 Series 200 Model 216, 236 2 Mbytes (HP 85870A); 1.5 Mbytes (HP 85864C)
<b>Memory Requirements*</b>	
<b>Mass Storage*</b>	HP 9122S/D, 9153A, 9153B
<b>Plotters</b>	HP 7440A, 7475A, 7550A
<b>Printers</b>	HP 2225A, 82906A, 2227B
<b>DMA Controller</b>	HP 98620B
<b>Floating Point Card</b>	HP 98635A
<b>SRM interface</b>	HP 50962A

\*Minimum equipment required

#### Ordering Information

	<b>Price</b>
<b>HP 85864C EMI Measurement Software</b>	\$0
Opt. 630 3½-inch media	\$3080
Opt. 655 5¼-inch media	\$3080
<b>HP 85870A OEMS Software</b>	\$0
Opt. 630 3½-inch media	\$5100
Opt. 655 5¼-inch media	\$5100
<b>HP 85874A Bundled EMI Software</b>	
Includes HP 85864C and 85870A	\$0
Opt. 630 3½-inch media	\$7140
Opt. 655 5¼-inch media	\$7140

# SIGNAL ANALYZERS

## RF Preselector, 20 Hz to 2 GHz/Quasi-Peak Adapter

Models 85685A, 85650A

- Automatic filter tracking
- Input overload protection
- Low system noise

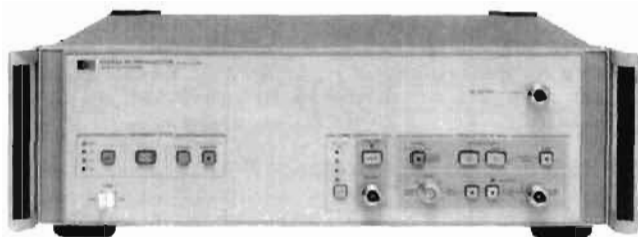

HP 85685A



HP 85650A



### HP 85685A RF Preselector

The HP 85685A RF Preselector makes a multi-purpose test receiver of an HP 8566B, 8567A, or 8568B Spectrum Analyzer. In addition to an instrument for general-purpose spectrum analysis, you now have a test receiver for specialized applications. The RF preselector, with tracking filters and preamplifiers covering the 20 Hz to 2 GHz range, improves spectrum analyzer measurement sensitivity while providing overload protection from out-of-band signals. The resulting test receiver system operating in the presence of high-level interference, has a measurement range 30 dB greater than that of a spectrum analyzer alone.

The test receiver/spectrum analyzer measures signals within the preselector filter passband and rejects out-of-band interference by 40 dB. This enables low-level signals to be monitored in the presence of high-level ambients. The preselector decreases input overload from out-of-band signals, thereby increasing the range for measuring low-level signals. Fast, wideband measurements mean a reduction in measurement time.

Combining the HP 85685A RF Preselector with an HP 8566B, 8567A, or 8568B Spectrum Analyzer and the HP 85650A Quasi-Peak Adapter gives you an EMI receiver that meets the recommendations of CISPR Publication 16\*.

The RF preselector adds the measurement sensitivity and overload protection needed for FCC and VDE radiated emission testing at open sites. For commercial and MIL-STD conducted EMI tests, the low-frequency input withstands large impulses and Line Impedance Stabilization Network (LISN) transients. A built-in calibrator ensures  $\pm 2.0$  dB absolute-amplitude accuracy as required by the FCC and VDE, and a convenient linearity check tests for system overload.

Operating the test receiver is easy. Use only the spectrum analyzer controls—the RF preselector automatically adjusts input-filter tracking, and the spectrum analyzer reports preselector operating conditions on the CRT. The receiver system is fully HP-IB programmable, and the HP 85685A comes equipped with the hardware needed to connect it to any compatible spectrum analyzer.

### HP 85650A Quasi-peak Adapter

The HP 85650A Quasi-peak Adapter works with the HP 8566B, 8567A, and 8568B Spectrum Analyzers and with the 85685A RF Preselector to complete an EMI test receiver system. The quasi-peak adapter adds the special bandwidth filters and quasi-peak detection capability specified in CISPR Publication 16\*. These bandwidth filters (200 Hz, 9 kHz, and 120 kHz) have 6 dB resolution and may be selected using either peak or quasi-peak detection.

- Quasi-peak detection
- CISPR-specified bandwidths
- Bypass for regular spectrum analyzer operation

A bypass switch enables the spectrum analyzer to bypass the quasi-peak adapter, and a Normal mode allows use of the three CISPR bandwidths whether or not the quasi-peak detector is being used. The HP 85650A is fully programmable over the HP-IB for automated measurements, and it has both an internal speaker and an audio output jack (for external headphones) for monitoring signals.

### HP 8567A EMI Receiver Functions

This set of softkey programs simplifies commercial EMI measurements performed manually using HP EMI receiver/spectrum analyzers (see page 124). An external computer is not needed after the softkeys are downloaded into spectrum analyzer non-volatile RAM. You can select a CISPR\* band, make automatic quasi-peak measurements at up to six discrete frequencies, and directly print or plot measurement data using front-panel softkeys.

Features of the EMI Receiver Functions include a quasi-peak softkey that automatically chooses resolution bandwidths, video bandwidths, CISPR bandwidths, and sweep times for fast, accurate quasi-peak measurements. Up to six quasi-peak markers and numeric values can be displayed at the same time. This lets you simultaneously view a wide frequency span and the quasi-peak values of up to six signals. A numeric keypad overlay for the spectrum analyzer is included to help you select the right softkey, and a help function gives the purpose of each softkey. Spectrum analyzer options are available for factory installation of this product.

### Ordering Information

	Price
HP 85685A RF Preselector	\$20,435.00
Option 010, Rack mount slide kit	add \$385.00
Option 908, Rack flange kit without handles	add \$32.50
Option 910, Extra manual	add \$50.00
Option 913, Rack flange kit with handles	add \$35.00
HP 85650A Quasi-peak Adapter	\$5,080.00
Option 908, Rack flange kit without handles	add \$32.50
Option 910, Extra manual	add \$50.00
Option 913, Rack flange kit with handles	add \$35.00
HP 8567A EMI Receiver Functions	
Option 630 3 1/2-inch media	\$250.00
Option 655 5 1/2-inch media	\$250.00

\*CISPR Publication 16 is the Comité International Spécial des Perturbations Radioélectrique specification for radio interference measuring apparatus and measurement methods.



## Impulse Bandwidth Option/Close-field Probes/EMI Accessories and Transducers

### HP 8566B/68B Option 462

Option 462 for HP 8566B and 8568B spectrum analyzers provides impulse bandwidths for making MIL-STD EMI measurements. Standard HP 8566B and 8568B models have 12 resolution bandwidth filters (10 Hz to 3 MHz in a 1, 3, 10 sequence) specified in terms of their 3 dB bandwidth. Option 462 modifies the 1 kHz to 3 MHz resolution bandwidth filters to correspond to their impulse bandwidth instead.

In addition to enhancing instrument capability for MIL-STD 461A/B and 462 EMI measurements, spectrum analyzers with Option 462 can still make all commercial EMI and general-purpose measurements. Option 462 spectrum analyzers are compatible with the HP 85650A Quasi-peak Adapter, HP 85685A RF Preslector, HP 85865C EMI Measurement Software, HP 85870A Open-site Measurement Software and the HP 85867A EMI Receiver Functions program. Existing HP 8566B and 8568B spectrum analyzers can be modified to include Option 462. For more information, contact your local sales office.

### HP 11940A and 11941A Close-field Probes

These small, hand-held electromagnetic-field sensors are used with a spectrum analyzer for EMI diagnostic and troubleshooting applications. A dual-loop configuration and balun structure enable them to make repeatable, absolute magnetic-field measurements. The HP 11941A operates from 9 kHz to 30 MHz; the HP 11940A, from 30 MHz to 1 GHz.

Designed to measure radiation from surface currents, slots, and cables, these probes are ideal for diagnostic testing of printed circuit boards, cabling, and shielded enclosures. Five antenna factor points appear on the back of each probe for calculating absolute magnetic-field strength (dBuA/m) from the spectrum analyzer's dBuV reading.

Double-shielded cables and adapters are included with the HP 11945A Close-field Probe Set, which includes both probes. Option E51 adds the HP 8447F Option H64 Pre-amplifier and a convenient carrying bag. In addition, the HP 8590A Option H51 portable spectrum analyzer has EMC diagnostic capabilities tailored for use with the close-field probes.



### Ordering Information

	Price
HP 8566B/68B Option 462	\$2,500
HP 11945A Close-field Probe Set	\$1,110
Option E51 adds preamplifier, accessory-carrying bag, and 36-inch, Type N cable	\$2,355
HP 11941A Close-field Probe (9 kHz-30 MHz)	\$620
HP 11940A Close-field Probe (30 MHz-1 GHz)	\$620
Option 001 Rotary Joint	\$375

### EMI Accessories

	Price
Turntable for Radiated Emission Testing	
Equipment Testing Turntable with HP-IB control.	
HP 85865A Option K40: 50-60 Hz, 100-120 volts	\$8,000
HP 85865A Option K41: 50-60 Hz, 220-240 volts	\$8,000
Tower for Radiated Emission Testing.	
Antenna Positioning Tower with HP-IB and polarization control.	
HP 85865A Option K42: 50-60 Hz, 100-120 volts	\$12,000
HP 85865A Option K43: 50-60 Hz, 220-240 volts	\$12,000

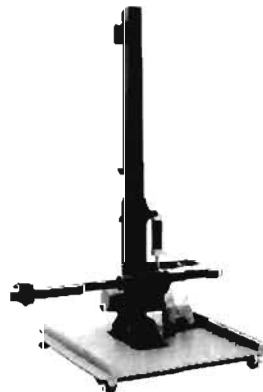

Antenna Positioning Tower



Log Periodic Antenna

### Recommended EMI Transducer Kits

Commercial			
Test	Freq. Range	Transducer Kit	Price
VDE 0871 FCC Part 15j	Radiated	10 kHz-30 MHz HP 11965A (100-120 volt) Opt. 001 (220-240 volt) N/C Opt. 002 Tripod 695 Opt. 003 BNC cable, 25 ft. 140	\$2,150
		10 kHz-1 GHz HP 11965B (100-120 volt) Opt. 001 (220-240 volt) N/C Opt. 002 Tripod 695 Opt. 003 BNC cable, 25 ft. 140 Opt. 004 Type N cable, 25 ft. 170	\$5,085
FCC Part 15j (only)	Conducted	10 kHz-30 MHz HP 11965C (LISN)	\$1,525
	Radiated	30 MHz-1 GHz HP 11965D Opt. 001 Tripod 695 Opt. 002 BNC cable, 25 ft. 140 Opt. 003 Type N cable, 25 ft. 170	\$2,935
		HP 85685A Opt. K09 Dipole antennas	\$2,250
Conducted	10 kHz-30 MHz	HP 11965C (LISN)	\$1,525

MIL-STD			
Test	Freq. Range	Transducer Kit	Price
Radiated RE-02	14 kHz-1 GHz	HP 11965M (Circularly polarized) \$4,645 or HP 11965N (Linearly polarized) 4,835	
		Opt. 001 (220-240 volt) N/C Opt. 002 Tripod 695 Opt. 003 BNC cable, 25 ft. 140 Opt. 004 Type N cable, 25 ft. 170	
MIL-STD 461A/B/C 462	1-10 GHz	HP 85685A Opt. K22 (Circularly polarized antenna) \$10,100 or HP 85685A Opt. K23 (Linearly polarized antenna) 11,480	
		Conducted CE-03	10 kHz-50 MHz HP 11965R (Current Probe) \$1,585

# SIGNAL ANALYZERS

## Spectrum Analyzer, 10 kHz to 1.8 GHz

Model 8590A

- Powerful features at a new, low cost
- Lightweight and portable
- Optional CATV functions and 75 $\Omega$  input
- Programmable via HP-IB, HP-IL, or RS232C
- Direct printer and plotter output



HP 8590A



### HP 8590A Portable RF Spectrum Analyzer

This compact, portable RF spectrum analyzer offers many features of a high-performance model for a low, affordable price. With a wide frequency range (10 kHz to 1.5 GHz or optional 1.8 GHz), large amplitude range (-115 dBm to +30 dBm), and 50- or optional 75-ohm input, the new HP 8590A has the versatility to make most RF signal measurements. Lightweight and sturdy, the analyzer goes where you need it—from the bench into the field. Over 100 functions can be programmed from an optional computer interface, and many accessories are available to expand basic spectrum analyzer capabilities. Whatever the application, from automatic testing on the production line to servicing equipment in the field, the HP 8590A fits the job.

### Digital Display

The raster-scan display of this spectrum analyzer gives a flicker-free and parallax-free graticule. Display menus simplify operation and reduce the number of front-panel controls. Easy-to-read control settings surround the graticule, and a 50-character label can be added to the top of the screen by the operator. Expanded display size and remote viewing of the screen are possible using the HP 82913A video monitor.

### Simple Operation

Special training is not required to run the HP 8590A. Use the three main control keys and the data entry knob or keypad to measure any signal. Center the signal with **FREQUENCY**; resolve the signal with **SPAN**; move the signal up and down with **AMPLITUDE**. The analyzer automatically adjusts internal parameters such as resolution bandwidth, sweep time, IF gain, and input attenuation. Commonly used functions are built into dedicated keys. These include markers for reading out amplitude and frequency values, and **PLOT** and **PRINT** keys for recording test results easily on ordinary typing paper. Display-menu softkeys access nearly 100 additional time-saving functions.

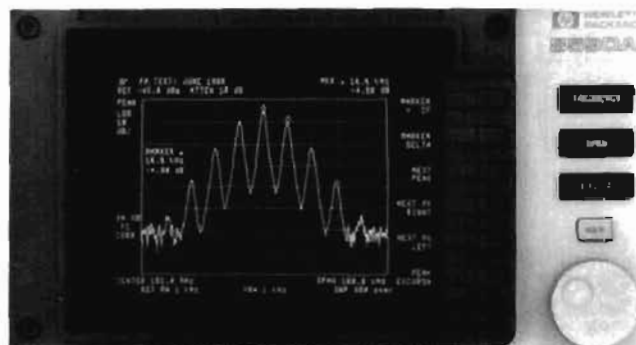

### Hardworking Functions

The many built-in functions make complex measurements much easier. SIGNAL TRACK captures a signal in a crowded spectrum and holds it at center screen, thus allowing the operator to "zoom in" by changing frequency span. Marker functions display signal amplitude with 0.05 dB resolution. PEAK SEARCH places a marker on the highest signal displayed; NEXT PEAK moves the marker to the next highest signal. Other marker keys measure amplitude and frequency differences between signals and pause the analyzer at a marker while a demodulated signal is monitored.

The spectrum analyzer uses trace storage, two active traces, and trace math to eliminate frequency response variations caused by the analyzer and an external source. The screen displays the frequency response of the input signal alone (see below). Related functions are MAX HOLD, which displays a signal's peak amplitude and frequency drift, and VIDEO AVERAGE, which smooths displayed-noise peaks.

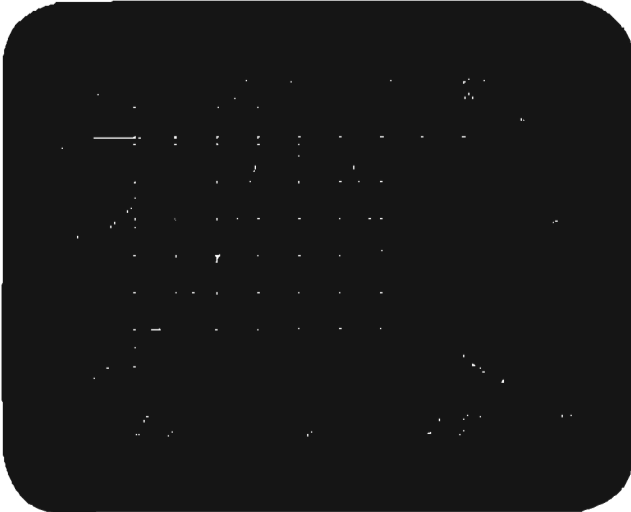

Special functions perform measurements such as %AM, 99% power bandwidth, and signal-to-noise. The 3 dB POINTS and 6 dB POINTS softkeys determine filter bandwidth. An FFT (Fast Fourier Transform) measures AM sidebands. Even though the analyzer's minimum IF bandwidth is 1 kHz, the FFT detects sub-Hz signals and transforms the RF display into a low-frequency display (see below).

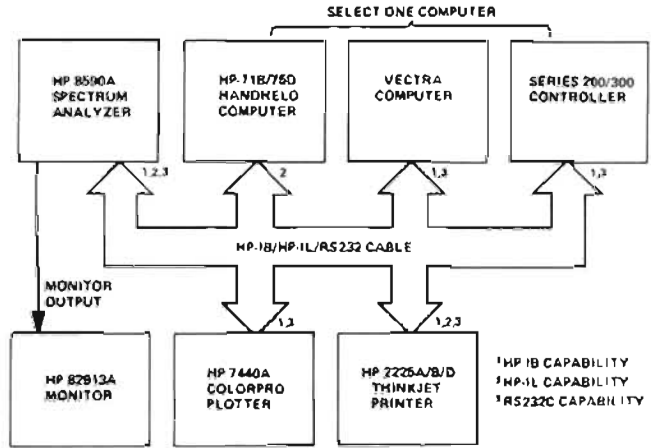
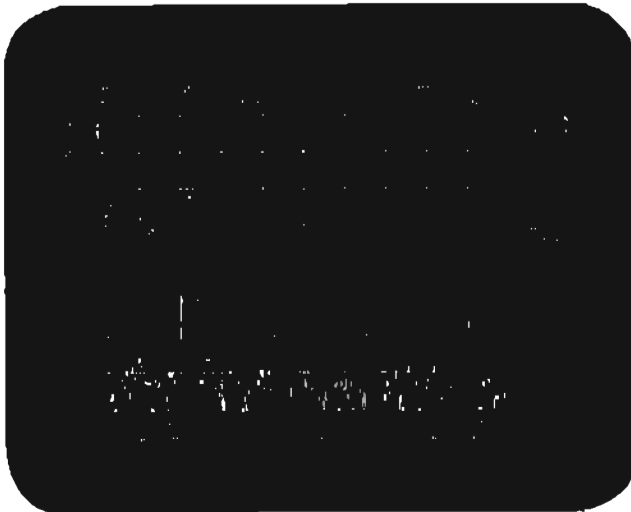

EQUIPMENT CONFIGURATION FOR AUTOMATIC TESTING

### Automatic Control

Three computer-interface options are available to automate the spectrum analyzer's many functions: HP-IB<sup>1</sup>, HP-IL<sup>2</sup>, and RS232C. Programs can be written using a desktop or handheld computer. With over 80 programming commands built into the analyzer, any front-panel measurement can be automated and results can be stored as well. Even without a computer, the interface will send display data to a printer or plotter. The HP 8590A improves your efficiency with fast, repeatable, automatic measurements.

### Portability and Performance

With this analyzer you can get the same quality test results in the field that you get in the factory. The analyzer weighs only 30 pounds and has a "briefcase" handle to make carrying easy, and it's small enough to slip under an airline seat. It can be taken anywhere—from isolating electromagnetic emissions in a mainframe computer to troubleshooting signal interference in the field. Automatic tests can be made using the HP-71B handheld computer, which fits into the analyzer's optional front cover. Wherever you need performance, you can depend on the HP 8590A.

### Add-on Features

For specialized test needs, the portable spectrum analyzer is compatible with accessories such as computers, multi-pen plotters, a video monitor, and more. The HP 8444A Tracking Generator turns the HP 8590A into a stimulus-response system that makes frequency-response and insertion-loss measurements on RF components. Use a preamplifier and the HP 11940A Close Field Probe with the analyzer and tracking generator for a swept, broadband system that does EMI troubleshooting. To record important test results, use the HP ThinkJet Printer or the HP-71B Handheld Computer (a program is available for storing up to 30 display traces along with analyzer control settings).

### HP 8590A Option H18 1790 MHz Operation

Option H18 extends the upper limit of the HP 8590A's frequency range to 1790 MHz.

### HP 8590A Option H50 CATV Functions

This option adds a set of nine functions to simplify cable TV testing. The added functions are: channel selection, carrier level, carrier-to-noise, power line hum, crossmodulation, composite triple beat, modulation depth, system frequency response, and save/recall traces. A 75-ohm input (no-cost Option 001) minimizes mismatch loss in cable testing. All of the standard spectrum analysis capability of the standard HP 8590A is retained. The HP 8590A Option H50 allows you to perform proof-of-performance measurements, headend testing, and trunk maintenance.

<sup>1</sup>HP-IB is Hewlett-Packard's hardware, software, documentation, and support for IEEE-488 and IEC-625 worldwide standards for Interfacing Instruments.  
<sup>2</sup>HP-IL is the Hewlett-Packard Interface Loop for serial-interfacing instrument systems.

# SIGNAL ANALYZERS

## Spectrum Analyzer, 10 kHz to 1.8 GHz (cont'd)

Model 8590A

### HP 8590A Specifications

#### Frequency

**Frequency range:** 10 kHz to 1.5 GHz with 4-digit resolution  
 10 kHz to 1.79 GHz with Opt. H18  
 1 MHz to 1.5 GHz with Opt. 001

**Readout accuracy:**  $\pm(5 \text{ MHz} + 1\% \text{ of span})$  (50- $\Omega$  termination on 1<sup>st</sup> LO Out)

#### Frequency stability

**Drift:** < 50 kHz/5 min. after 2-hour warmup and 5 min. after setting center frequency

**Signal track:** signal held at display center compensates for drift

**Noise sidebands:** < -65 dBc at 30 kHz offset (1 kHz RBW, 30 Hz VBW)

**Frequency span range:** zero and 50 kHz to 1.5 GHz with 4-digit resolution

**Readout accuracy:**  $\pm 3\%$  of indicated frequency span

#### -3 dB Bandwidth (Characteristic)

**Resolution BW (RBW):** 1 kHz to 3 MHz in 1.3 sequence (Gaussian shape)

**Video BW (VBW):** 30 Hz to 3 MHz in 1.3 sequence

**Sweptime range:** 20 ms to 100 s

**Readout accuracy:**  $\pm 10\%$  of indicated setting

#### Amplitude

##### Amplitude range (1 MHz to 1.3 GHz)<sup>3</sup>

**50- $\Omega$  calibration:** -115 dBm to +30 dBm

**75- $\Omega$  calibration (Opt. 001):** -60 dBmV to +72 dBmV

**Readout resolution (with markers):** < 0.05 dB for log scale; < 0.05% of Ref. Level for linear scale

**Amplitude units:** dBm, dBmV, dBuV, volt, watt

**Amplitude scale:** -20 dB/div. in 1 dB steps and linear

**Maximum input power:** +30 dBm (1 W) continuous; 0 V dc

**Maximum dynamic range:** 70 dB for on-screen viewing; 70 dB for signal-to-distortion; 105 dB for IF compression-to-noise

**Displayed average noise:** 1 MHz to 1.3 GHz (0 dB input attenuation, 1 kHz RBW, 30 Hz VBW)<sup>3</sup>

**50- $\Omega$  calibration:** < -115 dBm

**75- $\Omega$  calibration (Opt. 001):** < -60 dBmV

**Gain compression:** < 1 dB for -10 dBm total power at input mixer

#### Spurious responses

**Second Harmonic:** < -70 dBc for -45 dBm at input mixer, input > 5 MHz<sup>3</sup>

**Third-order intermod.:** < -70 dBc for two -30 dBm signals at input mixer, > 50 kHz signal separation

**Residual responses:** < -95 dBm for no input signal (0 dB input atten. and 50- $\Omega$  termination on RF Input and 1<sup>st</sup> LO Out)

#### Amplitude Accuracy

##### Frequency response

**Absolute variation:**  $\pm 1.5$  dB referenced to Cal Out signal (10 dB atten.)

**Peak variation:**  $\pm 1$  dB referenced to mid-point between highest and lowest peak excursions

##### Calibrator accuracy (for 299.9 MHz $\pm$ 300 kHz Cal Out signal)

**50- $\Omega$  calibration:**  $\pm 1$  dB for -20 dBm level

**75- $\Omega$  calibration (Opt. 001):**  $\pm 1$  dB for +28.75 dBmV level

##### Reference level setting (log scale)

**0-60 dB atten.:**  $\pm 1.75$  dB for +30 to -120 dBm range

**10 dB atten.:**  $\pm 1.25$  dB for 0 to -120 dBm range;  $\pm 0.5$  dB for 0 to -59 dBm range

**Resolution BW switching:**  $\pm 0.25$  dB for 3 kHz to 3 MHz RBW range

**Log scale switching:** no significant error for -20 dB/div. scale range

**Log scale fidelity:**  $\pm 0.1$  dB/dB change over 70 dB range with  $\pm 0.75$  dB max. over -60 dB range from Ref. Level;  $\pm 1.0$  dB max. over -70 dB range from Ref. Level

**Linear scale fidelity:**  $\pm 3\%$  of Reference Level setting

#### Input/Output Characteristics

##### Front-panel connectors

**RF input:** 50- $\Omega$  BNC (standard); 75- $\Omega$  BNC (Opt. 001)

**Probe power output:** +15 V, -12.6 V, GND, 150 mA max.

##### Cal output

**50- $\Omega$  BNC (standard):** -20 dBm, 299.9 MHz

**75- $\Omega$  BNC (Opt. 001):** +28.75 dBmV, 299.9 MHz

**1<sup>st</sup> LO output:** 50- $\Omega$  BNC, +10 dBm, 2.05 to 3.55 GHz

##### Rear-panel connectors

**Aux video output:** 50- $\Omega$  BNC, 0 to 1 V

**Monitor output:** 50- $\Omega$  BNC, NTSC format, 19.2 kHz horiz. sync.

**High sweep in/Out:** BNC, high TTL = sweep, low TTL = retrace

**Sweep output:** BNC, 5 k- $\Omega$ , 0 to +10 V ramp

**Aux IF output:** 50- $\Omega$  BNC, -10 to -60 dBm, 21.4 MHz

**Ext. trigger input:** BNC, TTL levels, positive edge trigger

**Interface connector:** HP-1B (Opt. 021), HP-1L (Opt. 022), or RS232C (Opt. 023)

**HP-1B codes:** SH1, AH1, T6, L4, SR1, RL1, PP0, DC1, DT1, C1, C2, C3, C28

#### General

**Temperature:** 0° to 55°C operating; -40° to +75°C storage

**Temperature stability:** 2 hours after storage at a constant temp. between 0° and +55°C and 30 minutes after analyzer turn-on at the same constant temperature

**EMI compatibility:**<sup>2</sup> CISPR pub. 11 (1985) and FTZ 526/527/79

**Audible noise:** < 37.5 dBA pressure and < 5.0 Bels power (ISO DP7779)

**Power requirements:** 86-127 or 195-253 V RMS; 47-66 Hz; 120 VA max.

**Weight (characteristic):** 13.5 kg (29.8 lb)

**Size (characteristic):** 213 mm (8.4") H x 366 mm (14.4") W x 460 mm (18.1") D

**Warranty:**<sup>2</sup> One year limited warranty for materials and workmanship

#### Recommended Accessories

HP 2225A/B/D ThinkJet Printer

HP 7440A ColorPro Plotter

HP-71B Handheld Computer

HP 8444A Opt. 059 Tracking Generator

HP 82913A Monitor

HP 10855A Broadband Preamplifier

HP 11940A Close Field Probe

HP 11867A RF Limiter

HP 11694A 50-75 $\Omega$  Matching Transformer

**Rack Slide:** P/N 1494-0060 (for HP 8590A Options 908/909)

**Transit Case:** P/N 9211-5604

#### Ordering Information

	Price
<b>HP 8590A Portable RF Spectrum Analyzer</b>	\$9690
<b>Option 001:</b> 75- $\Omega$ Input Impedance	\$0
<b>Option 021:</b> HP-1B Interface	\$450
<b>Option 022:</b> HP-1L Interface	\$450
<b>Option 023:</b> RS232C Interface	\$450
<b>Option 040:</b> Front Panel Cover	\$200
<b>Option 908:</b> Rack Mount Without Handles	\$250
<b>Option 909:</b> Rack Mount With Handles	\$300
<b>Option 910:</b> Extra Operating and Installation Manuals	\$24
<b>Option 915:</b> Support Manual and Extra Operating and Installation Manuals	\$110
<b>Option H18:</b> 1790 MHz Operation	\$350
<b>Option H50:</b> CATV Functions and Front Panel Cover	\$500

<sup>1</sup>Refer to Installation Manual (08590-90003) and Operation Manual (08590-90005) for more information

# SIGNAL ANALYZERS

## Spectrum Analyzers, 1 kHz to 325 GHz

Models 8562A and 8562B

131

- Synthesized tuning
- Frequency counter
- Factory adjusted preselector
- AM/FM demodulators

- Test and Adjustment Module
- One Year Calibration Cycle
- MIL-T-28800C Rugged
- Lightweight and Portable



HP 8562A

The new HP 8562A and 8562B spectrum analyzers put high-performance, synthesized technology into a lightweight, portable package. Ruggedized to military specifications, these analyzers are engineered to survive harsh field conditions. They perform a wide variety of jobs from communication-system and component testing to radar and millimeter measurements. Both models are packed with advanced HP technology and HP-IB is standard.

### The Choice is Yours

The HP 8562A has a frequency range of 1 kHz to 22 GHz with microwave preselection. External mixers extend the range to 325 GHz. If measurements below 2.9 GHz are your main interest, order the economical HP 8562B, which covers the same frequency range as the HP 8562A but without preselection.

### Use Them Anywhere

The compact size and shape of the HP 8562A/B make them easy to transport to remote sites. They even slide under an airplane seat. Of course, these portable analyzers also make good sense in the laboratory and on the production line. They fit easily onto crowded work benches or instrument racks. And if there's no room on your bench, they will operate upright on the floor.

### Ease of Use

For over 20 years, Hewlett-Packard has been designing spectrum analyzers that are easy to use for both new and experienced operators. The HP 8562A/B represent the fifth generation of spectrum analyzers. Dedicated keys with large, easy-to-read lettering provide the basic tune, zoom, and measure steps. They allow fast access to frequently used functions such as markers, save/recall, and direct plotter output. In ten minutes or less, you'll become familiar enough with this analyzer to perform basic measurements.

### Rugged and Dependable

The HP 8562A/B are built to perform in adverse conditions. They have been ruggedized to meet MIL-T-28800C requirements for temperature, pulse shock, and transit drop. These analyzers withstand 30

g's of shock, so there is no need to worry if they are knocked around. Climate isn't a problem either—these models warm up in five minutes in ambient temperatures from -10°C to +55°C.

A removable impact cover fits over the front panel for maximum protection during transit. Inside the cover there are several convenient compartments for small accessories like adapters, BNC cables, and external mixers. You'll find a handy, pocket-size operating guide there too.

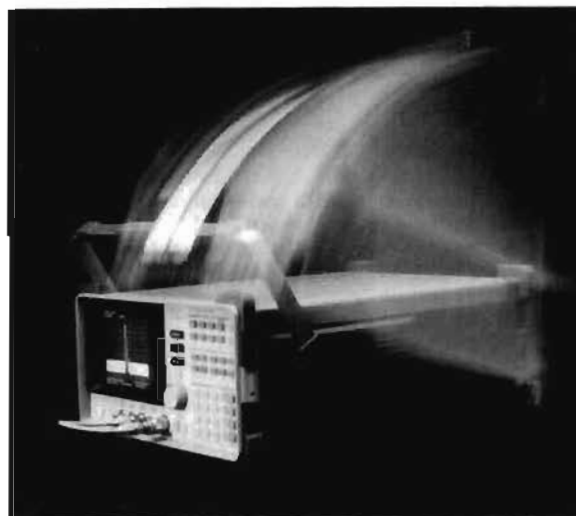

The HP 8562A/B meet MIL-T-28800C standards for ruggedness.

# SIGNAL ANALYZERS

Spectrum Analyzers, 1 kHz to 325 GHz (cont'd)

Models 8562A/B



## Communications Measurements

The HP 8562A/B are ideal tools for CATV/Broadcast measurements, terrestrial point-to-point microwave link maintenance, troubleshooting the interference problems of devices and systems, and measuring low level signals in the presence of high level ambients. The built-in AM/FM demodulator/speaker indicates over-modulation, clipping, synch buzz, and troublesome "birdies." The built-in frequency counter accurately measures the frequency of the carrier. Direct carrier-to-noise measurement can be made with delta markers and noise normalization.

## Component Testing

Fast, accurate, synthesized tuning allows high-speed measurements of mixing-product suppression. Excellent intermodulation distortion and sensitivity improve dynamic range for distortion measurements.

The HP 8562A/B are ideal choices for stimulus response measurements. They provide up to 118 dB dynamic range and offset tracking capability when synthesized sources are used for stepped distortion and stepped conversion-loss measurements.

The HP 8562A/B spectrum analyzers are valuable tools for electromagnetic compatibility (EMC) design and trouble-shooting. In conjunction with the HP 11945A Close-Field Probe Set, the HP 8562A/B can be used to localize sources of high emissions and to evaluate shielding effectiveness.

## Radar Measurements

Some analyzers with digital displays have difficulty capturing short-duration radar pulses. With such analyzers it is not certain whether variations from sweep to sweep are due to equipment under test or to the analyzer itself. The HP 8562A/B have a digitization uncertainty specification of  $\pm 1$  dB and typical repeatability of 0.2 dB. Users can be sure that observed amplitude variations—those caused by magnetron moding, misfiring, or rotary joint problems—are due to the equipment under test, not the analyzer.

## Millimeter Measurements

The HP 8562A/B, used with the HP 11970 series of external mixers (18 to 110 GHz), offer excellent specified performance for sensitivity, flatness, and absolute amplitude accuracy. Each mixer is individually calibrated and provided with conversion loss data, which can be entered into the analyzer directly. No costly LO amplifier is required. These analyzers also supply the bias required for other external mixers operating up to 325 GHz.

## Automatic Measurements

The HP 8562A/B reflect HP's commitment to automated testing. Synthesized performance, low temperature rise, and an 8.75-inch rackmount option make the HP 8562A/B ideal for automatic measurements. The one-year calibration interval reduces downtime, and the continuously self-aligning IF ensures measurements you can rely on.



The compact size and direct plotter output of the HP 8562A/B are convenient for bench and production applications.

**Test and Adjustment Module**

The HP 85629A Test and Adjustment Module or "TAM" is a new approach to servicing spectrum analyzers. It plugs onto the rear panel of the HP 8562A/B and performs high level diagnostics, self tests, and much more. The TAM is a must for anyone doing his own repair. And one module can service multiple spectrum analyzers.

**Detect Fault**

Automatic Fault Isolation makes functionality checks of the CPU, ADC, IF, LO, and RF sections. Just connect the CAL OUTPUT, press a few keys, and many failures can be isolated to a single board within minutes. No external test equipment is required.

**Find Fault**

Using the TAM's 8-input voltmeter and the twenty-six 16-pin test connectors spread throughout the analyzer, you can make more than 1000 measurements, isolating the faulty board or component quickly, without racks of equipment.

**Readjustment**

Once you've repaired the analyzer, readjustment is fast and accurate because the TAM controls both internal analyzer settings and external test equipment. For example, the TAM performs the frequency-response adjustment in 10 minutes. The same adjustment performed manually takes an hour. After readjustment, use the TAM's functional tests for immediate confidence that the repair was completed successfully.



The HP 85629A Test and Adjustment Module plugs into the rear panel to provide extensive servicing capability.

**Specifications**

**Frequency**

**Frequency Range:** 1 kHz to 22 GHz (to 325 GHz with external mixers)

Harmonic mode (n)	Center frequency
1	1 kHz - 2.9 GHz
1	2.75 GHz - 6.46 GHz
2	5.86 GHz - 13.0 GHz
3	12.4 GHz - 19.7 GHz
4	19.1 GHz - 22.0 GHz

**Frequency Readout Accuracy:** Start, Center, Stop, or Marker:  $\pm(\text{freq readout} \times \text{freq reference accuracy} + 5\% \text{ of span} + 15\% \text{ of res BW} + 250 \text{ Hz})$

**Counter Resolution:** 10 Hz - 1 MHz (selectable)

**Counter Accuracy:**  $\pm(\text{marker freq} \times \text{freq reference accuracy} + 50 \text{ Hz} \times n + 1 \text{ LSD})$  for  $S/N \geq 25 \text{ dB}$

**Delta Counter Accuracy:**  $\pm(\text{delta freq} \times \text{freq reference accuracy} + 100 \text{ Hz} \times n + 2 \text{ LSD})$  for  $S/N \geq 25 \text{ dB}$

**Frequency Reference Accuracy:**  $< 4 \times 10^{-6} / \text{year}$  (includes aging, temperature drift, settability)

**Frequency Stability**

**Residual FM:**  $< 50 \text{ Hz} \times n \text{ p-p}$  in 0.1 sec (zero span)

**Spectral Purity**

**Noise Sidebands:**  $< (-100 + 20 \text{ Log } n) \text{ dBc/Hz}$  at 30 kHz offset

**Frequency Span**

**Range:** 0 Hz, 2.5 kHz to 19.25 GHz

**Accuracy:**  $< 5\%$

**Resolution Bandwidth (-3 dB)**

**Range:** 100 Hz - 1 MHz in a 1,3,10 sequence

**Accuracy:**  $\pm 30\%$  100 Hz,  $\pm 10\%$  300 Hz to 300 kHz,  $\pm 25\%$  1 MHz

**Selectivity:**  $< 15:1$  ( $-60 \text{ dB}/-3 \text{ dB}$ )

**Shape:** Synchronously-tuned, 4-pole filter

**Video Bandwidth**

**Range:** 1 Hz - 1 MHz in a 1,3,10 sequence

**Amplitude Range**

**Amplitude Range:** +30 dBm to displayed average noise level

**Maximum Safe Input**

**Average Continuous Power:** +30 dBm (1 Watt) with input atten  $\geq 10 \text{ dB}$

**Peak Pulse Power:** +50 dBm (100 Watt) with input atten  $\geq 30 \text{ dB}$  for  $< 10 \text{ usec}$  pulse width and  $< 1\%$  duty cycle

**DC:** 0 Volts

**Display Range**

**Display:**  $10 \times 10$  Division Graticule

**Calibration:** Log 10,5,2 and 1 dB per division, Linear 10% of Reference Level/division

**Reference Level Range:** Log, -119.9 to +30 dBm in 0.1 dB steps; linear 2.2 uVolts to 7.07 Volts in 1% steps

**Input Attenuation Range:** 0 to 70 dB in 10 dB steps

**Dynamic Range**

**Maximum Dynamic Range**

**Compression to Noise:** 118 dB

**Signal to Distortion:**

**Harmonic:**  $\geq 2.9 \text{ GHz}$ : 100 dB (77.5 dB unpreselected),  $< 2.9 \text{ GHz}$ : 77.5 dB

**Intermodulation:** 86 dB

**Displayed Average Noise Level:** With 100 Hz res BW, 0 dB Input Attenuator, 1 Hz video filter: -90 dBm, 10 kHz: -100 dBm, 100 kHz: -121 dBm, 1 MHz to 2.9 GHz: -121 dBm, 2.75 GHz to 6.46 GHz: -110 dBm, 5.86 GHz to 13.0 GHz: -105 dBm, 12.4 GHz to 19.7 GHz: -100 dBm, 19.1 GHz to 22.0 GHz.

**1 dB Gain Compression:** -3 dBm at input mixer above 10 MHz

**Spurious Responses:** Signals generated by the analyzer due to input signals. For mixer level  $< -40 \text{ dBm}$ : all harmonic and intermodulation distortion  $> 60 \text{ dB}^1$  below input signal.

**Second Harmonic Distortion:** for mixer level = -40 dBm:  $< -72 \text{ dBc}$ , 10 MHz to 2.9 GHz;  $< -60 \text{ dBc}$  (8562B only) above 2.75 GHz. For mixer level = -10 dBm:  $< -100 \text{ dBc}$  (8562B unspecified) above 2.75 GHz.

<sup>1</sup>to 6.46 GHz 8562A, to 22.0 GHz 8562B

# SIGNAL ANALYZERS

## Spectrum Analyzers, 1 kHz to 325 GHz (cont'd)

Models 8562A and 8562B

**Third Order Intermodulation Distortion:** for mixer level  $< -30$  dBm:  $< -70$  dBc, 10 MHz to 2.9 GHz;  $< -75$  dBc above 2.75 GHz.

**Image, Multiple, and Out-of-Band Responses:**  $< -70$  dBc,  $< 18$  GHz (8562B unspecified);  $< -75$  dBc,  $< 22$  GHz (8562B unspecified)

**Residual Responses:** No signal at input, 0 dB input atten.  $< -90$  dBm, 200 kHz to 6.46 GHz.

### Amplitude Accuracy

**Frequency Response (flatness):** 10 dB attenuation.

Frequency Range	8562A	8562B
1 kHz - 2.9 GHz	$\pm 1.2$ dB	$\pm 1.2$ dB
2.75 - 6.46 GHz	$\pm 2.5$ dB	$\pm 2.0$ dB
5.86 - 13.0 GHz	$\pm 3.6$ dB	$\pm 2.5$ dB
12.4 - 19.7 GHz	$\pm 4.0$ dB	$\pm 3.0$ dB
19.1 - 22.0 GHz	$\pm 4.3$ dB	$\pm 4.3$ dB

**Calibrator Accuracy:**  $\pm 0.3$  dB

**IF Gain Uncertainty:**  $\pm 1$  dB for 0 dBm to  $-80$  dBm reference level

**Scale Fidelity:** 0.4 dB/4 dB to a maximum of  $\pm 1.5$  dB over 0 to 90 dB range. Linear:  $\pm 3\%$  of Reference Level

**Input Attenuator Switching Accuracy:** With 20 to 70 dB settings referenced to 10 dB.  $\pm 1.1$  dB/10 dB step, 2.0 dB max, 0 to 12.4 GHz;  $\pm 1.3$  dB/10 dB step, 2.5 dB max, 12.4 to 19.4 GHz;  $\pm 1.8$  dB/10 dB step, 3.5 dB max, 19.4 to 22 GHz

**Resolution Bandwidth Switching Uncertainty:**  $\pm 0.5$  dB reference to 300 kHz BW

**Pulse Digitization Uncertainty:** Pulse response mode, PRF  $> 720$ /sweep time. Log (peak to peak): 1 dB; Linear (peak to peak): 4% of ref level, Nominal Standard deviation: 0.2 dB

### Sweep

#### Sweep Time

**Range:** 50  $\mu$ sec to 60 sec for zero span, 50 msec to 100 sec for span  $\geq 2.5$  kHz

**Sweep Trigger:** Free Run, Linc, Single, Video, External

### Demodulation

**Modulation Type:** AM and FM

**Audio Output:** Speaker and phone jack with volume control

### Inputs & Outputs

#### Front Panel Connectors

**RF Input:** Precision type N female, nominal impedance 50 ohm

**VSWR:**  $< 1.5:1$  for  $< 2.9$  GHz and  $\geq 10$  dB Input Attenuation (nominal);  $< 2.3:1$  for  $> 2.9$  GHz and  $\geq 10$  dB Input Attenuation (nominal);  $< 3.0:1$  for 0 dB Input Attenuation (nominal)

**LO Emission Level (average):** With 10 dB input atten.  $< -80$  dBm (8562A nominal),  $< -10$  dBm (8562B nominal)

**Second IF Input:** SMA female, nominal frequency: 310.7 MHz; nominal impedance 50 ohms; NF: 7 dB (nominal); Gain Compression:  $-20$  dBm (nominal)

**First LO Output:** SMA female, nominal impedance: 50 ohm; nominal frequency range: 3.0000 - 6.8107 GHz, amplitude  $+16.5$  dBm  $\pm 2$  dB

**Calibrator Output:** BNC female, nominal impedance: 50 ohm

#### Rear Panel Connectors

**10 MHz Reference (Input/Output):** BNC female, nominal impedance: 50 ohm; nominal input range:  $-2$  to  $+10$  dBm

**Video Output:** BNC female, nominal impedance: 50 ohms (DC coupled)

**LO Sweep/0.5 V per GHz Output:** Shared BNC female, nominal impedance: 2k ohm (DC coupled); nominal LO sweep output: 0 to  $+10$  V (no load)

**External Trigger Input:** BNC female, nominal impedance  $> 10$  k ohm; trigger level: rising edge of TTL level

**HP-IB:** Interface Functions: SH1, AH1, T6, L4, SR1, RLI, PPO, DCI, DT1, CO, EI. Direct plotter outputs: HP 7225A, 7440A, 7470A, 7475A, 7550A, 9872A/B/C/T

### General Specifications

#### Environmental

**Military Specification:** Meets MIL-T-28800C, Type III, Class 3, Style C.

**Calibration Interval:** 1 year

**Warmup:** 5 minutes from ambient conditions

**Temperature:** Operating:  $-10^\circ$  to  $+55^\circ$ C. Non-operating:  $-62^\circ$  to  $+85^\circ$ C

**Humidity:** 95% @  $40^\circ$ C for 5 days

**Altitude:** Operating: 15,000 ft. Non-operating: 50,000 ft.

**Rain Resistance:** Drip-proof at 16 liters/hour/square foot

**Vibration:** 5-15 Hz: 0.059 inch p-p excursion; 15-25 Hz: 0.039 inch p-p excursion; 25-55 Hz: 0.020 inch p-p excursion

**Pulse Shock:** half sine: 30 g's for 11 ms duration

**Transit Drop:** 8-inch drop on 6 faces and 8 corners

**Electromagnetic Compatibility:** Conducted and radiated interference is in compliance with CISPR publication 11 (1985), and FTZ 526/527/79. Meets MIL-STD-461B, Part 4 with the exceptions shown below.

**Conducted Emissions.** CE01 (Narrowband): 1 kHz to 15 kHz only. CE03 (Narrowband): Full limits. CE03 (Broadband): 20 dB relaxation from 15 kHz to 100 kHz.

**Conducted Susceptibility.** CS01: Full limits (limited to 36 Hz for HP 8562B). CS02: Full limits. CS06: Full limits.

**Radiated Emissions.** RE01: 15 dB relaxation to 28 kHz, and exceptioned from 28 kHz to 50 kHz. RE02: Full limits  $< 1$  GHz.

**Radiated Susceptibility.** RS01: Full limits. RS02: Exceptioned. RS03: Limited to 1 V/meter from 14 kHz to 1 GHz, with 20 dB relaxation at IF frequencies.

#### Power Requirements

**115 VAC operation:** Voltage: 90 - 140 V RMS; Current: 3.2 A RMS MAX; Frequency: 47 - 440 Hz

**230 VAC operation:** Voltage: 180 - 250 V RMS; Current: 1.8 A RMS Max; Frequency: 47 - 66 Hz

**Maximum Power Dissipation:** 180 Watts

**Nominal Weight:** 8562A: 20 kg (44 lbs.); 8562B: 19 kg (41.8 lbs.)

**Dimensions:** 163 mm high  $\times$  325 mm wide  $\times$  427 mm deep (nominal, without handle, feet, or cover).

### Ordering Information

	Price
HP 8562A Spectrum Analyzer	\$35,000
HP 8562B Spectrum Analyzer	\$31,000
Option 001: Second IF Output	\$800
Option 908: Rackmount Kit with flanges	\$250
Option 909: Rackmount Kit with handles and flanges	\$300
Option 910: Extra Manual Set	\$165
Option 915: Technical Reference Manual	\$275
HP 8562A/B Option 916: Extra Pocket Operating Guide (English)	\$15
HP 8562A Option W30:	\$700
2 additional years Return-to-HP Service	
HP 8562B Option W30:	\$620
2 additional years Return-to-HP Service	
HP 85629A Test and Adjustment Module	\$2,000
Product Support Kit P/N 08562-60021	
HP 8562A/B +22C 1 year Return-to-HP CAL	\$180
HP 8562A/B +22X 1 year Return-to-HP MIL-STD CAL	\$276



# SIGNAL ANALYZERS

## Microwave Spectrum Analyzer, 10 MHz to 21 GHz

### Model 8559A and 853A

135

- Portable
- Simple three-knob operation
- Direct plotter control

- Display annotation and storage
- Digital display with trace arithmetic
- Resolution bandwidths from 1 kHz to 3 MHz

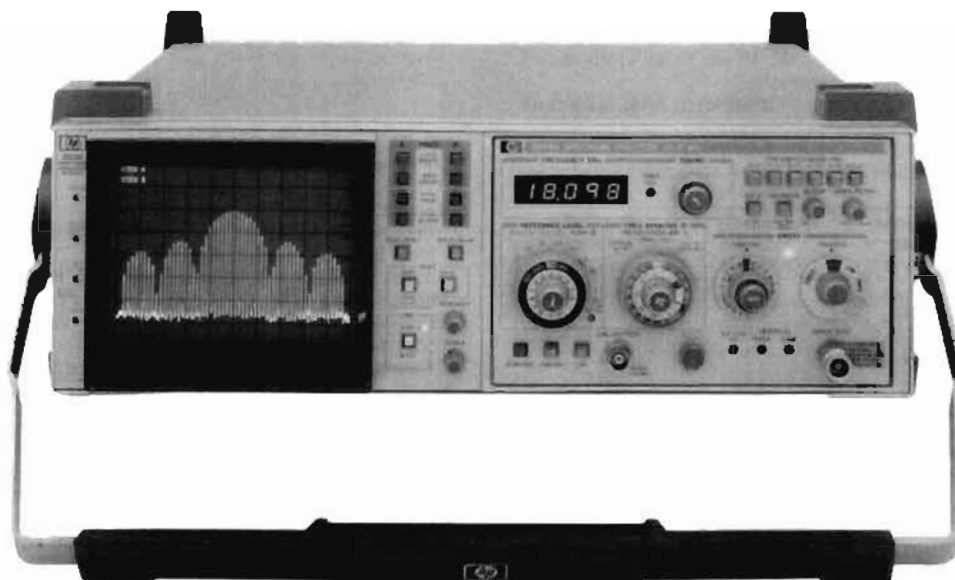

HP 8559A and 853A



## HP 8559A/853A Spectrum Analyzer

### Performance Plus Economy

The excellent performance and convenient operation of this economical spectrum analyzer make it ideal for a variety of applications in production, R & D, and field-service measurements. The HP 8559A/853A covers the frequency range from 10 MHz to 21 GHz.

### Simple 3-Knob Operation

Preset this spectrum analyzer to color-coded, "basic-operation" settings and use the coupled controls to make most measurements in three easy steps. Tune to a signal; the LED readout displays its frequency. Zoom in on the signal by reducing span width; the resolution bandwidth, video filter, and sweep time automatically change to an optimum value for a calibrated display. Then, adjust the reference level to bring the peak of the signal to the top of the screen for the most accurate amplitude measurement.

### Digital Display

The HP 853A is a digital display mainframe for use with the HP 8557A, 8558B, and 8559A spectrum analyzer plug-ins. Signals are displayed on either of two independently stored digital traces. Display processing capabilities include maximum hold, digital averaging, and trace normalization for extended measurement capability. A built-in microprocessor manages the display operation and provides access (via the front panel) to built-in test routines for display calibration and testing.

### HP-IB Capability Includes Direct Plotter Control

A hard-copy record of the displayed traces and graticule can be made on a digital plotter via HP-IB using the front-panel buttons of the HP 853A. A controller is not required. Although analyzer controls are not themselves programmable, the HP-IB can be used for applications that include using a controller to record trace data and to prompt the operator on the HP 853A CRT. The digital display and processing functions can be remotely programmed, and the analyzer sweeps can be initiated over the HP-IB.

### Two Configurations

The display is offered in two styles. The HP 853A (pictured) is a ruggedized, portable mainframe complete with tilt-bail handle and drip-proof, protective front cover. The HP 853A is ideally suited for rugged field environments and any areas where system mobility is required. The HP 853A Option 001 offers the digital display in a full module bench or rack-mount configuration.

### HP 11870A Low Pass Filter

For RF measurement applications needing extended coverage to 2.6 GHz, the HP 11870A Low Pass Filter rejects signals above 3 GHz by more than 60 dB for image-free measurements over the entire 10 MHz to 26 GHz range.

### HP 8559A Specifications

#### Frequency Specifications

**Frequency range:** 0.01 to 21 GHz in six selectable ranges.

#### Frequency Spans

**Fullband:** displays entire spectrum of selected band.

**Per division:** 10 kHz to 200 MHz/div in a 1, 2, 5 sequence.

**Zero span:** analyzer functions as a manually-tuned receiver.

#### Frequency Accuracy

**Tuning accuracy:** 0.01 to 3 GHz,  $\pm(1 \text{ MHz} + 0.3\% \text{ of center frequency})$ ; 3 to 21 GHz,  $\pm(5 \text{ MHz} + 0.2\% \text{ of center frequency})$ .

**Frequency span accuracy:**  $\pm 5\%$  of displayed frequency separation.

#### Spectral Resolution

**Resolution bandwidths:** 8 selectable, 3-dB resolution bandwidths from 1 kHz to 3 MHz in a 1, 3 sequence. Bandwidth and frequency span are independently variable or may be coupled for optimum display when control markers are aligned.

**Resolution bandwidth accuracy:** 3-dB points are  $\pm 1.5\%$  (except for 3 MHz bandwidth,  $\pm 30\%$ ).

**Selectivity:** (60-dB/3-dB bandwidth ratio)  $< 15:1$ .

**Spectral stability** (fundamental mixing, bands 0.01-3 GHz and 6-9 GHz)

**Residual FM:**  $< 2 \text{ kHz p-p}$  in 0.1 second.

**Noise sidebands:**  $\geq 70 \text{ dB}$  down,  $\geq 30 \text{ kHz}$  from center of CW signal with 1 kHz resolution bandwidth and video filter at Max.

# SIGNAL ANALYZERS

## Microwave Spectrum Analyzer, 10 MHz to 21 GHz (cont'd)

Model 8559A and 853A

### Amplitude Specifications

**Amplitude range:** -111 to +30 dBm.

#### Maximum Input (Safe) Levels

**Total power:** +20 dBm (100 mW, 2.2 V RMS) with 0 dB input attenuation; +30 dBm (1 W, 7.1 V RMS) with  $\geq 10$  dB input attenuation.

**Voltage:**  $\pm 7.1$  V dc or 7.1 V RMS (<100 Hz).

**Peak pulse power:** +50 dBm (100 W, 10 sec pulse width, 0.01% duty cycle) with  $\geq 30$  dB input attenuation.

**Gain compression:** <0.5 dB for a -10 dBm input level, with 0 dB input attenuation.

**Average noise level:** see table below for maximum average noise level with 1 kHz resolution bandwidth, 0 dB input attenuation, and video filtering at MAX.

Frequency Range (GHz)	Avg. Noise Level (dBm/1 kHz)	Frequency Response ( $\pm$ dB max.)	Amplitude Accuracy <sup>1</sup> ( $\pm$ dB max.)
0.01-3	-111	1.0	2.3
6.0-9	-108	1.0	2.3
3.0-9	-103	1.5	2.8
9.0-15	-98	1.8	3.1
6.0-15	-93	2.1	3.4
12.1-18	-92	2.3	3.6
18.0-21	-90	3.0	4.3

**Alternate IF:** regular IF at 3.0075 GHz; alternate IF available at 2.9925 GHz for all frequency bands (minimum frequency is 25 MHz).

### Calibrated Display Range

**Log:** 70 dB with 10 dB/div scale; 8 dB with 1 dB/div scale.

**Linear:** 8 divisions with linear (LIN) amplitude scale.

### Amplitude Accuracy

**Calibrator:** -10 dBm  $\pm 0.3$  dB (into 50 ohms), 35 MHz  $\pm 400$  kHz.

**Reference level:** 10 dB steps and 12 dB vernier for calibrated adjustment from -112 dBm to +60 dBm<sup>2</sup>.

**Step accuracy (with 0 dB input attenuation):** -10 to -80 dBm,  $\pm 0.5$  dB; 10 to -100 dBm,  $\pm 0.5$  dB.

**Vernier accuracy:**  $\pm 0.5$  dB.

**Frequency Response:** see table above; includes input attenuator, mixer flatness, and mixer-mode gain variation (band-to-band) with 0 or 10 dB input attenuation.

**Input attenuator:** 0 to 70 dB, selectable in 10 dB steps.

**Step accuracy:**  $\leq \pm 1.0$  dB per 10 dB step (0 to 60 dB, 0.01 to 18 GHz).

**Maximum cumulative error:**  $\leq \pm 2.4$  dB (0 to 60 dB, 0.01 to 18 GHz).

### Bandwidth Switching (Amplitude Variation)

**3 MHz to 300 kHz:**  $\leq \pm 0.5$  dB

**3 MHz to 1 kHz:**  $\leq \pm 1.0$  dB.

### Display Fidelity

**Log incremental accuracy:**  $\pm 0.1$  dB/dB from Reference Level.

**Log maximum cumulative error:**  $\leq \pm 1.5$  dB over 70 dB range.

**Linear accuracy:**  $\pm 3\%$  of Reference Level.

### Spurious Responses

**Second harmonic distortion:** typically >70 dB below a -40 dBm signal with 0 dB input attenuation.

**Third order intermodulation distortion:** typically >70 dB below two -30 dBm input signals separated by  $\geq 50$  kHz with 0 dB input attenuation.

**Residual responses:** <-90 dBm with 0 dB input attenuation and no signal present at input (0.01<sup>3</sup>-3 GHz, 6-9 GHz).

**Signal identifier:** available in all frequency bands and spans, usable from 10 MHz to 100 kHz/div.

### Sweep Characteristics

#### Sweep Time

**Automatic:** sweep time is automatically adjusted to maintain absolute amplitude calibration for any combination of frequency span, resolution bandwidth, and video filter bandwidth.

**Calibrated sweep times:** 2 usec to 10 sec/div in a 1,2,5 sequence (except 2 sec/div),  $\pm 10\%$  accuracy ( $\pm 20\%$  for 5/10 sec/div).

**Manual sweep:** analyzer may be swept manually in either direction with front-panel control.

### Signal Input Characteristics

**Input impedance:** 50 ohm nominal, precision type-N female connector.

**Input SWR:** typically <2.0, 0 dB input attenuation; <1.3, 10 dB input attenuation.

### Digital Display

**Traces:** dual trace, digitally stored display with resolution of 481 horizontal by 801 vertical points per trace.

**Signal processing:** maximum hold, digital averaging, and trace normalization.

**Internal service routines:** front-panel buttons access test routines for maintenance of digital hardware.

### HP-IB

**Direct plotter control:** all displayed information transferable to HP-IB plotter using front-panel buttons.

#### Controller Interface functions:

**Trace data transfer:** all trace data values are transferable to or from HP 853A with controller.

**Input messages:** controller input instructions or annotation can be displayed on either of two 60-character lines.

**Display control:** all trace-processing functions can be remotely controlled.

**Sweep control:** analyzer sweeps can be initiated and monitored.

**HP-IB interface functions:** SH1, AH1, T5, L4, SRI, RLI, PP0, DC1, DT1, C0, and E2.

### Output Characteristics (Rear Panel)

**Vertical output, AUX A:** BNC output (50 ohms) provides detected video from 0 to 0.8 V for 8 divisions deflection on CRT display.

**Penlift/blanking, AUX B:** BNC output provides 0 V pendown/blanking signal at low impedance; 15 V penlift/unblanking at 10 k-ohm impedance.

**21.4 MHz IF output, AUX C:** BNC output (50 ohms) provides signal proportional to RF input. Level is about -10 dBm (into 50 ohms) with signal displayed at Reference Level. Output controlled by settings of RES BW, Input Atten, and Ref Level.

**Horizontal output, AUX D:** BNC output (5 k-ohms) provides horizontal sweep from -5 V to +5 V for full 10 division CRT horizontal deflection.

**HP-IB interface port:** 24-pin connector provides digital interface for IEEE 488-1978 standard parallel bus.

### General

**Temperature Range:** operating, 0° to +55° C; storage, -40° to +75° C

**EMI:** conducted and radiated interference is within requirements of Methods CE03 and RE02 of MIL-STD 461A, CISPR Publication 11 (1975), and Messerfaenger Postverfuegung 526/527/79 (kennzeichnung Mit F-Nummer/Funkschutzzzeichen).

**Power:** <200 VA with display, 48 to 440 Hz (48 to 66 Hz at 220 or 240 Vac); with HP 853A: 100, 120, 220, or 240 Vac, +5%, -10%.

### Weight

**HP 8559A:** net, 5.5 kg (12 lb), Shipping, 9.1 kg (20 lb).

**HP 853A:** net, 15.9 kg (35 lb), Shipping, 17.3 kg (38 lb).

**HP 853A Opt. 001:** net, 14.5 kg (32 lb), Shipping, 17.3 kg (38 lb).

### Size

**HP 853A/Plug-In:** 158.8mm H x 501.7mm W x 524.5mm D (6.25" x 19.75" x 20.65").

**HP 853A Opt. 011/Plug-In:** 133mm H x 425.5mm W x 473.3mm D (5.25" x 16.75" x 18.65").

### Ordering Information

#### HP 8559A Spectrum Analyzer

**Opt. 910:** extra Operating and Service Manual

**HP 853A Portable Spectrum Analyzer Display**

**Opt. 001:** full module bench/rack configuration

**Opt. 910:** extra Operating and Service Manual

<sup>1</sup> Using IF substitution, total accuracy is sum of frequency response, calibration, and reference level errors.

<sup>2</sup> Input levels not to exceed maximum levels.

<sup>3</sup> 25 MHz with Alternate IF ON.

### Price

\$12,345

add \$20

\$6,000

less \$200

\$10

- 1kHz to 18 GHz, external mixing to 40 GHz
- Absolute amplitude calibration

- Tracking generators for component test
- Tracking preselector for simpler measurements

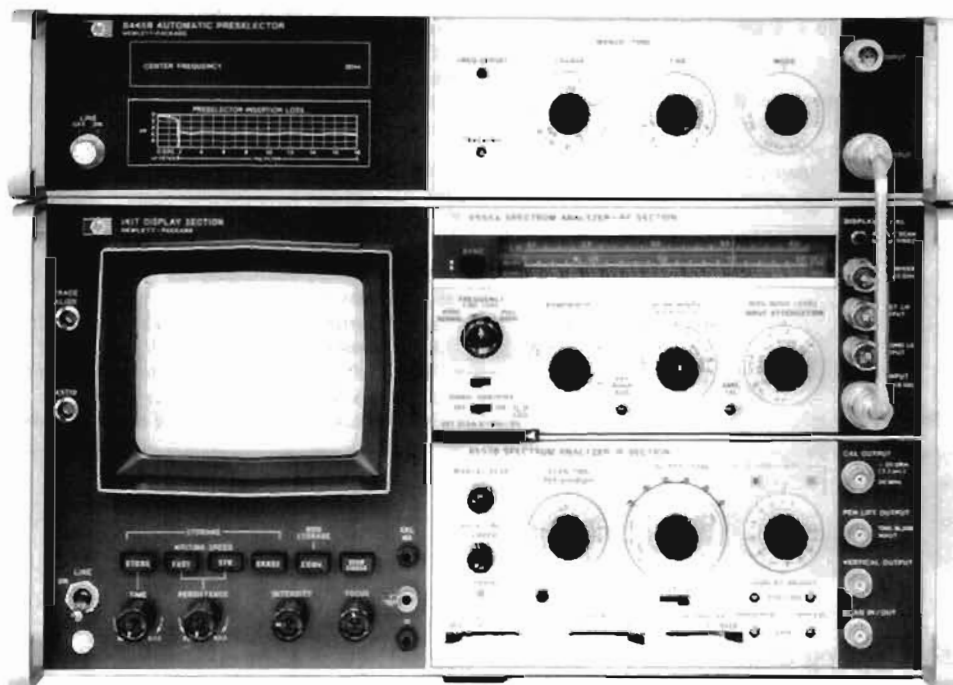

HP 141T Spectrum Analyzer System

### HP 141T Spectrum Analyzer System

Hewlett-Packard's 141T Spectrum Analyzer System permits measurements at frequencies ranging from 1 kHz to 18 GHz by means of two plug-in tuning sections. For measurements in the 18 to 40 GHz region, an accessory external mixer may be used with the microwave tuning section. The modularity of this system allows you to keep pace with changing measurement requirements.

An HP 141T Spectrum Analyzer System is comprised of a main-frame/display, one tuning section, and one IF section. Each tuning section covers a different frequency range, allowing you to purchase those which best meet your current requirements. The HP 8553B covers 1 kHz to 110 MHz, and the HP 8555A from 10 MHz to 18 GHz. The HP 8552B IF section provides bandwidth/gain selection and detection.

For swept frequency testing of components, the HP 8443A or 8444A Opt 059 Tracking Generator can function as a swept signal source that, through locking, accurately tracks the frequency to which the analyzer is tuned. A microwave tracking preselector, the HP 8445B, simplifies measurements and improves the dynamic range of the HP 8555A Tuning Section for use in dense signal environments.

Calibrated frequency and amplitude measurements can be made over the entire frequency range. Logarithmic and linear scaling allow display of amplitude in dBm and voltage, respectively. A warning light indicates uncalibrated conditions due to improper control settings.

### HP 141T Characteristics

**Plug-ins:** accepts Models 8552B, 8553B, and 8555A. Power requirements: 100, 120, 220, or 240V  $\pm 5\%$ ,  $-10\%$ ; 50 to 60 Hz, normally less than 225W (includes plug-ins used).

### Weight

**Model 8552B IF section:** net, 4.1 kg (9 lb). Shipping, 6.4 kg (14 lb).

**Model 141T display section:** net, 19.2 kg (43 lb). Shipping, 26 kg (57 lb).

### HP 8553B & 8443A Specifications

#### Frequency Specifications

**Frequency range:** 1 kHz-110 MHz (0-11 MHz and 0-110 MHz tuning ranges).

#### Scan Width (on 10-division CRT horizontal axis)

**Per division:** 18 calibrated scan widths from 20 Hz/div to 10 MHz/div in a 1.25 sequence.

#### Frequency Accuracy

**Center frequency accuracy:** the dial indicates the display center frequency within  $\pm 1$  MHz on the 0-110 MHz tuning range;  $\pm 200$  kHz on the 0-11 MHz tuning range with FINE TUNE centered and temperature range of 20°C to 30°C.

#### Resolution

**Bandwidth:** IF bandwidths of 10 Hz to 300 kHz are provided in a 1.3,10 sequence.

# SIGNAL ANALYZERS

## HP 141T Spectrum Analyzer System (cont'd)

### Model 141T System

#### Tracking Generator-Counter (HP 8443A) Specifications

**Frequency range:** 100 kHz to 110 MHz.

**Amplitude range:**  $< -120$  dBm to  $+10$  dBm in 10 and 1 dB steps with a continuous 1.2 dB vernier.

#### Counter

**Display:** 7 digits with 1 digit over-range. Reads to  $+10$  Hz increments.

**Accuracy:**  $\pm 1$  count  $\pm$  time-base accuracy.

**Time-base aging rate:**  $< 3 \times 10^{-7}$  /day (0.3 Hz/day) after warm-up.



#### HP 8444A Opt 059 Tracking Generator Specifications

**Frequency range:** 0.5 MHz to 1500 MHz.

**Frequency resolution:** 1 kHz.

**Residual FM (peak-to-peak):** 200 Hz (stabilized).

#### Amplitude Range

**Spectrum analyzer display:** from  $-130$  dBm to  $+10$  dBm, 10 dB/div on a 70-dB display or 2 dB/div on a 16-dB display.

**Tracking generator (drive level to test device):** 0 to  $-10$  dBm continuously variable.

#### Amplitude Accuracy

##### Absolute Amplitude Calibration Range

**System frequency response:**  $\pm 2.7$  dB.

**Tracking generator calibration:** 0 dBm at 30 MHz to  $\pm 0.5$  dB.

**Dynamic range:**  $> 90$  dB.

**Counter output:** typically 0.1 V rms.

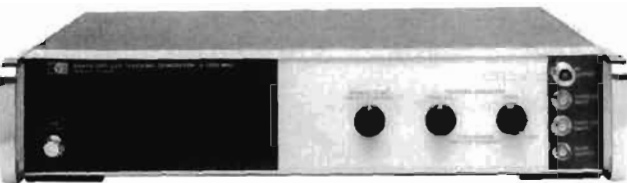

#### HP 8555A & 8445B Specifications

##### Frequency Specifications

**Frequency range:** 0.01-40 GHz.

##### Tuning Range

**With internal mixer:** 0.01-18.0 GHz.

**With external mixer:** 12.4-40 GHz.

##### Scan Width

**Per division:** 16 calibrated scan widths from 2 kHz/div to 200 MHz/div in a 2.5,10 sequence.

##### Frequency Accuracy

**Dial accuracy:**  $n \times (\pm 15$  MHz) where  $n$  is the mixing mode.

##### Resolution

**Bandwidth range:** selectable 3 dB bandwidths from 100 Hz to 300 kHz in a 1,3,10 sequence.

#### Amplitude Specifications

##### Measurement Range

**Log reference level:** from  $-60$  dBm to  $+10$  dBm.

**Linear sensitivity:** from  $0.1 \mu\text{V/div}$  to  $100$  mV/div.

**Sensitivity and frequency response with internal coaxial mixer noise level:** specified for 1 kHz bandwidth.

**Frequency response with 10 dB input attenuator setting**

Frequency Range (GHz)	Mixing Mode (n)	Average Noise Level (dBm max.)	Frequency Response* (dB max.)
0.01-2.05	1-	-115	$\pm 1.0$
1.50-3.55	1-	-117	$\pm 1.0$
2.07-6.15	2-	-108	$\pm 1.3$
2.60-4.65	1+	-117	$\pm 1.0$
4.11-6.15	1+	-115	$\pm 1.0$
4.13-10.25	3-	-103	$\pm 1.5$
6.17-10.25	2+	-105	$\pm 1.5$
6.19-14.35	4-	-95	$\pm 2.0$
8.23-14.35	3+	-100	$\pm 2.0$
10.29-18.00	4+	-90	$\pm 2.0$

\*Includes mixer frequency response, RF attenuator frequency response, mixing mode gain variation, RF input VSWR.

#### HP 8445B Tracking Preselector

##### Frequency Specifications

**Frequency range:** dc-1.8 GHz low-pass filter; 1.8-18 GHz tracking filter.

#### Ordering Information

HP 141T Variable Persistence Display	\$4845
Opt 008: Rack flange kit	+ \$45
HP 8552B High Resolution IF Section	\$5560
HP 8553B RF Section	\$5205
HP 8443A Tracking Generator-Counter	\$8620
HP 8444A Opt 059 Tracking Generator	\$5090
HP 8555A Tuning Section	\$11,425
Opt 001: APC-7 connectors	+ \$40
Opt 002: Internal limiter	+ \$210
HP 8445B Tracking Preselector, dc-18 GHz	\$7140
Opt 001: APC-7 connectors	+ \$155
Opt 002: Add manual controls	+ \$80
Opt 003: Add digital frequency readout	+ \$670
Opt 004: Delete low-pass filter	- \$425
Opt 005: Delete interconnect rigid coax	- \$50
HP 11517A External Mixer (taper section req'd)	\$560
HP 11518A Taper Section, 12.4 to 18 GHz	\$410
HP 11519A Taper Section, 18 to 26.5 GHz	\$410
HP 11520A Taper Section, 26.5 to 40 GHz	\$410

- 0.01 to 22 GHz, external mixing to 115 GHz & above
- Internal preselection, 1.7 to 22 GHz
- Wide resolution range, 100 Hz to 3 MHz

- Simple three knob operation
- Digital display of dual traces and control settings
- Direct plotter output - no controller needed

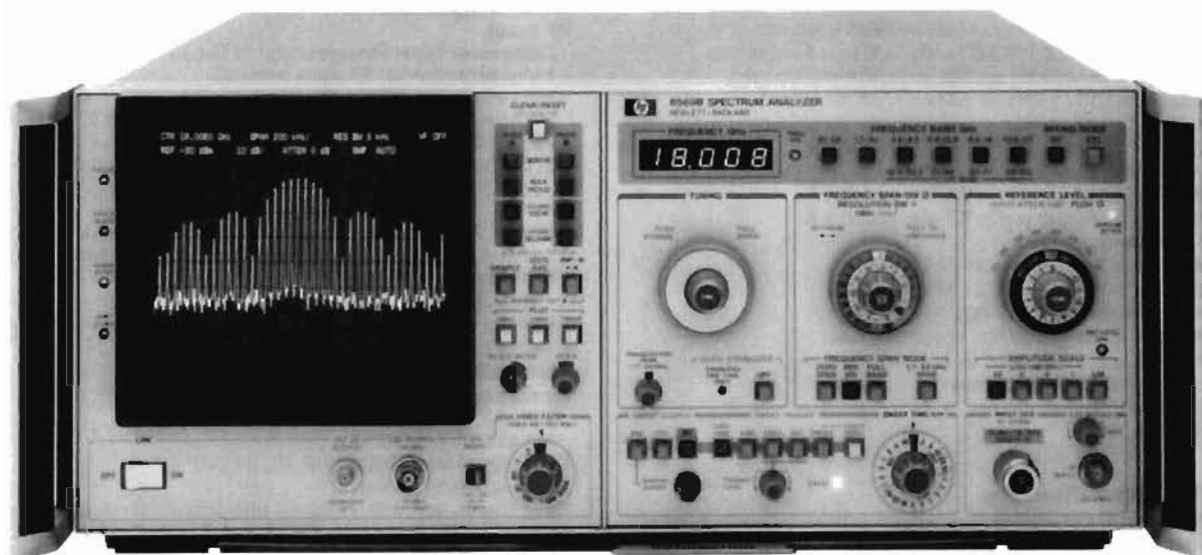

HP 8569B



### HP 8569B Spectrum Analyzer

High performance and simple operation are combined with unique microprocessor-controlled capabilities in the HP 8569B Microwave Spectrum Analyzer. Excellent sensitivity and internal preselection assure the wide, spurious-free measurement range necessary for production applications, while the digital display and coupled controls speed measurement routines. The internal frequency range of 10 MHz to 22 GHz is extended using external mixers: to 40 GHz in two bands with the HP 8569B Option E02; to 71 GHz with HP 11971 series mixers; and to 115 GHz with other commercially available mixers. For more information on external harmonic mixers see page 141. For semi-automatic operation, connect a desktop computer to the HP 8569B via HP-IB to allow access to the displayed trace data and the control settings necessary to analyze or record measurements, or display operator messages and prompts on the CRT. Direct, hard copy output to a digital plotter is possible without the need of a controller or any programming.

### Wide Range of Signal Resolution

Optimum resolution is possible for a wide range of signal characteristics with ten IF filters available from 100 Hz to 3 MHz. Fully automatic stabilization in narrow spans reduces residual FM to allow accurate measurements of closely spaced signals using the narrow bandwidths. The wide 1 and 3 MHz resolution bandwidths allow fast sweeps in wide spans and increased dynamic range for pulsed RF applications. All resolution filters are Gaussian-shaped for repeatable measurements, faster undistorted sweeps, and best pulse-response.

### High Accuracy and Wide Dynamic Range

Absolute signal levels from  $-123$  to  $+30$  dBm are easily and accurately measured using IF substitution because the HP 8569B displays the reference level value directly on the CRT above the graticule. Damage to the mixer is prevented for signal levels of  $+30$  dBm with a built-in limiter below 1.8 GHz and a preselector from 1.7 to 22 GHz. The internal preselector also ensures maximum use of this wide measurement range by reducing internal distortion products as much as 120 dB. In addition, flat frequency response ensures accuracy for relative as well as absolute power measurements.

### Convenient Operation with Digital Display

Preset the HP 8569B to the color-coded, "basic operation" settings and use the coupled controls to make most measurements in three

easy steps: tune to the signal, select a span and raise it to the reference level. While in the AUTO sweep time position, a calibrated amplitude display is ensured. However, the microprocessor also monitors manually-selected sweep times and displays a warning if the sweep speed chosen is too fast for calibrated measurements. Signals are displayed on either of two independent digitally stored traces with all major control settings annotated above the graticule area. Display processing capabilities include Max Hold, digital averaging and trace normalization for extended measurement capability.

### HP-IB Includes Direct Plotter Control

A hard-copy record of the displayed traces, control settings and graticule can be made on a digital plotter via HP-IB quickly and simply using the HP 8569B's front-panel pushbuttons without need for a controller. For maximum capability, attach a controller to the HP 8569B to read the trace data and control settings for a measurement analysis. Also, you can illustrate the test parameters for each measurement with display lines and instruct the operator with messages on the analyzer CRT. The controller can verify correct control settings before taking the test data or going on to the next step.

### HP 8570A Spectrum Analyzer

The HP 8570A is identical to the HP 8569B except for a lower price and some specification differences. The HP 8570A minimum resolution bandwidth is 1 kHz. There is no provision for the use of external mixers. The minimum displayed average noise level is  $-110$  to  $-85$  dBm, and some other specifications have been reduced such as frequency span accuracy, noise sidebands and frequency response.

### HP 8569B and HP 8570A Specifications

#### Frequency Specifications

**Frequency Range:** 10 MHz to 22 GHz.

The HP 8569B is extendable to 40 GHz with Option E02, to 71 GHz with the HP 11971Q/U/V Mixers, and to 115 GHz with commercially available mixers. See page 141 for more information on external mixers.

# SIGNAL ANALYZERS

## Microwave Spectrum Analyzers (cont'd)

Models 8569B and 8570A

### Center Frequency Accuracy

HP 8569B:  $\pm(5 \text{ MHz or } 0.02\%$  of center frequency, whichever is greater; +20% of Frequency Span/Div).

HP 8570A:  $\pm(9 \text{ MHz or } 0.03\%$  of center frequency, whichever is greater; +20% of Frequency Span/Div).

### Frequency Spans

1.7 to 22 GHz; multiband span from 1.7 to 22 GHz in one sweep.

**Full Band:** displays spectrum of entire band selected.

**Per division:** 1 kHz to 500 MHz/div in a 1, 2, 5 sequence.

**Accuracy:**  $\pm 5\%$ , 20 kHz to 500 MHz/div unstabilized.

HP 8569B:  $\pm 15\%$ , 1 kHz to 100 kHz/div stabilized.

HP 8570A:  $\pm 20\%$ , 1 kHz to 100 kHz/div stabilized.

### Stability

#### Total residual FM

HP 8569B: < 100 Hz p-p in 0.1 sec. stabilized.

HP 8570A: < 200 Hz p-p in 0.1 sec. stabilized.

#### Noise sidebands

HP 8569B: > 75 dB down, at 30 kHz offset.

HP 8570A: > 70 dB down, at 30 kHz offset.

### Resolution Bandwidths (-3 dB)

HP 8569B: 100 Hz to 3 MHz, in 1, 3 sequence.

HP 8570A: 1 kHz to 3 MHz, in 1, 3 sequence.

### Resolution Bandwidth Accuracy

HP 8569B:  $\pm 15\%$ .

HP 8570A:  $\pm 20\%$ .

### Amplitude Specifications

#### Maximum Safe Input Power

**Total average continuous power:** +30 dBm.

**Peak pulse power:** +50 dBm (<10  $\mu\text{s}$  pulse width, 0.01% duty cycle) with  $\geq 20$  dB input attenuation.

#### Gain Compression: $\leq -7$ dBm at the mixer for <1 dB compression

#### Input Attenuator

**Range:** 0 to 70 dB, in 10 dB steps.

**Step Accuracy:**  $\leq 1.0$  dB to 18 GHz,  $\leq 1.5$  dB to 22 GHz.

#### Displayed Average Noise Level: (1 kHz RBW, 3 Hz VBW, 0 dB input attenuation).

Frequency (GHz)	Average Noise (dBm)	
	HP 8569B	HP 8570A
0.01-1.8	-113	-110
1.7-4.1	-110	-105
3.8-8.5	-107	-100
5.8-12.9	-100	-95
8.5-18	-95	-90
10.5-22	-90	-85

### Amplitude Accuracy

**Frequency response:** (Ref. to 100 MHz, -10 dBm with 10 dB attenuation).

Frequency (GHz)	Frequency Response* ( $\pm$ dB max)	
	HP 8569B	HP 8570A
0.01-1.8	1.2	1.5
0.01-4.1	1.5	2.0
0.01-12.9	2.5	3.0
0.01-18	3.0	3.5
0.01-22	4.5	5.5

\*Frequency response includes input attenuator, preselector and mixer frequency response plus mixing mode gain variation (band to band).

### Reference Level

**Range:** +60 dBm to -112 dBm in 10 dB steps and continuous 0 to -12 dB vernier.

### IF Step Gain

HP 8569B:  $\leq 0.5$  dB, -10 to -70 dBm; 1.0 dB, -80 to -100 dBm.

HP 8570A:  $\leq 1.5$  dB, -10 to -100 dBm.

### Calibrator Output: 100 MHz $\pm 10$ kHz; -10 dBm $\pm 0.3$ dB.

### Display Range

**Log:** 1, 2, 5, 10 dB/div over 8 divisions.

**Linear:** 0.56  $\mu\text{V}$  to 224 V in 50 ohm.

### Display Accuracy

**Log:**  $< \pm 0.1$  dB/dB to  $\pm 1.5$  dB max, 0 to 70 dB range

#### Linear

HP 8569B:  $< \pm 3\%$  over full 8 division deflection.

HP 8570A:  $< \pm 5\%$  of reference level.

### Residual Responses: < -90 dBm, with 0 dB input atten. and no signal at input.

### Sweep Specifications

#### Sweep Time

**Auto:** sweep time is automatically controlled by Frequency Span/Div, Resolution Bandwidth and Video Filter controls to maintain an absolute amplitude calibrated display.

**Calibrated sweep times:**  $2\mu\text{s}$  to 10 s/div in 1,2,5 sequence.

### Input Output Characteristics

#### RF Input

**Connector type:** Precision type N female.

**Input impedance:** 50 ohms nominal.

#### SWR (with > 10 dB input atten.)

HP 8569B: < 1.3, 0.01 to 1.8 GHz; < 2.0, 1.7 to 22 GHz.

HP 8570A: typically < 2.0 to 18 GHz.

#### LO Emission (2.0 to 4.48 GHz): < -60 dBm, 0.01 to 1.8 GHz; < -80 dBm, 1.7-22 GHz

#### HP-IB

**Direct Plotter Control:** all displayed information can be transferred to an HP-IB plotter by using only front-panel pushbuttons.

**Interface Functions:** AH1,CO,DC1,DT0,E2,L4,PP0,

RL0,SH1,SR0,T7.

**Auxiliary Inputs:** Blanking, External Sweep and Trigger, Retrace.

**Auxiliary Outputs:** Blanking, Horiz. Sweep, 21.4 MHz IF, Vertical.

### General Specifications

#### Operating Temperature

HP 8569B: 0 to 55°C

HP 8570A: 0 to 45°C

#### Operating Humidity: 95% R.H., 0 to 40°C.

#### Warm-up Time: 1 hour.

**EMI:** Conducted and radiated interference is in compliance with MIL-STD 461A methods CE03 and RE02, CISPR Publication 11 (1975), and Messempfänger-Poostverfuegung 526/527/79 (Kennzeichnung Mit F-Nummer/Funkschutzzeichen).

### Power-Line Requirements

**Operating Voltage:** 100, 120, 220, or 240 (+5%, -10%) VAC.

**Operating Frequency:** 48 to 66 Hz.

**Maximum Power:** 280 VA.

### Weight

#### Net

HP 8569B: 29.2 kg (64 lb).

HP 8570A: 26.8 kg (59 lb).

#### Shipping

HP 8569B: 41 kg (90 lb)

HP 8570A: 38.6 kg (85 lb)

### Standard Options Available

**Opt 001, Internal Comb Generator:** 100 MHz comb signals visible through 22 GHz for increased frequency accuracy (error <0.007%, typically  $\pm 1$  MHz at 22 GHz) and preselector peaking verification.

**Opt 002, Delete 100, 300 Hz Bandwidths (HP 8569B only):** standard specifications apply except minimum resolution bandwidth is 1 kHz with 15:1 shape factor, residual FM <200 Hz when stabilized.

**Opt 003, High Power LO Output (HP 8569B only):** provides  $\geq +14$  dBm for direct use with HP 11971 series external mixers.

**Opt 400, 400 Hz Power Line Operation:** Extends line frequency operation for 100 and 120 VAC lines; 48 to 440 Hz  
HP Part No. 1450-0654 — Transit Case. For casters order HP Part No. 1490-0913.

### Ordering Information

#### HP 8569B Spectrum Analyzer

**Opt 001:** Internal Comb Generator add \$1,425

**Opt 002:** Delete 100, 300 Hz Bandwidths less \$800

**Opt 003:** High Power LO Output add \$1,000

**Opt 400:** 400 Hz Power Line Operation add \$350

**Opt 908:** Rack Flange Kit Without Handles add \$35

**Opt 910:** Extra Operating & Service Manual add \$85

**Opt 913:** Rack Flange Kit with Handles add \$40

**Opt E02:** Extended Frequency Range to 40 GHz add \$4,200

#### HP 8444A Opt 059 Tracking Generator

HP 11971 Series Harmonic Mixers extend frequency

range to 71 GHz. See page 141.

#### HP 8570A Spectrum Analyzer

**Opt 001:** Internal Comb Generator add \$1,425

**Opt 400:** 400 Hz Power Line Operation add \$350

**Opt 908:** Rack Flange Kit Without Handles add \$35

**Opt 910:** Extra Operating & Service Manual add \$50

**Opt 913:** Rack Flange Kit With Handles add \$40

## Harmonic Mixers, 18 to 110 GHz Models 11970 Series, 11971 Series & 11517A

- Low conversion loss
- Individually amplitude calibrated

- No bias or tuning adjustments
- High 100 mW safe input level



HP 11970A

**Bias requirements:** None

**Typical odd order harmonic suppression:** > 20dB

**Maximum CW RF input level:** +20 dBm (100 mW)

**Maximum peak pulse power:** 24 dBm (250 mW) with <1 usec pulse (avg. Power: +20 dBm)

**Environmental:** Meets MIL-T-28800C, Type III, Class 3, Style C.

**IF/LO connectors:** SMA female

**LO Range:** HP 11970 Series, 3.0 to 6.1 GHz

HP 11971 Series, 2.0 to 4.5 GHz

HP Model	Frequency Range	LO Harm. Number	Conversion Loss (dB)	Noise Level (dB) 1kHz (RBW)	Freq. <sup>1</sup> Response (dB)	Gain Compression (dBm)
11970K	18-26.5	6+	24	-110	±1.9	-3
11970A	26.5-40	8+	26	-108	±1.9	-5
11970Q	33-50	10+	28	-104	±1.9	-7
11970U	40-60	10+	28	-104	±1.9	-7
11970V	50-75	14+	40	-92	±2.1	-3
11970W	75-110	18+	46	-85	±3.0	-1
11971K	18-26.5	6+	24	-110	±2.1	-3
11971A	26.5-40	10+	28	-106	±2.1	-7
11971Q	33-50	16+	40	-92	±2.3	-3
11971U	40-60	16+	40	-92	±2.3	-3
11971V	50-75 <sup>2</sup>	16+	42	-89	±2.5	-3

### HP 11970 and 11971: Exceptional Performance

The HP 11970 and 11971 series of waveguide Mixers are general purpose harmonic mixers employing state-of-the-art, dual diode design to achieve flat frequency response and low conversion loss. These mixers are available in six bands from 18 GHz through 110 GHz.

### Easy to Use

The excellent frequency response and low conversion loss of the HP 11970 and 11971 series Harmonic Mixers are achieved without external dc bias or tuning stubs. Manual operation as well as computer controlled operation of hardware is simplified because no mixer bias or tuning adjustments are required.

### HP 11517A Harmonic Mixer

This low-cost, wide-frequency-range harmonic mixer provides a economical solution for measurements not requiring amplitude calibration in the frequency range covering 12.4 to 40 GHz. Waveguide adapters are available to make measurements in more than one waveguide band.

The HP 11517A has an IF range of DC to 2 GHz and an LO range of 2 to 6 GHz, which makes this biased mixer compatible with a wide range of instruments.

### Extends Spectrum Analysis Frequency

The HP 11970 and 11971 series Harmonic Mixers extend the frequency range of the HP 8562A/B, 8566B, 8569B, and 70000 series microwave Spectrum Analyzers. The HP 11975A Amplifier provides the optimum LO power to the mixers when using the HP 8566B or 8569B Spectrum Analyzers. The HP 11517A external Harmonic Mixer extends the frequency range of the HP 8555A Spectrum Analyzer

### Harmonic Mixer Selection Guide

HP Spectrum Analyzer	HP Compatible Mixer Series	HP LO Drive Amplifier
8562A/B	11970	NONE
8566B	11970	11975A
70000	11970	70907A
8569B	11971	11975A
8569B Opt. 003	11971	internal <sup>1</sup>
8555A	11517A with adapters	11975A (optional)

### HP 11970 and 11971 Series Specifications

**IF range:** DC to 1300 MHz

**LO amplitude range:** +14 to +18 dBm, +16 dBm optimum

**Calibration accuracy:** ±2.0dB with optimum LO amplitude

**Typical RF input SWR:** <2.2:1

### HP 11517A Characteristics

**IF range:** DC to 2 GHz

**LO frequency range:** 2.1 to 6.1 GHz

**LO amplitude range:** 0 to +10 dBm (+10 dBm optimum)<sup>3</sup>

**Typical flatness:** ±3 dB over a 1 GHz span with biased peaked

**Typical DC bias range:** 0 to 3.5mA

**Maximum CW RF input level:** +10 dBm

**Typical 3 dBm gain compression:** -15 dBm

**Typical noise level:** (using HP 8555A or with 1 kHz RBW)

-85 dBm 12.4 to 18 GHz, -80 dBm 18 to 26.5 GHz, -70 dBm 26.5 to 40 GHz

**Waveguide adapters:**

12.4 to 18 GHz, HP 11518A; 18 to 26.5 GHz, HP 11519A, 26.5 to 40 GHz, HP 11520A

### Ordering Information

HP 11970K 18 to 26.5 GHz Mixer \$1530

HP 11970A 26.5 to 40 GHz Mixer \$1580

HP 11970Q 33 to 50 GHz Mixer \$1735

HP 11970U 40 to 60 GHz Mixer \$1890

HP 11970V 50 to 75 GHz Mixer \$2295

HP 11970W 75 to 110 GHz Mixer \$2600

HP 11970T 18 to 40 GHz Mixers and Case \$3165

Opt 001: Adds 40 to 60 GHz Mixer to 11970T add \$1890

Opt 002: Adds 33 to 50 GHz Mixer to 11970T add \$1735

HP 11971K 18 to 26.5 GHz \$1530

HP 11971A 26.5 to 40 GHz \$1580

HP 11971Q 33 to 50 GHz \$1735

HP 11971U 40 to 60 GHz \$1890

HP 11971V 50 to 75 GHz \$2295

Opt 009: Mixer Connection Set contains three 1 meter low-loss SMA cables, a wrench, and an allen driver for use with any of the mixers listed above. Space is provided in carrying case for cables and tools. \$450

HP 11971T 18 to 40 GHz Mixer Set and Case \$3165

HP 11969A Carrying Case for one to five mixers, SMA cables and tools \$580

HP 11517A Harmonic Mixer (Waveguide Adapter required) \$560

HP 11518A 12.4 to 18 GHz Waveguide Adapter \$410

HP 11519A 18 to 26.5 GHz Waveguide Adapter \$410

HP 11520A 26.5 to 40 GHz Waveguide Adapter \$410

HP 11975A 2 to 8 GHz Amplifier \$4285

<sup>1</sup>Frequency response of the mixers is reduced by 1 dB for LO range of 14 to 18 dBm.

<sup>2</sup>Operates to 75 GHz with the HP 8569B.

<sup>3</sup>The HP 11975A Amplifier can be used to provide sufficient LO power to the mixers.

# SIGNAL ANALYZERS

## Spectrum Analyzer Accessories

Models 8406A, 8447 Series, 8721A, 11693A, 11694A, 11867A, 11940A, 11941A, 11975A



HP 11975A



HP 8447 Series



HP 11693A



HP 11867A



HP 11694A

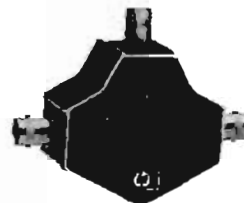

HP 8721A



HP 8406A



HP 11941A



HP 11940A

### HP 8447 Series Amplifiers (0.1 to 1300 MHz)

The HP 8447 Series Amplifiers feature low noise and wide bandwidth. This makes them ideal for improving spectrum analyzer sensitivity and noise figure while providing input isolation. Accurate measurements over a wide frequency range are assured due to the broad frequency coverage, flat frequency response, and low distortion of these amplifiers. Option H64 for the HP 8447F provides dual amplifiers with type N connectors and covers a frequency range from 9 kHz to 1.3 GHz. (See page 395.)

### HP 11975A Amplifier (2 to 8 GHz)

A wide variety of sources can be leveled to  $\pm 1$  dB and amplitude calibrated up to +16 dBm using the HP 11975A in a stimulus response system. As a preamp, the small signal gain of the HP 11975A varies between 9 and 15 dB depending on the frequency. For measurements above 18 GHz, the HP 11975A is ideal for amplifying the local oscillator signal from a spectrum analyzer or network analyzer to drive a waveguide mixer like the HP 11970 or 11971 Series Harmonic Mixers. (See page 393.)

### HP 11867A and 11693A Limiters

The input circuits of spectrum analyzers, counters, amplifiers, and other instrumentation is protected against high power levels with minimum effect on measurement performance. The HP 11867A RF Limiter (dc-1800 MHz) begins reflecting signal levels over 1 milliwatt without damage up to 10 watts avg. power and 100 watts peak power. Insertion loss is  $< 0.75$  dB. The HP 11693A Microwave Limiter (0.1-12.4 GHz, useable to 18 GHz) guards against input signals over 1 milliwatt up to 1 watt avg. power and 10 watts peak power.

### HP 11694A 75 $\Omega$ Matching Transformer (3 to 500 MHz)

Allows measurements in 75 $\Omega$  systems while retaining amplitude calibration with a 50 $\Omega$  spectrum analyzer input. VSWR is  $< 1.2$ , and insertion loss is  $< 0.75$  dB. See Options 001 and 002 for 75 $\Omega$  versions of the HP 8590A.

### HP 8721A Directional Bridge (100 kHz to 100 MHz)

Used for return-loss measurements made with a swept source such as the HP 8443A Tracking Generator and a spectrum analyzer. 6dB insertion loss and 6dB coupled to auxiliary arm. Frequency response  $\pm 0.5$  dB (0.1-110MHz). Directivity  $> 40$  dB (1 to 110 MHz). Load part return loss  $< 0.03$ . Max input power +20 dBm. 50 $\Omega$ ; Option 008: 75 $\Omega$ . (See page 333.)

### HP 11940A and 11941A Close-field Probes

These small, hand-held, electromagnetic-field sensors are used with a spectrum analyzer for EMI diagnostic and troubleshooting applications. Repeatable, absolute magnetic-field measurements are made from 9 kHz to 30 MHz with the HP 11941A and from 30 MHz to 1 GHz with the HP 11940A.

Five antenna factor points appear on the back of each probe for calculating absolute magnetic-field strength (dBuA/m) from the spectrum analyzer's dBuV reading. The probes can also be used for localized susceptibility testing.

The HP 11945A offers both probes as a set. Option E51 adds the HP 8447F Option H64 Preamp, cables, adapters, and a convenient carrying bag. In addition, the HP 8590A Option H51 portable spectrum analyzer has EMC diagnostic capabilities tailored for use with the close-field probes. See page 127.

### HP 8406A Frequency Comb Generator

Produces frequency markers at 1, 10, and 100 MHz increments accurate to  $\pm 0.01\%$  and useable to beyond 5 GHz. An external oscillator can be used to generate precision interpolation sidebands. For an internal comb generator option to the HP 8569B.

### Ordering Information

	Price
HP 8447A 0.1 to 400 MHz Preamp	\$1,225
HP 8447D 0.1 to 1300 MHz Preamp	\$1,325
HP 8447E 0.1 to 1300 MHz Power Amplifier	\$1,530
HP 8447F 0.1 to 1300 MHz Preamp and Power Amplifier	\$2,295
Opt. H64 9 kHz to 1.3 GHz Preamp	\$2,250
HP 11975A 2 to 8 GHz Amplifier	\$4,285
HP 11867A RF Limiter	\$420
HP 11693A Microwave Limiter	\$470
HP 11694A 75 $\Omega$ Matching Transformer	\$205
HP 8721A Directional Bridge	\$325
HP 11940A Close-Field Probe	\$620
HP 11941A Close-Field Probe	\$620
HP 11945A Close-Field Probe Set	\$1,110
HP 8406A Frequency Comb Generator	\$2,175



# SIGNAL ANALYZERS

## 5 Hz to 50 kHz Spectrum Analyzer

### Model 3580A

143

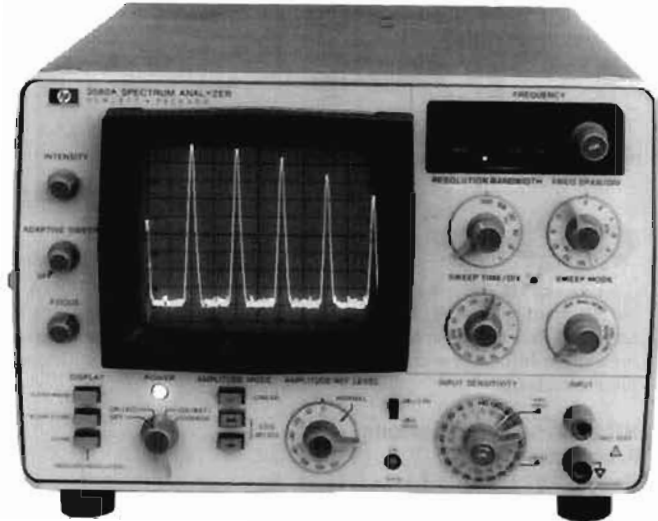

HP 3580A

### Description

Hewlett-Packard's 3580A Spectrum Analyzer is a low frequency high performance analyzer. Its 1 Hz bandwidth allows the user to examine noise and extraneous signal content close in to a signal of interest.

For low frequency applications where sweep speeds can be slow and time-consuming, a special feature, adaptive sweep, allows the user to set a threshold above which only the spectra of interest are observed. In this mode, the CRT is rapidly swept. When a signal is encountered, the sweep slows down to reproduce full response. A factor of ten speed gain is possible.

Digital storage is another important feature which enhances the display for slowly swept low frequency signals. The analyzed signals are digitized and stored in memory. Trace information is then read from memory at a rate appropriate for obtaining an analog-like display.

### Digital Storage for Spectra Comparison

Digital storage makes it possible to store one or two traces. When two are stored, both may be simultaneously displayed for easy comparison.

### Digital Frequency Display

The display provides 1 Hz resolution for setting analysis range and for determining tuned frequency. In the automatic sweep modes, the sweep start or center frequency is displayed. In the manual sweep mode, actual tuned frequency is indicated. This mode effectively provides a cursor function for easy and accurate determination of the frequency at any point on the screen.

### 1 Hz Bandwidth

Resolution bandwidths as narrow as 1 Hz are available to expose and measure closely-spaced spectral components like 50-60 Hz power line sidebands or low-rate modulation. This resolution is available at all frequencies.

### Specifications

#### Frequency Characteristics

**Range:** 5 Hz to 50 kHz.

**Digital Frequency Display**

**Resolution:** 1 Hz

**Accuracy:**  $\pm 3.5$  Hz, 0 to 55°C.

**Typical stability:**  $\pm 10$  Hz/hr after 1 hour:  $\pm 5$  Hz/°C.

Bandwidths: (accuracy $\pm 15\%$ )	1 Hz (25°C $\pm 5$ C)	3 Hz	10 Hz	30 Hz	100 Hz	300 Hz
Shape factor:						8

**Out of range blank:** if controls are set so portions of displayed signal lie below 0 Hz or above 50 kHz, the baseline is displayed.

### Amplitude Characteristics

#### Overall Instrument Range

Linear: 20 V —100 nV full scale

Log: +30 dBm or dB V;  
—150 dBm or dB V

#### Amplitude Accuracy

Frequency response:

20 Hz–20 kHz

5 Hz–50 kHz

Switching between bandwidths (25°C):

3 Hz–300 Hz

1 Hz–300 Hz

Amplitude display

Input attenuator

Amplitude reference level:

(1F attenuator)

Most sensitive range

All other ranges

**Dynamic range:** 80 dB

**IF feedthru:** input level > 10 V, —60 dB; < 10 V, —70 dB.

**Spurious responses:** > 80 dB below input reference level.

**Smoothing:** 3 positions, rolloff is a function of bandwidth.

**Overload indicator:** this LED indicator warns of possible input amplifier overloading. Without this indication it would be possible to introduce spurious responses without knowing it.

#### Sweep Characteristics

**Scan width:** 50 Hz to 50 kHz.

**Log sweep:** 20 Hz to 43 kHz  $\pm 20\%$  after 3 sweeps.

**Sweep times:** 0.1 s to 2000 s.

**Rep:** repetitive sweeps over the specified band.

**Reset:** resets to the beginning of the sweep—used to adjust start or center frequency

**Manual:** in combination with the concentric knob, manual sweep fully duplicates the span of the electronic sweep.

**Adaptive sweep:** when in adaptive sweep below the threshold level, scan speed is 20 to 25 times faster. Threshold is adjustable to cover 0–60% of screen. Signals greater than about 6 dB above threshold are detected and swept slowly.

**Sweep error light:** this LED indicates a sweep that is too fast to capture full response. When the light is on, response can be > 5% lower than it should.

**Zero scan:** to look at the time varying signal at the center or start frequency within the bandwidth selected, the zero scan is used.

#### Output Characteristics

**Tracking generator output:** (also known as BFO or tracking oscillator output).

**Range:** 0 to 1 V rms into 600  $\Omega$ .

**Frequency response:**  $\pm 3\%$ , 5 Hz to 50 kHz.

**Impedance:** 600  $\Omega$ .

**Total harmonic and spurious content:** 40 dB below 1 volt signal level.

#### X-Y Recorder Analog Outputs

**Vertical:** 0 to +5 V  $\pm 2.5\%$ .

**Horizontal:** 0 to +5 V  $\pm 2.5\%$

**Impedance:** 1 k $\Omega$ .

**Pen lift:** contact closure to ground during sweep.

**Recommended Accessory:** HP 7090A Measurement Plotting System.

**Size:** 203.2mm H x 285.8mm W x 412.8mm D (8" x 11 1/4" x 16 1/4").

**Weight:** net, 12.25 kg (27 lb); HP 3580A Opt 001: net, 15.88 kg (35 lb)

**Temperature range:** 0°C to 55°C.

**Power:** 100 V, 120 V, 220 V, or 240 V  $\pm 5\%$  —10%; 48 to 440 Hz: 35 VA max.

**Opt 001 battery:** 5 hours from full charge, 14 hours to fully recharge. The internal battery is protected from deep discharge by an automatic turn off. Useful life of batteries is over 100 cycles.

#### Ordering Information

**HP 3580A Spectrum Analyzer**

**Opt 001:** internal rechargeable battery

**Opt 002:** balanced input

**Opt 003:** rack mount

**Opt W30:** Extended Warranty

**Price**

**\$8,400**

\$700

\$260

\$335

\$350

# SIGNAL ANALYZERS

## Dual-Channel, Dynamic Signal Analyzer 0.02 Hz to 25.5 kHz

Model 3582A

- Transfer function magnitude and phase measurements
- Coherence function measurement
- Phase spectrum measurement
- Transient capture and frequency domain analysis
- Internal periodic and random noise source

### Description

The HP 3582A offers outstanding value in a dual-channel, real-time spectrum analyzer that solves bench and systems measurement problems in the frequency range of 0.02 Hz to 25 599 kHz. Sophisticated LSI digital filtering combined with microcomputer execution of the Fast Fourier Transform (FFT) provides exceptional measurement capability and performance.

### Exceptional Frequency Resolution And Coverage

Unlike conventional dynamic signal analysis which extends from dc to some maximum frequency, the HP 3582A can "zoom in" to analyze any selected band of frequencies with dramatically improved resolution. The start or center frequency of the 5 Hz to 25 kHz band analysis spans can be adjusted in 1 Hz increments to cover the entire frequency range of the instrument. This provides resolution, representing as much as a 5000 to 1 improvement over conventional "base-band" analysis. With frequency ranges from 25 kHz down to 1 Hz full scale, the HP 3582A is extremely well suited to audio and sub-audio measurements.

### Real Time Measurement Speed and Wide Dynamic Range

In high volume testing or in applications requiring substantial on-line tuning, long measurement times are both expensive and inconvenient. Since the HP 3582A uses an advanced microcomputer to execute the FFT, it can perform equivalent measurements as much as one to two orders of magnitude faster than a swept analyzer. For a spectrum analyzer to provide useful information about low level components in the presence of a large signal, it must offer wide dynamic range. The HP 3582A dynamic range is specified as 70 dB—more than adequate for most applications.

### Phase Spectrum Measurement

Most spectrum analyzers can measure only the amplitude spectrum of a signal, yet complete characterization in the frequency domain also requires phase information. The advanced digital signal processing techniques incorporated in the HP 3582A provides direct measurement of phase spectra.

### Transient Capture and Analysis

By using digital processing techniques, the HP 3582A can capture and analyze transients as short as a few milliseconds. This means that spectrum analysis and transfer function analysis are no longer limited to stable, time invariant signals.

### Transfer Function Measurements

The HP 3582A directly measures the complete transfer function, both magnitude and phase. With dual channels analysis of linear and non-linear networks, respectively. In addition, the sources are band-limited to concentrate all stimulus energy in the analysis range.

The HP 3582A coherence function indicates the probability for causality between the two input signals at each frequency. If the coherence between input and measured output is low, the output signal contains a large amount of energy that is not related to the input. Thus, the transfer function measured at that frequency is not reliable.

### Digital Averaging Capability

The RMS averaging mode takes the power average of 4 to 256 successive spectra in order to reduce the uncertainty of the estimate of random spectral components.

When a synchronizing trigger signal is available, the TIME average can enhance the signal-to-noise ratio by as much as 24 dB. Since it involves the averaging of successive time records before transformation, it is also significantly faster than other types of averaging.

### Powerful HP-IB Capability

All major front panel controls are fully programmable via the HP-IB.

HP 3582A

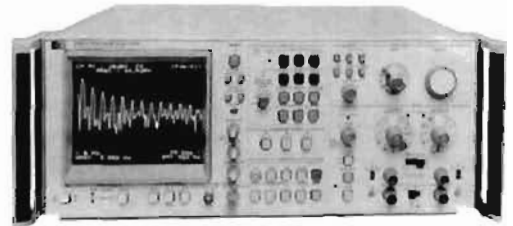

From the HP-IB it is a simple matter to command the HP 3582A to output results, as well. Not only can the various control settings be retrieved, but numeric marker data can be extracted. More importantly, the full display can be read in ASCII format along with complete annotation.

### HP 3582A Specifications

#### Frequency

**Range:** 0.02 Hz to 25.5 kHz

**Spans:** 1 Hz to 25 kHz in a 1-2.5-5-10 sequence.

**Accuracy:**  $\pm 0.003\%$  of display center frequency.

**Resolution:** 0.4% of the frequency span for single channel or 0.8% of the frequency span for dual channels.

#### Amplitude

##### Display Modes

**Log:** 10 dB/division or 2 dB/division

**Linear:** constant voltage/division

##### Measurement Range

**Log:** +30 dBV to -120 dBV noise floor

**Linear:** +30 V to 1  $\mu$ V noise floor

**Dynamic range:** 70 dB

**DC response:** adjustable to >40 dB below maximum input level

##### Accuracy

**Accuracy at the Passband Center**  $\pm 0.5$  dB

**Flat top filter:** +0, -0.1 dB

**Hanning filter:** +0, -1.5 dB

**Uniform filter:** +0, -4.0 dB

**Note:** overall accuracy is the sum of the accuracy at the passband center plus the selected filter accuracy.

##### Resolution

**Log:** 0.1 dB

**Linear:** 3 digits

#### Phase

**Display range:** +200° to -200°

**Accuracy:**  $\pm 10^\circ$

**Resolution:** 1°

#### Transfer Function

##### Measurement Range

**Log:** +160 dB full scale to -80 dB full scale

**Linear:**  $4 \times 10^8$  full scale to  $4 \times 10^{-8}$  full scale

**Phase display range:** +200 degrees to -200 degrees

##### Input

**Impedance:** 10 $\Omega$   $\pm 5\%$  shunted by <60 pF from input high to low (for less than 75% relative humidity)

**Isolation:** input low may be floated up to 30V

**Coupling:** switch selection of ac or dc coupling. The low frequency 3 dB roll off is <1 Hz.

**Common Mode Rejection:** >58 dB

#### General

**Power Requirements:** 100, 120, 220 or 240 volts (+5%, -10%); 48-66 Hz; less than 150 VA

##### Dimensions

**Size:** 425.5 W x 552.5 D x 188 mmH (16.75" x 21.75" x 7.4")

**Weight:** net, 24.5 kg (54 lb); shipping, 29 kg (63 lb)

**HP 3582A Spectrum Analyzer**  
W30 Extended Warranty

**\$12,800**  
\$560

## Single Channel, Dynamic Signal Analyzer 0.000125 Hz to 100 kHz

Model 3561A

- Spectrum and network analysis, waveform recording,  $\frac{1}{3}$  and  $\frac{1}{6}$  octave analysis
- High accuracy,  $\pm 0.15$  dB
- 80 dB dynamic range and full alias protection
- High speed (7.5kHz Real Time Rate)
- Band selectable zoom analysis for 640  $\mu$ Hz resolution

- Full CRT annotation and softkey ease-of-use
- Auto-ranging, auto-calibration, auto-scaling
- Internal non-volatile memory stores 2 traces and 6 states. Optional non-volatile memory stores 127 traces and states.



HP 3561A

### Description

The HP 3561A is a versatile, single channel, real time spectrum analyzer with applications in electronics, vibration analysis, and acoustics. It is actually several instruments in one, operating in both the frequency domain and the time domain. In the frequency domain it serves as a spectrum analyzer with  $\pm 0.15$  dB amplitude accuracy and 2 degrees triggered phase accuracy. Utilizing the built-in tracking noise source, it also can serve as a network analyzer. (Trace math can be used when phase response or high accuracy is desired.) Digital signal processing allows the HP 3561A to digitally synthesize  $\frac{1}{3}$  or  $\frac{1}{6}$  octave filters, providing a high accuracy, drift free octave analyzer. Operating in the time domain the HP 3561A can be used as a low frequency digital storage oscilloscope. The HP 3561A contains a 40k-sample time buffer and complete triggering flexibility, so waveform recording is easy. Time or frequency measurements can be stored in an optional non-volatile memory for later analysis. Annotated hardcopy is easily obtained by pressing "plot" . . . the HP 3561A will control HP-GL plotters and raster dump printers directly. All of these capabilities in one portable instrument make the HP 3561A a powerful addition to any bench, and with a standard HP-IB interface, the HP 3561A makes an excellent systems instrument as well.

### Spectrum Analysis

The HP 3561A offers swept analyzer performance with FFT speed. Up to two orders of magnitude speed improvement can be realized, especially in measurements requiring 1 Hz or better frequency resolution. The HP 3561A delivers 158 dB of automatically calibrated measurement range, from +27 dBV (22.4 volts RMS) to -131 dBV (0.28 microvolts RMS). Dynamic range is 80 dB, and amplitude accuracy is  $\pm 0.15$  dB on the +27 dBV to -40 dBV ranges ( $\pm 0.25$  dB on the -41 dBV to -51 dBV ranges). Signals can be read in RMS volts, volts squared, milliwatts, dBV, dBm (with user-selected impedance), and user-defined engineering units. Band, harmonic and sideband power can be computed directly using the built-in special marker

functions. Frequencies spaced as narrow as 640  $\mu$ Hz can be resolved throughout the 100 kHz range, with frequency accuracy  $\pm 0.003\%$  of display center frequency. Phase spectra relative to a trigger signal can be measured with up to 2 degrees phase accuracy, useful for machinery balancing.

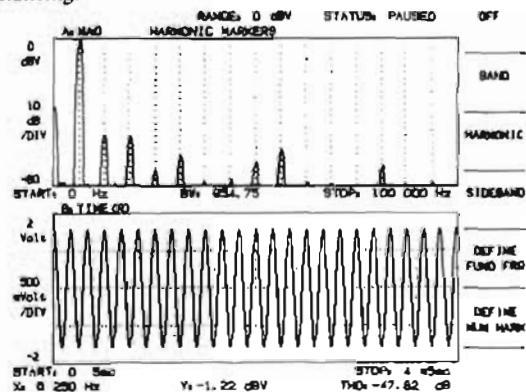

Harmonic marker function computes total harmonic distortion (THD) directly in dB or percent.

### Network Analysis

A band-limited, band-translated noise source allows the HP 3561A to make amplitude and phase frequency response measurements. To make a network measurement, connect the internal noise source to the device under test, adjust the source amplitude, and measure the input spectrum. Store the input spectrum in memory and measure the response spectrum. A simple trace math operation produces the desired frequency response. Amplitude resolution is 0.01 dB and phase resolution is 0.1 degree.

# SIGNAL ANALYZERS

## Single Channel, Dynamic Signal Analyzer 0.000125 Hz to 100 kHz (cont'd)

Model 3561A

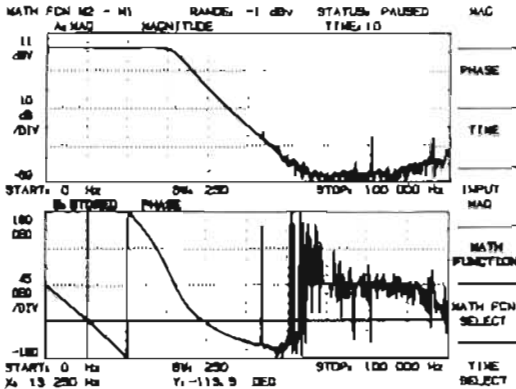

Figure 2: Network amplitude and phase response are measured using the unique internal noise source and trace math.

### Waveform Recording

A high linearity 13 bit analog-to-digital converter makes the HP 3561A a natural for waveform recording. Forty-three sample rates ranging from 256 kHz to 0.026 Hz can be selected. If other sample rates are required, the analyzer can be made to sample on an external TTL clock signal. Up to 40k samples of time data can be stored internally in buffer memory, with complete trigger control. Trigger on an analog level with positive or negative slope and variable level. In either mode you can specify pre- or post-trigger values from 40k samples pre-trigger to 1023k samples of post-trigger delay. Data collected in the time domain is easily analyzed in the frequency domain, making the HP 3561A extremely useful in analyzing transients and other non-steady-state signals.

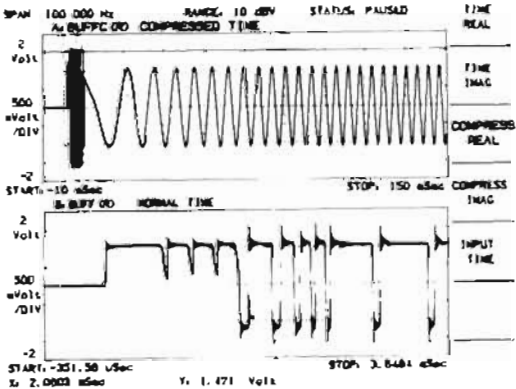

Figure 3: Up to 40,000 samples of a transient waveform can be captured, with analysis in either the time domain or the frequency domain.

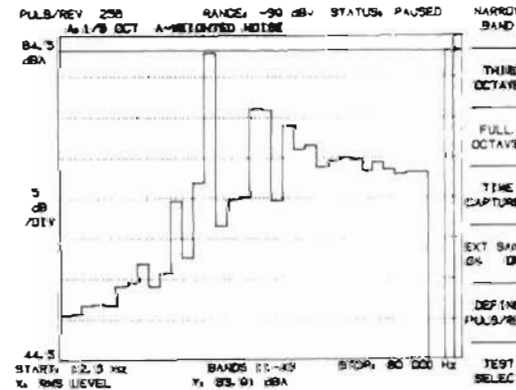

Figure 4: The combination of octave and narrowband analysis makes the HP 3561A a powerful instrument for noise and vibration analysis.

### 1/2 and 1/3 Octave Analysis

Octave analysis is often used in acoustic and vibration work for analyzing signals that are "proportional bandwidth". That is, they exhibit bandwidths that are proportional to their center frequencies. The HP 3561A digitally synthesizes a series of parallel bandpass filters, each with

bandwidth proportional to center frequency. The advantage of the digital technique is better stability and accuracy — there are no analog components to drift, age, or respond to temperature. A built-in hardware A-weight filter can be switched in for acoustic signals where the effects of the human ear must be taken into account.

### Digital Averaging

Digital averaging is provided for improving a measurement in the presence of noise. RMS, RMS exponential, time and peak averaging are provided. Automatic overload signal rejection can be invoked to prevent an otherwise valid reading from being contaminated by one overloaded spectrum. A fast average display mode can be selected which speeds up the averaging process by turning off the display refresh during intermediate averages. This can result in a factor of 3 speed improvement over normal averaging mode. Coupled with its high real time rate, the HP 3561A can make averaged measurements in the same amount of time it formerly took to make an unaveraged measurement!

### Flexible Display Formats and Complete Annotation

Display a single trace, two traces in upper/lower format, or two traces overlaid in front/back format. When several traces must be viewed at once, use the "spectral map" format which can display up to 60 separate traces stacked onto one display. Choose log or linear frequency spacing and log or linear amplitude units. Define your own units, give them a name, and the analyzer will read out in your units! Each trace is completely annotated and can be labelled with your own alphanumeric trace label. A view state display function is provided to quickly give you a summary of the analyzer's current setup state.

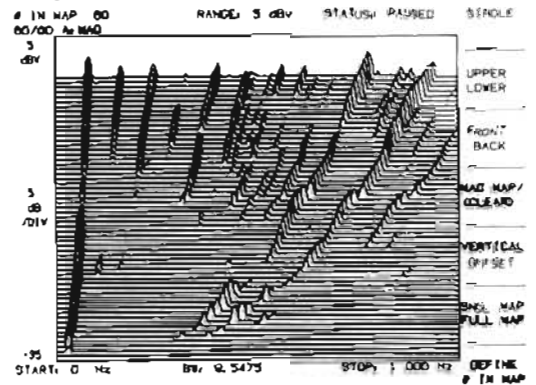

Figure 5: Spectral maps greatly reduce the time required to analyze changes in up to 60 successive measurements.

### Internal Mass Storage

The standard HP 3561A contains 2 traces and 6 setup states of nonvolatile memory. When more storage is required, such as when you wish to store a 40,000-sample waveform captured in waveform recording mode, the "non-volatile memory" option can be installed. This memory allows you to store any combination of 127 traces and states internally. Data stored in internal memory can be transferred via HP-IB to a computer for further analysis or archiving.

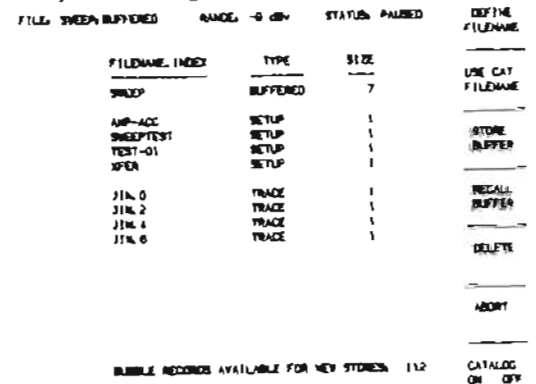

Figure 6: Traces and setups are stored in non-volatile memory by file name. The memory catalog makes recall of stored files easy.

### Annotated Hardcopy

You can obtain fast hardcopy of any display just by pressing the plot button. The HP 3561A controls HP-GL plotters and HP raster dump printers directly. A "marker plot" key allows you to annotate several locations on a plot with amplitude and frequency, or amplitude and time. Simply tune the cursor to the point of interest, press marker plot and the

analyzer annotates the location of interest. Do this as many times as you wish for complete, accurate documentation of measurements.

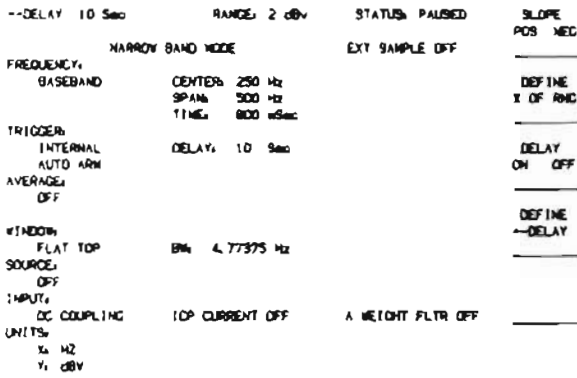

Figure 7: Plots of the view state display provide quick hard copy of instrument setup for complete measurement documentation.

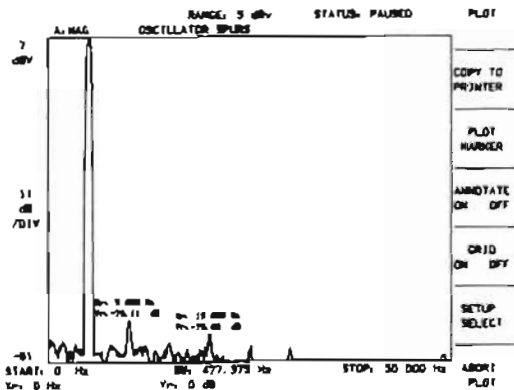

Figure 8: The marker plot function prints x and y marker values for any number of points on the plot.

**Other Features**

In most noise and vibration measurements, a transducer is used to convert the physical phenomena to voltage. These transducers generally require some type of signal conditioning. The HP 3561A contains an internal power supply for ICP type (integrated circuit piezoelectric) transducers. This eliminates an extra piece of equipment, which enhances portability and saves money. Trace math operations are provided that allow you to manipulate traces like numbers on a calculator. This is useful for converting units, compensating for systematic errors, and displaying spectra as a percentage of some reference value.

**HP 3561A Specifications**

**Frequency**

**Range:** 0.000125 Hz to 100 kHz  
**Span:** 0.01024 Hz to 100 kHz in a 1, 2, 2.5, 5, 10 sequence. Other spans are available but are too numerous to list here.  
**Accuracy:** ± 0.003% of display center frequency.  
**Resolution:** 0.25% of frequency span.  
**Window:** Flat Top, Hann, Uniform, and Exponential.

**Bandwidth**

	Flat Top	Hann	Uniform
3 dB Bandwidth (% of frequency span)	0.90%	0.36%	0.22%

**Real Time Bandwidth:** (Typical) Single display, 3.0 kHz. Fast average display, 7.5 kHz.

**Amplitude**

**Measurement Range:** +27 to -120 dBV noise floor (22.4 VRMS to 1µV noise floor.) Input range is selected in 1-dB steps from +27 to -51 dBV. Optimum range is determined automatically in the autorange mode.

**Dynamic range:** 80 dB

**Accuracy at the Passband**

**Center:** ± 0.15 dB +27 to -40 dBV input ranges  
 ± 0.25 dB -41 to -51 dBV input ranges

**Flat Top window:** +0, -0.01 dB

**Hann window:** +0, -1.5 dB

**Uniform window:** +0, -4.0 dB

**Note:** Overall accuracy is the sum of the accuracy at the passband center plus the selected window accuracy.

**Resolution**

**Log:** 0.01 dB

**Linear:** 4 digits

**Phase**

**Accuracy:** ±2 degrees, dc-10 kHz; ± 10 degrees, 10-100 kHz (signals no more than 40 dB below full range).

**Resolution:** 0.1 degree.

**Input**

**Impedance:** 1X10<sup>6</sup> ohms ± 5% shunted by 95 pF maximum.

**Isolation:** Input low may be connected to chassis ground or floated up to 30 volts RMS (42 volts peak) above ground.

**Coupling:** signal by be ac or dc coupled. Low frequency 3-dB point <1 Hz in ac mode.

**A-weighting:** Hardware A-weighting filter conforms to ANSI standard S1.4-1971 (R1976).

**ICP current:** Nominal 4 mA current source provided, compatible with integrated circuit piezoelectric accelerometers.

**Output**

**Source:** Band-limited, band-translated, pseudo-random, random, or impulse, or TTL "synch" signals are available on rear panel. Level is selectable between 0.7 and 0.007 volts RMS, nominal. Impedance 50Ω ± 5Ω.

**Print/Plot:** Controls HP-GL plotters and HP raster dump printers directly.

**Display**

**General:** Magnitude, phase, time and math traces may be selected. Units available are: Horizontal: Hz, seconds, RPM, orders; linear or log spacing. Vertical: dBV, dBm (selectable Z), volts, volts squared, and user-defined units.

**Scale:** Linear or log magnitude scales may be selected. Full scale, dB/division, and degrees/division are user definable. Center scale user definable in phase or time traces.

**Math:** Arithmetic operations can be performed on new or recalled frequency spectra. Add, subtract, multiply, divide, integrate, differentiate and user-defined constants are provided. 1/BW is provided for Power Spectral Density (PSD) computations.

**Internal Memory**

	Non-volatile	Volatile
<b>Standard:</b>	2 traces, 6 states	40 time records
<b>Optional:</b>	Traces + states + (1 + 2 <sup>n</sup> time capture records) = 127	40 time records

**Marker**

Single, relative, harmonic, sideband, and power cursors are provided. THD can be calculated from up to 20 harmonics. Sideband power relative to specified carrier can be calculated from up to 10 sidebands. MKR to peak, MKR to center, MKR to full scale and marker peak track are provided.

**General**

**Power:** 100/120 Vac +5%, -10%, 48-440 Hz; 220/240 Vac +5%, -10%, 48-66 Hz.

**Weight:** 15 kg (33 lb) net, 21.6 kg (47.5 lb) shipping.

**Dimensions:** 335 mm W x 595 mm D x 197 mm H (13.2" x 23.4" x 7.8")

**\*HP-IB Interface Functions:** Implementation of IEEE Std. 488-1978 SH1, AH1, T5, TE0, L4, LE0, SR1, RL1, PP0, DC1, DT1, C0.

**Ordering Information**

	Price
<b>HP 3561A Dynamic Signal Analyzer</b>	\$11,200
Option 001 Extended Non-volatile Memory	\$1,550
Option W30 Extended Warranty	\$170

# SIGNAL ANALYZERS

## Dual-Channel, Dynamic Signal Analyzer 64 $\mu\text{Hz}$ to 100 kHz Model 3562A

- Network, spectrum, waveform and transient analysis
- Linear, logarithmic and swept sine measurement modes
- 10 kHz real time rate
- 80 dB dynamic range with full alias protection
- High accuracy ( $\pm 0.15$  dB)
- High resolution (801 Lines)
- Band selectable zoom analysis
- Direct control of disc drives and HP-GL plotters
- Fully Programmable

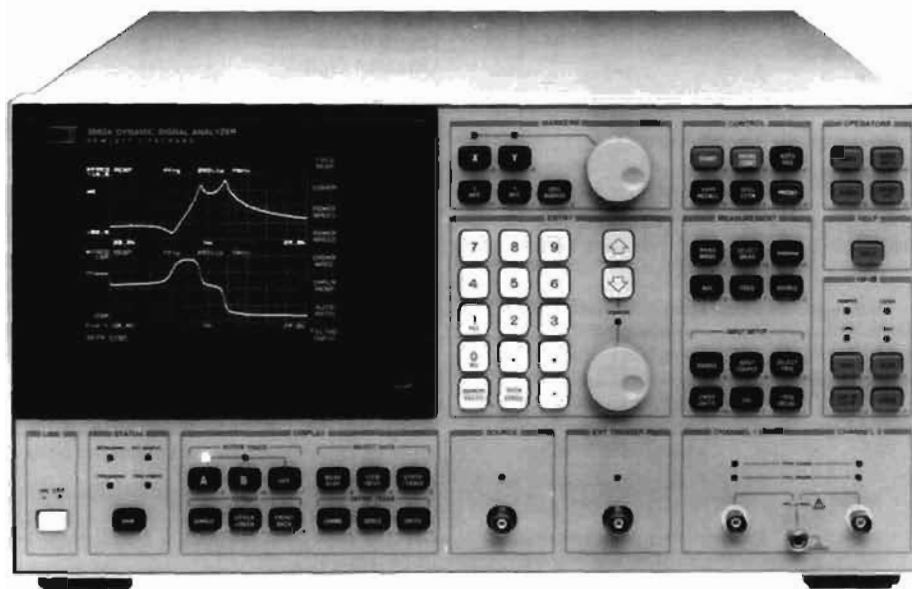

HP 3562A



The HP 3562A Dynamic Signal Analyzer is well suited for the design test and analysis of electronics, mechanical systems, and electromechanical control systems. With two input channels, a dc-to-100 kHz frequency range, 150 dB measurement range and 80 dB dynamic range, this FFT-based analyzer offers the versatility and performance needed to make even the most difficult network, spectrum, and waveform measurements — in both the time and frequency domains.

The two high performance input channels and a built-in signal source (noise and sine signals) address network analysis needs on the bench or in a test system. Zoom analysis with frequency resolution up to 25.6 Hz plus a powerful AM, FM and PM demodulation function makes the HP 3562A a versatile spectrum analyzer. For transient or waveform analysis, signals can be sampled, digitized then stored in internal memory, or sent via HP-IB to an external disc drive (without a computer). Then stored waveforms can be recalled and analyzed in the time, frequency and amplitude domains (baseband and zoom analysis).

In addition, features such as vector averaging, Waveform Math, a 40-pole/40-zero Curve Fitter, and Frequency Response Synthesis offer a full range of analysis and design capabilities. The HP 3562A is fully programmable both through its own built in Auto Sequence programming capability, or with computers over the HP-IB bus. If hardcopy results or storage of data is required, the HP 3562A can control digital plotters and external disc drives directly via HP-IB.

### Network Analysis

Accurate, high resolution frequency response measurements of electronic and mechanical systems can be performed with Linear Resolution FFT, Logarithmic Resolution and Swept Sine analysis. A built-in signal source provides a variety of random noise and sinewave signals to meet the requirements of the system under test.

Linear Resolution is the measurement technique common to all Dynamic Signal Analyzers. In the HP 3562A, 1048-point time records are Fourier-transformed into 801-line frequency spectra. For

network analysis, frequency response magnitude and phase, as well as input and output power spectra, can be measured with 801 lines of resolution. Accuracy for the frequency response magnitude and phase is  $\pm 0.1$  dB and  $\pm 0.5^\circ$ .

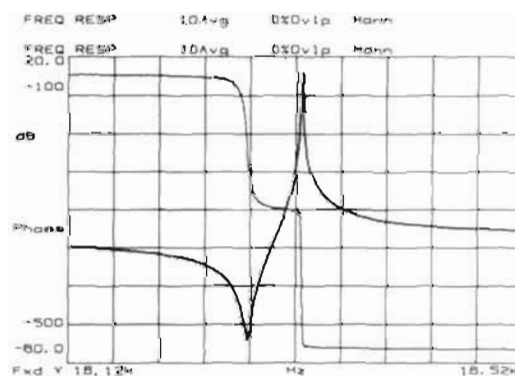

Logarithmic Resolution uses the speed of Linear Resolution FFT measurements to create frequency responses similar to a log-sweep swept sine test. Linear Resolution points are combined internally (rather than just reformatted), on the fly, to create 80-point-per-decade measurements over 1 to 5 decades. Start and stop frequencies can be selected in a 1-2-5 sequence from 0.1 Hz to 100 kHz (for  $\approx 0.1$  Hz start frequency the maximum stop frequency is 10 kHz — 5 decades).

The Swept Sine mode reconfigures the HP 3562A as a powerful swept sine frequency response analyzer. The source can generate linear or logarithmic sweeps with increasing or decreasing frequency; user-selectable sweep rate and resolution are also standard source

functions. Input channel functions include user-selectable averaging and integration time; automatic input ranging can be activated to provide over 130 dB of dynamic range for measurements of high performance systems.

### Spectrum Analysis

On-line analysis of distortion, drift, modulation and phase noise can benefit from the speed and accuracy of the HP 3562A. High resolution measurements are typically 100 times faster than tuned spectrum analyzers — and, since the HP 3562A is an FFT-based analyzer, you can see transient events that a tuned analyzer would probably miss.

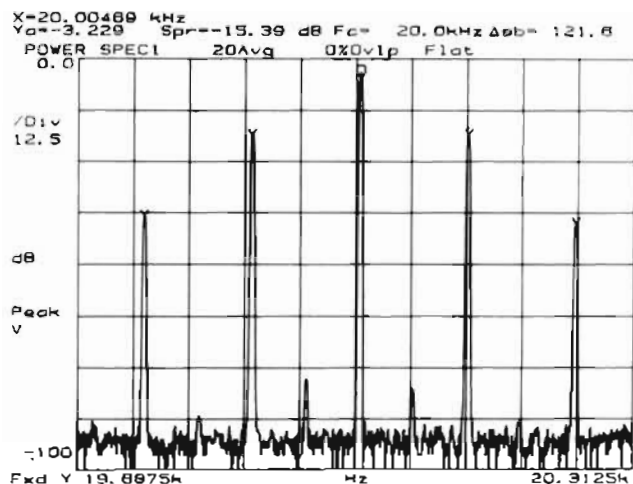

The HP 3562A is essentially a dual-channel spectrum analyzer which provides resolution to 25.6  $\mu$ Hz anywhere within the dc-to-100 kHz measurement range. Single channel accuracy is  $\pm 0.15$  dB with 80 dB of dynamic range. Modulation analysis can be performed on either or both channels with harmonic and sideband markers as well as with the built-in demodulation capability; zoom measurements can be AM, FM or PM demodulated with carrier frequencies up to 99.9 kHz.

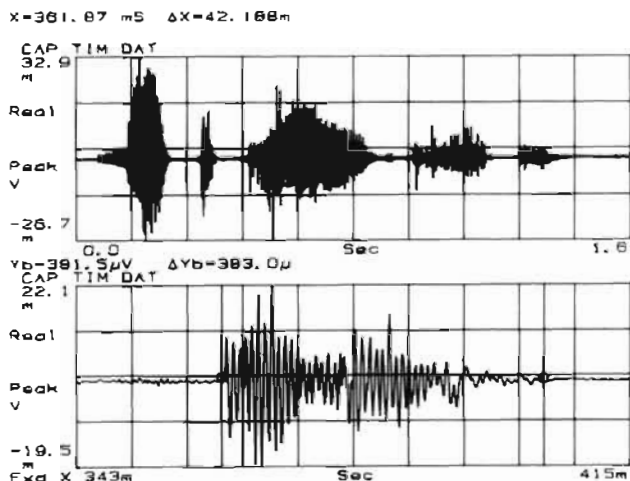

### Waveform and Transient Analysis

Perform complete analysis of waveforms and transients in the time and frequency domains. Sampled and digitized waveforms can be

stored in internal memory (single-channel Time Capture) or on disc in an external disc drive (single- or dual-channel Time Throughput). Data can be recalled for time domain analysis as single time records or as a compressed display of up to 10 time records (Time Capture mode). Data can also be recalled for baseband and zoom analysis in the frequency domain, with vector averaging if needed.

A complete array of triggering capabilities are included to enhance both waveform recording modes. Pre- and post-trigger delays can be specified to capture the rising edge of a transient or to compensate for delays in the system under test.

### Data Throughput to a Disc Drive

When access to prototypes is limited, make your test time more efficient with the Time Throughput capability: through direct control of external disc drives, the HP 3562A can store time data directly to disc without a computer. Set up a measurement and specify the quantity of single- or dual-channel data to be collected. Time data will be sampled, digitized and stored on disc for later analysis as individual time records or as baseband and zoom frequency spectra.

### Hardcopy and Mass Storage with Plotters and Disc Drives

To speed and simplify documentation of results, direct control of plotters and disc drives via HP-IB is a standard feature in the HP 3562A. Literally anything displayed on the analyzer screen can be plotted or saved on disc: measurement results, setup state tables, synthesis tables, curve fit tables and Auto Sequence or Auto Math program listings. Plotting is enhanced with user-selectable line types, pens and paging controls. For mass storage operations, files can be given 8-letter user-defined names; and disc catalog can be recalled and displayed to show file name, type (data, setup, etc.) and date and time of storage.

### Automation for Improved Productivity

Versatile automation capabilities and a wide range of response-only or stimulus/response measurement functions in the HP 3562A help you create productive solutions for your automated testing needs. As a standalone solution, the analyzer can "learn" a series of keystrokes and then perform them on command (Auto Sequence programming). Up to five Auto Sequence programs can be stored internally, with additional programs stored in an external disc drive.

For networked HP-IB systems, the HP 3562A provides complete HP-IB programmability. Custom display graphics and messages can be created through direct programming of the high resolution vector display — user-defined softkey menus can also be created to simplify interactive testing. Rear-panel outputs for large screen displays are also standard.

### HP 3562A Specifications

#### Frequency

**Measurement Range:** 64  $\mu$ Hz to 100 kHz, both channels, single- or dual-channel operation

**Accuracy:**  $\pm 0.004\%$  of frequency reading

**Resolution:** Span/800, both channels, single- or dual-channel operation

Spans:	Baseband	Zoom
Number of spans	66	64
Min span	10.24 mHz	20.48 mHz
Max span	100 kHz	100 kHz
Time record (seconds)	800/span	800/span

**Window Functions:** Hann, Flat Top, Uniform, Force, Exponential, and User Defined

Window Parameters:	Flat Top	Hann	Uniform
3 dB BW (% of span)	0.45%	0.18%	0.11%

**Typical Real Time Bandwidth:** 10 kHz single-channel, 5 kHz dual-channel, with fast averaging on.

# SIGNAL ANALYZERS

## Dual-Channel, Dynamic Signal Analyzer 64 $\mu$ Hz to 100 kHz (cont'd)

Model 3582A

### Amplitude

#### Accuracy (Linear Resolution)

Defined as Full Scale Accuracy at any of the 800 calculated frequency points. Overall accuracy is the sum of absolute accuracy, window flatness and noise level.

#### Absolute Accuracy

Single Channel (Channel 1 or Channel 2)  $\pm 0.15$  dB  $\pm 0.015\%$  of input range (+27 dBV to -40 dBV)  
 $\pm 0.25$  dB  $\pm 0.025\%$  of input range (-41 dBV to -51 dBV)

#### Frequency Response Channel Match:

$\pm 0.1$  dB,  $\pm 0.5$  degree

#### Window Flatness

**Flat Top:** +0, -0.01 dB

**Hann:** +0, -1.5 dB

**Uniform:** +0, -4.0

**Noise Floor:** (Flat top window, 50  $\Omega$  source, 50  $\Omega$  input termination)  
20 Hz to 1 kHz (1 kHz span)  $< -126$  dBV ( $-134$  dBV/ $\sqrt{\text{Hz}}$ )  
1 kHz to 100 kHz (100 kHz span)  $< -116$  dBV ( $-144$  dBV/ $\sqrt{\text{Hz}}$ )

**Dynamic Range:** All distortion (intermodulation and harmonic), spurious and alias products  $\geq 80$  dB below full scale input range

### Phase

**Accuracy:** Single channel, referenced to the trigger point.

$< 10$  kHz  $\pm 2.5^\circ$

10 kHz to 100 kHz  $\pm 12.0^\circ$

### Inputs

**Input Impedance:** 1 M  $\Omega$   $\pm 5\%$  shunted by 100 pF maximum

**Input Coupling:** The inputs may be ac or dc coupled; ac rolloff is  $< 3$  dB at 1 Hz

**Crosstalk:**  $-140$  dB (50  $\Omega$  source, 50  $\Omega$  input termination, input connectors shielded)

#### Common Mode Rejection:

0 Hz to 66 Hz 80 dB

66 Hz to 500 Hz 65 dB

#### Common Mode Voltage:

 dc to 500 Hz

Input Range (dBV rms) Maximum (ac + dc)

+27 to -12  $\pm 42.0$  Vpeak

-13 to -51  $\pm 18.0$  Vpeak\*

\*For the -43 to -51 dBV input ranges, common mode signal levels cannot exceed  $\pm 18$  Vpeak or (Input Range) + (Common Mode Rejection), whichever is the lesser level.

**Common Mode Voltage:** 500 Hz to 100kHz. The ac part of the signal is limited to 42 Vpeak or (Input Range) + (10dB), whichever is the lesser level.

**Common Mode Distortion:** For the levels specified, distortion of common mode signals will be less than the level of the rejected common mode signal.

**External Trigger Input Impedance:** Typically 50 k $\Omega$   $\pm 5\%$

**External Sampling Input:** TTL compatible input for signals  $\leq 256$  kHz (nominal maximum sample rate).

#### External Reference Input

**Input Frequencies:** 1, 2, 5 or 10 MHz  $\pm 0.01\%$

**Amplitude Range:** 0 dBm to +20 dBm (50  $\Omega$ )

### Trigger

**Trigger Modes:** Free Run, Input Channel 1, Input Channel 2, Source and External Trigger. Free Run applies to all Measurement Modes: Input Channel 1, Input Channel 2, Source and External Trigger apply to the Linear Resolution, Time Capture and Time Throughput measurement modes.

#### Trigger Conditions

**Free Run:** A new measurement is initiated by the completion of the previous measurement.

**Input:** A new measurement is initiated when the input signal to either Channel 1 or Channel 2 meets the specified trigger conditions. Trigger Level range is  $\pm 110\%$  of Full Scale Input Range; Trigger Level is user-selected in steps proportional to the input range.

**Source:** Measurements are synchronized with the periodic signal types (burst random, sine chirp and burst chirp).

**External:** A new measurement is initiated by a signal applied to the front panel External Trigger input. Trigger Level range is  $\pm 10$  V peak; Trigger Level is user selected in 80 mV steps.

### Trigger Delay

**Pre-Trigger:** The measurement can be based on data from 1 to 4096 samples (1/2048 to 2 time records) prior to trigger conditions being met. Resolution is 1 sample (1/2048 of a time record).

**Post-Trigger:** The measurement is initiated from 1 to 65 536 samples (1/2048 to 32 time records) after the trigger conditions are met. Resolution is 1 sample (1/2048 of a time record).

### Source

**Source Types:** Band limited, band translated random noise, burst random, sine chirp, and burst chirp, as well as fixed sine and swept sine signals are available from the front panel Source output. DC Offset is also user-selectable.

**Output Impedance:** 50  $\Omega$   $\pm 5\%$

**Output Level:** between  $-10$  and  $+10$  V peak (ac + dc) into a  $\geq 10$  k $\Omega$ ,  $< 1000$  pF load. Maximum current = 20 mA.

**AC Level:**  $\pm 5$  V peak ( $\geq 10$  k $\Omega$ ,  $< 1000$  pF load)

**DC Offset:**  $\pm 10$  V peak in 100 mV steps. Residual offset at 0 V offset  $\leq 10$  mV.

**% In-Band Energy** (1 kHz span, 5 kHz center frequency)

**Random Noise:** 70%

**Sine Chirp:** 85%

**Accuracy and Purity:** Fixed or Swept Sine

**Flatness:**  $\pm 1$  dB

**Distortion** (including subharmonics):

dc to 10 kHz -60 dB

10 kHz to 100 kHz -40 dB

### General

Specifications apply within 5°C and 2 hrs of last internal calibration.

**Ambient temperature:** 0° to 55° C.

**Relative Humidity:**  $\leq 95\%$  at 40° C.

**Altitude:**  $\leq 4,572$  m (15,000 ft.)

#### Storage

**Temperature:**  $-40^\circ$  to  $+75^\circ$  C.

**Altitude:**  $\leq 15,240$ m (50,000 ft)

#### Power:

115 VAC  $+10\%$ ,  $-25\%$ , 48 to 440 Hz

230 VAC  $+10\%$ ,  $-15\%$ , 48 to 66 Hz

450 VA maximum

#### Weight:

26 kg (56 lb) net

35 kg (77 lb) shipping

#### Dimensions:

222 mm (8.75 in) high

426 mm (16.75 in) wide

578 mm (22.75 in) deep

### HP-IB

Implementation of IEEE Std 488-1978

**HP-IB Interface Functions<sup>1</sup>:** SH1 AH1 TS TE0 L4 LE0 SR1 RL1 PP0 DC1 DT1 C0. Supports the 91XX and 794X families of HP disc drives, as well as Hewlett-Packard Graphic Language (HP-GL) digital plotters.

### Accessories Supplied

Operating, Programming and Service Manuals

### Accessories Available

Transit Case for one HP 3562A: HP P/N 9211-2663

### Ordering Information

**HP 3562A** Dynamic Signal Analyzer

**Price**

\$25,500

**Option 907** Front Handle Kit

\$77

**Option 908** Rack Mount Kit

\$41

**Option 909** Rack Mount and Front Handle Kit

\$102

**Option 910** Extra Operating Manuals

\$179

**Option 914** Delete Service Manuals

less \$100

**Option W30** Extended Warranty

\$530

<sup>1</sup>For more on these codes refer to the HP-IB section of this catalog





- Time and Frequency Domain Analysis of Low Frequency Signals
- Expandable from 2 to 62 Input Channels
- Multiple Input, Multiple Output (MIMO) Measurement Capability

#### Modularity to Meet Your Measurement Needs Today

The modular architecture of the HP 3565S Signal Processing System allows you to easily configure a system to meet your needs for signal acquisition and analysis from 64  $\mu$ Hz to 51.2 kHz. Beginning with a basic two channel system, add either input or source modules to provide up to 62 channels of data collection. The advanced algorithms and data management required to quickly set up measurements and analyze signals is provided by HP VISTA Signal Processing Software. Choose from one of several HP Series 300 workstations to provide the computational power suited to your specific processing needs.

#### Hardware Flexibility to Meet Your Measurement Needs Tomorrow

Based around the 35650A Mainframe, the HP 3565S measurement hardware allows you to purchase only the hardware you need today without limiting future expansion. Providing power, cooling, and access to system buses, each mainframe will accommodate up to eight system modules. If more than eight modules are required, up to eight mainframes can be interconnected to provide up to 64 system slots. After making large channel count measurements, mainframes and modules can be distributed into smaller systems; providing optimum use of the measurement hardware.

#### Take Advantage of Integrated Measurement Hardware and Signal Processing Software

To make the operation of the HP 3565S system convenient and straightforward, the HP VISTA Signal Processing Software includes a complete user interface to the 3565S measurement hardware. This

- Direct ADC Throughput to Disc
- Applications In Low-Frequency Electronics, Acoustics, Vibration Analysis and Structural Testing

integration between data acquisition and analysis functions makes the operation of the HP 3565S system as direct as using a benchtop instrument. Reduced setup times also result from HP VISTA's use of spreadsheets to manage hardware setup parameters and advanced algorithms to perform automatic system configuration at turn-on. Measurement hardware accuracy is also enhanced by HP VISTA's use of calibration routines and correction tables to automatically remove repeatable error from measured data.

#### Mainframe - HP 35650A

The 35650A mainframe houses the system modules and provides power and cooling in addition to triggering and sampling synchronization. A mainframe can support up to eight modules and up to eight mainframes can be connected together to provide 64 system slots. (Each system requires at least one 35650A Mainframe, one 35651A HP-IB/Signal Processor module, two 35652A 51.2 kHz Input modules and one 35653A Source module. Any remaining slots can be filled with either Source or Input modules.)

#### HP-IB/Signal Processing Module - HP 35651A

The 35651A HP-IB/Signal Processor Module is the heart of the measurement hardware. This single module controls and manages all modules on the system bus and is also the link between the measurement hardware and the Series 300 computer. Dedicated processors within the 35651A can be programmed from the system computer to perform basic signal processing functions such as windowing and fast Fourier transforms. This provides high speed signal processing and allows the system computer to focus on management,

# SIGNAL ANALYZERS

## Multi-channel Signal Processing System, 64 $\mu$ Hz to 51.2 kHz (cont'd)

Model 3565S

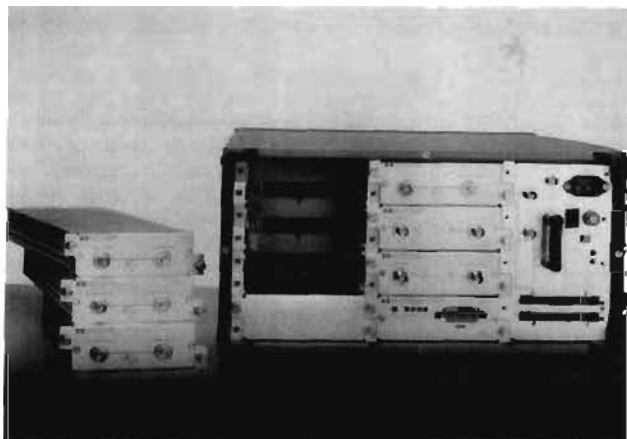

advanced processing and display of the data provided by the hardware. The 35651A can also control disc drives directly, allowing ADC throughput of sampled data from Input modules at rates in excess of 491 Kbytes per second. (Note: this module supports complete HP-IB programming of all system modules and limited programming of its internal signal processors. An optional HP-IB programming manual provides example programs demonstrating how this measurement hardware can be used in a Rocky Mountain Basic environment for integration into existing measurement systems or for custom development of focused measurement/analysis solutions.)

- Internal FFT Computation Time: 1024-point complex transform in approximately 67 ms (nominal, includes windowing)
- Maximum Throughput Rate to Disc: > 491 Kbytes/second

### 51.2 kHz Input Module - HP 35852A

The 35852A Input module digitizes signals at a 262 kHz sample rate. A 50.0 kHz anti-alias filter, digital filtering, and hardware zoom provide the necessary components for fast, flexible and accurate frequency domain analysis. A built-in 4 mA current source and charge-coupled amplifier provide complete signal conditioning for voltage, charge, and ICP-type transducers. This module also supports features such as auto-ranging, overload detection, and DC offset subtraction to ensure high quality results.

- Time Record Block Sizes: 4 to 8192 in powers of two (block sizes of 1024 and greater are supported by HP VISTA)
- Full Scale Voltage Range: 1.26 mVp (-58 dBVp) to 39.8 Vp (+32 dBVp) in increasing steps of 25% (2dB)
- Full Scale Charge Range: -18 dBpCp to +72 dBpCp in 2 dB steps.
- Effective Sample Rates (using internal sample clock): from 0.5 Hz to 262 kHz in X2 steps (all sampling frequencies between 0.5 and 131 kHz inclusive are fully alias protected and are supported by HP VISTA to provide frequency spans from 195 mHz to 51.2 kHz).
- Dynamic Range: < -80 dB relative to full scale (Rs=50 ohms, Cs=1000 pF, 16 averages, internal sampling)

### Source Module - HP 35653A

The 35653A Source module provides the excitation signals necessary to stimulate devices under test. Random noise and fixed sine wave signals are available in both continuous and burst formats. When more than one Source module is installed in a system, the random noise outputs are uncorrelated to support advanced measurements such as multiple input, multiple output (MIMO) testing. The system calibration signal is also provided by this module

- Signal Types: Random, Burst Random, Fixed Sine, Gated Sine, Variable Pulse
- AC Output Level: 1.26 mVp (-58dBVp) to 10.00 Vp (+20dBVp) in 0.375 dB steps

### HP VISTA Signal Processing Software - HP 35630A

HP VISTA provides both complete control of the 3565S measurement hardware and advanced analysis of measured signals in the time and frequency domains. Time histories of signals can be obtained either directly from input modules or from signal data stored on the system's ADC throughput disc. Correction algorithms based on measurement hardware calibrations enhance the accuracy of amplitude, gain and phase measurements to provide high quality signal analysis and network characterizations. Advanced multiple input, multiple output (MIMO) analysis algorithms combined with random, uncorrelated stimuli from the measurement hardware provide an advanced measurement tool for making high quality, repeatable measurements on mechanical structures.

Running on HP-UX, VISTA makes optimum use of windows and pop-up menus to provide a friendly user environment for systems ranging from 2 to 62 Input Modules. Program interaction through an HP-HIL mouse places a wide variety of system information and measurement results at the user's finger tips for quick and easy analysis.

- Measurements: Time record, linear spectrum, auto power spectrum, cross power spectrum, frequency response function, power spectral density and coherence (ordinary, multiple, and partial)
- Frequency Spans: 19 baseband spans from 195 mHz to 51.2 kHz in X2 steps. 18 zoom spans from 390 mHz to 51.2 kHz in X2 steps.
- Windows: Hann, flat top, force and response, exponential, P301, P310, and user-specified
- Absolute Amplitude Accuracy (calibrated system):  $\pm 0.15$  dB  $\pm 0.015\%$  of full scale (+32 to -48 dBVp ranges)
- Cross-Channel Accuracy (calibrated system):  $\pm 0.1$  dB,  $\pm 0.5$  degrees

### System Computer - HP 9000 Series 300

Using an HP 9000 Series 300 workstation allows you to choose the computational power and support peripherals that best suit your measurement and documentation needs. When the 3565S system is not being used, the Series 300 can be used with a variety of other software products to address needs ranging from design to documentation.

### Ordering/Configuration Information

#### Bundled Systems

74791S 4-Channel 3565S System (includes: 1 Mainframe, 1 HP-IB/Signal Processing Module, 4 Input Modules, 1 Source Module and HP VISTA) \$28,100

74792S 8-Channel 3565S System (includes: 2 Mainframes, 1 HP-IB/Signal Processing Module, 8 Input Modules, 1 Source Module and HP VISTA) \$43,950

74791S 16-Channel 3565S System (includes: 3 Mainframes, 1 HP-IB/Signal Processing Module, 14 Input Modules, 1 Source Module and HP VISTA) \$72,650

#### Measurement Hardware

HP 35650A Mainframe \$3010  
 HP 35651A HP-IB Signal Processing Module \$3315  
 HP 35852A Input Module \$3210  
 HP 35653A Source Module \$1785  
 HP 35805A 720 mm Rack \$1530  
 HP 35806A 1600 mm Rack \$2040

#### Software

HP 35630A HP VISTA Signal Processing Software \$7140

- Calibrated, Automated Phase Noise Measurements with
- Specified amplitude accuracy of  $\pm 2$  dB
  - Offset frequency range of 0.01 Hz to 40 MHz
  - Carrier frequency range from 5 MHz to beyond 18 GHz
  - Spurs separated from noise spectra
  - Optimization for several measurement techniques

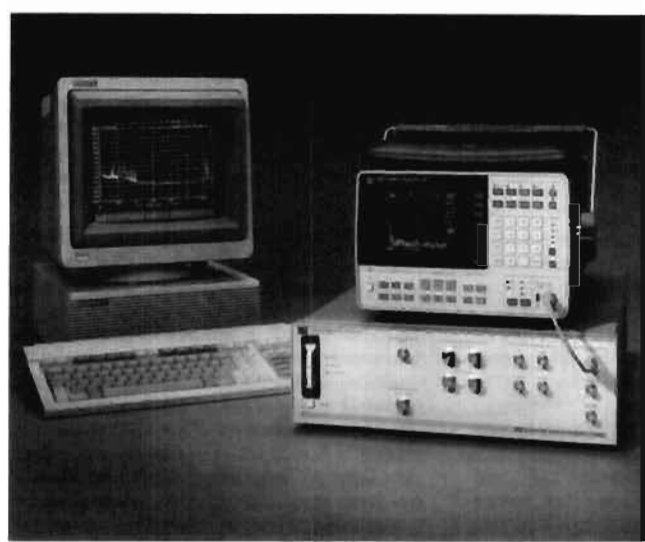

HP 3048A Phase Noise Measurement System controlled by an HP 98580A Desktop Computer.

The HP 3048A Phase Noise Measurement System uses the power of a flexible software program to automate the measurement of the phase noise of a carrier signal. The basic HP 3048A system includes the HP 11848A Phase Noise Interface containing the phase detectors and phase lock loop circuitry, the HP 3561A Dynamic Signal Analyzer, measurement software, and a comprehensive operator training course that teaches measurement procedures. Using an HP 98580A Desktop Computer, this basic system will measure carrier frequencies from 5 MHz to 1.6 GHz (to 18 GHz with option 201) and characterize the demodulated phase noise over an offset range of 0.01 Hz to 100 kHz. Adding other HP spectrum analyzers such as the HP 8566B, 8567A, 8568B, 3585A, 71000S, or 8590A provides automated measurements to offsets of 40 MHz. A variety of signal generators such as the HP 8662A, 8663A, 8642A or 8642B can also be added to the system to provide a low-noise reference signal up to a frequency of 2.56 GHz. Adding an HP 11729C Carrier Noise Test Set in combination with an HP 8662A or HP 8663A provides a low-noise reference signal for measuring carrier signals up to 18 GHz.

The HP 3048A system software uses the HP 11848A interface to demodulate the phase noise of a carrier in the frequency range of 5 MHz to 18 GHz (and beyond with external, user-supplied mixers) and measures the resulting baseband signal with the spectrum analyzers. Measurement menus allow the operator to specify the measurement to be made and the system software controls the measurement process, including the calibration of the system. Several output formats are available to the user, including plots of the single sideband phase noise power of a signal, integrated noise power, or the calculated Allen variance. A real-time measurement mode is available to monitor the level of phase noise and discrete spurs as changes are made to the device under test.

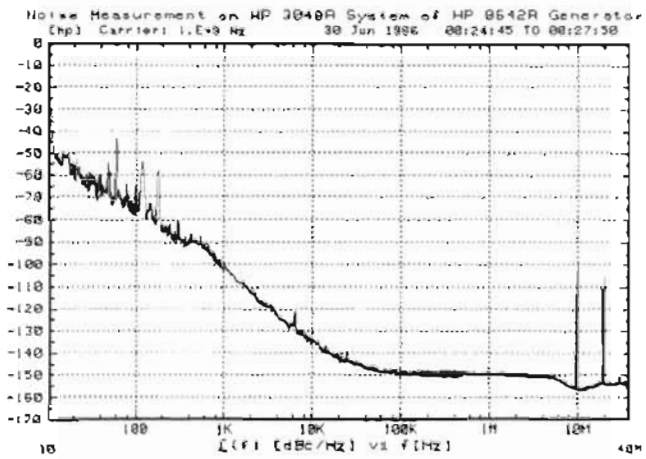

Typical single sideband phase noise measurement by the HP 3048A Phase Noise Measurement System.

As measured by the HP 3048A, the term "phase noise" includes all forms of a signal's frequency and phase instabilities. Randomly occurring frequency and phase noise modulation, as well as discrete sidebands resulting from power-line phase modulation and phase jitter, are detected and accurately measured. Coherent signals are displayed at the power level that was detected while random phase signals are normalized for a 1 Hz bandwidth. The HP 3048A system is optimized for several measurement techniques that are chosen based on the stability and tuning capability of the signal to be measured and the availability of comparable reference oscillators. The two primary techniques for demodulating the phase noise of a signal use either a phase detector or a frequency discriminator as the following diagrams illustrate.

#### Operation with a Phase Detector

This measurement technique uses a double-balanced mixer included in the HP 11848A interface as a phase detector and a separate reference oscillator to demodulate the phase noise from the carrier being tested. With the two signals in quadrature, the phase detector offers excellent sensitivity to reveal very low level phase noise sidebands of the carrier. Based on the tuning range of the source under control, the system automatically sets up a phase lock loop to hold the two signals in quadrature. An offset range of 0.01 Hz to 40 MHz can be measured regardless of the bandwidth of the phase lock loop as the software measures the loop's bandwidth and removes its effects from the measured phase noise. Due to this combination of excellent sensitivity and broadband operation, the HP 3048A system can provide calibrated ( $\pm 2$  dB) phase noise plots of almost any type of source ranging from frequency standards to free-running VCOs. The phase detector method also provides two port measurements of amplifiers, mixers, multipliers, etc.

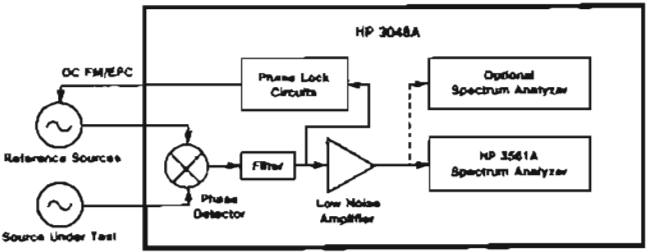

Typical test set-up for measuring the phase noise of relatively stable oscillators.

# SIGNAL ANALYZERS

## Automated Spectrum Analysis (cont'd)

### Model 3048A

#### Operation with a Frequency Discriminator

With the HP 3048A, fully calibrated phase noise measurements of drifting or less stable signals are possible with user-supplied frequency discriminators. The HP 3048A software calibrates the system for the discriminator that is used to maintain the  $\pm 2$  dB amplitude accuracy of the measurement. Although the frequency discriminator limits the system's sensitivity close-in to the carrier, it does allow measurement of noisy or drifting sources that cannot be phase locked to a reference oscillator.

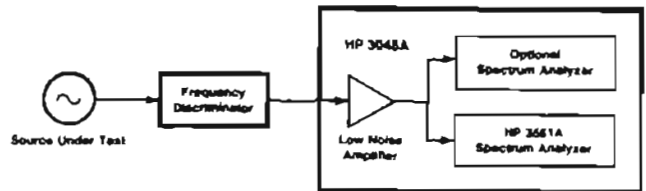

Typical test set-up for measuring the phase noise of drifting and less stable sources.

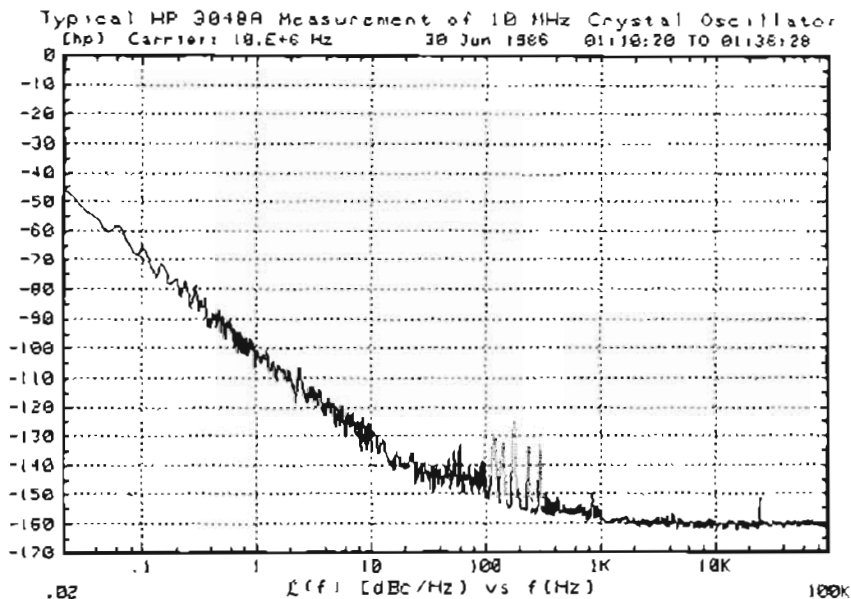

Typical HP 3048A system measurement results for a 10 MHz crystal oscillator.

#### Specifications Summary

##### Sensitivity

The system's sensitivity is a function of the measurement technique that is used. The following graph indicates the sensitivity of the system as limited by its own internally-generated noise for a signal under test of +15 dBm. Also plotted is the phase noise that would limit the measurement sensitivity for a 1 GHz signal using HP signal generators as reference sources.

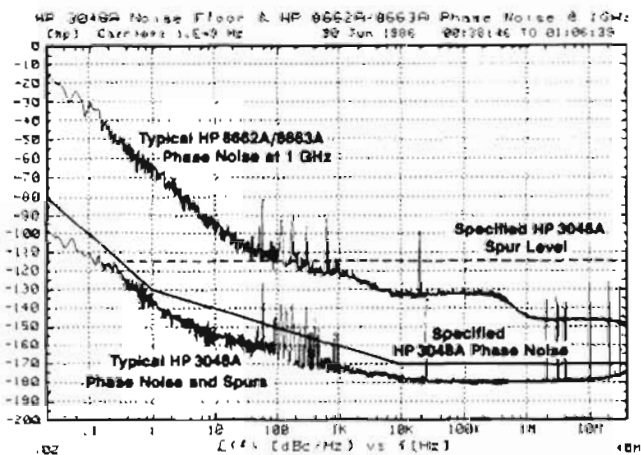

##### Carrier Frequency Range

**Internal Mixer:** 5 MHz to 1.6 GHz, optional to 18 GHz.

**External (user-supplied) Mixer:** The frequency range of the carrier is limited only by the frequency range of the external mixer or the frequency discriminator that is used.

**Offset Frequency Range:** 0.01 Hz to 100 kHz, extended to 40 MHz with an optional spectrum analyzer such as the HP 3585A.

**Amplitude Accuracy:**  $\pm 2$  dB to 1 MHz offset;  $\pm 4$  dB for offsets greater than 1 MHz. This accuracy is verified by the system at the time of the measurement. The system advises the user of any potential accuracy degradations detected during measurement set-up.

##### Ordering Information

**HP 3048A Phase Noise Measurement System** **Price**  
\$32,200

Includes the **HP 11848A Phase Noise Interface**.

**HP 3561A Dynamic Signal Analyzer**, measurement software and operator training

Reference oscillator options:

**Opt 001** Adds HP 8662A Opt. 003 Synthesized Signal Generator (0.01 to 1280 MHz) **\$34,700**

**Opt 002** Adds HP 8663A Opt. 003 Synthesized Signal Generator (0.01 to 2560 MHz) **\$47,950**

**Opt 003** Adds HP 11729C Carrier Noise Test Set (5 MHz to 18 GHz) **\$22,700**

**Opt 005** Adds HP 8642A Opt. 001 Synthesized Signal Generator (0.1 to 1057 MHz) **\$24,950**

**Opt 006** Adds HP 8642B Opt. 001 Synthesized Signal Generator (0.1 to 2114 MHz) **\$33,655**

**System Computer:** HP 98580A Opt. 008 Desktop **\$9,500**

Computer with 3 megabytes of memory and HP-HIL knob.

For full details on available system options and ordering information, see the HP 3048A Phase Noise Measurement System Ordering Information Guide.

- 10 MHz to 18 GHz
- Phase noise and AM noise measurements
- Low system noise floor



HP 11729C

### HP 11729C Carrier Noise Test Set

#### Versatile Phase and AM Noise Measurements

The HP 11729C, combined with an HP 8662A synthesized signal generator and a baseband spectrum analyzer, provides a broadband measurement system for phase noise and AM noise measurements on microwave oscillators, 10 MHz to 18 GHz. The HP 11729C may be ordered with either full frequency coverage, or in a number of bands to specifically match the application. The HP 11729C supports both the phase detector and frequency discriminator phase noise measurement techniques, as well as AM noise measurements, at offsets from the carrier <math>< 1\text{ Hz}</math> to 10 MHz. The HP 11729C also supports pulsed AM and phase noise measurements.

The HP 11729C is fully programmable via HP-IB. A software package called EASY- $\mathcal{L}$  is a modular program that allows automatic operation of the HP 11729C/8662A/8663A, along with the necessary spectrum analyzer (HP 8566/68A/B). EASY- $\mathcal{L}$  implements both the phase detector and frequency discriminator methods, and provides a plot of the phase noise data in  $\mathcal{L}(f)$  (dBc/Hz). For more information on this software package, refer to HP Product Note 11729C-3 "A Users' Guide for Automatic Phase Noise Measurements".

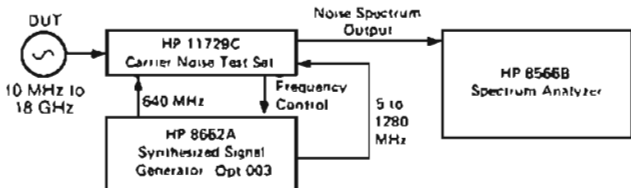

Complete carrier noise characterization system can be assembled from standard instruments.

#### Typical System Noise

The HP 11729C/8662A combination includes the critical low noise microwave reference signal (which determines the system noise floor). The HP 11729C also features a new Surface-Acoustic-Wave (SAW) filter which can be configured into an internal SAW oscillator. This built-in oscillator allows the HP 11729C to be used as a low-cost frequency discriminator system for measurements on free-running oscillators. This discriminator mode uses the HP 11729C in a "stand-alone" configuration, combined with a simple length of external delay line (such as RG 223 cable) and an available baseband analyzer.

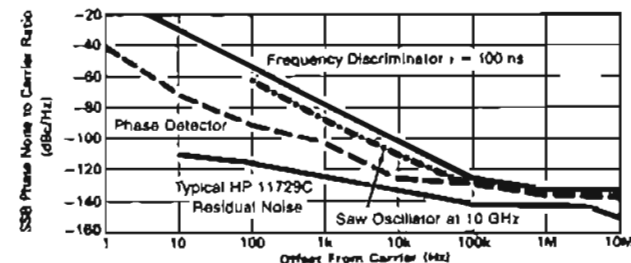

Figure 1. Typical HP 11729C/8662A and HP 11729C self-oscillator mode system sensitivity using the phase detector and frequency discriminator methods at X-Band. Typical HP 11729C residual noise.

#### Abbreviated HP 11729C/8662A Specifications

**Frequency Range:** 10 MHz to 18 GHz in 8 bands.

**Absolute System Noise Floor, Phase Detector Method**

System noise is specified only when the HP 11729C is used with an HP 8662A or HP 8663A Option 003. See the HP 11729C data sheet for more information.

#### Test Signal Requirements

**Amplitude:** +7 dBm minimum to +18 dBm maximum (typically useable to -15 dBm with noise floor degradation).

#### HP 11729C Outputs

##### IF Output

**Bandwidth:** 5 to 1280 MHz.

**Level:** +7 dBm minimum.

##### Noise Spectrum Outputs

- 1) Noise Spectrum Output <math>< 1\text{ MHz}</math>: dc coupled, 600 $\Omega$  nominal.
- 2) Noise Spectrum Output <math>< 10\text{ MHz}</math>: 10 Hz to 10 MHz, 50 $\Omega$  nominal, nominal 40 dB of gain over <math>< 1\text{ MHz}</math> output.
- 3) Auxiliary Noise Spectrum Output: dc coupled, 600 $\Omega$  nominal.

#### Phase Lock Loop Function

##### Frequency Control Outputs

**To crystal oscillator:**  $\pm 10\text{V}$ .

**To dc FM:**  $\pm 1\text{V}$ .

**Lock bandwidth factor:** nominal 1, 10, 100, 1k, 10k selectable.

#### Remote Programming

All front panel functions are HP-IB programmable. In addition, the HP 11729C can output current settings and out-of-lock indication.

#### AM Noise Detection (Option 130)

**Frequency:** 10 MHz to 18 GHz.

**Input level:** 0 dBm minimum to +18 dBm maximum.

**AM noise floor (at +10 dBm input level, dBc/Hz):**

Offset from Carrier (Hz)	Typical	Specified
1k	-147	-138
10k	-152	-145
100k	-161	-155
1M	-165	-160

#### General

**Operating temperature range:** 0° to +55°C.

**Power:** 100, 120, 220, 240 V, +5%, -10%; 48 to 66 Hz; <math>< 75\text{ VA}</math> max.

**Weight:** net, 10.4 kg (23 lb); shipping, 13.2 kg (29 lb).

**Size:** 425 W x 99 H x 551 mm D (21.7 x 16.8 x 3.9 in.). 1 MW x 3/4 H x 20 D System II module.

#### Ordering Information

HP 11729C Carrier Noise Test Set (10 MHz to 18 GHz) **Price** \$22,300

Note: Each of options 003 to 027 (only one may be ordered) also includes 0.005 to 1.28 GHz coverage

Option 003 (1.28 to 3.2 GHz)	-\$8500
Option 007 (3.2 to 5.76 GHz)	-\$8500
Option 011 (5.76 to 8.32 GHz)	-\$8500
Option 015 (8.32 to 10.88 GHz)	-\$8500
Option 019 (10.88 to 13.44 GHz)	-\$8500
Option 023 (13.44 to 16.0 GHz)	-\$8500
Option 027 (16.0 to 18.0 GHz)	-\$8500
Option 130 AM noise detection	\$1100
Option 140 Rear panel connectors	+\$500
Option 907 Front panel handle kit	+\$343
Option 908 Rack mounting flange kit	+\$25
Option 909 Front panel handle plus rack mounting flange kit	+\$65
Option 910 Additional operating and service manual	+\$35

# SIGNAL ANALYZERS

## Measuring Receiver, 150 kHz to 1300 MHz Model 8902A

- RF power: digital power meter accuracy
- Tuned RF level: 0 dBm to  $-127$  dBm dynamic range
- Carrier Noise: AM and phase noise measurements to  $-140$  dBc/Hz
- AM and FM, 1% accuracy;  $\emptyset$ M, 3% accuracy
- RF frequency: 1 Hz resolution
- Audio: frequency, level and distortion

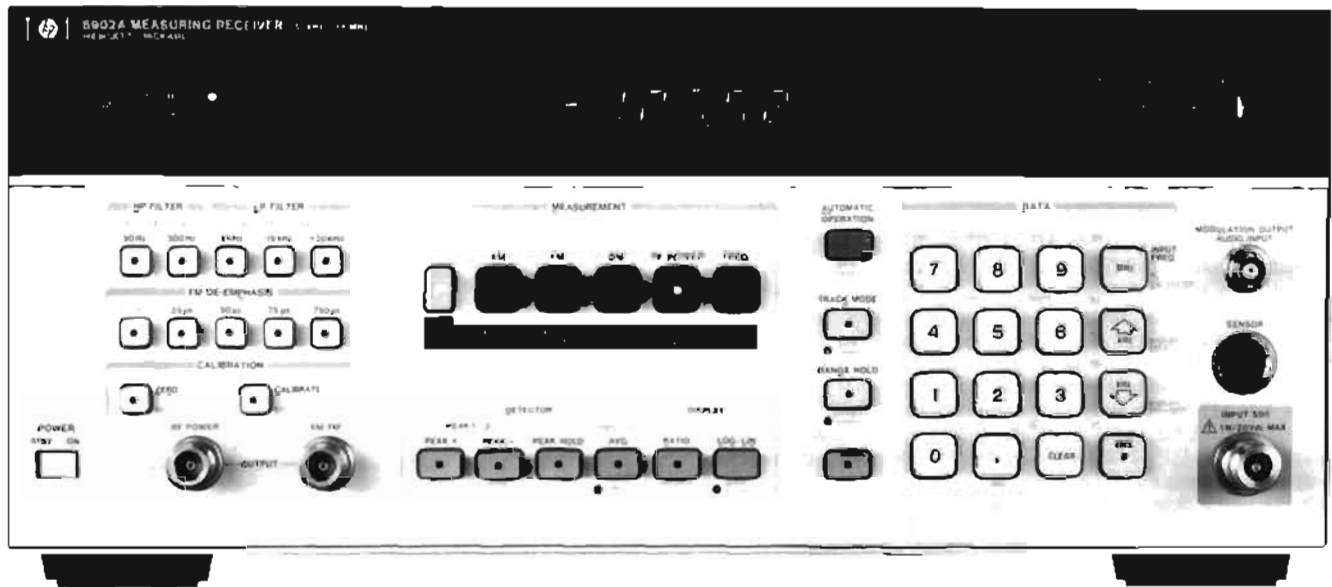

HP 8902A

### HP 8902A Measuring Receiver

The HP 8902A Measuring Receiver combines six precise measurement functions into one fully automatic, HP-IB programmable instrument. It accurately measures RF power, tuned RF level, carrier noise/adjacent channel power, modulation and RF frequency, and characterizes audio signals. For precise signal analysis, the HP 8902A Measuring Receiver provides the performance you need.

RF Power delivers the accuracy and resolution of a high performance power meter. The HP 8902A with the HP 1172A Sensor Module measures power from  $+30$  dBm to  $-20$  dBm at frequencies from 100 kHz to 2.6 GHz. The HP 8902A also accepts all HP 8480 series power sensors for extended measurement capability.

Tuned RF level's minimum sensitivity of  $-127$  dBm with exceptional accuracy is a major contribution of the HP 8902A. You can make relative level measurements with accuracy you would only expect from a transfer standard:  $\pm 0.02$  dB  $\pm 1$  digit (worst case) for up to 10 dB step, increasing to  $\pm 0.30$  dB  $\pm 1$  digit at 110 dB step.

Carrier noise, phase noise and adjacent channel power measurements are simple, fast and accurate with the HP 8902A's high selectivity options (030-037). You select the noise filter bandwidth, measure the source under test's carrier power, tune the analyzer to the frequency offset desired (5 kHz to 1300 MHz) and measure the noise in seconds. The analyzer's measurement accuracy is better than  $\pm 0.5$  dB to  $-129$  dBc/Hz, typically better than  $\pm 1$  dB to  $-140$  dBc/Hz.

AM and FM measurements offer 1% accuracy (3% accuracy for  $\emptyset$ M) and fast one-key operation. The HP 8902A has extremely low internal noise, and very low AM/ $\emptyset$ M and  $\emptyset$ M/AM conversion. For accurately measuring residual and incidental AM, FM and  $\emptyset$ M on a wide range of simple and complex modulated signals.

RF frequency of complex modulated signals can be difficult to measure, but not with the HP 8902A. It tunes to the largest input signal or to any user specified frequency. The HP 8902A counts signals with 1 Hz resolution.

Audio distortion, frequency and level measurements provide comprehensive characterization of the modulation signal.

### Metrology and Calibration

The HP 8902A Measuring Receiver makes signal generator and attenuator calibration easier than ever before.

The HP 8902A quickly and accurately measures your signal generator's RF frequency, RF level flatness, output level accuracy to  $-127$  dBm, incidental and residual AM, FM and phase modulation, phase noise to  $< -140$  dBc/Hz and characterizes the demodulated audio signals.

For attenuator calibration and other relative measurements, the HP 8902A gives you the accuracy and dynamic range you need. Tuned RF level makes relative measurements with 127 dB dynamic range and 0.001 dB resolution. The combined dynamic range of tuned RF level and RF power is 157 dB.

### RF Signal Characterization

The HP 8902A Measuring Receiver is an excellent lab and production tool for accurately characterizing RF signals from 150 kHz to 1300 MHz.

Level measurements down to  $-127$  dBm with superb accuracy make the HP 8902A ideal for testing devices such as antennas, multiplexers, log/linear amplifiers, filters and mixers. Unlike diode detectors, the HP 8902A's power meter accurately measures signals with harmonics and spurious.

The HP 8902A makes accurate AM to  $\emptyset$ M and AM to AM conversion measurements of phase and amplitude sensitive devices such as bandpass filters and multiple channel receivers. Excellent isolation between AM and FM makes it simple to separate the AM and  $\emptyset$ M of AM stereo, incidental AM of FM (transmitters and the AM, FM and  $\emptyset$ M components of complex signals).

### Automatic Test Systems

The HP 8902A is an important component of automatic RF test systems. All functions — power, level, frequency count, carrier noise, modulation, audio analysis — are fully automatic and easily programmed. With these measurements combined into one instrument, interfacing requirements, hardware costs, and software development time are reduced.

The HP 8902A's excellent measurement accuracy and dynamic range also make it a valuable tool for calibrating automatic test systems.

### HP 8902A Specifications

#### RF Power (with HP 11722A Sensor Module)

**Range:** +30 dBm (1W) to -20 dBm (10  $\mu$ W).  
**Frequency range:** 0.1 MHz to 2.6 GHz.  
**Linearity:**  $\pm 0.02$  dB (within range)  $\pm 0.02$  dB per range change from reference range  $\pm 1$  count LSD.  
**Input SWR:** <1.15.

#### Tuned RF Level

**Range:** 0 dBm to -127 dBm.  
**Frequency range:** 2.5 MHz to 1300 MHz.  
**Relative accuracy:**  $\pm 0.02$  dB  $\pm 0.02$  dB per IF range change  $\pm 0.04$  dB per RF range change  $\pm 1$  digit.

#### Selective power measurements (carrier noise, options 030-037)

**Frequency range:** 10 MHz to 1300 MHz  
**Carrier power range:**  
 +30 dBm to -20 dBm; 12.5 kHz, 25 kHz and 30 kHz filters  
 +30 dBm to -10 dBm; carrier noise filter.

#### Relative measurement accuracy:

$\pm 0.5$  dB; levels > -95 dBc; 12.5 kHz, 25 kHz and 30 kHz filters.  
 $\pm 0.5$  dB; levels > -129 dBc/Hz; carrier noise filter.

**Filter bandwidths:** 2.5 kHz, Carrier Noise filter: 8.0 kHz, 12.5 kHz filter; 16.0 kHz, 25 kHz filter, 30.0 kHz, Cellular Radio filter.

#### RF Frequency

**Range:** 150 kHz to 1300 MHz  
**Maximum resolution:** 1 Hz.

#### Amplitude Modulation

**Rates:** 20 Hz to 100 kHz.  
**Depths:** to 99%.  
**Accuracy:**  $\pm 1\%$  of reading  $\pm 1$  digit, for rates 50 Hz to 50 kHz and depths  $\geq 5\%$ .

#### Frequency Modulation

**Rates:** 20 Hz to 200 kHz.  
**Deviations:** to 400 kHz.  
**Accuracy:**  $\pm 1\%$  of reading  $\pm 1$  digit, for rates 50 Hz to 100 kHz.

#### Phase Modulation

**Rates:** 200 Hz to 20 kHz.  
**Deviations:** to 400 radians.  
**Accuracy:**  $\pm 3\%$  of reading  $\pm 1$  digit.

#### Audio Level, Frequency and Distortion Capability

**Audio Level**  
**Accuracy:**  $\pm 4\%$  of reading, 100 mV to 3V.

#### Audio Frequency

**Display resolution:** 6 digits, to 250 kHz.

#### Audio Distortion

**Accuracy:**  $\pm 1$  dB, 400 Hz and 1 kHz.

#### Ordering Information

HP 8902A Measuring Receiver	\$22,950
Opt 001 Rear panel instead of front panel connections for input, modulation output, and calibrators	+ \$205
Opt 002 $1 \times 10^{-9}$ /day internal reference oscillator	+ \$765
Opt 003 RF connectors on rear panel only	+ \$400
Opt 004 Operation from 48 Hz to 400 Hz power line (temp. <40°C)	+ \$275
Opt 021 Add HP 11722A Sensor Module	+ \$2,040
Opt 030 High selectivity (select only two filter options)	\$2450
(Options 032-037 require Option 030. Option 030 includes Option 003 connections for external local oscillator.)	
Opt 032 12.5 kHz Filter	\$0
Opt 033 25.0 kHz Filter	\$0
Opt 035 Cellular Radio Filter	\$0
Opt 037 Carrier Noise Filter	\$0
Opt 907 Front panel handle kit	+ \$65
Opt 908 Rack Mounting Flange Kit	+ \$35
Opt 909 Front Panel Handle plus Rack Mounting Flange Kit	+ \$90
Opt 910 Additional operating and service manual	+ \$275

#### Price

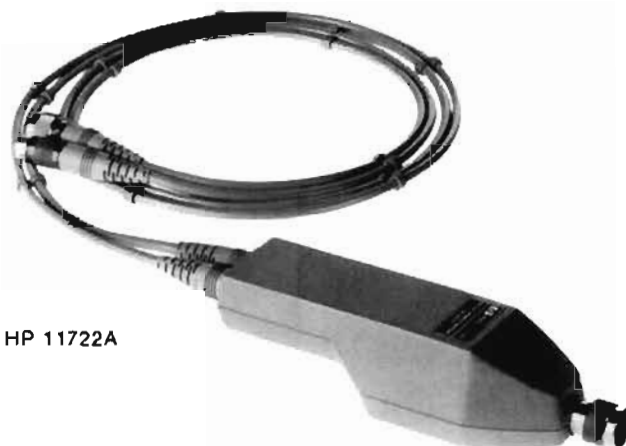

HP 11722A

### HP 11722A Sensor Module

The HP 11722A Sensor Module was designed for use with the HP 8901B Modulation Analyzer and HP 8902A Measuring Receiver. The HP 11722A contains a silicon monolithic thermocouple as a power sensing element.

With the HP 11722A Sensor Module, you get all the performance of the HP 8901B or HP 8902A, plus superb power measurement accuracy, at a single connector. You can characterize a signal without switching back and forth between the power sensor and the analyzer's RF input.

Each HP 11722A Sensor Module is individually calibrated, traceable to the U.S. National Bureau of Standards. The calibration factors are printed on the sensor module for easy reference. Enter these factors into the HP 8901B or 8902A's non-volatile memory and the instrument automatically compensates for the power sensor's efficiency and mismatch loss at each frequency.

### HP 11722A Specifications

**Frequency range:** 100 kHz to 2.6 GHz.  
**Power range:** +30 dBm (1 watt) to -20 dBm (10  $\mu$ W).  
**Input SWR (Connected to an HP 8901B or 8902A):** <1.15, for RF power measurements.  
**Power sensor linearity:** +2%, -4%; +30 dBm to +20 dBm. Negligible deviation, levels <+20 dBm.  
**Calibration factors:** Each HP 11722A Sensor Module is individually calibrated. The calibration factors are printed on the HP 11722A Sensor Module for easy reference.

### Cal Factor Uncertainty

Frequency	RSS Uncertainty	Worst Case Uncertainty
0.1 MHz	0.7%	1.6%
0.3 MHz	0.7%	1.6%
1.0 MHz	0.8%	1.7%
3.0 MHz	0.8%	1.7%
10.0 MHz	0.9%	2.0%
30.0 MHz	0.9%	2.0%
50.0 MHz	0.0% (ref.)	0.0% (ref.)
100.0 MHz	1.1%	2.2%
300.0 MHz	1.1%	2.2%
1000.0 MHz	1.1%	2.2%
2600.0 MHz	1.2%	2.3%

### Ordering Information

HP 11722A Sensor Module	\$2,040
Opt 910 Additional operating and service manual	+ \$15

### Price

# SIGNAL ANALYZERS

150 kHz to 26.5 GHz

Models 8902S, 11792A, 11793A, 11794A

- RF power: digital power meter accuracy
- Tuned RF level: 0 dBm to -100 dBm dynamic range
- AM and FM: 1% accuracy, FM: 3% accuracy
- Carrier Noise (AM and phase noise measurements):  $\pm 0.5$  dB accuracy
- RF frequency: 10 Hz resolution
- Audio: frequency, level and distortion

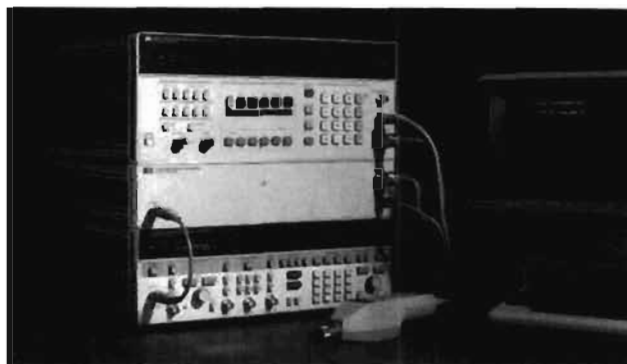

HP 8902S

## HP 8902S Measurement System

The HP 8902S Measurement System extends the superb measurement performance of the HP 8902A Measuring Receiver to microwave frequencies. The HP 8902S system delivers the accuracy and resolution of a high performance power meter at frequencies from 50 MHz to 26.5 GHz and levels from +30 dBm to -100 dBm. It accurately measures AM, FM and FM (including residuals and incidentals) with a single keystroke. Adding options 030-037 to the HP 8902A extends the system's capability to include carrier noise measurements (AM and phase noise) with  $\pm 0.5$  dB accuracy to 26.5 GHz and down to the noise floor of the system's local oscillator. The HP 8902S counts signals to 26.5 GHz with 10 Hz resolution and excellent long-term frequency stability.

The HP 8902S Measurement System consists of the HP 8902A Measuring Receiver, HP 11793A Microwave Converter, HP 11792A Sensor Module, an instrument controller, HP 11794A Software Pac and a choice of microwave local oscillators. You can choose from the HP 8671B, 8672A and 8673B/D/E Synthesized Signal Generators and the HP 8340A/B and 8341A/B Sweep Oscillators.

### Improves Quality

The HP 8902S minimizes measurement errors. The system's high performance instruments deliver superb accuracy. AM and FM,  $\pm 1\%$  level and power,  $\pm 0.02$  dB  $\pm 0.02$  dB/10 dB; and carrier frequency, 10 Hz resolution.

Special care is taken to minimize the HP 8902S's input SWR, RFI susceptibility and insertion loss. 26.5 GHz hardware and a specially-designed flexible RF input cable with extremely stable insertion loss and input SWR help make your measurements repeatable.

### Increases Confidence and Saves Time

The HP 8902S performs fast, accurate and repeatable microwave measurements traceable to the U.S. National Bureau of Standards.

Even difficult tasks such as measuring levels down to -100 dBm, residual FM down to <17 Hz and incidental FM of <0.03 radians in the presence of 50% AM, are performed in just a few seconds.

The HP 8902S can be assembled and running in minutes. For critical down-time applications, move the HP 8902S to the device-under-test and test it in place. Since the HP 8902S consists of general purpose HP-IB programmable equipment, it can also be used for other applications.

### System Software

Under the control of the HP 11794A Software Pac, the HP 8902S Measurement System functions as a single instrument. You select the frequency and measurement from the front panel of the HP 8902A.

The software then calculates and sets the local oscillator frequency, then releases the HP 8902A to make the measurement and display the results. Entering power sensor calibration factors is also fast and easy using the Cal Factor Manager function.

For automatic attenuator calibration, add the HP 11806A Attenuator Test Software and an RF or microwave source to drive the attenuator. The HP 11806A adds the efficiency and repeatability of automation to the outstanding accuracy of the HP 8902A Measuring Receiver. By entering a table of frequencies, levels and specification limits, you can test any RF or microwave attenuator - fixed, manual or programmable - quickly and accurately. Adding an SWR bridge and 50 ohm termination will allow the system to test the SWR of the DUT. Flexible system configuration, various output formats and multiple test frequencies make the HP 11806A the ideal software pac for all your attenuator calibration needs.

Add the HP 8903B Audio Analyzer and HP 11795A software pac and the system expands to become an HP 8952S RF or Microwave Signal Generator Test System. (See next page for more information on the HP 8952S.)

## HP 11793A Microwave Converter

The HP 11793A Microwave Converter down converts microwave signals to the frequency range of the HP 8902A Measuring Receiver. When you want to make a tuned RF level, modulation or frequency measurement above 1.3 GHz, the HP 11793A Microwave Converter routes the signal through its internal mixer. Below 1.3 GHz, signals are routed directly to the input of the HP 8902A.

The HP 11793A requires +8 dBm leveled output from the local oscillator. For LOs with insufficient power above 18 GHz, the HP 11793A offers an optional 18 to 26.5 GHz amplifier.

## HP 11792A Sensor Module (50 MHz to 26.5 GHz)

When used with the HP 11793A Microwave Converter, the HP 11792A Sensor Module gives you all the performance of the HP 8902S system, plus superb power measurement accuracy, at a single connector. You can characterize a signal without manually switching back and forth between the power sensor and the receiver input.

Each HP 11792A Sensor Module is individually calibrated, traceable to the U.S. National Bureau of Standards. The calibration factors are printed on the sensor module for easy reference. Enter these factors into the HP 8902A's non-volatile memory and the instrument automatically compensates for the power sensor's efficiency and mismatch loss at each frequency. The HP 11792A is available with either a 3.5 mm precision or Type-N connector.



## Microwave Measurement System, Signal Generator Test Set

Models 8902S, 8952S, 11795A

### HP 8902S Specifications

#### RF Power (with HP 11792A Sensor Module)

Range: +30 dBm (1W) to -20 dBm (10  $\mu$ W).

Frequency range: 50 MHz to 26.5 GHz.

Linearity:  $\pm 0.02$  dB (within range)  $\pm 0.02$  dB per range change from reference range  $\pm 1$  digit.

Input SWR:  $< 1.10$ ,  $f_c \leq 2.0$  GHz.

$< 1.28$ ,  $2.0$  GHz  $< f_c \leq 18$  GHz.

$< 1.40$ ,  $18.0$  GHz  $< f_c \leq 26.5$  GHz.

#### Tuned RF Level<sup>1</sup>

Frequency range<sup>2</sup>: 2.5 MHz to 26.5 GHz.

#### Range:

+10 dBm to -117 dBm,  $2.5$  MHz  $\leq f_c \leq 1300$  MHz.

0 dBm to -100 dBm,  $1300$  MHz  $< f_c \leq 18.0$  GHz.

0 dBm to -95 dBm,  $18.0$  GHz  $< f_c \leq 26.5$  GHz.

Relative accuracy:  $\pm 0.02$  dB  $\pm 0.02$  dB per 1F range change  $\pm 0.04$  dB per RF range change  $\pm 1$  digit.

#### RF Frequency

Range<sup>2</sup>: 150 kHz to 26.5 GHz.

Maximum resolution: 10 Hz.

Time base aging rate:  $< 5 \times 10^{-10}$ /day, for HP 8672A, HP 8673B/D/E;  $< 1 \times 10^{-9}$ /day, for HP 8340A, HP 8341A.

#### Amplitude Modulation

Frequency range<sup>2</sup>: 150 kHz to 26.5 GHz.

Rates: 20 Hz to 100 kHz.

Depths: to 99%.

Accuracy:  $\pm 1\%$  of reading  $\pm 1$  digit, for rates 50 Hz to 50 kHz and depths  $\geq 5\%$ .

#### Frequency Modulation

Frequency range<sup>2</sup>: 150 kHz to 26.5 GHz.

Rates: 20 Hz to 200 kHz.

Deviations: to 400 kHz.

Accuracy:  $\pm 1\%$  of reading  $\pm 1$  digit, for rates 50 Hz to 100 kHz.

#### Phase Modulation

Frequency range<sup>2</sup>: 150 kHz to 26.5 GHz.

Rates: 200 Hz to 20 kHz.

Deviations: to 400 radians.

Accuracy:  $\pm 3\%$  of reading  $\pm 1$  digit.

#### General

Temperature: Operating, 15° C to 35° C; storage, -25° C to 60° C.

Power: 100, 120, 220, or 240V (+5%, -10%); 48-66 Hz; 1300 VA maximum (worst case).

Weight: Net 122.3 kg (270 lb); shipping, 153.3 kg (338.3 lb) worst case.

#### Ordering Information

##### HP 8902S Measurement System

The HP 8902S system consists of an HP 8902A Measuring Receiver, HP 11792A Sensor Module, HP 11793A Microwave Converter, a controller, two HP 10833 HP-IB cables, three accessory cables (included with HP 11793A) and a choice of synthesized microwave local oscillators. For complete ordering information, see the "HP 8902S Measurement System Ordering Information" guide, or call your HP sales office.

HP 11794A Software Pac \$250

HP 11808A Attenuator Test Software \$2,000

##### HP 8952S Signal Generator Test System

The HP 8952S Signal Generator Test System eases your signal generator calibration workload, performing automatic performance verification for incoming inspection, maintenance, and calibration.

<sup>1</sup>An HP 11722A Sensor Module may be used with the HP 8902S to make tuned RF level measurements from 2.5 MHz to 1300 MHz at levels from 0 dBm to -127 dBm.

<sup>2</sup>Frequency range may be limited by the frequency range of the LO.

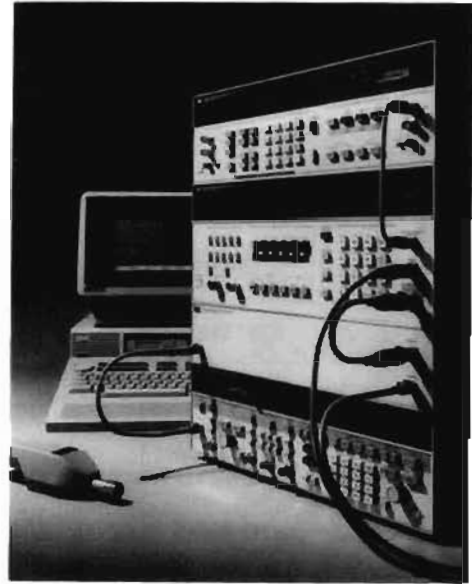

HP 8952S



The HP 8952S includes the HP 8902A Measuring Receiver, the HP 8903B Audio Analyzer, a printer, and your choice of HP 9000 controllers. Model 216S, 220S, 226S, 236S or Series 300 controller (Basic 3.0 or 4.0 operating systems). The frequency range of the HP 8952S can be extended from 1.3 GHz to 26.5 GHz by adding the HP 11792A Sensor Module, the HP 11793A Microwave Converter and a synthesized microwave signal generator. With these instruments you can perform 80% of all tests typically required to verify both RF and microwave signal generator performance.

The HP 8952S test system makes fast, accurate and repeatable measurements and provides you with a hardcopy output of the results. The system is easy to use and is easily expanded to include additional instruments.

To test your HP signal generators, select from the HP 11795A software pac series. Each software pac follows the verification procedures called out by the appropriate signal generator service manual.

The HP 11795A Performance Verification Option 209 (HP 8656B) uses either the HP 8568A/B or HP 8566A/B Spectrum Analyzer to perform harmonic, spurious and, with an HP 8952A-K01 Phase Noise Demodulator and another HP 8656B, phase noise measurements. Option 204 (HP 8640B) now uses the HP 8116A Pulse/Function Generator and HP 1980B Oscilloscope Measurement System to characterize pulse modulation. Future software pacs will use these new instruments to perform complete testing of signal generator performance.

#### Ordering Information

HP 8952A Signal Generator Test Set \$31,600

HP 11795A Signal Generator Test Software \$0

(Must order one option in addition to one disc media option)

Opt 101, User Interface \$1,030

(Required to run Performance Verification software options)

Performance Verification Options (select one or more):

204, HP 8640B Performance Verification software \$500

205, HP 8642A/B Performance Verification software \$750

208, HP 8656A Performance Verification software \$500

209, HP 8656B Performance Verification software \$500

214, HP 8662A Performance Verification software \$500

218, HP 8663A Performance Verification software \$500

317, HP 8672A Performance Verification software \$750

319, 8673A/B/C/D/E/M Performance Verification software \$1,000

# SIGNAL ANALYZERS

## Modulation Analyzer, 150 kHz to 1300 MHz

### Models 8901A, 8901B

- Measures AM and FM to 1% accuracy
- Measures RF frequency
- Measures RF Power

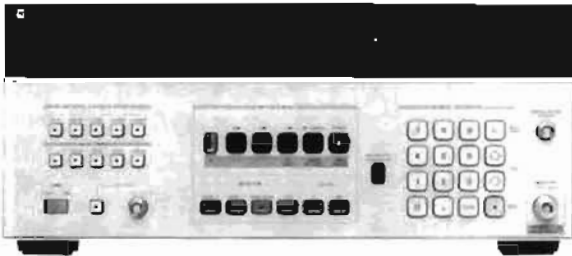

HP 8901A

- Low Internal noise
- Completely automatic

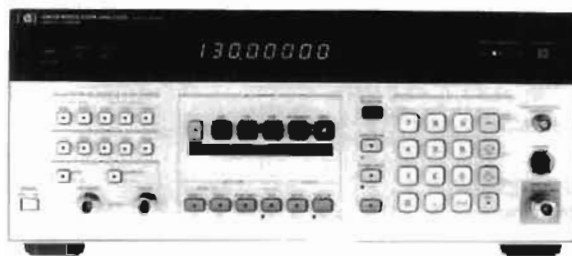

HP 8901B

### HP 8901A and HP 8901B Modulation Analyzers

The HP 8901A and HP 8901B modulation analyzers combine the capabilities of several RF instruments to give complete, accurate characterization of modulated signals in the 150 kHz to 1300 MHz frequency range. Both instruments very accurately measure modulation and recover the modulation signal. They determine RF frequency and measure RF power. The major additional capabilities of the HP 8901B are its improved power meter accuracy, its ability to use external power sensors, to make adjacent channel power measurements or carrier noise measurements (with options 030-037) and its ability to count audio frequencies and measure distortion on 400 Hz and 1 kHz signals. Both instruments are fully automatic and make all major measurements with the push of a key or under HP-IB control.

#### Modulation Measurement Accuracy

Very accurate modulation measurements along with very low internal noise enable the HP 8901A/B to characterize even high performance signal sources. Their detection systems are configured for wideband recovery of the entire modulation spectrum so that highly precise measurements such as signal-to-noise or distortion can be made on the modulation signal. Modulation depth and deviation accuracy is generally  $\pm 1\%$  of reading. Residual AM noise in a 50 Hz to 3 kHz bandwidth is  $< 0.01\%$  while FM noise is  $< 8$  Hz for 1300 MHz carrier frequencies, decreasing linearly to  $< 1$  Hz below 100 MHz. Because the AM and FM demodulators are independent and highly insensitive to each other and because the analyzer has very low residual AM and FM, accurate incidental AM and FM measurements can be made.

Three detectors are available for depth and deviation measurements: positive peak, negative peak, and an average-responding detector with rms (sinewave) calibration. A PEAK HOLD function captures and displays the maximum peak modulation of a signal and is ideal for making transient measurements such as modulation limiting on mobile radios. The HP 8901B also has a true rms detector and the ability to measure peak to peak divided by two.

For measuring convenience, two high-pass (50 Hz and 300 Hz) and three low-pass (3 kHz, 5 kHz and  $> 20$  kHz) post-detection filters are included for filtering the recovered modulation. The  $> 20$  kHz Bessel filter minimizes overshoot on square-wave modulation. This allows accurate measurement of signals which are digitally modulated, such as FSK. Four de-emphasis networks commonly used in FM systems (25, 50, 75, and 750  $\mu$ s) are also provided.

A modulation output provides calibrated signal levels relative to the displayed modulation reading. The HP 8901B can make measurements on this demodulated signal such as frequency and distortion level.

Modulation calibrators (standard on the HP 8901B, Option 010 on the HP 8901A) provide two precision modulation standards. One is an amplitude modulated signal whose depth is calibrated to better than 0.1% accuracy. The second standard is a frequency modulated signal with peak deviation calibrated to 0.1% accuracy. The HP 11715A AM/FM Test Source is necessary to fully test and calibrate other modulation parameters.

#### Frequency Measurements

The HP 8901A/B modulation analyzers are more than just high quality modulation meters. They also perform as frequency counters. Resolution for the HP 8901A's 150 kHz to 1300 MHz frequency counter is 10 Hz below 1000 MHz, and 100 Hz above 1000 MHz. Resolution is 1 Hz for the HP 8901B. Sensitivity is  $-25$  dBm (12 mV rms) below 650 MHz, and  $-20$  dBm (22 mV rms) above 650 MHz. The standard instrument's time base stability is  $1 \times 10^{-6}$ /month, or an optional time base is available with  $1 \times 10^{-9}$ /day stability.

#### RF Power Measurements

The HP 8901A uses a diode detection circuit to measure RF input power. This technique measures peak voltage and is calibrated from 1 mW to 1 W for sinewave inputs. The RF level measurement accuracy is  $\pm 1.5$  dB from 150 MHz to 1300 MHz.

The HP 8901B delivers the accuracy and resolution of a high performance power meter. The HP 8901B, with the HP 11722A Sensor Module, measures power from  $+30$  dBm to  $-20$  dBm at frequencies from 100 kHz to 2.6 GHz. The HP 8901B also accepts all HP 8480 series power sensors for extended measurement capability.

#### Adjacent Channel Power and Direct Spectrum Noise Measurements

The HP 8901B offers optional selective power measurement capability (options 030-037). With this capability you can quickly and accurately make adjacent channel power measurements to CEPT standards. The HP 8901B provides a choice of selectable filters for testing transceivers with 12.5, 25 and 30 kHz channel spacings.

To meet the CEPT standard at frequencies greater than 300 MHz, the HP 8901B requires an external local oscillator (LO) such as the HP 8656B Synthesized Signal Generator. Dedicating a signal generator as the external LO is not necessary. When not being used as the LO, a built-in RF switch in the HP 8901B routes the signal generator's output out the back panel.

Used with a low-phase-noise external LO, the HP 8901B also makes single-sideband (SSB) noise measurements to 1.3 GHz. To make the noise measurement, you just select the carrier noise filter and the frequency offset from the carrier (5 kHz to 1300 MHz). The HP 8901B then makes a selective power measurement (2.5 kHz BW) and converts the power to a 1 Hz bandwidth. The noise floor of the HP 8901B is  $-150$  dBc/Hz. The HP 8901B's measurement accuracy is better than  $\pm 0.5$  dB down to  $-139$  dBc.

Phase noise usually dominates the carrier-noise measurement at most offsets of interest, so direct-spectrum noise measurements provide a convenient and simple way to measure phase noise of many sources. Adding the HP 11793A Microwave Converter and a low-phase-noise microwave source such as the HP 8673B Synthesized Signal Generator extends this measurement to 26.5 GHz.

### HP 8901A and HP 8901B Specifications

#### RF Input

Frequency range: 150 kHz to 1300 MHz

#### Operating level:

12 mVrms to 7 Vrms, 150 kHz to 650 MHz.  
22 mVrms to 7 Vrms, 650 MHz to 1300 MHz.

Input impedance: 50Ω nominal.

Tuning: manual frequency entry, automatic, or track (frequencies >10 MHz only).

Acquisition time (automatic operation): ~1.5 seconds.

Maximum safe input level (typical): 35 Vrms (25W for source SWR <4), ac; 40V, dc.

#### Frequency Modulation

##### Rates:

20 Hz to 10 kHz, 150 MHz to 10 MHz.  
20 Hz to 200 kHz, 10 MHz to 1300 MHz.  
20 Hz to 20 kHz with 750 μs filter, 10 MHz to 1300 MHz.

##### Deviations:

40 kHz peak maximum, 150 kHz to 10 MHz.  
400 kHz peak maximum, 10 MHz to 1300 MHz.  
40 kHz peak maximum with 750 μs filter, 10 MHz to 1300 MHz.

##### Accuracy<sup>1,2</sup>:

±2% of reading ±1 digit, 20 Hz to 10 kHz rates, 250 kHz to 10 MHz.  
±1% of reading ±1 digit, 50 Hz to 100 kHz rates; ±5% of reading ±1 digit, 20 Hz to 200 kHz rates, 10 MHz to 1300 MHz.

##### Demodulated output distortion<sup>3</sup>:

<0.1% THD, deviations <10 kHz, 400 kHz to 10 MHz.  
<0.1% THD, rates and deviations <100 kHz, 10 MHz to 1300 MHz.

AM rejection (for 50% AM at 400 Hz and 1 kHz rates)<sup>1</sup>: <20 Hz peak deviation measured in a 50 Hz to 3 kHz BW.

Residual FM (50 Hz to 3 kHz BW): <8 Hz rms @ 1300 MHz, decreasing linearly with frequency to <1 Hz rms for 100 MHz and below.

##### Maximum deviation resolution:

0.1 Hz (rms detector on HP 8901B only), <4 kHz peak deviation.  
1 Hz, <4 kHz peak deviation.  
10 Hz, 4 kHz to 40 kHz peak deviation.  
100 Hz, 40 kHz to 400 kHz peak deviation.  
Resolution is increased one digit with 750 μs de-emphasis and pre-display "on" and with rms detector.

Stereo separation (50 Hz to 15 kHz): >47 dB typical.

#### Phase Modulation

Carrier frequency: 10 MHz to 1300 MHz.

Rates: 200 Hz to 20 kHz; typically usable from 20 Hz to 100 kHz with degraded performance.

Deviation and maximum resolution:

Accuracy<sup>1</sup>: ±3% of reading ±1 digit.

Demodulated output distortion: <0.1% THD.

AM rejection (for 50% AM at 1 kHz rate)<sup>1</sup>: <0.03 radian peak deviation (50 Hz to 3 kHz BW).

#### Amplitude Modulation

##### Rates:

20 Hz to 10 kHz, 150 kHz to 10 MHz.  
20 Hz to 100 kHz, 10 MHz to 1300 MHz.

Depth: to 99%.

##### Accuracy<sup>1,2,4</sup>:

±2% of reading ±1 digit, 50 Hz to 10 kHz rates, >5% depth; ±3% of reading ±1 digit, 20 Hz to 10 kHz rates, 150 kHz to 10 MHz.

±1% of reading ±1 digit, 50 Hz to 50 kHz rates, >5% depth; ±3% of reading ±1 digit, 20 Hz to 100 kHz rates, 10 MHz to 1300 MHz.

Flatness (variation in indicated AM depth for constant depth on input signal): ±0.3% of reading ±1 digit, 90 Hz to 10 kHz rates, 20% to 80% depth, 10 MHz to 1300 MHz.

Demodulated output distortion: <0.3% THD for ≤50% depth; <0.6% THD for >50% depth.

FM Rejection (at 400 Hz and 1 kHz rates, 50 Hz to 3 kHz BW)<sup>1</sup>:

<0.2% AM for <5 kHz peak deviation, 250 kHz to 10 MHz.

<0.2% AM for <50 kHz peak deviation, 10 MHz to 1300 MHz.

Residual AM (50 Hz to 3 kHz BW): <0.01% rms.

##### Maximum Depth Resolution:

0.01% for depths ≤39.99%; 0.1% for depths ≥40%. Resolution increases 1 digit with rms detector (HP 8901B only).

#### Frequency Counter

Range: 150 kHz-1300 MHz.

Accuracy: ±3 counts of least significant digit ± reference accuracy.

##### Internal Reference:

Frequency: 10 MHz.

Aging rate: <1x10<sup>-6</sup>/month (optional<sup>5</sup>); 1x10<sup>-9</sup>/day).

##### Maximum resolution:

HP 8901A: 10 Hz for frequencies <1 GHz; 100 Hz for frequencies ≥1 GHz.

HP 8901B: 1 Hz.

#### HP 8901A RF Level (Peak Voltage Responding, RMS Sine Wave Power Calibrated)

Range: 1 mW to 1W.

Instrumentation accuracy: ±1.5 dB (150 kHz to 1300 MHz); 0.7 dB typical.

SWR: ≤1.3, 150kHz to 650 MHz; ≤1.5, 650 MHz to 1300 MHz.

Resolution: 0.1 mW for levels 0.1W to 1W; 0.01 mW for levels 0.01W to 0.1W; 0.001 mW for levels <0.01W.

#### HP 8901B RF Level (True RMS)

Frequency range with HP 11722A: 100 kHz to 2.6 GHz.

Power range: -20 dBm to +30 dBm.

RF range linearity (using recorder output):

±0.02 dB, RF ranges 2 - 5.

±0.03 dB, RF range 1.

Using front-panel display, add ±1 count of least-significant digit.

##### RF range-to-range change error:

±0.02 dB/RF range change from reference range.

input SWR: <1.15, using HP 11722A Sensor Module.

##### Zero set (digital settability of zero):

±0.07% of full scale on lowest range.

Decrease by a factor of 10 for each high range.

##### RF power resolution:

0.1% of full scale in watts or volts mode.

0.01 in dBm or dB relative mode.

<sup>1</sup> Peak residuals must be accounted for in peak readings.

<sup>2</sup> But not to exceed 50 Hz to 40 kHz rates for stated accuracy with rms detector (HP 8901B only).

<sup>3</sup> With 750 μs de-emphasis and pre-display "off", distortion is not specified for modulation outputs >4V peak. This can occur near maximum deviation for a measurement range at rates <2 kHz.

<sup>4</sup> For peak measurements only, AM accuracy may be affected by distortion generated by the Modulation Analyzer. In the worst case, this can decrease accuracy by 0.1% of reading for each 0.1% of distortion.

<sup>5</sup> After 30 day warm-up.

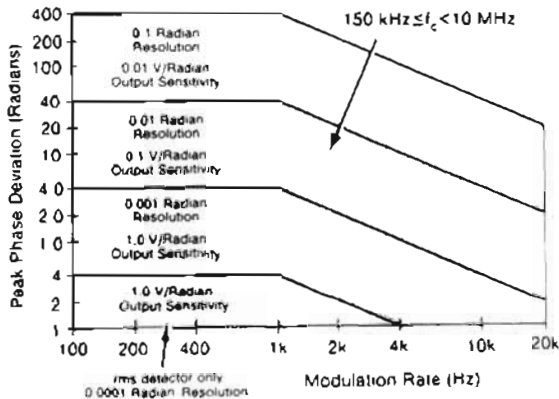

# SIGNAL ANALYZERS

**Modulation Analyzer, 150 kHz to 1300 MHz; AM/FM Test Source**  
**Models 8901A, 8901B, 11715A**

## HP 8901B Selective Power Measurements (options 030-037)

**Frequency range:** 10 MHz to 1.3 GHz.

**Carrier power range:** +30 dBm to -20 dBm, 12.5, 25 and 30 kHz filters; +30 dBm to -10 dBm, Carrier Noise Filter.

**Dynamic range:** 115 dB.

**Carrier rejection (temp.  $\leq 35^\circ\text{C}$ ):** >90 dB, for offsets  $\geq 1$  channel spacing or 5 kHz, whichever is larger.

**Relative accuracy:**  $\pm 0.5$  dB, levels  $\geq -95$  dBc or levels  $\geq -129$  dBc/Hz.

**Filter bandwidths:**

2.5 kHz, Carrier Noise Filter

8.5 kHz, 12.5 kHz Filter

16.0 kHz, 25 kHz Filter

30.0 kHz, Cellular Radio Filter

## Power Reference

**Power output:** 1.00 mW. Factory set to  $\pm 0.7\%$ . Tracable to the U.S. National Bureau of Standards.

**Accuracy:**  $\pm 1.2\%$  worst case ( $\pm 0.9\%$  rss) for one year ( $0^\circ\text{C}$  to  $55^\circ\text{C}$ ).

## Audio Filters

**High pass (3 dB cutoff frequency):** 50 Hz and 300 Hz

**Low pass (3 dB cutoff frequency except >20 kHz filter):** 3 kHz, 15 kHz, >20 kHz.

**De-emphasis filters:** 25  $\mu\text{s}$ , 50  $\mu\text{s}$ , 75  $\mu\text{s}$ , and 750  $\mu\text{s}$ .

## Calibrators (Standard HP 8901B, Option 010 HP 8901A)

**AM calibrator depth and accuracy:** 33.33% depth, nominal; internally calibrated to an accuracy of  $\pm 0.1\%$ .

**FM calibrator deviation and accuracy:** 34 kHz peak deviation, nominal; internally calibrated to an accuracy of  $\pm 0.1\%$ .

## General Characteristics

**Operating temperature range:**  $0^\circ$  to  $55^\circ\text{C}$ .

**Power requirements:** 100, 120, 220, or 240V (+5, -10%); 48-66 Hz; 200 VA max.

**Weight:** HP 8901A—net 20 kg (44 lb), shipping 25 kg (55 lb); HP 8901B—net 23 kg (52 lb), shipping 31 kg (69 lb).

**Size:** HP 8901A, 190 mm H x 425 mm W x 468 mm D (7.5 in. x 16.8 in. x 18.4 in.); HP 8901B, 190 mm H x 425 mm W x 551 mm D (7.5 in. x 16.8 in. x 21.7 in.).

## Ordering Information

### HP 8901A Modulation Analyzer

Opt 001 RF connectors on rear panel only +\$105

Opt 002  $1 \times 10^{-9}$ /day internal reference +\$765

Opt 003 Connections for external local oscillator +\$410

Opt 004 Operation from 48 to 440 Hz power (Temp.  $< 40^\circ\text{C}$ ) +\$280

Opt 010 AM and FM calibrators +\$635

### HP 8901B Modulation Analyzer

Opt 001 RF connectors on rear panel only +\$205

Opt 002  $1 \times 10^{-9}$ /day internal reference +\$765

Opt 003 Connections for external local oscillator +\$400

Opt 004 Operation from 48 to 440 Hz power (Temp.  $< 40^\circ\text{C}$ ) +\$275

Opt 021 Add 11722 Sensor Module +\$2,040

Opt 030 High selectivity (select only 2 filter options) +\$2,450  
 (Options 032-037 require Option 030; Option 030 includes Option 003 connections for external local oscillators.)

Opt 032 12.5 kHz filter \$0

Opt 033 20.0/25.0 kHz filter \$0

Opt 035 Cellular Radio Filter \$0

Opt 037 Carrier Noise Filter \$0

## Price

\$9,600

+\$105

+\$765

+\$410

+\$280

+\$635

\$13,560

+\$205

+\$765

+\$400

+\$275

+\$2,040

+\$2,450

\$0

\$0

\$0

\$0

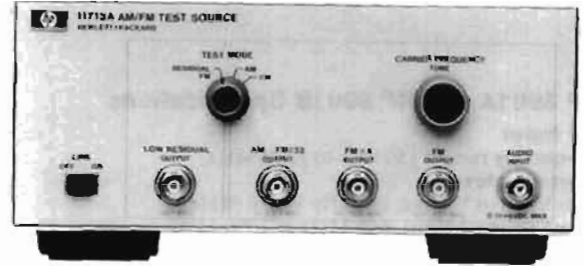

HP 11715A

## HP 11715A AM/FM Test Source

The HP 11715A AM/FM Test Source provides very flat, wide-bandwidth, and low distortion amplitude or frequency modulated RF signals. Designed primarily for performance tests and adjustments of the HP 8901A/B Modulation Analyzer and HP 8902A Measuring Receiver, it will also serve as a high quality modulated test oscillator where its frequency ranges apply.

The major components of the HP 11715A are a low-noise voltage controlled oscillator (VCO), two digital dividers, and a double-balanced mixer. The VCO is the primary signal source, with a typical frequency range of 330 to 470 MHz at the FM OUTPUT. FM is produced by directly coupling the external modulation source to the VCO's tune input, providing very wide bandwidth modulation with low phase shift. This design also ensures very little incidental AM.

The HP 11715A can also be used in conjunction with an HP 8901A/B and an HP 8902A as a calibrated signal source for special applications. In particular, the U.S. commercial FM broadcast band of 88 to 108 MHz is covered by the FM  $\div 4$  OUTPUT of the HP 11715A.

## HP 11715A Specifications

### FM Outputs

#### Frequency Range:

11 to 13.5 MHz, AM FM  $\div 32$  output.

88 to 108 MHz, FM  $\div 4$  output.

352 to 432 MHz, FM output.

#### Peak Deviation:

> 12.5 kHz, 11 to 13.5 MHz carrier.

> 100 kHz, 88 to 108 MHz carrier.

> 400 kHz, 352 to 432 MHz carrier.

#### Distortion:

$< 0.025\%$  THD ( $< -72$  dB) for

Carrier frequency	Peak deviation	Modulation rate
12.5 MHz	12.5 kHz	$< 10$ kHz
100 MHz	100 kHz	$< 100$ kHz
400 MHz	400 kHz	$< 100$ kHz

### Flatness:

$\pm 0.1\%$ , dc to 100 kHz rates.

$\pm 0.25\%$ , dc to 200 kHz rates.

**Stereo separation (88 to 108 MHz carrier, 75 kHz peak deviation, 1 kHz rate):** >60 dB typical.

### AM Output

**Frequency range (AM FM  $\div 32$  output):** 11 to 13.5 MHz.

**Depth:** to 99%.

#### Distortion:

$< 0.05\%$  THD ( $< -66$  dB), 50% AM, 20 Hz to 100 kHz rates.

$< 0.1\%$  THD ( $< -60$  dB), 95% AM, 20 Hz to 100 kHz rates.

**Flatness:**  $\pm 0.1\%$ , 50 Hz to 50 kHz rates;

$\pm 0.25\%$ , 20 Hz to 100 kHz rates.

**Linearity:**  $\pm 0.1\%$ ,  $< 95\%$  AM;  $\pm 0.2\%$ ,  $< 99\%$ .

## Ordering Information

HP 11715A AM/FM Test Source

## Price

\$2,550

## Audio Analyzer, 20 Hz to 100 kHz; Distortion Analyzer, 20 Hz to 100 kHz

Models 8903B, 8903E

- Measures distortion, SINAD, signal-to-noise
- Measures true-RMS ac volts, dc volts, frequency
- Low-distortion programmable source
- RMS, average and quasi-peak detection

- Measures distortion, SINAD
- Measures true-RMS ac volts, dc volts, frequency
- RMS, average and quasi-peak detection

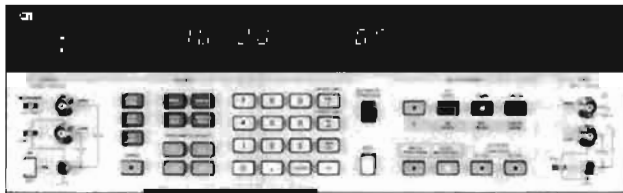

HP 8903B



HP 8903E

### HP 8903B Audio Analyzer and HP 8903E Distortion Analyzer

The HP 8903B Audio Analyzer and HP 8903E Distortion Analyzer provide unparalleled versatility and performance for audio measurements from 20 Hz to 100 kHz. The HP 8903B combines the functionality of a low-distortion audio source, high-performance distortion analyzer, frequency counter, ac voltmeter, dc voltmeter and SINAD meter into one compact package. With microprocessor control of source and analyzer, the HP 8903B can perform stimulus-response measurements, such as signal-to-noise ratio and swept distortion, automatically with no additional equipment. The HP 8903E Distortion Analyzer is the analyzer portion of the HP 8903B Audio Analyzer. (The HP 8903E has no source.)

For ease of use, most measurements on the HP 8903B and HP 8903E are made with only one or two keystrokes. Both instruments automatically tune and autorange for maximum accuracy and resolution. For quick identification of input signals, the analyzer counts and displays the input frequency in all ac measurement modes.

### Low Frequency Applications

The HP 8903B/E have many features which make difficult audio measurements easy. These include flexible data display formats, a selectable balanced or unbalanced input, plug-in filters, and automatic notch filter tuning. With the ratio key, you can establish a reference in % or dB and directly make frequency response and 3 dB bandwidth measurements without computation. A fully balanced analyzer input allows testing of bridged power amplifiers found in many radios and car stereos as well as professional balanced audio equipment.

With two internal plug-in filter slots and six optional filters to choose from, we simplify your audio measurements by providing the filter networks required by international standards. (See the next page for a complete list of filters.) The HP 8903B and HP 8903E both use true-RMS detection (for all signals with crest factor 3) for accurate measurement of complex waveforms and noise. Average and quasi-peak detectors are also available. (Quasi-peak is selectable only via HP-IB on the HP 8903E.) Accurate distortion measurements typically can be made down to less than  $-90$  dB (0.003%) from 20 Hz to 20 kHz.

For receiver testing, both instruments have a tunable SINAD notch filter. On the HP 8903B, the filter is automatically tuned to the source frequency. With the HP 8903E, a front-panel key allows the operator to lock the notch filter at any given input frequency.

### HP 8903B and HP 8903E Specifications

#### System Specifications

(HP 8903B only, source and analyzer combined)

#### Distortion

**Residual Distortion and Noise** (the higher of):

**80 kHz BW:**  $-80$  dB (0.01%) or  $17 \mu\text{V}$ , 20 Hz to 20 kHz.

**500 kHz BW:**  $-70$  dB (0.032%) or  $50 \mu\text{V}$ , 20 Hz to 50 kHz.

$-65$  dB (0.056%) or  $50 \mu\text{V}$ , 50 kHz to 100 kHz.

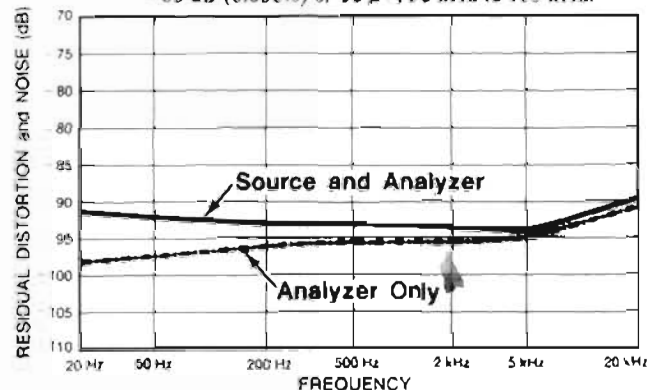

Typical residual THD + noise of source and analyzer combined (source voltage set to 1.5V, 80 kHz BW). Dashed line represents typical residual THD + noise for the analyzer only.

#### Signal-to-Noise

**Frequency range:** 50 Hz to 100 kHz.

**Display range:** 0 to 99.99 dB.

**Accuracy:**  $\pm 1$  dB.

**Input voltage range:** 50 mV to 300V.

**Residual noise (the higher of):**  $-85$  dB or  $17 \mu\text{V}$ , 80 kHz BW.  $-70$  dB or  $50 \mu\text{V}$ , 500 kHz BW.

#### Source Specifications (HP 8903B only)

##### Frequency

**Range:** 20 Hz to 100 kHz.

**Resolution:** 0.3%.

**Accuracy:** 0.3% of setting.

##### Output Level

**Range:** 0.6 mV to 6V open circuit.

**Resolution:** 0.3% or better.

**Accuracy (open circuit):** 2% of setting 60 mV to 6V, 20 Hz to 50 kHz; 3% of setting 6 mV to 6V, 20 Hz to 100 kHz; 5% of setting 0.6 mV to 6 mV, 20 Hz to 100 kHz.

# SIGNAL ANALYZERS

## Audio Analyzer, 20 Hz to 100 kHz; Distortion Analyzer, 20 Hz to 100 kHz (cont'd)

Models 8903B, 8903E

**Flatness (1 kHz reference):**  $\pm 0.7\%$  ( $\pm 0.06$  dB), 20 Hz to 20 kHz;  
 $\pm 2.5\%$  ( $\pm 0.22$  dB), 20 Hz to 100 kHz.

**Distortion and noise (the higher of):**

**80 kHz BW:** -80 dB (0.01%) or 15  $\mu$ V, 20 Hz to 20 kHz.

**500 kHz BW:** -70 dB (0.032%) or 38  $\mu$ V, 20 Hz to 50 kHz.  
-65 dB (0.056%) or 38  $\mu$ V, 50 kHz to 100 kHz.

**Impedance:** 600 $\Omega$   $\pm 1\%$  or 50 $\Omega$   $\pm 2\%$ , Front panel selectable. (HP-IB programmable.)

**Sweep mode:** log sweep with up to 500 points per decade or 255 points total between entered start and stop frequencies.

### HP 8903B and HP 8903E

#### Analyzer Specifications

##### Distortion

**Fundamental frequency range:** 20 Hz to 100 kHz.

**Display range:** 0.001% to 100% (-99.99 to 0 dB).

**Accuracy:**  $\pm 1$  dB, 20 Hz to 20 kHz;  $\pm 2$  dB, 20 kHz to 100 kHz.

**Input voltage range:** 50 mV to 300V.

**Residual distortion and noise (the higher of):**

**80 kHz BW:** -80 dB (0.01%) or 15  $\mu$ V, 20 Hz to 20 kHz.

**500 kHz BW:** -70 dB (0.032%) or 45  $\mu$ V, 20 Hz to 50 kHz.  
-65 dB (0.056%) or 45  $\mu$ V, 50 kHz to 100 kHz.

##### Supplemental Characteristics

**3 dB measurement bandwidth:** 10 Hz to 500 kHz.

**Detection:** true rms or rms calibrated average.

##### SINAD

**Fundamental frequency range:** 20 Hz to 100 kHz.

**Display range:** 0 to 99.99 dB.

**Residual distortion and noise:** same as listed under Distortion.

**Accuracy:**  $\pm 1$  dB, 20 Hz to 20 kHz;  $\pm 2$  dB, 20 kHz to 100 kHz.

**Input voltage range:** 50 mV to 300V.

##### Supplemental Characteristics

**Detection:** true rms or rms-calibrated average.

**Tuning:** HP 8903B: notch filter is tuned to the internal source frequency. HP 8903E: notch filter is tuned to the counted input frequency. Notch filter hold function available on front panel.

##### AC Level

**Full range display:** 300.0V, 30.00V, 3.000V, .3000V, 30.00 mV, 3.000 mV, 0.3000 mV.

**Overrange:** 33%, except on 300V range.

**Accuracy:**  $\pm 2\%$ , 50 mV to 300V, 20 Hz to 20 kHz;  $\pm 4\%$ , 0.3 mV to 50 mV, 20 Hz to 100 kHz;  $\pm 4\%$ , 50 mV to 300V, 20 kHz to 100 kHz.

##### Supplemental Characteristics

**AC converter:** true-rms responding for signals with crest factor up to 3, rms-calibrated average detection and quasi-peak.

**3 dB measurement bandwidth:** > 500 kHz.

##### DC Level

**Full range display:** 300.0V, 48.00V, 16.00V, 4.000V.

**Overrange:** 33%, except on 300V range.

**Accuracy:**  $\pm 1.0\%$  of reading, 600 mV to 300V.  
 $\pm 6$  mV,  $V_{in} < 600$  mV.

##### Frequency Measurement

**Measurement range:** 20 Hz to 150 kHz. (20 Hz to 100 kHz in distortion and SINAD modes.)

**Resolution:** 5 digits (0.01 Hz for input frequencies < 100 Hz).

**Accuracy:**  $\pm (0.004\% + 1$  digit).

**Sensitivity:** 50 mV in distortion and SINAD modes, 5.0 mV in ac level and signal-to-noise (HP 8903B only) modes.

##### Standard Audio Filters

###### 30 kHz Low-Pass Filter

**3 dB cutoff frequency:** 30 kHz  $\pm 2$  kHz.

**Rolloff:** third-order Butterworth: 18 dB/octave or 60 dB/decade.

###### 80 kHz Low-Pass Filter

**3 dB cutoff frequency:** 80 kHz  $\pm 4$  kHz.

**Rolloff:** third-order Butterworth: 18 dB/octave or 60 dB/decade.

##### Internal Plug-in Filter Options

Both the HP 8903B and HP 8903E have TWO internal plug-in filter slots, each of which will accept one of six optional filters. The standard HP 8903B and HP 8903E come with 30 kHz and 80 kHz low-pass filters, but with NO PLUG-IN FILTERS. The appropriate filter options must be ORDERED for the analyzers to have any of the filters listed below. Each filter option has TWO option numbers: the 010 series for the left filter slot and the 050 series for the right filter slot. Each filter option ordered (maximum of two) adds additional cost to the instrument.

Filters	Option Numbers Filter Position	
	Left Slot	Right slot
400 Hz High-Pass	010	050
CCITT Weighting Filter	011	051
CCIR Weighting Filter	012	052
C-MESSAGE Weighting Filter	013	053
CCIR/ARM Weighting Filter	014	054
"A" Weighting Filter	015	055

##### Analyzer Input

**Input type:** Balanced (full differential).

**Input impedance:** 100 k $\Omega$   $\pm 1\%$  shunted by < 300 pF, each side to ground. (In dc-level mode the input resistance is 101 k $\Omega$   $\pm 1\%$ ).

**Max input (maximum peak input voltage, any combination of ac/dc):**

**HP 8903B:** 425 volts peak, applied differentially or between either input to ground.

**HP 8903E:** 42 volts peak, Low side to ground.

425 volts peak, differentially or High side to ground.

**CMRR:** > 60 dB, 20 Hz to 1 kHz,  $V_{in} < 2V$ ; > 45 dB, 20 Hz to 1 kHz;  
> 30 dB, 20 Hz to 20 kHz.

##### General

**Temperature:** operating, 0°C to 55°C; storage, -55°C to 75°C.

**Power:** 100, 120, 220, or 240V (+5, -10%); 48-66 Hz, 100 or 120V +5, -10%; 48-440 Hz, 100 VA maximum.

**Weight:** HP 8903B: net 12.3 kg (27 lb.); shipping 16.4 kg (36 lb.) HP 8903E: net 11.8 kg (26 lb.); shipping 15.9 kg (35 lb.)

**Dimensions:** 146 mm H x 425 mm W x 462 mm D. (5.75 x 16.8 x 18.2 in.)

##### Ordering Information

###### Analyzer Mainframes

HP 8903B Audio Analyzer \$5900.00

**Opt 001** moves OUTPUT and INPUT + \$100.00

connectors to rear panel

**Opt 915** add service manual + \$34.00

**Opt 910** Additional operating and service manual + \$50.00

HP 8903E Distortion Analyzer \$4040.00

**Opt 001** moves OUTPUT and INPUT + \$200.00

connectors to rear panel

**Opt 915** add service manual + \$34.00

**Opt 910** Additional operating and service manual + \$50.00

###### Options for both HP 8903B and HP 8903E

**Opt 010 or 050** 400 Hz High-Pass filter + \$205.00

**Opt 011 or 051** CCITT Weighting filter + \$205.00

**Opt 012 or 052** CCIR Weighting filter + \$205.00

**Opt 013 or 053** C-Message Weighting filter + \$205.00

**Opt 014 or 054** CCIR/ARM Weighting filter + \$205.00

**Opt 015 or 055** "A" Weighting filter + \$205.00

**Opt 907** front panel handle kit + \$55.00

**Opt 908** rack mounting flange kit + \$32.50

**Opt 909** front panel handle plus rack flange kit + \$80.00

- Ultra low distortion measurements
- Built-in low distortion oscillator
- Automatic
- True RMS detection



HP 339A

## Description

Hewlett-Packard's Model 339A Distortion Measurement Set is an ultra low distortion measuring system complete with total harmonic distortion (THD) analyzer, true-rms voltmeter, and sinewave oscillator. This small, lightweight bench measurement set allows you to make THD distortion measurements as low as 0.0018% over a 10 Hz to 110 kHz frequency band including harmonics to 330 kHz.

For fast and easy THD measurements the built-in tracking oscillator in HP's 339A saves test time because you tune one instrument instead of two. Frequency and level measurements are easy to do with HP's 339A's voltmeter, which offers you a 1 mV to 300 V measurement range. The Relative Level mode has been included to further simplify frequency response measurements. Just set a 0 dBm reference at any frequency from 10 Hz to 110 kHz. Gain measurements can be read directly from the easy-to-read meter.

## Operation Simplicity

Automatic frequency tuning and set-level features allow you to make rapid, error free THD measurements. The HP 339A's built-in tracking oscillator eliminates the need to find the fundamental frequency and tune the analyzer for a null. Just select your oscillator frequency and the rest is automatic. Automatic set-level saves time by automatically setting 0 dB (100%) reference in the distortion measuring mode. Front panel directional indicators light when the input range setting is improper insuring accurate and repeatable measurements. Automatic set-level also greatly simplifies measurements where distortion as a function of level (SINAD<sup>1</sup>, for example) is desired. Without this feature, measurements are very time consuming and tedious.

When an external stimulus is used, analyzer tuning is simplified by directional indicator lights for reaching the fundamental null quickly and easily.

<sup>1</sup>SINAD is a sensitivity measurement computed from the ratio of signal plus noise and distortion to noise and distortion.

## Specifications

### Distortion

**Fundamental frequency range:** 10 Hz to 110 kHz continuous frequency coverage in 4 decade ranges with 2-digit resolution. Distortion analyzer and oscillator are simultaneously tuned.

**Distortion measurement range:** 0.01% full scale to 100% full scale (-80 dB to 0 dB) in 9 ranges.

**Detection and meter indication:** true rms detection for waveforms with crest factor  $\leq 3$ . Meter reads dB and % THD (Total Harmonic Distortion). Meter response can be changed from NORMAL to VU ballistics with a front panel switch.

### Distortion Measurement Accuracy

20 Hz to 20 kHz:  $\pm 1$  dB

10 Hz to 50 kHz: +1, -2 dB

50 kHz to 110 kHz: +1.5, -4 dB

**Note:** the above specifications apply for harmonics  $\leq 330$  kHz.

### Fundamental Rejection (3 V scale or above)

10 Hz to 20 kHz: > 100 dB

20 kHz to 50 kHz: > 90 dB

50 kHz to 110 kHz: > 83 dB

### Distortion Introduced by Instrument (Input > 1V rms)

10 Hz to 10 kHz: < -95 dB (0.0018%) THD

10 kHz to 20 kHz: < -92 dB (0.0035%) THD

20 kHz to 30 kHz: < -90 dB (0.0056%) THD

30 kHz to 50 kHz: < -85 dB (0.01%) THD

50 kHz to 110 kHz: < -70 dB (0.032%) THD

**Residual noise** (fundamental frequency settings < 20 kHz, 80 kHz filter IN, source resistance  $\leq 1$  k $\Omega$  shielded): < -92 dB referenced to 1V.

**Input level for distortion measurements:** 30 mV to 300 V rms (100 mV range minimum).

**Input impedance:** 100 k $\Omega$   $\pm$  1% shunted by < 100 pF input High to Low.

**Monitor:** provides scaled presentation of input signal after fundamental is removed for further analysis using oscilloscope or low frequency spectrum analyzer. Output voltage: 1V rms  $\pm$  5% open circuit for full scale meter indication, proportional to meter deflection. Output resistance: 1k $\Omega$   $\pm$  5%.

**Auto set level:** no set level adjustment required. Distortion measurements are made directly over 10 dB range selected by input range switch. Two LED annunciators provide a fast visual indication to change input range for valid distortion measurement. Correct range is indicated when both annunciators are extinguished.

**Automatic fine tuning:** using internal oscillator: No separate analyzer tuning necessary when using internal oscillator as signal source. Oscillator frequency controls simultaneously tune the analyzer. Using external frequency source: Two LED annunciators provide a quick visual indication for the operator to increase or decrease the frequency. When the analyzer is rough tuned to within one least significant digit of the fundamental frequency, the indicator lights are extinguished and the HP 339A auto-null circuitry takes over to provide a fast, accurate null without tedious operator tuning.

**Input filters (usable on all functions):** low pass: 30 kHz -3 dB point at 30 kHz, + 2.6 kHz, -3 kHz with 60 dB/decade rolloff. Provides band limiting required by FCC for proof-of-performance broadcast testing. 80 kHz -3 dB point at 80 kHz, + 7 kHz, -7.9 kHz with 60 dB/decade rolloff. Normally used with fundamental frequencies < 20 kHz to reduce the effect of higher frequency noise present in the measured signal. High Pass: 400 Hz -3 dB point at 400 Hz, + 35 Hz, -40 Hz with 60 dB/decade rolloff. Normally used with fundamental frequencies > 1 kHz to reduce the effect of hum components in the input signal.

**DC Isolation:** input low may be connected to chassis ground or floated to 30 V to reduce the effects of ground loops on the measurement.

### Relative Input Level Mode

Provides a ratio measurement relative to an operator selected reference level with readout directly in dBV or dBm (600 $\Omega$ ). Voltage range, frequency range, accuracy specifications, and monitor are the same as in Voltmeter mode. (Accuracy is relative to 0 dB set level input.)

### Oscillator

**Frequency range:** 10 Hz to 100 kHz in 4 overlapping decade ranges with 2 digit resolution. Frequency vernier provides continuous frequency tuning between 2nd digit switch settings.

# SIGNAL ANALYZERS

## Distortion Analyzers

### Model 339A (cont.), 334A

**Output level:** variable from  $< 1$  mV to  $> 3$  V rms into  $600\ \Omega$  with 10 dB/step Level control and  $> 10$  dB Vernier adjustment. OSC Level position on function switch allows a quick check of oscillator level without disconnecting leads to device under test. Off position on Oscillator Level control provides fast signal-to-noise measurement capability. Oscillator output terminals remain terminated in  $600\ \Omega$ .

**Frequency accuracy:**  $\pm 2\%$  of selected frequency (with Frequency Vernier in Cal position).

**Level flatness:**  
20 Hz to 20 kHz:  $\leq \pm 0.1$  dB  
10 Hz to 110 kHz:  $\leq \pm 0.2$  dB

**Distortion ( $\geq 600\ \Omega$  load,  $\leq 3$  V output)**

10 Hz to 20 kHz:  $< -93$  dB (0.0022%) THD  
20 kHz to 30 kHz:  $< -85$  dB (0.0056%) THD  
30 kHz to 50 kHz:  $< -80$  dB (0.01%) THD  
50 kHz to 80 kHz:  $< -70$  dB (0.032%) THD  
80 kHz to 110 kHz:  $< -65$  dB (0.056%) THD

**Output resistance:**  $600\ \Omega \pm 5\%$

### Voltmeter

**Voltage range:** 1 mV rms full scale to 300 V rms full scale ( $-60$  dB to  $+50$  dB full scale, meter calibrated in dBV and dBm into  $600\ \Omega$ ).

**Detection and meter indication:** true rms detection for waveforms with crest factor  $\leq 3$ . Meter reads true rms volts, dBm into  $600\ \Omega$ , and dBV.

**Accuracy (% of range setting)**

20 Hz to 20 kHz:  $\pm 2\%$

10 Hz to 110 kHz:  $\pm 4\%$

**Frequency range:** 10 Hz to 110 kHz.

**Input impedance:**  $100\ \text{k}\Omega \pm 1\%$  shunted by  $< 100$  pF between input High to Low.

**Monitor:** provides scaled presentation of input signal for further analysis using oscilloscope or low frequency spectrum analyzer. Output voltage: 1 V rms  $\pm 5\%$  open circuit for full scale meter indication, proportional to meter deflection. Output resistance:  $1\ \text{k}\Omega \pm 5\%$ .

### Option 001

**Voltage range:** 0.1 mV rms full scale to 300 V rms full scale ( $-80$  dBV to  $+50$  dBV full scale); (.1 mV and .3 mV ranges—external source resistance must be  $< 10\ \text{k}\Omega$ .)

**Accuracy: 1 mV to 300 V Ranges**

20 Hz to 20 kHz  $\pm 2\%$

10 Hz to 110 kHz

.1 mV and .3 mV Ranges

20 Hz to 20 kHz:  $\pm 2\%$

10 Hz to 30 kHz:  $\pm 4\%$

30 kHz to 80 kHz:  $+10/-30\%$

**Noise Floor ( $600\ \Omega$  source impedance)**

30 kHz filter  $< 6\ \mu\text{V}$

80 kHz filter  $< 8\ \mu\text{V}$

### AM Detector

**Frequency range:** carrier frequencies: 550 kHz to 1.6 MHz. Modulation frequencies: 20 Hz to 20 kHz.

**Distortion introduced by AM detector (with 30 kHz filter switched IN):** up to 85% Modulation:  $< -36$  dB (1.6%) THD  
85% to 95% Modulation:  $< -30$  dB (3%) THD

**Input level:** maximum: 60V peak. Modulation signal level: 2V rms minimum; 10V rms maximum.

**Monitor (with modulated RF carrier applied to AM detector input)**

**Distortion mode:** provides scaled presentation of demodulated input signal after fundamental is removed.

**Voltmeter and relative input mode:** provides scaled presentation of demodulated input signal. Output voltage and output resistance are the same as in Distortion mode.

### General

**Power:** 100/120/220/240 V  $+5\%$ ,  $-10\%$  48 Hz to 56 Hz line operation, 200 mA maximum.

**Size:** 146 mm H x 426 mm W x 375 mm D (5.75" x 16.75" x 14.75").

**Weight:** net 8.2 kg (18 lb). Shipping 11.3 kg (25 lb).

**HP 339A Distortion Measurement Set**

\$3,800

**Option 001**

\$280

**Option W30 Extended Warranty**

\$140



HP 334A

### Description

Hewlett-Packard's model HP 334A Distortion Analyzer measures total distortion down to 0.1% full scale at any fundamental frequency between 5 Hz and 600 kHz; harmonics are indicated up to 3 MHz. Noise levels as low as 25 microvolts can be measured. The HP 334A includes automatic fundamental nulling and amplitude modulation detector. A Meter with VU ballistic characteristics and a 30 kHz low pass filter are optional.

### HP 334A Specifications

**Input level for distortion measurements:** 0.3 V rms for 100% set level or 0.245 V for 0 dB set level (up to 300 V may be attenuated to set level reference).

**Harmonic Measurement Accuracy (full scale)**

#### Fundamental Input Less Than 30 V

Range	$\pm 3\%$	$\pm 6\%$	$\pm 12\%$
100%–0.3%	10 Hz–1 MHz	10 Hz–3 MHz	
0.1%	30 Hz–300 kHz	20 Hz–500 kHz	10 Hz–1.2 MHz

**Fundamental rejection:**  $> 80$  dB

**Residual distortion:**  $> -70$  dB (0.03%) from 5 Hz to 200 kHz;  $> -64$  dB (0.06%) from 200 kHz to 600 kHz. Meter indication is proportional to average value of a sine wave.

**Frequency calibration accuracy:** better than  $\pm 5\%$  from 5 Hz to 300 kHz. Better than  $\pm 10\%$  from 300 to 600 kHz.

**Input impedance:** distortion mode:  $1\ \text{M}\Omega \pm 5\%$  shunted by  $< 70$  pF.

**DC Isolation:** signal ground may be  $\pm 400$  V dc from external chassis  
**Voltmeter range:** 300  $\mu\text{V}$  to 300 V rms full scale (13 ranges) 10 dB per range. Average responding calibrated in rms.

**Noise measurements:** voltmeter residual noise on the 300  $\mu\text{V}$  range:  $< 25\ \mu\text{V}$  rms, when terminated in 600 (shielded) ohms.

**Output:** 0.1  $\pm 0.01$  V rms open circuit.

**Output impedance:** 2 k $\Omega$

**Automatic nulling mode:** set level: at least 0.2 V rms

**Frequency ranges:** X1, manual null tuned to less than 3% set level; total frequency hold-in  $\pm 0.5\%$  about true manual null. X10 through X10k, manual null tuned to less than 10% of set level; total frequency hold-in  $\pm 1\%$  about true manual null.

**Automatic null accuracy:** 5 Hz to 100 Hz: meter reading within 0 to  $+3$  dB of manual null. 100 Hz to 600 kHz: meter reading within 0 to  $+1.5$  dB of manual null.

**High pass filter:** 3 dB point at 400 Hz with 18 dB per octave roll off.

**AM detector:** 550 kHz to 65 MHz; 40 Vp-p max input.

**Distortion introduced by detector:** carrier frequency: 550 kHz: 1.6 MHz:  $< 50$  dB (0.3%) for 3–8 V rms carriers modulated 30%. 1.6 MHz–65 MHz:  $< 40$  dB (1%) for 3–8 V rms carriers modulated 30%.

### General

**Power:** 100V/120V/220V/240V  $-10\%$   $+5\%$ , 48–66 Hz.

**Size:** 426 mm W x 126 mm H x 337 mm D (16.75" x 5" x 13.25").

**Weight:** net 7.89 kg (17.75 lb). Shipping 10.35 kg (23 lb).

**HP 334A Distortion Analyzer**

**Price**

\$3,300

**Opt 001 VU Characteristics**

\$25

**Opt 002 30 kHz low pass filter**

\$130

**Opt 003 (combined 001 and 002)**

\$150

**Opt W30 Ext Warranty**

\$120





HP 3581A

### Description

Hewlett-Packard's 3581A Wave Analyzer resolves and measures the amplitude and frequency of spectral components. This instrument offers accurate amplitude and good frequency resolution in the form of a portable, easy-to-use measuring tool. Since not all signals originate from a stable frequency source, the HP 3581A incorporates an AFC circuit which locks to a drifting signal for stable, accurate measurements.

The HP 3581A has other important features that are necessary when making measurements of small voltages from transducers and harmonic signals. Its 30 nV sensitivity becomes important for these measurements. Battery operation can be used to reduce the line related interference common in low level measurements so only the real spectrum is measured.

Digital readout of tuned frequency is located above the analog meter. It has been grouped with the meter for ease of reading. Resolution of the digital readout is 1 Hz for any frequency between 15 Hz and 50 kHz. Readout is updated five times per second so delay between tuning and reading is minimized.

Four meter scales are used to provide a wide range of displays. Two scales are used for linear voltage readings. Two log scales provide either a 90 dB or 10 dB display. In any case, the large meter with its mirror backing can present readings in dBV, dBm or volts. A meter was specifically chosen for amplitude display rather than digital readout because it is easier to peak a meter reading and because it's much easier to get a feel for noise or other amplitude variations by watching the meter. The same voltage used to drive the meter is also available on the rear panel for driving X-Y recorders

### Specifications

#### Frequency Characteristics

**Range:** 15 Hz to 50 kHz.

**Display:** 5 digit LED readout.

**Resolution:** 1 Hz.

**Accuracy:**  $\pm 3$  Hz., 0 to 55°C.

**Typical stability:**  $\pm 10$  Hz/hour after 1 hour and  $\pm 5$  Hz/°C.

**Automatic frequency control (AFC) hold-in range:**  $\pm 800$  Hz.

#### Amplitude Characteristics

##### Instrument Range

**Linear:** 30 V to 100 nV full scale.

**Log:** +30 dBm or dBV to -150 dBm or dBV.

##### Amplitude Accuracy

	Log	Linear
Frequency response, 15 Hz-50 kHz	$\pm 0.4$ dB	$\pm 4\%$

**Dynamic range:** >80 dB.

**Noise sidebands:** greater than 70 dB below CW signal, 10 bandwidths away from signal.

**Spurious responses:** >80 dB below input reference level.

#### Sweep Characteristics

**Scan width:** 50 Hz to 50 kHz, adjustable in a 1-2-5 sequence from 50 Hz to the full frequency range.

**Sweep error light:** this LED indicates a sweep that is too fast to capture full response. When the light is on, response will be lower than it should be.

**External trigger:** a short to ground stops the normal sweep. Opening the short then enables a sweep.

#### Input Characteristics

**Impedance:** 1 M $\Omega$ , 30 pF.

**Maximum input level:** 100 V rms,  $\pm 100$  V dc.

#### Output Characteristics

**Tracking generator output:** (also known as BFO or tracking oscillator output).

**Range:** 0 to >1 V rms into 600  $\Omega$ .

**Frequency response:**  $\pm 3\%$  15 Hz to 50 kHz.

#### X-Y Recorder Analog Outputs

**Vertical:** 0 to +5 V  $\pm 2.5\%$ .

**Horizontal:** 0 to +5 V  $\pm 2.5\%$ .

**Impedance:** 1 k $\Omega$ .

**Recommended Accessory:** HP 7090A Measurement Plotting System.

**Pen lift:** contact closure to ground during sweep.

**Restored output:** acts as a narrow band amplifier.

#### General

**Power requirements:** 100 V, 120 V, 220 V, or 240 V +5% -10%, 48 Hz to 440 Hz, 10 VA typical.

**Size:** 203.2 mm H x 285.8 mm W x 412.8 mm D (8" x 11 1/4" x 16 1/4").

**Weight:** 11.5 kg (23 lb). Opt 001: 13.5 kg (30 lb).

#### Options

##### HP 3581A Wave Analyzer

**001:** Internal battery 12 hours from full charge. Internal battery is protected from deep discharge by an automatic turnoff. Useful battery life is over 100 cycles.

**003:** Rack Mount

**910:** Extra manual

**W30:** Extended Warranty

#### Price

**\$8,100**

**\$700**

**\$335**

**\$36**

**\$300**

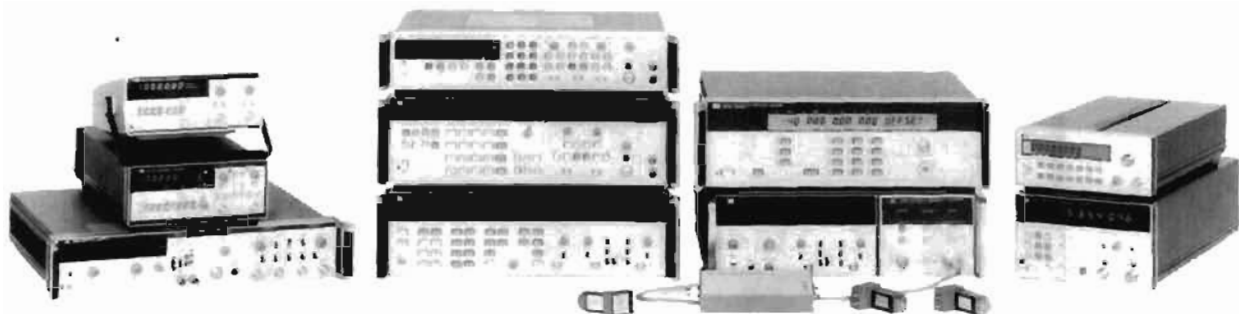

HP offers a wide selection of counters to fit your particular frequency and time measurement needs.

### Measure Time and Frequency Quickly and Cost Efficiently

HP electronic counters offer the best value solution to frequency, period and time interval measurements. The results you get with an HP counter are fast and accurate. And HP counters are simple to operate; operator training is minimal.

You not only measure frequency and time, but you get the added benefits of data reduction, pulse characterization and reduced external circuitry. These features allow you to acquire useful information without investing in expensive equipment or spending valuable time on processing masses of raw data.

Built-in peak amplitude measurements and automatic trigger level setting greatly speed your analysis tasks. Math capabilities reduce data to rise and fall times, slew rates, duty cycle or phase difference. Built-in arming and gating allow you to select the time interval of interest in complex waveforms or profile a changing frequency.

### A Counter To Meet Your Needs

Choose from the world's broadest line of high quality electronic counters:

- Frequency counters from the 225 MHz HP 5384A to the 100 GHz HP 5355A/5356D.
- Universal counters which add time interval measurement ability, from the 100 ns single shot HP 5314A to the 100 ps single shot HP 5370B.
- High performance counters like the HP 5345A for maximum flexibility and the HP 5355A pulsed microwave or millimeter plug-in counters.
- State-of-the-art continuous measurement technology in the new HP 5371A 500 MHz Frequency and Time Interval Analyzer.

Whatever your measurement requirements, there is an HP counter to meet your needs. See the selection guide on the next page for more information on the full range of HP counters.

### Bench or System Compatibility

HP electronic counters are designed for easy use on the bench and are also completely programmable for automatic system performance. HP-IB is standard on many counters and an option on many others. Accurate time and frequency information can be transferred rapidly to your system, improving throughput for increased productivity in manufacturing applications. **Here are some examples:**

Counters such as the HP 5345A can provide frequency measurements to 500 MHz or single shot time interval measurements to 2 ns resolution at rates to 9000 measurements per second.

The HP 5370B can give you better than 100 ps accuracy at several hundred results per second, and 100 ps resolution measurements at up to 6000 measurements per second.

The HP 5334B provides a low cost systems solution of frequency or time interval to 2 ns resolution.

The HP 5316B features basic universal counter capability.

The HP 5352B is capable of 40.0 GHz frequency measurements at 80 readings per second.

### Measurement Techniques

The **traditional** method of counting the number of input cycles over a selected gate time gives you the advantage of low cost at the expense of limited resolution at low frequencies — 1 Hz per second of gate time.

**Reciprocal** counting gives you the enhancement of significantly more useful digits of resolution at lower frequencies. Measuring 100 Hz with the HP 5384A provides 8 digits in one second, compared to only 3 with a traditional counter.

**Interpolation** gives you yet more useful digits of resolution at a lower cost. The HP 5370B allows for 10 digits per second.

**Time interval averaging** increases your resolution — 10 times for 100 measurements — at the expense of requiring a repetitive signal and greater measurement time.

### Introducing the HP 5371A Continuous Measurement Frequency and Time Interval Analyzer

The new HP 5371A Frequency and Time Interval Analyzer is an entirely new approach to timing and frequency measurement. The 5371A introduces HP's continuous measurement technology and combines enhanced universal counter features, internal high-speed memory and built-in analysis and display.

You can directly characterize FM on carriers up to 500 MHz or see the frequency or phase-coding profile of radar-pulses using the Time Variation display. For timing analysis, use the histogram and statistics features, 150 ps rms single-shot resolution, 1 ns minimum pulse widths, and unmatched arming and triggering flexibility are just some of the outstanding performance features of this new analyzer.

The HP 5371A is ideal for applications in frequency-agile communications, jitter and wander in digital communications, radar/EW, electrical/mechanical systems, serial data storage-retrieval, modulation analysis and basic research.

### Find Out More About Counters and Applications

These five Applications Notes explain the fundamentals of counter technology and offer tutorial information on applications. Data Sheets and Product Notes are also available on specific products. Fill in the card at the back of this catalog to request more information.

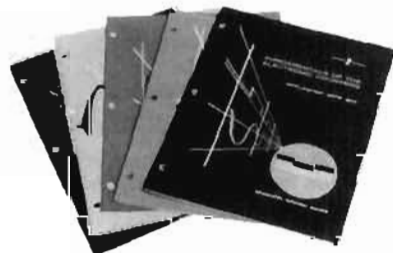

**Counter Selection Guide**

Model	Frequency A	Frequency B	Frequency C	Single Shot Time Interval	Display Digits	Resolution vs. Time	Sensitivity	HP-IB Readings/s	Enhanced Capabilities Available	Standard Price	Page
<b>Basic Frequency Counters</b>											
5384A	10 Hz-100 MHz	50 MHz-225 MHz			11	9 digits/s	10 mV	4	Oven time base, battery	\$1400	179
5385A	10 Hz-100 MHz	90 MHz-1 GHz			11	9 digits/s	10 mV	4	Oven time base, battery	\$1700	179
5386A	10 Hz-100 MHz	100 MHz-3 GHz			11	9 digits/s	15 mV	4	Oven time base	\$3100	179
<b>Microwave And Millimeter CW Counters</b>											
5386A	10 Hz-100 MHz	100 MHz-3 GHz			11	9 digits/s	-23.5 dBm	4	Oven time base	\$3100	179
5340A	10 Hz-18 GHz	10 Hz-250 MHz			8	varies	-35 dBm	10	Oven time base, limiter	\$15000	175
5342A	500 MHz-18 GHz	10 Hz-520 MHz			11	1 Hz/s	-25 dBm	10	Oven time base, limiter, amplitude	\$6900	173
5343A	500 MHz-26.5 GHz	10 Hz-520 MHz			11	1 Hz/s	-33 dBm	10	Limiter, offset, totalize	\$8200	173
5350B	500 MHz-20 GHz	10 Hz-525 MHz			11	1 Hz/s	-40 dBm	to 120	Oven time base, limiter, math, fast acquisition	\$5000	170
5351B	500 MHz-26.5 GHz	10 Hz-525 MHz			11	1 Hz/s	-40 dBm	to 120	Oven time base, limiter, math, fast acquisition	\$6000	170
5352B	500 MHz-40 GHz	10 Hz-525 MHz			11	1 Hz/s	-30 dBm	to 120	Oven time base, math, fast acquisition	\$10000	170
5356D		36 GHz-110 GHz			11	<2 Hz/s	-20/-3 dBm	to 9000	Frequency averaging	\$6000*	176
<b>Microwave And Millimeter Pulse Counters</b>											
5355A	400 MHz-1.4 GHz		0-500 MHz	2 ns	11	>8 digits/s	-15 dBm	to 9000	Frequency profile, pulse width	\$5350*	176
5356A	1.5 GHz-18 GHz	400 MHz-1.4 GHz	0-500 MHz	2 ns	11	1 Hz/s	-25 dBm	to 9000	Frequency profile, pulse width	\$1800*	176
5356B	1.5 GHz-26.5 GHz	400 MHz-1.4 GHz	0-500 MHz	2 ns	11	1 Hz/s	-20 dBm	to 9000	Frequency profile, pulse width	\$2000*	176
5356C	1.5 GHz-40 GHz	400 MHz-1.4 GHz	0-500 MHz	2 ns	11	<2 Hz/s	-15 dBm	to 9000	Frequency profile, pulse width	\$2500*	176
5356D	36 GHz-110 GHz	400 MHz-1.4 GHz	0-500 MHz	2 ns	11	<2 Hz/s	-20/-3 dBm	to 9000	Frequency profile, pulse width	\$6000*	176
<b>Basic Universal Counters</b>											
5314A	10 Hz-100 MHz			100 ns	7	10 or 1 Hz/s	25 mV		Period, ratio, totalize, battery	\$550	199
5315A	.1 Hz-100 MHz		50 MHz-1 GHz	100 ns	8	7 digits/s	10 mV		Period, ratio, totalize, battery, oven TB	\$1100	196
5316B	1 Hz-100 MHz		50 MHz-1 GHz	100 ns	8	7 digits/s	10 mV	10	Oven time base	\$1475	196
<b>Performance Universal Counters</b>											
5328B	0-100 MHz		90 MHz-1.3 GHz	10 ns	8	1 Hz/s	25 mV	to 500	DVM, oven time base	\$4400	195
5334B	.001 Hz-100 MHz	.001 Hz-100 MHz	90 MHz-1.3 GHz	2 ns	9	9 digits/s	35 mV	to 140	Auto pulse characterization	\$1950	190
5335A	.002 Hz-200 MHz		150 MHz-1.3 GHz	2 ns	12	9 digits/s	25 mV	15	Auto pulse characterization, statistics	\$4000	192
5345A	0-500 MHz		(see 5355A, 5356 A/B/C/D)	2 ns	11	>9 digits/s	25 mV	to 9000	External gate, frequency average	\$9250	188
<b>Precision Time Interval Counter</b>											
5370B	0-100 MHz			20 ps	16	>11 digits/s	35 mV	to 8000	Statistics, external gate	\$9900	181
<b>Enhancement Products</b>											
HP 5363B Time Interval High Impedance Probes										\$4450	187

\*needs 5345A, 5355A and mixers

**Frequency and Time Interval Analyzer Selection Guide**

Model	Frequency A and B	Single Shot Time Interval Res.	Analysis and Display	Max. Continuous Measurement Rate	Memory Size	HP-IB Results/s	Standard Price	Page
5371A	.125 Hz-500 MHz	150 ps rms	Histogram Time Variation Event Timing Numeric	10x10 <sup>6</sup> samples/s	1000	to 20,000	\$21,500	184

# ELECTRONIC COUNTERS

## Low-Cost, High-Performance CW Microwave Frequency Counters

Models 5350B, 5351B, 5352B

- Frequency coverage from 10 Hz to 40 GHz, direct inputs
- Exceptional sensitivity to  $-40$  dBm
- 1 GHz/second tracking speed
- 60-millisecond acquisition time
- 100 measurements/second over HP-IB in automatic mode
- Two years of extended hardware support with Option W30



HP 5350B, HP 5351B, HP 5352B

### HP 5350B/5351B/5352B Microwave Frequency Counters

The HP 5350B/5351B/5352B are automatic CW Microwave Frequency Counters that measure to 20, 26.5, and 40 GHz respectively. With resolution as fine as 1 Hz, these counters provide you with fast and precise frequency measurements.

By integrating all microwave components onto a single hybrid GaAs circuit, these counters offer you high performance at low prices. Wide frequency coverage, exceptional sensitivity, fast tracking speed, high measurement throughput, and wide FM tolerance are but a few of the high-performance features that you get with these low-cost counters.

With a built-in microprocessor, the HP 5350B/5351B/5352B also have math capabilities such as measurement scaling and offset. These functions are useful when you need indirect measurement results. Also, automatic amplitude discrimination automatically measures frequency of the highest-amplitude signal in a multi-signal environment. Other convenience features include diagnostic routines that let you perform tests on the counter for general information and troubleshooting.

The HP 5350B/5351B/5352B are ideal components for test systems. They are easy to program and their English-like commands simplify systems integration by reducing your programming effort. Their high measurement throughput also saves you money by reducing test time. In automatic test systems, the programmable alphanumeric liquid-crystal display (LCD) can serve as a message center; and if operational security is a concern, keyboard and display lockout can be activated. In noise-sensitive environments, you can put these counters in the SLEEP mode to reduce kickback noise to as low as  $-70$  dBm.

### Direct Inputs to 40 GHz, Providing Low-cost Solutions for your Expanding Needs

The HP 5350B/5351B/5352B provide a full range of high-performance, low-cost products to meet your expanding measurement needs. The HP 5350B and HP 5351B measure frequency from 10 Hz to 20 GHz and 26.5 GHz respectively. The HP 5352B, which extends input capability to 40 GHz, now lets you make measurements in the millimeter-wave range directly without having to purchase expensive mixers.

### Exceptional Sensitivity, Making Direct Measurement of Low-Level Signals Possible

As these counters have input sensitivity to  $-40$  dBm ( $-30$  dBm for HP 5352B), accurately measuring your low-energy signals becomes a simple task. For example, you no longer need expensive microwave amplifiers to make low-level measurements. Also, you no longer have to worry about signal attenuation by the probe when you make frequency measurements at different nodes within your circuit. These conveniences simplify measurements in applications such as receiver front-end testing.

### Reduced Acquisition Time, Significantly Improving Your Measurement Throughput

With acquisition time reduced to 60 milliseconds in automatic, fast-acquisition tracking mode (20 milliseconds in manual mode), these high-speed microwave counters can significantly improve your measurement throughput.

In bench-top applications, this high-speed throughput gives you fast measurement response. The liquid-crystal display (LCD) will update measurements rapidly to shorten your evaluation time. For applications that require fast measurement response to source tuning, these counters are ideal solutions.

In systems environments, the counters' fast measurement throughput also contributes to your overall system efficiency. Delivering more than 100 measurements/second over HP-IB in automatic mode, the counters' systems performance saves you money by reducing test time.

### 1 GHz/second Tracking Speed, Accurately Measuring Your Fast-Moving Signals

Fast acquisition also offers you fast tracking speed. With acquisition time below 60 milliseconds, these counters can track source drift to 1 GHz/second effortlessly. For example, in measuring the response of a voltage-controlled oscillator (VCO) to voltage-source tuning, these counters will track the changing frequency rapidly to measure the transfer characteristics.

### Option W30 Provides you with Convenient Service and Support For the Second and Third Year of Ownership

In addition to the one-year service that HP normally provides for all of its instruments, Option W30 gives you two additional years of support at the time of purchase. This optional support reflects HP's commitment to product reliability and customer satisfaction.

**HP 5350B/5351B/5352B Specifications**

**Input 1**

**Frequency range:** HP 5350B: 10 Hz to 20 GHz  
 HP 5351B: 10 Hz to 26.5 GHz  
 HP 5352B: 10 Hz to 40 GHz

**Sensitivity, in dBm (specification/typical performance @ 25°C)**  
**HP 5350B/5351B: 500 MHz to 12.4 GHz:** -32/-40; Option 002: -31/-39; Option 006: -29/-37.  
**HP 5350B/5351B: 12.4 GHz to 20 GHz:** -27/-35; Option 002: -25/-33; Option 006: -23/-31.  
**HP 5351B: 20 GHz to 26.5 GHz:** -16/-28; Option 002: -13/-25; Option 006: -11/-23.  
**HP 5352B: 500 MHz to 26.5 GHz:** -25/-30; 26.5 GHz to 40 GHz, linear decrease to -15/-20.

**Maximum Input:** +7 dBm.  
**Damage level:** +25 dBm; HP 5350B/5351B Option 006: 500 MHz to 6 GHz + 39 dBm; 6 GHz to 18 GHz + 36 dBm; 18 GHz to 26.5 GHz + 34.8 dBm.  
**SWR (typical):** 500 MHz to 10 GHz 2:1; Option 002/006 2.5:1. 10 GHz to 26.5 GHz 3:1; Option 002/006 3.5:1. 26.5 GHz to 40 GHz 3.5:1.

**Coupling:** dc to 50Ω termination, ac to instrument.  
**Accuracy:** ± 1 LSD ± time-base error × frequency. (See Graphs 3 & 5).  
**Residual stability:** when counter and source use common 10 MHz time base or counter uses external higher stability time base, .3 LSD rms typical for resolution 1 Hz - 1 kHz at 25°C; HP 5352B .7 LSD typical 26.5 - 40 GHz; LSD = least significant digit.  
**Resolution:** selectable 1 Hz to 1 MHz.

**FM Tolerance** (see Graph 2: FM Rate Tolerance)  
**Maximum deviation:** Auto: 20 MHz p-p (12 MHz 5350B). Manual: 60 MHz p-p (55 MHz 5352B).  
**Maximum FM rate:** 10 MHz.

**Tracking Speed**  
**Fast-acquisition track:** 1 GHz/s.  
**Normal FM rate:** 1 MHz/s.  
**Low FM rate:** 80 kHz/s.

**AM tolerance:** any modulation index provided the minimum signal level is not less than the sensitivity specification.

**Modes of Operation**  
**Automatic:** counter automatically acquires and displays highest level signal within sensitivity range.  
**Manual:** center frequency must be entered to within ± 20 MHz or input frequency; ± 3 MHz worst case below 1 GHz; increases measurement and data output rate.

**Automatic amplitude discrimination:** automatically measures the largest of all signals present, providing that signal is >6 dB (typical) above any signal within 500 MHz; >20 dB (typical) above any signal within 500 MHz to 20 (40) GHz.

**Acquisition time**  
**Automatic mode:** fast-acquisition track: <60 ms. normal FM rate: <125 ms. low RM rate: <1.25 s  
**Manual mode:** <20 ms.

	TCX0	Option 001	Option 010
Aging Rate	1 x 10 <sup>-1</sup> per month	5 x 10 <sup>-10</sup> per day	2 x 10 <sup>-11</sup> per year
Short Term	1 x 10 <sup>-10</sup> per s	1 x 10 <sup>-10</sup> per s	1 x 10 <sup>-10</sup> per s
Temperature 0 - 50	1 x 10 <sup>-11</sup>	1 x 10 <sup>-11</sup>	1 x 10 <sup>-11</sup>
Line 10% change	1 x 10 <sup>-11</sup>	1 x 10 <sup>-11</sup>	1 x 10 <sup>-11</sup>
Warm up to <5 x 10 <sup>-11</sup> @ 25°C		10 minutes	10 minutes

Figure 1. Time Base (10 MHz).

**Input 2:**

**Frequency range:** 10 Hz to 525 MHz.  
**Mode of Operation**  
**50 Ω:** 10 MHz to 525 MHz.  
**1M Ω:** 10 Hz to 80 MHz.  
**Sensitivity:** full operating environment:  
**50 Ω:** 10 MHz to 525 MHz, 25 mV rms; 15 mV typical @ 25°C;  
**1M Ω:** 10 Hz to 80 MHz, 25 mV rms; 15 mV typical @ 25°C;  
 Gate Time = 1/resolution: 1 ms minimum.  
**Resolution:** selectable 1 Hz to 1 MHz.  
**High resolution:** 1M Ω mode: 0.001 Hz for <100 kHz input; 0.01 Hz for <1 MHz input; 0.1 Hz for <10 MHz input; 1 Hz for >10MHz input; 1 second gate.  
**Accuracy:** (See Graphs 4 & 5). ±1 LSD  

$$\left( \frac{\pm 1.4 \times \text{Trigger Error}^{(1)} \pm \text{Time Base}}{\text{Gate Time}} \right) \times \text{Frequency}$$

**Impedance:** selectable 1M Ω nominal shunted by <70 pF or 50 Ω nominal.  
**Coupling:** ac.  
**Connector:** replaceable fuse, type BNC female.  
**Maximum Input:** 50 Ω: +10 dBm; 1M Ω: 1V rms.  
**Damage level:** 50 Ω or 1M Ω dc - 5 kHz: 250 V (dc + ac peak); >5 kHz: 5.5 V rms (+ 28 dBm) + 1.25 X 10<sup>6</sup> V rms/FREQ.  
**Panel label:** 5.5 V rms (+ 28 dBm).  
**Time base output:** 10 MHz and 1 MHz, 2.4 V square wave AC coupled into 1k Ω; 1.5V p-p into 50 Ω; available from rear panel BNC connectors whenever the instrument has AC power connected.  
**External time base:** 1, 2, 5 or 10 MHz, 0.7 V min to 8 V max. p-p sine wave or square wave into > 1K Ω shunted by < 30 pF, via rear-panel BNC connector. External reference automatically selected when signal is present.

**General**

**Display:** segmented 24-character alphanumeric LCD (backlighted).  
**Keyboard:** set-up stored in STBY mode.  
**Self-check:** tests for correct circuit operation.  
**Diagnostics:** front-panel or HP-1B selectable, Display and Keyboard Lockout, Service Diagnostics and User Information.  
**Data output:** over HP-1B bus; varies with Frequency and Resolution.  
**Auto mode:** >100 readings/s, 10 kHz resolution, no math functions, "DUMP" mode.  
**Manual mode:** >120 readings per second formatted at 10 kHz resolution, no math functions "DUMP MODE".  
**Math functions:** result = measurement x scale + offset.  
**Offset:** measurement is offset by entered value.  
**Scale:** measurement is multiplied by entered value.  
**Smooth:** displayed resolution is determined using exponential averaging; displays only stable digits.  
**Sample rate:** variable from less than 50 ms between measurements to HOLD, which holds the display indefinitely or until trigger occurs.  
**Display rate:** 5/s, variable over HP-1B.  
**Overload indication:** "OVRLOAD" A user message.  
**Sleep mode:** input 1 emissions reduced to <-70 dBm typical when sleep mode or input 2 is selected.  
**IF output:** rear panel BNC provides 30 - 110 MHz down-converted microwave signal at >-20 dBm into 50 Ω, ac coupled.  
**HP-1B interface functions:** functions and diagnostics are programmable; address-set at front panel, default switches on rear panel; teach/learn programming; IEEE 728 compatible command structure; function subset SH1, AH1, T5, RFI, RLI, PP0, DC1, DT1, C0, E1 (see page 542).

**Reset/local:** returns to local control.  
**Operation temperature:** 0° C to 50° C.  
**Power requirements:** 100 VA max.  
**Line select:** 100 V (90-105 VAC rms; 47.5 - 440 Hz).  
 115/120 V (104/126 VAC rms; 47.5 - 440 Hz).  
 220 V (198-231 VAC rms; 47.5 - 66 Hz).  
 230/240 V (207-252 VAC rms; 47.5 - 66 Hz).

**Accessories furnished:** power cord, manual.  
**Size:** 33mmH x 407 mmW x 358 mmD (5 1/4 in. H x 16 in. W x 14 in. D)  
**Weight:** 11 kg (24 lb).

<sup>(1)</sup> Trigger Error  $\sqrt{e_1^2 + e_n^2}$  s rms

Input Slew Rate in V/s at Trigger Point  
 Where e<sub>1</sub> = effective rms noise of counter's input channel (100 μV typical)  
 e<sub>n</sub> = rms noise of the input signal for a 500 MHz bandwidth

# ELECTRONIC COUNTERS

Low-Cost, High-Performance CW Microwave Frequency Counters (cont'd)

Models 5350B, 5351B, 5352B

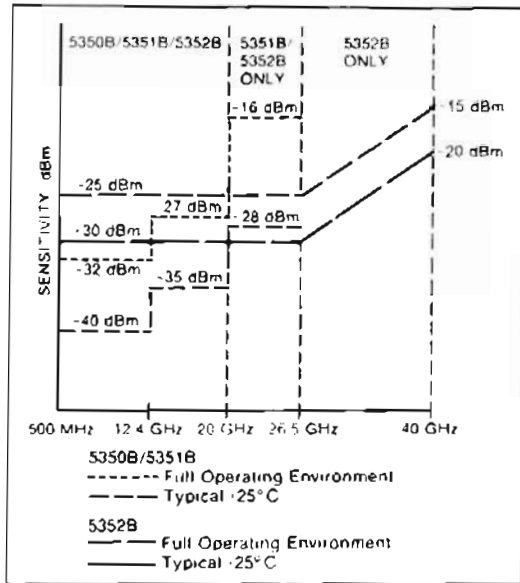

Graph 1. Sensitivity

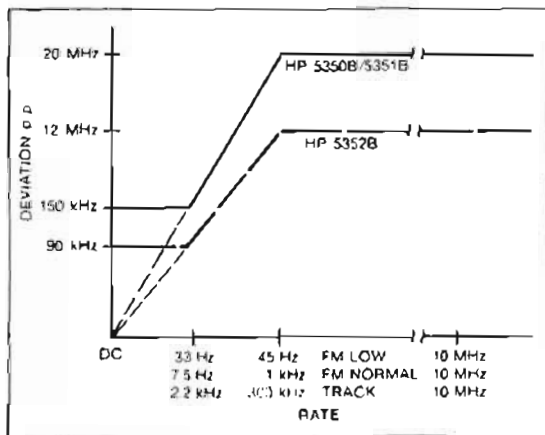

Graph 2. FM Rate Tolerance

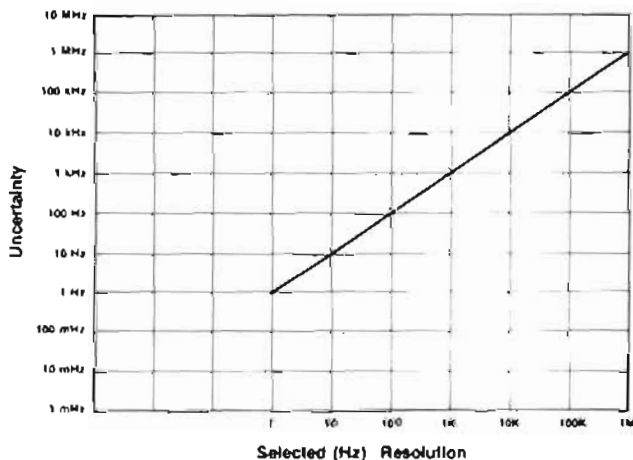

Graph 3. Input 1 uncertainty due to selected resolution

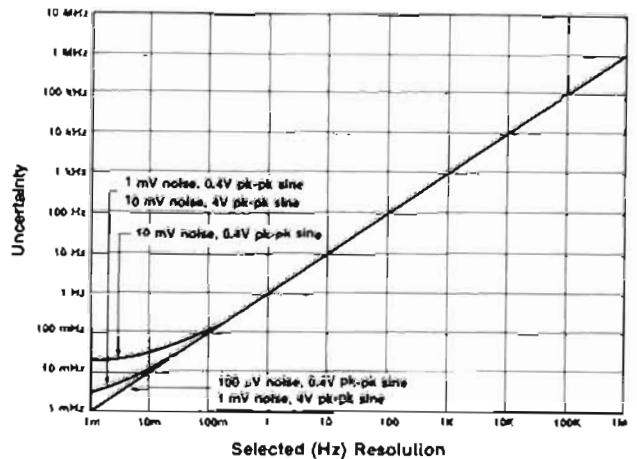

Graph 4. Input 2 uncertainty due to selected resolution and trigger error.

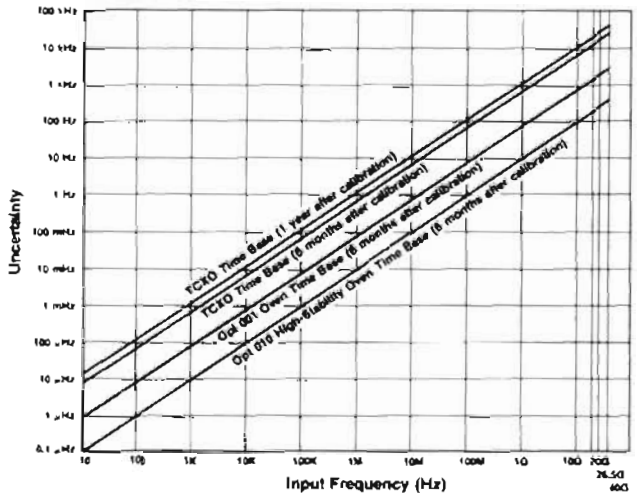

Graph 5. Uncertainty due to time-base error. Time-base error can be reduced by calibrating the time base more frequently, or by using a time base with a slower aging rate.

**Ordering Information**

<b>HP 5350B</b> 20 GHz Microwave Frequency Counter	\$ 5,000
<b>HP 5351B</b> 26.5 GHz Microwave Frequency Counter	\$ 6,000
<b>HP 5352B</b> 40 GHz Microwave Frequency Counter	\$10,000
<b>Opt 001</b> Oven Time Base	+\$750
<b>Opt 002</b> Rear Panel Inputs (HP 5350B/51B only)	+\$300
<b>Opt 006</b> Microwave Level Limiter (HP 5350B/51B only)	+\$500
<b>Opt 010</b> High Stability Oven Time Base	+\$1,500
<b>Opt 910</b> Additional Operating & Service Manual	+\$40
<b>Opt 908</b> Rack Mount Kit for use with front handles removed	+\$55
<b>Opt 913</b> Rack Mount Kit for use with supplied front handles	+\$55
<b>Opt W30</b> 2-year extended hardware support	+\$160
<b>Additional Equipment Available:</b>	
Transit Case	9211-2643
Waveguide (3" straight) adapter WR28-APC3.5	05356-20217
Waveguide (3" straight) to coaxial adapter WR42-APC3.5	05356-20216
Adapter - In series APC 3.5 Male to Male	1250-1748
Adapter - In series APC 3.5 Female to Female	1250-1749

# ELECTRONIC COUNTERS

## CW Microwave Frequency Counters

### Models 5342A & 5343A

173

- Automatic measurements to 18 GHz/26.5 GHz
- Portability
- Wide FM tolerance

- Amplitude measurement in dBm (HP 5342A Option 002)
- High input sensitivity
- Digital-to-analog converter (Option 004)



HP 5342A



HP 5343A



## HP 5342A & 5343A Microwave Counters

### Portability

The HP 5342A and HP 5343A Microwave Counters provide automatic frequency measurement to 18 or 26.5 GHz in highly portable packages. The operating range of the HP 5342A can be extended to 24 GHz with Option 005.

### Amplitude Measurements (Option 002, HP 5342A only)

Option 002 adds the ability to measure and display the power level of the input in dBm. The 11-digit LED display presents amplitude measurement to 0.1 dBm resolution. Also, the same option extends the instrument's dynamic range to enable frequency measurements to +22 dBm.

### FM Tolerance

Measuring a carrier frequency while it is being frequency modulated has broad appeal in the communication industry and elsewhere. Both the HP 5342A and HP 5343A can tolerate peak-to-peak FM deviation to 50 MHz.

### Digital-To-Analog Converter (Option 004)

Option 004 lets you convert any three consecutive displayed digits (frequency or amplitude) into an analog voltage output on the rear panel. This makes the monitoring of microwave-oscillator-frequency drift easy to make with only a stripchart recorder.

### Scaling and Offset Functions

The versatility of the microprocessor-controlled keyboard allows you to perform math functions by means of a few key strokes. Frequency values to 1 Hz resolution can be added to or subtracted from the measured frequency for IF offset application. The HP 5343A also offers an  $mx \pm b$  mode for both scaling and offset functions.

## HP 5342A Specifications

### Signal Input

#### Input 1

**Frequency range:** HP 5342A: 500 MHz to 18 GHz.

HP 5343A: 500 MHz to 26.5 GHz.

**Sensitivity:** HP 5342A: 500 MHz to 12.4 GHz: -25 dBm.  
12.4 GHz to 18 GHz: -20 dBm.

HP 5343A: 500 MHz to 12.4 GHz: -33 dBm.  
12.4 GHz to 18 GHz: -28 dBm.  
18.0 GHz to 26.5 GHz: -23 dBm.

**Maximum input:** +17 dBm (See Option 002, 003 for higher levels).

**Impedance:** 50, nominal.

**Connector:** HP 5342A: Precision Type N female.

HP 5343A: APC 3.5 male with collar.

**Damage level:** +25 dBm, peak (See Option 006 for +39 dBm protection).

**Coupling:** dc to load, ac to instrument.

**SWR:** < 2:1, 500 MHz-10 GHz.

< 3:1, 10 GHz-18 GHz/26.5 GHz.

**FM tolerance:** switch selectable (rear panel)

**Wide:** 50 MHz p-p worst case.

**Normal:** 20 MHz p-p worst case.

**Narrow:** (HP 5343A only) 6 MHz p-p worst case.

For Modulation Rates from dc to 10 MHz.

**AM tolerance:** any modulation index provided the minimum signal level is not less than the sensitivity specification.

**Automatic amplitude discrimination:** automatically measures the largest of all signals present, providing that signal is 6 dB above any signal within 500 MHz; 20 dB above any signal, 500 MHz-18 /26.5 GHz.

### Modes of Operation

**Automatic:** counter automatically acquires and displays highest level signal within sensitivity range.

**Manual:** center frequency entered to within  $\pm 40$  MHz of true value.

### Acquisition Time

#### Automatic Mode

Narrow FM 200 ms worst case (HP 5343A only)

Normal FM 530 ms worst case

Wide FM 2.4 s worst case

**Manual mode:** 80 ms after frequency entered.

### Input 2

**Frequency range:** 10 Hz to 520 MHz direct count.

**Sensitivity:** 50  $\Omega$ : 10 Hz to 520 MHz: 25 mV rms. 1 M  $\Omega$ : 10 Hz to 25 MHz: 50 mV rms.

**Impedance:** selectable 1 M  $\Omega$ , <50 pF or 50  $\Omega$  nominal.

**Coupling:** ac

**Connector:** type BNC female.

**Maximum input** 50  $\Omega$ : 3.5 V rms (+24 dBm) or 5 V dc, fuse protected

1 M  $\Omega$ : 200 V dc + 5 V rms.

### Time Base

**Crystal frequency:** 10 MHz.

### Stability

**Ageing rate:** <  $1 \times 10^{-7}$ /month.

**Temperature:** <  $\pm 1 \times 10^{-6}$  over the range 0°C to 50°C.

**Short term:** <  $1 \times 10^{-9}$  for 1 second averaging time.

**Line variation:** <  $\pm 1 \times 10^{-3}$  for 10% change from nominal.

**Output frequency:** 10 MHz,  $\geq 2.4$  V square wave (TTL compatible) 1.5 p-p V into 50  $\Omega$  available from rear panel BNC.

**External time base:** requires 10 MHz, 3.0 V p-p sine wave or square wave into 1 k  $\Omega$  via rear panel BNC connector. Switch selects either internal or external time base.

# ELECTRONIC COUNTERS

## Automatic Microwave Counters

Models 5342A & 5343A

### Optional Time Base (option 001)

Crystal frequency: 10 MHz.

#### Stability

**Aging rate:**  $< 5 \times 10^{-10}$ /day after 24-hour warmup.

**Temperature:**  $< 7 \times 10^{-9}$  over the range 0°C to 50°C.

**Short term:**  $< 1 \times 10^{-10}$  for 1 second averaging time.

**Line variation:**  $< 1 \times 10^{-10}$  for 10% change from nominal.

**Warm-up:**  $< 5 \times 10^{-9}$  of final value 20 minutes after turn-on, at 25°C.

### Amplitude Measurement (opt 002) (HP 5342A only)

#### Input 1

**Frequency range:** 500 MHz–18 GHz.

#### Dynamic range (frequency and level)

–22 dBm to +22 dBm 500 MHz to 12.4 GHz

–15 dBm to +22 dBm 12.4 GHz to 18 GHz

**Maximum operating level:** +22 dBm.

**Damage level:** +25 dBm, peak.

**Resolution:** 0.1 dBm.

**Accuracy:**  $\pm 1.5$  dB (excluding mismatch uncertainty).

**SWR:**  $< 2:1$  (amplitude measurement).

$< 5:1$  (frequency measurement).

**Measurement time:** 100 ms + frequency measurement time.

**Display:** simultaneously displays frequency to 1 MHz resolution and level. (Option 011 provides full frequency resolution on HP-1B).

#### Input 2 (50 $\Omega$ impedance only)

**Frequency range:** 10 MHz–520 MHz.

**Dynamic range (frequency and level):** –17 dBm to +20 dBm.

**Damage level:** +24 dBm.

**Accuracy:**  $\pm 1.5$  dB (excluding mismatch uncertainty).

**SWR:**  $< 1.8:1$ .

**Measurement time:** 100 ms + frequency measurement time.

**Display:** simultaneously displays frequency and input level.

### Extended Dynamic Range (opt 003) (HP 5342A only)

**Frequency range:** 500 MHz to 18 GHz.

**Sensitivity:** 500 MHz to 12.4 GHz: –22 dBm.

12.4 GHz to 18 GHz: –15 dBm.

**Maximum operating level:** +22 dBm.

**Dynamic range:** 500 MHz to 12.4 GHz: 44 dB.

12.4 GHz to 18 GHz: 37 dB.

**Damage level:** +25 dBm, peak.

**SWR:**  $< 5:1$ .

### Microwave Limiter (option 006)

#### Input 1

**Frequency range:** HP 5342A: 500 MHz – 18 GHz.

HP 5343A: 500 MHz – 26.5 GHz.

**Sensitivity:** HP 5342A: 500 MHz – 12.4 GHz: –21 dBm.

12.4 GHz – 18 GHz: –15 dBm.

HP 5343A: 500 MHz – 12.4 GHz: –30 dBm.

12.4 GHz – 18 GHz: –24 dBm.

18 GHz – 26.5 GHz: –18 dBm.

**Maximum operating level:** +7 dBm.

**Damage level:** 500 MHz – 6 GHz: +39 dBm (8W).

6 GHz – 18 GHz: +36 dBm (4W).

(HP 5343A only) 18 GHz – 26.5 GHz: +34.8 dBm (3W).

**SWR:** 2.5:1, 500 MHz – 10 GHz.

3.5:1, 10 GHz – 18 GHz/26.5 GHz.

**Note:** Option 006 is incompatible with Option 002. Option 003, and Option 005 for HP 5342A. Please consult factory special to combine Options 005 and 006.

#### General

**Accuracy:**  $\pm 1$  LSD  $\pm$  time-base error.

**Resolution:** front panel push buttons select 1 Hz to 1 MHz.

**Display:** 11 digit LED display, sectionalized to read GHz, MHz, kHz, and Hz.

**Self-check:** selected from front panel pushbuttons displays 75 MHz for resolution chosen.

**Frequency offset:** selected from front panel pushbuttons. Displayed frequency is offset by entered value to 1 Hz resolution.

**Frequency multiply:** (HP 5343A only) (mx  $\pm$  b) measured data is multiplied by any integer up to 99. Offset can then be added or subtracted. Front-panel selectable.

**Totalize (HP 5343A only):** input 2 can totalize at rates up to 520 MHz. Readout on the fly is controlled by front panel or HP-1B.

**Sample rate:** variable from less than 20 ms between measurements to HOLD which holds display indefinitely.

**IF out:** rear panel BNC connector provides 25 MHz to 125 MHz output of down-converted microwave signal.

**Power requirements:** 100/120/220/240 V rms, +5%, –10%, 48–66 Hz; 100 VA max.

**Weight:** net 9.1 kg (20 lb). Shipping 12.7 kg (28 lb).

**Size:** 133 mm H x 213 W x 498 mm D (5.25 in. H x 8.38 in. W x 19.6 in. D).



Graph 1. Uncertainty due to selected resolution.

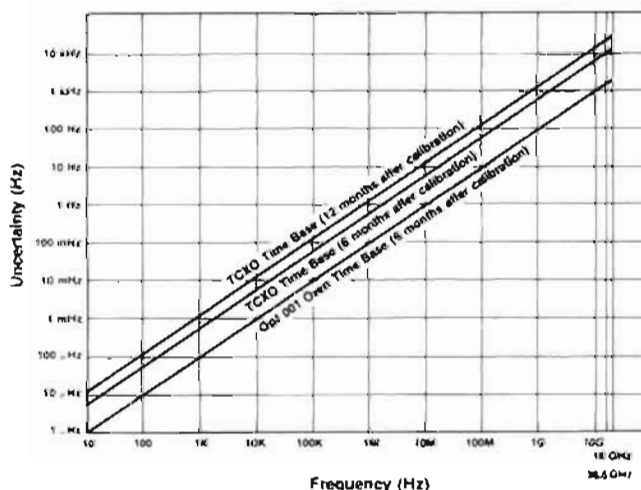

Graph 2. Uncertainty due to timebase error can be reduced by calibrating the timebase more frequently, or by using a timebase with a lower aging rate.

### Ordering Information

HP 5342A Frequency Counter

Price

\$6900

HP 5343A Frequency Counter

\$8200

#### Options and Accessories (both models)

Opt 001 High Stability Time Base

+ \$750

Opt 002 Amplitude Measurement (HP 5342A Only)

+ \$1700

Opt 003 Extended Dynamic Range (HP 5342A Only)

+ \$650

Opt 004 Digital-To-Analog Converter

+ \$400

Opt 005 Frequency Extension to 24 GHz (HP 5342A Only)

+ \$500

Opt 006 Limiter Input Protection (+39 dBm)

+ \$600

Opt 011 Digital Input/Output (HP-1B) (Cable Not Incl)

+ \$550

Opt 908 Rack Mounting Adapter Kit

+ \$45

HP K70-59992A: Rack Mounting Adapter Kit With Slot for access to front connectors from rear.

HP 10842A: Extender Board Kit

\$500



# ELECTRONIC COUNTERS

## Automatic Microwave Counters (cont'd)

175

Model 5340A

- Single Input 10 Hz to 18 GHz
- Automatic amplitude discrimination
- High sensitivity -35 dBm

- Optional extension to 23 GHz
- High AM and FM tolerance
- Exceptional reliability



HP 5340A



### HP 5340A Frequency Counter

The HP 5340A Frequency Counter is an easily used, versatile instrument for direct measurement of frequencies from 10 Hz through 18 GHz via a single input connector.

The exceptional sensitivity of this instrument enhances measurement in the microwave field, where signals are commonly low-level and connected via directional coupler or lossy devices.

Access to the HP Interface Bus via Option 011 provides a flexible systems interface. The ability to program octave range through this input reduces acquisition time to less than 40 ms (typical).

### HP 5340A Specifications

#### Signal Input

##### Input 1

**Range:** 10 Hz to 18 GHz.

**Symmetry:** sinewave or squarewave input (40% duty factor, worst case).

**Sensitivity:** -30 dBm, 10 Hz to 500 MHz; -35 dBm, 500 MHz to 10 GHz; -25 dBm, 10 to 18 GHz.

**Dynamic range:** 37 dB, 10 Hz to 500 MHz; 42 dB, 500 MHz to 10 GHz; 32 dB, 10 GHz to 18 GHz.

**Impedance:** 50 Ω.

**VSWR:** <2:1, 10 Hz-12.4 GHz; <3:1, 12.4-18 GHz.

**Connector:** precision Type N.

**Coupling:** dc to load, ac to instrument.

**Damage level:** +30 dBm.

Total power (ac + dc) not to exceed 1 watt. See Option 006 for up to +39 dBm protection.

**Acquisition time:** <150 ms mean typical.

##### Input 2

**Range:** 10 Hz-250 MHz direct count

**Sensitivity:** 50 mV rms, 150 mV p-p pulses to 0.1% duty factor; minimum pulse width 2 ns.

**Impedance:** 1 MΩ shunted by <25 pF.

**Connector:** type BNC female.

**Coupling:** ac.

**Maximum input:** 200 V rms, 10 Hz to 100 Hz; 20 V rms, 100 Hz to 100 kHz; 2 V rms, 100 kHz to 250 MHz.

**Automatic amplitude discrimination:** automatically selects the strongest of all signals present (within 250 MHz to 18 GHz phase-lock range), providing signal level is: 6 dB above any signal within 200 MHz; 10 dB above any signal within 500 MHz; 20 dB above any signal, 250 MHz-18 GHz (typical performance).

**Maximum AM modulation:** any modulation index as long as the minimum voltage of the signal is not less than the sensitivity specification.

#### Time Base

**Crystal frequency:** 10 MHz.

#### Stability

**Aging rate:** <3 × 10<sup>-7</sup> per month.

**Short term:** <5 × 10<sup>-10</sup> rms for 1 second averaging time.

**Temperature:** <±2 × 10<sup>-6</sup> over the range of 0°C to 50°C.

**Line variation:** <±1 × 10<sup>-7</sup> for 10% line variation from nominal.

**Output frequency:** 10 MHz, ≥2.4 V square wave (TTL compatible) available from rear panel BNC.

**External time base:** requires 10 MHz approximately 1.5 V p-p sine wave or square wave into 1 kΩ via rear panel BNC. Switch selects either internal or external time base.

**Optional time base (opt 001) aging rate:** <5 × 10<sup>-10</sup> per day after 24-hour warm-up for less than 24 hour off-time.

#### General

**Accuracy:** ±1 LSD ± time-base error.

**Resolution:** front-panel switch selects 1 Hz to 1 MHz.

**Display:** eight digit LED with positioned decimal point and appropriate measurement units of kHz, MHz, or GHz.

**Self check:** counts and displays 10 MHz for resolution chosen.

**Sample rate:** controls time between measurements. Continuously adjustable from 50 ms typical to 5 seconds. HOLD position holds display indefinitely. RESET button resets display to zero and activates a new measurement.

**HP-IB interface functions:** SH1, AH1, T1, L2, SL1, RL2, PP0, DC1, DT1, C0, E1 (see page 542).

**Operating temperature:** 0°C to 50°C.

**Power:** 115 V or 230 V +5%, -10%, 48-66 Hz, 100 VA.

**Weight:** net, 11.3 kg (25 lb). Shipping, 14.1 kg (31 lb).

**Size:** 88.2 mm H x 425 mm W x 467 mm D (3.47 in. x 16.75 in. x 18.39 in.).

#### Ordering Information

HP 5340A Frequency Counter

Opt 001 High Stability Time Base

Opt 002 Rear Panel Connectors

Opt 005 Frequency Extension to 23 GHz

Opt 008 Limiter Input Protection (+39 dBm)

Opt 011 Remote Programming-Digital Output (HP-IB)

Opt 008 Rack Flange Kit

#### Price

\$15,000

+ \$750

+ \$200

+ \$600

+ \$600

+ \$550

+ \$30

# ELECTRONIC COUNTERS

## Pulse and CW Microwave Frequency Counters

Models 5345A/5355A/5356A,B,C,D

- -25 dBm sensitivity
- 100 Hz measurement resolution
- 75 nanoseconds minimum pulse width
- 20 nanoseconds minimum external gate
- CHIRP profile or VCO post-tuning drift

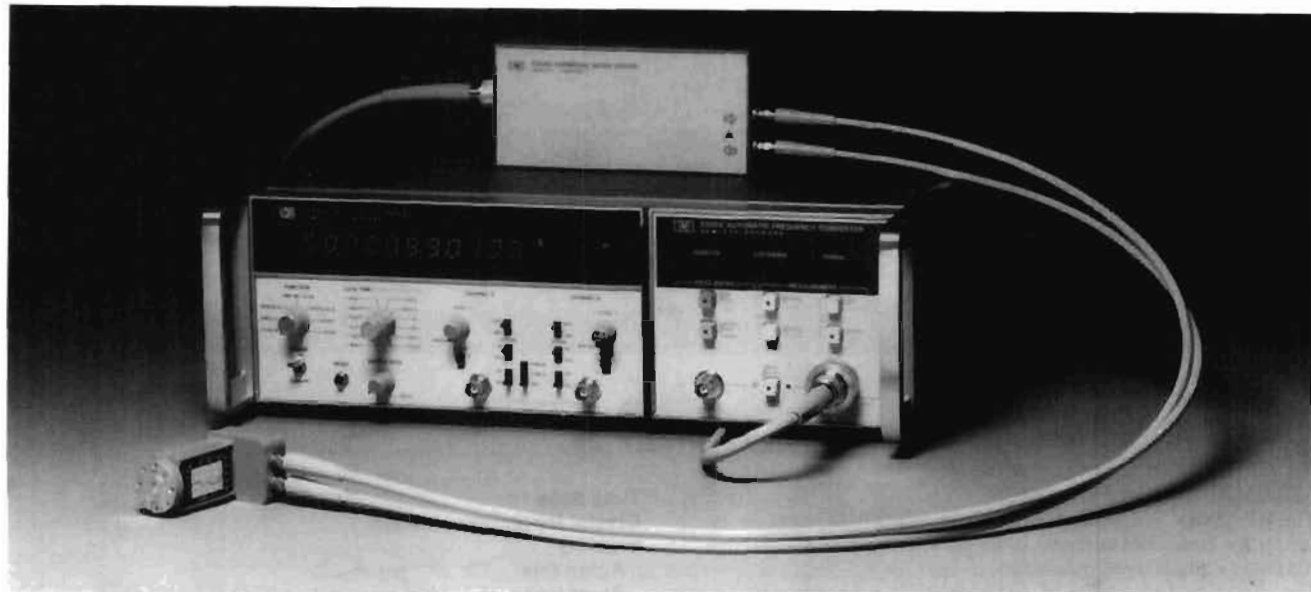

Extending the frequency range of CW and pulse measurements to 100 GHz.



### Pulse and CW Measurements to 110 GHz

HP 5355A Automatic Frequency Converter/5345A Counter, together with the HP 5356A, 5356B, 5356C, 5356D Frequency Converter Heads, provide pulse and CW frequency measurement capability to 18, 26.5, 40, and 110 GHz respectively. The HP 5355A's internal microprocessor controls the measurement algorithm, computes the input microwave frequency, and displays the result on the HP 5345A with 11 digits of resolution.

### Automatic Pulse Detection

This 110 GHz counter is a versatile tool for characterizing pulsed signals. Internal pulse-detection circuitry (Figure 1) can detect incoming RF bursts as short as 75 nanoseconds and generate a measurement gate for the counter. With this internally-generated detection gate, the counter can then measure the average frequency of the RF burst.

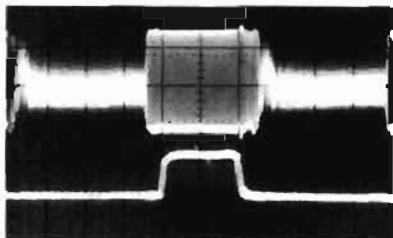

Figure 1. Automatic Pulse Detection

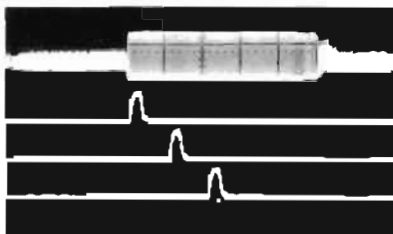

Figure 2. External gates as short as 20 ns

### Pulse Frequency Profiling

If there is FM on the burst carrier, the counter can also accept external measurement gates as short as 20 nanoseconds (Figure 2) to perform dynamic frequency profilings. This external gating capability is useful in applications such as radar CHIRP characterization. (Figure 3) It can also help VCO manufacturers measure oscillator's post-tuning drift (Figure 4).

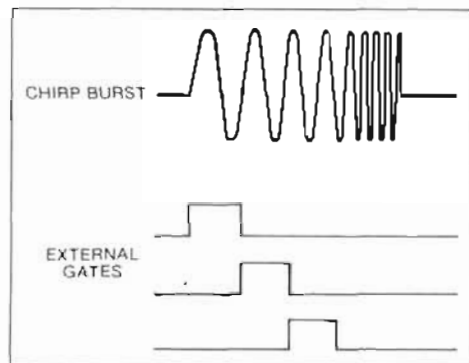

Figure 3. CHIRP radar characterization

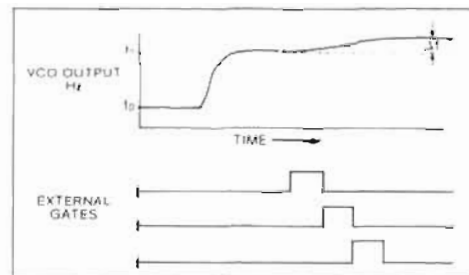

Figure 4. VCO post-tuning drift characterization

**Exceptional Resolution, High Accuracy**

You can select the measurement gate time of this counter from 50 nanoseconds to 1000 seconds. Increasing the measurement gate time increases the resolution of measurement results. In fact, this counter can measure a 110 GHz signal with 100 Hz resolution and 3 kHz accuracy in pulse mode. This performance improves to 1 Hz in CW mode.

Even if your application requires narrow external gates, the counter can still achieve fine resolution through an automatic frequency averaging scheme (Figure 5). When the measurement gate is longer than the external gate, the counter will automatically take several measurements of the repetitive signal. It will then average the results to yield better resolution. The measurement process is completely automatic—making the counter easy to work with.

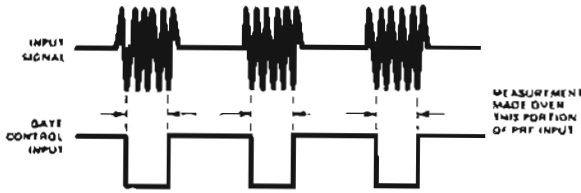

Figure 5. Frequency averaging to increase resolution

**Sensitivity, FM Tolerance, Automatic Amplitude Discrimination**

HP's pulse counters have sensitivity performance to -25 dBm, making measurement of low-level microwave and millimeter-wave signals reliable and accurate. For signals with frequency modulation, these counters also offer high peak-to-peak amplitude discrimination automatically measures the signal with the highest amplitude.

**Systems Performance, 9000 Measurements/Second**

These counters are fully programmable over HP-IB. Measurement throughput of 9000 measurements/second saves you money by reducing test time.

**Input Specifications (pulse and CW mode)**

	HP 5356A	HP 5356B	HP 5356C	HP 5356D
Frequency Range	15-18 GHz	15-26.5 GHz	15-40 GHz	36-110 GHz
Sensitivity				
1.5-12.4 GHz	-20 dBm	-20 dBm	-25 dBm	---
12.4-18 GHz	-15 dBm	-15 dBm	-20 dBm	---
18-26.5 GHz	---	-15 dBm	-20 dBm	---
26.5-34 GHz	---	---	-15 dBm	---
34-40 GHz	---	---	-10 dBm	---
36-50 GHz	---	---	---	-20 dBm
40-60 GHz	---	---	---	-15 dBm
50-75 GHz	---	---	---	-10 dBm
75-95 GHz	---	---	---	-7 dBm
95-105 GHz	---	---	---	-5 dBm
105-110 GHz	---	---	---	-3 dBm
Maximum Input				
1.5-12.4 GHz	+5 dBm	+5 dBm	+5 dBm	---
12.4-18 GHz	+5 dBm	+5 dBm	+15 dBm	---
18-26.5 GHz	---	+5 dBm	+15 dBm	---
26.5-40 GHz	---	---	+15 dBm	---
36-110 GHz	---	---	---	+5 dBm
Damage Level	+25 dBm peak	+25 dBm peak	+25 dBm peak	+24 dBm peak +20 dBm CW
Impedance	50 Ω NOMINAL	50 Ω NOMINAL	50 Ω NOMINAL	Waveguide
SWR (TYPICAL)				
1.5-10 GHz	<2.1	<2.1	<2.1	---
10-18 GHz	<3.1	<3.1	<3.1	---
18-26.5 GHz	---	<3.1	<3.1	---
26.5-34 GHz	---	---	<3.1	---
34-40 GHz	---	---	<5.1	---
36-110 GHz	---	---	---	<3.1
Connector	N Male	SMA Male	APC 3.5 Male	Waveguide

① HP 5356A/B: See Option 006 for higher damage protection to +39 dBm.  
 ② 1.5-6 GHz: +0 dBm (+5 dBm, TYPICAL)  
 6-12.4 GHz: +5 dBm

**CW Mode**

	HP 5356A/B/C Auto Mode	HP 5356A/B/C/D Man Mode	HP 5356D Auto Mode
FM Tolerance	5356A/B: 15 MHz p-p 180 MHz p-p in special FM model, rate dc -10 MHz 5356C: 60 MHz p-p, rate dc -10 MHz	80 MHz p-p rate dc -10 MHz	Fig 6
AM Tolerance	Any modulation index provided the minimum signal level is greater than the counter sensitivity		50%
Multiple Signal Discrimination	Automatic Amplitude Discrimination (AAD). Automatically measures largest signal provided signal is 8 dB (TYPICAL) greater than any signal within 500 MHz and 20 dB (TYPICAL) greater than any signal over the full frequency range of the head		15 dB TYP
Acquisition Time (TYPICAL)	HP 5356A/B = 400 ms HP 5356C = 1.4 s	15 ms	① 100 ms
Measurement Time (TYPICAL)	Gate Time ≤ 100 ms: Acquisition time = 4 × HP 5345A GATE TIME + 5345A Sample Rate × 125 ms Gate Time = 100 ms: Acquisition time = HP 5345A GATE TIME + HP 5345A Sample Rate × 35 ms		
Tracking Rate	---		100 MHz/s (TYPICAL)
LSD Displayed	1 Hz = HP 5345A Gate Time		
Resolution	±2 × LSD ±10 <sup>-10</sup> rms ± FREQ		
Accuracy	±2 × LSD ± 1 × 10 <sup>-10</sup> rms ± FREQ ± time base error ± FREQ		

① 100 ms (input level -5 to +5 dBm).  
 300 ms (input level -15 to -5 dBm).  
 400 ms (input level -20 to -15 dBm).

**Pulse Mode**

	HP 5356A/B/C/D Input Auto Mode	HP 5356A/B/C/D Input Man Mode
FM Tolerance (TYPICAL)	50 MHz p-p Chirp	80 MHz p-p Chirp
Acquisition Time (TYPICAL)	<ul style="list-style-type: none"> <li>HP 5356A/B/C Input Man Mode: 0</li> <li>HP 5356A/B Input Auto Mode: 100 μs + (EXT GATE WIDTH × PRF) + 650 ms for EXT GATE ≤ 100 μs (2 × PRF) + 650 ms for EXT GATE &gt; 100 μs</li> <li>HP 5356C Input Auto Mode: (8 × PRF) + 1.55s + 100 μs - (EXT GATE WIDTH × PRF) for EXT GATE ≤ 100 μs (10 × PRF) + 1.55s for EXT GATE &gt; 100 μs</li> <li>HP 5356D -5 to +5 dBm: (X) = 2.5</li> <li>HP 5356D -15 to -5 dBm: (X) = 3.5</li> <li>HP 5356D -20 to -15 dBm: (X) = 4.5</li> </ul> $(X) = 2 \left( \frac{100 \mu s}{EXT GATE WIDTH + PRF} \right) \text{ For EXT GATE } \leq 100 \mu s$ $(X) = \frac{2}{PRF} \text{ For EXT GATE } > 100 \mu s$ <ul style="list-style-type: none"> <li>HP 5356D Limited Search: (X) = 1: Range 1 to 6 GHz or ±3 GHz from center frequency</li> </ul>	
Calibration Time	$\left( \frac{HP 5345A GATE TIME}{EXT GATE WIDTH + PRF} \right) + 75 \text{ ms}$ Performed during 10 consecutive measurements when PULSE Mode is selected after any front panel change, or when the EXTERNAL GATE width changes by more than 12%. Only calibrates if External Gate ≤ 100 μs	
Measurement Time (TYPICAL)	Acquisition Time + Calibration Time + HP 5345A SAMPLE RATE + HP 5345A GATE TIME or 100 μs (whichever is greater)	Acquisition Time + Calibration Time + HP 5345A SAMPLE RATE + 60 ms + (1 μs × HP 5345A GATE TIME) / EXT GATE WIDTH × PRF
Pulse Width Min	100 ns (50 ns, HP 5356D with Opt. 110)	75 ns
Pulse Width Max	20 ms	20 ms
Pulse Repetition Frequency Min	50 Hz	50 Hz
Min (HP 5356D only)	500 Hz	500 Hz
Max	2 MHz	2 MHz
Minimum On/OFF RATIO	25 dB TYPICAL	
Maximum Video Feed Through	15 mV p-p TYPICAL for r1 burst rise and fall times > 10 ns for HP 5356A/B/C. No limitation for HP 5356D (Waveguide beyond cutoff)	
Minimum EXT GATE WIDTH	20 ns	
LSD Displayed	1 Hz = HP 5345A GATE TIME	
Resolution	±2 × LSD ± 100 Hz rms ±	
Accuracy	$\pm 2 \times LSD \pm 100 \text{ Hz rms} \pm$ $\left( 1 + \sqrt{\frac{HP 5345 GATE TIME \times EXT GATE TIME WIDTH}{EXT GATE WIDTH}} \right) \pm$ $\left( 1 + \sqrt{\frac{HP 5345 GATE TIME \times EXT GATE TIME WIDTH}{EXT GATE WIDTH}} \right) \pm$ $\frac{Df}{EXT GATE WIDTH} \pm 3 \text{ kHz}$ ± time base error ± FREQ	

① For (HP 5345 GATE TIME) > 10 ms and PULSE WIDTH > 10 μs, use  

$$\left( 3 + \sqrt{\frac{HP 5345 GATE TIME \times EXT GATE TIME WIDTH}{EXT GATE WIDTH}} \right) \pm$$

For EXT GATE signals generated by the HP 5355A, the EXT GATE WIDTH equals the input PULSE WIDTH minus 30 ns (TYPICAL) for the HP 5356A/B/C/D input and equals input PULSE width minus 65 ns (TYPICAL) for the HP 5355A 0.4-1.5 GHz input.

# ELECTRONIC COUNTERS

## Pulse and CW Microwave Frequency Counters (cont'd)

Models 5345A/5355A/5358A,B,C,D

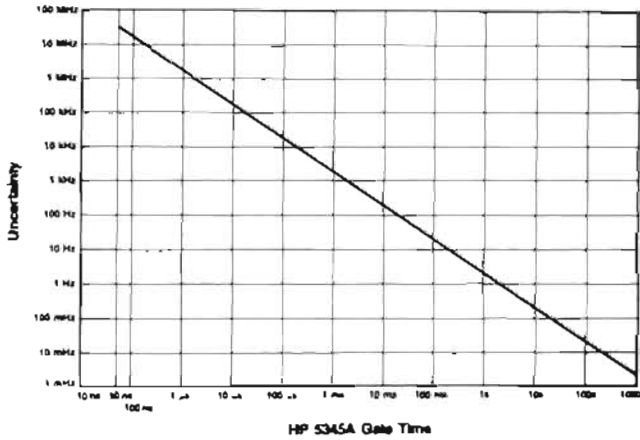

Graph 1. Uncertainty (2 × LSD) due to selected 5345A gate time.

### Input Specifications

5355A 0.4 - 1.6 GHz (condensed)

**Sensitivity:** -15 dBm.

**Maximum input:** +5 dBm.

**Impedance:** 50 Ω nominal.

**Damage level:** +24 dBm peak (fuse in BNC connector).

**Pulse width:** 150 ns to 1 s

**Pulse repetition rate:** 100 Hz to 2 MHz.

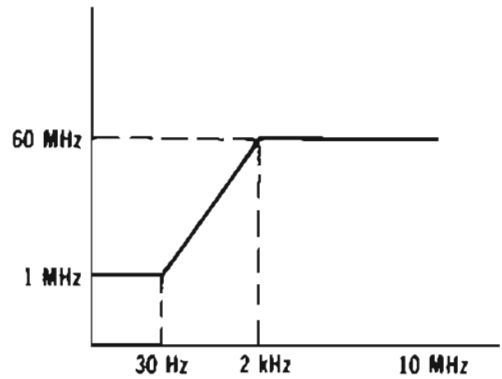
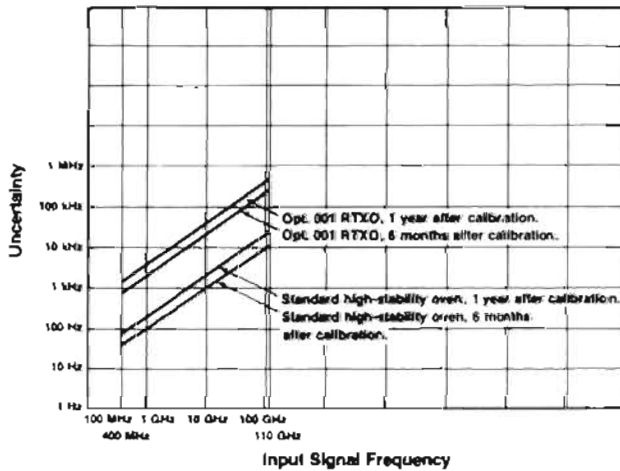
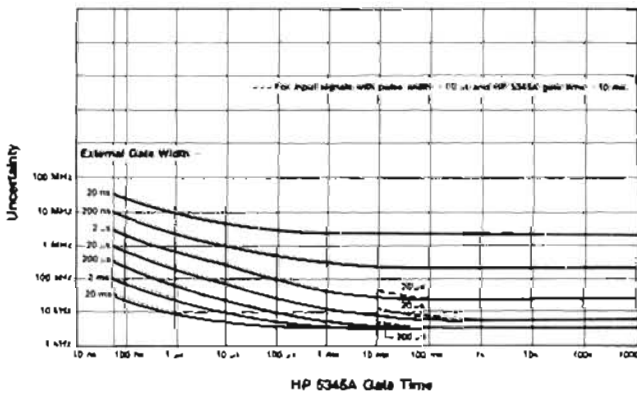

Figure 6 HP 5358D FM Tolerance



Graph 2. Uncertainty, due to time-base error. Time-base error can be reduced by calibrating the time base more frequently



Graph 3. Uncertainty due to jitter (rms jitter) and gate error  
 $\left( \frac{.04}{\text{EXT GATE WIDTH}} \right) \pm 3 \text{ kHz}$

### Ordering Information

Model	Description	Price
HP 5345A	Electronic Frequency Counter	\$9,250
HP 5355A	Automatic Frequency Converter	\$5,350
HP 5358A	18 GHz Frequency Converter	\$1,800
HP 5358B	26.5 GHz Frequency Converter	\$2,000
HP 5358C	40 GHz Frequency Converter	\$2,500
HP 5358D	36-110 GHz Harmonic Mixer Driver	\$6,000

### Options for HP 5345A

Opt 001	Room Temperature Time Base	- \$320
Opt 010	HP-IB Talk Only	+ \$350
Opt 011	HP-IB includes remote programming	+ \$950
Opt 012	HP-IB similar to Opt 011, but also includes slope and trigger level controls	+ \$1,600
Opt 008	Rack Flange Kit, HP 5060-8740	+ \$22

### Options for HP 5358A

Opt 001	High Pass Filter	+ \$220
Opt 006	Limiter	+ \$450

### Options for HP 5358B

Opt 001	18-26.5 GHz Waveguide (WR-42)	+ \$950
Opt 006	Limiter	+ \$450

### Option for HP 5358C

Opt 001	26.5-40 GHz Waveguide (WR-28)	+ \$850
---------	-------------------------------	---------

**Options for HP 5358D** (requires an HP 5355A with S/N prefix greater than 2620 - xxxx and one of the following mixer options)

Opt 050	(HP 11970Q) 36-50 GHz Harmonic Mixer	+ \$1,700
Opt 060	(HP 11970U) 40-60 GHz Harmonic Mixer	+ \$1,850
Opt 075	(HP 11970V) 50-75 GHz Harmonic Mixer	+ \$2,250
Opt 110	(HP 11970W) 75-110 GHz Harmonic Mixer	+ \$2,500
Opt 005	(two HP 5061-5458 parts) 2 cables to connect HP 5358D to HP 11970Q/U/V or W	+ \$230

☞ Fast-Ship Product — see page 758.

# ELECTRONIC COUNTERS

## Low Cost Counters for Frequency Measurements

Models 5384A, 5385A, 5386A

179

- Frequency measurements to 3 GHz (HP 5386A)
- Up to 11 digits of resolution, 9 digits per second
- -23.5 dBm sensitivity



HP 5386A: 10 Hz to 3 GHz (pictured above).  
 HP 5385A: 10 Hz to 1 GHz (not shown).  
 HP 5384A: 10 Hz to 225 MHz (not shown).

### HP 5384A/5385A/5386A Frequency Counters

The HP 5384A/85A/86A are HP's lowest priced system counters. They provide outstanding measurement performance for bench, field, and systems applications. Combining wide frequency range, high resolution, high sensitivity, and HP-IB compatibility, these counters compare with instruments which cost much more.

**Portable:** The half-rack-width package makes the HP 5384A/85A/86A portable and saves rack or bench space.

**Versatile Display:** The twelve-digit, liquid-crystal display has larger characters than other LED displays and is easier to read in sunlight. The added feature of remote display extends the usefulness of these counters beyond that of simply making and displaying frequency measurements. User-friendly messages, prompts and measurement units can now be displayed.

**Low Cost Of Ownership:** Integrated design and extensive self-tests result in greater reliability, easier serviceability, and ultimately lower cost of ownership.

### Performance

If your frequency measurement needs are below 3 GHz, the HP 5386A will provide you with the basic performance of traditional microwave counters, at about half the price. The HP 5386A measures frequencies from 10 Hz to 3 GHz with only two input ports, instead of the three ports found with other counters. The high-frequency input measures frequencies from 100 MHz to 3 GHz with -23.5 dBm sensitivity (10 mV rms). In addition, pre-scaling techniques offer peak-to-peak FM tolerance of at least 100 MHz for your communications applications. You can select the number of digits displayed from 3-to-11 to blank meaningless digits from an unstable signal source. The HP 5386A also solves your systems problems with full remote programmability (via HP-IB standard feature) and remote display capabilities. The high-stability timebase option will lengthen the required calibration period (for kHz accuracy at 3 GHz) from six months to a full year.

### Applications

The HP 5386A fits well in the following application areas for local oscillator, IF, and radio transmitter frequency measurements:

- Military and private communications
- TACAN, DME, and Identify Friend or Foe
- Global Positioning System
- MDS Television

- HP-IB standard
- Systems performance and portability

### Condensed Specifications

**Input Channel A (HP 5384A/85A/86A):** 1 M ohm // 25 pF.

**Range:** 10 Hz to 100 MHz.

**Sensitivity:** 15 mV rms sine wave 50 Hz (10 Hz for HP 5386A) to 100 MHz; HP 5384A/85A Only: 25 mV rms sine wave 10 Hz to 50 Hz; 45 mV peak-to-peak 5 ns minimum pulse width.

**Dynamic Range:** 45 mV to 4 V peak-to-peak X attenuator setting.

**Attenuator:** X1 or X20 nominal above 50 Hz input.

**Low Pass Filter:** 100 kHz nominal 3 dB point.

**Manual Trigger Level:** variable, -0.1 V to +0.1 V X attenuator.

**Damage Level X1:** 10 - 200 Hz 350 V (dc + ac peak).

0.2 - 420 kHz 170 V (dc + ac peak).

0.42 - 10 MHz ( $5 \times 10^7$  V rms Hz)/FREQ.

>10 MHz 5 V rms.

X20: <1 MHz, Same as X1; >1 MHz, 50 V rms.

**Input Channel B (HP 5384A):** 50 ohm.

**Range:** 50 to 225 MHz.

**Sensitivity:** 10 mV rms 50 to 200 MHz; 15 mV rms 200 to 225 MHz.

**Dynamic Range:** 10 mV to 1 V rms.

**Manual Attenuator:** variable, X1 to X5 (0 to 14 dB) nominal.

**Damage Level:** 350 V dc + 5 V rms ac.

**Input Channel B (HP 5385A):** 50 ohm, fused.

**Range:** 90 to 1000 MHz.

**Sensitivity:** 10 mV rms (-27 dBm) 100-1000 MHz; 15 mV rms (-33 dBm) 90 - 100 MHz.

**Dynamic Range:** 10 mV to 7 V rms (-27 to +30 dBm).

**Manual Attenuator:** variable, X1 to X18 (0 to 25 dB) nominal.

**Damage Level:** ac >1 MHz + 30 dBm (7 V rms).

ac <1 MHz 2 V rms, dc  $\pm$  5 V.

**Input Channel B (HP 5386A):** 50 ohm nominal, VSWR 2.5, typical.

**Range:** 100 MHz to 3 GHz, pre-scaled.

**Coupling:** ac.

**Sensitivity:** 15 mV rms (-23.5 dBm).

**Dynamic Range:** 10 mV rms to .5 V rms (-23.5 dBm to +7 dBm)

**Damage Level:** ac: +27 dBm, dc:  $\pm$  5 V.

NOTE: Manual attenuator not active for channel B.

### Frequency A and B

**Range Channel A:** 10 Hz - 100 MHz.

**Range Channel B:** (HP 5384A) 50 MHz - 225 MHz; (HP 5385A) 90 MHz - 1.0 GHz; (HP 5386A) 100 MHz - 3 GHz

**LSD Displayed:** 10 Hz to 1 nHz.

**Accuracy:**  $\pm$  Resolution  $\pm$  Timebase Error X Frequency (see Graphs 1 and 3).

### Period A

**Range:** 10 ns to 0.1 s.

**LSD Displayed:** .001 fs to 10 ns.

**Accuracy:**  $\pm$  Resolution  $\pm$  Timebase Error X Period (see Graphs 2 and 3).

### Timebase

**Standard HP 5384A:** 10 MHz.

**Aging Rate:**  $< 3 \times 10^{-7}$ /mo.

**Temperature:**  $< 5 \times 10^{-6}$ , 0° to 50°C, ref. 25°C.

**Line Voltage:**  $< 1 \times 10^{-1}$  for  $\pm$  10% variation.

**Standard HP 5385A/86A, Option 001 (HP 5384A):** TCXO, 10 MHz.

**Aging Rate:**  $< 1 \times 10^{-7}$ /mo.

**Temperature:**  $< 2 \times 10^{-6}$ , 0° to 40°C, ref. 25°C.

**Line Voltage:**  $< 5 \times 10^{-3}$  for  $\pm$  10% variation.

### Oven Timebase (Option 004)

**Frequency:** 10 MHz.

**Aging Rate:**  $< 3 \times 10^{-8}$ /mo. after 30 days continuous operation.

**Temperature:**  $< 1 \times 10^{-7}$ , 0° to 50°C, ref. 25°C.

**Line Voltage:**  $< 2 \times 10^{-9}$  for  $\pm$  10% variation.

**Battery Operation (HP 5384A/85A Only):** the instrument operates for 3 hours (typ.) with Option 004. In STBY, the oven will operate continuously for 24 hours (typ.)

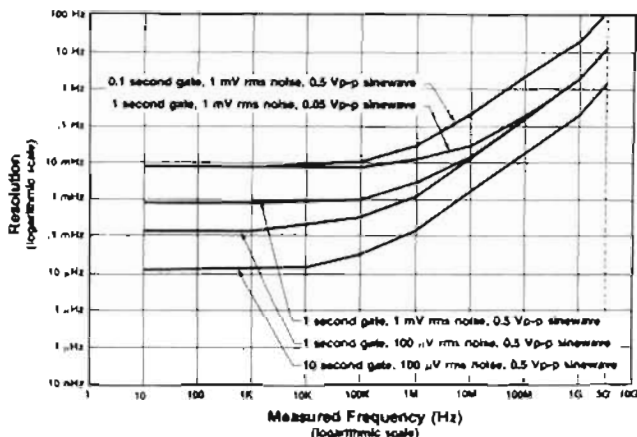

Graph 1. Frequency Resolution. Uncertainties which limit resolution can be reduced by increasing the gate time, reducing the noise on the Input signal, or increasing the Input signal amplitude.

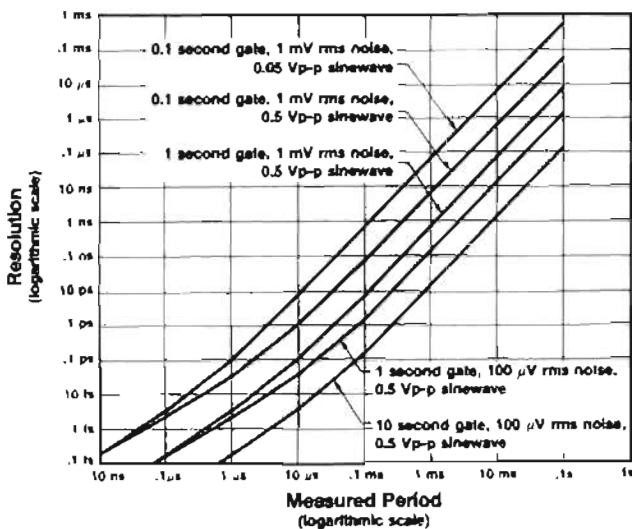

Graph 2. Period Resolution. Uncertainties which limit resolution can be reduced by increasing the gate time, reducing the noise on the Input signal, or increasing the Input signal amplitude.

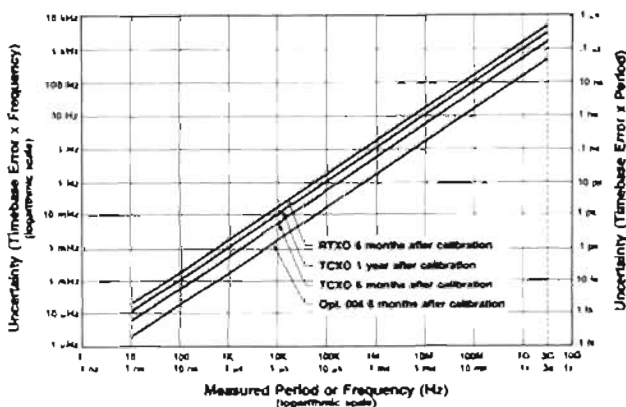

Graph 3. Frequency and Period Uncertainty due to Timebase Error. Timebase error can be reduced by calibrating the timebase more frequently, or by using a timebase with a better aging rate.

### I/O Interface

#### HP-IB Standard

**Programmable Functions:** Frequency A, Frequency B, Period A.  
**Programmable Controls:** ATTN A, FILTER A, MAN LEVEL A, MAN LEVEL A/B (HP 5384A/85A Only), Gate Time.

**Display:** Normal, Increment, Decrement (digits displayed); Remote, Local; any 12-character message can be displayed on the LCD via a system controller.

**Data Output:** output will be maximum resolution/gate time.

**Format:** 17 characters plus CR and LF.

**Rate:** 4 readings/s maximum at 0.1 s gate.

**HP-IB Interface Functions:** SH1, AH1, T5, TE0, L4, LE0, SR1, RL1, PP0, DC1, DT1, C0, E1 (see page 542).

**Talk Only:** Set with address switch = 31.

### Battery Pack (Option 005 - HP 5384A/85A Only)

**Battery Type:** sealed lead-acid.

**Capacity:** 4 hours (typ.) at 25°C without Option 004.

**Recharge Time:** 16 hours (typ.) in the standby mode.

**Battery Low Annunciator:** enabled 20 minutes prior to instrument shutdown nominally.

**Battery Save Switch (rear panel):** prevents discharge of interval battery by the oven timebase, Option 004, during instrument standby (STBY).

**Line Failure Protection:** instrument automatically switches to battery in case of line failure.

**Weight:** Option 005 adds 1.4 kg (3 lb) to instrument weight.

### General

**Check:** 10 MHz self-test.

**Gate Times:** 0.1, 1, or 10 seconds (nominal).

**Display:** 12-digit alphanumeric liquid crystal.

**Display Digits (variable):** frequency 3 to 11; period 3 to 8.

**Timebase Output:** 10 MHz, 25 mV p-p (nominal) into 50 ohm.

**External Timebase Input:** 10 MHz, 0.5 V rms into 500 ohm; 15 V (dc + ac peak) maximum.

**Operating Temperature:** 0° to 50°C.

#### Power Requirements

**AC:** selectable, 18 VA max. (30 VA max., HP 5386A) 115 V + 10%, -25%; 230 V + 10%, -15%; 48 - 66 Hz; 115 V ± 10%; 380 - 420 Hz.

**DC:** (HP 5384A/85A Only): 9 - 15 V dc, 1.0 A maximum.

#### Weight

**HP 5384A/85A:** net, 2.5 kg (4.5 lb). Shipping, 4.5 kg (9 lb).

**HP 5386A:** net, 3.5 kg (7.5 lb). Shipping 5.5 kg (11 lb).

#### Size:

**HP 5384A/85A:** 212 mmW x 98 mmH x 276 mmD (8 3/8 in. x 3 3/4 in. x 10 3/4 in.); **HP 5386A:** 212.3 mmW x 88.1 mmH x 421.6 mmD (8 1/2 in. x 3 1/2 in. x 16 1/2 in.).

### Ordering Information

Model	Price
HP 5384A Frequency Counter 225 MHz	\$1400
HP 5385A Frequency Counter 1.0 GHz	\$1700
HP 5386A Frequency Counter 3.0 GHz	\$3100
Opt 004 High Stability Ovenized Timebase	+ \$500
Opt 910 Additional Operating/Service Manual	+ \$20
<b>HP 5384A/85A Only:</b>	
Opt 001 High Stability TCXO (HP 5384A)*	+ \$150
Opt 005 Battery Pack	+ \$300
HP 5061-1171 Slide Handle Kit	\$19
HP 5060-0173 Rack Mount Kit (single)	\$64
HP 5060-0174 Rack Mount Kit (dual)	\$62.50
HP 34110A Vinyl Carrying/Operating Case	\$40
*TCXO timebase is standard with HP 5385A/86A	
<b>HP 5386A only:</b>	
Side Handle Kit: HP P/N 5061-9688	\$50
Rack Mount Kit (single), HP P/N 5061-9672	\$50
Rack Mount Kit (dual), HP P/N's 5061-9674 and 5061-9694	\$55

Fast-Ship product — see page 758.

- 20 ps single shot LSD
- $\pm 100$  ps accuracy achievable
- 8000 measurements/s possible

- Built-in statistics functions
- Positive, zero and negative time
- Frequency and period to 100 MHz

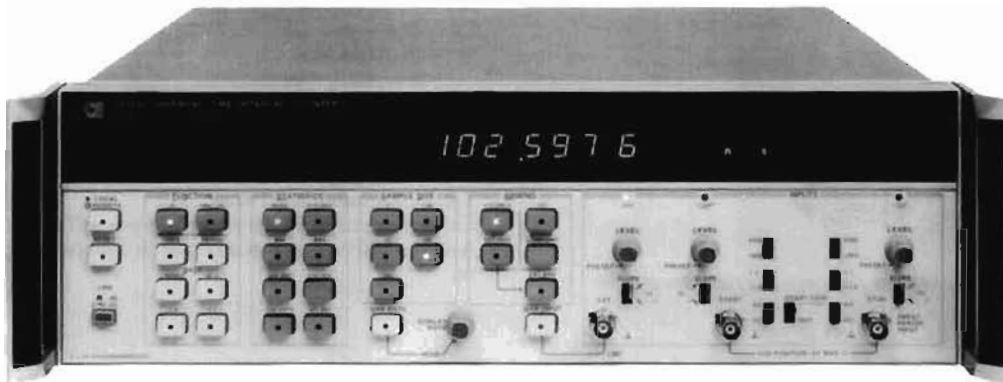

With the HP 5370B, you can make high-precision, time-interval measurements at up to 8000 measurements/second, making it ideal for your production applications.



### Increase Productivity with the HP 5370B's Precision and Measurement Speed

- IC Tester performance verification
- Fast IC characterization
- Disc drive manufacture
- Digital communications - jitter analysis
- Radar/laser ranging calibration
- Nuclear systems
- Calibration Labs

### Use the full range of functions

**Time Interval:** you can get 20 ps single shot LSD on time intervals from zero to 10 s, including negative time (where the STOP channel event occurs before the START channel event).

**Frequency:** measure up to 100 MHz with 11 digits of resolution in one second. Choose gate times down to one period: use one period with average mode and access the powerful STATISTICS capabilities.

**Period:** measure period average from one to 100k samples and use STATISTICS

**Statistics:** will reduce your external computations, reduce random errors and improve measurement throughput.

**Sample size:** you can select 1, 10, 1k, 10k or 100k samples from the front panel, or 1 to 16,777,215 samples over HP-IB. For the selected sample size you can compute:

- Mean
- Standard Deviation
- Minimum
- Maximum

### Select the time interval you want from complex waveforms:

use the extremely flexible arming and gating to select:  
 +T1 or  $\pm$ T1 with internal arming, external arming - no hold-off, or with external arming - external hold-off.

### Program all major capabilities of the HP 5370B over HP-IB:

Data output rates:

- up to 8000 readings/second in fast binary mode - 125  $\mu$ s dead time.
- 10 to 20 readings/second fully formatted - 330  $\mu$ s dead time

### Condensed Specifications

**Sensitivity:** 100 mV p-p, 35 mV rms sine wave  $\times$  attenuator setting.

**Impedance:** selectable 1 M $\Omega$ //45 pF or 50  $\Omega$  nominal.

**Trigger level:** -2 V to +2 V, adjustable; 10 mV displayed resolution.

**Trigger slope:** independent selection of + or - slope.

**Attenuators:**  $\div 1$  and  $\div 10$  nominal.

#### Dynamic Range (preset)

50  $\Omega$   $\div 1$ : 100 mV to 4 V p-p pulse;  $\div 10$ : 1 V to 7 V p-p pulse.

1 M $\Omega$   $\div 1$ : 100 mV to 4 V p-p pulse;  $\div 10$ : 1 V to 10 V p-p pulse.

Dynamic range for rms sine wave is one-third of the above values.

#### Signal Operating Range

50  $\Omega$   $\div 1$ : -4 V to +4 V;  $\div 10$ : -7 V to 7 V.

1 M $\Omega$   $\div 1$ : -4 V to +4 V;  $\div 10$ : -25 V to 10 V.

**Coupling:** ac or dc switch selectable.

**Minimum pulse width:** 5 ns.

#### Maximum Input

50  $\Omega$   $\div 1$ :  $\pm 7$  V dc

7 V rms below 5 MHz

3.5 V rms (+24 dBm) above 5 MHz.

$\div 10$ :  $\pm 7$  V dc, 7 V rms (+30 dBm).

1 M $\Omega$   $\div 1$ :  $\pm 350$  V dc

250 V rms to 20 kHz decreasing to 3.5 V rms above 5 MHz.

$\div 10$ :  $\pm 350$  V dc

250 V rms to 20 kHz decreasing to 35 V rms above 5 MHz.

#### Common Input

All specifications are the same as for separate operation with the following differences:

**Impedance:** 1 M $\Omega$  becomes 500 k $\Omega$  shunted by <80 pF.

50  $\Omega$  same as in separate.

#### Sensitivity (preset)

50  $\Omega$   $\div 1$ : 200 mV p-p, 70 mV rms;  $\div 10$ : 2 V p-p, 700 mV rms.

1 M $\Omega$ : same as in separate.

#### Dynamic Range (preset)

50  $\Omega$   $\div 1$ : 200 mV to 5 V p-p pulse;  $\div 10$ : 2 V to 5 V p-p pulse.

1 M $\Omega$ : same as in separate.

#### Maximum Input

50  $\Omega$   $\div 5$  V dc or 5 V rms.

1 M $\Omega$  same as in separate.

**Attenuators:** becomes  $\div 2$  and  $\div 20$  for 50  $\Omega$ .

# ELECTRONIC COUNTERS

## Universal Time Interval Counter (cont'd)

### Model 5370B

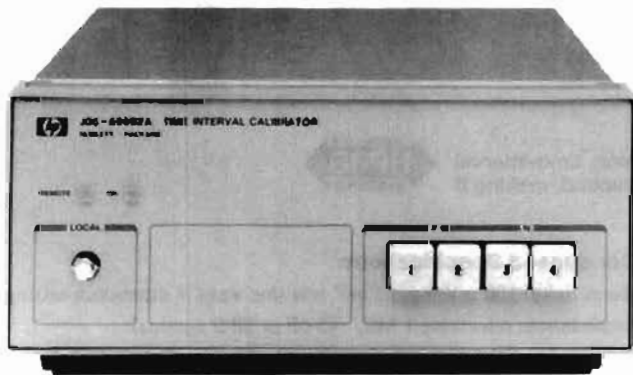

The J06-59992A Time Interval Calibrator gives you the ability to remove systematic errors from your measurement system, so that the 5370B can measure with uncertainties of  $< \pm 100$  ps.

#### Time Interval Measurement

##### Range

- $\pm$ TI:  $-10$  to  $+10$  s, including zero.
- +TI: 10 ns to 10 s.

##### Accuracy

The accuracy (uncertainty) in a time interval measurement is influenced by:

- 1) internal systematic uncertainty;
- 2) trigger level timing error, for each edge;
- 3) crystal oscillator aging;
- 4) noise on the input signal; and
- 5) internal timing jitter.

Factors 1, 2 and 3 can be significantly reduced by calibration -- 1 and 2 by using the J06-59992A Time Interval Calibrator.

Factors 4 and 5 can be significantly reduced by averaging: (by  $\sqrt{N}$ , where N is the number of measurements averaged).

##### Total Uncertainty

Add together the following:

- 1) Systematic uncertainty is:
  - 1 ns worst case, or
  - 400 ps typical, or
  - 20 ps typical after calibration.
- 2) Trigger level timing error is:
  - read from graph 1 for each edge, or
  - 40 ps typical after calibration. Total error is the lower of the two.
- 3) Crystal aging influence is:
  - read from graph 2.
- 4) Input signal noise influence is:
  - read from graph 3 for each edge.
- 5) Internal timing jitter influence is:
  - 100 ps for up to 1 s intervals.

#### Example

Measure a time interval of 500 ns, from a 1V, 10 ns rise time edge to a 1V, 10 ns edge. Input signal noise (in a 500 MHz bandwidth) is 1mV. It is 1 year since oscillator calibration. The measurement will be made single shot.

- 1) is typically 400 ps.
- 2) is 250 ps.
- 3) is negligible.
- 4) is  $2 \times 10$  ps: 20 ps.
- 5) is 100 ps.

Total uncertainty is  $\pm 770$  ps.

Calibrate out systematic errors and you will reduce this to  $\pm 180$  ps. Average 100 readings in addition to calibration, and reduce to  $\pm 72$  ps.

#### Calibration is a simple procedure, which can be automated with HP-IB.

The Time Interval Calibrator, in conjunction with a suitable pulse generator, provides the counter with signals which will let you measure the systematic errors. Once measured, you simply subtract them from your results to make Time Interval or Pulse Width measurements with uncertainties of  $< \pm 100$  ps.

#### Calibrate to the probe tips of the HP 5363B Time Interval Probes

The calibration works equally well when high impedance probes are needed to make your measurement.

#### Frequency and Period Measurement

**Frequency range:** 0.1 Hz to 100 MHz.

**Period range:** 10 ns to 10 s.

**Internal gate times:** 1 period, 0.01, 0.1, 1 s.

**External gate times:** 20 ns to 10 s.

##### Accuracy

The accuracy (uncertainty) in a frequency measurement is influenced by:

- 1) crystal oscillator aging;
- 2) internal uncertainty; and
- 3) noise on the input signal.

Factor 1 can be reduced by calibration.

Factors 2 and 3 can be reduced by selecting longer gate times.

##### Total Uncertainty

Add together the following:

- 1) Crystal aging influence is:
  - read from graph 4.
- 2) Internal uncertainty is:
  - read from graph 5.
- 3) Input signal noise influence is:
  - read from graph 6.

##### Example

Measure a 1 MHz, 2V pk-pk sine wave. Input signal noise (in a 500 MHz bandwidth) is 1mV. It is 1 year since oscillator calibration. The selected gate time is 0.1 second.

- 1) is 180 mHz.
- 2) is 1 mHz.
- 3) is 3.2 mHz.

Total uncertainty is 184 mHz.

If you had calibrated the oscillator within the last month, this could be reduced to 19.2 mHz.

Select a one second gate time in addition to the recent calibration, and reduce this to 15.3 mHz.



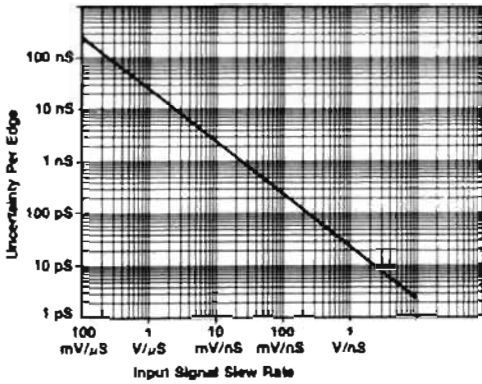

Graph 1. Trigger level timing error varies with input signal slew rate. Uncertainty is associated with both start and stop edges.

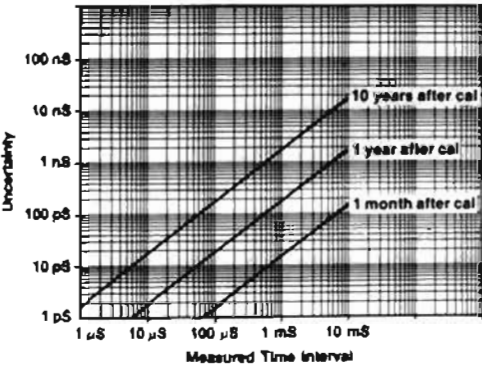

Graph 2. Time base crystal aging affects a time interval or pulse width measurement.

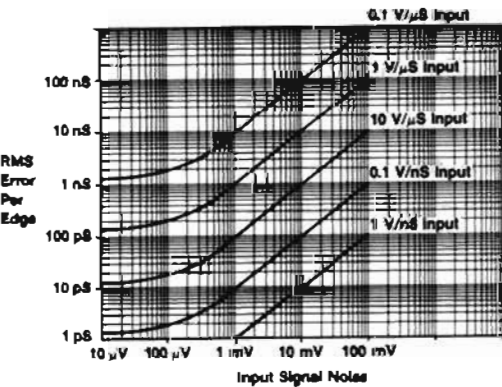

Graph 3. Noise on the input signal will add uncertainty to a time interval measurement. Averaging will reduce the effects of random noise.

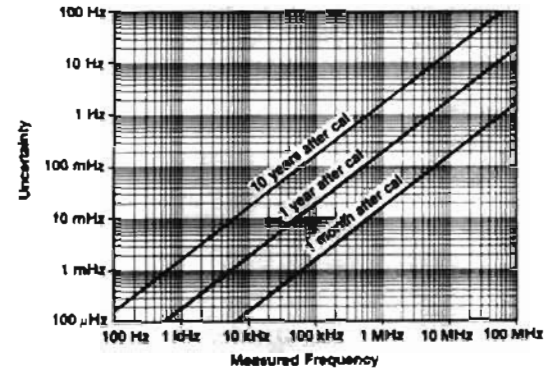

Graph 4. Time base crystal aging affects Frequency and Period measurements. You can further reduce the uncertainty by using an atomic frequency standard.

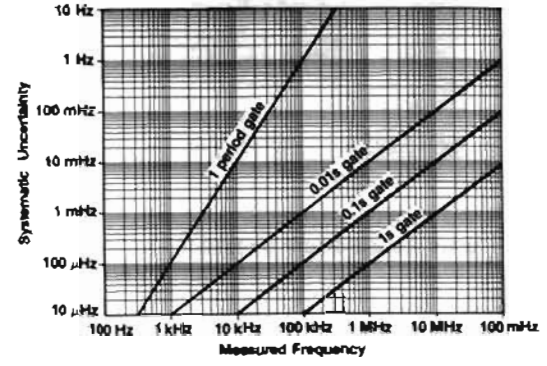

Graph 5. Internal uncertainties affect Frequency and Period measurements.

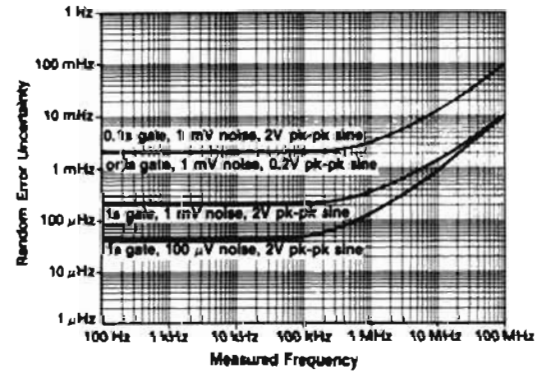

Graph 6. Noise on the input signal will add uncertainty to a Frequency or Period measurement. Longer gate times and averaging will reduce the effects of random noise.

**General - 5370B**  
**Display:** 16 digits, suppressed leading zeros.  
**Size:** 133 H x 426 W x 526 mm D (5.25 x 16.75 x 20.5).  
**Weight:** 14.55 kg (32 lb.).  
**Power requirements:** 100, 120, 220, or 240 V ac +5% -10%, 48 to 66 Hz, less than 250 VA.  
**Front handles:** supplied with instrument.

**General - J06-59992A**  
**Size:** 102 H x 213 W x 295 mm D (4.0 x 8.38 x 11.6).  
**Weight:** 3.0 kg (6.6 lb.).  
**Power requirements:** 115 or 230 V ac +10% -15%, 48 to 66 Hz, 10 VA.

**Ordering Information**

<b>HP 5370B</b> Time Interval Counter	<b>Price</b> <b>\$9900</b>
<b>J06-59992A</b> Time Interval Calibrator	<b>\$3000</b>
<b>Opt 913</b> (5370B Rack Flange Kit - use with supplied front handles)	<b>+ \$30</b>
<b>Opt 908</b> (5370B Rack Flange Kit - without handles)	<b>+ \$33</b>
<b>HP 10870A</b> Service Kit Accessory	<b>\$750</b>

Note: Ask your local HP sales representative for Product Note 5370 B-2 for details on the HP J06-59992A Time Interval Calibrator (see page 760).

# ELECTRONIC COUNTERS

## A New Concept In Frequency and Timing Analysis

Model 5371A

- New solutions for jitter and timing measurements
- Characterizes frequency and phase changes vs time
- Built-in statistical and graphical analysis
- Extremely flexible triggering and arming for measuring complex signals
- DC to 500 MHz frequency range with continuous measurement technology



The HP 5371A offers an entirely new approach to frequency and time-interval analysis. It introduces HP's continuous measurement technology so you don't miss important information, and features built-in analysis so you can see processed results quickly and easily.

### A New Analyzer Concept

The HP 5371A Frequency and Time Interval Analyzer is an entirely new product concept for characterizing frequency, phase, time-interval, jitter and more. Using HP's new continuous measurement technology, it measures dynamic and transient signal conditions, unlike traditional counters that are limited by extremely slow measurement rates. Measurements are captured in a high-speed internal memory. Built-in post-processing with graphic display provides results in easily understandable form. You can display Histograms and statistics, time profiles (Time Variation graphs) and numeric information quickly and easily, without off-line processing.

And you won't miss important data either, because the HP 5371A uses HP's new continuous measurement technology. With sampling intervals as short as 100 ns, the HP 5371A acquires measurements with no dead-time. This means you can now directly measure time-interval, frequency or phase phenomena, without missing information, up to 1000 times faster than previously possible with traditional counting methods... on signals up to 500 MHz.

For measurement capability, the HP 5371A offers all the two-channel Universal Counter features you would expect and much more, including new arming and triggering features that reduce or eliminate custom external circuitry. The HP 5371A is an ideal front-end for ATE applications. Full HP-IB programmability, data transfer rates up to 20,000 results/second and data reduction reduce programming effort and increase measurement throughput.

### Performance Summary

- DC to 500 MHz frequency range
- 150 ps rms single-shot resolution
- Continuous Frequency and Time Interval measurements
- Histogram, Time Variation and other displays
- 1 ns minimum pulse width
- 15 mV input sensitivity, 2 mV trigger resolution
- Continuous Totalize measurements to 500 MHz
- 1000-measurement internal memory
- Automatic trigger level setting modes
- Statistics and Limit Testing features
- 20,000 results/second binary data transfer rate

### Faster, Easier Signal Characterization

The HP 5371A is ideally matched for measurements of basic time-domain parameters where high-resolution, wide-bandwidth time profiling, data distributions or statistical data is desired. Measure and analyze: time-interval, frequency, pulse width, duty cycle, rise and fall times, period, relative phase, totalize and more. The HP 5371A's combined performance and analysis mean better measurement solutions for:

- **Pulse-to-pulse** jitter in PCM systems
- **Data jitter** in disc-drive development
- **Timing** and jitter in electro-mechanical designs
- **Radar-signal** frequency profiling and phase-code demodulation
- **Frequency and phase** modulation, frequency agile analysis
- **Random event** and error totalizing
- **Zero-dead-time** Allan Variance measurements
- **Ring laser** gyro "random walk" characterization
- **VCO transient** characteristics
- **Frequency drift** profiles

Whether your applications are in digital communications, radar/EW, electrical/mechanical, data-storage peripherals, modulation analysis or basic research, the HP 5371A provides the measurement performance and analysis flexibility you need for complex time-interval, frequency, phase, and totalizing characterization.

### Powerful Built-in Post-Processing

With the HP 5371A's built-in graphic display and data reduction, you get immediate information from your measurement data. This minimizes the need for external processors and test-code develop-

ment. Your results can be presented in any of the following ways . . . quickly and easily:

- **Numeric formats**—five different formats are provided for numeric information;
- **Histogram**—with pertinent statistics, displaying the data distribution in graphical form; and
- **Time Variation**—plotting the data vs time for time profiling applications or modulation envelope plots.

In addition, display features such as markers, zooming, auto-scaling, and scrolling simplify viewing of result details. Math functions (Normalize, Offset and Scale) can be used to display calibrated results. Limit values, to flag out-of-tolerance data, can also be specified. To aid in analysis, the following statistical values are calculated for all measurements:

- Maximum, Minimum and Mean values
- Variance, Standard Deviation, and rms
- Allan Variance, root Allan Variance

**Histogram Graph**

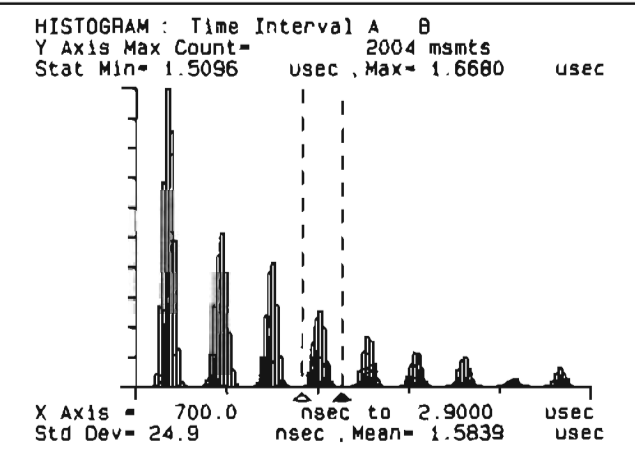

This histogram of pulse-widths from a compact disc shows the nine characteristic pulse-width distributions found in eight-to-fourteen modulation (EFM) coding. Each distribution can be statistically analyzed without recapturing the data.

**Time Variation Graph**

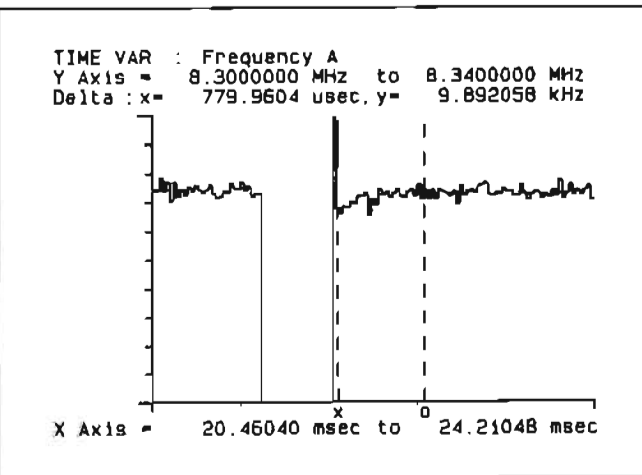

This frequency vs time (Time Variation) display shows frequency overshoot on a stepped VCO. This analysis mode is extremely useful for characterizing frequency-agile signals and FM or PM on carriers up to 500 MHz.

**Numerical Results**

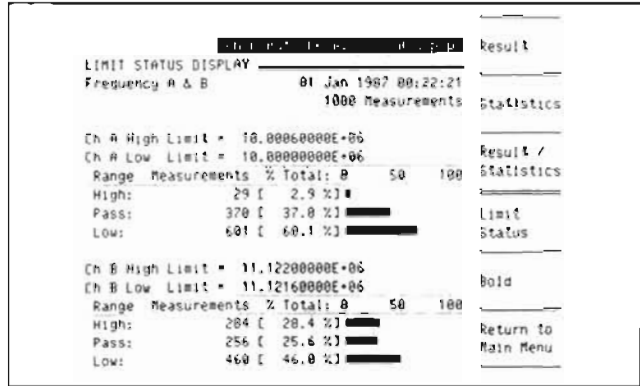

Five numerical display choices show detailed results, statistics, and test-limit data. This display summarizes test-limit information from a two-channel frequency measurement. Bar-graphs aid in interpreting pass-fail results.

**Flexible Triggering and Arming**

A major contribution of the HP 5371A is its wide variety of arming and measurement control. This flexibility helps you reduce or eliminate external arming and control circuitry . . . a real problem in many timing-related measurement setups.

To start, control and stop measurements, you can select many combinations of events, trigger conditions, and time delays. This flexibility is extremely useful for analyzing complex time waveforms such as serial-data streams. In disc-drive development, for example, data-to-clock jitter is an important parameter. For this application, the HP 5371A's arming and control menus are easily set up to selectively measure data jitter only in the data field of a sector — a difficult task with traditional instrumentation, which often requires custom external circuitry.

**Computer-Aided-Test Features**

The standard HP 5371A is fully compatible with the Hewlett-Packard Interface Bus (HP-IB). All menu functions and front-panel controls are programmable. A logical, structured programming command set simplifies writing and modifying test programs. The HP 5371A has three output formats for maximum test-program flexibility. Since fast data transfer is important in many computer-aided-test applications, the binary format is optimized to provide data transfer rates as high as 20,000 results/second. The HP 5371A brings the full capabilities of a Frequency and Time-Interval Analyzer to the automatic-test-system environment while simplifying test-program development.

**Easy to Learn and Use**

The HP 5371A helps increase your engineering productivity by reducing the time you spend on instrumentation problems. Special ease-of-use and error-safeguarding features reduce measurement setup times and operator errors. Cursor-driven menus select instrument settings, and softkeys are used to select various options for each menu parameter. Help menus provide quick references for instrument functions and parameters. Hardcopy documentation (via HP-IB) of graphic displays or numerical data is as easy as pressing a key.

Default settings allow you to proceed right from the start, so you can see results while you fine-tune setup parameters. Features such as Auto Trigger and Peak Amplitude save time and provide important signal information. Nine user-defined measurement setups can be saved in nonvolatile memory providing faster throughput while eliminating setup errors.

**Get More Information on the HP 5371A**

Find out how the HP 5371A can help you in your application. Contact your local HP Instrument Sales Representative and ask for a product brochure and the latest HP 5371A application notes.

See the next page for more information.

# ELECTRONIC COUNTERS

## A New Concept In Frequency and Time Interval Analysis

Model 5371A

### Performance Summary

#### Measurement Capabilities

The following basic measurements and ranges are provided:

**Frequency A and/or B, A  $\pm$  B, B-A, ratio A/B, B/A:** 125 MHz to 500 MHz.

**Period A and/or B:** 2 ns to 8.0 s

**Time Interval A, B, A  $\rightarrow$  B, B  $\rightarrow$  A:** 10 ns to 8.0 s (+ mode), -8.0 s to +8.0 s ( $\pm$  mode).

**Rise and Fall Time A:** 1 ns to 100  $\mu$ s transitions.

**Positive/Negative Pulse-Width A:** 1 ns to 1 ms.

**Duty Cycle A:** 0% to 100% (pulse width  $\geq$  1 ns and period  $\leq$  8.0 s).

**Phase A relative to B, B ref A:** unrestricted,  $> \pm 360$  degrees.

**Totalize A and/or B, A  $\pm$  B, B-A, ratio A/B, B/A:** 0 to  $(2^{32}-1)$  events.

**Peak Amplitude A or B:** 200 mV to 2 V p-p (X1), dc and 1 kHz to 200 MHz.

**Memory size:** 1000 measurements using front panel, 4095 when using external controller (binary format data.).

#### Continuous Measurement Rate

**Frequency or Period measurements, A or B:** 100 ns minimum gate time (sample time) for continuous measurements.

**Time Interval:** Maximum rate is 10,000,000 measurements/s (100 ns sample time) for Continuous Time Interval A  $\rightarrow$  A or B  $\rightarrow$  B. For all other measurements, the maximum rate is 5,000,000 measurements/s (200 ns sample time). For higher rates, the number of intermediate events is logged.

#### Resolution and Accuracy

The following are nominal values. Refer to the product data brochure for specific accuracy and resolution information.

**Basic time-measurement resolution:** 150 ps rms single-shot.

**Time-measurement systematic error:** 1 ns (can be reduced to  $< 10$  ps with the HP J06-59992A Calibrator).

**Frequency measurement least significant digit:** (200 ps  $\times$  freq)/gate time for A and B simultaneously.

**Time base stability:** Short-term:  $< 1 \times 10^{-10}$  for 1 s average; Aging rate:  $< 5 \times 10^{-10}$ /day, after 24-hour warm up.

#### Analysis and Display

**Histogram graph:** Displays the number of measurements vs the measured values (time, frequency, duty cycle, phase, peak amplitude or totalize events). Cumulative to specified total number of measurements ( $2 \times 10^9$  max). Statistics displayed (min, max, mean and std dev) over selected marker ranges using the Display Statistics mode.

**Time Variation graph:** Displays the measured values vs the time each measurement was acquired for the most recent set of up to 1000 measurements.

**Event Timing graph:** Displays the starting (up tic) and the ending (down tic) time of each measurement for the most recent set of up to 1000 measurements.

**Numeric results:** Displays a list of numerical results, statistics, and limit data. Scrolling provided.

**Graphics features:** Markers with peak, center and delta features, limit lines, zooming, auto-scale, scrolling, dual-display mode, and histogram statistics. Hard-copy to HP-IB printers and plotters.

**Math Operations:** Scale, Offset, Normalize, Limit Testing, Set/Clear Reference for each channel.

**Statistics features:** Minimum, Maximum, Mean, Standard Deviation, Variance, Root Mean Square, Allan Variance and Root Allan Variance.

#### Input Characteristics (Channels A and B)

Two HP 54002A 50 ohm pods are supplied with the HP 5371A. Other pods are available as accessories. See "Ordering information" below. Characteristics shown are for HP 54002A pods.

**Frequency range:** 0 to 500 MHz, dc coupled.

**Attenuator:** X1 or X2.5, nominal, for 50 ohm termination to GND.

**Sensitivity (X1):** 15 mV rms sine wave,

45 mVp-p at 1 ns minimum pulse-width.

**Dynamic range (X1):** 45 mV to 2 Vp-p.

**Signal operating range (X1):** -2 to +2 V (dc + peak ac).

**Impedance:** 50 ohm nominal to GND, or to -2 Vdc nominal (for ECL signals). 1 Mohm and 10 kohm input pods are available.

#### Manual Trigger (Channels A and B)

**Trigger level:** Slope selectable. Level adjustable via knob or keypad from -2 to +2 Vdc in 2 mV steps (X1); -5 to +5 Vdc in 5 mV steps (X2.5), nominal.

**Accuracy:** 20 mV  $\pm$  1% of setting.

#### Auto Trigger (requires repetitive input signal)

**Frequency range:** 1 kHz to 200 MHz (operative to 500 MHz, but accuracy not specified).

**Minimum signal:** 200 mV (X1).

**Trigger level:** Slope selectable. Level adjustable between -pk and +pk of input signal.

**Accuracy:**  $\pm 20\%$  of pk-pk amplitude of input signal  $< 200$  MHz.

#### External Arm input characteristics

**Frequency range:** 0 to 100 MHz, dc coupled.

**Sensitivity:** 50 mV rms sine wave, 150 mVp-p at a minimum pulse width of 5 ns.

**Impedance:** 1 Mohm, nominal, shunted by  $< 50$  pF.

**Signal operating range:** -5 to +5 V (dc + peak ac).

**Trigger level:** Slope selectable, level adjustable from -5 to +5 Vdc in 20 mV steps, nominal.

#### Arming Control

**Event delay range:** 0 to  $(2^{32}-1)$  events.

**Time delay range:** 24 ns to 8.0 s, with 2 ns resolution.

#### Hewlett-Packard Interface Bus (Standard)

The HP 5371A is fully compatible with HP-IB. All menu functions and front-panel controls (except power switch) are programmable. Three formats are provided for outputting measurement results: ASCII, binary and floating point.

**Output rate:** up to 20,000 results/s using binary format.

**HP-IB interface functions:** SH1, AH1, T5, TE0, L4, LE0, DT1, DC1, RLI, SR1, PPO, C0, E2 (see page 542).

#### General

**Operating temperature:** 0 to 40°C

**Power requirements:** 100, 120, 220 or 240 Vac (+10%, -10%), 47-63 Hz; 500 VA max.

**Weight:** net, 23.2 kg (51 lb); Shipping, 24.5 kg (54 lb).

**Dimensions:** 177 H x 425 W x 574 mm D (7.0" x 16.75" x 22.6")

#### Ordering information

	Price
<b>HP 5371A</b> Frequency and Time Interval Analyzer (includes 2 HP 54002A 50 ohm input pods).	\$21,500
<b>Opt 060</b> Rear panel inputs (50 ohm, BNC) for channels A, B, and External Arm. Pods not usable with Opt 060. No pods supplied.	No charge
<b>Opt W30</b> Two additional years of "return-to-HP" service and support.	\$400.00

#### Accessories

<b>HP 54001A</b> 1 GHz Miniature Active Probe (10:1, 10 kohm)	765.00
<b>HP 54003A</b> 1 Mohm Probe (with 10:1 scope probe)	665.00
<b>HP 2225A</b> ThinkJet Printer (HP-IB Interface) (requires an HP-IB interface cable, see pp 549).	495.00
<b>HP J06-59992A</b> Calibrator	3000.00

- Precise trigger level setting
- Wide input dynamic range



HP 5363B



HP 10855A

### HP 5363B Time Interval Probes

#### Enhanced Counter Measurements

The HP 5363B provides the necessary input signal conditioning to allow a universal counter to make highly accurate and repeatable time interval measurements. Counters such as the HP 5345A, 5370B, 5335A, 5334A, 5334B, and 5328B when teamed up with the HP 5363B can now make more accurate rise time, fall time, slew rate, propagation delay, and other complex measurements.

#### Wide Dynamic Range, Fine Trigger Level Settability

Greatly improved dynamic range allows the trigger point to be selected in 10 mV increments from -9.99 V to +9.99 V.

#### Minimized Circuit Loading

High impedance, low capacitance active probes minimize circuit loading and pulse distortion. Each probe contains two measurement channels, start and stop, so timing measurements on one waveform are possible. As example, the input/output rise (propagation delay) of a device can be measured between the probes.

#### Eliminate Systematic Timing Errors

Delays through probes, cables and inherent differential delays between a counter's input channels limit the absolute accuracy of time interval measurements.

A calibration procedure using the HP 5363B can equalize such systematic delays to set the counter to read 0.0 ns. This is possible with counters that can measure down to 0 ns like the HP 5370B, 5334A, 5334B, and 5335A. For counters with a minimum time interval specification (HP 5345A and 5328B have 10 ns minimum capability), the HP 5363B can add a fixed offset of 10 ns to permit measurements of zero time interval.

#### Condensed Specifications

**Operating range:**  $\pm 10$  V.  
**Minimum input voltage:**  $\pm 100$  mV about trigger point.  
**Damage level:**  $\pm 30$  V.  
**Voltage resolution:** 10 mV.  
**Impedance:** 1 M  $\Omega$  shunted by  $< 20$  pF.  
**Effective bandwidth:** 350 MHz (1 ns rise time).  
**Minimum pulse width:** 5 ns at  $\pm 100$  mV about trigger point  
**Output to counter:** separate start/stop outputs; -0.5 V to +0.5 V into 50  $\Omega$ , slew rate through zero volts exceeds 0.25 V/ns.  
**Delay compensation range:** 2 ns adjustable about 0 ns or 10 ns.  
**Power:** 100, 120, 220, 240 V<sub>ac</sub> (+5-10%), 48-440 Hz; 40 VA max.  
**Weight:** net 3.0 kg (6.5 lb). Shipping 5.5 kg (12 lb).

**Dimensions:** 88.1 H x 212 W x 295 mm D (3.5 in. x 8.4 in. x 11.6 in.).

#### Absolute Accuracy

$$\pm 1 \text{ ns} \pm \frac{\text{START TLA} + \text{START NTE}}{\text{START slew rate}} \pm \frac{\text{STOP TLA} + \text{STOP NTE}}{\text{STOP slew rate}}$$

where TLA denotes trigger accuracy and NTE denotes noise trigger error.

**Noise trigger error:**  $\sqrt{(125 \mu\text{V})^2 + e_n^2}$  volts where 125  $\mu\text{V}$  is the typical input noise on the HP 5363B and  $e_n$  is the input signal noise for a 350 MHz bandwidth.

#### Accessories Available

HP 10821A Probe Accessory Kit including 2 of each of the following: HP 10229A Hook Tip; HP 10218A BNC to Probe Adapter; HP 10100C 50 ohm Feedthrough termination; HP 1250-0655 BNC Tee to Probe Adapter; and HP 8710-0661 HP Probe tips (extra).

#### HP 10855A 2-1300 MHz Preamp

The HP 10855A Preamp provides a minimum of 22 dB gain from 2 MHz to 1300 MHz to enhance measurements of very low-level signals. The  $\pm 1.5$  dB flat response reduces distortion in non-sinusoidal waveforms. The HP 10855A operates conveniently with a variety of HP measuring instruments having probe power outlets, or will work with the HP 1122A Probe Power Supply. The HP 5334A/5335A Option 030 and HP 5328B Option 031 counters all measure frequency to 1300 MHz and are compatible for use with the HP 10855A.

#### HP 10855A Specifications

**Frequency range:** 2 MHz-1300 MHz.  
**Gain (minimum):** 22 dB; 24 dB typical.  
**Gain flatness across full frequency range:**  $\pm 1.5$  dB.  
**Noise figure:**  $< 8.5$  dB typical.  
**Output power for 1 dB gain compression:** 0 dBm.  
**Harmonic distortion:** -30 dB for -15 dBm output, typical.  
**Output for  $< -66$  dB harmonic distortion:** -25 dBm, typical.  
**VSWR:**  $\sim 2.9$ , typical.  
**Impedance:** 50  $\Omega$  nominal  
**Reverse isolation:**  $\sim 45$  dB.  
**Maximum input:** 3.5 V rms (+24 dBm), fuse protected.

#### Ordering Information

HP 5363B Time Interval Probes  
 HP 10855A 2-1300 MHz Preamp  
 HP 10821A Probe Accessory Kit  
 ☎ Fast-Ship product — see page 758.

**Price**  
 \$4450  
 \$600 ☎  
 \$300

# ELECTRONIC COUNTERS

## Our Fastest Universal Systems Counter

### Model 5345A

- 500 MHz Direct Count, Conversion Plug-Ins to 110 GHz
- 2 ns Single Shot Resolution, 2 ps Averaged

- 25 mV Sensitivity to 500 MHz
- Up to 9000 readings/second over HP-IB

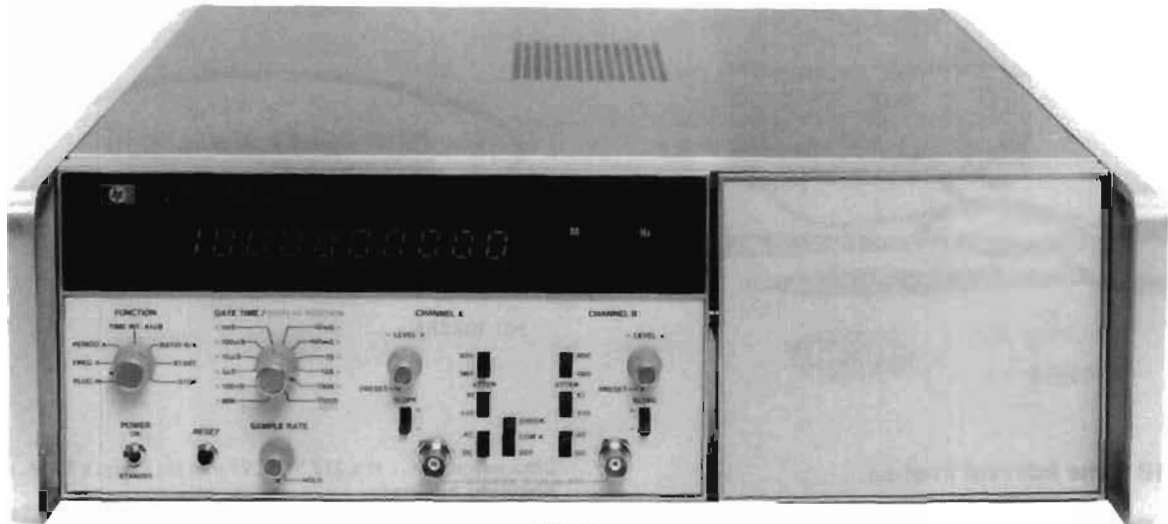

HP 5345A



#### Versatile, High-Speed Measurement Power

- High resolution pulsed Frequency measurements and pulse profiling to 110 GHz with the HP 5355A and HP 5356A/B/C/D.
- Rapid 2 ns resolution Time Interval measurements for jitter characterization.
- High throughput Frequency, Period, Ratio, Totalize, and Scale measurements to 500 MHz.

#### HP 5345A Condensed Specifications

##### Input Channels A and B

**Range:** 0 to 500 MHz dc coupled 50  $\Omega$  and 1 M $\Omega$ ; 4 MHz to 500 MHz ac coupled, 50  $\Omega$ ; 200 Hz to 500 MHz ac coupled, 1 M $\Omega$ .

**Impedance:** selectable, 1 M $\Omega$  shunted by less than 45 pF or 50  $\Omega$  (nominal).

**Sensitivity (X1):** 50 $\Omega$ , 25 mV rms sine wave and 75 mV p-p pulse, 1 M $\Omega$ , 25 mV rms sine wave and 75 mV p-p pulse to 300 MHz; 50 mV rms sine wave and 150 mV p-p pulse to 500 MHz.

**Trigger level:** adjustable over  $\pm 2.0$  V dc

**Output:** rear-panel BNC connectors bring out CHAN A TRIG LEVEL and CHAN B TRIG LEVEL for convenient DVM monitoring.

##### Common Input

**Range:** ac coupled 50  $\Omega$ , 4 MHz to 400 MHz; ac coupled 1 M $\Omega$ , 300 Hz to 400 MHz; dc coupled, 0 to 400 MHz.

**Impedance:** 50  $\Omega$  remains 50  $\Omega$ ; 1 M $\Omega$  becomes 500 k $\Omega$  shunted by <80 pF.

**Sensitivity (X1):** 50  $\Omega$ , 50 mV rms sine wave and 150 mV p-p pulse, 1 M $\Omega$ , 25 mV rms sine wave and 75 mV p-p pulse to 50 MHz; 75 mV rms sine wave and 150 mV p-p pulse to 200 MHz; 120 mV rms sine wave and 360 mV p-p pulse to 400 MHz.

##### Frequency A

**Range:** 0.00005 Hz to 500 MHz.

**Resolution:** See Graph 1

**Accuracy:**  $\pm$  Resolution  $\pm$  Time-Base Error (Graph 2).

##### Period A

**Range:** 2 ns to 20,000 s.

**Resolution and Accuracy:**  $\Delta$ Freq |Per|/Freq (Graphs 1 and 2).

**Time Interval/Time Interval Average**

**Range:** 10 ns to 20,000 s.

**Minimum Dead Time:** 10 ns.

**Trigger Pulse Width:** 1 ns (typical) minimum width input at minimum voltage input.

##### Resolution

**Time Interval:** 2 ns  $\pm$  Noise Trigger Error (Graph 3).

**Time Interval Average:**  $\pm$  T.I. Resolution  $\pm$  2 picoseconds.

$\sqrt{\text{intervals averaged}}$

**Accuracy:**  $\pm$  Resolution  $\pm$  Time Base Error (Graph 2)  $\pm$  Trigger Level Timing Error (Graph 4)  $\pm$  700 ps.

##### Ratio B/A

**Range:** both channels accept dc to 500 MHz.

**LSD:** Ratio/[Freq B x Gate Time].

**Resolution and Accuracy:**  $\pm$  LSD  $\pm$  [A Trigger Error (Graph 3)/Gate time] x Ratio.

##### Start/Stop

**Range:** both inputs dc to 500 MHz.

**Modes:** A, A  $\pm$  B determined by rear-panel switch.

##### Scaling

**Range:** dc to 500 MHz.

**Scaling Factor:** selectable by GATE TIME setting. Scaling factor equals GATE TIME setting/10<sup>-9</sup> seconds.

**Input:** input signal through channel A.

**Output:** output frequency equals input frequency divided by scaling factor.

##### Time Base

**Standard High Stability Oven**

**Frequency:** 10 MHz.

**Aging rate:**  $< 5 \times 10^{-10}$  per day.

**Short term:**  $< 1 \times 10^{-11}$  for 1 s average.

**Temperature:**  $< 7 \times 10^{-9}$ , 0°C to 55°C.

##### Opt 001

**Frequency:** 10 MHz.

**Aging rate:**  $< 3 \times 10^{-7}$  per month.

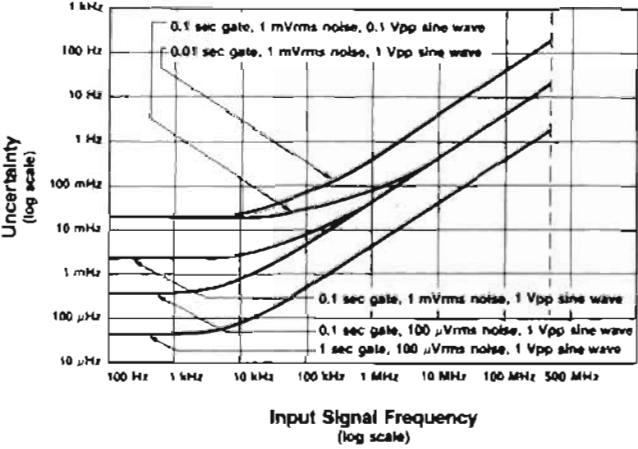

Graph 1, Frequency Resolution Error: Noise on the input signal and internal uncertainties affect Frequency and Period measurements. Longer gate times will reduce this error. (For Period, invert and find the  $\Delta F/F$ , then multiply by the Period. This yields Period Uncertainty ( $\Delta P$ .)

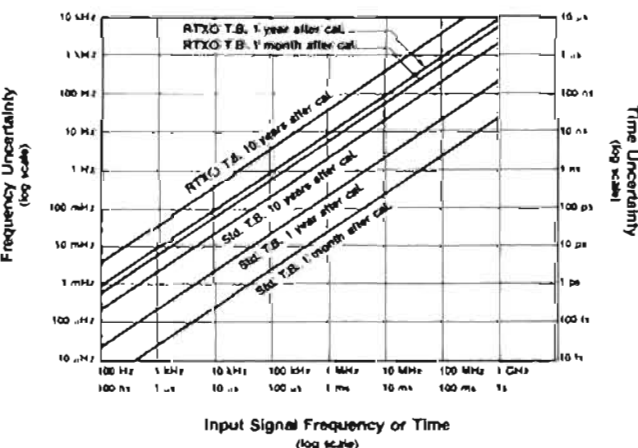

Graph 2, Time-Base Error: Environment and aging of the crystal affects all measurements. Frequent calibration and a better time base will reduce this error.

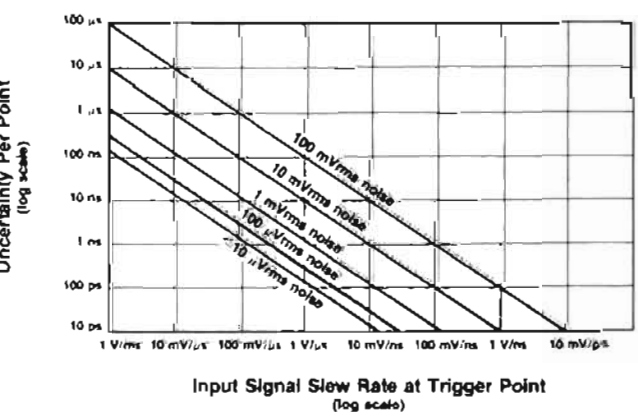

Graph 3, Input Noise Trigger Error: Noise on the Input signal affects both the Start and Stop points of all time Interval measurements. Averaging will reduce this error.

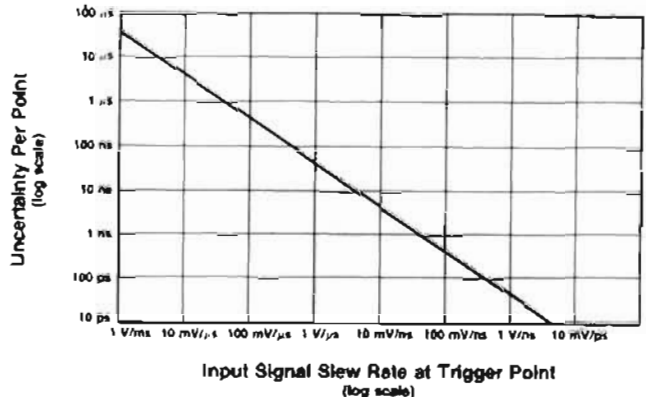

Graph 4, Trigger Level Timing Error: Affects the Start and Stop points, total error is the larger of the two. Input calibration will reduce this error.

**Opt 001 (cont.)**  
**Short term:**  $< 2 \times 10^{-9}$  rms for 1 s.  
**Temperature:**  $< 2 \times 10^{-6}$ , 25°C to 35°C.  
 $< 5 \times 10^{-6}$ , 0°C to 55°C.  
**Line voltage:**  $< 1 \times 10^{-3}$ ,  $\pm 10\%$  from nominal.  
**External frequency standard input:** input voltage  $> 1.0$  V rms into 1 k $\Omega$  required from source of 1, 2, 2.5, 5 or 10 MHz  $\pm 5 \times 10^{-8}$  ( $\pm 5 \times 10^{-6}$  for option 001).  
**Frequency standard output:**  $> 1$  V rms into 50  $\Omega$  at 10.0 MHz sine wave.

**General**  
**Display:** 11-digit LED display and sign.  
**Gate time:** 1000 s to 100 ns in decade steps;  $< 50$  ns in MIN position.  
**Measurement speed**

Mode of Operation	Readings per Second
Normal Operation (Max sample rate)	10
Externally armed	500
Externally gated	500
Computer dump	9,000

**Overflow:** asterisk is illuminated when display is overflowed.  
**Sample rate:** continuously variable from  $< 0.1$  s to  $> 5$  s with front-panel control. In HOLD position the last reading is maintained until the counter is reset.  
**External arm input:** counter can be armed by a  $-1.0$  V signal applied to the rear panel 50  $\Omega$  input.  
**External gate input:** same conditions as for EXT ARM.  
**Gate output:**  $> 1$  V into 50  $\Omega$ .  
**Operating temperature:** 0°C to 55°C.  
**Power requirements:** 100/120/220/240 V rms  $\pm 5\%$  -10% 48 to 66 Hz, maximum power 250 VA.  
**Weight:** 17 kg (37 lb).  
**Size:** 132.6 mmH x 425 mmW x 495 mmD (5.22 in x 16.75 in x 19.5 in).

**Ordering Information**

HP 5345A Plug-In Counter	\$9,250
Opt 001 Room Temperature Time Base	- \$320
Opt 010 HP-IB Talk Only	+ \$350
Opt 011 HP-IB includes remote programming	+ \$950
Opt 012 HP-IB similar to Opt 011, but also includes slope and trigger level controls	+ \$1,600
Opt 808 Rack Flange Kit, HP 5060-8740	+ \$65
HP 10595A Board Extender Kit: For troubleshooting	\$1,000

☑Fast-Ship product — see page 758.

# ELECTRONIC COUNTERS

## 100 MHz Universal Counters

### Model 5334B

- Two matched 100 MHz input channels; optional C Channel to 1.3 GHz
- 9 digits per second resolution from .001 Hz to 1.3 GHz
- 2 ns time interval resolution, 200 ps with averaging
- Automatic rise/fall time, pulse width and ac/dc voltage measurements
- Complete HP-IB programmability standard
- MATE interface optional

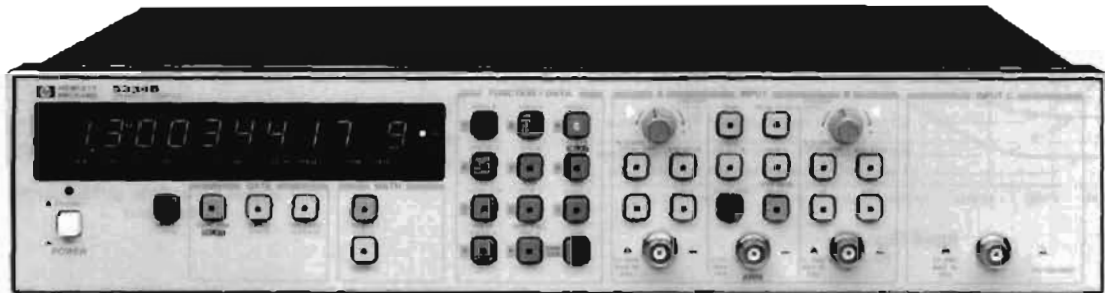

HP 5334B



#### Expanded Universal Counter Capability for Bench or System

- Rise/Fall Time and Pulse Width measurements at the push of a button.
  - Measure the AC/DC voltage of the input signal.
  - Offset, Normalize, and Average measurements for greater usability of results.
  - Auto Triggering and Auto Attenuation for user convenience.
- As well as**
- 100 MHz Frequency and Period measurements with resolution of 9 digits per second of gate time.
  - Time Interval and Time Interval Delay to 2 ns resolution, 200 ps with averaging.
  - Full HP-IB programmability standard with optional rear inputs for system applications. Make up to 140 readings per second.
  - 1.3 GHz C Channel, MATE Interface, and High Stability Oven Time Base options.
  - External Arming/Gating for synchronizing measurements to external events.

#### Condensed Specifications

##### Input Characteristics (channels A and B)

###### Range

DC coupled: 0 to 100 MHz.

AC coupled: 1 M $\Omega$ , 30 Hz to 100 MHz; 50 $\Omega$ , 1 MHz to 100 MHz.

###### Sensitivity

15 mV rms sine wave to 20 MHz, 35 mV rms sine wave to 100 MHz.

100 mV peak-to-peak at a minimum pulse width of 5 ns.

###### Dynamic Range (X1)

45 mV to 5 V peak-to-peak, to 20 MHz.

100 mV to 2.5 V peak-to-peak, to 100 MHz.

###### Trigger Level Range

Manual (auto trigger off): continuously adjustable over  $\pm 5.1$  V ( $\times$  ATTN), displayed in 20 mV steps ( $\times$  ATTN).

Preset: 0V NOMINAL in Sensitivity Mode.

###### Auto Trigger

DC coupled: 100 Hz to 100 MHz.

AC coupled: 1 M $\Omega$ , 100 Hz to 100 MHz; 50 $\Omega$ , 1 MHz to 100 MHz.

Trigger Slope: independent selection of + or - slope.

Impedance: 1 M $\Omega$  or 50 $\Omega$ , NOMINAL, switch selectable.

###### Attenuator

Manual:  $\times 1$  or  $\times 10$  NOMINAL, switch selectable.

Auto: attenuator automatically switched when in Auto Trigger.

Low Pass Filter: 100 kHz NOMINAL, Channel A, switchable.

###### External Arm

Sensitivity: 500 mV peak-to-peak at Min. pulse width of 50 ns.

Signal Operating Range: -5 V dc to +5 V dc.

Slope: independent selection of START and STOP ARM slopes: +, -, or OFF.

###### Frequency A and Frequency B

Range: .001 Hz to 100 MHz.

Resolution: See Graph 1

Accuracy:  $\pm$  Resolution  $\pm$  Time Base Error (Graph 2).

###### Period A

Range: 10 ns to 10<sup>3</sup> s (single gate), 10 s (100 GATE AVERAGE)

Resolution and Accuracy:  $\Delta$ FREQ {PER}/FREQ (Graph 1 and 2)

###### Time Interval A to B

Range: -1 ns to 10<sup>3</sup> (single shot), 10 s (100 GATE AVERAGE).

LSD: 1 ns (100 ps using 100 GATE AVERAGE).

Resolution:  $\pm$  LSD  $\pm$  Noise Trigger Error (Graph 3)  $\pm$  1 ns rms.

Accuracy:  $\pm$  Resolution  $\pm$  Time Base Error (Graph 2)  $\pm$  Trig Level

Timing Error (Graph 4)  $\pm$  Trig Level Setting Error (Graph 5)  $\pm$  2 ns.

###### Time Interval Delay

Selectable delay can be inserted between START and STOP of Time Interval A to B. Inputs during delay are ignored. Delay Range is 1 ms to 99,999 s.

###### Ratio A/B

Range: .001 Hz to 100 MHz both channels.

LSD:  $4 \times$  RATIO / {FREQ A  $\times$  GATE TIME}.

Resolution and Accuracy:  $\pm$  LSD  $\pm$  [B Trig Error (Graph 3)/GATE TIME].

###### Totalize

Range: 0 to 10<sup>12</sup> -1.

Resolution and Accuracy: 1 count of input signal.

###### Pulse Width A

Range: 5 ns to 10 ms.

LSD, Resolution, Accuracy: same as Time Interval A to B except  $\pm 2$  ns in Accuracy deleted.

###### Rise/Fall Time A

Range: 30 ns to 10 ms.

Minimum Amplitude: 500 mV peak-to-peak.

Dynamic Range: 500 mV to 40 V peak-to-peak.

LSD, Resolution, Accuracy: same as Time Interval A to B.

###### AC/DC Voltage

Max. and Min. peaks or dc level of Channel A or Channel B input are displayed.

Frequency Range: dc, 100 Hz to 20 MHz.

Dynamic Range: 0-40 V peak-to-peak;  $\pm 51$  Vdc.

Resolution:  $\times 1$ : 20 mV  $\times 10$ : 200 mV

###### Time Base

Frequency: 10 MHz.

Aging Rate:  $< 3 \times 10^{-7}$  per month.

###### Math

Display = (Measurement/Normalize) + Offset.

Entry Range:  $\pm 1 \times 10^{-10}$  to  $\pm 9.9999999999 \times 10^9$ .

Single Cycle: one measurement per push of RESET.

100 Gate Average: 100 measurements accumulated and average value displayed. Adds one digit of resolution to measurements and reduces resolution error by 10.

###### Hewlett-Packard Interface Bus

Programmable Controls: all front-panel controls and functions, except power on/stby switch.

Trigger Level: set Channel A or B in 20 mV steps ( $\times$  ATTN).



**Data Output**

**Normal Operation:** ten readings/second, formatted.  
**High Speed Mode:** up to 140 readings/second (55 readings/second with Option 700), unformatted.  
**HP-IB Interface Functions:** SH1, AH1, T5, TE0, L4, LE0, SR1, RLI, PP0, DC1, C0, E2 (see page 542).

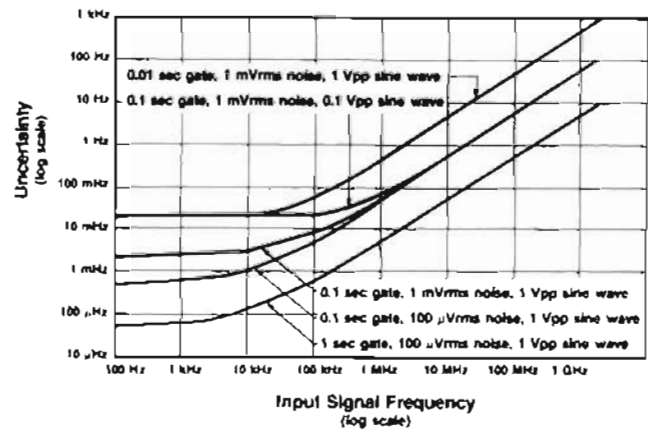

Graph 1, Frequency Resolution Error: Noise on the input signal and internal uncertainties affect Frequency and Period measurements.

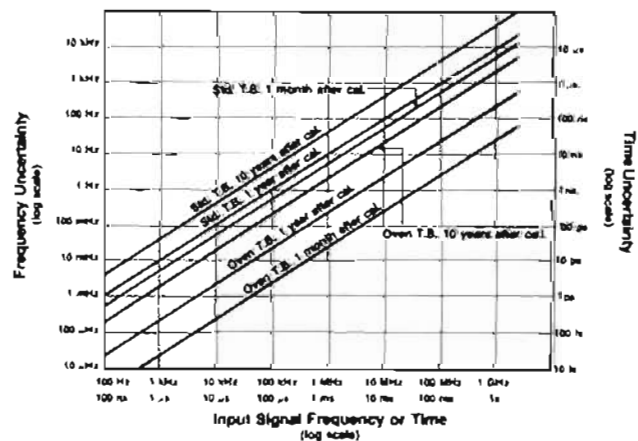

Graph 2, Time Base Error: Crystal environment and aging affects all measurements.

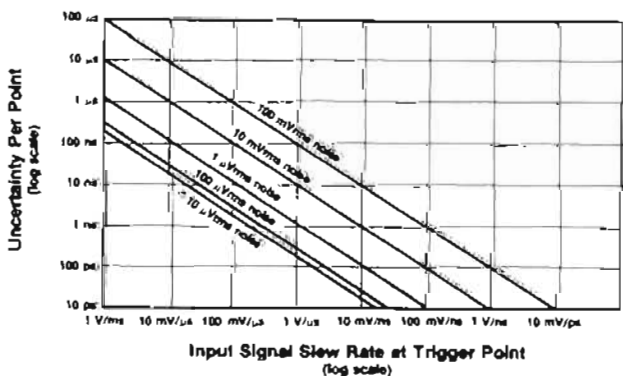

Graph 3, Input Noise Trigger Error: Noise on the Input signal affects both the Start and Stop points of all time interval measurements.

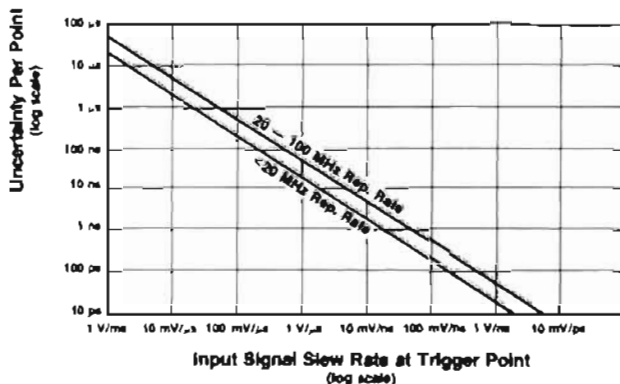

Graph 4, Trigger Level Timing Error: Affects the Start and Stop points of all time-interval measurements. Total error is the larger of the two trigger point errors.

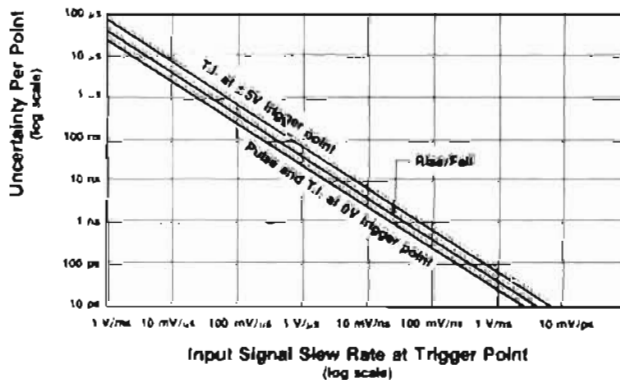

Graph 5, Trigger Level Setting Error: Affects both the Start and Stop points of all time interval measurements.

**Options**

**Option 010 High Stability Time Base (Oven)**

**Frequency:** 10 MHz.

**Aging Rate:**  $5 \times 10^{-10}$ /day after 24-hour warm up.

**Option 030 1300 MHz C Channel**

**Range:** 90 MHz to 1300 MHz.

**Sensitivity:** 15 mV rms (-23.5 dBm) sine wave, 90 MHz to 1000 MHz. 75 mV rms (-9.5 dBm) sine wave, 1000 MHz to 1300 MHz.

**Resolution and Accuracy:** same as Frequency A and B.

**Option 700 Internal CIL Interface (MATE)**

**Measurement Functions Provided:**

Frequency A, B, and C; Period A, Time Interval A to B, Ratio A/B, Totalize A, Rise/Fall Time A, Pulse Width A, Read Levels A and B (AC/DC Voltage and Trigger).

**Programmable Controls:**

Channel A and B: Trigger Level, Auto Trigger, Coupling, Trigger, Slope, Impedance, Attenuator, Common.

External Arm: External Arm Select, Slope.

General: Gate Time

**Measurement Data Output Rate:** 2.5 readings/second.

**Ordering Information**

**HP 5334B Universal Counter**

**Opt 010 Oven Oscillator**

**Opt 030 Channel C**

**Opt 060 Rear Terminals**

Channel A,B and ARM in parallel with front inputs.

Option 030 at rear panel only.

**Opt 700 Internal CIL Interface (MATE)**

**Fast-Ship product — see page 758.**

**Price**

\$1950

+ \$800

+ \$550

+ \$125

+ \$375

# ELECTRONIC COUNTERS

## Our Highest Performance Universal Systems Counter

### Model 5335A

- A high performance 200 MHz/2 ns Universal Counter
- Built-in automatic rise time, duty cycle, pulse width, slew rate and phase measurements
- Advanced automatic triggering capabilities
- HP-IB plus math and statistics functions standard

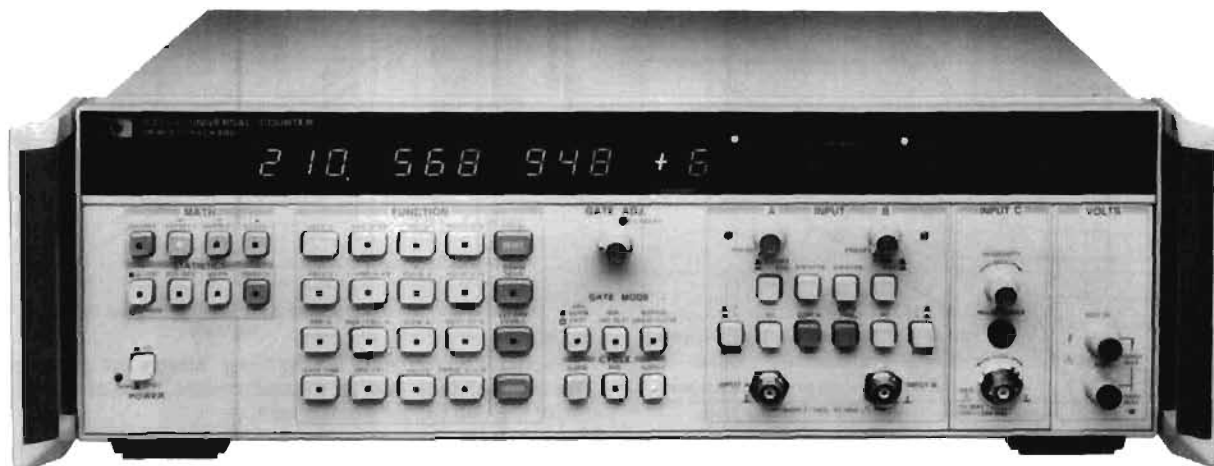

HP 5335A



### Remarkable Automatic Measurement Power

The HP 5335A is an advanced universal counter with automatic measurement power built in. Designed either for bench or systems applications, the counter has 16 front-panel measurement functions, plus four "phantom" functions, all automatically selected by push button or by HP-IB. These twenty functions, plus greatly expanded arming and triggering capability, make the HP 5335A a most powerful universal counter. In addition, math and statistics features, matched Channel A and B input amplifiers, and HP-IB are all included in the standard unit, making the HP 5335A easily the most advanced universal counter available at its price.

### Pulse Characterization Measurements

The HP 5335A possesses the expected universal measurements, and does them better than ever before. Beyond the expected measurement set, the HP 5335A has the ability to automatically measure waveform characteristics for various applications. Op amp characterization is one area where a number of measurements are needed to define the amplifier's performance. Using the HP 5335A and a signal source, rise and fall times, output slew rate, and propagation times can be measured with one test set-up. Also, duty cycle can be measured to see the distortion on a square wave through the amplifier due to different rising and falling slew rates. Phase measurements are also push-button selectable and automatically performed by the counter.

### Complete Triggering Capability

To get good measurement results, a counter must properly trigger on the input signal. The HP 5335A employs both manual and automatic trigger modes to quickly and easily set the right trigger points.

### Manual Triggering

The counter has a  $\pm 5$  Vdc range to help reduce input attenuator use for most input signals, including TTL.

### Automatic Triggering

Two auto trigger modes help you trigger automatically. Just press *auto trig* or select *auto trig* on the HP-IB and the counter automatically selects 10%-90% rise/fall time trigger points, 50% phase trigger points, or the preset value of your choice. Then it tracks the signal's dc offset continuously to stay on the right trigger point. Option 040 allows programmability of trigger levels via HP-IB.

### Trigger Level DVM

Built into the basic counter. Just press TRG LVL to see both input channel trigger levels displayed.

### A Full Set of Universal Measurement Functions

In addition to waveform characterization features, the HP 5335A has an extremely wide set of measurement functions covering frequency, time, events and volts. These functions let you characterize signals quicker and more thoroughly than ever before possible.

### Frequency

Frequency is the most common measurement performed by counters. The HP 5335A measures to 200 MHz in Channel A, 100 MHz in Channel B, and 1.3 GHz in its optional Channel C. Due to the counter's advanced design and reciprocal measurement technique, resolution is a constant 9 digits per second of gate time across its entire measurement range.

### Time

In a universal counter, a time interval measurement equates to a stopwatch measurement started and stopped by unique events. Precision is dependent on the counter's circuitry.

To ensure precision, the HP 5335A has matched custom input amplifiers to greatly reduce trigger errors that might be produced if the start and stop signals were amplified differently. Further, the counter employs an analog interpolation technique that turns its 10 MHz clock into the equivalent of a 1 GHz time base. The HP 5335A is thus able to resolve single shot time interval measurements to better than 2 nanoseconds (100 ps with averaging). This analog interpolation eliminates the need found in some counters for a phase-modulated (jittered) time base for time interval average measurements.

### Math and Statistics

Averaging techniques are often used to extend the resolution of a counter. For averaging, the HP 5335A provides sample sizes of  $N = 100$  or  $N = 1,000$ . Best of all, averaging can be employed for all measurements except phase. In addition to mean, and selection of sample size, the counter takes standard deviations of the current measurement for the sample size selected.

Math functions are another built-in feature that provide operator convenience. These functions let you convert the display into direct indications of parameters like flow, speed, pressure, and temperature. Additionally, the counter remembers the offset, scale, and normalize factors for each measurement function.

## Condensed Specifications

### Input Characteristics (channel A and B)

#### Range

DC coupled, 0 to 100 MHz.  
AC 1 M $\Omega$ , 30 Hz to 100 MHz.  
AC 50  $\Omega$ , 200 kHz to 100 MHz.  
NOTE: Channel A range 200 MHz when in Frequency A and Ratio modes.

#### Sensitivity (00.001)

25 mV rms sinewave.  
75 mV peak-to-peak pulse at minimum pulse width of 5 ns.

#### Dynamic Range (00.001)

75 mV to 5 V peak-to-peak, to 100 MHz.  
75 mV to 2.5 V peak-to-peak, > 100 MHz.

#### Signal Operating Range (00.001, DC)

-5 V dc to +5 V dc.

#### Trigger Level Range (00.001)

##### Auto Trigger OFF

Preset: set to 0 V dc NOMINAL.  
Adjustable: -5 V dc to +5 V dc.

##### Auto Trigger ON

Preset: set to nominal 50% point of input signal.  
Adjustable: nominally between + and - peaks of input signal.

#### Auto Trigger (00.001)

##### Range (50% duty cycle)

DC coupled, 30 Hz to 200 MHz.  
AC 1 M $\Omega$ , 30 Hz to 200 MHz.  
AC 50  $\Omega$ , 200 kHz to 200 MHz.

Minimum signal: 100 mV rms.

Duty cycle range: 10% to 90%.

Response time: 3 seconds, typical.

NOTE: Auto Trigger requires a repetitive signal.

Coupling: ac or dc, switchable.

Impedance: 1 M $\Omega$ , nominal, shunted by <35 pF or 50  $\Omega$  nominal, switchable. In COMMON A, 1 M $\Omega$  is shunted by <50 pF.

Attenuator: 00.001 or 00.0010 nominal, switchable.

Slope: independent selection of + or - slope.

Channel input: SEPARATE or COMMON A, switchable.

#### Frequency A

Range: 0 to 200 MHz, prescaled by 2.

#### LSD Displayed

$\frac{1 \text{ ns}}{\text{Gate Time}} \times \text{FREQ.}$  (e.g. 9 digits in a second).

#### Resolution

$\pm (2 \times \text{LSD}) \pm 1.4 \frac{\text{Trigger Error}}{\text{Gate Time}} 00.00 \text{ FREQ.}$

Accuracy:  $\pm (\text{Resolution}) \pm (\text{Time Base Error}) \times \text{FREQ.}$

#### Period A

Range: 10 ns to 10<sup>7</sup> s.

#### LSD Displayed

$\frac{1 \text{ ns}}{\text{Gate Time}} \times \text{PER.}$  (e.g. 9 digits in a second).

Period average: user selects MEAN function, and n = 100, or n = 1,000.

#### Time Interval A→B

Range: 0 ns to 10<sup>7</sup> s.

LSD displayed: 1 ns (100 ps using MEAN).

Resolution:  $\pm (2 \times \text{LSD}) \pm (\text{START Trigger Error}) \pm (\text{STOP Trigger Error})$ .

Accuracy:  $\pm (\text{Resolution}) \pm (\text{Time Base Error}) \times \text{TI} \pm (\text{Trigger Level Timing Error}) \pm (2 \text{ ns})$ .

Gate mode: MIN only.

Time interval average: user selects MEAN function, and n = 100, or n = 1,000.

#### Time Interval Delay (holdoff)

Front panel Gate Adjust control inserts a variable delay between START and enabling of STOP. Electrical inputs during delay are ignored. Delay ranges are same as gate time ranges (100  $\mu$ s, to 4 s NOMINAL) for gate modes of Fast, Norm, and Manual.

#### Inverse Time Interval A→B

Range: 10<sup>-7</sup> to 10<sup>9</sup> units/second.

LSD Displayed, Resolution, and Accuracy are inverse of Time Interval A→B specifications.

#### Rise and Fall Time A

Range: 20 ns to 10 ms transition with 50 Hz to 25 MHz repetition rates (50% duty cycle).

Minimum pulse height: 500 mV peak-to-peak.

Minimum pulse width: 20 ns.

Duty cycle range: 20% to 80%.

LSD Displayed and Resolution are same as Time Interval A→B Specifications.

#### Pulse Width A

Range: 5 ns to 10<sup>2</sup> s.

Trigger point range: 40% to 60% of pulse height.

LSD Displayed and Resolution are same as Time Interval A→B specifications.

#### Duty Cycle A

Range: 1% to 99%, 0 to 100 MHz.

Trigger point range: 40% to 60% of pulse height.

LSD displayed:  $\frac{1 \text{ ns}}{\text{PER}} \times 100\%$

NOTE: Constant duty cycle required during measurement.

#### Slew Rate A

Range: 50 V/s to 10<sup>8</sup> V/s slew rate with 50 Hz to 25 MHz repetition rates (50% duty cycle). Minimum Pulse Height, Width, and Duty Cycle Range are same as Rise and Fall Time A.

Input mode: automatically set to COMMON A with 10% and 90% trigger levels.

#### Ratio A/B

Range: Channel A, 0 to 200 MHz (prescaled by 2).  
Channel B, 0 to 100 MHz.

LSD displayed:  $\frac{\text{RATIO}}{\text{FREQ} \times \text{Gate Time}}$  where FREQ is higher frequency after prescaling.

#### Totalize A

Range: 0 to 100 MHz.

LSD displayed: 1 count of input.

HP-IB output: at end of gate.

#### Manual

Count reset: via RESET key.

HP-IB output: totalize data on-the-fly sent if Cycle mode set to Single. Input frequency range in this mode is 0 to 50 Hz nominal.

#### Gated

Count reset: automatic after measurement.

#### Phase A Rel B

Range: -180° to 360°, Range Hold off, or 0° to 360°, Range Hold on, with signal repetition rates of 30 Hz to 1 MHz.

Minimum signal: 100 mV rms.

LSD displayed: 0.1°.

#### Gate Time

Range: 100 ns to 10<sup>7</sup> s.

LSD displayed: up to three digits with Ext. Arm Enable OFF, 100 ns when ON. MIN Gate Mode display zero.

# ELECTRONIC COUNTERS

## Our Highest Performance Universal Systems Counter (cont'd)

### Model 5335A

#### Trigger Level

**Range:**  $\times 1$ , +5 to -5 V;  $\times 10$ , +50 to -50 V.

**Resolution:**  $\times 1$ , 10 mV;  $\times 10$ , 100 mV.

**Accuracy ( $\times 1$ ):**  $\pm 20$  mV,  $\pm 0.5\%$  of reading.

#### Time Base

**Standard Crystal**

**Frequency:** 10 MHz.

**Aging rate:**  $< 3 \times 10^{-7}$ /month.

**Temperature:**  $< 4 \times 10^{-6}$ , 0 to 50°C.

**Line voltage:**  $< 1 \times 10^{-7}$  for 10% change.

**High stability crystal:** see Option 010.

**External time base input:** rear panel BNC accepts 5 or 10 MHz, 200 mV rms into 1 k $\Omega$ ; 5 V rms maximum.

**Time base out:** 10 MHz,  $> 1$  V p-p into 50  $\Omega$  via rear panel.

#### Statistics

**Sample size:** selectable between either  $n = 100$  or  $n = 1,000$  samples.

**Std. dev.:** displays a standard deviation of selected sample size.

**Mean:** displays mean estimate of selected sample size.

**Smooth:** performs a weighted running average and truncates unstable least significant digits from display.

#### Math

All measurement functions, with exception of GATE TIME, Totalize in Scale Mode, and TRIG LVL, may be operated upon by Math functions. Offset, Normalize, and Scale may be used independently or together as follows:

$$\text{Display} = \frac{\text{Measurement} + \text{Offset}}{\text{Normalize}} \times \text{Scale}.$$

**Number value range:**  $\pm 1 \times 10^{-9}$  to  $\pm 9 \times 10^9$ .

**Last display:** causes value of previous display to Offset (negative value), Normalize, or Scale all subsequent measurements.

**Measurement t-1:** causes each new measurement to be Offset (negative value), Normalized, or Scaled by each immediately preceding measurement.

#### Hewlett-Packard Interface Bus

**Programmable controls:** all measurement functions, Math, Statistics, Reset, Range Hold, Ext. Arm Enable/Slope, Check, Gate Adj. ( $\sim 1$  ms to 1 s), Gate Open/Close (gate times to  $\infty$ ), Gate Mode, Cycle, Preset, Slope, Common A, Auto Trigger.

**Special functions:** FREQ B, PULSE B, TIME B  $\rightarrow$  A, TOT A-B, LEARN, MIN, MAX, all internal diagnostic routines.

**Interface functions:** SH1, AH1, TS, TEQ, L4, SL1, RL1, PP0, DC1, DT1, C0, E1 (see page 542).

**Data output:** fixed output format consisting of 19 characters plus CR and LF output is typically 8 ms.

**Option 040:** adds complete systems programmability; see column at right.

#### General

**Gate:** minimum, manual, or continuously variable (NORM/FAST) via Gate Adj. control.

**NORM:** 20 ms to 4 s NOMINAL.

**FAST:** 100  $\mu$ s to 20 ms NOMINAL.

**MIN:** minimum gate time. Actual time depends on function.

**MANUAL:** each press opens or closes gate.

**Cycle:** determines delay between measurements.

**NORM:** no more than 4 readings per second, nominal.

**MIN:** updates display as rapidly as possible ( $\sim 15$  readings per second, depending on function).

**SINGLE:** one measurement taken with each press of button.

**Arming:** Ext. Arm Enable key allows rear panel input to determine Start and/or Stop point of a measurement. External gate defined by both Start and Stop armed. All measurements are armable except Manual Totalize, Phase, and Trigger Level.

**Start arm:** + or - slope of arm input signal starts measurement.

**Stop arm:** + or - slope of arm input signal stops measurement. When used, Start Arm must occur before Stop Arm.

**Ext. arm input:** rear panel BNC accepts TTL into 20 k $\Omega$ . Minimum Start To Stop Time: 200 ns.

**Trigger level out:** dc output into 1 M $\Omega$  via rear panel BNCs for Channel A and B; not adjusted for attenuators.

**Accuracy at dc ( $\times 1$ ):**  $\pm 15$  mV  $\pm 0.5\%$  of TRIG LVL reading.

**Gate out:** TTL level into 50  $\Omega$ ; goes low when gate open; rear panel BNC.

**Range hold:** freezes decimal point and exponent of display.

**Reset:** starts a new measurement cycle when pressed.

**Check:** performs internal self test and lamp test.

**Display:** 12-digit LED display in engineering format; exponent range of +18 to -18.

**Operating temperature:** 0 to 50°C.

**Power requirements:** 100, 120, 220, 240 VAC (+5%, -10%), 48-66 Hz; 130 VA max.

**Weight:** net, 8.8 kg (19 lb 8 oz). Shipping, 13.6 kg (30 lb).

**Dimensions:** 425.5 mm W x 132.6 mm H x 345.4 mm D (16 $\frac{1}{4}$  in. x 5 $\frac{1}{4}$  in. x 13 $\frac{1}{2}$  in.), not including removable handles.

#### Options

**Option 010: High Stability Time Base (oven)**

**Frequency:** 10 MHz.

**Aging rate:**  $< 5 \times 10^{-10}$ /day after 24-hour warm up.

**Short term:**  $< 1 \times 10^{-10}$  rms for 1s average.

**Temperature:**  $< 7 \times 10^{-9}$ , 0 to 50°C.

**Line voltage:**  $< 1 \times 10^{-10}$  for 10% change.

**Warm-up:** within  $5 \times 10^{-9}$  of final value in 20 minutes.

**Option 020: DC Digital Voltmeter**

**Range:** 4 digits, autoranging, autopolarity, in  $\pm 10$ ,  $\pm 100$ ,  $\pm 1000$  V ranges

**Sensitivity:** 100  $\mu$ V, 1 mV, 10 mV, 100 mV for  $\pm 1$  V,  $\pm 10$  V,  $\pm 100$  V,  $\pm 1000$  V readings.

**LSD displayed:** same as sensitivity.

**Input type:** floating pair.

**Input impedance:** 10 M $\Omega$   $\pm 1\%$ .

**Option 030: 1.3 GHz C Channel**

**Input Characteristics**

**Range:** 150 MHz to 1.3 GHz.

**Sensitivity:** 10 mV rms sinewave (-27 dBm) to 1 GHz, 100 mV rms sinewave (-7 dBm) to 1.3 GHz.

**Frequency C**

**Range:** 150 MHz to 1.3 GHz, prescaled by 20. LSD Displayed, Resolution, and Accuracy are same as Frequency A.

**Ratio C/A**

**Range:** channel A, 0 to 200 MHz.

channel C, 150 to 1300 MHz.

**Option 040: Complete Systems Programmability**

Adds remote selection of low pass filter, ac/dc coupling,  $\times 1$ - $\times 10$  attenuation, dc trigger level and input impedance for both Channel A and B.

#### Definitions

**Duty cycle:** percentage of time a signal is high or low, depending on Slope A setting. Trigger point is high/low dividing point.

$$\text{DUTY CY} = \frac{\text{PULSE}}{\text{PER}} \times 100\%.$$

**Slew rate:** effective slope between 10% and 90% points of rising or falling signal depending on Slope A setting.

$$\text{SLEW} = \frac{V_B - V_A}{T_1}$$

**Phase:** angle, with respect to B signal, between 50% points of channel A and B signals, trigger slopes selected by Channel A and B slope switches.

$$\text{PHASE} = \frac{(T_{11} + T_{12}) 360^\circ}{2 \text{ PER}}$$

$T_{11}$  is time between 50% points of A then B signals using slopes defined during Phase measurement.

$T_{12}$  is time between 50% points of A then B signals using complement slopes to  $T_{11}$ .

**Front handles:** supplied with instrument.

#### Ordering Information

**HP 5335A Universal Counter**

**Opt 010 Oven Oscillator**

**Opt 020 DVM**

**Opt 030 C Channel**

**Opt 040 Expanded HP-IB Control**

**Opt 908 Rack Flange Kit for use without handles.**

**Opt 913 Rack Flange Kit for use with supplied front handles.**

**Price**

**\$4000**

+ \$800

+ \$550

+ \$800

+ \$750

+ \$32

+ \$65

- 100 MHz and 1300 MHz
- 10 ns Time Interval
- T.I. Averaging to 10 ps resolution

- "Armed" measurements
- DVM option
- HP-IB interface standard

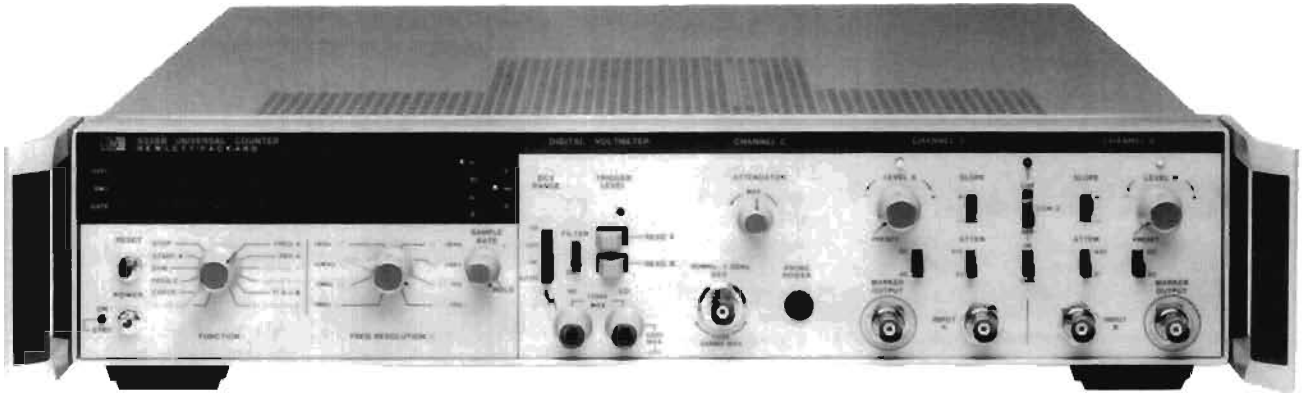

HP 5328B



### Solid Universal Counter Performance for Bench or System

- Frequency measurements to 100 MHz, 1.3 GHz optional.
- 10 ns Time Interval resolution, 10 ps with averaging.
- 10 ns Period resolution, 1 fs with averaging.
- $\pm 1000$  V dc DVM and High Stability Oven Time Base options.
- HP-IB programming and External Arming standard.

### Condensed Specifications

#### Input Characteristics

**Sensitivity:** 25 mV rms, to 40 MHz; 50 mV rms, 40 MHz-100 MHz.  
**Attenuators (nominal):**  $\times 1$ ,  $\times 10$  switch selectable.

#### Frequency A

**Range:** 0 to 100 MHz.

#### Period A

**Range:** 100 ns to  $10^7$ s with resolution to 10 ns.

#### Period Average A

**Range:** 100 ns to  $10^7$ s with resolution to 1 fs.

#### Time Interval A $\rightarrow$ B

**Range:** 10 ns to  $10^7$ s with resolution to 10 ns.

#### Time Interval Average A $\rightarrow$ B

**Range:** 0.1 ns to 1 s with resolution to 10 ps.

**Minimum Dead Time:** 40 ns.

#### Ratio B/A

**Range:** Channel A, 0 to 10 MHz; Channel B, 0 to 100 MHz.

### HP-IB Interface Bus

**Programmable functions:** Functions, resolution, sample rate, (maximum or manual control), arming, display modes, measurement modes, output mode, and reset commands. Trigger level, trigger slope, input impedance, coupling, separate/common/check, invert A and B. Trigger level is programmable in 10 mV steps in  $\times 1$ : 100 mV in  $\times 10$ . Trigger level accuracy under remote control in  $\times 1$ :  $\pm 35$  mV.

**Interface functions:** SH1, AH1, TI, L2, SR1, RLI, PP0, DC1, DT1, C0, E1. (See page 542).

**Service request (SRQ):** if enabled, indicates end of measurement.

**Maximum data output rate:** 500 readings/s.

### General

**Display:** 9-digit LED display.

**Sample Rate:** Variable from less than 2 ms between measurements to HOLD, which holds display indefinitely.

**Gate Output:** rear panel output; TTL levels.

**Time Base Output:** rear panel output; TTL levels.

**Operating Temperature:** 0° to 50°C.

**Power Requirements:** 100/120/240 V rms, +5%, -10% (switch selectable), 48-66 Hz; 150 VA max.

### Time Base Oscillators

#### Standard Crystal Oscillator

**Frequency:** 10 MHz.

**Aging Rate:**  $< 3 \times 10^{-7}$ /month.

**Temperature:**  $< 2.5 \times 10^{-6}$ , 0° to 50°C.

**Line Voltage:**  $< 1 \times 10^{-3}$  for 10% change.

#### Option 010: Oven Oscillator

**Frequency:** 10 MHz.

**Aging Rate:**  $< 5 \times 10^{-10}$ /day after 24-hour warm-up.

**Short Term:**  $< 1 \times 10^{-10}$  rms/s.

**Temperature:**  $< 7 \times 10^{-9}$ , 0° to 50°C.

**Line Voltage:**  $< 5 \times 10^{-9}$  for 10% variation.

**Warm-Up:** within  $5 \times 10^{-9}$  of final value in 20 minutes.

#### Option 021: High Performance Digital Voltmeter

**Range:**  $\pm 10$ ,  $\pm 100$ ,  $\pm 1000$  V dc and Autorange.

**Sensitivity:** 10  $\mu$ V, 100  $\mu$ V, 1 mV, 10 mV, 100 mV for measurement times of 10 s, 1 s 0.1 s, 10 ms, 1 ms respectively.

**Input:** floating pair, 10 M $\Omega$  nominal.

**Maximum Input:** hi to low:  $\pm 1100$  V all ranges; low to chassis ground:  $\pm 500$  V.

**Trigger Level Measurements:** 1 mV display resolution.

#### Option 031: 1300 MHz C-Channel

##### Input Characteristics

**Sensitivity:** 20 mV rms sine wave (-21 dBm).

**Maximum Input:** 5 V rms,  $\pm 5$  Vdc, fuse protected.

##### Frequency C

**Range:** 90 MHz to 1300 MHz, prescaled by 4 with resolution to 0.1 Hz.

##### Ratio C/A

**Range:** channel A, 0 to 10 MHz; channel C, 90 to 1300 MHz

**Attenuation:** continuously variable for optimum noise suppression.

### Ordering Information

HP 5328B Universal Counter

Opt 010 High Stability Time Base

Opt 021 High Performance DVM

Opt 031 1300 MHz Channel C

Opt 050 DVM and Channel C

Opt 908 No Handles Rack Flange Kit

Opt 913 With Handles Rack Flange Kit

### Price

\$4400

+ \$800

+ \$800

+ \$1000

+ \$1800

+ \$30

+ \$30

# ELECTRONIC COUNTERS

## Universal Counters

Models 5315A, 5316B

- Frequency, period, ratio, and totalize to 100 MHz
- Portable, and HP-IB models
- 1 GHz capability available

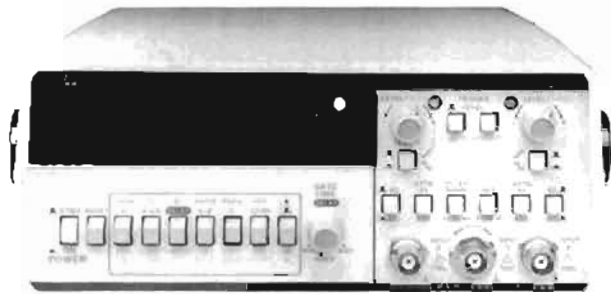

HP 5315A

- Uses reciprocal technique for full low-frequency resolution
- 100 ns time interval, 10 ps T.I. averaging
- Oven option for increased accuracy



HP 5316B



## HP 5315A and HP 5316B Universal Counters

### A Quiet Revolution in Capability . . .

HP's economical HP 5315A and HP 5316B counters provide all the universal counter capability you've come to expect at much higher prices. That's because they use a unique custom circuit called the MRC (Multiple Register Counter) which packs counting and computing power into this popular counter series. To a user, the differences in operation from conventional direct models can be listed quickly: low frequency resolution is an outstanding 7 digits per second of gate time and reliability is extremely good due to the counter's low chip count. Also, the continuously adjustable gate time allows automatic selection of sample size for easy trade-offs between measurement time and resolution.

Much of the counter's performance is based on reciprocal counting techniques first pioneered in HP's high-performance HP 5360A computing counter, and the current HP 5345A Universal Counter. The use of these techniques coupled with HP's MRC and a microprocessor provides a quiet but powerful revolution in counter performance within the HP 5315A and HP 5316B. For example, this counter gives you its full 7-digits/second resolution over the range from 1 Hz to 100 MHz. This, simply stated, shows the power of the MRC and reciprocal counting.

### High Performance, Low Price

In addition to its economy, the MRC counter offers a full set of universal counter measurements, and there are very few limitations to this capability. Increased accuracy in low-cost portable and system counters is also available with the oven oscillator option through improved temperature stability and lower aging rates.

### Frequency to 100 MHz, C-Channel to 1.0 GHz

The MRC counter measures frequency to 100 MHz. Additionally the optional C-Channel measures to 1.0 GHz for both CW and pulsed RF signals as narrow as 60 ns. The C-Channel option is particularly useful in navigation and communications equipment testing due to this pulsed RF measurement feature.

### Time Interval to 100 ns, T.I. Averaging to 10 ps

The MRC counter provides three time measurement modes. Single-shot time interval allows measurements over a range of 100 ns to 100,000 seconds. This capability can be used to measure pulse width. Time interval averaging provides greater resolution for repetitive events. Finally, time interval delay avoids measurement of spurious signals by holding off the counter's trigger point by a precise, operator-selectable amount of time.

### A Full Set of Measurements

Besides the frequency and time functions mentioned above, the MRC counter has other measurement functions that make it a truly impressive value:

**Period A**—allows single period measurements via Channel A.

**Ratio A/B**—allows frequencies to 100 MHz into both Channel A and B.

**A By B**—totalizes the A input between 2 events on B channel.

**Totalize**—a manually gated totalize mode of operation.

### Input Signal Conditioning Versatility

A full complement of input signal conditioning controls are provided for both channels. These include  $\pm$  slope,  $\pm 2.5$  Vdc trigger level, and ac/dc coupling. Other controls are a Separate/Common switch, and a 100 kHz low-pass filter for Channel A.

### A Choice of Portable or System Models

**HP 5315A:** a portable, light-weight unit best suited for field applications. This unit has a convenient carrying handle and optional battery power is available for up to 4 hours continuous operation.

**HP 5316B:** this model possesses all the characteristics of the HP 5315A, and it has HP-IB capability built-in as standard equipment. It has low RFI, it is rackable, and it is functionally identical to the HP 5315A. In addition to programmable measurement functions, the user can also select dc trigger level and  $\pm$  slope under HP-IB control. Channel A and B trigger levels are brought out to the front panel on this unit for easy measurement with a DVM.

## HP 5315A, 5316B Condensed Specifications

### Input Characteristics (channel A and channel B)

**Range:** dc coupled, 0 to 100 MHz.

ac coupled, 30 Hz to 100 MHz.

**Sensitivity:** 10 mV rms sine wave to 10 MHz; 25 mV rms sine wave to 100 MHz; 75 mV peak-to-peak pulse at minimum pulse width of 5 ns.

Sensitivity can be varied continuously up to 500 mV rms *NOMINAL* by adjusting sensitivity control. In sensitivity mode, trigger level is automatically set to 0 V *NOMINAL*.

### Dynamic Range

30 mV to 5 V peak-to-peak, 0 to 10 MHz.

75 mV to 5 V peak-to-peak, 10 to 100 MHz.

**Coupling:** ac or dc, switchable.

**Filter:** low pass, switchable in or out of Channel A. 3 dB point of 100 kHz *NOMINALLY*.

**Impedance:** 1 MΩ *NOMINAL* shunted by less than 40 pF.

**Signal operating range:** +2.5 Vdc to -2.5 Vdc.

**Attenuator:** X1 or X20 *NOMINAL*.

**Trigger level:** variable between +2.5 Vdc and -2.5 Vdc.

**Slope:** independent selection of + or - slope.

**Common input:** all specifications are the same for Common A except the following:

**Sensitivity:** 20 mV rms sine wave to 10 MHz; 50 mV rms to 100 MHz; 150 mV peak-to-peak at a minimum pulse width of 5 ns.

**Dynamic range:** 60 mV to 5 V peak-to-peak to 10 MHz; 150 mV to 5 V peak-to-peak, 10-100 MHz.

**Impedance:** 500 kΩ *NOMINAL* shunted by less than 70 pF.

### Frequency (channel A)

**Range:** 0.1 Hz to 100 MHz.

**Resolution:** Sec Graph 1

**Accuracy:** ± Resolution ± Time Base Error (Graph 2)

### Period

**Range:** 10 ns to 10<sup>3</sup> s.

**Resolution:** Sec Graph 1

**Accuracy:** ± Resolution ± Time Base Error (Graph 2)

### Time Interval

**Range:** 100 ns to 10<sup>3</sup> s

**LSD displayed:** 100 ns.

**Resolution:** ± LSD ± Noise Trigger Error (Graph 3)

**Accuracy:** ± Resolution ± Time Base Error (Graph 2)

### Time Interval Average

**Range:** 0 ns to 10<sup>3</sup> s.

**LSD displayed:** 100 ns/√N, 10 ps maximum.

**Number of intervals averaged (N):** N = Gate Time x FREQ

**Minimum dead time (stop to start):** 200 ns.

**Resolution:** ±LSD ± [Noise Trigger Error (Graph 3)]/√N

**Accuracy:** ± Resolution ± Time Base Error (Graph 2) ± 4 ns

### Time Interval Delay (holdoff)

Front panel gate time knob inserts a variable delay of *NOMINALLY* 500 μs to 20 ms between START (Channel A) and enabling of STOP (Channel B). Electrical inputs during delay time are ignored. Delay time may be digitally measured by simultaneously pressing T.I. Averaging, T.I. Delay and blue key. Other specifications are identical to Time Interval

### Ratio

**Range:** 0.1 Hz to 100 MHz, both channels.

**LSD:** {(2.5 x Period A)/Gate Time} x Ratio.

### Totalize

#### Manual

**Range:** 0 to 100 MHz.

#### A gated by B

Totalizes input A between two events of B. Instrument must be reset to make new measurement. Gate opens on A slope, closes on B slope.

**Range:** 0 to 100 MHz.

### General

#### Standard Time Base

**Frequency:** 10 MHz.

**Aging rate:** < 3 × 10<sup>-7</sup>/mo.

**Temperature:** ± 5 × 10<sup>-6</sup>, 0° to 50°C.

**Line voltage:** < 1 × 10<sup>-7</sup> for a ± 10% variation.

**Check:** counts internal 10 MHz reference frequency.

**Error light:** LED warning light activated if logic error is found during instrument turn-on self-check.

**Display:** 8-digit LED display, with engineering units annunciator.

**Overflow:** only frequency and totalize measurements will overflow. In case of overflow, eight least significant digits will be displayed and front panel overflow LED will be actuated. All other measurements which would theoretically cause a display of more than 8 digits will result in the display of the 8 most significant digits.

**Gate time:** continuously variable, *NOMINALLY* from 60 ms to 10 s or 1 period of the input, whichever is longer.

**Sample rate:** up to 7 readings per second *NOMINALLY* except in time interval mode, where it is continuously variable *NOMINALLY* from 250 ms to 10 s via Gate Time Control.

**Operating temperature:** 0° to 50°C.

**Power requirements:** 100, 120, 220, 240 V (+5%, -10%) 48-66 Hz; 15 VA maximum or 30 VA maximum (HP 5316B).

**Weight:** net, 2.2 kg (4 lb 12 oz); Shipping, 4.1 kg (9 lb).

**Dimensions:** 238 mm W x 98 mm H x 276 mm D (9 3/8 in. x 3 3/8 in. x 10 7/8 in.).

### Additional HP 5316B Specifications

Rack and stack metal case with rear panel, switchable ac power line module. Specifications same as HP 5315A except as follows:

**Rack mount kit:** HP 5061-9672 recommended.

**Oscillator output:** 10 MHz, 50 mV p-p into 50 Ω load on rear panel.

**External frequency standard input:** 1, 5, 10 MHz, 1 V rms into 500 Ω, or rear panel.

**Trigger level output:** ±5%, ±15 mV, over ±2.0 Vdc range at front panel connectors.

**Dimensions:** 212 mm W x 88 mm H x 415 mm D (8 3/8 in. x 3 1/2 in. x 16 1/2 in.).

**Weight:** net, 3.7 kg (8 lb 2 oz); Shipping, 6.3 kg (14 lb).

### Hewlett-Packard Interface Bus

**Programmable functions:** Frequency A and C, Frequency A Armed by B, Period A, Totalize A Gated by B, Ratio A/B, Time Interval A→B, Time Interval Average A→B, Time Int. Delay, Read Gate Time.

**Programmable controls:** Gate Time Command which sets long (60 ms to 10 s) or short (500 μs to 30 ms) range; Trigger Level Commands which set Channel A and/or B slope (±) and Channel A and/or B trigger from -2.50 Vdc to +2.50 Vdc in steps of .01V.

**HP-IB Interface Functions:** SH1, AH1, T1, L2, SR1, RL1, PP0, DC1, DT1, C0, E1 (see page 542).

### Options

**Opt. 001:** High Stability Time Base (TCXO).

**Frequency:** 10 MHz.

**Aging rate:** < 1 × 10<sup>-7</sup>/mo.

**Temperature:** ± 1 × 10<sup>-6</sup>, 0° to 40°C.

**Line voltage:** < 1 × 10<sup>-8</sup> for ± 10% variation.

# ELECTRONIC COUNTERS

## Universal Counters (cont'd)

Models 5315A, 5316B

**Opt. 002:** Battery (HP 5315A only).

**Type:** rechargeable lead-acid (sealed).

**Capacity:** TYPICALLY 4 hours of continuous operation at 25 °C.

**Recharging time:** TYPICALLY 16 hours to 98% of full charge, instrument non-operating. Charging circuitry included with Option. Batteries not charged during instrument operation.

**Low voltage indicator:** instrument turns itself off automatically when low battery condition exists. *Discharge* LED flashes slowly when this happens. *Discharge* LED is on whenever battery is supplying power to instrument. *Charge* LED indicates state of charge of battery during charging only and is on whenever battery is charged to 95% *NOMINAL* of capacity. *Charge* LED flashes when 90% *NOMINAL* of charge taken out is replaced. *Charge* LED is off if charge is less than 70% *NOMINAL* of capacity.

**Line failure protection:** instrument automatically switches to battery in case of line failure.

**Weight:** Opt 002 adds 1.4 kg (3 lb) to weight of instrument.

**Option 003:** C Channel.

**Input Characteristics**

**Range:** 50 to 1000 MHz, prescaled by 10.

**Sensitivity:** 15 mV rms sinewave (-23.5 dBm) to 650 MHz. 75 mV rms sinewave (-9.5 dBm) to 1000 MHz. Sensitivity can be decreased continuously by up to 20 dB *NOMINAL*, 50 to 500 MHz and 10 dB *NOMINAL*, 500 to 1000 MHz by adjusting sensitivity control. Trigger level is fixed at 0 V *NOMINAL*.

**Dynamic range:** 15 mV to 1 V rms (36 dB), 50 to 650 MHz. 75 mV to 1 V rms (20 dB), 650 to 1000 MHz.

**Signal operating range:** +5 Vdc to -5 Vdc.

**Coupling:** ac.

**Impedance:** 50 Ω *NOMINAL* (VSWR, < 2.5:1 TYPICAL).

**Damage level:** ±8 V (dc + ac peak), fuse protected. Fuse located in BNC connector.

**Resolution and Accuracy:** same as Frequency A.

**Option 004:** High Stability OVEN Time Base (HP 5315A only).

**Frequency:** 10 MHz.

**Aging rate:**  $< 3 \times 10^{-8}$ /mo.\*

**Temperature:**  $\pm 1 \times 10^{-7}$ , 0° to 50°C.

**Line voltage:**  $< 1 \times 10^{-8}$ , for a 10% variation.

Oven will operate continuously off of a fully charged battery for > 24 hours, typically, when in standby mode (no power applied, instrument OFF, and Freq. A button depressed).

(HP 5316B)

**Frequency:** 10 MHz.

**Aging rate:**  $< 3 \times 10^{-8}$ /mo.\*\*

**Temperature:**  $\pm 2 \times 10^{-8}$ , 0° to 50°C.

**Line Voltage:**  $< 1 \times 10^{-9}$ , for a 10% variation.

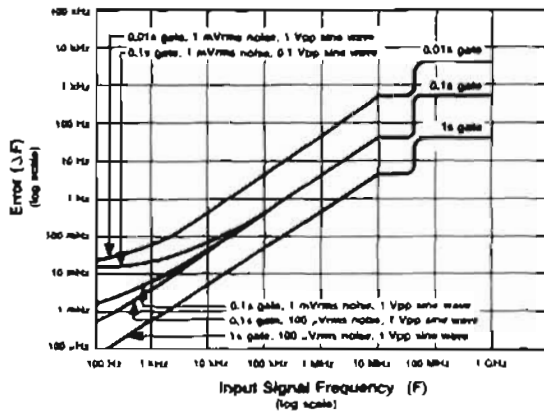

**Graph 1. Frequency Resolution Error:** Noise on the Input signal and internal uncertainties affect Frequency and Period measurements. For Period, Invert the period (P) of the Input signal, and find frequency uncertainty (ΔF). Period uncertainty (ΔP) = (ΔF/F) × P.

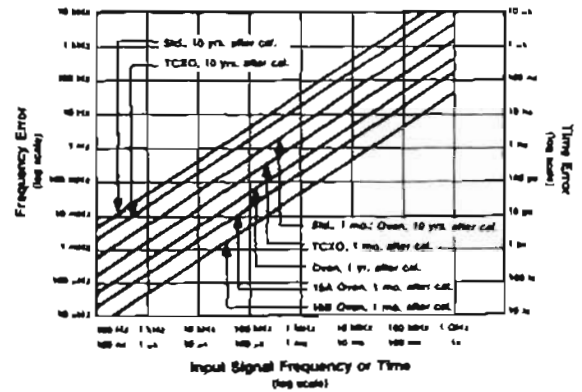

**Graph 2. Timebase Error:** Environment and aging of the crystal affects all measurements.

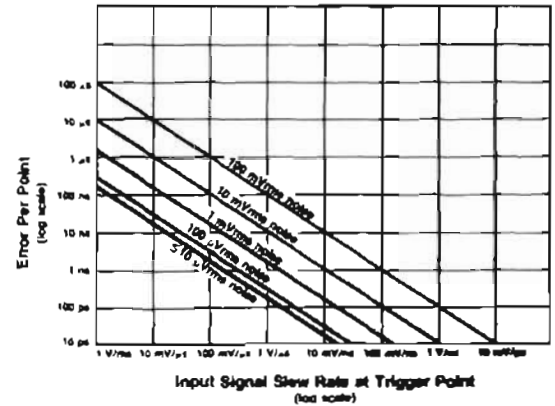

**Graph 3. Input Noise Trigger Error:** Noise on the input signal affects both the Start and Stop points of all Time Interval measurements.

\* After 30 days continuous operation (ac power applied, in OFF or ON position).  
 \*\* After 30 days continuous operation,  $< 5 \times 10^{-8}$ /mo., after 7 days continuous operation.

**Ordering Information**

HP 5315A Universal Counter **\$1100** ☞

HP 5316B Universal Counter **\$1475** ☞

		HP 5315A	HP 5316A	Price
Opt 001	TCXO Time Base	X	X	+ \$150
Opt 002	Battery Pack	X		+ \$300
Opt 003	C-Channel (1.0 GHz)	X	X	+ \$400
Opt 004	High Stability Time Base	X	X	+ \$600

All HP 5315A orders must include one (1) of these line power options:

Opt 100	90-105 VAC	N/C
Opt 120	108-126 VAC	N/C
Opt 220	198-231 VAC	N/C
Opt 240	216-252 VAC	N/C

☞ Fast-Ship product—see page 758.



- 100 MHz
- 100 ns time Interval
- Portable



HP 5314A

**HP 5314A Universal Counter**

The HP 5314A Universal Counter combines excellent performance and traditional HP quality at a very attractive price. This counter is designed to deliver reliable, high quality operation in such areas as: Production Test, Frequency Monitoring, Education, Training, Service and Calibration. Additionally, the optional battery (option 002) makes the HP 5314A especially attractive for field and portable applications.

**Input Characteristics (channels A and B)**

**Range:** CHANNEL A: 10 Hz to 10 MHz Direct.  
1 MHz to 100 MHz Prescaled.  
CHANNEL B: 10 Hz to 2.5 MHz.

**Sensitivity:** CHANNEL A: 25 mV rms to 100 MHz.  
75 mV peak-to-peak at minimum pulse width of 5 ns (100 MHz range).

CHANNEL B: 25 mV rms to 2.5 MHz.  
75 mV peak-to-peak at minimum pulse width of 200 ns.

**Coupling:** ac.

**Impedance:** 1 MΩ NOMINAL shunted by less than 30 pF.

**Attenuator:** ×1 or ×20 NOMINAL (A channel only).

**Trigger level:** continuously variable ± 350 mV times attenuator setting around average value of signal.

**Slope:** independent selection of + or - slope.

**Channel input:** selectable SEPARATE OR COMMON A.

**Dynamic range:** 75 mV p-p to 4 V p-p.

**Frequency**

**Range:** 10 Hz to 10 MHz direct count.

1 MHz to 100 MHz prescaled by 10.

**Least significant digit (LSD) displayed:** direct count 0.1 Hz, 1 Hz, 10 Hz switch selectable. Prescaled 10 Hz, 100 Hz, 1 kHz switch selectable.

**Resolution:** ± LSD.

**Accuracy:** ± LSD ± (time base error) × Freq.

**Period**

**Range:** 10 Hz to 2.5 MHz.

**LSD displayed:**  $\frac{100 \text{ ns}}{N}$  for N=1 to 1000 in decade steps of N.

**Resolution:** ± LSD ±  $\frac{(1.4 \times \text{TRIGGER ERROR})}{N}$

**Accuracy:** ± LSD ±  $\frac{(1.4 \times \text{TRIGGER ERROR})}{N}$

± (time base error) × Period.

**Time Interval**

**Range:** 250 ns to 1 s.

**LSD displayed:** 100 ns.

**Resolution:** ± LSD ± START trigger error ± STOP trigger error.

**Accuracy:** ± LSD ± START trigger error

± STOP trigger error ± (time base error) × T1.

External arming required for START/STOP channels.

**Ratio (A to B)**

**Range:** 10 Hz to 10 MHz CHANNEL A.

10 Hz to 2.5 MHz CHANNEL B.

**LSD displayed:** 1/N in decade steps of N for N = 1 to 1000.

**Resolution:** ± LSD ± (B trigger error × Frequency A)/N.

**Accuracy:** ± LSD ± (B trigger error × Frequency A)/N.

**Totalize**

**Range:** 10 Hz to 10 MHz.

**Resolution:** ± 1 count of input.

Totalize controlled by front panel switch.

**General**

**Check:** counts internal 10 MHz oscillator.

**Display:** 7 digit amber LED display with gate and overflow indication.

**Max sample rate:** 5 readings per second.

**Operating temperature:** 0° to 50 °C.

**Power requirement:** 115, +10%, -25%; 230 V, +9%, -17%; 48-66 Hz; 10 VA max.

**Weight:** 2.0 kg (4.4 lb).

**Dimension:** 238 mm W x 98 mm H x 276 mm D (9 1/2 in. x 3 7/8 in. x 10 7/8 in.).

**Time Base**

**Frequency:** 10 MHz.

**Aging rate:** < 3 parts in 10<sup>7</sup> per month.

**Temperature:** < ± 1 part in 10<sup>7</sup>, 0 to 50 °C

**Line voltage:** < ± 1 part in 10<sup>7</sup> for ± 10% variation.

**Options****Option 001 TCXO**

**Frequency:** 10 MHz.

**Aging rate:** < 1 part in 10<sup>7</sup> per month.

**Temperature:** < ± 1 part in 10<sup>7</sup>, 0 to 40 °C.

**Line voltage:** < ± 1 part in 10<sup>7</sup> for ± 10% variation.

**Option 002 Battery**

**Type:** rechargeable lead-acid (sealed).

**Capacity:** typically 8 hours of continuous operation at 25 °C.

**Recharging time:** typically 16 hours to 98% of full charge, instrument non-operating. Charging circuitry included with option. Batteries not charged during instrument operation.

**Battery voltage sensor:** automatically shuts instrument off when low battery condition exists.

**Line failure protection:** instrument automatically switches to batteries in case of line failure.

**Weight:** Option 002 adds typically 1.5 kg (3.3 lb) to weight of instrument.

**Definitions**

**Resolution:** smallest discernible change of measurement result due to a minimum change in the input.

**Accuracy:** deviation from the actual value as fixed by universally accepted standards of frequency and time.

**Trigger error:**

$$\frac{\sqrt{(80 \mu\text{V})^2 + e_n^2}}{\text{input slew rate at trigger point } (\mu\text{V/s})} \text{ (rms)}$$

Where  $e_n$  is the RMS noise of the input for a 100 MHz bandwidth in CHANNEL A and 10 MHz bandwidth in CHANNEL B.

**Ordering Information**

**HP 5314A** 100 MHz/100 ns Universal Counter

Opt 001 High Stability Time Base

Opt 002 Battery

All orders must include one (1) of these line power options:

Opt 115 86-127 V

Opt 230 190-250 V

☎ Fast-Ship product — see page 758.

**Price**

\$550

+ \$150

+ \$150

N/C

N/C

# POWER METERS

## Power Measurements

### Average Power Measurements

At microwave frequencies, power is the best measure of signal amplitude because, unlike voltage and current, power remains constant along a lossless transmission line. For this reason, power meters are almost indispensable for microwave measurements. Typical applications include monitoring transmitter power levels, calibrating signal generators, leveling signal sources, and measuring transmission characteristics of unknown devices.

To satisfy the requirements of this broad range of applications Hewlett-Packard has developed a family of general purpose microwave power meters and power sensors. The power sensors use a diode, thermocouple, or thermistor as the power sensing element, and it is important to understand the merits of each of these sensors before choosing a particular power meter.

### Power Meters and Sensors

Hewlett-Packard makes five average-reading power meters. The HP 438A is a dual channel power meter designed for ATE systems applications. The HP 435B and the 436A are analog and digital meters, which are designed to operate with HP's line of thermocouple and diode power sensors. The HP 432 power meters are designed to operate with HP's line of thermistor mounts: the HP 432A is an analog power meter, and the HP 432B is digital with BCD output.

Thermocouple power sensors are generally preferred for measuring power because they exhibit lower SWR and wider dynamic range than previously used thermistor elements. Low SWR is directly responsible for superior accuracy since mismatch errors are lower.

Thermocouple sensors (HP 8481, 8482, 8483, 8485A, R8486A, Q8486A) are available from 100 kHz to 50 GHz and range from -30 dBm to +44 dBm. The HP 8484A diode sensor operates with the same meters and extends the input level down to -70 dBm. This sensor uses a Low-Barrier Schottky Diode to achieve exceptional 100 pW (-70 dBm) sensitivity and low noise and drift. Because the diode is always operated in its square law region (voltage out  $\propto$  power in), the HP 8484A can be used to measure the true power of complex as well as CW waveforms.

Thermistor power sensors (HP 478A, 486A series) operate with the HP 432A and 432B power meters. Since these power meters are based on balanced bridge principles, they are used whenever a direct dc-substitution technique is required. In addition, waveguide thermistor mounts are available from 8.20 to 40 GHz.

### Peak Power Measurements

A frequent requirement in microwave work is the measurement of peak power in a periodic pulse. Rather than calculate peak power from an average power measurement, it would be more convenient to measure peak power directly. Hewlett-Packard produces two versatile instruments that accurately and conveniently measure peak power from 50 MHz to 18 GHz, and from 0 dBm to +20

dBm on pulses with widths from 100 nanoseconds to CW.

The HP 8900C is an economical analog power meter calibrated in watts and dBm. The HP 8900D has an easy to read 3½ digit display calibrated in watts. Both of these peak power meters work with the HP 8481A peak power sensor that conveniently detaches from the meters for storage, recalibration, or replacement.

The HP 8900C/D meters feature two modes of operation, Direct and Compare. In the Direct mode, the meter automatically measures and displays the maximum RF power. In the Compare mode, an oscilloscope and a meter front panel control are used to measure power at arbitrary points on the pulsed waveform. In this mode, the detected pulse train and an accurate reference line, supplied by the HP 8900C/D, can be simultaneously displayed on the oscilloscope CRT. The front panel control moves the reference line up or down with respect to the detected waveform. The user can then measure power at any desired point on the waveform by simply moving the reference line to that point.

### Automatic Systems to Calibrate Power Sensors and Attenuators

Power sensors and attenuators, in most cases, are the standards against which signal levels are compared. For this reason, it is essential that they be periodically recalibrated to maintain measurement integrity. Power sensors and attenuators are calibrated by either a highly accurate and fast, but expensive automatic network analyzer or by an economical, manual, but slow and tedious system. There is very little calibration capability offered in between. But now, HP offers an automatic power sensor and attenuator calibration system, the HP 436A-E40. The heart of this system is a power meter based reflectometer controlled by the HP-85 computer. Calibration systems similar to the HP 436A-E40 have been in use for several years at key Hewlett-Packard calibration laboratories throughout the world.

Figure 1 shows the system configuration. In operation, for power meter calibration, test signals are standardized against a specially calibrated power sensor standard. The sensor to be calibrated is compared against the standardized signals and a calibration chart is plotted or table printed.

The system is also ideal for attenuation calibration. The accuracy and linearity of power meters plus the low SWR of power sensors offer attenuation accuracy surpassed only by error correcting automatic network analyzers.

The reports for Cal Factor and attenuation are printed in either tabular or graph form and they include the calibration uncertainty. Coaxial power sensors and attenuators can be calibrated from 100 MHz to 26.5 GHz in 3 bands, 100 MHz to 2 GHz, 2 to 18 GHz, and 18 to 26.5 GHz. Waveguide thermistor sensors can be calibrated in X, P, and K bands.

The reports for Cal Factor and attenuation are printed in either tabular or graph form and they include the calibration uncertainty. Coaxial power sensors and attenuators can be calibrated from 100 MHz to 26.5 GHz in 3 bands, 100 MHz to 2 GHz, 2 to 18 GHz, and 18 to 26.5 GHz. Waveguide thermistor sensors can be calibrated in X, P, and K bands.

### Literature

Application Note 64-1, *Fundamentals of RF and Microwave Power Measurements*, deals with the general theory of microwave power measurements. It covers the basic principals of measurement, calculation of measurement uncertainty, traceability, etc.

Application Note 64-2, *Extended Applications of Automatic Power Meters*, discusses an automatic power meter system for measuring attenuation, gain saturation and the calibration factor of power sensors.

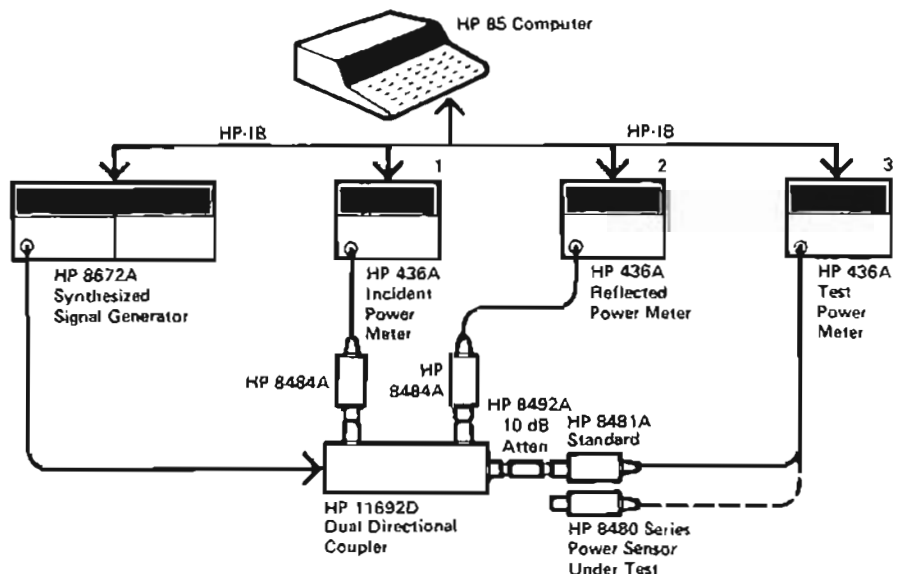

Figure 1. Power sensors and attenuators calibration system.

- Ideal for ATE applications
- Dual power sensors
- Innovative ratio & difference measurements



HP 438A

DESIGNED FOR  
MATE  
SYSTEMS



The HP 438A Power Meter is a dual channel power meter designed specifically for ATE systems. The compact front panel is designed to save space in rack mounted systems, while the dual channel design allows simple measurements of the ratio and difference of power levels from two separate sensors. Compatible with the HP 8480 series of thermocouple and diode sensors, the power and frequency range of the meter extends from  $-70$  dBm to  $44$  dBm and from  $100$  kHz to  $50$  GHz.

Important measurement contributions are a programmable digital filter for optimizing resolution and measurement speed, independent offset (in dB) values for each channel,  $0.001$  dB resolution available, and a power difference mode for displaying absorbed power in transmission lines. Up to 19 different operating states of the meter can be stored into non-volatile memory for later recall.

The programmable digital averaging filter gives the user control over the inherent tradeoff between speed and accuracy. The AUTO filter mode is usually adequate for fully settled readings with  $0.01$  dB resolution. Less digital averaging leads to faster but noisier readings, if speed is the critical issue.

The Hewlett-Packard Interface Bus (HP-IB) capability is standard on the HP 438A with programming codes printed on the front panel for easy reference. For U.S. Air Force MATE (Modular Automatic Test Equipment) system applications, Option 700 provides the HP 438A with the internal capability to be controlled by the MATE language CILL (Control Interface Intermediate Language). All measurement modes are programmable including zeroing, calibration, and Cal Factor. Complete interrupt capability with flexible SRQ operation optimizes the efficiency of program execution in automatic systems.

### HP 438A Specifications

**Frequency range:**  $100$  kHz to  $50$  GHz (depending on power sensor used).

**Power range:**  $-70$  dBm to  $+44$  dBm ( $100$  pW to  $25$  W), sensor dependent. Uses HP 8480 series power sensors; see sensor specs for details.

**Operating temperature range:**  $0$   $-55^{\circ}$  C.

#### Instrumentation Accuracy

**Single channel, linear mode:**  $\pm 0.5\%$

**Log mode:**  $\pm 0.02$  dB.

**Dual channel, linear mode:**  $\pm 1\%$ .

**Log mode:**  $\pm 0.04$  dB.

**Zeroing:** automatic,  $\pm 0.5\%$  full scale on most sensitive range.

#### Power Reference

**Power output:**  $1.00$  mW. Factory set to  $\pm 0.7\%$ , traceable to the U.S. National Bureau of Standards.

**Accuracy:**  $\pm 1.2\%$  worst case ( $\pm 0.9\%$  rss) for 1 year.

**Connector:** front panel type N female (also on rear panel, Opt 002).

#### Meter Adjustments

**Cal factor:** values from  $1\%$  to  $150\%$  in  $0.1\%$  steps can be entered to account for sensor frequency response. Sensor calibration: automatic self calibration to  $1.00$  mW.

### General

**Display:** four digit display (five digits in high resolution mode) with  $20\%$  over-range capability on all ranges. Annunciators to indicate measurement mode, Cal Factor, offset value, fixed or automatic range and filter values, and error conditions.

**Recorder output:** linearly proportional to power in watts. One volt corresponds to full scale;  $1k\Omega$  output impedance, BNC rear panel female connector.

**Line voltage:**  $100$ ,  $120$ ,  $220$  or  $240$  Vac  $+5\%$   $-10\%$ .  $100$  and  $120$  volts,  $48$  to  $66$  Hz and  $300$  to  $440$  Hz.  $220$  and  $240$  volts,  $48$  to  $66$  Hz only.

**Power requirements:**  $65$  VA,  $35$  watts, maximum.

**Weight:** net,  $5.9$  kg ( $13$  lb). Shipping,  $9.1$  kg ( $20$  lb).

**Dimensions:**  $89$  mmH x  $213$  mmW x  $418$  mmD ( $3.5$  x  $8.4$  x  $16.8$  in).

**HP-IB interface codes:** SH1, AH1, T5, TE0, L4, LE0, SR1, RL1, PP1, DC1, DT1, C0.

### Accessories

**Furnished:** HP 11730A, 2 each,  $1.5$  metre ( $5$  ft) power sensor cables. Power cable, 1 each,  $2.4$  metres ( $7.5$  ft). Mains plug matches destination requirements.

**Available:** To select non-standard lengths for power sensor cables, select option 004 (delete sensor cables) and order as required from HP 11730A-F, power sensor cables. Lengths are available from  $1.5$  metres ( $5$  ft) to  $61$  metres ( $200$  ft).

### HP 11730A-F Power Sensor Cables

The HP 11730 series power sensor cables are for use with the HP 435B, 436A, and 438A power meters and the HP 8480 series thermocouple and diode power sensors. These cables are designed to reduce RFI effects on low power readings with an improved shielding design in the cable itself. Cables may be ordered individually or in pairs in any combination desired for single and dual channel measurements.

The HP 11730A cable is the standard cable for the HP 435B, 436A, and 438A (2 cables shipped) meters. To order a non-standard cable, select Option 004 for the meter in question, and order the desired cable from below.

### Ordering Information

HP 438A Dual Channel Power Meter

**Option 002:** Rear panel sensor connectors (in parallel with front panel) and additional reference oscillator with rear panel output.

**Option 700:** Internal MATE programming

**Option 004:** Delete power sensor cables

**Option 910:** Additional manual

HP 11730A  $1.5$  metre ( $5$  ft) sensor cable

HP 11730B  $3.0$  metre ( $10$  ft) sensor cable

HP 11730C  $6.1$  metre ( $20$  ft) sensor cable

HP 11730D  $15.2$  metre ( $50$  ft) sensor cable

HP 11730E  $30.5$  metre ( $100$  ft) sensor cable

HP 11730F  $61.0$  metre ( $200$  ft) sensor cable

☛ Fast-ship product—see page 758.

### Price

\$5,100 ☛

+ \$325

+1000

-\$146

\$25

\$75 ☛

\$85 ☛

\$105 ☛

\$165 ☛

\$215 ☛

\$355 ☛

# POWER METERS

## Thermocouple Power Meter

### Model 436A

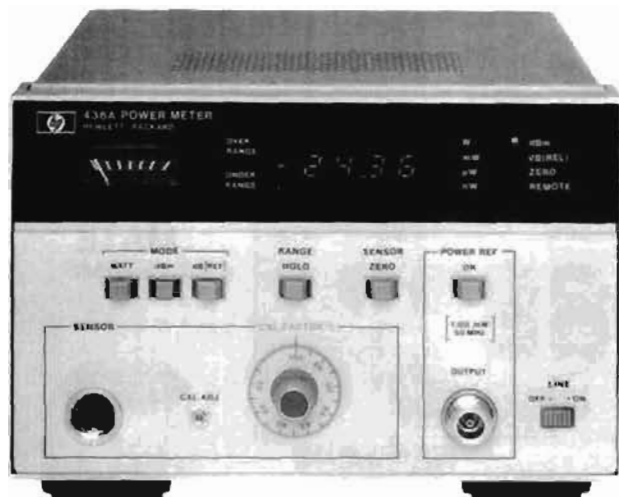

HP 436A



### HP 436A Power Meter

The HP 436A Power Meter is a general purpose digital power meter intended for manual and automatic RF and microwave power measurements. It is compatible with the entire series of HP 8480 Power Sensors. Depending on which power sensor is used, the HP 436A can measure power from  $-70$  dBm (100 pW) to  $+44$  dBm (25 W) at frequencies up to 50 GHz.

The logically organized and uncluttered front panel, and the convenience of push-button operation and digital display make the HP 436A both easy to interpret and easy to use in any application. The auto ranging capability allows for "hands-off" operation.

The HP 436A measures either absolute or relative power. It displays absolute power in either watts or dBm, and relative power in dB.

The HP 436A Power Meter also features optional programmability; the Hewlett-Packard Interface Bus (HP-IB) interface is available. This interface allows full remote control of all power meter functions (CAL function can be programmed to either 100 percent or the CAL factor which has been manually set on the front panel). This option may be added by the user at a later time.

### HP 436A Specifications

**Frequency range:** 100 kHz to 50 GHz (depending on power sensor used).

**Temperature range:** 0–55°C.

**Power Range** (display calibrated in watts, dBm, and dB relative to reference power level).

**With HP 8481A, 8482A, 8483A, 8485A, R8486A, Q8486A sensors:** 50 dB with 5 full-scale ranges of  $-20$ ,  $-10$ , 0, 10, and 20 dBm (10  $\mu$ W to 100 mW).

**With HP 8481B or 8482B sensors:** 44 dB with 5 full-scale ranges of 10, 20, 30, 40, and 44 dBm (10 mW to 25 W).

**With HP 8481H or 8482H sensors:** 45 dB with 5 full-scale ranges of 0, 10, 20, 30 and 35 dBm (1 mW to 3 W).

**With HP 8484A sensor:** 50 dB with 5 full-scale ranges of  $-60$ ,  $-50$ ,  $-40$ ,  $-30$ , and  $-20$  dBm (1 nW to 10  $\mu$ W).

### Accuracy

#### Instrumentation

**Watt mode:**  $\pm 0.5\%$ .

**dBm mode:**  $\pm 0.02$  dB  $\pm 0.001$  dB/°C

**dB (REL) mode:**  $\pm 0.02$  dB  $\pm 0.001$  dB, °C

\* Specifications are for within range measurements. For range-to-range accuracy add another  $\pm 0.02$  dB

**Zero:** automatic, operated by a front-panel switch.

**Zero set:**  $\pm 0.5\%$  of full scale on most sensitive range, typical;  $\pm 1$  count on other ranges.

**Zero carry over:**  $\pm 0.2\%$  of full scale when zeroed on the most sensitive range

**Power reference:** internal 50 MHz oscillator with Type N female connector on front panel (or rear panel, Option 003 only).

**Power output:** 1.0 mW. Factory set to  $\pm 0.7\%$  traceable to the National Bureau of Standards.

**Accuracy:**  $\pm 1.2\%$  worst case ( $\pm 0.9\%$  rss) for one year.

### Supplemental Characteristics

**Noise** (typical, at constant temperature, peak change over any one-minute interval): 20 pW (HP 8484A); 40 nW (HP 8481A, 8482A, 8483A, 8485A, R8486A, Q8486A); 40  $\mu$ W (HP 8481B, 8482B); 4  $\mu$ W (HP 8481H, 8482H).

**Drift** (1 hour, typical, at constant temperature after 24-hour warm-up): 20 pW (HP 8484A); 10 nW (HP 8481A, 8482A, 8483A, 8485A, R8486A, Q8486A); 10  $\mu$ W (HP 8481B, 8482B), 1  $\mu$ W (HP 8481H, 8482H).

**Response time** typical, measured at recorder output, 0 to 99% of reading.

Range 1 (most sensitive range) < 10 seconds

Range 2 < 1 second.

Ranges 3 through 5 < 100 milliseconds.

**Cal factor:** 16-position switch normalizes meter reading to account for calibration factor. Range 85% to 100% in 1% steps.

**Cal adj:** front-panel adjustment provides capability to adjust gain in meter to match power sensor in use.

**Recorder output:** linearly proportional to indicated power with 1 volt corresponding to full scale and 0.316 volts to  $-5$  dB; 1 k $\Omega$  output impedance, BNC connector.

**RF blanking:** open collector TTL; pulls low during meter zeroing. Useful for turning off RF input to sensor during auto-zeroing. BNC connector.

**Display:** four-digit display with 20% over-range capability on all ranges; analog uncalibrated peaking meter to show fast changes.

**Power consumption:** 100, 120, 220, or 240 V ( $\pm 5\%$ ,  $-10\%$ ), 48 to 66 Hz, and 360 to 440 Hz; < 20 V  $\cdot$  A (< 23 V  $\cdot$  A with option 022).

**HP-IB Function codes:** AH1, C0, DC2, DT0, LE0, PP0, RL2, SH1, SR0, T3, TE0. (For more on these codes refer to the HP-IB section in this catalog.)

**Weight:** net, 4.5 kg (10 lb). Shipping, 5.5 kg (12 lb).

**Size:** 134 H x 213 W x 279 mm D (5.2" x 8.4" x 11.0").

### Accessories

**Furnished:** HP 11730A, 1.5 m (5 ft) cable for power sensor; 2.3 m (7.5 ft) power cable. Mains plug shipped to match destination requirements.

**Available:** To select non-standard lengths for power sensor cables, select option 004 (delete sensor cables) and order as required from HP 11730A-F, power sensor cables. Lengths are available from 1.5 metres (5 ft) to 61 metres (200 ft). To rack mount one HP 436A by itself, order HP 5061-9657 Rack Mount Adapter Kit.

### Ordering Information

HP 436A Power Meter

### Price

\$2900

**Option 003:** Reference oscillator output on rear panel no charge only.

**Option 004:** Delete power sensor cable less \$73

**Option 022:** Digital input/output, fully compatible added \$500 with HP Interface Bus (HP-IB)

**Option 908:** Kit for rack mounting one HP 436A \$35

**Option 910:** Extra operating and service manual added \$25

## Thermocouple Power Meter, Range Calibrator

Models 435B, 11683A



HP 435B

### HP 435B Power Meter

The HP 435B Power Meter is an analog power meter, compatible with the entire series of HP 8480 Power Sensors. Depending on which sensor is used, the HP 435B can measure power from  $-65$  dBm to  $+44$  dBm, full scale, at frequencies from 100 kHz to 50 GHz. This versatile instrument also features  $<1\%$  instrumentation uncertainty, low noise and drift, auto-zero, recorder output, optional battery operation, and long cable options up to 61 m (200 ft).

### HP 11683A Range Calibrator

The HP 11683A Calibrator is specifically designed for use with the HP 435B, 436A and 438A Power Meters. It allows verification of full-scale meter readings on all ranges, as well as meter tracking. Simply connect the cable between the power meter and calibrator. The CAL ADJ control on the power meter is used to set the meter to full scale on the 1 mW range. The calibrator and meter are then stepped through the other ranges verifying accuracy within  $\pm 1\%$  plus noise and drift. The HP 11683A also has a polarity switch which tests the Auto-Zero circuit.

### HP 435B Specifications

**Frequency range:** 100 kHz to 50 GHz (depending on power sensor used).

**Temperature range:** 0  $-55^{\circ}\text{C}$ .

**Power Range** (calibrated in watts and dB in 5 dB steps).

With HP 8481A, 8482A, 8483A, 8485A, R8486A or Q8486A:  $-25$  dBm ( $3 \mu\text{W}$ ) to  $+20$  dBm (100 mW) full scale.

With HP 8481B or 8482B:  $+5$  dBm ( $3 \text{ mW}$ ) to  $+44$  dBm (25 W) full scale.

With HP 8481H or 8482H:  $-5$  dBm ( $0.3 \text{ mW}$ ) to  $+35$  dBm (3 W) full scale.

With HP 8484A:  $-65$  dBm (300 pW) to  $-20$  dBm (10  $\mu\text{W}$ ) full scale.

### Accuracy

**Instrumentation:**  $\pm 1\%$  of full scale on all ranges.

**Zero:** automatic, operated by front-panel switch.

**Zero set:**  $\pm 0.5\%$  of full scale on most sensitive range, typical.

**Zero carryover:**  $\pm 0.5\%$  of full scale when zeroed on the most sensitive range.

**Power reference:** internal 50 MHz oscillator with Type N female connector on front panel (or rear panel, Option 003 only).

**Power output:** 1.00 mW. Factory set to  $\pm 0.7\%$  traceable to the National Bureau of Standards.

**Accuracy:**  $\pm 1.2\%$  worst case ( $\pm 0.9\%$  rss) for one year

### Supplemental Characteristics

**Noise** (typical, at constant temperature, peak change over any one-minute interval): 20 pW (HP 8484A); 40 nW (HP 8481A, 8482A, 8483A, 8485A, R8486A, Q8486A); 40  $\mu\text{W}$  (HP 8481B, 8482B); 4  $\mu\text{W}$  (HP 8481H, 8482H).

**Drift** (1 hour, typical, at constant temperature after 24-hour warm-up): 40 pW (HP 8484A), 15 nW (HP 8481A, 8482A, 8483A, 8485A, R8486A, Q8486A); 15  $\mu\text{W}$  (HP 8481B, 8482B); 1.5  $\mu\text{W}$  (HP 8481H, 8482H).



HP 11683A

**Response Time** (typical, measured at recorder output, 0 to 99% of reading):

Range 1 (most sensitive range)  $<10.0$  seconds

Range 2  $<3.8$  seconds

Range 3  $<1.3$  seconds

Ranges 4 to 5  $<500$  milliseconds.

**Cal factor:** 16-position switch normalizes meter reading to account for calibration factor; range 85% to 100% in 1% steps.

**Recorder output:** linearly proportional to indicated power with 1 volt corresponding to full scale; 1 k $\Omega$  output impedance, BNC connector.

**RF blanking output:** provides a contact closure to ground. Used for turning off RF input to sensor during auto-zeroing. BNC connector.

**Cal adj:** front-panel adjustment provides capability to adjust gain of meter to match power sensor in use.

**Power consumption:** 110 or 120 V ( $+5\%$ ,  $-10\%$ ), 48 to 66 Hz and 360 to 440 Hz; also 220 or 240 V ( $+5\%$ ,  $-10\%$ ), 48 to 66 Hz only:  $<20\text{V} \cdot \text{A}$ .

**Weight:** net, 2.7 kg (5.9 lb). Shipping, 4.2 kg (9.2 lb).

**Size:** 155 H x 130 W x 279 mm D (6.3" x 5.1" x 11").

### Accessories

**Furnished:** HP 11730A, 1.52 m (5 ft) cable for the power sensor; 2.3 m (7.5 ft) power cable (mains plug shipped to match destination requirements).

**Available** (See page 201).

To select non-standard lengths for power sensor cables, select option 004 (delete sensor cables) and order as required from HP 11730A-F, power sensor cables. Lengths are available from 1.5 metres (5 ft) to 61 metres (200 ft).

**HP 11076A:** Carrying case.

**HP 5060-8762:** Rack adapter frame (holds three instruments the size of the HP 435B).

### Combining Cases

**HP 1051A:** 286 mm (11.25 in.) deep.

**HP 1052A:** 416 mm (16.4 in.) deep.

These combining cases accept  $1/2$ -module Hewlett-Packard instruments for bench use or rack mounting.

### HP 11683A Range Calibrator

**Calibration functions:** outputs corresponding to meter readings of 3, 10, 30, 100 and 300  $\mu\text{W}$ ; 1, 3, 10, 30, and 100 mW.

**Calibration uncertainty:**  $\pm 0.25\%$  in all ranges.

**Power:** 100, 120, 220, or 240 Vac ( $+5\%$ ,  $-10\%$ ), 48-440 Hz, less than 10 V  $\cdot$  A.

**Weight:** net, 1.13 kg (2.5 lb). Shipping, 1.9 kg (4.2 lb).

**Size:** 89 H x 133 W x 216 mm D (3.5" x 5.25" x 8.5").

### Ordering Information

HP 11683A Range Calibrator

HP 435B Power Meter

### HP 435B Options

**001:** Rechargeable battery installed provides up to 16 hours of continuous operation add \$100

**002:** Input connector placed on rear panel in parallel with front add \$25

**003:** Parallel sensor inputs front and rear panels, reference oscillator output on rear panel. add \$25

**004:** Delete power sensor cable less \$73

**910:** Extra operating and service manual add \$7.50

### Price

\$750

\$1500

# POWER METERS

## Power Sensors

Models 8481A/B, 8481H, 8482A/B, 8482H, 8483A, 8484A, 8485A, R/Q 8486A, 11708A

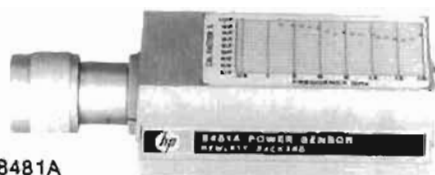

HP 8481A

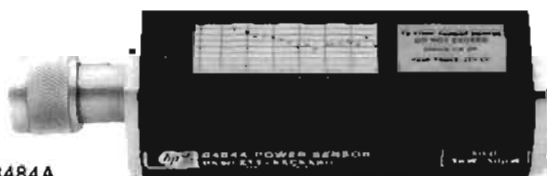

HP 8484A



HP 8481H



HP 8485A

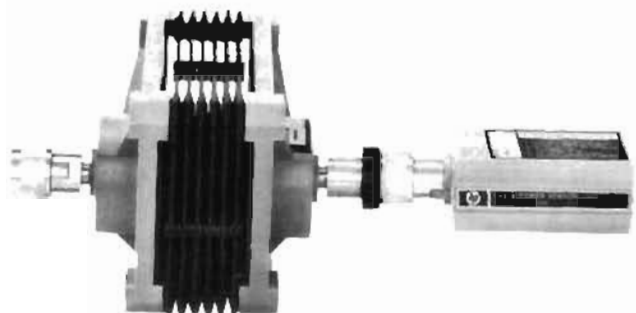

HP 8481B

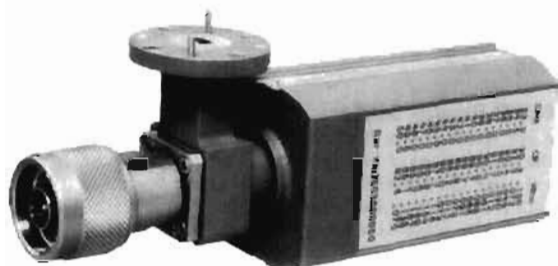

HP Q8486A

### HP 8480 Series Power Sensors

The HP 8480 series of Power Sensors have been designed for use with the HP 435B, 436A, and 438A Power Meters. They feature wide frequency and power ranges in addition to very low SWR.

The power measurement range of these sensors is from 0.1 nW to 25 watts. With just three sensors a power measurement range of 114 dB can be achieved.

### Wide Frequency Range for Many Applications

Power measurements can be made over a frequency range of 100 kHz to 50 GHz. The six frequency ranges covered with these units are: 10 MHz to 18 GHz, 100 kHz to 4.2 GHz, and 50 MHz to 26.5 GHz, in 50  $\Omega$  sensors; and 100 kHz to 2 GHz, with the 75-ohm sensor, and 26.5 to 40 GHz and 33 to 50 GHz in Waveguide.

### Low SWR for Low Measurement Uncertainty

The HP 8481/82/83/85/86 series of sensors use a silicon monolithic thermocouple as the sensing element. The small physical size of the thermocouple enables the sensors to have a very low SWR even at 50 GHz. A low SWR reduces mismatch uncertainty error, typically the largest single source of error in power measurements. The HP 8484A sensor uses a crystal detector for higher sensitivity and low SWR.

### Individually Calibrated for More Confidence in Results

Each sensor is individually calibrated, traceable to the National Bureau of Standards. A control on the meter compensates for power sensor Cal Factor at any frequency. A precise automatic network analyzer printout for Cal Factor and reflection coefficient is supplied with the HP 8481A/B/H, 8484A, 8485A, and R/Q8486A. This means you can significantly reduce mismatch uncertainty by calculating the mismatch error.

### High Power Sensors to 25 Watts

The HP 8481B and 8482B High Power Sensors both have a power range of 1 mW to 25 watts. The HP 8481B covers a frequency range of 10 MHz to 18 GHz and the HP 8482B has a frequency range of 100 kHz to 4.2 GHz.

Previous methods of measuring high power levels usually required adding a separate attenuator in front of a low power sensor. With the HP 8481/82B power sensors, the attenuator and sensor are combined into one unit. This reduces mismatch uncertainty error and improves accuracy by including the attenuator in the measured Calibration Factor curves. In addition, light-weight, heat-dissipating fins on the attenuator prevent burns.

### Medium Power Sensors to 3 Watts

The HP 8481H measures power from 100  $\mu$ W to 3 watts over a frequency range of 10 MHz to 18 GHz. The HP 8482H measures power from 10  $\mu$ W to 3 watts over a frequency range of 100 kHz to 4.2 GHz.

### Standard Sensors to 100 mW

The HP 8481A, 8482A, 8483A, and 8485A Power Sensors all measure power over a range of 1  $\mu$ W to 100 mW. The HP 8481A is a 50-ohm sensor with a frequency range of 10 MHz to 18 GHz. The HP 8482A is a 50-ohm sensor with a frequency range of 100 kHz to 4.2 GHz. The HP 8483A is a 75-ohm sensor with a frequency range of 50 MHz to 26.5 GHz. The HP 8485A is a 50-ohm sensor with a frequency range of 100 kHz to 2 GHz.

### High Sensitivity Sensors

The HP 8484A measures power from 0.1 nW to 10  $\mu$ W over a frequency range of 10 MHz to 18 GHz. It is furnished with the HP 11708A 50-MHz reference attenuator for precise calibration with 1 mW power meter reference oscillator. Noise and drift have been reduced to less than 5% of full scale on the 300 pW range (only 15 pW) when it is used with the HP 435B power meter. Noise and drift are even less with the HP 436A and 438A power meters.

### Millimeter-Wave Power Sensors

The HP R8486A and Q8486A Thermocouple Waveguide Power Sensors measure true, average power from 1  $\mu$ W to 100 mW over the frequency ranges of 26.5 to 40 GHz (R-band) and 33 to 50 GHz (Q-band).

**HP 8480 Series Specifications**

HP Model (Nominal Impedance)	Frequency Range	Power Range	Maximum Power	Power Linearity <sup>2</sup>	Maximum SWR (Reflection Coefficient)	Size mm (In.)	RF Connector	Price
						Shipping Weight kg (lb)		
8481A (50 Ω)	10 MHz-18 GHz	1 μW to 100 mW	300 mW avg. 15 W peak 30 W • μs (per pulse)	+10 to -20 dBm ±2, -4%	10 MHz - 30 MHz: 1.40 (0.166) 30 MHz - 50 MHz: 1.18 (0.083) 50 MHz - 2 GHz: 1.10 (0.048) 2 - 12.4 GHz: 1.18 (0.083) 12.4 - 18 GHz: 1.28 (0.123)	30 x 38 x 105 (1.2 x 1.5 x 4.1)	N(m)	\$650
Option 001						0.5 (1)	APC-7	add \$25
8481B (50 Ω)	10 MHz-18 GHz	1 mW to 25W	0-35°C: 30 W avg. 35°C-55°C: 25 W avg.  10 MHz-5.8 GHz 500 W peak 5.8-18 GHz 125 W peak  500 W • μs (per pulse)	+35 to +44 dBm ±4%	10 MHz - 2 GHz: 1.10 (0.048) 2-12.4 GHz: 1.18 (0.083) 12.4-18 GHz: 1.28 (0.123)	83 x 114 x 248 (3.25 x 4.5 x 9.75)	N(m)	\$1430
8481H (50 Ω)	10 MHz-18 GHz	100 μW to 3W	3.5 W avg. 100 W peak 100W • μs (per pulse)	+25 to +35 dBm ±5%	10 MHz - 8 GHz: 1.20 (0.091) 8-12.4 GHz: 1.25 (0.110) 12.4 - 18 GHz: 1.30 (0.130)	30 x 38 x 149 (1.2 x 1.5 x 5.9)	N(m)	\$900
8482A (50 Ω)	100 kHz-4.2 GHz	1.0 μW to 100 mW	300 mW avg. 15 W peak 30 W • μs (per pulse)	+10 to +20 dBm ±2, -4%	100-300 kHz: 1.60 (0.231) 300 kHz - 1 MHz: 1.20 (0.091) 1 MHz - 2 GHz: 1.10 (0.048) 2-4.2 GHz: 1.30 (0.130)	30 x 38 x 105 (1.2 x 1.5 x 4.1)	N(m)	\$630
8482B (50 Ω)	100 kHz-4.2 GHz	1 mW to 25W	0-35°C: 30 W avg. 35°C-55°C: 25 W avg.  500 W peak  500 W • μs (per pulse)	+35 to +44 dBm ±4%	100 kHz - 2 GHz: 1.10 (0.048) 2 GHz - 4.2 GHz: 1.18 (0.083)	83 x 114 x 248 (3.2 x 4.5 x 9.7)	N(m)	\$1375
8482H (50 Ω)	100 kHz-4.2 GHz	100 μW to 3W	3.5 W avg. 100 W peak 100 W • μs (per pulse)	+25 to +35 dBm ±5%	100 kHz-4.2 GHz: 1.20 (0.091)	30 x 38 x 149 (1.2 x 1.5 x 5.9)	N(m)	\$775
8483A <sup>3</sup> (75 Ω)	100 kHz-2 GHz	1.0 μW to 100 mW	300 mW avg. 10 W peak 30 W • μs (per pulse)	+10 to +20 dBm ±2, -4%	100-600 kHz: 1.80 (0.286) 600 kHz - 2 GHz: 1.18 (0.083)	30 x 38 x 105 (1.2 x 1.5 x 4.1)	N(m) 75 Ω	\$630
8484A <sup>4</sup> (50 Ω)	10 MHz-18 GHz	0.1 nW to 10 μW	200 mW avg. 200 mW peak	-30 to -20 dBm ±1%	10-30 MHz: 1.40 (0.166) 30 MHz - 4 GHz: 1.15 (0.070) 4-10 GHz: 1.20 (0.091) 10-15 GHz: 1.30 (0.130) 15-18 GHz: 1.35 (0.149)	36 x 44 x 133 (1.4 x 1.7 x 5.2)	N(m)	\$900
8485A (50 Ω)	50 MHz-26.5 GHz	1 μW to 100 mW	300 mW avg. 15 W peak 30 W • μs (per pulse)	+10 to +20 dBm ±2, -4%	50 MHz-100 MHz: 1.15 (0.070) 100 MHz-2 GHz: 1.10 (0.048) 2-12.4 GHz: 1.15 (0.070) 12.4-18 GHz: 1.20 (0.091) 18-26.5 GHz: 1.25 (0.111)	30 x 38 x 95 (1.2 x 1.5 x 3.7)	APC-3.5(m)	\$950
R8486A (Waveguide)	26.5-40 GHz	1 μW to 100 mW	300 mW avg. 15 W peak 30W • μs pulse	+10 to +20 dBm ±2, -4%	1.4 (0.167)	30 x 38 x 126 (1.2 x 1.5 x 5.0)	Waveguide Flange UG-599/U	\$1530
Q8486A (Waveguide)	33-50 GHz	1 μW to 100 mW	300 mW avg. 15 W peak 30W • μs pulse	+10 to +20 dBm ±2, -4%	1.5 (0.200)	30 x 38 x 126 (1.2 x 1.5 x 5.0)	Waveguide Flange UG-383/U	\$1750

<sup>1</sup>For pulses greater than 30 W the maximum average power (Pa) is limited by the energy per pulse (E) in W • μs according to Pa = 30-0.02E.

<sup>2</sup>Negligible deviation except for those power ranges noted.

<sup>3</sup>Includes HP 1250-0587 adapter from 75 Ω type N to 50 Ω type N for calibration.

<sup>4</sup>Includes HP 11708A 30 dB attenuator for calibrating against a 0 dBm, 50 MHz power reference.

**Uncertainty of Calibration Factor Data for HP 8482A and 8483A**

Frequency (MHz)	Sum of Uncertainties (%) <sup>1</sup>				Probable Uncertainties (%) <sup>2</sup>			
	HP Model				HP Model			
	8482A	8482B	8482H	8483A	8482A	8482B	8482H	8483A
0.1	±2.3	±5.7	±3.3	±2.6	±1.3	±2.8	±1.6	±1.5
0.3	2.2	5.7	3.2	2.5	1.2	2.8	1.6	1.4
1.0	2.2	5.7	3.2	2.5	1.2	2.8	1.6	1.4
3.0	2.5	5.7	3.2	2.5	1.2	2.8	1.6	1.4
10.0	2.5	5.7	3.5	3.0	1.3	2.8	1.6	1.6
30.0	2.6	5.7	3.6	3.1	1.4	2.8	1.7	1.6
50.0	Q(ref)	2.7	Q(ref)	Q(ref)	Q(ref)	2.7	Q(ref)	Q(ref)
100.0	3.1	5.6	4.1	3.9	1.6	3.3	1.9	2.0
300.0	3.1	5.6	4.1	3.9	1.6	3.3	1.9	2.0
1000.0	2.7	5.7	3.7	3.7	1.4	3.3	1.7	2.0
10000.0	2.7	5.5	3.7	3.9	1.4	3.1	1.7	2.1
40000.0	2.8	5.5	3.8	—	1.5	3.1	1.8	—

**Uncertainty of Calibration Factor Data for HP 8481A/B, 8484A 8485A<sup>3</sup>**

Frequency (GHz)	Sum of Uncertainties (%) <sup>1</sup>					Probable Uncertainties (%) <sup>2</sup>				
	HP Model					HP Model				
	8481A	8481B	8481H	8484A	8485A	8481A	8481B	8481H	8484A	8485A
0.1	±3.1	±6.4	±4.1	±4.4	±1.6	±3.0	±1.9	±1.9	—	—
2	2.7	5.8	3.7	4.0	±1.6	3.1	1.7	1.8	±2.1	—
4	2.8	5.8	3.8	4.1	1.5	3.1	1.8	1.8	—	—
6	2.8	5.8	3.8	4.1	1.5	3.1	1.8	1.8	2.3	—
8	3.2	6.0	4.2	4.6	1.7	3.2	2.0	2.0	—	—
10	3.6	6.2	4.6	5.1	1.9	3.3	2.2	2.2	2.7	—
12	3.9	7.8	4.9	6.5	2.1	4.1	2.4	2.8	—	—
14	4.8	7.9	5.8	7.4	2.6	4.1	2.8	3.2	3.2	—
16	5.2	8.0	6.2	7.8	2.9	4.2	3.0	3.4	—	—
18	5.8	8.3	6.8	8.4	3.2	4.3	3.4	3.7	3.6	—
22	—	—	—	6.8	—	—	—	—	—	3.7
26.5	—	—	—	7.3	—	—	—	—	—	4.0

<sup>1</sup>Includes uncertainty of reference standard and transfer uncertainty. Directly traceable to NBS

<sup>2</sup>Square root of sum of the individual uncertainties squared (RSS).

<sup>3</sup>For R/Q8486A uncertainty data see the data sheet (5853-6482).

Fast-Ship product—see page 758.

# POWER METERS

## Thermistor Power Meters & Power Meter Calibrator

Models 432A/B, 8477A

- Automatic zero
- High accuracy

- Recorder outputs, analog & digital
- Long cable options



HP 432A



HP 432B

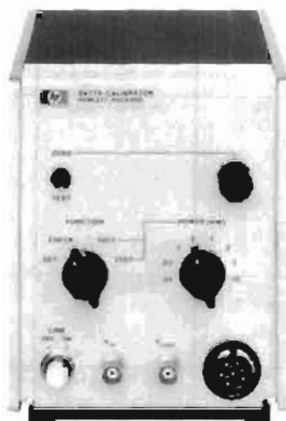

HP 8477A

### HP 432A/B Power Meters

**High accuracy—no thermoelectric error:** high accuracy over a wide temperature range is featured on the HP 432 Power Meters. By measuring the output voltage of the thermistor bridges, and computing the corresponding power, even higher accuracy of  $\pm 0.2\% \pm 0.5 \mu\text{W}$  can be obtained.

Accuracy can be maintained on even the most sensitive range because the error due to thermoelectric effect is reduced to a negligible level.

**Calibrated mounts:** each thermistor mount is furnished with data stating the Calibration Factor\* and Effective Efficiency\* at various frequencies across the operating range. For easy and accurate power measurements, the front panel of the HP 432 contains a calibration factor control, calibrated in 1% steps from 88% to 100%, that compensates for losses in the mount and eliminates the need for calculation.

**Instrument type:** automatic, self-balancing power meter for use with temperature-compensated thermistor sensor.

\*"Calibration Factor" and "Effective Efficiency" are figures of merit expressing the ratio of the substituted signal measured by the power meter to the microwave power incident on and absorbed by the sensor.

### Specifications (partial)

#### Power Range

**HP 432A:** seven ranges with full-scale readings of 10, 30, 100, and 300  $\mu\text{W}$ , 1, 3, and 10 mW; also calibrated in dBm from  $-20$  dBm to  $+10$  dBm full scale in 5 dB steps.

**HP 432B:** four ranges with full-scale readings of 10 and 100  $\mu\text{W}$ , and 1 and 10 mW.

**Noise:** less than 0.25% of full scale peak (typical).

**Response time:** at recorder output, 35 ms time constant (typical).

**Fine zero:** automatic, operated by front panel switch.

**Zero carryover:** less than 0.50% of full scale when zeroed on most sensitive range.

#### Meter

**HP 432A:** tau-band suspension, individually calibrated, mirror-backed scales. Milliwatt scale more than 108 mm (4.25 in.) long.

**HP 432B:** three digits with one digit overrange, 20% overrange capability on all ranges.

**Calibration factor control:** 13-position switch normalizes meter reading to account for thermistor sensor calibration factor. Range 100% to 88% in 1% steps.

**Thermistor sensor:** thermistor sensors are required for operation of the HP 432A/B. For microwave sensors HP 478B, 8478B and 486 series see page 207.

**Recorder output:** proportional to indicated power with 1 volt corresponding to full scale 1 k $\Omega$  output impedance.

**BCD output:** 8, 4, 2, 1 code. "1" positive. TTL compatible logic. Operates with HP 5150A, Opt 002 (BCD) Digital Recorder. "Print" and "Inhibit" lines available. (HP 432B only.)

#### Power Consumption

**HP 432A:** 115 or 230 Vac  $\pm 10\%$ , 50 to 400 Hz, 1.5 watts.

**HP 432B:** 115 or 230 Vac  $\pm 10\%$ , 50 to 400 Hz, 10 watts.

#### Weight

**HP 432A:** net, 2.3 kg (5.5 lb). Shipping, 4.6 kg (10 lb).

**HP 432B:** net, 3 kg (6.5 lb). Shipping, 4.8 kg (10.5 lb).

**Size:** 130 W x 155 H x 279 mm D (5.2" x 6.1" x 11.0").

### HP 8477A Power Meter Calibrator

The HP 8477A Calibrator is specifically designed for use with the HP 432 Power Meter. It allows you to verify full-scale meter readings on all ranges, and meter tracking. Simply connect three cables between the power meter and calibrator; no charts or additional instruments are required.

**Power:** 115 or 230 Vac  $\pm 10\%$ , 50 to 400 Hz, 3 watts.

### Ordering Information

HP 432A Power meter

Price

\$1450

HP 432B Power meter

\$2100

#### HP 432A/B Options

**001:** rechargeable battery installed, provides up to 20 hours continuous operation (HP 432A only) add \$105

**002:** input connector placed on rear panel in parallel with front add \$25

**003:** input connector on rear panel only add \$10

**009:** 3.1 m (10 ft) cable for 110- $\Omega$  or 200- $\Omega$  sensor add \$30

**010:** 6.1 m (20 ft) cable for 100- $\Omega$  or 200- $\Omega$  sensor add \$55

**011:** 4.52 m (15 ft) cable for 100- $\Omega$  or 200- $\Omega$  sensor add \$105

**012:** 30.5 m (100 ft) cable for 100- $\Omega$  or 200- $\Omega$  sensor add \$155

**013:** 6.1 m (20 ft) cable for 100- $\Omega$  or 200- $\Omega$  sensor add \$260

**100:** 100 Vac operation, 48–66 Hz no charge

**910:** extra operating and service manual add \$5

**HP 8477A Power Meter Calibrator** \$830



# POWER METERS

## Thermistor Mounts, Peak Power Sensor & Peak Power Meters Models 478A, 8478B, 486 Series, 8900C/D, 84811A



HP 84811A



HP 478A



HP 8478B



HP 486 Series



HP 8900C



HP 8900D

### Temperature Compensated Thermistor Mounts

High efficiency and good RF match are characteristic of the HP 478A and 8478B coaxial and 486A series waveguide Thermistor Mounts. Used in conjunction with the HP 432 Power Meter they provide high accuracy even in routine power measurements. These thermistor mounts are temperature-compensated for low drift, even in the presence of thermal shocks, permitting measurement of microwave power as low as one microwatt. Each mount contains data showing Calibration Factor and Effective Efficiency at six frequencies, directly traceable to the National Bureau of Standards at those frequencies where NBS provides calibration service.

### HP 486, 478, 8478B Specifications

HP Model	Frequency range, GHz	Maximum SWR	Operating Resistance (Ohms)	Price
478A	10 MHz to 10 GHz	1.75, 10 to 25 MHz 1.3, 25 MHz to 7 GHz 1.5, 7 to 10 GHz	200	\$435
8478B <sup>1</sup>	10 MHz to 18 GHz	1.75, 10 to 30 MHz 1.35, 30 to 100 MHz 1.1, 0.1 to 1 GHz 1.35, 1 to 12.4 GHz 1.6, 12.4 to 18 GHz	200	\$550
X486A	8.20 to 12.4	1.5	100	\$570
P486A	12.4 to 18.0	1.5	100	\$640
K486A <sup>2</sup>	18.0 to 26.5	2.0	200	\$750
R486A <sup>2</sup>	26.5 to 40.0	2.0	200	\$830

<sup>1</sup>Option 011: furnished with APC-7 RF connector add \$25  
<sup>2</sup>Circular flange adapters:  
 K-band (UG-425/U) HP 115 16A \$210  
 R-band (UG-381/U) HP 115 16A \$210

### HP 84811A Peak Power Sensor

The HP 84811A Peak Power Sensor works with the HP 8900C/D Peak Power Meters to measure the peak power of RF pulses. It is supplied with a 4 foot flexible cable to easily reach the pulse source being measured. The HP 84811A also conveniently detaches from the meter for storage, recalibration or replacement.

### HP 8900C/D Peak Power Meters

The HP 8900C and 8900D Peak Power Meters directly display the peak power of RF pulses over a 100 MHz to 18 GHz frequency range. Measurements can be made on pulses with widths from 1 μs (100 ns in Compare mode) to CW, and repetition rates from 100 Hz (0 Hz in Compare mode) to 100 kHz.

The HP 8900C is an economical analog meter calibrated in watts and dBm. The analog display with its large, easy-to-read scale makes it simple to peak or null pulsed power systems. The HP 8900D has a high resolution 3½ digit digital display calibrated in watts. The direct reading display and range annunciators make the digital version a good choice for production and field applications where unambiguous or frequent readings are required.

### HP 8900C/D Peak Power Meters Specifications

- Frequency range:** 100 MHz to 18 GHz.
- Dynamic range:** 20 dB (0 to +20 dBm).
- HP 8900C:** 4 ranges of 3, 10, 30 and 100 mW full scale.
- HP 8900D:** 2 ranges of 10 and 100 mW full scale.
- Pulse Response**
  - Direct Mode**
    - Pulse width:** 1 μs to CW.
    - Repetition rate:** 100 Hz to 100 kHz.
  - Compare Mode**
    - Pulse width:** 100 ns (typical) limited by rise time specification.
    - Repetition rate:** 0 to 100 kHz.
    - Rise time:** 75 ns.
    - Fall time:** 125 ns (as measured on video output).
- Power consumption:** 100 and 120 Vac +5, -10%, 48-66 Hz and 360-440 Hz; 220 and 240 Vac +5, -10%, 48-66 Hz.

Meter Accuracy	CW	Pulse	Transfer Accuracy CW to Pulse
Direct	±0.2 dB	±0.35 dB	±0.2 dB
Compare	±0.2 dB	±0.25 dB	±0.1 dB

### HP 84811A Peak Power Sensor Specifications

- Power range:** 0 to +20 dBm (1 mW to 100 mW).
- Frequency range:** 100 MHz to 18 GHz.
- SWR:** 100 MHz to 12 GHz < 1.5. 12 GHz to 18 GHz < 2.0.
- Maximum peak power:** +24 dBm (250 mW) for 5 minutes.
- Connector type:** N (male).
- Calibration:** every 2 GHz from 2 to 10 GHz. Every 1 GHz from 11 to 18 GHz.
- Operating temperature:** 0 to +55°C.
- Calibration accuracy:** (+10 to +40°C): ±0.7 dB 0.1 to 12 GHz. ±1.0 dB to 18 GHz 0-10°C and 40-55°C: add ±0.2 dB.

### Ordering Information

- HP 8900C Analog peak power meter \$2050
- HP 8900D Digital peak power meter \$2550
- HP 84811A Peak power sensor \$800

Fast-Ship product—see page 758.

# NOISE FIGURE METER

## Noise Measurements



### What is Noise Figure?

Modern receiving systems must often process very weak signals. Noise added by the receiving system components often determines whether or not an input signal can be processed properly. Unlike other ways to measure receiver noise (minimum discernable sensitivity, tangential sensitivity, etc.) noise figure is an objective measure, it does not depend on the judgement of the person measuring. In addition, noise figure is universal; it may be determined for transistors, amplifiers, and mixers as well as entire systems.

Noise figure can be expressed as the ratio of total output noise power (at a source temperature of 290K) compared to the output noise power if there were no noise added by the device under test (DUT).

Noise figure is typically measured by applying two known noise powers to the test device input and measuring the corresponding output powers. Assuming the device is linear, it can then be characterized with respect to total output noise power for all values of input noise power. Noise figure is calculated (ratio of total output noise power versus output noise power assuming no device noise) assuming an input noise power generated from a 290K thermal noise source.

To learn more about noise figure basics and measurement, read HP Application Note 57-1 (see Literature on this page).

### Single- and Double-sideband Noise Figure Measurements

There are both advantages and disadvantages to single- and double-sideband measurements.

Double sideband microwave measurements are easy. The most basic set-up requires only a mixer and local oscillator. However, the resulting noise figure is the average of the test device performance at the two down-converted frequencies. If the device characteristics vary rapidly with fre-

quency, such as transistors or amplifiers with narrow passbands, double-sideband measurement can introduce significant error. In addition, spurious and harmonically-related signals can also render double-sideband measurement data invalid.

Single-sideband measurements eliminate double-sideband problems. Double-sideband problems like image, spurious, and harmonic signals are removed by pre-selecting the desired noise sideband before mixing. Single-sideband measurements, however, require accurately designed filtering systems (like temperature-compensated YIG filters) which are difficult to design and maintain. In spite of its difficulties, single-sideband is the only way to make a standard, down-converted noise figure measurement - its measured value does not depend on the device characteristics.

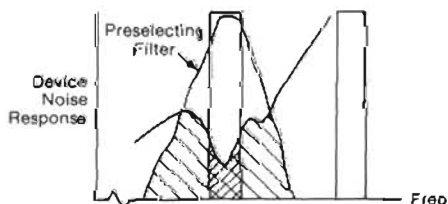
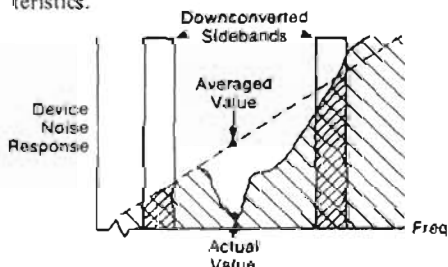

▨ Noise input to mixer  
▩ Down-converted noise

### Noise Figure Measurement Applications

Hewlett-Packard's noise figure measurement equipment is exceptional in applications like these:

**Amplifiers:** 1) Simultaneous noise figure and gain measurement, 2) Results automatically corrected for ENR variations, ambient temperature, and mixer, LO, and IF noise contributions, 3) Real-time, swept, corrected output to oscilloscope for easy tuning (display is digitally stored), 4) Single-test-port calibration and measurement from 10 MHz to 18 GHz (with the 8970S/T systems).

**Transistors:** All the benefits of measuring amplifiers plus: 1) Easy real-time tuning for best noise figure and gain, 2) real-time tuning to actual transistor  $f_{min}$  without second stage effects, 3) Broadband (10 MHz to 18 GHz) single-sideband measurement (with the HP 8970S/T system), 4) Low mismatch effects (the HP 346A features virtually identical impedance for  $T_h$  and  $T_c$ ), 5) Easy to program for automatic systems.

**Receivers and mixers:** 1) Simultaneous measurement of gain (conversion loss) and noise figure, 2) Tunable and swept IF from 10 to 1600 MHz (with the HP 8970B) and 10 MHz to 18 GHz (with the HP 8970S/T), 3) No external IF gain needed, 4) Automatic ENR correction, even for broadband sweeps, 5) Effects of LO power, IF power, and IF frequency changes on noise figure are easily observed, 6) Easy to program.

### Literature

**Product Note 8970B-2, Applications and Operation of the HP 8970B Noise Figure Meter**, describes the HP 8970B and many of its applications in more detail. It is both an introduction to the HP 8970B and a summary reference manual.

**Application Note 57-1, Fundamentals of RF and Microwave Noise Figure Measurements**, explains the theory behind noise figure and its measurement. This note includes an extensive glossary of noise related terms.

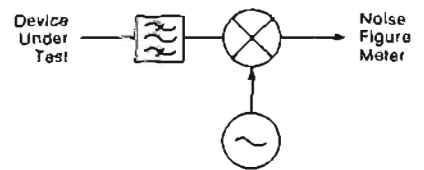
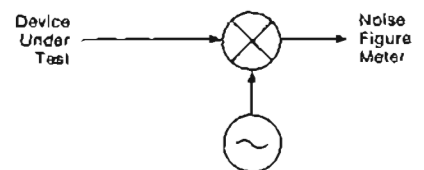

# NOISE FIGURE METER

## Automatic Noise Figure Meter

Model 8970B

209

- 10 MHz to 1600 MHz.
- Accurate and simple, swept or CW measurements.
- Second stage correction.

- Displays both noise figure and gain.
- Calibrated display on oscilloscope, recorder, or plotter.
- Powerful special function enhancements.



HP 8970B



### HP 8970B Noise Figure Meter

With the HP 8970B Noise Figure Meter, noise figure measurements are easy, accurate, and repeatable. Automatic second stage correction makes accurate noise figure readings possible even for low gain devices. The HP 8970B's dynamic range allows gain measurements of at least 40 dB (higher in some cases) or loss measurements to -20 dB, with no external attenuation or amplification. The HP 8970B can store up to 4 ENR (Excess Noise Ratio) noise source calibration tables. It also properly interpolates ENR values at each measurement frequency.

### Microprocessor and Controller Functions

The HP 8970B takes the mystery out of noise figure measurements. It uses a microprocessor to make the calculations and corrections necessary for truly accurate, convenient, and flexible noise figure measurements. The meter also controls external local oscillators (such as the HP 8670 series synthesizers, HP 8340 series synthesized sweepers, or the HP 8350 sweep oscillator) and the HP 8971B Noise Figure Test Set. This makes accurate, broad-band microwave measurements of amplifiers, mixers, and transistors as simple as RF measurements.

Virtually all of the HP 8970B's front panel keys and functions are accessible over HP-IB, Hewlett Packard's enhanced version of IEEE-488. The meter has an independent System Interface Bus (SIB) to control the HP 8971B and local oscillator. This additional bus frees you from having to write computer code to control an instrument on the SIB (like the local oscillator) when used in an automated set-up. Pass-through capability allows other instrument controllers to send messages through the meter to any other instrument on the SIB.

### Simple Calibration and Second Stage Correction

Noise figure measurement accuracy is enhanced because the meter measures its own noise figure (and that of the rest of the measurement system) at up to 181 points. It stores this information, interpolates where necessary, and corrects for it when displaying the device-under-test noise figure. The HP 8970B also measures the test device gain.

### Display

The HP 8970B's front panel LEDs display frequency, gain, and noise figure. Rear panel BNC connectors allow swept display of noise figure and gain versus frequency on an oscilloscope or x-y recorder. You can also get the noise figure and gain vs. frequency display sent to a digital plotter over the HP 8970B's System Interface Bus. All display modes are easily and accurately scaled to the desired resolution from the meter's front panel. The swept oscilloscope display allows you to optimize your test device in real time for both noise figure

and gain. You can easily change the noise figure display from noise figure to effective noise temperature ( $T_e$ ) or Y factor.

### Front Panel and Special Functions

The HP 8970B front panel keys control the number entry, calibration, and measurement functions. STORE, RECALL, and SEQ keys allow up to 9 front panel settings to be stored and sequenced automatically or manually to save set-up time. Smoothing INCREASE and DECREASE keys are used to average up to 512 readings before display. This increases accuracy and eliminates display flicker.

For those who need greater measurement power than that provided by the HP 8970B's simple front panel, there are more than 200 special functions selected by pressing a numerical code and the special function key. Two examples are hot-cold measurements and automatic compensation for losses at the input of the test device. One of the special functions is a catalog that quickly shows you the current special functions being used. Three pull-out cards serve as a mini-reference manual for the instrument. They include most of the special functions, the HP-IB formats and codes, error messages, and typical measurement set-ups.

### HP 8970B Partial Specifications

- (See technical data sheet for complete specifications)
- Noise figure (gain) measurement range:** 0 to 30 dB (-20 to at least 40 dB).
- Noise figure (gain) instrumentation uncertainty:**  $\pm 0.1$  dB for 0 to 55°C ( $\pm 15$  dB).
- Noise figure resolution:** .01 dB (.001 dB over HP-IB).
- Gain resolution:** .01 dB (.001 dB over HP-IB).
- Frequency range:** tunable from 10 to 1600 MHz.
- Tuning accuracy (from 10 to 40°C):**  $\pm (1\text{ MHz} + 1\%$  of frequency), 6MHz maximum.
- Frequency resolution:** 1 MHz.
- Noise figure (for input power levels below -60 dBm):**  $< 7$  dB + .003 dB/MHz.
- Maximum operating input power:** -10 dBm.
- Maximum net external gain:** 65 dB between noise source and HP 8970B RF input.
- Noise source drive:** 28.0  $\pm$  .1 volt.
- Operating temperature:** 0°C to 55°C.
- Storage temperature:** -55° to 75°C.
- Power:** 100, 120, 220, or 240 V (+5%, -10%); 48-66 Hz; 150 VA maximum.
- Dimensions:** 143 H x 427 W x 476 mm D (5.68" x 16.75" x 18.38").
- Weight:** Net, 15.5 kg (34 lb) Shipping, 18.5 kg (40 lb).

# NOISE FIGURE METER

## Noise Figure Measurement System

Models 8970S/T, 8971B

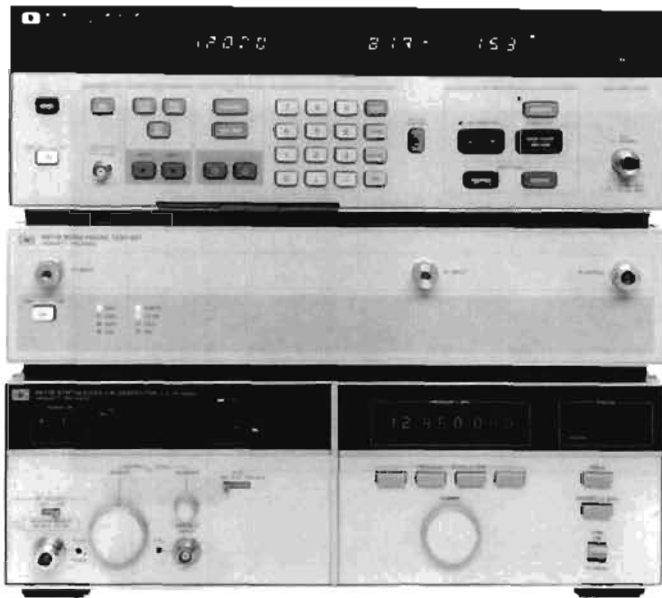

HP 8970 S/T

### HP 8970S/T Microwave Noise Figure Measurement Systems

Until now, there was no standardized way to make a microwave noise figure measurement, users had to design and support their own microwave system, and measurements crossing from RF to microwave were difficult because they required multiple system configurations.

Hewlett Packard's answer to these problems is the HP 8970S and HP 8970T noise figure measurement systems. Each system consists of the HP 8970B Noise Figure Meter, the HP 8971B Noise Figure Test Set, and a synthesized local oscillator. (The recommended LOs for the 8970S are listed in the 8970S Partial Specifications; the HP 8970T uses the HP 8671B Synthesized CW Generator as its local oscillator.)

The HP 8970S/T system eliminates the tedious job of designing the measurement system and selecting components. The HP 8970B acts as the controller to the system so all system operation is transparent to you, the user. To insure specified performance, the HP 8970S/T systems are given specifications just like an RF noise figure meter (i.e. HP 8970B).

#### HP 8970S/T Partial Specifications

(See 8970S technical data sheet for complete specifications)

**Frequency range:** 10 MHz to 18 GHz.

**Noise figure measurement range:** 0 to 30 dB.

**Noise figure instrumentation uncertainty:**  $\pm 0.25$  dB (for a 14 to 16 dB ENR noise source in a 0 to 55°C environment).

**Gain instrumentation uncertainty:**  $\pm 0.45$  dB.

**Noise figure (max):** 10 to 1600 MHz: 12 dB + .003 dB/MHz

1.6 to 2.4 GHz: 24 dB

2.4 to 12 GHz: 22 dB

12 to 15 GHz: 24 dB

15 to 18 GHz: 28 dB

**Input SWR:** 10 to 1600 MHz: 1.7

1.6 to 2.4 MHz: 2

2.4 to 18 GHz: 2

**Gain/noise figure repeatability:**  $\pm 0.2$  dB.

**Recommended local oscillators:** HP 8671B, 8672A, 8673B/C/E, 8340B, and 8341B.

- 10 MHz to 18GHz
- Fully specified system
- Removes double-sideband inaccuracies
- As easy to operate as the 8970A or B

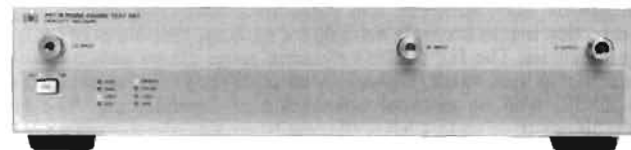

HP 8971B

#### HP 8971B Noise Figure Test Set

The HP 8971B Noise Figure Test Set brings the simplicity of double sideband measurements and the accuracy of single sideband measurements together in one package. Careful design and high performance components, including a stable YIG filter, allow broadband single-sideband measurements from 10 MHz to 18 GHz with a single calibration and sweep.

Measurement modes in the HP 8970B allow for double down-conversion using the HP 8971B as the second down-converter. These new modes can be used for millimeter-wave measurements of amplifiers and transistors and measurements of receivers and mixers with IFs above 1.6 GHz.

HP recommends using an isolator and preamplifier between the test device and measurement system. This reduces two of the largest sources of noise figure measurement uncertainty - mismatch uncertainty and second stage noise figure.

#### HP 8971B Partial Specifications

(See 8970S technical data sheet for complete specifications)

**Frequency range:** 10 MHz to 18 GHz.

**Gain/noise figure repeatability:**  $\pm 0.2$  dB.

**Input SWR:** 1.5 (10 MHz to 1.6 GHz)

2 (1.6 to 2.4 GHz)

2 (2.4 to 18 GHz)

**Image and odd-harmonic rejection:** 20 dB

**Accessories supplied:**

1 LO-to-HP 8971B cable - SMA(f), 300 mm

1 HP 8971B-to-HP 8970B cable - N(m), 190 mm

1 N(m)-to-SMA(m) adapter

2 HP-IB cables - 5 m



HP 346C

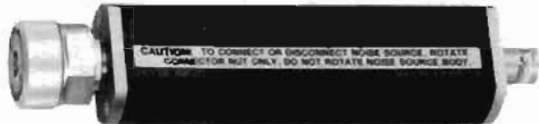

HP 346A (option 002)



HP R/Q347B



### HP 346A/B/C Broadband Noise Sources

The ideal companion to the HP's noise figure meter and systems is the HP 346 family of noise sources. Since they are broadband (10MHz to either 18 or 26.5 GHz), they eliminate the necessity for several sources at different frequency bands. Each source has individually calibrated ENR values at specific frequencies. The calibration is printed on its label (see illustration) for easy loading into the HP 8970B. The low SWR of each noise source reduces a major source of measurement uncertainty - re-reflections of test signals. In addition, the variety of connectors available reduces the need for degrading accuracy with connector adapters.

The HP 346 family of noise sources are designed for a broad range of measurement applications. The HP 346C covers the broadest frequency range, 10 MHz to 26.5 GHz. The HP 346B's high ENR, low SWR, and variety of connectors make it a general purpose noise source. The HP 346A is designed especially for accurate characterization of input-impedance-sensitive devices (like GaAsFETs and many UHF amplifiers). Its very small change in reflection coefficient (<0.01) from ON to OFF minimizes errors when measuring noise figure and gain as a function of input impedance.

FREQ GHz	ENR dB
0.01	15.16
0.10	15.29
1.0	15.26
2.0	15.17
3.0	14.93
4.0	14.85
5.0	14.91
6.0	14.81
7.0	14.98
8.0	15.04
9.0	15.28
10.0	15.31
11.0	15.43
12.0	15.50
13.0	15.41
14.0	14.93
15.0	15.51
16.0	15.55
17.0	15.62
18.0	15.66

SERIAL NO.  
062740042C

Example label of HP 346B Noise Source

### HP 346 A/B/C Partial Specifications

(See technical data sheet for complete specifications.)

**Frequency range:** 10 MHz to 18 GHz for HP 346A/B; 10 MHz to 26.5 GHz for HP 346C.

**Excess noise ratio (ENR) limits:** HP 346A: 4.5 to 6.5 dB; HP 346B: 14 to 16 dB; HP 346C: 12 to 16 dB (10 MHz to 12 GHz) and 14 to 17 dB (12.0 to 26.5 GHz).

**Maximum SWR (reflection coefficient) on and off:**

**HP 346A/B:** 10 to 30 MHz — 1.3 (0.13); 30 to 5000 MHz — 1.15 (0.07); 5 to 18 GHz — 1.25 (0.11).

**HP 346C:** 10 MHz to 18 GHz — 1.25 (0.11); 18 to 26.5 GHz — 1.35 (0.15).

**Power required:** 28 ± 1 Vdc.

**Dimensions:** 140 H x 21 W x 30 mm D (5.5" x 0.8 x 1.2").

**Weight:** net. 0.108 kg (3.5 oz). Shipping. 0.5 kg (1 lb).

**Standard connector:** APC-7 (m)

### HP R & Q347B Solid-state Noise Sources

The performance and reliability you have come to expect from Hewlett-Packard RF and microwave solid-state noise sources, is now extended to millimeter-wave frequencies with the HP R347B (26.5 to 40 GHz) and HP Q347B (33 to 50 GHz) noise sources. A new GaAs avalanche diode specifically designed for high noise output and long term reliability was developed for the HP R/Q347B Noise Sources. This results in excellent ENR stability over time. In turn, this insures long recalibration cycles and very accurate noise figure measurements.

### HP R & Q347B Noise Sources

(See technical data sheet for complete specifications)

**Frequency Range:** R347B - 26.5 to 40 GHz

Q347B - 33 to 50 GHz

### Excess Noise Ratio (ENR) Range:

HP R347B: 10 to 13 dB

HP Q347B: 9.5 to 12.5 dB (33 to 44 GHz)  
6.75 to 11.25 dB (44 to 50 GHz)

### Max. SWR (reflection coefficient):

HP R347B: <1.42 (.17)

HP Q347B: <1.31 (.13)

### Supplemental Characteristics

**ENR Variation with temperature:** <.006 dB/C

**ENR Variation with time:**

R 347B: .15 dB typ. (over 2000 hrs.)

Q 347B: .15 dB typ. (over 2000 hrs.)

### Ordering Information

HP 8970B Noise Figure Meter

**Price**

\$10,600

**Option H18:** Increases upper frequency from 1600 to 1800 MHz

add \$350

**Option 907:** Front panel handle kit

add \$43

**Option 908:** Rack mounting flange kit

add \$25

**Option 909:** Both options 907 and 908

add \$65

HP 8971B Noise Figure Test Set

\$15,500

HP 8970T Noise Figure Measurement System

\$50,100

HP 8970S Noise Figure Measurement System

See HP8970S Ordering Guide)

HP 346A Noise Source

\$1,500

HP 346B Noise Source

\$1,400

HP 346C Noise Source

\$1,900

**Option 001** (HP 346A/B only): Type N (m) connector

N/C

**Option 002** (HP 346A/B only): APC-7 connector

add \$25

**Option 004** (HP 346A/B only): Type N (f) connector

N/C

HP R347B Noise Source

\$2,200

HP Q347B Noise Source

\$2,800

# NETWORK ANALYZERS

## Complete Characterization of Linear Networks

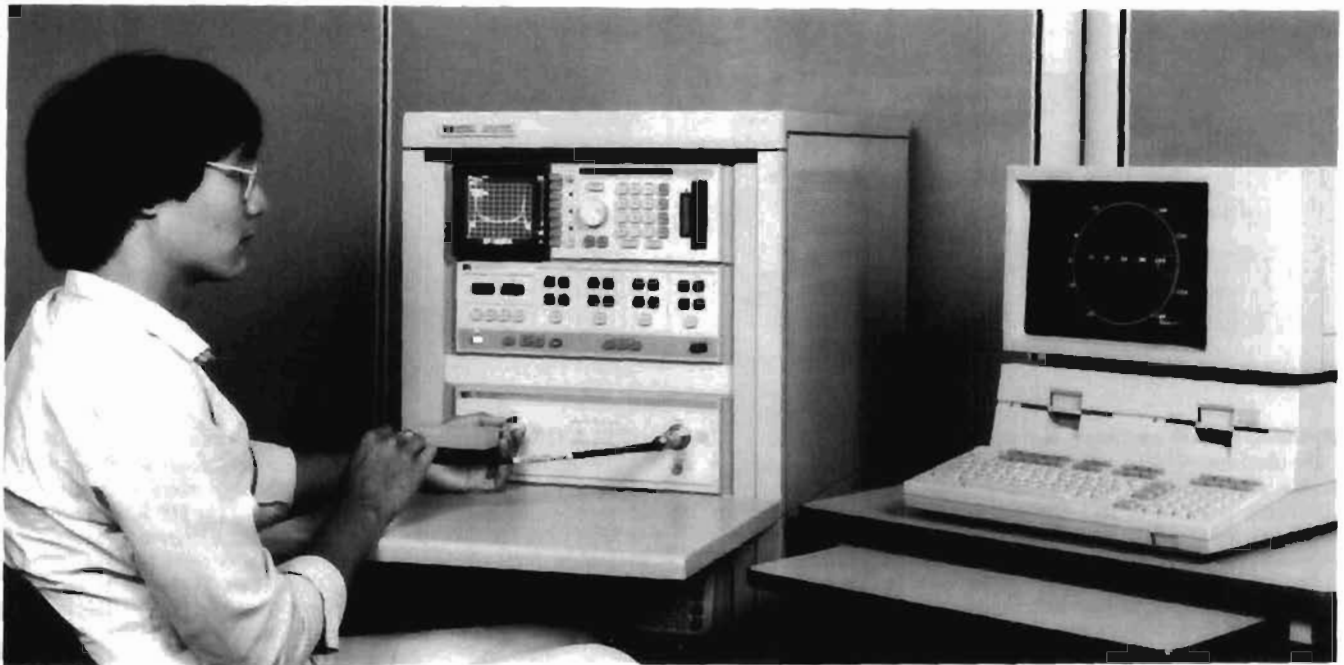

### Why Network Analysis?

Characterizing the behavior of linear networks that will be stimulated by arbitrary signals and interfaced with a variety of other networks is a fundamental problem in both synthesis and test processes. For example, the engineer designing a multi-component network must predict with some certainty the final network performances from knowledge of the individual components. Similarly, a production manager must know allowable tolerances on the products manufactured and whether the final products meet the specified tolerances. Network analysis offers a solution to these problems through complete description of linear network behavior in the frequency domain. Additionally, some network analyzers offer the capability to transform measurement data, taken in the frequency domain, to the time domain providing further insight into the behavior of linear networks.

Network analysis accomplishes the description of both active and passive networks by creating a data model of such component parameters as impedances and transfer functions. However, these parameters not only vary as a function of frequency but are also complex variables in that they have both magnitude and phase. Swept network analyzers now measure magnitude and phase (the total complex quantity) as a function of frequency with less difficulty than conventional CW measurements. Impedance and transfer functions can then be conveniently displayed on a swept CRT, as in Figure 1, X-Y recorder, or computer controlled peripherals such as a printer and/or a plotter.

Thus, network analysis satisfies the engineering need to characterize the behavior of linear networks quickly, accurately, and completely over broad frequency ranges. Hewlett-Packard manufactures a full line of scalar network analyzers (magnitude only) and vector network analyzers (both magnitude and phase).

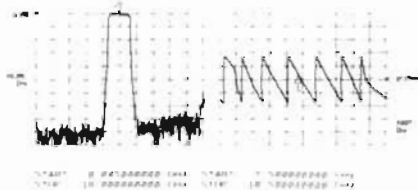

Figure 1. 45 MHz to 18 GHz measurement of magnitude and phase in a single sweep.

### What Is Network Analysis?

Network analysis is the process of creating a data model of the transfer and/or impedance characteristics of a linear network through stimulus-response testing over the frequency range of interest. All network analyzers in the HP product line operate according to this definition.

At frequencies above 1 MHz lumped elements actually become "circuits" consisting of the basic elements plus parasitics like stray capacitance, lead inductance, and unknown absorptive losses. Since parasitics depend on the individual device and its construction they are almost impossible to predict. Above 1 GHz component geometries are comparable to a signal wavelength, intensifying the variance in circuit behavior due to device construction.

Network analysis is generally limited to the definition of linear networks. Since linearity constrains networks stimulated by a sine wave to produce a sine wave output, sine wave testing is an ideal method for characterizing magnitude and phase response as a function of frequency. For non-linear measurements, refer to the sections on spectrum analyzers, wave analyzers (signal analyzers) and vector modulation products in this catalog.

### Network Analyzers

Hewlett-Packard network analyzers are instruments that measure transfer and/or impedance functions of linear networks through sine wave testing. A network analyzer system accomplishes these measurements by configuring its various components around the device under test. The first requirement of the measurement system is a sine wave signal source to stimulate the device under test. Since transfer and impedance functions are ratios of various voltages and currents, a means of separating the appropriate signals from the measurement ports of the device under test is required. Finally, the network analyzer itself must detect the separated signals, form the desired signal ratios, and display the results.



Figure 2. Input impedance of microcircuit amplifier is read directly with Smith Chart overlay for Polar Display.

### Signal Sources and Signal Separation

In the general case, any sine wave source meeting the network analyzer's specifications can be used to stimulate the device under test. If the analyzer is capable of swept measure-

ments, great economies in time can be achieved by stimulating the device under test with a sweep oscillator or synthesized sweeper. This allows quick and easy characterization of devices over broad frequency ranges.

At high frequencies the problem of signal separation usually involves traveling waves on transmission lines and becomes correspondingly more difficult. Hewlett-Packard manufactures test sets applicable for separating the appropriate traveling waves in a variety of high frequency measurements.

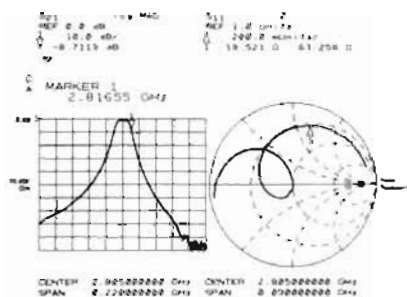

Figure 3. Simultaneous measurement of transmission response and passband reflection coefficient.

**Broadband and Narrowband Detection**

After the desired signals have been obtained from the test set they must be detected by the network analyzer; HP network analyzers can use one of two detection methods. Broadband detection accepts the full frequency spectrum of the input signal while narrowband detection involves tuned receivers that convert CW or swept RF signals to a constant IF signal. There are certain advantages to each detection scheme.

Scalar analyzers usually employ broadband detection techniques. Broadband detection reduces instrument cost by eliminating the IF section required by narrowband analyzers but sacrifices noise and harmonic rejection. However, noise is not a factor in many applications. Finally, broadband systems can make measurements where the input and output signals are not of the same frequency, as in the measurement of the insertion loss of mixers and frequency doublers. Narrowband systems cannot make these measurements.

Vector network analyzers normally employ narrowband detection techniques. Narrowband detection makes a more sensitive low noise detection of the constant IF possible. This allows increased accuracy and dynamic range for frequency selective measurements (as compared to broadband systems).

All network analyzer phase measurements are relative measurements with the reference channel signal considered to have zero phase. The analyzer then measures the phase difference of the test channel with respect to the reference channel.

Phase information complements amplitude data in the measurement of low frequency parameters. Phase is more sensitive to network behavior and it is a required component of complex impedance and transfer functions.

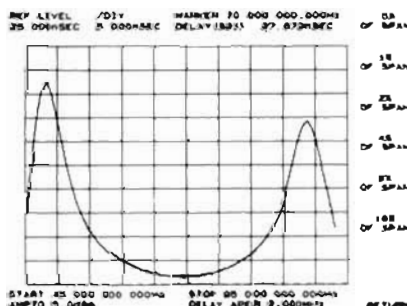

Figure 4. Direct measurement of group delay with digital readout at marker.

**Signal Processing and Display**

Once the RF has been detected, the network analyzer must process the detected signals and display the measured quantities. All HP network analyzers are multi-channel receivers utilizing a reference channel and at least one test channel; absolute signal levels in the channels, relative signal levels (ratios) between the channels, or relative phase difference between channels can be measured depending on the analyzer.

Relative ratio measurements are usually made in dB, which is the log ratio of an unknown signal (Test Channel) with a chosen reference signal (Reference Channel). This allows the full dynamic range of the instrumentation to be used in measuring variations of both high and low level circuit responses. For example, 0 dB implies the two signal levels have a ratio of unity while ±20 dB implies a 10:1 voltage ratio between two signals.

Phase data is also required to measure delay distortion or group delay of networks. Delay distortion occurs when different frequency components of a complex waveform experience nonlinear phase shifts as they are transmitted through a network. Group delay is a measure of this distortion and is defined as:

$$T_g = - \frac{d\theta}{d\omega}$$

An alternative method for measuring phase distortion is deviation from linear phase or differential phase. Deviations from linear phase can be measured by introducing enough electrical length in the network analyzer's reference channel to linearize a device's phase shift.

Scattering parameters or S-parameters were developed to characterize linear networks at high frequencies. S-parameters de-

fine the ratios of reflected and transmitted traveling waves measured at the network ports. A two-port device is modeled with S-parameters in Figure 5.  $S_{11}$  is the complex re-

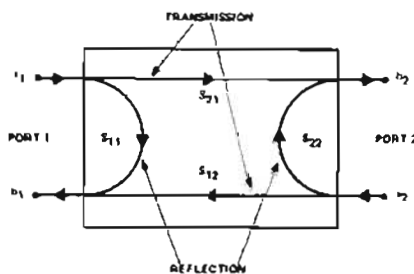

Figure 5. S-parameter model for a two-port linear network.

flexion coefficient at port 1 and is the ratio of  $b_1/a_1$ , if  $a_2 = 0$  (port 2 terminated in its characteristic impedance).  $S_{21}$  is the complex transmission coefficient from port 1 to port 2,  $b_2/a_1$ , if  $a_2 = 0$ . The "a" and "b" signals represent the amplitude and phase of the incident and emerging or reflected traveling waves. By reversing the ports and terminating port 1 in its characteristic impedance,  $S_{22}$  and  $S_{12}$  can be similarly defined.

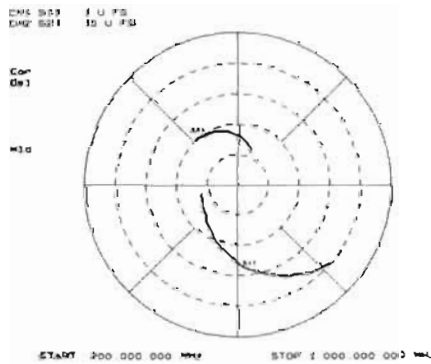

Figure 6. Simultaneous measurement of transistor S-parameters.

**Additional Capabilities**

Precision design work and manufacturing tolerances demand highly accurate measurements, but most errors in network measurements are complex quantities that vary as a function of frequency. By characterizing and virtually removing these systematic errors, measurement accuracies are improved by several orders of magnitude. Hewlett-Packard now offers network analyzers with built-in, high-speed computational hardware that can perform the complex mathematics required for sophisticated error correction.

Computer controlled network analyzers can be programmed to set up and make many measurements automatically. The measurement process is further accelerated by the computer's ability to store, transform, summarize, and output data in a variety of formats to a number of peripherals. These capabilities make the computer controlled network analyzer ideal for both computer aided design or automatic production testing.

# NETWORK ANALYZERS

## Complete Characterization of Linear Networks (cont'd)

### Network Analyzer Product Line Summary

Network Analyzer			
HP Model	Frequency Range	Source	Measurement Capabilities
3562A Dual Channel Dynamic Signal Analyzer Page 148	64 uHz-100 kHz	Swept and fixed sine, chirp, burst, random noise and burst random noise	Transfer functions, magnitude/phase, 40-pole curve fitter, frequency response synthesis, time domain functions, and spectrum analysis HP-IB programmable
3577A Network Analyzer Page 230	5 Hz to 200 MHz	Synthesized Source	Transfer functions, magnitude/phase, insertion loss/gain, attenuation, electrical length, gain compression, Group Delay, Deviation from Linear Phase HP-IB Programmable
4195A network/spectrum/impedance analyzer Page 226	10 Hz-500 MHz	Synthesized source	Transfer functions, magnitude/phase, insertion loss, gain, attenuation, group delay, s-parameters, return loss, SWR, complex impedance, full accuracy enhancement analysis, HP-IB programmable
8754A Network Analyzer Page 236	4-1300 MHz	Swept source included external source usable.	Magnitude and phase transmission coefficient reflection coefficient and return loss S-parameters, impedance.
8753A Network Analyzer Page 239	300 kHz-3 GHz	Swept Synthesized Source Included	Transfer functions - magnitude/phase insertion loss/gain, attenuation, gain compression, s-parameters, electrical length, group delay, deviation from linear phase. Impedance - magnitude/phase - Return Loss, r1x Full Accuracy Enhancement Time Domain Capability HP-IB programmable
8410C Network Analyzer Page 248	110 MHz-18 GHz	HP 8350, 8620 Series Sweep Oscillators HP 8340B or 8341B Synthesized Sweepers	Transmission/Reflection Characteristics, S-parameters 50 $\Omega$ Coax Measurements 110 MHz to 18 GHz Continuous Multioctave Measurements with HP 8620 and 8350 Series Sweepers DC Bias for Semiconductor Measurements
8510 Series Network Analyzer Page 243	45 MHz to 100 GHz	HP 8350 Series Sweep Oscillators HP 8340B, 8341B Synthesized Sweepers	Transmission/Reflection Characteristics S-parameters Active device characterization Full Accuracy Enhancement Time domain capability HP-IB programmable

### Vector Voltmeter

HP Model	Frequency Range	Source	Measurement Capabilities
3575A Gain Phase Meter Page 235	1 Hz-13 MHz	None	Gain, Phase and Amplitude
8405A Vector Voltmeter Page 238	1 MHz-1 GHz (CW)	HP 3200B Oscillator, VHF Signal Generators, HP 8654 (UHF), and HP 8640 A/B	Voltmeter Transfer Functions, Phase and Amplitude

### Scalar Analyzer

HP Model	Frequency Range	Source	Measurement Capabilities
8756A Scalar Network Analyzer Page 223	10 MHz-60 GHz	HP8350 or 8620 Series Sweep Oscillators, HP 8340B/8341B Synthesized Sweeper	Scalar Transmission/Reflection Measurements 50 $\Omega$ Coax Measurements 10 MHz-26.5 GHz 75 $\Omega$ Coax Measurements 10 MHz-2.4 GHz Waveguide Measurements 26.5 GHz-60 GHz Open/Short Averaging, Normalization, Averaging Storage Registers, HP-IB Programmable
8757A Scalar Network Network Analyzer page 215	10 MHz-60 GHz	HP 8350 or 8620 Series Sweep Oscillators, HP 8340B or 8341B Synthesized Sweepers	Scalar Transmission/Reflection Measurements 50 $\Omega$ Coax Measurements 10 MHz-26.5 GHz 75 $\Omega$ Coax Measurements 10 MHz-2.4 GHz Waveguide Measurements 26.5 GHz-60 GHz Open/Short Averaging, Normalization, Averaging, Limit Testing Storage Registers, HP-IB Programmable



# NETWORK ANALYZERS

## Automatic Scalar Network Analyzer System (10 MHz to 60 GHz)

Model 8757S

215

- Measure Insertion loss or gain, VSWR, and power
- Customize automatic tests without programming

- Plot and display data
- Troubleshoot waveguide and coax



HP 8757S

The HP 8757S is a complete automatic scalar network analyzer for measurements of insertion loss or gain, return loss, and power from 10 MHz to 60 GHz. The system is based on the HP 8757A scalar network analyzer and is controlled by an HP 9000 series 200 or 300 computer over the Hewlett-Packard Interface Bus (HP-IB). Also included in the system are a swept source (HP 8350B sweep oscillator with RF plug-in or HP 8340B/8341B synthesized sweeper), a high directivity (40 dB) directional bridge, detectors, accessories, and the HP 85015B or 85016B system software. All analyzer and source controls are completely programmable.

### Flexible Plot and Print Formats

Plot or print data and CRT graphics in your choice of formats without any programming. Select automatic scaling of either the vertical or horizontal axes (or both). Customize your own plot configuration with or without labels, grid lines, limit lines, and out-of-spec indicators. Plot up to four plots on a single page or print the data in the format you find most useful.

### Easy to Use

In either manual or automatic operation, the HP 8757S is easy to operate. The fully annotated HP 8757A CRT is the system's control center with convenient display of frequency, power, and scaling parameters. Manual measurements can be easily controlled with the front panel function keys. With the system software and the entire HP 8757S system, even complex scalar measurements can be performed with ease.

### High Performance

Each component of the HP 8757S is a high performance instrument in its own right. Together they form a very high performance automatic scalar network analyzer.

The HP 8757A scalar network analyzer offers 76 dB of dynamic range (+16 to -60 dBm) in three (or optionally four) independent inputs (A, B, (C), and R) when used with the HP 11664A/F detectors. Single inputs or ratio combinations of the inputs can be displayed on any of four independent display channels. Using AC modulation and detection, the HP 8757A provides excellent performance in the presence of unmodulated noise and spurious signals. The HP 11664 detectors cover the range from 10 MHz to 40 GHz and the HP 11664C detector adapter can be used with waveguide detectors for higher frequency operation. The HP 85025 and 85026 series detectors cover the range from 10 MHz to 60 GHz and offer the choice between AC and DC detection. In DC mode, the HP 85025 detectors can be used to provide excellent swept power measurements (dBm).

Test signals are provided by the HP 8350B sweep oscillator with an RF plug-in or by the HP 8340B/8341B synthesized sweepers. All source front panel functions are fully programmable via HP-IB and are also easy to use in manual applications. Frequency and power entries can be made with a knob, a numeric keypad, or with increment and decrement keys. Up to nine independent front panel settings may be saved or recalled at the touch of a key or through HP-IB.

# NETWORK ANALYZERS

## System Specifications

Model 87578

### System Specifications

#### ACCURACY

**Transmission Loss or Gain Measurement Accuracy:** Transmission loss or gain measurements are made relative to a 0 dB reference point established at calibration. The measurement accuracy is equal to the uncertainty due to the change in power level, called dynamic accuracy, plus mismatch uncertainty. The frequency response errors of the source, detectors, bridge and power splitter may be removed via calibration.

**Dynamic Power Accuracy** (25 ± 5°C, 0 dBm reference):

#### Coax Detectors\* (50 MHz)

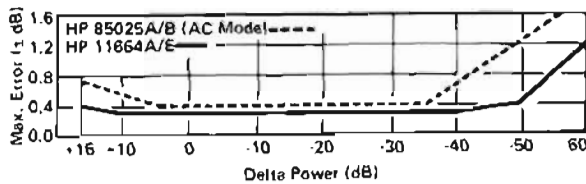

\* For ≤ 20 dB change of power within +10 to -40 dBm, the specification for the HP 8757A with the HP 11664A/E is ±(0.1 dB + 0.01 dB/dB).

#### Waveguide Detectors

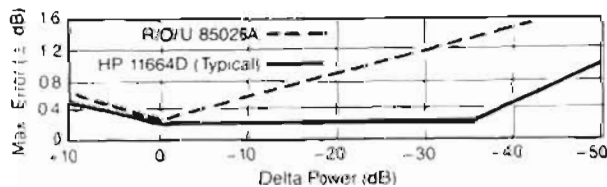

**Absolute Power Measurement Accuracy:** This specification is useful for determining the accuracy of power measurements in dBm when using the HP 85025A/B detectors in the DC mode. The total uncertainty is the sum of the detector frequency response, power accuracy, and mismatch uncertainties.

**Absolute Power Accuracy** (HP 85025A/B detectors in DC mode, detector offsets removed via power meter cal, 25 ± 5°C):

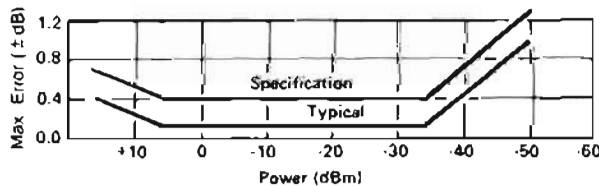

**Detector Frequency Response** (HP 85025A/B detectors, -10 dBm, 25 ± 5°C):

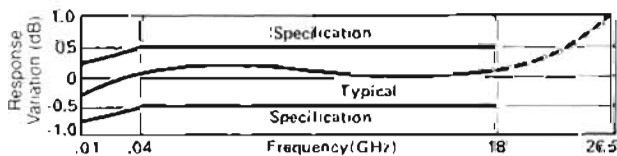

#### DYNAMIC RANGE (on all HP 8757A detector inputs):

Detector	AC Mode	DC Mode
HP 11664A/E	+16 to -60 dBm	
HP 11664D	+10 to -50 dBm	
HP 85025A/B	+16 to -55 dBm	+16 to -50 dBm
HP R/Q/U85026A	+10 to -50 dBm	+10 to -45 dBm

**Reflection Measurement Accuracy:** Uncertainties due to calibration error and the frequency response of the source, detectors and bridge are removed via open/short averaging. The remaining uncertainties are primarily the sum of directivity uncertainty, effective source match uncertainty, and dynamic power accuracy. As shown in the graphs below, directivity is the dominant error term when measuring small reflected signals (high return loss) and source match is dominant when measuring large reflected signals (low return loss).

#### The Effect of Effective Source Match on Reflection Uncertainty:

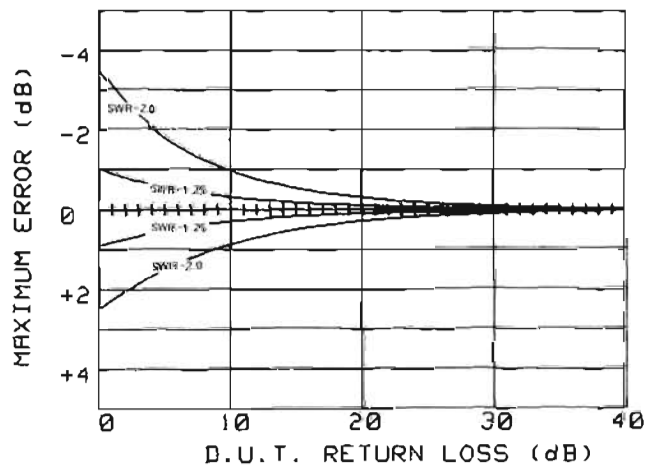

#### The Effect of Directivity on Reflection Uncertainty:

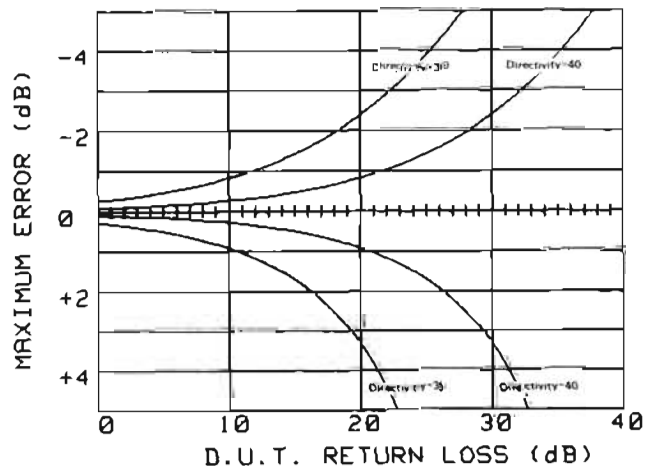

**Dynamic Power Accuracy** (HP 85027/20 bridges, 50 MHz, 25 ± 5°C, +7 dBm input):

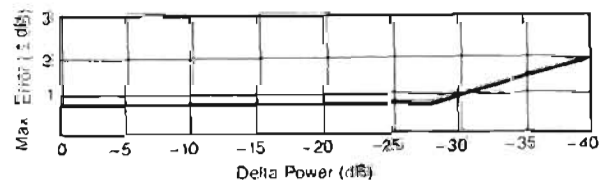

# NETWORK ANALYZERS

## Scalar Network Analyzer, 10 MHz to 60 GHz Model 8757A

- 76 dB dynamic range
- Accurate swept power measurements (dBm)
- 40 dB directivity bridges

- Four independent display channels
- Limit testing built in
- Save/recall setup and cal data
- Direct plotter or printer output

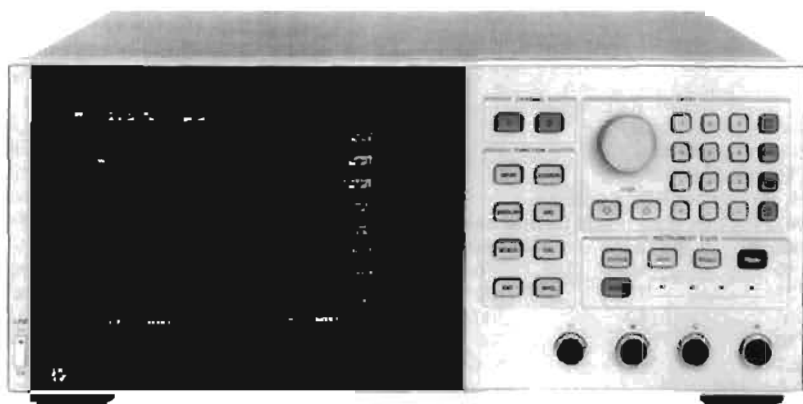

HP 8757A Option 001

### Description

Measure insertion loss or gain, return loss, SWR, and power quickly and accurately with the HP 8757A scalar network analyzer. With high performance detectors and directional bridges and a companion HP source and digital plotter, the HP 8757A becomes the basis of a complete measurement system with superb performance.

### Performance

The HP 8757A features 76 dB of dynamic range (-60 dBm to +16 dBm) when used with the HP 11664A/E detectors. With square wave modulation and detection (AC), the HP 11664 detectors enable reliable, drift-free measurements from 10 MHz to 40 GHz. With the HP 85025 and 85026 AC/DC detectors, make scalar measurements with or without modulation to 60 GHz. In DC mode (no modulation), use the HP 85025A/B to make accurate swept-frequency measurements of power (dBm).

High directivity bridges (> 40 dB) covering RF and microwave frequencies help produce excellent measurement results. Using the HP 85020 series and 85027 series directional bridges, make accurate measurements of reflection and transmission parameters simultaneously.

Calibrate your test system, and make normalized measurements with 0.01 dB vertical resolution. Select the optimum horizontal resolution for your application, by choosing 101, 201, 401, 801, or 1601 data points. Lower resolution allows faster sweep times. Calibrate with full 1601 point resolution over your frequency range. Then zoom in on a narrower frequency span and retain calibration. The HP 8757A interpolates the calibration data automatically.

### Easy to Use

With a combination of simple front panel keys and powerful menu-driven soft keys, the HP 8757A allows you to set up the system and make accurate measurements fast. Menus appear on the display, and you control them with the front panel soft keys. The soft keys give you powerful capabilities without adding front panel complexity. Press CAL and let the menu guide you through calibration procedures. Press AUTOSCALE to bring your measurement into view quickly. Activate the "Cursor" and dial it to any point on your data trace for an accurate high resolution reading of magnitude (and frequency with the HP 8350B/8340B/8341B). Measurements are fast and easy.

### Productivity Without a Controller

The HP 8757A increases productivity in scalar measurements even without a controller. Decrease the time it takes you to set up and make measurements, while improving the quality of the results.

Enter your own limit lines for easy comparison of measurement results to upper and lower specification limits. Or use these lines as

your own reference calibration and remove the frequency responses of devices that are inserted after calibration.

Four independent display channels add new capabilities to the system. Each channel can display the data taken from any of the three (or optionally four) detector inputs. Each channel can display a single input (A, B, C, R) or a ratio combination of two inputs (A/R, B/R, A/B, etc.). With four inputs, measure multi-port devices or characterize several devices simultaneously. Or compare the response of the test device to the stored response of your "reference" device.

When used with the HP 8350B sweep oscillator or the HP 8340B/8341B synthesized sweepers, the HP 8757A acts as a system controller by managing the source via the "8757 System Interface." Using this interface the HP 8757A can extract frequency information and annotate the display. When used alone, the HP 8757A can save and recall up to nine front panel states in non-volatile memory, complete with calibration or measurement data, limit lines, and plot labels. With the system interface and a companion HP source, the HP 8757A can save and recall not only its own front panel state, but the source's as well. Configure often repeated measurements only once. Then just recall that set-up and connect your device.

Combining the HP 8757A with an HP 8350B/8340B/8341B also enables the useful "alternate sweep" function, which allows you to sweep different frequency ranges or power levels and display them both in real time.

The HP 8757A can adapt to any sweep ramp input in the 0-10 V range, such as a 2-5 V ramp. Test voltage-controlled oscillators and attenuators, using your test voltage ramp to drive the HP 8757A display. Plot output power or attenuation versus tuning voltage.

### Document Your Results

The HP 8757A also uses the "8757 System Interface" to drive an HP-1B digital plotter or "ThinkJet" printer. Plot what appears on the CRT or define your own plot and plot size. Get crisp, permanent, annotated plots without a controller. Print graphics or tabular data listings on the HP "ThinkJet" printer.

### Millimeter Wave Measurements

Extend scalar measurements to millimeter-wave frequencies with the HP 8757A and the waveguide detector for your frequency range. The HP R, Q, and U85026A detectors offer fully calibrated scalar measurements in the frequency bands 26.5-40 GHz (Ka) 33-50 GHz (Q) and 40-60 GHz (U). Add an HP millimeter-wave source and waveguide coupler for a complete scalar measurement system to 60 GHz. Above 60 GHz use your own waveguide detector with either the HP 85025C (AC/DC) or 11664C (AC only) detector adapters.

# NETWORK ANALYZERS

## 8757/8756 System Accessories

Models 8757A, 85027A/B/C/E, 85020A/B, 85025A/B/C/E, 11664A/C/D/E, R/Q/U 85026A

### HP 8757A Specifications

#### Amplitude Characteristics

Independently controlled for each channel.

**Reference offset:** offset level adjustable in 0.01 dB increments from -70 to +20 dBm (power measurement) or -90 to +90 dB (ratio measurement).

#### Display characteristics

##### Resolution

**Vertical:** 0.003 dB (power measurement)  
0.006 dB (ratio measurement)  
0.01 dB for "Display Cursor"

**Horizontal:** 101, 201, 401, 801, or 1601 data points

##### #Points Minimum Sweep Time (ms) (log magnitude format only)

	1 Trace	2 Traces	3 Traces	4 Traces
101	40	50	60	70
201	50	75	90	100
401	100	100	150	200
801	200	250	NA	NA
1601	400	NA	NA	NA

**Modulation Requirements** (for HP 11664 detectors and HP 85025/26 detectors in AC mode):

Square-wave amplitude modulation

Frequency 27.778 ± 20 Hz

≥ 30 dB on/off ratio

45% to 55% symmetry

**Averaging:** 2, 4, 8, 16, 32, 64, 128, or 256 traces may be averaged.

**Normalization:** traces are stored and normalized with the highest resolution, independent of display scale/division or offset. Calibration data can be saved and recalled with the first four instrument states, and is interpolated when the frequency span is decreased.

#### HP-IB Characteristics

**Transfer formats:** Data may be transferred either as ASCII strings (nominally six characters per reading) or as 16 bit integers (most significant byte first). Readings may be taken at a single point, or an entire trace may be transferred at once.

##### Transfer speed:

ASCII format, 401 point trace: 800 ms typical.

ASCII format, point: 10 ms typical.

Binary format, 401 point trace: 24 ms typical.

Binary format, point: 5 ms typical.

#### System Interface

**Description:** the HP 8757A system interface is a dedicated HP-IB port used exclusively by the HP 8757A to control and extract information from a swept source and a digital plotter or "Thinkjet" printer.

**Swept sources:** HP 8350B with RF plug-in, HP 8340B/8341B synthesized sweeper, or any source that provides a sweep ramp in the range of 0-10 volts.

**Plotters:** HP 7440A, 7475A, 7550A, 7090A

**Printers:** HP 2225A

#### General Specifications

**Power requirements:** 48 to 62 Hz, 115/230 V ± 10%, typically 100 watts.

**Dimensions:** 178 H x 425 W x 482 mm D (7.0 x 16.75 x 19.0 in.).

**Weight:** net, 21 kg (46 lb); shipping, 26 kg (57.5 lb).

#### Directional Bridges

The HP 85020 series and HP 85027 series are directional bridges designed especially for the HP 8757A, 8756A and 8755C scalar network analyzers. Each bridge features outstanding directivity and test port match in a compact, rugged package.

Within each bridge, one zero-bias Schottky diode detector measures the return loss of the test device. Ratio measurements can be made by adding a power splitter (HP 11667A/B) and detector (HP 11664 series or HP 85025 series).

#### HP 85027A/B/C/E Directional Bridges

The HP 85027 series directional bridges are designed to operate with the HP 8757, 8756 and 8755 scalar network analyzers for reflection measurements from 10 MHz to 26.5 GHz. A switch on the HP 85027 series bridges allows the user to configure them for operation with the HP 8757 or the HP 8756 and 8755 scalar network analyzers.

When used with the HP 8757A scalar network analyzer, the HP 85027 series bridges allow the user to choose the measurement mode that best suits the application. Use the bridge's AC mode (modulated RF) for measurements in the presence of undesired signals such as broadband noise or electromagnetic interference. Or choose the bridge's DC mode (unmodulated RF) to measure the return loss of modulation sensitive devices such as amplifiers with gain control circuits. Use the companion HP 85025 series detectors for AC and DC measurement versatility or the HP 11664 series detectors for AC only measurements.

High (40 dB) directivity and excellent test port match ensure accurate reflection measurements over a broad swept frequency range. The HP 85027B bridge operates from 10 MHz to 26.5 GHz and has an SMA compatible, precision female APC-3.5 test port connector. The HP 85027A/C bridges operate from 10 MHz to 18 GHz. The HP 85027A has a rugged APC-7\* test port connector and the HP 85027C has a precision Type-N connector. The HP 85027E operates from 10 MHz to 26.5 GHz and has an SMA compatible, precision male APC-3.5 test port connector.

##### Measuring SMA devices

Hewlett-Packard recommends using the HP 85027A bridge and an APC-7 to APC-3.5 adapter for measuring SMA devices from 10 MHz to 18 GHz. For SMA measurements to 26.5 GHz, HP recommends using APC-3.5 to APC-3.5 adapters (included with the HP 85027B bridge) to preserve the HP 85027B/E output connector.

#### HP 85020A/B Directional Bridges

The economical HP 85020A/B directional bridges also offer high (40 dB) directivity and excellent port match at RF (to 4.3 GHz) frequencies. For 50 ohm measurements choose the HP 85020A. The HP 85020B is designed for 75 ohm environments. Both RF bridges have Type-N connectors.

#### Detectors

Two types of detectors are available for use with HP scalar network analyzers for measurements up to 60 GHz. All detectors provide excellent impedance match, and therefore minimize mismatch uncertainty in scalar measurements.

#### HP 85025 and 85026 Series Detectors (AC/DC)

The HP 85025 and 85026 series detectors are designed specifically for operation with the HP 8757A Scalar Network Analyzer and are not compatible with either the HP 8756A or the 8755. The HP 85025/26 detectors detect either a modulated (AC) or an unmodulated (DC) microwave signal. In AC mode, the HP 85025/26 series detect the envelope of the 27.8 kHz modulated microwave signal, provided internally by the HP 8350B Sweep Oscillator with RF plug-in or externally with the HP 8340/41 synthesized sweepers. In DC mode, the HP 85025/26 series detectors measure the microwave power directly without modulation. The user can change detection modes from the HP 8757A front panel.

#### HP 11664 Series Detectors (AC Only)

The HP 11664 series detectors are designed to operate with the HP 8757A, 8756A and 8755C scalar analyzers in AC mode only. The HP 11664A/E cover the 10 MHz to 26.5 GHz range, and the HP 11664D covers from 26.5 to 40 GHz.

#### Detector Adapters

The HP 85025C and the HP 11664C Detector Adapters match the scalar analyzer display to most standard crystal, silicon, and gallium arsenide detectors. This enables the user to operate in any frequency band, such as above 60 GHz with the HP 8757A, and above 40 GHz with the HP 8756A.

\*APC-7 is a U.S. registered trademark of the Bunker Ramo corporation.

# NETWORK ANALYZERS

## 8757/8756 System Accessories (cont'd)

Models 85027 A/B/C/E, 85020 A/B, 85025 A/B/C/E, R/Q/U 85026A, 11664 A/C/D/E

The HP 85025C Detector Adapter is designed for use with the HP 8757A only, and can operate in either AC or DC detection modes. A softkey calibration sequence calibrates the HP 8757A display to your particular detector for an accurate display of power level. The analyzer can then account for the voltage versus input power characteristics of the detector in use. This calibration requires two known calibration inputs, one at a high level (linear operating region, above 0 dBm) and one at a low level (square law region, below -20 dBm).

The HP 11664C Detector Adapter is designed for use with the HP 8757A, 8756A, and 8755C scalar analyzers. The HP 11664C is matched to the particular diode used via two screwdriver adjustments. One adjustment sets the adapter's amplifier gain to the correct power level indication on the scalar network analyzer. The second adjustment matches the input impedance of the adapter to the load impedance of the detector. Together, the voltage versus power characteristics of the detector are calibrated for the scalar analyzer display.

### DIRECTIONAL BRIDGE SUMMARY

For use with the HP 8757A, 8756A, or 8755C in AC detection mode only:								
Bridge	Freq. Range (GHz)	Nominal Impedance	Connector		Directivity (dB)	Test Port Match (SWR)	Weight	
			Input	Test port			Net	Shipping
85020A	.01-4.3 GHz	50 ohms	Type-N (f)	Type-N (f)	.01-3 GHz: 40 dB 3-4.3 GHz: 34 dB	.01-3 GHz: <1.22 3-4.3 GHz: <1.25	0.5 kg (1.2 lb)	2.3 kg (5 lb)
85020B	.01-2.4 GHz	75 ohms	Type-N (f)	Type-N (f)	40 dB	.01-1.3 GHz: <1.25 1.3-2.4 GHz: <1.43	"	"
For use with the HP 8756A, or 8755C in AC detection mode or with the HP 8757A in either AC or DC detection modes:								
85027A	.01-18 GHz	50 ohms	Type-N (f)	APC-7	40 dB	.01-8.4 GHz: <1.15 8.4-12.4 GHz: <1.25 12.4-18 GHz: <1.43	0.5 kg (1.2 lb)	2.3 kg (5 lb)
85027B	.01-26.5 GHz	50 ohms	APC-3.5 (f)	APC-3.5 (f)	.01-20 GHz: 40 dB 20-26.5 GHz: 36 dB	.01-8.4 GHz: <1.15 8.4-20 GHz: <1.43 20-26.5 GHz: <1.75	"	"
85027C	.01-18 GHz	50 ohms	Type-N (f)	Type-N (f)	.01-12.4 GHz: 36dB 12.4-18 GHz: 34 dB	.01-8.4 GHz: <1.15 8.4-12.4 GHz: <1.25 12.4-18 GHz: <1.43	"	"
85027E	.01-26.5 GHz	50 ohms	APC-3.5 (f)	APC-3.5 (m)	.01-20 GHz: 40dB 20-26.5 GHz: 36 dB	.01-8.4: <1.15 8.4-20 GHz: <1.43 20-26.5 GHz: <1.75	"	"

### Detector Summary

For use with the HP 8757A, 8756A, or 8755C in AC detection mode only:

Detector	Freq. Range (GHz)	Connector Type	Return Loss (dB)	Dynamic Range		Weight	
				8757	8756	Net	Shipping
11664A <sup>1</sup>	.01-18	Type-N (M)	.01-.04 GHz: 10 dB .04-4 GHz: 20 dB 4-12 GHz: 18 dB 12-18 GHz: 16 dB	+16 to -60 dBm	+10 to -50 dBm	0.17 kg (0.4 lb)	0.9 kg (2 lb)
11664E	.01-26.5	APC-3.5 (M)	.01-.04 GHz: 10 dB .04-6 GHz: 20 dB 6-20 GHz: 16 dB 20-26.5 GHz: 12 dB	+16 to -60 dBm	+10 to -50 dBm	"	"
11664D	26.5-40	WR-28	12 dB	+10 to -50 dBm	+10 to -50 dBm	0.24 kg (0.5 lb)	1.0 kg (2.2 lb)
11664C	'	SMA (M)	'	'	'	0.17 kg (0.4 lb)	0.9 kg (2 lb)

For use with HP 8757A only in either AC or DC detection modes:

	Freq. Range	Connector	Return Loss	AC mode	DC mode	Weight	
						Net	Shipping
85025A <sup>1</sup>	.01-18	Type-N (M)	.01-.04 GHz: 10 dB .04-4 GHz: 20 dB 4-18 GHz: 17 dB	+16 to -55 dBm	+16 to -50 dBm	0.24 kg (0.5 lb)	1.0 kg (2.2 kg)
85025B	.01-26.5	APC-3.5 (M)	.01-18 GHz: Same as 85025A 18-26.5 GHz: 12 dB	+16 to -55 dBm	+16 to -50 dBm	"	"
R85026A <sup>2</sup>	26.5-40	WR-28	12 dB	+10 to -50 dBm	+10 to -45 dBm	"	"
Q85026A <sup>2</sup>	33-50	WR-22	12 dB	+10 to -50 dBm	+10 to -45 dBm	"	"
U85026A <sup>2</sup>	40-60	WR-19	12 dB	+10 to -50 dBm	+10 to -45 dBm	"	"
85025C <sup>2</sup>	'	SMA (M)	'	'	'	"	"

- Option 001 changes to APC-7 connector
- The HP 85026 series detectors and the HP 85025C require HP 8757A firmware revision 2.0 or higher. To upgrade previous revisions order the HP 11614A Firmware Enhancement.
- Depends on the particular external detector used.

# NETWORK ANALYZERS

## 8757/8756 System Accessories (con't)

Models 11679A/B, 85023A/B/C/D, 85022A, 85028A, 11614A, 11668A, 11678A



HP 11679A



HP 85022A



HP 85028A



HP 85023C



HP 11668A



HP 11678A

### HP 11679A/B Extension Cables

**Function:** These cables extend the distance between the scalar network analyzer and the detector or bridge to a maximum of 200 feet without degradation of performance.

HP 11679A: 7.6 m (25 ft) extension cable

HP 11679B: 61 m (200 ft) extension cable

### HP 85023A/B/C/D Verification Kits

The HP 85023 Series system verification kits each contain a set of precision components used to perform a system verification procedure for the HP 8757S/56S scalar network analyzer system. This procedure, which is in the HP 8757A/56A Operating and Service Manuals, checks system installation and can be used as a daily functional test.

Choose a system verification kit to match your device under test. For APC-7 applications, select the HP 85023A. If you are measuring SMA or APC-3.5 devices, choose the HP 85023B. For 50 ohm, Type-N applications, select the HP 85023C. These kits (HP 85023A/B/C) all include an open, short, 10 dB fixed attenuator, 50 ohm termination, and a source to directional bridge adapter of the corresponding connector type. The HP 85023D verification kit, for 75 ohm Type-N measurements, consists of a short, a 75 ohm termination, a 50 ohm 10 dB fixed attenuator and two HP 11852B 50 to 75 ohm minimum loss pads (for 50/75 ohm impedance conversion).

**Frequency range:** HP 85023A/C, dc to 18 GHz

HP 85023D, dc to 1.3 GHz.

HP 85023B, dc to 26.5 GHz.

**Connector type:** HP 85023A, APC-7.

HP 85023B, APC-3.5.

HP 85023C, Type-N, 50 ohm.

HP 85023D, Type-N, 75 ohm.

**Characteristic impedance:** HP 85023A/B/C, 50 ohm.

HP 85023D, 75 ohm.

**Weight:** net, 0.5 kg (1.2 lb); shipping, 1.2 kg (2.9 lb).

### HP 85022A System Cable Kit

The HP 85022A contains all the BNC and HP-1B cables to connect an HP 8350B sweep oscillator (or HP 8340B synthesized sweeper), an HP Series 200 computer, and a printer to the HP 8757A or 8756A. This kit contains 3 one-metre HP-1B cables (HP 10833A), 3 two-foot BNC cables (HP 11170B), and 1 four-foot BNC cable (HP 11170C).

**BNC connectors:** N-Male, N-Male.

**BNC impedance:** 50 ohm.

**Weight:** net, 0.5 kg (1.2 lb); shipping, 1.2 kg (2.9 lb).

### HP 85028A APC-7 Directivity Verification Standards for HP 85021A/85027A

The HP 85028A allows on-site verification of the 40 dB directivity of the HP 85021A and 85027A directional bridges. For frequencies below 2 GHz, a precision 52 dB return loss load is used. For frequencies from 2 to 18 GHz, a sliding mismatch is used to establish a ripple pattern from which the directivity can be calculated. The HP 85028A includes a precision 50 ohm termination, a high-performance sliding mismatch, an APC-7 open/short, an APC-7 connector gage kit, and a torque wrench.

**Weight:** net, 2.0 kg (4.5 lb); shipping, 3.5 kg (8.0 lb).

### HP 11614A Firmware Enhancement

The HP 11614A firmware enhancement updates the HP 8757A scalar network analyzer to firmware revision 2.0. (HP 8757As with serial number prefix 2546A or higher already have revision 2.0 firmware). Firmware revision 2.0 adds several new features to previous versions of the HP 8757A. These include the ability to display and plot reflection traces in units of standing wave ratio (SWR), tabular listings of numerical data on an HP ThinkJet printer, full calibration and operation with the HP 85025C detector adapter and R/Q/U85026A waveguide detectors, and the ability to display and plot an external voltage applied to a rear panel input. All revision 2.0 features are HP-1B programmable.

### HP 11668A High Pass Filter

The HP 11668A high pass filter accessory is recommended when making measurements on active devices that have gain below 50 MHz. Use of the HP 11668A, placed after the HP 11665B, reduces the modulator drive feedthrough from 8 mV to 1 mV and prevents possible amplifier saturation. Use of the HP 11668A filter is not necessary for passive measurements since the feedthrough from the HP 11665B is -65 dBm and causes no degradation in system performance.

**Frequency range:** 50 MHz to 18 GHz.

	Insertion Loss	Return Loss
50-100 MHz	≤ 2.5 dB	≥ 12 dB
100 MHz-8 GHz	≤ 1.0 dB	≥ 16 dB
8-12 GHz	≤ 1.0 dB	≥ 14 dB
12-18 GHz	≤ 1.5 dB	≥ 14 dB

**Maximum input:** +27 dBm.

**Connectors:** N-female, N-male.

**Weight:** net, 0.13 kg (5 oz); shipping, 0.28 kg (10 oz).

### HP 11678A Low Pass Filter Kit

**Description:** the HP 11678A low pass filter kit contains five filters. Low pass filters reduce harmonics generated by the RF source when making precision measurements.

**Frequency Range** (low pass filters, cutoff frequency  $f_c$ )

HP 11688A: 2.8 GHz.

HP 11689A: 4.4 GHz.

HP 11684A: 6.8 GHz.

HP 11685A: 9.5 GHz.

HP 11686A: 13.0 GHz.

**Insertion loss:** ≤ 1.1 dB at 0.95  $f_c$ .

**Rejection** (at 1.25  $f_c$ ): greater than 40 dB.

**Impedance:** 50 ohm normal.

**Connectors:** N-Female, N-Male.

**Weight:** net, 0.44 kg (1 lb); shipping, 1.2 kg (2.9 lb).

## 8757/8756 System Accessories (cont'd)

Models 11613B, 11667A/B, 11636A/B, 11665B, 11679A/B, 11852B

### HP 11613B Calibrator

HP 8757A and 8756A verification/calibration is recommended every 12 months. This can be accomplished at an HP service center or on-site using the HP 11613B calibrator and an HP 9000 series 200 or series 300 computer.

The HP 11613B is a dedicated transfer standard for calibration of the HP 8757A and 8756A. The HP 11613B provides the standard a 27.778 kHz source and a series of precision attenuators. The calibrator includes software (both 3.5 and 5.25 inch formats) that operates on an HP 9000 series 200 or series 300 computer, the BASIC operating system (BASIC 2.0, 2.1, 3.0 or 4.0) and a GP-IO cable for use when calibrating the HP 8756A. The software verifies (and adjusts if necessary) the internal calibration parameters stored in the non-volatile memory of the HP 8757A and 8756A. All HP 8757A and 8756A detector inputs can be calibrated in a matter of minutes. Re-calibration of the HP 11613B is recommended every two years.

**Memory Requirement:** 1/2M byte, including BASIC.

**Hardware Requirement:** HP 98622A 16-bit GP-IO interface card for use with HP 8756A

**Dimensions:** 40 H x 185 W x 203 mm D (1.5 x 7.3 x 8.0 in).

**Cable length:** 1.22 m (48 in).

**Weight:** Net 0.91 kg (2 lbs). Shipping 1.4 kg (3 lbs).



HP 11667B



HP 11665B



HP 11667A

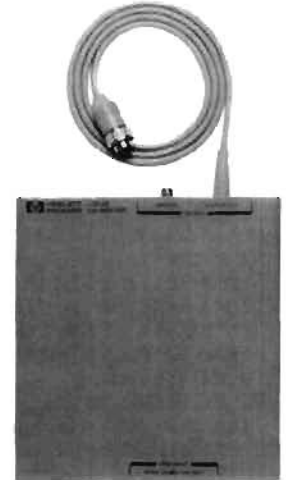

HP 11613B

### HP 11667A/B Power Splitter

The HP 11667A/B power splitters are recommended when making wideband ratio measurements using the HP 8757A, 8756A or 8755C scalar network analyzer. These two-resistor type splitters provide excellent output SWR at the auxiliary arm when used for source leveling or ratio measurement applications. The tracking between output arms over a frequency range from dc to 18 GHz allows wideband measurements to be made with a minimum of uncertainty.

#### Frequency Range:

HP 11667A: DC to 18 GHz.

HP 11667B: DC to 26.5 GHz.

**Impedance:** 50 ohms nominal.

**Insertion Loss:** 6 dB nominal.

	DC to 4 GHz	DC to 8 GHz	DC to 18 GHz	DC to 26.5 GHz
--	----------------	----------------	-----------------	-------------------

#### Input SWR:

HP 11667A:  $\leq 1.15$

HP 11667B:  $\leq 1.22$

#### Equivalent Output SWR: (leveling or ratio measurements)

HP 11667A:  $\leq 1.10$

HP 11667B:  $\leq 1.22$

#### Output Tracking: (between output arms)

HP 11667A:  $\leq 0.15$  dB

HP 11667B:  $\leq 0.20$  dB

#### Typical Phase Tracking: (between output arms)

HP 11667A: 0.5 deg

HP 11667B: 1.5 deg

#### Maximum Input Power: +27 dBm.

#### Connectors:

HP 11667A: N-female on all ports.

HP 11667B: APC-3.5 female on all ports.

#### Dimensions:

HP 11667A: 46 H x 52 W x 19 mm D (1.8 x 2.0 x 0.7 in).

HP 11667B: 40 H x 47 W x 10 mm D (1.6 x 1.9 x 0.4 in).

#### Weight:

HP 11667A: net, 0.14 kg (0.31 lb); shipping, 0.22 kg (0.5 lb)

HP 11667B: net, 0.06 kg (0.13 lb); shipping, 0.14 kg (0.3 lb).

### HP 11636A/B Power Dividers

The HP 11636A/B power dividers/combiners are recommended when making wideband comparison measurements without ratioing, and in fault location measurements with the HP 8757S/85016. Detailed specifications are on page 333.

### Other Signal Separation Devices

Many other signal separation devices are available from HP for use with the HP 8757A, 8756A and 8755C. Coaxial couplers from 0.1 to 18 GHz are available with the HP 770 series, the 790 series, and the HP 11692. Higher directivity HP 752 series waveguide couplers can also be used with the HP 8757A, 8756A or 8755C with the addition of appropriate HP 281 series waveguide-to-coax adapters.

### 11665B Modulator

**Function:** absorptive on-off modulator designed for and powered by the HP 8757A, 8756A or 8755C scalar network analyzers.

Frequency Range	Return Loss On and Off	Insertion Loss On Off
15-40 MHz	$\geq 10$ dB	$\leq 7.0$ dB >35 dB
40 MHz-4 GHz	$\geq 15$ dB	$\leq 3.2$ dB >35 dB
4-8 GHz	$\geq 12$ dB	$\leq 3.8$ dB >40 dB
8-12 GHz	$\geq 8$ dB	$\leq 4.3$ dB >45 dB
12-18 GHz	$\geq 8$ dB	$\leq 5.0$ dB >45 dB

**Modulator drive feedthrough:**  $\leq 8$  mV (peak) at 27.8 kHz at either port when powered by the HP 8757A, 8756A or 8755C. Reduced to  $\leq 1$  mV (peak) using the HP 11668A. (See HP 11668A High Pass Filter).

**Drive current:** nominally +50 mA in On condition, -50 mA Off condition.

**Weight:** net, 0.17 kg (6 oz); shipping, 0.9 kg (2 lb).

### HP 11852B 50 ohm/75 ohm Minimum Loss Pad

The HP 11852B is a low SWR minimum loss pad required between 75 ohm devices and 50 ohm sources and detectors. For more information, see page 241.

# NETWORK ANALYZERS

## Ordering Information

Models 8757/8758

### Ordering Information

The HP 8757S Automatic Scalar Network Analyzer is ordered with multiple line items to give you maximum flexibility in specifying a system that meets your needs. This ordering guide lists the HP 8757S line items required for software compatibility. It is not necessary to order any line item you already own. Consult your local HP Sales Office if you would like assistance.

	Price \$0
<b>HP 87578 Scalar Network Analyzer System</b>	
This system model number ensures coordination of shipments and compatibility of instruments and software.	
<b>Analyzer</b>	
HP 8757A Scalar Network Analyzer	\$11,000
Opt. 001 Fourth detector input	\$1,500
Opt. W30 Two years extended service	\$220
<b>Sweep Oscillators</b> (choose either HP 8350B with an RF Plug-in 8340B or 8341B)	
HP 8350B Sweep Oscillator Mainframe	\$4,800
HP 83522A 0.01-2.4 GHz RF Plug-in	\$8,200
HP 83592A 0.01-20 GHz RF Plug-in	\$20,500
HP 83595A 0.01-26.5 GHz RF Plug-in	\$26,000
Other RF Plug-in (see HP 8350B catalog entry for model and options)	
HP 8341B 0.01-20 GHz Synthesized Sweeper	\$39,500
Opt. 003 -50 dBc harmonics (1.4-20 GHz)	\$1,500
<b>Directional Bridges</b> (choose at least one)	
HP 85027A 0.01-18 GHz, APC-7, 50 ohm	\$2,500
HP 85027B 0.01-26.5 GHz, APC-3.5 female, 50 ohm	\$2,950
HP 85027C 0.01-18 GHz, Type-N female, 50 ohm	\$2,500
HP 85027E 0.01-26.5 GHz, APC-3.5 male, 50 ohm	\$2,950
HP 85020A 0.01-4.3 GHz, Type-N female, 50 ohm	\$1,150
HP 85020B 0.01-2.4 GHz, Type-N female, 75 ohm	\$1,300
<b>Detectors</b> (choose at least one)	
HP11664A 0.01-18 GHz, Type-N male	\$500
Opt. 001 APC-7 connector	add \$50
HP 11664E 0.01-26.5 GHz, APC-3.5 male	\$680
HP 11664D 26.5-40 GHz, WR-28 waveguide	\$1,100
HP 11664C Detector Adapter	\$255
HP 85025A 0.01-18 GHz, Type-N male	\$900
Opt. 001 APC-7 connector	add \$50
HP 85025B 0.01-26.5 GHz, APC-3.5 male	\$950
HP 85026A 26.5-40 GHz, WR-28 waveguide	\$1,500
HP 85026A 33-50 GHz, WR-22 waveguide	\$1,700
HP 85026A 40-60 GHz, WR-19 waveguide	\$1,700
HP 85025C Detector Adapter	\$600
<b>System Verification Kits</b> (choose at least one)	
HP 85028A APC-7 directivity verification standards	\$5,000
HP 85023A APC-7, 50 ohm	\$600
HP 85023B APC-3.5, 50 ohm	\$850
HP 85023C Type-N, 50 ohm	\$500
HP 85023D Type-N, 75 ohm	\$900
<b>Filter Kits</b>	
HP 11668 High Pass Filter Kit	\$555
HP 11678 Low Pass Filter Kit	\$1,380
<b>System Cable Kit</b>	
HP 85022A System Cable Kit	\$355
<b>Computer</b> (choose one)	
HP 9816S Series 200, Model 16S Computer	\$6,045
HP 98257A 1M byte Memory Board	\$1,450
HP 98580A Series 300, Model 310	\$5,750
<b>Disc Drives</b> (one required for HP 9816S)	
HP 9122D 3.5 inch Dual Flexible Disc Drive	\$1,390
<b>Software</b> (choose one option)	
HP 85015B System Software for HP 8757S	\$2,000
Opt. 630 for Computer with HP 9121D/22D Disc Drive	N/C
Opt. 655 for either HP 9826S or 9836S Computer	N/C
HP 85016B Transmission Line Test Software for HP 8757S	\$4,500
Opt. 630: for Computer with HP 9121D/22D Disc Drive	N/C
Opt. 655: for either HP 9826S or 9836S Computer	N/C

### Recommended Accessories

<b>Printer</b> (choose at least one)																																																																																																																																																													
HP 2225A ThinkJet Printer	\$495																																																																																																																																																												
HP 2673A Intelligent Graphics Printer	\$2,240																																																																																																																																																												
HP 2932A Opt 046 Impact Graphics Printer	\$2,645																																																																																																																																																												
<b>Plotter</b> (choose at least one)																																																																																																																																																													
HP 7440A Opt. 002 Eight-pen Graphics Plotter (8.5" x 11")	\$1,295																																																																																																																																																												
HP 7650 Eight-pen Vector Plotter (11" x 17")	\$3,900																																																																																																																																																												
<b>Optional Accessories</b> (for ratio and/or modulation measurements)																																																																																																																																																													
HP 11636A Power Divider DC to 18 GHz	\$450																																																																																																																																																												
HP 11636B Power Divider DC to 26.5 GHz	\$950																																																																																																																																																												
HP 11665B Modulator	\$900																																																																																																																																																												
HP 11667A Power Splitter DC to 18 GHz	\$930																																																																																																																																																												
Opt. 001 N-male on input port; N-female on output ports:	N/C																																																																																																																																																												
Opt. 002 N-female on input port; APC-7 on output ports:	add \$75																																																																																																																																																												
HP 11667B Power Splitter DC to 26.5 GHz	\$950																																																																																																																																																												
HP 11852B 50 to 75 ohm Minimum Loss Pad	\$350																																																																																																																																																												
<b>Service and Support Products</b>																																																																																																																																																													
HP 11613B Calibrator	\$900																																																																																																																																																												
HP 8757S+23N Onsite Installation (where available)																																																																																																																																																													
HP 8757S+02B Onsite Service (where available)																																																																																																																																																													
<b>Compatible HP 8350B Plug-ins</b>																																																																																																																																																													
(HP 86200 series plug-ins require the HP 11869A adapter for use with the HP 8350)																																																																																																																																																													
	<table border="0"> <thead> <tr> <th>HP Model Number</th> <th>Frequency Range (GHz)</th> <th>Power Out (mW)</th> <th>Price</th> </tr> </thead> <tbody> <tr><td>83595A</td><td>0.01-26.5</td><td>2.5</td><td>\$26,000</td></tr> <tr><td>83592A</td><td>0.01-20.0</td><td>10</td><td>20,500</td></tr> <tr><td>83592B</td><td>0.01-20.0</td><td>20</td><td>23,500</td></tr> <tr><td>83592C</td><td>0.01-20.0</td><td>4</td><td>22,000</td></tr> <tr><td>83525A</td><td>0.01-8.4</td><td>20</td><td>12,800</td></tr> <tr><td>83525B</td><td>0.01-8.4</td><td>10</td><td>14,000</td></tr> <tr><td>83522A</td><td>0.01-2.4</td><td>20</td><td>8,200</td></tr> <tr><td>83594A</td><td>2.0-26.5</td><td>2.5</td><td>22,820</td></tr> <tr><td>83590A</td><td>2.0-20.0</td><td>10</td><td>18,500</td></tr> <tr><td>83550A</td><td>8.0-20.0</td><td>60</td><td>16,000</td></tr> <tr><td>83540A</td><td>2.0-8.4</td><td>40</td><td>9,900</td></tr> <tr><td>83540B</td><td>2.0-8.4</td><td>20</td><td>10,500</td></tr> <tr><td>83545A</td><td>5.9-12.4</td><td>50</td><td>9,900</td></tr> <tr><td>83570A</td><td>18.0-26.5</td><td>10</td><td>12,500</td></tr> <tr><td>83572A<sup>2</sup></td><td>26.5-40.0</td><td>2</td><td>15,000</td></tr> <tr><td>83572B<sup>2</sup></td><td>26.5-40.0</td><td>5</td><td>18,000</td></tr> <tr><td>83554A<sup>1</sup></td><td>26.5-40.0</td><td>5</td><td>9,000</td></tr> <tr><td>83555A<sup>1</sup></td><td>33.0-50.0</td><td>3.2</td><td>9,000</td></tr> <tr><td>83556A<sup>1</sup></td><td>40.0-60.0</td><td>2</td><td>9,000</td></tr> <tr><td>86222A</td><td>0.01-2.4</td><td>20</td><td>6,000</td></tr> <tr><td>86222B</td><td>0.01-2.4</td><td>20</td><td>7,000</td></tr> <tr><td>86235A</td><td>1.7-4.3</td><td>40</td><td>5,400</td></tr> <tr><td>86290B</td><td>2.0-18.6</td><td>10</td><td>15,600</td></tr> <tr><td>86290C</td><td>2.0-18.6</td><td>20</td><td>20,000</td></tr> <tr><td>86240A</td><td>2.0-8.4</td><td>40</td><td>6,600</td></tr> <tr><td>86240B</td><td>2.0-8.4</td><td>20</td><td>7,800</td></tr> <tr><td>86240C</td><td>3.6-8.6</td><td>40</td><td>7,600</td></tr> <tr><td>86241A<sup>1</sup></td><td>3.2-6.5</td><td>3.2</td><td>4,700</td></tr> <tr><td>86245A</td><td>5.9-12.4</td><td>50</td><td>8,100</td></tr> <tr><td>86242D</td><td>5.9-9.0</td><td>10</td><td>5,600</td></tr> <tr><td>86250D</td><td>8.0-12.4</td><td>10</td><td>5,500</td></tr> <tr><td>86251A</td><td>7.5-18.6</td><td>10</td><td>11,000</td></tr> <tr><td>86260B<sup>1</sup></td><td>10.0-18.6</td><td>10</td><td>6,700</td></tr> <tr><td>86260A<sup>1</sup></td><td>12.4-18.0</td><td>10</td><td>6,500</td></tr> <tr><td>86260C<sup>1</sup></td><td>17.0-22.0</td><td>10</td><td>9,500</td></tr> <tr><td>8620C sweep oscillator mainframe</td><td></td><td></td><td>4,000</td></tr> <tr><td>8350B sweep oscillator mainframe</td><td></td><td></td><td>4,800</td></tr> <tr><td>11869A adapter for HP 86200 plug-in</td><td></td><td></td><td>500</td></tr> </tbody> </table>	HP Model Number	Frequency Range (GHz)	Power Out (mW)	Price	83595A	0.01-26.5	2.5	\$26,000	83592A	0.01-20.0	10	20,500	83592B	0.01-20.0	20	23,500	83592C	0.01-20.0	4	22,000	83525A	0.01-8.4	20	12,800	83525B	0.01-8.4	10	14,000	83522A	0.01-2.4	20	8,200	83594A	2.0-26.5	2.5	22,820	83590A	2.0-20.0	10	18,500	83550A	8.0-20.0	60	16,000	83540A	2.0-8.4	40	9,900	83540B	2.0-8.4	20	10,500	83545A	5.9-12.4	50	9,900	83570A	18.0-26.5	10	12,500	83572A <sup>2</sup>	26.5-40.0	2	15,000	83572B <sup>2</sup>	26.5-40.0	5	18,000	83554A <sup>1</sup>	26.5-40.0	5	9,000	83555A <sup>1</sup>	33.0-50.0	3.2	9,000	83556A <sup>1</sup>	40.0-60.0	2	9,000	86222A	0.01-2.4	20	6,000	86222B	0.01-2.4	20	7,000	86235A	1.7-4.3	40	5,400	86290B	2.0-18.6	10	15,600	86290C	2.0-18.6	20	20,000	86240A	2.0-8.4	40	6,600	86240B	2.0-8.4	20	7,800	86240C	3.6-8.6	40	7,600	86241A <sup>1</sup>	3.2-6.5	3.2	4,700	86245A	5.9-12.4	50	8,100	86242D	5.9-9.0	10	5,600	86250D	8.0-12.4	10	5,500	86251A	7.5-18.6	10	11,000	86260B <sup>1</sup>	10.0-18.6	10	6,700	86260A <sup>1</sup>	12.4-18.0	10	6,500	86260C <sup>1</sup>	17.0-22.0	10	9,500	8620C sweep oscillator mainframe			4,000	8350B sweep oscillator mainframe			4,800	11869A adapter for HP 86200 plug-in			500
HP Model Number	Frequency Range (GHz)	Power Out (mW)	Price																																																																																																																																																										
83595A	0.01-26.5	2.5	\$26,000																																																																																																																																																										
83592A	0.01-20.0	10	20,500																																																																																																																																																										
83592B	0.01-20.0	20	23,500																																																																																																																																																										
83592C	0.01-20.0	4	22,000																																																																																																																																																										
83525A	0.01-8.4	20	12,800																																																																																																																																																										
83525B	0.01-8.4	10	14,000																																																																																																																																																										
83522A	0.01-2.4	20	8,200																																																																																																																																																										
83594A	2.0-26.5	2.5	22,820																																																																																																																																																										
83590A	2.0-20.0	10	18,500																																																																																																																																																										
83550A	8.0-20.0	60	16,000																																																																																																																																																										
83540A	2.0-8.4	40	9,900																																																																																																																																																										
83540B	2.0-8.4	20	10,500																																																																																																																																																										
83545A	5.9-12.4	50	9,900																																																																																																																																																										
83570A	18.0-26.5	10	12,500																																																																																																																																																										
83572A <sup>2</sup>	26.5-40.0	2	15,000																																																																																																																																																										
83572B <sup>2</sup>	26.5-40.0	5	18,000																																																																																																																																																										
83554A <sup>1</sup>	26.5-40.0	5	9,000																																																																																																																																																										
83555A <sup>1</sup>	33.0-50.0	3.2	9,000																																																																																																																																																										
83556A <sup>1</sup>	40.0-60.0	2	9,000																																																																																																																																																										
86222A	0.01-2.4	20	6,000																																																																																																																																																										
86222B	0.01-2.4	20	7,000																																																																																																																																																										
86235A	1.7-4.3	40	5,400																																																																																																																																																										
86290B	2.0-18.6	10	15,600																																																																																																																																																										
86290C	2.0-18.6	20	20,000																																																																																																																																																										
86240A	2.0-8.4	40	6,600																																																																																																																																																										
86240B	2.0-8.4	20	7,800																																																																																																																																																										
86240C	3.6-8.6	40	7,600																																																																																																																																																										
86241A <sup>1</sup>	3.2-6.5	3.2	4,700																																																																																																																																																										
86245A	5.9-12.4	50	8,100																																																																																																																																																										
86242D	5.9-9.0	10	5,600																																																																																																																																																										
86250D	8.0-12.4	10	5,500																																																																																																																																																										
86251A	7.5-18.6	10	11,000																																																																																																																																																										
86260B <sup>1</sup>	10.0-18.6	10	6,700																																																																																																																																																										
86260A <sup>1</sup>	12.4-18.0	10	6,500																																																																																																																																																										
86260C <sup>1</sup>	17.0-22.0	10	9,500																																																																																																																																																										
8620C sweep oscillator mainframe			4,000																																																																																																																																																										
8350B sweep oscillator mainframe			4,800																																																																																																																																																										
11869A adapter for HP 86200 plug-in			500																																																																																																																																																										

<sup>1</sup>Requires HP 11665B modulator.

<sup>2</sup>Requires Option 006 for internal 27.8 kHz modulator.

<sup>3</sup>Source module, requires a 11-20 GHz swept source



# NETWORK ANALYZERS

## Scalar Network Analyzer, 10 MHz to 60 GHz

Model 8756A/S

223

- High (40 dB) directivity bridges
- "Autoscale" for fast measurements
- Full HP-IB programmability

- Fully annotated digital display
- Nine "Save/Recall" registers
- Direct digital plot capability

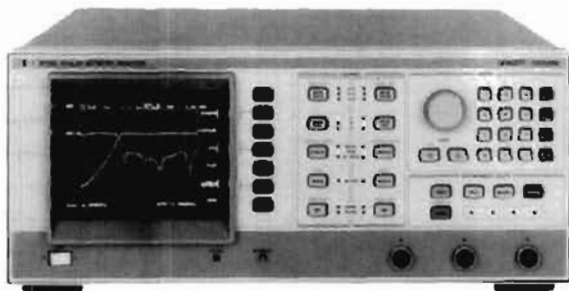

HP 8756A



### Description

Measure insertion loss and gain, return loss, and absolute power quickly and accurately with the HP 8756A scalar network analyzer. These scalar measurements can be performed over a broad 10 MHz to 60 GHz frequency range. The HP 11664 diode detectors and AC modulation make accurate, reliable, and drift-free measurements. High-directivity directional bridges covering RF and microwave frequencies produce excellent reflection measurements. The HP 85020 and 85027 bridges, HP 11664 detectors and other scalar accessories are described on pages 218 through 219.

### Easy-to-Use

The HP 8756A features two independent display channels with separate controls. Complete measurements can be performed using only five control keys for each channel.

Make even faster measurements with one key—the "Autoscale" key. Press it and the built-in microprocessor chooses the optimum scale and reference level to display your measurement. Use the convenient display cursor to read out magnitude and frequency at each data point.

### For Automatic or Manual Systems

When used with the HP 8350B sweep oscillator or HP 8341B/8340B synthesized sweepers, the HP 8756A acts as a system controller by managing the other instruments through the "8756 System Interface." Using the system interface, the HP 8756A extracts frequency information from the sweeper and uses it to annotate the digital display.

When used alone, the HP 8756A can save and recall up to nine front-panel states. With the HP 8350B or 8340B/41B, it saves and recalls not only its own front-panel state, but the sweeper's as well.

Another benefit of the HP 8756A/8350B combination is "Alternate Sweep"; the ability to sweep two different frequency ranges or power levels and display them simultaneously.

System control also extends to an HP-IB digital plotter. The HP 8756A can directly plot the CRT's image onto a plotter such as the HP 7475A or 7440A. Crisp, permanent, annotated plots can be created just by selecting the PLOT soft key. Adjustable horizontal resolution (101, 201 or 401 points) is available as Option H20.

### Programmability Features

Since all of the controls of the HP 8756A are completely programmable, computer-controlled automatic systems can make full use of the HP 8756A and its built-in features. Order the HP 8756S automatic scalar network analyzer system and choose the configuration of source, analyzer, computer, and peripherals for your needs. Add the HP 85015B system software for custom testing and storage of data and measurement configurations. The HP 85016B transmission line test software adds accurate fault location to the capabilities of the HP 85015B system software.

### Specifications

**Function:** The HP 8756A processes and displays the demodulated 27.8 kHz signals from the HP 11664 detectors and the HP 85020 or 85027 bridges.

**Dynamic range:** +10 dBm to -50 dBm in all three inputs (A, B, and R).

**Dynamic accuracy:** dynamic accuracy of a single channel measurement using HP 11664A/D/E Detector. Measurement taken over +10 to -50 dBm at 25°C and at 50 MHz.

±(0.1 dB + 0.01 dB/dB) from +10 to -40 dBm.

±(0.2 dB + 0.02 dB/dB) from -40 to -50 dBm.

**Scale resolution:** 0.1, 0.2, 0.5, 1, 2, 5, 10, or 20 dB per division. Independently controlled for each measurement channel.

**Reference offset:** offset level adjustable in 0.01 dB increments from -70.00 to +20.00 dBm (absolute) or -90.00 to +90.00 dB (ratio).

### Resolution

Vertical: 0.006 dB for display.

0.01 dB for "Display Cursor."

Horizontal: 401 points.

**Adjustable horizontal resolution** (101, 201 or 401 points) is available as Option H20.

**Sweep time:** minimum sweep time ≥ 150 ms (50 ms with Opt. H20).

**Averaging:** 2, 4, 8, 16, 32, 64, 128, or 256 traces may be averaged. Independent control of each display channel.

**Normalization:** traces are stored and normalized to 0.006 dB resolution, independent of scale/division or offset. The horizontal resolution is 401 points.

**Transfer formats:** data may be transferred as either ASCII strings (nominally 6 characters per reading) or as 16 bit integers. Readings may be taken at a single point or as an entire 401 point measurement trace.

### Transfer Speed

ASCII format, trace: 800 ms typical.

ASCII format, point: 10 ms typical.

Binary format, trace: 35 ms typical.

Binary format, point: 5 ms typical.

**Description:** the HP 8756A System Interface is an HP-IB port used exclusively by the HP 8756A to control and extract information from a sweep oscillator and a digital plotter.

**Sweep oscillators:** HP 8350B with RF plug-in, HP 8340B/8341B synthesized sweep oscillators.

**Plotters:** HP 7440A Opt. 002, HP 7475A Opt. 002, HP 7550A Opt. 002, HP 9872C.

**Power requirements:** 48 to 62 Hz, 115/230V ±10%, typically 100 watts.

**Dimensions:** 178 H x 425.5 W x 451 mm D (7.0 x 16.75 x 17.75 in.).

**Weight:** Net, 15 kg (33 lb). Shipping, 20 kg (44 lb).

### Ordering Information

HP 8756A scalar network analyzer

Option W30 two-years extended service

### Price

\$8,500

\$170

# NETWORK ANALYZERS

## Scalar Network Analyzer Software for the HP 8757S/8756S

Models 85015B, 85016B, 86399-10001

- Custom tests without programming
- Friendly menu operation
- Measure insertion and return loss

- Plot or store data
- Test coax and waveguide
- Locate faults in transmission lines

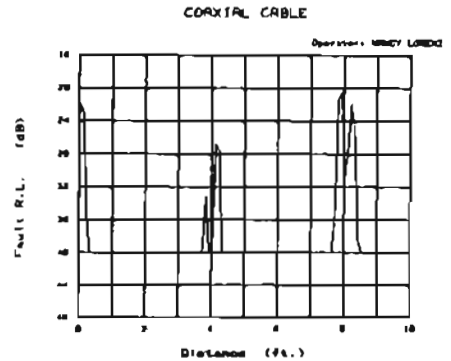

### HP 85015B System Software

Using the HP 85015B system software for the HP 8757S/8756S, you can create and run complete scalar measurements without programming. The software guides you all the way from setup to output. Just make your selections using the computer's knob and softkeys. The software makes all the necessary settings on the scalar analyzer and source to provide fast, accurate measurements that can be stored for later reference.

### Easy To Learn

Use the BASIC mode to get up to speed quickly on the software's operation. It prompts you with a few simple questions, then sets up your source and analyzer automatically. The software prompts you to make all the connections necessary for calibration and measurement sequences, then automatically plots the data on the CRT display. For a permanent record, send the plot to a graphics plotter with a single keystroke.

### Use The Analyzer CRT

With the HP 8757, use the scalar analyzer as the control center for your measurements. The analyzer knob and softkeys control the software menus which appear on the CRT of the HP 8757A, instead of the computer's.

### Customized Measurement Setups

Use the GENERAL and ADVANCED modes to access more of the software's powerful features. Define up to 4 measurements in one sequence. Specify particular power levels for your test device and enter your specification limits as point, line, or sloped limits. These limit lines allow simple pass/fail testing, or real time adjustment to within the spec limits.

Then output the data using your own customized format with labels, limit lines and "out-of spec" indicators. Make up to 4 plots on a single page. Store the data on computer disc for archival purposes, then recall it later for further analysis.

The software makes it easy to save your configuration, complete with all the parameters you've specified and the calibration data. When you want to run this test later, just recall the configuration and connect the device. The software recalls cal data, plot formats, labels, limit lines . . . everything you need to run complete automated tests.

### Test Transmission Lines

The HP 85016B transmission line test software provides all the capability of the HP 85015B plus fault location for complete testing of coax and waveguide transmission lines. Test frequency response (insertion and return loss), then find faults (mismatches) that affect the signals in your frequency range. Troubleshoot your ECM, radar or communication system quickly and without guesswork.

Fault location is accomplished using frequency domain reflectometry, a technique that uses frequency domain reflection data and the inverse Fast Fourier Transform to characterize reflection as a function of distance. This enables you to locate impedance mismatches resulting from bad connections or faulty cables.

### MISMATCH SUMMARY

Cable or Waveguide Type: Coax  
Relative Velocity: .695  
Loss/100 ft: 50  
Length (Range): 10 ft  
Center Frequency: 5 GHz  
Distance Resolution: 1 ft  
Current Window is: Normal

### Measurement 1:

Operator: NANCY LORENZ

COAXIAL CABLE			
Distance (ft)	F.L. R.L. A (dB)	F.L. R.L. B (dB)	% OF TOTAL MISMATCH
.020	21.91		36.347
4.120	26.84		20.607
7.920	20.44		43.046

### Ordering Information

Each software package comes with 5 discs, including a data disc. Order the option that corresponds to your computer configuration. The HP 85015B/16B can run on BASIC 2.0 or greater and requires 1½ Mbytes of RAM memory.

### HP 85015B system software

Opt. 630: 3.5 inch discs

Opt. 655: 5.25 inch discs

### HP 85016B transmission line test software

Opt. 630: 3.5 inch discs

Opt. 655: 5.25 inch discs

Price  
\$2000  
N/C  
N/C  
\$4500  
N/C  
N/C

### Amplifier Test Software

#### Tailored for Amplifier Testing

The Amplifier Test Software (HP Part No. 86399-10001) allows rapid and systematic characterization of amplifier gain compression. Specifically, the software automates measurements of amplifier output power at the 1-dB compression point at frequencies of interest. The software runs with the HP 8757A and 8756A, and the HP 8350B sweep oscillator of HP 8340B/41B synthesized sweepers. Besides compression testing, the software also allows measurements of gain and return loss/SWR.

#### Easy to Operate and Modify

The Amplifier Test Software's menu-driven, friendly user interface is designed so that measurements can be configured and run soon after the system is set up. Its limited feature set allows for a short program, which can be easily modified by the user to suit his needs. The documentation provided with the software includes a complete program listing, flow diagram, and variable dictionary.

#### Ordering Information

Each software package comes with the software on both 3-1/2" and 5-1/4" formats, and Product Note 8757-6, which documents operation of the software. The Amplifier Test Software can run on BASIC 2.0 or higher on HP 9000 series 200 or 300 computers with at least 1 Mbyte of RAM memory.

HP 86399-10001 Amplifier Test Software

\$250

# NETWORK ANALYZERS

## Transmission Line Test System

Model HP 8328A

225

- High resolution - 0.25%
- Fast computation
- Three user levels

- Automatic data correction
- Completely self-contained
- Pass/fail and limit testing



HP 8328A

The HP 8328A Transmission Line Test System tests the performance of waveguide runs and coaxial cables with swept frequency measurements of insertion loss and return loss. Additionally, the HP 8328A system can make fault location tests to find impedance mismatches as a function of distance, quickly and without guesswork.

The HP 8328A is a dedicated transmission line test system for tests from 10 MHz to 18 GHz. It is configured in a rugged, transportable container. The system is self-contained for ease of use and is ideal for accessing transmission lines in difficult-to-reach installations such as aircraft. Although all testing can be done automatically, full manual capability is retained.

The HP 8328A contains the HP 8757A Scalar Network Analyzer, the HP 8350B Sweep Oscillator with the HP 83592A RF Plug-In for coverage from 10 MHz to 18 GHz, the powerful HP 9000 Model 310 computer, the HP 85016B Transmission Line Test Software, and scalar analyzer accessories. The software is accessed from the front panel softkeys and knob of the HP 8757A. Complete measurements including pass/fail and limit testing can be configured and run easily like the HP 85016B software.

It is recommended that the HP 8328A Option 100, an HP 35731A monitor, an HP 46021A keyboard, and an HP 9122D dual disc drive be included for system diagnostics and disc backup for long-term data storage and retrieval.

### Swept Distance Capability

**Measurements vs. distance:** Return loss (dB), SWR, or reflection coefficient.

**Resolution** (distance between data points as a percentage of the transmission line length):

1% (101 pts), 0.5% (201 pts), 0.25% (401 pts).

**Data correction:** Data is normalized to the response with a 50 ohm load at the test port. Data is also completely corrected for line losses and preceding mismatches. If waveguide is tested, the effects of phase dispersion are automatically removed from the response. The correction data for the coaxial cable or waveguide run is contained in a lookup table with over 100 entries stored in the program. This table can be modified to improve entries or updated with new cables.

**Range and resolution (vs. frequency):** The standard RF plug-in for the system is an HP 83592A, with a span from 10 MHz to 18 GHz. This span allows a minimum test range of 2 ft. and a resolution of 0.01 ft. (for 201 distance points and 0.5% resolution). Maximum test range is 500 ft. with a resolution of 2.5 ft.

### Swept Frequency Capability

**Measurements vs. frequency:** Insertion loss, gain, return loss, VSWR, reflection coefficient, and power in dBm, dBW, or mW.

**Frequency range:** 10 MHz to 18 GHz with HP 83592A plug-in; Option 001, 10 MHz to 8.4 GHz with HP 83525B plug-in

**Resolution:** User selectable up to 1024 pts. for swept measurements, or stepped CW measurements.

**Dynamic range (HP 11864A detectors and HP 8757A):** 76 dB (+16 to -60 dBm)

### General

**User modes:** BASIC, GENERAL, and ADVANCED. These user levels vary the level of sophistication to match the experience level of the user and the requirements of the measurement.

### Measurement and data storage:

**Configurations per data volume (typical):** 99

**Measurements per configuration:** 4

**Measurement data sets per data volume:** 99

Additional storage can be obtained with the HP 8328A option 100 and the recommended optional equipment.

### Ordering Information

HP 8328A Transmission Line Test System

Opt 001: 10 MHz to 8.4 GHz only

Opt 100: Adds support software

### Price

\$64,000

less \$7,000

add \$250

# NETWORK ANALYZERS

## Combined Network/Spectrum Analysis, 10Hz to 500MHz

### Model 4195A

- Linear and non-linear device measurement and analysis
- High accuracy and resolution
- User functions
- Color graphics, graphics analysis and direct copy capability
- Direct save/recall with internal disc drive



HP 4195A



#### Description

The HP 4195A is a high performance, cost effective and intelligent analyzer with combined vector network and spectrum analysis capabilities. The frequency is covered from 10Hz through 500MHz with an excellent 0.001Hz resolution for audio, baseband, HF, VHF and IF applications. It directly measures amplitude ratio, phase, group delay and spectrum level needed for characterizing linear/non-linear analog circuits or components used in communications, telecommunications, consumer electronics and other equipment.

The HP 4195A's excellent accuracy and resolution meets the severe measurement requirements for developing advanced equipment.

A color display allows you to readily differentiate between multiple traces. Convenient softkey operation and marker functions make deriving device parameters quick and easy. Measurement results can be directly copied to printer or plotter without an external computer. Furthermore, the HP 4195A has internal user functions for computing and self controlling capability. User Program, User Defined Function and User Math allows you to quickly customize the setups most suited to your application without using an external computer. A built-in 3.5 inch disc drive can save the instrument state, data and user functions.

## Combined Vector Network and Spectrum Analysis

Network analyzers and spectrum analyzers have become essential tools for evaluating subsystems or components used in electronic equipment. Especially, the importance of phase and group delay measurements is rapidly increasing. The HP 4195A offers full network and spectrum analysis from 10Hz to 500MHz at half the price. It has very wide applications. Network analysis functions include characterizing the gain/group delay ripple of filters and amplifiers. Spectrum analysis functions include the harmonic, intermodulation distortion of amplifiers or IF subsystems in communications and telecommunications. S-parameters can also be measured by using 2 transmission/reflection test sets, without changing direction of the device.

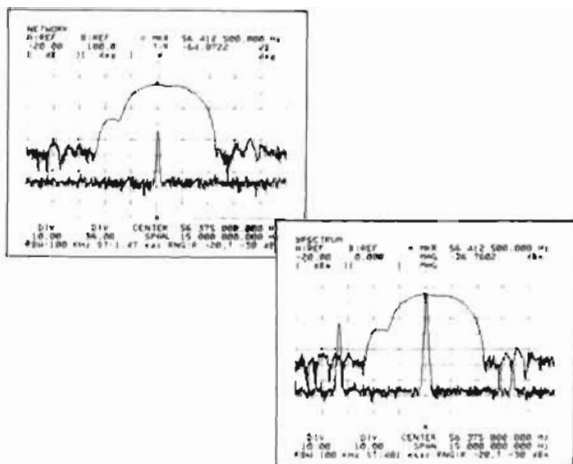

## High Accuracy and Resolution Measurement

The HP 4195A measures amplitude ratio and phase with an accuracy of  $\pm 0.05\text{dB}/\pm 0.3\text{ deg}$  and a resolution of  $0.001\text{dB}/0.01\text{ deg}$ . The amplitude and phase distortion of transmission devices, such as filters, amplifiers, delay lines and cables, affect the quality of information and create bit errors in PSK or QAM systems. The HP 4195A can evaluate distortion with high accuracy and resolution. For accuracy enhancement, 1 Port Full Cal, 1 Port Partial Cal, Normalization and Port Extension capabilities are available. For spectrum analysis, high level accuracy of  $\pm 0.1\text{dB}$  and fully synthesized local OSC allow you to obtain stable and reliable C/N, harmonic distortion or intermodulation distortion measurements. In addition the high shaped digital IF filter technique makes discrimination of closely spaced signals easy, so 50/60 Hz power-line sidebands can be measured using the 10Hz RBW.

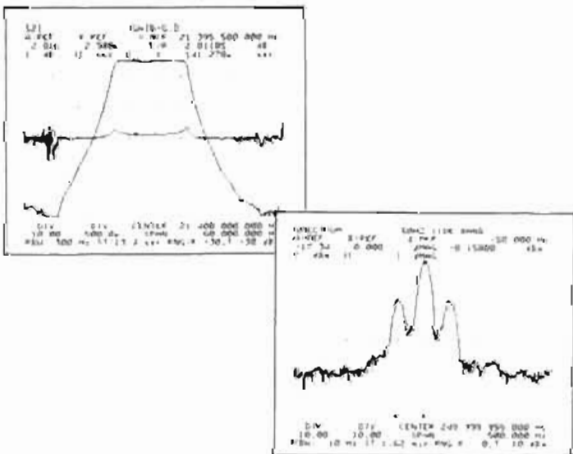

## User Functions for Easy Customized Operation

The HP 4195A has three user functions for customizing operations for your applications without using an external computer. The User Program gives you a one key solution for performing your application. You can program a sequence from measurement and marker control, computing, through printing a hard copying. This function is very useful and improves efficiency for C/N (Carrier Noise ratio), THD (Total Harmonic Distortion) measurements or automatic device parameter extraction, such as an amplifier's gain, group delay, gain compression or harmonic distortion. The User Math function helps you put the result in the form you need by using the built-in math operators and arithmetic functions. For example, you can display level in volt peak-to-peak instead of volts rms or perform differentiation of gain or max hold. The User Defined Function gives you the power to define functions which can be called with softkeys as you like, such as input of step size, signal tracking, transmission/reflection alternate sweep or gain/level spectrum alternate sweep. In addition, the HP 4195A has the Program Sweep function which can arbitrarily sweep the points programmed in the table. This increases measurement efficiency by reducing excessive points in the Lin or Log sweep. Also, the resolution bandwidth can be independently set for each programmed point. The above user functions and program sweep table can be saved into the built-in 3.5 inch disc, so you can start your application at any time.

```
SPECTRUM C/N-MEASUREMENT
PROGRAM EDITOR
FILE NAME: CNI

1: C/N-MEASUREMENT
20 DELT 1
30 INACT 1
40 MARK
50 DMW=1 MW=PI*0
60 FOR RPT TO 10
70 SWTNG
80 R1=DMW/4
90 R2=R1/4
100 DISP C/N:DBLV:R2
110 NEXT R2
120 CRT C/N-MEASUREMENT
130 END
```

User Program for C/N Measurement

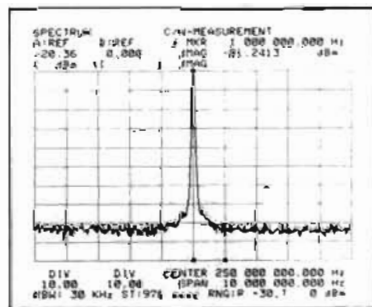

Result of C/N Measurement

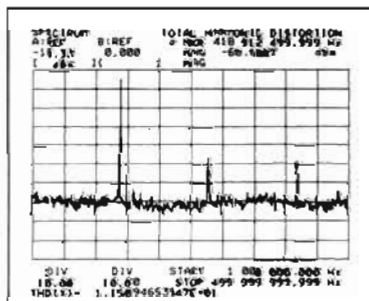

THD Measurement by Using User Define Function

# NETWORK ANALYZERS

## Combined Network/Spectrum Analysis, 10Hz to 500MHz (cont'd)

### Model 4195A

#### Advanced Marker Action on Color Graphics

The application oriented marker functions are very useful for both network and spectrum measurements. You can quickly obtain the desired results from the easy to see color graphics CRT. The Next Peak is convenient for searching harmonic or spurious signals. The marker target is used for extraction of SAW filter's 3dB bandwidth or an amplifier's -1 dB gain compression point. The delta marker is used for C/N measurement, and the noise marker is used for noise measurements. A maximum of four traces can be simultaneously displayed on the CRT, so it is easy to compare the data. The smith/polar chart is convenient for impedance matching in circuit design. In addition, the results can be directly copied to a compatible plotter or printer without an external computer.

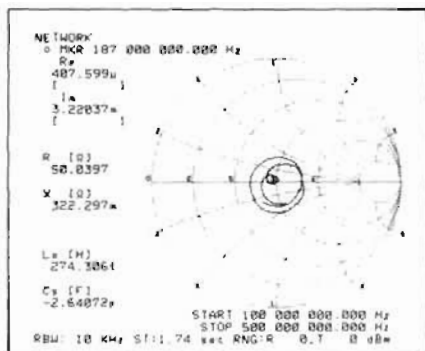

#### 41951A Impedance Test Kit

The HP 4195A and HP 41951A Impedance Test Kit, which is designed to use with the 4195A, can be used to perform impedance analysis from 100kHz to 500MHz. The direct reading of impedance parameters, error compensation, variable test signal/dc bias level, and dedicated analysis functions are all convenient for evaluation of components, such as crystal/SAW resonators, coils, and varicap diodes. The equivalent circuit function is very useful for modeling and evaluating components under actual operating conditions to improve the quality and reliability of circuit design.



HP 4195A with HP 41951A

#### Specifications

##### Network Measurement

###### Source

**Frequency:** 10Hz to 500MHz, 1mHz resolution  
**Power:** -50 dBm to +15 dBm, 0.1dB resolution  
**Sweep Parameters:** Frequency, power and dc bias level  
**Sweep Types:** Linear, log, cw, program and partial  
**Output:** 2 outputs  
**DC bias level:**  $\pm 40V$ , 10mV resolution

###### Receiver

**Frequency:** 10Hz to 500MHz  
**Input:** 4 inputs, 50  $\Omega$  nominal  
**Resolution Bandwidth:** 3Hz to 300kHz, 1 or 3 step  
**Input Crosstalk:**  $\leq -100dB$

###### Magnitude Ratio

**Dynamic Range:** > 100dB  
**Resolution:** 0.001dB  
**Dynamic Accuracy ( $23 \pm 5^\circ C$ , -30dBm R input):**  $\pm 0.05dB$  @ -70dBm to -30dBm T input.

###### Phase

**Range:**  $\pm 180^\circ$   
**Resolution:** 0.01°  
**Dynamic Accuracy ( $23 \pm 5^\circ C$ , -30dBm Input):**  $\pm 0.3^\circ$  @ -70 to -30dBm T input.

###### Delay

**Range:** 10ps to 500s  
**Resolution:** 10ps @ 3.6 MHz aperture  
**Accuracy:** depends on phase accuracy

###### Error Compensation

**Mode:** Normalization, 1 port partial cal, 1 port full cal and port extension.

##### Spectrum Measurement

###### Frequency

**Measurement Range:** 10Hz to 500MHz  
**Resolution:**

**RBW:** 3Hz to 300kHz, 1 or 3 step  
**Selectivity (80/3dB):** 4 for 3Hz to 30Hz  
 8.5 for 100Hz

###### Amplitude

**Measurement Range:** -135 dBm to +20 dBm  
**Accuracy:**  $\pm 1.0dB$  @ 50MHz

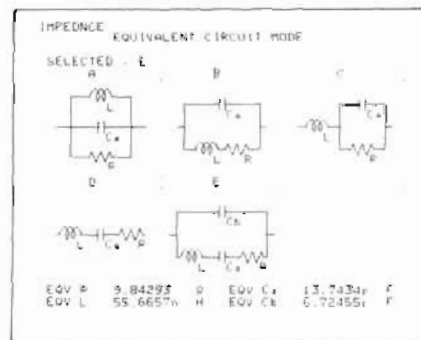

**Linearity** ( $23 \pm 5^\circ\text{C}$ ):  $\pm 0.1\text{dB}$  @  $-40$  to  $0\text{dB}$ ;  $\pm 0.2\text{dB}$  @  $-60$  to  $-40\text{dB}$

**Frequency Response:**  $\pm 1.5\text{dB}$

**Dynamic Range** ( $23 \pm 5^\circ\text{C}$ )

**Second Harmonic Distortion:**  $\leq -70\text{dBc}$  @  $\geq 2\text{MHz}$

**T.O.I Distortion:**  $\leq -80\text{dBc}$  @  $\geq 2\text{MHz}$

**Residual Response:**  $-110\text{dB}$  @  $\geq 100\text{kHz}$ .

**Average Noise Level:** typically  $-140\text{dBm}$  @  $10\text{Hz RBW}$ ,  $\geq 2\text{MHz}$

#### Sweep

**Sweep Type:** Linear, log, cw, program and partial

**Sweep Mode:** Continuous, single and manual

**Sweep Time:** approximately  $500\text{ms}/\text{span}$  to  $1800\text{s}/\text{span}$

#### Input

**Number of Inputs:** 4 inputs

**Impedance:**  $50\ \Omega$  nominal

**Damage level:**  $+30\text{dBm}$

**Attenuator:** 0 to  $50\text{dB}$ ,  $10\text{dB}$  step

#### Display and Analysis

**Display:** 7.5 inch color CRT

**Display Format:** Rectangulars, Table, Smith and Polar

**Traces:** 4 traces max

**Scale Type:** Linear, log

**Autoscale**

**Phase Display Expansion:** Display phase continuously more than  $\pm 180\text{deg}$ .

**Video Filter:** Digital video filtering reduces random noise

**Comment Entry:** Display a comment used alphabet, numeral and special characters (. . %, etc).

**Marker:** MKR  $\rightarrow$  Max (Min, Ref, Center, Start and Stop), Next Peak, Width and Delta reading mode.

#### User Functions

##### User Math:

Puts the result in the form needed for your application by using built-in math operators, arithmetic functions and editing capability.

##### User Defined Function:

Provides one-key solution for a specific application without an external computer. 6 user functions can be created and soft-keys can be labeled as you like.

##### User Program (Auto Sequence Program):

Allows to program the control or measurement, analysis, copy and other sequence without an external computer.

#### Hardcopy:

Hardcopy of traces, measurement data, results of analysis and annotations are produced by the 4195A and HP plotters or printers with LISTEN only capability.

**Dump Mode:** Copy the CRT display to a graphics printer

**Plot Mode:** Copy the traces, graticule and annotations to an HP-GL compatible digital plotter

**Print Mode:** Copy measurement data in tabular form to a printer

#### Storage

Instrument state, trace data, table of Program Sweep and User Program can be independently saved or recalled from the built-in 3.5 inch floppy disk memory via SAVE/GET function.

Instrument state includes active control setting of measurement, active calibration data, active display format, active scale setting, User Math and User Define Function.

#### Remote programming

HP-IB interface operates according to IEEE 488-1987 and IEC 625 standards and IEEE 628-1982 recommended practices

**Interface Function:** SH1, AH1, T5, TE0, L4, LE0, SR1, RLI, PP0, DCI, DT1, C0, E1

**Transfer Formats:** ASCII

32/64 bit IEEE 754 floating point format



#### HP 41951A Impedance Test Kit

The HP 41951A can be used for impedance measurements from  $100\text{kHz}$  to  $500\text{MHz}$  when used with the HP 4195A.

**Measured Parameters:**  $|Z|$ ,  $|Y|$ ,  $\theta$ , L, C, R, X, G, B, D, and Q

**Error Compensation:** 1 port cal, open/short offset and port extension

**Equivalent Circuit Analysis:** Circuit constants approximation and simulation of frequency characteristics

**Available Accessories:** Refer to page 277.

#### General Characteristics:

##### Operating Conditions:

**Temperature:**  $0^\circ\text{C}$  to  $+45^\circ\text{C}$

**Humidity:** 95% RH at  $40^\circ\text{C}$

##### Non-Operating Conditions:

**Temperature:**  $-40^\circ\text{C}$  to  $+70^\circ\text{C}$

**Safety:** Based on IEC-348, UL-1244

**Power:** 100, 120,  $220\text{V} \pm 10\%$ ,  $240\text{V} -10\% +5\%$ , 48Hz to 60Hz, 500VA (max)

**Dimensions:** 425 (W) x 375 (H) x 620 (D) mm

**Weight:** Approximately 41 kg

#### Accessories Available

HP 85044A/B Transmission/Reflection Test Set

Refer to page 242.

#### Ordering Information

4195A Network/Spectrum Analyzer

**Opt 001:** High Stability Frequency Reference Improve the stability of frequency for evaluation high Q devices such as crystal filter, oscillator or resonator.

Frequency Accuracy:  $\pm 1\text{ppm}$  ( $23^\circ\text{C} \pm 5^\circ\text{C}$ )

Frequency Stability:  $\pm 1 \times 10^{-8}$  ( $23^\circ\text{C} \pm 5^\circ\text{C}$ )

**Opt 007:** Front Handle Kit

**Opt 008:** Rack Flange Kit

**Opt 009:** Rack and Handle Kit

41951A Impedance Test Kit

#### Price

\$2300

\$850

\$130

\$72.50

\$185

\$1500

# NETWORK ANALYZERS

## Audio/Video/Baseband/IF Network Analyzer, 5 Hz to 200 MHz

### Model 3577A

- High speed/high accuracy measurements
- .001 dB, .005 degree, 1 ps, .001 Hz resolution
- Built-in three-term error correction plus normalization
- Magnitude, phase, polar, real, imaginary, and group delay display modes
- Convenience features including direct plotter control and vector math functions

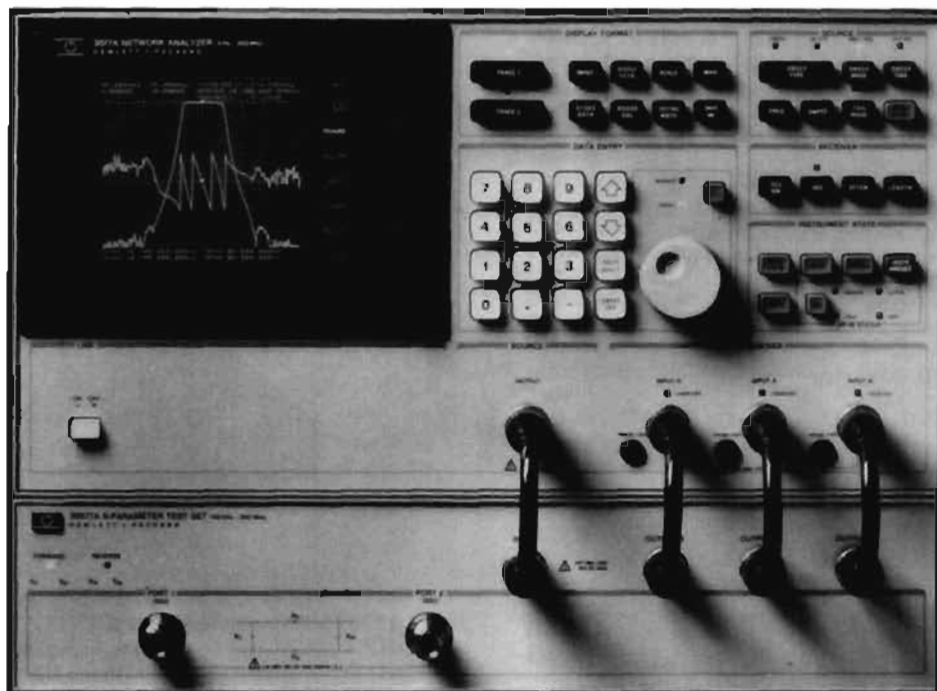

HP 3577A



### HP 3577A Network Analyzer

HP Model 3577A is a high performance network analyzer for audio, video, baseband and IF applications from 5Hz to 200MHz. The 3577A makes precision measurements to characterize filters, amplifiers, crystal devices, cables, and subsystems used in communications, telecommunications, consumer electronics, components and general purpose testing.

Convenient soft-key selection of measurement functions allows you to quickly measure transfer functions, magnitude/phase, insertion loss/gain, attenuation, electrical length and gain compression. In addition, measurement of phase distortion parameters such as group delay and deviation from linear phase can be made with high resolution. With the HP 3577A's flexible receiver input impedances, you can measure in either 50- $\Omega$  or high impedance (1 M $\Omega$ ) environments. Use the HP 35677A/B S-Parameter Test Sets or the HP 35676A/B Reflection/Transmission Test Kits with the HP 3577A to make reflection measurements such as return loss, reflection coefficient and impedance in 50- $\Omega$  or 75- $\Omega$  systems, while simultaneously displaying transmission parameters.

With the addition of an HP 9000 Series 200 or 300 Computer and appropriate system software, the HP 3577A becomes the hub of a powerful network measurement solution, the HP 3577S Network Analyzer System. A full description of the HP 3577S is on page 234.

### Unprecedented Measurement Precision

Precision measurements can be made to characterize both wideband and narrowband devices with high accuracy and resolution. Dynamic magnitude and phase accuracy is 0.02 dB and 0.2 deg, respectively. Device responses can be examined in fine detail with 0.001 dB, 0.005 deg, and 1 ps resolution. A built-in synthesized LO and tracking generator assure superb frequency accuracy with 0.001 Hz resolution. Dynamic range is 100 dB and the noise floor is -130 dBm for the most demanding measurements.

### Versatility and Convenience

User-defined Vector Math functions operate on measured data, constants and functions to present measurement results in the form you need. Multiple Display Formats with electronic graticules provide accurate display in rectangular, polar or Smith chart coordinates. Frequency Sweep (Logarithmic, Linear or Alternate) and Amplitude Sweep capabilities meet measurement needs in a wide range of applications. Accessories such as S-Parameter Test Sets, Power Splitters, Minimum Loss Pad, Cables, Calibration Kits, Transistor Fixtures, Adapters, and Current and Voltage Probes ensure a complete solution to your measurement needs.

The built-in autoscale functions put the measurement on the screen quickly with a full scale display. Digital Display Markers with Marker  $\rightarrow$  Min or Max and Marker Offset capabilities provide accurate, high resolution readout of data points on a fully annotated dual trace display. Direct Digital Plot (using an HP graphics plotter without a computer) of displayed traces, graticule, annotation and marker data provides quick, cost-effective hard copy of measurement results. Non-volatile Save/Recall Memory of five front panel instrument states is convenient for making rapid and repeatable measurements.

Similarly, trace data can be stored in magnitude and phase format in any one of four data registers. Since data is stored with full accuracy and resolution, it can be rescaled as needed.

### Measurement Display Modes

Magnitude, phase, polar, real, imaginary, and delay modes are directly accessible from the soft key display menu. Input data, stored data and user-defined constants can then be combined using built-in vector math functions (+, -, \*, /) to create arbitrary measurement display modes. As an example, a feedback amplifier can be mathematically analyzed by measuring its open loop gain, storing the data, and then adjusting a complex variable which represents the amount of feedback in the closed-loop gain equation.



### High-Performance Group Delay Measurements

The HP 3577A measures group delay directly by dividing the measured phase changes across a selected frequency aperture by the aperture value. The frequency aperture can be set from 0.5% to 16% of span with annotation directly in Hertz, thus allowing the user to change span and still retain the same effective smoothing.

Sophisticated measurements of both magnitude and phase distortion in communication systems can be made.

Cables and transmission lines can be tested for maximally flat delay with a resolution of up to 1 psec.

### Vector Noise Averaging

Noise reduction in the HP 3577A is accomplished by Vector Noise Averaging and/or selectable Resolution Bandwidth filters. With the proper use of these two noise reduction methods, greater than 130 dB dynamic range can typically be achieved.

### Built-in Error Correction

Three-term Vector Error Correction in the HP 3577A is used to remove the effects of directivity, frequency response, and source mismatch from one-port measurements. Similarly, vector normalization enhances the accuracy of two-port measurements at the push of a button. These powerful accuracy enhancement routines can be used to cancel the repeatable error introduced by cable and test fixtures. Moreover, the HP 3577A can be easily upgraded to an HP 3577S Network Analyzer System with full twelve-term Vector Error Correction, as the need for uncompromising measurement accuracy arises.

### HP-IB Programmability

The HP 3577A is fully programmable over the Hewlett-Packard Interface Bus. Simple programming codes minimize the time it takes to develop control software for automatic measurements. Quickly access a single point or an entire 401-point trace in either fast binary or ASCII modes. Customize the built-in vector display via the HP-IB to draw test limit lines, operator instructions or connection diagrams.

### HP 3577A Network Analyzer

#### Abbreviated Specifications

##### Source

##### Frequency

Range: 5 Hz to 200 MHz

Resolution: 0.001 Hz

Stability:  $\pm 5 \times 10^{-4}$ /day, 0 to 55°C

##### Amplitude

Range: +15 dBm to -49 dBm (1.26 V<sub>rms</sub> to 793  $\mu$  V<sub>rms</sub>; 2 dBV to -62 dBV) into a 50  $\Omega$  load

Resolution: 0.1 dB

Accuracy:  $\pm 1$  dB at +15 dBm and 100 kHz. Below +15 dBm, add the greater of  $\pm 0.02$  dB/dB or 0.2 dB

Flatness: 1.5 dBp-p from 5 Hz to 200 MHz

Impedance: 50  $\Omega$ ; > 20 dB return loss at all levels

RF Output Connector: 50  $\Omega$  Type N female

Sweep Types: Linear, alternate, cw and log frequency; log amplitude

Sweep Time: 100 ms/span to 200 ms/span for frequency sweep; 1 ms/step to 16 s/step for amplitude sweep.

Sweep Modes: Continuous, single, manual

Trigger Modes: Free run, immediate, line, external

##### Input Characteristics

Frequency Range: 5 Hz to 200 MHz

Inputs: Three receiver inputs (A, B and R)

Input Impedance: Selectable 50  $\Omega$  with > 25 dB return loss, or 1 M $\Omega$  in parallel with approximately 30 pF

Input Connectors: 50  $\Omega$  Type N female

Full Scale Input Level: -13 dBV from 10 kHz to 200 MHz with internal 20 dB attenuators ON (0 dBm at 50  $\Omega$ )

Resolution Bandwidth: Selectable 1 kHz, 100 Hz, 10 Hz, or 1 Hz

Sensitivity (Due to noise and internal crosstalk between source and receiver inputs):

Resolution Bandwidth	30 kHz - 200 MHz (50 $\Omega$ )	
	30 kHz - 20 MHz (1 M $\Omega$ )	
	Internal 20 dB Attenuator ON	Internal 20 dB Attenuator OFF
1 Hz	-110 dBm	-130 dBm
10 Hz	-110 dBm	-130 dBm
100 Hz	-105 dBm	-125 dBm
1 kHz	-95 dBm	-115 dBm

Crosstalk: > 100 dB isolation between inputs.

Electrical Length/Reference Plane Extension: Provides equivalent electrical line length, or delay at inputs A, B and R. Range: -3 x 10<sup>6</sup> m to +3 x 10<sup>6</sup> m or +1 s to -1 s

Resolution: 5 digits or 0.1 cm (3.3 ps) whichever is greater

Accuracy:  $\pm 0.1$  cm or  $\pm 0.02\%$  whichever is greater.

### Magnitude Characteristics

Range: Full Scale Input to Sensitivity

#### Resolution

Marker: 0.001 dB (log); 5 digits (linear)

Display: 0.01 dB/div to 20 dB/div (log absolute); 0.01 dB/div to 200 dB/div (log ratio); 0.1 nV/div to 10 V/div (linear absolute); 10<sup>-10</sup>/div to 10<sup>20</sup>/div (linear ratio)

Display Units: dB, dBm, dBV, V, and linear ratio.

Accuracy (at 100 kHz, 25°C, and Full Scale Input)

Absolute (A, B, R):  $\pm 0.2$  dB

Ratio (A/R, B/R, A/B):  $\pm 0.15$  dB (50  $\Omega$ );  $\pm 0.2$  dB (1 M $\Omega$ ).

Dynamic Accuracy:

Error		Input Level Relative to Full Scale Input
Resolution Bandwidth		
1 kHz, 100 Hz, 10 Hz	1 Hz	
$\pm 0.04$ dB	$\pm 0.04$ dB	0 dB to -10 dB
$\pm 0.02$ dB	$\pm 0.02$ dB	-10 dB to -50 dB
$\pm 0.05$ dB	$\pm 0.05$ dB	-50 dB to -60 dB
$\pm 0.15$ dB	$\pm 0.25$ dB	-60 dB to -80 dB
$\pm 0.75$ dB	$\pm 0.75$ dB	-80 dB to -90 dB
$\pm 0.75$ dB	$\pm 3.00$ dB	-90 dB to -100 dB

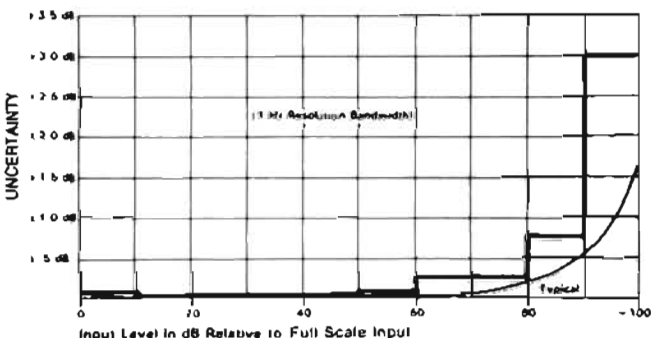
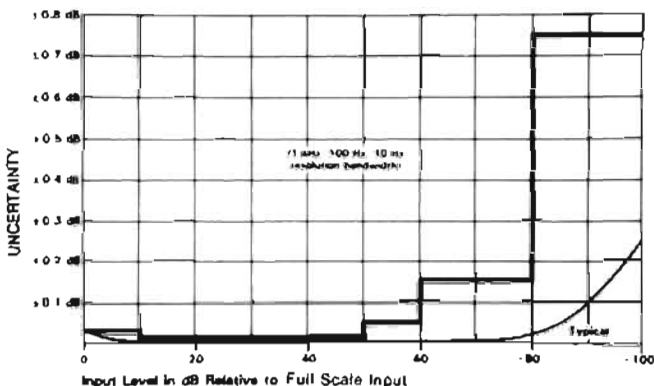

# NETWORK ANALYZERS

## Audio/Video/Baseband/IF Network Analyzer, 5 Hz to 200 MHz (cont'd)

Models 3577A, 35677A/B, 35676A/B

### Frequency Response (when driven from a 50 $\Omega$ source and with 50 $\Omega$ receiver input impedance)

**Absolute (A,B,R):** 0.3 dBpp from 20 Hz to 20 MHz; 0.6 dBpp from 5 Hz to 200 MHz

**Ratio (A/R, B/R, A/B):** 0.3 dBpp from 20 Hz to 20 MHz; 0.4 dB from 5 Hz to 200 MHz

### Reference Level

**Range:** -207 dBm to +33 dBm (-220 dBV to +20 dBV) (Log absolute); -400 dB to +400 dB (log ratio); 0 V to 10 V (linear absolute); 0 to 10<sup>20</sup> (linear ratio)

**Resolution:** 0.001 dB (log); 5 digits (linear)

### Stability

**Temperature:** Typically  $\leq \pm 0.02$  dB/ $^{\circ}$ C

**Time:** Typically  $\leq \pm 0.05$  dB/hour at 25 $^{\circ}$ C

### Phase Characteristics (A/R, B/R, A/B)

**Range**  $\pm 180$  deg.

#### Resolution

**Marker:** 0.005 deg (0.001 rad)

**Display:** 0.01 deg/div to 200 deg/div (0.00018 rad/div to 3.49 rad/div)

**Accuracy** (at 100 kHz, 25 $^{\circ}$ C, and Full Scale Input):  $\pm 2.0^{\circ}$

### Dynamic Accuracy:

Error	Input Level Relative to Full Scale Input
$\pm 4$ deg	0 dB to -10 dB
$\pm 2$ deg	-10 dB to -50 dB
$\pm 5$ deg	-50 dB to -60 dB
$\pm 1.5$ deg	-60 dB to -80 dB
$\pm 7.5$ deg	-80 dB to -100 dB

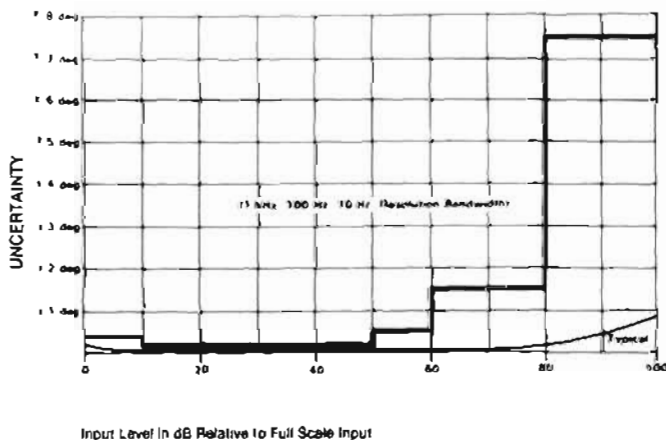

**Reference Level Resolution:** 0.01 deg.

**Temperature Stability:** Typically  $\leq \pm 0.05$  deg/ $^{\circ}$ C.

**Time Stability:** Typically  $\leq \pm 0.05$  deg/hr at 25 $^{\circ}$ C

### Delay Characteristics

**Range:** 1 ps to 20,000s

**Resolution:** .01ns/div to 1000s/div

**Normalized Accuracy:**  $\frac{\text{Dynamic Phase Accuracy}}{360 \times \text{Aperture [Hz]}} + 2\text{nS}$

**Aperture Range:** 0.5% to 16% of frequency span.

**Reference Level:**  $\pm 10^5$

### General Display Characteristics

#### Traces

**No. Traces:** Two simultaneous traces may be present with a rectangular graticule. One trace with polar or Smith graticules.

**Markers:** Each trace has one main marker and an offset marker. Markers indicate data at corresponding trace coordinates in the same units as used to set the Reference Level. Markers can be used to modify certain display parameters. Marker resolution is the same as horizontal display resolution.

#### Graticules

**Rectangular Graticule:** 0% to 100% full scale deflection in 0.05% increments. Logarithmic and Linear.

**Polar/Smith Chart Graticule:**  $\pm 500$  deg in 0.001 deg increments.

#### Noise Averaging

**Type:** Exponentially weighted vector averaging on successive sweep data.

**Averaging Factor:** Selectable 1 (off), 4, 8, 16, 32, 64, 128, 256.

**Linear Phase Slope Compensation:** Provides linear phase slope offset of -72,000 deg/span to +72,000 deg/span.

#### Calibration

**Transmission:** Both traces can be normalized to measured data with full accuracy and resolution.

**Reflection:** Corrects for directivity, frequency response and source match errors.

### Programming Characteristics

**Capability:** Remote programming via the Hewlett-Packard Interface Bus (HP-IB). The HP 35677A/B S-Parameter Test Sets are programmable through the HP 3577A interface only.

**Interface Functions:** SH1, AH1, TS, TE0, L4, LE0, SR1, RL1, PPI, DC1, DT1, C0, E1. For more on these codes refer to the HP-IB section of this catalog.

**Output Data Transfer Time:** 401 data points (single parameter) can be transferred directly to an HP 200 series computer in Basic language as follows:

**ASCII mode:** Typically 1500 ms.

**Binary-floating point mode:** Typically 160 ms.

**Graphics Capabilities:** 12 lines of text with 40 alphanumeric characters per line, and high resolution line vectors can be displayed through HP-IB commands.

### General Characteristics

#### External Reference Frequency Input

**Frequency:** 10 MHz/N, N is an integer from 1 to 100.

**Level:** 0 dBm  $\pm 10$  dB, nominal.

**Impedance:** 50 $\Omega$ , nominal.

**Connector:** BNC female, rear panel.

#### Reference Frequency Output

**Frequency:** 10 MHz.

**Level:** Typically 0 dBm.

**Impedance:** 50 $\Omega$ , nominal.

**Connector:** BNC female, rear panel.

**External Trigger:** Triggers on negative TTL transition or contact closure to ground.

**Connector:** BNC female, rear panel.

**Plotter Control:** Directly compatible with HP-IB graphics plotters that use Hewlett-Packard Graphics Language (HP-GL) with listen only capability: HP 7470A, HP 7475A, HP 7550A, HP 7090A.

**Save/Recall:** Front-panel setups can be stored in non-volatile memory locations 1 through 5. Last state is saved when power is removed.

### Operating Conditions

**Temperature:** 0 $^{\circ}$ C to +55 $^{\circ}$ C.

**Relative Humidity:**  $< 95\%$  at 40 $^{\circ}$ C.

**Altitude:**  $< 4,572\text{m}$  (15,000 ft).

### Non-Operating Conditions

**Temperature:** -40 $^{\circ}$ C to +75 $^{\circ}$ C.

**Altitude:**  $< 15,240\text{m}$  (50,000 ft).

**Power:** 115V  $\pm 10\%$ ,  $-25\%$  (47 Hz to 440 Hz), or 230 V  $\pm 10\%$ ,  $-15\%$  (47 Hz to 66Hz), 450 VA maximum.

**Weight:** 31 kg (67 lb) net; 41 kg (90 lb) shipping.

**Dimensions:** 222 mm H x 426 mm W x 578 mm D (8.75 in. x 16.75 in. x 22.75 in.).

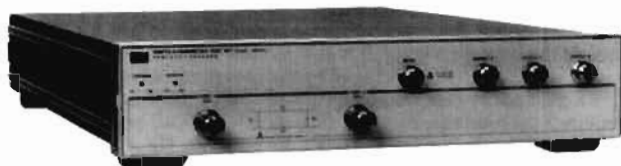

HP 35677A

### HP 35677A/B S-Parameter Test Sets

While test setups can be constructed from discrete RF components such as power dividers, directional bridges, cables, pads, etc., it is much easier to use a fully integrated test set such as the HP Model 35677A/B.

The test set contains the hardware required to make transmission and reflection measurements in both the forward and reverse directions. The only setup required is to connect the device under test to the two measurement ports: the HP 3577A Network Analyzer controls the switching functions, so that even reverse measurements can be made without changing device connections. The HP 35677A is used for 50Ω systems and the HP 35677B is used for 75Ω systems.

### HP 35677A/B S-Parameter Test Set Specifications

**Frequency Range:** 100 kHz to 200 MHz.

**Test Port Impedance**

HP 35677A: 50Ω.

HP 35677B: 75Ω.

**Directivity:** > 40 dB.

**Frequency Response**

**Transmission ( $S_{21}$ ,  $S_{12}$ ):**  $\pm 1$  dB,  $\pm 5$  degrees.

**Reflection ( $S_{11}$ ,  $S_{22}$ ):**  $\pm 1$  dB,  $\pm 5$  degrees.

**Port Match**

**Test Ports 1, 2:** HP 35677A, > 26 dB; HP 35677B, > 24 dB.

**Test Ports 1, 2 Open/Short Ratio:** HP 35677A,  $< \pm 0.75$  dB magnitude and  $< \pm 5$  degrees phase; HP 35677B,  $< \pm 1$  dB magnitude and  $< \pm 7.5$  degrees phase.

**Input Port:** > 20 dB return loss.

**Output Ports A, B, and R:** > 26 dB return loss.

**Test Port Isolation:** > 100 dB.

**Insertion Loss**

**RF Input to Test port 1 or 2:** HP 35677A, typically 13 dB; HP 35677B, typically 19 dB.

**RF Input to Output Ports A, B, or R:** HP 35677A, typically 19 dB; HP 35677B, typically 31 dB.

**Test Port Reciprocity**

**Transmission ( $S_{21}$ ,  $S_{22}$ ):** Typically  $< \pm 0.5$  dB magnitude and  $< \pm 5$  degrees phase.

**Reflection ( $S_{11}$ ,  $S_{22}$ ):** Typically  $< \pm 0.5$  dB magnitude and  $< \pm 5$  degrees phase.

**Incident Power Ratio (Test Port 1 to Test Port 2):** Typically  $< \pm 1.5$  dB.

**RF Input Maximum Operating Level:** +25 dBm or  $\pm 30$  Vdc.

**RF Input Damage Level:**  $\pm 27$  dBm or  $\pm 30$  Vdc.

**Port 1 or 2 Damage Level:** +27 dBm or  $\pm 30$  Vdc.

**Connectors**

**Input Port and Output Ports A, B, and R:** 50Ω Type N female.

**Test Ports 1 and 2:** HP 35677A, 50Ω Type N female; HP 35677B, 75Ω Type N female.

**DC Bias Inputs:** BNC female, rear panel.

**DC Bias Range:** Typically  $\pm 30$  Vdc and  $\pm 20$  mA with some degradation of RF specifications; 200 mA damage level.

**Accessories Supplied**

4 ea. 190 mm (7.5 in.) 50Ω cables with Type N male connectors for connection to HP 3577A (HP Part No. 8120-4387).

1 ea. Test Set interconnect cable to HP 3577A (HP Part No. 35677-61620).

1 ea. Rear Panel Lock Foot Kit (HP Part No. 5061-0099)

1 ea. Service Manual (HP Part No. 35677-90010).

**General Characteristics**

**Power:** All power is obtained through the HP 35677A interconnect cable.

**Weight:** 6 kg (13 lb) net; 122 kg (25 lb) shipping.

**Dimensions:** 90mm H x 425mm W x 584mm D (3.5 in. x 16.75 in. x 22.75 in.). Add 1/8 inch to depth to include front panel connectors.



HP 35676A

### HP 35676A/B Reflection/Transmission Test Kits

Low frequency and broadband measurements with the HP 3577A are greatly simplified with the HP 35676A/B Reflection/Transmission Test Kits. Operating in conjunction with internal calibration routines in the HP 3577A, the test kits provide all the measurement capabilities required for reflection, transmission, and impedance measurements throughout the entire 5 Hz to 200 MHz frequency range. Separate versions are available for 50Ω (HP 35676A) or 75Ω (HP 35676B) environments. Each HP 35676A/B Reflection/Transmission Test Kit contains a precision resistive divider, 50Ω (HP 35676A) or 75Ω (HP 35676B) reference load, coaxial short, carrying case, and all cables and hardware necessary for basic measurements with the HP 3577A Network Analyzer.

### HP 35676A/B Operating Characteristics\*

**Freq. Range:** 5 Hz to 200 MHz

**Test Port Impedance:** 50  $\pm$  2% typical (HP 35676A)

75  $\pm$  2% typical (HP 35676B)

**Insertion Loss (Source Input to Test Output):** 10  $\pm$  1 dB typical

**Equivalent Directivity:** 40 dB typical.

**Equivalent Source Match:** 30 dB typical (HP 35676A)

25 dB typical (HP 35676B).

\*Typical, assuming proper calibration with accessories supplied.

# NETWORK ANALYZERS

## Audio/Video/Baseband/IF Network Analyzer, 5 Hz to 200 MHz (cont'd)

Model 3577S, 35675A



### HP 3577S Network Analyzer System

The HP 3577S Network Analyzer System combines the HP 3577A Network Analyzer, HP 9000 Series 200 or 300 Computer, HP 35677A/B S-Parameter Test Set, HP 35678A/B Calibration Kit, and HP 35675A Accuracy Enhancement Software to form a powerful automated network measurement solution. Using HP-IB programming, HP 3577S can be integrated with other Hewlett-Packard instruments to solve difficult measurement problems.

### HP 35675A Accuracy Enhancement Software

At the heart of the system, HP 35675A Accuracy Enhancement Software expands the measurement capabilities of the HP 3577A Network Analyzer. First, it adds full two-port, twelve-term error correction capability. Second, it adds conversion from s-parameters to h, y, or z parameters. Finally, it adds convenient transfer of instrument, calibration, and measurement data between the HP 3577A and HP 9000 Series 200 or 300 computers.

### Two-port, Twelve-term Error Correction

Repeatable errors due to the effects of cables and connectors are removed from reflection and transmission measurements by a 2-port, 12-term error correction algorithm. Fast, 8-term partial error correction is also available for measuring transmission parameters of well-matched devices. Accurate measurements can be made inside environmental chambers and at remote or custom test fixtures. The entire test setup is characterized by measuring its response to open-circuit, short-circuit, thru, and reference terminations furnished with the HP 35678A/B Calibration Kit, from which the error coefficients are calculated.

### Parameter Conversion

Error-corrected s-parameters can be converted to hybrid (h), admittance (y), or impedance (z) parameters, allowing device or network behavior to be expressed in the most appropriate form. For example, semiconductor h-parameters can be derived from s-parameter measurements and outputted directly to an HP printer, plotter, computer monitor, or HP 3577A display; all with only a few keystrokes.

### Computer Disc Storage of Entire Test Setups

Entire test setups can be labeled and stored in computer disc memory for later use, allowing complicated measurements to be repeated simply by recalling previously stored instrument setup and calibration data. Actual measured data can be transferred to disc memory for storage, processing, or further mathematical analysis.

### Friendly Operator Interface

The software guides the operator through easy-to-understand menus, automatically "remembering" every keystroke in an auto-sequence buffer. When a complicated measurement sequence has been completed, simply give it a name and store it in computer disk memory for later use. Because the most recent instrument state is also remembered, the operator needs only to redefine those variables of interest for each measurement, and on the entire setup. This feature is especially helpful when linking a series of frequency sweeps together to increase resolution.

The entire HP 3577S Network Analyzer System can be controlled from the computer keyboard, eliminating the need for an in-depth understanding of the HP 3577A. A mastery of computer programming is not necessary either.

### Program Modifications

Although program modification is not required, Hewlett-Packard encourages the experienced operator to tailor the HP 35675A Accuracy Enhancement Software to their specific application. An entire section of the operating manual is devoted to a detailed description of every subroutine and function used by the program; including format, purpose, pass parameter, common variables, error messages, and other required subroutines. Another section describes all program variables and labels. A custom subroutine written in HP Basic can be "installed" in system software and accessed from the menu with a single keystroke.

### HP 3577S Network Analyzer System Characteristics

**Frequency Range:** 100 kHz to 200 MHz

**System Impedance:** 50Ω (with HP 35677A)

75Ω (with HP 35677B)

**Error Correction:** One and two port 8- or 12-term

**Typical Performance:** (401 point, 12 term mode):

**Calibration:** 2 minutes including time to connect devices

**Measurement plus corrections:** 30 seconds

### HP 9000 Series 200 Computers

HP 35675A Accuracy Enhancement Software and HP 3577S will run on any properly configured Series 200 Computer, including HP 9816A, 9826A, 9836A, 9836C, and 9920A. One Mbyte RAM is recommended, and up to 1.3 Mbytes may be required when an SRM and additional Basic extensions are used. The HP 35675A software will run on Series 200 Basic versions 2.0, 3.0, and 4.0. Basic 4.0 is included with all Series 200 Computers. Please consult the HP 3577A/S Configuration Guide (# 5953-5184) for more information.

### HP 9000 Series 300 Computers

HP 35675A Accuracy Enhancement Software and HP 3577S will run on any properly configured Series 300 Modular Computer System. A properly configured system includes one each: System Processor Unit (SPU), video board, video monitor, keyboard, mass storage device, and Basic 4.0 operating system. Either specify option 008 (Display Compatibility Interface), or create a system from individual components. Please consult the HP 9000 Series 300 Hardware Technical Data Guide (# 5953-9572) and Pricing Information Guide (# 5953-9573) to ensure proper coordination of systems and components.

### HP Printers and Plotters

Permanent documentation of test results can be obtained from a number of different HP graphics printers and plotters including HP ThinkJet 2225A, 7470A, 7475A, and 7550A.

### Ordering Information

	Price
HP 3577S Network Analyzer System	\$0
Specify this system reference number to ensure coordination of shipments and guarantee compatibility of instruments and software.	
A complete HP 3577S Network Analyzer System includes HP 3577A, HP 35675A, HP 35677A/B, HP 35678A/B, and a properly configured HP 9000 Series 200 or 300 Computer. It is not necessary to order components already owned.	
HP 3577A Network Analyzer	\$24,500
Option 907: Front Handle Kit	+ \$77
Option 908: Rack Mount Kit	+ \$41
Option 909: Rack Mount and Front Handle Kit	+ \$102
Option 910: Extra Operating and Service Manuals	+ \$245
Option W30: Extended Warranty	\$530
03577-84401: Service Accessory Kit for HP 3577A	\$470
HP 35675A Accuracy Enhancement Software	\$1,550
Option 042: software on 5.25" disks	\$0
Option 044: software on 3.5" disks	\$0
HP 35676A 50Ω Reflection/Transmission Test Kit	\$1,300
Option W30: Extended Warranty	\$120
HP 35676B 75Ω Reflection/Transmission Test Kit	\$1,550
HP 35677A 50Ω S-Parameter Test Set	\$3,900
HP 35677B 75Ω S-Parameter Test Set	\$3,900
Option 907: Front Handle Kit	+ \$50
Option 908: Rack Mount Kit	+ \$26
Option 909: Rack Mount and Front Handle Kit	+ \$61
Option 910: Extra Operating and Service Manuals	+ \$46
HP 35678A 50Ω Type N Calibration Kit	\$750
HP 35678B 75Ω Type N Calibration Kit	\$1,450
HP 35679A 50Ω Type N Port Extension Cables	\$500
HP 35679B 75Ω Type N Port Extension Cables	\$1,700

# NETWORK ANALYZERS

Gain/Phase Meter 1 Hz to 13 MHz

Model 3575A

235

- Magnitude, Phase
- Broadband Measurements
- Gain/Loss, Transfer Functions

HP 3575A



## Description

The HP 3575A Gain-Phase Meter is a versatile two-channel analyzer which can measure the absolute amplitude level, amplitude ratio or phase of its input signals. The HP 3575A is easy to use because it is a broadband device and no tuning is required. A wide range of signal waveforms can be measured, including sine, square and triangular, thus adding versatility to its measuring capability.

## Applications

The HP 3575A can be used to make both magnitude and phase measurements of gain/loss, transfer functions, impedance, and other signal ratios. It is useful, for example, to measure the response of feedback amplifiers and control systems for determining stability margins or creating Bode plots. Its broadband capability allows easy measurement of mixers and doublers where the input and output frequencies are different. The HP 3575A also can be used to measure absolute signal levels at either of its two inputs.

## Specifications

### Inputs

**Frequency:** 1 Hz to 13 MHz  
**Level:** 200  $\mu$ V rms to 20 V rms.  
**No. Channels:** 2  
**Impedance:** 1 M $\Omega$  30 pF.  
**Protection:**  $\pm$ 40 V dc, 20 V rms.

### Outputs

**Analog**  
**Phase:** 10 mV/degree.  
**Amplitude:** 10 mV/dB or dBV.  
**Output impedance:** 1 k $\Omega$

## Amplitude Accuracy\*

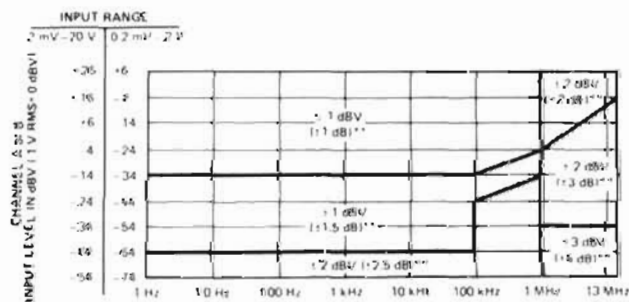

FREQUENCY

\* Conditions: Temperature: 25°C  $\pm$  10°C; accuracy applies to dBV and ratio measurements with the same frequency on both channels; for ratio measurements, the lowest level channel determines accuracy; analog output accuracy (rear panel).

\*\* Ratio (B/A) tolerances

**Amplitude functions:** A dBV, B dBV or B/A dB.

**Range:** A dBV, B dBV: -74 dBV to +26 dBV (in two ranges). B/A dB: -100 to +100 dB.

**Resolution:** 0.1 dB.

## Amplitude and Phase

Amplitude measurements can be made with an 80dB dynamic range over a 100dB measurement range and 0.1dB resolution. Stable phase measurements can be made in the presence of noise with excellent accuracy. Errors of less than two degrees are possible with a signal-to-noise ratio of 30dB. Additional noise rejection can be obtained by selection of three internal filters. Even harmonic and in-phase odd harmonic signal components do not cause phase errors.

## Readout

A three-digit display may be selected to read amplitude level/ratio or phase of the input signals. An analog output signal is available to drive a recorder such as the HP 7090A. An optional dual three-digit readout and analog output is available for simultaneous amplitude and phase measurements.

## Phase Accuracy\*

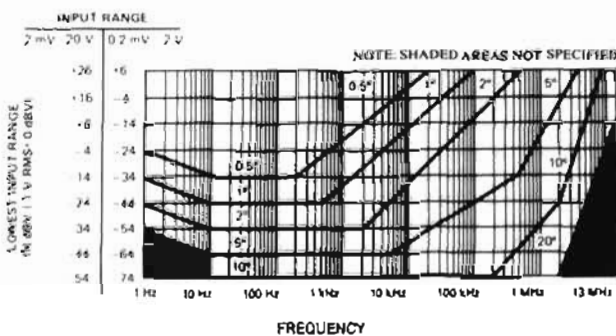

FREQUENCY

\* Conditions: Temperature: 25°C  $\pm$  10°C; Frequency range switch on lowest applicable range; Analog Output accuracy (rear panel).

**Range:**  $\pm$ 180° with 12° of overrange.

**Resolution:** 0.1°.

## General

**Power:** 115 V/230 V  $\pm$  10%, 48 Hz to 440 Hz, 40 VA.

**Weight:** net, 8.3 kg (18.4 lb). Shipping, 11.3 kg (25.8 lb).

**Size:** 88 H x 425 W x 337 mm D (3.47" x 16.75" x 13.25").

## Options

Options	Price
001: Dual Readouts/Dual Outputs	\$650
*002: BCD Programming (Negative true)	\$1100
*003: BCD Programming (Positive true)	\$1100
908: Rack Flange Kit	\$36
910: Extra Manual	\$51
W30: Extended Warranty	\$220
*Note: Includes option 001	
HP 3575A Gain/Phase Meter	\$5,700

# NETWORK ANALYZERS

## RF Network Analyzer, 4 MHz to 1300 MHz Model 8754A

- Integrated source, receiver, and display
- Lock to external source
- Three inputs, two measurement channels
- 80 dB dynamic range



HP 8754A

### Description

The HP 8754A is a complete stimulus/response test system which combines a 4-1300 MHz swept source, three-input narrowband, tuned receiver, and both rectilinear and polar displays in a compact package. The convenient built-in source incorporates digital display of the start or center frequency, the ability to sweep all or any portion of the 4-1300 MHz range, and crystal markers at 1, 10, or 50 MHz intervals to enable accurate frequency calibration and measurement. The receiver provides 80 dB dynamic range in two independent measurement channels to allow simultaneous measurement of any two transmission or reflection parameters using a single test setup. Measurements of absolute power, magnitude ratio, phase angle, and reflection coefficient (or return loss) are displayed on the fully calibrated CRT with resolutions up to 0.25 dB and 2.5 degrees per major division. With these features the HP 8754A offers a high level of operating convenience and technical performance to swept magnitude and phase measurements in laboratory, production, and field testing applications at an economical price.

A comprehensive line of 50-ohm and 75-ohm test sets allow you to tailor your test setup for a specific measurement using the minimum of equipment, or to provide the maximum in versatility for a wide range of applications. Signal separation devices include the HP 11850 Power Splitter for precision transmission measurements, and the HP 85044 Transmission/Reflection Test Set for simultaneous transmission and reflection measurements. Matched cable sets, precision adapters, and transistor fixtures provide convenient, reliable connections to the test device. Adding the HP 8750A Storage Normalizer provides flicker-free rectilinear displays regardless of sweep rate. The HP 8750A will automatically store and subtract out the frequency response of a test set or cable if necessary, eliminating the need to use a grease pencil when making normalized measurements. For applications that require exceptional frequency accuracy and stability, the HP 8754A may be used with external sources such as the HP 8660, 8662A, 8663A, 8556B, or 8642A/B Signal Generators.

### HP 8754A Network Analyzer Specifications

**Frequency range:** 4 to 1300 MHz.

**Spectral Purity** (+10 dBm RF output level)

**Residual FM** (swept and CW):  $\leq 7$  kHz rms (10 kHz bandwidth).

**Harmonics:**  $-28$  dBc.

**Output power range:** 0 to +13 dBm typical,  $\pm 0.5$  dB flatness.

**Input channel:** two test inputs (A and B) and one reference (R) input.

**Input connectors:** type-N Female, 50 ohms nominal impedance.

**Input port match:**  $\geq 20$  dB Return Loss (1.22 SWR).

**Maximum input level:** 0 dBm at R, A, B inputs.

**Damage level:** +20 dBm (50 Vdc).

**Noise level:**  $< -80$  dBm at A and B inputs.

**Minimum R input level:**  $-40$  dBm ( $\geq -40$  dBm required to operate R input phase-lock).

**Crosstalk between channels:**  $> 83$  dB.

**Magnitude frequency response** (flatness)

Absolute (A,B):  $\leq \pm 1$  dB.

Ratio (A/R, B/R):  $\leq +0.3$  dB.

**Magnitude dynamic accuracy:**  $\pm 0.3$  dB from 0 to  $-50$  dBm,  $\pm 0.5$  dB from  $-50$  to  $-60$  dBm,  $\pm 1$  dBm from  $-60$  to  $-70$  dBm,  $\pm 2.5$  dB from  $-70$  to  $-80$  dBm.

**Absolute power measurements** (A, B, and R): typically  $\pm 0.5$  dBm at 0 dBm, 50 MHz input.

**Phase frequency response:**  $\pm 2.5^\circ$  (typically  $\pm 1^\circ$ );

**Phase range:**  $\pm 180^\circ$ .

**Phase dynamic accuracy:**  $\pm 2^\circ$  from 0 to  $-50$  dBm,  $\pm 4^\circ$  from  $-50$  to  $-70$  dBm.

**Electrical length adjustment range:** typically 0 to 16 cm length for transmission phase; typically 0 to 8 cm reference plane extension for reflection measurements.

### Display

**Measurement functions:** CRT displays either polar trace or Channel 1 and Channel 2 rectilinear traces.

**Video filter:** typically 100 Hz (10 kHz without filter).

**Graticule size:** rectilinear 10 cm by 8 cm; polar 8 cm in diameter.

**Smith chart overlays:** 2, 1, 0.2 and 0.1 full scale (furnished).

**CRT photography:** Tektronix C-5B Oscilloscope Camera is recommended (UV illumination will not excite P39 CRT phosphor for graticule exposure).

**Resolution:** 10, 2.5, 1, 0.25 dB magnitude per major division. 90, 45, 10, 2.5 degrees phase per major division.

**Accuracy:**  $\pm 2\%$   $\pm 0.05$  division for rectilinear trace. Within 2.5 mm for polar trace.

### General

**Sweep output:**  $-5$  V to  $+5$  V.

**External sweep inputs:** 0 to 10 V nominal.

**X-Y Recorder/External CRT Output**

**Horizontal and vertical:** 0.1 V/div.

**Penlift/blinking:** +5 V Blanking and Penlift.

**External marker input:** typically  $-13$  dBm RF signal produce a marker at the frequency of the RF signal.

**Magnitude/phase output:**  $-10$  mV/degree and  $-100$  mV/dB.

**Probe power:** Two +15 Vdc and  $-12.6$  Vdc.

**Storage-Normalizer interfaces:** directly compatible with the HP 8750A Storage-Normalizer. HP 8501A Storage-Normalizer requires a single internal adjustment for compatibility.

**Programming connector:** outputs include magnitude/phase and sweep outputs and inputs described above as well as measurement mode selection by TTL levels or contact closures.

**External source:** the HP 8754A sweep-out voltage is provided to frequency modulate (sweep) an external signal generator for narrow-band measurement applications. A sweep input is provided to synchronize the CRT display for use with an externally swept source (HP 8620 and 8350 series).

### Temperature

**Operating:**  $0^\circ$  to  $55^\circ$  C except where noted.

**Storage:**  $-40^\circ$  C to  $+75^\circ$  C.



HP 85044A

	HP 85044A	HP 85044B
<b>Impedance:</b>	50 ohm	75 ohm
<b>Frequency Range:</b>	300 kHz - 3 GHz	300 kHz - 2 GHz
<b>Directivity:</b>	35 dB to 1.3 GHz 30 dB to 3.0 GHz	35 dB to 1.3 GHz 30 dB to 2.0 GHz
<b>Typical Tracking:</b>		
<b>Transmission Magnitude, Phase:</b>		
.3 MHz to 2.0 MHz	±1.0 dB, +10°	±1.0 dB, ±10°
2.0 MHz to F <sub>max</sub>	±1.0 dB, ±5°	±1.0 dB, ±5°
<b>Reflection Magnitude, Phase:</b>		
.3 MHz to 2.0 MHz	±1.0 dB, ±25°	±1.0 dB, ±25°
2.0 MHz to F <sub>max</sub>	±1.0 dB, ±5°	±1.0 dB, ±5°
<b>Effective Source Match:</b>		
<b>Test Port:</b>		
.3 MHz to 2.0 MHz	15 dB	15 dB
2.0 MHz to 1.3 GHz	20 dB	17 dB
1.3 GHz to F <sub>max</sub>	16 dB	16 dB



HP 11850C

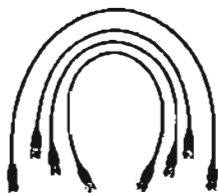

HP 11851B

**HP 11850C 50 Ω Three-Way Power Splitter**

**HP 11850D 75 Ω Three-Way Power Splitter**

**General:** one output port provides the reference output and the other two output ports can be used for independent transmission measurements. Use the HP 11851B RF Cable Set for interconnections. Detailed specifications on page 241.

**HP 11851B RF Cable Set**

**General:** three 61 cm (24 in.) 50 Ω cables, phase matched to ±2° and one 86 cm (34 in.) 50 Ω cable. Used with HP 85044A/B and 11850C/D. Detailed specifications on page 241.

**EMI:** VDE 0871/0875 and CISPR publication 11.

**Safety:** conforms to the requirements of IEC 348.

**Power:** selection of 100, 120, 220 and 240 V +5% -10%. 48 to 66 Hz, 20 VA max.

**Size:** 425.5 mm W x 133 mm H x 505 mm D (16 1/4" x 5 1/4" x 19 3/4").

**Weight:** net, 16.8 kg (37 lb); shipping, 19 kg (42 lb).

**Adapter Kits**

**General:** the HP 11853A, 11854A, 11855A, and 11856A accessory kits are available to provide precision Type N and BNC adapters and calibration standards for use with the HP 11850C/D, and 85044A/B test setups. Detailed specifications on page 241.

**HP 85044A 50 Ohm Transmission/Reflection Test Set**

**HP 85044B 75 Ohm Transmission/Reflection Test Set**

**General:** the HP 85044 contains a power splitter and directional bridge that permits simultaneous transmission and reflection measurements. Detailed specifications on the HP 85044A and 85044B appear on page 241. For interconnections from the HP 85044A to the HP 8754A use the HP 11851B RF Cable Set. The major specifications of the HP 85044A and 85044B are:

**Ordering Information**

	Price
HP 8754A Network Analyzer	\$15,540
Opt 908: Rack Flange Kit	add \$32.50
Opt 910: Extra Manual	\$80
Opt 913: Rack Mount Kit	add \$35
HP 11850C 50 Ω Three-Way Power Splitter	\$900
HP 11850D 75 Ω Three-Way Power Splitter	\$1,400
HP 85044A 50 Ω Transmission/Reflection Test Set	\$3,000
HP 85044B 75 Ω Transmission/Reflection Test Set	\$3,500
HP 11851B RF Cable Set	\$800
HP 11857D Test Port Extension Cables	\$1,050

# NETWORK ANALYZERS

## Vector Voltmeter

### Model 8405A

- Accurate voltage and phase measurement
- 1 to 1000 MHz
- 50/75  $\Omega$  coaxial measurements

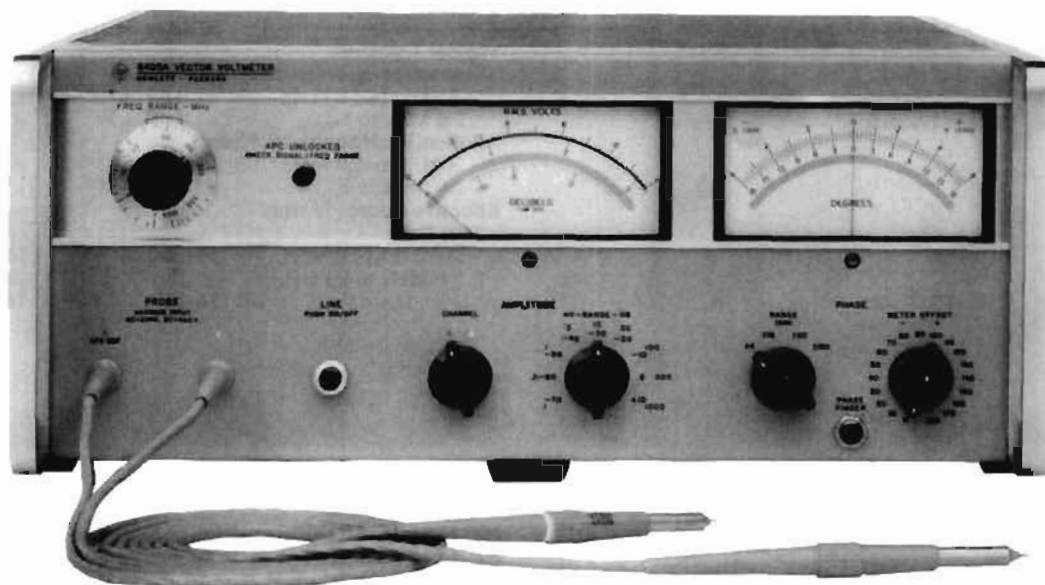

HP 8405A

The HP 8405A Vector Voltmeter measures voltage vectors described by both magnitude and phase. This capability makes the HP 8405A a unique instrument for about any design and test application in the frequency range 1 to 1000 MHz.

In addition to absolute voltage measurements, capabilities include insertion loss and phase bandpass filters and other transmission devices, gain and phase margin of amplifiers, complex impedance of mixers, antennas, matching the electrical lengths of cables, s-parameters of transistors, amplitude modulation index, RF distortion measurements and in-circuit probing. Simultaneous 50/75 ohm coaxial transmission and reflection measurements can be made using the HP 85044A/B transmission/reflection test set, and 50/75 ohm coaxial high resolution transmission comparison measurements can be made using the HP 11850C/D three-way power splitter. The HP 11852B 50-to-75 ohm minimum loss pad can be used to adapt the HP 11536A 50 ohm tee to a 75 ohm environment.

The HP 8405A achieves this measurement versatility through its two-channel capability enabling voltage magnitude measurements in either channel, thus allowing ratio measurements and phase difference measurements between the two channels. Gain or loss in excess of 90 dB and phase measurements with 0.1° resolution over a 360° phase range are possible.

Accuracy is achieved through the 1 kHz bandwidth entailing response only to the fundamental frequency of the input signal. Also, phase-locked coherent sampling to translate 1 to 1000 MHz RF signals to 20 kHz IF signals enables accurate detection of voltage magnitude and phase. Automatic phase-locked tuning makes it possible to select the one of 21 overlapping octave ranges which contains the input signal frequency by simply rotating a switch.

### Specifications

**Frequency range:** 1 MHz to 1 GHz in 21 overlapping octave bands; tuning automatic within each band.

**Isolation between channels:** 1 to 300 MHz, >100 dB; 300 to 1,000 MHz >80 dB.

**Maximum input:** ac, 2 V peak; dc,  $\pm 50$  V.

**Input impedance (nominal):** 0.1 M $\Omega$  shunted by 2.5 pF; 1 M $\Omega$  shunted by 2 pF when HP 11576A 10:1 Divider is used; 0.1 M $\Omega$  shunted by 5 pF when HP 10216A Isolator is used. AC coupled.

### Voltage Range (rms)

Channel	1 - 10 MHz	10 - 500 MHz	500 - 1000 MHz
A	1.5 mV - 1.0 V	300 $\mu$ V - 1.0 V	500 $\mu$ V - 1.0 V
B	<100 $\mu$ V - 1.0 V	<100 $\mu$ V - 1.0 V	<100 $\mu$ V - 1.0 V

**Voltmeter ranges:** 100  $\mu$ V to 1 V rms full scale in 10 dB steps.

**Voltage ratio accuracy:** 1-200 MHz, 0.2 dB for -60 to 0 dB ranges and 0.5 dB for -70 dB and +10 dB ranges; 200-1000 MHz, 0.2 dB for -60 to -10 dB ranges, 0.5 dB for -70 dB and 0 dB ranges and 1.5 dB for +10 dB range.

**Phase range:** 360° indicated on zero-center meter with end-scale ranges of  $\pm 180^\circ$ ,  $\pm 60^\circ$ ,  $\pm 18^\circ$ , and  $\pm 6^\circ$ .

**Phase resolution:** 0.1° at any phase angle.

**Phase meter offset:**  $\pm 180^\circ$  in 10° steps.

**Phase accuracy:**  $\pm 1.5^\circ$  (equal voltage Channel A and B).

**Accessories furnished:** two HP 11576A 10:1 Dividers, two HP 10216A Isolators, two HP 10218A BNC Adapters, six ground clips for HP 11576A or 10216A; six replacement probe tips.

**Bandwidth:** 1 kHz.

**Power:** 115 or 230 V  $\pm 10\%$ , 50 to 60 Hz, 35 W.

**Weight:** net, 13.9 kg (31 lb); shipping, 16.3 kg (36 lb).

**Size:** 177 H x 425 W x 467 mm D (7.0" x 16.75" x 18.38").

### HP 11570A Accessory Kit

**50  $\Omega$  Tee:** HP 11536A: for monitoring signals on 50  $\Omega$  transmission lines without terminating line. Kit contains two with type N RF fittings.

**50  $\Omega$  Power splitter:** HP 11549A: all connectors Type N female.

**50  $\Omega$  Termination:** HP 908A: for terminating 50  $\Omega$  coaxial systems in their characteristic impedance.

**Shorting plug:** HP 11512A: Shorting Plug, Type N male.

### Ordering Information

HP 8405A Vector Voltmeter

Opt 002: linear dB scale

HP 11570A Accessory Kit (measurement in 50  $\Omega$  systems only)

**Price**

\$5,690

add \$25

\$955



# NETWORK ANALYZERS

## RF Network Analyzer, 300 kHz to 3 GHz

Model 8753A

- 300 kHz to 3 GHz
- Integrated 1 Hz resolution synthesized source
- Direct save/recall to an external disc drive
- Time domain analysis

- 100 dB of dynamic range
- Group delay and deviation from linear phase
- 0.001 dB, 0.01 deg, 0.01 nanosec marker resolution
- Built-in accuracy enhancement

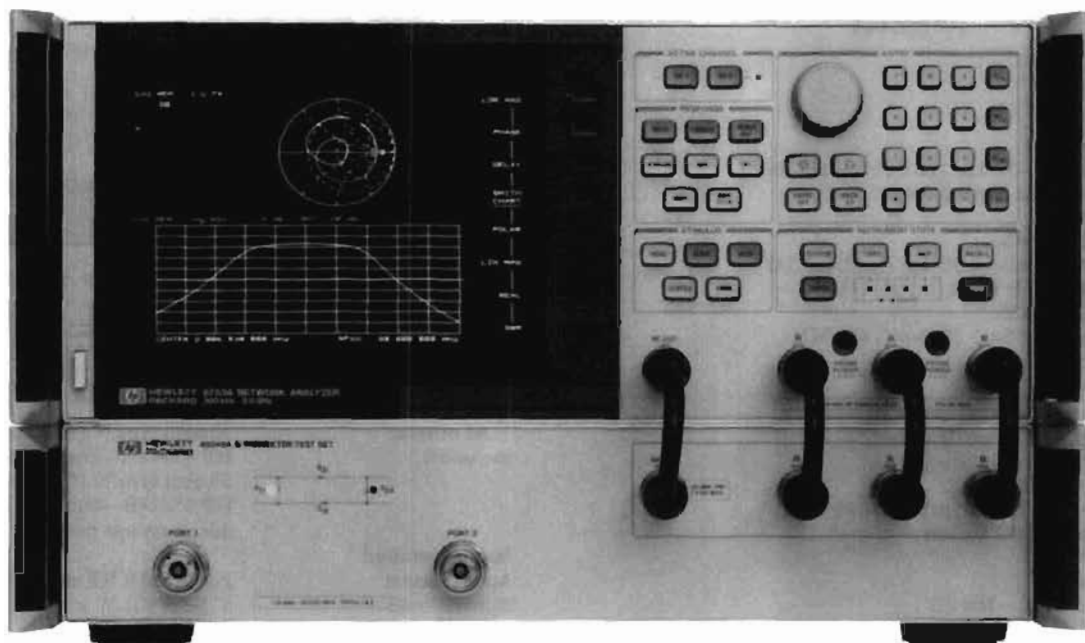

HP 8753A with HP 85046A



### Description

The HP 8753A provides excellent RF network measurements for the lab and production test areas. When combined with a test set, it yields a complete solution for characterizing the linear behavior of either active or passive networks, devices, or components from 300 kHz to 3 GHz. With two independent display channels available, you can simultaneously measure and display the reflection and transmission characteristics of the device under test. The easy-to-use soft-key selection of measurement functions allows you to quickly measure the magnitude, the phase, or group delay characteristics of your device under test. Directly measure the electrical length of a single device or phase match multiple devices. Data can be displayed in log magnitude, linear magnitude, SWR, phase, group delay, polar, real, or Smith Chart formats. The two independent display channels can be viewed separately or simultaneously in overlay or split screen formats.

The HP 8753A's integrated synthesized source provides > 100 mw of output power, 1 Hz frequency resolution, and linear or logarithmic frequency sweeps.

All of the functions of the HP 8753A are completely programmable from an external computer through the Hewlett-Packard Interface Bus. Draw/label custom graphics onto the CRT of the HP 8753A using Hewlett-Packard Graphics Language commands. The entire CRT display - including the custom graphics - can be copied to a compatible HP-GL plotter or printer.

### Time Domain Analysis

The HP 8753A (with Option 010) has the capability of displaying the time domain response of a network, obtained by computing the Inverse Fourier Transform of the frequency domain response. The time domain response displays the reflection coefficient versus time, yielding the magnitude and location of each individual discontinuity of the network. It can also display the transmission coefficient versus time, yielding simulated transient response analysis of the network.

The HP 8753A offers two time domain modes. The Low Pass mode provides the traditional Time Domain Reflectometer (TDR) measurement capability and gives the response of the network to a (mathematically-simulated) step or impulse response. This mode gives information of the type of impedance (R, L, C) present at the discontinuity. The Band Pass time domain mode, which has only the impulse stimulus, may be used over any frequency range to give the time domain response of frequency selective devices such as SAW filters or antennas.

Gating is another powerful time domain feature that may be used to selectively isolate a single response in time and then convert just that response back to the frequency domain. For reflection measurements, this provides the capability to view the return loss of individual portions of a high frequency component without disturbing the actual circuit. For transmission measurements, one can view the frequency and time domain responses of individual transmission paths.

### HP 8753A Specifications Summary

#### Source

- Frequency Characteristics**
- Frequency Range:** 300 kHz to 3 GHz
- Frequency Resolution:** 1 Hz
- Frequency Accuracy (25 C):** ±10 ppm

#### Output Characteristics

- Power Range:** -5 to +20 dBm
- Power Accuracy (50 MHz, +10 dBm):** ±0.5 dB
- Power Linearity (relative to +10 dBm, 25 ± 5 C):**
- 5 to +15 dBm: ±0.2 dB
- +15 to +20 dBm: ±0.5 dB

#### Impedance: 50

- Harmonics:** ≤ -25 dBc (20 dBm output level)
- typically < -50 dBc (0 dBm output level)

# NETWORK ANALYZERS

## RF Network Analyzer, 300 kHz to 3 GHz (cont'd)

Model 8753A



HP 85044A



HP 11850C



HP 11851B

### Nonharmonics:

**Mixer Related:**  $\leq -32$  dBc (20 dBm output level)

typically  $\leq -55$  dBc (0 dBm output level)

### Other Spurious:

$f < 135$  MHz:  $-60$  dBc

$f \geq 135$  MHz:  $-60$  dBc +  $20 \log(f/135 \text{ MHz})$

**Phase Noise** (0 kHz offset in 1 Hz BW):

$f < 135$  MHz:  $-90$  dBc

$f \geq 135$  MHz:  $-90$  dBc +  $20 \log(f/135 \text{ MHz})$



HP 11857D



HP 11852B

### Receiver

**Frequency Range:** 300 kHz to 3 GHz

**Inputs:** A, B 100 dB dynamic range

**Sensitivity** (noise level):

3 kHz BW:  $-90$  dBm

10 Hz BW:  $-100$  dBm (typically  $-110$  dBm)

**Maximum Input Level:** 0 dBm

**Impedance:** 50

**Input Crosstalk:**

300 kHz to 1 GHz:  $-100$  dB

1 GHz to 3 GHz:  $-90$  dB

**Dynamic Accuracy:**  $\pm 0.05$  dB,  $\pm 0.5$  deg over a 50 dB input range

**Delay Characteristics:**

**Range:**  $1/2^\circ$  (1/minimum aperture)

**Aperture:** selectable (frequency span)/(# points - 1) to 20% of the frequency span

**Resolution:** 27.8/(aperture in Hz)

typically 0.01 nanoseconds

**Accuracy:** (phase accuracy)/( $360^\circ$  aperture in Hz)

**Dimensions:**

178mm H x 425mm W x 498mm D

(7.0 x 16.75 x 20.0 in)

**Weight:**

Net 22 kg (48 lb); Shipping 25 kg (55 lb)

### RF Connectors:

**Test Port:**

precision 7 mm 75 ohm type N (f)

**All others:**

50 ohm type N (f) 50 ohm type N (f)

**Includes:**

HP 85044A—one precision 7 mm to 50 ohm type N (f) adapter;  
HP 85044B—one HP 11852B minimum loss pad.

### Recommended

**Accessories:**

HP 11851B RF cable kit

**Dimensions:**

615H x 101 W x 204 mm D

(2.44 x 7.5 x 8.0 in)

**Weight:**

net 1.7 kg (3.8 lb)

### HP 85046A/B S-Parameter Test Set

The HP 85046A/B s-parameter test sets provide the capability to measure impedance and transmission characteristics (including s-parameters) of 2 port devices in either direction with a single connection. The test sets are controlled from the HP 8753A and include a programmable step attenuator. Test port connectors are precision 7 mm and 75 ohm type N (f) respectively. Both connectors can be adapted to other interfaces with the appropriate precision adapters.

### HP 8753A Accessories

#### HP 85044A 50 Ohm Transmission/Reflection Test Set

#### HP 85044B 75 Ohm Transmission/Reflection Test Set

The HP 85044 A/B Transmission/Reflection test sets provide the capability to simultaneously measure the impedance and transmission characteristics of 50 and 75 ohm devices. Two-port devices must be physically turned around to measure their reverse direction characteristics. Test port connectors are precision 7 mm and 75 ohm type N (f), respectively.

Specifications	HP 85044A	HP 85044B
<b>Impedance:</b>	50 ohms	75 ohms
<b>Frequency Range:</b>	300 kHz to 3 GHz	300 kHz to 2 GHz
<b>Directivity<sup>1</sup>:</b>	35 dB to 1.3 GHz 30 dB to 3.0 GHz	35 dB to 1.3 GHz 30 dB to 2.0 GHz

#### Typical Tracking:

Transmission Magnitude, Phase <sup>1,2</sup> :	HP 85044A	HP 85044B
.3 MHz to 2.0 MHz	$\pm 1.5$ dB, $\pm 10^\circ$	$\pm 1.5$ dB, $\pm 10^\circ$
2.0 MHz to $F_{max}$ <sup>2</sup>	$\pm 1.5$ dB, $\pm 10^\circ$	$\pm 1.5$ dB, $\pm 10^\circ$
Reflection Magnitude, Phase <sup>1,2</sup> :		
.3 MHz to 2.0 MHz	$\pm 1.5$ dB, $\pm 25^\circ$	$\pm 1.0$ dB, $\pm 25^\circ$
2.0 MHz to $F_{max}$	$\pm 1.5$ dB, $\pm 10^\circ$	$\pm 1.0$ dB, $\pm 10^\circ$

#### Effective Source Match<sup>3</sup>:

(Test Ports):	HP 85044A	HP 85044B
.3 MHz to 2.0 MHz	14 dB	14 dB
2.0 MHz to 1.3 GHz	20 dB	17 dB
1.3 GHz to $F_{max}$	16 dB	16 dB

### Specifications

	HP 85046A	HP 85046B
<b>Impedance:</b>	50 ohms	75 ohms
<b>Frequency Range:</b>	300 kHz to 3 GHz	300 kHz to 2 GHz
<b>Directivity:</b>	35 dB to 1.3 GHz 30 dB to 3.0 GHz	35 dB to 1.3 GHz 30 dB to 2.0 GHz

#### Typical Tracking:

Transmission Magnitude, Phase <sup>1,2</sup> :	HP 85046A	HP 85046B
.3 MHz to 2.0 MHz	$\pm 1.5$ dB, $\pm 20^\circ$	$\pm 1.5$ dB, $\pm 20^\circ$
2.0 MHz to $F_{max}$ <sup>2</sup>	$\pm 1.5$ dB, $\pm 10^\circ$	$\pm 1.5$ dB, $\pm 10^\circ$
Reflection Magnitude, Phase <sup>1,2</sup> :		
.3 MHz to 2.0 MHz	$\pm 1.5$ dB, $\pm 25^\circ$	$\pm 1.5$ dB, $\pm 25^\circ$
2.0 MHz to $F_{max}$	$\pm 1.5$ dB, $\pm 10^\circ$	$\pm 1.5$ dB, $\pm 10^\circ$
Effective Source Match <sup>3</sup> :		
(Test Ports):		
.3 MHz to 2.0 MHz	14 dB	14 dB
2.0 MHz to 1.3 GHz	20 dB	17 dB
1.3 GHz to $F_{max}$	16 dB	16 dB

<sup>1</sup>Degrees, specified as deviation from linear phase.

<sup>2</sup> $F_{max}$  is the upper frequency limit of the associated test set.

<sup>3</sup>Can be improved through Accuracy Enhancement.

**RF Connectors:**

**Port 1, 2:** precision 7 mm 75 ohm type N (f)  
**All others:** 50 ohm type N (f) 50 ohm type N (f)  
**Includes:** Four 190 mm (7.5") cables with type N (m) connectors for connection to the HP 8753A. One HP 8753A test set interconnect cable.

**Recommended**

**Accessories:** HP 11857D cables HP 11857B cables  
**Dimensions:** 90 H x 426 W x 553 mm D  
 (3.5 x 16.75 x 21.5 in.)  
**Weight:** 9.1 kg (20 lb)

<sup>1</sup>Degrees, specified as deviation from linear phase.

<sup>2</sup>F<sub>max</sub> is the upper frequency limit of the associated test set.

**HP 11850C/D Three-Way Power Splitters**

Specifications	HP 11850C	HP 11850D
<b>Impedance:</b>	50 ohms	75 ohms
<b>Frequency Range:</b>	DC to 3 GHz	DC to 2 GHz
<b>Tracking:</b>	±.25 dB, +3°	±.2 dB, ±2.5°
<b>Equivalent Source Match (ratio or leveling)</b>	30 dB @ 1.3 GHz 20 dB @ 3 GHz	30 dB @ 1.3 GHz 20 dB @ 3 GHz
<b>Nominal Insertion Loss:</b>	9.5 dB +1 dB/GHz	7.8 dB
<b>Input Port Match:</b>		
DC to 1.3 GHz	20 dB	20 dB
1.3 GHz to F <sub>max</sub> <sup>1</sup>	10 dB	10 dB
<b>Maximum Operating Level:</b>	+20 dBm	+20 dBm
<b>Damage Level:</b>	+30 dBm	+30 dBm
<b>RF Connectors:</b>		
<b>RF Input:</b>	50 ohm type N (f)	50 ohm type N (f)
<b>All Others:</b>	50 ohm type N (f)	75 ohm type N (f)
<b>Includes:</b>		3 ea HP 11852B 50 to 75 ohm min. loss pads
<b>Recommended Accessories:</b>	HP 11851B RF Cable Kit	

<sup>1</sup>F<sub>max</sub> is the upper frequency limit of the associated power splitter.

**HP 11851B RF Cable Kit**

**General:** three 610 mm (24 in.) 50 Ω cables phase matched to 4° at 1.3 GHz and one cable 860 mm (34 in.). Connectors are Type N Male. Recommended for use with HP 85044A/B Transmission/Reflection Test Set and HP 11850C/D Power Splitter.  
**Weight:** net, 0.91 kg (2 lb); shipping, 1.36 kg (3 lb).

**HP 11852B 50 Ω/75 Ω Minimum Loss Pad**

**General:** the HP 11852B is a low SWR minimum loss pad required for transmission measurements on 75 Ω devices with HP 8753A receiver (50 Ω).

**Frequency range:** dc to 2.0 GHz.

**Insertion loss:** 5.7 dB.

**Return loss:** 75 Ω typically ≥30 dB, 50 Ω typically ≥26 dB.

**Maximum input power:** 250 mW (+24 dBm).

**Connectors:** 50 Ω Type N female and 75 Ω Type N male.

**Size:** 14 D x 70 mm L (0.56" x 2.75").

**Weight:** net, 0.11 kg (4 oz); shipping, 0.26 kg (9 oz).

**HP 11853A 50 Ω Type N Accessory Kit**

**General:** the HP 11853A furnishes the RF components required for measurement of devices with 50Ω Type N Connectors using the HP 11850C, 85044A, or 85046A. Kit contains a Type N Female short, a Type N Male short, two Type N Male barrels, two Type N Female barrels and storage case.  
**Weight:** net, 0.91 kg (2 lb); shipping, 1.36 kg (3 lb).

**HP 11854A 50 Ω BNC Accessory Kit**

**General:** the HP 11854A furnishes the RF components required for measurement of devices with 50Ω BNC Connectors using the HP 11850C, 85044A, or 85046A. Kit contains two Type N Male to BNC Female adapters, two Type N Male to BNC Male adapters, two Type N Female to BNC Female adapters, two Type N Female to BNC Male adapters, a BNC Male short and storage case.  
**Weight:** net, 1.13 kg (2½ lb).

**HP 11855A 75 Ω Type N Accessory Kit**

**General:** the HP 11855A provides the RF connecting hardware generally required for measurement of devices with 75 Ω Type N connectors using the HP 85044B, 85046B or 11850D. Kit contains two 75 Ω Type N Male barrels, two Type N Female barrels, a 75 Ω Type N Female short, a 75 Ω Type N Male short, a 75 Ω Type N Male termination, and storage case.  
**Weight:** net, 0.91 kg (2 lb); shipping, 1.36 kg (3 lb).

**HP 11856A 75 Ω BNC Accessory Kit**

**General:** the HP 11856A provides the RF connecting hardware generally required for measurement of devices with 75 Ω BNC connectors using the HP 85044B, 11850D, or 85046B. Kit contains two Type N Male to BNC Female adapters, two Type N Male to BNC Male adapters, two Type N Female to BNC Female adapters, two Type N Female to BNC Male adapters, a BNC Male short, a 75 Ω BNC Male termination, and storage case.  
**Weight:** net, 0.91 kg (2 lb); shipping, 1.36 kg (3 lb).

**HP 11857D 50 Ω APC-7 Test Port Extension Cables**

**General:** two precision 61 cm (24 in.) cables, phase matched to 2° at 1.3 GHz for use with HP 85046 A S-parameter test set. Connectors are 50 Ω APC-7.

**Weight:** net, 0.91 kg (2 lb); shipping, 2.3 kg (5 lb).

**HP 11857B 75 Ω Type N Test Port Extension Cables**

**General:** two precision 61 cm (24 in.) cables, phase matched to 2° at 1.3 GHz for use with HP 85046B S-parameter test set. One cable has 75 Ω Type N Male connectors on both ends; the other has one Type N Male and one Type N Female connector.

**Weight:** net, 0.91 kg (2 lb); shipping, 2.3 kg (5 lb).

**HP 11858A Transistor Fixture Adapter**

**General:** the HP 11858A adapts the HP 11600B and 11602B transistor fixtures (vertical test port configuration) to the HP 85046A S-parameter test set. Connectors are APC-7.

**Weight:** net, 0.91 kg (2 lb); shipping, 1.36 kg (3 lb).

**HP 85043B Systems Cabinet**

The HP 85043B systems cabinet has been ergonomically designed specifically for the HP 8753A and the HP 85046A/B s-parameter test sets. The 122 cm (48-inch) system cabinet includes a bookcase, a drawer, and a convenient work surface.

# NETWORK ANALYZERS

## Accessories (cont'd)

### 8753A Series

#### Calibration Kits

Accuracy enhancement procedures characterize the systematic errors of the measurement system by measuring known devices (standards) on the system over the frequency range of interest. The calibration kits in the HP 8753A family contain precision standards with which to characterize the systematic errors of a HP 8753A measurement system. These standards have been optimized for the 300 kHz to 3 GHz frequency range and are available in various connector types that are compatible with the HP 8753A.

#### HP 85031B 7 mm Calibration Kit

The HP 85031B 7 mm calibration kit contains a set of precision 7 mm fixed terminations, an open circuit, and a short circuit used to calibrate the HP 8753A and its 50 ohm test sets for measurement of devices with precision 7 mm connectors.

#### HP 85032B 50 $\Omega$ Type N Calibration Kit

The HP 85032B Calibration Kit contains precision 50  $\Omega$  type N standards used to calibrate the HP 8753A and its 50  $\Omega$  test sets for measurement of devices with 50  $\Omega$  type N connectors. Precision phase-matched 7 mm to 50  $\Omega$  type N adapters are included for accurate measurements of non-insertable devices. Standards include fixed terminations, open circuits, and short circuits.

#### HP 85033C 3.5 mm Calibration Kit

The HP 85033C Calibration Kit contains precision 3.5 mm standards used to calibrate the HP 8753A and its 50  $\Omega$  test sets for measurement of devices with 3.5 mm and SMA connectors. Standards include fixed terminations, open circuits, and short circuits. Precision 7 mm to 3.5 mm adapters are included for accurate measurements of non-insertable devices.

#### HP 85036B 75 $\Omega$ type N Calibration Kit

The HP 85036B Calibration Kit contains precision 75  $\Omega$  type N standards used to calibrate the HP 8753A and its 75  $\Omega$  test sets for measurement of devices with 75  $\Omega$  type N connectors. Standards include fixed terminations, open circuits, and short circuits. Precision phase-matched adapters are included for accurate measurements of non-insertable devices.

#### Verification Kits

Measuring known devices, other than the calibration standards, is a convenient way of verifying that the HP 8753A measurement system is operating properly.

#### HP 85029A 7 mm Verification Kit

The HP 85029A Verification Kit contains a set of precision 7 mm devices, with data traceable to NBS, used to verify the calibrated performance of an HP 8753A measurement system. The devices have precision 7 mm connectors and include a 20 dB pad, a 50 dB pad and a mismatch attenuator. Verification process requires only an HP 85031B calibration kit, an HP 85029A verification kits and an external 3.5" disc (HP 9122S or HP 9122D) connected to the HP 8753A.

#### Software

#### HP 85180A Measurement Automation Software

Measurement Automation Software simplifies device measurements by providing guided measurements, limit testing, sequencing to test all four S-parameters, data formatting flexibility (data files can be formatted to be compatible with Touchstone® linear circuit simulation programs) and complete save/recall capability to a floppy disc. Once configured, simply recall a test file and calibration data, connect the device-under-test, and output the results. Software operates with a BASIC operating system using an HP Series 300 computer (2 megabytes of memory required).

#### Service and Support Products

Service and support products are available for HP 8753A measurement systems. On-site support products require a specific 50 ohm two-port measurement configuration.<sup>1</sup> Contact your local HP sales office for availability and price.

#### HP 8753A Return-to-HP Service

#### HP 8753A Option W30 3-Year Extended Return-to-HP Support

Adds two additional years of return-to-HP support to your normal one year return-to-HP warranty for the HP 8753A network analyzer (does not include test sets, cables, or calibration kits). Return-to-HP support does not include annual maintenance or calibrations of the network analyzer.

#### Ordering Information

	Price
HP 8753A Network Analyzer	\$25,500
Option 010 Time Domain	\$4,800
Option 908 Rack Mounting Kit (without handles)	\$40
Option 910 Extra Manuals	\$75
Option 913 Rack Mounting Kit	\$40
Option W03 On-Site Warranty Conversion	\$0
Option W30 Three-Year Extended Return-to-HP Support	\$470
HP 85046A 50 $\Omega$ S-Parameter Test Set	\$7,800
Option 908 Rack Mounting Kit (without handles)	\$40
Option 913 Rack Mounting Kit	\$40
Option W03 On-Site Warranty Conversion	\$0
Option W30 Three-Year Extended Return-to-HP Support	\$140
HP 85046B 75 $\Omega$ S-Parameter Test Set	\$7,800
Option 908 Rack Mounting Kit (without handles)	\$40
Option 913 Rack Mounting Kit	\$40
Option W30 Three-Year Extended Return-to-HP Support	\$140
HP 85044A 50 $\Omega$ Transmission/Reflection Test Set	\$3,000
Option W30 Three-Year Extended Return-to-HP Support	\$70
HP 85044B 75 $\Omega$ Transmission/Reflection Test Set	\$3,500
Option W30 Three-Year Extended Return-to-HP Support	\$70
HP 85029A Precision 7 mm Verification Kit	\$1,500
HP 85031B Precision 7 mm Calibration Kit	\$1,000
HP 85032B 50 $\Omega$ type N Calibration Kit	\$1,500
HP 85033C Precision 3.5 mm Calibration Kit	\$2,500
HP 85036B 75 $\Omega$ type N Calibration Kit	\$2,000
HP 85043B Systems Rack	\$2,900
HP 85033A SMA Kit	\$1,000
HP 85160A Measurement Automation Software	\$1,500
HP 11850C 50 $\Omega$ Power Splitter	\$900
HP 11850D 75 $\Omega$ Power Splitter	\$1,400
HP 11851B type N RF Cable Kit	\$800
HP 11852B 50 to 75 $\Omega$ Minimum Loss Pad	\$350
HP 11853A 50 $\Omega$ type N Accessory Kit	\$350
HP 11854A 50 $\Omega$ BNC Accessory Kit	\$350
HP 11855A 75 $\Omega$ type N Accessory Kit	\$450
HP 11856A 75 $\Omega$ BNC Accessory Kit	\$450
HP 11857B 75 $\Omega$ type N Test Port Extension Cables	\$1,455
HP 11857D 50 $\Omega$ APC-7 Test Port Extension Cables	\$1,050
HP 11858A Transistor Fixture Adapter	\$980

<sup>1</sup>The specific 50 ohm two-port measurement system includes the HP 8753A, the HP 85046A S-parameter test set, the HP 85031B 7 mm calibration kit, and the HP 11857D 7 mm test port extension cable set. This is a minimum configuration required for on-site verification.

# NETWORK ANALYZERS

## Microwave Network Analyzers, 45 MHz to 100 GHz

8510 Series

- 45 MHz to 100 GHz frequency range
- "Real Time" error-corrected measurements
- 60 dB effective directivity and source match

- 70 dB to 100 dB dynamic range
- 0.001 dB, 0.01 degree, 0.01 nanosecond measurement resolution
- Time domain analysis



HP 8510B

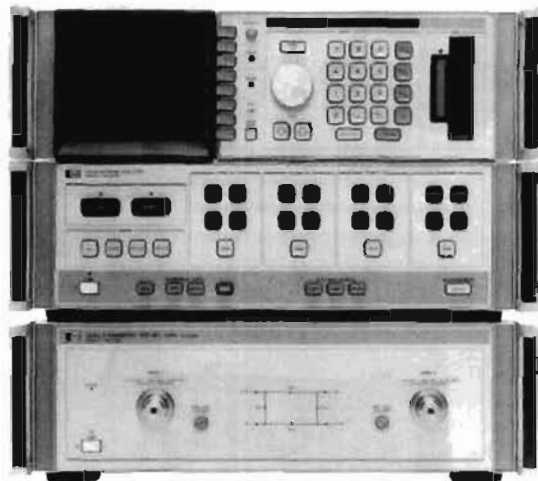

HP 8515A

### Description

The HP 8510 series microwave vector network analyzers provide a complete solution for characterizing the linear behavior of either active or passive networks over the 45 MHz to 26.5 GHz frequency range. A complete system comprises the HP 8510B network analyzer, either an HP 8514B or 8515A S-parameter test set, and a compatible RF source. For millimeter-wave measurement needs, complete systems operating to 100 GHz can be configured.

The S-parameter test sets offer a single test setup solution for complete characterization of two-port devices. The HP 8514B covers the frequency range of 45 MHz to 20 GHz. The HP 8515A spans the frequency range of 45 MHz to 26.5 GHz. Each test set includes bias tees and step attenuators useful for active device testing. Option 002 deletes these components for applications where primarily passive components are tested. The HP 8511A is a four-channel frequency converter that covers the 45 MHz to 26.5 GHz frequency range. For all three test sets, Option 001 adds IF switching circuitry for HP 8510B operation with multiple test sets.

Each measurement presented on the CRT display consists of 51, 101, 201, 401 or 801 discrete points of data, and when the system source is a synthesizer, the frequency of each data point is synthesized.

Measurement results can be displayed on one of two independent, yet identical, channels. The channels may be displayed individually, or simultaneously, with results presented in either logarithmic/linear magnitude, phase, or group delay format on rectangular or polar coordinates. Direct measurement of normalized impedance is possible with the Smith chart format. The value and frequency of any one data point can be read with one of five independent markers. The entire measurement trace can be copied directly to a plotter, such as the HP 7474A, 7475A, or 7550A without the need of an external computer. Also, a list of the trace values can be sent to a printer such as the 2225A.

Powerful measurement enhancement functions are also available. Data averaging can be employed to narrow the effective receiver IF bandwidth, extending dynamic range and increasing signal-to-noise ratio. Trace smoothing aids in the interpretation of measurement results and is used to control the aperture of group delay measurements. The equivalent of an electronic line stretcher is available with the electrical delay function.

Built-in storage provides the capability to save and recall up to eight different front panel states, eight separate measurement calibrations, and four separate measurements in nonvolatile memory. Extension of the internal storage capacity is practically limitless via the built-in tape cassette unit.

### High Performance

Along with the capability to completely characterize a microwave network with a single connection over the extremely broad 45 MHz to 26.5 GHz frequency range, the HP 8510 system offers wide dynamic range. Depending on the test set used, 80 dB to 100 dB of dynamic range is available. The precision IF processing and detection system contributes as little as  $\pm 0.05$  dB and  $\pm 0.5$  degree measurement uncertainty at a level of 50 dB below the reference. Meaningful resolutions of 0.001 dB, 0.01 degree, and 0.01 nanosecond are easily achievable.

### "Real Time" Error Correction

The HP 8510's built-in, high speed computer provides the capability to characterize and effectively remove the impact of systematic errors through accuracy enhancement techniques. Effective directivity and source match can be improved to as much as 60 dB. The data processing speed of the system is such that a fully error-corrected, 401 point trace of data is updated in under one second. This virtual "real time" display of error-corrected data means that you can easily adjust your test device while it's being measured, with the assurance that you are viewing the data at the highest possible accuracy.

### Time Domain Analysis

The HP 8510 (with option 010) has the capability of displaying the time domain response of a network, obtained by computing the Inverse Fourier Transform of the frequency domain response. The time domain response displays the reflection coefficient of the network versus time, which displays the magnitude and location of each individual discontinuity, or else the transmission coefficient versus time, which displays each individual transmission path.

### Ordering Information

	<b>Price</b>
<b>HP 8510B</b> Network Analyzer	\$33,800
<b>Option 010</b> Time Domain Capability	9,800
<b>HP 8511A</b> Frequency Converter	18,500
<b>Option 001</b> add IF Switching	add 2,000
<b>HP 8514B</b> S-parameter Test Set	27,000
<b>Option 001</b> add IF Switching	add 2,000
<b>Option 002</b> delete Attenuators and Bias Tees	delete 6,500
<b>HP 8515A</b> S-parameter Test Set	37,900
<b>Option 001</b> and IF Switching	add 2,000
<b>Option 002</b> delete Attenuators and Bias Tees	delete 7,000

# NETWORK ANALYZERS

## Accessories

### 8510 Series

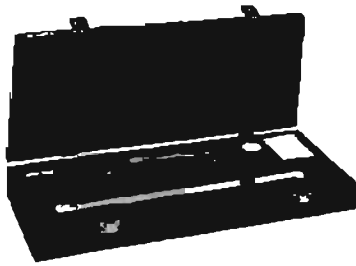

HP 85050B



HP 85050D

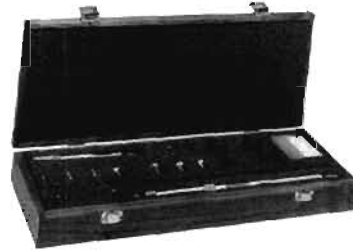

HP 85052E



HP 11644A



HP 85050C



HP 85052B



HP 85054B

### Calibration Kits

Error-correction procedures require that the systematic errors in the measurement system be characterized by measuring known devices (standards) on the system over the frequency range of interest. The calibration kits in the HP 8510 family contain precision standard devices to characterize the systematic errors of the HP 8510 system.

#### HP 85050B 7 mm Calibration Kit

The HP 85050B 7 mm calibration kit contains a set of precision calibration standards used to calibrate the HP 8510 system for measurements of devices with precision 7 mm connectors. The calibration standards include open and short circuits, and fixed and sliding terminations. Also included are a precision 7 mm connector gage and tools for verifying and maintaining the connector interfaces.

#### HP 85050C 7 mm Precision Calibration Kit

The HP 85050C 7 mm precision calibration kit contains a set of calibration standards used to calibrate the HP 8510 system for measuring devices with precision 7 mm connectors. The standards are for use with the offset load and TRL calibration methods. The kit contains open and short circuits, fixed terminations, and a precision airline section (7 mm long). Also included are a connector gage and tools for maintaining the connector interfaces.

#### HP 85050D 7 mm Economy Calibration Kit

The HP 85050D 7 mm economy calibration kit contains a set of calibration standards used to calibrate the HP 8510 system for measuring devices with precision 7 mm connectors. The standards include an open and short circuit and a 40 dB broadband fixed termination. A connector torque wrench is also included.

#### HP 85052B 3.5 mm Calibration Kit

The HP 85052B 3.5 mm calibration kit contains a set of precision calibration standards used to calibrate the HP 8510 system for measurements of devices with 3.5 mm connectors (precision 3.5 mm or SMA). The calibration standards include open and short circuits, and fixed and sliding terminations. Connector gages are supplied for verifying critical mechanical tolerances of the 3.5 mm connector interface.

#### HP 85052E 3.5 mm Economy Calibration Kit

The HP 85052E 3.5 mm economy calibration kit contains a set of precision calibration standards used to calibrate the HP 8510 system for measuring devices with 3.5 mm connectors. The calibration standards include open and short circuits, fixed terminations, and one sliding load. A connector torque wrench is included.

#### HP 85054B Type N Calibration Kit

The HP 85054B Type N calibration kit contains a set of precision calibration standards used to calibrate the HP 8510 system for measurements of devices with Type N connectors. The calibration standards include open and short circuits, and fixed and sliding terminations. Also included are precision 7 mm to Type N adapters.

#### HP 11644A Series Waveguide Calibration Kits

The HP 11644A series waveguide calibration kits contain a set of precision waveguide calibration standards used to calibrate an HP 8510 system configured for millimeter-wave measurements. There are five kits available supporting the 26.5 to 40 GHz, 33 to 50 GHz, 40 to 60 GHz, 50 to 75 GHz, and 75 to 100 GHz waveguide bands. Each kit contains a planar short circuit, a  $\lambda/4$  wavelength section of waveguide, and a precision termination. Also included are precision test port extenders and system verification device.

### Ordering Information

	Price
HP 85050B 7 mm Calibration Kit	\$4,000
HP 85050C 7 mm Precision Calibration Kit	4,900
HP 85050D 7 mm Economy Calibration Kit	1,500
HP 85052B 3.5 mm Calibration Kit	7,000
HP 85052E 3.5 mm Economy Calibration Kit	4,000
HP 85054B Type N Calibration Kit	4,500
HP R11644A WR-28 Calibration Kit	3,600
HP Q11644A WR-22 Calibration Kit	3,850
HP U11644A WR-19 Calibration Kit	4,200
HP V11644A WR-15 Calibration Kit	4,200
HP W11644A WR-10 Calibration Kit	4,400

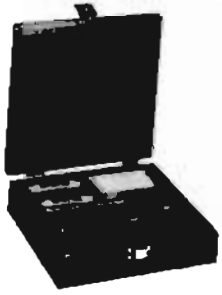

HP 85051B

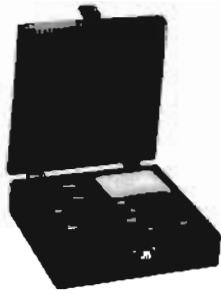

HP 85053B

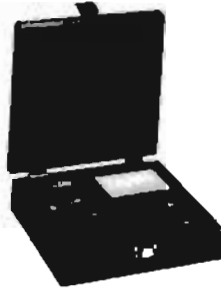

HP 85055A



HP 85130B

## Verification Kits

Measuring known devices, other than the calibration standards, is a straightforward way of verifying that the HP 8510 system is operating properly. Hewlett-Packard offers verification kits that include standard devices, with data, for verifying the error-corrected measurement performance of the HP 8510 system.

### HP 85051B 7 mm Verification Kit

The HP 85051B 7 mm verification kit contains a set of precision devices, with data, used to verify the error-corrected performance of the HP 8510 system. The devices have precision 7 mm connectors and include 20 dB and 50 dB attenuators, a 10 cm beadless airline, and a 10 cm beadless stepped impedance airline (25 ohms nominal).

### HP 85053B 3.5 mm Verification Kit

The HP 85053B 3.5 mm verification kit contains a set of precision devices, with data, used to verify the error-corrected performance of the HP 8510 system. The devices have precision 3.5 mm connectors and include 20 dB and 40 dB attenuators, a 7.5 cm beadless airline, and a 7.5 cm beadless stepped impedance airline (25 ohms nominal).

### HP 85055A Type N Verification Kit

The HP 85055A Type N Verification Kit contains a set of precision devices, with data, used to verify the performance of the HP 8510 system. The devices have Type N connectors and include 20 dB and 50 dB attenuators, a 10 cm beadless airline, and a 10 cm beadless stepped impedance airline (25 ohms nominal).

## Test Port Return Cables

Hewlett-Packard offers a variety of high quality RF cables that are used to return the transmitted signal to the test set when measuring two-port devices.

### HP 85131C 3.5 mm Test Port Return Cable

The HP 85131C is a single test port return cable for use with either the HP 8514B or 8515A test sets (when connecting the device directly to Port 1).

**Frequency Range:** dc to 26.5 GHz

**Length:** 91 cm (36 in.)

**VSWR:** 1.22:1, typical

**Connectors:** Special 3.5 mm, and precision 3.5 mm (female)

### HP 85131D 3.5 mm Test Port Return Cable Set

The HP 85131D is a pair of test port return cables for use with either the HP 8514B or 8515A test set. The device is connected between the cables during measurement.

**Frequency Range:** dc to 26.5 GHz

**Length:** 66 cm (24 in.) each

**VSWR:** 1.22:1, typical

**Connectors:** Special 3.5 mm, and precision 3.5 mm (one male, or female)

### HP 85132C 7 mm Test Port Return Cable

The HP 85132C is a single test port return cable for use with either HP 8514B or 8515A test sets (when connecting the device directly to Port 1).

**Frequency Range:** dc to 18 GHz

**Length:** 91 cm (36 in.)

**VSWR:** 1.2:1, typical

**Connectors:** Special 3.5 mm and Precision 7 mm (Test end)

### HP 85132D Test Port Return Cable Set

The HP 85132D is a pair of test port return cables for use with either the HP 8514B or 8515A test set. The device is connected between the cables during measurement.

**Frequency Range:** dc to 18 GHz

**Length:** 66 cm (24 in.) each

**VSWR:** 1.2:1, typical

**Connectors:** Special 3.5 mm and Precision 7 mm (Test end)

### HP 85130B Special 3.5 mm to 7 mm Adapter Set

The HP 85130B kit contains a set of precision special 3.5 mm to 7 mm adapters used for converting the test ports of the HP 8513A, 8514B and 8515A test sets to a precision 7 mm interface.

## System Rack

### HP 85043A System Rack Kit

The HP 85043A system rack stands 123.7 cm (48.7") high, 60 cm (23.6") wide, and 80 cm (31.5") deep. Complete with support rails and ac power distribution (suitable for 50 to 60 Hz, and 110–240 Vac), it includes rack mounting hardware for all instruments. Thermal design is such that no rack fan is needed.

## System Software

### HP 85161A Measurement Automation Software

The HP 85161A Measurement Automation Software provides a more simplified and flexible user interface to the HP 8510B system. The program leads the operator through the measurement sequence one-step-at-a-time, from system setup and calibration, to device measurement and hard copy output. Complete measurement configurations can be saved to disc for later recall. Also, data printout formats can be customized by the operator.

The HP 85161A software is designed for use with HP 9000 Series 200 or 300 computers and the BASIC operating system (3.0 or higher).

### Ordering Information

	Price
HP 85051B 7 mm Verification Kit	\$2,750
HP 85053B 3.5 mm Verification Kit	2,750
HP 85055A Type N Verification Kit	2,750
HP 85131C 3.5 mm Test Cable	700
HP 85131D 3.5 mm Test Cable Set	1,200
HP 85132C 7 mm Test Cable	600
HP 85132D 7 mm Test Cable Set	1,000
HP 85130B Special 3.5 mm to 7 mm Adapters	700
HP 85043A System Rack Kit	2,900
HP 85161A Measurement Automation Software	1,500
Option 630 3 1/2" disc media	N/C
Option 655 5 1/4" disc media	N/C

# NETWORK ANALYZERS

## Accessories (cont'd)

### 8510 Series

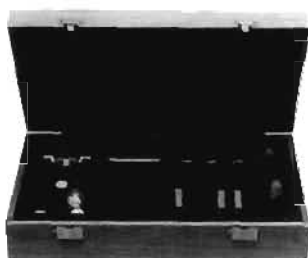

HP 85041A



HP 8717B



HP 11590B



HP 11612A



HP 11635A

#### Active Device Test

Hewlett-Packard offers an extensive array of accessories designed for the needs of active device test and measurement, including fixtures, bias supplies, bias networks, and application software.

#### HP 85041A Transistor Test Fixture Kit

The HP 85041A transistor test fixture (TTF) kit is a comprehensive measurement system for testing and characterizing stripline packaged microwave transistors. Only useful when used with the HP 85014A active device measurement software.

**Frequency Range:** dc to 18 GHz

**Transistor Package Inserts:** 70 mil and 100 mil

**Verification Devices:** Short and through circuits

**Connectors:** precision 7 mm

**Accessories Supplied:** fixture stand, torque tool, tweezers, and lid opening tool

#### HP 8717B Transistor Bias Supply

The HP 8717B transistor bias supply provides manual or automatic biasing for transistor testing. This supply 8717B has two meters for independently monitoring current and voltage. Bias connections are conveniently selected for all transistor configurations with a front panel switch.

**Voltage Ranges:** 1, 3, 10, 30, 100 V

**Current Ranges:** 0.1, 0.3, 1, 3, 10, 30, 100, 300, 1000 mA

**Accuracy:** 4% of full scale for both current and voltage

**Option 001:** programmable D/A converter

**Option 011:** programming cable for HP Series 200/300 computers

#### HP 11590B Bias Network

The HP 11590B is a rugged, broadband bias network. This bias network provides dc bias to the center conductor of a coaxial line which can be connected to the device under test while blocking DC bias from the RF circuit.

**Frequency Range:** 0.1 to 12.4 GHz (Option 001, 1.0 to 18.0 GHz)

**Maximum insertion loss:** 1.0 dB, 0.1 - 1.0 GHz

0.8 dB, 1.0 - 12.4 GHz

1.2 dB, 12.4 - 18.0 GHz (Option 001)

**Minimum return loss:** 16 dB, 0.1 - 1.0 GHz

19 dB, 1.0 - 12.4 GHz

14 dB, 12.4 - 18.0 GHz (Option 001)

**Maximum Bias Current:** 0.5 A, each bias port

**Maximum Bias Voltage:** 100 V

**Connectors:** BNC for dc bias; Type N female for RF (Option 001, precision 7 mm)

#### HP 11612A Bias Network

The HP 11612A is an insertable, extremely broadband bias network with excellent port match and low insertion loss. This bias network provides dc bias to the center conductor of a coaxial line which can be connected to the device under test while blocking DC bias from the RF circuit.

**Frequency Range:** 45 MHz to 26.5 GHz

**Insertion loss:** 0.8 dB, 45 MHz - 12.4 GHz

(max) 1.3 dB, 12.4 - 26.5 GHz

**Minimum return loss:** 20 dB, 45 MHz - 8.0 GHz

18 dB, 8.0 - 18.0 GHz

14 dB, 18.0 - 26.5 GHz

**Maximum Bias Current:** 0.5 A

**Maximum Bias Voltage:** 40 V

**Connectors:** SMB snap-on for dc bias; precision 3.5 mm for RF

#### HP 11635A Bias Decoupling Network

The HP 11635A bias decoupling network is a recommended accessory for prevention of bias oscillations when biasing microwave bipolar transistors with any HP bias network or s-parameter test set. Installing the HP 11635A between the bias supply and the base bias network prevents low frequency oscillations.

#### Application Software

Hewlett-Packard offers application software packages that complement the HP 8510 system providing automated calibration and measurement capability. Software is available for HP Series 200/300 desktop computers using BASIC 2.0, 3.0, 4.0 or 5.0 operating systems on both 3 1/2" and 5 1/4" disc media.

#### HP 85014B Active Device

##### Measurement Application Pac

The HP 85014B software pac provides the capability to the HP 8510 system for measurement of RF and microwave transistors. Features include automated device biasing with the HP 8717B bias supply, system calibration, and de-embedding of s-parameters when using the HP 85041A transistor test fixture. It is also usable with other HP transistor fixtures as well as user-designed fixtures. Plotted and listed output of device S, H, Y, and Z parameters, as well as the device amplifier summary and termination summary are provided. Also available is the capability to store and retrieve s-parameter data in formats suitable for computer-aided-design applications.

#### Ordering Information

	Price
HP 85041A Transistor Test Fixture	\$5,500
HP 8717B Transistor Bias Supply	4,635
Option 001 Programmable Operation (GP-IO)	670
Option 011 Programming Cable	250
HP 11590B Bias Network	675
HP 11612A Bias Network	700
HP 11635A Bias Decoupling Network	275
HP 85014B Active Device Measurement Software	3,000



# NETWORK ANALYZERS

## Millimeter-wave Measurement System

### 8510 Series

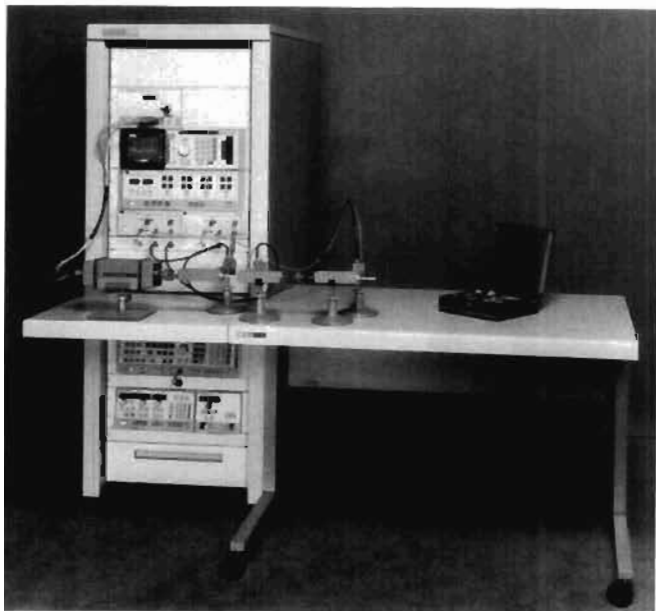

HP 8510 Millimeter-wave Network Analyzer System

The HP 8510B is easily configured for making measurements at millimeter-wave frequencies. Hewlett-Packard offers hardware for configuring systems in the 26.5 to 40 GHz, 33 to 50 GHz, 40 to 60 GHz, 50 to 75 GHz, and 75 to 100 GHz waveguide bands.

#### HP 85106A Millimeter-wave Network Analyzer Subsystem

The HP 85106A millimeter-wave network analyzer subsystem includes an HP 8510B network analyzer, an 8340B RF source, an 8350B/83540A LO source, an 8349B RF source amplifier and an 85100A LO/IF kit rack - mounted in a single bay rack with extendable worksurface and table. Add an HP 11643A series test set kit, 11644A series calibration kit, and millimeter-wave source module for a complete measurement system.

Option 001 adds an HP 8515A test set (with Option 001) and associated RF switching and control hardware to offer combined microwave and millimeter-wave measurement capability.

For systems that require a synthesizer as the LO source (V- and W-bands), Option 002 replaces the HP 8350B/83540A source with an HP 8341B synthesizer.

#### HP 85100A LO/IF Kit

For user-configured benchtop applications, the HP 85100A combines the LO and IF amplifiers, a power divider, waveguide stands, and the interconnect cables that are part of the HP 8510 millimeter-wave system under one model number for ordering convenience.

Kit Includes:<sup>1</sup>

Quantity	Model Part Number	Description
2	11975A	2-8 GHz LO Amplifier
1	8447A	IF Amplifier
1	8447A	Option 001
1	0955-0264	Dual IF Amplifier
1	08510-60105	2-8 GHz Power Divider
1	11540A	IF Interconnect Cable
4	Option E85	Waveguide Stand

<sup>1</sup> Also includes miscellaneous interconnect hardware.

#### HP V11643A V-Band Test Set Kit

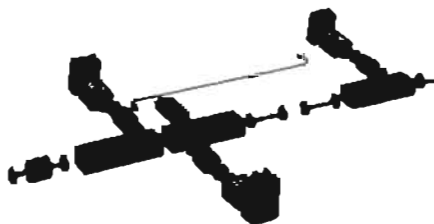

HP 85100A LO/IF Kit

#### HP 11643A-Series Test Set Kits

The millimeter-wave test set kits contain the band-dependent hardware necessary to assemble a reflection/transmission test set for use with the HP 8510 millimeter-wave system. The kit includes directional couplers, harmonic mixers, isolators, a fixed termination, a power divider, and miscellaneous connecting hardware.

Kit includes:<sup>1</sup>

Quantity	Model Part Number	Description
3	7520-series	20 dB <sup>2</sup> Directional Coupler
3	11970A-series	Harmonic Mixer
4	365A-series	Isolator
1	910A-series	Fixed Termination
1	0955-0264	2-8 GHz Power Divider
2	898A-series	Waveguide Twist

<sup>1</sup> Also includes miscellaneous interconnect hardware.

<sup>2</sup> The V-band and W-band test set kits consist of two 20 dB couplers and one 10 dB coupler.

#### Ordering Information

<b>HP 85106A</b> mm-Wave Network Analyzer Subsystem	\$151,000
<b>Option 001</b> add Microwave Test Set (HP 8515A)	add 44,000
<b>Option 002</b> Synthesized LO (HP 8341B)	add 24,800
<b>HP R11643A</b> WR-28 Test Set Kit	14,000
<b>HP Q11643A</b> WR-22 Test Set Kit	15,000
<b>HP U11643A</b> WR-19 Test Set Kit	16,500
<b>HP V11643A</b> WR-15 Test Set Kit	18,500
<b>HP W11643A</b> WR-10 Test Set Kit	21,500
<b>HP 85100A</b> LO/IF Kit	13,000

# NETWORK ANALYZERS

## Microwave Network Analyzer, 110 MHz to 18 GHz

### Model 8410 Series

- Economical vector performance
- Measures all network parameters
- Multioctave swept frequency measurements
- Eliminate harmonic and spurious responses

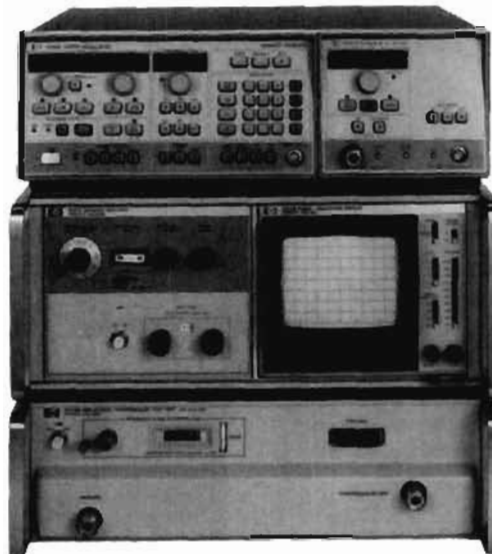

#### Receiver

The HP 8410C network analyzer and HP 8411A harmonic frequency converter comprise the nucleus of the swept-frequency system which provides magnitude and phase measurement capability from 110 MHz to 18 GHz in coax. Automatic frequency locking allows continuous multioctave sweeps. Frequency conversion from RF to IF gives high sensitivity and greater than 60 dB dynamic range, free of spurious and harmonic responses. Calibrated IF substitution makes possible accurate gain or insertion loss measurements.

#### Displays

The HP 8412B Phase/Magnitude Display displays magnitude and phase versus frequency. The HP 8414B Polar Display provides a polar plot of magnitude and phase. These displays are interchangeable plug-ins for the HP 8410C mainframe. The HP 8418B Auxiliary Display Unit can be added to provide simultaneous rectilinear and polar display capability.

#### Sources

Although the HP 8410C can produce octave-width sweeps using any swept source, continuous multi-octave sweeps limited only by the frequency range of the test set are possible with the HP 8620C or 8350B Sweep Oscillators.

#### Test Sets

The HP 8745A, 8743B, and 8746B test sets contain all the necessary splitters and couplers required to provide stimulus to the device under test and route the reference and reflected or transmitted signals to the receiver. Accessories allow the test sets to be configured for active and passive coaxial measurements as well as for semiconductor measurement applications.

#### System Ordering Convenience

HP 8410S systems enable ordering a complete network analyzer system, except for source, using a single model number. Each option has been configured for making general measurements on coaxial or semiconductor devices. The HP 8410S systems enable the operator to view a real time CRT display over octave or multioctave bands with a dynamic range of 60 dB amplitude and 360° phase. Multioctave, continuous network measurements over the frequency range of 2 to 18 GHz are possible when the HP 8410C is used with the HP 8620C or 8350B Sweep Oscillator.

The HP 8410S systems' upper frequency limit for coaxial and semiconductor measurements is 12.4 GHz; however, individual instruments may be ordered that will expand coaxial measurement capability to 18 GHz (option 018 instruments).

#### HP 8410S Network Analyzer Systems

GENERAL PURPOSE MEASUREMENTS			All HP 8410S Systems Include the Following Instrument Model Numbers: HP 8410C, 8411A, 8412B, 8414B, 11609A, and 8750A opt. 003										
Frequency Range	Option No.	Measurement Port Configuration	HP 8743B	HP 8745A	HP 8746B	HP 8717B	HP 11600B	HP 11602B	HP 11608A	HP 11604A	HP 11610B	HP 11650A	Price
0.11 to 2 GHz	110	Coaxial (APC-7)		X						X		X	\$35,510
0.11 to 12.4 GHz	310	Coaxial (APC-7)	X	X						X	X	X	\$45,830
2 to 12.4 GHz	210	Coaxial (APC-7)	X								X	X	\$35,850
SEMICONDUCTOR CHARACTERIZATION													
0.11 to 2 GHz	400	T018/T072 Packages		X		X	X						\$38,775
0.11 to 2 GHz	401	T05/T012 Packages		X		X		X					\$38,775
0.5 to 12.4 GHz	500	Stripline			X	X			X				\$42,785



HP 8411A

HP 8410C



HP 8412B



HP 8414B

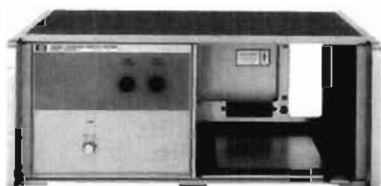

HP 8418B



HP 11866A



HP 11650A



HP 11609A

## Specifications

### HP 8410C/8411A Network Analyzer

**Function:** HP 8411A converts RF signals to IF signals for processing in HP 8410C mainframe. HP 8410C is the mainframe for display plug-in units. Mainframe includes tuning circuits (octave bands or multioctave bands when used with HP 8620C or 8350B sweep oscillator), IF amplifiers and precision IF attenuator. HP 8410C allows injection of an external local oscillator used in automatic applications to lock the HP 8410C receiver to an external source such as the HP 3335A.

**HP 8410C frequency range:** 0.11 to 18 GHz.

**HP 8411A frequency range:** 0.11 to 12.4 GHz.

**Opt 018:** 0.11 to 18 GHz.

**HP 8411A input impedance:** 50 ohms nominal. SWR <1.5, 0.11 to 2.0 GHz; <2.0, 2.0 to 16.0 GHz; 3, 6.0 to 18.0 GHz.

**Channel isolation:** >65 dB, 0.11 to 6 GHz; >60 dB, 6 to 12.4 GHz; >50 dB, 12.4 to 18 GHz.

### Magnitude Range

**Reference channel:** -18 to -35 dBm, 0.11 to 12.4 GHz; -18 to -25 dBm from 12.4 to 18.0 GHz.

**Test channel:** -10 to -75 dBm from 0.11 to 12.4 GHz; -10 to -68 dBm from 12.4 to 18 GHz.

**Maximum RF input to either channel:** 50 mW.

**IF gain control:** 69 dB range in 10 dB and 1 dB steps with a maximum cumulative error of  $\pm 0.2$  dB.

### Phase

**Phase range:** 0 to 360°

**Control:** vernier control  $\leq 90^\circ$

**Connectors (HP 8411A):** APC-7.

**Power:** 115 or 230 V  $\pm 10\%$ , 50-60 Hz, 70 watts (includes HP 8411A)

### Weight

**HP 8410C:** net, 14.9 kg (33 lb); shipping, 18.5 kg (41 lb).

**HP 8411A:** net, 3.2 kg (7 lb); shipping, 4.5 kg (10 lb).

### Size

**HP 8410C:** 191 H x 425 W x 467 mm D (7.5" x 16.75" x 18.38").

**HP 8411A:** 67 x 228 W x 143 mm D (2.63" x 9" x 5.63") exclusive of connectors and cable.

### HP 8412B Phase-Magnitude Display

**Function:** plug-in CRT display unit for HP 8410C. Displays relative amplitude in dB and/or relative phase in degrees between reference and test channel inputs versus frequency. Programmable 180° phase offset by ground closure.

### Amplitude

**Range:** 80 dB display range with selectable resolutions of 10, 2.5, 1 and 0.25 dB/division.

**Accuracy:** 0.08 dB/dB from midscreen.

### Phase

**Range:**  $\pm 180^\circ$  display range with selectable resolutions of 90, 45, 10, and 1°/division.

**Accuracy:** 0.065°/degree from midscreen.

**Phase offset:** 0.3°/20° step cumulative  $< 3^\circ$ .

**Power:** 23 watts supplied by mainframe.

**Weight:** net, 7.8 kg (17 lb); shipping, 10 kg (22 lb).

**Size:** 152 H x 186 W x 395 mm D (6" x 7.28" x 15.56") excluding front panel knobs.

### HP 8414B Polar Display

**Function:** plug-in CRT display unit for HP 8410C. Displays amplitude and phase data in polar coordinates on 5-in. cathode ray tube.

**Range:** normalized polar coordinate display; magnitude calibration 20% of full scale per division. Scale factor is a function of IF setting on HP 8410C. The beam center function is controllable by an external contact closure.

**Accuracy:** error circle on CRT  $\pm 3$  mm.

**Power:** 35 watts supplied by mainframe.

**Weight:** net, 5.8 kg (13 lb); shipping, 8.1 kg (18 lb).

**Size:** 152 H x 186 W x 395 mm D (6" x 7.28" x 15.56") excluding front panel knobs.

### HP 8418B Auxiliary Display Holder

**Function:** the HP 8418B auxiliary display holder provides power for operating of the HP 8412B or the 8414B display units. Used in conjunction with the HP 8410C network analyzer, it provides the capability of viewing amplitude and phase readout in both rectangular and polar coordinates simultaneously. Includes a remotely programmable 0-70 dB IF attenuator required for autoranging in automatic applications.

**Weight:** net, 11.2 kg (25 lb); shipping, 19.7 kg (44 lb).

**Size:** 177 H x 483 W x 450 mm D (6.97" x 19" x 17.13").

### HP 11650A Accessory Kit

**Function:** accessories normally used for transmission and reflection tests with the HP 8745A and 8743B.

**Weight:** net, 1.34 kg (3 lb); shipping, 2.23 kg (5 lb).

### HP 11866A APC-7 Calibration Kit

**Function:** a 50 $\Omega$  (>52 dB return loss 2 GHz) termination, a short circuit and a shielded open circuit are used with automatic network analyzers to quantify directivity, source math, and frequency tracking errors.

**Weight:** net 0.57 kg (1.25 lb); shipping, 0.91 kg (2.0 lb).

**Size:** 50.8 H x 127 W x 127 mm D (2.0" x 5.0" x 5.0").

### HP 11609A Cable Kit

**Function:** interconnecting cables normally required for network measurements using the HP 8410C network analyzer.

**Weight:** net, 0.9 kg (2 lb); shipping 1.36 kg (3 lb).

### Ordering Information

HP 8410C mainframe

HP 8411A Frequency Converter

Opt 018: 0.11 to 18 GHz

HP 8412B Phase-Magnitude Display

HP 8414B Polar Display

HP 8418B Auxiliary Display Holder

HP 11650A Accessory Kit

HP 11866A APC-7 Calibration Kit

HP 11609A Cable Kit

### Price

\$8,550

\$5,520

add \$550

\$4,520

\$3,865

\$4,040

\$1,605

\$500

\$180

# NETWORK ANALYZERS

## Test Sets and Accessories

### Model 8410 Series



HP 8745A



HP 11857D



HP 11602B HP 11600B

#### HP 8745A S-Parameter Test Set

**Function:** wideband RF power splitter and reflectometer with calibrated line stretcher. Pushbutton operated for either forward or reverse transmission or reflection measurements with network analyzer.

**Frequency range:** 100 MHz to 2 GHz.

**Impedance:** 50 ohms nominal.

**Source reflection coefficient:**  $\leq 0.057$ , 0.11 to 2.0 GHz.

**Termination reflection coefficient:**  $< 0.10$ , 100, to 200 MHz;  $< 0.063$ , 200 MHz to 2.0 GHz.

**Directivity:**  $\geq 36$  dB, below 1 GHz;  $\geq 32$  dB, 1 to 2 GHz.

**Reference plane extension:** 0 to 15 cm for reflection; 0 to 30 cm for transmission.

**Maximum RF power:** 2 watts.

**Connectors:** RF input type N female; all other connectors APC-7; Option 001, type N female.

**Remote programming:** ground closure.

**Power:** 115 or 120 V  $\pm 10\%$ , 50 to 400 Hz, 40 watts.

**Weight:** net, 15.4 kg (34.25 lb); shipping, 18.0 kg (40 lb).

**Size:** 140 H x 425 W x 654 mm D (5.50" x 16.75" x 25.75").

#### HP 11600B/11602B Transistor Fixtures

**Function:** mounts on front of HP 8745A S-Parameter Test Set; holds devices for s-parameter measurements in a 50 ohm, coax circuit. Other devices also fit the fixture (tunnel diodes, etc.).

##### Transistor Base Patterns

**Model 11600B:** accepts TO-18/TO-72 packages.

**Model 11602B:** accepts TO-5/TO-12 packages.

**Calibration references:** short circuit termination and a 50 ohm through-section.

**Frequency ranges:** dc to 2 GHz.

**Impedance:** 50 ohms nominal.

**Reflection coefficient:**  $< 0.05$ , 100 MHz to 1.0 GHz;  $< 0.09$ , 1.0 to 2 GHz.

**Connectors:** hybrid APC-7; Option 001, type N female.

**Weight:** net 1.1 kg (2.38 lb); shipping, 1.8 kg (4 lb).

**Size:** 152 H x 44 W x 229 mm D (6" x 1.75" x 9").

#### HP 11857D 50 $\Omega$ APC-7 Test Port Extension Cables

**General:** two precision 61 cm (24 in.) cables, for use with HP 8745A S-Parameter Test Set. Connectors are 50  $\Omega$  APC-7.

**Weight:** net, 0.91 kg (2 lb); shipping, 2.3 kg (5 lb).

#### HP 8410S Opt 110 Specifications

**Function:** the HP 8410S option 110 measurement system configuration is described on page 252. Following are specifications describing

measurement capabilities of the HP 8410C/8411A when used with the HP 8745A/11604A over the frequency range of 110 MHz to 2 GHz.

**Frequency range:** 0.11 to 2.0 GHz.

**RF input:** 20 dB range between +5 dBm and -12 dBm.

**Source reflection coefficient:**  $\leq 0.067$ , 0.11-2.0 GHz.

**Termination reflection coefficient:**  $\leq 0.11$ , 100-200 MHz;  $\leq 0.07$ , 200-2000 MHz.

**Directivity:**  $\geq 28$  dB 0.11-1.0 GHz;  $\geq 27$  dB 1.0-2.0 GHz.

**Insertion loss, RF input to test port:** 4 dB nominal.

##### Frequency Response

**Transmission:** typically  $\pm 0.35$  dB amplitude and  $\pm 5^\circ$  phase.

**Reflection:** typically  $\pm 0.06$  magnitude and  $\pm 5^\circ$  phase with a short on the test port.

**Transmission measurement accuracy:** (see common performance specifications).

**Reflection measurement accuracy (using HP 8414B):** sources of error included in the accuracy equations are directivity, source match, and polar display accuracy.

##### Magnitude Accuracy

$\rho_u = \pm (0.0398 + 0.03 \rho_L + 0.067 \rho_L^2)$  0.11-1.0 GHz.

$\rho_u = \pm (0.0447 + 0.03 \rho_L + 0.067 \rho_L^2)$  1.0-2.0 GHz.

$\rho_u =$  magnitude uncertainty.

$\rho_L =$  measured reflection coefficient magnitude.

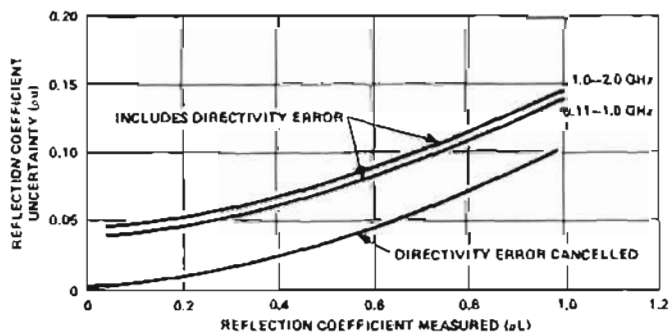

##### Phase Accuracy

$\phi_u = \sin^{-1} \rho_u / \rho_L$  for  $\phi_u < 90^\circ$ .

$\phi_u =$  phase uncertainty.

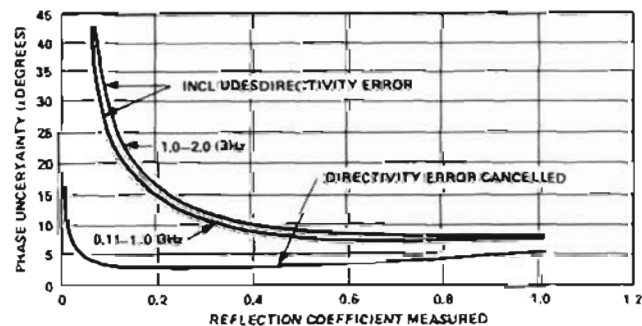

See HP 8410S network analyzer systems table for price and instrument breakdown.

##### Ordering Information

HP 8745A Test Set

Opt 001: Type N Test Port Connectors

HP 11600B/11602B Transistor Fixtures

Opt 001: Type N Female Connectors

HP 11857D 50  $\Omega$  APC-7 Test Port Extension Cables

**Price**

\$10,280

N/C

\$1,800

less \$30

\$1,050

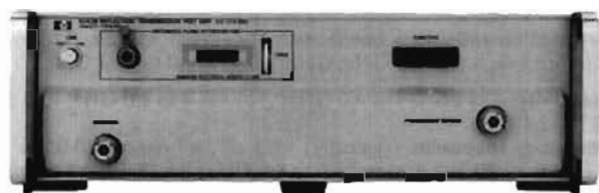

HP 8743B

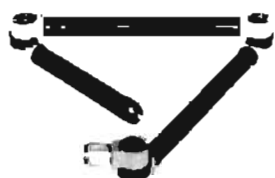

HP 11605A



HP 11610B

### HP 8743B Reflection/Transmission Test Unit

**Function:** wideband RF power splitter and reflectometer with calibrated line stretcher. Pushbutton operated for either transmission or reflection measurement with network analyzer. Designed for use with the HP 11610B test port extension cable.

**Frequency range:** 2 to 12.4 GHz (Opt 018: 2 to 18 GHz).

**Impedance:** 50 ohms nominal.

**Source reflection coefficient:**  $\leq 0.09$ , 2.0 to 8.0 GHz;  $\leq 0.13$ , 8.0 to 12.4 GHz;  $< 0.2$ , 12.4 to 18 GHz.

**Termination reflection coefficient:**  $\leq 0.13$  in reflection mode, 2.0 to 12.4 GHz;  $\leq 0.2$  in transmission mode, 2.0 to 12.4 GHz; typically  $< 0.2$ , 12.4 to 18 GHz.

**Directivity:**  $\geq 30$  dB, 2.0 to 12.4 GHz;  $\geq 18$  dB, 12.4 to 18 GHz.

**Reference plane extension:** 0 to 15 cm for reflection; 0 to 30 cm for transmission.

**Connectors:** RF input, type N female; all other connectors APC-7.

**Remote programming:** ground closure.

**Power:** 115 or 230 V  $\pm 10\%$ , 50-400 Hz, 15 W.

**Weight:** net, 12.1 kg (29 lb); shipping, 15.3 kg (34 lb).

**Size:** 140 H x 425 W x 467 mm D (5.50" x 16.75" x 18.38").

### HP 11610B Microwave Cable

**Function:** a high quality semirigid coaxial cable used with the network analyzer at frequencies up to 18 GHz. It is designed for applications which require excellent magnitude and phase repeatability from connection to connection. The cable exhibits minimum change in transmission characteristics when flexed during normal use. The HP 11610B is the recommended transmission return cable for use with the HP 8743B and the HP 8746B.

**Frequency range:** dc to 18 GHz.

**Impedance:** 50 ohms nominal. Reflection coefficient of ports  $< 0.14$ .

**Insertion loss:**  $< 0.7$  dB + 0.12 dB/GHz.

**Stability with three repeated flexings:**  $< 0.3$  dB,  $< 0.5$  degrees +0.12 degrees/GHz change.

**Connectors:** APC-7.

**Length:** 1.07 m (42 inches).

### HP 11605A Flexible Arm

**Function:** mounts on front of HP 8743B test set; connects to device under test. Rotary air-lines and rotary joints connect to any two-port geometry. Primarily intended for use with existing HP 8743As but can be used with HP 8743B (HP 11610B recommended for use with HP 8743B).

**Frequency range:** dc to 18 GHz.

**Impedance:** 50 ohms nominal. Reflection coefficient of ports:  $\leq 0.11$ , dc to 2.0;  $\leq 0.23$ , 2.0 to 12.4 GHz;  $\leq 0.31$ , 12.4 to 18 GHz.

**Connectors:** APC-7.

**Weight:** net, 1.8 kg (4 lb); shipping, 2.7 kg (6 lb).

**Length:** 257 mm (10.09") closed; 648 mm (25.50") extended.

### HP 8410S Opt 210 Specifications

**Function:** the HP 8410S Option 210 measurement system configuration is described on page 248. Following are specifications describing measurement capabilities of the HP 8410C/8411A when used with the HP 8743B/11610B over the frequency range of 2 GHz to 12.4 GHz.

**Frequency range:** 2.0 to 12.4 GHz.

**RF input:** 20 dB range between +12 dBm and -5 dBm.

**Source reflection coefficient:**  $\leq 0.09$ , 2-8 GHz;  $\leq 0.13$ , 8-12.4 GHz.

**Termination reflection coefficient:**  $\leq 0.09$ , 2-8 GHz;  $\leq 0.13$ , 8-12.4 GHz.

**Directivity:**  $\geq 30$  dB, 2-12.4 GHz.

**Insertion loss, RF input to test port:** 20 dB nominal.

#### Frequency Response

**Transmission:** typically  $< \pm 0.5$  dB amplitude and  $< \pm 5^\circ$  phase.

**Reflection:** typically  $< \pm 0.09$  magnitude and  $< \pm 6^\circ$  phase, with a short on the unknown port.

**Transmission Measurement accuracy** (see Common Performance Specifications).

**Reflection measurement accuracy (using HP 8414B):** sources of error included in the accuracy equations are directivity, source match, and polar display accuracy.

#### Magnitude Accuracy

$\rho_u = \pm (0.0316 + 0.03 \rho_L + 0.09 \rho_L^2)$  2-8 GHz.

$\rho_u = \pm (0.0316 + 0.03 \rho_L + 0.13 \rho_L^2)$  8-12.4 GHz.

$\rho_u$  = magnitude uncertainty.

$\rho_u$  = measured reflection coefficient magnitude.

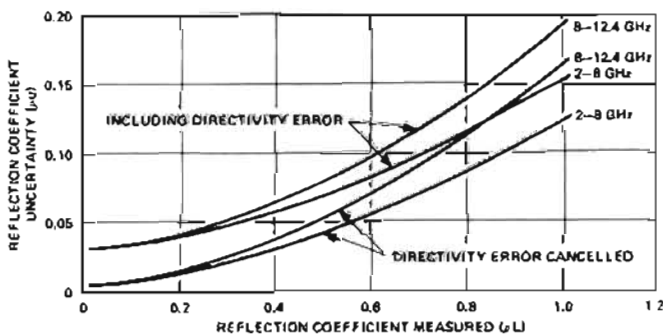

#### Phase Accuracy

$\phi_u = \sin^{-1} \rho_u / \rho_L$  for  $\phi_u < \pm 90^\circ$ .

$\phi_u$  = phase uncertainty.

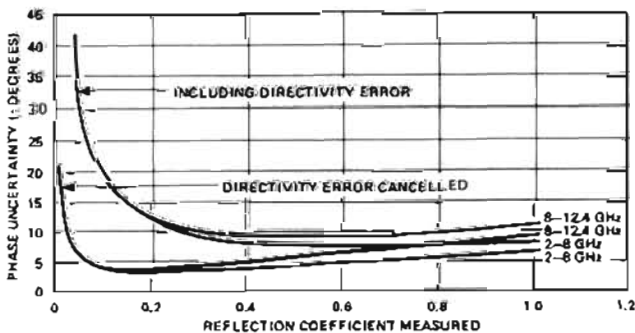

See HP 8410S network analyzer systems table for price and instrument breakdown.

#### Ordering Information

HP 8743B Reflection/Transmission Test Unit

Opt 018: 2 to 18 GHz

HP 11610B Microwave Cable

HP 11605A Flexible Arm

#### Price

\$7,820

add \$800

\$655

\$3,000

# NETWORK ANALYZERS

## Test Sets and Accessories (cont'd)

### Model 8410 Series



HP 8746B



HP 11608A

#### HP 8746B S-Parameter Test Set

**Function:** wideband RF power divider and reflectometer with calibrated line stretcher and a selectable 0-70 dB incident signal attenuator. Provides internal bias for completely characterizing two port active devices.

**Frequency range:** 0.5 to 12.4 GHz.

**Source and termination reflection coefficient:**  $\leq 0.13$ .

**Directivity:**  $\geq 30$  dB, 0.5 to 4.0 GHz;  $\geq 26$  dB, 4.0 to 12.4 GHz.

**Incident attenuation:** 0-70 dB in 10 dB steps  $\pm 5\%$ .

**Reference plane extension:** adds 0 to 15 cm for reflection, 0 to 30 cm for transmission.

**Remote programming:** ground closure.

**Transistor biasing:** via 36-pin connector.

**Connectors:** input type N female, test ports APC-7.

**Opt 001:** provides 10 dB higher power level at the test port.

**Power:** 115 or 230 V  $\pm 10\%$ , 48 to 440 Hz, 110 VA max.

**Weight:** net, 16.1 kg (35 lb); shipping, 19.1 kg (42 lb).

**Size:** 140 H x 425 W x 467 mm D (5.5" x 16.75" x 18.38").

#### HP 11608A Transistor Fixture

**Function:** provides the capability of completely characterizing stripline transistors. A through-line microstrip and bolt-in grounding structure machineable by customer is included.

**Frequency range:** dc to 12.4 GHz.

**Reflection coefficient:**  $< 0.05$ , dc to 4 GHz;  $< 0.07$ , 4.0 to 8.0 GHz;  $> 0.15$ , 8 to 12.4 GHz.

#### Package Styles

**Opt 003:** 0.205 inch diameter packages.

**Calibration references:** option 003 only, short circuit termination and a 50-ohm through-section.

**Connectors:** APC-7 hybrid.

**Weight:** net, 0.9 kg (2 lb); shipping, 1.4 kg (3 lb).

**Size:** 25 H x 143 W x 89 mm D (1" x 5.63" x 3.5").

#### HP 8410S Opt 500 Specifications

**Function:** the HP 8410S option 500 measurement system configuration is described on page 632. Following are specifications describing measurement capabilities of the HP 8410C/8411A when used with the HP 8746B/11608A over the frequency range of 500 MHz to 12.4 GHz.

**Frequency range:** 0.5 to 12.4 GHz.

**Transistor dc bias selection;** front panel slide switches establish proper dc biasing for both Bi-polar and FET transistors. The voltage and current controls operate independently and are continuously adjustable over a current range of 0 to 500 mA and a voltage range of 0 to 30 Vdc.

**RF input:** 20 dB range between +12 and -5 dBm.

**Incident attenuation range:** 0 to 70 dB in 10 dB steps.

**Source reflection coefficient:** (typically)  $\leq 0.132$ , 0.5 to 4.0 GHz;  $\leq 0.135$ , 4.0 to 8.0 GHz;  $\leq 0.141$ , 8.0 to 12.4 GHz.

**Termination reflection coefficient:** (typically)  $< 0.139$ , 0.5 to 4.0 GHz;  $< 0.148$ , 4.0 to 8.0 GHz;  $< 0.170$ , 8.0 to 12.4 GHz.

**Directivity:**  $\geq 28$  dB, 0.5 to 4.0 GHz;  $\geq 24$  dB, 4 to 8.0 GHz;  $\geq 23$  dB, 8.0 to 12.4 GHz.

**Frequency response:** (typically)  $< 0.5$  dB,  $\pm 7$  degrees, 0.05 to 4.0 GHz;  $< 0.75$  dB,  $\pm 7$  degrees, 4.0 to 8.0 GHz;  $< 1.25$  dB,  $\pm 7$  degrees, 8.0 to 12.4 GHz.

**Transmission measurement accuracy:** (see Common Performance Specifications).

**Reflection measurement accuracy:** sources of error included in the accuracy equation are directivity and source match.

#### Magnitude Accuracy

$\rho_m = \pm(0.04 + 0.08 \rho_L + 0.13 \rho_L^2)$  0.5 to 4.0 GHz.

$\rho_m = \pm(0.06 + 0.09 \rho_L + 0.135 \rho_L^2)$  4.0 to 8.0 GHz.

$\rho_m = \pm(0.074 + 0.098 \rho_L + 0.14 \rho_L^2)$  8.0 to 12.4 GHz.

$\rho_m$  = magnitude uncertainty.

$\rho_L$  = measured reflection coefficient magnitude

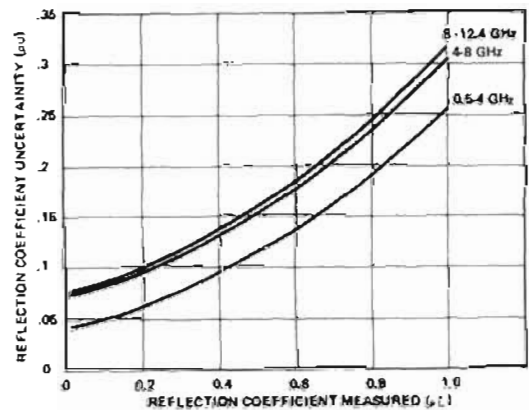

#### Phase Accuracy

$\Phi_m = \sin^{-1} \rho_u / \rho_L$  for  $\Phi_m < 90^\circ$ .

$\Phi_m$  = phase uncertainty.

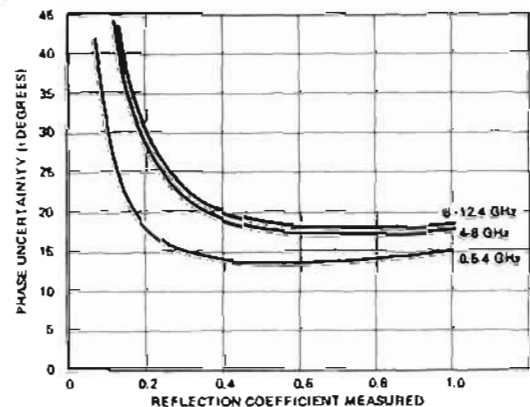

See HP 8410S network analyzer systems table for price and instrument breakdown.

#### Ordering Information

HP 8746B Test Unit

Opt 001: Large Signal

HP 11608A Transistor Fixture Customer Machineable

Opt 003: 0.205 inch diameter package style

#### Price

\$12,380

N/C

\$1,705

add \$450

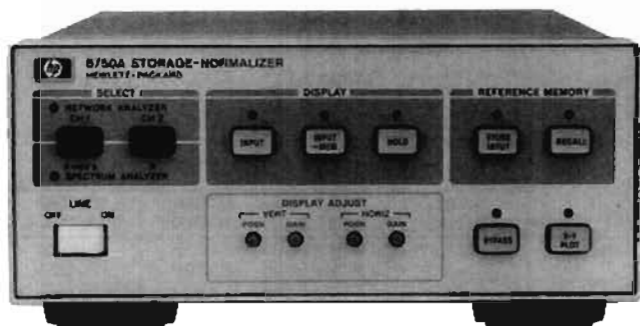

HP 8750A

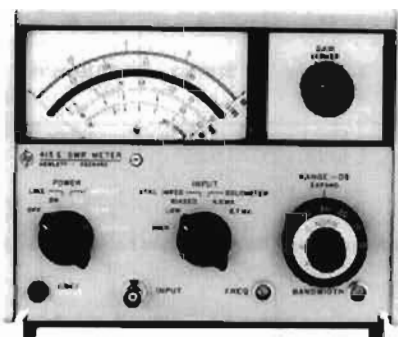

HP 415E

### HP 8750A Storage Normalizer

With HP's versatile 8750A Storage-Normalizer, you can make your network analyzer or spectrum analyzer measurements faster, easier, and more accurately through the simple addition of digital storage and normalization. This useful instrument accessory is directly compatible via a single interface cable with the following Hewlett-Packard instruments; the HP 8755 Scalar Network Analyzer, the HP 8410/8412B, the HP 8754A and the HP 8505A Networks Analyzers and HP 8557A, 8558B, 8565A and 8559A Spectrum Analyzers. A special I/O adapter (opt 001 or opt 002) is available for interfacing instruments (like HP 140 Series Spectrum Analyzers) that are not directly compatible with the HP 8750A. An external oscilloscope can then be used for digitally stored and normalized displays. (The HP 8750A is not compatible with the HP 8414B Polar Display or the polar mode of the HP 8505A or the HP 8754A.)

In network analyzer applications, digital storage always yields a flicker-free display of the complete device response, facilitating easy adjustment of test devices under slow sweep conditions. Measurement accuracy is also improved since frequency response errors can be automatically removed through digital normalization. This effectively eliminates the need to manually record calibration traces on a CRT or x-y recorder and allows high resolution measurements of attenuator, amplifier, or filter passband flatness.

In spectrum analyzer applications, the HP 8750A's digital storage feature simplifies many difficult tests requiring slow scan times such as high resolution modulation measurements. Drift tests are also easy since two traces, a stored reference and the current input, can be displayed simultaneously.

Hard copy documentation can be obtained quickly and easily since data can be frozen on the CRT for straightforward CRT photography or output to an x-y recorder at a constant 30 second sweep rate.

### Supplemental Performance Characteristics

#### Display

**Horizontal memory resolution:** two display channels, 256 points per channel (0.4% of full scale, 8 bit word)

**Vertical memory resolution:** 512 points displayed full scale (0.2% of full scale, 10 bit word) plus a 50% overrange (256 points) both above and below full screen.

**Horizontal input sweep rates:** 100 s max./10 ms min.

**Display refresh rate:** 6 ms.

#### Video Detection

**Network analyzer:** average detection (20 kHz).

**Spectrum analyzer:** peak detection.

#### General

**Interface cards:** the HP 8750A is supplied with two general plug-in interface cards, one for use with the HP Spectrum Analyzers listed above and one for use with the HP 8407A/8412B and 8505A Network Analyzer. When the HP 8750A is to be used primarily with an 8755C Scalar Network Analyzer, HP 8350B/8620C sweep oscillator, HP 8410C/8412B Network Analyzer, or the HP 8754A Network Analyzer, calibration and adjustment of the HP 8750A to these instruments can be greatly simplified by ordering one of the plug-in interface cards dedicated to these instruments (Opt. 003 and 004). All offset and gain adjustments are significantly reduced. When Opt. 003 or 004 are ordered, the two general interface cards are also included, so you have the flexibility to change your test set-up at any time.

**Power:** selection 100, 120, 220, or 240 V +5% -10%. 48 to 440 Hz and <20 VA (<20 watts).

**Size:** 102 H x 212 W x 280 mm D (4" x 8.4" x 11.2").

**Weight:** net, 2.72 kg (6.1 lbs); shipping, 5.0 kg (11 lbs).

### HP 415E SWR Meter

HP 415E SWR Meter is a low noise, 1000 Hz tuned amplifier and voltmeter, calibrated in dB and SWR. Designed for use with square law detectors, it measures SWR, attenuation, and gain directly from metered scales, or drives an X-Y recorder for RF substitution measurements. Front panel INPUT switch selects unbiased low (50-200  $\Omega$ ) or high (2500-10,000  $\Omega$ ) impedance crystal, biased crystal (1 V into 1 k $\Omega$ ), or low or high current bolometer (4.5 or 8.7 mA  $\pm$  3% into 200  $\Omega$ ).

An internal precision 60 dB attenuator allows the HP 415E to operate over a 70 dB range in 10 or 2 dB steps, with  $\pm$ 0.05 dB accuracy for a 10 dB step; maximum cumulative error between any two 10 dB steps is  $\pm$ 0.1 dB. Sensitivity is 0.15  $\mu$ V rms for full scale deflection at maximum bandwidth (1  $\mu$ V rms on high impedance crystal input).

Continuously adjustable bandwidth can be adjusted from 15 Hz for maximum sensitivity at CW frequencies to 130 Hz for swept frequency uses. An optional rechargeable battery pack provides up to 36 hours of continuous operation for portable use.

**Weight:** Net 4 kg (9 lb); shipping 5.8 kg (13 lb).

**Power:** 115-230 V  $\pm$ 10%, 50-400 Hz, 1 VA.

**Dimensions:** 155Hx190Wx279mm D(6 $\frac{1}{2}$ x7 $\frac{2}{3}$ x11 in.)

#### Ordering Information

	Price
HP 8750A Storage-Normalizer	\$2,600
Opt 001: BNC Interface Adapter (Deletes direct interface cable)	N/C
Opt 002: BNC Interface Adapter (Retains direct interface cable)	add \$180
Opt 003: HP 8755C or 8412B/8620C Plug-in Interface Card	add \$150
Opt 004: HP 8754A Plug-in Interface Card	add \$150
HP 415E SWR Meter	\$2300
Opt 001: rechargeable battery installed	add \$105
Opt 002: rear panel input connector	add \$25

# LOGIC ANALYZERS

## State, Timing, Analog, and Stimulus/Response Analysis

Model 1631A/D, 1650A, 1651A, 16500A, 16510A, 16515A/16A, 16520A/21A, 16530A/31A



### Introducing HP's New Family of Logic Analyzers and Logic Analysis Systems . . .

#### Performance

- Up to 400 channels of general-purpose logic analysis.
- Up to 80 channels of 1 GHz timing analysis.
- Up to 204 channels of 50 Mbit/s pattern generation.
- Up to 8 channels of 400 Msamples/s digitizing oscilloscope capability.

#### Ease-of-use

- Save time and avoid errors using the HP 16500A's color touch screen or mouse.
- Make measurements quickly with the HP 1650A/1651A's simplified user-interface.
- Give the knob a spin to change values quickly or move measurement markers.

#### Value

- Rely on HP's traditional reliability and quality for low cost-of-ownership.
- With Option W30, get 3 year protection for your HP 1650A/1651A/16500A.
- These products come with a one year standard warranty. Option W30 adds two additional years of return-to-HP service.
- Get assistance when and where you need it with HP's worldwide sales and support organization.

#### Setup Convenience

- Set up your digitizing oscilloscope or your timing analyzer with push button ease using HP's Auto-Scale.
- Connect to your circuit with new lightweight passive probes and flexible cables.
- Hook up quickly to today's most popular 8-, 16-, and 32-bit microprocessors with HP's preprocessors.
- Store and recall configurations from built-in disc drives for fast setup.

	HP 1650A	HP 1651A
Timing	100 MHz on ALL 80 channels	100 MHz on ALL 32 channels
State	25 MHz on ALL 80 channels	25 MHz on ALL 32 channels

Memory	1 Kbit/channel	1 Kbit/channels
Microprocessor support	Today's most popular 8-, 16-, and 32-bit microprocessors	Today's most popular 8-bit microprocessors
Price	\$7800	\$3900

	LOGIC ANALYSIS	1 GHz TIMING	PATTERN GENERATION	DIGITIZING OSCILLOSCOPE
Module	HP 16510A**	HP 16515A/ HP 16516A	HP 16520A/ HP 16521A	HP 16530A/ HP 16531A
Channels Per Card	80	16	12/48	2
Maximum Channels Per System	400	80	204	8
Memory Depth	1K	8K	4K	4K
Maximum Rate	25 MHz State 100 MHz Timing	1 GHz Timing	50 Mbits/s	400 Msamples/s 100 MHz Bandwidth
PRICE	\$5200	\$7800/ \$6500	\$3700/ \$4000	\$1500/ \$4000

\*\*The HP 16510A has the same capabilities as the HP 1650A and contains 5 of HP's Logic-Analyzer-on-a-Chip.

#### Simple, Yet Does the job . . . and More

- Lengthen your timing window with transitional timing on ALL channels.
- Capture elusive glitches with glitch detection on ALL channels.
- Configure the HP 1650A/1651A in four ways: one state analyzer, one timing analyzer, or one state and one timing analyzer.
- Store setups and measurement results with the built-in disc drive for fast recall or permanent records.
- Generate report-quality documentation with push button ease.
- Program the HP 1650A/1651A with easily understood commands through the built-in RS-232C interface.

#### Fits Where You Need It . . . Goes Where You Want It

- Compact: With its small footprint, the HP 1650A/1651A fits easily on your bench, within the same field of vision as what you're working on.
- Portable: At only 22 lbs., the HP 1650A/1651A can be easily carried with its built-in handle or the HP 1540-1066 soft carrying case.
- One Piece: Keep everything together, in one place; the probes and cables fit conveniently into the pouch attached to the top of the instrument.

#### Solutions for Individual Requirements and Group Needs

- Customize your own system by adding cards to the HP 16500A's five card slots.
- Make time-correlated measurements between cards using the HP 16500A's Intermodule Bus.
- Compare measurement data from hardware with design simulation data using the HP Electronic Design System and the HP 16500A Logic Analysis System.
- Program the HP 16500A with easily understood commands through HP-IB or RS-232C built-in interfaces.
- Store setups and measurement results in either of two built-in disc drives for fast recall or permanent record.
- Generate report-quality documentation with push button ease.



## Today's Best Value in General-purpose Logic Analyzers

### Model 1650A, 1651A

- HP 1650A-80 channels, HP 1651A-32 channels of 25 MHz state or 100 MHz timing
- Transitional timing for deep effective memory
- Supports most popular 8-, 16-, and 32-bit micro-processors
- Lightweight passive probing
- Simultaneous state/state, simultaneous state/timing

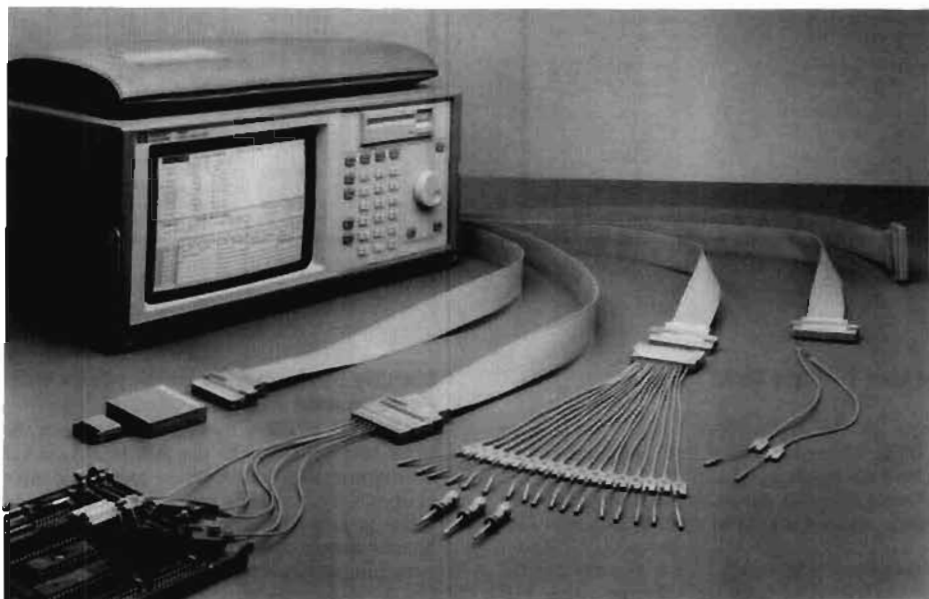

HP 1650A

#### Hook Up Quickly and Reliably to Your Circuit

HP's new passive probes are small and lightweight. With an input impedance at the probe tip of 100k ohms in parallel with 8 pF, these probes won't load down your circuit. Individual probes and cables can be removed when they get in the way. Additionally, the HP 01650-63201 Terminating Adaptor enables you to connect your logic analyzer directly to PC boards with 2x10, 0.1" center connectors

#### Debug Quickly with up to 80 Channels

The HP 1650A/1651A/16510A's 5 ns minimum glitch capture on all channels looks for activity between samples. Pattern search helps you to find a specific event quickly. Overlay mode places several timing signals on one display line, so that you can see where timing violations occur. Infinite persistence shows the changes in waveforms during repetitive acquisitions. When more channels means spending less time to find the problem, use up to 80 channels.

#### Capture the Data You Want to See

Trigger on a pattern across the full number of channels. Or you can qualify a pattern by specifying a duration, glitch, or edge. Specify a pattern duration to capture error conditions indicated by a pattern that exceeds a specified limit. When you need to see what is happening around a troublesome glitch or hardware interrupt signal, use glitch or edge triggering.

#### Focus on the Information You Need

The HP 1650A/1651A/16510A's complex state triggering filters out unnecessary data and provides a listing of the crucial data:

- 5 clock inputs and 4 clock qualifiers allow your system to determine when the analyzer takes a sample.
- Storage qualification allows you to specify which states are stored in memory.
- 8 sequence levels determine the sequence of states required for trigger and help you to focus on a specific area of code execution.
- 8 pattern recognizers, 1 range recognizer or logical combinations of these are used to identify states that are stored.
- Tagging keeps track of the amount of time or the number of states between stored states.
- Enable/Disable can be used to restrict storage to the activity of a specific routine.
- Pre-store stores two qualified states that precede the states that are normally stored.

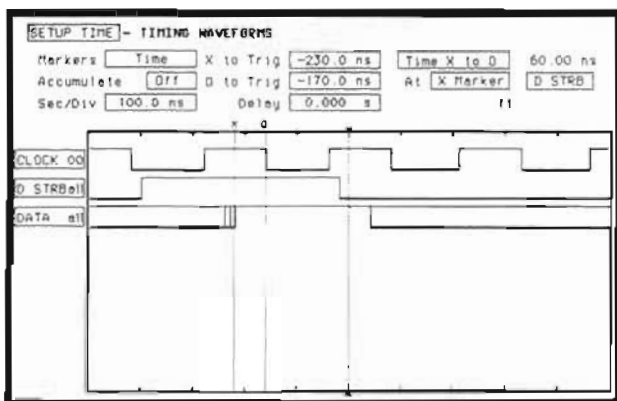

Overlap all data channels on the display to measure when all lines are stable.

#### Extend the Memory of Your Timing Analyzer with Transitional Timing

Traditionally, a timing analyzer samples the input channels based on its own internal clock and then stores every sample in memory. The HP 1650A/1651A/16510A store data only when there is a transition, thus avoiding redundant data. This effectively extends the memory by lengthening the time covered by an acquisition. The timing analyzer samples at full speed so that events that are seconds or even minutes apart are captured with 10 ns resolution.

# LOGIC ANALYZERS

Today's Best Value in General-purpose Logic Analyzers (cont'd)

Model 1650A, 1651A

Label	Base	ADDR	Hex	6809/6809E Mnemonic	STAT
+0120		F80A	LDY	#1000	OPCODE
+0121		F80B	BE	program read	PROGRAM
+0122		F80C	10	program read	PROGRAM
+0123		F80D	00	program read	PROGRAM
+0124		F80E	LDU	#1000	OPCODE
+0125		F80F	10	program read	PROGRAM
+0126		F810	00	program read	PROGRAM
+0127		F811	TFR	B,DP	OPCODE
+0128		F812	98	program read	PROGRAM
+0129		F813	ABX		OPCODE
+0130		F814	ADCA	#55	OPCODE
+0131		F815	55	program read	PROGRAM
+0132		F816	ADCA	<0039	OPCODE
+0133		F817	39	program read	PROGRAM
+0134		0039	FF	data read	DATA
+0135		F818	ADCA	1000	OPCODE

Label	Base	ADDR	Hex	80386 Mnemonic	STAT
+0004		FFFFFFFB	JMP	FFFF0H:0024H	CODE RD
+0005		FFFFFFFA	xxxxF00H	code read	CODE RD
+0006		FFFFFFFC	ADD	IBX:1511.AL	CODE RD
+0007		FFFFFFFE	ADD	no operand	CODE RD
x+0008		000FF24	CLI		CODE RD
+0009		000FF26	xxxx000H	code read	CODE RD
+0010		000FF28	MOV	DI,#0100H	CODE RD
+0011		000FF2A	MOV	CX,#0018H	CODE RD
+0012		000FF2C	xxxx0018H	code read	CODE RD
+0013		000FF2E	CLD		CODE RD
+0014		000FF24	CLI		CODE RD
+0015		000FF26	xxxx000H	code read	CODE RD
+0016		000FF28	MOV	DI,#0100H	CODE RD

Motorola 6809 state listing and Intel 80386 state listing, both with inverse assembly.

### Debug Designs that Use Today's Most Popular Microprocessors

HP's preprocessors tailor the HP 1650A/1651A/16510A to microprocessors from Intel, Motorola, Zilog, and National. These preprocessors simplify hookup by plugging directly into the CPU's socket. Companion software converts the acquired state data into microprocessor mnemonics, making it easy to monitor program execution.

For designs that use custom or proprietary CPUs, you can use the HP 10320C User-definable Interface to connect the HP 1650A/1651A/16510A to your system. The HP 10391A Inverse Assembler Development Package can be used to develop custom software that converts the acquired state data into your CPU's mnemonics.

### View Time-correlated Activity of Two Parts of Your System

The HP 1650A/1651A/16510A can be configured into two independent state analyzers, or one state and one timing analyzer. Measurements that might have required two instruments before can now be made with one instrument.

For example, by using the state analyzer to focus on a specific I/O routine, you can watch both the program execution and the activity on the I/O lines with a time correlated display. Or, when you need to examine the interaction of two microprocessors, the HP 1650A/1651A/16510A can display time-correlated state listings.

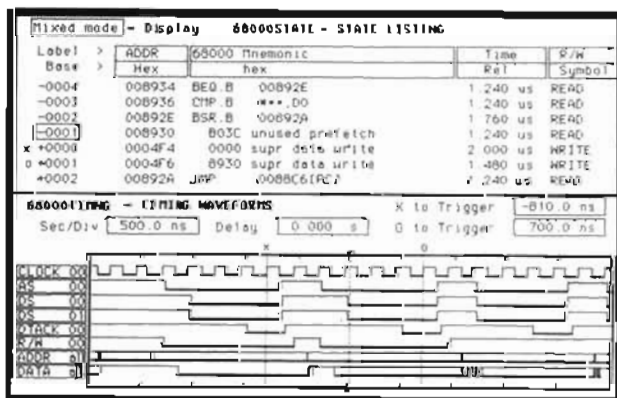

Make simultaneous measurements in both the state and timing domains.

### Identify Performance Bottlenecks with System Performance Analysis

The HP 10390A System Performance Analysis software adds three measurements to the HP 1650A/1651A/16510A. The State Histogram and State Overview measurements can display the intensity of activity in specific areas of memory or identify modules that are prime targets for optimization. The Time Interval measurement can be used to measure execution time of a module, time between calls to a module, or time between two different modules.

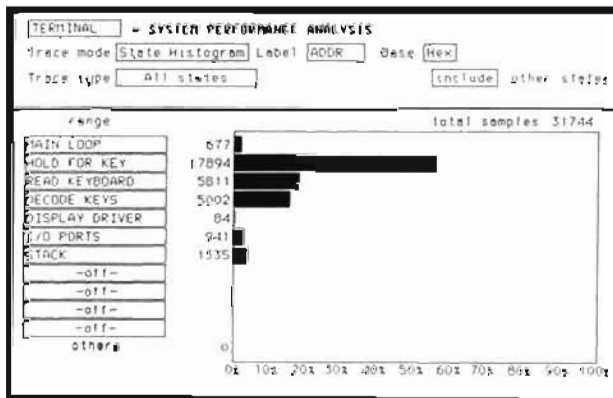

State Histogram... for characterizing the usage of software modules.

### Use Cross-Domain Triggering For Complex Measurements.

Use state to arm timing, or use timing to arm state when the symptom of a problem is best isolated with one analyzer and the cause is best isolated with the other. For example, track a microprocessor's program flow around a hardware interrupt by using the timing analyzer to find the edge of the interrupt signal. Then the timing analyzer can arm the state analyzer to acquire data.

- Built-in two-channel digitizing oscilloscope—50 MHz bandwidth and 200 M sample/second rate
- Up to 43 state channels and 16 timing channels

- Interactive measurements
- Automatic time-interval measurements



The HP 1631A/D logic analyzer has a built-in digitizing oscilloscope, enabling digital hardware designers to make the cross-domain measurements needed to troubleshoot and characterize systems.

### Three Instruments in One Box: HP 1631D

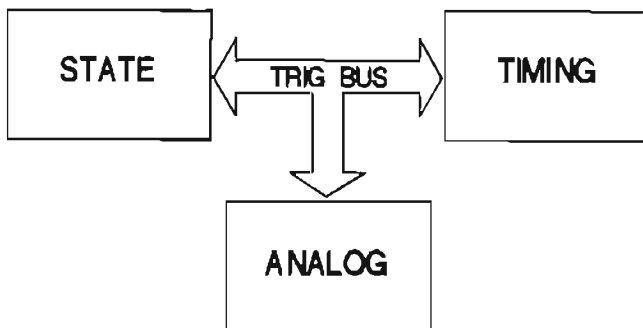

The HP 1631A/D provides three instruments in one, linked by an internal trigger bus. Interactive measurements allow you to trigger on the symptom with one instrument, and analyze the cause with another.

#### HP 1631A/D Logic Analyzer . . .

The HP 1631A/D provides a digitizing oscilloscope and a logic analyzer in one low-cost instrument. Its analog, timing, state, and system performance analysis capabilities function separately or interactively to serve the needs of digital design and test engineers.

The A and D models differ only in state/timing channel width. The HP 1631A provides up to 35 state channels, eight timing channels, and two analog channels. The HP 1631D provides up to 43 state channels, 16 timing channels, and two analog channels.

#### The One Tool For Every Phase Of Digital Design And Test

##### A 50 MHz digitizing oscilloscope

- 200 megasample/second digitizing rate for capturing single-shot waveforms
- Two simultaneous channels
- Single-shot time intervals to  $\pm 1.5$  ns

##### A complete logic analyzer

- 100 MHz timing analyzer
- Time-interval accuracy to  $\pm 1.5$  ns
- 25 MHz state analyzer

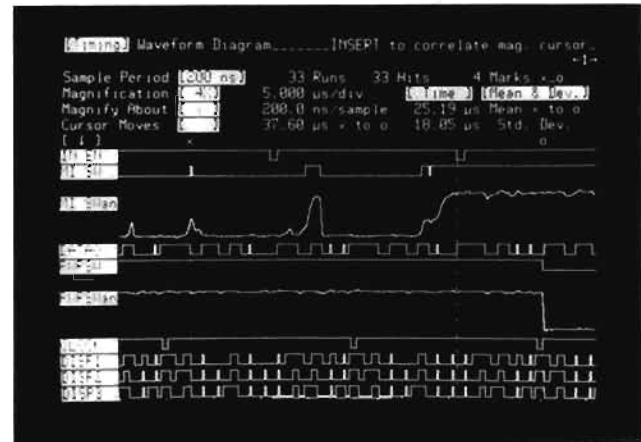

Interactive measurements allow you to use the timing analyzer to locate and trigger on a glitch, and then use the analog analyzer (with higher vertical resolution) to analyze the cause.

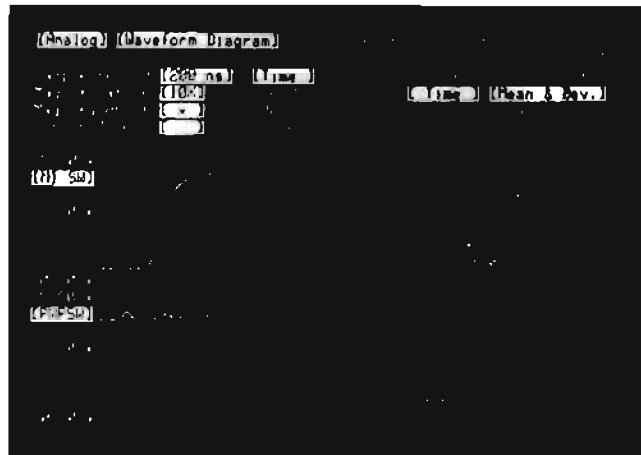

With a built-in oscilloscope, the HP 1631A/D provides two channels of analog analysis plus automatic time-interval measurements and statistics.

#### Interactive Analysis

You can use one of the HP 1631A/D's analyzers to capture the symptom and then use one of the other analyzers to analyze the cause. Depending on your measurement needs, you can select state, timing, or analog as master. The other two then become slave. When the master's trigger specification is met, it simultaneously triggers the slave—while maintaining time correlation between the analyzers.

#### Analog Waveform Analysis

Analog waveform analysis provides simultaneous display of up to two channels. User-definable labels, wide magnification range, and direct readout of time and voltage between cursors are available.

#### State Analysis

State listings and waveforms provide displays and windowing of address, data, status, and control line activity. Selectable display modes include binary, octal, decimal, hexadecimal, ASCII, relocation, user-defined mnemonics, and microprocessor-specific mnemonics. You can assign labels, and display and/or trigger on code in terms of relocatable or absolute addresses, or user-defined mnemonics.

#### Timing Analysis

Timing waveform diagrams provide simultaneous display of up to 16 channels, with user-definable labels. Wide magnification range, glitch display, and direct readout of time between cursors are available.

# LOGIC ANALYZERS

## Logic Analysis Systems

Model 16500A, 16510A, 16515A, 16516A, 16520A, 16521A, 16530A, 16531A

- Up to 400 channels of general-purpose logic analysis
- Up to 80 channels of 1 GHz timing analysis
- Up to 204 channels of 50 Mbit/s pattern generation
- Up to 8 channels of 400 Msample/s digitizing oscilloscope capability
- CAE Software ..... HP 74240A/B



HP 16500A



**HP 16500A Logic Analysis System . . . working interactively to serve the breadth of your system design and test needs.**

### Configurable

The HP 16500A Logic Analysis System can be configured for your debug, characterization, or pass/fail testing applications. Start with a focused system, then expand it as your group's needs grow and evolve. For example, start with an 80 channel logic analyzer and a two channel oscilloscope then add more capability as needed.

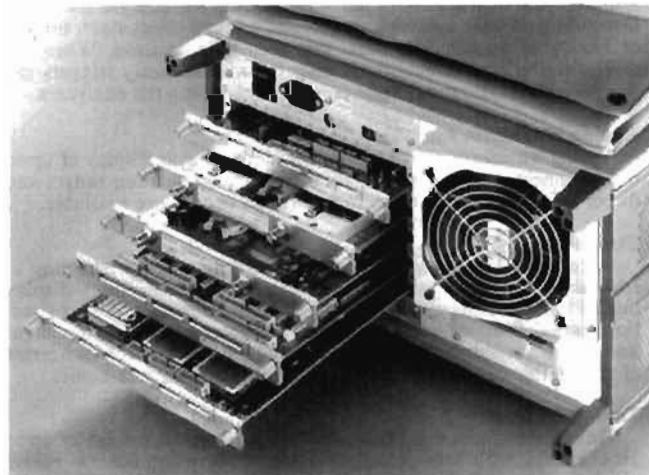

HP 16500A's five card slots provide flexible solutions.

### High performance system

Verify or analyze the performance of your circuits through combined analog, state, and timing measurements. The HP 16500A's five card slots hold state/timing cards, timing cards, pattern generator cards, and digitizing oscilloscope cards. Use these cards in combination to make measurements that could not be made with separate instruments. For example, state can arm both oscilloscope and timing waveform capture, so you can display a mixture of timing and scope waveforms on screen to measure time relationships between events.

### Ease-of-use . . . saves time

You'll enjoy making measurements with the HP 16500A's 9" color touch-screen, knob, pop up windows and optional mouse. The HP 16500A's pop up windows show all choices for a given task, for easy and fast selection without having to hunt. You'll be more productive when you automate measurements through easily understood programming. Color discriminates overlapped traces, emphasizes important points, and can be customized for personal preference and environmental considerations. Even infrequent users will spend less time making measurements and more time analyzing the results.

### Instant documentation

With the push of a button, you can document your results professionally through the standard hardcopy feature. Documentation will help you trace your steps and communicate your findings to others. The HP 16500A supports ThinkJet, LaserJet, PaintJet, QuietJet, and Epson printers.

### Store setups and data quickly

It's easy to store and retrieve measurement results and setups with the HP 16500A's two built-in 3 1/2" floppy disc drives

### Correlate 1 GHz Timing with Oscilloscope Waveforms

Connect several 1 GHz timing lines while probing simultaneously with oscilloscope channels. For example, configure 32 channels of 1 GHz timing and 4 oscilloscope channels to provide time correlation from a single trace point. Capture the number of channels you need while simultaneously capturing parametric information.

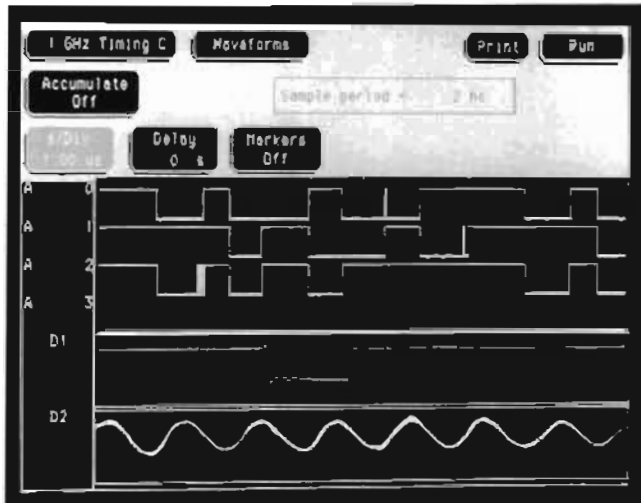

Make time interval measurements between oscilloscope and timing waveforms.

### Interactive Measurements with a Complete Logic Analyzer and a 400 Megasamples/s Digitizing Oscilloscope

For those who need both logic analysis and an oscilloscope to debug and test, the HP 16500A offers unparalleled interactive measurements. The HP 16500A provides enough channels for multiple 8, 16, or 32-bit microprocessor environments while allowing 100 MHz simultaneous single-shot oscilloscope waveform capture. These channels allow you to perform cause and effect analysis between the state, timing, and analog domains.

#### Application Driven Trigger Selection

Select the trigger mode that best suits your application. Use glitch, state, analog, or timing triggers to capture state, analog, and/or timing data. For example, to analyze interrupt handling in a microprocessor system, use the oscilloscope to arm timing, state, and analog capture on the asynchronous interrupt. Then capture microprocessor program flow with state, capture control lines with timing, and capture the interrupt line with the scope. The HP 16500A Logic Analysis System connects state, timing, analog, and pattern generation (trigger qualification serially in any order to meet your needs).

#### Generate Patterns Interactively

Generate patterns triggered by the Intermodule Bus or by the pattern generator's external qualification. The Intermodule Bus provides state, analog, timing, and/or pattern generator program flow qualification. Test your circuit's response to patterns that arrive at the right time, for rigorous functional analysis of prototypes. Also, quickly program simple patterns for applications where you need to toggle just a few lines.

#### Mix 1 GHz Timing with 100 MHz Timing

100 MHz timing channels give you the width you need to look at complex systems. The 1 GHz timing channels give you the timing speed and memory depth you need to make 1 ns resolution measurements up to 8 ns before or after the trigger event for precise edge placement measurements.

#### Perform Time Correlated State Analysis

In today's multiple microprocessor environments, systems are driven by multiple clocks. The HP 16500A/16510A provides simultaneous capture of separately clocked systems, while time tagging all

states. You can capture the states from several microprocessors, then analyze their flow with interleaved, time-correlated state displays.

### HP 74240A/74240B . . . Bring Real World Measurements Into Your Simulated Environment

The HP 74240A Electronic Design System-To-HP 16500A Logic Analysis System CAE Link translates Electronic Design System (EDS) simulations via HP-IB or disc media into HP 16520A/21A patterns; translates HP 16510A and HP 16515A/16A timing data into simulation vectors.

The HP 74240A also controls tests from the simulated environment by setting up the HP 16500A instrument (assign channels and labels, arm analyzer, and set clock rates), downloading patterns, and making measurements automatically (runs patterns and captures response).

The HP 74240B Simulation Data File Comparator compares data files between any two simulated or measured data files; stimulus-to-stimulus, response-to-response, or stimulus-to-response.

### Prototype verification with CAE simulations

Compare prototype behavior with simulated behavior. By sending simulation test vectors through the HP 74240A link to create prototype tests, you avoid manual test generation and typing in test vectors. The time to create the tests is reduced and the test accuracy is increased. Analysis is easier because you do not need to leave your familiar workstation environment when verifying a prototype. Use the comparison's results to find circuit problems such as setup and hold time violations. Begin developing test patterns in the prototype stage instead of waiting until the product is in the production stage.



HP 74240A Electronic Design System-To-HP 16500A Logic Analysis System CAE Link.

### Enhance your simulations

Capture complex circuit activity that is difficult to model, and use this activity in the simulation environment. For example, complex bus activity can be added to the simulation without having to model all the systems feeding the bus. Just capture a representative group of activity from the bus with the HP 16500A (with HP 16510A or HP 16515A/16516A) and feed it into the simulation through the HP 74240A. Then use it as stimulus and response in your model.

# LOGIC ANALYZERS

## Logic Analyzer-on-a-Card

Model 16510A

- 80 channels of 25 MHz state or 100 MHz timing
- Transitional timing for deep effective memory
- Configure up to 400 channels

- Debug multiple 32-bit microprocessor systems
- Supports 8-, 16-, and 32-bit microprocessors
- Lightweight passive probing

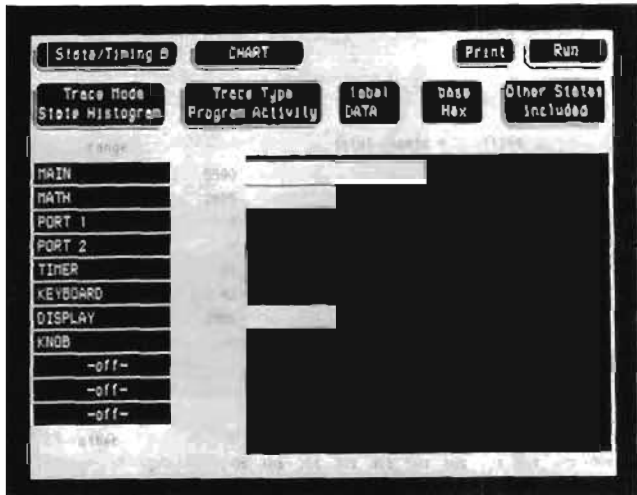
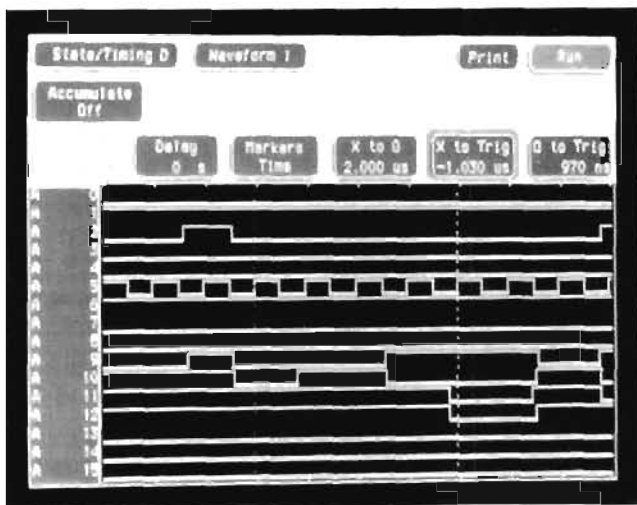

Types of Analysis	25 MHz state, 100 MHz timing, simultaneous state/state, simultaneous state/timing.
Glitch Detection	5 ns minimum pulse width between samples; trigger on and/or capture on all channels.
Marker Measurements	Time interval; number of states; pattern search; minimum, maximum, and average time interval statistics.
Timing Violation Measurements	Acquire data until time interval between two specified patterns violates a specified condition.
System Performance Analysis	State label, time interval, state overview; requires HP 10390A.
Data Display/Entry	Binary, octal, decimal, hexadecimal, ASCII (display only), user-defined symbols.
Deep Effective Memory	Uses transitional timing to store data only when there is a transition.
Debug Modes	Overlap mode allows viewing of timing violations. Infinite persistence shows waveform changes during repetitive acquisitions.
Triggering and Pattern Qualification	Duration, glitch, or edge specify error conditions, 8 sequence levels, 8 pattern recognizers, 1 range recognizer, state armed timing or timing armed state.
Small Lightweight Probing	100 kohm; 8 pF; individually grounded: 2 x 10, .1" center connectors.
Microprocessor Support	Most popular 8-, 16-, and 32-bit microprocessors.
Data Qualification	5 clock inputs, 4 clock qualifiers, storage qualification, time and number of state tagging, pre-store.
Interactive Measurements	Configure each HP 16510A module as two independent state analyzers, or one state and one timing analyzer.

\* Refer to the HP 1650A section for more information on the HP 16510A's capabilities.

### HP 16510A Logic Analyzer . . .

#### an HP 1650A on a card\*

Number of Channels 80 channels per card, up to 400 channels in one HP 16500A.

- 400 Megasamples/s single-shot analysis
- Better than 1 ns time interval accuracy (single-shot)
- Up to 8 simultaneous oscilloscope channels



### HP 16530A/16531A Digitizing Oscilloscope . . .

#### Capture and Time Correlate Single-shot Events

##### Precision Time Interval Measurements

Make time interval measurements with markers at better than 1 ns accuracy single-shot (after deskewing). Accuracy at the probe tip is assured by a calibration routine that reduces channel-to-channel skew.

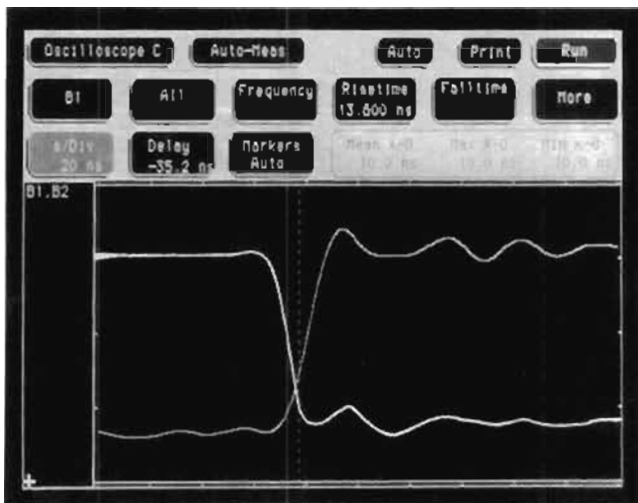

##### Single-shot Analysis

The HP 16531A 2 channel, 400 megasamples/s digitizing oscilloscope captures 100 MHz bandwidth signals single-shot. Multiple channels can be captured simultaneously so that you can determine relationships between infrequent events. A high-resolution color display and post-capture scroll and zoom allow you to examine waveforms in detail.

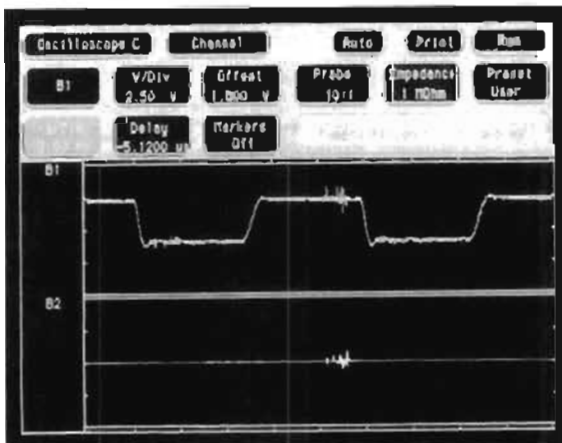

##### Capture Many Waveforms Simultaneously

Run up to four HP 16531A oscilloscope cards with a single HP 16530A timebase card for simultaneous acquisition. Your HP 16530A/16531A oscilloscope module can be configured to acquire from two to eight signals simultaneously. Save time when debugging and characterizing systems by observing multiple test points during each test.

- 4 ksamples memory depth/channel for pre-trigger debugging
- Oscilloscope triggered by logic analyzer
- Automatic measurement and setup aids

##### Measure Slow and Fast Events Simultaneously

Use the 4K memory depth to measure periods and time intervals; then zoom in for risetime measurements. Add a second oscilloscope module to create a dual timebase digitizing oscilloscope.

##### Find the Causes of Errors

Each channel has 4K memory depth for capturing events before or after the trigger event. View events up to 10 us before the trigger event with greater than 1 ns accuracy.

##### View Analog and Digital Waveshapes . . . and More

Capture random signal variations with Accumulate mode. Filter out noise with Average mode. Show true single-shot events with Single mode. Scan many periods of the waveform easily with Connect-the-dots. View analog-like waveshapes with 6 bit vertical resolution. Analyze differential waveshapes with the A-B mode.

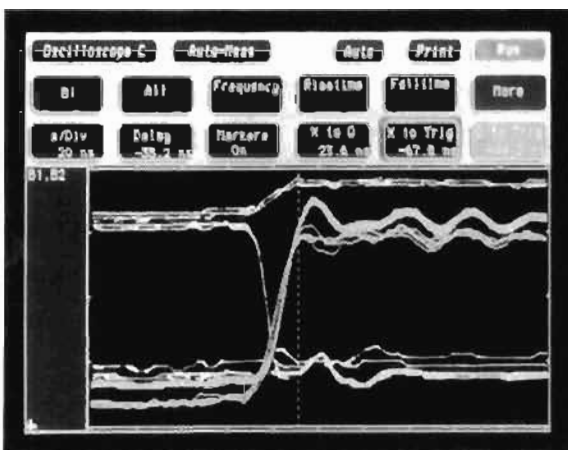

##### Automatic Measurements

Automatic pulse parameters allow fast analysis without having to count graticules. Parameters such as frequency, period, pulse width, peak-to-peak voltage, maximum voltage, minimum voltage, risetime, falltime, preshoot, and overshoot are just one keystroke away. Also measure voltage and timing relationships by placing the markers and reading the answer on the display. Display the time between markers, acquire until capturing specified time between markers, perform statistical analysis on the time between markers. Setup is easy with automatic waveform scaling, TTL & ECL presets aid scaling, and automatic marker placement on specified edges.

# LOGIC ANALYZERS

## 1 GHz Timing Analyzer-on-a-Card

Model 16515A, 16516A

- 1 GHz timing for 1 nanosecond resolution
- 16 channels/card for up to 80 channels/frame
- 8 Kbits per channel memory depth
- Lightweight passive probing
- Easy-to-use scope-like controls



### HP 16515A/16516A . . . Capture High-speed Events with 1 Gigahertz Timing

#### Measure Time Intervals Precisely with 1 ns Resolution

Measure precise time relationships on high speed TTL, CMOS, and ECL circuits with 1 ns single-shot resolution.

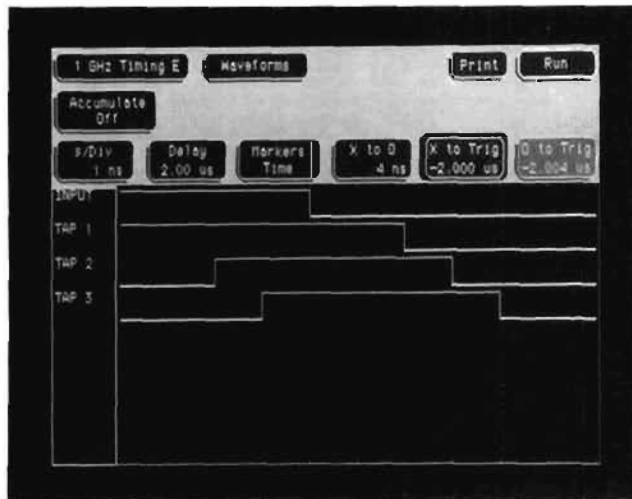

#### Debug Quickly with up to 80 Channels

Avoid having to move probes. Find problems faster by capturing more channels at the same time, and solve applications that require several simultaneous channels. Each HP 16515A/16516A timing card offers 16 simultaneous channels. Add up to five cards for a total of 80 channels for applications where having more channels means taking less time to find the problem.

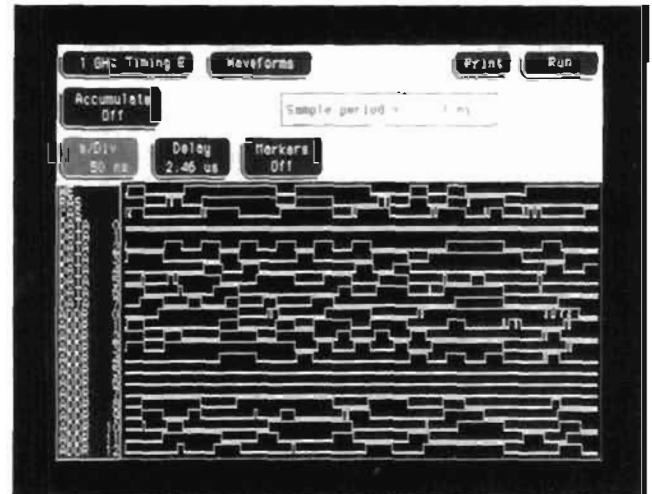

#### Find the Cause of Problems with 8 Kbit/channel Memory Depth

Find and analyze events that occur before or after the trigger event. Each channel stores 8K samples to allow 8 us of negative time capture with 1 ns resolution, for pre-trigger applications. Deep memory stores data over several clock cycles while retaining precise edge placement information. Deep memory also helps you find elusive problems more quickly when you're not sure exactly where to trigger.

#### Hook Up Easily to Your Circuit with HP's New Lightweight Probes

HP's new 50 kohm, 2 pF passive probes are lightweight and easy to connect. These probes are color-coded and can be connected with probe tips or plugged directly into any .1" grid with .026" to .033" diameter round pins or .025" square pins. Individual grounds are provided for each channel to shorten ground loops.

#### Easy-to-use

Enjoy the HP 16515A/16516A timing module's scope-like controls by selecting seconds/division and delay. Automatic pattern search quickly finds patterns. Statistical time interval analysis measures the dynamics of your circuits.





# LOGIC ANALYZERS

## 50 Mbit/s Pattern Generation-on-a-Card

Model 16520A, 16521A

- 12 non-return-to-zero (NRZ) channels 16520A
- 48 NRZ channels 16521A
- 204 NRZ channels maximum/system



### HP 16520A/16521A 50 Mbit/s Pattern Generation ... When Analysis Requires Both Stimulus and Response

#### Synergistic Solution

Configure the HP 16500A to provide both stimulus and response in one instrument. Use the HP 16520A 50 Mbit/s Pattern Generator Master card and the HP 16521A 50 Mbit/s Pattern Generator Expansion card to provide the functional stimulus. Use the digitizing oscilloscope, 25 MHz state/100 MHz timing cards, or 1 GHz timing cards to capture functional and parametric circuit response. Also use the HP 16500A stimulus/response capability in HP's CAE environment to provide prototype functional testing.

#### Debug Digital Circuits Easily

Quickly generate the patterns necessary to put your circuit in a given state, or single-step your circuit through a series of states.

Generate patterns to isolate and analyze glitches in a repetitive environment.

Two menus (format and listing menus) allow complete data entry. The format menu allows you to group data channels together for easy data entry. Enter data in hex, octal, binary, decimal, or symbols. Editing is enhanced with delete, insert, and copy functions. Merge stored programs to create more complex data files quickly. Macros allow you to repeat portions of code quickly. Apply these complex patterns to duplicate your system's loops, jumps, and subroutines. Run control for the pattern generator can be derived from the screen, external sources, or Intermodule Bus, allowing you to generate patterns when complex trigger conditions occur.

- 50 Mbit/s maximum data rate
- 4095 bits memory depth/channel
- Lightweight passive probing

#### Friendly Circuit Connection

Easily attach to boards through probe tips or 2 x 10, .1" center connectors on your circuit board. Standard connectors eliminate the need to purchase special connectors or to build custom fixtures to hook into your DUT. The lightweight and passive probing system provides ECL or TTL patterns through 50 ohm connections. Series termination eliminates the need for external 50 ohm terminations. HP also offers the HP 10345A ECL differential Driver and the HP 10346A TTL Tristate Pod.

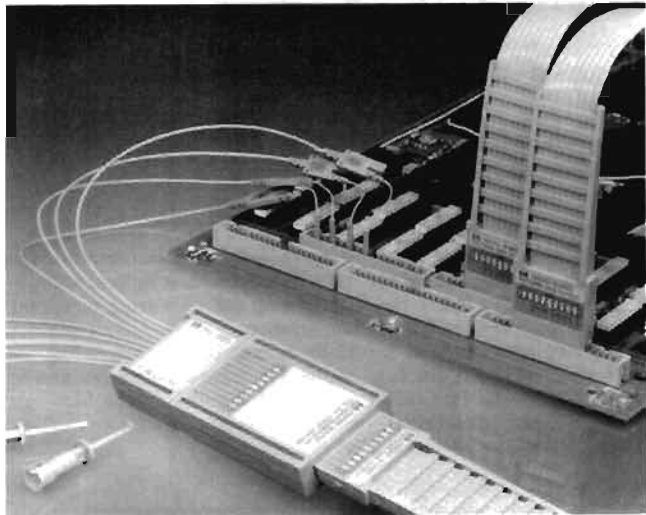

Light passive probing provides easy connections to your DUT.

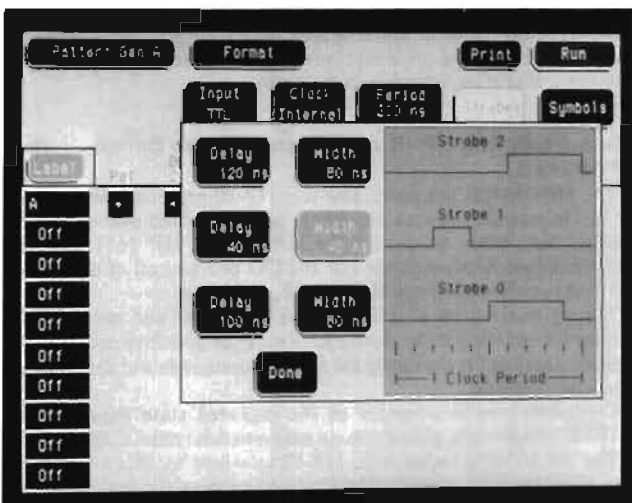

Define strobes with easy pop-up menu.

#### Perform Functional Verification

Avoid designing custom hardware or using other time consuming methods to provide stimulus to your circuit. The HP 16520A/16521A offers functional tests at a low cost-per-channel.

#### Shorten Your Design Cycle

Test partial systems, even though they are missing components. The HP 16520A/16521A can be used to substitute for boards, ICs, and buses. Instead of waiting for the missing pieces, you can continue to test and verify your design.

# LOGIC ANALYZERS

## Preprocessors And Interface Modules

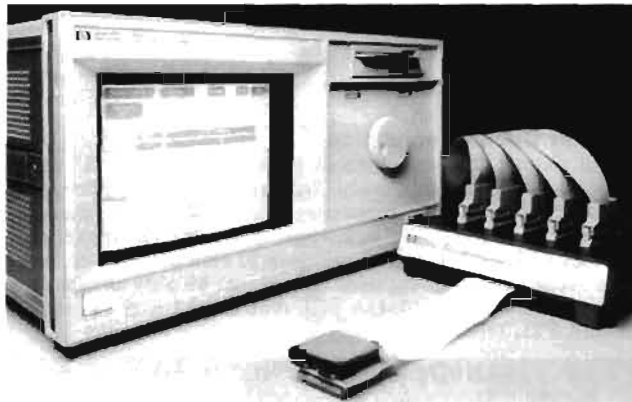

HP 10314B with HP 10269C for Intel 80386 support.

### Simplified Data Interpretation and Interconnections

#### Microprocessor Support

Analyze the code in your microprocessor-based system while the system is running at full speed. HP's microprocessor support accessories allow you to follow the path of your software—from power-up, through interrupts, to fatal system crashes.

HP now offers support for 32-bit microprocessors, including the Motorola 68020 and the Intel 80386. Or, trace the flow of common 16-bit CPU's—the Intel 8086 and 80286 families or the Motorola 68000 devices. In addition, you can completely monitor your Zilog, Intel, National or Motorola 8-bit system.

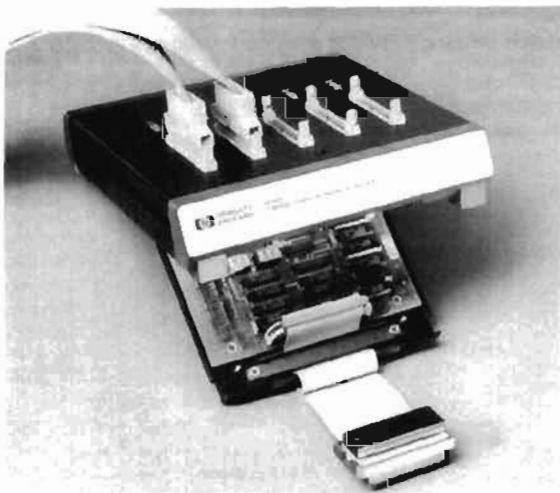

Preprocessors for your microprocessor connect to the logic analyzer probes through the HP 10269C General Purpose Probe Interface.

#### Hook Up Quickly and Reliably to Your Microprocessor System

HP's microprocessor preprocessors are the mechanical and electrical link between your target system and the logic analyzer. They provide: reliable, correct, fast and convenient connections to your microprocessor system; all clocking and demultiplexing circuits needed to correctly capture your system's operation; additional status lines to further decode the operation of your CPU; queuing circuits to weed out the unexecuted instructions that were pre-fetched by your microprocessor.

#### Display Captured Data In Your Microprocessor's Mnemonics

Inverse Assembly software translates the ones and zeros captured by the logic analyzer into a display that you're familiar with—microprocessor mnemonics. The resulting display can easily be compared to original assembly language listings to track down software defects.

Each preprocessor includes an inverse assembler on a 3.5 inch disc. When loaded into the logic analyzer from the internal disc drive, it configures the instrument for use with your preprocessor and transforms the data and status of each state into the microprocessor's mnemonics.

#### Microprocessor Preprocessors

Microprocessor	HP Preprocessor Model No.
8085	HP 10304B
8086/88	HP 10305B
80186/88	HP 10306B
80286	HP 10312D
80386	HP 10314B
6800/02	HP 10307B
6809/09E	HP 10308B
68018	HP 10310B
68000/10	HP 10311B (DIP)
68000/10	HP 10311G (PGA)
68020	HP 10313G
NSC800	HP 10303B
Z80	HP 10300B

#### Monitor Your Interface and Information Flow

The HP 10342B Bus Preprocessor provides analysis capabilities for three popular interface buses: HP-IB (Hewlett-Packard's implementation of IEEE-488-1978), RS-232C/CCITT V.24, or RS-449. This package gives you: convenient and reliable access to the signals on your bus; software that sets up the HP 1650A, HP 1651A and HP 16510A Logic Analyzers for the measurement at hand; and a complete view of asserted control lines, as well as conversion of the captured data into easy to understand mnemonics.

With the HP 10342B, you'll be able to analyze noise or other hardware problems on the physical layer of your network, as well as capture the traffic transmitted over the network.

#### When Analyzing HP-IB Away from the Lab Bench... the HP 10342G

The HP 10342G is a small, low-cost HP-IB preprocessor designed for service applications on-site, where portability and ease-of-use are crucial. Yet, when used with the HP 1650A, HP 1651A or HP 16510A Logic Analyzers, the HP 10342G provides all of the HP-IB analysis capabilities of the HP 10342B, including:

- Timing analysis on all HP-IB data, handshake and management lines for isolating noise, faulty hardware, or defective cables.
- State analysis for capturing the HP-IB commands and data flowing across your bus.
- Complete inverse assembly of the captured state data into the IEEE mnemonics, giving you an easy-to-understand display.

The HP 10342G includes the HP-IB interface board, two termination adaptors (HP p/n 01650-63201) to connect the logic analyzer probes to the interface board and software on a 3.5" disc to set up the logic analyzer and provide inverse assembly of the captured data.

#### Minicomputer Interfaces for Three Popular Minicomputer Buses

When you need to monitor the flow of information from card to card in your minicomputer, turn to HP's minicomputer interfaces. These modules plug into your minicomputer backplane to give your logic analyzer access to the important address, data and control lines that transfer information between slots in the cartridge.

You can choose from the UNIBUS interface for the DEC PDP-11.

the Q-BUS interface for the DEC LSI-11 or an interface for the Intel MULTIBUS\*. Each card buffers the signals from the backplane and generates the proper clocking signals for the logic analyzer. In addition, switches on each card will filter out unwanted bus cycles, so only the information of interest is sent to the logic analyzer. The interface cards output the buffered backplane signals over two 40-pin ribbon cables. To connect these cables to the logic analyzer, use the HP 10320C User-Definable Interface and the HP 10269C G.P. Probe Interface to mechanically route the cable signals to the logic analyzer probes. Detailed instructions are included with the HP 10320C for constructing the interface, as well as set-up information for your logic analyzer to allow complete analysis of your minicomputer backplane.

### See an Overall Picture of Your System to Find the Routines that Are Slowing You Down

The HP 10390A System Performance Analysis Software (SPA) converts your HP 1650A, HP 1651A or HP 16510A Logic Analyzer into a powerful tool for finding bottlenecks in your system. SPA can help you: find the routines that are called most often in your system; identify inefficient use of discs and peripherals that slow your system down; and find processes that use too much CPU time.

The logic state analyzer is configured to repetitively sample your target system as it operates. The analyzer takes a sample of your system, sorts the captured data into ranges, then delays a random amount of time before starting to sample again. (The random delay ensures that the measurement won't sync on only a small portion of your system.)

After each acquisition, the captured information is translated into histograms and bar charts to present the big picture of your system's operation.

SPA performs three kinds of measurements-State Overview, State Histogram and Time Interval measurements.

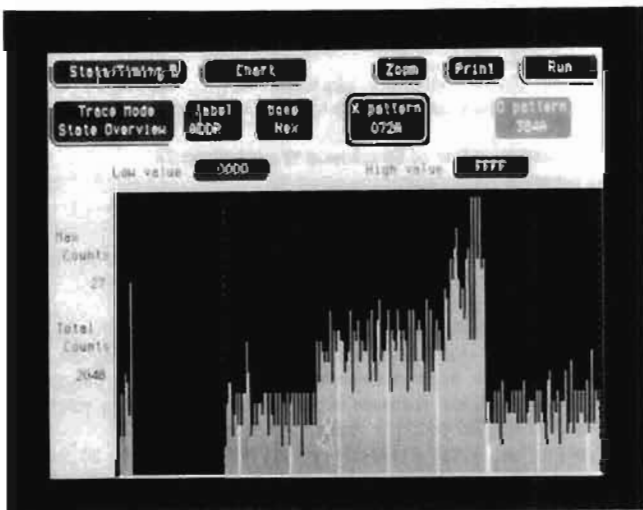

State Overview measurements quickly show which addresses have activity.

### Designing Your Own Preprocessor . . . the HP 10320C

The HP 10320C User-Definable Interface allows you to build a custom preprocessor—a preprocessor that meets your own strict specifications. Use the HP 10320C when you need:

- an interface for analyzing custom or proprietary devices with your HP 1650A, HP 1651A or HP 16510A logic analyzer,
- a semi-custom test fixture for using your logic analyzer in a manufacturing test environment, or
- a link for ribbon cables or connections to your logic analyzer.

The HP 10320C provides a breadboard that fits inside the HP 10269C General Purpose Probe Interface. In addition, the kit includes mechanical hardware to mount the breadboard in place and connectors for sending your signals to the HP 10269C. The accompanying manual discusses the interface design process, including what to look for in your target system, how to design so that set up and hold requirements are met, and tips on power supply distribution.

### Building and Connection the Interface . . . Extra Convenience with HP's Parts Kit and Special Cables

Companion accessories enhance the utility of the HP 10320C. The HP 10321A Microprocessor Interface Kit provides many of the parts needed when designing an interface that used IC's and other active devices. It includes sockets, bypass capacitors and a fuse for power distribution, and wire-wrap headers to simplify the wiring of your interface. With the HP 10321A, the user only needs to provide the specific components and active parts used in the interface design.

The HP 10322A, HP 10323A and HP 10324A Cables provide a reliable mechanical and electrical connection between a socket on your target system and the HP 10320C User-Definable Interface. The cable has a special socket assembly for easy connection without damaging the pins of your device. Simply remove your IC from your system, plug the cable in its place, then plug your chip into the Zero-Insertion-Force socket on the cable. This technique minimizes the capacitive loading to your system, as well as giving you a low-profile, reliable hook-up.

For 40-pin DIP packages, order the HP 10322A; 48-pin devices require the HP 10323A. 64-pin DIP IC's are supported by the HP 10324A.

### A Display With Your Mnemonics . . . to Match Your Custom Interface

Just as the HP 10320C allows you to design custom hardware, the HP 10391A Inverse Assembler Development Package allows you to design a custom inverse assembler for the HP 1650A, HP 1651A or HP 16510A Logic Analyzers. This software package allows you to write an inverse assembler that will display your system's operation in mnemonics you're familiar with.

The HP 10391A is a macro assembler that runs on the HP Vectra, the IBM-PC or PC compatibles. The HP 10391A includes: Pascal-like instructions, such as CASE and IF-THEN statements; Strong bit-manipulation capabilities allowing the extraction of single bits, or conditional branching on a few bits within a word; Assembly-language constructs, including AND, ROTATE and INCREMENT/DECREMENT instructions.

To write your own inverse assembler, the HP 10391A requires the following equipment: 1) HP Vectra, IBM-PC\* or PC compatible with a minimum of 256K of memory and MS-DOS\* 2.1 or above. 2) 1 floppy disc drive with an internal hard disc (recommended configuration) for the PC, or two floppy disc drives. 3) RS-232C port and cable. Recommended card: HP 24540A Serial/Parallel Card or HP 24541A Dual Serial card. For 25-pin ports, use cable HP 13242G or equivalent. For 9-pin ports, use cable HP 24542G or equivalent. 4) HP 1650A or HP 1651A Logic Analyzer, or HP 16500A Logic Analysis System with an HP 16510A State/Timing card installed.

\*IBM-PC is a trademark of International Business Machines Corporation. MS-DOS is a trademark of MicroSoft Corporation. DEC, UNI-BUS, PDP-11, Q-BUS and LSI-11 are registered trademarks of Digital Equipment Corporation.

# LOGIC ANALYZERS

## Specifications And Characteristics

Models 1650A, 1651A, 16500A, 16510A, 16515/16A, 16520A/21A, 16530A/31A

### HP 1650A, 1651A, 16510A Specifications

#### Probes

**Minimum Swing:** 600 mV peak-to-peak.

**Threshold Accuracy:**  $\pm 150$  mV accuracy over the range  $-2.0$  to  $2.0$  volts;  $\pm 300$  mV accuracy over the ranges  $-9.9$  to  $-2.1$  volts and  $2.1$  to  $9.9$  volts.

**Dynamic Range:**  $\pm 10$  volts about the threshold.

#### State Mode

**Clock Repetition Rate:** Single phase is 25 MHz maximum. With time or state counting, minimum time between states is 60 ns. Both mixed and demultiplexed clocking use master-slave clock timing; master clock must follow slave clock by at least 10 ns and precede the next slave clock by  $> 50$  ns.

**Clock Pulse Width:**  $\geq 10$  ns at the threshold.

**Setup Time:** Data must be present prior to clock transition,  $\geq 10$  ns.

**Hold Time:** Data must be present after rising clock transition, 0 ns.

#### Timing Mode

**Minimum Detectable Glitch:** 5 ns wide at the threshold.

### Characteristics

#### Probes

**Input RC:** 100 K $\Omega$   $\pm 2\%$  shunted by approximately 8 pF at the probe tip.

**Minimum Input Overdrive:** 250 mV or 30% of the input amplitude, whichever is greater.

**Maximum Voltage:**  $\pm 40$  volts peak.

**Threshold Setting:** Threshold levels may be defined for pods 1 and 2 individually (HP 1651A). Threshold levels may be defined for pods 1, 2, and 3 on an individual basis and one threshold may be defined for pods 4 and 5 (HP 1650A/16510A).

**Threshold Range:**  $-9.9$  to  $+9.9$  volts in 0.1 volt increments.

#### State Analysis

##### Memory

**Data Acquisition:** 1024 samples/channel

##### Trace Specification

**Clock:** Five clocks (HP 1650A/16510A) or two clocks (HP 1651A) are available and can be used by either one or two state analyzers at any time. Clock edges can be ORed together and operate in single phase, two phase demultiplexing, or two phase mixed mode. Clock edge is selectable as positive, negative, or both edges for each clock.

**Clock Qualifier:** The high or low level of four clocks (HP 1650A/16510A) or one clock (HP 1651A) can be ANDed with the clock specification. Setup time: 20 ns; hold time: 5 ns.

**Pattern Recognizers:** Each recognizer is the AND combination of bit (0, 1, or X) patterns in each label. 8 pattern recognizers are available when one state analyzer is on. 4 are available to each analyzer when two state analyzers are on.

**Range Recognizer:** Recognizes data which is numerically between or on two specified patterns (ANDed combination of zeros and/or ones). One range term is available and is assigned to the first state analyzer turned on. The maximum size is 32 bits.

**Qualifier:** A user-specified term that can be anystate, nostate, a single pattern recognizer, range recognizer, or logical combination of pattern and range recognizers.

**Sequence Levels:** There are 8 levels available to determine the sequence of events required for trigger. The trigger term can occur anywhere in the first 7 sequence levels.

**Branching:** Each sequence level has a branching qualifier. When satisfied, the analyzer will restart the sequence or branch to another sequence level.

**Occurrence Counter:** Sequence qualifier may be specified to occur up to 65535 times before advancing to the next level.

**Storage Qualification:** Each sequence level has a storage qualifier that specifies the states that are to be stored.

**Enable/disable:** Defines a window of post-trigger storage. States stored in this window can be qualified.

**Prestore:** Stores two qualified states that precede states that are stored.

#### Tagging

**State Tagging:** Counts the number of qualified states between each stored state. Measurement can be shown relative to the previous state or relative to trigger. Maximum count is  $4.4 \times 10^{11}$ .

**Time Tagging:** Measures the time between stored states, relative to either the previous state or to the trigger. Maximum time between states is 48 hours. With tagging on, the acquisition memory is halved; minimum time between states is 60ns.

#### Symbols

**Pattern Symbols:** User can define a mnemonic for the specific bit pattern of a label. When data display is SYMBOL, mnemonic is displayed where the bit pattern occurs. Bit patterns can include zeros, ones, and don't cares.

**Range Symbols:** User can define a mnemonic covering a range of values. Bit pattern for lower and upper limits must be defined as a pattern of zeros and ones. When data display is SYMBOL, values within the specified range are displayed as mnemonic + offset from base of range.

**Number of Pattern and Range Symbols:** 100 per analyzer. Symbols can be down-loaded over RS-232C.

#### Timing Analysis

**Transitional Timing Mode:** Sample is stored in acquisition memory only when the data changes. A time tag stored with each sample allows reconstruction of waveform display. Time covered by a full memory acquisition varies with the number of pattern changes in the data.

**Sample Period:** 10 ns

**Maximum Time Covered by Data:** 5000 seconds

**Minimum Time Covered by Data:** 10.24 us

**Glitch Capture Mode:** Data sample and glitch information is stored every sample period.

**Sample Period:** 20 ns to 50 ms in a 1-2-5 sequence dependent on sec/div and delay settings.

**Time Covered by Data:** Sample period  $\times$  512

#### Waveform Display

**Accumulate:** Waveform display is not erased between successive acquisitions.

**Overlay Mode:** Multiple channels can be displayed on one waveform display line. Primary use is to view summary of bus activity.

**Maximum Number of Displayed Waveforms:** 24

#### Time Interval Accuracy

**Sample Period Accuracy:** 0.01% of sample period.

**Channel-to-channel Skew:** 4 ns typical

**Time Interval Accuracy:**  $\pm$ (sample period + channel-to-channel skew + 0.01% of time interval reading)

#### Trigger Specification

**Asynchronous Pattern:** Trigger on an asynchronous pattern less than or greater than specified duration. Pattern is the logical AND of specified low, high or don't care for each assigned channel. If pattern is valid but duration is invalid, there is a 20 ns reset time before looking for patterns again.

**Greater than Duration:** Minimum duration is 30 ns to 10 ms with 10 ns or 0.01% resolution, whichever is greater. Accuracy is  $\pm 0$  ns to  $-20$  ns. Trigger occurs at pattern + duration.

**Less than Duration:** Maximum duration is 40 ns to 10 ms with 10 ns or 0.01% resolution, whichever is greater. Pattern must be valid for at least 20 ns. Accuracy is  $\pm 20$  ns to  $-0$  ns. Trigger occurs at the end of the pattern.

**Glitch/Edge Triggering:** Trigger on glitch or edge following valid duration of asynchronous pattern and while the pattern is still present. Edge can be specified as rising, falling or either. Less than duration forces glitch and edge triggering off.

#### Measurement And Display Functions

**Autoscale (Timing Analyzer Only):** Autoscale searches for and displays channels with activity on the pods assigned to the timing analyzer.

**Acquisition Specifications**

**Arming:** Each Analyzer can be armed by the Run key, the other Analyzer, the external trigger in port (HP 1650A/1651A) or the In-termodule Bus (HP 16500A).

**Trace Mode:** Single mode acquires data once per trace specification; repetitive mode repeats single mode acquisitions until stop is pressed or until time interval between two specified patterns is less than or greater than a specified value, or within or not within a specified range. There is only one trace mode when two analyzers are on.

**Labels:** Channels may be grouped together and given a 6-character name. Up to 20 labels in each analyzer may be assigned with up to 32 channels per label. Primary use is for naming groups of channels such as address, data, and control busses.

**Indicators**

**Activity Indicators:** Provided in the Configuration, State Format, and Timing Format menus for identifying high, low, or changing states on the inputs.

**Markers:** Two markers (X and O) are shown as dashed lines in the display.

**Trigger:** Displayed as a vertical dashed line in the timing waveform display and as line 0 in the state listing display.

**Marker Functions**

**Time Interval:** The X and O markers measure the time interval between one point on a timing waveform and trigger, two points on the same timing waveform, two points on different waveforms, or two states (time tagging on).

**Delta States (State Analyzer Only):** The X and O markers measure the number of tagged states between one state and trigger, or between two states.

**Patterns:** The X or O marker can be used to locate the nth occurrence of a specified pattern before or after trigger, or after the beginning of data. The O marker can also find the nth occurrence of a pattern before or after the X marker.

**Statistics:** X to O marker statistics are calculated for repetitive acquisitions. Patterns must be specified for both markers, and statistics are kept only when both patterns can be found in an acquisition. Statistics are minimum X to O time, maximum X to O time, average X to O time, and ratio of valid runs to total runs.

**HP 18530A/16531A 400 Megasample/s Digitizing Oscilloscope**

**Specifications**

**Vertical (at BNC)**

**Bandwidth (-3 dB):** dc to 100 MHz (dc-coupled)

**Range:** 40 mV to 16 V full scale (adjustable with 2-digit resolution).

**DC Gain Accuracy:** ±3% of full scale (valid within ±10°C of auto-calibration temperature)

**Analog-to-digital Conversion (ADC) Resolution:** ±1.6% of full scale (6 bits)

**DC Offset Accuracy:** ±1% of offset ±3.2% of full scale (valid within ±10°C of auto-calibration temperature).

**DC Offset Range/Resolution:**

Vertical Range	Offset Range	Offset Resolution
<800 mV	±800 mV	1 mV
≥800 mV	±16 V	20 mV

**Voltage Measurement Accuracy (DC):**

Single Cursor (X or O): = Gain accuracy + ADC resolution + offset accuracy.

Dual Cursor (X to O measurements on the same waveform): = Gain accuracy + 2 (ADC resolution)

**Horizontal**

**Range:** 50 ns to 100 s full scale, adjustable with 3-digit resolution.

**Time Interval Measurement Accuracy (dual channel for deskewed channels with equal rise and fall times):**

±0.75 ns ±0.2% of timebase range ±0.02% of reading (2.5 ns sample period)

± sample period ±0.2% of timebase range ±0.02% of reading (≥ 5 ns sample period)

**Delay (Time Offset)**

**Pre-trigger Range:** 4096 × sample period

**Post-trigger Range:** 500 screen diameters

**Resolution:** Fine adjustment to 0.2% of screen diameter

**Characteristics**

**Vertical**

**Transition Time (10% to 90%):** ≤ 3.5 ns

**Input Coupling:** dc

**Input RC:** 1 MΩ ±2% or 50 ohm ±3%, shunted by approximately 13 pF.

**Maximum Safe Input Voltage:** 1 MΩ input, ±40 V (dc + peak ac), 50 Ω input, ± 5 V (dc + peak ac)

**Probe Factors:** Any integer ratio from 1:1 to 1:1000, to scale the oscilloscope to represent voltages seen at the probe tip.

**Time Base**

**Deskewing:** Skew between channels can be nulled out to compensate for probe cable lengths.

**Digitizer**

**Resolution:** 6 bits (1 part in 64)

**Digitizing Rate:** up to 400 megasamples/second

**Digitizing Technique:** Real-time digitizing; each 4K record is acquired on a single acquisition.

**Acquisition Memory Size:** 4096 samples per channel

**Waveform Display**

**Display Formats:** Waveforms can be displayed in an overlapping and/or non-overlapping format.

**Display Resolution:** 500 points horizontally.

**Display Modes**

**Single:** New acquisitions replace old acquisitions on screen.

**Accumulate:** New acquisitions are added to the screen and displayed with older acquisitions until screen is erased.

**Average:** New acquisitions are averaged with older acquisitions with updated waveform displayed until erased.

**Overlay:** Up to 8 acquired waveforms can be overlaid in the same display area.

**Connect-the-dots:** Provides a display of the sample points connected by straight lines.

**Waveform Reconstruction:** When there is insufficient data to fill every horizontal location, a post-acquisition reconstruction filter fills in the missing locations.

**Waveform Math:** Display capability of A-B and A+B functions is provided.

**Measurement Aids**

**Markers:** Two vertical markers are provided for measurements of time and voltage. Capabilities are: measure voltage of X and O on each analog waveform; measure time from X to trigger, O to trigger, and X to O; automatic marker placement by specifying voltage level, edge number, and rising or falling edge type; run until X to O greater than, less than, in-range, and not-in-range provides selective event search; X to O statistics (mean, max, and min) provide analysis of time interval deviation.

**Automatic Measurements:** The following pulse parameter measurements can be performed automatically:

Frequency	Rise time	+ pulse width
Period	Fall time	- pulse width
Vpp	Preshoot	V <sub>top-base</sub>
	Overshoot	

**Setup Aids**

**Auto:** Auto sets the vertical and horizontal ranges, offset, and trigger level to display the input signals. Requires an amplitude above 10 mV peak, and a frequency between 50 Hz and 100 MHz.

**Presets:** Scale the vertical range, offset, and trigger level to predetermined values for displaying ECL or TTL waveforms.

# LOGIC ANALYZERS

## Specifications And Characteristics (cont'd)

Models 1650A, 1651A, 16500A, 16510A, 16515/16A, 16520A/21A 16530A/31A

### HP 16515A/16516A 1 GHz Timing Analyzers

#### Specifications

##### Probes

**Minimum Swing:** 600 mV peak-to-peak.  
**Threshold Range:** - 3.5 to +5.0 volts in 0.1 volt increments.  
**Threshold Accuracy:**  $\pm 1.25$  mV  $\pm 2.5\%$   
**Dynamic Range:**  $\pm 7.0$  volts

##### Timing Accuracy

**Timing Accuracy:**  $\pm 1$  Sample Period + Sample Rate Accuracy  
 $\pm (300$  ps within a pod, 1 ns between pods)  
**Sample Rate Accuracy:**  $\pm 0.01\%$  of measurement added to:  
 $\pm 300$  ps at 1 GHz  
 $\pm 400$  ps at 250 MHz and 500 MHz  
 $\pm 800$  ps at 125 MHz  
 $\pm 1.6$  ns at  $\pm 62.5$  MHz

#### Characteristics

##### Probes

**Input RC:** 50 K $\Omega$   $\pm 2\%$  shunted by  $\leq 3$  pF at the probe tip  
**Minimum Input Overdrive:** 250 mV or 25% of the input amplitude, whichever is greater.  
**Maximum Input Voltage:**  $\pm 40$  volts.

##### Symbols

**Pattern Symbols:** User can define a mnemonic covering a range of values. When data display is SYMBOL, mnemonic is displayed where the bit pattern occurs. Bit patterns can include Zeros, Ones, and Don't Cares.

**Range Symbols:** User can define a mnemonic covering a range of values. Bit pattern for lower and upper limits must be defined as a pattern of Zeros and Ones. When data display is SYMBOL, values within the specified range are displayed as mnemonic  $\pm$  offset from base of range.

**Number of Available Pattern and Range Symbols:** 200 symbols can be down-loaded from controller.

**Labels:** Up to 20 labels may be assigned channels in any configuration up to 32 channels per label. Primary use is for naming groups of channels such as address, data, and control busses

##### Indicators

**Activity Indicators:** Provided in the format menu for identifying high, low, or changing states on the inputs.

**Markers:** Two markers (X and O) are shown as dashed lines in the display.

**Tracepoint:** Displayed as vertical dashed line in the waveform display. Defined as trigger + delay.

##### Marker Functions

**Time Interval:** The X and O markers measure the time interval between one point on a timing waveform and trigger, two points on the same timing waveform, or two points on different waveforms

**Pattern Search:** The X and O marker can be used to locate a specified pattern.

**Statistics:** X to O marker statistics are calculated for repetitive full-memory acquisitions. Pattern must be specified for both markers, and statistics are kept only when both patterns can be found in an acquisition (i.e., a hit). Statistics are minimum X to O time, maximum X to O time, number of hits and number of acquisitions.

### HP 16520A/16521A 50 Mbit/s Pattern Generator

#### Specifications

##### Clock Sources (16520A Only)

##### Internal Clock

**Clock Period:** programmable from 20 ns to 200  $\mu$ s in a one-two-five sequence.

**Data Period Accuracy:**  $\pm 2\%$  (of period)  $\pm 1$  ns

##### External Clock (provided by user)

**Input Clock Period:** 1 Hz to 50 MHz (20 ns min period) ECL or TTL, internal frequency divide (/1, /5, or /10) provided.

**Duty Cycle:** 10 ns minimum high time, 10 ns minimum low time

##### Strobes (16520A Only)

**Number of Strobes:** 3 (ECL or TTL)

**Bits/Channel:** 4095

**Maximum Bit Rate:** 20 MBit/s (50 ns Period)

**Edge Placement:**  $\leq 10$  MBit/s: (cnths of period)

$> 10$  MBit/s to 20 MBit/s: fifths of Period

(Delay + Width  $\leq$  Period)

**Minimum Delay:** 0/10 (0/5), maximum delay is 9/10 (4/5) data period.

**Minimum Width:** 1/10 (1/5) of data period, maximum width is the data period (values in parentheses apply to 20 MBit/s timebase setting). If strobes are desired while operating with external clock, the data rate will be divided to 1/5 or 1/10 the external clock rate.

#### Characteristics

**Output:** Eight channel pods can be assigned as either standard ECL or TTL levels. All characteristics are valid at the probe tip.

	ECL	TTL
$V_{OH}$ (steady state)	- 0.98V	2.7V
$V_{OL}$ (steady state)	- 1.55V (into 10K $\Omega$ , 10 pf)	0.6V (into 10K $\Omega$ , 10 pf)
Risetime/ Falltime (typ)	2.3 ns (-0.98 V to -1.55 V)	2.5 ns (0.6 V to 2.7 V)
Channel-to- channel Skew* (same card)	$\leq 5$ ns	$\leq 5$ ns
Channel-to- channel Skew* (card-to-card)	$< 10$ ns	$< 10$ ns
Number of Std Loads	3 (10 KH ECL @ $V_{th} = 150$ mV)	3 (LS, @ $V_{th} = 250$ mV)

(Output measurements made into a load consisting of 10 K $\Omega$  in series shunted with 10 pF to ground.)

(\* Skew measured at (+1.6 V) TTL and (-1.3 V) ECL levels.

DATA CAPACITY	16520A	16521A
Number of Channels	32	48
Bits Per Channel	4095	4095
Maximum Bit Rate	50 MB/s NRZ (20ns Period)	50 MB/s NRZ (20ns Period)
INPUT	ECL	TTL
$V_{ih}$ (min)	-0.91V	2.08V
$V_{il}$ (max)	-1.69V	1.12V

**Maximum Input Voltage:**  $\pm 40$ V

**Input Impedance:** 100 K $\Omega$ , 8 pF

**External Clock-in to Clock-out Delay:** 50 ns

##### Data Instruction Set

**Break:** Stops program execution, last data vector is held at output.

**Repeat:** Repeats vector up to 256 times.

**Wait IMB:** Wait for intermodule trigger.

**Wait External:** Wait for user-defined 3-bit pattern on external input pod to become true. No data cycle latency when pattern is true between 30 ns and 0 ns before next clock edge.

**Signal IMB:** Arms other measurement cards.

**Macro:** Four different macros may be defined and inserted as needed. Six character labels may be defined for each macro. Macros contain REPEAT, WAIT EXTERNAL, WAIT IMB, BREAK, and SIGNAL IMB instructions.

## General Characteristics

### Auxiliary Power Available Through Cables:

**HP 1650A/1651A/16510A:** 1/2 amp @ 5V per cable; 2 amp @ 5V per HP 1650A/1651A/16510A; 16.3 amp-current draw of installed cards @ 5V per HP 16500A.

**Current draw per card (@ 5V):** 3.0 amp per HP 16510A, 1.3 amp per HP 16515A, 1.4 amp per HP 16516A, 0.7 amp per HP 16520A, 0.8 amp per HP 16521A, 0.4 amp per HP 16530A, 1.1 amp per HP 16531A.

**Programmability:** Instrument settings and operating modes, including automatic measurements, may be remotely programmed via RS-232C or HP-IB (IEEE-488). HP-IB is available only on HP 16500A.

### Hardcopy Output

**Printers Supported:** HP ThinkJet, HP QuietJet, HP LaserJet, Epson and Epson-compatible printers (e.g., Epson FX80) via RS-232C or HP-IB (HP 16500A only).

**RS-232C Configurations:** Protocol: XON/XOFF. Hardware: Data bits: 7, 8; Stop bits: 1, 1 1/2, 2; Parity: none, odd, even; Baud rate: 110, 300, 600, 1200, 2400, 4800, 9600, 19200.

### Ordering Information

	Price
<b>Logic Analyzers</b>	
HP 1631A (35 channels, plus two analog)	\$11,300
HP 1631D (43 channels, plus two analog)	\$13,300
HP 1650A (80 channels)	\$7800
HP 1651A (32 channels)	\$3900
HP 16500A Logic Analysis System	\$7200
HP 16510A (80 channels)	\$5200
HP 16515A (16 channels, 1 GHz timing)	\$7800
HP 16516A (16 channels, 1 GHz timing)	\$6500
HP 16520A (12 channels, pattern generation)	\$3700
HP 16521A (48 channels, pattern generation)	\$4000
HP 16530A (400 MSa/s oscilloscope timebase)	\$1500
HP 16531A (400 MSa/s oscilloscope acquisition)	\$4000
<b>Probe Interface</b>	
HP 10269C G.P. Probe Interface	\$470
Microprocessor Preprocessors-note, inverse assembly is provided on 3.5-inch disc	
HP 10304B Intel 8085	\$880
HP 10305B Intel 8086/88	\$1235
HP 10306B Intel 80186/88	\$2000
HP 10312D Intel 80286	\$2040
HP 10314B Intel 80386	\$2200
HP 10307B Motorola 6800/02	\$1110
HP 10308B Motorola 6809/09E	\$1110
HP 10310B Motorola 68008	\$1110
HP 10311B Motorola 68000/10, 64-pin DIP	\$1320
HP 10311G Motorola 68000/10, 68-pin PGA	\$600
HP 10313G Motorola 68020	\$850
HP 10303B National NSC800	\$1010
HP 10300B Zilog Z80	\$880
<b>Bus Preprocessors</b>	
HP 10342B HP-IB, RS-232C and RS-449	\$1220
HP 10342G HP-IB	\$350
<b>Minicomputer Interfaces</b>	
HP 10275A PDP-11 UNIBUS**	\$470
HP 10276A LSI-11 Q-Bus**	\$520
HP 52126A Intel Multibus***	\$370
<b>Accessory Software</b>	
HP 10390A System Performance Analysis	\$500

### User-Definable Interface

HP 10320C User-definable Interface	\$270
HP 10321A Microprocessor Interface Parts Kit	\$235
HP 10322A 40-pin DIP Interface Cable	\$410
HP 10323A 48-pin DIP Interface Cable	\$470
HP 10324A 64-pin DIP Interface Cable	\$570
HP 10391A Inverse Assembler Development Package	\$1000

### Printers and Accessories

HP 2225A ThinkJet Printer with HP-IB Interface	\$495
HP 10833A HP-IB Cable, 1m	\$80
HP 2225D ThinkJet Printer with RS-232C Interface	\$495
13242-60010 RS-232C Cable	\$69
HP 92261A Print Cartridge	\$10
HP 92261N Jet Paper (2500 Sheets, fanfold)	\$50
HP 92261S Mini-printer Stand	\$49

### Oscilloscope Accessories

HP 10503A BNC-to-BNC cable, 1.2m	\$20
HP 10017A 10:1, 1 Mohm, 8 pF miniprobe, 1m	\$130
HP 10018A 10:1, 1 Mohm, 10 pF miniprobe, 2m	\$140
HP 10020A 10:1, 100:1, 10 Mohm, 10 pF resistive divider probe set, 1.5m	\$435
HP 10021A 1:1, 36 pF, mini-probe, 1m	\$90
HP 10022A 1:1, 62 pF, mini-probe, 2m	\$95
HP 10026A 1:1, 50 ohm, mini-probe, 1m	\$90
HP 10027A 1:1, 50 ohm, mini-probe, 2m	\$95
HP 10032A 100:1, 3 Mohm, 3 pF mini-probe, 1m	\$150
HP 10240B BNC-to-BNC AC coupling capacitor	\$45
HP 10211A 24-pin IC test clip	\$75

### Logic Analyzer Accessories

01650-61607 16-Channel Probe Cable for HP 1650A and HP 1651A	\$130
16510-61601 16-Channel Probe Cable for HP 16510A	\$160
16515-61602 8-Channel Probe Cable for HP 16515A and HP 16516A	\$170
01650-61608 16-Channel Lead Set for HP 1650A, HP 1651A and HP 16510A (grey tip)	\$190
16515-62102 8-Channel Lead Set for HP 16515A and HP 16516A (blue tip)	\$195
01650-63201 Termination Adaptor for HP 1650A, HP 1651A and HP 16510A	\$100
5959-0288 Grabbers (package of 20)	\$20

### Pattern Generator Accessories

16520-61601 Input qualifier Probe Cable	\$130
16520-61602 8-Channel Data Probe Cable	\$165
16520-61603 Clock Probe Cable	\$190
HP 10347A Pattern Generator Probe Lead Set	\$200
16520-69501 Input Qualifier Probe Kit	\$140
HP 10345A 8-Channel ECL Differential Driver Pod	\$120
HP 10346A 8-Channel TTL Tristate Buffer Pod	\$120
5959-0288 Grabber (package of 20)	\$20

### Other Accessories

HP 1008A Option 006 Testmobile	\$1240
1540-1066 Soft Carrying Case (for HP 1650A and HP 1651A)	\$135
HP 46060A HP Mouse (for 16500A only)	\$148
HP 92192A Black double-sided 3.5" microfloppy discs (box of 10)	\$55
5061-6175 HP 1650A & HP 1651A Rackmount Kit	\$320
5061-9679 HP 16500A Rackmount Kit	\$40
9211-2658 HP 16500A Transit Case	\$520
9211-2645 HP 1650A & 1651A Transit Case	\$430

\*\*PDP-11, LSI-11, Unibus and Q-bus are trademarks of Digital Equipment Corporation.

\*\*\*Multibus is a trademark of Intel Corporation.

# DIGITAL CIRCUIT TESTERS

## Signature Multimeter, Combines Counter and Multimeter Functions with Signature Analysis

### Model 5005B

- Digital and analog measurement capability optimized for digital troubleshooting
- Easy to use single probe measurement of logic signals, voltage, and frequency



HP 5005B Programmable Signature Multimeter

### HP 5005B

Total checkout of a digital system often requires characterizing both digital data activity and analog signal parameters. A typical troubleshooting procedure may specify a digital multimeter for checking power supplies and circuit board integrity (shorts and opens), a universal counter to measure clock frequencies and time intervals between signals, and a means to verify the analog integrity of active digital signals. The HP 5005B Signature Multimeter offers, in a single instrument, a measurement set optimized for these types of digital troubleshooting applications.

- Field proven Signature Analysis (for multiple logic families).
- Digital multimeter (DC volts, resistance and differential voltage).
- Frequency counter (frequency, totalize, time interval).
- Voltage threshold (upper voltage peak, lower voltage peak).
- Multifunction probe.

### Signature Analysis

HP's patented Signature Analysis technique enables the HP 5005B to generate a compressed, four digit "fingerprint" or signature of the digital data stream at a logic node. Any fault associated with a device connected through the node will force a change in the data stream and, consequently, produce an erroneous signature.

Specific features of the HP 5005B Signature Analyzer include:

- Multiple logic family compatibility—preset threshold levels for TTL, CMOS, and ECL or adjustable thresholds (+12.5 V to -12.5 V) assure coverage of a wide variety of logic device types.
- 25 MHz clock frequency—extends Signature Analysis to high speed circuits such as CRT controllers.
- Qualified signature mode—speeds fault isolation in complex products by windowing signature collection to specific modules or devices without requiring major test setup changes. This simplifies the engineering involvement in hardware and software testability and accelerates test procedure preparation.

### Digital Multimeter

Certain digital problems result from analog circuit failures: a low power supply voltage, an open or shorted circuit path, a faulty A/D or D/A converter. Each may contribute to a system failure. The HP 5005B contains a 4½ digit dc voltmeter, ohmmeter, and differential voltmeter, each with performance geared toward analog measurements necessary in digital troubleshooting.

The implementation of each multimeter function emphasizes simplicity and convenience. Automatic internal self calibration and auto-ranging maximize troubleshooting efficiency by eliminating unnecessary interaction with the instrument. Improvements in display interpretation also aid troubleshooting. The ohmmeter, for example, when measuring an open circuit, produces an "OPEN" indication on the display rather than the typical overload display.

- 25 MHz, multiple logic family signature analysis with qualified clocking mode
- Complete HB-IB programmability of every function

### Frequency Counter

The counter within the HP 5005B provides totalize and frequency measurements to 50 MHz, and time interval measurements to 100 nanosecond resolution. Intended to extend the digital troubleshooting capabilities of the Signature Analysis (synchronous measurements), the counter functions provide the ability to characterize one-shots and timers through time interval measurement; test interrupt lines, reset lines, and asynchronous communication interfaces (RS-232) through totalize; and verify clock and clock driver circuitry through frequency measurement.

### Voltage Threshold

Logic level degradation is a common and troublesome malfunction in digital products. Isolating this failure typically requires displaying and interpreting the waveform. The HP 5005B's peak voltage measurement mode provides a simple, direct method of measuring logic high and logic low voltage of active digital signals.

The peak voltage measurement mode allows the HP 5005B to characterize and display either the greatest (positive peak) or lowest (negative peak) voltage measured at the probe. Selection of either positive peak or negative peak mode displays the appropriate measured threshold for comparison against the specifications of the logic family.

### Multifunction Probe

Several measurement functions incorporated into a single instrument can provide optimal troubleshooting efficiency only when each function is easy to use. The operator, when troubleshooting, must be able to measure the analog signal parameters and digital functional characteristics of a node without requiring time consuming and error-prone probe or instrument setup changes. The HP 5005B multifunction probe solves this problem by providing automatic access to the Signature Analyzer, multimeter, and counter functions through a single probe. All signal multiplexing to the appropriate measurement function is accomplished inside the HP 5005B.

This efficient probing scheme becomes particularly important in automatic applications. The HP 5005B takes advantage of the several functions available in the multifunction probe. A switch, located on the side of the probe, allows the operator to trigger automatic measurement. The instrument controller can then characterize both the analog parameters and functional digital operation of a circuit node while the operator probes the same point. This greater automatic measurement efficiency translates into increased troubleshooting productivity.

### HP-IB Programmability

Complete programmability makes the HP 5005B an ideal choice for automatic digital testing and troubleshooting. Every HP 5005B measurement and control function can be programmed through the HP-IB interface. This flexibility allows the automatic test system designer full access to the many measurement functions in the instrument.

Simplified programming enhances the automatic testing and troubleshooting productivity improvements inherent in the HP 5005B. Straightforward commands and data output formats aid in accelerating test program development. A measurement trigger switch located in the probe allows direct operator communication to the controller. Audible feedback, supplied by the beeper in the HP 5005B, can then indicate the completion of the measurement cycle. This closed-loop communication (controller-to-operator) aids in improving troubleshooting efficiency.



## HP 5005B Specifications

### Signature

**Display:** 4 digits. Characters 0-9, ACFHPU.  
**Fault detection accuracy:** 100% probability of detecting single-bit errors; 99.998% probability of detecting multiple-bit errors.  
**Minimum gate length:** 1 clock cycle (1 data bit) between START and STOP.  
**Maximum gate length:** no limit.

**Minimum timing between gates:** 1 clock cycle between STOP and START.

### Data Probe Timing

**Setup time:** 10 ns (data to be valid at least 10 ns before selected clock edge.)  
**Hold time:** 0 ns (data to be held until occurrence of selected clock edge.)

### START, STOP, QUAL Timing

**Setup time:** 20 ns (signals to be valid at least 20 ns before selected clock edge.)  
**Hold time:** 0 ns (signals to be held until occurrence of selected clock edge.)

### CLOCK Timing

**Maximum clock frequency:** 25 MHz.  
**Minimum pulse width:** 15 ns in high or low state.

**Quality mode:** allows data clock qualification by an external signal. DATA probe input impedance  $\approx 50\text{ k}\Omega$  to the average value of "0" and "1" threshold settings ( $\pm 6\text{ V}$  max); 15 pF.

**START, STOP, CLOCK, QUAL input impedance:**  $\approx 100\text{ k}\Omega$ ; 15 pF.  
**Front panel indicators:** flashing GATE light indicates detection of valid START, STOP, CLOCK conditions. Flashing UNSTABLE light indicates a difference between 2 successive signatures, and possible intermittent faults.

### Frequency

**Display:** 5 digits.  
**Ranges:** 100 kHz, 1 MHz, 10 MHz, 50 MHz, autoranged.  
**Resolution:** 1 LSD (1 Hz on 100 kHz range).  
**Accuracy:**  $\pm 0.01\%$  of reading  $\pm 1$  count.  
 Minimum pulse width  $\approx 10\text{ ns}$  in high or low state.  
 Gate time  $\approx 1\text{ s}$ , fixed.  
 Input impedance  $\approx 50\text{ k}\Omega$  to the average value of "0" and "1" threshold settings ( $\pm 6\text{ V}$  max); 15 pF.

### Totalizing

**Display:** 5 digits.  
**Range:** 0-99,999 counts.  
**Resolution:** 1 count.  
 Maximum input frequency  $\approx 50\text{ MHz}$ , with a minimum pulse width of 10 ns, and minimum pulse separation of 10 ns.  
 Minimum START/STOP pulse width  $\approx 20\text{ ns}$ .  
 DATA input impedance  $\approx 50\text{ k}\Omega$  to the average value of "0" and "1" threshold settings ( $\pm 6\text{ V}$  max); 15 pF.  
 START, STOP input impedance  $\approx 100\text{ k}\Omega$ ; 15 pF.

### Time Interval

**Display:** 5 digits.  
**Ranges:** 10 ms, 100 ms, 1 s, 10 s, 100 s, autoranged.  
**Resolution:** 1 count (100 ns on 10 ms range).  
**Accuracy:**  $\pm 0.01\%$  of reading  $\pm 2$  counts.  
 Minimum START/STOP pulse width  $\approx 20\text{ ns}$ .  
 START, STOP input impedance  $\approx 100\text{ k}\Omega$ ; 15 pF.

### Resistance

**Display:** 4 or 5 digits, depending on range.  
**Ranges:** 30 k $\Omega$ , 300 k $\Omega$ , 1 M $\Omega$ , 3 M $\Omega$ , 10 M $\Omega$ , autoranged.  
**Accuracy:** (at 15°C-30°C).

RANGE	FULL SCALE	ACCURACY	DISPLAY RESOLUTION
30 k $\Omega$	29,999 k $\Omega$	$\pm 1\%$ of reading $\pm 2\ \Omega$	1 $\Omega$
300 k $\Omega$	299,99 k $\Omega$	$\pm 1\%$ of reading	10 $\Omega$
1 M $\Omega$	999.9 k $\Omega$	$\pm 1\%$ of reading	100 $\Omega$
3 M $\Omega$	2999. k $\Omega$	$\pm 10\%$ of reading	1 k $\Omega$
10 M $\Omega$	10000. k $\Omega$	$\pm 10\%$ of reading	10 k $\Omega$

Input impedance  $\approx 20\text{ k}\Omega$  to  $\pm 2\text{ V}$

### DC Voltage

**Display:** 4½ digits.  
**Ranges:**  $\pm 25\text{ V}$ ,  $\pm 250\text{ V}$ , autoranged; referenced to earth ground.  
**Accuracy:** (at 15°C-30°C).

RANGE	ACCURACY	RESOLUTION
25 V	$\pm 0.1\%$ of reading $\pm 2\text{ mV}$	1 mV
250 V (<100 V)	$\pm 0.25\%$ of reading $\pm 20\text{ mV}$	10 mV
250 V ( $\geq 100\text{ V}$ )	$\pm 0.25\%$ of reading $\pm 20\text{ mV}$	100 mV

Input impedance  $\approx 10\text{ M}\Omega$ .

### Differential Voltage

**Reading:** reads input voltage present at the probe and displays difference between it and voltage at the time  $\Delta\text{V}$  key was depressed.  
**Specifications:** same as for DCV, above. Voltage range is determined by larger of 2 compared voltages.

### Peak Voltage

**Display:** 3½ digits.  
**Range:** 0- $\pm 12\text{ V}$ p.  
**Resolution:** 50 mV.  
**Accuracy:**  $\pm 2\%$  of reading  $\pm 5\%$  of p-p signal  $\pm 100\text{ mV}$ .  
 Minimum peak duration  $\approx 10\text{ ns}$ .  
 Maximum time between peaks  $\approx 50\text{ ms}$ .  
 Input impedance  $\approx 100\text{ k}\Omega$ ; 15 pF.

### Signature Analyzer Logic Thresholds

Preset thresholds: TTL, ECL, CMOS.  
**Adjustable thresholds:** each preset threshold can be adjusted.  
**Range:**  $\pm 12.5\text{ V}$ , in 50 mV steps.  
**Accuracy:**  $\pm 2\%$  of setting,  $\pm 2\text{ V}$   
 Logic threshold circuitry is operative during NORM, QUAL, kHz, TOTLZ and ms measurements.

### General

**Data probe tip:** acts as high-speed logic probe in the NORM, QUAL, kHz and TOTLZ modes. Lamp indicates high, low, bad-level and pulsing states.  
 Minimum detected pulse width is 10 ns.

### Data Probe Protection

**Continuous Overload**  
**DCV,  $\Delta\text{V}$ , k $\Omega$  modes only:**  $\pm 250\text{ V}$  ac/dc.  
**All other modes:**  $\pm 150\text{ V}$  ac/dc, 20 V rms at input frequencies > 2 MHz.  
**Intermittent overload:**  $\pm 250\text{ V}$  ac/dc, up to 1 min, for all modes.

### Timing Pod Protection

**Continuous overload:**  $\pm 100\text{ V}$  ac/dc, 20 V rms at input frequencies > 2 MHz.  
**Intermittent overload:**  $\pm 140\text{ V}$  ac/dc, up to 1 min.  
**Auxiliary power supply:** three rear-panel connectors supply 5 V at 0.7A total for accessories (HP 5005A only)  
**Operating temperature:** 0°C to +55°C.  
**Power:** selectable 100 V, 120 V, 220 V or 240 V ac line (+5%-10%), 48-66 Hz, 35 VA maximum.  
**Weight:** Net: 5.5 kg (12.0 lb.) Shipping: 8.7 kg (19 lb.).  
**Size:** 133 mm H x 212 mm W x 432 mm D (5¼" x 8¾" x 17"), excluding handle.

**Ordering Information**  
 HP 5005B Signature Multimeter  
 Opt 910: Additional Manual

**Price**  
 \$4,600  
 + \$70

# DIGITAL CIRCUIT TESTERS

## Signature Analyzer, A Digital Troubleshooting Tool

Model 5006A

- Reduce warranty and service support costs
- Full at-speed testing of digital products

- Reduce comparisons to documentation with composite signature
- Compare signatures in groups with signature memory



HP 5006A

### HP 5006A Signature Analyzer The Technique

Signature Analysis is a fast and accurate troubleshooting method for digital circuits. Fault finding is reduced to tracing signal flow and comparing measured signatures to those recorded on paper or in a computer. Troubleshoot with Signature Analysis by probing the circuit, reading the display and comparing to the known good signature. A signature is a cyclic redundancy code (CRC) used as an error detection check on blocks of data. Test patterns may be generated within a circuit or simulated externally.

### Programmability Means Efficiency

The HP 5006A is completely programmable using the optional HP-IB interface. Upgrade production test and troubleshooting systems to include digital troubleshooting by adding the HP-IB option.

Signatures compress the necessary troubleshooting information of a bit stream into 16 bits. Instead of entire bit streams, only signatures need be compared to detect bit errors in the unit under test.

### Time Savers

Composite signature and signature memory save time for the troubleshooter who does not have a computer-aided system. Composite signature is the binary sum of individual signatures. The HP 5006A computes it for any grouping of digital signals (i.e., bus or IC). Only one "composite" signature need be compared to documentation if all signals for that group are good.

Signatures are stored in the HP 5006A memory after the probe switch is pushed. The memory stores the last 32 signatures probed. Individual signatures can now be compared in groups instead of after each probe by reviewing the memory in the RECALL mode.

### HP 5006A Specifications

#### General

**Display:** 4 digits. Characters 0-9, ACFHPU.

**Fault detection accuracy:** 100% probability of detecting single-bit errors; 99.998% probability of detecting multiple-bit errors.

**Composite signature:** maximum number of signatures: No limit.

Sums all signatures, triggered by probe switch, following depression of CLEAR key, or power-up.

**Signature memory:** signatures recallable by probe switch: The last 32 signatures triggered by probe switch.

#### Timing

**Clock:** maximum frequency: 25 MHz. Minimum clock time: 15 ns in high or low state

**Probe:** setup time: 10 ns with 0.2 V overdrive. (Data to be valid at least 10 ns before selected clock edge.) Hold time: 0 ns. (Data to be held after occurrence of selected clock edge.)

**Start, stop, qualifier:** setup time: 20 ns with 0.2 V overdrive. (Data to be valid at least 20 ns before selected clock edge.) Hold time: 0 ns. (Data to be held until occurrence of selected clock edge.) Minimum gate length: 1 clock cycle (1 data bit) between START and STOP.

Maximum gate length: no limit.

Minimum timing between gates: 1 clock cycle between STOP and START.

#### Input Impedance

**Probe:** 50 k $\Omega$  to ground nominal.

**Pod:** 100 k $\Omega$  to ground nominal.

#### Overload Protection

**Probe:**  $\pm 150$  V continuous.

$\pm 250$  V intermittent.

250 Vac for 1 minute.

**Pod:**  $\pm 20$  V continuous.

$\pm 140$  V intermittent.

$\pm 140$  Vac for 1 minute.

**CMOS sense:** 20 Vdc maximum.

#### TTL Thresholds

**Probe:** Logic one: 2 V + .2-.3. Logic zero: 0.8 V +.3-.2

**Pod:** 1.4 V  $\pm$  .6

#### CMOS Thresholds

**Logic one:** 70% of sensed voltage.

**Logic zero:** 30% of sensed voltage.

#### Display and Indicators

**Signature:** four seven-segment digits with decimal point.

**Lamps:** Key Status: Recall, edit, signature latch, unstable latch, qualify mode, timing polarities. Programmable: Remote, talk, listen, SRQ. (Option 040). Status: Composite signature, gate, unstable.

**Probe:** logic levels indicated: High, low, open and pulsing. Minimum pulse width: 10 ns.

#### Other

**Selectable power:** 115 V +10%-25% ac line, 48-440 Hz.

230 V +10-15% ac line, 48-66 Hz, 25 VA maximum.

**Operating environment:** temperature: 0-55°C. Humidity: 95% RH at +40°C. Altitude: 4600 m (15,000 ft).

**Size:** 89 mm H x 216 mm W 279 mm D (3-1/2 in. x 8-1/2 in. x 11 in.).

**Net weight:** 2.4 kg (5.3 lb). Shipping weight: 4.1 kg (9 lb).

#### Ordering Information

HP 5006A Signature Analyzer

Opt 40 HP-IB Interface

Opt 910 Additional Manual

HP 5060-0173 Half Rack Mount Kit

#### Price

\$1550

+ \$300

+ \$16.50

\$68

# DIGITAL CIRCUIT TESTERS

## Logic Probe, Logic Pulser, Digital Current Tracer

Models 545A, 546A, 547A

### HP 545A TTL/CMOS Logic Probe

The HP 545A Logic Probe contains all the features built into other HP probes, plus switch-selectable, multi-family operation and built-in pulse memory. Employing straightforward one-lamp display the HP 545A operates from 3 to 18 volts in CMOS applications or from 4.5 to 15 Vdc supplies in the TTL mode while maintaining standard TTL thresholds.

The probe's independent, built-in pulse memory and LED display help you capture hard to see, intermittent pulses. Just connect the probe tip to a circuit point, reset the memory, and wait for the probe to catch those hard to find glitches.

The hand-held HP 545A is light, rugged, overload protected, and very fast: 80 MHz in TTL, 40 MHz in CMOS. It also employs handy power supply connectors that enable you to easily hook up to supply voltage almost anywhere in the unit under test.

### HP 545A Probe Specifications

**Input current:**  $\leq 15 \mu\text{A}$  (source or sink).

**Input capacitance:**  $\leq 15 \text{ pF}$ .

#### Logic thresholds

**TTL:** Logic one  $2.0 \pm 0.4$ ,  $-0.2 \text{ V}$ . Logic zero  $0.8 \pm 0.2$ ,  $-0.4 \text{ V}$ .

**CMOS:** 3–10 Vdc supply

Logic one:  $0.7 \times V_{\text{supply}} \pm 0.5 \text{ Vdc}$ .

Logic zero:  $0.3 \times V_{\text{supply}} \pm 0.5 \text{ Vdc}$ .

**CMOS:**  $\geq 10$ –18 Vdc supply.

Logic one:  $0.7 \times V_{\text{supply}} \pm 1.0 \text{ Vdc}$ .

Logic zero:  $0.3 \times V_{\text{supply}} \pm 1.0 \text{ Vdc}$ .

**Input minimum pulse width:** 10 ns using ground lead (typically 20 ns without ground lead).

**Input maximum pulse repetition frequency:**

TTL, 80 MHz. CMOS, 40 MHz.

**Input overload protection:**  $\pm 120 \text{ V}$  continuous (dc to 1 kHz);  $\pm 250$  for 15 seconds (dc to 1 kHz).

**Pulse memory:** indicates first entry into valid logic level; also indicates return to initial valid level from bad level for pulse  $\geq 1 \mu\text{s}$  wide.

#### Power Requirements

**TTL:** 4.5 to 15 Vdc\*.

**CMOS:** 3 to 18 Vdc.

**Maximum current:** 70 mA.

**Overload protection:**  $\pm 25 \text{ Vdc}$  for one minute.

**Accessory included:** ground clip.

\*  $\pm 5\%$  10% Vdc power supply, usable to  $\pm 15 \text{ Vdc}$  with slightly increased logic low threshold.

### HP 546A Logic Pulser

The Logic Pulser solves the problem of how to pulse IC's in digital circuits. Merely touch the Pulser to the circuit under test, press the pulse button and all circuits connected to the node (outputs as well as inputs) are briefly driven to their opposite state. No unsoldering of IC outputs is required. Pulse injection is automatic, high nodes are pulsed low and low nodes, high, each time the button is pressed.

Automatic polarity pulse output, pulse width, and amplitude make for easy multi-family operation when you use the HP 546A Logic Pulser. But, the real surprise comes when you code in one of its six ROM-programmable output patterns (single pulses; pulse streams of either 1, 10, or 100 Hz; or bursts of 10 or 100 Hz; or bursts of 10 or 100 pulses). This feature allows you to continually pulse a circuit when necessary, or it also provides an easy means to put an exact number of pulses into counters and shift registers. Used with our multi-family IC Troubleshooters, the HP 546A acts as both a voltage and current source in digital troubleshooting applications.

### HP 546A Pulser Specifications

#### Output

Family	Output Current	Pulse Width	Typical Output Voltage	
			HIGH	LOW
TTL/DTL	$\leq 650 \text{ mA}$	$\geq 0.5 \mu\text{s}$	$\geq 3 \text{ Vdc}$	$\leq 0.8 \text{ Vdc}$
CMOS	$\leq 100 \text{ mA}$	$\geq 5.0 \mu\text{s}$	$\geq (V_{\text{supply}} - 1) \text{ Vdc}$	$\leq 0.5 \text{ Vdc}$

**Power supply requirements:** TTL; 4.5 to 5.5 Vdc at 35 mA, CMOS; 3 to 18 Vdc at 35 mA, protected to  $\pm 25 \text{ Vdc}$  for 1 min.

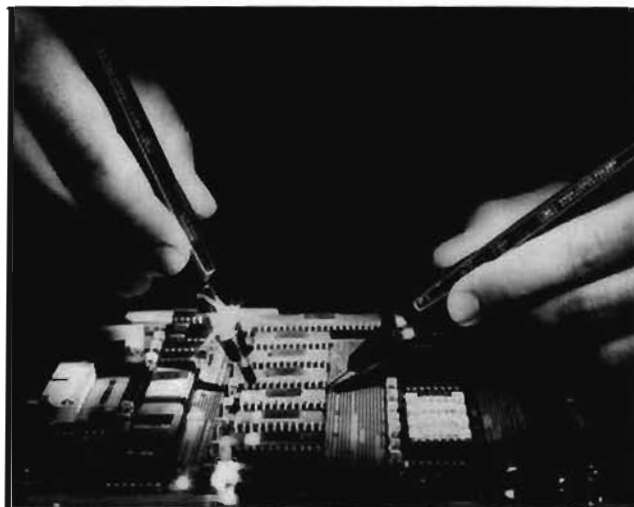

HP 547A/546A

### HP 547A Digital Current Tracer

The HP 547A Current Tracer precisely locates low-impedance faults in digital circuits by locating current sources or sinks. For example, on a bad node the Tracer can verify that the driver is functioning and also show where the problem is by tracing current flow to the source or sink causing the node to be stuck. The Tracer is designed to troubleshoot circuits carrying fast rise-time current pulses. The Tracer senses the magnetic field generated by these signals in the circuit and displays transitions, single pulses, and pulse trains using a simple one-light indicator. Because it is not voltage sensitive, the Tracer operates on all logic families having current pulses exceeding 1 mA, including CMOS, where even lightly loaded outputs can have up to 2 to 3 mA of instantaneous charging current.

To use the Tracer, align the dot on its tip at a reference point, usually the output of a node driver. Set the sensitivity control to indicate the presence of ac current activity. As you probe from point to point or follow traces, the lamp will change intensity; when you find the fault the Tracer will indicate the same brightness found at the reference point.

### HP 547A Current Tracer Specifications

#### Input

**Sensitivity:** 1 mA to 1 A.

**Frequency response:** light indicates single-step current transitions; single pulses  $\geq 50 \text{ ns}$  in width; pulse trains to 10 MHz (typically 20 MHz for current pulses  $\geq 10 \text{ mA}$ ).

**Risetime:** light indicates current transitions with risetime  $\leq 200 \text{ ns}$  at 1 mA.

#### Power Supply Requirements

**Voltage:** 4.5 to 18 Vdc.

**Input current:**  $\leq 75 \text{ mA}$ .

**Maximum ripple:**  $\pm 500 \text{ mV}$  above 5 Vdc.

**Overvoltage protection:**  $\pm 25 \text{ Vdc}$  for one minute.

#### Accessories Available

HP 00545-60104: Tip Kit for HP 546A Pulser, 545A Probe	\$51
HP 10526-60002: Multi-Pin Stimulus Kit	\$72.50
HP 1250-1948 Adapter, Coax Str.	\$22

#### Ordering Information

HP 545A Logic Probe	\$200
HP 546A Logic Pulser	\$265
HP 547A Digital Current Tracer	\$475

☛ Fast-ship product—see page 758.

# DIGITAL CIRCUIT TESTERS

## Logic Clip, Logic Comparator

Models 548A & 10529A

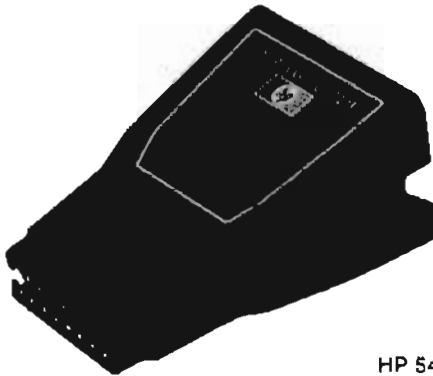

HP 548A

### HP 548A Logic Clip

The Logic Clip is an extremely handy service and design tool which clips onto dual-in-line package (DIP) ICs, instantly displaying the states of up to 16 pins. Each of the clip's 16 LEDs independently follows level changes at its associated pin. Lit diodes are logic High, extinguished diodes are Low.

The Logic Clips's real value is in its ease of use. It has no controls to set, needs no power connections, and requires practically no explanation as to how it is used. The clip has its own gating logic for locating ground and  $V_{CC}$  pins and its buffered inputs reduce circuit loading.

The Logic Clip is much easier to use than either an oscilloscope or a voltmeter when you are interested in whether a circuit is in the high or low state, rather than its actual voltage. The Clip, in effect, is 16 binary voltmeters, and the user does not have to shift his eyes away from his circuit to make the readings.

The intuitive relationship of the input to the output—lighted diode corresponding a high logic state—greatly simplifies the troubleshooting procedure. The user is free to concentrate his attention on his circuits, rather than on measurement techniques. Also, timing relationships become especially apparent when clock rates can be slowed to about 1 pulse per second.

When used in conjunction with the Logic Pulser, the Logic Clip offers unparalleled analysis capability for troubleshooting sequential Logic Devices used to inject pulses between gates allowing it to supply signals to the IC under test absolutely independent of gates connected to the IC. All outputs may then be observed simultaneously on the Logic Clip. Deviations from expected results are immediately apparent as the Pulser steps the IC through its truth table.

### HP 548A Multi-Family Logic Clip

Fully automatic and protected to 30 Vdc, and employing bright individual LEDs in its display, the HP 548A brings multi-family operation to the HP line of IC Troubleshooters. The Clip can be externally powered, if desired, using a simple power connector.

### HP 548A Specifications

**Input threshold:**  $(\geq 0.4 \pm 0.06 \times \text{Supply Voltage}) = \text{Logic High}$ .

**Input impedance:** 1 CMOS load per input.

**Input protection:** 30 Vdc for 1 minute.

**Supply voltage:** 4-18 Vdc across any two pins.

**Auxiliary supply input:** 4.5 to 20 Vdc applied via connector. Supply must be  $\geq 1.5$  Vdc more positive than any pin of IC under test.

**Supply current:** <55 mA.

### HP 548A Logic Clip

☛ Fast-ship product—see page 758.

\$240 ☛

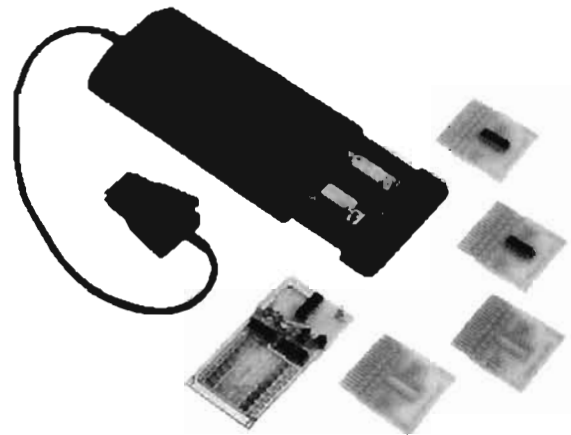

HP 10529A

### HP 10529A Logic Comparator

The HP 10529A Logic Comparator clips onto powered TTL or DTL ICs and detects functional failures by comparing the in-circuit test IC with a known good reference IC inserted in the Comparator. Outputs of the particular IC to be tested are selected via 16 miniature switches which tell the Comparator which pins of the reference IC are inputs and which are outputs. Any logic state difference between the test IC and reference IC is identified to the specific pin(s) on 14- or 16-pin dual in-line packages on the Comparator's display. A lighted LED corresponds to a logic difference. Intermittent errors as short as 300 nanoseconds (using the socket board) are detected, and the error indication on the Comparator's display is stretched for a visual indication. A failure on an input pin, such as an internal short, will appear as a failure on the IC driving the failed IC; thus a failure indication actually pinpoints a malfunctioning node. A test board is supplied to exercise all of the circuitry, test leads, and display elements to verify proper operation.

**HP 10541A:** twenty additional blank reference boards; identical to the 10 boards provided with the Logic Comparator.

**HP 10541B:** twenty preprogrammed reference boards. The 10541B includes the following ICs: 7400, 7402, 7404, 7408, 7410, 7420, 7430, 7440, 7451, 7454, 7473, 7474, 7475, 7476, 7483, 7486, 7490, 7493, 74121, 9601.

### HP 10529A Specifications

**Input threshold:** 1.4 V nominal (1.8 V nominal with socket board), TTL or DTL compatible.

**Test IC loading:** outputs driving Test IC inputs are loaded by 5 low-power TTL loads plus input of Reference IC. Test IC outputs are loaded by 2 low-power TTL loads.

**Input protection:** voltages  $< -1$  V or  $> 7$  V must be current limited to 10 mA.

**Supply voltage:** 5 V  $\pm 5\%$ , at 300 mA.

**Supply protection:** supply voltage must be limited to 7 V.

**Maximum current consumption:** 300 mA.

### Sensitivity

**Error sensitivity:** 200 ns with reference board or 300 ns with socket board. Errors greater than this are detected and stretched to at least 0.1 second.

**Delayed variation immunity:** 50 ns. Errors shorter than this value are considered spurious and ignored.

**Frequency range:** maximum operational frequency varies with duty cycle. An error existing for a full clock cycle will be detected if the cycle rate is less than 3 MHz.

**Accessories included:** 1 test board; 10 blank reference boards; 1 programmable socket board; 1 carrying case.

### Accessories Available

HP 10541A: Twenty Blank Reference Boards

HP 10541B: Twenty Pre-programmed Boards

### HP 10529A Logic Comparator

☛ Fast-ship product—see page 758.

Price

\$110 ☛

\$330 ☛

\$825 ☛

# DIGITAL CIRCUIT TESTERS

## Logic Troubleshooting Kits

Models 5011T, 5021A, 5022A, 5023A & 5024A

- Complete multi-family kits
- Stimulus-response capability
- In-circuit fault finding

- In-circuit analysis
- Dynamic and static testing
- Multi-pin testing



HP 5011T

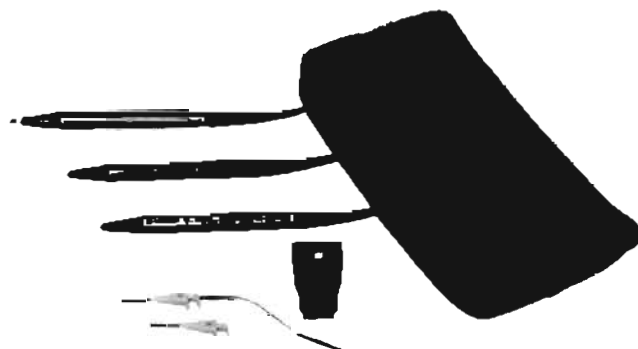

HP 5022A

FAULT	STIMULUS	RESPONSE	TEST METHOD
Shorted Node <sup>1</sup>	Pulser <sup>2</sup>	Current Tracer	<ul style="list-style-type: none"> <li>• Pulse shorted node</li> <li>• Follow current pulses to short</li> </ul>
Stuck Data Bus	Pulser <sup>2</sup>	Current Tracer	<ul style="list-style-type: none"> <li>• Pulse bus line(s)</li> <li>• Trace current to device holding the bus in a stuck condition</li> </ul>
Signal Line Short to Vcc or Ground	Pulser	Probe, Current Tracer	<ul style="list-style-type: none"> <li>• Pulse and probe test point simultaneously</li> <li>• Short to Vcc or Ground cannot be overridden by pulsing</li> <li>• Pulse test point, and follow current pulses to the short</li> </ul>
Supply to Ground Short	Pulser	Current Tracer	<ul style="list-style-type: none"> <li>• Remove power from circuit under test</li> <li>• Disconnect electrolytic bypass capacitors</li> <li>• Pulse across Vcc and ground using accessory connectors provided</li> <li>• Trace current to fault</li> </ul>
Internally Open IC	Pulser <sup>2</sup>	Probe	<ul style="list-style-type: none"> <li>• Pulse device input(s)</li> <li>• Probe output for response</li> </ul>
Solder Bridge	Pulser <sup>2</sup>	Current Tracer	<ul style="list-style-type: none"> <li>• Pulse suspect line(s)</li> <li>• Trace current pulses to the fault</li> <li>• Light goes out when solder bridge passed</li> </ul>
Sequential Logic Fault in Counter or Shift Register	Pulser	Clip	<ul style="list-style-type: none"> <li>• Circuit clock de-activated</li> <li>• Use Pulser to enter desired number of pulses</li> <li>• Place Clip on counter or shift register and verify device truth table</li> </ul>

1. A node is an interconnection between two or more IC's.  
 2. Use the Pulser to provide stimulus or use normal circuit signals, whichever is most convenient.

Used individually, each of HP's IC Troubleshooters provide their own unique and important troubleshooting function. Together they become invaluable stimulus-response testing partners that help pinpoint faults and ensure fast non-destructive repair of digital circuits.

To help you take advantage of the usefulness of the IC Troubleshooters, HP has packaged them into kits which offer both ordering convenience, and cost savings. Also, applications information is available, such as AN 163-2, "New Techniques of Digital Troubleshooting", to help users derive maximum benefit from these instruments.

The table shows a series of typical node and gate faults and the combination of tools used to troubleshoot the circuit. As with all sophisticated measuring instruments, operator skill and circuit knowledge are key factors once the various clues or "bits" of information are obtained using the IC Troubleshooters.

To accomplish troubleshooting at the node and gate level, both stimulus (Pulser) and response (Probe, Tracer, Clip and Comparator) instruments are needed. Moreover, instruments with both voltage and current troubleshooting capability help isolate electrical faults where the precise physical location is hard to identify.

The HP 547A Current Tracer, the latest and most sophisticated of these troubleshooters, lets you "see" current flow on nodes and buses that otherwise appear stuck at one voltage level. Used with the HP 546A Pulser, stimulus-response testing is now also possible in the current domain.

### IC Troubleshooter Kits Ordering Information

Kit	H mm (in)	W mm (in)	D mm (in)	Net Wt kg (lbs, oz)	Ship Wt kg (lbs, oz)
HP 5011T	82.6 (3.25)	203 (8)	311 (12.25)	1.49 (3.5)	2.11 (4.11)
HP 5021A	64 (2.5)	146 (5.75)	298 (11.75)	0.51 (1.2)	0.62 (1.6)
HP 5022A	64 (2.5)	146 (5.75)	298 (11.75)	0.65 (1.7)	0.76 (1.11)
HP 5023A	225 (8.88)	200 (7.88)	337 (13.25)	1.63 (3.10)	2.19 (4.14)
HP 5024A	64 (2.5)	146 (5.75)	298 (11.75)	0.60 (1.5)	0.71 (1.9)

### IC Troubleshooter Kits Selection Guide

HP MODEL	545A TTL/CMOS Probe	546A TTL/CMOS Pulser	547A TTL/CMOS Current Tracer	548A TTL/CMOS Clip	10529A TTL Comparator	PRICE \$
5011T Kit	X	X		X	X	1360 ☞
5021A Kit	X	X		X		700 ☞
5022A Kit	X	X	X	X		1150 ☞
5023A Kit	X	X	X	X	X	1960 ☞
5024A Kit	X	X	X			910 ☞

☞ Fast-ship product—see page 758.

### Accessories Available

- HP 00545-60104: Tip Kit for HP 545A Probe, and 546A Pulser **\$51 ☞**
- HP 10526-60002: Multi-pin Stimulus Kit for Logic Pulser **\$72.50**
- HP 10529-60006: External Reference Kit for HP 10529A Comparator **\$430**
- HP 10541A: Twenty blank reference boards for HP 10529A Comparator **\$110 ☞**
- HP 10541B: Twenty pre-programmed reference boards for HP 10529A Comparator **\$330 ☞**
- ☞ Fast-ship product—see page 758.

# COMPONENT MEASUREMENT

## General Information Impedance Measurement

Application Area	Component/Manufacturer/Manufacturer			Component User
	R & D and QA	Production	Incoming Inspection	
Major Requirements	Verify that device has sufficient performance	Perform GO/NO-GO testing based on MIL, IEC, etc.	Incoming Inspection	Evaluate device/circuits under actual working conditions
Required Measurement Functions	Multi-function/General Purpose Wide freq. range Auto freq. sweep Variable signal level & DC Bias Multi-parameter High accuracy and resolution	High Speed/Single Function High Speed Fixed frequency level and DC Bias Single parameter		Multi-function/General Purpose High frequency resolution Auto freq. sweep Variable signal level & DC Bias Multi-parameter High accuracy and resolution
HP Product Offering				
Objects for Test	<b>Materials</b> Magnetic materials Dielectric materials High polymers Optical materials (Fibers, etc.) Semiconductor materials etc.	<b>Components</b> Capacitors Inductors Transformers Magnetic heads Piezo-electrics Cables Transistors Sensors Hybrid ICs Filters etc.	<b>Equipments</b> TVs Audio/video products Fax Communication equipments Computers etc.	

Table 1 Component measurement applications and HP products

### Component Measurement

An impedance-measuring instrument measures impedance characteristics of electronic components, materials and circuits HP impedance instruments provide:

1. A broad product line, to fit each application;
2. Full evaluation of impedance characteristics under conditions of varying frequency, test-signal level and DC bias.
3. High-precision, high-resolution impedance measurement, with error correction for test-lead or test-fixture effects.

Impedance-measuring instruments can be divided into two general categories: LCR meters and impedance analyzers. The LCR meter primarily measures the inductance, capacitance and resistance of a test device. The impedance analyzer, in addition to all of the functions of the LCR meter, measures the impedance and phase of the test device, and makes detailed analysis of the impedance measurement.

The major applications of impedance-measurement instruments are in electronic-component materials manufacture and electronic equipment manufacture (electronic component users). Table 1 shows the type of evaluation and the functions required according to instrument application.

Impedance measurements can be divided into two general categories:

1. Tests of whether the test device functions properly under application conditions and
2. Tests under conditions stipulated by MIL or IEC standards.

When type 1 measurements are conducted in an R&D department, the purpose is to shorten development time through careful evaluation. Therefore, a multi-function, general-purpose instrument for the measurement of many characteristics is required, such as an impedance analyzer or high-resolution LCR meter.

Type 2 measurements are conducted for go/no-go tests in manufacturing or incoming inspection. The measurement data are fed back to vendors or manufacturing processes for correction and improvement. Because of volume, test costs must be minimized. Therefore, a high-speed, single-function instrument may be used. Sorting and interpreting test results may be required, so an LCR meter with a comparator option can be used.

Table 2 shows HP's line of instruments arranged according to measurement frequency and performance. Test frequencies of these instruments range from 5 Hz to 1 GHz, and some have fixed MIL/IEC standard frequencies between 1 kHz and 1 MHz.

Since the time that HP introduced the first digital LCR meter, the company has continued to create high-performance impedance-measurement instruments. Because of this effort, it is now possible for virtually anyone to make the most difficult impedance measurements with ease and great accuracy.

\*HP 4195A: Refer to page 226.

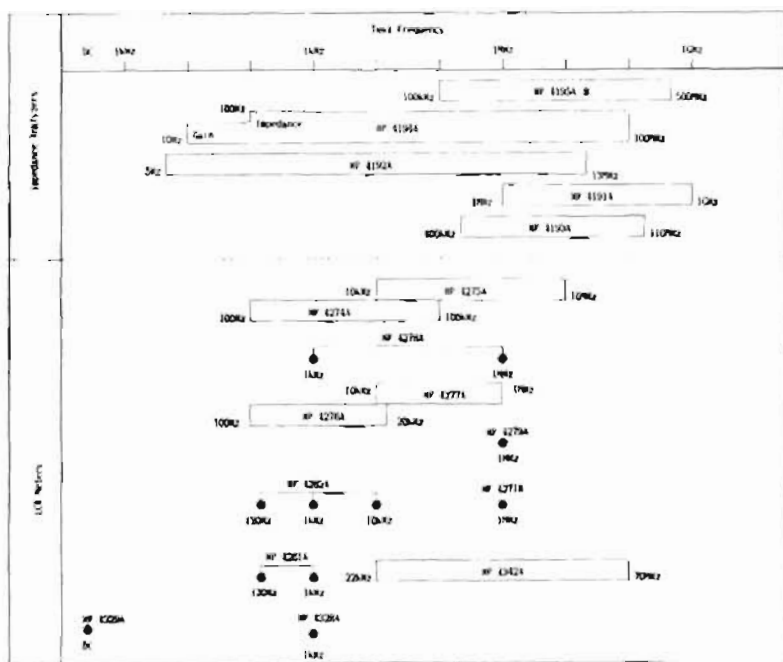

Table 2 HP Component measurement products vs. test frequency

**Variety of available test fixtures**

A variety of test fixtures are available for the HP LCR meters for many applications. Tables 3 to 5 are compatibility charts for the test fixtures and HP's LCR meters.

Refer to the individual LCR meter data sheet for details.

	4191A	4193A	4194A with 41941A/B	4195A with 41951A
16001A	○	○*12	○*12	○
16092A	○*15	○*12	○*12	○
16093A	○*14	○*12	○*12	○*14
16093B	○*18	○*12	○*12	○*13
16094A	○*13	○*12	○*12	○*13

Table 3 Instruments with APC-7<sup>o</sup> connector or probe vs. accessories

	4201A	4202A
16001A	○	○
16092A	○	○
16093A	○	○

Table 4 Instruments with banana plugs vs. accessories

- \*1:  $\leq 3\text{MHz}$
- \*2:  $\leq 13\text{MHz}$
- \*3:  $\leq 2\text{MHz}$
- \*4:  $\geq 100\text{Hz}$
- \*5: At 10MHz, an inductance approximately 1 $\mu\text{H}$  cannot be measured due to circuit resonance.
- \*6:  $\leq 100\text{kHz}$
- \*7: 2m cable can be used but causes an additional error.
- \*8:  $\geq 50\text{Hz}, \leq 2\text{MHz}$
- \*9: Use with the HP 16085A.
- \*10:  $\leq 15\text{MHz}$
- \*11: Use only for making floating measurements.
- \*12: Use with the HP 16099A
- \*13:  $\leq 125\text{MHz}$
- \*14:  $\leq 250\text{MHz}$
- \*15:  $\leq 500\text{MHz}$

	4192A	4194A	4271B	4274A	4275A	4276A	4277A	4278A	4279A
16002A	×	×	○	×	×	×	×	×	×
16002A	×	×	○	×	×	×	×	×	×
16003A	×	×	○	×	×	×	×	×	×
16034A	×	×	○	×	×	×	×	×	×
16034B	○*1	○*1	×	○	○*1	○	○*1	○	○
16034E	○	○	×	○	○	○	○	○	○
16038A	×	×	(Furnished)	×	×	×	×	×	×
16039A	×	×	○	×	×	×	×	×	×
16045A	○	○	×	○	○	○	○	○	○
16047A	(Furnished)	○*2	×	(Furnished)	(Furnished)	(Furnished)	(Furnished)	○	○
16047B	○*3	○*3	×	○	○*3	○	○*3	○	○
16047C	○	○	×	○	○	○	○	○	○
16047D	○*4	(Furnished)	×	○	○	○	○	○	○
16048A	○	○	×	○	○*5	○	○	○	○
16048B	○	○	×	○	○*5	○	○	○	○
16048C	○*6	○*6	×	○	○*6	○	○*6	○*6	×
16048D	○*7	○*7	×	○*7	○*7	○	○	○	○
16085A	○*8	○*3	×	○	○*3	○	○*3	○	○
16085A	○	○	×	○	○	○	○	○	○
16091A	○*9	○*9	×	○*9	○*9	○*9	○*9	○*9	○*9
16092A	○*9	○*9	×	○*9	○*9	○*9	○*9	○*9	○*9
16093A	○*9	○*9	×	○*9	○*9	○*9	○*9	○*9	○*9
16093B	○*9	○*9	×	○*9	○*9	○*9	○*9	○*9	○*9
16094A	○*9	○*9	×	○*9	○*9	○*9	○*9	○*9	○*9
16095A	○	○	×	○*11	○*11	○*11	○*11	○*11	○*11
16096A	○	○*10*11	×	○*11	○*11	○*11	○*11	○*11	○*11
16094A	○	○*10	×	○	○	○	○	○	○

Table 5 Instruments with BNC connectors vs. accessories

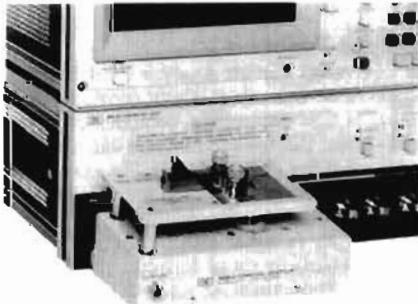

HP 16092A with HP 16085A

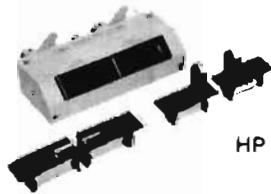

HP 16047A



HP 16048A



HP 16047C



HP 16093A with HP 16099A



HP 16034E



HP 16334A

# COMPONENT MEASUREMENT

## Impedance/Gain-Phase Analyzer

Model 4194A

- High Accuracy and Wide Range

**Impedance Measurement:**

100Hz to 40MHz, 0.1m $\Omega$  to 1.6M $\Omega$ , 0.17%

10 kHz to 100 MHz, 0.1 $\Omega$  To 1M $\Omega$ , 1.5% when used with the HP 41941A/B

**Gain-Phase Measurement:**

10Hz to 100MHz, -107dBm to +15dBm, 0.1dB resolution

- Flexible Measurement, Computation and Analysis Capabilities on a Color Graphic Display
- Fully Programmable

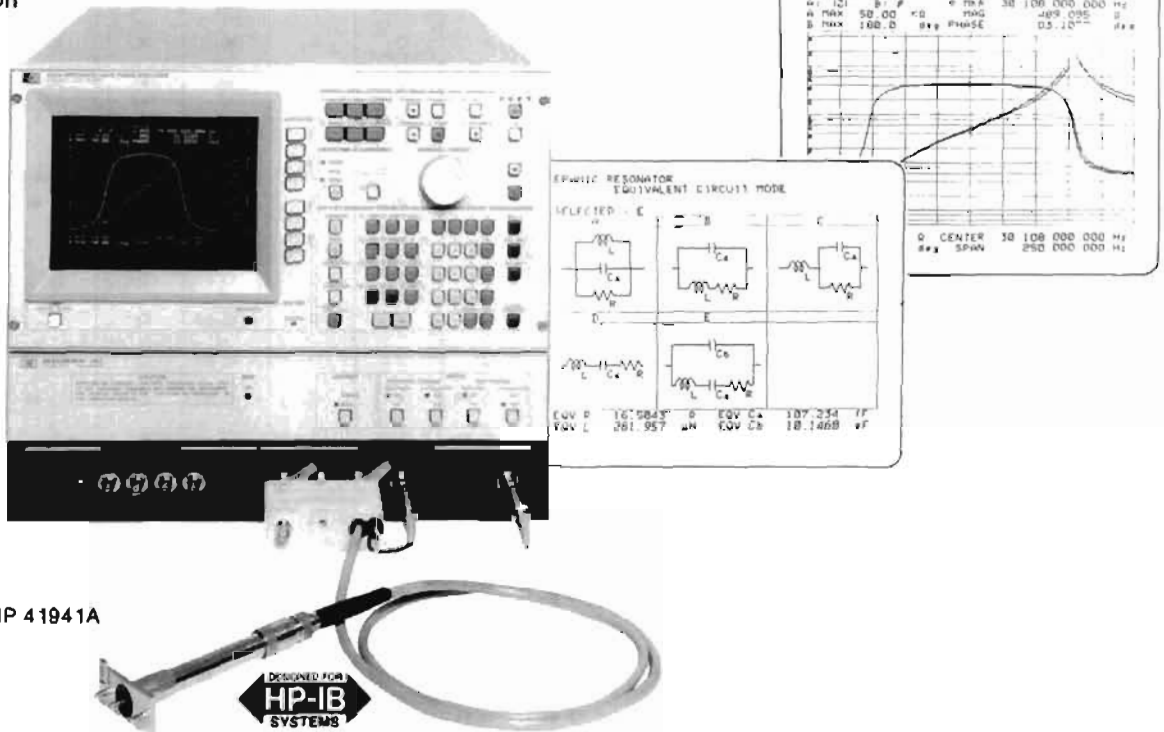

HP 4194A with HP 41941A

### Description

The HP 4194A Impedance/Gain-Phase Analyzer is an integrated solution for efficient measurement and analysis or go/no-go testing of components and circuits. Detailed impedance and transmission characteristics including secondary parameter derivations can be simply and quickly evaluated or tested. The HP 4194A can contribute to improving engineering productivity and reducing test cost. The analyzer is flexible and has wide measurement capabilities in both impedance and transmission measurements, plus it is fully programmable using Auto Sequence Programming (ASP). Desired measurements and computations, including graphics analysis, can be programmed simply by storing front panel keystroke operations, allowing you to customize measurement, computation and analysis functions. The HP 4194A also features high accuracy and error elimination functions to ensure reliable measurements.

### Wide Range Accurate Measurement

Featuring a wide test frequency range — 100Hz to 40MHz for impedance measurements (10kHz to 100MHz when using the HP 41941A/B Impedance Probe Kit) and 10Hz to 100MHz for gain-phase measurements — the HP 4194A satisfies a wide spectrum of needs. Realistic device characteristics can be analyzed under actual operating conditions by varying the test frequency, test signal level, and dc bias. The HP 4194's high degree of measurement accuracy — 0.17% for impedance measurements (1.5% when using the HP 41941A/B) with an amplitude ratio of 0.1 dB — ensures that you'll improve the quality of your test devices.

### Quick Analysis

The HP 4194A makes high speed measurements, (approximately 3.7ms per point), displays results on a color CRT, and performs parameter analysis of components and circuits quickly and efficiently;

substantially reducing development and evaluation time. The analysis function not only provides you with impedance and transmission characteristics, but also allows you to determine secondary parameters. Using the marker and line cursor functions, you can obtain the resonating frequency of resonators and the pass band width of band pass filters quickly.

### Equivalent Circuit Analysis Function

Using the HP 4194A's Equivalent Circuit Analysis Function, you can easily and quickly obtain those equivalent circuit constants that, until now, required a number of time-consuming, complicated calculations. By using measured values, this unique function can approximate the circuit constant values of five circuit models. For example, a resonator's equivalent circuit elements or a coil's self inductance, lead resistance, and stray capacitance can be easily obtained.

The equivalent Circuit Analysis function also simulates the frequency characteristics of components by using derived circuit values or values you specify. By using approximation and simulation, you can compare design values to measurement values, and thereby, improve component design efficiency.

### Auto Sequence Program (ASP)

The HP 4194A's ASP function, an internal programming feature, allows you to control all HP 4194A operations (measurement, display, and analysis) without the need for an external computer. By using ASP and actual measurement values, you can readily calculate many secondary parameters that you may need to evaluate. You can



then use the HP 4194A's powerful analysis functions to analyze these calculated parameters.

You can also use ASP to enhance such HP 4194A functions as alternate sweep, sweep timing control, and marker tracking. Because ASP eliminates the need for external controller, thereby eliminating data transfer time, the HP 4194A can quickly and efficiently perform production line go/no-go testing of components such as resonators and filters. All these features combine to increase your engineering and manufacturing productivity.

### Increased Capabilities With The HP 41941A/B Impedance Probe Kit

When using the HP 4194A with the HP 41941A/B Impedance Probe Kit, you can perform reliable impedance evaluations up to 100MHz. Measurement errors due to residual impedance and stray admittance are eliminated by using the calibration standards furnished with the HP 41941A/B and the HP 4194A's automatic calibration function. This makes it possible to make highly accurate measurements (basic measurement accuracy 1.5 to 3%) over a wide measurement range of 100mΩ to 1MΩ. Calibration accuracy is guaranteed to the tips of the HP 41941A (1.5m) and HP 41941B (3m) impedance probes.

The HP 41941A/B can be used as a grounded probe to evaluate the impedance of in-circuit components such as printed circuit patterns, and the input/output impedance of circuits. In addition, you can connect an external dc bias source directly to the HP 41941A/B to perform dc biased measurements up to  $\pm 150V/0.5A$ , to measure the dc characteristics of inductors, capacitors, materials, and semiconductors. To perform swept dc bias measurements, use the HP 4194A's  $\pm 40V$  internal dc bias source.

### Specifications

#### Impedance Measurements

**Measurement Parameters:**  $|Z|$ ,  $|Y|$ ,  $\theta$ , R, X, G, B, L, C, D, Q. 20 parameter combinations are available.

**Test Frequency:** 100 Hz - 40 MHz (CABLE LENGTH: 0m), 100Hz - 15 MHz (CABLE LENGTH: 1m), 1mHz resolution.

**OSC Level:** 10mV - 1Vrms ( $\leq 10MHz$ ), 10mV - 0.5Vrms ( $> 10MHz$ ) (UNKNOWN terminal open), 3 digit resolution

**DC Bias:** 0 -  $\pm 40V$ , 10mV resolution

**Measurement terminal:** 4 - terminal pair configuration

**Measurement Range and Maximum Resolution:**

Measurement Parameter	Range	Max Resolution
$ Z , R, X$	10mΩ to 100MΩ	100μΩ
$ Y , G, B$	10nS to 100S	1nS
$\theta$	$\pm 180^\circ$	0.01°
L	1nH to 100μH	10pH
C	10fF to 0.1F	0.1fF
D	0.001 to 10	0.0001
Q	0.1 to 1000	0.1

**Basic Measurement Accuracy:** 0.17%

**Level Monitor:**

#### Gain-Phase Measurements

**Measurement Parameters:** Tch/Rch (dB, Linear Ratio), Tch, Rch (V, dBm, dBV),  $\theta$  (degree, rad),  $\tau$

Tch = Test Channel, Rch = Reference Channel,  $\tau$  = Group Delay

**Measurement Frequency:** 10Hz - 100MHz, 1mHz resolution

**Aperture Frequency Range (Group Delay Measurements):** 0.5% - 100% of frequency span

**OSC Level:** -65dBm - +15dBm, 0.1dB resolution

**Measurement Range:**

**Tch/Rch:** 0 -  $\pm 120dB$ , 0.001dB resolution

**Tch, Rch:** -107dBm - -5dBm (0dB Attenuator)  
-87dBm - +15dBm (20 dB Attenuator)  
0.001dB resolution

$\theta$ :  $\pm 180^\circ$  (can display phase continuously with the phase scale expansion function), 0.01° resolution

$\tau$ : 0.1ns - 1s, 0.1ns resolution

**Basic Measurement Accuracy:**

**Tch/Rch:** 0.1dB, 0.5°

**Tch, Rch:** 0.35dBm

$\theta$ : 0.5°

**Level Monitor**

#### Impedance Measurements using the HP 41941A/B

The specifications listed below are for the HP 4194A when used with the HP 41941A/B.

**Frequency Range:** 10 kHz - 100 MHz, 1 mHz resolution

**OSC Level:** Opt. 350: 10 mV - 1.28 Vrms

Opt. 375: 10 mV - 1.54 Vrms

**DC Bias:** Internal:  $\pm 40V$ ,  $\pm 20 mA$

External:  $\pm 150V$ ,  $\pm 500 mA$ , max 25 W

**Measurement Range:** 100 mΩ - 1 MΩ

**Basic Measurement Accuracy:**

$\pm 1.5%$  to 3% ( $\geq 100 kHz$ ),  $\pm 3%$  to 6% ( $< 100 kHz$ )

**Cable Length:** HP 41941A: 1.5 m, HP 41941B: 3 m

### Common Specifications

**Trigger Mode:** Internal, External and Manual

**Sweep Capability:**

**Sweep Parameter:** Frequency, OSC Level, DC Bias (impedance measurements only)

**Entry:** START/STOP or CENTER/SPAN

**Sweep Type:** LIN, LOG, ZERO SPAN (DC Bias: LIN or ZERO SPAN only)

**Number of Measurement Points:** 2 to 401 points

**Sweep Functions:** Partial Sweep, Expand Markers Sweep, Program Points Measurement

### Display

**CRT:** 7.5 inch color CRT

**Display Mode:** Rectangular (X - A & B), Rectangular (A - B), Table

**Display Control:** Autoscale, Superimpose and Storage

### Analysis

**Maker:** Single, Delta, Double Makers

**Line-Cursor:** Line-Cursor, Delta-Line Cursor

**Equivalent Circuit Function:** Approximation, Simulation

**Arithmetic Operation**

**Data Register Manipulation:** Use arithmetic operations and functions to manipulate data registers.

**GO/No-Go Limits**

### Programming

**Auto Sequence Program (ASP):** Control the HP 4194A's operation with an internal program language. ASP Programs can be entered using the front panel keys or downloaded from HP-IB.

**Program Memory Size:** 20k Bytes of non-volatile memory

**Copy:** Dump, Plot, Print Mode

### General Specifications

**Operating Temperature and Humidity:** 0°C - 40°C (HP 41941A/B: -20 - +65°C),  $\leq 95\%RH$  at 40°C

**Storage Temperature:** -30°C - +60°C (HP 41941A/B: -40 - +65°C)

**Safety:** Based on IEC - 348, UL - 1244

**Power:** 100, 120, 220V  $\pm 10\%$ , 240V - 10% + 5%, 48 - 66Hz, 400VA (max)

**Dimensions:** 425 (W) x 375 (H) x 620 (D) mm

**Weight:** Approximately 37kg (net)

### Reference Data

**Typical Measurement Speed:**

**Impedance:** Approximately 3.7ms/point

**Gain-Phase:** Approximately 3.5ms/point

**Impedance when used with the HP 41941A/B:** Approximately 6 ms/point

### Accessories Furnished

**HP 18047D:** Direct Coupled Test Fixture

**HP 8120-1838:** 30cm BNC Cable (2ea) (OPT.350)

**HP 04194-81840:** 30cm BNC Cable (2ea) (OPT.375)

**HP 8120-1839:** 60cm NNC Cable (OPT.350)

**HP 04194-81841:** 60cm NNC Cable (OPT.375)

**HP 1250-0080:** BNC Adapter

### Accessories Available

Refer to page 277

### Ordering Information

**4194A Impedance/Gain-Phase Analyzer**

**Opt 350\*:** 50 Ohm System

**Opt 375\*:** 75 Ohm System

**Opt 001:** High Stability Frequency Reference

**HP 41941A\* Impedance Probe Kit (1.5m)**

**HP 41941B\* Impedance Probe Kit (3 m)**

\*Must select either OPT.350 or 375

**Price**

\$20,200

\$0

\$0

\$800

\$1730

\$1730

# COMPONENT MEASUREMENT

## LF Impedance Analyzer (5 Hz to 13 MHz)

Model 4192A

- 5 Hz to 13 MHz variable measuring frequency
- Gain-phase measurement: amplitude, phase, group delay
- Floating or grounded devices
- Impedance measurement:  $|Z| \cdot |Y| \cdot \theta \cdot R \cdot X \cdot G \cdot B \cdot L \cdot C \cdot D \cdot Q \cdot \Delta \cdot \Delta\%$
- Standard HP-IB

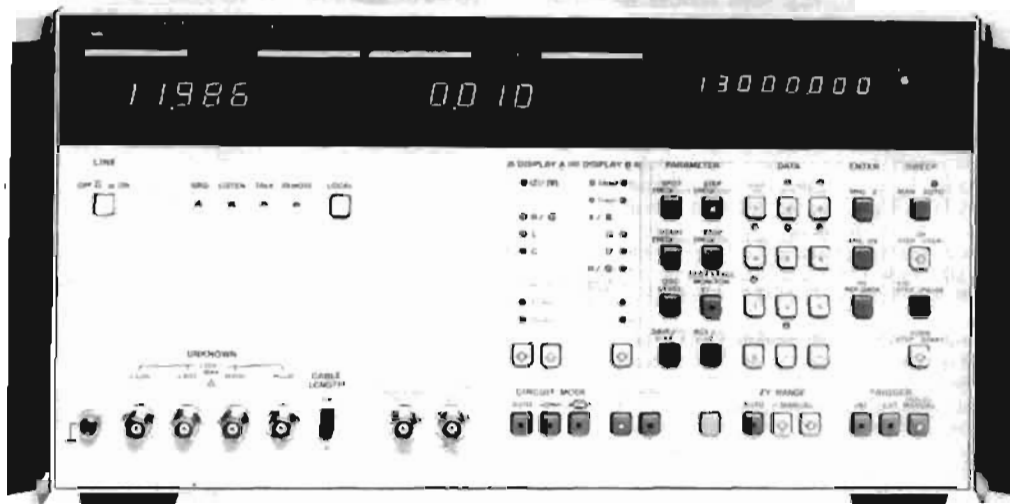

HP 4192A (shown with Opt. 907 handles)



### Description

The HP 4192A LF Impedance Analyzer performs both network analysis and impedance analysis on devices such as telecommunication filters, audio/video electronic circuits, and basic electronic components. Both floating and grounded devices can be tested.

### Automatic Swept Frequency Measurement of All Impedance Parameters

The HP 4192A can measure 11 impedance parameters ( $|Z|$ ,  $|Y|$ ,  $\theta$ ,  $R$ ,  $X$ ,  $G$ ,  $B$ ,  $L$ ,  $C$ ,  $D$ ,  $Q$ ) over a wide range  $|Z|$ : 0.1 m $\Omega$  to 1 M $\Omega$ ;  $|Y|$ : 1 nS to 10 S).

The built-in frequency synthesizer can be set from 5 Hz to 13 MHz with a maximum resolution of 1 mHz. This feature allows accurate characterization of high Q devices such as crystals. Test signal level is variable from 5 mV to 1.1 V with 1 mV resolution. Also, an internal dc bias voltage source provides  $\pm 35$  V at 10 mV increments. Thus, the HP 4192A can evaluate components and entire circuits near actual operating conditions.

### Specifications (complete specifications on data sheet)

#### Measuring signal (23 $\pm$ 5 $^{\circ}$ C)

**Frequency range:** 5 Hz to 13 MHz

**Frequency step:** 0.001 Hz (5 Hz to 10 kHz), 0.01 Hz (10 kHz to 100 kHz), 0.1 Hz (100 kHz to 1 MHz), 1 Hz (1 MHz to 13 MHz).

**Frequency accuracy:**  $\pm 50$  ppm

**OSC level:** 5 mV to 1.1 Vrms variable into 50  $\Omega$  (amplitude-phase measurement) or open circuit (impedance measurement).

**OSC level step:** 1 mV (5 mV to 100 mV), 5 mV (100 mV to 1.1 V).

**OSC level accuracy:** 5 Hz to 1 MHz:  $\pm((5 + 10/f)\%$  of setting + 2 mV) where  $f$  is in Hz. 1 MHz to 13 MHz:  $\pm((4 + 1.5 \times F)\%$  of setting + 2 mV) where  $F$  is in MHz.

**Level monitor** (impedance measurement): current through or voltage across sample can be monitored

**Control:** spot and sweep via front panel or HP-IB

#### Measuring Mode

**Spot measurement:** at specific frequency (or dc bias)

**Swept measurement:** manual or automatic sweep from START to STOP frequency (or dc bias) at selected STEP frequency (or dc bias) rate

**Sweep mode:** linear or logarithmic (frequency only)

**Recorder outputs:** output dc voltage proportional to each measured value, and frequency or dc bias.

**Maximum output voltage:**  $\pm 1$  V

**Output voltage accuracy:**  $\pm(0.5\%$  of voltage + 20 mV)

**Key status memory:** 5 sets of measuring conditions can be stored and recalled at any time.

**HP-IB data output and remote control:** standard

**Self-test:** automatic introspective testing

**Trigger:** internal, external, manual or HP-IB

### Amplitude—Phase Measurement

**Parameter measured:** relative amplitude B-A (dB) and phase  $\theta$  (degrees or radians), B-A and group delay, absolute amplitude A (dBm or dBV) or B (dBm or dBV), and deviation ( $\Delta$ ,  $\Delta\%$ ) of all parameters

**Reference amplitude:** 0 dBV = 1 Vrms, 0 dBm = 1 mW (with 50  $\Omega$  termination)

**OSC output resistance:** 50  $\Omega$

**Channels A and B:** input impedance: 1 M $\Omega$   $\pm 2\%$ , shunt capacitance:

25 pF  $\pm 5$  pF

### Display Range and Resolution

**B-A:** 0 to  $\pm 100$  dB, 0.001 dB (0 to  $\pm 20$  dB), 0.01 dB ( $\pm 20$  to  $\pm 100$  dB)

$\theta$ : 0 to  $\pm 180^{\circ}$ , 0.01 $^{\circ}$

**Group delay:** 0.1 ns to 19 s, max. resolution 4 1/2 digits

**A or B:** +0.8 to -100 dBV, 0.001 dB ( $> -20$  dB), 0.01 dB ( $\leq -20$  dB), +13.8 to -87 dBm, 0.001 dB ( $> -20$  dBm), 0.01 dB ( $\leq -20$  dBm)

**Measuring accuracy (23  $\pm$  5 $^{\circ}$ C):** specified at BNC unknown terminals after 30 minute warmup (test speed: normal or average)

**B-A (relative amplitude) and  $\theta$  (phase) Measurement**  
Determined by sum of channel A and B accuracies given below (accuracy of each channel changes according to absolute input level)

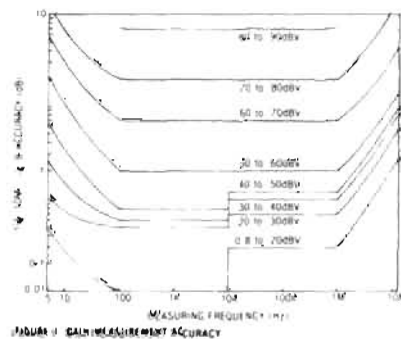

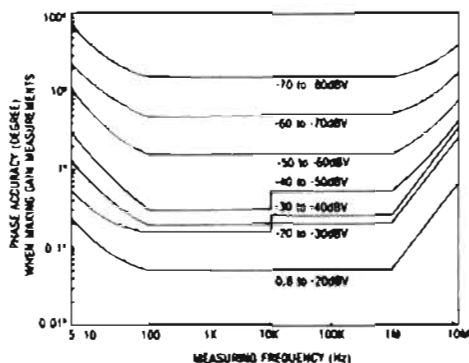

FIGURE 2: PHASE ACCURACY WHEN MAKING GAIN MEASUREMENTS

### Impedance Measurement

**Parameter measured:**  $|Z|$  -  $\theta$ ,  $|Y|$  -  $\theta$ , R - X, G - B, L - D • Q • R • G, C - D • Q • R • G and deviation ( $\Delta$ ,  $\Delta\%$ ) of all parameters

**Display:** 4½ digits, max. display 12999 counts, 19999 for L & C.

**Circuit mode:** series equivalent circuit (—□—) and parallel equivalent circuit (□—). Automatic selection available.

**Auto ZERO adjustment:** automatic normalization of the readout offset due to residuals of the test fixture by pushbutton operation (at spot frequency)

**Measuring range and accuracy (23 ± 5°C):** specified at BNC unknown terminals after 30 minute warmup when OSC level is more than 0.1 V and when auto ZERO adjust is performed (test speed: normal or average). Accuracy given below is only valid when the measured value is equal to full scale of each range.

**$|Z|$  -  $\theta$ , R - X measurement:** range:  $|Z|$ , R, X: 0.1 m $\Omega$  to 1.2999 M $\Omega$ ;  $\theta$ : -180.00° to +180.00°. Accuracy: R accuracy (D ≥ 10); X accuracy (D < 1)

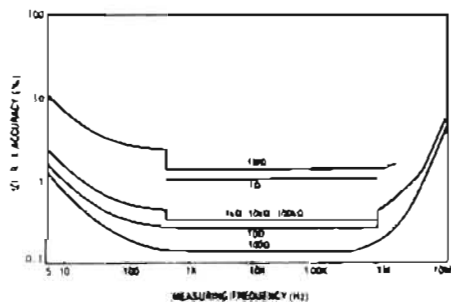

FIGURE 3: |Z| - θ, R, X ACCURACY

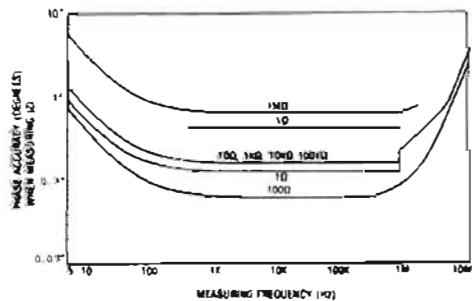

FIGURE 4: PHASE ACCURACY WHEN MEASURING |Z|

**$|Y|$  -  $\theta$ , G - B measurement:** range:  $|Y|$ , G, B: 1 nS to 12.999 S;  $\theta$ : -180.00° to +180.00°. Accuracy: G accuracy (D > 1); B accuracy (D ≤ 0.1).

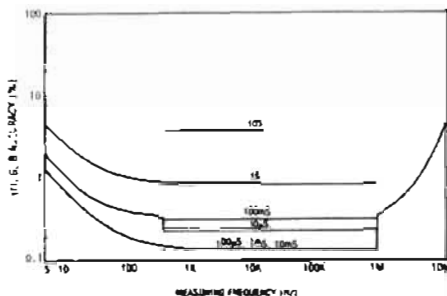

FIGURE 5: L, C ACCURACY

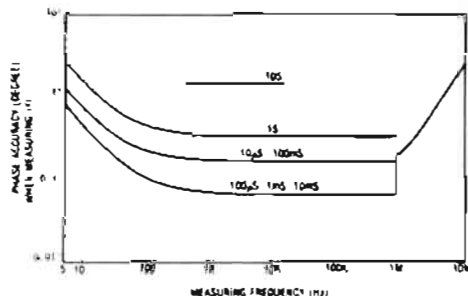

FIGURE 6: PHASE ACCURACY WHEN MEASURING |Y|

**L - D • Q, C - D • Q measurement:** (automatically calculated from measured Z/Y values)

Parameter	Measuring Range*	Basic Accuracy
L	0.01 nH to 1000 H	0.27%
C	0.1fF to 199** mF	0.15%
D(1/Q)	0.0001 to 19.999	0.001 (C-measurement) 0.003 (L-measurement)

\*Varies with measuring frequency except for D(1/Q)

\*\*Accuracy of C ranges over 100 mF is not specified.

**Internal dc bias:** standard (impedance measurement only)

**Voltage range:** -35 V to +35 V, 10 mV step

**Setting accuracy (23 ± 5°C):** 0.5% of setting + 5 mV

**Bias control:** spot and swept, using front panel controls or HP-1B

### General

**Measuring Time (high speed mode)**

**B-A and  $\theta$ , A or B:** 88 to 127 ms (≥ 400 Hz)

**Impedance parameters:** 58 to 91 ms (≥ 1 kHz)

**Test Level Monitor Range (impedance measurement)**

**Voltage:** 5 mV to 1.1 V

**Current:** 1  $\mu$ A to 11 mA

**Operating temperature:** 0 to 55°C, ≤ 95% RH at 40°C

**Power:** 100, 120, 220 V ± 10%, 240 V + 5% to -10%, 48 to 66 Hz, 150 VA max.

**Size:** 425.5 mm W x 235 mm H x 615 mm D (16.75" x 9" x 22.6")

**Weight:** approx. 19 kg (41.9 lb)

**Furnished accessories and parts:** HP 16047A test fixture, HP 11048C 50  $\Omega$  feed thru terminations (2 ea.), power splitter, HP 11170A BNC cables (2 ea.), BNC adapter

### Accessories available

HP 16095A Probe Fixture

HP 16096A 2-port Component Test Fixture

HP 16097A Accessory Kit

HP 16047C Test Fixture

HP 16048A Test Leads (BNC connector)

HP 16048C Test Leads with alligator clip

Refer To Page 277

**HP 4192A LF Impedance Analyzer**

Fast-Ship product - see page 758.

### Price

\$715 ☞

\$1275 ☞

\$1,850 ☞

\$305 ☞

\$325 ☞

\$420 ☞

**\$14,200**

# COMPONENT MEASUREMENT

## RF Impedance Analyzer

Model 4191A

- 1-1000 MHz variable test frequency with sweep capability
- Direct reading of  $|Z| - \theta, |Y| - \theta, |T| - \theta$ ;  
 $L \cdot C - R \cdot G \cdot D \cdot Q$   
 $R - X, G - B, \Gamma_x - \Gamma_y$
- High resolution—4½ digit max
- Wide measuring range—1 m $\Omega$  – 100 k $\Omega$  ( $|Z|$ )
- Versatile, easy-to-use test fixtures

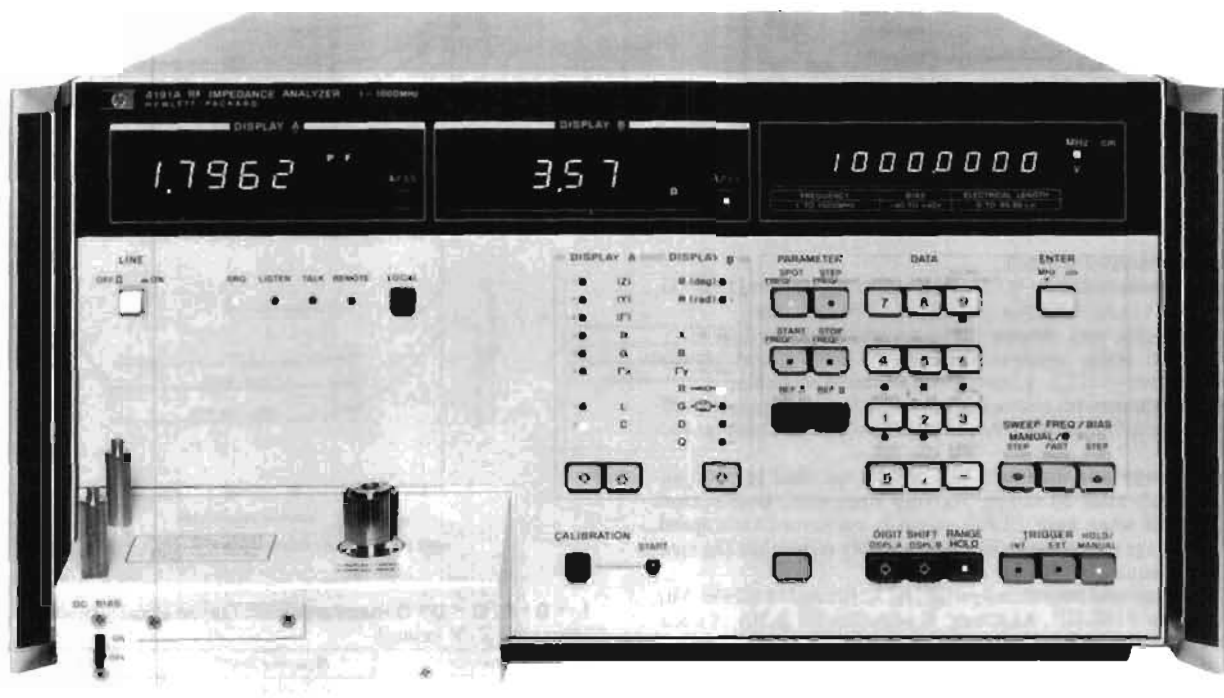

HP 4191A (Shown with Opt 007 Handles)



### Description

The HP 4191A RF Impedance Analyzer measures 14 parameters with a maximum resolution of 4½ digits. The internal synthesizer provides variable frequencies from 1 MHz through 1000 MHz covering the UHF, VHF and video bands with automatic sweep capability. An internal dc bias supply with auto sweep function covers the voltage range of  $\pm 40$  V in 10 mV steps.

The HP 4191A permits reliable measurements over a wide measuring range. Its outstanding repeatability, frequency response and accuracy are made possible by unique error correction capability and specially designed test fixtures. These features allow the HP 4191A to be used in evaluation of electronic materials, components and circuitry.

The internal synthesizer provides a maximum resolution of 100 Hz (Opt 002) with an accuracy of 3 ppm, allowing small changes in the resonant frequency of the device under test to be easily detected. The swept frequency capability aids in the analysis of frequency characteristics of the device.

Two complete front panel settings (parameter selection and the sweep control) can be stored in a non-volatile memory and recalled at any time with a single key operation. This, together with the standard HP-IB interface, makes the HP 4191A extremely efficient either as a stand-alone or systems instrument.

These unique features permit very wide applications in: (1) semiconductor testing such as surface state evaluation at high frequencies (C-V/G-V and conductance ( $G/\omega$ )) characteristics, and the input/output impedance evaluation of diodes and transistors, (2) resonator, filter, and magnetic and dielectric materials testing, (3) evaluation of LCR components such as high frequency chip and leaded components, and (4) testing of communications related components such as cables, connectors, etc.

### Specifications

**Parameter measured:**  $|Z| - \theta, |Y| - \theta, |T| - \theta$   
 $R - X, G - B, \Gamma_x - \Gamma_y$   
 $L - R \cdot G \cdot D \cdot Q, C - R \cdot G \cdot D \cdot Q$

**Display:** 4½ digit, max display 19999 counts

**Deviation Measurement** (deviation from stored reference)

$\Delta$ : -19999 to +19999 counts

$\Delta\%$ : -1999.9 to +1999.9%

**Measuring Signal** ( $23 \pm 5^\circ\text{C}$ )

**Frequency range:** 1 MHz to 1000 MHz

**Frequency step:** Standard: 100 kHz, 1-500 MHz  
 200 kHz, 500-1000 MHz

Opt 002: 100 Hz, 1-500 MHz

200 Hz, 500-1000 MHz

**Frequency accuracy:**  $\pm 3$  ppm

**Signal level (into 50 $\Omega$ ):**  $-20 \pm 3$  dBm

**Frequency control:** spot and swept

### Measuring Mode

**Spot measurement:** at specific frequency (or dc bias)

**Swept measurement:** manual or automatic sweep from start to stop frequency (or dc bias) at step frequency (or dc bias) rate in linear or logarithmic form.

### Auto Calibration

Automatic error compensation referenced to connected terminations (0  $\Omega$ , 50  $\Omega$ , 0 S)

**Calibration frequency:** 51 frequencies including start and stop frequencies.

**Electrical length compensation:** automatic compensation for electrical length of test fixtures.

Compensating range: 0 to 99.99 cm.

**DC Bias**

**Internal dc Bias**

**Voltage range:** -40 to +40 V, 10 mV step  
**Setting accuracy:** 0.1% of setting +10 mV  
**Bias control:** spot and swept

**External dc Bias**

**Voltage range:** -40 to +40 V  
**Max allowable current:** 100 mA

**Key status memory:** 2 sets of measuring conditions can be stored and recalled at any time. These conditions are kept in storage even when LINE is turned off.

**Ranging:** Auto/Range hold

**Trigger:** Internal, External or Manual

**Self-test:** automatic internal program test

**HP-IB data output and remote control:** standard

**Measuring Range, Resolution and Accuracy**

Specified at APC-7 UNKNOWN connector for reflect coefficient measurement at measuring frequency and ambient temperature (0 - 55°C) where calibration is performed after the warm-up time of 40 minutes. Refer to General Information for temperature coefficient and typical measuring range/resolution and accuracies of other measuring parameters (see data sheet for detailed specifications).

**$|Γ| - θ/Γ_x - Γ_y$  Measurement**

**Measuring Range**

$|Γ|, Γ_x, Γ_y$ : 0.0001 to 1.0000  
 $θ$ : 0° to ±180.00° (0 to ±π rad.)  
 $|Γ|, Γ_x, Γ_y$  resolution: 0.0001

**Reference Data (Not Specified)**

**Temperature coefficient for  $|Γ|$ :** 0.0001/°C (23 ± 5°C)  
**Measuring time:** <800 ms or <250 ms (high speed mode)  
**Frequency switching time:** ≤ 200 ms

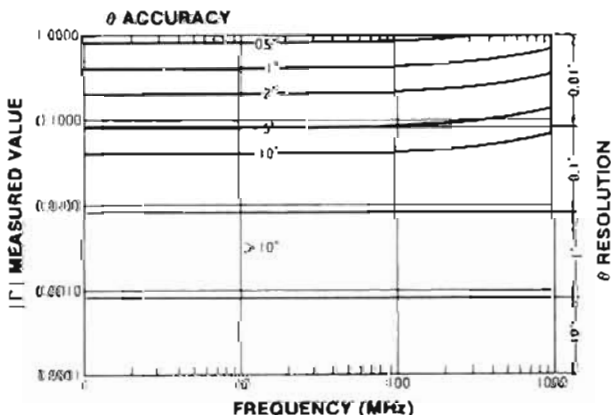
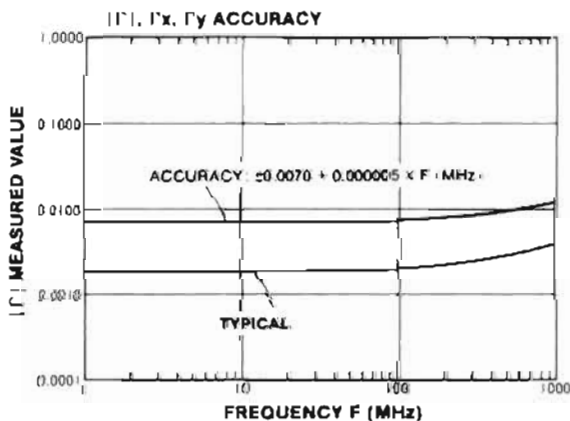

**REFERENCE DATA (NOT SPECIFIED)  
 TYPICAL ACCURACY**

Y(S) Z(Ω)

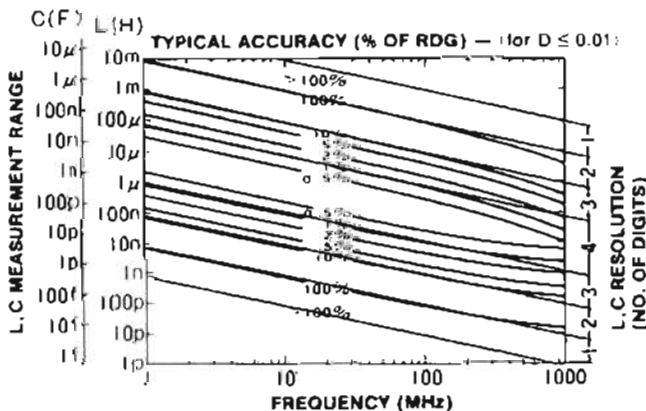
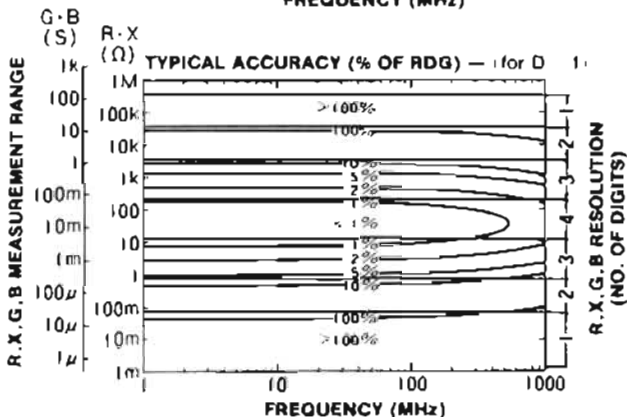
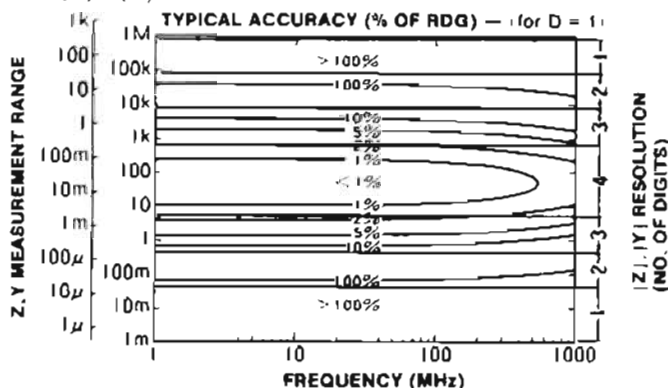

**General**

**Temperature:** 0 - 55°C, < 95% RH  
**Power:** 100, 120, 220 V ± 10%, 240 V + 5% - 10%, 48 - 66 Hz, 150 VA max.

**Size:** 425.5 mm W x 230 H x 574 mm D (16.75" x 9" x 22.6")

**Weight:** approx. 24 kg (52.8 lb)

**Accessories furnished:** accessory case (with reference terminations included).

**Accessories Available**

Accessory	Price
HP 16091A Coaxial Test Fixture	\$560
HP 16092A Spring Clip Test Fixture	\$540
HP 16093A Binding Post Test Fixture	\$204
HP 16093B Binding Post Test Fixture	\$234
HP 16094A Probe Fixture	\$204

Refer to page 277.

**Options**

002: 100 Hz/200 Hz resolution synthesizer	\$2,000
004: Recorder Outputs	\$510

**HP 4191A RF Impedance Analyzer** **\$17,300**

Fast-Ship product - see page 758.

# COMPONENT MEASUREMENT

## Vector Impedance Meter (400 kHz to 110 MHz)

Model 4193A

- 400 kHz to 110 MHz spot or swept frequency
- Measure impedance magnitude (10 mΩ to 120 kΩ) and phase (−180.0° to +180.0°)
- Test components in-circuit and out-of-circuit
- Fixtures include low-grounded probe, spring clip fixture and binding post fixture
- Standard HP-IB and analog outputs



HP 4193A

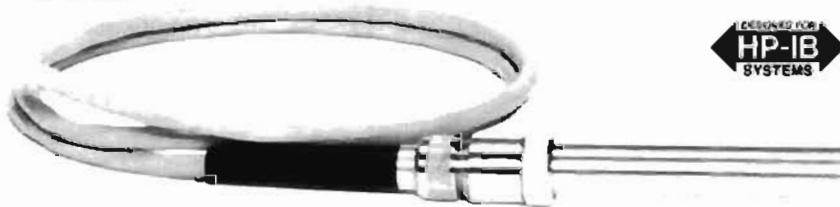

DESIGNED FOR  
HP-IB  
SYSTEMS

### Description

The HP 4193A Vector Impedance Meter measures impedance magnitude and phase. An internal oscillator provides test signals from 400 kHz to 110.0 MHz. The test signal is constant current between 10 μA and 100 μA, depending on IZL range.

### Reliable and Accurate Impedance Measurement

The HP 4193A can measure and display impedance magnitudes from 10 mΩ to 120 kΩ. Impedance phase is displayed from +180.0° to −180.0°. Accuracy is as good as 3.0% of reading (magnitude) and 3.2° (phase).

Also, the HP 4193A's 3½ digit resolution makes it easy to see small changes in measurement results during adjustment procedures, for example.

### Frequency Sweep for Complex Component Testing

When testing complex components like ceramic resonators, it is useful (1) to sweep frequency to get the big picture and (2) identify critical impedance points such as the series resonant point. This requires both swept measurement and measurements at individual "spot" frequencies. The HP 4193A can do both.

The HP 4193A can be tuned to any individual frequency from 400 kHz to 110.0 MHz with maximum resolution of 1 kHz. If greater frequency resolution is required, it can be provided by connecting an external synthesized source such as the HP 3335A or HP 8656B to the HP 4193A EXT OSC input.

Flexible internal frequency sweep is an exciting HP 4193A feature. Frequency can be swept linearly over any portion of the HP 4193A frequency range—or swept logarithmically over the entire 400 kHz to 110.0 MHz range.

### Test In-Circuit and Out-of-Circuit Components

Several test fixtures help adapt the HP 4193A to your device under test. For example, the handy L-ground probe is useful for in-circuit

testing. The HP 16099A Test Fixture Adapter and three associated fixtures help connect to out-of-circuit devices of various sizes and shapes.

### Easy to Use—Both Manually and Under HP-IB Control

The HP 4193A front panel is amazingly simple. In just a few minutes you can become an expert operator. This is a big time saver over most other impedance meters which are usually much more difficult to operate. Plus, the HP 4193A has standard HP-IB, making it a good choice for automated testing in R & D, incoming inspection, production and product assurance.

### Specifications

#### Test Signal Output Specifications

Test signal is output from the furnished low-ground probe.

**Frequency range:** 400 kHz to 110.0 MHz

#### Frequency Resolution

**400 kHz to 9.999 MHz:** 1 kHz resolution

**10.00 MHz to 99.99 MHz:** 10 kHz resolution

**100.0 MHz to 110.0 MHz:** 100 kHz resolution

**Frequency accuracy:** ±0.01% of setting after calibration.

**Frequency stability:** ±100 ppm per month (0 to 55 °C)

#### Frequency Control

**Spot:** spot frequency is set using coarse, medium and fine controls

**Full sweep:** logarithmic sweep at 43 points over full range of 400 kHz to 110 MHz

**Partial sweep:** linear sweep from selected START to STOP frequency. Number of steps is selected as 100, 1000 or "HIGH RESOLN". When "HIGH RESOLN" steps are selected, the operator must also select "coarse", "medium" or "fine" resolution.

**EXT OSC:** increase frequency resolution by connecting an external frequency synthesizer.  
**Input signal level:** 0 dBm to +5 dBm  
**Input impedance:** 50 ohms ±10%  
**Frequency range:** 400 kHz to 110 MHz

**Impedance Measurement Specifications**

**Input configuration:** low-grounded probe (furnished)  
**Digital display of impedance:** 3½ digits  
**|Z|:** 0 to 1999 counts (0 to 120 counts on 100 kΩ range)  
**θ:** -1800 to +1800 counts (-180 to +180 counts on 100 kΩ range)  
**Measurement trigger:** internal, external, and manual  
**Measurement range control:** auto, hold, and manual  
**Measurement Range**  
**|Z|:** Five decade ranges: 10 Ω, 100 Ω, 1 kΩ, 10 kΩ, 100 kΩ  
**minimum |Z| (sensitivity):** 10 mΩ  
**maximum |Z|:** 120 kΩ  
**θ:** One range: -180.0° to +180.0°

**Reference Data**

**Test Signal Output**  
**Frequency settling time:** 5 ms to 400 ms. Best case is when (Δf/f)% is less than 10% (below 10 MHz) and less than 1% (above 10 MHz).  
**Signal Purity**  
**Spurious:** -60 dBc (dBc is dB below carrier)  
**Harmonics:** -30 dBc  
**Residual FM:** measured in a 100 Hz band centered on the carrier  
**1 MHz to 110 MHz:** 100 Hz p-pFM  
**Test level:** constant current source

Z  Range	Current in μA ±20%
10 Ω	100
100 Ω	100
1 kΩ	100
10 kΩ	50
100 kΩ	10

**|Z| and θ Measurement Accuracy: in the Table below, "f" is in MHz**

Range	Accuracy	Measuring Frequency in Megahertz		
		0.1	1	10
10 Ω Range	Z  Accuracy	±[(5.7 + 0.56/f)% rdg + 9 counts]	±(6.3% rdg + 6 counts)	±[(4.5 + 0.18f)% rdg + 4 counts]
	θ Accuracy	±(1.7 + 1.8/f + 35/ Z  counts) deg	±(3.3 + 0.20f + 35/ Z  counts) deg	
100 Ω Range	Z  Accuracy	±[(2.4 + 0.56/f)% rdg + 4 counts]	±(3.0% rdg + 4 counts)	±[(2.6 + 0.037f)% rdg + 4 counts]
	θ Accuracy	±(1.5 + 1.9/f + 35/ Z  counts) deg	±(3.3 + 0.035f + 35/ Z  counts) deg	
1 kΩ Range	Z  Accuracy	±[(3.2 + 0.56/f)% rdg + 4 counts]	±(3.7% rdg + 4 counts)	±[(2.7 + 0.11f)% rdg + 4 counts]
	θ Accuracy	±(1.6 + 1.8/f + 35/ Z  counts) deg	±(3.3 + 0.11f + 35/ Z  counts) deg	
10 kΩ Range	Z  Accuracy	±[(2.9 + 0.56/f)% rdg + 4 counts]	±[(3.2% + 0.29f)% rdg + 4 counts]	±[(0.74 + .53f)% rdg + 4 counts]
	θ Accuracy	±(1.8 + 1.9/f + 35/ Z  counts) deg	±(3.1 + 0.53f + 35/ Z  counts) deg	±(8.3 + 0.01f + 35/ Z  counts) deg
100 kΩ Range	Z  Accuracy	±[(3.3 + 0.56/f)% rdg + 4 counts]		
	θ Accuracy	±(3.0 + 1.9/f + 35/ Z  counts) deg		Not specified

**Guideline for Use of the |Z| and θ Accuracy Table**

- "f" is in MHz.
- "rdg" is display reading, for example, 50.0 ohms.
- "counts" is display counts in the |Z| display.
- "deg" is degrees of arc.

**Example:** calculate the |Z| and θ accuracy for a device which gives HP 4193A readings of |Z| = 50.0 Ω and θ = -45.0°. Assume an 0.9 MHz test frequency 100 Ω range, and normal measuring speed.

|Z| = 50.0 Ω ± [(2.4 + 0.56/f) % of rdg + 4 counts]

|Z| = 50.0 Ω ± [(2.4 + 0.56/0.9) % \* 50.0 + 0.4 Ω]

|Z| = 50.0 Ω ± 1.91 Ω

θ = -45.0° ± (1.5 + 1.9/f + 35/|Z| counts) deg

θ = -45.0° ± (1.5 + 1.9/0.9 + 35/500) deg

θ = -45.0° ± 3.68°

**Recorder output:** dc voltage proportional to measured |Z|, θ and measurement frequency.

**Output voltage:** accuracy specification for all recorder output voltages is ±(1% + 20 mVdc)

**|Z|:** 0 Vdc (0000 display counts) to +1 Vdc (2000 display counts)

**θ:** -1 Vdc (-180.0°) to +1 Vdc (+180.0°)

**Frequency**

**Full sweep:** 0 Vdc (400 kHz) to +1 Vdc (110 MHz), log sweep

**Partial sweep:** 0 Vdc (START frequency) to +1 Vdc (STOP frequency), linear sweep

**HP-IB remote control and data output:** standard

**Self-test:** standard

**Impedance Measurement**

**Residual Impedance of Probe** (at probe tip)

**Resistance:** ≤0.55 Ω

**Inductance:** ≤(4.9 + 10/f) nH where f is measuring frequency in MHz

**Parallel Capacitance:** ≤0.11 pF

**Measuring speed:** assumes range is fixed; recorder output is OFF

**HI SPEED:** approximately 150 ms per measurement

**NORMAL:** approximately 1 s per measurement

**Ranging time:** approximately 1.2s

**Temperature coefficient** at 23°C ± 5°C

**|Z|:** 2 mΩ/°C, θ: 0.02°/°C

**General**

**Operating temperature/humidity:** 0 to 55°C, ≤95% RH @ 40°C. Note that measurement error in 0°C to 55°C temperature range is typically double the error in the 23°C ± 5°C range.

**Power:** 100/120/220 V ±10%, 240 V -10% to +5%, 48 to 66 Hz, 150 VA max

**Size:** 426 mm W x 178 mm H x 498 mm D, (16.75" x 7" x 19.6").

**Weight:** 18 kg (40 lb)

**Accessories furnished:** low-ground probe kit includes probe, spare pins, spare clips, BNC adapter, component mounting adapter, probe socket and accessory case.

**Accessories Available**

HP 16099A Test Fixture Adapter (used with HP 16092A and HP 16093A/B) **\$470**

HP 16092A Spring Clip Fixture (used with HP 16099A) **\$540**

HP 16093A Binding Post Fixture (used with HP 16099A) **\$204**

HP 16093B Binding Post Fixture (used with HP 16099A) **\$234**

Refer to page 277.

**HP 4193A Vector Impedance Meter**

Fast-Ship product - see page 758.

**\$9,400**

# COMPONENT MEASUREMENT

## Multi-Frequency LCR Meters

Models 4274A & 4275A

- Test frequencies – HP 4274A: 100 Hz to 100 kHz  
HP 4275A: 10 kHz to 10 MHz
- Test signal level – HP 4274A: 1 mV to 5 Vrms  
HP 4275A: 1 mV to 1 Vrms
- 0.1% basic accuracy
- High resolution – 5½ digit; D=0.00001
- Measure L/C – D/Q/ESR/G; |Z| –  $\theta$ ,  
R-X/B/L/C;  $\Delta$ LCRZ,  $\Delta\%$

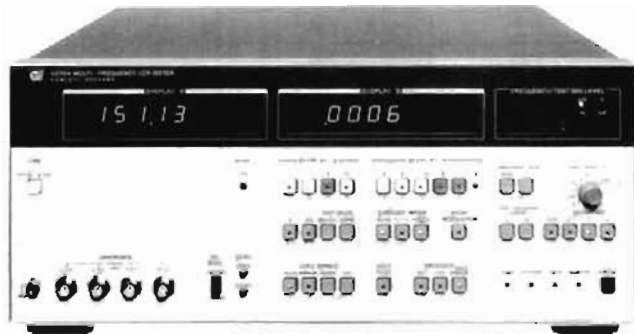

HP 4274A

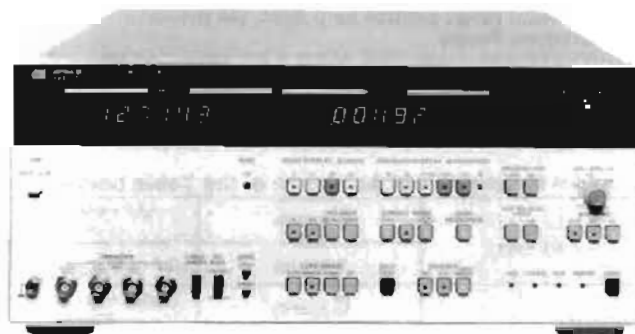

HP 4275A



### Description

The HP 4274A and HP 4275A Multi-frequency LCR Meters, microprocessor-based impedance measuring instrumentation. Both instruments offer LCR components, complex components, electronic circuits "tested under actual working conditions", and semiconductor materials. A measurement under conditions similar to the intended use contributes to the improvements in quality and reliability of electronic components, devices and circuits.

### Reliable Measurements with 5½ Digit Resolution

The HP 4274A and HP 4275A measure only the value of the component and/or device under test, with 5½ resolution and 0.1% basic accuracy by reducing the possibility of errors due to self or mutual inductance, stray capacitance and/or residual inductance in the test leads or test fixture used. This measurement is obtained by a state-of-the-art four terminal pair configuration and a built-in automatic ZERO-offset capability to compensate for these errors.

The fast measurement speed, high resolution, and high accuracy can make major contributions for the component manufacturer and user who is concerned about reducing his costs, improving quality, and throughput efficiency. In these areas, the HP 4274A and the HP 4275A are ideal for D-measurements of film capacitors or insulation material (with the high resolution of 0.00001), the C-G measurements of semiconductors (with maximum resolutions of 0.01 pF, 0.01 nS, respectively), and for the low impedance measurement of aluminum electrolytic capacitors (with a maximum resolution of 0.001 m $\Omega$ ).

### Multi-Frequency Capability

To insure the high reliability in circuits and devices, it is most important that they be tested and evaluated at test signals similar to those of actual operating conditions.

The HP 4274A covers the wide frequency range of 100 Hz to 100 kHz in 11 spot frequencies and the HP 4275A has 10 spot frequencies from 10 kHz to 10 MHz, in 1-2-4 step sequence with 1-3-5 as an option. This feature produces the frequency characteristics of components or devices. In addition, two optional special frequencies (for example, 455 kHz and 10.7 MHz) are available within the frequency

range of each instrument. This wide frequency range selection offers evaluation of circuit design with a continuously variable test signal over the range of 1 mV to 5 Vrms (to 1 Vrms for the HP 4275A), and with internal dc bias optionally available with 1 mV maximum resolution. The test voltage or current values can be monitored on the 3-digit display for accurately setting the actual conditions under which the device-under-test will operate.

### Multi-Parameter Measurements

The HP 4274A and HP 4275A measure equivalent series resistance (ESR), impedance (|Z|), phase angle ( $\theta$ ), reactance (X), susceptance (B), and conductance (G), in addition to the conventional L,C,R,D and Q parameters in certain combinations with a dual 5½ digit display, and an HP-IB standard for systems integration.

This wide selection of 11 parameters provides for more accurate evaluation of electronic materials or components with high measurement speed for most needed combined parameters; for example, the C-G measurement of semiconductors, an R-X measurement in circuit design, or the C-ESR or |Z| -  $\theta$  measurement of tantalum capacitors.

In addition, a deviation measurement capability ( $\Delta$ ,  $\Delta\%$ ) for the L,C,R, and |Z| functions displays the difference between the actual value and a stored reference, either as a difference value or in percent. Deviation applications include, for example, a temperature dependence measurement of devices in environmental tests.

### Automatic Semiconductor and Component Measurements with HP-IB

Integrating the HP 4274A and the HP 4275A into an HP-IB controlled system is an excellent method for improving efficiency and cost savings both in the laboratory and on the production line. These automatic measurement systems are assembled by connecting the HP-IB cables between the instruments to be utilized for a specific task.

For example, the evaluation of semiconductors based on the frequency dependence of its C-V characteristics that requires a wide range and fast measurement speeds is easily accomplished with these instruments.



## Specifications

Refer to the HP 4274A & HP 4275A data sheet for details.

### Parameters Measured

L: inductance	Q: =1/D	$\theta$ : phase angle
C: capacitance	ESR: equivalent series resistance	$\Delta$ : deviation for L, C, R, Z
R: resistance	G: conductance	$\Delta\%$ : % of deviation
Z: impedance	X: reactance	
D: dissipation factor	B: susceptance	

### Measurement Range

MODEL	HP 4274A	HP 4275A
L	100.00 nH - 1000.0 H	100.00 nH - 10.00 H
C	1.0000 pF - 1.00 F	1.0000 pF - 100.00 $\mu$ F
R,  Z , ESR, & X	100.00 m $\Omega$ - 10.000 M $\Omega$	1.0000 $\Omega$ - 10.000 M $\Omega$
D	0.00001 - 9.9999	0.00001 - 9.9999
Q (L/D)	0.01 - 9900	0.01 - 9900
G & B	1.0000 $\mu$ S - 100.00 S	1.0000 $\mu$ S - 10.00 S
$\theta$	0 - $\pm 180^\circ$	0 - $\pm 180^\circ$

### Measurement Accuracy

FREQUENCY RANGE	C-D/Q	L-D/Q
	D-range: 0.0001-9.9999 Q-range: 0.01-9900 (=1/D) (C & D accuracies apply only when C: full scale and D: $\leq 0.1$ )	D-range: 0.0001-9.9999 Q-range: 0.01-9900 (=1/D) (L & D accuracies apply only when L: full scale and D: $\leq 0.1$ )

#### HP 4274A

100 Hz	C: 1000 pF-1000 mF, 0.1% + 3 D: 0.33% + 0.0008 + 1	L: 100 $\mu$ H-10 kH, 0.1% + 3 D: 0.33% + 0.0013 + 1
200 Hz	C: 1000 pF-1000 mF, 0.1% + 2 D: 0.32% + 0.0007 + 1	L: 100 $\mu$ H-10 kH, 0.1% + 3 D: 0.32% + 0.0012 + 1
400 Hz	C: 100 pF-100 mF, 0.14% + 1 D: 0.34% + 0.0013 + 1	L: 100 $\mu$ H-10 kH, 0.1% + 3 D: 0.31% + 0.0011 + 1
1 kHz	C: 100 pF-100 mF, 0.1% + 3 D: 0.33% + 0.0008 + 1	L: 10 $\mu$ H-1000 H, 0.1% + 3 D: 0.33% + 0.0013 + 1
2 kHz	C: 100 pF-100 mF, 0.1% + 2 D: 0.32% + 0.0007 + 1	L: 10 $\mu$ H-1000 H, 0.1% + 3 D: 0.32% + 0.0012 + 1
4 kHz	C: 10 pF-10 mF, 0.14% + 1 D: 0.34% + 0.0013 + 1	L: 10 $\mu$ H-1000 H, 0.1% + 3 D: 0.31% + 0.0011 + 1
10 kHz	C: 10 pF-10 mF, 0.1% + 3 D: 0.33% + 0.0008 + 1	L: 1 $\mu$ H-100 H, 0.1% + 3 D: 0.33% + 0.0013 + 1
20 kHz	C: 10 pF-10 mF, 0.1% + 2 D: 0.32% + 0.0007 + 1	L: 1 $\mu$ H-100 H, 0.1% + 3 D: 0.32% + 0.0012 + 1
40 kHz	C: 1 pF-1000 $\mu$ F, 0.14% + 1 D: 0.34% + 0.0013 + 1	L: 1 $\mu$ H-100 H, 0.1% - 3 D: 0.31% + 0.0011 - 1
100 kHz	C: 1 pF-1000 $\mu$ F, 0.1% + 3 D: 0.33% + 0.0008 + 1	L: 100 nH-10 H, 0.1% + 3 D: 0.33% + 0.0013 + 1

#### HP 4275A

10 kHz	C: 10 pF-100 $\mu$ F, 0.1% + 3 D: 0.33% + 0.0008 + 1	L: 10 $\mu$ H-100H, 0.1% + 3 D: 0.33% + 0.0013 + 1
20 kHz	C: 10 pF-100 $\mu$ F, 0.1% + 2 D: 0.32% + 0.0007 + 1	L: 10 $\mu$ H-100 H, 0.1% + 3 D: 0.32% + 0.0012 + 1
40 kHz	C: 1 pF-10 $\mu$ F, 0.14% + 1 D: 0.34% + 0.0009 + 1	L: 10 $\mu$ H - 100 H, 0.1% + 3 D: 0.31% + 0.0011 + 1
100 kHz	C: 1 pF-10 $\mu$ F, 0.1% + 3 D: 0.33% + 0.0008 + 1	L: 1 $\mu$ H - 10 H, 0.1% + 3 D: 0.33% + 0.0013 + 1
200 kHz	C: 10 pF-100 $\mu$ F, 0.1% + 2 D: 0.32% + 0.0007 + 1	L: 1 $\mu$ H - 1000 mH, 0.2% + 3 D: 0.53% + 0.0023 + 1
400 kHz	C: 1 pF-1000 nF, 0.14% + 1 D: 0.34% + 0.0009 + 1	L: 1 $\mu$ H - 1000 mH, 0.2% + 3 D: 0.51% + 0.0021 + 1
1 MHz	C: 1 pF-1000 nF, 0.1% + 3 D: 0.33% + 0.0008 + 1	L: 100 nH - 100 mH, 0.2% + 3 D: 0.55% + 0.0025 + 1
2 MHz	C: 10 pF-100 nF, 0.3% + 3 D: 0.55% + 0.0025 + 1	L: 1 $\mu$ H - 10 mH, 0.5% + 5 D: 1.0% + 0.0033 + 1
4 MHz	C: 1 pF-10 nF, 1% + 20 + 0.002 pF D: 3.3% + 0.01 + 1	L: 1 $\mu$ H - 10 mH, 1% + 5 D: 2.0% + 0.0063 + 1
10 MHz	C: 1 pF-10 nF, 2% + 20 + 0.002 pF D: 4% + 0.011 + 1	L: 100 nH - 1 mH, 2% + 7 D: 3.1% + 0.002 + 1

**Range:** full scale range, accuracy: % of reading + counts (D accuracy: % of reading + absolute D value + count).

(Conditions: Warm-up time  $\geq 30$  minutes, environment temperature:  $23^\circ\text{C} \pm 6^\circ\text{C}$ )

Refer to technical data sheet for accuracy details.

### Measurement Frequencies

HP 4274A: 100 Hz-100 kHz, 11 spots (100 Hz, 120 Hz, 200 Hz, 400 Hz, 1 kHz, 2 kHz, 4 kHz, 10 kHz, 20 kHz, 40 kHz, 100 kHz;  $\pm 0.01\%$ )

HP 4275A: 10 kHz-10 MHz, 10 spots (10 kHz, 20 kHz, 40 kHz, 100 kHz, 200 kHz, 400 kHz, 1 MHz, 2 MHz, 4 MHz, 10 MHz;  $\pm 0.01\%$ )



### Test Signal Level:

HP 4274A: 4-ranges (1 mVrms-5 Vrms) continuously variable

HP 4275A: 3-ranges (1 mVrms-1 Vrms) continuously variable

**Test Signal Level Monitor:** standard.

**Displays:** dual 5 1/2-digit and single 3-digit; maximum display 199999 (full scale and overrange in high resolution mode), and 4 1/2-digit; maximum display 19999 in normal mode. (Number of digits depends on measurement frequency, test level, and range).

**Circuit modes:**  series equivalent circuit and  parallel equivalent circuit. Automatic selection available in AUTO mode.

**Deviation measurement:** difference between recallable stored reference and displayed is deviation value (count or percent).

**Ranging:** AUTO or MANUAL (UP/DOWN).

**Trigger:** internal, external or manual.

**Measurement terminals:** four-terminal pair with guard.

**Auto zero adjustment:** automatic normalization of the readout off-set due to residuals of the test fixture by pushbutton operation.

**Normalization range:** C < 20 pF, L < 2000 nH, R < 0.5 $\Omega$ , G < 5  $\mu$ S.

**Self test:** automatic operational verification check indicates pass or fail condition.

### Reference Data

**Measurement time:** (typical) 140-180 ms (> 1 kHz); 140-210 ms  $\leq 1$  kHz (measurement time depends on range, sample value and off-set adjustment value).

**Z -  $\theta$  measurement time:** 170-210 ms > 1 kHz; 170-240 ms  $\leq 1$  kHz.

**High resolution mode:** approximately 8 times the normal measurement time.

**Auto ranging time:** 100 ms - 300 ms per range change.

### General Information

**Operating Temperature and Humidity:**  $0^\circ\text{C} - 55^\circ\text{C}$ ,  $\leq 95\%$  RH at  $40^\circ\text{C}$

**Power:** 100, 120, 220V  $\pm 10\%$ , 240V + 5% - 10%, 48 - 66Hz, 135VA max. (HP 4274A); 165VA max. (HP 4275A)

**Size:** 177H x 425W x 574Dmm (7" x 16.75" x 22.6")

**Weight:** 18kg (39.6lbs)

### Accessory Furnished

HP 16047A: Direct coupled test fixture.

### Accessory Available

HP 16023B: dc Bias Controller, for control of dc bias \$340

Opt 001: 002 Internal Bias Supply.

Refer to page 277.

### Special Options

One or two arbitrary test frequencies for each instrument are available. For more details, please contact nearest HP sales office.

### Selectable Frequency Range

HP 4274A: 100 Hz to 100 kHz to  $\pm 0.1\%$ . If two frequencies are added, at least one frequency must satisfy the following equation:  $f = 1200/N$  kHz where N is an integer from 12 to 12000.

HP 4275A: 10 kHz to 10.7 MHz  $\pm 0.1\%$ .

### Ordering Information

HP 4274A 100 Hz - 100 kHz Multi-Frequency LCR

Meter

HP 4275A 10 kHz - 10 MHz Multi-Frequency LCR

Meter

Opt 001: 0 to  $\pm 35$  internal dc bias, max resolution:

1 mV steps

Opt 002: 0 to  $\pm 99.9$  V internal dc bias, resolution:

100 mV steps.

Opt 004: Frequency steps in 1-3-5 sequence

N/C

Fast-Ship product—see page 768.

# COMPONENT MEASUREMENT

## 1 kHz / 1 MHz Capacitance Meter

Model 4278A

- Measurement Speed: 6.5ms/10ms/21ms
- Measurement Parameters: C-D•Q•ESR•G
- C-D Measurement Accuracy:  
0.07%, 0.0005(1kHz, 21ms)  
0.05%, 0.0002(1MHz, 21ms)

- High Resolution: 6 digit, D:0.00001
- Intelligent Built-In Comparator: 10-bin Sorting

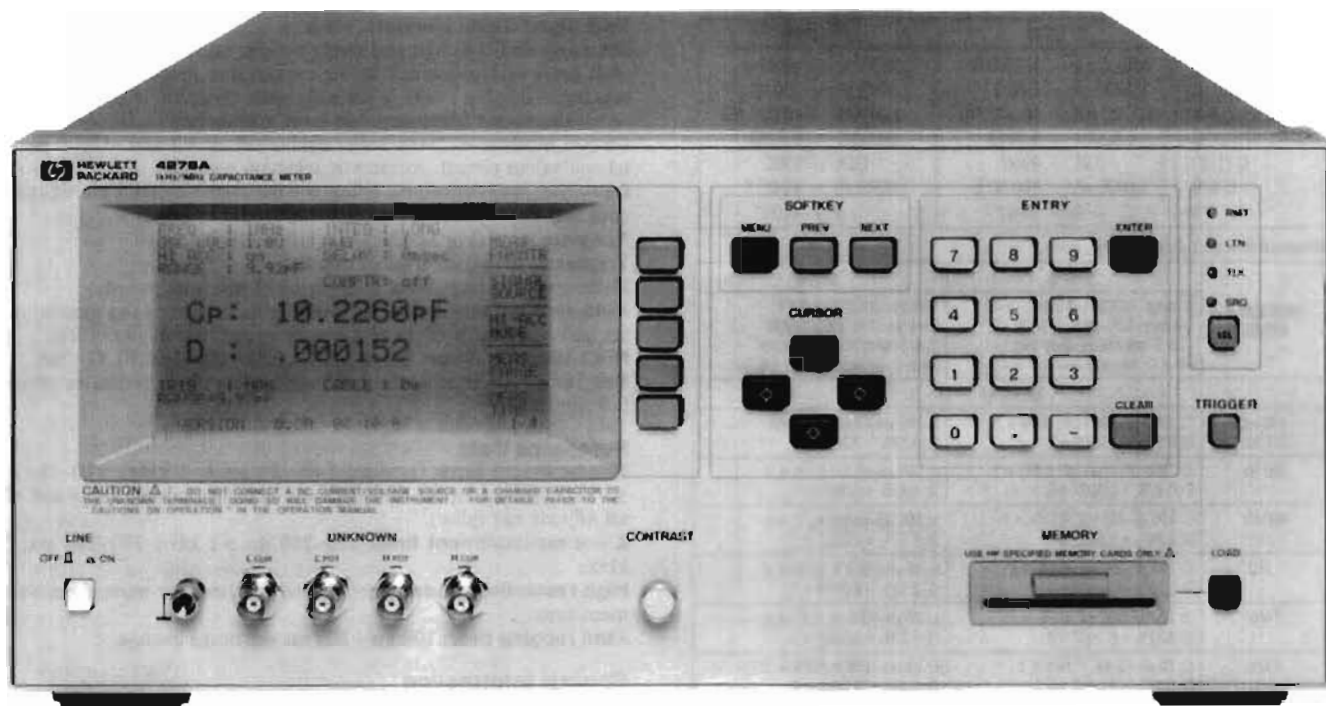

### Description

The HP 4278A 1kHz/1MHz Capacitance Meter is a high speed, highly reliable, precision test instrument aimed at incoming/outgoing capacitor inspection applications on the production line and in quality control. The HP 4278A will improve test efficiency by performing comparative measurements of low to medium value capacitors (up to 200  $\mu$ F—a range that covers most ceramic and film capacitors) several times faster than previously available capacitance meters.

The HP 4278A's standard measurement frequencies and oscillator output levels are 1kHz/1MHz and from 0.1V to 1V in 0.1V steps, respectively. The HP 4278A's ability to make precision capacitance measurements and to measure low dissipation values will give you an edge in improving the quality of your devices.

The built-in comparator function of the HP 4278A gives you the ability to sort parts into ten bins. A high speed HP-IB interface and an optional handler interface are available for combining the HP 4278A with an automatic handler and an external computer to build a total solution for automatic testing and data acquisition and analysis.

### High Speed Measurements

One of the HP 4278A's main features is its selection of high measurement speeds: 6.5ms (153 measurements/sec), 10ms (100 measurements/sec), or 21ms (47 measurements/sec), with a fast settling time. Additionally, the HP 4278A's built-in comparator and high speed HP-IB interface make it possible to construct a measurement system using an automatic handler and an external computer to minimize production test time, and, therefore, cost.

### High Accuracy and Resolution

Dissipation factor (D), the parameter measured to determine the quality of capacitors, can be measured with an accuracy of 0.0002 (1MHz) and 0.0005 (1kHz) with a resolution of 0.00001 without degrading measurement speed. The HP 4278A has high capacitance measurement accuracy, 0.05% (1MHz) and 0.07% (1kHz) with 6 full digits of resolution in all measurement ranges, 1pF to 2048 pF (1MHz), and 100pF to 100  $\mu$ F (1kHz).

The pushbutton zero adjustment function is used to compensate for stray impedance and admittance of the handler and test fixture. The auto calibration function, when used with a capacitance standard, can be used to calibrate the system up to the point of device connection.

### Intelligent Built-in Comparator

The intelligent built-in comparator gives the HP 4278A the capability to use nine sets of high and low capacitance values and one set of dissipation limits to sort capacitors into nine bins, according to their capacitance values and whether or not they meet the dissipation limits. Capacitors which are not within the capacitance limits or do not meet the dissipation limits go into the tenth or no-go bin.

All comparator settings can be controlled and monitored using an external computer, and the results of the comparisons can be transferred to a handler interface (optional). All control settings and comparator parameters can be saved on the removable EEPROM memory module (memory card) to facilitate instrument setup and to minimize the chance of an instrument setup error.

## Specifications

(refer to data sheet for complete specifications)

**Measurement Parameters:** C-D-Q-ESR-G

**Display:** Dot-matrix LCD. Displays measurement values with 4, 5, or 6 digit resolution, control settings, comparator limits, the comparator's decision, self test messages and annunciators.

**Measurement Circuit Modes:** Parallel and Series

**Test Signals:**

**Frequency:** 1kHz and 1 MHz,  $\pm 0.02\%$

**Signal Level:** 0.1 to 1 Vrms,  $\pm 10\%$  ( $C \leq 20\mu\text{F}$ ), in 0.1 Vrms steps

**Measurement Time Modes:** SHORT, MEDIUM, and LONG

**Measurement Times:**

Mode	SHORT	MEDIUM	LONG
Time*	6.5ms	10ms	21ms

\* Measurement time includes Settling, Integration (analog measurements), Calculation, and Comparison times.

No additional measurement time is required for measurements performed in an overload (shorted capacitor) condition.

### Measurement Range

Measurement Parameter	1 KHz	1 MHz Normal Mode	
		1 MHz High Accuracy	
C	0.001 pF to 200 000 $\mu\text{F}$	0.00001 pF to 1280.00 pF 0.00001 pF to 2663.00 pF	0.00001 pF to 9.99999 .000001 to 9.99999
DF	0.00001 to 9.99999	0.1 to 99999.9 20 to 99999.9	0.00001 $\mu\text{S}$ to 9.99999 mS 0.00001 $\mu\text{S}$ to 9.99999 mS
Q	0.1 to 99999.9	0.001 $\Omega$ to 999.999 k $\Omega$ 0.001 $\Omega$ to 999.999 k $\Omega$	
G	0.00001 $\mu\text{S}$ to 9.99999 S		
ESR	0.00001 $\Omega$ to 9.99999 M $\Omega$		

- 1 kHz Normal Mode: 7 decade ranges 100pF to 100 $\mu\text{F}$  full scale, 100% overranging on all ranges, (max. 200000 counts) when  $D \leq 0.5$ .
- 1 MHz Normal Mode: 11 binary ranges, 1pF to 1024pF full scale, 25% overranging on all ranges, when  $D \leq 1$ .
- 1 MHz High Accuracy Mode: Measurement range is  $\pm 30\%$  of the user defined nominal value, maximum 2048pF. When  $D \leq 0.05$ .

### Measurement Accuracy

It is specified at the UNKNOWN terminals and at the end of standard 1 or 2 meter test leads under the following conditions. Refer to data sheet for details.

1. Warm Up Time:  $\geq 10$  minutes.
2. Ambient Temperature is  $23 \pm 5^\circ\text{C}$  and variance is less than  $0.2^\circ\text{C}/\text{minute}$ .
3. Test signal level is set to 1 Vrms.
4. Test cable length is 0, 1, or 2 meters (HP 16048A/B/D).
5. Zero OPEN/SHORT compensation has been performed.
6.  $D \leq 0.05$  for 1MHz High Accuracy Mode.  
 $D \leq 0.1$  for 1kHz and 1MHz Normal Modes.
7. Accuracies are only valid when the measured value is equal to full scale of each range.
8. Accuracy stated in the tables is given for MEDIUM (upper) and LONG (lower) integration times.
9. Accuracy equations are read as follows:  
C:  $\pm$  (% of reading + % of full scale)  
D:  $\pm$  (% of reading + absolute D value)  
(C:  $\pm$  (% of reading + absolute C value) for Table 3)

**Table 1 1kHz Measurement Accuracy**

C range	C	D
100 $\mu\text{F}$	0.13% + 0.3% 0.07% + 0.025%	0.13% + 0.003 0.065% + 0.0025
100pF - 10 $\mu\text{F}$	0.1% + 0.05% 0.05% + 0.025%	0.1% + 0.001 0.05% + 0.0005

**Table 2 1MHz Normal Mode Measurement Accuracy**

C range	C	D
256 - 1024pF	0.2% + 0.02% 0.1% + 0.02%	0.2% + 0.002 0.1% + 0.0005
4 - 128pF	0.2% + 0.02% 0.05% + 0.02%	
2pF	0.2% + 0.03% 0.05% + 0.03%	
1pF	0.2% + 0.06% 0.05% + 0.06%	0.2% + 0.004 0.1% + 0.001

**Table 3 1MHz High Accuracy Mode Measurement Accuracy**

Nominal C + Open Circuit C	C	D
1024 - 2048pF	0.11% 0.11%	0.0007 0.0004
256 - 1024pF	0.11% 0.07%	0.0007 0.0003
4 - 256pF	0.11% 0.05%	0.0007 0.0002
2 - 4pF	0.1% + 0.0004pF 0.06% + 0.0004pF	0.0008 0.0003
0 - 2pF	0.1% + 0.0004pF 0.06% + 0.0004pF	0.0016 0.0006

**Trigger Modes:** Internal, External, or Manual

**Measurement Terminals:** Four-terminal pair, guarded

**Cable Length Compensation:** 0, 1, or 2m

**Compensation Function**

**Zero OPEN/SHORT:** Compensation range:  $R \leq 20\Omega$ ,  $G \leq 20\mu\text{S}$ , and unlimited C and L.

**Standard:** Improves measurement accuracy by using a standard capacitor as a reference.

**Offset:** Arithmetic correction of measurement data.

**Comparator:** Ten-bin sorting for capacitance, and go/no-go testing for D, Q, ESR, and G.

**Sorting Modes:** Sequential sorting into un-nested bands with absolute limits, and tolerance sorting into nested bands with absolute or percent limits.

**Self Test:** Checks the HP 4278A's basic operation.

**Memory Card:** External memory for storing and recalling control settings and comparator limits.

### General Specifications

**Operating Temperature and Humidity:**  $0-55^\circ\text{C}$ , 95% RH @  $40^\circ\text{C}$

**Power:** 100, 120, 220VAC  $\pm 10\%$ , 240VAC  $\pm 5-10\%$ , 48-66Hz, 200VA max.

**Dimensions (in mm):** Approximately 426(W) by 177(H) by 498(D)

**Weight:** Approximately 10kg (22lb., standard)

### Reference Data

**Stability:** LONG integration and constant operating temperature.

$C \leq 0.01\%/ \text{day}$

$D \leq 0.0001/ \text{day}$

**Temperature Coefficient:** LONG integration and  $12 \pm 5^\circ\text{C}$ .

$C \leq 0.01\%/^\circ\text{C}$ ; 1kHz and 1MHz.

$D \leq 0.0001/^\circ\text{C}$ ; 1kHz and 1MHz Normal Mode.

$D \leq 0.00004/^\circ\text{C}$ ; 1MHz High Accuracy Mode.

**HP-IB Data Output Speed:** Maximum 100 bytes/ms, typically 3ms for handshake, depending on the system controller.

### Accessories Available

HP 16270A: Memory Card Set \$275

HP 16334A: Tweezer-type Test Fixture for Chip Components \$430

HP 16047A: Direct-coupled Test Fixture \$265

HP 16047C: Test Fixture \$305

HP 16048A: Test Leads, BNC (1m) \$325

HP 16048B: Test Leads, SMC (1m) \$325

HP 16048D: Test Leads, BNC (2m) \$420

HP 16380A: Standard Capacitor Set \$2955

HP 16380C: Standard Capacitor Set \$4075

Refer to page 297.

### Ordering Information

HP 4278A 1kHz/1MHz Capacitance Meter \$7130

Opt 001: 1kHz test frequency only -\$750

Opt 002: 1MHz test frequency only -\$330

Opt 003: 1% frequency shift: prevents possible test signal interference when component test contacts are located close to those of other test units \$0

Opt 101: HP-IB compatibility \$224

Opt 201: Handler Interface \$255

Fast-ship product, see page 758.

# COMPONENT MEASUREMENT

## LCZ Meters

Models 4276A & 4277A

- 3-digit frequency setting:
  - 100 Hz to 20 kHz (801 spots)
  - 10 kHz to 1 MHz (701 spots)
- High speed measurements
- Measure L/C-D/Q/ESR/G,  $|Z| - \theta$ , high speed L/C
- 10-bin component sorting-comparator (OPT. 002)
- 0.1% basic accuracy over impedance range of 100 m $\Omega$  to 10 M $\Omega$  (HP 4276A), 10 $\Omega$  to 1 M $\Omega$  (HP 4277A)

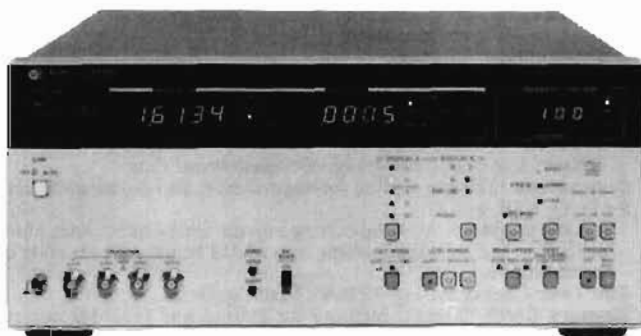

HP 4276A

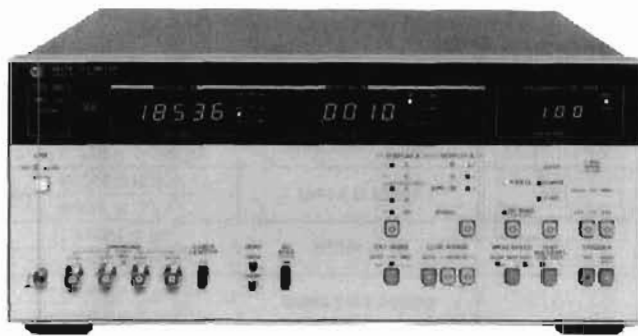

HP 4277A



### Description

HP's 4276A and 4277A LCZ Meters are general purpose impedance measuring instruments designed to measure circuit components such as capacitors and inductors using frequency and dc bias conditions identical to those of the intended application. Both HP 4276A and HP 4277A feature variable test frequency (100 Hz - 20 kHz and 10 kHz - 1 MHz respectively), optional dc bias variable from 0 to  $\pm 40$  V, multiple parameters (L • C •  $|Z|$  • D • Q • FSR • G •  $\theta$ ) with fully automatic high speed measurements, and 4½ digit resolution. The HP 4276A has an impedance range of 100 m $\Omega$  to 10 M $\Omega$  and the HP 4277A 10  $\Omega$  to 1 M $\Omega$ .

Both instruments are ideal for production line, quality control, and circuit design applications, and are versatile enough for stand-alone use or systems use under HP-IB control (standard). An optional comparator for 10-bin sorting with measurement time of less than 100 ms make the HP 4276A/4277A a good choice for production line testing of discrete components.

### Variable Test Parameters: Frequency, Bias, Signal Level

HP's 4276A and 4277A offer variable test frequency, optional internal dc bias, and selectable test signal level (HIGH and LOW). This makes it possible to measure components under conditions almost identical to those of the intended circuit.

The HP 4276A (100 Hz to 20 kHz) and the HP 4277A (10 kHz to 1 MHz) provide 801 and 701 test frequencies, respectively. Test frequencies of both instruments are linearly spaced along a logarithmic scale. The most commonly used test frequencies for production line measurements—100 Hz, 120 Hz, 1 kHz and 1 MHz, all of which are

specified in MIL/IEC standards are included. Frequency setting resolution is 3 digits.

Both instruments feature selectable test signal levels—1 V/50 mV (Cp) (HP 4276A) and 1 V/20 mV (Cp) (HP 4277A)—and both can be equipped with an optional internal dc bias source that is variable from 0 to  $\pm 40$  V in 10 mV (0 to 10 V) or 100 mV (10 to 40 V) steps. Thus, bias conditions that suit the measurement and the DUT can be selected, an important consideration for semiconductor C-V measurements.

The features described above satisfy most impedance measurement requirements for component development and circuit design. HP-IB enhances these features.

### High Speed Measurements

The HP 4276A and HP 4277A provide high speed measurements with 3½ to 4½ digits resolution. The typical time required for a C-D measurement, for example, is 65ms at 1kHz, and 75ms at 1MHz. Also, when the instrument is set to high speed C measurement mode, measurement time is 35ms at 1kHz, and 40ms at 1MHz. Refer to Reference Data on next page.

Such high speeds considerably improve the efficiency and increase the throughput of high volume measurements such as outgoing inspection on the production line and incoming inspection by component end users. If an HP-IB system is configured, measurement efficiency is further improved because HP-IB is capable of packed binary data output format, which can be processed much faster than the usual ASCII format. Even when the HP-IB capability is not used, the HP 4276A/4277A can increase production line throughput if the optional comparator is used.

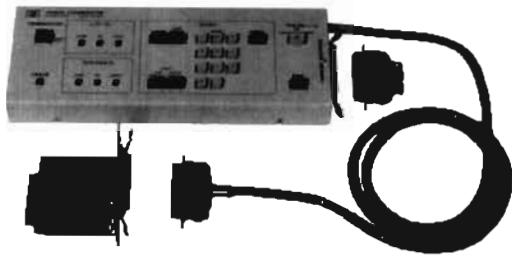

Option 002 Comparator

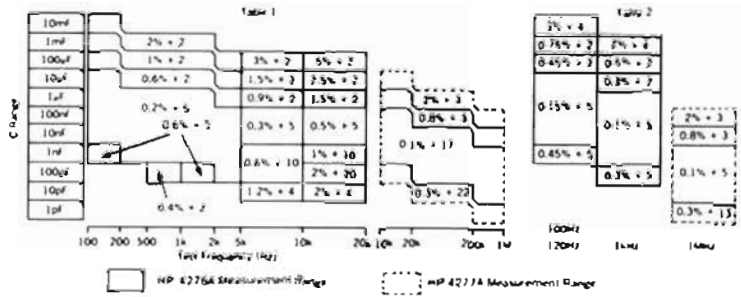

**Optional Ten-Bin Component Sorting**

A 10-bin comparator (option 002) is available. Nine sets of bin limits (high and low) can be input for L, C or |Z|. Also, high and low limits for D,Q,ESR, or G can be set to provide go/no-go testing.

Multiple bin sorting is especially beneficial on the production line and in incoming inspection. Test costs can be significantly reduced using the HP 4276A/4277A's high speed measuring capability. When the optional handler interface is used for automatic component sorting, measurement efficiency is better than that when using HP-IB. This is because time for data handshake is not needed.

Output data from the handler interface is at TTL or open collector level, which improves system noise immunity. Particularly, three lines—external trigger and measurement complete signals—are photo-isolated, so a reliable sorting system free from noise can be constructed.

Measurement reliability is improved by other comparator features such as front panel lock-out and auto zeroing of fixture residuals.

Plus, all comparator functions can be HP-IB controlled. So a fully automatic component sorting system can be constructed for use in outgoing/incoming inspection.

**Specifications** (Refer to data sheet for complete specifications)

Common to HP 4276A and HP 4277A

**Parameters measured:** C-D\*Q\*ESR\*G

L-D\*Q\*ESR\*G

high speed L, high speed C

|z|-θ and Δ(deviation for any parameter)

**Display:** 4½ digits (max), maximum display 19999

**Measurement circuit modes:** Auto, Parallel, and Series

**Frequency control modes:** SPOT, COARSE (10 freq./decade), and FINE (max. freq. resolution).

**Test Signal Level** (unknown terminal open)

	HIGH	LOW
HP 4276A	1 Vrms ± 10%*	50 mV ± 20% (Cp only)
HP 4277A	1 Vrms ± 10%	20 mV ± 15%

\*at 1 kHz only

**Output impedance:** 100 Ω

**Ranging modes:** Auto and Manual (up-down)

**Trigger:** Internal, External or Manual

**Measurement terminals:** 5-terminal (HP 4276A)

4-terminal pair (HP 4277A)

**Measurement speed modes:** FAST, MED, and SLOW

**Offset adjustments:** front panel OPEN and SHORT adjustments to compensate for residual impedance and stray admittance of the test fixture.

**Test frequencies:** HP 4276A - 100 Hz to 20 kHz ± 0.01% (801 points)

HP 4277A - 10 kHz to 1 MHz ± 0.01% (701 points)

**Measurement accuracy and range:** specified at the front panel unknown connectors when all of the following conditions are satisfied:

- (1) warmup time ≥ 30 min.
- (2) test signal level is set to HIGH (1 Vrms)
- (3) measurement speed mode: MED or SLOW
- (4) ambient temperature is 23°C ± 5°C
- (5) cable length switch is set to Om (HP 4277A)
- (6) OPEN and SHORT adjustments have been made
- (7) D ≤ 0.1

**C-D/C-Q (1/D) measurement accuracy:** accuracies for C measurements are given in Table 1 (frequencies other than 100, 120, 1k, and 1 MHz) and Table 2 (100, 120, 1k and 1 MHz only). The HP 4277A's C accuracies in the tables are for the full scale value of each C range.

Accuracies given in Tables 1 and 2 are read as ±(% of reading + number of counts)

Refer to data sheet for details.

**DC Bias**

**Internal dc bias (opt.): 0 to ±40 V**

**Reference Data**

**Measurement Speed (Typical):** (Circuit mode: AUTO, test signal level: HIGH, display digit: 3 digits)

HP 4276A (at 1kHz):

C-D\*ESR\*G Measurements: 65 ms (FAST mode)

L-D\*ESR\*G Measurements: 75 ms (FAST mode)

Z-θ Measurements: 80 ms (FAST mode)

High Speed C Measurements: 35 ms (FAST mode)

HP 4277A (at 1MHz):

C-D\*ESR\*G Measurements: 75 ms (FAST mode)

L-D\*ESR\*G Measurements: 65 ms (FAST mode)

Z-θ Measurements: 75 ms (FAST mode)

High Speed C Measurements: 40 ms (FAST mode)

**General Specifications**

**Operating temperature and humidity:** 0° to 55°C, ≤ 95% RH at 40°C.

**Power requirements:** 100/120/220 Vac ± 10%, 240 V + 5% - 10%; 48 to 66 Hz.

**Power consumption:** 65 VA max (HP 4276A); 75 VA max (HP 4277A).

**Size:** 188 mm H x 426 mm W x 422 mm D (7½" x 16¼" x 16½").

**Weight:** approx. 8.5 kg (18.7 lb).

**Special Options**

HP 4276A Opt H05: 1 kHz C-D measurement only (1V/100mV)

HP 4276A Opt H06: 1 kHz C-D measurement only (1V/300mV)

HP 4276A Opt H07: 1 kHz C-D measurement only (1V/500mV)

HP 4277A Opt H03: Programmable DC bias for high speed C-V measurement (1V/20mV, 1 MHz only)

HP 4277A Opt H04: Programmable DC bias for high speed C-V measurement (500mV/20mV, 1 MHz only)

HP 4277A Opt H07: High accuracy DC bias

Contact your nearest HP sales office for more information.

**Accessories**

**Furnished accessories:** HP 16047A Direct Coupled Test Fixture

**Accessories Available**

HP 16064A: Retrofit Kit for Comparator (HP 4276A/

HP 4277A, Opt 002)

Refer to page 277.

**Ordering Information**

HP 4276A LCZ Meter \$4,840

HP 4277A LCZ Meter \$6,930

Opt 001: Internal dc bias, 0 to ±40 V, max resolution 10 mV/100 mV. \$214

Opt 002: 10-bin sorting for L/C/|Z| and go/no-go testing for D/Q, interfaced with component handler, usable only with HP 4276A/4277A. \$745

# COMPONENT MEASUREMENT

## 1MHz C-V Meter

Model 4279A

- Built-in programmable dc bias sweep source with a voltage accuracy of 0.1%
- High speed C-V measurements: 10ms, 20ms, and 30ms/meas point

- 0.1% basic accuracy and 6 digit resolution for C measurement
- Automatic dc bias polarity control
- High reliability for production testing

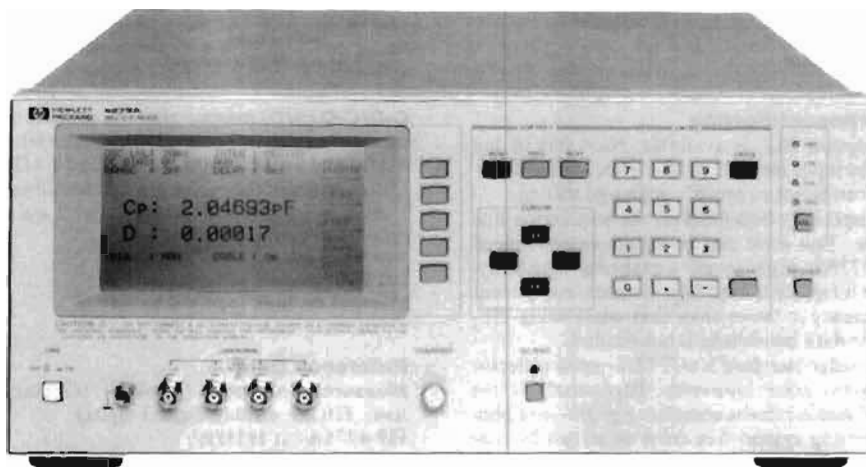

HP 4279A

### Description

The HP 4279A 1MHz C-V Meter offers the optimum solution for increasing quality and throughput when measuring the capacitance vs bias voltage characteristics of semiconductors. The HP 4279A measures capacitance over a range of 0.00001 pF to 1280.00 pF with a basic accuracy of 0.1% and a 6 digit display resolution, while sweeping the dc bias voltage. An internal, programmable dc bias sweep source with a 0.1% voltage accuracy throughout the  $\pm 38$ V range assures very low measurement error due to bias voltage uncertainty. It makes the HP 4279A ideal for the precise characterization and testing of varactor diodes, MOS diodes, etc.. Measurement time can be selected from three modes of 10ms, 20ms and 30ms/meas to maximize productivity. The HP 4279A's very fast ranging and high speed HP-IB data transfer capabilities reduce test time. The automatic bias polarity control feature allows quick selection of the correct polarity bias voltage for the device under test. This new function eases manual testing of samples in incoming/outgoing inspection and provides a simple method of polarity control for automatic test systems.

### Specifications

**Parameters measured:** C-D-Q-ESR-G

**Display:** 4, 5, 6 digits, selectable, maximum display 999999

**Measurement circuit modes:** Series and parallel.

**Ranging modes:** Auto, Manual and Program

**Measurement frequency:** 1MHz  $\pm 0.02\%$

**Test signal level (unknown terminal open):** 20mV, 50mV, 100mV, 200mV, 500mV and 1Vrms, selectable

**Measurement terminals:** 4-terminal pair

**Test cable length compensation:** 0m, 1m and 2m

**Error-correction:** OPEN and SHORT adjustments and STD and temperature compensation functions

Measurement time:	Mode	SHORT	MEDIUM	LONG
	Time		10ms	20ms

**Ranging time:** Less than 3ms in program mode (unspecified)

**Trigger:** Internal, External and Manual

**Delay time:** 0 to 1000ms, programmable in 1ms steps

### Measuring range and accuracy

**C-D measurement range:** 0.00001 pF to 1280.00 pF:  
0.00001 to 9.99999D

**C measurement accuracy:** Specified at the front panel unknown terminals and the ends of standard 1m or 2m test leads (HP 16048A/B/D) when all of the following conditions are satisfied:

- (1) Ambient temperature is 23°C  $\pm 5^\circ$ C and temperature variance  $\leq 0.2^\circ$ C/min
- (2) Warmup time  $\geq 10$ min.

- (3) OPEN, SHORT and temperature compensations have been made
- (4)  $D \leq 0.1$

Accuracies for C measurements in MEDIUM mode are given in Table 1 and are read as  $\pm$ (% of reading + % of full scale value). (Refer to the HP 4279A data sheet for complete accuracy specifications, including D/Q/ESR/G accuracies.)

C range	Test signal level			
	20mV	50mV	100mV	200mV-1V
1024pF 512pF 128pF	0.07%+0.03%	0.07%+0.03%	0.07%+0.03%	0.07%+0.03%
32pF				
8pF	0.06%+0.04%	0.06%+0.04%		
2pF	0%+0.3%	0%+0.15%	0%+0.1%	0.06%+0.04%

### DC bias

**Internal dc bias:** 0V to  $\pm 38$ V

Bias voltage	Voltage step	Accuracy (at 23°C $\pm 5^\circ$ C)
$\pm(0.000-4.000)$ V	1mV	$\pm(0.1\%$ of setting +1mV)
$\pm(4.002-8.000)$ V	2mV	$\pm(0.1\%$ of setting +2mV)
$\pm(8.005-20.000)$ V	5mV	$\pm(0.1\%$ of setting +3mV)
$\pm(20.01-38.00)$ V	10mV	$\pm(0.1\%$ of setting +10mV)

**Bias voltage sweep:** Max. 51 sweep points can be programmed via HP-IB

**Auto bias polarity control:** Completed within 4ms after triggered (unspecified)

**External dc bias:** 0V to  $\pm 100$ V via rear panel connector

**HP-IB:** Standard. Remote control and ASCII or binary data output (packed data output when swept bias measurements are made.)

### General

**Operating temperature and humidity:** 5°C to 45°C,  $\leq 95\%$ RH at 40°C

**Power:** 100/120/220V  $\pm 10\%$ , 240V +5% -10%; 48 to 66Hz; 200VA maximum

**Size:** 177mmH x 426mmW x 498mmD (7" x 16.8" x 19.6")

**Weight:** Approximately 15kg

### Accessories Available

Refer to page 277.

### Ordering information

HP 4279A 1MHz C-V Meter

**Opt. 003:** 1% frequency shift

**Opt. 009:** Delete manual

**Opt. 910:** Extra manual

**Price**

\$9700

\$0

-\$36

\$36

# COMPONENT MEASUREMENT

## Digital LCR Meters

### Models 4261A and 4262A

293

- Automatic balancing, ranging & circuit mode selection
- Test frequencies: HP 4261A, 120 (100) Hz and 1 kHz  
HP 4262A, 120 (100) Hz, 1 kHz and 10 kHz

- Versatile accessories and options
- High reliability

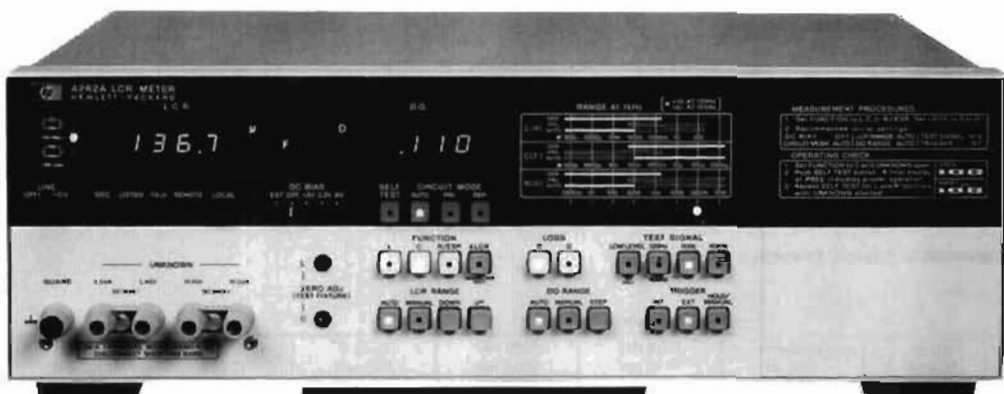

HP 4262A



HP 4261A

### Description

The HP 4261A and HP 4262A are 3½ digit LCR meters that meet today's requirements for component measurements. Both instruments feature fully automatic operation over wide measuring ranges. Simply select the measuring functions and one of the test frequencies, then insert the device to be measured. The instrument does the rest—automatically selecting the proper measuring range and equivalent circuit mode. The HP 4261A and HP 4262A basic features are summarized in the table below.

	HP 4261A	HP 4262A
Test Frequency	120 (100) Hz, 1 kHz	120 (100) Hz, 1 kHz, 10 kHz
Signal Level	1 V, 50 mV (Cp)	1 V, 50 mV (Cp)
Parameters Measured	C-D L-D R	C-D • Q L-D • Q R (ESR) Δ (Deviation)
HP-IB	No	Yes (opt.)
Digital Comparison	No	Yes (opt.)
BCD Output	Yes (opt.)	Yes (opt.)

In addition to automatic measurements, the HP 4261A and HP 4262A provide high accuracy (0.2% reading), internal dc bias, and series and parallel equivalent circuit modes.

These relatively low cost and easy-to-use LCR meters are capable of a wide range of applications—measuring electrolytic/ceramic capacitors, filter coils, pulse transformers, internal resistance of dry cells and semiconductor junction capacitance, as well as ordinary LCR components. Extended features of these reliable instruments include optionally available HP-IB (HP 4262A) and BCD (HP 4261A) data output capabilities and a comparator option which is convenient for production line applications.

**Specifications** (refer to data sheet for complete specifications) Measurement ranges and accuracies: see table on next page. Accuracy applies over a temperature range of 23°C ±5°C (at 0° to 55°C, error doubles). 10 kHz and Q specifications are given only for the HP 4262A.

	HP 4261A	HP 4262A
Parameters measured	L-D, C-D R	L-D • Q, C-D • Q R (ESR), Δ LCR
Display	3½ digits max. display 1900	3½ digits max. display 1999
Test frequency	120 (100) Hz, 1 kHz ±3%	120 (100) Hz, 1 kHz 10 kHz ±3%
Test signal level (typical)	1 V, 50 mV (Cp mode only)	
DC bias	Int	1.5 V, 2.2 V, 6 V ±5%, selectable
	Ext	0 to +30 V
Equivalent circuit modes	auto, parallel, series	
Ranging modes	LCR	auto, manual
	Cp	D only — fixed
Trigger	internal, external, manual	
Measuring terminal	5-terminal configuration	

**Deviation measurement (HP 4262A):** displays the difference between a stored value (that is, measured value when Δ LCR switch is depressed) and subsequent measured data.

**Offset adjustments (HP 4262A):** front panel adjustments to compensate for stray capacitance and residual inductance of the test fixture.

**C:** 0 to 10 pF      **L:** 0 to 1 μH

**Self-test (HP 4262A):** automatically checks the HP 4262A's basic functions.

### General

**Measuring time (typical):** for a 1000 count measurement on a low loss component on a fixed range:

1 kHz, 10 kHz: C/L 220-260 ms, R 120-160 ms

120 (100) Hz: C/L 900 ms, R 700 ms

### Ranging Time

1 kHz, 10 kHz: 180 ms/range step

120 (100) Hz: 670 ms/range step

**Reading rate:** INT (internal trigger) approximately 30 ms between end of measurement cycle and start of the next cycle. EXT (external trigger) measuring cycle is initiated by a remote trigger input.

# COMPONENT MEASUREMENT

## Digital LCR Meters (cont'd)

### Models 4261A and 4262A

C-D/C-Q Measurement

Range	C	120 (100) Hz 1 kHz 10 kHz	1000 pF 100.0 pF 10.00 pF	10.00 nF 1000 pF 100.0 pF	100.0 nF 10.00 nF 1000 pF	1000 nF 100.0 nF 10.00 nF	10.00 μF 1000 nF 100.0 nF	100.0 μF 10.00 μF 100.0 nF	1000 μF 100.0 μF 10.00 μF	10.00 mF 1000 μF 100.0 μF
	D	0.001 to 1.900 (HP 4261A), 0.001 to 19.9 (HP 4262A)								
	Q <sup>21</sup>	0.050 to 1000 (4 ranges, HP 4262A)								
C Accuracy <sup>22</sup>		0.2% + 1 <sup>23</sup>				0.3% + 2			0.5% + 2	1% + 2 <sup>24</sup>
		At 120 (100) Hz, 1 kHz		At 10 kHz					0.5% + 2	1% + 2
D (1/Q) Accuracy <sup>25</sup>		0.2% + (2 + 200/Cx)				At 120 (100) Hz, 1 kHz				
		0.5% + (2 + 200/Cx)				At 10 kHz				
		At 120 (100) Hz, 1 kHz				0.3% + (2 + Cx/500)			1% + (5 + $\frac{Cx}{500}$ )	
		At 10 kHz				0.5% + (2 + Cx/500)			1% + (5 + $\frac{Cx}{500}$ ); 5% + (5 + $\frac{Cx}{500}$ )	

<sup>21</sup> Calculated as the reciprocal of D.  
<sup>22</sup> % of reading + number of counts, Cx is capacitance readout in counts. Accuracies in this table apply when D < 1.900.  
<sup>23</sup> Add 0.2 pF for HP 4261A.  
<sup>24</sup> (5% + 2 counts) at 1 kHz.

L-D/L-Q Measurement

Range	L	120 (100) Hz 1 kHz 10 kHz	1000 μH 100.0 μH 10.00 μH	10.00 mH 1000 μH 100.0 μH	100.0 mH 10.00 mH 1000 μH	1000 mH 100.0 mH 10.00 mH	10.00 H 1000 mH 100.0 mH	100.0 H 10.00 H 1000 mH	1000 H 100.0 H 10.00 H	
	D	0.001 to 1.900 (HP 4261A), 0.001 to 19.9 (HP 4262A)								
	Q <sup>21</sup>	0.050 to 1000 (4 ranges, HP 4262A)								
L Accuracy <sup>22</sup>		At 120 (100) Hz, 1 kHz				0.3% + 2			1% + 2	
		At 10 kHz							1% + 2	5% + 2
D (1/Q) Accuracy <sup>25</sup>		0.2% + 2 <sup>27</sup>				At 120 (100) Hz, 1 kHz				
		0.3% + 2				0.2% + 2			At 10 kHz	
		At 120 (100) Hz, 1 kHz				0.3% + (3 + Lx/500)			1% + (3 + Lx/500)	
		At 10 kHz				0.5% + (3 + Lx/500)			1% + (3 + Lx/500); 5% + (5 + $\frac{Lx}{500}$ )	
		0.2% + (3 + 200/Lx)				At 120 (100) Hz, 1 kHz				
		0.5% + (3 + 200/Lx)				At 10 kHz				

<sup>21</sup> Calculated as the reciprocal of D.  
<sup>22</sup> % of reading + number of counts, Lx is inductance readout in counts. Accuracies in this table apply when test signal level is 1 V and D < 1.900.  
<sup>23</sup> Add 0.2 μH for HP 4261A.

R (ESR)<sup>21</sup> Measurement

Range	120 (100) Hz 1 kHz 10 kHz	1000 mΩ	10.00 Ω	100.0 Ω	1000 Ω	10.00 kΩ	100.0 kΩ	1000 kΩ	10.00 MΩ
Accuracy <sup>22</sup>		0.2% + 1				0.3% + 2 <sup>23</sup>			

<sup>21</sup> ESR measuring range is from 1 mΩ to 10 kΩ (typical). These values vary depending on the series capacitance or inductance value of the device under test.  
<sup>22</sup> % of reading + number of counts.  
<sup>23</sup> (5% + 2 counts) on 10.00 MΩ range at 10 kHz.

	HP 4261A	HP 4262A
Operating temperature and humidity	0°C to 55°C ≤95% RH at 40°C	
Power requirements	100/120/220/240 V ± 10%	100/120/220 V ± 10%, 240 V ± 5%
Power consumption	48-66 Hz	-10%, 48-66 Hz
Power consumption	≤25 VA	≤55 VA
Size	134 H x 213 W x 422 mm D (5 1/4" x 8 3/8" x 16 5/8")	147 H x 426 W x 345 mm D (5 3/4" x 16 7/8" x 13 5/16")
Weight (approx.)	7.5 kg (16.51 lb)	8 kg (17.51 lb)

### Options Available

Option	HP 4261A <sup>21</sup>	HP 4262A <sup>22</sup>
001	BCD data output (L/C/R and D simultaneously)	BCD data output
002	BCD data output (L/D, C/D, R alternately)	—
003	BCD remote control	—
004	—	Digital comparator
101	—	HP-IB

<sup>21</sup> Options 001 and 002 are mutually exclusive.  
<sup>22</sup> Option combinations 101/001 and 101/004 cannot be ordered.

**Accessories available:** HP 16061A: test fixture, direct couple, 5-terminal; HP 16062A: test leads with alligator clips, 4-terminal (for low impedance measurements); HP 16063A: test leads with alligator clips, 3-terminal (for high impedance measurements).

Ordering Information (4261A)	Price
HP 16061A Test Fixture, Radial/Axial lead devices	\$224
HP 16062A Test Leads, 4-wire	\$122
HP 16063A Test Leads, 3-wire	\$112
Opt 001: BCD Output (Simultaneous)	\$234
Opt 002: BCD Output (Alternately)	\$204
Opt 003: BCD Remote Control	\$107
Opt 010: 100 Hz Test Frequency	N/C
Opt 910: Extra Manual	\$23
<b>HP 4261A Digital LCR Meter</b>	<b>\$2,955</b>

Ordering Information (HP 4262A)	Price
Opt 001: BCD Output	\$405
Opt 004: Digital Comparator	\$980
Opt 010: 100 Hz Test Frequency	N/C
Opt 101: HP-IB Interface	\$660
Opt 907: Front Handle Kit	\$56
Opt 908: Rack Flange Kit	\$33
Opt 909: Rack/Handle Kit	\$82
Opt 910: Extra Manual	\$30
HP 16061A Test Fixture for Radial/Axial Lead Devices	\$224
HP 16062A Test Cables, 4-wire	\$122
HP 16063A Test Cables, 3-wire	\$112
<b>HP 4262A Digital LCR Meter</b>	<b>\$4,075</b>

Fast-Ship product — see page 758.

Fast-Ship product — see page 758.



- Frequency range: 22 kHz to 70 MHz
- Q range: 5 to 1000

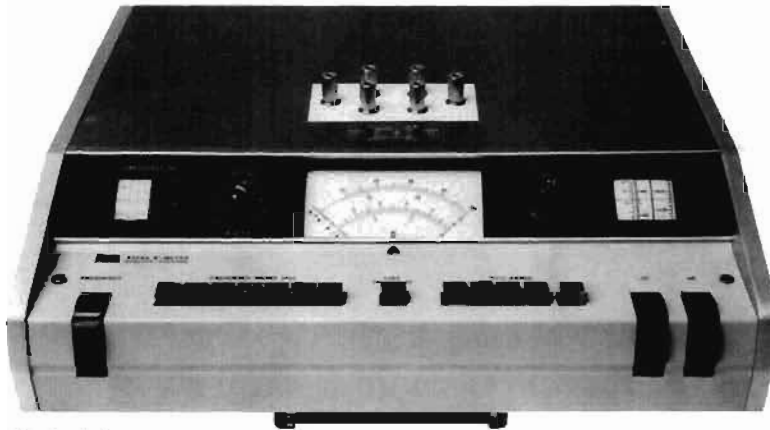

HP 4342A

### Description

The direct-reading expanded scale of the HP 4342A permits measurement of Q from 5 to 1000 and readings of very small changes in Q resulting from variation in test parameters. The HP 4342A is solid state with the elimination of specially matched, fragile thermocouple components.

The HP 4342A will measure dissipation factor and dielectric constant of insulating materials. The Q meter can measure coefficient of coupling, mutual inductance, and frequency response of transformers. RF resistance, reactance, and Q of resistors and capacitors can also be determined.

Pushbutton operation of frequency range and Q/ $\Delta$ Q range selection provides straightforward measurement. Automatic indication of meter scales, frequency dials and frequency multipliers are featured, adding to simplicity and reading speed.

### Specifications

#### RF Characteristics

**RF range:** 22 kHz to 70 MHz in 7 bands: 22 to 70 kHz, 70 to 220 kHz, 220 to 700 kHz, 700 to 2200 kHz, 2.2 to 7 MHz, 7 to 22 MHz, 22 to 70 MHz.

**HP 4342A Opt 001:** 10 kHz to 32 MHz in 7 bands: 10 to 32 kHz, 32 to 100 kHz, 100 to 320 kHz, 320 to 1000 kHz, 1 to 3.2 MHz, 3.2 to 10 MHz, 10 to 32 MHz.

**RF accuracy:**  $\pm 1.5\%$  from 22 kHz to 22 MHz;  $\pm 2\%$  from 22 MHz to 70 MHz;  $\pm 1\%$  at "L" point on frequency dial.

**HP 4342A Opt 001:**  $\pm 1.5\%$  from 10 kHz to 10 MHz;  $\pm 2\%$  from 10 MHz to 32 MHz;  $\pm 1\%$  at "L" point on frequency dial.

**RF increments:** approximately 1% resolution.

#### Q Measurement Characteristics

**Q range:** 5 to 1000 in 4 ranges: 5 to 30, 20 to 100, 50 to 300, 200 to 1000.

**Q accuracy:** % of indicated value: (at 25°C)

	HP 4342A & HP 4342A Opt. 001	HP 4342A
Q Freq.	22 kHz-30MHz	30 MHz-70 MHz
5-300	$\pm 7$	$\pm 10$
300-600	$\pm 10$	$\pm 15$
600-1000	$\pm 15$	$\pm 20$

**Q increments:** upper scale, 1 from 20 to 100; lower scale, 0.5 from 5 to 30.

**$\Delta$ Q range:** 0 to 100 in 4 ranges: 0 to 3, 0 to 10, 0 to 30, 0 to 100.

**$\Delta$ Q accuracy:**  $\pm 10\%$  of full scale.

**$\Delta$ Q increments:** upper scale, 0.1 from 0 to 10; lower scale, 0.05 from 0 to 3.

#### Inductance Measurement Characteristics

**L range:** 0.09  $\mu$ H to 1.2 H, direct reading at 7 specific frequencies.

**L accuracy:**  $\pm 3\%$  after substitution of residuals (approx. 10 nH).

#### Resonating Capacitor Characteristics

**Capacitor range:** main dial, 25 to 470 pF, vernier dial,  $-5$  to  $+5$  pF.

**Capacitor accuracy:** main dial,  $\pm 1\%$  or 1 pF, whichever is greater; vernier dial,  $\pm 0.1$  pF.

**Capacitor increments:** main dial, 1 pF from 25 to 30 pF, 2 pF from 30 to 200 pF, 5 pF from 200 to 470 pF; vernier dial, 0.1 pF.

#### General

##### Rear Panel Outputs

**Frequency monitor:** 170 mV rms min. into 50  $\Omega$ .

**Q analog output:** 0 to 1 V  $\pm 50$  mV dc after 15 minutes warmup, proportional to meter deflection. Output impedance approximately 1 k $\Omega$ .

**Over limit signal output:** contact closure at the rear panel. Relay contact capacity 0.5 A/15 VA.

**Over limit display time:** selectable, 1 s or continuously on, after limit exceeded.

**Temperature range:** 0°C to 50°C.

**Power:** 115 or 230 V  $\pm 10\%$ , 50-400 Hz, approximately 40 VA.

**Size:** 138 mm H x 425 mm W x 414 mm D ( $5\frac{1}{8}$ " x  $16\frac{1}{2}$ " x  $16\frac{3}{16}$ ").

**Weight:** net, 14 kg (31 lb); shipping, 18.45 kg (41 lb).

##### Accessories Available

**HP 16014A series loss test adaptor:** designed for measuring low-value inductors and resistors and high-value capacitors.

**HP 16451A Dielectric Test Adapter:** designed for measuring the dielectric constant, capacitance and dissipation factor of insulating materials.

**HP 16462A Auxiliary Capacitor:** designed to extend the Q and L measurement capability of the HP 4342A Q Meter. It is especially useful for measuring small inductors at low frequencies.

**HP 16470A Reference Inductors:** A range of 20 inductors (any of which can be supplied separately) which can be used with the HP 4342A Q Meter when measuring the RF characteristics of capacitors, resistors, or insulating materials.

**HP 16470B Stable Inductors:** A set of 4 inductors (any of which are separately available) which can be used to compensate indicated Q values and/or instrumental variation in the maintenance of the HP 4342A Q Meter. They are usable over a range of 800 kHz to 50 MHz with excellent long-term temperature stability.

#### Options and Accessories

**Opt 001:** Frequency Range (10 kHz - 32 MHz)

**Opt 010:** Extra Manual

**HP 16014A Series Loss Test Adaptor**

**HP 16451A Dielectric Test Adapter**

**HP 16462A Auxiliary Capacitor**

**HP 16470A Reference Inductors, set of 20**

**HP 16470B Stable Inductors, set of 4**

**HP 16470C Complete set of 24 Inductors (HP 16470A**

**+ HP 16470B)**

**HP 4342A Q Meter**

#### Price

\$295

\$21

\$163

\$660

\$610

\$2750

\$1580

\$4280

**\$8,060**

# COMPONENT MEASUREMENT

## Milliohmmeter/High Resistance Meter

Model 4328A/4329A

- 20  $\mu\Omega$  resolution on 1 m $\Omega$  range
- Four terminal measurement
- Low test voltage

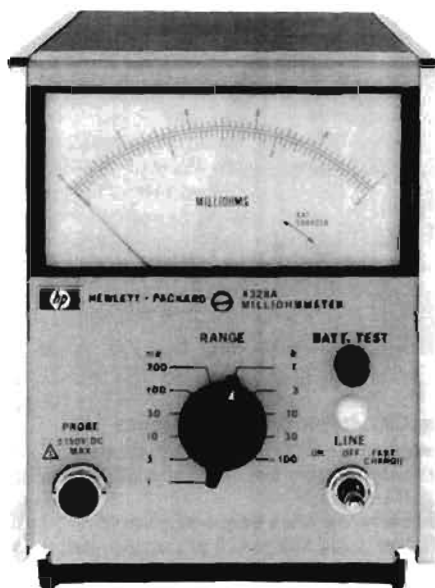

HP 4328A

### Description

HP's 4328A Milliohmmeter is a high sensitivity portable instrument for measurement of low resistances. The 1 m $\Omega$  to 100  $\Omega$  measuring range and 20  $\mu\Omega$  resolution make the HP 4328A ideal for measuring the contact resistance of switches, relays, and connectors and the resistivity of conductors and semiconductors. Series reactances of up to twice the full scale resistance will not affect the accuracy. The maximum voltage across a sample, with the instrument at the proper range, is less than 200  $\mu$ V peak. Even at incorrect range settings, the voltage across the sample will not exceed 20 mV peak.

The special probes that allow four-terminal measurement in two probes are furnished with the HP 4328A.

The basic HP 4328A is line operated but Opt 001 permits operation from rechargeable batteries for 15 continuous hours.

### Specifications

**Range:** 0.001 to 100 ohms full scale in a 1, 3 sequence.

**Accuracy:**  $\pm 2\%$  of full scale. No additional error is caused by series reactance of samples up to two times full scale

**Measuring frequency:** 1000 Hz  $\pm 100$  Hz.

**Voltage across sample:** 200  $\mu$ V peak at full scale

**Maximum voltage across sample:** 20 mV peak.

**Superimposed dc:** 150 V dc maximum (external source).

**Recorder output:** 0.1 V dc output at full scale, output resistance approx. 1 k $\Omega$ .

**Applied current (mA):** constant by range, 150/(full scale value in milliohms).

### General

**Power requirements:** 115/230 V  $\pm 10\%$ , 50 to 60 Hz, 1.5 VA.

**Weight:** 3.2 kg (7 lb).

**Size:** 155 mm H x 130 mm W x 280 mm D (6 $\frac{1}{8}$ " x 5 $\frac{1}{8}$ " x 11").

**Accessories furnished:** HP 16005A Probe, HP 16006A Probe, HP 16007A/B Test Leads and HP 16143A Probe Cable.

### Ordering Information

HP 4328A Milliohmmeter

Opt 001: Rechargeable battery operation

Opt 910: extra manual

Price

\$2000

\$130

\$15

- Wide range: 500 k $\Omega$  to  $2 \times 10^{16} \Omega$
- Selectable test voltages: 10 V to 1000 V

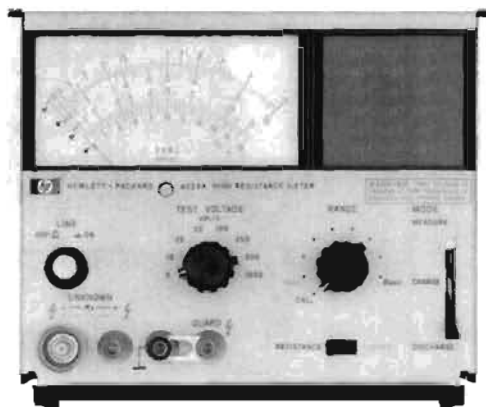

HP 4329A

### Description

The HP 4329A is a solid-state insulation resistance meter designed for easy, accurate and direct readings of the very high resistance values typically found in synthetic resins, porcelain, insulating oils and similar materials. It is also useful for measurements in electrical components such as capacitors, transformers, switches and cables. Seven fully regulated dc test voltages (between 10 and 1000 Vdc) are provided as test sources.

The HP 4329A is instantly convertible from ungrounded-to-grounded-sample operation via a simple relocation of the front panel ground strap from "guard" to "+" position.

The HP 4329A also has a current measurement capability. Minute currents as low as 0.05 pA can be readily measured.

The HP 16008A Resistivity Cell, designed for use with the HP 4329A, can safely, rapidly and conveniently measure the volume and surface resistivity of sheet insulation materials (maximum sample size: 125 mm W x 125 mm D x 7 mm H).

### Specifications

#### Resistance Measurement

**Range:** 500 k $\Omega$  to  $2 \times 10^{16} \Omega$ . (Depends on the test voltage).

**Accuracy:** total accuracy is determined by test voltage and range used. At low resistance end of each scale, accuracy is  $\pm 3\%$ , near center scale  $\pm 5\%$ , and near the specified upper limit on the meter scale (a quarter of full scale), accuracy is  $\pm 10\%$ . Accuracy is not specified above these limits. On all voltage ranges, if multiplier is set to Rmax., an additional  $\pm 3\%$  is included.

**Test voltages:** 10 V, 25 V, 50 V, 100 V, 250 V, 500 V and 1000 V  $\pm 3\%$ .

#### Current Measurement

**Range:**  $5 \times 10^{-14}$  to  $2 \times 10^{-5}$  A in 8 ranges.

**Accuracy:**  $\pm 5\%$  of full scale deflection (there can be an additional  $\pm 3\%$  error at the top decade).

### General

**Recorder output:** 0 to 100 mV dc, proportional to meter deflection; 1 k $\Omega$  output resistance.

**Power:** 115/230 V  $\pm 10\%$ , 50-60 Hz, approximately 3 VA.

**Size:** 155 mm H x 198 mm W x 204 mm D (6 $\frac{1}{8}$ " x 7 $\frac{7}{8}$ " x 8 $\frac{1}{8}$ ").

**Weight:** 3.5 kg (7.7 lb).

**Accessory furnished:** HP 16117A Low Noise Test Leads.

**Accessory available:** HP 16008A Resistivity Cell.

### Ordering Information

HP 16008A Resistivity cell

HP 4329A High resistance meter

Opt B10: extra manual

Price

\$1020

\$2600

\$15

# COMPONENT MEASUREMENT

## Standard Capacitor Set and Decade Capacitor

Models 16380A, 16380C, 4440B

297

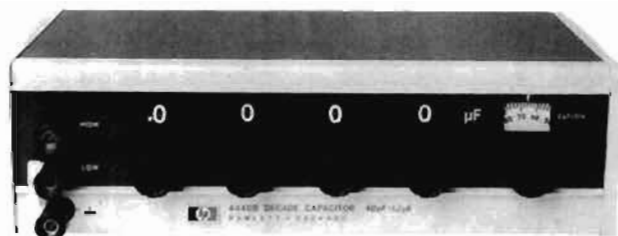

### HP 16380A, HP 16380C Description

The HP 16380A and HP 16380C are precision standard capacitor sets that cover the range of 1 pF to 1  $\mu$ F in decade steps. The HP 16380A consists of four discrete air-dielectric capacitors with nominal values of 1 pF, 10 pF, 100 pF, and 1000 pF. Similarly, the HP 16380C consists of four discrete capacitors, but with solid dielectrics and with nominal values of 0.01  $\mu$ F, 0.1  $\mu$ F, and 1  $\mu$ F.

Both the HP 16380A and HP 16380C are furnished with test certification of 0.01% calibration accuracy. Capacitance stability with respect to time varies from capacitor to capacitor but is specified in the range of  $\pm 50$  or  $\pm 300$  ppm/year.

The HP 16380A and HP 16380C both have the four-terminal pair configuration to allow direct connection to any of Hewlett-Packard's many four-terminal pair impedance measuring instruments. The HP 16380A/C can be easily adapted to two-, three-, and five-terminal configurations.

### HP 16380A, 16380C Specifications (valid at 1 kHz, $23 \pm 5^\circ\text{C}$ )

Capacitance	1 pF	10 pF	100 pF	1000 pF
Nominal Accuracy			$\pm 0.1\%$	
Calibration Accuracy			$\pm 0.01\%$	
Stability			$< 300$ ppm/yr	
Dissipation Factor			$< 0.0001$	
Dimensions	112 mm (H) x 142 mm (W) x 88 mm (D)			
Weight	8.0 kg (includes case)			

### HP 16380C

Capacitance	0.01 $\mu$ F	0.1 $\mu$ F	1 $\mu$ F
Nominal Accuracy			$\pm 0.1\%$
Calibration Accuracy			$\pm 0.01\%$
Stability			$< 50$ ppm/yr
Dissipation Factor	$< 0.0004$	$< 0.0005$	$< 0.0007$
Dimensions	117 mm (H) x 142 mm (W) x 88 mm (D)		
Weight	6.3 kg (includes case)		

### HP 4440B Description

The Hewlett-Packard 4440B Decade Capacitor is a high accuracy instrument providing usable capacitances from 40 pF to 1.2  $\mu$ F. Its 0.25% accuracy makes it an ideal aid for circuit design or as a working standard.

The use of silvered-mica capacitors in all four decades provides higher accuracy, lower dissipation factor and good temperature coefficient. An air capacitor vernier provides 100 pF (from 40 pF to 140 pF) with resolution of 1 pF. Capacitors are housed in a double shield in such a way that increased capacitance from two terminals to three terminals is held to 1 pF.

### 4440B Specifications

**Capacitance:** 40 pF to 1.2  $\mu$ F in steps of 100 pF with a 40 pF to 140 pF variable air capacitor providing continuous adjustment to better than 2 pF between steps.

**Direct reading accuracy:**  $\pm(0.25\% + 3 \text{ pF})$  at 1 kHz for three-terminal connection.

**Resonant frequency:** typical values of the resonant frequency are 450 kHz at 1  $\mu$ F, 4 MHz at 0.01  $\mu$ F and 40 MHz at 100 pF

**Dissipation factor:** for  $C \geq 1040$  pF, 0.001 max. at 1 kHz.  
for  $C < 1040$  pF, 0.005 max. at 1 kHz.

**Temperature coefficient:**  $< +70$  ppm/ $^\circ\text{C}$ .

**Insulation resistance:** 5 G $\Omega$  minimum, after 5 minutes at 500 V dc.

**Maximum voltage:** 42 Vdc or 30 Vrms.

**Weight:** net, 2.5 kg (5 1/2 lb); shipping, 3.6 kg (8 lb).

**Size:** 76 mm H x 264 mm W x 152 mm D (3" x 11" x 6").

### Ordering Information

HP 16380A Standard Capacitor Set (1 pF, 10 pF, 100 pF, 1000 pF)

HP 16380C Standard Capacitor Set (0.01  $\mu$ F, 0.1  $\mu$ F, 1  $\mu$ F)

HP 4440B Decade Capacitor

### Price

\$2955

\$3775

\$1425



# COMPONENT MEASUREMENT

Standard Capacitor Set and Device Capacitors



Figure 1



Figure 2

The first of the two capacitors is a 100 pF capacitor. The second is a 10 nF capacitor. The third is a 100 nF capacitor. The fourth is a 1000 nF capacitor. The fifth is a 10000 nF capacitor. The sixth is a 100000 nF capacitor. The seventh is a 1000000 nF capacitor. The eighth is a 10000000 nF capacitor. The ninth is a 100000000 nF capacitor. The tenth is a 1000000000 nF capacitor.

The first of the two capacitors is a 100 pF capacitor. The second is a 10 nF capacitor. The third is a 100 nF capacitor. The fourth is a 1000 nF capacitor. The fifth is a 10000 nF capacitor. The sixth is a 100000 nF capacitor. The seventh is a 1000000 nF capacitor. The eighth is a 10000000 nF capacitor. The ninth is a 100000000 nF capacitor. The tenth is a 1000000000 nF capacitor.

The first of the two capacitors is a 100 pF capacitor. The second is a 10 nF capacitor. The third is a 100 nF capacitor. The fourth is a 1000 nF capacitor. The fifth is a 10000 nF capacitor. The sixth is a 100000 nF capacitor. The seventh is a 1000000 nF capacitor. The eighth is a 10000000 nF capacitor. The ninth is a 100000000 nF capacitor. The tenth is a 1000000000 nF capacitor.

The first of the two capacitors is a 100 pF capacitor. The second is a 10 nF capacitor. The third is a 100 nF capacitor. The fourth is a 1000 nF capacitor. The fifth is a 10000 nF capacitor. The sixth is a 100000 nF capacitor. The seventh is a 1000000 nF capacitor. The eighth is a 10000000 nF capacitor. The ninth is a 100000000 nF capacitor. The tenth is a 1000000000 nF capacitor.

Component	Value
1	100 pF
2	10 nF
3	100 nF
4	1000 nF
5	10000 nF
6	100000 nF
7	1000000 nF
8	10000000 nF
9	100000000 nF
10	1000000000 nF

## SOURCES/ANALYZERS

<b>Fiber Optic Test Equipment .....</b>	<b>300</b>
<b>Data Generators &amp; Data Analyzers.....</b>	<b>310</b>
<b>Vector Modulation Generators &amp; Analyzers .....</b>	<b>318</b>
<b>Transceiver Test Equipment.....</b>	<b>322</b>
<b>Microwave Test Equipment.....</b>	<b>326</b>
<b>Dimensional Measurements.....</b>	<b>342</b>
<b>Pressure &amp; Temperature.....</b>	<b>344</b>

Some HP products combine the functions of source and analyzer. These products usually take the form of matched stimulus and response test equipment that together can characterize a wide range of components and systems. These products include fiber optic test equipment, data generators and analyzers, transceiver test equipment, and vector generators and analyzers. Also included in this group are auxiliary components such as microwave couplers and detectors (microwave test equipment), amplifiers, and sensors.

Sources/Analyzers

# FIBER OPTIC TEST EQUIPMENT

## General Information

Probably the most remarkable fact about the evolution of fiber optics has been their rapid market growth. Design work began some twenty years ago, with trial projects carrying live telephone traffic being installed ten years later. Today, optical fibers are mass-produced for many applications worldwide.

### Technical Background

In general, all fiber optic systems incorporate the following elements: transmitters, fibers, repeaters, and receivers, all of which are linked by connectors and/or splices.

Today, size, lifetime, reliability and ruggedness are major factors in the choice of sources and receivers for optical communication links.

Sources employ LED's or LD's (laser diodes) to generate the optical output, while APD's or PIN diodes are used to detect the incident optical power on the receiving side.

### Optical Sources

LED's are primarily used in short distance systems (<10km) with data rates below 100MHz. A limiting factor is their broad spectral width and the low coupling efficiency compared with an LD. Advantages are their simpler drive electronics, a higher reliability, and the lower price.

LD's, on the other hand, feature a small spectral width, an excellent coupling efficiency, and reach data rates up to 2 GHz. Thus LD's enable repeaterless data transmission over great distances (40km).

### Optical Fibers

Inside the fiber, light is guided by total reflection at the core/cladding boundary due to corresponding differences in the refractive indices. Fibers employed as transmission media fall into three categories:

**Step Index Fiber.** Nowadays this type is of less importance due to its low bandwidth (<5MHz), high multimode dispersion, and high attenuation. Mainly used in industrial applications (in avionics, vessels, or automobiles).

**Graded Index Fiber.** This type features higher data rates (up to 800MHz x km), a lower dispersion and attenuation. This fiber is frequently used in datacom or LAN applications.

**Single-Mode Fiber.** This fiber is preferred when highest data rates are required. Based on data rates up to 100GHz x km and low dispersion and attenuation, this fiber is the ideal transmission media in long-haul telecommunication systems.

### Optical Receivers

To convert light back into an electrical signal for further processing PIN diodes serve as receiving detectors when high data rates are required. This property is combined with favorable linearity and high stability. When increased sensitivity is of major concern, APD's are preferred. Due to their non-linearity, APD's are used only for purely digital applications, while PIN diodes can be used in both analog and digital systems.

### Fiber Optic Test Environments

HP's line of fiber optic test equipment offers new measurement capabilities for design and production engineers in a number of different application areas.

### Computers

The increasing sophistication of computers and their distributed services, prompted by the need for greater data handling capabilities and higher memory densities, has resulted in a demand for fiber optic systems. Major application areas include the mutual interfacing of central processors, the linking of them to peripheral devices, and data transmission within the mainframe. Reduced bit error rates — free from environmental interference — are assured.

### Local Area Networks

The development of Local Area Networks has been stimulated by the availability of low-cost, intelligent, digital terminal hardware and the trend towards distributed data acquisition and processing. Here also, optical fibers often serve as the transmission medium in networks which may be configured as ring, star or bus structures. Such systems are primarily installed in business environments to support office operations, manufacturing facilities or private automatic branch exchanges; they all take advantage of the absence of crosstalk, electromagnetic interference or echoes — often a problem in twisted pair and coax systems.

### Industrial Electronics

Industrial environments represent an ideal market for numerous fiber optic applications. Examples include power plants, railroad networks and the metal industry, where data acquisition, control and process signals need to be transmitted, without being affected by strong electromagnetic fields.

Some automobile and avionics manufacturers have begun to install optical fibers instead of copper cables to increase safety and reliability, and to save weight.

Fiber optic sensors are gaining importance in hazardous environments to monitor chemical, biological, and physical processes.

### Telecommunications

The telecommunications industry has traditionally been the sphere of greatest interest and highest investment for fiber optics technology. The majority of resources are employed to investigate, design and install new information transfer and processing equipment; long-haul transmission systems (submarine fiber optic cables linking continents,

for example), and networks in high traffic environments.

### Measurement Problems and Solutions

Designers, manufacturers and end-users of fiber optic components, modules or systems face a large variety of measurement tasks. These tasks range from physical measurements, such as fiber geometry or numerical aperture, to system performance tests in the time or frequency domain.

HP offers three powerful lines of fiber optic test instruments. The first line consists of the HP 8150A Optical Signal Source, the HP 8151A Pulse Power Meter, and the HP 81511/81512A Optical Heads. This test equipment offers new ways to perform parametric tests with reliable and repeatable results in the 850 and 1300nm wavelength range.

Testing the sensitivity or defining the pulse response of a receiver demands a stimulus such as the HP 8150A. With the help of this instrument, it is an easy task to perform parametric tests at calibrated levels, under fully-specified and precisely-controlled conditions.

Its counterpart the HP 8151A, together with the HP 81511/81512A, provides technicians and engineers with an ideal tool for verifying analog and digital power level parameters in terms of peak and average power.

The second line consists of the HP 8152A Optical Average Power Meter with two different optical heads for the 450–1700nm range, the HP 8154B LED Sources for 850nm, 1300nm and 1550nm (option 001, 002, and 003), the HP 8155A LD Sources for 1300nm and 1550nm (option 002 and 003), the HP 8157A Optical Attenuator for 1200–1650nm, single-mode, the HP 8158B Optical Attenuators for 600–1200nm and 1200–1650nm (option 001 and 002), for multimode and single-mode, and the HP 8159A Optical Switch.

The HP 8152A features excellent accuracy (directly traceable to NBS and PTB) and linearity (typically better than 1%) for absolute and relative power measurements.

The 8157A Optical Attenuator offers very high optical return loss and polarization insensitivity for tests on your fastest transmitters and automated bit error rate measurements. The HP 8158B Optical Attenuator is very flexible as it handles all fibers with an NA <0.3.

And the HP 8154B LED Sources and HP 8155A LD Sources serve as very stable stimuli for insertion loss measurements. The HP 8159A Optical Switch allows to automate these reference measurements.

The third line consists so far of one instrument, the HP 8145A Optical Time Domain Reflectometer. It is a portable, high performance unit for field maintenance and applications in a factory environment. Large dynamic range and superb measurement speed are its main contributions.

# FIBER OPTIC TEST EQUIPMENT

## Optical Signal Source

301

Model 8150A

- E/O transducer capability with 250 MHz bandwidth
- Calibrated output power levels from 1 nW to 2 mW

- Built-in modulator (50 MHz)
- Wavelength 850 nm  $\pm$  15 nm

### HP 8150A Specifications

#### Optical Characteristics

**Wavelength:** 850nm  $\pm$  15nm

**Output:** 50/125 $\mu$ m graded index, multimode; NA=0.2

#### Transducer Mode

**Conversion range:** 1.80nW/V to 1.80mW/V

**Absolute accuracy:**  $\pm$  2dB of setting

**Relative accuracy:**  $\pm$  0.5dB of setting

**Stability:**  $\pm$ 0.05dB (12 hours, T <  $\pm$  2°C)

**Electrical input swing:** 0.1 V<sub>pp</sub> to 1.0V<sub>pp</sub>

**Electrical input window:**  $\pm$  0.5V

**Input impedance:** 50 Ohm

**Offset compensation range:**  $\pm$  1.2V

**Bandwidth:** DC to 170MHz @ - 1.5dB,  
to 250MHz @ -3.0dB)

**Flatness:**  $\pm$  0.25dB (1Hz to 99.9kHz),  
 $\pm$  0.5dB (100kHz to 9.99MHz),  
 $\pm$  1.5dB (10MHz to 170MHz)

**Pulse response:** < 2.0ns; perturbations: < 15% of amplitude

#### Modulator Mode (using internal pulse/function generator)

##### Output power

**High level:** 1.18nW to 2.00mW; **Low level:** 1.00nW to 1.01mW

**Mesial level:** 1.09nW to 1.10mW;

**Extinction ratio:** 1.18 to 10.0

**Accuracy High/Low/Mesial level (at 30Hz):**  $\pm$  2dB

**Accuracy Extinction ratio (at 30Hz):**  $\pm$  20%

#### Timing Parameters of Internal Modulator

**Frequency Range:** 1mHz to 50MHz (3 digit resolution)

**Operating modes:** Normal, Ext. Trigger\*/Gate\*/Width, Int. Trigger\*/Gate\*

\*Selectable ( $-90^\circ$ ) start phase for haversine/havertriangle

**Control Modes:** FM, AM, PWM and VCO

#### General

##### HP-IB capability

**Interface functions:** SH1, AH1, T6, L4, SR1, RL1, PP0, DC1, DT1, C0

**Recalibration period:** 1 year

##### Environmental

**Storage temperature:** - 40°C to + 65°C

**Operating temperature:** 0°C to + 55°C

**Humidity:** 95% R.H. from 0°C to + 40°C

**Power:** 100/120/220/240 Vrms; + 5%, - 10%, 48 - 66 Hz, 140 VA max

**Weight:** net 12.5kg (27lbs), shipping 16.5kg (36.3lbs)

**Size:** 133mm(H) x 426mm(W) x 422mm(D) (5.2" x 16.8" x 16.6")

#### Ordering Information

HP 8150A Optical Signal Source

Opt 907: Front handle kit HP P/N 5061-9689

Opt 908: Rack mount kit HP P/N 5061-9677

Opt 909: Rack flange and handle combination kit

HP P/N 5061-9683

Opt 910: Extra operating and service manual

HP 15475A: Cleaning kit (supplied with instrument)

\*For fiber optic cables, see "Fiber Optic Test Accessories" on page 307.

☛ Fast-Ship product—see page 758.

#### Prices

\$16,500

\$65 ☛

\$32.50 ☛

\$80 ☛

\$60

\$102



HP 8150A



The HP 8150A is a universal light stimulus for the parametric testing of fiber optic components and systems employing an LD with an 850 nm center-wavelength. The instrument's transducer permits the conversion of both digital and analog electrical signals up to 250 MHz ( $-3$  dBm) into their optical equivalents. The internal modulator features additional capabilities which allow the HP 8150A to function as pulse/function generator with an optical output. All specifications refer directly to the open end of the 2m pigtail fiber and provides the user with well-defined signal conditions at his device under test.

#### Transducer

In the transducer operating mode, the HP 8150A can be adapted to the user's absolute power level requirements with an adjustable gain from 1.80 nW/V to 1.80 mW/V. Transition times of less than 2 ns ensure the generation of clean, high-speed digital signals up to 250 MHz. Its large bandwidth and optical power range make the HP 8150A a suitable tool for testing large optical systems.

#### Modulator

The modulator operating mode offers a straightforward method for generating accurate, calibrated, repeatable power levels, by simply programming high or low power values at the frontpanel, or via the HP-IB. In addition, the mesial power level (50% amplitude level) and extinction ratio values (high/low power) of signals are selectable, allowing the user to simulate attenuation effects of fiber optic systems. A rearpanel monitor output allows the permanent control of the electrical signal responsible for modulating the transducer. The internal modulator also offers the choice of various waveforms with adjustable duty cycles or true pulses with variable width. A host of other features, such as FM, AM, PWM and VCO, can be externally and internally activated and contribute to the versatility of the HP 8150A as a stimulus for fiber optic system and automated bench applications.

#### Traceability and safety

The specifications of the HP 8150A are traceable to the NBS in the USA and other national standard bureaus, such as the PTB in Germany.

A set of safety features are provided in order to meet international safety regulations. The ON/OFF safety key, remote interlock facility and appropriate safety labeling are other standard HP 8150A features which help eliminate hazards to the operator.

# FIBER OPTIC TEST EQUIPMENT

## Optical Pulse Power Meter

Model 8151A with 81511A/81512A

- Peak and average power measurements
- Accuracy  $\pm 2.5\%$
- O/E transducer capability

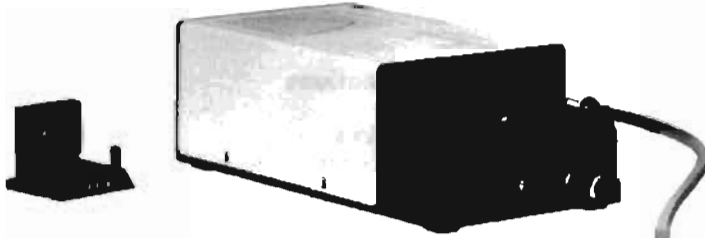

HP 81510A

HP 81511A

The HP 8151A, in combination with the HP 81511A/81512A Optical Heads, is a response measuring instrument for the level characterization of fiber optic components, modules and systems. In addition to performing average power measurements, the HP 8151A enables the user to accurately determine upper and lower peak power levels - important in digital applications. This feature is also useful for applications where non-repetitive signals need to be evaluated, or where threshold levels are to be determined. The instrument's versatility is further enhanced by capabilities which allow the user to measure the amplitude, mesial power and extinction ratio of a signal.

The instrument's transducer has a frequency range of 250MHz, and outputs an electrical signal which corresponds directly to the optical input waveform. The transducer output can be applied to other instruments for further processing, or displayed on an oscilloscope. By using the transducer, timing related measurements as functions of optical power (e.g. propagation delay versus power) are possible.

HP-IB programmability is a standard feature of this instrument, (thereby giving the user total remote control of all power meter functions).

### HP 81511A and HP 81512A Optical Heads

These products complement the operation of the HP 8151A Optical Pulse Power Meter. The HP 81511A Optical Head is for use at operating wavelengths between 550 and 950nm (calibrated for 850nm), and the HP 81512A for use between 900 and 1725nm (calibrated for 1300nm). The HP 8151A cannot be operated without an optical head. All heads carry interface adapters for fiber connectors and bare fibers. The manual z-microdrive facilitates the optimum coupling of the fiber end to the PIN diode in the head. The HP 8151A's front panel trend meter assists in determining the coupling efficiency.

A calibration grid on top of each optical head indicates typ. correction factors to be entered into the HP 8151A for operating wavelengths other than that for which the head is calibrated. Thus, the HP 8151A can be adapted to operate at any wavelength in the 550 to 1725nm range.

### HP 8151A Specifications

#### Optical Characteristics of HP 81511A/81512A Optical Heads

**Wavelength range** HP 81511A: 550 to 950nm, cal for 850nm  
 HP 81512A: 900 to 1725nm, cal for 1300nm  
**Maximum core diameter:** HP 81511A: 200 $\mu$ m  
 HP 81512A: 100 $\mu$ m

#### Optical Power Measurements

**Parameters measured:** high, low, and mesial power levels, amplitude, extinction ratio, average power

**Measurement range:** HP 81511A: +10dBm to -60dBm  
 HP 81512A: 0dBm to -50dBm

**Resolution:** 3 digits (Watts), 1pW min.  
 4 digits (dB), 0.01dB min.



HP 8151A



**Accuracy:** (applies to linear display in Watt, rel. to calibration):

Range [dBm]	$\pm$ (of read + counts)	HI/Low Peak Power		Average Power $\pm$ (of read + counts)
		Flatness		
+10 <sup>1</sup>	0.3 dB $\pm$ 5	200 Hz - 9.99MHz: $\pm 0.4$ dB of ampl. <sup>2</sup>		0.1 dB $\pm$ 5
0	0.3 dB $\pm$ 30 <sup>2</sup>	10 MHz - 99.9 MHz: $\pm 0.6$ dB of ampl. <sup>2</sup>		0.1 dB $\pm$ 5
-10	0.35 dB $\pm$ 50			0.1 dB $\pm$ 5
<b>Bandwidth</b>				
-20	0.2 dB $\pm$ 10	10kHz		0.1 dB $\pm$ 5
-30	0.2 dB $\pm$ 10	6kHz		0.1 dB $\pm$ 5
-40	0.2 dB $\pm$ 20 <sup>2</sup>	1kHz <sup>2</sup>		0.15 dB $\pm$ 10 <sup>2</sup>
-50	0.2 dB $\pm$ 50 <sup>2</sup>	1kHz <sup>2</sup>		0.2 dB $\pm$ 50 <sup>2</sup>
-60 <sup>1</sup>	0.3 dB $\pm$ 80 <sup>2</sup>	4kHz <sup>2</sup>		0.2 dB $\pm$ 50 <sup>2</sup>

1) not valid for HP 81512A 2) better specifications for HP 81511A

#### Transducer (opto-electric conversion)

Actual waveform depends on measurement range. Calibrated for 850nm (HP 81511A)/1300nm (HP 81512A).

#### Conversion Accuracy (for 30Hz squarewave):

Range [dBm]	Conversion Factor DC	Accuracy of Conversion	Bandwidth w/o Lowpass	rms Noise [dBm]
+10 <sup>1</sup>	1V/10mW <sup>2</sup>	$\pm 0.3$ dB $\pm 10$ mV <sup>1</sup>	DC-250MHz <sup>2</sup>	-20 <sup>1</sup>
0	1V/1mW	$\pm 0.3$ dB $\pm 10$ mV	DC-250MHz <sup>2</sup>	-20 <sup>1</sup>
-10	1V/1mW	$\pm 0.35$ dB $\pm 20$ mV	DC-250MHz <sup>2</sup>	-30
-20	1V/10 $\mu$ W	$\pm 0.3$ dB $\pm 20$ mV	DC-10 kHz	-40 <sup>2</sup>
-30	1V/1 $\mu$ W	$\pm 0.3$ dB $\pm 20$ mV	DC-6 kHz	-50 <sup>2</sup>
-40	1V/1 $\mu$ W	$\pm 0.3$ dB $\pm 20$ mV	DC-1 kHz <sup>2</sup>	-60 <sup>2</sup>
-50	1V/10nW	$\pm 0.3$ dB $\pm 50$ mV <sup>2</sup>	DC-1 kHz <sup>2</sup>	-60 <sup>2</sup>
-60 <sup>1</sup>	1V/1nW <sup>1</sup>	$\pm 0.3$ dB $\pm 20$ mV <sup>1</sup>	DC-4 kHz <sup>2</sup>	-70 <sup>1</sup>

1) for HP 81511A only 2) 150MHz for HP 81512A 3) better specifications for HP 81511A

#### Pulse Response

**Transition time:**  $\leq 2$ ns (full bandwidth) ( $\leq 3$ ns for HP 81512A)

**Perturbations:**  $\leq 10\%$  of amplitude

#### General

##### HP-IB capability

**Interface functions:** SH1, AH1, T6, L4, SR1, RLI, PP0, DC1, DT1, C0

**Recalibration period:** 1 year

##### Environmental

**Storage temperature:** -40°C to +70°C

**Operating temperature:** 0°C to +55°C.

**Humidity:** 95% R.H. from 0°C to +40°C

**Power:** 100/120/220/240 Vrms;  $\pm 5\%$ , -10%, 48 to 66Hz, 100VA max.

**Weight:** HP 8151A: net 8kg (17.5lbs), shipping 10kg (22lbs)

HP 81511A: net 1.3kg (2.9lbs), shipping 2kg (4.4lbs)

HP 81512A: same as for HP 81511A

**Size:** HP 8151A: 140mm(H) x 220mm(W) x 530mm(D) (5.7" x 9" x 21.6")

HP 81511A: 60mm(H) x 96mm(W) x 200mm(D) (2.5" x 3.9" x 8.2")

HP 81512A: same as for HP 81511A

#### Ordering Information

HP 8151A Optical Pulse Power Meter

Opt 907: Front handle kit HP P/N 5061-9689

Opt 908: Rack mount kit HP P/N 5061-9657

Opt 910: Extra operating and service manual

HP P/N 08151-90001

HP 81511A Optical Head 550 to 950nm

HP 81512A Optical Head 900 to 1725 nm

Note: The HP 8151A cannot be used without an optical head and connector adapter. For connector adapters and cleaning kit, see 'Fiber Optic Test Accessories' on page 307

Fast-Ship product—see page 758.

#### Price

\$7650

\$ 65~~2~~

\$ 42~~2~~

\$ 60

\$3800

\$5100



- Calibrated O/E conversion
- DC to 400 MHz bandwidth
- $\pm 0.3\text{dB}$  conversion accuracy

- Insertion loss  $< 3.5\text{dB}$  incl. two connectors
- Crosstalk attenuation  $> 50\text{dB}$
- Repeatability  $0.2\text{dB}$



HP 81519A



HP 8159A



The HP 81519A is a linear transducer which converts optical signals into their electrical equivalents. The instrument is designed as a front-end interface to conventional electronic test equipment and as a general purpose receiving device for testing fiber optic modules and systems.

A PIN diode, calibrated at 850nm, serves as opto/electric converter in the range between 550 and 950nm. The characteristic curve on top of the instrument indicates the transducer gain in this range.

With the wide demodulation frequency band of DC to 400 MHz and an intrinsic transition time of less than 1.1 ns, the HP 81519A is a valuable tool for testing fiber optic devices in computer, local area network and aerospace applications. When operating in conjunction with other equipment, measurements such as pulse response and bandwidth in the time and frequency domains can be performed accurately.

With the adjustable offset, the conversion window can be conveniently shifted between 0 and 1 mW in accordance with the optical input power.

### HP 81519A Specifications

#### Optical Characteristics

**Wavelength range:** 550 to 950 nm, cal for 850 nm  
**Input:** Adapts to core diameters up to 80  $\mu\text{m}$ ; N.A.  $\leq 0.2$   
**Input swing:** 1 mW (min. low level 0mW, max. high 1.5 mW)  
**Input connector:** Diamond<sup>®</sup> HFS1  
**Connector uncertainty:**  $\pm 0.1\text{ dB}$

#### Transducer Characteristics

**Conversion, opto/electric**  
**Conversion gain:**  $-1\text{ V/mW}$ ; **Accuracy:**  $\pm 0.3\text{dB} \pm 10\mu\text{W}$   
**Small signal bandwidth:** DC to 400 MHz (@  $-3.0\text{dB}$ )  
**Flatness of conversion:**  $\pm 0.3\text{dB}$  (DC to 150 MHz)  
**NEP:**  $< 700\text{nW}$  (rms); **Distortion:** typ. 20dB (40dBel.)

#### Output (Into 50 Ohm)

**Range:**  $\pm 0.5\text{V}$ ; Output impedance: 50 Ohm  $\pm 2\%$

#### Response

**Transition time:**  $\leq 1.1\text{ ns}$ ; Perturbations:  $< 10\%$  of ampl.

#### General

##### Environmental

**Storage temperature:**  $-40^\circ\text{C}$  to  $+70^\circ\text{C}$   
**Operating temperature:**  $0^\circ\text{C}$  to  $+55^\circ\text{C}$   
**Humidity:** 95% R.H. from  $0^\circ\text{C}$  to  $+40^\circ\text{C}$   
**Power:** 115/230 Vrms,  $\pm 10\%$ ,  $-22\%$ , 48 to 66 Hz, 16VA max  
**Weight:** net 1.7 kg (3.6 lbs), shipping 2.4 kg (5 lbs)  
**Size:** 95mm(H) x 105mm(W) x 345mm(D) (3.8" x 4.3" x 13.6")

#### Ordering Information

HP 81519A Optical Receiver  
 Opt 910: Extra operating and service manual

#### Price

\$3100  
 \$ 20

The HP 8159A Optical Switch features two optical inputs,  $A_{in}$  and  $B_{in}$ , and two outputs,  $A_{out}$  and  $B_{out}$ . The following switch combinations can be chosen either manually or via HP-IB:  $A_{in}$  to  $A_{out}$ ,  $B_{in}$  to  $B_{out}$  or  $A_{in}$  to  $B_{out}$ .

In areas where reference measurements are of great interest, e.g. in production environments, the HP 8159A helps to save valuable test time, formerly spent for time-consuming re-connections between the device under test and the reference power meter. Full programmability permits R & D or production engineers to truly automate their measurements.

The high switching rate of 20Hz shortens the measuring time, thus increasing the throughput. With excellent switching repeatability of 0.2dB and high performance Diamond<sup>®</sup> connectors, the HP 8159A specifically assists the user in performing accurate, reliable and repeatable measurements.

The HP 8159A features customer-exchangeable connector adapters to accommodate Diamond<sup>®</sup> HMS-10/HP, FC/PC, DIN 47256 and ST connectorized optical cables.

### HP 8159A Specifications

#### Optical Characteristics

**Fiber type:** 50/125 $\mu\text{m}$ , G.I.  
**Numerical aperture:**  $0.2 \pm 0.02$   
**Input/Output connector:** Diamond<sup>®</sup> HMS-10/HP, FC/PC, DIN 47256, ST

**Insertion loss** (incl. 2 connectors, for all switching paths):  $< 3.5\text{dB}$

**Typical:**  $< 2.8\text{dB}$

**Switch repeatability** (1000 cycles,  $\pm 2^\circ\text{C}$  window): 0.2dB window

**Crosstalk attenuation:**  $> 50\text{dB}$

#### Supplementary Performance Characteristics

**Wavelength range:** 780 - 1350nm  
**Switching rate:** 20 Hz  
**Settling time:**  $< 25\text{ms}$   
**Lifetime:**  $10^6$  cycles

#### General

**HP-IB capability**  
**Interface function:** SH1, AH1, T6, L4, SR1, RLI, PP0, DC1, DT0, C0

#### Environmental

**Storage temperature:**  $-40^\circ\text{C}$  to  $+75^\circ\text{C}$   
**Operating temperature:**  $0^\circ\text{C}$  to  $+55^\circ\text{C}$   
**Humidity:**  $< 95\%$  R.H. from  $0^\circ\text{C}$  to  $+40^\circ\text{C}$   
**Power:** 100/120/220/240Vrms, 48 - 400Hz,  $\pm 5\%$ ,  $-10\%$ , 35VA max

**Weight:** net 3.75kg (8.3lbs), shipping 7.8kg (17.2lbs)  
**Size:** 89mm(H) x 212.3mm(W) x 345mm(D) (3.5" x 8.36" x 13.6")

#### Ordering Information

HP 8159A Optical Switch  
 Opt 907: Front handle kit HP P/N 5061-9688  
 Opt 908: Rack flange kit HP P/N 5061-9672  
 Opt 910: Add. operating and service manual  
 P/N 5061-9701 Bail handle kit

#### Price

\$4785  
 \$50<sup>☛</sup>  
 \$50<sup>☛</sup>  
 \$40  
 \$38<sup>☛</sup>

☛ Fast-Ship product—see page 758.

# FIBER OPTIC TEST EQUIPMENT

## Optical Average Power Meter

Model 8152A/81520A/81521B

- Two optical inputs
- Optical heads individually calibrated from 450 to 1700nm
- Multi- and single-mode
- 1% typical linearity



HP 8152A



The HP 8152A Optical Average Power Meter and its optical heads provide the accuracy and versatility for absolute and relative power measurements in a fiber optic test environment. Applications range from output power measurement of active optical components, or loss/attenuation measurement of passive optical components, to ratio measurement of power splitters.

Individually calibrated optical heads ensure highly precise measurement results over the entire wavelength range from 450 to 1700nm. After entering the operating wavelength, the appropriate sensitivity correction factor will automatically be taken into account to ensure the correct measurement value is displayed.

The combination of 2 independent optical inputs, the capability to perform ratio measurements, plus an HP 81000AS/BS Optical Power Splitter provides a fast, easy solution to determine the power ratio of an optical splitter or eliminating the instabilities of an optical source.

All functions can be set manually via front panel controls, or programmed via HP-IB for complete remote control. The HP 8152A is therefore an ideal tool for departments such as R&D, production and incoming evaluation.

### HP 8152A/81520A/81521B Specifications

	81520A	81521B
Wavelength Range	450-1020nm	900-1700nm
Measurement Range	+10 to -100dBm	+3 to -80dBm
Resolution	0.01dB, 0.1pW	0.01dB, 10pW
Absolute Accuracy	±4%	±5%
Linearity (typ.)	±0.05dB (1%)	±0.05dB (1%)
Sensor Element	cooled Si PIN diode	cooled Ge PIN diode
Sensor Diameter	5mm	5mm
Bandwidth (typ.)	700Hz	700Hz

### General

#### HP-IB capability

Interface function: SH1,AH1,T6,L4,SR1,RL1,PP0,DC1,DT1,C0

Recalibration period: 1 year

Warm-up time: 15 minutes

#### Environmental

Storage temperature: -40°C to +75°C

Operating temperature: 0°C to +55°C

Humidity: <95% R.H. from 0°C to +40°C

Power: 100/120/220/240Vrms, +5%, -10%, 90VA max., 48-400Hz

Weight: HP 8152A: net 4.3kg (9.5lbs), shipping 8.6kg (19lbs)

HP 81520A/21B: net 0.45kg (1lbs), shipping 1kg (2.2lbs)

Size: HP 8152A: 89mm(H) x 212.3mm(W) x 345mm(D)  
(3.5" x 8.36" x 13.6")

HP 81520A/21B: 37.7 diameter, 140mm length (1.5" x 5.5")

### Ordering Information

HP 8152A Optical Average Power Meter

HP 81520A Optical Head 450 to 1020nm

HP 81521B Optical Head 900 to 1700nm

Opt 907: Front handle kit (HP P/N 5061-9688)

Opt 908: Rack flange kit (HP P/N 5061-9672)

Opt 918: Additional operating manual

P/N 5061-9701: Bail handle kit

### Price

\$3350

\$1400

\$2250

\$50

\$50

\$40

\$38

Note: The HP 8152A cannot be used without an optical head, appropriate connector adapter and optical lens. For additional information, see "Fiber Optic Test Accessories" on page 307.

Fast-Ship product—see page 758.

# FIBER OPTIC TEST EQUIPMENT

305

## LED Source / Laser Diode Source

Model 8154B opt.003 (850nm), opt.002 (1300nm), opt.003 (1550nm) / Model 8155A opt.002 (1300nm), opt.003 (1550nm)

- Stability  $\pm 0.003\text{dB}/12\text{h}$
- External modulation up to 1MHz
- Customer-exchangeable connector adapters

- Stability  $\pm 0.005\text{dB}/12\text{h}$
- External modulation up to 850MHz
- Customer-exchangeable connector adapters



HP 8154B, option 002, option 011



The HP 8154B is a high performance LED source, optional for 850nm, 1300nm and 1550nm. Whether the insertion loss of connectors, attenuation of cables or the splice loss of optical links needs to be evaluated, the HP 8154B provides the required power level stability of typically 0.003dB at constant ambient temperature over 12h.



HP 8155A, option 002, option 011



The HP 8155A is a narrow linewidth laser diode source, optional for 1300nm and 1550nm with excellent short- and longterm stability. It outputs CW or 270Hz chopped light. External modulation up to 850MHz is also possible, and allows signal performance tests on fast telecommunication links.

Both, the HP 8154B and the HP 8155A, offer customer-exchangeable connector adapters.

### HP 8154B, 8155A Specifications

#### Optical Characteristics

	option 001	LED 8154B option 002	option 003	LD 8155A option 002	option 003
Wavelength	850 $\pm$ 30nm	1300 $\pm$ 40nm	1550 $\pm$ 40nm	1310 $\pm$ 30nm	1560 $\pm$ 40nm
Spectral Bandwidth	30-90nm	40-90nm	70-150nm	<3nm (RMS)	<3nm (RMS)
Optical Power	$\geq -17\text{dBm}$	$\geq -20\text{dBm}$	$\geq -23\text{dBm}$	$\geq -4\text{dBm}$	$\geq -4\text{dBm}$
Stability/15min./const. temp	—	—	—	$\pm 0.003\text{dB}$	$\pm 0.003\text{dB}$
Stability/12h/const. temp.(typ.)	$\pm 0.005\text{dB}$	$\pm 0.003\text{dB}$	$\pm 0.003\text{dB}$	$\pm 0.005\text{dB}$	$\pm 0.005\text{dB}$
Stability/12h/ $\pm 2\text{C}$	$\pm 0.02\text{dB}$	$\pm 0.02\text{dB}$	$\pm 0.03\text{dB}$	$\pm 0.03\text{dB}$	$\pm 0.03\text{dB}$
Fiber Type	50/125 $\mu\text{m}$	50/125 $\mu\text{m}$	50/125 $\mu\text{m}$	9/125 $\mu\text{m}$	9/125 $\mu\text{m}$

Connector: Diamond\* HMS-10/HP, FC/PC, DIN 47256, ST

#### Supplementary Performance Characteristics

##### Digital Input

Input levels: TTL (8154B),  $\pm 0.2\text{V}$  (8155A)

Max. input voltage:  $\pm 10\text{V}$  (8154B),  $\pm 2.5\text{V}$  (8155A)

Input impedance: 10 kOhm (8154B), 50 Ohm (8155A)

Input frequency: 0 to 1MHz (HP 8154B), DC, 1kHz to 850 MHz (HP 8155A)

##### Operating Modes

Output disable: LED, LD switched off

External modulation enable: Activates the digital input

Internal modulation enable: Activates internal 270Hz generator

##### General

Recalibration period: 1 year

Warm-up time: 45 minutes for  $\pm 0.02\text{dB}$  stability

##### Environmental

Storage Temperature:  $-40^{\circ}\text{C}$  to  $+75^{\circ}\text{C}$

Operating Temperature:  $0^{\circ}\text{C}$  to  $+55^{\circ}\text{C}$

Humidity: <95% R.H. from  $0^{\circ}\text{C}$  to  $+40^{\circ}\text{C}$

Power: 100/120/220/240Vrms,  $\pm 10\%$ , 48-400Hz, 35VA max. (8154B), 45VA max. (8155A)

After being switched off the instruments will come up with the output and digital input disabled.

Dimensions: 89mm(H) x 212.3mm(W) x 345mm(D) (3.5" x 8.36" x 13.6")

Weight: net 3.75kg (8.3lbs), shipping 7.8kg (17.2lbs) (HP 8154B)  
net 4.5kg (9.9lbs), shipping 8.55kg (18.85lbs) (HP 8155A)

#### Ordering Information

##### HP 8154B LED Source

Option	Price
Opt 001: 850nm	\$1170
Opt 002: 1300nm	\$3055
Opt 003: 1550nm	\$4175

##### HP 8155A LD Source

Opt 002: 1300nm	\$2500
Opt 003: 1550nm	\$8900
	\$10600

Opt 011<sup>1</sup>: Diamond\* HMS-10/HP connector interface \$290

Opt 012<sup>1</sup>: FC/PC connector interface \$290

Opt 013<sup>1</sup>: DIN 47256 connector interface \$290

Opt 014<sup>1</sup>: ST connector interface \$290

Opt. 907: Front handle kit (HP P/N 5061-9688) \$50

Opt. 908: Rack flange kit (HP P/N 5061-9672) \$50

Opt. 916: Additional operating manual \$40

P/N 5061-9701 Bail handle kit \$38

<sup>1</sup> for both the HP 8154B and the HP 8155A, customer-exchangeable

For adapters, cables and other accessories see "Fiber Optic Test Accessories" on page 307

Fast-Ship product—see page 758.

# FIBER OPTIC TEST EQUIPMENT

## Optical Attenuator

Model 8158B option 001 (600-1200nm), option 002 (1200-1650nm)/Model 8157A (1200-1850nm)

- High resolution of 0.01dB
- Short settling time (typ. 20ms)
- Suited for multimode and single-mode fibers (8158B)



HP 8158B option 002 option 011



The HP 8158B Optical Attenuator is a fully programmable and highly flexible test instrument. Due to its state-of-the-art fiberless design, all applications employing fibers with a numerical aperture up to 0.3 are covered with one instrument. Multimode and single-mode measurements can thus be easily performed.

### HP 8158B Specifications

All specs. are measured with Diamond® HMS-10/HP connectors

#### Optical Characteristics

**Wavelength Range:** 600-1200nm (opt. 001), 1200-1650nm (opt. 002)

**Applicable Fiber Type:** all fiber types with an NA ≤ 0.3

**Attenuation Range** (excluding insertion loss): 60.00dB

**Insertion loss** (incl. both connectors)

	single-mode 9µm <sup>1</sup>	multimode 50µm
worst case	<4.0dB	<2.0dB
typical	2.0dB	1.0dB

<sup>1</sup>option 002 only

**Linearity:** <±0.4dB for single-mode, <±0.2dB for multimode

**Return loss** (excluding connectors): > 27dB

### HP 8157A Specifications

#### Optical Characteristics

All specifications are measured with Diamond® HMS-10/HP connectors. The connectors must have Manufacturing Date Code Week 31-87 or higher.

**Wavelength Range:** 1200-1650nm

**Applicable Fiber Type:** single-mode fiber

**Attenuation Range** (excluding insertion loss): 60.00dB

**Insertion loss** (incl. two Diamond® HMS-10/HP connectors): <4.0dB

**Linearity:** ±0.2dB (typical ± 0.05dB)

**Return loss** (incl. Diamond® HMS-10/HP connectors and terminated fiber-end): > 33dB

### HP 8157A/HP 8158B Specifications

#### Display

**Display range:** 0.00 to 64.00dB

**Display resolution:** 0.01dB (min. step size)

#### Supplementary Performance Characteristics

**Repeatability** (of attenuation after a max. of 6 matings with same connector):

**single-mode** (9µm): <0.2dB

**multimode** (50µm): <0.1dB (HP 8158B only)

#### Operating Modes

**Output disable:** Optical signal path interrupted

**λ:** Entering of wavelength for automatic correction of attenuation using typical correction values

**Att:** Attenuation is displayed and can be varied

**Cal:** Entry of calibration factor to adjust display so that displayed value indicates actual power level at output connector of attenuator. Range: ±99.99dB

- Customer-exchangeable connector adapters (8157A)
- > 36dB typical return loss (8157A)



HP 8157A shown with all four available connector options (In the foreground)



The 8157A is a high performance single-mode attenuator for the 1200-1650nm wavelength range. Its excellent linearity, very high return loss and polarization insensitivity make it the ideal attenuator for bit error rate tests on fast optical systems.

### General

#### HP-IB Capability

All modes and parameters can be programmed

**Listen** (time to receive, verify and set up parameter)

**Output disable/enable, attenuation, λ:** < 20 to 550ms (HP 8157A)

λ: < 20 to 400ms (HP 8158B)

(depending on actual setting/programmed parameter)

**Cal:** <5ms

**HP-IB Interface Function Code:** SH1, AH1, T6, L4, SR1, RL1, PP0, DC1, DT0, C0

**Recalibration period:** 1 year

No warm-up time required if previously stored within operating temperature range.

#### Environmental

**Storage Temperature:** -40°C to +75°C

**Operating Temperature:** 0°C to +55°C

**Humidity:** <95% R.H. from 0°C to +40°C

**Power:** 100/120/220/240Vrms, ±5%, 10%, 48-400Hz, 90VA max.

**Battery back up** (for non-volatile memory): with instrument switched off all current modes and data will be maintained for at least 10 years after instrument delivery

**Dimensions:** 89mm(H) x 212.3mm(W) x 345mm(D) (3.5" x 8.36" x 13.6")

**Weight:** net 5.3kg (11.7lbs), shipping 9.6kg (21.2lbs)

### Ordering Information

**HP 8158B Optical Attenuator**

**Opt. 001:** 600-1200nm

**Opt. 002:** 1200-1650nm

**Opt. 011:** Diamond® HMS-10/HP connector

**Opt. 012:** FC/PC connector<sup>1</sup>

**Opt. 013:** DIN 47256 connector

**Opt. 014:** ST connector<sup>1</sup>

**HP 8157A Optical Attenuator 1200-1650nm**

**Opt. 011:** Diamond® HMS-10/HP connector

interfaces

**Opt. 012:** FC/PC connector interfaces

**Opt. 013:** DIN 47256 connector interfaces

**Opt. 014:** ST connector interfaces

**Opt. 907:** Front handle kit (HP P/N 5061-9688)

**Opt. 908:** Rack flange kit (HP P/N 5061-9672)

**Opt. 916:** Additional operating manual

**P/N 5061-9701** Bail handle kit

<sup>1</sup>multimode only

For interface adapters, cables and accessories see "Fiber Optic Test Accessories" on page 307.

☎ Fast-Ship product—see page 758.

### Price

\$2240

\$3970

\$3970

\$710

\$1020

\$1020

\$1020

\$8400

\$580

\$580

\$580

\$580

\$50

\$50

\$31

\$38

### Accessories

#### Fiber optic test accessories for HP 8150A, HP 8151A, HP 81511A/81512A and HP 81519A

One end of the 2m optical cable is terminated with the standard Diamond® HFSI/KV connector. The other end can be selected from the following table.

Customer Connector	Adapter for Optical Head	Price	Cable 50/125um 3.5mm Ferrule	Price
Diamond® HFSI/KV	HP 81510A	\$255	HP 81500A	\$660
NEC D4	HP 81510B	\$204	HP 81500B	\$660
Bare Fiber, 50/125um	HP 81510C	\$204	HP 81500C	\$345
Bare Fiber, 200/250um	HP 81510D	\$204	—	—
Amphenol 906 SMA	HP 81510E	\$204	HP 81500E	\$660
FC	HP 81510G	\$204	HP 81500G	\$660
Biconic	HP 81510H	\$204	—	—
F&G 3702	HP 81510J	\$204	HP 81500J	\$660
Stratos 430	HP 81510K	\$204	HP 81500K	\$660
AMP-SMA	HP 81510N	\$204	HP 81500N	\$660
Optical Base Plate	HP 81510Q	\$132	—	—
Parallel Beam Adapter	HP 81510R	\$460	—	—
Blank Adapter	HP 81510Z	\$112	—	—

#### Fiber optic test accessories for HP 8152A, HP 81520A, HP 81521B

To interface the optical head to the optical fiber use one of the following connector adapters.

Customer Connector	Adapter for Optical Head	Price
Diamond® HMS-10/HP	HP 81000AA	\$132
Bare Fiber, 50/125um	HP 81000BA	\$460
Bare Fiber, 100/140um	HP 81000CA	\$480
Radial	HP 81000DA	\$112
FC	HP 81000FA	\$112
NEC D4	HP 81000GA	\$132
Amphenol 906 SMA	HP 81000JA	\$112
AMP-SMA	HP 81000KA	\$112
F&G 3702	HP 81000LA	\$112
Stratos 430	HP 81000NA	\$112
PC	HP 81000FA	\$112
DIN 47256	HP 81000SA	\$112
ST	HP 81000VA	\$112
Biconic	HP 81000WA	\$112
Diamond® HFS-1	HP 81000YA	\$132
Blank Adapter	HP 81000ZA	\$36

#### Lenses

If accurate power measurements from a fiber are required, one of the following optical head lenses must be used.

<b>HP 81050AL:</b> Lens for 450–1020nm and NA=0.2 fibers <sup>1</sup>	\$142
<b>HP 81050BL:</b> Lens for 900–1700nm and NA=0.2 fibers <sup>1</sup>	\$142
<b>HP 81010BL:</b> Lens for 900–1700nm and NA=0.1 fibers	\$142

<sup>1</sup>can be used for NA=0.3 fibers too

#### HP 81000AF Filterholder

\$71

This filterholder picks up all presently available standard filters with a diameter up to 1".

#### Optical Power Splitter

The optical power splitter is mode- and polarization insensitive. The split ratio is appr. 1:10. It has to be used with an optical head such as the HP 81521B. One connector option must be ordered.

<b>HP 81000AS:</b> Optical Power Splitter for 600–1200nm	\$1375
<b>HP 81000BS:</b> Optical Power Splitter for 1200–1600nm	\$1375

Available Connector Options:

HMS-10/HP Connector (Option 011)	\$460
FC/PC Connector (Option 012)	\$460
DIN 47256 Connector (Option 013)	\$460
ST Connector (Option 014)	\$460

#### HP 81000RA Non-Reflective Adapter

\$490

Less insertion loss (Typ. 0.06db) and high return loss

Available Connector Interfaces	Typ. Return Loss	Price
HP 81000 AI Diamond® HMS-10/HP	38 dB	\$290
HP 81000 FI PC	32 dB	\$290
HP 81000 SI DIN 47256	36 dB	\$290
HP 81000 VI ST	25 dB	\$290

#### Fiber optic test accessories for HP 8145A, HP 81520A, HP 81521B, HP 8154B, HP 8155A, HP 8157A, HP 8158B and HP 8159A

One end of the 2m optical cable is terminated with the standard Diamond® HMS-10/HP connector. The other end can be selected from the following table.

Customer Connector	Cable 10/125um 2.5mm Ferrule	Price	Cable 50/125um 2.5mm Ferrule	Price	Cable 62.5/125um 2.5mm Ferrule	Price	Cable 100/140um 2.5mm Ferrule	Price
Diamond® HMS-10/HP	HP 81101AC	\$610	HP 81501AC	\$560	HP 81621AC	\$560	HP 81991AC	\$560
Bare Fiber	HP 81101BC	\$305	HP 81501BC	\$345	HP 81621BC	\$345	HP 81031BC	\$345
FC	HP 81101FC	\$610	HP 81501FC	\$560	—	—	—	—
NEC D4	HP 81101GC	\$610	HP 81501GC	\$560	—	—	—	—
Amphenol 906 SMA	—	—	HP 81501HC	\$560	—	—	HP 81991HC	\$560
AMP-SMA	—	—	HP 81501JC	\$560	—	—	HP 81991JC	\$560
F&G 3702	—	—	HP 81501LC	\$560	—	—	—	—
Stratos 430	—	—	HP 81501NC	\$560	—	—	—	—
PC	HP 81101PC	\$865	—	—	—	—	—	—
DIN 47256	HP 81101SC	\$610	HP 81501SC	\$560	—	—	—	—
ST	—	—	HP 81501VC	\$560	HP 81621VC	\$560	—	—
Biconic	HP 81101WC	\$610	HP 81501WC	\$560	—	—	—	—
Diamond® HFS-1	—	—	HP 81501YC	\$610	—	—	—	—

#### HP 81000AM Through Adapter Diamond®

\$345

#### HP 15475A Cleaning Kit

\$102

The kit consists of cleaning brush, tissue and tape etc. to clean the optical surfaces of fibers and lenses. It is supplied in a plastic carrying case. This kit is supplied with the HP 8150A Optical Signal Source.

# FIBER OPTIC TEST EQUIPMENT

## Optical Time Domain Reflectometer

Model 8145A option 002 (1300nm), option 003 (1550nm), option 023 (1300nm/1550nm)

- Dynamic range of 28dB (1300nm)/26dB (1550nm) with single-mode fiber
- Up to 150 times faster than conventional units
- Customer-Installable laser modules (1300nm or 1550nm)
- Easy-to-learn softkey-guided menu concept
- Non-volatile memory for more than 100 waveforms
- Rugged and light-weight

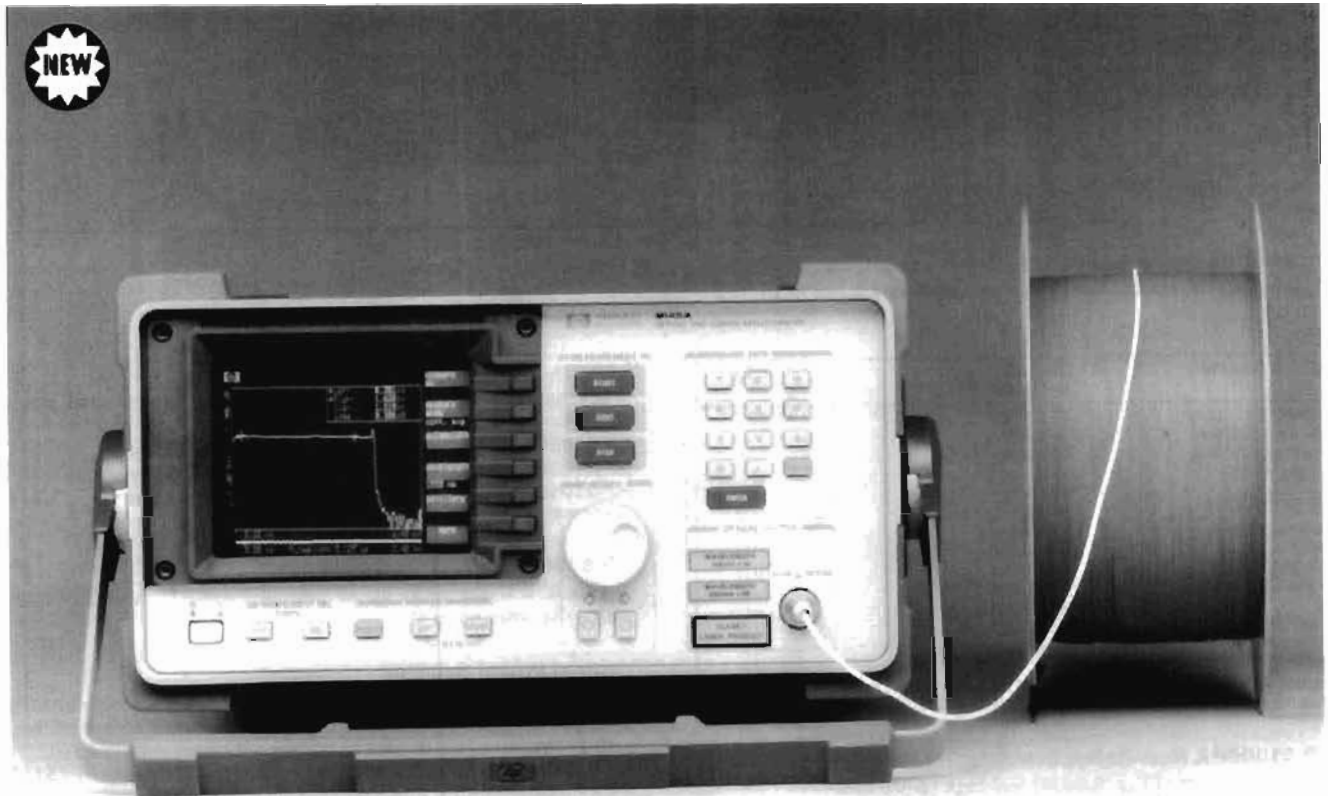

HP 8145A



The HP model 8145A is a high performance optical time domain reflectometer for field maintenance and bench applications. A unique data correlation technique increases the dynamic range to more than 28dB at 1300nm (26dB at 1550nm, regardless, whether the 1300nm module is installed) single-mode and drastically reduces the measurement time. The HP 8145A OTDR can, therefore, perform precise measurements much deeper in the fiber and up to 150 times faster than conventional units.

For field maintenance the HP 8145A features light weight and rugged design. It may be operated on batteries (12 to 30V DC), due to its low power consumption, or mains (90 to 260V AC). Resolution is 0.01dB and 1m over the entire range of 200km

Unhandy dataloggers and external disk drives which are sensitive to temperature changes, humidity and dust are not needed any more, as a plug-in non-volatile memory module (HP 81450A) stores more than 100 traces, each with all related measurement information. If immediate documentation is required, any data set can be directly printed out on a fast Thinkjet printer without a controller

For bench applications including performance tests on optical fibers and cables in design and production the HP 8145A OTDR offers an excellent set of features.

Any previously taken trace may be recalled as reference and compared against the presently sampled one. This ensures fast and easy detection of inhomogeneities and attenuation changes.

The HP 8145A has an easy-to-learn softkey guided operating concept. The user can customize the softkeys individually. The OTDR is also fully HP-IB programmable.

By means of two optional laser modules the HP 8145A operates at either of the wavelengths 1300nm, 1550nm or both. The laser modules are user-installable.

Four exchangeable connector options (Diamond<sup>®</sup> HMS-10, FC/PC, DIN47256, and ST) are available.

# FIBER OPTIC TEST EQUIPMENT

## Optical Time Domain Reflectometer

Model 8145A Option 002 (1300nm), Option 003 (1550nm), Option 023 (1300nm/1550nm)

### HP 8145A Specifications

#### Optical Characteristics

	option 002	option 003	option 023
Wavelength	1300±30nm	1540±40nm	both wavelength
Dynamic range one way backscatter (SNR=1)*	28dB	26dB	28/26dB
Fresnel reflection (4%)*	42dB	40dB	42/40dB

\* typically 6dB lower for 50/125um multimode fibers, 2.5dB lower for peak noise

Both wavelength options are user-installable. If both are installed in the HP 8145A, they are switch-selectable. Dynamic range figures are independent of number of options installed.

**Measurement time:** 22dB dynamic range after 10 seconds (16dB after 1 second) at 1300nm on fiber without end reflection (worst case condition for break detection)

**Pulse width:** 125/250/500ns/1/2/4us

**Output connector:** optional Diamond\* HMS-10, FC/PC, DIN 47256, ST. All options are user-exchangeable.

#### Horizontal Parameters

**Start-km:** 0.000 - 199.500km (see "Resolution")

**Span:** 0.000km - 200.000km (see "Resolution")

**Center-km:** 0.250km - 199.750km (see "Resolution")

**Resolution:** 1m in all three cases for parameter setting and distance read-out

**Accuracy:** ±6m ±10<sup>-5</sup> x measured value, uncertainty of fiber refractive index not included

**Refractive index:** 1.4000 - 1.5999, in steps of 0.0001 settable

**Length correction:** 1.000 - 9.999, in steps of 0.001 settable. Serves to enter actual ratio of fiber/cable length into the OTDR

#### Vertical Parameters

**Vertical scale:** 0.20 - 5.00dB/div

**Resolution:** 0.01dB for parameter setting, 0.001dB for attenuation/loss read-out

**Linearity:** 0.05dB/dB

**Zoom:** All combinations of horizontal and vertical parameters can be entered while the instrument is running. Serves to zoom in on any point of the waveform and allowing close examinations without interrupting the averaging process.

#### Documentation

**Waveform memory:** 10 waveforms and related instrument settings can be stored in the HP 8145A in non-volatile memory and recalled. More than 100 waveforms and related instrument settings can be stored in each HP 81450A Memory Module and recalled. The modules contain non-volatile memory and plugs into the rearpanel of the HP 8145A.

**ID Codes:** An identification code of up to 38 alpha-numerical characters can be entered for each memory location. All ID codes are displayed when the directory is called up.

**Compare mode:** Presently displayed waveform can be compared against any previously stored one, if the horizontal parameters are identical. Zooming capability is provided.

**Dump to printer:** Any displayed or previously stored waveform can be directly dumped to a Thinkjet printer. Print time per copy is less than 15 seconds.

**Instrument settings:** storage and recall of 9 user selectable instrument settings, recall of 1 standard setting.

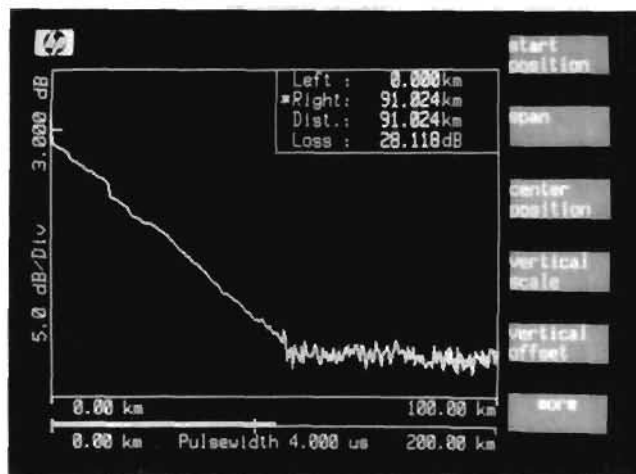

#### General

**CRT:** 15cm (6"), green

**Laser safety class:** Class 1

**Recalibration period:** 1 year

#### HP-IB Capability

All modes and parameters can be programmed

**HP-IB Interface Function Codes:** SH1, AH1, T5, L3, SR1, RL1, PP0, DC1, DT1, C0

#### Environmental

**Storage temperature:** -40°C to +75°C

**Operating temperature:** -20°C to +65°C (-10°C to +55°C to meet specs)

**Humidity:** ±95% R.H. from 0°C to +40°C

#### Power

**DC:** 12 - 30V DC, 80Wmax

**AC:** 100/120/220/240Vrms ±10%, 90VAmax, 48-400Hz

**Battery back up (for non-volatile memory):** with instrument switched off all current modes and data will be maintained for at least 10 years at 25°C temp.

**Dimensions:** 190mm H, 340mm W, 465mm D (7.5" x 13.5" x 18.3")

**Weight:** net 16 kg (35.3 lbs), shipping 22 kg (48.5 lbs)

#### Ordering Information

<b>8145A Optical Time Domain Reflectometer</b>	<b>\$12900</b>
<b>Option 002:</b> 1300nm	\$10800
<b>Option 003:</b> 1550nm	\$14800
<b>Option 023:</b> 1300nm/1550nm	\$21800
<b>Option 011:</b> Diamond* HMS-10/HP connector interface	\$ 290
<b>Option 012:</b> FC/PC connector interface	\$ 290
<b>Option 013:</b> DIN 47256 connector interface	\$ 290
<b>Option 014:</b> ST connector interface	\$ 290
<b>81450A:</b> Memory module	\$ 1100

The connector-interfaces for Diamond\* HMS-10/HP FC/PC, DIN47256 and ST connectors are available as additional accessories.

For adapter cables and other accessories see "Fiber Optic Test Accessories" on page 307.

# DATA GENERATORS & DATA ANALYZERS

## General Information

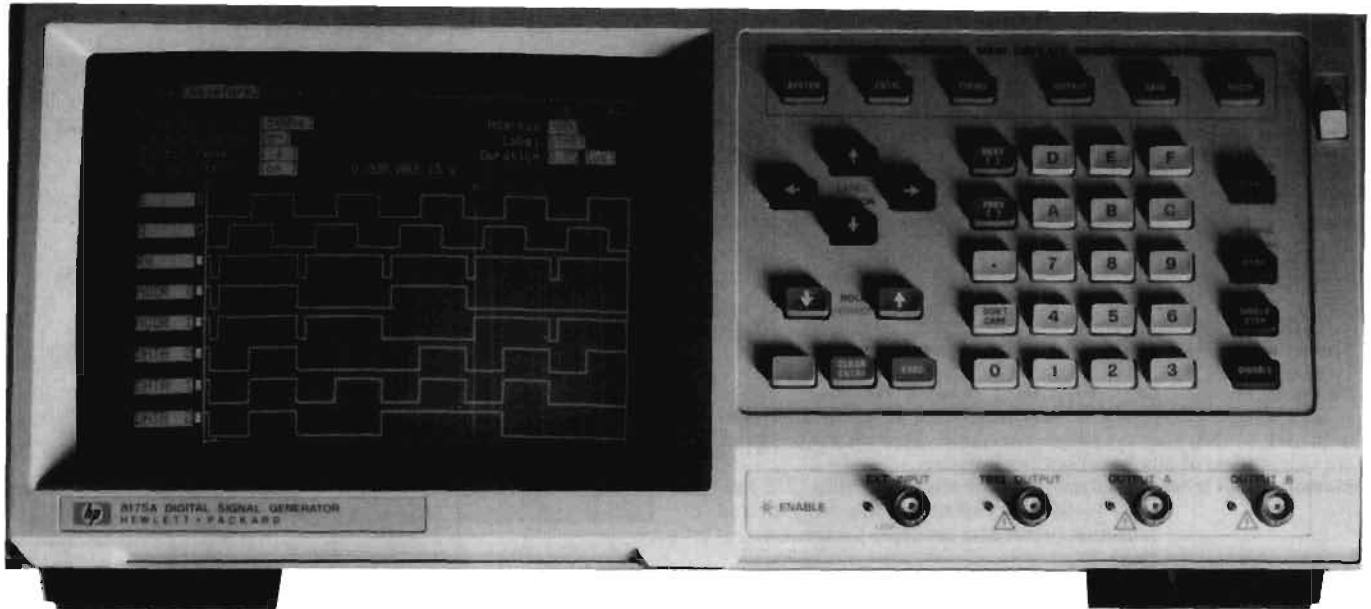

Data Generator Selection and Technical Data Chart

MODEL PARAMETER	8180A (8181A)	8016A	8175A	8080A D01, D02,D03	8018A	8170A
DATARATE (Mb/s)	50	50	50 PARALLEL 100 SERIAL	300	50	2
NUMBER OF CHANNELS	8 PARALLEL (16 OPT.) (128 WITH EXTENSION)	8 PARALLEL	24 PARALLEL OR 2 SERIAL	1 SERIAL (2 SERIAL)	2 SERIAL	16 PARALLEL
MEMORY DEPTH (PATTERNS)	1024	32/8 CH., 64/4 CH., 128/2 CH., 256/1 CH.	1024 PARALLEL 8096 SERIAL	64 SERIAL	1024/2 CHANNEL 2048/1 CHANNEL	2048/16 CH, 4096/8 CH
VARIABLE DELAY AND WIDTH	0...999 ns (8 CH.)	0...1 $\mu$ s (4 CH.) DELAY 10 ns...1 $\mu$ s WIDTH POTENTIOMETER	20...40 ns, (4 CH.) DELAY ONLY	SPECIAL OPTION	NO	NO
RESOLUTION	100 ps		100 ps			
RZ/NRZ	RZ/NRZ	RZ/NRZ	NRZ	RZ/NRZ	RZ/NRZ	NRZ
PATTERN DURATION	NO	NO	20 ns...9.9 s	NO	NO	NO
RESOLUTION			10 ns			
OUTPUT LEVELS (HL=HIGH LEVEL, LL=LOW LEVEL)	TTL,ECL,VAR +1...+17 V (HL) -2...+16 V (LL) (HIGH IMPEDANCE)	TTL,ECL,VAR 1...2.5 V (HL TTL) -0.9...+1.1 V (HL ECL) AMPLITUDE VAR. 0.3...1 V (ECL) POTENTIOMETER	TTL,ECL,TRI STATE VAR 2.4...9.9 V (HL)	D01: 0.2...2 V D02, D03: 0.6...1.2 V PEAK TO PEAK OFFS. D01: +/- 1.0 V, D02/03: +/- 1.2V POTENTIOMETER	ECL,VAR 1.25...15 V POTENTIOMETER	TTL,VAR 3...15 V (HL) -0.5...+0.4 V(LL) POTENTIOMETER
RESOLUTION	10 mV (50 OHM), 20 mV (10 KOHM)		100 mV			
50 OHM SOURCE IMPEDANCE	YES	YES	NO	YES	YES	NO



# DATA GENERATORS & DATA ANALYZERS

311

## 50 MHz Digital/Analog Signal Generator

Model 8175A

- 24 channels / 1 kbits ea / 50 Mbits/s ea  
2 channels / 8 kbits ea / 100 Mbits/s ea
- Individual pattern duration 20 ns to 9.99 s

- Virtual Memory Expansion
- Interaction with DUT
- Dual Arbitrary Waveform Generator (opt)

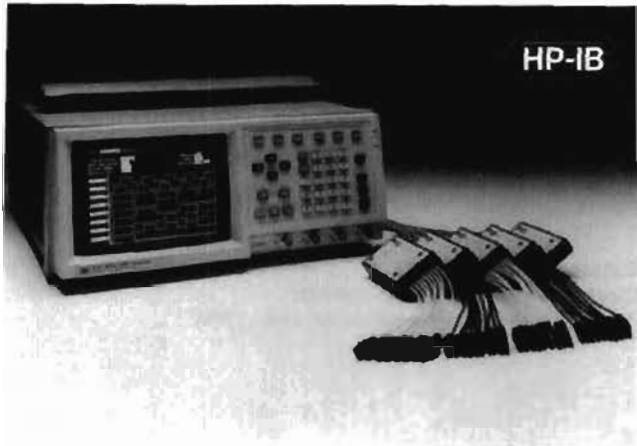

HP 8175A with output pods (15481A/15482A/15464A) and trigger pod (15483A)

### HP 8175A Digital/Analog Signal Generator

The HP 8175A delivers high-speed parallel and serial data with programmable patterns, adequate for at-speed testing of most of present and future logic circuits. Individually Programmable Pattern Durations permit complex timing set-ups for simulation of extreme, asynchronous timings without wasting memory. Virtual Memory Expansion allows very long data sequences by branching to up to 255 user-definable memory segments. Interaction with a device under test provides for simulation of a wide range of data paths in digital systems. Output pods provide the appropriate levels for most logic families and flexible interface adapters ensure the specified signal quality at the probe tip, a precondition for reliable results.

A Fine Timing option (opt. 001) enhances the timing resolution provided with Programmable Pattern Durations in order to delay four channels with 100 ps.

Operational convenience is stressed through a large, menu driven CRT, a comprehensive data editor including waveform graphics and the capability to directly access (via HP-IB) a printer for documentation and a flexible disc drive for use as a test data library.

In Engineering Test, this versatile feature set provides early simulation of elements not yet available, speeding design cycles through reduced integration time at circuit, module and system level.

In Production Test and Incoming Inspection, automated at-speed testing at the module and system level results in early failure detection, thus reducing production cost and improving quality.

Combining the HP 8175A Digital Signal Generator with a HP 1630/31 family logic analyzer results in a complete Stimulus-Response measurement system. For more information on the HP 1630/31 family logic analyzers refer to the respective pages in this catalog.

### Option 002 (Dual Arbitrary Waveform Generator)

With Option 002, the HP 8175A provides two arbitrary channels in addition to the full capabilities of the standard digital signal generator. Thus, some of the stimulation challenges -whether digital, analog or both together- can be met with a single unit (for further information about the analog capabilities, see page 406).



### Data Page: Pattern Set-Up

Data can be entered and displayed in various codings. Channels to be displayed can be selected. Comprehensive data editing support is provided. For instance, segments can be moved or copied to other memory addresses or data segments can be "block modified". Easy exchange of data between channels avoids having to rearrange probes at the test fixture. Also, fixed patterns such as up and down counters with selectable start and stop address are loaded with a few key-strokes. All codings from the pattern Set-Up page will be automatically converted into a timing diagram when switched to this page. Or, the data can be set-up from scratch or easily edited in terms of waveforms.



### Program Page: Segment Assignment

This page gives an example of how pattern sequencing can be defined. Up to 255 segments of data memory can be defined by first and last addresses or labels in the 0000 to 0255 address range. During data execution the segments are real-time sequenced in the given order thus virtually expanding the memory depth far beyond the physical depth of 0256 data patterns.

# DATA GENERATORS & DATA ANALYZERS

## 50 MHz Digital/Analog Signal Generator (cont'd)

Model 8175A

### Specifications

Specifications apply for operating temperatures from 0°C to 55°C.

#### Parallel / Serial Data Generator

**Number of channels:** 24 parallel, 2 serial

**Bits per channel:** 1024 parallel, 8192 serial

**Max. NRZ Bit rate per ch.:** 50 Mbit/s parallel, 100 Mbit/s serial

**Pattern Duration (with internal clock):**

In *Parallel* mode the duration of each individual pattern is programmable. In *Serial* mode the duration of the data bits is programmable with successive bits always having the same duration. The duration is equal for all channels.

**Range/Resolution:**

(10) <sup>n</sup> , 20 ns - 9.99 $\mu$ s	/ 10 ns
10 $\mu$ s - 999 $\mu$ s	/ 1 $\mu$ s
1 ms - 99.9 ms	/ 100 $\mu$ s
0.1 s - 9.99 s	/ 10 ms

\* 10 ns in serial mode with fixed timing

**Accuracy:**

- $\pm 0.05\%$  of progr. duration  $\pm 2.5$ ns (asynchronous start)
- $\pm 0.5\%$  of progr. duration  $\pm 2.5$ ns (synchr. start, clock calibration)
- $\pm 3.0\%$  of progr. duration  $\pm 2.5$ ns (synchr. start, no clock cal.)

**Jitter (max.):** 0.1% of progr. value  $\pm 150$ ps

**Pattern Duration (with external clock):** Period of ext. clock  $\times$  m

m (Range)	/ Resolution:
(1)2** to 999	/ 1 period
1 000 to 99 900	/ 100 periods
100 000 to 9 990 000	/ 10 000 periods
10 000 000 to 999 000 000	/ 1 000 000 periods

\*\* Min. Pattern duration in parallel mode 20ns, in serial mode 10ns.

#### Clock

The clock has a programmable period. It is available on line 7 of the pod for the output flags. In serial mode an additional Clock is available providing a pulse at every bit.

**Period (with internal clock):**

**Range / Resolution:** 20ns - 9.99 $\mu$ s / 10ns; 2 $\mu$ s - 999 $\mu$ s / 1 $\mu$ s

**Accuracy:**

- $\pm 0.05\%$  of progr. value  $\pm 2.5$ ns (asynchronous start)
- $\pm 0.5\%$  of progr. value  $\pm 2.5$ ns (synchr. start, clock cal.)
- $\pm 3\%$  of progr. value  $\pm 2.5$ ns (synchr. start, no clock cal.)

**Period (with external clock):** Period of external clock  $\times$  m

**Range:** m = 2, 3, 4, ..., 999, 1000, 1100, 1200, ..., 99 900

**Skew** (maximum time difference between the leading or trailing data bit edges of the same memory address with Fine Timing off)

**across ECL pods:**  $\leq 6$  ns; typical  $\leq 3$  ns

**across TTL/CMOS pods:**  $\leq 7$  ns; typical  $\leq 3$  ns

#### Option 001 Fine Timing

(can be retrofitted in HP service office)

**Parallel Data Generator**

**Channels:** 0, 1, 2 and 3 of pod 0

**Delay (Range/Resolution):** 20 ns to 40 ns / 100 ps

**Accuracy:**  $\pm 5\%$  of progr. value  $\pm 1$  ns

**Serial Data Generator**

**Channels:** 0 and 2 of pod 0

**Delay (Range/Resolution):** 0 ns to 20 ns / 100 ps

**Accuracy:**  $\pm 5\%$  of progr. value  $\pm 2$  ns

#### External Input (BNC)

This connector can be used to start / stop datacycling with selectable transitions.

**Impedance:** 10 k $\Omega$  / 50 pF

**Threshold (Range/Resolution):** -9.9V to +9.9V / 100 mV

**Accuracy:**  $\pm 5\%$  of progr. value  $\pm 250$  mV

**Min. swing:** 600 mV pp

**Min. overdrive:** 250 mV or 30% of input amplitude

**Max. input voltage:**  $\pm 20$  V

#### External Clock (BNC)

**Clock rate (Range):** 8Hz to 100 MHz

All other specifications see External Input (BNC).

#### External Reference (BNC)

**Input characteristics:** LS TTL compatible

#### Ordering Information

##### HP 8175A Digital/Analog Signal Generator

Note: HP 8175A must be ordered with at least one of the options #002, #003, #004, #005 or individual pods, as required.

**Options:**

**Opt. 001** Fine Timing: 4 channels, 100 ps resolution add \$1325

**Opt. 002** Dual Arbitrary Waveform Generator add \$3465

**Opt. 003** Set of 4 ECL Pods Model HP 15461A and 1 Trigger Pod Model HP 15463A add \$4430

**Opt. 004** Set of 4 TTL Pods Model HP 15464A and 1 Trigger Pod Model HP 15463A add \$3005

**Opt. 005** Set of 4 TTL/CMOS Pods Model HP 15462A and 1 Trigger Pod Model HP 15463A add \$6670

**Opt. 908** Rack Flange Kit (PN 5061-9678) add \$36

**Opt. 910** Additional Operating/Programming/Service Manual add \$204

**Opt. 916** Additional Operating/Programming Manual add \$36

**HP 15461A** ECL Pod (fixed ECL levels, includes 1 ea HP 15429A) \$970

**HP 15462A** TTL/CMOS Pod (programmable High Level, incl. 1 ea HP 15429A) \$1530

**HP 15463A** Trigger Pod (includes lead set and 10 ea probe tip) \$560

**HP 15464A** TTL Pod (fixed TTL levels, includes 1 ea HP 15429A) \$610

**Adaptors for HP 15461A, HP 15462A and HP 15464A:**

**HP 15408A** plug-on grabbers with ground leads 5 ea \$76

**HP 15409A** plug-on BNC adaptors, 5 ea \$76

**HP 15410A** plug-on SMB adaptors, 5 ea \$76

**HP 15411A** plug-on coax open-end adaptors, 5 ea \$61

**HP 15415A** plug-on miniprobe, usable with HP 10024A IC clip, 5 ea \$76

**HP 15429A** solder-in receptacles (standard accessory, 5x2 ea) \$51

**Adaptors for HP 15463A:**

**HP PN 15463-63201** lead set \$65

**HP PN 10230-62101** probe tip, 1 ea (10 ea necessary per pod) \$3

**Others:**

**HP 15430A** cable for synchronized master-slave operation of two ea HP 8175A \$76

**HP 10062A** Protective Cover (for front panel) \$75

Fast-Ship product—see page 758

# DATA GENERATORS & DATA ANALYZERS

313

## Data Generator/Analyzer System

Models 8180A/B, 8181A/B, 8182A/B

- Digital ac parametric and functional evaluation
- 50MHz, 1kbit - 16kbit vector memory depth
- 100ps timing/10mV level resolution

- Variable sampling point in synchronous mode
- Real-time data comparison
- Transparent softkey operating/measurement concept

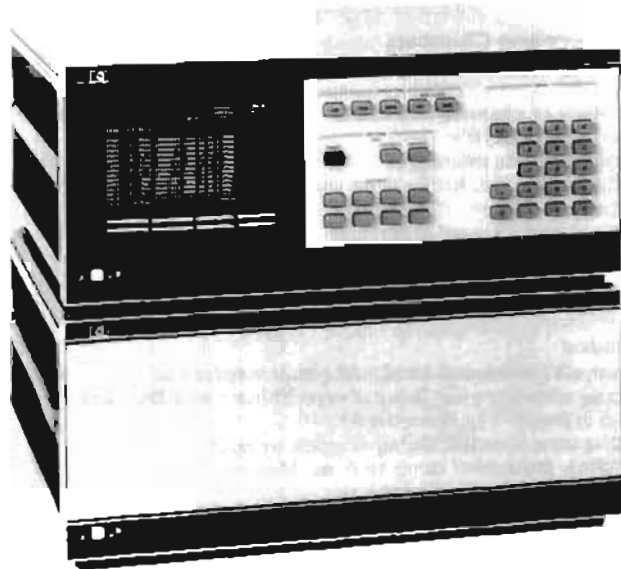

Upper: HP 8180A/B Data Generator  
Lower: HP 8181A/B Data Generator Extender

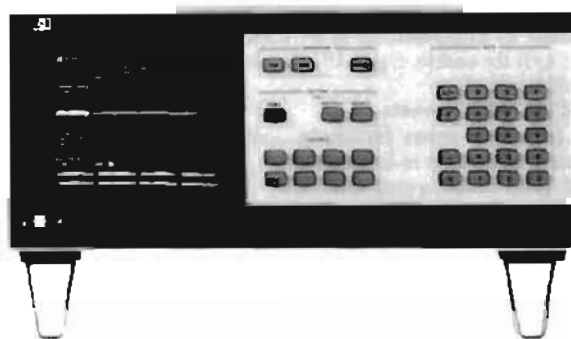

HP 8182A/B Data Analyzer

### The Tool for At-Speed Evaluation of Digital IC's, Boards & Modules

The HP 8180A and 98180B are modular, high speed Data Generators for the stimulation of digital IC's and boards. For the analysis of a digital circuit's response the HP 8182A and the HP 8182B provide capabilities for data capture and comparison and for level and timing characteristics measurements. The Data Generators and Data Analyzers are matched in performance with regard to vector rates, vector memory depth and measurement accuracy and functionality. They can be used as stand-alone instruments, in Stimulus-Response Setups or as modules in complete IC Test Systems.

### Modular Configurations - From Stand-Alone to Complete Systems

Stand-alone operation is supported by an autonomous operating and measurement concept. Stacking instruments expands the channel counts, thus enabling you to adapt the system size exactly to the individual test and budget requirements. The universal HP-IB interface makes the system open to the integration of other measurement equipment e.g. for DC measurement units etc. In addition, for IC Test applications, HP is offering complete Test Systems including mainframe (rack, power provisions etc.) Testhead and System Software. This provides the turn - key solution required in applications like IC Design Verification and Prototype Evaluation, Failure Analysis, Low- Volume Production and Incoming Inspection.

### Applications that Reflect in Features

For at-speed functional verification of prototype circuits the Generators and Analyzers offer programmable digital patterns at clock rates up to 50 MHz. The linear vector memory depth of

1kbit/channel ("A" versions) and 16kbit/channel ("B" versions) allows you to generate and capture the immense number of testvectors required for testing the most complex devices. Real-time comparison between "expected" data and captured data generates an "Error Map" which gives immediate feedback and increases throughput.

For thorough characterization of a circuits performance limits, timing edges can be positioned with a best resolution of 100 ps and level pairs can be programmed with a 10 mV resolution. On the Analyzer side, the sampling point can be swept in 100ps steps for measurements of set-up/hold time and propagation delays. "Window Comparison" simultaneously checks proper upper and lower logic level and timing conditions. This makes the equipment the ideal tool for Critical Path Analysis of prototype circuits and for in-depth analysis of circuits failing a test.

### Operation - Interactive or under Software Control

On the bench the Data Generators and Analyzers are fully operational without an external controller due to a softkey - driven, interactive operating concept. This gives a quick access to each parameter while a large CRT provides a transparent overview of the current instrument settings.

For remote operation, all set-ups can be programmed with an external controller via the standard HP-IB interface. This enables interactive operation as well as full automation under program control. For IC Test System applications a software package provides a shell which enables the user to concentrate on the device under test rather than the test machine itself.

For a detailed description of IC Test System configurations, Testhead and software refer to the model HP 81810S in this catalog (page 510). HP-IB is Hewlett-Packards implementation of IEEE-488

# DATA GENERATORS & DATA ANALYZERS

## Data Generator/Analyzer System (cont'd)

Models 8180A/B, 8181A/B, 8182A/B

### Specifications

Specifications apply for operating temperatures from 0°C to 50°C.

### HP 8180A/B, 8181A/B Data Generator/Extender

#### Memory and Channels

**Memory depth:** 1024 bit/channel ("A" version);  
16384 bit/channel ("B" version)

**Number of channels:** up to 64 using HP 8180A/B with two HP 8181A/B Extenders. Up to 192 channels with 3 sets of equipment in parallel operation.

#### HP 8180A/B Channels

**RZ (return-to-zero) channels:** independent variable delay and width in each of up to 8 channels.

**NRZ (non-return-zero) channels:** Up to 16 channels minus the number of RZ channels. Fixed timing.

**Strobe channel:** NRZ data or clock. Fixed timing

**Clock channels:** independent delay and width in each of 2 channels. Clock 1 can be selected to run continuously in Break state (see 'Cycle modes').

#### HP 8181A Channels

**NRZ:** up to 24 channels. Fixed timing within an Extender, group delay with respect to HP 8180A/B.

#### Memory Loading

**Codes:** bin, oct, hex, dec (address codes: oct, hex, dec).

**Entry:** Keyboard or HP-IB.

**Displayed channel order:** user-defined.

**Line edit:** insert, delete, macro.

**Channel edit:** clear, set, copy, prbs, counts, entry mask.

### Cycle Modes

Single, Auto, Initialization + Auto, Gated, Initialization + Gated. (Initialization data is output at the beginning of the first cycle only).

**Break state:** implemented by manual or external BREAK command or by strobe channel bit. Data is held at current address. Manual or external RUN command cause same cycle to continue.

**Stop state:** implemented by manual or external STOP command. Data is held at current address and the cycle is terminated. Manual or external RUN command trigger a new cycle.

### Timing

**Clock period:** 20 ns to 950 ms (1.05 Hz to 50 MHz). Ext clock 0 to 50 MHz.

#### Delay

(relative to strobe channel): 0.0 ns to 950 ms, max 90% period - 18 ns.

**Width:** 10.0 ns to 950 ms, max 90% period - 8 ns.

**Skew:**  $\leq 2$  ns for NRZ channels and RZ channels programmed for zero delay.

**Resolution:** 3 digits (best case 100 ps).

**Accuracy:**  $\pm 5\%$  of programmed value  $\pm 1$  ns.

**Jitter:**  $\leq 0.2\% + 100$  ps (+ additional 50 ps for delay and width).

### Outputs

**Output impedance:** 50 Ohm

**Data and clock:** 4 different high level / low level pairs can be defined and assigned to any number of individual outputs. Each channel has independent normal / complement switching. Common 'off'.

**Read-out:** can be selected for 50 Ohm or high impedance load (common selection for all channels).

	50 Ohm load	High-impedance load
<b>High level:</b>	-1.50 to +5.50 V	-1.00 to +17.0 V
<b>Low level:</b>	-2.00 to +5.00 V	-2.00 to +16.0 V
<b>Resolution:</b>	3 digits (10 mV)	3 digits (best case 20 mV)
<b>Amplitude:</b>	0.5 to 5.5 V	1.0 to 17 V

### Transitions:

10% to 90% (3 + |0.2 ampl|) ns (3 + |0.5 ampl|) ns

20% to 80% at ECL levels: 1.5 ns

**Strobe:** ECL/TTL selectable

### HP 8182A/B Data Analyzer

#### Memory and Channels

**Memory depth:** 1024 bit/channel ("A" version);  
16384 bit/channel ("B" version)

**Number of channels:** up to 32. Up to 128 by parallel operation of four HP 8182A/B's.

**Expected data memory:** 1024 to 16384 bit/channel, segmentable.

**Codes:** bin, oct, hex (address code: dec).

**Entry:** Keyboard, HP-IB or read-in from DUT.

**Displayed channel order:** user-defined.

**Line edit:** word mask (don't care), insert, delete.

**Channel edit:** clear, set, copy, mask (don't care), exchange.

### Modes

**Analysis / store-and-compare:** synchronous sampling with variable analog sampling point delay or asynchronous sampling. Comparison with expected data, if required.

**Displays:** state list, timing diagram, or error map.

**Glitch detection:** down to 5 ns. Memory depth is halved when glitch detection is selected.

**Trigger condition:** can be selected to start or stop analysis.

**Real-time compare:** comparison of actual with expected data throughout a time window. Window has variable analog delay and width. Real-time and latched error output signals are provided.

**Display:** error map.

**Trigger conditions:** starts comparison.

### Timing

**External clock:** 0 to 50 MHz.

#### Delay

(relative to external clock): 0.0 ns to 1 s, max 95% period - 1 ns

**Compare window width:** 10.0 ns to 1 s, max 95% period - 9 ns

**Channel skew:**  $\leq 2$  ns

**Resolution:** 3 digits (best case 100 ps).

**Accuracy:**  $\pm 5\%$  of programmed value  $\pm 1$  ns.

**Internal clock:** 1 Hz to 50 MHz (1-2-5 steps).

### Inputs

**Data:** 6 different thresholds or dual threshold pairs can be defined and assigned to any number of individual inputs.

**Clock:** programmable threshold and selectable slope (positive, negative, both).

**Input impedance:** 1 MOhm,  $< 7$  pF.

**Control signals:** (100 kOhm / 50 Ohm selectable input impedance)

**Trigger arm and ext stop signals:** independent programmable thresholds and selectable slope (positive, negative, don't care).

**Trigger qualifier and clock qualifier signals:** independent programmable threshold and selectable levels (high, low, don't care).

**Threshold range:** -10.0 to +10.0 V.

**Dynamic range:** threshold  $\pm 10$  V.

**Resolution:** 3 digits (best case 10 mV).

### Trigger

Trigger arm, word and qualifier, digital filter (1 to 16), clock and qualifier, delay (0 to 65535).

### Ordering and Literature

For Ordering Information (also on accessories) and detailed Technical Data Sheets and Application Notes on the products covered in this chapter, please contact your HP sales office.

# DATA GENERATORS & DATA ANALYZERS

## 9-Bit Parallel, 32-Bit Serial, 50 MHz Word Generator

### Model 8016A

315

- 2 complementary outputs per channel, RZ/NRZ formats
- Variable RZ width, 4 delay channels
- Channel serializer
- TTL/ECL output levels selectable

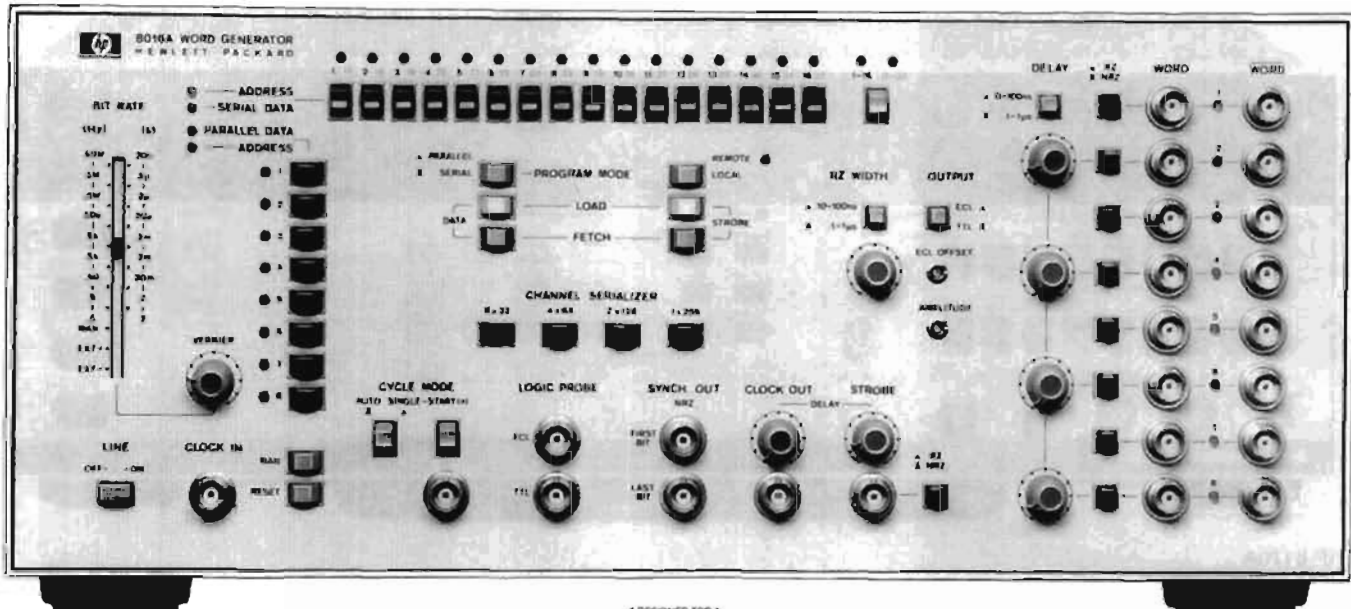

HP 8016A

DESIGNED FOR  
**HP-IB**  
SYSTEMS  
with Option 001

The HP 8016A is a 9-channel data generator capable of serialization up to 256 bits. For the digital designer the HP 8016A is a natural companion to multichannel data display devices such as logic analyzers. As a bench or systems component, the HP 8016A provides programmable digital patterns plus adjustable timing parameters necessary for testing ICs and circuit boards.

### Functional Test

Bit pattern programmability combined with fast cycle time (50 MHz clock) make the HP 8016A especially effective in simulating worst case conditions, e.g. high speed IC testing. The HP 8016A saves time in component evaluation environments because test setups can be rapidly built and reconfigured to meet the demands of testing small quantities of a wide variety of IC types.

### Parametric Test

Complete testing of digital circuits and systems requires not only digital patterns for functional test but control of the analog parameters of the pulses as well. Adjustable pulse widths, levels, and interchannel delays contribute to measurements such as setup and hold times, clock pulse width sensitivities, and system sensitivity to propagation delay variations. To meet these testing requirements, the HP 8016A includes 6 independent delay circuits. Output levels of the HP 8016A's 50  $\Omega$  output amplifiers are selectable for ECL or TTL test specifications and can be adjusted. In addition, a choice of RZ or NRZ formats with variable RZ pulse width is provided.

### Specifications

**Data capacity:** 8 data channels plus 1 strobe channel, each 32 bits. 8 data channels can be serialized as four 64-bit channels, two 128-bit channels or a single 256-bit channel.

**Data loading:** address channel, enter 32 serial bits in that channel. Alternatively, address parallel word, enter (max 8) bits in that word. Addressing/entry by pushbuttons/LEDs or via HP-IB (option 001).

**Data Outputs:** (50  $\Omega$  source into 50  $\Omega$  load).

**Format:** independent RZ/NRZ selection in each channel.

**RZ width:** single continuous adjustment in ranges 10-100 ns, 0.1-1  $\mu$ s.

**Width jitter:**  $\leq 0.2\% + 50$ ps

**Complement:** simultaneous normal and complement outputs for each channel.

**Delay:** channels 2, 4, 6, 8 can be delayed independently within the ranges 0-100 ns, 0.1-1  $\mu$ s with respect to odd channels.

**Jitter:**  $\leq 0.1\% + 5$  ps

**Skew (undelayed):**  $\pm 1$  ns

**Levels:** ECL/TTL selectable

**Transition times:**  $\leq 3.0$  ns (ECL  $\leq 2.5$  ns)

**Bit Rate**

**Internal:** 0.5 Hz to 50 MHz.

**External:** dc to 50 MHz, or manual.

### Data Cycling

**Auto:** Sequence recycles continuously.

**Single cycle:** Sequence is triggered/gated by external pulse/level.

### General

**Operating temperature:** 0°C to +50°C.

**Power:** 100/120/220/240 Vrms; +5%, -10%; 48 Hz to 66 Hz, 200 VA (maximum)

**Weight:** net, 14.5 kg (32 lb). Shipping 16 kg (35.3 lb).

**Size:** 177 H x 426 W x 422 mm D (7" x 16.8" x 16.6").

### Ordering Information

HP 8016A Word Generator

Opt 001: HP-IB for data loading\*

Opt 907: Front Handle Kit (Part No. HP 5061-9690)

Opt 908: Rack Flange (Part No. HP 5061-9678)

Opt 909: Opt 907, 908 combined (Part No. HP 5061-9684)

Opt 910: Additional Operating and Service Manual

\*HP-IB cables: Refer to page 549.

☎ Fast-Ship product — see page 758

### Price

\$9880

add \$865

add \$66 ☎

add \$36 ☎

add \$92 ☎

add \$49

# DATA GENERATORS & DATA ANALYZERS

## Logic Pattern Generator

Model 8170A

- 4k/2k memory depth
- 8 bit/16 bit parallel output
- 2 wire/3 wire handshake capability
- Internal and external addressing

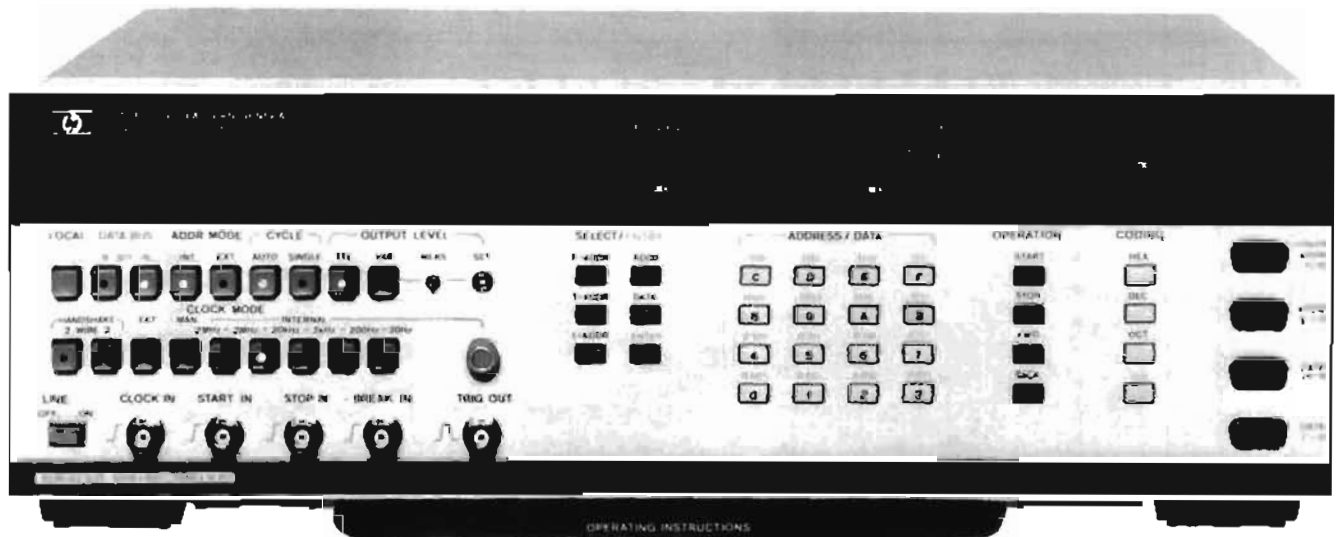

HP 8170A



Parts, memories and peripherals can be verified at all stages in design and production because the HP 8170A allows testing in isolation from the system. Busses or devices can be stimulated synchronously or asynchronously with data from the HP 8170A's memory. Address outputs (Option 002) allow writing into a RAM for subsequent comparison on e.g. a logic analyzer. In external address mode, software can be setup, verified and modified in the HP 8170A before committing ROM's.

The HP 8170A memory can be programmed manually, via HP-IB or by selecting one of the fixed patterns. User codes can be used directly because conversion is handled automatically.

### Specifications

**Memory:** 4k/2k, 8- or 16 bit width, selectable. Freely programmable or selectable patterns (Set/reset/prbs/count up/down).

#### Address Modes

**Internal:** ascending sequence between user-defined addresses.

**External:** 10-line address plus 4 enable lines. Max rate 2 Mbit/s.

#### Clocking

**Internal:** 20 Hz to 2 MHz in 5 ranges.

**External:** dc to 2 MHz.

**Manual:** forward/backward data stepping.

**Handshake:** 2-wire/3-wire (IEEE 488) selectable.

#### Cycle Modes (applies to Int Address mode)

**Auto cycle:** data cycled continuously.

**Single cycle:** data is cycled once per Start In command.

#### Outputs

**Data:** 8 or 16 lines, selectable. Pos/neg true selectable.

**Control:** data valid. Pos/neg true selectable.

**Status:** 2 lines indicate whether data is clocked, static or off.

**Levels:** TTL or adjustable +3 V to +1.5 V

**Address (via Opt 002 pod):** 10 lines, +2.4 V true, +0.5 V false.

### Inputs

**Address:** 10 lines (12 lines in Opt 001).

**Control:** ready for Data and data accepted lines.

**Enable:** 4 lines

**Levels:** high +2.0 V, low +0.8 V.

**Remote control:** HP-IB, RS-232C (CCITT V.24).

### HP-IB

**Interface functions:** SH1, AH1, L4, SR1, RL1, T5, PP0, DC0, DT0, C0.

### General

**Power:** 100/120/220/240 V rms: +5%, -10%; 48-66 Hz, 110 VA max.

**Operating temperature:** 0°C to 55°C.

**Weight:** net 11 kg (24.3 lbs). Shipping 15 kg (33.2 lbs).

**Dimensions:** 133 H x 426 W x 422 mm D (5.2" x 16.8" x 16.6").

### Ordering Information

	Price
HP 8170A Logic Pattern Generator**	\$7,440
Opt 002: Address Driver Pod (HP 15452A)	add \$480
Opt 907: Front Handle Kit (HP part number 5061-9689)	add \$56
Opt 908: Rack Mount Kit (HP part number 5061-9677)	add \$33
Opt 909: Opt 907, 908 combined (HP p/n 5061-9683)	add \$82
Opt 910: Extra Operating and Service Manual	add \$71
HP 15457A Pod Connector (Pods can be easily plugged into DUT when this accessory is wired in)	add \$66
HP 15459A 1.5 m pod extension cable	add \$194

### Supplied Accessories

HP 15453A Address input pod	\$480
HP 15454A Control Pod	\$480
HP 15455A Data Pod (D0-D7)	\$480
HP 15456A Data Pod (D8-D15)	\$480
HP 15458A Snap-on Assembly (one per pod)	\$153
HP 10230-62101 Hook-on Clip	\$3

\* For more on these codes refer to the HP-IB section of this catalog

\*\* HP-IB cables not furnished, see page 540

Fast-Ship product — see page 758

# DATA GENERATORS & DATA ANALYZERS

## 50 MHz Serial Data/PRBS Generator

Model 8018A

317

- 2048 bit, dual channel memory
- Variable word and pattern length

- TTL, ECL, CMOS compatible
- Programmable, prbs and mixed data

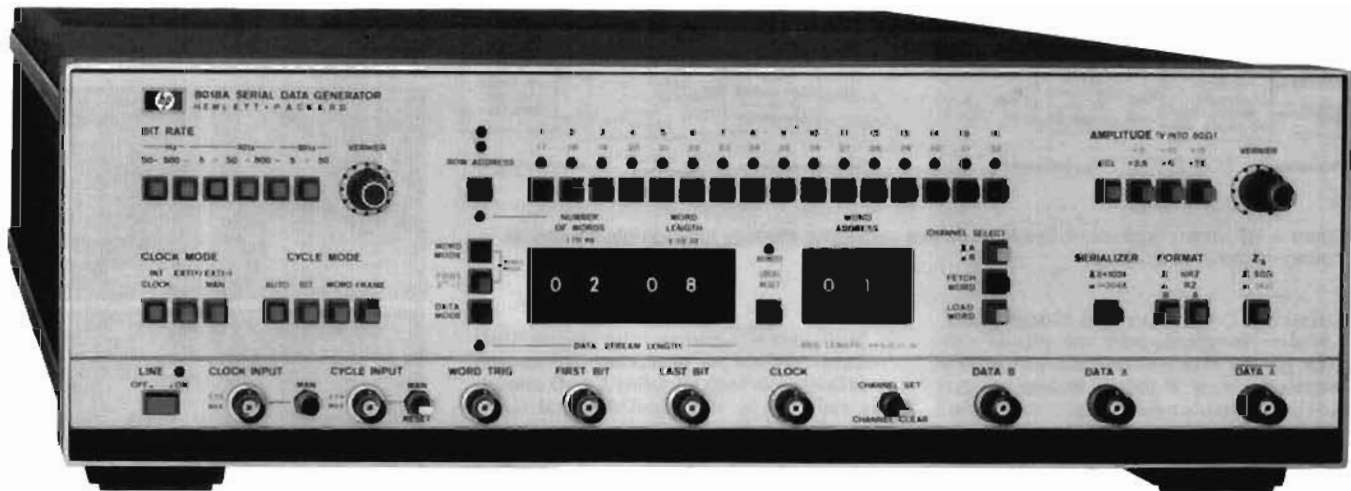

HP 8018A



with Option 001

With 2048 programmable bits, and a choice of pseudo-random binary sequences (prbs) ranging to over 1 Mbits, the HP 8018A is a powerful stimulator for serial digital systems and devices requiring high bit rate and fast pulses. Even preamble-data-post-amble data link patterns are feasible by combining prbs and programmed data. Useful synch outputs simplify testing by locking scope or analyzer to unique points in the data stream.

For data link patterns, mixed mode inserts a prbs after each odd word

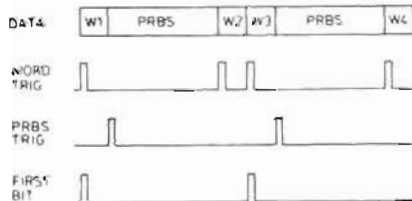

For dual-channel applications, the memory splits so that the outputs have independent 1 Kbits of data.

A high performance output amplifier adds to the HP 8018A's wide applicability. It delivers clean, 6 ns pulses with repetition rates from dc to 50 Mbits/s. Output amplitude is variable up to 1.5 volts into 50 Ω. This enables you to directly drive logic circuits ranging from TTL to CMOS. Output levels for emitter-coupled-logic (ECL) are also provided.

To handle patterns for repetitive tests more conveniently, data can be loaded via HP-IB (Option 001).

### Specifications

#### Data Capacity and Modes

**Programmable memory:** 2 channels, each 1 kbit, serializable. Thumbwheel switches define data stream length or frame length (N words of Mbits), and set up synch signals accordingly.

**Prbs:** pseudo-random binary sequences of 511, 1023, 32767 and 1048575 bits. Synch pulse at beginning of sequence.

**Mixed:** prbs is inserted after every odd-numbered programmable word

### Data Outputs

**Channel A:** simultaneous normal and complement outputs. ECL levels or variable +1.5 V amplitude. Selectable 50 Ω/1 kΩ output impedance. RZ/NRZ format.

**Data length:** up to 1024 bit or (serialized with B data) 1025 to 2048 bit.

**Transitions (50 Ω into 50 Ω):** ≤ 6 ns (ECL ≤ 5 ns)

**Preshoot, overshoot, ringing:** ≤ 10% (ECL ≤ 1%)

**Channel B:** normal output. 2.4 V (50 Ω into 50 Ω), up to 1024 bits. RZ/NRZ selectable.

### Bit Rate

**Internal:** 50 Hz to 50 MHz (40 MHz in Mixed mode), jitter 0.2%

**External:** dc to 50 MHz (40 MHz in Mixed mode) or manual.

### Data Cycling

**Auto:** sequence recycles continuously.

**Bit:** bits are triggered/gated by external pulses/level.

**Word:** words are triggered/gated by external pulses/level.

**Frame:** sequence is triggered/gated by external pulses/level.

**Manual:** switch triggers single bits/words/frame.

### General

**Power:** 100/120/230/240 V rms; +5%, -10%; 48 to 440 Hz. 230 V A max.

**Temperature range:** 0°C to 50°C.

**Weight:** net 12 kg (26.5 lbs). Shipping 16 kg (35.3 lbs).

**Size:** 133 H x 426 W x 422 mm D (5.2" x 16.8" x 16.6").

### Ordering Information

HP 8018A Serial Data Generator

**Price**

\$5600

Opt 001: HP-IB for data loading\*

add \$815

Opt 907: Front Handle Kit (Part No. HP 5061-9689)

add \$56

Opt 908: Rack Flange Kit (Part No. HP 5061-9677)

add \$33

Opt 909: Opt. 907, 908 combined

add \$82

(Part No. HP 5061-9683)

Opt 910: Extra Operating and Service Manual

add \$39

\*HP-IB cables: refer to page 549.

☎ Fast-Ship product—see page 758

# VECTOR MODULATION GENERATORS & ANALYZERS

## General Information

### A. MICROWAVE SYSTEM

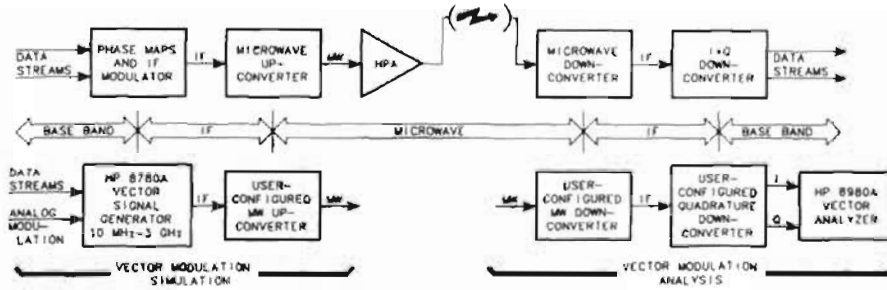

### B. TEST EQUIPMENT

Figure 1. HP vector modulation products have a packaging strategy fully complementary to modern microwave systems.

## Coherent Detection and Modulation

Modern communications and defense electronic systems have been pushed to new levels of complexity. Many of today's systems use data rates in the tens of megabits, digital modulations schemes such as BPSK and QPSK, and coherent detection to demodulate the incoming signal to an in-phase and quadrature-phase two-channel data stream.

The previous unavailability of off-the-shelf test equipment for these complex and wideband modulations systems has necessitated special user configured test systems.

## A Vector Measurement Test System

HP's product strategy for meeting the emerging technical requirements of these advanced systems is to provide both parts of the system test picture. The HP 8780A Vector Signal Generator can be thought of as a calibrated transmitter for use in testing system receivers. Similarly, the HP 8980A Vector Analyzer displays and analyzes the demodulated received signal and can thus be substituted as a calibrated receiver display.

Figure 1 above shows a microwave digital-communications system. With a few transmitter changes, the same principle could be diagrammed for a radar/EW system as well. In operation, digital data streams enter a phase-mapping function and I/Q modulator. The modulated signal is then filtered and up-converted as in traditional systems. On the receiver side, after down-converting to IF the signal is coherently demodulated using a quadrature mixer arrangement to recover the dual data stream with in-phase and quadrature-phase components.

In the case of a modern radar receiver, these coherent in-phase and quadrature data streams usually are sent to an ultra-fast A-to-D converters and then to sophisticated digital signal processing circuitry. When coherently compared to a reference transmission signal, dramatically more target resolution and discrimination is gleaned than with amplitude-only detection.

The functional performance of both the vector analyzer, and the vector signal generator, correspond closely to one of the basic system functional modules in the block diagram above. By adding several user-configured instruments — an RF up-converter, down-converter, plus a dual channel quadrature down-converter — a fully flexible test-instrument architecture emerges.

An example of one such test configuration for characterizing the system demodulator is shown in Figure 2. This setup can be used to measure and adjust demodulator I/Q balance, dc offset, and quadrature.

## HP Vector Modulation Product Offering

The HP 8780A Vector Signal Generator is a 10 MHz to 3 GHz synthesized signal generator with exceptionally wide FM, AM and pulse modulation bandwidths. For radar testing, it can generate Barker-coded pulses and chirps with up to 50 MHz deviations in less than 50 nanoseconds. Likewise, for communications testing it has built-in modulation from BPSK to 64QAM with separate clocks and burst capabilities for simulating offset modulation or satellite TDMA signals.

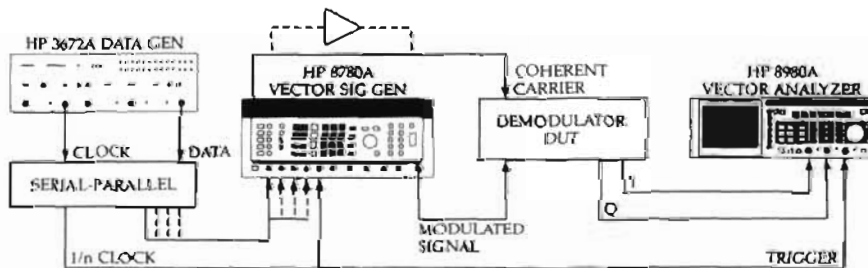
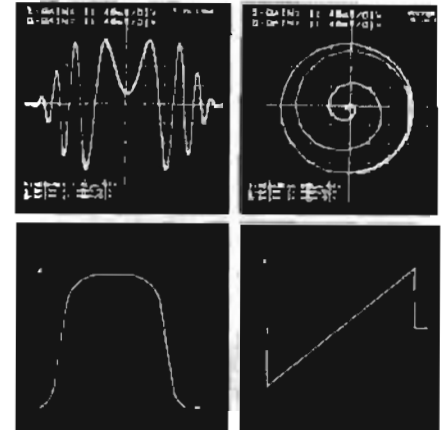
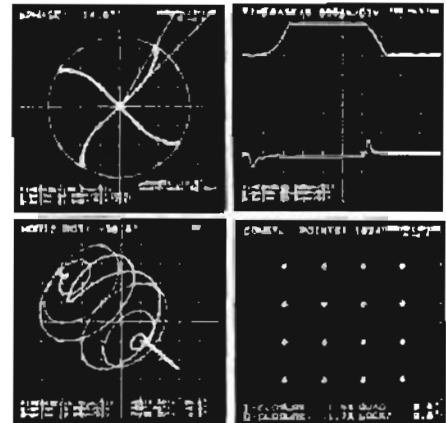

Figure 2. Characterizing a receiver demodulator. The HP 8780A Vector Signal Generator supplies a test signal while the HP 8980A Vector Analyzer displays quadrature errors, gain imbalances, and dc offsets. The demodulator is then adjusted while watching the results on the vector display.

The HP 8980A Vector Analyzer is optimized for performance testing of two-channel coherent (I/Q) detector systems. Conceptually similar to a two-channel sampling oscilloscope, the HP 8980A combines the utility of a general purpose oscilloscope with a 12-bit A/D converter, a host of specialized measurement functions, and extensive internal software that provide exceptional capabilities.



Visual analysis of a vector-demodulated chirp signal is enhanced by looking at the signal in the time domain and the vector domain. For further analysis, the signal is digitized and sent to a computer over HP-IB. Magnitude, phase, and frequency versus time can be calculated and plotted from the digitized I and Q values.



Examples of HP 8980A measurements 1) AM-AM and AM-PM distortion, 2) split screen view of pulse shows I and Q waveforms simultaneously, 3) 3-D view of a radar chirp, 4) automated constellation analysis of a 16QAM signal.

## Literature

- I/Q Tutor: The Hewlett-Packard Digital Communications Tutorial (See page 490)
- AN 343-1 Measurement Applications in Digital Microwave Radio
- AN 343-3 Coherent Pulsed Tests of Radar and Electronic Warfare Systems
- PN 8780A-1 Introductory Operating Guide to the HP 8780A Vector Signal Generator
- PN 8980A-1 Introductory Operating Guide to the HP 8980A Vector Analyzer
- Prog. N. 8980A-1 Vector Analyzer Programming Note



# VECTOR MODULATION GENERATORS & ANALYZERS

319

Vector Analyzer

Model 8980A

- Analyzes coherent phase and amplitude modulation
- 350 MHz Q vs. I bandwidth

- Markers for measuring phase, amplitude, and time
- 12 bit digitizing for HP-IB measurements



HP 8980A



## Applications

The vector analyzer is well suited to receiver measurements of baseband I and Q channels in a coherent detector or demodulator. The HP 8980A gives both visual and quantitative measures of receiver performance. Measurement aids include five separate markers for measuring I channel voltage, Q channel voltage, magnitude, phase, and time. Each marker has a delta function associated with it.

For speed and accuracy, automated constellation measurements give readouts of closure, lock angle error, and quadrature error on six common modulation schemes from QPSK to 256QAM.

Cable length compensation, gated TDMA measurements, and transient analysis are just a few of the tasks made easier with the vector analyzer's flexible timing, triggering, and gate features. Timing can be controlled from .5 nsec/div to 2 ms/div and I and Q can be delayed differentially up to 1/2 screen, or together up to 20 ms.

The HP8980A was designed for intuitive, self-guided use, and minimum keystroke setup. Ten instrument states can be stored and recalled. Additional convenience features like Auto Scope and Preset help the user find the signal or put the instrument into a known state.

## Specifications

### I and Q Channels

**Bandwidth (-3dB):** 350 MHz dc coupled; approximately 1 kHz to 350 MHz, ac coupled

**Deflection Factor Range:** 5 mV/div to 1 V/div, continuously adjustable; full scale is 10 divisions

**I or Q Offset Range:**  $\pm 10$  divisions

**DC Vector Accuracy Using Internal ADC:**  $\pm 1\%$  of full scale (or 2 mV if greater)  $\pm 1\%$  of offset

**I vs. Q Differential Voltage Accuracy Using Internal ADC:**  $\pm 1\%$  measured at 100 mV full-scale deflection, typical at all ranges

**Maximum DC Coupled Input Voltage:**  $\pm 5$  V peak

**Maximum AC Coupled Input Voltage:**  $\pm 25$  V dc;  $\pm 5$  V peak ac

**Transition Time (10% to 90%):** 1.1 ns

**Deflection Factor Accuracy:**  $\pm 2\%$

**Display Offset Accuracy:**  $\pm 2\%$  of full-scale (or 2 mV if greater), for a zero volt signal and I Offset, Q Offset = 0.

**I-Q Crosstalk:** -60 dB or 1% of full-scale peak, whichever is greater, dc to 350 MHz

**Input Termination:** 50 ohms or 75 ohms.

**Input Coupling:** each channel independently: ac, dc, or ground (input disconnected).

### Timing

**Acquisition Method:** repetitive sampling

**Time per Division Range:** 500 ps/div to 2 ms/div, continuously adjustable

**Delay I&Q Range:** 0 to 100 divisions for specified performance, 20 ms maximum

**I Delay, Q Delay Range:** 0 to 5 divisions, 20 ms maximum

**Delta Time Accuracy:**  $\pm 3\%$  specified for delta times greater than 6 ns or 2 div, whichever is larger; start times greater than 20 ns or 1 div, whichever is larger; and delay less than 100 divisions; both start and stop time on screen

**I vs. Q Timing Accuracy:**  $\pm 1$  ns or 2% of full-scale, whichever greater, for delays up to 100 divisions, and I Delay, Q Delay=0.

**Time/Division Accuracy:**  $\pm 3\%$

**Delay Reference Accuracy:** Internal trigger only: less than 5 ns or 2% of full scale, whichever is greater. Delay I & Q = 0.

**Delay Accuracy:**  $\pm 3\%$  + Delay Reference Accuracy

**Time Base Jitter:** 2% of full-scale rms for delays less than 20 divisions

### Triggering

**Minimum Signal:**

**External Trigger:** 100 mV p-p (dc to 80 MHz), 200 mV p-p (80 MHz to 150 MHz)

**Internal Trigger:** 2 divisions p-p (dc to 80 MHz), 3 divisions (80 to 150 MHz).

**Trigger Sources:** selectable from external, internal I, internal Q, or LINE.

**External Trigger Terminations:** Selectable 50 or 75 ohms.

**ECL:** 50 ohms or 75 ohms to -2V

**QND:** 50 ohms or 75 ohms to gnd

**Internal I or Q Trigger Levels:** selectable ac or dc internal coupling. Adjustable internal trigger levels.

**Pulse Triggering:** for pulses greater than 3 ns, minimum trigger signal is 200 mv p-p external triggering, 20% of full-scale p-p internal triggering

**Gate Operation:** a rear panel input. Gate blanks the display and disables measurements asynchronously with the trigger rate.

**Gate Input Terminations and Trigger Levels:**

GND termination with TTL trigger level

-2V termination with ECL trigger level

GND termination with 0 V trigger level

**Minimum Gate Pulse Width:** 100 ns (on or off)

**Gate Timing:** 0 to 5 ns prior to display time instant

**Digitizing Resolution:** 12 bits

**Digitizing Rate:** 3 kHz maximum

**Measurement Noise:**  $\pm 4$  counts rms

### Temperature

**Operating:** 0 deg C to +55 deg C (+32 deg F to +131 deg F).

**Non-operating:** -20 deg C to +75 deg C (-4 to +167 deg F).

### Humidity

**Operating:** up to 95% relative humidity at +40 deg C (+104 F).

### Power Requirements

**Voltage:** 100, 120, 220, 240 Vac, -10% to +5%; 48-66 Hz

**Power:** 245 watts, 320 VA maximum

### Weight

**Net:** approximately 20 kg (45 lb).

**Shipping:** approximately 24 kg (53 lb).

**Dimensions:** Package is 5-1/4 inch rack height, one module width 23D HP System II cabinet.

### Ordering Information

HP 8980A Vector Analyzer

Price

\$19,000

# VECTOR MODULATION GENERATORS & ANALYZERS

## Vector Signal Generator

### Model 8780A

- 700 MHz of arbitrary modulation using vector or "I,Q" inputs
- 10 MHz to 3 GHz IF testing
- Pulse modulation with 1 ns rise times
- Coherent Carrier Output
- BPSK, QPSK, 8PSK, 16QAM, 64QAM, digital modulation and Pulse
- Wideband FM: over 50 MHz p-p deviations
- Linear amplitude modulation with >50 dB dynamic range and 350 MHz bandwidth

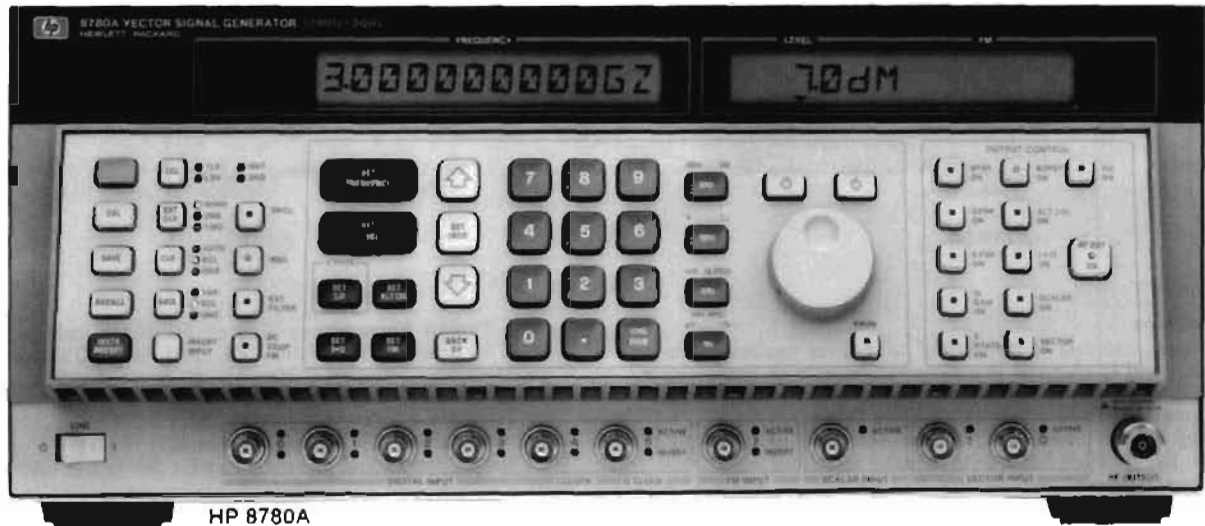

#### Description

The HP 8780A Vector Signal Generator is a synthesized IF source with exceptional modulation for modern receiver and component testing. It is capable of modulation bandwidths almost 100 times wider than previous synthesizers, and has built-in DACs (digital-to-analog-converters) to simplify generation of common digital modulations. Its extra-wide modulation bandwidth comes from a vector modulator that effectively doubles baseband modulation bandwidths for 700 MHz of output modulation. The Vector Signal Generator's wideband modulation is complemented with an unmodulated coherent carrier output for demodulation of test signals.

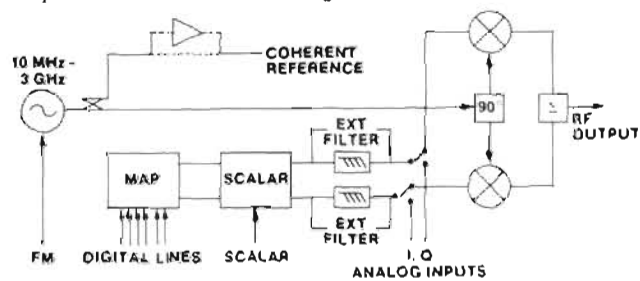

#### HP 8780A Block Diagram

The Vector Signal Generator offers a wide variety of modulation using both digital and analog inputs. It generates many standard digital modulations like QPSK and 16QAM and traditional modulations like FM, AM and pulse. By combining the different modulation types, signals as diverse as Barker-coded radar pulses and doppler-shifted satellite signals can be simulated.

#### Applications

The Vector Signal Generator is well suited to receiver measurements where wideband or complex modulations are required. Its coherent carrier output makes it particularly valuable for systems employing vector demodulators and for pulsed phase measurements of components.

#### Modulation

The Vector Signal Generator vector modulation capabilities are some of its most valuable. The 350 MHz I and Q (In-phase and Quadrature-phase) analog inputs combine to generate arbitrary phase and amplitude modulation within a 700 MHz output band-

width. With the proper I and Q signals, the Vector Signal Generator can generate an infinite variety of modulations. Some of the most likely sources for I and Q driving signals are two HP 8770A Arbitrary Waveform Synthesizers, the output of a signal generator and quadrature hybrid or other baseband waveform generators.

The HP 8780A generates extremely wideband AM (350 MHz) with typical dynamic range and accuracy of 50 dB and 2% respectively. A variety of amplitude-only modulations like gaussian-shaped pulses and pulse trains of different amplitudes can be easily generated using this technique.

#### Digital modulation

HP 8780A offers a more convenient way to generate modulations using only digital inputs. The Vector Signal Generator generates several standard modulations (BPSK, QPSK, 8PSK, 16QAM, and 64QAM with Opt. 064) using digital inputs, and other common modulations can be generated by combining the Vector Signal Generator modulations. For example, the HP 8780A can generate TDMA (time-division-multiple-access) modulation by combining Burst modulation with one of the PSK modulations. Radar Barker codes and spread spectrum modulations can be generated in similar ways.

The Vector Signal Generator frequency modulation capabilities are also wideband with peak-to-peak deviations up to 50 MHz and rates up to 12 MHz. The FM performance has low distortion and good low frequency response for satellite video applications. If wider deviations are required, the FM input can be safely overdriven for typical deviations of > 200 MHz p-p.

The Vector Signal Generator also generates simultaneous modulations to simplify receiver tests and IF measurements. For example, the envelope of a digitally modulated signal can be varied to test receiver AGC performance, or a Barker-coded radar modulation can be simultaneously frequency modulated to simulate doppler shifts. The table below shows which modulations can be combined and some applications for the combinations.

	FM	Scalar
Digital	Receiver carrier recovery loop characterization	Receiver AGC testing and compression measurements
Vector	Simulating doppler shifts	N/A
FM	N/A	Receiver AGC testing
Scalar	Receiver AGC testing	N/A

HP 8780A Specifications

Frequency
Range: 10 MHz to 3 GHz.
Resolution: 1 Hz.
Switching speed: <220 ms normally
Accuracy and stability: Same as reference oscillator (<5 x 10^-10/day after 10 day warm up for internal reference).

Output
Level range: +10 to -100 dBm <2.5 GHz.
+4 to -100 dBm >=2.5 GHz.
(+12 dBm <=3 GHz with Opt 064)
Resolution: 0.1 dB.
Accuracy: +/-2.5 dB for levels >=-30 dBm.
+/-3.5 dB for levels <-30 dBm and >-100 dBm.
SWR: typically < 1.3:1.
Flatness: +/-1dB.

Coherent Carrier Output
Unmodulated (except for FM) and unlevelled version of front panel RF output available at rear panel.
Frequency range: 10 MHz to 3 GHz.
Output level: typically >-20 dBm (+10 dBm with Opt. 002)

Spectral Purity
Residual phase noise
Table with 5 columns: Offset from carrier, CW\* specified, CW\* typical, DCFM typical, ACFM typical. Rows include 100 Hz, 1 kHz, 100 kHz, 1 MHz, 10 MHz (>+7dBm).

Harmonics: <-35dBc for output levels <=+7dBm to 2.5 GHz.
Non-harmonically related spurious for CW, digital, vector, and scalar modulated signals >-40dBm:
<-60 dBc for 10 MHz to 3 GHz, >=20 MHz from carrier
<-55 dBc for 10 MHz to 3 GHz, <20 MHz from carrier
<-55 dBc for <10 MHz & >3 GHz to 18 GHz.
Residual FM for CW, digital, vector or scalar modulated signals:
<4 Hz rms for 300 Hz to 3 kHz detection BW at 50 MHz.

AC Coupled Frequency Modulation
Rates (3 dB frequencies): 20 Hz to 12 MHz.
Deviation ranges: 50 kHz to 50 MHz peak-to-peak (up to >250 MHz p-p possible with slightly higher distortion by overdriving FM input).
Sensitivity: 1V peak-to-peak for displayed deviation.
Sensitivity Accuracy: <6% for rates 50 Hz to 6 MHz and deviations <30 MHz p-p.
Input impedance: 50 ohms nominal.
Residual FM for 300 Hz to 3 kHz BW and 50kHz deviation range: <200 Hz rms.
Supplemental Characteristics
Distortion to 3 MHz rates at 10 MHz p-p: <.75%.
Carrier spurious responses (>20 kHz offset): <-60 dBc.
Frequency flatness (50 Hz to 8 MHz): <=0.5dB.
Differential gain at 27.8 MHz p-p: <2%.
Differential phase at 27.8 MHz p-p: <1 degree.
Field time distortion: <1%.
Luminance-to-chrominance delay: <20 ns.

DC Coupled Frequency Modulation
Maximum rate (3 dB frequency): 10 kHz.
Deviation ranges: 150 Hz to 150 kHz peak-to-peak.
Sensitivity: 1V peak-to-peak for displayed deviation.
Sensitivity Accuracy: <10% for rates <1 kHz and deviations <150 kHz p-p.
Distortion at 1kHz rate and 150 kHz p-p deviation: <5%
Input impedance: 50 ohms nominal.
Residual FM for 300 Hz to 3 kHz BW and 150kHz deviation range: <5 Hz rms.
Supplemental Characteristics
Carrier spurious responses: <-60 dBc for >1 kHz offsets,
<-50 dBc for 100 Hz - 1 kHz offsets.

Digital Modulation
Modulation types: BPSK, QPSK, 8PSK, 16QAM (64QAM with Opt. 064), Arbitrary 2-State, Burst.
Simultaneous burst: Available with BPSK, QPSK, 8PSK, or CW (Burst/8PSK not available with Opt. 064).
Alternate level: Available with BPSK, QPSK, BPSK and Burst, QPSK and Burst (last two not available with Opt. 064.)
I<Q: Available with all digital modulations.
Clock modes: Single, separate I and Q (except with Opt. 064), or asynchronous.
Parallel data rates: 0 to 150 MHz clocked (except 64 QAM), 0 to 100 MHz clocked 64QAM w/Opt. 064, 0 to 50 MHz asynchronous.
Serial data rates (only with Opt. 064): 0 to 150 MHz clock and data line for 0 to 25 MHz 64QAM clock rate.
Data input levels: ECL (-2V termination), ground, or variable -2.5V to 2.5V.
Baseband filters: Three internal; external ports supplied.
Data and clock input impedances: 50 ohms nominal.
Data and clock drive requirements: 0.3 to 3.0 Vp-p.
Data dc accuracy at 140 MHz carrier and <=+7dBm levels: +/-1.0% of full scale for BPSK, QPSK, +/-1.2% of full scale for 8PSK, +/-2% of full scale for 16QAM, 2-state, alt-lvl, I<Q.
Burst dc on/off ratio: >50 dB for 140 MHz carrier.
Supplemental Characteristics 10 MHz to 3 GHz
Data asymmetry: <1 ns for clocked modes.
Data skew: <1 ns for single clock operation.

Pulse Modulation (Burst)
Pulse rates: 0 to 75 MHz.
Pulse dc on/off ratio: >50 dB for 140 MHz carrier (except Opt. 064).
Pulse rise/fall times: <= 1ns

Scalar Modulation/AM
Traditional AM modulation requires a dc offset of 0.5 V to be added to the scalar input.
Sensitivity: 0 to +1 volt for 0 to full scale envelope modulation
DC accuracy: <2% of full scale for 140 MHz carrier and for +7 dBm levels.
DC offsets: <1% of full scale
Frequency response: dc to 500 kHz (-3dB).
Input impedance: 10k ohms nominal.

Vector Modulation (using analog I/Q inputs)
Frequency response: dc to 350 MHz (-3dB) at 1 GHz carrier frequency.
DC accuracy: <1.5% of full scale for 140 MHz carrier at <=+7 dBm and sqrt(I^2 + Q^2) <= 0.5V.
DC offsets: <1% of full scale for 140 MHz carrier.
Sensitivity: +/-0.5V into 50 ohms for +/-100% I and Q.
Supplemental Characteristics over 10 MHz to 3 GHz frequency range
Input impedance: 50 ohms.
SWR: <1.5:1 dc to 350 MHz.
Frequency Response: dc to 350 MHz for carriers 400 MHz to 3 GHz.

Remote Programming
All functions HP-IB programmable except line switch. The HP 8780A can output over the interface frequency and output level settings, error/malfunction codes, and operational status codes.
Interface Functions: SH1, AH1, T6, TE0, L3, LE0, SRI, RLI, PPI, DCI, DT0, C0.

General
Operating temperature range: 0 degrees C to +55 degrees C.
Power: 100, 120, 220, 240 V, +5%, -10%, 48-440 Hz; 500 VA max.
Weight: net, 31.5 kg (70 lb). Shipping, 35.5 kg (78 lb).
Size: 177 mm H x 425 mm W x 637 mm D (7.0" x 16.7" x 25.1").

Ordering Information
Table with 2 columns: Option, Price. Rows include HP 8780A Vector Signal Generator, Option 001, Option 002, Option 064, Option 907, Option 908, Option 909, Option 916, Option 918.

# TRANSCEIVER TEST EQUIPMENT

Automated Test Systems

Models 8953A, 8955A, 8957S



## Transceiver Test Systems

Hewlett-Packard's transceiver test product line was designed to offer maximum flexibility, modularity and expandability to the mobile communications market. All systems are based on three "designed for systems" instruments: the HP 8656B Synthesized Signal Generator, the HP 8903B Audio Analyzer, and the HP 8901A/B Modulation Analyzer. These products together perform the majority of in-channel tests on any AM or FM transceiver. Combining these three basic building blocks, together with a programmable interface for system integration, creates a modular solution that is flexible enough to meet your needs today and tomorrow. These systems then can be automated using one of the many software packages available for the Series 300 and Vectra computers.

Based on the three basic measurement instruments and our system interface product line, Hewlett-Packard has created three separate test systems: the HP 8953A Transceiver Test Set, the HP 8955A RF Test System and the HP 8957S Cellular Radio Test System. From these beginnings, you can add or change instruments depending on your requirements.

### HP 8953A

The HP 8953A Transceiver Test Set is Hewlett-Packard's lowest-priced system. It combines the measurement power of the three basic measurement instruments with the HP 8954A Transceiver Interface to create a solution capable of performing the majority of in-channel tests and expandable enough to meet all but the most demanding of testing requirements.

#### Ordering Information

HP 8953A Transceiver Test System (consisting of:)

- HP 8901A Modulation Analyzer
    - Opt 001 RF output connectors on rear panel only
    - Opt 002 high stability time base
  - HP 8656B Synthesized Signal Generator
    - Opt 002 RF output connectors on rear panel only
  - HP 8903B Audio Analyzer
    - Opt 001 RF output connectors on rear panel only
    - Opt 010 400 Hz high pass filter
    - Opt 051 CCITT weighting filter
  - HP 8954A Transceiver Interface
  - HP 8498A Attenuator
    - Opt 030 25 watt, 30 dB
- Cables and connectors

**Price**

\$29,000

### HP 8955A

The HP 8955A RF Test System is a powerful and versatile system developed for designers, manufacturers and users of RF communication equipment. It provides a flexible combination of instruments for testing transmitters, receivers, subassemblies and modules in the frequency range from 150 kHz to 1000 MHz. The basic system consists of the three basic measurement instruments and the HP 436A Power

Meter for increased measurement accuracy. The instruments are then integrated together using the HP 8956A System Interface. The system also includes a cabinet, side table and comprehensive documentation.

Before a system is shipped, it is assembled and tested at the factory. This includes integrating and configuring the instruments into the rack and thoroughly testing them as a system, ensuring that the HP 8955A meets its specifications.

#### Ordering Information

HP 8955A RF Test System (consisting of:)

- HP 8901A Modulation Analyzer
  - Opt 001 RF connectors on rear panel only
  - Opt 002 high stability time base
- HP 8656B Synthesized Signal Generator
  - Opt 002 RF connectors on rear panel only
- HP 8903B Audio Analyzer
  - Opt 001 RF connectors on rear panel only
  - Opt 010 400 Hz high pass filter
  - Opt 051 CCITT weighting filter
- HP 8956A System Interface
- HP 436A Power Meter
- HP 8482A Power Sensor
- Cabinet
- Cables and connectors

**Price**

\$55,000

### HP 8957S

The HP 8957S Cellular Radio Test System combines the three basic measurement instrument with the HP 8958A Cellular Radio Interface. This system will perform all signaling necessary to test AMPS and TACS compatible cellular radios. By adding the HP 11799A Signaling Box, the systems capabilities can be increased to include NMT cellular radios.

#### Ordering Information

HP 8957S Cellular Radio Test System (consisting of:)

- HP 8901B Modulation Analyzer
  - Opt 001 RF connectors on rear panel only
  - Opt 002 high stability time base
- HP 8656B Synthesized Signal Generator
  - Opt 002 RF connectors on rear panel only
- HP 8903B Audio Analyzer
  - Opt 001 RF connectors on rear panel only
  - Opt 010 400 Hz high pass filter
  - Opt 051 CCITT weighting filter (for TACS only)
  - Opt 053 C-Message weighting filter (for AMPS only)
- HP 8958A Cellular Radio Interface
- HP 6024A Power Supply
- HP 11804A Accessory Kit

**Price**

\$0  
\$13,000  
+\$200  
+\$650  
\$6,500  
+\$175  
\$5,800  
+\$1000  
+\$200  
+\$200  
+\$200  
\$11,000  
\$1,300  
\$2,400



### Automated Transceiver Test

Hewlett-Packard's transceiver test solutions are flexible combinations of instrumentation and software for automatically testing radio transmitters and receivers. This approach to transceiver test gives you comprehensive, expandable solutions for a wide range of applications, allowing you to choose the right combination of hardware and software to fit your needs today and in the future.

### Simplifies Workflow

The diagram below illustrates a typical workflow using manual test equipment. In this case, a technician must manually test each radio and repair it if there is a problem. Then, he checks the radio again to verify that the fault was corrected. Because these tests are tedious and time-consuming, often only a cursory check is performed. The second diagram illustrates the effect of an automatic test system. This system quickly and completely tests the radio. If a fault is found, the technician makes the necessary repairs and the system verifies proper operation. Often, the system finds that an incoming radio is operating properly, saving the technician valuable time.

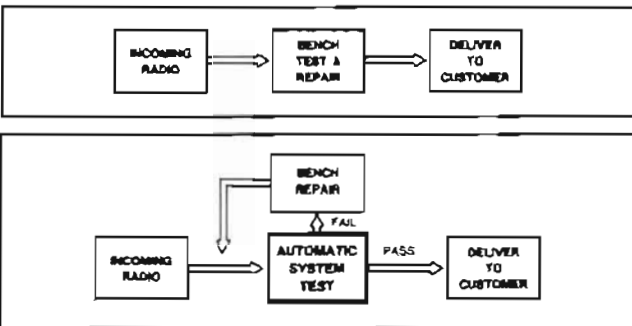

### Ensures Quality

An automatic test system can make a thorough test of every radio, helping to find latent problems. An HP transceiver test system lets you make more measurements at more data points in less time than with manual testing. And it follows the same procedure every time, eliminating operator errors while maintaining consistent testing.

### Improves Productivity

You can save time with an automatic test system. It frees highly skilled technicians for more productive work and allows for expansion to meet the growing demand for mobile radio products and services. Because they perform the tedious and repetitive tasks, automatic test systems help to increase job satisfaction as well.

### System Software

An integral part of Hewlett-Packard's transceiver test product line is the wide variety of software application test packages available. Designed to meet your testing needs, these packages offer a broad spectrum of solutions ranging from basic in-channel measurements to full radio characterization. With test times typically measured in seconds, these packages will quickly and accurately measure your transceiver's performance.

### HP 11790A/B Transceiver Test Software

#### Expandable Starter Software

The HP 11790A/B application packages were designed to meet the testing needs of small service repair facilities and users of land mobile communications equipment. Each software package includes three separate programs capable of performing most in-channel AM and FM tests. The software is written in BASIC language, creating an excellent solution that is easily customized. All test routines are derived from the EIA-AM, EIA-FM and CEPT standards.

Using the HP 11790A/B to test radios is simplified with a single path execution sequence and helpful screen prompts. The test results are then printed in an easy-to-read format which includes audio frequency response plots. Written in BASIC language, it can be easily customized to most applications.

### HP 11805A Transceiver Test Software

#### Exceptional Flexibility and Expandability

The Hewlett-Packard 11805A Transceiver Test Software Package is an easy-to-use, comprehensive solution for automatically testing radio receivers and transmitters. The HP 11805A software package provides quick and easy testing with full softkey operation, concise graphics, and easy-to-read test results.

The software consists of a main executive program coupled with a separate series of measurement test packages. With this format, you purchase only the measurement capability you need, with the ability to expand with full compatibility at a later date. This new approach to software development allows the HP 11805A to fit into any testing environment, dependent only on the measurement capability purchased. If you have a specialized application, the software is written in BASIC language and can be easily modified.

The HP 11805A will test multiple channel radios and, for standard FM and AM radios, can encode and decode Continuous Tone Controlled Squelch (CTCSS) and Digital Coded Squelch (DCS) tones automatically. In addition, all test packages allow you to perform all tests on all channels, selected prime channels, or to select any test/channel combination you desire.

# TRANSCEIVER TEST EQUIPMENT

## System Software (cont'd)

For cellular radio applications the HP 11805A offers test packages that are fully compatible with the AMPS, TACS and EIA-800 cellular radio test standards. In addition, there are application packages capable of fully testing AM and SSB-SC radios.

Pass/Fail limit testing allows you to quickly verify your radio's performance. Optimized for speed and repeatability, the HP 11805A increases productivity and efficiency. With the optional bar code reader, radio parameters can be entered in seconds and stored on disc for future use. In addition, a Manual Mode allows you to manually control test instrument settings through the computer without leaving the program. Clear instructions, easy-to-read graphics, and helpful program prompts guide you through every step of the program.

Utility programs are also among the powerful capabilities of the HP 11805A software package. The System Interconnection Verification program is designed to ensure that all instruments are responding to the computer controller. The System Calibration program measures all the path losses from the radio through the interface. These path losses are then accounted for in the measurement test routines, increasing the accuracy and repeatability of the test results.

### HP 11798A Cellular Radio Software

#### NMT Cellular Radio Software

The HP 11798A Cellular Radio Test Software provides the comprehensive RF and signaling tests required for testing cellular mobile radios conforming to the 450 and 900 MHz standards of the Nordic Mobile Telephone (NMT) system. With user-written software, the system is also capable of simulating a mobile station for base station signaling tests.

Tests can be selected and run in any order, giving you complete control of your test routines. These routines include call processing functions such as origination, origination reorder and paging. The results are then displayed in a concise format with Pass/Fail limits, allowing you to quickly verify your radios performance. The HP 11798A is an excellent solution to your NMT cellular radio testing needs.

Additional features of the HP 11798A include a calibration utility capable of measuring and correcting for the insertion and path losses in the system and a special Manual mode which allows you to manually control the test instruments from the computer controller.

#### Ordering Information

	Price
HP 11790A Software Application Pac	\$250
HP 11805A Software Application Pac	\$0
Opt 001 Operating System Executive	\$1,500
Opt 100 North American FM Tests	\$500
Opt 101 Extended North American FM Tests	\$750
Opt 200 European $\phi$ M Tests	\$500
Opt 201 Extended European $\phi$ M Tests	\$750
Opt 300 AM Radio Tests	\$500
Opt 400 SSB-SC Radio Tests	\$750
Opt 500 AMPS Cellular Radio Tests	\$750
Opt 510 TACS Cellular Radio Tests	\$750
Opt 520 EIA-800 Cellular Radio Tests	\$750
Opt 530 TACS with AMPS Bus Cellular Radio Tests	\$750
HP 11798A Software Application Pac	\$1,100

Both 3.5 in. and 5.25 in. disc mediums are shipped with each application package.

HP Model No.s	11790A/B	11805A Options										11798A
		100	101	200	201	300	400	500	510	520	530	
Type of radios Tested	AM FM	FM	Extended FM	PM	Extended PM	AM	SSB-SC	AMPS	TACS	EIA-800	TACS w/ AMPS Bus	NMT
Controllers Supported <sup>1</sup>	200 300	200 300 Vectra	200 300 Vectra	200 300 Vectra	200 300 Vectra	200 300 Vectra	200 300 Vectra	200 300 Vectra	200 300 Vectra	200 300 Vectra	200 300 Vectra	200 300
Language Supported	BASIC 5.0	BASIC 5.0	BASIC 5.0	BASIC 5.0	BASIC 5.0	BASIC 5.0	BASIC 5.0	BASIC 5.0	BASIC 5.0	BASIC 5.0	BASIC 5.0	BASIC 5.0
Systems Supported	8953A <sup>2</sup>	8953A 8955A 8957S	8953A <sup>2</sup> 8955A	8953A 8955A 8957S	8953A <sup>2</sup> 8955A	8953A 8955A	8953A 8955A		8957S	8957S	8957S	8957S 8957S <sup>3</sup>
Measure Squelch	CTCSS	CTCSS DCS	CTCSS DCS	CTCSS DCS	CTCSS DCS							
Generate Squelch		CTCSS DCS	CTCSS DCS	CTCSS DCS	CTCSS DCS							
Number of tests Performed	18	20	9	17	8	17	16	35	20	19	29	21

<sup>1</sup> Only selected configurations are supported.

<sup>2</sup> Order HP 11790B if HP 8953A Option 100 is ordered.

<sup>3</sup> HP 8953A system must include Option 100.

<sup>4</sup> HP 11798A is also required.

# TRANSCEIVER TEST EQUIPMENT

## RF Interfaces

Models 8954A, 8956A, 8958A, 11799A

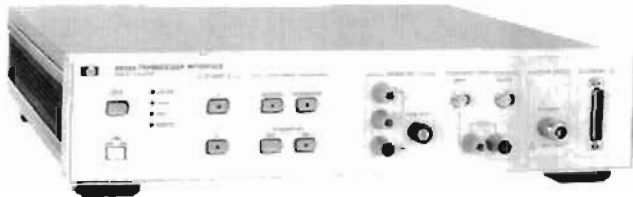

HP 8954A



HP 8958A



HP 8956A

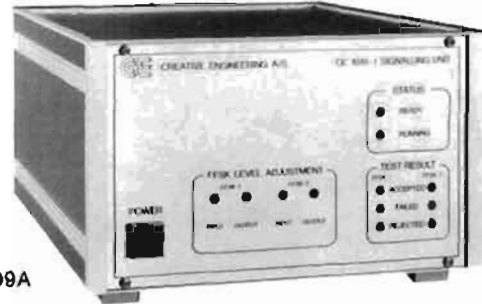

HP 11799A

### HP 8954A Transceiver Interface

The HP 8954A is Hewlett-Packard's lowest priced transceiver test interface. It is fully programmable and uses microwave switches and hardware in all RF paths. Designed for dc to 18 GHz measurements, the HP 8954A Transceiver Interface provides the flexibility needed for most AM, FM and SSB receiver and transmitter testing.

### HP 8954A-H03 Transceiver Interface

The HP 8954A Option H03 Transceiver Interface is a full-duplex version of the standard HP 8954A. The standard RF switching hardware is replaced with a power divider network that is designed for 100 kHz to 1300 MHz use. The HP 8954A Option-H03, when used with the HP 11799A Signaling Unit, is part of the recommended configuration for testing NMT (Nordic Mobile Telephone) cellular radios.

### HP 8956A System Interface

The HP 8956A System Interface, with its multiple paths and connections, provides added flexibility in the designing of systems in the frequency range from dc to 1000 MHz. It has two RF test ports for duplex testing, stimulus/response testing and reduced connect/disconnect times. A built-in, switchable 120 watt 30 dB attenuator can be inserted for transmitter testing and removed for receiver testing, increasing receiver measurement range.

Additional functions of the HP 8956A include current drain and timing measurements.

### HP 8958A Cellular Radio Interface

The HP 8958A Cellular Radio Interface gives your system the capability to fully test a cellular radio. With the flexible Channel Simulator, you can simulate cell-site operation, verify signaling protocol, or perform highly complex and sophisticated tests using an external controller to generate and analyze data content.

### HP 11799A Signaling Unit

For testing cellular radios compatible with the 450 and 900 MHz protocols of the Nordic Mobile Telephone (NMT) system, Hewlett-Packard recommends and supplies the Creative Engineering CE1019-1 Signaling Unit. The CE1019-1 can be ordered from Hewlett-Packard as HP Model 11799A.

When used with the three basic transceiver test instruments and a duplex interface, the HP 11799A simulates a base station and mobile exchange for over-the-air RF and signaling tests of cellular mobile radios.

### Ordering Information

	Price
HP 8954A Transceiver Interface	\$3,875
HP 8954A-H03 Transceiver Interface	\$5,715
HP 8956A System Interface	\$13,260
HP 8958A Cellular Radio Interface	\$11,205
HP 11799A Signaling Unit	\$14,000

### System Interface Comparison

	HP 8954A	HP 8954A-H03	HP 8956A	HP 8958A
Frequency Range	DC to 18 GHz	10 to 1500 MHz	DC to 1000 MHz	10 to 1500 MHz
Number of RF Ports	4	4	6	6
Number of Audio Ports	2	2	4	2
Number of UUT Ports	1	1	2	1
Duplex Capabilities	NO	YES	YES	YES
Typical Applications	AM, FM, 0M, SSB	AM, FM, 0M, SSB, NMT <sup>1</sup>	AM, FM, 0M, SSB	AMPS, TACS, NMT <sup>1</sup>

<sup>1</sup>Requires the HP 11799A Signaling Unit

# MICROWAVE TEST EQUIPMENT

## Microwave Measurements and Products



### Microwave measuring techniques

Hewlett-Packard offers a complete line of microwave coaxial and waveguide measuring equipment. Measuring systems can be assembled from this equipment to make accurate reflection and transmission measurements on other components such as filters, mixers, cables, etc. Signal characteristics such as frequency, power, or spectral content may be measured using other associated equipment.

HP equipment capability ranges from inexpensive systems for point-by-point, narrow-band work to powerful analyzers which furnish dynamic displays of error-corrected network scattering parameters across wide frequency bands. Equipment selection and measuring techniques depend primarily on the accuracy, speed, and cost requirements of the application.

Some applications require complete phase and amplitude characterization of microwave components. These vector measurements are usually made in design labs to aid in component design or in evaluating performance to phase specifications. Such phase measurements require relatively sophisticated equipment and techniques.

But the majority of microwave measurements made in production, test, maintenance, and calibration require only amplitude (scalar) characteristics. Scalar test procedures are popular because they are straightforward, easy-to-use, and low cost, yet yield an excellent measure of the quality of the test device part.

### Coaxial/Waveguide Measurement Accessories Catalog Available

More detailed information is available in the Coaxial & Waveguide Measurement Accessories Catalog, literature number 5954-6401. The catalog includes product and applications information on more than 400 products operating from dc to 110 GHz. Seventeen product sections include attenuators, detectors, couplers, filters, power sensors, scalar analyzer accessories, noise figure equipment and even 75 ohm accessories.

More than 27 pages of this 112 page catalog are devoted to microwave measurement techniques and reference information, summarizing common scalar techniques of attenuation and SWR, as well as other measurements in component and system test such as power, frequency, noise figure, spectrum, waveform, carrier noise and modulation analysis. Waveguide and Coax band designations and flange data are included in the reference section, along with 9 pages of associated equipment descriptions.

This catalog will prove useful for design engineers, production test personnel, quality assurance and metrology engineers, field-test and system-maintenance engineers.

### Confidence in Component Performance

The performance of every unit manufactured is verified on an error-correcting automatic network analyzer that has been calibrated with standards that are directly or indirectly traceable to the National Bureau of Standards. This means you can be assured that the product you receive has been properly tested and meets the specifications you expect.



## Coaxial Switches

Models 8761A/B, 33311B/C, 33312B/C, 33313B/C, 33321H, 33323K



HP 33311B



HP 33313B

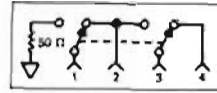

HP 33312B/C



HP 33313B/C

Wiring Diagrams

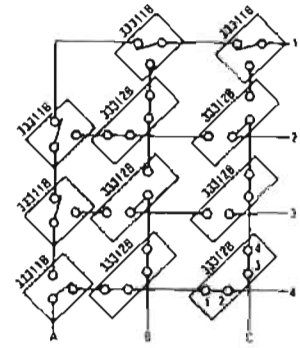

Typical Matrix Application

### HP 8761A/B, 33311B/C, 33312B/C, 33313B/C Coaxial Switches

HP coaxial switches all feature low SWR, low insertion loss, and excellent isolation. The HP 8761A/B is an SPDT switch for dc to 18 GHz. It is controlled by latching solenoids and is break-before-make. Six connector options plus a 50-ohm termination may be specified for each port, making switch "traces" possible.

The HP 33311B (dc - 18 GHz) and 33311C (dc - 26.5 GHz) switches are also SPDT type. They feature exceptional isolation of >90 dB to 18 GHz, as well as internally-switched 50-ohm loads resulting in all ports maintaining a 50-ohm match. They use latching solenoids and the switching current is automatically cut off when switching is complete. Their compact size and high repeatability and reliability make them very suitable for OEM use.

HP 33312B/C (4-port) and 33313B/C (5-port) serve a variety of uses such as "transfer" switches to insert or remove a component from a signal path. They can also be used as the intersection switching element in a larger microwave matrix as shown above. HP 33312B/C features one internal 50-ohm switched load while HP 33313B/C brings all 5 ports to 5 connectors. B-models cover dc - 18 GHz and C-models, dc - 26.5 GHz. Ask for Application Note 332 for more information on microwave switching.

### HP-IB Compatible

The HP 33311B/C, 33312B/C, 33313B/C, and the 8761A/B Switches can be remotely controlled by the HP-IB with either the HP 11713A Attenuator/Switch Driver or the HP 59306A Relay Actuator. See the catalog index for page reference.

### How to Order HP 8761A/B Switches

Specify solenoid voltage and connectors (including built-in 50-ohm termination) by the alphabetic suffix on the switch model number and the appropriate three-digit option number.

A Model: 12-15 V Connector Option Number 0 0 1  
 B Model: 24-30 V (See table) Port 1 Port 2 Port C

Option Code	Connector Type	Option Code	Connector Type
0	N (f)	4	APC-7 for UT-230 Coax
1	N (m)	5	SMA (f)
2	APC-7	6	SMA (m)
3	w/Threaded sleeve APC-7 w/Coupling nut	7	50Ω Termination

### SP4T, SP5T, SP6T Switches

For applications requiring a single-pole, 4-throw, 5-throw, or 6-throw coaxial switch, HP has designed modified versions of the edge-line design which works well from dc to 18 GHz or dc to 26.5 GHz. Depending on the connection configuration, port isolation ranges from 25 dB to 50 dB at 26 GHz and 40 dB to 90 dB at 2 GHz.

The switches are fully programmable with HP-IB, and are built into the very compact form factor of the HP 33321H or 33323K Step Attenuators shown elsewhere in this catalog section. Standard solenoid voltage is 24 Vdc. Contact HP for further applications information and specifications.

### Ordering Information

Model	Option	Price
33323K Opt. K14 (SP4T version)	1-9	\$980
	10-24	930
33323K Opt. K15 (SP5T version)	1-9	1180
	10-24	1100
33323K Opt. K16 (SP6T version)	contact HP for prices	

### HP 33311B/C, 33312B/C, 33313B/C, 8761A/B Specifications

HP Models	Freq. Range (GHz)	SWR 50 ohm nominal	Insertion Loss	Isolation	Switching Speed	RF Connector	Dimensions H * W * D (mm)	Shipping Weight (grams)	Price
33311B	dc - 18	< 1.25: to 12.4 GHz < 1.4: to 18.0 GHz	< 0.5 dB @ 18 GHz	> 90 dB to 18 GHz	30 msec	SMA (f)	54 * 53 * 14	220	\$ 585
33311C	dc - 26.5	< 1.5: to 16 GHz < 1.9: to 26.5 GHz	< 1.4 dB @ 26.5 GHz	> 90 dB to 18 GHz > 50 dB to 26.5 GHz	30 msec	APC-3.5 (f)	54 * 53 * 14	220	\$ 665
33312B	dc - 18	< 1.25: to 12.4 GHz < 1.4: to 18 GHz	< 0.5 dB @ 18 GHz	> 90 dB to 18 GHz	30 msec	SMA (f)	54 * 53 * 14	220	\$ 630
33312C	dc 26.5	< 1.5: to 16 GHz < 1.9: to 26.5 GHz	< 1.4 dB @ 26.5 GHz	> 90 dB to 18 GHz > 50 dB to 26.5 GHz	30 msec	APC-3.5 (f)	54 * 53 * 14	220	\$ 710
33313B	dc - 18	< 1.25: to 12.4 GHz < 1.4: to 18 GHz	< 0.5 dB @ 18 GHz	> 90 dB to 18 GHz	30 msec	SMA (f)	54 * 53 * 14	220	\$ 670
33313C	dc - 26.5	< 1.5: to 16 GHz < 1.9: to 26.5 GHz	< 1.4 dB @ 26.5 GHz	> 90 dB to 18 GHz > 50 dB to 26.5 GHz	30 msec	APC-3.5 (f)	54 * 53 * 14	220	\$ 735
8761A	dc - 18	1.2: to 12.4 GHz 1.25: to 18GHz	0.8 dB @ 18 GHz	> 50 dB to 12.4 GHz > 45 dB to 18 GHz	35-50 msec	See Table: How to Order the HP 8761A/B	41 * 38 * 38	300	\$ 310
8761B	dc - 18	1.2: to 12.4 GHz 1.25: to 18 GHz	0.8 dB @ 18 GHz	> 50 dB to 12.4 GHz > 45 dB to 18 GHz	35-50 msec		41 * 38 * 38	300	\$ 310

### SPECIFICATIONS COMMON TO ALL MODEL NUMBERS

Life: > 1,000,000 switchings  
 Max Power Input: 1 W average, or 100 W Peak (Max. 10 μsec P.Width) Except HP 8761A/B, 10 W average, 5kW peak

Solenoid voltage (dc or pulsed): 24 volts for HP 33311B/C; 12B/C; 13B/C (diode protected to reduce transients)  
 12 to 15 volts for HP 8761A  
 24 to 30 volts for HP 8761B  
 15 volt solenoid voltage: Option 015 for HP 33311B/C; 12B/C; 13B/C  
 5 volt solenoid voltage: Option 011 for HP 33311B/C; 12B/C; 13B/C

# MICROWAVE TEST EQUIPMENT

## Coaxial Fixed Attenuators

Models 8490D, 8491A/B, 8492A, 8493A/B/C, 8498A, 11581/2/3A/3C, 33340A/B/C/D

- Flat frequency response
- Low SWR
- Specifications traceable to NBS



HP 11581A

### HP 8490D, 8491A/B, 8492A, 8493A/B/C Fixed Attenuators

Hewlett-Packard coaxial fixed attenuators provide precision attenuation, flat frequency response, low SWR over broad frequency ranges (dc-50.0 GHz) at low prices. Attenuators are available in nominal attenuations of 3-dB and 6-dB, also 10-dB increments from 10 dB to 60 dB. These attenuators are swept-frequency tested to ensure meeting specifications at all frequencies. Calibration points are provided on a nameplate chart attached to each unit.

### HP 11581A, 11582A, 11583A/C Attenuator Sets

A set of four Hewlett-Packard attenuators—3, 6, 10 and 20 dB—are furnished in a handsome walnut accessory case. The HP 11581A set consists of HP 8491A Attenuators; the HP 11582A set, HP 8491B Attenuators; the HP 11583A set, HP 8492A Attenuators; and the HP 11583C set, HP 8493C Attenuators. The set includes calibration reports certified traceable to the National Bureau of Standards, containing both the attenuation and the reflection coefficients for each attenuator at four frequencies for the HP 11581A (dc, 4, 8, 12.4 GHz) and five frequencies for the HP 11582A and HP 11583A (dc, 4, 8, 12.4, 18 GHz). By specifying option 890, calibration data is given at 26 frequencies (HP 11581A) or 42 frequencies (HP 11582A and 11583A). The HP 11583C set includes option 890 calibration data. See next page for exact frequency lists.

These sets are ideal for calibration labs or where precise knowledge of attenuation and SWR is desired.

### HP 8498A High Power Attenuator

The HP 8498A Option 030 is designed to meet the needs of high power attenuation applications in the RF and microwave frequency range. It is specified from dc to 18 GHz at 25 watts average, 500 watts peak, from dc to 5.8 GHz and 125 watts peak from 5.8 to 18 GHz. Available only in a 30 dB model (option 030), the unit offers low SWR (<1.30 at 18 GHz) and good accuracy ( $\pm 1$  dB at 18 GHz). The unit also features 'human engineered' cooling fins that prevent operator burns even under continuous maximum input power conditions.



HP 33340C



HP 8490D

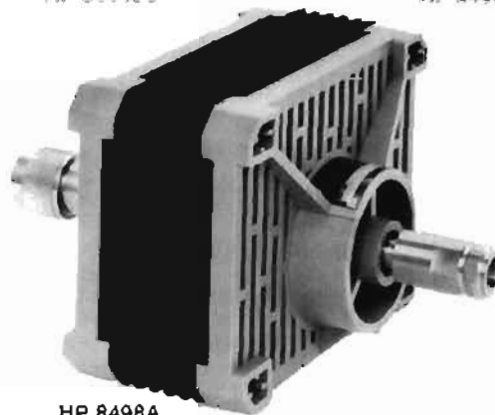

HP 8498A  
Option 030

### Option 890 Calibration Data

Extensive calibration data is available on HP attenuators at low cost. When option 890 is specified for the fixed attenuators or microwave step attenuators, standardized calibration data in frequency steps no larger than 500 MHz is provided over the frequency range of the units. This data is generated from measurements made on an HP 8542 Automatic Network Analyzer and features excellent accuracy (traceable to NBS) and low cost. Data is given for attenuation and the SWR (reflection coefficient for the HP 8493C) of each port and is provided in a protective plastic envelope.

Calibration data has important uses in applications such as RF substitution measurements and test system verification. Using the actual calibration data rather than data sheet specifications allows the attenuation uncertainty to be reduced 60% or more. Also, the calculated mismatch uncertainty for a test system is lower if the actual SWR data for the attenuators is used. Similar calibration data is used in HP production areas to verify the performance of manual and automated test systems. For automated system checkout, the calibrated unit is tested and the results are compared to the previously stored calibration data. If the differences are within the measurement uncertainty, proper operation is ensured. For step attenuators, the calibration data can be used in automated test systems to more accurately characterize a device's characteristics. By storing the calibration data for the individual steps, the measurement results can be adjusted by the actual amount of attenuation (for example, when a nominal 10 dB step is actually 9.6 dB).

The calibration data frequencies, prices, and ordering information for fixed attenuators are on the next page, and the same information for step attenuators is on page 331.

### HP 33340A/B/C/D Fixed Attenuators

The HP 33340A, 33340B, 33340C, and 33340D are Coaxial Fixed Attenuators intended for OEM and systems use. Frequency range specifications are dc—12.4 GHz, dc—18 GHz, dc—26.5 GHz and dc—50 GHz respectively. These OEM attenuators are similar to the HP 8493 and HP 8490 Series Attenuators.

For more information regarding the HP 33340 series refer to the data sheet (5952-8279).

### Ordering Information

HP 33340A Coaxial Fixed Attenuator (SMA)	\$90
Option 890	add \$20
HP 33340B Coaxial Fixed Attenuator (SMA)	\$120
Option 890	add \$25
HP 33340C Coaxial Fixed Attenuator (APC-3.5)	\$250
Option 890	add \$40
HP 33340D Coaxial Fixed Attenuator (2.4 mm)	\$375

**MISSING PAGE**

**MISSING PAGE**

**How to Order the HP 8494/5/6/7 Series Attenuators**

Each order must include basic model number, suffix letter, and connector option.

Optional calibration data.

**HP 8494 A Option 001 Option 890**

- |                            |                                |                       |
|----------------------------|--------------------------------|-----------------------|
| 4 (1 dB step, 11 dB max)   | A (Manual, dc—4 GHz)           | 001 (N-Female)        |
| 5 (10 dB step, 70 dB max)  | B (Manual, dc—18 GHz)          | 002 (SMA Female)      |
| 6 (10 dB step, 110 dB max) | D (Manual, dc—26.5 GHz)*       | 003 (APC-7)           |
| 7 (10 dB step, 90 dB max)  | G (Programmable, dc—4 GHz)     | 004 (APC-3.5 Female)* |
|                            | H (Programmable, dc—18 GHz)    |                       |
|                            | K (Programmable, dc—26.5 GHz)* |                       |
- \* Option 004 is only available on 'D' and 'K' models.

**HP 355 Series, 8494/5/6/7 Series Specifications**

HP Model and (Switching Mode)	Frequency Range (GHz)	Incremental Attenuation (dB)	SWR Maximum (50 Ω Nominal)	Insertion Loss (0 dB setting)	Attenuation Accuracy	Power Rating, Minimum Life	Solenoid Voltage Speed Power	Size, Shipping Weight	Connector Options Available	Price
355C (Manual)	dc—1	0—12 1 dB steps	dc—0.25 GHz: 1.2 dc—0.5 GHz: 1.3 dc—1.0 GHz: 1.5	0.11 dB + 1.39 dB/GHz	±0.1 dB @ 1000 Hz ±0.25 dB @ dc—0.5 GHz ±0.35 dB: dc—1.0 GHz	0.5 W avg 350 W peak 0.3 million cycles per section	— 15—18 V <65 ms 3.0 W	67 H × 70 W × 152 mm D (2.6" × 2.75" × 6") 1.4 kg (3 lb)	BNC (f) See Note 1	\$435 \$800
355E (Programmable)										
355D (Manual)	dc—1	0—120 10 dB steps	dc—0.25 GHz: 1.2 dc—0.5 GHz: 1.3 dc—1.0 GHz: 1.5	0.11 dB + 1.39 dB/GHz	±0.3 dB @ 1000 Hz ±1.5 dB to 90 dB, and ±3 dB to 120 dB @ 1 GHz	0.5 W avg 350 W peak 0.3 million cycles per section	— 15—18 V <65 ms 3.0 W	67 H × 70 W × 152 mm D (2.6" × 2.75" × 6") 1.4 kg (3 lb)	BNC (f) See Note 1	\$435 \$800
355F (Programmable)										
8494A (Manual)	dc—4	0—11 1 dB Steps	1.5	0.6 dB + 0.09 dB/GHz	±0.2 dB: 1—2 dB ±0.3 dB: 3—6 dB ±0.4 dB: 7—10 dB ±0.5 dB: 11 dB	1 W avg 100 W peak 10 μs max. 5 million cycles per section	— 20—30 V <20 ms 2.7 W	43 H × 73 W × 159 mm D (1.7" × 2.9" × 6.2") 0.9 kg (2 lb) 43 H × 73 W × 142 mm D (1.7" × 2.9" × 5.6")	001 002 003 See Note 2	\$720 \$1,100
8494Q (Programmable)										
8494B (Manual)	dc—18	0—11 1 dB steps	dc—8 GHz: 1.5 dc—12.4 GHz: 1.6 dc—18 GHz: 1.9	0.6 dB + 0.09 dB/GHz	dc—12.4 GHz ±0.3 dB: 1—2 dB ±0.4 dB: 3—4 dB ±0.5 dB: 5—6 dB ±0.6 dB: 7—10 dB ±0.7 dB: 11 dB dc—18 GHz ±0.7 dB: 1—5 dB ±0.8 dB: 6—9 dB ±0.9 dB: 10—11 dB	1 W avg 100 W peak 10 μs max. 5 million cycles per section	— 20—30 V <20 ms 2.7 W	43 H × 73 W × 159 mm D (1.7" × 2.9" × 6.2") 0.9 kg (2 lb) 43 H × 73 W × 142 mm D (1.7" × 2.9" × 5.6")	001 002 003 See Note 2	\$915 \$1,400
8494H (Programmable)										
8495A (Manual)	dc—4	0—70 10 dB steps	1.35	0.4 dB + 0.07 dB/GHz	±1.7% of setting or ±0.4 dB, whichever is greater	1 W avg 100 W peak 10 μs max. 5 million cycles per section	— 20—30 V <20 ms 2.7 W	43 H × 73 W × 130 mm D (1.7" × 2.9" × 5.1") 0.9 kg (2 lb) 43 H × 73 W × 114 mm D (1.7" × 2.9" × 4.5")	001 002 003 See Note 2	\$515 \$920
8495Q (Programmable)										
8495B (Manual)	dc—18	0—70 10 dB steps	dc—8 GHz: 1.35 dc—12.4 GHz: 1.5 dc—18 GHz: 1.7	0.4 dB + 0.07 dB/GHz	±3%: dc—12.4 GHz ±4%: dc—18 GHz % in dB from Atten. Setting	1 W avg 100 W peak 10 μs max. 5 million cycles per section	— 20—30 V <20 ms 2.7 W	43 H × 73 W × 130 mm D (1.7" × 2.9" × 5.1") 0.9 kg (2 lb) 43 H × 73 W × 114 mm D (1.7" × 2.9" × 4.5")	001 002 003 See Note 2	\$670 \$1,030
8495H (Programmable)										
8495D (Manual)	dc—26.5	0—70 10 dB steps	dc—12.4 GHz: 1.6 12.4—18 GHz: 1.9 18—26.5 GHz: 2.2	0.5 dB + 0.13 dB/GHz	±3%: dc—12.4 GHz ±4%: dc—18 GHz ±7%: dc—26.5 GHz % in dB from Atten. Setting	1 W avg 100 W peak 10 μs max. 5 million cycles per section	— 20—30 V <20 ms 2.7 W	43 H × 52 W × 159 mm D (1.7" × 2.1" × 6.2") 0.9 kg (2 lb) 43 H × 52 W × 168 mm D (1.7" × 2.1" × 6.6")	004 APC-3.5 See Note 2	\$875 \$1,300
8495K (Programmable)										
8496A (Manual)	dc—4	0—110 10 dB steps	1.5	0.6 dB + 0.09 dB/GHz	±1.7% of setting or ±0.4 dB, whichever is greater	1 W avg 100 W peak 10 μs max. 5 million cycles per section	— 20—30 V <20 ms 2.7 W	43 H × 73 W × 159 mm D (1.7" × 2.9" × 6.2") 0.9 kg (2 lb) 43 H × 73 W × 142 mm D (1.7" × 2.9" × 5.6")	001 002 003 See Note 2	\$720 \$1,100
8496Q (Programmable)										
8496B (Manual)	dc—18	0—110 10 dB steps	dc—8 GHz: 1.5 dc—12.4 GHz: 1.6 dc—18 GHz: 1.9	0.6 dB + 0.09 dB/GHz	±3%: dc—12.4 GHz ±4%: dc—18 GHz % in dB from Atten. Setting	1 W avg 100 W peak 10 μs max. 5 million cycles per section	— 20—30 V <20 ms 2.7 W	43 H × 73 W × 159 mm D (1.7" × 2.9" × 6.2") 0.9 kg (2 lb) 43 H × 73 W × 142 mm D (1.7" × 2.9" × 5.6")	001 002 003 See Note 2	\$915 \$1,400
8496H (Programmable)										
8497K (Programmable)	dc—26.5	0—90 10 dB steps	dc—6 GHz: 1.25 6—12.4 GHz: 1.45 12.4—18.0 GHz: 1.6 18.0—26.5 GHz: 1.8	0.6 dB + 0.09 dB/GHz	±0.3 dB at 6 GHz 10 dB attenuation to ±2.8 dB at 26.5 GHz 90 dB atten- uation. See Data Sheet 5952-8278 for details.	1 W avg 100 W peak 10 μs max. 5 million cycles per section	5 V or 24V	43 H × 52 W × 143 mm D (1.7" × 2.1" × 5.6") 0.9 kg (2 lb)	004 APC-3.5 See Note 2	\$1600
Option 890 Calibration Data		Option 890 Frequency List (MHz)				Models				Option 890 Price
		DC to 4 GHz Models: 100, 300, 500, 700, 900, 1000, 1250, 1500, 1750, 2000, 2500, 3000, 3500, 4000				8494A/G, 8496A/G, 33320A/G, 33322A/G 8495A/G, 33321A/G				add \$130 add \$110
		DC to 18 GHz Models: Same as above to 4000 MHz, every 500 MHz to 16000 (plus 12400 MHz), every 250 MHz from 16000 to 18000				8494B/H, 8496B/H, 33320B/H, 33322B/H 8495B/H, 33321B/H 8495D/H, 8497K				add \$170 add \$150 add \$250
Note 1: 355C/D/E/F connector options (BNC (f) standard)		Price add \$25 add \$10 add \$55				Note 2: 8494/5/6/7 orders must specify connector option. See ordering example above.				N/C N/C add \$50 N/C
Option 001 N(f)						Option 001 N(f)				
Option 005 TNC(f)						Option 002 SMA(f)				
Option 007 Transistor protection (355E/F only)						Option 003 APC-7				
						Option 004 APC-3.5 (HP 8495D/K, 8497K only)				

Fast-ship product—see page 758.

# MICROWAVE TEST EQUIPMENT

## Variable, Fixed Attenuators and OEM Step Attenuators

Models 370, 382 Series, 33300 Series, 33320 Series

HP Q382A



HP P382A



HP Q370A



HP 33321H

### HP 33300 Series, 33320 Series OEM Step Attenuators

HP 33300 Series Step Attenuators provide wideband programmable signal level control. Magnetic latching solenoids switch individual attenuating elements into and out of contact with a 50-ohm transmission line. D models have separate indicator contacts and A/B models have no indicator contacts. Three three-digit connector options (0XY) must be specified. X is the input connector. Y is the output connector. first digit is always 0. See specifications table for option numbers.

HP 33320 series Step Attenuators are compact versions of the HP 8494/5/6/7 bench Attenuators on page 330 (same specifications) and are configured for designing into microwave systems and instruments. Manual or electrically-actuated versions are available. The manual models take less than 1.5 square inches of panel space. OEM quantity discounts are available for HP 33300 and 33320 series. HP 33320 series have 5-million-step reliability specification.

### Ruggedized Versions

For applications in harsh environments, the HP 33320H, 33321H, and 33322H Programmable Step Attenuators are available as an Option H22. These special ruggedized configurations have been type tested to meet the requirements of MIL-STD-202 for salt spray (method 101, test conditions B) and humidity (method 103, test condition A). In addition, operation is warranted over the -40 to +75°C temperature range.

### HP 33300 Series, 33320 Series Specifications

HP Model	Freq Range (GHz)	Mode	Range	Remarks	Price
33304 B D	dc-18	Prog.	0-11 dB 1 dB steps	Connector options available:	\$1600 \$1665
33305 B D	dc-18	Prog.	0-110 dB 10 dB steps	0: N(f), 1: N(m) 2: 7mm(f), 3: 7mm(m) 5: SMA(f), 6: SMA(m)	\$1615 \$1665
33320A B	dc-4 dc-18	Manual	1-11 dB 1dB steps	Specifications identical to 8494 series page 330	\$ 700 \$ 895
33320G H	dc-4 dc-18	Prog.		SMA(f) connectors	\$1080 \$1380
33321A B D	dc-4 dc-18 dc-26.5	Manual	0-70 dB 10 dB steps	Specifications identical to 8495 series page 330	\$ 495 \$ 650 \$ 860
33321G H K	dc-4 dc-18 dc-26.5	Prog.		SMA (f) connectors (APC-3.5 on D/K)	\$ 900 \$1010 \$1280
33322A B	dc-4 dc-18	Manual	0-110 dB 10 db steps	Specifications identical to 8496 series page 330	\$ 700 \$ 895
33322G H	dc-4 dc-18	Prog.		SMA (f) connectors	\$1080 \$1380
33323K	dc-26.5	Prog.	0-90 dB 10 dB steps	Specifications identical to 8497K page 330 APC-3.5 only	\$1570

### HP 370A/B/C Millimetre-Wave Fixed Attenuators

The HP Q and U 370 Fixed Attenuators offer precise attenuation, flat frequency response, and low SWR. Their ruggedness, reliability, and small size make them ideal for bench systems applications. They are also useful for general purpose applications, like the reduction of power levels to sensitive components and systems.

### HP 370A/B/C Fixed Attenuator Specifications

HP Model	Frequency Range (GHz)	SWR (Max)	Max. Input Power	Attenuation	Attenuation Accuracy	Waveguide & Equivalent Flange	Price
Q370A	33-50	1.2	.5W Avg. 100W Peak	3dB	±0.3dB	WR-22	\$450
Q370B				6dB	±0.6dB	UG-383/U	
Q370C				10dB	±0.3dB		
U370A	40-60	1.2	.5W Avg. 100W Peak	3dB	±0.3dB	WR-19	\$480
U370B				6dB	±0.6dB	UG-383/U (Mod.)	
U370C				10dB	±0.6dB		

### HP 382 Series Waveguide Attenuators

Operation of these HP 382 series rotary-vane, continuously-variable attenuators depends on a mathematical law rather than on the resistivity of the attenuator card. They are direct-reading and provide accurate attenuation from 0 to 50 dB regardless of temperature and humidity.

### HP 382 Series Specifications

HP Model	Frequency Range (GHz)	Accuracy	Attenuation Range (dB)	Waveguide & Equivalent Flange	Price
X382A	8.2-12.4	±2% of reading or 0.1 dB whichever greater	0-50	WR 90 UG-135/U	\$1700
P382A	12.4-18.0	±2% of reading or 0.1 dB whichever greater	0-50	WR 62 UG-419/U	\$1700
K382A	18.0-26.5	±2% of reading or 0.1 dB whichever greater	0-50	WR 42 UG-597/U	\$2845
R382A	26.5-40.0	±2% of reading or 0.1 dB whichever greater	0-50	WR 28 UG-599/U	\$2845
Q382A	33.0-50.0	±2% of reading or 0.1 dB	0-50	WR-22 UG-383/U	\$2065
U382A	40.0-60.0	(whichever greater)		WR-19 UG-383/U (Mod.)	\$2125

# MICROWAVE TEST EQUIPMENT

Transmission Reflection Test Sets, Power Splitters, Power Dividers  
 Models 8721A, 85044A/B, 11850C/D, 11667A/B, 11636A/B



HP 85044A

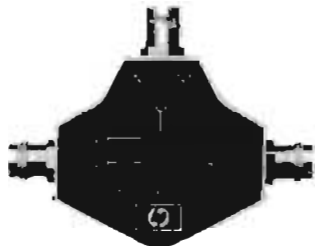

HP 8721A



HP 11850C



HP 11667A



HP 11636A

## Description

Accurate broadband measurements of transmission and reflection parameters are highly dependent on the device used to separate signals for the measurement. Some devices separate the reflected and transmitted signals and some split power for ratio and comparison measurements.

### HP 8721A Directional Bridge HP 8721A Option 008 75 Ohm Version

**Frequency range:** 0.1 - 110 MHz.  
**Directivity:** >40 dB, 1 - 110 MHz, typically >30 dB, 0.1 - 1 MHz.  
**Load port match:** >30 dB (VSWR <1.07).  
**Transmission arm:** Nominal loss, 6 dB. Frequency response, <0.2 dB.  
**Coupling arm:** Nominal coupling, 6 dB. Frequency response, <0.6 dB.  
**Maximum input power:** +20 dBm.  
**Weight:** net, 0.55 kg (0.25 lb); shipping, 1.1 kg (0.5 lb).  
**Size:** 59 H x 39 W x 123 mm D (1.5 x 1 x 3.13 in.).

### HP 85044A 50 Ohm Transmission Reflection Test Set HP 85044B 75 Ohm Transmission Reflection Test Set

The HP 85044 contains a power splitter and directional bridge that permits simultaneous transmission and reflection measurements with over 30 dB directivity from 300 kHz to 3.0 GHz. Detailed specifications on the HP 85044A and HP 85044B appear on page 241.

### HP 11850C 50 Ohm Power Splitter HP 11850D 75 Ohm Power Splitter

These three-way power splitters are designed for ratio measurements from dc to 3.0 GHz (11850C) or 2 GHz (11850D). One output port provides the reference and the other two output ports can be used for independent transmission measurements. They provide 0.25 dB tracking and >20 dB output match. Detailed specifications are on page 241.

### HP 11667A Power Splitter (Type N) HP 11667B Power Splitter (APC-3.5)

These two-way, two-resistor splitters provide good input and output source match in ratio measurement and source leveling applications. The HP 11667A operates from dc to 18 GHz with output match >17 dB and tracking <0.25 dB. The HP 11667B operates from dc to 26.5 GHz and has output source match >18 dB and tracking <0.4 dB. Detailed specifications are on page 221.

### HP 11636A/B Power Dividers/Combiners

The HP 11636A/B are two-way, three-resistor power dividers for use in non-ratio measurements. They can also be used as power combiners for combining two independent signals. They are ideal for fault location measurements made with the HP 8757S and the HP 85016A software.

#### Frequency Range

HP 11636A: DC to 18 GHz.

HP 11636B: DC to 26.5 GHz.

**Impedance:** 50 ohms nominal.

**Insertion loss:** 6 dB nominal.

	DC-10 GHz	DC-18 GHz	DC-26.5 GHz
<b>Input SWR</b>			
HP 11636A	<1.25	<1.35	
HP 11636B	<1.22	<1.29	<1.29
<b>Output SWR</b> (non-ratio measurements)			
HP 11636A	<1.25	<1.35	
HP 11636B	<1.22	<1.29	<1.29
<b>Output Tracking</b> (between output arms)			
HP 11636A	<0.4 dB	<0.5 dB	
HP 11636B	<0.25 dB	<0.25 dB	<0.5 dB
<b>Typical Phase Tracking</b> (between output arms)			
HP 11636A	2°	2°	
HP 11636B	2°	2.5°	3°
<b>Maximum Input Power</b>			
HP 11636A	+30 dBm		
HP 11636B	+27 dBm		
<b>Connectors</b>			
HP 11636A:	Type N male input port, female output ports.		
HP 11636B:	APC-3.5 female on all ports.		
<b>Dimensions</b>			
HP 11636A:	42 H x 45 W x 18 mm D (1.64 x 1.75 x 0.69 in.)		
HP 11636B:	40 H x 47 W x 10 mm D (1.6 x 1.9 x 0.4 in.)		
<b>Weight</b>			
HP 11636A:	net, 0.14 kg (0.31 lb); shipping, 0.45 kg (1 lb)		
HP 11636B:	net, 0.06 kg (0.13 lb); shipping, 0.14 kg (0.3 lb)		

### Ordering Information

	Price
HP 8721 Directional Bridge	\$325
Option 008: 75 Ohm Version	add \$50
HP 85044A 50 Ohm Transmission Reflection Test Set	\$3,000
HP 85044B 75 Ohm Transmission Reflection Test Set	\$3,500
HP 11850C 50 Ohm Power Splitter	\$900
HP 11850D 75 Ohm Power Splitter	\$1,400
HP 11667A Power Splitter (DC - 18GHz)	\$930
Option 001: Type N Male Input, Type N Female Outputs	N/C
Option 002: Type N Female Input, APC-7 On Outputs	add \$75
HP 11667B Power Splitter (DC - 26.5 GHz)	\$950
HP 11636A Power Divider (DC - 18 GHz)	\$450
HP 11636B Power Divider (DC - 26.5 GHz)	\$950

# MICROWAVE TEST EQUIPMENT

## Coaxial Single and Dual-Directional Couplers

Models 770 Series, 11691D, 11692D

- Broadband coverage
- High directivity
- Close tracking

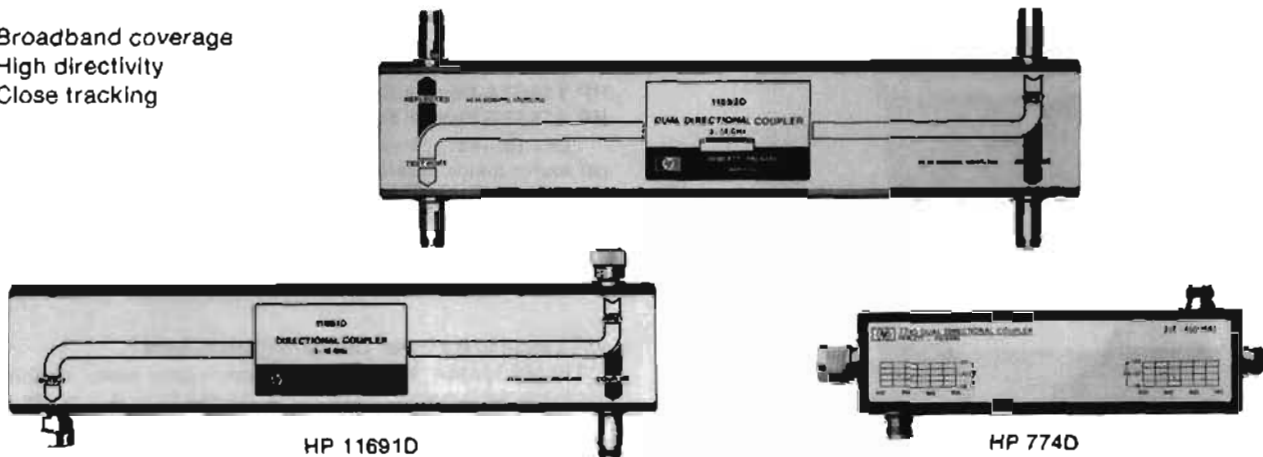

### HP 779D Directional Coupler

The HP 779D spans more than two octaves from 1.7 to 12.4 GHz with excellent directivity. With increased coupling factors (typically 24 dB), the HP 779 is useful down to 500 MHz. Upper frequency usefulness extends to 18 GHz with directivity reduced to about 15 dB. Various connector options are available.

### HP 11691D Directional Coupler

The HP 11691D is an ultra-wide-band single directional coupler covering 2 to 18 GHz with high directivity. It is useful as a power monitoring or leveling coupler, or for making reflection measurements. Couplers are preferred over broadband bridges in reflectometer applications in situations where the power level of the source is limited, or where simultaneous measurement of return loss and insertion loss is desired.

### HP 774D-777D Dual-Directional Couplers (octave bands)

The economical HP 774D-777D Couplers cover frequency spreads of more than two-to-one, each centered on one of the important VHF/UHF bands. With their high directivity and a mean coupling accuracy of  $\pm 0.5$  dB, these couplers are ideal for reflectometer applications. Furthermore, the close tracking of the auxiliary arms makes these couplers particularly useful for reflectometers driven by sweep oscillators such as the HP 8350B with its appropriate plug-in. Power ratings are 50 W average, 500 W peak.

### HP 778D, 11692D Dual-Directional Couplers (multi-octave bands)

These couplers are ideal for swept-frequency reflectometer testing of broadband coaxial components. The HP 778D covers 100 MHz to 2 GHz and the HP 11692D covers 2 to 18 GHz. High directivity and close tracking of the auxiliary arms are featured. Various connector options are available. Both couplers handle 50 W average power. Peak power: HP 778D, 500 W; HP 11692D, 250 W.

### HP 779D, 11691D Specifications

HP Model	Frequency Range (GHz)	Mean Output Coupling (dB)	Output Coupling Variation (dB)	Minimum Directivity (dB)	Equivalent <sup>1</sup> Source Match	Price
779D	1.7-12.4	20 $\pm$ 0.5	$\pm$ 0.75	1.7-4 GHz: 30 4-12.4 GHz: 26	1.2	\$1130 <sup>2</sup>
11691D	2-18	22 Nominal	$\pm$ 1.0	2-8 GHz: 30 dB 8-18 GHz: 26 dB	1.2	\$1575
<b>HP 779D Standard connectors</b> Primary Line: N(m) input, N(f) output; auxiliary arm: N(f)						
<b>Option 010:</b> Primary Line: N(f) input, N(m) output; auxiliary/output: N(f)						N/C
Other options: APC-7 for any or all ports. Contact HP						
<b>HP 11691D Standard connectors</b> Primary line: APC-7, APC-7; Auxiliary Arm: N(f)						
<b>Option 001:</b> All N(f)						less \$30
<b>Option 005:</b> All APC-7						add \$25
<sup>1</sup> Apparent SWR at the output port of a coupler when used in a closed-loop leveling system.						

### HP 774D, 775D, 776D, 777D, 778D, 11692D Specifications

HP Model	Frequency Range (GHz)	Nominal Coupling (dB)	Maximum Coupling Variation (dB)	Minimum Directivity (dB)	SWR Primary Line Maximum (500 Nom.)	Price
774D	0.215-0.450	20	$\pm$ 1	40	1.15	\$930
775D <sup>1</sup>	0.450-0.940	20	$\pm$ 1	40	1.15	\$930
776D <sup>1</sup>	0.940-1.90	20	$\pm$ 1	40	1.15	\$930
777D	1.90-4.0	20	$\pm$ 0.4	30	1.2	\$1050
778D	0.10-2.0	20	$\pm$ 1.5	0.1-1 GHz: 36 <sup>2</sup> 1-2 GHz: 32	1.1	\$1050
11692D	2.0-18.0	22	$\pm$ 1 incident to test port	2-8 GHz: 30 8-18 GHz: 26 <sup>1</sup>	2-12.4 GHz: 1.3 12.4-18 GHz: 1.4	\$2800

#### HP 774D-777D Standard connectors

Primary Line: N(m), N(f)  
Auxiliary Arm: N(f), N(f)

#### HP 778D Standard connectors

Primary Line: N(m), N(f); Auxiliary Arms: N(f), N(f)

**Option 011:** Primary Line: APC-7, N(f)

add \$25

**Option 012:** Primary Line: N(m), N(f)

N/C

#### HP 11692D Standard connectors

Primary line: N(f), APC-7; Auxiliary Arms: N(f), N(f)

**Option 001:** Primary Line: N(f), N(f)

less \$15

**Option 002:** Primary Line: N(m), N(m)

less \$15

<sup>1</sup>Maximum auxiliary arm tracking: 0.3 dB for HP 776D; 0.5 dB for HP 777D  
<sup>2</sup>30 dB, 0.1 to 2 GHz, input port.

<sup>3</sup>24 dB with Type N connector on the test port.



# MICROWAVE TEST EQUIPMENT

## Frequency Meters, Isolators and Waveguide Directional Couplers

Models 365 Series, 532 Series, 537A, 752 Series



HP V752A



HP X752A



HP Q532A



HP Q365A

### HP 752 Series Waveguide Directional Couplers

The HP 752 series Couplers are specified to meet a wide variety of microwave applications. Every coupler has a minimum directivity of 40 dB over its entire frequency range. Each coupler is swept-frequency tested to ensure that the main guide SWR and directivity specifications are accurate. Performance characteristics are unaffected by humidity, temperature, and time, making these units especially useful in microwave "standards" measurements.

The HP 752 Couplers are an essential part of many waveguide measurement systems. Attenuation measurements, reflectometer setups, power measurements, source leveling and network analysis are just a few areas in which these couplers are used.

### HP 752 Series Specifications

HP Model	Frequency Range (GHz)	Nominal Coupling (dB)	Mean Coupling Accuracy (dB)	Maximum Coupling Variation (dB)	Minimum Directivity (dB)	Waveguide & Flange	Price
X752A	8.2-12.4	3	±0.4	±0.6	40	WR90 UG-135/U	\$745
X752C		10					
X752D		20					
P752A	12.4-18.0	3	±0.4	±0.5	40	WR62 UG-419/U	\$745
P752C		10					
P752D		20					
K752A	18.0-26.5	3	±0.7	±0.5	40	WR42 UG-595/U	\$900
K752C		10					
K752D		20					
R752A	26.5-40.0	3	±0.7	±0.6	40	WR28 UG-599/U	\$1000
R752C		10					
R752D		20					
Q752A	33.0-50.0	3	±0.7 dB	±0.7	36	WR-22 UG-383/U	\$1175
Q752C		10					
Q752D		20					
U752A	40.0-60.0	3	±0.7 dB	±0.7	36	WR-19 UG-383/U (Mod.)	\$1175
U752C		10					
U752D		20					
V752C	50.0-75.0	10	±1.0	±1.0	33	WR-15 UG-381/U	\$1275
V752D		20					
W752C	75.0-110.0	10	±1.0	±1.0	30	WR-18 UG-387/U (Mod.)	\$1360
W752D		20					

### HP 365A Millimetre-Wave Waveguide Isolators

The HP Q and U365A Isolators use a Faraday-rotation-type design consisting of a section of waveguide containing low-loss ferrite material and impedance matching elements. A permanent magnet supplies the external magnetic bias field to the ferrite core. This results in excellent broadband isolation ratios of at least 25 dB along with low SWR and insertion loss.

### HP 365A Waveguide Isolator Specifications

HP Model	Frequency Range (GHz)	SWR (Max.)	Maximum Insertion Loss (dB)	Minimum Isolation (dB)	Maximum Input Power (Avg)	Waveguide & Equivalent Flange	Price
R365A	26.5-40.0	1.4	1.5	25	1.5W	WR-28 UG-599/U	\$800
Q365A	33-50	1.4	1.5			WR-22 UG-383/U	\$1010
U365A	40-60	1.4	1.8			WR-19 UG-383/U (Mod.)	\$1220
V365A	50-75	2.0	3.0			WR-15 UG-381/U	\$1510
W365A	75-110	2.0	3.0			WR-10 UG-387/U (Mod.)	\$1970

### HP 532 Series, 537A Frequency Meters

These direct-reading frequency meters measure frequencies from 33.0 to 60.0 GHz in waveguide and from 3.7 to 12.4 GHz in coax quickly and accurately. Their long scales and numerous calibration marks provide high resolution which is particularly useful when measuring frequency differences or small frequency changes. Frequency is read directly in GHz so neither interpolation nor charts are required.

The instruments comprise a special transmission section with a high-Q resonant cavity which is tuned by a choke plunger. A 1 dB or greater dip in output indicates resonance; virtually full power is transmitted off resonance. Overall accuracy of each frequency meter includes allowance for 0 to 100 percent relative humidity and temperature variation from 13 to 33°C.

### HP 532 Series, 537A Specifications

HP Model	Frequency Range (GHz)	Overall Accuracy (%)	Calibration Increment (MHz)	W/G-Coax Equivalent Flange (Connector)	Price
537A	3.7-12.4	0.170	10	Coax Type N(f)	\$1300
Q532A	33.0-50.0	0.12	20	WR-22 UG-383/U	\$2020
U532A	40.0-60.0	0.15		WR-19 UG-383/U (Mod.)	\$2125

# MICROWAVE TEST EQUIPMENT

## Coaxial Crystal Detectors

Models 423B, 8470B, 8472B, 8473B/C/D/E, 33330B/C/D/E

- 10 MHz to 50 GHz
- Flat frequency response
- High burnout protection
- Low SWR
- Field replaceable detector elements



HP 33330B



HP 8470B Opt 012



HP 423B



HP 8473D

## HP 423B, 8470B, 8472B, 8473B/C, 33330B/C Low Barrier Schottky Diode (LBSD) Detectors

The low-barrier Schottky diode (LBSD) detectors are a state-of-the-art addition to the HP family of high performance detectors. Various models provide coverage to 12.4, 18, and 26.5 GHz and input connectors are Type N, APC-7, or APC-3.5 depending on frequency range. Output connector is BNC (f) except for the HP 33330B/C (SMC).

Matched pairs (Opt 001), square-law load (Opt 002), and positive polarity output (Opt 003) are available for most models.

## HP 8473D, 33330D Planar Doped Barrier (PDB) Detectors

These detectors are the newest addition to HP's family of high performance detectors. They feature a broadband, very flat frequency response ( $\pm 1.25$  dB from .01 to 33 GHz) as well as superior SWR performance ( $< 1.36$  to 26.5 GHz,  $< 2.96$  to 33 GHz).

Positive polarity output (Opt 003) is available for both models. Due to their exceptional frequency response, any two standard 8473D's or 33330D's are a matched pair (the matched pair option, Opt 001, is not needed).

### Coaxial Crystal Detector Specifications

HP Model	Frequency Range (GHz)	Frequency Response (dB)	SWR Maximum (50 $\Omega$ Norm.)	Low Level Sensitivity	Maximum Input (Peak or Average)	Short-Term Maximum Input (<1 min.)	Option 001 Matched Pair (order 2 units for each pair)	Options Available	Input Connector	Output Connector	Price
423B	0.01-12.4 LBSD	$\pm 0.2$ /octave to 8 GHz $\pm 0.3$ overall	$< 1.15$ to 4 GHz $< 1.3$ to 12.4 GHz	$> 0.5$ mV/ $\mu$ W	200 mW	1 watt	$\pm 0.2$ dB to 12.4 GHz	001 002	N (m) 003	BNC (f)	\$245
8470B	0.01-18.0 LBSD	$\pm 0.2$ /octave to 8 GHz $\pm 0.3$ to 12.4 GHz $\pm 0.6$ to 18 GHz	$< 1.15$ to 4 GHz $< 1.3$ to 15 GHz $< 1.4$ to 18 GHz	$> 0.5$ mV/ $\mu$ W	200 mW	1 watt	$\pm 0.2$ dB to 12.4 GHz $\pm 0.3$ dB to 18 GHz	001 002 003	APC-7	BNC (f)	\$310
8470B Opt 012									N (m)		
8472B	01-18 LBSD	$\pm 0.3$ to 12.4 GHz $\pm 0.5$ to 15 GHz $\pm 0.6$ to 18 GHz	$< 1.20$ to 4.5 GHz $< 1.35$ to 7 GHz $< 1.50$ to 12.4 GHz $< 1.70$ to 18 GHz	$> 0.5$ mV/ $\mu$ W	200 mW	1 watt	$\pm 0.2$ dB to 12.4 GHz $\pm 0.3$ dB to 18 GHz	002 003	SMA (m)	BNC (f)	\$310
8473B	0.01-18.0 LBSD	$\pm 0.2$ /octave to 8 GHz $\pm 0.6$ to 18 GHz	$< 1.2$ to 4.0 GHz $< 1.5$ to 18 GHz	$> 0.5$ mV/ $\mu$ W	200 mW	1 watt	$\pm 0.2$ dB to 12.4 GHz $\pm 0.3$ dB to 18 GHz	001 003	APC-3.5 (m)	BNC (f)	\$320
8473C	0.01-26.5 LBSD	$\pm 0.6$ to 20 GHz $\pm 1.5$ with a -3.5 dB slope, 20 to 26.5 GHz	$< 1.2$ to 4 GHz $< 1.5$ to 18 GHz $< 2.2$ to 26.5 GHz	$> 0.5$ mV/ $\mu$ W to 18 GHz $> 0.18$ mV/ $\mu$ W to 26.5 GHz	200 mW	1 watt	$\pm 0.2$ dB to 12.4 GHz $\pm 0.3$ dB to 18 GHz $\pm 0.5$ dB to 26.5 GHz	001 003	APC-3.5 (m)	BNC (f)	\$360
8473D	0.01-33.0 PDB	$\pm 0.25$ to 14 GHz $\pm 0.4$ to 26.5 GHz $\pm 1.25$ to 33 GHz	$< 1.20$ to 14 GHz $< 1.36$ to 26.5 GHz $< 2.96$ to 33 GHz	$> 0.5$ mV/ $\mu$ W	200 mW	1 watt	N/A	003	APC-3.5 (m)	BNC (f)	\$430
8473E	0.01-50.0 PDB	$\pm 0.6$ to 40 GHz $\pm 0.8$ to 50 GHz	$< 1.36$ to 33 GHz $< 1.90$ to 50 GHz $< 2.0$ to 50 GHz	$> 0.4$ mV/ $\mu$ W	200 mW	1 watt	N/A	003	APC-2.4 (m)	BNC (f)	\$430
33330B	0.01-18.0 LBSD	$\pm 0.6$	$< 1.2$ to 4.0 GHz $< 1.5$ to 18 GHz	$> 0.5$ mV/ $\mu$ W	200 mW	1 watt	$\pm 0.2$ dB to 12.4 GHz $\pm 0.3$ dB to 18 GHz	001 003	APC-3.5 (m)	SMC (m)	\$300
33330C	0.01-26.5 LBSD	$\pm 0.6$ to 20 GHz $\pm 1.5$ with a -3.5 dB slope 20 to 26.5 GHz	$< 1.5$ to 18 GHz $< 2.2$ to 26.5 GHz	$> 0.5$ mV/ $\mu$ W to 18 GHz Degrades to 0.18 mV/ $\mu$ W at 26.5 GHz	200 mW	1 watt	$\pm 0.3$ dB to 18 GHz $\pm 0.5$ dB to 26.5 GHz	001 003	APC-3.5 (m)	SMC (m)	\$335
33330D	0.01-33.0 PDB	$\pm 0.35$ to 14 GHz $\pm 0.4$ to 26.5 GHz $\pm 1.25$ to 33 GHz	$< 1.20$ to 14 GHz $< 1.36$ to 26.5 GHz $< 2.96$ to 33 GHz	$> 0.5$ mV/ $\mu$ W	200 mW	1 watt	N/A	003	APC-3.5 (m)	SMC (m)	\$395
33330E	0.01-50 PDB	$\pm 0.6$ to 40 GHz $\pm 0.8$ to 50 GHz	$< 1.36$ to 33 GHz $< 1.90$ to 40 GHz $< 2.0$ to 50 GHz	$> 0.4$ mV/ $\mu$ W	200 mW	1 watt	N/A	003	APC-2.4 (m)	SMC (m)	\$395

### Options

**Option 001:** Matched response. Must order two (2) option 001s for a pair of detectors with matched frequency response. add \$25

**Option 002:** Optimum square law load. add \$25

**Option 003:** Positive polarity output. add \$35

Planar Doped Barrier Diodes		Low Barrier Schottky Diodes			
HP Model	Opt. 003	HP Model	Opt. 001	Opt. 002	Opt. 003
8473D	add \$35	423B	add \$25	add \$25	add \$35
33330D	add \$30	8470B	add \$25	add \$25	add \$35
8473E	add \$35	8472B	add \$25	n/a	add \$35
33330E	add \$30	8473B	add \$25	n/a	add \$35
		8473C	add \$25	n/a	add \$35
		33330B	add \$20	n/a	add \$30
		33330C	add \$20	n/a	add \$30

Fast-ship product — see page 758.



HP K422C



HP 10514A



HP 11970/11971 Series

### HP 422 Series Crystal Detectors

The HP 422A/C Crystal Detectors combine high sensitivity with flat frequency response and low SWR to provide waveguide band coverage from 18.0 to 60 GHz. They deliver between 0.2 and 0.5 mV/μW output at low level and handle 100 mW peak input. SWR ranges from 1.3 at 6K-band to 3 at R-band.

The HP K422C detector uses a planar doped barrier (PDB) diode. This superior diode technology results in a frequency response 5 times better than the former HP K422A (± 0.4 dB vs. ± 2.0 dB).

HP Q/U422 Series millimetre-wave detectors use Low-Barrier Schottky diodes for low video impedance and low junction capacitance. Their SWR is below 2.0, low-level sensitivity is 0.2 mV/μW.

For reflectometer applications in which both flat frequency response and square-law characteristics are important, these models can be supplied as matched pairs (Option 001) and with optimum square-law loads (Option 002). Due to its exceptionally flat frequency response, and any two standard HP K422Cs become a matched pair, and therefore the matched pair option, Option 001, is not needed.

### HP 422 Series Waveguide Crystal Detector Specifications

HP Model	Frequency Range (GHz)	Frequency Response (dB)	Option 001 Matched Response (dB)	Low-Level Sensitivity mV/μW	SWR	Waveguide & Equivalent Flange	Price
K422C	18.0-26.5	±0.4	N/A	>0.5	1.36	WR42 UG-595/U	\$800
R422A	26.5-40.0	±2	±1 dB	>0.3	3.0	WR28 UG-599/U	\$850
Q422A	33.0-50.0	±1.5	N/A	>0.25	2.0	WR-22 UG-383/U	\$1150
U422A	40.0-60.0	±1.5	N/A	>0.20	2.0	WR-19 UG-383/U (mod)	\$1350

Option 001: Matched response. Must order two (2) option 001's for a pair of detectors with matched frequency response.  
 Option 002: optimum square-law load.  
 Option 003: positive polarity output. (available with Q/U422A)

#### Option Prices

HP Model	Opt. 001	Opt. 002	Opt. 003
K422C	N/A	add \$20	N/A
R422A	add \$45	add \$20	N/A
Q422A	N/A	N/A	N/C
U422A	N/A	N/A	N/C

### HP 10514A, 10534A Double Balanced Mixers

These mixers are excellent in a variety of mixing applications as well as AM, pulse, and square-wave modulation applications. The careful balancing of the hot carrier diodes in the HP 10514A and 10534A provides excellent output suppression of the local oscillator and input frequencies. Frequency ranges are 0.2-500 MHz for the HP 10514A and 0.05-150 MHz for the HP 10534A. Connectors are BNC.

### HP 11970 and 11971 Series Harmonic Mixers

Although designed for operation with HP spectrum analyzers, these broadband mixers also serve a wide variety of general-purpose uses for the frequency bands from 18 to 110 GHz. Such uses include down-conversion for noise figure and network analysis measurements.

As down-conversion mixers for test receivers, the HP 11970 and 11971 offer flat response, low SWR, and low conversion loss without requiring bias. These mixers can also serve as harmonic generators with input signals from 2 to 6.1 GHz (depending on the model). Outputs are at the band specified, and each mixer is individually calibrated for conversion loss over its complete band. See page 141 for more technical performance information.

### Ordering Information

HP 10514A Double Balanced Mixer (0.2-500 MHz)	Price \$185
HP 10534A Double Balanced Mixer (0.05-150 MHz)	\$133

### HP 11970/11971 Series Specifications

HP Models	Frequency Range (GHz)	Freq. Response (dB)	Waveguide and Equivalent Flange	Price
11970K 11971K	18 - 26.5	±1.9 ±2.1	WR-42 UG-595/U	\$1550 <del>\$1600</del>
11970A 11971A	26.5 - 40	±1.9 ±2.1	WR-28 UG-599/U	\$1650 \$1550
11970Q 11971Q	33 - 50	±1.9 ±2/3	WR-22 UG-383/U	\$1700 \$1700
11970U 11971U	40 - 60	±1.9 ±2.3	WR-19 UG-383/U (mod)	\$1850 \$1850
11970V 11971V	50 - 75	±2.1 ±2.5	WR-15 UG-385/U	\$2250 \$2250
11970W	75 - 110	±3.0	WR-10 UG-385/U (mod)	\$2850

# MICROWAVE TEST EQUIPMENT

## 2.4 mm Coaxial Connector Family Adapters and Standards

Models HP 11900-11904, 85138, 85140, 85141

- DC-50 GHz frequency range
- Rugged instrument and metrology grades

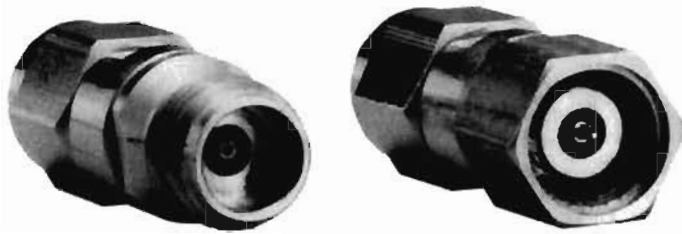

HP 11900A/C

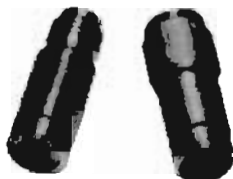

HP 86138 A/B

The 2.4 mm connector permits microwave components and systems to operate with coaxial interconnections at frequencies up to 50 GHz. Such systems need no longer be restricted to waveguide. Using the 2.4 mm connector, broadband devices operating from DC to 50 GHz are possible, simplifying and speeding the design and manufacture of components and systems.

The 2.4 mm connector interface was conceived by Hewlett-Packard and has been jointly developed by HP, Amphenol Products, and M/A-COM Omni Spectra. Supporting this development are products from HP, Amphenol Products, M/A-COM Omni Spectra and Maury Microwave.

Design goals for this connector included: a rugged interface with excellent return loss characteristics, a connector with very repeatable performance, and reasonable connector cost in systems applications. By foregoing compatibility with existing connector types, a design was achieved that optimizes performance over the entire DC to 50 GHz range, not just at the higher frequencies.

Implementation of the 2.4 mm connector concept is in the form of three levels or grades of the connector series, each of which is totally compatible with the others because each conforms to the connector interface dimensions. Three connector grades permit best application fit, with trade-offs in performance versus cost. M/A-COM Omni Spectra offers the "production-grade" OS-50 series for use in components, cabling and microstrip. Its design emphasizes economy and assembly simplicity. The "instrument-grade" APC-2.4 series from Amphenol Products is intended for use with test and measurement equipment where the connector must withstand many connect/disconnect cycles. Designed for traceability to national measurement standards, the "metrology-grade" connector will be used by HP on calibration standards.

### HP 11900A/B/C, 11901A/B/C/D, 11902A/B, 11903A/B/C/D, 11904A/B/C/D Between-Series Adapters

The HP 11900 series of 2.4 mm connector adapters allow 2.4 mm connectors of either sex to be mated to other types of connectors. These metrology-grade adapters are recommended for use where high precision and repeatability are required. The electrical lengths of the adapters are matched within the same adapter families (e.g., all 2.4 mm to APC-3.5), allowing accurate non-insertable device measurements. For information on 2.4 mm coax to R- and Q-band waveguide adapters, refer to page 339.

- Adapters to all common connector types
- Standards for reflection calibration

### HP 11900A/B/C, 11901A/B/C/D, 11902A/B, 11903A/B/C/D, 11904A/B/C/D Specifications

Type (from)	Sex <sup>1</sup>	Type (to)	Sex <sup>2</sup>	Model #	Return Loss <sup>3</sup> (dB)	Repeatability <sup>4,5</sup> Typically Better Than:	U.S. Price
2.4 mm	(m)	2.4 mm	(m)	11900A	≥32 (DC to 26.5 GHz)	-50 dB	\$450
2.4 mm	(f)	"	(f)	11900B	≥25 (26.5 to 40 GHz)	-45 dB	
2.4 mm	(m)	"	(f)	11900C	≥20 (40 to 50 GHz)	-40 dB	
2.4 mm	(m)	APC-3.5	(m)	11901A	≥32 (DC to 20 GHz)	-45 dB	\$375
2.4 mm	(f)	"	(f)	11901B	≥28 (20 to 26.5 GHz)	-45 dB	
2.4 mm	(m)	"	(f)	11901C	"	-45 dB	
2.4 mm	(f)	APC-3.5	(m)	11901D	"	-45 dB	
2.4 mm	(m)	APC-7*	-	11902A	≥30 (DC to 18 GHz)	-50 dB	\$350
2.4 mm	(f)	"	-	11902B	"	-50 dB	
2.4 mm	(m)	type-N	(m)	11903A	≥28 (DC to 18 GHz)	-48 dB	\$375
2.4 mm	(f)	type-N	(f)	11903B	≥28 (DC to 18 GHz)	-48 dB	
2.4 mm	(m)	type-N	(f)	11903C	≥28 (DC to 18 GHz)	-48 dB	
2.4 mm	(f)	type-N	(m)	11903D	≥28 (DC to 18 GHz)	-48 dB	
2.4 mm	(m)	K-2.92**	(m)	11904A	≥24 (DC to 40 GHz)	-40 dB	\$500
2.4 mm	(f)	"	(f)	11904B	"	-40 dB	
2.4 mm	(m)	"	(f)	11904C	"	-40 dB	
2.4 mm	(f)	"	(m)	11904D	"	-40 dB	
2.4 mm	(f)	"	(m)	119040	"	-40 dB	

### HP 85138A/B, 85140A/B, 85141A/B Calibration Accessories

The HP 85138A/B terminations are instrument-grade, 50 ohm loads designed for device termination and reference calibration where high performance is important. The HP 85140A/B and HP 85141A/B are metrology-grade, precision shielded open and short circuits for maximum reflection calibration accuracy for vector and scalar network analyzers. The open circuit utilizes a specially designed plastic center conductor support, to provide the proper center pin setback and uniform open circuit capacitance required for a high level of performance.

### HP 85138A/B, 85140A/B, 85141A/B Specifications

Type	Sex <sup>1</sup>	Model #	Electrical Specifications	Repeatability <sup>4</sup> Typically Better Than:	U.S. Price
2.4 mm Short	(m)	85140A	At 50 GHz, ±6° from nominal**	-50 dB	\$250
2.4 mm Short	(f)	85140B	"	-50 dB	275
2.4 mm Open	(m)	85141A	At 50 GHz, +6° from nominal**	-44 dB	275
2.4 mm Open	(f)	85141B	"	-44 dB	300
2.4 mm 50Ω Termination	(m)	85138A	≥30 dB (DC to 26.5 GHz) ≥25 dB (26.5 to 40 GHz) ≥20 dB (40 to 50 GHz)	-40 dB	475
2.4 mm 50Ω Termination	(f)	85138B	≥30 dB (DC to 26.5 GHz) ≥25 dB (26.5 to 40 GHz) ≥20 dB (40 to 50 GHz)	-40 dB	525

<sup>1</sup>m=jack, m=plug

<sup>2</sup>At the 2.4 mm port only

<sup>3</sup>Repeatability =  $20 \log |\Delta \Gamma|$ , where  $|\Delta \Gamma| = |\Gamma_m - \Gamma_n|$ . This is the difference between two measurements  $\Gamma_m$  and  $\Gamma_n$ , before and after one disconnect/connect cycle. Repeatability depend upon proper torque and pin-depth.

<sup>4</sup>This specification applies to the location of the effective shorting plane.

<sup>5</sup>Nominal, in this case, is the center of the distribution of all parts manufactured over time.

\*\*The phase shift of any HP 85141 A&B open relative to any HP 85140 A&B short is  $180^\circ \pm 12^\circ$ .

\*APC-7 is a U.S. registered trademark of the Bunker Ramo corporation

\*\*The K connector is developed and manufactured by the Wiltron Company (Morgan Hill, CA).

# MICROWAVE TEST EQUIPMENT

## Adapters, Waveguide/Coax, Waveguide/Waveguide

### Models 281A/C, 292A/B, 11515/6A, 897A/B, 898A/B, 899A/B



HP UV292A

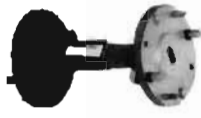

HP Q898A



HP Q899A



HP Q281B



HP Q897A



HP U896D

## HP 281A/C, 292A/B, 11515A/6A Coax and Waveguide Adapters

HP 281A Adapters transform waveguide transmission line into 50-ohm coaxial line. The HP 281C family has improved SWR. HP R/Q281 Adapters use the new 2.4 mm coaxial connector capable of non-modifying performance all the way to 50 GHz.

HP 292A/B Waveguide-to-Waveguide Adapters connect two different waveguide sizes with overlapping frequency ranges. HP 11515A/16A adapt circular to rectangular flanges in K-band and R-band.

### HP 281A/B/C Specifications

HP Model	SWR	Frequency Range (GHz)	Waveguide Size EIA	Coaxial Connector	W/G Flange UG-Q U	Price
S281A	1.25	2.60-3.95	WR284	N (f)	584	\$260
G281A	1.25	3.95-5.85	WR187	N (f)	407	\$215
J281A	1.25	5.30-8.20	WR137	N (f)	441	\$160
H281A	1.25	7.05-10.0	WR112	N (f)	138	\$160
X281A	1.25	8.20-12.4	WR90	N (f)	135	\$135
X281C	1.05	8.20-12.4	WR90	APC-7	135	\$360
Option 012				N (m)		less \$15
Option 013				N (f)		less \$15
P281B	1.25	12.4-18.0	WR62	APC-7	419	\$240
Option 013				N (f)		less \$15
P281C	1.06	12.4-18.0	WR62	APC-7	419	\$375
Option 012				N (m)		less \$15
Option 013				N (f)		less \$15
K281C	1.07	18.0-26.5	WR42	APC-3.5 (f)	597	\$440
Option 012				APC-3.5 (m)		N/C
R281A	1.1	26.5-40.0	WR-28	2.4 mm (f)	381	\$850
R281B				2.4 mm (m)		\$800
Q281A	1.1	33.0-50.0	WR-22	2.4 mm (f)	383	\$850
Q281B				2.4 mm (m)		\$800

### HP 292A/B, 11515A, 11516A Specifications

HP Model	Frequency Range (GHz)	SWR	W/G Size Flange	to	W/G Size Flange	Price
HX292B	8.2-10.0	1.05	WR 112 UG-51/U		WR 90 UG-39/U	\$240
MX292B	10.0-12.4	1.05	WR 75 Cover		WR 90 UG-39/U	\$310
MP292B	12.4-15.0	1.05	WR 75 Cover		WR 62 UG-419/U	\$240
NP292A	15.0-18.0	1.05	WR 51 Cover		WR 62 UG-419/U	\$240
NK292A	18.0-22.0	1.05	WR 51 Cover		WR 42 UG-595/U	\$240
RQ292A	33.0-40.0	1.15	WR-28 UG-381/U		WR-22 UG-383/U	\$460
QU292A	40.0-50.0	1.15	WR-22 UG-383/U		WR-19 UG-383/U (Mod.)	\$470
UV292A	50.0-60.0	1.15	WR-19 UG-383/U (Mod.)		WR-15 UG-385/U	\$480
11515A	18.0-26.5	-	WR 42 UG-425/U		WR 42 UG-595/U	\$240
11516A	26.5-40.0	-	WR 28 UG-381/U		WR 28 UG-599/U	\$240

### HP 896, 897, 898, 899 Millimetre-Wave Waveguide Accessories

Waveguide accessories, such as E- & H-Plane bends, twists, and straight sections, are necessary and useful for assembling waveguide measurement systems.

HP offers HP R/Q/U/V/W 897A/B E-Plane and H-Plane bends of 90 degrees. HP R/Q/U/V/W 898A/B twists can be specified for either right rotation (A-Model) or left rotation (B-Model) of 90 degrees. And, finally, several HP R/Q/U/V/W 899A/B straight sections are available in 2.5 and 5.0 cm lengths to fill out the proper dimensions of complicated test set-ups.

All of the above waveguide accessories use standard waveguide tubing and standard circular cover flanges with alterant alignment pins and captive holding screws. The table listing shows the newly-adopted MIL-F-3922 flange nomenclature.

Network analysis calibration is verified by measuring a precise and traceable reference impedance. HP's R/Q, and U896 Standard Sections are this kind of references.

They have very low SWR, less than 1.016. Their impedance is traceable to the National Bureau of Standards, using laser interferometry to accurately measure waveguide dimensions.

The HP Q/U896 have a unique precision flange design. When mating with a standard MIL-spec flange, this design improves repeatability by about a factor of two (when mating two HP precision flanges, repeatability is improved by a factor of five).

### HP 897A/B, 898A/B, 899A/B Waveguide Accessories Specifications

Frequency Range (GHz)	Description and HP Model	SWR	W/G	Equip. Flange	Price
Bends					
33 - 50 40 - 60 50 - 75 75 - 110	H-Plane Q897A	1.1	WR-22	UG-383/U	150
	E-Plane Q897B				
	U897A	1.1	WR-19	UG-383/U(mod)	150
	V897A	1.15	WR-15	UG-385/U	160
	W897A	1.15	WR-10	UG-387/U(mod)	160
Twists					
33 - 50 40 - 60 50 - 75 75 - 110	90°R.H. Q898A	1.1	WR-22	UG-383/U	155
	90°L.H. Q898B				
	U898A	1.1	WR-19	UG-383/U(mod)	155
	V898A	1.1	WR-15	UG-385/U	165
	W898A	1.15	WR-10	UG-387/U(mod)	165
Straights					
26.5 - 40 33 - 50	2.5cm 5cm R896B	1.016	WR-28	UG-599/U	\$460
	10cm R896D				
Q899A	Q899B	1.1	WR-22	UG-383/U	\$145
	Q896B	1.016	WR-22	UG-383/U	\$490
40 - 60	U899A	1.1	WR-19	UG-383/U(mod)	\$145
	U896B	1.016	WR-19	UG-383/U(mod)	\$510
50 - 75	V899A	1.1	WR-15	UG-385/U	\$155
	V896B	1.02	WR-15	UG-385/U	\$590
75 - 110	W899A	1.1	WR-10	UG-387/U(mod)	\$155
	W896B	1.03	WR-10	UG-387/U(mod)	\$600

# MICROWAVE TEST EQUIPMENT

## Waveguide Stands, Filters, Coaxial Terminations

Models 11540 Series, 11566/7/A, 362 Series, 908A, 909 Series



HP 11566A



HP X362A



HP 11540A



HP 909C



HP 909D



HP 11742A

### HP 11566A, 11567A Air Line Extension

Impedance: 50 ohms.

Frequency: dc-18 GHz.

Reflection coefficient: 0.018 + (0.001 x frequency in GHz).

Connector: APC-7.

Length: 11566A, 102.5 mm (4 in.); 11567A, 202.5 mm (8 in.).

Shipping weight: 0.45 kg (1 lb).

### HP 11540 Series Waveguide Stand, Waveguide Holders

The HP 11540A Waveguide Stand locks HP waveguide holders at any height from 70 to 133 mm (2.75 in. to 5.25 in.). The waveguide holders are offered in five sizes to hold waveguide covering frequencies from 22 to 40 GHz.

### HP 11742A Blocking Capacitor

The HP 11742A is a high performance outside blocking capacitor. It features broadband performance, low SWR (1.2 from .01 to 26.5 GHz) and low insertion loss (.6dB from .01 to 26.5 GHz). The HP 11742A comes with APC-3.5 connectors. It is ideal for use with high frequency oscilloscopes and in bias circuits for the attenuation of low frequencies and D.C. voltages from signal paths where D.C. voltages do not exceed 50V.

### HP 362 Series Waveguide Low Pass Filters

These Hewlett-Packard low-pass filters facilitate microwave measurements by eliminating undesirable signals (such as harmonics) from the measurement system. Suppression of such signals is particularly important in applications such as broadband reflection and transmission measurements or slotted line measurements where harmonics generated by the signal source could otherwise impair measurement accuracy.

### Ordering Information

	Price
HP 11566A Air line extension	\$325
HP 11567A Air line extension	\$375
HP 11540A Waveguide stand	\$75
HP 11545A X-Band,	each \$45
HP 11546A P-Band, 11547A K-Band, 11548A R-Band	each \$45
Waveguide holders	
HP 11742A Blocking Capacitor	\$170

Fast-Ship product — see page 758.

### HP 908A, 909A/C/D/E Coaxial Fixed Terminations (50 and 75 Ω)

The HP 908A, 909A and 909D Terminations are low reflection loads for terminating 50 Ω coaxial systems in their characteristic impedance. The HP909C (50 Ω) and HP909E (75 Ω) are precision ultra low reflection terminations intended for use as calibration standards.

### HP 908A, 909A/C/D Specifications

HP Model	Frequency Range (GHz)	Impedance (ohms)	SWR	Power Rating	Connector	Price
908A	dc-4	50	1.05	1/2 W avg. 1 kW pk	N (m)	\$115
909A	dc-18	50	1.05: 0-4 GHz	2 W avg. 300 W pk	APC-7	\$180
			1.1: 4-12.4 GHz		Opt. 012 N (m)	Less \$15
909A Option 012 Option 013			1.06: 0-4 GHz 1.11: 4-12.4 GHz 1.3: 12.4-18 GHz		Opt. 013 N (f)	
909C	dc-2	50	1.005	1/2 W avg. 100 W pk	APC-7	\$310
909C Option 012 Option 013			1.01		Opt. 012 N (m)	Less \$25
					Opt. 013 N (f)	
909C Option 200	dc-0.2	50	1.005	1/2 W avg. 100 W pk	Must be ordered with Opt. 012 N (m) or Opt. 013 N (f)	N.C.
			1.01			Less \$20
909C Option 201					Must be ordered with Opt. 012 N (m)	
909D	dc-26.5	50	1.07: dc-4 GHz 1.12: 4-12.4 GHz 1.22: 12.4-26.5 GHz	2 W avg. 100 W pk	APC-3.5 (m)	\$260
909D Option 011					Opt. 011 APC-3.5 (f)	N.C.
909D Option 040			1.02: dc-4GHz 1.12: 4-12.4GHz 1.22: 12.4-26.5GHz		APC-3.5 (m) Opt. 011 APC-3.5 (f)	add \$15
909E Option 201	dc-0.2	75	1.01	1/2 W avg. 100 W pk.	N(m)	\$265
909F	dc-6	50	1.005: dc-5 GHz	1/2 W	APC-7	\$325
			1.01: 5-6 GHz			
909F Option 012	dc-6	50	1.007: dc-2 GHz	1/2 W	N(m)	\$300
			1.01: 2-3 GHz 1.02: 3-6 GHz			
909F Option 013					N(f)	
85138A	dc-50	50	1.22	1/2 W	2.4 mm (m)	\$475
85138B	dc-50	50	1.22	1/2 W	2.4 mm (f)	\$525

### HP 362 Waveguide Low Pass Filter Specifications

HP Model	Passband (GHz)	Stopband (GHz)	Passband Insertion Loss	Stopband Rejection	SWR Maximum	Waveguide Size	Equivalent Flange	Length mm (in)	Shipping Weight kg (lb)	Price
X362A	8.2-12.4	16-37.5	<1 dB	At least 40dB	1.5	WR 90	UG-39/U	136 (5.4)	0.9 (2)	\$1300
P362A	12.4-18.0	23-54			1.5	WR 62	UG-419/U	94 (3.7)	0.37 (13 oz)	\$1200
K362A'	18.0-26.5	31-80			1.5	WR 42	UG-595/U	64 (2.5)	0.15 (5.3 oz)	\$1120
R362A'	26.5-40.0	47-120	<1 dB	>35 dB	1.7	WR 28	UG-599/U	42 (1.7)	0.11 (4 oz)	\$1120

'Circular Flange Adapters: For X-Band, specify HP 11515A (UG-425/U). For R-Band, specify HP 11516A (UG-381/U).

\$240

# MICROWAVE TEST EQUIPMENT

## Coaxial and Waveguide Terminations

Models HP 905, 910, 911, 914, 920, 921

341

- Precision loads and shorts for measurements to 60 GHz



HP Q921A



HP R921A



HP U921A



HP 11512A



HP Q914C



HP 911C



HP X914B



HP X910B

### HP 905A, 911C Coaxial Sliding Loads

The HP 905A is a movable, low reflection 50  $\Omega$  loads for precision measurements. It is supplied with three interchangeable connectors, N-male, N-female and APC-7.

The HP 911C is a sliding load designed for 3.5 mm coaxial transmission lines and uses the APC-3.5 connector. This permits mode-free operation to 26.5 GHz. The HP 911C is furnished with interchangeable male and female connectors in a carrying case.

### HP 905A, 911A, 911C Specifications

HP Model	Frequency Range (GHz)	Load SWR	Power Rating	Length (mm) In.	Shipping Weight	Price
905A	1.8-18	1.05	1 W avg. 5 kW pk	(440) 17.25	(2.4 kg) 3 lb	\$790
911C	2-26.5	1.2, 2-10 GHz 1.07, 10-26.5 GHz	1 W avg. 5 kW pk	(266) 10.5	(1.7 kg) 3.8 lb	\$1240

### HP 11511A, 11512A, 11565A Coaxial Shorts and Opens

These shorts and opens are used for establishing measurement planes for known reflection phase and magnitude in 50  $\Omega$  and 75  $\Omega$  coaxial systems for various connectors.

### Ordering Information

HP 11511A N-(f) short (50 ohm)	\$55
HP 1250-1531 N-(f) short (75 ohm)	\$44
HP 11512A N-(m) short (50 ohm)	\$55
HP 1250-1530 N-(m) short (75 ohm)	\$55
HP 11565A APC-7 short (50 ohm)	\$105
HP 0960-0054 SMA-(f) short (50 ohm)	\$22.50
HP 0960-0055 SMA-(m) short (50 ohm)	\$11
HP 85138A 2.4mm (m) 50 ohm Termination	\$475
HP 85138B 2.4mm (f) 50 ohm Termination	\$525
HP 85140A 2.4mm (m) short	\$250
HP 85140B 2.4mm (f) short	\$275
HP 85141A 2.4mm (m) open	\$275
HP 85141B 2.4mm (f) open	\$300

Fast-Ship product—see page 758.

### HP 920C, 921A Waveguide Shorts

The HP R920C, Q920C and U920C are low-loss movable shorts for waveguide systems operating from 26.5 to 60.0 GHz.

The HP 921A, Q921A and U921A are fixed shorts for waveguide systems.

### HP 920C, 921A Specifications

HP Model	Frequency Range (GHz)	Type	Waveguide Size EIA	Price
R920C	26.5-40.0	movable	WR28	\$750
Q920C	33.0-50.0	movable	WR22	\$750
U920C	40.0-60.0	movable	WR19	\$750
R921A	26.5-40.0	fixed	WR28	\$ 65
Q921A	33.0-50.0	fixed	WR22	\$ 70
U921A	40.0-60.0	fixed	WR19	\$ 70

### HP 910A/B/C, 914B/C Waveguide Fixed and Movable Terminations

The HP 910A/B/C are fixed terminations for waveguide systems. The HP 914A/B are similar to the HP 910A/B/C, except that their absorptive elements are movable and locking plungers control the position of the elements. HP 914C models use micrometer adjustment.

### HP 910A/B/C, 914A/B/C Specifications

HP Model	Frequency Range (GHz)	SWR	Power Rating	Type	Waveguide Size (EIA)	Price
X910B	8.2-12.4	1.015	1 watt	fixed	WR90	\$250
P910A	12.4-18.0	1.02	1 watt	fixed	WR62	\$250
R910A	26.5-40.0	1.03	1 watt	fixed	WR42	\$225
Q910A	33.0-50.0	1.03	1 watt	fixed	WR22	\$250
U910A	40.0-60.0	1.04	1 watt	fixed	WR19	\$250
V910C	50.0-75.0	1.025	0.3 watt	fixed	WR15	\$590
W910C	75.0-110.0	1.03	0.2 watt	fixed	WR10	\$615
X914B	8.2-12.4	1.01	1 watt	sliding	WR90	\$550
P914A	12.4-18.0	1.01	1/2 watt	sliding	WR62	\$615
K914B	18.0-26.5	1.01	1/4 watt	sliding	WR42	\$788
R914C	26.5-40.0	1.01	1/2 watt	sliding	WR28	\$715
Q914C	33.0-50.0	1.01	1/2 watt	sliding	WR22	\$750
U914C	40.0-60.0	1.01	1/2 watt	sliding	WR19	\$820

# DIMENSIONAL MEASUREMENTS

## Laser Position Transducer System

Model 5527A

- High Accuracy
- High Stability
- High Resolution



5507A



### HP 5527A Laser Position Transducer System

The HP 5527A Laser Position Transducer System measures linear position to sub-micron accuracy for high performance measurement and position control of precision equipment. Continuous introduction of new products has improved system accuracy, repeatability, and stability, and has increased the slew rate and maximum number of axes.

Applications include IC wafer steppers and inspection equipment, flat panel display steppers, disc drive track writers, near-field antenna measurements, and precision machine tools and coordinate measuring machines.

### System Components

#### Laser Heads

The new HP 5517B Laser Head is half the size of the HP 5517A and offers 25% greater slew rates. It uses the same laser tube for proven reliability, and is completely compatible with the earlier HP 5517A, which is still available.

#### Optics

New optics have enhanced system performance. The HP 10717A Wavelength Tracker, with its associated compensation electronics, offers improved accuracy and repeatability through superior WOL (wavelength of light) compensation. The new HP 10715A Differential Interferometer provides extremely stable measurements even if the environmental, and therefore the optics, temperature varies. The new HP 10706B High Stability Plane Mirror Interferometer offers nearly the thermally stable performance of the HP 10715A at a lower price and in a smaller package.

Additional optics include the HP 10702A Linear Interferometer and HP 10703A Linear Retroreflector for general applications, and the HP 10705A Single Beam Interferometer and HP 10704A Single Beam Retroreflector for space-limited applications.

Beam bending and splitting optics are available. The HP 10706A/B and HP 10715A are used with plane (flat) mirrors that must be supplied by the user for individual applications.

- High Slew Rate
- High Reliability
- Small Size

### Electronics

The HP 5507A Laser Position Transducer Electronics combine superior performance, enhanced reliability, and ease-of-use. The HP 5507A offers a noise-free environment with RF shielding, ground loop protection, and a built-in power supply and fan. It is fully HP-IB controlled to simplify programming, and the HP 10941A Prototyping Kit enables you to include your own electronics.

The new HP 10946B Automatic Compensation Board works with the new HP 10717A or the HP 10751A Air Sensor and HP 10757A Material Temperature Sensor to automatically compensate for WOL and material temperature effects. The new HP 10780B Receiver is more sensitive than the receiver it replaces and enables the system to have up to six measurement axes.

### HP 5527A Specifications

**Laser:** Two frequency HeNe, 1.0mW maximum output power.

**Accuracy:**  $\pm 0.1$  parts per million (in vacuum). ( $\pm 0.02$ ppm if laser head is factory calibrated to MIL STD 45662.)

**Stability:** 0.002ppm short term, 0.02ppm lifetime (typical).

**Resolution:** Linear or Single Beam optics, 10nm (0.4 $\mu$ in.). Plane or Differential optics, 5nm (0.2 $\mu$ in.).

**Measurement Velocity (optics slew rate) with HP 5517B Laser Head:** Linear or Single Beam optics: 50.7cm/s (20in./s).

Plane or Differential optics: 25.3cm/s (10in./s).

**Number of Measurement Axes:** Up to six, depending on optical layout.

**Output:** 32-bit parallel position and position error output updated at 1.9-2.4MHz (with HP 5517B). HP-IB interface to controller, input (destination and commands) at 75-350kHz dependent on data format; output (position and status) at 80-1500kHz, dependent on software and configuration.

**Power:** 115V ac  $\pm 10\%$ ,  $-25\%$ ; 230V ac  $\pm 10\%$ ,  $-25\%$ , 48-66Hz.



### Ordering Information

For complete ordering information, please contact your local Hewlett-Packard sales office (see page 760). The HP 5527A data sheet (02-5952-7916) is available for more details. Everything you need to know to design the HP 5527A into your application is described in the HP 5527A Designer's Guide (P/N 05527-90003).

System prices range from \$16,100 to \$57,000.



# DIMENSIONAL MEASUREMENTS

## Laser Transducer and Laser Measurement Systems

Models 5501A, 5528A

343

- Flexible, high performance electronics
- Proven reliability

- Transportable and easy to use
- Optimized for machine tool calibration
- Acceptance test new machine tools
- Improve productivity and part quality
- Reduce scrap, rework, and inspection costs



HP 5501B

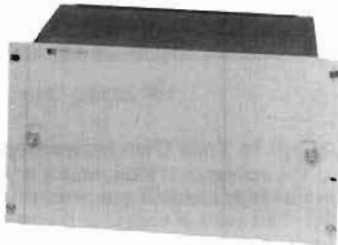

10740A



### HP 5501A Laser Transducer System

The HP 5501A uses the same laser heads and optics as the HP 5527A system. It has different electronics to perform additional applications compared to the HP 5527A. It takes advantage of the new optics and receivers developed for the HP 5527A to offer improved accuracy, stability, and number of axes this year.

Typical applications include installation in IC wafer steppers, E-beam pattern-generators, IC inspection devices, precision machine tools, coordinate measuring machines, disc drive track-writers, and near-field antenna measurement systems.

### Electronics

The HP 5501A features electronics for position or position error output, English/Metric (A quad B) output for machine tool controllers, and pulse output. These electronics plug into the HP 10740A Coupler, which provides a backplane. Interfacing to a controller is provided by the HP 10746A Binary Interface. Automatic WOL and material temperature compensation are available.

### HP 5501A Specifications

- Laser:** Two frequency HeNe. 1.0mW maximum power output.
- Accuracy:**  $\pm 0.1$  parts per million (in vacuum). ( $\pm 0.02$ ppm if laser head is factory calibrated to MIL STD 45662.)
- Stability:** 0.002ppm short term, 0.02ppm lifetime (typical).
- Resolution:** From 0.16  $\mu\text{m}$  (6.0  $\mu\text{in.}$ ) to 5nm (0.2  $\mu\text{in.}$ ), depending on electronics and optics used.
- Measurement Velocity (optics slow rate):** Up to 18.3m/min. (720 in./min.) maximum, depending on optics and resolution used.
- Number of Measurement Axes:** up to six, depending on system design.
- Maximum data output rate:** 700Hz - 300KHz, depending on number of axes, system electronics, and type of controller used.



### HP 5528A Laser Measurement System

The HP 5528A Laser Measurement System is a transportable, stand-alone system that is optimized for machine tool calibration. In addition to calibration of machine tools, coordinate measuring machines, and printed-circuit board drilling machines, it is also used extensively in metrology standards labs and R&D applications, where its ease of use is important for fast, accurate results.

### Modular Design

Although the HP 5528A measures distance and velocity, additional optics are available to also measure pitch, yaw, flatness, straightness, squareness and parallelism. The basic system consists of the HP 5508A Measurement Display, HP 5518A Laser Head, and applicable measurement optics. Available optics kits are:

- HP 55280A Linear Measurement Kit (distance and velocity);
- HP 55281A Angular Optics Kit (pitch and yaw);
- HP 55282A Flatness Accessory Kit (surface plate flatness);
- HP 55283A Straightness Measurement Kit (straightness and parallelism); and
- HP 10777A Optical Square (squareness).

Additional accessories allow compensation for WOL changes (HP 10751A Air Sensor) and material temperature variations (HP 10757A Material Temperature Sensor). The HP 55288S Dimensional Metrology Analysis System provides a controller and software to collect, store, analyze, and plot the data taken by the HP 5528A.

### HP 5528A Specifications

- Accuracy:**  $\pm 0.1$  parts per million (ppm) in vacuum  
 $\pm 0.02$  ppm in vacuum if the laser head is factory calibrated to MIL STD 45662  
 $\pm 1.7$  ppm using the HP 10751A Air Sensor (15-25 C.)
- Resolution:** 0.01  $\mu\text{m}$  (1.0  $\mu\text{in.}$ )
- Measurement Range:** 40m (130 ft)
- Measurement Velocity:** 27.4m/min (1080in./min)
- Display Update Rate:** 40Hz nominal
- Power:** 100, 120, 220, 240V AC, (+%5, -10%), 48-66Hz, 175VA max.

### Ordering Information

For complete specifications and ordering information, please see the system data sheet (02-5952-7864) or contact your local Hewlett-Packard sales office (see page 760).

### Ordering Information:

For complete ordering information, please contact your local Hewlett-Packard sales office (see page 760). Further details are available in these HP 5501A Laser Transducer System publications: system brochure (02-5952-7751), system electronics (02-5952-7749), and system configuration guide (02-5952-7879).

System prices range from \$15,000 to \$45,000.

System prices range from \$17,500 to \$49,500.

# PRESSURE & TEMPERATURE

## Quartz Pressure Probe, Quartz Pressure Set, & Pressure Signal Processor

Models 2813E/D, 2816A

- 0.001 psi resolution (6.9 Pa)
- High performance



HP 2813E Quartz Pressure Probe

### HP 2813E/D Quartz Pressure Probe and Pressure Set

The quartz technology that Hewlett-Packard first introduced to the oil- and gas-well industry in 1970 is still the standard for pressure measurement applications requiring extremely high accuracy, resolution and repeatability. These features, combined with its rugged construction, make the 2813E probe ideally suited for petroleum applications, oceanographic research and subterranean hydrodynamic studies.

### High Precision, Resolution and Repeatability

Capable of sensing wellbore pressure changes as small as 0.001 psi, the probe's measurements can be instantly observed and recorded on the surface. With an accuracy better than  $\pm 1.0$  psi and  $\pm 0.01\%$  of the pressure reading, the HP 2813E/D gives you confidence in the precision of your measurements. Also, with a repeatability of 0.4 psi over the full calibrated pressure range (200 - 11,000 psia) at constant temperature, you can be confident that changes in successive measurements are due to changes in the well, not probe measurement error.

### Advanced Calibration Procedures

Advanced calibration procedures also contribute to the probe's high performance, with each probe being checked at 105 discrete calibration points over its full operating pressure and temperature range. The calibration data is processed by computer to yield coefficients of an equation that describe the relationship between frequency output, applied pressure and temperature.

### Faster Thermal Restabilization

Based on the earlier Model HP 2813B/C, the HP 2813E thermally restabilizes four to ten times faster than the HP 2813B/C. This performance, due to a redesigned mechanical package, shortens costly test time.

### Higher Temperature Range

Improvements in the sensor crystal's processing have increased the probe's temperature range from 302°F to 350°F.

### Rugged and Reliable

Though a precision instrument, the HP 2813E is rugged and reliable in an oil field environment. Housed in a 1 1/8 inch OD case made of Nitronic 50 stainless steel, the probe can withstand pressures of up to 12,000 psia and temperatures of up to 350°F.

### Easy to Use and Service

The simplicity of the HP 2813E's mechanical design makes it easy to use and service in the field.

### Quick Factory Service

Your probe receives immediate attention when we receive it. An exchange set of the reference crystal, sensor crystal and electronics pc board is available, reducing repair time to one week. Standard recalibrations and repairs take four weeks or less.

- Rugged and reliable
- Simple operation



HP 2813D Quartz Pressure Set

### Adapt to Your Own Instrumentation System

The reference crystal, sensor crystal and electronics pc board are available as matched components in the HP 2813D Quartz Pressure Set. This enables designing the essential pressure-measuring components of the HP 2813E into your own downhole instrumentation package.

### How it Works

The essential pressure-measuring components of the HP 2813E Quartz Pressure Probe are its sensor crystal, reference crystal and electronics pc board. The sensor crystal, which is in direct fluid communication with the well, changes the frequency of its oscillations in response to pressure. The reference crystal, which is protected from applied pressure, subtracts the effects of temperature changes from the sensor crystal's frequency.

The resulting frequency is then transmitted by the electronics pc board through a center conductor, armored-electric line to an HP 2816A Signal Processor on the surface. This processor conditions the pressure-related signal to drive a frequency counter. The counter's signal can then be converted to a pressure reading when processed with the calibration data in a desktop computer.

The sensor crystal's high resolution is essentially constant and independent of operating pressure and temperature. Its stability minimizes hysteresis and zero drift, thus eliminating the need for frequent recalibration.

### HP 2816A Signal Processor

Specifically designed to process the pressure-related signal from the HP 2813E/D, this processor conditions the signal to drive a frequency counter. The processed output frequency changes about 105 Hz/psi, allowing a resolution of 0.001 psi. It also supplies dc operating power to the probe through a center conductor, armored-electric line.

### HP 2813E/D Specifications

#### Operating Environment

**Calibrated pressure range:** 200-11,000 psi (1.38-75.8 MPa).  
**Calibrated temperature range:** 95-350°F (35-177°C).

#### Static Measurement (pressure and temperature are constant)

**Accuracy:**  $\pm 1.0$  psi (6.9 kPa) (due to curve fit error)  $\pm 0.01\%$  of actual pressure (due to calibration system error).

**Repeatability:**  $\pm 1.0$  psi (6.9 kPa) over the entire calibrated pressure and temperature range; or,  $\pm 0.4$  psi (2.76 kPa) over the entire calibrated pressure range with temperature held to a single value.

**Aging:** Error due to aging of sensor and reference crystal pair is typically less than  $\pm 0.5$  psi (3.45 kPa) per year.

**Temperature uncertainty error:**  $(\Delta T) \cdot (0.28 \text{ psi} + 0.02\% \text{ of actual pressure in psi})$  for temperature in degrees F.

**Resolution:** 0.001 psi (6.9 Pa) when sampling for 1 second.

**Sensitivity:** 105 Hz/psi (15.2 Hz/kPa) nominal at output of HP 2816A Signal Processor. The HP 2816A multiplies the incoming signal from the HP 2813E/D by 72 as part of the signal processing.

#### Non-Operating Characteristics (HP 2813E)

**Outside diameter:** 1 1/8 in. (37 mm.).

**Length:** 34.3 in. (998 mm.).

**Weight:** 11 lb (5 kg).

**Static Tensile Pull Strength:** >20,000 lb (9070 kg)

**Steel Case Material:** Nitronic 50 high strength.

HP 2813E Quartz Pressure Probe

\$22,900

HP 2813D Quartz Pressure Set

\$17,900

HP 2816A Signal Processor

\$2,100

# PRESSURE & TEMPERATURE

## Quartz Thermometer

### Model 2804A

345



HP 2804A



- $\pm 0.04^\circ\text{C}$  absolute accuracy
- $0.0001^\circ\text{C}$  or  $0.001^\circ\text{F}$  resolution
- $-80^\circ$  to  $+250^\circ\text{C}$  range
- Display of absolute or differential temperature
- Flexible HP-IB system Interface
- Variable resolution analog output
- Easy ice-point or triple-point adjustment

### HP 2804A Quartz Thermometer

The HP 2804A Quartz Thermometer allows you to easily measure temperature with exceptionally high accuracy and resolution. Absolute accuracy is  $\pm 40$  millidegrees Celsius over the range of  $-50^\circ\text{C}$  to  $+150^\circ\text{C}$ , NBS traceable to IPTS-68. The useable resolution of  $0.0001^\circ\text{C}$  allows you to measure temperature changes that could not be detected by other digital thermometers.

The HP 2804A can be used with one or two temperature sensing probes. The temperature of either probe, or their difference, can be measured and displayed under pushbutton control. Display resolution is selectable from  $0.01$  to  $0.0001^\circ\text{C}$  ( $0.1$  to  $0.001^\circ\text{F}$ ) by pushbuttons. An internal switch allows you to easily select measurement in the Celsius or Fahrenheit temperature scale.

Temperature is measured and displayed automatically with the microprocessor and electronics provided in the HP 2804A package. There is no need to balance a bridge, perform calculations using resistance- or voltage-temperature tables or curves, or to use calibration correction tables. The only adjustment necessary to remove effects of thermal history on the sensor is a simple ice point or triple point calibration adjustment using the front panel thumbwheel switches.

### How It Works

The HP 2804A temperature sensor is a quartz crystal whose precise angle of cut gives a stable and repeatable relationship between resonant frequency and temperature. Each quartz sensor is individually calibrated at the factory over the full temperature range. The calibration data for each sensor is processed and stored in a calibration module which is supplied with the probe.

In operation, a microprocessor in the thermometer performs the complex control and calculation operations to accurately measure temperature from the quartz sensor frequency and probe calibration information in the calibration module. The microprocessor also performs self-checks to detect fault conditions. If a problem occurs that would give an improper measurement, an error message is displayed to indicate the source of the problem.

### System Oriented Design

The HP-IB (standard) offers you a simple, yet flexible, way to connect the Quartz Thermometer to either an HP computing controller or printer. Temperature data can easily be sent to a computer for processing and recording. All front-panel controls can be operated automatically by commands sent on the bus.

The analog output (standard) converts any three consecutive digits to a voltage between  $0$  and  $+10$  volts to drive a chart recorder. Front-panel controls allow easy adjustment of pen zero and full scale as well as normal or offset (center-zero) operation. Any three digits can be selected for conversion, allowing you to change the full scale value on the recorder.

### HP 2804A Specifications

#### Performance

**Range:**  $-80$  to  $250^\circ\text{C}$ .

**Absolute accuracy:** HP 2804A with HP 18110A, or HP 18111A

Quartz Probe —

$\pm 0.040^\circ\text{C}$  from  $-50$  to  $150^\circ\text{C}$

$\pm 0.075^\circ\text{C}$  from  $-80$  to  $250^\circ\text{C}$

NBS traceable to IPTS-68

**Resolution:** three levels can be selected:

Level of selection	Resolution		Nominal time between readings in seconds	
	$^\circ\text{C}$	$^\circ\text{F}$	T1 or T2	T1 - T2
Low	0.01	0.1	0.1	0.2
Medium	0.001	0.01	1	2
High	0.0001	0.001	10	20

#### General

**Display:** 7-digit LED with polarity, decimal, and degree C or F annunciator.

**Probes:** laboratory probes are available for use with the HP 2804A. Refer to the data sheet for specifications and sheath configurations.

#### Power Required

100, 120, 220, or 240 Vac,  $+5\%$ – $10\%$ , 48 to 66 Hz,  $< 30$  VA.

#### Accessories and Probes

HP 18107A External Oscillator	Price
HP 18110A Laboratory Probe and cal module, 25 mm (1 in.), Opt 001 Extra Prom	\$400
HP 18111A Laboratory Probe and cal module, 230 mm (9.1 in.), Opt 001 Extra Prom	\$2100
HP 2804A Quartz Thermometer	\$6000
Opt 002 Threaded Connector for HP 18111A	\$50



HP  
Hewlett-Packard Company  
1990



## SOURCES

<b>Signal Generators</b> .....	<b>348</b>
<b>Sweep Oscillators</b> .....	<b>376</b>
<b>Amplifiers</b> .....	<b>393</b>
<b>Frequency, Function &amp; Waveform Synthesizers</b> .....	<b>396</b>
<b>Pulse Generators</b> .....	<b>416</b>
<b>Power Supplies</b> .....	<b>430</b>
<b>Frequency &amp; Time Standards</b> .....	<b>462</b>

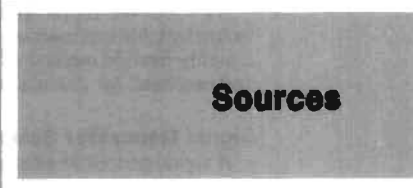

**Sources**

Many of HP's products generate an output used as a stimulus in measurement. Examples include a constant or controlled dc voltage, a swept-frequency signal used to test a filter, or a modulated RF or microwave signal used in communications test. These test and measurement instruments include power supplies; signal generators and sweep oscillators; pulse, function and waveform generators and frequency and time standards.

# SIGNAL GENERATORS

## Signal Generators to 60 GHz

Hewlett-Packard offers the widest selection of high-performance signal sources from dc to 60 GHz. They cover every application range from low-frequency navigation signals, through cellular mobile radio to millimeter-wave satellite systems. Each offers calibrated frequency and level and a wide range of modulation capabilities.

Signal generators can be mechanically tuned, synthesized or more recently, digitally synthesized. Mechanically-tuned generators combine fundamental cavity-tuned oscillators with solid-state circuitry to yield spectrally pure signals with very good spurious performance and low residual FM. Collectively covering a frequency range from 10 kHz to 26.5 GHz (and to 60 GHz with multipliers), synthesized signal generators offer programmability and high frequency stability and accuracy. Modulation capabilities range from AM, FM,  $\phi$ M, and pulse to complex formats such as QPSK, 16- and 64-QAM up to 150 Mbaud.

HP's newest signal generators provide ultra-high-speed digital technology for synthesizing fully-arbitrary waveforms. This gives you a highly flexible method of simulating complex signal environments and baseband for modulation drive.

### Signal Generator Selection Guide

A signal generator selection guide provides concise information on over 20 RF and microwave sources, ranging from sweepers to synthesized signal generators. With its summaries and specification comparisons, it provides an excellent resource for determining which source meets your application.



### Signal Generator Summary

Frequency Range	HP Model	Characteristics	Page
dc to 50 MHz	8770A/S Arbitrary Waveform Synthesizer	Simulates highly complex baseband and modulated carriers for radar/EW, communications, disc drive, and other applications. 12-bit resolution, excellent spectral purity, 125 MHz clock rate. HP 11776A Waveform Generation Software runs on HP Technical Desktop Computer.	364
0.5 to 1024 MHz	8640B, 8640B Opt. 004 Signal Generators	Calibrated and leveled output from +19 to -145 dBm. AM, FM, and external pulse modulation. Built-in counter and phase lock capability. Avionics option available (Opt. 004).	360
0.1 to 1057.5 MHz 0.1 to 2115 MHz	8642A, 8642B Synthesized Signal Generators	High spectral purity. 1 Hz frequency resolution. $\pm 1$ dB absolute output level accuracy. AM, FM, $\phi$ M and pulse. Sweep 2 hour. On-site repair.	351
0.1 to 990 MHz	8656B Synthesized Signal Generator	$\pm 1.0$ dB absolute level accuracy from +13 to -127 dBm in 0.1 dB steps. Calibrated AM and FM. Frequency resolution of 10 Hz. Time base aging rate of $\pm 2$ ppm/year.	349
0.01 to 1280 MHz	8662A Synthesized Signal Generator	Low close-in noise. 0.1 Hz frequency resolution. $5 \times 10^{-10}$ /day stability. Calibrated and leveled output from +13 to -140 dBm. Digital sweep. Completely HP-IB programmable. AM/FM modulation. Fast switching.	354
0.1 to 2560 MHz	8663A Synthesized Signal Generator	Low close-in noise. 0.1 Hz frequency resolution. $5 \times 10^{-10}$ /day stability. Calibrated and leveled output from +16 to -130 dBm. Digital sweep. Completely HP-IB programmable. AM, FM, $\phi$ M, pulse modulation. Fast switching.	354
0.01 to 110 MHz 1 to 1300 MHz 1 to 2600 MHz	8660D Synthesized Signal Generator	1 Hz frequency resolution. $3 \times 10^{-10}$ /day stability. Calibrated and leveled output from +13 to -146 dBm. HP-IB and BCD programmable. AM, FM, $\phi$ M, pulse modulation. Plug-ins determine frequency range and modulation capability.	357
10 to 3000 MHz	8780A Vector Signal Generator	Synthesized signal generator for wideband and complex modulation formats. Digital formats from BPSK to 64 QAM. Vector (quadrature) bandwidths dc to 350 MHz. +10 to -100 dBm.	320
2.3 to 6.5 GHz 5.4 to 12.5 GHz	8683/84 B Signal Generators	High spectral purity, stability. $\pm 2.5$ dB absolute level accuracy from +10 to -110 dBm. AM, FM standard. High perf. internal pulse modulator and pulse generator. Portable, rugged (19.1 kg).	366
2.3 to 13 GHz 5.4 to 18 GHz	8683/84D Signal Generators	Same as B model except with wideband frequency coverage. DC coupled FM with $\pm 10$ MHz deviations available. -3dBm standard output power in doubled frequency band. +10 dBm available with option 001.	366
2 to 18 GHz	8671B Synthesized CW Generator	1 to 3 kHz frequency resolution. $5 \times 10^{-10}$ /day stability. +8 to -120 dBm output. Completely HP-IB programmable.	370
2 to 18 GHz	8673E Synthesized Signal Generator	1 to 3 kHz frequency resolution. $1.5 \times 10^{-10}$ /day stability. +8 to -120 dBm output. Pulse, amplitude and frequency modulation. Digital sweep. Completely HP-IB programmable.	371
2 to 18 GHz	8672A Synthesized Signal Generator	1 to 3 kHz frequency resolution. $5 \times 10^{-10}$ /day stability. Calibrated and leveled output from +3 to -120 dBm. Completely HP-IB programmable. Metered external AM and FM.	374
0.01 to 18 GHz	8672S Synthesized Signal Generator	1 to 3 kHz frequency resolution. $5 \times 10^{-10}$ /day stability. Internal pulse modulator. Calibrated and leveled output from +2 to -120 dBm. Metered external AM and FM. Completely HP-IB programmable.	374
0.05 to 18.6 GHz 0.05 to 26.5 GHz	8673C, 8673D Synthesized Signal Generators	Harmonics and sub-harmonics $< -60$ dBc. 1 to 3 kHz resolution. C-model: 1 to 4 kHz, D-model: +2 to -100 dBm output. C-model: +5 to -100 dBm, D-model: Pulse, amplitude and frequency modulation. Digital sweep. Completely HP-IB programmable.	372
0.01 to 20 GHz	8341B Synthesized Sweeper	1-3 Hz frequency resolution. $1 \times 10^{-9}$ /day stability. +12 to -110 dBm output. Pulse, frequency and amplitude modulation. Continuous analog sweep with spans from 100 Hz to 19.99 GHz. Low harmonic option. Completely HP-IB programmable.	378
2 to 26.5 GHz	8673B Synthesized Signal Generator	1 to 4 kHz frequency resolution. $5 \times 10^{-10}$ /day stability. +8 to -100 dBm output. Pulse, amplitude and frequency modulation. Digital sweep. Completely HP-IB programmable.	372
10 to 3000 MHz	86792A Agile Upconverter	Synthesized generator for IF upconversion applications. In conjunction with HP 8770A/S provides modern multiple signal simulations for system test. Switches in 100 nanosec. Contact HP for more technical information.	368
0.01 to 26.5 GHz	8340B Synthesized Sweeper	1 to 4 kHz frequency resolution. $1 \times 10^{-9}$ /day stability. +12 to -110 dBm output. Pulse, frequency and amplitude modulation. Continuous analog sweep with spans from 100Hz to 26.49 GHz. Completely HP-IB programmable.	388
26.5 to 40 GHz 33 to 50 GHz 40 to 60 GHz	83554A, 83555A, 83556A Millimeter-Wave Source Modules	Effectively extends the performance of an 11 to 20 GHz microwave source 8673B/C/D, 8340, 8341, 8350B) to the millimeter-wave frequency ranges.	388

- 100 kHz to 990 MHz
- $\pm 1.0$  dB absolute level accuracy
- Amplitude offset and phase adjustment capability

- 150 millisecond frequency switching speed
- Versatile simultaneous modulation including dc FM
- Fully HP-IB programmable



HP 8656B



### Description

The HP 8656B is a programmable synthesized signal generator that offers exceptional value through a powerful combination of performance, quality and economy.

### Frequency

The HP 8656B provides frequency coverage from 0.1 to 990 MHz (with under-range to 10 kHz). This wide range covers the IF and LO frequencies as well as the RF frequencies of most receivers. It also allows testing in a variety of communication systems including the 800 MHz FM mobile band and some telemetry bands. For automated testing, the 150 ms frequency switching speed of the HP 8656B (specified to be within 100 Hz of the final frequency) increases throughput. Frequency resolution of 10 Hz allows convenient setting of increments including narrow channel spacings, while characterization of phase sensitive devices is made easier with the help of the phase increment/decrement feature. The standard internal reference has an aging rate of 2 ppm/year. Improved stability and accuracy can be achieved by adding the optional  $1 \times 10^{-7}$ /day high stability time base (Option 001) or using an external reference of 1, 5 or 10 MHz.

### Output

The output attenuator of the HP 8656B has been designed with high volume automatic test system use in mind. The 8656B also features  $\pm 1.0$  dB absolute level accuracy and 0.1 dB resolution for accurate receiver sensitivity tests, circuit characterization and R&D applications. The output levels are calibrated from +13 dBm (over-range to +17 dBm) to -27 dBm and may be set and displayed in any one of 14 convenient units including dBm, volts, dB $\mu$ V or Veff. The output level can also be offset to compensate for cable and/or other losses external to the generator, or turned on or off with a dedicated key. Shielding keeps leakage at  $< 1.0 \mu$ V for testing RFI susceptible devices, and standard resettable reverse power protection for up to 50 watts guards against accidental damage from transmitters.

### Modulation

The HP 8656B's versatile modulation capabilities include simultaneous and mixed modulation modes (AM/AM, FM/FM and AM/FM) from internal (1 kHz and 400 Hz) and external sources. AM is ac coupled while FM can be either ac or dc coupled. The new, patented dc coupling technique used in the HP 8656B provides exceptional long term stability ( $< 10$  Hz/hour) and center frequency accuracy ( $\pm 500$  Hz) eliminating the need for retuning in the dc FM mode. For calibrated external modulation, a 1V peak signal is required, and HI/LO annunciators on the HP 8656B indicate when the external signal is within 5% of the correct amplitude.

### Ease of Operation

A microprocessor-based controller provides a broad range of operating features for simple, but efficient control. Keyboard data entry uses a function/data/units format, and all function entries are made using a left-to-right keystroke sequence. All information entered is visible via LED displays and annunciators. Modulation, frequency, and level functions can be individually incremented by step sizes that are set by convenient keyboard entries. In addition, resolution control keys allow coarse and fine tuning of frequency in decade steps.

Up to ten front-panel setups can be stored and recalled. A sequence function allows you to cycle through stored setups at the touch of a key or via remote control. The microprocessor also makes troubleshooting aids available at the front panel, enhancing the serviceability of the HP 8656B.

### HP-IB Programmability

Full HP-IB programmability is standard in the HP 8656B. Each programming command has an easy-to-remember, two-character, alpha-numeric HP-IB code that is also labeled next to each key. All functions are quickly and easily programmed using the same function/data/units format as in the manual mode.

# SIGNAL GENERATORS

## Synthesized Signal Generator (cont'd)

### Model 8656B

#### HP 8656B Specifications

##### Frequency

**Range:** 100 kHz to 990 MHz (8 digit LED display).

**Frequency underrange:** 10 kHz with uncalibrated output.

**Resolution:** 10 Hz.

**Accuracy and stability:** same as internal time base.

##### Time Base Characteristics

Typical Characteristics	Standard Time Base	Option 001 Time Base
Aging Rate	±2 ppm/year	1x10 <sup>-7</sup> /day
Frequency	50 MHz	10 MHz
External Reference Input (rear panel)	Accepts any 1, 5, or 10 MHz (±0.002%) frequency standard at a level >0.15 V <sub>rms</sub> into 50 ohms.	

**Frequency switching speed (to be within 100 Hz of final frequency):** <150 ms.

**Phase Offset:** adjustable via HP-IB or from the front panel in nominal 1 degree increments.

##### Spectral Purity

**Spurious Signals (≤ +7 dBm output levels)**

**Harmonics:** < -30 dBc.

**Non-harmonic spurious (greater than 5 kHz from carrier in CW mode):** < -60 dBc.

**Sub-harmonics:** none.

##### Residual FM

Post Detection Noise Bandwidth	Frequency Range (MHz)			
	0.1 to 123.5	123.5 to 247	237 to 494	494 to 990
0.3 to 3 kHz	<7 Hz rms	<2 Hz rms	<4 Hz rms	<7 Hz rms
0.05 to 15 kHz	<15 Hz rms	<4 Hz rms	<8 Hz rms	<15 Hz rms

**Residual AM (0.05 to 15 kHz post detection noise bandwidth):** 0.025%.

##### SSB Phase Noise (CW only)

Offset from Carrier	0.1 to 123.5 MHz (dBc/Hz)	123.5 to 247 MHz (dBc/Hz)	247 to 494 MHz (dBc/Hz)	494 to 990 MHz (dBc/Hz)
20 kHz	<-114	<-126	<-120	<-114

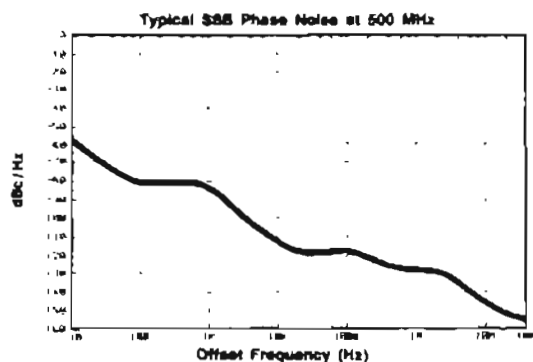

##### Output

**Level range (into 50 ohms):** 13 dBm to -127 dBm (3 1/2 digit LED display; uncalibrated output to 17 dBm).

**Resolution:** 0.1 dB.

**Absolute level accuracy:** ±1.0 dB; 123.5 to 990 MHz

<±1.5 dB; f<sub>c</sub> < 123.5 MHz, levels > +7 dBm and < -124 dBm.

**Level flatness (100 kHz to 990 MHz):** ±1.0 dB at an output level setting of 0.0 dBm.

**Reverse power protection:** protects signal generator from application of up to 50 watts (from a 50Ω source) of RF power to 990 MHz into generator output; dc voltage cannot exceed 25V.

##### Amplitude Modulation (2 digit LED display)

**AM depth<sup>1</sup>:** 0 to 99% to +7 dBm and 0 to 30% to +10 dBm.

**Resolution:** 1%.

**AM rate:** internal 400 Hz and 1 kHz, ±3%; external (1 dB bandwidth), 20 Hz to 40 kHz.

**AM distortion (at internal rates):** <1.5%, 0-30% AM; <3%, 31-70% AM; <4%, 71-90% AM.

**Indicator accuracy (for depths <90% internal rates and levels < +7 dBm)<sup>1</sup>:** ±(2% + 4% of reading).

**Incidental phase modulation (at 30% AM depth and internal rates):** <0.3 radian peak.

##### Frequency Modulation (2 digit LED display)

###### FM Peak Deviation

Center Frequency	Maximum Peak Deviation	
	AC Mode	DC Mode
0.1 to 123.5 MHz	The lesser of 99 kHz or 4000 x rate (Hz)	99 kHz
123.5 to 247 MHz	50 kHz or 1000 x rate (Hz)	50 kHz
247 to 494 MHz	99 kHz or 2000 x rate (Hz)	99 kHz
494 to 990 MHz	99 kHz or 4000 x rate (Hz)	99 kHz
FM not specified for f <sub>c</sub> - (Δf <sub>pk</sub> ) < 100 kHz		

**Resolution:** 100 Hz for deviations less than 10 kHz; 1 kHz for deviations greater than 10 kHz.

**FM rate:** internal 400 Hz and 1 kHz, ±3%; external (1 dB BW), dc coupled, dc to 50 kHz; ac coupled, 20 Hz to 50 kHz.

**Center frequency accuracy in dc FM mode:** <±500 Hz.

**Center frequency stability in dc FM mode:** <10 Hz/hour.

**FM distortion (internal rates and ≥3 kHz peak deviations):** <0.5%.

**Indicator accuracy<sup>1</sup>:** ±5% of reading at internal rates.

**Incidental AM (for center frequency ≥500 kHz, peak deviation <20 kHz and internal rates):** <0.1%.

##### Remote Programming

**Interface:** HP-IB (Hewlett-Packard's implementation of IEEE - 488).

**HP-IB interface functions:** SH0, AH1, T0, L2, SR0, RL1, PP0, DC1, DT0, C0 and E1. (For more on these codes, refer to the HP-IB section of this catalog.)

##### General

**Operating temperature range:** 0° to +55° C.

**Leakage:** conducted and radiated interference is within the requirements of methods CE03 and RE02 of MIL STD 461B, FTZ 1115. Furthermore, RF leakage of less than 1.0 μV is induced in a two-turn loop, 2.5 cm in diameter, held 2.5 cm away from the front surface.

**Power requirements:** 100, 120, 220, or 240 Vac; +5%, -10%; 48 to 440 Hz, 125 VA maximum.

**Weight:** net, 18.2 kg (40 lb); shipping, 23.6 kg (52 lb).

**Size:** 133 H x 425 W x 520 mm D (5.25" x 16.75" x 20.5"). HP System 11 module size: 5 1/4 H x 1 MW x 17 D. For cabinet accessories, see page 738.

**Rack slides and transit case:** HP part numbers are: slide kit, 1494-0018; tilt slide kit, 1494-0025; full module transit case, 9211-2661.

##### Ordering Information

HP 8656B Signal Generator <sup>2</sup>	Price
Opt 001 High stability time base	\$6,650
Opt 002 RF connectors on rear panel only	+ \$865
Opt 007 Front handle kit	+ \$180
Opt 808 Rack flange kit	+ \$55
Opt 909 Rack flange and front handle kit	+ \$32.50
Opt 910 Additional operating & service manual	+ \$80
	+ \$85

<sup>1</sup>AM depth and FM deviation are further limited by Indicator Accuracy specifications.

<sup>2</sup>HP-IB cables not supplied. For description and price, see HP-IB section.



- 100 kHz to 2.115 GHz
- $-147$  dBc/Hz SSB phase noise at 20 kHz offset
- $-100$  dBc nonharmonic spurious

- $+20$  dBm maximum output level
- AM, FM,  $\Phi$ M and pulse modulation
- On-site repair and calibration

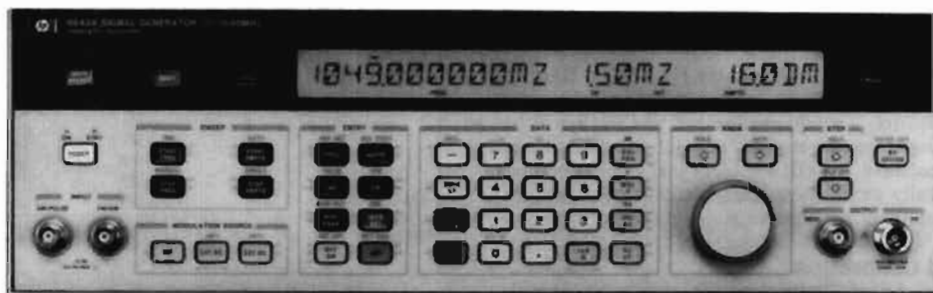

HP 8642A

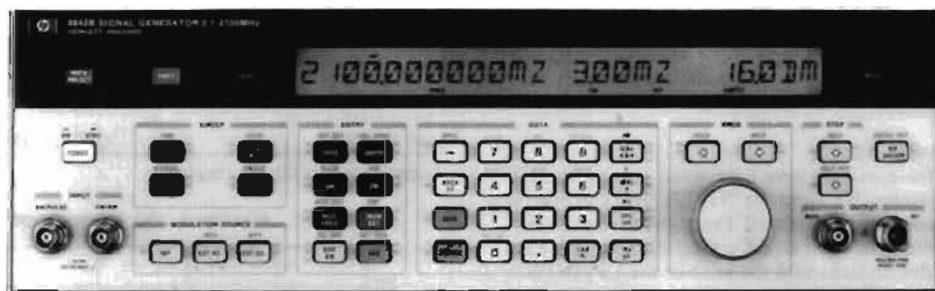

HP 8642B



### HP 8642A/B Synthesized Signal Generators

The HP 8642A and HP 8642B synthesized signal generators are high performance programmable signal generators intended for the most demanding out-of-channel RF receiver measurements and other stringent RF applications. The HP 8642A covers the frequency range from 100 kHz to 1057.5 MHz and the HP 8642B covers the frequency range from 100 kHz to 2115 MHz. The two generators are otherwise very similar.

#### Low SSB Phase Noise

The HP 8642A/B improve the state-of-the-art in SSB phase noise at typical receiver adjacent channel spacings over the cavity tuned HP 8640B signal generator. This improvement is made possible through the use of high-Q Surface Acoustic Wave resonator oscillators operating near 800 MHz. SSB phase noise at 20 kHz offset from a 1 GHz carrier is  $-134$  dBc/Hz, approximately 6 dB lower than the HP 8640B. The HP 8642A/B are an ideal choice to characterize selectivity on high performance receivers up to 1 GHz or 2 GHz. Furthermore, their advanced control features simplify measurements on the bench and in ATE systems.

#### $-100$ dBc Spurious

Nonharmonic spurious are held to below  $-100$  dBc on the HP 8642A/B up to 1 GHz and to below  $-94$  dBc on the HP 8642B above 1 GHz. These two generators allow receiver spurious rejection tests to be fully automated with the utmost confidence in test results. In the HP 8642A/B design, high performance mixers reduce typical synthesizer spurious, and rigid die castings with resilient RF gasketing provide up to 140 dB of circuit isolation to ensure low spurious content on the output.

#### $\pm 1$ dB Output Level Accuracy

Absolute output level accuracy is  $\pm 1$  dB down to  $-127$  dBm (0.1  $\mu$ V). In R&D or on the production line, the HP 8642A/B will accurately measure receiver sensitivities. Excellent output level repeatability is obtained with a high reliability attenuator specifically

designed for continuous ATE system use. At any output level setting, the attenuator can be fixed and level varied up or down 10 dB in a transient free manner.

#### Up to $+20$ dBm Output Level

Up to  $+20$  dBm is available from the HP 8642A/B to perform a variety of high level measurements, often eliminating the need for external amplifiers.

In ATE system use, this extra power is available to overcome cabling losses. Using the relative amplitude feature, the display can be offset to show correct output level at the end of the cable.

In receiver design, there is sufficient output power to drive high level mixers and perform receiver blocking tests. Intermodulation measurements can be made with high confidence since intermodulation distortion products on the HP 8642A/B are specified.

#### AM, FM, $\Phi$ M and Pulse Modulation

The HP 8642A/B offer AM, FM,  $\Phi$ M and pulse modulation across their full frequency ranges with a unique dual output section to improve modulation characteristics at lower carrier frequencies.

The HP 8642A/B, like their predecessor the HP 8640B, use an RF divider output chain to obtain lower frequency coverage with improved spectral purity. However, the HP 8642A/B can, on demand, switch in a separate heterodyne (HET) output section below 132.2 MHz to obtain improved modulation performance over the divided output.

For testing FM mobile radios, the HP 8642A/B have built-in 750  $\mu$ s preemphasis (FM PRE) to simplify receiver audio flatness tests. Simultaneous modulation capability allows two-tone modulation tests.

A low distortion internal modulation oscillator can be used to modulate the HP 8642A/B up to 100 kHz rates or as a stand-alone audio source. The output, available at the front panel, is programmable both in frequency and level providing an independent audio oscillator.

# SIGNAL GENERATORS

## Synthesized Signal Generators (cont'd)

Models 8642A and 8642B

### Fit for ATE System Use

To improve instrument availability or "uptime", the HP 8642A/B have been designed to reduce failures and simplify the service procedure in the event of a failure. When used in ATE systems, the HP 8642A/B will improve overall system up-time, thus leading to increased productivity.

### Extended Calibration Interval

The recommended calibration interval for the HP 8642A/B is two years, the result of a quality design, environmental-type testing and stringent production control. This means the HP 8642A/B will be more available for critical measurements, not out for calibration. When calibration is necessary, the HP 8952A Signal Generator Test System can automatically verify most warranted specifications for the HP 8642A/B in less than 20 minutes.

### On-Site Repair and Calibration

The HP 8642A/B can be repaired and recalibrated on site in typically less than two hours. The fourteen internal modules that make up the HP 8642A/B all have rigid I/O specifications allowing a module-exchange repair strategy. Faulty modules can be quickly isolated using internal diagnostic hardware and software. A replacement module can be easily fitted and calibration data transferred to the instrument's main memory with a simple front-panel key sequence. Calibration and adjustments are primarily made electronically with ROM memory ICs and D/A converters.

### A Unique Help Feature

Convenient control features help save time when putting the HP 8642A/B to work in systems. By using the "HELP" feature, special function codes and associated operational descriptions can be displayed by the alphanumeric back-lit liquid crystal display. It is easy to scroll through these descriptions with the knob or the UP/DOWN keys. The "HELP" feature eliminates the need to check manuals or pull-out cards by providing easy access to all special functions.

Through the LCD, messages in English clearly show instrument state and inform users of entry errors to help write programs that run smoothly from the start.

### HP 8642A/B Specifications

#### Frequency

**Range:** 100 kHz to 1057.5 MHz, HP 8642A; 100 kHz to 2115 MHz, HP 8642B.

**Bands:** Both generators cover their ranges in one continuous span. However, many other specifications are dependent on carrier frequency. To simplify such specifications, the HP 8642A and 8642B carrier frequency ranges are divided into bands shown in the table below.

Band	Carrier Frequency (MHz)	Band	Carrier Frequency (MHz)
10	1057.500001-2115 (HP 8642B)	4	16.523438- 33.046875
9	528.750001-1057.5	3	8.261719- 16.523437
8	264.375001- 528.75	2	4.130860- 8.261718
7	132.187501- 264.375	1	0.1 - 4.130859
6	66.093751- 132.1875	HET	0.1 -132.1875
5	33.046876- 66.09375		

**Resolution:** 1 Hz, 0.1 Hz with special function.

**Stability:** same as reference oscillator.

#### Internal Reference Oscillator

**Typical stability, standard:** aging rate:  $\pm 2$  ppm/year.

**Stability, option 001:**  $< 10^{-9}$ /day aging rate after 8 days warm-up.

#### Spectral Purity

**Residual FM; CW, AM or Angle Modulation  $\leq 1/3$  Maximum Peak Deviation:**

Carrier Frequency	Post Detection Bandwidth, kHz	
	0.3 to 3 (Hz rms)	0.05 to 15 (Hz rms)
band 10 (HP 8642B)	$< 5$	$< 9$
band 9	$< 2$	$< 5$
band 8	$< 1.2$	$< 2$
bands 1 thru 7	$< 1$	$< 1.2$
band HET	$< 3.5$	$< 5$

**SSB Phase Noise; CW, AM, or Angle Modulation  $< 1/30$  Maximum Peak Deviation:**

Carrier Frequency Band	SSB Phase Noise 20 kHz Offset dBc/Hz	SSB Phase Noise Floor 200 kHz Offset dBc/Hz
10	-125	-134
9	-134	-143
8	-137	-144
7	-141	-144
6	-144	-145
5	-145	-145
4	-146	-147
3	-147	-148
2	-148	-149
1	-137	-138
HET	-125	-137

**Residual AM:**  $< 0.01\%$  AM rms, 0.3 to 3 kHz post-detection BW.

### Spurious

Type of Spurious	HP 8642A/B Bands 1-9 and HET	HP 8642B Band 10
Harmonics		
Output Level $\leq +10$ dBm	-30 dBc	-25 dBc
Output Level $\leq +16$ dBm	-20 dBc	-20 dBc
Sub-harmonics	none	-45 dBc
Non-harmonics, $> 10$ kHz from the carrier	-100 dBc <sup>1</sup>	-94 dBc

### Supplemental Characteristics

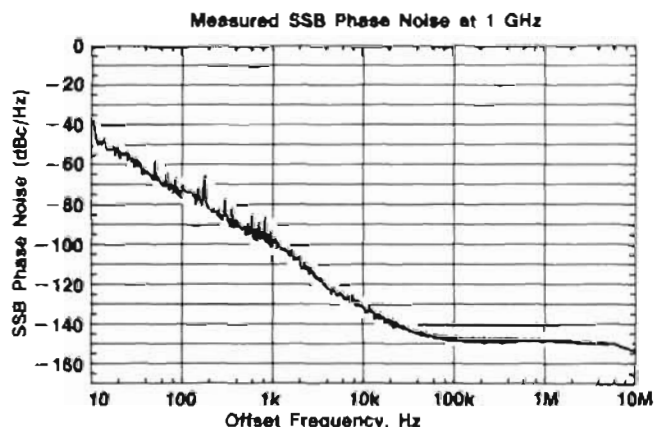

### Output

**Level range:** from maximum available to  $-140$  dBm ( $0.023 \mu\text{V}$ ).

**Maximum Level Available:**

	HP 8642A	HP 8642B
+20 dBm (2.24V)	bands 1 thru 7	bands 1 thru 7
+19 dBm (2.00V)	n/a	band 8
+18 dBm (1.78V)	bands 8 & HET	HET
+17 dBm (1.58V)	n/a	band 9
+16 dBm (1.41V)	band 9	band 10

**Resolution:** 0.1 dB.

**Absolute accuracy:**  $\pm 1$  dB, output level  $\geq -127$  dBm.

**Flatness:**  $\leq \pm 0.75$  dB, +10 dBm output level.

**Impedance:** 50 ohms nominal.

**SWR:**  $< 1.5:1$  for output levels  $< 0$  dBm;

$< 2.0:1$  for output levels  $\geq 0$  dBm.

**Reverse power protection:** 50W, from a 50 $\Omega$  source 25 Vdc, HP 8642A; 25W, 50 Vdc, HP 8642B.

**Third order intermodulation:**  $< -50$  dBc at +10 dBm, two generators 25 kHz apart into a resistive combiner. Typically decreases 10 dB for every 5 dB of combined level decrease.

**Available calibration units:** V, mV,  $\mu\text{V}$ , dBm, and EMF. REL ZERO or REF SET can be used to obtain settings such as dB $\mu\text{V}$ , dBEMFV, dBf, etc.

<sup>1</sup>Not specified in HET band.

**Amplitude Modulation**

**AM depth:** 0 to 99.9%, output level  $\leq +10$  dBm.

**AM resolution:** 0.1%.

**AM indicator accuracy at 1 kHz rate and up to 90% AM:**

$\pm(3.5\%$  of setting  $+1\%$  AM), HP 8642A/B bands 1-8 and HET, HP 8642B band 9.

$\pm(5\%$  of setting  $+1\%$  AM), HP 8642B band 9, HP 8642B band 10.

**AM distortion at 1 kHz rate:**

Depth, %	Distortion	
	HP 8642A/B bands 1-8 HP 8642B band 9	HP 8642B band 9 HP 8642B band 10 HP 8642A/B band HET
0 to 30	<1%	<2%
30 to 70	<2%	<4%
70 to 90	<4%	<6%

**AM 3 dB bandwidth, depth  $\leq 90\%$ :**

**External dc/ac coupling:** dc/20 Hz to 100 kHz, bands 1 and 5 thru 10; dc/20 Hz to 20 kHz, bands 2,3,4.

**Internal:** same as external ac.

**Incidental phase modulation at 1 kHz rate and 30% AM:** <0.2 radians peak.

**Frequency Modulation**

**Maximum FM deviation:**

Carrier Frequency Band	Maximum Deviation DC Coupled	Maximum Deviation AC Coupled or Internal
		(the smaller of)
10	3 MHz	3 MHz or $f_{mod} \times 2160$
9	1.5 MHz	1.5 MHz or $f_{mod} \times 1080$
8	750 kHz	750 kHz or $f_{mod} \times 540$
7	375 kHz	375 kHz or $f_{mod} \times 270$
6	187 kHz	187 kHz or $f_{mod} \times 135$
5	93.8 kHz	93.8 kHz or $f_{mod} \times 67.5$
4	46.9 kHz	46.9 kHz or $f_{mod} \times 33.75$
3	23.4 kHz	23.4 kHz or $f_{mod} \times 16.88$
2	11.7 kHz	11.7 kHz or $f_{mod} \times 8.44$
1	93.8 kHz	93.8 kHz or $f_{mod} \times 67.5$
HET	1.5 MHz	1.5 MHz or $f_{mod} \times 1080$

**FM resolution:** 0.7% of setting or 0.0004% of maximum deviation, whichever is larger.

**FM indicator accuracy:**

$\pm(5\%$  of setting  $+10$  Hz).

Rates dc to 100 kHz, external dc coupling.

Rates 20 Hz to 100 kHz, external ac and internal.

**FM distortion:** 4% for maximum dc coupled deviation, 2% for  $1/2$  maximum dc deviation, 0.4% for  $1/3$  maximum dc coupled deviation, rates 20 Hz to 100 kHz.

**FM 3 dB bandwidth:**

**External dc/ac coupling:** dc/20 Hz to 200 kHz.

**Internal:** dc/20 Hz to 200 kHz

**Incidental AM:** 0.2%, 20 kHz peak deviation, 1 kHz rate, >400 kHz carrier frequency.

**Carrier frequency offset when entering FM or phase modulation modes:** AC and internal: none; DC: <500 Hz, HP 8642A/B; <1 kHz, HP 8642B band 10.

**Phase Modulation**

**Maximum phase deviation:**

Carrier Frequency Band	Maximum Deviation (Radians)
10	200
9	100
8	50
7	25
6	12.5
5	6.25
4	3.13
3	1.56
2	0.78
1	6.25
HET	100

**Phase modulation accuracy:**  $\pm(5\%$  of setting  $+0.09$  radians), 1 kHz rate.

**Phase modulation resolution:** 0.7% of setting or 0.0004% of maximum deviation, whichever is greater.

**Phase modulation distortion:** <0.4%, 1 kHz rate.

**Phase modulation 3 dB bandwidth:** 20 Hz to 15 kHz, internal and external ac. DC to 15 kHz, external dc.

**Pulse Modulation (for output levels  $\leq +15$  dBm)**

**Pulse on/off ratio:** >40 dB, HP 8642A/B; >80 dB, HP 8642B band 10.

**Rise/fall time:** <400 ns, 10% to 90%.

**Maximum repetition frequency:** 100 kHz.

**Minimum pulse width:** 2  $\mu$ s.

**Nominal peak input threshold level:** 1.5V.

**Internal Modulation Oscillator**

**Rates:** 20 Hz to 100 kHz.

**Frequency resolution:** 1% of setting.

**Frequency accuracy:** 2% of setting.

**Output level range:** 0 to 3V peak into 600 ohms.

**Output level resolution:** 4 mV.

**Distortion:** >0.5V peak: <0.02%, 0.02 kHz to 15.8 kHz; <0.15%, >15.8 kHz.

**Output level accuracy:**  $\pm(4\% +15$  mV) within 1 second.

**Output impedance:** 600 ohms  $\pm 10\%$ .

**Frequency Sweep**

**Digitally stepped sweep:**

**Start-stop sweep:** sweeps between two selected endpoints in a linear step-wise manner. Endpoints can be anywhere within the frequency range of the instrument.

**Phase continuous sweep:**

**Start-stop sweep:** instrument sweeps between two selected endpoints in a linear, phase continuous manner.

**Maximum span:** up to 400 kHz, HP 8642A/B; up to 800 kHz, HP 8642B band 10.

**X axis output:** 0 to 10 Vdc,  $\pm 10\%$ .

**Z axis output:** TTL positive true for crt display blanking during retrace.

**Remote Programming**

**Interface:** HP-IB (IEEE-488-1978).

**Functions controlled:** all functions controlled from the front panel or over HP-IB from 00 to 30 (5 bit decimal equivalent).

**Interface function:** listener, talker, and controller.

**HP-IB interface functions:** SH1, AH1, T5, TE0, L3, LE0, SR1, RL1, PP1, DC1, DT1, C1, C3, C28, E2.

**General**

**Operating temperature range:** 0° to 55° C.

**Storage temperature:** -55° C to +75° C.

**Leakage:** conducted and radiated interference is within the requirements of MIL STD 462B method CE03 and RE02. Interference is also within the standards set by FTZ 1115. Also, RF leakage of <0.5  $\mu$ V is induced in a two turn loop 2.5 cm in diameter, held 2.5 cm away from any surface for output levels  $\leq 0$  dBm.

**Power requirements:** 100V, 120V, 220V, or 240V; +5%, -10%; 48 to 440 Hz; 300 VA max.

**Size:** 133H X 425W X 617D mm (5.25" X 16.75" X 24.3").

**HP System II module size:** 5 1/4 H X 1 MW X 23D.

**Weight:** Net, 32.7 kg (71.5 lb); shipping, 43 kg (95 lb).

**Ordering Information**

	Price
HP 8642A Synthesized Signal Generator	\$22,900
HP 8642B Synthesized Signal Generator	\$31,500
Opt 001 High stability time base	+ \$2,040
Opt 002 RF connectors on rear panel only	+ \$155
Opt 710 On-site repair manual	+ \$572
Opt 907 Front handle kit	+ \$55
Opt 908 Rack flange kit	+ \$32.50
Opt 909 Front handle kit & rack flange kit	+ \$80
Opt 910 Additional operating and service manual	+ \$210
Opt W03 90 day on-site warranty conversion	\$0
Opt W30 Three-year extended hardware support:	
HP 8642A	+ \$450
HP 8642B	+ \$600
HP 11801A On-site repair kit for HP 8642A	\$20,000
HP 11801B On-site repair kit for HP 8642B	\$26,500
HP 11801C On-site repair kit for HP 8642A and 8642B	\$28,000

# SIGNAL GENERATORS

## Synthesized Signal Generators

Models 8662A, 8663A

- 10 kHz to 1280 MHz frequency range
- $< -147$  dBc/Hz SSB phase noise at 10 kHz offset
- 0.1 Hz frequency resolution



HP 8662A



### HP 8662A Synthesized Signal Generator

The HP 8662A derives exceptional RF performance from an indirect frequency synthesis technique that results in frequency resolution of 0.1 Hz from 10 kHz to 640 MHz and 0.2 Hz from 640 MHz to 1280 MHz.

Output level accuracy is held to  $\pm 1$  dB using microprocessor correction. This makes the HP 8662A an ideal generator for performing precise receiver sensitivity tests either manually or in automated systems.

The HP 8662A offers versatile phase-locked AM/FM using either internal 400 Hz and 1 kHz rates or externally applied modulating signals, which can be either dc or ac coupled. Several different modes of simultaneous modulation (such as AM + FM or FM + FM) are possible.

### Exceptional Spectral Purity

The key contribution of the HP 8662A is spectral purity. Fast-tuning, switched-inductance, voltage-controlled oscillators combined with a low noise reference multiplication chain result in very low SSB phase noise, especially at small offsets from the carrier. The phase noise at 20 kHz to 50 kHz offsets is comparable to that of the best cavity-tuned fundamental oscillators. Such excellent noise performance makes possible complete automation of receiver out-of-channel measurements.

With its excellent long and short-term frequency stability, high output power, fine frequency resolution, and broad frequency range the HP 8662A also meets the requirements of the most critical low noise local oscillator applications. In addition, its fast frequency switching and sweep capabilities also permit its use in many frequency agile and swept local oscillator applications.

An advanced microprocessor-based controller allows convenient keyboard control of all HP 8662A functions. For example, all functions can be incremented and decremented in any user-defined step size within the resolution of the synthesizer using the increment keys and the knob. Up to nine full front panel setups can be stored in the HP 8662A's memory and recalled for later use in any user-defined sequence at the touch of a pushbutton. This permits time-saving semi-automation of generator operation in production setups where the generator must perform many different tests.

### Precision Digital Sweep

Fast frequency switching combined with microprocessor control gives the HP 8662A a powerful sweep capability. Automatic, single, and manual modes are available for both linear and logarithmic sweeps with user-selectable step size and number of steps. Five different sweep speeds can be chosen and up to five amplitude or Z-axis markers can be set. All sweep parameters can be controlled with full synthesizer resolution.

- 100 kHz to 2560 MHz frequency range
- AM/FM/ $\emptyset$ M/pulse in one generator
- Internal variable modulation oscillator



HP 8663A



### HP 8663A Synthesized Signal Generator

The HP 8663A provides all the features and the exceptional spectral purity of the HP 8662A with increased frequency range and modulation capability.

The HP 8663A also has U.S. Air Force MATE (Modular Automatic Test Equipment) system compatibility, Option 700. Option 700 is an external translator that provides the HP 8663A with the capability to be controlled by the MATE language CIIL (Control Interface Intermediate Language).

### Broad Frequency Range

The HP 8663A utilizes the complete frequency synthesis portion of the HP 8662A with the addition of an internal frequency doubler to achieve a broad frequency range of 100 kHz to 2560 MHz in a single instrument. In the HP 8663A, the exceptional spectral purity of the HP 8662A is maintained up to 1280 MHz. Above this, phase noise is typically increased 6 dB to a level of  $-124$  dBc/Hz at 10 kHz offset from a 2.5 GHz carrier. High output power of +16 dBm (with over-range to 19.9 dBm) is available for efficiently driving frequency translators when low noise microwave signals are needed. Combined with a microwave synthesizer such as the HP 8673A, full frequency coverage from 100 kHz to 26 GHz is possible.

### Flexible Modulation

Complete modulation capability across a wide carrier frequency range is the key contribution of the HP 8663A. AM and FM characteristics are similar to those offered in the HP 8662A. The HP 8663A adds high performance pulse and biphasic modulation with wide bandwidth linear phase modulation available with Option 002. For complete flexibility the HP 8663A Option 002 has the capability to simultaneously provide AM+FM+pulse+phase modulation across its entire frequency range. AM, FM, and linear phase are either AC or DC coupled while biphasic and pulse are DC coupled. This modulation flexibility assures exact signal simulation when testing complex systems such as those involving pulsed doppler radar and electronic warfare. An internal 100 kHz sinusoidal modulation synthesizer phase locked to the 10 MHz time base is standard. Microprocessor flexibility allows the sweep functions to be applicable to the internal audio synthesizer, as well as the RF synthesizer, making applications involving swept modulation possible with a single instrument.

### Similarity to the HP 8662A

Because the HP 8663A has been designed to be upward compatible with the HP 8662A, the two generators have identical control and performance characteristics for those functions that are common. Either generator can be combined with the HP 11729A Microwave Converter and the HP 3048A Phase Noise Measurement System to perform microwave phase noise measurements simply and quickly.

## HP 8662A Specifications

### Frequency

**Range:** 10 kHz to 1280 MHz (1279.9999998 MHz).

**Resolution:** 0.1 Hz (0.2 Hz above 640 MHz).

**Accuracy and stability:** same as reference oscillator.

**Internal reference oscillator:** 10 MHz quartz oscillator. Aging rate  $< 5 \times 10^{-10}$ /day after 10 day warm-up (typically 24 hrs in normal operating environment).

### Spectral Purity

**Residual SSB Phase Noise in 1 Hz BW ( $320 \leq f_c < 640$  MHz)**

Offset from Carrier				
10 Hz	100 Hz	1 kHz	10 kHz	100 kHz
-100 dBc	-112 dBc	-121 dBc	-131 dBc	-132 dBc

**SSB broadband noise floor in 1 Hz BW at 3 MHz offset from carrier:**  $< -146$  dBc for  $f_c$  between 120 and 640 MHz at output levels above +10 dBm.

### Spurious Signals

	Frequency Range (MHz)				
	0.01 to 120	120 to 160	160 to 320	320 to 640	640 to 1280
Spurious non-harmonically related <sup>1,2</sup>	-90 dBc	-100 dBc	-96 dBc	-90 dBc	-84 dBc
Sub-harmonically related ( $\frac{1}{2}, \frac{3f}{2}$ , etc.)	none	none	none	none	-75 <sup>3</sup> dBc
Power line (60Hz) related or microphonically generated (within 300 Hz) <sup>4</sup>	-90 dBc	-85 dBc	-80 dBc	-75 dBc	-70 dBc
Harmonics	$< -30$ dBc				

### Output

**Level range:** +13 to -139.9 dBm (1V to 0.023  $\mu$ V<sub>rms</sub> into 50 $\Omega$ ).

**Resolution:** 0.1 dB.

**Absolute level accuracy (+15° to +45°C):**  $\pm 1$  dB between +13 and -120 dBm,  $\pm 3$  dB between -120 and -130 dBm.

**SWR:** typically from 1.5 to 1.8 depending on output level and frequency.

**Reverse power protection:** typically up to 30W or  $\pm 8$  Vdc.

### Amplitude Modulation

**Depth:** 0 to 95% at output levels of +8 dBm and below (+10 dBm in uncorrected mode). AM available above these output levels but not specified.

**Resolution:** 1%, 10 to 95% AM; 0.1%, 0 to 9.9% AM.

**Incidental PM (at 30% AM):** 0.15-640 MHz,  $< 0.12$  radian peak; 640-1280 MHz,  $< 0.09$  radian peak.

**Incidental FM (at 30% AM):** 0.15-640 MHz,  $< 0.12 \times f_{mod}$ ; 640-1280 MHz,  $< 0.09 \times f_{mod}$ .

**Indicated accuracy:**  $\pm 5\%$  of reading  $\pm 1\%$  AM. Applies for rates given in table below, internal or external mode, for depths  $\leq 90\%$ .

### Rates and Distortion with Internal or External Modulating Signal

Frequency range	AM rate	AM Distortion		
		0-30% AM	30-70% AM	70-90% AM
0.15-1 MHz	dc-1.5 kHz	2%	4%	5.75%
1-10 MHz	dc-5 kHz	2%	4%	5.75%
10-1280 MHz	dc-10 kHz	2%	4%	5.75%

### Frequency Modulation

**FM rates (1 dB bandwidth):** external ac, 20 Hz to 100 kHz; external dc, dc to 100 kHz.

**FM deviation:** from 25 to 200 kHz depending on carrier frequency.

**Indicated FM accuracy:**  $\pm 8\%$  of reading plus 10 Hz (50 Hz to 20 kHz).

**FM resolution:** 100 Hz for deviations  $< 10$  kHz, 1 kHz for deviations  $\geq 10$  kHz.

**Incidental AM (AM sidebands at 1 kHz rate and 20 kHz deviation):**  $< -72$  dBc,  $f_c < 640$  MHz;  $< -65$  dBc,  $f_c \geq 640$  MHz.

**FM distortion:**  $< 1.7\%$  for rates  $< 20$  kHz,  $< 1\%$  for rates  $> 1$  kHz.

**Center frequency accuracy and long term stability in AC mode:** same as CW mode.

### Supplemental Characteristics

**Typical Absolute and Residual SSB Phase Noise, 639 MHz Carrier.**

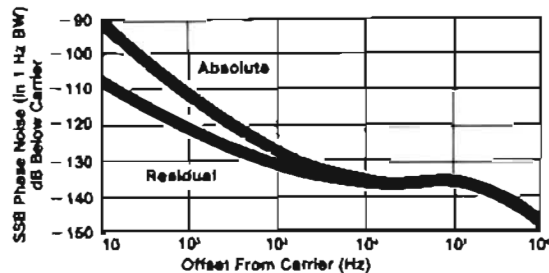

**Frequency switching speed:**<sup>5</sup> From 420  $\mu$ sec to 12.5 msec, depending on the programming mode.

## HP 8663A Specifications

The HP 8663A signal generator is related to the HP 8662A in both concept and structure. The HP 8662A concept of an extremely low phase noise signal source incorporating signal generator modulation capabilities and output characteristics is carried even further by the HP 8663A. While maintaining high spectral purity, the HP 8663A offers increased frequency range to 2560 MHz, increased output level to +16 dBm, and the addition of phase and pulse modulation. The result is a highly flexible and powerful signal generator that utilizes and extends the proven circuitry of the HP 8662A. Thus, the HP 8662A and HP 8663A share many of the same specifications as shown below:

### Frequency

**Range:** 100 kHz to 2560 MHz (2559.9999996 MHz)

**Resolution:** 0.1 Hz ( $f_c < 640$  MHz)

0.2 Hz (640 MHz  $\leq f_c < 1280$  MHz)

0.4 Hz ( $f_c \geq 1280$  MHz)

**Accuracy, stability, and internal reference oscillator:** identical to HP 8662A.

<sup>1</sup>In the remote mode it is possible to have microprocessor clock related spurious signals spaced 3 MHz apart at an absolute level of typically less than -145 dBm.

<sup>2</sup>Spurious signals can be up to 3 dB higher in the dc FM mode.

<sup>3</sup>1/2 spurs not specified for carrier frequencies above 850 MHz.

<sup>4</sup>At a 50 Hz line frequency, power line or microphonically related spurious signals may be up to 3 dB higher and appear at offsets as high as 1 kHz from the carrier.

<sup>5</sup>Due to automatic leveling loop bandwidth changes, brief (30 msec) level inaccuracies may occur when switching through 150 kHz and 1 MHz RF output frequencies.

# SIGNAL GENERATORS

## Synthesized Signal Generators (cont'd)

Models 8662A, 8663A

### Spectral Purity

**Residual SSB phase noise in 1 Hz BW ( $320 \leq f_c < 640$  MHz):** identical to HP 8662A.

**Typical SSB phase noise:** identical to the HP 8662A for  $f_c$  between 100 kHz and 1280 MHz (see graph). For  $f_c$  between 1280 and 2560 MHz, the noise will be approximately 12 dB higher than the 639 MHz curve on the "typical SSB phase noise" graph.

**Absolute SSB phase noise in a 1 Hz BW:** identical to the HP 8662A for  $f_c$  between 100 kHz and 1280 MHz. For  $f_c$  between 1280 and 2560 MHz, the specified noise is 6 dB higher than the 640 to 1280 MHz specification in the table.

**Spurious signals:** identical to HP 8662A except for  $f_c$  between 1280 and 2560 MHz the spurious non-harmonics are  $-78$  dBc, the subharmonically related ( $f/2$ ,  $3f/2$ , etc.) between 640 and 1280 MHz are  $-70$  dBc and between 1280 and 2560 MHz are  $-40$  dBc, and the power line (60 Hz) or microphonically generated spurious are  $-65$  dBc.

**Harmonics:**  $< -30$  dBc,  $\pm 13$  dBm output.  $< -25$  dBc,  $+13$  dBm to  $+16$  dBm output.  $f_c < 1280$  MHz:  $< -25$  dBc,  $f_c \geq 1280$  MHz

### Output

**Level range:**  $+16$  dBm to  $-129.9$  dBm

**Resolution:** 0.1 dB

**Absolute level accuracy ( $+15^\circ$  to  $+45^\circ$ C):**  $\pm 1$  dB,  $+16$  dBm to  $-119.9$  dBm;  $\pm 3$  dB for  $-120$  dBm and below.

**SWR:**  $< 1.5$

### Amplitude Modulation

**Depth:** 0 to 95% at levels of  $+10$  dBm and below

**Resolution:** 0.1%

**Incidental FM (at 30% AM):** identical to HP 8662A except:  $< 0.3 \times f_{mod}$  for  $1280 \leq f_c < 2560$  MHz

**Indicated accuracy:**  $\pm 6\%$  of reading  $\pm 1\%$  AM (400 Hz and 1 kHz, depth 90%)

**AM Bandwidth (1dB):**

DC to  $> 1.5$  kHz,  $0.15$  MHz  $\leq f_c < 1$  MHz; DC to  $> 5$  kHz, 1 MHz  $\leq f_c \leq 10$  MHz; DC to  $> 10$  kHz,  $f_c > 10$  MHz; External dc coupling. External ac coupling or internal; low frequency coupling is 20 Hz.

**Distortion (400 Hz and 1 kHz):**  $< 2\%$  (0–30% AM);  $< 4\%$  (30–70% AM);  $< 6\%$  (70–90% AM).

### Frequency Modulation

**FM rates (1 dB bandwidth):** external ac, 20 Hz to 100 kHz, external dc, dc to 100 kHz.

**Maximum allowable peak deviation:** identical to HP 8662A for  $f_c$  between 100 kHz and 1280 MHz. Up to 400 kHz for  $f_c$  between 1280 and 2560 MHz.

**Indicated FM accuracy (50 Hz to 20 kHz):**  $\pm 9\%$  of setting  $+10$  Hz.

**FM resolution:** 100 Hz to 1 kHz depending on  $f_c$  and deviation setting.

**Incidental AM (AM sidebands at 1 kHz rate and 20 kHz deviation):**  $< -72$  dBc ( $10 \leq f_c < 640$  MHz);  $< -65$  dBc ( $640 \leq f_c < 2560$  MHz)

**FM distortion:**  $< 1.25\%$  (400 Hz and 1 kHz rates);  $< 1.75\%$  (rates less than 20 kHz).

### Phase Modulation (Option 002)

**Maximum peak phase deviation:** from  $\pm 25^\circ$  for  $f_c$  between 120 and 160 MHz up to  $\pm 400^\circ$  for  $f_c$  between 1280 and 2560 MHz.

**Maximum rate:** from 10 kHz for  $f_c$  between 0.15 and 10 MHz up to 10 MHz for  $f_c$  between 250 and 2560 MHz.

**Phase deviation resolution:**  $1^\circ$  ( $0.1 \leq f_c < 640$  MHz);  $2^\circ$  ( $640 \leq f_c < 1280$  MHz);  $4^\circ$  ( $1280 \leq f_c < 2560$  MHz).

**Phase modulation distortion:** 10% at maximum rate.

### Biphase Modulation

Biphase modulation is available on the standard HP 8663A for  $f_c$  less than 640 MHz and available for all  $f_c$  with Option 002.

**Deviation:**  $\pm 90^\circ$ .

**Carrier null when modulated with 1 MHz, 50% duty cycle square wave:**  $> 25$  dBc.

**Modulation input required:** TTL positive true. The internal modulation oscillator can be used for 50% duty cycle modulation. External input is on rear panel.

### Pulse Modulation<sup>1</sup>

**Pulse on/off ratio:**  $> 80$  dB (50–2560 MHz).

**Pulse rise/fall time:**  $< 250$  ns (50–120 MHz);  $< 780$  ns (120–640 MHz);  $< 100$  ns ( $f_c \geq 640$  MHz).

**Pulse Repetition Frequency (50% duty cycle):**

Internal: 10 Hz to 99.9 kHz.

External: 10 Hz to 2 MHz, 50 MHz  $< f_c < 640$  MHz; 10 Hz to 5 MHz,  $f_c > 640$  MHz.

**Internal Modulation Oscillator**

**Rates:** 10 Hz to 99.9 kHz.

**Frequency resolution:** 3 digits.

**Frequency accuracy:** same as reference oscillator.

**Output level (available on rear panel):** 1 volt peak into 600 $\Omega$ .

**Output impedance:** 600 $\Omega$ .

**Flatness (referenced to 1 kHz):**  $\pm 1\%$ .

**Distortion:**  $< 1\%$ .

### Other HP 8662A and HP 8663A Information

**Remote programming:** the HP-IB interface is standard on the HP 8662A and HP 8663A signal generators. All functions controlled from the front panel with the exception of the line switch are programmable with the same accuracy and resolution as in manual mode.

**Operating temperature range:**  $0^\circ$  to  $+55^\circ$ C.

**Leakage:** meets radiated and conducted limits of MIL STD 461A methods RE02 and CE03 as well as VDE 0871.

**Power requirements:** 115 (90–126) V or 230 (198–252) V; 48 to 66 Hz; 450 VA max.

**Weight:** HP 8662A: net, 30 kg (65.5 lb.); shipping, 36 kg (80 lb.).

HP 8663A: net, 33.8 (74 lb.); shipping, 40 kg (88 lb.).

**Size:** HP 8662A: 178H x 425W x 572 mmD (7" x 16.75" x 22.5").

HP 8663A: 178H x 425W x 642 mmD (7" x 16.75" x 25.3"). Note: depth includes front panel depth of 45 mm (1.75").

### Ordering Information

	Price
HP 8662A 1280 MHz Signal Generator <sup>2</sup>	\$34,200
Opt 001 RF connectors on rear panel only	+ \$355
Opt 003 Specified SSB phase noise for 640 MHz output	+ \$500
Opt 907 Front Handle kit	+ \$65
Opt 908 Rack flange kit	+ \$35
Opt 909 Rack flange & front handle kit	+ \$90
Opt 910 Additional operating & service manual	+ \$40
HP 11721A External frequency doubler for operation to 2.56 GHz (HP 8662A only)	\$660
HP 8663A 2560 MHz Signal Generator <sup>2</sup>	\$47,450
Opt 001 RF connectors on rear panel only	+ \$355
Opt 002 Wideband linear phase modulation	+ \$5,355
Opt 003 Specified SSB phase noise for 640 MHz output.	+ \$500
Opt 700 External MATE translator	+ \$6,630
Opt 907 Front handle kit	+ \$65
Opt 908 Rack flange kit	+ \$35
Opt 909 Rack flange & front handle kit	+ \$90
Opt 910 Additional operating & service manual	+ \$53
HP 11714A Service Support Kit (required for servicing HP 8662A/8663A)	\$1,275

<sup>1</sup>Pulse modulation is available for  $f_c < 50$  MHz but is unspecified.

<sup>2</sup>HP-IB cables not supplied. For description and price, see HP-IB section.

- 10 kHz to 2600 MHz
- Synthesizer stability and accuracy
- 1 Hz resolution (2 Hz above 1300 MHz)

- Ten digit display
- Calibrated output over > 140 dB range
- AM, FM,  $\Phi$ M, or pulse modulation



HP 8660D

## HP 8660D Synthesized Signal Generator

### System Concept

The HP 8660 is a modular, solid-state, plug-in system. Each system includes: 1) a programmable, synthesized signal generator mainframe, 2) an RF section plug-in, and 3) a modulation section. Synthesized accuracy and stability, along with complete programmability, make the HP 8660 ideal for automated receiver, subsystem and component testing.

### Mainframes

The HP 8660D offers front panel and HP-IB or BCD control of center frequency and frequency sweep. An external reference may be used to replace the internal, high stability reference oscillator.

### Plug-In RF Sections

The HP 86601A (0.01 – 110 MHz), HP 86602B (1 – 1300 MHz), and HP 86603A (1 – 2600 MHz) are the three RF section choices. The HP 11661B Frequency Extension Module (mainframe Option 100) must be used with the HP 86602B and HP 86603A and is installed internally to an HP 8660 mainframe. (When using the HP 8660A mainframe, the HP 86603A plug-in must be ordered with Option 003.)

### Plug-In Modulation

There are five modulation sections from which to choose. The HP 86631B Auxiliary Section provides external AM and pulse modulation. The HP 86632B offers AM and FM and utilizes a free-running VCO to provide high FM deviations and rates while the HP 86633B provides AM and phase locked FM. The HP 86634A offers high performance phase modulation with rates to 10 MHz while the HP 86635A provides both FM and phase modulation. (The HP 86634A and HP 86635A must be used with Option 002 RF Section.)

### HP 8660D Mainframe Specifications

**Frequency accuracy and stability:** CW frequency accuracy and long term stability are determined by internal reference oscillator, or by external reference.

#### Reference Oscillator

**Internal:** 10 MHz quartz oscillator. Aging rate less than  $\pm 3$  parts in  $10^9$  per 24 hours.

**External:** rear panel switch allows operation from 5 MHz or 10 MHz frequency standard at a level between 0.5 and 2.5 Vrms into 170 ohms.

**Reference output:** rear panel BNC connector provides output of reference signal selected at level of at least 0.5 Vrms into 170 ohms.  
**Digital sweep:** auto, single, or manual. Selectable speeds 0.1, 1, or 50 seconds.

### Remote Programming

#### Functions

**HP 8660D:** CW frequency, frequency stepping (STEP], STEP }, output level, and most modulation functions are programmable.

#### Programming Input

**Connector type:** 36-pin Cinch type 57 (mating connector supplied). 24-pin Cinch type 57 for HP-IB control. BCD and HP-IB control internal jumper selectable.

**Logic:** TTL compatible (negative true).

**Switching time:** less than 5 ms to be within 100 Hz of any new frequency selected. (Less than 100 ms to be within 10 Hz.)

### General

**Operating temperature range:** 0° to +55°C.

**Power:** 100, 120, 220, or 240 volts +5%, -10%, 48-400 Hz; approximately 350 watts.

**Weight (mainframe only):** net, 23.2 kg (51 lb). Shipping, 28.6 kg (63 lb).

### Supplemental Characteristics

#### Typical Single Sideband Phase Noise

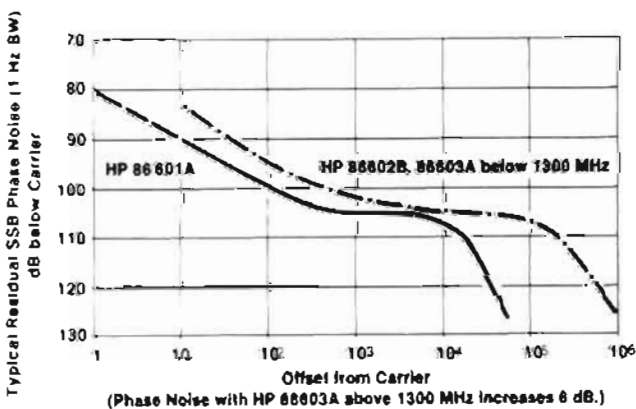

# SIGNAL GENERATORS

## Synthesized Signal Generators (cont'd)

Models 86601A-86603A, 86631B-86635A

10 kHz to 110 MHz



HP 86601A

1 MHz to 1300 MHz



HP 86602B (HP 11661B required)

1 MHz to 2600 MHz



HP 86603A (HP 11661B required)

### RF Section Specifications (installed in HP 8660D mainframe)

		HP 86601A	HP 86602B (requires HP 11661B)	HP 86603A (requires HP 11661B)		
FREQUENCY CHARACTERISTICS	Frequency Range	0.01-110 MHz (109.999999 MHz)	1-1300 MHz (1299.999999 MHz)	1-2600 MHz (2599.999998 MHz)		
	Frequency Resolution	1 Hz	1 Hz	CF < 1300 MHz	CF ≥ 1300 MHz	
	Harmonics	≤ -40 dBc	≤ -30 dBc (< -25 dBc above +3 dBm)	≤ -20 dBc <sup>1</sup>		
	Spurious Non Harmonically Related	≤ -80 dBc	≤ -80 dBc below 700 MHz ≤ -80 dBc above 700 MHz within 45 MHz of carrier ≤ -70 dBc above 700 MHz > 45 MHz from carrier	≤ -74 dBc within 40 MHz of carrier <sup>1</sup> ≤ -64 dBc > 45 MHz from carrier ≤ -64 dBc		
	Power Line Related (CW, AM, φM only) <sup>2</sup>	≤ -70 dBc	≤ -50 dBc on +10 dBm range	≤ -70 dBc		
OUTPUT CHARACTERISTICS	Signal To Phase Noise Ratio (CW, AM, φM only, offsets > 300 Hz)	> 50 dB	> 45 dB	> 39 dB		
	Output Level (into 50Ω)	+13 dBm to -146 dBm	+10 to -146 dBm	+10 to -136 dBm	+7 to -136 dBm <sup>2</sup>	
	Output Accuracy (local and remote)	±1 dB, +13 to -66 dBm ±2 dB, -66 to -146 dBm	±1.5 to -76 dBm ±2.0 to -146 dBm	±2.5 dB to -76 dBm <sup>2</sup> ±3.5 dB to -136 dBm		
	Flatness (output level variation with frequency)	< ±0.75 dB	< ±1.0 dB	< ±2.0 dB (1-2600 MHz)		
	Impedance	50Ω				
MODULATION CHARACTERISTICS	AM	AM Modulation Depth	0 to 95%	0 to 90% <sup>3</sup>	0 to 50% <sup>3</sup>	
		3 dB Bandwidth:	0-30%	200 Hz, CF < 0.4 MHz 10 kHz, 0.4 ≤ CF < 4 MHz 100 kHz, CF ≥ 4 MHz	10 kHz, CF < 10 MHz 100 kHz, CF ≥ 10 MHz	10 kHz
			0-70%	125 Hz, CF < 0.4 MHz 6 kHz, 0.4 ≤ CF < 4 MHz 60 kHz, CF ≥ 4 MHz	6 kHz, CF < 10 MHz 60 kHz, CF ≥ 10 MHz	N/A
	0-90%		100 Hz, CF < 0.4 MHz 5 kHz, 0.4 ≤ CF < 4 MHz 50 kHz, CF ≥ 4 MHz	5 kHz, CF < 10 MHz 50 kHz, CF ≥ 10 MHz	N/A	
	FM	Distortion, <sup>4</sup> THD at 30% AM at 70% AM at 90% AM	< 1%, 0.4-110 MHz < 3%, 0.4-110 MHz < 5%, 0.4-110 MHz	< 1% < 3% < 5%	< 5% N/A N/A	
		FM Rate	dc to 1 MHz with HP 86632B 20 Hz to 100 kHz with HP 86633B	dc to 200 kHz with HP 86632B and HP 86635A 20 Hz to 100 kHz with HP 86633B		
		Maximum Deviation (peak)	1 MHz with HP 86632B 100 kHz with HP 86633B	200 kHz with HP 86632B and HP 86635A 100 kHz with HP 86633B	400 kHz w/HP 86632B, 86635A 200 kHz w/HP 86633B	
	PULSE	Distortion, THD (at rates up to 20 kHz)	< 1% up to 200 kHz dev. < 3% up to 1 MHz dev.	< 1% up to 200 kHz dev.		
		Pulse Rise/Fall Time	200 ns	50 ns		
		ON/OFF Ratio (with pulse level control at max.)	> 50 dB	> 40 dB		
φM	φM Rate	N/A	dc to 1 MHz with HP 86635A dc to 1 MHz for CF < 100 MHz dc to 10 MHz for CF ≥ 100 MHz with HP 86634A			
	Maximum Peak Deviation	N/A	0 to 100 degrees			
	Distortion, THD	N/A	< 5% up to 1 MHz rates < 7% up to 5 MHz rates < 15% up to 10 MHz rates			
GENERAL	Weight	Net 5 kg (11 lb) Shipping 6.8 kg (15 lb)	Net 4.1 kg (9 lb) Shipping 5.5 kg (12 lb)	Net 5 kg (11 lb) Shipping 6.4 kg (14 lb)		
		HP 11661B: Net 2.3 kg (5 lb); shipping 2.7 kg (6 lb)				

<sup>1</sup>For output levels +3 dBm and below; slightly higher +3 to +7 dBm.

<sup>2</sup>Measured in a 30 kHz band centered on the carrier excluding a 1 Hz band centered on the carrier.

<sup>3</sup>For +3 to +7 dBm output levels, output accuracy and flatness will be slightly degraded (above 1300 MHz only)

<sup>4</sup>For RF output level meter readings from +8 dB to -8 dB and only at +3 dBm and below.

<sup>5</sup>Applies only at 400 Hz and 1 kHz rates with output meter set between 0 and +3 dB. At -8 dB meter setting the distortion approximately doubles.

<sup>6</sup>Phase modulation is only possible with Option 002 RF Section A.



Pulse/AM

AM/High Deviation FM

AM/ $\phi$  Locked FMHigh rate  $\phi$ M $\phi$ M/FM

HP 86631B

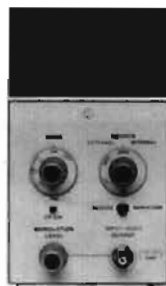

HP 86632B



HP 86633B

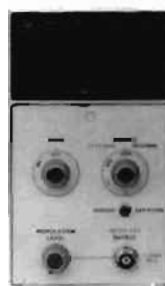

HP 86634A



HP 86635A

### Modulation Section Specifications

		HP 86631B	HP 86632B	HP 86633B	HP 86634A	HP 86635A
	Functions	Ext. Only	Int. and Ext.	Int. and Ext.	—	—
AM	Indicated Accuracy (at 400 and 1000 Hz rates)	—	$\pm 5\%$ of full scale With HP 86601A RF Section: $\pm 7\%$ , center frequency $\geq 100$ MHz. With HP 86603A RF Section: $\pm 10\%$ , center frequency $\geq 1300$ MHz.		—	—
FM	Functions	—	Int. and Ext., FM CF CAL	Int. and Ext.	—	Int. and Ext., FM CF CAL
	Center Frequency Long Term Stability	—	Typically less than 200 Hz/hr	Same as in CW Mode ( $3 \times 10^{-8}$ /day)	—	Typically less than 200 Hz/hr
	Indicated Accuracy (up to 20 kHz rates)	—	$\pm 5\%$ of full scale		—	$\pm 5\%$ of full scale
Pulse	Functions	Ext. Only	—	—	—	—
$\phi$ M	Functions	—	—	—	Int. and Ext.	Int. and Ext.
	Indicated Accuracy (15°C to 35°C)	—	—	—	$\pm 5\%$ of full scale up to 100 kHz rates $\pm 8\%$ of full scale up to 2 MHz rates $\pm 15\%$ of full scale up to 10 MHz rates	
Meter		—	0–100% AM 0–10, 100, 1000 kHz FM Pk. Dev. (0–20, 200, 2000 kHz FM for CF $\geq 1300$ MHz)	0–100% AM 0–10, 100 kHz FM Pk. dev. (0–20, 200 kHz FM for CF $\geq 1300$ MHz)	0–100% Peak $\phi$ M (0–200° for CF $\geq$ 1300 MHz)	0–10, 100, 1000 kHz FM, 0–100° Pk. $\phi$ M (0–20, 200, 2000 kHz FM, 0–200° Pk. $\phi$ M for CF $\geq 1300$ MHz)
Internal Modulation Source Output		None	400 Hz and 1 kHz $\pm 5\%$ 200 mV minimum into 10 k $\Omega$ . Available at front panel BNC connector			
Input Impedance		500 Pulse 6000 AM	6000	6000	500	6000
Weight		Net, 1.4 kg (3 lb) Shipping, 2.3 kg (5 lb)	Net, 2.7 kg (6 lb) Shipping, 4.1 kg (9 lb)	Net, 2.7 kg (6 lb) Shipping, 4.1 kg (9 lb)	Net, 1.8 kg (4 lb) Shipping, 3.2 kg (7 lb)	Net, 2.7 kg (6 lb) Shipping, 4.1 kg (9 lb)

### Ordering Information

HP 8660D Synthesized Signal Generator mainframe

#### Options for HP 8660D

Opt 001  $\pm 3 \times 10^{-9}$ /day internal reference oscillator

Opt 002 no internal reference oscillator

Opt 003 operation from 50 to 400 Hz line

Opt 005 Factory configured for HP-IB programming operation.

Note: HP-IB cables not supplied, see page 549.

Opt 100 HP 11661B factory installed inside main frame

Opt 900 Rack Flange Kit

HP 86601A 0.01–110 MHz RF Section

### Price

\$14,000

\$0

– \$300

\$0

\$0

+ \$5,825

+ \$110

\$7,650

HP 86602B 1–1300 MHz RF Section

HP 86603A 1–2600 MHz RF Section

Note: HP 86602B and 86603A RF sections require an HP 11661B for operation.

Opt 001 no RF output attenuator (all RF Sections)

Opt 002 adds phase modulation capability (HP 86602B, 86603A only)

Opt 003 allows operation of HP 86603A with HP 8660A mainframe

HP 11661B Frequency Extension Module

HP 86631B Auxiliary Section

HP 86632B AM/FM Modulation Section

HP 86633B AM/FM Modulation Section

HP 86634A  $\phi$ M Modulation Section

HP 86635A  $\phi$ M/FM Modulation Section

HP 11672A Service Accessory Kit

HP 11707A Test Plug-in

\$8,160

\$10,095

— \$600

+ \$2,295

+ \$250

\$5,825

\$715

\$3,470

\$3,470

\$2,755

\$3,775

\$1,250

\$2,550

# SIGNAL GENERATORS

## Mechanically Tuned VHF Signal Generators

### Models 8640B and 8640B Option 004

- 0.5 to 512 MHz frequency range with optional coverage to 1024 MHz
- +19 to -145 dBm output power range
- Low SSB phase noise



HP 8640B (with Option 001, 002, 003)

### HP 8640B Signal Generator

The HP 8640B Signal Generator covers the frequency range 500 kHz to 512 MHz (450 kHz to 550 MHz with band overrange) and can be extended to 1024 MHz with an internal doubler (Opt. 002). Using the HP 11710B Down Converter, the HP 8640B frequency range can be extended down to 10 kHz. An optional audio oscillator (Opt. 001) is also available with a frequency range of 20 Hz to 600 kHz. This broad coverage, together with calibrated output and modulation, provides for complete RF and IF performance tests on virtually any type of HF, VHF, or UHF receiver.

A solid state generator, the HP 8640B has an output level range of +19 to -145 dBm (2V to 0.013  $\mu$ V) which is calibrated, metered, and leveled to within  $\pm 0.5$  dB across the full frequency range of the instrument.

It provides AM, FM, and pulse modulation for a wide range of receiver test applications. This modulation is calibrated and metered for direct readout under all operating conditions.

A reverse power protection option (Opt. 003) is available to eliminate instrument damage due to accidental transmitter keying. This module protects against up to 50 watts of applied power.

### Spectrally Pure Output Signals

Noise performance of the HP 8640B is extremely low beyond 10 kHz offsets. The high-Q cavity oscillator has been optimized with use of a low-noise microwave transistor for spectrally pure output signals. At a 20 kHz offset from the carrier, SSB phase noise is  $< -130$  dBc for carrier frequencies from 230 to 450 MHz, and rises to  $-122$  dBc at 550 MHz. The SSB phase noise level decreases by approximately 6 dB for each division of the output frequency down to the broadband noise floor of better than 140 dB/Hz. This exceptional noise performance is also preserved during FM modulation and in the phase-locked mode.

### Built-in Counter

The internal 6-digit counter displays the output frequency and also can be used to count external input signals from 20 Hz to 550 MHz. This eliminates the need for a separate frequency counter in many measurement systems.

### Internal Pushbutton Synchronizer

At the push of a button, the HP 8640B built-in phase lock synchronizer locks the RF output frequency to the crystal time base used in the counter. In this locked mode, the output stability is better than  $5 \times 10^{-8}$ /hr and the spectral purity and FM capability of the unlocked mode are preserved. For higher stability, it is possible to lock to an externally applied 5 MHz standard. Two HP 8640Bs also can be locked together for various 2-tone measurements.

### FM While Phase Locked

In the phase locked mode, full FM capability is preserved down to modulation rates of 50 Hz. The narrow bandwidth of the phase lock loop ( $< 5$  Hz) provides for FM modulation up to 250 kHz rates and insures no degradation in noise from the unlocked mode. This crystal stability, coupled with the precision modulation and low noise, makes the HP 8640B ideal for testing narrowband FM or crystal-controlled receivers.

- Calibrated, metered AM, FM, and pulse modulation
- Internal phase lock/synchronizer, digital frequency readout, external count capability to 550 MHz
- Avionics version



HP 8640B Option 004 (with Option 001, 003)

### HP 8640B Specifications

(See technical data sheet for complete specifications.) All specifications apply over the nominal frequency ranges and over the top 10 dB of the output level vernier range unless otherwise specified.

#### Frequency

**Range:** 500 kHz to 512 MHz in 10 octave ranges (to 1024 MHz with Option 002 internal frequency doubler).

**Ranges and range overlap:** ranges extend approximately 10% below and 7% above the nominal frequency ranges shown below.

Frequency ranges (MHz)		
0.5-1	8-16	128-256
1-2	16-32	256-512
2-4	32-64	512-1024
4-8	64-128	(Opt 002)

#### Fine Tuning

**Unlocked:**  $> 1000$  ppm total range.

**Locked mode:**  $\geq \pm 20$  ppm by varying internal time base vernier.

#### Internal Counter Resolution (unlocked)

Frequency Ranges (MHz)	Normal Mode	Expand X10	Expand X100
0.5-1	10 Hz	1 Hz	0.1 Hz
1-16	100 Hz	10 Hz	1 Hz
16-128	1 kHz	100 Hz	10 Hz
128-1024	10 kHz	1 kHz	100 Hz

#### Optimum Counter Resolution When Phase-Locked

Frequency Ranges (MHz)	With 6 Digits	$\frac{1}{2}$ Digit
0.5-0.9999995	1 Hz	0.5 Hz
1.0-9.999995	10 Hz	5 Hz
10.0-99.99995	100 Hz	50 Hz
100.0-999.9995	1 kHz	500 Hz
1000-1024	10 kHz	5 kHz

**Accuracy:**  $6\frac{1}{2}$  digit LED display with X10 and X100 expand; accuracy depends on internal or external reference used.

**Stability (after 2 hour warmup)**

**Normal:**  $< 10$  ppm/10 min.

**Locked:**  $< 0.05$  ppm/hr.

**Restabilization Time After Frequency Change**

**Normal:**  $< 15$  min.

**Locked:**  $< 1$  min. after relocking to be within 0.1 ppm of steady state frequency.

**Output**

Range: 10 dB steps and 18 dB vernier provide the following output power settings into 50Ω.

Frequency Range (MHz)	HP 8640B	With Option(s)		
		002	003	002/003
0.5 to 512	+19 to -145 dBm	+18.5 to -145 dBm	+18.5 to -145 dBm	+18 to -145 dBm
512 to 1024 (Option 002)		-13 to -145 dBm		+12 to -145 dBm

**Level Flatness** (referred to output at 50 MHz and applies to 1V range and for top 10 dB of vernier range)

Frequency Range (MHz)	HP 8640B	With Option(s)		
		002	003	002/003
0.5 to 64	±0.5 dB	±0.75 dB	+0.75 dB -1.25 dB	+1.0 dB -2.0 dB
64 to 512		±1.0 dB		
512 to 1024 (Option 002)		±1.5 dB		±2.0 dB

**Level accuracy:** (worst case as indicated on level meter) ±1.5 dB to ±4.5 dB depending on level, frequency, and options installed.

**Spectral Purity**

**Harmonics (at 1 volt, +10 dBm output range and below)**

- > 30 dB below fundamental, 0.5 to 512 MHz.
- > 12 dB below fundamental, 512 to 1024 MHz (Option 002).

**Spurious Output Signals (excluding frequencies within 15 kHz of the signal whose effects are specified in residual AM and FM)**

Frequency Range (MHz)	Subharmonically Related	Non-harmonically Related
0.5 to 512	< -100 dBc	< -100 dBc
512 to 1024 (Option 002)	< -20 dBc	

**Residual AM (averaged rms):** 0.3 to 3 kHz post-detection noise bandwidth < -85 dBc.

**Residual FM (averaged rms):** 0.3 to 3 kHz post-detection noise bandwidth. (CW and up to 1/2 maximum allowable peak deviation.)

0.5 to 512 MHz: < 5 Hz.  
512 to 1024 MHz: < 10 Hz.

**Measured SSB noise (typical):** in graph below, triangular markers indicate specified limits.

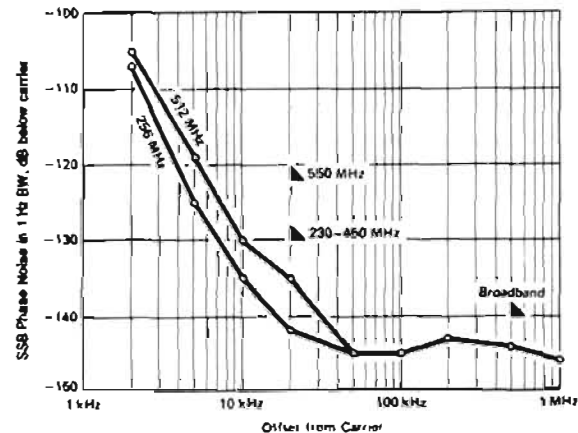

**Modulation**

**General**

**Types:** internal AM and FM; external AM, FM, and PULSE; simultaneous AM and FM or PULSE and FM.

**Internal modulation sources** (independently adjustable output level is available at front panel):

**Standard:**

**Frequency:** fixed 400 Hz and 1 kHz, ±3%.

**Output level:** 10 mV to 1V rms into 600Ω.

**Optional** (internal variable audio oscillator Option 001):

**Frequency:** variable 20 Hz to 600 kHz, ±15% plus fixed 400 Hz and 1 kHz ±3%.

**Output level:** 1 mV to 3V rms into 600Ω.

**Amplitude Modulation**

**Depth**

**0.5 to 512 MHz:** 0 to 100% for output levels from +13 dBm and below.

**512 to 1024 MHz:** 0 to 100% for output levels of +7 dBm and below, excluding the top 6 dB of output vernier range.

**AM rates:** INT and EXT ac, 20 Hz to AM 3 dB bandwidth; EXT dc, dc to AM 3 dB bandwidth.

**AM 3 dB Bandwidth**

Frequency Ranges	0 to 50% AM	50 to 90% AM
0.5 to 2 MHz	20 kHz	12.5 kHz
2 to 8 MHz	40 kHz	25 kHz
8 to 512 MHz	60 kHz	50 kHz
512 to 1024 MHz	60 kHz	50 kHz

**AM Distortion (at 400 Hz and 1 kHz rates)**

Frequency Ranges	0 to 30% AM	30 to 50% AM	50 to 90% AM
0.5 to 512 MHz	< 1%		< 3%
512 to 1024 MHz	< 10%	< 20%	

**External AM Sensitivity (400 Hz and 1 kHz rates)**

**0.5 to 512 MHz:** (0.1 ± 0.005)% AM per mV peak into 600Ω with AM vernier at full clockwise position.

**512 to 1024 MHz:** nominal 0.1% AM per mV peak into 600Ω with AM vernier at full clockwise position.

**Indicated AM Accuracy (400 Hz and 1 kHz rates using internal meter)**

**0.5 to 512 MHz:** ±(5.5% of reading + 1.5% of full scale) from 0° to 50°C.

**512 to 1024 MHz:** not specified; each generator can be individually calibrated using operating manual procedure.

**Peak Incidental Phase Modulation (at 30% AM)**

**0.5 to 128 MHz:** < 0.15 radian.

**128 to 512 MHz:** < 0.3 radian.

**512 to 1024 MHz:** < 0.6 radian.

**Peak incidental frequency deviation:** equals peak incidental phase deviation x modulation rate.

**Pulse Modulation<sup>1</sup>**

	Frequency Ranges (MHz)					
	0.5-1	1-2	2-8	8-32	32-512	512-1024
Rise and Times Fall	< 9 μs	< 4 μs	< 2 μs	< 1 μs		< 1 μs (typical)
Pulse Repetition Rate	50 Hz to 50 kHz	50 Hz to 100 kHz	50 Hz to 250 kHz	50 Hz to 500 kHz		
Pulse Width Minimum <sup>2</sup>	10 μs	5 μs	2 μs			
Pulse ON/OFF ratio at max. vernier	> 40 dB				> 60 dB	
Peak Input Required	Nominally +0.5V (5V max) Sinewave or pulse return to zero into 500					

<sup>1</sup>Pulse performance degrades below 500 Hz repetition rates.

<sup>2</sup>For level accuracy within 1 dB of CW (> 0.1% duty cycle).

# SIGNAL GENERATORS

## Mechanically Tuned VHF Signal Generators (cont'd)

Models 8640B and 8640B Option 004

### Frequency Modulation

**Deviation:** maximum allowable deviation equals 1% of lowest frequency in each nominal output frequency range.

Frequency Range (MHz)	Maximum Peak Deviation (kHz)
0.5-1	5
1-2	10
2-4	20
4-8	40
8-16	80
16-32	160
32-64	320
64-128	640
128-256	1280
256-512	2560
512-1024	5120

**FM 3 dB bandwidth:** internal and external ac, 20 Hz to 250 kHz; external dc, dc to 250 kHz. (Locked mode: FM above 50 Hz only.)

### FM Distortion (at 400 Hz and 1 kHz rates):

<1% for deviations up to 1/4 maximum allowable.

<3% up to maximum allowable deviation.

**External FM sensitivity:** 1 volt peak into 600Ω yields maximum deviation indicated on PEAK DEVIATION switch with FM vernier at full clockwise position.

**Indicated FM accuracy (400 Hz and 1 kHz rates from 15° to 35°C, using internal meter):** ±(7% of reading +1.5% of full scale).

### Incidental AM (at 400 Hz and 1 kHz rates)

**0.5 to 512 MHz:** <0.5% AM for FM up to 1/4 maximum allowable deviation; <1% AM for FM at maximum allowable deviation.

**512 to 1024 MHz (Opt 002):** <1% AM for FM up to 1/4 maximum allowable deviation; <7% AM for FM deviations up to maximum allowable.

### Counter

**Frequency range:** 1 Hz to 550 MHz.

**Sensitivity:** ≥100 mV rms into 50Ω, ac only.

**Resolution:** 6-digit LED display.

Mode	Normal	Expand X10	Expand X100
0-10 MHz	100 Hz	10 Hz	1 Hz
10-550 MHz	10 kHz	1 kHz	100 Hz

**External reference input:** 5 MHz, nominally >0.5V p-p (5V maximum) into 1 kΩ.

**Internal Reference (after 2 hr warm-up and calibration at 25°C)**

**Aging rate:** <0.05 ppm/hr; <2 ppm/90 days.

### Temperature Drift

<±2 ppm from 15° to 35°C.

<±10 ppm from 0° to 50°C.

**Typical overall accuracy (within 3 months of calibration and from 15° to 35°C):** ±2 ppm.

### General

**Operating temperature range:** 0° to 55°C.

**Power requirements:** 100 or 120 volts (+5%, -10%) from 48 to 440 Hz; or 220 or 240 volts (+5%, -10%) from 48 to 66 Hz. 175 VA max (Opt 002: 190 VA max).

**Weight:** net, 20.8 kg (46 lb). Shipping, 24.1 kg (53 lb).

**Size:** 140 H x 425 W x 476 mm D (5.5" x 16.75" x 18.75").

### HP 8640B Avionics Option 004 Signal Generator

The Hewlett-Packard Model 8640B Option 004 NAV/COM Signal Generator is an HP 8640B AM/FM signal generator specially adapted for testing ILS (Marker Beacon, Localizer and Glide Slope), VOR and VHF communications receivers used throughout the aviation industry. Designed with versatile AM and FM modulation, Option 004 features low distortion modulation when used with suitable, external VOR/ILS audio generators.

Operation and specifications of the HP 8640B Option 004 are the same as the standard HP 8640B AM/FM signal generator with the following additions:

### Demodulated Output

One front panel BNC connector provides demodulated output from the RF peak detector for precise AM settings. A choice of combined ac/dc at 1V rms or ac only at 5V rms is provided.

### Output Level Setting

To ensure the best possible demodulated output linearity, Option 004 combines a 10 dB step attenuator and a 1 dB step attenuator with a vernier. This provides output levels from +15 dBm to -142 dBm (1.3 V to 0.018 μV). The output level can be read directly from the attenuator dial in 1 dB steps or from the front panel meter in dBm or volts.

### External AM Input Impedance

External AM input impedance of 2 kΩ allows compatible operation with old and new generations of external audio generators.

### Low Distortion Modulation

The HP 8640B Option 004 provides flat AM response and minimum phase shift at 30 Hz and 9960 Hz, as well as constant group delay between 9 kHz and 11 kHz, for accurate VOR and ILS testing.

### HP 8640B Option 004 Specifications

(These specifications apply to HP 8640B Option 004 in addition to standard HP 8640B specifications. See HP 8640B AM/FM Signal Generator technical data for complete specifications.)

### Spectral Purity

**Noise:** SSB broadband noise floor greater than 1 MHz offset from carrier: <-130 dBc.

### Output Characteristics

**Range:** +15 dBm to -142 dBm (1.3V to 0.018 μV).

**Attenuators:** a 10 dB step attenuator plus a 1 dB step attenuator with vernier allow selection of any output level over the full output level range.

**Vernier:** >2 dB continuously variable from a CAL detent position.

**Level flatness (referred to 190 MHz and for +10 to -10 dBm without Option 003):** <±0.75 dB from 0.5 to 512 MHz; <±0.5 dB from 108 to 336 MHz.

### Level Accuracy

Output Level (dBm)	+15 to -10	-10 to -50	-50 to -142	With Option 003
Total Accuracy as Indicated on Level Meter	±1.5 dB	±2.0 dB	±2.5 dB	Add ±0.5 dB except from 108 to 336 MHz

### Modulation Characteristics

**Demodulated output (output vernier in CAL position, 108 to 118 and 329 to 336 MHz and 20% - 80% AM):** an internal selector switch allows selection of ac only or ac and dc at the demodulated output.

**AC only output:** directly proportional to AM depth (90 to 150 Hz modulation frequency).

**% AM equals:** (20 ± 0.6)% per V rms, 0° to 55°C; (20 ± 0.4)% per V rms, 20° to 30°C; (20 ± 0.2)% per V rms (using the DEMOD CAL label provided).

**AC and dc output:** ac output voltage is directly proportional to AM depth (90 to 150 Hz modulation frequency). DC output equals (1.4 ± 0.01) V dc with vernier in CAL position.

**% AM equals:** (100 ± 3)% per V rms, 0° to 55°C; (100 ± 2)% per V rms, 20° to 30°C; (100 ± 1)% per V rms (using the DEMOD CAL label provided).

### AM Characteristics (+10 dBm output and below)

**External input impedance:** nominally 2 kΩ.

**Frequency response:** <±0.04 dB from 90 Hz through 150 Hz (108 to 118 and 329 to 336 MHz.); <±0.1 dB, 9 kHz through 11 kHz (108 to 118 MHz).

**Phase shift from audio input to demodulated output (108 to 118 MHz, AM EXT DC mode)**

30 Hz <±0.01°; 30 Hz to 10 kHz <±3°; 9 kHz to 11 kHz <±2°.

### Ordering Information

8640B Signal Generator	Price
Opt 001 internal variable audio oscillator, 20 Hz to 600 kHz	\$11,200.00
Opt 002 internal doubler 512-1024 MHz	+ \$510.00
Opt 003 reverse power protection	+ \$1025.00
Opt 004 avionics option	+ \$360.00
Opt 908 rack mount kit	+ \$1535.00
Opt 910 additional operating and service manual	+ \$37.50
	+ \$190.00

# SIGNAL GENERATORS

## Accessories, Frequency Doublers

Models 11509A, 11687A, 11690A, 11710B, 11721A

363

- Additional capabilities for signal generators



HP 11687A



HP 11509A



HP 11710B



HP 11690A



HP 11721A

### HP 11509A Fuseholder

Accidental burnout of attenuators in HP 8640 and HP 8654 signal generators can be prevented by using this fuse element between the signal generator and a transceiver. The fuseholder has a frequency range of dc to 480 MHz, insertion loss of  $\leq 1$  dB, SWR of  $\leq 1.35$  (50 $\Omega$  load), and Type N connectors. Ten extra fuses are furnished.

### HP 11687A 50-75 $\Omega$ Adapter

This 50-75 $\Omega$  adapter with Type N connectors is recommended for use with HP 8640, 8642, 8654, 8660, 8656, and 8662 signal generators for measurements in 75 $\Omega$  systems. The voltage calibration on the output level meter is unaffected by use of the adapter, but 1.76 dB must be subtracted from the dB scale on the meter to determine the output in dBm into 75 $\Omega$ . Frequency range is dc to 1300 MHz.

### HP 11690A Frequency Doubler

The HP 11690A extends the frequency range of all HP 8640 series signal generators by doubling the 256-512 MHz frequency band up to 1024 MHz (to 110 MHz with band overrange). All HP 8640s indicate the correct doubled output frequency on a dial or counter when the 512-1024 MHz range is selected. The HP 11690A will also perform well with any source meeting the input requirements of 200-550 MHz at +10 to +19 dBm. Conversion loss is  $< 13$  dB, output flatness has  $< 4$  dB total variation, and the first and third input harmonics are suppressed  $> 20$  dB. Connectors are BNC.

### HP 11710B Down Converter

The HP 11710B Down Converter is an accessory for the HP 8640 and HP 8654 series signal generators. Frequency inputs from 50.01 to 61 MHz are down converted to the 10 kHz to 11 MHz range respectively. The output level and modulation functions of the HP 8640 and HP 8654 remain calibrated. A straight-through selection switch allows the input to pass through unchanged, and thus minimizes the necessity to move cables when testing. Option 001 provides rails and semi-rigid coax for combining the HP 11710B with an HP 8654A/B Signal Generator.

### HP 11710B Specifications

#### Input

**Down-conversion mode:** 50.01 to 61.00 MHz at  $\leq 0$  dBm.

**Straight-through mode:** 0.01 to 1100 MHz (dc coupled).

#### Down-Converted Output

**Frequency range:** 10 kHz to 11 MHz.

**Level range:** 0 to  $-107$  dBm

**Level flatness:** RF source flatness  $\pm 0.5$  dB (referred to 4.0 MHz).

**Total level accuracy:**  $\pm 1$  dB plus input level accuracy.

**Harmonics:**  $> 35$  dB below the carrier (dBc).

**Intermixing spurious:**  $> 60$  dBc.

**Local oscillator feed-through (50 MHz):**  $< -100$  dBm.

### Internal Reference Characteristics

**Time base output:** 1 MHz or 5 MHz selectable, nominally  $> 0.5$  V p-p into 500 $\Omega$ . This will drive an HP 8640B external time base input.

**Typical overall accuracy:** (within 3 months of calibration and from 15°C to 35°C):  $\pm 2$  ppm.

### General

**Operating temperature range:** 0° to 55°C.

**Power requirements:** 100, 120, 220, 240V (+5%, -10%), 48 to 440 Hz; 25 VA maximum.

**Weight:** net, 3.2 kg (7 lb); shipping, 4.5 kg (9 lb).

**Size:** 102 H  $\times$  266 W  $\times$  295 mm D (4"  $\times$  10.5"  $\times$  11.6"). 1/2 MW  $\times$  4 H  $\times$  11 D System 1 Module.

### HP 11721A Frequency Doubler

The HP 11721A Doubler is an ideal accessory for extending the usable frequency range of signal generators, frequency synthesizers, or other signal sources. Operating on input frequencies of 50 MHz to 1300 MHz, it provides a doubled output in the range of 100 MHz to 2600 MHz. The HP 11721A will work well with any RF source with an output in the range 50 to 1300 MHz.

The 50 $\Omega$  passive circuit of the HP 11721A offers low conversion loss, low spurious, and excellent flatness over its entire frequency range when operated above +10 dBm.

### HP 11721A Specifications

**Input frequency range:** 50 to 1300 MHz.

**Output frequency range:** 100 to 2600 MHz.

**Conversion loss (+13 dBm input, 50 to 1280 MHz):**  $< 15$  dB.

**Spurious referenced to desired output frequency f (+13 dBm input with harmonics  $< -50$  dBc, 50 to 1280 MHz):**  $f/2$ ,  $-15$  dB;  $3f/2$ ,  $-15$  dB.

**Input SWR:** 1.5 typical.

**Input/output impedance:** 50 $\Omega$  nominal.

**Operating temperature range:** 0° to +50°C.

**Connectors:** input, type N male; output, type N female.

**Size:** 161 L  $\times$  30 W  $\times$  20.5 mm H (6 1/4"  $\times$  1 1/16"  $\times$  13/16").

**Weight:** net, .02 kg (0.5 lb); shipping, 0.4 kg (1 lb).

### Ordering Information

HP 11509A Fuseholder

HP 11687A 50 $\Omega$ -75 $\Omega$  Adapter

HP 11690A Frequency Doubler

HP 11710B Down Converter

Opt 001 Combining Kit

Opt 910 Additional operating & service manual

HP 11721A Frequency Doubler

☛ Fast ship product — see pg. 758

### Price

\$255.00

\$210.00 ☛

\$305.00

\$3060.00

+\$155.00

+\$11.25

\$660.00

# SIGNAL GENERATORS

## Signal Simulator System, dc - 50 MHz

Models 8770S, 8770A, 11776A

- A new source of "real-life" signals to 50MHz
- Excellent spectral purity
- Accurate margin tests with precise degradations
- The standard for simulating complex signals



### Simulate Signals for Radar, EW, Communications, and Other Applications

Today's sophisticated electronic systems require "real-life" functional testing to ensure that they will perform properly under their intended operating conditions. The HP 8770S accurately simulates real-life signals in radar, EW, communications, and other applications. The HP 8770S helps test if your radar can detect and decode multiple targets. It tests if your EW receiver can correctly identify possible threats. It tests if your digital receiver can reconstruct transmitted signals in the presence of jamming. And, in magnetic disc applications, it simulates the signals necessary to test sensitive read/write and servo circuitry.

### Description

The HP 8770S Signal Simulator System consists of the:

- HP 8770A Arbitrary Waveform Synthesizer
- HP Series 200 or 300 Technical Computer
- HP 11776A Waveform Generation Software.

Design waveforms with the software, then generate the waveforms with the HP 8770A. Use this advanced simulation system to generate complex baseband and IF signals from dc to 50 MHz. Add precise amounts of distortion and noise to test the operating margins of your system early in the development cycle. All signal parameters are under complete software control, allowing quick changes to meet new test demands. The HP 8770A has a complete HP-IB command set for full automatic control and easy downloading of waveform data previously defined by the HP 11776A or by other means. Regardless of your application, the use of precise complex test signals improves the evaluation of your circuits and systems.

The HP 8770A Arbitrary Waveform Synthesizer (AWS) forms the heart of the HP 8770S. Advanced digital synthesis techniques ensure precise waveform generation.

### Features

- 8 ns Sample Update Rate
- 12-bit Words
- 125 MHz Internal Clock (phase-locks to crystal osc.)
- Special "Deglitching" Circuits
- 110 dB RF Attenuator
- 512K Memory

### Benefits

- Rapid Signal Parameter Changes
- High Amplitude Resolution
- Time base with Synthesizer Accuracy
- Low Harmonic and Spurious Distortion Levels
- 12-bit Resolution Even at Low Signal Levels
- Highly Complex Waveforms, Longer Waveform Sequences

- Quicker R & D turnaround
- Reduce artificial guardbands
- 125MHz sample rate
- 12-bit resolution, 512K word memory



The HP 11776A Waveform Generation Software operates on the HP 9000 Series 200 or 300 technical computers. It consists of the Waveform Generation Language (WGL), an HP BASIC operating system, and application discs for powerful waveform development. Use over 100 easy commands and math functions to create and manipulate waveforms as desired. Add noise or spurs to generate real-life test signals. Add waveforms together to create harmonically distorted waves, or multiply waves to create complex modulated signals. Create waves in either the frequency or time domain and quickly convert from one to the other. Capture data from other instruments such as spectrum analyzers and oscilloscopes. Or, use a graphics tablet to facilitate waveform entry. Once waveforms have been developed, you can download them into the HP 8770A for immediate generation or store them on a disc for later use in multiple stations. Thus, WGL makes "what if" testing to determine a device's performance easy and affordable.

### Build Waveform Libraries for Complete Tests

Any HP-IB computer can control the HP 8770A and download previously defined waveform data. Generate a library of test waveforms with the HP 11776A software. Then download them to the HP 8770A from the computer in your ATE system for use in your applications.

### Stretch Memory with Sequencing

Certain parts of waveforms often repeat themselves and quickly fill up even the largest memory. This leaves less memory to define the rest of the desired test signal. The HP 8770A avoids this problem by allowing sections of memory (packets) to be repeated any number of times and in any order. This sequencing capability and the large 512K word memory free large amounts of memory for greater flexibility when defining complex waves. Many test signals can also be stored simultaneously in the memory and accessed at any time with the sequencer.

### Applications Overview

#### Radar

The HP 8770S simulates multiple targets for more effective radar testing. Simulate complex radar video and IF signals. Add noise, pulse jitter, and clutter. Shape radar chirps to exact specifications. Stagger multiple radar pulses. Vary the PRF as a function of time. Control radar pulse parameters with extremely precise resolution. Finally, manipulate doppler shift and range or superimpose multiple targets together, resulting in complex, demanding test signals.

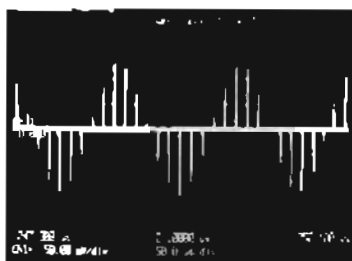

Doppler shifted return of moving target

### Electronic Warfare

Fast digital synthesis techniques let you test sophisticated EW receivers. Simulate signal processor data or antenna scan patterns to correctly identify the carrier frequency, PRF, scan rate, and pulse width of emitting radars. Simulate complex modulated pulse trains with varying amplitude, rise and fall times, pulse width, PRI and stagger.

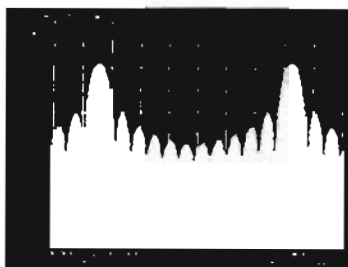

Antenna scan pattern

### Communications

The HP 8770S is an excellent signal simulator for conventional analog communication systems, digital microwave radios, and satellite communications systems. Design and generate amplitude-, frequency-, and phase-modulated communications signals with digital precision. Exploit memory sequencing to hop from one frequency to the next with fast frequency switching speed and phase continuity. Simulate Nyquist filter responses in software to eliminate time-consuming and costly hardware filters.

### Other Applications

- **Video and Imaging**
- **Component Test**
- **Disc Drives:** The Signal Simulator System continues to be very successful in magnetic disc applications. It tests sensitive read/write and servo circuitry such as peak shift, missing bit, extra bit, and timing jitter.

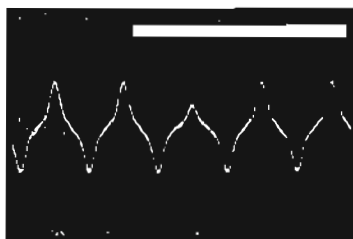

Missing bit

### HP 8770A Performance Characteristics

#### Frequency

**Range:** dc to 50 MHz

**Frequency Switching Speed:** 8 ns, phase continuous

#### RF output

**Power range:** +10 dBm to -110 dBm

**Attenuator:** 110 dB in 10 dB steps

**Max Output Voltage:** 2 V p-p into 50 or 75 ohms  
**Number of DAC bits:** 12 true bits, monotonic  
**Amplitude Resolution:** .024% of full scale  
**Amplitude Flatness:**  $< \pm 0.65$  dB  
**Phase Linearity (dc - 50MHz):**  $\pm 5$  deg.  
**Output Impedance:** 50 ohms (75 ohms for option 002)  
**Output SWR:**  $< 1.2:1$   
**Connector:** Type N (female)

### Spectral Purity

**Harmonic Distortion (output level = +10dBm):**

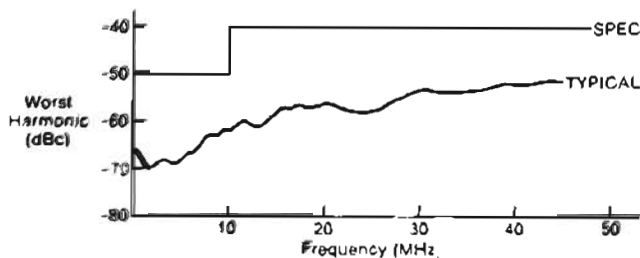

**Inband Spurious and Nonharmonic Distortion:**

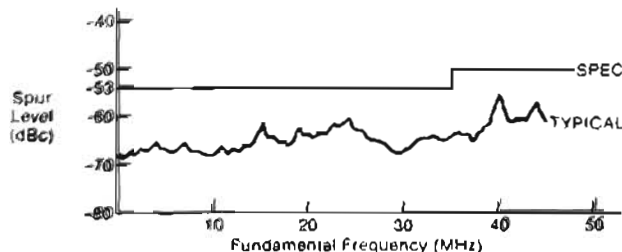

**Two-Tone Intermodulation Distortion:**  $< -65$  dBc for a 10.000 MHz and 10.124 MHz signal at +4 dBm each.

**SSB Phase Noise @ 10MHz:**  $< -120$  dBc/Hz @ 10kHz offset.

### Modulation Capabilities

AM, FM,  $\Phi$ M, Chirp, Pulse, Digital (BPSK, QPSK, BPSK, QAM), Antenna Scan, I/Q.

**Triggering:** Scan Start Output, Packet Start Output, Sequence Start Output, Address Equal Output, Packet Advance Ready Output; Packet Advance Trigger Input, Sequence Start Trigger Input

### Clock

**Sampling Clock Rate:** 125 MHz (externally variable)

**Reference Oscillator:** 10 MHz quartz crystal. Aging rate  $< 5 \times 10^{-6}$  /day after a 24 hour warmup and an oscillator time-off of less than 24 hours.

### Remote Operation

HP-IB, 16-bit GPIO parallel port

### General

**Operating Temperature:** 15-40 C

**Power:** 445 VA

**Weight:** Net, 23.6 kg (52 lb), Shipping, 29.5 kg (65 lb)

**Size:** 235 H x 425.5 W x 622 mm D (9.25" x 16.75" x 24.5")

### Ordering Information

HP 8770S Signal Simulator System

To ensure coordination of shipments and compatibility of instruments, computers and software, use the system model number when ordering individual components. Obtain the HP 8770A and HP 11776A Data Sheet and an HP 8770S Ordering Guide from your local sales office.

HP 8770A Arbitrary Waveform Synthesizer \$25,000

Option 002: 75 ohm Output Impedance N/C

HP 11776A Waveform Generation Software (5.25" \$5,500

Diskettes Standard)

Option 830: 3.5" Diskettes Only N/C

# SIGNAL GENERATORS

## Solid-State Microwave Signal Generators Models 8683/8684A,B,D

- Portable signal generators with high performance modulation
- Wide frequency ranges from 2.3- 18 GHz
- Wideband FM for satellite video  $\pm 10$  MHz peak deviation
- dc-10 MHz FM rates



HP 8684D

### HP 8683/8684 Microwave Signal Generators

The HP 8683 and 8684 are rugged portable signal generators designed for demanding benchtop and field maintenance environments. Operating in four overlapping frequency ranges, with a choice of features including a high performance internal pulse generator, the family provides a wide range of benefits for various radar, communications and electronic warfare applications.

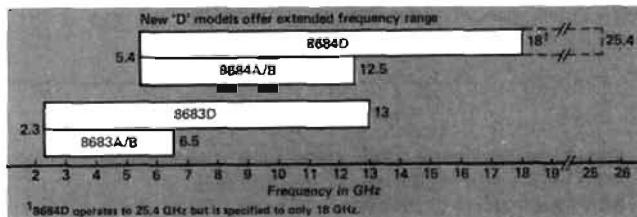

### Clean, Stable, Cavity-Tuned Oscillator

At the heart of each signal generator is a mechanically tuned cavity oscillator. State-of-the-art electronics teamed with sophisticated mechanical design provide excellent frequency stability, spectral purity and quick warm-up times necessary for accurate measurements. With low spurious outputs and a low noise floor, the HP 8683 and 8684 are excellent for receiver sensitivity measurements and out-of-channel communications receiver measurements where high performance at low signal levels is required.

### Microprocessor-Enhanced Measurement Accuracy

Characteristics of microwave components such as oscillators, amplifiers, and attenuators vary considerably with frequency and power level. An internal microprocessor effectively compensates for these variations, providing accurate output level in dBm, dB relative to a user-selected power level, or power level with a specified cable offset. These conveniences translate to faster measurements and reduced possibility of operator error in interpreting observations.

### Reliability and Serviceability

The HP 8683 and 8684 were designed with high reliability and serviceability as major considerations. The instruments exceed rigorous military specifications (MIL-T-28800C Class V) for operating and non-operating temperature, humidity, condensation, shock and vibration, and EMI. The instruments success in these tests is an indication that they are rugged enough to provide accurate, reliable measurements in environments where many instruments would fail. For added reliability in the A and B models Option 002 may be selected for reverse power protection. With this option the possibility of instrument failure due to operator error is substantially reduced, allowing for as much as 10 watts average or 2000 watts peak reverse power with no

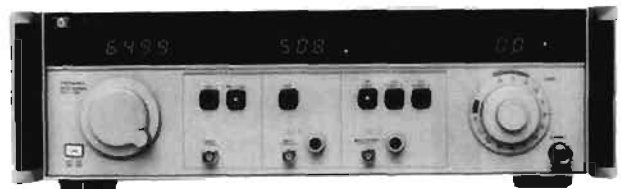

HP 8683A

damage to the instrument. The reliability of these generators is reflected in a demonstrated MTBF in excess of 20,000 hours.

Confidence in signal generator performance is provided by diagnostic tests which automatically execute at turn-on and monitor most critical nodes prior to entering the operation mode. If a failure is detected, in most cases it can be isolated to at least the circuit function level with the aid of the front panel display. The generators' open, accessible internal design and complete service manuals result in excellent serviceability, minimizing repair time if a failure should occur.

### HP 8683/8684 A,B,D Features

A variety of modulation capabilities, frequency ranges, and power specifications are available in the HP 8683/8684 Microwave Signal Generator family.

Sharing the same rugged dependable design with the rest of the family, the A models provide AM and FM for conventional communications applications in an affordable package. All A models are specified to have maximum output power of 0 dBm throughout their frequency range; however, if required, Option 001 may be selected to provide  $\pm 10$  dBm output power.

The B and D models add a high performance pulse modulator and internal pulse generator for the simulation of a wide variety of sophisticated radar transmissions. Simultaneous FM and pulse allow chirping, while simultaneous AM and pulse allow simulation of antenna scan patterns. Of course, basic receiver sensitivity and AGC measurements can also be made easily.

For users with multi-band, broadband or general purpose applications, the D models, with twice the frequency coverage of the A and B models, offer exceptional performance, versatility and economy in a single box. Not only is frequency coverage increased, but in doubled mode, FM peak deviation is also doubled to 10 MHz at dc to 10 MHz rates making possible the direct test of satellite video receivers. If required, the high-power Option 001 may be selected to boost maximum output power in the frequency-doubled bands from  $-3$  dBm to the  $+10$  dBm level already provided in the main bands. By combining



proven, rugged, dependable design with the versatility of twice the frequency coverage and wideband FM, the D models offer cost-effective, high performance solutions to radar and communications receiver test problems.

Distinguishing features of the A, B, & D models			
	A	B	D
Output Power	0 dBm	+10 dBm	+10 dBm, -3 dBm <sup>1</sup>
Opt 001 Power	+10 dBm	N/A	+10 dBm <sup>1</sup>
Internal Pulse Generator/Modulator	No	Yes	Yes
FM Deviation (DC To 10MHz Rate)	5 MHz	5 MHz	10 MHz <sup>1</sup>

<sup>1</sup> These specifications for the doubled mode

## HP 8683A/B/D, HP 8684A/B/D Specifications

### Frequency Specifications

#### Range

**HP 8683A/B:** 2.3–6.5 GHz.  
**HP 8683D:** 2.3–13.0 GHz.  
**HP 8684A/B:** 5.4–12.5 GHz.  
**HP 8684D:** 5.4–18.0 GHz.

**Resolution:** HP 8683, 5 MHz using a 4 digit LED display; HP 8684, 10 MHz using a 3 1/2 digit LED display.

**Calibration accuracy:** HP 8683A/B/D,  $\pm 1.25\%$  < 4.0 GHz,  $\pm 0.75\%$  4.0 to 6.5 GHz; HP 8683D x2 band,  $\pm 1.25\%$  6.5 to 8.0 GHz,  $\pm 0.75\%$  > 8 GHz; HP 8684A/B/D,  $\pm 1.25\%$  5.4 to 9.0 GHz,  $\pm 0.75\%$  9.0 to 12.5 GHz; HP 8684D x2 band,  $\pm 1.25\%$  12.5 to 18.0 GHz.

#### Stability (typical)

**vs. time (20 min. after turn-on):** < 30 kHz/min.  
**vs. time (60 min. after turn-on):** < 100 kHz/hr.  
**vs. temperature (0 to 55° C):** HP 8683, < 15 MHz; HP 8684, < 30 MHz.  
**vs. line voltage (transients of +5%/-10%):** < 20 ppm.

### Spectral Purity

**Harmonics (< 18GHz, at specified max output):** < -25 dBc.

HP 8683/84D harmonics are unspecified in x2 frequency band.

**Fundamental feedthrough (at specified max. output):** HP 8683D, < -25 dBc 6.5–9.5 GHz; HP 8684D, < -25 dBc 12.5–18.0 GHz. Not specified for D models with Option 001.

**Spurious (non-harmonically related):** < -80 dBc; typ. < -90 dBc.

**Residual FM (50 Hz to 15 kHz post detection BW):** < 5 kHz peak.

HP 8683/84D in doubled band: < 10 kHz peak.

**Single-sideband phase noise (avg. rms, 1 Hz BW, 10 kHz offset from carrier, typical):** HP 8683A/B, < -72 dBc; HP 8683D, < -66 dBc; HP 8684A/B, < -65 dBc; HP 8684D, < -59 dBc.

**Residual AM (avg. rms, 300 Hz to 15 kHz post detection BW):** < 0.15%.

### Output Specifications

**Range (levelled into 50Ω):** HP 8683/84A, 0 to -130 dBm; HP 8683/84A opt. 001 and HP 8683/84B, +10 to -130 dBm; HP 8683/84D, +10 to -130 dBm (main band), -3 to -130 dBm (x2 band), +10 dBm in x2 bands available with Option 001.

**Resolution:** 0.1 dB using a 3 1/2 digit LED display.

**Accuracy:**  $\pm 2.5$  dB from maximum specified output power to -110 dBm (to -100 dBm in x2 bands);  $\pm 3.5$  dB to -120 dB and 0 to +10 dBm for Opt 001. Typ.  $\pm 0.9$  dB at -100 dBm. Option 002 affects level accuracy  $\pm 0.5$  dB.

**Fatness (power level > -10 dBm):**  $\pm 1.0$  dB. (Not for Opt. 001)

**Reverse power protection:** the standard models typically accept 1 watt avg. or 100 watts peak power with no damage resulting. Option 002 (on A and B models only) increases this protection to 10 watts avg. or 2kW peak.

**Auxiliary output:** rear panel, typically > -15 dBm into 50Ω, prior to AM, pulse, or frequency doubling; source impedance approx. 50Ω.

### Modulation Specifications

**Types:** internal and external AM, FM, and Pulse (except HP 8683/84A). Simultaneous AM, FM, Pulse.

**Metering:** 3-digit LED, selectable for % AM or FM deviation.

### Amplitude Modulation

**Depth (1 kHz rate):** 0-70%.

**Rates (3 dB BW at 40% depth):** dc to 10 kHz (dc coupled); 50 Hz to 10 kHz (ac coupled).

**Distortion (THD):** < 10% at 40% depth and 1 kHz rate.

**Indicated AM accuracy (depth 50%, 1 kHz rate):**  $\pm 5\%$  of full scale.

**Incidental FM (30% AM depth):** < 15 kHz peak to peak. (< 30 kHz p-p in doubled band, HP 8683/84D.)

**Internal AM:** fixed 1 kHz nom. square wave with 50  $\pm 5\%$  duty cycle.

### Frequency Modulation

**Peak deviation:** HP 8683/84 A/B,  $\pm 5$  MHz; HP 8683/84D,  $\pm 5$  MHz (main);  $\pm 10$  MHz (x2 band).

**Rates (3 dB BW):** dc to 10 MHz, 100 Hz to 10 MHz (ac coupled).

**Distortion:** < 5% at 100 kHz rate and < 1 MHz peak deviation.

**Indicated accuracy (typ., 10 MHz/V range):**  $\pm 10\%$  of full scale, deviations < 5 MHz, 100 kHz rate.

**Incidental AM (rate < 100 kHz, peak deviation < 1 MHz):** < 6%.

**Internal FM:** FM sawtooth with a fixed sweep rate of 1 kHz nom. and variable deviation up to  $\pm 5$  MHz ( $\pm 10$  MHz for D models, x2 bands).

**Phase lock input:** typical sensitivity of -5 MHz/V.

### Pulse Modulation

#### HP 8683/84 B/D Internal Pulse Generator

**Rate:** 10 Hz to 1 MHz continuously adjustable in 5 ranges.

**Width:** 50 ns to 100 ms continuously adjustable in 7 ranges.

**Delay (time between sync out and video out):** < 50 ns to 100 ms in 7 ranges with continuous adjustment within ranges.

**Accuracy:** calibration accuracy is 20% of full scale.

#### HP 8683/84 B/D External Pulse Input Requirements

**Rate:** 0 to 1 MHz.

**Width:** > 100 ns.

**Level:** on > +1.0 V peak; off < +0.4 V peak.

#### HP 8683/84 B/D RF Pulse Specifications

**Rise/fall time:** < 10 ns.

**On/off ratio:** > 80 dB.

**Minimum pulse width:** < 100 ns.

**Maximum pulse repetition frequency:** > 1 MHz.

**Peak pulse power:**  $\pm 0.5$  dB of level set in CW mode.

### General

**Operating temperature range:** 0° to 55°C.

**EMI:** MIL-STD-461, VDE0871, CISPR Pub. 11.

**Safety:** meets the requirements of IEC 348.

**Power:** 100, 120, 220 or 240V, +5%, -10%; 48 to 66 Hz; (Opt. 003 adds 400 Hz operation at 100 or 120 V); < 200 VA max.

**Dimensions:** 145 H x 457 W x 472 mm D (5.7" x 18" x 18.6").

**Weight:** HP 8683, 17.9kg (39 lb) net, 23.4 kg (51 lb) shipping; HP 8684, 16.5 kg (36 lb) net, 22.0 kg (48 lb) shipping.

### Ordering information

	Price
HP 8683A Microwave Signal Generator	\$12,900
HP 8684A Microwave Signal Generator	\$12,900
Option 001: +10 dBm output power, HP 8683/84 A	add \$1,500
HP 8683B Microwave Signal Generator	\$16,000
HP 8684B Microwave Signal Generator	\$16,000
HP 8683D Microwave Signal Generator	\$20,000
Option 001 +10 dBm in x2 band, HP 8683D	add \$3,000
HP 8684D Microwave Signal Generator	\$20,000
Option 001: +10 dBm in x2 band, HP 8684D	add \$5,000
Option 002: Reverse power protection (except D models)	add \$725
Option 003: 400 Hz line frequency operation (all models)	add \$180
Option 910: Extra operating and service manual	add \$25
Option 913: Rack mounting flange kit	add \$35
HP 11727A Support kit	\$475

# SIGNAL GENERATORS

## Signal Simulation For Agile and Wideband Modulation Systems

Models 8770A, 86792A, 8780A



### HP 86792A Agile Upconverter

#### Description

Greatly expanding the versatility of the HP 8770A Arbitrary Waveform Synthesizer is a dramatic new introduction from HP which can upconvert 32 MHz of complex modulation from the AWS, positioning it anywhere from 10 MHz to 3 GHz. The HP 86792A is an ultra-high-speed upconverter that switches frequency in 250 nanoseconds, and maintains the frequency, phase, and amplitude modulation of the baseband synthesizer (AWS) throughout its entire range.

This new capability will serve many simulation needs in radar, EW, and communications. With complete software control of extremely complex signal environments, the design engineer and production test engineer can simulate real-life conditions of multiple and fast-changing signals.

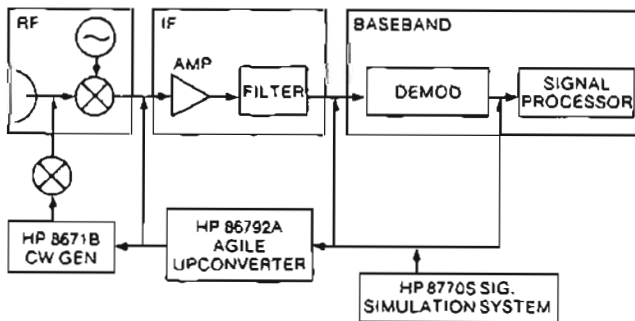

A complete simulation system for your radar, EW, and communication testing requirements

The HP 8770A Arbitrary Waveform Synthesizer and the HP 86792A Agile Upconverter team up to offer a complete signal simulation system for baseband, IF, and RF tests. This system can simulate realistic signals by switching among many modulated RF carriers in only 250 nanoseconds over a 3 GHz range. This complex generation capability can be extended to microwave frequencies using a synthesizer such as the HP 8671B.

### HP 86792A Specifications

#### Frequency

Range: 10 MHz to 3 GHz

Switching Speed: 250 nsec

#### Modulation

Types: Dependent on the input signal (e.g. HP 8770A)

Bandwidth: 32 MHz

#### Output

Range: +10 to -107 dBm

#### Spectral Purity

SSB Phase Noise: -125 dBc/Hz (typical) @ 10 kHz offset from 3 GHz carrier

Harmonics: < -30 dBc

Spurious: < -55 dBc

Contact HP for more technical and performance information.

### HP 8780A Vector Signal Generator

#### Description

The high bandwidth requirements of modern radar/EW and communications systems and higher-complexity modulation formats require a new generation of test equipment. The new HP 8780A Vector Signal Generator provides an "open architecture" which allows the user to match those more demanding modulation needs.

The HP 8780A is the only HP signal generator which accepts digital data streams and directly produces digital phase modulations from BPSK to 64QAM. While traditional generators provide modulation bandwidths in the low megahertz range the HP 8780A is capable of bandwidths up to 700 MHz. And the modulation information is handled in the In-phase (I) and Quadrature (Q) format, common to radar and digital microwave communication systems which use coherent transmission and detection. With its 10 to 3000 MHz output frequency range, the HP 8780A can directly test IF and low microwave bands. For higher frequencies, user-configured upconverters easily place the carrier into the desired band, and the 3 GHz range allows enough sideband separation to make filtering easy.

See page 320 for HP 8780A product information and specifications.

#### Simulation Of Complex Wideband Signals with I/Q Modulation

For wideband modulated signals up to 100 MHz bandwidth, two HP 8770A synthesizers can be precisely synchronized to drive the I/Q channel inputs of the HP 8780A Vector Signal Generator. With the proper I and Q driving signals an infinite variety of modulations can be created for simulation of real world conditions. Multipath fades, wideband shaped chirps, and doppler-shifted signals are a few examples of the signal simulation capabilities of the combined HP 8770A and HP 8780A system.

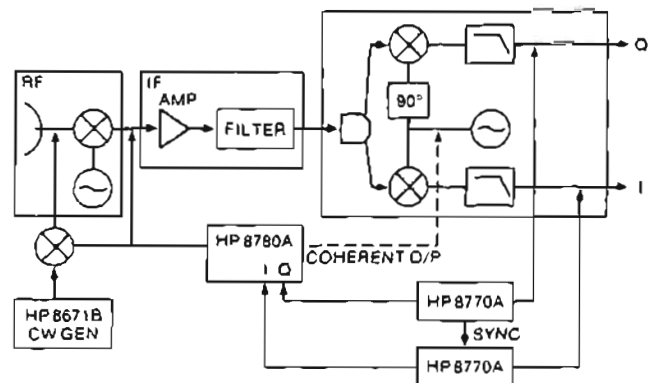

HP's 8770A, 86792A, and 8780A join together to offer new solutions for today's sophisticated electronic systems that require "real-life" functional testing. The table below presents the different systems that can be put together to satisfy your signal simulation requirements.

Signal Requirements	Baseband	IF	RF
<ul style="list-style-type: none"> <li>Complex Modulations<sup>1</sup></li> <li>Frequency Agility<sup>2</sup></li> </ul>	HP 8770A	HP 8770A + HP 86792A	HP 8770A + HP 86792A + RF/microwave Signal Generator
<ul style="list-style-type: none"> <li>I/Q Baseband Signals</li> <li>Wideband Modulation (up to 100 MHz)</li> </ul>	Two HP 8770A's	Two HP 8770A's + HP 8780A	Two HP 8770A's + HP 8780A + RF/microwave Signal Generator

- 1 to 4 Hz frequency resolution
- Low spurious and phase noise
- 100 ns leveled pulse width capability
- +10 dBm to -110 dBm calibrated output

- Complete analog sweeper
- DC to 100 kHz amplitude modulation
- <-50 dBc harmonics 1.4 to 20 GHz, on HP 8341B opt. 003



HP 8341B

### HP 8340B/8341B Synthesized Sweepers

The HP 8340B/8341B Synthesized Sweepers deliver the combined high-performance of a synthesizer and a broadband sweep oscillator in one instrument that is completely controllable via the Hewlett-Packard Interface Bus (HP-IB). This efficient combination of performance and versatility is ideal for manual or automatic test systems and enables the HP 8340B/8341B to replace a sweep oscillator, a frequency counter, an RF synthesizer, and a microwave synthesizer.

### Frequency Precision and Spectral Purity

The synthesized broadband frequency coverage and the precise 1 to 4 Hz frequency resolution (depending on frequency band) are generated by indirect synthesis techniques, enabling HP 8340B/8341B to achieve the same low single-sideband phase noise performance as the HP 8671B, 8672A and 8673 series Synthesized Signal Generators.

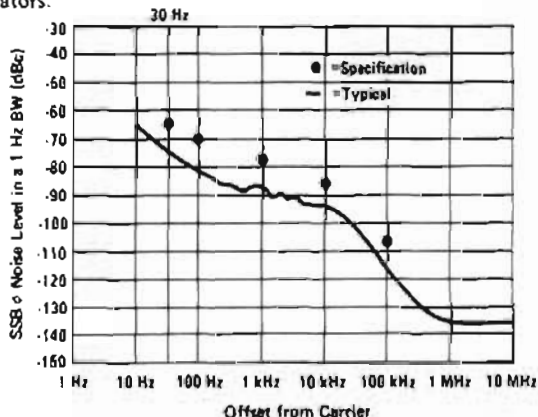

HP 8340B Phase Noise Performance from 2.3 to 7.0 GHz.

### Stepped CW Switching Times

The HP 8340B/8341B feature CW switching times of better than 50 ms (typically <35 ms). Additionally, a Fast Phase-lock programming command can be used to reduce typical CW switching times to between 11 and 22 ms (depending on frequency step size and absolute frequency value).

### Output Power

The HP 8340B/8341B provide high output power which can be varied all the way down to the minimum level (-110 dBm) with .05 dB resolution and feature power sweep capability with >20 dB dynamic range for complete characterization of level-sensitive devices.

### Pulse, Amplitude, and Frequency Modulation

The HP 8340B/8341B have high-performance pulse modulators with ON/OFF ratio >80 dB and rise and fall times <25 ns. Pulse amplitude is leveled and can be as narrow as 100 ns. The HP 8340B/8341B also feature dc-coupled amplitude modulation with a 3 dB bandwidth of 100 kHz and a minimum depth of 90%. Pulse and amplitude modulation can be used simultaneously.

The HP 8340B/8341B also offer frequency modulation capability, with modulation rates from 50 kHz to 10 MHz and peak deviations to 10 MHz.

### HP 8341B Option 003: <-50 dBc Harmonics

Option 003 on the HP 8341B delivers excellent harmonic performance with harmonics at least 50 dB below the carrier from 1.4 to 20 GHz.

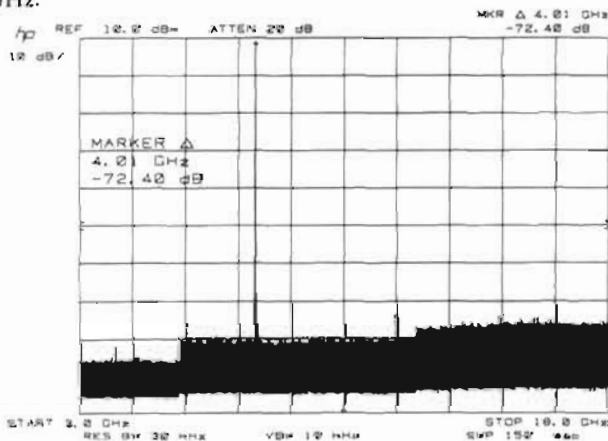

Harmonic Performance of the HP 8341B Opt. 003

For additional performance and ordering information about the HP 8340B/8341B, refer to page 378.

# SIGNAL GENERATORS

## Synthesized CW Generator

Model 8671B

- 2 to 18 GHz frequency range
- +8 dBm calibrated output power
- Low spurious signals

- Low phase noise
- 128 dB dynamic range
- 1 to 3 kHz frequency resolution



HP 8671B

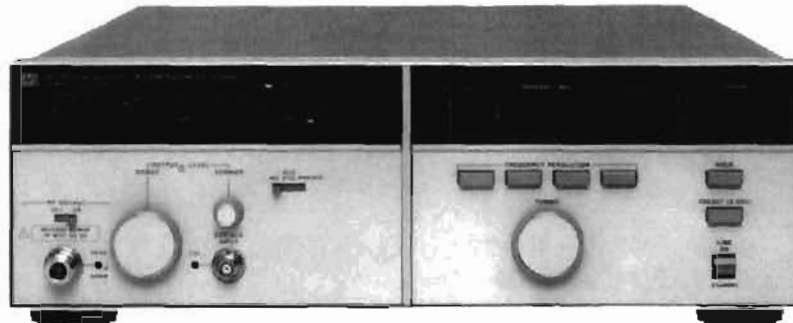

### HP 8671B Synthesized CW Generator

The HP 8671B is an economy 2.0 to 18.0 GHz synthesized CW generator. It meets all the requirements for a clean CW source. It features synthesized output with 1, 2 or 3 kHz resolution, 128 dB dynamic range, +8dBm calibrated output power, full programmability, low phase noise and low spurious signals.

#### General Purpose Measurements

For applications requiring a microwave local oscillator, the HP 8671B is the ideal solution. A simple, uncluttered, easy to use generator, the HP 8671B provides accurate, clean signals to upconvert and downconvert signals into the desired measurement frequency range.

The +8dBm output capability (with plenty of reserve) is just what you need to drive mixers. You can now take full advantage of the entire 2.0 to 18.0 GHz frequency range from a single instrument. The HP 8671B provides broadband synthesizer capability for the price of a non-synthesized source.

As a microwave source for downconversion, important measurements like noise figure and modulation analysis become more affordable. The HP 8671B with an external mixer allows you to make these measurements at an IF with the HP 8970A and 8970B Noise Figure Meters and the HP 8901A/B Modulation Analyzers. Other downconverted measurements may include network, spectrum, and waveform analysis.

#### ATE Systems

The +8dBm output capability of the HP 8671B provides the extra margin you need for automated systems. Higher power at the source means sufficient power at the unit under test, even after losses through cables and switches. For automated systems, the requirements for low phase noise, low spurious signals, and precise frequency settability are easily accommodated by the HP 8671B.

### HP 8671B Specifications

#### Frequency Characteristics

**Frequency range:** 2.0–18.0 GHz (18.6 GHz overrange).

**Frequency bands and resolution:** band 1: 2.0 to 6.2 GHz 1 kHz  
band 2: 6.2 to 12.4 GHz 2 kHz  
band 3: 12.4 to 18.0 GHz 3 kHz

**Time base:** internal 10 MHz ( $<5 \times 10^{-10}$ /day aging rate) or external 5 or 10 MHz.

**Frequency switching time:** <15 ms to be within specified resolution, all bands.

#### Spectral Purity

**Single-sideband phase noise (1 Hz BW, CW mode):**

$f_c$	Offset from $f_c$				
	10 Hz	100 Hz	1 kHz	10 kHz	100 kHz
Band 1	-58 dBc	-70 dBc	-78 dBc	-86 dBc	-110 dBc
Band 2	-52 dBc	-64 dBc	-72 dBc	-80 dBc	-104 dBc
Band 3	-48 dBc	-60 dBc	-68 dBc	-76 dBc	-100 dBc

**Harmonics (up to maximum frequency, output level meter readings <0 dB on 0 dBm range and below):** <-25 dBc.

**Sub-harmonics and multiples thereof:** <-25 dBc.

#### Spurious

**Non-harmonically related:** <-70 dBc, Band 1; <-64 dBc, Band 2; <-60 dBc, Band 3.

**Power line related and fan rotation related within 5 Hz below line frequency and multiples thereof:**

$f_c$	Offset from $f_c$		
	<300 Hz	300 Hz to 1 kHz	>1 kHz
Band 1	-50 dBc	-60 dBc	-65 dBc
Band 2	-44 dBc	-54 dBc	-59 dBc
Band 3	-40 dBc	-50 dBc	-55 dBc

#### Output Characteristics

**Output level (+15°C to +35°C):** +8 to -120 dBm

**Flatness (0 dBm range, +15°C to +35°C):**  $\pm 0.75$  dB, Band 1,  $\pm 1.00$  dB, Band 2,  $\pm 1.25$  dB, Band 3.

**Output level switching time:** <20 ms, internally leveled  
<10 ms, typical within one output level range

**Source impedance:** 50 ohms nominal.

#### Remote Operation

**Frequency:** Programmable over full range with same resolution as manual mode

**Output Level:** Programmable in 1 dB steps

**RF:** Choice of either ON or OFF

**ALC:** Choice of either internal leveling, diode leveling, or power meter leveling

#### Interface functions:

SH1, AH1, T6, TE0, L4, LE0, SRI, RL0, PP2, DC1, DT0, C0, E1.

#### General

**Operating temperature range:** 0°C to +55°C.

**Power:** 100, 120, 220, 240 V, +5%, -10%, 48-66 Hz; 300 VA max.

**Weight:** net, 27 kg (60 lb). Shipping, 32.5 kg (72 lb).

**Size:** 133 mm H x 425 mm W x 603 mm D (5.25" x 16.75" x 23.75").

#### Ordering Information

	Price
HP 8671B Synthesized CW Generator	\$24,000
Option 907: Front panel handle kit	+\$55
Option 908: Rack mounting flange kit	+\$33
Option 909: Front panel handle kit plus rack mounting flange kit	+\$80
Option 910: Extra operating and service manual	+\$60

- 2 to 18 GHz
- +8 to -120 dBm calibrated output
- 0.1 dB resolution, digitally displayed

- AM/FM/Pulse Modulation
- Low spurious and phase noise
- 1 to 3 kHz frequency resolution



HP 8673E



### HP 8673E Synthesized Signal Generator

The HP 8673E is a synthesized signal generator that delivers value-oriented performance in precise microwave signal simulation. It is optimized for applications requiring high performance signal generation in the 2.0 to 18.0 GHz frequency range while also providing 128 dB dynamic output range. The HP 8673E includes the necessary modulation features required in a full performance microwave synthesizer.

#### Exceptional Output Performance

The HP 8673E provides frequency coverage from 2.0 to 18.0 GHz with resolution of 1, 2, or 3 kHz depending upon frequency band. Optimized for output level flexibility, power is internally (or externally) leveled and calibrated from -120 dBm to +8 dBm. Adding to your measurement convenience, the output level is displayed on the front panel with 0.1 dB resolution with a digital display.

#### Flexible Modulation

As a full performance synthesized signal generator, the HP 8673E includes amplitude, frequency, and pulse modulation capability. AM depth up to 75% at rates up to 10 kHz is ideal for most applications. The HP 8673E features two types of FM: locked and unlocked operation. In the locked mode, operation is like other synthesizers providing up to 3 MHz deviation that is dependent upon modulation index. The unlocked mode allows up to 10 MHz deviation at rates as low as 50 Hz. Internally leveled pulse modulation over the entire 2 to 18 GHz range with ON/OFF ratios > 70 dB is available with any externally supplied TTL-level input signals. Output pulses will have rise/fall times typically less than 50 ns.

#### Many More Features

The HP 8673E includes many more features including excellent spectral purity and a YIG-tuned oscillator phase-locked to a 10 MHz quartz crystal reference. Full HP-IB and digital sweep capability identical to the HP 8673B/C/D is also included.

### HP 8673E Specifications

#### Frequency Characteristics

**Range:** 2.0 - 18.0 GHz (1.95 - 18.6 GHz overrange)  
**Resolution:** 1 kHz, 2.0 - 6.6 GHz  
 2 kHz, 6.6 - 12.3 GHz  
 3 kHz, 12.3 - 18.0 GHz

#### Spectral Purity

**Single-sideband phase noise (1 Hz BW, 1 kHz offset, CW mode):**  
 $\leq -60$  dBc  
**Harmonics:**  $\leq -40$  dBc at +3 dBm  
**Subharmonics and multiples thereof:**  $-35$  dBc at +3 dBm

#### Output Characteristics

**Output level (+15°C to +35°C):** +8 to -120 dBm  
**Resolution:** 0.1 dB, digital display

#### Pulse Modulation

**ON/OFF ratio:**  $\geq 70$  dB  
**Rise/fall times:** < 50 ns, typical  
**Pulse repetition frequency:** 50 Hz to 1 MHz  
**Minimum duty cycle:** < 0.0001 for leveled performance

#### Amplitude Modulation

**Depth:** 0 to 75%, at 0 dBm maximum carrier level, 15°C to 35°C  
**Rate (30% depth):** 10 Hz - 50 kHz,  $\pm 3$  dB  
**Sensitivity:** 30%/V and 100%/V ranges

#### Frequency Modulation

Deviation Range	Rate ( $\pm 3$ dB BW)	Maximum Peak Deviation
30 kHz/V	100 Hz - 2 MHz	the smaller of 3 MHz or: $f_{mod} \times 5$ , 2.0 - 6.6 GHz $f_{mod} \times 10$ , 6.6 - 12.3 GHz $f_{mod} \times 15$ , 12.3 - 18.0 GHz
100 kHz/V	100 Hz - 2 MHz	
300 kHz/V	3 kHz - 2 MHz	
1 MHz/V	3 kHz - 2 MHz	
3 MHz/V	3 kHz - 2 MHz	
10 MHz/V (unlocked)	50 Hz - 2 MHz, (typical)	10 MHz

#### Digital Sweep Characteristics

Identical to HP 8673B/C/D

#### Remote Programming

All functions HP-IB programmable except line switch.  
**Interface functions:** SH1, AH1, T5, TE0, L3, LE0, SR1, RL1, PP1, DC1, DT1, C0, E1

#### General

**Operating temperature range:** 0°C to +55°C  
**Power:** 100, 120, 220, 240V, +5%, -10%; 48-66 Hz; 400 VA max  
**Weight:** 29 kg (64 lb.) net  
**Size:** 620 mm D x 425 mm W x 146 mm H (24.4" x 16.8" x 5.7")

#### Ordering Information

Item	Price
HP 8673E Synthesized Signal Generator	\$36,500
Option 907: Front panel handle kit	55
Option 908: Rack mounting flange kit	33
Option 909: Front panel handle with rack mounting flange kit	80
Option 910: Extra manual	65

# SIGNAL GENERATORS

## Synthesized Signal Generators (cont'd)

Models 8673B, 8673C, and 8673D

- 10 MHz to 26.5 GHz frequency range
- $< -60$  dBc harmonics/subharmonics
- Low spurious and phase noise

- $+8$  to  $-100$  dBm calibrated output
- Internally leveled AM/FM/pulse modulation
- Frequency extension capability to 60 GHz

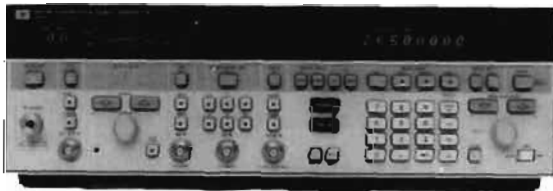

HP 8673B

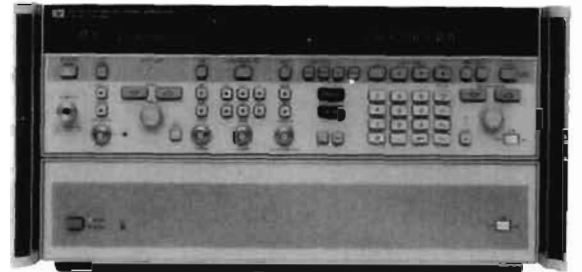

HP 8673D



### HP 8673B, 8673C, and 8673D Synthesized Signal Generators

The HP 8673B/C/D Synthesized Signal Generators are full performance synthesizers designed to generate precise microwave signals over the 50 MHz to 26.5 GHz frequency range. These generators offer calibrated and leveled power, AM, FM, pulse modulation, digital sweep, programmability, and frequency extension capability to 60 GHz. The HP 8673B covers the 2.0 to 26.5 GHz range, while the HP 8673C/D pair cover from 50 MHz to 18.6 GHz and 26.5 GHz respectively.

#### Excellent Spectral Purity

A variety of applications ranging from microwave radar to communications systems require the frequency stability available from the HP 8673B/C/D. The broadband frequency coverage is derived from multiplying a fundamental 2.0 to 6.6 GHz YIG-tuned oscillator. This technique provides the widest possible frequency coverage from a single instrument. Indirect synthesis phase-locks the YIG-tuned oscillator to a 10 MHz quartz crystal reference to provide excellent long term and short term stability (frequency drift  $< 5 \times 10^{-10}$  per day). Phase locked loops are optimized for lowest possible single-sideband phase noise. The HP 8673C and HP 8673D include an internal tracking YIG-filter to further reduce unwanted harmonic, subharmonic, and nonharmonic spurious signals above 1.2 GHz to  $< -60$  dBc.

#### Wide Dynamic Output Range

For broadband component and receiver testing applications, the HP 8673B/C/D delivers exceptionally flat power output across the full frequency ranges. For receiver sensitivity measurements, power is internally (or externally) leveled to  $-100$  dBm. Maximum available power varies with frequency as shown in Figure 1.

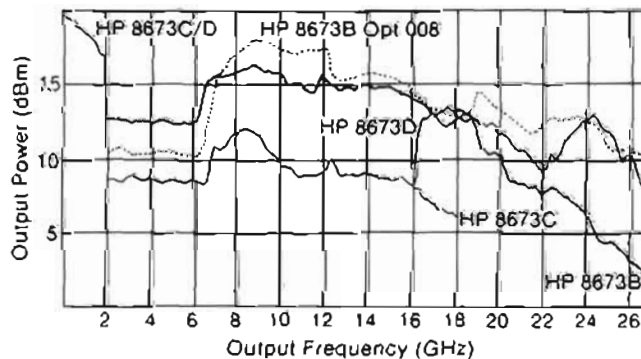

Figure 1. Maximum power typically available from HP 8673D, 8673C, 8673B, and 8673B Option 008 at 25°C

#### Internally Leveled Pulse Modulation

The HP 8673B/C/D features an internal pulse modulator that provides high-quality pulse modulation over the entire 50 MHz - 26.5 GHz range. Since the modulation is done before the frequency multiplication, the peak pulsed power can be leveled and calibrated to within typically  $+1.5$  to  $-1.0$  dBm of the set level referenced to CW. External TTL level pulse rates up to 1 MHz and pulse widths as narrow as 100 ns can be easily accommodated by the HP 8673B/C/D to provide ON/OFF ratios in excess of 80dB.

#### Calibrated AM/FM Modulation

AM and FM capability is included in the HP 8673B/C/D to expand the versatility in receiver testing applications. AM depth at rates up to 100 kHz can be accurately set using the front panel meter. Six ranges of metered FM are available at rates and peak deviations up to 10 MHz. Both AM depth and FM deviation are linearly controlled by varying the externally supplied modulating input voltage up to 1V peak. Simultaneous modulation of AM, FM, and pulse is possible to simulate complex environments.

#### Frequency Extension to 60 GHz

The HP 8673B/C/D can be used as microwave drivers for the HP 83550-series millimeter wave source modules. This combination (with the addition of the HP 8349B Microwave Amplifier) can provide leveled output signals up to 60 GHz with the "System Leveling" mode. The resultant output frequency can be displayed on the HP 8673B/C/D front panel by entering the multiplication factor of the source module.

#### Full Programmability and Digital Sweep

The HP 8673B/C/D provides full programmability of all front panel functions for automatic test applications. Output level can be controlled in steps as fine as 0.1dB. An internal microprocessor is used to simplify HP-IB program code generation and follow front-panel keystroke sequences. This design allows the implementation of digital sweep. Sweep spans can be set over the entire frequency range with variable rates, step sizes, and selectable markers available.

**HP 8673B/C/D Specifications**

**Frequency Characteristics**

**Frequency Range:** HP 8673B: 2.0–26.0 GHz (1.95 to 26.5 GHz in overrange).

HP 8673C: 0.05–18.6 GHz (0.01–18.6 GHz in overrange).

HP 8673D: 0.05–26.0 GHz (0.01–26.5 GHz in overrange).

**Frequency Bands:** Band 0: 0.05–2.0 GHz

Band 1: 2.0–6.6 GHz

Band 2: 6.6–12.3 GHz

Band 3: 12.3–18.6 GHz

Band 4: 18.6–26.0 GHz

**Frequency Resolution:** 1 kHz Band 0 and 1      3 kHz Band 3  
2 kHz Band 2      4 kHz Band 4

**Time base:** internal 10 MHz (<5 × 10<sup>-10</sup>/day aging rate) or external 5 or 10 MHz.

**Frequency switching time:** <25 ms (HP 8673B) and <50 ms (HP 8673C/D) to be within specified resolution, all bands.

**Spectral Purity**

**Single-sideband phase noise (1 Hz BW, CW mode):**

F <sub>c</sub>	Offset from F <sub>c</sub>				
	10 Hz	100 Hz	1 kHz	10 kHz	100 kHz
Band 0	-64 dBc	-70 dBc	-78 dBc	-86 dBc	-105 dBc
Band 1	-58 dBc	-70 dBc	-78 dBc	-86 dBc	-110 dBc
Band 2	-52 dBc	-64 dBc	-72 dBc	-80 dBc	-104 dBc
Band 3	-48 dBc	-60 dBc	-68 dBc	-76 dBc	-100 dBc
Band 4	-46 dBc	-58 dBc	-66 dBc	-74 dBc	-98 dBc

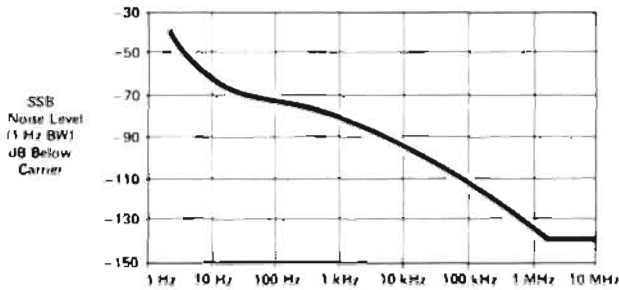

Figure 2. Typical HP 8673B/C/D single-sideband phase noise performance using the internal standard, Band 1.

**Harmonics (up to maximum frequency, output level meter readings <0 dB on 0 dBm range and below):** <-40 dBc (HP 8673B), <-40 dBc, 50 MHz–1.2 GHz, <-60 dBc, 1.2–26.0 GHz (HP 8673C/D).

**Sub-harmonics and multiples thereof:** <-60 dBc (HP 8673C/D) <-25 dBc, Bands 1–3; <-20 dBc, Band 4 (HP 8673B).

**Spurious (CW and AM modes)**

**Non-harmonically related:** <-60 dBc, Band 0; <-70 dBc, Band 1; <-64 dBc, Band 2; <-60 dBc, Band 3; <-58 dBc, Band 4.

**Power line related and fan rotation related within 5 Hz below line frequency and multiples thereof:**

F <sub>c</sub>	Offset from F <sub>c</sub>		
	<300 Hz	300 Hz to 1 kHz	>1 kHz
Band 0	-50 dBc	-60 dBc	-65 dBc
Band 1	-50 dBc	-60 dBc	-65 dBc
Band 2	-44 dBc	-54 dBc	-59 dBc
Band 3	-40 dBc	-50 dBc	-55 dBc
Band 4	-38 dBc	-48 dBc	-53 dBc

**Output Characteristics**

**Output level (+15°C to +35°C):**

8673B		8673C		8673D	
Level (dBm)	Freq. (GHz)	Level (dBm)	Freq. (GHz)	Level (dBm)	Freq. (GHz)
+8 to -100	2-18	+11 to -100	.05-2.0	+11 to -100	.05-2.0
+4 to -100	18-22	+5 to -100	2-16	+5 to -100	2-22
0 to -100	22-26	+2 to -100	16-18.6	+6 to -100	22-26

**Flatness (0 dBm range, +15°C to +35°C):** ±0.5 dB through Band 0, ±0.75 dB through Band 1, ±1.0 dB through Band 2, ±1.25 dB through Band 3, ±1.75 dB through Band 4.

**Remote programming output level resolution:** 0.1 dB.

**Source impedance:** 50 ohms nominal.

**Pulse Modulation**

**ON/OFF ratio:** >80 dB.

**Rise/fall times:** <20 ns, Band 0; <35 ns, Bands 1–4.

**Minimum leveled pulse width:** <100 ns.

**Pulse repetition frequency:** dc–1 MHz.

**Maximum peak power:** same as in CW mode.

**Peak level accuracy (relative to CW, +15°C to +35°C):** ±1.5 dB.

**Pulse modulation input requirements:** normal mode, positive-true TTL levels; complement mode, negative-true TTL levels.

**Video feedthrough:** typically <-50 dBc.

**Amplitude Modulation**

**Rates (3 dB BW, 30% depth):** 20 Hz–100 kHz.

**Sensitivity:** 30%/V, 100%/V ranges. Max. input 1 V peak into 600 Ω.

**Frequency Modulation**

Sensitivity	Rate (3 dB BW, typical)	Maximum Peak Deviation the smaller of 10 MHz or: fmod x 5, Band 0 fmod x 5, Band 1 fmod x 10, Band 2 fmod x 15, Band 3 fmod x 20, Band 4
30 kHz/V	50 Hz to 10 MHz	
100 kHz/V	50 Hz to 10 MHz	
300 kHz/V	1 kHz to 10 MHz	
1 MHz/V	1 kHz to 10 MHz	
3 MHz/V	1 kHz to 10 MHz	
10 MHz/V	1 kHz to 10 MHz	

**Digital Sweep Characteristics**

**Sweep function:** start/stop or ΔF (span) sweep.

**Sweep modes:** manual, auto, or single sweep.

**Step size:** maximum of 9999 frequency points per sweep; minimum step size equals frequency resolution.

**Dwell time:** set from 1 to 255 ms per frequency.

**Markers:** 5 independent, settable frequency markers.

**Sweep outputs:** 0 to +10 V ramp start to stop; 0.5 V/GHz ramp; Z-axis blanking/markers; tone marker; pen/fit.

**Remote Programming**

All functions HP-IB programmable except line switch. The HP 8673B/C/D can output over the interface frequency and output level settings, error/malfunction codes, and operational status codes.

**Interface functions:**

SH1, AH1, TS, TE0, L3, LE0, SR1, RL1, PP), DC1, DT1, C0, E1.

**General**

**Operating temperature range:** 0°C to +55°C.

**Power:** 100, 120, 220, 240 V, +5%, -10%, 48-66 Hz; 400 VA max. (HP 8673B), 500 VA max. (HP 8673C/D)

**Weight:** HP 8673B: net 29 kg (64 lb); shipping 34.5 kg (76 lb).

HP 8673C/D: net 42.4 kg (94 lb.); shipping 46.5 kg (103 lb).

**Size:** HP 8673B: 133 mm x 425 mm x 603 mm (5.25" x 16.75" x 23.75") HxWxD. HP 8673C/D: 234 mm x 425 mm x 613 mm (9.2" x 16.8" x 24.1") HxWxD.

**Ordering Information**

Option	Description	Price
	HP 8673B Synthesized Signal Generator	\$45,000
Option 001:	Delete RF output attenuator	less \$600
Option 002:	Delete reference oscillator	less \$735
Option 003:	Operation at 400 Hz line	add \$460
Option 004:	Rear panel RF output	add \$75
Option 005:	Rear panel RF output without RF attenuator	less \$525
Option 006:	Chassis slide kit	add \$75
Option 008:	+7 dBm output level	add \$7,000
Option 907:	Front panel handle kit	add \$55
Option 908:	Rack mounting flange kit	add \$33
Option 909:	Front panel handle kit plus rack mounting flange kit	add \$80
Option 910:	Extra operating and service manual	add \$65
	HP 8673C Synthesized Signal Generator	\$43,500
Options 001, 002, 003, 004, 005, and 006: same as HP 8673B		
Option 908:	Rack mounting flange kit	add \$55
Option 913:	Rack flanges for standard front handles	add \$45
Option 910:	Service and extra operating manual	add \$85
Option 915:	Service manual	add \$20
Option 916:	Extra operating manual	add \$65
	HP 8673D Synthesized Signal Generator	\$53,000
Options 001, 002, 003, 004, 005, 006, 908, 913, 910, 915, and 916: Same as HP 8673C		
	HP 11726A Support Kit (for HP 8673B)	\$1,005

# SIGNAL GENERATORS

## Synthesized Signal Generators

Models 8672A and 8672S

- 2 to 18 GHz frequency range
- Low spurious and phase noise
- Metered AM/FM

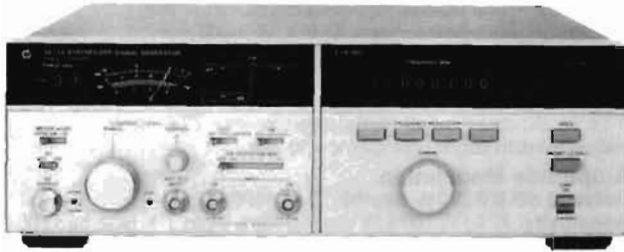

HP 8672A



### HP8672A and 8672S Synthesized Signal Generators

The HP 8672A Synthesized Signal Generator delivers precise microwave signals over the 2.0 to 18.0 GHz frequency range. It features calibrated and leveled output power, AM/FM modulation capability, and full HP-IB programmability.

The HP 8672A delivers exceptionally flat power across the full frequency range. For receiver sensitivity measurements, power is internally (or externally) leveled and calibrated to  $-120$  dBm.

The HP 8672S consists of an HP 8672A and an HP 86720A frequency extension unit. This unit uses a heterodyne technique to extend the frequency coverage down to 10 MHz. It also adds pulse modulation capability over the entire 10 MHz to 18.0 GHz frequency range. Calibrated output level in this mode is available up to 2 GHz, while  $>80$  dB ON/OFF ratio is available across the entire 18 GHz frequency range.

Specifications for the HP 8672S are identical to those of a standard HP 8672A for the 2 to 18 GHz frequency range with the exception of 1 dB less maximum output power and no AM modulation below 2 GHz.

Existing HP 8672A Signal Generators can be retrofitted to the HP 8672S configuration by ordering the HP 86720A Frequency Extension Unit and an HP 11731A or 11732A Frequency Extension Retrofit Kit.

### HP 8672A and 8672S Specifications

#### Frequency Characteristics

**Frequency range:** HP 8672A: 2.0–18.0 GHz (18.6 GHz overrange)  
HP 8672S: 0.01–18.0 GHz (18.6 GHz overrange)

#### Frequency bands and resolution:

Band 0:	0.01–2.0 GHz	1 kHz
Band 1:	2.0–6.2 GHz	1 kHz
Band 2:	6.2–12.4 GHz	2 kHz
Band 3:	12.4–18.0 GHz	3 kHz

**Time base:** internal 10 MHz ( $<5 \times 10^{-10}$ /day aging rate) or external 5 or 10 MHz.

**Frequency switching time:**  $<20$  ms to be within specified resolution, all bands

#### Spectral Purity

**Single-sideband phase noise:** same as HP 8673B/C/D

**Harmonics (up to maximum frequency, output level meter readings  $<0$  dB on 0 dBm range and below):**  $<-25$  dBc.

**Sub-harmonics and multiples thereof:**  $<-25$  dBc, Bands 1–3.

**Spurious (CW and AM modes):** Same as HP 8673B/C/D

#### Output Characteristics

**Output level ( $\pm 16^\circ\text{C}$  to  $+35^\circ\text{C}$ ):** HP 8672A:  $+8$  to  $-120$  dBm  
HP 8672S:  $+13$  dBm to  $-120$  dBm, 0.01–2.0 GHz;  $+2$  dBm to  $-120$  dBm, 2.0–18.0 GHz

**Flatness (0 dBm range,  $\pm 15^\circ\text{C}$  to  $+35^\circ\text{C}$ ):**

HP 8672A: same as HP 8673B/C/D

HP 8672S: same as HP 8672A degraded by  $\pm 0.25$  dB

**Remote programming output level resolution:** 1.0 dB.

**Source Impedance:** 50 ohms nominal.

- 10 MHz–18 GHz frequency range
- Internal pulse modulator
- HP-IB programmability

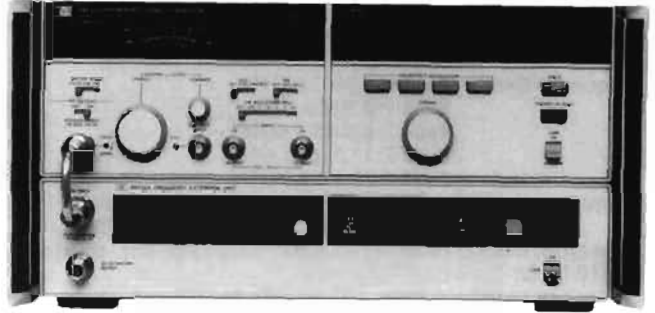

HP 8672S



### Modulation Characteristics

**Amplitude Modulation:** same as HP 8673B, C/D (2–18 GHz)

**Frequency Modulation:** same as HP 8673B/C/D

**Pulse Modulation:** HP 8672S only

$>80$  dB ON/OFF ratio;  $<15$  ns rise/fall times, peak pulsed power within 1.0 dB of level selected in CW mode for 0.01–2 GHz, uncalibrated for 2.0–18.0 GHz.

### General

**Programming:** all functions HP-IB programmable except line switches and meter mode.

**Interface functions:** SH1, AH1, T6, TE0, L4, LE0, SR1, RL0, PP2, DC1, DT0, C0, E1.

**Operating temperature range:** 0 to  $+55^\circ\text{C}$ .

**Power:** 100, 120, 220, 240V,  $\pm 5\%$ ,  $-10\%$ , 48–66 Hz; 400 VA max.

**Weight:** HP 8672A: net 27 kg (60 lb); shipping 32.5 kg (72 lb).

HP 8672S: net 39.5 kg (87 lb); shipping 43.6 kg (96 lb).

**Size:** HP 8672A: 133 mm  $\times$  425 mm  $\times$  603 mm (5.25"  $\times$  16.75"  $\times$  23.75") H  $\times$  W  $\times$  D

HP 8672S: 222 mm  $\times$  425 mm  $\times$  620 mm (8.8"  $\times$  16.8"  $\times$  24.4") H  $\times$  W  $\times$  D

### Ordering Information

	Price
HP 8672A Synthesized Signal Generator	\$39,000
Option 001: Delete RF output attenuator	less \$600
Option 002: Delete reference oscillator	less \$550
Option 003: Operation at 50/60/400 Hz line	add \$250
Option 004: Rear panel RF output	add \$75
Option 005: Rear panel RF output without RF attenuator	less \$525
Option 008: Chassis slide kit	add \$45
Option 907: Front panel handle kit	add \$55
Option 908: Rack mounting flange kit	add \$33
Option 909: Front panel handle plus rack mounting flange kit	add \$80
Option 910: Extra operating and service manual	add \$60
HP 8672S Synthesized Signal Generator	\$55,000
Options 001 and 002: same as HP 8672A	
Option 004: Rear panel RF output	add \$150
Option 006: Rear panel RF output w/o RF attenuator	less \$450
Option 008: Chassis slide kit	add \$80
Option 009: Delete internal pulse modulator	less \$1,100
Option 010: Delete pulse modulator and step attenuator	less \$1,700
Option 908: Rack flange kit	add \$55
Option 913: Rack flanges for standard front panel handles	add \$45
Option 910: Extra operating and service manuals	add \$50
HP 86720A Frequency Extension Unit	\$17,000
HP 11731A Frequency Extension Retrofit Kit	\$1,000
HP 11732A Frequency Extension Retrofit Kit	No Charge
HP 11712A Support Kit	\$800



# SIGNAL GENERATORS

## PIN Modulators, Pulse Driver, Pulse Modulator

Models 8730 Series, 8403A, 11720A



HP 8403A

### HP 8730 Series PIN Modulators

With HP 8730 series PIN Modulators, signal sources, including klystrons, can be pulse-modulated, leveled or amplitude-modulated with sinusoidal and complex waveforms. Fast rise times, low incidental FM and a nearly constant impedance match to source and load are typical of these absorption-type modulators.

### HP 8403A Modulator

The HP 8403A provides complete control of the HP 8730 Series PIN modulators, supplying the appropriate modulation wave shapes and bias levels for fast rise times, rated on/off ratios and amplitude modulation. An internal square-wave and pulse modulator with PRF of 50 Hz to 50 kHz and adjustable pulse width and delay also provide square wave and pulses for general pulse applications. For applications requiring an absorption-type modulator plus controls in a single unit, a PIN modulator can be installed inside the HP 8403A, for any specified frequency range.

### HP 8403A Specifications

**Output Characteristics** (available separately at front panel).  
**For driving HP 8730 PIN modulators:** AM and pulse output, pulse output specially shaped for optimum RF rise and decay times.  
**For general pulse applications:** positive dc-coupled pulse 25 to 30 volts in amplitude, approximately symmetrical about 0 volt; no AM signal.

#### Modulation

**Internal Square Wave**  
**Frequency:** variable from 50 Hz to 50 kHz.  
**Symmetry:** better than 45/55%.

**Internal Pulse**  
**Repetition rate:** variable from 50 Hz to 50 kHz.  
**Delay:** variable from 0.1  $\mu$ s to 100  $\mu$ s, between sync out pulse and RF output pulse.  
**Width:** variable from 0.1  $\mu$ s to 100  $\mu$ s.

#### General

**Power:** 115 or 230 volts  $\pm$ 10%, 50 to 400 Hz, approximately 10 watts.  
**Size:** 96 H x 425 W x 467 mm D (3.75" x 16.73" x 18.4").  
**Weight:** net, 7.4 kg (16.5 lb). Shipping, 9 kg (20 lb).

#### Ordering Information

HP 8403A Modulator **Price**  
\$3200

#### Options

- 002: HP 8731B PIN Modulator installed in HP 8403A add \$1900
- 004: HP 8732B PIN Modulator installed in HP 8403A add \$2000
- 006: HP 8733B PIN Modulator installed in HP 8403A add \$2150
- 008: HP 8734B PIN Modulator installed in HP 8403A add \$2150
- 009: Input and Output Connectors on rear panel add \$50
- 908: Rack flange kit add \$35
- 910: Extra Manual add \$7.50

### HP 8730 Series Specifications

HP Model	Frequency Range (GHz)	Attn Min/Max (dB)	SWR On/Off	Rise time/Fall time nanosec	Price
8731B-H10*	0.4 - 1.2	2 0/36	1.5/2.0	40/30	\$1950
8731B	0.8 - 2.4	2 0/80	1.6/2.0	30/20	\$1950
8732B	1.8 - 4.5	4 0/80	2.0/2.3	30/20	\$2050
8733B	3.7 - 8.3	3 0/80	2.0/2.2	30/20	\$2200
8734B	7.0 - 12.4	5 0/80	2.3/2.2	30/20	\$2200

\*External high-pass filter required.

### 2 to 18 GHz Pulse Modulator

- < 10 ns rise and fall times
- > 80 dB ON/OFF ratio



HP 8730B Series

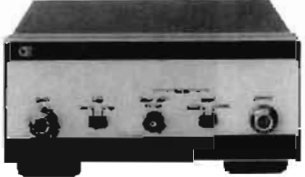

HP 11720A

### HP 11720A Pulse Modulator

The HP 11720A Pulse Modulator is a high performance microwave pulse modulator covering the range of 2 to 18 GHz. Because of this wide frequency coverage, it can be used to increase the modulation capabilities of many microwave sources (sweepers or signal generators) and eliminate the need for several individual modulators in broadband applications.

In addition to wide frequency coverage, the HP 11720A features extremely short rise and fall times (<10 ns) and a high on/off ratio (>80 dB), making it suitable for almost any pulsed RF application.

The modulator used in the HP 11720A is a unique series-shunt PIN diode switch offering superior performance to that of a simple shunt-diode switch which reflects the input power back to the source in the "off" state. In the HP 11720A the series components reduce this reflection without significantly increasing the insertion loss.

The HP 11720A contains all the necessary modulator drive circuitry to achieve specified performance so that a standard pulse generator, or any other source that can deliver >3 V peak into 50 ohms, can supply the input. In addition, a normal/complement function is provided to adapt the HP 11720A to positive-true or negative-true logic inputs.

### HP 11720A Specifications

**Frequency range:** 2 to 18 GHz.  
**ON/OFF ratio:** >80 dB.  
**Rise and fall times:** <10 ns.  
**Insertion loss:** <6 dB, 2 to 12.4 GHz; <10 dB, 2 to 18 GHz.  
**Maximum RF input power:** +20 dBm.  
**Maximum repetition rate:** >5 MHz.  
**Minimum RF pulse width:** <50 ns.  
**Video feedthrough:** <60 mV peak-to-peak.  
**Pulse input**  
**Normal mode:** >3 V (on), <0.5 V (off).  
**Complement mode:** <0.5 V (on), >3 V (off).  
**Impedance:** 50  $\Omega$  nominal.  
**Operating temperature:** 0°C to +55°C.  
**Power:** 100, 120, 220, 240 V +5, -10%; 48-400 Hz; 25 VA max.  
**Weight:** net, 2.6 kg (5 lb 12 oz); shipping, 3.6 kg (8 lb).  
**Size:** 101 mm H x 212 mm W x 290 mm D (4.0" x 8.4" x 11.4").  
 1/2 MW x 3 1/2 H x 11 D System II Module.

#### Ordering Information

HP 11720A Pulse Modulator **Price**  
\$3350  
 Option 910: Extra manual add \$5.00

# SWEEP OSCILLATORS

## General Information

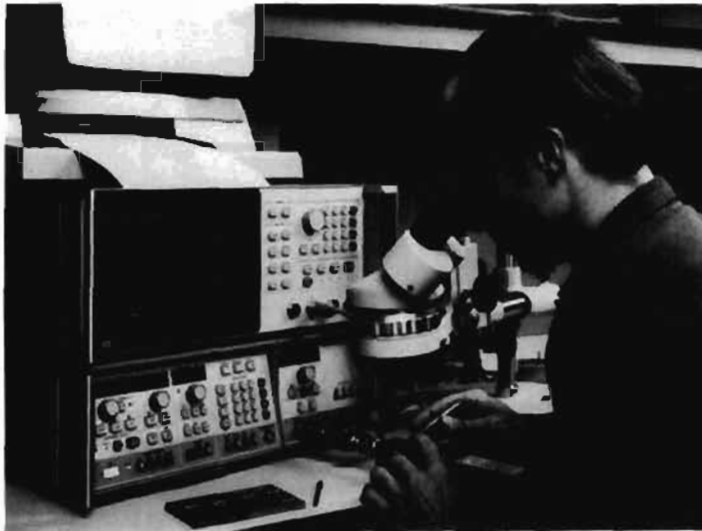

### Sweep Oscillators

Sweep oscillators are important in a number of applications where the characteristics of a device or system must be determined over a continuous range of frequencies. By replacing laborious point-by-point techniques, swept measurements increase the speed and convenience of broadband testing. The continuous frequency characterization of the unknown device or system also eliminates the chance of missing important information between frequency points.

Hewlett-Packard sweepers cover the entire frequency spectrum from dc to 60 GHz. The HP 8620 and HP 8350 family of solid state oscillators provide a versatile choice of configurations—single band, straddle band, or very wide band plug-ins. The HP 8340B and the HP 8341B are broadband synthesizers that combine the excellent stability, frequency accuracy, and phase noise of a synthesizer with the versatile characteristics of a sweep oscillator. And for coverage in the millimeter-wave frequency range, the HP 83550-series frequency multipliers effectively extend the excellent performance of Hewlett-Packard's sweep oscillator family to 60 GHz.

A chart of the complete frequency coverage of Hewlett-Packard's line of sweep oscillators is shown on page 377.

#### Sweep Flexibility

Every HP sweeper has several different sweep modes available for setting the frequency limits of the instrument. A full band or independently adjustable start/stop frequency sweep can be selected. Alternately, a marker sweep or a symmetrical  $\Delta F$  sweep about the desired center frequency can be chosen. Sweep times from 0.01 to more than 100 seconds are possible.

Marker capability, both Z-axis intensity dots and RF pips, are available on HP sweepers to note important measurement frequencies. Two or more independent markers are offered on all sweepers with up to five markers on the HP 8340B/41B and HP 8350 mainframe. Crystal markers are also offered on the HP 86222B, 83522A, and 83525A/B RF plug-ins.

Another powerful feature available on the HP 8340B/8341B and 8350 sweeper mainframe is Save/Recall Mode where up to nine complete front panel states can be stored in memory and later recalled when the measurement is repeated.

The HP 8340/8341, 8350 sweep oscillator mainframe and 83500 series RF plug-ins offer total HP-IB control of all front panel functions. The HP 8620C solid state sweeper offers optional HP-IB programming capability.

#### Power Output and Leveling

Power output is continuously adjustable at the front panel with built-in attenuators available on most plug-ins for greater power control. Internal or external leveling capability ensures high accuracy when making swept measurements.

For applications that require high power, the HP 83550A with the HP 8350 sweep oscillator mainframe offers at least +20 dBm of leveled output power from 2 to 18.6 GHz and +18 dBm to 20 GHz.

When higher output is required from an existing source, the HP 8349B microwave amplifier (2 to 20 GHz) can be driven by the RF output of the sweeper to provide a full +20 dBm of output power from 2 to 18.6 GHz. The amplifier can be easily leveled via its built-in directional detector and the automatic level control (ALC) circuitry of the sweeper.

Power as well as frequency can be swept with the HP 8340B/8341B or the HP 8350 and 83500 series plug-ins using the Power Sweep function. This means that both the frequency response and power response of level sensitive devices like transistors and amplifiers can be measured using the same test set-up. Using the power sweep function the 1 dB gain compression can easily be measured at a CW frequency. Also, the ability to alternate between two successive sweeps allows a swept measurement of the 1 dB gain compression point.

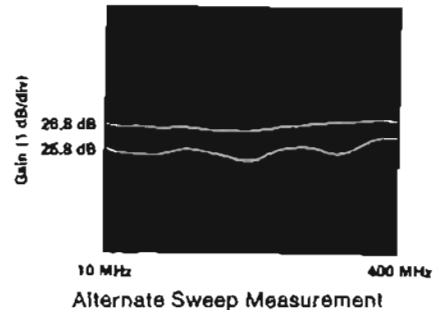

### Modulation

Modulation capabilities further extend the sweeper's usefulness both as a sweeper and a signal generator for signal simulations. The sweep oscillators described here offer versatile pulse, FM and AM modulation capabilities.

All HP 83500 and most 86200 series plug-ins (when used with the HP 8350 sweep oscillator mainframe) are capable of producing the 27.8 kHz square wave modulation required by the HP 8755, 8756A and 8757A scalar network analyzers directly, eliminating the need for an external modulator. The HP 8340B/8341B may be externally modulated with the 27.8 kHz square wave, via the scalar analyzer's modulator drive.

### Low Harmonics

For those measurements requiring low harmonics from a swept source there are several choices available. The HP 83592C RF plug-in for the HP 8350 sweep oscillator mainframe offers -55 dBc harmonic suppression from 3.5 to 20 GHz. The HP 8341B Option 003 specifies -50 dBc harmonics from 1.4 to 20 GHz.

### Covering Millimeter-wave Frequencies

The new HP 83550-series millimeter-wave source modules answer the growing need for high-performance sweep oscillators in the millimeter-wave frequency ranges. The source modules are frequency multipliers that effectively extend the excellent performance of HP sweep oscillators covering the 1 to 20 GHz range to the 26.5 to 40 GHz (HP 83554A), the 33 to 50 GHz (HP 83555A), and the 40 to 60 GHz (HP 83556A) millimeter-wave frequency ranges.

### Digital Sweeping Synthesizers

A digital sweep is a progression of discrete CW frequencies that can be stepped through at a specified rate. Digital sweeping synthesizers combine this ability with the excellent frequency accuracy and stability of a synthesizer. Some additional features are phase-continuous linear/log sweep in the HP 3325A and amplitude sweeping in steps as small as 0.01 dB in the HP 3330B.

**Sweeper Applications**

Sweepers are an integral part of many kinds of test applications. Their versatility and extensive feature set make them the perfect choice for scalar/vector network analysis, noise figure measurements, frequency translation measurements, signal simulation and many other applications. The sweepers described here are designed to be compatible with all relevant measurement solutions from HP.

Sweepers are used extensively with swept scalar network analyzers to characterize the amplitude responses of broadband devices or with vector network analyzers when the amplitude and phase characteristics of the device (i.e. s-parameters) are needed. Examples of such analyzers are the HP 8756A and HP 8757A scalar network analyzers and the HP 8510 vector network analyzer. The HP 8340B/8341B and HP 8350B sweepers can be controlled by these analyzers via a private "system interface bus." This makes use of the sweepers full programmability and creates synergistic performance.

For scalar measurements requiring more dynamic range, the HP 8349B microwave amplifier can be used to extend the dynamic range from 76 dB to typically > 90 dB.

For measurements that require an entirely spurious-free environment and phase invariance, sweepers may be used with vector

network analyzers such as the HP 8510. Extremely high performance vector measurements can be made with the HP 8340B/8341B and the HP 8510.

Noise figure measurements above 1500 MHz can be made using the HP 8970 noise figure meter with either the HP 8340B/8341B or the HP 8350 serving as the local oscillator. With this equipment noise figure and gain measurements can be made

is accomplished by phase-locking the difference frequency of two sweep oscillators to a very stable source. The sweepers may then be swept across the band of interest.

In communications applications where up-converter simulation is required in conjunction with the HP Microwave Link Analyzer, several of the HP 86200 series plug-ins are compatible (as an option) with such a system to permit very accurate RF to RF, RF to IF and RF to BB distortion measurements.

The modulation and built-in attenuator features of Hewlett-Packard sweep oscillators make them useful in many traditional CW signal generator applications. The excellent stability, phase noise, frequency range and modulation capability of the HP 8340B and 8341B make them well suited for most of these applications. In addition, the accuracy, linearity, and flatness of the HP 83500/86200 series broadband plug-ins make them more than adequate in many applications requiring a general purpose CW generator. For wideband applications these RF plug-ins feature performance that rivals octave band oscillators in the areas of frequency purity and accuracy, harmonics, flatness, and power.

A Product Line Summary of Swept Microwave Sources (HP Part No. 5954-8354), as well as specific data sheets, application notes and product notes are available from your local Hewlett-Packard sales office.

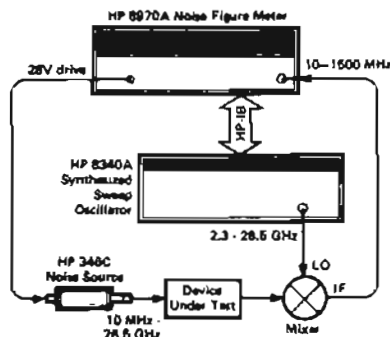

on microwave components such as amplifiers, transistors or mixers. The HP 8340B/41B can also be used as a microwave LO in an HP 8902S and 8952S measurement systems that makes several important measurements on microwave sources.

Two-tone sweep testing of devices such as mixers and receiver front ends requires two signals offset from each other by the IF. This

**Sweep Oscillator—Summary Chart**

Frequency Range*	Model Number			Frequency													
	8350 Series	8620 Series**	Other Sweepers	100 kHz	1 MHz	10 MHz	100 MHz	1 GHz	2 GHz	4 GHz	8 GHz	12 GHz	18 GHz	26 GHz	40 GHz	50 GHz	60 GHz
DC-13MHz 10 Hz-21 MHz 1 µHz-21 MHz 1 mHz-50 MHz 200 Hz-80 MHz 10 kHz-1280 MHz 10 kHz-2600 MHz			3326A 3336A/B/C 3325A 8165A 3335A 8662A 8660C														
100 kHz-1.058 GHz 100 kHz-2.115 GHz 100 kHz-2.56 GHz 10 MHz-2.4 GHz 10 MHz-8.4 GHz 10 MHz-20 GHz 10 MHz-26.5 GHz 50 MHz-18.6 GHz 50 MHz-26.5	83522A 83525A/B 83592A/B/C 83595A	86222A/B	8642A 8642B 8663A  8341B 8340B 8673C 8673D														
1.7-4.3 GHz 2-8.4 GHz 3.6-8.6 GHz 2-18 GHz 2-18.6 GHz 2-20 GHz 2-22 GHz 2-26.5 GHz	83540A/B   83590A 83594A	86235A 86240A/B 86240C  86290B/C 86290B Opt H08	8673E   8673B														
3.2-6.5 GHz		86241A															
5.9-9.0 GHz 5.9-12.4 GHz 7-11 GHz 7.5-18.6 GHz 8-12.4 GHz 8-20 GHz	83545A   83560A	86242D 86245A 86250D Opt H08 86251A 86250D															
10-15.5 GHz 12.4-18 GHz 17-22 GHz 18-26.5 GHz 26.5-40 GHz	83570A 83572A/B	86260B 86260A 86260C															
26.5-40 GHz*** 33-50 GHz*** 40-60 GHz***			83564A 83555A 83556A														

\*Other Special Frequency Ranges Can Be Provided Upon Request.  
 \*\*HP 86200 Series RF Plug-ins are usable with the HP 8350B Mainframe via the HP 11869A Adapter. HP 83500 Series Plug-ins are not usable in the HP 8620C Mainframe.  
 \*\*\*The HP 83550-series millimeter-wave source modules are frequency multipliers that require a +17 dBm microwave input. See pages 388-389.

# SWEEP OSCILLATORS

## Synthesized Sweepers

Models 8340B, 8341B

- 1 to 4 Hz frequency resolution
- Low spurious and phase noise
- +10 dBm to -110 dBm calibrated output
- Pulse, Amplitude, and Frequency Modulation
- Complete analog sweeper
- <-50 dBc harmonics 1.4 to 20 GHz on HP 8341B Option 003



HP 8340B



### HP 8340B/8341B Synthesized Sweepers

The HP 8340B and 8341B Synthesized Sweepers deliver the combined high performance of a synthesizer and a broadband sweep oscillator in one instrument that is completely controllable via the Hewlett-Packard Interface Bus (HP-IB). This efficient combination of performance and versatility is ideal for manual or automatic test systems and in many cases enables the HP 8340B/8341B to replace a sweep oscillator, a frequency counter, an RF synthesizer, and a microwave synthesizer.

### Frequency Precision and Spectral Purity

The synthesized broadband frequency coverage (10 MHz to 26.5 GHz on the HP 8340B and 10 MHz to 20 GHz on the HP 8341B) and the precise 1 to 4 Hz frequency resolution (depending on frequency band) are generated by indirect synthesis techniques, enabling the HP 8340B/8341B to achieve the same low single-sideband phase-noise performance as the HP 8671B, 8672A and 8673 series Synthesized Signal Generators. The HP 8340B/8341B long-term stability is also outstanding at  $1 \times 10^{-5}$ /day.

The HP 8340B/8341B feature CW switching times of better than 50 ms (typically <35 ms). Additionally, a "Fast Phase-lock" programming command can be used to reduce typical CW switching times to between 11 and 22 ms (depending on frequency step size and absolute frequency value).

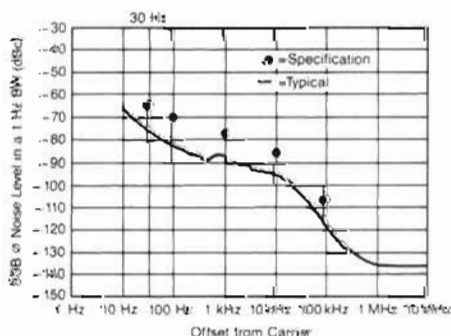

HP 8340B/8341B Phase Noise performance from 2.3 to 7.0 GHz.

### HP 8341B Option 003: <-50 dBc Harmonics

Option 003 on the HP 8341B delivers excellent harmonic performance, at least 50 dB below a 1.4 to 20 GHz carrier. This low-harmonics option is particularly useful for demanding EW receiver testing, and scalar analysis of frequency selective devices such as filters.

### Output Power

The HP 8340B/8341B provide high output power which can be controlled down to -110 dBm with 0.05 dB resolution. High power resolution is complemented by outstanding accuracy and flatness. The HP 8340B/8341B also feature power sweep capability with > 20 dB dynamic range for complete characterization of level-sensitive devices.

### Pulse, Amplitude, and Frequency Modulation

The HP 8340B/8341B have a high-performance pulse modulator with ON/OFF ratio >80 dB and rise and fall times <25 ns. Pulse amplitude is leveled and can be as narrow as 100 ns. The HP 8340B/8341B also feature dc-coupled amplitude modulation with a 3 dB bandwidth of 100 kHz and a minimum depth of 90%, and frequency modulation with rates from 50 kHz to 10 MHz and peak deviations to 10 MHz. And with the HP 8340B/8341B, pulse, amplitude, and frequency modulation can be used simultaneously.

### Swept Capability

Analog sweep widths as narrow as 100 Hz or as broad as the full frequency range of the HP 8340B/8341B permit rapid and thorough testing of any device within their broad frequency ranges. To simplify swept measurements, five frequency markers are provided along with useful marker functions such as marker sweep, marker to center frequency (MKR-CF), and marker difference.

### Network Analyzer Companions

Besides being excellent stand-alone general purpose sources, the HP 8340B/8341B are also ideal sources for precision microwave network analysis, where a significant part of measurement accuracy depends on the frequency accuracy, stability, signal purity, and source/analyzer interface of the sweeper used. As well as being the preferred HP 8510 vector network analyzer source, the HP 8340B/8341B can be teamed with the HP 8757/8756 Scalar Network Analyzers for precision scalar analysis, magnitude-only applications where data at accurate frequencies is needed. In addition to frequency accuracy, the HP 8340B/8341B have a "phase-locked sweep." For sweep widths of  $n \times 5$  MHz or less ( $n$  = frequency band number), one of the phase-locked loops is swept, producing synthesizer-class frequency accuracy and stability in a continuous sweep. As an example, see the figure at right, where an 832 MHz SAW resonator is swept over a width of 400 kHz by an HP 8341B with less than 60 Hz of residual FM.

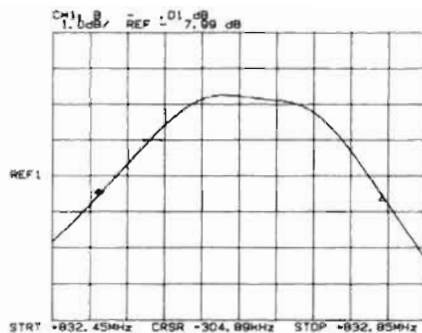

HP 8341B 400 kHz sweep of 832 MHz SAW resonator

### HP 8340B/8341B Specifications Summary

(see technical data sheet for complete specifications)

(All specifications apply to the 8341B up to 20 GHz)

#### Frequency

**Range:** HP 8340B, 10 MHz to 26.5 GHz  
 HP 8341B, 10 MHz to 20.0 GHz

#### Resolution (CW Mode):

- 1 Hz, 0.01 to <7.0 GHz
- 2 Hz, 7.0 to <13.5 GHz
- 3 Hz, 13.5 to <20.0 GHz
- 4 Hz, 20.0 to 26.5 GHz

**Time Base:** Internal 10 MHz time base. Aging rate: less than  $1 \times 10^{-9}$ /day and  $2 \times 10^{-7}$ /year after 30 day warm-up.

**Swept Capability:** Analog sweep,  $\Delta F$  from 100 Hz to 26.49 GHz (19.99 GHz on 8341B); sweep times from 45 ms to 200 sec full span.

#### Spectral Purity

**Harmonics** (up to 26.5 GHz) of output frequency:  
 < -35 dBc

**Subharmonics and Multiples thereof** (up to 26.5 GHz) of output frequency:

- < -25 dBc, 7.0 to <20.0 GHz
- < -20 dBc, 20.0 to 26.5 GHz

**HP 8341B Option 003 Harmonics, Subharmonics and Multiples thereof** (up to 20.0 GHz):

- < -35 dBc, 0.01 to < 1.4 GHz
- < -50 dBc, 1.4 to 20.0 GHz

**Non-Harmonically Related Spurious** (CW and Manual Sweep mode only):

- 50 dBc, 0.01 to <2.3 GHz
- 70 dBc, 2.3 to <7.0 GHz
- 64 dBc, 7.0 to <13.5 GHz
- 60 dBc, 13.5 to <20.0 GHz
- 58 dBc, 20.0 to 26.5 GHz

**Single-Sideband Phase Noise** (dBc/1 Hz Noise BW, CW Mode):

Frequency Range (GHz)	Offset from Carrier				
	30 Hz	100 Hz	1 kHz	10 kHz	100 kHz
0.01 to < 2.3	-64	-70	-78	-86	-107
2.3 to < 7.0	-64	-70	-78	-86	-107
7.0 to < 13.5	-58	-64	-72	-80	-101
13.5 to < 20.0	-54	-60	-68	-76	-97
20.0 to 26.5	-52	-58	-66	-74	-95

#### RF Output

**Range:** -110 dBm to +20 dBm

**Resolution:** 0.05 dB in ENTRY DISPLAY

#### Maximum Levelled Power:

- +10.0 dBm, 0.01 to <2.3 GHz
- +12.0 dBm, 2.3 to <7.0 GHz
- +10.0 dBm, 7.0 to <13.5 GHz
- +9.0 dBm, 13.5 to <20.0 GHz
- +3.0 dBm, 20.0 to <23.0 GHz
- +1.0 dBm, 23.0 to 26.5 GHz

**RF Output Connector:** APC-3.5 Male on HP 8340B, Type N Female on HP 8341B; nominal 50 ohm output impedance.

#### Modulation

##### Pulse Modulation

- ON/OFF Ratio:** > 80 dB
- Rise and Fall Times:**  $\leq 25$  ns
- Minimum Internally Levelled RF Pulse Width:**  $\leq 100$  ns
- Minimum Unlevelled RF Pulse Width:** typically  $\leq 25$  ns

##### Amplitude Modulation

- Rates (3 dB BW):** DC to 100 kHz
- Depth:** 0 to 90%
- Sensitivity:** 100%/V

##### Frequency Modulation

- Modulation Rate (3 dB BW):** 50 kHz to 10 MHz
- Peak Deviation:** The lesser of 10 MHz or
  - $5 \times$  Mod Rate, 0.01 to <7.0 GHz
  - $10 \times$  Mod Rate, 7.0 to <13.5 GHz
  - $15 \times$  Mod Rate, 13.5 to <20.0 GHz
  - $20 \times$  Mod Rate, 20.0 to 26.5 GHz

**Sensitivity:** either 1 MHz/Volt or 10 MHz/Volt, user selectable.

#### Ordering Information

**HP 8340B Synthesized Sweeper**  
 Please see your local Hewlett-Packard sales representative for current prices and options on the HP 8340B.

**Price**

# SWEEP OSCILLATORS

## Model 8350 Series: 10 MHz to 40 GHz

### Model 8350 Series

- Versatile microprocessor-controlled mainframe
- Single-band, straddle-band and broad band plug-ins
- 10 MHz to 40 GHz in two plug-ins
- 10 mW output power to 26.5 GHz
- Total HP-IB programmability



HP 8350B



### HP 8350 System

The HP 8350 is a powerful general-purpose source for swept microwave measurements, wideband CW signal generation and automatic testing. It incorporates the efficiency of microprocessor control with state-of-the-art YIG-tuned oscillators and GaAs FET amplifiers to produce a high performance sweep oscillator system ideally suited for either manual or automatic measurements.

You can easily configure a source to meet your application's frequency coverage and power requirements. Just combine the versatile HP 8350 mainframe with any of the 32 standard RF plug-ins (see table at right) and you are ready to make measurements. Both the advanced HP 83500 series plug-ins and the existing HP 86200 series plug-ins (via the HP 11869A adapter) are accepted by the HP 8350 mainframe.

### HP 8350 Mainframe

The HP 8350 has been designed to include many features that not only speed up and simplify measurements but also improve accuracy. In addition, it is compatible with HP network analyzers, counters, noise figure meters, power meters, and microwave link analyzers to provide complete solutions.

All function values (sweep limit frequencies, marker frequencies, etc.) are indicated on high resolution digital displays. Function values are easily modified using the appropriate knob, step keys, or data entry keyboard.

Five independent, continuously variable markers are available to note your measurement frequencies. The active marker frequency or the difference frequency between any two markers is read easily from high resolution digital display. You can also use marker sweep to zoom in on a particular frequency span while retaining your original sweep limits.

Another particularly useful feature in making repetitive measurements is the HP 8350's Save/Recall Mode. Once the sweeper has been set for a particular measurement, all front panel settings (HP 8350 and HP 83500 series plug-in) can be *Saved* and later *Recalled* to repeat the measurement by accessing one of nine internal storage registers.

In the past, HP-IB programming of sweepers was limited to a series of CW frequencies. With the HP 8350 all front panel functions, e.g. sweeps, markers, sweep time, even output power (HP 83500 series plug-ins) can be programmed. This means there are no limitations in designing your own customized test systems. Utilizing the Learn Mode function, the HP 8350 becomes a "talker" as well as "listener" on the bus, transferring all manually entered front panel controls to the computer.

Full compatibility with both the HP 8510 and the HP 8410C Network Analyzers, the HP 8756A and the HP 8757A Scalar Network Analyzers are provided for convenient vector and scalar measurements with the HP 8350. The HP 5343A Counter can be combined with the HP 8350 to measure Start, Stop, or marker frequencies with up to 100 kHz accuracy while sweeping. Microwave noise figure measurements may be made using the HP 8350 with the HP 8970 Noise Figure Meter. In addition, the HP 8350B, with an appropriate plug-

in driving the HP 8349B microwave amplifier, provides up to +20 dBm of output power across a 2 to 18.6 GHz range.

### HP 83500 Series Plug-Ins

Broadband frequency coverage from 10 MHz to 40 GHz with high output power is provided in the HP 83500 series RF plug-ins. One plug-in, the HP 83595A, operates over the entire 10 MHz to 26.5 GHz range without sacrificing frequency accuracy ( $\pm 12$  MHz at 26.5 GHz). The HP 83592C, 10 MHz to 20 GHz RF plug-in has  $-55$  dBc harmonics and subharmonics from 2 to 20 GHz. The HP 83550A provides +20 dBm of output power from 8.0 to 18.6 GHz, +18 dBm from 18.6 to 20.0 GHz and also has a built-in source module interface to drive the HP 83550-series millimeter-wave source modules. The 18 GHz to 26.5 GHz band is filled by the HP 83570A RF plug-in and boasts a 10 mW power level (comparable to most BWOs). The millimeter-wave bands are covered by the HP 83550-series millimeter-wave source modules, frequency multipliers that provide coverage in the 26.5 to 40 GHz (HP 83554A), 33 to 50 GHz (HP 83555A), and 40 to 60 GHz (HP 83556A) bands by effectively extending the characteristics of an 11 to 20 GHz microwave source to the millimeter frequency range.

The HP 83500 series plug-ins offer output power level control previously unavailable on a swept source. Power level control is calibrated with 0.1 dB resolution and up to 80 dB range (with Opt 002 attenuator). Calibrated power sweeps are available for characterizing device performance as a function of power. Slope and internal leveling controls are standard on all units. The HP 83500 series plug-ins (except the HP 83572A/B) are also capable of power meter leveling with the HP 432A/B/C, 436A, and 438A power meters.

All HP 83500 series front panel functions are HP-IB programmable including power level. This means your automatic test systems can now characterize a device both as a function of frequency and input power level.

### HP 86200 Series Plug-Ins

Simply combining the HP 86200 series plug-in (including the one you may already own) with an HP 11869A Adapter makes all the convenient digital controls, markers, and HP-IB capability of the HP 8350 immediately available to you. The HP 86200 series are a particularly attractive plug-in choice when economical single-band operation is desired with the HP 8350 mainframe. For measurements with HP Microwave Link Analyzers, specially characterized HP 86200 series plug-ins can be used with the HP 8350 to create an upconverter for communications distortion measurements.

The HP 86290B/C plug-ins cover the 2-18 GHz frequency range with 10 mW and 20 mW of output power respectively. Frequency accuracy at 18 GHz is 20 MHz, exceeding that available on most single-band plug-ins. Both HP 83500 series and HP 86200 series plug-ins compatible with the HP 8350 mainframe are summarized in the table. Note that the HP 11869A Adapter is required with all HP 86200 series plug-ins.

- Accurate, high resolution, digital displays
- Five markers with marker  $\Delta$  and marker sweep
- Save/recall 9 complete front panel states

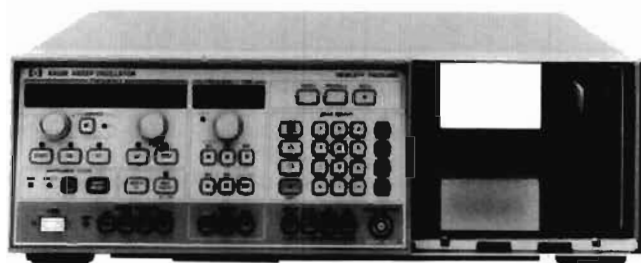

HP 8350B



## HP 8350B

Sweep Oscillator applications are greatly enhanced by the features of the HP 8350B. Along with the traditional swept and CW frequency functions, the HP 8350B adds extensive marker capabilities, versatile data entry and complete HP-IB programmability. Besides the popular HP 83500-series RF plug-ins, the HP 8350B also accepts the HP 86200-series plug-ins via the HP 11869A adapter. And the HP 8350B is directly compatible with such measurement systems as the HP 8510/8410C vector network analyzers and the HP 8756A/8757A scalar network analyzers. Frequency accuracy is easily enhanced by using the HP 5343A counter to count the START, STOP, or ACTIVE MARKER frequencies.

The HP 8350B has three methods of changing function values: control knobs, keyboard entry, or step key entry.

Five markers are available with the HP 8350B. These markers, combined with the high resolution digital readout, make the accurate location of important frequency responses easy. A key marker feature, marker  $\Delta$ , computes the difference between any two markers. The markers can also modify the center frequency (marker  $\rightarrow$  CF) or the START/STOP frequency (Marker Sweep).

A necessity in making repetitive measurements or automatic tests is the Save/Recall feature. This feature supplies nine memory locations, each storing a complete front panel set-up. Nonvolatile memory is included so that all memories are retained even when line power is removed.

The HP 8350B makes "simultaneous" comparison of two separate frequency ranges or power levels easy via the alternate sweep mode. When the alternate sweep mode is activated, the HP 8350B alternates between the current front panel setting and any stored memory setting on successive sweeps. The output from this function may be processed through a network analyzer such as the HP 8756A or the HP 8757A and viewed on a two channel display.

All front panel controls (except the ac line switch) may be programmed or controlled via the HP-IB. The HP 8350B may interact as a listener or as a talker on the HP-IB.

A self test is performed at turn on or whenever the instrument preset function is activated. This function verifies that the HP 8350B is functioning properly. If there is a problem, error codes are displayed on the front panel to help locate the problem quickly to the board and component level.

## HP 8350B Specifications

### Frequency Control Functions

Refer to RF plug-in for frequency range, linearity and accuracy specifications.

**START/STOP sweep:** sweeps up from the START frequency to the STOP frequency.

**CF/ $\Delta$ F Sweep:** sweeps symmetrically upward, centered on CF.

$\Delta$ F: frequency width of sweep continuously adjustable from zero to 100% of frequency range.

- Accepts all HP 83500 series plug-ins
- Total HP-IB programmability
- Compatible with HP Network Analyzers

**CF Resolution:** 0.00038% (262,144 points across band).

**$\Delta$ F Resolution:** 0.1% of full band (1024 points across band),  
0.012% of band for  $\frac{1}{4}$  of band or less, 0.0015% of band for  $\frac{1}{16}$  of band or less.

**Display resolution:** 5 digits.

**CW operation:** single frequency RF output.

**CW resolution:** same as CF.

**Vernier:** adjusts CW frequency or swept center frequency up to 0.05% of RF plug-in band being swept.

**Vernier resolution:** 4 ppm (64 points between each CW point; 262,144 points across band).

**Offset:** allows the CW frequency or center frequency to be offset by any amount up to the full range of the plug-in.

**Frequency markers:** five frequency markers are independently adjustable and fully calibrated over the entire sweep range. Amplitude or intensity markers available.

**Resolution:** 0.4% of selected sweep width (256 points/sweep).

### Sweep and Trigger Modes

**Internal:** sweep recurs automatically.

**Line:** sweep triggered by ac power line frequency.

**External trigger:** sweep is actuated by external trigger signal.

**Single:** selects mode and triggers a single sweep.

**Sweep time:** continuously adjustable from 10 ms to 100 seconds.

**Manual sweep:** continuous manual adjustment of frequency between end frequencies.

**External sweep:** sweep is controlled by external signal applied to SWP OUTPUT/SWP INPUT connector.

**Sweep output:** direct-coupled sawtooth, zero to approximately +10 volts, concurrent with swept RF output.

### Instrument State Storage

**Save n/recall n:** 9 different front panel settings can be stored.

**All n:** causes the RF output to alternate on successive sweeps between the current front panel setting and a setting stored in memory.

### Modulation

**External AM:** refer to RF unit specifications.

**Internal AM:** Selectable to 27.8 kHz or 1 kHz. On/off ratio, refer to RF unit specifications.

**External FM:** refer to RF unit specifications.

### Remote Programming (HP-IB)

The HP 8350B has both input and output capability. All front panel controls except the ac line power switch are programmable.

**Frequency resolution:** same as CF/ $\Delta$ F plus vernier.

**Power resolution:** see HP 83500 Series Plug-ins.

**HP-IB interface functions:** SH1, AH1, T6, L4, SR1, RLI, PPO, DCI, DT1, CO, EI.

### General Specifications

**Nonvolatile memory:** continuous memory that retains the contents of all instrument state storage registers, the HP-IB address, and current instrument state when ac line power is off.

**Operating temperature range:** 0°C to +55°C.

**Power:** 100, 120, 220 or 240 volts  $\pm$  10%, 50 to 60 Hz (Option 400, 60 to 400 Hz). Approximately 270 volt-amperes including RF unit.

**Weight (not including RF unit):** Net 16.5 kg (36.4 lb), Shipping 22.7 kg (50 lb).

**Dimensions:** 425 mm wide, 133.3 mm high, 422 mm deep (16.75" x 5.25" x 16.6").

### Ordering Information

**HP 8350B Sweep Oscillator Mainframe Options**

	Price
<b>803:</b> HP 5343A Interface Cables	add \$60
<b>850:</b> HP 8410C Source Control Cables	add \$100
<b>910:</b> Extra Manual	add \$80
<b>W30:</b> Two Years Extended Service	add \$100

For transit cases see page 732

# SWEEP OSCILLATORS

## Model 8350 Series: RF Plug-Ins

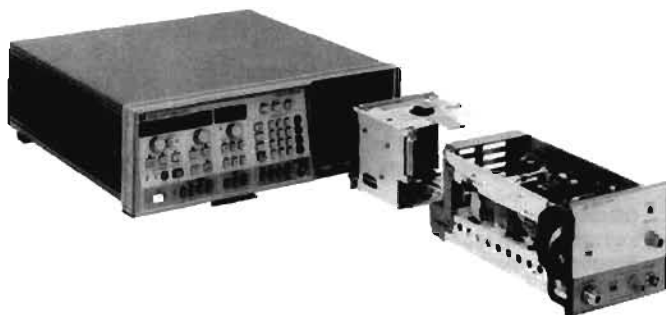

### HP 11869A Adapter

The HP 11869A adapter provides the electrical and mechanical interface between the HP 8350 and 86200 series plug-ins. All of the HP 8350's standard operating features, including HP-IB remote programming, are available. However, specific plug-in functions (output power level, RF on/off, etc.) cannot be controlled or remotely programmed by the HP 8350 mainframe.

### Plug-ins Compatible With The HP 11869A Adapter

The HP 11869A adapter attaches to the back of the HP 86200 series plug-in and is equipped with a switch for setting the specific interface code for the plug-in being used.

The following plug-ins will operate in the HP 8350 by using the HP 11869A.

HP 86220A <sup>1,2</sup>	HP 86240A/B/C	HP 86250A <sup>1</sup> /B <sup>1</sup> /C/D <sup>1</sup>
HP 86222A/B	HP 86241A <sup>1</sup>	HP 86251A <sup>3</sup>
HP 86230B <sup>1,2</sup>	HP 86242A <sup>1</sup> /C/D <sup>1</sup>	HP 86260A <sup>1</sup> /B <sup>1</sup> /C <sup>1</sup>
HP 86235A	HP 86245A	HP 86290A <sup>1</sup> /B/C

### Ordering Information

**HP 11869A Adapter** Price  
\$500

#### Options

**004:** Extension Cables for Plug-ins with Rear Panel RF Output add \$200

**006:** Type N Aux Out Interface Connector for HP 86251A and 86290A<sup>1</sup>/B/C add \$200

<sup>1</sup> Not compatible with 27.8 kHz square wave modulation.

<sup>2</sup> Models HP 86230B, 86290A, 86250A/B/C, and 86242A/C are obsolete. However, existing models can interface to HP 8350B mainframe via the HP 11869A adapter.

<sup>3</sup> Requires a special PROM for the HP 11869A, which is shipped with every HP 86251A, 86260 B/C.

### RF Plug-in Summary

	HP Model number	Frequency range (GHz)	Levelled power output	Frequency accuracy (MHz)	Complete specifications on page
Broad-band Plug-ins	83595A	0.01-26.5	2.5 mW	±12	383
	83594A	2-26.5	2.5 mW	±12	383
	83592A/B	0.01-20	10 mW/20 mW*	±10	383
	83592C	0.01-20	4 mW	±10	383
	83590A	2-20	10 mW	±10	383
	83525A/B	0.01-8.4	20 mW/10 mW	±12	385
	83522A	0.01-2.4	20 mW	±5	385
	86222A/B	0.01-2.4	20 mW	±10	392
	86290B	2-18.6	10 mW	±30	392
86290C	2-18.6	20 mW	±30	392	
Straddle-band Plug-ins	83540A/B	2-8.4	40 mW/20 mW	±12	386
	86240A	2-8.4	40 mW	±20	392
	86240B	2-8.4	20 mW	±20	392
	86240C	3.6-8.6	40 mW	±20	392
	86251A	7.5-18.6	10 mW	±20	392
	83550A	8.0-20.0	100 mW/63 mW**	±20	386
Single-band Plug-ins	86235A	1.7-4.3	40 mW	±20	392
	96241A	3.2-6.5	5 mW	±30	392
	86242D	5.9-9	10 mW	±35	392
	83545A	5.9-12.4	50 mW	±20	386
	86245A	5.9-12.4	50 mW	±40	392
	86250D	8.0-12.4	10 mW	±40	392
	86260B	10-15.5	10 mW	±50	392
	86260A	12.4-18	10 mW	±50	392
	86260C	17-22	10 mW	±50	392
	83570A	18-26.5	10 mW	±30	387
	83572A	26.5-40	1.6 mW (Opt 001)	±100	387
	83572B	26.5-40	4 mW (Opt 001)	±100	387

NOTE: The HP 11869A Adapter is required to interface HP 86200 series plug-ins with the HP 8350B mainframe.

\*HP 83592B: 20 mW to 18.6 GHz.

\*\*HP 83550A: 100 mW to 18.6 GHz.



# SWEEP OSCILLATORS

## Model 8350 Series: Broadband RF Plug-Ins

### Models 83595A, 83592A/B/C, 83594A, 83590A

- Calibrated output power with 0.1 dB resolution
- +13 dBm from 0.01 to 18.6 GHz
- 12 MHz frequency accuracy at 26.5 GHz

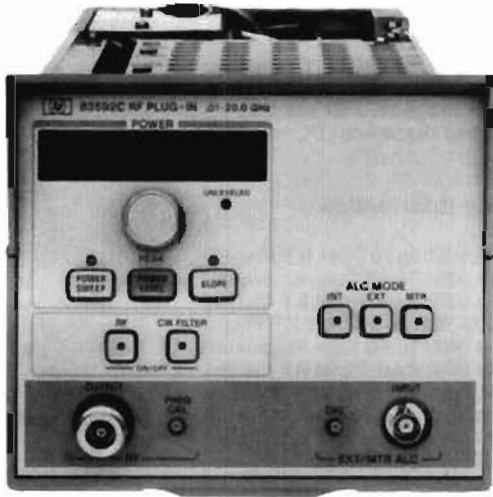

HP 83592C



The six HP 83590 series plug-ins feature wideband frequency coverage as exemplified by the HP 83595A which covers 0.01–26.5 GHz in a single sweep. While the HP 83590 series feature broadband sweeps, they still maintain narrowband precision. The frequency output exhibits excellent stability and accuracy. At 26.5 GHz (the HP 83595A maintains an accuracy of  $\pm 12$  MHz). The HP 83592B does not sacrifice power for broadband high frequency coverage; the output power is internally leveled for a minimum +13 dBm (to 18.6 GHz) output with  $\pm 0.9$  dB flatness. The HP 83592C provides a clean test signal with  $-55$  dBc harmonic and subharmonic levels (3.5–20 GHz) to maximize dynamic range. Power output capabilities have been expanded to provide power sweep and slope control. In addition, the HP 83590 series plug-ins are completely HP-IB programmable.

The most outstanding feature of the HP 83590 series plug-ins is their broad frequency range. Innovative technology is used to create this precision frequency range. The principle behind this technology is the Switched YIG Tuned Multiplier circuit (SYTM). The YTM circuit uses the output of a fundamental oscillator to drive a high-efficiency multiplier that has been integrated with a tracking YIG filter in order to create and select high order harmonics to be used as output frequencies.

A figure of merit for the HP 83590 series is their flat output power over the entire frequency range. The output power is internally leveled within 0.9 dB with a displayed resolution of 0.1 dB. The power level may be controlled to a minimum settable power level of  $-5$  dBm ( $-2$  dBm for the HP 83592B). This level may be extended to  $-75$  dBm on the HP 83592A and HP 83590A or to  $-72$  dBm on the HP 83592B with Option 002 (70 dB Step Attenuator), or to  $-60$  dBm on the HP 83592C, the HP 83595A and HP 83594A with Option 002 (55 dB Step Attenuator).

Since power parameters are critical to high frequency measurements, the HP 83590 Series (along with all HP 83500 series plug-ins) offer many modes of power output. In addition to a single power output, the HP 83590 Series offer a Power Sweep function. The Power Sweep function sweeps a power range for characterizing level sensitive devices like amplifiers and transistors. The Slope mode is supplied to provide compensation for cable or test set losses. In all these modes the power output is internally monitored and leveled. If preferred, the power may be externally leveled. The HP 83590 Series plug-ins are capable of power meter leveling with the HP 432A/B/C, 436A, and 438A power meters.

HP-IB programmability is an essential feature when one of the HP 83590 series is used in automatic test systems. For example, the automated tests of amplifiers for gain compression are possible. These plug-ins are completely programmable, which means the power mode may be selected and the power level may be set with 0.1 dB resolution.

- $-55$  dBc harmonics and subharmonics from 3.5 to 20 GHz
- Internal leveling and slope standard
- HP-IB

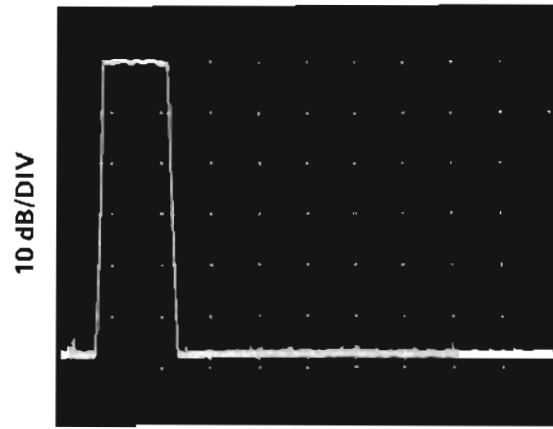

2.0 GHz

1.8 GHz/DIV

20.0 GHz

### General Specifications

**Sweep time (minimum):** 10 ms for a single band (Bands 0, 1, 2, 3, 4), 25 ms for full band (HP 83590A, 83592A/B), 30 ms for full band (HP 83594A, 83595A), 35 ms for full band (HP 83592C).

**Switch points:** HP 83595A, 83592A/B/C: Internal bands are 0.01–2.4 GHz, 2.3–7.0 GHz, 6.9–13.5 GHz, 13.4–20.0 GHz and 19.9–26.5 GHz (HP 83595A only). Broadband switch points are at approximately 2.4 GHz, 7.0 GHz, 13.5 GHz and 20.0 GHz (HP 83595A only). HP 83594A, 83590A: Internal bands are 2.0–7.0 GHz, 6.9–13.5 GHz, 13.4–20.0 GHz and 19.9–26.5 GHz (HP 83594A only). Broadband switch points are at approximately 7.0 GHz, 13.5 GHz and 20.0 GHz (HP 83594A only).

**Auxiliary output:** HP 83595A, 83592A/B/C: Rear panel 2.3–7.0 GHz fundamental oscillator output, nominally 0 dBm. HP 83594A, 83590A: Rear panel 2.0–7.0 GHz fundamental oscillator output, nominally 0 dBm.

**Frequency reference output:** (1 V/GHz or 0.5 V/GHz internal switch selectable, rear panel BNC output): HP 83595A, 83592A/B/C: nominal 1 V/GHz (0.01–18 GHz)  $\pm 25$  mV; nominal 0.5 V/GHz (full frequency coverage)  $\pm 25$  mV. HP 83594A, 83590A: nominal 1 V/GHz (2–18 GHz)  $\pm 25$  mV, nominal 0.5 V/GHz (full frequency coverage)  $\pm 25$  mV.

**RF output connector:** HP 83595A, 83594A: Type APC 3.5 male. HP 83592A/B/C, 83590A: Type N female.

**Weight:** net, 6.0 kg (13.2 lb); shipping, 9.2 kg (20 lb).

### Improved Network Measurement Capabilities

These plug-ins are compatible with the:

- HP 8510 Network Analyzer
- HP 8410 Network Analyzer
- HP 8757A Scalar Network Analyzer
- HP 8756A Scalar Network Analyzer
- HP 8970B Noise Figure Meter
- HP 8709A Phase-Lock Synchronizer

### Output Characteristics

**Impedance:** 50  $\Omega$  nominal.

**VSWR:** < 1.9:1

**Power Sweep** (with option 002 Power Sweep cannot cross an attenuator step)

**Calibrated range:** HP 83590A, 83592A/B/C:  $> 9$  dB (15 dB typical); HP 83594A, 83595A: 9 dB

**Accuracy** (including linearity):  $\pm 1.5$  dB typical.

**Resolution:** 0.1 dB.

# SWEEP OSCILLATORS

## Model 8350 Series: Broadband RF Plug-Ins (cont'd)

Models 83595A, 83592A/B/C, 83594A, 83590A

**Slope Compensation** (with option 002 Slope cannot cross an attenuator step).

**Calibrated range:** up to 5 dB/GHz (10 dB over full range).

**Linearity:** <0.2 dB typical.

**Resolution:** 0.01 dB/GHz.

**Attenuator Accuracy** ( $\pm$ dB referenced from the 0 dB setting, HP 83590A, 83592A/B only).

Frequency Range (GHz)	Attenuator Setting (dB)						
	10	20	30	40	50	60	70
0.01-12.4	0.6	0.7	0.9	1.8	2.0	2.2	2.3
12.4-18.0	0.7	0.9	1.2	2.0	2.3	2.5	2.8
18.0-20.0	0.9	1.5	2.5	3.0	3.2	3.3	3.5

### Modulation Characteristics

#### External AM

**Frequency response:** typically 100 kHz.

**Input Impedance:** approximately 10 k $\Omega$ .

**Range of amplitude control:** typically 15 dB.

**Sensitivity:** 1 dB/V typical.

**Maximum input:** 15 V.

**Pulse In** (HP 83595A and 83592A/B/C only)

TTL Compatible: Logic high = RF on, logic low = RF off.

0.01 to 20.0 GHz: Squarewave modulation up to 30 kHz.

On/Off Ratio:  $\geq$ 30 dB below specified maximum leveled power.

0.01 to 2.5 GHz

Rise/Fall Time: typically 50 ns.

Minimum Pulse Width

Leveled: 1  $\mu$ sec.

Unleveled: typically 200 ns.

2.5 to 20 GHz

Rise/Fall Time: typically 10 ns.

Minimum Pulse Width

Leveled: typically 1  $\mu$ s.

Unleveled: typically 100 ns.

#### External FM

##### Maximum Deviations for Modulation Frequencies

**DC to 100 Hz:**  $\pm$ 75 MHz.

**100 Hz to 1 MHz:**  $\pm$ 7 MHz.

**1 MHz to 2 MHz:**  $\pm$ 5 MHz.

**2 MHz to 10 MHz:**  $\pm$ 1 MHz.

##### Sensitivity

**FM Mode:** -20 MHz/V typical.

**Phase-lock mode:** -6 MHz/V typical.

**Input Impedance:** 2 k $\Omega$  nominal.

**Frequency response** (DC to 2 MHz):  $\pm$ 3 dB.

### Ordering Information

### Price

HP 83590A 2.0 to 20 GHz RF Plug-in	\$18,500
Option 002: 70 dB Step Attenuator	add \$1,305
Option 004: Rear Panel RF Output	add \$200
HP 83592A 0.01 to 20 GHz RF Plug-in	\$20,500
Option 002: 70 dB Step Attenuator	add \$1,305
Option 004: Rear Panel RF Output	add \$200
HP 83592B 0.01 to 20 GHz (13 dBm) RF Plug-in	\$23,500
Option 002: 70 dB Step Attenuator	add \$1,305
Option 004: Rear Panel RF Output	add \$200
HP 83592C 0.01 to 20 GHz (-55 dBc harmonics) RF Plug-in	\$22,000
Option 002: 55 dB Step Attenuator	\$1,305
Option 004: Rear Panel RF Output	\$200
HP 83594A 2.0 to 26.5 GHz RF Plug-in	\$22,820
Option 002: 55 dB Step Attenuator	add \$1,305
Option 004: Rear Panel RF Output	add \$200
HP 83595A 0.01 to 26.5 GHz RF Plug-in	\$26,000
Option 002: 55 dB Step Attenuator	add \$1,305
Option 004: Rear Panel RF Output	add \$200

	HP 83592A/B/C HP 83590A (excluding Band 0)					HP 83594A HP 83594A (excluding Band 0)					
	Band <sup>A</sup> 0	Band <sup>A</sup> 1	Band 2	Band 3	Full <sup>A</sup> Band	Band 0	Band <sup>A</sup> 1	Band 2	Band 3	Band 4	Full <sup>A</sup> Band
	01-2.4	2.4-7.0	7.0-13.5	13.5-20	01-20	01-2.4	2.4-7.0	7.0-13.5	13.5-20	20-26.5	01-26.5
<b>Frequency Characteristics</b>											
Accuracy (25°C $\pm$ 5°C)											
CW Mode: (MHz)	$\pm$ 5	$\pm$ 5	$\pm$ 10	$\pm$ 10	$\pm$ 10	$\pm$ 5	$\pm$ 5	$\pm$ 10	$\pm$ 10	$\pm$ 12	$\pm$ 12
Typically: (MHz)	$\pm$ 2	$\pm$ 2	$\pm$ 3	$\pm$ 4	$\pm$ 4	$\pm$ 2	$\pm$ 2	$\pm$ 3	$\pm$ 4	$\pm$ 5	$\pm$ 5
All Sweep Modes (100ms Sweep Time): (MHz)	$\pm$ 15	$\pm$ 20	$\pm$ 25	$\pm$ 30	$\pm$ 50	$\pm$ 15	$\pm$ 20	$\pm$ 25	$\pm$ 30	$\pm$ 35	$\pm$ 50
Linearity: Typ. (MHz)	$\pm$ 2	$\pm$ 2	$\pm$ 4	$\pm$ 6	$\pm$ 10	$\pm$ 2	$\pm$ 2	$\pm$ 4	$\pm$ 6	$\pm$ 10	$\pm$ 15
<b>Stability</b>											
With Temperature: Typically (MHz/°C)	$\pm$ 0.2	$\pm$ 0.2	$\pm$ 0.4	$\pm$ 0.6	$\pm$ 0.6	$\pm$ 0.2	$\pm$ 0.2	$\pm$ 0.4	$\pm$ 0.6	$\pm$ 0.8	$\pm$ 0.8
With 10 Power Level Change: (kHz)	$\pm$ 200	$\pm$ 200	$\pm$ 400	$\pm$ 600	$\pm$ 600	$\pm$ 200	$\pm$ 200	$\pm$ 400	$\pm$ 600	$\pm$ 800	$\pm$ 800
With 3:1 Load VSWR: (kHz)	$\pm$ 100	$\pm$ 100	$\pm$ 200	$\pm$ 300	$\pm$ 300	$\pm$ 100	$\pm$ 100	$\pm$ 200	$\pm$ 300	$\pm$ 400	$\pm$ 400
With Time (after 1 hour warmup at the same frequency) Typically (kHz)	<100	<100	<200	<300	<300	<100	<100	<200	<300	<400	<400
Residual FM (20 Hz-15kHz bandwidth, peak): (kHz)	<8	<5	<7	<9	<9	<5	<5	<7	<9	<12	<12
<b>Output Characteristics</b>											
Maximum Leveled Power <sup>a</sup> : (mW) (25°C)	10,(20) <sup>b</sup>	10,(20),(4) <sup>c</sup>	10,(20),(4) <sup>c</sup>	10,(25) <sup>d</sup>	10,(25) <sup>d</sup>	10	10	10	10	2.5	2.5
Opt 002	10,(16) <sup>e</sup>	7,(14) <sup>f</sup> (3.2) <sup>f</sup>	6.3,(13) <sup>f</sup> (2.5) <sup>f</sup>	5,(1.4) <sup>f</sup>	5,(1.4) <sup>f</sup>	10	7	6.3	5	1.25	1.25
<b>Power Level Accuracy</b>											
(Internally Leveled): (dB)	$\pm$ 1.5	$\pm$ 1.3	$\pm$ 1.3	$\pm$ 1.4	$\pm$ 1.5	$\pm$ 1.5	$\pm$ 1.3	$\pm$ 1.3	$\pm$ 1.4	$\pm$ 1.7	$\pm$ 1.8
Minimum Settable Power: (dBm)	-5(-2) <sup>g</sup>	-5(-2) <sup>g</sup>	-5(-2) <sup>g</sup>	-5(-2) <sup>g</sup>	-5(-2) <sup>g</sup>	-5	-5	-5	-5	-5	-5
With Opt 002	-75(-72) <sup>h</sup>	-75(-72) <sup>h</sup>	-75(-72) <sup>h</sup>	-75(-72) <sup>h</sup>	-75(-72) <sup>h</sup>	-60	-60	-60	-60	-60	-60
Remote Programming Resolution Displayed: (dB)	0.1	0.1	0.1	0.1	0.1	0.1	0.1	0.1	0.1	0.1	0.1
Settable: (dB)	.01	.01	.01	.01	.01	.01	.01	.01	.01	.01	.01
<b>Power Variation</b> (Max. Rated Pwr)											
Internally Leveled: (dB)	$\pm$ 0.9	$\pm$ 0.7	$\pm$ 0.7	$\pm$ 0.8	$\pm$ 0.9	$\pm$ 0.9	$\pm$ 0.7	$\pm$ 0.7	$\pm$ 0.8	$\pm$ 0.9	$\pm$ 1.0
Externally Leveled (Excludes Coupler/Detector Variation) (For Negative Crystal Detector and Power Meter): (dB)	$\pm$ 2( $\pm$ 25) <sup>i</sup>	$\pm$ 2( $\pm$ 25) <sup>i</sup>	$\pm$ 2( $\pm$ 25) <sup>i</sup>	$\pm$ 2( $\pm$ 25) <sup>i</sup>	$\pm$ 2( $\pm$ 25) <sup>i</sup>	$\pm$ 2	$\pm$ 2	$\pm$ 2	$\pm$ 2	$\pm$ 2	$\pm$ 2
With Temperature: (dB/°C)	0.1	0.1	0.1	0.1	0.1	0.1	0.1	0.1	0.1	0.1	0.1
<b>Residual AM in 100 kHz Bandwidth:</b> (dBc)	<-50	<-50	<-50	<-50	<-50	<-50	<-50	<-50	<-50	<-50	<-50
<b>Spurious Signals</b>											
Harmonically Related: (dBc)	<-25,( $\pm$ 20) <sup>j</sup>	<-25 <sup>k</sup>	<-25,( $\pm$ 55) <sup>l</sup>	<-25,( $\pm$ 55) <sup>l</sup>	<-25,( $\pm$ 20) <sup>j</sup>	<-25	<-25	<-25	<-25	<-20	<-20
Typically: (dBc)	<-35,( $\pm$ 27) <sup>m</sup>	<-40 <sup>n</sup>	<-35,( $\pm$ 60) <sup>o</sup>	<-35,( $\pm$ 60) <sup>o</sup>	<-35,( $\pm$ 27) <sup>m</sup>	<-35	<-40	<-35	<-35	<-35	<-35
Non-Harmonics: (dBc)	<-25	<-50,( $\pm$ 55) <sup>p</sup>	<-50,( $\pm$ 55) <sup>p</sup>	<-50,( $\pm$ 55) <sup>p</sup>	<-25 <sup>q</sup>	<-25	<-50	<-50	<-50	<-50	<-25

<sup>A</sup> Band 1 on the HP 83590A and the HP 83594A covers 2.0-7.0 GHz, and Full Band on the HP 83590A and 83594A covers 2-20 GHz and 2-26.5 GHz

<sup>B</sup> HP 83592B only.

<sup>C</sup> HP 83592C only.

<sup>D</sup> 0.5 dB lower with Opt 004.

<sup>E</sup> HP 83592C only:  $\pm$ 45 dBc (1.4-2.4 GHz)

<sup>F</sup> HP 83592C only:  $\pm$ 50 dBc (2.4-3.6 GHz)

<sup>G</sup>  $\pm$ 85 dBc (3.6-7.0 GHz)

<sup>H</sup> HP 83592 only:  $\pm$ 35 dBc (2.4-3.5 GHz)

<sup>I</sup>  $\pm$ 60 dBc (3.5-7.0 GHz)

<sup>J</sup> HP 83590A only:  $\pm$ 50 dBc

<sup>K</sup> HP 83594A only:  $\pm$ 50 dBc

# SWEEP OSCILLATORS

## Model 8350 Series: Broadband RF Plug-Ins (cont'd) Models 83522A, 83525A and 83525B

- 10 MHz–2.4 GHz and 10 MHz–8.4 GHz in one continuous sweep

- 1, 10, and 50 MHz crystal markers
- HP 83525B with  $< -45$  dBc harmonics from 2–8.4 GHz

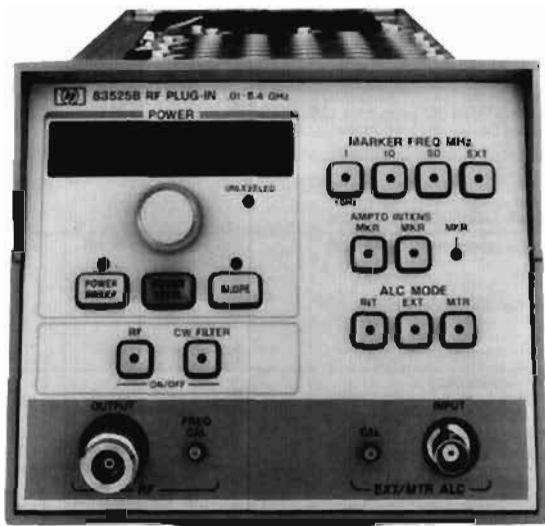

HP 83525B



### HP 83522A

The HP 83522A provides high performance 10 MHz to 2.4 GHz frequency coverage in one continuous sweep. Frequency accuracy is maintained within 5 MHz over the full band. The power output is internally leveled to  $\pm 0.25$  dB flatness over the entire range while maintaining a power level  $\geq 13$  dBm.

### HP 83525A/B

The HP 83525A/B cover the frequency range of 10 MHz to 8.4 GHz with excellent frequency stability, accuracy, and output power. The HP 83525A/B maintain excellent frequency parameters and accuracies within  $\pm 12$  MHz.

The HP 83525A plug-in, with its extremely broad frequency range, does not sacrifice power. This plug-in provides at least +13 dBm of output power while being internally leveled to a flatness of  $\pm 1$  dB.

The HP 83525B plug-in provides the same outstanding specifications as the HP 83525A plus 45 dBc harmonics for maximum dynamic range in RF component and system measurements.

### Crystal Marker Capability

A powerful feature offered by the HP 83522A and the HP 83525A/B is crystal marker capability. This capability provides harmonic markers at 10 or 50 MHz intervals over the full range of the HP 83522A and below 2 GHz with the HP 83525A/B. In addition, 1 MHz harmonic markers are available below 1 GHz.

### Output Power and Programmability

The HP 83522A and the HP 83525A/B plug-ins have a calibrated output power range of typically 15 dB that may be extended to  $> 80$  dB with Option 002 (70 dB attenuator). The output power level accuracy is within 1 dB on the HP 83522A and within 1.5 dB on the HP 83525A/B.

The power sweep function sweeps a 15 dB power range for characterizing level sensitive devices like amplifiers and transistors. The slope mode is supplied to provide compensation for cable or test set losses.

The HP 83522A and the HP 83525A/B are completely programmable plug-ins. This infers that the power level, power mode (power sweep, slope, etc.), crystal markers and other plug-in functions may be externally controlled via the HP-IB.

### Network Measurements

Increased dynamic range scalar measurements can be made using either the HP 83522A or the 83525A with the HP 8756A or the HP 8757A Scalar Network Analyzer. In addition, these plug-ins are directly compatible with the HP 8510 and the HP 8410C network analyzers, for vector and scalar measurements, and with the HP 8970 Noise Figure Meter for noise level analysis.

### Frequency Characteristics

Range	HP 83522A	HP 83525A/B	
	0.01-2.4 GHz	0.01-2 GHz	2-8.4 GHz
Accuracy* (25°C $\pm 5^\circ$ C)			
CW Mode:	$\pm 5$ MHz	$\pm 5$ MHz	$\pm 12$ MHz
Typically:	$\pm 1.5$ MHz	$\pm 1.5$ MHz	$\pm 3.5$ MHz
All Sweep Modes:	$\pm 15$ MHz	$\pm 15$ MHz	$\pm 20$ MHz
Residual FM (20 Hz-15 kHz Bandwidth), peak:	$< 5$ kHz	$< 5$ kHz	$< 7$ kHz

### Output Characteristics

Maximum Leveled Output Power (25°C $\pm 5^\circ$ C)	+20 mW	+20 mW (10 mW) <sup>†</sup>	+20 mW (10 mW) <sup>†</sup>
Power Level Accuracy (Internally Leveled):	$\pm 1$ dB	$\pm 1.5$ dB	$\pm 1.5$ dB
Resolution (displayed):	0.1 dB	0.1 dB	0.1 dB
Remote Programming (settable):	$\pm 0.01$ dB	$\pm 0.01$ dB	$\pm 0.01$ dB
Power Variation (Max. Rated Pwr) Internally Leveled:	$\pm 0.25$ dB	$\pm 1$ dB	$\pm 1$ dB
Externally Leveled: Crystal Detector or Power Meter:	$< \pm 0.1$ dB	$< \pm 0.1$ dB	$< \pm 0.1$ dB
Spurious Signals Harmonics (for 10 mW output pwr):	$< -25$ dBc	$< -20$ dBc (30) <sup>†</sup>	$< -20$ dBc (45) <sup>†</sup>
Non-Harmonics:	$< -25$ dBc	$< -30$ dBc	$< -60$ dBc
Output VSWR (Internally leveled)	$< 1.5$	$< 2.0$	$< 1.6$

### Modulation Characteristics

External FM Maximum Deviations for Modulation Frequencies DC to 100 Hz 100 Hz to 1 MHz 1 MHz to 2 MHz 2 MHz to 10 MHz Sensitivity: Typically FM Mode Phase-Lock Mode	$\pm 75$ MHz $\pm 7$ MHz $\pm 5$ MHz $\pm 1$ MHz $-20$ MHz/V $-6$ MHz/V	$\pm 75$ MHz $\pm 7$ MHz $\pm 5$ MHz $\pm 1$ MHz $-20$ MHz/V $-6$ MHz/V	
External AM Frequency Response: Typically Range: Typically Sensitivity: Typically	100 kHz 15 dB 1 dB/V	100 kHz 15 dB 1 dB/V	
External Pulse Modulation Rise/Fall Time: Typically Minimum RF Pulse Width: Typically Internally Leveled Unleveled	N/A	N/A	20 ns 1 $\mu$ s (5 $\mu$ s) <sup>†</sup> 100 ns
Internal AM: selectable to 1 kHz or 27.8 kHz square wave On/Off Ratio	$> 30$ dB	$> 30$ dB	$> 40$ dB

\*When calibrated using internal crystal markers and FREQ CAL adjustment.  
<sup>†</sup>HP 83525B only.

### Crystal Marker Capability

**Internal crystal markers:** Harmonic markers of 10 and 50 MHz are available over the full range of the HP 83522A and below 2 GHz with HP 83525A/B. 1 MHz harmonic markers are available below 1 GHz with the HP 83522A and 83525A/B.

### General Specifications

- Sweep Time (minimum over full band):** 10ms (HP 83522A), 17ms (HP 83525A/B)
- Switch points (HP 83525A/B only):** low band .01-2.1 GHz, high band 2.0-8.4 GHz.
- RF Output connector:** type N female
- Weight:** net, 4.5 kg (10 lb); shipping, 7.7 kg (17 lb)

### Ordering Information

<b>HP 83522A (+13 dBm) .01-2.4 GHz RF Plug-in</b>	<b>Price</b>
Opt 002: 70 dB Step Attenuator	\$8,200
Opt 004: Rear Panel RF Output	add \$1,005
Opt W30: Two Years Extended Service	add \$200
Opt W30: Two Years Extended Service	add \$170
<b>HP 83525A (+13 dBm) .01-8.4 GHz RF Plug-in</b>	\$12,800
<b>HP 83525B (+10 dBm) .01-8.4 GHz RF Plug-in</b>	\$14,000
Opt 002: 70 dB Step Attenuator	add \$1,105
Opt 004: Rear Panel RF Output	add \$200
Opt W30: Two Years Extended Service (HP83525A)	add \$250
Opt W30: Two Years Extended Service (HP83525B)	add \$270

# SWEEP OSCILLATORS

## Model 8350 Series: RF Plug-Ins

Models 83540A, 83540B, 83545A, and 83550A

- HP 83540A: 40 mW internally leveled 2–8.4 GHz output
- HP 83545A: 50 mW internally leveled 5.9–12.4 GHz output
- HP 83540B: <–45 dBc harmonics 2–8.4 GHz output
- HP 83550A: 100 mW internally leveled 8–18.6 GHz output, built in source module interface

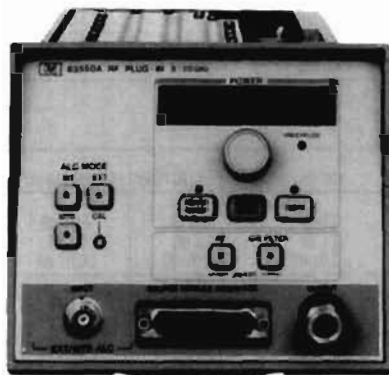

HP 83550A

### HP 83540A/B

High power, high performance, straddle band frequency coverage from 2–8.4 GHz is provided by the HP 83540 plug-ins. The frequency outputs are accurate to within  $\pm 1.5$  MHz. The output power is leveled at a minimum of +16 dBm from the HP 83540A and +13 dBm from the HP 83540B with variations less than  $\pm 1$  dB. The calibrated power output range is 15 dB which may be extended to >80 dB with Option 002 (70 dB step attenuator).

The HP 83540B provides the additional performance of 45 dBc harmonics for extended dynamic range in precision RF scalar measurement systems.

### HP 83545A

The HP 83545A plug-in features high performance 5.9–12.4 GHz frequency coverage with accuracies within  $\pm 20$  MHz. The output power is internally leveled to at least +17 dBm, with power variations less than  $\pm 0.6$  dB. The calibrated output power has a range of 15 dB that is expandable to >80 dB with option 002 (70 dB step attenuator).

### HP 83550A

The HP 83550A is a high power 8.0–20.0 GHz plug-in that provides +20 dBm of output power to 18.6 GHz and +18 dBm of output power from 18.6 to 20.0 GHz. This high output power is internally leveled with variations of less than  $\pm 1.25$  dB. The output power has a range of at least 18 dB that is expandable to >68 dB with option 002 (50 dB step attenuator) and the frequency output is accurate to  $\pm 20$  MHz.

The HP 83550A is also equipped to drive the HP millimeter-wave source modules directly. These modules are frequency multipliers that effectively extend Hewlett-Packard's microwave sources like the HP 83550A to the millimeter-wave frequency range.

### Other Features

The power sweep function provides the capability to perform power response measurements over a 15 dB power range (18 dB for the HP 83550A). Another power function is slope compensation which adjusts for high frequency cable or test set losses. And as with all HP 83500 series plug-ins, all functions are completely HP-IB programmable.

### Network Measurements

Network analysis is simplified since these plug-ins directly provide the 27.8 kHz square wave modulation for complete compatibility with the HP 8756A and 8757A scalar network analyzers. They are also directly compatible with the HP 8510 and 8410C vector network analyzers as well as the HP 8970 noise figure meter.

### General Specifications

**RF output connector:** type N female  
**Sweep time** (minimum over full band): 10 msec  
**Weight:** net, 4.5 kg (10 lb); shipping, 7.7 kg (17 lb)

### Frequency Characteristics

	HP 83540A/B	HP 83545A	HP 83550A
<b>Range:</b>	2-8.4 GHz	5.9-12.4 GHz	8-20 GHz
<b>Accuracy (25°C ± 5°C)</b> CW Mode:	$\pm 1.5$ MHz ( $\pm 1.2$ MHz) <sup>1</sup> $\pm 3.5$ MHz	$\pm 20$ MHz	$\pm 20$ MHz
Typical: All Sweep Modes (for sweep times > 100 msec): Residual FM: (20 Hz-15 kHz bandwidth) peak	$\pm 20$ MHz <9 kHz (<7 kHz) <sup>1</sup>	$\pm 10$ MHz $\pm 35$ MHz <15 kHz	— $\pm 50$ MHz <25 kHz

### Output Characteristics

<b>Maximum Leveled Power: (25°C ± 5°C)</b>	>40 mW (>20 mW) <sup>1</sup>	>50 mW	>100 mW, 8-18.6 GHz >63 mW, 18.6-20 GHz
With Opt. 002	>32 mW (>16 mW) <sup>1</sup>	>40 mW	>50 mW, 8-18.6 GHz >32 mW, 18.6-20 GHz
<b>Power Level Accuracy</b> Internally Leveled: Opt 002: (at 0 dB attenuator step)	$\leq \pm 1.5$ dB $\leq \pm 1.7$ dB	$\leq \pm 1$ dB <sup>1</sup> $\leq \pm 1$ dB <sup>1</sup>	$\leq \pm 1.5$ dB $\leq \pm 1.7$ dB
Resolution (displayed) Resolution (adjustable)	0.1 dB 0.01 dB	0.1 dB 0.01 dB	0.1 dB 0.01 dB
<b>Power Variation (at max rated power)</b> Internally Leveled: Externally Leveled (Excluding coupler/detector variations) Crystal Detector or Power Meter:	$\leq \pm 1$ dB $\leq \pm 0.1$ dB	$\leq \pm 0.6$ dB $\leq \pm 0.1$ dB	$\leq \pm 1.25$ dB $\leq \pm 0.1$ dB <sup>1</sup>
<b>Spurious Signals:</b> Harmonically Related:	$\leq -20$ dBc ( $\leq -45$ dBc) <sup>1</sup>	$\leq -17$ dBc, 5.9-7 GHz $\leq -20$ dBc, 7-12.4 GHz	$\leq -15$ dBc, 8-11 GHz $\leq -20$ dBc, 11-20 GHz
Non-Harmonics:	$\leq -60$ dBc	$\leq -60$ dBc	$\leq -50$ dBc
<b>Source VSWR:</b> Internally leveled:	<1.6	<1.6	<2.5

### Modulation Characteristics

<b>External FM</b> Maximum Deviations DC to 100 Hz: 100 Hz to 1 MHz: 1 MHz to 2 MHz: 2 MHz to 6 MHz: 6 MHz to 10 MHz:	$\pm 75$ MHz $\pm 7$ MHz $\pm 5$ MHz $\pm 1$ MHz $\pm 1$ MHz	$\pm 75$ MHz $\pm 7$ MHz $\pm 5$ MHz $\pm 1.5$ MHz $\pm 1.5$ MHz	$\pm 75$ MHz $\pm 12$ MHz $\pm 12$ MHz $\pm 12$ MHz —
Sensitivity: Nominal FM Mode: Phase-lock Mode:	-20 MHz/V -6 MHz/V	-20 MHz/V -6 MHz/V	-20 MHz/V -6 MHz/V
<b>External AM</b> Frequency Response: Typical Range: Typical Sensitivity:	100 kHz 15 dB 1 dB/V	100 kHz 15 dB 1 dB/V	100 kHz 20 dB -1 dB/V
<b>External Pulse Modulation</b> Rise/Fall Time: Typical Minimum Pulse Width Leveled: Typical	20 nsec 1 $\mu$ sec (5 $\mu$ sec) <sup>1</sup> 100 nsec	15 nsec 1 $\mu$ sec	25 nsec 1 $\mu$ sec
Unleveled: Typical	100 nsec	100 nsec	100 nsec
<b>Internal AM:</b> Selectable to 1 kHz or 27.8 kHz square wave On/Off Ratio:	>30 dB	>40 dB	>30 dB

<sup>1</sup> HP 83540B only.

<sup>1</sup> Denotes typical value.

### Ordering Information

	Price
<b>HP 83540A</b> 2-8.4 GHz Plug-in	\$9,900
002: 70 dB Step Attenuator	add \$1,105
004: Rear Panel RF Output	add \$200
W30: Two Years Extended Service	add \$200
<b>HP 83540B</b> 2-8.4 GHz Plug-in	\$10,500
002: 70 dB Step Attenuator	add \$1,105
004: Rear Panel RF Output	add \$200
W30: Two Years Extended Service	add \$210
<b>HP 83545A</b> 5.9-12.4 GHz Plug-in	\$9,900
002: 70 dB Step Attenuator	add \$1,105
004: Rear Panel RF Output	add \$200
W30: Two Years Extended Service	add \$200
<b>HP 83550A</b> 8-20 GHz Plug-in	\$16,000
002: 50 dB Step Attenuator	add \$1,305
004: Rear Panel RF Output	add \$200
006: Rear Panel AUX OUT	add \$450
W30: Two Years Extended Service	add \$300

# SWEEP OSCILLATORS

## Model 8350 Series: RF Plug-Ins (cont'd)

### Models 83570A, 83572A and 83572B

- HP 83572B offers 5 mW minimum unlevelled 26.5-40 GHz output
- HP 83570A offers 10 mW internally leveled 18-26.5 GHz output

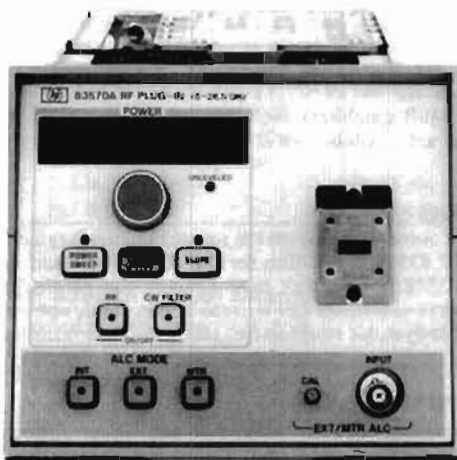

HP 83570A

With high frequency coverage, complete HP-IB programmability and outstanding leveled output power, the HP 83570A or HP 83572A/B plug-ins, combined with the many features of the HP 8350 mainframe add a new dimension to microwave measurements from 18 GHz to 40 GHz.

#### HP 83570A

Precision measurements from 18 to 26.5 GHz are possible with the solid state HP 83570A plug-in. This frequency range maintains an accuracy of 30 MHz and a minimum leveled output power of 10 dBm. Power is internally leveled to a flatness  $\pm 1.4$  dB. At the output, power losses are minimized with a waveguide output connector (a coaxial output connector may be made using the HP K281C adapter).

#### HP 83572A/B

The HP 83572A/B RF Plug-in extends the frequency coverage from 26.5 GHz to 40.0 GHz with 100 MHz frequency accuracy. The plug-ins offer minimum unlevelled output power of 7 dBm (HP 83572B), and 3 dBm (HP 83572A). Option 001 provides 6 dBm (HP 83572B), and 2 dBm (HP 83572A) calibrated externally leveled output power for regulated power control during swept and CW operations.

#### Output Power

The output power has a calibrated range of 11 dB (7dB for HP 83572A). The power level may be manually set to a 0.1 dB resolution, or the power level may be remotely HP-IB programmed to a 0.01 dB resolution. In addition to a single output power, these plug-ins also have a power sweep function. This function sweeps the power from one level to another over an 11 dB power range (7 dB for 83572A). Another important feature that these plug-ins offer is slope compensation. This compensates for high frequency power losses in external tests by attenuating the power at lower frequencies.

#### Network Measurement

Scalar measurements at high frequencies may be easily made since these plug-ins provide the internal 27.8 kHz modulation (Option 006 on the HP 83572) required for interface with the HP 8756A or the HP 8757A Scalar Network Analyzer in the AC detection mode. In addition to simplifying the interface circuitry, internal modulation reduces connection losses which are critical at high frequencies.

#### Frequency Characteristics

	HP 83570A	HP 83572A/B
<b>Range</b>	18-26.5 GHz	26.5-40 GHz
<b>Accuracy (25°C <math>\pm 5^\circ</math>C)</b>		
CW Mode:		
Typical:	$\pm 30$ MHz	$\pm 100$ MHz
All Sweep Modes:	$\pm 20$ MHz	$\pm 20$ MHz
Residual FM: (in 20 Hz-15 kHz bandwidth, CW mode):	$\pm 55$ MHz	$\pm 150$ MHz
	$< 30$ kHz	$< 60$ kHz

#### Output Characteristics

<b>Maximum Leveled Power (25°C <math>\pm 5^\circ</math>C):</b>	$> 10$ mW	$> 2$ mW (5 mW) <sup>1</sup>
<b>Minimum Unlevelled Power (25°C <math>\pm 5^\circ</math>C):</b>		1.0 dB less
Opt. 001 (at output of external leveling coupler):		1.5 dB less
Opt. 006 (at waveguide output of plug-in):		
<b>Power Level Accuracy: Typical</b>		
Internally leveled:	$\pm 1.8$ dB	$\pm 1.5$ dB
Externally Leveled (Opt. 001):		0.1 dB
Resolution (displayed):	0.1 dB	$\pm 0.01$ dB
Remote Programming (settable)	$\pm 0.01$ dB	
<b>Power Variation (At max. rated power)</b>		
Internally Leveled:	$< \pm 1.4$ dB	$< \pm 3$ dB
Unlevelled: Typically	$< \pm 2$ dB	
Externally Leveled (Excluding coupler/detector variation):		
Crystal Detector or Power Meter	$< \pm 0.1$ dB	$< \pm 0.2$ dB
<b>Spurious Signals:</b>		
Harmonically Related:	$< -25$ dBc	$< -20$ dBc
Non-Harmonics:	$< -50$ dBc	$< -50$ dBc
<b>Source VSWR: 50 <math>\Omega</math> nominal impedance</b>		
Internally leveled:	$< 2.5$	$< 1.5$
Externally leveled (Opt. 001)		

#### Modulation Characteristics

<b>External FM</b>		
Maximum Deviations for Modulation Frequencies		
DC to 100 Hz:	$\pm 75$ MHz	$\pm 150$ MHz
100 Hz to 200 kHz:		$\pm 3.5$ MHz
100 Hz to 1 MHz:	$\pm 7$ MHz	
1 MHz to 2 MHz:	$\pm 5$ MHz	
2 MHz to 10 MHz:	$\pm 1.0$ MHz	
Sensitivity: Nominal		
FM Mode:	$-20$ MHz/V	$-20$ MHz/V
Phase-lock Mode:	$-6$ MHz/V	$-6$ MHz/V
<b>External AM</b>		
Frequency Response: Typically	100 kHz	10 kHz
Range: Typically	11 dB	—
Option 001:	—	7 dB (11 dB) <sup>1</sup>
Unlevelled:	—	30 dB
Sensitivity:	1 dB/V	1 dB/V (Opt. 001)
<b>External Pulse Modulation<sup>2</sup></b>		
Rise/Fall Time:	20 ns	300/50 ns
Minimum RF Pulse Width: (Typically)		
Internally Leveled:	1 $\mu$ s	—
Unlevelled:	100 ns	500 ns
Modulation Rate:	—	0.5kHz-1 MHz
On/Off Ratio:	$> 25$ dB	$> 20$ dB
<b>Internal AM:</b> Selectable to 1 kHz or 27.8 kHz square wave		
On/Off Ratio:	$> 25$ dB	$> 20$ dB

<sup>1</sup>HP 83572B only

<sup>2</sup>HP 83572A/B Option 006, unlevelled output

#### External Leveling: Option 001

Calibrated crystal detector (option 001): approximately  $-10$  to  $-200$  mV for specified leveling at rated output; for use with negative polarity detectors such as HP 422 Series Crystal detectors. SHIFT DET switch selects internal calibration for an external coupler, a crystal detector, and a BNC cable, all included in Option 001 of HP 83572.

#### General Specifications

**Sweep Time** (minimum over full band): 10 ms

#### RF Output Connector

HP 83570A type WR42 waveguide.

HP 83572A/B type WR28 waveguide.

**Auxiliary output:** (HP 83570A) real panel 9-13.25 GHz fundamental oscillator output, nominally 0 dBm.

**Weight:** net 5.4 kg (12 lbs). Shipping 8.7 kg (19 lbs).

#### Ordering Information

HP 83570A 18-26.5 GHz RF Plug-in (Internal leveling standard) \$12,500

Opt W30: Two Years Extended Service add \$240

HP 83572A 26.5-40.0 GHz RF Plug-In \$15,000

Opt 001: Calibrated External Leveling add \$1,605

Opt 006: Internal Pulse and Square Wave Modulation capability add \$1,805

Opt W30: Two Years Extended Service add \$290

HP 83572B 26.5-40.0 GHz RF Plug-in \$18,000

Opt 001: Calibrated External Leveling add \$1,600

Opt 006: Internal Pulse and Square Wave Modulation capability add \$1,800

Opt W30: Two Years Extended Service add \$350

# SWEEP OSCILLATORS

## HP 83550 Series Millimeter-Wave Source Modules

Models 83554A, 83555A and 83556A

- 26.5 to 80 GHz frequency range
- Internally-leveled high output power
- Can be driven by many HP microwave sources

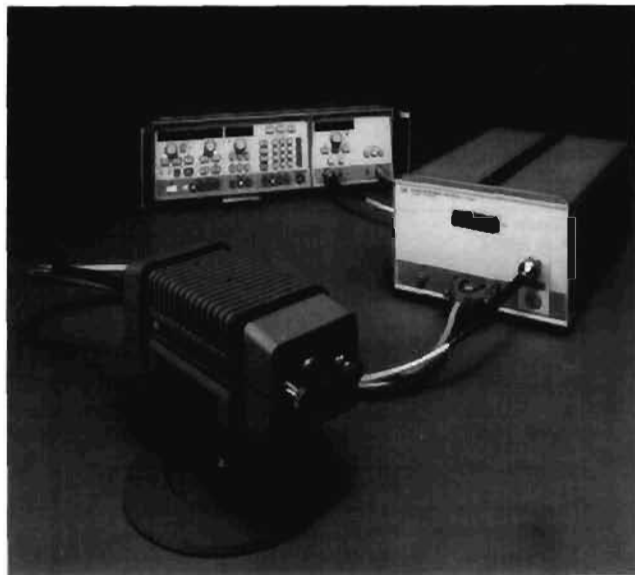

The three HP 83550 series millimeter-wave source modules provide a simple approach to extend the frequency range of 11 to 20 GHz sources to cover 26.5 to 40 GHz (HP 83554A), 33 to 50 GHz (HP 83555A) and 40 to 60 GHz (HP 83556A) bands. The HP 83550 series source modules offer internally-leveled high output power, full waveguide band frequency coverage, and the high frequency accuracy and resolution of the driving microwave source.

As shown in Figure 1, there are two basic ways of configuring a millimeter-wave source to best suit your specific needs. Your choice can range from a sweep oscillator (HP 8350B/83550A) to a sophisticated synthesized sweeper (HP 8341B/8349B).

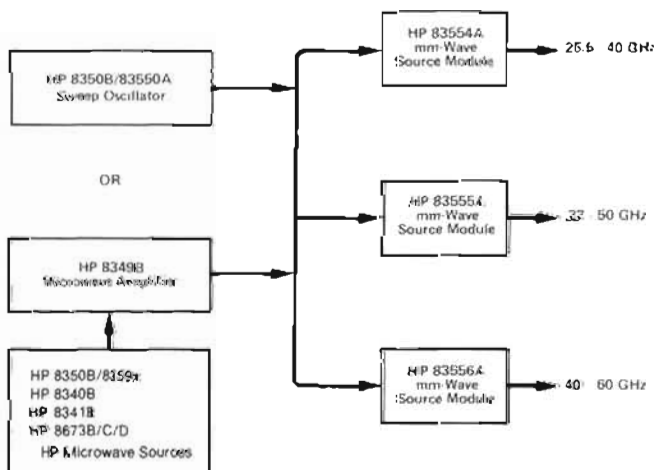

### Frequency Precision and Spectral Purity

An advantage of using frequency multiplication to generate millimeter-wave signals is that the module output translates many of the capabilities and features of the microwave source driver. The frequency accuracy and resolution are multiplied by a factor of two or three depending on whether the drive frequency is doubled or tripled. For example, a millimeter-wave source based on the HP 8341B/8349B will have frequency resolution of 6 Hz from 26.5 to 40 GHz, and 9 Hz from 40 to 60 GHz.

- Source module remotable up to a meter length
- Low entry cost

The HP 83550 series source modules offer 20 to 50 dBc of harmonic and subharmonic suppression depending on the source configuration used. The high stability and low phase noise characteristics of the HP 8340B/8341B or HP 8673B/C/D synthesizers (combined with the required HP 8349B amplifier) are also translated through the source modules and are available for a variety of signal simulation applications.

### High Output Power

Internally-leveled output power from the source modules is rated at +8 dBm for the HP 83554A, +3 dBm for the HP 83555A and +3 dBm for the HP 83556A. This high output power can permit the source module to serve as a mixer LO in some applications, and also expands the available dynamic range in frequency response measurements.

### Pulse, AM and FM Modulation

The high performance pulse modulators of the HP synthesized sources offer >80 dB ON/OFF ratio and <50 ns rise and fall times. Pulse amplitudes are leveled for pulse widths as narrow as 1  $\mu$ s.

The HP 8340B/8341B also feature de-coupled AM with a 3 dB bandwidth of 100 kHz. Pulse and amplitude modulation can be used to simultaneously simulate antenna scan patterns.



HP 8340B/8349B/83554A Pulse Performance at 36 GHz. Pulse width = 5  $\mu$ s.

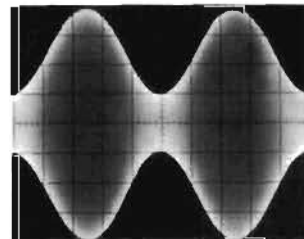

HP 8341B/8349B/83554A AM Performance at 30 GHz. AM rate is 17 kHz and depth is 70%.

FM rates between 100 Hz and 10 MHz may be applied to the HP 8673B/C/D synthesizer input to achieve deviations up to 20 MHz (HP 83554A) and 30 MHz (HP 83555A, 83556A) at millimeter-wave frequencies.

### Operational Simplicity

Simple front panel operations let you enter a display multiplier, so that the actual output frequency of the source module may be entered and displayed directly on the microwave source driver. The output power of the source module is displayed on the source or amplifier (depending on your millimeter-wave source configuration) and can be controlled again from the microwave driver.

In addition, the small size of the HP 83550-series source modules allows you to use them even on a crowded benchtop. The source modules may be placed up to 1 meter from the driving source allowing you to bring your source to your test system instead of the other way around.

This combination of performance and versatility, plus total HP-1B programmability (via the microwave source driver), makes the HP millimeter-wave sources ideal in many automatic test or bench applications.

### All at a Lower Cost

The HP 83550-series source modules combine performance and quality with a low cost of entry. This is possible because the source modules are backward-compatible with existing HP microwave sources. Thus, you can generate a full waveguide band of millimeter-wave frequencies for just the cost of the HP 8349B and a source module. Also, the cost of ownership to you is reduced even further by the two-year warranty on the microcircuits of the HP 83550-series source modules and the HP 8349B microwave amplifier.

**HP 83554A Output Characteristics<sup>1</sup>**

	HP 8350B/83550A	HP 8350B/ 83590 Series/8349B	HP 8340B/8349B, HP 8341B/8349B	HP 8673B/C/D/8349B
<b>Maximum Leveled Power</b> (25°C±5°C)	+8 dBm, 26.5-37.2 GHz +7 dBm, 37.2-40.0 GHz	+8 dBm, 26.5-37.2 GHz +7 dBm, 37.2-40.0 GHz	+8 dBm, 26.5-37.2 GHz +7 dBm, 37.2-40.0 GHz	+8 dBm, 26.5-37.2 GHz +7 dBm, 37.2-40.0 GHz
<b>Minimum Settable Power:</b>	-5 dBm	-5 dBm	-5 dBm	-5 dBm
<b>Power Level Accuracy<sup>2</sup></b> (25°C±5°C)	±2.00 dB	±2.00 dB	±2.00 dB	±2.00 dB
<b>Power Flatness</b> (at max leveled power)	±1.50 dB	±1.50 dB <sup>3</sup>	±1.50 dB <sup>3</sup>	±1.50 dB <sup>3</sup>
<b>Source Output SWR</b>	<2.0	<2.0	<2.0	<2.0
<b>Spurious Signals</b> (expressed in dB relative to the carrier level (dBc)). Harmonically related spurious:				
26.5 to 26.7 GHz	<-25 dBc	<-25 dBc	<-25 dBc	<-25 dBc
26.7 to 40.0 GHz	<-50 dBc	<-20 dBc <sup>4</sup>	<-20 dBc <sup>5</sup>	<-20 dBc <sup>6</sup>

**HP 83555A Output Characteristics<sup>1</sup>**

	HP 8350B/83550A	HP 8350B/ 83590 Series/8349B	HP 8340B/8349B, HP 8341B/8349B	HP 8673B/C/D/8349B
<b>Maximum Leveled Power</b> (25°C±5°C)	+3 dBm	+3 dBm	+3 dBm	+3 dBm
<b>Minimum Settable Power:</b>	-5 dBm	-5 dBm	-5 dBm	-5 dBm
<b>Power Level Accuracy<sup>2</sup></b> (25°C±5°C)	±2.00 dB	±2.00 dB	±2.00 dB	±2.00 dB
<b>Power Flatness</b> (at max leveled power)	±1.50 dB	±1.50 dB <sup>3</sup>	±1.50 dB <sup>3</sup>	±1.50 dB <sup>3</sup>
<b>Source Output VSWR</b>	<2.0	<2.0	<2.0	<2.0
<b>Spurious Signals</b> (expressed in dB relative to the carrier level (dBc)). Harmonically related spurious:				
33.0 to 37.5 GHz	<-20 dBc	<-20 dBc	<-20 dBc	<-20 dBc
37.5 to 49.5 GHz	<-50 dBc	<-20 dBc <sup>4</sup>	<-20 dBc <sup>5</sup>	<-20 dBc <sup>6</sup>
49.5 to 50.0 GHz	<-20 dBc	<-20 dBc	<-20 dBc	<-20 dBc

**HP 83556A Output Characteristics<sup>1</sup>**

	HP 8350B/83550A	HP 8350B/ 83590 Series/8349B	HP 8340B/8349B, HP 8341B/8349B	HP 8673B/C/D/8349B
<b>Maximum Leveled Power</b> (25°C±5°C)	+3 dBm	+3 dBm	+3 dBm	+3 dBm
<b>Minimum Settable Power:</b>	-5 dBm	-5 dBm	-5 dBm	-5 dBm
<b>Power Level Accuracy<sup>2</sup></b> (25°C±5°C)	±2.25 dB	±2.25 dB	±2.25 dB	±2.25 dB
<b>Power Flatness</b> (at max leveled power)	±1.75 dB	±1.75 dB <sup>3</sup>	±1.75 dB <sup>3</sup>	±1.75 dB <sup>3</sup>
<b>Source Output VSWR</b>	<2.0	<2.0	<2.0	<2.0
<b>Spurious Signals</b> (expressed in dB relative to the carrier level (dBc)). Harmonically related spurious:				
40.0 to 45.0 GHz	<-20 dBc	<-20 dBc	<-20 dBc	<-20 dBc
45.0 to 60.0 GHz	<-50 dBc	<-20 dBc <sup>4</sup>	<-20 dBc <sup>5</sup>	<-20 dBc <sup>6</sup>

<sup>1</sup>All specifications apply to internally leveled operation only<sup>2</sup>Specified with respect to HP 83550A or HP 8349B power display. Includes power level flatness<sup>3</sup>Must have 0.5 V/GHz modification on microwave source.<sup>4</sup>Except for the HP 83592C which is -45 dBc.<sup>5</sup>Except for the HP 8341B Option 003 which is -40 dBc.<sup>6</sup>Except for the HP 8673C/D which are -50 dBc.**Other Specifications****Frequency Resolution:** 2 (HP 83554A) or 3 (HP 83555A, 83556A) times the resolution of the input frequency.**Frequency Accuracy and Stability:** 2 (HP 83554A) or 3 (HP 83555A, 83556A) times the accuracy and stability of the input frequency for sweep oscillator. Same as the time base for synthesized sources.**Single-Sideband Phase Noise** (synthesized sources only): Same as the input signal plus 6 dB (HP 83554A) or 10 dB (HP 83555A, 83556A).**External Pulse Modulation:****On/Off Ratio:** >80 dB (>60 dB, for HP 8350B/83550A)**Minimum Leveled RF Pulse Width:** 1μs (5μs, for HP 8673)**Minimum Unleveled RF Pulse Width:** 100 ns (50 ns, for HP 8673)**Amplitude Modulation:****Rate** (3 dB BW): DC-100 kHz (DC-80 kHz, for HP 8673)**Sensitivity:** 1 dB/V (100%/V, for synthesized sources)**Frequency Modulation:****Maximum Deviations:** Follows input with 2 (HP 83554A) or 3 (HP 83555A, 83556A) times the deviation.**Output Sensitivity:** 2 (HP 83554A) or 3 (HP 83555A, 83556A) times the input sensitivity.**General Specifications****Waveguide Output Connector**

HP 83554A: EIA size WR 28 waveguide; JAN UG-599 flange.

HP 83555A: EIA size WR 22 waveguide; JAN UG-383 flange.

HP 83556A: EIA size WR 19 waveguide; JAN UG-383 (mod.) flange.

**Weight:** Net, 1.7 kg (4 lb).**Dimensions:** Module, 80 mm W x 80 mm H x 210 mm D (3.15" x 3.15" x 8.27")**Furnished with Each Source Module:** Operating and Service Manual, Modification Procedures for 0.5 V/GHz output, Type-N RF Cable, Module Base Assembly, Synthesizer Interface Cable.**Ordering Information**

HP 83554A 26.5-40.0 GHz mm-Wave Source Module \$9,000

HP 83555A 33.0-50.0 GHz mm-Wave Source Module \$9,000

HP 83556A 40.0-60.0 GHz mm-Wave Source Module \$9,000

Opt 910: Extra Manual add \$40

Opt W30: Two Years Extended Service add \$160

**Price**

\$9,000

\$9,000

\$9,000

add \$40

add \$160

# SWEEP OSCILLATORS

Model 8620 Series: 10 MHz to 22 GHz

Model 8620 Series

- Broadband, straddle-band and single-band plug-ins
- External phase-lock capability
- High Output Power, > 10 mW to 22 GHz
- Internal Leveling Standard



HP 8620C with HP 86222B, 86290B

## HP 8620 Sweeper System

The HP 8620 solid-state sweeper system offers the flexibility of the HP 8620C mainframe in addition to a wide choice of broadband, straddle-band, and single-band plug-ins. The HP 8620 system also offers high output power with solid-state reliability; greater than 10 mW (leveled) to 22 GHz.

The fundamental oscillators used in the plug-ins are YIG-tuned-transistor or bulk-effect circuits. YIG tuning results in exceptional tuning linearity, low noise, and low spurious content. It also allows frequency modulation at high rates and wide deviations with low distortion.

Combining flexibility, powerful features, and reliability, the HP 8620 system is useful in network analysis, signal simulation, or local oscillator applications.

TYPICAL UNLEVELED POWER OUTPUT

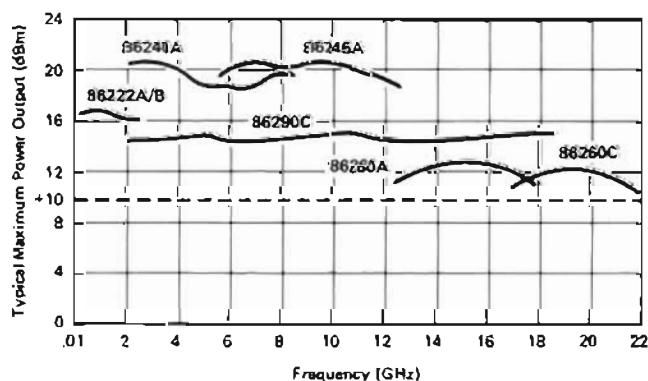

## HP 8620C Sweeper Mainframe

The HP 8620C has many features highly useful in stringent applications. With convenient functionally-grouped controls and lighted pushbutton indicators, the mainframe offers ease of operation and flexibility. Additionally, it can be an HP-IB programmable source for automatic system and signal simulation applications.

## HP 86222A/B and 86290B/C Broadband Plug-Ins

The 10 MHz to 18.6 GHz frequency range can be covered with just two plug-ins, the HP 86222A/B and 86290B/C. Besides their broad frequency ranges, these plug-ins offer many special features including unique crystal markers in the HP 86222B and better than  $\pm 30$  MHz frequency accuracy in the HP 86290B/C.

## HP 86240A/B/C and 86251A Straddle-Band Plug-Ins

Covering more than an octave of frequency, the HP 86240A/B span 2 to 8.4 GHz and the HP 86251A spans 7.5 to 18.6 GHz (covering the primary TWT amplifier frequencies) with major advances in power output and spectral purity. The HP 86240A offers more than 40 mW while the HP 86251A provides over 10 mW of leveled output power across their full bands. All three plug-ins deliver high-quality test signals of low harmonic content, with the HP 86240B providing harmonics less than  $-45$  dBc. This can be very important when making multi-octave measurements.

## HP 86200 Series Single-Band Plug-Ins

The HP 86200 series of plug-ins covers the frequency spectrum from 1.7 to 22 GHz with a choice of eight plug-ins.

## Plug-In Compatibility with the HP 8350B Mainframe

The entire line of HP 86200 series plug-ins can be used in the HP 8350 Sweep Oscillator mainframe using the HP 11869A Adapter.





# SWEEP OSCILLATORS

Model 8620 Series: Mainframe

Model 8620C

391

- Optional BCD or HP-IB programming
- 3 markers

- 100%  $\Delta F$  capability, fully calibrated

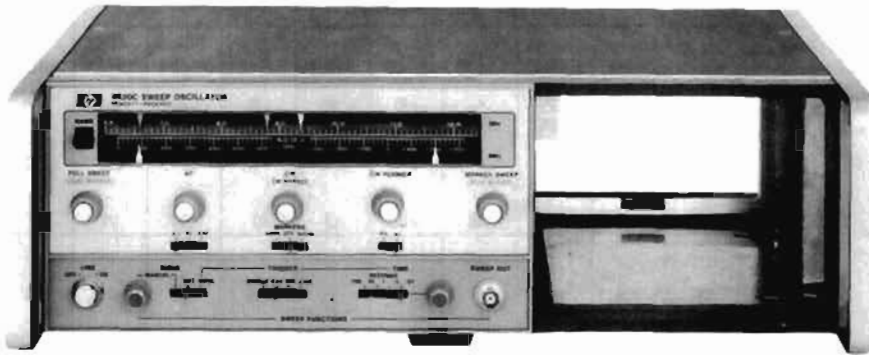

HP 8620C

The HP 8620C offers many features as standard equipment. For example, up to four separate bands and their respective frequency scales can be selected with a band-select lever to the left of the dial scale. Pushbuttons, concentrically located in the frequency control knobs, light when actuated to indicate the sweep function in use. Three frequency markers are available.

The HP 8620C is fully calibrated for any  $\Delta F$  sweep width. When in CW/ $\Delta F$  or CW modes, the CW vernier knob allows excellent frequency resolution by increasing the effective length of the dial scale to 7.5 metres (300 inches).

Another powerful feature is the capability to program the sweeper. The standard HP 8620C includes inputs for band selection, sweep function selection, and analog frequency control. Additionally, more flexible digital frequency programming is available to control the HP 8620C via HP-IB (Option 011).

## HP 8620C Specifications

Frequency, output level, and modulation capabilities depend on the RF plug-in installed; these specifications are summarized on the following page.

### Sweep Functions

**FULL SWEEP:** sweeps the full band as determined by the plug-in and the band select lever.

**MARKER SWEEP:** sweeps from START MARKER to STOP MARKER frequency settings, up to the full plug-in range, either up or down in frequency.

**$\Delta F$  sweep:** sweeps upward in frequency, centered on CW setting. CW vernier can be activated for fine control of center frequency.

**Width:** continuously adjustable and calibrated from zero to 1%, 10%, or 100% of frequency band.

**CW operations:** single-frequency RF output controlled by CW MARKER knob, selected by depressing pushbutton in CW MARKER control.

**CW vernier:** calibrated directly in MHz about CW setting. CW vernier activated by depressing pushbutton in CW VERNIER control.

**Frequency markers:** three constant-width markers are fully calibrated and independently adjustable over the entire range in FULL SWEEP function, controlled by START MARKER, STOP MARKER, and CW MARKER controls. In  $\Delta F$  sweep START and STOP MARKERS are available, and in MARKER SWEEP the CW MARKER is available. Amplitude or intensity markers available.

**Marker output:** rectangular pulse, typically  $-5$  volts peak, available from Z-axis BNC connector on rear panel.

### Sweep and Trigger Modes

**Internal:** sweep recurs automatically.

**Line:** sweep triggered by ac power line frequency.

**External trigger:** sweep actuated by external signal.

**Single:** selects mode and triggers a single sweep.

**Sweep time:** continuously adjustable from 10 ms to 100 seconds.

**Sweep output:** direct-coupled sawtooth, zero to approximately  $+10$  volts, concurrent with swept RF output.

**Remote Control:** band can be selected remotely by three binary contact closure lines available at rear panel connector.

### HP-IB Frequency Programming, Option 011

#### Functions

**Band:** manual enable or remote control of up to four bands.

**Modes:** seven modes are selectable, including digital control in three modes with a resolution of 10,000 points.

#### HP-IB interface functions

SH0, AH1, T0, L2, SR0, RL2, PP0, DC0, DT0, C0, E1.

**Size:** 132.6 mm H x 425 mm W x 337 mm D (5.29" x 16.75" x 13.25").

### Ordering Information

HP 8620C Sweep Oscillator Mainframe  
Opt 011: HP-IB Frequency Programming  
Opt 007: Rear Sweep Out  
Opt 820: 8410C Interface Cable  
Opt W30: Two Years Extended Service

**Price**  
\$4,000  
add \$955  
add \$75  
add \$50  
add \$100

# SWEEP OSCILLATORS

## Model 8620 Series: Mainframe (cont'd)

### Model 8620C

HP 86200 Series Plug-ins: Specifications Summary	Broadband		Straddle-Band					Single-Band						
	HP 86222B <sup>1</sup>	HP 86290B <sup>2</sup>	HP 86240A	HP 86240B	HP 86240C	HP 86251A	HP 86251A	HP 86251A	HP 86252D	HP 86253A	HP 86290D	HP 86290B	HP 86290A	HP 86290C
<b>Frequency Characteristics</b>														
Range (GHz)	0.01-2.4	2.0-18.6	2.0-8.4	2.0-8.4	3.6-8.6	7.5-18.6	1.7-4.3	3.2-6.5	5.9-9.0	5.9-12.4	8.0-12.4	10.0-15.5	12.4-18.0	17.0-22.0
Accuracy (MHz, 25°C)														
CW Mode	±10	±30	±25	±25	±25	±60	±20	±30	±35	±40	±40	±50	±50	±50
Remote Programming, typical	±1.5	±2.5	±3.5	±3.5	±3.5	±20	±2.5	±10.5	±5.0	±20	±20	±25	±25	±25
All Sweep Modes (sweep time >100 ms)	±15	±40	±40	±50	±35	±60	±30	±33	±40	±50	±50	±70	±70	±70
Residual FM (kHz peak, 20 Hz-15 kHz bandwidth)	<5	<25	<25	<25	<15	<15	<15	<7	<7	<30	<9	<9	<9	<20
<b>Output Characteristics</b>														
Maximum Leveled Power (mW, 25°C)	>20	>10	>40	>20	>40	>10	>40	>5	>10	>50	>10	>10	>10	>10
Power Variation (dB, at max specified power)														
Internally Leveled	±0.25	±0.7	±2	±2	±2	±0.8	±2	±0.8	±0.5	±0.6	±0.5	±0.7	±0.7	±0.7
Externally Leveled (excluding coupler and detector variations)	±0.1	±0.15	±0.1	±0.1	±0.1	±0.15	±0.1	±0.1	±0.1	±0.1	±0.1	±0.1	±0.1	±0.1
Spurious Signals (dBc, at max specified power)														
Harmonically Related	<-25	<-25	<-16	<-45	<-16	<-35	<-20	<-16	<-30	<-17	<-30	<-25	<-25	<-25
Non-harmonics	<-25	<-50	<-60	<-60	<-60	<-50	<-60	<-60	<-60	<-60	<-60	<-50	<-50	<-50
Source SWR (50 ohms nominal, internally leveled)	<1.5	<1.9	<1.6	<1.6	<1.6	<1.9	<1.6	<1.6	<1.6	<1.6	<1.6	<1.6	<1.6	<1.6
<b>Modulation Characteristics</b>														
<b>External Pulse</b>														
Rise/Fall Time, typical (ns)	n/a	n/a	20	20	20	n/a	20	n/a	n/a	n/a	n/a	n/a	n/a	n/a
On/Off Ratio (dB)			40	40	40		40							
For input (volts)			+6	+6	+6		+6							
<b>External FM<sup>3</sup></b>														
Maximum Deviation (MHz)														
DC to 100 Hz Rates	±75	±75	±75	±75		±75	±75	±25	±150	±150	±150			
100 Hz to 1 MHz Rates	±5	±5	±5	±5	MLA <sup>4</sup>	±5	±5	±2	±15	±15	±15			
1 MHz to 2 MHz Rates	±2	±5	±2	±2		±5	±2		±5	±5	±5			
DC to 200 Hz Rates												±75	±75	±75
200 Hz to 200 kHz Rates												±5	±5	±5
Sensitivity, nominal (MHz/volt)	-20/-6	-20/-6	-20/-6	-20/-6	-20/-6	-20/-6	-20/-6	-6	-20/-6	-20/-6	-20/-6	-20/-6	-20/-6	-20/-6
<b>External AM</b>														
<b>Linear Mode</b>														
Frequency Response, Typical (kHz)	150	300	50	50	50	300	50	30	30	30	30	300	300	300
Attenuation (dB), typical, For input (volts)	>30	>30	>30	>30	>30	>30	>30	>25	>20	>20	>20	>25	>25	>25
Square Wave Mode On/Off Ratio (dB), For input (volts)	n/a	>30	n/a	n/a	n/a	>30	n/a	n/a	>40	>40	>40	n/a	n/a	n/a
Compatible with HP 8757/8756 Mod Drive signal	Yes	Yes	Yes	Yes	Yes	Yes	Yes	No	Yes	Yes	Yes	No	No	No
<b>Internal AM</b>														
1 kHz Square Wave On/Off Ratio (dB)	>30	>25	>40	>40	>40	>25	>40	>25	>40	>40	>40	>25	>25	>25
<b>Prices</b>														
Plug-in	\$7,000 (86222A: \$6,000)	\$15,600 (86290C: \$20,000)	\$6,600	\$7,800	\$7,600	\$11,000	\$5,400	\$4,700	\$5,600	\$8,100	\$5,500	\$6,700	\$6,500	\$9,500
With Opt 002 (70 dB Attenuator)	+ \$750	n/a	+ \$905	+ \$905	+ \$905	n/a	+ \$850	n/a	n/a	n/a	n/a	n/a	n/a	n/a
With Opt 004 (Rear Panel RF Output)	+ \$200	+ \$200	+ \$200	+ \$200	+ \$200	+ \$200	+ \$200	+ \$200	+ \$200	+ \$200	+ \$200	+ \$200	+ \$200	+ \$200

<sup>1</sup>HP 86222A specifications identical to HP 86222B, except that the HP 86222B has 1, 10, and 50 MHz crystal markers which allow enhancement of frequency accuracy to better than ±200 kHz.

<sup>2</sup>HP 86290C specifications identical to HP 86290B, except that the HP 86290C has maximum leveled power >20 mW. HP 86290B specifications listed apply to frequencies 6 to 12.4 GHz.

<sup>3</sup>Many HP 86200 series plug-ins have optional Microwave Link Analyzer (MLA) compatibility capabilities, see page 487 for details.

- 2 GHz to 8 GHz wideband frequency coverage
- 40 milliwatts (+16 dBm) output power
- Adjustable, calibrated power level

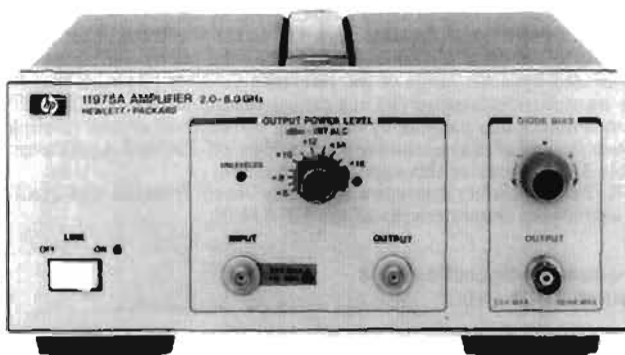

HP 11975A

### Convenient Microwave Amplifier

The HP 11975A is a general purpose microwave amplifier that offers versatility, convenience, and reliability at an economical price. Combining state-of-the-art GaAs FET technology with a regulated power supply and control circuits makes this amplifier a complete tool for lab and production.

### Broadband, Leveled Power

The amplifier delivers up to 40 milliwatts (+16 dBm) of leveled power for broadband input signals from 2 to 8 GHz. With  $\pm 1$  dB frequency response and  $\pm 2$  dB absolute power accuracy, the HP 11975A provides calibrated power for fixed or swept frequency needs.

### Versatile Features

The HP 11975A has many features designed for general-purpose use:

- Automatic level control (ALC):** output power is normally leveled unless the ALC switch (rear panel) is OFF or less than the minimum input power required for leveling is available. An "unleveled" light indicates the non-ALC condition.
- Adjustable output power:** calibrated output power can be adjusted from +6 to +16 dBm. An "uncalibrated" light indicates when greater than +16 dBm is present at the output connector.
- Diode bias:** positive or negative bias current needed for some harmonic mixers is provided by a separate connector and control knob.

### Applications

- The HP 11975A supports many general-purpose testing needs:
- As an LO booster and isolation amplifier, the HP 11975A improves mixer performance and testing.
- As a pre-amplifier, the HP 11975A increases counter sensitivity and improves spectrum analyzer noise figure.
- As an LO line driver for a harmonic mixer (such as an HP 11517A or HP 11970), the HP 11975A increases sensitivity, improves frequency response, and reduces gain compression.

### Specifications

#### Frequency Specifications

**Frequency range:** 2.0 to 8.0 GHz in one band.

#### Output Specifications

##### Distortion

- Harmonics (2nd and 3rd):**  $< -20$  dBc for  $P_{out} \leq +16$  dBm.
- Non-harmonics:**  $< -60$  dBc typical for  $P_{out} \leq +16$  dBm.
- Third order intercept (ALC OFF):** +25 dBm typical.
- 1 dB gain compression (ALC OFF):** +18 dBm typical.
- Noise figure:** 13 dB typical.

##### Output Power (ALC ON)

**Power level control:** single-turn knob with 11 calibrated divisions in 1 dB steps; spring-loaded detent for uncalibrated power above +16 dBm.

- Automatic level control (ALC)
- Diode bias supply for harmonic mixers

**Power range:** +6 dBm to +16 dBm.

**Absolute power accuracy:**  $\pm 2.0$  dB;  $\pm 1.5$  dB typical.

**Frequency response:**  $\pm 1.0$  dB;  $\pm 0.5$  dB typical.

**Uncalibrated power range:** +16.75 dBm to +19 dBm typical; uncalibrated light warns of high level.

**Reverse isolation:**  $> 40$  dB typical at +16 dBm output.

#### Output Connection

**Connector:** SMA female.

**Impedance:** 50 ohm nominal.

**SWR:** 1.7:1, ALC ON; 2.5:1 typical, ALC OFF.

**Short circuit protection:** continuous.

#### Input Specifications

**Minimum input power:** minimum power for leveling.

**Small signal gain:** gain with less than minimum input for leveling or with ALC switch OFF (rear panel).

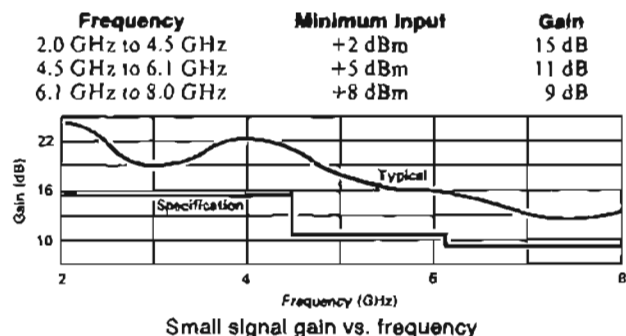

#### Input Connection

**Connector:** SMA female.

**Impedance:** 50 ohm nominal.

**SWR (ALC OFF):** 2.7:1 typical.

**Maximum input:** = +30 dBm (1 watt);  $\pm 35$  Vdc.

#### Diode Bias Specifications

**Bias control:** five-turn knob for positive and negative current adjustment with 10  $\mu$ A resolution.

**Current range:** 0 to  $\pm 10$  mA typical for single-diode load.

#### Output Connection

**Connector:** BNC female.

**Maximum voltage:**  $\pm 3$  Vdc typical.

**Short circuit protection:**  $\leq 11$  mA @ 25° C.

#### General Specifications

**Power requirements:** 100, 120, 220, or 240 Vac (user selectable), +5%, -10%; 48 to 440 Hz; less than 36 VA; convection cooled.

**Environmental:** per MIL-T-28800C, Type III, Class S, Style E.

**Temperature:** operating 0° to +55° C; storage -40° to +75° C.

**EMI:** conducted and radiated interferences are in compliance with methods CEO3 and REO2 of MIL STD 461A and CISPR Pub. 11 (1975).

**Weight:** net, 3.04 kg (6.8 lb). Shipping, 5.45 kg (12.2 lb).

**Size:** 102 H  $\times$  213 W  $\times$  297 mm D (4.0"  $\times$  8.4"  $\times$  11.7").

#### Ordering Information

- HP 11975A Amplifier
- Opt 001: Type N Female Connectors
- Opt 907: Front Handles
- Opt 910: Extra Operating and Service Manual
- Rack Mounting Kit: (HP P/N 5061-0072)
- Fast-Ship product—see page 758.

**Price**  
 \$4,275  
 add \$100  
 add \$50  
 add \$5  
 add \$53

# AMPLIFIERS

## Microwave Amplifier

### Model 8349B

- Continuous 2 to 20 GHz coverage
- 15 dB gain to 18.6 GHz



HP 8349B

The HP 8349B Microwave Amplifier delivers increased microwave power performance across a 2 to 20 GHz frequency range. This general-purpose broadband power amplifier is designed for maximum reliability and configured for the greatest convenience in interfacing with Hewlett-Packard's microwave sources, the HP 8350B or HP 8620C Sweep Oscillators, HP 8340B/8341B Synthesized Sweepers, and HP 8671B, 8672A, or 8673 series Synthesized Signal Generators.

Providing 100 mW (+20 dBm) of unlevelled output power from 2 to 18.6 GHz, 63 mW (+18 dBm) from 18.6 to 20 GHz, the HP 8349B offers one of the broadest operating bandwidths available from a solid-state power amplifier. This performance is achieved using a multiple stage GaAs FET design, resulting in >15 dB of gain from 2 to 18.6 GHz, and >12 dB of gain from 18.6 to 20 GHz.

The HP 8349B can also provide externally leveled output power without using an external coupler and detector, since these components are built-in and are compatible with Hewlett-Packard microwave sources. The HP 8349B is also equipped with an output power display, minimizing the need for an external power meter and enhancing the amplifier's utility. For example, the HP 8349B can be placed at the end of a long RF cable where the microwave output needs to be amplified, leveled and monitored.

Naturally, the versatile power control features of the microwave source (e.g., calibrated power, power sweep, power slope and remote power control via the Hewlett-Packard Interface Bus) can be accurately transmitted through the HP 8349B during external leveling operations.

The HP 8349B also has a built-in source module interface, enabling it to properly bias and control the HP 83550 series millimeter-wave source modules. Using the HP 8349B and a millimeter source module extends the capabilities of any 1) to 20 GHz HP microwave source to millimeter-wave frequencies.

### Applications

The broadband high power of the HP 8349B is ideal, whether in a versatile bench-top arrangement or a dedicated rack-mount system. In antenna testing, the HP 8349B can be placed at the end of long RF cables, delivering high power right to the device under test. In EW/ECM systems, the HP 8349B can be combined with the HP 8340B/8341B, or the HP 8673 series Synthesized Signal Generators to provide high power pulses with little degradation in pulse performance. The HP 8349B is also an excellent choice as a microwave driver for TWTs, high power amplifiers, or mixers. And with a typical noise figure <13 dB, the HP 8349B is often used as a pre-amplifier for spectrum analyzers and frequency counters.

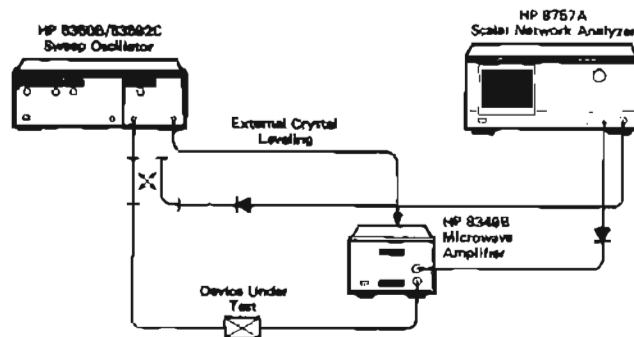

Extended Dynamic Range Configuration

- 100 milliwatts across 2 to 18.6 GHz
- <13 dB typical noise figure

The dynamic range of a scalar network analyzer measurement system is limited by the maximum output power of the microwave source and the sensitivity of the detectors. Using the illustrated configuration, up to 100 dB of dynamic range can be achieved by combining the calibrated dynamic range of the reference detector (R) with that of the transmission detector (B) in a ratio measurement (B/R). The HP 8349B makes this possible by extending the external crystal leveling power control of the microwave source. Hewlett-Packard Application Note 327-1 discusses this application in detail.

RFI susceptibility tests can also greatly benefit from the high quality amplifying characteristics of the HP 8349B.

### Frequency Specifications

Range: 2.0-20 GHz

### Output and Input Specifications (25°C ±5°C)

Minimum Output Power (at +5dBm input):

Frequency Range (GHz)	Output	
	Leveled	Unleveled
2.0 to 18.6	19 dBm (80mW)	20 dBm (100mW)
18.6 to 20.0	17 dBm (50mW)	18 dBm (63mW)

1 dB Compression Point: +21 dBm, nominal

Power Flatness (Leveled): ±1.25 dB

Minimum Small Signal Gain (at -5 dBm input):

2.0 to 18.6 GHz: 15dB

18.6 to 20.0 GHz: 12dB

Noise Figure: <13 dB, typical

Impedance (Input and Output): 50 ohms, nominal

VSWR:

Frequency Range (GHz)	Input	Output	
		Leveled	Unleveled (typical)
2.0 to 5.0	≤2.8	≤2.5	≤4.8
5.0 to 11.0	≤2.8	≤2.5	≤3.8
11.0 to 18.0	≤2.8	≤2.5	≤3.2
18.0 to 20.0*	≤2.8	≤2.5	≤3.2

\*SWR from 18.0 to 20.0 GHz is typical

Maximum Continuous Input, to the input or output ports:

+27 dBm (RF), ±10V (DC)

### Spectral Purity

Harmonics (at +20 dBm output):

2.0 to 11.0 GHz: <-20 dBc

11.0 to 20.0 GHz: <-30 dBc typical

Non-Harmonic Spurious: ≤-55 dBc.

Third Order Intercept: +33 dBm, nominal.

### Pulse Transmission Capability

Rise/Fall Time: <10 ns typical

### General

Reverse Isolation: >50 dB, typical

RF Input/Output Connectors: Type N Female

Size: 133 H x 214 W x 366 mm D (5.2" x 8.36" x 13.6").

Weight: Net, 7 kg (15 lb); shipping, 14 kg (31 lb).

### Ordering Information

HP 8349B 2 to 20 GHz Microwave Amplifier

Opt 001 Rear Panel RF Input/Output

Opt 002 Rear Panel RF Input with Front Panel RF Output

Opt 010 Extra Service Manual

Price

\$7,850

add \$100

add \$100

add \$15

- Wide band (multi-decade)
- Low noise
- Flat response



HP 8447D

The HP 8447 series of general-purpose amplifiers offers high reliability and the convenience of a small, lightweight package.

### High Performance

These low noise, high gain amplifiers provide the flat frequency response and low distortion required for a wide range of uses. They can be used to improve the sensitivity of counters, spectrum analyzers,

RF voltmeters, EMI meters, power meters, and other devices; or to increase the maximum power available from a signal generator or sweeper.

### Broadband Frequency Coverage

The HP 8447 series offers an amplifier for nearly every application in the 100 kHz to 1.3 GHz frequency range. The amplifiers' wide bandwidths are compatible with other wideband instruments used for making measurements involving broadband spectra.

### Options

Standard connectors are BNC (f) on all amplifiers.  
 Option 010 ..... N (f) connectors on single channel amplifier.  
 Option 001 ..... Dual channel amplifier, BNC (f) connectors.  
 Option 011 ..... Dual channel amplifier, N (f) connectors.  
**Note:** dual-channel amplifiers are ideal for dual-channel systems such as oscilloscopes or network analyzers. Channels may also be cascaded for increased small-signal gain.

### General

**Weight:** net, 1.56 kg (3.4 lb). Shipping, 2.30 kg (5.1 lb).  
**Size:** 85.8 H x 130 W x 216 mm D (3.4" x 5.1" x 8.5").  
**Power requirements:** 110 or 230 V ac  $\pm$  10%, 48-440 Hz, 15 watts.

### Ordering Information

	Price
HP 8447A Preamp	\$1225
Opt 910: Extra Operating and Service Manual (HP 8447A)	\$2
HP 8447D Preamp	\$1325
HP 8447E Power Amp	\$1530
HP 8447F Preamp-Power Amp	\$2295
Opt 910: Extra Operating and Service Manual (HP 8447D/E/F)	\$4

### Specifications

	HP 8447A Preamp	HP 8447D Preamp	HP 8447E Power Amp	HP 8447F Preamp-Power Amp
Frequency Range	0.1-400 MHz	100 kHz-1.3 GHz	100 kHz-1.3 GHz	100 kHz-1.3 GHz
Typical 3 dB Bandwidth	50 kHz-700 MHz	75 kHz-1.7 GHz	75 kHz-2.0 GHz	50 kHz-1.4 GHz
Gain (Mean, per channel)	20 dB $\pm$ 1.0 dB at 10 MHz	>26 dB (20°C-30°C)	22 dB $\pm$ 1.5 dB (20°C-30°C)	
Gain Flatness Across Full Frequency Range	$\pm$ 0.7 dB	$\pm$ 1.5 dB	$\pm$ 1.5 dB	-HP 8447D AND 8447E COMBINED IN A SINGLE PACKAGE
Noise Figure	<6 dB	<8.5 dB	<11 dB typical	
Output Power for 1 dB Gain Compression	>+6 dBm	>+7 dBm typical	>+13.5 dBm <1 GHz	
Harmonic Distortion	-32 dB for 0 dBm output	-30 dB for 0 dBm output (typical)	-30 dB for +8 dBm output	
Typical Output for <-60 dB Harmonic Distortion	-25 dBm	-30 dBm	-20 dBm	
VSWR	<1.7	<2.0 input <2.5 output 1-1300 MHz	<2.2 input <2.5 output 1-1300 MHz	
Impedance	50 $\Omega$	50 $\Omega$	50 $\Omega$	
Reverse Isolation	>30 dB	>40 dB	>40 dB	
Maximum DC Voltage Input	$\pm$ 10 V	$\pm$ 10 V	$\pm$ 10 V	
Options Available	001	001, 010, 011	010	
Option Prices	add \$600	add \$650, \$100, \$1000	add \$100	add \$385

# FREQUENCY, FUNCTION & WAVEFORM SYNTHESIZERS

## General Information

### Introduction

Hewlett-Packard offers a wide variety of signal sources for almost any application, including function generators and frequency or waveform synthesizers. Output frequencies range from 1  $\mu$ Hz to 80 MHz.

For higher-frequency applications, refer to the "Signal Generators" and "Sweep Oscillators" sections of this catalog.

### Signal Quality

The common specifications that describe signal sources include frequency range and resolution, amplitude range and resolution, distortion and stability.

Additional specifications that are pertinent to the synthesizer are phase noise and spurious content. Phase noise describes the short-term frequency stability of a signal source. It is typically specified as single side-band spectral density or integrated (total) phase noise. Spurious signals are discrete, nonharmonically related signals appearing in the output.

### Sweep Capability

The HP 3314A, 3325A, 3326A, 3335A and 3336A/B/C are exceptionally linear sweepers. Keyboard control of microprocessors gives these instruments digital control of sweep start/stop frequencies and sweep times. Log sweep is also available on many models.

### Synthesizers

Hewlett-Packard offers a wide range of high quality frequency synthesizers and synthesized signal generators covering the frequency range of dc to 26 GHz. In addition to being high performance synthesized signal sources, they incorporate many additional features which allow them to fulfill the needs of either bench or programmable applications.

### Frequency Synthesis Techniques

Traditional approaches to indirect synthesis techniques require a phase-locked loop for every decade of frequency resolution. This method provides adequate performance, but many component parts leads to an expensive product. However, a new technique has been



Source Summary

Type	HP Model	Frequency Range	Page
Function Generator	3312A	1 $\mu$ Hz to 100 MHz	412
	3314A		413
Pulse/Function Generator	8111A	10 Hz to 10 MHz	411
	8116A		409
Arbitrary Waveform Generator Opt. 002	8770A (DC)	10 Hz to 10 MHz	364
	8175A (DC)		406
Synthesizer/Function Generator	3325A (DC)	10 Hz to 10 MHz	400
	3326A (DC)		402
	8165A		408
Synthesizer/Level Generator	3335A	10 Hz to 10 MHz	404
	3336A/B/C		405 & 482

developed by Hewlett-Packard that allows a single phase-locked loop to offer multidigit resolution. The process is called Fractional Frequency Synthesis or Fractional N—a method of relating the VCO frequency to the crystal reference by other than an integer N. Up to 11 digits of frequency resolution can be achieved from a single phase-locked loop with this new technique. Significant cost savings and increased reliability result.

### Frequency Synthesizers

Today's measurement needs are placing increasingly stringent requirements on signal sources for greater frequency resolution and stability. Narrowband component testing, satellite and terrestrial communications, local oscillator and automatic test systems are only a few of the many applications that continually require higher precision sources.

### Synthesizer Summary

HP Model	Frequency Range	Frequency Resolution	Frequency Stability	Level Range dBm - 50 $\Omega$	Level Resolution	Remote Control	Other Features*	Page
3325A**	DC-21 MHz (sine) DC-11 MHz (square)	0.000001 Hz or 0.001 Hz (11 digits)	$5 \times 10^{-11}$ /yr	-56.02 to +23.98 (sine)	0.01 dB or 0.001 mV to 0.01 V (4 digits)	All functions	4, 6, 7, 8	400
3326A	DC-13 MHz	0.000001 Hz or 0.001 Hz (11 digits)	$5 \times 10^{-11}$ /yr	-56.02 dBm to +23.98 dBm	0.01 dB or 0.001 mV to 0.01 V (4 digits)	All functions	4, 6, 7, 8, 11	402
8904A	DC-600 kHz	0.1 Hz	50 ppm	140 $\mu$ V-10Vp-p	3 1/2 Digits	All functions	3, 8, 9, 10, 12	398
3335A	200 Hz-80 MHz	0.001 Hz	$10^{-10}$ /day	-87 to +13	0.01 dB (4 digits)	All functions	1, 2, 4	404
3336A/B/C	10 Hz - 21 MHz	0.001 Hz or 11 digits	$1.5 \times 10^{-10}$ /day	-71 to +8	0.01 dB	All functions	4, 6, 7, 8	482, 405
8165A	1 MHz to 50 MHz	4 digits	$1 \times 10^{-10}$ /day	1.0 mV to 20 Vp-p	3 digits	Modulation & trigger	2, 4, 5	408

\* Other features: (1)  $5 \times 10^{-10}$ /day, (2) digital freq. sweep, (3) internal AM/FM,  $\theta$ M, (4) HP-IB, (5) external AM & FM, (6)  $5 \times 10^{-10}$ /week stability optional, (7) external AM &  $\theta$ M, (8) phase-continuous sweep, (9) independent and simultaneous A, FM, PM and pulse modulation, (10) harmonically-related spurious  $< -60$  dBc, (11) The HP 3326A is a two-channel synthesizer with internal modulation, square waves, discrete (user-defined) frequency sweep, and four operating modes including two-phase, two-tone, pulse, and two-channel. (12) The HP 8904A is a multiple function generator and a four channel, two output synthesizer with digital channel summation and modulation.

\*\* The HP 3325A Synthesizer/Function Generator includes squarewaves, positive and negative ramps, and triangle waveforms in addition to sinewaves.

**FUNCTION GENERATOR SUMMARY**

Function Generators	Arbitrary Waveform/Function Generators					Pulse/Function Generators		Synthesizer/Function Generators		
	HP Models	3312A	3314A	8175A	8904A	8770A	8111A	8116A	3325A	3326A
Frequency Min Max	0.1 Hz 13 MHz	1.0 MHz 20 MHz	DC 25 MHz	0.1 Hz 600 kHz-sine 50 kHz-square, ramp, triangle	DC 50 MHz	1.0 Hz 20 MHz	1.0 MHz 50 MHz	1 $\mu$ Hz 21 MHz-sine 11 MHz-square 11 kHz-triangle	DC 13 MHz	1 MHz 50 MHz 20 MHz-
Waveforms (symmetry)	20-80%	5-95%	Full Arbitrary Waveform	50% 50%, 0-100% with 001 1.7 s 50%	Full Arbitrary Waveform	10-90%	10-90%	50%	50%	50%
Sine	20-80%	5-95%				10-90%	10-90%	50%	1-99%	20, 50, 80%
Square	<20 ns	<9 ns				<10 ns	<6 ns	<20 ns	<15 ns	<5 ns
Transition time	20-80%	5-95%				10-90%	10-90%	50% + ramp	-	20, 50, 80%
Triangle										
Output (into 50 Ohms)										
Amplitude (o-p)	10 V	10 V	16 V	10 V	2 V	16 V	16 V	10 V	10 V	20 V
DC Offset	$\pm 5$ V	$\pm 5$ V	$\pm 8$ V	$\pm 5$ V	-	$\pm 8$ V	$\pm 8$ V	$\pm 5$ V	$\pm 5$ V	$\pm 5$ V
Output Impedance- $\Omega$	50	50	50	50	50	50	50	50	50	50/1000
Modes										
Counted Burst	-	1 to 1999		Creates signals from six basic waveforms	Full Arbitrary Waveform	1 to 1999	1 to 1999	-	-	1 to 1999
Gate	int/ext	int/ext	Full Arbitrary Waveform		Full Arbitrary Waveform	ext	ext	-	-	ext
Phase Lock	-	$\pm 200$ deg				-	-	-	-	ext
Trigger	int/ext	int/ext				ext	int/ext	-	int/ext	ext
Arbitrary	-	150 vectors				-	-	-	-	-
Modulation/Sweep										
AM	int/ext	ext	Full Arbitrary Waveform	int	Full Arbitrary Waveform HP 11775A	-	ext	ext	int/ext	option
FM	int/ext	ext				-	ext	PM	int/ext	ext
PWM	-	-				-	ext	-	ext	-
VCO	int/ext	ext				ext	ext	-	-	ext
Lin Sweep	int/ext	int				-	-	int	int	-
Log Sweep	-	int				-	option	int	discrete	option
Programmability	-	HP-IB	HP-IB	HP-IB	HP-IB	-	HP-IB	HP-IB	HP-IB	HP-IB
Catalog page	412	413	406	398	364	411	409	400	402	408
Notes	50% above 1 MHz	also 1/2 cycle bursts	2 analog outputs, dig./analog signals simultaneously	4 internal channels. One is modulated or sequenced	Requires HP Series 200 Controller	50% above 1 MHz	20-80% above 1 MHz	40 Vp-p to 1 MHz option	two channel synthesizer	

Square waves, triangle waves, and pulses are signals typically associated with non-synthesized sources. This situation is changing. Precision signals of these types are finding important applications in mechanical, civil and environmental engineering.

Increased amplitude accuracy and resolution are also requirements in many applications. The telecommunications industry's Frequency Division Multiplex (FDM) systems require high amplitude accuracy and resolution (0.01 dB) as well as high frequency resolution and stability. These requirements are becoming commonplace in R&D and production test environments.

**Synthesized Level Generators**

The HP 3335A is a synthesized level generator covering the range of 200 Hz to 80 MHz. This instrument is ideal as a stand-alone generator with synthesizer stability or as a companion generator for the HP 3745A/B SLMS and HP 3586A/B/C Selective Level Meters. It offers the traditional range of connectors and output impedances, balanced and unbalanced, required by the telecommunications industry. The HP 3336A/B/C is a 21-MHz synthesized level generator with a similar set of telecommunications features. It, too, is ideal as a stand-alone generator or as a companion for HP's 3586A/B/C Selective Level Meters. For more information on these generators, refer to the Telecommunications section of this catalog.

**Function Generators**

The function generator is a versatile, multi-waveform signal source capable of very wide frequency coverage.

The HP 3312A, HP 3314A and HP 3325A offer a complete set of functions including sine, square, triangle, ramp and even arbitrary waveforms (HP 3314A). For extended pulse capabilities, the HP 8111A and HP 8116A Pulse/Function Generators include precise timing waveforms.

In addition to this complete set of waveforms, Function Generators include versatile modulation capabilities such as amplitude, frequency, phase, pulse width and VCO control.

**Synthesizer/Function Generator**

The HP 3325A is a function generator whose functions are derived from a primary synthesized oscillator. It provides a high purity synthesized sine wave from 0.000001 Hz to 21 MHz, precision square waves to 11 MHz, linear ramps and triangle waveforms to 11 kHz, 11 digit resolution (1  $\mu$ Hz < 100 kHz), wideband phase-continuous sweep, and HP-IB programmability. The low price makes the HP 3325A an excellent choice for automatic test systems or bench applications.

The HP 3326A is a two-channel synthesizer with internal modulation, sine and square waves, and four operating modes including two-phase, two-tone, two-channel, and pulse. Discrete sweep and nonvolatile storage of instrument states make the HP 3326A an ideal choice for ATE applications, where high-performance and versatility are important.

**Arbitrary Waveform Synthesizer**

The HP 8770A Arbitrary Waveform Synthesizer provides completely arbitrary waveforms from DC-50 MHz. It offers 12-bit amplitude resolution on 125 million samples per second. Waveforms are constructed using an HP 9000 Series 200 or 300 Desktop Computer and HP 11776 Waveform Generation Software. For more information, see the "Signal Generators" section of this catalog.

**Multifunction Synthesizer**

The new HP 8904A Multifunction Synthesizer digitally creates a multitude of complex signals from six simple waveforms. It begins with a synthesizer/function generator with sinewaves to 600 kHz; square, ramp, and triangle waveforms to 50 kHz; and dc and noise. An option then adds another output for a second synthesizer. The most distinctive option is the addition of three synthesizers or channels which can either modulate the first synthesizer or be summed to the output. Modulation capabilities include AM, FM, OM, DBS, and pulse. With these multiple combinations, digitally precise signals can be generated for specific applications such as VOR, FM stereo and communications signalling.

**Analog/Digital Arbitrary Waveforms**

For applications requiring simultaneous generation of analog arbitrary waveforms and their digital equivalents, see the HP 8175A Digital Signal Generator, Option 002.

# FREQUENCY, FUNCTION & WAVEFORM SYNTHESIZERS

## Multifunction Synthesizer

Model 8904A

- Sinewaves dc to 600 kHz
- Square, ramp, triangle dc to 50 kHz
- Direct digital synthesis
- Tone, DTMF, digital sequence modes
- One or two outputs
- One to four internal channels
- AM, FM,  $\theta$ M, DSBSC and pulse modulation
- External timing control for fast hop



HP 8904A

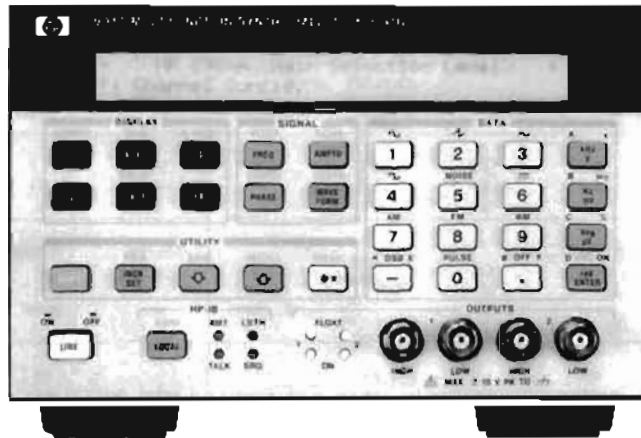

### HP 8904A Multifunction Synthesizer

The HP 8904A Multifunction Synthesizer uses the latest VSLIC technology to create complex signals from six fundamental waveforms. The standard HP 8904A digitally synthesizes precise sine, square, triangle, ramp, white noise, and dc waveforms and routes these signals to a single output. Option 001 adds three more identical internal synthesizers (channels) which either can modulate the first synthesizer or be summed to the output. Frequency, amplitude, waveform, phase, and destination can be set independently for each synthesizer. Available modulation types for channel A include AM, FM,  $\theta$ M, DSBSC, and pulse modulation. Option 002 adds a second output, providing a second, separate signal for two-channel applications. Option 003 adds fast hop and digital modulation capability to the HP 8904A. All this unique capability makes the HP 8904A a powerful new tool for demanding applications like VOR, ILS, FM Stereo, and communications signaling.

#### Function Synthesizer

The HP 8904A Multifunction Synthesizer delivers synthesizer accuracy, along with six waveforms in a compact, economical package. Broad sinewave frequency coverage from 0 Hz to 600 kHz with 0.1 Hz resolution make the HP 8904A ideal for a number of low-frequency applications. In addition to sinewave generation, the HP 8904A has five other standard functions: square, triangle, ramp, dc, and Gaussian white noise. Of these five, square, ramp, and triangle functions are available from 0 Hz to 50 kHz. All waveform values in the HP 8904A are DIGITALLY calculated in real time by Hewlett-Packard's Digital Waveform Synthesis IC. The use of this chip results in signals with very well-defined accuracy and exact repeatability.

#### Two Outputs

Option 002 adds a second, identical synthesizer and floating output section to make the HP 8904A TWO synthesizers in one half-rack width instrument. Frequency, amplitude, waveform, and phase can be independently set for each of the two synthesizers.

Although both synthesizers are independent, the relative phase between the two outputs can be controlled precisely. Either synthesizer can be varied in phase from 0 degrees to 359.9 degrees with a resolution of 0.1 degree. Testing phase detectors, servo systems, shaft encoders, sonar, and other phase sensitive two-port devices is easy and accurate with the HP 8904A Option 002.

#### Complex Signal Generation

By adding three more (total of four) internal synthesizers which can modulate or be summed with synthesizer A (channel A), Option

001 is the key to complex signal generation for the HP 8904A Multifunction Synthesizer. All four internal synthesizers can be set to generate different waveforms, frequencies, amplitudes, and phase offsets at the same time. These signals then can be DIGITALLY summed before routing to the output. In addition to summing, Option 001 allows channels B, C, and D to be used as modulation sources for channel A. The allowable modulation types for channel A are: AM, FM,  $\theta$ M, DSBSC (Double Sideband Suppressed Carrier) and pulse modulation. Using summation and modulation, the HP 8904A Option 001 can generate precise VOR composite, ILS composite, and FM Stereo Multiplex composite signals. Only your imagination limits the possibilities for signal generating with the HP 8904A Multifunction Synthesizer.

#### Communication Signaling

In addition to the extra channels, Option 001 also adds three sequence modes to the HP 8904A: tone sequence mode, DTMF sequence mode, and digital sequence mode. These modes make the HP 8904A a powerful tool for generating sequences used in communications signaling. Tone sequence mode allows entry of sixteen unique sine wave tones, each with an "on-time" and "off-time". From these sixteen tones, sequences can be built up to a length of 250 tones. The minimum on and off time duration is 800  $\mu$ s with 10  $\mu$ s resolution while the maximum value is 655.35 ms. Digital sequence mode can generate digital bit streams up to 1000 bits in length. Minimum period in the digital mode is 100  $\mu$ s with 10  $\mu$ s resolution. On and off "levels" in the digital mode can be set to any value for simulating different logic families and asserted "high" or asserted "low" logic conventions. For ease of entry, data may be entered in binary, octal, or hexadecimal formats. All three modes contain extensive sequence-editing features and three control modes: single sequence, continuously repeat sequence, and manual step-through the sequence.

#### Fast Hop

Option 003 adds the ability to hop the HP 8904A in frequency, phase, and/or amplitude. Up to 16 frequency/phase/amplitude states can be entered into the "HOP RAM" memory. To hop, an external device must address the four-bit TTL-level address bus provided on the digital port connector on the rear panel. As the address supplied to the bus is varied, the HP 8904A will hop to the frequency/phase/amplitude state that corresponds to that address of the HOP RAM memory. Fast hop can be performed only on channel A. Phase continuous frequency switching can be done in as little as 8  $\mu$ s.



## HP 8904A Specifications

### Frequency

#### Range:

**Sinewave:** 0 Hz to 600 kHz.

**Square, triangle, ramp:** 0 Hz to 50 kHz.

**Resolution:** 0.1 Hz.

#### Accuracy:

**Internal 10 MHz timebase:**  $\pm 50$  ppm.

### AC Amplitude

**Range:** 0 to 10V p-p into a 50 $\Omega$  load.

**Resolution:** 3  $\frac{1}{2}$  digits.

**Accuracy (>40 mV p-p into 50 $\Omega$ ):**

**Sine:** 1%, 0.1 Hz to 100 kHz; 3%, 100 kHz to 600 kHz.

**Flatness (>830 mV p-p into 50 $\Omega$ ):**  $\pm 0.1\%$  ( $\pm 0.009$  dB), 0.1 Hz to 100 kHz.  $\pm 1.0\%$  ( $\pm 0.09$  dB), 100 kHz to 600 kHz.

### DC Amplitude

**Range:** 0 to  $\pm 10$ V open circuit.

**Resolution:** 3  $\frac{1}{2}$  digits.

**Accuracy:**  $\pm 6$  mV or  $\pm 0.6\%$ , whichever is greater.

### Spectral Purity (sine wave)

**THD+N (including spurs, amplitude >50 mV rms):**

-66 dBc rms (0.05%), 20 Hz to 7.5 kHz, 30 kHz BW.

-66 dBc rms (0.05%), 7.5 kHz to 20 kHz, 80 kHz BW.

-55 dBc rms (0.18%), 20 kHz to 100 kHz, 750 kHz BW.

*Typical THD+Noise in 80 kHz measurement BW at 5V<sub>p-p</sub> into a 50 $\Omega$  Load.*

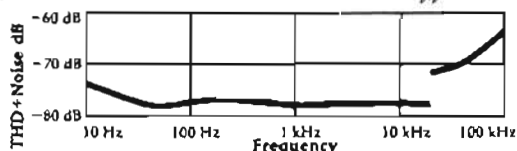

### Phase (sine wave)

**Range:** 0° to 359.9°.

**Resolution:** 0.1°.

**Increment accuracy (relative to 0° for a fixed frequency):**

$\pm 0.05^\circ$ , 0.1 Hz to 100 kHz.

### Gaussian Noise

**Spectral characteristic:** Equal energy per unit bandwidth ("white").

**Flatness (>100 mV p-p into 50 $\Omega$ ):** typically

$\pm 0.5$  dB, 0.1 Hz to 100 kHz.

$\pm 1.0$  dB, 100 kHz to 600 kHz.

### Option 001 Specifications

Modulation for channel A ONLY, and specified for sinewave carrier and modulation. Internal channels B, C, and D can be used to modulate channel A either collectively with one modulation type, or to provide simultaneous modulation of channel A with any of the available modulation types. External modulation is NOT possible.

#### Amplitude Modulation (with Option 001)

**Rate:** 0 Hz to 600 kHz.

**Depth range:** 0% to 100% of carrier amplitude.

**Resolution:** 0.1% of carrier amplitude.

#### Frequency Modulation (with Option 001)

**Range:** 0 Hz to 600 kHz.

**Deviation range:** 0 Hz to 600 kHz.

**Resolution:** 0.1 Hz or 3  $\frac{1}{2}$  digits, whichever is less.

#### Phase Modulation (with Option 001)

**Rate:** 0 Hz to 600 kHz.

**Range:** 0° to 179.9°/channel, except:

[ $(\text{mod. freq.} \times \text{deviation}/57.3) + \text{carrier freq.}$ ]  $\leq 600$  kHz.

**Resolution:** 0.1° or 0.001 radians.

### Pulse or DSBSC Modulation (with Option 001)

**Rate:** 0 Hz to 50 kHz (up 600 kHz for DSBSC).

### Summation (with Option 001)

Two, three or four channels may be summed into a single output. Two or three channels may be summed for modulation of channel A. All combinations of channels are acceptable, EXCEPT FOR: [A+C and B+D] or [A+D and B+C] at the same time.

**FM stereo multiplex separation (L-R):** typically  $> 65$  dB, audio frequency 20 Hz to 15 kHz.

**Channel to channel phase accuracy (equal amplitude sinewaves summed to one output):**  $\pm 0.1^\circ$  or 30 ns, 0.1 Hz to 100 kHz, whichever is greater.

### Tone Sequence (with Option 001)

**Number of different frequencies:** 16 user-definable tones each with an individual on time and off time.

**On/off time duration:** 0 ms, 0.80 ms to 655.35 ms.

**Sequence length:** 250 tones, user-definable from front panel or HP-IB programmable.

### DTMF Sequence (with Option 001)

**Number of tone pairs:** 16 standard DTMF tone pairs (0-9, A-D, #, \*).

**On/Off time duration:** 0 ms, 1.0 ms to 655.35 ms.

**Sequence length:** 250 DTMF tones, user-definable from front panel or HP-IB programmable.

### Digital Sequence (with Option 001)

**User definable:** On level, Off level, and period.

**Sequence entry:** Binary, Octal, or Hexadecimal.

**Sequence length:** up to 1000 bits.

**Period duration:** 0.10 ms to 655.35 ms.

### General

**Output impedance:** 50 $\Omega \pm 3\%$  typically, 0.1 Hz to 600 kHz.

**Output type:** floating or grounded, HP-IB programmable.

**Maximum float voltage (signal+float):** 10V peak maximum from high or low side to chassis ground.

**Operating temperature range:** 0° C to 50° C.

**Storage temperature range:** -20° C to 70° C.

**Humidity range:** 95% RH, 0° C to 40° C.

**Remote operation:** HP-IB. All functions except the line switch are remotely controllable.

**HP-IB functions:** SH1, AH1, T6, TE0, L4, LE0, SR1, RL1, PP1, DC1, DT0, C0.

**Power requirements:** 100V, 120V;  $\pm 10\%$ ; 48 to 440 Hz.

220V, 240V;  $\pm 10\%$ ; 48 to 66 Hz, 80 VA max.

**Weight:** Net, 5.9 kg (12.8 lb); shipping, 13 kg (28.6 lb).

**Size:** 133H X 213W X 513 mmD (5.25" X 8.36" X 20.2").

### Ordering Information

HP 8904A Multifunction Synthesizer (one output standard)	Price
<b>Opt 001</b> Add three (two when ordered with option 002) internal channels, (Channel A modulation summation, and sequence capability)	+\$1,500
<b>Opt 002</b> Add second internal synthesizer and output	+\$1,200
<b>Opt 003</b> Add fast hop and digital modulation capability	+\$500
<b>Opt 004</b> Connectors on rear panel only	+\$50
<b>Opt 910</b> Additional operating and service manual	+\$175
<b>Opt 915</b> Additional service manual	+\$125
<b>HP 8904A Retrofit Kits</b>	
<b>HP 11816A</b> Retrofit Kit for option 001	\$1,800
<b>HP 11817A</b> Retrofit Kit for option 002	\$1,450
<b>HP 11818A</b> Retrofit Kit for option 003	\$600

# FREQUENCY, FUNCTION & WAVEFORM SYNTHESIZERS

## 1 $\mu$ Hz to 21 MHz Synthesizer/Function Generator

Model 3325A

- Synthesizer
- Function generator
- Sweeper
- Programmable

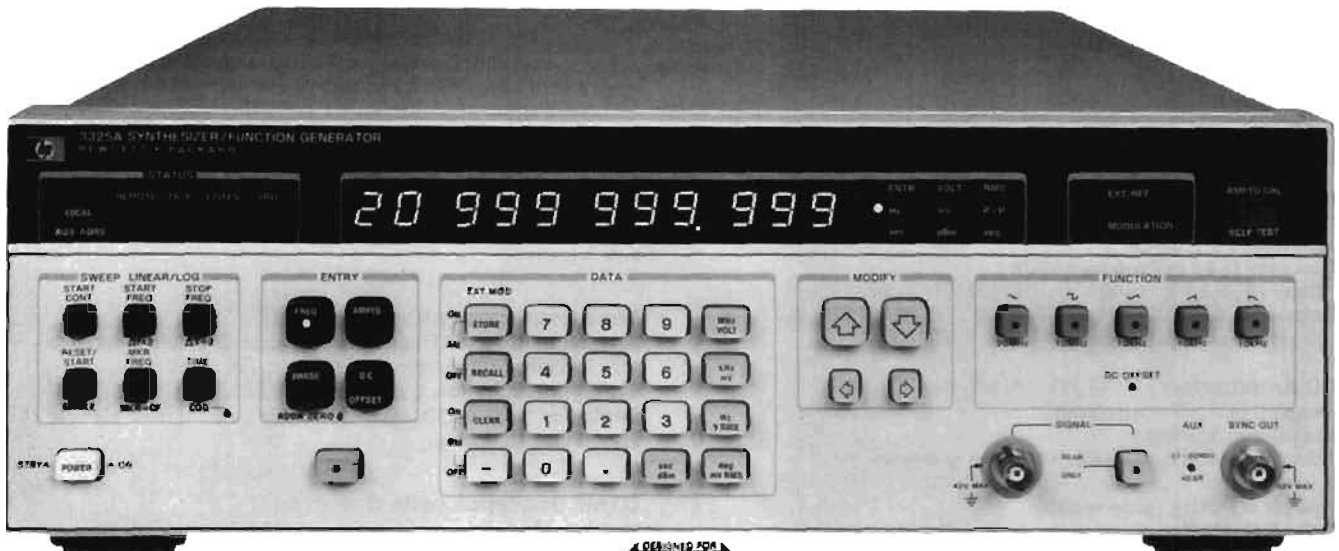

HP 3325A



### Description

The HP 3325A Synthesizer/Function Generator is an uncompromising, high performance synthesizer with 11 digit resolution, a function generator with precision waveforms, a wideband sweeper, and a fully programmable systems instrument.

### Synthesizer

The HP 3325A is first with microhertz resolution below 100 kHz along with frequency coverage from .000001 Hz to 20.999 999 999 MHz. Signal purity, accuracy and stability are as good or better than earlier stand-alone HP synthesizers. Harmonics are 65 dB down below 50 kHz and you can externally modulate with AM and PM.

### Function Generator

The HP 3325A is also a high performance function generator providing precision waveforms with synthesizer accuracy and resolution. Squarewaves to 10.999 999 999 MHz have 20 ns rise and fall times. Triangles and ramps with .05% linearity are available up to 10.999 999 999 kHz. All waveforms can be dc and phase offset.

### A Wideband Sweeper

A major contribution is wideband phase continuous sweep, covering up to the full frequency range of each waveform. Sweep log or linear, single or continuous without the phase discontinuities usually associated with synthesizers. Phase lock loop testing is made easier.

Make convenient swept frequency network measurement on filters, amplifiers or any passive or active network. Use the TTL marker to check the frequency of points of interest on a swept frequency display. Use the convenient "zoom" functions  $\Delta F \times 2$  and  $\Delta F \div 2$  to quickly change the frequency span for the display desired.

### Fully Programmable

All necessary functions are programmable on the HP-IB, including frequency, amplitude, all functions, phase and dc offset, modulation, all sweep parameters, amplitude cal and self-test, making the HP 3325A a very versatile and powerful addition to automatic test systems. The isolated interface combined with floating outputs and inputs and talk mode make the HP 3325A easy to use in Automatic Test Systems.

### More Features

The phase of the output can be changed  $\pm 719.9^\circ$  with  $0.1^\circ$  resolution. The phase is advanced (or retarded) with respect to the starting

phase. Two HP 3325A units can be phase locked together for dual phase output applications.

DC offset is capable of  $\pm 4.5$  Vdc on the standard instrument. The high voltage option (Opt 002) allows ac voltages up to 40 Vpp and ac + dc up to  $\pm 18$  V total (ac peak + dc).

Ten storage registers can be programmed with ten different combinations of function/parameter settings from the front panel, stored and then recalled.

The HP 3325A can display 11 digits of frequency and 4 digits of volts or millivolts from 1 mV to 10 volts peak to peak. Conversion to RMS or dBm is simple with the touch of a button.

### New Technology

The HP 3325A provides unprecedented performance per dollar thanks to several major contributions from advances in HP technology. A single loop Fractional-N synthesis technique allows synthesizer accuracy with 11 digits of resolution and, as an added bonus, phase continuous frequency sweep. Fewer parts and integrated circuit technology make the difference. A unique method of triangle and ramp waveform generation provides excellent linearity. Add microprocessor control and Hewlett-Packard Interface Bus (HP-IB) operation and the result is more performance, flexibility and versatility on the bench or in automatic test systems than previously available, and at a lower cost.

### Specifications

Refer to the HP 3325A data sheet for complete specifications.

### Waveforms

Sine, Square, Triangle, negative and positive Ramps.

### Frequency

#### Range

**Sine:** 1  $\mu$ Hz to 20.999 999 999 MHz

**Square:** 1  $\mu$ Hz to 10.999 999 999 MHz

**Triangle/ramps:** 1  $\mu$ Hz to 10.999 999 999 kHz

**Resolution:** 1  $\mu$ Hz,  $< 100$  kHz

1 mHz  $\geq 100$  kHz

**Aging rate:**  $\pm 5 \times 10^{-6}$ /year,  $20^\circ$  to  $30^\circ$ C

**Warm-up time:** 20 minutes to within specified accuracy

**Main Signal Output (all waveforms)**

**Impedance:** 50 Ω

**Connector:** BNC; switchable to front or rear panel, nonswitchable with option 002, except by internal cable change.

**Amplitude**

**Range:** 1 mV to 10 V<sub>p-p</sub> in 8 amplitude ranges, 1-3-10 sequence (10 dB steps), into 50 Ω load.

Function	Sine		Square		Triangle/Ramps	
	min	max	min	max	min	max
Units Displayed						
peak-peak	1.000 mV	10.00 V	1.000 mV	10.00 V	1.000 mV	10.00 V
rms	0.354 mV	3.536 V	0.500 mV	5.000 V	0.289 mV	2.887 V
dBm (50 Ω)	-56.02	+23.98	-53.01	+26.99	-57.78	+22.22

**Resolution:** 0.03% of full range or 0.01 dB (4 digits).

**Amplitude Accuracy** (without dc offset, relative to programmed amplitude and accuracy)

**Sinewave Amplitude Accuracy**

1 MHz to 100 kHz: ±0.1 dB, ≥3 V<sub>pp</sub>; ±0.2 dB, <3 V<sub>pp</sub>

100 kHz to 20 MHz: ±0.4 dB, ≥3 V<sub>pp</sub>; ±0.6 dB, 0.1 to 3 V<sub>pp</sub>

**Squarewave Amplitude Accuracy**

1 MHz to 100 kHz: 1%, ≥3 V<sub>pp</sub>; 2.2%, <3 V<sub>pp</sub>

100 kHz to 10 MHz: 11.1%, ≥3 V<sub>pp</sub>; 13.6%, <3 V<sub>pp</sub>

**Triangle Amplitude Accuracy**

1 MHz to 2 kHz: 1.5%, ≥3 V<sub>pp</sub>; 2.7%, <3 V<sub>pp</sub>

2 kHz to 10 kHz: 5%, ≥3 V<sub>pp</sub>; 6.2%, <3 V<sub>pp</sub>

**Sinewave Spectral Purity**

**Phase noise:** -60 dB for a 30 kHz band centered on a 20 MHz carrier (excluding ±1 Hz about the carrier) with high-stability option 001 installed.

**Spurious:** all non-harmonically related output signals will be more than 70 dB below the carrier (60 dB with dc offset), or less than -90 dBm, whichever is greater.

**Sinewave harmonic distortion:** harmonically related signals will be less than the following levels (relative to the fundamental) at full output for each range:

Frequency Range	Harmonic Level
0.1 Hz to 50 kHz	-65 dB
50 kHz to 200 kHz	-60 dB
200 kHz to 2 MHz	-40 dB
2 MHz to 15 MHz	-30 dB
15 MHz to 20 MHz	-25 dB

**Squarewave Characteristics**

**Rise/fall time:** ≤20 ns, 10% to 90% at full output

**Overshoot:** ≤5% of peak to peak amplitude, at full output

**Settling time:** <1 μs to settle to within .05% of final value.

**Phase Offset**

**Range:** ±719.9° with respect to arbitrary starting phase or assigned zero phase

**Resolution:** 0.1°

**Accuracy:** ±0.2°

**DC Offset**

**Range:** dc only (no ac signal): 0 to ±5.0 V/50 Ω.

dc + ac: Maximum dc offset ±4.5 V on highest range, decreasing to ±4.5 mV on lowest range.

**Resolution:** 4 digits

**Sinewave Amplitude Modulation**

**Modulation depth at full output for each range:** 0-100%

**Modulation frequency range:** dc to 400 kHz (0-21 MHz carrier frequency)

**Sensitivity:** ±5 V peak for 100% modulation

**Sinewave Phase Modulation**

**Range:** ±850°, ±5 V input

**Modulation frequency range:** dc -5 kHz

**Frequency Sweep**

**Sweep Time**

**Linear:** 0.01 s to 99.99 s

**Logarithmic:** 2 s to 99.99 s single, 0.1 s to 99.99 s continuous

**Maximum sweep width:** full frequency range of the main signal output for the waveform in use, except minimum log start frequency is 1 Hz.

**Phase continuity:** sweep is phase continuous over the full frequency range of the main output.

**Auxiliary Inputs and Outputs**

**Reference input:** for phase-locking HP 3325A to an external frequency reference signal from 0 dBm to +20 dBm into 50 Ω. Reference signal must be a subharmonic of 10 MHz from 1 MHz to 10 MHz.

**Auxiliary frequency output:** 21 MHz to 60.999 999 999 MHz, under range coverage to 19.000 000 001 MHz, frequency selection from front panel; 0 dBm; output impedance 50 Ω.

**Sync output:** square wave with V (high) ≥1.2 V, V (low) ≤0.2 V into 50 Ω.

**X-Axis drive:** 0 to >+10 V dc linear ramp proportional to sweep frequency, linearity, 10-90%, ±0.1% of final value.

**Sweep marker output:** high to low TTL compatible voltage transition at selected marker frequency.

**Z-Axis blank output:** TTL compatible voltage levels capable of sinking 200 mA from a positive source.

**1 MHz reference output:** 0 dBm output for phase-locking additional instruments to the HP 3325A.

**10 MHz oven output:** 0 dBm internal high stability frequency reference output for phase-locking HP 3325A. (Opt. 001 only)

**HP-IB interface Functions:** SH1, AH1, T6, L3, SR1, RL1, PP0, DC1, DT0, C0, E1.

**Recommended Accessory:** HP 7090A Measurement Plotting System.

**Option 001 High Stability Frequency Reference**

**Aging rate:** ±5 × 10<sup>-8</sup>/week (72-h warm up); ±1 × 10<sup>-7</sup>/month (after 15 days continuous operation).

**Ambient stability:** ±5 × 10<sup>-8</sup> (0° to +55°C).

**Warm-up time:** reference will be within ±1 × 10<sup>-7</sup> of final value 15 minutes after turn-on for an off time of less than 24 hours.

**Option 002 High Voltage Output**

**Frequency range:** 1 μHz to 1 MHz

**Amplitude**

**Range:** 4.00 mV<sub>pp</sub> to 40.00 V<sub>pp</sub> (≥500 Ω, ≤500 pF load).

**Accuracy and Flatness at Full Output**

**Sine, square, and triangle waves:** ±2% at 2 kHz

**Ramps:** ±2% at 500 Hz

**Flatness:** ±10% relative to programmed amplitude

**Sinewave distortion:** harmonically related signals will be the same as the standard instrument to 1 MHz

**Maximum output current:** 80 mA<sub>p-p</sub>.

**Output impedance:** <2 Ω at dc, <10 Ω at 1 MHz

**DC offset range:** 4 times the specified range of the standard instrument.

**General**

**Operating environment**

**Temperature:** 0°C to 55°C.

**Relative humidity:** 95%, 0°C to 40°C.

**Altitude:** ≤15,000 ft.

**Storage temperature:** -40°C to +75°C.

**Storage altitude:** ≤50,000 ft.

**Power:** 100/120/220/240 V, +5%, -10%, 48 to 66 Hz; 90 VA, 120 VA with all options; 10 VA standby.

**Weight:** 9 kg (20 lb) net; 14.5 kg (32 lb) shipping.

**Size:** 132.6 H x 425.5 W x 497.8 mm D (5.25" x 16.75" x 19.63").

**Ordering Information\***

	Price
HP 3325A Frequency Synthesizer	\$4,590
Opt. 001 High Stability Frequency Reference	\$765
Opt. 002 High Voltage Output	\$255
Opt. 907 Front Handle Kit (standalone orders P/N HP 5061-0089)	\$56
Opt. 908 Rack Flange Kit (standalone orders P/N HP 5061-0077)	\$33
Opt. 909 Rack Flange and Handle Combination Kit (standalone orders P/N HP 5061-0083)	\$82
Opt. W30 Extended Warranty	\$170

\*HP-IB cable not supplied. See page 549.

Fast-Ship product—see page 768.

# FREQUENCY, FUNCTION & WAVEFORM SYNTHESIZERS

## Two-Channel Synthesizer, DC to 13 MHz

Model 3326A



HP 3326A



The HP 3326A Two-Channel Synthesizer combines two independent synthesizers, flexible modulation, and control circuitry into a single, powerful package. This single instrument can provide precise phase offset, two-tone sweep, fast frequency switching, internal modulation, and pulse signals for bench or systems use.

### Complete Two-Phase Solution

The HP 3326A can provide two signals whose phase is adjustable and calibrated anywhere in its 13 MHz frequency range without an external phasemeter.

Self-calibration can be performed internally or externally and yields accuracy of  $\pm 0.2$  degrees below 100 kHz. Phase can be set with 0.01 degree resolution at all frequencies. Using its unique phase-calibration circuitry, calibrated multi-phase signals are easily achieved with two or more HP 3326As.

### Powerful Two-Tone Capability

The HP 3326A is the single-source answer for producing a wide variety of broadband two-tone signals. Its two channels can be offset up to  $\pm 100$  kHz, either in the CW mode or while sweeping.

Channel amplitudes and functions (sine or square) can be selected independently and provided from separate outputs or through the built-in signal combiner. Low sinewave distortion (harmonics are at least  $-70$  dBc below 100 kHz) makes low-distortion intermodulation measurements a simple task.

### Versatile ATE Source

With two complete synthesizers in a single instrument, rack space and power are conserved. Features like internal amplitude and phase modulation, two-tone, and pulse modes allow this one instrument to do the job of several sources.

All functions, modes, and parameters of the HP 3326A are completely programmable over the HP-IB. Maximum accuracy is ensured with amplitude/phase calibrations that can be enabled, disabled and initiated under remote control.

### High Performance Modulation and Pulses

Precise amplitude and phase modulation is easy with both channels of the HP 3326A. Each channel can be used with simultaneous AM and PM, or one channel can modulate the other. Amplitude modulation frequency is dc to 100 kHz and envelope distortion is better than  $-46$  dB.

In the pulse mode both pulse and pulse-complement outputs are provided. Symmetry range is 1% to 99% and is settable in 0.1% increments. In addition, both pulse amplitudes and their offsets are independently controllable.

### Other Features

The HP 3326A has a host of convenience features to speed and simplify signal generation. Nine complete setup states can be stored in nonvolatile memory, along with automatic storage of the power-off state. A discrete sweep mode is available to generate from 2 to 63

frequency pairs with dwell times individually selectable for each frequency and each channel. Several flexible triggering modes allow hardware or software triggers to initiate frequency, amplitude, or phase changes, and sweeps.

DC offset is available in all modes, and all outputs are floating. Frequency resolution is 11 digits, and all sweeps and frequency changes are phase-continuous.

### Specifications

For complete specifications refer to the HP 3326A data sheet.

### Operating Modes

**Two Channel:** Channels A and B are independent

**Two-Phase:** Channels A and B are the same frequency, with calibrated phase offset between the two signals

**Two-Tone:** Channel B frequency offset 0 to 100 kHz from channel A frequency

**Pulse:** Channel B is the complement of Channel A

### Frequency (Waveforms are Sine, Square, Pulse, and DC)

**Range:** 0 Hz to 13 MHz

**Resolution:** 1  $\mu$ Hz below 100 kHz, 1 mHz at and above 100 kHz

**Stability:**  $\pm 5 \times 10^{-6}$ /year, 20° to 30°C. See also option 001, High Stability Frequency Reference.

**Accuracy:**  $\pm 5 \times 10^{-6}$  of selected value, 20° to 30°C, at time of calibration with standard frequency reference

### Sinewave Spectral Purity

**Harmonics:** Harmonically related signals will be less than the following levels relative to the fundamental, or  $< -90$  dBm, whichever is greater:

	10 Hz	50 kHz	100 kHz	1 MHz	13 MHz
+23.98 dBm	-80 dBc	-70 dBc	-55 dBc	-30 dBc	
+13.98 dBm	-80 dBc	-80 dBc	-65 dBc	-50 dBc	
-36.02 dBm					

**Integrated Phase noise:**  $-66$  dBc (Option 001 only, for a 30 kHz band centered on a 10 MHz carrier excluding  $\pm 1$  Hz about the carrier)

### Main Signal Outputs (Channels A & B, All Waveforms Unless Noted)

**Connectors:** Front panel BNC female

**Impedance:** 50  $\Omega$ ; output may be floated to  $\pm 42$  V peak

**Sync A:** TTL level squarewave at Channel A frequency.

### Output Amplitude (Sine Mode)

**Range:** 1 mVpp to 10 Vpp in 8 ranges without DC offset. See also option 002 High Voltage Output

**Units:** Volts peak-peak, Volts rms, dBm (50  $\Omega$ ), dBV

**Resolution:** 0.1% of full range for peak-peak entry  
 0.3% of full range for rms entry  
 0.01 dB for dBm or dBV entry

**Accuracy:** Relative to programmed value after self-calibration

	0.001 Hz	100 kHz	1 MHz	13 MHz
+23.98 dBm	-----	-----	-----	-----
+3.98 dBm	±0.1 dB	±0.3 dB	±0.6 dB	-----
-36.02 dBm	±0.2 dB	±0.5 dB	-----	±0.8 dB
-56.02 dBm	-----	-----	-----	±1.0 dB

**Squarewave and Pulse Characteristics**  
**Rise/fall time:** ≤15 ns, 10% to 90% at full output  
**Overshoot:** ≤5% of peak-to-peak amplitude at full output  
**Pulse width range:** 1% to 99% of period or 20 ns, whichever is greater  
**Pulse width resolution:** 0.01% of period  
**Pulse width accuracy:** ≤±1% of period ±20 ns  
**Amplitude accuracy:** ±2%, 0.001 Hz to 100 kHz

**DC Offset**  
**Range:** (See also option 002, high voltage output)  
**DC only:** 0 to ±5 V  
**DC+AC:** DC+AC peak ≤5V; Max. DC offset is affected by AC range, Maximum is 4.5 V decreasing to 4.5 mV on lowest range  
**Resolution:** 3 digits  
**Accuracy:** (After self-calibration)  
**DC only:** ±75 mV  
**DC+AC:** (Sinewave) 10 Hz to 1 MHz: ±2% of range  
 1 MHz to 13 MHz: ±5% of range

**Phase Offset**  
 (Channel A vs B in Two-Phase mode)  
**Range:** ±720 degrees  
**Resolution:** 0.01 degree  
**Accuracy:** After self-calibration, for equal-level sinewaves 1 V to 10 V peak-peak

0.1 Hz to 10 Hz	±0.5 degrees
10 Hz to 100 kHz	±0.2 degrees
100 kHz to 1 MHz	±0.3 degrees
1 MHz to 13 MHz	±2.0 degrees

**Amplitude Modulation**  
 Specifications apply to Channel A and Channel B with external modulation or to Channel A internal modulation with Channel B as the modulation source. External modulation is allowed in all modes; internal modulation is allowed only in the two-channel mode.  
**Waveforms:** Sine, square, or (external only) pulse, DC, etc.  
**Frequency Range:** Carrier: DC to 13 MHz  
 Modulation: DC to 100 kHz  
**Modulation Depth:** 0 to 100%

**Phase Modulation**  
 Specifications apply to Channel A and Channel B with external modulation or to Channel A internal modulation with Channel B as the modulation source. External modulation is allowed in all modes; internal modulation is allowed only in the two-channel mode.  
**Waveforms:** Sine, square, or (external only) pulse  
**Frequency Range:** Carrier: DC to 13 MHz  
 Modulation: DC to 5 kHz  
**Phase Deviation:** 0° to 360°

**Frequency Sweep**  
**Sweep Types:** Linear, discrete  
**Sweep Forms:** Triangle, ramp  
**Sweep Time:** 5 ms to 1000 s  
**Sweep Elements** (Discrete): 2 to 63 frequency pairs and dwell times, user defined; dwell times = 5 ms to 1000 s/element  
**Maximum Sweep Width:** 13 MHz

**Output Combiner**  
 Channel A and B are combined on the Channel A output. B output is off. Combiner may be used in the two-channel, two-phase, and two-tone modes. DC offset is automatically set to 0 V.  
**Frequency Range:** DC to 13 MHz  
**Return Loss:** >20 dB

**Auxiliary Outputs (All Connectors are Rear-Panel BNC)**  
**10 MHz reference:** +3 dBm output to phase lock other instruments to the HP 3326A  
**10 MHz oven output:** +3 dBm oven-stabilized frequency reference (option 001 only)  
**X-axis drive:** Linear ramp proportional to sweep time  
**Z-axis blank:** TTL low during sweep  
**Sweep Marker:** TTL low at selected marker frequency in sweep  
**20-33 MHz LO:** >100 mV square wave output offset 20 MHz from Channel B output

**Auxiliary Inputs (All Connectors are Rear-Panel BNC)**  
**Reference Input:** For phase-locking to an external frequency reference. Signal of 1, 2.5, or 10 MHz. ±10 ppm, 0 to +20 dBm  
**External Trigger Input:** TTL level to initiate linear or discrete sweep on high to low transition  
**Channel A and B external phase calibration inputs**  
**Channel A and B external amplitude modulation inputs**  
**Channel A and B external phase modulation inputs**

**HP-IB Remote Control**  
 Compatible with IEEE Standard 488-1978  
**Interface Functions:**  
 SH1, AH1, T6, L4, SR1, RLI, PP0, DC1, DT1, C0, E1

**Option 001 High Stability Frequency Reference**  
**Stability:** ±5×10<sup>-7</sup>/week after 72 hours continuous operation  
 ±1×10<sup>-7</sup>/month after 15 days continuous operation

**Option 002 High Voltage Output**  
 Multiplies the output level by 4 and expands the allowable DC offset range. Specifications apply to both channels in all modes with the internal combiner off.  
**Frequency range:** DC to 1 MHz  
**Output impedance:** <2 Ω, DC to 50 kHz; <10 Ω, 50 kHz to 1 MHz  
**Amplitude range:** 4 mV to 40 Vpp into >1k Ω, <200 pF load without DC offset (must be entered in peak-to-peak units only)  
**DC offset:** ±20 V, independent of amplitude range. DC + AC peak must not exceed 20 V

**Option 003 Rear Terminal Outputs**  
 Provides Channel A and B main outputs only on rear panel BNC's. Front panel main outputs are removed. Specifications unchanged.

**General**  
**Power:** 100/120/220/240 V, +5%, -10%, 48 to 66 Hz; 120 VA, 150 VA with all options, 10 VA standby  
**Weight:** 27 kg (60 lb) net, 37 kg (81 lb) shipping  
**Dimensions:** 177 mm H x 425.5 mm W x 497.8 mm D (7" x 16 1/4" x 19 3/4")

**Accessories Available**  
**HP 15507A Isolator:** For isolation of signal ground between frequency reference and instrument input/output  
**HP 9211-2856 transit case** for protection in transportation and storage

Ordering Information	Price
HP 3326A Two-Channel Synthesizer	\$9,760
Option 001 High Stability Frequency Reference	\$665
Option 002 High Voltage Output	\$305
Option 003 Rear Terminal Outputs (Rear only)	N/C
Option 907 Front Handle Kit	\$61
Option 908 Rack Flange Kit	\$36
Option 909 Rack Flange and Handle Combination Kit	\$92
Option 910 Extra Operating Manual	\$102
Option 914 Delete Service Manual	less \$115
Option W30 Ext. Warranty	\$190

# FREQUENCY, FUNCTION & WAVEFORM SYNTHESIZERS

## Synthesizer/Level Generator 200 Hz to 81 MHz

Model 3335A

- 1 MHz resolution
- High spectral purity
- Precision amplitude control
- Program storage
- HP-IB

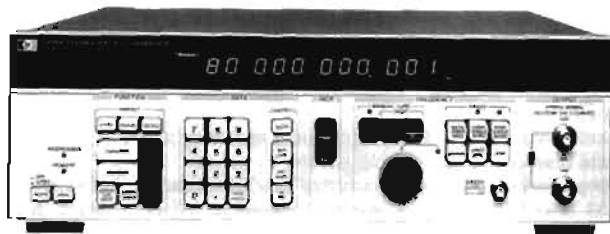

HP 3335A



### Description

Covering a frequency range of 200 Hz–81 MHz, the HP 3335A Synthesizer/Level Generator has performance characteristics that make it ideally suited for the telecommunications industry, as well as for traditional synthesizer applications, including testing of Frequency Division Multiplex (FDM) equipment and R & D and production testing of communications systems. It features precision level control, millihertz resolution, high spectral purity, internal frequency sweep, HP-IB programmability and numerous user conveniences.

### Internal Storage

Up to 10 different front panel settings (frequency, level,  $\phi$  incr, etc.) can be stored in internal memory registers for later recall. The DISPLAY key allows viewing of register contents without altering the synthesizer output.

### Precision Amplitude

Increasing channel capacity of Frequency Division Multiplex (FDM) systems is continually placing more stringent requirements on the testing of transmission parameters. To meet these performance standards, the HP 3335A incorporates a state-of-the-art attenuator resulting in attenuator accuracies of up to  $\pm 0.25$  dB over the 81 MHz frequency range.

### HP-IB Programmability

IEEE STD 488-1978 Definition SH0, AH1, T0, L2, SR0, RL1, PP0, DC1, DT0, C0.

### Frequency Stability

The HP 3335A synthesizes its output frequency from an internal temperature-controlled crystal oscillator which provides  $\pm 1 \times 10^{-8}$ /day frequency stability ( $\pm 5 \times 10^{-10}$  is optional). The HP 3335A can also be phase-locked to any external frequency standards.

### Automatic Frequency Sweep

The HP 3335A combines the precision frequency accuracy and stability of a synthesizer with the time-saving convenience of a digital sweeper.

### SLMS - Tracking Generator

The HP 3335A operates as a tracking generator with the HP 3746A/B Selective Level Measuring Set (SLMS), or the HP 3586A/B/C Selective Level Meter for automatic or semi-automatic testing of FDM systems. For closed-loop tracking where the HP 3335A and HP 3746A/B are in the same location, the frequency of the generator is controlled by the microprocessor in the SLMS.

### Options

**Standard:** equipped with switch-selectable 50 $\Omega$  and 75  $\Omega$  outputs (BNC connectors).

**001:** High-stability frequency reference

**002/004:** Equipped with 75 $\Omega$  unbalanced and 124 $\Omega$  and 135 $\Omega$  balanced connectors as follows.

	Option	Fits WECO Type	Spacing	Accepts WECO Type
75 $\Omega$	002	477B	N/A	358A
	004	560A		439A/440A
124 $\Omega$	002	477B	16 mm (.625")	372A
	004	560A	12.7 mm (.5")	443A
135 $\Omega$	002/004	223A	16 mm (.625")	241A

**003:** 75 $\Omega$  unbalanced BNC output and 150  $\Omega$  balanced output using a pair of BNC connectors at 20 mm (0.80 in.) spacings.

### Abbreviated Specifications

(For complete specifications, refer to the HP 3335A data sheet.)

#### Frequency Range

**Standard:** 200 Hz–81 MHz;

**Opt. 002/004:** 75 $\Omega$ , 200 Hz–81 MHz; 124 $\Omega$ , 10 kHz–10 MHz; 135/150 $\Omega$ , 10 kHz–2 MHz;

**Opt. 003:** 75 $\Omega$ , 200 Hz–81 MHz; 150 $\Omega$ , 10 kHz–2 MHz

**Frequency resolution:** .001 Hz.

**Stability, long term:**  $\pm 1 \times 10^{-8}$ /day;  $\pm 1 \times 10^{-7}$ /month.

**Opt. 001** (high stability frequency reference)

**Aging rate:**  $\pm 5 \times 10^{-10}$ /day;  $\pm 2 \times 10^{-9}$ /month;  $\pm 1 \times 10^{-7}$ /year

**Warmup:** Within  $5 \times 10^{-9}$  of final value 20 minutes after turn-on at 25°C

#### Spectral Purity

**Harmonic distortion:** 200 Hz–10 MHz:  $< -45$  dBc; 10 MHz–81 MHz:  $< -40$  dBc

**Phase noise** (30 kHz band, excluding  $\pm 1$  Hz, centered on the carrier): 9.9 MHz:  $< -63$  dBc; 20 MHz:  $< -70$  dBc; 40 MHz:  $< -64$  dBc; 81 MHz:  $< -58$  dBc

**Spurious:** nonharmonically related signals: the greater of  $-75$  dBc or  $-125$  dBm (50/75  $\Omega$ ),  $-97$  dBm (124  $\Omega$ ),  $-68$  dBm (135/150  $\Omega$ )

#### Amplitude Range

**Standard:** 50 $\Omega$ : +13.01 dBm to  $-86.98$  dBm; 75 $\Omega$ : +11.25 dBm to  $-88.74$  dBm.

**Opt. 002/004:** 75/124/135 $\Omega$ : +11.25 dBm to  $-88.74$  dBm

**Opt. 003:** 75/150 $\Omega$ : +11.25 dBm to  $-88.74$  dBm

**Signal balance (124 $\Omega$ , 135 $\Omega$ , 150 $\Omega$  balanced outputs):**  $> 60$  dB at 100 kHz

**Resolution:** 0.01 dB

**Absolute level accuracy (max. output at 100 kHz, 20°C to 30°C):** 50/75  $\Omega$   $\pm 0.05$  dB; 124/135/150  $\Omega$ :  $\pm 0.1$  dB

**Flatness (relative to 100 kHz, full amplitude):** 50/75 $\Omega$ : 1 kHz–25 MHz:  $\pm 0.07$  dB; 200 Hz–81 MHz:  $\pm 0.15$  dB. 124 $\Omega$ : 10 kHz–10 MHz:  $\pm 0.15$  dB, 10 kHz–10 MHz  $\pm 0.4$  dB, 135/150 $\Omega$ : 10 kHz–2 MHz:  $\pm 0.18$  dB

#### Attenuator:

Range: 0 to 98 dB in 2 dB steps

Accuracy: (1 year)

50 $\Omega$ :

ATTENUATION	FREQUENCY
0 to 38 dB	$\pm 0.25$ dB
40 to 58 dB	$\pm 0.3$ dB
60 to 98 dB	$\pm 0.9$ dB

75 $\Omega$ :

ATTENUATION	FREQUENCY		
	200Hz	25 MHz	80 MHz
0 to 18 dB	$\pm 0.4$ dB	$\pm 1.5$ dB	$\pm 2.5$ dB
20 to 58 dB	$\pm 0.9$ dB	$\pm 2.0$ dB	$\pm 5.0$ dB
60 to 98 dB	$\pm 2.0$ dB		

### Options

**001:** Hi-stability reference  $\pm 5 \times 10^{-10}$ /day

**002:** Connector option (75/124/135 $\Omega$ )

**003:** Connector option (75/150 $\Omega$ )

**004:** Connector option (75 $\Omega$ , miniature WECO on 124/135 $\Omega$ )

**W30** Extended Warranty

### Price

\$1235

\$560

\$355

\$560

\$400

**HP 3335A Synthesizer/Level Generator**

**\$11,300**

# FREQUENCY, FUNCTION & WAVEFORM SYNTHESIZERS

405

Synthesizer/Level Generator

Model 3336C

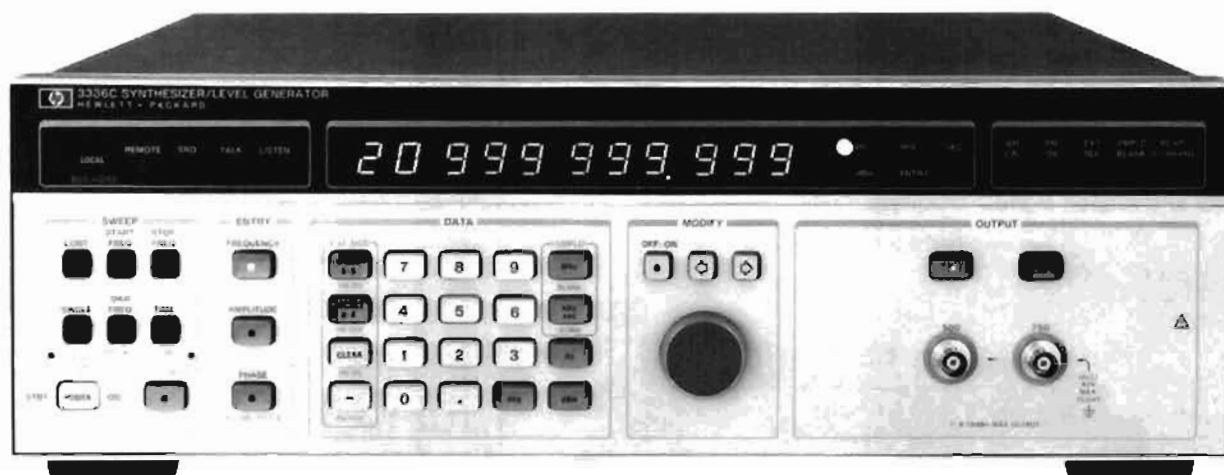

HP 3336C



## Description

Covering a frequency range of 10 Hz to 20,999 MHz, the HP 3336C is designed for traditional synthesizer applications as well as R&D and production testing of systems or components. It features precision level control, high spectral purity, optional frequency stability of  $\pm 5 \times 10^{-6}$ /week, internal frequency sweep and numerous user conveniences. All models include HP-IB.

## Precision Frequency Measurements

Major advances in HP technology have provided a single loop, fractional-N synthesis technique which allows synthesizer accuracy with 11 digits of resolution, with completely phase continuous frequency sweep over any of the instrument's frequency ranges. Microhertz resolution below 100 kHz allows precise frequency measurements over a range of 10 Hz to 20,999 999 999 MHz. Harmonics are below -60 dBc over the range from 50 Hz to 1 MHz (-50 dBc to 20 MHz), with spurious signals below -70 dBc or -100 dBm in the standard instrument, -115 dBm with an option. Integrated Phase Noise is -64 dBc (30 kHz BW).

## $\pm 0.05$ dB Amplitude Accuracy

New HP attenuator technology coupled with custom designs in leveling loops and thermal converters produce amplitude accuracies seen only in instruments at much greater cost. The fast leveling loop makes extremely flat sweeps possible at high sweep speeds. External leveling is also available for those custom applications where a control loop is desired.

## Other Features

Models HP 3336 A & B are also available for the telecommunications industry. See page 482. All three models (the HP 3336A, B & C) have 10 storage registers; amplitude blanking capability during frequency switching; linear or logarithmic phase continuous sweep capabilities; RPG (rotary pulse generator) to simplify modification of any digit in the display; phase offset capability; output connector and impedance flexibility; AM and PM modulation; and many other features. Refer to the data sheet for complete information.

## Abbreviated Specifications

### Frequency

Range: 10 Hz to 20,999 999 999 MHz

Resolution: 1  $\mu$ Hz for frequencies < 100 kHz, 1 mHz for frequencies  $\geq 100$  kHz

Aging rate:  $\pm 5 \times 10^{-6}$ /year (20° to 30°C)

Warm-up time: 30 minutes to within specified accuracy

### Amplitude

Range: 50  $\Omega$ : -11.23 to +8.76 dBm; 75  $\Omega$ : -72.99 to 7.00 dBm

Absolute accuracy:  $\pm 0.05$  dB, 20° to 30°C (for the top 9.99 dB of amplitude range at 10 kHz),  $\pm 0.08$  dB, 0° to 55°C

Flatness: 50/75  $\Omega$ ,  $\pm 0.1$  dB ( $\pm 0.07$  dB with option 005) referenced to 10 kHz

Attenuator Accuracy: (instruments without option 005)

	10 Hz	1 MHz	10 MHz	20.9 MHz
10 to 19.99 dB		$\pm 1$ dB	$\pm 1.5$	$\pm 2$ dB
20 to 39.99 dB		$\pm 1.5$ dB	$\pm 2$ dB	$\pm 2.5$ dB
40 to 79.99 dB		$\pm 2$ dB	$\pm 2.5$ dB	$\pm 3$ dB

Note: Amplitude Accuracy is the sum of the Absolute Accuracy and, as necessary, Flatness and Attenuator Accuracy.

## Phase Offset

Range:  $\pm 719.9^\circ$  with respect to arbitrary reference phase.

## Amplitude Modulation

Modulation depth: 0 to 100%

Modulation frequency range: 50 Hz to 50 kHz

Envelope distortion:  $< -30$  dB to 80% modulation (1 kHz modulating freq.)

## Phase Modulation

Range:  $0^\circ$  to  $\pm 850^\circ$

Linearity:  $\pm 0.5\%$  from best fit straight line

Modulation frequency range: dc to 5 kHz

Input sensitivity:  $\pm 5$  V peak for  $850^\circ$  phase shift (170°/volt)

## Frequency Sweep

Sweep time: Linear: 0.01 s to 99.99 s. Single Log: 2 s to 99.99 s. Continuous Log: 0.1 s to 99.99 s.

Maximum sweep width: specified frequency range of selected output

Minimum sweep width: Log: 1 decade. Linear: minimum BW (Hz) = .1 (Hz/s) x Sweep Time (s)

Phase continuity: phase is continuous over full frequency range.

Sweep flatness: fast leveling  $\pm 0.15$  dB, 10 kHz to 20 MHz, 0.3 s sweep time. Normal leveling:  $\pm 0.15$  dB, 50 Hz to 1 MHz, 0.5 s sweep time.

## HP-IB Interface Functions:

SH1, AH1, T6, L3, SRI, RLI, PP0, DC1, DT0, C0, E1.

## General

### Operating Environment

Temperature: 0° to 55°C

Relative humidity:  $\leq 85\%$ , 0° to 40°C

Altitude:  $\leq 35,000$  ft. (10,667 metres)

Storage temperatures: -50° to +65°C

Storage altitude:  $\leq 50,000$  ft. (15,240 metres)

Power requirements: 100/120/220/240 V,  $\pm 5\%$ , -10%, 48 to 66 Hz, 60 VA. (100 VA with all options), 30 VA standby

Size: 132.6 mm H x 425.5 mm W x 497.8 mm D. (5.2" x 16.8" x 19.6")

Weight: net, 10 kg. (22 lb). Shipping, 15.5 kg. (34 lb)

## Ordering Information

HP 3336C Synthesizer/Level Generator (General Purpose) \$5,000

Opt 004 High Stability Frequency Reference \$665

Opt 005 High Accuracy Attenuator \$665

Opt 907 Front Handle Kit \$56

Opt 908 Rack Flange Kit \$33

Opt 909 Rack Flange and Handle Kit \$83

Opt W30 Extended Warranty \$190

# FREQUENCY, FUNCTION & WAVEFORM SYNTHESIZERS

## Dual Arbitrary Waveform Generator

Model 8175A Option 002

- 2 analog channels / 1 kpoints ea / 50 MHz ea
- Individual datapoint durations 20 ns to 9.99 s
- 10 bit amplitude resolution
- digital and analog signals simultaneously
- 4 waveform entry modes; calculator, graphical editing, abs. and rel. levels, various codings
- up to 32 Vp-p output voltage (into open), separately programmable offset (max  $\pm 16$  V)



HP 8175A, Option 002; Data Page:  
Waveform Setup

With the Option 002, the Dual Arbitrary Waveform Generator, the HP 8175A offers the new Arbitrary Waveform mode in addition to the existing Parallel and Serial modes. In the Arbitrary Waveform mode, you have: Dual arbitrary waveform channels, and simultaneous equivalent digital signals. This means you have the ideal source for difficult applications, for example:

- simulation of two dependent variables, like force and distance, at the same time.
- digital and analog stimulation of devices like programmable filters.
- stimulus and compare signals at the same time for DACs or ADCs.

The arbitrary outputs are 50 Mpoints/s, synchronous, but independent in shape and amplitude (max 16 V p-p into 50 Ohm and max 32 V p-p into open), and the waveforms can be set up by means of: a) algorithms (a fundamental set of mathematical functions are available, including noise), b) interpolations (linear and spline), c) graphic or tabular entry of instantaneous level (or amplitude and offset), d) tabular entry of equivalent digital pattern. Additionally, any existing waveform can be modified. One way is simply by tabular or graphical editing. A more powerful alternative is the "Combine" feature. This allows you to combine an algorithm arithmetically with any desired part of the current waveform.

### Application Examples

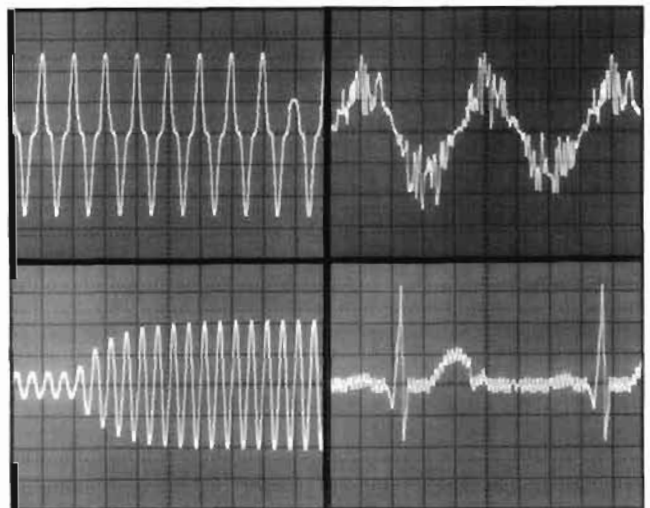

The comprehensive feature set, together with the outstanding memory management and interaction capability, mean that "real-life" simulation for the most exacting circuits is within your grasp.

For further information about the digital capabilities of the HP 8175A see page 311.





**Data Page: Calculator**

The built in Calculator provides a comfortable method of setting up very complex, mathematically-definable waveforms by simply entering the formula. Softkeys support most of the fundamental mathematical functions. The Combine capability allows any previously generated function to be combined with the current calculated function. By this means, noise can be introduced into any desired parts of the waveform.

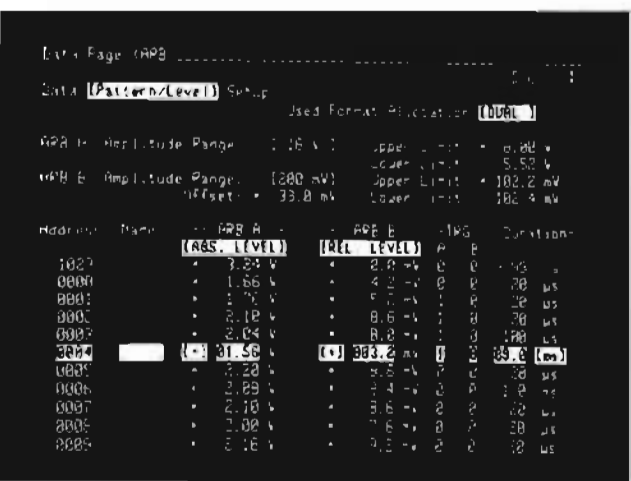

**Data Page: Pattern/Level Set-Up**

Data Points of a waveform can be entered and displayed in absolute or relative levels or in various codes. Comprehensive waveform editing support is provided. For instance, segments of data points can be moved or copied to other memory locations or waveform segments can easily be exchanged between the two analog channels. In this way it is easy to produce phase shifted signals. Graphical editing of the waveform, including interpolation between data points, is possible on this menu.

**Specifications**

apply for operating temperatures from 0° to 55°C.

**Option 002 Dual Arbitrary Waveform Generator (can be retrofitted in HP service office)**

- Number of Analog Outputs: 2
- Number of Bits: 10
- Number of Data Points:
  - Horizontal: 1024 points
  - Vertical: 1000 points with additional 24 points override
    - 800 points for 16 V p-p Output Voltage Range
    - 640 points for 32 V p-p Output Voltage Range
- Differential Non-Linearity: ≤1 LSB (monotonic)
- Output Impedance: 50 Ohm ±5%

**Output Levels**

- Load Impedance: 50 Ohm:
  - 7 Output Voltage Ranges: 0.2 V to 16 V, Res. 0.2 mV to 20 mV
  - 2 Offset Ranges: ±0.8 V and ±8 V (Output Volt. Range > 1 V)
- Load Impedance: ≥50 kOhm:
  - 7 Output Voltage Ranges: 0.5 V to 32 V, Res. 0.5 mV to 50 mV
  - 2 Offset Ranges: ±1.6 V and ±16 V (Output Volt. R. > 2V)

**Accuracy (Output A and Output B)**

- Amplitude Accuracy: ±4% ±4 LSB
- Offset Accuracy: ±1% of programmed value
  - ±2% of (progr. High Level of p-p Output Volt. + progr. Low Level of p-p Output Volt.) (if High and Low Level are identical in magnitude, but opposite in sign, this error will be zero).

plus:

- Into 50 Ohm: ±10 mV for 0.2 V, 0.5 V and 1 V ranges
  - or: ±25 mV for 2 V and 5 V range
  - or: ±50 mV for 10 V and 16 V range
- Into ≥50 kOhm: ±20 mV for 0.5 V, 1 V and 2 V ranges
  - or: ±50 mV for 5 V and 10 V range
  - or: ±100 mV for 20 V and 32 V range

**Timing (for Output A and B)**

The maximum sample update rate is 50 MHz.  
The Data Point Duration is 20 ns to 9.99 s.

**Trigger Output Characteristics:**

- Number of Trigger Output Channels: 2
- Trigger Output Impedance: 50 Ohm ±5%
- Trigger Output Levels: ECL into 50 Ohm
- Trigger Pulse Width: TTL into 50 Ohm and ≥50 kOhm
- Trigger Pulse Width: The trigger can be set for each individual data point to High Level or Low Level. The trigger width depends on the programmed Data Point Duration.

**Ordering Information**

**Price**

HP 8175A Digital/Analog Signal Generator	\$10800
Note: HP 8175A must be ordered with at least option #002 or one of the digital options (refer to page 312).	
Option 002 Dual Arbitrary Waveform Generator	\$3465
Option 908 Rack Flange Kit (P/N 5061-9678)	\$36
Option 910 Additional Operating/Programming/Service Manual	\$204
Option 916 Additional Programming Manual	\$36
Fast-Ship product—see page 758	

# FREQUENCY, FUNCTION & WAVEFORM SYNTHESIZERS

## 50 MHz Programmable Signal Source

Model 8165A

- Pulse/function capability
- Sine, triangle, square to 50 MHz
- Pulses and ramps to 20 MHz
- Trigger, gate and counted burst
- Synthesizer stability, precision amplitude
- Storage of operating parameters



Picture shows 8165A with option 002, AM and Logarithmic Sweep.

### Versatility and Simplicity for Systems and Bench

The HP 8165A Programmable Signal Source is a versatile function generator with good accuracy and many trigger features. Microprocessor control assures rapid, accurate setup whether programming locally or via HP-IB.

### Operating Set Storage

Ten complete sets of operating information can be stored and recalled. In the event of power failure, battery back up retains all data plus the active settings.

### Stability and Resolution

Stable frequency is ensured with an internal crystal. The four-digit frequency display provides a 1  $\mu$ Hz resolution in the 1 to 9.999 MHz range. In Normal mode, the accuracy is 0.001% with a stability of  $\pm 1 \times 10^{-6}$ .

### Specifications

#### Waveforms and Frequency Range

**Sine, square, triangle (50% duty cycle):** 1.000 mHz to 50.00 MHz.  
**Pulse/ramp (20, 80% symmetry):** 1.000 mHz to 19.99 MHz.  
**Haversine/havertriangle:** please inquire for special option.

#### Output Characteristics

**Range:** amplitude and offset independently variable within  $\pm 10$  V window.

**Source impedance:** selectable 50  $\Omega \pm 1\%$  or 1 k $\Omega \pm 10\%$ .

**Amplitude:** 10.0 mV<sub>pp</sub> to 10.0 V<sub>pp</sub> (50  $\Omega$  into 50  $\Omega$ )  
 2.00 V<sub>pp</sub> to 20.0 V<sub>pp</sub> (1 k $\Omega$  into 50  $\Omega$ )

Accuracy	Sine V <sub>rms</sub>	Square	Triangle (50%)	Ramp (20%-80%)	Pulse (20%-80%)
<1kHz	$\pm 3\%$	$\pm 2\%$	$\pm 3\%$	$\pm 3\%$	$\pm 2\%$
1kHz-4.99MHz	$\pm 3\%$	$\pm 2\%$	$\pm 3\%$	$\pm 5\%$	$\pm 2\%$
5 MHz-19.9MHz	$\pm 8\%$	$\pm 5\%$	$\pm 10\%$	$\pm 10\%$	$\pm 5\%$
20MHz-50MHz	$\pm 8\%$	$\pm 5\%$	+5% to -20%	-	-

**Offset:** 0  $\pm 10$  mV to  $\pm 5.00$  V (50  $\Omega$  into 50  $\Omega$ )

0  $\pm 20$  mV to  $\pm 10.0$  V (1 k $\Omega$  into 50  $\Omega$ )

**Accuracy:**  $\pm 1\%$  programmed value  $\pm 1\%$  signal V<sub>pp</sub>  $\pm 20$  mV.

#### Sine Characteristics

**Distortion:** total harmonic distortion (THD) for fundamental up to 1 MHz:  $\pm 1\%$ .

**Harmonic signals:** (fundamental 1-10 MHz):  $\leq -36$  dB

**Harmonic signals:** (fundamental above 10 MHz):  $\leq -30$  dB.

#### Square/Pulse Characteristics

**Transition times:** (10% to 90%)  $\leq 5$  ns (50  $\Omega$  into 50  $\Omega$ ),  $\leq 7$  ns (1 k $\Omega$  into 50  $\Omega$ )

**Preshoot/Overshoot/ringing:**  $\leq \pm 5\%$  (50  $\Omega$  into 50  $\Omega$ ),  $\pm 10\%$  (1 k $\Omega$  into 50  $\Omega$ ).

#### Triangle/Ramp Characteristics

**Linearity:** (10% to 90%):  $\leq \pm 1\%$  ( $\leq \pm 5\%$  above 5 MHz).

### Operating Modes

**Norm** (continuous phase locked), **VCO** (external sweep voltage).

**Trig** (ext or man. one-shot), **Gate**, **Burst** (1-9999 counted cycles).

#### Frequency Modulation

**HP-IB:** control and learn capability for all modes and parameters. **Interface functions\*:** SH1, AH1, T6, L4, SR1, RL1, PP0, DC0, DT1, C0, E1.

### General

**Memory:** non volatile, 10 addressable locations plus one for active operating state. Each location can store a complete set of operating parameters and modes.

**Power:** 100/120/220/240 Vrms;  $\pm 5\%$ ,  $-10\%$ ; 48 to 66 Hz, 200 V A max.

**Operating temperature:** 0° to 50°C

**Weight:** net 12 kg (26.5 lbs). Shipping 16 kg (35.3 lbs).

**Size:** 133 H x 426 W x 422 mm D (5.2" x 16.8" x 16.6").

### Ordering Information

HP 8165A Programmable Signal Source\*\*

**Opt 002:** AM and logarithmic sweep

**Opt 003:** Rear Panel Connectors

**Opt 907:** Front Handle Kit (Part No HP 5061-9689)

**Opt 908:** Rack Mounting Kit (Part No HP 5061-9677)

**Opt 909:** Opt 907, 908 combined (Part No HP 5061-9683)

**Opt 910:** additional Operating and Service Manual

\* For more on these codes refer to the HP-IB section of this catalog

\*\* HP-IB cables not supplied, see page 549.

☛ Fast-Ship product—see page 758

### Price

\$7950

add \$1070

N/C

add \$36 ☛

add \$33 ☛

add \$82 ☛

add \$71

# FREQUENCY, FUNCTION & WAVEFORM SYNTHESIZERS

1 mHz–50 MHz Pulse/Function Generator

Model 8116A

409

- Sine, triangle, square, haversine functions and dc
- 1 mHz–50 MHz, 32 Vpp for all waveforms
- Variable (10 ns min) pulse width, 6 ns transitions

- Wide range of operating capability
- Self-prompting operating concept
- Error recognition and self test



Picture shows 8116A with Option 001, Burst and Logarithmic Sweep.

The fully programmable HP 8116A features pulse as well as function generator capabilities in one small unit. A broad 1 mHz–50 MHz band for all waveforms and a wide choice of operating and modulating modes assure high flexibility. These factors, plus good repeatability, make the HP 8116A a sound, long-term investment.

## Unique Operating Concept Saves Engineering Time

HP's custom IC's have made it feasible to put the many HP 8116A capabilities into such a small volume. Handling is simplified by a unique, microprocessor-controlled, operating concept which ensures a clear overview of the compact front panel at all times. When the mode and waveform have been selected, illuminated labels show which parameters must be set. There's no clutter, no confusion.

**Auto vernier.** In normal mode, the HP 8116A's auto-vernier increments any desired parameter continuously until a stop signal is applied. This means that thresholds can be measured automatically, without a controller.

**Level or amplitude programming.** The HP 8116A's output can be programmed in terms of high and low levels or in terms of amplitude and offset. Consequently a direct, automatic, conversion is always feasible so that the HP 8116A can be programmed in the same terms as the device is specified.

**Safe limit.** Devices can be protected by the limit feature. This prevents the output from exceeding a given magnitude.

## Rectangular Waveforms

For applications such as laser diodes or dc motors, square waves can be programmed for constant duty cycles from 10% to 90%. For digital test, or for simulating very low duty-cycle events, pulse width can be programmed down to 10 ns. Square wave and Pulse modes provide clean 6 ns edges that are ideal for many technologies. Pulse width modulation and pulse recovery capability are available in Pulse mode.

## Sine and Triangle Functions

10% to 90% duty cycle, programmable in 1% steps, provides ramps and asymmetrical sine waves for testing VCO's, servos, amplifier linearity and industrial process control systems. Haversine functions,

available in External Trigger, Gate and Burst modes, extend the applications to areas such as telephone line and vibration testing.

## Modulation

All waveforms can be amplitude or frequency modulated. VCO operation allows frequency variation over two decades with an external voltage; consequently transducer output can be conditioned for mag tape recording, or frequency-shift keying or linear sweep can be carried out.

## Option 001

**10 1/2-decade log sweep.** Sweep mode covers the wide 1 mHz–50 MHz band in a single up sweep. Test setups require no more than an X-Y recorder or scope because all necessary control signals are available. The HP 8116A sweeps can be internally triggered, if desired.

**Accurate, counted bursts.** A preprogrammed number of cycles of any waveform can be generated in Burst mode. With sine, triangle and square functions, bursts can be triggered internally as well as externally.

**Hold capability.** For material stress testing, low frequency functions can be held at instantaneous levels. Hold is controlled by an external signal.

## Low-Cost Automation for Bench and Systems

Powerful capability, small size and wide specified temperature range make the HP 8116A a good choice for automatic test systems. Also, the low cost means that it's now realistic to automate those routine bench jobs and leave more time for design. Comfortable software features such as easy syntax and flexible format contribute to rapid system design.

## Operating Confidence

There's reliance in the HP 8116A's output because proper operation is always ensured by the instrument's error detector. This helps the user to recover from an incorrect front panel or programming operation by indicating the offending parameter. Also, the built-in test and diagnosis feature verifies correct function each time the instrument is switched on.

Specifications overleaf

# FREQUENCY, FUNCTION & WAVEFORM SYNTHESIZERS

## 1 MHz–50 MHz Pulse/Function Generator (cont'd)

### Model 8116A

#### Specifications

Specifications apply with 50-ohm load and temperatures in the range 0°C to 55°C.

#### Functions

Sine, triangle, ramp, square, pulse, haversine, havertriangle, dc.

#### Timing

##### Frequency

**Range:** 1 mHz to 50 MHz (3-digit resolution).

**Accuracy<sup>1</sup>** (pulse mode, 50% d/c):  $\pm 3\% \pm 0.3$  mHz below 100 kHz,  $\pm 5\%$  above 100 kHz.

**Jitter** (pulse mode, 50% d/c):  $< 0.1\% + 100$  ps.

**Stability:**  $\pm 2\%$  (1 hour),  $\pm 5\%$  (24 hours).

##### Duty cycle: (sine, triangle, square, haversine, havertriangle).

**Range:** 10% to 90% (20% to 80% above 1 MHz), 2-digit resolution.

**Accuracy<sup>1</sup>:**  $\pm 0.5$  digits ( $\pm 3$  digits above 1 MHz).

##### Pulse Width

**Range:** 10.0 ns to 999 ms (3-digit resolution).

**Accuracy<sup>1</sup>:**  $\pm 5\% \pm 2$  ns.

**Jitter:**  $< 0.1\%$  ( $0.2\% + 200$  ps for width  $\leq 10$   $\mu$ s).

#### Output Characteristics

(voltages double into high impedance).

##### Amplitude

**Range:** 10.0 mVpp to 16.0 Vpp (3-digit resolution).

**Accuracy<sup>1</sup>:**  $\pm 5\%$  (at 1 kHz for sine and triangle).

**Flatness (sine):**  $\pm 3\%$  ( $\pm 5\%$  above 1 MHz,  $+5$ – $-15\%$  above 10 MHz).

**Flatness (triangle):**  $\pm 3\%$  ( $\pm 5\%$  above 1 MHz,  $+5$ – $-25\%$  above 10 MHz).

##### Offset and dc Mode

**Range:** 0.00 to  $\pm 7.95$  V (0 to  $\pm 795$  mV for amplitude  $< 100$  mVpp).

**Resolution:** 3 digits.

**Accuracy<sup>1</sup>:** 0.5% of setting  $\pm 1\%$  of ampl  $\pm 40$  mV ( $+2$  mV if ampl  $< 100$  mVpp,  $\pm 20$  mV in dc mode).

##### Distortion (sine, normal mode, 50% duty cycle).

**Total harmonic distortion (10 Hz–50 kHz):**  $< 1\%$  ( $-40$  dB)\*.

**Harmonic related signals (50 kHz–1 MHz):**  $< -34$  dB.  
(1 MHz–50 MHz):  $< -23$  dB\*.

\* May increase by 3 dB below 10°C and above 45°C.

##### Non-linearity (triangle, ramp, 100 mHz–1 MHz): $< \pm 3\%$ .

#### Pulse and Square Wave Characteristics

**Transitions:**  $< 7$  ns.

**Pulse perturbations:**  $< \pm 5\% \pm 2$  mV.

**Output impedance:** 50 ohm  $\pm 5\%$ .

#### Operating Modes

Normal, trigger\*, gate\*, external width.

#### Additional Modes in HP 8116A Option 001

##### Logarithmic Up Sweep (for all waveforms).

**Range:** Start and stop frequencies selectable up to full range (1 mHz–50 MHz).

**Sweep time:** selectable in 1-2-5 sequence from 10 ms to 500 seconds per decade.

**Sweep repetition:** continuous sweeps (internal sweep) or externally triggered.

##### Counted Burst\* (for all waveforms).

**Burst length:** 1 to 1999 cycles.

**Burst repetition:** internally triggered at selectable intervals from 100 ns to 999 ms (except in Pulse mode), or externally triggered, up to 40 MHz.

\*Selectable ( $-90^\circ$ ) start-phase for haversine, havertriangle.

#### Control Modes

##### Frequency modulation: $\pm 5\%$ max deviation.

**Sensitivity:** 1 V for 1% deviation.

**Modulating frequency:** dc to 20 kHz.

##### Amplitude Modulation

**Sensitivity:**  $\pm 2.5$  V for 100% mod. ( $+2.5$  V to  $-7.5$  V for DSBS).  
**Modulating frequency:** dc to 1 MHz.

<sup>1</sup>Applies from 15°C to 35°C. %-error increases 0.05 per °C outside this range

#### Pulse Width Modulation

**Range:** 10 ns to 1 s in 8 non-overlapping decade ranges.

**Max. width ratio:** 10:1.

**Sensitivity:**  $\pm 9$  V for 1:10 ratio.

#### Voltage-Controlled Oscillator

**Range:** 2 decades in range 1 MHz–50 MHz.

**Sensitivity:** 0.1 V to 10 V for 2 decades.

**Modulating frequency:** dc to 1 kHz.

#### Auxiliary Modes

**Manual:** simulates external input.

**1 cycle (option 001):** triggers single output cycle in Trigger, Gate and Ext Burst modes.

**Auto vernier:** continuous vernier which can be remotely or manually stopped.

**Limit:** programmable maximum output levels to protect DUT.

**Complement:** selectable normal/complement output.

**Disable:** relay disconnects output.

#### Auxiliary Inputs and Outputs

##### External Input

**Threshold:**  $\pm 10$  V adjustable.

**Max input voltage:**  $\pm 20$  V.

**Sensitivity:** 500 mVpp.

**Min pulse width:** 10 ns.

**Input impedance:** 10 k $\Omega$  typ.

**Trigger slope:** positive, negative and off.

##### Control Input

**Max input voltage:**  $\pm 20$  V.

**Input impedance:** 10 k $\Omega$  typ.

##### Trigger Output

**Output levels:** 0/2.4 V typ.

**Output impedance:** 50 ohm typ.

**X-Output (Option 001)** for sweep X-Y recording (rear panel).

**Output levels:** 0 V (= start frequency) to 10 V max.

**Slope:** 1.5 V per sweep decade.

**Marker Output (Option 001)** for sweep (rear panel).

**Output levels:** TTL

**Leading edge:** positive at selected marker frequency.

**Hold Input (Option 001),** rear panel.

**Input levels:** TTL

**Leading edge:** positive transition causes HP 8116A output ( $f < 10$  Hz) to hold at instantaneous level. Output droop 0.01% per second.

**Max input voltage:**  $\pm 20$  V

#### HP-IB Capability

All manual key operations are programmable. Talk mode provides learn, status byte and error report capabilities.

#### Memory

Battery-backup RAM retains current operating state.

#### General

**Repeatability:** factor 4 better than accuracy.

#### Environmental

**Storage temperature:**  $-40^\circ\text{C}$  to  $+70^\circ\text{C}$ .

**Operating temperature:**  $0^\circ\text{C}$  to  $55^\circ\text{C}$ .

**Humidity:** 95% RH,  $0^\circ\text{C}$  to  $40^\circ\text{C}$ .

**Power:** 100/120/220/240 V rms;  $\pm 5\%$ ,  $-10\%$ ; 48 to 440 Hz; 120 VA max.

**Weight:** net, 5.9 kg (13 lb). Shipping, 8.0 kg (18 lb).

**Size:** 89 H x 212.3 W x 422 mm D (3.5" x 8.36" x 16.6").

#### Ordering Information

HP 8116A Programmable Pulse/Function Generator\* \$3775

Opt 001: Burst and Logarithmic Sweep add \$510

Opt 010: Extra Operating & Service Manual add \$41

HP 5061-9701: Bail Handle Kit \$38 

HP 5061-9672: Rack Mount Kit (single HP 8116A) \$49 

HP 5061-9674: Rack Mount Kit (two instruments) \$30 

HP 5061-9694: Lock Link Kit (for use with \$25 

HP 5061-9674)

\*HP-IB cables not supplied, see page 549.

 Fast-Ship product — see page 758

# FREQUENCY, FUNCTION & WAVEFORM SYNTHESIZERS

411

## 1 Hz-20 MHz Pulse/Function Generator

Model 8111A

- Sine, triangle, square, haversine functions
- 20 MHz, 32 Vpp for all waveforms
- Variable duty cycle or pulse width

- Trigger, gate, VCO and optional burst
- Digital display for all parameters
- Error recognition



Picture shows 8111A with Option 001, Counted Burst.

The HP 8111A combines pulse generator and function generator capabilities in a single, compact unit. Triggered operation for all waveforms, and the ability to define rectangular waveforms in terms of pulse width or duty cycle, are examples of the HP 8111A's versatility.

### Saves Space and Equipment

Small size and manifold capability make the HP 8111A an ideal source for service and bench. Digital display, error detector and good repeatability assure high operating confidence. This reduces the need for output monitoring and consequently saves equipment.

### Flexible

Operating modes include VCO which permits frequency-shift keying and dc-to-frequency conversion as well as sweep and FM applications. Option 001's Burst mode simplifies tone burst generation and digital preconditioning by generating a precise number of waveform cycles. An "extra cycle" feature activated after a burst allows critical events to be examined.

Pulse mode's variable width down to 25 ns and clean 10 ns transitions provide useful digital test capability. High analog flexibility is assured because all waveforms can be generated in trigger, gate and burst modes. Adjustable duty cycle up to 999 kHz means that CRT sawtooth waveforms and rectangular signals for dc motor control can be simulated.

### Specifications (50-ohm load resistance)

#### Waveforms

sine, triangle, ramp, square, pulse, haversine functions.

#### Timing

##### Frequency

**Range:** 1.00 Hz to 20.0 MHz (3-digit resolution).  
**Accuracy (50% duty cycle):**  $\pm 5\%$  ( $\pm 10\%$  below 10 Hz).  
**Jitter:**  $< 0.1\%$  + 50 ps.  
**Stability:**  $\pm 0.2\%$  (1 hour),  $\pm 0.5\%$  (24 hours).

##### Duty Cycle (sine, triangle, square, haversine functions):

	Calibrated	Variable (below 1 MHz)
Range:	50% nominal	10% to 90%
Resolution:	2 digits	2 digits
Accuracy:	$\pm 1$ digit	$\pm 6$ digits ( $\pm 3$ in range 20 to 99%)

##### Pulse Width

**Range:** 25.0 ns to 100 ms (3-digit resolution).  
**Accuracy:**  $\pm 5\%$   $\pm 2$  ns.

### Output Characteristics

(voltages double into high impedance)

#### Amplitude

**Range:** 160 mVpp to 16.00 Vpp (3 $\frac{1}{2}$  digit resolution).  
**Accuracy:**  $\pm 5\%$  (at 1 kHz for sine and triangle).  
**Flatness (sine, triangle):**  $\pm 3\%$  (+10%, -15% above 1 MHz).

#### Offset

**Range:** 0.00 mV to  $\pm 8.00$  V (3-digit resolution).  
**Accuracy:**  $\pm 5\%$  setting  $\pm 2\%$  amplitude  $\pm 20$  mV  
 (ampl  $\geq 160$  mVpp),  
 $\pm 5\%$  setting  $\pm 2\%$  amplitude  $\pm 1$  mV  
 (ampl  $< 160$  mVpp).

**Distortion:** THD (1 Hz-1 MHz)  $< 3\%$  (-30 dB); harmonics (1 MHz-20 MHz)  $< -26$  dB. Distortion may increase by 3 dB below 10°C and above 45°C.

**Linearity (triangle):**  $< \pm 3\%$  ( $< \pm 1\%$  below 1 MHz)

#### Pulse and Squarewave Performance

**Transitions:**  $< 10$  ns.  
**Perturbations:**  $< \pm 5\%$  ( $< \pm 10\%$  below 0.16 Vpp).

#### Output Impedance:

$\pm 50$  ohm  $\pm 5\%$ .

#### Modes

normal, trigger\*, gate\*, VCO and (Option 001) burst\*.  
 \*Adjustable start-phase for haversine, haversinangle

**VCO range:** 2 decades, ext. signal 0.1 V to 10 V (dc to 1 kHz).

**Burst length:** 1 to 1999 periods for all waveforms

#### General

**Repeatability:** factor 2.5 better than accuracy.

#### Environmental

**Storage temperature:**  $-40^\circ\text{C}$  to  $+75^\circ\text{C}$ .

**Operating temperature:**  $0^\circ\text{C}$  to  $55^\circ\text{C}$ .

**Humidity:** 95% RH,  $0^\circ\text{C}$  to  $40^\circ\text{C}$ .

**Power:** 100/120/220/240 V rms;  $+5\%$  -  $10\%$ ; 48 to 440 Hz; 70 VA max.

**Weight:** net, 4.6 kg (10 lb). Shipping, 6.6 kg (15 lb).

**Size:** 89 H x 212.3 W x 345 mm D (3.5" x 8.36" x 13.6").

#### Ordering Information

HP 8111A Pulse/Function Generator

Opt 001: Burst

Opt 910: Extra Operating and Service Manual

HP 5061-9701: Bail Handle Kit

HP 5061-9672 Rack Mount Kit (single HP 8111A)

HP 5061-9674 Rack Mount Kit (two instruments)

HP 5061-9694 Lock Link Kit (for use with HP 5061-9674)

☎ Fast-Ship product - see page 758

#### Price

\$2400 ☎

add \$480

add \$39

\$38 ☎

\$49 ☎

\$20 ☎

\$35 ☎

# FREQUENCY, FUNCTION & WAVEFORM SYNTHESIZERS

## Function Generator

Model 3312A

- Two function generators in one instrument
- AM-FM, sweep, trigger, gate and burst (internal and external)



HP 3312A

### Description

Hewlett-Packard's 3312 A Function Generator combines two separate, independent function generators with a modulator section in one compact instrument.

The main generator can—via pushbutton control—be triggered by the modulation generator to provide sweep functions, AM, FM or tone burst.

Ten Vp-p into 50  $\Omega$  provides adequate power for most applications. The output attenuator has a range of more than 10,000:1 so clean low-level signals from 10 V to 1 mVp-p into 50  $\Omega$  can be obtained. The main generator includes dc offset up to 10 volts p-p into 50  $\Omega$ .

The HP 3312A is an effective low cost solution for generating a multitude of functions.

### Specifications

**Output waveforms:** sine, square, triangle,  $\pm$  ramp, pulse, AM, FM, sweep, triggered and gated.

#### Frequency Characteristics

**Range:** 0.1 Hz to 13 MHz in 8 decades ranges.

**Dial accuracy:**  $\pm 5\%$  of full scale. Unspecified in Uncal Mode.

**Square wave rise or fall time (10% to 90%):**  $< 20$  ns.

**Aberrations:**  $< 10\%$ .

**Triangle linearity error:**  $< 1\%$  at 100 Hz.

**Variable symmetry:** 80:20:80 to 1 MHz.

**Sine wave distortion:**  $< 0.5\%$  ( $-46$  dB) THD from 10 Hz to 50 kHz. (10 kHz range maximum).  $> 30$  dB below fundamental from 50 kHz to 13 MHz, at full-rated output.

#### Output Characteristics

**Impedance:** 50  $\Omega$   $\pm 10\%$ .

**Level:** 20 Vp-p into open circuit,  $> 10$  Vp-p into 50  $\Omega$  at 1 kHz.

**Level flatness (sine wave):**  $\pm 3\%$  from 10 Hz to 100 kHz at full rated output (1 kHz reference).  $\pm 10\%$  from 100 kHz to 10 MHz.

**Attenuator:** 1:1, 10:1, 100:1, 1000:1 and  $> 10$ :1 continuous control.

**Attenuator error:**  $< 5\%$ .

**Sync output:** impedance: 50  $\Omega$   $\pm 10\%$ ,  $> 1$  Vp-p square wave into open circuit. Duty cycle varies with symmetry control.

**DC offset:** variable up to  $\pm 10$  volts. Instantaneous ac voltage + Vdc offset cannot exceed  $\pm 10$  V (open circuit) or  $\pm 5$  V (terminated 50 ohm).

#### Modulation Characteristics

**Types:** internal AM, FM, sweep, trigger, gate or burst, external AM, FM, sweep, trigger, gate or burst.

**Waveforms:** sine, square, triangle, ramp or variable symmetry pulse.

**Frequency range:** 0.01 Hz to 10 kHz.

**Output level:**  $> 1.0$  Vp-p into 10 k $\Omega$ .

#### Amplitude Modulation

**Depth:** 0 to 100%.

**Modulation frequency:** 0.01 Hz to 10 kHz (internal). DC to  $> 1$  MHz (external).

**Carrier 3 dB bandwidth:**  $< 100$  Hz to  $> 5$  MHz.

**Carrier envelope distortion:**  $< 2\%$  at 70% sine wave modulation with  $f_c = 1$  MHz,  $f_m = 1$  kHz.

**External sensitivity:**  $< 10$  Vp-p for 100% modulation.

#### Frequency Modulation

**Deviation:** 0 to  $\pm 5\%$  (internal).

**Modulation frequency:** internal: 0.01 Hz to 10 kHz; external: DC to  $> 50$  kHz.

**Distortion:**  $< -35$  dB at  $f_c = 10$  MHz,  $f_m = 1$  kHz, 400 kHz peak deviation.

#### Sweep Characteristics

**Sweep width:**  $> 100$ :1 on any range.

**Sweep rate:** 0.01 Hz to 10 kHz, 90:10 ramp, and 0 Hz Range (provides manual setting of "Sweep Start" without modulation generator oscillating).

**Sweep mode:** repetitive linear sweep between start and stop frequency settings. Retrace time can be increased with symmetry control.

**Ramp output:** 0 to  $> -4$  V into 5 k $\Omega$ .

#### Gate Characteristics

**Start/stop phase range:**  $+90^\circ$  to  $-80^\circ$ .

**Frequency range:** 0.1 Hz to 1 MHz (useful) to 10 MHz).

**Gating signal frequency range (external):** dc to 1 MHz, TTL compatible.

#### External Frequency Control

**Range:** 1000:1 on any range.

**Input requirement:** with dial set at 10, 0 to  $-2$  V  $\pm 20\%$  will linearly decrease frequency  $> 1000$ :1. An ac voltage will FM the frequency about a dial setting within the limits  $(0.1 < f < 10) \times$  range setting.

**Linearity:** 0.5% of  $F_{max}$  for  $F_{max} \leq 1$  MHz 5.0% of  $F_{max}$  for  $F_{max} > 1$  MHz. Deviation is from a best fit straight line. VCO frequency span  $\leq 100$ :1

**Input impedance:** 2.8 k $\Omega$   $\pm 5\%$ .

#### General

**Operating temperature:**  $0^\circ\text{C}$  to  $+55^\circ\text{C}$ ; specifications apply from  $0^\circ\text{C}$  to  $40^\circ\text{C}$ .

**Storage temperature:**  $-40^\circ\text{C}$  to  $+75^\circ\text{C}$ .

**Power:** 100 V, 120 V, 220 V, 240 V  $\pm 5\%$ ,  $\pm 10\%$ , switchable: 48 Hz to 440 Hz;  $\pm 30$  VA

**Size:** 102 mm H x 213 mm W x 377 mm D ( $4'' \times 8.4'' \times 14.8''$ ).

**Weight:** net, 3.8 kg (8.4 lb) Shipping, 5.9 kg (13 lb).

#### HP 3312A Function Generator

W30 Extended Warranty

Fast-Ship product — see page 758.

\$1,450

\$80

# FREQUENCY, FUNCTION & WAVEFORM SYNTHESIZERS

1 MHz to 20 MHz Function Generator with Arbitrary Waveforms

Model 3314A

413

- Lin/Log sweeps
- AM/FM/VCO
- Phase lock  $\times N$  and  $\div N$

- Gate and counted burst
- 1/2 cycle mode
- Arbitrary waveform generator



HP 3314A

## HP 3314A Multi-Waveform Generator

The HP 3314A is a Function/Waveform Generator with the precision and versatility to produce numerous waveforms. Its feature set includes accurate sine, square, and triangle waves, with ramps and pulses available using variable symmetry. Additional features include counted bursts, gate, lin/log sweeps, AM, FM/VCO, dc offset, and phase lock. For increased versatility, the Arbitrary waveform mode allows a countless number of user defined waveforms. Since complete programmability is provided, all of these capabilities are available for ATE systems, as well as bench applications.

### Precise Functions

The HP 3314A provides sine, square, and triangle waveforms from 0.001 Hz to 19.99 MHz with an amplitude range of 0.01 mV to 10 Vp-p into 50 ohms, with optional 30 Vp-p into > 500 ohms.

Continuous waveforms are provided with high accuracy and low distortion, with frequency accuracy on the upper ranges of 0.01% and sine distortion  $< -55$  dBc to 50 kHz.

Pulses and ramps are provided to 2 MHz using the variable symmetry control over the full 5% to 95% symmetry range. This provides narrow pulses with 9 ns rise/fall times for digital circuit testing, and positive or negative ramps for amplifier testing and process control.

Independent dc offset to  $\pm 5$  V (into 50 ohms) can be added to any ac signal. A post-attenuator summing technique is used to provide large ac signals with small offsets and vice versa.

### Burst and Gate

The HP 3314A's N Cycle burst mode generates an integer number of complete cycles at each trigger. Bursts of 1 to 1999 cycles are possible for use in applications ranging from sonar testing to digital circuits. Variable symmetry and start/stop phase can be used to produce single ramps and haversines.

Like burst mode, gate mode can be triggered internally or externally. In gate, the HP 3314A output consists of complete cycles, pulses or arbitrary waveforms which start when the trigger is true, and stop after the trigger goes false. In gate and burst modes, the full frequency range applies for sine, square, triangle, pulse, and ramp waveforms.

### New 1/2 Cycle and "Integer" Phase Lock Modes

The new 1/2 Cycle burst mode allows simulation of specialized signals found in electronics. At each trigger, alternating 1/2 cycles of sines or triangles are produced. With the addition of variable start/stop phase and symmetry, pulses with variable rise/fall time and overshoot can be produced. Repetition rate, 1/2 cycle frequency, symmetry, and phase can be set independently to produce a variety of waveforms.

The  $\text{Fin} \times N$   $\text{Fin} \div N$  modes provide powerful phase locking capability. With "integer" phase lock, fractions or multiples of the reference signal can be provided, and  $\pm 200$  deg of phase offset is available. Since the HP 3314A phase locks to the plus or minus edge of the trigger signal, it can lock to a variety of signals such as sines, squares, pulses, ramps, and others—with complete control of output function, symmetry, N, phase, amplitude and offset.

### Modulation and Sweep

Complete AM, FM/VCO modulation give the HP 3314A versatile signal modifying capabilities. With 100 kHz bandwidths, AM and FM/VCO can be used separately or simultaneously to produce a multitude of waveforms.

Multi-frequency measurements can be made with the HP 3314A's sweep capabilities. Linear, logarithmic, and manual sweep make measurements of filters, amplifiers, and other networks convenient and accurate. X drive, marker, and trigger output signals are also provided.

### Arbitrary Waveforms

For specialized low frequency applications, the HP 3314A's Arbitrary (ARB) waveform mode lets you create custom waveforms as a series of voltage ramps or vectors. Values are easy to enter from the front panel using the modify knob as a "pencil" and an oscilloscope as a "pad". For remote programming, use a desktop or mainframe computer to calculate the values, then program them using the HP-IB. Arbitrary waveforms are automatically stored in non-volatile memory for quick recall.

### Two Sources in One

A square wave trigger source is included for generation of complex waveforms with a single HP 3314A. The 0.5 MHz to 500 kHz internal trigger is useful in gated, burst, and phase locked waveforms. This signal is provided as an output for synchronizing the HP 3314A to other devices.

### Source for your System

Because all front panel controls are programmable, the HP 3314A's precision and versatility can be utilized in automated test systems.

System efficiency can be improved with standard features such as Service Request (SRQ) interrupt capability and buffered transfer mode.

In production test environments, the HP 3314A's Query commands can be used when an operator and computer are sharing control of the instrumentation. Parameters can be read from the HP 3314A into the computer where its computational capabilities can be utilized.

# FREQUENCY, FUNCTION & WAVEFORM SYNTHESIZERS

## 1 MHz to 20 MHz Function Generator with Arbitrary Waveforms (cont'd)

Model 3314A

### SAMPLE WAVEFORMS

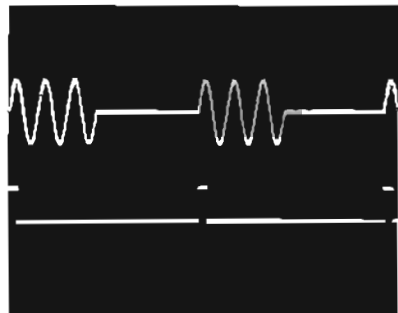

Counted burst with ext. trigger

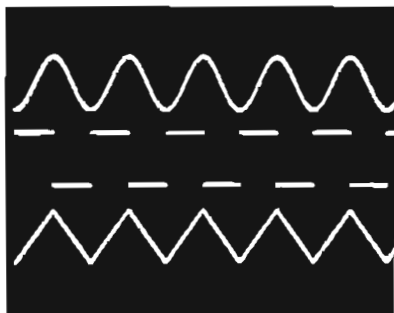

Sine, square, and triangle to 20 MHz

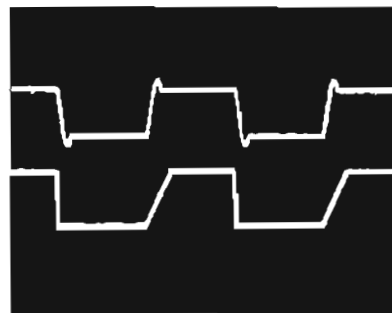

1/2 cycle mode simulating overshoot and variable rise/fall pulses

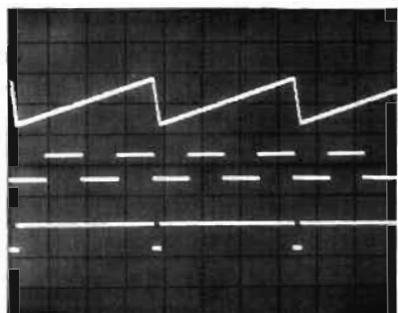

Ramp output phase locked to internal trigger. Shown with sync output.

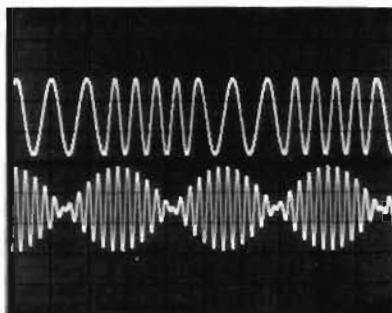

FM and AM (suppressed carrier)

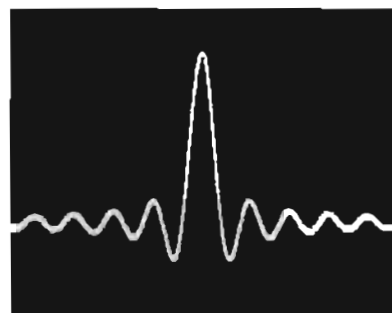

$\frac{\text{sine } x}{x}$  arbitrary waveform

### Arbitrary Waveforms Made Easy

With complete control of each vector, the modify knob is used as a "pencil" to draw the waveform on an oscilloscope.

1. After -20 unit vectors have been inserted, use modify to set the marker, VMKR, to #1. Then set the height of #1 to 400.

2. Press V LEN and use modify to set the length to 3.

3. Press V HGT twice, and set the height of #2 to -190.

4. Continue to use V HGT and V LEN to create the desired waveform, and INS (insert) or DEL (delete) vectors as needed. Amplitude and frequency can now be set without affecting the vector values. Waveform parameters are automatically stored in non-volatile memory while they are being created.

5. Later, if a slightly different waveform is needed, just use the marker to select an individual vector, and modify its height and length without affecting the height and length of other vectors!

### Specifications

#### Frequency

**Frequency range:** 0.001 Hz to 19.99 MHz-sine, square and triangle waveforms, 0.001 Hz through 2 MHz range when symmetry  $\neq$  50%

**Resolution:** 3½ digits

#### Frequency Accuracy

HP-IB #	Range	Minimum Frequency		Maximum Frequency	Accuracy
		Range Hold	Autorange		
1	2 Hz	.001 Hz	.001 Hz	1.999 Hz	$\pm(0.4\% \text{ setting} + 0.2\% \text{ range})$
2	20 Hz	0.01 Hz	1.50 Hz	19.99 Hz	
3	200 Hz	0.1 Hz	15.0 Hz	199.9 Hz	$\pm(0.2\% \text{ setting} + 0.1\% \text{ range})$
4	2 kHz	0.01 kHz	1.50 kHz	1999 Hz	
5	20 kHz	0.01 kHz	1.50 kHz	19.99 kHz	
6	200 kHz	0.01 kHz	15.0 kHz	199.9 kHz	
Synthesized					
7	2 MHz	0.01 kHz	150 kHz	1999 kHz	$\pm(0.01\% \text{ setting} + 50 \text{ ppm/year})$
8	20 MHz	0.01 MHz	1.50 MHz	19.99 MHz	

Accuracy applies in the Free Run mode, with VCO Off, and Symmetry = 50% (Fixed)

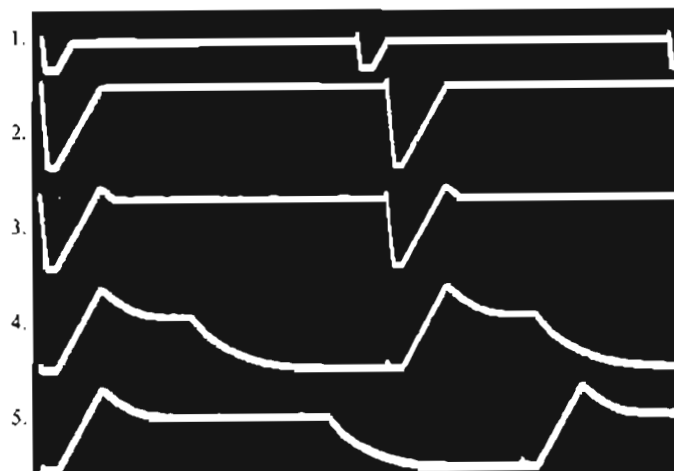

#### Amplitude

**Amplitude range:** 0.01 mVp-p to 10 Vp-p into 50  $\Omega$

**Resolution:** 3½ digits

HP-IB #	Range	Minimum (Range Hold)	Minimum (Autorange)	Maximum	Step Attenuator
1	10 mV	0.01 mV	0.01 mV	10.00 mV	60 dB
2	100 mV	0.1 mV	10.00 mV	100.0 mV	40 dB
3	1 V	.001 V	100.0 V	1.000 V	20 dB
4	10 V	0.01 V	1.000 V	10.00 V	0 dB

#### Absolute Amplitude Accuracy

$\pm(1\% \text{ of display} + 0.035 \text{ Vp-p})$ , sine and square wave  
 $\pm(1\% \text{ of display} + 0.06 \text{ Vp-p})$ , triangle

**Amplitudes:** 1.00 Vp-p to 10.00 Vp-p (Range 4)

**Frequency:** 10 kHz, Autorange ON

**Flatness-sine wave:** relative to 10 kHz, 1.00 V to 10.0 V (Range 4)





## Frequency Sweep

	Range (decades)	Start Freq	Stop Freq	Sweep Time
linear	0 to 2	≥.001 Hz	≤19.99 MHz	7.2 ms to 1999 s/sweep
log	1 to 7 (integer only)	≥0.2 Hz	≤19.99 MHz	40 ms to 1999 s/decade

### Manual Sweep

Modify knob tunes between start and stop frequencies. X drive follows sweep.

### X Drive Start/Stop Voltage

-5 V to +5 V into 1 kΩ load

### Z Axis Output

Blanking Pulse, > +5 V

Baseline, 0V ± 1 V

Marker Pulse, < -5 V into 1 kΩ load

## Modulation Inputs

	Bandwidth	Sensitivity	Range	Z
AH	dc to 100 kHz	2 Vp-p for 100% -1 Vdc for suppressed carrier	>100%	10 kΩ
FM	100 Hz to 100 kHz	±1 Vp for ±1% of range deviation	1% of Freq. range	10 kΩ
VCO	dc to 100 kHz	10%/volt	+1 to -10V	10 kΩ

## Waveform Characteristics

### Sine Harmonic Distortion

Individual harmonics will be below these levels, relative to the fundamental. Offset = 0V. Function Invert = OFF. Range Hold = OFF.

20 Hz	50 kHz	1490 kHz	19.99 MHz
	-55 dB*	-40 dB	-25 dB

\*add 4 dB for ambient temperature 0 to 5°C and 45 to 55°C, 20 Hz to 50 kHz

### Square Wave Rise/Fall Time

< 9 ns, 10% to 90% at 10 Vp-p output

### N Integer

N = 1 to 1999, Preset to 1

For Phase-lock  $F_{in} \div N$ ,  $F_{in} \times N$

or N CYCLE (counted burst)

### Function Invert

Inverts ac portion of signal outputs

Sine, square, triangle, ramp, pulse, and ARBs

Does not affect Sync and Trigger outputs or dc offset setting

## Phase

### Phase Offset—Phase Lock Modes

Resolution: 0.1°

Range: ±199.9°

Accuracy: ±2° (50 Hz to 15 kHz)

Phase Offset is Referenced to

signal output for  $F_{in} \div N$

signal input for  $F_{in} \times N$

### Start/Stop Phase—Burst Modes

Resolution: 0.1°

Range: ±90.0° for frequencies to 19.99 MHz

Accuracy: ±3° (applies from .001 Hz to 1 kHz)

## Trigger

### Internal Trigger

Range: .002 ms (500 kHz) to 1999 s (0.5 mHz) square wave.

Period Accuracy:

± (0.01% + 50 ppm/year) of displayed interval (excluding sweep intervals)

Trigger output: low < 0.5 V, high > 2.5 V; output resistance 1 kΩ

### External Trigger

For Gate, N Cycle, ½ Cycle,  $F_{in} \times N$ ,  $F_{in} \div N$ , and external sweep triggers

Frequency range: 50 Hz to 20 MHz

Trigger slope: selectable, positive or negative

Trigger level: Selectable to 0 V or +1 V

Trigger level hysteresis: ±0.15 V

Input resistance = 1 kΩ

## Symmetry

Symmetry range: 5% to 95% of period

Frequency range: 2 Hz to 2 MHz ranges

## Arbitrary Waveforms

Output consists of a series of voltage ramps called vectors. Arbitrary waveforms can be composed of 2 to 150 vectors. A maximum of 160 vectors can be stored in six available storage registers with a minimum of 2 vectors per waveform (#1 and return-to-start vectors).

## Waveform Parameters

Key	Range	Description
Δt	0.2 ms to 19.99 ms	sets the time value for each unit of V LEN (length)
V HGT	0 to ±1999	sets the relative height of an individual vector
V LEN	1 to 127	sets the length in time of an individual vector in integral multiples of Δt
V MKR	1 to 150	marker is used to select an individual vector
INS		Insert is used to add a vector before the marker location
DEL		deletes the vector at marker location
FREQ	.002 Hz to 2.5 kHz	$FREQ = \frac{1}{\Delta t(VLEN_1 + VLEN_2 + \dots VLEN_n)}$
AMPTD	.01 mV to 10 Vp-p	sets amplitude window for ARB waveform
OFFSET	0 to ± 5 Vdc	offsets the ARB waveform independent of AMPTD setting
PHASE	+90° to -90°	sets wave start/stop voltage within the window defined by AMPTD

Marker output: located on Z axis rear panel connector

Sync output: low during the return-to-start vector

Gate mode: allows external gating of ARB output (complete ARB waveforms only)

## Option 001 - Voltage Multiplier

Simultaneous ×3 amplitude output on rear panel (into > 500 Ω).

30 Vp-p max, dc to 1 MHz.

## General

### Specifications Apply When

Main signal output terminated into 50 ± 0.1 Ω

Warm-up > 30 minutes

Within ±5°C and 24 hours of last internal calibration

Temperature: 0 to 55°C

Relative humidity: <95% at 40°C

Altitude: <15,000 ft

Storage temperature: -40 to +75°C

### Power

100/120/220/240 V + 5% -10%, 48 to 66 Hz

90 VA maximum

Weight: net, 7.3 kg (16 lb). Shipping, 10.5 kg (23 lb).

Dimensions: 132.6 mm (5.22 in.) H x 212.3 mm (8.36 in.) W x 419.0 mm (16.50 in.) D

### HP-IB

IEEE Standard 488-1978 abbreviated definition

SH1 AH1 T6 TE0 L3 LEO SRI RLI PP0 DCI DT1 C0 E2

### Accessories

Transit case for one HP 3314A

HP P/N9211-2677

## Ordering Information

HP 3314A Function Generator

Option 001: simultaneous X3 output

Option W30: Extended Warranty

## Price

\$4,485

\$255

\$190

# PULSE GENERATORS

## General Information

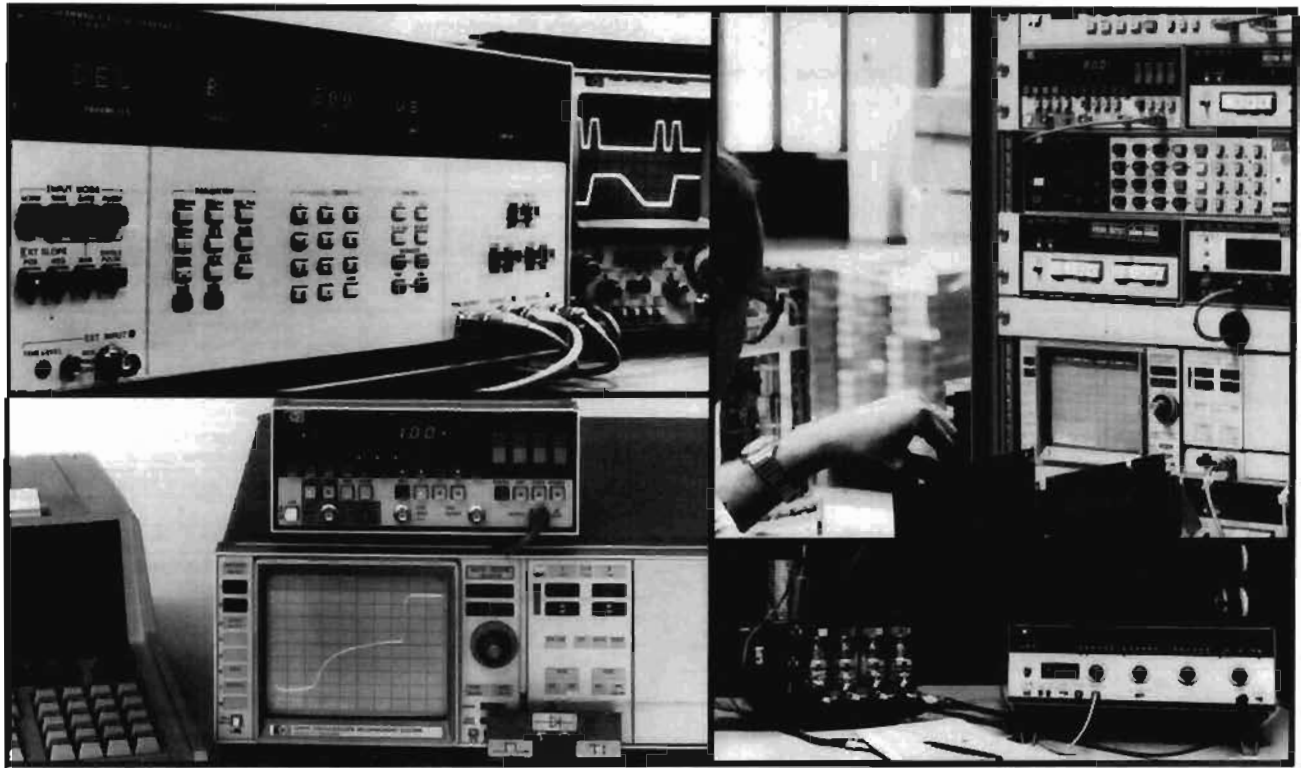

### Analog and Digital Test

HP's *pulse generators* range from simple, inexpensive units to high performance, microprocessor-based instruments offering precision pulse generation. Depending on model, variable clock speeds to 1 GHz and variable amplitudes up to 100 V are available.

Pulse parameters are independently variable for thorough characterization and worst-case testing. Variable pulse transitions permit parametric analysis like trigger circuit hysteresis, and the fastest settings are ideal for at-speed logic test and amplifier transient investigations.

*Pulse/function generators* combine pulse capability with all features expected of a function generator. The benefits are high flexibility for analog requirements plus an entry into logic test.

### Operating Comfort

Clear front panel layout, guided parameter selection, and error detection and recovery features, mean quick familiarization and rapid, error-free use. In addition, great emphasis is placed on ruggedness, reliability and serviceability. The generators are developed and produced using high quality standard components and custom-designed ICs. Resultant technical benefits are, for exam-

ple, broad operating temperature range and clean 50-Ohm output impedance.

Selectable polarity, complement and offset help make hook-up simpler and, for further flexibility, *inverters, adders and splitters* are available (page 428\*).

Complex waveform capability allows glitches, ringing and multi-level signals to be simulated. Constant numbers of pulses, unaffected by other parameters are available in HP's counted burst mode.

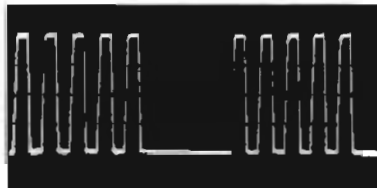

### Bench and Automatic Test

A new generation of very versatile models offer good repeatability and high operating comfort for fast, accurate testing. These instruments also offer HP-IB which makes bench automation a reality for time-consuming tests. Setup time is a minimum because the syntax is simple and uses the same command sequence as the front panel.

Straight-forward syntax helps develop ATS software quickly: good repeatability and error reporting eliminate the need for software measurement loops. Specified performance over the entire 0°C to 55°C operating temperature range guarantees reliability in system racks.

### Time Synthesis (page 429\*)

Time Synthesizers are mainly used in radar and laser ranging, component and circuit testing, and precise triggering and calibrating applications. They give a precisely timed output pulse with an accurate, adjustable delay which may be incremented in steps as small as 50 pico-seconds. A fixed, virtually jitter-free insertion delay allows phase locking to equipment under test.

### Logic Capability

**CMOS:** HP 8011A, 8015A, 8111A, 8112A, 8116A, 8160A

**TTL:** HP 8012B, 8013B, 8015A, 8111A, 8112A, 8116A, 8160A.

**LS-TTL:** HP 8082A, 8161A

**ECL:** HP 8082A (0.7 ns), 8080A (0.5 ns/0.2 ns, depending on configuration), HP 8161A (0.9 ns). Figures in brackets are the equivalent ECL switching time, 20% to 80% of amplitude.

**Pulse Generator Selection Chart**

HP Model Page	Pulse Generators											Pulse/Function Generators		
	214B 423	8005B 424	8011A 424	8012B 425	8013B 425	8015A 426	8062A 427	8080A 428	HP-IB 8112A 418	HP-IB 8160A 420	HP-IB 8161A 420	HP-IB 8111A 411	HP-IB 8116A 409	HP-IB 8165A 408
<b>Timing</b>														
Max frequency (MHz)	10	20	20	50	50	50	250	300/1000	50	50	100	20	50	50
Transition time (ns)	15	10 var	10	5 var	3.5	6 var	1 var	0.8/0.3	5 var	6 var	1.3 var	10	6	5
Var width (ns) min	25	25	25	10	10	10	2	Sp Op1	10	10	4	25	10	10
Square/duty cycle (%)	1-10	Sq	Sq	Sq	Sq	Sq	Sq	Sq	1-99			10-90	10-90	20/50/80
Variable delay	*	*	*	*	*	*	*	*	*	*	*			
<b>Output (max values are quoted: see specifications for conditions).</b>														
Amplitude (V)	100	10	16	10	10	30	5	4/2.4	32	20	5	32	32	20
Offset/Window (V)		±4/±10		±2.5/±7.5	±2.5/±7.5	±28/±16	±2/±5	±2/±4	±16/±16	±20/±20	±5/±5	±16/±16	±16/±16	±10/±10
Format	+/-	*	*	*	*	*	*	*	*	*	*	*	*	*
* = positive, negative, symmetrical, normal and complement formats.														
<b>Outputs</b>	1	+ and -	1	1	+ and -	2	1	Configurable	1	2-chan option	2-chan option	1	1	1
<b>Additional outputs</b>		TTL				TTL	Compl				Compl			
<b>Operating Modes</b>														
Trigger	*	*	*	*	*	*	*	*	*	*	*	*	*	*
Ext width				*	*	*	*	*	*	*	*	*	*	*
Gate	*	*	*	*	*	*	*	*	*	*	*	*	*	*
Ext burst	Option		Option			Option			*	*	*	Option	Option	*
Int burst									*	*	*		Option	
Double pulse	*	*	*	*	*	*	*	*	*	*	*	*	*	*
<b>Control (Modulation) Modes</b>									*	*	*	*	*	*

**Pulse Generator Definitions**

**Time Reference Point:** Median (50% amplitude point on pulse edge).

**Pulse Period:** The time interval between the leading edge medians of consecutive trigger output pulses.

**Trigger Delay:** Interval between trigger point of input signal and the trigger output pulse's leading edge median. Applies in trigger, external width, gate and burst modes.

**Pulse Delay:** Interval between leading edge medians of trigger output pulse and output pulse.

**Double Pulse:** Interval between leading edge medians of the double pulse.

**Interchannel Delay/Skew:** Interval between corresponding leading edge medians.

**Pulse Width:** Interval between leading and trailing edge medians.

**Additional Information for Pulse Generators with Variable Transition Times**

**Pulse Width:** The specified and displayed value is that obtained with fastest edges; essentially equal to the interval from the start of the leading edge to the start of the trailing edge.

By designing so that the pulse edges turn about their start points, the interval from leading edge start to trailing edge start stays unchanged when transition times are varied. This is more convenient for programming and the width display is easy to interpret.

*\*In practice, start points may shift with change in transition time.*

**Delay:** The specified and displayed value is that obtained with the fastest leading edge. For a slower edge, the actual delay exceeds the displayed delay by the combined shift of start-point and median.

**Transition Time:** Interval between the 10% and 90% amplitude points on the leading/trailing edge.

**Linearity:** Peak deviation of an edge from a straight line through the 10% and 90% amplitude points, expressed as percentage of pulse amplitude.

**Jitter:** Short-term instability of one event with respect to another. Unless stated otherwise, value is p-p, expressed as a percentage of the main parameter.

**Stability:** Long-term average instability, expressed as percentage of main parameter over a specific time duration, e.g. hour, year. Exclude jitter.

**Pulse Level:** High level and low level. Any limitation is expressed by an amplitude specification.

**Pulse Amplitude (alternative to level definition):** Pulse amplitude and offset\* are specified. Any limitation is expressed by a window (max high level, min low level).

*\*Pulse generators use baseline offset. Function generator outputs are symmetrical and consequently use median offset.*

**Preshoot, Overshoot, Ringing:** Preshoot and overshoot are peak distortions preceding/following an edge. Ringing is the positive peak and negative peak distortion excluding overshoot, on pulse top or base. A combined preshoot/overshoot/ringing specification of e.g. ±5% implies:

- Overshoot/undershoot < 5%
- Largest pulse-top oscillation < 1.5% of pulse amplitude.

**Settling Time:** Time taken for pulse levels to settle within level specification, measured from 80% point on leading edge.

**Duty Cycle:** Percentage ratio of pulse width to period. In pulse/function generators, this term is also used to define sine and triangle symmetry.

**Output Impedance/Resistance:** Effective pulse source impedance/dc resistance.

**Reflection Coefficient:** Reflection at pulse generator output expressed in percent of incident pulse amplitude. (Test pulse edges correspond to generator's fastest transitions).

**Repeatability:** When an instrument operates under the same environmental conditions, and with the same settings, the value of a parameter will lie within a band inside the accuracy window. Repeatability defines the width of this band.

**HP-IB Programming Times**

**Listen Time:** The time an instrument occupies the bus to receive and verify a message. The NAKED signal is active during this period.

**Settling Time:** The time taken by the instrument to execute an HP-IB message, and for the output to settle within the accuracy specification, NRFD inactive.

**Execution Time:** The sum of Listen Time and Settling Time.

**Talk Time:** The time an instrument occupies the bus to output a specified string. Output data is typically instrument error status, or current or stored parameters.

# PULSE GENERATORS

## Programmable Low Cost Pulse Generator

### Model 8112A

- Full pulse capability
- Modulation
- Ramps and haversines
- Width/duty cycle
- Device protection
- Error recognition and self test



HP 8112A

The HP 8112A is fully programmable 50 MHz pulse generator with 5 ns transitions and 32 Vpp (into open circuit) max output amplitude. All pulse parameters are variable including delay and double pulse spacing.

Besides the comprehensive trigger modes, external modulation capabilities extend applicability. 3-level signals and upper level, width, period and delay-modulated signals are available. These can be combined with the trigger modes so that complex real-life signals like modulated bursts are simulated easily.

Step response and trigger hysteresis measurements require fast transitions or sawtooth signals as obtained in the HP 8112A's linear transition mode—either fixed 5 ns or variable from 6.5 ns. The new cosine transitions, also variable from 6.5 ns, mean that band-filtered signals are now just as simple to obtain.

Sensitive devices are protected by programming output limits and the upper level can be controlled by the device supply. Also, constant energy or constant width can be programmed.

Dual channel operation is feasible by operating HP 8112A's in a master/slave combination.

For really easy operation a green button gives error-free settings. A new softkey operating concept plus detailed error recognition make the HP 8112A's powerful versatility easy to handle.

#### Specifications

Specifications apply with 50-ohm load, and temperatures in the range 0°C to 55°C.

#### Timing (specifications apply for min transition times)

**Period:** 20.0 ns to 950 ms.

**Delay:** 65.0 ns to 950 ms.

**Double pulse:** 20.0 ns to 950 ms.

**Width:** 10.0 ns to 950 ms.

**Accuracy:**  $\pm 5\%$  of progr value  $\pm 2$  ns (delay:  $\pm 4$  ns).

**Duty cycle:** 1% to 99% (Min: 10 ns. Max: period - 10 ns).

Accuracy:  $\pm 10\%$  of progr value.

**Pulse Characteristics** (voltages double when driving into open circuit)

#### Levels

High level: -7.90 V to 8.00 V.

Low level: -8.00 V to 7.90 V.

Accuracy:  $\pm 1\%$  of progr value  $\pm 3\%$  amplitude  $\pm 40$  mV.  
Settling time: 100 ns + transition time.

#### Transition times

Fixed: 5 ns typical

Linear and Cosine: 6.5 ns to 95.0 ms (max edge ratio 1:20 within a 1.5-decade range. Ranges overlap by 0.5 decade).

Accuracy:  $\pm 5\%$  of programmed value  $\pm 2$  ns.

**Preshoot, overshoot, ringing:**  $\pm 5\% \pm 10$  mV (variable transitions),  $\pm 10\% \pm 10$  mV (fixed transitions).

**Output resistance:** 50 ohm  $\pm 5\%$ .

**Operating modes:** Normal, Trigger, Gate, Ext Width (pulse restoration), Ext Burst (1 to 1999 pulses).

#### Control (Modulation) Modes

**Period, delay, width** covered in 8 non-overlapping decades (max input frequency 8 kHz.).

**High level:** -8 V to +8 V, independent of progr low level (min input transition 200  $\mu$ s).

#### General

**HP-IB:** all keys programmable. Learn, status and error reporting capability. Interface functions, SH1, AH1, T6, L4, SRI, RLI, PPO, DC1, DT1.

**Memory:** retains current operating state. 9 store/recall locations. 1 fixed set of parameters.

**Repeatability:** factor 4 better than accuracy.

#### Environmental

**Storage temperature:** -40°C to +65°C.

**Operating temperature:** 0°C to 55°C.

**Humidity:** 95% RH, 0°C to 40°C.

**Power:** 100/120/220/240 V rms;  $\pm 5\%$ , -10%; 48 to 440 Hz; 120 VA max

**Weight:** net . 5.9 kg (13 lb). Shipping, 8.0 kg (18 lb).

**Size:** 89 H x 212.3 W x 450 mm D (3.5" x 8.36" x 17.7").

#### Ordering Information

HP 8112A Programmable Pulse Generator\*

Opt 910 Extra Operating and Service Manual

HP 5061-9701 Bail Handle Kit

HP 5061-9672 Rack Mount Kit (single HP 8112A)

HP 5061-9674 Rack Mount Kit (two instruments)

HP 5061-9694 Lock Link Kit (for use with HP 5061-9674)

\* HP-IB cables not supplied, see page 549

☎ Fast-Ship product—see page 758

**Price**

\$5600

add \$49

\$38

\$49

\$30

\$35

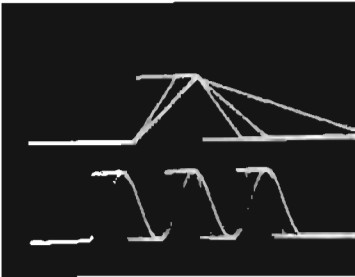

**Linear Transitions**  
(upper trace) supply everything from fast pulses through trapezoids to ramps and triangles. These solve the stimulus requirements for such diverse applications as transient response evaluation

measurements, component stress characterization and materials testing. Variable transition times allow digital devices to be tested under the exact conditions specified by the IC manufacturer. Also, reflections caused by mismatch can be reduced by increasing the transition times.

**Cosine-Shaped Transitions**

Selectable cosine edges reduce signal bandwidth for transmission line testing. As shown in the lower trace in the above photograph, even haversines (which are ideal for simulating radar and similar signals) can be generated when the pulse width is set equal to transition time.

**Counted Burst Mode**

The external signal (upper trace) triggers a counted number of output pulses which can be used for clocking digital devices to an exact condition. The External signal can also be used to trigger single or double pulses, or to gate the output.

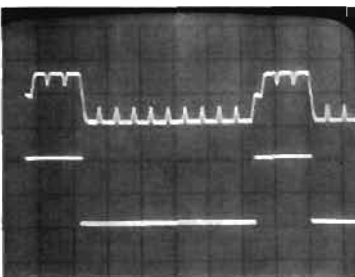

**External Width Mode**  
The clean lower trace has been recovered from the noisy signal applied to the HP 8112A's External Input.

**Flexible Transition Time Handling**

allows excessive settings so that noise spikes (like those in the upper trace) as well as triangular waveforms can be generated.

**Delay Control Mode**

Phase Modulated signals can be simulated by controlling delay with an external voltage. The lower trace shows the effect on a double-pulse signal.

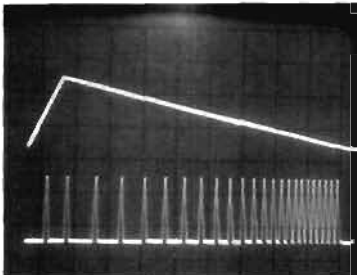
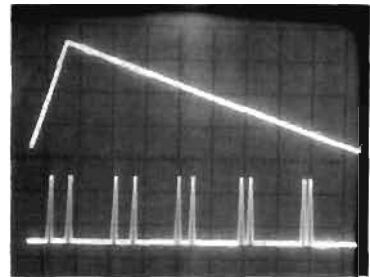

**Period Control**

PLL tracking accuracy and settling time can be evaluated with the period-modulated signals (lower trace) generated in the Period Control mode.

**Width Control**

As shown in the lower trace, PWM control signals can be simulated in this mode. As in the other timing control modes, the dynamic range is 1:10.

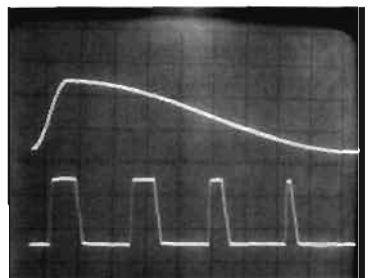

**Dual-Edge Triggering**

Both edges can be selected for triggering as well as just positive or negative. The lower trace shows how a magnetic storage device signal can be simulated by applying a signal (upper trace) simultaneously as external trigger and high-level control voltage.

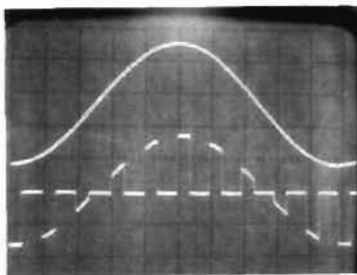
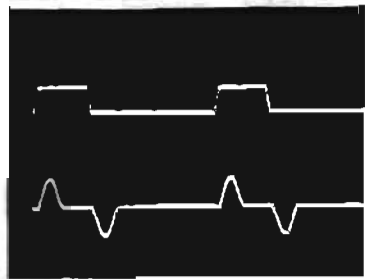

**High-Level Control**

In addition to producing 3-level signals like that in the previous photograph, high-level control mode can be used for simulating PAM signals and also for protecting CMOS.

# PULSE GENERATORS

## Programmable Precision Pulse Generators

Models 8160A, 8161A

- 50 MHz repetition rate
- 6.0 ns variable transition time
- 20 V output amplitude
- 1-3% pulse parameter accuracy
- Full dual channel capability (option 020)
- 1 year recalibration period

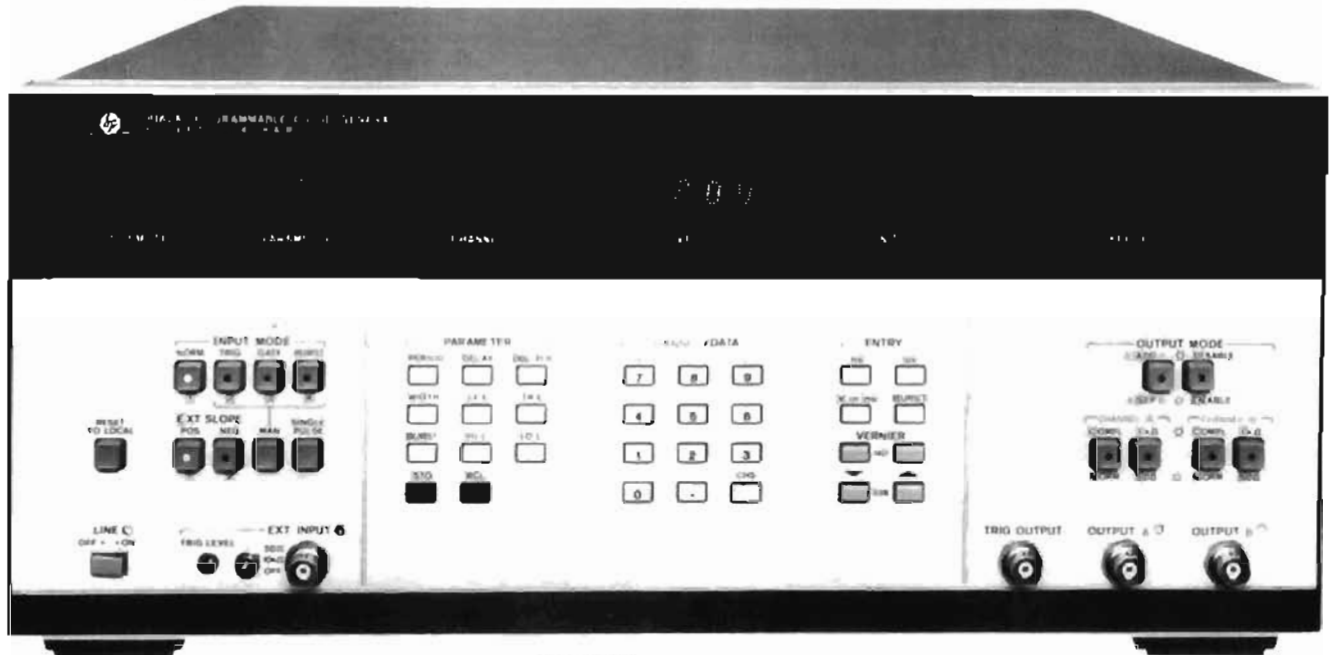

Designed For  
MATE  
Systems



Picture shows 8160A  
with Option 020, Dual Channel  
with Option 700, MATE/CIL compatibility

- 100 MHz repetition rate
- 1.3 ns variable transition time
- 5 V amplitude
- 1-3% basic timing accuracy
- Full dual channel capability (option 020)
- 1 year recalibration period

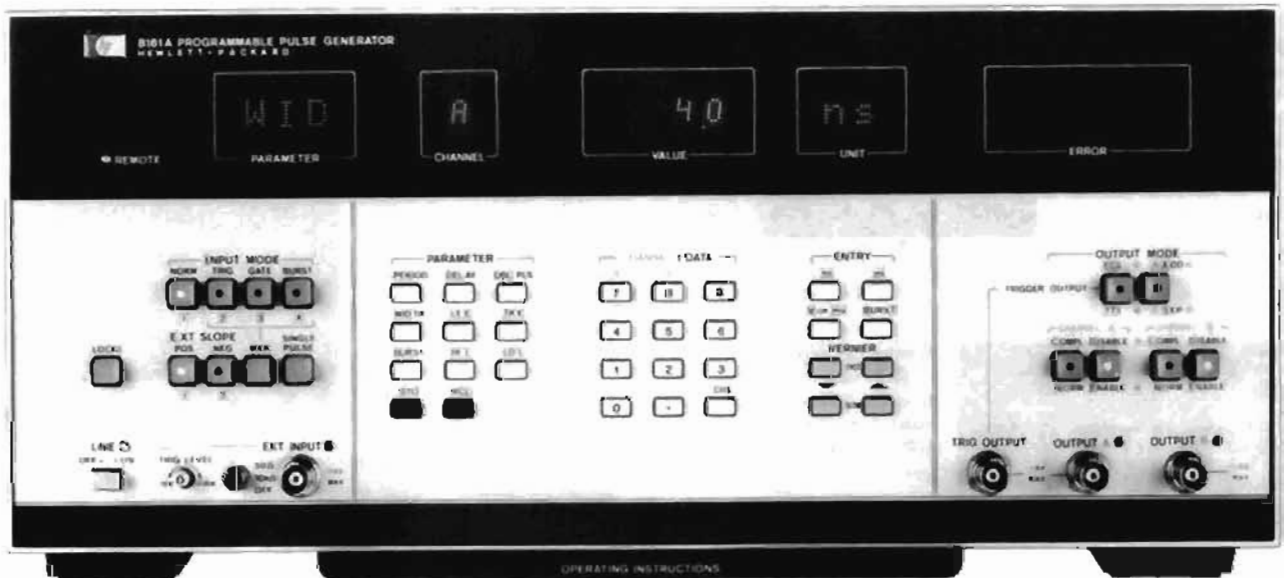

Designed For  
MATE  
Systems



Picture shows 8161A  
with Option 020, Dual Channel  
with Option 700, MATE/CIL compatibility

The HP 8160A and 8161A are fully programmable pulse generators designed for high performance applications on the bench and in automatic test systems. Operation is made easy because the pulse parameters are controlled independently and do not inter-react. Dual channel options permit synchronous or complex waveforms to be generated. With its 50 MHz repetition rate, 20 V output, and 6 ns variable transition times, the HP 8160A is a general purpose pulse generator. The HP 8161A covers the high end of technology with its 100 MHz, 5 V and 1.3 ns variable transition times. Measured between the 20% to 80% amplitude points, these transitions are faster than 1 ns and meet ECL requirements.



HP 8161A input pulse (upper) and ECL memory output pulse (lower).

Combining high programming accuracy with microprocessor-based control capabilities, pulses can be set up without a measuring instrument. Pulse parameters are entered and displayed numerically, and generated with a basic timing accuracy of 1-3%, depending upon parameter.

An easy-to-use HP-IB interface brings high-accuracy pulses to automatic test. All parameters and operating modes are remotely programmable using straight-forward command sequences. Faster, easier program generation and reduced software costs are direct benefits.

### Precision Pulse Generation

Both models provide precision control over all parameters of their output pulses. The HP 8160A's leading and trailing edge transition times may be independently programmed down to 6 ns. The HP 8161A's transitions have a common control from 1.3 ns to 5 ns, and are independent above 5 ns. Variable transition times are indispensable when digital IC's need to be characterized: either the IC's data sheeted input transition time is required, or the IC's functioning range with various transitions needs to be evaluated.

Direct entry of the high and low levels of the output pulse enables easy adjustment to the logic levels concerned. Pulse width is variable from 4 ns (HP 8161A) or 10 ns (HP 8160A) to 1 s, giving a wide range of duty cycle programmability. Delay shifts the output pulse in relation to the trigger output or, in double pulse mode, defines the pulse spacing.

In the dual-channel versions, double pulse can be selected in either or both channels. This means, for example, that simultaneous clock and data signals can be generated.

### Complex Signals

Independent pulse parameters plus individual programmability of the Option 020's dual outputs are augmented by the A ADD B mode. Summation allows complex signals to be precisely and easily set up. Here are some examples:

Applications such as radar coincidence circuits and special codes in communications require 3- and 4-level signals. These are conveniently generated by combining channel A and channel B pulses

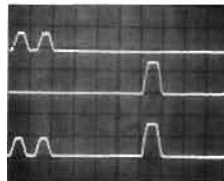

A  
SEP  
B

A ADD B

Transponder circuits need accurate delays, often with respect to a double-pulse interrogation signal. In the HP 8160A, this is arranged by operating one channel in double pulse mode and setting up the transponder delay in the other.

A critical test for digital circuits and IC's is its glitch and noise sensitivity, which can be easily performed with the A ADD B mode.

A  
SEP  
B

A ADD B



### Counted Burst

Using Burst Mode, a predetermined number of pulses is generated independent of frequency. Bursts from 0 to 9999 pulses in length may be produced, and can be triggered via an external signal manually or with an HP-IB command.

### Wide Temperature Range for System Reliability

The HP 8160A's and 8161A's 0-50°C operating range ensures calculable performance. Indeed, temperatures will generally be between 20-40°C where there is no derating factor.

### User Features

#### Fast, Reliable Setup

Microprocessor control promotes highly accurate pulses. Parameters are directly entered via the instrument's keyboard, and are then displayed on numeric LED's with 3-digit resolution.

In bench applications, the vernier controls give a fine adjust capability to "tweak-in" any pulse parameter. You can increment or decrement the selected parameter either in single steps or at speed.

Error detection by the microprocessor further simplifies pulse setup by solving the old problem of incompatible settings. Should pulse width exceed pulse period, for example, the microprocessor indicates a TIMING error. All possible mis-settings are detected and the type of error is indicated to aid rapid correction.

#### HP-IB Programming

Microprocessor control over all interface functions makes remote programming as easy and straight-forward as manual control. The instruments employ keystroke programming so that data entry via the HP-IB is an exact simulation of manual entry. Bus commands for each front panel key simply replace manual keystrokes.

#### Parameter Storage

Complete parameter and mode information for 9 independent instrument set-ups can be stored. Waveforms may be stored and recalled either manually or via the HP-IB.

By utilizing a single command to recall an entire instrument set-up, controller time is saved. In simple repetitive testing applications, storage of test waveforms gives a high degree of user convenience without an external controller.

Specifications overlaid

# PULSE GENERATORS

## Programmable Precision Pulse Generators (cont'd)

Models 8160A, 8161A

### Learn Mode

When interrogated by the system controller, the instruments output a character string to the interface bus. This string completely describes the pulser's current set-up or any one of its stored parameter sets. Using Learn Mode, you can enter and try out waveforms manually and then automatically transfer them via the HP-IB to the controller for storage in a program.

### Verification Software for the 8160A

Test system accuracy is guaranteed by accessory software which verifies the HP 8160A's performance standards. The software is fully documented and comes recorded on a cassette suitable for HP Model 9825A Desktop Computer.

In the event of a failure, downtime is minimized because the software also delivers diagnostic information to accelerate repair and calibration.

### Specifications

(50-ohm source into 50-ohm load). Standard instruments are single channel. Option 020 provides independent dual channels with common pulse period.

Timing (with minimum transitions)	HP Model 8160A	HP Model 8161A
<b>Period</b> Range: Accuracy: Max Jitter:	20 ns to 999 ms. ±3% of progr value ±0.3 ns (period < 100 ns); ±2% of progr value (period ≥ 100 ns). 0.1% of progr value + 50 ps.	10 ns to 980 ms. ±3% of progr value ±0.5 ns (period < 100 ns); ±2% of progr value (period ≥ 100 ns). 0.1% of progr value + 50 ps.
<b>Delay, Double Pulse, Width</b> Delay Range: Double Pulse Range: Width Range: Accuracy: Max Jitter	0.0 ns to 999 ms. 20.0 ns to 999 ms. 10.0 ns to 999 ms. ±1% of progr value ±1 ns. 0.1% + 50 ps (≤999 ns); 0.05% (999 ns < - ≤9.99 μs); 0.005% (>9.99 μs).	0.0 ns to 990 ms. 8.0 ns to 990 ms. 4.0 ns to 990 ms. ±1% of progr value ±1 ns. 0.1% + 50 ps (≤999 ns); 0.05% (999 ns < - ≤9.99 μs); 0.005% (>9.99 μs).
<b>Output Characteristics</b>  <b>Output levels</b> High Level Range: Low Level Range: Amplitude: Level Accuracy:  Settling Time:	<b>50 Ω into open</b> or 1 kΩ into 50 Ω 50 Ω into 50 Ω -9.89 V to 9.99 V. -9.99 V to 9.89 V. 0.10 V min, 9.99 V max. ±1% of progr value ±1% of ampl ±50 mV. 40 ns	<b>50 Ω into open</b> or 1 kΩ into 50 Ω -19.7 V to 19.9 V -19.9 V to 19.7 V 0.2 V min, 19.9 V max -4.95 V to 5.00 V. -5.00 V to 4.95 V. 0.06 V min, 5.00 V max. ±1% of progr value ±3% of ampl ±25 mV. 20 ns plus transition time.
<b>Transition Times (10 - 90% amplitude)</b> Leading Edge: Trailing Edge: Accuracy: Linearity:	6.0 ns to 9.99 ms 6.0 ns to 9.99 ms. ±3% of progr value ±1 ns ±3% for transitions > 30 ns.	1.3 ns to 900 μs. 1.3 ns to 900 μs. ±10% of progr value ±1 ns. ±5% for transitions > 30 ns.
<b>Preshoot, Overshoot, Ringing:</b>	±5% of ampl ±10 mV.	±5% of ampl ±10 mV (may increase to ±10% of ampl ±10 mV for transitions < 2.5 ns).
<b>A ADD B:</b>	Adds channel A and B outputs (Opt 020 only).	Adds channel A and B outputs (Opt 020 only).
<b>Output Format:</b>	Normal/Complement Selectable. (Independently selectable in each channel in Option 020.)	Simultaneous Normal and Complement Outputs. (Independently selectable in each channel in Option 020.)
<b>Source Impedance:</b>	50 ohm/1 kohm selectable.	50 ohm.

**Operating modes:** Normal, Trigger, Gate, Ext Burst (0-9999 pulses).

**HP-IB capability:** all modes and parameters can be programmed. Talk mode for status, error messages, stored parameters.

**Memory:** 9 programmable locations\*,  
1 location for active operating state\*,  
1 location with fixed parameter set.

**Capacity:** 1 complete operating state per location.  
\* Battery back-up for power-off storage

### General

**Recalibration period:** 1 year.

**Repeatability:** factor 2 better than specified accuracy.

**Operating temperature:** 0°C to 50°C (Specifications apply from 20°C to 40°C. Accuracy derating factors for 0°C to 20°C and 40°C to 50°C).

**Power:** 115/230 V ac + 10%, -22%, 48-66 Hz; 675 VA max.

**Weight:** net 20.8 kg (46 lbs). Shipping 25 kg (55 lbs).

**Size:** 178 H x 426 x 530 mm D (7" x 16.8" x 20.9").

### Ordering Information

### Price

	HP 8160A	HP 8161A
HP 8160A/8161A Programmable Pulse Generator*	\$14,400	\$16,700
Opt 001: Rear panel inputs and outputs	N/C	N/C
Opt 020: Second channel (Rate common)	\$7,040	\$7,230
Opt 700: Built-in MATE/CIL compatibility	\$3,060	\$3,055
Opt 907: Front handle kit (P/N HP 5061-9690)	\$66	\$66 ☞
Opt 908: Rack flange kit (P/N HP 5061-9678)	\$36	\$36 ☞
Opt 909: Opt 907, 908, combined (P/N HP 5061-9684)	\$92	\$92 ☞
Opt 910: Additional Operating Manual	\$122	\$153

\* HP-IB cables not supplied, see page 649

☞ Fast-Ship product—see page 758



# PULSE GENERATORS

## Fast, High Power Pulse Generator

423

Model 214B

- High power 100 V, 2 A output
- 10 MHz repetition rate

- Constant duty cycle
- Counted pulse burst option

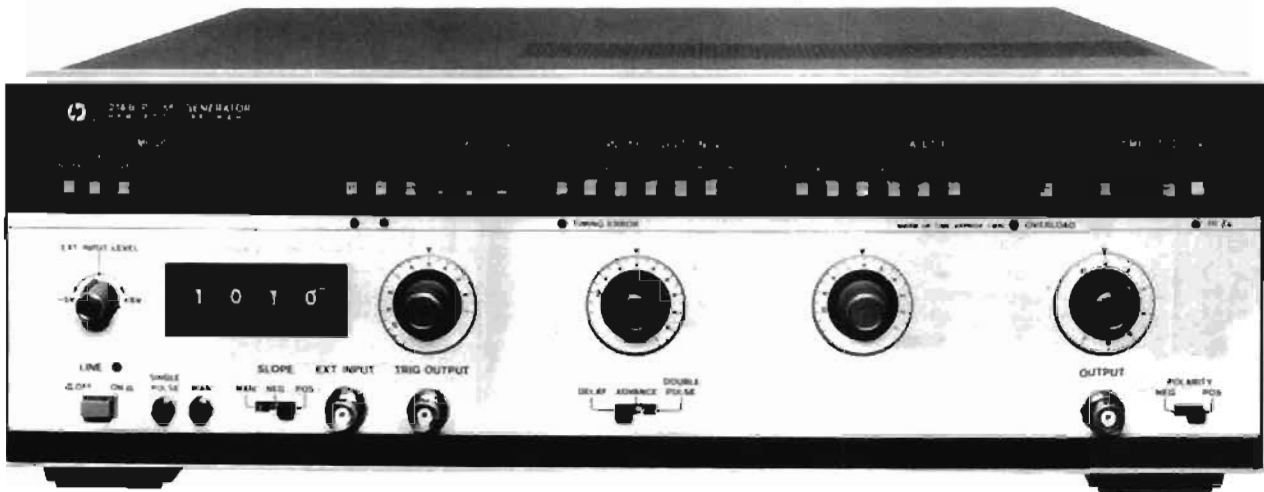

Picture shows 214B with Option 001, Counted Burst.

The HP 214B pulse generator employs semiconductor technology for high power pulse generation at up to 10 MHz repetition rate. Delivering 100 V pulses with 15 ns risetimes, the HP 214B meets the speed demands of today's applications.

State-of-the-art VMOS FETS used as current sources for the output amplifier tubes enable pulse width to be specified down to 25 ns. The HP 214B is thus well-equipped for low duty cycle applications such as laser diode pulsing or transient simulation.

Where changing duty cycle threatens destruction to the device under test, the HP 214B Constant Duty Cycle (CDC) mode provides device protection. In CDC operation the duty cycle, hence power, remains constant as frequency is varied. The HP 214B is itself protected against excessive duty cycles via an overload protect circuit.

Easy operation is assured by the timing error indication. Calibrated dials enable fast accurate adjustments. Operating into unmatched loads, clean pulse shape is guaranteed by the low reactance 50  $\Omega$  source impedance. Pulse distortions such as preshoot and overshoot are specified as 5% at all amplitudes.

## Specifications

### Timing

**Repetition rate:** 10 Hz to 10 MHz in 6 ranges. In 30 V - 100 V amplitude range, maximum rep. rate is 4 MHz. Calibrated vernier provides continuous adjustment within ranges. **Vernier accuracy:**  $\pm(10\%$  of setting + 1% full scale). **Period Jitter:**  $\leq 0.1\% + 300$  ps.

**Pulse delay/advance:** pulse can be delayed/advanced with respect to the trigger output from 10 ns to 10 ms ( $\pm$  fixed delay of 45 ns) in 5 ranges. Calibrated vernier provides continuous adjustment within ranges. **Vernier accuracy:**  $\pm(10\%$  of setting + 1% full scale) + fixed delay. **Position Jitter:**  $\leq 0.1\% + 500$  ps

**Maximum pulse position duty cycle:**  $\geq 50\%$

**Double pulse:** 5 MHz maximum in all ranges except 30 V - 100 V range which is max. 2 MHz. Minimum separation is 100 ns.

**Pulse width:** 25 ns to 10 ms in 6 decade ranges. Calibrated vernier provides continuous adjustment within ranges. **Accuracy:**  $\pm(10\%$  of setting + 1% full scale) + 5 ns. **Width Jitter:**  $\leq 0.1\% + 500$  ps.

**Max. duty cycle:**  $\geq 10\%$  for 30 - 100 V range,  $\geq 50\%$  all other ranges.

**Constant duty cycle mode (disabled in ext. trigger mode):** duty cycle of output pulse remains constant as the period is varied. The duty cycle limits in this mode are typically 8% fixed for the 10 M - 1 MHz range (max. 4 MHz); 2.5% to 10% for 1 MHz - .1 MHz range; .25% to 10% for .1 MHz - 10 kHz range; 0.1% for all other ranges. Calibrated vernier provides continuous adjustment within ranges.

**Accuracy:**  $\pm(15\%$  of setting + 1% of full scale).

### Trigger Output

**Amplitude:**  $\geq +5$  V (50 ohm into open circuit).

**Pulse width:** 10 ns typical.

### External Operating Modes

**External Input (impedance 10 k ohm, dc coupled)**

**Repetition rate:** dc to 10 MHz. **Sensitivity:** 500 mVpp, dc coupled.

**Slope:** pos. or neg. **Trigger level:** +5 V to -5 V adjustable.

**Maximum input level:**  $\pm 100$  V. **Trigger pulse width:**  $\geq 10$  ns.

**EXT TRIG mode:** an output pulse is generated for each input pulse. **GATE mode:** gate signal turns on rep. rate generator synchronously. Last pulse always completed.

**BURST mode (optional):** preselected number of pulses generated on receipt of trigger signal. **Number of pulses:** 1 to 9999. Minimum spacing between bursts: 200 ns.

**Manual:** pushbutton can be used for triggering single pulses (EXT TRIG mode), generating gate signals (GATE mode) or triggering pulse bursts (BURST mode).

### Output

**Amplitude:** 0.3 V to 100 V in 5 ranges. Calibrated vernier provides adjustment within ranges. **Vernier accuracy:**  $\pm 10\%$  of setting.

**Source impedance:** fixed 50  $\Omega$  nominal on ranges up to 10 V. Selectable 50  $\Omega$  nominal or HI-Z on 10 - 30 - 100 V ranges (with 50  $\Omega$  / 50  $\Omega$  impedance, amplitude decreases to 5 - 15 - 50 V).

**Polarity:** pos. or neg. selectable.

**Transition times:**  $\leq 15$  ns for leading and trailing edges.

**Pulse top perturbations:**  $\leq \pm 5\%$  of amplitude.

### General

**Operating temperature:** 0°C to 55°C.

**Power:** 100/120/220/240 Vrms; +5%, -10%. 48 to 66 Hz, 360 VA max.

**Size:** 133 mm H x 426 mm W x 422 mm D (5.2" x 16.8" x 16.6").

**Weight:** net 13.6 kg (30 lb). Shipping 15.6 kg (34.3 lb).

### Ordering Information

HP 214B Pulse Generator

Opt 001: Counted Burst

Opt 002: Rear Panel Connectors

Opt 003: 48-440 Hz Line

Opt 907: Front Handle Kit (part number HP 5061-9689).

Opt 908: Rack Mount Kit (part number HP 5061-9677).

Opt 909: Opt 907, 908 Combined (part number HP 5061-9683).

Opt 910: extra Operating and Service Manual

☛ Fast-Ship product—see page 758

### Prices

\$4585

add \$660

n/c

add \$120

add \$56 ☛

add \$33 ☛

add \$82 ☛

add \$34

# PULSE GENERATORS

## 20 MHz Pulse Sources

Models 8005B, 8011A

- Dual outputs, +10 V and -10 V
- TTL output
- Gating, square wave, double pulse modes



HP 8005B

The HP 8005B is a general purpose, triple output pulse generator. This instrument has all parameters variable and produces simultaneous pos. and neg. pulses. It also has a TTL output with all parameters variable except amplitude. This feature, together with the normal/complement facility, greatly improves the ease of operation.

### HP 8005B Specifications

#### Pulse Characteristics

**Transition times:**  $\leq 10$  ns to 2 s. Edges independently variable.  
**Non-linearity:** for transition times  $> 30$  ns,  $< 4\%$  of pulse amplitude.  
**Preshoot, overshoot, ringing:**  $< 5\%$  of pulse amplitude.  
**Pulse width:**  $< 25$  ns to 3 s. **Jitter:**  $< 0.1\%$  of setting + 50 ps.  
**Max. duty cycle:**  $> 80\%$  (0.3 Hz - 1 MHz),  $> 50\%$  (1-20 MHz).  
**Square wave:** 0.15 Hz - 10 MHz.  
**Pulse delay:**  $< 100$  ns to 3 s. **Jitter:**  $< 0.1\%$  of setting + 50 ps.  
**Pulse outputs:** simultaneous pos., neg. and TTL outputs.  
**Pulse amplitude:** 300 mV to 10 V.  
**Output protection:** max. external voltage  $\pm 10$  V.  
**Source impedance:** 50 ohms  $\pm 10\%$  or high impedance selectable.  
**TTL compatible output:**  $\pm 4.6$  V norm. or comp. 50  $\Omega$  impedance.

#### Repetition Rate and Trigger

**Repetition rate:** 0.3 Hz to 20 MHz in 5 ranges. **Jitter:**  $< 0.1\%$  + 50 ps.  
**Double pulse:** 10 MHz max. Simulates 20 MHz.  
**Trigger output:**  $> +2$  V ampl. across 50 ohms. **Width:**  $> 6$  ns.

#### External Operating Modes

##### External Triggering (dc to 20 MHz)

**Delay:** approx. 35 ns trig. input to trig. output.  
**Maximum input:**  $\pm 10$  V. **Sensitivity:** sine 2 Vpp  
**Impedance:** approx. 1k ohms, dc coupled. **Pulses:**  $\pm 1$  Vpeak.  
**Input pulse width:**  $\geq 10$  ns.

##### Gating

**Synchronous:** gate signal turns on repetition rate. Last pulse is always completed.

**Asynchronous:** gate signal controls output of rate generator

##### Gate Input (impedance 1 k ohms dc coupled)

**Amplitude:** 2 V to 20 V (max.). **Polarity:** negative.

#### General

**Operating temperature:** 0°C to 55°C.  
**Power:** 115/230 V rms;  $+10\%$ ,  $-15\%$ ; 48 to 440 Hz, 180 VA max.  
**Weight:** net 7 kg (15.5 lb). Shipping 9 kg (20 lb).  
**Size:** 130 H x 426 W x 290 mm D (5.1" x 16.8" x 11.4").

#### Ordering Information HP 8005B, 8011A

HP 8011A Pulse Generator	\$1,250	☎
Opt 001: Pulse Burst	add \$370	
Opt 910: extra Operating and Service Manual	add \$20	
HP 15179A (for HP 8011A): Adapter frame, Rack mount for 1 or 2 units, includes blank panel for single-unit operation.	\$235	
HP 8005B Pulse Generator.	\$3565	
Opt 908: Rack Flange Kit (part number HP 5060-8740).	add \$38	☎
Opt 910: extra Operating and Service Manual.	add \$28	
☎ Fast-Ship product—see page 758		

- Repetition rate 0.1 Hz to 20 MHz
- Positive/negative/symmetrical output
- Normal/complement switch



Picture shows 8011A with Option 001, Burst.

The HP 8011A is a versatile, reliable, low cost pulse generator. This compact instrument features an uncomplicated design using high quality components to ensure long, dependable service. Ease of operation results from the logical and simple front panel layout. These qualities and the many pulse formats available emphasize the HP Model 8011A's cost-effectiveness in a wide application range.

### HP 8011A Specifications

#### Pulse Characteristics (50 ohm source/load impedances)

**Transition times:**  $< 10$  ns fixed.  
**Overshoot, ringing and preshoot:**  $< \pm 5\%$  of pulse amplitude. May increase to 10% at counter-clock wise positions of amplitude vernier.  
**Pulse width:** 25 ns to 100 ms in four ranges. Vernier provides continuous adjustment within each range.  
**Width jitter:**  $< 0.1\%$  + 50 ps on any width setting.  
**Maximum duty cycle:**  $> 50\%$  (100% using pulse complement)  
**Maximum output:** 8 V. With internal 50  $\Omega$  and external Hi-Z or internal Hi-Z/external 50  $\Omega$ , then 16 V max.  
**Attenuator:** 3-step attenuator provides the ranges 0.25 V - 1 V - 4 V - 16 V. Vernier provides continuous adjustment within each range.  
**Source impedance:** 50  $\Omega$   $\pm 10\%$  shunted by 30 pF, except in 4 V - 16 V range which is 50  $\Omega$ /Hi-Z, switch selectable.  
**Polarity/format:** pos., neg., or sym./norm. or compl., switch select.

#### Repetition Rate and Trigger

0.1 Hz to 20 MHz in 5 ranges. Vernier provides continuous adjustment within each range. **Period jitter:**  $< 0.1\%$  + 50 ps of per. setting.  
**Square Wave:** 0.05 Hz to 10 MHz.  
**Trigger output:** dc coupled 50  $\Omega$  (typ.) source delivering  $\geq +1$  V into 50  $\Omega$  (can increase to +5 V). **Trigger pulse width:** 20 ns  $\pm 10$  ns.

#### External Operating Modes

**Input impedance:** 50  $\Omega$   $\pm 10\%$ . **Trigger polarity:** positive.  
**Maximum input:**  $\pm 5$  V. **Sensitivity:** 1 V.  
**Manual:** front panel pushbutton for generating single pulse.  
**Repetition rate:** 0 to 20 MHz. In square wave, output frequency is half the input frequency.  
**Trigger source:** manual or ext. signal. Min. ext. signal width 20 ns.  
**Pulse burst mode (option 001):** preselected number of pulses generated on receipt of trigger.  
**Burst trigger source:** man. or ext. signal. Min. signal width 25 ns.

#### General

**Operating temperature:** 0°C to 55°C.  
**Power:** 100/120/220/240 V rms;  $+5\%$ ,  $-10\%$ ; 48 Hz to 440 Hz, 70 VA max.  
**Weight:** net, 4 kg (9 lb). Shipping, 6.5 kg (14.6 lb).  
**Dimensions:** 126 H x 200 W x 280 mm D (5" x 7.9" x 11").

- Variable transition times down to 5 ns
- $\pm 10$  V amplitude; selectable source impedance
- Ideal for testing TTL

- Fixed 3.5 ns transition times
- 10 V amplitude; selectable source impedance
- 2 outputs



HP 8012B



HP 8013B

The HP 8012B and 8013B are at the top of their class for versatility, ease of operation and wide range of application. They provide the ideal solution to almost all digital logic testing problems with fixed 3.5 ns transition times on the HP 8013B and variable transition times down to 5 ns on the HP 8012B. The well-composed layout of the front panel controls (horizontal controls for horizontal parameters, vertical controls for vertical parameters) enables output pulses to be set up quickly and accurately with minimum risk of incompatible settings. Both models feature normal and complement outputs and a switchable internal 50 ohm source.

## Specifications

### Pulse Characteristics

Parameter	HP Model 8012B		HP Model 8013B	
	Int. load IN	Int. load OUT	Int. load IN	Int. load OUT
Transition times	5 ns—0.5s 4 ranges. Verniers provide separate control of both edges within ranges up to max. ratios of 100:1 or 1:100.	6 ns—0.5s	3.5 ns fixed	5 ns fixed
Source impedance	50 ohms $\pm 10\%$ shunted by typically 20 pF	>50 ohms	50 ohms $\pm 3\%$ shunted by typically 20 pF	>50 ohms

Parameter	HP Models 8012B/8013B	
	Internal load IN	Internal load OUT
Overshoot ringing	$\pm 5\%$ of pulse amplitude	May increase to $\pm 10\%$ when amplitude is between 0.4—4 V
Maximum output	5 V across 50 ohms, 10 V across open circuit. Short cct. protection.	10 V across 50 ohms. Short cct. protection.
Attenuator	4-step, reduces output to 0.2 V.	4-step, reduces output to 0.4 V.
DC offset	$\pm 2.5$ V across 50 ohms. Independent of amplitude settings.	DC offset switched off.

**Linearity (HP 8012B):** for transition times  $> 30$  ns, maximum straight line deviation is 5% of pulse amplitude.

**Preshoot:**  $< \pm 5\%$  of pulse amplitude.

**Pulse width:**  $< 10$  ns to 1 s in four ranges. Vernier provides continuous adjustment within ranges.

**Width jitter:**  $< 0.1\% + 50$  ps on any width setting.

**Maximum duty cycle:**  $> 75\%$  from 1 Hz to 10 MHz, decreasing to  $\geq 40\%$  at 50 MHz. Up to 100% in COMPL mode.

**Polarity:** HP 8012B; positive or negative selectable. NORM/COMPL/SYM selectable; HP 8013B, one positive + one negative channel, NORM/COMPL selectable.

**Pulse delay:**  $< 35$  ns to 1 s (with respect to trigger output) in four ranges; vernier provides continuous adjustment within ranges.

**Delay jitter:**  $< 0.1\% + 50$  ps on any setting.

### Repetition Rate and Trigger

1 Hz to 50 MHz in four ranges, continuous adjustment within ranges.

**Period jitter:**  $< 0.1\% + 50$  ps on any rate setting.

**Square wave:** 0.5 Hz to 25 MHz in four ranges. Duty cycle 50%  $\pm 5\%$  up to 1 MHz, tolerance increases to  $\pm 15\%$  at 25 MHz.

**Trigger output:**  $> +1$  V across 50  $\Omega$ , 16 ns  $\pm 10$  ns wide.

### External Triggering

0 to 50 MHz; for square wave output, frequency divided by factor 2.

**Trigger input:** sine waves 1.5 V p-p (about zero) or pulses  $> 0.8$  V either polarity,  $> 7$  ns wide. Maximum input  $\pm 7$  V.

**Impedance:** 50  $\Omega \pm 10\%$ , dc coupled.

**Delay:** 25 ns  $\pm 8$  ns leading edge trig. input to trig. output.

**Manual:** pushbutton for single pulse.

### Gating

**Synchronous gating:** gating signal turns generator "on". Last pulse is completed even if the gate ends during pulse.

**Gate input:** dc-coupled; voltage at open connector approx. +1.8 V.

Shorting current  $\leq 12$  mA. Input impedance  $\approx 160$   $\Omega$

**Gate input signal:** voltage  $> +1.5$  V or resistor  $> 1$  k  $\Omega$  to ground enables rep. rate generator. Voltage  $< +0.8$  V or resistor  $< 160$   $\Omega$  disables rep. rate generator. Input TTL compatible, max.  $\pm 5$  V.

### External Width and RZ

**External width:** output pulse width determined by width of drive input signal. Amplitude, transition times selectable. Trigger output independent of external width input signal.

**RZ mode:** external drive input switched to delay generator. Period determined by period of drive input signal. Delay, amplitude and width selectable.

**Input signal:**  $> +1$  V,  $> 7$  ns wide. Max.  $\pm 5$  V, 50  $\Omega$  dc coupled.

### General

**Operating temperature:** 0°C to 55°C.

**Power:** 100/120/220/240 V rms;  $+5\%$ ,  $-10\%$ ; 48 to 400 Hz, 100 VA max.

**Weight:** net, 4 kg (8.8 lb). Shipping, 6.5 kg (14.6 lb).

**Size:** 126 H x 200 W x 280 mm D (5 x 7.9 x 11 in.)

### Ordering Information

HP 8012B Pulse Generator

Opt 910: extra operating and service manual

HP 8013B Pulse Generator

Opt 910: extra operating and service manual

HP 15179A Adapter frame. Rack mounting for 1 or 2 units, includes blank panel for single-unit requirements

### Prices

HP 8012B Pulse Generator \$1950

add \$20

HP 8013B Pulse Generator \$1900

add \$13

HP 15179A Adapter frame \$235

# PULSE GENERATORS

## 50 MHz, Dual Output

Model 8015A

- Two independent  $\pm 16$  V outputs
- Additional TTL output
- Remote control and counted burst options
- Complex waveforms



Picture shows 8015A with Option 002, Burst

Offering B Delay mode in addition to variability of all pulse parameters, the HP 8015A is ideal for analyzing critical timing conditions or generating 2-phase clocks.

A + B mode gives a 30 V output within a  $\pm 16$  V window. Combined with B Delay mode, three-level signals, special codes or simulated biomedical signals can be generated.

Option 002 Burst mode generates an exact number of pulses by means of an internal counter.

Direct access to either or both output amplifiers (Option 007) converts to MOS/CMOS levels. Alternatively, high-level tracking capability ensures that clock and data signals follow the supply, and thus safeguards CMOS devices.

For use in automatic test, Option 003 allows all pulse parameters to be controlled remotely.

### Specifications

#### Timing

**Repetition rate:** 1 Hz to 50 MHz (square wave and double pulse to 25 MHz, A + B mode to 40 MHz, B delay 20 MHz).

**Width:** 10 ns to 1 s or square wave.

**Delay:** 20 ns to 1 s (both channels, interchannel or double pulse).

**Jitter:** 0.1%  $\pm$  50 ps.

**Output** (50  $\Omega$  Output Impedance into 50  $\Omega$  termination. Voltages double in 50  $\Omega$  / 1 k $\Omega$  or 1 k $\Omega$  / 50  $\Omega$  operation).

**Magnitude:** 1 V to 8 V amplitude (2 V to 16 V in A + B mode).

**High level:** -7 V to +8 V. **Low level:** -8 V to +7 V.

**Transition times:** 6 ns to 0.5 s in four ranges, independent leading/trailing vernier adjustment.

**Non-linearity:** 5% for transitions > 30 ns.

**Preshoot, overshoot and ringing:** 5%.

**A + B mode:** sum of channel A and channel B outputs.

**Complement:** independently selectable.

**Impedance:** 50  $\Omega$  / 1 k $\Omega$ , independently selectable.

#### Trigger Input

**Impedance:** 50  $\Omega$  / 500  $\Omega$  selectable.

**Level:** adjustable +1 V to -1 V (50  $\Omega$ ), +10 V to -10 V (500  $\Omega$ ).

**Slope:** + or - selectable.

#### Auxiliary Outputs

**TTL:** 50  $\Omega$  output impedance, timing as channel A.

**Trigger output:** 1 V, 50  $\Omega$  into 50  $\Omega$ .

#### Option 002 Burst Mode

**Burst length:** 1-9999 pulses, selectable.

**Pulse repetition rate:** 1 Hz to 40 MHz.

**Burst trigger:** trigger input.

**Minimum burst separation:** 200 ns.

#### Option 003 Remote Control

**Timing ranges:** TTL or contact closure.

**Timing verniers:** current, voltage or resistor programming.

**Output levels:** voltage programming.

**Burst:** BCD, TTL/contact closure.

#### Option 007 Amplifier and Tracking Modes

##### Dual Amplifier Mode

**Gain:** 0.8 to 6.4.

**Frequency response (-3 dB):** 0 to 80 MHz.

##### Upper Level Tracking Mode

**Upper level:** input voltage  $\pm 5\%$ .

**Lower level:** 0 V  $\pm 250$  mV.

**Settling time:** 400  $\mu$ s to  $\pm 5\%$  of final value.

#### General

**Operating temperature:** 0°C to 55°C.

**Power:** 100/120/220/240 V rms; +5%, -10%; 48 to 440 Hz, 180 VA max.

**Weight:** net, 11 kg (24.26 lb). Shipping, 14.7 kg (32.4 lb).

**Size:** 133 H x 426 W x 346 mm D (5.2" x 16.75" x 13.6").

#### Ordering Information

HP 8015A Pulse Generator

Opt 002: Pulse Burst

Opt 003: Remote Control

Opt 007: Dual Amplifier and Level Tracking modes

Opt 907: Front Handle Kit (Part No. HP 5061-9689)

Opt 908: Rack Flange Kit (Part No. HP 5061-9677)

Opt 909: Opt. 907, 908 combined

(Part No. HP 5061-9683)

Opt 910: Additional Operating and Service Manual

Fast-Ship product—see page 758

#### Price

\$5300

add \$715

add \$1630

add \$480

add \$56

add \$33

add \$82

add \$39

- < 1 ns variable transition times
- Ultra-clean 50 ohm source

- Switch-selectable ECL levels
- Dual  $\pm 5$  V outputs



HP 8082A

The HP 8082A is Hewlett-Packard's fastest pulse generator with all pulse parameters variable. With repetition rates to 250 MHz, transition times down to 1 ns and amplitudes to 5 V, the HP 8082A is ideally suited for state-of-the-art TTL and ECL logic designs. Using the HP 8082A, you can rapidly test logic circuits under all operating conditions by simply varying pulse parameters. Although a highly sophisticated instrument, the HP 8082A is still easy to operate because of its logical front panel layout and switch-selectable ECL output levels. Another feature that contributes to ease of operation is the square wave mode. You can, for example, carry out toggle rate tests in this mode up to 250 MHz without having to worry about pulse duty cycle.

Hybrid IC's, manufactured by Hewlett-Packard, are used extensively in the design of the HP 8082A. These ICs eliminate the need for fans, reduce power consumption and enable a low reactance 50 ohm source impedance to be used. This source impedance absorbs 98% of reflections from signals up to 4 V amplitude.

## Specifications

### Pulse Characteristics (50 $\Omega$ source and load impedance)

**Transition times:** (10% to 90%): 1 ns to 0.5 ms in 6 ranges at amplitudes >1.8 V and >4.5 V respectively in the two upper output ranges. Minimum value may increase to 1.2 ns at other amplitudes. Leading/trailing times are common on fastest range, and independently variable over 1:10 ratio on other ranges.

**Overshoot and ringing:**  $\leq \pm 10\%$  of pulse amplitude may increase to  $\pm 10\%$  with amplitude vernier CCW.

**Prehoot:**  $\leq \pm 5\%$  of pulse amplitude.

**Linearity:** linearity aberration for both slopes  $\leq 5\%$  for transition times >5 ns.

**Output:** maximum amplitude is 5 V from 50  $\Omega$  into 50  $\Omega$ . Maximum output voltage is  $\pm 5$  V (amplitude + offset).

**Offset:**  $\pm 2$  V, into 50  $\Omega$ .

**DC-source impedance:** 50  $\Omega \pm 5\%$   $-10\%$ .

**Reflection coefficient:** 5% in ECL setting, increasing to 15% in 5 V range.

**Output protection:** cannot be damaged by open or short circuits or application of ext.  $\leq \pm 6$  V or  $\pm 200$  mA independent of control settings.

**Attenuator:** two separate three step-attenuators reduce the outputs to 1 V. Vernier is common for both outputs and reduces the output to 0.4 V minimum. A further position provides ECL-compatible outputs ( $-0.9$  V to  $-1.7$  V typ. open circuit).

### Timing

**Repetition rate:** 250 MHz to 1 kHz in 6 ranges.

**Period jitter:** <0.1% of setting +50 ps.

**Delay:** 2 ns  $-0.5$  ms in 6 ranges plus typ. 17 ns fxd. with respect to trigger output. Duty cycle >50%.

**Delay jitter:** <0.1% of setting +50 ps.

**Double pulse:** up to 125 MHz max. (simulates 250 MHz).

**Pulse width:** 2.4 ns to 0.5 ms in 6 ranges.

**Width jitter:** <0.1% of setting +50 ps.

**Width duty cycle:** >50%.

**Square wave:** delay and double pulse are disabled, max. Rep. Rate 250 MHz. Duty cycle is 50%  $\pm 10\%$  up to 100 MHz, 50%  $\pm 15\%$  for >100 MHz.

**Trigger output:** negative going Square Wave (50% duty cycle (yp.) >500 mV from 50  $\Omega$  into 50  $\Omega$ . Internal 50  $\Omega$  can be switched off by slide-switch on PC-board. Amplitude up to 1 V into 50  $\Omega$  up to 200 MHz.

**Trigger output protection:** cannot be damaged by short circuit or application of external  $\pm 200$  mA.

### External Operating Modes

#### External Input

**Input impedance:** 50  $\Omega \pm 10\%$ , dc coupled.

**Maximum input:**  $\pm 6$  V.

**Trigger level:** adjustable  $-1.5$  V to  $+1.5$  V.

**Slope control:** positive, negative or manual selectable. In the manual position all ext. functions can be controlled by push button. Button pushed in simulates an "on-signal."

**Sensitivity:** sine-wave >200 mV p-p pulses >200 mV.

**Repetition rate:** 0 to 250 MHz.

#### External-Controlled Modes

**External trigger:** there is approximately 7 ns delay between the external input and the trigger output. Rep. rate is externally controlled (is triggered by external signal). Trigger output provides the pulse-shaped input signal.

**Synchronous gating:** gating signal turns rep. rate generator on. Last pulse normal width even if gate ends during pulse.

**External width:** output pulse width determined by width of drive input. Rep. rate and delay are disabled. Trigger output provides shaped input signal.

### General

**Operating temperature:** 0°C to 55°C.

**Power:** 100/120/220/240 Vrms;  $\pm 5\%$ ,  $-10\%$ ; 48-440 Hz, 85 VA max.

**Weight:** net, 7.9 kg (17.44 lb). Shipping 8.9 kg (19.63 lb).

**Size:** 133 mm H x 426 W x 345 mm D (5.2" x 16.75" x 13.6").

### Ordering Information

HP 8082A Pulse Generator

Opt 907: Front Handle Kit (part number HP 5061-9689).

Opt 908: Rack Flange Kit (part number HP 5061-9677).

Opt 909: Opt 907, 908 Combined (part number HP 5061-9683).

Opt 910: Additional Operating and Service Manual

Fast-Ship product—see page 758

### Price

\$5840

add \$36

add \$33

add \$82

add \$28

# PULSE GENERATORS

## Configurable Pulse/Data Stimuli

### HP 8080A Series

Example: HP 8080A SO4

- 1 GHz, 300 ps transitions
- Interchannel delay



HP 8091A Rate Generator	HP 8092A Delay Generator	CHA CHB HP 8093A Output Amplifiers	HP 15400A Blank Panel
-------------------------------	--------------------------------	--	-----------------------------

Example: HP 8080A DO1

- 300 MHz, 800 ps transitions
- Manually programmable data

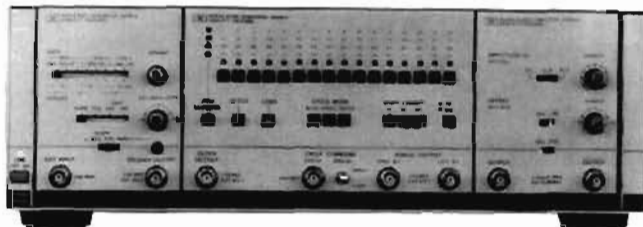

HP 8081A Rate Generator	HP 8084A Word Generator	HP 8083A Output Amplifier
----------------------------	----------------------------	------------------------------

Research and development in advanced technologies such as subnanosecond ICs, fiber optics and nucleonics, require fast pulses for thorough characterization. HP 8080A configurations can generate simultaneous 1 GHz clock and simulated NRZ data for testing today's fastest memories. (see 8080A#SO4, above). Another example (8080A#DO3) is simultaneous normal and complement data with up to 64 bits and fast 300 ps edges.

A series of Multi-channel Data and Pulse Generator configurations are available, and further variations can be factory-systemized on request.

Full details on all the modules and some of the factory-systemized configurations are contained in the HP8080A data sheet. Users who wish to do their own systemizing should request the Systemizing Guide (publication number 5952-9546).

### Leading Characteristics (50-ohm load)

#### HP 8080A SO4

##### Timing

**Repetition rate:** 100 Hz – 1 GHz.

**Interchannel delay:**  $\pm 9.9$  ns in 0.1 ns steps.

**Channel B divider:** 0.5 f selectable for simulating NRZ data.

**Width:** Square wave.

**Modes:** Int, Ext Width, Gate, Manual.

##### Independent 50-ohm Outputs

**Amplitude:** 0.6 V to 1.2 Vpp.

**Offset:**  $\pm 1.2$  V.

**Transitions times (10% to 90%):** <300 ps.

**Polarity:** selectable

**Format:** Normal/Complement selectable

#### HP 8080A DO1

##### Timing

**Repetition rate:** 10 Hz–300 MHz.

**Width:** square wave (RZ) or NRZ.

**Modes:** Int, Ext/Manual Width.

**Data cycle modes:** Ext/Man Single and Gated Cycle, Auto Cycle.

**Data:** Serial, 16/32/64 bit selectable.

##### Simultaneous Normal and Complement 50-ohm Outputs

**Amplitude:** 0.2 V to 2 V.

**Offset:**  $\pm 1$  V.

**Transition times (10% to 90%):** <800 ps.

**Polarity:** selectable.

### General

**Operating temperatures:** 0°C to 55°C.

**Power:** 115/230 V rms; +10%, -22%; 48 to 66 Hz, 200 VA max.

**Weight:** (typical, HP 8080A Mainframe plus full complement of modules) 9.4 kg (16.6 lbs) net; 19.7 kg (43.3 lbs) shipping.

**Size:** (HP 8080A Mainframe): 133 H x 426 W x 422 mm D (5.24" x 16.77" x 16.61").

### Ordering Information

**HP 8080A Mainframe**

**Opt 907:** Front handle kit

**Opt 908:** Rack flange kit

**Opt 909:** Opt 907, 908 combined

**Opt Series S:** Single- and Multi-Channel Pulse Generator systems

**Opt Series D:** Single- and Multi-Channel Data Generator systems

HP 8081A 300 MHz Rate Generator module

HP 8083A 300 MHz Output Amplified module

HP 8084A 300 MHz Word Generator module

HP 8091A 1 GHz Rate Generator module

HP 8092A 1 GHz Delay Generator module

HP 8093A 1 GHz Output Amplifier module

HP 8093A Opt 001: Variable-width operation  
(requires HP 8092A)

**Additional manuals:** Opt 910, per module

### Accessories Available

HP 15400A Blank Panel,  $\frac{1}{4}$  mainframe width

HP 15401A Blank Panel,  $\frac{1}{2}$  mainframe width

HP 15402A BNC Feedthru panel,  $\frac{1}{4}$  width

### Pulse Generator Accessories



HP 15104A/15115A

HP 15116A

HP 15104A Pulse Adder/Splitter dc to 2 GHz

HP 15116A Pulse Inverter 3 MHz to 2 GHz

HP 15115A Pulse Splitter/Inverter 3 MHz to 2 GHz

☎ Fast-Ship product — see page 758

\$2,855

add \$56

add \$33

add \$82

ask for  
information  
and prices

ask for  
information  
and prices

\$1,785

\$1,785

\$4,280

\$5,400

\$4,280

\$2,955

add \$480

add \$28

\$122

\$92

\$270

\$107

\$270

\$214

# PULSE GENERATORS

## High Resolution Time Synthesizer

### Model 5359A

429

- Precise digital delays 0-160 ms
- 50 ps increments
- Jitter < 100 ps

- Programmable
- Fully synchronous to external trigger
- Automatic calibration



HP 5359A



### HP 5359A Time Synthesizer

The HP 5359A Time Synthesizer produces two extremely precise, low jitter time delays. These delays,  $T_d$  and  $T_w$ , are individually selectable by means of the keyboard, in 50 ps or greater steps to generate delays of up to 160 ms.

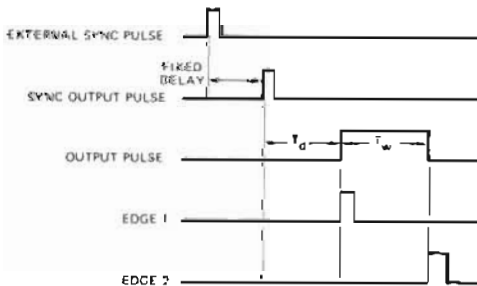

The HP 5359A has many applications and may be used for the calibration of Radar, Loran, DME and Tacan Systems, or for precision generation of delayed sweeps in oscilloscopes, and for extremely accurate "time positioning" control of external gates on frequency counters. In component and circuit test, the instrument may be used for extremely accurate delay line simulation.

### Condensed Specifications

#### Modes

**External trigger mode:** the delays from the sync out to the beginning of the output pulse, and the width of the output pulse, are selected.

**Internal trigger mode:** the "period" or "frequency", and the width of the output pulse, are selected.

#### Range

**Delay  $T_d$ :** 0 ns to 160 ms.

**Width  $T_w$ :** 5 ns to 160 ms (width & delay  $\leq$  160 ms).

**Period:** 100 ns min or width + 85 ns; 160 ms max.

**Frequency:** same as corresponding "period".

**Repetition rate:** 10 MHz max.

**Accuracy:**  $\pm 1$  ns + time base error ( $\pm 100$  ps  $\pm$  time base error after external calibration).

**Insertion delay:** fixed at < 150 ns; selectable as < 50 ns for delays > 100 ns.

**Jitter:** typical 100 ps rms; maximum 200 ps rms (delays to 10 ms).

**External trigger input:** -2 V to + 2 V slope selectable.

**Sync output:** 1 V - 50  $\Omega$ ; 5 V - 1 M $\Omega$ . Width 35 ns nominal

#### Output Pulse

**Amplitude:** 0.5 V to 5 V into 50  $\Omega$ .

**Polarity:** positive or negative.

**Offset:** -1 V to 1 V, or OFF.

**Transition time:** < 5 ns.

External voltage must not be applied. Offset and Amplitude voltage into 50  $\Omega$  may be displayed.

**EDGE 1 OUTPUT (rear panel):** occurs in Sync with leading edge of output pulse (same spec. as Sync out).

**EDGE 2 OUTPUT (rear panel):** occurs in Sync with falling edge of output pulse (same spec. as Sync out).

**Events mode:** substitutes external input (to 100 MHz) for the internally counted clock (delay and width must both be specified in terms of events instead of time).

**Triggered frequency mode:** the same as internal frequency mode except the output is a burst beginning in synchronism with an external trigger signal, and continues for the duration of this signal.

**Calibrate mode:** performs an internal calibration to remove the effects of internal delay differences.

**External probes:** provides outputs to control the HP 5363B probes and accepts inputs from the probes to include external devices in the calibration loop.

**HP-IB:** All controls except trigger levels are programmable as standard.

#### Time Base

High Stability Oven Oscillator

**Frequency:** 10 MHz.

**Aging:**  $< 5 \times 10^{-10}$ /day.

**Temperature:**  $< 2.5 \times 10^{-8}$ , 0°C to 50°C

**Line voltage:**  $< 1 \times 10^{-13}$ ,  $\pm 10\%$  from nominal.

**Size:** 133 H x 426 W x 521 mm D (5.25 in. x 16.75 in. x 20.50 in.).

**Weight:** 13.6 kg (30 lb).

**Power requirements:** 100, 120, 220, or 240 Vac  $\pm 5\%$  -10%, 48 to 66 Hz, less than 250 V.A.

**Front handles:** supplied with instrument.

#### Ordering Information

**HP 5359A Time Synthesizer**

**Opt 908 Rack Flange Kit** for use without handles

**Opt 913 Rack Flange Kit** for use with supplied handles

**HP 10870A Service Kit**

#### Price

\$10,500

+ \$32.50

+ \$35

\$750

# POWER SUPPLIES

## General Information

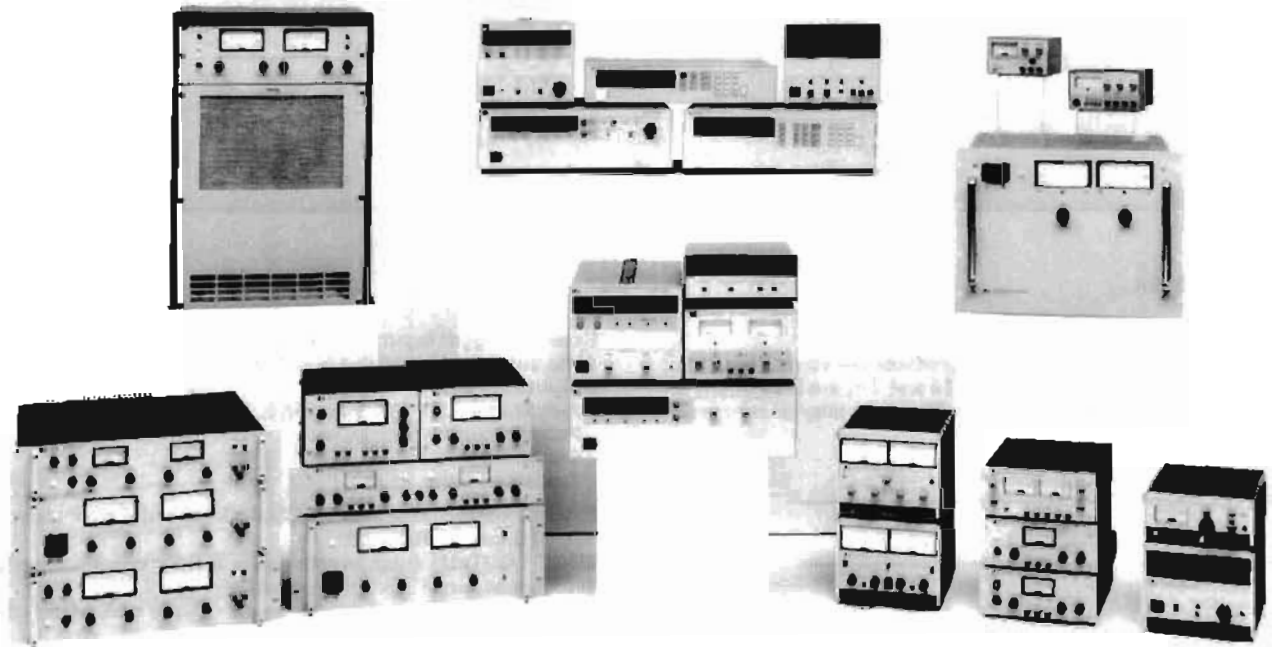

### Introduction

Hewlett-Packard's extensive variety of power supplies serve a wide range of applications, in research and development, industrial applications, and computer automated test systems. All power supplies are designed for high reliability and ease of use. Hewlett-Packard provides advanced capabilities through innovative technology.

### Selecting a Power Supply

There are three selection tables

- HP-IB Programmable Power Supplies
- Analog Programmable Power Supplies
- Special Purpose and Laboratory Bench Power Supplies

Choose the table that most closely fits your requirements. Each table is structured in ascending order of maximum output voltage. Upon selection of a model which fits your needs reference the appropriate page number for further information. If you are unsure of a selection or require additional information contact the nearest Hewlett-Packard sales office. A complete listing of Hewlett-Packard sales offices can be found toward the rear of this catalog.

### Remote Programming

Hewlett-Packard has power supplies which can be remotely programmed via resistance, voltage, or directly through the HP-IB. The new "One-Box Solution" system power supplies (HP models 6030A-6038A, 6621A-6624A, 6632A-6634A) have built-in HP-IB programmers for voltage and current. Also included is a built-in DVM and precision current shunt for measured read-back of voltage and current via the HP-IB.

### New 1987/88 Power Supply Catalog

For more details concerning Hewlett-Packard power supplies, ask your HP sales representative for a DC Power Supply Catalog, or fill in the card at the rear of this catalog.







### Power Supply Selection Tables

Pages 432 to 434

- HP-IB Programmable Power Supplies
- Analog Programmable Power Supplies
- Special Purpose and Laboratory Bench Power Supplies



### HP-IB Programmable Power Supplies

Pages 436 to 447

- 100 Watt Single Output
- Multiple Output
- 200 and 1000 Watt Autoranging
- CIL Programming
- Precision Bipolar

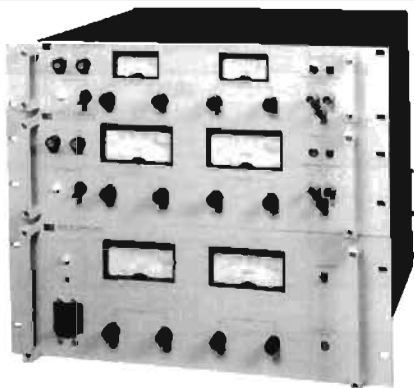

### Analog Programmable Power Supplies

Pages 448 to 455

- HP-IB Programmer for Analog Programmable Power Supplies
- General Purpose 25-200 Watt
- 200 and 1000 Watt Autoranging
- General Purpose 120-2000 Watt
- General Purpose 300-11,000 Watt

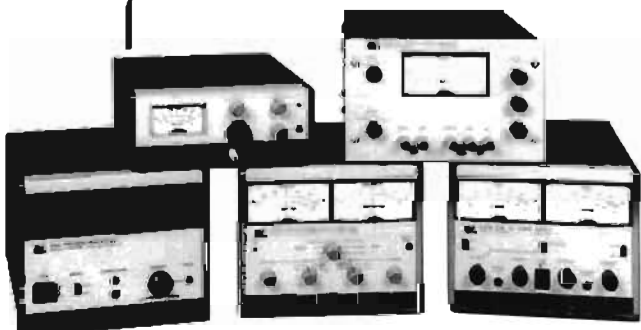

### Special Purpose and Laboratory Bench Supplies

Pages 456 to 461

- Bipolar/Amplifiers
- Single Output Bench
- Dual Output Bench
- Triple Output Bench
- Precision Voltage and Current Sources

# POWER SUPPLIES

## Voltage Rating Index



### HP-IB Programmable Supplies

The power supplies listed in this table are directly programmable via the HP-IB. Their system oriented features include remote programming and readback in a single unit.

Max Volts (DC)	Max Amps (DC)	Type	HP Model Number	Page
6.7	30	HP-IB Autoranging	6033A	440
7	5	Multiple Output Linear	6623A 6624A	438 438
7	10	Multiple Output Linear	6621A 6623A	438 438
7	120	HP-IB Autoranging	6031A	440
±10	0.01	DAC Programmer	59501B	447
20	2	Multiple Output Linear	6623A 6624A	438 438
20	4	Multiple Output Linear	6621A 6622A 6623A	438 438 438
20	5	Single Output Linear	6632A	436
20	10	High Performance Autoranging†	6002A	438
20	10	HP-IB Autoranging	6033A	440
20	10	HP-IB Autoranging	6038A	440
20	50	HP-IB Autoranging	6031A	440
20	50	HP-IB Autoranging	6032A	440
50	0.8	Multiple Output Linear	6623A 6624A	438 438
±50	±1	Precision Bipolar Voltage*	6130C	446
50	2	Multiple Output Linear	6622A	438
50	2	Single Output Linear	6633A	436
50	4	High Performance Autoranging	6002A	445
±50	±5	Precision Bipolar Voltage*	6129C	446
60	3.3	HP-IB Autoranging	6038A	440
60	17	HP-IB Autoranging	6030A	440
60	17.5	HP-IB Autoranging	6032A	440
±100	±0.16	Precision Bipolar Current*	6140A	446
±100	±0.5	Precision Bipolar Voltage*	6131C	446
100	1	Single Output Linear	6634A	436
200	17	HP-IB Autoranging	6030A	440

\* Does not include remote programming and readback in a single unit

† Option 001 must be ordered to operate the HP 6002A on the HP-IB.

**Analog Programmable Supplies**

The power supplies listed in this table are programmable with either an analog voltage or resistance signal. They may be incorporated into a system application or a laboratory or bench environment.

Max Volts (DC)	Max Amps (DC)	Type	HP Model Number	Page
6.7	30	Autoranging	6023A	450
7	120	Autoranging	6011A	450
7.5	5	CV/CC	6281A	448
8	1000	CV/CC	6464C	454
10	10	CV/CC	6282A	448
10	50	CV/CC	6259B	452
10	100	CV/CC	6260B	452
15	200	CV/CC	6453A	454
16	600	CV/CC	6466C	454
18	500	CV/CC	6466C	454
20	0.6	Dual Output (20 V, 20 V)	6205C	457
20	1.5	CV/CC	6200B	457
±20	±2	Bipolar PSA	6825A	456
20	3	CV/CC	6284A	448
20	3	Dual Output (20 V, 20 V)	6253A	448
20	10	Autoranging	6023A	450
20	10	Autoranging	6024A	450
20	10	CV/CC	6263B	452
20	10	CV/CC	6286A	448
20	20	CV/CC	6264B	452
20	50	Autoranging	6011A	450
20	50	Autoranging	6012B	450
20	50	CV/CC	6261B	452
25	2	Dual Output (25 V, 25 V)	6227B	448
30	1	CV/CC	6206B	457
36	100	CV/CC	6456B	454
36	300	CV/CC	6469C	454
40	0.3	Dual Output (40 V, 40 V)	6205C	457
40	0.75	CV/CC	6200B	457
40	1.5	CV/CC	6289A	448
40	1.5	Dual Output (40 V, 40 V)	6255A	448
40	5	CV/CC	6266B	452
40	5	CV/CC	6291A	448

Max Volts (DC)	Max Amps (DC)	Type	HP Model Number	Page
40	5.7	Autoranging	6024A	450
40	10	CV/CC	6267B	452
40	25	CV/CC	6434B	454
40	30	Autoranging	6012B	450
40	30	CV/CC	6268B	452
40	50	CV/CC	6269B	452
50	0.5	Precision Current	6177C	461
50	1	Dual Output (50 V, 50 V)	6228B	448
±50	±1	Bipolar PSA	6826A	456
60	0.5	CV/CC	6206B	457
60	1	CV/CC	6294A	448
60	3	CV/CC	6296A	448
60	3.3	Autoranging	6024A	450
60	15	CV/CC	6274B	452
60	17	Autoranging	6010A	450
60	17.5	Autoranging	6012B	450
64	50	CV/CC	6459A	454
64	150	CV/CC	6472C	454
100	0.25	Precision Current	6181C	461
±100	±0.5	Bipolar PSA	6827A	456
100	0.75	CV/CC	6299A	448
110	100	CV/CC	6475C	454
120	2.5	CV/CC	6443B	454
200	5	Autoranging	6010A	450
220	50	CV/CC	6477C	454
300	0.1	Precision Current	6186C	453
300	35	CV/CC	6479C	454
320	0.1	CV/CC	6209B	457
440	25	CV/CC	6483C	454
500	20	CV/CC	6483C	454
600	1.5	CV/CC	6448B	454
600	15	CV/CC	6483C	454

# POWER SUPPLIES

## Voltage Rating Index

### Special Purpose and Laboratory Bench Power Supplies

The power supplies listed in this table include special purpose (current sources, bipolar, four-quadrant power supplies and precision power supplies) and laboratory bench power supplies. Although some of the special purpose supplies may be programmed with an analog signal, most of the power supplies listed here are controlled manually.

Max Volts (DC)	Max Amps (DC)	Type	HP Model Number	Page
6	1	Triple Output (6, $\pm 18$ V)	6235A	457
6	2.5	Triple Output (6, $\pm 20$ V)	6236B	457
10	1	CV/CC	6214C	457
18	1	Triple Output (18, $\pm 20$ V)	6237B	457
$\pm 18$	0.2	Triple Output (6, $\pm 18$ V)	6235A	457
$\pm 20$	0.5	Triple Output (6, $\pm 20$ V)	6236B	457
$\pm 20$	0.5	Triple Output (18, $\pm 20$ V)	6237B	457
$\pm 20$	$\pm 2$	Bipolar Amplifier	6825A	456
20	2	Precision Voltage	6114A	460
25	0.2	Dual Output (25, 25 V)	6234A	457
25	0.4	CV/CC	6216C	457
40	1	Precision Voltage	6114A	460
50	0.2	CV/CC	6218C	457
50	0.5	Precision Current	6177C	461
50	0.8	Precision Voltage	6115A	460
$\pm 50$	$\pm 1$	Bipolar Amplifier	6824A	456
$\pm 50$	$\pm 1$	Bipolar Amplifier	6826A	456
100	0.1	CV/CC	6212C	457
100	0.25	Precision Current	6181C	461
100	0.4	Precision Voltage	6115A	460
$\pm 100$	$\pm 0.5$	Bipolar Amplifier	6827A	456
300	0.1	Precision Current	6186C	461

## Power Supply Terms and Specification Definitions

**Power Supply Terms**

**Ambient temperature:** the temperature of the air immediately surrounding the power supply.

**Auto-parallel operation:** a master-slave connection of the outputs of two or more supplies used for obtaining a current output greater than can be obtained from one supply.

**Autoranging power supply:** a power supply that can provide maximum rated power over a wide range of voltage and current without external intervention to change range.

**Auto-series operation:** a master-slave connection of the outputs of two or more supplies used for obtaining a voltage greater than can be obtained from one supply.

**Auto-tracking operation:** a master-slave connection of two or more supplies each of which has one of its output terminals in common with one of the output terminals of all of the other supplies.

**Complementary tracking:** a master-slave interconnection of two supplies in which the voltage of the slave is equal to or proportional to that of the master and of opposite polarity with respect to a common point.

**Compliance voltage:** the output voltage of a power supply operating in the constant-current mode.

**Constant-current (CC) power supply:** a power supply that stabilizes output current with respect to changes in influence quantities. Thus, for a change in load resistance, the output current remains constant while the output voltage changes by whatever amount necessary to accomplish this.

**Constant-voltage (CV) power supply:** a power supply that stabilizes output voltage with respect to changes in influence quantities. Thus, for a change in load resistance, the output voltage remains constant while the output current changes by whatever amount necessary to accomplish this.

**Constant-voltage/constant-current (CV/CC) power supply:** a power supply that operates as a constant voltage power supply or a constant-current power supply depending on load conditions. It acts as a constant-voltage source for comparatively large values of load resistance and as a constant-current source for comparatively small values of load resistance.

**Constant-voltage/current-limiting (CV/CL) power supply:** a power supply similar to a constant-voltage/constant-current supply except that at comparatively small values of load resistance, its output current is limited instead of being stabilized.

**Crowbar:** see overvoltage protection.

**Current limiting:** the action of limiting the output current of a constant-voltage supply to some predetermined maximum value (fixed or adjustable) and automatically restoring the output voltage to its normal value when the overload or short circuit is removed. There are three types of current limiting: 1) by constant-voltage/constant-current crossover, 2) by decreasing the output voltage as the current increases, 3) by decreasing both voltage and current as the load resistance decreases (referred to as foldback or cutback current limiting).

**Drift:** the maximum change of an output voltage or current during an 8-hour period following a 30-minute warmup, with all influence and control quantities maintained constant during the warm-up time and the period of drift measurement. Drift includes both periodic and random deviations over the bandwidth from zero frequency (dc) to a specified upper frequency limit (usually 20 Hz).

**Load effect:** formerly known as load regulation, load effect is the change in the steady-state value of the stabilized output voltage or current resulting from a full-load change in the load current of a constant-voltage supply or the load voltage of a constant-current supply, with all other influence quantities maintained constant.

**Load effect transient recovery time:** the time interval between a specified step change in the load current of a constant-voltage supply (usually a full-load or 5-ampere change, whichever is smaller) or in the load voltage of a constant-current supply and the instant when the stabilized output quantity returns to and stays within the specified transient recovery band.

**Master-slave operation:** a method of interconnecting two or more supplies such that one of them (the master) serves to control the others (the slaves). The outputs of the slave supplies always remain equal to or proportional to the output of the master. The outputs of

the master supply and of one or more slaves may be connected in series, in parallel, or with just their negative or positive output terminals in common. (See also complementary tracking.)

**Nominal value:** the value that exists "in name only," not the actual value. For example, in the case of a power supply with a calibrated output control, the nominal value is the value indicated by the control setting. For a supply with a fixed output, the nominal output is the output indicated on the nameplate. The nominal value of a 120-volt  $\pm$  10% line voltage is 120 volts.

**Output impedance:** the complex ratio of a sinusoidal voltage and sinusoidal current at the output terminals, the one being caused by the other and being of external origin.

**Overcurrent protection:** protection of the power supply and/or connected equipment against excessive output current.

**Overtemperature protection:** protection of the power supply or parts of it against temperatures exceeding specified values.

**Overvoltage protection:** protection of the power supply and/or connected equipment against excessive output voltage. Overvoltage protection is usually by means of a crowbar protection circuit, which rapidly places a low resistance shunt across the supply's output terminals to reduce output voltage to a low value if a predetermined voltage is exceeded. A supply equipped with an overvoltage crowbar must also be protected by a means of limiting or interrupting output current.

**PARD (acronym for periodic and random deviation):** the term PARD replaces the former term ripple and noise. PARD is the periodic and random deviation of a dc output voltage or current from its average value, over a specified bandwidth (20 Hz to 20 MHz) and with all influence and control quantities maintained constant.

**Programming speed:** the maximum time required for the programmed output voltage or current to change from a specified initial value (usually zero or maximum output) to a value within a specified tolerance band of a specified newly programmed value (for most models 99.9% or 0.1% of maximum output, respectively; 99% and 1% for the HP 6114A, 6115A, 6177C-6186C, and HP 6434B-6483C) following the onset of a step change in an analog programming signal, or the gating of a digital signal.

**Remote control:** also referred to as remote programming, remote control is the setting of the power supply voltage, current, or other function by means of an external control quantity such as a variable resistance, voltage, or current, or a digital signal.

**Remote sensing:** remote sensing, or remote error sensing, is a means by which a power supply monitors the stabilized voltage directly at the load using extra sensing leads. The resulting circuit action compensates for voltage drops in the load leads (up to a specified limit).

**Resolution:** for a bench supply, the smallest change in output voltage or current that can be obtained using the front panel controls. For a system supply, the smallest change that can be obtained using either the front panel controls or a computer.

**Reverse voltage protection:** protection of the power supply against reverse voltage applied at the output terminals.

**Slave operation:** see master-slave operation.

**Source effect:** formerly known as line regulation, source effect is the change in the steady-state value of the stabilized output voltage on current resulting from any change in the source voltage within its specified range, with all other influence quantities maintained constant. Source effect may be measured at any output voltage and current within rating.

**Temperature effect coefficient:** the maximum steady-state change in a power supply's output voltage or current per degree Celsius following a change in the ambient temperature within specified limits, with all other influence quantities maintained constant.

**Voltage limiting:** the action of limiting the output voltage of a constant-current supply to some predetermined maximum value (fixed or adjustable) and automatically restoring the output current to its normal value when the load conditions are restored to normal. There are two types of voltage limiting: 1) by constant-voltage/constant-current crossover, 2) by decreasing the output current as the voltage increases.

**Warm-up time:** the time interval after switching on a power supply until it complies with all performance specifications.

# POWER SUPPLIES

## Single Output Linear System Power Supplies

- 100 Watt Linear Output
- Current Sinking Capability
- Built-In HP-IB Interface

- Overvoltage & Overcurrent Protection
- Readback Measured Voltage and Current Output Via HP-IB

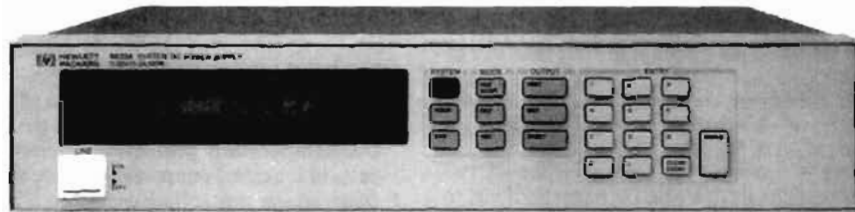

HP 6633A



### Description

#### HP Models 6632A-6634A

HP Models 6632A-6634A are 100 Watt, single output, series pass regulated power supplies optimized for systems applications. They provide a high performance output with a full set of programmable features.

The following voltage and current combinations are available:

HP 6632A: 0-20 V	0-±5 A
HP 6633A: 0-50 V	0-±2 A
HP 6634A: 0-100 V	0-±1 A

Most importantly, these models are one-box solutions for system power supply requirements. Both the voltage and current output can be programmed for either CV or CC operation. A built-in DVM and precision current shunt measure (readback) the actual power supply output. The internal HP-IB interface allows for complete programmability, including status reporting and interrupt generation with user designated fault conditions. In addition, programming commands (such as VSET for voltage programming) are easy-to-use and self-documenting.

#### Current Sinking

HP Models 6632A-6634A sink as well as source current. This provides very fast down programming times and speeds throughput in production test applications. The negative current setting tracks the user-programmed positive current (CC) setting.

#### Remote Sensing

Remote sense terminals allow for precise voltage regulation at the load. This feature will compensate for load lead IR drops of up to 2 volts per lead.

#### Protection Features

HP Models 6632A-6634A have Overvoltage and Overcurrent protection. Both features are programmable via the front panel keypad and HP-IB. The Overvoltage protection includes an SCR crowbar.

#### Selftest

HP Models 6632A-6634A have a built-in selftest capability. This feature verifies the function of all HP-IB circuitry, D/A's, and A/D's at power on and upon HP-IB command.

#### Software Calibration

Software calibration eliminates shock sensitive potentiometers normally used for calibration of power supplies and programmers. This

feature enables calibration of these models via the HP-IB while mounted in the rack. An internal jumper is provided which, when removed, prevents recalibration of the power supply.

#### Fast/Normal Mode Operation

A rear-panel switch designates one of two operating modes. In Fast Mode, the output capacitors are disconnected to speed up the output response time. Normal Mode is optimized for minimal output PARD. See specifications for more information.

#### Front Panel Binding Posts (Option 020)

Option 020 adds a front panel output in parallel with the rear panel output terminal strip. These front panel binding posts provide flexibility in accessing the power supply output, and are very useful in bench applications and system development.

#### HP-IB Functions

The following functions can be programmed via the HP-IB:

Programmable Functions	Readback Functions
— Voltage Output	— Actual Measured Voltage Output
— Current Output	— Actual Measured Current Output
— Overvoltage Protection	— Present Status
— Overcurrent Protection	— Accumulated Status
— Output Enable/Disable	— Programming Error Codes
— Fault Interrupt	— Fault Codes
— Software Calibration	— Service Request
— Selftest	

#### Specifications (Data Subject to Change)

**HP-IB Interface Functions:** The following HP-IB functions are implemented:

SH1, AH1 T6, L4, SR1, RL1, PP1, DC1, DT0 and E1.

**Safety Agency Compliance:** HP Models 6632A-6634A power supplies are designed to comply with the following regulatory standards:

IEC 348, VDE 0411, UL 1244 and CSA Electrical Bulletin 556B.

**Weight kg (lb) (all models):** Net 10.5 (23), Shipping 12.3 (27)

**Input Current:** 100 VAC 120 VAC 220 VAC 240 VAC  
(Max. rms all models) 3.3 A 2.9 A 1.7 A 1.6 A

**Input requirements:** 350 VA max.  
250 watts max.

**Specifications (Data Subject to Change)**

Note: Specifications are worst case unless otherwise noted.

	Volts	0-20 V	0-50 V	0-100 V	
	Amps	0-5 A	0-2 A	0-1 A	
	Watts	100 W	100 W	100 W	
<b>Hewlett-Packard Model</b> Specified over an operating temperature range of 0-55°C.		6632A	6633A	6634A	
<b>Load Effect (Load Regulation):</b> For a load change from zero to maximum rated voltage or current of the supply.*	Voltage	2 mV	4 mV	5 mV	
	Current	1 mA	1 mA	1 mA	
<b>Source Effect (Line Regulation):</b> Given for any change within the rated line voltage for any output within the rated output voltage, current, and power of the supply.	Voltage	0.5 mV	1 mV	1 mV	
	Current	0.5 mA	0.25 mA	0.25 mA	
<b>PARD (Ripple and Noise):</b> rms/peak-peak (20 Hz - 20 MHz).	Voltage(Normal)	0.3 mV/3 mV	0.5 mV/3 mV	0.5 mV/3 mV	
	Voltage(Fast)	1 mV/10 mV	1 mV/15 mV	2 mV/25 mV	
	Current(rms)	2 mA	2 mA	2 mA	
<b>Drift (Stability):</b> Change in output over 8-hour interval under constant line, load, and ambient temperature following 30-minute warm-up.	Voltage	0.01%+0.5 mV	0.01%+1 mV	0.01%+1 mV	
	Current	0.01%+1 mA	0.01%+0.5 mA	0.01%+0.3 mA	
<b>Load Effect Transient Recovery:</b> Maximum time required for output voltage to recover within a band of 0.1% of rated voltage around the nominal voltage following a 50% change in load current.	Normal	100 μs	100 μs	100 μs	
	Fast	50 μs	50 μs	50 μs	
<b>Programming:</b> (25±5°C) Given for control of the output over the HP-IB or with front panel controls.	Voltage	Resolution	5 mV	12.5 mV	25 mV
		Accuracy	0.05%+10 mV	0.06%+20 mV	0.05%+50 mV
	+Current	Resolution	1.25 mA	0.5 mA	0.25 mA
		Accuracy	0.15%+7 mA	0.15%+2 mA	0.15%+1 mA
Minimum CC programming current.		20 mA	8 mA	4 mA	
<b>Temperature Coefficient:</b> Output change per degree Celsius change in ambient following 30-minute warm-up.	Voltage	70ppm+0.25 mV	70ppm+0.5 mV	70ppm+1 mV	
	+Current	150ppm+500 μA	150ppm+150 μA	150ppm+75 μA	
<b>Output Response:</b> Maximum time for output voltage to change within ±0.025% of final value (LSB), and from 10% to 90%, or 90% to 10% of voltage excursion (Tr/Tf).	Normal	Tr/Tf	15 ms	15 ms	15 ms
		LSB	60 ms	60 ms	60 ms
	Fast	Tr/Tf	400 μs	400 μs	400 μs
		LSB	2 ms	2 ms	2 ms
<b>HP-IB Programming Command Processing Time:</b> (Display disabled)	Typical	10 ms	10 ms	10 ms	
<b>Voltmeter:</b> (25±5°C) Refers to data read back to the controller from the HP-IB and as viewed via the front panel display.	Resolution	5 mV	12.5 mV	25 mV	
	Accuracy	0.07%+15 mV	0.07%+30 mV	0.06%+70 mV	
<b>Ammeter:</b> (25±5°C) Refers to data read back to the controller from the HP-IB and as viewed via the front panel display.	Resolution	1.25 mA	0.5 mA	0.25 mA	
	Accuracy	0.18%+9 mA	0.17%+3 mA	0.15%+2 mA	
<b>DC Output Isolation:</b> Maximum voltage either output terminal (±) may be from chassis ground.		±240 VDC	±240 VDC	±240 VDC	
<b>Remote Sensing:</b> Maximum allowable voltage drop per load lead.		2 VDC	2 VDC	2 VDC	

\* Specification under Local Sensing.

**Ordering Information**

6632A: 20 volts, 5 amperes	Price*	\$1500
6633A: 50 volts, 2 amperes		\$1500
6634A: 100 volts, 1 amperes		\$1500
<b>(NOTE: Line voltage Option (100, 120, 220 or 240) must be specified)</b>		
100: 87-106 Vac, 48-63 Hz, (for Japan only)		N/C
120: 104-127 Vac, 48-63 Hz.		N/C
220: 191-233 Vac, 48-63 Hz.		N/C
240: 209-250 Vac, 48-63 Hz.		N/C
020: Front Output Binding Posts		\$75
908: Rack Mount Kit for one unit. (HP P/N 5061-9674)	add	\$30
909: Rack Mount Kit with Handles (HP P/N 5061-9675)		\$72.50
Accessory: Rack Slide Kit (HP P/N 1494-0059)		\$100
910: One each extra operating and service manuals. (Operating manual only is shipped with standard unit.)	add	\$30
W30: 2 Year Additional Return-to-HP Service		\$50

**Dimensions**

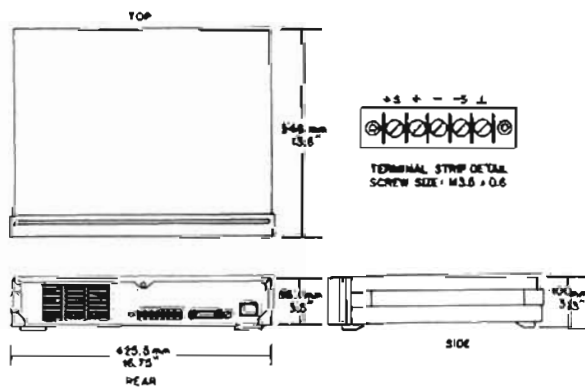

# POWER SUPPLIES

## Multiple Output Linear System Power Supplies

Models 6621A, 6622A, 6623A and 6624A

- 2, 3 or 4 Independent Isolated Outputs per Model
- 160 Watts Total Output Power per Model
- HP-IB Programming of Voltage and Current

- HP-IB Measurement of Voltage and Current
- Full Local Control or Local Lockout
- Programmable Overvoltage and Overcurrent Protection



HP 6624A

### Description

These HP-IB multiple output series regulated system power supplies feature a combination of intelligence, performance and low price which makes them the choice for power systems applications.

Four models, each offering a total of 160 watts output power, offer a variety of output combinations of 40 and 80 watts with voltages up to 50 volts and currents to 10 amps. Each output can produce power in two ranges (see fig. 1). For example, model 6622A has two 80 watt outputs. Each of these can produce 80 watts at either 20 volts or 50 volts. When operating below 20 volts, each output can source or sink up to 4 amps. When operating between 20 volts and 50 volts, it can source or sink up to 2 amps. Output combinations include:

- 6621A - 2 outputs at 80 watts, either 0-7 or 0-20 volts
- 6622A - 2 outputs at 80 watts, either 0-20 or 0-50 volts
- 6623A - 1 output at 80 watts, 0-7 or 0-20 volts; 1 at 40 watts, 0-20 or 0-50 volts; 1 at 40 watts, 0-7 or 0-20 volts
- 6624A - 4 outputs at 40 watts: two at 0-7 or 0-20 volts and two at 0-20 or 0-50 volts

The built-in interface is tailored to the power supply, resulting in simpler programming. Specifications supplied with these power supplies already take both the power supply and programming interface into account as a system. Self-contained measurement and readback capabilities eliminate the need for scanning the output or using a separate DVM.

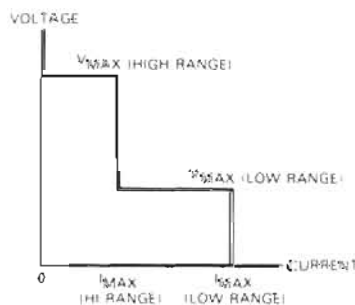

Fig 1. Output Characteristic Curve for HP 662X Series Power Supplies

### Programming Capabilities

These power supplies share the programming command set of HP Models 6632A, 6634A and 6030A-6038A programmable power supplies. (see page 440) The following functions are implemented:

- Output Voltage and Current Programming
- Output Voltage and Current Measurement and Readback
- Present and Accumulated Status Readback
- Programmable Service Request Mask
- Programmable Overcurrent Protection
- Programmable Overvoltage Protection
- Storage and Recall of Programmed Value Sets (all outputs)
- Echo Queries of Programmed Functions/Settings
- Output Channel Enable/Disable
- Programming Syntax Error Detection
- Reprogramming Delay Time for Service Request Mask

Operating voltage and current range is selected programmatically, with the last parameter programmed (voltage or current) determining the range. No separate command is required to switch output range.

Programmed command processing time is typically 7 milliseconds. Response time to within settling band is additional.

### Protection Features

Local lockout capability enables the programmer to disable all front panel controls over the HP-IB except the channel select (to allow display of the output voltage and current of any channel.)

Protection against overcurrent conditions is provided by either the current limit or overcurrent protection. Current limit will prevent the output current from exceeding a programmed value, while overcurrent protection will disable the supply if that value of current is reached. Current limit is always active, while overcurrent protection can be enabled or disabled.

As an example of its use, consider testing PC board subassemblies with a programmable power supply. A shorted component would cause current to be drawn from the power supply at the current limit value, possibly burning the board. Enabling overcurrent protection would cause the power supply to disable itself when the current limit value is reached, thus minimizing damage.

Protection against output overvoltage conditions is also provided. Normally, the power supply voltage will not exceed the programmed voltage setting. Programmable overvoltage protection guards your load against hardware faults by disabling and down-programming the power supply output if the programmed overvoltage setting is exceeded. A crowbar circuit is activated and shorts the output under these conditions.

This series also provides protection from unregulated output in the event of line voltage dropout and also guards against overtemperature conditions. The output is disabled when either of these conditions exists.

A service request can be generated to inform the controller in the event of any user-defined combination of overvoltage, overcurrent, overtemperature or mode change.

Fault trips which disable the output can be reset over the HP-IB.

### Output Ratings And Combinations

OUTPUT	CHANNEL	NUMBER OF OUTPUTS PER MODEL			
		6624A (4 output)	6623A (3 output)	6622A (2 output)	6621A (2 output)
0-20/ 0-2	0-7/ 0-5	2	1	-	-
0-50/ 0-0.8	0-20/ 0-2	2	1	-	-
0-20/ 0-4	0-7/ 0-10	-	1	-	2
0-50/ 0-2	0-20/ 0-4	-	-	2	-



**Software Calibration And Selftest**

With this series of power supplies, calibration is performed without removing the instrument's cover. All that is required is a shunt, a dvm, a controller and a few lines of code. Simple commands instruct the power supply to go to preset adjustment points, where voltages or currents are read with the dvm and shunt. Then the readings are sent to the power supply, which adjusts its calibration. Calibration is maintained through line voltage cycling.

Calibration integrity can be assured by using a jumper inside the box which, when removed, will prevent the supply from accepting calibration commands.

These supplies also have considerable selftest capability, which is exercised at power on and upon receipt of the selftest command over the HP-IB. Running selftests over the HP-IB will not cause the output to change.

**System Configuration**

This series of power supplies offers a number of significant benefits in the area of simplicity and flexibility of system configuration.

A convenient rear panel line voltage module allows switching of input line voltage without removing the covers. (The line voltage option determines line cord plug configuration.)

For applications which require different combinations of voltage and current for different loads, the dual range full power feature will be useful (see fig. 1). If this is not enough, two outputs can be combined in parallel or series combinations for more power at a given voltage or current level.

Where a precisely regulated voltage is required at the load, remote sensing at the load can be used. This capability will compensate for load lead IR drops of up to 1 volt per load lead. Add 1mV to the load effect specification for each 200 mV drop in the negative load lead when remote sensing.

All outputs of these power supplies are isolated for up to 240 volts dc from chassis ground and each other.

For applications which require a hardware trip signal separate from the HP-IB remote disable, terminals are provided on the rear panel barrier block of each output which provide bidirectional overvoltage protection trip capability. These terminals can be used to monitor for an OVP trip signal, strapped together to disable all outputs when one OVP is tripped or used as a remote disable separate from the HP-IB.

These models can sink as well as source current. This means that downprogramming without a load takes the same time as upprogramming. Quick discharging of reactive loads is another benefit resulting from this capability.

**Front Panel Control**

To aid in system program development, the following capabilities of these power supplies are controllable from the front panel:

- Output Channel Select (Controls and Display)
- OVP Setting
- Overcurrent Protection Enable
- Storage and Recall of Programmed Settings
- Voltage Setting
- Current Setting
- SRQ Mask Delay Time
- Output Enable/Disable
- OVP, OCP Reset
- Local

The alphanumeric LCD display will normally display output voltage and current for the channel selected. When programming from the front panel, the function being programmed and the present value will be displayed. Fault conditions will be spelled out in alpha characters. Output channel is indicated by an annunciator.

Changing the HP-IB address is done from the front panel, using the address key and the numeric keypad.

**Relay Controls, Fault Indicator, and Remote Inhibit Option 750**

The new Option 750 for the HP 662XA series includes protection features and relay controls. The protection features include the discrete fault indicator line (FLT) and the remote inhibit line (INH). The relay controls (RLY), together with external user-supplied relay, physically disconnect the power supply outputs from the load (or system). Each of the four open collector RLY controls can sink 120 mA. They can be programmed over HP-IB with the RELAY and OUT commands or operated with the front panel OUTPUT ON/OFF function key.

**General Specifications**

**HP-IB interface functions:** SH1, AH1, T6, L4, SR1, RL1, PP1, DC1, DT0. For more information on these codes, refer to the HP-IB section of this catalog.

**Safety agency compliance:** This series of power supplies is designed to comply with the following regulatory standards: IEC 348, VDE 0411, UL 1244, ANSI C39.5, and CSA Electrical Bulletin 556B.

**Dimensions (all models):** 132.6 mm H x 425.5 mm W x 497.8 mm D. (5.22 in. H x 16.75 in. W x 19.6 in. D)

**Input current:** 100 VAC 120 VAC 220 VAC 240 VAC  
(max.rms, all models) 6.3 A 5.4 A 3.0 A 3.0 A

**Weights kg(lb) (all models):** NET 17.4(38) SHIPPING 22.7(50)

**Prices And Option Descriptions**

- 6621A:** Dual output system power supply. \$3160
- 6622A:** Dual output system power supply. \$3160
- 6623A:** Triple output system power supply. \$3670
- 6624A:** Quad output system power supply. \$4180

(NOTE: Line voltage option (100, 120, 220 or 240) must be specified)

- 100:** 87- 106 Vac, 47-66 Hz. (for Japan only) N/C
- 120:** 104-127 Vac, 47-66 Hz. N/C
- 220:** 191-233 Vac, 47-66 Hz. N/C
- 240:** 209-250 Vac, 47-66 Hz. N/C

**700:** CIII, programming for MATE in place of HP-IB add \$510

**750:** Protection Feature and Relay Controls add \$255

**908:** Rack Mount Kit for one unit (no handles) add \$31

**909:** Rack kit with handles add \$82

**910:** One each extra operating and service manuals. (Operating manual only is shipped with standard unit.) add \$31

**Output Channel Specifications (READ ACROSS FROM PREVIOUS PAGE) (at 0° to 55° C unless otherwise specified)**

HP-IB OUTPUT SETTINGS				HP-IB MEASUREMENT READBACK ACCURACY				PARO (p-p/rms)		REGULATION				PROGRAMMING SPEED		
RESOLUTION		ACCURACY**		**				LOAD EFFECT		SOURCE EFFECT		TIME	RESPONSE	SETTLING		
VOLTAGE	CURRENT	VOLTAGE	CURRENT	VOLTAGE	CURRENT	VOLTAGE	CURRENT	VOLTAGE	CURRENT	VOLTAGE	CURRENT	CONSTANT	TIME	BAND		
6 mV	25 mA	19 mV + 0.06%*	50 mA + 0.16%*	20 mV + 0.05%*	10 mA + 0.1%*	3 mV/ 500 uV	1 mA rms	2 mV	1 mA	1 mV + 0.01%*	1 mA + 0.06%*	250 uS	2 mS	20 mV		
15 mV	10 mA	50 mV + 0.06%*	20 mA + 0.16%*	50 mV + 0.05%*	4 mA + 0.1%*	3 mV/ 500 uV	1 mA rms	2 mV	0.5 mA	1 mV + 0.01%*	1 mA + 0.06%*	750 uS	6 mS	50 mV		
6 mV	50 mA	19 mV + 0.06%*	100 mA + 0.16%*	20 mV + 0.05%*	20 mA + 0.1%*	3 mV/ 500 uV	1 mA rms	2 mV	2 mA	1 mV + 0.01%*	2 mA + 0.06%*	250 uS	2 mS	20 mV		
15 mV	20 mA	50 mV + 0.06%*	40 mA + 0.16%*	50 mV + 0.05%*	8 mA + 0.1%*	3 mV/ 500 uV	1 mA rms	2 mV	1 mA	1 mV + 0.01%*	2 mA + 0.06%*	750 uS	6 mS	50 mV		

\*% of setting. \*\* For a ±5°C range about the calibration temperature

# POWER SUPPLIES

## Autoranging System Power Supplies

Models 6030A, 6031A, 6032A, 6033A, and 6038A

- HP-IB programming of voltage and current
- Readback of voltage, current and status
- Overvoltage and overcurrent protection

- Optional CIL programming
- Built-in self-test and diagnostics
- Up to 1200 watts output
- Full local control enable/disable



HP 6033A, 6038A

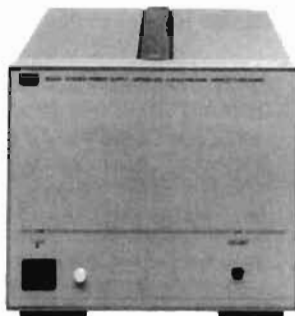

HP 6033A and 6038A  
with Opt 001

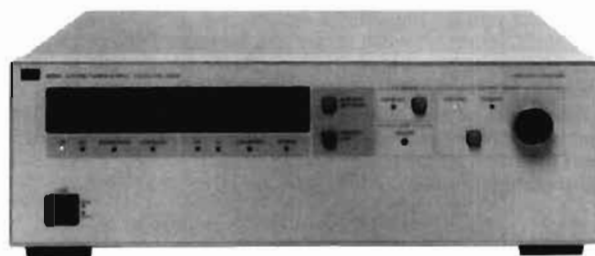

HP 6030A, 6031A and 6032A

### Description

These HP-IB CV/CC dc power supplies have many productivity-oriented features which make them easy to program, integrate into systems and use.

A conventional power supply subsystem capable of monitoring and controlling power supply voltage and current requires a variety of hardware in addition to the actual supply. These new power supplies, however, have built-in capabilities which eliminate the need for D/A programmers, DVMs, and associated auxiliary circuitry. Fewer instruments mean less rack space, easier calculation of system specifications, quicker configurations, higher system reliability, more rapid troubleshooting, and simpler software. As autoranging power supplies, these models can provide a wide and continuous range of voltage and current combinations at the maximum rated power. This often allows both present and future requirements to be satisfied with fewer supplies, also reducing the number of instruments in the system.

### Front Panel Control

Most of the extensive programmable instruction set can be simulated with front panel controls, thus facilitating design and debugging of system hardware and software. During system operation, if local control is not needed, the front panel controls can be disabled with a computer command. If operator interaction is required, a computer command can place limits on the output voltage and current available. Often, control and monitoring via the front panel is very useful during system development, but not needed afterwards. If the system is reproduced without further development, power supplies without front panel controls and meters (Option 001) can then be used. Ordering your power supplies with Option 001 significantly decreases the cost.

### Protection Features

Because of the delicate nature of most loads, these system power supplies provide several different types of protection. Since they are CV/CC supplies, both the output voltage and current will be automatically limited to the programmed values. If reaching a programmed value indicates an undesirable condition, the power supply can be instructed to automatically down-program to zero output. For example, if the programmed current limit is reached while testing a PC board assembly, it may indicate a shorted component. In this case, the FOLDBACK feature, if enabled, would be able to serve as an overcurrent protection circuit and down-program the power supply automatically. FOLDBACK can be enabled and reset over the HP-IB.

The built-in overvoltage protection circuit is adjustable with a front panel control. The set trip level can be displayed on the front panel meter and also can be read back over the HP-IB, thus making adjusting the level easy. The OVP circuit, once tripped, can be reset over the HP-IB.

Production procedures sometimes require the operator to adjust the output voltage or current of a power supply locally with the front panel controls. If this is done, programmed levels can be set to limit the available adjustment range to a safe margin.

Potentially harmful conditions, such as overtemperature and high or low ac input, will trigger the power supply to automatically down-program to zero output. When these conditions occur, or the FOLDBACK or OVP circuits trip, LEDs on the front panel light to indicate the failure. This status can also be read back to the computer over the HP-IB and can be used to generate interrupts.

### Specifications

Ratings		Autorange Output*								Regulation				10% Change Transient Recovery
		V <sub>1</sub>		P <sub>1</sub>		V <sub>2</sub>		P <sub>2</sub>		Load Effect		Source Effect		
Volts	Amps	V <sub>1</sub>	P <sub>1</sub>	V <sub>2</sub>	P <sub>2</sub>	V <sub>1</sub>	P <sub>1</sub>	V <sub>2</sub>	P <sub>2</sub>	HP Model	Voltage	Current	Voltage	Current
0-20	0-30	20V	200W	14V	242W	6.7V	200W	6033A	0.01% +2mV	0.01% +9mA	0.01% +1mV	0.01% +6mA	1ms / 50mV	
0-20	0-120	20V	1000W	14V	1064W	7V	840W	6031A	0.01% +3mV	0.01% +15mA	0.01% +2mV	0.01% +25mA	2ms / 100mV	
0-60	0-10	60V	200W	40V	240W	20V	200W	6038A	0.01% +3mV	0.01% +5mA	0.01% +2mV	0.01% +2mA	1ms / 75mV	
0-60	0-50	60V	1000W	40V	1200W	20V	1000W	6032A	0.01% +5mV	0.01% +10mA	0.01% +3mV	0.01% +10mA	2ms / 100mV	
0-200	0-17	200V	1000W	120V	1200W	60V	1020W	6030A	0.01% +5mV	0.01% +10mA	0.01% +5mV	0.01% +5mA	2ms / 150mV	

\*See the generalized autoranging output characteristic curve.

**Programmable Features**

Below are the parameters which can be programmed on the HP 6030A — 6038A and the information which is available for readback over the HP-IB. All of these features are included with the standard user-friendly programming language.

**Programmable Functions**

- Output Voltage
- Output Current
- Output Disable/Enable
- Soft Voltage Limit
- Soft Current Limit
- Group Trigger
- Foldback Mode
- Device Clear
- Interrupt Mask
- Interrupt Delay
- Pre-set Power Supply States
- Self-Test
- Local Lockout

**Readback Functions**

- Programmed Voltage
- Programmed Current
- Actual Voltage
- Actual Current
- OVP Trip Level
- Soft Voltage Limit
- Soft Current Limit
- Foldback Mode
- Present Status
- Accumulated Status
- Interrupt Mask
- Programming Error Codes
- Self Test Error Codes
- Output Disable/Enable
- Device ID

For added flexibility now a CIIIL programming language. Option 700. is available.

**System Configuration**

If your application requires more power than the output capability of a single unit, you can use an auto-series connection for greater output voltage or an auto-parallel connection for greater output current. Consult your local HP sales office regarding restrictions/limitations for auto-series and auto-parallel operation.

Remote sensing can be used to maintain the CV load effect specification at the load with up to 0.5 volt drop per load lead, and sense wires which are less than 0.2 ohm per lead. Operation is possible with up to 2.0 volts drop per lead; however, the load effect specification may be degraded.

Either terminal may be grounded, or may be floated up to ± 240 (± 550 volts for the HP 6030A) volts from chassis ground.

Analog programming inputs and monitoring terminals are provided on the rear panel in addition to the HP-IB programming capabilities. Zero to full scale voltage or current can be programmed with either 0-5 volt voltage signals, or 0-4000 ohm resistance signals. The monitoring terminals present 0-5 volt buffered signals which are proportional to the output voltage and current.

HP models 6030A, 6031A, 6032A, and 6038A are stable when operating in CC into inductive loads up to 100 mH, and the HP 6033A and 6038A can handle up to 1 H. A special modification is available for HP Models 6030A, 6031A and 6032A to ensure stable operation when operating into inductive loads up to 10 H.

**General Specifications**

HP-IB interface functions: SH1, T6, AH1, L4, SR1, RL1, PP1, DC1, DT1. For more on these codes, refer to the HP-IB section of this catalog.

Dimensions: HP 6033A and 6038A: 177.0 mm H x 212.3 mm W x 443.6 mm D (6.97" x 8.36" x 17.872")

HP 6030A, 6031A and 6032A: 132.6 mm H x 425.5 mm W x 503.7 mm D (5.2" x 16.75" x 19.83")

**Specifications cont.**

PARO (rms/p-p) 20 Hz-20 MHz	Remote Control					General						
	Resolution		Accuracy			AC Input Current				Weight - kg (lbs)		Price
	Voltage	Current	Voltage	Current	100 Vac	120 Vac	220 Vac	240 Vac	Net	Shipping		
3mV/30mV	15mA/-	5mV	7.5mA	0.035% ±9mV	0.15% ±20mA	6.0A	6.5A	3.8A	3.6A	9.6(21)	11.4(25)	\$2525
8mV/50mV	120mA/-	5mV	30mA	0.035% ±15mV	0.25% ±250mA	24A	24A	15A	14A	17.2(38)	22.7(50)	\$3235
3mV/30mV	5mA/-	15mV	2.5mA	0.035% ±40mV	0.065% ±10mA	6.0A	6.5A	3.8A	3.6A	9.6(21)	11.4(25)	\$2525
8mV/40mV	25mA/-	15mV	12.5mA	0.035% ±40mV	0.2% ±85mA	24A	24A	15A	14A	16.3(36)	21.8(48)	\$3235
22mV/50mV	15mA/-	50mV	4.25mA	0.035% ±145mV	0.2% ±25mA	24A	24A	15A	14A	16.3(36)	21.7(48)	\$3235

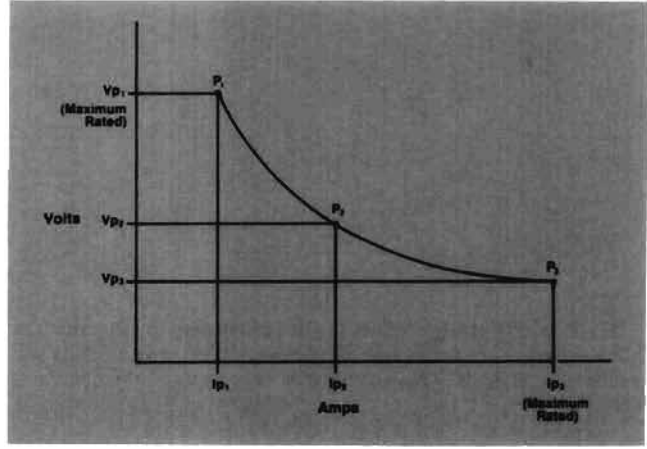

Generalized autoranging output characteristic curve

**Fault Indicator and Remote inhibit**

These HP-IB DC power supplies include discrete fault indicator line (FLT) and remote inhibit line (INH). See page 444 for a complete description.

**CIIIL/Discrete Fault Indicator/Remote Inhibit (Option 700)**

CIIIL (Control Interface Intermediate Language) for military test applications. Included is a Fault Indicator Line, FLT, which is a two pin TTL output port that will go true whenever the power supply goes into fault mode. Also included is a Remote Inhibit Line; INH is a two pin TTL port that provides a means for disabling the power supply directly. Both the Fault Indicator and Remote Inhibit Lines are separate from, and in addition to, the HP-IB programming control.

**Option Descriptions**

- 001:** Front panel which has only line switch, line indicator, and OVP adjust. less \$300
- 100:** 87-106 Vac, 48-63 Hz. This option is for use in Japan only. The power supply output power is 75% of the output power available with the other line voltage options. N/C
- 120:** 104-127 Vac, 48-63 Hz. N/C
- 220:** 191-233 Vac, 48-63 Hz. N/C
- 240:** 208-250 Vac, 48-63 Hz. N/C
- 700:** CIIIL programming language/Fault Line/Remote Inhibit add \$510
- 800:** Rack mount kit for two units side by side. This applies to HP 6033A and 6038A only. add \$ 77
- 908:** Rack mount kit for a single unit. A blank filler panel is supplied when this option is ordered with HP 6033A and 6038A.
  - HP 6033A and 6038A add \$ 82
  - HP 6030A, 6031A and 6032A add \$ 31
- 910:** One extra operating and service manual shipped with each power supply. add \$ 31

# POWER SUPPLIES

## System Power Supply Programming Features



HP-IB system power supplies are extremely easy to program. The following tables are a complete list of the available programming and readback commands. These commands only apply to the models as listed.\*

Command	Header	Description	HP 6030A to HP 6038A	HP 6621A to HP 6624A	HP 6632A to HP 6634A
Set voltage	VSET	Programs output voltage setting	X	X	X
Set current	ISET	Sets output current limit	X	X	X
Set overvoltage	OVSET	Sets overvoltage trip level		X	X
OC protection on/off	OCP	Enable or disable over current protection	2	X	X
Output on/off	OUT	Enable or disable output	X	X	X
Unmask	UNMASK	Defines conditions which generate a fault which is latched into the fault register	X	X	X
Reprogram delay (in seconds)	DLY	Delays the onset of certain fault conditions and prevents the power supply from registering a fault when these conditions are true	X	X	X
Reset overvoltage	OVRST	Resets OVP once it's been triggered	1	X	1
Reset overcurrent	OCRST	Resets OCP once it's been triggered	1	X	1
Service request	SRQ	Enable or disable service request capability	X	X	X
Power-on SRQ on/off	PON	Enable or disable service request capability at power-on		X	X
Display on/off	DSP	Turns on/off the front panel display		X	X
Display character	DSP	Displays messages of up to 12 characters on the front panel display		X	
Store settings	STO	Stores voltage and current settings	X	X	
Recall settings	RCL	Recalls stored settings	X	X	
Clear supply	CLR	Clears all settings and returns power supply to initial power-on values	X	X	X
Trigger	TRG	Implements values stored using hold command	X		
Hold	HOLD	Stores values which are implemented by the trigger command	X		
Voltage maximum	VMAX	Sets maximum voltage value power supply will accept	X		
Current maximum	IMAX	Sets maximum current value power supply will accept	X		
Foldback	FOLD	Enable or disable foldback	X	2	2
Reset	RST	Resets OVP, OCP or foldback when triggered	X		X
Calibration mode	CMODE	Turns calibration mode on or off		X	X

\* The High Performance Autoranging Supply, HP Model 6002A, and the Precision Bipolar System Supplies, HP Models 6129C, 6130C and 6140C, are programmed by an ASCII or binary code. Only the voltage, current and range may be programmatically controlled.

The reset command accomplishes this function.

Foldback (HP Models 6030A-6038A) is a protection feature similar to overcurrent protection (HP 6621A-6624A and HP 6632A-6634A).



Query	Header	Action Taken by Power Supply	HP 6030A to HP 6038A	HP 6621A to HP 6624A	HP 6632A to HP 6634A
Voltage setting	VSET?	Returns programmed voltage value	X	X	
Current setting	ISET?	Returns programmed current value	X	X	
Voltage output	VOUT?	Voltage output value measured	X	X	X
Current output	IOUT?	Returns measured current value	X	X	X
OVP setting	OVSET?	Returns programmed OVP trip level	X	X	
OCP protection on/off	OCP?	Returns condition of OCP (enabled/disabled)	1	X	
Output on/off	OUT?	Returns condition of the output (on/off)		X	
Unmask setting	UNMASK?	Returns a number corresponding to the unmasked settings in the fault register	X	X	
Delay setting	DLY?	Returns delay setting	X	X	
Status	STS?	Returns a number corresponding to the present status	X	X	X
Accumulated status	ASTS?	Returns contents of accumulated status register	X	X	X
Fault	FAULT?	Returns contents of fault register	X	X	X
Error	ERR?	Returns error code	X	X	X
Service request setting	SRQ?	Returns condition of SRQ (enabled/disabled)	X		X
Power-on SRQ on/off	PON?	Returns condition of the SRQ at power-on (enabled/disabled)		X	
Display on/off	DSP?	Returns condition of front panel display (enabled/disabled)		X	
Model number	ID?	Returns model number	X	X	X
Selftest	TEST?	Initiates selftest	X	X	X
Calibration mode	CMODE?	Reports calibration mode		X	
Foldback setting	FOLD?	Reports foldback setting	X	1	1
Hold setting	HOLD?	Reports hold setting	X		
Voltage maximum	VMAX?	Reports voltage soft limit	X		
Current maximum	IMAX?	Reports current soft limit	X		

1. Foldback (HP Models 6030A-6038A) is a protection feature similar to overcurrent protection (HP 6621A-6624A and HP 6632A-6634A).

# POWER SUPPLIES

## Protection Features and CIIL Programming

### CIIL Programming for the Multiple Output and Autoranging System DC Power Supplies

CIIL (Control Interface Intermediate Language) is now a test instrument module programming language standard for many military test equipment programs, including all new U.S. Air Force programs and some U.S. Navy and U.S. Marine programs.

CIIL, which is a compiled form of ATLAS, provides a uniform programming format for all basic test instrumentation. The CIIL standard reduces the effort required for system upgrades and modifications, such as those needed to keep a system up to date with the latest technology.

One difficulty with CIIL is how to handle instrument capabilities that do not fit in with any approved CIIL command. Such commands are handled in the instrument's native language which is accessible through the CIIL Go to Alternate Language <GAL> command.

The CIIL programmable HP Power Supply (ordered as Option 700) contains a CIIL interpreter in ROM internal to the power supply.

HP system DC power supplies with Option 700 are designed to follow the guidelines of CIIL standard 2806763 Rev. B. The signal type produced by a DC power supply is designated by the CIIL noun <DCS>. Of the many noun modifiers defined by CIIL, five apply to the DC signal produced by an HP system power supply. These are voltage <VOLT>, current <CURR>, voltage limit <VLTL>, current limit <CURL>, and settling time <SETT>.

The following CIIL commands are accepted: FNC, SET, SRX, SRN, INX, FTH, RST, OPN, CLS, STA, IST, CNF, and GAL.

All of the basic functions of a standard HP system power supply can be implemented with the Option 700 unit. Output voltage and current measurement readback is implemented with the CIIL <INX> and <FTH> commands. Some features, such as the Foldback protection available with the HP 603XA series or the Over-Current Protection available with the HP 662XA series, must be programmed in the alternate language because CIIL does not provide for them. The alternate language also contains most of the standard HP system DC power supply commands, including all of the output setting commands, the measurement readback commands, the echo query commands, the output disable command, and the self test, status, reset, and clear commands.

Option 700 is available with HP's line of programmable system DC power supplies, Models HP 6030A, 6031A, 6032A, 6033A, 6038A, 6621A, 6622A, 6623A, and 6624A.

The FLT and INH lines can be chained together to cause a network of power supplies to shut down if a fault occurs.

### Protection Features for Programmable System Power Supplies

#### Discrete Fault Indicator or Status Monitor Line

The fault indicator line, FLT, is a two pin TTL output port accessible on the rear panel of our system DC power supplies. The FLT line will go true whenever the power supply has gone into Fault Mode. The conditions which could cause the supply to enter Fault Mode are listed below.

CV	-constant voltage mode
CC	-constant current mode
OR	-over range
OV	-overvoltage protection circuit tripped
OT	-overtemperature protection tripped
AC	-input AC out of range
FLD or OCP	-foldback or overcurrent protection tripped
ER	-programming error occurred
RI	-remote inhibit line tripped

By programming a special mask register, the programmer can select which of these nine conditions will cause the power supply to enter Fault Mode. For example, if constant voltage operation is preferred, then the user can set up the power supply to enter Fault Mode if it goes into constant current. Any or all of the conditions in the status register can be masked to cause a fault if they occur.

Both the FLT line and the HP-IB SRQ line are set by the same fault register. The FLT line will provide redundancy for the SRQ line in the event of an HP-IB or controller interruption or failure.

#### Remote Inhibit Line

The remote inhibit line, INH, is a two pin TTL input port accessible from the rear panel of our system DC power supplies. This line provides the means for disabling the power supply directly, without involving the HP-IB. When the INH line is invoked, the power supply output goes to zero and the Remote Inhibit (RI) bit is set in the status register.

Together, the FLT and INH lines can be used in a variety of configurations to provide added protection.

These features are standard with HP's line of programmable system DC power supplies, Models HP 6030A, 6031A, 6032A, 6033A, 6038A. HP Models 6621A, 6622A, 6623A and 6624A incorporate these features in Option 750. See page 438 for ordering information.

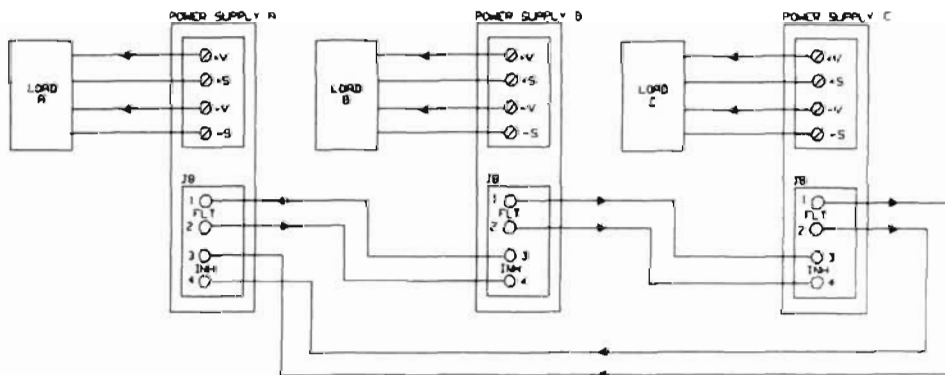

# POWER SUPPLIES

## 200 Watt System Power Supply

### Model 6002A

- 200 watt autoranging dc output
- Constant-voltage/constant-current operation
- HP-IB programming option



HP 6002A

### Description

The HP 6002A dc power supply offers an exceptional combination of performance and flexibility. It employs a unique control concept which provides for an autoranging output with the performance characteristics of linear regulation. The HP 6002A is a 200 watt CV/CC power supply, which may be remotely programmed via the HP-IB when equipped with Option 001.

As an autoranging power supply, the HP 6002A can provide 200 watts over a wide range of voltage and currents without external intervention. This allows it to take the place of multiple conventional power supplies. For example, the HP 6002A can replace both a 50 volt, 4 ampere supply and a 20 volt, 10 ampere supply.

### System Features/Remote Control

Analog programming of output voltages and current can be accomplished through the use of remotely controlled resistance or voltage applied to rear panel terminals. Additional control terminals are provided for remote load voltage sensing, auto-series or parallel operation, and for remotely activating the crowbar circuit. A pulse output from the crowbar terminal indicates the overvoltage circuit has been self-activated. A voltage step change appearing on terminal indicates a changeover to or from constant-current operation.

### HP-IB Option

Digital programming via Option 001 permits control of output voltage or current by the Hewlett-Packard Interface Bus (HP-IB). Two programmable ranges allow better resolution below 10 volts or 2 amperes. The selection of HP-IB control of either voltage or current is done by rear panel switches. The IEEE 488 interface functions supported by the HP 6002A with Option 001 are basic listener (L2) and acceptor handshake (AH1). Complete explanation of these interface functions is available in the IEEE Std. 488-1 1978.

### Specifications

**DC output:** voltage and current output can be adjusted over the ranges indicated by front panel controls, analog programming, or an optional HP-IB interface.

**Voltage:** 0-50 V. **Current:** 0-10 A.  
Maximum 200 watts output from 20 V to 50 V.

- Built-in overvoltage protection crowbar
- CV/CC operating status indicators
- Remote analog programming and sensing

### Autoranging Output Characteristic

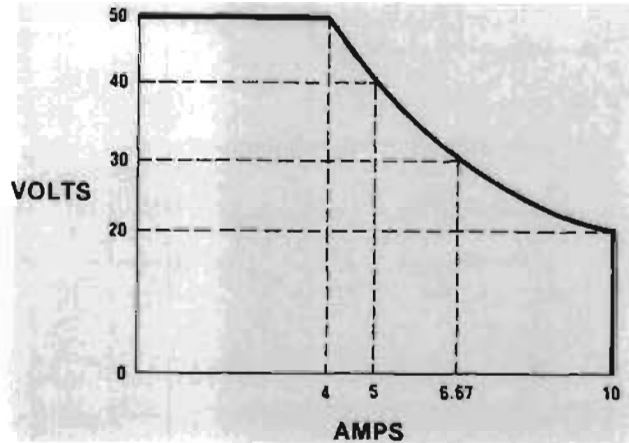

**Load effect:** constant-voltage, 0.01% + 1 mV. Constant-current, 0.01% + 1 mA.

**Source effect:** CV, 0.01% + 1 mV; CC, 0.01% + 1 mA.

**RIPPLE (ripple and noise):** rms/p-p, 20 Hz to 20 MHz; CV, 1 mV/10 mV; CC, 5 mA rms.

**Temperature coefficient:** CV, 0.02% + 200  $\mu$ V/ $^{\circ}$ C; CC 0.02% + 5 mA/ $^{\circ}$ C.

**Drift:** CV, 0.05% + 1 mV/8 h; CC, 0.05% + 5 mA/8 h.

**Load transient recovery:** 100  $\mu$ s for output voltage to recover within 15 mV of nominal voltage setting following a load current change of 50% to 100% or 100% to 50% of full load current.

**Response time:** maximum time for output voltage to change between 0 to 99.9% or 100% to 0.1% of maximum rated output voltage. Up Programming: no load, 100 ms; full load, 100 ms. Down Programming: no load, 400 ms; full load, 200 ms.

**Overvoltage protection:** trip voltage adjustable from 2.5 V to 60 V. **DC output isolation:** 150 V dc.

**Power:** 100, 120, 220, or 240 V ac (-13%, +6%), 48-63 Hz.

**Temperature rating:** 0 $^{\circ}$ C to 55 $^{\circ}$ C operating, -40 $^{\circ}$ C to +75 $^{\circ}$ C storage. Supply is cooled by built-in fan.

**Size:** 180 H x 212 W x 422 mm D (6.97" x 8.36" x 16.6").

**Weight:** net, 14.5 kg (32 lb); shipping, 15.9 kg (35 lb).

### HP-IB Option

**Programmable ranges:** high: 0-50 V or 0-10 A,  
low: 0-10 V or 0-2 A.

**Programming speed:** same as response time.

**Accuracy:** hi range: CV, 0.2% + 25 mV; CC, 0.2% + 25 mA.  
lo range: CV, 0.2% + 10 mV; CC, 0.2% + 25 mA.

**Resolution:** hi range: CV, 50 mV; CC, 10 mA. (12 bit)  
lo range: CV, 10 mV; CC, 2 mA. (12 bit)

**Isolation:** 250 volts dc from bus data lines to power supply.

### Options

Options	Price
001: HP-IB interface	add \$570
800: rack flange kit to mount 2 locked HP 6002As	\$77
908: rack mounting adapter kit for one HP 6002A; includes blank filler panel.	\$82
910: one extra operating and service manual	add \$7.50

HP 6002A Autoranging DC Power Supply **\$2245**

# POWER SUPPLIES

## Precision Bipolar System Supplies

### Models 6129C-6131C & 6140A

- Fast, accurate, high resolution programming
- Bipolar output
- Current sink or source

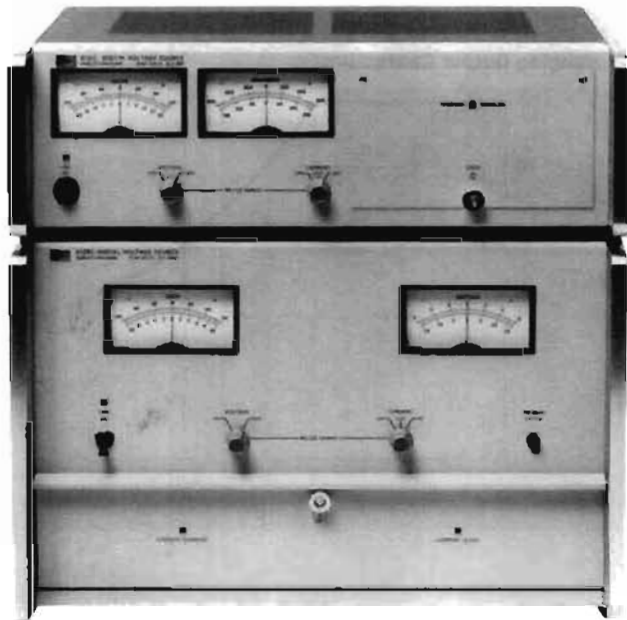

HP 6131C (top) & 6129C

### Description

The family of Precision Bipolar System Supplies consists of three voltage sources (HP 6129C, 6130C and 6131C) and one current source (HP 6140A). They provide easy, fast and accurate programming of their dc outputs, with many features oriented specifically towards efficient integration in automatic systems.

### Isolation

All digital inputs are completely isolated from the analog outputs.

### Programmable Current Limit (Voltage Source)

Valuable loads can be protected by a user programmable current latch. Output power goes to zero when the latch circuit is tripped. The reaction time to the latch can be adjusted, if desired, to avoid tripping when reprogramming with a capacitive load. There is also a fixed current limit at 110% of rated current output.

### Current Monitoring Terminals (Voltage Sources)

A voltage is available at the rear barrier strip which is proportional to the output current.

### Analog Input

An ac signal may be injected into the output amplifier to simulate various noise and ripple conditions.

### Precision Bipolar System Current Source

The HP 6140A Current Source has features which correspond to the voltage sources. It has a programmable voltage limit, voltage monitoring terminal, as well as isolation, and analog input capabilities.

### Accessories Furnished

HP 1251-0086 50-contact rear plug.  
 HP 5060-7948 Plug-in extender board for voltage source.  
 HP 5060-7948/5060-7982. Two plug-in extender boards for current source.

- Programmable current latch (on voltage sources) or voltage limit (on current sources)
- Isolated output

### Specifications

	Binary Instruments Option J20 & P05		BCD Instruments Option J99	
	X1 Range	X10 Range	X1 Range	X10 Range
<b>HP 6129C</b>				
Output	$\pm 16.384$ V, 5 A	$\pm 50.00$ V, 5 A	$\pm 9.999$ V, 5 A	$\pm 50.00$ V, 5 A
Accuracy	1.5 mV	15 mV	1.5 mV	15 mV
Resolution	0.5 mV	5 mV	1 mV	10 mV
<b>HP 6130C</b>				
Output	$\pm 16.384$ V, 1 A	$\pm 50.00$ V, 1 A	$\pm 9.999$ V, 1 A	$\pm 50.00$ V, 1 A
Accuracy	1.5 mV	10 mV	1 mV	10 mV
Resolution	0.5 mV	5 mV	1 mV	10 mV
<b>HP 6131C</b>				
Output	$\pm 16.384$ V, 0.5 A	$\pm 100.00$ V, 0.5 A	$\pm 9.999$ V, 0.5 A	$\pm 99.99$ V, 0.5 A
Accuracy	1.5 mV	10 mV	1 mV	10 mV
Resolution	0.5 mV	5 mV	1 mV	10 mV
<b>HP 6140A</b>				
Output	$\pm 16.384$ mA, 100 V	$\pm 163.84$ mA, 100 V	$\pm 9.999$ mA, 100 V	$\pm 99.99$ mA, 100 V
Accuracy	1 $\mu$ A $\pm 0.01\%$	10 $\mu$ A $\pm 0.01\%$	10 $\mu$ A $\pm 0.01\%$	10 $\mu$ A $\pm 0.01\%$
Resolution	0.5 $\mu$ A	5 $\mu$ A	1 $\mu$ A	10 $\mu$ A

### Options

#### AC Power Option

**028:** transformer tap change for 230 V ac  $\pm 10\%$ , single-phase input on HP 6130C and 6131C.

(HP 6129C and 6140A are 115/230 switch selectable.)

**J20:** 16 bit binary interface for HP 12661A I/O programmer card for Hewlett-Packard computers.

**Price**

N/C

N/C

#### Accessories Available

**HP 14533B:** Pocket programmer permits manual programming of all input functions by switch closure.

\$460

**HP 14534A:** Pocket programmer extension cable (3 ft).

\$204

**HP 14535A:** HP computer interface kit includes HP 12661A computer I/O card, HP 14539A cable, verification software and RTE Driver. Up to eight PBSS's may be controlled from one HP 14535A.

\$1760

**HP 14536A:** Chaining cable connects an additional PBSS to the existing chain of PBSS's.

\$305

#### Ordering Information

An interface option must be ordered.

**HP 6129C:** Digital Voltage Source

\$8160

**Opt 908:** Rack Flange Kit

add \$51

**HP 6130C, 6131C:** Digital Voltage Source

\$4590

**HP 6140A:** Digital Current Source

\$8160

**Opt 908:** Rack Flange Kit

add \$38

**Opt 910:** One extra operating and service manual shipped with each power supply

\$20



# POWER SUPPLIES

## Digital Programmable: HP-IB Programmer

### Model 59501B

- HP-IB power supply control
- HP-IB-to-power-supply isolation
- Programmable range



HP 59501B

### Description

The HP 59501B is an isolated digital-to-analog converter designed to provide a convenient interface between the Hewlett-Packard Interface Bus and HP power supplies. With the HP 59501B, a wide range of dc voltages and currents becomes automatically controllable via the HP-IB. With proper wiring, the built-in isolation devices protect other instrumentation on the HP-IB from damage that could be caused by power supply outputs. In addition, an internal control circuit holds the output level near zero until programmed data is received. A programmable High/Low range control improves resolution by ten-to-one.

Power supply control is accomplished through the HP 59501B's programmable output voltage and programming network (see below). By making the appropriate connections between the 59501B's rear terminals and the remote programming terminals on the supply, the output voltage (or current) of the supply can be programmed from zero to its full rated output. The HP 59501B front panel controls provide fast and easy calibration of power supply outputs. The Zero Adjust enables the user to correct for small offsets in power supply response to programmed inputs. The Power Supply Full Scale Adjust (part of programming network) enables the user to set the maximum output desired from the power supply when the HP 59501B is programmed to its maximum value. For example, this adjustment would normally be used to calibrate the maximum programmable output of a 320Vdc power supply to 320 volts. However, it could also be used to set the maximum to 200 volts.

The HP 59501B also can be used directly as a low level dc signal source. Unipolar and bipolar output modes are available with output voltages programmable from zero to 9.99 volts, or minus 10.0 to plus 9.98 volts. Output current up to 10 milliamperes is available and is automatically limited to protect the HP 59501B and user equipment. The HP 59501B produces a full scale voltage change in approximately 250  $\mu$ s from the time the digital data is received.

- Programmable 10-volt dc output
- Unipolar/bipolar operation
- Fast digital to analog conversion

### Specifications

#### Digital to Analog Converter

**DC output voltage:** programmable in high or low ranges within the voltage limits shown below. Output mode is unipolar or bipolar and is selected by a rear panel switch.

**Unipolar:** 0 to 9.99 V (low range, 0 to 0.999 V).

**Bipolar:** -10 to +9.98 V (low range, -1 to +0.998 V).

**DC output current:** 10 mA maximum.

**PARD (ripple and noise):** 2 mV rms/10 mV p-p.

**Resolution:** unipolar, 10 mV (low range, 1 mV). Bipolar, 20 mV (low range, 2 mV).

**Accuracy:** specified at 23°C  $\pm$  5°C.

**Unipolar:** 0.1%  $\pm$  5 mV (low range, 0.1%  $\pm$  1 mV).

**Bipolar:** 0.1%  $\pm$  10 mV (low range, 0.1%  $\pm$  2 mV).

**Stability:** change in output over 8 hour interval under constant line, load, and ambient following a 30 minute warm-up. Stability is included in accuracy specification measurements over the temperature range indicated.

**Unipolar:** 0.04%  $\pm$  0.5 mV (low range, 0.04%  $\pm$  0.1 mV).

**Bipolar:** 0.04%  $\pm$  1 mV (low range, 0.04%  $\pm$  0.2 mV).

**Temperature coefficient:** unipolar, 0.01%/°C  $\pm$  0.5 mV/°C (low range, 0.1%/°C  $\pm$  0.1 mV/°C). Bipolar, 0.01%/°C  $\pm$  0.5 mV/°C (low range, 0.01%/°C  $\pm$  0.1 mV/°C).

**Zero adjust:** plus or minus 250 millivolts.

**D/A full scale adjust:** plus or minus 5%.

**Programming speed:** (the time required for output to go from zero to 99% of programmed output change is 250  $\mu$ s (measured with resistive load connected to output terminals).

#### Power Supply Programming

**Programming network specifications:** in the following specifications, M represents the calibrated full scale value of the supply being programmed and P is the actual programmed output. The full scale value (M) can be any value within the supply's output range and is calibrated with the HP 59501B programmed to its maximum high range output.

**Accuracy:** specified at 23°C  $\pm$  5°C.

**Unipolar:** 0.05% M  $\pm$  0.25% P (low range, 0.01% M  $\pm$  0.25% P).

**Bipolar:** 0.1% M  $\pm$  0.25% P (low range, 0.02% M  $\pm$  0.25% P).

**Isolation:** 600 V dc between HP-IB data lines and output terminals.

**Temperature coefficient:** 0.005% M/°C  $\pm$  0.015% P/°C (low range, 0.01% M/°C  $\pm$  0.015% P/°C).

**Programming resolution:** 0.1% M (low range, 0.01% M).

**Programming speed:** D/A programming speed plus the programming speed of the power supply.

#### General

**Temperature range:** operation, 0 to 55°C; storage, -40 to 75°C.

**Power:** 100, 120, 220, or 240 Vac (+6% -13%) 47-63 Hz, 10 VA (selectable on rear panel).

**Size:** 101.6 H x 212.9 W x 294.6 mm D (4" x 8.38" x 11.6").

**Weight:** net, 1.82 kg (4 lb); shipping, 2.27 kg (5 lb).

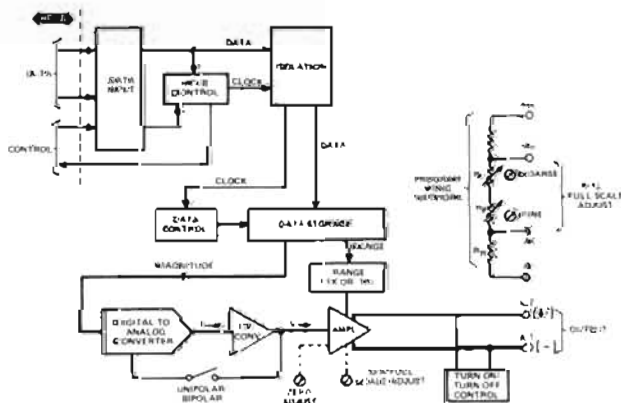

Several programming notes are available to assist in operating the HP 59501B Power Supply Programmer with the HP desktop computers.

#### Accessories

HP 5060-0173: rack mounting adapter kit for one HP 59501B

HP 5060-0174: rack mounting adapter kit to connect two HP 59501B's

#### Ordering Information

HP 59501B HP-IB Isolated D/A Power Supply Programmer

#### Price

\$68

\$70

#### Price

\$775

# POWER SUPPLIES

General Purpose: 25–200 W Output

Models 6227B–6299A

- Constant voltage/constant current operation
- Remote sensing and programming
- Auto-series, -parallel, & -tracking operation

- Front and rear output terminals
- Floating output—use as positive or negative source
- Bench or rack mounting



HP 6281A, 6284A, 6289A,  
6294A, 6299A



HP 6282A, 6286A,  
6291A, 6296A

## Description

### HP 6281A–6299A Single Output

This series of medium-power constant voltage/constant current power supplies is available in two power ranges: 37–75 watts (packaged in 3½-inch high half-rack cases) and 100–200 watts (packaged in 5¼-inch high half-rack cases). All models except HP 6294A and 6299A have separate coarse and fine voltage and current controls that allow the voltage and current outputs to be varied from zero to the maximum rated values. The latter two models have ten-turn voltage controls. Crossover from constant voltage to constant current operation occurs automatically when the load current exceeds the value established by the current control settings. A four-position meter function switch selects either of two output voltage or output current ranges (X1, X0.1) for display on the panel meter.

The 37–75 watt models are of the series-regulated type. They have excellent regulation and ripple characteristics and include a special output-capacitor discharge circuit for improved programming speed. The 100–200 watt models employ a series-regulator/SCR-preregulator configuration to achieve the high efficiency necessary for a convection-cooled package of this size. They also have excellent regulation, low ripple and noise, and moderate programming speeds.

## Specifications

RATINGS			PERFORMANCE							
DC Output		HP Model	Load Effect		Source Effect		PAR (rms/p-p)		Drift (stability)	
Volts	Amps		Voltage	Current	Voltage	Current	Voltage	Current	Voltage	Current
0–7.5	0–5	6281A	5 mV	0.01% + 250 µA	0.01% + 2 mV	0.01% + 250 µA	200 µV/1 mV	4 mA rms	0.1% + 2.5 mV	0.1% + 12.5 mA
0–10	0–10	6282A	0.01% + 1 mV	0.05% + 1 mA	0.01% + 1 mV	0.05% + 1 mA	500 µV/25 mV	5 mA rms	0.1% + 2.5 mV	0.1% + 25 mA
0–20	0–3	6253A*	0.01% + 4 mV	0.01% + 250 µA	0.02% + 2 mV	0.01% + 250 µA	200 µV/1 mV	2 mA rms	0.1% + 2.5 mV	0.1% + 7.5 mA
0–20	0–3	6284A	0.01% + 4 mV	0.01% + 250 µA	0.01% + 2 mV	0.01% + 250 µA	200 µV/1 mV	2 mA rms	0.1% + 2.5 mV	0.1% + 7.5 mA
0–20	0–10	6286A	0.01% + 1 mV	0.05% + 1 mA	0.01% + 1 mV	0.05% + 1 mA	500 µV/25 mV	5 mA rms	0.1% + 2.5 mV	0.1% + 25 mA
0–25	0–2	6227B*	0.01% + 1 mV	0.01% + 250 µA	1 mV	100 µA	250 µV/4 mV	250 µA/2 mA	0.2% + 2 mV	0.2% + 3 mA
0–40	0–1.5	6255A*	0.01% + 2 mV	0.01% + 250 µA	0.01% + 2 mV	0.01% + 250 µA	200 µV/1 mV	500 µA rms	0.1% + 2.5 mV	0.1% + 4 mA
0–40	0–1.5	6289A	0.01% + 2 mV	0.01% + 250 µA	0.01% + 2 mV	0.01% + 250 µA	200 µV/1 mV	500 µA rms	0.1% + 2.5 mV	0.1% + 4 mA
0–40	0–5	6291A	0.01% + 1 mV	0.05% + 1 mA	0.01% + 1 mV	0.05% + 1 mA	500 µV/25 mV	3 mA rms	0.1% + 2.5 mV	0.1% + 12.5 mA
0–50	0–1	6228B*	0.01% + 1 mV	0.01% + 250 µA	1 mV	100 µA	250 µV/4 mV	250 µA/2 mA	0.2% + 2 mV	0.2% + 1.5 mA
0–60	0–1	6294A	0.01% + 2 mV	0.01% + 250 µA	0.01% + 2 mV	0.01% + 250 µA	200 µV/1 mV	500 µA rms	0.1% + 2.5 mV	0.1% + 2.5 mA
0–60	0–3	6296A	0.01% + 1 mV	0.05% + 1 mA	0.01% + 1 mV	0.05% + 1 mA	500 µV/25 mV	3 mA rms	0.1% + 2.5 mV	0.1% + 7.5 mA
0–100	0–0.75	6299A	0.01% + 2 mV	0.01% + 250 µA	0.01% + 2 mV	0.01% + 250 µA	200 µV/1 mV	500 µA rms	0.1% + 2.5 mV	0.1% + 2 mA

\*Models 6227B, 6228B, 6253A, and 6255A contain two identical, independently-adjustable power supplies.

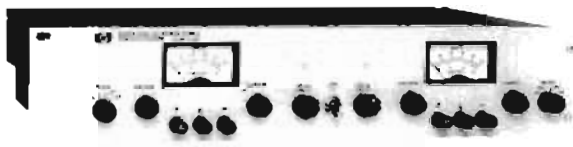

HP 6253A, 6255A



HP 6227B, 6228B

Each side of the dual supply can be operated as a constant voltage or constant current source, and each has its own crowbar for overvoltage protection. In the tracking mode, an overvoltage condition in either supply trips both crowbars. The power supply outputs are isolated up to 300 V from output to chassis or output to output.

**Specifications—General**

**Load effect transient recovery:** time, 50  $\mu$ s; level, 15 mV.  
**Meter accuracy:** 3% of full scale.  
**Power:** standard input voltage is 115 V ac  $\pm$  10%. Order Option 028 for 230 V ac  $\pm$  10% operation. Input power frequency, maximum input current, maximum power consumption are:  
 HP 6227B and 6228B, 48–63 Hz, 2.7 A, 260 W;  
 HP 6253A, 48–440 Hz, 2.6 A, 235 W; HP 6255A, 48–440 Hz, 2.6 A, 235 W; HP 6281A, 48–440 Hz, 1.3 A, 118 W; HP 6282A, 57–63 Hz, 3.5 A, 200 W; HP 6284A, 48–440 Hz, 1.5 A, 128 W; HP 6286A, 57–63 Hz, 5.5 A, 320 W; HP 6289A, 48–440 Hz, 1.3 A, 110 W; HP 6291A, 57–63 Hz, 5.5 A, 280 W; HP 6294A, 48–440 Hz, 1.3 A, 114 W; HP 6296A, 57–63 Hz, 4.5 A, 250 W; HP 6299A, 48–440 Hz, 1.5 A, 135 W.  
**Size:** 6227B, 6228B: 155 H x 197 W x 309.55 mm D (6 $\frac{1}{8}$ " x 7 $\frac{7}{8}$ " x 12 $\frac{1}{16}$ ").  
 HP 6253A, 6255A: 87 H x 483 W x 403 mm D (3 $\frac{1}{8}$ " x 19" x 15 $\frac{7}{8}$ ").  
 HP 6281A, 6284A, 6289A, 6294A, 6299A: 87 H x 209 W x 398 mm D (3 $\frac{1}{8}$ " x 8 $\frac{1}{8}$ " x 15 $\frac{7}{8}$ ").  
 HP 6282A, 6286A, 6291A, 6296A: 131 H x 210 W x 435 mm D (5 $\frac{1}{8}$ " x 8 $\frac{1}{4}$ " x 17 $\frac{1}{8}$ ").

**Option Descriptions**

**005:** 50 Hz ac input: optimizes power supplies that require adjustment/modification for 50 Hz operation. N/C  
**010:** Chassis slides. Enable convenient access to rack-mounted power supply for maintenance. add \$87

**011:** Internal overvoltage protection crowbar. Protects sensitive loads against power supply failure or operator error. Monitors the output voltage and places a virtual short circuit (conducting SCR) across load after preset trip voltage is exceeded.  
 HP 6281A, 6284A, 6289A, 6294A, 6299A add \$128  
 HP 6282A, 6286A, 6291A, 6296A add \$209  
 HP 6253A, 6255A add \$209 N/C  
**028:** 230 Vac  $\pm$  10%, single-phase input. Factory modification reconnects the multi-tap input power transformer for 230 V operation.  
**040:** Interfacing for Multiprogrammer operation. Prepares standard HP power supplies for resistance programming by the HP 6940B, 6942A, 6944A or 6954A. Price per output. add \$78  
**910:** one additional operating and service manual shipped with the power supply  
 HP 6227 add \$10  
 HP 6253A, 6255A, 6228B add \$7.65  
 HP 6281A, 6282A, 6284A, 6286A, 6289A, 6291A, 6294A, 6296A, 6299A add \$5.20

**Accessories**

**HP 14513A:** 3.5 in. high rack kit for one HP 6281A, 6284A, 6289A, 6294A, 6299A \$57  
**HP 14523A:** 3.5 in. high rack kit for two above supplies \$31  
**HP 14515A:** 5.25 in. high rack kit for one HP 6282A, 6286A, 6291A, 6296A \$62  
**HP 14525A:** 5.25 in. high rack kit for two above supplies \$36  
**HP 5060-8760:** blank filler panel for HP 6227B, 6228B \$44   
**HP 5060-8762:** adapter frame for rack mounting one or two HP 6227B, 6228B \$150

**Specifications, continued**

REMOTE CONTROL FEATURES						GENERAL							
Resistance Coefficient		Voltage Coefficient		Speed, UP*		Speed, DOWN*		Overvoltage		Weight		Options	Price
Voltage	Current	Voltage	Current	NL	FL	NL	FL	Range	Margin	Net	Shipping		
200 $\Omega$ /V $\pm$ 1%	200 $\Omega$ /A $\pm$ 10%	1 V/V $\pm$ 1%	0.2 V/A $\pm$ 10%	1 ms	2 ms	10 ms	6 ms	2.5-10 V	4% + 2 V	6.4 kg/14 lb	7.2 kg/16 lb	11, 28, 40	\$920
200 $\Omega$ /V $\pm$ 1%	100 $\Omega$ /A $\pm$ 10%	1 V/V $\pm$ 1%	100 mV/A $\pm$ 10%	70 ms	200 ms	9 s	40 ms	1-13 V	7% + 1 V	11.3 kg/25 lb	13.6 kg/30 lb	5, 11, 28, 40	\$1070
200 $\Omega$ /V $\pm$ 1%	500 $\Omega$ /A $\pm$ 10%	1 V/V $\pm$ 1%	0.33 V/A $\pm$ 10%	30 ms	80 ms	400 ms	100 ms	2.5-23 V	4% + 2 V	11.2 kg/25 lb	17.7 kg/39 lb	10, 11, 28, 40	\$1530
200 $\Omega$ /V $\pm$ 1%	500 $\Omega$ /A $\pm$ 10%	1 V/V $\pm$ 1%	0.33 V/A $\pm$ 10%	30 ms	80 ms	400 ms	100 ms	2.5-23 V	4% + 2 V	6.8 kg/14 lb	7.2 kg/16 lb	11, 28, 40	\$765
200 $\Omega$ /V $\pm$ 1%	100 $\Omega$ /A $\pm$ 10%	1 V/V $\pm$ 1%	100 mV/A $\pm$ 10%	150 ms	150 ms	9 s	70 ms	2-22 V	7% + 1 V	10.8 kg/24 lb	13.3 kg/29 lb	5, 11, 28	\$1175
200 $\Omega$ /V $\pm$ 1%	500 $\Omega$ /A $\pm$ 10%	1 V/V $\pm$ 1%	5 V/A $\pm$ 10%	40 ms	200 ms	400 ms	75 ms	5-28 V	7% + 1.5 V	11.1 kg/24 lb	12.9 kg/28 lb	40	\$1785
200 $\Omega$ /V $\pm$ 1%	500 $\Omega$ /A $\pm$ 10%	1 V/V $\pm$ 1%	0.66 V/A $\pm$ 10%	15 ms	45 ms	200 ms	40 ms	2.5-44 V	4% + 2 V	12.7 kg/28 lb	17.7 kg/39 lb	10, 11, 28, 40	\$1530
200 $\Omega$ /V $\pm$ 1%	500 $\Omega$ /A $\pm$ 10%	1 V/V $\pm$ 1%	0.66 V/A $\pm$ 10%	15 ms	45 ms	200 ms	40 ms	2.5-44 V	4% + 2 V	6.4 kg/14 lb	7.2 kg/16 lb	11, 28, 40	\$765
200 $\Omega$ /V $\pm$ 1%	200 $\Omega$ /A $\pm$ 10%	1 V/V $\pm$ 1%	200 mV/A $\pm$ 10%	275 ms	275 ms	13 s	275 ms	6-43 V	7% + 1 V	11.3 kg/25 lb	12.7 kg/28 lb	5, 11, 28	\$1175
200 $\Omega$ /V $\pm$ 1%	1 k $\Omega$ /A $\pm$ 10%	1 V/V $\pm$ 1%	5 V/A $\pm$ 10%	50 ms	350 ms	1 s	50 ms	5-55 V	7% + 1.5 V	11.1 kg/24 lb	12.9 kg/28 lb	40	\$1785
300 $\Omega$ /V $\pm$ 1%	1 k $\Omega$ /A $\pm$ 10%	1 V/V $\pm$ 1%	1 V/A $\pm$ 10%	25 ms	80 ms	2 s	175 ms	5-65 V	4% + 2 V	5.9 kg/13 lb	6.8 kg/15 lb	11, 28, 40	\$815
300 $\Omega$ /V $\pm$ 1%	500 $\Omega$ /A $\pm$ 10%	1 V/V $\pm$ 1%	333 mV/A $\pm$ 10%	600 ms	600 ms	5 s	200 ms	9-66 V	7% + 1 V	11.3 kg/25 lb	12.7 kg/28 lb	5, 11, 28	\$1175
300 $\Omega$ /V $\pm$ 1%	1 k $\Omega$ /A $\pm$ 10%	1 V/V $\pm$ 1%	1.3 V/A $\pm$ 10%	25 ms	200 ms	1.5 s	260 ms	20-106 V	4% + 2 V	5.9 kg/13 lb	6.8 kg/15 lb	11, 28, 40	\$815

\*UP = increasing output voltage. NL = No output load current. FL = Full rated output load current.

Fast-Ship product — see page 758.

# POWER SUPPLIES

## Autorangeing Power Supplies

Models 6010A, 6011A, 6012B, 6023A, and 6024A

- Complete front panel control/display
- Constant voltage/constant current operation
- Remote programming and sensing
- Autorangeing output
- High efficiency, compact, and light weight
- Ten-turn voltage and current controls



HP 6024A

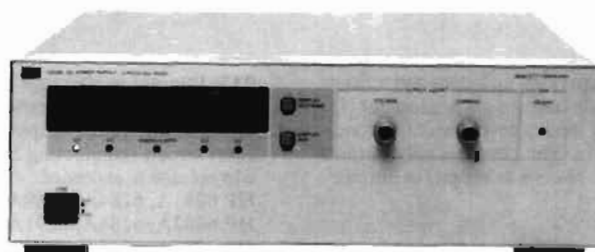

HP 6010A, 6011A, 6012B



HP 6023A

### Description

#### HP Models 6010A, 6011A, 6012B, and 6023A

This versatile family of dc power supplies provides laboratory grade performance along with many features to meet both laboratory and system needs.

Ten-turn front panel controls provide the means to precisely adjust the output voltage and current. The settings of these controls can be observed on the front panel meters by pressing the Display Settings button. This allows the current limit to be set when operating in the CV mode without shorting the output terminals and the voltage limit to be set when operating in the CC mode without opening the load leads.

Three and one-half digit front panel meters provide a convenient means for monitoring the output voltage and current. The accuracy of these meters allow them to replace external DVMs and monitor resistors in many applications that require monitoring of the power supply output.

The overvoltage protection (OVP) trip level can also be displayed on the front panel meters, allowing the trip level to be accurately adjusted without actually activating the OVP circuitry or disconnecting loads. In addition to the protection provided to the power supply and load by the OVP, these supplies also have protection against operating under excessive ac line or thermal conditions.

As autorangeing power supplies, these units can operate at their maximum rated power over a wide and continuous range of voltage and current combinations. This often allows both present and future requirements to be satisfied with fewer supplies.

HP Model 6023A is stable when operating in the CC mode into inductive loads up to one henry. HP Models 6010A, 6011A and 6012B are stable when operating in the CC mode into inductive loads up to 100 mH, and a special modification is available for these three models to assure stability with loads up to ten henries.

### System Features

The output voltage and current of these supplies can be remotely controlled with either 0-5 volt or 0-4000 ohm analog programming signals. The actual output levels can be monitored without complicated external circuitry by connecting DVMs to the buffered 0-5 volt monitor outputs. All programming and monitoring signals are referenced to the same common and are accessed through the rear panel barrier strip.

Either terminal may be grounded, or floated up to  $\pm 240$  volts from chassis ground for the HP 6011A, 6012B and 6023A, and  $\pm 550$  volts for the HP 6010A.

If more output voltage or current is needed than a single unit can provide, auto-series or auto-parallel configurations can be used. Up to four 1000-watt units, or up to two 200-watt units can be connected in auto-parallel, and any combination can be used in auto-series providing up to 240 volts total (550 Vdc for HP 6010A) from chassis ground including output voltage. Remote sensing can be used to maintain the CV load effect specification at the load with up to 0.5 volt drop per load lead and sense wires that are less than 0.2 ohm per lead. Operation is possible with up to 2.0 volts per lead; however, load effect specification may be degraded. For more system control and monitoring capabilities, see Option 002.

### Specifications

Ratings*		Autorangeing Output*								Regulation				10% Change Transient Recovery	
Volts	Amperes	CV				CC				HP Model	Load Effect		Source Effect		Time / Level
		V <sub>o</sub>	P <sub>o</sub>	V <sub>o</sub>	P <sub>o</sub>	V <sub>o</sub>	P <sub>o</sub>	V <sub>o</sub>	P <sub>o</sub>		Voltage	Current	Voltage	Current	
0-20	0-30	20V	200W	14V	242W	6.7V	200W	6023A	0.01% +2mV	0.01% +3mA	0.01% +1mV	0.01% +6mA	1ms / 90mV		
0-20	0-120	20V	1000W	14V	1064W	7V	840W	6011A	0.01% +3mV	0.01% +15mA	0.01% +2mV	0.01% +25mA	2ms / 100mV		
0-60	0-10	60V	200W	40V	240W	20V	200W	6024A	0.01% +3mV	0.01% +3mA	0.01% +5mV	0.01% +5mA	1ms / 75mV		
0-60	0-50	60V	1000W	40V	1200W	20V	1000W	6012B	0.01% +5mV	0.01% +10mA	0.01% +3mV	0.01% +10mA	2ms / 100mV		
0-200	0-17	200V	1000W	120V	1200W	60V	1020W	6010A	0.01% +5mV	0.01% +10mA	0.01% +5mV	0.01% +5mA	2ms / 150mV		

\* See the generalized autorangeing output characteristic curve.

**HP Model 6024A**

As an autoranging dc power supply, the HP 6024A can provide 200 watts over a wide and continuous range of voltage and current combinations, with maximums of 60 volts and 10 amperes. This provides greater flexibility than traditional power supplies that have only one maximum power point.

Ten-turn potentiometers provide precise control of the output voltage and current. The output levels can be observed on the separate front panel voltage and current meters. Terminals are available on both the front and rear panel for load connections.

The built-in OVP is adjustable from the front panel. Other protection features include over-temperature and high ac line detection.

The HP 6024A has many system oriented features. It can be remotely programmed with 0-5 volt or 0-2500 ohm analog signals. The output current can be easily monitored without an external shunt with the proportional 0-5 volt buffered monitor output. Remote sensing can be used to eliminate the effects of voltage drops in the load leads, and either terminal may be floated up to  $\pm 240$  volts from chassis ground. Several units can be combined in auto-series, auto-parallel, and auto-tracking configurations, further increasing the HP 6024A's flexibility.

For more system features, see Option 002.

**General Specifications**

**Dimensions**

**HP 6010A, 6011A and 6012B:** 132.6 mm H x 425.5 mm W x 516.4 mm D (5.2" x 16.75" x 20.33").

**HP 6023A:** 177.0 mm H x 212.3 mm W x 443.6 mm D (6.97" x 8.36" x 17.872").

**HP 6024A:** 133.4 mm H x 212.3 mm W x 415.33 D (5.25" x 8.36" x 16.35").

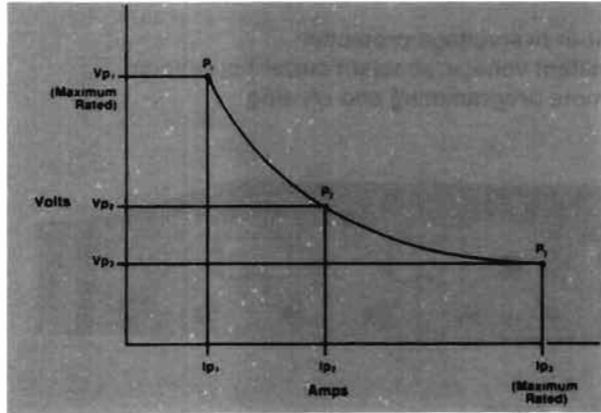

Generalized autoranging output characteristic curve

These features can all be taken advantage of with an HP 6940B or 6942A Multiprogrammer instrument sub-system configured with an HP 69520A or 69709A Power Supply Programming Card. The Multiprogrammer provides a cost-effective solution for controlling a group of power supplies, and also can provide many other digital and analog monitoring and control functions, all on the HP-IB. The voltage and current programming resolution available with either card is 1/1000th of full scale.

The features available with Option 002 can also be interfaced to your own external circuitry rather than an HP Multiprogrammer.

**Ordering Information**

**Option Descriptions**

**002:** provides extra programming and monitoring capabilities for system use. A card inserted into the power supply is accessible through a 37-pin connector on the rear panel. It provides easy access to the control and monitor signals available on standard units, as well as these additional features:

- OVP trip and reset
- power supply inhibit
- status bits indicating CV mode, CC mode, unregulated output, OVP tripped, overtemperature condition, and ac line drop-out
- remote programming via a 0-2 mA current sink
- bias supplies for your circuitry: +5 volts at 100 mA, +15 volts at 75 mA, and -15 volts at 75 mA.
- buffered 0-5 volt outputs representing both the output voltage and output current. (HP 6010A, 6011A, 6012B, and 6023A provide this feature standard, but HP 6024A only provides a scaled 0-5 volt output to represent the output current, not the output voltage.)
- programmable remote/local for use when programming with a current sink.

**Price**

\$335.00

**100:** 87-106 Vac, 48-63 Hz. HP 6024A Only! This option is for use in Japan only. The power supply output power is 75% of the output power available with the other line voltage options. For HP 6024A only.

**120:** 104 to 127 Vac, 48-63 Hz.

**220:** 191 to 233 Vac, 48-63 Hz.

**240:** 208 to 250 Vac, 48-63 Hz.

**800:** Rack-mount kit for two units side by side. This applies to HP 6023A and 6024A only.

**908:** Rack-mount kit for a single unit. A blank filler panel is supplied when ordered for half rack width units.

**910:** One extra operating and service manual shipped with each power supply.

N/C  
N/C  
N/C  
N/C

HP 6023A \$77.00  
HP 6024A \$71.00

HP 6010A, 6011A, 6012B \$31.00  
HP 6023A \$82.00  
HP 6024A \$55.00

HP 6024A \$10.00  
HP 6010A, 6011A, 6012B, 6023A \$20.00

PARO (rms/p-p) 20Hz-20MHz		Programming Response Time						General*						Price
		UP			DOWN			AC Input Current				Weight (kg (lbs))		
		Setting Band	Full Load	No Load	Full Load	Light Load		100 Vac	120 Vac	220 Vac	240 Vac	Net	Shipping	
3 mV 30 mV	15 mA —	5 mV	100 ms	100 ms	200 ms	500 ms	50 $\Omega$	—	6.5 A	3.8 A	3.6 A	8.6 (19)	10.5 (23)	\$1785
8 mV 50 mV	120 mA —	30 mV	300 ms	300 ms	500 ms	1.5 sec	50 $\Omega$	—	24 A	15 A	14 A	16.8 (37)	22.2 (49)	\$2650
3 mV 30 mV	5 mA —	60 mV	200 ms	200 ms	300 ms	600 ms	Open	5.3 A	5.3 A	2.9 A	2.7 A	5.4 (12)	7.3 (16)	\$1480
8 mV 40 mV	25 mA —	90 mV	300 ms	300 ms	2.0 sec	3.0 sec	100 $\Omega$	—	24 A	15 A	14 A	15.9 (35)	21.3 (47)	\$2650
22 mV 50 mV	15 mA —	300 mV	300 ms	300 ms	600 ms	3.5 sec	Open	—	24 A	15 A	14 A	16.3 (36)	21.7 (48)	\$2650

\* An ac input option must be specified when ordering.

# POWER SUPPLIES

General Purpose: 120–2000 W Output  
Models 6259B–6274B

- Built-in overvoltage protection
- Constant voltage/constant current operation
- Remote programming and sensing

- Remote sensing
- Auto-series, -parallel, and -tracking operation
- $\leq 50 \mu\text{s}$  load transient recovery

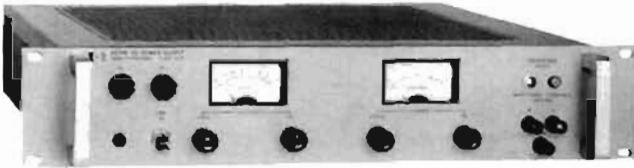

HP 6263B, 6266B

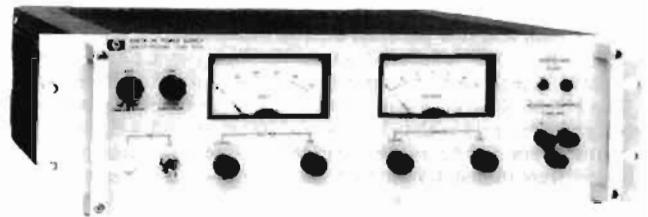

HP 6264B, 6267B

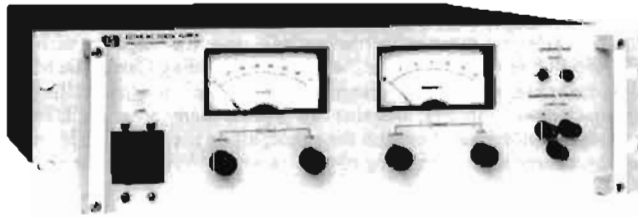

HP 6274B

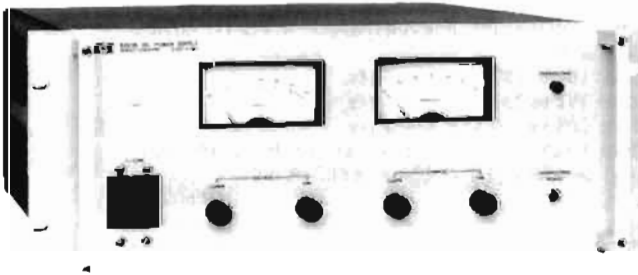

HP 6259B, 6260B, 6261B, 6268B, 6269B

## Description

### Models 6259B–6274B

This series of high-performance constant voltage/constant current supplies includes twelve models with output rating from 10 to 60 V. All models employ a transistor series-regulator/triac-preregulator circuit to achieve high efficiency, excellent regulation, low ripple and noise, and moderate programming speeds in a compact full-rack width package.

Separate coarse and fine voltage and current controls allow the voltage and current outputs to be varied from zero to the maximum rated value, crossover from constant voltage to constant current operation occurs automatically when the load current exceeds the value established by the current control settings.

Additional features include built-in overvoltage crowbar protection; remote error sensing; and auto-series, auto-parallel, and auto-tracking operation. The crowbar trip point adjustment and associated overvoltage indicator are conveniently located on the front panel.

Auto-series, auto-parallel, and auto-tracking connections should ordinarily include no more than three supplies. If a specific application requires the use of more than three supplies in any of the three connections, consult your local HP Field Engineer for additional information.

All dc output, ac input, sensing, control, and programming connections are made to rear-panel terminals. Either the positive or negative output terminal may be grounded or the supplies may be operated floating at up to 300 volts above ground. Models 6263B, 6264B, 6266B and 6267B are convection cooled. All other models in this series employ cooling fans. Models which output more than 200 watts are equipped with terminal blocks for ac input and are not shipped with line cords.

## Specifications†

RATINGS		PERFORMANCE								
DC Output		HP Model	Load Effect		Source Effect		PAR (rms/p-p)		Drift (stability)	
Volts	Ampere		Voltage	Current	Voltage	Current	Voltage	Current	Voltage	Current
0-30	0-50	6259B	0.01% + 200 $\mu\text{V}$	0.02% + 1 mA	0.01% + 200 $\mu\text{V}$	0.02% + 1 mA	500 $\mu\text{V}/5 \text{ mV}$	25 mA rms	0.03% + 2 mV	0.03% + 10 mA
0-10	0-100	6260B	0.01% + 200 $\mu\text{V}$	0.02% + 2 mA	0.01% + 200 $\mu\text{V}$	0.02% + 2 mA	500 $\mu\text{V}/5 \text{ mV}$	50 mA rms	0.03% + 2 mV	0.03% + 20 mA
0-20	0-10	6263B	0.01% + 200 $\mu\text{V}$	0.02% + 500 $\mu\text{A}$	0.01% + 200 $\mu\text{V}$	0.02% + 500 $\mu\text{A}$	200 $\mu\text{V}/10 \text{ mV}$	3 mA rms	0.03% + 500 $\mu\text{V}$	0.03% + 6 mA
0-20	0-20	6264B	0.01% + 200 $\mu\text{V}$	0.02% + 500 $\mu\text{A}$	0.01% + 200 $\mu\text{V}$	0.02% + 500 $\mu\text{A}$	200 $\mu\text{V}/10 \text{ mV}$	5 mA rms	0.03% + 500 $\mu\text{V}$	0.03% + 6 mA
0-20	0-50	6261B	0.01% + 200 $\mu\text{V}$	0.02% + 1 mA	0.01% + 200 $\mu\text{V}$	0.02% + 1 mA	500 $\mu\text{V}/5 \text{ mV}$	25 mA rms	0.03% + 2 mV	0.03% + 10 mA
0-40	0-5	6266B	0.01% + 200 $\mu\text{V}$	0.02% + 500 $\mu\text{A}$	0.01% + 200 $\mu\text{V}$	0.02% + 500 $\mu\text{A}$	200 $\mu\text{V}/10 \text{ mV}$	3 mA rms	0.03% + 500 $\mu\text{V}$	0.03% + 3 mA
0-40	0-10	6267B	0.01% + 200 $\mu\text{V}$	0.02% + 500 $\mu\text{A}$	0.01% + 200 $\mu\text{V}$	0.02% + 500 $\mu\text{A}$	200 $\mu\text{V}/10 \text{ mV}$	3 mA rms	0.03% + 2 mV	0.03% + 3 mA
0-40	0-30	6268B	0.01% + 200 $\mu\text{V}$	0.02% + 2 mA	0.01% + 200 $\mu\text{V}$	0.02% + 2 mA	1 mV/5 mV	20 mA rms	0.03% + 2 mV	0.03% + 5 mA
0-40	0-50	6269B	0.01% + 200 $\mu\text{V}$	0.02% + 2 mA	0.01% + 200 $\mu\text{V}$	0.02% + 2 mA	1 mV/5 mV	25 mA rms	0.03% + 2 mV	0.03% + 10 mA
0-60	0-15	6274B	0.01% + 200 $\mu\text{V}$	0.02% + 500 $\mu\text{A}$	0.01% + 200 $\mu\text{V}$	0.02% + 500 $\mu\text{A}$	200 $\mu\text{V}/20 \text{ mV}$	5 mA rms	0.03% + 2 mV	0.03% + 5 mA

†Refer to page 435 for complete specification definitions

## Specification—General

**Load effect transient recovery:** time, 50  $\mu$ s; Level, 10 mV.

**Resolution:** voltage control, less than 0.02%; current control, less than 0.15%.

**Temperature coefficient per °C:** 0.01% of output plus 200  $\mu$ V.

**Temperature ratings:** operating, 0 to 55°C; storage, -40 to 75°C.

**Remote control programming:** these power supplies are capable of being programmed in constant voltage and constant current operation by using an external resistance or dc voltage with coefficients as shown in the table below.

Rear terminal wiring configurations for remote control operation are specified in the operating and service manual supplied with the power supply. For remote control programming procedures and timing considerations, contact your local HP field engineer.

**Power:** input voltage tolerance is  $\pm 10\%$ , 57-63 Hz. For other input voltage and frequency options available, see constant listing in the specifications table below. Standard input voltage, maximum input current, and maximum power are:

HP 6259B, 230 V ac, 6 A, 850 W;  
 HP 6260B, 230 V ac, 12 A, 1600 W;  
 HP 6263B, 115 V ac, 4.5 A, 350 W;  
 HP 6266B, 115 V ac, 4 A, 325 W;  
 HP 6268B, 230 V ac, 12 A, 1600 W;  
 HP 6261B, 230 V ac, 12 A, 1500 W;  
 HP 6264B, 115 V ac, 8 A, 600 W;  
 HP 6267B, 115 V ac, 8 A, 550 W;  
 HP 6269B, 230 V ac, 18 A, 2500 W;  
 HP 6274B, 115 V ac, 15 A, 1200 W;

**AC line connections:** three wire, five foot ac power cord included—HP 6263B and 6266B.

Three-terminal barrier strip provided on power supply for ac power connections—HP 6259B, 6260B, 6261B, 6264B, 6267B, 6268B, 6269B and 6274B.

**Size**  
 HP 6263B, 6266B, 83.7 H x 483 W x 479.4 mm D (3.296" x 19" x 18.875").

HP 6264B, 6267B, 6274B: 127 H x 483 W x 479.4 mm D (5.00" x 19" x 18.875").

HP 6259B, 6260B, 6261B, 6268B, 6269B: 173 H x 483 W x 479.4 mm D: (6.812" x 19" x 18.875").



Models 6259B - 6274B can be HP-IB controlled by using the HP 59501B HP-IB Programmer.

## Option Descriptions

**005:** 50 Hz ac input: optimizes power supplies that require adjustment/modification for 50 Hz operation.

**010:** chassis slides. For access to rack mounted power supplies: HP 6263B, 6264B, 6266B, 6267B

HP 6274B, 6259B, 6260B, 6261B, 6268B, 6269B

**016:** Model 6260B only. 115 Vac  $\pm 10\%$  single phase input. Consists of replacing power transformer and circuit breaker, and reconnecting bias transformer, RFI choke and fans.

**022:** voltage and current programming adjust. Allows the V and I programming coefficients and zero output to be conveniently adjusted to 0.1% accuracy via access holes in the rear panel. Consists of four potentiometers and resistors located inside the rear panel.

**026:** 115 Vac  $\pm 10\%$ , single phase input. Consists of replacing the input circuit breaker and reconnecting the power transformer, bias transformer, RFI choke, and fans. Models 6259B, 6261B and 6268B only.

**027:** 208 Vac,  $\pm 10\%$ , single phase input. Consists of reconnecting power transformer taps, and other components where necessary.

**028:** 230 Vac  $\pm 10\%$ , single phase input. Consists of reconnecting power transformer taps, and other components where necessary.

**040:** Multiprogrammer interface. Prepares standard HP power supplies for resistance programming by the HP 6940B, 6942A, 6944A or 6954A Multiprogrammers. This option includes Option 022, special calibration, and protection check-out procedures (where required).

**010:** one additional operating and service manual shipped with each power supply. HP 6259B-6274B

## Price

N/C

add \$88

add \$163

add \$122

add \$62

N/C

N/C

N/C

add \$78

add \$7.60

## Specifications, Continued

REMOTE CONTROL FEATURES								GENERAL					
Resistance Coeff.		Voltage Coeff.		Speed Up*		Speed Down*		Overvoltage		Weight		Options	Price
Voltage	Current	Voltage	Current	NL	FL	NL	IFL	Range	Margin	Net	Shipping		
200 $\Omega/V \pm 1\%$	4 $\Omega/A \pm 10\%$	1 V/V $\pm 1\%$	10 mV/A $\pm 10\%$	70 ms	70 ms	200 ms	100 ms	1-12 V	5% $\pm$ 2V	31.3 kg/69 lb	35.3 kg/78 lb	5, 10, 22, 26, 27, 40	\$1910
200 $\Omega/V \pm 1\%$	2 $\Omega/A \pm 10\%$	1 V/V $\pm 1\%$	5 mV/A $\pm 10\%$	70 ms	70 ms	200 ms	75 ms	2-12 V	5% $\pm$ 2V	43.9 kg/97 lb	48 kg/106 lb	5, 10, 16, 22, 27, 40	\$2245
200 $\Omega/V \pm 1\%$	100 $\Omega/A \pm 10\%$	1 V/V $\pm 1\%$	50 mV/A $\pm 10\%$	150 ms	150 ms	7 s	350 ms	2-23 V	5% $\pm$ 1V	15.4 kg/34 lb	18.6 kg/41 lb	5, 10, 22, 27, 28, 40	\$1530
200 $\Omega/V \pm 1\%$	10 $\Omega/A \pm 10\%$	1 V/V $\pm 1\%$	25 mV/A $\pm 10\%$	140 ms	140 ms	10 s	150 ms	2.5-23V	5% $\pm$ 1V	21.3 kg/47 lb	24.5 kg/54 lb	5, 10, 22, 27, 28, 40	\$1630
200 $\Omega/V \pm 1\%$	4 $\Omega/A \pm 10\%$	1 V/V $\pm 1\%$	10 mV/A $\pm 10\%$	150 ms	150 ms	250 ms	250 ms	2-23 V	5% $\pm$ 2V	35.3 kg/78 lb	39.4 kg/87 lb	5, 10, 22, 26, 27, 40	\$2040
200 $\Omega/V \pm 1\%$	200 $\Omega/A \pm 10\%$	1 V/V $\pm 1\%$	100 mV/A $\pm 10\%$	275 ms	275 ms	13 s	1.5 s	2.5-45 V	5% $\pm$ 1V	15.4 kg/34 lb	18.6 kg/41 lb	5, 10, 22, 27, 28, 40	\$1530
200 $\Omega/V \pm 1\%$	100 $\Omega/A \pm 10\%$	1 V/V $\pm 1\%$	50 mV/A $\pm 10\%$	275 ms	275 ms	13 s	750 ms	2.5-45 V	5% $\pm$ 1V	17.7 kg/39 lb	20.8 kg/46 lb	5, 10, 22, 27, 28, 40	\$1630
200 $\Omega/V \pm 1\%$	6 $\Omega/A \pm 10\%$	1 V/V $\pm 1\%$	16.7 mV/A $\pm 10\%$	300 ms	300 ms	1 s	650 ms	4-45 V	5% $\pm$ 1V	34.4 kg/76 lb	38.1 kg/84 lb	5, 10, 22, 26, 27, 40	\$2040
200 $\Omega/V \pm 1\%$	4 $\Omega/A \pm 10\%$	1 V/V $\pm 1\%$	10 mV/A $\pm 10\%$	350 ms	350 ms	1 s	600 ms	4-45 V	5% $\pm$ 1V	40.3 kg/89 lb	44 kg/98 lb	5, 10, 22, 27, 40	\$2440
300 $\Omega/V \pm 1\%$	67 $\Omega/A \pm 10\%$	1 V/V $\pm 1\%$	33.3 mV/A $\pm 10\%$	800 ms	800 ms	40 s	800 ms	6-66 V	5% $\pm$ 1V	21.7 kg/48 lb	24.5 kg/54 lb	5, 10, 22, 27, 28, 40	\$1630

\* Up = increasing output voltage. NL = No output load current. FL = Full rated output load current

# POWER SUPPLIES

General Purpose: 300—11,000 W Output  
Models 6434B—6483C

- Outstanding value—low cost/watt
- Up to 75% efficiency at full output
- Constant voltage/constant current operation

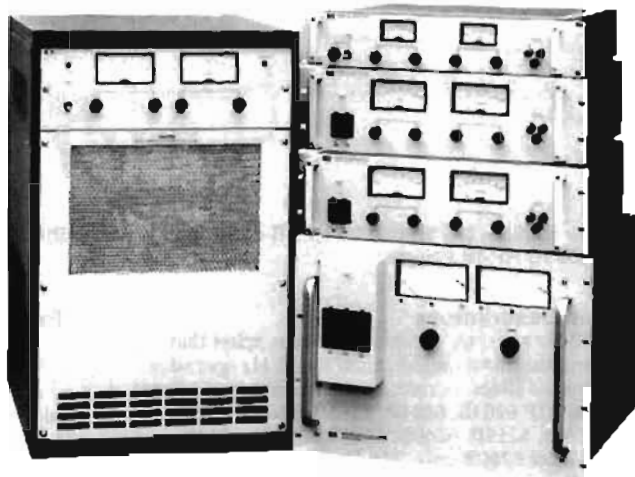

HP 6434B—6483C

## Description

This series of SCR-regulated power supplies is designed for medium to high-power applications requiring a fixed or variable dc source with moderate regulation and ripple. For supplies with better regulation, faster response time, and lower ripple, see models HP 6259B—6274B on page 452.

## Operating Features

All supplies in this series are of the constant voltage/constant current type. Large easy-to-read panel meters continuously monitor output voltage current.

Input and output power, remote sensing, remote programming, and auto-series, -parallel, and -tracking connections are made to bus bars and terminal blocks on the rear panel.

## Protective Features

In addition to the overload protection inherent in constant voltage/constant current operation, there are many other built-in protective features included in these supplies. The features vary within the three model classifications as follows:

**HP 6434B—6448B:** (1) Reverse voltage protection. (2) Fused ac input.

**HP 6453A, 6456B, 6459A:** (1) AC line loss protection circuit monitors 3-phase input and cuts off SCR's and opens output bus if a phase drops out; operation resumes when ac input returns to normal. (2) 3-phase input circuit breaker. (3) Optional internal crowbar (Option 006) protects load from overvoltage condition.

**HP 6464C—6483C:** (1) High-temperature protection thermostat opens input to power transformer and lights front panel indicator if supply overheats. (2) Prolonged overload protection circuit is activated and lights front panel indicator if output current exceeds approximately 115% of maximum rating. (3) Optional internal crowbar (except on HP 6464C) protects load from overvoltage condition. (4) Turn-on circuit limits peak line current during start-up into low impedance loads. (5) Phase-balance circuit permits operation with line-to-line input voltage imbalance up to 8%. (6) Overcurrent and over-voltage circuits of master slave supplies used in auto-series, -parallel, or -tracking operation can be interlocked.

## Auto-Series, -Parallel, -Tracking Operation

Supplies may be connected in auto-series, or auto-tracking (except HP 6448B and 6483C, which cannot be connected in auto-series).

Up to three lower-power models (HP 6434B—6448B) may be connected in any of the above configurations. Higher-power model (HP 6453A/6483C) interconnection should ordinarily include no more than two supplies.

## Remote Programming

The voltage and current outputs of the supplies can be programmed by a remote resistance, or for most models, a remote voltage source. Programming speeds and coefficients are detailed in the specifications table.

## AC Power Requirements

The ac power requirements vary with the three model classifications (see option listings). When powered from a 50 Hz source (possible with option 005), the rms ripple and transient response specifications increase by 50%. The p-p ripple specification is unchanged by line frequency.

## Specifications†

RATINGS		PERFORMANCE							
DC Output		HP Model	Load Effect		Source Effect		PARD $\Delta$ rms/p-p	Temperature Coefficient	Drift
Voltage <sup>‡</sup>	Ampere <sup>§</sup>		Voltage	Current	Voltage	Current			
0-8	0-1000	6464C	0.05% + 5 mV	0.1% + 1 A	0.05% + 5 mV	0.1% + 1 A	80 mV/1 V	0.03% + 100 $\mu$ V	0.03% + 1 mV
0-15	0-200	6453A	0.2% + 10 mV††	1% or 2 A††	0.2% + 10 mV††	1% or 2 A††	150 mV rms	0.05% + 2 mV	0.25% + 10 mV
0-16 or 18	0-600 or 500*	6466C	0.05% + 5 mV	0.1% + 0.6 A	0.05% + 5 mV	0.1% + 0.6 A	180 mV/1 V	0.03% + 200 $\mu$ V	0.2% + 1 mV
0-36	0-100	6456B	0.2% + 10 mV††	1% or 1 A††	0.2% + 10 mV††	1% or 1 A††	180 mV rms	0.05% + 2 mV	0.25% + 10 mV
0-36	0-300	6469C	0.05% + 5 mV	0.1% + 0.3 A	0.05% + 5 mV	0.1% + 0.3 A	180 mV/1 V	0.03% + 400 $\mu$ V	0.15% + 1 mV
0-40	0-25	6434B	40 mV	200 mA	18 mV	200 mA	40 mV/500 mV	0.03% + 5 mV	0.1% + 20 mV
0-64	0-50	6459A	0.2% + 10 mV††	1% or 0.5 A††	0.2% + 10 mV††	1% or 0.5 A††	160 mV rms	0.05% + 2 mV	0.25% + 10 mV
0-64	0-150	6472C	0.05% + 100 mV	0.1% + 0.15 A	0.05% + 100 mV	0.1% + 0.15 A	160 mV/2 V	0.03% + 4 mV	0.15% + 16 mV
0-110	0-100	6475C	0.05% + 100 mV	0.1% + 0.1 A	0.05% + 100 mV	0.1% + 0.1 A	200 mV/2 V	0.03% + 5 mV	0.15% + 20 mV
0-120	0-2.5	6443B	120 mV	25 mA	60 mV	25 mA	240 mV/400 mV	0.03% + 20 mV	0.1% + 60 mV
0-220	0-50	6477C	0.05% + 100 mV	0.1% + 50 mA	0.05% + 100 mV	0.1% + 50 mA	330 mV/2 V	0.03% + 8 mV	0.15% + 35 mV
0-300	0-35	6479C	0.05% + 100 mV	0.1% + 35 mA	0.05% + 100 mV	0.1% + 35 mA	330 mV/3 V	0.03% + 11 mV	0.15% + 45 mV
0-440, 500 or 600	0-25, 20, 15*	6483C	0.05% + 100 mV	0.1% + 35 mA	0.5% + 100 mV	0.1% + 35 mA	600 mV/5 V	0.03% + 20 mV	0.15% + 80 mV
1-600	5 mA-1.5 A	6448B	1 V	40 mA	600 mV	15 mA	600 mV/2 V	0.03% + 100 mV	0.1% + 300 mV

† Refer to page 435 for complete specification definitions.

†† Specified for combined line and load regulation.

$\Delta$  For operation with a 50 Hz input (possible only with Option 005), the rms ripple and transient response specifications are increased by 50%.

\* The output current rating is given in the same order corresponding with the voltage rating.

$\S$  Under light loading conditions, power supply may not meet all published specifications. The graph on the next page defines the permissible operating regions for CV and CC modes of operation.

For operation with a 50 Hz input (possible only with Option 005), output current is linearly derated from 100% at 40°C to 80% at 50°C.



POWER SUPPLY OUTPUT RESTRICTIONS AS A FUNCTION OF LOADING

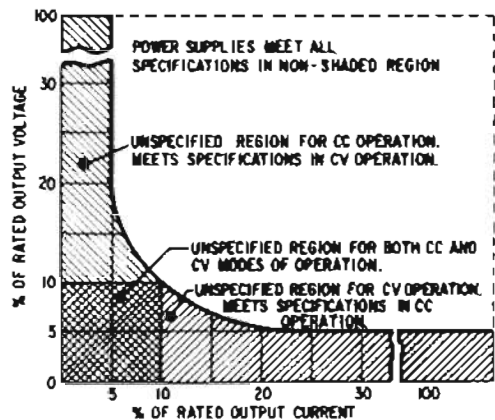

An ac Input option must be specified when ordering.

**Line Cords**

Line cords are not supplied with models 6434B, 6448B and 6453A-6483C.

**Size**

- Model 6443B:** 89 H x 483 W x 445 mm D (3.5" x 19" x 17.5").
- Models 6434B, & 6448B:** 133 H x 483 W x 432 mm D (5.25" x 19" x 17").
- Models 6453A, 6456B, & 6459A:** 356 H x 483 W x 500 mm D (14" x 19" x 19.7").
- Models 6484C, 6486C, 6489C, 6472C, 6475C, 6477C, 6479C, & 6483C:** 705 H x 483 W x 715 mm D (27.75" x 19" x 28.12").

**Option Descriptions**

**HP 6434B-6448B**

- Std:** 115 V ac, ± 10%, single phase, 57-63 Hz
- 005:** realignment for 50 Hz operation
- 010:** chassis slides
- 027:** 208 V ac, ± 10%, single phase, 57-63 Hz
- 028:** 230 V ac, ± 10%, single phase, 57-63 Hz
- 910:** one extra operating and service manual shipped with each power supply

- Price N/C
- N/C
- add \$163
- N/C
- N/C
- add \$10

**Specifications, continued**

REMOTE CONTROL												GENERAL			
Resolution		Load Transient Recovery <sup>Δ</sup>	Resistance Coefficient		Voltage Coefficient <sup>†</sup>		Up		Down		Net Weight		Options	Price	
V	C		Voltage	Current	Voltage	Current	NL	FL	NL	FL	Kg	lb			
8 mV	1 A	100 ms, 500 mV	200 Ω/V ±2%	1 Ω/A ±2%	1 V/V ±1%	6.2 mV/A ±7%	1.6 s	0.6 s	6 s	0.1 s	235	518	1, 2, 3, 5, 23, 31, 32, 40	\$9690*	
65 mV	1 A	50 ms, 150 mV	200 Ω/V ±2%	1 Ω/A	0.4 V/V	30 mV/A	1 s	0.5 s	20 s	0.2 s	108	238	1, 2, 3, 5, 6, 30, 31, 32	\$4895*	
18 mV	0.5 A	100 ms, 500 mV	200 Ω/V ±2%	1.66 Ω/A ±2%	1 V/V ±1%	10.3 mV/A ±7%	1.6 s	0.6 s	15 s	0.2 s	226	500	1, 2, 3, 5, 6, 23, 31, 32, 40	\$9690*	
90 mV	0.5 A	50 ms, 300 mV	200 Ω/V ±2%	2 Ω/A	166 mV/V	60 mV/A	1 s	0.5 s	60 s	0.5 s	108	238	1, 2, 3, 5, 6, 10, 31, 32	\$4590*	
36 mV	0.3 A	100 ms, 500 mV	200 Ω/V ±2%	3.33 Ω/A ±2%	1 V/V	206 mV/A ±7%	1.6 s	3 s	20 s	0.5 s	226	500	1, 2, 3, 5, 6, 23, 31, 32, 40	\$9180*	
10 mV	12.5 mA	200 ms, 200 mV	200 Ω/V ±2%	12 Ω/A	1 V/V	**	0.3 s	1.2 s	75 s	1.2 s	30.4	67	5, 10, 27, 28	\$1990	
100 mV	0.25 A	50 ms, 600 mV	300 Ω/V ±2%	4 Ω/A	98 mV/V	120 mV/A	1 s	0.5 s	45 s	0.7 s	108	238	1, 2, 3, 5, 6, 10, 31, 32	\$4590*	
64 mV	0.15 mA	100 ms, 750 mV	300 Ω/V ±2%	6.7 Ω/A ±2%	1 V/V ±3%	6.7 mV/A ±7%	1.4 s	2.5 s	55 s	0.7 s	226	500	1, 2, 3, 5, 6, 23, 31, 32, 40	\$9180*	
22 mV	0.1 A	100 ms, 1 V	300 Ω/V ±2%	10 Ω/A ±2%	1 V/V ±3%	62 mV/A ±7%	1.5 s	2 s	80 s	0.7 s	226	500	1, 2, 3, 5, 6, 23, 31, 32	\$9180*	
30 mV	1.3 mA	200 ms, 600 mV	300 Ω/A ±2%	120 Ω/A	1 V/V	**	0.5 s	2 s	210 s	2 s	14	31	5, 10, 27, 28	\$1480	
44 mV	50 mA	100 ms, 2 V	300 Ω/V ±2%	20 Ω/V ±2%	1 V/V ±3%	124 mV/A ±7%	1.5 s	2 s	95 s	1 s	226	500	1, 2, 3, 5, 6, 23, 31, 32	\$9180*	
60 mV	35 mA	100 ms, 3 V	300 Ω/V ±2%	28.6 Ω/A ±2%	1 V/V ±3%	177 mV/A ±7%	1.5 s	2 s	75 s	1.6 s	226	500	1, 2, 3, 5, 6, 23, 31, 32	\$9180*	
60 mV	25 mA	100 ms, 5 V	300 Ω/V ±2%	40 Ω/A ±2%	1 V/V ±3%	0.25 V/A ±7%	1.5 s	2 s	120 s	2 s	226	500	1, 2, 3, 5, 6, 23, 31, 32	\$9690*	
60 mV	0.75 mA	200 ms, 3 V	300 Ω/V ±2%	600 Ω/A	1 V/V	**	0.2 s	1 s	45 s	2 s	27.6	61	5, 10, 27, 28	\$1990	

<sup>Δ</sup>For operation with a 50 Hz input (possible only with Option 005), the rms ripple and transient response specifications are increased by 50%.

\*\* This feature is not available.

<sup>†</sup>An ac input option must be specified when ordering these 3-phase models.

<sup>†</sup>Special Option J30 must be ordered with models 6434B-6448B and 6486C-6483C to be programmed with an HP 6950 1B Power Supply Programmer. Contact your local HP Field Engineer for ordering instructions.

**HP 6453A, 6456B, 6459A**

An ac input option must be specified when ordering.

AC input connections are by means of a 4-conductor connector at rear of unit. Low voltage (208 V, 230 V) models are furnished with an Arrow Hart and Hageman plug (HP 1251-6896). High voltage (380 V, 400 V, 460 V) models are furnished with an Arrow Hart and Hageman plug (HP 1251-6897).

- 001:** 208 V ac, ± 10%, 3-phase, 15.5 A/phase, 57-63 Hz N/C
- 002:** 230 V ac, ± 10%, 3-phase, 14 A/phase, 57-63 Hz N/C
- 003:** 460 V ac, ± 10%, 3-phase, 7 A/phase, 57-63 Hz add \$102
- 005:** realignment for 50 Hz operation N/C
- 008:** overvoltage protection crowbar
- HP 6453A, 6459A** add \$505
- HP 6456B** add \$665
- 010:** chassis slides add \$260
- 031:** 380 V ac, ± 10%, 3-phase, 8.5 A/phase, 57-63 Hz add \$153
- 032:** 400 V ac, ± 10%, 3-phase- 8.0 A/phase, 57-63 Hz \$153
- 910:** one extra operating and service manual shipped with each power supply. \$10

**HP 6484C-6483C**

An ac input option must be specified when ordering.

AC input connections are by means of enclosed 4-wire terminal block

- 001:** 208 V ac, ± 10%, 3-phase, 55 A/phase, 57-63 Hz N/C
- 002:** 230 V ac, ± 10%, 3-phase, 50 A/phase, 57-63 Hz N/C
- 003:** 460 V ac, ± 10%, 3-phase, 25 A/phase, 57-63 Hz add \$260
- 005:** realignment for 50 Hz operation N/C
- 008:** internal overvoltage protection crowbar
- HP 6477C, 6479C, 6483C** add \$410
- HP 6466C** add \$590
- HP 6469C** add \$525
- HP 6472C, 6475C** add \$575
- 023:** rack mounting attachments for standard 19" rack add \$133
- 031:** 380 V ac, ± 10%, 3-phase, 30 A/phase, 57-63 Hz add \$260
- 032:** 400 V ac, ± 10%, 3-phase, 28.5 A/phase, 57-63 Hz add \$260
- 040:** prepares power supply to be programmed with resistance by an HP 6940B, 6942A, 6944A or 6454A. add \$102
- 910:** one extra operating and service manual shipped with each power supply. add \$15

**Accessory**

- 14545A:** casters for HP 6464C-6483C—set of four \$88

# POWER SUPPLIES

## Special Purpose: DC Power Supply/Amplifiers

### Models 6824A-6827A

- High speed remote programming
- Overload protection
- Wide-band response
- Bipolar voltage
- Current sink or source



HP 6825A-6827A



HP 6824A

### Description

The Power Supply/Amplifier is a general-purpose instrument useful in any laboratory engaged in research and development of electronic systems, circuitry, or components. The unit can be operated in one of two basic operating modes: power supply or amplifier. Terminals at the rear permit access to various internal control points to further expand the operational capabilities of the instrument. The resulting flexibility lends the Power Supply/Amplifier to an almost unlimited number of applications.

### Models 6825A Through 6827A

These models feature dual-range output and constant-voltage/constant-current operation. Output voltage and current as a dc supply, or gain as a power amplifier, are remotely controllable and are compatible with Hewlett-Packard Multiprogrammer Systems.

The unit can furnish a bipolar, constant-voltage or constant-current output. It can be remotely programmed with a resistance, voltage, or current and its high speed programming characteristics adapt it to a wide variety of laboratory and production testing applications. The unit can sink, as well as source, current permitting it to serve as a variable load device.

As a direct-coupled power amplifier, each unit offers a signal-to-noise ratio of approximately 80 dB at full output with low distortion and a frequency response up to 40 kHz in the fixed gain mode.

### Model 6824A

Although this model does not provide quite the level of performance and flexibility of Models 6825A through 6827A, it is lower in cost and is suitable for many applications.

As a power supply, this unit offers constant-voltage/current-limiting operation, remote programming, and auto-series, auto-parallel operation.

As a power amplifier, the unit exhibits a high signal-to-noise ratio with a 20 dB gain from dc to 10 kHz. It is useful in servo systems, as a pulse or oscillator amplifier, for motor control, and a variety of other applications.

### General Specifications

**Temperature:** operating, 0 to 55°C; storage, -40 to +75°C.

**Power:** HP 6824A, standard input voltage is 104-127 V ac, 48-63 Hz. Order Option 028 for 230 V  $\pm$  10% operation. HP 6825A, 6826A, 6827A, switchable, 100, 120, 220, or 240 V ac, -13% +6%, 48-63 Hz, 150 W.

**Size:** HP 6824A, 131 H x 209 W x 303 mm D (5<sup>1</sup>/<sub>2</sub>" x 8<sup>1</sup>/<sub>2</sub>" x 11<sup>1</sup>/<sub>16</sub>"); HP 6825A, 6826A & 6827A, 155 H x 198 W x 316 mm D (6<sup>1</sup>/<sub>2</sub>" x 7<sup>7</sup>/<sub>16</sub>" x 12<sup>1</sup>/<sub>16</sub>").

**Weight:** HP 6824A, 7.7 kg (17 lb); 6825A, 6826A & 6827A, 8.2 kg (18 lb).

### Specifications

RATINGS		POWER SUPPLY PERFORMANCE						POWER AMPLIFIER PERFORMANCE						Options	Price	
DC Output		HP Model	PARO (rms/p-p)		Transient Recovery		Resolution		Voltage Gain		Frequency Response, +1, -3 dB		Distortion at full output			
Volts	Ampere		Voltage	Current	Time	Level	Voltage	Current	Fixed	Variable	Fixed Gain	Variable Gain	100 Hz	10 kHz		
-5 V to +5 V -20 V to +20 V	0-2.0 A Both Ranges	6825A	10/30 mV	5/15 mA	100 $\mu$ s	20 mV	40 mV	6 mA	1X 4X	0-2X 0-8X	dc -40 kHz	dc -15 kHz	0.1% THD	0.5%	910	\$2245
-5 V to +5 V -50 V to +50 V	0-1.0 A Both Ranges	6826A	6/35 mV	0.8/5 mA	100 $\mu$ s	50 mV	100 mV	3 mA	1X 10X	0-2X 0-20X	dc -40 kHz	dc -15 kHz	0.1% THD	0.5%	910	\$2245
-10 V to +10 V -100 V to +100 V	0-0.5 A Both Ranges	6827A	10/50 mV	0.4/5 mA	100 $\mu$ s	100 mV	200 mV	1.5 mA	2X 20X	0-4X 0-40X	dc -30 kHz	dc -15 kHz	0.1% THD	1%	910	\$2245
-50 V to +50 V	0-1.0 A	6824A	10 mV rms	-	100 $\mu$ s	0.02% +5 mV	-	-	-	0-10X	-	dc -10 kHz	0.1% THD	-	910	\$1530

### Options Descriptions

**028:** 230 V ac  $\pm$  10%, single phase input

**910:** one additional manual shipped with each power supply

HP 6824A, add \$5.20  
HP 6825A, 6826A, 6827A, add \$15

### Prices

N/C

### Accessories

**HP 5060-8762:** adapter frame for rack mounting one or two HP 6825A-6827A units \$150

**HP 5060-8760:** blank filler panel to be used with above units \$44

**HP 14515A:** rack mounting kit for one HP 6824A \$62

**HP 14525A:** rack mounting kit for two HP 6824As \$36

- HP 6212C-6218C . . . 10 watts output
- Compact, impact-resistant stackable case
- Short-circuit proof

- HP 6200B-6209B . . . 30 watts output
- Auto series, parallel, and tracking
- Remote sensing



Single Output: HP 6212C-6218C



Single Output: HP 6200B-6209B



Dual Output: HP 6234A

## Description—Single Output Models

### Models 6212C-6218C

These popular low-cost CV/CC bench supplies are designed for general laboratory use and are equipped with front-panel mounted voltage and current controls, a combination volt/ammeter, and output binding posts. Output voltage and current are continuously variable, via coarse and fine controls from 0 to 15% above the maximum rated output. A switch selects either output voltage or current for display on the panel meter.

Load connections are made via three binding posts. Either the + or the - post may be grounded through an adjacent GND terminal or the supply may be operated floating at up to 300 volts above ground.

The supplies can also be operated as constant current sources with 500  $\mu$ A load regulation. All of these models can be connected in series or parallel.

The molded, impact-resistant case includes an interlocking feature for stacking several units vertically, thus minimizing bench space required for multiple supplies. Alternatively, up to three units can be mounted side by side in a 19" rack using Rack Mounting Kit HP 14521B. These supplies measure 86 H x 133 W x 368 mm D (3.40" x 5.25" x 8") and weigh 2 kg (4.4 lb).

### Models 6200B-6209B

This series of low-cost bench supplies includes three models covering an output voltage range from 0–20 V to 0–320 V. All models are equipped with ten-turn voltage and current controls, (except the HP 6206B, which does not have a current control), volt/ampere meter, meter function/range switch, and front and rear output terminals. In addition, on the dual-range models (HP 6200B and 6206B), an output range switch permits the selection of either a high or a low output voltage range.

The constant voltage/current limiting supply, HP 6206B, is short-circuit protected by a fixed current limiting circuit which is activated at approximately 110% of rated load current. The current-limit point can be reduced by changing the value of a single internal resistor. For the constant voltage/constant current supplies, ten-turn current controls allow the current-limit point to be set to any value within the current rating. Using these controls the CV/CC supplies can also be operated as constant-current sources.

Units may be bench operated or rack mounted individually or in pairs using accessory rack mounting hardware.

All models in this group of supplies measure 89 H x 216 W x 317 mm D (3.50" x 8.50" x 12.50") and weigh 4.5 kg (10 lb).

## Description—Dual Output Models

### Model 6234A

Model 6234A is a low-cost, dual-output bench power supply with two independently adjustable and isolated power sources in one compact unit. Both of the dc power sources are of the constant voltage/current limit type with each output voltage being adjustable continuously over a 0 to 25 V range. The maximum current available per output is 0.2 A and is limited automatically to prevent overload.

The HP 6234A offers considerable flexibility to the user with output voltages that can be arranged to provide identical or different voltages in any polarity combination with respect to 0 or other common positive or negative voltage points. The outputs can also be connected in series to provide up to 50 V at 0.2 A. Both sources are fully isolated to permit either of the output terminals to be grounded.

With pushbutton switches, users can select either voltage or current for each output to be monitored on the unit's meter. Other features include two multiple-turn controls for precise voltage setting, regulation to 0.01%, and ripple and noise of less than 200 microvolts rms.

With dimensions of only 93 mm high, 157 mm wide and 210 mm deep (3.64" x 6.17" x 8.25"), the HP 6234A supply takes up a minimum amount of bench space. Its weight is 2.3 kg (5 lb). The unit can be powered from a 115 V or an optional 230 V, 47-63 Hz ac input, (Option 028).

### Model 6205C

This low-cost bench supply is equipped with ten-turn output voltage controls, volt/ampere meter, meter function/range switch, and front and rear output terminals. In addition, an output range switch permits the selection of either a high or a low output voltage range.

Model 6205C combines the versatility of a dual power supply with the flexibility of auto-parallel and auto-series operation to extend the output ratings of this supply to 20 V/1.2 A, 40 V/0.6 A, and 80 V/0.3 A. In addition, using the supply's auto-tracking capability, opposite

# POWER SUPPLIES

Laboratory: Single & Multiple Output, 10W to 38W (cont'd)

Models 6200B-6218C and 6234A-6237B

- Dual output to 24 watts
- Short-circuit proof
- Independent voltage controls
- Triple output to 38 watts
- Short circuit proof
- Tracking  $\pm 20$  volt outputs



Dual Output: HP 6205C



Triple Output: HP 6235A



Triple Output: HP 6236B, 6237B

polarity voltages ( $\pm 20$  V,  $\pm 40$  V) can conveniently be obtained from this one supply.

This constant voltage/current limiting supply is short-circuit protected by a fixed current limiting circuit which is activated at approximately 110% of rated load current. The current-limit point can be reduced by changing the value of a single internal resistor. Units may be bench operated or rack mounted individually or in pairs using accessory rack mounting hardware.

## Description—Triple Output Models

### HP 6235A

This compact, low-cost, three-in-one power supply is a handy addition to the lab bench where single or multiple voltages are needed for designing and testing breadboards and prototypes. The HP 6235A delivers three adjustable dc output voltages: 0 to +6 V at 1 A, 0 to +18 V at 0.2 A, and 0 to -18 V at 0.2 A. A single 0 to 36 volt output at 0.2 A can also be obtained by connecting across the +18 V and -18 V terminals.

The controls, meter, and binding posts are conveniently arranged on the front panel. One voltage control simultaneously adjusts the +18 V and -18 V outputs, which track one another and can be used to power operational amplifiers and other circuits requiring balanced positive and negative voltages. The supply's dual outputs have added versatility with an adjustable tracking ratio control (TRACK) that can set the negative output to a lower voltage than the positive output. Once the tracking ratio control has established a voltage ratio between the positive and negative outputs, the ratio remains constant as the +18 V voltage control is adjusted. A third control sets the 0 to +6 V output voltage.

The supply is a constant voltage/current limit type with each output voltage continuously adjustable over its range, while the maximum current available is automatically limited to prevent overloading. The power supply's outputs share a common terminal and are isolated from chassis ground so that any output terminal can be grounded if desired. Each output voltage or current can be quickly selected and monitored with the push-button meter switches.

Model 6235A measures 89 H x 157 W x 210 mm D (3.5" x 6.17" x 8.25") and weighs 2.3 kg (5 lb).

### HP 6236B and 6237B

Microprocessors, digital and linear integrated circuits, and displays used in lab development frequently require triple output power supplies for operating prototypes. The HP 6236B and 6237B are valued additions to the design bench due to their multiple output voltages, small size, ease of operation and application-related performance.

These compact constant voltage/current limiting supplies combine 0 to  $\pm 20$  V tracking outputs rated at 0.5 A with a single output rated at 0 to +6 volts at up to 2.5 A in the HP 6236B, and 0 to +18 volts at 1 A in the HP 6237B.

Controls, meters, and binding posts are logically arranged on a neatly laid out front panel. One voltage control simultaneously adjusts the 20 V and -20 V outputs, which track within 1% to power operational amplifiers and circuits requiring balanced voltages. A tracking ratio control can disable the 1:1 tracking feature and set the negative output to a lower voltage than that of the positive output. Once the tracking ratio control has established a voltage ratio between the positive and negative outputs, the ratio remains constant as the  $\pm 20$  V voltage control varies both outputs. Another voltage control sets the 0 to +6 V (HP 6236B) or 0 to +18 V (HP 6237B) output.

All outputs are protected against overload and short-circuit damage by fixed current limiting circuits. For any overload condition, the  $\pm 20$  V and -20 V outputs in both models are limited to 0.55 A and the +18 V output in the HP 6237B is limited to 1.1 A. The overload protection circuit for the +6 V output in the HP 6236B has a current foldback characteristic that reduces the maximum available current from about 2.75 A at a 6 V terminal voltage to 1 A at zero volts (or short circuited). This foldback limiting characteristic maximizes the available current in the important 5 to 6-volt range while minimizing dissipation during overloads.

Another protective feature safeguards sensitive load circuitry by preventing an output voltage overshoot when the supply is turned on or off.

Separate dual-range panel meters allow both the voltage and current of any output to be monitored simultaneously. A three-position switch selects the output which the meters will monitor.

Both models measure only 89 H x 216 W x 319 mm D (3.5" x 8.5" x 12.5") and weigh 4.3 kg (9.5 lb).

## Specifications

RATINGS		PERFORMANCE							GENERAL	
DC Output		HP Model	Load Effect	Source Effect	PARO rms/p-p	Control Mode and Resolution	Remote Control Coefficients	Power 115 V ac ± 10%	Options	Price
Volts	Amps									
<b>SINGLE OUTPUT—10 WATTS</b>										
0-10	0-1	6214C	4 mV	4 mV	200 $\mu$ V/1 mV	CV/CC 5mV/75 $\mu$ A	**	48-440 Hz 0.3 A, 28 W	28	\$375
0-25	0-0.4	6216C	4 mV	4 mV	200 $\mu$ V/1 mV	CV/CC 5mV/20 $\mu$ A	**	48-440 Hz 0.3 A, 28 W	28	\$375
0-50	0-0.2	6218C	4 mV	4 mV	200 $\mu$ V/1 mV	CV/CC 10mV/10 $\mu$ A	**	48-440 Hz 0.3 A, 28 W	28	\$375
0-100	0-0.1	6212C	8 mV	4 mV	200 $\mu$ V/1 mV	CV/CC 20mV/10 $\mu$ A	**	48-440 Hz 0.3 A, 28 W	28	\$460
<b>SINGLE OUTPUT—UP TO 30 WATTS</b>										
Dual range 0-20 or 0-40	0-1.5 0-0.75	6206B	0.01% + 4 mV	0.01% + 4 mV	200 $\mu$ V/1 mV	CV/CC 10 mV/2 mA	2000/V $\pm$ 1% 0.5 k $\Omega$ /A $\pm$ 10% or 1 k $\Omega$ /A $\pm$ 10%	48-440 Hz 0.9 A, 70 W	11, 28	\$715
Dual range 0-30 or 0-60	0-1 0-0.5	6206B	0.01% + 4 mV	0.01% + 4 mV	200 $\mu$ V/1 mV	CV/CL 10 mV/*	3000/V $\pm$ 1%	48-440 Hz 1 A, 66 W	11, 28	\$715
0-320	0-0.1	6209B	0.02% + 2 mV	0.02% + 2 mV	1 mV/40 mV	CV/CC 40 mV/200 $\mu$ A	3000/V $\pm$ 1% 150 k $\Omega$ /A $\pm$ 10%	48-63 Hz 1 A, 60 W	28	\$865
<b>DUAL OUTPUT—10 WATTS</b>										
Dual output 0-25 and 0-25	0.2 0.2	6234A	0.01% + 1 mV	0.01% + 1 mV	200 $\mu$ V/1 mV	CV/CL	**	104-127 Vac 47-63 Hz 0.26A, 35 W	28	\$460
<b>DUAL OUTPUT—24 WATTS</b>										
Two dual ranges 0-20/0-40 and 0-20/0-40	0-0.6/0.3 0-0.6/0.3	6205C	0.01% + 4 mV	0.01% + 4 mV	200 $\mu$ V/1 mV	CV/CL 10 mV/*	2000/V $\pm$ 1%	48-440 Hz 0.5 A, 50 W	11, 28 40	\$715
<b>TRIPLE OUTPUT—13 WATTS</b>										
Triple output 0 to 6 and 0 to 18 and 0 to -18	0-1 0-0.2 0-0.2	6225A	8 mV 10 mV 10 mV	8 mV 15 mV 15 mV	1 mV/5 mV 1 mV/5 mV 1 mV/5 mV	CV/CL	** ** **	47-63 Hz 0.26 A, 35 W	28	\$490
<b>TRIPLE OUTPUT—35 WATTS*</b>										
Triple output 0 to +6 and 0 to +20 and 0 to -20	2.5 0.5 0.5	6236B	0.01% + 2 mV	0.01% + 2 mV	350 $\mu$ V/1.5 mV	CV/CL 70 mV/*	**	104-127 Vac 47-63 Hz 1.2 A, 112 W	100 120 220 240	\$715
<b>TRIPLE OUTPUT—38 WATTS*</b>										
Triple Output 0 to +18 and 0 to +20 and 0 to -20	1 0.5 0.5	6237B	0.01% + 2 mV	0.01% + 2 mV	350 $\mu$ V/1.5 mV	CV/CL 70 mV/*	**	104-127 Vac 47-63 Hz 1.2 A, 112 W	100 120 220 240	\$715

\*fixed current limit

\*\*remote control not available

\*ac input voltage option must be specified when ordering

## Option Descriptions

**011:** internal overvoltage protection crowbar. Protects delicate loads against power supply failure or operator error. Dual output model has dual crowbar.

HP 6200B, 6206B

add \$102

HP 6205C

add \$204

NC

**028:** 230 Vac  $\pm$  10%, single phase input. Consists of reconnecting power transformer taps, and other components where necessary.

**040:** Multiprogrammer interface. Prepares HP 6205C power supplies for resistance programming by the HP 6940B or 6942A Multiprogrammer

add \$78

**100:** 87-106 Vac, 47-63 Hz, single phase input

NC

**120:** 104-127 Vac, 47-63 Hz, single phase input

NC

**220:** 191-233 Vac, 47-63 Hz, single phase input

NC

**240:** 208-250 Vac, 47-63 Hz, single phase input

NC

**910:** one additional operating and service manual is shipped with each power supply

HP 6200B-6237B

add \$5.20

### Accessories

**HP 14513A:** rack kit for one HP 6200-6209B, 6236B, or 6237B supply

\$57

**HP 14523A:** rack kit for two of the above power supplies

\$31

**HP 14521C:** rack kit for one, two or three HP 6212C-6218C power supplies

\$87

☎ Fast-Ship product — see page 758.

# POWER SUPPLIES

## Special Purpose; Precision Voltage Sources

Models 6114A and 6115A

- 0.025% output voltage accuracy
- Pushbutton voltage control
- Five minute warm-up



HP 6114A & 6115A

### Description

#### HP Models 6114A and 6115A

These 40-watt precision power supplies are high-accuracy instruments designed for use as low-cost calibrators, working voltage standards, systems reference supplies, or high-performance lab supplies. They are ideal for applications where an accurate, highly stable, and easy-to-use source of dc voltage is required.

#### Output Ratings

Both models feature automatic dual-range operation. For example, the HP 6114A can supply 0-20V at 0-2A, and 20-40V at 0-1A, without manual range switching. Automatic output current range cross-over occurs when the supply is providing greater than one-half of the maximum rated output voltage.

#### Output Voltage Controls

Pushbutton voltage controls allow the output voltage to be set rapidly and accurately. The setting is displayed in large, easy-to-read numerals. A four-digit pushbutton switch increases or decreases the output voltage in unit steps, and the switches go directly from "9" to "0" without backing down. A fifth digit, set via a separate front-panel control, provides output voltage resolution of 200  $\mu$ V.

The output voltage accuracy is 0.025% (250 ppm) plus 1 mV. For example, at 40 volt output, the output voltage of Model 6114A is accurate within  $\pm 11$  mV. This accuracy is attained after only five minutes' warmup, thus making these supplies especially suitable as portable calibrators.

#### Output Current Controls

A front-panel current control allows the maximum output current of these supplies to be set to any desired value within the maximum rating. Using this control, the supplies can be operated as constant-current sources with 0.01% current regulation. A current mode indicator (a light-emitting diode) immediately lights when the supply is operated in the gross current limit region or when the output current level established by the setting of the front-panel control is reached. When the indicator is lighted, the output voltage is uncalibrated, but the front panel voltmeter continues to indicate the output voltage with an accuracy of 2%. A ten-turn current control with a three-digit graduated dial provides 2 mA current resolution.

#### Remote Programming

Models 6114A and 6115A are designed to be programmed with either the HP Multiprogrammer or the HP-IB Isolated D/A Power Supply Programmer. Interfacing for Multiprogrammer operation is included as a standard feature in these models, therefore, the addition of Option 040 is not required. See pages 447, 582 and 586 for additional information on digital programming interfaces for power supplies. Both supplies can also be remote programmed by means of an external voltage or resistance. However, most specifications will change to those of the programming source.

The output capacitor can be disconnected to reduce current surges, thereby improving the performance of the supply as a constant-current source; this also increases the programming speed by approximately an order of magnitude. Note, however, that some capacitance

- May be used with HP-IB Power Supply Programmer
- Overvoltage and overcurrent indicators
- Built-in overvoltage crowbar

at the load may be required to maintain power supply stability under all loading conditions when the output capacitor is disconnected.

#### Overvoltage Protection

A built-in overvoltage protection circuit (an SCR crowbar) monitors the output and reduces the output voltage and current to zero whenever a preset voltage limit (adjustable from the front panel) is exceeded. This feature provides a convenient method of limiting the maximum output voltage supplied to voltage-sensitive loads.

#### Specifications

**DC Output:** voltage and current output can be adjusted over the range indicated by front-panel controls or analog programming.

**HP 6114A:** 0-20 volts, 0-2 amperes

20-40 volts, 0-1 amperes

**HP 6115A:** 0- 50 volts, 0-0.8 amperes

50-100 volts, 0-0.4 amperes

Both models feature automatic dual-range operation, which eliminates manual range switching.

**Load effect:** constant-voltage deviation, 0.0005% + 100  $\mu$ V; constant-current deviation, 0.01% + 500  $\mu$ A.

**Source effect:** over the rated input voltage range, constant-voltage, 0.0005% + 100  $\mu$ V; constant-current, 0.005% + 40  $\mu$ A.

**PARD (ripple and noise):** rms/p-p, 20 Hz to 20 MHz; CV 40  $\mu$ V/200  $\mu$ V, CC 200  $\mu$ A/1 mA.

**Temperature coefficient:** CV, 0.0001% + 15  $\mu$ V/ $^{\circ}$ C; CC, 0.02% + 50  $\mu$ A/ $^{\circ}$ C.

**Drift:** CV, 0.0015% + 15  $\mu$ V per 8 hours, 0.0075% + 30  $\mu$ V per 90 days.

**Output voltage accuracy:** output voltage accuracy obtained from front-panel controls at  $23 \pm 3^{\circ}$ C at any ac line voltage and load current within rating and following a five-minute warm-up: 0.025% + 1.0 mV.

**Resolution:** front-panel voltage control, 200  $\mu$ V; front-panel current control, 2 mA.

**Output impedance:** typical value is approximated by 0.05  $\Omega$  in series with 3 mH.

**Load transient recovery time:** less than 50  $\mu$ S is required for output voltage (constant voltage operation) to recover within 50 mV of the nominal output level following a change in output current equal to the current rating of the supply.

**Remote programming speed:** up programming of voltage at full load: HP 6114A, 1.75s; HP 6115A, 4.5s. Down programming, no load: HP 6114A, 350 ms; HP 6115A, 500 ms.

**Overvoltage protection crowbar:** adjustable front-panel screwdriver control from 0.5 to 45 volts on the HP 6114A and 0.5 to 110 volts on the HP 6115A.

**Power:** 104-127 or 208-254 Vac (switchable), 48-440Hz, 150 VA max.

**Temperature rating:** operating, 0 to 50 $^{\circ}$ C; storage, -40 to +75 $^{\circ}$ C.

**Size:** 197 mm W x 165 mm H x 337mm D (7.75" x 6.5" x 13.25")

**Weight:** 7.7 kg (17 lb) net, 9.5 kg (21 lb) shipping.

#### Accessories

**5060-8762:** adapter frame for rack mounting one or two 1/2 rack width units. This frame applies to HP 6114A, 6115A

**5060-8760:** blank filler panel. This 1/2 rack width panel applies to HP 6114A, 6115A

#### Price

\$150

\$44

#### Ordering Information

HP 6114A Precision Power Supply

\$1835

HP 6115A Precision Power Supply

\$1835

## Special Purpose: Precision Constant Current Sources

Models 6177C, 6181C & 6186C

- Continuously variable voltage limit
- Output useful to micro-ampere region



HP 6177C, 6181C

HP 6186C

- High output impedance—no output capacitor

voltage to vary from zero to maximum.

**Source effect (line regulation):** less than 25 ppm of output + 5 ppm of range switch setting for any change in the line voltage between 104 and 127 V ac at any output current and voltage within rating.

**Load effect transient recovery:** less than 800  $\mu$ s for recovery to within 1% of nominal output current following a full load change in output voltage. (On HP 6186C, recovery time for 100 mA/10 mA/1 mA ranges is 1 ms/1.6 ms/4 ms, respectively.)

**Temperature coefficient:** output change per degree C is less than 75 ppm of output current + 5 ppm of range switch setting.

**Drift (stability):** less than 100 ppm of output current + 25 ppm of range switch setting. Stability is measured for eight hours after one hour warm-up under conditions of constant line, load, temperature, and output setting.

**Resolution:** 0.03% of range switch setting.

**Temperature rating:** operating 0. to 55°C; storage, -40 to +75°C.

### Description

These solid-state constant-current sources are ideal for semiconductor circuit development, component testing, and precision electroplating applications.

Their high-speed remote programming characteristics make these supplies useful in testing and sorting semiconductors, resistors, relays, meters, etc. The ability to superimpose ac modulation on the dc output permits the supplies to be used for measurement of dynamic or incremental impedance of circuit components. When remotely programmed, accuracy, stability and some other specifications change to those of the programming source.

### Specifications

**Load effect (load regulation):** less than 25 ppm of output + 5 ppm of range switch setting for a load change which causes the output

### Accessories

**HP 5060-8764:** rack adapter for rack mounting one or two HP 6177C or 6181C supplies \$150

**HP 5060-8762:** rack adapter for rack mounting one or two HP 6186C supplies \$150

**HP 5060-8530:** filler panel for HP 6177C, 6181C \$65

**HP 5060-8760:** filler panel for HP 6186C \$44

### Options

**028:** 230 V ac  $\pm$  10%, single-phase input. N/C

**910:** one additional operating and service manual add \$7.65

### Ordering Information

**HP 6177C, 6181C Constant Current Source** \$1580

**HP 6186C Constant Current Source** \$2245

Model		HP 6177C	HP 6181C	HP 6186C
Output Current <sup>††</sup>		0-500 mA	0-250 mA	0-100 mA
Voltage Compliance $\Delta$		0-50 V dc	0-100 V dc	0-300 V dc
Output Ranges	A	0-5 mA	0-2.5 mA	0-1 mA
	B	0-50 mA	0-25 mA	0-10 mA
	C	0-500 mA	0-250 mA	0-100 mA
AC Input		115V ac $\pm$ 10%, 48-63 Hz; 0.6 A, 55 W at 115 V ac For 230 V ac see Option 028	115 V ac $\pm$ 10%, 48-63 Hz; 0.6 A, 55 W at 115 V ac For 230 V ac see Option 028	115/230 V ac, 48-63 Hz; 0.9 A, 90 W at 115 V ac 115/230 V ac switch
Constant Current	Voltage Control (accuracy: 0.5% of output current + 0.4% of range)	Range A	200 mV/mA	1 V/mA
		Range B	20 mV/mA	100 mV/mA
		Range C	2 mV/mA	10 mV/mA
Remote Programming	Resistance Control (accuracy: 1% of output current + 0.04% of range)	Range A	400 ohms/mA	10 k $\Omega$ /mA
		Range B	40 ohms/mA	200 ohms/mA
		Range C	4 ohms/mA	20 ohms/mA
Voltage Limit Remote Programming	Voltage Control (Accuracy: 20%)		1 V/V	1 V/V
		Resistance Control	870 ohms/V	435 ohms/V
		Accuracy	25%	25%
Typical Output Impedance (R in parallel with C) <sup>*</sup>	Range A	R = 330 Meg, C = 500 pF	R = 1330 Meg, C = 10 pF	R = 10,000 Meg, C = 900 pF
	Range B	R = 33 Meg, C = 0.005 $\mu$ F	R = 133 Meg, C = 100 pF	R = 1,000 Meg, C = 700 pF
	Range C	R = 3.3 Meg, C = 0.05 $\mu$ F	R = 13.3 Meg, C = 1000 pF	R = 100 Meg, C = 1500 pF
PARD (Ripple and Noise): rms/p-p (20 Hz to 20 MHz) with either output terminal grounded	Range A	1.6 $\mu$ A rms/40 $\mu$ A p-p	0.8 $\mu$ A rms/20 $\mu$ A p-p	0.2 $\mu$ A rms/5 $\mu$ A p-p
	Range B	16 $\mu$ A rms/200 $\mu$ A p-p	8 $\mu$ A rms/100 $\mu$ A p-p	2 $\mu$ A rms/50 $\mu$ A p-p
	Range C	160 $\mu$ A rms/1 mA p-p	80 $\mu$ A rms/500 $\mu$ A p-p	20 $\mu$ A rms/500 $\mu$ A p-p
Programming Speed: from 0 to 99% of range switch setting with a resistive load <sup>**</sup> (Output Current Modulation)		6 ms	6 ms	10 ms
Dimensions:		7.75" (W) x 3.44" (H) x 12.38" (D) 197 mm (W) x 88 mm (H) x 315 mm (D)	7.75" (W) x 3.44" (H) x 12.38" (D) 197 mm (W) x 88 mm (H) x 315 mm (D)	7.75" (W) x 3.44" (H) x 12.38" (D) 197 mm (W) x 158 mm (H) x 315 mm (D)
Weight: (Net/Shipping)		4.53 kg (10 lb)/5.9 kg (13 lb)	4.53 kg (10 lb)/5.9 kg (13 lb)	5.9 kg (13 lb)/7.7 kg (17 lb)

\* This network is a simplified representation of a complex network. The formula  $Z = R\sqrt{1 + \omega^2 C^2} + X_C^2$  is used for frequencies up to 1 MHz by substituting the values given for R and C. Above 1 MHz, the output impedance is greater than the formula would indicate.

\*\* Output current can be modulated 100% up to 50 Hz; percent modulation decreases

linearly to 10% at 500 Hz.

<sup>††</sup> For operation above 40°C the maximum output current must be reduced linearly to 80% of rating at 55°C (maximum temperature).

$\Delta$  Minimum voltage obtainable with voltage limit control is 0.5 V.

# FREQUENCY & TIME STANDARDS

## General Information

Hewlett-Packard offers frequency standards and clocks which provide accurate frequency, time interval and timekeeping capabilities. Further, Hewlett-Packard standards provide means for comparing these quantities against national standards such as the National Bureau of Standards (NBS) and the U.S. Naval Observatory. Units of frequency or time cannot be kept in a vault for ready reference. They must be generated for each use, hence be regularly compared against recognized primary standards.

Frequency standards and clock systems manufactured by Hewlett-Packard are used for control and calibration at observatories, national centers for measurement standards, physical research laboratories, missile and satellite tracking stations, communication systems, radio navigation systems, manufacturing plants and radio monitoring and transmitting stations.

### Types of Frequency Standards

At the present time, three types of frequency standards are in common use. These are:

1. The cesium atomic beam controlled oscillator.
2. The rubidium gas cell controlled oscillator, and
3. The quartz crystal oscillator.

Hewlett-Packard manufactures all three types of frequency standards. Of these three standards, the first is a primary frequency standard and the last two are secondary frequency standards. The distinction between a primary standard and a secondary standard is that the primary standard does not require any other reference for calibration; whereas the secondary standard requires calibrations both during manufacturing and at intervals during use depending on the accuracy desired.

### Cesium Beam Frequency Standard

Cesium beam standards are in use wherever the goal is a very high accuracy primary frequency standard. In fact, the NBS frequency standard itself is of the cesium beam type. The cesium beam standard is an atomic resonance device which provides access to one of nature's invariant frequencies in accord with the principles of quantum mechanics. The cesium standard is a true primary standard and requires no other reference for calibration.

### Rubidium Frequency Standard

Rubidium frequency standards feature a high order of both short-term and long-term frequency stability. These are both important in certain fields such as deep-space communications, satellite ranging, and doppler radar.

Rubidium standards are similar to cesium beam standards in that an atomic resonant element prevents drift of a quartz oscillator through a frequency lock-loop. Yet the rubidium gas cell is dependent upon gas mixture and gas pressure in the cell. It must be calibrated and then it is subject to a small degree of drift. The drift is typically 100 times less than the best quartz crystal standard.

TABLE 1 Comparison of Frequency Standards

Standard	Principal construction feature	Principal advantage
Cesium Atomic Beam Resonator Controlled Oscillator.	Beam of free cesium atoms, spatially state selected, is subjected to a microwave signal at resonance frequency.	High intrinsic reproducibility and long-term stability. Designated as primary standard for definition of time interval.
Rubidium Gas Cell Resonator Controlled Oscillator.	Gas buffered resonance cell with optically pumped state selection.	Compact and light weight. High degree of short-term stability.
Quartz Crystal Oscillator.	Piezoelectrically active quartz crystal with electronic stabilization.	Very compact, light and rugged. Inexpensive.

### Quartz Crystal Oscillators

Quartz oscillators are used in virtually every frequency control application including atomic standards. The excellent short-term stability and spectral purity of the quartz oscillators used in Hewlett-Packard atomic standards contribute to the high quality of the output signal of these standards. For less demanding applications where some long-term drift can be tolerated, quartz oscillators are used as independent frequency sources.

### Frequency Standards and Clocks

Frequency standards and clocks have no fundamental differences—they are based upon dual aspects of the same phenomenon. Time and frequency are intangible quantities which can be measured only with respect to some physical quantity. The basic unit of time, the second, is defined as the duration of 9,192,631,770 periods of transition within the cesium atom. Conversely an unknown frequency is determined by counting the number of cycles over the period of a second. The Master Clock at the U.S. Naval Observatory, one of the world's most accurate clocks, is made of an ensemble of more than a dozen Hewlett-Packard cesium beam frequency standards. The USNO directly controls the distribution of precise time and time interval (frequency) from Naval radio stations, Loran-C (operated by U.S. Coast Guard), Omega and Satellite Navigation Systems. Hewlett-Packard portable cesium standards, "flying clocks," are used to periodically check the synchronization between these stations and the Master Clock.

Hewlett-Packard cesium beam standards are widely used to drive precision clocks because of the extremely good long-term stability and reliability of this primary standard. If a quartz oscillator or other secondary standard is used, it must be evaluated for rate of drift and be corrected periodically.

### Time Scale

The time interval of the atomic time scale is the International Second, defined in October 1967 by the Thirteenth General Conference of Weights and Measures. Since January 1972 the frequency offset between UTC and Atomic Time has been zero and the UTC time scale is kept in synchronism with the rotation of the earth to within  $\pm 0.9$  second by step-time adjustments of exactly 1 second, when needed (see Hewlett-Packard Application Note 52-2).

The U.S. National Bureau of Standards (NBS) and USNO provide the official basis for Standard Time for the United States. The UTC signal is broadcast from the NBS stations WWV and WWVB and by several other stations throughout the world. (See Hewlett-Packard Application Note 52-1, Fundamentals of Time and Frequency Standards, for a list of stations broadcasting time signals).

### Standby Power Supplies

Minimum down-time, important for any system, is vital to a time standard. Its worth depends directly on continuity of operation. Noninterrupted operation is also important to ultra-precise quartz oscillators.

Hewlett-Packard standby power supplies ensure continued operation despite line interruptions, and operate over a range of ac line voltage to supply regulated dc to operate frequency standards and frequency dividers and clocks. The batteries in the supplies assume the full load immediately when ac power fails.

### Hewlett-Packard Time and Frequency Standard

The Hewlett-Packard House Standard at the Santa Clara Division consists of an ensemble of five Hewlett-Packard Cesium Beam Standards each with the Option 004 High Performance Tube.

The standard is compared to the U.S. Naval Observatory Master Clock in Washington, D.C. by means of the Global Positioning (GPS) navigation system. It is also compared with the U.S. National Bureau of Standards Frequency Standard (NBS FS) at Boulder, Colorado by means of GPS through the Naval Observatory. The frequency uncertainty of the standard is within a few parts in  $10^{13}$  with respect to the standards maintained by the NBS and the USNO.

Time is maintained relative to the Naval Observatory and the National Bureau of Standards master clocks to an accuracy of better than  $\pm 1.0$  microseconds. This accuracy is verified with flying clock trips from the Naval Observatory to both Hewlett-Packard Santa Clara Division and Hewlett-Packard Geneva. Both locations have been designated U.S. Naval Observatory Time Reference Stations.



#### HP 5061B

- Improved accuracy  $\pm 3 \times 10^{-12}$
- Primary standard
- Proven reliability

#### HP 5061B, Opt 004

- Accuracy  $\pm 2 \times 10^{-12}$
- Settability  $\pm 1 \times 10^{-13}$
- Time domain stability  $5 \times 10^{-12}$  (1 s avg)



HP 5061B

#### HP 5061B Cesium Beam Standard

The first Hewlett-Packard Cesium Beam Standard, the HP 5060A, was introduced in 1964. This was followed in 1967 with the improved HP 5061A, in 1973 with the high performance beam tube option for the HP 5061A and in 1986 with the 5061B. Since this time the accuracy and reliability of Hewlett-Packard cesium beam standards continues to be demonstrated and these standards have become the world-wide standard for frequency and time keeping. The HP 5061B has provision for an optional digital divider and reliable, easy-to-read LCD clock (Option 003) and for a battery with 1/2 hour standby power capacity with automatic charging.

**Reliability and warranty:** over 100 million operation hours have proven the performance and reliability of Hewlett-Packard cesium beam standards in various world-wide applications. The units have provided dependable microsecond accuracy in aircraft, ship and fixed environments.

A five-year warranty on the HP 5061B standard cesium beam tube is provided as a result of proven field reliability. This warranty includes replacement of the cesium beam tube if it should fail within the warranty period.

The design concept of the high-performance beam tube includes unique HP designed dual-beam optics with higher beam intensity to accomplish better short-term stability and greater immunity to effects of shock and vibration. A 50 percent increase in resonance cavity length without change in the overall beam tube size contributes to better accuracy and settability because of the high Q of the narrower resonant line width. This tube retains the unique cesium standard feature of virtually no long term instability or aging.

The intrinsic accuracy is improved to  $\pm 2 \times 10^{-12}$  which provides an excellent reference standard without need of calibration. If desired, as in many timekeeping applications, two or more units may be calibrated to determine the difference in rate or may be adjusted to the same frequency. With the improved settability specifications of  $1 \times 10^{-13}$  small changes in frequency are accomplished rapidly and accurately. A provision for degaussing the tube without adversely affecting the instrument operation allows removal of any residual magnetic field in the tube. This is important in achieving the settability performance.

The short term stability specification is improved by a factor of ten with this tube. The  $5 \times 10^{-12}$  (1 s avg.) performance compares very favorably with that of rubidium type standards which are noted for their excellent short term stability. An important advantage from the better short term stability is the capability to make measurements to 1 sigma precision of  $1 \times 10^{-12}$  in about one minute compared to the two hours required previously. The HP 5061B with the Option 004 High Performance Tube has the same high reliability as the HP 5061B with the standard tube. The new high performance tube is warranted for three years, but is designed to have the same long life as the standard tube.\*

#### HP E21-5061B Flying Clock

The HP E21-5061B consists of a HP 5061B Cesium Beam Standard with Option 003 LCD Clock and Special Option E21, all fastened to an HP 5089A Standby to form a portable unit. The power supply, which can be operated from 11 to 30 V dc, 85 to 255 V ac, will provide approximately 10 hours standby power (from sealed immobilized electrolyte lead calcium batteries) for the HP 5061B Cesium Beam Standard.

This wide range of operating power capabilities enable the HP E21-5061B to operate on local power in virtually any country in the world. The 10 hours standby capability makes it possible to travel where there is no power available and, of course, allows the HP E21-5061B to conveniently be transported between power sources and operated in almost any air or surface vehicle as a "flying clock" (see Hewlett-Packard Journal, August 1966 and December 1967).

The Option 004 tube, because of the improved shielding, offers a significant increase in accuracy under the varying earth's magnetic field conditions experienced by flying clocks and is a desirable addition to the HP E21-5061B. In addition, the better short term stability permits more accurate and rapid comparison of standards.

\*See page 466 for ordering information.



Option 004, High Performance Cesium Beam Tube with three-year warranty

#### HP 5061B with Opt 004, High Performance Cesium Beam Tube

The Hewlett-Packard 5061B primary frequency standard with the Option 004 Cesium Beam Tube offers increased stability and accuracy in the instrument which has become the worldwide standard of frequency and time keeping since its introduction in 1967. Improvements in magnetic shielding, ruggedization and environmental performance permit improved performance and expansion of navigation and communication systems.

# FREQUENCY & TIME STANDARDS

## Atomic Frequency Standards (cont'd)

Model 5061B



HP 10638A

### HP 10638A Degausser

The HP 10638A Degausser is designed for use with the Option 004 High Performance Cesium Beam Tube without interrupting normal operation. The degausser removes residual magnetism in the shields of the beam tube which can build up over time, due to a changing magnetic environment, and can cause a frequency offset. Relaxation of the residual magnetism insures a settability of  $\pm 1 \times 10^{-11}$ , allowing stable precise changes in output frequency and a reproducibility of  $\pm 1.5 \times 10^{-11}$ . The degausser should be used when initially setting up the HP 5061B with Option 004 or after the instrument has been moved or adjusted.\*

### HP 5061B with Option 003, Time Standard and Standby Power Supply

The HP 5061B has provision for an optional digital divider and reliable, easy to read LCD, time-of-day, 24-hour digital clock (Option 003). By including this option, the number of applications and the versatility of the cesium standard is increased. The one-pulse-per-second output can simplify the comparison with other standards (such as portable and secondary standards) as well as GPS and Loran Systems. The techniques for such comparisons are described in Application Note AN-52. Option 003 also includes an internal battery power supply which will provide at least 45 minutes of standby power if the line power should fail. This will prevent phase and frequency interruptions due to intermittent or an extended power failure. Battery power also enables moving the cesium beam standard to locations of other secondary standards without losing time.\*



HP K34-5999 1A

### HP K34-59991A Phase Comparator

The HP K34-59991A Broadband Linear Phase Comparator accurately compares the phase relationship of the output signals of two frequency standards having the same nominal frequency. This will enable resolving extremely small differences between precision frequency sources. The Phase Comparator operates over a frequency range of 10 kHz to 50 MHz and input levels between 100 mV and 10 V rms. A linear dc output voltage, proportional to the phase differences between the two standards, is available at both the front and rear panels. This voltage is also monitored on a front-panel meter and is suitable for driving a stripchart recorder, thus allowing longterm monitoring of the frequency standards. By using this comparator, very small frequency differences can be detected and adjustments can be made to frequency standards to correct for timekeeping errors.\*

### HP J45-5061 Certified Stability of $1 \times 10^{-11}$

The HP J45-5061B is a special option which will certify that the Model HP 5061B with standard Options 003 and 004 has stability performance of better than or equal to  $1 \times 10^{-11}$  in a day, when measured each day for any five consecutive days. This means that the cesium standards absolute deviation from the HP Santa Clara Division House Standard is less than or equal to 8.64 ns per day on each of the five consecutive days during the certification. The certification applies only to original shipments and is performed under calibration laboratory conditions with the cesium beam tube degaussed and operating in a stable magnetic environment and over a restricted temperature range of  $\pm 2.5$  degrees range at any temperature between 15 and 35 degrees C.\*

\* See page 466 for ordering information.

# FREQUENCY & TIME STANDARDS

## Atomic Frequency Standards (cont'd)

Model 5065A

485

- Compact, high reliability, proven performance
- Long term drift rate  $< 1 \times 10^{-11}$ /month
- Time domain stability  $< 5 \times 10^{-13}$  (100 s, avg)
- High reliability

- Proven performance
- Compact
- Long-term drift rate  $< 1 \times 10^{-11}$ /month
- Time domain stability  $< 5 \times 10^{-13}$  (100 s, avg.)

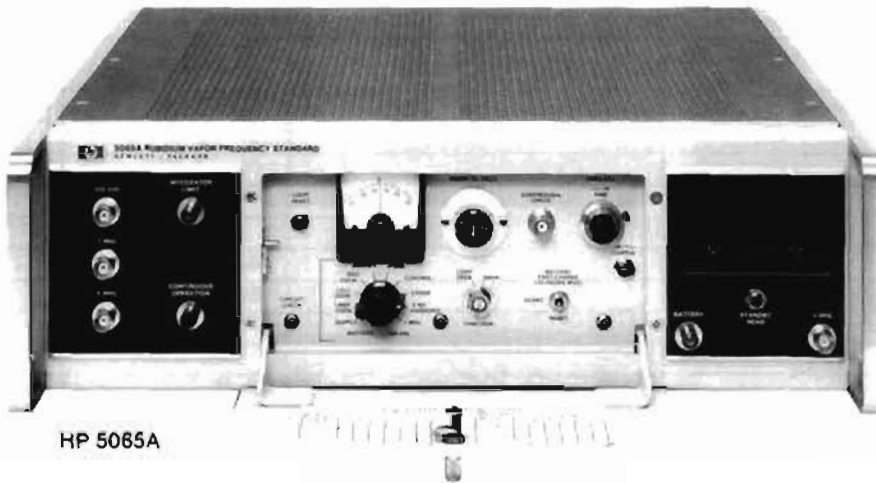

### HP 5065A Rubidium Frequency Standard

The HP 5065A is an atomic-type secondary frequency standard which uses a rubidium vapor resonance cell as the stabilizing element. As a result, it has long-term stability of better than  $1 \times 10^{-11}$  per month which exceeds that of high quality quartz oscillator frequency standards by 50 to 100 times. Furthermore, it has excellent short-term stability. These features contribute to its desirability as a coherent signal source, as a master oscillator for radio and radar systems where special requirements for stability and/or narrow bandwidth must be met, as a precision time keeper where the better performance of a cesium beam primary standard is not required, and as a house frequency standard for improved accuracy with fewer NBS calibrations compared to that required with quartz standards.

Front panel controls and circuit check meter of the HP 5065A are protected by a panel door. The magnetic field control provides fine frequency adjustment with which the frequency can be set to a precision of better than  $2 \times 10^{-12}$  without reference to a chart. The low noise quartz oscillator is phase-locked to the atomic frequency and provides the standard 5 MHz, 1 MHz, and 100 kHz outputs. The circuit check meter with selector switch monitors key voltages and currents for routine maintenance readings, calibration procedures, and fault finding.

The HP 5065A is designed for assured operation—to give the user confidence that the standard output signals are correct and locked to the atomic frequency. Logic within the unit maintains power to a “continuous” operation light on the front panel. If operation is interrupted, even momentarily, for any reason the light goes out and stays out until manually reset. An integrator limit light warns when the frequency correcting servo loop is approaching the limit of its dynamic range.

The HP 5065A is contained in a small-size package and is lightweight in comparison to a cesium beam standard. Additionally the rubidium resonance cell is much more frequency stable than quartz oscillators while subjected to shock and vibration, EMC, humidity, and magnetic field effects.

**Reliability and warranty:** the most significant module in the HP 5065A in terms of performance is the Rubidium Vapor Frequency Reference (RVFR). This temperature controlled, magnetically shielded unit includes the Rb gas cell and a photo sensitive detector

designed for maximum possible reliability. Field experience, including several million hours of operation, have demonstrated this reliability and the RVFR is now warranted for a period of three years. This increased warranty protects the owner in the event of random failure.

The Option 001 Digital Clock has an easy to read LED time-of-day display. The olive black upper panel provides a dark background around the readout for excellent contrast and readability. Initial clock setting is accomplished by means of pushbuttons easily accessible by removing the top cover. The LED display offers high reliability, freedom from errors due to mechanical shock, and performance over the full environmental range of the HP 5065A. A sync button on the digital divider permits automatic synchronization of this 1 PPS pulse to an external pulse. The clock 1 PPS is adjustable in decade steps from 1  $\mu$ s to 1 s, with respect to the synchronized reference, with 6 thumbwheel switches. A screwdriver adjustment allows fine continuous adjustment over a range of 1  $\mu$ s.

To conserve battery power, the display is not illuminated when ac power is not available. A STANDBY READ pushbutton below the display is used for readout when operating on the internal battery or external dc.

The Option 002 Standby Battery provides the HP 5065A with a minimum of 10 minutes standby power at 25°C. Switchover from line to battery is automatic so there is no interruption of operation if ac line power should fail. A front panel ac interruption light warns when ac power has failed or has been disconnected. Fast or float charging rates may be selected when ac power is available.

The Option 003 combines the Option 001 Clock and Option 002 Battery and should be specified if both Options 001 and 002 are required.

### HP E21- 5065A Portable Time Standard

HP E21- 5065A Portable Time Standard is a complete system for precision timekeeping and for transporting time from one location to another. It consists of the HP 5065A Rubidium Standard with digital clock and divider (Option 001) and the HP 5089A Power Supply with 6 or more hours standby capability. The component units are held together by side bars, and the interconnecting cables are protected by a back cover.

# FREQUENCY & TIME STANDARDS

## Atomic Frequency Standards (cont'd)

Models 5061B, 5065A

### Specifications — Frequency Standards

Instrument:	HP 5061B Option 004	HP 5061B	HP 5065A
Type of Standard:	Cesium	Cesium	Rubidium
Accuracy: maintained in a dc magnetic field to 2 gauss over a temperature range of 0-50°C	$\pm 3 \times 10^{-12}$	$\pm 5 \times 10^{-12}$	$\pm 1 \times 10^{-11}$ (months)
Accuracy: limited temp. range(1)	$\pm 2 \times 10^{-12}$	$\pm 3 \times 10^{-12}$	
Reproducibility	$\pm 1.5 \times 10^{-12}$	$\pm 3 \times 10^{-12}$	
Retrace	$\pm 5 \times 10^{-13}$	$\pm 3 \times 10^{-12}$	
Settability (frequency)	$\pm 1 \times 10^{-13}$	$\pm 7 \times 10^{-13}$	$\pm 2 \times 10^{-12}$
Long-term Stability (for life of cesium tube)	$\pm 2 \times 10^{-12}$	$\pm 2 \times 10^{-12}$	
DC Magnetic Field Stability, freq. change, any orientation in a 2 gauss field	$< \pm 2 \times 10^{-13}$	$< \pm 2 \times 10^{-12}$	$< \pm 5 \times 10^{-12}$ (1 gauss field)
Time Constant, quartz OSC control loop	1s	1s	
Warm-up Time at 25°C	30 min	45 min	$5 \times 10^{-11}$ 4 hrs(2)
Tube Warranty	3 yrs.	5 yrs.	3 yrs.
Sinusoidal Outputs	10 MHz, 5 MHz, 1 MHz, 100 kHz		5 MHz, 1 MHz, 100 kHz
Output Voltage	1 volt into 50 $\Omega$		
Harmonic Distortion	>40 dB (from rated output)		
Non-Harmonic Distortion	>80 dB (from rated output)		
Temperature, Operating	0-50°C		
Temperature, Non-operating	-40 to 70°C(3)		
Power, AC	50, 60 or 400 Hz $\pm 10\%$ , 115/230V $\pm 10\%$ , 44W (Cesium) 49W (Rd)		
Power, DC	22 to 30V, 30W		23 to 30V, 35W
Power, AC/DC with options - add	5 to 16W		0 to 16W
Dimensions (H x W x D): mm; inches:	221 x 425 x 416 8.7 x 16.7 x 16.4		133 x 425 x 416 5.2 x 16.7 x 16.4
Weight (lb/kg) Option 001 Option 002 Option 003	70/31.8 6/2.7	67/30.5 6/2.7	34/15.4 2/0.9 3.5/1.6
Time Standard (Clock)			
1 PPS Outputs: Master: Clock: Amplitude Width Rise Time Fall Time	Front & Rear BNC	Front and Rear BNC	Front BNC
	$\pm 10V$ Peak into 50 $\Omega$ load		
	20 $\mu$ s min. <50 ns <50 ns	20 $\mu$ s min. <50 ns <50 ns	20 $\mu$ s min. <50 ns <50 $\mu$ s
Jitter, pulse-to-pulse	<1 ns, rms	<1 ns, rms	<5 ns, rms
Synchronization	Automatic, 100 ns $\pm$ 100 ns delay	Automatic, 100 ns $\pm$ 100 ns delay	Automatic, 100 $\pm$ 100 ns delay
Clock Pulse Adjustment Range:	.1 $\mu$ s to 1s		
Clock Display:	LCD	LCD	LED
Standby Power Supply-Capacity at 25°C w/clk	45 min.	45 min.	10 min.
Recharge	Automatic, fast charge	Automatic, fast charge	switch

(1) Static mechanical and atmospheric and electromagnetic environment  $\pm 2.5^\circ\text{C}$  range at any temperature between 15 and 35°C.  
 (2) After 24 hours off @ 25°C.  
 (3) If options installed in HP 5065A Non-Op. Temp -40°C to +50°C.  
 NOTE: Tubes are intrinsically capable of meeting these specifications when installed in HP 5061B's currently in production.

### Ordering Information

**HP 5061B** Cesium Frequency Standard  
**Opt 003** Clock and Standby Power Supply  
**Opt 004** High Performance Beam Tube  
**Opt 908** Rack Flange Kit

**Special Option HPE21-5061B** Flying Clock  
 Consists of: HP5061B, Opt 003, E21, + 5089A.  
 (The 5061B, + Opt 003 are not included in the E21 price.)

**Weight:** 64 kg (141 lb).

**Size:** 425 H x 405 W x 546 mm D (16.7 in. x 15.9 x 21.5 inches) includes handles.

**HP 10838A Degausser**

### Price

\$32,500  
 \$4,400  
 \$5,200  
 \$45  
 +\$6,275

\$1,425

**Special Option K34-59991A** Phase Comparator

**HP 5065A** Rubidium Frequency Standard

**Opt 001** Clock  
**Opt 002** Standby Power Supply  
**Opt 003** Clock and Standby Power Supply  
**Opt 908** Rack Flange Kit

**Special Option HP E21-5065A** Portable Standard

Consists of: HP 5065A, E21, Opt 001 + 5089A  
 Standby power supply. (The 5065A, + Opt 001 are not included in the E21 price.)

**Weight:** 50 kg (110 lb).

**Size:** 314 H x 425 W x 546 mm D (8.4 x 16.7 x 21.5 inches) includes handles.

\$1,150

\$25,800

\$3,300

\$770

\$4,100

\$45

+\$6,350

- High spectral purity
- Well-buffered outputs
- Aging <  $5 \times 10^{-10}$  per day

- Excellent stability
- High reliability
- Built-in 8-hour standby battery

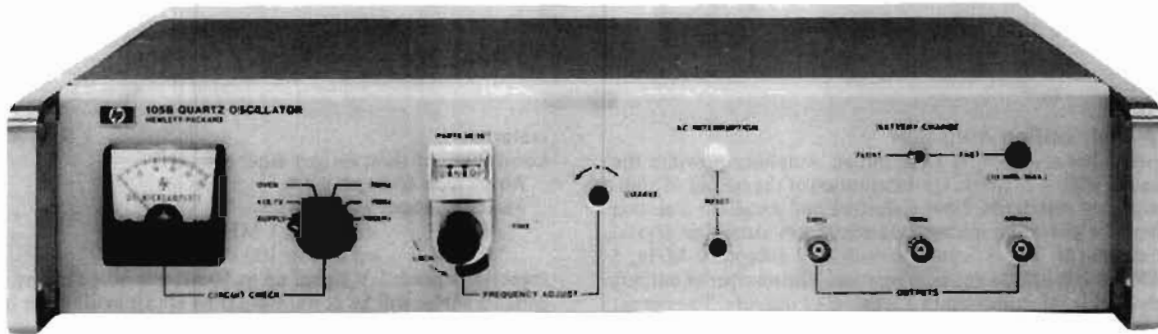

HP 105B

#### HP 105B Quartz Oscillator

The HP 105B Quartz Oscillator provides state-of-the-art performance in precision frequency and time systems because of its excellent long and short term stability characteristics, spectrally pure output, unexcelled reliability, and ability to operate under a wide range of environmental conditions. The HP 105B fills a need for a small and economical yet highly stable precision quartz oscillator for frequency and time standards. The HP 105B can be operated from the ac line. It also has a built-in 8-hour standby battery for uninterrupted operation should line power fail. The 5 MHz, 1 MHz and 100 kHz buffered sinusoidal outputs have excellent short term stability (5 parts in  $10^{12}$  rms for 1 s averaging time) and aging rate (< 5 parts in  $10^{10}$  per day).

The HP 105B features rapid warm-up. Typically, the oscillator will be within 5 parts in  $10^9$  of the final frequency in 15 minutes after an "off" period of 24 hours. The basis of these oscillators is an extremely stable "SC" cut quartz crystal developed by Hewlett-Packard. New technologies in the crystal mounting and packaging have resulted in a cleaner crystal which in turn has a lower aging rate. The crystal, oscillator and AGC circuit are all enclosed in a proportional oven which reduces the temperature effects on these components and circuits.

Particular care was taken to provide a spectrally pure 5 MHz output which, when multiplied high into the microwave region, provides signals with spectra only a few cycles wide. Spectra less than 1 Hz wide can be obtained in X-band (8.2 to 12.4 GHz). The stability and purity of the 5 MHz output make it suitable for doppler measurements, microwave spectroscopy, and similar applications where the reference frequency must be multiplied by a large factor.

#### Specifications

**Outputs:** 5 MHz, 1 MHz, 100 kHz; 1 V rms into 50  $\Omega$  front and rear connectors.

**Clock output:** 1 MHz or 100 kHz; 0.5 V rms into 1 k $\Omega$ , rear connector. Normally supplied wired for 1 MHz output.

#### Frequency Stability

**Aging rate:** <  $5 \times 10^{-10}$  per 24 hours.

**Short-term stability:** for 5 MHz output only.

$\tau$ (sec)	$\sigma\Delta f/f(2,\tau)$
$10^{-2}$	$1.5 \times 10^{-10}$
$10^{-1}$	$1.5 \times 10^{-11}$
$10^0$	$5 \times 10^{-12}$

**Temperature:** <  $2.5 \times 10^{-9}$  total change 0°C to 50°C.

**Load:**  $\pm 1 \times 10^{-10}$  open to short circuit, 50  $\Omega$  R, L or C load change.

**Supply voltage:**  $\pm 5 \times 10^{-11}$  for 22–30 V dc from 26 V dc reference and for 115/230 V  $\pm 10\%$ .

**Warm-up (at 25°C):** to within  $5 \times 10^{-9}$  of final frequency in 15 min.

#### Distortion (5 MHz, 1 MHz, 100 kHz) Below Rated Output

**Harmonic:** > 40 dB.

**Non-harmonic:** > 80 dB.

#### Frequency Adjustments

**Fine:**  $\pm 5 \times 10^{-8}$  range with digital dial reading parts in  $10^{10}$ .

**Coarse:**  $1 \times 10^{-6}$  front-panel screwdriver control.

**Phase locking:** external +5 V to –5 V allows >  $2 \times 10^{-8}$  frequency control for locking to external source.

#### Environmental

**Temperature, operating:** 0°C to +50°C.

**Temperature, storage:** –40°C to +50°C (+75°C without standby battery).

**Altitude:** 15.24 km (50,000 ft.).

**Standby supply capacity:** 6 hours at 25°C ambient temperatures.

**Power requirements:** 115/230 V  $\pm 10\%$ , 50–400 Hz at 18 W (70 W warm-up) Add 1 W for float charge and 12 W for fast charge. 22–30 V dc at 8 W (16 W warm-up).

**Size:** 88 mm H x 425 mm W x 286 mm D (3 1/2 in. x 16 1/4 in. x 1 1/4 in.).

**Weight:** 105B—nct, 11 kg (24 lb). Shipping, 14 kg (31 lb).

#### Ordering Information

HP 105B Quartz Oscillator

Opt 808 Rack Flange Kit

Opt 910 Extra manual

#### Price

\$6800

+ \$45

+ \$25

# FREQUENCY & TIME STANDARDS

## Distribution Amplifier

Model 5087A

- Versatile with 3 input and 12 output channels
- Low noise, high stability, and isolation
- Exceptional phase stability
- Plug-in modular construction

HP 5087A

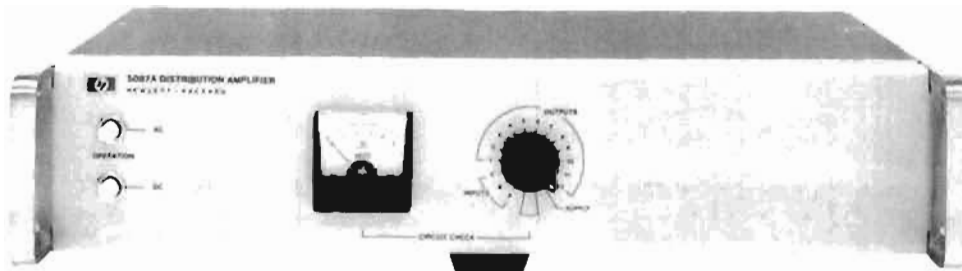

### HP 5087A Distribution Amplifier

The Hewlett-Packard 5087A Distribution Amplifier provides the isolation and flexibility required for distribution of the output of high-quality frequency standards. Low distortion and excellent isolation make it ideal for providing multiple outputs from atomic or crystal frequency standards. The 3 input channels will accept 10 MHz, 5 MHz, 1 MHz or 100 kHz in any combination. The number of outputs for each channel is selectable up to a total of 12 outputs. The output levels are individually adjustable from 0 to 3 V rms. All input and output levels are monitored on a front-panel meter.

The Distribution Amplifier features plug-in modular construction, short circuit isolation, exceptional phase stability, low noise and cross-talk, and uninterrupted switchover to standby dc in event of ac power failure.

The shielding around each input and output plug-in amplifier assures minimum noise and crosstalk. The tuned output amplifiers provide clean signals and high channel-to-channel isolation.

The instrument is designed for maximum versatility and can be supplied to meet a wide variety of special requirements. The standard configuration of input and output amplifiers is shown in Figure 1.

Several other commonly used configurations are also available and special combinations of the various input and output modules can be supplied. Input and output amplifiers can be added or the configuration easily changed at any time.

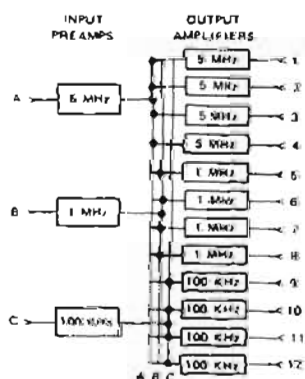

Figure 1. HP 5087A Distribution Amplifier with Option 031. Standard Configuration Input and output amplifiers.

### Specifications

**Inputs:** (up to three, rear panel BNC).

**Frequencies:** 10 MHz, 5 MHz, 1 MHz or 100 kHz.

**Level:** 0.3 to 3.0 V rms, 50 ohms.

**Outputs:** (up to 12 rear panel BNC).

**Frequencies:** 10 MHz, 5 MHz, 1 MHz or 100 kHz.

**Level:** 0–3 V into 50 ohms (screwdriver adjustment).

**Harmonic distortion:** > 40 dB below rated output.

**Non-harmonic distortion:** > 80 dB below rated output.

### Isolation

**Load** (open or short on any other channel)

**Amplitude change:** 0.1%.

**Phase change:** <0.1 ns at 5 or 10 MHz.

<0.5 ns at 1 MHz.

<5.0 ns at 100 kHz.

**Injected signal:** 1 V signal up to 50 MHz applied to any output except 10 MHz, will be down more than 60 dB in all other outputs; 10 MHz output channel will be down more than 50 dB.

**SSB phase noise (5 MHz):** > 145 dB below signal in 1 Hz BW for frequencies > 1 kHz from carrier.

**Short term stability degradation (5 MHz):** <  $1 \times 10^{-11}$  in 10 kHz band. (1 s average).

### Environmental

**Temperature:** MIL-E-16400, Class 4.

**Operating:** 0–50°C; storage: –62° to +75°C.

### Stability

**Amplitude:** ±0.5 dB, 0° to 50°C.

**Phase:** <0.1 ns/°C., 5 and 10 MHz.

**Humidity:** 95% at 40°C.

**Altitude:** up to 30,000 ft.

### General

**Power:** 115 or 230 V ±10%, 48 to 440 Hz, 20 VA, max, or 22–30 V dc, 500 milliamperes, max.

**Dimensions:** 88 mm H x 425 mm W x 286 mm D (3.5 in. x 16.7 in. x 11.3 in.).

**Weight:** typical, Opt 031—Net 7 kg (15 lb).

### Ordering Information

**HP 5087A Distribution Amplifier Mainframe** \$2000

**Normal Configurations** (input and output amplifiers)

**Opt 031** 5, 1 and 0.1 MHz inputs and 4 outputs at each frequency + \$2220

**Opt 032** Single 5 MHz input and 12 outputs + \$2060

**Opt 033** Single 10 MHz input and 12 outputs + \$2060

**Opt 034** Single 5 MHz input, 4 each outputs at 5, 1 and 0.1 MHz + \$2060

### Special Configurations

**Input Preamplifiers** (up to 3 total)

**Opt 004** Input Preamplifier (0.1 to 10 MHz) + \$80

**Opt 005** 5 to 1 MHz Input Divider + \$165

**Opt 006** 1 to 0.1 MHz Input Divider + \$220

**Opt 011** 5 to 10 MHz Input Doubler + \$250

**Opt 013** 10 to 5 MHz Input Divider + \$165

**Opt 014** 10 to 1 MHz Input Divider + \$275

**Output Amplifiers** (up to 12 total)

**Opt 001** 5 MHz Output Amplifier + \$165

**Opt 002** 1 MHz Output Amplifier + \$165

**Opt 003** 0.1 MHz Output Amplifier + \$165

**Opt 012** 10 MHz Output Amplifier + \$165

**Opt 008** Rack Flange Kit + \$35

# FREQUENCY & TIME STANDARDS

## Standby Power Supply

Model 5089A

489

- 15 ampere-hour capacity
- Maintenance free lead-calcium batteries

- Used In "Flying Clocks"
- Automatic recharge

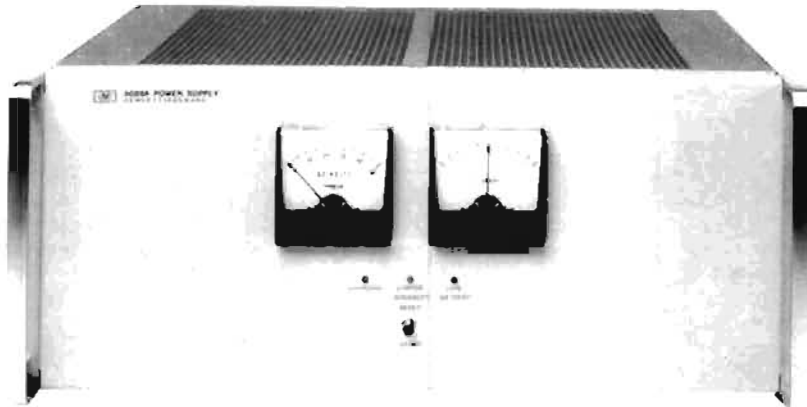

HP 5089A

### HP 5089A Standby Power Supply

The HP 5089A Standby Power Supply furnishes dc power to keep frequency or time standard systems operating during extended interruptions of ac line power. For applications where it is essential to maintain continuous operation and avoid loss of precise time, the use of a standby power supply is an absolute necessity. This unit is designed for use with Hewlett-Packard Cesium Beam Standards, Rubidium Vapor Standards, Quartz Oscillators, and other equipment which will operate from 22 to 28 V dc. No switching is used in transferring power from line to battery operation and back again, thus assuring uninterrupted operation.

### Versatility

The HP 5089A is an extremely versatile unit. It was designed both as a portable power supply for the HP 5061B and HP 5065A "flying clocks", and as a standby supply for stationary applications.

### Portable Applications

Portable or "flying clock" applications require a power supply to operate from a wide range of power sources, along with the standby capability to maintain continuous operation where no external power is available. A special inverter permits operation from a 12 V dc automobile battery. In addition, the 85 to 255 V ac, and 11 to 30 V dc capability enables the HP 5089A to operate from almost any power source in the world. The 15 ampere-hour standby batteries are the double sealed lead-calcium type, and thus are virtually spillproof. Mounting hardware is available to attach the HP 5089A to either the HP 5061B or the HP 5065A standards to make a portable frequency time standard package. These portable packages are available from Hewlett-Packard under HP E21-5061B and HP E21-5065A.

### Stationary Applications

Stationary applications require long periods of power supply operation in a float or standby mode. Then, when an ac supply failure occurs, the supply must provide full standby capability. The charging circuits inside the HP 5089A are designed to charge the batteries in such a way that they will provide both long, trouble-free, reliable operation, and full standby power. After use, when ac power is restored, the HP 5089A will fully recharge its batteries. The double sealed batteries will not leak or require maintenance of any kind. Thus, the HP 5089A allows you to add standby capability to your system with very little increase in maintenance costs.

### Ease of Operation

In normal operation there is virtually no required operator intervention. The HP 5089A automatically maintains the batteries in a fully charged state, ready to supply standby power. Should regular line power fail, the HP 5089A will provide uninterrupted dc power (to the limit of its standby capacity) for your equipment. After normal operating power is restored, the HP 5089A will automatically recharge its batteries back to the standby level.

The HP 5089A tells you its operational status at a glance through three LED lamps: GREEN indicates the battery is being charged; YELLOW indicates there has been an ac line failure; a RED lamp lights when the battery is almost fully discharged. Two front-panel meters show battery voltage and charge/discharge current.

### Batteries

The HP 5089A utilizes the "immobilized electrolyte" technology in its maintenance-free lead-calcium batteries. The lead-calcium grid gives these batteries longer life with better reliability than conventionally designed batteries. The batteries are double sealed to provide virtually leakproof, and thus maintenance-free operation.

### HP 5089A Specifications

#### Input Voltage

**AC charging:** 85 V to 130 V ac rms, 48 to 440 Hz, 300 VA max.  
85 V to 255 V ac rms, 48 to 66 Hz, 300 VA max.

**DC operation:** 11 V to 30 V dc, 110 W max.

**Output voltage:** 22 V to 28 V dc (nominal), 2 A maximum.

**Standby capacity:** 15 AH at +25°C when fully charged.

**Recharge:** complete recharge in 24 hours when operating from ac line.

**External low battery voltage alarm:** floating contact closure at rear-panel barrier block for external visible or audible "low battery" warning. Contact rating is 30 V dc at 2 amperes.

#### Operating Environment

**Temperature:** 0°C to 50°C.

**Humidity:** up to 95% at 40°C (with no internal condensation).

**Altitude:** 12,000 metres (40,000 feet).

#### Storage Environment

**Temperature:** -40°C to +65°C.

**Humidity:** up to 95% noncondensing.

**Altitude:** 15,000 metres (50,000 feet).

**Dimensions:** 177 mmH x 425 mmW x 416 mmD (7 in. x 16.7 in x 16.4 in).

**Weight:** net weight 30.5 kg (67 lb).

### Accessories Supplied

HP 05061-6091: AC Power Input Cable Assembly  
HP 05089-60102: DC Power Input Cable Assembly  
HP 05089-60101: DC Output Cable Assembly  
HP 5060-0169: Extender Board Assy (Dual 25 Pin)

### Ordering Information

	Price
HP 5089A Standby Power Supply	\$5800
Opt 001 Spare AI Board Assembly (HP 05089-60001)	+\$700
Opt 908 Rack Mounting Adapter Kit	+\$300
Opt 910 Extra Operating and Service Manual	+\$10



1. Accuracy  
2. Frequency

3. Frequency  
4. Accuracy

HP 5055A

The HP 5055A is a highly accurate frequency standard. It is designed to provide a stable and accurate frequency reference for a wide range of applications. The accuracy of the HP 5055A is maintained over a wide range of operating conditions, including temperature, humidity, and vibration.

The HP 5055A is a highly accurate frequency standard. It is designed to provide a stable and accurate frequency reference for a wide range of applications. The accuracy of the HP 5055A is maintained over a wide range of operating conditions, including temperature, humidity, and vibration.

**HP 5055A Specifications**

- Frequency: 10 MHz
- Accuracy:  $\pm 1 \times 10^{-11}$  (1 part in 100 billion)
- Stability:  $\pm 1 \times 10^{-11}$  (1 part in 100 billion)
- Temperature Coefficient:  $\pm 1 \times 10^{-11}$  (1 part in 100 billion)
- Vibration Coefficient:  $\pm 1 \times 10^{-11}$  (1 part in 100 billion)
- Humidity Coefficient:  $\pm 1 \times 10^{-11}$  (1 part in 100 billion)
- Power Consumption: 10 W
- Dimensions: 10 cm x 10 cm x 10 cm
- Weight: 1 kg
- Operating Temperature: 0°C to 50°C
- Storage Temperature: -40°C to 70°C
- Relative Humidity: 10% to 90%
- Vibration: 10 g

The HP 5055A is a highly accurate frequency standard. It is designed to provide a stable and accurate frequency reference for a wide range of applications. The accuracy of the HP 5055A is maintained over a wide range of operating conditions, including temperature, humidity, and vibration.

The HP 5055A is a highly accurate frequency standard. It is designed to provide a stable and accurate frequency reference for a wide range of applications. The accuracy of the HP 5055A is maintained over a wide range of operating conditions, including temperature, humidity, and vibration.

The HP 5055A is a highly accurate frequency standard. It is designed to provide a stable and accurate frequency reference for a wide range of applications. The accuracy of the HP 5055A is maintained over a wide range of operating conditions, including temperature, humidity, and vibration.

The HP 5055A is a highly accurate frequency standard. It is designed to provide a stable and accurate frequency reference for a wide range of applications. The accuracy of the HP 5055A is maintained over a wide range of operating conditions, including temperature, humidity, and vibration.

The HP 5055A is a highly accurate frequency standard. It is designed to provide a stable and accurate frequency reference for a wide range of applications. The accuracy of the HP 5055A is maintained over a wide range of operating conditions, including temperature, humidity, and vibration.



## TELECOM/DATACOM TEST

<b>Telecommunications</b>	
<b>Test Equipment.....</b>	<b>472</b>
<b>Data Communications</b>	
<b>Test Equipment.....</b>	<b>492</b>

Testing of data-communication and telecommunication equipment is significantly different from testing other equipment and devices. These measurement instruments often deal with specialized signal formats and may be standalone, portable or system. Therefore, we have separated the equipment for making these tests from the rest of the product groups. This group consists of the largely analog test equipment needed for telecommunication test, as well as the digital sources and analysis equipment needed for datacom test.

**Telecom/Datacom  
Test**

# TELECOMMUNICATIONS TEST EQUIPMENT

## Digital Communications Measurements

### Introduction

Digital networks have advanced rapidly from the early days when junction PCM systems were used to increase the capacity of trunks between local switching centers. The driving forces behind the ever-increasing deployment of digital transmission are still: the ability to regenerate a signal with no cumulative noise degradation and the simplicity of digital signal processing hardware. These benefits were realized originally in transmission and switching systems and are expanding steadily towards customer premises as the Integrated Digital Network (IDN) era ushers in new Integrated Services Digital Networks (ISDN).

New technology has resulted in new testing needs, and new services have brought about changes in existing test requirements.

### PCM Conversion Measurements

Today's IDNs are almost exclusively based on 64 kb/s PCM voice channels to one of two coding standards, CEPT A-law or Bell  $\mu$ -law, both of which are now standardized by the CCITT. These coding standards both use 8 kHz speech sampling and 8-bit PCM companding to achieve high quality digitized voice transmission through 64 kb/s circuit-switched digital exchanges. Circuits can also carry multiplexed low-speed or wideband high-speed data with the result that future networks will carry a mixture of voice and data services via digital transmission systems. At present, the majority of data carried by IDNs is "conventional" analog modulated data from modems at customers' premises which is then PCM encoded at the nearest serving exchange switching center. In addition to dial-up data circuits through digital switches, an increasing number of leased non-switched circuits are provided, at least in part, via PCM transmission systems between switching offices.

These developments have increased demand for measurements in the PCM signal of parameters affecting both voice and data

services. The key to testing circuits including PCM sections is the ability to measure PCM voice and analog data transmission performance at both analog and digital access points i.e. in a mixed analog/digital network. HP's 3776 PCM Terminal Test Set can make both PCM voice and analog data measurements in both analog and digital domains and can be connected to test ports of digital cross-connect switches.

The HP 3776 has also made significant advances in the field of PCM measuring technology by implementing most of the measurements using digital signal processing. This allows comprehensive measurement capability to be integrated into a smaller, lower cost, more portable package than previously possible. The HP 3776 can be used manually, or coupled with HP's computational products, when it becomes a powerful system component of automated remote access and test systems for monitoring and maintaining mixed analog/digital networks.

The HP 3779 Primary Multiplex Analyzer has a complementary focus. Its internal intelligence provides major benefits: an exceptionally friendly front panel, built-in automatic measurement sequencing with limit-testing, and channel scanner and printer control. The HP 3779 is therefore optimized for R&D, production test and commissioning of line cards and PCM multiplexers/channel banks.

### Digital Data Transmission

An alternative to using analog modems to transmit data to at least the local exchange is to provide end-to-end digital transmission facilities. Point-to-point services are available at low-speed "modem" rates of a few kb/s through 64 kb/s and beyond to rates of Mb/s and tens of Mb/s.

These systems offer high (often guaranteed) transmission quality and allow the end-user to be flexible in the mix of services carried on the links; they are the pre-cursors to full-blown ISDN systems.

Although digital systems are generally reliable, high quality digital data services demand the best network performance.

While the network is carrying traffic, in-service tests can provide the performance data to manage an effective preventive maintenance program, and can be invaluable in tracking down intermittent time- or traffic-related problems. Conversely, if there is a serious problem, comprehensive out-of-service tests are needed to locate the fault and diagnose the problem so that down-time is minimized.

The HP 3787B Digital Data Test Set operates on the North American digital hierarchy, at rates up to DS1C (3.152 Mb/s). It can make measurements on T1 leased circuits and on the lower speed Digital Data Services (DDS).

As a T1 tester, not only can it check the basic DS1 signal parameters both in-service and out-of-service, but also it has a built-in multiplexer/demultiplexer so it can extract and examine the data in each of the constituent timeslots.

This multiplexing capability is extended to testing in the DDS world, where the instrument can access at many points in the system, handling DS0A, DS0B and DS1 signals with equal ease. It can insert and extract test patterns and control codes into customer sub-rate streams and network datalinks to check each section of a complex network from virtually any access point.

This combination of the capabilities of several individual instruments makes it a powerful circuit-tracing and fault-finding tool for network maintenance, and a flexible component in manufacturing test applications.

### TDM Transmission Measurements

Digital transmission over cable, radio, satellite and, more recently, optical fiber is becoming an increasingly large proportion of inter-exchange and long haul transmission.

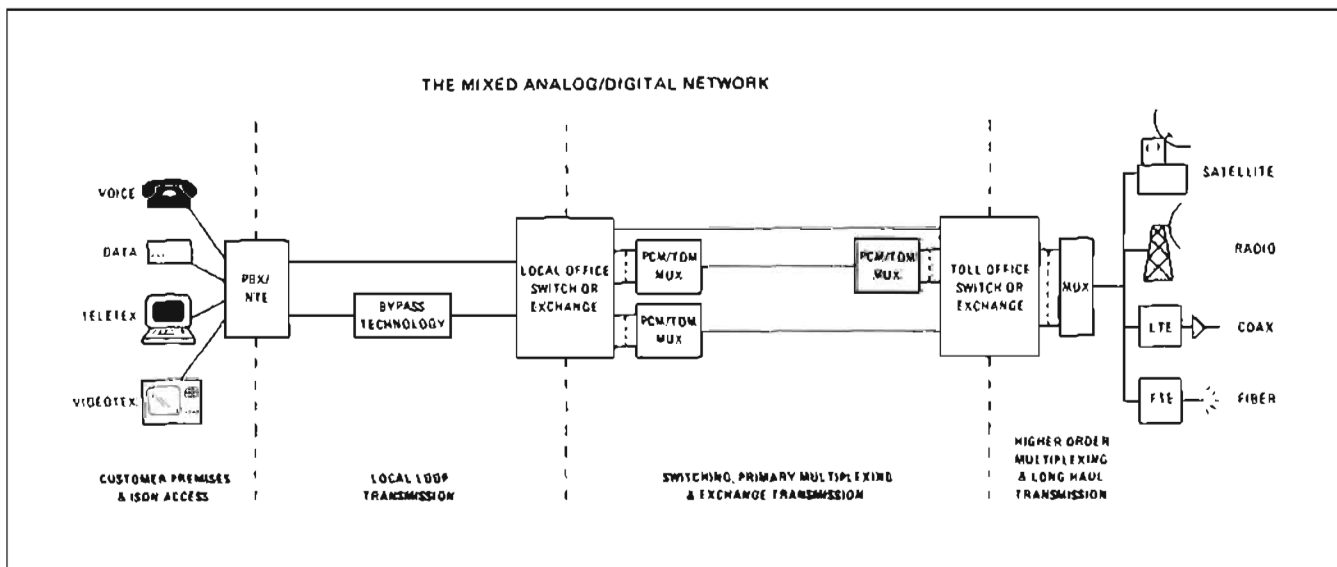

As IDNs evolve and other services are added into the ISDN concept, transmission measurements have shifted from basic measures of bit error ratio and peak-peak jitter towards more thorough analysis of systems in terms of error performance or distribution with time. There is an increasing emphasis on evaluating "availability" of digital circuits. This requires more powerful analysis capability to be built into test instrumentation and the possibility of collecting large amounts of data for evaluation off-line in computers. HP is uniquely placed with advanced measuring and computational technology to provide measurement solutions for these needs. A comprehensive range of error and jitter performance test equipment is now available covering bit rates from 1 kb/s to 170 Mb/s. Many special features are included for the principal IDN digital transmission hierarchies now standardized by the CCITT.

### CEPT Hierarchy

The CEPT digital hierarchy has four currently defined levels: 2, 8, 34 and 140 Mb/s. Higher capacity fiber optic based systems may eventually require a further interface standard at 565 Mb/s but for the moment, the 4 levels suffice for network interconnection and test. Fiber optics is also penetrating the junction network, expanding the requirements for testing at 34 Mb/s, and is making inroads into some segments of the local loop. Fiber systems operate with large distances between regenerators, so network jitter measurements are of less importance here, however the increasing demand for high capacity customer connections and high quality services has increased the requirement for error analysis - typically to CCITT recommendation G.821 which specifies the "error performance of an international digital connection forming part of an integrated services digital network".

The HP 3764A Digital Transmission Analyzer is available in a number of variants to cater for different testing needs: a 2, 8, 34 and 140 Mb/s BER version for general network test, a 140 Mb/s BER only version for high capacity trunk testing, and a 140 Mb/s BER and Jitter version for troubleshooting and manufacturing applications. A new option gives offset frequency operation at all rates.

All versions of the instrument provide G.821 error analysis and there is a choice of built-in printer or cassette for logging measurement and analysis results. Full HP-IB

control makes this instrument a powerful tool in automated production testing.

For testing on lower capacity systems, the HP 3780A Pattern Generator/Error Detector provides flexible operation at rates up to 50 Mb/s in a single package. The 3781A Pattern Generator and 3782A Error Detector give similar capability with a two box package which is useful in field trial testing or when multiple generators are needed to test load a system. It provides HP-IB control for system test applications.

### North American Hierarchy

The North American hierarchy has three levels: DS1 (1.544 Mb/s), DS2 (6.312 Mb/s) and DS3 (44.736 Mb/s). Higher capacity systems generally use DS3 or CEPT 139 Mb/s, as the interface standard.

As the network has evolved, DS3 has become the high capacity building block, while DS1 has become the local distribution unit. DS2 is little used as a transmission level, and current multiplex equipment translates directly from DS1 to DS3.

Many of the changes in testing philosophy in the USA have resulted from the divestiture of the Bell system. Carriers are now divided into exchange and inter-exchange (local and long-haul), and are not allowed to test on each other's premises.

A long haul carrier generally has responsibility for the end-to-end performance of a circuit, but has little control over the source traffic. Trouble-shooting even a simple fault over a LATA boundary is as much a matter of determining who is responsible as fixing the fault.

For testing at all three hierarchy levels, the HP 3781B Pattern generator and 3782B Error detector can interface and measure at DS1, DS2 and DS3. The two box configuration gives flexibility for end-to-end trials or for tests where multiple generators are required. These instruments have full HP-IB control for automated testing, and can talk directly to suitable printers for data logging of measurement results and analysis.

The new HP 3789 DS3 Transmission Test Set is available in two models - the HP 3789A has the basic pattern generation and error detection capability required for installation and network maintenance applications, and offers a one-box solution for applications where portability is important.

The HP 3789B is a more sophisticated set which can not only measure BER and Jitter on a DS3 signal but can extract and measure

BER and jitter on each of the component digroups. This solves the problem of locating where a fault arises in the network, as the source traffic in a DS3 stream can now be tested at any DS3 access point.

For further analysis, any DS1 stream can be demultiplexed and output to either the HP 3776 PCM Terminal Test Set or HP 3787B Digital Data Test Set for PCM voice frequency or digital channel measurements respectively.

So now inter-exchange carriers can test individual customer timeslots from anywhere in their networks.

### Jitter and Digital Networks

The increasing interest in and significance of timing jitter in digital networks has made this parameter of key importance in PCM/TDM measurements. This phenomenon has not been well understood until relatively recently, but is now recognized to be a major source of errors and other transmission impairments.

... HP offers a comprehensive range of jitter testing capability in the form of the stand alone HP 3785 Jitter Generator and Receiver, and also several instruments which combine BER and Jitter.

Manufacturers need both generation and measurement capability to allow them to stress test systems - in CEPT systems the HP 3785A caters for rates up to 34 Mb/s and the HP 3764A covers 140 Mb/s. In North America, the HP 3785B covers the DS1, DS2 and DS3 levels. Ease-of-use features such as built-in jitter tolerance mask sweeping, and full HP-IB control make these instruments powerful tools in production test and field trial applications.

Network operators are generally only interested in making jitter measurements - to ensure that cumulative jitter is less than the input jitter tolerance of network equipment, so the combination of BER and jitter measurement in one package gives them an effective test solution.

The HP 3764A covers this requirement at 140 Mb/s in the CEPT hierarchy.

For North American networks, the HP 3787B has optional DS1 jitter, and the HP 3789B can not only measure jitter directly on a DS3 signal, but can also measure the jitter on each of the component digroups.

Read on for a more detailed look at the comprehensive range of HP products for digital communications test applications.

# TELECOMMUNICATIONS TEST EQUIPMENT

## PCM Terminal Test Set, Primary Multiplex Analyzer, HP-IB Controlled Channel Selector

Models 3776A, 3776B, 3779C, 3779D, 3777A

### HP 3776A/B

- Network test of 4 kHz channels
- VF and 2/1.5 Mb/s Interface as standard
- Voice, PCM and data (option 001) measurements in one portable Instrument
- Direct output to printer or plotter
- Framing and signaling bits setting and monitoring



HP 3776A

### HP 3779C/D

- Manufacturing/R&D test of digital line cards/channel banks
- VF interface standard, 2/1.5 Mb/s interface optional
- Comprehensive PCM in-band and out-of-band measurements (to 40 kHz)
- Direct control of printer and channel selector
- HP 3779C tests multiplex alignment and alarm functions (D-A mode)

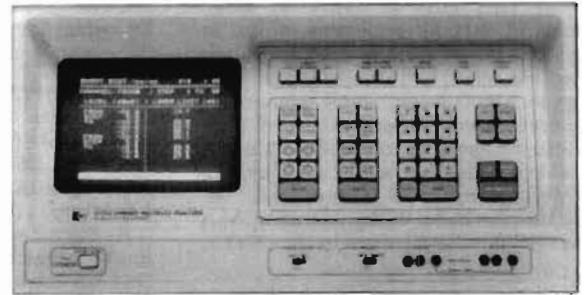

HP 3779C



### HP 3776A/B PCM Terminal Test Set

The HP 3776A is designed for CEPT/CCITT compatible networks. Model 3776B is designed for Bell/Japanese/CCITT compatible networks. Full information and specifications are contained in the data sheet and specification booklet.

- HP 3776A has 30/31 channel voice testing capability
- HP 3776B has Bell extended superframe (ESF) & B8ZS line coding capability

#### HP 3776A Options

**STD:** analog connections are Siemens 3-pin; digital are 120 ohm bal Siemens 3-pin and 75 ohm unbal BNC

**001:** adds data measurements

**002:** BNC connectors replaced with 75 ohm unbal Siemens

#### HP 3776B Options

**STD:** connectors are WECO 310 and Bantam jack

**001:** adds data measurements

**002:** Japanese measurements/connectors

**004:** all connectors Trompeter triaxial type BJ77 located on the rear panel

### HP 3777A Channel Selector

- DC to 110 kHz
- 2-wire/4-wire balanced switching
- Remote control only (HP-IB)

The HP 3777A is a 4-pole access switch for telecom applications. It may be configured as a single 4-wire switch or as two, independent, 2-wire switches. Channel capacity is arranged by adding standard modules. Unselected channels are switched to 600 ohm terminations.

#### HP 3777A Options

No. of Channels	Connectors	
	Siemens 3-Pin	WECO 310
6	Opt H07	Opt H16
12	Opt 002	Opt 003
18	Opt H13	Opt H17
24	Opt H14	Opt 001
30	Std	Opt H05

#### Ordering Information

**HP 3776A** PCM Terminal Test Set (CEPT)

**HP 3776B** PCM Terminal Test Set (Bell)

**HP 3777A** Channel Selector

#### Price

\$11,600

\$12,700

\$5,000

### HP 3779C/D Primary Multiplex Analyzer

The HP 3779C is designed for CEPT/CCITT compatible networks. Model 3779D is designed for Bell/Japanese/CCITT compatible networks. Full information and specifications are contained in the data sheet and specification booklet.

- Standard PMA provides A-A and E-E (end-to-end) measurements
- Options provide all measurement modes and a single-channel TTL-compatible interface for codec and line card testing

#### HP 3779C Options

**STD:** A-A and E-E; Siemens 3-pin

**001:** all modes; digital connectors 75 ohm unbal BNC

**002:** as 001 except digital connectors 75 ohm unbal Siemens

**003:** as 002 except PCM and co-directional clock connectors 120 ohm bal Siemens

#### 3779D Options

**STD:** A-A and E-E; WECO 310 connectors

**001:** all modes; digital connectors WECO 310

**002:** digital option is Mu-law at 2 Mb/s via single channel interface only

**003:** as option 001 except digital connectors 75 ohm unbal BNC

#### Accessories

**HP 15518A/B/C:** dual-port loop-holding accessory for HP 3776A/B/B opt 002

**HP 15515B:** loop-holding unit, 24 mA current sink; WECO connectors

**HP 15512A:** 1m length 600 ohm bal cable; Siemens 3-pin connector both ends

**HP 15513A:** 1m length 600 ohm bal cable; WECO 310 jack plug both ends

#### Ordering Information

**HP 3779C** Primary Multiplex Analyzer (CEPT)

**HP 3779D** Primary Multiplex Analyzer (Bell)

**HP 15512A** Cable

**HP 15513A** Cable

**HP 15515B** Loop Holding Unit

**HP 15518A/B/C** Loop Holding Accessory

#### Price

\$22,200

\$22,200

\$75

\$60

\$290

Each \$430

# TELECOMMUNICATIONS TEST EQUIPMENT

475

## Dedicated PCM/TDM Error Measuring Sets

Models 3781A, 3782A, 3781B, 3782B

### HP 3781A/B

- Versatile selection of test patterns
- Internal jitter modulation
- Additional delayed data output

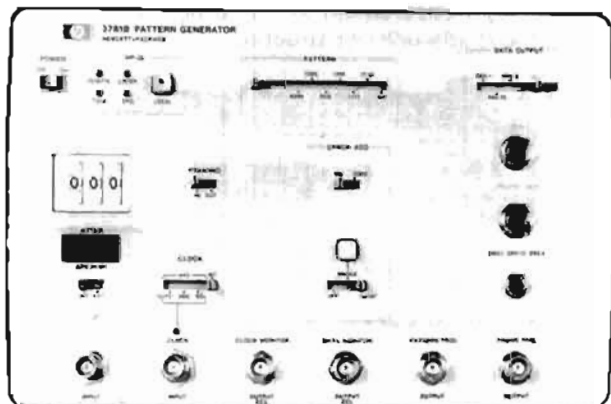

HP 3781B

### HP 3782A/B

- Binary and code error measurements
- Error ratio, error count, error seconds and error-free seconds displayed
- Powerful error distribution analysis

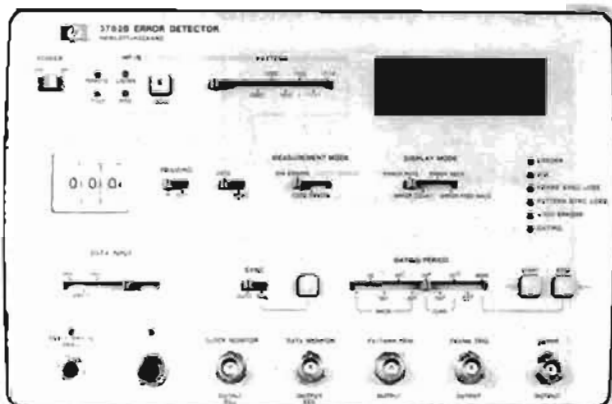

HP 3782B



The HP 3781A Pattern Generator and HP 3782A Error Detector form a high performance error measuring system which complements the existing HP 3780A Pattern Generator/Error Detector. Designed to conform with CEPT and CCITT standards, the HP 3781A/3782A provide four bit rates (up to 50 Mb/s) of the digital hierarchy in one compact system. Applications of the system are in R&D, field trial and production testing, especially where an automatic and remote measurement capability via the HP-IB is required.

In the HP 3781A, binary or code errors can be injected as single shot or at  $10^{-3}$  or  $10^{-5}$  rates into a wide range of PRBS and 16-bit WORD test patterns coded in AMI or HDB3. The test patterns provided include standard  $2^9-1$ ,  $2^{15}-1$ , and  $2^{23}-1$  bit PRBS to CCITT Recommendations, fully programmable 16-bit WORD, and two 8-bit WORDS which may be alternated under the control of an external signal. Zero substitution (up to 120 zeros) for PRBS patterns is included to examine, for example, the clock recovery performance of regenerators. 75  $\Omega$  unbalanced and 120  $\Omega$  balanced pseudo-ternary outputs and binary TTL monitor outputs are provided. A jitter modulation input facility is provided for simple oscillator connection, with direct LED display of pk-pk bits of jitter. This can be used to measure the input jitter tolerance of digital transmission equipment. A second data output with 12 bits delay provides adequate simulation of an independent sequence for thorough testing of 4 $\phi$ PSK digital radio systems. As an option, four extra data outputs coded in AMI or HDB3 can be included on the rear panel for driving adjacent radio channels.

The HP 3782A detects binary or code errors which can be displayed in the form of error ratio, error count, error seconds, and error-free seconds over a wide choice of gating periods. All four results are computed simultaneously over the same gating period. For ease of use there is a built-in automatic check for compatibility of switch position combinations. An error code flashes on the display if incompatibility is detected. When the monitor mode is used, the HP 3782A can be used for in-service monitoring of digital transmission links.

Measurement results are available on the HP-IB and a rear panel result threshold switch allows pre-selection of an error threshold above which results will be printed. This provides useful data reduction and a first order error distribution analysis. With a built-in real-time clock, results can be output with time, if required.

The HP 3781B Pattern Generator and HP 3782B Error Detector form a dedicated error measurement system for testing and evaluating the performance of Bell digital transmission terminal and link equipment, up to and including the DS-3 level in the digital hierarchy. The HP 3781B/3782B can be used in production testing, field installation, and maintenance of the Bell digital transmission system, including PCM/TDM transmission over cable, radio, satellite, and fibre optic links. The principal application is at the DS-3 level in the Bell digital hierarchy.

The HP 3781B/3782B are designed to interface at Bell System standard cross connect points with appropriate ternary coding and interface voltage levels at each hierarchical level. Interfacing at the DS-1C and DS-2 levels is limited to T1-C and T2 line systems. At the DS-3 level, a choice of four data formats is available. Alternatively, binary ECL interfaces can be used.

The HP 3781B Pattern Generator provides a selection of standard  $2^9-1$ ,  $2^{15}-1$ , and  $2^{20}-1$  bit PRBS and fixed WORD test patterns with a choice of single error or 1 in  $10^5$  error simulation on the digital data stream for normal measurements and troubleshooting. A pattern of 17 ones/15 zeros and zero substitution (up to 999 zeros) for PRBS patterns are included to examine phase sensitive circuitry such as clock recovery of regenerators. A jitter modulation input facility is provided for simple oscillator connection, with direct LED display of pk-pk bits of jitter. This can be used to measure the input jitter tolerance of digital transmission equipment. A second DS-3 output channel with 22 bits delay provides adequate simulation of an independent sequence for thorough testing of 4 $\phi$  PSK digital radio systems. As an optional extra, four DSX-3 BNC outputs on the rear panel can be included for driving adjacent radio channels.

The HP 3782B Error Detector detects any binary or code errors generated by the system under test. At the DS-3 level, it can perform in-service or out-of-service measurements of parity errors within the digital transmission system. The HP 3782B can measure simultaneously error rate, error count, error seconds, and error free seconds over a single gating period. When the DS-3 MON facility is used, in-service measurements (eg parity errors) of live traffic are possible. For ease of use, there is a built-in automatic check for compatibility of switch position combinations. An error code flashes on the display if incompatibility is detected. Hard copies of results can be obtained on a printer via HP-IB control, either in the "talk-only" or "addressable" modes. In addition, a preselectable error rate threshold and a real time clock allows selection for printing results which exceed a defined threshold (with local time, if required).

### Ordering Information

HP 3781A Pattern Generator  
HP 3782A Error Detector

### Price

\$8,068  
\$7,371

### Ordering Information

HP 3781B Pattern Generator  
HP 3782B Error Detector

### Price

\$8,662  
\$8,068

# TELECOMMUNICATIONS TEST EQUIPMENT

## PCM/TDM Error Measuring Set & Digital Transmission Analyzer

Models 3780A, 3764A

### HP 3780A

- Easy-to-use portable unit
- Binary and code error measurements
- Clock frequency offset generation and measurement
- Ternary coded and binary interfaces
- Data logging and graphs to external printer



HP 3780A  
Option 001

### HP 3780A Pattern Generator/Error Detector

The HP 3780A Pattern Generator/Error Detection is a Comprehensive error measuring set in one portable package for use in manufacturing, field trials, commissioning and maintenance of digital transmission terminal and link equipment.

The instrument measures binary errors and code errors in digital transmission equipment operating at rates between 1 kb/s and 50 Mb/s. Frequency offset generation and measurement are provided at the standard PCM/TDM transmission rates.

A range of standard PRBS test patterns and automatic pattern recognition/synchronisation are provided for simple performance checks. It also has flexible WORD generation and zero substitution to explore regenerator timing recovery performance and detect systematic errors.

Binary clock and data or ternary coded data interfaces can be selected with automatic equalisation at 2, 8 and 34 Mb/s on the Receiver.

Results are displayed as error COUNT or BER over a range of gating periods, and can be logged or presented graphically on an external printer.

#### Ordering Information

**HP 3780A Standard:** internal fixed rates of 2048, 8448 & 1536 kb/s; HDB3/HDB2 ternary coding. **Price** \$8,200

**Option 232:** RS-232 printer port replaces BCD printer and plotter outputs. **Price** NC

#### Frequency/Ternary coding Options

**Option 100:** internal fixed rates of 2048, 8448 & 34368 kb/s; HDB3/HDB2 ternary coding. **Price** \$235

**Option 101:** internal fixed rates of 1544, 6312 & 44736 kb/s; B6ZS/B3ZS ternary coding. **Price** NC

**Option 102:** internal fixed rates of 1544, 6312 & 3152 kb/s; B6ZS/B3ZS ternary coding. **Price** NC

**Option 103:** internal fixed rates of 2048, 8448 & 34368 kb/s; 2 23-1 PRBS replaces 2 9-1; HDB3 ternary coding. **Price** \$550

**Option 104:** as option 103 but with Siemens 1.6 mm connectors. **Price** \$600

#### Frequency Offset Option

**Option 099:** frequency offset measurement only, frequency offset generation deleted. **Price** -\$165

#### Word/Connector Options

**Option 001:** all words replaced by a 16 bit front panel programmable word. **Price** \$230

**Option 002:** Siemens 1.6 mm connectors. **Price** \$85

**Option 003:** options 001 and 002 combined. **Price** \$290

### HP 3764A

- Error analysis at 2, 8, 34 & 139 Mbit/s based on latest G.821 Recommendation or error & jitter measurement and analysis at 139 Mbit/s only
- Powerful data logging facilities
- Single key measurement set-up using preset memory
- Portable single-unit construction



HP 3764A



### HP 3764A Digital Transmission Analyzer

The HP 3764A Digital Transmission Analyzer is available in three versions. The standard instrument offers a low-cost solution to users who want to perform error measurements at 139 Mbit/s only. The option 001 instrument is a multirate error analyzer in a single, rugged, low-weight case particularly suited to field installation and maintenance applications. The option 002 instrument performs a full set of bit error and jitter measurements at 139 Mbit/s to match development or manufacturing requirements.

#### Specifications Summary

##### Generator Section

**Clocks:** Standard & Opt 002, 139.264 MHz with fixed frequency offsets; Opt 001, 139.264, 34.368, 8.448 & 2.048 MHz, with fixed frequency offsets available as Opt 005.

**Data outputs:** CMI format at 139 Mbit/s; HDB3 format at 34, 8 & 2 Mbit/s; binary-RZ from 1 to 150 Mbit/s, NRZ from 1 to 170 Mbit/s (using external clock source), ECL levels, 75 ohm unbalanced.

**Data patterns:** PRBS  $2^{15}-1$  and  $2^{23}-1$ ; word, programmable 16-bit or two alternating 8-bit words; errors, single error or fixed  $1 \times 10^{-3}$  rate.

##### Receiver Section

**Recovered clock:** 139.264 Mbit/s  $\pm$  3 Mbit/s; 34, 8, 2 Mbit/s  $\pm$  100 ppm.

**Binary clock:** 1 kHz to 170 MHz.

**Data inputs:** 75 ohm terminated; monitor (25 dB additional gain); binary, RZ or NRZ, ECL levels.

**Error analysis:** Error count, error ratio, error seconds, error-free seconds, % unavailability, % errored seconds, % severely-errored seconds, % degraded minutes. All measurements made simultaneously and in accordance with Recommendation G.821.

**Jitter analysis:** Peak-to-Peak, hit count, hit seconds, hit-free seconds. Further analysis possible using internal jitter filters and demodulated jitter output.

**Internal printer:** Any combination of analysis parameters can be selected for printing.

#### Ordering Information

**HP 3764A Standard:** Error analysis at 139 Mbit/s. **Price** \$10,400

**Option 003:** Standard with 3 additional delayed outputs. **Price** \$800

**Option 002:** Error & jitter analysis at 139 Mbit/s. **Price** \$2,800

**Option 001:** Error analysis at 2, 8, 34 & 139 Mbit/s. **Price** \$820

**Option 005:** Multirate fixed-frequency offsets for Option 001. **Price** \$1,400

**Option 010:** Tape cartridge unit replaces the printer. **Price** NC

# TELECOMMUNICATIONS TEST EQUIPMENT

## Dedicated PCM/TDM Jitter Generator and Receiver

### Models 3785A, 3785B

477

- Jitter generation and measurement on data and clock
- Jitter specifications designed to CCITT recommendation 0.171
- Transient-free sweeping of internal CCITT defined jitter tolerance masks

- Single portable unit for up to 4 internal bit rates
- Built-in measurement filters to CCITT recommendations
- Comprehensive jitter analysis against real-time and jitter amplitude

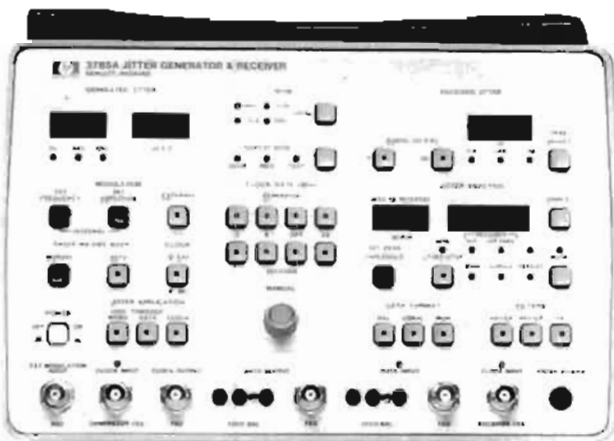

HP 3785A (2048, 8448, 34368 and, optionally, 25776 kHz)  
CEPT

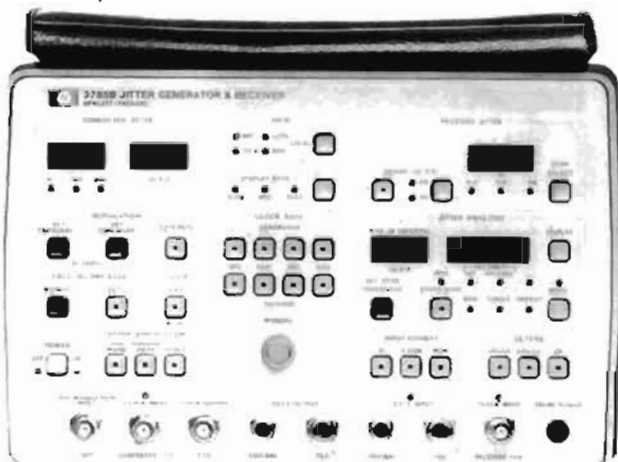

HP 3785B (DS-1, DS-1C, DS-2 and DS-3)  
Bell



The HP 3785A/B Jitter Generator and Receiver is a dedicated jitter measurement system for testing and evaluating the performance of CEPT or Bell digital transmission terminal and link equipment up to and including the third level (34368 kb/s or DS-3) in the digital hierarchy. The HP 3785A/B can be used in production testing, field installation and maintenance of the CEPT or Bell digital transmission system including PCM/TDM transmission over cable, radio, satellite, and fiber optic links. The principal application is thorough testing to current CCITT Recommendations at each level in the digital hierarchy.

In addition to providing a comprehensive measurement capability which includes in-service jitter measurements, the microprocessor-controlled Jitter Generator and Receiver is easy to use with ergonomic layout of switches and connectors on the front panel. The instrument is designed to interface fully with the HP-IB, allowing bus-controlled operation and automatic measurement sequencing.

The Jitter Generator may be used to phase modulate an internally provided crystal clock, an externally applied clock (at a nominal digital hierarchy bit rate) or an externally applied data stream. Sinusoidal modulation is provided by an internal synthesizer whose amplitude and frequency can be set manually or swept, transient-free, through a CCITT shaped jitter tolerance mask programmed into the instrument. Alternatively, external modulating signals can be applied. The amplitude of generated jitter in unit intervals (U.I.) pk-pk and the frequency of internal modulation are in accordance with CCITT Recommendation 0.171 and are displayed on the front panel.

The modulated clock output can be applied to an external pattern generator such as the HP 3780A, 3762A, 3781A or 3782B. For jitter transfer function measurements, the CCITT standard 1000 repetitive pattern is provided within the HP 3785A/B. In addition, for demultiplexer jitter transfer function, jitter can be applied to an externally applied data stream which has the necessary framing and justification digits. Consult the data sheet for full technical specifications.

Consult the data sheet for full technical specifications.

#### Measurements

The Jitter Receiver offers six types of measurement:

- Absolute jitter amplitude in U.I. pk-pk
- Jitter peak, positive or negative
- Jitter hit count of the number of times received jitter exceeds a user-defined hit threshold in U.I. pk

- Jitter hit seconds count of the number of seconds in which one or more jitter hits occur
- Jitter hit-free seconds count of the number of seconds which are free of jitter hits
- Maximum absolute jitter amplitude in U.I. pk-pk is held during the jitter analysis gating period

Simultaneous measurement of all six parameters is possible with result display selection. In addition, the Receiver has a built-in interval timer and real-time clock to allow measurements of jitter distribution against time to be made.

The measurements can be made on clock or data inputs with or without internal filtering. Two high pass filters and one low pass filter as specified by CCITT are provided for each of the four bit rates. In addition, external filters can be connected between the demodulated jitter output and the measuring circuitry input. The demodulated jitter output can also be used to measure rms jitter amplitude on an external voltmeter or to display jitter spectrum on an external analyzer.

The clock reference for the jitter measurements can be internally derived from the applied data or clock via a narrow band phase-locked loop or externally derived from an applied reference.

The data input allows out-of-service or in-service measurements. The MON facility for in-service measurements has built-in additional gain to compensate for the flat loss at the protected monitor points.

#### HP-IB Operation

The capabilities of the HP 3785A/B can be enhanced by using the HP-IB to provide remote operation and automatic sequencing of results.

The HP-IB facility offers several principal features:

- Remote control of front panel switches and pushbuttons using programming codes
- Control codes which are set to default values on power-on and can be user-defined with the controller
- The ability to transfer all desired switch positions and masks onto a tape memory and reloaded back onto the instrument at a later time
- Output of the result data to a printer (eg HP Thinkjet Printer) or storage memory

#### Ordering Information

HP 3785A Jitter Generator and Receiver (CEPT)

HP 3785B Jitter Generator and Receiver (Bell)

#### Price

\$13,538

\$15,930

# TELECOMMUNICATIONS TEST EQUIPMENT

## DS3 Transmission Test Sets

Models 3789A/B

### 3789A

- Binary bit-by-bit error detection
- Parity, Frame and BPV error measurements
- Error analysis to latest recommendations
- Portable, single-unit construction
- Single-key measurement setup using preset memory
- Integrated access switch controller



HP 3789A  
RS-232-C

### 3789B

- Built-in DS3 to DS1 demultiplexer (B only)
- Error & Jitter tests at DS1 & DS3 (B only)
- External Events and Voltages monitor Inputs
- Optional DC operation from station batteries
- Full remote control via HP-IB and RS-232-C
- Optional built-in data logger

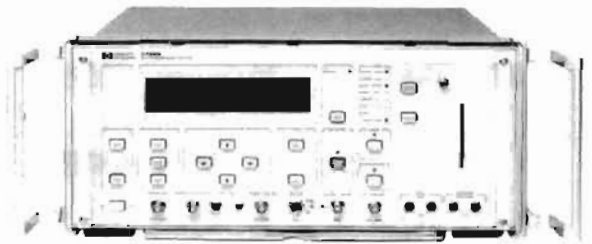

HP 3789B  
RS-232-C



### HP 3789A/B DS3 Transmission Test Set

The HP 3789A and HP 3789B are new DS3 test sets which provide the user with a choice of how best to satisfy all of his main test requirements with one integrated instrument.

#### Applications

- System turn up checks
- Routine testing of trunks
- Fault sectionalization
- Identifying fault mechanisms
- Preventive maintenance
- Service quality verification
- Outage detection & isolation
- Trouble referral verification
- Equipment & route assessment
- Longterm performance monitoring

The HP 3789A has all the basic pattern generation and error measurement capability required for the installation, commissioning and maintenance of DS3 transmission systems. The integrated package is easy-to-use manually and has HP-IB and RS-232-C ports for automated test and remote monitoring applications. A built-in access switch controller to select from a number of DS3 inputs is included as standard. Its capability can be extended with an optional built-in printer and 24/48 volt DC operation.

The HP 3789B is a more powerful and sophisticated test set which offers extraordinary troubleshooting capability. It has all the power of the HP 3789A but in addition it has a built-in demultiplexer which allows it to perform measurements on both DS1 and DS3 signals from a DS3 access point. Optional enhancements include: jitter measurements at DS1 and DS3; the ability to perform and display any two measurements simultaneously; DC operation from 24/48 volt station batteries; and a choice of built-in printer or disc drive for data logging.

Specification Summary (for both the A & B models except as noted)

#### Measurements

**DS3 Errors:** Bit, Frame, Parity and Code (BPV) in the form of Error Count, Error Ratio, Error Secs/Free Secs.

**DS3 Analysis:** %Availability, %Unavailability, %Error Secs, %Degraded Mins. These can be configured to give numeric results or Pass/Fail results for go/no go tests.

**DS3 Jitter (HP 3789B only):** Jitter Hit Count, Hit Bit Count, Hit Bit Ratio, Hit Second/Hit Free Second Count, Maximum Peak Amplitude.

**DS1 Errors (HP 3789B only):** Bit, Frame, CRC (Extended Superframe Format only)

**DS1 Jitter (HP 3789B only):** Max pk-pk, max positive peak, max negative peak, jitter hit count.

**Error Bursts:** The number of bursts with > 100 errors is counted.

**Error Second Distribution:** Error Seconds containing 1 error, 2 to 10 errors and > 10 errors are counted. The total for each group is counted.

#### Generator

**Data Outputs:** Six fixed-level outputs are provided. *Framing:* On or off, selectable.

**Patterns:** PRBS: 2<sup>15</sup>-1; WORD: 8 bit programmable; Blue Signal Clock: Internal: 44.736 MHz ± 20ppm; External: 44.736 MHz ± 2%

#### Receiver

**Data Input:** Line Code: B3ZS; Rate: 44.736 MHz ± 30ppm; Levels: DS3 Hi; DSX-3; DS3 Lo; DSX-3 Lo; 900'; 900' Lo.

**DS1 Output (HP 3789B Only):** This output provides a selected DS1 digroup signal demultiplexed by the HP 3789B from the input DS3 signal which may be further demultiplexed by external equipment for testing at lower rates. Both WECO 310 and bantam jacks are provided.

**Level/Impedance/Shape:** As per Bell Capability Bulletin No. 119 for the DS1 crossconnect.

**Coding:** AMI or B8ZS selectable

#### External Control

Both HP-IB and RS-232-C ports are fitted as standard. Either can be used to control the HP 3789A/B remotely and to dump measurement results to an external printer.

#### General

**Power Supply:** AC: 90 to 126V and 196 to 253V; 48 to 66 Hz; approx 175 watts consumption. DC: -22V to -57V (with option 005); approx 210 watts consumption.

**Dimensions:** 191mm high; 426mm wide; 559mm deep (7.5 × 16.75 × 22 ins.)

**Net Weight:** 16kg (35lb) approx depending on option structure

**Operating Temperature:** 0° to +50°C

**Storage Temperature:** -40° to +75°C

#### Ordering Information

**HP 3789A:** The standard package consists of receiver; generator with 6 O/P's; both HP-IB and RS-232-C ports fitted; real-time clock; WECO 560A type connectors fitted to Rx and Tx; integral access switch controller. For additional capability select from the following:

Option 005: Built-in operation from 24/48V DC supplies	\$850
Option 010: 24-col built-in printer	\$550
Option 100: WECO 477 type connectors on the Tx and Rx	\$0
Option 200: BNC connectors on the Tx and Rx	\$0
Option 908: 19-inch rack mount	\$40

#### HP 3789B

The standard package consists of receiver; generator with 6 O/P's; built-in demultiplexer to DS1; DS1 output port; both HP-IB and RS-232-C ports fitted; real-time clock; WECO 560A type connectors fitted to Rx and Tx; integral access switch controller. For additional capability select from the following:

Option 003: 2nd measurement capability (including jitter measurements at DS1 and DS3)	
Option 005: Built-in operation from 24/48V DC supplies	\$850
Option 010*: 24-col built-in printer	\$550
Option 011*: Built-in 3.5-inch disc drive	\$700
Option 100: WECO 477 type connectors on the Tx and Rx	\$0
Option 200: BNC connectors on the Tx and Rx	\$0
Option 908: 19-inch rack mount	\$40

\*NOTE: Options 010 and 011 are mutually exclusive. HP 3789B

**HP 3789A DS3 Transmission Test Set** \$8,300

**HP 3789B DS3 Transmission Test Set** \$11,200



# TELECOMMUNICATIONS TEST EQUIPMENT

A total Solution for Digital Data Services and Equipment Testing

Model 3787B

479

- Comprehensive bit error measurements and analysis at DS1C, DS1, DS0 and DDS Interfaces.
- Sub-rate drop and Insert capability.

- Built-in data logging capability.
- DS1 Jitter analysis.

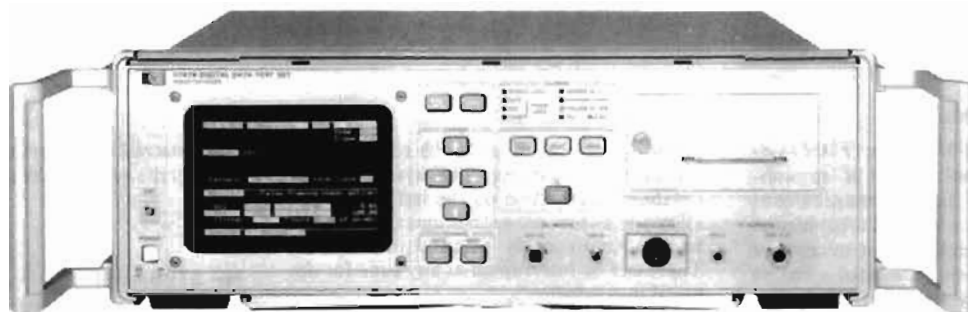

HP 3787B

RS-232-C



## HP 3787B Digital Data Test Set

### Description

The HP 3787B Digital Data Test Set is a Bit Error Rate Tester (BERT) designed for use on T1 leased, Digital Data System (DDS), 56kbit/s switched and Packet Switched services transmission line and multiplexing equipment.

Digital data circuits are sold with a guaranteed Quality-of-Service (eg DDS circuits offer >99.5% Error Free Seconds in a 24 hour period and 99.95% Availability). To maintain this high quality of service, Service Providers need test equipment that will provide in-service network monitoring and fast out-of-service testing.

The HP 3787B has a comprehensive range of in-service features (eg. Frame, CRC, BPV and Jitter analysis, alarm monitoring, internal printer for data logging etc) which maximizes circuit availability by detecting circuit deteriorations and intermittents, before they seriously affect the service.

The HP 3787B also provides comprehensive out-of-service features (eg Logic (binary) test patterns, full range of T1/DDS loopback codes etc) which are used to provide qualitative results for circuit troubleshooting and end-to-end test results which relate to actual in-service performance.

### Who needs an HP 3787B?

If you are involved in manufacturing, installing, commissioning or maintaining combined DS1/1C/DDS systems you have the problem of buying test gear to match your test requirements. You need DS1/1C testers, DDS testers and DS1/1C channel access equipment etc.

The HP 3787B solves this problem by satisfying all of these test requirements and more in a single unit. The combination of three test sets in one is not the end of our total solution - we also have a built-in printer, many methods for presenting the error information (e.g. Count, BER, ES, EFS etc) and error analysis (e.g. % Availability, %EFS, %Severely Errored Seconds etc).

### Ease of Use

With so many measurements in one instrument you might think the HP 3787B difficult to use. This is far from the truth - using a CRT and intelligent cursor you can use the HP 3787B after minimal training. Each decision is made in order of importance - you can only make sensible choices. After each choice the screen updates less important fields to guide the user. The HP 3787B tries to help the user and will not hassle the user with difficult error messages.

### Specifications

For details, ask your local HP sales Office for an HP 3787B data sheet and specification booklet.

### Drop and Insert

If the Transmitter/receiver signal is suitably framed (eg a DS1 ESF signal), test patterns or control codes can be inserted to/extracted from the following.

An individual customer timeslot (64k and 56kbit/s).  
DDS 2.4k, 4.8k, 9.6k and 56 kbit/s primary and secondary channels (DS0A and DS0B).  
4kbit/s Datalink (DS1 ESF).  
4kbit/s Fs channel (DS1 Ft).  
8kbit/s R-channel (DS1 T1DM).

### Measurement Capability

**Operating Frequency:** DS0 (64kbit/s), DS1 (1.544Mbit/s), DS1C (3.152Mbit/s).

**Framing:** DS1 (SF, ESF, T1DM and Ft only), DS1C and DS0B.

**Line Code:** B8ZS, AMI.

**Error Types:** Logic (Binary), Bipolar Violations, Frame Word, CRC-6 Word.

**Error Results:** Error Count, Error Ratio, Error Seconds, Error Free Seconds, % Error Free Seconds.

**Error Analysis:** % Availability, % Unavailability, % Severely Errored Seconds, % Error Seconds, % Degraded Minutes.

**Alarm Seconds:** Instrument Power Loss Seconds, Signal Loss Seconds, AIS Loss Seconds, Frame Loss Seconds (ie DS1C, DS1 or DS0B), Test Pattern Loss Seconds.

**DS1/DS1C Signal Voltage:** Positive and Negative peak voltage displayed.

**DS0 Bit Monitor:** Selected received customer bytes displayed.

**Signalling Bits:** A,B (SF) or A,B,C,D (ESF) signalling bits can be set and displayed when 56kbit/s circuit switched is selected.

### DS1 Jitter (Option 001)

**Peak-to-Peak Jitter:** Range 0.00 to 10.00 Unit Intervals (UI) pk-to-pk, in 0.01 UI steps.

**Jitter Filters:** LP=2Hz to 40kHz, HP1+LP=10Hz to 40kHz, HP2+LP=8kHz to 40kHz.

**Jitter Threshold:** 0.05 to 10.00 UI pk-to-pk in 0.01 UI pk-to-pk increments.

**Jitter Hit Measurements:** Jitter Hit Count, Jitter Hit Bit Count, Jitter Hit Bit Ratio, Jitter Hit seconds, Jitter Hit Free Seconds.

### HP 3787B Options

	Prices
001: DS1 Jitter.	\$800
002: DC Capability.	\$500
009: 19-inch Rackmount.	\$150
910: Extra Operating and Service Manuals.	\$100
W30: Extended Warranty - two further years (total 3 years).	\$160

### Accessories available

HP 15668A: Front Panel DDS Clock Cable.	\$125
HP 15669A: Rear Panel DDS Clock Cable.	\$125

### Ordering Information

HP 3787B Digital Data Test Set.	\$8000
---------------------------------	--------

# TELECOMMUNICATIONS TEST EQUIPMENT

## General Information: Radio and FDM Carrier System Testing

### FDM Measurements

Frequency Division Multiplex (FDM) systems are the traditional method of transmitting a number of telecommunications channels over a single wideband transmission medium such as coaxial cable or microwave radio, each channel being allocated a unique part of the frequency spectrum. In narrow satellite or radio channels there might be only 12 or 24 telephone channels, whereas in a high capacity 12 MHz or 18 MHz system 2700 or 3600 channels can be transmitted simultaneously.

Hewlett-Packard supplies a comprehensive range of manual and automatic test equipment, summarized in the table below, for FDM baseband, microwave radio and satellite systems. The HP 3586A/B Selective Level Meter (SLM) and its companion Synthesizer/Level Generator the HP 3336A/B are specifically designed for manual measurements in manufacturing installation and maintenance. Both instruments incorporate synthesizer tuning for stability and resolution and provide absolute level accuracy of  $\pm 0.2$  dB (SLM) and  $\pm 0.15$  dB (Generator). The HP 3586A/3336A combination is optimized for testing to CCITT standards and the HP 3586B/3336B to Bell or North American standards. Both HP 3586A/B and HP 3336A/B are HP-IB programmable.

The HP 3746A SLMS, developed from the HP 3586A/B, has been optimized for FDM maintenance measurements, particularly in automatic network monitoring systems.

The performance objectives for present day networks and customer expectations (particularly business customers and data users) demand rapid fault location and analysis of system degradation. Hewlett-Packard offers two automatic FDM network monitoring systems designed around the HP 3746A SLMS: the HP 37051S based on the HP 9000 series 300 computer and the HP 37050S system based on the HP 1000 A-series computer. The 37051S is a low-cost measurement system for smaller networks

providing control of up to 10 remote measurement subsystems. The system stores database information on the test points and allows an automatic measurement routine to be run continuously using sequence files. These can be interrupted at any time for demand measurements.

The HP 37050S system has all of these features and in addition can control up to 16 remote subsystems per computer. It provides comprehensive data reduction and results reporting - for the larger system this is essential. The computer utilizes powerful Real-Time Executive (RTE) operating system software, so (unlike the HP 37051S) can provide simultaneous measurements at multiple sites and support several users at local or remote terminals. The HP 37050S can be readily extended to cover a very large network by linking computers using distributed system software.

### Analog Radio Measurements

"Traditional" radio measurements divide into two categories: IF/RF transmission measurements and qualitative baseband measurements.

The HP 3711A/3712A Microwave Link Analyzer provides a comprehensive set of transmission measurements at 70/140 MHz IF. These measurements can be extended to RF interface points with the HP 8350B Up Conversion Simulator and the HP 3730B Down Converter.

Baseband qualitative measurements such as white-noise testing can be performed at IF interface points by using the HP 3717A 70 MHz Modulator/Demodulator.

### Digital Radio Measurements

Some analog radio measurements are suitable for digital radio systems, but specific dedicated measurements are also required to fully characterize digital radio performance. For example, the evaluation of Bit Error Ratio (BER) performance under flat-fade conditions and at residual noise levels.

New techniques are now available to allow in-service performance evaluation: Constellation analysis provides detailed information

about overall radio performance at a glance, without the need to take the radio out of service.

### HP 3708A

The overall performance measure of any digital transmission system is BER. A radio is subject to sources of error such as fading phenomena which decrease the system C/N ratio, and reduce the BER performance. The HP 3708A Noise and Interference Test Set is designed to accurately and easily set up C/N conditions to allow C/N vs BER measurements to be performed. In addition to C/N testing, the HP 3708A provides a fast alternative technique for measuring the BER performance of a radio at residual noise levels, based on the Carrier-to-Interference (C/I) test. The HP 3708A also has direct application in satellite modems and other areas. This instrument is simple to operate, and allows fast, easy, and accurate characterization of radio systems, all in one portable package.

### HP 3709B

The HP 3709B Constellation Analyzer uses constellation pattern analysis to detect and isolate small distortions in a radio which cause higher than expected BER during a fade. The HP 3709B is simple to operate with dedicated gratitudes and an automatic timebase. A guide to typical impairments is provided with each instrument. In addition to displaying patterns, the HP 3709B can measure the total and individual distortions shown on the constellation pattern. Measurements include: closure, lock angle error, quad angle error, non-linearity and eye reduction. The constellation pattern and associated measurement data can be dumped to a ThinkJet printer to provide a hardcopy record of radio performance. For more detailed testing using constellation pattern analysis, the data from the HP 3709B can be transferred over HP-IB to a computer.

		MAINTENANCE/ MONITORING	INSTALLATION	MANUFACTURE
FDM Measurements	Manual	HP 3586A/B, 3746A	HP 3586A/B, 3336A/B	HP 3586A/B, 3336A/B
	Automatic	3746A	3746A 3336A/B	-
	Surveillance	HP 37050S, 37051S	-	-

# TELECOMMUNICATIONS TEST EQUIPMENT

## Selective Level Measuring Set, Access/Distribution Switches

Models 3746A, 3754A, 3755A, 3756A, 3757A

481

### HP 3746A

- Fast, accurate measurements on frequency division multiplex (FDM) systems
- Selective filters for pilot, channel and (optionally) group power and weighted noise measurements
- Automatic tuning to stored frequency plans with comparison of measured level to stored limits

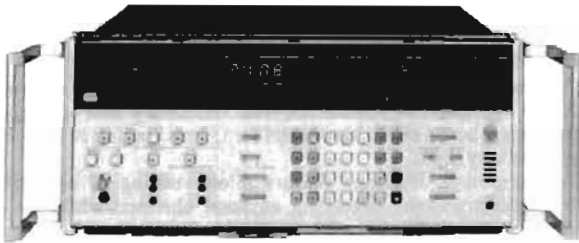

HP 3746A

### HP 3746A Selective Level Measuring Set (SLMS) (50 Hz to 32 MHz)

The HP 3746A SLMS makes fast, accurate selective level measurements. A built-in synthesiser gives high tuning accuracy and 1 Hz resolution across the entire 50 Hz to 32 MHz frequency range. Tuning can be performed by: entering a single frequency, stepping between frequency limits, stepping through a set of unrelated frequencies, or by FDM plan description.

The instrument's measurement filters are purpose designed for FDM testing. The flat-topped 3.1 kHz channel filter extracts a voice channel while rejecting adjacent carriers, pilots and other traffic. The 38 Hz pilot filter is flat topped over 22 Hz so AFC is not required, but rejects adjacent tones so that carrier leak can be tested on an active system. A built-in counter can be used to check tone frequencies. Options include: group power, C-message or psophometric noise measurements, noise-with-tone, phase jitter and single-level impulse noise.

The SLMS is optimised for FDM maintenance measurements and network monitoring. It has built-in "intelligence" to allow scanning of FDM signals and limit checking of measured levels. Special hot-tone search routines can rapidly detect high-level signals (See Application Note AN 323). The SLMS can directly control access switches for system applications, and has a built-in real-time clock and printer drivers for data logging. It is fully HP-IB programmable, and can be used as the heart of a self-contained measurement system, or integrated into a computer-controlled systems such as the HP 37050S FDM Network Monitoring System or HP 37051S Measurement System.

#### Ordering Information

	Price
HP 15580A Active Probe	\$460
HP 15581B Passive Probe	\$375
HP 15582A Return Loss Kit	\$670
HP 15589A Instrument Cart	\$780

#### HP 3746A Options

001: Siemens series 1.6/5.6 mm 75 ohm connectors	N/C
005: WECO 477B/223A (equivalent) connectors	\$65
011: 48 kHz group filter	\$1,100
012: tracking generator	\$340
014: high stability frequency reference	\$730
015: channel impairments - CCITT	\$500
018: channel impairments - North America	\$500

HP 3746A Selective Level Measuring Set \$13,100

### HP 3754A, 3755A, 3756A, 3757A

- Select 1 from a possible 10 RF Inputs/outputs
- Cascade up to 111 switches to allow selection from 1000 inputs/outputs
- Mix different switches for the most cost-effective solution



HP 3757A



HP 3754A



HP 3756A



HP 3755A

### HP 3754A, HP 3756A, HP 3757A Switches and HP 3755A Switch Controller

The HP 3754A, 3756A and 3757A Switches and the HP 3755A Switch Controller have been developed to meet the requirements of four main areas:

1. Frequency division multiplex (FDM) system surveillance and maintenance - the switch arrangement is used in conjunction with a selective level measuring set (SLMS), such as the HP 3746A, to monitor pilot and traffic levels at various points in the multiplex. The HP 3746A SLMS can control the access switches directly without needing the HP 3755A Switch Controller.
2. Production testing - where automatic selection or distribution of RF signals is required.
3. IF access and distribution - 70 MHz IF signals can be switched using the HP 3756A for connection to the HP 3717A 70 MHz Modulator/Demodulator.
4. Access and distribution of digital communications signals up to 34 Mb/s (CEPT) or 44.7 Mb/s (DS-3).

**Options:** The standard versions of these switches have BNC connectors and 75 ohm terminations. Different connectors are available as options on some models and 50 ohm versions are available as options or to special order on all models - see data sheet for full details.

#### Ordering Information

	Price
HP 3754A 25 MHz Access Switch	\$2,700
HP 3755A Switch Controller	\$2,600
HP 3756A 90 MHz Bi-directional Switch	\$3,300
HP 3757A 8.5 MHz Access Switch	\$1,060

# TELECOMMUNICATIONS TEST EQUIPMENT

## Selective Level Meter and Synthesizer

Models 3586A/B & 3336A/B

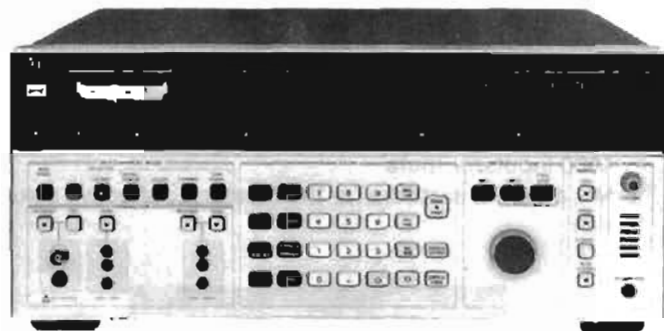

HP 3586A Selective Level Meter (CCITT)



### General

The HP 3586A/B Selective Level Meters and HP 3336A/B Tracking Synthesizers offer the high performance necessary to meet the demanding requirements in the design, manufacture, commissioning and maintenance of Frequency Division Multiplex (FDM) systems. The HP 3586 and HP 3336 "A" models meet CCITT requirements, and the "B" models meet North American (Bell) standards. Both are fully programmable over the HP Interface Bus. The HP 3586A & B Selective Level Meter provides a unique combination of features, including wideband power and optional telephone impairment measurement of impulse noise, phase jitter, noise with tone, and signal-to-noise with tone ratio. The HP 3586A & B's wide frequency coverage to 32.5 MHz allows measurements to be made at both voice channel and carrier frequencies. Microprocessor control adds many ease-of-use features such as amplitude offset measurements of tone and noise level in units of dBmO, dBmCO, or dBpWO. Convenience features include simultaneous analog and digital level displays, precise frequency setting with HP's fractional N synthesized local oscillator, accurate frequency counter and tone measurements with automatic channel alignment for 800 Hz (CCITT) or 1004 Hz (Bell) test tone or carrier frequency reference.

The HP 3336 A/B Synthesizer/Level Generator is an excellent precision tracking signal source for the HP 3586A and B Selective Level Meter. When the Selective Level Meter and Synthesizer are in the tracking mode, the frequency of the synthesizer is automatically set to the frequency of the SLM. Frequency coverage is 10 Hz to 20.9 MHz, making the HP 3336 A and B useful for telephone circuit loop testing on most FDM systems, transfer function and distortion measurements in telecommunications manufacturing.

### Carrier Frequency and Voice Channel

The HP 3586A & B can make both carrier frequency measurements to 32.5 MHz and voice channel measurements from 50 Hz to 100 kHz.

You can measure tone levels, idle channel noise or weighted noise at voice channel, then compare at carrier frequency.

### Transmission Impairments

The Transmission Impairments capability permits phase jitter, weighted noise, noise-with-tone, signal-to-noise-with-tone ratio, and single level impulse noise measurements. The HP 3586A's capability to make these transmission impairment measurements at both FDM voice channel and carrier frequencies is unique.

### Frequency and Amplitude Precision

The HP 3336 A/B provides frequency resolution of one microhertz (0.00001 Hz) up to 300 kHz and one millihertz (0.001 Hz) to 20.9 MHz. Level accuracy is  $\pm 0.5$  dB at full output over the full frequency range with  $\pm 1.2$  dB optional. Harmonic levels are more than 60 dB down up to 1 MHz and more than 50 dB down up to 20.9 MHz, performance not previously available in a synthesizer.



HP 3336A Synthesizer/Level Generator (CCITT)

### FDM Testing

The flexible output section allows different connectors to be provided either by option or special request. Frequency entry is accomplished by keyboard or analog control for manual tuning or frequency stepping of any digit.

The Amplitude Blanking feature allows testing of operational FDM systems without disturbing adjacent channels while the frequency is changed. The output is blanked to less than  $-85$  dBm until the next desired frequency is reached.

### General Purpose Features

The HP 3336 A/B Synthesizer provides wide band sweep capability—sweep the full frequency range (or as little as two microhertz), log or linear, single or continuous. Single phase lock loop design means the sweep is phase continuous and you can modulate with AM to 50 kHz or PM to 5 kHz. Ten storage registers can be used to keep different test settings available for repetitive test. All necessary functions on the HP 3336 A/B can be remotely programmed by HP-IB control for automatic testing.

### Designed-In Serviceability

The HP 3586 A/B Selective Level Meter and the HP 3336 A/B Synthesizer/Level Generator have been designed for reliable operation and excellent accessibility with many useful service features.

### North American (Bell) and CCITT Requirements

The HP 3586A & B Selective Level Meter and HP 3336 A & B Synthesizer/Level Generator are designed to meet most world-wide connector and impedance requirements for both carrier and voice channel measurements. Special or regional connectors can be provided by option or special request.

### Input Configuration

#### CCITT Requirements

HP 3586A SLM	75 $\Omega$ /10 k $\Omega$ Unbalanced 150 $\Omega$ , 600 $\Omega$ /10 k $\Omega$ Balanced
HP 3336A Synthesizer	75 $\Omega$ Unbalanced 150 $\Omega$ , 600 $\Omega$ Balanced

#### North American (Bell) Requirements

HP 3586B SLM	75 $\Omega$ /10 k $\Omega$ Unbalanced 124 $\Omega$ , 135 $\Omega$ , 600 $\Omega$ /10 k $\Omega$ Balanced
HP 3336B Synthesizer	75 $\Omega$ Unbalanced 124 $\Omega$ , 135 $\Omega$ , 600 $\Omega$ Balanced

### Fully Programmable

HP-IB control is standard, allowing automatic operation to be controlled by a desktop calculator such as the HP 9816A, Series 200, or 300, or by a mainframe computer, such as the HP 1000. FDM tests such as surveillance can be made from a remote location to reduce maintenance costs and increase troubleshooting efficiency.

### High Impedance Accessory Probes

Models HP 15580A and HP 15581B unbalanced high impedance probes and model HP 15576A balanced high impedance probe are available for use with the HP 3586A/B to facilitate bridging measurements.

**HP 3586A/B Abbreviated Specifications**  
**Frequency**

Signal Input	HP 3586A	HP 3586B
75 Ω Unbalanced	50 Hz to 32.5 MHz	
124 Ω Balanced		4 kHz to 10 MHz
135 Ω Balanced		4 kHz to 1 MHz
150 Ω Balanced	4 kHz to 1 MHz	
600 Ω Balanced	100 Hz to 108 kHz	

The 124 Ω, 135 Ω, 150 Ω and 600 Ω inputs are usable over wider frequency ranges, but are not specified in under and overrange operation.

**Frequency resolution:** 0.1 Hz.

**Center frequency accuracy:**  $\pm 1 \times 10^{-3}$ /year ( $\pm 2 \times 10^{-7}$ /year with option 004).

**Counter accuracy:**  $\pm 1.0$  Hz in addition to center frequency accuracy for signals within the 60 dB bandwidth of the IF filter chosen or greater than -100 dBm (largest signal measured).

**Frequency display:** 9 digit LED.

**Selectivity**

**3 dB Bandwidth,  $\pm 10\%$**

HP 3586 (CCITT)	HP 3586B (N. American)
20 Hz	20 Hz
400 Hz	400 Hz
3100 Hz	3100 Hz
Psophometric Noise Weighting	C-Message Noise Weighting

**Adjacent channel rejection:** 75 dB minimum at  $\pm 2850$  Hz, 3100 Hz BW.

**Passband flatness:**  $\pm 0.3$  dB.

**Amplitude**

**Measurement range:** +20 to -130 dBm.

**Amplitude resolution:** .01 dB.

**Level accuracy:** 10 dB autorange, low distortion mode, after calibration, 20 Hz and 400 Hz BW below -80 dBm.

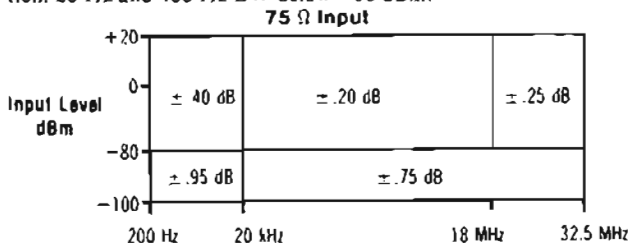

124 Ω Input (HP 3586B):  $\pm 0.6$  dB, 4 kHz to 10 kHz:  $\pm .35$  dB, 50 kHz to 5 MHz:  $\pm .50$  dB, 10 kHz to 50 kHz, and 5 MHz to 10 MHz for +20 to -80 dBm.

135 Ω/150 Ω Input (HP 3586A or B):  $\pm 0.6$  dB, 4 kHz to 10 kHz:  $\pm .35$  dB, 50 kHz to 1 MHz:  $\pm .50$  dB, 10 kHz to 50 kHz for +20 to -80 dBm.

600 Ω Input (3586 A/B):  $\pm .35$  dB, 100 Hz to 108 kHz for +20 to -80 dBm.

**Level accuracy: 100 dB range (after calibration):** add correction to 10 dB auto-range accuracy for dB below full scale. (Not required when in 10 dB autorange).

dB Below Full Scale	Accuracy Correction
0 to -20 dB	$\pm .25$ dB
-20 to -40 dB	$\pm .50$ dB
-40 to -80 dB	$\pm 2.0$ dB

**Dynamic Range**

**Spurious Responses**

**Image rejection (100-132 MHz):** -80 dBc.

**IF rejection:** 15625 Hz, -80 dBc; 50 MHz, -60 dBc.

**Non-harmonic spurious signals:** > 1600 Hz offset, -80 dBc; 300 Hz to 1600 Hz offset, -75 dBc.

**Distortion**

**Harmonic distortion:** -70 dB below full scale (> 4 kHz on 75 Ω and 600 Ω inputs), low distortion mode.

**Intermodulation distortion:** 60 dB below full scale, 200 Hz to 50 kHz offset; 70 dB below full scale, 50 kHz to 1 MHz offset.

**Wideband power accuracy:** after calibration, 100 dB range, averaging on, -45 to +20 dBm.

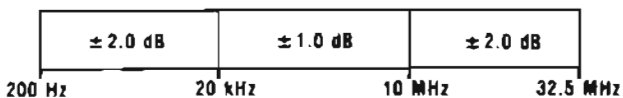

**Noise Floor (full scale setting -35 to -120 dBm)**

Frequency	Bandwidth	Noise Level
100 kHz to 32.5 MHz	3100, 1740, 2000 Hz	-116 dBm
	20 Hz, 400 Hz	-120 dBm
10 kHz to 100 kHz	All	-105 dBm

The noise floor for full scale settings of -30 to +24 dBm will be 80 dB below full scale for > 100 kHz, or 60 dB below full scale for 2 kHz-100 kHz.

**Signal Inputs**

HP Model	Impedance	Frequency	Mating Connector
3586A	75 ohms unbalanced	50 Hz to 32.5 MHz	BNC
	150 ohms balanced	4 kHz to 1 MHz	Siemens 3-prong
	600 ohms balanced	50 Hz to 108 kHz	9 Pin 6 AC
3586B	75 ohms unbalanced	50 Hz to 32.5 MHz	WECO 439/440A
	124 ohms balanced	4 kHz to 10 MHz	WECO 443A
	135 ohms balanced	4 kHz to 1 MHz	WECO 241A
	600 ohms balanced	50 Hz to 108 kHz	WECO 310

**Connector Options**

**Opt 001 (HP 3586A):** 75 ohms mates with Siemens 1.6/5.6 mm coaxial.

**Opt 001 (HP 3586B):** 75 ohms mates with WECO 358A, 124 ohms mates with WECO 372A.

(Contact local sales office for other special connectors.)

**Return loss:** -30 dB (50/75 Ω); -25 dB (600 Ω).

**Balance**

Input	Frequency	Balance
124 Ω	10 kHz to 10 MHz	-36 dB
135 Ω or 150 Ω	10 kHz to 1 MHz	-36 dB
600 Ω	50 Hz to 108 kHz	-40 dB

**Demodulated Audio Output**

Output Level: 0 dBm into a 600 Ω load, adjustable.

Output Connector: mates with WECO 347A.

**HP-IB Interface Functions:** SH1, AH1, T6, TE0, L4, LE0, SR1, RL1, PP1, DC1, DT1, C1, C3, C28.

**Additional Options**

**HP 3586A (CCITT)**

**Opt 001:** 75 Ω input connector option. Siemens 1.6/5.6 mm coaxial connector replaces BNC.

**Opt 004:** High Stability Frequency reference 10 MHz oven stabilized reference oscillator improves frequency stability to  $\pm 2 \times 10^{-7}$ /year.

**HP 3586B (N. American)**

**Opt 001:** 75 Ω and 124 Ω input connector option. Changes 75 Ω input connector to mate with WECO 358A and 124 Ω input to mate with WECO 372A.

**Opt 004:** High Stability Frequency reference. Same as Opt 004-HP 3586A.

**Auxiliary Signal Inputs/Outputs**

**Tracking generator:** 0 dBm rear panel tracking output.

**External reference input:** 1 MHz, 10 MHz or sub-harmonic input.

**Reference output:** 10 MHz, +8 dBm output.

# TELECOMMUNICATIONS TEST EQUIPMENT

## Selective Level Meter and Synthesizer (cont'd)

### Models 3586A/B & 3336 A/B

**Probe power:** front panel dc output for HP active high impedance accessory probes.

**HP-IB Interface Functions:** rear panel interface meeting IEEE 488-1978 for remote operation. Used for tracking synthesizer interface. SHI, AHI, T6, L3, SR1, RLI, PP0, DC1, C0, E1.

**Additional outputs:** rear panel demodulated audio, phase jitter meter.

### General

#### Operating Environment

**Temperature:** 0° to 55°C.

**Relative humidity:** 95%, 0° to 40°C.

**Altitude:** ≤15,000 ft; ≤4600 metres.

#### Storage Environment

**Temperature:** -40°C to 75°C.

**Altitude:** ≤50,000 ft; ≤15,240 metres.

**Power:** 100/120/220/240 V, +5%, -10% 48 to 66 Hz, 150 VA.

**Weight:** 23 kg (50 lb) net; 30 kg (65 lb) shipping

**Size:** 177 mm H x 425.5 mm W x 466.7 mm D (7" x 16.75" x 18.38").

### HP 3336 A & B Abbreviated Specifications

(See data sheet or manual for complete specifications)

### Frequency

#### Frequency Range of Signal Outputs

Signal Output	HP 3336A	HP 3336B
75 Ω Unbalanced	10 Hz to 20 999 999 999 MHz	
124 Ω Balanced		10 kHz to 10 999 999 999 MHz
135 Ω Balanced		10 kHz to 2 099 999 999 MHz
150 Ω Balanced	10 kHz to 2 099 999 999 MHz	
600 Ω Balanced	200 Hz to 109 999 999 kHz	

All balanced outputs are usable over wider frequency ranges but are not specified in under and overrange operation.

**Resolution:** 1 μHz for frequencies < 100 kHz, 1 mHz for frequencies ≥ 100 kHz.

**Aging rate (Instruments without option 004):** ±5 × 10<sup>-6</sup>/year (20° to 30°C).

**Warm-up time:** 30 minutes.

### Amplitude

**Range:** 75 and 600 Ω outputs: -72.99 to +7.00 dBm.

124, 135 and 150 Ω outputs: -78.23 to +1.76 dBm.

**Level accuracy, 20° to 30°C**

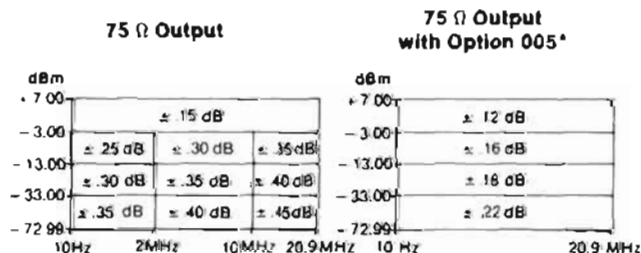

\*High accuracy attenuator

124 Ω output: 50 kHz to 10.9 MHz ±15 dB -8.23 to +1.76 dBm, ±0.3 dB -18.23 to -8.24 dBm, ±35 dB -38.23 to -18.24 dBm ±4 dB -78.23 to -38.24 dBm.

135 Ω/150 Ω output: 10 kHz to 2.09 MHz, ±17 dB -8.23 to +1.76 dBm, ±32 dB -18.23 to -8.24 dBm, ±37 dB -38.23 to -18.24 dBm, ±42 dB -78.23 to -38.24 dBm.

600 Ω output: 200 Hz to 109.9 kHz, ±30 dB -3.00 to +7.00 dBm/ ±40 dB -13.00 to 2.99 dBm, ±45 dB -33.00 to -12.99 dBm ±50 dB -72.99 to -32.99 dBm.

1. Add ±0.08 dB for 0° to 55°C operation

2. Warm-up time is 30 minutes.

**Amplitude blanking:** <-85 dBm output during blanking

### Spectral Purity

**Phase noise:** <-72 dB, HP 3336A and HP 3336B, for a 3 kHz band, 2 kHz either side of a 20 MHz carrier.

**Harmonic level:** -35 dB, 10 Hz to 30 Hz; -50 dB, 30 Hz to 50 Hz; -60 dB, 50 Hz to 1 MHz; -55 dB, 1 MHz to 5 MHz; -50 dB, 5 MHz to 20 MHz.

**Spurious:** all non-harmonically related signals will be more than 70 dB below the fundamental or -100 dBm (-115 dBm with option 005 except 150 or 600 Ω), whichever is greater.

### Phase Offset

**Range:** ±719.9° with respect to arbitrary starting phase or assigned zero phase.

**Resolution:** 0.1°.

**Increment accuracy:** ±0.2°.

**Ambient stability:** ±1.0 degree of phase per degree C

### Frequency Sweep

**Sweep time:** linear sweep, 0.01 s to 99.99 s; single log sweep, 2 s to 99.99 s; continuous log sweep, 0.1 s to 99.99 s.

**Maximum sweep width:** specified frequency range of selected output.

**Minimum sweep width:** log sweep, 1 decade; linear sweep, minimum sweepwidth (Hz) = 0.1 (Hz/s) × sweep time(s).

**Phase continuity:** sweep is phase continuous over full frequency range.

**Sweep flatness:** ±0.15 dB, fast leveling, 10 kHz to 20 MHz, 0.03 s sweep time; ±0.15 dB, normal leveling, 50 Hz to 1 MHz, 0.5 s sweep time.

**Amplitude modulation:** modulation depth, 0 to 100%. Modulation frequency range, 50 Hz to 50 kHz.

**Phase modulation:** range, 0 to ±850°. Linearity, ±0.5% from best fit straight line. Modulation frequency range, dc to 5 kHz.

**External leveling:** input from an external voltage source to regulate the signal amplitude at a remote point

**HP-IB Interface Functions:** rear panel interface meeting IEEE 488-1978 for remote operation. Used for tracking synthesizer interface. SHI, AHI, T6, L3, SR1, RLI, PP0, DC1, C0, E1.

### Options

#### Option 001, HP 3336A/B Synthesizer/Level Generator

1.6/5.6 mm 75 Ω input, (HP 3336A). 75 Ω mates with WECO 358A, (HP 3336B). 124 Ω connector mates with WECO 372A, (HP 3336B).

#### Option 004, High Stability Frequency Reference

**Aging rate:** ±5 × 10<sup>-6</sup>/week after 72 hours continuous operation ±8 × 10<sup>-7</sup>/month after 15 days continuous operation.

**Ambient stability:** ±5 × 10<sup>-7</sup> maximum, 0° to 55°C

**Option 005, high accuracy attenuator:** improves level accuracy and spurious level. See main specifications.

### General

#### Operating Environment

**Temperature:** 0° to 55°C.

**Relative humidity:** ≤85%, (0° to 40°C).

**Altitude:** ≤15,000 ft., ≤4600 metres.

#### Storage Environment

**Temperature:** -50° to +65°C.

**Altitude:** ≤50,000 ft., ≤15,240 metres.

**Power requirements:** 100/120/220/240 V, +5%, -10%, 48 to 66 Hz, 60 VA, (100 VA with all options), 10 VA standby.

**Size:** 132.6 mm high x 425.5 mm wide x 425.5 mm deep (5 1/4" x 16 1/4" x 16 1/4")

**Weight:** Net wt., 10 kg (22 lb). Shipping wt., 15.5 kg (34 lb).

### Ordering Information

Ordering Information	Price
<b>HP 3586A Selective Level Meter (CCITT)</b>	<b>\$11,200</b>
Opt 001: 1.6/5.6 mm 75 Ω Connector	\$100
Opt 004: High Stability Frequency Reference	\$750
<b>HP 3586B Selective Level Meter (N. American)</b>	<b>\$11,200</b>
Opt 001: 75 Ω Connector mates with WECO 358A and 124 Ω Connector mates with WECO 372A	\$100
Opt 004: Same as HP 3586A	\$750
<b>HP 3336A Synthesizer/Level Generator (CCITT)</b>	<b>\$5,200</b>
Opt 001: 1.6/5.6 mm 75 Ω Connector	\$102
Opt 004: High Stability Frequency Reference	\$665
Opt 005: High Precision Attenuator	\$665
<b>HP 3336B Synthesizer/Level Generator (N. American)</b>	<b>\$5,200</b>
Opt 001: 75 Ω WECO 358A, 124 Ω WECO 372A	\$102
Opt 004, 005: Same as HP 3336A	

- Voice grade testing
- Wideband data circuit testing
- Single frequency interference
- Spectrum analysis



HP 3581C

#### Description

The HP 3581C Selective Voltmeter has found wide application in testing special service circuits in both inside and outside plant maintenance. The HP 3581C is used to do spectrum analysis, measure non-linear distortion (harmonic distortion) and to locate and measure unwanted spurious and induced tones. The unit can be operated from ac line or from optional internal batteries.

#### Specifications

**Frequency range:** 15 Hz to 50 kHz.  
**Display:** 5 digit LED readout. Resolution: 1 Hz. Accuracy:  $\pm 3.5$  Hz.  
**Typical stability:**  $\pm 10$  Hz/h after 1 hour.  $\pm 5$  Hz/ $^{\circ}$ C.  
**Automatic frequency control (AFC), hold-in range:**  $\pm 800$  Hz.  
**Pull-in range:**  $> 5 \times$  bandwidth for 3 Hz to 100 Hz bandwidth;  $> 800$  Hz for 300 Hz bandwidth for full-scale signal.  
**Lock frequency:** center of passband  $\pm 1$  Hz.

#### Amplitude

##### Instrument Range

**Linear:** 30 V to 100 nV full scale.

**Log:** +30 dBm or dBV to -150 dBm or dBV.

##### Amplitude Accuracy\*

	Log	Linear
15 Hz–50 kHz, frequency response	$\pm 0.4$ dB	$\pm 4\%$
Switching between bandwidths (@ 25 $^{\circ}$ C)	$\pm 0.5$ dB	$\pm 5\%$
Amplitude display	$\pm 2$ dB	$\pm 2\%$
Input attenuator	$\pm 0.3$ dB	$\pm 3\%$
Amplitude reference level, Most sensitive range	$\pm 1$ dB	$\pm 10\%$
All other ranges	$\pm 1$ dB	$\pm 3\%$

**Dynamic range:**  $> 80$  dB.

**Noise sidebands:** greater than 70 dB below CW signal, 10 bandwidths away from signal.

**IF feedthrough:** input level  $> 10$  V;  $-60$  dB; input level  $< 10$  V;  $-70$  dB.

**Spurious responses:**  $> 80$  dB below input reference level.

#### Sweep

**Scan width:** 50 Hz to 50 kHz. These scans can be adjusted to cover a group of frequencies within the overall instrument range.

**Sweep error light:** this LED indicates a sweep that is too fast to capture full response.

\*Note: these specifications cover the full temperature frequency and amplitude range, and represent worst case. Accuracy is significantly better for measurements not at the extremes.

**External trigger:** a short to ground stops normal sweep. Opening the short then enables a sweep.

#### Input

##### Unbalanced (UNBAL)

**Impedance:** 1 M $\Omega$ /40 pF.

##### Balanced/Bridged (BRDG)

**Impedance:** 10 k $\Omega$ .

**Frequency response:** 40 Hz–20 kHz,  $\pm 0.5$  dB for signals  $< 20$  dBm.

##### Balanced/Terminated (TERM)

**Impedance:** 600  $\Omega$ /900  $\Omega$  balanced.

**Frequency response:** same as balanced/bridging.

**Input connector:** accepts WECO 310 plug.

#### Output Characteristics

**Tracking generator output** (also known as BFO or tracking oscillator output). Switchable on rear panel to restored output (HP 3581C acts as a narrow band amplifier).

**Range:** 0 to 2 V RMS.

**Frequency response:**  $\pm 3\%$  15 Hz to 50 kHz

**LO output:** 100 mV signal from 1 MHz to 1.5 MHz as input is tuned from 0 to 50 kHz.

**Output connector:** WECO 310, for connection to tracking generator output or restored output. In addition to monitoring restored output with headphones, an internal speaker also provides an audio indication of signal content.

**Restored output:** acts as a narrow band amplifier.

**X-Y recorder analog outputs:** 0 to +5V  $\pm 2.5\%$ .

#### General

**Operating temperature range:** 0 $^{\circ}$ C to 55 $^{\circ}$ C.

**Humidity:** 95% relative, maximum at 40 $^{\circ}$ C.

**Power requirements:** 100 V, 120 V, 220 V, 240 V  $\pm 5\%$  –10%, 10 VA typical, 48 Hz to 440 Hz

**Size:** 203.2 mm H x 285.8 mm W x 412.8 mm D (8" x 11 1/2" x 16 1/2").

**Weight:** 11.5 kg (25 lb). Option 001, 13.5 kg (30 lb).

**Accessory available:** HP 7090A Measurement Plotting System.

**Option 001: rechargeable battery:** used to make floating measurements; 12 hours to fully charge. Also includes front panel dust cover.

#### Ordering Information

HP 3581C Selective Voltmeter

Opt 001: Battery Pack, dust cover

Opt 003: Rack Mount

Opt W30: Extended Warranty

#### Price

\$6,900

\$700

\$335

\$300

# TELECOMMUNICATIONS TEST EQUIPMENT

## Microwave Link Analyzer

Models 3711A/3712A, 3730B, 3717A, 8350B, 8620C, 86200 Series RF Plug-ins

- Comprehensive testing of microwave radio links and components.
- Baseband and IF (70/140 MHz) interface on MLA.
- Extension to RF (0.5 to 18 GHz) with up/down converter.

- Baseband qualitative measurements via 70 MHz modulator/demodulator.
- Test analog and digital radios.

### 70/140 MHz IF MLA System

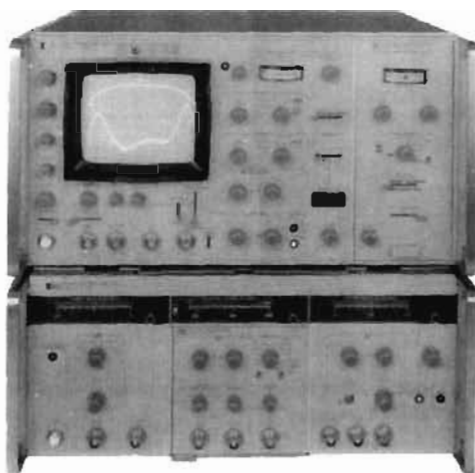

HP 3711A IF/BB Transmitter  
 HP 3791B BB Transmitter (Plug-in)  
 HP 3712A IF/BB Receiver  
 HP 3793B Diff. Phase Detector (Plug-in)

### 70 MHz Modulator/Demodulator



HP 3717A

### HP 3711A/3712A Microwave Link Analyzer

The HP 3711A/3712A MLA system provides a comprehensive range of microwave radio measurements at baseband and IF (70 or 140 MHz) including: amplitude and group delay response, modulator/demodulator linearity and sensitivity, differential phase and gain, power and frequency. These measurements can be made on individual components of an analog or digital radio or over a radio link, without needing a reference channel.

The HP 8350B or HP 8620C Sweeper with HP 86200 series of MLA Upconverter Simulation Plug-ins upconverts the MLA transmitter signal to RF channels in the range 0.5 to 18 GHz. (The HP 11869A Adapter is required for HP 8350B.)

The HP 3730B RF Down Converter with plug-ins converts RF signals in the 1.7 to 14.5 GHz range to a 140 MHz or 70 MHz IF. (This range can be extended with external LOs.)

Together, the HP 8350B/HP 8620C and HP 3730B extend the MLA system to make measurements on RF channels and devices over bandwidths of up to 1 GHz.

At non-demodulating repeater stations, the HP 3717A 70MHz Modulator/Demodulator allows qualitative baseband tests such as white-noise loading, TV waveform testing and baseband-frequency response to complement the MLA swept IF measurements. The HP 3717A is a high-quality modem which can be substituted for operational equipment to isolate system faults.

### RF to IF Down Conversion



HP 3730B Mainframe HP 3737B plug-in

### MLA Upconverter Simulation



HP 8350B/86245A

### Ordering Information

Price

#### MLA System:

HP 3711A IF/BB Transmitter	\$7,900
HP 3791B BB Transmitter (Plug-in)	\$1,700
HP 3712A IF/BB Receiver	\$9,700
HP 3793B Diff. Phase Detector (Plug-in)	\$1,850

See data sheet for details of connector, test tone and other options, and accessories.

HP 3730B Down Converter	\$4,800
HP 3736B RF Module 1.7 to 4.2 GHz	\$6,100
HP 3737B RF Module 3.7 to 8.5 GHz	\$7,300
HP 3738B RF Module 5.9 to 11.7 GHz	\$8,600
HP 3739B RF Module 10.7 to 14.5 GHz	\$12,400

See data sheet for details of options and accessories.

HP 8620C Sweeper Mainframe	\$4,000
HP 8350B Sweeper Mainframe	\$4,800
HP 11869A Adapter	\$500

### HP 86200 MLA Upconverter Simulation Plug-ins

Plug-in Model Number	MLA Option Number	Freq Range (GHz)
86222A/B	H80	0.5 - 2.8
86235A	008	1.7 - 4.3
86240C	-	3.6 - 8.6
86242D	008	5.9 - 9.0
86245A	008	9.9 - 12.4
86250D	008	8.0 - 12.8
86260A	H82	12.0 - 18.0

### HP 3717A 70 MHz Modulator/Demodulator \$13,300

See data sheet for details of connector, emphasis network and other options.



# TELECOMMUNICATIONS TEST EQUIPMENT

## RF Sweeper MLA Upconverter Simulation

Models 8350, 8620C, 86200 Series RF Plug-Ins

- MLA upconverter simulator options 0.5 to 18.0 GHz
- Use with MLA or as a general purpose sweeper
- Swept and CW RF source
- Test digital & analog microwave radio systems & components

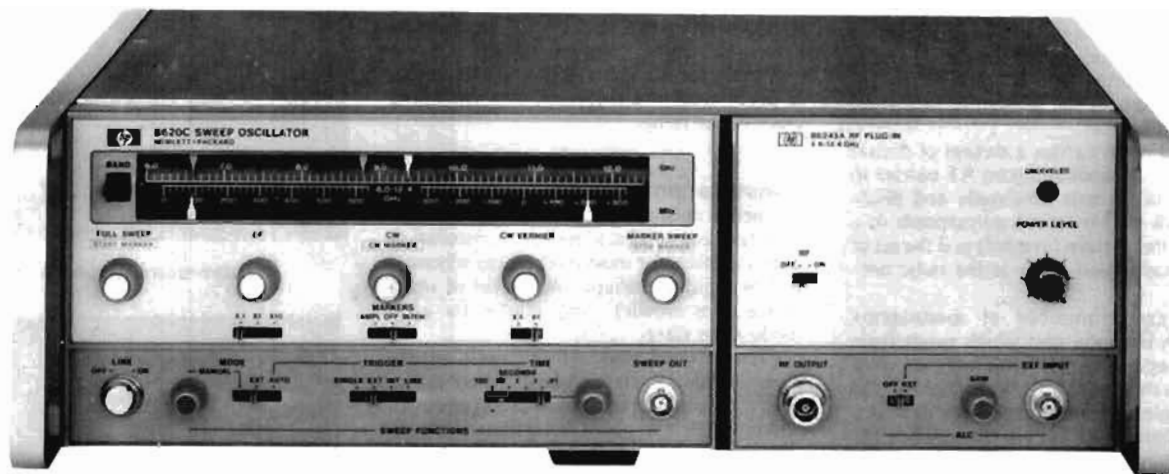

HP 8620C/86245A

### Description

The HP 8620C Sweep Oscillator and HP 86200 Series of RF plug-ins provide a high performance, solid state source for Microwave Radio System tests via MLA Upconverter Simulation Options. These permit accurate RF-to-BB, RF-to-IF and RF-to-RF distortion measurements to be made with the HP 3700 Series MLA System. The plug-ins can also be used as standard sweeper plug-ins, with the only basic difference being modified FM circuitry. The RF-to-RF measurements must be made in conjunction with the HP 3730B RF Down Converter. This allows group delay, linearity, differential gain and phase measurements to be made on RF devices and components within the Microwave Radio System. The HP 8350 Sweep Oscillator Mainframe is also compatible with the HP 86200 series MLA option plug-ins through the use of the HP 11869A Adapter (see page 382).

### Specifications

The HP 8620C/86200 Series MLA Upconverter Simulation Plug-ins are optimized for group delay, linearity, and differential gain and

phase over the specified frequency range. All plug-ins can be used with MLA sweep widths of 100 MHz (200 MHz with Option H42) or less. The following specifications supplement the standard HP 8620C system specifications (covered on pages 390-392).

### Complementary Equipment

HP 8350 Sweeper Mainframe	\$4,800
HP 11869A Adapter	\$500
HP 8620C Sweeper Mainframe (required)	\$4,000

To properly interface the HP 8620C/86200 Series plug-in to the item under test, the following are recommended for optimal performance:

HP 784C Directional Detector (1.7 - 12.4 GHz)	\$2,000
Flatness over any 30 MHz: $< \pm 0.1$ dB	
Equivalent source match: typically $\leq 1.5$	
HP 11675B Leveling Cable Assembly (1.7 - 12.4 GHz)	\$900
Group delay: $\leq 0.25$ ns p-p (with 1.25 SWR at each end)	

### MLA Upconverter Simulation Plug-In Specifications (25°C)

HP Model Number <sup>1</sup>	MLA Option Number	MLA Freq. Range (GHz)	Group Delay (ns) p-p		Linearity (%)	Diff. Gain (%)	Diff. Phase (°)	FM Sens. (MHz/V)	Price w/MLA Option
			@ 27.7 kHz	@ 5.6 MHz <sup>2</sup>					
Across any 30 MHz BW									
86222A/B	H80	0.5-2.4	<3	<2.5	<2.5	<2.5	<3	N/S	\$7,505/8,505
86235A	008	1.7-4.3	<2	<2.0	<2.0	<2.0	<2	+20	\$6,405
86240C	-	3.6-8.6	<1	<0.5	<0.5	<0.5	<1	+20	\$7,600
86242D	008	5.9-9.0	<1	<0.5	<0.5	<0.5	<1	+20	\$6,605
86245A	008	5.9-12.4	<1	<0.5	<0.5	<0.5	<1	+20	\$9,105
86250D	008	8.0-12.4	<1	<0.5	<0.5	<0.5	<1	+20	\$6,505
86260B	H82	10.0-15.5	<3	<2.5	<2.5	<2.5	<3	N/S	\$8,205
86260A	H82	12.0-18.0	<3	<2.1	<2.5	<2.5	<3	N/S	\$8,005

<sup>1</sup>Internal leveling is standard for all HP 86200 series plug-ins.

<sup>2</sup>Except HP 86222A/B & 86260A which are tested @ 2.4 MHz.

For applications requiring better distortion specifications, HP also offers plug-in systems which include a leveling cable and directional coupler. These systems are available in the following bands: 5.8-6.5 GHz, 7.0-8.6 GHz, 10.7-11.7 GHz, and 12.2-12.7 GHz. The system specifications are as follows:

Group delay @ 500 kHz:  $< 0.5$  ns p-p

Linearity @ 500 kHz:  $< 0.25\%$

Flatness:  $< \pm 0.1$  dB

For more information consult your local HP Field Engineer.

The options shown after each plug-in provide the special MLA interface capability. Refer to pages 390-392 for details on other RF Sweeper plug-in specifications and options.

# TELECOMMUNICATIONS TEST EQUIPMENT

## Radio System Testing

### Measurements on Digital Radio Systems

#### Introduction

Digital microwave radio systems form part of many communications networks, being more cost effective and simpler to install, over long distances and difficult terrain, than either cable or fiber.

A digital radio carries a stream of digital information by modulating an RF carrier to a number of discrete amplitude and phase states. Each of these states corresponds to a unique digital pattern (symbol) and the set of possible modulation states is the radio constellation.

There are a number of modulation schemes in common use, which range from simple schemes like QPSK to more complex schemes such as 64QAM and 256QAM. The more complex schemes carry more data in a given RF bandwidth but are more difficult to implement and are more easily upset by impairments such as noise and interference, or degradations internal to the radio. However these schemes are gaining in popularity in line-of-sight applications, while simple but robust schemes are used extensively in satellite and military applications.

#### Constellation Pattern Analysis

Constellation pattern analysis is a powerful technique for troubleshooting and diagnosing in-service degradations on a digital radio.

The introduction of the HP 3709B provides digital radio manufacturers and operators with any easy-to-use, low-priced constellation pattern analyzer for applications in the manufacture, installation, commissioning, and maintenance of digital radio systems.

In addition, the new HP 8980 provides vector analysis capabilities for radio, R&D and manufacturing applications.

All digital radio systems share a similar block diagram (see below). The HP 3709B and HP 8980A connect to monitor points on the demodulator of the digital radio receiver which give access to the I (in-phase), Q (quadrature) and symbol timing clock sig-

nals. They can display the individual I and Q signals versus time (eye diagrams) or the I signal versus the Q signal in a phase plane diagram (constellation pattern). As the analysis is non-intrusive, it can be performed on a radio carrying live traffic with no interference to the traffic.

Timing for the HP 4709B and HP 8980A is taken from the recovered symbol timing clock of the radio.

#### Constellation Patterns

During normal operation a digital radio will produce a characteristic constellation pattern which, for most modulation schemes, will be regular in shape and consist of small clusters (or clouds) - one cluster for each modulation state.

(The internal noise of the radio causes each modulation state to be a cluster rather than a pinpoint on the constellation pattern).

Amplitude and phase distortions of the radio signals, caused by individual impairments, uniquely deform the constellation pattern. By assessing the disturbance to the pattern, the impairment can be both recognized and measured.

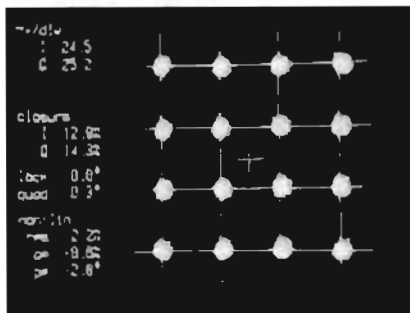

Constellation Pattern (Normal - 16QAM radio)

The following examples, taken from a 16QAM radio system, illustrate the distinctive constellation patterns caused by impairments

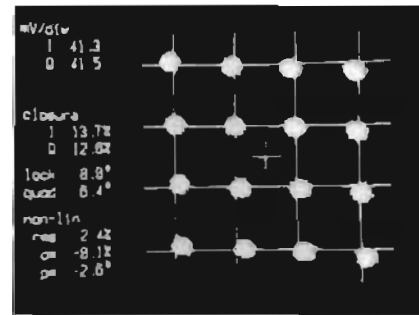

Quadrature Angle Error

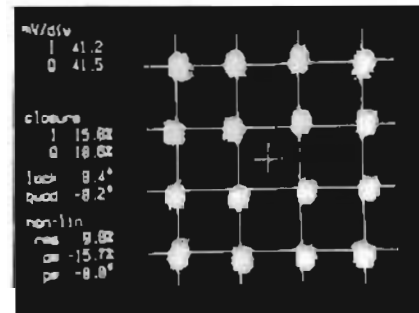

AM-AM / AM-PM

To assist the user in identifying problems on a digital radio, an example impairment catalog is provided with each instrument.

#### Constellation Measurements (eg using the HP 3709B):

The HP 3709B provides measurement routines and reference graticules for common modulation schemes used in digital radios: QPSK, 16QAM, 64QAM, 256QAM, 9QPR, 25QPR, 49QPR and 81QPR.

Measurements provided by the HP 3709B include:

- closure** - ratio of rms cluster size to cluster separation.
- lock** - any phase misalignment of I and Q signals from carrier.
- quad** - any deviation from quadrature (90°) between I and Q signals.
- non-lin** - any non-linear distortion (rms total, AM-AM and AM-PM)
- eye reduction** - the total degradation for the I and Q signals.

To calculate these parameters, the HP 3709B accumulates (randomly taken) samples of the levels of the I and Q signals, then calculates the mean position and variance for each cluster on the constellation. It uses these intermediate statistics to calculate the displayed results.

The raw values (I, Q pairs), intermediate statistics, or the displayed results can be accessed via the Hewlett-Packard Interface Bus (HP-IB).

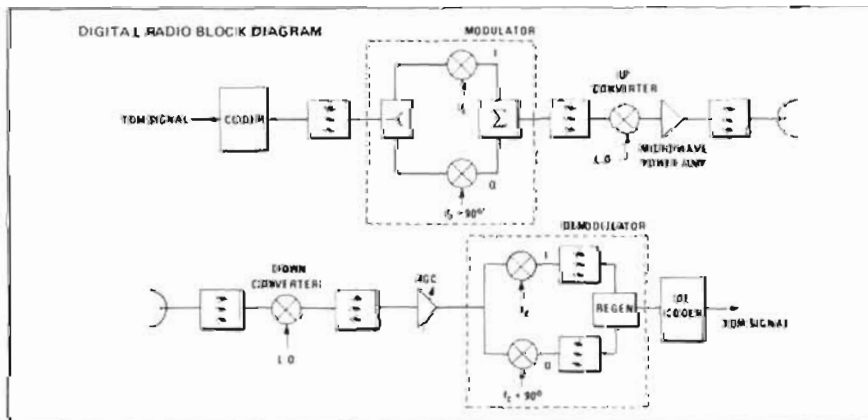

Digital Radio Block Diagram

# TELECOMMUNICATIONS TEST EQUIPMENT

## Microwave Radio Noise and Interference Test Set; Digital Radio Constellation Analyzer

Models 3708A, 3709B, 15709A

### HP 3708A

- Carrier tracking maintains accurate & repeatable C/N & C/I conditions
- Fast, alternative residual BER measurement
- Accurate simulation of radio system interference



HP 3708A



### HP 3709B

- For troubleshooting, fine-tuning and preventive maintenance
- Identifies digital radio impairments
- Analyzes magnitude of distortions



HP 3709B



HP 15709A

### HP 3708A Noise and Interference Test Set

To minimise lost transmission revenue and the cost of equipment repair, an accurate, overall performance assessment of radio systems is required. This allows potential faults to be corrected before they begin to cause problems. The HP 3708A provides an accurate method of assessing performance of microwave radio and satellite modem systems by providing the Carrier to Noise (C/N) and Carrier to Interference (C/I) conditions necessary to make C/N & C/I vs Bit Error Ratio (BER) measurements.

The instrument is designed for easy access to the IF section of the radio system. The carrier level is monitored and calibrated levels of interference and Gaussian noise are added to stress the system in a controlled way. Accurate and repeatable C/N and C/I ratios can be maintained even in the presence of severe signal variations.

The HP 3708A has the flexibility to accommodate a wide variety of radio designs, a selection of calibrated internal filters giving accurately specified Carrier to Noise ratios in any noise bandwidth. The interference facility allows the addition of a wide variety of interference signals to accurately simulate the effects of radio interference on system performance.

CCIR recommendations 594 recognize the importance of residual BER in assessing the overall performance of digital radio systems. The HP 3708A provides the capability to significantly reduce residual BER measurement time, and increase the confidence in measurement accuracy.

From initial manufacturing test to final commissioning and routine maintenance, the HP 3708A will make a significant contribution to radio testing, improving your measurements, and saving you money. It provides a valuable addition to your tool kit.

#### Options

**Std:** 75 ohm unbalanced connector. Reference tone oscillator frequency is 70/140 MHz.

**001:** 50 ohm unbalanced connector.

**Special options:** Reference tone oscillator frequencies, specifically for portable application of the HP 3708A in determining residual BER, are available on a special order basis.

HP 3708A Noise and Interference Test Set

\$15,500

### HP 3709B Constellation Analyzer

The HP 3709B is used to characterize the performance and condition of digital radios both in-service and out-of-service by analysis of constellation patterns. In addition to displaying constellation patterns, the HP 3709B can measure the linear and non-linear distortions revealed by the patterns, and can provide a formatted report containing the pattern and measurement results on a ThinkJet printer.

#### Measurements

**Constellation:** closure, lock angle error, quad angle error, non-linear distortion; Eye: reduction.

Supported Radio Parameters

**Modulation schemes:** QPSK, 16QAM, 64QAM, 256QAM, 9QPR, 25QPR, 49QPR, 81QPR.

#### Monitor Points

(1) **I and Q signals:** Any of the above schemes with signal levels in the range 30 to 400 mV p-p across the constellation. (dc offset must be no more than 0.5 x signal amplitude).

(2) **Clock:** 1 MHz to 80 MHz (100 mV to 1 V p-p)

**Impedance level:** All HP 3709B inputs are 75 ohm terminated

#### Options

**001:** 50 ohm unbalanced input connectors

**003:** Siemens series 1.6/5.6 mm input connectors

**130:** High Impedance Interface Kit. Contains 1 x HP 15709A High Impedance Interface and 3 x HP 10017A 1 metre 10:1 probes

**Special Options:** A low bit rate version (0.1 - 8 MHz) is available to special order.

### HP 15709A High Impedance Interface

This specially designed accessory provides three high impedance, filtered inputs which allow the HP 3709B to be connected to radios without protected 75 or 50 ohm monitor points, using standard oscilloscope passive probes (eg HP 10017A 10:1, 1 metre probe).

**Gain:** x 5 (= overall x 0.5 gain when used with 10:1 probes)

**Impedance:** 1 Mohm.

HP 3709B Constellation Display

\$10,800

# TELECOMMUNICATIONS TEST EQUIPMENT

## Vector Signal Generator and Analyzer, I-Q Tutor

Models 8780A, 8980A, 11736A

### HP 8780A

- 10 MHz to 3 GHz synthesizer
- BPSK, QPSK, 8PSK, 16QAM, Optional 64QAM
- Burst digital modulation

### HP 8980A

- Analyzes coherent phase and amplitude modulation
- 350 MHz I vs. Q bandwidth
- Markers for measuring phase, amplitude and time
- 12-bit digitizing for HP-IB measurements

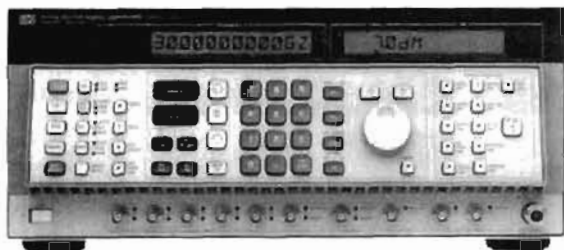

HP 8780A



HP 8980A



### HP 8780A Vector Signal Generator

The HP 8780A Vector Signal Generator is a synthesized source with exceptional modulation for modern digital microwave radio and satellite communications testing. The Vector Signal Generator offers a wide variety of modulation using both digital and analog inputs. It generates standard formats from BPSK to 64QAM and traditional modulation like FM, AM, and pulse, as well as sophisticated complex modulation.

### HP 8980A Vector Analyzer

The HP 8980A Vector Analyzer is a 350 MHz two-channel X-Y sampling oscilloscope. It is designed to analyze the in-phase (I) and quadrature phase (Q) components of modern digital microwave radio signals such as QPSK, 16QAM, and 256QAM.

### Applications

The vector signal generator and vector analyzer form the perfect pair for testing modern terrestrial and satellite receivers.

The HP 8780A standard modulation patterns — BPSK, QPSK, 8PSK, 16QAM and 64QAM (with Opt. 064) — are easily generated using standard data generators. Asynchronous TDMA modulation can be simulated using the Burst feature along with one of the PSK modulations. A coherent carrier output simplifies quadrature and gain alignment of vector (I/Q) demodulators.

The HP 8980A constellation analysis feature gives non-intrusive measures of closure, quadrature error, and lock angle error for partial response and QAM formats from QPSK to 256QAM. In addition, five markers are provided for quick and convenient measurement of phase, magnitude, and time. The 12-bit digitizing capability and HP-IB programmability of the vector analyzer make it ideally suited for production test applications.

For more information about the HP 8780A and the HP 8980A, refer to the Vector Modulation Generators and Analyzers section of this catalog.

### I-Q Tutor

- Models a modern digital microwave radio system
- Shows time, vector, and constellation diagrams
- Simulates system degradations such as noise, multipath fades, and nonlinearities
- Includes training manual with lab exercises



I-Q Tutor is available on the HP 9000 Series 200 computers, or on the HP Vectra or IBM PC, PC/XT, or PC/AT.

### I-Q Tutor

Imagine a practice workbench that simulates a full digital communications system from voice channel through transmission and back to voice. I-Q Tutor is just that — it's an interactive software training package that simulates the major building blocks of a modern digital communications system. Whether used in a university setting or R & D lab, I-Q Tutor provides insight to the trade-offs of modern digital communications designs.

On the computer screen, the user selects the system node to be examined. Time and frequency domain signals can be viewed at that node, as well as vector signals. Notebook pages for each system node explain what is happening to the signal.

The power and versatility of I-Q Tutor come from the ease of changing system parameters, and then viewing the effects of those changes. For instance, the user can change signal-to-noise ratio, or select from several different filter alphabets, to examine how these changes affect the system error rate and bandwidth. An advanced design screen is available for exploring multipath fades, AM-AM, and AM-PM distortion effects.

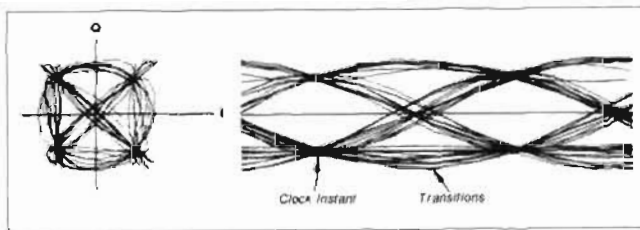

Eye diagram and vector diagram of a QPSK Signal as viewed on the I-Q Tutor screen.

### Ordering Information:

**HP 11736A** runs on the HP 9000 Model 216A, 217A, and 236A computers with 640 Kbytes of memory, or the model 236C with 896 Kbytes. It requires BASIC 2.0 or BASIC 3.0 with Graph and GraphX extensions. **Price \$95.00**

**HP 11736B** runs on the HP Vectra and most IBM PC-compatible computers (PC/XT/AT) with a monochrome or color graphics card. **Price \$95.00**

#### HP 37050S, HP 37051S

- Continually monitor FDM network performance
- Early identification of degradations allows effective preventative maintenance
- Collect performance statistics on leased facilities
- Minimize repair time through rapid fault identification



By continually monitoring the performance of an FDM transmission network, the HP 37050S and HP 37051S systems allow deteriorations or faults to be isolated and rectified in the shortest possible time. The HP 37050S has been designed to meet the demands of large, high-capacity FDM networks, whereas the HP 37051S provides a low-cost solution for small FDM networks.

Both systems combine the extensive measurement capability and built-in intelligence of HP 3746A Selective Level Measuring Sets (SLMSs) with access switches and dedicated control software to provide comprehensive measurements which include:

Pilots	Channel noise
Carrier leaks	Inter-supergroup slot noise
Power	Fast 'hot tone' searches

Automatic measurement sequences can be created for network monitoring. User-initiated measurements, temporarily interrupting any sequence, can be made to investigate a problem highlighted through monitoring.

#### HP 37050S FDM Network Monitoring System

The HP 37050S is a flexible, automatic measurement system designed for comprehensive performance monitoring of large FDM transmission networks.

The system operates under the direct control of an HP 1000 A-Series computer system which simultaneously gathers measurement data from up to 16 remote sites. Simultaneous access to system facilities by a number of users is accommodated. Specialized results modes are provided that reduce the mass of data available to only that which is relevant.

Two or more computer systems can be linked together enabling an HP 37050S system to be expanded beyond 16 sites.

#### HP 37051S FDM Measurement System

The HP 37051S is the ideal answer for the operator of a small FDM network who wishes to make measurements at several remote FDM installations and present the information obtained at one central location.

This system operates under the control of an HP 9000 Series 300 computer that provides control of up to 10 remote sites in succession.

HP 37051S operators can expand their monitoring system to the HP 37050S as their network grows or needs change.

#### HP 37100S

- Remotely test private circuits from a convenient central site without moving from the keyboard of a computer terminal
- Dramatically improve the productivity of telephone maintenance operations by reducing troubleshooting and technician-travel time
- User-friendly software means no special keyboard skills are required
- Software-generated reports and features which save time and effort

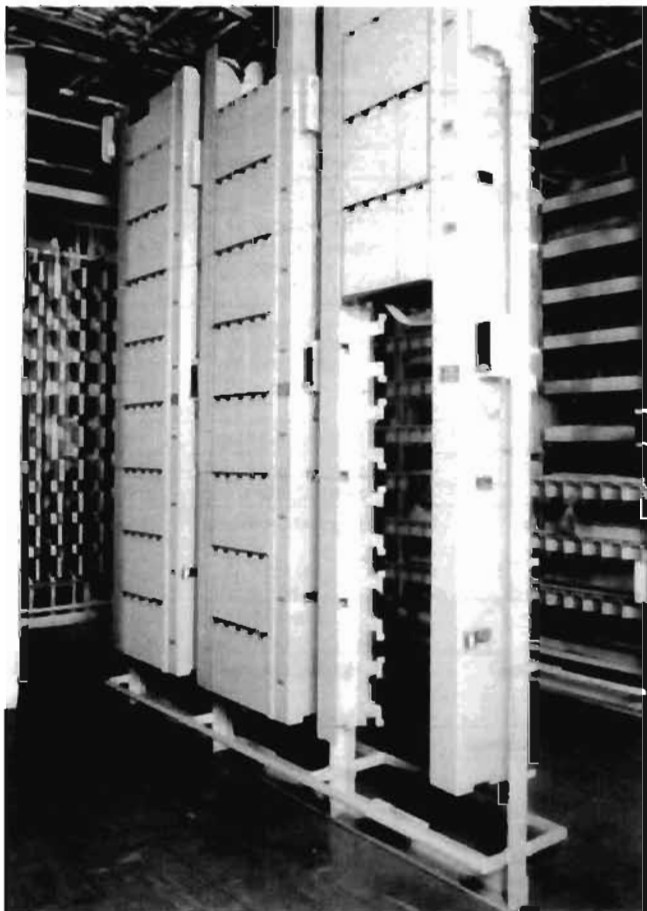

#### The HP 37100S Remote Access and Test System

The HP 37100S Remote Access and Test System (HP RATES) provides the hardware, software and support for nationwide testing and troubleshooting of special-service metallic telephone lines. Applications include testing of 2, 4, 6 or 8-wire private circuits which are permanently routed through the equipment and can be accessed and tested at a remote site under the control of a central-site operator.

The HP RATES system uses the well-proven HP 1000 A-Series computer as the system controller running applications software packages, controlling the remote site access and test equipment via modem connections over dedicated or dial-up telephone lines. An operator using a terminal connected to the central site computer, interacts with the applications software to verify circuit performance, accessing the circuit at a remote location and performing the tests from the central location. Extensive use is made of a graphics screen presentation to ensure a user-friendly man/machine interface which relates directly to the tests being performed.

The HP RATES system has been designed to be modular at all levels, providing solutions for the large and small telephone companies. The modularity allows expansion throughout: additional circuits, extra test features and more test personnel are all easily accommodated.

# DATA COMMUNICATIONS TEST EQUIPMENT

**The Hewlett-Packard Protocol Analyzer Family**  
Hewlett-Packard offers a family of five powerful, general purpose protocol analyzers, with software and accessories to meet your special needs. Software and/or hardware accessories extend the capabilities of your HP analyzer in new protocols or applications. Application packages ensure your HP protocol analyzer will meet your changing needs.

While maintaining family compatibility, each analyzer is tailored for a different environment, with different features and characteristics. All share common operating, setup, remote transfer and display characteristics. See the chart listed below for each analyzer's characteristics.



☆ = NEW

	HP 4951C	HP 4952A	☆ HP 4954A	HP 4955A	☆ HP 4972A
<b>Size (HWD - cm) (HWD - inches)</b>	16.0x27.9x34.3 cm 6.3x11.0x13.5 in.	16.0x27.9x34.3 cm 6.3x11.0x13.5 in.	19.6x42.5x56.5 cm 7.7x16.8x22.3 in.	19.6x42.5x65.4 cm 7.7x16.8x25.8 in.	19.6x42.5x56.5 cm 7.7x16.8x22.3 in.
<b>Net Weight</b>	6.7 kg (14.8 lb)	6.8 kg (15 lb)	22.2 kg (47 lb)	22kg (49 lb)	19.6 kg (43 lb)
<b>Price (typical)</b>	\$4,400 US	\$7,250 US	\$17,000 US	\$20,880 US	\$17,000 US
<b>Physical Interfaces</b>	RS-232C/V.24, RS-449/422A/423A, MIL-188C, V.35	RS-232C/V.24, RS-449/422A/423A, MIL-188C, X.21, V.35	RS-232C/V.24, RS-449/422A/423A, MIL-188C, X.21, V.35	RS-232C/V.24, RS-449/422A/423A, MIL-188C, X.21, V.35	IEEE-802.3 (ETHERNET)
<b>Protocols</b>	Async, Sync, Bisync, SDLC, HDLC, SNA, IPARS, DDCMP, X.25	Async, Sync, Bisync, SDLC, HDLC, SNA, IPARS, DDCMP, X.25, X.21	Async, Sync, Bisync, SDLC, HDLC, SNA, DDCMP X.25, X.21, Bisync-framed X.25, CCITT#7/CCS7	Async, Sync, Bisync, SDLC, HDLC, SNA, DDCMP X.25, X.21, Bisync-framed X.25, CCITT#7	TCP/IP, DECNET, XNS, User Defined
<b>Data Rate</b>	50 bps-19.2 kbps	50 bps-64 kbps	50 bps-72 kbps	50 bps-72 kbps	10 Mbps
<b>Display</b>	5 in. diagonal, 16 lines, 32 chars/line	5 in. diagonal, 16 lines, 32 chars/line	9 in. diagonal, 25 lines, 80 chars/line	9 in. diagonal, 25 lines, 80 chars/line	9 in. diagonal, 25 lines, 80 chars/line
<b>Mass Store</b>	3.5 in. Microfloppy	3.5 in. Microfloppy	3.5 in. Microfloppy 20 Mbyte Winchester expandable through HP-IB to 4 Gbytes	Dual 512 Kbyte Tapes	3.5 in. Microfloppy 20 MByte Winchester expandable through HP-IB to 100 MBytes
<b>Video Out</b>	RS-170	RS-170	Hi Resolution	No	Hi Resolution (opt. color)
<b>Programming</b>	Softkey Menus	Enhanced Softkey Menus	Softkey Menus, SNA Testing Language, X.21 State Simulator	Softkey Menus, opt. BASIC	Enhanced Softkey Menus
<b>Timers/Counters</b>	5/5	5/5	5/5	5/5	16/16
<b>Triggers</b>	63 Simultaneous	63 Simultaneous	63 Simultaneous	63 Simultaneous	16 Filters with up to 62 characters each
<b>Send String</b>	1750 characters total 255 per message	1750 characters total 255 per message	1750 characters total 1350 per message	1750 characters total 255 per message	16 Messages of 2022 characters each
<b>Auto Increment N(s),N(r),P(s),P(r)</b>	No	No	Yes	Yes	Not Applicable
<b>BERT</b>	63, 511, 2047 PRBS	63, 511, 2047, 4095 PRBS	No	No	No
<b>Autoconfigure</b>	Yes	Yes	No	No	Node Table (Statistics Package)
<b>Cursor Timing</b>	No	Yes	Yes	No	Yes
<b>Data Capture Buffer</b>	32 Kbyte NV-RAM	32 Kbyte NV-RAM opt 3/4 Mbyte	256 Kbyte	256 Kbyte	1 Mbyte
<b>Printer Output</b>	Any RS-232C/V.24	Any RS-232C/V.24	Any RS-232C/V.24, Graphics with 2225D ThinkJet, 2227/8A OmniJet	HP-IB Graphics with HP 2932A, 2934A	HP-IB HP 2225A ThinkJet, P/letter Output
<b>Remote Operation</b>	Transfer Data, Menus via RS-232C/V.24	Transfer Data, Menus, SW Applications via RS-232C/V.24	Transfer Data, Menus, SW Applications via RS-232C/V.24 Unattended control via RS-232C/V.24	Transfer Data, Menus, SW Applications via RS-232C/V.24 Unattended control via HP-IB	Transfer Data, Menus, SW Applications via RS-232C/V.24 Unattended control via RS-232C/V.24
<b>Other</b>	- Battery Backup of Menus, Data - Terminal Emulator	- Battery Backup of Menus, Data - Autostart Disc File - Terminal Emulator - Data Filter	- Autobid Directory - Data Filter - HP-IB Mass Store - Real-time Clock	- HP-IB - Real-time Clock - External Trigger In/Out	- Real-time Clock

#### HP 4951C and HP 4952A Protocol Analyzers

The HP 4951C (19.2 kbps) and HP 4952A (64 kbps synchronous, 19.2 kbps asynchronous) are portable protocol analyzers used for troubleshooting during installation, maintenance and design of data communications networks and equipment.

#### Applications

The HP 4951C and HP 4952A allow you to monitor and decode data transmission, test remote facilities from your location, simulate network components, and perform bit error rate tests. They can also be used as asynchronous terminals.

Protocols that can be tested include Async, BSC, SDLC (NRZI), HDLC, X.25, SNA, DDCMP and user-defined protocols. The HP 4952A also tests X.21.

#### HP 4951C and HP 4952A Features

**Autoconfigure** enables you to automatically determine line parameters and start monitoring data with the push of a key.

**3 1/2" micro floppy disc** stores 618 Kbytes of data, timing, lead status, programs and configurations.

**RS-170 video port** lets you view data externally. Printouts to all RS-232C/V.24/ASCII printers via a separate port.

**Nonvolatile memory** stores data, programs and configurations.

#### Additional HP 4952A Features

- 64 kbps
- 3/4 Mbyte extended capture buffer (Option 002)
- Nonvolatile application storage (Option 002)
- Unattended remote testing
- Cursor timing
- Enhanced programming features: run time user comments, softkey triggering, subroutines.
- Buffer data filtering to maximize capture buffer
- Selective store to disc
- Complete disc copying capability

#### Datacomm Solutions

##### X.25 and SNA Link Level Performance Analysis

With specialized software, the HP 4952A can be transformed into a statistical performance analyzer for the link level (level 2) of SNA and X.25 networks (SDLC and HDLC respectively). The HP 18264A provides link level statistics for the HP 4952A.

This solution provides a new way for network troubleshooters to look at data communications links. Key link events indicate the health of the network and are displayed in both columns and bar charts. These statistics can be stored to disc and reviewed at a later time. Printer capability is provided when hardcopy results are necessary.

##### 3270 Installation and Maintenance

If you have IBM 3270 or compatible terminal systems, you know that problems with newly installed or suspect systems can devastate hosts and users. The HP 18332D (for the HP 4951C) and HP 18263A (for the HP 4952A) 3270 installation and maintenance software packages provide easy, automatic, offline testing of multiple 3270 clusters by emulating many of the functions of a host computer.

##### HP 4951C/4952A Data Communications Test Library

This convenient data communications test library is included with every HP 4951C and HP 4952A at no additional cost. The library contains over 100 general purpose monitor and simulate programs on a single 3 1/2-inch floppy diskette to help you evaluate your network quickly and easily. Programs are written for common configurations of the protocol analyzer and diagnose common datacomm problems. Documentation is provided to tailor the programs for special configurations and applications. The library also contains several installation and acceptance tests for printers and terminals.



#### Ordering Information

	<b>Price</b>
<b>HP 4951C: Protocol Analyzer</b> (interface pod not included)	\$3750
<b>Opt. 101:</b> Adds HP 18174A RS-449/422A/423A interface pod	\$500
<b>Opt. 102:</b> Adds HP 18180A RS-232C/V.24 and RS-449/422A/423A interface pod	\$900
<b>Opt. 103:</b> Adds HP 18179A RS-232C/V.24 interface pod with full breakout box	\$650
<b>Opt. 105:</b> Adds HP 18177A V.35 interface pod	\$700
<b>Opt. 908:</b> Rack mount kit	\$400
<b>Opt. W30:</b> 2 additional years of return-to-HP service	\$170
<b>HP 18331D:</b> SNA, DDCMP, X.25 analysis	\$350
<b>HP 18332D:</b> 3270 installation and maintenance software	\$350
<b>HP 18347A/X:</b> Customer training course	\$300

<b>HP 4952A: Protocol Analyzer</b> (interface pod not included)	\$6600
<b>Opt. 002:</b> Extended memory plus	\$1500
<b>Opt. 101:</b> Adds HP 18174A RS-449/422A/423A interface pod	\$500
<b>Opt. 102:</b> Adds HP 18180A comb. RS-232C/V.24 and RS-449/422A/423A interface pod	\$900
<b>Opt. 103:</b> Adds HP 18179A RS-232C/V.24 interface pod with full breakout box	\$650
<b>Opt. 104:</b> Adds HP 18260A X.21 and RS-232C/V.24 interface pod	\$1000
<b>Opt. 105:</b> Adds HP 18177A V.35 interface pod	\$700
<b>Opt. 908:</b> Rack mount kit	\$400
<b>Opt. W30:</b> 2 additional years of return-to-HP service	\$210
<b>HP 18263A:</b> 3270 installation and maintenance software	\$350
<b>HP 18264A:</b> X.25 and SNA link level performance analysis	\$500
<b>HP 18265A:</b> DDCMP analysis	\$350

#### HP 4951C and HP 4952A Common Accessories

<b>HP 18190A:</b> Soft vinyl carrying case	\$125
<b>HP 92192A:</b> Set of 10 double-sided discs	\$69
<b>HP 2225D:</b> RS-232C/V.24 ThinkJet printer	\$495
<b>9211-1290:</b> Hard transit case	\$390
<b>5062-2119:</b> Data communications test library (shipped standard with each HP 4951C and HP 4952A)	\$NC

# DATA COMMUNICATIONS TEST EQUIPMENT

## Protocol Analyzer

Model HP 4954A



### HP 4954A Protocol Analyzer

The HP 4954A is a high speed, multi-protocol, expandable protocol analyzer for designing datacomm products and analyzing network performance. Softkey driven operation combined with a variety of display formats allows you to quickly and efficiently identify problems, perform tests and solve complex problems. The general purpose capability of the HP 4954A can be expanded through application software to offer enhanced capability for currently supported, or new and emerging protocols. The standard mass storage, a 20 Mbyte hard disc and 3.5 in. floppy, may be extended through HP-IB to literally hundreds of megabytes of on-line data storage.

#### Features

**High speed state-of-the-art multiprocessor design** guarantees reliable sophisticated analysis and simulation of full duplex bit oriented protocols to 72 kbps and data capture of bit oriented protocols at lower line utilizations up to 256 kbps.

**Multi-protocol testing capabilities** allow you to monitor, analyze, and simulate popular protocols such as X.25, SNA/SDLC, Bisync, Async, DDCMP, X.75, HDLC, BSC-framed X.25, and character oriented synchronous protocols X.21, and CCITT #7/CCS7 support is also available through easy to use application software.

**Mass storage** with an integral 20 Mbyte hard disc and 613 Kbyte 3.5" floppy disc provide easy access to setup menus, user written programs, buffer data, application programs, and data codes. Any HP 4954A file may be autoloaded at power-on to instantly configure the protocol analyzer for your individual needs. The 4954A's mass storage capacity can be further extended through HP-IB subset 80 disc drives. Setup menus, user written programs and buffer data stored to floppy disc may be shared with the HP 4951C and HP 4952A.

**The internal 256 Kbyte data capture buffer** can be expanded through the integral hard disc up to 20 Mbytes. Even greater data capture buffers are possible with external HP-IB driven disc drives.

**Programming flexibility** through high level protocol analysis and simulation is a standard capability of the HP 4954A. Custom measurements and tests are easy to perform with softkey driven entry of monitor and simulation programs with triggering based upon datacomm events. The HP 4954A gives you programmatic control of send strings, timers and counters.

#### Datacomm Solutions

Expandability is provided with extensive application software memory which makes the HP 4954A one of the most expandable protocol analyzers available. Many software and hardware accessories are now available to broaden the HP 4954A analysis and simulation capabilities. For example, the SNA Emulation Language eases the development and testing of SNA compatible products. A variety of physical interface pods enables the HP 4954A to access the most common datacomm interfaces such as RS-232C/V.24, V.35, RS-449, and MIL-188C and X.21.

#### SNA Development System

The HP 18380A SNA Emulation Language is an HP 4954A software solution that is specifically designed to aid in the development of SNA compatible devices. It consists of an SNA specific softkey driven programming language combined with complete link and path control emulators. The HP 18361A SNA 3270 Device Exerciser and HP 18362A LU6.2 Node Exerciser are user-modifiable tests written in the SNA Emulation Language to thoroughly test 3270 and LU6.2 devices.



#### X.21 Development System

The HP 18352A X.21 State Simulator is an HP 4954A software solution that is specifically designed to aid in the development of X.21 DTEs and DCEs. It consists of an X.21 specific softkey driven programming language combined with a state level decode. This state level decode explicitly shows the current and past states of the interface in terms of the actual CCITT X.21 state number.

Included with the X.21 state simulator is the X.21 DTE analysis pack; a set of user modifiable tests written in the X.21 state simulator language that thoroughly tests an X.21 DTE for protocol conformance.

#### X.25 Network Performance Analyzer

The HP 18370A X.25 Network Performance Analyzer is an HP 4954A software solution that gathers statistical information about the performance of an X.25 data link. The following information is available in both tabular and graphical format:

**Efficiency:** Throughput, Utilization, Packets/Seconds, and Data Packet Size

**Error and Incidents:** Link Setups, Link Disconnects, Bad FCSs, Abort Sequences, REJ Frames, FRMR Frames, Resets, Restarts, and Unsuccessful Calls

**Response Times:** Link Setup, Link Disconnect, Call Setup, Call Clear, Reset, and Restart

#### Physical Specifications

##### Dimensions

44.9 cm x 43.1 cm x 55.8 cm (7.75 in. x 17 in. x 22 in.) Rack mountable

##### Weight

20 kg (44 lb)

#### Ordering Information

	Price
HP 4954A: Protocol Analyzer (includes one interface pod referenced by option number)	\$15,850
Opt. 100: Adds RS-232C/V.24 interface pod	\$1,150
Opt. 101: Adds RS-449 interface pod	\$1,150
Opt. 102: Adds V.35 interface pod	\$1,450
Opt. 103: Adds MIL-188C interface pod	\$1,150

#### Application Software

HP 18352A: X.21 State Simulator	\$3,500
HP 18353A: Password Security	\$450
HP 18355A: CCITT#7/CCS7 Analysis	\$900
HP 18360A: SNA Emulation Language	\$2,500
HP 18361A: 3270 Device Exerciser	\$1,000
HP 18362A: LU6.2 Node Exerciser	\$2,000
HP 18370A: X.25 Network Performance Analysis	\$1,200



# DATA COMMUNICATIONS TEST EQUIPMENT

## WAN and LAN Protocol Analyzers

HP 4955A and HP 4972A

495



HP 4955A



HP 4972A



### HP 4955A Protocol Analyzer

The HP 4955A Protocol Analyzer is a high level tool for R&D and manufacturing, as well as for network performance analysis. In addition to the standard capabilities provided within the protocol analyzer family, the HP 4955A offers **BASIC programming**, **HP-IB control**, a **real-time clock**, and **dual tape drives**.

Troubleshooting is straightforward with the softkey driven menus. The datacomm-enhanced BASIC (option 001) programming language can be used for sophisticated analysis or for unique applications. BASIC uses many of the menu routines, maintaining softkey ease-of-use, while giving you the capability to write your own programs as needed. The HP 4955A, combined with the HP 18150JA X.25 Conformance Testing and Certification System, provides you with a very powerful tool for certifying equipment for use in X.25 networks. This package contains more than 700 individual test sequences for verifying conformance to the CCITT X.25 specification. These tests were designed in accordance with the National Bureau of Standards' X.25 verification procedure, FS 1041/FIPS 100. This package also contains a link level DTE and DCE emulation program which allows easy packet level testing by automatically handling the link level. Together, the HP 4955A and HP 18150JA, offer an extremely powerful X.25 problem-solving system.

Please call the HP sales office near you for more information and/or a demo of this product.

### HP 4972A LAN Protocol Analyzer

The HP 4972A is a high-performance protocol analyzer for managing performance and for troubleshooting problems on your IEEE 802.3 or Ethernet local area network. The HP 4972A provides accurate and complete information under all operating conditions.

#### Performance Management

To assist in the management of network performance, the HP 4972A provides statistical information about network, node or connection-level utilization. Errors and other operating parameters are measured and counted for each node. Automatic test sequences make it easy to set up long-term tests and repeat the tests at regular intervals. Users can even define their own parameters for statistical measurements. The performance management software will help you fine-tune your network. To keep it running - and running well.

#### Troubleshooting

The 4972A is also equipped for troubleshooting when sudden changes or unavoidable circumstances take your network down. The softkey-guided programming language can help you test for troublesome network conditions as they occur or you can log network events to the disc and use the same program to sort them out afterwards. A user-definable display format helps you define critical information from each frame displayed.

**Performance analysis software** lets you measure network utilization, identify busy or error-prone nodes, monitor connections between nodes and evaluate the traffic profile of your network over periods of days, weeks or months.

**Softkey-guided programming language** allows you to write your own application programs and selectively capture frames from the network. It makes programming easy, even for the first time user. 20 Mbyte internal disc stores test setups, programs and statistical or frame data.

**Printer or plotter output** enables you to print test setups, programs or data on the HP 2225A ThinkJet printer. Graphical displays can be plotted on the ThinkJet printer or any of several HP pen plotters.

**Composite video output** for external monochrome display.

Optional color RGB outputs are available for external color display of statistics measurements.

Optional remote interface permits the analyzer to be controlled by another HP 4972A via RS-232C/V.34 link.

**Electromagnetic compatibility:** Tested for compliance with VDE 0871 Level B, radiated and conducted.

#### Physical Specifications

##### Dimensions

44.9 cm x 43.1 cm x 35.8 cm (7.75 in. x 7 in. x 22 in.) Rack mountable

##### Weight

19 kg (42 lb)

#### Ordering Information

HP 4972A: LAN Protocol Analyzer

Opt. 001: Adds RGB color video outputs

Opt. 002: Adds Remote Interface

Opt. 908: Adds Rack Mount Kit

##### Price

\$47,000

\$1,500

\$565

\$80

# DATA COMMUNICATIONS TEST EQUIPMENT

## General Information: Data and Voice Testing

### Data Network Testing

There are a wide variety of tests that can be made on a data communications system. Depending on the point in the system at which the tests are made, quite different philosophies and techniques apply.

Protocol analysis is usually concerned with overall network performance, determined through monitoring or simulating network software (protocol and/or data). Digital testing involves measuring modem-channel-modem efficiency in terms such as Bit Error Rate (BER) and Block Error Rate (BLER). Analog testing measures the tariffed and other key parameters of the transmission line itself.

The interrelationships of these measurement results are complicated and difficult to understand. For example, how is envelope delay distortion of the line related to the BER or the throughput of the system? Generally speaking, the three measurement techniques are related in a hierarchical fashion. Nonintrusive network monitoring by protocol analyzers gives an indication of overall performance and can often isolate problems to the component or section. When monitoring is insufficient, such as during software debugging or systems integration, protocol analyzers also can be used to simulate network components such as front-end processors or terminals. Once sectionalized, BER testers are used to verify and quantify the link dysfunction, and analog measurements determine which tariffed parameter is out of specification should the telephone line be the problem.

Combined protocol, digital, and analog tests can be used synergistically to restore the network quickly and efficiently. Protocol Analysis has been previously described. The next sections detail the analog and digital testing.

### Digital Measurements

Data error analyzers are used to test the quality of both the modem and the transmission facility. They provide information about the modem and transmission line, but no information about the DTE they replace.

The overall quality of the link is indicated by its BER. A good link will have an error rate better than  $1 \times 10^{-5}$  per bit. This measurement will include the effect of both transmission line impairments and the modem's ability to overcome them. Modems vary widely in their sensitivity to line impairments. Low speed (less than 300 bps) and adaptively equalized modems are less sensitive than high speed (more than 4800 bps) and non-adaptively equalized modems.

Since data communications systems transmit data and control information in blocks, these instruments also measure BLER and Percent Error Free Seconds (%EFS). BER, BLER and %EFS can be used together to examine the statistics of the error mechanism.

If the BER and BLER are both high, and %EFS low, the impairment is random and probably due to noise. If the BER and %EFS are high but the BLER is low, the impairment is more bursty. This happens when lines are switched, synchronization is temporarily lost, or impulse noise is too high.

	Instrument	In-Service Testing										Basic Testing				Conditioned Circuit Testing				Additional Testing for Complete Troubleshooting			
		BER	CCITT	V.A.N.F	Loss Continuity	Noise Loss vs. Freq.	Signal/Noise Ratio	Impulse Noise	Whiteband Impulse Noise	P/AF	Envelope or Group Delay	Attenuation Distortion	NLD or Intermodulation Distortion	Phase Jitter	Amplitude Jitter	Bus Dropouts	Return Loss	Loop Holding	Signaling Testing	Digital Access	Auto End-To-End Testing		
Instruments	3651A																						
	4935A																						
	4937A																						
	4938A																						
	4947A																						
	3776B*																						
	4945A																						
	3552A																						
	4936A																						
Private Line Access & Test System	3776A*																						
	4948A**																						

\*Information about the HP 3776A, HP 3776B and HP 37100S can be found in the Telecommunications Test Equipment section.

\*\*In-service Testing is discussed in the description of the HP 4948A in this section.

Error rates are quantitative checks of the data communications system that can be made in a few minutes. If the system is bad, diagnostic measurements are provided to help isolate the problem. Dropouts, clock slips, error skew, jitter, and total peak distortion indicate some of the problems that can occur with a modem or on a link. These measurements are made simultaneously with the error rate measurements and can be printed out in automatic unattended mode if desired.

Catastrophic failures can usually be found with self-tests and loop-back switches built into the modem. Data error analyzers can find failures that are not illuminated by internal self-tests.

Modem dynamics are another source of data transmission problems. Modern modems have automatic equalization circuits to compensate for telephone line distortions. It is important to let the equalization process settle, particularly with switched carrier modems, so data is not transmitted too soon.

Measurements that verify modem dynamics are RTS-CTS delay and modem start up tests such as ping-pong.

### Analog Impairments Affect Performance

Analog impairments on the telephone line can significantly affect the efficiency of data communications. What the user notices is a slow down in throughput (because of frequent retransmission of blocks of data), gar-

bled data or no data at all. These effects are a result of the line impairments distorting the modem signal so that the receiving modem cannot make correct decisions. Data bits and blocks are received in error.

The various modem types are susceptible to each impairment in differing degrees. Low speed modems generally use simple modulation schemes and are mostly affected by problems of continuity, loss, signal-to-noise ratio, and impulse noise.

As modem speeds increase, the modulation schemes become more complex and so they are more susceptible to impairments. Automatic equalization helps take care of bandwidth reduction, and envelope (group) delay distortion problems. But to significantly reduce the impairing effects and improve error performance specially, selected and conditioned leased telephone lines are used.

A number of levels of conditioning are available to suit the circuit to the speed of the modem, each tariffed at a different rate. Conditioning can minimize noise, bits, dropouts, phase jitter, non-linear (inter-modulation) distortion, bandwidth reduction and envelope (group) delay distortion.

So there is a need for testing: by the circuit supplier, when he installs or repairs a conditioned circuit, to check if impairment levels are within the agreed limits; by the circuit user, to ensure he is getting the quality of circuit he is paying for.

# DATA COMMUNICATIONS TEST EQUIPMENT

## Transmission Impairment Measuring Sets Model 4945A, 4947A

### HP 4945A

- Complete analog testing to North American standards for: voice grade data circuits, program circuits, metallic digital circuits
- Versatile I/O for systems use
- Master/Slave capability for flexible end-to-end testing

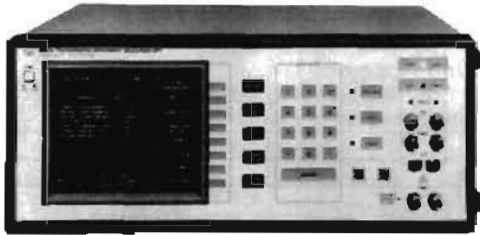

RS 232



HP 4945A

### HP 4947A

- Voice grade data circuit testing to North American Standards
- High performance at an affordable price
- Automatic sequence for end-to-end testing

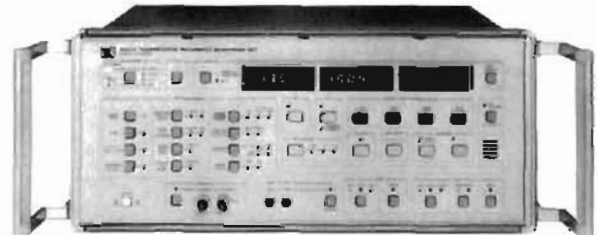

HP 4947A

### HP 4945A Product Description

The HP 4945A Transmission Impairment Measuring Set provides the complete set of measurements needed to quickly isolate faults and qualify circuits for voice, data or broadcast transmission up to 110 kHz and local distribution of digital data services up to 56 kbps. All measurements are compatible with Pub 41009 and IEEE 743-1984 and include:

- |                               |                             |
|-------------------------------|-----------------------------|
| Level/Frequency (20Hz-110kHz) | Phase Jitter                |
| Attenuation Distortion        | Amplitude Jitter            |
| Envelope Delay Distortion     | Intermodulation Distortion* |
| Gain Slope                    | 3-Level Impulse Noise       |
| Message Circuit Noise         | Gain Hits                   |
| Notched Noise                 | Phase Hits                  |
| Signal-to-Noise               | Dropouts                    |
| Noise-to-Ground               | P/AR                        |
| Noise Filters: C-Mess, 3kHz,  | 2/4-Wire Return Loss        |
| 15kHz, Program, 50 kbit       | ERL, SRL Hi, SRL Lo, Sine   |

The HP 4945A contains all the measurements you need for installation, maintenance and troubleshooting in a portable package. The use of softkeys make the HP 4945A extremely flexible while maintaining ease of operation by making all appropriate selections readily available.

### Versatile I/O Interfaces

The HP 4945A lends itself to a systems environment by providing three interfaces, HP-IB, HP-IL, and RS-232-C as accessory modules.

### Master/Slave Capability

The HP 4945A has Master/Slave capability for remote control and data collection. Master/Slave saves time and money by allowing you to control the remote (slave) TIMS from the local (master) TIMS. This HP pioneered and patented technique allows the master HP 4945A to completely and flexibly control and collect data from the remote slave HP 4945A over the lines under test.

### Flexible Hardcopy Output

The HP 4945A can provide you with date and time stamped hard copy results on HP-IB, HP-IL or RS-232-C printers.

### Ordering Information

#### HP 4945A Transmission Impairment Measuring Set

- |   |          |
|---|----------|
| Option 001: 100/200 Volt operation            | \$15,250 |
| Option 101: Adds HP 18162A HP-IB module       | N.C.     |
| Option 102: Adds HP 18163A RS-232-C module    | \$500    |
| Option 103: Adds HP 18165A HP-IL module       | \$500    |
| Option 104: Adds HP 18169A 19" rack mount kit | \$350    |
| Option 105: Adds HP 18170A soft vinyl case    | \$75     |

\* The Intermodulation Distortion technique is licensed under Hewlett Laboratories, Inc. US Patent No. 3862380

### HP 4947A Product Description

The HP 4947A Transmission Impairment Measuring Set (TIMS) is a test set with the high measurement capability required to test a long distance data circuit. With built-in DTMF dialing and many other time and labor saving features it offers high productivity in line testing. Its operation is modeled on the proven HP 4935A TIMS which makes it simple to use. Its measurement methods are in accordance with IEEE 743-1984 and include:

- |                             |                             |
|-----------------------------|-----------------------------|
| Level/Frequency (50-5004Hz) | Phase Jitter                |
| Attenuation Distortion      | Intermodulation Distortion* |
| Envelope Delay Distortion   | 3-Level Impulse Noise       |
| Gain Slope                  | Gain & Phase Hits           |
| Message Circuit Noise       | Dropouts                    |
| Notched Noise               | P/AR                        |
| Signal-to-Noise             | 4-Wire Return Loss          |
| Noise-to-Ground             | ERL, SRL HI, SRL Lo         |
| Noise Filters: C-Mess, 3kHz |                             |

### Easy End-to-End Testing

The HP 4947A has a simple solution for fast, trouble-free end-to-end testing. You only need to use two HP 4947As and the circuit under test. With a couple of keystrokes you can run a sequence of tests which measure all the key data transmission parameters. And the system is robust enough to support remote start-up and auto restart on power failure or signal loss. Each HP 4947A stores the results of its own measurements in non-volatile memory. Later, results can be dumped to a printer or controller, or read from the display.

The measurements made in the sequence are: P/AR, Gain Slope, Frequency, Noise with Tone, S/N, Idle Channel Noise, Intermodulation Distortion (both uncorrected and corrected for S/N), Level, Frequency, Phase Jitter, Phase and Gain Hits, Dropouts and Impulse Noise.

### Print/Plot to HP ThinkJet

The HP 4947A can print results on a HP ThinkJet, and can even generate plots using its graphics mode. You can record graphs of EDD, level and attenuation vs frequency.

#### HP 4947A Transmission Impairment Measuring Set

- |                                  |         |
|----------------------------------|---------|
| Option 908: 19" rack mount kit   | \$8,000 |
| Option 910: Extra set of manuals | \$40    |

#### Accessories for HP 4945A and HP 4947A

- |  |       |
|--|-------|
| HP 18178A: 23" rack mount kit HP 4945A                 | \$160 |
| HP 18182A: 1.5m cable with Weco 310 to alligator clips | \$60  |
| HP 15513A: 1m cable with Weco 310s on each end         | \$60  |
| 9211-2850: Hard transit case for HP 4945A or HP 4947A  | \$480 |

# DATA COMMUNICATIONS TEST EQUIPMENT

## In-Service Transmission Impairment Measuring Set

Model 4948A

- Voice-grade data circuit testing - without disturbing traffic
- True preventive maintenance
- Network management information - without special modems
- Suitable for North American and CCITT environments



HP 4948A



### Description

The HP 4948A is a unique Transmission Impairment Measuring Set (TIMS) which lets you test data circuits carrying voice grade modem traffic while they are still in service.

A simple connection to the data circuit carrying the modem signal, at a voice frequency access point, is all that is required for the HP 4948A to measure the impairments that have been added between signal generation and the measurement point.

The HP 4948A is very simple to use; with one keystroke the HP 4948A can automatically identify the modem type and measure all the transmission impairments simultaneously. It remembers all the previous test conditions so no time need be wasted setting up a test, and flexible printout capabilities let you document test results with ease.

### The HP 4948A Simplifies Testing

The in-service capability of the HP 4948A opens up new test strategies. The HP 4948A lets you see if the analog signal is good where you are testing. Because you are measuring on the live modem signal, only one instrument need be used, which removes the problem of co-ordinating an end-to-end test. This speeds up the fingerpointing that helps you establish who has the responsibility to repair a fault in today's multi-vendor networks.

You can respond to trouble reports immediately without taking the line from service. All the impairments are measured at once so you can quickly and easily recognize the problem. The HP 4948A sees the line like a modem sees it (same bandwidth, same response) letting you identify the impairments that are really causing data errors. And with the HP 4948A's long term data logging capabilities, you can even track down difficult, intermittent faults.

With the HP 4948A you can implement a preventive maintenance policy and routinely check lines against a benchmark. While the circuits are still operating, carrying traffic, you will see any degradations and be able to clear problems before they cause data errors. Testing can be done at convenient times, even when the circuits are being heavily used and the network is under most stress.

All the capability of the HP 4948A can be remotely controlled and so it can be used to build a network monitoring system. The HP 4948A is an economic means of producing data for private network management - even for small systems, or systems using a variety of modem types.

### Networks

You can use the HP 4948A at any point along a datacommunications circuit. In multi-point circuits, testing the host-to-slave link is as easy as for point-to-point circuits. To test the slave-to-host link, only one slave modem must be transmitting data while the HP 4948A analyzes the signal.

### Measurement Capability

Level Frequency S/N Phase Jitter {4-20Hz, 20-300Hz} Amplitude Jitter {4-20Hz, 20-300Hz}	Dropouts Gain Hits Phase Hits Impulse Noise	On modem signals only Attenuation Distortion Delay Distortion
---	--	---

The results are all computed simultaneously, with the received signal constellation available from the rear panel XY outputs.

### Compatible Modems

The HP 4948A has been designed to operate with many of the common high speed modems in use today.

Compatible Modem Types (4-Wire)	
Data rate	Examples
9600 bps	CCITT V.29, AT&T 209, AT&T 2096 V.29 with 1800Hz carrier 4x4 QAM with 1700Hz carrier
4800 bps	CCITT V.27, AT&T 208, AT&T 2048
2400 bps	CCITT V.26 A&B, AT&T 201 B&C

NOTE: It is expected that further schemes will be added to this list.  
AT&T is a trademark of the American Telephone and Telegraph Company.

### Measuring Impairments on a Modem Signal

The HP 4948A measures the effects of the same line impairments that are measured by a conventional, intrusive TIMS. A TIMS measures the effects on a simple known signal (tone) but the HP 4948A measures the effects on the full bandwidth of the data signal with level and frequency properties dependant on the transmitting modem and the data. In addition, the HP 4948A measures impairments at its data detection point - as a modem would see them. From these measurements the HP 4948A predicts conditions on the line and presents its results in conventional form. In most practical situations, the results from the HP 4948A are very similar to those from a TIMS. However, they cannot be directly equated because of the different techniques involved.

### Data Logging

Result data can be stored in the test set's own internal non-volatile memory for later interrogation and printout. The HP 4948A can be left unattended for long periods monitoring a line. This lets you look back at intermittents after they have occurred, or comprehensively characterize a circuit's performance over time.

### Out-of-Service Testing

The HP 4948A can transmit and measure on a tone, so it can interwork with tone sources and conventional test sets. It can also transmit a simulation of a high-quality modem signal of each of the compatible modem types. This allows out-of-service testing and circuit benchmarking with another HP 4948A.

### Ordering Information

	Transmit & Receive Connectors	
	WECO 310 & Bantam	Siemens 3-pin
Stand-alone front connectors adjustable legs	HP 4948A Standard	HP 4948A Option 003
For rack mounting front connectors flat base	HP 4948A Option 001	HP 4948A Option 004
For rack mounting rear connectors flat base	HP 4948A Option 002	HP 4948A Option 005

Option 908: 19" rack mount kit

Option 910: Extra set of manuals

9211-2861: Hard transit case

**HP 4948A In-Service Transmission Impairment \$12,700 Measuring Set**

# DATA COMMUNICATIONS TEST EQUIPMENT

## Transmission Impairment Measuring Sets (TIMS)

Models HP 4935A/4936A HP 3551A/3552A



HP 4935A

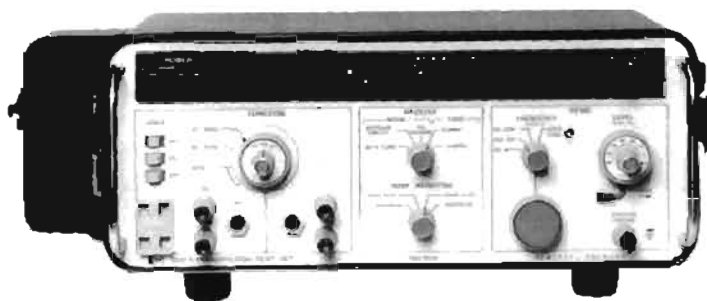

HP 3551A

### Product Description

#### Qualify Circuits for Voice, Data or Program

The HP 4935A/4936A Transmission Impairment Measuring Sets and the HP 3551A/3552A Transmission Test Sets are rugged, portable test sets that provide the basic analog tests to isolate faults and to qualify circuits for voice, data, and broadcast service. In addition, the HP 4935A, with its 110 kHz bandwidth, performs the required tests to qualify the local loop for Digital Data System (DDS) up to 56 kbps. The Peak-to-Average Ratio (P/AR) measurement option on the HP 4935A gives users a powerful, yet simple measure of the combined factors that affect the overall data transmission quality of the line.

#### Different Instruments for Different Standards

The HP 4935A and HP 3551A perform measurements compatible with the Bell standards (BSTR 41009) and IEEE standards (IEEE 743-1984). These standards are primarily used in North America. The HP 4936A and HP 3552A are compatible with the recommendations of the CCITT.

#### HP 4935S Data Transmission Test System

The HP 4935S combines the analog test power of the HP 4935A with the compact, yet powerful digital test abilities of the HP 4925B to form a complete data installation and maintenance tool. This is especially useful for those technicians who have both analog and BERT test needs. See page 499 for more information.

#### Capability Summary

##### HP 4935A/4936A

##### Measurements

- Level
- Frequency
- Circuit Noise
- Noise-with-Tone
- Signal-to-Noise Ratio
- 3 Level Impulse Noise (quiet) ('36A)
- 3 Level Impulse Noise (with tone)
- Noise-to-Ground ('35A)
- P/AR (option '35A)

##### Ranges

- Trans. Level: -40 to +13 dBm
- Trans. Freq.: 20 Hz to 110 kHz

- Rec. Level: -60 to +13 dBm ('35A)  
-70 to +13 dBm ('36A)
- Rec. Freq.: 20 Hz to 110 kHz
- Message Circuit Noise  
(600 and 900 ohm): 0 to 100 dBm ('35A)  
-90 to +10 dBm ('36A)

- Noise-with-Tone:  
(600 and 900 ohm): 10 to 100 dBm ('35A)  
-80 to +10 dBm ('36A)

- Noise-to-Ground: 50 to 130 dBm ('35A)

- Signal-to-Noise Ratio: 10 to 45 dB

- Impulse Noise Threshold:  
30 to 109 dBm ('35A)  
-60 to +16 dBm ('36A)

- Impulse Noise Separation: 4 dB ('35A)  
3 dB ('36A)

- P/AR Range: 0 to 120 P/AR units ('35A)

##### General

- Impedances: 135, 600, 900 ohms ('35A)  
150, 600, 900 ohms ('36A)

##### Filters

##### 4935A:

- C-Message
- 3 kHz flat
- Program
- 15 kHz flat
- 50 kbit
- 1010 Hz notch

##### 4936A:

- Psophometric (P.53)
- 275-3250 Hz flat (0.71 Impulse noise)
- Sound unweighted (J.16)
- Sound weighted (J.16)
- 820 Hz notch (1020 Hz optional)
- Size: 127 x 279 x 381 mm (5.0 x 11.0 x 15.0 in.)
- Weight: 5.0 kg (11 lb), 6.5 kg (14 lb) with battery

##### 3551A/3552A:

- Measurements
- Level
- Frequency
- Circuit Noise
- Noise-with-Tone
- Noise-to-Ground

##### Range

- Trans. Level: -60 to +10 dBm
- Trans. Freq.: 40 Hz to 60 kHz
- Rec. Level: -70 to +15 dBm
- Rec. Freq.: 40 Hz to 60 kHz
- Message Circuit Noise:  
0 to 85 dBm ('51A)  
-90 to -5 dBm ('52A)

- Noise-with-Tone:  
(600 and 900 ohm) 10 to 85 dBm ('51A)  
-80 to -5 dBm ('52A)
- Noise-to-Ground: 40 to 125 dBm ('51A)  
-50 to +35 dBm ('52A)

##### General

- Impedances: 135, 600, 900 ohms ('51A)  
150, 600, 900 ohms ('52A)

##### Filters

##### 3551A:

- C-Message
- 3 kHz flat
- Program
- 15 kHz flat

##### 3552A:

- Psophometric
- 3 kHz flat
- Program
- 15 kHz flat
- 1010 Hz notch

- Size: 159 H x 368 W x 273mm D (6.3" x 14.5" x 10.8")

- Weight: 6.6 kg (14 lb)

##### Ordering Information

- |  | Price   |
|--|---------|
| HP 3551A Transmission Test Set                                       | \$3,575 |
| HP 3552A Transmission Test Set (CCITT)                               | \$4,200 |
| HP 4935A Transmission Impairment Measuring Set                       | \$3,360 |
| Option 001: Adds Rechargeable Battery Pack                           | \$ 375  |
| Option 002: Adds P/AR Measurement in place of Noise-to-Ground        | \$ 300  |
| Option 003: Adds both Battery Pack and P/AR, deletes Noise-to-Ground | \$ 430  |
| Option 910: Adds extra HP 4935A Operating and Service Manual         | \$ 25   |
| HP 4936A Transmission Impairment Measuring Set                       | \$4,200 |
| Option 001: Includes 820 Hz tone with rechargeable Battery Pack      | \$ 490  |
| Option 002: 1020 Hz tone   | \$ NC   |
| Option 003: Includes 1020 Hz tone with rechargeable Battery Pack     | \$ 495  |
| Option 910: Adds extra HP 4936A Operating and Service Manual         | \$ 35   |

# DATA COMMUNICATIONS TEST EQUIPMENT

## Transmission Impairment Measuring Sets (TIMS)

Models HP 4935A/4936A HP 3551A/3552A



HP 4935A

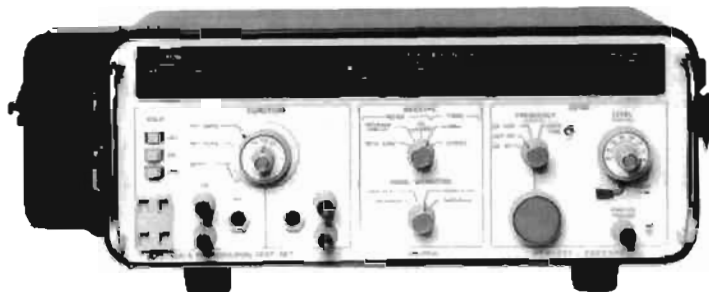

HP 3551A

### Product Description

#### Quality Circuits for Voice, Data or Program

The HP 4935A/4936A Transmission Impairment Measuring Sets and the HP 3551A/3552A Transmission Test Sets are rugged, portable test sets that provide the basic analog tests to isolate faults and to qualify circuits for voice, data, and broadcast service. In addition, the HP 4935A, with its 110 kHz bandwidth, performs the required tests to qualify the local loop for Digital Data System (DDS) up to 56 kbps. The Peak-to-Average Ratio (P/A/R) measurement option on the HP 4935A gives users a powerful, yet simple measure of the combined factors that affect the overall data transmission quality of the line.

#### Different Instruments for Different Standards

The HP 4935A and HP 3551A perform measurements compatible with the Bell standards (BSTR 41009) and IEEE standards (IEEE 743-1984). These standards are primarily used in North America. The HP 4936A and HP 3552A are compatible with the recommendations of the CCITT.

#### HP 4935S Data Transmission Test System

The HP 4935S combines the analog test power of the HP 4935A with the compact, yet powerful digital test abilities of the HP 4925B to form a complete data installation and maintenance tool. This is especially useful for those technicians who have both analog and BERT test needs. See page 499 for more information.

#### Capability Summary

##### HP 4935A/4936A

##### Measurements

##### Level

##### Frequency

##### Circuit Noise

##### Noise-with-Tone

##### Signal-to-Noise Ratio

##### 3 Level Impulse Noise (quiet) ('36A)

##### 3 Level Impulse Noise (with tone)

##### Noise-to-Ground ('35A)

##### P/A/R (option '35A)

##### Ranges

Trans. Level:  $-40$  to  $+13$  dBm

Trans. Freq.: 20 Hz to 110 kHz

Rec. Level:  $-60$  to  $+13$  dBm ('35A)  
 $-70$  to  $+13$  dBm ('36A)

Rec. Freq.: 20 Hz to 110 kHz

Message Circuit Noise  
(600 and 900 ohm): 0 to 100 dBm ('35A)  
 $-90$  to  $+10$  dBm ('36A)

Noise-with-Tone:  
(600 and 900 ohm): 10 to 100 dBm ('35A)  
 $-80$  to  $+10$  dBm ('36A)

Noise-to-Ground: 50 to 130 dBm ('35A)

Signal-to-Noise Ratio: 30 to 45 dB

Impulse Noise Threshold:  
30 to 109 dBm ('35A)  
 $-60$  to  $+16$  dBm ('36A)

Impulse Noise Separation: 4 dB ('35A)  
3 dB ('36A)

P/A/R Range: 0 to 120 P/A/R units ('35A)

#### General

Impedances: 135, 600, 900 ohms ('35A)  
150, 600, 900 ohms ('36A)

#### Filters

##### 4935A:

##### C-Message

##### 3 kHz flat

##### Program

##### 15 kHz flat

##### 50 kbit

##### 1010 Hz notch

##### 4936A:

##### Psophometric (P.53)

##### 275-3250 Hz flat (0.71 impulse noise)

##### Sound unweighted (J.16)

##### Sound weighted (J.18)

##### 820 Hz notch (1020 Hz optional)

Size: 127 x 279 x 381 mm (5.0 x 11.0 x 15.0 in.)

Weight: 5.0 kg (11 lb), 6.5 kg (14 lb) with battery

##### 3551A/3552A:

##### Measurements

##### Level

##### Frequency

##### Circuit Noise

##### Noise-with-Tone

##### Noise-to-Ground

##### Range

Trans. Level:  $-60$  to  $+10$  dBm

Trans. Freq.: 40 Hz to 60 kHz

Rec. Level:  $-70$  to  $+15$  dBm

Rec. Freq.: 40 Hz to 60 kHz

##### Message Circuit Noise:

0 to 85 dBm ('35A)

$-90$  to  $-5$  dBm ('32A)

#### Noise-with-Tone:

(600 and 900 ohm): 10 to 85 dBm ('31A)  
 $-80$  to  $-5$  dBm ('32A)

Noise-to-Ground: 40 to 125 dBm ('31A)  
 $-50$  to  $+35$  dBm ('32A)

#### General

Impedances: 135, 600, 900 ohms ('31A)  
150, 600, 900 ohms ('32A)

#### Filters

##### 3551A:

##### C-Message

##### 3 kHz flat

##### Program

##### 15 kHz flat

##### 3552A:

##### Psophometric

##### 3 kHz flat

##### Program

##### 15 kHz flat

##### 1010 Hz notch

Size: 159 H x 368 W x 273mm D (6.3" x 14.5" x 10.8")

Weight: 6.6 kg (14 lb)

#### Ordering Information

HP 3551A Transmission Test Set \$3,575

HP 3552A Transmission Test Set \$4,200

(CCITT) \$3,360

HP 4935A Transmission

Impairment Measuring Set

Option 001: Adds Rechargeable

Battery Pack \$ 375

Option 002: Adds P/A/R

Measurement in place of Noise-to-

Ground \$ 300

Option 003: Adds both Battery

Pack and P/A/R, deletes Noise-to-

Ground \$ 430

Option 910: Adds extra HP 4935A

Operating and Service Manual \$ 25

HP 4936A Transmission

Impairment Measuring Set \$4,200

Option 001: Includes 820 Hz tone

with rechargeable Battery Pack \$ 490

Option 002: 1020 Hz tone \$ NC

Option 003: Includes 1020 Hz tone

with rechargeable Battery Pack \$ 495

Option 910: Adds extra HP 4936A

Operating and Service Manual \$ 35

# DATA COMMUNICATIONS TEST EQUIPMENT

501

Network Circuit Access Test Set, Transmission Impairment Measuring Set

Models 4938A/4937A



<b>HP 4935S Data Transmission Test Set</b>	\$4,705
<b>Option 001:</b> Adds rechargeable Battery Pack to HP 4935A	\$375
<b>Option 002:</b> Adds P/AR measurement in place of Noise-to-Ground in HP 4935A	\$300
<b>Option 003:</b> Adds both battery Pack and P/AR to HP 4935A, deletes Noise-to-Ground	\$430
<b>Option 101:</b> Adds RS-232C/V.24 Interface to HP 4925B	\$390
<b>Option 102:</b> Adds V.35 Interface and HP 18184A Power Module (115V) to HP 4925B	\$570
<b>Option 104:</b> Adds V.35 Interface and HP 18194A Power Module (220V) to HP 4925B	\$615
<b>Option 910:</b> Adds extra HP 4935A and HP 4925B Operating and Service Manuals	\$60

## HP 4937S Network Access Transmission Test Set

HP 4937S = HP 4937A + HP 4938A

### A Transmission Test Set With Signaling

The HP 4937S Network Access Transmission Test Set provides transmission tests, supervisory signaling simulation, and network access capabilities for installation and maintenance of networks and PBXs. It is a field-service, portable test set designed for craft-level use. All the transmission measurements are compatible with current Bell standards.

### One Instrument for Installation/Maintenance of PBXs and Networks.

The HP 4937A contains a set of voiceband transmission tests — level/frequency measurement, noise, and 2- and 4-wire return loss measurements. It also has the ability to seize and hold three types of E/M lines. In addition, the HP 4937A simulates signaling both from the central office and from the PBX at the network interface.

The HP 4938A provides additional network access and margin testing capabilities. It includes access to 4-wire simplex leads, generating ringing signal, and providing access for loop current and ringing voltage measurement.

### HP 4937A Specifications

<b>Level/Frequency Transmitter</b>
<b>Level:</b> -40 dBm to +13 dBm
<b>Frequency:</b> 20 Hz to 9999 Hz
<b>Receiver</b>
<b>Level:</b> -60 dBm to +13 dBm
<b>Frequency:</b> 20 Hz to 9999 Hz

### Noise Measurements

<b>Noise:</b> 0 to 99 dBm
<b>Noise-with-Tone:</b> 10 dBm to 99 dBm
<b>Signal-to-Noise Ratio:</b> 10 to 45 dB
<b>Noise-to-Ground:</b> 50 to 99 dBm
<b>Filters:</b> C-Message, 3 kHz flat, 1010 Hz notch

### Return Loss

**Impedances:** 600 and 900 ohms  
**Signal Spectra:** Echo return loss, singing return loss high, singing return loss low.

#### Return Loss, 2-Wire

<b>Transmitter Level:</b> -26 dBm to -2 dBm
<b>Receiver Range:</b> 0 to 40 dB

#### Return Loss, 4-Wire

<b>Transmitter Level:</b> -26 dBm to -2 dBm
<b>Receiver Range:</b> 0 to 50 dB

**Transhybrid Loss Compensation:** -29.9 to +29.9 dB

### Supervisory Signaling

<b>E/M Signaling:</b> Types I, II, III
<b>Loop Signaling:</b> Loop start, Ground start, Loop Reverse Battery
<b>Battery:</b> -48 Vdc current limited to 29 mA
<b>Hold Circuit:</b> 2 each drawing 20 mA at a minimum voltage of 8.5 Vdc
<b>Wink:</b> Idle state, 100 ms; off-hook state, 200 ms

### General

<b>Battery Supply (Optional):</b> Typically 5 hours of continuous operation at +25°C. Complete recharging in 14 hours with unit in STBY
<b>Dimensions:</b> 127 H x 279 W x 380 mm D (5.0" x 11.0" x 15.0")
<b>Weight:</b> 5.3 kg (12 lb), 7.6 kg (17 lb) with batteries

### HP 4938A Specifications

<b>Ringing Voltage Generator</b>
<b>Output Level:</b> 86 Vrms into a REN-3 load
<b>Frequencies:</b> 20 Hz and 30 Hz
<b>Ring Trip Threshold:</b> 17 mA typical
<b>Ringing Termination:</b> REN-3 keypad, ring trip distance (330 ohms)

**Loop Signaling Network:** loop start, 430 ohms; ground start, 550 ohms from ring to ground

**4-Wire Network Access:** 2 dual center-tapped simplex transformers

**Battery Simulator:** 48 Vdc maximum current 100 mA

### General

**Dimensions:** 91 H x 261 L x 126 mm W (3.6 x 10.3 x 4.9 in.)  
**Weight:** 1.5 kg (3.2 lb)

### Ordering Information

<b>HP 4937S Network Access Transmission Test Set</b>	\$5,310
<b>Option 001:</b> Rechargeable batteries for HP 4937A	\$250
<b>Option 002:</b> Replace 900 ohms with 150 ohms on HP 4937A	N.C.
<b>HP 4937A Transmission Impairment Measuring Set</b>	\$4,340
<b>Option 001:</b> Rechargeable batteries	\$250
<b>Option 002:</b> Replace 900 ohms with 150 ohms	N.C.
<b>HP 4938A Network Circuit Access Test Set</b>	\$1,070
<b>Option 910:</b> Adds extra HP 4937A and HP 4938A Operating and Service Manuals.	\$23

### Accessories

<b>HP 18132A:</b> 19 in. rack mount for HP 4935A and HP 4937A	\$150
<b>HP 18134A:</b> Soft Vinyl Carrying Case for HP 4935A or HP 4935S	\$125
<b>HP 15512A:</b> 1 m audio cable with two 3-pin connectors (Siemens type) (for the HP 4936A)	\$75
<b>HP 15513A:</b> 1 m audio cable with two WECO 310 jack plugs (for the HP 4935A and HP 4937A)	\$60
<b>HP 18182A:</b> 1.5 m audio cable, WECO 310 plug to alligator clips	\$60
<b>HP 18064A:</b> Noise-to-ground adapter for the HP 4935A. Allows P/AR instruments (options 001 and 003) to measure noise-to-ground	\$125
<b>HP 18161A:</b> Ladder bracket for HP 4935A and HP 4937A	\$25

See also HP 4925B

# DATA COMMUNICATIONS TEST EQUIPMENT



The following information is provided for your information only. It is not intended to be used as a substitute for the actual equipment or its operation. The information is provided for your information only. It is not intended to be used as a substitute for the actual equipment or its operation.

The following information is provided for your information only. It is not intended to be used as a substitute for the actual equipment or its operation. The information is provided for your information only. It is not intended to be used as a substitute for the actual equipment or its operation.

The following information is provided for your information only. It is not intended to be used as a substitute for the actual equipment or its operation. The information is provided for your information only. It is not intended to be used as a substitute for the actual equipment or its operation.

The following information is provided for your information only. It is not intended to be used as a substitute for the actual equipment or its operation. The information is provided for your information only. It is not intended to be used as a substitute for the actual equipment or its operation.

The following information is provided for your information only. It is not intended to be used as a substitute for the actual equipment or its operation. The information is provided for your information only. It is not intended to be used as a substitute for the actual equipment or its operation.

The following information is provided for your information only. It is not intended to be used as a substitute for the actual equipment or its operation. The information is provided for your information only. It is not intended to be used as a substitute for the actual equipment or its operation.

The following information is provided for your information only. It is not intended to be used as a substitute for the actual equipment or its operation. The information is provided for your information only. It is not intended to be used as a substitute for the actual equipment or its operation.

The following information is provided for your information only. It is not intended to be used as a substitute for the actual equipment or its operation. The information is provided for your information only. It is not intended to be used as a substitute for the actual equipment or its operation.



## **SEMICONDUCTOR TEST & BOARD TEST**

<b>Semiconductor Test Equipment .....</b>	<b>504</b>
<b>Board Test Systems.....</b>	<b>528</b>

This product group covers test equipment for semiconductor device testing (for engineering and manufacturing applications) and circuit board testing (primarily for manufacturing applications). Semiconductor test equipment is available for ASIC device characterization, parametric measurement and analysis, and linear/mixed signal device test — both systems and individual instruments. Electronic circuit board test systems, with links to CAE systems, include functional test systems and systems with both in-circuit and functional test capabilities.

**Semiconductor  
Test &  
Board Test**

# SEMICONDUCTOR TEST EQUIPMENT

## General Information

### Parametric Measurement

#### Semiconductor Parametric Measurement

Semiconductor parametric measurement instruments are used for measuring and evaluating the electrical characteristics of semiconductors.

Competition within the semiconductor field is fierce, and major goals are: developing new products rapidly, improving yield and reducing costs.

HP semiconductor parametric measurement instruments provide:

1. Precise, high-resolution measurements for accurate and reliable evaluation and
2. Automated operation from measurement through analysis.

Semiconductor measurement applications vary widely, from device R & D to large-volume manufacture on mass-production lines. Measurement equipment must fit the measurement functions required.

In R & D, parametric testers make comprehensive physical and electrical evaluations of new materials, prototype devices and evaluation test patterns. As the integration and performance of semiconductors advance, measurement instruments must have the expandability to adapt to the high resolution and precision demanded by new evaluation methods.

For production departments, parametric testing helps stabilize new processes for mass production and helps make process yield improvements. Functional testing is used mostly in outgoing inspection. Cost reduction for both types of test requires high-speed, multiple-pin measurements and reduced downtime. The yield of new VLSI devices is less than 10 percent, and bad devices must be discarded. The accurate parametric testing pro-

vided by HP parametric testers can help improve processes and raise yields.

Parametric measurements are generally divided into capacitance (C) and DC, AC, and functional measurements. The following summarize each type of measurement.

1. Capacitance measurements include, primarily, capacitance vs voltage (C-V), capacitance vs time (C-t) and deep-level transient spectroscopy (DLTS) measurements.

These capacitance measurements require correct measurement timing and good capacitance measurement resolution.

2. DC measurements measure the DC current vs voltage (I-V). DC parameter evaluation is based on I-V curve evaluation (eg. threshold voltage, breakdown voltage, leakage current). These measurements require high speed and resolution.

3. AC measurements evaluate the dynamic characteristics of the semiconductor device. With a digital IC, timing measurements such as rise time and propagation delay are the primary ones, so timing resolution is important. Determining the AC gain characteristics of linear ICs requires a wide dynamic range over a wide frequency band.

4. Functional testing evaluates the input/output operation and digital characteristics of semiconductor devices, especially logical devices. This measurement creates an input/output truth table and determines whether the desired output is attained or not.

Table 1 shows HP's semiconductor parametric-test line according to the purpose of the device being measured.

Table 2 shows the parametric measurements required by each application area, with the HP parametric-measurement products that apply.

Device Type	NO. OF Pins	MOS						Bipolar				
		DLTS	C-t	C-V	I-V	DC	AC	Functional	Functional	AC	AC	DLTS
Diodes -Junction -Schottky -MIS	2	HP 4280A						HP 4280A				
		HP 4274A/4275A		HP 4140B		HP 4274A/4275A						
		HP 4061A						HP 4061A				
		HP 4064A						HP 4064A				
Transistor	4	HP 4141B						HP 4141B				
		HP 4145B						HP 4145B				
	2-8	HP 4142B						HP 4142B				
	6/12	HP 4063A						HP 4063A				
Test Pattern	12-48	HP 4145B/4085M						HP 4145B/4085M				
		HP 4062B/C						HP 4062B/C				
IC's	16-256	HP 81810S						HP 81810S				
	52-128	HP 9480						HP 9480				

Table 1. HP Semiconductor-measurement instruments by device and measurement type.

	Lab/R&D			Production		User
	Base Technology	Process Development	Circuit Design	Process Engineering	Testing/Quality Assurance	Incoming Inspection
C	C-V	•	•	•		
	C-t	•	•			
	DLTS	•	•			
D	I-V	•	•	•		
	Parameter	•	•	•	•	
AC Parameter			•		•	•
Functional			•		•	•
Instruments	C-V	HP 4274A/4275A				
		HP 4280A				
		HP 4140B				
	I-V	HP 4141B				
		HP 4142B				
HP 4145B						
Systems	I-V	HP 4145B/4085M				
		HP 4061A				
	C-V	HP 4062B/C				
		HP 4063A				
		HP 4064A				
Functional	HP 81810S					
	HP 9480					

Table 2. Measurements and HP Instruments/systems by application area.



### Mixed-Signal Device Testing

Ongoing developments in mixed-signal devices place a difficult burden on testing technology. Today's—and tomorrow's—testers require:

- Precision, per-pin DC measurement capability
- Low-distortion signal and arbitrary waveform generation capabilities for high frequency analog testing
- High speed data generation, lots of memory, minimum timing skew, and low input capacitance for high speed digital testing
- Analog and digital signal synchronization for analog and digital testing

### HP 9480 Analog LSI Test System

What if there were a test system that could provide a total solution for analog and digital device testing? There is. Now.

No matter what the device, from the most basic device to state-of-the-art mixed signal devices, the HP 9480 Analog LSI Test System provides you with all the analog and digital test capabilities you require to totally characterize your test devices. With the HP 9480, you can expect:

- Lower test costs
- Lower test development costs
- Economical upgrade capability

### Digital Signal Processing Architecture

The HP 9480's Digital Signal Processing (DSP) architecture provides precise signal generation and detection of both analog and digital signals by using the same digital signal processing modules, thereby minimizing analog test hardware requirements.

### Configuration Flexibility

Thanks to the HP 9480's modular configuration, you can choose from over 80 hardware modules to configure a test system to suit your testing requirements: from 1 pA DC parametric measurements, to analog testing up to 128MHz and digital testing up to 128Mwords per second. Also, you can equip the HP 9480 with up to 128 test pins.

The HP 9480 integrates into one system the testing capabilities that previously required a number of test systems.

### High Test Throughput

The HP 9480's high speed per-pin DC measurement function (typically 0.5ms per pin) cuts DC testing times by 50% or more. Also, the 1GHz Sampler, 20MHz Digitizer, and 1MHz Digitizer functions contribute significantly to reduce test times by detecting both DC and AC signals. The system's Dither module, which can detect such parameters as ADC threshold voltage in as little as 40 $\mu$ s (typical), greatly reduces ADC test time.

To ease the workload on the system controller and to increase data manipulation speed, the HP 9480 provides an intelligent array processor. The array processor performs DSP functions for executing complex matrix computations such as Fast Fourier transforms (FFT) and discrete Fourier transforms (DFT), at high rates of speed.

The end result of all these features? Maximum test device throughput.

### Wafer Testing

For precision, high frequency wafer testing, the HP 9480 sets the industry standard. The HP 9480's test head architecture ensures accurate, dependable wafer measurement results to save you packaging costs and testing time.

### Off-line Debugging

The off-line debugger simulates exact hardware and device responses to a test program independently of the test hardware. This means that you can run a test program using the test hardware while simultaneously debugging another test program, thereby saving you valuable time.

### Test Development Efficiency

To optimize test device throughput, you can connect off-line workstations to the system via a Local Area Network (LAN). The HP 9480's flexible networking capabilities allow you to connect Data Analysis Stations (DASs) and Test Development Stations (TDSs) to the system, so you can instantaneously analyze measurement results and develop test programs while the system is performing tests.

### Expandable

The HP 9480's architecture is modular and expandable to accommodate future testing requirements. This approach provides the most cost-effective method for system expansion, while minimizing initial investment. In addition, the HP 9480's system software is designed for upward compatibility, so you can upgrade your system by adding modules, without worrying about modifying existing test programs.

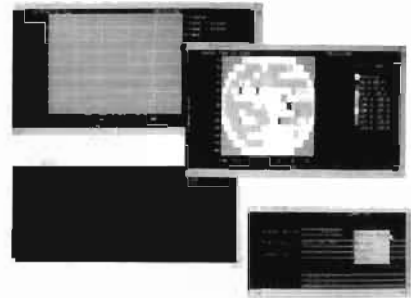

# SEMICONDUCTOR TEST EQUIPMENT

## General Information (cont'd)

### IC Design Verification & Parameter Extraction

#### Digital IC Test

The need for testing occurs several times in the early life cycle of digital IC's. In order to prove what logic simulation had predicted, the first prototypes encounter functional debugging, characterization of performance limits and critical path analysis in the design centers and foundries. During volume manufacturing a series of tests is conducted in order to isolate parts which are faulty as a result of a critical process which is prone to distortion. Parts failing are subject to thorough failure analysis because the results gained may help to control and optimize the process. In addition to Quality Control actions at the manufacturer site, the customer tests samples again in Incoming and Materials Engineering. After assembly the device gets tested again at board level until the final product is finished.



IC Design Verification System HP 81810S

#### A Dedicated Design Verification System cuts IC development time

The HP 81810S IC Design Verification System gives the IC designer a dedicated tool to diagnose chip faults at the prototype stage. This avoids the risk of committing a faulty chip to production and thereby saves additional mask costs and shortens the design cycle. For manufacturers of Application Specific IC's (ASIC's), a short time-to-market provides the competitive edge. ASIC users can also benefit from the system because they are increasingly confronted with the design, debugging and release of ASIC's rather than printed circuit boards.

#### Application Specific IC's create new tester demands

Valuable time gained by using CAE tools could be easily wasted by the engineer if the appropriate verification tools are lacking. This is the case when depending on an expensive production ATE system located in production. Tied up with production part testing, it is not readily available. Also, the engineer is primarily a designer and so does not usually have the expertise required to operate the ATE system.

The HP 81810S addresses these problems head on. It is a personal tester which makes it easy to interactively set up and run tests. The feature set reflects the demanding needs created by IC Design Verification: a close link to CAE simulators, high measurement performance, and ease of system operation. Modular price/performance makes it affordable for the Design Lab.



Now, IC designers can save valuable design time by using HP's powerful TECAP system to analyze DC, C-V, and AC behavior of MOS, Bipolar, and Gallium Arsenide devices in an integrated, accurate, and interactive environment.

#### Cost-Effective Test of SSI and MSI IC's

While the overall performance qualifies the HP 81810S for Design Verification, it is often a prime candidate for other IC test applications. Capabilities such as precise characterization of ac and dc parameters make it an ideal fit for Failure Analysis of parts rejected by the production ATE. Often it is an excellent alternative to big ATE systems at much lower cost, for example, for Production Test or Incoming Inspection of standard SSI/MSI logic circuits or when low volumes do not justify an expensive system. This is particularly true for ASIC's with a typical lot size of a few hundred devices. Other applications include Quality Control and Vendor Qualification.

#### Modularity in Mind

The HP 81810S can be configured for a specific user environment. This enables an optimum application fit. As a result of this modularity HP offers solutions ranging from stand-alone set-ups (see page 510) through small benchtop stimulus-response systems (see page 510) up to complete IC Design Verification and Test Systems (see page 510).

#### CAD Software for Parameter Extraction

HP recently enhanced TECAP (Transistor Electrical Characterization and Analysis Program), used with the company's parametric-measurement equipment. This software package greatly simplifies the task of using mathematical models in circuit design. It measures real devices and computes the parameters needed for circuit-simulation programs such as SPICE.

#### TECAP Automatically Generates Physically Meaningful Parameters

There are three steps to TECAP's model parameter extraction methodology. First, TECAP identifies regions of device operation to be modeled and measures devices in those regions of operation. You may accomplish

parameter "weighting" simply by selecting more data points in each region you wish to emphasize. The model parameters are then automatically grouped into subsets that most directly affect the device characteristics in each of the selected regions of operation. TECAP selects the regions of operation and parameter groupings for the UCB Level 2 and 3 MOS Models and the UCB Gummel-Poon Bipolar Model, but you also have the flexibility to tailor these to your own extraction strategy.

In the second step, powerful, pre-defined functions quickly extract model parameters directly from the measured data points. This step ensures that you generate a physically meaningful set of final model parameters. Again, you can tailor these functions to your own extraction strategy if necessary.

Finally, if you wish, you can "fine-tune" your model parameters using TECAP's powerful optimizer. This optimizer determines parameter values that minimize the difference between measured and simulated device characteristics. You have the option of setting "boundaries" on each parameter value prior to optimization. These user-defined constraints decrease optimization time and guarantee that your final model parameters will be physically meaningful. The non-linear, least-squares-fit algorithm combines the Gauss-Newton and steepest-descent optimization methods for the most accurate fit.

TECAP provides the environment for complete, automated device characterization inside your company. You have the flexibility to use the standard extraction methodologies, or you can customize the program and use TECAP as a "shell" to integrate and automate your own particular extraction strategies. Either way, TECAP provides a practical, universally-satisfying solution to all of your parameter extraction needs. (See page 526.)

# SEMICONDUCTOR TEST EQUIPMENT

507

## Modular DC Source/Monitor

Model 4142B



- Flexible, Modular Architecture
- Wide Measurement Range with High Resolution  
V:  $\pm 4\mu\text{V} - \pm 200\text{V}$ , 0.05%  
I:  $\pm 20\text{fA} - \pm 1\text{A}$ , 0.2%
- Pulse Measurement Capabilities  
Pulse Width 1ms - 50 ms, 100 $\mu\text{s}$  Resolution
- High Speed Measurements (Typical)  
Sourcing or Monitoring: 4ms  
Vth, hFE extracting: 12ms
- Internal Memory  
Program Memory: >500 Commands (Typical)  
Data Memory: 4004 Measurement Points

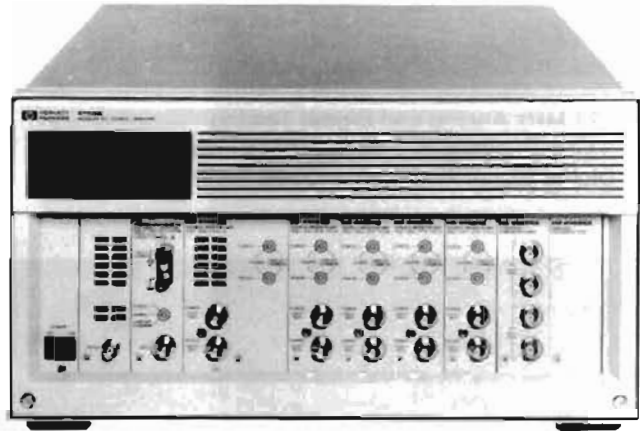

### Description

Offering a wide measurement range and excellent sensitivity, the HP 4142B Modular DC Source/Monitor is a system-use DC measurement instrument especially designed for high throughput DC semiconductor testers. A completely user-definable system component, the HP 4142B's modular architecture allows you to build a custom-configuration to suit your measurement needs.

Eight plug-in module slots can accommodate any combination of the four presently available modules, and as new modules become available, you can upgrade your measurement capabilities with ease. Choose from two types of Source/Monitor Units (SMUs) to force or measure up to  $\pm 200\text{V}$  and  $\pm 1\text{A}$ ; a Voltage Source/Voltage Monitor Unit (VS/VMU); and an Analog Feedback Unit (AFU).

The pulsed voltage and current output and measurement capabilities of the SMUs and the VS/VMU allow you to virtually eliminate the effects of test device thermal drift when testing high power devices. By using enhanced analog feedback technology (the AFU), you can optimize throughput by minimizing extraction times for such parameters as Vth and hFE.

Also, the HP 4142B's instrument command and measurement data storage capabilities, coupled with the high speed HP-IB interface, minimize computer loading, enhance throughput, and simplify systemization.

### Specifications

#### Measurement unit

##### 41420A Source/Monitor Unit (SMU)

V:  $40\mu\text{V} - 200\text{V} \pm 0.05\%$   
I:  $20\text{fA} - 1\text{A} \pm 0.2\%$

#### SMU Range, Resolution and Accuracy (at 18°C–28°C)

Voltage Range	Set Res.	Meas Res.	Accuracy	Max. Current
$\pm 2\text{V}$	100 $\mu\text{V}$	40 $\mu\text{V}$	$\pm 0.05\% \pm 1\text{mV}$	1A
$\pm 20\text{V}$	1mV	400 $\mu\text{V}$	$\pm 0.05\% \pm 10\text{mV}$	1A ( $V \leq 14\text{V}$ ) 0.7A ( $V > 14\text{V}$ )
$\pm 40\text{V}$	2mV	800 $\mu\text{V}$	$\pm 0.05\% \pm 20\text{mV}$	350mA
$\pm 100\text{V}$	5mV	2mV	$\pm 0.05\% \pm 50\text{mV}$	125mA
$\pm 200\text{V}$	10mV	4mV	$\pm 0.05\% \pm 100\text{mV}$	50mA

Current Range	Set Res.	Meas Res.	Accuracy	Max. Voltage
$\pm 1\text{nA}$	50fA	20fA	$\pm 1\% \pm (0.1 + 0.2 \times V_o/100)\%$ $\pm 5\text{pA}$	200V
$\pm 10\text{nA}$	500fA	200fA	$\pm 0.5\% \pm (0.1 + 0.2 \times V_o/100)\%$	
$\pm 100\text{nA}$	5pA	2pA		
$\pm 1\mu\text{A}$	50pA	20pA		
$\pm 10\mu\text{A}$	500pA	200pA	$\pm 0.2\% \pm (0.1 + 0.2 \times V_o/100)\%$	
$\pm 100\mu\text{A}$	5nA	2nA		
$\pm 1\text{mA}$	50nA	20nA		
$\pm 10\text{mA}$	500nA	200nA		
$\pm 100\text{mA}$	5 $\mu\text{A}$	2 $\mu\text{A}$	$\pm 0.5\% \pm (0.1 + 0.2 \times V_o/100)\%$	
$\pm 1\text{A}$	50 $\mu\text{A}$	20 $\mu\text{A}$		
				100V (I < 50mA)
				200V (I $\leq$ 50mA)
				100V (125mA $\geq$ I > 50mA)
			40V (350mA $\geq$ I > 125mA)	
				20V (0.7A $\geq$ I > 350mA)
				14V (I > 0.7A)

\* $V_o$  is the SMU output voltage, in volts

HP 4142B

#### 41421B Source/Monitor Unit (SMU)

V:  $40\mu\text{V} - 100\text{V}$ ,  $\pm 0.05\%$   
I:  $20\text{fA} - 100\text{mA}$ ,  $\pm 0.2\%$

#### 41424A Voltage Source/Voltage Monitor Unit (VS/VMU)

Source:  $1\text{mV} - 40\text{V}$ ,  $\pm 0.1\%$   
Monitor:  $4\mu\text{V} - 40\text{V}$ ,  $\pm 0.05\%$

#### 41425A Analog Feedback Unit (AFU)

Search Voltage Range: 2V, 20V

Ground Unit: Max Sink 1.6A

No. of Plug-in Module Slots: 8 max.

#### Measurement Modes:

Spot/Sweep (log/linear)/Pulse/Pulsed Sweep/Analog feedback for either voltage or current

Program Memory: Approx. 500 steps

Data Buffer Memory: 4004 (binary format)/1001 (ASCII format)

#### BASIC Subprograms (Furnished):

Test Instruction Set (34 Sub's); Parameter Meas. Library (8 Sub's)

#### General Information

Power: 100/120/220V  $\pm 10\%$ , 240V  $-10\% + 5\%$ ; 48-66Hz, 750V Amax

Size: 426mmW X 235mmH X 676mmD (16.8" X 9.5" X 26.6")

Weight: 4142B 23kg(50.7lb), 41420A 4kg(8.8lb), 41421B/4A/5A 2kg(4.4lb)

#### Ordering Information

- HP 4142B Modular DC Source/Monitor  
 Opt. 001 System Cable for Use with 16058A  
 Opt. 002 Accessory Kit for System Use GDU/Interlock Cables, Conn. Plate  
 Opt. 400 Install 41420A (needs 2 slots)  
 Opt. 401 Triaxial Cable for 41420A  
 Opt. 402 Quadaxial Cable for 41420A  
 Opt. 410 Install 41421B (needs 1 slot)  
 Opt. 411 Triaxial Cable for 41421B  
 Opt. 412 Quadaxial Cable for 41421B  
 Opt. 440 Install 4142A (needs 1 slot)  
 Opt. 442 Vs/Vm Cables (coaxial)  
 Opt. 450 Install 41425A (needs 1 slot)  
 HP 41420A Source/Monitor Unit  
 Opt. 402 Quadaxial Cable  
 HP 41421B Source/Monitor Unit  
 Opt. 402 Quadaxial Cable  
 HP 41424A Voltage source/Voltage Monitor  
 Opt. 442 Vs/Vm Cables (coaxial)  
 HP 41425A Analog Feedback Unit  
 16058A Test Fixture  
 Opt. 001 System Cable for 4142B

#### Price

- \$10,950  
 \$215  
 \$345  
 \$4,300  
 \$160  
 \$570  
 \$3,540  
 \$160  
 \$570  
 \$3,220  
 \$320  
 \$1,720  
 \$4,300  
 \$570  
 \$3,540  
 \$570  
 \$3,220  
 \$320  
 \$1,720  
 \$2,650  
 \$56

# SEMICONDUCTOR TEST EQUIPMENT

## Analog LSI Test System

Model 9480

- 128 MHz Analog and Digital Testing
- 1 GHz Bandwidth, 1 ps Sampling Resolution
- Digital Signal Processing (DSP) Technology
- Modular Architecture
- Multi-User, Multi-Tasking Capability
- Off-Line Test Development



### Description

The HP 9480 Analog LSI Test System integrates powerful test hardware and software to perform precise high frequency signal measurements. You can use the HP 9480 to test and characterize a wide variety of devices, from mixed signal devices such as flash ADCs, video DACs, telecommunication devices, etc., to purely analog or purely digital ICs. The HP 9480 provides full data sheet test coverage in a single insertion, thus eliminating the problem of time-consuming and costly multiple insertion testing.

The HP 9480's modular architecture allows you to combine many state-of-the-art hardware and software features into a configuration that best suits your measurement needs. The system can generate digital stimulus patterns and analog stimulus waveforms up to 128 MHz, and can capture DUT digital response patterns up to 128 MHz. For

analog DUT response, the system offers 16 and 12-bit real time waveform digitizers and 1 GHz bandwidth samplers with 1 ps resolution. Digital patterns, DC voltage, and DC current can be input or output to up to 128 pins. Analog signals can be input or output using up to 4 channels. Digital Signal Processing (DSP) allows complex waveform generation and high speed signal analysis via a full floating point array processor. The HP 9480's system software is based on the HP-UX operating system. Powerful debugging tools, including an off-line debugger, virtual panel, and virtual scope, significantly minimize debugging time. Further, HP 9480 software is easy to operate because it incorporates menus, a user-friendly multi-window environment, and mouse capability. These features increase test throughput and minimize time spent on program development.

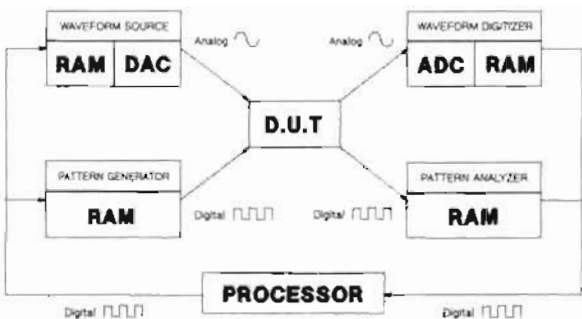

## Hardware

### Device Testing Under In-circuit Conditions

The HP 9480's analog and digital signal test capability enables you to test the dynamic parameters of devices under their true operating conditions.

For AC signal stimulus, the HP 9480 generates low distortion sine waves (up to 128 MHz), arbitrary waveforms with 12-bit resolution (up to 128 MHz clock rate), and arbitrary waveforms with 18-bit resolution (up to 1 MHz clock rate). For recording high frequency signals up to 1 GHz, with 12 bit resolution, the system offers 4 sampler channels that sample a signal with 1 ps resolution. For recording signals in real time, the system offers two choices—20 MHz/12-bit and 1 MHz/16-bit digitizers. For digital testing, the system offers up to 128 I/O pins, and features 16 kword memory for each pin. The system can generate digital stimulus patterns and clocks, and can analyze response patterns from the test device at a data rate of 128 Mwords/s with 100 ps resolution. And because the HP 9480 can synchronize analog waveforms with digital signals, and can automatically execute timing adjustments, you can perform precise tests on mixed signal devices under actual operating conditions. The HP 9480 allows you to perform DC parametric testing on each pin independently. This allows efficient testing because you can simultaneously perform different tests on different pins.

### Digital Signal Processing (DSP) Technology

The HP 9480 uses Digital Signal Processing to generate and analyze analog and digital signals.

For example, you can easily and quickly modify and create waveforms in the frequency domain by using FFT commands. The HP 9480 can easily synchronize analog signals with system clocks because the waveform data is recorded into system memory. Multiple parameters such as differential gain, differential phase, differential nonlinearity, etc., can be extracted from the recorded data without running the test again. A 32-bit full floating point array processor minimizes system controller loading by performing complex matrix computations for digital signal processing. DSP technology shortens test times by allowing multiple parameter extraction from a single test, and minimizes hardware costs because analog and digital processing are performed by the same modules.

### Modular Architecture

The modular system architecture of the HP 9480 allows easy adaptability to your changing test needs. This means that the system's usefulness and value are maintained well into the future, because system upgrades and enhancements are easy and cost-effective. Also, maintenance costs are minimized because only faulty modules need to be repaired or replaced in the event of a system malfunction.



## Software

The HP 9480's HP-UX operating system provides multi-user and multi-tasking capabilities. Multiple terminals (including the system console) can be connected to the HP 9480, and each terminal can be used to perform a different function. These features allow you to maximize engineering productivity because you can execute tests and develop programs at the same time.

## User Interface

The HP 9480 features a multi-window environment for simultaneously displaying more than one window on the same screen. In the multi-window environment, smooth and efficient system operation is facilitated by allowing you to select operations from pop-up menus using a mouse. And you can easily set up conditions and values for test execution and data analysis, thanks to the HP 9480's fill-in-the-blanks format, by simply entering the appropriate information into the mask fields displayed on the screen.

## Debugging

The HP 9480 features two debugging modes and three useful debugging tools to enable you to use the test hardware effectively and to reduce the amount of time spent debugging.

The two debugging modes are off-line and the standard on-line debugging. A hardware simulator is used with off-line debugging. Therefore, off-line debugging and device test execution can be performed at the same time because the test hardware is not used for off-line debugging. This guarantees efficient system utilization.

The three debugging tools are the symbolic debugger, virtual panel, and virtual scope. The symbolic debugger contains a number of features that enable the user to debug at the source code level. The symbolic debugger decreases debugging time because it allows you to modify test conditions without program recompilation. The virtual panel displays the hardware settings and output conditions in real time when debugging, thereby allowing you to confirm program measurement conditions. The multi-window function displays hardware information on a module-by-module basis. The virtual scope displays the stimulus waveform or data pattern specified in the program, and the response waveform output from the test device. This enables you to verify whether the program has executed properly.

## Data Analysis

The HP 9480's software capabilities are complemented by a comprehensive set of data analysis functions. These functions allow you to make effective use of all test data collected during device testing. The following reports can be set up and displayed so that you can easily analyze measurement results: Tabular Reports, Scattergrams, Control Charts, Wafer Maps, X-Y Graphs, Shmoo Plots, and Bar Charts.

## Tester Workstations (Sold Separately)

The HP 9000 Series 300 computer, the HP 9480's system controller, can connect directly to Ethernet/IEEE802.3 Local Area Networks (LAN). When networked, HP 9480 tasks can be distributed between workstations in the network. This increases system efficiency because tasks previously managed by one computer are now distributed between workstations. For example, you can use a Test Development Station (TDS) as a stand-alone workstation for test program development, such as editing, compiling, and off-line debugging, while using a Data Analysis Station (DAS) as a stand-alone workstation for analyzing measurement data.

## Application Support for Rapid Start Up

HP Semiconductor System Centers (SSCs) offer quality application support for quick start up of your HP 9480 system. Application support packages include consultation with expert HP personnel, and the tailoring of test program software and hardware to your specific test requirements.

# SEMICONDUCTOR TEST EQUIPMENT

## IC Design Verification System

Model HP 81810 S

- At-speed functional test
- AC/DC parametric characterization
- 50 MHz vector rate
- 100ps/10mV resolution
- Ease-of-use
- System Software



HP 81810S (in the foreground): The actual appearance of the system will depend upon the configuration ordered.



### The HP 81810S IC Design Verification System - When It Comes To Professional Digital IC Test

Owing to the modular architecture which allows you to combine instrument modules as required, the system is extremely flexible in terms of functionality, performance and price. This enables you to tailor the system and achieve the optimum application fit in IC Prototype Verification or Characterization, Low-Volume Production, Failure Analysis or Incoming Inspection.

#### Design Verification and Prototype Evaluation

The HP 81810S can be linked directly to a CAE design station, allowing you to verify exactly what simulation predicted. A "production type" tester would be misused in this application and would hardly be readily available. What's more, as the Prototype Test task shifts away from the tester expert towards the designer of the IC, an ease of operation is required which enables the designer to do the Prototype test as easily as the simulation and get immediate results.

#### Cost - Effective Test of SSI and MSI ICs

Capabilities such as precise characterization of AC and DC parametrics make it an ideal fit for failure analysis of parts rejected by the production ATE system. The same is true for Quality Control and Vendor Qualification. Often it is an excellent alternative to big ATE systems at a much lower cost, for example, for Production Test or Incoming Inspection of standard SSI/MSI logic circuits. It is also an excellent fit for Production Test applications when low volumes do not justify an expensive system. This is particularly true for ASICs with a typical lot size of a few hundred devices.

#### Test System Modules

The HP 81810S is composed of the HP 8180A/B, HP 8181A/B and HP 8182A/B Data Generators and Data Analyzers, the HP 15425A Test Head (including a Performance Board) or HP 15466A Test Head, a systemizing mainframe, the HP 4141B DC Source/

Monitor, the HP 6624A Device Power Supply and a range of accessories. Also included is an HP 9000 series 200 or 300 workstation plus the System Software. The key capabilities of these modules are outlined in the following.

#### Digital Data Generation, Capture and Analysis - HP 8180/81/82 A/B

For at-speed functional tests the Test System offers programmable digital patterns at clock rates up to 50 MHz. The vector memory depth of up to 16kbit/channel allows you to generate and capture the immense number of testvectors required for testing LSI/VLSI devices. Real-time comparison between "expected" data and captured data generates an "Error Map" which gives immediate feedback and increases throughput.

For thorough characterization of a circuit's performance limits, timing edges can be positioned with a best resolution of 100 ps and level pairs can be programmed with a 10 mV resolution. On the Data Capture side, the sampling point can be swept in 100ps steps for measurements of set-up/hold times and propagation delays. "Window Comparison" simultaneously checks proper upper and lower logic levels and timing conditions. The driver and receiver circuits deliver programmable levels and thresholds as required for testing CMOS, TTL, ECL and "mixed" logic. "High Impedance" or 50 Ohm termination is selectable.

#### Power Supplies - HP6624A

The HP 81810S Test System integrates a fully programmable Power Supply featuring four isolated outputs with read-back measurement capabilities and full protection against over-current conditions. This means it can be used to supply the power for the DUT and simultaneously provide other voltages/currents e.g. for DUT loads.





Bring separate tests together with the sequencer

#### DC Source/Monitor - HP 4141B

Four source/monitor units (SMU's) coupled with two voltage source units provide fast access to the DUT's DC parameters such as input and output currents and voltage levels. The SMU's are routed to the desired pin of the IC by switching relays in the Test Head. This integrates high resolution DC measurements and completes the full set of functional and AC-parametric resources of the system.

#### Interface to the Device Under Test (DUT) - HP 15425A/15466A

To bring the measurement resources to the DUT, the Test System offers a Performance Board and two types of Test Head. Featuring a 50 Ohm strip-line technique the DUT interface products are matched to the driver and receiver circuits which ensures the best test signal quality at the device pins. The 15425A Test Head (includes a Performance Board) allows you to connect up to 84 DUT pins (57 uni-directional and 27 bi-directional). For higher pin counts and when bi-directional pins have to be tested the HP15466A Test Head is recommended. It allows the connection of up to 256 uni-directional or 128 bi-directional pins. Four DC-parametric measurements can be made simultaneously on one HP 15466A Test Head. The Test Heads are HP-IB controlled which allows you to switch the relays from functional and AC-parametric measurements to DC-parametrics.

#### System Controller - HP 9000 Series 200 or 300

The HP81810S IC Design Verification System is controlled by an HP 9000 computer. It allows you to fully automate your tests or operate the System remotely via HP-IB. It increases the universality of the System, giving access to mass data storage devices and printers. With the RS-232-C interface (in addition to the HP-IB) it also provides links for host computer communication. Operation, Program Generation and links to other systems are supported from the System Software.

#### System Software

The System Software provides a shell around the hardware resources and enables you to focus on the device under test rather than on the test machine. Because it is easy to use, users need little training to work with this tool. The software packages consist of three parts: Interactive Operation, Program Generation and CAE Links.

**Interactive Operation:** Softkey-driven menus guide the user through Test System configuration, parameter set-up, pattern editing, pin labeling and assignments etc. These tasks have to be done once per device type, and the information can be stored in files. When performing a test the user quickly sets up the entire system by calling the configuration from the file. After a few key-strokes the user can then perform various tests e.g. functional truth-table verification or automatic

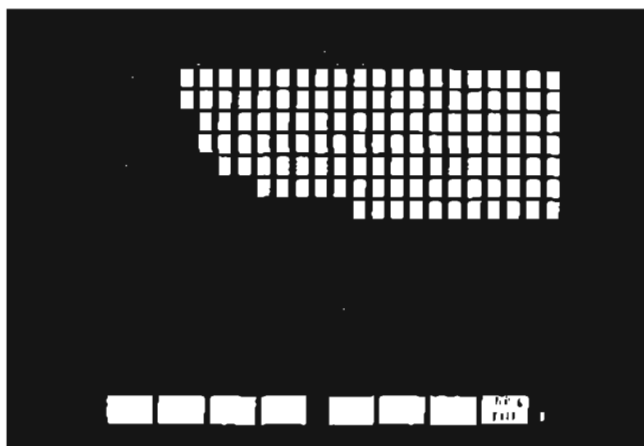

The Shmoo plot shows the ASIC operating limits.

edge and level search as required for measuring propagation delays or set-up and hold times. Shmoo plots show graphically what the effect of varying one DUT parameter has on another parameter.

**Program Generation:** In the program mode, configurations, measurements and analysis routines set-up during interactive operation can be included in a BASIC program. This aids the user in generating test programs efficiently since it takes away the burden of tasks which are common to most devices.

#### CAE Links

This part of the software allows you to link directly to CAE Design Workstations or Host computers running simulation programs. The physical link is via RS-232-C using the System Controller in the VT100 terminal Emulator Mode. The software provides turn-key programs for downloading data vectors which are compatible with HILO 3 or FACTOR (SENTRY) data formats. After downloading, the testvectors are readily available in the Test System for execution. For other data formats, the software helps the user to create his individual "front-end" to the entire link program.

#### System Rack

All System Modules except the Controller can be installed in one or two racks, depending on the configuration. The rack provides the mechanical housing plus the necessary provisions for over-heat protection and for electrical safety (transformers).

#### SYSTEM SPECIFICATIONS

<b>TIMING</b>
1 Hz - 50 MHz
RZ, NRZ data formats plus 2 clocks and strobe
100 ps edge resolution
<b>LEVELS</b>
10 mV resolution for voltage levels and thresholds
-2.0V to +5.5V into 50 Ohm
<b>VECTORS</b>
1k or 16k vector memory depth
Synchronous or asynchronous data capture
Real time compare, Dual Threshold and Window Compare
Glitch Detect

#### More Information

For more information on the System modules refer to the respective pages (see Model Number Index at the beginning of this catalog). For further, Configuration, Ordering, and Technical Information, Technical Data Sheets and Application Notes on the products covered in this chapter, please contact your next HP sales office.

# SEMICONDUCTOR TEST EQUIPMENT

## Semiconductor Parametric Test System Model 4062C

- 25ms  $V_{th}/hFE$  Extraction (typical)
- $\pm 20fA$  to  $\pm 1A$  Precise Wafer Measurements



### Description

The HP 4062C Semiconductor Parametric Test System is a high throughput, high resolution computer-controlled system for measuring the DC voltage and current, and 1MHz capacitance and conductance parameters of wafer-state devices, as well as discrete and packaged devices. Based on its predecessor, the HP 4062B, this enhanced system will enable you to significantly improve IC yield and quality, and increase efficiency during new process development.

Precise 20fA, 4 $\mu$ V, and 1fF measurements to  $\pm 200V$  and  $\pm 1A$  are possible through the 4062C's low-noise, reliable switching matrix, which you can configure with up to 48 DUT pins. And specifications are guaranteed at all DUT pins. The heart of the HP 4062C, the high speed HP 4142B Modular DC Source/Monitor, provides fast throughput over a wide measurement range—without sacrificing resolution—for wafer process monitoring and evaluation. Highly reliable wafer measurement results can quickly be fed back to design and process engineers to improve your IC yield and quality.

The HP 4062C's language system is the simple, yet powerful, HP BASIC. Parameter measurements, such as threshold voltage and current gain, can be performed with a simple two-line program thanks to the HP 4062C's measurement utility subprograms. By including the optional Test Management Shell software, you can create, execute, and manage tests through a completely menu-driven BASIC interface to even further minimize programming requirements. For analyzing measurement results, the HP 4062C's optional TekBase relational database software provides you with maximum data flexibility and allows you to analyze data in a wide variety of formats. Maximize software development capabilities, reduce development time, and increase engineering efficiency with the HP 4062C's powerful, easy-to-use software.

### High Speed Measurements over a Wide Measurement Range

In production environments where measurement speed is prerequisite, the HP 4062C comes through. The HP 4062C's DC measurement subsystem provides high speed device/process parameter extractions, while maintaining measurement resolutions down to 20fA and 4 $\mu$ V. For example, by using the DC measurement subsystem's Analog Feedback Unit (AFU), such key device parameters as threshold voltage ( $V_{th}$ ) and forward current gain ( $hFE$ ) can be obtained in as little as 25ms: roughly 4 times faster than the HP 4062B.

The HP 4062C's switching matrix subsystem enables reliable measurement results by virtually eliminating the effects of environmental noise, while minimizing leakage current and stray capacitance. Also, the HP 4062C's expanded measurement range of  $\pm 20fA$  to  $\pm 1A$  and  $\pm 4\mu V$  to  $\pm 200V$  is guaranteed to the tip of each switching matrix

- Interactive Programming (option)
- Powerful Database Integrated with Graphics Presentation

DUT pin. This exacting performance ensures precise, reliable semiconductor parameter measurements through the switching matrix for each system instrument.

### Easy To Program

The HP 4062C's Test Instruction Set (TIS) software makes programming easy, and the fast execution of TIS programs ensures high speed measurements. By using the furnished measurement library, you can quickly create and execute programs. For example, to perform a  $V_{th}$  or  $hFE$  measurement requires only one or two program lines.

### Fast, Easy Test Generation and Integrated Database Capabilities

The optional Test Management Shell (TMS) software provides an elaborate HP 4062C user interface, eliminating the need to generate application programs. All test generation functions are accomplished through a series of menus that first determine the task you wish to perform, followed by the information required to perform the task. No programming knowledge is required to generate test programs when using TMS.

The HP 4062C's optional TekBase relational database software provides enhanced data analysis capabilities. With TekBase, you can quickly retrieve measurement results using a powerful QUERY language, and can then present these results in a number of useful formats, including wafer maps, trend charts, histograms, 3-D maps, etc. Measurement data can also be easily exported to other computers by using the IMPORT/EXPORT functions.



Block diagram of Analog Feedback Unit

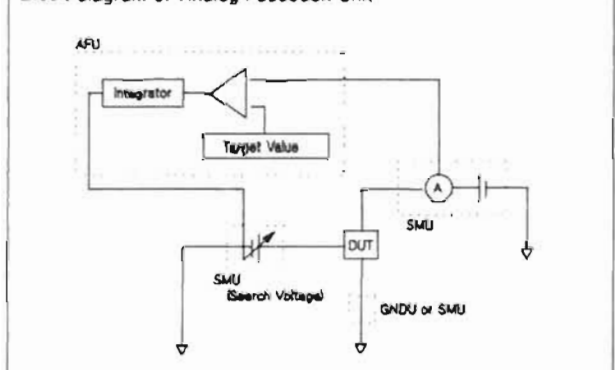

### System Configuration

- Modular DC Source/Monitor (HP 4142B)
- Switching Matrix (48-pin configuration)
- Switching Matrix Controller
- 1MHz C Meter/C-V Plotter (HP 4280A)
- Rack Cabinet (HP 29402C)

## Specifications

**Measurement Functions:** I, V, I-V, C-G-V, C-G-I, Pulse I/V, Pulse I-V, Analog Search

### Switching Matrix

**Number of pins (to DUT):** 48 pins (standard) with options for 12, 24, and 36 pins.

**Number of ports (to instrument):** 9 ports

**High Resolution Source/Monitor Unit:** 1 port

**High Power Source/Monitor Unit:** 1 port

**Source/Monitor Units:** 2 ports

**Ground Unit:** 1 port

**Auxiliary:** 4 ports (for V Sources/V Monitors and C Meter)

**Maximum voltage at each port:**  $\pm 200\text{V}$  (High Power SMU port)  
 $\pm 100\text{V}$  (other SMUs and Aux. ports)

**Maximum current through ports to pins:**  $\pm 1.6\text{A}$  (GNDU port)  
 $\pm 1\text{A}$  (High Power SMU port)  
 $\pm 500\text{mA}$  (other SMU ports)

### DC Source/Monitor Units (SMUs)

**High Resolution SMU:** 1 unit

**V:**  $\pm 40\mu\text{V}$  to  $\pm 100\text{V}$

**I:**  $\pm 20\text{fA}$  to  $\pm 100\text{mA}$

Basic accuracy:  $\pm 0.05\%$

Basic accuracy:  $\pm 0.2\%$

**High Power SMU:** 1 unit - Kelvin

**V:**  $\pm 40\mu\text{V}$  to  $\pm 200\text{V}$

**I:**  $\pm 2\text{pA}$  to  $\pm 1\text{A}$

Basic accuracy:  $\pm 0.05\%$

Basic accuracy:  $\pm 0.2\%$

**SMUs:** 2 units - Kelvin

**V:**  $\pm 40\mu\text{V}$  to  $\pm 100\text{V}$

**I:**  $\pm 2\text{pA}$  to  $\pm 100\text{mA}$

Basic accuracy:  $\pm 0.05\%$

Basic accuracy:  $\pm 0.2\%$

\*V force resolution is  $100\mu\text{V}$

\*I force resolution is  $50\text{fA}$  (High Resolution SMU) and  $5\text{pA}$  (other SMUs)

**Ground Unit (GNDU):** 1 unit

$\pm 1.6\text{A}$

Accuracy:  $\pm 1\text{mV}$

**Voltage Sources (VSs):** 2 units

$\pm 1\text{mV}$  to  $\pm 40\text{V}$

Basic Accuracy:  $\pm 0.1\%$

**Voltage Monitors (VMs):** 2 units

$\pm 40\mu\text{V}$  to  $\pm 40\text{V}$

Basic Accuracy:  $\pm 0.05\%$

\*Differential Voltage Measurements are possible with  $4\mu\text{V}$  resolution

All SMUs can function as a DC voltage source/current monitor or as a DC current source/voltage monitor. Pulse measurements can be performed with SMUs and VSs.

### Capacitance-Conductance Measurements

**Test frequency:**  $1\text{MHz}$ ,  $\pm 0.01\%$

**OSC level:**  $30\text{mVrms}$   $\pm 10\%$ , and  $10\text{mVrms}$   $\pm 10\%$

**Measurement range:** (maximum resolution to full scale)

**C:**  $0.001\text{pF}$  to  $1.2\text{nF}$

Basic accuracy:  $\pm 0.5\%$

**G:**  $0.01\mu\text{S}$  to  $12\text{mS}$

Basic accuracy:  $\pm 1.5\%$

**DC bias voltage for capacitance measurements:**  $\pm 100\text{V}$

### Reference Data (typical)

**Command Execution Time**

**Connect (relays):** 4.5ms

**DC Source/Monitor<sup>1</sup>:**

**Force (current or voltage):** 4.5ms

**Measure (current or voltage):** 6ms

**Analog Search<sup>2</sup>:** 25ms

<sup>1</sup>When integration time is short and range is not  $1\text{nA}/10\text{nA}$ . Does not include wait time set by user.

<sup>2</sup>Analog search controls the output of one SMU to set the output of another SMU to a specified value.

### General Specifications

**Operating temperature range:**  $5^\circ\text{C}$  to  $40^\circ\text{C}$ , 55% to 70% RH

**Permissible temperature change:**  $\leq 3^\circ\text{C}$  after calibration

**Air cleanliness:** class 100,000 or higher clean room required

**Power requirements:**  $100\text{V}$  ( $90\text{V}$  to  $110\text{V}$ ),  $120\text{V}$  ( $108\text{V}$  to  $127\text{V}$ ),  $220\text{V}$  ( $198\text{V}$  to  $242\text{V}$ ),  $240\text{V}$  ( $216\text{V}$  to  $252\text{V}$ ),  $48\text{Hz}$  to  $66\text{Hz}$ ,  $1170\text{VA}$  maximum

**Dimensions:** cabinet,  $535\text{mm}$  (W) by  $1632\text{mm}$  (H) by  $762\text{mm}$  (D) switching matrix,  $406\text{mm}$  (W) by  $210\text{mm}$  (H) by  $380\text{mm}$  (D)

**Weight:** cabinet with instruments, approximately  $216\text{kg}$  switching matrix, approximately  $22\text{kg}$

**HP 4142B power limitation:**  $32\text{W}$

### Furnished Accessories

**HP 16066A:** Test Fixture Adapter

**HP 16067A:** 24-Pin DIP Low Leakage Fixture

**HP 16068A:** 48-Pin DIP Low Leakage Fixture

**HP 16069A:** Universal Low Leakage Fixture

**HP 16070A:** General Purpose DIP Fixture

**HP 16071A:** Universal Fixture

**HP 16072A:** Personality Board (for connecting probe card)

**HP 16075A:** Relay Test Adapter

**HP 16076A:** System Test Module

**HP 16077A:** Extension Cable Fixture

### Available Accessories

**HP 16320B:** Pin Board

### System Controller

**Required controller:** HP 9000 Series 300 Model 310, 320, 330, or 350

**System language:** BASIC 5.0

**Memory size:**  $1\text{M}$  byte

**Interface:** In addition to internal HP-IB I/O, 2 extra HP-IB I/O's (98624A's) are required.

### Prober interface

Automatic wafer probers used with the HP 4062C must be equipped with HP-IB capability. Hardware for mounting the switching matrix on the prober is also required. Contact the prober manufacturer for details concerning necessary mounting hardware. Control software for Electroglas 1034X/2001X and TSK A-PM6000/7000 probers is furnished.

### Ordering Information

**HP 4062C Semiconductor Parametric Test System** \$116,000  
(does not include controller)

**OPT. 050/060:** for 50/60Hz Line Frequency<sup>1</sup> N/C

**OPT. 100/120/220/240:** for 100/120/220/240V Line Voltage<sup>2</sup> N/C

**OPT. 001:** 12-Pin Configuration (delete 36 pins) \$-21,600

**OPT. 002:** 24-Pin Configuration (delete 24 pins) \$-14,400

**OPT. 003:** 36-Pin Configuration (delete 12 pins) \$-7,200

**OPT. 004:** Additional Pin Board \$600

**OPT. 020:** Four 41421B SMUs Configuration \$-750

**OPT. 021:** Add 41421B SMU ( $100\text{V}/100\text{mA}$ ) \$3,540

**OPT. 022:** Add 41420A SMU ( $200\text{V}/1\text{A}$ ) \$4,300

**OPT. 023:** Add 41424A VS/VMU \$3,220

**OPT. 024:** Delete 41421B SMU ( $100\text{V}/100\text{mA}$ ) \$-3,540

**OPT. 025:** Delete 41420A SMU ( $200\text{V}/1\text{A}$ ) \$-4,300

**OPT. 026:** Delete 41424A VS/VMU \$-3,220

**OPT. 027:** Delete 41425A AFU \$-1,720

**OPT. 102:** Delete 4280A \$-10,600

**OPT. 110:** Delete Packaged Device Test Fixtures \$-4,190

**OPT. 410:** Test Management Shell Software (TMS) \$6,000

**OPT. 411:** TMS Right-To-Copy \$3,800

**OPT. 420:** TckBase Software \$3,500

**OPT. 421:** TckBase for Model 320/330/350 Computers \$3,500

**OPT. 503:** Personality Board for EG 1034X/2001X probers<sup>3</sup> N/C

**OPT. 701:** Series 300 SPU Rack Mount Kit \$250

**OPT. 702:** Series 300 SPU & Expander Rack Mount Kit \$220

**OPT. 710:** 9153A/B, 9154A/B Hard Disc Rack Mount Kit \$340

**OPT. 720:** 9133H, 7957A, 7958A Hard Disc Rack Mount Kit \$260

**OPT. 730:** 7946A Hard Disc Rack Mount Kit \$190

**OPT. 740:** 9144A Linus Tape Drive Rack Mount Kit \$190

**OPT. 910:** Extra System Library \$320

<sup>1</sup>Must select OPT. 050 or 060, depending on the line frequency used.

<sup>2</sup>Must select OPT. 100, 120, 220, or 240, depending on the line voltage used

<sup>3</sup>Must select OPT. 503 if using an Electroglas prober.

# SEMICONDUCTOR TEST EQUIPMENT

## Semiconductor Parametric Test System

### Model 4062B

- Precise, high speed probed wafer measurements
- 1pA resolution at all 48 pins

- Easy to program with Probing Pattern Generator
- Virtual front panel simplifies operation



HP 4062B  
(System controller, printer and tables are sold separately.)

#### Description

The HP 4062B Semiconductor Parametric Test System will help you improve IC yield and quality in production plus increase engineering efficiency. The system measures DC voltage/current and 1 MHz capacitance/conductance of wafers with high resolution and speed.

Precise 1pA and 1fF measurements are performed using a low noise switching matrix with up to 48 DUT pins. All specifications are guaranteed on these DUT pins. High speed measurement units provide fast throughput of high resolution measurements for wafer process monitoring and evaluation. Highly reliable measurements performed on wafers can be fed back to design and process engineers to improve your IC yield and quality.

The HP 4062B is programmed with the simple and powerful HP BASIC. Parameter measurements such as threshold voltage or current gain can be made by a two line program using the HP 4062B's measurement utility subprograms. Prober control software is supplied to allow users to easily operate a wafer prober with the HP 4062B. The system software features an extensive program library that includes statistical analysis, trend charts, and the Virtual Front Panel (VFP) for convenient manual measurement. The HP 4062B will help you reduce software development time and increase engineering efficiency with easy programming.

#### High speed, high resolution measurements

The HP 4062B can perform high speed measurements with 1 pA resolution. Measurement speed is important to customers, especially on production lines. The HP 4062B's switching matrix is designed to eliminate the effects of noise and reduce leakage current while minimizing stray capacitance. The system's measurement instruments were specially developed for high speed, high resolution measurements. Therefore, the total measurement speed, including data transfer, is very high. For example, Vth (threshold voltage) measurement takes approximately 140 ms.

#### Easy to program

Using the furnished measurement library - e.g., threshold voltage and current gain - you can perform measurements with a one or two line program. You can also quickly create probing programs using the interactive probing pattern generator furnished with the HP 4062B. The HP 4062B's Test Instruction Set (TIS) makes programming easy. TIS programs execute very quickly, ensuring high speed measurement. Also furnished is software for statistical analysis of measurement data. This software allows you to create wafer maps, trend charts, and Scattergrams

#### Sample Program Using TIS

```

100 !
110 Connect ('Smu1, D)
120 Connect ('Smu2, G)
130 Connect (Gnd, S, Sb)
140 Force_vfD, Vd, Vrange, Vlimit
150 Set_bsearch (G, D, 4, Va, Vb, Ith)
160 Search (Vth)
170 !

```

— Connect DUT  
 — Set drain voltage  
 — Set binary search conditions  
 — Execute binary search

#### Sample Program Using Utility Library

```

60 !
70 Set_tr (S, I, B, Sb)
80 Vth=FNVth4 (Ith, Vd, Va, Vb)
90 !

```

— Connect DUT  
 — Measure threshold voltage

#### Reliable measurements

The switching matrix, test leads and test fixtures are designed specifically for use in a parametric test system to ensure precise high speed measurements and to guarantee the performance of each measurement instrument in the system. The HP 4062B's specifications are guaranteed up to the DUT pins, so the HP 4062B provides practical high speed measurements with 1 pA resolution. In addition, the HP 4062B is easy to maintain and is set up for on-site service to minimize down time.

#### Software Library

##### Virtual Front Panel (VFP)

##### Test Instruction Set (TIS)

- Switching matrix control
- DC measurements
- Capacitance measurements
- Timing control
- Prober control
- System initialization

##### Graphics Library

- C-V graph
- I-V (linear-linear) graph
- I-V (linear-log) graph

##### Parameter Measurement Library

- Resistivity (2-wire or 4-wire)
- Breakdown voltage
- DC current gain
- Drain current
- Threshold voltage (4 kinds)
- Lateral diffusion effect ( $\Delta L$  and  $\Delta W$ )

##### Auto Prober Control Library

- Probing pattern generation
- Probing control

##### Data Processing Library

- Data file creation
- Wafer map
- Histogram
- Scatter plot
- Trend chart

##### Diagnostic Program

#### System Configuration

- DC Source/Monitor (HP 4141B)
- Switching Matrix (48-pin configuration)
- Switching Matrix Controller
- 1 MHz C Meter/C-V Plotter (HP 4280A)
- Rack Cabinet (HP 29402C)

Specifications

Switching Matrix

Number of pins (to DUT): 48pins (standard) with options for 12, 24 and 36 pins.

Number of ports (to instrument): 9 ports

High Resolution Source and Monitor Unit: 1 port

Source and Monitor Units: 3 ports

Ground: 1 port

C Measurement: 2 ports

Auxiliary: 2 ports

Maximum allowable voltage between ports: 220 Vdc

Maximum allowable current at pins: 500 mAdc

Maximum stray capacitance between pins: 6 pF

DC Source and Monitor Units

High resolution source and monitor unit (8MU1\*): 1 unit

Output/Measurement Range: Current, ±1 pA - ±100 mA, Basic Accuracy, 0.3%; Voltage, ±1 mV - ±100 V, Basic Accuracy, 0.1%

Source and monitor units (8MU2-4\*): 3 units

Output/Measurement Range: Current, ±100 pA - ±100 mA, Basic Accuracy, 0.3%; Voltage, ±1 mV - ±100 V, Basic Accuracy, 0.1%

Ground unit: 1 unit

Output Voltage: OV; Accuracy, ±2 mV

Current Range: ±500 mA

Voltage source (Vs): 2 units

Output Range: 1 mV - ±20 V; Basic Accuracy, 0.5%

Voltage monitor (Vm): 2 units

Measurement Range: ±100µV - ±20 V, Basic Accuracy, 0.2%

\*SMU 1-4: Each SMU can function either as a dc voltage source/current monitor or as a dc current source/voltage monitor.

Capacitance-Conductance Measurements

Test frequency: 1 MHz ±0.01%

OSC level: 30 mVrms ±20% and 10 mVrms ±20%

Measurement range: (Maximum resolution to full scale)

C: 0.001 pF - 1.2 mF; basic accuracy, 0.5%

G: 0.01 µS - 12 mS; basic accuracy, 1.5%

DC bias voltage for capacitance measurements: ±100V

Reference Data

Command Execution Time

Connect (Relays): 8ms

DC Source/Monitor<sup>1</sup>:

Force (Current or Voltage): 10ms

Measure (Current or Voltage): 14ms

Sequential Force/Measure: 23ms

Binary Search<sup>2</sup>: 100ms (10 iterations)

Linear Search<sup>2</sup>:

80 - 100ms (10 point sweep)

440 - 640ms (100 point sweep)

- 1. When integration time is short and range is not 1nA/10nA. Does not include wait time set by user.
2. This command searches a specified measurement value by repetitive halving of the force voltage/current range.
3. This command searches a specified measurement value by using linear sweep.

General Specifications

Operating temperature range: 10°C - 40°C, ≤70% RH at 40°C

Permissible temperature change: ≤1°C/5 minutes

Air cleanliness: class 100,000 or higher clean room required

Power requirements: 100 V, 120 V, 200 V ±10%; 240V +5% -

10%; 48-66 Hz, 510 VA max.

Dimensions: cabinet, 535 mm(W) x 1635 mm(H) x 770 mm(D);

switching matrix, 406 mm(W) x 210 mm(H) x 380mm (D)

Weight: cabinet with instruments, approximately 200 kg; switching

matrix, approximately 25.3 kg

Accessories Furnished

HP 16066A: Test Fixture Adapter

HP 16067A: 24 pin DIP Low Leakage Fixture

HP 16068A: 48 pin DIP Low Leakage Fixture

HP 16069A: Universal Low Leakage Fixture

HP 16070A: General Purpose Dip Fixture

HP 16071A: Universal Fixture

HP 16072A: Personality Board (for connecting probe card)

HP 16075A: Relay Test Adapter

HP 16076A: System Test Module

HP 16077A: Extension Cable Fixture

System Controller

Required Controller: HP 9000 Series 200 Model 236A, 236C, 236S or 236CS, or Series 300 Model 310, 330 or 350

System Language: BASIC 5.0 for Series 200/300

Memory Size: ≥832 K byte

Interface: In addition to standard HP-IB, 2 HP-IB interface Cards (HP 98624A) are required.

Prober Interface

Automatic wafer probers used with the HP 4062B must be equipped with HP-IB capability. Hardware for mounting the switching matrix on the prober is also required. Contact the prober manufacturer for details concerning necessary mounting hardware.

Accessories Available

Table with 2 columns: Item Name and Price. Includes HP 16269A Process Test Manager (\$0.00), Opt 410 Test Management Shell (\$6000.00), Opt 411 Test Management Shell (\$6000.00), Opt 412 Test Management Shell (\$6000.00), Opt 420 TekBase (\$3500.00), Opt 422 TekBase (\$3500.00), Opt 424 TekBase (\$3500.00), Opt 421 TekBase (\$3500.00), Opt 423 TekBase (\$3500.00), Opt 425 TekBase (\$3500.00).

Ordering Information

Table with 2 columns: Item Name and Price. Includes HP 4062B Semiconductor Parametric Test System (\$90.850), Opt 050/060 For 50/60Hz Line Frequency (N/C), Opt 100/120/220/240 For 100/120/220/240 Line Voltage (N/C), Opt 001: 12-pin Configuration (\$-17,400), Opt 002: 24-pin Configuration (\$-11,600), Opt 003: 36-pin Configuration (\$-5,800), Opt 004: Additional Pin Board (\$490), Opt 011: SMU Board (\$1,325), Opt 030: For HP 9000 Series 300 Controller (N/C), Opt 036: For HP 9000 Model 236 A/S/C/CS Controller (N/C), Opt 102: Delete 4280A (\$-10,600), Opt 110: Delete Test Fixtures for Packaged Devices (\$-4,190), Opt 401: SPN Data File Creation Software (\$1,935), Opt 503: Personality Board for EG 1034X, EG 2001X (N/C), Opt 920: Extra System Library (\$335).

1Must select OPT. 050 or 060 according to the power line frequency used.
2Must select OPT. 100, 120, 220 or 240 according to the power line voltage used.
3Must select OPT. 503 if using an Electroglas Prober.
4Must select OPT. 030 or 036 according to the system controller used.

# SEMICONDUCTOR TEST EQUIPMENT

## Semiconductor Parameter Analysis System

Model 4063A

- 1fA, 10 $\mu$ V and 1fF resolution through a wafer prober
- Wide variety of application programs



HP 4063A

(System controller, printer and tables are sold separately.)

### Description

The HP 4063A offers plenty of advantages and benefits for applications in the semiconductor development lab. You can use the system to reduce your semiconductor development time and cost, ensure the accuracy and reliability of your measurements, and eliminate the long start-up times characteristic of other test systems.

The HP 4063A is the first semiconductor parameter analysis system capable of stable 1fA resolution measurements of wafer devices. Since precise measurements of wafer devices is possible, evaluation results can be fed back to control the semiconductor process. The result is that semiconductor development time and cost can be reduced.

Precise 1fA and 10 $\mu$ V DC measurements plus 1fF capacitance measurements at 1 MHz are performed through the HP 4063A switching matrix. All these measurements can be made at any one of the 6 (standard) or 12 (option) switching matrix DUT channels. That means you can make measurements with a single probing to ensure accuracy and reliability.

The entire system is controlled by menu-driven software. This simplifies operation so that you can become an expert operator quickly. The system includes a wide selection of application programs so that you can begin measurements as soon as the system is installed. This will virtually eliminate the long start-up time characteristic of other test systems.

### System configuration

Digital Voltmeter (HP 3456A)  
pA meter/DC Voltage Source (HP 4140B)  
DC Source/Monitor (HP 4141B)  
1 MHz C Meter/C-V Plotter (HP 4280A with OPT.001)  
Switching Matrix  
Switching Matrix Controller  
Rack Cabinet (HP 29402C)

### Application Package

The following programs are furnished with the 4063A. These are easy to execute with a few keystrokes.

**MOSFET DC Characteristics**  
**Bipolar Tr. DC Characteristics**  
**MOS Diode Capacitance Characteristics**  
**Junction Diode Capacitance Characteristics**  
**SPN Data File Creation (OPT. 401)**  
**Wafer Measurement (OPT. 411)**

### Specifications

#### Switching Matrix

Number of DUT channels: 6 (standard) or 12 (optional)

- Easy menu-driven operation
- Powerful programming tools

Number of AUX terminals: 2

Connection method: guarded Kelvin connection

Maximum voltage between DUT Channels when switch is open:  $\pm 200$  Vdc

Maximum ground-referenced voltage at DUT Channel:  $\pm 100$  Vdc

Maximum current at DUT channel: 500 mA

### DC Measurements

Source and Monitor: 4 units

Output Measurement Range: current, 0 A to  $\pm 100$  mA, 0.3% basic accuracy, 1 pA max resolution; voltage, 0 to  $\pm 100$  V, 0.1% basic accuracy, 1 mV max resolution.

#### Ground Unit

Output Voltage: 0 V  $\pm 7$  mV

#### Low Current Measurements

Measurement Range: 0 A to  $\pm 19.99$  mA, 0.5% basic accuracy, 1 fA max resolution

#### Voltage Source for Low Current Measurements

Output Modes:



Output Range: 0 to  $\pm 100$  V, 10 mV max resolution

#### High Resolution Voltage Measurements

Measurement Range: 0 V to  $\pm 200$  V, 0.0078% basic accuracy, 10  $\mu$ V max resolution

#### Voltage Source: 2 units

Output Range: 0V to  $\pm 20$  V, 0.5% basic accuracy, 1 mV max resolution

### Capacitance-Conductance Measurements

Test Frequency: 1 MHz  $\pm 0.01\%$

OSC Level: 30 mVrms  $\pm 30\%$  and 10 mVrms  $\pm 30\%$

#### Measurements Range:

C: to 1.2 nF, 0.35% basic accuracy, 1fF max resolution

G: to 11 mS, 0.55% basic accuracy, 10 nS max resolution

DC Bias Source: 0 to  $\pm 100$  V

### General Specifications

Operating Temperature Range: 10°C to 40°C,  $\leq 70\%$  RH at 40°C

Power Requirements: 750 VA max (standard system)

Dimensions: 535mm W x 1635mm H x 800mm D

Additional cabinet will be added for options 301, 302, 311.

Weight: approximately 230 kg (standard)

### System Controller

Required Controller: HP 9000 Series 200 model 236C/236CS/236A/236S Personal Technical Computer

### Ordering Information

Item	Price
HP 4063A Semiconductor Parameter Analysis System (does not include controller)	\$111,350
Opt. 050/060: <sup>1</sup> for 50/60 Hz Line frequency	N/C
Opt. 100/120/220/240: <sup>2</sup> for 100/120/220/240 V line voltage	N/C
Opt. 311: 12-channel configuration	\$33,700
Opt. 331: LF capacitance measurement ( $\pm 35$ V DC Bias Operation)	\$11,300
Opt. 332: LF capacitance measurement ( $\pm 100$ V DC Bias Operation)	\$11,200
Opt. 351: Add rack cabinet (for OPT 301, 302, 311, 332)	\$4,585
Opt. 352: Add rack cabinet (for OPT.311)	\$4,585
Opt. 401: SPN data file creation software	\$2,140
Opt. 411: Wafer measurement software	\$1,170
Opt. 501: Electroglas 1034X prober control software	\$2,955
Opt. 502: Electroglas 2001X prober control software	\$2,955
Opt. 521: TSK A-PM 6000 prober control software	\$2,955
Opt. 801: Extra SMU board	\$1,325
Opt. 910: Extra system library	\$224

1. Must select OPT. 050 or 060 according to the power line frequency used.

2. Must select OPT. 100, 120, 220 or 240 according to the power line voltage used.

# SEMICONDUCTOR TEST EQUIPMENT

## Semiconductor/Component Test System

Model 4061A

517

- Ready to use—supplied with 7 turn-key application pacs
- Reliable impedance and current measurements with one probing
- Productivity Improvement through accurate and fast measurement over wide range



HP 4061A

System controller and table are sold separately

### Description

The HP 4061A Semiconductor/Component Test System is a dedicated system for making efficient, automatic evaluation of the fundamental characteristics of semiconductor and electronic components required in R & D and production areas. This system employs reliable, accurate measurements and high speed data processing to perform more reliable evaluations with speed and less manpower. The HP 4061A is supplied with 7 sophisticated applications programs and is flexible in both software and hardware. Thus, the system can output measurement results in nearly any required data format.

The switching subsystem, designed especially for use with the HP 4061A, allows both impedance and current measurement without changing DUT connection. Using this new switching subsystem, and by making impedance measurements, the HP 4061A performs evaluation of Doping profile, Oxide capacitance, Flat band condition, Threshold voltage, Surface charge, and Minority carrier life time/surface generation velocity. The HP 4061A also measures leakage current and reverse/forward current-voltage characteristics. Surface state density evaluation, using both high (e.g., 1 MHz) and low frequency (Quasi-static) C-V measurements and data processing are also possible by making modifications to system software.

The system offers significant improvement in both yield and quality in production through fast and reliable measurements and evaluations. It is also a valuable evaluation tool for the development of new materials and devices. The HP 4061A provides the flexibility to meet the future measurement requirements of the electronics industry.

### System Configuration

- pA Meter/DC Voltage Source (4140B)
- Multi-frequency LCR Meter (4275A)
- Switching Subsystem
- Rack Cabinet (29402C)

### Furnished Application Software

Semiconductor high/low frequency C-V characteristics, I-V characteristics, C-t characteristics and Zerbst analysis, Impedance Frequency/Bias characteristics, Ideal C-V curve.

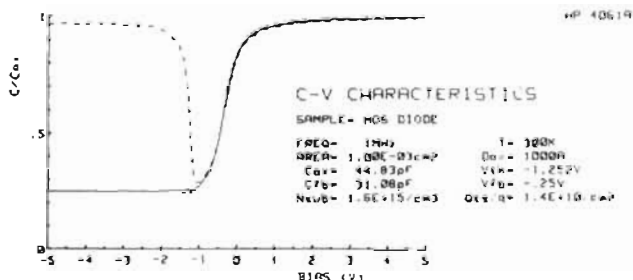

### Specification

For detailed specifications on each of the instruments used in the HP 4061A, refer to the individual data sheets.

### Switching Subsystem

The switching subsystem consists of a switch control module and switching module with interconnecting cables.

**Function:** Switches connection from DUT to either Multi-frequency LCR Meter or the pA Meter/DC Voltage source.

**System Measurement Range** (only deviations from individual instrument specifications are listed.)

#### Impedance Measurements (HP 4275A)

**Frequency range:**  $\leq 1$  MHz

**Measurement parameters:** C-G

**Capacitance:**  $\leq 2000$  pF (with  $D \leq 0.1$ )

\* **Accuracy:** (accuracy of HP 4275A)  $\times 1.5 + \Delta C$  (at  $23^\circ\text{C} \pm 5^\circ\text{C}$ ).

$$\Delta C = 1.4 \times 10^{-3} C \times f^2 \text{ (pF)} + 5 \text{ counts}$$

**Conductance:**  $\leq 12$  mS ( $D \leq 0.1$ )

\* **Accuracy:** (accuracy of 4275A)  $\times 1.5 + \Delta G$  (at  $23^\circ\text{C} \pm 5^\circ\text{C}$ )

$$\Delta G = 6 \times 10^{-3} C \times f(S) + 5 \text{ counts}$$

\* f: frequency in MHz

Cx: Measured capacitance value in pF

At  $5^\circ\text{C}$  to  $40^\circ\text{C}$ ,  $\Delta C$  and  $\Delta G$  doubles. Example: Assuming  $C_x = 1000$  pF and  $f = 1$  MHz,  $C = (1.4 \times 10^{-3} \cdot 10^3 \cdot (1)^2) \text{ pF} + 5$  counts =  $1.4$  pF + 5 counts

#### Current Measurements (HP 4140B)

**Accuracy:** (accuracy of HP 4140B)  $\times 1.5 + 5$  counts

After one-hour warmup and at DUT terminal of switching module

#### Impedance Measuring Section (HP 4275A)

See the HP 4275A's page.

#### Current Measurement Section (HP 4140B)

See the HP 4140B's page.

### General Information

**Operating temperature:**  $5^\circ\text{C}$  to  $40^\circ\text{C}$ ,  $\leq 70\%$  RH at  $40^\circ\text{C}$

**Power:** 100, 120, 220, and 240V,  $+5\%$  -  $10\%$ , 48 to 66 Hz, 520 VA

**Size:** 535mm W x 1635 mm H x 770 mm D

**Weight:** Approximately 125 kg.

### System Controller

HP 9000 Series 200 Model 226A, 226S, 236A or 236S, or Series 300 Model 310 or 330

### Ordering Information

**HP 4061A Semiconductor/Component Test System** (does not include controller) **Price** \$40,950

**Opt. 001:**  $\pm 100$  V dc Bias for HP 4275A N/C

**Opt. 002:** 1-3-5 Frequency Steps for HP 4275A N/C

**Opt. 026\*:** For HP 9000 Model 226 A/S controller N/C

**Opt. 031\*:** For HP 9000 Model 310 or 330 controller N/C

**Opt. 036\*:** For HP 9000 Model 236 A/S controller N/C

\* Must order either OPT. 026, 031 or 036.

# SEMICONDUCTOR TEST EQUIPMENT

## DC Source/Monitor

### Model 4141B

- High speed measurements down to the pA range
- High reliability at low cost

- High accuracy and resolution  
V:  $\pm 100\mu\text{V} - \pm 100\text{V}$ , 0.1%  
I:  $\pm 501\text{A} - \pm 100\text{mA}$ , 0.3%

HP 4141B

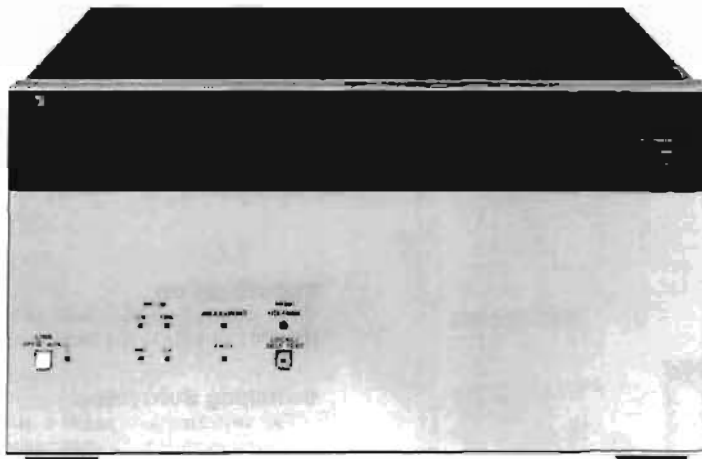

### Description

The HP 4141B DC Source/Monitor is designed for use as a system component in user-designed semiconductor I-V or DC parametric test systems. With its wide DC measurement range, high resolution, high-speed measurement capabilities, remote sensing, and high accuracy, the HP 4141B will contribute towards quality improvement and increased measurement throughput in the lab or on the production line.

### High Speed Measurements with High Resolution

Four source/monitor units (SMU's) coupled with two voltage-source units (Vs's), two voltage monitor units (Vm's), and one ground unit (GNDU) make the HP 4141B equivalent to twenty one instruments. A stand-alone instrument capable of measuring dc parameters, the HP 4141B features high resolution measurements (50fA/100 $\mu\text{V}$ ) and a built-in timing controller. Typical time for a current or voltage measurement, which includes data transfer, is approximately 25ms. A swept measurement (51 points) takes approximately 490ms. High accuracy and high speed measurements, especially in the low current range, are exclusive features of the HP 4141B.

### High Reliability

The HP 4141B's high reliability significantly simplifies maintenance and reduces maintenance costs. To reduce system down time, the HP 4141B is designed for on-site service. Performance verification and diagnostics software for user troubleshooting is also available.

### Specifications

#### Measurement Unit

**Source and monitor units (SMU):** 4 channels (Kelvin connection)  
Each SMU can be programmed to source voltage and monitor current, or conversely to source current and monitor voltage.

#### SMU Range, Resolution and Accuracy

Voltage range	Resolution	Accuracy	Max. Current
$\pm 20\text{V}$	1mV	0.1% + 0.05%	100mA
$\pm 40\text{V}$	2mV		50mA
$\pm 100\text{V}$	5mV		20mA
Current Range	Resolution	Accuracy	Max. Voltage
$\pm 100\text{mA}$	100 $\mu\text{A}$	0.3% + (0.1 + 0.2 x Vout*/100)%	20V (I > 50mA)
$\pm 10\text{mA}$	10 $\mu\text{A}$		40V (20mA < I $\leq$ 50mA)
$\pm 1000\mu\text{A}$	1 $\mu\text{A}$		100V (I $\leq$ 20mA)
$\pm 100\mu\text{A}$	100nA		
$\pm 10\mu\text{A}$	10nA		
$\pm 1000nA$	1nA		
$\pm 100nA$	100pA	0.5% + (0.1 + 0.2 x Vout*/100)%	
$\pm 10nA$	10pA		1% + (0.1 + 0.2 x Vout*/100)%
$\pm 1000pA$	1pA**		

\* Vout is the SMU output voltage, in volts.

\*\* Max. Measurement Resolution is 50fA.

1. Accuracy specifications are given as % of reading when measuring or % of setting when reading.
2. Accuracy tolerances are specified at 23°C  $\pm$  5°C, after a 40-minute warm-up, with AUTO CAL on, and are specified at the rear panel connector terminals referenced to SMU common. Tolerances double for the extended temperature range of 10°C to 40°C.

**Output/Measurement resolution:** Voltage - 4 1/2 digits  
Current - 4 digits

**Voltage source units (Vs):** 2 channels

#### Voltage Range, Resolution, and Accuracy

Output voltage range	Resolution	Accuracy	Max. Current
$\pm 20\text{V}$	1mV	0.5% of setting + 10mV	10mA

**Voltage monitor units (Vm):** 2 channels

#### Voltage Range, Resolution and Accuracy

Measurement voltage range	Resolution	Accuracy
$\pm 2\text{V}$	100 $\mu\text{V}$	0.5% of reading + 10mV
$\pm 20\text{V}$	1mV	0.2% of reading + 10mV

**Ground Unit:** 1 channel (kelvin connection)

**Current range:**  $\pm 500\text{mA}$

### General Specifications

**Operating Temperature Range:** +10°C to +40°C,  $\leq 70\%$  RH at 40°C. Permissible temperature change  $\leq 1^\circ\text{C}/5\text{min}$ . Maximum wet-bulb temperature is 29°C.

**Power requirements:** 100/120/220V  $\pm 10\%$ , 240V-10%+5%, 48 to 66Hz, 240/VA max.

**Dimensions:** Approximately 426mm (16.77in)W x 235mm (9.25in)H x 612mm (24.1in)D

**Weight:** Approximately 19kg (41.5 lbs)

### Accessories Furnished

HP 04085-81851 Interconnect Cable Assembly

HP 04141-80001 Connector Plate

HP 04145-81830 BNC Cable (3m) 4ca.

### Accessories Available

HP 18058A Test Fixture

HP 18059A Adapter (Using with 18058A)

### Ordering Information

4141B DC Source/Monitor

Opt.001: Extra SMU Board

Opt.050/060: \*50Hz/60Hz Line Frequency

\* Must select Opt. 050 or 060 according to the power line frequency used.

Price

\$2,650

\$600

Price

\$20,350

\$1,275

N/C



- 48 pins with 1pA resolution

- Easy programmable switching

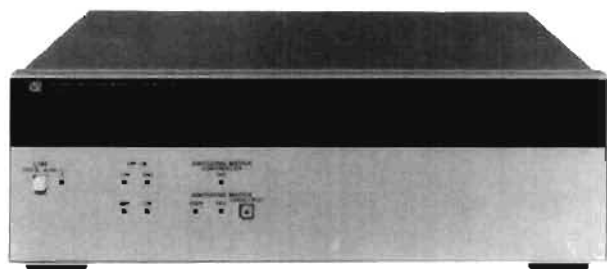

Switching Matrix Controller

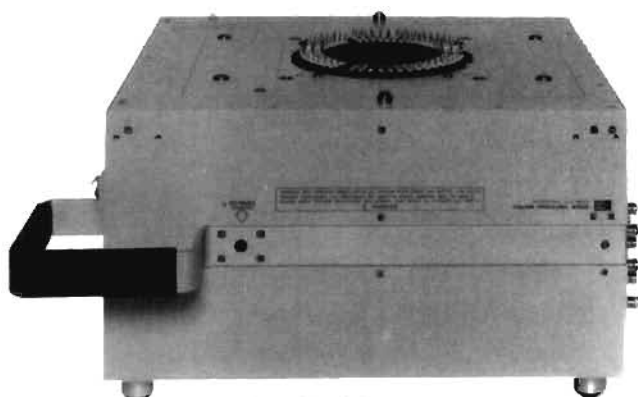

Switching Matrix

HP 4085M

### HP 4085M Description

Combining the HP 4085M switching matrix with the HP 4145B Semiconductor Parameter Analyzer produces a 1 pA, 1 mV switching system capable of 48-pin high resolution semiconductor testing.

A design which minimizes both noise and leakage current means exceptional built-in dc measurement capabilities and the realization of 1 pA resolution measurements at any one of the 48 pins.

The software included with the system makes it possible to freely switch any one of the eight instrument ports to any one of the test pins from the system controller. A number of fixtures are available for wafer and various packaged device measurements. The HP 4085M retains the HP 4145B's full measurement capabilities to obtain highly reliable wide range dc parameter measurements.

### Specifications

#### Switching Matrix

**DUT Pins:** From 12 to 48 pins can be installed.

**Instrument Ports:**\* Eight instrument ports are included.

**Low Leakage SMU Port:** 1 ea. (Port 1)

**SMU Ports:** 3 ea. (Port 2 - 4)

**Vs Ports:** 2 ea. (Vs Port 1 and 2)

**Vm Ports:** 2 ea. (Vm Port 1 and 2)

\*SMU: Stimulus Measurement Unit

Vs : Voltage Source

Vm : Voltage Monitor

**Maximum Voltage between Instrument Ports:** ±220 Vdc

**Maximum Current at each DUT Pin:** ±500 mA dc

#### General Specifications

**Operating temperature:** 10°C to 40 °C; <70% RH at 40°C

**Air cleanliness:** class 100,000 or higher clean room required.

**Power requirements:** 100, 120, 220V ± 10%; 240V+5%-10%; 48 to 66 Hz, 130VA max

**Size:** Switching Matrix, 406W × 210H × 380D mm; Switching Matrix Controller, 426W × 134H × 432D mm

**Weight:** Switching Matrix, approximately 25.3kg; Switching Matrix Controller, approximately 8kg

#### System Controller

**Required Controller:** HP 9000 Series 200 Model 216S, 236A or 236S, or Series 300 Model 310, 330 or 350

**System Language:** Basic 2.0 or later version

**Memory Size:** ≥ 320k byte

#### Ordering Information

**HP 4085M Switching Matrix** (does not include controller) **Price** \$45,750

**Opt. 001:** 12-pin system \$-17,400

**Opt. 002:** 24-pin system \$-11,600

**Opt. 003:** 36-pin system \$-5,800

**Opt. 004:** Add one pin \$490

**Opt. 016:**\* For HP 9000 Model 216A/S controller N/C

**Opt. 030:**\* For HP 9000 Model 310 controller N/C

**Opt. 036:**\* For HP 9000 Model 236 A/S controller N/C

\* Must select Opt. 016, 030 or 036 according to the system controller used.

### System Configuration Example

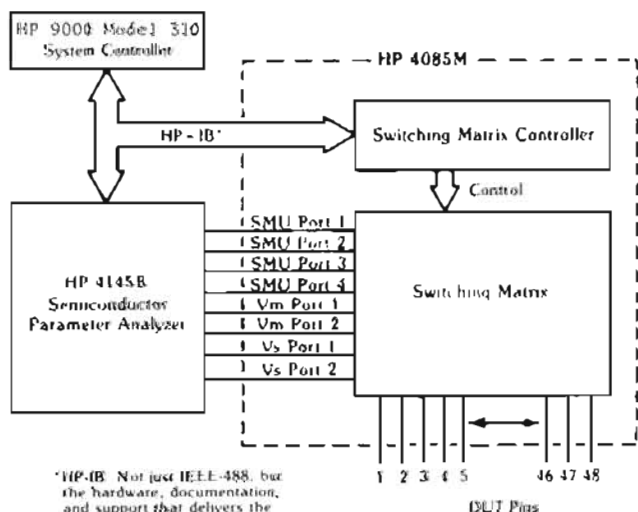

\*HP-IB: Not just IEEE-488, but the hardware, documentation, and support that delivers the shortest path to a measurement system.

# SEMICONDUCTOR TEST EQUIPMENT

## Semiconductor Parameter Analyzer

Model 4145B

- Fully automatic, high-speed dc characterization of semiconductor devices.
- High resolution, wide range sourcing and measurement.  
I: 50fA – 100mA, V: 1mV – 100V
- Maximum 1150 measurement and display points for precise measurement and analysis.
- Flexible graphic analysis functions for quick parameter extraction.
- Built-in micro flexible disc drive for storage of 240 user programs or 105 measurement results.

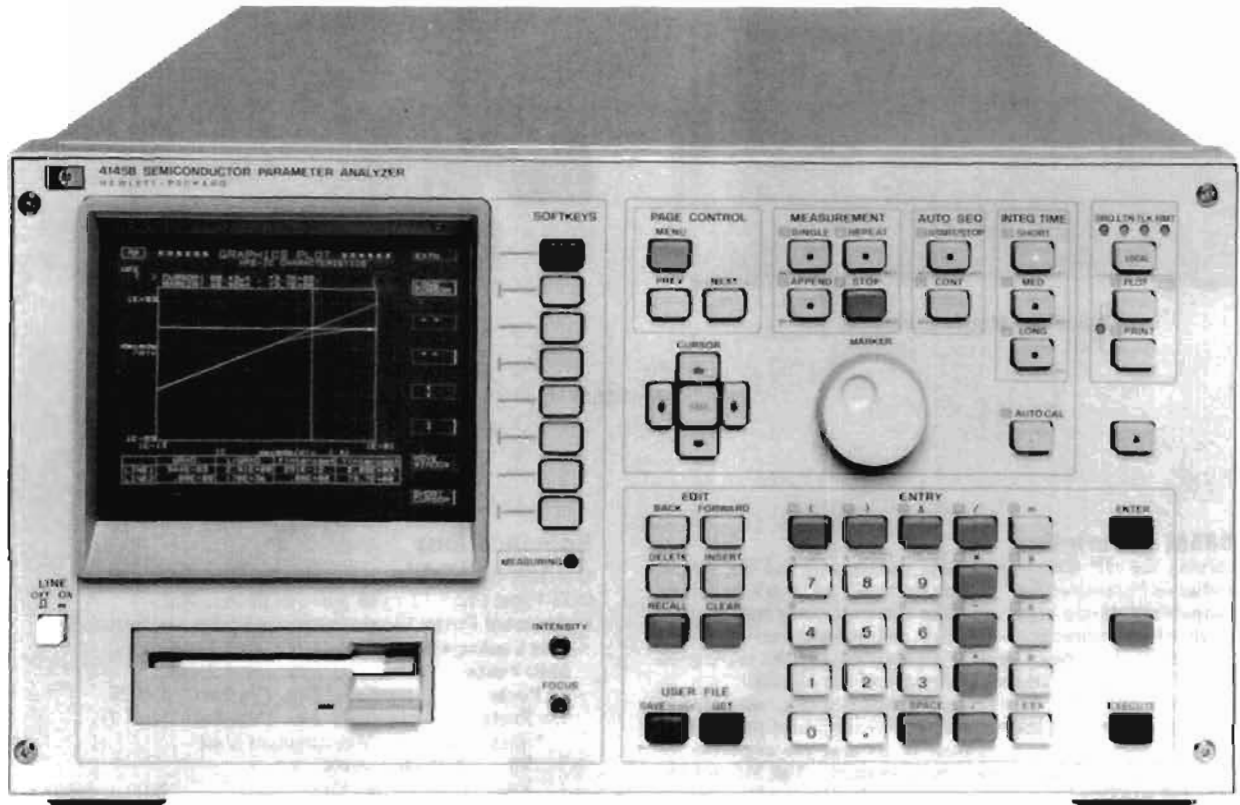

HP 4145B



### Description

Designed for production line and laboratory use, the HP 4145B is the electronics industry's first stand-alone instrument capable of complete dc characterization of semiconductor devices and materials. It stimulates voltage and current sensitive devices, measures the resulting current and voltage responses, and displays the results in a user-selectable format (graph, list, matrix or schmo) on a built-in CRT display. An on-board programmable calculator provides real-time calculation of voltage/current dependent parameters, such as the current gain ( $h_{FE}$ ) and transconductance ( $g_m$ ) of transistors, which also can be displayed on the CRT. A number of powerful graphic analysis tools—marker, cursor, line function, interpolation—enhance the HP 4145B's basic capabilities and provide fast, accurate analysis of semiconductor devices, leading to increased production yields and improved device quality.

Four built-in source monitor units (SMUs) are the heart of the HP 4145B. Each SMU can be independently programmed to function as either a voltage source/current monitor or a current source/voltage monitor. Thus, a bipolar transistor, for example, can be completely characterized in common-base, common-emitter, and common-collector configurations without changing connections—only changing the SMUs' operating modes is required. The HP 4145B is also equipped with two voltage sources and two voltage monitors for measurements on devices having more than four terminals, such as ICs.

The HP 4145B can be controlled from the front panel, via the HP-IB (standard), or by measurement setups stored on micro flexible discs.

Displayed information—measurement setups, auto-sequence programs, measurement results—can be dumped directly onto an external graphics printer/plotter to obtain publication quality hard copies. Additionally, the built-in  $3\frac{1}{2}$ " flexible disc drive enables you to store measurement setups and measured data, which can be accessed by another compatible HP disc drive for further processing.

### Auto Sequence Programs

Measurement programs stored on a HP 4145B micro flexible disc can be linked by an auto sequence program, making it possible to perform a series of measurements with just one keystroke.

### Four User-Selectable Display Formats to Suit the Evaluation

Measurement results can be displayed in one of four display formats: GRAPHICS, LIST, MATRIX or SCHMOO. After measurement has been made and the results displayed, the softkeys can be used to access various analysis functions for complete device evaluation. These functions include MARKER for numeric readout of measured value at any point along a plotted curve, CURSOR for numeric readout of value at any graphic point and for line positioning, STORE/RECALL for overlay comparisons, AUTO SCALE for optimum graphic scaling, and LINE FUNCTION for direct readout of line gradient and X-Y axes intercept values.

## Specifications

### Measurement

**Source/Monitor unit (SMU):** four SMUs are built into the HP 4145B. Each SMU can be programmed to source voltage and monitor current, or conversely to source current and monitor voltage. Each SMU can also be programmed to COM mode. This sets voltage at 0 volts and current compliance at 105 mA.

**Output/measurement resolution:** voltage, 4½ digits; current, 4 digits

**Voltage measurement input resistance/current source output resistance:**  $\geq 10^{12}\Omega$

**Maximum capacitive load:** 1000 pF

### SMU Voltage Range, Resolution and Accuracy

Voltage Range	Resolution	Accuracy <sup>1,2</sup>	Max. Current
$\pm 20V$	1mV	$\pm(0.1\%+10mV+0.4\times I_o)$	100mA
$\pm 40V$	2mV	$\pm(0.1\%+20mV+0.4\times I_o)$	50mA
$\pm 100V$	5mV	$\pm(0.1\%+50mV+0.4\times I_o)$	20mA

<sup>1</sup> $I_o$  is SMU output current in amps.

### SMU Current Range, Resolution and Accuracy

Current Range	Resolution	Accuracy <sup>1,2</sup>	Max. Voltage
$\pm 100mA$	100 $\mu A$	$\pm(0.3\%+100\mu A+2\mu A\times V_o)$	20V( $\leq 50mA$ ) 40V( $> 20mA$ )
$\pm 10mA$	10 $\mu A$	$\pm(0.3\%+10\mu A+200nA\times V_o)$	100V( $\leq 20mA$ )
$\pm 1000\mu A$	1 $\mu A$	$\pm(0.3\%+1\mu A+20nA\times V_o)$	
$\pm 100\mu A$	100nA	$\pm(0.3\%+100nA+2nA\times V_o)$	
$\pm 10\mu A$	10nA	$\pm(0.3\%+10nA+200pA\times V_o)$	
$\pm 1000nA$	1nA	$\pm(0.5\%+1nA+20pA\times V_o)$	
$\pm 100nA$	100pA	$\pm(0.5\%+100pA+2pA\times V_o)$	
$\pm 10nA$	10pA	$\pm(1\%+15pA+200fA\times V_o)$	
$\pm 1000pA$	2pA	$\pm(1\%+6pA+20fA\times V_o)$	

<sup>1</sup> $V_o$  is SMU output voltage in volts.

<sup>2</sup>50 fA resolution in current monitor mode.

- Accuracy specifications are given as % of reading or setting value  $\pm$  % of range.
- Accuracy tolerances are specified at 25°C  $\pm$  5°C, after a 40 minute warm-up time, with AUTO CAL on, and specified at the rear panel connector terminals referenced to SMU common. Tolerances are doubled for the extended temperature range of 10°C to 40°C.

### SMU Voltage/Current Compliance

**Maximum voltage compliance:** 20 V, 40 V, or 100 V, depending on the output current range.

**Maximum current compliance:** 20 mA, 50 mA, or 100 mA, depending on the output voltage range.

**Compliance setting resolution:** same as current and voltage output/measurement resolution. Maximum current compliance resolution, however, is 50 pA.

**Compliance accuracy:** voltage compliance accuracy is the same as voltage output/measurement accuracy. Current compliance accuracy is current output/measurement accuracy  $\pm$  (1% of range + 10 pA).

### Voltage/Current Sweep Characteristics

Output from up to three SMUs or voltage sources can be swept in one of three modes: VARI, VAR2, or VAR1'.

**VARI:** linear or logarithmic staircase sweep

**VAR2:** linear staircase sweep. Output from the VAR2 source is incremented after completion of each VARI sweep.

**VAR1':** output from the VARI' source is synchronized with VARI but at levels proportional to a user-selectable ratio or offset relative to VARI.

**Ratio:**  $\pm 0.01$  to  $\pm 10$

**Offset:** any value that will not cause VARI' to exceed maximum allowable output.

**Hold time:** 0 to 650 seconds,  $\pm(0.5\% + 9\text{ ms})$  with 10 ms resolution

**Delay time:** 0 to 6.5 seconds,  $\pm(0.1\% + 5\text{ ms})$  with 1 ms resolution

**No. of Measurement Steps:** 1024 for a single VAR 1 sweep, 1150 for a multiple sweep

### Voltage Sources (Vs) Characteristics

**Number of sources:** two

**Output resistance:**  $\leq 0.2\Omega$

**Maximum capacitive load:** 1000 pF

### Voltage Output Range, Resolution and Accuracy

Output Voltage Range	Resolution	Accuracy	Max. Output Current
$\pm 20V$	1 mV	$\pm(0.5\%$ of setting + 10 mV)	10 mA

### Voltage Monitors (Vm) Characteristics

**Number of monitors:** two

**Input resistance:** 1 M $\Omega$   $\pm$  1% shunted by 100 pF  $\pm$  10%

### Voltage Measurement Range, Resolution and Accuracy

Measurement Voltage Range	Resolution	Accuracy
$\pm 2V$	100 $\mu V$	$\pm(0.5\%$ of reading + 10 mV)
$\pm 20V$	1 mV	$\pm(0.2\%$ of reading + 10 mV)

### Characteristics Common to SMUs, Voltage Sources & Voltage Monitors

**Maximum allowable terminal voltage:** 100 V peak across SMU and  $V_m$  input terminals, or SMU and  $V_S$  output terminals, or between those terminals and guard; and 42 V maximum from Common to Ground.

### Display

CRT size and screen resolution: 152.4 mm (6 inch) diagonal; 2048 x 2048 points.

**Display modes:** Graphics, Schmo, List, Matrix, and Time Domain  
**External CRT analog output:** X, Y and Z outputs of 0 to 1 Vdc into 330  $\Omega$  (X and Y) and 240  $\Omega$  (Z).

### Analysis

**Calculation:** two user functions can be input and keyboard calculations can be done using the following 11 operators: +, -, \*, /,  $\sqrt{\quad}$ , EXP, LOG, LN, \*\* (power), ABS (absolute) and  $\Delta$  (differential).

### Constants Available on the Keyboard

q: Electron charge ( $1.602189 \times 10^{-19}$  coulomb)

k: Boltzmann's Constant ( $1.380662 \times 10^{-23}$  J/ $^{\circ}$ C)

e: Dielectric constant of vacuum ( $8.854185 \times 10^{-12}$  F/m)

**Analysis functions:** overlay comparison with STORE/RECALL, Marker, Interpolate, Cursor, Auto scale, Zoom function ( $\leftarrow$ ,  $\rightarrow$ ,  $\uparrow$ ,  $\downarrow$ )  
Line and Move Window.

### General Specifications

**Operating temperature range:** +10°C to +40°C;  $\leq 70\%$  RH at 40°C, permissible temperature change:  $\leq 1^{\circ}$ C/5 min.

**Power requirements:** 100/120/220 V  $\pm 10\%$ ; 240 V - 10% + 5%; 48 to 66 Hz; 270 VA max

**Dimensions:** 426 mm W x 235 mm H x 612 mm D (16.75" x 9.06" x 24.1")

**Weight:** 27 kg (59 lb) approximately.

### Reference Data

**SMU measurement time:** measurement time = response time + ranging time + integration time.

### SMU Response Time

Current Range	Setup/Settling Time	SMU Wait Time
100 nA to 100 mA 1 nA and 10 nA	2.7 ms	12.2 ms 47.5 ms

**Ranging time:** varies from 4 ms to 74 ms

**Integration time:** SHORT, MED and LONG

	SHORT	MED	LONG
50 Hz		20 ms	320 ms
60 Hz	3.6 ms	16.7 ms	267 ms

### Accessories Furnished

HP 16058A Test Fixture

HP 04145-61501 System Disc

HP 04145-60001 Connector Plate

HP 04145-61622 Triaxial Cable (3m), 4 ea.

HP 04145-61630 BNC Cable (3m), 4 ea.

HP 04145-61623 Shorting Connector

### Ordering Information

HP 4145B Semiconductor Parameter Analyzer \$24,450  
Opt. 050/060: 50Hz/60Hz Line Frequency N/C

# SEMICONDUCTOR TEST EQUIPMENT

## pA Meter/DC Voltage Source

Model 4140B

- 3 basic semiconductor measurements: I, I-V and quasi-static C-V
- Two programmable voltage sources
- Basic accuracy: 0.5%
- High resolution:  $0.001 \times 10^{-12}$
- HP-IB standard

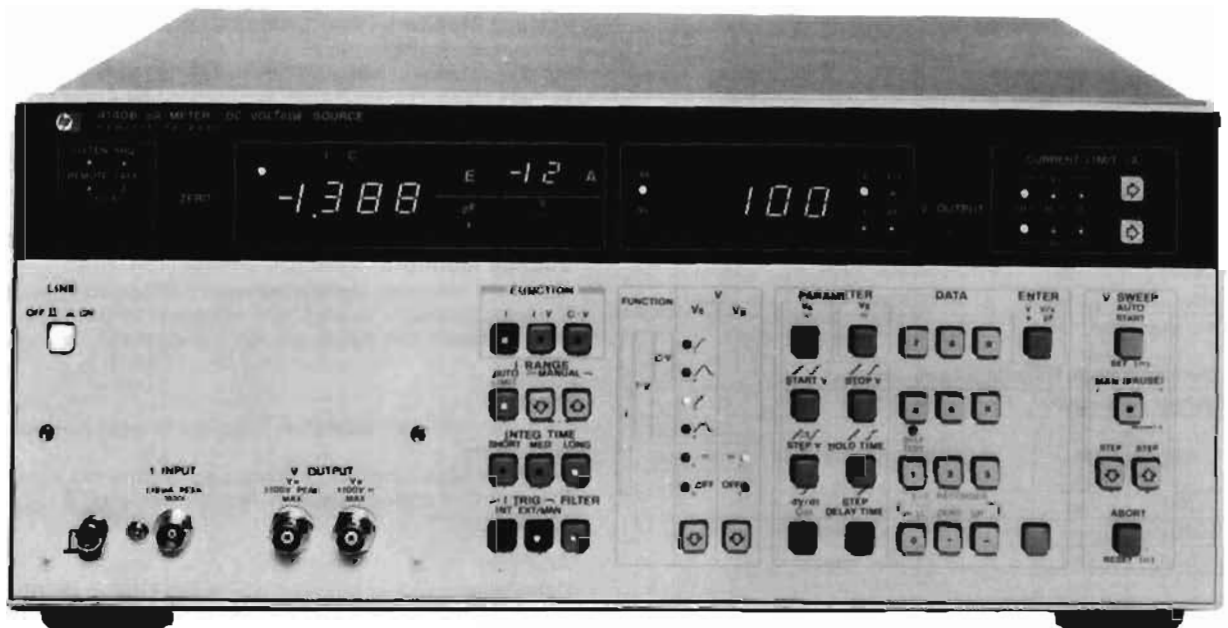

HP 4140B



### Description

The HP 4140B pA Meter/DC Voltage Source is another in Hewlett-Packard's new generation of Component Measurement instrumentation. It consists of an extremely stable picoampere meter and two programmable dc voltage sources, one of which operates as a ramp and staircase generator as well as a dc source. These features make the HP 4140B ideal for making dc characteristic measurements such as leakage current, current-voltage characteristics and quasi-static C-V measurements required by the semiconductor industry for new product development and for improving production yields. It is equally useful in measurements of electronic components and materials to determine leakage currents or insulation resistances.

The HP 4140B can contribute to the development, production and quality control of semiconductor devices and to the improvement in the reliability of electronic components and equipment.

### Stable pA Measurements

Stable picoampere measurements can be made with the HP 4140B with a maximum resolution of  $10^{-12}$  A. This is made possible by a new measurement technique in conjunction with an offset current capability, low noise test leads, and an electrostatic and light shielded test fixture. These features provide both stable and fast picoampere measurements.

This measurement technique is very useful in making small leakage current measurements and determining dc parameters of semiconductor devices or measuring the insulation resistance and leakage current for dielectric absorption measurements necessary in the analysis of capacitors or insulation materials.

### Synchronized I-V Measurements

The HP 4140B makes automatic, synchronized current-voltage measurements that have required a large instrumentation system in the past.

The two voltage sources in the HP 4140B operate over a range of  $-100$  V to  $+100$  V with a maximum resolution of 10 mV. One operates only as a stable dc source while the other generates a staircase voltage, a precise ramp or a stable dc level.

By adding precise, programmable timing capability, we can now make fast, accurate I-V and C-V measurements. Device stabilization times. (time between the applied voltage and the subsequent current

measurement) can now be programmed from the front panel of the HP 4140B or via the HP-IB bus.

### Quasi-Static C-V Measurements

Automatic quasi-static C-V measurements are easily accomplished by the ramp voltage capability of the HP 4140B. This measurement is highly significant in evaluating basic semiconductor characteristics.

The HP 4140B operates over a capacitance range of 0.1 pF to 1999 pF with a dc voltage ramp rate of 1 mV/s to 1 V/s in 1 mV/s increments. Capacitance, which is calculated from the measured current divided by the ramp rate, can also be provided as a percent of the capacitance of the oxide film ( $C_{ox}$ ) over a range of 0.0 to 199.9%. By providing the output voltage at each capacitance measurement point, we have the dc (quasi-static) C-V characteristics of the device under test.

### HP-IB Capability

Interfacing the HP 4140B to an HP-IB system improves measurement efficiency and takes advantage of its high speed (approx 5 ms) measurement rate. Such a system will minimize measurement time of dc parameters of semiconductors and the insulation resistance and leakage current of electric components and materials. This allows rapid feedback to production for fast evaluation of a new device in the development stage.

### Specifications

**Measurement functions:** I, I-V and C-V

**Voltage sources:** two separate sources ( $V_A$  and  $V_B$ )

$V_A$ :  $\pm 100$  V programmable source/function generator

$V_B$ :  $\pm 100$  V programmable dc voltage source

**Measurement Function/Source Selection**

Function	$V_A$	$V_B$
I		
I-V		
C-V		

**Voltage sweep:** auto or manual (pause)

**Current Measurements**

**Displays:** current, 3½ digits with 2 character annunciator. Voltage, 3½ digits.

**Measurement range:** ±0.001 × 10<sup>-12</sup>A to 1.000 × 10<sup>-2</sup>A full scale in 11 ranges.

**Overrange capability:** 99.9% on all ranges.

**Range selection:** auto (lowest current range is selectable) and manual

**Measurement Accuracy/Integration Time**

Range	Accuracy* ± (% of rdg. + counts)	Integration Time** (ms)		
		Short	Medium	Long
10 <sup>-7</sup> – 10 <sup>-9</sup>	0.5 + 2	20	80	320
10 <sup>-10</sup>	2 + 2			
10 <sup>-11</sup>	5 + 3	80	320	1280
10 <sup>-12</sup>	5 + 8	160	640	2560

\* Accuracy for long integration time: 23°C ± 5°C, humidity ≤ 70%. For short and medium integration time, see reference data section.

\*\* Integration times specified at 60 Hz. For 60 Hz operation, multiple time by 1/4.

**Zero offset:** cancels leakage current of test leads or test fixtures.

**Offset range:** 0 to ±100 × 10<sup>-15</sup>A.

**Trigger:** INT, EXT and HOLD/MAN

**Input terminal:** triaxial

**Capacitance-Voltage (C-V) Measurement**

**Measurement ranges:** 0.0 pF – 100.0 pF and 200 pF – 1000 pF full scale in two ranges; 99.9% overrange

**Ranging:** auto

**% C:** capacitance change of device under test is displayed as a percent of the set value of the oxide capacitance (Cox = 100%)

**% C range:** 0.0% – 199.9%

**Cox setting ranges (2 ranges):** 0.1 pF – 199.9 pF and 200 pF – 1999 pF

**Capacitance calculation accuracy:** accuracy is dependent on accuracy of both the current measurement and ramp voltage.

**Zero offset:** cancels stray capacitances of test fixtures and test leads.

**Offset range:** 0 to 100 pF

**High speed I data output:** available with HP-IB interface only. Outputs current measurement data at 4 ms intervals (max rate).

**DC Voltage Sources**

**Output Modes, V<sub>A</sub> and V<sub>B</sub>**

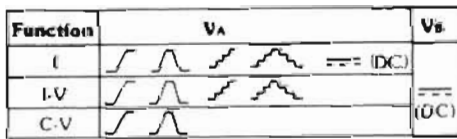

**Voltage ranges (V<sub>A</sub> and V<sub>B</sub>):** 0 to ±10.00 V and 0 to ±100.0 V in 2 ranges, auto range only.

**Maximum current:** 10 mA, both sources.

**Voltage sweep:** auto and manual (pause), up/down step in manual (pause) mode. Sweep abort standard.

**Operating Parameter Setting Ranges**

**Start voltage and stop voltage:** 0 – ±10.00 V, 0.01 V steps; 0 – ±100.0 V, 0.1 V steps

**Step voltage:** 0 – ±10.00 V, 0.01 V steps; 0 – ±100.0 V, 0.1 V steps

**Hold time:** 0 – 199.9 seconds in 0.1 s increments; 0 – 1999 seconds in 1.0 s increments

**Step delay time:** 0 – 10.00 seconds in 0.01 s increments; 0 – 100.0 seconds in 0.1 s increments

**Ramp rate (dV/dt):** 0.001 V/s – 1.000 V/s in 0.001 V/s increments

**Accuracy (at 23°C ±5°C)**

**Output voltage:** ±10 V, ±(0.07% + 11 mV); ±100 V, ±(0.09% + 110 mV)

**Linearity:** typically 0.5%, 0 – ±10 V; <5%, >10 V.

**Current limit:** 100 μA, 1 mA and 10 mA, ±10% (V<sub>A</sub> and V<sub>B</sub>)

**Output terminals:** BNC; L-GND

**Reference Data**

**Current Measurement**

**Current Measurement Accuracy\***

Range	Integration Time	
	Short	Medium
10 <sup>-7</sup> – 10 <sup>-9</sup>	0.5 + 3	0.5 + 2
10 <sup>-10</sup>	0.5 + 3	0.5 + 3
10 <sup>-11</sup>	2 + 4	2 + 3
10 <sup>-12</sup>	5 + 10	5 + 4
10 <sup>-13</sup>	5 + 20	5 + 10

\* ± (% of rdg. + counts), 23°C

**Current ranging times:** 20 ms to 7.76 s. (longer ranging time needed for large changes in input signal level, especially on lowest current ranges).

\*When FILTER is on, current ranging time increases 60 ms (60 Hz power line) or 50 ms (60 Hz power line)

**Warm-up time:** ≥ 1 hour

**Common mode rejection ratio:** ≥ 120 dB (≤ 2 counts)

**Analog Output I, C and V<sub>A</sub>**

**Accuracy:** ±(0.5% + 20 mV)

**Low pass filter:** 3 position: OFF, 0.22 s ±20% and 1s ±20% applied to both V<sub>A</sub> and I/C data outputs

**Pen lift output:** TTL low level (≤0.8V) during sweep period in I-V and C-V functions

**Recorder output scaling:** pushbutton scaling of lower left and upper right limits of X-Y recorder

**HP-IB Interface**

**Remote controlled functions:** measurement function, current range, integration time, I data output trigger, voltage sweep controls, current limit, V<sub>A</sub> and V<sub>B</sub> voltages, zero (offset), self test and parameter settings (voltages, sweep/hold/delay times)

**Data Output**

Measured data (I, C and V<sub>A</sub>).

Voltage setting (V<sub>A</sub> and V<sub>B</sub>).

Parameter settings

**General Information**

**Power:** 100, 120, 220, V ±10%, 240 V +5% – 10%; 48-66 Hz, 135 VA max

**Size:** 426 mm W x 177 mm H x 498 mm D (16.5" x 7" x 19.6")

**Weight:** 14.4 kg (31.7 lb)

**Accessories Furnished**

**HP 18053A test leads:** consists of one triaxial cable, two each BNC-BNC cables and one connection plate with mating female panel-mount connectors. Cables are one meter in length.

**HP 18055A test fixture:** for general device measurements. Provides electrostatic and light shielding for stable pA measurements.

**Accessories Available**

**HP 18054A connection selector:** provides a simple method to select appropriate connection of low lead for the pA meter section.

**HP 18056A current divider (10:1):** for use only on the 10 mA range to extend the measurement capability to 100 mA.

**Ordering Information**

	Price
<b>Accessories</b>	
HP 16054A Connection Selector	\$375 ☞
HP 16056A Current Divider (10:1)	\$204 ☞

**Options**

Opt 907 Front Handle Kit (HP P/N 5061-0090)	\$66
Opt 908 Rack Flange Kit (HP P/N 5061-0078)	\$36
Opt 909 Rack & Handle Kit (HP P/N 5061-0084)	\$92
Opt 910 Extra Manual	\$51

**HP 4140B pA Meter/DC Voltage Source** **\$10,200**  
☞ Fast-Ship product — see page 758.

# SEMICONDUCTOR TEST EQUIPMENT

## 1 MHz C Meter/C-V Plotter

Model 4280A

- Built-in sweepable dc bias source and timer for C-V (Capacitance-Voltage)/C-t (Capacitance-Time) measurements
- High speed C-t measurements with minimum measurement interval of 10 ns (10  $\mu$ s if an external pulse generator is used)
- Basic C measurement accuracy: 0.1%
- Test lead extension up to 5 m
- 5½-digit display resolution (option) for C measurement

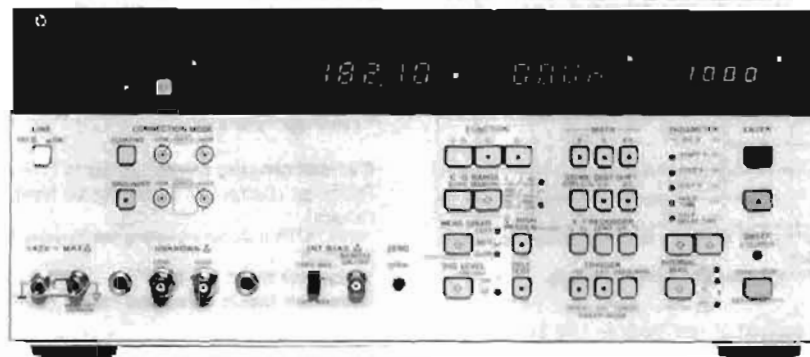

HP 4280A



### Description

The HP 4280A 1 MHz C Meter/C-V Plotter measures the capacitance and conductance of semiconductor devices and materials as functions of applied voltage (C-V) or time (C-t). The HP 4280A consists of a precision 1 MHz C-G meter, a programmable dc bias source that can be swept in staircase fashion, and accurate timing control.

### C-V and C-t Measurements

The HP 4280's internal dc bias source has a range of 0 V to  $\pm 100$  V with 1 mV resolution on the most sensitive range. Various measurement parameters for C-V and C-t measurements—hold time (bias pulse width) and delay time (measurement interval)—can be manually set from the front panel. Or these parameters can be set under program control via the HP-IB. Settable range for C-t measurement interval is 10 ns to 32s with a best case resolution of 10  $\mu$ s. If an external pulse generator is used, however, measurement intervals as short as 10  $\mu$ s can be set. Up to 9999 readings can be set for a C-t measurement. These capabilities make it possible for the HP 4280A to measure the C-t characteristics of virtually any device.

### High Speed C-t Measurement

A special sampling integration technique employed in the HP 4280A provides measurement intervals as short as 10  $\mu$ s using an external pulse generator, such as the HP 8112A or HP 8160A, to provide the bias pulse. Short measurement interval makes the HP 4280A applicable to Deep Level Transient Spectroscopy (DLTS) measurements, which are commonly used to analyze the physical characteristics of semiconductors.

### Precision, High Resolution Measurements

The HP 4280A measures capacitances up to 1,900 nF, over three ranges, with 0.001 pF resolution on the most sensitive range. Conductance up to 12 mS can be measured with a maximum resolution of 10  $\mu$ S.

C and G measurements are made at 1 MHz. AC signal level is selectable between 10 mVrms or 30 mVrms, suitable for semiconductor measurements. Basic measurement accuracy is 0.1%. Maximum display resolution is 4½ digits. With Option 001, however, display resolution for capacitance is 5½ digits.

The accuracy and resolution of the HP 4280A satisfy the stringent requirements of laboratory and R and D measurements, which require the detection of minute changes in device characteristics.

### Probed Measurements On Wafers

HP 4280A has an automatic error correction function that makes

it possible to use test leads up to 5 m long (HP P/N 8120-4195). The HP 4280A can measure either floating or grounded devices. Thus, the HP 4280A can be connected to a wafer prober and still provide stable, accurate C and G measurements.

### Easy, Low Cost Systemization

HP-IB is standard on the HP 4280A. So, a process evaluation system or a lab automation system capable of evaluating the physical characteristics of semiconductor devices can be easily constructed.

The HP 4280A is equipped with analog outputs to allow users to plot device characteristics on an X-Y recorder or large screen display.

### Specifications (refer to data sheet to complete specifications)

Measurement functions: C, C-V and C-t

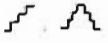
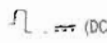
Function		Available Internal dc Bias Function
Basic Function	Selection	
C	C only, G only C-G only	OFF, $\infty$ (DC)
C-V	C-V G-V C & G-V	
C-t	C-t G-t C & G-t	 $\infty$ (DC), OFF

### C Measurement

#### Test Signal

Frequency: 1 MHz  $\pm 0.01\%$

OSC level: 30 mVrms or 10 mVrms  $\pm 10\%$

Measurement terminals: two-terminal-pair configuration (High, Low and Guard).

Connection mode: sets connection configuration between DUT (floating/grounded) and measurement circuit.

Ranging: auto or manual

#### Error Compensation

Cable length: 0 m, 1 m or 0-5 m. The standard cable (HP P/N 8120-4195) up to 5 m can be internally compensated.

Zero open: compensate stray capacitance and conductance at the test fixture.

External error compensation: compensate errors by external computer to eliminate other error factors not listed above.

Measurement speed: FAST, MED or SLOW

Trigger: Internal, External or Hold/Manual

Internal dc bias mode: OFF or  $\infty$  (DC)

## Measurement Range/Resolution/Accuracy

Range <sup>1</sup>	Resolution <sup>1</sup>	Max. Display <sup>2</sup>	Accuracy <sup>3</sup> ± (% of rdg + counts)	
			OSC: 30 mV	OSC: 10 mV
10 pF/100 μS	0.001 pF 0.01 μS	19,000 pF 120,000 μS	±(0.1% + 5) ±(0.2% + 5)	±(0.2% + 5) ±(0.3% + 5)
100 pF/1 mS	0.01 pF 0.1 μS	190,000 pF 1,200,000 μS	±(0.1% + 3) ±(0.2% + 3)	±(0.2% + 3) ±(0.3% + 3)
1 nF/10 mS <sup>5</sup>	0.1 pF 0.001 mS	19,000 nF 12,000 mS	±(0.1% + 3) ±(1.2% + 3)	±(0.2% + 3) ±(1.2% + 3)

<sup>1</sup> 100 pF/1 mS and 1 nF/10 mS ranges only in grounded measurement.

<sup>2</sup> When measurement speed is set to FAST (10 mV/30 mV) or MED (10 mV), resolution and Max. display become 1 digit less (3½ digit display).

<sup>3</sup> Approx. 50 pF at 100 pF/1 mS range and 1.75 nF at 1 nF/10 mS range in grounded measurement. Error correction to offset residuals will reduce maximum value which can be measured.

<sup>4</sup> Accuracy is specified at UNKNOWN terminals and at the end of HP 16082A Test Leads (1 m) after warm-up ≥ 30 min., at temperature 23°C ± 5°C, zero open calibration is performed, and CORRECTION is enabled. Front panel settings are C-G, FLOATING and 0 m or 1 m (CABLE LENGTH). Some errors will be added at other settings (refer to data sheet). G accuracy is specified when D < 0.05 and G accuracy is specified when counts of C < 1/100 of range. Error double at 0°C-55°C.

<sup>5</sup> Add 0.1% of rdg for C and 0.2% of rdg for G when HP 16082A is used.

## C-V Measurement

**Function:** measures C-V, G-V or C & G-V characteristics using internal staircase bias.

**Measurement speed:** FAST, MED or SLOW

## C-t Measurement

**Function:** measures C-t, G-t or C & G-t characteristics using internal and/or external pulse bias source.

**Internal measurement mode:** Burst or Sampling Mode automatically selected.

**Burst mode:** apply one pulse then make repetitive measurement with specified time interval between measurements.

**Sampling mode:** repeated pulse with single samples between pulses. Delay between application of measure voltage and sample can be specified.

**Measurement speed:** FAST or MED

## DC Bias Source

**Output Mode:**  (DC) or OFF

**Output Voltage Range/Resolution/Accuracy**

Output Voltage Range	Resolution	Accuracy <sup>4</sup> ± (% of setting + volts)
±1.999 V	1 mV	±(0.2% + 0.01 V)
±19.99 V	10 mV	±(0.1% + 0.02 V)
±100.0 V	100 mV	±(0.1% + 0.1 V)

<sup>4</sup> at 23°C ± 5°C, at 0°C - 55°C error doubles

## Staircase Sweep Parameter Settings (C-V Basic Function Only)

**Start/stop voltage:** 0 V - ±100 V (max. 1 mV resolution)

**Step voltage:** 0 V - 200 V (max. 1 mV resolution)

**Hold/step delay time (th/td):** 3 ms - 650s (max. 1 ms resolution)

**Pulse Bias Parameter Settings (C-t basic function only)**

**DC/pulse/measurement voltage:** 0 V - ±100 V (max. 1 mV resolution)

**Number of readings:** 1-9999

**Hold time (th):** max. 10 μs resolution

**Internal bias:** 10 ms - 32 s

**Ext bias slow:** 50 μs - 32 s

**Ext bias fast:** 10 μs - 32 s

**Delay time (td):** 10 μs - 32 s (max. 10 μs resolution)

## Burst Mode

Function	Meas. Speed	Block Mode	Non Block Mode:	
			Data Format	
			Binary	ASCII
C-t G-t	FAST	10 ms-32 s	20 ms-32 s	1.50 ms-32 s
	MED			
C & G-t	FAST	50 ms-32 s		200 ms-32 s
	MED	100 ms-32 s		250 ms-32 s

## Sampling Mode

**Ext bias slow:** 200 μs - 5 s

**Ext bias fast:** 10 μs - 5 s

**Math functions:** displays measured C/G values as differential values (Δ), % ratio (%) or differential % (Δ%) of the reference value.

## Other

**HP-IB:** not just IEEE-488, but the hardware, documentation and support that delivers the shortest path to a measurement system.

**Data output format:** ASCII or Binary

**Block mode output:** can make C-V/t characteristics measurement and store measured data (C-V/t or G-V/t Function: 680 data, C & G-V/t Function: 400 data) into the internal data buffer. Then, packed data can be output.

## Recorder Output

**Output voltage:** ±10 V for C, G and V/t data

**Accuracy:** ±(% of output voltage + V)

**C or G:** ±(0.5% + 20 mV)

**V or t:** ±(0.15% + 40 mV)

**Self test:** verifies normal measurement operations (not including calibration)

## Options

**Option 001:** High Resolution Offset Capacitance Measurement

**Function:** increase C measurement resolutions by one digit with offset reference value.

**C offset range:** 0 pF - 1023 pF (1 pF increment). C offset value can be set by measured data or numeric key.

## General Specifications

**Operating temperature range:** 0°C to 55°C; 95% RH at 40°C

**Power requirements:** 100/120/220 V ±10%, 240 V + 5% - 10%; 48 to 66 Hz; 140 V A max.

**Dimensions:** 426 mm W x 177 mm H x 498 mm D (16.5" x 7" x 19.5")

**Weight:** 15.3 kg (33.7 lb)

## Accessories Furnished

**HP 16080A:** Direct Coupled Test Fixture

## Reference Data

## Measurement Time

MEAS SPEED	Measurement Function		
	C-G	C	G
FAST	30 (70)	10 (30)	10 (30)
MED	70 (110)	40 (60)	35 (55)
SLOW	400 (440)	270 (290)	220 (240)

When measured values are displayed on the front panel and the recorder outputs are used, measurement times in parentheses apply.

**Residual L-R compensation:** error compensation for residual L-R (max. 19 μH/190 Ω) is available using an external controller.

**Internal DC Characteristics of High and Low Unknown Terminals (Without DC Bias)**

**Maximum offset voltage:** ±1 mV

**Maximum allowable current:** 100 mA

## Internal DC Bias

**Settling time (99.9% of final value):** 0.05 × voltage swing (V) + 1.7 (ms)

**Maximum output current:** ±6 mA

**Hold time/step delay time/th/td:** 0.02% (basic accuracy)

**Response time of the EXT SLOW bias circuit (99.9% of final value):** 100 μs

## Option 001

**C offset accuracy:** ±(2% of reference value + 0.5 pF) can be compensated by CORRECTION ENABLE key.

## Ordering Information

**Opt 001 C-High Resolution (not field installable)**

**HP 16081A Test Leads, 2 m double shielded, BNC**

**HP 16082A Test Leads, 1 m, BNC**

**HP 16083A Pulse Bias Noise Clipper**

## Price

\$420

\$715

\$244

\$385

**HP 4280A 1 MHz C Meter/C-V Plotter**

Fast-Ship product - see page 758.

**\$10600**

# SEMICONDUCTOR TEST EQUIPMENT

## Parameter Extraction Software

### TECAP Characterization System

- Shortens IC design time
- Improves circuit designs
- Lowers chip costs
- Maximizes yields
- Accurate circuit simulations
- Device AC and DC measurements

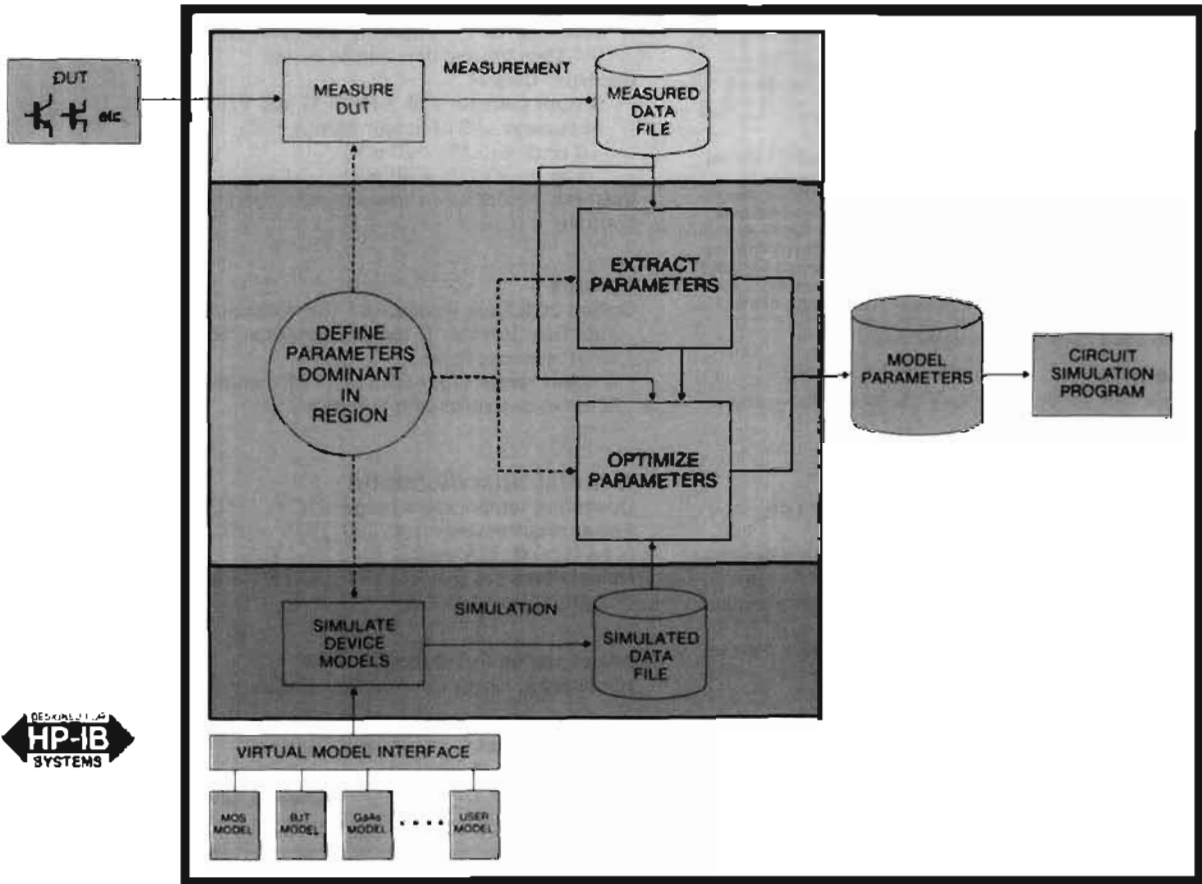

TECAP automatic parameter extraction methodology

### TECAP Lets You Design New IC's in Less Time - With Less Cost

Hewlett-Packard's TECAP characterization System shortens your IC design cycles and lowers design costs. TECAP - Transistor Electrical Characterization and Analysis Program - provides fast, reliable analysis of device behavior. Model parameters generated with the TECAP system will improve your circuit simulation and IC designs.

TECAP provides engineers with a complete system for device characterization. The easy-to-use display environment and extensive set of calibration and measurement drivers streamlines data collection. Simple commands allow you to quickly extract model parameters from measured data. Integrated, powerful simulation tools allow you to perform real-time analysis of your device performance.

### Design IC's and New Devices Faster

TECAP lets you perform your design revisions using CAE analysis. Because this is more economical and much faster than multiple fabrication runs, you save valuable engineering and production resources. Accurate model parameters form the foundation for error-free circuit simulation and precise IC design. TECAP's integrated measurement, extraction, and simulation tools provide you with accurate model parameters in seconds. Because you can now begin wafer fabrication with a superior design, you minimize passes through the fab line, slash your design cycles, and deliver products to your customers in a timely manner.

### Develop and Understand New Device Models

You can implement your own transistor models into TECAP to be completely compatible with proprietary circuit simulation programs or emerging new semiconductor technologies. You can use the versa-

tile simulation tools to develop and test new model equations. TECAP gives you the immediate feedback you need to evaluate and understand equation behavior. TECAP replaces pages of batch printouts with vivid, colorful graphics so you may clearly visualize the effects of model parameters and complex, multi-order equations.

### Get Maximum Performance From Your Process

TECAP allows you to significantly improve the performance of your existing IC process. With TECAP, you can determine those parameters which have the greatest effects on performance measures such as speed, power, and logic levels. Using TECAP's statistical tools, you can accurately determine worst case performance of your process using those dominant parameters. TECAP gives you the vehicle to construct worst case models which will allow you to increase the performance of your process with minimal process development and lower cost.

### TECAP Extracts Model Parameters in Seconds

TECAP software can automatically extract UCB Level 2, 3, 4, MOS, UCB Bipolar, or GaAs model parameters in seconds. These models can simulate second-order effects, such as channel-length modulation, and offer direct compatibility with the UCB SPICE circuit simulator developed at the University of California, Berkeley.

The TECAP system can also extract parameters for your new transistor models. Newly implemented models have the same parameter extraction, optimization, and simulation capabilities as standard TECAP models. You can even add a custom extraction module to the program to fully automate parameter extraction for your model.





TECAP software is fully compatible with a wide range of standard HP-IB Instrumentation.

### Configure System Hardware to Satisfy Your Price and Performance Requirements

The TECAP system works with a wide range of standard Hewlett-Packard computers and HP-IB instrumentation, allowing you to choose the equipment which meets your exact needs. You can build an entry level system to start with. Then, as your requirements expand, you can add the latest in high performance measurement tools to fit your changing situation.

### TECAP Is Easy to Use

TECAP provides both ease-of-use for the occasional user and advanced features and capabilities for the expert user. You can access any TECAP command from one convenient menu - so you don't get lost in menu hierarchies. The "main menu" always displays program status to keep you updated on program action. These human-engineering features have been designed into TECAP to automate the process of parameter extraction and new model development.

To measure a device, extract model parameters, or simulate device performance, you select the appropriate command. If the system needs more information from you, it will supply a diagram or table for you to edit. Every table is already furnished with default values or configurations. The table entry method allows you to have immediate access to all of your characterization routines - this lets you use the design tools more productively.

### Integrated System Saves Time

TECAP's integrated environment lets you concentrate on evaluating results, so you don't waste time figuring out how to get them. You can measure devices, extract parameters, simulate device models, and plot results all with the same program.

TECAP minimizes setup preparation time so each user can immediately begin extracting parameters from their devices. For example, you can save a complete system environment on a disc and use it in seconds. You can retrieve instrument setups, extraction routines, and device models with a single command. You can create system configurations for every process in your company. You can quickly setup an environment to perform characterization on NMOS, CMOS, bipolar, or GaAs devices - using the SAME system.

You can operate the TECAP system without knowledge of the computer hardware, the computer operating system, or the measurement instruments. The system automatically adapts to handle all the

instrument setups and measurements you need for device characterization. To give you maximum flexibility, the software lets you control a wide variety of measurement and computation hardware.

### TECAP Software Specifications

**Operating system:** Pascal Workstation language system, Version 3.2.

**Measurement:** voltage, current, capacitance, and 2-port ac parameters vs. bias and frequency.

#### Model Parameter Generation

##### Extraction:

- direct extraction from measured data
- predefined routines for automatic extraction
- interactive parameter extraction mode
- user definable extraction routines

##### Optimization:

- numerical fine tuning of extracted parameters using integrated SPICE-like simulator for highly accurate fits
- compatible with user defined models
- Levenberg-Marquardt algorithm for nonlinear, least-squares fit
- constrained optimization

**Simulation:** voltage, current, capacitance, and 2-port ac parameters vs. bias and frequency.

#### Available models:

- UCB MOS Levels 1, 2, 3 and 4 (BSIM)
- UCB bipolar (Gummel-Poon)
- Curtice GaAs MESFET Levels 1 (quadratic) and 2 (cubic)
- Yacger-Dutton GaAs HEMT
- UCB JFET
- Diode
- PN Junction Capacitance
- MOS Gate Capacitance
- Classical MOS
- Up to 7 user definable models

### Ordering Information

Please call your local HP Sales Office listed on page 760 for a data sheet, prices, or applications assistance.

# BOARD TEST SYSTEMS

## Model 3065 Board Test Family

- Combinational Testers
- Guaranteed 99% Uptime Service



### Description

The HP 3065 Board Test Family is the result of many years of experience in automatic testing and advanced computer technology. The entire HP 3065 Family, from the low cost HP 3065ST Standard Technologies Tester to the HP 3065AT Advanced Technologies Combinational Tester, features high speed digital in-circuit testing, our proven 6-wire analog in-circuit testing and analog functional testing. The Advanced Technologies testers provide high speed combinational test capabilities as well. The distributed intelligence architecture allows a single controller to support multiple test stations, multiple programming and repair stations, and a variety of peripherals without sacrificing high throughput in production test. The HP 3065 Family of testers consists of two system controllers (HP 3065CL PLUS and 3065CX PLUS), two test stations (HP 3065HL and 3065HX), and the HP 3065ST Standard Technologies Tester. Adding the Advanced Technologies Hardware and Software Modules adds still another member to the family... the HP 3065AT Advanced Technologies Combinational Tester.

### In-circuit Test Performance

Exceptional test effectiveness is achieved by the HP 3065 Family's analog and digital in-circuit test capabilities.

Digital in-circuit testing techniques are to detect IC pin faults on the loaded PC board. Using a "computer-behind-the-pins" and "keep" and "toggle" vector states, in addition to the standard 1, 0, X and Z states, provides an almost unlimited vector capability. Pattern application rates are programmable up to 5 MHz on all hybrid pins.

An extensive library of digital tests now includes over 4500 part numbers of SSI, MSI, LSI, and VLSI devices. Additional capabilities have recently been added for the thorough testing of mixed signal telecommunications devices (CODEC's) and serial digital signal devices (ISDN).

The HP 3065 Family also features the HP Safeguard In-circuit® analysis package to minimize the risk of tester-caused damage to digital devices.

HP's advanced analog in-circuit testing is based on the proven analog techniques pioneered in the HP 3060A/61A/62A board test systems that have become the industry standard. The HP 3065 Family can perform 2-, 3-, 4- and 6-wire measurements for testing critical components precisely in complex circuits. Hybrid devices such as CODEC's A-to-D's, DAC's and other complex circuits can easily be measured by simply synchronizing the digital and analog subsystem capabilities.

### Combinational Test

Both analog and digital functional testing is offered on the HP 3065 Family to increase test yields. Functional testing increases test effectiveness by finding faults that are difficult to find with in-circuit testing and allowing tuning and adjustments of circuits by the system operator

Analog functional testing is a standard feature on all members of the HP 3065 Family. Sources and detectors are provided and, if additional test capability is required, optional test instrumentation can be added via the standard HP-IB (IEEE 488) interface.

Digital functional testing can be added to the HP 3065SL/X systems of the HP 3065 Family by adding the Advanced Technologies Hardware and Software Modules to the standard systems. The resultant HP 3065AT Tester provides enhanced testing of VLSI, ASIC and SMD based PC boards. It features high speed data capture, clock speeds for testing 32-bit microprocessors, and control line capability for bus emulation testing. Increased use of VLSI devices has changed the test feature set needed to find both manufacturing and device faults. The HP 3065AT meets these requirements with data application rates of 10 M patterns/sec and clock rates to 167 MHz. DUT's with onboard clocks of up to 40 MHz can be synchronized directly to the tester hardware with the sync-to-clock capability.

Advanced VLSI devices also require extensive timing control capabilities for complex bus protocols. The HP 3065AT provides programmers with eight trigger inputs, eight clock waveform inputs and outputs, and twelve programmable waveform pins. A total of fifteen timing sets are available for controlling bus protocols.

Often the physical layout (SMD's) or electrical limitations (PAL's) make it difficult or impossible to automatically probe or backdrive a component or group of components. The HP 3065AT allows the unaccessible circuits to be tested in a cluster and, by using the Backtrace Probe algorithms, the faulty device can be accurately pinpointed.

Testing of ASIC devices is made easier on the HP 3065AT by the optional Pattern Capture Format (PCF) Module. The HP PCF allows custom vector sets to be entered directly from a CAE system into the 3065AT test program. HP PCF can also be used to capture vectors for simulator-based functional testing.

The time required to debug complex digital tests is greatly reduced using HP's Graphical Debug Module. The programmer can view eight programmed waveforms or 16 ASCII representations at a time to verify the waveform sets. Once the waveform sets are verified, the actual waveforms can be viewed as they are applied to the DUT using sampling intervals as low as 30 nsec.

### Protect Your Investment

The modularity and flexibility of these test systems allow the user to keep pace with today's rapidly changing board test technology. Hewlett-Packard's on-going enhancement program has produced many advances in both the hardware and software areas. These advances include doubling the in-circuit pattern application rate to 5 MHz, adding combinational test capabilities to the HP 3065 Family, increased disc storage on all controllers, faster pattern application rates, a new direct functional test access card, and a new family of test fixtures.

The HP Q-STAR network provides enhanced software application packages including HP NS/3065 and BTL PLUS test management software, HP PR PLUS paperless repair management software, and HP Q-STATS II quality management software.

Another important factor in protecting your investment is system compatibility. Test programs and fixtures developed on one system are easily transported to others within the family. Therefore training, test programs and fixtures are not abandoned when the need for additional capacity arises.

In many areas around the world, HP offers a 99% Guaranteed Uptime Service on all members of the HP 3065 Family. This is made possible by the excellent reliability record of the HP 3065 and HP's outstanding support organization. HP offers a complete solution to your application, hardware, and software support needs.

### HP 3065 Board Test Family

For an informative brochure on the HP Board Test Family or more information on the 99% Guaranteed Uptime Service program, call 1-800-634-8378 in the U.S., or your local Hewlett-Packard Sales Service office.

Prices start at \$95,000.

## Model 3065ST Board Test System

- Complete Test System
- Low Cost . . . Easy to Program



### Description

The HP 3065ST Standard Technologies Board Test System is the newest addition to the HP 3065 Family of testers. The HP 3065ST is a complete, low-cost board test system that includes a test station, controller, two terminals, repair message printer, and automatic, easy-to-use software. Everything you need is included in one system: proven digital in-circuit testing; outstanding analog test capability; built-in analog functional test instruments; simultaneous testing and program development; automatic program generation; quick turn-on of tests; and built-in SQC software.

### Digital In-circuit Testing

The HP 3065ST digital in-circuit test capability provides safe, repeatable tests for both parts faults and manufacturing defects. Digital in-circuit tests are automatically generated by HP IPG-II for a wide variety of SSI, MSI, LSI and VLSI devices. The basis for this wide coverage and easy programming is a library of over 4300 HP-developed device tests which includes most logic families. Tests are available for the most popular microprocessor families (68000, 80286, 80386, etc.), static and dynamic RAMs, and ASICs when using the optional HP Pattern Capture Format Module.

The 2.5 MHz pattern application rate of the HP 3065ST allows a greater number of today's LSI and VLSI devices to be tested. Currents of up to 500 mA can be applied to test high current logic devices such as the FAST family. The HP 3065ST's digital in-circuit tests are easy to develop and provide fast, accurate diagnostics to pinpoint defective devices on the board under test.

### Analog Test Capability

Analog in-circuit testing techniques used on the HP 3065ST are widely considered to be the industry standard for comparison. The proven 6-wire measurement technique allows the HP 3065ST to test a wide variety of components in complex circuit configurations by reducing the measurement error from parallel impedances, fixture impedances and system errors. Analog measurements are also enhanced by the use of phase synchronous detection, enhanced measurement mode, and extra digit mode.

Analog functional test instrumentation is a standard part of the HP 3065ST. Sources and detectors are available to further enhance testing of the analog portion of the board under test. Programming of these devices is via HP BT-BASIC programming language.

### Simultaneous Testing and Program Development

The HP 3065ST provides the user with simultaneous testing and program development capability. The HP 3065ST provides two workstations controlled by its multi-tasking operating system, each with its own display terminal. This allows the test programmer to enter board

data, use the automatic program generator, edit test programs and analyze test data . . . without slowing down production testing.

The automatic programming station is provided for the development of new test programs or modifying existing ones. Board topology is entered through HP Board Forms, which provides easy entry of wire and parts lists through twelve softkey selected screens. Program modification is made easy with HP BT-BASIC with its full-screen editor and automatic syntax checking. HP Q-STATS is provided for production process evaluation using Statistical Quality Control analysis techniques.

The test station includes the testbed, display terminal, message printer, and operator keypad. Its primary function is the production testing of loaded printed circuit assemblies. When the test station terminal is not being used for production testing, it can be used as an automatic programming station.

### Automatic Program Generation

The HP 3065ST provides an automatic in-circuit program generator (HP IPG-II) to generate both analog and digital in-circuit tests quickly and easily. The circuit description can be entered either manually via the standard HP Board Forms screens or through the optional HP CAD-VANTAGE software that automatically extracts the parts and wire lists from almost any CAD system. Once the board topology has been entered into the system, HP IPG-II does the rest.

Programming digital in-circuit tests, even for complex devices, is easy. The program selects the library tests for the devices to be tested. It then automatically adjusts each test to compensate for circuit topology as the test plan is generated. In addition, to avoid the possibility of device damage during testing, the HP 3065ST provides the HP Safeguard In-circuit analysis package. This software analyzes each digital test as it is generated, taking into consideration device parameters such as package type, power dissipation, voltage overshoot, and overdrive currents. If unsafe conditions exist, the programmer is notified and corrective action can be taken.

Programming analog in-circuit tests on the HP 3065ST is just as simple. HP IPG-II generates tests for all components on the board, analyzing the entire circuit and automatically specifying any needed measurement enhancements. These tests provide accurate, repeatable measurements on the device under test. Concise diagnostic information as to which part failed, and how it failed, greatly reduces repair times.

### Quick Test Turn-on

Hewlett-Packard's automatic in-circuit program generator, IPG-II, has evolved through continuous improvements since its introduction in 1978. These improvements cover every phase of in-circuit testing, including enhanced automatic guarding algorithms, better shorts testing, and improved digital library tests. This assures an in-circuit test that is repeatable as well as portable from system to system without additional debug effort. Best of all, it's all done automatically.

The output of HP IPG-II is a testplan that includes a shorts test, analog in-circuit test, and digital in-circuit test. It also generates fixture/scanner interface information. The analog in-circuit enhancement modes and the compensation of digital library tests for circuit topology allow a test to move into production with a minimum of debug effort. This lets test programmers concentrate their efforts on improving outgoing test yields and production processes. Typically, 90% of the device tests generated turn on the first time.

### Protect Your Investment

Because the HP 3065ST Standard Technologies Board Test System is a member of the HP 3065 Family, it provides the same protection for your investment. It offers proven performance demonstrated at hundreds of sites throughout the world. The reliability of the HP 3065ST allows it to participate in the 99% Guaranteed Uptime Service offered in many parts of the world. Since Hewlett-Packard has over 85 service locations worldwide, we are there when you need us.

The HP 3065ST provides an automatic, easy-to-program test system with unsurpassed reliability and test repeatability for your manufacturing operation.

Prices start at \$95,000.

# BOARD TEST SYSTEMS

## HP Q-STAR Test Network Software System



### Description

Automatic testing is not the total solution to productivity or product quality. Software applications must exist to form the framework for using board test data to improve product quality as well as provide timely feedback to improve the manufacturing process using Statistical Quality Control (SQC) techniques. There must also be an overall strategy for linking computer-aided solutions throughout the entire manufacturing facility. Hewlett-Packard offers Computer Integrated Manufacturing (CIM) products and services linking all areas within the facility. Timely communication among production, engineering and administration is essential if control of the manufacturing facility is to be maintained.

The HP Q-STAR Test Network offers the basis for implementing SQC and CIM in the manufacturing process while providing the optimum solution for your test workcell needs. It provides the tools to implement quality management techniques, paperless repair across the network, and test program management at minimal additional cost to you.

The modular structure of the applications software in the HP Q-STAR Network provides the flexibility to select only the capability you need now and then add others as your needs expand. Some of the basic applications (PRR, Q-STATS) are provided as a standard part of the system software. Then, as your needs increase, test management software (NS/3065 and BTL PLUS), network-wide paperless repair (PR PLUS), and more sophisticated quality management software (Q-STATS II) can be added.

### Test Software Management

HP NS/3065 (HP 44670C/L/X) provides transparent network services for multiple HP 3065 board test systems and is built on an HP AdvanceNet foundation. HP NS/3065 gives you the flexibility to create a network that meets your needs today and expands to cover your board test needs in the future. Linking test systems together with HP NS/3065 gives you the advantages of:

- File sharing, for automatic program archiving and downloading
- Resource sharing, lowering your investment in peripherals
- File security, ensuring revision control of test programs, protection of proprietary programs, and prevention of accidental data loss
- Compatibility with existing programs, for shorter learning curves
- Distributed processing, for more uptime and unlimited expansion

In addition to linking board test systems, NS/3065 also provides high-speed connections to other computer systems for data processing and storage.

HP BTL PLUS links the HP 3061A/3062A into the HP Q-STAR Network via the HP-IB (IEEE-488) interface. The software package (HP 44582A) is an enhanced version of the standard HP 3061A/3062A system software, so compatibility with existing software is preserved. Networking the HP 3061A/3062A systems with the HP 3065CL/CX controllers that have Network Services (NS/3065) allows these systems to become an integral part of your test workcell.

HP BTL PLUS allows you to:

- Archive your test programs in one central location
- Monitor your production process by collecting data
- Analyze this production data with HP Q-STATS software
- Ensure data accuracy with automatic datalogging and bar code reader capability
- Create a centralized paperless repair station for several testers
- Download current test programs from central disc storage
- Protect your data and programs with HP Q-STAR file security

### Paperless Repair Software

Two paperless repair software packages are available as a part of HP's Q-STAR Network. The first, Paperless Repair/Reporting (PRR), is a standard part of the HP 3065 Family software. HP PRR with its bar code capability automates the diagnostics flow between the test and repair areas of a board test cluster (test stations and systems tied to a single HP 3065 Controller) and provides board tracking through the test/repair cycle. Actual failure data from the board test cluster is collected and sent to the HP Q-STATS data base for analysis. Alarms are built in to alert the operator to repeated defects to minimize repair and scrap.

HP PR PLUS (HP 44671C/L/X) has all the benefits of PRR plus additional features to provide the most efficient use of available resources. It allows paperless repair across the entire board test network so boards can be repaired on any available terminal. Failure data is transferred into the HP Q-STATS II data base from any repair terminal on the network. In addition, HP PR PLUS supports local language screens to allow the repair operator to quickly understand the problem.

HP's paperless repair software streamlines the repair operation while providing timely feedback to improve production processes.

### Quality Management Software

Analysis of data gathered in the test/repair loop is performed by HP Q-STATS, another standard feature of the HP 3065 Family software. Statistical analysis of raw data from a board test cluster provides useful information required by programmers, test engineers, and managers. For example, producibility reports provide a statistical measure of the quality and repeatability of a test. HP Q-STATS provides production management information in several different formats based on Statistical Quality Control concepts. Tabular reports highlight production parameters such as yield, volume of boards tested, and average wait, test and repair times. Pareto charts give detailed information such as board failures by component designator.

HP Q-STATS II (HP 44672A) extends the SQC-analysis features across the entire test workcell that may include HP 3065's, 3061/62A's, and other automatic test systems. It integrates data from all these sources into one data base and analyzes all this data to produce useful SQC information. HP Q-STATS II contains reporting features that HP Q-STATS does not have, including presentation-quality graphical formats and new reports such as control charts, overview histograms, and various other production summaries.

Two additional features of HP Q-STATS II are SQL ad hoc queries of the data base and the use of an HP 9000 workstation with an HP-UX operating system as the host computer. The use of the separate workstation allows the data to be analyzed and reports generated without impacting the throughput of the test systems. Add NS/1000 and a link to HP QDM/1000 and the data in HP Q-STATS II can be integrated into a facility-wide quality data base.

Since HP Q-STATS II implements a turnkey data collection function, test managers will find it easier to implement SQC practices to improve quality and increase the productivity of the production processes.

### Ordering Information

HP 44582A BTL PLUS Software  
 HP 44670C/L/X NS/3065 Software  
 HP 44671C/L/X PR PLUS Software  
 HP 44672A Q-STATS II Software

### Price

\$5,100.00  
 \$4,590-\$7,650.00  
 \$4,590-\$7,650.00  
 \$40,800.00

## Model 3065 Board Test Family Fixturing Products

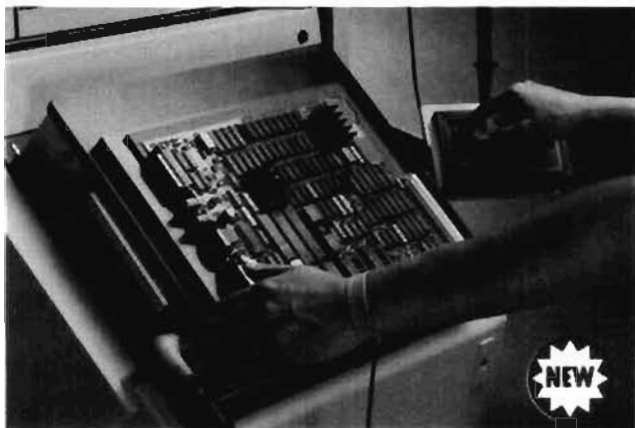

### Description

A new series of vacuum-actuated test fixtures, the HP 44203 SimPlate Series, now offers higher probing accuracy, greater reliability and easier maintenance than the conventional dual plate design. The HP SimPlate fixtures have an easily removable support plate instead of the familiar top plate. This support plate is slightly larger than the board under test, providing support to the board while acting as a vacuum seal between it and the bottom plate. The elimination of the top plate and associated hardware reduces the parts count by 35 percent and decreases the weight of the fixture up to 23 percent. Fewer parts mean lower assembly costs and higher reliability.

### Performance

Improved probe location accuracy gives the HP SimPlate fixtures the ability to contact boards with tight physical tolerances. The result is a ten-fold improvement in probing accuracy, making these fixtures an excellent choice for testing both conventional and surface mount technologies.

The accuracy and the repeatability of the probing is accomplished by referencing both the board and the probes to the same plate. The probes are mounted in the bottom plate to allow full travel while minimizing unsupported probe height. To further control probing accuracy, hardened steel tooling pins to guide the travel of the board are mounted on the same plate as the probes.

The support plate assembly is positioned in the lower left corner of the fixture to optimize both mechanical and electrical performance. This locates the support assembly directly above the vacuum port to maximize air flow, resulting in quick actuation and reliable probe contact. The board is located directly above the scanner cards, reducing wire lengths for improved signal integrity.

### Easy Maintenance

When routine maintenance is required, the simple design of the HP SimPlate fixtures provides immediate probe access without tools. The support plate simply lifts off the fixture, allowing easy probe access for cleaning or replacement. For high volume applications, a spare support assembly (HP 44203K) is available. Using this spare, testing can continue while PC board gasket and vacuum seal maintenance is performed on the original unit.

### Test Fixtures Available in Three Sizes

The HP SimPlate Series is available in three sizes. The standard fixture, HP 44203S, accepts boards up to 28.2 cm x 37.1 cm (11.1" x 14.6"). The HP 44203L handles boards up to 37.1 cm x 59.9 cm (14.6" x 23.6"). The dual fixture, HP 44203D, accepts two boards the same size as the standard test fixture. All three of these fixtures are compatible with all HP 306X Board Test Systems.

### Test Fixture Accessories

#### Probes

Four different probe styles are available, each with two spring tension ratings. The "H" suffix is the eight ounce tension, the "L" indicates a four ounce tension. The probes can be ordered with sixty degree single point tips (HP 44561H/L), crown or star point tips (HP 44563H/L), serrated multi-point tips, (HP 44562H/L), and the spear point tips (HP 44564H/L). The 8-ounce probe tensions are recommended for all but high pin density applications. In high probe

density applications, the 4-ounce spring tension should be used. Probes are available in bags of 100.

#### Receptacles

The sockets (HP 44274S) are specially designed for low air leakage and reliability. The sockets are made of nickel silver to minimize contact resistance. They are press-fitted into the fixture without adhesives. Therefore, they do not degrade the high isolation resistance of the fixture plate material.

#### Patch Panel Plugs

HP UniPlug patch panel plugs provide positive contact between the test fixture and the system scanner. Every HP plug uses gold plated barrels for low contact resistance. Plug tips are made from acetal to insure that the plug doesn't scratch or leave a residue on the scanner paddle pins. HP plugs are available in three wiring styles: pre-wired twisted pair for digital testing, pre-wired single wire for analog testing, and unwired. Both analog and digital pre-wired plugs are available in various configurations to simplify the fixture construction.

#### Extenders

HP extenders provide additional space inside the test fixture for wiring or for custom test circuitry. They are available in two types. The HP 44560S extender adds 3" to the vertical height of the standard test fixture and the HP 44560D adds 1.6" to the large or dual fixtures. An angled extender is available in both sizes (HP 44560SA and 44560DA) and provide a horizontal mounting surface needed for interfacing to robotics or automated board handling.

#### Spare Parts Kit

A spare support assembly can be constructed for each fixture used in high volume applications. The Fixture Spare Parts Kit (HP 44203K) provides all parts necessary to construct the support assembly.

#### Conversion Parts

The HP 44203C Conversion parts kit makes it possible to convert existing HP 445XXA Fixture Kits to the HP SimPlate fixture. It contains all the parts necessary to change the upper head assembly of the standard (Option 1), the large (Option 2), and the dual (Option 3) fixtures.

#### Assembly Tools

The HP 44210A Assembly Tools contain the hardware and tools required to assemble the HP 44203 SimPlate fixtures. Only one tool kit is needed for each assembly station.

#### Advanced Technologies Fixture Accessory

The HP 44685A Advanced Technologies Fixture Accessory contains components commonly used with the HP 3065AT tester for combinational test fixturing. One HP 44685A is recommended for each HP 3065AT test fixture.

### Ordering Information

	Price
HP 44203S SimPlate Standard Test Fixture Kit	\$610
HP 44203D SimPlate Dual Well Fixture Kit	\$895
HP 44203L SimPlate Large Fixture Kit	\$815
HP 44203C SimPlate Conversion Kit	
Option 001 For Standard Fixture	\$345
Option 002 For Large Fixture	\$430
Option 003 For Dual Fixture	\$440
HP 44203K SimPlate Spare Parts Kit	\$204
HP 44210A SimPlate Assembly Tools	\$143
HP 44685A Advanced Technologies Fixture Accessory	\$184
HP 44274S HP SimPlate Receptacle, 100 per bag	\$36
HP 44561L/H LF or HF Single (60) point, 100 per bag	\$102
HP 44562L/H LF or HF Serrated point, 100 per bag	\$102
HP 44653L/H LF or HF Star point, 100 per bag	\$102
HP 44564L/H LF or HF Spear (30) point, 100 per bag	\$163
HP 44589S Single Plug non-wired, 100 per bag	\$61
HP 44589SA UniPlug-single wire analog, 50 per bag	\$87
HP 44589DA UniPlug-dual wire analog, 50 per bag	\$117
HP 44589SD UniPlug-single pair digital, 50 per bag	\$87
HP 44589DD UniPlug-dual pair digital, 50 per bag	\$117
HP 44590D Dual Plug non-wired, 100 per bag	\$163
HP 44590DW Dual Plug pre-wired, 100 per bag	\$189
HP 44591A HP 3065 DUT Power Pin Kit, 18 per bag	\$66
HP 44592A HP 3065 Driver/Receiver 5-plug, 50 per bag	\$515
HP 44592H Hybrid Driver/Receiver 5-plug, 50 per bag	\$615
HP 44592G Hybrid Ground Plug, 10 per bag	\$82



## **CONTROLLERS & CAT**

<b>Controllers .....</b>	<b>534</b>
<b>Hewlett-Packard Interface Bus .....</b>	<b>538</b>
<b>Data Acquisition Systems .....</b>	<b>552</b>
<b>Computer Aided Test .....</b>	<b>569</b>
<b>PC Instruments .....</b>	<b>596</b>

HP manufactures a broad line of computers used in instrument-control applications, most of them using a form of the BASIC language especially designed for instrument control. Products in this group include those dependent upon a controller for their use. Most HP instruments have HP-IB, HP's implementation of the IEEE-488 standard. This capability turns controller and instruments into a powerful, flexible and versatile general-purpose automated system, easily adapted to any application. HP also makes software and hardware specifically designed for product and process characterization, including card-cage instruments and data-acquisition products used for switching, monitoring, and control. Also included here are test management and test executive software.

**Controllers  
& CAT**

# CONTROLLERS

## HP 9000 Family Measurement Automation Controllers and Systems

### General Information



Breadth and flexibility make HP's family of Instrument controllers more capable than any other solution available for a broad range of measurement automation needs. HP has more than 15 years experience in building Instrument controllers, together with more than 1,400 HP Instruments, and HP-IB, the industry-standard Instrument control interface.

#### Instrument Controllers

Hewlett-Packard has for many years been a leading supplier of instrument controllers for measurement automation, data acquisition, automatic testing, laboratory and factory automation.

Today, the breadth and flexibility of Hewlett-Packard's family of instrument controllers makes it the best answer to your measurement automation needs.

Hewlett-Packard developed the company's HP-IB industry standard interface, also known as IEEE-488 or GP-IB, in the early 1970's to provide a standard bus for instrumentation and peripherals. Since then, this interface has grown to become the standard way to communicate with instruments throughout the measurement automation community.

With over fifteen years of experience in building instrument controllers, HP has optimized these systems to work with over 1,400 Hewlett-Packard instruments and peripherals via this industry standard interface. No family of controllers makes it easier to build a measurement system to meet your needs. Furthermore, all components can come from a single company long known for its high standards of quality.

#### Computer Aided Test

HP instrument controllers, coupled with data acquisition systems and instruments you'll find in this catalog, make it easy to build custom test systems for use in R & D environments for unattended testing, or for manufacturing test and quality control applications outside the R & D lab. Software packages such as FTM/300, DACQ/300 and

DACQ/PC (see pages 594 and 592) take full advantage of features of HP instrument controllers to aid you in the development and execution of your computer aided test and data acquisition applications.

#### Manufacturing and Industrial Monitoring

Accurate monitoring of analog and digital signals is key to product quality in both manufacturing and industrial environments. HP 9000 computers, and the HP 1000 real-time systems described on page 684, combine computational speed and reliability for real-time data acquisition, even in harsh environments. Engineers can immediately spot trends or deviations in critical variables or processes. HP controllers are well known for their reliability and ruggedness.

#### Laboratory Monitoring and Analysis

Analytical applications can also be automated using HP controllers. The ChemStation family of analytical systems make use of the power of HP instrument controllers as well. (see page 662)

#### A Wide Range of Controllers

Hewlett-Packard offers the widest range of instrument controllers in the industry today. Each controller system has been optimized to meet the needs of measurement automation customers.

Controllers are available for price sensitive users as well as for applications requiring the absolute highest performance from the instrument controller. You have a variety of

controller operating systems to choose from as well, each with their own unique advantages.

#### HP BASIC Controllers

A Hewlett-Packard controller in conjunction with the HP BASIC language offers a highly optimized environment for the development and execution of instrument control applications.

HP BASIC offers a programming environment unsurpassed in ease of use and user friendliness. You do not have to be an expert computer programmer to develop very sophisticated software for your instrument control application. An advanced program editor proofreads your program as you type it in to check for syntax errors. You do not have to wait until your program executes to realize that you have made a typing error. Advanced commands for moving and copying program lines are fully integrated into HP BASIC as well as features useful in producing very readable, self-documenting, programs. Features like automatic program indentation, string search and replacement and automatic renumbering of program lines are a standard part of the HP BASIC environment.

Access to the most highly optimized device I/O subsystem available is just a few statements away. Full interrupt processing is supported offering fifteen levels of user definable software priorities. Data transfer of various data types is also fully supported. Data



formatting is handled automatically for data types such as REAL, INTEGER, COMPLEX, STRING and arrays of these data types as well.

In addition to supporting multiple data types, the HP BASIC I/O system has been refined over time to be able to determine the optimal data transfer method available based upon system configuration. For example, data transfer will take advantage of Direct Memory Access if DMA hardware is present in the system. No programming changes are required to take advantage of this DMA transfer technique, simply adding the DMA hardware will suffice.

Support of separate context subprograms within HP BASIC allows you to develop modular, reusable program segments that may be loaded and unloaded during program execution. This helps to increase programmer productivity since modules are easily reused or replaced with new modules in future controller software applications.

HP BASIC also provides the capability of using compiled subprograms, or CSUBS, that have been developed using the Pascal Workstation system. These CSUBS provide increased performance of many operations while still providing the benefit of execution within the HP BASIC environment. Program modules are written in either HP Pascal or MC68000 assembly language, compiled or assembled, and then the optional CSUB utilities are used to transform these program segments into compiled subprograms that are loaded into the HP BASIC environment and executed.

**HP BASIC** runs on a variety of hardware systems.

The HP 9000 Series 200 and Series 300 controller systems (see pages 633 to 637) take full advantage of Motorola MC68000, MC68010 and very high performance MC68020 microprocessors to provide the highest performance HP BASIC controllers possible. These systems offer a variety of interface cards, display systems and peripherals which allows you to configure a controller system which best meets your individual needs.

With the introduction of the HP BASIC Language Processor (see page 638), the HP Vectra Personal computer will also offer the added benefit of a full implementation of HP BASIC. The language processor board contains a MC68000 microprocessor, system RAM, HP-IB and support electronics required to emulate a Series 200 controller while taking advantage of the Vectra's keyboard, display and internal mass storage. This language processor provides the advantages of HP BASIC while offering access to PC-DOS based peripherals and application software. The addition of HP BASIC to a PC-DOS based instrument controller provides a clear path between PC-DOS systems and the higher performance Series 200 and Series 300 HP BASIC instrument controllers.

#### PC DOS Based Controllers

With the growing acceptance of PC's in the measurement automation environment, Hewlett-Packard understands the need to provide a controller which provides the ad-

vantages of native PC-DOS based systems within its family of instrument controllers. The HP Vectra Personal Computer (See page 638) provides IBM PC/AT compatibility and more for those instrument controller users developing measurement automation software in the native PC-DOS environment. A ruggedized version of the HP Vectra is also available for applications that require the controller to function in a harsh environment.

Use of the HP-IB Interface and Command Library provides PC's, such as the Vectra, with the capability to perform sophisticated instrument control. Support of a variety of standard PC-DOS programming languages is available from the HP-IB Command Library as well.

Hewlett Packard has also been working with LOTUS Development Corporation in the development of their MEASUREF package which provides instrument control capabilities to users of LOTUS 1-2-3.

#### HP-UX Based Controllers

High performance UNIX workstations are quickly becoming the standard platform for Computer Aided Design and Engineering applications. Hewlett-Packard's HP-UX offering is a complete UNIX System V implementation with selected enhancements added to provide HP-UX systems with features necessary for use in the measurement automation environment. A variety of programming languages is available for the development of your instrument controller application. Access to powerful networking and database tools are also readily available from HP-UX.

One such enhancement is the Device I/O Library, or DIL. This library provides HP-UX systems with the capability of providing very high performance instrument control. Direct support of DMA and burst mode I/O is available from DIL. Interrupt response time is minimized in a number of ways. Real-time extensions have been added to HP-UX to allow the user to determine which programs have the highest priorities. Additionally, the Series 800 family of HP-UX

workstations provides kernel preemption, which allows the core of the operating system to be interrupted and therefore provide predictable interrupt response times.

The addition of the HP Series 300 DOS Coprocessor (see page 633) provides Series 300 controller systems with the capability of running PC/AT compatible application software. Running in an HP-UX environment, the DOS Coprocessor bridges the gap between UNIX and PC-DOS worlds, creating a dual purpose system.

A variety of HP-UX controller systems are available from Hewlett-Packard.

The HP Integral Personal Computer (see page 639) offers the advantage of an integrated, transportable package for those users developing HP-UX controller applications.

The Series 300 (see page 633) offers a wide range of performance to meet the needs of your HP-UX controller application. The Model 310 provides the lowest cost HP-UX system within the Series 300 line and the Models 330 and 350 HP-UX systems take full advantage of the 32 bit architecture of the Motorola MC68020 microprocessor. An additional feature of the Series 300 HP-UX systems is the ability of HP BASIC to share files and even disks with HP-UX. HP BASIC revision 5.0 uses the same file system (HFS) as the Series 300 HP-UX systems, and you can simply reboot from HP-UX to HP BASIC and back again to take advantage of the features of each operating system as desired.

The Series 800 line of Technical Workstations (see page 628) also offers the power of HP-UX for the high end controller customer. Based upon HP Precision Architecture, these workstations provide superior price/performance to other supermini computers with similar specifications. Kernel preemption provides reliable interrupt response times and the Device I/O Library with its real time extensions provide for very good I/O performance.

Please refer to the chart on the following page which details feature availability within the various controller families.



# CONTROLLERS

## Overview

### Comparison Matrix

#### HP Instrument Controller Comparison Matrix

Feature	Controller Family	71B	IPC	VECTRA	Language Processor	200	300	800	1000
Operating System	MS-DOS			•			•		
	BASIC	•			•	•	•		
	PASCAL				•	•	•		
	HP-UX		•			•	•	•	•
	RTE A								•
Internals Documentation				○	•	•	•		•
Languages	BASIC	•	•	•	•	•	•		•
	COMPILED BASIC			•	•	•	•		•
	PASCAL		•	•	•	•	•	•	•
	FORTRAN		•	•		•	•	•	•
	C		•	•		•	•	•	○
	LISP			○			•		
	PROLOG			○			•		
ADA			○			•		•	
RAM	Minimum	17.5 KB	512 KB	256 KB	512 KB	256 KB	512 KB	8 MB	512 KB
	Maximum	33.5 KB	5.5 MB	3.6 MB	4 MB	7.7 MB	32 MB	128 MB	32 MB
Interfaces	HP-4B	•	•	•	•	•	•	•	•
	PC-1B			•		•	•		
	GPIB		•		•	•	•	•	•
	HP-IL	•	•	•					
	RS-232	•	•	•	•	•	•	•	•
	RS-232 MUX					•	•	•	•
	BCD		•			•	•		
	Custom (breadboard)					•	•		•
	VME Connection					•	•		
Networking	LAN			•		•	•	•	•
	SMB				•	•	•		
	X.25		•	•		•	•	•	•
	Officeshare			•					
Transportable	•	•							
DMA Capability	HP-4B			•		•	•	•	•
	GPIB					•	•	•	•
Interrupts	Polling Only			•					
	Full Interrupts	•			•	•	•	•	•
	Kernel Preemption							•	•

Notes: - Not all features apply to all controllers within a family or to all operating systems  
 - VECTRA and language processor columns may be combined to reflect features of this controller combination  
 • available from HP ○ available from third party

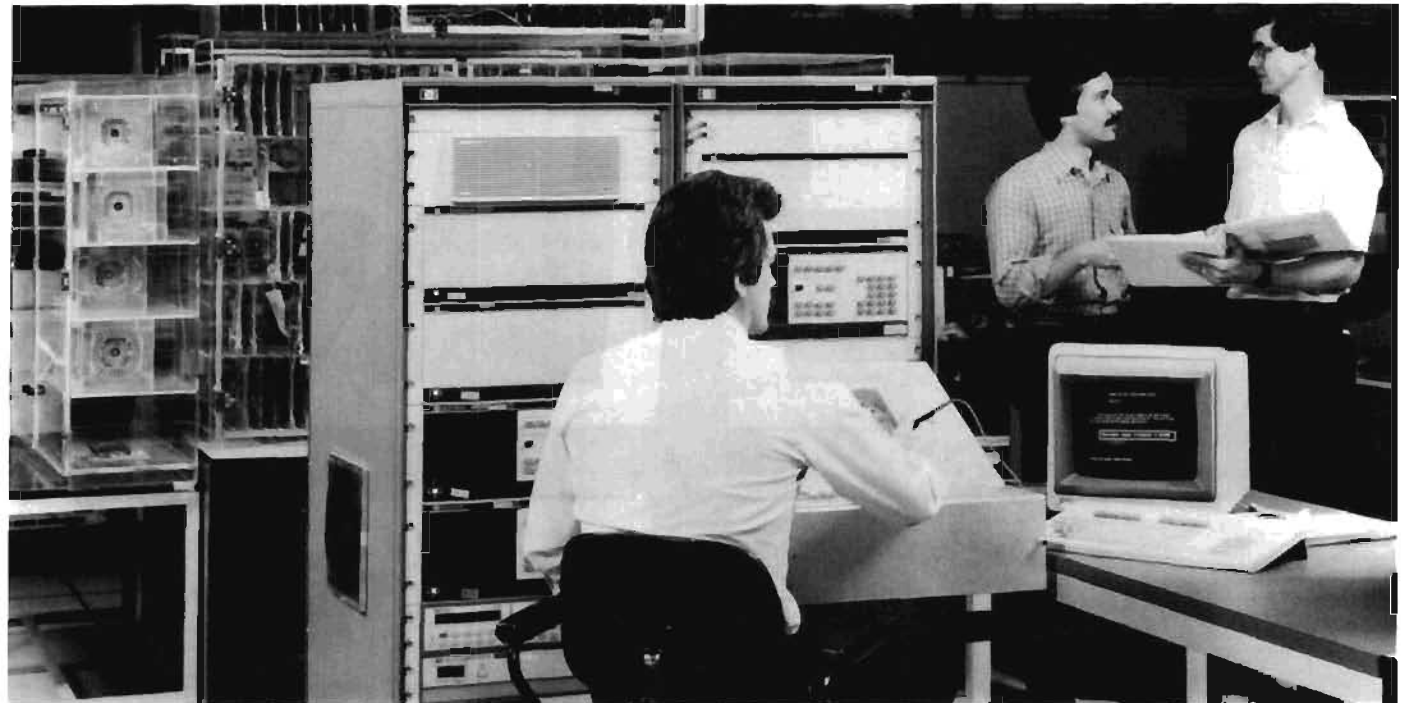

### Bundled Systems

Some bundled systems have been established to simplify ordering the best instrument controller for your application.

#### **82316A Model PC-305 MF HP BASIC Controller** (see page 638)

This low cost controller system provides the capabilities of a general purpose PC with the power of HP BASIC. This controller includes a 1.4 MB 3 $\frac{1}{2}$ " floppy drive and monochrome display system. The system takes advantage of the HP BASIC Language Processor. The language processor included in this bundle contains a ROM based version of the HP BASIC language.

#### **82317A Model PC-305 MH HP BASIC Controller** (see page 638)

This controller system includes all of the features of the PC-305 MF with the addition of a 20 MB Winchester disc. This addition provides you with higher performance mass storage and the capability of storing vast amounts of data and programs.

#### **82318A Model PC-305 C HP BASIC Controller** (see page 638)

This controller system is also based upon the combination of a PC and the HP BASIC Language Processor. The addition of a high resolution EGA color graphics display system provides color capabilities to this low cost controller system. Also included is a 1.4 MB 3 $\frac{1}{2}$ " floppy drive and a 20 MB winchester disc to meet your mass storage requirements.

#### **82314A Model PC-308M HP BASIC Controller** (see page 638)

This HP Vectra/HP BASIC Language Processor combination offers you the advantages of HP BASIC without giving up access to DOS capabilities. A monochrome display system provides high resolution graphics and a 20 MB winchester and 1.2 MB floppy disc completes the bundle.

#### **82315A Model PC-308C HP BASIC Color Controller** (see page 638)

The PC-308C provides you with HP BASIC as well as a high resolution EGA display system for applications that can benefit from color. As with the PC-308M, this controller provides easy access to the DOS environment of the HP Vectra.

#### **98580A Model 310 Controller** (see page 633)

This powerful controller offers a 12" monochrome display and the performance that you would expect from a MC68010 microprocessor. Four available DIO slots allow for the addition of RAM, DMA, floating point math and other Series 200/300 interface cards.

#### **98581A Model 310 Color Controller** (see page 633)

A color version of the 98580A, this controller answers the need for color in an instrument control application.

#### **98580M Model 330 Controller** (see page 633)

This instrument controller provides all the power of a MC68020 microprocessor and MC68881 floating point math coprocessor and a 12-inch monochrome display. The built in fast disc interface and DMA enable you to separate your instrumentation from your mass storage while increasing overall performance.

#### **98581M Model 330 Color Controller** (see page 633)

Another instrument controller based upon the powerful MC68020. This controller provides all of the advantages of the 98580M in addition to a 12" color display system to further enhance your instrument control application.

If these bundled systems do not meet the specific needs of your application, please refer to the Technical Computer Systems section of this catalog for details about additional instrument controller systems, options, and configurations. (see page 626)

# HEWLETT-PACKARD INTERFACE BUS

## Versatile Interconnect System for Instruments and Controllers

### General Information

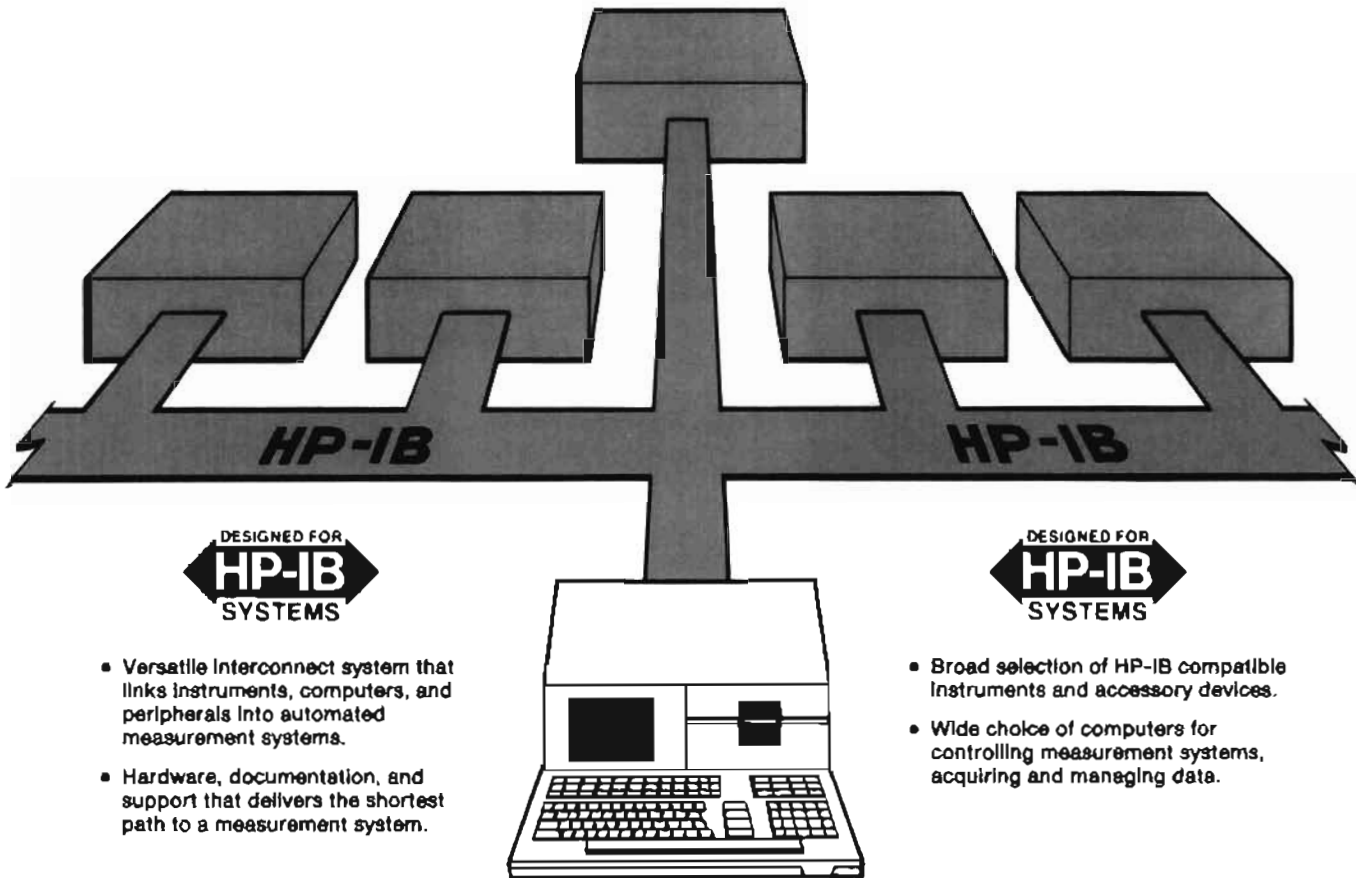

#### Advantages of HP-IB Systems

There are many applications where the measurement power of interactive instruments can be further enhanced by coupling them to desktop or minicomputers. Operating in a remote mode can provide more exact, error-corrected results as compared with conventional manual operation techniques.

Presently, three major parameters combine to reduce significantly the engineering development costs of configuring measurement systems:

1. The Hewlett-Packard Interface Bus, also known as "HP-IB";
2. Distributed computing through the growing number of "smart" instruments with internal microprocessors;
3. The broad choice of computers ranging from "friendly", easy-to-program desktop computers to more sophisticated computer systems capable of managing multi-station instrument clusters and complex data bases.

#### Relationship Between HP-IB and Other Interface Standards

Hewlett-Packard is committed to the overall advancement of measurement technology and has for some time been working on the problems of simplifying and standardizing means of instrumentation interfacing. An example of such an effort is the intimate involvement with the HP-IB from its conception at HP to its present status as a world instrumentation interface standard (IEEE 488-1978 and IEC 625-1).

In mid-1972, Hewlett-Packard began to participate in various international standardization bodies. The U.S. Advisory Committee, composed of diverse interests represented by both users and manufacturers, first established initial goals, then adopted the interface concept utilized by the HP Interface Bus as an appropriate starting point. A draft document was subsequently written and evaluated by members of the Committee, then submitted as the U.S. Proposal to the IEC (International Electrotechnical

Commission) Working Group in the autumn of 1972. Since then, the interface definition has undergone a number of minor changes to accommodate various needs at the international level.

In September 1974, the parent technical committee, IEC TC66, approved the main interface draft document for a formal ballot among the member nations of the IEC. Balloting took place in 1976, and IEC recommendation 625-1 was adopted. The IEC recommendation, using a different connector, is totally compatible with the present definition of the HP-IB.

Meanwhile, the IEEE Standards Board approved IEEE Standard 488-1975 "Digital Interface for Programmable Instrumentation", first published in 1975 and again published in 1978 with minor editorial changes as IEEE Standard 488-1978. The IEEE standard is also fully compatible with the HP-IB. In January 1976, the American National Standards Institute adopted the

IEEE Standard and published it initially as ANSI Standard MC 1.1.

The standardized interface concept is now widely accepted. Hundreds of manufacturers in more than fourteen countries offer thousands of products that use the HP-IB concepts articulated in IEEE-488. As more instrumentation interface standards evolve from the HP-IB, we will clearly indicate the relationship of the Hewlett-Packard Interface Bus to those standards, just as we have done with ANSI/IEEE Standard 488 and IEC Publication 625-1.

### Why the HP Interface Bus Name?

As the list of HP products available with the "new digital interface" grew, our customers sought a convenient way to identify those products having the interface capability. In response, in 1974 we adopted the name "Hewlett-Packard Interface Bus" or simply "HP-IB". We will continue to use the identifying name and this symbol:



Both are used with appropriate HP products so that their interface capabilities may be readily identified.

The Hewlett-Packard Interface Bus fully complies with IEEE Standard 488. As such, it incorporates the mechanical, electrical and functional specifications of the Standard. A fourth and vital element of any interface system is the operational aspect of a product at both the human-machine interface and the machine-machine interface at the HP-IB port. HP-IB capability provides additional

user benefits that are beyond the scope of IEEE Standard 488. Typical user conveniences include high-level language implementation of interface functions, underscored program codes on instrument front panels for easy programming, convenient data output formats, and designed-in learn modes. In addition, we provide complete support documentation in the form of programming and interfacing guides, application notes and operators' manuals that illustrate the added benefits for users of products with HP-IB capability.

### Single-Source Systems Approach

The decision to use a "system" instead of conventional manual methods must be based on an engineering evaluation of benefits versus costs. The many benefits associated with a systems approach include:

- More consistent results in repeated measurements because a system is not subject to operator fatigue.
- Greater throughput because systems are generally faster.
- More thorough testing because system speed allows more parameters to be measured in a shorter time.
- Results expressed in engineering or scientific units because many systems controllers are capable of on-line data manipulation.
- Greater accuracy because system errors can be measured automatically, stored and accounted for in the results.
- "Adaptive" data acquisition wherein a system can be programmed to branch to other measurements to help pinpoint an abnormal condition.
- Measurement results stored in computer memory or on hard copy.



Measurement automation can simplify and customize the operation of HP-IB Instruments. For example, in the system shown here HP 85160A Measurement Automation Software controls an HP 8753A RF Network Analyzer to provide instructions, custom data hardcopy, and archival data for the final test of RF devices.

It is our objective to make the integration of instrumentation systems easier by providing instruments and computers designed for systems applications. Computers are designed with HP-IB options that allow easy hook-up to the bus and incorporate easy-to-use bus commands in their software. HP's policy when designing HP-IB compatible instruments is to eliminate interfacing ambiguities associated with controllers and instruments operating per the ANSI/IEEE and IEC standards by adopting guidelines for consistent interface design.

Proper training on system components is very important for efficient use of any interface system. Therefore, we offer training at sales and service offices worldwide on HP desktop computers, computer systems and instruments as they relate to the HP-IB. In the area of HP-IB support documentation, we offer general interface technical descriptions, Operating and Service Manuals with programming information, Instrument/Controller Introductory Operating Guides, Quick Reference Guides and Application Notes.

Technical assistance during system development is available at most local HP sales and service offices from resident systems engineers who specialize in desktop computers, computer systems and instruments.

### How the HP Interface Bus Operates

All active interface circuitry is contained within the various HP-IB devices, and the interconnecting cable (containing 16 signal lines) is entirely passive. The cable's role is



HP 9000 Series 300 computers have found application in a wide variety of environments, due in part to HP-IB. HP-IB overcomes compatibility issues, simplifies the assembly of instrument and control systems, and enables users to choose and use the widest range of instruments and peripherals.

# HEWLETT-PACKARD INTERFACE BUS

## Versatile Interconnect System for Instruments and Controllers (cont'd)



### General Information

limited to that of interconnecting all devices in parallel so that any one device may transfer data to one or more other participating devices.

Every participating device (instrument, controller, accessory module) must be able to perform at least one of the roles of TALKER, LISTENER or CONTROLLER. A TALKER can transmit data to other devices via the bus, and a LISTENER can receive data from other devices via the bus. Some devices can perform both roles (e.g., a programmable instrument can LISTEN to receive its control instructions and TALK to send its measurement results).

A minimum HP-IB system consists of one TALKER and one LISTENER, without a CONTROLLER. In this configuration, data transfer is limited to direct transfer between one device manually set to "talk only" and one or more devices manually set to "listen only" (e.g., a measuring instrument talking to a printer for semi-automatic data logging).

A CONTROLLER manages the operation of the bus system primarily by designating which devices are to send and receive data, and it may also command specific actions within other devices.

The full flexibility and power of the HP-IB become more apparent, however, when one device that can serve as CONTROLLER/TALKER/LISTENER (e.g., calculator or computer) is interconnected with other devices that may be either TALKERS or LISTENERS, or both (e.g., frequency synthesizers, counters, power meters, relay actuators, displays, printers), depending on the application. An HP-IB controller participates in the measurement by being programmed to schedule measurement tasks, set up individual devices so that they can perform these tasks, monitor the progress of the measurement as it proceeds, and interpret the results of the measurement. HP offers controllers that can be programmed in high-level languages such as BASIC, FORTRAN, HPL, and Pascal.

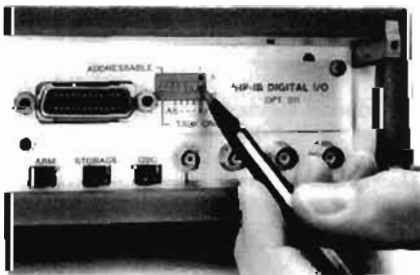

Rear panel switches are set so instrument will either be addressable by controller in a multi-device system, or will simply "talk only" to another device such as a printer.

### HP-IB Connections and Structure

The HP-IB has a party-line structure wherein all devices on the bus are connected in parallel. The 16 signal lines within the passive interconnecting HP-IB cable are grouped into three clusters according to their functions:

1. Data Bus (8 signal lines)
2. Data Byte Transfer Control Bus (3 signal lines)
3. General Interface Management Bus (5 signal lines).

The DATA BUS consists of eight signal lines that carry data in bit-parallel, byte-serial format across the interface. These signal lines carry addresses, program data, measurement data, universal commands and status bytes to and from devices interconnected in a system. Identification of the type of data present on the DIO signal lines is indicated by the ATN (attention) signal. When the ATN signal is true (asserted), either addresses or universal commands are present on the data bus and all connected devices are required to monitor the DIO lines. When the ATN message is false, device-dependent data (e.g., programming data) is carried between devices previously addressed to talk and listen.

Transfer of each byte on the Data Bus is accomplished via a set of three signal lines. DAV (data valid), NRFD (not ready for data), and NDAC (not data accepted).

These signals operate in an interlocked handshake mode. Two signal lines, NRFD and NDAC, are each connected in a logical AND (wired OR) to all devices connected to the interface. The DAV signal is sent by the talker and received by potential listeners whereas the NRFD and NDAC signals are sent by potential listeners and received by the talker.

The General Interface Management Lines manage the bus to effect an orderly flow of messages. The IFC (interface clear) message places the interface system in a known quiescent state. SRQ (service request) is used by a device to indicate the need for attention or service and to request an interruption of the current sequence of events. REN (remote enable) is used to select between two alternate sources of device program data. EOI (end or identify) is used to indicate the end of a multiple byte transfer sequence or, in conjunction with ATN, to execute a polling sequence.

It is not possible in this limited space to go into detail on each signal line's role. But you should note that every HP-IB device need not be able to respond to all the lines. As a practical and cost-effective matter, each HP-IB device usually responds only to those lines that are pertinent to its typical function on the bus. (Details are covered in each device's operating manual.)

### HP-IB and the new IEEE 488.2

In June of 1987, the IEEE approved a new standard for programmable instruments called IEEE Std. 488.2-1987 Codes, Formats, Protocols, and Common Commands. It works with the IEEE Standard Digital Interface for Programmable Instrumentation, IEEE 488-1978 (now 488.1). HP-IB is Hewlett-Packard's implementation of IEEE 488.1.

As with IEEE 488.1, Hewlett-Packard was active in the development of IEEE 488.2. Many of the new HP instruments introduced this year already follow this new standard, and many more HP instruments to be introduced in the near future will also follow IEEE 488.2.

This new standard addresses issues involved with sending messages between devices on the bus. Its features include:

- A required minimum set of IEEE 488.1 capabilities.
- Reliable transfer of complete messages between a computer and an instrument.
- A precise description of the syntax in those messages.
- A set of commands useful in all instruments.
- Common status reporting capability using serial poll.
- Techniques for guaranteeing synchronization of application programs with instrument functions.
- A way of automatically assigning addresses.

The desired benefit from these features is to make the job of an instrument system designer easier. IEEE 488 standardized the electrical and mechanical interface. This new standard ensures compatibility at the next higher level.

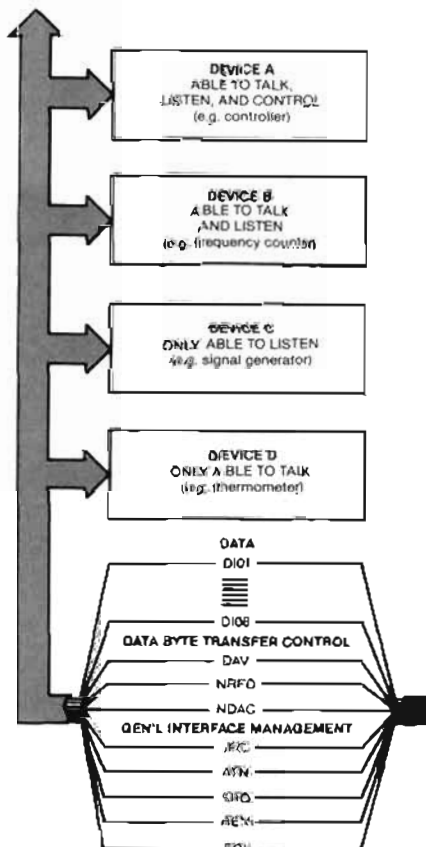

Interface connections and bus structure.

**488.1 Requirements**

The IEEE 488.2 Standard requires that each device provide a minimum set of 488.1 interface capabilities. In essence, this means that each device must be able to source and accept bytes, talk and listen, do service request, and respond to device clear.

IEEE 488.2 allows more freedom by making other capabilities optional. However, it requires a minimum capability when these functions are implemented. This applies to the Remote Local, Parallel Poll, Device Trigger, and Controller capabilities.

**Message Exchange**

IEEE 488.1 provides a reliable means of transferring bytes between a talker and a listener. In addition, devices need a reliable means of transferring programming commands and measurement results. IEEE 488.2 provides this means.

**Syntax**

IEEE 488.2 requires that devices listen in a "forgiving" manner. The level of forgiveness is, however, precisely defined. The meaning of every data byte is well defined, while several characters sometimes have the same meaning.

Whereas the listening syntax may be forgiving, an instrument is required to talk precisely. Talking precisely greatly increases the chances of a message being accepted by any controller.

**Common Commands**

Certain functions are useful across all types of instruments. IEEE 488.2 defines a set of commands that all instruments must implement. Required commands include identifying the instrument by manufacturer and model number, resetting the instrument to a known state, and performing a self-test.

Other commands that may be useful in some instruments are also described in the standard. They are included so that if the functions are implemented, they will be done in standard ways. For example, there are commands for calibration, triggering, macros, and passing control. There are a total of 13 required commands and 26 optional commands.

**Status Reporting**

IEEE 488.1 exactly describes how the Request Service (RQS) message behaves, but it says very little about the status byte, STB. The meanings of the bits are left to the designer. Some instruments clear the status byte after a serial poll, others do not. Many instruments allow the programmer to configure what causes a service request, but here too the techniques for doing so are varied.

IEEE 488.2 describes a hierarchical status reporting model in which the contents of other data structures are summarized in the status byte. It does not specify the exact meaning of all of the bits in the status byte. However, it does describe the meaning of two more of the bits, Message Available (MAV) and Event Status (ESB).

**Synchronization**

Many instruments can accept commands faster than they can execute them. While this feature can improve system throughput, it also creates a need to know when the instrument actually completes all of its commands. IEEE 488.2 requires three common commands that enable the application program to detect when all pending operations are complete.

**Auto-configuration**

Whenever a test system is assembled, the addresses of the instruments must be set so there are no collisions. Additionally, the application has to know the address of every instrument. Currently, addresses have to be set manually via the front panel or a bank of switches. IEEE 488.2 describes a protocol between the controller and all the auto-configurable instruments on the bus that identifies each instrument and assigns it an address.

**Future**

Codes, formats, protocols, and common commands cover new ground for instrument-to-computer communication. Most of the concepts involved can be used on any physical interface whether HP-IB, RS232, or VME. If a new physical interface should displace or co-exist with HP-IB, the syntax of messages, the common commands, the status reporting, and the synchronization techniques can all survive.

**HP-IB Training and Support**

To assist you in configuring HP-IB measurement systems, Hewlett-Packard has field sales people trained in electronic instruments, desktop computers and computer systems. Also available for technical consultation are computing controller systems engineers and HP-IB instrumentation specialists.

HP-IB training courses on HP-IB controllers and instruments are listed below. Courses are conducted at a convenient HP location. Some courses can be taught at your site with special arrangements.

- HP-IB Theory
- HP-IB for MOS-DOS Personal Computers
- HP-IB Instrument Control Using HP Series 200/300 BASIC
- HP-IB Instrument Control Using HP 1000E/F Series Controllers

**HP-IB Service and Warranty**

Hewlett-Packard has dedicated measurement system service people who perform on-site maintenance of HP instrumentation on customer-configured systems as well as HP-configured systems. Service contract coverage is available to meet your specific measurement system service needs and can be tailored to include extended warranty, calibration and extended hours of coverage. Contact your local sales and service office for further information on HP-IB service contract information.

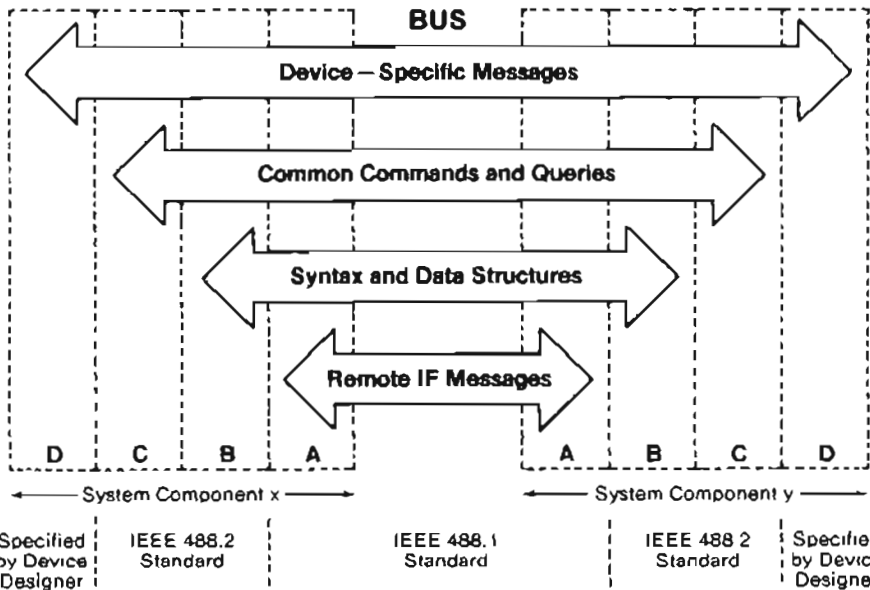

This diagram shows the relationship between the IEEE-488.1 standard and the new IEEE 488.2 standard. The new standard expands and compliments IEEE 488.1 by addressing issues involved with sending messages between devices on the bus. Layer D represents device functions, layer C represents common system functions, layer B represents message communications functions, and layer A represents interface functions. Layers D, C and B contain IEEE 488.1 device-dependent messages and layer A contains IEEE 488.1 interface messages.

# HEWLETT-PACKARD INTERFACE BUS

## Versatile Interface Bus for Instruments and Controllers (cont'd)

### General Information



Every HP-IB device and HP-configured system carries a standard Hewlett-Packard warranty appropriate to that product. The warranty period for each product will be provided on request at the time of sale and is specified in documentation supplied with the product. HP takes responsibility for standard HP-IB systems performing as specified. However, software or interfacing that has not been provided by Hewlett-Packard as part of a standard system delivered by HP is not covered by this warranty.

In all cases, overall operational responsibility for those HP-IB systems assembled by a customer from individual HP-IB devices rests with the customer.

### HP-IB Specifications Summary

#### Interconnect Devices

Up to 15 maximum on one contiguous bus.

#### Interconnection Path

Star or linear bus network; total transmission path length 2 metres times number of devices or 20 metres, whichever is less. Operating distances can be extended; see page 551.

#### Message Transfer Scheme

Byte-serial, bit-parallel asynchronous data transfer using locked 3-wire handshake technique.

#### Data Rate

One megabyte per second maximum over limited distance; 250-500 Kbytes per second typical over full transmission path (actual data rate depends on individual device characteristics).

#### Address Capability

Primary addresses, 31 TALK and 31 LISTEN; secondary (2-byte) addresses, 961 TALK and 961 LISTEN. Maximum of 1 TALKER and up to 14 LISTENERS at a time.

#### Control Shift

In systems with more than one controller, only one can be active at a time. A currently active controller can pass control to another, but only the designated system controller can assume control over others.

#### Interface Circuits

Driver and receiver circuits are TTL-compatible.

#### HP-IB Interface Functions

HP-IB functions are the predefined capabilities that can be designed into an HP-IB device. These capabilities and their alphanumeric codes are summarized in the table. Because the codes completely describe interface capability and are therefore particularly useful to system designers and specifiers, they are more and more frequently appearing in technical data and on system components. On HP system-ready products they are listed near the HP-IB connector, and they are included in the specifications for most of the HP-IB products in this catalog.

#### HP-IB Connector Lock Screw Compatibility

HP-IB products delivered now and in recent years are equipped with connectors having ISO metric-threaded lock screws and stud mounts. Very early HP-IB products have non-metric parts, but are readily distinguished from the metric by color: metric-threaded parts are black, whereas non-metric parts have a shiny nickel finish. HP-IB Metric Conversion Kit (HP P/N 5060-0138) is available to convert these early instruments.

#### HP-IB Reference Publications

- *Tutorial Description of the Hewlett-Packard Interface Bus*. This 94-page reference chronicles the development of byte-serial, bit-parallel interface system stan-

dards, describes their relationship to HP-IB, presents a working overview of HP-IB, and includes useful information. Free copies are available from your nearest HP office. Ask for publication number 5952-0156.

- *ANSI/IEEE 488.1-1987, Digital Interface for Programmable Instrumentation, and IEEE Std. 488.2-1987, Codes, Formats, Protocols, and Common Commands*, published by the Institute of Electrical and Electronics Engineers, 345 East 47th Street, New York, NY 10017.
- *IEC 625-1, An Interface System for Programmable Measuring Apparatus (Byte Serial Bit Parallel)*, published by the International Electrotechnical Commission, 1 rue de Varembe, 1211 Geneva 20, Switzerland.

#### HP-IB Interface Capability Codes for HP Products

Interface Function	Basic Code	Capability Code
Source Handshake	SH	SH0 No capability
		SH1 Full capability
Acceptor Handshake	AH	AH0 No capability
		AH1 Full capability
Talker (Extended Talker)	T(TE)	T(TE)0 No capability
		T(TE)1 Basic talker, serial poll, talk only
		T(TE)2 Basic talker, serial poll
		T(TE)3 Basic talker, talk only
		T(TE)4 Basic talker
		T(TE)5 Basic talker, serial poll, talk only, unaddresses if MLA <sup>1</sup>
		T(TE)6 Basic talker, serial poll, unaddresses if MLA <sup>1</sup>
		T(TE)7 Basic talker, talk only, unaddresses if MLA <sup>1</sup>
T(TE)8 Basic talker, unaddresses if MLA <sup>1</sup>		
Listener (Extended Listener)	L(LE)	L(LE)0 No capability
		L(LE)1 Basic listener, listen only
		L(LE)2 Basic listener
		L(LE)3 Basic listener, listen only, unaddresses if MTA <sup>2</sup>
L(LE)4 Basic listener, unaddresses if MTA <sup>2</sup>		
Service Request	SR	SR0 No capability
		SR1 Full capability
Remote Local	RL	RL0 No capability
		RL1 Full capability
		RL2 No local lockout
Parallel Poll	PP	PP0 No capability
		PP1 Remote configuration
		PP2 Local configuration
Device Clear	DC	DC0 No capability
		DC1 Full capability
		DC2 Omit selective device clear
Device Trigger	DT	DT0 No capability
		DT1 Full capability
Driver Electronics	E	E1 Open collector (250kb/s max)
		E2 Tri state (1Mb/s max)
Controller <sup>3</sup>	C	C0 No capability
		C1 System controller
		C2 Send IFC and take charge
		C3 Send REN
		C4 Respond to SRQ
C5 Send interface messages, receive control, pass control to self, parallel poll, take control synchronously		

<sup>1</sup>MLA: My Listen Address

<sup>2</sup>MTA: My Talk Address

<sup>3</sup>There are 29 controller levels. These are the more significant levels.





# HEWLETT-PACKARD INTERFACE BUS

## Versatile Interconnect System for Instruments and Controllers (cont'd)

HP-IB Measurement Systems

### Standard HP-IB Systems

Many application requirements can be satisfied with a standard HP-IB measurement system — a system assembled, tested, and

documented by Hewlett-Packard. Pre-configured systems save you design and setup time, and HP guarantees overall specified

system performance. Installation and service contracts are available through your local HP Office.

### Standard HP-IB Measurement Systems

Application	HP Model	HP Controller	System Name/Characteristics	Page
Data Logging, Acquisition, and Control	ATS	1000	Automatic test systems for general-purpose functional testing.	588
	3421A	71B	Data Acquisition System	554
	3497A	Series 200, 300	Data Acquisition/Control System	558
	3852S	Series 200, 300	Data Acquisition/Control System	560
Network Analysis	3577S	Series 200	Network Analyzer System: 100 kHz to 200 MHz; full 12-term error correction; S to H, Y or Z parameters; disc storage/recall.	234
	8328A	Series 200, 300	Transmission Line Test System: 10 MHz to 18 GHz; measures insertion loss, return loss, fault location.	225
	8510B	Series 200, 300	Microwave Network Analyzer: measures transmission and reflection parameters, 45 MHz to 26.5 GHz.	243
	8753A	Series 200, 300	Automatic RF Network Analyzer: measures complex impedance, transfer functions, group delay, 300 kHz to 3.0 GHz.	239
	8757S	Series 200, 300	Automatic Scalar Network Analyzers: measure insertion loss, gain, return loss, SWR, reflection coefficient & power.	215
	8970S/T	Series 200, 300	Noise Figure Measurement System, 10 MHz to 18 GHz.	210
Spectrum Analysis	8566S	Series 200, 300	Automatic Spectrum Analyzer: covers 100 Hz to 22 GHz; exceptional frequency tuning accuracy and resolution	118
	8567S	Series 200, 300	Automatic Spectrum Analyzer: 10 kHz to 1.5 GHz	118
	8568S	Series 200, 300	Automatic Spectrum Analyzer: covers 100 Hz to 1.5 GHz; exceptional frequency tuning accuracy and resolution.	118
	8573A, 8574A 71000S	Series 200, 300 Series 200, 300	CISPR EMI Spectrum Analyzer/Receiver for FCC, VDE EMI tests. Modular Automatic Spectrum Analyzer Systems.	124 113
Phase Noise Analysis	3048A	Model 236	Phase Noise Measurement System: high resolution measurements.	153
Signal Analysis	3565S	Series 300	Multichannel, Multiple Function Signal Processing System: spectrum, network, waveform analysis; 64 $\mu$ Hz to 50 kHz; 2 to 62 channels.	151
	8902S	Series 200, 300	Microwave Measurement System for accurate modulation, frequency, and low-level power measurements to 26.5 GHz.	158
Waveform Analysis/Generation	8770S	Series 200, 300	Arbitrary waveform synthesizer system: dc to 50 MHz.	364
	5182S	Series 200, 300	Waveform Generation System: draw, trace, edit, create arbitrary waveforms; modify captured waveforms for playback.	71
	5180S	(all models) or HP Vectra with HP 82300A	Waveform Measurement System: automatic time-domain measurements of captured waveforms.	69
	5180/83/85T		Precision Digitizing Oscilloscopes (two channels): dc to 1 MHz, 12 bits (5183T); dc to 10 MHz, 10 bits (5180T); dc to 100 MHz, 8 bits (5185T).	68, 66, 64
	5180/83U		Precision Digitizing Oscilloscopes (four channels): dc to 1 MHz, 12 bits (5183U); dc to 10 MHz, 10 bits (5180U).	68, 66
Signal Generator Calibration	8952A	Series 200, 300	RF Signal Generator Test Set: performance verification for HP 8640B, 8642A/B, 8656A/B, 8662A, 8663A Signal Generators.	159
Transceiver Testing	8953A	85/Series 200, 300	Transceiver Test Set for AM and FM transceivers, 150 kHz to 990 MHz.	322
	8955A	Series 200, 300	RF Test System for AM and FM transceivers to 1000 MHz, transmitters to 120 W.	322
	8957S	Series 200, 300	Cellular Radio Test System: compatible with U.S., UK, Scandinavian protocols; complete RF testing to 1000 MHz.	322
Circuit Testing	3065ST	1000 A Series	In-circuit Test System	529
	3065L/X	1000 A Series	In-circuit Test Systems	528
	3065AT	1000 A Series	Combinational Test System	528
Frequency Division Multiplex (FDM) Network Surveillance	37050S	1000	FDM Network Monitoring System: simultaneous control of multiple selective level measuring sets.	491
	37051S	Series 300	FDM Measurement System: sequential control of multiple selective level measuring sets.	491
Analog LSI Testing	9480	Models 320, 350	Analog LSI Test System: 128-MHz analog/digital, mixed signal testing; 128-pin I/O; 4 channel.	508
Semiconductor/Component Testing	4061A	Model 310 & Series 200	Semiconductor/Component Test System: I-V, multifrequency C-V, quasi-static C-V.	517
	4062B	Models 236, 310	Semiconductor Parametric Test System: I-V, 1-MHz C-V through the 48-pin switching matrix.	514
	4062C	Series 200, 300	Semiconductor Parametric Test System: I-V, 1-MHz C-V through the 48-pin switching matrix.	512
	4063A	Model 236	Semiconductor Parameter Analysis System: precise I-V, 1-MHz C-V, temperature measurements through the 6/12-channel switching matrix.	516
Power Sensor Calibration	436A-E40	85	Calibrates RF & MW power sensors: good for metrology labs.	200

# HEWLETT-PACKARD INTERFACE BUS

## Versatile Interconnect System for Instruments and Controllers (cont'd)

### Individual HP-IB Product Summary



#### Individual Hewlett-Packard Products Available with HP-IB Capability

Products Related to	HP Model	Product Name/Characteristics	Page	
Control and Computation	25	Vectra Personal Computer	672	
	35	Vectra Personal Computer	672	
	45	Vectra Personal Computer	672	
	HP 150	Touchscreen Personal Computer	670	
	HP 260 Series 30	Business Computer System	690	
	HP 260 Series 40	Business Computer System	690	
	HP 1000 A400	Computer (HP 2424A, 2434A; uses HP 12009A Interface)	654	
	HP 1000 A600+	Computer (HP 2156B, 2426E/F and 2436A/E; uses HP 12009A Interface)	654	
	HP 1000 A700	High Performance Computer (HP 2137A and 2437A; uses HP 12009A Interface)	654	
	HP 1000 A900	High Performance Computer (HP 2139A and 2439A; uses HP 12009A interface)	654	
	A1005A	HP 9000 Model 825SRX Superworkstation	632	
	HP 3000 Series 52	Business Computer System	692	
	HP 3000 Series 58	Business Computer System	692	
	HP 3000 Series 70	Business Computer System	692	
	HP 3000 Series 930	Business Computer System	692	
	HP 3000 Series 950	Business Computer System	692	
	HP 3000 Micro 3000	Business Computer System	692	
	HP 3000 Micro 3000XE	Business Computer System	692	
	6954A	Multiprogrammer ATE/CAT Controller	578	
	9742A	HP 9000 Model 8505 Superminicomputer	630	
	9807A	The Integral Personal Computer	639	
	9816S	HP 9000 Model 216	637	
	9826A/S	HP 9000 Model 226 Computer/Controllers	637	
	9826U/CU	HP 9000 Model 236 Computers	637	
	9920A/S/U	HP 9000 Model 220 Modular Computers	637	
	82314A	Vectra PC Technical Workstation	638	
	82315A	Vectra PC Technical Workstation	638	
	98561A	HP 9000 Model 310 Computer	634	
	98561B	HP 9000 Model 320 Computer	634	
	98562A	HP 9000 Model 330 Computer	633	
	98562B	HP 9000 Model 350 Computer	633	
	98563A	HP 9000 Model 318M Monochrome Workstation	635	
	98580A	HP 9000 Model 310M Measurement Automation Workstation	635	
	98580M	HP 9000 Model 330MMA Monochrome Instrument Controller	635	
	98581A	HP 9000 Model 310C Low-Cost Color Workstation	635	
	98581M	HP 9000 Model 330CMA Color Instrument Controller	635	
	98582C	HP 9000 Model 350M Monochrome Workstation	635	
	98582M	HP 9000 Model 330M Monochrome Workstation	635	
	98583C	HP 9000 Model 350C Color Workstation	634	
	98583L	HP 9000 Model 330C Color Workstation	635	
	98587B	HP 9000 Model 350SRX Solid Modeling Workstation	634	
	98588A	HP 9000 Model 350CH Color Workstation	634	
	Distance Extension	37201A	HP-IB Extender: long distance via modems and telephone lines	551
		37204A	HP-IB Extender: up to 1250 metres via coaxial or fiber-optic cable	551
37204B		HP-IB Extender: 250-metre printer extension for HP 3000 Computers	551	
Stimulus	3314A	Function Generator: 0.001 Hz to 19.99 MHz	413	
	3325A	Synthesizer/Function Generator/Sweeper: 1 $\mu$ Hz to 21 MHz	400	
	3326A	Two-Channel Synthesizer: dc to 13 MHz	402	
	3335A	Synthesizer/Level Generator: 200 Hz to 81 MHz	404	
	3336A/B	Synthesizer/Level Generator: 10 Hz to 21 MHz	482	
	3708A	Noise and Interference Test Set	489	
	3764A	Digital Transmission Analyzer	476	
	3787B	Digital Data Test Set	479	
	3789A/B	DS3 Transmission Test Sets	478	
	3781A	Pattern Generator: CEPT and CCITT PCM/TDM Systems	475	
	3781B	Pattern Generator: BELL PCM/TDM Systems	475	
	5182A	Waveform Recorder/Generator: 20 MHz, 10 bits, 16K word memory	70	
	5359A	Time Synthesizer: 1 ns accuracy; 50 ps increments, 100 ps jitter	429	
	6002A Option 001	DC Power Supply: 200 W autoranging, Listen only	445	
	6030A	System Power Supply: 1000W, 200 Vdc, 17A, autoranging with status readback	440	
	6031A	System Power Supply: 1000W, 20 Vdc, 120A, autoranging with status readback	440	
	6032A	System Power Supply: 1000W, 60 Vdc, 50A, autoranging with status readback	440	
	6033A	System Power Supply: 200W, 20 Vdc, 30A, autoranging with status readback	440	
	6038A	System Power Supply: 200W, 60 Vdc, 10A, autoranging with status readback	440	
	6129C Opt. P05 or J99	Precision Voltage Source: $\pm$ 50 Vdc at 5 A (requires HP 59301A)	446	
	6130C Opt. P05 or J99	Precision Voltage Source: $\pm$ 50 Vdc at 1A (requires HP 59301A)	446	
	6131C Opt. P05 or J99	Precision Voltage Source: $\pm$ 100 Vdc at 0.5 A (requires HP 59301A)	446	
	6140A Opt. P05 or J99	Precision Current Source: $\pm$ 100 mA at 100 Vdc (requires HP 59301A)	446	
	6621A	System Power Supply: dual output, dual range, 20V/4A or 7V/10A per output	438	
	6622A	System Power Supply: dual output, dual range, 10V/1.6A or 20V/4A per output	438	

## Individual Hewlett-Packard Products Available with HP-IB Capability (cont.)

Products Related to	HP Model	Product Name/Characteristics	Page
Stimulus (cont.)	6623A	System Power Supply: triple output	438
	6624A	System Power Supply: quad output	438
	6632A	System Power Supply: 100W, 20 Vdc, 5A	436
	6633A	System Power Supply: 100W, 50 Vdc, 2A	436
	6634A	System Power Supply: 100W, 100 Vdc, 1A	436
	6940B	Multiprogrammer (requires HP 59500A)	585
	6942A	Multiprogrammer: automatic test, data acquisition and control	581
	6954A	Multiprogrammer	578
	8016A Option 001	Word Generator: 9 x 32 bit. Listen only	315
	8018A Option 001	Serial Data Generator: 50 MHz, 2048-bit memory. Listen only	317
	8112A	Programmable Low Cost Pulse Generator: 20 ns to 950 ms period	418
	8116A	Programmable Pulse/Function Generator: 1 mHz to 50 MHz	409
	8150A	Optical Signal Source: 850 nm, 250 MHz	301
	8154B	LED Source: 1300 nm, $\pm 0.02$ dB/12 h	305
	8155A	LD Source	305
	8160A	Programmable Pulse Generator: 20 ns to 999 ms period	420
	8161A	Programmable Pulse Generator: 10 ns to 980 ms period	420
	8165A	Programmable Signal Source: 0.001 Hz to 50 MHz	408
	8170A	Logic Pattern Generator: 8 x 4096/12 x 2048 bit; 2 MHz	316
	8175A	Digital Signal Generator: 24 x 1024/2 x 8192 bit, 50/100 MHz	311, 406
	8180A/B	Data Generator: 50 MHz, 1024 bit/channel (8180A), 16384 bit/channel (8180B)	313
	8181A/B	Data Generator Extender: 1024 bit/channel (8181A), 16384 bit/channel (8181B)	313
	8340B	Synthesized Sweeper: 10 MHz to 26.5 GHz	378
	8341B	Synthesized Sweeper: 10 MHz to 20 GHz	378
	8350B	Sweep Oscillator: 10 MHz to 40 GHz	380
	8620C Option 011	Sweep Oscillator: 10 MHz to 22 GHz	390
	8642A/B	Synthesized Signal Generator: 100 kHz to 1.057/2.115 GHz	351
	8656B	Signal Generator: 0.1 to 990 MHz	349
	8660D	Synthesized Signal Generator: 10 kHz to 2.6 GHz. Listen only	357
	8662A	Synthesized Signal Generator: 10 kHz to 1280 MHz.	354
	8663A	Synthesized Signal Generator: 100 kHz to 2560 MHz.	354
	8671B	Synthesized CW Generator: 2 to 18 GHz	370
	8672A	Synthesized Signal Generator: 2 to 18 GHz	374
	8672S	Synthesized Signal Generator: 100 MHz to 18 GHz	374
	8673B/E	Synthesized Signal Generator: 2 to 26.5 GHz/2 to 18 GHz	372, 371
	8673C/D	Synthesized Signal Generator: 50 MHz to 18/26.5 GHz	372
	8770A	Arbitrary Waveform Synthesizer: dc to 50 MHz	364
	8780A	Vector Generator: complex modulation, 50 MHz to 3 GHz	320
	8904A	Multifunction Synthesizer: dc to 600 kHz	398
	16520A	Timing Card: pattern generation, 50 Mbit/s	263
	16521A	Timing Card: pattern generation, 50 Mbit/s	263
59501B	Power Supply Programmer: Isolated D-to-A Converter $\pm 10$ Vdc at 10 mA	447	
Measurement	436A Option 022	Power Meter: -70 dBm to +44 dBm, to 50 GHz	202
	438A	Dual-channel Digital Power Meter: -70 dBm to +44 dBm, to 50 GHz	201
	853A	Spectrum Analyzer Display	135
	1631A/D	Logic Analyzers with built-in scopes	257
	2804A Option 010	Quartz Thermometer: 0.05°C accuracy	345
	3421A	Data Acquisition/Control Unit	554
	3437A	System Digital Voltmeter: high speed, 3½ digits	97
	3455A	Digital Voltmeter: 5½ or 6½ digits, auto calibration	97
	3456A	Digital Voltmeter: 3½ to 6½ digit voltmeter, 1 nV sensitivity	92
	3457A	Multimeter: 3½ to 6½ digits; measures voltage, current, resistance, frequency	94
	3478A	Digital Multimeter: 3½ to 5½ digits; 5 functions	90
	3497A	Data Acquisition Control Unit	558
	3561A	Dynamic Signal Analyzer: 125 $\mu$ Hz to 100 kHz	145
	3562A	Dynamic Signal Analyzer: dual channel, 64 $\mu$ Hz to 100 kHz	148
	3577A	Network Analyzer: 5 Hz to 200 MHz	230
	3582A	2-channel Real Time (FFT) Spectrum Analyzer	144
	3585A	Swept Spectrum Analyzer: 20 Hz to 40 MHz	106
	3586A/B/C	Selective Level Meters: 50 Hz to 32.5 MHz	109, 482
	3708A	Noise and Interference Test Set	489
	3709B	Constellation Analyzer	489
	3717A	Wideband 70 MHz modem	486
	3746A	32.5 MHz Selective Level Measuring Set: CCITT and Bell FDM Systems	481
	3764A	Digital Transmission Analyzer	476
	3776A	PCM Terminal Test Set: CEPT/CCITT networks	474
	3776B	PCM Terminal Test Set: Bell/Japanese/CCITT networks	474
	3779C	Primary Multiplex Analyzer: CEPT 2 Mb/s PCM systems	474
	3779D	Primary Multiplex Analyzer: Bell 1.5 Mb/s PCM systems	474
	3781A/3782A	Pattern Generator/Error Detector: CEPT and CCITT PCM/TDM systems	475
	3781B/3782B	Pattern Generator/Error Detector: Bell PCM/TDM systems	475
	3785A	Jitter Generator and Receiver: CEPT PCM/TDM systems	477
	3785B	Jitter Generator and Receiver: Bell PCM/TDM systems	477

# HEWLETT-PACKARD INTERFACE BUS

## Versatile Interface Bus for Instruments and Controllers (cont'd)

### Individual HP-IB Product Summary



#### Individual Hewlett-Packard Products Available with HP-IB Capability (cont.)

Products Related to	HP Model	Product Name/Characteristics	Page
Measurement (cont.)	3787B	Digital Data Test Set	479
	3789A/B	DS3 Transmission Test Sets	478
	3852A	Data Acquisition/Control System	560
	4140B	mA Meter/DC Voltage Source	522
	4141B	DC Source/Monitor	518
	4142B	Modular DC Source/Monitor	507
	4145B	Semiconductor Parameter Analyzer	520
	4191A	RF Impedance Analyzer: 1 to 1000 MHz	282
	4192A	LF Impedance Analyzer: 5 Hz to 13 MHz	280
	4193A	Vector Impedance Meter: 400 kHz to 110 MHz	284
	4194A	Impedance/Gain-Phase Analyzer	278
	4195A	Network/Spectrum Analyzer: 10 Hz to 500 MHz	226
	4262A Option 101	Digital LCR Meter	293
	4274A	Multifrequency LCR Meter: 11 spots, 100 Hz to 100 kHz	286
	4275A	Multifrequency LCR Meter: 10 spots, 10 kHz to 10 MHz	286
	4276A	LCZ Meter: 801 spots, 100 Hz to 20 kHz	290
	4277A	LCZ Meter: 701 spots, 10 kHz to 1 MHz	290
	4278A Option 101	Capacitance Meter: 1 kHz/1 MHz	288
	4279A	1 MHz C-V Meter	292
	4280A	1-MHz C Meter/C-V Plotter	524
	4945A Option 101	Transmission Impairment Measurement System (TIMS)	497
	4947A	Transmission Impairment Measuring Set	497
	4948A	In-Service Transmission Impairment Measuring Set	498
	4954A	Protocol Analyzer	494
	4955A	Protocol Analyzer	495
	4972A	LAN Protocol Analyzer	495
	5006A	Signature Analyzer	272
	5180A	Waveform Recorder	68
	5180T/U	Precision Digitizing Oscilloscopes: dc to 10 MHz/10 bits	68
	5182A	Waveform Recorder/Generator	70
	5183T/U	Precision Digitizing Oscilloscopes: dc to 10 MHz/12 bits	68
	5185T	Precision Digitizing Oscilloscope: dc to 100 MHz/8 bits	64
	5316B	Universal Counter: 100 MHz/1.3 GHz, 100 ns TI	196
	5328B	Universal Counter: to 512 MHz, 10 ns TI	195
	5334B	Automatic Universal Counter: 100 MHz/1.3 GHz, 2ns TI	190
	5335A	Automatic Universal Counter: 200 MHz/1.3 GHz, 2ns TI	192
	5340A Option 011	Automatic Microwave Counter: 10 Hz to 18 GHz	175
	5342A Option 011	Automatic Microwave Counter: 10 Hz to 18 GHz	173
	5343A Option 011	Microwave Frequency Counter: 10 Hz to 26.5 GHz	173
	5345A Option 011,012	General Purpose Plug-In Counter	176
	5350B	Microwave Frequency Counter: 10 Hz to 20 GHz	170
	5351B	Microwave Frequency Counter: 10 Hz to 26.5 GHz	170
	5352B	Microwave Frequency Counter: 10 Hz to 40 GHz	170
	5355A	Pulse, CW Counter: 400 Hz to 110 GHz	176
	5356A/B/C/D	Frequency Converter	176
	5363B	Time Interval Probes	187
	5370B	Precision Time Interval Counter: $\pm 20$ ps single-shot LSD	181
	5371A	Frequency & Time Interval Analyzer	184
	5384A	225 MHz Frequency Counter	179
	5385A	1 GHz Frequency Counter	179
	5386A	Frequency Counter: 3 GHz	179
	5517B	Laser Transducer	342
	5527A	Laser Position Transducer	342
	5528A	Laser Measurement System	343
	6030A	System Power Supply: 1000 W, 200 Vdc, 17A, autoranging with status readback	440
	6031A	System Power Supply: 1000 W, 20 Vdc, 120 A, autoranging with status readback	440
	6032A	System Power Supply: 1000 W, 60 Vdc, 30 A, autoranging with status readback	440
	6033A	System Power Supply: 200 W, 20 Vdc, 30 A, autoranging with status readback	440
	6038A	System Power Supply: 200 W, 60 Vdc, 10 A, autoranging with status readback	440
	6621A	System Power Supply: dual output, dual range, 20V/4A or 7V/10A per output	438
6622A	System Power Supply: dual output, dual range, 50V/1.6A or 20V/4A per output	438	
6623A	System Power Supply: triple output	438	
6624A	System Power Supply: quad output	438	
6632A	System Power Supply: 100W, 20Vdc, 5A	436	
6633A	System Power Supply: 100W, 50Vdc, 2A	436	
6634A	System Power Supply: 100W, 100Vdc, 1A	436	
6940B	Multiprogrammer (requires HP 59500A interface)	585	
6942A	Multiprogrammer: automatic test, data acquisition and control	581	
6954A	Multiprogrammer	578	
7090A	Measurement Plotting System: 3-channel A-D converter to 3 kHz	78	
8145A	Optical Time Domain Reflectometer: 1300/1550nm	308	
8151A	Optical Pulse Power Meter: 250 MHz	302	

## Individual Hewlett-Packard Products Available with HP-IB Capability (cont.)

Products Related to	HP Model	Product Name/Characteristics	Page	
Measurement (cont.)	8152A	Optical Average Power Meter: 2 channel, 450-1700 nm	304	
	8182A/B	Data Analyzer: 50 MHz; 1024 bit/channel (8182A). 16384 bit/channel (8182B)	313	
	8510B	Network Analyzer	243	
	8562A/B	Spectrum Analyzers: 100Hz to 325 GHz	131	
	8566B	Spectrum Analyzer: 100 Hz to 325 GHz	119	
	8567A	Spectrum Analyzer: 10 kHz to 1.5 GHz	121	
	8568B	Spectrum Analyzer: 100 Hz to 1.5 GHz	121	
	8569B	Spectrum Analyzer: 10 MHz to 115 GHz	139	
	8570A	Spectrum Analyzer: 10 MHz to 22 GHz	139	
	8573A, 8574A	CISPR EMI Receivers	124	
	8590A	Spectrum Analyzer: 10 kHz to 1.5 GHz	128	
	8753A	RF Network Analyzer: 300 kHz to 3.0 GHz	239	
	8756A/8757A	Scalar Network Analyzer: 10 MHz to 60 GHz	217, 223	
	8901A	Modulation Analyzer: 150 kHz to 1.3 GHz	160	
	8901B	Modulation Analyzer: 150 kHz to 1.3 GHz	160	
	8902A	Measuring Receiver: 150 kHz to 1.3 GHz	156	
	8903B	Audio Analyzer: 20 Hz to 100 kHz	163	
	8903E	Distortion Analyzer: 20 Hz to 100 kHz	163	
	8954A	Transceiver Interface	325	
	8956A	System Interface	325	
	8958A	Cellular Radio Interface	325	
	8970B	Noise Figure Meter: 10 to 1600 MHz	209	
	8971B	Microwave Noise Figure Test Set: 2 to 18 GHz	210	
	8980A	Vector Analyzer, X-Y Display: 350 MHz	319	
	11729C	Carrier Noise Test Set: 5 MHz to 18 GHz	155	
	16500A	Logic Analysis System	258	
	16510A	Timing Card: 80 channel, 25 MHz state/100 MHz	260	
	16515A, 16516A	Timing Cards: 1 GHz	262	
	16520A, 16521A	Timing Cards: pattern generation, 50 Mbit/s	263	
	16530A, 16531A	Digitizing Oscilloscope Cards: 400 Msample/s	261	
	54100A/D, 54110D	Digitizing Oscilloscopes: 1 GHz	56	
	54200A/D, 54201A/D	Digitizing Oscilloscopes: 200 M samples/s; 50 MHz, 300 MHz	52	
	54300A	Probe Multiplexer	74	
	54111D	Digitizing Oscilloscope: 500 MHz	58	
	54112D	Digitizing Oscilloscope: 100 MHz	59	
	54120T	Digitizing Oscilloscope: 20 GHz	60	
	59992A-J06	Time Interval Calibrator	182	
	70300A	Tracking Generator Module: 20 Hz to 2.9 GHz	116	
	70310A	Precision Frequency Reference Module	116	
	70700A	Digitizer Module	110	
	71100A	RF Spectrum Analyzer: 100 Hz to 2.9 GHz	113	
	71200A	Microwave Spectrum Analyzer	113	
	71300A	Millimeter Wave Spectrum Analyzer	113	
	85650A	Quasi-Peak Adapter	126	
	85685A	RF Preselector: 20 Hz to 2 GHz	126	
	Switching, Scanning, Translation or Timing	3235A	Switch/Test Unit	570
		3326A	Two-Channel Synthesizer/Sweeper: dc to 13 MHz	402
3421A		Scanner: to 30 channels; A/D converter	554	
3488A		Versatile switching for automated testing (VHF, matrix general purpose)	574	
3497A		Data Acquisition/Control Unit	558	
3754A		25 MHz Access Switch (requires HP 3755A switch controller)	481	
3756A		90 MHz Switch (requires HP 3755A)	481	
3757A		8.5 MHz Access Switch (requires HP 3755A)	481	
3777A		Telecommunications Channel Selector, up to 30 channels; dc to 110 kHz	474	
3852A		Data Acquisition/Control Unit	560	
4085M		Switching Matrix	519	
6940B		Multiprogrammer (requires HP 59500 interface)	585	
6942A		Multiprogrammer (no interface required)	581	
6954A		Multiprogrammer	578	
8157A		Optical Attenuator: 1200-1650nm, single-mode	306	
8158B		Optical Attenuator: 600-1650 nm, single- and multi-mode	306	
8159A		Optical switch, 780-1300 nm	303	
9411B		Switch Controller	588	
9412A		Modular Switch (requires HP 9411B switch controller)	588	
9413A		VHF Switch (requires HP 9411B)	588	
9414A		Matrix Switch (requires HP 9411B)	588	
11713A		Attenuator/Switch Driver: controls coax switches, step attenuators and microwave matrix switches	330	
59306A		Relay Actuator: for programmable switches, attenuators	550	
59307A		VHF Switch: two 50-ohm, bidirectional, dc to 500 MHz	550	
59309A		Digital Clock: month, day, hour, minute, second	550	
59501B		Power Supply Programmer: isolated D-to-A converter $\pm 10$ Vdc at 10 mA	550	

# HEWLETT-PACKARD INTERFACE BUS

## Versatile Interconnect System for Instruments and Controllers (cont'd)

### Individual HP-IB Product Summary



#### Individual Hewlett-Packard Products Available with HP-IB Capability (cont.)

Products Related to	HP Model	Product Name/Characteristics	Page
<b>Storage</b>	3964A Option 007	Instrumentation Tape Recorder: 4 channel, listen only	86
	3968A Option 007	Instrumentation Tape Recorder: 8 channel, listen only	86
	5180A	Waveform Recorder (digital oscilloscope): 20 MHz, 10 bits, 16K-word capacity	68
	7907A	Disc Drive: 20 Mb fixed, 20 Mb removable	707
	7935H	Disc Drive: 404 Mb removable	707
	7935XP	Disc Drive: 404 Mb removable plus 1 Mb controller cache	707
	7936H	Disc Drive: 307 Mb formatted capacity	709
	7936XP	Disc Drive: 307 Mb formatted plus 2 Mb read/5Kb write caches	709
	7937H	Disc Drive: 571 Kb formatted capacity	709
	7937XP	Disc Drive: 571 Kb formatted plus 2 Mb read/4Kb write caches	709
	7942A	Disc/Tape Drive: 24 Mb fixed, 67 Mb 1/4" tape cartridge	708
	7946A	Disc/Tape Drive: 55 Mb fixed, 67 Mb 1/4" tape cartridge	708
	7957A	Disc Drive: 81 Mb formatted capacity	708
	7958A	Disc Drive: 130 Mb formatted capacity	708
	9114B	Portable 3 1/2" Disc Drive: 710 Kb formatted capacity	706
	91220/S	Double-sided 3 1/2" Disc Drive: 1420 Kb dual (HP 9122D), 710 Kb single-sided (HP 9122S), random access storage	706
	9123D	Dual 3 1/2" Drive for HP Touchscreen II	706
	9127A	Single 5 1/4" Flexible Disc Drive: up to 360 Kb formatted, IBM/HP format compatible	706
	9133L	40 Megabyte Winchester hard disc plus 3 1/2" microfloppy	706
	9153B	Disc Drive: 20Mb hard disc plus 3 1/2" microfloppy	706
	9154B	Disc Drive: 20MB hard disc (Winchester)	706
	9134L	40 Megabyte Winchester hard disc: stand-alone model	706
	9142A	1/4" Tape Backup Subsystem: up to 60 Mb formatted capacity	706
	9144A	1/4" Tape Backup Subsystem: 16 and 67 Mb formatted capacity	710
	9153A	10 Megabyte Winchester Hard Disc plus 3 1/2" microfloppy	706
	9154A	10 Megabyte Winchester Hard Disc: stand-alone model	706
	35401A	Tape Drive: 1/4" cartridge autochanger	710
88500A	IBM Disc/Tape Interface: single 5 1/2" disc drive providing data compatibility with IBM-PC from the HP Touchscreen	706	
<b>Printers, Plotters, Recorders</b>	2225A	ThinkJet Ink-jet Printer	715
	2227B	QuietJet Plus Printer	715
	2235B/D	RuggedWriter 480 Printer	716
	2563B, 2564B	Line Printers: 300, 600 lines/minute dot matrix	716
	2566B, 2567B	Line Printers: 900/1200 lines/minute dot matrix	716
	2680A	Laser Page Printer	716
	2932A	Impact Printer	716
	2934A	Dual Mode Impact Printer	716
	3630A Option 002	PaintJet Color Graphics Plotter	714
	7090A	Measurement Plotting System: 6-pen	78
	7440A	Graphics Plotter: 8-pen	718
	7475A	Graphics Plotter: 6-pen	719
	7550A	Automatic Sheet-Feed 8-Pen Plotter	720
	7570A	DraftPro: 8-pen drafting plotter	722
	7595A	DraftMaster I: high-performance drafting plotter	724
7596A	DraftMaster II: roll-feed drafting plotter	698	
<b>Interface Cabling</b>	10833A-10833D	HP-IB Interconnection Cables	549
	10834A	HP-IB Interconnection Cable Adapter: 2.3 cm (0.91 in.)	549
<b>Design/Serviceing</b>	59401A	Bus System Analyzer	549



# HEWLETT-PACKARD INTERFACE BUS

Versatile Interconnect System for Instruments and Controllers

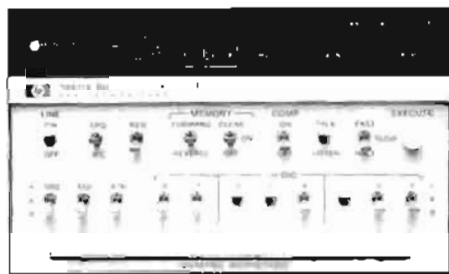

HP 59401A



HP 10833A/B/C/D



HP 10834A

## HP 59401A Bus System Analyzer

The HP-IB (IEEE 488) concept has greatly simplified many of those things which have in the past made instrument interfacing a burdensome task. Even so, software errors can occur if the system designer does not completely understand the bus system or the capabilities of the instruments and other devices being interfaced. Hardware problems can occur if the instruments/devices are not functioning properly, or if they are not completely compatible with the bus standard.

The HP 59401A Bus System Analyzer is especially useful in design and service work. It simplifies and speeds up the diagnosis of software and hardware problems by allowing the user to see the status of all bus lines, including the actual characters on the bus data lines. Because the HP 59401A can also drive all bus lines, it can completely exercise another Talker, Listener or Controller—which is especially useful in verifying compatibility of new or user-designed products with the HP-IB.

There are several choices of analyzer operating speed. It may be operated at one character at a time (useful for software debugging), at 2 characters per second, or at regular bus speed. It may also be operated at a variable rate as determined by the external clock input.

The analyzer's 32 character memory can be used to store bus characters in the Listen mode, or to output characters to the bus in the Talk mode. When the analyzer is in the Compare mode, a stream of bus traffic may be stopped on a pre-selected character—and at that time a trigger pulse is available, which is very useful when analyzing transient or timing problems related to the bus.

## HP 59401A Specifications

**Display:** monitors all bus lines. Represents data lines, any memory location, or DIO front panel switch settings; in octal code and ASCII character.

**Listen mode:** stores up to 32 characters of bus traffic in memory for real time and repetitive testing. In Compare mode, halts bus traffic when a selected character is present, and user can display any one of the previous 31 characters stored in memory.

**Timing:** accept <750 ns; ready <750 ns

**Talk mode:** bus lines can be driven directly from front panel switches; memory can be loaded from front panel switches for driving bus with a 32 character sequence.

**Timing:** (1) data changed >500 ns before DAV pulled low; (2) ATN driven low >1  $\mu$ s before DAV pulled low; (3) DAV driven high <700 ns after NDAC is false; (4) DAV driven low <700 ns after NRFD is false, if conditions 1 and 2 are met.

**Operating speeds:** one character at a time, 2 characters per second, regular bus speed, or variable rate determined by external clock input; in either Listen or Talk mode.

**External clock input:** 1 standard power TTL gate input;  $\leq$ 10 MHz repetition rate.

**Compare output:** provides 1 standard power TTL gate output (LOW TRUE) sync pulse when bus character is same as front panel switches.

**HP-IB load:** 1 bus load (capable of driving 14 other bus devices).

## General

**Temperature ranges:** operating, 0 to 50°C; storage, -40 to +75°C.

**Humidity:** 95% relative, 0 to 40°C.

**Power requirements:** 100, 120, 220, or 240 V +5%, -10%; 48 to 66 Hz;  $\leq$ 42 VA.

**Size:** 145.5 H, 205.1 W, 495.3 mm D (5.730" x 8.075" x 19.500").

**Weight:** net, 5.64 kg (12.44 lb).

## Accessories

HP 5081-9689 (metric) front handle kit

HP 10833B 2 m (6.6 ft) bus cable, furnished

## Price

\$55 ☎

## HP 59401A Bus System Analyzer

\$4080

## HP-IB Interconnection Cables

Cables for interconnecting HP-IB devices are available in four different lengths. The connector block at both ends of each HP-IB cable (photo above) has a plug on one side and a matching receptacle on the other, so that several cables may be conveniently connected in parallel, thus simplifying system interconnection. Lock screws provide for secure mounting of each connector block to an HP-IB instrument, or to another cable connector block.

**SPECIAL NOTE:** HP-IB cables are not always included with individual HP-IB devices, particularly those that normally connect directly to an HP computing controller. (The HP-IB interface for HP computing controllers contains the necessary cable and connector). Product listings in this catalog should be checked to see if HP-IB cables are furnished.

The HP 10833 series of cables feature an improved shielding design to help improve RFI levels in systems. This series of cables, with the RFI shielding, exhibits significantly lower radiated emissions than previous HP-IB cables.

The HP 10834A adapter is a shielded HP-IB to HP-IB adapter. It provides additional clearance (approximately 2.3 cm) between the HP-IB cable and the rear panel of the instrument. This allows easier access to switches, cables, and other connectors that may be in close proximity to the HP-IB connector.

## Ordering Information

HP 10833A HP-IB Cable, 1m (3.3 ft)

HP 10833B HP-IB Cable, 2m (6.6 ft)

HP 10833C HP-IB Cable, 4m (13.2 ft)

HP 10833D HP-IB Cable, 0.5m (1.6 ft)

HP 10834A Adapter

☎ Fast-Ship product — see page 758.

## Price

\$80 ☎

\$90 ☎

\$100 ☎

\$80 ☎

\$30 ☎

# HEWLETT-PACKARD INTERFACE BUS

Versatile Interconnect System for Instruments & Controllers

Models 59306A, 59307A, 59309A, 59501B

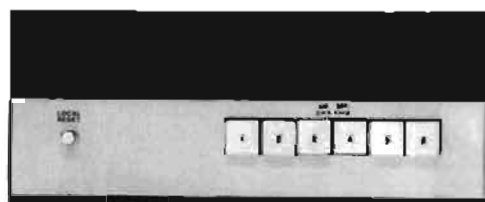

HP 59306A



HP 59307A

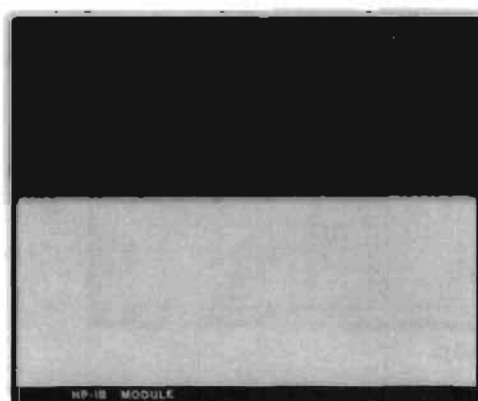

HP 59309A

## HP-IB Accessory Modules

Modules in the HP 59300, 59400 and 59500-series are ideal building blocks for use with instruments to extend measurement capabilities. Modules listed here can be interconnected via the HP-IB to HP measuring instruments, signal sources and recording devices capable of operating directly on the HP-IB. In addition, these modules frequently serve as useful ways to interconnect with devices which are not themselves capable of direct HP-IB operation.

### HP 59306A Relay Actuator

Has six Form-C relays that provide for control of external devices either manually from front panel pushbuttons or remotely from the HP-IB. Relay contacts are specified to switch 24 V dc or 115 V ac at 0.5 A. Each relay can be programmed independently or multiple relays can be switched together. Front panel pushbuttons light to indicate the state of each relay.

The HP 59306A is ideal for providing control of microwave coaxial switches (HP 876) A/B as well as control of microwave programmable step attenuators (HP 8494 through 8496 G/H) using external dc power supplies.

### HP 59307A Dual VHF Switch

This module provides two single pole 4-throw switches controlled from front panel pushbuttons or remotely from the HP-IB. The HP 59307A is a dc to 500 MHz 50  $\Omega$  switch designed to maintain fast pulse transition times. The switches are independent and bidirectional for optimum use in multiplexing 50  $\Omega$  signal lines into measuring instruments. The HP 59307A is ideal to switch a standard delay, frequency, or voltage into a measurement loop for purposes of system calibration.

HP 59501B



### HP 59309A HP-IB Digital Clock

Displays month, day, hour, minute, and second, and upon command will output time via the interface bus. Time can be set into the clock by local control, or by remote commands received from the HP-IB. The clock accepts a small internal battery which can provide more than a day's standby in case of short power interruptions. Additionally, an auxiliary power supply such as the K10-59992 can sustain the clock for up to one year.

### HP 59501B Power Supply Programmer (isolated DAC)

This single-channel digital-to-analog converter can control a wide range of power supplies (output voltage, or current), as well as other analog programmable devices. It may also be used as a low level signal source, depending on the speed of the controller. It has two output ranges (0-1 and 0-10 V dc in unipolar mode; -1 to +1 and -10 to +10 V dc in bipolar mode), as well as photo-isolators which electrically separate HP-IB control and data lines from power supply circuitry by up to 600 V dc. (For additional details see page 447).

HP Model	Description	Dimensions—max. height x width x depth mm (Inches)	Net Weight kg (lb)	Shipping Weight kg (lb)	Price
59306A	Relay Actuator	101.6 x 212.9 x 294.6 (4 x 8.38 x 11.6)	2.64 (5.87)	3.23 (7.18)	\$1500
59307A	VHF Switch	101.6 x 212.9 x 294.6 (4 x 8.38 x 11.6)	2.64 (5.87)	3.23 (7.18)	\$1300
59309A	HP-IB Digital Clock	101.6 x 105.9 x 294.6 (4 x 4.17 x 11.6)	1.70 (3.78)	2.84 (6.31)	\$2150
59401A	Bus System Analyzer	145.5 x 205.1 x 495.3 (5.73 x 8.08 x 19.5)	5.64 (12.44)	9.1 (20)	\$4080
59501B	Power Supply Programmer	101.6 x 212.9 x 294.6 (4 x 8.38 x 11.6)	2.61 (5.80)	3.17 (7.04)	\$ 775



# HEWLETT-PACKARD INTERFACE BUS

## Versatile Interconnect System for Instruments and Controllers

Models 37201A, 37204A/B

### HP 37204A

- High-speed HP-IB extension up to 1250 metres
- Adds flexibility to the design of CAT, data acquisition/control, or office systems
- Multi-point capability allows up to 30 remote sites
- Coaxial cable or optical fiber serial link
- Drops into a system without requiring software changes
- Error-free transmission and new chain-truncation feature ensure uninterrupted operation of computer



HP 37204A/B



### HP 37201A

- Long-distance HP-IB extension over telephone lines (leased or dial-up)
- Data acquisition systems can operate over unlimited distances
- Multi-drop capability
- Use with full-duplex synchronous/asynchronous modems from 300 to 19,200 bit/s
- RS-366 or CCITT V.25 autodial capability



HP 37201A

### HP 37204A Multi-point HP-IB Extender

Adding HP 37204As to an HP-IB system allows the 2-metre separation between HP-IB devices to be extended up to 1250 metres. The HP 37204A is "transparent" to HP-IB commands and data, therefore, software changes are not needed to turn a bench-top system into an extended system. Multi-point capability means remote sites can be daisy-chained together, using only one HP 37204A at each site. Chain truncation allows the computer site to continue operation, even in the event of remote power failure or link failure.

The HP 37204A has a maximum HP-IB transfer rate of 60 kbyte/s, however, the maximum achievable rate depends on many factors, such as speed and behaviour of each device connected to the HP-IB, number of remote sites, and distance. Increased absolute transmission delay affects parallel poll response time, and makes HP-IB extension inadvisable for some high-speed memory peripherals.

The following table shows some examples of maximum transfer rate. It should be noted that the serial transmission rate over coaxial cable must be reduced to 1/10th speed for distances greater than 250 metres.

Average Inter-extender Cable Length	Number of Extenders per Chain		
	2	3	5
100 metres - coaxial cable	54 kbyte/s	26 kbyte/s	14 kbyte/s
optical fiber	52 kbyte/s	25 kbyte/s	13 kbyte/s
500 metres - coaxial cable	5.9 kbyte/s	2.8 kbyte/s	1.4 kbyte/s
optical fiber	36 kbyte/s	17 kbyte/s	9 kbyte/s

HP 3000 systems are recommended to use the HP 37204B. It provides up to 250 metres extension over coaxial cable for HP 256x A/B, and HP 2680A printers.

### Ordering Information

- HP 37204A:** Equipped with dual coaxial ports. **Price** \$950  
**Option 001:** Fiber-optic interface - end. Adds a single fiber-optic port. **Price** \$460  
**Option 002:** Fiber-optic interface - middle. Adds dual fiber-optic ports. Required for the middle of a multi-point optical-fiber chain. **Price** \$860  
**Option 303:** Half-width rack mount adapter for mounting adjacent to instruments with an HP SYSTEM II cabinet. **Price** \$75  
**Option 305:** Standard 19-inch rack mount adapter. Holds one or two HP 37204As (includes pop-out blanking panel). **Price** \$75

### Cables

- HP 92179Q:** 75 ohm shielded coaxial cable (min order 100 metres). **Price** NPA  
**HP 92226A:** Male BNC connectors for above. Two required per cable. **Price** NPA  
**HP 99201B-6B:** Duplex fiber-optic cable. Ready fitted with HFBR-4000 series connectors. **Price** NPA  
 ☎ Fast ship-product - see page 758

### HP 37201A HP-IB Extender

The HP 37201A allows HP-IB devices to be interconnected over virtually unlimited distances. It is used in conjunction with modems where the HP 37204A does not have sufficient range (ie > 1250 metres).

The HP 37201A is "transparent" to most HP-IB commands, therefore in most cases, software modifications will not be needed to add HP 37201As into a system. Exceptions are that parallel poll and pass control functions are not supported. Software commands are required to use auto-dial, multi-drop, and idle facilities described below. Error correction ensures trouble-free performance, even over the worst phone lines. Multi-drop operation is possible using leased lines and modems with transmission (carrier) controlled by "request-to-send". Unlike the HP 37204A, remote sites must be accessed sequentially. The HP 37201A has an idle mode to allow faster operation at the computer site when remote communication is not required.

The data interface is compatible with RS-232-C/CCITT V.24 and V.28 standards. Full-duplex asynchronous or synchronous modems may be used. Asynchronous data rates provided are 150, 300, 600, 1200 bit/s. It should be noted that asynchronous modems must be capable of supporting 11-bit words (9 bits + start & stop bits). Although most asynchronous modems are insensitive to word length, some BELL 212 type modems only support up to 10-bit words, and so must be operated in synchronous mode. Synchronous modems can be operated at any bit rate up to 19.2 kbit/s.

The HP 37201A has an RS-366/CCITT V.25 parallel autodial interface. For many applications, the HP 37212A/B Modem can offer an alternative autodial solution. It requires a spare RS-232-C port on your computer, but obviates the need for a separate RS-366/CCITT V.25 autodialler. Manually-dialled connections are also supported.

The data byte transfer rate of the HP 37201A depends primarily on the serial data rate, data link length, and data link error rate. The following nominal transfer rates are for a short error-free link.

Synchronous modem interface: 744 data byte/s at 19.2 kbit/s, and pro-rata at lower serial rates.

Asynchronous modem interface: 38 data byte/s at 1200 bit/s, and pro-rata at lower serial rates.

### Ordering Information

### Price

- HP 37201A HP-IB Extender** **Price** \$2,600  
**Option 907:** Front handle kit **Price** \$57  
**Option 908:** Rack flange kit **Price** \$37  
**Option 909:** Front handle/rack flange kit **Price** \$81.50

# DATA ACQUISITION SYSTEMS

## General Information

- Reduce Manufacturing Costs
- Reduce Product Development Time
- On-Going Payback



- Improve Product Quality
- Higher Process Throughput
- More Process Up-Time

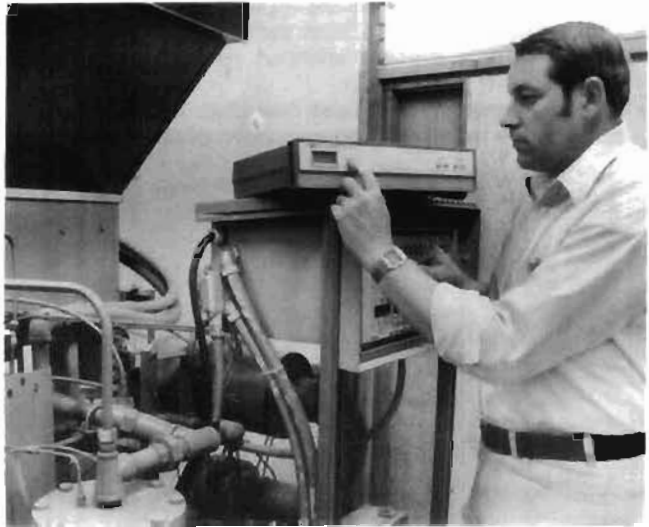

Data Acquisition is the generally accepted term for the procedure of characterizing a product or a process using electronic instruments. A "process" is defined as any procedure used to build a product or provide a service. A product or process is characterized by measuring it in minute detail so that all significant operating parameters are accurately known. Once characterized, improvements can be made that reduce costs and/or increase a product's performance/price ratio. A data acquisition system is a tool for increasing your bottom-line profitability.

Experience has shown that profit robbing inefficiencies are usually caused by many small errors rather than a few large ones. Today's modern electronic data acquisition systems can perform thousands of measurements per second, detect changes smaller than one part in one million and respond to those changes in less than 1/100th of a second. This high performance allows even large products and processes to be characterized in detail so that very high efficiencies can be attained.

The products and processes that can benefit from data acquisition are very broad. Producers of everything from automobiles to zucchini, research and development labs, utilities, educators, and the military services all have found that data acquisition is a cost effective technique.

The block diagram at the right shows how a typical data acquisition system is configured. A test program is stored in the computer. When executed, the program adjusts the product or process to a desired condition through the control functions in the data acquisition instrument. Then the computer directs the data acquisition instrument to take measurements. The measurements are analyzed and a report printed that describes the characteristics being tested. Based on the results, the product or process is modified to improve its performance. This cycle continues until optimization is achieved. Once the

critical control parameters and measurements are determined, the computer can be further programmed to automatically control the process or product at its optimum point.

Hewlett-Packard has been building electronic data acquisition systems for over 20 years. More than 150,000 systems have been installed worldwide. In addition to a broad

range of high quality computers and instruments, Hewlett-Packard has an ever-expanding offering of software and support services that provide a total data acquisition system solution. The following data acquisition system components from Hewlett-Packard can handle most applications in manufacturing, R&D, education, utilities and military/aerospace.

Product/Process Characterization Block Diagram

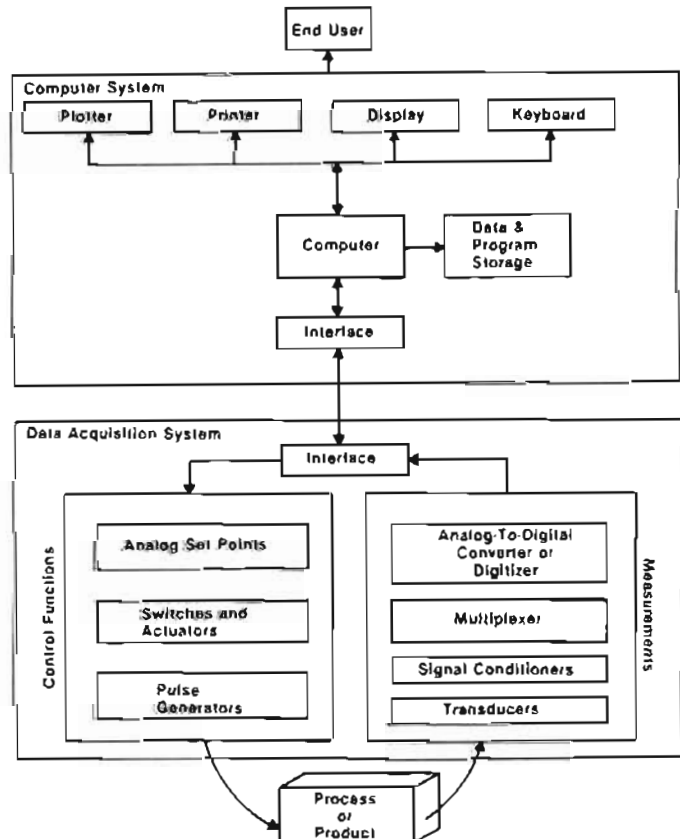



### HP Data Acquisition System Components

#### Instruments

HP 3421A Data Acquisition Unit

- Low Cost
- Portable

HP 3497A Data Acquisition/Control Unit

- Built-in DVM and RS-232
- Large Selection of Plug-in Accessories

HP 3852A Data Acquisition/Control Unit

- Powerful Built-in Operating System
- Broad Functionality with Complete Line of Plug-in Accessories

HP 48000 Remote Terminal Unit

- Designed for Industrial Environments
- Remotely Locatable

#### Computers

HP 71B Handheld Computer

- Portable
- HP BASIC in ROM

HP Vectra Personal Computer

- IBM PC/AT Compatible
- Independent HP BASIC Language Processor

HP 9000 Series 300 Technical Computer

- High Performance
- Modular

HP 1000 Real-Time Computer

- Real-Time Processing
- Multi-User Operating System

#### Software

Lotus Measure

- Loads Data Directly into Spreadsheet
  - Use with Personal Computer
- HP DACQ/PC Data Acquisition Manager
- Data Acquisition Software Tools
  - Use with HP Vectra PC

HP DACQ/300 Data Acquisition Manager

- Data Acquisition Software Tools
- Use with HP Series 300 Technical Computer

Value Added Suppliers

- Software Packages Available for All HP Computers
- Expanding Selection

### The Total Data Acquisition System Solution

Every data acquisition system requires a combination of computers, instruments, transducers and software. The extent to which these pieces are packaged together is dependent upon your individual needs. Whether its a completely integrated turnkey system, system components, **plug-in board** products or a customized in-house system, Hewlett-Packard can help. Turnkey solutions can be provided by HP's own Customer Support Group or through an expanding net-

work of independent Systems Integrators and Software Suppliers. Contact your local HP sales office for more information about these programs.

Information on data acquisition **plug-in board** products for Series 1000 and Series 9000 computers can be found on pages 654 and 627 respectively. Information on temperature transducers can be found on page 567. Data acquisition software products are de-

scribed on pages 592-595. Information on instruments and computers for custom-built systems can be found under the headings for those products. The remainder of this section contains detailed information on data acquisition component systems. These systems provide solutions for a very broad range of applications. Contact your local Hewlett-Packard sales office for more information on how these systems can work for you.

# DATA ACQUISITION SYSTEMS

## Instruments for Measurement and Control

### HP Model 3421A

- Up to 30 differential channels, 56 single-ended channels
- Electronic calibration for repeatable answers
- Built-in 5½ digit A/D converter with 1 µV sensitivity
- HP-IL (standard) and HP-IB (optional) with rear panel switch
- Optional 12 volt remote charging adapter
- "Sleep mode" for extended battery life in remote locations
- Front terminals for convenient DCV, ACV, 2 & 4-wire ohms, frequency and temperature
- Display shows channels closed, digital states and self-test conditions



### Description

If your measurement needs exceed the capabilities of plug-in cards but don't quite call for a top-of-the-line data acquisition unit, the HP 3421A is just what you are looking for. The HP 3421A is the instrument that beats the high cost of data logging. Use it for small data acquisition projects with the assurance that it will quickly pay its own way. The HP 3421A can be configured with several different computers into a variety of systems designed for low to medium sized applications.

#### The HP 3421A with the HP 71B Handheld computer

The HP 3421A and HP 71B, with an HP 82401A Interface Module and HP 82479A Data Acquisition Pac ROM, form a versatile and powerful data acquisition system that is also portable. The low cost of this system makes computerized data acquisition available to almost everyone.

#### The HP 3421A with the Vectra Personal Computer

The HP 3421A is an ideal instrument companion for the Vectra Personal Computer. The HP 3421A and Vectra PC offer lab-quality measurements with PC convenience at an affordable price. Two software packages are available to support this combination. Lotus Measure (see page 591) loads measurement data directly into a 1-2-3 or Symphony spreadsheet for quick analysis. DACQ/PC Data Acquisition Manager software (see page 592) provides powerful software tools for gathering, storing, analyzing, and presenting measurement data from more sophisticated data acquisition applications.

#### The HP 3421A with the Series 300 Technical Computer

For data acquisition applications that are computation intensive, the HP 3421A can be coupled with a Series 300 Technical Computer. DACQ/300 Data Acquisition Manager software (see page 592) offers the same powerful tool set as DACQ/PC with enhanced data transfer, system configuration routines, and color graphics.

### The Instrument

The HP 3421A scans up to 30 channels, measuring DCV, ACV, 2- and 4-wire Ohms, Frequency, and Temperature. It also reads and writes digital information and stores up to 30 analog readings. The standard HP 3421A comes with an HP-IL interface for battery-powered flexibility or optionally HP-IB for more computational power.

Up to three of the following assemblies may be added to the HP 3421A mainframe:

- 10-channel analog multiplexer/actuator assembly with thermocouple compensation.
- 8-bit input/8-bit output digital assembly.
- Breadboard assembly for custom circuitry.

### Measurement Integrity

With its 5½, 4½, 3½ digit A/D converter, the HP 3421A can resolve 1 µV out of 300 mV to monitor thermocouples and other low-level transducers. Or it can read higher level signals by auto-ranging up to 300 volts dc.

### System Versatility

Each HP 3421A can scan up to 30 differential channels or 56 single-ended channels of analog information. The HP 3421A is battery-powered with latching relays that will not change state when the ac line power is removed. Battery power gives the HP 3421A its own uninterruptible power supply.

All functions are remotely programmable via either HP-IL or HP-IB. Use HP-IL with the HP 71B handheld calculator as a self-contained battery-powered data logger, or use HP-IB with Vectra and Series 300 Computers for more programming performance.

The HP 3421A is not limited to portable applications. It is equally useful in laboratory situations, where its 0.01% accuracy, 1 microvolt sensitivity and 5½ digit resolution assure you of reliable answers.

Digital inputs, actuator outputs and a breadboard assembly give the laboratory designer a great deal of instrument flexibility while HP-IB compatibility adds the option of a more powerful instrument controller.

### System Specifications

These rates assume 30 readings taken on a fixed range with no function change. Speeds are independent of channel sequence. These rates reflect the time to read and store information in the 30-reading buffer of the HP 3421A. They do not include computer transfer time.

#### Approximate Maximum Reading Rates (readings/second)

	DCV II		ACV		Frequency	Type T Thermocouple
	Auto Zero On	Auto Zero Off	Auto Zero On	Auto Zero Off		
5½ Digit	2	3.8	—	—	0.1	0.95
4½ Digit	13	18	0.3	0.3	0.9	0.95
3½ Digit	21	24	0.4	0.4	7.0	0.95

### HP 3421A Mainframe Specifications

- The HP 3421A mainframe comes with:
- A 5½, 4½, and 3½ digit integrating A/D converter
  - Thermocouple compensation
  - Type T thermocouple linearization built in
  - HP-IL
  - 30-reading storage buffer
  - LCD 30 channel display with power and error indicators
  - Electronic calibration
  - Rechargeable battery
  - High level command set
- All specifications apply for relative humidity less than 85% at 30 degrees C.

**DC Voltage**

**Ranges:** 300 mV, 3 V, 30 V, 300 V, Autorange  
**Basic accuracy:**  $\pm(.009\%$  reading + 3 counts); 5 1/2 digits  
**Reading rates:** 2 to 35 readings/second

**Resistance**

**Ranges:** 300  $\Omega$ , 3 k $\Omega$ , 30 k $\Omega$ , 300 k $\Omega$ , 3 M $\Omega$ , 30 M $\Omega$ ; Autorange  
**Basic accuracy:**  $\pm(.012\%$  reading + 3 counts); 5 1/2 digits  
**Reading rates:** 2 to 35 readings/second

**AC Voltage**

**Ranges:** 3 V, 30 V, (300 V with HP 44469A divider)  
**Converter type:** averaging  
**Resolution:** 3 1/2 or 4 1/2 digits  
**Basic accuracy:** 4 1/2 digits:  $\pm(0.5\%$  reading + 60 counts), 45 Hz to 500 Hz;  $\pm(1\%$  reading + 60 counts), 30 Hz to 1 kHz; providing the input voltage is at least 10% of range.

**Counter**

The counter is part of the mainframe circuit, and is multiplexed through the channel relays.  
**Resolution:** 65,535 counts  
**Frequency:** 1 Hz to 10 kHz  
**Modes:** frequency, totalize

**Thermocouple Thermometer**

Type T thermocouple linearization is built in. For other thermocouple types, the reference junction temperature is available on each multiplexer assembly.

**Temperature Errors**

These errors include the linearization error of the HP DACQ/PC software, thermal offset voltages, A/D error and reference junction error. They do not include transducer errors.

J,E,T Thermocouples

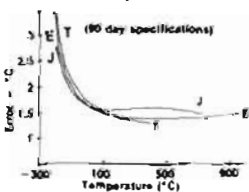

K,R,S Thermocouples

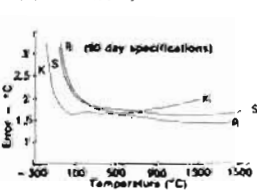

2.2 k $\Omega$  Thermistor

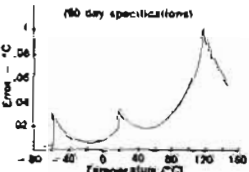

100  $\Omega$  Platinum RTD  $\alpha = 00365$

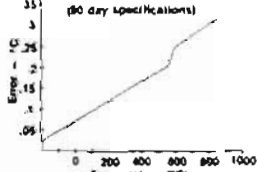

**Option 020, 021, 022 Multiplexer/Actuator Assemblies**

The configuration of multiplexer and actuators depends on the option you order. Option 020 has 8 multiplexer/2 actuator channels; Option 021 has 9 multiplexer/1 actuator channels; Option 022 has 10 multiplexer channels. The actuators are capable of switching 252 Vac. One HP 3421A mainframe can hold up to 3 assemblies.

**Option 040 Breadboard Assembly**

The breadboard assembly is convenient for constructing custom circuitry. It comes complete with a manual describing the circuit that enables the HP 3421A to communicate directly with an 8-bit microprocessor.

**Option 050 Digital I/O Assembly**

Option 050 has 8 isolated input lines and 8 isolated output lines for both monitoring and controlling external digital devices.

**Option 201 HP-IB**

The Option 201 adds an HP-IB interface to the HP 3421A. This allows the use of either HP-IB or HP-IL. HP-IB Interface function includes: SH1, AH1, T6, TE0, LE0, L4, SR1, RL0, PP0, DC1, DT1, C0. For more on these codes, see the HP-IB section of this catalog.

**Option 214 12 Volt Remote Charging Adapter**

This optional assembly provides the necessary isolation and regulation for a 12 volt automotive battery or system to charge the batteries of the HP 3421A, HP 71B Handheld Computer, and peripherals such as the HP 9114B Portable 3 1/2" Microfloppy and HP 2225B Thinkjet Personal Printer. Option 214 is mutually exclusive with Option 201 (HP-IB).

**Ordering Information**

Input and I/O Assembly Options	Price
<b>020:</b> 8 Channel Multiplexer/2 Channel Actuator Assembly	\$385
<b>021:</b> 9 Channel Multiplexer/1 Channel Actuator Assembly	\$385
<b>022:</b> 10 Channel Multiplexer Assembly	\$385
<b>040:</b> Breadboard Assembly with connector block	\$95
<b>050:</b> 8 bit in, 8 bit out Digital I/O Assembly with connector block	\$385
<b>201:</b> add HP-IB interface. Allows use of EITHER an HP-IB or HP-IL controller	\$280
<b>214:</b> add 12 volt remote charging adapter. Cannot be added if opt 201 is specified	\$410
<b>Rack Mount and Manual Options</b>	
<b>401:</b> Side Handle Kit	\$26
<b>907:</b> Front Handle Kit	\$51
<b>908:</b> Rack Mount Kit	\$31
<b>909:</b> Rack Mount with Handle	\$76
<b>910:</b> Extra Manuals	\$92
<b>Field Installation Kits*</b>	
<b>HP 44461A:</b> Add HP-IB interface. Allows use of either an HP-IB or HP-IL Controller (same as Opt 201)	\$310
<b>HP 44462A:</b> 8-Channel Multiplexer/2 Channel Actuator Assembly with thermocouple compensation, connector block. (Same as Opt 020. Can be reconfigured to same as Opt 021 or Opt. 022)	\$385
<b>HP 44463A:</b> extra connector block for HP 44462A (same as Opt 040)	\$36
<b>HP 44464A:</b> Breadboard Assembly with connector block (same as Opt 040)	\$95
<b>HP 44465A:</b> 8 bit in, 8 bit out digital I/O assembly with connector block (same as Opt 050)	\$385
<b>HP 44466A:</b> Extra connector block for digital or breadboard assembly	\$15
<b>HP 44469A:</b> Seven 10:1 dividers for measuring 300 Vac	\$15

**Accessories**

<b>HP 2225B:</b> Thinkjet Personal Printer (HP-IL)	\$495
<b>HP 9114B:</b> Portable 3 1/2" Microfloppy (HP-IL)	\$595
<b>HP 11340A:</b> 20-metre HP-IL Cable	\$100
<b>HP 11340B:</b> 50-metre HP-IL Cable	\$180
<b>HP 11340C:</b> 100-metre HP-IL Cable	\$360
<b>HP 82161A:</b> Digital Cassette Drive (HP-IL)	\$550
<b>HP 82162A:</b> Printer/Plotter (HP-IL)	\$450
<b>HP 82402A:</b> Dual HP-IL Adapter	\$99
<b>HP 82479A:</b> HP-71 Data Acquisition Pac ROM	\$195
<b>Related Products</b>	
<b>HP 71B Handheld Computer</b>	\$525
<b>HP 3488A Digital Multimeter</b>	\$750

**HP 3421A Data Acquisition/Control Unit \$1,660**

\* Field installation is recommended to be performed only by service trained personnel.  
 ☞ Fast-ship product — see page 758.

# DATA ACQUISITION SYSTEMS

## Instruments for Measurement and Control

### HP Model 48000 RTU

- For Industrial Monitoring and Control
- Stand-Alone or System Operation
- Radio/Modem/Wireline Datacom
- Rugged Design for Harsh Environments
- Menu Driven Configuration
- Multi-Tasking BASIC



HP 48000 RTU

#### Description

The HP 48000 RTU Measurement and Control Unit is a microprocessor based front-end, designed for distributed monitoring and control in a variety of industrial applications.

Prime applications include:

- Oil and Gas Production Systems
- Pipeline SCADA Systems
- Electrical Utility SCADA Systems
- Machine Monitoring and Control
- Process Monitoring and Control
- Facility or Energy Management
- Waste and Water Treatment Systems
- Status Alarm Systems

By choosing from the comprehensive line of modular hardware that makes up the HP 48000 product family, system designers can easily configure the HP 48000 RTU to address their front-end I/O requirements.

Local intelligence, rugged environmental specifications and the flexible data communications of the HP 48000 RTU simplifies system integration.

#### Built-in Intelligence and Easy Programming

Intelligent processing is easy to implement on the HP 48000 RTU, because HP provides the tools: over 60 built-in signal-processing functions, along with a built-in BASIC compiler. Both can be accessed through the Application Development Software, which runs on a variety of HP personal computers. (See "Application Development Software" below.)

#### User-Configurable Functions

To offload host-computer processing, the HP 48000 incorporates over 60 of the most commonly required signal-processing functions. These include PID loop control, AGA flow calculations, engineering unit conversion, and alarm checking. When the database of the HP 48000 is being configured, these functions can be chained to perform multiple processing of input and output signals.

#### BASIC Programming

The HP 48000 contains a built-in BASIC that can be used for more complex signal processing, and for custom control routines. The BASIC is incrementally compiled, providing fast program execution in a multi-tasking environment. Up to eight BASIC tasks may reside in a single HP 48000 RTU.

#### Application Development Software

Hewlett Packard's menu-driven Application Development Software for the HP 48000 lets system designers quickly configure the RTU database to their own specifications. This software runs on the HP Vectra, the HP 150 and the HP Portable Plus. To configure the database, the user simply selects the field on the display screen and keys in values relating to his specific application. (The database can also be configured from the HP 3081A Portable Operator Panel or a host computer.)

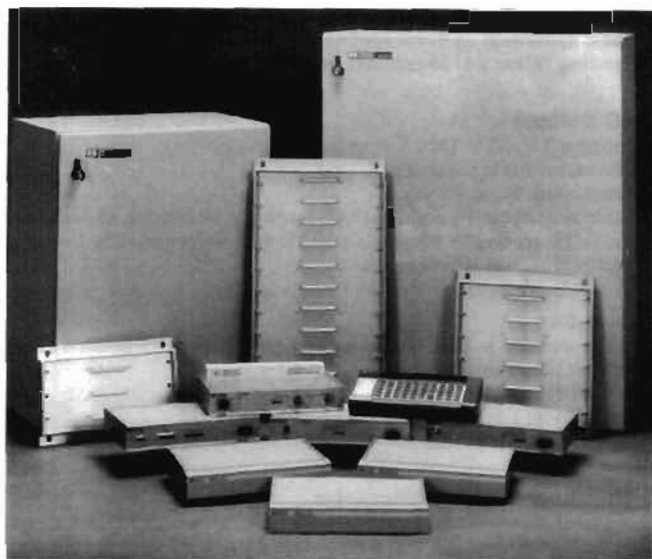

- The Application Development Software also allows designers to:
- Load configurations and programs in the 48000 RTU
  - Store configurations and programs on disc
  - Print configurations and programs

#### Rugged Design

The HP 48000 RTU is designed to withstand harsh environments. It is so rugged and reliable that a typical configuration has a Mean Time Between Failures of over five years!

Here are some features that make such performance possible.

- Use of CMOS technology contributes to the wide operating temperature specifications
- Aluminum module enclosures shield circuit boards from physical contact and ESD damage
- Transient voltage suppressors protect the electronics from electrical surges on the power line and field terminal wiring
- I/O modules are internally protected from field-wiring shorts
- Pin-and socket connectors provide reliable interconnection

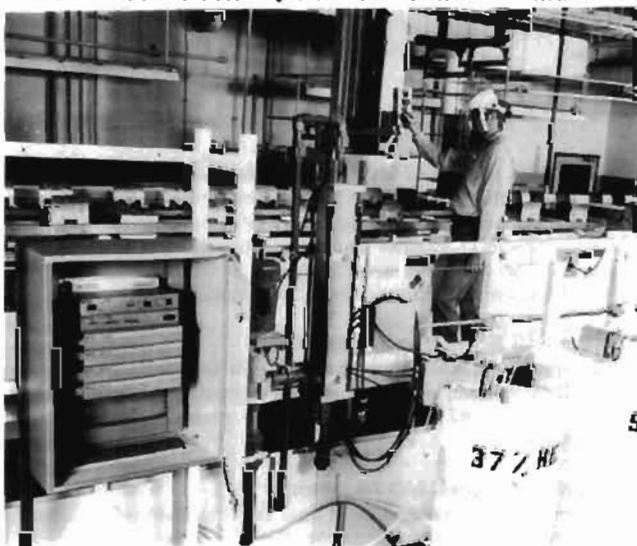

## Communications Flexibility

The diagram to the right shows some of the types of networks that can be configured with the HP 48000 RTU. Remote data acquisition and control systems are easily implemented using twisted-pair wireline, radio-communication links or telephone company facilities.

The host computer accesses data in a network of remote units in one of three modes:

- Standard poll/response
- Polled Report-By-Exception (PRBX)
- Spontaneous Report-By-Exception (SRBX)

This choice of communication modes, and the availability of both HEX ASCII and Radix-64 ASCII protocols, lets users maximize communication efficiency for their applications.

Other data communication features of the HP 48000 RTU products include:

- A Modem Module 202T or CCITT frequency
- A RS232 C port that supports smart auto-dial modems
- A FCC and DOC approved Radio Datacom Module
- A data link Repeater to extend wireline communications
- Communication Handler software for HP host computer interface
- Multi-drop networking capabilities of up to 90 RTUs over a maximum distance of 3.6 kilometers (2.25 miles)

## General Module Specifications

**Temperature Range:** -40°C to +65°C (operating); -65°C to +85°C (storage)

**Humidity Range:** 5 to 95% non-condensing

**RFI Susceptibility:** 1 volt/meter from 14 KHz to 1 GHz

**EMI Emissions:** Meets VDE 0871 level B

**Vibration:** Random vibration 0.30 Grms 5 to 500 Hz (functional). Random vibration 2.41 Grms 5 to 500 Hz (survival).

**Shock:** Half-sine shock pulse of < 3 ms duration with 175 cm/s velocity change (functional). Trapezoidal shock pulse of 30 G with 742 cm/s velocity change (survival).

**Transient Protection:** Meets IEEE 472/ANSI-C37.90a for ability to withstand surges at all communications and field wiring points. Meets IEEE 587 standards for ability to withstand power-line surges.

**Dimensions:** 330mm W x 215mm D x 55mm H (13" x 8.5" x 2.17")

**Electrical Classification:** General Non-Hazardous Area (CSA-, FM- & TUV approved).

## Ordering Information

Hardware	Price
HP 48001A 3-Slot Backplane	\$204
HP 48002A 6-Slot Backplane	\$255
HP 48003A 11-Slot Backplane	\$355
HP 48004A System Enclosure (3 or 6 slot)	\$510
HP 48005A System Enclosure (11 slot)	\$510
HP 48010A Master Controller Module	\$2600
HP 48020A Configurable I/O Module (16 chls)	\$1760
HP 48021A Analog Output Module (4 chls)	\$1630
HP 48022A Low Level Input Module with thermocouple compensation (16 chls)	\$3310
HP 48023A Isolated Digital Relay Output Module (8 chls)	\$1225
HP 48024A Digital Input Module (32 chls)	\$1250
HP 48025A Isolated Digital Input Module (16 chls)	\$1225
HP 48026A Isolated Digital Triac Output Module (8 chls)	\$1325
HP 48030A Power Supply Module	\$1350

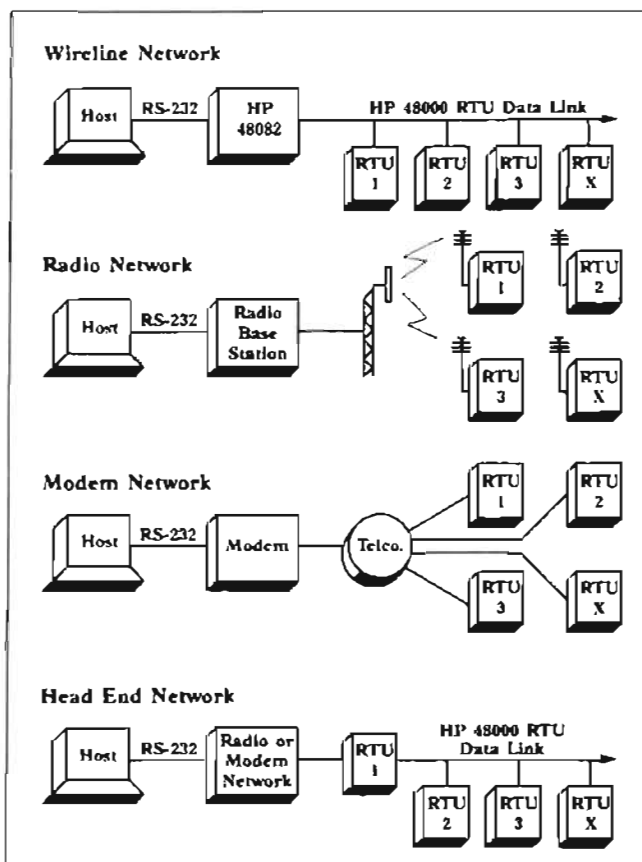

HP 48040A Radio Datacom Module	\$2345
Opt 001 150.8 to 174 MHz	N/C
Opt 002 450 to 475 MHz	N/C
Opt 003 928 to 960 MHz	\$970
Opt 004 406 to 430 MHz	N/C
Opt 100 Constant carrier operation	N/C
Opt 101 CCITT Modulation Frequencies	N/C
HP 48041A Modem Module	\$865
<b>Application Development Software</b>	
HP 40070A HP 150 based (3 1/2" SS disc)	\$255
HP 40071A HP Portable Plus based (3 1/2" SS disc)	\$255
HP 40072A HP Vectra based (5 1/4" DS disc)	\$255
<b>Communication Handlers</b>	
HP 48079A HP 1000/A Series (CS 80 tape)	\$127
HP 48075A HP 9000/Series 200 & 300 (3 1/2" SS disc)	\$76
HP 48076A HP Vectra (5 1/4" DS disc)	\$76
HP 48077A HP-UX on the HP 9000 Series 300 (CS 80 tape)	\$153
HP 48078A DEC VAX/VMS (TK 50)	\$153
<b>Accessories</b>	
HP 48032A Power Transformer	\$76
HP 48081A Repeater	\$740
HP 48082A Datacommunications Adapter	\$790
HP 48085A Complete Manual Set	\$610
HP 3081A/004 Workstation Terminal Plus Option	\$1022
48010-80020 Keyboard Overlay	\$61

# DATA ACQUISITION SYSTEMS

## Instruments for Measurement and Control

HP Model 3497A

- Relay multiplexing
- DVM
- FET multiplexer
- Real time clock
- Bridge completion

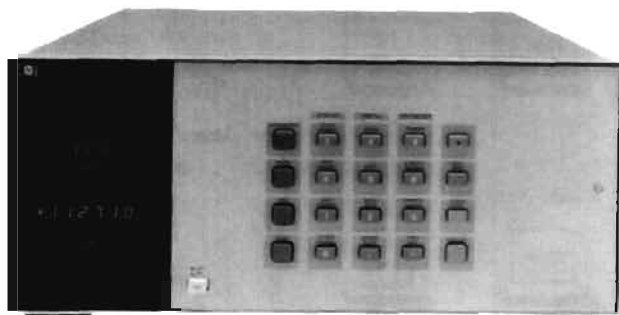

HP 3497A

### Description

The HP 3497A Data Acquisition/Control Unit combines the capabilities of several instruments and is a basic building block of an automatic data acquisition and control system. The HP 3497A will be used in an HP-IB automated system and can be viewed as a precision measurement and control computer peripheral.

The HP 3497A has been designed to be a very versatile and very powerful instrument. A basic HP 3497A consists of a mainframe that includes a front panel keyboard and display, a non-volatile real time clock, and an HP-IB interface. Available as an option is a 5½ digit integrating digital voltmeter and current source that occupies a dedicated slot in the HP 3497A chassis. Capability is added to the HP 3497A by using any combination of plug-in assemblies. Available plug-in assemblies are:

- Relay Multiplexers with or without thermocouple compensation
- FET Multiplexer
- Digital Input/Interrupt
- Counters
- Strain gage/bridge completion
- Actuators
- Programmable voltage and current D/As
- Breadboard Assembly

Up to 5 assemblies can be added to a HP 3497A and the HP 3498A Extender chassis can hold up to 10 more plug-in assemblies.

### High Performance

The HP 3497A DVM can resolve 1 microvolt signals and is ideal for the precise measurement of the outputs of thermocouples, strain gauges and other transducers. Included on the DVM is a programmable current source that allows four-terminal resistance measurements. The multiplexer assemblies switch 3 wires (Hi, Lo, and Guard) and add less than 2 microvolts of thermal offset to the measured signal.

### Flexible Hardware Configuration

The HP 3497A card cage can hold 5 of any combination of the plug-in assemblies. This allows the multiplexing of up to 100 3-wire inputs to the DVM in a single HP 3497A or a single HP 3497A might contain 60 multiplexer channels, 16 digital inputs, 16 actuator outputs, and a DVM. By using HP 3498A Extenders, up to 1000 analog channels or 1360 digital channels can be controlled, all at a single bus address.

### Ease of Use

The HP 3497A keyboard and display make the HP 3497A very easy to use and make debugging of a HP 3497A based system easy. The calibration adjustments for the HP 3497A DVM are located behind a hinged front panel; this allows complete calibration of the DVM without removing it from the test rack. Connections to all of the HP 3497A assemblies are made using screw terminals, eliminating the need for soldering.

### Real Time Clock

The HP 3497A mainframe includes a quartz-referenced, non-volatile, real-time clock. In addition to providing timing data, the clock can mea-

- Digital inputs/outputs
- Counter
- Programmable D/As
- Optional RS-232C interface

sure elapsed time, interrupt at a presettable time, and output a programmable pulse train.

### Clock Format

Month:Day:Hours:Minutes:Seconds (U.S. Format)

Day:Month:Hours:Minutes:Seconds (European Format)

### Option 001—5½ Digit DVM and Current Source

The HP 3497A DVM assembly is a systems quality, 5½ digit, 1 microvolt sensitive dc voltmeter. The DVM is fully guarded and uses an integrating A/D conversion technique; this yields excellent common and normal mode noise rejection.

Included on the DVM assembly is a three level programmable current source. The current source, when used simultaneously with the DVM, can be used to make high accuracy four terminal resistance measurements with 1 milliohm resolution. Maximum speed is 300 readings per second in 3½ digit mode.

**Buffer size:** packed format: 100 readings. ASCII format: 60 readings

Scanning Speeds	Number of Digits Selected	Series 200/300	1000A*
Sequential Channels using external increment	5½ digits	39	39 (25)
	4½ digits	103	108 (79)
	3½ digits	123	127 (99)
Random Channels using software	5½ digits	27	24 (20)
	4½ digits	51	41 (34)
	3½ digits	55	43 (36)

\*A600\* speeds in FORTRAN

### Option 010—20 Channel Relay Multiplexer

This assembly uses reed relays to multiplex signals to the DVM or other instruments. Each assembly switches 20 channels, each channel consists of Hi, Lo, and Guard lines. Two channels may be closed per assembly and relays may be closed in a random sequence or incremented between programmable limits. The low thermal offset of the relays make it suitable for measuring the outputs of strain gage and other transducers. Each channel can be configured with a filter or current shunt for additional flexibility.

### Option 020—Relay Multiplexer with Thermocouple Compensation

The option 020 assembly uses the same relay multiplexer as option 010 but incorporates a special isothermal connector block to allow thermocouple compensation. Two types of compensation (selectable by the user) are available. A temperature-dependent voltage is generated for software compensation; this voltage is then used in a computer program to compensate the thermocouple voltage. Hardware compensation involves inserting a voltage in the measurement circuit that automatically compensates the thermocouple voltage.

### Option 030—20 Channel FET Multiplexer Assembly

The option 030 assembly is used to multiplex input signals to a DVM in a manner similar to option 010. The option 030 assembly provides high speed, low level multiplexing. Maximum signal levels are 12 volts peak between any high, low or guard input and any other guard input, guard common or chassis ground.

**Maximum sequential scanning rate:** 4800 readings/s (at 60 Hz) using an HP 3437A Voltmeter and HP Series 200 computer (4000 readings/s at 50 Hz power).

### Option 050—16 Channel Isolated Digital Input/Interrupt

The option 050 assembly can sense up to 16 channels of digital data. The first 8 channels can also be used as interrupt lines to detect transient signals. The assembly can accept inputs of 5, 12 or 24 volts and all functions and masks are fully programmable. A five-volt supply is provided for driving external contact closures and open collector outputs.



**Option 060—100 kHz Reciprocal Counter**

This option can be used to measure mechanical and low frequency electronic signals. The counter can measure the period of signals up to 100 kHz and the pulse width of signals down to 18  $\mu$ s. The counter can also count up or down from a programmable start point. It can accept inputs of 5, 12, or 24 volts including CMOS, open collector TTL and passive contact closures.

**Option 070—120 Ohm Strain Gage/Bridge Completion Assembly**

**Option 071—350 Ohm Strain Gage/Bridge Completion Assembly**

The option 070/071 assemblies may be used to provide bridge completion for measuring strain gages, RTDs pressure sensors and load cells. Each card uses an internal shared half bridge and can complete 10 channels of  $\frac{1}{4}$  and  $\frac{1}{2}$  and full bridges in any combination. When used with a +5 V excitation supply (such as the HP 6214A) and the HP 3497A DVM, the assembly provides 0.1  $\mu$  sensitivity with 1  $\mu$  accuracy. Provisions are made for shunt calibration and checking gage leakage and lead resistance.

**Option 110—16 Channel Actuator**

**Option 115—8 Channel High Voltage Actuator**

Option 110 consists of 16 mercury wetted form C (single pole-double throw) relays. Each relay can be individually closed and can switch 1A at 100V. The actuator assembly can be used to switch test fixture power or to actuate alarm bells. This flexibility of this assembly allows it to be used as a digital output or matrix switch.

Option 115 is an 8 channel high voltage actuator assembly that can switch voltages up to 252 Vrms and currents up to 2 amperes. The Option 115 assembly is ideal for switching power line voltages to small motors, alarm bells and lights, motor starters and solenoids.

	Option 110	Option 115
Switch Form	C	A
Contact Type	Mercury Wetted	Dry
Number of channels	16	8
Maximum Voltage	100 V Peak	252 Vrms 48 Vdc
Maximum Current	1 A	2 Arms or dc
Maximum Power	100 VA	500 VA ac 60 VA dc

**Option 120—Dual Voltage D/A**

**Option 130—Dual Current D/A**

Option 120 consists of two 0 to  $\pm 10$  V programmable voltage sources. These sources can be used to provide a programmable test stimulus or to control voltage programmed devices like power supplies and VCOs.

Option 130 consists of two 0 to 20 mA or 4 to 20 mA programmable current sources. These sources, especially when using the 4 to 20 mA range, can be used as transmitters in industrial current loops and can drive up to 600 ohms of total loop resistance.

**Option 120**

- Output:** 13 bits including polarity
- Least significant bit:** 2.5 mV
- Output range:** -10.2375 V to +10.2375 V
- Maximum output current:** 15 mA (output within specifications)

**Option 130**

- Output:** 12 bits
- Least significant bit:** 5  $\mu$ A (0 to 20 mA range)  
4  $\mu$ A (4 to 20 mA range)
- Output range:** 0 to 20.475 mA or 4 to 20.380 mA (each source jumper selectable)
- Compliance voltage:** 12.0 volts

**Option 140 Breadboard Card**

Option 140 is a breadboard card compatible with the HP 3497A cardage. Using this card, HP 3497A users can construct special purpose assemblies that communicate with the HP 3497A backplane.

**Option 232—RS232C Interface**

Option 232 to the HP 3497A deletes the standard HP-IB interface and adds an RS232C (CCITT/V.24) compatible interface allowing you to remotely locate the HP 3497A. The option 232 interface is also compatible with the new RS423 (CCITT/V.10) version of the RS449 interface.

**Option 298—HP 3498A Extender**

The HP 3498A Extender chassis allows low cost expansion of HP 3497A-based systems. Each HP 3498A can hold up to ten HP 3497A

plug-in assemblies. Use of one or more HP 3498As requires an HP 3497A (for control); all required connecting cables are supplied with the HP 3498A. Up to 13 HP 3498As can be controlled by a single HP 3497A.

**Software**

**Lotus Measure (HP 4446B/7B):** Load measurement data directly into a 1-2-3 or Symphony spreadsheet for quick and easy analysis with a personal computer (see page 591).

**HP DACQ/PC Data Acquisition Manager (HP 44459A/B/R):** Powerful software tools for gathering, storing, analyzing, and presenting measurement data with a Vectra Personal Computer (see page 592).

**HP DACQ/300 Data Acquisition Manager (HP 44468A/B/R):** Sophisticated software tools that provide all of the power of HP DACQ/PC plus enhanced data transfer, system configuration routines, and color graphics on Series 300 Technical Computers (see page 592).

**General**

**Size (HP 3497A or HP 3498A):** 190.5 mm H x 428.6 mm W x 520.7 mm D (7 $\frac{1}{2}$ " x 16 $\frac{1}{8}$ " x 20 $\frac{1}{2}$ ").

**Net weight:** HP 3497A, 20.4 kg (45 lb) and 3498A, 20.4 kg (45 lb) with assemblies in all slots.

**Shipping weight:** HP 3497A and HP 3498A maximum with assemblies in all slots are 26.3 kg (58 lb.)

**Operating temperature:** 0°C to 55°C

**Non-operating temperature:** -40°C to 75°C

**Humidity:** to 95% at 40°C except as noted

**Operating power:** switch selection of 110, 120, 220 and 240 volts  $\pm 10\%$ , 48-66 Hz, 150 VA 3497A and 3498A.

**Ordering information**

**Price**

Each HP 3497A can hold one DVM assembly (Opt 001) and up to 5 plug-in assemblies. Each HP 3498A (Opt 298) can hold 10 additional plug-ins. To order plug-ins without a mainframe, order as 444XXX Field Installation Kits as shown below.

Clock format and power line frequency and voltage will be set at the factory based on the country from which the order was placed.

<b>Opt 001 or 44420A:</b> 5 $\frac{1}{2}$ Digit DVM and Current Source	\$1,680
<b>Opt 010 or 44421A:</b> 20 Channel Relay Multiplexer Assembly	\$665
<b>Opt x20 or 44422x:</b> Relay Multiplexer Assembly Substitute A in place of x for software compensation. For hardware compensation, substitute the thermocouple type B, E, J, K, R, S, or T for x.	\$765
<b>Opt 030 or 44423A:</b> 20 channel FET Multiplexer Assembly	\$765
<b>Opt 050 or 44425A:</b> 16 channel Isolated Digital Input/Interrupt Assembly	\$560
<b>Opt 060 or 44426A:</b> 100 kHz Reciprocal Counter	\$615
<b>Opt 070 or 44427A:</b> 120 Ohm Strain Gage/Bridge Completion Assembly	\$920
<b>Opt 071 or 44427B:</b> 350 Ohm Strain Gage/Bridge Completion Assembly	\$920
<b>Opt 110 or 44428A:</b> 16 Channel Actuator/Digital Output Assembly	\$765
<b>Opt 115 or 44431A:</b> 8 Channel High Voltage Actuator Assembly	\$560
<b>Opt 120 or 44428A:</b> Dual Output Voltage DAC Assembly	\$1,020
<b>Opt 130 or 44430A:</b> Dual Output Current DAC Assembly	\$1,020
<b>Opt 140 or 44432A:</b> Breadboard Card	\$155
<b>Opt 232:</b> Delete HP-IB Interface, add RS232C Interface	\$255
<b>Opt 280:</b> Delete Keyboard and Display	less \$367
<b>Opt 298:</b> Add HP 3498A Extender & connecting cables	\$2,140

**HP 3497A Data Acquisition/Control Unit \$3,060**

# DATA ACQUISITION SYSTEMS

Instruments for Measurement and Control

HP Model 3852A

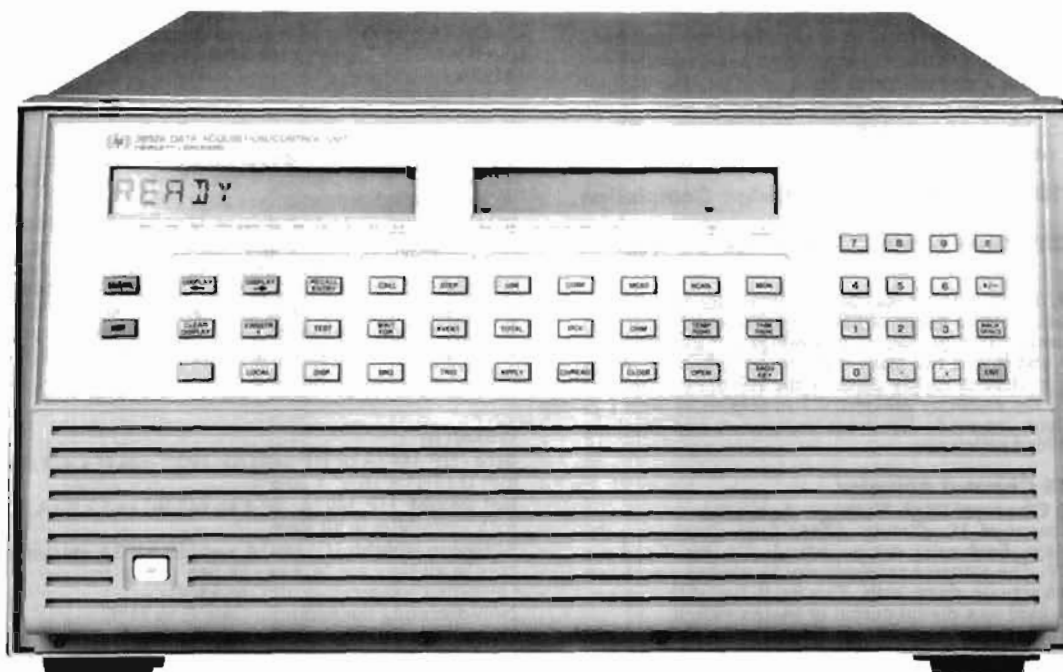

HP Model 3852A



## Configure the Capabilities You Need

You can easily configure an HP 3852S Data Acquisition and Control System to meet your needs for measuring physical parameters through transducers, and for providing control outputs. The HP 3852A Data Acquisition/Control Unit (mainframe) has eight slots for plug-in function modules. If more slots are needed, up to seven extenders can be added, each with ten additional slots. You can choose any combination of capabilities that include precision and high-speed plug-in voltmeters and a variety of analog and digital input/output functions.

A system clock and programmable pacer are built-in to drive your system. The clock — non-volatile for four years; 1 msec resolution — allows data to be time-stamped and events to be timed. The pacer — 0.25  $\mu$ sec resolution — provides powerful capabilities to initiate and pace measurements, scans, or events.

## Include High-Speed and Accurate Analog Measurements in One System

Choose from two digital voltmeters to meet your measurement needs. For applications that require sensitive, accurate measurements in the presence of noise (for example, thermocouples), use the 5 $\frac{1}{2}$ -Digit Integrating Voltmeter and Relay Multiplexers. If you need speed, the 13-Bit High-Speed Voltmeter and High-Speed FET Multiplexers are the answer, providing single-channel bursts, channel-to-channel, random channel, full auto-ranging, and direct DMA transfers to a hard disc at an honest 100,000 readings/sec. The system voltmeters can be used in the mainframe or any extender, and multiple voltmeters are allowed per card-cage.

## Add Versatility and Expandability to Your System

With the HP 3852S Data Acquisition and Control System, you'll have available a complete set of input and output plug-in modules for interfacing to measurements and for controlling and sequencing your tests. Modules are available to handle physical measurements of temperature, flow, pressure, level, and strain.

## Take Advantage of Extensive Front-End Intelligence

The HP 3852A mainframe has considerable built-in intelligence to increase the speed of collecting measurement and control data. Control decisions can be handled faster using subroutines running within the mainframe. This intelligence can be used to *return only significant data* to the computer, increasing its efficiency.

- Up to 5,500 readings can be stored in the standard HP 3852A mainframe. Expand this memory (used for storage of user routines as well as readings) to 256 kbytes, 1 Mbytes, 2 Mbytes, or 4 Mbytes with an Extended Memory board. Extended memory fits inside the mainframe controller module without using an I/O slot.

The power of this front-end intelligence in combination with an HP Series 300 Computer and the optional data acquisition software adapts easily to testing your complex product or characterizing your process. Of course, the mainframe can be also used with HP 1000 computers, HP Vectra PC, other IEEE-488 controllers and instruments, and a variety of computer peripherals.

## Reduce Your Test Development Investment

Optional data acquisition software for an HP Series 300/200 computer or HP Vectra PC gets your application running quickly and easily by providing off-the-shelf solutions for:

- Data base management — store large amounts of data in files that are easy to identify and access later.
  - Graphics presentations — display or plot color graphs, display a real-time strip chart, plot data with linear, log, semilog, or automatic axis scaling.
  - Data analysis — This software provides high-level subroutines as tools to be used in a test system program running with HP BASIC. Ease-of-use is exemplified by:
    - automatic creation of a data base for storing data using only one subroutine.
    - fast access to a single data item or a block of data items using only one subroutine.
    - manipulation and formatting of gathered data any way you wish.
- Program development time is leveraged using this software, while allowing a powerful, highly customized system to be developed. Furthermore, the software can be used with any HP-IB instrument.

### Data Acquisition and Control Unit —

#### HP 3852A

##### Mainframe Supports:

- Eight Function Module Slots
- Data Acquisition Operating System
- System Timer
- Measurement Pacer
- Full Alphanumeric Keyboard, Command and Result Displays

##### Benefits

- **Make real-time decisions and reduce data without burdening your computer:**
  - Multitasking operating system prioritizes and timeslices tasks
  - Powerful HP 3852A command statements simplify complex measurements.
  - Execution speed of command sequences are enhanced by executing subroutines stored in the HP 3852A memory.
  - Built-in, easy-to-use transducer conversions are supported for thermocouples, thermistors, RTDs, and strain gages.
  - Post-processing and data reduction before transferring results to a computer are achievable by first storing data to the HP 3852A internal memory.
  - Limit checking of analog measurements is performed in real time or after the measurements have been stored in mainframe memory.
- **Optimize measurement timing and throughput to meet your needs:**
  - Real-time interrupts allow higher priority tasks and external inputs to be serviced at any time
  - Asynchronous communication with a computer is achieved through input and output buffering.
  - Control can be timed using built-in clock and alarm capabilities (can cause an interrupt).
  - A built-in pacer simplifies measurement timing and triggering.
  - Multiple voltmeters can be used. The high-speed voltmeter can control scanning, timing, and triggering of its own high-speed FET multiplexer subsystem via ribbon cable. Several of these subsystems can run simultaneously.

### Data Acquisition Operating System

#### Multi-tasking

Several subroutines called "run tasks" can be assigned equal priority and the operating system will timeslice them such that it appears they are running simultaneously. "Queued tasks" can be defined to run after certain conditions are met. Priority assignment allows complete control over front panel, HP-IB, interrupt, and run task execution.

#### Real-time Interrupts

Interrupts from the front panel, HP-IB, plug-in accessories, or higher priority tasks are serviced immediately after the current command is done executing.

#### Commands:

Powerful data acquisition commands are easy to remember and use. For example, "MEAS TEMPK <channel list>" performs K-type thermocouple measurements, cold-junction compensation, linearization, and channel scanning—ALL AUTOMATICALLY. In addition, <channel list> may be a short list of channels—or possibly the name of an array containing a much longer list.

#### Down-Loaded Subroutines:

FOR...NEXT, IF...THEN...ELSE, WHILE...ENDWHILE Enhanced BASIC language constructs are available.

User subroutines with variables can be called for execution by a computer, other subroutines, or conditional interrupts.

#### Transducer Conversions:

Transducer conversions have been optimized to support high system accuracy and speed for these transducers:

- Thermocouples
- Thermistors
- Platinum RTDs
- Strain Gages

#### Special Conversions:

A special function permits user-defined tables of X,Y pairs to be used for linear interpolation (at a small price in memory usage, this function will typically execute much faster than high-order polynomial calculations).

#### Limit Testing:

Perform limit testing in real-time (data is tested as it is measured) or as a post-process (data previously stored in arrays is tested). Limit test failures can cause an interrupt if enabled.

#### Interrupts:

Time alarms, events that have just occurred, or limit tests of measurements can cause an HP-IB Service Request or a call to a stored subroutine.

#### Math Operations:

+, -, \*, /, <, >, ATN, BINAND, BINCMP, BINEOR, BINIOR, BIT, COS, EXP, LOG, SIN, SQR

#### Scaling:

Offset and scale factors (mx + b) can be performed on an entire array using just one command.

#### Statistics:

An easy-to-use function finds MIN, MAX, MEAN, and SIGMA (standard deviation) of the values stored in arrays.

### Extender Chassis — HP 3853A

#### Extender Supports:

- Ten Function Module Slots

#### Benefit

- **Expand your system with no loss of functional capability:**
  - Up to seven extenders may be used with each HP 3852A mainframe.
  - Any slot can be used for any function module and multiple voltmeters can be used with parallel triggering.
  - All mainframe functions, including interrupts and triggering, are available through the extender control cable.

### PRIORITY SCALE



#### RUN TASKS

- Maximum of 8 run tasks
- All tasks at the same priority will timeslice

#### QUEUED TASKS

- Maximum of 20 subroutines queued to execute in the run tasks

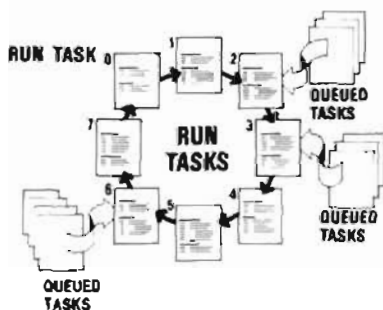

#### INTERRUPT TASKS

- System alarm
- Limits
- Digital transition
- Counter overflow



#### HP-IB TASKS

- Commands from a computer over HP-IB



#### FRONT PANEL TASKS

- Commands entered from instrument front panel

# DATA ACQUISITION SYSTEMS

## Instruments for Measurement and Control (cont'd)

HP Model 3852A

### 5½ to 3½ Digit Integrating Voltmeter -

#### HP 44701A

Directly Measures:

- DC Voltage
- Resistance
- AC Voltage

#### Benefits

- Accurately measure small signal changes in noisy environments:
  - Integrating A/D rejects normal mode noise at multiples of the power line frequency.
  - Guarded input maximizes common-mode rejection.
- Choose the resolution, accuracy, and noise rejection needed, while maximizing measurement speed:
  - Integration selection (number of power line cycles) is key to optimizing these performance parameters.
  - This voltmeter provides the fastest DC reading rates available with power line-related noise rejection.
- Optimize resistance measurements to the accuracy you need:
  - Use two-wire ohms for measurements where lead resistance is not critical.
  - Use four-wire ohms where inaccuracies due to measurement leads cannot be tolerated (*most accurate measurement technique for RTDs*).
  - Use offset-compensated ohms to correctly measure resistance in the presence of series voltages (often caused by thermocouple effects).

#### DC Voltage

##### Accuracy:

± (% of reading + volts), rear terminal input, one-hour warm-up, specified over time since last calibration, and operating temperature.

90 Days, 18 to 28°C, Auto-zero On

Integration Time in Number of Power Line Cycles (NPLC)

	1	0.1	0.005	0.0005
<b>Range:</b>				
30 mV	0.02% + 6 μV	0.02% + 8 μV	0.02% + 20 μV	0.02% + 60 μV
300 mV	0.008% + 6 μV	0.008% + 10 μV	0.008% + 40 μV	0.008% + 400 μV
3 V	0.008% + 8 μV	0.008% + 40 μV	0.008% + 400 μV	0.008% + 4 mV
30 V	0.008% + 300 μV	0.008% + 700 μV	0.008% + 4 mV	0.008% + 40 mV
300 V	0.008% + 700 μV	0.008% + 4 mV	0.008% + 40 mV	0.008% + 400 mV

#### Reading Rate/Noise Rejection:

Integration Time in Number of Power Line Cycles (NPLC)

	1	0.1	0.005	0.0005
<b>Integration Time</b> 60 Hz (50 Hz)	<b>18.7</b> (20.0) msec	<b>1.67 (2.0)</b> msec	<b>100</b> (100) μsec	<b>10</b> (10) μsec
Number of Converted Digits	6½	5½	4½	3½
Reading Rate (readings/sec) with auto-zero, auto-range off 60 Hz (50 Hz)	57 (48)	415 (360)	1350 (1350)	1600 (1600)
Min Noise Rejection (dB) Normal Mode Rejection at 50 or 60 Hz ± 0.09%	60	0	0	0
DC Common Mode Rejection with 1 kΩ in low lead	120	120	120	120
Effective Common Mode Rejection, at 50 or 60 Hz ± 0.09% with 1 kΩ in low lead	150	90	90	90



### 13-Bit High-Speed Voltmeter —

#### HP 44702A/B

Directly Measures:

- DC Voltage
- DC Resistance

#### Benefits

- Collect data quickly:

— A measurement rate of 100,000 readings/sec with auto-ranging is achieved by directly controlling up to six (eight in an extender) High-Speed FET Multiplexers through a dedicated ribbon cable.

— Multiple High-Speed Voltmeters can be triggered simultaneously.

- Maximize your measurement throughput:

— On-board buffer is included for over 8,000 readings (HP 44702A) or over 64,000 readings (HP 44702B) that can be transferred to mainframe internal memory or to hard disc via GPIO and a DMA controller while taking measurements.

— Dedicated triggering is achieved with on-board pacers.

— Balanced input, equal impedance between high-to-chassis and low-to-chassis, gives good common mode noise rejection

#### DC Voltage

##### Accuracy:

± (% of reading + volts), rear terminal input, one-hour warm-up, specified over time since last calibration, and operating temperature, with auto-zeroing performed within one minute of measurement.

90 Days, 18 to 28°C

		Accuracy
<b>Range:</b>	40 mV	0.05% + 68 μV
	320 mV	0.05% + 234 μV
	2.56 V	0.05% + 1.88 mV
	10.24 V	0.05% + 7.5 mV

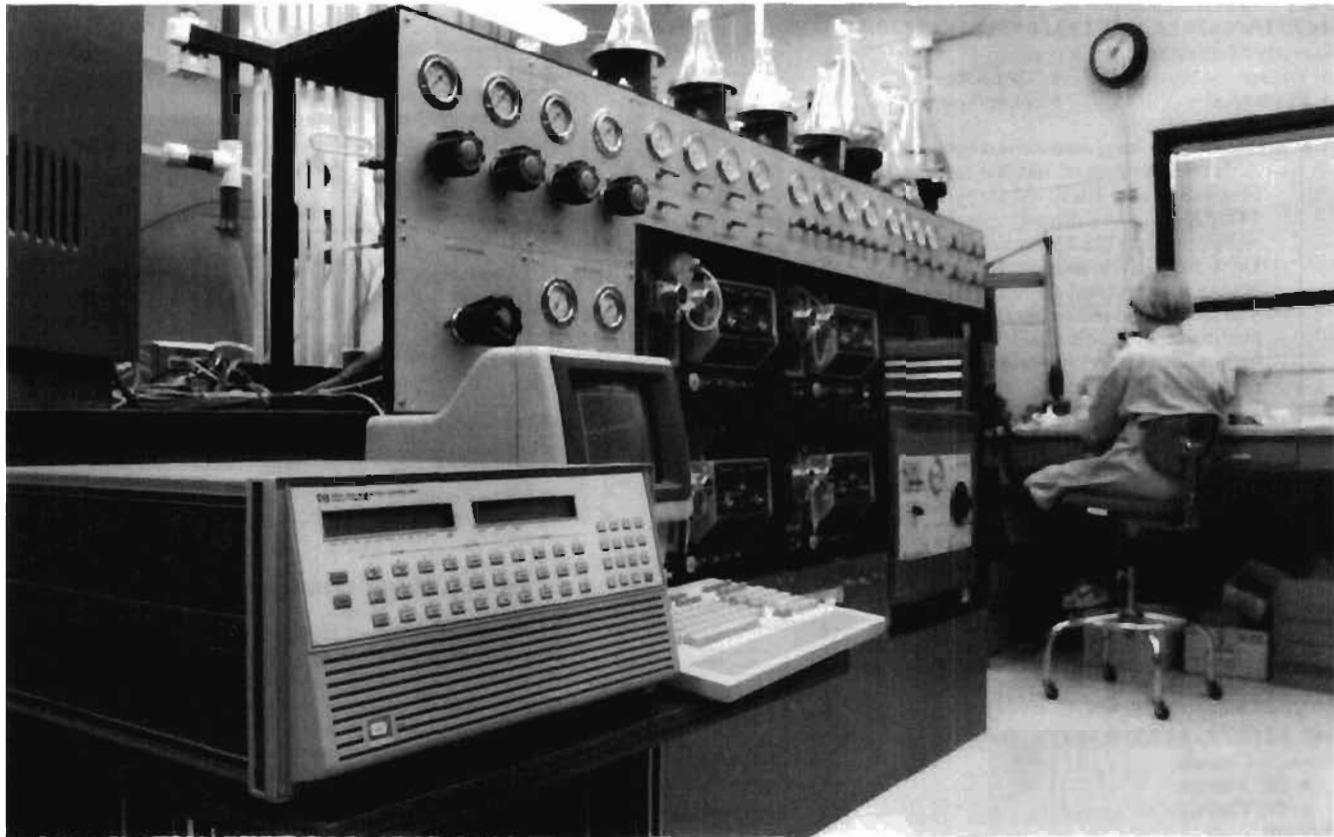

**Reading Rates:**

100,000 readings/sec with auto-ranging. Proper auto-ranging is ensured as long as a single-channel signal changes no more than 600 volts/sec during auto-ranging.

**Noise Rejection:**

Min effective common mode rejection specified in dB for DC to 60 Hz with 1 kΩ in low lead: maximum signal (high to low) + common mode voltage (low to chassis) for proper operation is ±10.24 volts.

**ECMR**

<b>Range:</b>		
	40 mV	90
	320 mV	80
	2.56 V	70
	10.24 V	70

**Relay Multiplexers — HP 44705A/44705H/44708A/44708A/44708H/44717A/44718A**

**Directly Multiplexes:**

- Voltage
- Resistance
- Thermocouples
- Strain Gages

**Benefits**

- Reduce the effects of real-world measurement errors in a multi-channel system:
  - Relay multiplexers minimize errors due to thermal DC offsets, crosstalk, and injected (bias) currents.
  - The relay multiplexers have high, low, and guard terminals to maximize common mode noise rejection.
  - A single-ended multiplexer (HP 44706A) lowers your cost per channel.
  - With shunt and series jumpers in each channel of the HP 44705A/H and 44708A/H multiplexers, you can easily install a one-pole low-pass filter for additional noise rejection, a voltage divider to extend relay lifetime, or a shunt resistor to measure current.

- Differential or common mode voltages up to 350 V peak or 250 Vdc can be handled by the HP 44705H and 44708H modules.
- Scanning is break-before-make to prevent inadvertent connections of circuits being measured.
- Each lead to the back-plane and common terminals has a 100Ω resistor in series to prolong the lifetime of the relay contacts. Due to placement, these resistors contribute no error when measuring 2-wire ohms resistance using the HP 44701A Integrating Voltmeter. The resistor can be shorted, but this can seriously shorten relay contact life if relatively high voltages or currents are switched.
- True switch relays automatically isolate each bank of relays from the back-plane to reduce crosstalk and improve settling time.
- Optimize thermocouple measurement accuracy:
  - Thermocouple types can be mixed on the HP 44708A/H multiplexer to optimize accuracy over the temperature ranges needed.
  - Thermocouple compensation is handled automatically with no extra wiring.
- Measure strain accurately:
  - Strain sensitivity can be optimized using finger-moveable jumpers to select between 1/4-, 1/2-, and full-bridge configurations. The HP 44717A and 44718A multiplexers each support 10 bridges for 120Ω and 350Ω strain gages.
  - No manual adjustments are required to balance the bridge.
  - Strain accuracy is independent of long-term bridge excitation voltage changes because the excitation voltage is automatically measured and included in the strain calculations.
  - The excitation voltage is always applied, never switched, reducing errors due to dynamic heating and cooling of the gages.
  - Connection to an available Wagner ground reduces errors due to gage leakage current.

# DATA ACQUISITION SYSTEMS

## Instruments for Measurement And Control (cont'd)

### HP Model 3852A

#### FET Multiplexers — HP 44709A/44710A/44711A/44712A/44713A/44719A/44720A

Directly Multiplexes:

- Voltage
- Resistance
- Thermocouples
- Strain Gages

#### Benefits

- **Maximize your measurement throughput:**
  - A throughput rate of 100,000 readings/sec is realized using High-Speed FET Multiplexers (HP 44711A/44712A/44713A) directly controlled through a dedicated ribbon cable by the 13-Bit High-Speed Voltmeter.
  - Up to six (eight in an extender) High-Speed FET Multiplexers can be controlled through this ribbon cable.
  - The 24-channel multiplexers switch high and low only. Each floating input is balanced (that is, equal impedance between high-to-chassis and low-to-chassis) to provide good common mode noise rejection.
  - For lower costs per channel, single-ended multiplexing of 48 channels (HP 44712A) is also available (has no common mode noise rejection, however).
- **Increase system reliability:**
  - FETs have no mechanical limitations (no wear out due to switching).
  - Similar to their relay counterparts, the HP 44709A/44710A/44719A/44720A FET multiplexers have high, low, and guard connections for better common mode rejection than the high-speed FET multiplexers.

#### Digital to Analog Converters —

##### HP 44727A/44727B/44727C

Directly Outputs:

- DC Voltage
- DC Current

#### Benefit

- **Simplify your test system by providing test or control of devices with one data acquisition control system:**
  - Four channels are provided on each module.
  - Each channel can be configured using finger-movable jumpers to output either unipolar or bipolar voltage, or unipolar current. Reconfiguration may require recalibration of the changed channel. Recalibration consists of adjustments to zero offset and gain potentiometers, and can be performed with the HP 44701A Integrating Voltmeter or equivalent. Three configurations (4-Channel Voltage—HP 44727A; 4-Channel Current—HP 44727B; 2-Channel Voltage, 2-Channel Current—HP 44727C) are available to make reconfiguration unnecessary in most cases.
  - Channels are isolated and can be connected in parallel for current or in series for voltage to expand the usable ranges.
  - Each channel configured for voltage has remote sense capabilities to ensure accurate voltages at the device.

#### DC Voltage

Ranges: 0 to +10.235 V or -10.235 to +10.235 V

Resolution: 2.5 mV (12 bits plus a sign bit for bipolar range)

#### DC Current

Ranges: 0 to +20.16 mA or +4 to +20.16 mA

Resolution: 2.5  $\mu$ A (13 bits)

#### 3-Channel Stepper Motor Controller - HP 44714A

Directly Provides:

- Stepper Motor Control Signals
- Limit Inputs
- Built-in Quadrature Counters
- Pulse Output

#### Benefit

- **Completely control three stepper motors with one module:**
  - Output a continuous stream or a fixed number of pulses.
  - Program separate acceleration and deceleration rates for trapezoidal motion profiles.

- Halt output pulses when limits are reached or from the emergency stop input.
- Built-in quadrature counter on each channel gives position feedback.
- **Use the module as a pulse generator.**
  - Output a set number of pulses or a continuous stream.
  - Set, accelerate, and decelerate both pulse width and pulse rate.

#### Trapezoidal Motion Profile

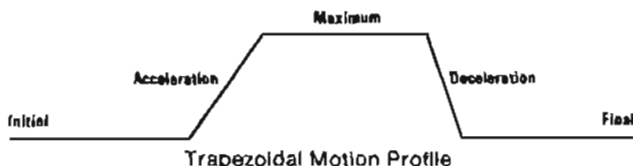

#### 5-Channel Counter/Totalizer — HP 44715A

Directly Provides:

- Count Measurements
- Period Measurements
- Frequency Measurements
- Interrupts

#### Benefit

- **Reduce your costs by taking advantage of frequency counting versatility:**
  - The counter/totalizer accurately measures logic or RMS inputs with frequencies up to 200 kHz.
  - By multiplexing between five isolated channels and five non-isolated channels, a total of ten connected channels is possible (only five can operate simultaneously).
  - Each DC logic channel independently counts on either positive or negative signal transitions. Non-isolated, low-level RMS inputs are measured using a zero-crossing detector.
  - Any channel that is totalizing can be programmed to set an interrupt for a counter roll-over to zero.
  - For isolated DC inputs, nominal voltages are separately selected for each channel by finger-movable jumpers. For non-isolated inputs, either TTL or low-level RMS inputs are also separately selected for each channel by finger-movable jumpers.
  - Debounce times (common to all channels) can be programmed to prevent false counts.
  - With shunt and series jumpers in each channel, you can easily install a one-pole low-pass filter for rejection of unwanted signals.

#### Digital Inputs with Totalize and Interrupt -

##### HP 44721A/44722A

Directly Provides:

- Logic Readings
- Totalize Count Measurements
- Interrupts

#### Benefit

- **Conveniently read a variety of digital values in your system:**
  - Isolated inputs detect the presence of DC (HP 44721A 16-channel digital input) or AC (HP 44722A 8-channel digital input) inputs based on nominal voltages selected by finger-movable jumpers.
  - Each channel can independently totalize positive or negative (whichever is selected) logic transitions.
  - Voltage selection and function can be set independently on each channel.
  - Any channel can be programmed to set an interrupt for an edge occurrence (positive or negative) or a counter roll-over to zero.
  - Debounce circuitry that is common to all channels prevents erroneous readings on inputs that are still changing after a logic level transition.
  - For detecting whether switches are opened or closed, the HP 44721A has a non-isolated five volt supply at the terminal module with 9.4 k $\Omega$   $\pm$ 10% pull-up resistors on each input.

**32-Channel High-Speed Digital Sense/Control**

**-HP 44723A**

Directly Provides:

- High-speed Digital Input and Output
- Triggered Input and Output
- Interrupts
- Output Handshaking

**Benefit**

- Input 16 channels or output 16 channels over 150,000 times per second.
- Capture and load 16-bit patterns with external triggers.
- Interrupt on any input channel on any transition or on a user-specified 16-bit pattern.

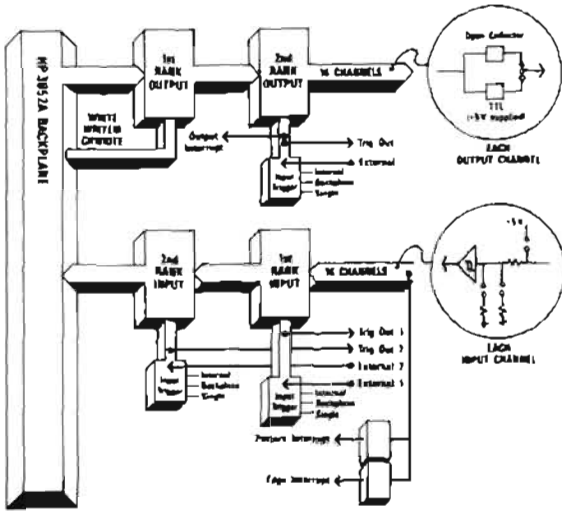

High-Speed Digital Sense/Control

**16-Channel Digital Output — HP 44724A**

Directly Provides:

- Open Drain Digital Outputs

**Benefit**

- Conveniently control DC devices or logic levels:
  - Open drain outputs are used to control DC devices with up to 55 V, or drive TTL logic levels. An external power supply and external pull-up resistors are required.

**Characteristics**

**Max Input Voltage:**

Between High and Low Terminal of Each Channel — 55 V DC  
 Between Channels or Between Any Terminal and Chassis — 354 V DC peak or 250 V DC

**Max Sink Current:** 500 mA DC per channel (1 A fuse protection)

**Max Reverse Polarity Current:** 500 mA DC per channel

**TTL Compatibility:** 200 mA per channel with  $V_{out} \leq 0.4$  volts

**Switching — HP 44725A/44728A/44729A**

Directly Switches:

- Voltage
- Current
- Power

**Benefit**

- Reliability switch the voltage, current, or power you need:
  - Both the HP 44725A and 44728A use single-pole double-throw (SPDT) Form-C relays that return to their normally

closed positions at power down. The HP 44725A 16-channel general purpose relays are for switching low-level power or moderate voltages and currents in an experiment while minimizing errors due to cross talk and thermal DC offsets. More DC or AC power can be switched with the HP 444728A 8-channel relay actuator.

- The HP 44729A 8-channel AC power controller distributes AC power. It switches "on" at the zero voltage crossing and "off" at the zero current crossing for long device life and low transient generation. Each channel has a relay and solid state switch in parallel to provide an exceptional combination of switch life and low on-resistance.

**Characteristics**

	Module		
	HP 44725A	HP 44728A	HP 44729A
Max Input Voltage ( $V_{max}$ ) Per Channel	30 V DC or RMS, 42 V peak	300 V DC, 250 V RMS	— 250 V RMS, 354 V peak
Max Input Current Per Channel	1.5 A DC, 1.5 A RMS	2 A DC, 3 A RMS (5 A fuse protection)	2.5 A RMS (3 A RMS if module is limited to 16 A RMS total; 4 A fuse protection per channel)
Max Sum of the Squared RMS Currents in Each Channel (per module; for any load type)	24 A <sup>2</sup>	26 A <sup>2</sup>	—
Max On Resistance	175 m $\Omega$	200 m $\Omega$	125 m $\Omega$ @ 3 A RMS; 200 m $\Omega$ @ 100 mA RMS
Switch Life (on/off cycles) Full Load	10 <sup>6</sup> ( $\leq 2$ switches per second)	10 <sup>6</sup>	5 $\times 10^6$
Min Load	10 <sup>6</sup> ( $\leq 2$ switches per second)	—	—
Max Wire Size	16 AWG	14 AWG	12 AWG (power in terminals); 14 AWG (power distribution terminals)

**New HP 3852A Accessories in 1988**

- **Arbitrary Waveform Digital-to-Analog Converter—HP 44726A**
  - Two channels
  - Waveforms stored in on-board memory
  - Repetitive or single-shot output
- **Track/Hold Multiplexer with Signal Conditioning—HP 44730A**
  - Four channels
  - Three selectable gains
  - Triggerable for simultaneous sampling
- **Dynamic Strain Gage Multiplexers - HP 44732A (120 ohm) HP 44733A (350 ohm)**
  - Four channels
  - Select 1/4, 1/2, or full bridge configurations
  - Electronic nulling

# DATA ACQUISITION SYSTEMS

## Instruments for Measurement and Control (cont'd)

### HP Model 3852A

#### Ordering Information

To order, specify an HP 3852S System with the appropriate software, controller, mainframe, extenders, function modules, racks, and extra terminal modules. The HP 3852S itself has no cost—each component of the system is priced individually.

#### Data Acquisition Manager

	Price
<b>HP 44458A</b> Data Acquisition and Control Software for Series 300/200 Computers on 3½" Flexible Discs (BASIC 4.0 and 5.0)	\$1990
<b>HP 44458B</b> Data Acquisition and Control Software for Series 200 Computers on 5¼" flexible Discs (BASIC 4.0 and 5.0)	\$1990
<b>HP 44458R</b> License to Reproduce HP 44458A or 44458B. Includes one set of software manuals.	\$1225
<b>HP 44459A</b> Data Acquisition and Control software for HP Vectra Computers on 3½" flexible discs (BASIC 5.0)	\$1480
<b>HP 44459B</b> Data Acquisition and Control software for HP Vectra Computers on 5¼" flexible discs (BASIC 5.0)	\$1480
<b>HP 44459R</b> License to reproduce HP 44459A/44459B. Includes one set of software manuals.	\$920

#### Mainframe

<b>HP 3852A</b> Data Acquisition and Control Unit	\$3800
<b>HP 44703A</b> Mainframe Extended Memory Card—256 kbytes*	\$615
<b>HP 44703B</b> Mainframe Extended Memory Card—1 Mbyte*	\$1480

\*Only one extended memory option may be added per mainframe.

Extended memory cards for 2 Mbytes and 4 Mbytes can be ordered from Infotek Systems, 1400 N. Baxter Street, Anaheim, CA 92806-1201, as AM220B and AM244B, respectively. These products have been *functionally tested, but are not warranted or supported by HP* (no RFI or environmental tests were conducted). Warranty for two years and support of individual cards are provided by Infotek.

#### Extender Chassis

<b>HP 3853A</b> Extender Chassis with ten additional slots for function modules. A 1-meter extender control cable, and two 1-meter (3 wires each) analog signal extender cables are included. All other mainframe functions, including interrupts and triggering, are available to the HP 3852A through the extender control cable. Multiple voltmeters can be used. A total of seven extenders may be added to a mainframe. Extender control cables are always needed. Analog signal extender cables are needed if analog voltages must be switched to the mainframe or another extender.	\$2450
--	--------

#### Voltmeters

<b>HP 44701A</b> 5½ to 3½-Digit Integrating Voltmeter	\$1530
<b>HP 44702A</b> 13-Bit High-Speed Voltmeter (100,000 readings/sec; buffer for over 8,000 readings)	\$2550
<b>HP 44702B</b> 13-Bit High-Speed Voltmeter (100,000 readings/sec; buffer for over 64,000 readings)	\$3060
<b>HP 44703C</b> High Speed Extended Memory Card for expanding HP 44702A Buffer to over 64,000 readings	\$560

#### Relay Multiplexers

<b>HP 44705A</b> 20-Channel Relay Multiplexer	\$765
<b>HP 44706H</b> 20-Channel High-Voltage Relay Multiplexer	\$970
<b>HP 44708A</b> 60-Channel Single-Ended Relay Multiplexer	\$920
<b>HP 44708A</b> 20-Channel Relay Multiplexer with Thermocouple Compensation	\$865
<b>HP 44708H</b> 20-Channel High-Voltage Relay Multiplexer with Thermocouple Compensation	\$1070
<b>HP 44717A</b> 10-Bridge 120 Ohm Static Strain Gage Relay Multiplexer	\$1020
<b>HP 44718A</b> 10-Bridge 350 Ohm Static Strain Gage Relay Multiplexer	\$1020

#### FET Multiplexers

<b>HP 44709A</b> 20-Channel FET Multiplexer	\$815
<b>HP 44710A</b> 20-Channel FET Multiplexer with Thermocouple Compensation	\$920
<b>HP 44719A</b> 10-Bridge 120 Ohm Static Strain Gage FET Multiplexer	\$1070
<b>HP 44720A</b> 10-Bridge 350 Ohm Static Strain Gage FET Multiplexer	\$1070
<b>HP 44711A</b> 24-Channel High-Speed FET Multiplexer	\$920
<b>HP 44712A</b> 48-Channel High-Speed Single-Ended FET Multiplexer	\$1070
<b>HP 44713A</b> 24-Channel High-Speed FET Multiplexer with Thermocouple Compensation	\$1020

#### Analog Outputs

<b>HP 44727A</b> 4-Channel Voltage DAC	\$1220
<b>HP 44727B</b> 4-Channel Current DAC	\$1220
<b>HP 44727C</b> 2-Channel Voltage; 2-Channel Current DAC	\$1220

#### Stepper Motor Controller

<b>HP 44714A</b> 3-Channel Stepper Motor Controller/Pulse Output	\$1900
--	--------

#### Counter

<b>HP 44715A</b> 5-Channel Counter/Totalizer (200 kHz)	\$970
--	-------

#### Digital Inputs/Outputs—Switching

<b>HP 44721A</b> 16-Channel Digital Input with Totalize and Interrupt	\$665
<b>HP 44722A</b> 8-Channel AC Digital Input with Totalize and Interrupt	\$665
<b>HP 44723A</b> 32-Channel High-Speed Digital Sense/Control	\$950
<b>HP 44724A</b> 16-Channel Digital Output	\$665
<b>HP 44725A</b> 16-Channel General Purpose Switch	\$765
<b>HP 44728A</b> 8-Channel Relay Actuator	\$615
<b>HP 44729A</b> 8-Channel Power Controller	\$920

#### Breadboard

<b>HP 44736A</b> Breadboard	\$360
-----------------------------	-------

#### High-Speed Accessories

<b>HP 98620B</b> 2-Channel DMA Controller for HP Series 300/200 Computers	\$500
<b>HP 98622A</b> GPIO Interface for HP Series 300/200 Computers	\$355
<b>HP 98625B</b> High-Speed HP-IB Disc Interface for HP Series 300/200 controllers	\$650
<b>HP 44744A</b> 2-Meter GPIO Cable with Mating for HP 44702A/B and HP 98622A	\$255
<b>HP 44744B</b> 4-Meter GPIO Cable with Mating for HP 44702A/B and HP 98622A	\$305
<b>HP 44745A</b> 4-Meter GPIO Cable with Mating for HP 44702A/B and HP 12006A (GPIO interface for HP 1000 Computers)	\$305

#### Service and Support Products and Courses

<b>HP 44743F</b> Service Kit consists of specially designed hardware and software for operationally verifying and calibrating the HP 3852A family of products. Menu-driven software (supplied on both 3½ and 5¼" media) provides semi-automatic testing of the HP 3852A mainframe, HP 44701A voltmeter, HP 44702A/B voltmeter, and all plug-in accessories (when used with the accessory fixtures listed below). Contains necessary hardware for functional verification of the HP 3852A mainframe, HP 44701A voltmeter, and HP 44702A/B voltmeter. Fixtures for individual accessories should be ordered separately below. (Accessory testing requires a DMM such as the HP 3478A, 44701A, or equivalent).	\$1480
<b>HP 50011B</b> HP-IB Course for HP Series 300/200 Computers	\$1320
<b>HP 50015A</b> Data Acquisition and Control Fundamentals Course	\$825
<b>HP 50016E</b> HP-IB Course for HP 1000 Computers	\$1050
<b>HP P/N 03852-88701</b> ROM Update Kit	\$300



- Thermocouples, thermistors and RTDs
- Supported by HP hardware and software



HP 40652 Series Thermocouple Wire

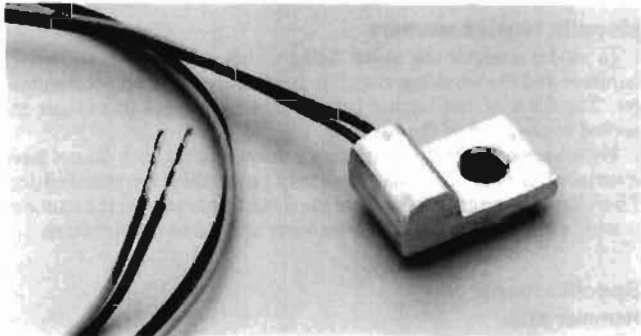

HP 40653 Series Thermistor Assemblies

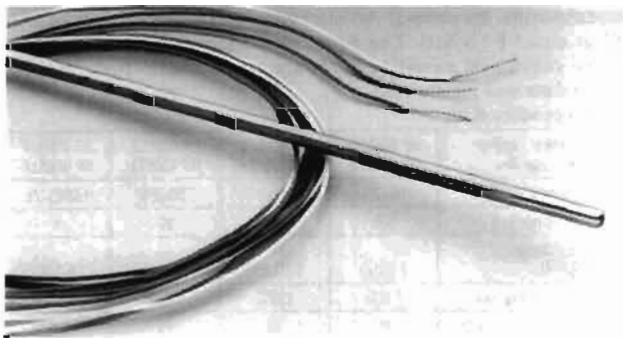

HP 40654A Stainless Steel Platinum RTD Probe



HP 40654B Surface Mounted Thin Film RTD

#### HP 40652 Series Thermocouple Wire

Thermocouples are rugged and inexpensive and cover a wide temperature range. All products come in 30 metre (100 feet) rolls.

- Temperature range -267°C to 260°C (-450°F to 500°F)
- 20 AWG wire size for durability and low series resistance
- Excellent resistance to abrasion, water submersion, solvents, acids and bases, flame and humidity with very good flexibility.

#### HP 40653 Series Thermistor Assemblies

Thermistors give you fast response for real-time measurements. The epoxy encapsulated sensor is housed in a screw mounted aluminum housing for easy surface mounting.

- 100°C maximum temperature
- Accurate ( $\pm 0.1^\circ\text{C}$ ) measurements
- 305 mm (12") Teflon<sup>®</sup> insulated leads
- Size: 12 H x 5 W x 8 mm D ( $\frac{1}{2}$ " x  $\frac{1}{4}$ " x  $\frac{1}{16}$ ")

#### HP 40654A Stainless Steel Platinum RTD Probe

RTDs are the most stable, most linear and most accurate temperature transducers.

- 304 stainless steel sheath is impervious to most environments
- Pre-wired for 4-wire  $\Omega$  measurements for maximum accuracy
- 100  $\Omega$  nominal resistance minimizes self-heating errors
- Conforms to European "E" curve ( $\alpha=0.00385$ )
- Probe: 318 mm (12.5") long. OD: 3 mm ( $\frac{1}{8}$ ")
- Teflon coated leads are 914 mm (36") long
- Maximum temperature 500°C (932°F)
- Ideal for fluids; install unmounted, potted or retain with set screw or compression fitting

#### HP 40654B Surface Mounted Thin Film RTD Probe

The large surface area/volume ratio means quick response time. The accurate platinum element is insensitive to vibration.

- Moisture proof, screw mounted housing is ideal for surface measurements
- Thin ceramic substrate has high thermal conductivity for good measurement of gases
- Conforms to European "E" curve ( $\alpha=0.00385$ )
- Wired for easy 2-wire  $\Omega$  measurement
- - 200°C to 125°C (-326°F to 257°F)
- Dimensions: 6 H x 6 W x 32 mm D ( $\frac{1}{4}$ " x  $\frac{1}{4}$ " x  $1\frac{1}{4}$ ")
- Silicone rubber coated leads are 610 mm (24") long

#### Ordering information

- HP 40652A Type K Thermocouple
- HP 40652B Type J Thermocouple
- HP 40652C Type T Thermocouple
- HP 40652D Type E Thermocouple

- HP 40653A 2252  $\Omega$  Thermistor
- HP 40653B 5000  $\Omega$  Thermistor
- HP 40653C 10,000  $\Omega$  Thermistor

- HP 40654A RTD Probe

- HP 40654B Surface Mounted RTD
- ☎ Fast-Ship Product-See page 758

	Price
	(1-2 units) (3-9 units)
HP 40652A Type K Thermocouple	\$90.00 ea. \$80.00 ea. ☎
HP 40652B Type J Thermocouple	\$86.00 ea. \$70.00 ea. ☎
HP 40652C Type T Thermocouple	\$67.00 ea. \$60.00 ea. ☎
HP 40652D Type E Thermocouple	\$100.00 ea. \$90.00 ea. ☎
	(1-4 units) (3-9 units)
HP 40653A 2252 $\Omega$ Thermistor	\$62.00 ea. \$55.00 ea. ☎
HP 40653B 5000 $\Omega$ Thermistor	\$62.00 ea. \$55.00 ea. ☎
HP 40653C 10,000 $\Omega$ Thermistor	\$62.00 ea. \$55.00 ea. ☎
	(1-4 units) (5-9 units)
HP 40654A RTD Probe	\$100.00 ea. \$90.00 ea. ☎
	(1-4 units) (5-9 units)
HP 40654B Surface Mounted RTD	\$75.00 ea. \$65.00 ea. ☎

# DATA ACQUISITION SYSTEMS

## Hammers and Accelerometers

Models 40651A/B and 40651C/D/E/F/G/H/J/K

- Complete kits
- Modally tuned hammers
- Accelerometers for many diverse applications

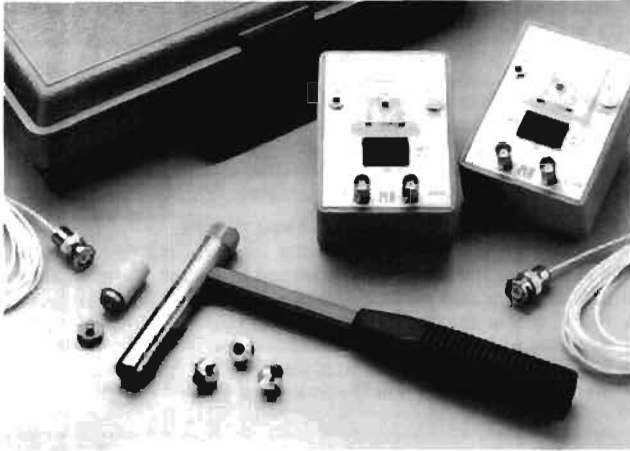

HP 40651A Hammer Kit

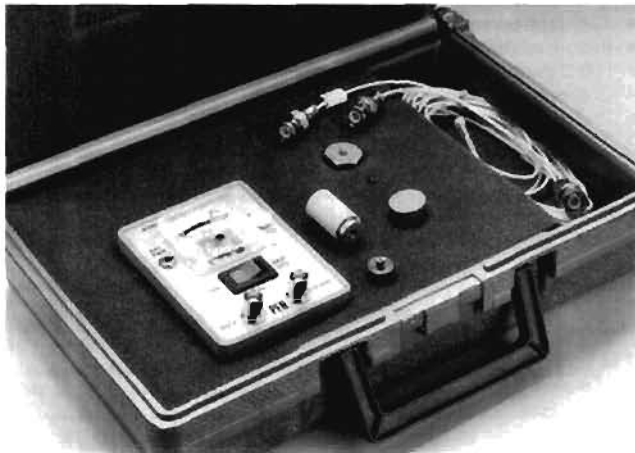

HP 40651G Accelerometer Kit

Accelerometers are used in many applications to convert mechanical motion into an electric signal. Typical applications include machine monitoring to prevent catastrophic failures and shock testing of new products to prevent damage in shipment.

Hammers are used in modal analysis which determines the dynamic properties of mechanical structures, such as machine tools, automobile subassemblies, and power line towers.

### Complete kits

Each product number contains all the accessories necessary for testing and monitoring: all cables, all appropriate mounting hardware including petro wax for temporary mounting, and complete operating instructions and calibration data. The hammer kits even come with accelerometers, selected to be appropriate for the same application as the hammer.

All kits come in a sturdy plastic case with a convenient handle. Custom cut-outs in the foam rubber insert hold each piece in place during transport.

### Accelerometers

The HP accelerometers are of the ICP (integrated circuit piezoelectric) type for ease of use and simple cable connections since the charge amplifiers are built in.

HP offers a wide selection of accelerometers to fit many applications from moderately small structures, such as disc drive actuator arms, to very large structures, such as buildings or bridges.

The 40651C/D/E and F kits do not include power supplies. They are especially designed for use with the HP 3561A Dynamic Signal Analyzer which features an internal supply.

The 40651G/H/J and K kits include a battery-operated supply (even the battery is included) for use with other analyzers, such as the HP 3582A and HP 3562A.

### Modally tuned hammers

In modal analysis the object being tested is struck by an impact hammer and the resulting vibration is measured with an accelerometer. The force of the impact is measured by a force transducer attached to the head of the hammer.

HP's hammers are modally tuned, meaning that they do not have structural resonances in the frequency range they are specified for. Therefore, the signal output from the force transducer on the hammer is truly representative of the force being applied to the structure.

### Specifications:

#### Hammer Kits:

##### Weight:

HP 40651A: 0.14 kg (0.3 lb) for small to medium structures

HP 40651B: 1.4 kg (3.0 lb) for medium to large structures

**Accessories furnished:** Accelerometers HP 40651C and D (A Kit) or E and F (B Kit), 2 ea power supplies, 3 ea removable impact tips, all cables and mounting hardware, operating instructions, calibration data and plastic case.

#### Accelerometer Kits:

	HP 40651C HP 40651G	HP 40651D HP 40641H	HP 40651E HP 40651J	HP 40651F HP 40651K
Sensitivity (mV/g)	10±2%	10 (nom)	100±2%	1,000±5%
Amplitude Range (+g pk)	500	500	50	5
Frequency Range (Hz, ±5%)	1-3,000	1-10,000	1-3,000	2.5-3,000
Maximum Shock (g pk)	5,000	2,000	5,000	5,000
Resonant Frequency (kHz)	45	70	25	25
Weight (gram)	25	1.9	87	68

**Accessories furnished:** All cables, mounting hardware including petro wax, operating instructions, calibration data, and plastic case. Power supplies with batteries are included in the G, H, J and K kits.

### Ordering information

HP 40651A Hammer Kit	\$1,675.00
HP 40651B Hammer Kit	\$2,155.00
HP 40651C Accelerometer Kit without power supply	461.00
HP 40651D Accelerometer Kit without power supply	322.00
HP 40651E Accelerometer Kit without power supply	410.00
HP 40651F Accelerometer Kit without power supply	550.00
HP 40651G Accelerometer Kit with power supply	595.00
HP 40651H Accelerometer Kit with power supply	456.00
HP 40651J Accelerometer Kit with power supply	545.00
HP 40651K Accelerometer Kit with power supply	685.00
☛ Fast-Ship product - See page 758	

The philosophy behind Computer Aided Test (CAT) is simple. If you can raise the quality of your product without raising its cost, your customer is happier and your company is more productive. The formula for executing this plan is equally simple: Monitor incoming parts, manufacturing processes and final products in great detail, and make corrections to improve them.

While the philosophy is simple, the implementation can sometimes be complex. That's where HP can help, with a full complement of computers, software, instruments, switches, and interconnect hardware designed specifically to make your CAT task easier.

A good CAT system is designed to improve manufacturing productivity. It minimizes the design time to build fixtures, write software and configure systems, and it also minimizes the time required to test devices.

### What to Look for in Hardware Cardcages

Performance is the main criteria in selecting instruments and switches. The switch and

instruments must meet your stringent requirements. It's a good idea to select an instrument and switch with slightly more performance than the initial specification requires. That way you can easily adapt to changing manufacturing specifications. Another consideration is throughput speed. An intelligent cardcage system, such as the HP 3235A, can run subroutines and make decisions, thereby off-loading the host computer to do the test sequencing and data reporting. The HP multiprogrammer products offer wide function versatility including timer/pacer, 500 kHz A to D, stepper motor controller and inter-card communications.

If your budget or application is relatively small, look to the HP 3488A Switch/Control Unit.

### Switching

If your application involves switching signals >1 MHz, you need to look at the HP 3235A for large point counts (>100) and the

HP 3488A for low point counts. Both products offer high performance switching in various topologies covering DC to 26.5 GHz.

### Interfacing and Cabling

For years, the cabling and fixturing of a CAT system have been neglected by CAT manufacturers. Test engineers and technicians had to build their own connection systems. But, today HP has commercial units to do most of the critical switching and cable management necessary in a CAT system. The availability of these switch units can save hundreds of hours of design time.

The interface system to the HP 3235A standardizes the way you cable your Unit-under-test to the test system. It adapts to complex components, pc boards, subassemblies and systems.

For those who need help in configuring, implementing or supporting a complex CAT system, HP offers the ATS 2000 which provides an integrated solution (including hardware, software, racking, cabling and system-level support).

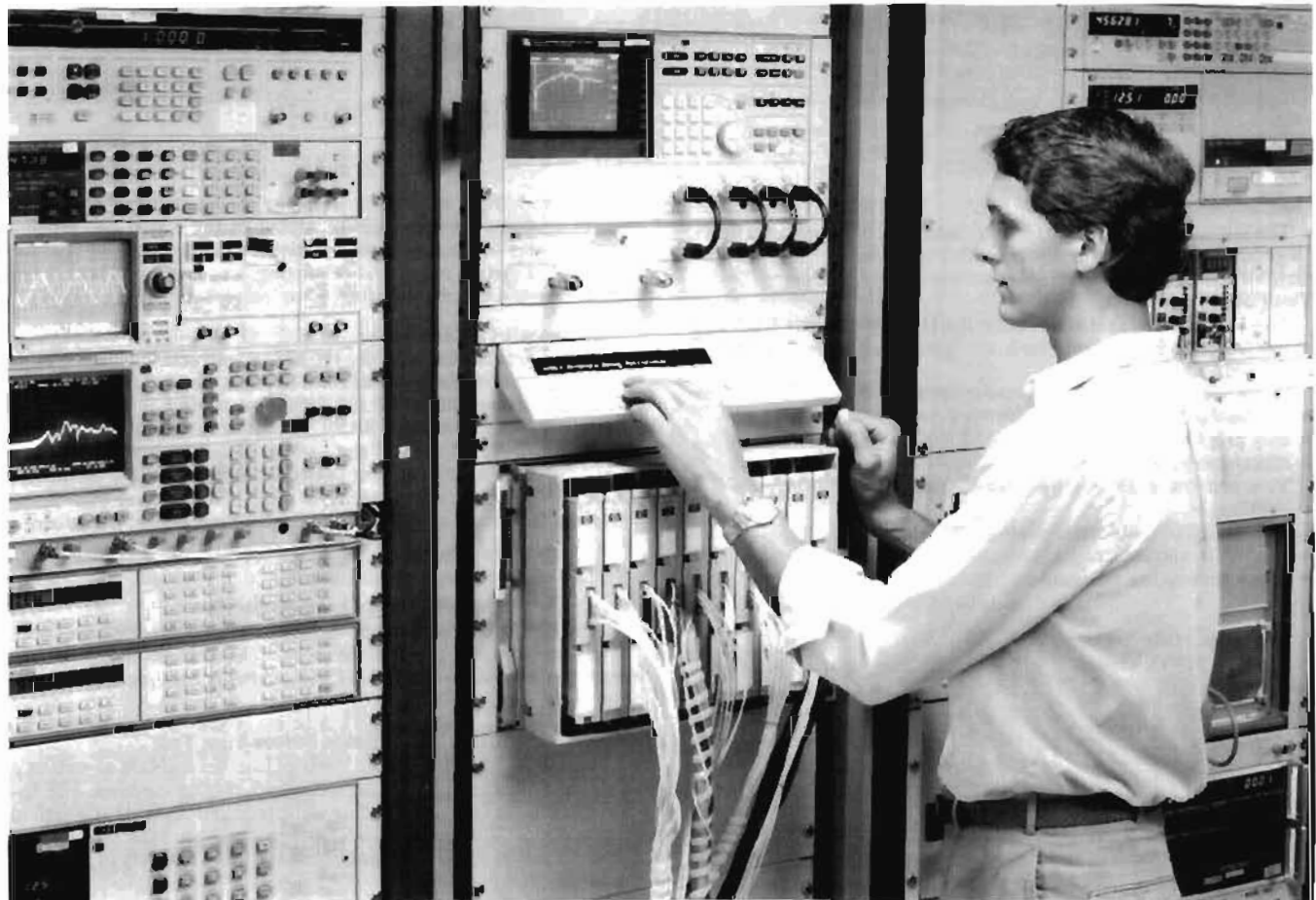

The HP 3235A Switch/Test Unit performs high integrity switching for signals from dc to 26.5 GHz. With its mass interconnected fixture, the HP 3235A can route signals from a multitude of instruments to the device under test, saving the test engineer the chore of designing a custom switch, and greatly simplifying cable management.

Programming the HP 3235A is extremely efficient, with high level BASIC commands. Faster test throughput speed is created by downloading test setups, and by direct communication between the internal switches and the internal 6½ digit multimeter or internal stimulus

# COMPUTER AIDED TEST

## High Performance Switching and Control

### HP Model 3235A

- For Medium to Large Systems
- 10-Slot, Intelligent Card Cage
- 13-Switch Modules for DC to 26.5 GHz Signals
- DMM, AC/DC Source, 4-channel D/A Digital I/O, Breadboard Modules
- Quick Interconnect Fixture
- Control Panel for Debugging



### Description

The HP 3235A Switch/Test Unit reduces test development of HP-IB production test systems by providing high performance off-the-shelf switching and interfacing to a wide variety of Devices Under Test (DUT)

This new Switch/Test Unit routes signals between your DUT and source/receiver instruments such as digital multimeters, counters, signal sources and analyzers.

Speed your test system development with:

- off-the-shelf tools
- easy programming
- reduced cabling

Your test system throughput increases with the HP 3235A's:

- intelligence
- plug-in digital multimeter module
- internal bus structure
- Quick Interconnect Fixture

### A Reconfigurable Architecture

The HP 3235A chassis is a 10-slot cardcage driven by a 16-bit processor backed with 256k of firmware. You control the cardcage over HP-IB using high level commands for easy programming. Thirteen different switch modules in various matrix and multiplexer topologies switch signals up to 10 Amps and from DC to 26.5 GHz. Also available are digital I/O, breadboard, four-channel D/A, DMM, and AC/DC source modules that are true "instruments-on-a-card."

For applications demanding numerous switch points, up to seven 10-slot HP 3235E Extenders can be slaved to the HP 3235A mainframe. 5120 two-wire analog points can now be controlled from one HP-IB address.

The Quick Interconnect Fixture allows easy reconfiguration of the customer's test system for different test devices. Operator errors are also reduced by minimizing the number of connections that must be made before starting a new test.

Four analog and two trigger buses link the switch and instrumentation modules. These internal paths provide a "soft-wired" connection that can be redefined by your test software. Analog signals get routed

conveniently from a multiplexer to the digital multimeter module during scanning. Or, a trigger generated by the digital I/O module can be routed to the digital multimeter module.

To aid in system set up and debugging, a control panel with a full alpha-numeric keypad and electro-luminescent display is available.

### Intelligence of a Computer

The powerful firmware of the HP 3235A instructs the plug-in modules with high level commands from the host computer. Storage and recall of hundreds of HP 3235A setups saves sending command sequences from the computer. BASIC language commands in the mainframe such as IF... THEN and FOR... NEXT, plus variables and math functions keep computer to switch interactions to a minimum, thereby increasing throughput. Use up to 90K bytes of mainframe memory for downloaded subroutines and stored values. Downloaded programs, including user defined data conversions or setups, execute rapidly.

### Complete Modularity Means In-Rack Service

The HP 3235A is completely in-rack serviceable, so you never need to remove the card cage from the rack. All assemblies, including power supply, controller, and HP-IB, remove easily because of the modular design.

### Simple Operational Verification Before Your Test

The HP 3235A offers three levels of internal self-test as well as a fixtured functional test for the individual plug-in modules. The fixtured test is performed using diagnostic terminal blocks that attach to the modules. These diagnostic fixtures, together with the internal DMM module, verify the integrity of the relay contacts in your system.

### 32-Channel Relay Modules (HP 34501/34502/34507)

These three flexible, 32-channel relay modules can be configured as a 32-channel multiplexer (HP 3450XA or HP 3450XB), 4x8 matrix (HP 3450XM), or for use with thermocouples (HP 3450XT), depending upon which terminal block is purchased. Channels switch two wire (High and Low) with DPST relays. These modules can be used as either input or output multiplexers

- Armature relays (HP 34501) provide quality switching for both high voltages and low level signals.
- Reed relays (HP 34502) provide high speed switching with scan rates >500 channels/sec.
- Mercury-wetted relays (HP 34507) offer long lifetimes.

### 32 Channel Multiplexers (one bank shown)

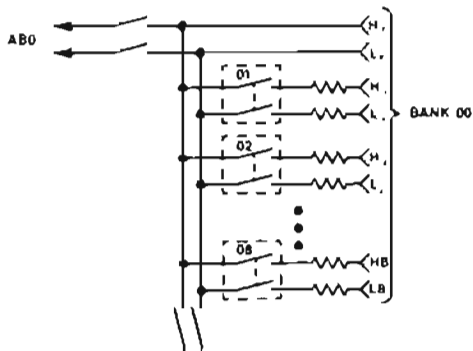

### 50 and 75 Ohm RF Multiplexers (HP 34505 and HP 34508)

These RF Multiplexers provide broadband switching of high frequency analog or digital signals. Excellent channel isolation assures quality wide-dynamic-range measurements. The HP 34505, with a 50 ohm characteristic impedance, is for general purpose instrumentation, while the HP 34508, with a 75 ohm impedance, is for video and telecommunications applications. The modules consists of one 1x3 and two 1x4 multiplexers for bi-directional switching of signals from DC to 1.3 GHz. Each of the three multiplexer banks are isolated from each other and from ground to prevent ground loops. Off-channels can be determined in 50 (75 ohm).

### RF Multiplexer (one bank shown)

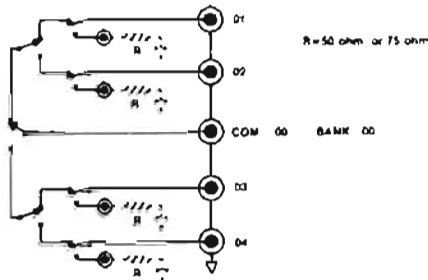

INPUT CHARACTERISTICS	HP34501	HP34502	HP34507
<b>Maximum Voltage</b> Terminal to Terminal	250V DC or AC RMS	125V DC or AC Peak	250V DC or AC RMS
Terminal to guard or chassis Guard to chassis		250V DC or AC RMS 42V DC+AC Peak	
<b>Maximum Current</b> per channel or common	2A DC or AC RMS	25mA DC or AC RMS	100mA DC or AC RMS
<b>Maximum Power</b> per channel or common	60W (Vmax ≤ 30VDC) 45W (Vmax > 30VDC) or 500VA AC	5W or .5VA	1W or 1VA
<b>Thermal Offset</b> (one frame)	<3uV	<3uV	<20uV
<b>Insulation Resistance</b> ≤(40 C, 95% RH)	>10 <sup>10</sup> Ω	>10 <sup>10</sup> Ω	>10 <sup>10</sup> Ω
<b>AC PERFORMANCE</b> (Z <sub>L</sub> = Z <sub>0</sub> = 50Ω)	≤10kHz	≤100kHz	≤1MHz
<b>Crosstalk (dB)</b>	<-90	<-70	<-55

	≤10MHz	≤100MHz	≤500MHz	≤1GHz
<b>Insertion Loss (dB):</b> ≤(40°C, 95% RH)	<.03	<.7	<1.5	<3.0
<b>Crosstalk (dB)</b> Channel-Channel	<-90	<-80	<-65	<-55
<b>VSWR</b>	<1.2	<1.25	<1.35	<1.55

### General Purpose Relay Module (HP 34503)

This module provides 16 independent Form C contacts for general signal switching or control of external devices. The high integrity contacts are ideal for switching signals when multiplexing isn't required.

### General Purpose Relay (one channel shown)

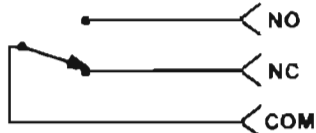

<b>Maximum Voltage</b> Terminal to terminal: 250 V DC or AC RMS Terminal to guard or chassis: 250 V DC or AC RMS Guard to chassis: 42 V DC+AC Peak			
<b>Maximum Current</b> per channel or common: 3 A DC or AC RMS			
<b>Maximum Power</b> per channel or common: 60 W (Vmax ≤ 300V DC); 45 W (Vmax > 300V DC); 750VA AC			
<b>AC Performance</b> (Z <sub>L</sub> = Z <sub>0</sub> = 50Ω)	≤10kHz	≤100kHz	≤1MHz
<b>Crosstalk (dB)</b>	<-80	<-60	<-40

### Switched-Shield Coaxial Multiplexer Module (HP 34504)

The coaxial module provides two 1x6 multiplexers for input or output scanning in 50 ohm systems or for signals up to 42V or 1A. Each channel switches the shield as well as the center conductor to eliminate ground loops in your system. Switched shields also allow you to measure test points with differing shield potentials.

### Switched-Shield Coaxial Multiplexer (one bank shown)

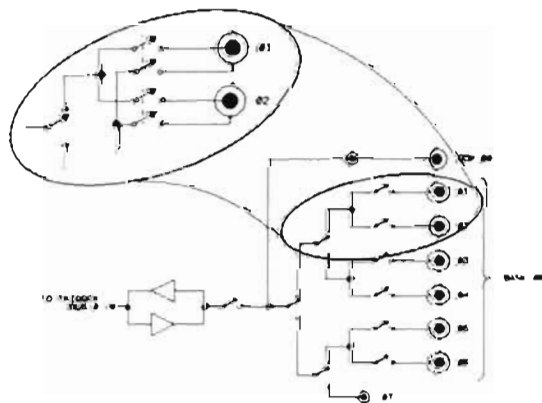

# COMPUTER AIDED TEST

## High Performance Switching and Control (cont'd)

HP Model 3235A

**Maximum Voltage:** Any center or shield to any other center, shield, guard or chassis: 42V DC+AC Peak. Guard to Chassis: 42V DC+AC Peak.

**AC Performance for  $Z_L = Z_0 = 50 \Omega$**

	$\leq 3\text{MHz}$	$\leq 10\text{MHz}$	$\leq 30\text{MHz}$	$\leq 100\text{MHz}$
Insertion Loss (dB)	<0.4	<0.5	<0.7	<1.0
Crosstalk (dB)	<-115	<-105	<-95	<-85
VSWR	<1.14	<1.35	<1.35	<1.50

### Switched-Shield Coaxial Matrix (HP34508)

This 4x8 full crossbar matrix offers highly flexible switching for 50 $\Omega$  systems. You can use the matrix to simultaneously connect any of four channels to any of eight channels. Similar to the coaxial multiplexer module, the coaxial matrix switches both center conductors and shields. Intended for 50 $\Omega$  systems.

#### Switched-Shield Coaxial Matrix

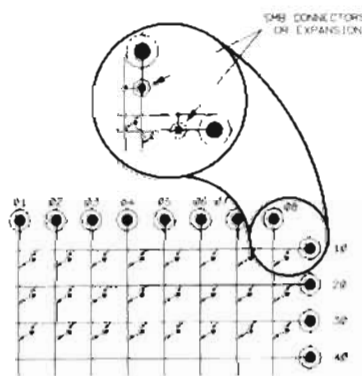

**Maximum Voltage:** Any center or shield to any other center, shield, guard or chassis: 42V DC+AC Peak. Guard to Chassis: 42V DC+AC Peak.

**Maximum Current** per row or column: 1A DC or AC RMS

**Maximum Power** per crosspoint: 24W or 24VA (resistive)

**AC Performance for  $Z_L = Z_0 = 50 \Omega$**

	$\leq 1\text{MHz}$	$\leq 3\text{MHz}$	$\leq 10\text{MHz}$	$\leq 30\text{MHz}$
Insertion Loss (dB)	<0.4	<0.5	<0.7	<1.0
Crosstalk (dB)	<-100	<-90	<-75	<-55
VSWR	<1.2	<1.2	<1.2	<1.6

### 32-Bit Digital Input/Output Module (HP 34522)

Digital sensing and control of your device under test or custom test tools is accommodated with the digital I/O module. Each module provides:

- 32 bi-directional TTL-compatible data lines. The data lines are grouped as four 8-bit ports each with their own handshake lines. The four ports can be configured to handle 8-, 16-, or 32-bit parallel data.
- 8 edge-triggered interrupt lines
- 16 high-power FET outputs furnish switchable high-power current sinks (40V, 500 mA) for actuating external devices
- Read or write rates >40KHz

### Breadboard Module (HP 34523)

The breadboard module furnishes a convenient way to incorporate special purpose circuits into your test system. This module lets you interface directly the HP 3235A's backplane control signals and backplane analog and trigger buses.

### 6 1/2 Digit Multimeter Module (HP 34520)

With the DMM module, you can integrate a high performance system multimeter into your test system without extensive cabling and software programming. The DMM module offers seven functions:

- DC volts with five ranges from 0.03V to 250V and reading rates >1450 rdgs./sec in the 3 1/2 digit mode.
- AC Volts with 1MHz AC Bandwidth
- Two and four-wire resistance measurements
- DC current up to 1.5A, with reading rates as fast as DC Volts and ohms
- AC Current up to 100kHz and 1A.
- Frequency and period from 10 Hz to 1.5MHz with 6 1/2 digit resolution.

The DMM module combines superb analog measurement capability with powerful system flexibility. Measurement inputs can be switched directly from the front of the module or, with the exception of current inputs, from any of the four internal HP 3235 analog buses.

### DC Voltage (90 day, $T_{cal} \pm 5^\circ\text{C}$ )

Range	Best 6 1/2 Digit Accuracy <sup>1</sup> ± (% of reading + volts)	Input Resistance
30mV	0053% + 5.40 $\mu\text{V}$	>10 G $\Omega$
300mV	0038% + 5.7 $\mu\text{V}$	>10G $\Omega$
3.0V	003% + 8 $\mu\text{V}$	>10G $\Omega$
30V	0048% + 220 $\mu\text{V}$	10 M $\Omega \pm 1\%$
250V	0063% + 700 $\mu\text{V}$	10 M $\Omega \pm 1\%$

### DC Current (90 day, $T_{cal} \pm 5^\circ\text{C}$ )

Range	Best 6 1/2 Digit Accuracy <sup>1</sup> ± (% of reading + amps)	Max. Burden Voltage at Fullscale
300 $\mu\text{A}$	025% + 15.4 nA	0.35 V
3mA	025% + 15.4 nA	0.35 V
30mA	025% + 1.54 $\mu\text{A}$	0.35 V
300mA	068% + 25.4 $\mu\text{A}$	0.6 V
1.5A	088% + 654 $\mu\text{A}$	1 V

### Resistance (2 and 4-wire ohms)<sup>2</sup> (90 day, $T_{cal} \pm 5^\circ\text{C}$ )

Range	Best 6 1/2 Digit Accuracy <sup>1</sup> ± (% of reading + ohms)	Current Output
30 $\Omega$	0078% + 5.4m $\Omega$	1mA
300 $\Omega$	0058% + 5.7m $\Omega$	1mA
3k $\Omega$	0048% + 9m $\Omega$	1mA
30k $\Omega$	0048% + 90m $\Omega$	100 $\mu\text{A}$
300k $\Omega$	006% + 1 $\Omega$	10 $\mu\text{A}$
3M $\Omega$	008% + 15 $\Omega$	1 $\mu\text{A}$
30M $\Omega$	032% + 830 $\Omega$	100 nA
300M $\Omega$	2.5% + 100k $\Omega$	100 nA
3G $\Omega$	25% + 1M $\Omega$	100 nA

1. After one hour warm up, integration time 100 PLC.  $T_{cal}$  is the temperature of the calibration environment between 18 and 28°C

2. For two-wire ohms, add 200M $\Omega$  to count error specifications.

3. For two-wire ohms only accuracy is specified following auto-cal (ACAL), under stable conditions ( $\pm 1^\circ\text{C}$ ).

### AC Voltage (RMS AC and RMS AC+DC)

ACV Bandwidth: 20 Hz to 1 MHz

Crest Factor: 3.5 to 1 at fullscale

Common Mode Rejection with 1 k $\Omega$  imbalance in the low lead, DC to 60 Hz. Guarded: >86dB; non-guarded >66dB.

### AC Volts (90 day, $T_{cal} \pm 5^\circ\text{C}$ )

Range	(100Hz to 20kHz) Best 5 1/2 Digit Accuracy <sup>1</sup> ± (% of reading + % of range)		Input Impedance
	AC Coupled	DC Coupled	
30mV	15% + .441%	.19% + .16%	1M $\Omega \pm 1\%$ shunted by <90pF
300mV	15% + .441%	.19% + .16%	
3.0V	15% + .441%	.19% + .16%	
30V	15% + .441%	.19% + .16%	
300V	21% + .053%	.25% + .203%	

1. Accuracy specified for sine wave inputs, >10% of range. DC component <10% of AC component after one hour warm up and within one week of autocal. AC Band set to <400 Hz.

### AC Current (RMS AC and RMS AC+DC)

ACI Bandwidth: 20 Hz to 100 kHz

Crest Factor: 3.5 to 1 at fullscale

### AC Current (90 day, $T_{cal} \pm 5^\circ\text{C}$ )

Range	(100 Hz to 20 kHz) Best 5 1/2 Digit Accuracy <sup>1</sup> ± (% of reading + % of range)	
	AC Coupled	DC Coupled
30mA	.292% + .101%	.35% + .157%
300mA	.292% + .101%	.35% + .157%
1A	.392% + .3%	.45% + .171%

1. Accuracy specified for sine wave inputs, >10% of range. DC component 10% of AC component after one hour warm up and within one week of autocal. AC Band set to <400 Hz.

**Frequency and Period:** Measures the frequency or period of the AC component of the AC or DC coupled voltage or current input. The counter uses a reciprocal counting technique to give constant resolution independent of input frequency.

**Frequency Range:** 10 Hz to 1.5 MHz (voltage input)  
10 Hz to 100 kHz (current input)

**Period Range:** .1 s to 667 ns (voltage input)  
.1 s to 3.33 us (current input)

**Sensitivity:** 10 mV RMS or 100 µA RMS (sinewave)

**Triggering:** Triggers and counts on zero crossings.

**Accuracy:** (1 year)

Frequency	Period	= % of Reading
10 Hz to 400 Hz	.1 s to 0.25 s	0.05
400 Hz to 1.5 MHz	0.25 s to 667 ns	0.01

**Measurement Characteristics**

	Number of Power Line Cycles (NPLC)					
	100	10	1	.1	.005	.0005
<b>Maximum No. of Useful Digits</b>	6½	6½	6½	5½	4½	3½
<b>Resolution (No. of Bits)</b>	22	22	22	19	15	12
<b>Resolution (PPM)</b>	.33	.33	.33	3.3	33	330
<b>DCV, DCI, Ω</b>						
<b>Maximum Reading Rate</b>						
60 Hz	49	4.9	56	360	1250	1450
50 Hz	4	4	47	312	1250	1450

**SimPlate Board Test Fixture (HP 34597A)**

The HP 34597A SimPlate Board Test Fixture is a vacuum actuated bed-of-nails test fixture kit for the HP 3235A Switch/Test Unit. SimPlate and the HP 3235A are tools developed for your "rack-and-stack" functional test systems. Unlike an edge connector test, SimPlate gives you access to all component leads to provide more functional test flexibility and improved fault isolation. Because of its unique single plate design, SimPlate can provide the close tolerance probing required for interfacing to Surface Mount Technology (SMT) boards.

SimPlate is delivered as a kit, that you must drill, wire, and assemble. The components in this kit are designed to probe printed circuit boards from a single side, with test pads as small as 0.030" diameter on 0.050" centers. Probes, receptacles and extra HP 3235A terminal blocks are ordered separately.

**New HP 3235A Accessories**

**32-Channel Relay Driver Module (HP 34509)**

- Drive latching relays and microwave multiplexers
- Internal 15 V and 28 V power supplies

**Microwave Switches and Attenuators (HP 3453X)**

- Remote mount switches and attenuators; up to 26.5 GHz
- Switches mounted within the HP 3235A; 18 GHz

**8-Channel Power Actuator Module (HP 34510)**

- 14 A carry or 10 A switched current
- Up to 250 VAC; Form C relays

**64-Channel Armature Relay Module (HP 34511)**

- Up to 130 VAC or 1 Amp
- Two-wire operation; four 1x16 multiplexers or 4x16 matrix
- One-wire operation; 1x128 multiplexer

**AC/DC Source Module (HP 34521)**

- AC Source: 12 bit resolution
  - 20 V output 100 mA
  - Arbitrary, sine and square waveforms up to 1 MHz
  - Triangle waveforms up to 100 KHz
- DC Source: with speed/resolution tradeoff
  - 6 digit resolution; ±100 usec settling time
  - 12 bit resolution; ±10 usec settling time
  - Voltage Mode: 10 V output 100 mA
  - Current Mode: 100 mA output ± 10 V

**4-Channel D/A Converter Module (HP 34524)**

- 14 bits plus sign of resolution; ± 10 V ± 20 mA
- Software programmable to either Voltage or Current mode
- <1.4 usec settling time

**Environmental:**

Operating Temperature: 0-55 C (32-130 F)  
Storage Temperature: -40 -75 C (-40 -165F)  
Humidity Range: 95% R.H., 0 to 40 C

**Power:**

Line Voltage: 90-132V (115V) or 192-264 (230V) switch selectable  
47-66 Hz. Fused at 5A (115V) or 2.5A (230V).

**Size:**

HP 3235 Cardcage: 310mm H (without feet) x 426mm W x 594 mm o (12.25"x16.75"x23.4")  
Height with Feet: 325mm (12.8")  
Depth with Terminal Blocks: 693mm (27.3")

Weight	Net	Shipping
HP 3235 Cardcage (max.)	21 kg (46 lbs)	28 kg (61 lbs)
Each Module (max )	5.5 kg (12 lbs)	6.6 kg (14.5 lbs)

**Ordering Information**

	Price
HP 3235A Switch/Test Unit	\$4490
Opt 580 Add System Expansion Card	\$360
Opt 590 Add Quick Interconnect	\$765
Opt 908 Rack Mount Kit (HP P/N 03235-80908)	\$97
HP 3235E Switch/Test Unit Extender	\$3775
HP 34550A Control Panel	\$560
HP 34551A Control Panel Rack Mount Kit	\$51

**Plug-in Accessories** are supplied with your choice of terminal blocks. Specify an "A" suffix if you want to permanently solder your wiring into place. Specify a "B" suffix if you want a quick, non-soldered connection for your system wiring. Specify a "C" suffix to delete the terminal blocks.

Specify an "M" suffix to change the 32-channel modules into a 4x8 matrix. Specify a "T" suffix to measure temperature with thermocouples.

**32 Channel Relay Module**

HP 34501A (solder-eye lugs)	\$1220
HP 34501B (screw-terminals)	\$1380
HP 34501M (screw-terminals)	\$1480
HP 34501T (screw-terminals)	\$1580

**32 Channel Reed Relay Module**

HP 34502A (solder-eye lugs)	\$1220
HP 34502B (screw terminals)	\$1380
HP 34502M (screw-terminals)	\$1480
HP 34502T (screw-terminals)	\$1580

**General Purpose Relay Module**

HP 34503A (solder-eye lugs)	\$815
HP 34503B (screw-terminals)	\$970

**Switched-Shield Coaxial Multiplexer Module**

HP 34504A (cable-terminated BNCs)	\$1530
HP 34504B (bulkhead BNCs)	\$1685
HP 34504C (no terminal block)	\$1325

**50 Ohm RF Multiplexer Module**

HP 34505A (cable-terminated BNCs)	\$1325
HP 34505B (bulkhead BNCs)	\$1480
HP 34505C (no terminal block)	\$1120

**Switched-Shield Coaxial Matrix Module**

HP 34506A (cable-terminated BNCs)	\$1735
HP 34506B (bulkhead BNCs)	\$1885
HP 34506C (no terminal block)	\$1530

**32 Channel Mercury-Wetted Reed Relay Module**

HP 34507A (solder-eye lugs)	\$1430
HP 34507B (screw-terminals)	\$1580
HP 34507M (screw-terminals)	\$1685
HP 34507T (screw-terminals)	\$1785

**75 Ohm RF Multiplexer**

HP 34508A (cable-terminal)	\$1580
HP 34508B (bulkhead)	\$1630
HP 34508C (no terminal block)	\$1225

**6½ Digit Multimeter Module**

HP 34520A (solder-eye lugs)	\$2600
HP 34520B (screw-terminals)	\$2650

**32 Bit Digital Input/Output Module**

HP 34522A (solder-eye lugs)	\$1120
HP 34522B (screw-terminals)	\$1275

**Breadboard Module**

HP 34523A (solder-eye lugs)	\$355
HP 34523B (screw-terminals)	\$510

# COMPUTER AIDED TEST

## Low Cost, Versatile HP-IB Switching & Control

HP Model 3488A

- DC—26.5 GHz signal switching
- Matrix, multiplexer, & general purpose relays
- Digital I/O control & actuation
- Up to 50 channels
- 40 configuration storage registers
- 6 switch & control modules

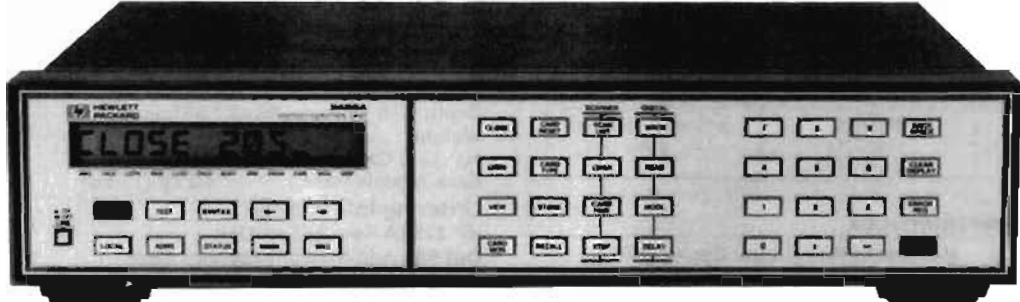

HP 3488A



### Description

The HP 3488A Switch/Control Unit brings versatile, HP-IB programmable switching to tests requiring multi-channel measurements. The HP 3488A provides signal switching with the integrity and isolation needed for high performance test systems in production. It also offers a flexible, low cost interconnection solution for automating experiments on the bench and for development testing in the lab. The HP 3488A is designed to hold any combination of up to 5 of the following optional switch and control modules:

- 10 Channel Relay Multiplexer
- 10 Channel General Purpose Relay
- Dual 4 Channel VHF Switch
- 4 x 4 Matrix Switch
- 16 Bit Digital Input/Output
- Breadboard
- 3 Channel 18 GHz Switch
- 7 Channel Form-C Relay
- 2 Channel Microwave Switch

### Flexible Switching

The HP 3488A offers an economical approach to switching flexibility through plug-in modules. The user can select the right combination of switching functions to meet both performance and budget requirements. Testing is simplified by having one solution for connections of low level DVM inputs, high level dc and ac power, and microwave signals to 26.5 GHz. Additional devices such as microwave relays and programmable attenuators are easily controlled with digital I/O functions. Custom circuitry can also be implemented on breadboard modules.

### Versatile Performance

The HP 3488A can store up to 40 complete switch configurations for convenient recall in automated test programs. Switch operation can be with multiple relay closures or with selectable channels in a break-before-make mode. Break-before-make closures and recallable complete switch configurations can be combined in a programmable scan list. The HP 3488A uses removable screw terminal connectors that provide easily interchangeable wiring configurations for each test. Built-in self-test capability assures proper operation.

### Multiplexer (Opt. 010/HP 44470A)

Option 010 is a 10 channel multiplexer for scanning or multiple signal connections. Channels switch 2 wires (Hi & Lo) with 2PST relays for DVM inputs and other signals up to 250 V and 2A. This module can also be used to multiplex signals to other switching functions such as the matrix module.

### General Purpose Relay (Opt. 011/HP 44471A)

This module consists of 10 SPST independent relays for general signal switching and control of external devices. The quality connections provided make this module ideal for switching signals when multiplexing isn't required or for supplying switchable power to the device under test.

### VHF Switch (Opt. 012/HP 44472A)

The VHF module provides broadband switching capability for high frequency and pulse signals. The 2 independent groups of bidirectional 1 x 4 switches can be used for signals from dc to 300 MHz. All channels have 50 ohm characteristic impedance and are break-before-make within a group of 4 channels. Each group is isolated from the other and from ground to prevent ground loops. Excellent isolation makes this module ideal for high frequency signal analyzer measurements requiring a large dynamic range.

### Matrix Switch (Opt. 013/HP 44473A)

Option 013 offers highly flexible switching with a 4 x 4, 2 wire matrix. Any combination of 4 input channels may be connected to any combination of 4 output channels. Each cross point or node in the matrix uses a 2PST relay to switch 2 lines (Hi & Lo) at a time. Multiple 4 x 4 modules can be connected to form larger matrices. Multiplexers can be used in conjunction with this module to effectively expand the number of inputs and outputs of the matrix.

### Digital I/O (Opt. 014/HP 44474A)

This module offers 16 very flexible bidirectional I/O lines and 4 TTL compatible handshake lines for sensing and control of external devices. The digital inputs can be used to sense contact closures to ground. Each channel provides current sinks for remote switching of external relays such as the HP 33311 series of coaxial switches.

### Breadboard (Opt. 015/HP 44475A)

The breadboard module provides a convenient way to implement custom circuits and special functions that interface directly with the HP 3488A's backplane control signals.

### Microwave Switch (Opt. 016/HP 44476A)

This microwave switch furnishes three independent SPST 50-ohm coaxial switches with excellent performance from DC to 18 GHz. The 3-mm SMA connector allows the user to easily connect cables for multiple system configurations.

### Form-C Relay (Opt. 017/HP 44477A)

This module provides seven separate SPDT channels for general purpose switching and control of external devices. Using a power supply, the module can drive programmable attenuators and non-HP coaxial switches.



**Microwave Switch (Opt. 018/HP 44476B)**

The module brings multi-port 50-ohm coaxial switching to your test system. The module can mount any two HP 3331XX Coaxial Switches. The HP coaxial relays come in three-, four-, and five-port configurations, different switches for a variety of applications. HP Coaxial Switches that can be used are listed on the following table.

HP Coaxial Switch	Port	Frequency
HP 33311B/Opt.011	3	dc - 18 GHz
HP 33311C/Opt.011	3	dc - 26.5 GHz
HP 33312B/Opt.011	4	dc - 18 GHz
HP 33312C/Opt.011	4	dc - 26.5 GHz
HP 33313B/Opt.011	5	dc - 18 GHz
HP 33313C/Opt.011	5	dc - 26.5 GHz

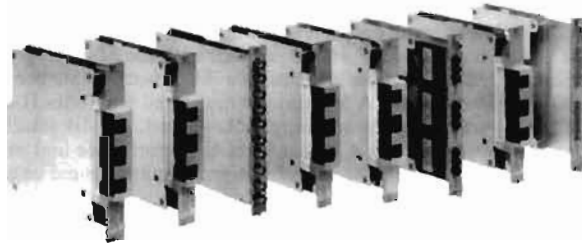

HP 3488A Plug-In Modules

**Specifications for Opt. 010/HP 44470A Multiplexer, Opt. 011/HP 44471A General Purpose Relay, and Opt. 013/HP 44473A Matrix Switch and Opt. 017/HP 44477A Form-C Relay Switch Modules**

**Input Characteristics**

**Maximum voltage (terminal-terminal or terminal-chassis):** 250 V dc, 250 Vac rms, 350 Vac peak  
**Maximum current:** 2A dc, 2A ac rms  
**Maximum power:** 60 W dc, 500 VA ac  
**Thermal offset:** < 3 μV

**DC Isolation (40°C, 60% RH)**

**Channel-channel, open channel:** > 10<sup>11</sup> Ω

**AC Isolation/Performance**

(50 Ω termination)	100 kHz	1 MHz	10 MHz
Insertion Loss (dB)	<0.30	<0.35	<0.90
Crosstalk (dB)	<-73	<-53	<-33

**Specifications For Opt. 012/HP 44472A VHF Switch Module**

**Input Characteristics**

**Maximum Voltage**

Center-center, center-low: 250 Vdc, 30 Vac rms, 42 Vac Peak  
 Low-chassis, low-low: 42 V dc

**Maximum current (per channel):** 30 mA dc, 300 mA ac rms

**Thermal offset:** < 15 μV per channel

**Characteristic impedance:** 50 Ω

**AC Isolation/Performance**

	30 MHz	100 MHz	300 MHz
Crosstalk (dB)			
Chan-Chan	<-100	<-85	<-65
Group-Group		<-85	<-50
Insertion Loss (dB)	<0.5	<0.75	<1.25
VSWR	<1.06	<1.12	<1.43

All channels break-before-make within a group of 4 channels.

**Specifications for Opt. 014/HP 44474A Digital I/O Module**

**I/O Lines**

**Maximum voltage =** +30 Vdc (line-chassis)

**Output characteristics:** V (high) ≥ 2.4 V; V (low) ≤ 0.4V

I (low) maximum = 125 mA @ V (low) ≤ 1.25 V; fused at 250 mA.

**Input characteristics:** V (high) ≥ 2 V; V (low) ≤ 0.8 V

**External increment:** advances HP 3488A to next programmed configuration on falling edge of TTL pulse.

**Channel closed:** indicates completion of new configuration; TTL pulse.

**Specifications for Opt. 016/HP 44476A Microwave Switch Module**

**Frequency Range:** dc to 18 GHz

**Isolation:** >90 dB

**Impedance:** 50 Ohms

**Insertion Loss:** <0.05 dB

**SWR:** 1.40

**Specifications for Opt. 018/HP 44476B Microwave Switch Module**

Refer to HP 3331XX specifications.

**General Specifications**

**Environmental**

Temperature: 0 to 55°C; humidity: 95%, 0 to 40°C

**Power:** 86-132 V/195-250 V, switch selectable; 48 - 440 Hz; 18 VA.

**Interface:** SH1AH1T6TE0L4LE0SR1RL1PP0DC1DT1E2

**Size:** 89 mm H (without feet) x 425 mm W x 292 mm D (3.5" x 16.75" x 11.5"). Allow 76 mm (3") additional depth for wiring.

**Weight:** net: 8.5 kg (18.5 lb). Shipping: 16 kg (36.5 lb).

**Connectors** Removable screw terminal connector. Each terminal accepts 18-26 gauge (16-40 mils) wire, with strain relief for wiring. Option 012/HP 44472A VHF Switch; BNC connectors. Opt. 016/HP 44476A and Opt. 018/HP 44476B Microwave Switch; SMA connectors.

**Ordering and Configuration Information**

Switch Modules-Includes Terminal Connectors	Price
Opt. 010/HP 44470A: 10 Channel Relay Multiplexer Module	\$410
Opt. 011/HP 44471A: 10 Channel General Purpose Relay Module	\$410
Opt. 012/HP 44472A: Dual 4 Channel VHF Switch Module	\$615
Opt. 013/HP 44473A: 4x4 Matrix Switch Module	\$510
Opt. 014/HP 44474A: 16 Bit Digital Input/Output Module	\$410
Opt. 015/HP 44475A: Breadboard Module	\$175
Opt. 016/HP 44476A: Microwave Switch Module	\$2245
Opt. 017/HP 44477A: Form-C Relay Module	410
Opt. 018/HP 44476B: Microwave Switch Module	410

**Rack Mounting and Manuals**

Opt. 401: Side Handle Kit (HP P/N 5061-1171)	\$20
Opt. 907: Front Handle Kit (HP P/N 5061-1170)	\$51
Opt. 908: Rack Flange Kit (HP P/N 5061-1168)	\$31
Opt. 909: Rack Flange with Handles (HP P/N 5061-1169)	\$73
Opt. 910: Extra Operating & Service Manuals	\$80
Opt. W30 Three Year Hardware Support	\$90

**HP 3488A Switch/Control Unit** \$1500

# COMPUTER AIDED TEST

## Multiprogrammer: User-Adaptable Instrumentation

Models 6940B, 6942A, 6944A and 6954A

- Build a test system tailored to your specific application
- Broad range of function-oriented I/O cards with a unified design
- Simultaneous and independent functions

- A cost-effective way to automate your test needs
- Isolated power supplies for analog functions
- Mainframe extenders for increased I/O capacity

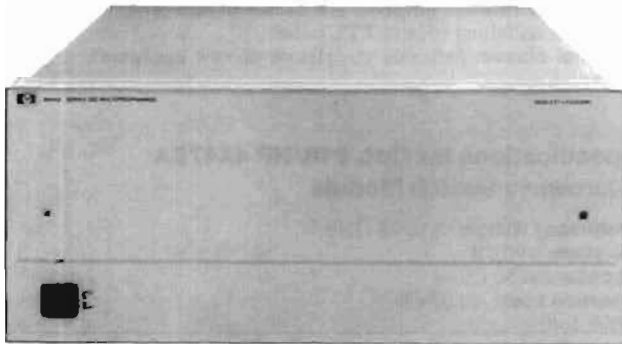

HP 6954A and HP 6944A

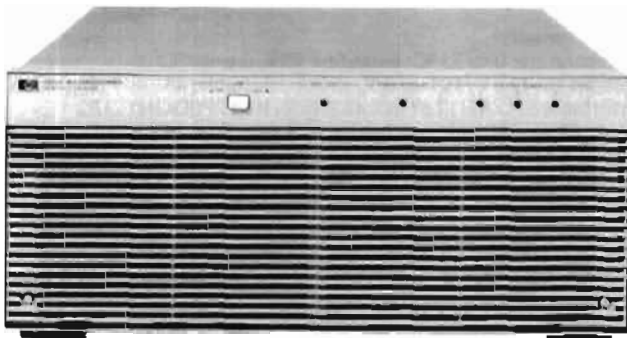

HP 6942A

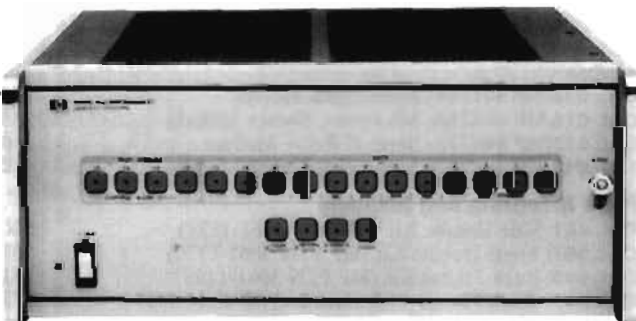

HP 6940B

### Introduction

Hewlett-Packard Multiprogrammer products provide solutions for a variety of data acquisition, control and test applications. The application flexibility is due to the architectural features of these products. The plug-in Multiprogrammer I/O cards allow card-to-card communication, isolated inputs and external triggering and provide a wide range of functions. The HP 6940B coupled with the Multiprogrammer Series I I/O cards offers low-cost solutions when operated on the GP-IO Bus. The HP 6942A Multiprogrammer and the Series II I/O cards are a medium-performance, medium-speed, HP-IB solution. For applications requiring a higher level of performance and more speed, the HP 6944A or HP 6954A Multiprogrammer should be considered for use with the Series II I/O cards.

The I/O cards have many benefits. Multiple-card configurations can be established that provide instrument-like functions. For example: high-speed scanning and multiple simultaneous-buffered analog-to-digital converters. Other features provide precise crystal-controlled timing or pacing of I/O operations. This allows the modular construction of instrumentation functions such as frequency measurement, time interval measurement and programmable pulse generation. The card-to-card communication feature allows the I/O operation of the Multiprogrammer to operate independently of the computer. The computer is then free to perform other tasks until it receives an interrupt from the Multiprogrammer. If the application requires the process to control data collection, it can be accomplished via the external trigger feature. This feature allows the process to time or pace operations independently of the computer. In addition, I/O data can be stored in the Multiprogrammer's plug-in memory system, allowing high-speed operation of other tasks the computer must perform.

### HP 6954A Features

- A Rugged Rack-mountable Test System in a Single Unit
- Built-in HP 9000 Series 310 Computer and 20 Megabyte Hard Disc
- Includes BASIC 5.0 and HP 14753A CAT Programming Package
- HP-IB, HP-HIL, RS-232, Audio and Video Interfaces
- Local or Remote Control via HP-HIL or RS-232
- Standard HP Multiprogrammer Series II I/O Cards
- Accepts HP 9000 Series 200/300 Memory, Accessory, and I/O Cards

### HP 6944A Features

- Data transfer rate of 180,000 readings/second
- HP 98633A interface to HP Series 200/300 computers
- Direct to disc at 180K words/second
- HP 14753A CAT programming package
- HP Multiprogrammer Series II I/O cards

### HP 6942A Features

- Data transfer rate 18,000 readings/second
- HP-IB interface
- HP 14753A CAT programming package
- HP Multiprogrammer Series II I/O cards

### HP 6940B Features

- Front panel control
- GP-IO or optional HP-IB interfacing
- Data transfer rate 20,000 readings/second
- HP multiprogrammer Series I I/O cards
- Temperature measurement capability

## The Power of the Multiprogrammers

HP Multiprogrammers are used mostly for automatic testing applications for many industries including manufacturers of communications products, circuit boards, aircraft instrumentation, electronic ignitions, dashboard electronics and missile guidance systems. Whether it's high speed data gathering that's needed or the ability to perform parallel tasks while the data is being captured, an HP Multiprogrammer can provide the solution.

### Testing Final Assemblies and Subassemblies

HP Multiprogrammers let you configure a flexible, reliable and powerful automatic test and control system for the production environment. HP Multiprogrammers test the final product as well as subassemblies at different stages of the manufacturing process.

The increasing level of sophisticated electronic devices and circuits found in today's automobiles challenges the auto manufacturer to explore equally sophisticated test techniques. High-speed measurements and analyses of multiple channels are key requirements in order to keep the constantly moving assembly lines supplied with high-quality components. Multiprogrammer A/Ds and scanning systems provide this high-speed measurement and multiple channel capability. Output functions, such as the Voltage and Current D/A cards and relay cards in matrix configurations, are used to stimulate electronic subassemblies.

### Measure Vibration in Machinery

In vibration analysis applications, the ability to capture waveforms in a wide frequency range, analyze the data and present it using a single system is an important requirement. The 500,000 samples/second digitizing capability of the Multiprogrammer and its local memory cards allow a large range of frequencies to be acquired.

For applications such as oil exploration and electrical power generation where large rotating machinery is used, vibration analysis is critical in ensuring trouble-free operation. Multiprogrammers can capture data and store it in memory while the computer analyzes previously captured data. This results in an uninterrupted stream of information being presented to the tester. In addition, the Multiprogrammers can be set to be event-triggered so that an event-related condition starts the data gathering process without operator intervention.

### Product Development and Evaluation

Multiprogrammers are used for developing state-of-the-art products for many aerospace and defense applications. These types of industries require powerful and flexible test systems because of their constant stream of new projects with unique requirements. When testing newly developed prototypes, large quantities of data are usually required in order to fully characterize the behavior of a unit when subjected to differing stimuli. The HP 6944A Multiprogrammer captures data and continuously stores it to an external hard disc at rates up to 200,000 samples/second.

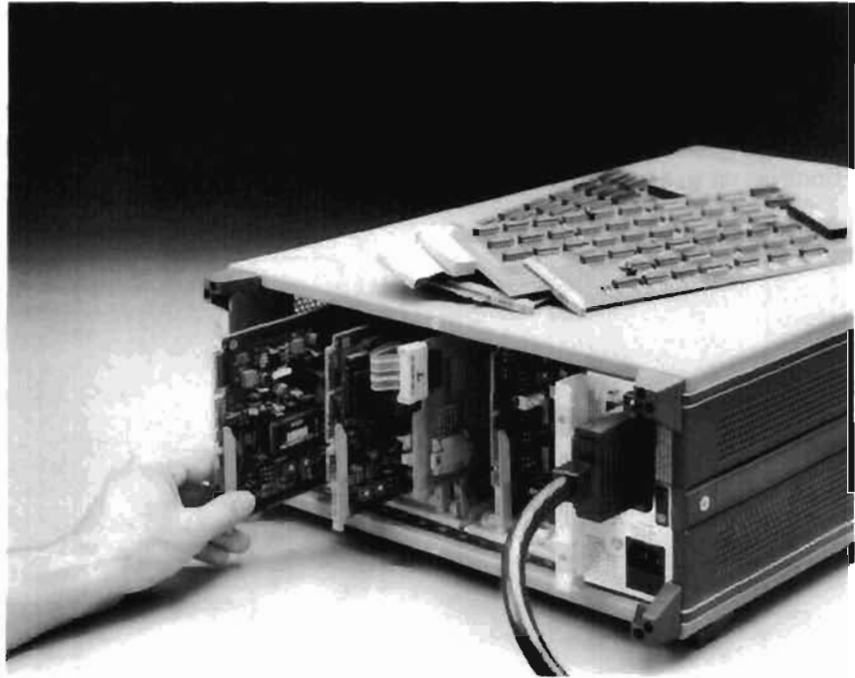

Failure analysis is another important product development process in military applications. A Multiprogrammer system can collect large quantities of data without the presence of an operator. If a failure does occur, the Multiprogrammer can stop the test and signal the operator.

### Component Evaluation

There is an increasing push for automation in the production environment to improve efficiency at all stages of the manufacturing process. For example, quality-conscious

manufacturers recognize the importance of thorough incoming component inspection that doesn't sacrifice smooth production flow.

Multiprogrammers satisfy these needs because of their speed and flexibility. Testing can be centrally controlled by a single operator or by several testers by linking a multiple-user computer system, such as the HP 1000 series, to HP 6942A Multiprogrammers. As a result, the manufacturing flow is uninterrupted and enhanced which leads to reduced manufacturing costs.

# COMPUTER AIDED TEST

## Multiprogrammer: User Adaptable Instrumentation

Model 6954A

- Built-in HP 9000 Series 300 Computer and 20 Megabyte Hard Disc
- Includes BASIC 5.0 and HP 14753A CAT Programming Package
- Controls up to 14 HP-IB instruments or peripherals
- Local or Remote Control via HP-HIL or RS-232
- Accepts standard HP Multiprogrammer Series II I/O Cards
- Accepts standard HP 9000 Series 200/300 Memory, Accessory, and I/O Cards



HP 6954A Option 001



### Description

The HP 6954A Multiprogrammer is the newest and most powerful addition to HP's family of Computer Aided Test products. The HP 6954A is a complete high speed data acquisition and control system in a single, compact, rack-mountable unit. The HP 6954A Multiprogrammer is suitable for applications in fields such as: electronic production test, automated electronic test, data acquisition, process control, and process/product characterization.

The HP 6954A Multiprogrammer features a built-in HP 9000 Series 300 System Processing Unit, One Megabyte of RAM, a 20 Megabyte Winchester disc drive, HP 98620B DMA card, RS-232, and HP-IB interfaces. The built-in HP-IB interface allows the HP 6954A to control up to 14 HP-IB instruments or peripherals. Connecting a keyboard and monitor to the HP 6954A allows it to be controlled locally. Or, you can control the system remotely via an RS-232 link to a terminal such as the HP 2623A or HP 3082A, a computer running a terminal software package such as The PORTABLE computer, or a host computer such as the HP 1000.

The HP 6954A has two card cages, one that accepts up to eight Multiprogrammer Series II I/O cards, and another that accepts up to three additional Series 200/300 memory, accessory, or I/O cards. You can expand the HP 6954A Multiprogrammer system's I/O ca-

pability by adding up to seven HP 6944A Multiprogrammers as extenders to give you 120 slots for standard Multiprogrammer Series II I/O cards. And when HP 6944A Multiprogrammers are used as extenders for the HP 6954A, no extra interface is required because a Multiprogrammer Interface is built into the HP 6954A.

The wide spectrum of capabilities offered by the Multiprogrammer Series II I/O cards gives the Multiprogrammer the capability to digitize analog data at up to 500 KHz, acquire up to 1 Megabyte of 16 bit data at rates up to 760 kHz, or continuously log data directly to internal disc at rates up to 54 kHz. Other I/O card stimulus and response functions include current output, voltage output, pulse output, switching, analog multiplexing, event counting, event sensing, and additional measurement and control functions offered on pages 582 and 583.

The HP 6954A can be used as a development station by simply adding the optional local control kit consisting of an HP keyboard and monitor. HP 9000 Series 200/300 BASIC 5.0 and the HP 14753A Computer Aided Test Programming package are included with the HP 6954A to give you one of the easiest to use instruments-oriented program development environments available. The HP 6954A is compatible with HP 9000 Series 200/300 software packages such as the DACQ/300 Data Acquisition Manager (HP 4445A/B) that features data management, data analysis, and data presentation.

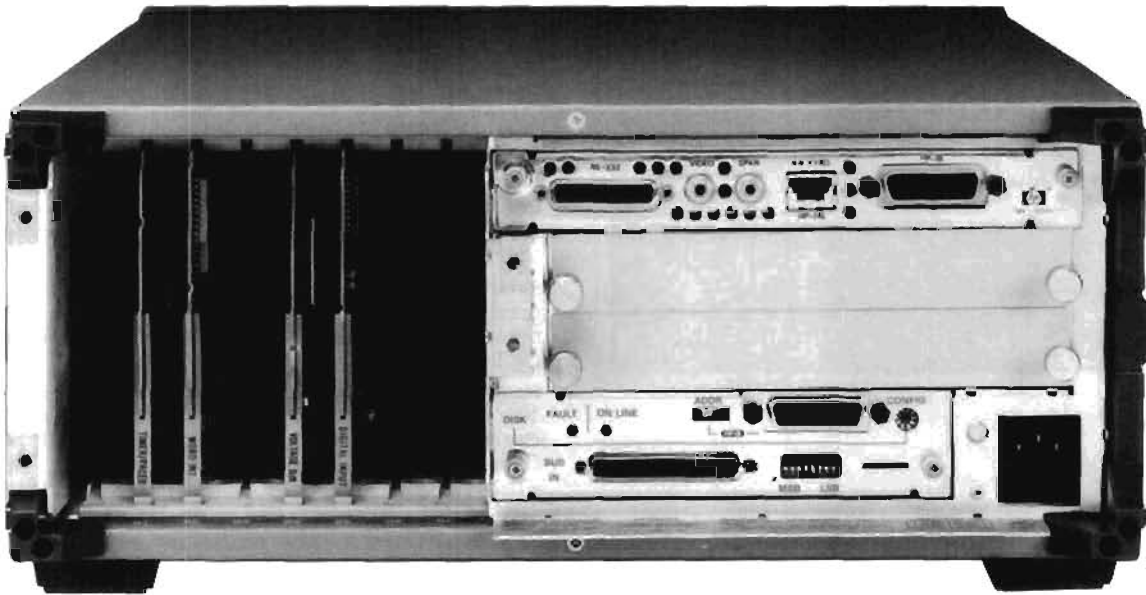

HP 6954A

HP has integrated and assembled the complete system into one rack-mountable unit: a powerful SPU and HP-IB interface for instrument control, a 20 Mbyte disc drive for program and data storage, 1 Mbyte of RAM, BASIC 5.0 and the CAT Programming package for easy program development, and two types of card cages for versatility and a large selection of I/O functions. The HP 6954A is one of the easiest, most cost effective ways to build an automated test system that is tailored to your specific application.

### Specifications

**Plug in I/O card positions:** A maximum of 8 Multiprogrammer Series II I/O card slots and 3 available HP 9000 Series 200/300 interface and accessory card slots (a fourth slot is occupied by the DMA card).

**Controller Interface:** Not applicable. Controller is built in.

**I/O Interfaces:** HP-IB, RS-232, HP-HIL, audio and composite video.

**Extender units:** Up to seven HP 6944A's can be linked to the HP 6954A using HP 14704A, B, or C interface cables.

**Maximum length of a link:** A link of up to seven HP 6944A's can extend nine meters long, maximum. This maximum length is the sum of all the HP 14704A, B, or C Interface cables.

**System Data Acquisition rate:** High data acquisition rates can be attained using Multiprogrammer I/O cards. For example, digital acquisition rates up to 1 MHz are possible using the HP 69791A Memory card and analog acquisition rates up to 500 kHz can be attained using the HP 69759A 500 kHz A/D.

**Data transfer rate:** Using the HP 98620B DMA card (takes up one slot of the four HP 9000 Series 200/300 interface and accessory card slots), data transfer rate between the Multiprogrammer I/O cards and the computer is up to 220,000 readings per second and direct to disc transfer of 200,000 words per second over HP-IB.

**Power Supplies:** All necessary power supplies for up to eight Multiprogrammer Series II cards, the controller, and up to four HP 9000 Series 200/300 interface and accessory cards are built into the HP 6954A. Three  $\pm 18$  V supplies (isolated from each other and from ground) are available for powering isolated I/O cards.

**Input Power:** 100/120/220/240 Vac (switch selectable),  $\pm 5\%$  to  $-10\%$ , 47 to 63 Hz, 630 VA.

**Operating Temperature Range:** 0 degrees C to +55 degrees C.

**Dimensions:** 177.0 mm high x 425.5 mm wide x 597.0 mm deep (7 in. x 16.25 in. x 23.5 in.)

**Weight (without I/O cards):** Net, 26.4 kg (58 lb.) Shipping, 33.6 kg (74 lb.)

### Ordering Information

	Price
<b>HP 6954A Multiprogrammer</b>	<b>\$10400</b>
Option 001: Local Control Kit	\$595
Option 002: Delete BASIC 5.0 and HP 14753A	-\$1000
Option W30: Two Year additional warranty (cannot be ordered with Option W03)	\$200
Option W03: Warranty conversion to 90-day on-site	N/C
Option 908: Rack mount kit	\$45
Option 910: Extra Installation and Service Manual	\$35

### Order one HP 14704A/B/C Interface cable for each HP 6944A extender used in the system:

HP 14704A Multiprogrammer Interface Cable (1 meter)	\$112
HP 14704B Multiprogrammer Interface Cable (2 meter)	\$112
HP 14704C Multiprogrammer Interface Cable (4 meter)	\$133

# COMPUTER AIDED TEST

## Multiprogrammer: User Adaptable Instrumentation

### Model 6944A

- Data transfer rate 200,000 readings/second
- Dedicated Interface (HP 98633A) to HP Series 200/300 Computers

- Direct-to-disc transfer rate of 200,000 words/second
- HP 14753A CAT programming package
- HP Multiprogrammer Series II I/O cards

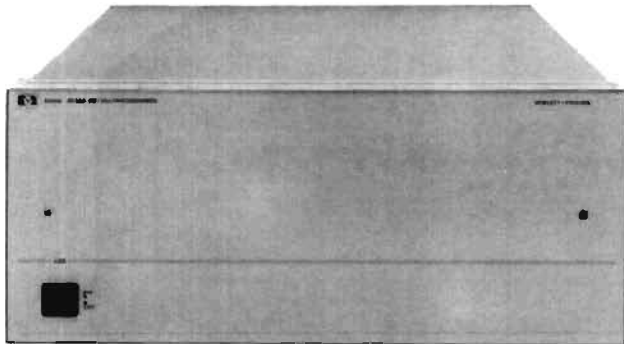

HP 6944A

### Description

The HP 6944A Multiprogrammer is a high-speed data acquisition and control system designed exclusively for use with HP Series 200/300 computers. The HP 6944A capitalizes on the HP Series 200/300 computer architecture by using the dedicated HP 98633A Multiprogrammer Interface and the HP 98620B DMA Controller to achieve high-speed data transfers.

The powerful HP Multiprogrammer Series II I/O cards provide a broad variety of I/O functions for the HP 6944A. These cards allow the user to configure the HP 6944A to implement many instrumentation functions such as high-speed scanning, analog waveform synthesis, limit checking and transient analysis.

The HP 6944A is programmed exclusively with the HP 14753A Computer Aided Test Programming Package. This software package effectively couples the flexible hardware architecture of the HP 6944A with the BASIC language system of the HP Series 200/300 Computers. The friendliness of this system is such that the system programmer only needs to be able to program in BASIC. The control statements are test oriented and closely linked to the application by a list of "Names" supplied by the user. An easy-to-use, menu-driven configuration process correlates the user-assigned "Names" to the system's I/O functions automatically from the BASIC program. The software, through the same menu-driven process, then leads the system programmer through the hardware configuration. The net result is fast program development, self-documented programs and the ability to maintain different configuration files on one disc.

### Features

The primary features of the HP 6944A evolve around the architecture of the HP 6944A, HP Series 200/300 Computers, and the Multiprogrammer Series II I/O cards.

The key feature of the HP 6944A is high-speed data transfer. With the HP 6944A, HP 69759A 500 kHz A/D, HP 69791A/92A High-Speed Memory I/O System, and the HP 98620B DMA Controller Card, data may be transferred to an HP Series 200/300 Computer at rates of 200,000 readings/second. Without the HP 98620B DMA Controller Card, transfer rates of nine kilowords/second are achieved.

A second key feature of the HP 6944A is its ability to unburden the HP Series 200/300 Computer from controlling each I/O task of the HP 6944A. This allows the HP Series 200/300 Computer time to perform numerical analysis or manage other instruments during these time periods.

### HP 6944A Specifications

**Plug in I/O card positions:** Maximum of 15 plug-in output or input cards per mainframe. Removable rear cover provides access to card slots.

**Computer interface:** The HP 6944A is connected to an HP Series 200/300 Computer via the HP 98633A Multiprogrammer Interface Card and HP 14704A, B or C cable.

**Extender units:** Up to eight HP 6944A Multiprogrammers can be connected to the Series 200/300 computer's HP 98633A Multiprogrammer Interface Card by using HP 14704A, B or C Interface Cables.

**Maximum length of a link:** A link of up to eight HP 6944A Series 200/300 Multiprogrammers can be nine metres long, maximum. This maximum length is the sum of the lengths of all the HP 14704A, B or C Interface Cables in the link.

**Power supplies:** All necessary power supplies for up to 16 I/O cards are built into each HP 6944A frame. Three  $\pm 18$  V supplies are isolated from each other and from ground, and are available for powering isolated I/O card circuits.

**Cooling:** Built-in forced air cooling draws air in through the side vents and exhausts air through the rear cover.

**Operating temperature range:** 0 degrees C to +55 degrees C.

**Power:** 100/120/220/240 Vac (switch, selectable), +5% to -10%, 47 to 63 Hz, 650 VA.

**Dimensions:** 177.0 mm high x 425.5 mm wide x 597.0 mm deep (7.0 in high x 16.25 in wide x 23.5 in deep).

**Weight (without I/O cards):** Net, 21 kg (46 lb); shipping, 28.6 kg (63 lb).

### Ordering Information

**Step 1: Select the necessary quantity of HP 6944As.**

HP 6944A Series 200/300 Multiprogrammer \$3800

**Option 908:** rack mount kit

**Option 910:** extra operating and service manual

**Option W03:** converts 1 yr return-to-HP warranty to a 90-day on-site warranty

**Step 2: Select the HP Series 200 Multiprogrammer Interface Card for HP 6944A.**

HP 98633A Multiprogrammer Interface Card \$355

**Step 3: Select number and lengths of cables required for connecting HP 98633A Interface to first frame.**

An additional cable is needed for each HP 6944A frame used as an extender.

HP 14704A Multiprogrammer Interface Cable, 1 m (3.3 ft) \$112

HP 14704B Multiprogrammer Interface Cable, 2 m (6.6 ft) \$112

HP 14704C Multiprogrammer Interface Cable, 4 m (13.2 ft) \$133

**Step 4: Select HP 14753A to receive necessary CAT software and documentation (mandatory).**

Select the option appropriate for the system controller.

HP 14753A Computer Aided Test Programming Package \$2050

**Option 044:** software provided on 3 1/2" flexible discs N/C

**Option 042:** software provided on 5 1/4" flexible discs N/C

**Option 910:** extra set of documentation \$76

HP 14753R: right to reproduce HP 14753A CAT programming package (documentation provided) \$1020

# COMPUTER AIDED TEST

## Multiprogrammer: User Adaptable Instrumentation

581

Model 6942A

- Action-oriented instructions
- Isolated analog inputs and outputs
- Built-in self test

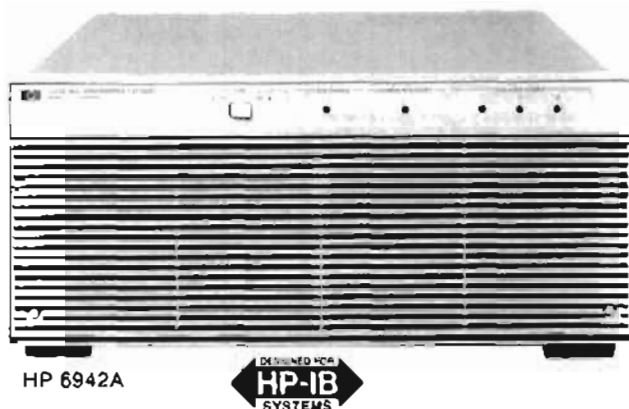

- Overlapped input and output
- Internal or external pacing
- Easy to configure

### Accessories

**HP 14700A extender kit:** this kit contains the transmission boards which go into the master mainframe (HP 6942A) and the last extender mainframe (HP 6943A) in the chain.

**HP 14701A Intermediate extender kit:** when more than two mainframes are in a chain, the card in this kit must be used in each intermediate extender mainframe.

**HP 14702A chaining cable:** this is the cable which chains together the master and extender mainframes. One cable is required for each extender mainframe. Length: 1.5 m (5 ft).

**HP 14703A card edge connector:** extra connectors for the I/O cards may be ordered in addition to the one supplied with each I/O card.

### HP 6942A/6943A Specifications

**Plug-in I/O card positions:** maximum of 16 plug-in output or input cards per mainframe. Removable rear cover provides access to card slots.

**Computer interface (HP 6942A only):** the Multiprogrammer is connected to a controller via the Hewlett-Packard Interface Bus (HP-IB), Hewlett-Packard's implementation of IEEE Std. 488.

**Real time clock (HP 6942A only):** the built-in real time clock is automatically synchronized with the 50/60 Hz ac power line frequency. The clock is read and set with data in the form of days, hours, minutes and seconds with a resolution of 0.1 second.

**Extender interface kits (HP 6943A only):** each HP 6943A Extender requires one HP 14700A or 14701A Interface Kit and one HP 14702A Chaining Cable for operation with the HP 6942A.

**Maximum number of mainframes per chain:** up to seven HP 6943A Multiprogrammer Extenders may be placed in a chain with one HP 6942A Multiprogrammer.

**Maximum chain length:** a chain of mainframes can be up to 152 meters (500 feet) long. This maximum length is the sum of the lengths of all HP 14702A Chaining Cables used in one chain.

**Power supplies:** all power supplies for up to 16 I/O cards are built-in including three  $\pm$  18 V supplies isolated from each other and from the ground.

**Cooling:** built-in forced air cooling draws air in through the front panel and exhausts air through the ventilated rear cover.

**Front panel indicators:** five light emitting diodes on the front panel indicate power supply and self-test status.

**Operating temperature range:** 0°C to 55°C.

**Power:** 100/120/220/240 Vac (selectable), +5%, -10%, 47 to 63 Hz, 600 VA.

**Dimensions:** 177.0 mm high x 425.5 mm wide x 597.0 mm deep. (6.969 in. high x 16.250 in. wide x 23.500 in. deep).

**Weight (without I/O cards):** net, 20 kg (45 lb); shipping, 27 kg (60 lb).

**Accessories furnished:** PC board Extender Card (HP Part No. 5060-2792).

### The Multiprogrammer Performs Operations in Parallel

With this one instrument you can control several processes at once. And, while you are controlling the processes, the Multiprogrammer can also be watching for interrupt conditions. The internal microprocessor manages all the parallel operations and monitors the alarm lines: when the operations have completed or if an alarm condition occurs, the Multiprogrammer interrupts the controller.

### How does the HP 6942A Connect With Your Controller?

The HP 6942A Multiprogrammer interfaces with your controller (desktop or minicomputer) using the HP-IB, Hewlett-Packard's implementation of IEEE Standard 488 and the identical ANSI Standard MCI.1. Data and status readback make use of the extended bus addressing features of the HP-IB.

### Programming Flexibility

Mnemonic, action-oriented instructions make the HP 6942A Multiprogrammer simple to learn and use. For instance, the output instruction "OP" works with all output cards. When you send an instruction, the internal microprocessor checks which type of card you are addressing and automatically converts the data to the proper format for that card. You select the units with which you want to program each card. Whether you want to use volts, millivolts, amps, degrees, feet, or any other units, the Multiprogrammer does the converting for you.

### Mainframe Memory Unburdens The Controller

The mainframe memory of the HP 6942A will accept up to 76 instructions from the controller at one time. This leaves your controller free for other processing activities while the Multiprogrammer works on the I/O operations. This mainframe memory may also be used to collect up to 1440 data readings and hold them until the controller is free to take them. (For even more data storage, up to 1 Meg words of data may be stored using the HP 69791A and HP 69792A Memory System Cards.)

### Real Time Clock

Built-in real-time clock gives you time-of-day readings and pacing of measurements. The clock detects which power line frequency you are using, 50 Hz, or 60 Hz, and automatically synchronizes itself to this frequency. The range of the clock is 65.534 days, with resolution to a tenth of a second.

### Computers and Documentation

The HP 6942A can be operated with a wide variety of computers, including the HP Series 80, Series 200, Series 300, Series 1000, 9825, and 9845 computers. Documentation packages are available for these computers. Each one contains a User's Guide with programming examples, a utility program tape or flexible disc, operating and service manuals, and a binder to hold this material. One no-charge documentation option must be specified to select the documentation appropriate for your computer.

### Ordering Information

	Price
Opt 010-233: One Set Documentation/Software	N/C
Opt 333-499: Extra Documentation/Software	\$103
Opt 908: Rack Flange Kit	\$41
Opt 910: Extra Manual	\$31
Opt W03: Converts 1 yr return-to-HP warranty to a 90-day on-site warranty	N/C
HP 14700A Extender Interface Kit	\$610
HP 14701A Extender Interface Kit	\$510
HP 14702A Chaining Cable	\$305
HP 14703A Spare Card Connector	\$76
<b>HP 6942A Multiprogrammer</b>	<b>\$4500</b>
<b>HP 6943A Multiprogrammer Extender</b>	<b>\$3400</b>









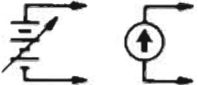

# COMPUTER AIDED TEST

## Multiprogrammer Series II I/O Cards: Broad Functionality with a Unified Approach

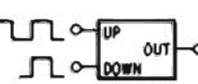
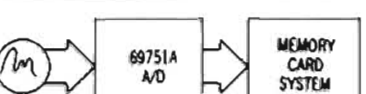
Models 69700A-69793A

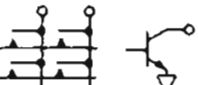
### Multiprogrammer Series II I/O Cards for the HP 6954A, 6944A, and 6942A

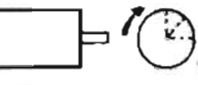
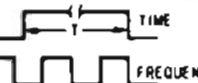
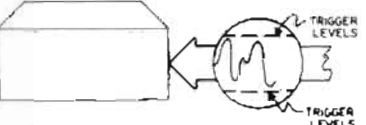
For a complete description of the Multiprogrammer Series II I/O Cards, ask for publication 5952-4175.

	Functions	Applications	Cards Used
STIMULUS	 <p>Programmable DC Voltage and Current</p>	The output voltage (up to 250V) and current (up to 1000A) of forty different HP power supplies can be programmed to provide bias in automatic test systems or control of electromechanical process equipment.	Resistance Output, HP 69700A-69706A; Power Supply Control, HP 69709A.
	 <p>Digital-to-Analog Conversion</p>	Twelve-bit voltage DAC's provide outputs for strip chart, x-y, and analog tape recorders as well as control of analog programmable instruments and stimulus of units under test. Control process equipment with 4-20 mA output.	Voltage DAC, HP 69720A; Current DAC, HP 69721A.
	 <p>Analog Waveform Synthesis</p>	The Memory card can continually supply pre-loaded data to the D/A card at rates of up to 100 kHz. Special waveforms may be loaded into the Memory card from the computer and used as stimuli for test and processes. The analog output is isolated from digital ground.	Memory card, HP 69790B; 69791A, 69792A Voltage DAC, HP 69720A; or Current DAC, HP 69721A.
MEASUREMENT	 <p>Voltage, Current, and Resistance Measurements</p>	A/D converters may be used to measure voltages from $\pm 50\mu\text{V}$ to $\pm 100\text{V}$ in the presence of 250 V of common-mode noise. Connecting a resistor across the input permits current measurements for 4-20 mA current loops used in process control. Combine the A/D with the current DAC for resistance measurements.	High Speed ADC, HP 69751A; HP 69759A
	 <p>Frequency Measurements</p>	The Pulse Counter card accumulates counts over a precise time interval when a Timer card is connected to the enable line of the Counter. The program divides the count by the time interval to measure frequencies from 1 MHz to less than 0.001 Hz.	Counter, HP 69775A; Timer HP 69736A.
	 <p>Pulse Counting Preset Up/Down</p>	The Counter may be preset to any value within the count range of 0 to 65,535 and can cause an interrupt when it rolls over. The Counter may be enabled and disabled by pulses or levels. The computer may read the count without disturbing the counting process.	Counter, HP 69775A.
	 <p>Offline Analog Acquisition</p>	Differential or single-ended signals may be digitized at rates up to 500 kHz by the A/D, and stored in the Memory system. Each Memory system can store up to one megawords. The digitizing process can take place independent of other Multiprogrammer activity.	High Speed ADC, 69751A; Memory cards, 69790B, 69791A/69792B.
	 <p>Scanner Systems</p>	Analog measurements from up to 960 channels may be acquired at 25,000 readings per second depending upon the scanner system configuration. Random access to any channel, as well as continuous scanning, are easily accomplished. (See Application Note AN316-3.)	Cards used: Scan Control, HP 69750A; FET Scanners, 69752A or 69755A; Relay Scanner, HP 69754A; High Speed ADC HP 69751A; Memory card HP 69790B, or 69791A/92A
	 <p>Digital Output and Switching</p>	Sixteen-bits of data in TTL, open collector, or SPST relay-contact form provide digital control of instruments and indicators. AC power, up to 6, can be switched to 12 loads with a HP 69731B, and HP 14570A AC Power Controller.	Digital Output, HP 69731B; Relay Output, HP 69730A; AC Power Controller, HP 14570A.
CONTROL	 <p>Digital Input</p>	Digital input cards accept 16-bits of data from digital measuring instruments, push-buttons, switches, relays, and other digital devices in the form of logic levels or contact closures. Digital data sources with more than 16-bits of data use several digital input cards.	Digital Input, HP 69771A; Isolated Digital Input, HP 69770A.
	 <p>Stepping Motor Control</p>	The Stepping Motor card can produce from 1 to 32767 pulses at either of two outputs (CW or CCW) to control motor translators. Output pulses are also used for pulse-train update of supervisory control stations. The pulse rate (motor speed) is also programmable.	Pulse Train/Stepping Motor, HP 69735A.
	 <p>Time and Frequency Reference</p>	Crystal controlled timing pulses, programmable from 1 $\mu\text{s}$ to 18 hours, may be used as a time-base reference for control, measurement, and data acquisition. Period, duty cycle, and number of pulses are all programmable.	Timer, HP 69736A or Pulse Train, HP 69735A.
	 <p>Level Detecting</p>	When signals cross preset levels, the Digital Input card can trigger the interrupt card to interrupt the computer. The alarm trigger levels can be programmed with the D/A or fixed with resistors.	Digital Input HP 69771A; Interrupt card, HP 69776A.
ALARM	 <p>Event Sensing</p>	A digital word may be used to trigger quick computer response with the interrupt card. The computer responds to the interrupt with a software routine. The interrupt may also cause immediate local response by triggering a preloaded output card.	Interrupt card, HP 69776A.



- HP 69752A 64 Channel FET Scanner Card** \$1,235  
 Scans 64 single-ended channels ( $\pm 10.24$  V input signal range) at up to 25,000 readings per second. Cards cascable to 960 channels in a single mainframe.
- HP 69755A 16 Channel FET Scanner Card** \$565  
 Same as 69752A, except scans 16 channels.
- HP 69754A 32 Channel Relay Scanner Card** \$930  
 Scans 32 single-ended (16 double-ended) channels with a  $\pm 100$  V input signal range at speeds up to 1000 readings per second (625 readings double-ended). Switches currents up to 50 mA.
- HP 69750A Scan Control/Pacer Card** \$670  
 Provides all pacing and control functions for the scanner cards listed above. One required for each group of scanner cards (maximum of 15 cards—see data sheet for further clarification).
- HP 69709A Power Supply Control Card** \$980  
 Used for full system control of 6024A and 6012A Autoranging Power Supplies.
- HP 14728A Buffered A/D Cable** \$255  
 Used to connect 69751A and 69790B in a buffered A/D configuration.
- HP 69700A-69706A Resistance output cards:** the output of each of these cards is a programmable resistance value. Twelve mercury wetted relay contacts close across binary weighted precision resistors in a series string. The cards are designed to program the voltage or current output of an HP power supply with option 040. \$565-615
- HP 69720A D/A voltage converter card:** provides a high speed, bipolar output voltage programmable from  $-10.240$  V to  $+10.235$  V up to 5 mA load current. \$720
- HP 69721A D/A current converter card:** provides a bipolar  $-20.480$  mA to  $+20.475$  mA current output. \$930
- HP 69730A Relay output card:** provides sixteen independent, normally open, mercury wetted relay contacts. Contacts rated at 100 Vdc; or 1 Amp; and 28 VA. \$565
- HP 69731B Digital output card:** provides sixteen TTL or CMOS compatible outputs, or sixteen 100 mA open-collector switches. \$415
- HP 69735A Pulse train output/stepping motor control card:** generates up to 32767 pulses at a programmable frequency. \$515
- HP 69736A Timer/pacer card:** outputs a programmable pulse from one microsecond to eighteen hours or a programmable square wave. \$515
- HP 69751A A/D converter card:** this card measures bipolar dc voltages in one of four ranges,  $\pm 100$  mV,  $\pm 1$  V,  $\pm 10$  V, or  $\pm 100$  V, with 12 bit resolution at up to 33,000 readings per second. \$980
- HP 69770A Isolated digital input card:** breaks the path of potential ground loops with an optically coupled isolator in each of the sixteen digital input lines. \$670
- HP 69771A Digital input/analog comparator card:** monitors up to sixteen contact closures, switches, TTL signals, CMOS signals, or analog signals. The switching threshold can be set to any value between  $\pm 9.5$  volts by a screwdriver-adjustable potentiometer on the card or may be externally programmed. \$615
- HP 69775A Counter/totalizer card:** counts contact closures, TTL or CMOS logic level pulses, or analog waveform transitions in the range of 0 to 65,535. \$745
- HP 69776A Interrupt card:** compares up to sixteen logic level or contact closure inputs with a sixteen-bit reference word and interrupts for =,  $\neq$ , <, > conditions. \$565
- HP 69790B Memory card** (occupies 2 I/O slots); provides 4096 16-bit words for use with the DAC cards or the ADC cards or for other input/output tasks that need to run independent of other Multiprogrammer or computer tasks. Several Memory cards may be used to implement truly simultaneous operations. \$1,010
- HP 69793A Breadboard card:** the generalized grid area on this card may be used for mounting custom circuits. \$153

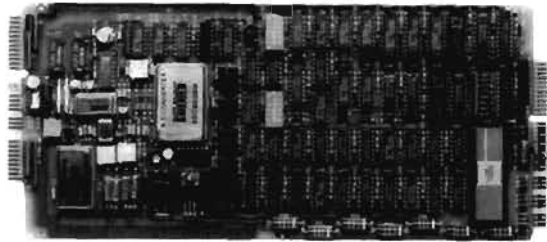

HP 69759A

**HP 69759A - 500 kHz A/D**

The HP 69759A 500 - kHz A/D converter measures bipolar voltages in four programmable ranges,  $\pm 100$  V,  $\pm 10$  V,  $\pm 1$  V, and  $\pm 100$  mV. The digitized values may be read directly by the controller or transferred into HP 69791A and HP 69792A memory buffer cards available for the Multiprogrammer system. Use of memory buffers permits simultaneous digitization of as many as 40 independent signal channels at rates up to 500 kHz per channel. Scanning subsystems designed specifically to work with the HP 69759A card provide additional measurement flexibility and permit expansion up to 7168 channels. Timebase and triggering functions may be added using other Multiprogrammer cards to form a complete analog measurement system that is precisely tailored to the requirements of the specific application.

Application Note 316-5, Data Capture, describes several ways that the HP 69759A can be used with other Multiprogrammer cards to solve several different applications. These descriptions include cable diagrams and program listings for both the HP 14752A and the HP 6942A native instructions.

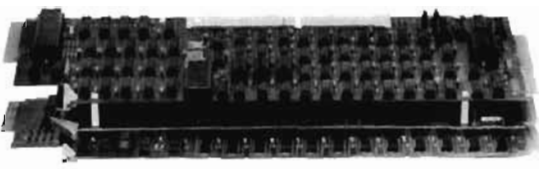

HP 69791A

**HP 69791A/92 - Memory System**

The HP 69791A and HP 69792A Memory Cards form a buffer used to perform input and output tasks without intervention from the controller. A memory card buffer can be used for inputs or outputs, or both. Data can be acquired at up to 760 kilowords/second or sent at up to 400 kilowords/second.

A memory card buffer has one HP 69791A Memory Card and up to five HP 69792A Memory Expansion Cards for a maximum memory size of 1M (1,048,576 16-bit words). The HP 69791A holds 64k (65,536 16-bit words) and the HP 69792A holds 192k (196,608 16-bit words). The memory card buffer functions as a single memory, regardless of how many HP 69792As are added.

The memory card subsystem can be used with the HP 69751A or HP 69759A A/D cards to input digitized analog measurements. Up to eight HP 69759A A/D Cards can be multiplexed into a single HP 69791A/69792A memory buffer. The A/Ds can be triggered by the same timebase for truly simultaneous readings which are then stored in sequential memory locations. This reduces memory costs and the number of mainframe slots required.

<b>Ordering Information</b>	<b>Price</b>
HP 69759A A/D Converter	\$2350
HP 69791A Memory Card	\$1530
HP 69792A Memory Card	\$1020

# COMPUTER AIDED TEST

## Multiprogrammer: System Software

### Model 14753A Computer Aided Test Programming Package

- Easy to use menu entry
- Faster software development
- Improved HP 6942A performance

#### Description

The HP 6954A, HP 6944A and the HP 6942A are easy to use computer-aided test systems that improve productivity by enabling you to implement your testing requirements more quickly. This is achieved through the use of a companion software package. The HP 14753A is a powerful CAT programming package which replaces the standard two-letter mnemonics of the HP 6942A Multiprogrammer and is the standard programming language for the HP 6944A and HP 6954A Multiprogrammers.

These systems are friendly and easy to use. Mnemonic-type language is not needed to program either the HP 6954A or the HP 6944A. In addition, the HP 14753A will increase the performance speed of the HP 6942A. The CAT programming package supports all of the Multiprogrammer Series II I/O cards.

#### CAT Programming Package

The CAT programming package is a comprehensive collection of software routines that provide the ATE system designer with a high-performance linkage between the BASIC language and Multiprogrammer hardware. Both friendliness and higher performance are combined in the software through an architecture which optimizes total system performance.

Friendliness is achieved by replacing traditional "computer language" statements with test-oriented commands. Communication with all supported instrumentation is via "functional names", chosen by the user, which have a close relationship with the function performed. For example, in the menu below, the name "value" is used to program a HP 69720A Voltage D/A Converter. This lets you program in terms that are familiar to you resulting in programs which are virtually self-documenting. Friendliness is further enhanced by convenient menu entries, which make it easy to enter all function names and parameters.

The CAT programming package reduces the amount of software written by the user thus speeding program development. Productivity is improved by shortening test development time. To create test software, the user enters functional names and other data into a series of menus. Then a program is written in Series 200/300 BASIC to handle all sequencing, computational, and decision-making operations. Whenever a stimulus, acquisition or control function is desired, the BASIC program is instructed to call a routine from the CAT programming package.

#### Features

Some of the CAT programming package features are highlighted in a menu below. The timeout feature can generate an error if an operation has not completed in a specified time. Since the error can be trapped like any other BASIC error, corrective action can be programmed to occur automatically. Limit-checking prevents out of range values from being executed, and data conversion permits programming with user specified units. Initial values can also be specified and, at run time, sent to all instrumentation with a single command.

User selected name matches test function

Stimulus, acquisition or control function selected from supported instrumentation

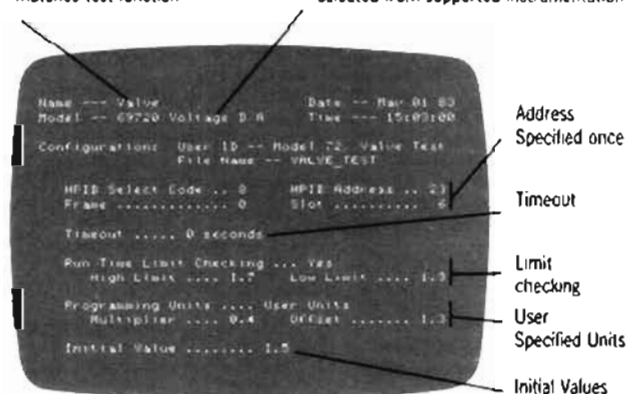

#### Multiprogrammer Series II I/O Cards

The CAT programming package supports the Multiprogrammer Series II I/O card functions, described on pages 582 and 583, and four popular multiple-card functions. These include combinations such as using a high-speed scanner, A/D, and memory card together. In addition, the HP 3478A 5½-digit Multimeter is supported for applications requiring high-accuracy and high-resolution measurements.

#### HP 6900 Series Multiprogrammer

The Multiprogrammer is a high-performance mainframe that provides the necessary interface for up to sixteen plug-in cards. Optional Multiprogrammer Extenders can be added to a system to further expand its capabilities. Up to seven Extenders, each holding up to sixteen plug-in cards, can be chained to one mainframe.

The new HP 6954A is a Multiprogrammer mainframe and controller in a single compact unit that contains an HP Model 310 Computer, a 20 Mbyte hard disc (containing HP BASIC 5.0, 14753A CAT Software, and utilities), built-in HP-IB, RS-232, HP-HIL, and video interfaces. An internal HP 98633A type interface is also included. The HP 6954A, capable of being the system controller in an HP-IB system, comes with a DMA card for high-speed data transfer and supports up to 3 additional DIO cards for flexibility. It accepts up to eight Multiprogrammer Series II I/O cards and, if more card slots are needed, just add up to seven HP 6944A Multiprogrammers as extender units.

The HP 6944A Multiprogrammer is a high-speed mainframe that has 16 slots available for Series II I/O cards. Up to eight HP 6944A Multiprogrammers can be controlled by a Series 200/300 computer via an HP 98633A interface.

The HP 6942A Multiprogrammer has 16 card slots for Series II I/O cards. Up to 128 card slots become available by adding HP 6943A Multiprogrammer Extender units. Although the HP 6942A can be programmed by any HP-IB computer using the HP 6942A internal instruction set, programming the HP 6942A is simplified by using the HP 14753A CAT Programming Package and a Series 200/300 computer.

#### System Performance Specifications

Mainframe	HP 6942A	HP 6954/44A
Interface	HP 98624A	HP 98633A
CAT Programming Package	HP 14753A	HP 14753A
Single Data Point Input	1.9 ms	1.5 ms
Single Data Point Output	2.1 ms	1.4 ms
Scaling to User Units	add 0.35 ms	add 0.35 ms
Interrupt Response Time	13.7 ms	13.7 ms
Maximum Block Transfer Input	12,500	180,000*
Maximum Block Transfer Output	18,000	30,000

#### Product Selection Guides

To order the HP 6954A, 6944A or 6942A, it is recommended that technical data sheet 5952-4175 be used

#### Ordering Information

	Price
HP 14753A Computer Aided Test Programming Package	\$2050
Opt 044 3½" Flexible Discs	N/C
Opt 042 5¼" Flexible Discs for 9826/9836	N/C
Opt 910 Extra Set of Documentation	\$ 76
HP 14753R Right to Reproduce HP 14753A CAT Programming Package (Interface and Documentation provided)	\$1020

# COMPUTER AIDED TEST

## Multiprogrammer: Automatic Test, Data Acquisition and Control

**Model 6940B**

- Front panel control
- GPIO or HP-IB
- Data transfer rate 20,000 readings/second

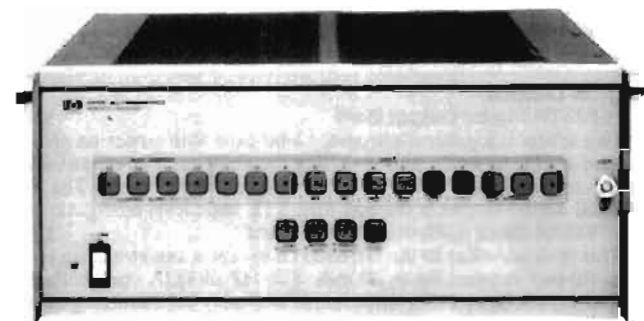

HP 6940B

### Description

The HP 6940B Multiprogrammer is a low-cost, medium-speed data acquisition and control system designed to be used with controllers or computers via the GP-IB, a 16-bit parallel interface bus. The HP 6940B is supported by a full complement of I/O cards. These I/O cards provide a broad range of instrumentation functions for acquisition, stimulus, measurement and control.

The HP 6940B is programmed by a set of word formats and octal coding. There are three word formats: a control word that selects the operating mode, a data word used to select and control output cards, and an address word to select and control an input card.

The HP 6940B may also be used as an HP-IB product. This requires an HP 59500A Multiprogrammer Interface Kit. This kit provides conversion of the HP-IB format to 16-bit parallel format.

### Features

A full-feature, front-panel switch register permits manual programming of all Multiprogrammer output, input and control functions. Fault isolation or manual system checkout of the computer, multiprogrammer or external devices is accomplished from the front panel.

Another feature of the HP 6940B is isolation of analog cards. Isolation from system ground is provided on analog cards. The HP 6940B has four isolated bias power supplies available to independently power the output circuitry of up to four groups of cards.

The HP 6940B Multiprogrammer has the capability of growing to meet the user's needs. Up to 15 HP 6941B extenders can be added to the system, allowing up to 240 I/O slots to be programmed from a single computer interface. The HP 6941B Multiprogrammer Extender has a blank front panel and all interfacing is provided in the HP 6940B Multiprogrammer.

### Specifications

**Plug-in I/O card position:** Maximum of 15 plug-in input or output cards per mainframe.

**Computer Interface:** Can be interfaced using the GP-IO, which requires an I/O slot of the computer and a GP-IO interface card. An HP 59500A Multiprogrammer Interface Kit is required for use on the HP-IB.

**Extender Units:** Up to 15 HP 6941B extenders can be chained together to create 240 programmable I/O slots. Extenders may be separated from one another by up to 30 metres.

**Data transfer rate:** 20,000 readings/second using the GP-IO interface.

**Cooling:** Natural convection

**Operating temperature range:** 0 to +55 degrees Celsius.

**Power:** 100/120/220/240 Vac (selectable), +5%, -10%. 48 to 440 Hz, 230 watts.

**Dimensions:** 172.2 mm high x 425.4 mm wide x 539.8 mm deep (6.78 in high x 16.75 in wide x 21.25 in deep).

**Weight (without I/O cards):** 15.9 kg (35.0 lb) net, 19.5 kg (43.0 lb) shipping.

- Temperature measurement capability
- Multiprogrammer Series I I/O cards

### Ordering Information

#### Step 1 - Select controller

Controller	ROM HP P/N	Description
HP-85B		HP-IB: Option 085 GP-IO: Option 185
HP-86B	00087-15003*	HP-IB: Option 085 GP-IO: Option 185
HP-87XM	00087-15003*	HP-IB: Option 085 GP-IO: Option 185
HP 9826A	N/A	BASIC: Option 026 HPL: Option 126
HP 9836A	N/A	Option 036
HP 1000	N/A	Option 010

\*Requires HP 6938A ROM drawer.

#### Step 2 - Select interface

Interface	GP-IO	HP-IB
HP-85B	HP 6940B Opt 185	HP 59500A and HP-85B Opt 007
HP-86B*	HP 6940B Opt 185	HP 59500A
HP-87XM*	HP 6940B Opt 185	HP 59500A
HP 9826A	HP 98622A Opt 003	HP 59500A, includes 2-metre HP-IB cable
HP 9836A	HP 98622A Opt 003	HP 59500A
HP 1000A	HP 14550B	HP 59500A and HP 59310B

\*When ordering an HP-86B or HP-87XM and using HP-IB Interface, an HP-IB cable must be ordered.

#### Step 3 - Determine I/O card set

Select I/O functions from Series I I/O cards (See page 586).

#### Step 4 - Select number of mainframes

	Price
HP 6940B - holds up to 15 I/O cards plus one HP 69351C voltage regulator card.	\$3100
Option 10: HP-1000	N/C
Option 85: HP-85B HP-IB	N/C
Option 185: HP-85B GP-IO	\$ 615
Option 028: HP 9826A BASIC	N/C
Option 128: HP 9826A HPL	N/C
Option 036: HP 9836A BASIC	N/C
Option 138: HP 9836A HPL	N/C
Option 808: Rack Mount Hardware for HP 6941B Extender, additional 15 I/O slots	\$ 41
Option 908: Rack Mounting Hardware	\$2550
HP 14541A Extender Cable; one for each HP 6941B	\$ 41
	\$ 125

#### Step 5 - Determine accessories

HP 59500A Multiprogrammer Interface; required for each HP 6940B on the HP-IB \$1300

#### Accessories

HP 14540A Main Input Cable Assembly, 3.6 m (12 ft)	\$ 305
HP 14541A Chaining Cable, HP 6940B to HP 6941B	\$ 204
HP 14550B Multiprogrammer Interface Kit for the HP 1000	\$1835
HP 14551A Service Kit for the HP 6940B	\$2550
HP 14555A Connector Kit for Series I Multiprogrammer I/O cards	\$ 20
HP 14556A Software Library for the HP 9825A	\$ 204
HP 14557A Power Supply Interconnect Cable for the HP 69520A Programming Card	\$ 255
HP 14558A Termination Panel; with 40 dual-screw terminals	\$ 204
HP 14560A Cable Assembly for Series I I/O cards; 15 conductors	\$ 102
HP 14561A Cable Assembly for Series I I/O cards; 30 conductors	\$ 153
HP 14562A Cable Assembly for Series I analog I/O cards; two shielded conductors	\$ 71

# COMPUTER AIDED TEST

## Multiprogrammer: Series I I/O Cards for HP 6940B and 6941B

### Power Supply Programming

#### HP 69500A-69513A Resistance

##### Programming Cards

\$355-\$410

HP 69500A is supplied without resistors. The HP 69501A-69506A are single output, 12-bit resolution cards designed to program a single HP power supply equipped with Option 040. The HP 69510A-69513A are dual-output cards with six-bit resolution designed to program the current output of HP power supplies equipped with Option 040.

#### HP 69520A Power Supply Programming Card

\$510

Provides full system control of HP 6023A, 6024A and HP 6011A, 6012A autoranging power supplies. Requires HP 14557A interconnect cable.

### Temperature Measurement

#### HP 69423A Low Level A/D and Scanner Card

\$765

Six channels of thermocouples or other low-level dc sources in the range of  $\pm 20$  mV can be measured with resolution of  $5 \mu\text{V}$ . A seventh channel is used to read the temperature of the isothermal input terminal block. An HP 69351C Voltage Regulator Card is required to provide the regulated isolated bias voltage to the HP 69423A. One HP 69351C will support up to four analog input cards.

### Analog Input

#### HP 69336B High Speed Scanner Card

\$510

This card features a FET multiplexer with 16 single-ended voltage input channels that can be scanned at 20,000 channels/second. Input voltage range is  $\pm 10.24$  volts with 100 V isolation from data common. Several cards can be cascaded to provide up to 224 channels.

#### HP 69422A High Speed A/D Card

\$715

The High Speed A/D Card measures bipolar dc voltages in one of four ranges,  $\pm 100$  mV,  $\pm 1$  V,  $\pm 10$  V, and  $\pm 100$  V. The three lower ranges are switch selectable. The  $\pm 100$  V input range is connected to an on-board divide-by-ten attenuator. Data conversion rate is 33,000 readings/second.

### Analog Output

#### HP 69321B D/A Voltage Converter Card

\$510

This model provides a high-speed (33 kHz), bipolar output voltage ( $\pm 10.24$  volts at 5 mA) that is the analog of the digital input data. Dual-rank storage, a feature that allows all D/A cards in a system to change their outputs simultaneously, is provided on the HP 69321B.

#### HP 69322A Quad D/A Voltage Converter Card

\$610

This D/A card provides four individually programmable, bipolar output voltages ( $-10.24$  V to  $+10.22$  V at 5 mA, 16 kHz maximum) that are the analog of the digital data input. Two of the 12 data-bits address the DACs, and the remaining ten data-bits provide the digital input data.

#### HP 69370A D/A Current Converter Card

\$815

This model provides a high-speed (33 kHz), constant-current output (0 to 20.475 mA at up to 10.5 V) that is the analog of the digital data input. Dual-rank storage, a feature that allows all D/A models in the system to change their outputs simultaneously, is provided on the HP 69370A.

#### HP 69351C Voltage Regulator Card

\$255

The Voltage Regulator Card provides four regulated, isolated bias supplies for the analog models and is inserted into the voltage regulator slot of the HP 6940B and HP 6941B. The HP 69351C is required for proper operation of the analog input and output models. It will support up to four of these models.

### Digital Input

#### HP 69430A Isolated Digital Input Card

\$255

This card employs photoisolators to provide up to 100 V RMS isolation between the 12 data lines and chassis ground. The model is designed to monitor only circuits that are active. This model may be ordered with any of three different logic options. One of these options must be specified when ordering this model:

**Option 069:** negative-true TTL logic levels

**Option 073:** positive-true TTL logic levels

**Option 088:** positive-true Hi level =  $\pm 12$  to 25 V.

#### HP 69431A Digital Input Card

\$255

The Digital Input Card provides 12 data lines that can be used to monitor contact closure or logic levels referenced to ac earth ground. Gate/flag circuitry provides the HP 69431A with the interface to the computer interrupt system. An option must be specified when ordering this model.

**Option 069:** negative-true TTL logic levels

**Option 073:** positive-true TTL logic levels

**Option 070:** positive-true Hi level = 6 to 14 volts

### Digital Output

#### HP 69331B Digital Output Card

\$305

This model is a general-purpose, 12-bit card with power-on preset, system enable/disable, and gate/flag capabilities. The output lines are jumper selectable for TTL or +12 volt logic levels. The HP 69331B digital output is shipped with TTL logic level configuration.

#### HP 69332A Open Collector Output Card

\$204

This card is similar to the HP 69331B except it can switch up to 30 volts dc and currents up to 40 mA. The HP 69332A open collector output card is designed to drive lamps and relay coils utilizing an external dc power source. The outputs of the HP 69332A may be random at power-on.

#### HP 69433A Relay Output with Readback Card

\$305

The relay card provides 12 independent SPST, mercury-wetted, normally-open contact pairs. The HP 69433A also allows the computer to examine the status of the relay coil drive circuits, before and after the contacts are changed. No external handshaking is available with this product.

### Functional

#### HP 69335A Stepping Motor Control Card

\$305

This model can be programmed to generate from 0 to 2047 square-wave pulses at either of two output terminals. The user may also configure the card to generate 0 to 4095 square-wave pulses. An 11-bit binary data word specifies the total steps and Bit-12 specifies direction of rotation.

#### HP 69435A Pulse Counter Card

\$305

This card will count pulses, up or down, with a maximum square-wave input frequency of 200 kHz. Carry and borrow pulses are generated so that the HP 69435A may be cascaded for greater counting capabilities.

#### HP 69602A Timer/Pacer Card

\$410

The Timer/Pacer Card provides a full programmable, crystal-controlled time base that can be used to pace Multiprogrammer I/O operations or generate accurate one-shot pulses. The HP 69602A coupled with the HP 69435A can satisfy requirement for frequency measurement (maximum of 200 kHz). Time interval measurement (10  $\mu\text{s}$  to 34 minutes) and time of day (2.8 minutes to 1084 years).

### Interrupt

#### HP 69434A Event Sense Card

\$610

The Event Sense Card monitors up to 12 external contact closures and interrupts the computer when one or more contacts change state with respect to the 12 reference bits stored on the card. Jumpers allow for reconfiguration to provide four logical arguments: equal to, not equal to, greater than, or less than.

#### HP 69436A Process Interrupt Card

\$410

This card provides an interrupt to the computer when any one or more of the 12 data lines being monitored change state. The HP 69436A has TTL and open collector compatible edge detectors and can detect any logic transition lasting 100 nanoseconds or longer.

### Breadboard

#### HP 69280A Breadboard Card

\$204

The Breadboard Card provides a generalized grid pattern for mounting custom circuitry. The HP 69280A plugs into the HP 6940B and HP 6941B, allowing access to the data lines and power supply lines of the Multiprogrammer backplanes.

#### HP 69380A Breadboard Output Card

\$204

This breadboard card is similar to the HP 69280A and has output storage buffer circuits that allow the Multiprogrammer backplane output data to drive external or custom circuits. A large portion of the printed circuit board has a plated grid and general-purpose circuit pattern.

#### HP 69480A Breadboard Input Card

\$255

The Breadboard Input Card is identical to the HP 69380A, except the on-board logic is the input buffer gates for driving the Multiprogrammer backplane.



### Technical Data

In addition to a broad range of products for integration of data acquisition, control and test systems, Hewlett-Packard provides a selection of technical literature as further support of the Multiprogrammer products. These technical brochures provide detailed operating specifications of the Multiprogrammer product family and are extremely helpful in configuring the best Multiprogrammer package for your application. Other literature available are Product Notes describing a specific product application and Application Notes.

This technical literature will provide information to help you choose the right Multiprogrammer products for your application. The Product Notes augment the Operating and Service Manuals and provide additional information on product configurations and actual applications. The Application Notes are more specific "how to" information aimed at a specific application and product configuration.

This technical literature is provided at no charge upon request. Ask your local Hewlett-Packard field engineer, or use the card at the rear of this catalog.

Publication Title	Publication Number
Multiprogrammer Model 6940B, 6941B	5952-4077
Multiprogrammer Databook Models 6942A, 6944A & 6954A	5952-4175

### Product Notes

A series of product notes is available for the Multiprogrammers. The first two, 6940B-1 and 6940B-2, are product oriented, and describe how to use particular Multiprogrammer cards. The others are product "Application Stories" which describe how Multiprogrammer customers have implemented specific applications.

#### 6940B-1 Scanning with the 6940B Multiprogrammer

Describes use of the HP 69336B FET scanning card for high-speed data acquisition.

#### 6940B-2 Power Supply Control

Describes use of the HP 69520A power supply programming card to control HP autoranging power supplies.

#### 6940B-3 Subassembly Testing

Details Ford Motor Company's use of a building block approach to increase the flexibility of Ford's systems testing while reducing cost and design times.

#### 6940B-4 Automating Manual Equipment

Describes the implementation of the HP 6940B in a radiation monitoring system.

#### 6940B-5 Basic Research

Describes the interfacing of an HP 6940B and HP 9845A to a scanning electron beam microscope.

#### 6940B-6 Product Evaluation

Describes the use by BF Goodrich of the HP 6940B to test the true effectiveness of tires for the different ice, snow, soil and load conditions.

#### 6942A-1 Production Line Testing

Describes Solitron Devices Inc. use of the HP 6942A for hybrid device testing.

#### 6942A-2 Heavy Industry

Describes Northwest Culvert Company's use of the HP 6942A to control metal pipe production and improve process control.

#### 6942A-3 Instrument Control

Describes the use of an HP 6942A to control RF test equipment in an automatic modem test system.

#### 6942A-4 Research and Development

Describes the use of an HP 6942A as control and data acquisition system for a heavy oil pump development test rig.

#### 6942A-5 Materials Evaluation

Describes the use of an HP 6942A to automate the measurement of fluid viscosities.

### Application Notes

A new series of application notes introduces a beginner to computer aided test, and makes it easier for any user to implement the most common HP 6942A Multiprogrammer configurations. Each of the notes contains a comprehensive study of an application, and includes theory, wiring information, and software listings for the basic functions. Information on advanced techniques is also provided. Although the programming information is oriented toward the HP 9826A and HP 9836A computers, the concepts are discussed in a general way that allows application to other computers. Copies of these application notes are available through your local HP sales office.

#### AN316-0 Introduction to Computer Aided Test

This introductory note is designed to take a computer aided test novice through the steps of evaluating, planning, and implementing a sample computer aided test system.

#### AN316-3 High-Speed FET Scanning

High speed data acquisition from many channels is easily accomplished with the Multiprogrammer scanner system consisting of an HP 69750A or HP 69755A scanner cards. This note covers sequential and random access scanning methods.

#### AN316-4 Power Supply Programming

Full system control of a power supply, including output voltage and current readback, is possible with a single Multiprogrammer card. The HP 69709A power supply control card is designed for control of HP 6023, HP 6024A, HP 6011, and HP 6012A power supplies equipped with Option 002.

#### AN316-5 Data Capture

This Application Note covers the full range of data capture capability of the HP 6942A and HP 6944A Multiprogrammers. The emphasis is on analog data capture but digital techniques are also presented. AN316-5 includes sections on random and burst scanning as well as buffering and multiplexing using the Multiprogrammer Memory system. Examples are presented using the HP 14753A CAT Programming statements, as well as Native Instruction programming for the HP 6942A. This Application Note also covers continuous data acquisition to an external hard disc drive. One section deals with performing accurate analog measurements using the Multiprogrammers' I/O cards.

# COMPUTER AIDED TEST

## Automatic Test Systems

### ATS 2000

- Complete Integration Services
- Standard Test Instrumentation Systems for Manufacturing or Maintenance
- Single-Vendor Solution

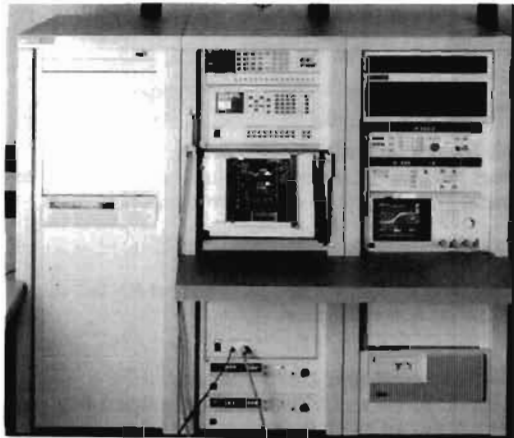

### ATS 2000 Automatic Test Systems

Hewlett-Packard's ATS 2000 provides functional and parametric test capability for digital, analog, or hybrid circuitry at the system or subsystem level. An ATS 2000 consists of both analog and digital standard test instrumentation, switching, Unit Under Test interface, system controller, and integration services. This modular approach promotes the use of standard products in the design of a test system which meets your exact needs. A broad instrument product line, coupled with computers designed for instrument control, puts HP in an excellent position to provide complete solutions to a wide range of test problems. With a wide range of integration services, you receive a fully integrated, tested and installed system ready to begin test software development. Application software can be developed by HP's Value-Added-Business partners, your HP Project Center or your own in-house resources.

ATS 2000 BLOCK DIAGRAM

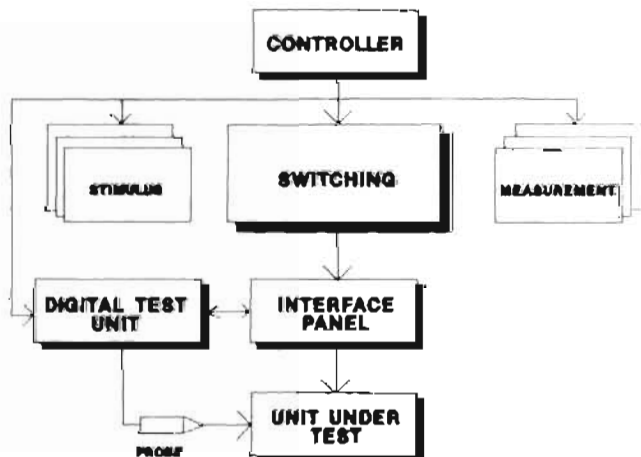

### Digital Test Unit

Required for digital test capability, a Digital Test Unit (DTU) generates input patterns to the Unit Under Test and analyzes the output responses.

Standard features include up to 512 programmable bidirectional channels, 5 types of memory: output, tristate, expected, mask, and result, and 4K bits memory depth. The Digital Test Executive provides links to simulators, and run-time executive and analyzer. To optimize test effectiveness, the DTE provides memory management, channel mapping and diagnostics.

### System Resource Interface

The ATS 2000 System Resource Interface (SRI) provides a well-defined, modular, high integrity signals path between the test system and the UUT. The SRI is available in 4000 or 8000 pin configurations for power, coax, general purpose switching, and up to 512 channels of digital.

### Switching

Switching products route signals between the UUT and stimulus/response instruments such as digital multimeters, counters, signal sources and analyzers. The HP 3235A is recommended for switching in most ATS 2000 systems. This switch reduces development time by providing high performance off-the-shelf switching and interfacing to a wide variety of UUTs.

### System Controller

A host controller drives the test system. It should be selected based upon computing requirements, testing requirements, and future needs of the customer. ATS 2000 offers a wide range of computing power from the HP 9000 Series 300 to the HP 1000 A-Series.

### Test Equipment

Through the use of HP standard stimulus and response instrumentation, ATS 2000 meets your needs cost effectively. However, should Hewlett-Packard be unable to provide a piece of equipment needed to meet your specifications, customer-furnished equipment can be integrated by HP as well.

### Ordering Information

Each ATS 2000 system is integrated according to customer specifications. The system design, configuration and purchase is a process involving the customer, Hewlett-Packard sales representative and Advanced Manufacturing Systems Operation, the HP division responsible for ATS. For more information consult your local HP Sales Office.

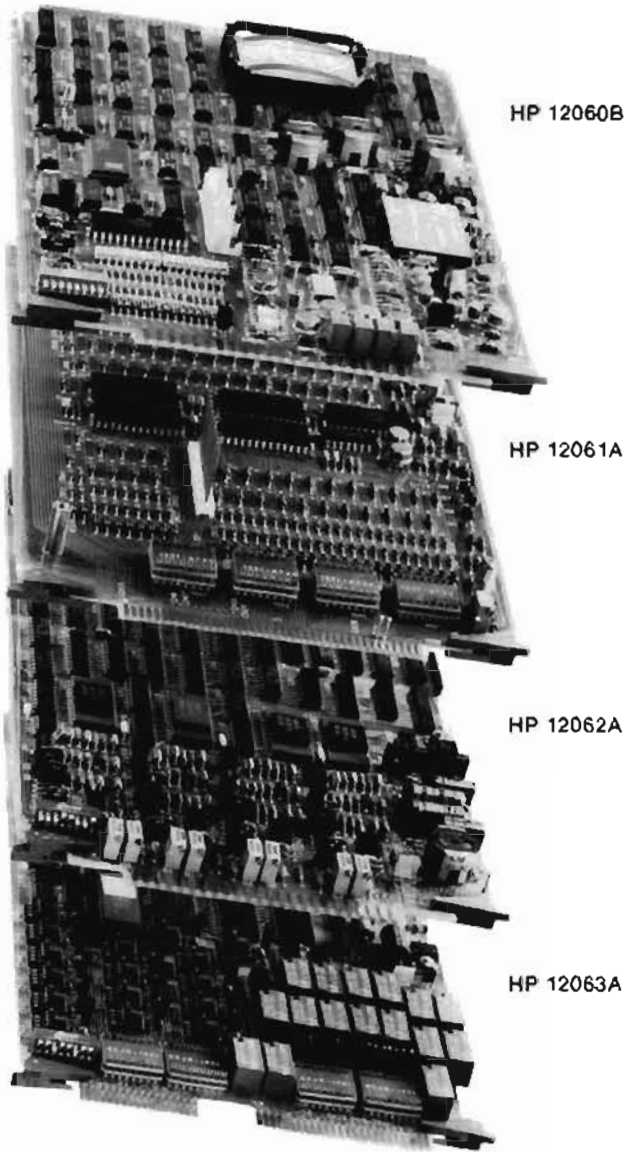

HP 12060B

HP 12061A

HP 12062A

HP 12063A

### HP 12061A 32 Channel Analog Input Expansion Card

The HP 12061A provides 32 additional differential inputs for the HP 12060B card. The HP 12061A card fastens directly onto the HP 12060B card, creating a two-board unit that occupies two I/O slots in an HP 1000 A-series computer. Programming information is passed from the HP 12060B directly to the HP 12061A; analog signals on the additional 32 channels are in turn passed back to the HP 12060B for digitizing. The HP 12061A includes removable plug-in headers so the user can add current sense resistors for current loop measurements. These headers allow the board to be adapted to the specific application without soldering components directly on the board and are easily removable for repair purposes.

### HP 12062A 4 Channel Analog Output Card

The HP 12062A Analog Output Card provides 4 independent bipolar voltage outputs. Remote sensing per channel provides accurate output voltages to compensate for long distances of field wiring. Undedicated digital outputs may be used in pen up/down control, CRT display, or X-Y plotters. DMA compatibility provides fast analog updates on a per-channel basis or between channels. Programmable time delay between DMA updates provides signal reconstruction capability with a full power bandwidth of 20 kHz.

### HP 12063A 32 Channel Digital Multifunction Card

#### Input Characteristics

The HP 12063B provides 16 fully isolated digital inputs via voltage threshold opto-couplers. Input voltage levels are selectable by the user for each channel by installing the appropriately valued resistors on removable plug-in headers (8 resistors per header = 8 channels). These headers allow the board to be adapted to the specific application without soldering components directly on the board, and are easily removed for repair purposes. Plug-in opto-couplers (supplied) allow user selection of ac or dc coupling for each channel by merely installing the opto-coupler in the ac position or dc position. For ac coupling, a plug-on jumper is provided for each channel to select 60 Hz ac filtering of the rectified input if desired.

#### Event Detection

In addition to status, any input may be user programmed to function as an interrupt to be generated on the rising edge or falling edge of the input or both (whichever occurs first). This capability is easily activated by the user via loading the appropriate pattern into the three registers. The on-card microprocessor takes over to cause the interrupt to be generated when that event occurs. User programming is required to service the interrupt.

#### Debounce Delay

The same microprocessor also provides the user-programmable debounce delay up to 246 ms on any input when monitoring contact closures and may be used in both status mode and event sense mode.

#### Output Characteristics

Sixteen form C (SPDT) relay outputs are provided on the same card. Both the normally open (NO) and normally closed (NC) contacts are available to users. Two removable headers allow for arc suppression devices to be added by the user for each channel without soldering directly to the board. Each header handles 8 output channels. Plug-on jumpers select the arc suppression across the NO or NC contacts. An on-card isolated power supply derived from the 25 kHz ac supply in the A-Series processor provides coil power for the relays. This technique minimizes any coupling of relay contact noise in the computer itself.

#### Ordering Information

	<b>Price</b>
HP 12060B 8 Channel Analog/Digital Converter	\$1830
HP 12061A 32 Channel Analog Input Expansion	\$915
HP 12062A 4 Channel Digital/Analog Converter	\$1320
HP 12063A 32 Channel Digital Multifunction Card	\$1680

### Description

The HP 12060B, 12061A, 12062A, and 12063A are plug-in cards for HP 1000 A-Series Computers. They provide low cost, high performance, analog and digital I/O for use in distributed measurement and control applications. The A-series product in which these cards are used must have a 25 kHz power supply. Hood connectors with each card allow users to build cables for connection to their applications.

### 12060B 8 Channel Analog Input Card

The HP 12060B is capable of acquiring up to 55,000 readings per second with 12-bit resolution. Auto scanning or single-channel sampling is possible to 55 kHz. Provisions for external pacing/trigging of sampling and scanning is provided. The HP 12060B includes four programmable full scale ranges from plus or minus 1.28 V to plus or minus 10.24 V. Maximum resolution is 0.625 mV on the 1.28 V range. A separate "zero reference" on the card allows the user to measure actual offset due to temperature drift, and correct readings on all channels for higher accuracy. The card has 8 differential channels.

# COMPUTER AIDED TEST Software

In most cases, Computer Aided Test (CAT) software represents a larger investment than the hardware itself. Good software tools can cut this investment by more than half. These tools should be easy to use, but not get in the way of system performance. And, you should be able to mix menu programming with lower level code, so the versatility of the system is not compromised.

HP can help your productivity in writing CAT software. You can choose software for applications including production test, data acquisition, and scientific analysis. The choice of computer and software must be considered together.

## Computers

Computers used in CAT are either designed as a superlative I/O device for high performance applications or adapted from a general purpose design. The languages on the computer should be optimized for instrument control. The computer also needs to transfer data to other factory computers, discs, printers, and plotters. A computer with the proper design and language can save enormous amounts of programming time and test time.

Basically, your choices in computers are personal computers, such as the HP Vectra, or the HP Series 300 Computers. The HP Vectra Personal Computer supports a BASIC language co-processor for high performance data acquisition and instrument control. Essentially, this co-processor is an HP Series 200 Computer on a card. The new HP Series 300 Model 330 Computer is the premier choice as an instrument controller.

## Software on PC's

If you are looking at a personal computer for CAT, HP software includes:

Lotus Measure for non-complex, quick setup, applications on engineering benches in R&D, development, production, and QA. Lotus Measure easily puts instrument readings into a spreadsheet for further analysis.

HP DACQ/PC is software tools as sub-routines for data management, graphics, and analysis in process or product characterization applications. HP DACQ/PC runs on the BASIC language co-processor in the HP Vectra.

## Software on HP Series 200/300

For data acquisition, especially process or product characterization, HP has DACQ/300 software. It is a set of subroutine tools for common functions such as data storage and retrieval, graphics, and analysis.

If you are doing production test, the HP Functional Test Manager (FTM/300) Software is fine tuned for you. It offers a structure for testing, a test executive, statistical quality control analysis, and many subroutine tools for instrument control.

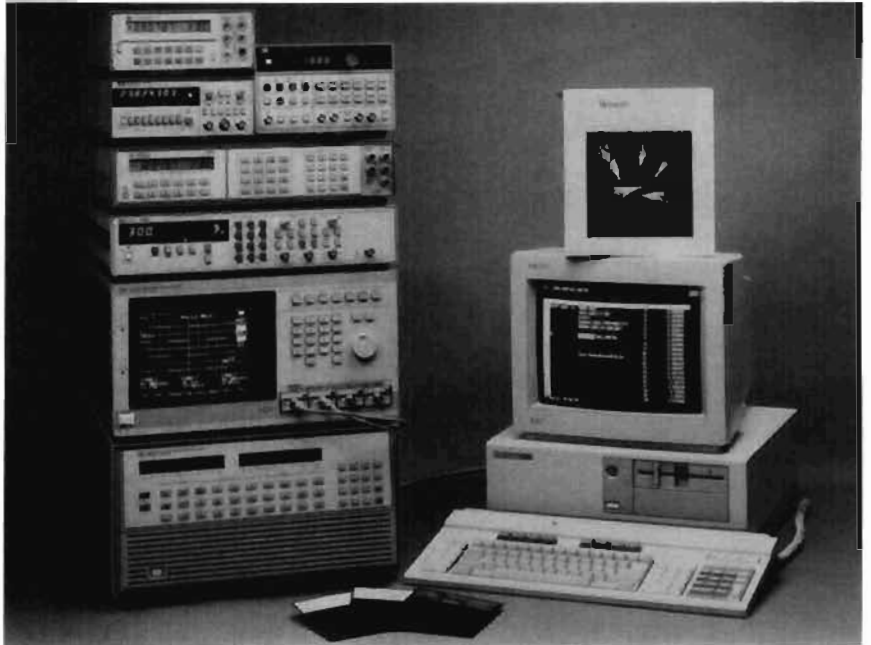

For quick and easy set ups, Lotus Measure controls any HP-IB Instrument and returns readings to a Lotus 1-2-3 spreadsheet for analysis. Measure runs on HP Vectra personal computers.



HP's new FTM/300 Functional Test Manager software is designed to replace up to 65% of the custom code you normally write when constructing a CAT system. HP FTM/300 works on HP 9000 Series 300 Computers and it works with any HP-IB Instrument.





### Lotus Measure for HP Instruments

If you use a PC and Lotus® 1-2-3, you will want to add Measure™ to your software library. Measure turns the world's most popular analysis tool, Lotus 1-2-3®, into a powerful data acquisition and analysis package that works immediately with all of HP's HP-IB instruments. Measure collects data from HP's HP-IB instruments directly into a Lotus 1-2-3 or Symphony™ worksheet for analysis, storage, and display. Your data immediately becomes part of 1-2-3 or Symphony.

### Software Designed for the Busy Engineer

Lotus Measure was designed specifically for engineers and scientists who work with 1-2-3 and Symphony. It eliminates the time-consuming steps of entering data by hand or importing it from different programs. Measure automatically collects data in real time for all of HP's HP-IB instruments directly in 1-2-3 or Symphony. It runs on all the most popular personal computers, including the HP Vectra, the IBM PC, XT, and AT, and the Compaq Portable. Because Measure works with so many different HP instruments, it supports applications in just about any technical or manufacturing area. In many cases, it effectively does away with the need for custom programming. It can do this by adapting the familiar user interface of 1-2-3 to the HP-IB IEEE-488 and RS-232-C Communications busses.

### Seamless Data Collection for HP's HP-IB to Lotus 1-2-3

Lotus Measure actually becomes part of 1-2-3. Measure adds a new series of menus and macro commands into 1-2-3 along with Interactive Command Testing, an automatic way to build all of your testing macro procedures. The power of this combination of HP's HP-IB instrument selection and versatility on the bus, the ease of use of Lotus 1-2-3 for analysis and graphic presentation on PC compatible machines, and Measure's data collection capability make an unbeatable combination.

### Context-Sensitive Help and Interactive Command Testing

When you use the Interactive Command Test mode in Measure, you can execute HP-IB commands as you enter them so that you will know immediately if they are correct. When you choose a command, Measure provides you with assistance in determining the parameters you need to complete the command. Upon modifying the command to execute to your satisfaction, you can automatically enter it as one of the program steps in a macro that the ICT is building for you. In this way, you automatically build and test a macro using Measure commands. Because Lotus Measure commands are so simple, after you

have used it several times you will simply write your macros directly into your spreadsheet. Any time in Lotus 1-2-3 or in the Measure menus, you can gain access to the help function simply by pressing the F1 key. It is aware of your position in the hierarchy of commands and will give you assistance appropriate to the command you are working with.

### Highlights of HP-IB and Measure

- Adds 21 advanced macro commands to 1-2-3 for managing IEEE-488 bus operations, data transfers, and error handling
- Supports up to 15 devices concurrently
- Provides Interactive Command Test (ICT) for testing bus commands and saving them as macro statements in a worksheet
- Stores board and instrument settings and bus configurations for immediate recall.
- Automates complete device setup and bus operations using macros

### Measure Configuration Guide

#### Supported Hardware:

Hewlett-Packard Vectra Personal Computer  
IBM PC, XT, AT, Compaq Portable  
Minimum 512K memory for all computers  
Hercules Graphics Card or compatible  
IBM Color Graphics Card or compatible  
IBM EGA Graphics Adapter or compatible

#### Supported Software:

Lotus 1-2-3 (Release 2.0 or higher)  
Lotus Symphony (Release 1.0 or higher)  
DOS 2.0 or higher

#### Supported Interfaces:

Hewlett-Packard HP-IB  
National Instruments PCII or PCIIA  
IBM GPIB Adapter  
RS-232 Asynchronous Port Configured as COM1 or COM2  
MetraByte DASH-16

#### Ordering Information HP 44460A/B

Price  
\$495

Lotus Measure is a trademark of Lotus Development Corporation. Lotus, 1-2-3, and Symphony are registered trademarks of Lotus Development Corporation. COMPAQ is a registered trademark of COMPAQ Computer Corporation. IBM and PC/AT are registered trademarks and PC/XT is a trademark of International Business Machines, Inc. GPIB-PCII and GPIB-PCIIA are trademarks of National Instruments.

# COMPUTER AIDED TEST

## Software Solutions

HP Data Acquisition Manager - DACQ/300 and DACQ/PC HP Model 44458A/B and 44459A/B

- Reduce Your Software Development Time
- Customize Your Data Management Needs
- Optimize Your Software Performance

- Use With the Controller of Your Choice: Either HP 9000 Series 200/300 or HP Vectra PC
- Use With Any HP-IB Instrument

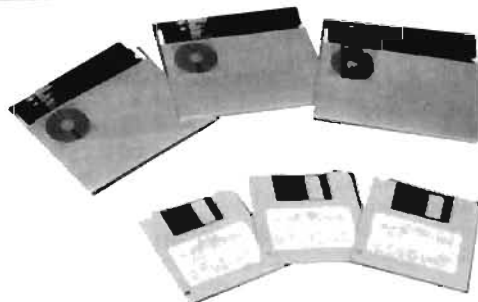
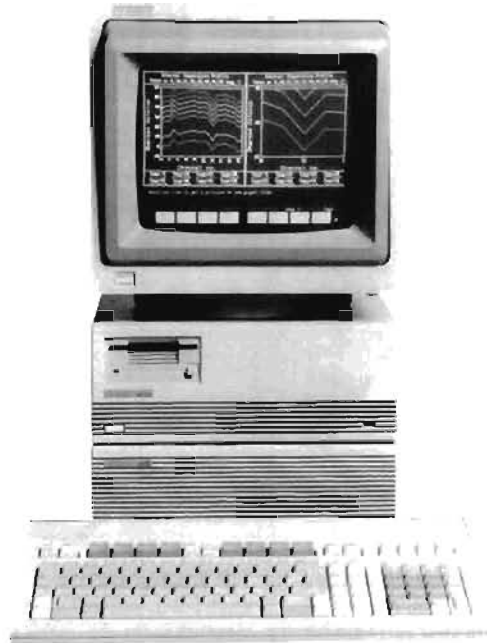

### Description

HP Data Acquisition Manager is a general-purpose Data Acquisition Manager for the HP 9000 Series 200/300 controllers (HP DACQ/300) or the HP Vectra Personal Computer (HP DACQ/PC). The software reduces your development time by providing you with software tools (subroutines written in HP BASIC and compiled Pascal) that you can add to your HP BASIC program to handle up to 90% of your data management functions. Customize your data management programs by adding these subroutines to match your final application needs. Optimize your software performance through HP Data Acquisition Manager's compiled Pascal subroutines and use of memory volumes (electronic disc). Eliminate the need to have several software packages because HP Data Acquisition Manager provides you with subroutines that cover a wide range of data acquisition and control tasks and works with any HP-IB instrument. Use HP Data Acquisition Manager with the controller of your choice - either the HP 9000 Series 200/300 controller or the HP Vectra Personal Computer. Both controllers offer you the HP BASIC language (on the HP Vectra PC through use of the HP BASIC Language Processor - HP 82321) for one of the most powerful and easy-to-use programming environments available for instrument control.

### Data Management

Use HP Data Acquisition Manager to:

- Set up a data base organized into archives, books and pages
- Specify the format of books and pages
- Collect data over HP-IB, GPIO, from the program, or the keyboard
- Time-stamp and store the data into the data base
- Document the data
- Retrieve the data from the data base to display, analyze or transmit it elsewhere

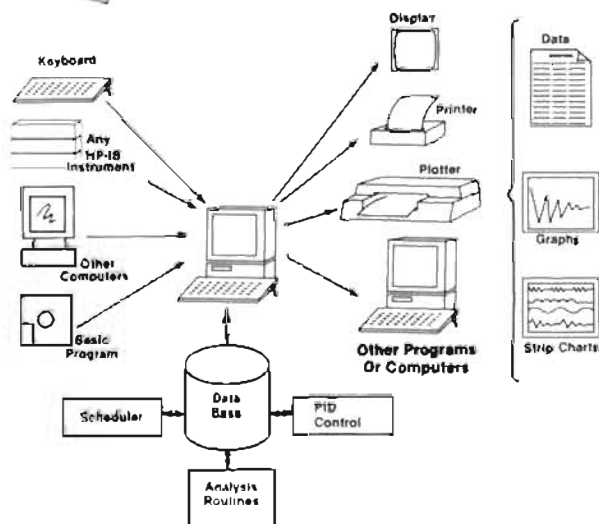

### Data Analysis

Entire arrays of data captured over HP-IB or retrieved from the data base can be analyzed quickly using the data analysis subroutines. Analysis functions available are:

- Scaling ( $mx+b$ )
- Limit checking
- Statistics (high, low, mean, standard deviation)
- Math (+, -, \*, /)
- FFT and inverse FFT
- Temperature conversions (thermocouples, thermistors, RTDs)
- Strain gage conversions
- User-defined look-up tables
- Unpacking packed readings

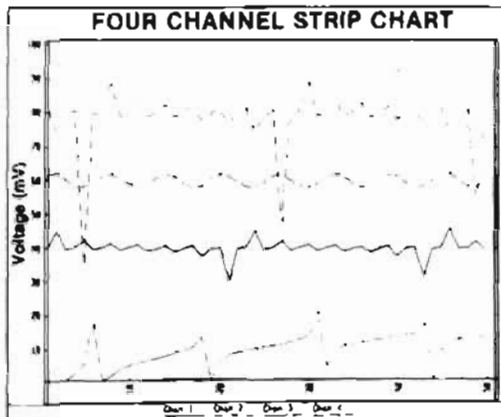
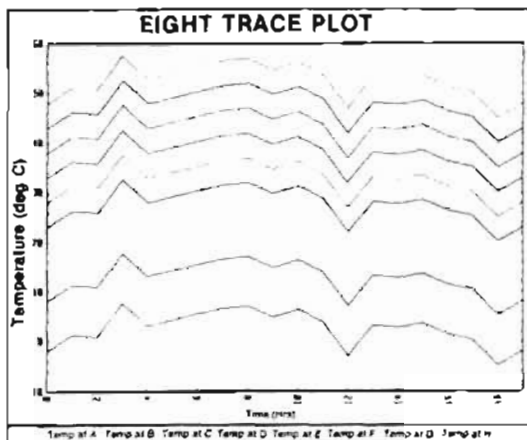

## Data Presentation

### Printing:

Captured data and sections of the data base can be formatted and printed on the controller display or to a supported printer.

### Plotting:

Plot subroutines allow you to plot up to eight traces per chart on either the controller display or an HP plotter. Labels, size, location, color (HP DACQ/300 only), and orientation of the chart are programmable, allowing you to have more than one chart per screen or page. Linear and logarithmic scaling (with or without grid lines) are available as well as auto-scaling of the entire chart.

### Real-time Stripcharting:

The stripchart subroutines allow you to plot up to four traces on the controller display as the readings are being received from the instrument (color traces for HP DACQ/300, monochrome for HP DACQ/PC). Once the screen is full, the data scrolls on the display from right to left. A file can be reserved to store values that scroll off the display. Data from the instrument can be plotted versus time or a user-defined array. If a hard copy of the stripchart is desired, the data can be saved and later sent to an HP plotter with the Plot subroutines.

## Data Transmission

Transmit data from the data base to another computer over RS-232 using the data transmission subroutines. These subroutines can be used to set up the HP 9000 Series 200/300 Datacomm Card (HP 98628A) with the desired protocols. The ENQ/ACK and X-ON/X-OFF protocols, baud rate, handshaking and the use of modems are all supported with these subroutines. Files of data can be transmitted using a default ASCII format or you can create your own format. When the default format is used, the files transferred can be used by Lotus 1-2-3™ or Wordstar™. The transferred ASCII file can also be transmitted to other computers using the HP Vectra PC's Advance-Link software.

## Process Control

Calculate up to 10 PID algorithms with one HP Data Acquisition Manager subroutine call. You specify the PID constants and send the measured values from your process to the subroutine. The subroutine performs the PID calculation and returns the final values. "Bumpless" control allows a smooth transition from manual to automatic control of your process using the PID subroutines. You can cascade two or more of the PID loops and adjust the PID constants ("tune your process control loops") while the process is still under automatic control.

## Task Scheduling

The scheduler subroutine assists you in scheduling tasks (in the form of subroutines) within your program. The software creates a table of up to 99 tasks and allows you to designate each task name and number, starting time, time interval between task runs, number of times the task is to be run and its priority. When the scheduler subroutine is called, it returns the number of the task with the highest priority scheduled for that time. Your program can then run that task by calling the appropriate subroutine.

## Configuration/Verification (HP DACQ/300)

The HP 9000 Series 200/300 version of HP Data Acquisition Manager (HP DACQ/300) also contains a menu-driven program that you can use to help document your equipment set-up and application. The program allows you to write a description of your application and prompts you to list the peripherals and instruments attached. The program automatically reads the configuration (processor, memory, plug-in interface cards, operating system) of the HP 9000 Series 200/300 controller. When you are finished, the entire set-up and description will be saved in a file. The program even contains a routine to verify that the present configuration matches a configuration stored in a file.

### Summary

HP Data Acquisition Manager is a powerful software package that provides you with "tools" to handle up to 90% of your data acquisition/control program. This leaves you time to concentrate on other aspects of your application. Collecting, storing, analyzing, transmitting, and scheduling data and subroutines are all handled by this software. Add only the routines that you need to customize your program and allow HP Data Acquisition Manager to optimize your software performance. Use this software with any HP-IB instrument on the controller of your choice, either the HP 9000 Series 200/300 or the HP Vectra PC, for virtually all of your data acquisition data management needs.

### Hardware Requirements:

#### HP DACQ/300:

HP 9000 Series 300 Model 310, 320, 330 or 350  
 HP 9000 Series 200 Model 216, 217, 220, 236\*  
 Operating System - HP BASIC 4.0, 5.0 or higher  
 Memory - 1 Megabyte or greater  
 Peripherals - any supported by HP 9000 Series 300  
 Instruments - any HP-IB instrument  
 Interface cards (optional)  
 HP 98620B - 2 channel DMA  
 HP 98635A - Floating point Math  
 HP 98628A - Datacomm (RS-232C)  
 HP 98622A - GPIO

#### HP DACQ/PC:

HP 82314A Model PC-308M BASIC Controller System (monochrome)  
 HP 82315A Model PC-308C BASIC Controller System (color)\*  
 These bundled systems include a 640 Kbyte Vectra SPU, 1.2 Mbyte flexible disc drive, 20 Mbyte hard disc, HP BASIC language Processor with 1 Mbyte of memory, HP BASIC 5.0 serial and parallel interfaces, Display, keyboard and Vectra DOS.  
 Peripherals - any supported by HP Vectra PC  
 Instrument - any HP-IB instrument

### Ordering Information

	<b>Price</b>
HP 44458A: HP DACQ/300 on 3 1/2" disc	\$1950
HP 44458B: HP DACQ/300 on 5 1/4" disc	\$1950
HP 44458R: HP DACQ/300 right-to-reproduce (includes certificate and documentation)	\$1200
HP 44459A: HP DACQ/PC on 3 1/2" discs	\$1450
HP 44459B: HP DACQ/PC on 5 1/4" discs	\$1450
HP 44459R: HP DACQ/PC right-to-reproduce (includes certificate and documentation)	\$900

\*No color support for HP 9000/Model 236 or HP 82315A/PC-308C

# COMPUTER AIDED TEST

## Functional Test Manager/300

HP FTM/300

- Speeds Functional Test Software Development



### Description

HP's Functional Test Manager/300 (HP FTM/300) is a general test software package designed for:

- Professionals writing test software for user-configured HP-IB test systems.
- Production functional testing of final products, subassemblies, and components.
- HP 9000 Series 200/300 Computers using BASIC 4.0/5.0 operating systems.

HP FTM/300 speeds development of functional test software with:

- Up to two-thirds of total test code already written.
- A framework or shell for developing tests, executing tests, analyzing test data, and transferring test data to other computers.
- Both turnkey tools and subprograms.

You benefit by getting custom test software with one-third the effort. Plus, HP FTM/300 modifies easily for your other functional test requirements. This one package standardizes your functional test software.

### Reduce Software Development Time by Up to 65%

Developing test software can be the most time consuming part of making a test system. As a powerful productivity tool, HP FTM/300 reduces the code you write by up to 65%.

HP FTM/300 speeds development in all phases of your test software by combining large portions of turnkey software and a library of subprogram tools into HP FTM/300 framework for developing and executing tests. HP FTM/300 software includes a turnkey SQC package, data storage and retrieval, data formatting and transfer, test sequencers, and program schedulers. A friendly user interface and twelve forms for specifying system characteristics further help developers quickly create test software. Not only will FTM/300 save you months of software development time, but the resulting test system will do more than most custom-developed test systems.

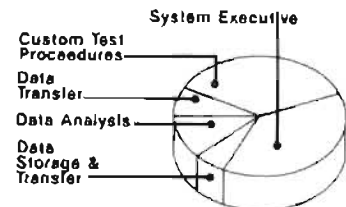

### HP FTM/300's Contribution

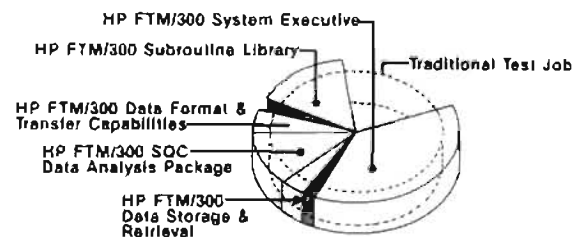

### Your Remaining Job

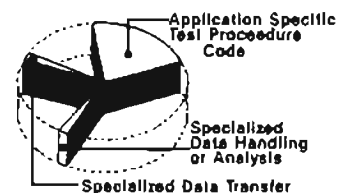

### Optimized for Test Throughput

HP FTM/300 executes as fast as most custom test software, and HP FTM/300's high level capabilities can be traded for program execution speed when you need it. With complete access to low level HP 9000 Series 200/300 BASIC 4.0/5.0 commands, HP FTM/300 lets test software developers add their own Unit-Under-Test (UUT)-specific routines optimized for speed in critical areas.

Also, HP FTM/300's strategy further optimizes throughput by using intelligent control of test flow, so you only execute necessary tests. For example, HP FTM/300 executes overall functional tests and skips troubleshooting tests unless the overall test fails.

### Customize Your Specific Test Needs

HP FTM/300 lets you concentrate on writing the application-specific software such as test procedures by giving you the non-application-specific code. Our studies show about 65% of test software consists of non-application-specific items such as data storage and retrieval, user interface, test sequencing and scheduling, and data analysis. Since HP FTM/300 provides these, you focus on writing custom test procedures. However, as further help, HP FTM/300's sub-program library may contribute up to half of this code. You keep the advantages of custom software with greatly reduced development times.

- Use the power and flexibility of HP 9000 Series 200/300 Computers and BASIC 4.0/5.0 in writing your test procedures.
- Re-use existing test procedures.
- Install your programs into HP FTM/300's menu.
- Use HP-supplied tools and software packages.

### Data Analysis and Report Generation

Now you can analyze and improve your production process besides just testing your products. HP FTM/300 monitors trends in your process with turnkey statistical quality control (SQC) analysis and report generation. You improve your process and your profits by monitoring production output trends as you tune your process. For a management summary, SQC reports include an overview page listing yield, units passed or failed, and graphics. In addition, this SQC software produces the following charts and graphs:

- Pareto charts for failure analysis
- Histograms of test values
- Control Charts ( $\bar{p}$  and  $\bar{X}$ ,  $s$ ) as process monitors

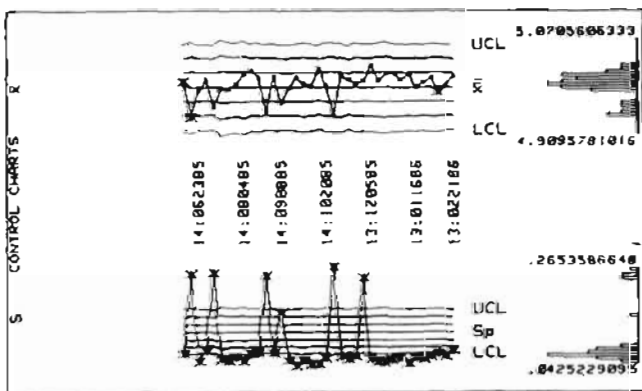

### Transfer Test Data to Other Computers

HP FTM/300 formats test data for transfer to other computing environments for further analysis or archiving. Using RS-232 transfer utilities such as HP AdvanceLink, HP FTM/300 test results are moved to DOS computers for access by spreadsheets such as Lotus® 1-2-3® and database managers such as dBASE III Plus on PC-DOS compatible computers or MS™-DOS computers.

Turnkey FTM/300 software transfers test data from HP FTM/300 to HP Q-STATS II area-wide information manager. HP Q-STATS II, working with the HP 306X Board Test Systems, is a quality solution for the test work cell including data base management, statistical analysis, and presentation quality graphics.

HP FTM/300 formats test data files into ASCII files (comma separated variables (CSV) and DIF for personal computer spreadsheets and data bases). Use any common file transfer means including RS-

232, HP-IB, HP's Shared Resource Manager (SRM), or IEEE 802.3 using HP's SRM network and a co-existing HP-UX environment.

### Reduce Your Software Maintenance Effort

Because you write up to 65% less code with FTM/300, you maintain less software. Also, HP FTM/300's organization and structure helps you maintain the portion of the software you write because you know how and where it fits in the total software. Using HP FTM/300's forms editor, it's much easier and more error-free to edit an entry in a form than to change lines of code. Now, you have a much smaller problem when a test developer changes jobs.

### Standardize on HP FTM/300 for All Your Testing

You further minimize software maintenance and documentation when you standardize on HP FTM/300 as your single test software package. The combination of powerful general test features and the ability to customize HP FTM/300 for each of your test applications makes HP FTM/300 an obvious choice for all your functional test needs.

### Product Requirements

**Computer:** HP 9000 Series 200 or 300 with display enhancements (HP 9826 not supported). Color highly recommended.

**Operating System:** BASIC 4.0/5.0

**Memory:** 2.25 Mbyte of RAM Maximum

**Disc:** 15 Mbyte recommended for local disc or any HP Shared Resource Manager (SRM) approved disc.

**Printer for HP FTM/300 Reports:** HP-IB, 80 characters per line; automatic page feed; HP Raster Interface Standard. For example, HP 2225A, HP 9876A, HP 293X, and HP 82906A.

**Plotter:** Optional

If used, requirements are: HP-IB, HPGL language (automatic sheet feed desirable). For example, HP 75XX, HP 74XX.

**Bar Code Reader:** Optional. Use HP 92916A.

### Ordering Information

### Price

HP FTM/300 is available as HP 34800, HP 34801, HP 34802, or HP 34803 for the two different source code protection schemes, media sizes, and source code revisions 1.0 and 2.0. Revision 1.0 will run only with BASIC 4.0, and Revision 2.0 will run only with BASIC 5.0.

### FTM/300 Rev. 1.0 (BASIC 4.0):

**HP 34800A** 3.5" disc for computers with HP-HIL \$3500

HP 46084A ID Module (order HP 46084A separately).

**HP 34800R Right-to-Use.** Requires previous purchase \$2100

of HP 34800A. Requires an HP 46084A HP-HIL ID

Module for each copy (order HP 46084A separately.)

**HP 34801A** 3.5" disc for computers without HP-HIL. \$3650

Includes HP-IB Security Module.

**HP 34801B** 5.25" disc for computers without HP-HIL. \$3650

Includes HP-IB Security Module.

**HP 34801R Right-to-Use.** Requires previous purchase \$2250

of HP 34801A (3.5" media). Includes HP-IB Security

Module.

**HP 34801T Right-to-Use.** Requires previous purchase \$2250

of HP 34801B (5.25" media). Includes HP-IB Security

Module.

### FTM/300 Rev. 2.0 (BASIC 5.0):

**HP 34802A** 3.5" disc for computers with HP-HIL \$3500

HP 46084A ID Module (order HP 46084A separately).

**HP 34802R Right-to-Use.** Requires previous purchase \$2100

of HP 34802A for HP 34803A/B. Requires an HP

46084A HP-HIL ID Module for each copy (order HP

46084A separately).

**HP 34803A** 3.5" disc for computers without HP-HIL. \$3650

Includes HP-IB Security Module.

**HP 34803B** 5.25" disc for computers without HP-HIL. \$3650

Includes HP-IB Security Module.

**HP 34803R Right-to-Use.** Requires previous purchase \$2250

of HP 34803A/B or HP 34802A. Required for com-

puters without HP-HIL. Includes one HP-IB Security

Module.

**HP 34802U** Upgrades Rev. 1.0 to Rev. 2.0 for 3.5" disc. \$250

**HP 34803U** Upgrades Rev. 1.0 to Rev. 2.0 for 5.25" \$250

disc.

®LOTUS® and 1-2-3® are registered trademarks of Lotus Development Corp.

™MS™-DOS is a trademark of Microsoft, Inc.

# PC INSTRUMENTS

## General Information

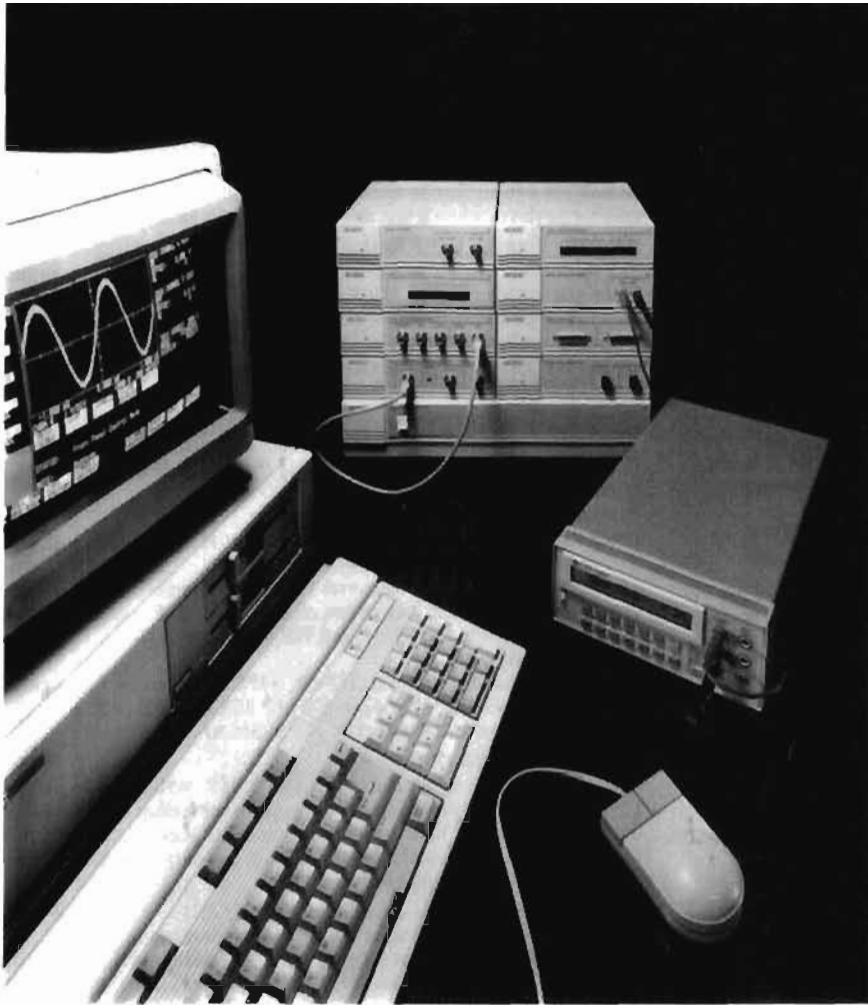

### Advanced Personal Computer Instrumentation

HP PC Instruments link test and measurement instrumentation to the HP Vectra PC, IBM PC/XT/AT, HP 9000 Series 200/300 and AT&T PC 6300. This instrumentation system represents a cost-effective way to achieve fast and consistent test results for many applications. PC Instruments are used primarily as entry level computer-aided-test (CAT) solutions for production test with other applications in research and development, and education.

### PCIB Interface

The interface between each instrument and your computer is via HP PCIB - the HP PC Instruments Bus. PCIB is implemented with a single interface card which plugs into one slot in the computer's backplane. You can monitor and control up to 16 instrument modules with a single interface. Multiple interfaces can be added allowing control of more PC Instruments.

### Powerful System Software - The Heart of HP PC Instruments

PC Instruments system software makes it easy for you to use the system in either a manual or a programmed mode. For manual

mode operation, the soft front panel duplicates the instrument control panels of traditional instruments on your CRT screen. Because the PC Instruments programming library uses high-level commands, it's easy to develop your own application programs in interpretative BASIC, compiled BASIC and C.

### PC Instruments Speed Test Development Time

The PC Instruments system software uses high-level, easy-to-remember commands such as SET, OUTPUT and MEASURE, to control all of the instruments. These commands, together with other system software features, let you develop your own PC Instruments test programs in approximately half the time that it would normally take to program traditional instruments.

PC Instruments system software also provides time-saving debugging features. The soft front panel lets you see the status of all instruments in the system at a glance. And you can easily switch between PANELS and your program for simple program debugging.

In addition, many instrument configurations can be easily set and stored on disc in one or more state files through the use of the

soft front panel. These state files can then be recalled and executed during a program with the INITIALIZE SYSTEM command. With this feature, you can save the instrument settings for a variety of tests and instantly recall complete setups for any one of the tests with a single command.

### Manual Mode Simplicity

For manual mode operation the system software generates a soft front panel on your computer screen that duplicates the front panel of its traditional instrument counterpart. You interact with the panel as you would with any other instrument to set functions, ranges and values, and to take measurements. Monitor and control adjustments to each instrument are performed through the use of cursor keys, a mouse, or the HP Touchscreen.

### Mix and Match PC Instruments with HP-IB Instruments

For optimum price and performance, mix traditional HP-IB instruments with any of the PC Instrument modules. For instance, you can combine an HP-IB 3457A high-performance DMM with PC Instruments to create a system capable of performing various tests (with PC Instruments modules) and making critical voltage measurements (with the HP 3457A) while still maintaining an overall low-cost test system. Both PC Instruments and HP-IB instruments can be controlled from the same BASIC program.

### Optional Software Packages

Optional HP PC Instruments Data Acquisition Software provides simple menu-driven programs to get you up and running quickly for voltage scanning and temperature measurement applications.

In addition, PC Instruments data files are compatible with a number of third-party software solutions, such as Lotus 1-2-3.

The DACQ/300 Data Acquisition Manager for HP9000 Series 200/300 computers is a software library of callable routines for HP BASIC that can be used with PC Instruments. DACQ/300 helps you perform data analysis, presentation and storage/retrieval as well as task scheduling and system configuration.

### Modular System Design

PC Instruments consist of ten advanced instrumentation modules, each with its own isolated power pack. These instruments are extremely compact and stackable to conserve bench space. For manufacturing environments, the optional rack shelf allows up to four PC Instruments to be mounted in standard 19-inch racks.

Since the PC Instrument modules are located outside the computer, valuable expansion slots are conserved, and the instruments are removed from the noisy environment of the computer. The simple design of the modules allows easy access to the measurement terminals and easy expansion of the instrument system as necessary.

In addition, an optional system power unit provides convenient, space-effective storage for the power packs of up to eight PC Instruments. Used on the bench, the system power unit provides an ideal base for PC Instruments. It is also rack mountable.

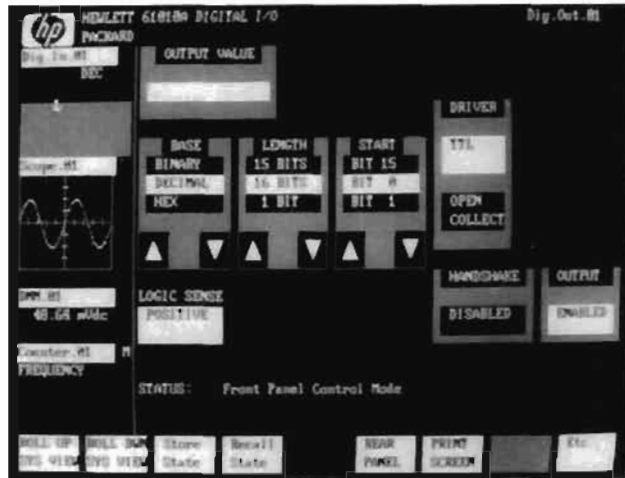

HP 61010A Digital I/O



HP 61011A Relay Multiplexer

### PC Instruments General Specifications

The following specifications hold for all PC Instruments modules, except where noted otherwise.

**Operating Temperature Range:** 0°C to 40°C.

**Storage Temperature Range:** -40°C to +80°C.

**Instrument Dimensions:** L = 295 mm (11.62 in); W = 212 mm (8.35 in); H = 64.5 mm (2.54 in). Each instrument comes with a power pack which provides isolated power.

**Power Pack Specifications:** L = 110 mm (4.33 in); W = 90 mm (3.54 in); H = 64.5 mm (2.54 in); Wgt = 0.87 kg (1.91 lbs).

**Input Voltage Domestic Power Pack:** 120 Vac  $\pm$ 12.5%, 57-63 Hz, 2.5 VA max.

**Input Voltage International Power Pack(s):** 100, 220 or 240 Vac,  $\pm$ 12.5%, 47-66 Hz, 2.5 VA max.

PC Instruments meet IEC 348 standards.



### HP 61010A Digital I/O

The HP 61010A Digital I/O can be used as both an input and an output device. It has 16 independent input lines and 16 independent output lines, which can be addressed as variable length words up to 16 bits long. The input and output connectors include two data control lines each. Both random asynchronous and synchronous transfers are available.

The instrument comes with two shrouded connectors for solder terminals. Accessory block (HP 14802A) allows easy screw termination.

**User Connections:** 16 input data bits; 2 input data control signals; 16 output data bits; 2 output data control signals.

**Digital Input Data Characteristics**

**Input Voltage Range:**  $\pm$ 10 V max.

**Input Impedance:** 100 k ohm pullup resistor to +5 V.

**Input Logic Threshold:** Programmable to  $\pm$ 10 V, Resolution = 80 mV, Accuracy =  $\pm$ 160 mV.

**Digital Output Data Characteristics**

**TTL Mode:**  $V_{ol} = 0.4$  V max @  $I_{ol} = 16$  mA max.

$V_{oh} = 2.4$  V min @  $I_{oh} = -4$  mA max.

**Open Collector Mode:**  $V_{ol} = 0.4$  V max @  $I_{ol} = 16$  mA max.

$V_{oh} = 0.7$  V max @  $I_{oh} = 40$  mA max.

$V_{oh} = 12$  V max (pullup resistor to external supply).

**Output Disabled Mode:**

$I_{or} = -50$   $\mu$ A max (with output bit pulled down to ground).

$I_{oz} = 250$   $\mu$ A max (with output bit pulled up to +12 V).

**Data Control Signals**

**ODAV (Output Data Available):** Same as output data bit.

**ODAC (Output Data Accepted):**  $V_{il} = 0.0$  V to 0.4 V,  $V_{ih} = 2.4$  V to 5.0 V (10 k ohm pullup resistor to +5 V); Minimum pulse width = 10  $\mu$ s.

**IDAV (Input Data Available):**  $V_{il} = 0.0$  V to 0.4 V,  $V_{ih} = 2.4$  V to 5.0 V (10 k ohm pullup resistor to +5 V); Minimum pulse width = 10  $\mu$ s.

**IDAC (Input Data Accepted):** Same as output data bit.

**Data Transfer Time:** OUTPUT or MEASURE statement, handshake disabled: HP Vectra PC: 8.0 ms/word.

HP Series 310: 1.5 ms/word.

**Weight:** 1.26 kg (2.78 lbs).

### HP 61011A Relay Multiplexer

The HP 61011A Relay Multiplexer features break-before-make scanning of up to eight double-ended channels. The relays are bi-directional so that they may be used to send up to eight signals to a single destination, or distribute one source among eight output channels. The 61011A can be teamed with a digital multimeter to provide thermocouple scanning. An onboard temperature reference allows accurate absolute temperature measurement.

The Relay Multiplexer comes with a plug-in screw terminal block for easy connection of user inputs and outputs.

**User Connections:** 8 Double-ended inputs; 1 Temperature reference voltage output; 1 Double-ended output.

**Channel Select Time:** OUTPUT statement, including automatic break-before-make: HP Vectra PC: 36 ms.

HP Series 310: 30 ms.

**Input Switching Characteristics**

**Max Voltage:** 250 Vdc, 250 Vac rms, 350 Vac peak.

**Max Current:** (Per channel or module) 1 Amp dc, 1 Amp ac rms.

**Max Power:** (Per channel or module) 50 W dc, 250 VA ac.

**Resistance (Input to Output):** 1 ohm typical.

**Thermal Offset (Input to Output):**  $<$ 6  $\mu$ V max.

**Isolation Voltage Rating:** 250 Vdc, 250 Vac rms, 350 Vac peak between any two input terminals or between an input and ground.

**DC Isolation Resistance:** ( $<$ 40°C, 80% RH)

Open Channel  $>$  2  $\times 10^8$  ohms

Channel-Channel  $>$  2  $\times 10^8$  ohms

Channel-Ground  $>$  2  $\times 10^8$  ohms

**AC Characteristics (50 ohm termination):**

Crosstalk (input to input) (dB)  $<$ -73  $<$ -53  $<$ -33

Feedthrough (input to output) (dB)  $<$ -73  $<$ -53  $<$ -33

Insertion Loss (input to output) (dB)  $<$ 0.2  $<$ 0.3  $<$ 0.5

Capacitance

(Open Channel, Channel to Channel)  $<$  5 pF

(Closed Channel)  $<$  25 pF

(Channel to Chassis)  $<$  50 pF

**Reference Junction Compensation Accuracy:**

$\pm$ 2°C ( $\pm$ 2°C to  $\pm$ 40°C ambient).

**Weight:** 0.95 kg (2.09 lbs).

# PC INSTRUMENTS

## Instrument Modules (cont'd)

Models 61012A and 61013A

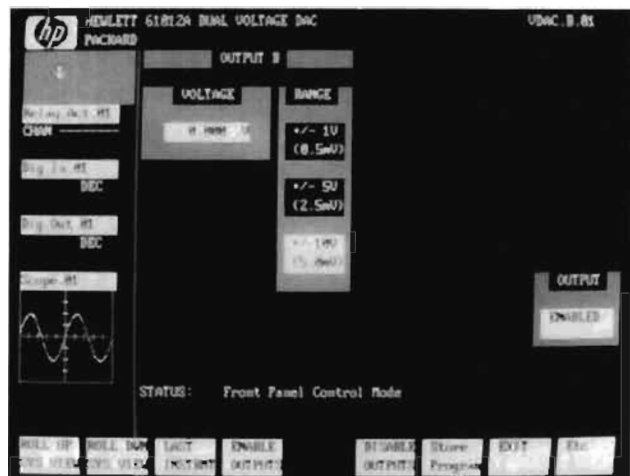

HP 61012A Dual Voltage DAC

### HP 61012A Dual Voltage DAC

The HP 61012A Dual Voltage DAC supplies two independently controlled voltage sources in three standard ranges. Each voltage source is electrically isolated.

The Dual Voltage DAC comes with two plug-in screw terminal blocks.

#### Output Voltage (at up to 5 mA):

- 1 V to + 1 V with 0.5 mV resolution.
- 5 V to + 5 V with 2.5 mV resolution.
- 10 V to +10 V with 5.0 mV resolution.

Accuracy:	Range	23°C ± 5°C	0°C - 40°C
	± 1 V	0.050% ± 0.6 mV	0.25 % ± 0.6 mV
	± 5 V	0.050% ± 3.0 mV	0.25 % ± 3.0 mV
	± 10 V	0.025% ± 6.0 mV	0.125% ± 6.0 mV

**Ripple and Noise:** Less than 3 mV p-p, 20 Hz to 20 MHz.

**Output Protection:** Outputs can withstand a short circuit for unlimited time.

**Settling Time:** Output voltage settles within 1 LSB of final value in less than 1 ms.

**Programming Time:** Time to change the voltage output of either source using an OUTPUT statement: HP Vectra PC: 15 ms  
HP Series 310: 7 ms

**Isolation Voltage Rating:** 250 Vdc, 250 Vac rms or 350 Vac peak between outputs or between either voltage output and ground.

**Output Disabled Mode:** 100 k ohm resistance across outputs.

**Weight:** 1.11 kg (2.44 lbs).

### HP 61013A Digital Multimeter

The HP 61013A Digital Multimeter measures dc voltages, ac voltages, and ohms. Its features include full programmability, autoranging and true rms.

The Digital Multimeter comes with two shrouded leads, test probes, and grabber clips.

**Digits:** 4½

**Functions:** ±DC Volts, AC Volts (true rms), Ohms.

**Programmable Ranges:**

	Range	Max Display	Resolution
DC (±) or AC Volts (rms)	200 mV	199.99 mV	0.01 mV
	2 V	1.9999 V	0.0001 V (0.1 mV)
	20 V	19.999 V	0.001 V (1 mV)
	200 V	199.99 V	0.01 V (10 mV)
Resistance	200 ohms	199.99 ohms	0.01 ohms
	2 k ohms	1.9999 k ohms	0.0001 k ohms (0.1 ohms)
	20 k ohms	19.999 k ohms	0.001 k ohms (1 ohm)
	200 k ohms	199.99 k ohms	0.01 k ohms (10 ohms)
	2 M ohms	1.9999 M ohms	0.0001 M ohms (100 ohms)
	20 M ohms	19.999 M ohms	0.001 M ohms (1 k ohms)

#### General

**Accuracy (at 23°C ± 5°C, 80% RH)** All ac specifications given for a sine wave.

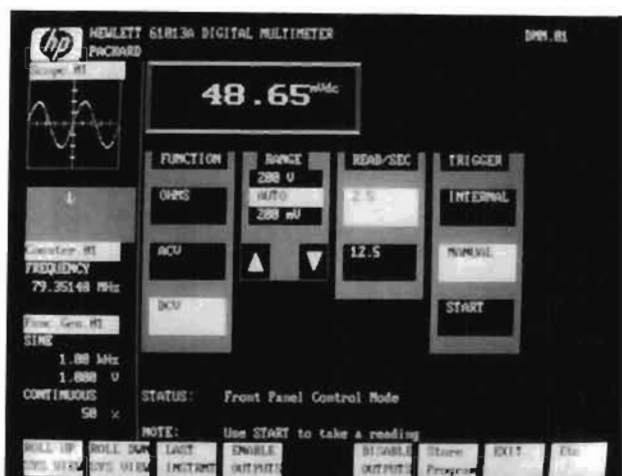

HP 61013A Digital Multimeter

### 2.5 readings/second:

**DC Volts:** ±0.05% of reading ±4 counts.

**AC Volts (45 Hz to 500 Hz):** ±0.5% of reading ±50 counts.

**AC Volts (30 Hz to 45 Hz, 500 Hz to 1 kHz):** ±1% of reading ±50 counts.

**Ohms:** ±0.1% of reading ±4 counts (200, 2 k, 20 k, 200 k, 2 M ohm ranges). ±0.35% of reading ±4 counts (20 M ohm range).

### 12.5 readings/second:

**DC Volts:** ±0.05% of reading ±10 counts.

**AC Volts (45 Hz to 500 Hz):** ±0.5% of reading ±56 counts.

**AC Volts (30 Hz to 45 Hz, 500 Hz to 1 kHz):** ±1% of reading ±56 counts.

**Ohms:** ±0.1% of reading ±10 counts (200, 2 k, 20 k, 200 k, 2 M ohm ranges). ±0.35% of reading ±10 counts (20 M ohm range).

**Accuracy (0°C - 40°C, 80% RH)**

### 2.5 readings/second:

**DC Volts:** ±0.1% of reading ±8 counts.

**AC Volts (45 Hz to 500 Hz):** ±0.75% of reading ±100 counts.

**AC Volts (30 Hz to 45 Hz, 500 Hz to 1 kHz):** ±1.5% of reading ±100 counts.

**Ohms:** ±0.2% of reading ±7 counts (200, 2 k, 20 k, 200 k, 2 M ohm ranges). ±0.5% of reading ±12 counts (20 M ohm range).

### 12.5 readings/second:

**DC Volts:** ±0.1% of reading ±14 counts.

**AC Volts (45 Hz to 500 Hz):** ±0.75% of reading ±106 counts.

**AC Volts (30 Hz to 45 Hz, 500 Hz to 1 kHz):** ±1.5% of reading ±106 counts.

**Ohms:** ±0.2% of reading ±13 counts (200, 2 k, 20 k, 200 k, 2 M ohm ranges). ±0.5% of reading ±18 counts (20 M ohm range).

**Maximum Settling Time:** DC: 150 ms (to 0.01%)

AC: 350 ms (to 0.1%)

Ohms: 75 ms (to 0.01%)

**Maximum Measurement Rate:** 12.5 readings/second (80 ms/reading with a MEASURE statement).

**Programmable Measurement Rates:** 2.5 readings/second or 12.5 readings/second.

**Input Impedance:** 10 M ohms minimum all dc ranges; 1 M ohms on all ac ranges.

**Input Overvoltage Protection:** 350 V peak (non-destructive).

#### Common Mode Rejection

DC Range	50/60 Hz NMR	50/60 Hz ECMRR*	DC CMRR*
2.5/s	>60 dB	>120 dB	>120 dB
12.5/s	0 dB	>60 dB	>120 dB

AC Range	DC-60 Hz CMRR*	DC CMRR*
2.5/s or 12.5/s	>60 dB	>120 dB

\*With 1K in LO lead.

**Isolation Voltage Rating:** 250 Vdc, 250 Vac rms, 350 Vac peak between any input terminal and ground.

**Weight:** 1.02 kg (2.25 lbs).



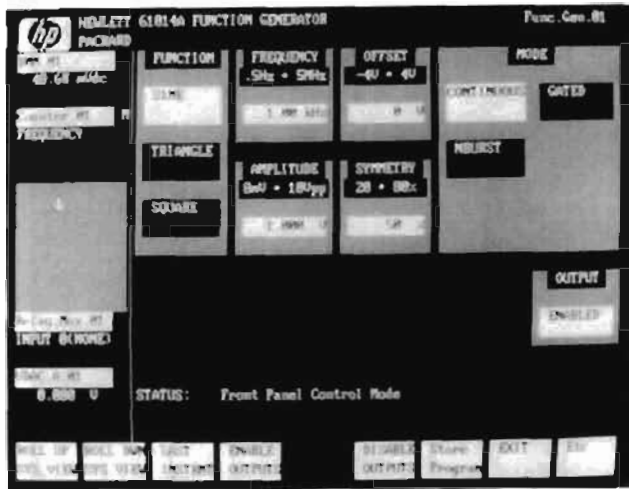

HP 61014A Function Generator

**HP 61014A Function Generator**

The HP 61014A Function Generator generates sine waves, square waves, triangle waves, ramps and pulses. The function, frequency, amplitude and offset can be set programmatically. The burst feature allows you to program a discrete number of cycles ranging from 1 to 65536. Inputs for VCO and AM modulation are also provided.

**Specifications:** All specifications are given at full rated output into a 50 ohm load unless otherwise noted

**Symmetry Range for Sine, Square, Triangle Waves:** 20% to 80% of duty cycle up to 500 kHz; 50% of duty cycle up to 5 MHz.

**Sine Wave Distortion:**

10 Hz to 50 kHz: All harmonics >40 dB below fundamental.

50 kHz to 5 MHz: All harmonics >30 dB below fundamental.

**Square Wave Rise Time and Fall Time:**

10% to 90% at 1 MHz: <50 ns (typical), <75 ns (maximum).

**Triangle Linearity Error:** <3% at 1 kHz.

**Output Impedance:** 50 ohms  $\pm$  10%.

**Flatness** (Measured with respect to a 1 kHz sine wave reference):

10 Hz to 100 kHz: Better than  $\pm$ 3% (in a single output range).

100 kHz to 5 MHz: Better than  $\pm$ 18% (in a single output range).

**Amplitude Characteristics**

**Amplitude range:** 8 mV to 10 V p-p.

**Resolution:** 0.8 V to 10 V: 40 mV, below 0.8 V: 4 mV.

**Offset:** Programmable from -4 V to 4 V.

**Offset Accuracy:**  $\pm$ 5%  $\pm$ 0.2 V (function amplitude >0.1 V p-p).  
 $\pm$ 5%  $\pm$ 25 mV (function amplitude <0.1 V p-p).

**Maximum Amplitude Including Offset:** 5 V

**Output Frequency Characteristics**

**Frequency Range:** 0.5 Hz to 5 MHz.

**Resolution:** 0.5 Hz to 50 Hz: 0.1 Hz

50 Hz to 500 Hz: 1 Hz

500 Hz to 5 kHz: 10 Hz

5 kHz to 50 kHz: 100 Hz

50 kHz to 500 kHz: 1 kHz

500 kHz to 5 MHz: 10 kHz

**Accuracy:**  $\pm$ 4% of the maximum frequency in each of the ranges listed above.

**External Modulation Characteristics**

**Amplitude Modulation:**

**Modulating signal:** dc to >100 kHz. Carrier Envelope Distortion at 70% sine wave modulation with  $f_c = 1$  MHz and  $f_m = 1$  kHz: <2% typical

**VCO:** The output frequency can be decreased from the maximum frequency associated with any given resolution: >100 to 1. The frequency versus voltage curve will be linear to within  $\pm$ 2% of maximum frequency associated with any given resolution.

**Output Control Characteristics**

**Free Run Mode:** Continuous Operation.

**N-Burst Mode:** The burst feature allows you to program a discrete number of cycles ranging from 1 to 65536.

**Gate Mode:** A logic zero applied to the gate input causes continuous operation. A logic one applied to the gate input will stop the output.

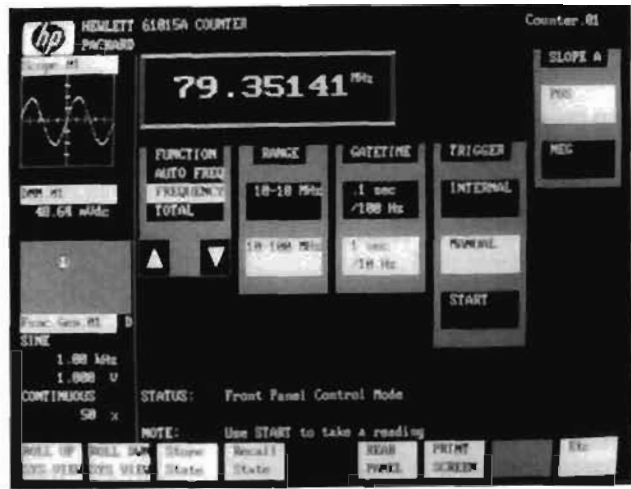

HP 61015A Universal Counter

**HP 61015A Universal Counter**

**Sync Output:** A TTL compatible square wave output at the frequency of operation.

**Disable Output Mode:** This command opens a relay in series with the output. The sync output remains operational.

**Short Circuit Protection:** A protection circuit reduces the signal to a safe level if the output is short circuited.

**Weight:** 1.56 kg (3.44 lbs).

**HP 61015A Universal Counter**

The HP 61015A Counter is a 100 MHz universal counter. It decodes commands from your computer, measures the input waveform, and returns the 8-digit measurement value back to the computer. Modes include frequency, period, and totalize for Channel A input. Channel B input is provided for frequency ratio and time interval measurement. Additional modes include auto-frequency and auto-period which use a reciprocal counting technique.

**Input Frequency Limits**

**Input A (positive slope):** 10 Hz to 100 MHz with prescaler.  
10 Hz to 10 MHz without prescaler.

**Input A (negative slope):** 10 Hz to 90 MHz with prescaler.  
10 Hz to 9 MHz without prescaler.

**Input B (positive or negative slope):** 10 Hz to 2.5 MHz.

**Input Characteristics**

**Input A Sensitivity:** 40 mV rms (10 Hz to 100 MHz).

**Input B Sensitivity:** 40 mV rms (10 Hz to 2.5 MHz).

**Input Coupling:** AC on both inputs.

**Input Impedance:** 1 M ohm (nominal) shunted by 30 pF.

**Frequency (Input A)**

**Ranges:** 10 Hz to 10 MHz (LSD = 10 Hz with 0.1 s gate time).  
10 Hz to 10 MHz (LSD = 1 Hz with 1 s gate time).  
10 Hz to 10 MHz (LSD = 0.1 Hz with 10 s gate time).  
10 Hz to 100 MHz (LSD = 100 Hz with 0.1 s gate time).  
10 Hz to 100 MHz (LSD = 10 Hz with 1 s gate time).

**Resolution:**  $\pm$  LSD

**Accuracy:**  $\pm$  LSD  $\pm$  (time base error in ppm) x frequency.

**Auto-Frequency (Input A)**

**Range:** 10 Hz to 100 MHz

**Period (Input A)**

**Range:** 400 ns to 0.1 s. Number of cycles of averaging (N) may be programmed from 1 to 1000 in decade steps.

LSD = 100 ns for 1 cycle averaging

LSD = 10 ns for 10 cycle averaging.

LSD = 1 ns for 100 cycle averaging.

LSD = 0.1 ns for 1000 cycle averaging.

**Resolution:**  $\pm$  LSD.

**Accuracy:**  $\pm$  LSD  $\pm$  1.4 x [(trigger error)/N]  $\pm$  (time base error in ppm) x period.

**Auto-Period (Input A):** Range: 10 Hz to 100 MHz.

**Time Interval**

**Range:** 250 ns to 10 s.

**LSD Displayed:** 100 ns.

**Resolution:**  $\pm$  1 SD.

**Accuracy:**  $\pm$  LSD  $\pm$  START trigger error  $\pm$  STOP trigger error  $\pm$  (time base error in ppm) x (time interval).

# PC INSTRUMENTS

## Instrument Modules (cont'd)

Models 61015A and 61016A

### HP 61015A Universal Counter (continued)

#### Ratio

**Range:** Channel A: 10 Hz to 100 MHz.

Channel B: 10 Hz to 2.5 MHz.

**LSD Displayed:** 10 Hz to 10 MHz: 1 part in (A/B) x N.

10 Hz to 100 MHz: 1 part in (A/B) x N x 0.1.

**Resolution:** ±LSD.

**Accuracy:** ±1 count of A ± [(B trigger error) x (frequency A)]/N where N is the number of cycles of averaging for channel B input. N may be programmed from 1 to 1000 in decade steps.

#### Totalize (A)

**Range:** 10 Hz to 100 MHz.

**Resolution:** 10 Hz to 10 MHz: ±1 count.

10 Hz to 100 MHz: ±10 counts.

#### Time Base

**Frequency:** 10 MHz.

**Time base error:** ±10 ppm.

#### General

**Trigger Error:**  $\sqrt{(80 \text{ uV})^2 + c_n^2}$  (rms)  
input slew rate at trig. pt. (uV/s)

Where  $c_n$  is the rms noise in mV of the input for a 100 MHz bandwidth in Channel A and 10 MHz bandwidth in Channel B.

**Maximum Measurement Rate:** 10 readings/second (100 ms/reading with a MEASURE statement).

**Operating Humidity Range:** - 80%.

**Weight:** 0.60 kg (1.31 lbs).

### HP 61016A Digitizing Oscilloscope

The HP 61016A Digitizing Oscilloscope is fully programmable, providing such features as automatic scaling, auto trigger, self-calibration, and direct readout of delta voltage and delta time. Waveforms captured using sophisticated random repetitive sampling techniques can be saved and recalled for analysis. This 50 MHz scope has an external trigger input and delayed trigger capability.

#### Specifications

All specifications are valid after the instrument has reached a stable temperature, and self-calibration is performed.

#### Vertical

**Bandwidth:** 0 to 50 MHz with dc coupling; 10 Hz to 50 MHz with ac coupling.

**Input Coupling:** ac, dc.

**Input RC:** 1 Meg ±2% shunted by approx. 18 pF.

**Max Input Voltage:** ±40 V (dc + peak ac).

**Range:** 40 mV to 40 V.

**Resolution:** (trigger level set within vertical range and offset to zero).

Vertical Range	Resolution
40 mV - 80 mV	0.67 mV
160 mV - 40 V	range/240

**Gain Accuracy:** ±3%.

**Zero Offset Error:** ±3% full scale ±3.0 mV.

Offset Range	Vertical Range	Offset Range
	40 mV - 4 V	±1.5 x range
	8 V - 16 V	±12 volts
	40 V	Not available

#### Timebase

**Range:** 100 ns to 5 s in 1-2-5 sequence.

Resolution	Timebase	Resolution
	100 ns - 200 ns	1 ns
	500 ns - 5 s	range/250

**Delay Range:** -0.5 to 250 x timebase range, with trigger referenced to center.

#### Trigger

**Source:** Either channel, pos or neg slope; or external trigger.

**Range:** ±2 x vertical range, limited to ±20 V.

Specification Sensitivity:	Vertical Range	Vertical Range
(<10 MHz)	40 mV - 1.6 V	4 V - 40 V
(>10 MHz)	15 mV	400 mV
	40 mV	1.0 V

**Level Accuracy:** ±3%  
±10% mV ±250 mV

**External Trigger:** 1 volt rising edge into 100 k ohms, with a risetime < 1 μs.

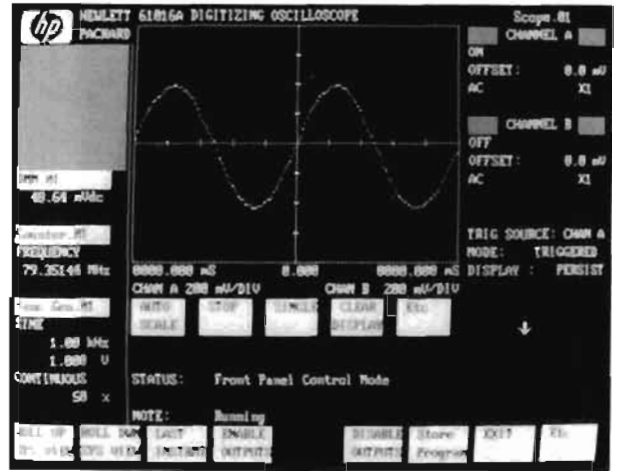

### HP 61016A Digitizing Oscilloscope

#### Characteristics

#### Vertical:

**Offset Accuracy:** Zero offset error + gain error.

**Noise:** 1.5% of full scale or 2.4 mV, whichever is larger.

**Single Marker Accuracy:** Gain accuracy + zero offset error.

**Dual Marker Accuracy:** Gain accuracy.

**Probe Scaling Factors:** 1:1, 10:1.

**Probe Compensation Signal:** ≈500 mV, 7 kHz square wave.

#### Trigger

**Modes:** Normal, Auto trigger, Auto level. Auto trigger mode will generate internal triggers at a 40 Hz rate in the absence of input trigger. Auto level will continuously adjust the trigger level to track the input signal with duty cycles between 30% and 70%.

#### Timebase

**Delay Accuracy:** ±0.02% ±0.4% of timebase range ±5 ns.

**Single Marker Accuracy:** Delay accuracy.

**Dual Marker Accuracy:** ±0.4% of timebase range ±2 ns.

#### Digitizer

**A/D Resolution:** 8 bits.

**Digitizing Technique:**

Timebase Range	Acquisition Mode	Digitizing Rate
100 ns - 50 μs	Random Repetitive	(not applicable)
100 μs - 20 ms	Random Sequential	5.814 kHz
50 ms - 5 s	Flash Acquisition	250/timebase range

**Throughput:** 300 samples/s on 100 ns range, 700 samples/s on 200 ns to 100 μs ranges, increasing to 2500 samples/s at 50 ms.

#### Measurements

Markers are provided for manual timing and voltage measurements. Automated measurements of the following waveform parameters can be made: Frequency, period, risetime, falltime, +width, -width, p-p volts, and overshoot. Waveforms can be saved and recalled for comparison.

#### Displays

**Variable Persistence:** This mode displays samples for a user set time, then erases them. The display time can be varied or set to infinite.

**Average:** Provides a display of the average of many samples. The averaging runs continuously, and can be set 1, 2, 4, 16, 32, 64, 128.

#### Autoscale

The Autoscale feature will display both channels with the proper vertical, trigger, and timebase setting. The coupling is set to ac, and the delay is set to zero. Requires a duty cycle of 20% to 80%, an amplitude of >20 mV and a frequency >50 Hz.

#### Self Calibration

This feature calibrates the vertical, trigger, and timebase to the published specifications. A self calibration occurs when the instrument is first turned on, and can be requested by the user at any time. Calibration time is typically 3 seconds.

**Weight:** 1.40 kg (3.09 lbs).

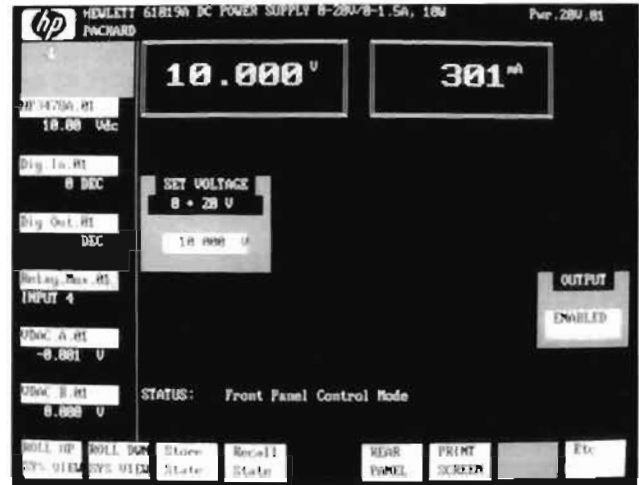
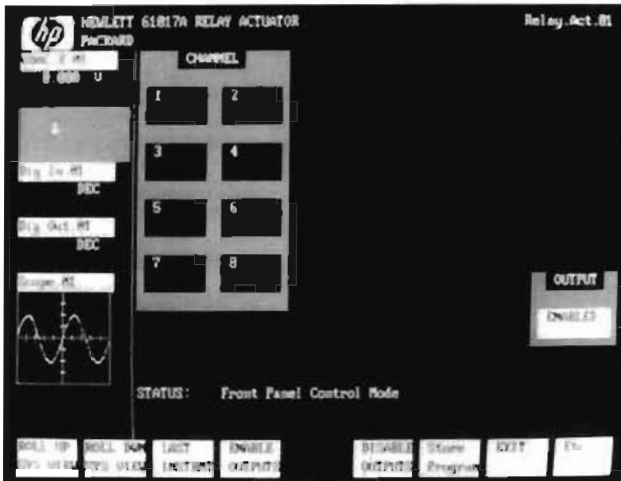

HP 61017A Relay Actuator

HP 61019A 20 Volt Power Supply

**HP 61017A Relay Actuator**

The HP 61017A Relay Actuator provides programmable control of eight independent relay switches. Each channel can carry up to one ampere of current, or can switch up to 250 volts dc or ac rms.

The Relay Actuator comes with a plug-in screw terminal block for easy connection of user inputs and outputs.

**User Connections:** 8 independent single-pole channels.

**Channel Open or Close Time:** Multiple channels, using an OUTPUT statement: HP Vecira PC: 22 ms

HP Series 310: 18 ms

**Switching Characteristics**

**Maximum Voltage:** 250 Vdc, 250 Vac rms, 350 Vac peak.

**Maximum Current:** Per channel: 1 amp dc, 1 amp ac rms.  
 Per module: 4 amp dc, 4 amp ac rms.

**Maximum Power:** Per channel: 50 W dc, 250 VA ac  
 Per module: 200 W dc, 1000 VA ac

**Resistance (per channel):** 1 ohm typical.

**Thermal Offset (per channel):** <6 uV maximum.

**Isolation Voltage Rating:** 250 Vdc, 250 Vac rms, 350 Vac peak between any two input terminals or between an input and ground.

**DC Isolation Resistance:** (<40°C, 80%RH)

Open Channel	>2 x 10 <sup>8</sup> ohms
Channel-Channel	>2 x 10 <sup>8</sup> ohms
Channel-Ground	>2 x 10 <sup>8</sup> ohms

**AC Characteristics (50 ohm termination):**

	100 kHz	1 MHz	10 MHz
Crosstalk (input to input) (dB)	<-73	<-53	<-33
Feedthrough (input to output) (dB)	<-73	<-53	<-33
Insertion Loss (input to output) (dB)	<0.2	<0.3	<0.5

**Capacitance:**

(Open Channel, Channel to Channel)	< 5 pF
(Closed Channel)	<25 pF
(Channel to Chassis)	<50 pF

**Weight:** 0.95 kg (2.09 lbs).

**HP 61018A Breadboard Module**

The HP 61018A Breadboard Module is a general-purpose circuit board, designed for integrating custom circuitry into an HP PC Instruments system. The unit is in kit form and must be assembled. A power pack that supplies one isolated ac power source with three voltage taps is also included.

There is no provision for connecting the unit to the HP PC Instruments Interface Bus. Any available HP PC Instruments module can be used as an interface to your custom circuits. Signals between the custom circuit and the rest of the system are routed through front-

panel connectors. Two different front panels are provided for design flexibility. One panel is blank, and the other panel is designed to accept the two 25-pin connectors, one male and one female, supplied with the kit. These connectors match the input and output connectors of the Digital I/O module (HP 61010A), which is particularly suited for digital communication with the Breadboard Module.

**Circuit board dimensions:** 255mm x 183mm (10 in. x 7.2 in.)

**Grid small hole size:** 1mm (0.039 in.)

**Grid large hole size:** 1.8mm (0.071 in.)

**Grid small hole spacing:** 2.54mm (0.1 in.)

**Maximum trace current:** 5 A (all tracks)

**Power dissipation:** 6 Watts maximum (typically gives 20°C rise in internal temperature)

**Component height:** 31.4 mm maximum

**Component to case spacing:** 3mm minimum

**25-pin connector current rating:** 1A, each contact

**LED forward current:** ≤30 mA @ 25°C

**LED forward voltage:** ≤3 V @ 25°C (2.4 V typ.)

**LED reverse breakdown voltage:** >3 V

**Output voltages:** (measured from center tap to winding at nominal line voltage and no load) 10.6 V p-p, 14 V p-p, 18.4 V p-p

**HP 61019A 20 Volt DC Power Supply**

The HP 61019A DC Power Supply is a general purpose programmable DC power supply. The supply's output voltage is programmable from 0 to 20 volts with a resolution better than 5 millivolts. The supply has a built-in current limit that is fixed at 1.5 amperes at 5 volts, 0.9 amperes at 10 volts, and 0.5 amperes at 20 volts. Current readback circuitry is included that allows you to monitor the output current. The current readback resolution is better than 7.5 milliamperes. Each DC power supply also has an enable/disable feature that allows you to turn the output on or off to simulate an on/off switch capability. See table on next page for specifications.

**HP 61025A 50 Volt DC Power Supply**

The HP 61025A DC Power Supply is a general purpose programmable DC power supply. The supply's output voltage is programmable from 0 to 50 volts with a resolution better than 12.5 millivolts. The supply has a built-in current limit that is fixed at .5 amperes at 20 volts, .286 amperes at 35 volts, and .2 amperes at 50 volts. Current readback circuitry is included that allows you to monitor the output current. The current readback resolution is better than 2.5 milliamperes. Each DC power supply also has an enable/disable feature that allows you to turn the output on or off to simulate an on/off switch capability. See table on next page for specifications.

# PC INSTRUMENTS

## Instrument Modules (cont'd)

### Models 61019A, 61020A and 61025A

Specifications	HP 61019A	HP 61025A
Output Operating Ranges		
Output Voltage Range	0-20 V with better than 5 mV resolution	0-50 V with better than 12.5 mV resolution
Programming Accuracy	0.1% $\pm$ 5 mV at 23°C 0.2% $\pm$ 5 mV at 0°C to 40°C.	0.1% $\pm$ 12 mV at 23°C $\pm$ 5°C. 0.2% $\pm$ 12 mV at 0° to 40°C.
Output Current Capability	1.5 A from 0 to 5 Vdc decreasing linearly to 0.9 A at 10 Vdc Decreasing linearly to 0.5 A at 20 Vdc.	0.5 A from 0 to 20 Vdc decreasing linearly to 0.286 A at 35 Vdc. Decreasing linearly to 0.2 A at 50 Vdc.
Current Readback Accuracy	$\pm$ 1% $\pm$ 7 mA with better than 7.5 mA resolution.	$\pm$ 1% $\pm$ 3 mA with better than 2.5 mA resolution.
Operating Temperature Range	0-40°C	0-40°C
Average Temperature Coefficient	(Output change per degree Celsius change): 0.01% $\pm$ 0.2 mV	(Output change per degree Celsius change): 0.01% $\pm$ 0.5 mV.
PARD (Ripple and Noise)	< 5 mV p-p (10 Hz to 20 MHz) $\pm$ 1 mV rms (10 Hz to 10 MHz)	< 5 mV p-p (10 Hz to 20 MHz) $\pm$ 1 mV rms (10 Hz to 10 MHz)
Load Effect Regulation	0.01% $\pm$ 2 mV	0.01% $\pm$ 2 mV
Output Protection	Output is protected against short circuits of unlimited duration.	Output is protected against short circuits of unlimited duration.
Output Response Time	With 5 mV error band (does not include computer command processing time.) Up with full load: 10 ms. Up with no load: 10 ms. Down with full load: 400 ms. Down with 2 k ohms load: 800 ms.	With 25 mV error band (does not include computer command processing time.) Up with full load: 10 ms. Up with no load: 10 ms. Down with full load: 400 ms. Down with 5 k ohms load: 800 ms.
Load Transient Recovery	(With 5 mV error band) 10% load change = 400 $\mu$ s.	(With 25 mV error band) 10% load change = 400 $\mu$ s.
Isolation Voltage Rating:	(From output terminals to ground) 250 Vdc; 250 Vac rms; 350 Vac peak	(From output terminals to ground) 250 Vdc; 250 Vac rms; 350 Vac peak.

#### HP 61020A Dual VHF Multiplexer

The HP 61020A Dual VHF Multiplexer consists of two independent four-to-one multiplexers that are specifically designed for broadband signal switching up to 300 MHz. Because the channels on the Dual VHF Multiplexer are bi-directional, the instrument can also be used as a demultiplexer.

**User Connections (per multiplexer):** 4 single-ended channels with 1 single-ended common

**Channel Select Time:** < 100 ms

(in GW-BASIC using an OUTPUT statement; includes break-before-make)

**Channel Impedance:** 50 ohms nominal

**Switching Characteristics:** Max voltage = 30 Vdc; 30 Vac rms; 42.4 Vac pk\*

Max current = 0.1 A dc; 0.1 A ac rms\*

Max power = 1 W dc; 1 VA ac\* rms

Min voltage = 10 mV; Min current = 0.01 mA

Isolation Voltage Rating: 30 Vdc; 30 Vac rms; 42.4 pk

#### High Frequency Characteristics:

	100 MHz	300 MHz
Crosstalk	< -50 dB	< -50 dB
Feedthrough	< -50 dB	< -50 dB
Insertion loss	> -0.4 dB	> -0.6 dB
Return loss	< -25 dB	< -20 dB
VSWR	< 1.12	< 1.22

**Address Bus Type:** serial

**Factory Defaults:** Labels (in GW-BASIC):

Multiplexer A = VHF.MUX.A.01 (VHF.MUX.A.02 for 2nd instrument)

Multiplexer B = VHF.MUX.B.01 (VHF.MUX.B.02 for 2nd instrument)

Channels = channel 1 selected; Output = disabled

**Weight:** 1.36 kg (3.0 lbs.)

\* To maintain compliance with VDE class B, use coaxial cable and limit your power level to  $\pm$  27 dBm from dc-30MHz; +3 dBm starting above 30 MHz and rolling off at 6dB/octave.

**HP 98647A HP 9000 Series 200/300 Interface**

These products provide a link between the HP Vectra PC, IBM PC/XT/AT and AT&T 6300 (HP 61061C) or the HP 9000 Series 200/300 family (HP 98647A) and up to 16 PC Instruments. They consist of a PCIB interface card; PC Instruments system software, PC Instruments system documentation, and two control cables. The interface card plugs into one of the accessory slots on the HP Vectra PC, IBM PC/XT/AT, AT&T PC 6300 and the HP 9000 Series 200/300. Maximum distance between computer and the instruments is 1.8 meters. PC Instruments system software makes it easy to use the system in either a manual or a programmed mode. This unique combination of hardware and software lets engineers and scientists automate tests quickly and at minimal cost.

**Manual mode simplicity**

PC Instruments system software generates an advanced soft front panel on your computer screen that duplicates the front panel of its traditional instrument counterpart. You interact with the soft front panel as you would with any other instrument to set functions, ranges and values, and to take measurements through the use of the HP touchscreen, a mouse, or cursor keys. Use of a mouse or touchscreen allows more rapid control of the instruments.

**Programmed mode productivity**

The PC Instruments system software uses high-level programming statements, such as SET.OUTPUT and MEASURE, to control all of the instruments. These commands are easier to remember and learn than the command mnemonics of traditional instruments. Therefore, you can develop your own PC Instruments test programs in less time than it takes to program traditional instruments.

The soft front panel lets you see the status of all instruments in the system at a glance, so you can switch between panels and your program for simple program debugging. In addition, many instrument configurations can be set and stored on disc in one or more state files through the function keys displayed on the soft front panel. These state files can then be recalled using the INITIALIZE.SYSTEM command. This feature lets you save the instrument settings and instantly recall them with a single command or keystroke.

You can also control an HP 3478A 5½-digit HP-IB Digital Multimeter with the HP 61061C PC Instruments System Software in a manner similar to other PC Instruments.

**Programming languages available with PC Instruments**

PC Instruments offer you several programming choices. With MS-DOS computers, you can use GW-BASIC/BASICA, QuickBASIC, or Lattice C. HP BASIC is used with the HP 9000 Series 200/300 computers.

Interpreted languages, such as BASICA or GW-BASIC, provide high-level commands that are easy to remember and learn. Programs execute line by line, making it simple to find program errors.

When execution speeds are critical to your test application, QuickBASIC and Lattice C provide the answer. These languages enable a program to run faster than programs written in an interpreted language. And since Lattice C can use a numeric co-processor, execution speeds can be further enhanced.

HP BASIC running on an HP 9000 Series 200/300 computer system is the language of choice for instrument control. This language provides enhanced features such as fast I/O speeds, structured programming, and built-in commands for HP-IB programming.

**Human Interface Toolkit**

To facilitate the development of friendlier PC Instruments application software, the Human Interface Toolkit for GW-BASIC/BASICA/., QuickBASIC, and Lattice C lets you quickly create interactive displays on your computer screen. This interaction is performed via soft fields - user-definable regions on the computer screen. Each soft field corresponds to a menu choice and can be selected using input devices such as the touchscreen, (HP Vectra only), function and cursor control keys, or a Microsoft Mouse compatible mouse. This lets an operator input data by "pointing" to a soft field rather than typing the data into the computer.

**PC Instruments Accessories**

**HP 61001A System Power Unit:** the optional System Power Unit provides convenient, space-effective storage for the individual power

packs of up to eight PC Instruments. Included in the unit are line conditioning, main fuse, power switch, and two auxiliary unswitched outlets. Used on the bench, the System Power Unit provides an ideal base for PC Instruments. It is also rack mountable.

**HP 14801A PC Instruments Rack Shelf:** the rack-mounting kit allows up to four PC Instruments and four power packs to be mounted in standard 19-inch racks. Three blank panels are also included for use when racking fewer than four instruments.

**HP 14802A Terminal Block:** for use with Digital I/O. Allows easy screw terminations.

**HP 5080-2064 Binder and Slipcase:** recommended for systems with more than three instrument modules. Provides neat storage for additional instrument manuals and application software documentation.

**HP 10040A Oscilloscope Probe:** Miniature Probe with a 10:1 division ratio and 9 pF shunt capacitance.

**HP 10021A Oscilloscope Probe:** Miniature Probe with a 1:1 division ratio and 36 pF shunt capacitance.

**Data Acquisition Software**

**HP 14856A, HP Vectra PC, IBM PC/XT/AT and AT&T PC 6300 Version**

**HP 14855A, HP Touchscreen Version**

HP's Data Acquisition Software is a menu-driven program that performs voltage scanning, thermocouple scanning, and analog recording. It also includes a graphics utility for presenting information in a simple listing, linear graph, or logarithmic plot form; and it can be easily modified to suit specific applications. The following describes the four applications that the package provides:

**The Voltage Scanner** supports up to two Relay Multiplexers and one DMM. It scans up to 16 channels.

**List Mode Scan Rate:** 8 seconds (for 16 channels). Tabular display of data collected.

**Trend Mode Scan Rate:** Post Run: 6 seconds (for 16 channels). Collects all data and then plots it. Real Time: 2 seconds (for 3 channels). Collects and plots data at the same time.

**Maximum Channel-to-Channel Delay:** P0.5 seconds. Trend Mode maximum channel-to-channel delay; post run: 0.375 seconds. Real time: 0.667 seconds.

**Maximum Number of Samples:** (Number of Scans) × (Number of Channels) = 3000. (Total number of samples with no user modification of program.)

**The Thermocouple Scanner** supports up to two Relay Multiplexers and one DMM. It scans up to 14 thermocouple inputs and provides compensation and linearization for T, J, E, R, K, & S type thermocouples.

**List Mode Scan Rate:** 25 seconds (for 14 channels).

**Trend Mode Scan Rate:** Post Run: 25 seconds (for 14 channels). Real Time: 5 seconds (for 3 channels).

**List Mode Maximum Channel-to-Channel Delay:** 1.8 seconds.

**Trend Mode Maximum Channel-to-Channel Delay:** Post Run: 1.8 seconds. Real Time: 1.8 seconds.

**Maximum Number of Samples:** (Number of Scans) × (Number of Channels) = 3000. (Total number of samples with no user modification of program.)

**Temperature Errors:** (Includes reference-junction error, thermal-off voltages, and linearization error; does not include DMM or transducer error) = -3.5 C.

**The Analog Recorder** supports up to three DMMs. It measures one, two or three channels vs. time, and one or two channels vs. a third channel. Maximum Channel-to-Channel Delay: (Time between successive measurements one sample interval) = 0.1 second.

**Maximum Number of Samples:** 500 (Total number of samples with no user modification of program.)

**The Graphics Utility** has 2 Y-axes and plots linear, semi-log, and log-log graphs.

**Common to All Applications Timebase:** Range: 1 second to 1800 seconds. Resolution: 1 second. Plotters: Direct support of HP 7470A and HP 7475A plotters.

# PC INSTRUMENTS

## Ordering Information

Following are step-by-step instructions for configuring and ordering your PC Instruments system. Included are descriptions, ordering instructions and prices for individual instruments and accessories.

### Step 1:

Select a computer system for use with HP PC Instruments. Refer to the configuration guide on the following page for a listing of supported computer hardware, software, and peripherals. Note that 640K bytes of RAM memory is required for MS-DOS computers and 1 M byte is typical for the HP 9000 Series 200/300 computers. Though not required, we recommend a single floppy with hard disc configuration for all computer systems.

### Step 2:

Select the correct PC Instruments interface for your computer. One interface can control up to sixteen instrument modules (eight parallel and eight serial).

**HP 61061C PC Instruments Interface and System Software for the HP Vectra PC, IBM PC/XT/AT, and AT&T PC 6300.**

Price

\$815

The number of PC Instruments interfaces that can be used in the HP Vectra PC, IBM PC/XT/AT, or AT&T PC 6300 is limited by the number of available computer slots. Each interface occupies one long slot in the computer's backplane. The system software is supported by the following programming languages: Microsoft QuickBASIC, GW-BASIC, BASICA and Lattice C.

**HP 98647A PC Instruments Interface and System Software for the HP 9000 Series 200/300 computers**

\$865

#### Option 001

-\$435

Delete system software and Documentation  
The number of interfaces used with the HP 9000 Series 200/300 computers are limited by the number of backplane card slots available. HP BASIC 4.0 is required for use of the system software.

**HP 98357A PC Instruments System Software Only for the HP 9000 Series 200/300 computers**

\$435

This product contains the system software and documentation.

**HP 98357R Right-to-Reproduce Software for the HP 9000 Series 200/300 computers**

\$220

This product contains the system documentation and a right-to-reproduce certificate for the HP 98357A system software.

#### Option 100

-\$52

Delete Documentation

You **must** select one media option below for either HP 98647A or HP 98357A.

Option 042 5/4" media format

Option 044 3/4" single-sided media format

Option 045 3/4" double-sided media format

Note: Select HP 98647A with Option 001 and HP 98357A and HP 98357R for multiple system orders.

### Step 3:

Select the instrument modules:

	PCIB Bus Type	Price
HP 61010A Digital I/O.....	Parallel.....	\$715
HP 61011A Relay Multiplexer.....	Serial.....	715
HP 61012A Dual Voltage DAC.....	Serial.....	815
HP 61013A Digital Multimeter.....	Serial.....	715
HP 61014A Function Generator.....	Serial.....	1530
HP 61015A Universal Counter.....	Serial.....	920
HP 61016A Digitizing Oscilloscope.....	Parallel.....	1530
HP 61017A Relay Actuator.....	Serial.....	715
HP 61018A Breadboard.....	—.....	305
HP 61019A 20-volt Power Supply.....	Serial.....	920
HP 61020A Dual VHF Multiplexer.....	Serial.....	1020
HP 61025A 50-volt Power Supply.....	Serial.....	920
HP 3478A Digital Multimeter.....	HP-IB.....	1095

Note: You must have the following equipment and software to use the

HP 3478A Multimeter with the PC Instruments System:

- HP 82990A or HP 61062B HP-IB Command Library

- HP-IB Interface (Interface Card included with HP 82990A/61062B)

- HP-IB Interface Cable

- HP 61061C PC Instruments Interface and System software

### Step 4:

Select from these optional software packages.

**HP 14856A Data Acquisition Software for the HP Vectra PC, IBM PC/XT/AT, and AT&T PC 6300** \$410

**HP 44458A/B DACQ/300 Data Acquisition Manager for the HP 9000 Series 200/300 computers** \$1990

Note: A version is shipped on 3 1/2" flexible discs

B version is shipped on 5 1/4" flexible discs

### Step 5:

Choose from these optional PC Instruments accessories:

**HP 61001A System Power unit** \$460

Optional, space-effective storage for the power packs of eight PC Instruments. Filters line current and provides two convenience outlets and a main power switch. Can be rack mounted using the HP 5061-9674 Metric Rack Mounting Flange Kit; support rails are recommended. Dimensions: 3.5" H x 19" W x 13.5" D

**HP 14801A Rack Shelf** \$127

Allows you to mount up to four PC Instruments and their power packs in a standard 19" instrument rack. Includes three blank front panels for use when fewer than four modules are racked. Dimensions: 5.25 H x 19" W x 21" D

**HP 14802A Terminal Block** \$179

Allows easy screw termination of user connections to HP 61010A Digital I/O.

**HP 5080-2064 Binder and Slipcase** \$15

Empty binder and slipcase sized to fit PC Instruments manual pages. Recommended for system consisting of more than three different PC Instruments modules.

**HP 10040A 10:0 Oscilloscope Probe** \$140

**HP 10021A 1:1 Oscilloscope Probe** \$90

These miniature probes are recommended for use with the HP 61016A digitizing oscilloscope.

### Step 6:

Order the following optional HP-IB interface:

**HP 82990A HP-IB Interface and Command Library for the HP Vectra PC, IBM PC/XT/AT, and AT&T PC 6300** \$410

Note: The HP-IB interface is built-in for the HP 9000 Series 200/300 computers.

### PC Instruments Computer Configuration and Supported Hardware

<b>COMPATIBLE COMPUTERS:</b>	<ul style="list-style-type: none"> <li>HP Vectra PC</li> </ul>	<ul style="list-style-type: none"> <li>IBM PC</li> <li>IBM PC/XT</li> <li>IBM PC/AT</li> </ul>	<ul style="list-style-type: none"> <li>AT&amp;T PC 6300</li> </ul>	<ul style="list-style-type: none"> <li>All HP 9000 Series 200 (2)</li> <li>HP 9000, Series 300 models 310 and 320</li> </ul>
<b>REQUIRED AMOUNT OF MEMORY:</b>	<ul style="list-style-type: none"> <li>640 K RAM</li> </ul>	<ul style="list-style-type: none"> <li>640 K RAM</li> </ul>	<ul style="list-style-type: none"> <li>640 K RAM</li> </ul>	<ul style="list-style-type: none"> <li>1 M Byte RAM typical (3)</li> </ul>
<b>SUPPORTED RAM:</b>	<ul style="list-style-type: none"> <li>HP 45971A 128 K byte Memory Expansion Kit (up to 3 kits)</li> <li>640 K byte RAM included with HP Models 45, 50 and 60 Vectra PC</li> </ul>	<ul style="list-style-type: none"> <li>IBM Memory Expansion Card</li> <li>Quadram Quadboard (384K)</li> </ul>	<ul style="list-style-type: none"> <li>AT&amp;T Memory Expansion Board</li> </ul>	<ul style="list-style-type: none"> <li>HP 98256A 256 K byte RAM card</li> <li>HP 98257A 1 M byte RAM card</li> </ul>
<b>SUPPORTED DISC DRIVES: (4)</b>	<ul style="list-style-type: none"> <li>Internal flexible disc drives (1)                             <ul style="list-style-type: none"> <li>HP 45811A 360 KB</li> <li>HP 45812A 1.2 MB high capacity</li> </ul> </li> <li>HP 45816A 20 MB internal hard disc subsystem with either a 360 KB or 1.2 MB flexible disc drive</li> <li>HP 45817A 40 MB internal hard disc subsystem with either a 360 KB or 1.2 MB flexible disc drive</li> </ul>	<ul style="list-style-type: none"> <li>Flexible disc drives (1)</li> <li>Winchester with either a 360KB or 1.2 MB flexible disc drive</li> </ul>	<ul style="list-style-type: none"> <li>Standard AT&amp;T flexible disc drive double sided</li> <li>Winchester with flexible disc drive</li> </ul>	<ul style="list-style-type: none"> <li>All disc drives supported by BASIC Language System</li> </ul>
<b>SUPPORTED GRAPHICS SYSTEMS:</b>	<ul style="list-style-type: none"> <li>HP 35731A 12" monochrome monitor HP 45981A Multimode Video Adapter</li> <li>HP 35741A 12" color monitor HP 45981A Multimode Video Adapter HP 45984A Multimode Color Adapter</li> <li>HP 35743A EGA 12" Color Monitor HP 45983A Enhanced Graphics Adapter</li> </ul>	<ul style="list-style-type: none"> <li>IBM Color Monitor IBM Color Graphics Adapter</li> <li>IBM Enhanced Graphics Display IBM Enhanced Graphics Adapter Card</li> </ul>	<ul style="list-style-type: none"> <li>Standard AT&amp;T 6300 Standard AT&amp;T 6300 Video Adapter</li> </ul>	<ul style="list-style-type: none"> <li>HP 35721A/B/C 14" monochrome monitor HP 98542A medium-resolution monochrome video board</li> <li>HP 35731A/B 12" monochrome monitor HP 98542A medium-resolution monochrome video board</li> <li>HP 35741A/B 12" color monitor HP 98543A medium-resolution, color video board</li> <li>HP 98781A 17" high-resolution monochrome monitor HP 98544A high-resolution, monochrome video board</li> <li>HP 98782A 19" high-resolution color monitor HP 98547A high-resolution, color video board</li> <li>HP 35731A 12" monochrome monitor HP 98546A medium-resolution, monochrome alpha/graphics video board</li> <li>HP 82913A 12" monochrome monitor HP 98204B Composite Video Card</li> <li>HP 82912A 9" monochrome monitor HP 98204B Composite Video Card</li> </ul> <p>(Models 226, 236A, 236C and 216 use built-in graphics adapters and come with standard monochrome monitors.)</p>
<b>OPERATING SYSTEM:</b>	<ul style="list-style-type: none"> <li>HP 45952A Vectra DOS 3.0 or later version</li> </ul>	<ul style="list-style-type: none"> <li>PC-DOS 3.0 or later version</li> </ul>	<ul style="list-style-type: none"> <li>AT&amp;T DOS 2.11 or later version</li> </ul>	<ul style="list-style-type: none"> <li>HP 98613B RAM-based BASIC 4.0 Language System</li> <li>HP 98603A ROM-based BASIC 4.0 Language System</li> </ul>
<b>SUPPORTED LANGUAGES:</b>	<ul style="list-style-type: none"> <li>HP 45952A Vectra BASIC 3.11 or later version</li> <li>Microsoft QuickBasic 1.00-2.00</li> <li>Lattice C 2.00-3.00 Large (L) model, small (s) model</li> </ul>	<ul style="list-style-type: none"> <li>BASICA 2.0 or later version</li> </ul>	<ul style="list-style-type: none"> <li>GW-BASIC 2.0 or later version</li> </ul>	<ul style="list-style-type: none"> <li>BASIC Language is included in operating system.</li> </ul>

### Supported Computer Peripherals

<b>PRINTERS:</b>	<ul style="list-style-type: none"> <li>HP 2225C ThinkJet Printer (Centronics Interface)</li> <li>IBM Graphics Printer</li> </ul>	<ul style="list-style-type: none"> <li>IBM Graphics Printer</li> <li>HP 2225C ThinkJet Printer (Centronics Interface)</li> </ul>	<ul style="list-style-type: none"> <li>HP 2225C ThinkJet Printer (Centronics Interface)</li> <li>IBM Graphics Printer</li> </ul>	<ul style="list-style-type: none"> <li>All printers supported by BASIC</li> </ul>
<b>PLOTTERS:</b>	<ul style="list-style-type: none"> <li>HP 7440A Color-Pro plotter (5)</li> <li>HP 7475A Six-pen plotter (5)</li> </ul>	<ul style="list-style-type: none"> <li>HP 7440A Color-Pro (5)</li> <li>HP 7475A Six-pen plotter (5)</li> </ul>	<ul style="list-style-type: none"> <li>HP 7440A Color-Pro (5)</li> <li>HP 7475A Six-pen plotter (5)</li> </ul>	<ul style="list-style-type: none"> <li>Not applicable</li> </ul>
<b>POINTING DEVICES:</b>	<ul style="list-style-type: none"> <li>HP 46060A HP-HIL Mouse</li> <li>HP 35723A HP Touch Accessory</li> <li>Microsoft Mouse</li> <li>Mouse Systems Mouse</li> </ul>	<ul style="list-style-type: none"> <li>Microsoft Mouse</li> <li>Mouse Systems Mouse</li> </ul>	<ul style="list-style-type: none"> <li>Microsoft Mouse</li> <li>Mouse Systems Mouse</li> </ul>	<ul style="list-style-type: none"> <li>HP 46060A HP-HIL Mouse</li> <li>HP 35723A HP Touch Accessory</li> <li>HP 46083A HP-HIL control-knob (Built-in knob is also supported).</li> </ul>

1. Flexible disc drive systems can be any combination of two 360 KB/1.2 MB drives or a single 1.2 MB drive.  
 2. Soft front panels are not supported on HP Models 216, 226 and 237  
 3. Memory requirements are based on: a) BASIC and loaded binaries; b) Number and types of PC Instruments in system and; c) Size of user's program.

4. A single-floppy drive with a hard disc configuration is recommended for use with PC Instruments.  
 5. Plotters supported with HP 14856A Data Acquisition Software only.





## **DESIGN AUTOMATION & TECHNICAL COMPUTERS**

<b>Design Automation.....</b>	<b>608</b>
<b>Technical Computer Systems.....</b>	<b>626</b>

HP offers a large family of design automation solutions integrated under a common design environment — HP DesignCenter — that allows electronic, mechanical and software projects to be linked together throughout the design process. HP also offers a broad range of technical computers and workstations for design, measurement automation, manufacturing, and real-time monitoring and control, including several new models using HP's Precision Architecture.

**Design Automation  
& Technical  
Computers**

# DESIGN AUTOMATION

## HP DesignCenter

### General Information

#### Design Automation

Design automation is the process of using computer-automated productivity tools to improve the quality of new products and the speed with which they can be moved through the design cycle and into manufacturing. When implemented effectively, design automation has a powerful, positive effect not only on quality and time to market, but on production costs, product reliability and other factors that ultimately affect the competitive position and profitability of your company.

Design automation has become something much greater than an opportunity for aggressive firms looking for a competitive edge. It is now crucial for survival in a growing number of markets.

Hewlett-Packard's approach to design automation has been to develop an integrated design environment that enables engineering teams in electronic, mechanical and software projects to link their efforts through the entire design process, from concept through manufacturing.

#### HP DesignCenter

HP DesignCenter is an integrated design environment for electronic, mechanical and software engineers, where tasks can be planned, executed and managed more effectively. HP DesignCenter includes tools for data management, documentation and communication, not just design automation software. It runs on a family of powerful workstations that link, through industry-standard networks, to computers from HP and other vendors.

DesignCenter will help the individual design engineer by providing an integrated set of tools to speed the design process from idea to final production, while also improving overall quality. DesignCenter comes with the support, documentation and training to ensure productive use of design tools.

#### HP Design Automation Products

HP Technical Computer Foundation 611

#### HP DesignCenter Electronic Engineering CAE/CAD Products

HP Electronic Design System 613  
 HP 64000-UX Microprocessor Development Environment 616  
 HP Printed Circuit Design System 620  
 HP Engineering Graphics System 622  
 HP Teamwork SW Analysis and Design Environment 616

#### HP DesignCenter Mechanical Engineering CAD/CAM Products

HP ME Series 5, 10 & 30 624

#### Value-added Solutions

HP Technical Software Catalog 612

#### HP 9000 Family

The HP 9000 family of technical computers is the foundation for HP DesignCenter. HP 9000 products include the Series 200, 300, 500 and 800 Technical Computers. This includes the Series 800 Precision Architecture computers (see page 628). The use of these computers in the design automation environment is discussed on page 611. Another section of this catalog is devoted to detailed discussions of HP technical computer products, beginning on page 626. HP's 9000 family features the HP-UX operating system which adheres to AT&T's UNIX\* System V interface definition, Issue 1. Individual workstations as well as total systems can be configured in a powerful IEEE 802.3 local-area network (LAN). See page 642 for networking information.

#### Electronic CAE/CAD Products

HP Electronic Design System captures both digital and analog schematics for automated electronic hardware design. The system includes more than 3500 logic and analog component library parts, a powerful schematic editor, HILO-3 logic simulation, analog simulation through the Analog Workbench, links to physical layout systems and a user interface that simplifies interaction with the design and verification tools. The HP Electronic Design System is available as a high-end system for use on the HP 9000 Series 300 technical workstation. See page 613.

\*UNIX is a registered trademark of AT&T in the U.S.A. and other countries.

#### HP DesignCenter EE CAE/CAD Solutions

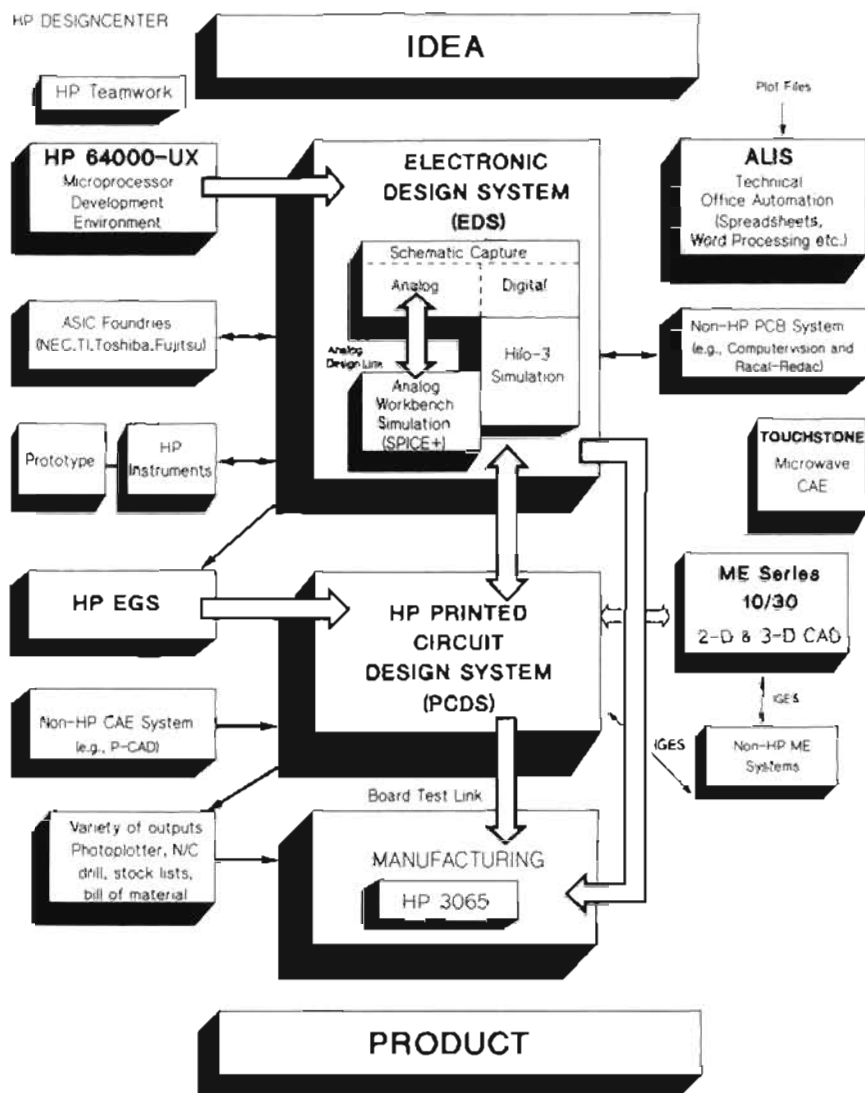



**HP 84000-UX Microprocessor Development Environment** is a natural evolution of HP's 64000 Logic Development System. This family of microprocessor development tools is fully compatible with the existing 64000 family, but adds a number of new capabilities. HP 64000-UX is fully integrated into the DesignCenter family, and uses the same computer platform, and provides links to other DesignCenter solutions. The system provides versatile networking to popular software on systems such as DEC VAX and the IBM PC. In-circuit emulators, language systems and analysis tools now are available for 8-, 16- and 32-bit microprocessors. A broad selection of price/performance options helps to select the best system for your needs. See page 616.

**HP Teamwork Software Specification and Design Environment** helps software engineers develop and manage software specifications and designs. HP Teamwork/SA,SD, RT, and ACCESS provide tools for structured analysis with realtime extensions, structured design, and integration of the resulting database with other software development tools. These teamwork products help to reduce the costs of software development by allowing rapid capture and maintenance efforts for software applications including embedded microprocessor systems, measurement automation, instrument control, and general scientific. See page 619.

**HP Printed Circuit Design System** couples printed-circuit-board layout to electrical engineering design, manufacturing and test. The system allows PCB designers to create highly manufacturable boards that perform as the design engineer intended. HP Printed Circuit Design System provides packing, placing and routing features to automatically lay out digital, analog and mixed digital/analog boards with through-hole and surface-mount technologies, with facilities

for thick-film hybrid design. The system has links to HP's ME Series products and to schematic capture systems from HP, P-CAD, FutureNet and others. The system also generates a complete range of manufacturing and test reports. HP Printed Circuit Design System software is derived from Northern Telecom Incorporated (NTI), and its subsidiary, Bell Northern Research (BNR). See page 620.

**HP Engineering Graphics System (EGS)** provides powerful tools for thick-film hybrid circuit design, interactive printed circuit board layout and schematic drawing, as well as mechanical drafting for the enclosures to house PCB designs. The product also includes a general drawing module for artwork such as overhead slides, project planning diagrams and floor plans. HP EGS can be easily

customized to perform specialized CAD tasks. All HP EGS modules run on HP 9000 Series 200 and 300 workstations and on the HP Vectra personal computer. See page 622.

**HP EE Test solutions** are the most highly rated in the business. HP is a leading supplier of logic analyzers, digitizing oscilloscopes, radio and microwave frequency sources and analyzers, low-frequency dynamic signal analyzers, board test systems and other products. Through extensive use of HP-IB (HP's implementation of IEEE 488), these products can be used in automated test systems, as well as in standalone applications, to verify design prototypes or production processes. See the alphabetical index of this catalog for the specific instruments of interest to you.

**Mechanical CAD/CAM Products**  
**HP Series 5, 10 & 30 Mechanical Engineering Systems** are a family of CAD products for mechanical drafting, 2D design and solids modeling, respectively. All three use the same user interface, developed to dramatically reduce system learning time to quickly improve designer productivity. ME Series 5, 10 & 30 provide a range of functions for design through modeling and drafting of complex mechanical parts and assemblies. The result is reduced prototyping requirements and faster creation and modification of drawings. See page 624.

**HP Mechanical Engineering Test Products** have grown out of the company's long-standing involvement with state-of-the-art instrumentation for vibration and structural analysis and test. In addition to the CAD/CAM products listed below, HP offers a large family of mechanical testing solutions. See page 145.

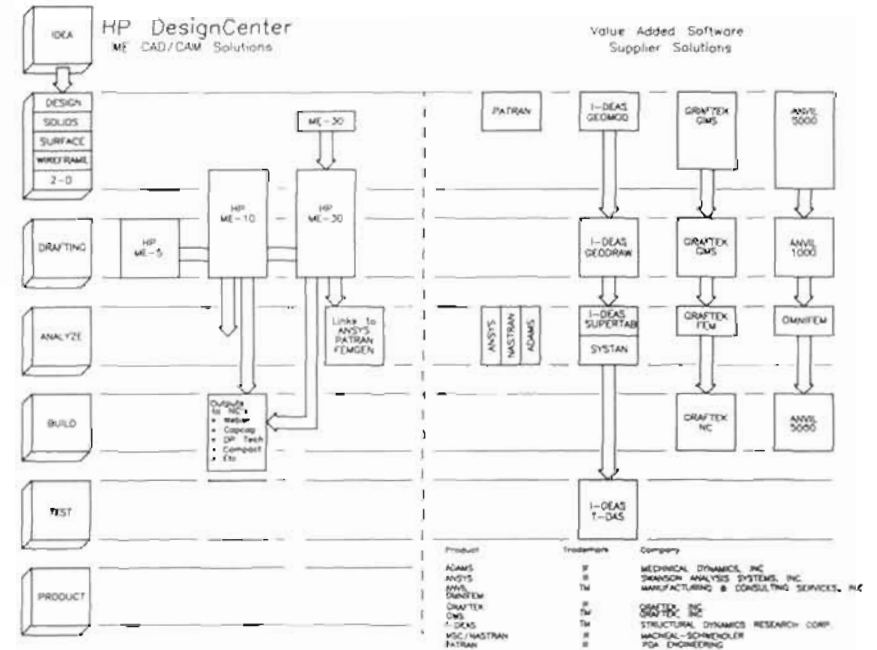

# DESIGN AUTOMATION

## HP DesignCenter (cont'd)

### General Information



#### Lots of Links

Ideally, a new product design should work right the first time, but many companies average six iterations. Integration is the key to reducing the number of times designs must be reworked. HP DesignCenter EE Series products can be tightly linked. See diagram on page 608.

HP Electronic Design System provides strong links to HP Technical Office Automation, HP EGS, HP 64000-UX Microprocessor Development Environment, HP Printed Circuit Design System and the HP 3065 Board Test System, with additional links to Racal Redac, Calay, Computervision, GenRad HiChip physical modeling and ASJC foundry links to NEC, Motorola, TI and others. HP Printed Circuit Design System not only receives net lists and parts information from HP Electronic Design System, but sends back engineering changes and back-annotation data.

#### Value-added Solutions

To increase the breadth of solutions available to HP customers, Hewlett-Packard actively seeks out and relies upon the expertise of Value-Added Software Suppliers to augment HP's proprietary solutions. More than 300 independent software vendors are working with HP to provide a large selection of software products for technical applications. See page 612

#### Sensitivity of Profits Over Product Life

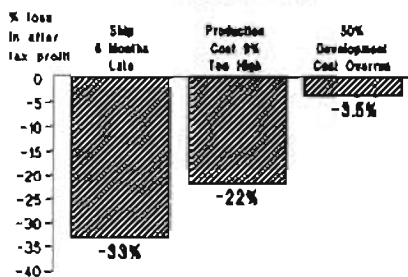

#### Why CAE/CAD/CAM?

During the past few years, several factors have influenced the typical product design process in ways that make the design engineer's task more demanding. Increasing global competition has compressed product development time as well as product life cycles, making the time saved in development even more critical than in the past.

The shorter the development time, the sooner the product goes to market and the longer the sales life of the product. A recent electronics industry study compared the impacts on product profitability of development costs, product costs and late product introduction.\*

Using a representative high-growth market with 5-year product life, 12% annual price erosion, and 20% growth per year, an overrun of 50% in product development costs will decrease after-tax profits by 3.5%. In contrast, a production-cost overrun of only 9% results in a 22% decrease in after-tax profits. Even more significant, a six-month delay in introduction costs 33% of the after-tax profits.

(\* Figure from Donald Reinstein, McKinsey & Co, Los Angeles, CA, Electronic Business, July 1983, P. 86. Copyright 1983, Cahners Publishing Company)

#### CAE/CAD/CAM

##### A Strategic Decision

Purchase of any computer system is an important decision that requires looking beyond today's needs and currently available product features to expected future requirements and growth paths. This is especially true in CAE/CAD/CAM since the user's entire design-to-manufacturing cycle can be linked to the selection of a CAE vendor. With technology and design requirements changing at an ever-increasing pace, the strategic directions of alternative CAE vendors are an important factor in the selection process.

HP's product strategy is founded on a major corporate commitment to the CAE/CAD/CAM business. The company's engineering expertise, reputation for quality and experience in test, measurement and technical computing, as well as its respected worldwide support organization, all contribute to HP's position as a leading supplier of CAE/CAD/CAM solutions

#### Summary

Hewlett-Packard has for many years been a leading supplier of computers and engineering workstations for measurement automation, data acquisition, automatic test, factory automation and many other technical applications.

Today, by combining its expertise in technical computers with its experience in state-of-the-art electronic design, HP supplies high-quality design systems to help improve the productivity of electronic, mechanical and software engineers.

Computer-aided engineering and design capabilities applied throughout the design cycle improve efficiency and quality at each step in the process and enhance communication and coordination between steps. With the increased capabilities and lower costs of technical workstations, peripherals, test equipment and application software, it is becoming feasible for every area of the factory to use these tools in collaboration so each can truly influence products in appropriate stages of design and development.

With the HP DesignCenter, an engineer will have access to a comprehensive offering of CAE/CAD/CAM solutions for electronic, mechanical and software development. Along with this comes the support, training and service that has distinguished Hewlett-Packard over the years, and that is so important to the successful use of these complex systems.

When the best solutions may be available through applications software from third parties and independent software vendors, HP cultivates relationships with other leaders in the market. This combination of the HP DesignCenter offerings complemented by renowned third-party products, provides the customer with the widest possible range of design automation solutions.

HP is committed to a technical and business relationship with CAE/CAD/CAM customers, which begins when the HP field engineer helps to define and analyze the customers' specific needs. This continues through system installation and implementation and extends through the life of the system and beyond as needs expand and new products become available.

#### Contact HP

HP's CAE/CAD/CAM offerings are continually expanding as new products are introduced at a rapid pace. The products on the following pages represent the current state of the HP DesignCenter family, but are by no means the whole story.

Contact your nearest Hewlett-Packard sales office for the more detailed information on HP's growing family of products for design automation solutions in CAE/CAD/CAM.



#### The Foundation

Success in implementing CAE/CAD/CAM depends not only on software solutions to design problems, but on using a family of computers and workstations that meets the demands of those solutions, both today and tomorrow. Engineers in these fields must have a broad selection of computer systems to meet the needs of a number of applications, both for their own development work, and as delivery vehicles for developed products.

These computer systems must provide flexibility in configuration choices for performance levels, programming languages and operating systems. HP provides all this in its HP 9000 family of computers, and offers a range of supporting products for networking, graphics, artificial intelligence, interfacing and technical office automation.

#### Technical Computing Environment

Hewlett-Packard's technical computing environment, shown in the diagram on this page, is comprised of computing systems, networking, high-resolution graphics, advanced data management systems, languages and a wide range of peripherals. HP is committed to the UNIX\* operating system as a standard, and to industry networking standards such as IEEE 802.3 and ARPA/Berkeley. Conformance to these and other standards allows systems to be configured into a powerful local area network (LAN), and provides an open system environment to support multi-vendor solutions.

#### Low Cost of Ownership

Hewlett-Packard's low cost of ownership reflects the quality of its computers, developed over years of computer design, manufacturing and support, that have placed more than 200,000 HP 9000 computers in businesses around the world.

#### HP-UX

HP-UX is the primary operating system offered on the HP 9000 family. HP-UX adheres to AT&T's System V Interface Definition, Issue 2, and offers compatibility with a large number of other UNIX operating systems.

Along with HP-UX, HP 9000 computers run Hewlett-Packard's BASIC and Pascal language systems. HP BASIC offers the ease-of-use of an interpreted language, yet features exceptional operating speed, while HP Pascal can help design engineers to fine-tune programs close to machine level.

#### Networking

HP is dedicated to maintaining compatibility across the HP 9000 family. A glance at the chart on the facing page shows that nearly all members of the HP 9000 family are available with an industry-standard operating system. See page 640 for details on languages and operating systems.

ARPA/Berkeley Networking Services add another level of capability to the HP 9000 family, making this defacto networking standard available on the Series 300 and 800 for communication between computers, and with non-HP computers, including products from DEC and Sun. HP 9000 LAN also adds depth to the ability of HP systems to communicate quickly and effectively with other computers. See page 642 for details.

UNIX is a registered trademark of AT&T in the U.S. and other countries.

#### Software Developers

The flexibility and scalability built into the HP 9000 family will make the software developer's job easier. Whether developing solutions for in-house use or for delivery to customers, software developers will find it much easier and faster to design software products on a system that is well equipped, and which is fully compatible with a broad range of other computer systems.

#### HP 9000 Family

Hewlett-Packard's HP 9000 family of technical computers and workstations has evolved to meet a variety of needs. The computer family now covers a broad range that includes:

- The latest in superminicomputers, superworkstations and minicomputers; the HP 9000 Models 850S, 840S, 825S and 825SRX, all based on HP's Precision Architecture RISC technology.
- Supermicro/minicomputers, including the HP 1000 family for manufacturing automation.
- Instrument controllers, including the HP 9000 Series 200, Series 300 Models 310 and 330, and the HP Vectra.
- Engineering workstations, including the HP 9000 Series 300 Models 310, 320, 330 and 350.
- Personal computers, including HP Vectra, Industrial Vectra, The Integral PC and HP 9000 Series 300 Model PC-308.

For more detailed information on the HP 9000 family of technical computers, please see the Technical Computer Systems pages of this catalog:

HP 9000 Technical Computer Systems	Page
HP 9000 General Information and Selection Guide	626
HP 9000 Series 800 General Information	628
HP 9000 Model 850S Superminicomputer	630
HP 9000 Model 840S Minicomputer	629
HP 9000 Model 825S Minicomputer	631
HP 9000 Model 825SRX Superworkstation	632
HP 9000 Series 300 Workstations	633
HP 9000 Series 200 Technical Computers	637
HP Technical Vectra	638
HP Integral PC	639
Languages and Operating Systems	640
Networking	642
X Window System	647
Artificial Intelligence	648
Graphics	649
Peripherals	651
Interfacing Summary	652
DOS Coprocessor	653
HP 1000 Minicomputers	654
HP Industrial Vectra	657

#### Controllers

The same flexibility that makes HP 9000 computers excel in design automation applications has provided superior performance in measurement automation applications for many years. Computer-aided test, test and engineering evaluation and analysis, manufacturing and industrial monitoring and laboratory monitoring and analysis are just a few of the applications. See page 534 for more information.

HP DesignCenter  
Technical Computing Environment

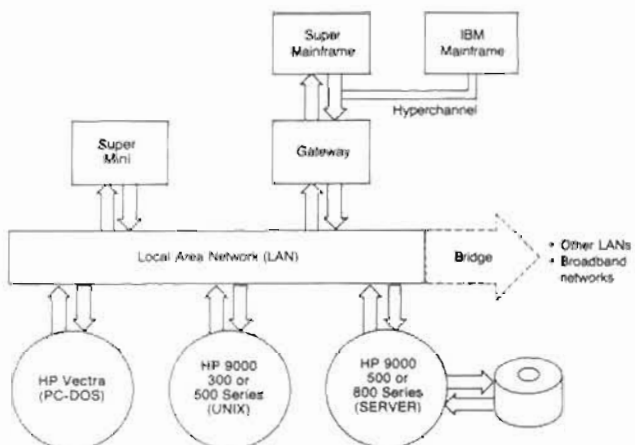

# DESIGN AUTOMATION

## HP Technical Software Catalogs



### HP Technical Software Catalog

The HP Technical Software Catalog is published twice a year (May and November) and contains more than 1000 software products from both HP and Value Added Software Suppliers. The catalog is divided into two sections: a Basic/Pascal/RTE section and an HP-UX section.

The products included in this catalog come from two sources:

1. Software submitted by independent software suppliers to the HP PLUS Program which offers more than 700 technical software packages — from aerospace simulators to water utility operations.

2. HP Proprietary software, which offers a broad selection of HP-proven technical applications, utilities and integrated solutions.

Applications areas range from AC circuit analysis to statistical quality control and from engineering graphics systems to data communications software. Software from fourteen different HP manufacturing divisions is included in this catalog. Specific information on HP-created software can be found elsewhere in this and other sections of the HP Catalog.

These software products run on the HP 9000, HP 1000, Series 80, Integral, Portable, and HP Vectra hardware families. The distribution of products to operating systems is roughly 43% Basic/Pascal, 31% HP-UX, 18% RTE and 7% other (MS-DOS, CP/M, etc.). There are applications from 20 different market/application areas:

- Aerospace/Aeronautical Engineering
- Architectural/Structural Engineering & Construction
- Artificial Intelligence
- Business Administration
- Civil Engineering
- Computer Aided Testing/Lab Automation
- Data Base Management
- Data Communications
- Earth Resources Engineering
- Electrical Engineering
- Graphics
- Languages/Compilers
- Manufacturing/Process Control
- Math/Statistics
- Mechanical Engineering

- Medical/Health
- Miscellaneous
- Software Engineering
- Professional Support
- Utilities/Conversion Aids

### HP PLUS Program

To service its more than 350 independent technical software suppliers, HP relies on a third party vendor program called HP PLUS. This program is administered by the HP Field Sales organization.

HP PLUS offers software in three different categories: Listed, Referenced and Distributed. The Listed category is for the supplier with the lowest level of HP involvement in marketing his products. The Referenced category is for user-proven software products. The Distributed category is for software which HP has elected to market, merchandise and sell.

Contact your local HP Sales Office for complete details on the HP PLUS Program.



### HP Vectra PC Technical Software Guide

This 320 page catalog lists nearly 1000 software products that are reported to be operationally compatible with the HP Vectra. Solutions ranging from off-the-shelf IBM PC/AT applications to popular business programs are included along with configuration recommendations. Each listing gives the name/address/phone number of the supplier and a short description of the product.

The HP Vectra PC Technical Software Guide is published twice a year (Spring and Fall) and is available from either your local HP Sales Office or contact your local HP Vectra PC Dealer.

### Ordering Information

The Hewlett-Packard Technical Software Catalog is offered free of charge to HP customers and independent software vendors. For your copy, please contact your local HP Sales Office and ask for HP Publication Number 5954-8289. For a free copy of the HP Vectra PC Technical Software Guide, ask for HP Publication Number 5954-9389.



### HP Electronic Design System

Hewlett-Packard's computer-aided engineering system for electronic design provides an integrated solution for automating electronic hardware design. This system includes over 3500 component library parts, a powerful schematic editor, HILO-3<sup>®</sup> simulation, links to popular physical layout systems, and a user interface that simplifies interaction with all the design and verification tools.

Available on the HP 9000 series 300 workstations, Hewlett-Packard's CAE solution is divided into five areas: Design Capture System, Design Verification System with HILO-3<sup>®</sup>, Analog Workbench<sup>®</sup> by Analog Design Tools, Inc. Design Interfaces to physical layout systems, and Parts Libraries.

Low-cost entry-level HP 9000 Series 300 workstations offer an economical method of starting logic design. As design needs grow, engineers can move to more powerful series 300 workstations without having to learn a new user interface or lose productivity.

### Team Design with Networking

The HP AdvanceNet network supporting IEEE 802.3 protocol provides the means for team communication among electronic designers and other members of the design environment. Furthermore, electronic design stations can physically coexist with other equipment on the network.

Networking allows large designs to be partitioned among a variety of stations. These individual design portions from other designers are transferred over the network to a central workstation and assembled into the complete hierarchical design. HILO-3 simulation is then performed on the complete logic design either locally or remotely on a shared simulation node. For analog designs, the user transfers the circuit to the Analog Workbench<sup>®</sup> for simulation and analysis.

Project management is simplified with a networked environment. Files can be archived and managed centrally to prevent duplication and unauthorized access. The progress of each team member can be reviewed easily by remotely accessing files on other workstations, transferring them over the network.

Another convenient and cost-saving advantage of networking is the ability to share peripherals. Printing and plotting requests can be handled over the network by workstations controlling those peripherals.

Illustrated in the diagram on the next page is a network of workstations that a large design team might use. For example, a logic design can be started on an entry-level series 300 workstation. At some point in the design, logical simulation may be needed. HILO-3 simulation can be performed over the network by simulation nodes that are optimally configured for this compute intensive task. For example, a powerful Model 350 workstation and the Precision Architecture, Series 800, serve as simulation nodes.

HP's design environment uses pop-up menus, icons and multiple-window management to accelerate the CAE learning curve.

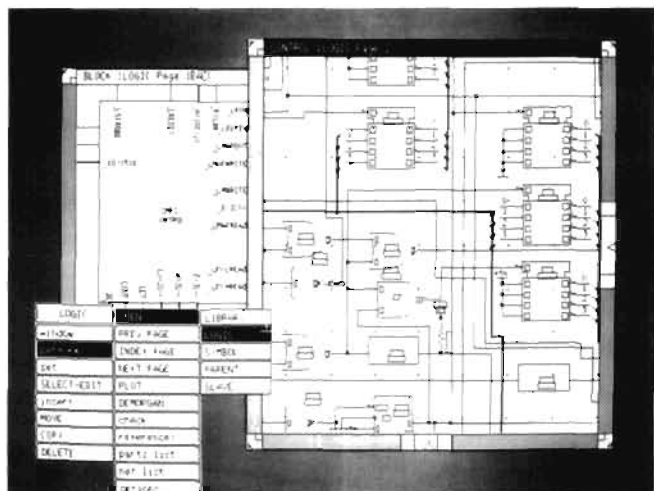

\*Analog Workbench is a trademark of Analog Design Tools, Inc.

# DESIGN AUTOMATION

## EE DesignCenter (cont'd)

### HP Electronic Design System

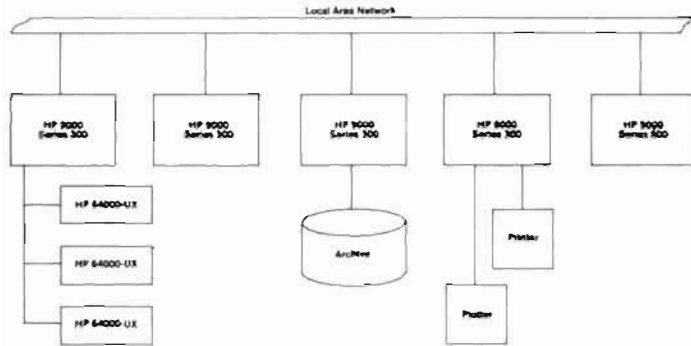

HP Electronic Design System makes possible systems ranging from a single standalone workstation to very powerful networks linking a number of personal computers, workstations and peripherals on a Local Area Network.

Other groups in an organization would also find networking valuable. For example the documentation or physical design group can access the most current revision of a document or design from a station on the network.

The investment in time required to become productive on a CAE system is a major concern. The HP electronic design system environment reduces learning time considerably with easy-to-learn design tools. An advanced user interface aids in design with pop-up menus, icons, and multiple window management. System operations are performed naturally, so the time spent learning and relearning a system is virtually eliminated. The on-line HELP facility is easily invoked by pressing a button on the mouse.

#### Start designing from a large library

The Design Capture System can be used to start designing immediately, rather than first spending time building library parts necessary for the design. HP offers a large selection of libraries of over 3500 off-the shelf TTL, ECL, MOS, microprocessor, and passive and active analog parts. Both library parts and designs may be shared over the network.

#### Discover logic errors early

On-line electrical rule checking occurs interactively while the designer is editing the schematic. In addition to the traditional connectivity checks for pins and nets (wires and buses), automatic load checking is performed on both flat and hierarchical designs. These early checks save time by identifying many circuit errors prior to simulation.

#### Generate quality forms and documentation

The Design Capture System's integrated forms and documents tools automate the documentation process. In addition to the ability to merge text and graphics, these tools provide a documentation system that automatically tracks the design.

Forms are used to establish a standard outline and format for engineering documents. Documents may contain one of these forms, portions of a design, notes explaining the circuit, or text inserted from an external file. Printer and plotter output is available in any ANSI or ISO industry-standard page size. This output can be automatically scaled or rotated at print time to best fit the page size or orientation.

#### Verify logic designs through simulation

The Design Verification System with HILO-3, provides accurate simulation results quickly. Verification tools in this industry-proven system help users develop designs more efficiently. Results are easily viewed through the Design Capture System interface. System designers have access to a large model library of TTL, ECL, and MOS parts as well as many complex microprocessors such as the Intel 8086 or the Motorola 68000.

#### Use flexible constructs for functional modeling

HILO-3's modeling provides flexible, functional modeling constructs, such as event expressions, register transfer functions, Boolean and arithmetic operators, loop constructs, and conditionals. Since the modeling language is an event-driven, nonprocedural language, asynchronous signals such as interrupts can be modeled just as they occur in hardware. Multilevel support in HILO-3 allows simulation of designs, even when some parts are specified at a functional level only.

#### Link hardware and software design tools

Designs containing a microprocessor with associated RAM/ROM models can be checked for hardware/software integration problems through the tight linkage of HP 64000-UX software development tools and the HILO-3 simulator. The HP Software Link provides an effective means to test software and hardware interaction while still in the simulation phase of development.

#### Save modeling effort with hardware modeling

The HICHIP® Hardware Modeling System provides an efficient method for modeling complex LSI/VLSI devices within the HP Electronic Design System. HICHIP simplifies board-level simulation by integrating hardware models, using the actual device, into logic simulation.

In simulations involving microprocessors, other hardware modeling systems only help model the complex device, which requires many cumbersome, error-prone tasks to simulate even simple hardware/software interaction. As an integrated part of the HP Electronic Design System, HICHIP combines with the HP Software Link to simulate the hardware device running software developed in the HP 64000-UX environment.

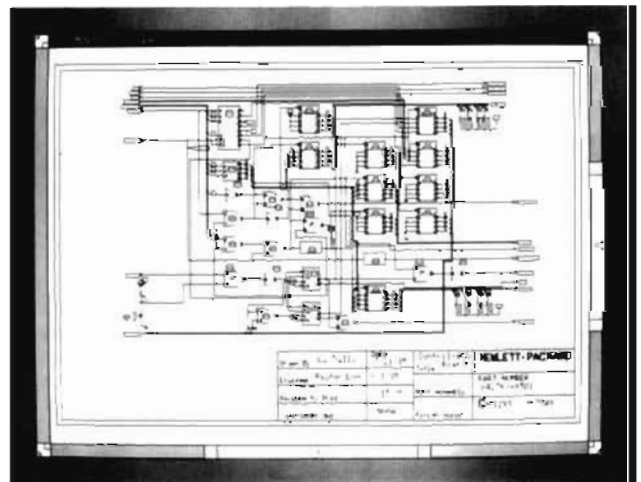

Integrated forms and documentation tools allow documentation to track design.



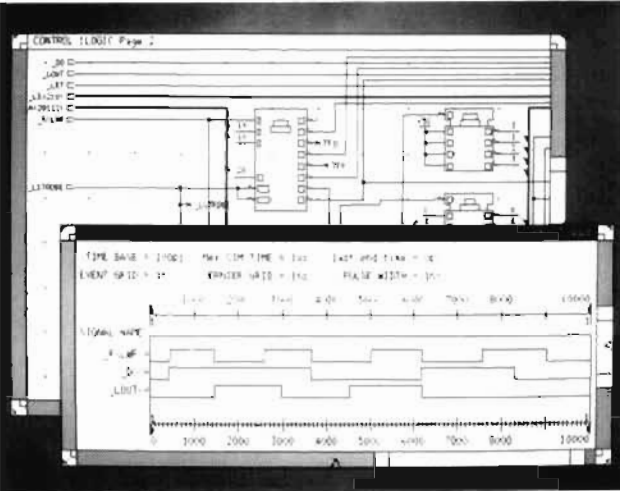

HP logic design verification tools, based on the industry standard Hilo-3 simulator, are tightly coupled to the Design Capture System

**Link simulation with instrumentation and test**

With HP's Links to Test Products, simulation tools can be linked to prototype test instrumentation and manufacturing PCB testers. A powerful bi-directional link between the Design Verification System and the HP 16500A logic analysis system allows designers to turn on systems faster with fewer design changes. A test program generator allows test vectors from the Design Verification System to be automatically transferred to the popular HP 3065 manufacturing PCB tester. This tool eliminates manual data entry and speeds the transition of designs into manufacturing.

**Verify Analog Designs Through Simulation**

Designers can use the Design Capture System to create their schematics. They can then transfer the analog portion of their schematic to Analog Design Tools' Analog Workbench® for simulation and analysis. The Analog Workbench System can reside on the same workstation as the Design Capture System, or be on a networked system. Once transferred to the Analog Workbench System, the design can be modified and the new schematic returned to the design capture system. This ensures that current information is passed on to physical design and documentation. This Design Interface to the Analog Workbench offers the benefits of both powerful analog simulation as well as documentation capability and interface to CAD systems.

**Transfer Design Information Between Systems**

Integrated tools for access and transfer of design information help ensure connectivity and naming consistency with physical design systems.

HP Design Interfaces provide bidirectional turnkey links to transfer information to and from physical design systems. Design information is easily back-annotated from a physical design file with a menu selection. In addition to HP's Printed Circuit Design System and HP EGS, HP Design Interfaces link non-HP CAD systems, such as SCICARDS, Racal Redac, Computervision and Calay printed circuit board systems.

When a netlist is required for linking to other systems, the Design Database Language (DDL) can be used to easily develop a netlist in the format required. Back-annotation of physical design information is also straightforward with the flexibility built into DDL. DDL can also be used for creating custom documentation such as a bill of materials or part lists.

**Additional Applications**

The electronic design workstations can be used for performing a variety of tasks. Application software for project management, word processing, presentation graphics, spreadsheet analysis, and more are available for the entire workstation family.

**Selecting an Electronic Design System**

Model 74200 Electronic Design System is a complex and dynamic family of design tools. It is recommended that an HP Field Engineer be contacted for a suggested configuration that will fit your application. Prices for selected components are listed below.

**Ordering Information**

Model	Description	
74210A	Design Capture System for HP 9000 Series 300	\$8160
74230A	Design Verification Interface for HILO (includes HP Software Link)	\$4080
74230B	HILO-3 Logic Simulator	\$9180
74230C	HILO-3 Simulator Models	\$5100
74230D	HILO-3 Fault Simulator	\$5100
74231A	HICHIP Hardware Modeling System	\$1800
74241A	EDS/3065 Test Program Generator	\$2040
74250A	HP Design Interface for SCICARDS	\$5000
74250B	HP Design Interface for Calay	\$5000
74250F	HP Design Interface for Racal Redac	\$5000
75250G	HP Design Interface for Computervision	\$5000
74260A	TTL Parts Library	\$2040
74260B	MOS Parts Library	\$1020
74260C	ECL Parts Library	\$1020
74260D	Microprocessor Parts Library	\$1530
74260E	PLD Parts Library	\$1020
74661A	R,L,C Parts Library	\$1530
74661B	Semiconductor Parts Library	\$1530

Analog design information can be transferred to the Analog Workbench module for analog simulation and analysis.

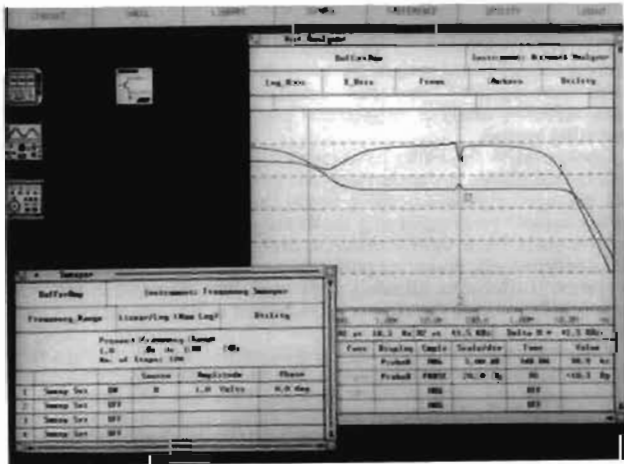

# DESIGN AUTOMATION

## HP DesignCenter

### HP 64000-UX Microprocessor Development Environment



#### HP 64000-UX Microprocessor Development Environment

The HP 64000 Microprocessor Development Environment provides a powerful solution to the development of microprocessor-based systems. The modular structure gives you the ability to select only the subsystems needed for a cost-effective solution to your development application. You also have the flexibility to expand the development environment as your need for additional measurements grows.

This modular system can be easily configured for single- or multi-user design environments. A wide selection of platforms, memory, peripherals, as well as hardware, software, and integration design tools ensures that the optimum configuration is available to solve your design problem. For intensive hardware/software designs, there are links to host computers, schematic capture, simulation, physical modeling and board test.

#### Increase Productivity

The HP 64000-UX is an effective solution to shortening the microprocessor based system design cycle. It combines advanced software development, realtime emulation, sophisticated hardware/software analysis capabilities and the power of the UNIX operating system.

Configuration flexibility combines with ease of operation to form a system that allows you to develop your product rapidly. Software project management tools running under the HP-UX operating system ensure smooth progress during the development cycle. Software engineers benefit from tightly coupled, high level development, debug, and analysis tools. Realtime performance analysis tools quickly point to system bottlenecks, allowing significant improvements in performance in a fraction of the time required when using conventional techniques.

Powerful, interactive, yet easy-to-use emulation and timing analysis speeds hardware development. The HP 64000-UX environment allows many engineers to share the same data base and combines interactive tools for hardware/software design tasks. System integration, often the most time consuming system development phase, is greatly enhanced. All this means product development schedules are

shorter and better products get to market sooner. The HP 64000-UX can grow with your needs and provide complete assurance that your investment is protected.

#### A System to Match Your Needs

HP 64000-UX workstations are capable of performing standalone or in clusters sharing peripherals. Expansion of a single, hard-disc-based station to a multistation system is as simple as connecting another station to the bus.

Large design environments can benefit from the HP 9000 series of workstations by running the UNIX® operating system. The workstation connects directly to an HP 64120A instrumentation card cage system bus so that it shares the same data base with the development system.

HP 9000 series workstations offer powerful networking capabilities for easy sharing of data between teams while preserving team independence for project management purposes. The UNIX operating system provides software revision control systems and automatic compiling and linking to ensure that only the current version of a module is used by team members.

HP 64000-UX cross-development and debug, and data communications software is available to run on DEC-VAX series computers. This means that you can protect existing investments and still take advantage of all the power of the HP microprocessor development environment. For very intensive microprocessor based system designs, there are links to host computers, schematic capture, simulation physical modeling, and board test, which makes the HP 64000-UX an integral part of the HP DesignCenter environment.

#### Modularity Provides Flexibility and Economy

A variety of system configurations are possible with the modular components in the HP 64000-UX microprocessor development environment. Starting with the powerful HP 9000 series 300 workstation as the controller, you can build a flexible development environment that supports a single user, a small development team, or a large team linked over a LAN. The series 300 workstation controls access to the instrumentation card cage which houses up to 10 feature cards for HP emulators and analyzers.

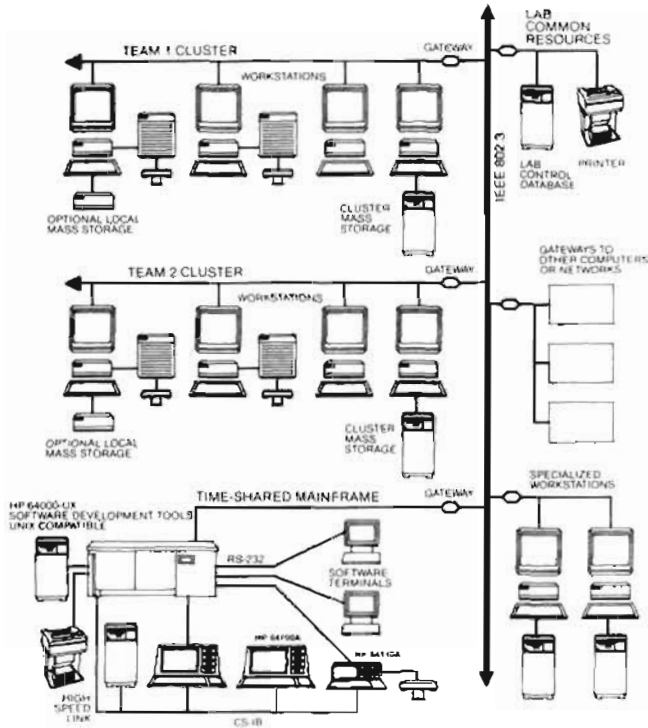

The HP 64000-UX Microprocessor Development Environment is easy to tailor to your design needs. Up to six stations can be assembled in a single cluster for small- to medium-sized teams with a central data base. Larger teams link to a multi-user HP-UX computer.

**Hosted on HP 9000 Series 300**

The HP 64000-UX Microprocessor Development Environment offers significant capabilities:

- Integration with HP's DesignCenter design automation system to support CAE/CAD/CAEE solutions on a platform common with the microprocessor development system.
- An open system with versatile networking to popular microprocessor software development environments such as DEC VAX and IBM PC.
- In-circuit emulators, language systems, high-level debuggers, and powerful analysis tools for 8-, 16-, and 32-bit microprocessors including custom processors and bit slice design.
- HP Computer-aided Software Engineering tools (CASE) that address the entire microprocessor software design cycle.
- An outstanding range of performance options, ranging from low cost RS-232 terminals to powerful, dedicated workstations. Small to large design teams are supported with equal flexibility.

**HP 64000-UX Microprocessor Development Environment**

Up to four card cages can be controlled by a single workstation. One station can support up to ten users performing a variety of development tasks such as coding, compilation, emulation, analysis, etc.

**Systems Environment Features**

An HP 64120A instrumentation cardcage houses the HP 64000 emulators and analyzers. Feature control software for these tools runs on the HP 9000 Technical Workstation. User interfaces on RS-232 terminals and Series 300 displays are consistent with the HP 64100/64110 stations, eliminating the need for current users to learn a new interface.

Users can choose from the most comprehensive language support available today for microprocessor development. Cross assemblers and compilers are available for more than 40 popular microprocessors and custom designs.

	MICROPROCESSOR	EVALUATOR	CROSS ASSEMBLER/TIMER	ANAL. CROSS COMPILER	STATE ANAL. TOOL	PRE-PROCESSOR	HIGH-LEVEL ANALYSIS	ASSEMBLER/TIMER	ANAL. LANGUAGE SYSTEM	C. LANGUAGE SYSTEM	SYSTEM SOFTWARE
Fairchild	F1450										
Hitachi	HD 6301V-6303R										
	8048-8049										
	8051-8751-8001										
	8080 *										
	8085										
	8086-80C86										
	8088-80C88										
	80186										
	80188										
	80286 *										
Motorola	6800-68A00-68B00 *										
	6802-6806 *										
	6801-6803										
	6805R-6805U										
	6805P										
	6809-68A09-68B09										
	6809E-68A09E-68B09E										
	146805E2										
	146805G2										
	68000										
NEC	68008										
	68010										
	68020										
	70116										
	70108										
National	75C800										
Texas Instruments	TMS32010-320M10 *										
Zilog	Z8001										
	Z8002										
	Z80 *										
	User Definable										
ROM											
Microprogrammable (bit slice)											

Summary of processors supported by the HP 64000 Microprocessor Development Environment.

**Compatibility with Existing HP 64000 Systems**

HP cross compilers and assemblers currently running on the HP 9000 Series 500 and HP 9000 Series 300 computers, DEC VAX computers and HP 64000 stations are fully compatible with the HP 64000-UX microprocessor development environment.

There are high-level software debug subsystems that provide an integrated design system. This integrated design capability includes structured analysis with real-time extensions, structured design, advanced technology language systems, debugging with either emulation control or simulation, coverage test, and software performance analysis.

Existing HP 64100 and 64110 stations are hardware and software compatible with the development environment for protection of your system investment. Migration paths are available for expanding existing HP 64000 stations, hosted HP 9000 Model 500s, or DEC VAXs into the system design environment.

**Emulation - 8, 16 & 32 BIT**

The HP 64000 Logic Development System offers a wide selection of emulators to support microprocessor-based product development. These emulators provide an essential link between the software development environment and the target system. Programs developed on the HP 64000 system or compatible computers are run on the emulator subsystem for real-time debug and analysis. Processor run controls in the emulator allow you to single-step, display and modify memory. Modifications and improvements to software are made quickly and easily in the early design phases; emulation gives you the flexibility to experiment before committing a product to firmware.

# DESIGN AUTOMATION

## HP DesignCenter (cont'd)

### HP 64000-UX Microprocessor Development Environment

For microprocessors that are not presently supported with a dedicated HP 64000 system emulator, a custom emulator can be developed using Model 64274S User Definable Emulator as a base. For ROM-based systems, there is a ROM Emulator, Model 64272S, to provide a controlled environment for software execution and analysis. Both user-defined emulators are powerful alternative tools for applications not served by processor-specific HP 64000 system emulators.

For multiprocessor applications emulators may be used interactively with the Intermodule Bus (IMB). The IMB links emulation bus analyzers for cross-arming modes, and the IMB can also establish larger measurement systems for interactive emulators, timing analyzers, and/or state analyzers. When emulation and analysis subsystems reside in separate HP 64100 stations, an IMB extender (HP 64303A) is available for cross-station measurement systems.

### Analysis

Analysis and system integration are major functions when designing and developing superior microprocessor based products. The HP 64000 System offers five analysis subsystems to meet measurement needs for troubleshooting, debugging, and optimizing target systems. The HP 64302A Emulation Bus Analyzer is a basic real-time analyzer used with an emulation subsystem. As well as providing the displays and triggering conditions for the emulator, the HP 64302A analyzer is the emulator's access point for interactive emulation/analysis; in addition, it supports the High-Level Software Analyzer (HP 64330) in an HP 64000 station for analysis in high-level programming languages of C and Pascal. The HP 64340 Real-time, High-level Analyzer is a hardware and software package that operates with an appropriate HP 64000 emulation subsystem and HP 64100A station. HP 64310A Software Performance Analyzer is also used with an emulator, providing overview measurements that aid in system-level evaluations. For complex problem solving, HP 64610S Logic Timing/State Analyzer and HP 64620S Logic State/Software Analyzer are high performance analyzers that may be used separately or interactively.

### Software Performance Analysis

Model 64310A Software Performance analyzer provides overview measurements to aid in evaluating total system effectiveness of programs operating in real time. Global measurements let software designers determine where system resources are being used, in terms of execution times, memory usage and interaction traffic. Software performance measurements aid in determining where to focus optimization efforts for maximum effect on system performance.

- Histogram displays for quick comparisons of software activity
- Tabular displays with continually updated means and standard deviations on current measurement
- Measurement modes of memory and program activity
- Measurement modes of event duration
- Measurement modes of intermodule linkages

### Logic State Analysis

Model 64620S Logic State/Software Analyzer offers real-time, transparent state software analysis for microprocessor systems. A modular system, the analyzer can be configured for 20 to 120 input channels.

- Multiple trigger parameters using symbols, ranges, NOT, and "don't care" terms as well as file names and line numbers
- Selective data storage for edited state listings
- Powerful 15-level sequencer that may also be used to form one or two measurement windows
- Extensive symbolic tracing for quick setups and easy interpretation
- Real-time, nonintrusive analysis feature set supports debug for high-level programming languages
- Two software performance overview modes for code optimization



The HP 64000-UX Microprocessor Development Environment is a natural evolution of the HP 64000 family and is compatible with existing 64000 systems. The development environment offers many capabilities, and shares a common workstation platform with many HP DesignCenter products.

### Preprocessors and Interfaces

Preprocessors and interface modules tailor the HP 64620S Logic State/Software Analyzer for use with specific microprocessor systems. Preprocessors provide quick, convenient connections between target systems and the logic analyzer. Control software and inverse assemblers are included with the processor specific interface modules that are installed in a general purpose preprocessor. The interface modules contain interface circuits and cabling to connect to the target system. Both processor-specific and userdefinable interface modules are available.

### Timing Analysis

Model 64610S High-speed Timing/State Analyzer subsystem offers powerful, high resolution, asynchronous and synchronous analysis with extensive postprocessing capabilities. Many triggering modes allow precise positioning of the display window to locate timing margin, state, execution and interaction problems. Postprocessing adds another dimension to timing/state analysis with the ability to perform operations on acquired data, such as automated compare and statistical analysis of raw data. To analyze the operation of high speed logic in bit slice, microprogrammable, and state machines in real time:

- Asynchronous sampling from 2 Hz to 400 MHz for excellent resolution
- Synchronous sampling to 125 MHz
- Compare level, range and fault qualifications for state and timing listings
- Memory depth of 4060 samples in wide sample mode and 8140 samples in fast sample mode
- Glitch capture and trigger for glitches as narrow as 3 ns to quickly locate transients
- Dual threshold mode for checking transition times, loading problems, and noise margins.

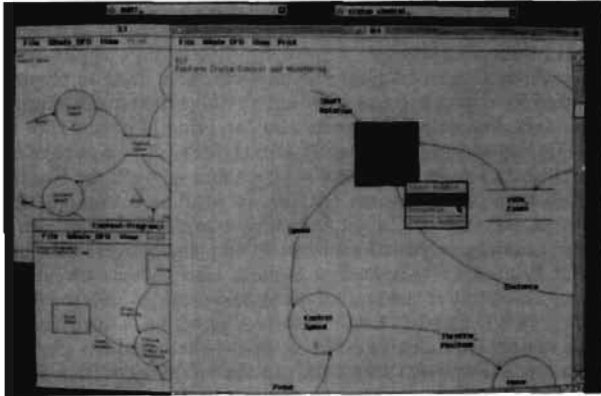

HP Teamwork/SA user interface windows provide a simultaneous view of data flow diagram from a variety of viewpoints. Pull-down menus permit easy function selection.

### Structured Analysis and Design

HP Teamwork products help software design engineers specify complex software systems for more accurate designs and identify the correct modules and module interfaces for the job. Next, integrated design tools eliminate interface problems and allow interactive measurements to simplify the identification of software defects. HP Teamwork products run on the HP 9000 series 300 engineering workstation with the HP-UX operating system. The HP 9000 and HP-UX combination provides a powerful, flexible environment for software development.

### HP Teamwork Analysis and Design

HP Teamwork is a computer-aided environment for structured systems development. HP Teamwork consists of HP Teamwork/SA for structured analysis, HP Teamwork/RT for real-time extensions to structured analysis, HP Teamwork/SD for structured design, and HP Teamwork/ACCESS for database access and interfacing to other CASE tools.

HP Teamwork provides interactive, multi-window, mousedriven graphics that promote rapid capture and manipulation of models. An intelligent editing system with an automatic consistency checker quickly identifies balancing errors in diagrams and checks for completeness.

Data dictionaries, diagrams, specifications, notes, and project management data are contained in an extensive project library database that can be shared by members of the design team. Networking with industry-standard NS-ARPA and Berkeley services provide communications between HP workstations, mainframes, DEC VAX computers, Sun workstations, etc. The HP Teamwork database can reside on any workstation on a network. Notes can be attached to any object or model to add further explanation and comments. Notes can be attached from within HP Teamwork or created on any terminal and moved into the database at the user's convenience.

Model configuration management with versioning, renumbering, and repartitioning of specifications provide a complete specification history to help track changes and revisions of specifications and designs. Users can experiment with changes, reuse pieces of a model, or return to previous versions of a specification.

Specifications from HP Teamwork can be exported to the coding and test environment, saving time and duplication of work. For even greater flexibility in the choice of environments and editors, data dictionaries, specifications, and notes can be written with any text editor and then imported into the HP Teamwork database. Also, text and graphics can be merged on data flow diagrams and structured charts from HP-UX text files.

File locking and write-access protection safeguard your database. Only one user is allowed write access to a file at one time, preventing the "he who saved last wins" problem. Read-only access can also be designated for specific objects or models.

Designers and analysts can enter specific project status information on preformatted status labels attached to the models and objects they are working on. Managers can then extract that information from the database for use in status reporting. In addition, the database can be interfaced to specialized project management tools to produce reports on estimates, budgets, status, and quality assurance.

HP Teamwork/ACCESS can integrate HP Teamwork with tools for configuration management, performance analysis, and code generation. The result is increased efficiency in implementing, testing, and managing a system that conforms to the requirements documented during specification and design.

An interface to document processing functions (troff in HP-UX or Atis/HP-UX\*, etc.) can be created so that users can produce high-quality documentation for all phases of the project, such as requirements documents, system specifications, and design documents. This has proven very useful for organizations that must satisfy specialized corporate or government standards, such as DOD-STD-2167.

Information from specification and design can be used to obtain metrics of project size and complexity for cost and manpower estimates. Standard metrics, such as the bang metric defined by Tom DeMarco in his book "Controlling Software Projects," and the design weight metric, can be calculated to give managers an idea of how to partition the project work and estimate the project's complexity to better evaluate time schedules and feasibility.

### Selecting a Logic Development System

The HP 64000-UX Microprocessor Development Environment is a complex and dynamic family of microprocessor-based system support tools. Consequently, it is recommended that an HP Field Engineer be contacted for a suggested system configuration that will fit your application. For a copy of our latest HP 64000 brochure, in the U.S., call 1-800-447-3282 (in Colorado call collect 590-5540). Outside the U.S., call your local HP sales office.

### Ordering Information

The system model numbers HP 64131S and 64132S are base numbers for bundled systems. Option numbers are used to specify the target processor for the development environment.

Model	Description	Price
HP 64131S	HP 64000-UX development environment with HP 9000 Model 330 workstation and 8-bit emulation	\$32,640
HP 64131S	HP 64000-UX development environment with HP 9000 Model 330 workstation and 16-bit emulation	\$35,700
HP 64131S	HP 64000-UX development environment with HP 9000 Model 330 workstation and 32-bit emulation	\$57,120
HP 64132S	HP 64000-UX development environment with HP 9000 Model 350 workstation and 8-bit emulation	\$50,490
HP 64132S	HP 64000-UX development environment with HP 9000 Model 350 workstation and 16-bit emulation	\$53,550
HP 64132S	HP 64000-UX development environment with HP 9000 Model 350 workstation and 32-bit emulation	\$72,420
HP 64702S	adds HP Teamwork/ACCESS to	\$1224
Opt 004	HP Teamwork/SA/SD	
HP 64710S	HP Teamwork/SA	\$9078
Opt 004		
HP 64712S	adds HP teamwork/SD to	\$3672
Opt 004	HP Teamwork/SA	
HP 64715S	adds HP Teamwork/RT to	\$3672
Opt 004	HP Teamwork/SA/SD	
HP 64717S	adds HP Teamwork/SA to	\$3672
Opt 004	HP Teamwork/SD	
HP 64720S	HP Teamwork/SD	\$9078

# DESIGN AUTOMATION

## EE Design Center

### HP Printed Circuit Design System



HP Printed Circuit Design System

### HP Printed Circuit Design System

Hewlett-Packard's Printed Circuit Design System is a computer-aided design (CAD) solution that couples printed circuit board layout to electrical engineering design, manufacturing, and test. HP Printed Circuit Design System is a part of HP DesignCenter, an integrated design environment for electrical, mechanical, and software engineering teams. HP Printed Circuit Design System consists of systems, software, and support in computer-aided engineering, design and manufacturing (CAE/CAD/CAM).

Based on the modular HP 9000 Series 300 technical workstations and HP-UX operating system, individual workstations as well as total systems can be configured for particular applications in a powerful local area network. HP-UX is derived from UNIX System V interface definition (UNIX is a trademark of AT&T in the U.S.A. and other countries).

HP Printed Circuit Design System transfers all the functionality of a mainframe-based system to a networked workstation environment. This software has been evolving for over 10 years, and provides a refined and highly tuned base for HP's integrated CAD solution. The system is the physical design link between logic design and manufacturing that allows printed circuit board designers to create highly manufacturable boards that perform as the electrical engineer intended. The open and documented design-file format eliminates redundant data entry and reduces chances for errors by making it easy to enter circuit data and to generate manufacturing and test reports and files.

### Features and Capabilities

HP Printed Circuit Design System packing, placing, and routing features can automatically lay out digital, analog and mixed digital/analog boards with through-hole and surface-mount technologies, and also contain facilities for thick-film hybrid design.

Designers use a keyboard and either a four-button puck and A- or B-size graphics tablet or a mouse to step through a dynamic, hierarchical menu. The menu structure logically groups commands for quick entry into design areas, and each successive menu displays only the functions appropriate to the current design area. Projects can be quickly initiated by using or modifying the many spacing and placement rules, manufacturing parameters, and board blanks provided by the system. On-line design rule checking notifies board designers of violations as they occur, but immediate correction is optional to allow opportunities for subsequent layout adjustments. To assure all violations are corrected eventually, a batch design rule checker can assess a completed board, automatically noting all previously uncorrected violations.

### Entering Circuit Data and Board Blank Information

Fully automatic transfer of netlist and part information is available for schematics created on the HP Electronic Design System (see page 613). This link also features automated back annotation and bi-directional engineering change.

Synchronization of logical and physical parts libraries eliminates the need for translation files while automatic parts transfer eliminates redundant data entry. Designers also can bring in circuit data from the HP Engineering Graphics System (HP EGS) — See page 622), as well as data from any vendor's system that supports the Electronic Design Interchange Format (EDIF). In addition to common EDIF features, HP Printed Circuit Design System EDIF format also supports packaging information and parts mapping between data bases.

HP Printed Circuit Design System also accepts circuit data through a variety of customized paths, and provides links to Hewlett-Packard's 2-D and 3-D CAD systems. Custom links to virtually any CAE system are available either as off-the-shelf products (for example, a link to Futurenet schematic capture software) or from HP project and consulting services. In addition, a link exists for users of schematic capture systems from P-CAD. Through this link, engineers can develop schematics on HP Vectra personal computers (see page 638) and then transfer the netlist for layout and routing on high-performance workstations running HP Printed Circuit Design System.

Finally, circuit data can be interactively entered through the Schematic Netlist Editor. This function-key, menu-driven editor allows easy, error-free entry of part and connection information into HP Printed Circuit Design System format.

Design teams with special board blank requirements can begin to design their boards on ME 10, HP's 2-D mechanical design system, and then transfer the board blank to HP Printed Circuit Design System. ME 10 allows designers to specify precise dimensioning, custom shapes, and pre-defined locations for mechanically significant information such as connectors or transformers. Once transferred, these board blanks can be saved as separate designs and reused across a family of products with similar board specifications.

### Design System Manager

System interaction begins with the Design System Manager, a work environment that secures and controls design file access, simplifies data sharing and networking and provides an easy-to-use interface to all applications on a system. The Design System Manager also makes it easier to move, archive, or report the status of design information by gathering files into functionally related groups, and then allowing operations to be performed on these groups. In addition, a simple versioning scheme automatically maintains copies of designs in progress, giving designers the flexibility to try innovative layout solutions while maintaining previous versions for comparison and use.

### Modular Software Design

HP Printed Circuit Design System is functionally divided into three modules: Design Module, Autorouter Module, and Library Module and Parts Library.

### Design Module

Most of a designer's interaction with the system is through the Design Module, which includes powerful automatic tools to aid the designer during printed circuit board layout. Among these tools are the automatic packer, placer and the interactive router, as well as routines for improving parts placement to ensure the highest possible router completion. For efficient system use, these placement improving routines may be run as a batch process while the designer performs other tasks or goes to lunch. The Design Module also includes routines for creating highly manufacturable boards, such as "Tidy." Tidy improves the manufacturability of boards by tear-dropping traces into pads to insure solid electrical connections, widening traces to increase electrical reliability and eliminating unnecessary vias to reduce costs.

The HP Printed Circuit Design System includes special features for placing, part swapping, and routing of surface mount devices (SMDs). Physical descriptions of over 800 SMDs are available in

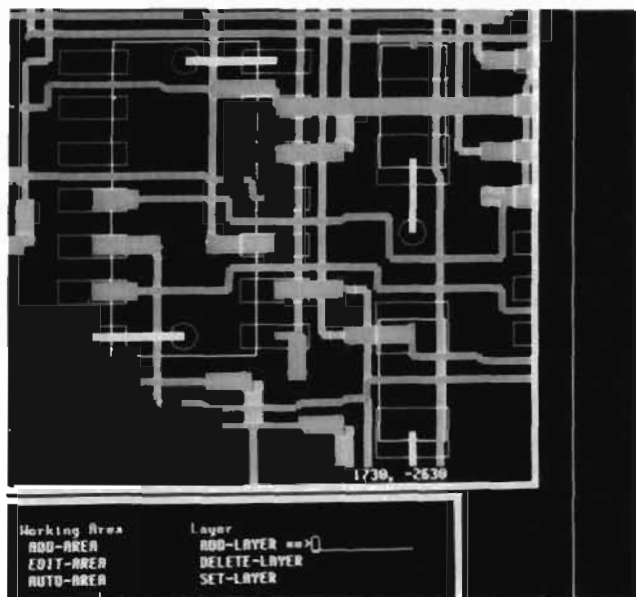

The Design Module provides special features for placing, part swapping and routing of surface mount devices. A pad and breakout for an SMD are shown here.

the Parts Library. Placement on both sides of a board and swapping between sides decreases logic length and ensures higher Autorouter completion. Breakouts to power and ground planes and a user-definable routing grid also aid the routing task, while definable SMD spacing parameters increase reliability and manufacturing yields.

**Autorouter Module**

A look-ahead algorithm preplans the most effective routing strategy for both through-hole and surface-mount devices, resulting in a fast automatic router with 100 percent completion rates for most boards.

The multiple-pass Autorouter Module routes up to four layers in one pass, with 90- and 45- degree angles to create easier-to-manufacture boards. Users can specify automatic routing and via grids to allow zero, one, two, or more traces between IC legs or SMD pads. The Autorouter Module can also handle areas of surface mount technology (SMT) on both sides of the board, including hidden or buried vias. Manual routing can be completed to 1 mil, allowing designers to route analog, ECL, and critical board areas separately. At any time, designers may interrupt the automatic routing, check on progress, and restart the routing as needed.

Autorouter Module provides user-definable routing grid to allow finline technology.

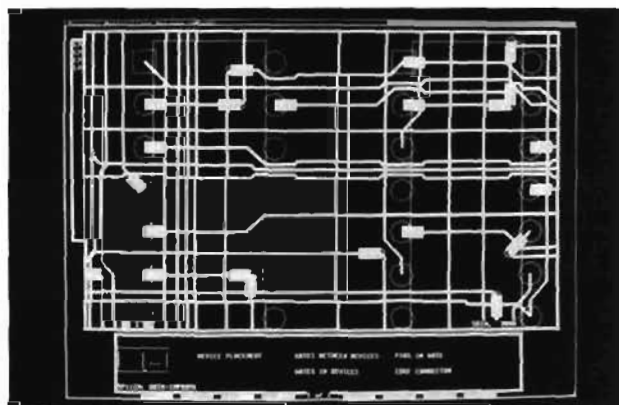

**Library Module and Parts Library**

More than 6,500 physical parts are included in the starter library. Designers can create, modify, validate, store and access these parts quickly and easily. The system provides strict centralized control over component usage to assure data integrity and standardization of parts.

**Manufacturing and Test Links**

HP Printed Circuit Design System does not stop with physical layout, but helps assure that the design is accurately transferred to manufacturing by automatically generating a range of reports and files such as photoplotter command files, numerical-control drill tapes, and production reports. In addition, an output file in Board Configuration Format (BCF) can be sent to the HP 3065 board test family to verify board connectivity and component values. The BCF file also lists X,Y locations of device pins and test pads for the board test operator.

For additional documentation or development of production drawings, designs can be transferred to ME 10 (see page 624), a 2-D mechanical design package that allows easy dimensioning and more complex assembly drawings. Once transferred to the ME 10, HP Printed Circuit Design System drawings can move through an Initial Graphics Exchange Specification (IGES) link to any other CAD system which supports the IGES 3.0 standard.

**Configuration**

The flexibility of the modular HP 9000 Series 300 technical workstations and HP Printed Circuit Design System allow a design team to configure a particular system, then upgrade and extend individual workstations or add to the overall system in a local area network.

For example, a design team may start with one complete HP Printed Circuit Design System, with all three modules running on a Series 350 and a high-resolution color monitor. Later the team can add more workstations with only the Design Module running on a more economical Series 330, sharing data over industry-standard networking (IEEE 802.3). The automatic router can be moved to a separate Series 350 workstation with only a small monochrome monitor to serve all the Design Module workstations on the network. A stand-alone router station may also reside on a Series 825 or 840 HP Precision Architecture computer. Designers can then delegate the compute intensive task of routing to these powerful compute servers while dedicating themselves to the more interactive tasks of printed circuit design.

Teams who combine board-layout with 3-D mechanical design can maximize their hardware resources by using both HP Printed Circuit Design System and ME 30 (see page 624) on a single high-performance 350SRX solids modeling display system.

**Ordering Information**

In addition to the products listed below, Account Management Support, Response Center Support, and Software Materials Subscription are also available.

HP Printed Circuit Design System, complete software, <b>Option 022*</b>	74400A	\$31,000
HP Printed Circuit Design System, complete software, <b>Option 022, Right-to-copy</b>	74400R	24,800
HP Printed Circuit Design System, Design Module software, <b>Option 022</b>	74410A	11,000
HP Printed Circuit Design System, Design Module software, <b>Option 022, Right-to-copy</b>	74401R	8,800
HP Printed Circuit Design System, Autorouter Module software, <b>Option 022</b>	74402A	14,000
HP Printed Circuit Design System, Autorouter Module software, <b>Option 022, Right-to-copy</b>	74402R	11,200
HP Printed Circuit Design System, Library Module software and Parts Library, <b>Option 022</b>	74403A	6,200
HP Printed Circuit Design System, Library Module software and Parts Library, <b>Option 022, Right-to-copy</b>	74403R	4,960

\*Software on 1/2 tape cartridge

# DESIGN AUTOMATION

EE Design Center

HP Engineering Graphics System



HP Engineering Graphics System

## HP EGS Engineering Graphics System

Hewlett-Packard's Engineering Graphics System (HP EGS) is an easy-to-use, entry-level computer-aided design (CAD) system for complete product design. HP EGS consists of several modules that enable the user to create schematic drawings, perform interactive PCB layout, design thick-film hybrid circuits, and generate general artwork ranging from card cage drawings and assembly diagrams to block diagrams and presentation slides. Artwork created on the system can be used directly or moved to more sophisticated design automation tools such as HP Printed Circuit Design System (HP PCDS). See page 620.

Among the built-in productivity tools provided by HP EGS are an on-line HELP facility, customizable screen and tablet menus, and user definable macros, or "super-commands." These macros allow a user to supply a familiar name to a sequence of often-used commands. In addition, users can develop custom modules for specific applications, defining everything from specialized macros to menus and on-line message prompts. In fact, the Hybrid Circuit Design Module is an example of a custom application built from HP EGS tools.

HP EGS is currently in use at more than 4,400 installations worldwide. It runs on the HP 9000 Series 200 and 300 workstations, bundled with a Pascal operating system. EGS also works with the HP Vectra Personal Computer (See page 638), running on a coprocessor board. Users may run HP EGS as a standalone system or as a Shared Resource Management (SRM) system. The SRM system allows multiple workstations or personal computers to share disc drives, printers and plotters, which can dramatically reduce total system cost. The SRM network also enables HP EGS users to easily share data such as drawings and library parts — offering significant productivity improvement. In addition, users can configure a local disc as a Hierarchical File System (HFS). The HFS configuration allows multiple operating systems to share the file system on a single disc. For example, an HP EGS file may contain a special suffix which makes it readable by HP-UX, HP's version of the UNIX\* operating system.

The HP Vectra fits smoothly into existing personal computer environments, providing the interactive power of HP EGS for schematic capture and hybrid circuit design, and the links to workstation CAD systems for logic simulation and PCB layout. For users who demand the highest graphics performance, High-Performance HP EGS provides a specially optimized version of HP EGS that takes advantage of high-end hardware capabilities available on Series 330 and 350 workstations. The customizability of HP EGS along with hardware platforms that range from the HP Vectra to the most advanced HP 9000 Series 300 workstations provides users with a single-vendor, cost-effective solution to their design automation problems.

## Features and Capabilities

At the heart of HP EGS is the graphics editor, the tool used to generate drawings on the screen. Drawings are created using elements such as lines, circles, rectangles, polygons, arcs, and text. Complex, frequently used shapes can be stored as library parts and called up as needed. Shapes on the screen can be altered with screen editing commands. It is easy to copy, delete, scale, rotate or stretch lines and objects. New drawings may also be created by modifying existing drawings. By storing these new drawings in separate files, you can easily maintain multiple revisions.

Pen plots of drawings can be obtained from any one of the full line of HP plotters — from an inexpensive A-size plotter to a roll-feed E-size drafting plotter. Many printers are supported on HP EGS, from the inexpensive ThinkJet printer to the HP LaserJet printer, which provide documentation-quality output for text as well as graphics.

## Work Environments

Five specialized work environments or modules are available with HP EGS. The Hybrid Circuit Design Module combines interactive and automatic features for designing thick-film hybrid circuits. The Printed Circuit Board Layout and Schematic Drawing Modules are designed to increase the productivity of electronic engineers and designers developing printed circuit boards. The Mechanical Drawing Module assists users in creating drawings of mechanical assemblies, and the Engineering Graphics Module allows the creation of general-purpose artwork.

## Hybrid Circuit Design Module

The Hybrid Circuit Design Module (HCD) tunes the extensive feature set of HP EGS to the needs of hybrid circuit designers, combining industry-tested interactive graphics with automatic tools that make this HP EGS module a great productivity aid for thick-film hybrid circuit designers. They can easily move from manual and other methods of hybrid circuit layout to this menu-driven CAD environment that fully employs their design expertise while reducing errors and speeding changes.

Designers can create and store standard substrate outlines, then readily modify or create new outlines as needed. Adding parts to a design is relatively automatic when using a connection list or material list derived from a schematic. Alternatively, part information can be entered directly from the keyboard or a tablet menu without using a list.

To generate resistors, designers can draw on a library of resistor-paste curves that stores a set of values based on manufacturer-supplied data or on measurements unique to a manufacturing process. For automatic resistor design, HCD uses the resistor value and reference designators from the Schematic Drawing Module. HCD then selects the optimum paste from the resistor paste curves, determines the required active resistor surface size, generates the resistor, and stores it on the display screen. If schematic data is not available, the designer can enter resistor information from the keyboard. Once a designer selects a resistor paste curve and specifies a resistor value, the module will generate an appropriate resistor.

For parts placement and conductor routing, designers use the flexible editing features of HP EGS to move, rotate, stretch, or mirror one or more parts at a time with grid resolution to .00001 mil. Conductor width can vary along individual conductors and from conductor to conductor, and dielectric layers can be added with a single menu selection.

After finishing the layout, designers can use the Connection List Compare routine to verify that the finished design matches the connectivity of the schematic. Designers can also create a manufacturing material list for information such as part numbers and prices. In addition, an area-calculating utility can help estimate material usage by measuring the paste area on each layer (resistive, conductive, and insulating) and then generating information for calculating how much ink will be needed.



### Printed Circuit Board Layout Module

The Printed Circuit Board Layout Module facilitates the creation of printed circuit board artwork for electronic designs. Among the productivity features in this module is the Rat's Nest Generator. From a schematic connection list, it produces 'airline' connections between placed PCB components. Users can move components to eliminate trace congestion, and, as components are moved, the connections remain intact. Then, with a ROUTE macro, users can select an airline and route it, locking the routed trace to pre-specified angles. In the process of routing the trace, users can change layers as necessary to complete the connection. A connection list routine compares the schematic connection list and the PCB connection list. A report is generated that notes any discrepancies, providing the user with a validation of the design.

Users who want to simulate schematics before starting the physical design may want to use HP Electronic Design System, a schematic capture system with links to logic simulators. That system will generate a net list in HP EGS format for users who want to use HP EGS for physical design.

### Schematic Drawing Module

The Schematic Drawing Module includes a library of common electronic schematic symbols. Users may also create their own parts, using any logic symbol representation and assigning unique attribute information to components. In this way users can create, modify, and expand their own custom symbol libraries. Once the schematic design is captured, the resulting connection list information can be passed to the HP EGS PCB Layout Module, the HP EGS Hybrid Circuit Design Module, or to another PCB layout system, such as HP Printed Circuit Design System.

### Engineering Graphics Module

The Engineering Graphics Module may be used for a multitude of applications... from diagramming PCB card cage assemblies, generating overhead slides, creating project scheduling diagrams, to any other general artwork. This module is where many new users begin to learn how to use HP EGS, and where many sophisticated users come to create their own applications.

### Mechanical Drawing Module

The Mechanical Drawing Module is designed to assist engineers and draftspeople in preparing 2-D mechanical drawings. The isometric grid capability allows the user to easily create 2-D representations of 3-D objects. The library for this module includes drawing paper templates, tolerancing and surface texture symbols, and macros for defining families of screws and bolts. Both metric and English units are available.

A library of resistor-paste curves aids automatic resistor design.

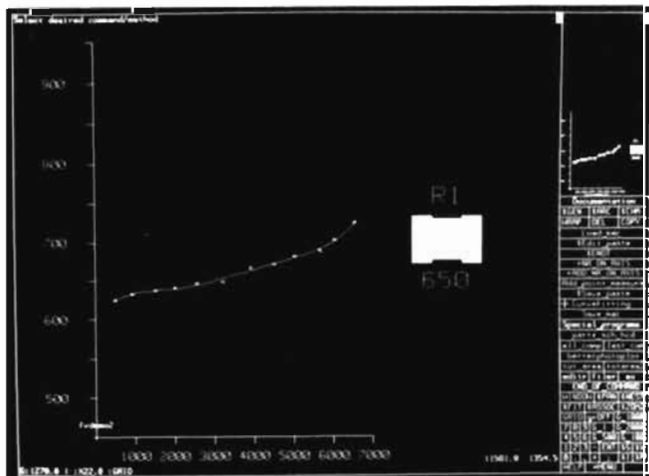

Powerful interactive and automatic features for thick-film hybrid design

### Additional Products

**HP TechWriter** — Documenting engineering tasks, writing reports, and developing presentation-quality materials that include illustrations consume a major portion of an engineer's time. HP EGS combined with HP TechWriter helps the user deliver high-quality presentation materials. This optional document editor works with the entire Series 200 and 300 family of workstations and with the HP Vectra and electronically merges text with the graphics created by HP EGS. HP TechWriter may also be used independently from HP EGS.

**Photoplot/NC Drill** — HP's optional photoplot/NC drill feature makes it easy to convert PCB and hybrid designs into Gerber photoplotter format or to provide PCB drilling information for Excellon drill machines.

**IGES Translator** — Conforming to the Initial Graphics Exchange Specification (IGES 3.0), HP's IGES Translator allows users to move HP EGS drawings to other CAD systems or move drawings from other systems to HP EGS. HP EGS can be used as a low-cost front end to your expensive CAD systems.

### Ordering Information

		Price
Modular HP EGS	74305A	\$6200
add Schematic Drawing Module	option 10x	1020
add PC Board Layout Module	option 20x	1020
Modular HP EGS Right-to-Copy	74305R	4960
Schematic Drawing Module Right-to-Copy	option 100	815
PC Board Layout Module Right-to-Copy	option 200	815
Add-on Modules for HP EGS	74306A	0
add Schematic Drawing Module	option 10x	2040
add PC Board Layout Module	option 20x	2040
add Mechanical Engineering Module	option 30x	2040
Hybrid Circuit Design Module	74307A	4100
Hybrid Circuit Design Module Right-to-Copy	74307R	3280
High Performance HP EGS	74308A	8200
High Performance HP EGS Right-to-Copy	74308R	6560
HP EGS Photoplotter/NC Drill Utility	98310A	3100
HP EGS Photoplotter/NC Drill Right-to-Copy	98310R	2480
HP EGS IGES Translator	98311A	5100
HP EGS IGES Translator Right-to-Copy	98311R	4080
HP TechWriter	98819A	810

Note: x in option number is either 2 or 4 and denotes 5/16" or 3/16" modules. Prices are subject to change without notice. Please consult your local HP Sales Representative for the latest pricing information.

# DESIGN AUTOMATION

## ME DesignCenter

ME Series 5, 10 and 30



HP's DesignCenter ME Series 10 is an advanced 2D design and drafting system for mechanical engineering applications. As shown here, the ME Series 10 runs on an HP 9000 Model 320 32-bit engineering workstation with high-resolution color.

### ME Series 5, 10 & 30

HP DesignCenter Series 5, 10 and 30 are a family of CAD systems for drafting, 2D design and solids modeling, respectively. All three products have been developed using the same friendly user interface philosophy — drastically reducing the learning time to allow greater designer productivity.

ME Series 5 provides comprehensive drafting functionality. The ME Series 10 adds extensive 2D design and integration capability to this core drafting block. The ME Series 30 takes the power of the ME Series 10 and integrates it with true solid modeling capabilities by adapting the use of 2D design techniques to model creation.

ME Series 5 and 10 run on the complete range of HP 9000 Series 300 engineering workstations under either the Pascal or HP-UX operating systems. ME Series 30 is available on the 32-bit HP 9000 Series 300 workstations running the HP-UX operating system.

Networking capabilities such as LAN allow users to set up a distributed system featuring all three products configured to address the full range of mechanical engineering CAD requirements. Similar networking capabilities allow further integration of CAD stations into manufacturing environments.

### User Interface

Short learning cycles and friendly system handling are essential for engineering productivity. The ME Series 5, 10 and 30 user interface is menu-driven and provides the ease-of-use beginners require. ME Series 10 and 30 also provide customizing capability for special applications.

Most importantly, the single user interface concept greatly reduces the education and skill needed by your engineers to be able to fully benefit from HP's full range of CAD tools.

In all three products, the user interface is optimized for mechanical design and drafting.

- System functions are directly accessible from the graphics tablet, complemented by screen menu subfunctions
- Easy-to-follow prompting and understandable commands like fillcut and mill enhance user interaction
- Multi-viewport capability eases handling of large and complex models, designs and drawings.
- On-line HELP facility provides detailed explanations of the use of commands
- Feedback mechanisms such as rubber banding and dynamic component tracking aid creation and modification operations.

ME Series 5 and 10 also offer a screen-only version of the user interface for use with a mouse.

### Functionality

ME Series 5, 10 and 30 offer a powerful range of functions for design through modeling to drafting of complex mechanical parts and assemblies. The result is high design efficiency, reduced prototyping requirements and fast creation and modification of drawings.

ME Series 5 drafting features include:

- Comprehensive construction geometry to facilitate accurate positioning of geometry elements
- An electronic 'ruler' to emulate drawing-board techniques that can be moved, rotated and set to isometric coordinate systems
- Full dimensioning capability according to international standards (ANSI, ISO, etc.)
- Dual dimensioning
- Automatic hatching
- Automated detail creation
- Full text input and editing capability

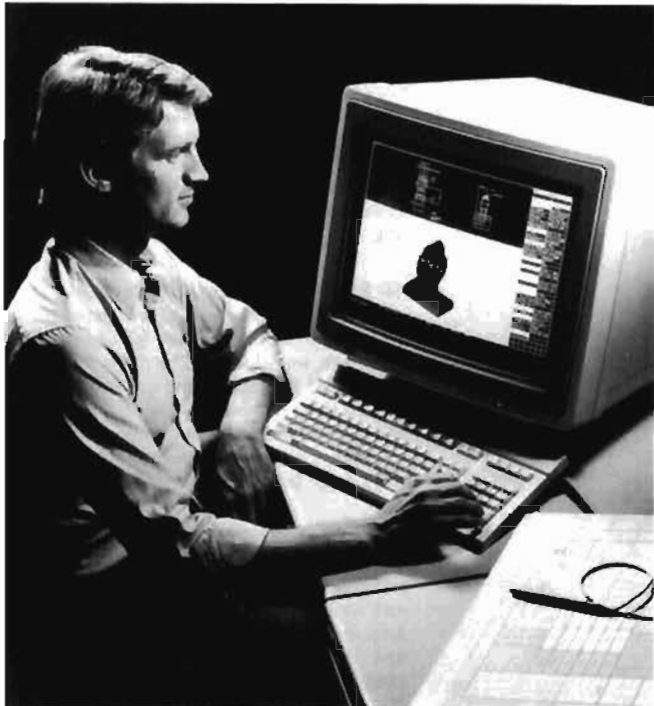

HP's DesignCenter ME Series 30 is an integrated 3D solid modelling, 2D design and drafting system for mechanical engineering applications. The system shown is operating on an HP 9000 Model 350SRX which provides dynamic rotation of hidden line and shaded models.

- Various text fonts according to international standards
- User-definable text font capability
- Leader lines with various terminator capabilities
- Comprehensive set of drafting symbols
- Semi-automatic isometric drawing creation
- Parts and assembly capability
- 'Shared part' feature to allow automatic update of several parts at once
- Unlimited number of layers available for drawing organization
- Modification functionality
- Fully variable drawing scale

**ME Series 10 ADDITIONAL design features include:**

- Parametric design capability
- Automated 'Design Feature' creation capability
- Advanced geometry modification for adapting designs, including move, copy, scale, rotate and mirror
- Associated information and attributes for material specifications and pricing details
- Measurement capabilities including moment of inertia

**ME Series 30 ADDITIONAL solids modeling features include:**

- 'Workplane' technique allows 3D model creation from 2D geometry
- Machining functions for model creation, including mill and stamp, to support use of 2D geometry for model creation
- 3D parametric design capability
- 'Primitives' for model creation
- Full assembly modeling capability
- Extensive design checking capability, including mass properties and interference
- Full modification capability for parts and assemblies including move, copy, scale, rotate, mirror and tweak
- Hardware supported dynamic rotation of hidden line and shaded models to enhance visualization

**Integration into Your Environment**

ME Series 5, 10 and 30 all offer extensive capabilities to use design data in the manufacturing environment.

**ME Series 5 integration capabilities include:**

- Parts list information for stock control systems
- Drawing data included in documentation systems such as Alis/HP-UX

**ME Series 10 ADDITIONAL integration capabilities include:**

- 2D geometry link to NC-programming systems
- 2D geometry link to finite element analysis systems such as HP FE
- IGES translator

**ME Series 30 ADDITIONAL integration capabilities include:**

- 3D geometry link to NC-programming systems
- 3D geometry link to finite element analysis systems

**Training and Support**

Full training and support programs are available to ensure successful implementation of ME Series systems.

**Support Products include:**

- Account Management Support
- Response Center Support
- Manual Update Service

**Training courses are structured as follows:**

- ME Series 5 Drafting Course 3 days
- ME Series 10 ADDITIONAL 2D Design Course 2 days
- ME Series 30 ADDITIONAL Solids Modeling Course 5 days

**Ordering Information**

		<b>Price</b>
ME Series 30	HP 74836A	\$18,000
ME Series 10 (HP-UX version)	HP 98366A	10,000
ME Series 10 (Pascal version)	HP 98365A	10,000
ME Series 5 (HP-UX version)	HP 98364A	5,500
ME Series 5 (Pascal version)	HP 98363A	5,500

Upgrade programs are available to expand your system capabilities as your requirements grow.

HP DesignCenter ME Series 5 is an entry level CAD system for mechanical engineering applications. The user interface and data are fully compatible with the ME Series 10 advanced design and drafting system. The system here operates on a low cost HP 9000 Model 310 computer and a medium resolution (512 x 400) color monitor.



# TECHNICAL COMPUTER SYSTEMS

Measurement & Design Automation, Manufacturing & Real-Time Monitoring & Control  
General Information

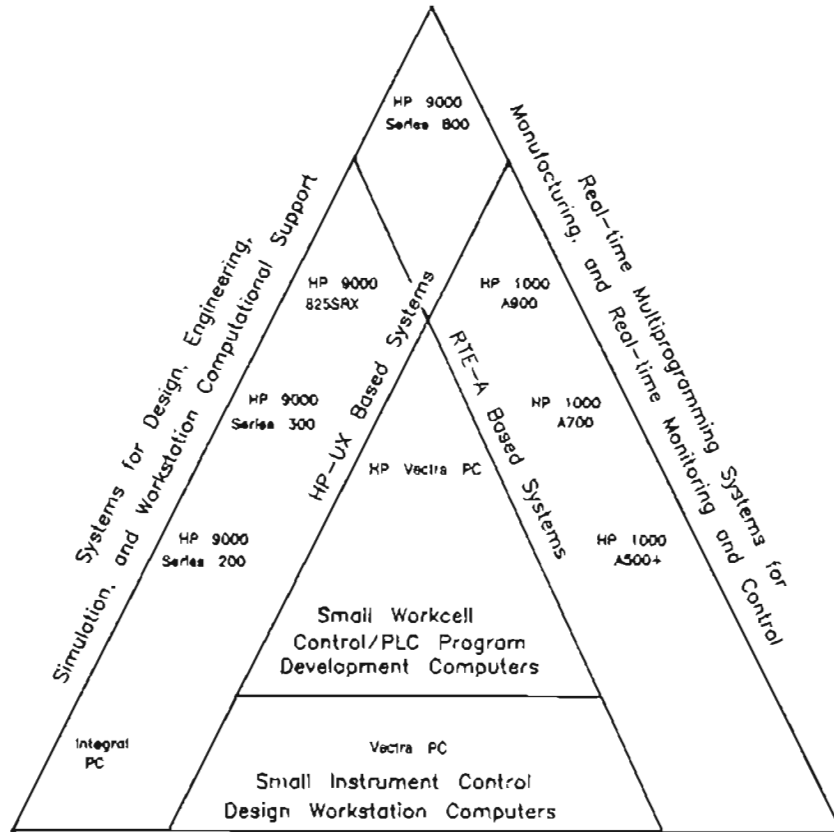

## Technical Computer Systems

Hewlett-Packard offers a wide range of technical computer systems for design, measurement automation, manufacturing, and real-time monitoring and control, as illustrated in the diagram above. The table on the facing page provides comparative data on the variety of technical systems available from HP.

### HP 9000 Series 800

Hewlett-Packard offers four different computers based on the RISC-based HP Precision Architecture technology. All offer superior price/performance when compared with alternative systems. All provide extremely high compatibility with other HP systems and industry standards. All provide the low cost of ownership and high reliability expected from HP.

The new HP 9000 Model 850S superminicomputer is the fastest member of the Series 800 family, with up to 60% better CPU performance and greater expandability than the Model 840S. Model 850S uses HP's proprietary NMOS III VLSI technology and runs the HP-UX operating system, equipped with HP's real-time enhancements to make it a top performer in applications of either the HP 9000 or HP 1000 families. Estimated relative throughput of the 850S is 7.2 MIPS, well ahead of other superminis in its price class.

HP 9000 Model 840S is the mid-range member of the Series 800 minicomputer line, with three times the CPU performance of an

HP 1000 A900 or HP 9000 Model 350 system. It provides all the industry standard software advantages of the Model 850S, with 4.5 MIPS performance.

HP 9000 Model 825S is the entry-level member of the Series 800 minicomputer family, with 1.5 to 2 times the performance of the HP 1000 A900 or HP 9000 Model 350 systems. Like all the Series 800 products, it is object code compatible with all other Series 800 systems, and source code compatible with HP 9000 Series 500, 300 and 200 products, with PORT/HP-UX facilities for application migration from HP 1000 systems.

HP 9000 Model 825SRX superworkstation combines high-performance computation with state-of-the-art 3D graphics for real-time design of complex assemblies. This system performs at 8.2 times the speed of the DEC VAX 11/780, while also providing industry-leading 3D graphics performance at 180,000 3D transforms per second.

### HP 9000 Series 300

The HP 9000 Series 300 is a flexible, scalable computer system offering a wide range of price/performance alternatives. With a low entry price, the low-end workstations are well-suited for dedicated instrument control applications as well as for entry-level engineering and technical office automation applications.

On the high end, Series 300 workstations provide complex engineering design capability and increased computation performance.

From the Model 350SRX premier graphics workstation to mid-range Model 330, the Series 300 offers a choice of workstations for every application. The addition of the HP DOS Coprocessor makes the Series 300 workstation IBM PC AT compatible—both an engineering and personal computer in one box.

### HP 9000 Series 200 Systems

The HP 9000 Series 200 is a line of technical workstations best suited for less computationally intensive workloads. They are especially well-suited for standalone use as instrument controllers. However, the Series 200 is equipped to handle light to moderate computational workloads and can offload excess work to an interfaced Series 800 machine.

### Technical PC Systems

The Integral PC is an HP-UX-based transportable computer that supports large and sophisticated applications programs for field-delivery applications. The Vectra PC and Vectra Industrial PC support the full range of DOS technical and commercial applications. Using the HP Language Processor, they can also support BASIC and Pascal.

### HP 1000 A-Series Systems

HP 1000 A-Series systems provide real-time operation at three different performance levels (A900, A700, and A600+), as listed in the facing table. Predictable response to real-time events equips these systems to function effectively as factory floor workcell controllers, or in other applications that require real-time responsiveness.

### Communications

HP technical computer systems can communicate with each other, via various networking protocols, a topic discussed on page 642.

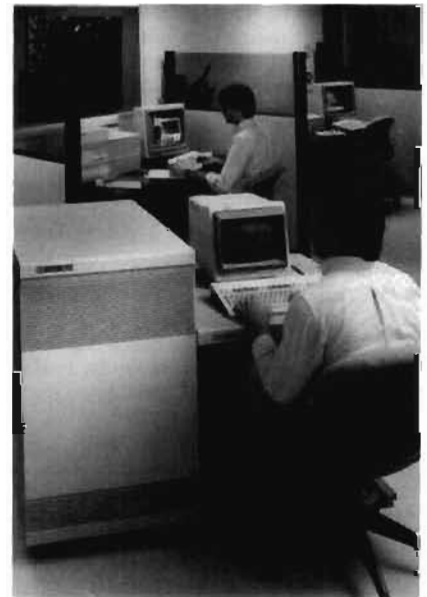

**Hewlett-Packard Technical Computer Systems Summary**

Processor	Base Speed	Ftg Pt Speed (KWIPS-BID)	Main Memory	Virtual Memory	Oper. Systems	Number of Users	Program Languages	System Software	Networking	Application Environments
HP 9000 Model 850S page 629	7.2 MIPS	2900	8-128 MB	281000 GB	HP-UX	1-90	C FORTRAN Pascal	X-Window Starbase GKS HP Allbase HPToday	ARPA/Berkeley Network Structures HP/NS to HP 1000 & HP 9000	Workstation
HP 9000 Model 840S page 630	4.5 MIPS	2000	8-96 MB	281000 GB	HP-UX	1-64	C FORTRAN Pascal	X-Window Starbase GKS HP Allbase HPToday	ARPA/Berkeley Network Structures HP/NS to HP 1000 & HP 9000	Workstation
HP 9000 Model 825S page 631	3.1 MIPS	2500	8-56 MB	281000 GB	HP-UX	1-64	C FORTRAN Pascal	X-Window Starbase GKS HP Allbase HPToday	ARPA/Berkeley Network Structures HP/NS to HP 1000 & HP 9000	Workstation
HP 9000 Model 825SRX page 632	8.2 MIPS	2500	8-48 MB	281000 GB	HP-UX	1-64	C FORTRAN Pascal	X-Window Starbase GKS HP Allbase HPToday	ARPA/Berkeley Network Structures HP/NS to HP 1000 & HP 9000	Workstation
HP 9000 Series 300 page 633	0.4 to 4 MIPS	150 to 2600	1 to 32 MB	16 MB or 4 GB	HP-UX	1 to 32	C FORTRAN Pascal LISP Ada Prolog BASIC	HP Windows; X Window; Technical Office Automation HPToday; HP-GKS; Starbase; and DGL/AGP Graphics; HP Allbase DOS Coprocessor	LAN Link to HP 1000, HP 3000, & HP 9000; and uucp comm to other UNIX systems ARPA/Berkeley Network Services Discless nodes NFS, IBM SNA	Workstation Multi-user Software Engineering
					BASIC	1	BASIC		SRM IBM 3270	Instrument Control
					Pascal	1	Pascal	DGL Graphics	IBM 2780/3780 RJE	Instrument Control
HP 9000 Series 200 page 637	0.2 to 0.9 MIPS	50 to 150	0.5 to 6 MB	not appl.	HP-UX	1 or 16	C FORTRAN Pascal	HPToday; and HP-GKS. Starbase, DGL/AGP, and EGS Graphics.	LAN Link to HP 1000, HP 3000, & HP 9000; and uucp comm to other UNIX systems	Multi-user
					BASIC	1	BASIC		SRM IBM 3270	Instrument Control
					Pascal	1	Pascal	DGL Graphics	IBM/RJE	Instrument Control
HP Vectra and Ruggedized Vectra PCs pages 638 and 657	0.3 MIPS	45 To 100	256 KB to 3.64 MB	not appl.	MS-DOS 3.1 HP BASIC Pascal	1	BASIC, Assembler Pascal	IBM PC/AT compatible software, incl. design & industrial applications software	RS-232C comm with host computers, 802.3/ARPA capabilities and SRM	Personal Productivity Instrument Control
HP 1000 A900 page 654	1.2 MIPS	800	0.75 to 24 MB	128 MB for data,	RTE-A	Up to 20	FORTRAN Pascal BASIC	IMAGE DBMS; DGL/AGP Graphics; PMC/1000; QDM/1000; PCIF/1000; & Datapair/1000	LAN Link to HP 1000, HP 3000, & HP 9000; NS/1000 pt-pt comm.	Manufacturing Control
HP 1000 A700 page 654	0.4 MIPS	370	0.5 to 8 MB	7.75 MB for code					w/HP 1000 & HP 3000; and RJE, MRJE, & Prog-to-Prog comm. with IBM & plug-compatible systems	Multi-user
HP 1000 A600+ page 654	0.4 MIPS	20								
HP Integral PC page 639	Not Spec'd	Not Spec'd	512 KB to 7.4 MB	not appl.	HP-UX/ RO 5.0	1	C BASIC FORTRAN Pascal	Standard HP-UX Software	RS-232C Communication with host computers, HP-UX serial Networking under $\mu$ CP	Software Engineering Instrument Control

# TECHNICAL COMPUTER SYSTEMS

## HP Precision Architecture: Simpler Means Better

### Overview

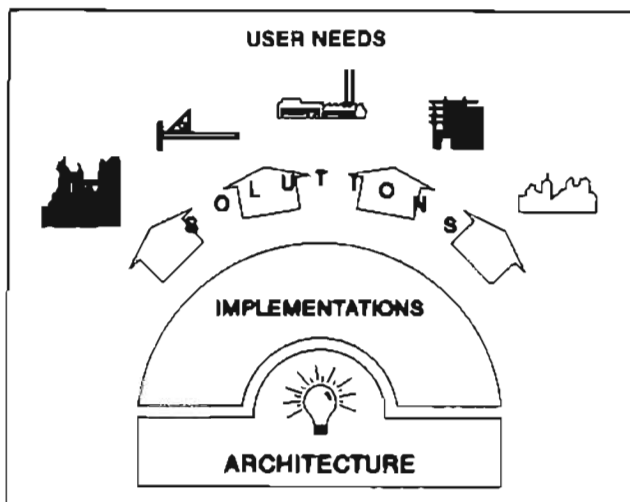

Figure 1: Relationship of Computer Architecture to User Needs

### What is Computer Architecture?

Computer architecture is the foundation upon which a computer and its solutions are built. The architecture defines the instruction set, the length of the instruction, the formats of data and instructions, and memory format. The design of the organization and interconnection of the hardware components is specified by the architecture.

Above the architecture is the implementation. For a given architecture, there may be several implementations. Implementation refers to the organization of the architecture in hardware and software. The implementation will vary with the goals of the system.

Finally, the system is implemented using some technology. For example, the system might use processors made from various IC families, such as, CMOS, TTL, NMOS, ECL, etc.

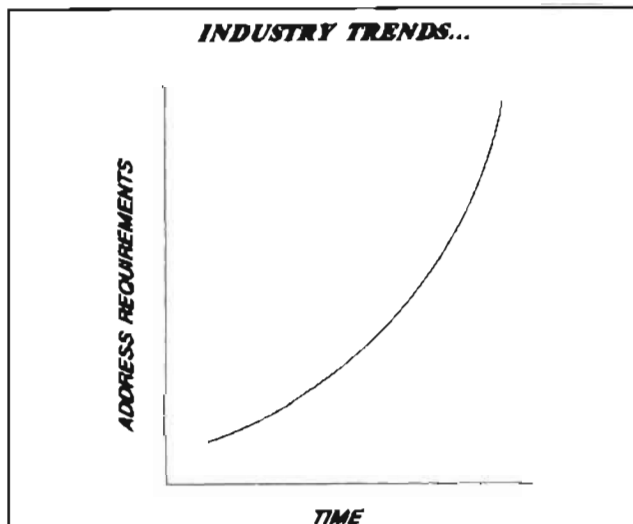

Figure 2: Address Requirements - Industry Trends

### Why is Architecture Important?

Solutions presented by a computer system are based upon the hardware and software implementations. These implementations are constrained by the underlying architecture. Hence, the architecture must take into account today's and tomorrow's solutions needs.

### HP Precision Architecture

As computer systems have evolved, they have progressed from very simple architectures to complex systems with hundreds of instructions and several means of accessing data. Each move to more complexity was intended to simplify the efforts of the programmer. High-

level languages were implemented to make communication with the computer easier. In turn, these led to having many instructions so that the compilers would be able to more closely parallel the high-level language functions.

In the late 1970's, several industry experts began an analysis of what real computers do when running real solutions. The results were not surprising. Complex Instruction Set Computers, CISC's, spend 80% of their time executing 20% of the instruction set. In addition, the most often used instructions were the simplest. What this means is that the complexity of a CISC system is not really a boon to the programmer. Instead, CISC causes a performance penalty whenever these simple instructions are being accessed. Hardware and software necessary to allow the complex instructions are rarely used.

This led to the development of RISC (Reduced Instruction Set Computer) architectures. A RISC system allows reduced complexity while increasing performance. The result is a faster, less expensive, more reliable system. The main features of a RISC system are:

1. Reduced instruction set
2. Single cycle execution of most instructions
3. Hardwired instructions (no microcode)
4. Register intensive operation
5. Fixed instruction size
6. Short-cycle load/store design

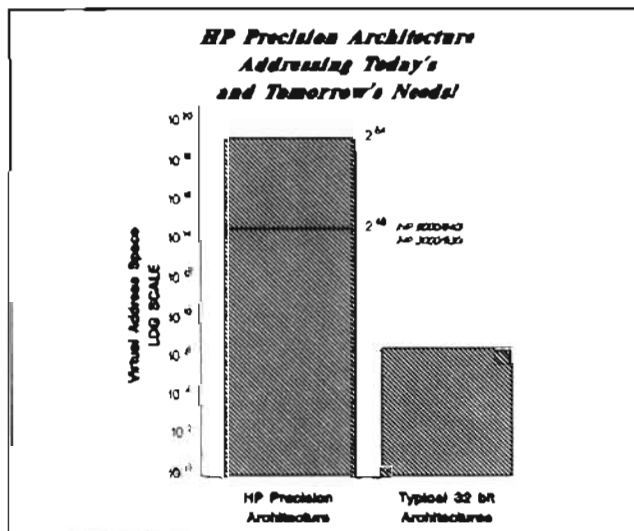

Figure 3: HP-PA Addressability

The result of these features is that the system is able to run faster, since extra decoding logic and data paths are eliminated; hardwired instructions execute faster than a microcoded instructions. Simpler hardware also means lower cost and higher reliability.

HP Precision Architecture is RISC and much more. HP Precision Architecture is scalable, allowing implementations in many technologies. Systems are available using TTL logic and NMOS VLSI chips. Other technologies, such as CMOS or ECL are also possible.

The architecture also accommodates attached processors and coprocessors. This means that implementations can be tuned to specific applications, such as when fast floating point calculations are required.

Finally, memory addressing needs are increasing rapidly. Modern programming techniques and artificial intelligence are using virtual address space at an almost alarming rate. To solve this problem, HP Precision Architecture offers a virtual address space sixty-four thousand times as big as other 32-bit systems. That's not all, to meet even the most ambitious projections for the future, the architecture allows a whopping total of 18.4 BILLION GBytes!

### The Bottom Line

HP Precision Architecture offers leading performance at reasonable prices today. In addition, a growth path to the future is assured by the scalability, provision for special processors, and vast virtual address space. In short, HP Precision Architecture is lasting value.

- More powerful supermini performance
- Price/performance leadership
- Standards-based software



Additionally, HP-UX includes real-time capability, a necessity for many industrial automation applications that require fast response to interrupts. Pre-emptive scheduling of the kernel allows execution of high priority processes immediately.

#### The Power of Industry Standards

In addition to an industry standard operating system, the Series 800 systems support IEEE 802.3, ARPA/Berkeley and TCP/IP networking standards. The ALLBASE database management system supports both IBM's Structured Query Language (SQL) relational data base, the de facto standard, and the IMAGE network data base. HP today can be added for fast, easy development of transaction entry and reporting applications. Graphics support includes the Starbase 2-D and 3-D graphics library, an implementation of the ANSI CG-VDI specifications, and the DGL/AGP graphics libraries for compatibility with existing applications using those libraries.

HP's Native Language Support (NLS), which enables localization and use of applications in 18 different languages, was adopted as the internationalization standard for X/OPEN.

#### Networking

The Model 850S communicates with HP 9000 and HP 1000 systems via LAN/9000 Series 800 and NS/9000 Series 800 communications products. Additional capability for communications with other UNIX systems, including non-HP systems, is offered by the ARPA Services/850 network services product.

HP's Model 850S supermini computer is the most powerful engineering, manufacturing and scientific computer in Hewlett-Packard history. The 850S is the fastest member of the HP 9000 Series 800 Precision Architecture family, outperforming other superminis in its price class with estimated relative throughput of 7.2 MIPS.

#### HP Precision Architecture's High End

The new HP 9000 Model 850S is the fastest member of the Series 800 family. The 850S offers up to 60% better CPU performance and greater expandability than the Model 840S.

It utilizes HP's proprietary VLSI NMOS III technology and runs under the HP-UX operating system. With enhancements added to equip the operating system for real-time supermini computer applications, the 850S represents a high capacity, high performance extension to both the HP 9000 and HP 1000 product lines.

The 850S is object code compatible with the other Series 800 systems, making applications migration simple and fast. The entire Series 800 family is highly compatible with the HP 9000 Series 500, 300, and 200 systems at the source code level.

#### Price/Performance Leadership in Multuser Applications

The Model 850S is clearly a price leader when compared to superminis with comparable specifications. With estimated relative throughput of 7.2 (to the 840S' 4.5), the 850S outperforms other superminis in its price class.

The 850S has the power to serve a department of scientific, engineering, or manufacturing users performing computation-intensive tasks. The speed and capacity of the 850S make it a good choice for scientific applications such as electronics modeling, circuit simulation, and finite element analysis.

In communications, the high data throughput capabilities of the 850S and industry standard HP-UX operating system meet the needs of network management, satellite control, and message switching applications. For use in the software development environment, the 850S offers large program support and sophisticated optimizing compilers which result in fast compile speeds.

#### Standard Operating System and More

The Model 850S, like the other members of the Series 800 family, executes the HP-UX operating system, which adheres to AT&T's UNIX® System V Interface Definition (SVID), Issue 2 Volume I. HP-UX also fully complies with the System V Verification Suite, which tests conformance with the SVID. HP-UX includes optimizing C, FORTRAN 77 and Pascal language compilers, a symbolic debugger, and all of the other applications development support features normally included with a full-featured UNIX system. Popular Berkeley features such as the C shell, sockets, job control, and the McKusick fast file system have been incorporated as well.

#### Ordering Information

	Price
HP9000 Series 800 Model 850S System**	HP 9742A \$200,000
with 16MB memory, floating point coprocessor, 2 bus converters, 2 channel adapters, 6-channel multiplexor, HP-IB interface, and 32-user HP-UX license.	
Additional Channel Adapter	HP A1101A \$ 15,000
Additional 16MB Main Memory	HP A1104A \$ 40,000
Cable Management System for up to 66 terminals, including a table for the system console.	HP I9749A \$ 900
HP-IB Interface	HP 27110B \$1,010
Parallel Asynchronous FIFO Interface	HP 27114A \$1,600
Asynchronous 6-channel Multiplexor	HP 27140A \$2,400
64-user HP-UX License	HP 92454A \$15,000
Credit for upgrade from 32-user license.	Opt. 0A2 -\$10,000
Unlimited HP-UX License	HP 92455A \$25,000
Credit for upgrade from 32-user license.	Opt. 0A2 -\$10,000
Credit for upgrade from 64-user license.	Opt. 0A3 -\$15,000
HP Native Language I/O and Stick Kanji Font	HP 92439A \$2,500
HP Simplex Kanji Font	HP 92433A \$1,200
HP FORTRAN 77/HP-UX for Model 850S	HP 92461A \$9,800
HP Pascal/HP-UX for Model 850S	HP 92462A \$9,800
HP Starbase/HP-UX Graphics Library for 850S	HP 92463A \$5,600
HP DGL/AGP/HP-UX Graphics Library for 850S	HP 92464A \$ 8,050
HP GK.S for 850S	HP 92529A \$4,620
ALLBASE/HP-UX and HProdav Developer Pack/HP-UX for 850S	HP 92468A \$56,000
ALLBASE/HP-UX for 850S	HP 92469A \$35,000
HP Vision for 850S	HP 92535A \$14,000
HProdav Developer Pack/HP-UX for 850S	HP 35307A \$35,700
HProdav Run-time Environment/HP-UX for 850S	HP 35308A \$7,100
LAN/9000 Series 800 Link for 850S	HP 91788A \$7,500
NS/9000 for 850S	HP 91789A \$6,000
ARPA/BSD Services for 850S	HP 50982A \$7,140

\* UNIX is a registered trademark of AT&T in the U.S. and other countries.

\*\* A system console and system table, ordered separately, are required to operate the HP 9742A.

# TECHNICAL COMPUTER SYSTEMS

## HP 9000 Model 840S System



HP 9000 Model 840S is shown here in expanded configuration, with new memory cards, I/O expander, 96 MB and 128 terminal or serial ports.

### HP Precision Architecture Performance

The new HP 9000 Series 800 Model 840S is Hewlett-Packard's first technical computer system based on the new foundation of HP Precision Architecture. Running under the HP-UX operating system, the Model 840S offers up to three times the CPU performance available on the HP 9000 Series 500 Model 550 or HP 1000 A900 system. Significant enhancements equip HP-UX to support real-time applications, making the Model 840S system a logical, high-capacity, high-performance extension of both the HP 9000 and HP 1000 computer system product lines. The Model 840S as an extension of the HP 1000 product line is specifically supported by extensive PORT/HP-UX facilities for applications migration from HP 1000 systems. The HP-UX based HP 9000 Series 500, 300, and 200 systems are highly compatible with the Model 840S because they operate under the same operating system, making data interchange and applications migration among HP 9000 systems virtually effortless. In addition, the Model 840S is object code compatible with the other members of the Series 800 family.

### Superior Price/Performance for Wide Applicability

The inherent design economy of HP Precision Architecture makes the 4.5 MIPS/2000KWIPS-BID performance of the Model 840S more affordable than other superminis with comparable specifications. The Model 840S is thus readily applicable to support computation-intensive applications found in engineering, scientific, business and industrial environments. Its large capacity and industry-standard HP-UX operating system affords an excellent environment for application developers.

### Real-time Functionality for Real-World Applications

HP-UX incorporates true real-time functionality. Predictable response to interrupts gives the Model 840S the ability to keep critical real-world processes under control. Automatic power-fail recovery restarts the Model 840S at the program statement whose execution was interrupted by a power failure. Priority-based pre-emptive scheduling gives execution preference to the most important programs so they can run immediately, if necessary. Process locking can keep programs and data in memory for fastest real-time response.

### Industry-Standard Software

As important as the true real-time performance of HP-UX is the fact that it has been achieved without compromising the compliance of HP-UX with the AT&T System V Interface Definition Issue 1 (SVID). HP-UX includes an optimizing C language compiler, a powerful symbolic debugger, and all of the other application development support features normally included with a full-featured UNIX® system. Additional optimizing compilers are available for FORTRAN 77 and Pascal programming. HP's new ALLBASE DBMS, which supports both industry-

standard SQL relational data management and IMAGE network-model data management, is available. HPtoday can be added for fast, easy development of transaction entry and reporting applications. HP VISOR can be added to provide easy access to HPSQL data. Graphics support includes the Starbase 2-D and 3-D graphics library, an implementation of the ANSI CG-VDI specifications, and the DGL and AGP graphics libraries for compatibility with existing applications that use those libraries. HP-UX and its supported software subsystems comply with official and de facto standards to the maximum extent practicable, to assure the widest possible usability of programs within the HP 9000 and HP 1000 system families and with respect to non-HP computer systems.

### Networking and Native Language Support

The Model 840 communicates with HP 9000 and HP 1000 systems via LAN/9000 Series 800 and NS/9000 Series 800 communications products. Additional capability for communication with other UNIX systems, including non-HP systems, is offered by the ARPA Services/800 network services product. HP-UX supports localization and use of applications in 16 different native languages and is available only from Hewlett-Packard.

### Memory and Graphics Support

The Model 840S has six available memory slots, and can be configured for up to 96MB of memory. Graphics software capabilities similar to the Series 300 offerings, including the Solid Rendering Display System (SRX), are also available.

### Model 840S I/O Expander

The Model 840S can be configured to include a two-bay system with the I/O Expander (option 601 or HP 19746B). The configurability with the 840S expander now supports up to 26 available CIO slots (28 including the MUX and HP-IB that come with the system), and can support up to 128 users.

### Ordering Information

	HP 9741A	Price
HP 9000 Series 800 Model 840S System*	HP 9741A	\$81,500
8MB memory, Floating Point, HP-UX, 6-channel MUX and HP-IB interface I/S		
Add 8MB of RAM	Opt 508	\$16,000
Replace 8MB RAM with 32MB RAM	Opt 531	\$36,000
Add 32MB of RAM	Opt 532	\$48,000
With 840S I/O Expander	Opt 601	\$27,000
Additional 8MB of RAM	HP 19748A	\$48,000
Additional 32MB of RAM	HP 19733A	\$64,000
Model 840S I/O Expander	HP 19746A	\$30,000
Cable Management System for u66 terminals, includes console table	HP 19749A	\$900
HP-IB Interface	HP 27110B	\$1,010
Parallel Asynchronous FIFO Interface	HP 27114A	\$1,600
Asynchronous 6-channel Multiplexer	HP 27140A	\$2,400
32-user HP-UX License	HP 92453A	\$10,000
Credit for upgrade from 16-user license	Opt 0A0	-\$5,000
64-user HP-UX License	HP 92454A	\$15,000
Credit for upgrade from 16-user license	Opt 0A1	-\$5,000
Credit for upgrade from 32-user license	Opt 0A2	-\$10,000
HP-UX Unlimited License	HP 92455A	\$25,000
Credit for upgrade from 16-user license	Opt 0A1	-\$5,000
Credit for upgrade from 32-user license	Opt 0A2	-\$10,000
Credit for upgrade from 64-user license	Opt 0A3	-\$15,000
HP FORTRAN 77/HP-UX	HP 92430A	\$7,000
HP Pascal/HP-UX	HP 92431A	\$7,000
ALLBASE/HP-UX	HP 36217A	\$25,000
HPtoday Developer Pack	HP 92440A	\$25,000
HPtoday Run Time Environment	HP 92441A	\$3,000
Starbase Graphics Library	HP 92436A	\$4,000
DGL/AGP, and Starbase Graphics	HP 92437A	\$5,750
Development system bundle, including FORTRAN 77 and Pascal compilers and DGL/AGP, and Starbase Graphics	HP 92438A	\$14,000
ALLBASE/HP-UX & HPtoday Developer Pack	HP 92442A	\$40,000
HP Display List	HP 92526A	\$1,500
HP VISOR Interface to HP SQL	HP 92534A	\$10,000
HP Simplex (KANJI font)	HP 92433A	\$1,200
Native Language I/O & Stick KANJI Font	HP 92439A	\$2,500
LAN/9000 Series 800 Link (with software)	HP 98194A	\$6,000
NS/9000 Series 800 Software	HP 98195A	\$4,000
ARPA Services/800	HP 50980A	\$10,000
Solid Rendering Display System with D Solid Graphics Accelerator	HP 98720A	\$11,000
Display Controller Interface	HP 98721A	\$10,000
8-plane Frame Buffer Memory	HP A1017A	\$2,500
	HP 98722A	\$4,500

\*The HP 9741A requires system console and system disc for operation





#### Superminicomputer Performance

The new HP 9000 Model 825S is the low end member of Hewlett-Packard's Series 800 line of superminicomputers based on HP Precision Architecture. Running under the HP-UX operating system, the Model 825S offers .5 to .7 times the supermini throughput of the Model 840S. The Model 825S is object code compatible with the Model 840S and 850S HP Precision Architecture systems so applications are completely portable. The Model 825S offers 1.5 to 2 times the performance of the HP 1000 A900 and HP 9000 Model 350. The Model 825S is a logical, high capacity, high performance extension of both the HP 1000 and HP 9000 product lines. HP-UX is the real-time implementation of the UNIX™ operating system and contains PORT/HP-UX facilities for application migration from HP 1000 systems. The HP-UX based HP 9000 Series 500, 300 and 200 systems are highly source code compatible with the Model 825S so application migration and data exchange is virtually effortless among HP 9000 systems.

#### Superior Price/Performance

Because HP Precision Architecture is based on reduced complexity principles, the Model 825S offers superior price/performance over other superminicomputers in its class. At 2.4 Million Double Precision Whetstone Instructions per Second, and 12.6 Million Dhrystone Instructions per Second, the Model 825S has very high CPU performance. In addition, the system offers a high degree of expandability with up to 64 users, 6.85 Gigabytes of disc memory, up to 14 I/O slots and 2 I/O channels. These characteristics along with UNIX-based HP-UX make Model 825S a powerful software development engine for multiple engineers who need simultaneous access to a high speed system. The high computation power make the Model 825S attractive for scientific users doing simulation, imaging or modeling. These characteristics also make the Model 825S well suited for seismic analysis, mapping and other earth resources applications. In manufacturing, the real-time capabilities of HP-UX and configurability make the Model 825S effective as an Area Manager in the CIM hierarchy. Its real-time functionality, capacity and power also equip the Model 825S for real-time monitoring, and control jobs, such as energy management systems or communications switch controllers. Powerful multiuser performance also makes the Model 825S well-suited for transaction-based business applications.

#### Real-time Functionality for Real-World Applications

HP-UX incorporates true real-time functionality. Predictable response to interrupts gives the Model 825S the ability to keep critical real-world processes under control. Optional automatic power-fail recovery restarts the Model 825S at the program statement whose execution was interrupted by a power failure. Priority-based pre-emptive scheduling gives execution preference to the most important programs so they can run immediately, if necessary. Process locking can keep programs and data in memory for fastest real-time response.

#### Industry-Standard Software

As important as the true real-time performance of HP-UX is the fact that it has been achieved without compromising the compliance of HP-UX with the AT&T System V Interface Definition Issue 1 (SVI1). HP-UX includes an optimizing C language compiler, a powerful symbolic debugger, and all of the other application development

support features normally included with a full-featured UNIX® system. Additional optimizing compilers are available for FORTRAN 77 and Pascal programming. HP's new ALLBASE DBMS, which supports both industry-standard SQL relational data management and IMAGE network-model data management, is available. HPtoday can be added for fast, easy development of transaction entry and reporting applications. HP VISOR can be added to provide easy access to HPSQL data. Graphics support includes the Starbase 2-D and 3-D graphics library, an implementation of the ANSI CG-VDI specifications, and the DGL and AGP graphics libraries for compatibility with existing applications that use those libraries. HP-UX and its supported software subsystems comply with official and de facto standards to the maximum extent practicable, to assure the widest possible usability of programs within the HP 9000 and HP 1000 system families and with respect to non-HP computer systems.

#### Networking and Native Language Support

The Model 840 communicates with HP 9000 and HP 1000 systems via LAN/9000 Series 800 and NS/9000 Series 800 communications products. Additional capability for communication with other UNIX systems, including non-HP systems, is offered by the ARPA Services/800 network services product. HP-UX supports localization and use of applications in 16 different native languages and is available only from Hewlett-Packard. See page 642 for more information.

#### Ordering Information

HP 9000 Series 800 Model 825S SPU w/8MB memory. Floating Point coprocessor, HP-UX operating system with 16 user license, 6 channel multiplexor and HP-IB interfaces, installation and manuals.	HP A1004A	\$42,500
Additional 2MB of RAM (max of 6 per 825S)	HP A1004A option 001	\$4,500
Additional 8MB of RAM (max of 6 per 825S)	HP A1004A Option 002	\$16,000
Add Model 825S CIO Expander Adds 7 CIO slots and includes channel adapter interface and cable	HP A1004A option 003	\$9,000
Add Battery Backup Unit	HP A1004A option OE1	\$2,200
Access Port Kit	HP A1015A	\$2,600
19 inch Rack Mount Kit for 825S	HP 97099A	\$550
19 inch Rack Mount Kit for Battery Backup	HP 19500B	\$85
HP-IB Interface	HP 27110B	\$1,010
Parallel Asynchronous FIFO Interface	HP 27114A	\$1,600
Asynchronous 6-channel Multiplexor	HP 27140A	\$2,400
32-user HP-UX License	HP 92453A	\$10,000
Credit for upgrade from 16-user license	Opt 0A0	-\$5,000
64-user HP-UX License	HP 92454A	\$15,000
Credit for upgrade from 16-user license	Opt 0A1	-\$5,000
Credit for upgrade from 32-user license	Opt 0A2	-\$10,000
HP FORTRAN 77/HP-UX	HP 92443A	\$4,550
HP Pascal/HP-UX	HP 92444A	\$4,550
ALLBASE/HP-UX	HP 92460A	\$16,250
HPVISOR HPSQL Interface	HP 92533	\$6,500
HPtoday Developer Pack	HP 35305A	\$16,250
HPtoday Run Time Environment	HP 35306A	\$3,250
Starbase Graphics Library	HP 92445A	\$2,600
DGL/AGP, and Starbase Graphics Libraries	HP 92446A	\$3,750
Development system bundle, including FORTRAN 77 and Pascal compilers and DGL/AGP, and Starbase Graphics Libraries	HP 92447A	\$9,100
ALLBASE/HP-UX & HPtoday Developer Pack	HP 92459A	\$29,250
LAN/9000 Series 800 Link (interface and software)	HP 91786A	\$4,000
NS/9000 Series 800 Software	HP 91787A	\$2,000
ARPA Services/800	HP 50981A	\$2,000

\* The HP 9741A requires system console and system disc for operation  
 \* UNIX is a trademark of AT&T in the U.S.A. and other countries.

# TECHNICAL COMPUTER SYSTEMS

## HP Precision Architecture

HP 9000 Model 825SRX



HP 9000 Model 825SRX Superworkstation combines high-performance computation with state-of-the-art 3D graphics for real-time design of complex assemblies. System processor performs at 8.2 times the DEC VAX 11/780, while the 3D graphics system performs 180,000 3D transforms per second.

### HP 9000 Model 825SRX Superworkstation

#### Mainframe Performance plus 3-D Graphics

The Model 825SRX is a superworkstation that combines high performance computation with state-of-the-art 3-D graphics. This combination provides the ability to perform real-time design of complex assemblies. You can enter design parameters, view the object in realistic terms, and simulate the performance of the part—all on the same workstation.

With earlier systems, there was always a trade-off between the simple user interface of the workstation and the compute power needed for simulation. The Model 825SRX gives you both. The system processor performs at 8.2 MIPS in a workstation environment, while the 3-D graphics system can perform 180,000 3-D transforms per second.

#### The System Processor

The heart of the Model 825SRX is the system processor. This SPU is an implementation of HP Precision Architecture using NMOS VLSI. Providing extremely high performance at reasonable cost, the Model 825SRX has the capability of performing tasks beyond the capabilities of other systems.

Simulations can be performed two times faster than most similar systems. This means that you can take the time to optimize designs without delaying the overall project. Better designs can be achieved faster.

The Model 825SRX SPU offers RAM capacity from 8 Mbytes to 48 Mbytes, all with built-in error detection and correction for high reliability. Virtual address space is unsurpassed, 281 thousand Gigabytes! Object-oriented programming will not cause you to exceed the capabilities of your system.

A built-in floating point processor allows high performance for the intensive floating point calculations often encountered in design simulations. With a performance rating of 2.5 million Whetstones per second (double precision), the Model 825SRX meets demanding requirements.

Optional battery backup allows the safeguarding of data in the event of a power failure. Should primary ac power be lost, the system will save its current state in system RAM and wait for power to return. When the power is restored, the system will resume execution where it left off. No complex restart is needed, and no data is lost.

#### 3-D Graphics Subsystem

The graphics system on the Model 825SRX is a high performance, solids rendering system for realistic rendering and interactive design. The basic system includes a high resolution, 19 inch color monitor and eight planes of frame buffer memory and four overlay planes. Both first-time displays and display updates are performed rapidly due to the tight coupling between the display system and the SPU. Hidden surface removal and shading are implemented in microcode in the display subsystem. Therefore, the SPU is not burdened by these activities, and throughput is improved.

For more demanding requirements, the system can be expanded to 32 planes, allowing the simultaneous display of 16.7 million colors.

A mouse and keyboard are used as the human interface, and these are included in the basic system. Output devices may include graphics plotters, printers, or ink jet plotters.

#### Ordering Information and Summary Specifications

##### SPU Specifications

CPU: HP-PA processor implemented in NMOS VLSI, 12.5 MHz clock rate  
 RAM: 8-48 Mbytes ECC RAM  
 Cache: 16 KBytes dual purpose cache  
 Virtual Memory: 281,000 GBytes (48 bits)  
 Performance:  
 Integer: 13,054 Dhrystones (version 1.1)  
 Floating Point: 2.5 MWhetstones/sec (double precision)  
 490 kFlops (double precision)

##### Graphics Specifications

Display Memory: 8 frame buffer planes plus 4 overlay planes, expandable to 32 frame buffer planes  
 Displayed Colors: 16 with 8 planes; 16.7 million with 32 planes  
 Monitor: 19 inch, 1280x1024, 60 Hz non-interlaced  
 Performance: 180,000 3-D transforms per second

A1005A Model 825SRX System \$69,500

##### Including:

SPU with 8 Mbytes ECC RAM and floating point processor  
 HP-IB Interface  
 LAN/9000 Link  
 ARPA/BSD Networking software  
 Workstation HP-UX Operating System  
 Keyboard  
 Mouse  
 Starbase Graphics Library  
 X-Window  
 Display Subsystem with 8-plane frame buffer, graphics accelerator, and 19 inch high resolution color monitor



HP 9000 Series 350SRX solid modeling workstation

#### HP 9000 Series 300

A modular family of high performance technical workstations designed for computer-aided design and instrument control applications, the Series 300 was developed with maximum flexibility in mind. Two levels of product structure are available: pre-configured systems to easily automate a wide range of design and measurement automation tasks. Or, for users with more customized requirements, a full range of individual component products are available making it feasible to build a system matched exactly to their specific needs.

Based on the Motorola 68010 and 68020 line of processors, the Series 300 is compatible with the Series 200 systems. Compatibility throughout the Series 300 family is ensured via object code compatibility.

#### System Processing Units

The basis for any Series 300 system is the system processing unit (SPU), which includes the CPU, RAM, floating point and standard system interfaces: HP-IB, RS-232, Battery-backed clock, HP-HIL, and timers. System expanders allow you to grow your 310, 320, 330 and 350 systems as your needs change.

#### Model 350

Based on the 25 MHz MC68020 processor with a 20 MHz MC 68881 floating point coprocessor, the Model 350 delivers up to 4 MIPS and the capability to address up to four Gbytes of virtual memory. The Model 350 houses four system boards: the processor board, an 8 Mbyte RAM board, and standard system interface board including standard system interfaces plus LAN, two channel DMA controller and high-speed disc interface. One system slot is available for installing a graphics board, interface board or a 2-slot DIO backplane. The 350 features a full 32-bit I/O Bus (DIO-II) and a dedicated 32-bit Memory Bus. Model 350 supports up to 32-Mbytes of RAM.

The full potential of the 25MHz 68020 is realized by the use of a 32 Kbyte cache with 32-bit wide entries operating at a 120 nsec cycle time. The custom Memory Management Unit translates virtual memory addresses into physical memory addresses in parallel with cache-miss detection. Maximum throughput is maintained for very large HP-UX programs and multiple concurrent processes.

**HP 98562B** \$21,900

Ideal applications: 3-D solid modeling, 3D design/analysis, wireframe design, PC circuit board design and routing, EE simulation and verification, AI program development, scientific simulation.

#### Model 330

The Model 330 is a 2 MIPS computer based on the Motorola: 16.67 MHz MC68020 processor, MC68881 floating point coprocessor, and MC 68851 Paged Memory Management Unit. Maximum system performance is ensured by operating 4 Mbytes of on-board RAM synchronously with the MC68020 processor. The 330 features a 32-bit Memory Bus, 32-bit DIO-II I/O Bus, plus the same system interface board as the 350. Two system slots are available for adding a RAM board, a graphics board or a 2-slot DIO backplane for accessories. Users can add an additional 4 Mbytes of RAM to this system.

**HP 98562A** \$10,000

Ideal applications: data manipulation and general computation, microprocessor system development, EE schematic capture, 2D mechanical design, personal productivity, computer-aided software engineering, data acquisition/analysis.

# TECHNICAL COMPUTER SYSTEMS

## HP 9000 Technical Computers (cont'd)

### HP 9000 Series 300



HP 9000 Series 300 workstation with options for design automation/measurement automation

#### Model 310

The Model 310 is a .4 MIPS computer consisting of a 10 MHz MC68010 processor, operating synchronously with one Mbyte built-in RAM. Configured with 16 Mbytes virtual memory, 16 bit memory bus, 512 × 400 B/W bit-mapped display interfaces, VLSI Memory Management Unit and standard interfaces. Box includes system slot for CPU, system slot for display board, plus 4 I/O slots for additional memory or interface cards.

**HP 98561A \$4,750**

Ideal application: Instrument Control, Architectural and Engineering Construction, Facilities Layout

#### Model 320

The Model 320 is a 1.8 MIPS computer consisting of a 16.67 MHz MC68020 processor, 16 Kbyte instruction and data cache (32-bit wide), 16.67 MHz MC68881 floating point coprocessor, one-Mbyte RAM board, 16 bit memory bus and a Human Interface board with standard interfaces.

**HP 98561B \$8,000**

Ideal applications: Data acquisition/analysis, data manipulation and general computation plus, EE schematic capture and 2-D mechanical design.

#### Series 300 Systems

**Design Automation:** The following Design Automation workstations are based on the UNIX® System V operating system, bringing together the high-powered 350 and 330 SPU's with industry leading graphics subsystems.

#### Model 350SRX Solid Modeling Workstation

The 350SRX, providing true interactive performance for design applications that require 3-D images and shaded solid models, consists of the 98562B 350 SPU, 98720A Solid Rendering Display Controller with 4-plane memory overlay, Opt. 721 3D Solid Graphics

Accelerator, Opt. 722 8-plane frame buffer memory, 98784A (1280 × 1024) 19-inch color monitor, 98725A interface card and cable for 98720A, 98290A RGB cable, 46021A keyboard, 46060A HP-HIL 2-button mouse, 46081A buffer box with speaker, 46084A ID module, 98515A Opt. 022 single user HP-UX AXE, plus 50952B Opt. 022 NS-ARPA Networking Services.

**HP 98587B \$54,900**

#### Model 350CH High-Performance 2-D Color Workstation

The 350CH couples high-power computation with industry leading 2-D graphics for such applications as printed circuit board and VLSI design, 2-D mechanical design, 2-D mapping and Architectural and Engineering Construction. It features the 98562B SPU, 98784A 19-inch color monitor, 8 planes frame buffer memory, 2 overlay planes, 98550A 1280 × 1024 resolution Color Graphics Board, 46021A keyboard, 46060A HP-HIL 2-button mouse, 46081A HP-HIL Extension with audio, 46084A HP-HIL ID module, 98515A Opt. 022 HP-UX Application Execution Environment, 50952B Opt. 022 NS-ARPA Networking Services.

**HP 98588A \$39,400**

#### Model 350C Color Workstation

The 350C provides high power computing for applications that require 2-D color capabilities. Included: the 98562B 350 SPU plus 98547A 6-plane color graphics board, 98782A 19" color monitor (1024 × 768), 46021A HP-HIL Keyboard, 46060A HP-HIL 2-button mouse, 46081A buffer box with speaker, 46084A ID module, 98290A RGB cable, 98515A Opt. 022 single-user HP-UX AXE, 50952B Opt. 022 NS-ARPA Networking Services.

**HP 98583C \$31,900**

\*For an AI Development workstation, order The Model 350AIC, which includes Common LISP and HP PROLOG/HP INRSB \$39,900

\*UNIX is a registered trademark of AT&T in the U.S. and other countries



HP 9000 Series 300 modular systems

#### Model 350M Monochrome Workstation

The 350M is a high-performance monochrome system well-suited for software engineering and AI application development, analog circuit design, and logic design and simulation. Based on the 98562B 330 SPU, it consists of the 98544B monochrome graphics board, 98786A 17-inch monochrome monitor (1024 × 768), 46021A HP-HIL keyboard, 46060A HP-HIL 2-button mouse, 46084A ID module, 98515A Opt. 022 single-user AXE and 50952B Opt. 022 NS-ARPA Networking Services.

HP 98582C \$24,600

\*For an AI Development workstation, order The Model 350AIM, which includes Common LISP and HP PROLOG/HP 98584B \$31,600

#### Model 330C Color Workstation

The Model 330C high-resolution system provides powerful personal computing for UNIX-based applications. It includes the 98562A 330 SPU, plus 98547A 6-plane color graphics board with RGB cable, 98785A 16-inch color monitor (1024 × 768), 46021A HP-HIL keyboard, 46060A HP-HIL mouse, 46081A HP-HIL buffer box, 46084A HP-HIL ID module, 98515A Opt. 022 single user AXE, 50952B Opt. 022 NS-ARPA Networking Services.

HP 98583L \$16,900

#### Model 330M Monochrome Workstation

The Model 330M high-resolution system provides personal, powerful computing for HP-UX applications. Based on the 98562A 330 SPU, the 330M adds a 98544B monochrome graphics board, 98786A 17" monochrome monitor, 46021A HP-HIL keyboard, 46060A HP-HIL mouse, 46084A HP-HIL ID module, 98515A Opt. 022 single-user AXE, 50952B Opt. 022 NS-ARPA, 1 meter HP-IB cable, RS-232 cable, HP-HIL cable, RGB cable.

HP 98582M \$12,700

#### Model 318M Monochrome Workstation

Utilizing the same 16.6 MHz CPU board as the Model 330, the Model 318M is a low-cost, restricted configuration, 2-board computer system. It includes a MC68881 Floating Point Coprocessor, four Mbyte RAM, 32-bit memory bus, 1024 × 768 bit-mapped monochrome display, IEEE-488 HP-IB interface, RS-232C Serial Interface, IEEE 802.3/Ethernet LAN interface with ThinMAU and "T" connector, HP Human Interface Link (HIL), Two-channel DMA controller, HP-IB and HP-HIL cables.

HP 98563A \$7,000

#### Measurement Automation

Combining the highest performance BASIC Language System found in the market today with the versatile, low-cost 330, 310 and 308 systems, the following workstations address applications in a wide range of measurement automation arenas.

#### Model 330MMA Monochrome Instrument Controller

The Model 330MMA consists of the 98562A 330 SPU, Opt. 010 98262A high-speed disc interface, Opt. 006 98242B 2-slot DIO backplane, 98542A medium resolution monochrome graphics board, 35731A 12-inch monochrome monitor, 46021A HP-HIL keyboard, 98616A Opt. 045 BASIC 5.0, 1 meter HP-IB cable, RS-232 adaptor cable.

HP 98580M \$12,500

#### Model 330CMA Color Instrument Controller

The Model 330CMA is based on the 98562A Model 330 SPU, plus Opt. 010 98262A high-speed disc interface, Opt. 006 98242B 2-slot DIO backplane, 98543A medium resolution color graphics board with RGB cable, 35741A 12-inch color monitor, 46021A HP-HIL keyboard, 98616A Opt. 045 BASIC 5.0, 1 meter HP-IB, RS-232 adaptor cable.

HP 98581M \$15,500

#### Model 310C Low-Cost Color Workstation

Based on the Model 310, this workstation consists of 98561A SPU, 98543A medium resolution color graphics board with RGB cables, 35741A 12" Color Monitor, 46021A keyboard, and BASIC 5.0. Includes a 10 MHz 68010 processor, HP-IB, RS-232, HP-HIL interfaces.

HP 98581A \$8,500

#### Model 310M Measurement Automation Workstation

Based on Model 310, this MA workstation consists of a 35731A 12" monochrome monitor, 46021A keyboard, 98616A Opt. 044 BASIC 5.0. Includes a 10 MHz MC68010 Processor, HP-IB, RS-232, HP-HIL and medium resolution monochrome graphics interfaces.

HP 98580A \$5,750

#### PC-308 HP Basic Controller

Based on the IBM-PC compatible HP Vectra, with an HP BASIC Language Processor plug-in card, the PC-308 workstations are ideally suited to applications that demand both the high performance of HP-BASIC and PC compatibility. The PC-308 offers the productivity and performance of HP-BASIC as well as access to all of the PC-DOS software of the IBM-PC compatible HP Vectra. Refer to the "Vectra Personal Computer" section for more details.

HP 82314A \$6,495

# TECHNICAL COMPUTER SYSTEMS

## HP 9000 Technical Computers (cont'd)

### HP 9000 Series 300

#### PC-305 HP BASIC Low-Cost Controllers

HP 82316A	\$3495
HP 82317A	\$3995
HP 82318A	\$4595

#### User-Configured Systems

For users with specialized requirements, all the SPUs and graphics components are available individually. In addition, the Series 300 includes a myriad of accessories and interfaces, from system expanders to customizable general purpose I/O cards.

#### Bit-Mapped Displays

All displays plug into Series 300 SPUs and require a system slot.

##### Graphics boards

Medium-resolution, monochrome, bit-mapped graphics board, 512x400 pixels displayed  
HP 98542A \$800

Medium-resolution, four-plane color, bit-mapped graphics board, 512 x 400 pixels, 16 colors  
HP 98543A \$2,400

High-resolution, monochrome, bit-mapped graphics board, 1024x768 pixels displayed  
HP 98544B \$1,400

High-resolution, six-plane color, bit-mapped graphics board, 1024x768 pixels displayed  
HP 98547A \$4,500

Medium-resolution, monochrome alpha/graphics video board set for Series 200 display compatibility, 512x390 pixels displayed  
HP 98546A \$850

High-resolution, 10 plane color, bit mapped graphics board, 1280 x 1024 pixels displayed  
HP 98550A \$9,800

Provides high-performance 3D graphics, 1280 x 1024 resolution, four-plane frame buffer upgradeable to 24 image planes, hardware Z-buffer, four overlay planes.  
HP 98720A \$11,000

3D transform engine and scan converter for use with HP 98720A to provide interactive 3D solid rendering.  
HP 98721A \$10,000

##### Monitors

12-inch monochrome monitor, 60 Hz, 115 Vac, for use with 98542A graphics board or 98561A graphics output  
HP 35731A \$325

12-inch monochrome monitor, 60 Hz, 115/230 Vac, for use with 98542A video board or 98561 compatibility display.  
HP 35731B \$340

12-inch color monitor, 60 Hz, 115 Vac, for use with 98543A graphics board  
HP 35741A \$1,195

12-inch color monitor, 60 Hz, 115/230 Vac, for use with 98543A graphics board  
HP 35741B \$1,195

16-inch high-resolution (1024 x 768) color monitor, 60 Hz, 115/230Vac, for use with the 98547A graphics board  
HP 98785A \$3,500

16-inch, high-resolution (1280 x 1024) color monitor 60Hz, 115/230Vac, for use with the 98550A graphics board or 98720A Display Controller  
HP 98789A \$3,500

17-inch high-resolution monochrome monitor, 60 Hz, 115/230 Vac, for use with 98544B graphics board.  
HP 98786A \$2,000

19-inch high-resolution, (1024 x 768) color monitor, 60 Hz, 115/230Vac, for use with the 98547A graphics board  
HP 98751A \$6,500

19-inch, high-resolution (1280 x 1024) color monitor, 60 Hz, 115/230Vac, for use with the 98550A graphics board or 98720A Display Controller  
HP 98752A \$6,500

##### HP-HIL Input Devices

Digitizer (11" x 11", 12 lines/inch resolution)  
HP 45911A \$499

Keyboard (U.S.ASCII version)  
HP 46021A \$225

Keyboard w/rotary knob for BASIC/Pascal systems  
HP 98203C \$750

Mouse  
HP 46060A \$148

2.4-meter extension  
HP 46080A \$85

2.4-meter extension w/audio  
HP 46081A \$205

15-meter remote extension w/audio, mouse  
HP 46082A \$720

30-meter remote extension w/audio, mouse  
HP 46082B \$1,015

Knob  
HP 46083A \$185

ID Module  
HP 46084A \$180

Control dial Module  
HP 46085A \$1,320

32-button Box programmable function keys  
HP 46086A \$875

Digitizer, ANSI A/ISO A4 size  
HP 46087A \$795

Add 4-button cursor w/crosshair  
Opt. 001 \$260

Digitizer, ANSI B/ISO A3 size  
HP 46088A \$1,275

Add 4-button cursor w/crosshair  
Opt. 001 \$260

4-button cursor for 46087/88  
HP 46089A \$260

Quadrature Port  
HP 46094A \$150

3-button Mouse, uses 46094A Quadrature Port  
HP 46095A \$150

Touchscreen Bezel  
HP 35723A \$395

Bar Code Reader  
HP 92916A \$590

##### Upgrades

I/O Card Cage Upgrade Kit - adds four-slot card cage to 98570, Opt. 004 which has no I/O, or to 330 SPU (98562A)  
HP 98242A \$450

I/O Card Cage Upgrade Kit - adds two-slot card cage to 98562A/B SPU or to 98570A Opt. 004  
HP 98242B \$380

Series 300 Processor Upgrade Kit - upgrade from Model 310 to 320  
HP 98243B \$5,750

Direct connect 8-slot I/O Expander  
HP 98568A \$1,900

Required option for 330 and 350  
Opt. 132 \$410

Direct connect DIO-II Expander - adds 2 DIO-II slots and 4 DIO slots to a 98582A/B SPU  
HP 98570A \$2,310

Delete 4-slot DIO backplane for total of 4-DIO II system slots  
Opt. 004 -400

16-slot DIO Expander - maximum of 2 allowed in system  
HP 9888A \$3,885

High speed disc interface for Model 330 system  
HP 98262A \$930

##### RAM

256 Kbyte RAM card  
HP 98256A \$600

1 Mbyte RAM card for 310, 320  
HP 98257A \$1,450

Quantity of 20 - 1 Mbyte RAM cards  
HP 98257P \$26,000

Fast ship product - See page 758

4 Mbyte RAM Controller for Models 330 and 350  
HP 98258A \$5,450

4 Mb RAM add-on for 350 only for total of 8 Mbytes  
HP 98258B \$4,950

12 Mb RAM add-on for 350 only for total of 16 Mbytes  
HP 98258C \$13,950

SPU Accessories

EIA 19-inch rack mounting kit - for 35731A  
HP 98567A \$225

EIA 19-inch rack mounting kit - for 35741A  
HP 98567B \$225

EIA 19-inch rack mounting kit - for SPU  
HP 98569A \$235

##### DOS Coprocessor

The Series 300 DOS Coprocessor System provides IBM PC AT DOS software compatibility for HP 9000 Series 300 Technical Workstations. DOS COPROCESSOR SYSTEM - includes DOS Coprocessor, interface card, and DOS Coprocessor software.

HP 98286S \$1,295

Please refer to Page 653 for more detailed information on the DOS Coprocessor.

##### VMEbus Connection

HP 9000 VMEbus Interface - Includes DIO interface card, VME card, cable and manual.  
HP 98646A \$1,272

VMEbus Software Drivers -

Pascal Opt. 24X  
HP 98358A \$106

HP-CX Opt. 34X  
HP 98358A \$212

BASIC Opt. 44X  
HP 98358A \$106

##### HP Networking

HP 9000 Series 200, 300, 500 and 800 computers using the HP-UX operating system offer a wide range of networking products such as Ethernet/IEEE 802.3 local area network. Please refer to page 642 for additional information.



Model 216

### Series 200 Bundled Systems

#### Model 216

The Model 216S has a 229mm (9-inch) monochrome CRT with 400×300 graphics, detached keyboard, 256 Kbyte internal RAM, plus an additional 256 Kbyte RAM (512 Kbyte total), and two backplane slots. HP-IB and RS-232C interfaces are built in. An option (Opt. 256) is provided to delete BASIC and 256K RAM if desired.

#### Model 220

The Model 220S includes the Model 220A base system plus 2M HP-IB cable, rack mount kit, HP 98203A keyboard and 3M extension cord, HP 98204A Composite Video Card set, and an additional 512 Kbyte RAM (640Kb total). It includes BASIC and Pascal.

#### Model 226

The Model 226S Computer includes the Model 226A base system, an additional 512 Kbyte RAM (640Kb RAM total), BASIC and Pascal.

#### Model 236

The Model 236CS includes the Model 236C base color system, with an additional 512Kb RAM (640Kb total), BASIC and Pascal. It has six additional backplane slots.

The Model 236S is based on the Model 236A, includes 512 Kbyte additional RAM (640Kb RAM total), BASIC and Pascal. Six backplane slots are available.

### Ordering Information

Model 216S Computer with BASIC	9816S	\$5,150
Model 220A Modular Computer	9920A	\$4,500
Model 220S Modular Computer with keyboard, BASIC, Pascal and 640 Kbyte RAM	9920S	\$8,000
Model 226A Computer/Instrument Controller	9826A	\$9,535
Model 220U Modular HP-UX Computer w/15-slot card cage	9920U	\$5,700
Model 226S Computer/Controller with BASIC, Pascal, SRM and 640 Kbyte RAM	9826S	\$11,555
Model 236U Computer with 12.5 MHz processor	9836U	\$13,595
Model 236CU Color Computer with 12.5 MHz Processor	9836CU	\$16,685

### HP 9000 Series 200

First introduced in 1981, the Series 200 technical workstation is based on the Motorola MC68000 family of micro-processors, with 16/32-bit internal architecture. The 68010 processor at 12.5 MHz is used in the 9920U and 9836U/CU models. Other Series 200 models use a 68000 processor at 8 MHz. All Series 200 computers support both BASIC and Pascal operating systems and can be configured as workstations in a Shared Resource Manager (SRM) network.

#### Model 220

The Model 220 Modular Computer is rack-mountable with separately available keyboards, monitors, and disc drives. The Model 220A has 128 Kbyte RAM. It includes the HP-IB interface and eight backplane slots.

#### Model 226

The Model 226 Technical Computer is ideal for Computer-Aided Test applications.

The Model 226A features a 178mm (7-inch) monochrome CRT with 400×300 graphics, 128 Kbyte internal RAM, integrated 5/4 inch flexible disc drive, integrated keyboard, and HP-IB interface. It has an eight-slot backplane and can support up to 7.25 Mbytes internal RAM.

#### Model 236

The Model 236 is the most integrated of the Series 200 and has applications from instrument control to electronic design and mechanical drafting.

The 236A Technical Computer features a 310mm (12-inch) monochrome CRT with 512×390 graphics, 128 Kbyte internal RAM, two integrated 5/4 inch flexible disc drives, integrated keyboard, and HP-IB interface. It has an eight-slot backplane and supports up to 7.25 Mbyte RAM. The Model 236C includes the same integrated keyboard, interface, disc drives, eight backplane slots, but substitutes a 12" color CRT with 512×390×4 programmable map graphics and 4,096 color shades.

The Model 236U has the same CRT, keyboard, disc drives, backplane slots and interface as the Model 236A. The Model 236CU features the same keyboard, color CRT, interface, backplane slots and disc drives as the Model 236C.



Model 236

# TECHNICAL COMPUTER SYSTEMS

## HP 9000 Technical Computers

Vectra PC HP BASIC, HP Pascal, & CAD Workstations



### Vectra PC Controllers

Hewlett-Packard offers prepackaged versions of the Vectra PC specially configured for our technical customers.

The PC-308M/C Vectra HP-BASIC Controllers provide the unequalled power of HP BASIC on a personal computer that can run the enormous variety of solutions available for the IBM® PC/AT® and its compatibles. The key to this match is the HP BASIC Language Processor System.

The Language Processor features a built-in HP-IB, and an optional GP-IO card for high-speed I/O access. An optional Shared-Resource-Manager (SRM) card allows a Vectra using the Language Processor System to act as a node on an SRM network. The Language Processor System allows up to 4 megabytes of RAM, for customers with large HP BASIC or Pascal programs.

Together, the Vectra PC and the Language Processor provide the best of both worlds: compatibility with the wealth of hardware and software available for the Vectra, and the convenience, speed, and power of HP's premier BASIC instrument-control language.

The Language Processor System (and accessories) can be purchased separately, allowing customers to convert their Vectra PCs into HP BASIC Controllers. (HP Pascal can also run on the Language Processor, and Pascal Software and Pascal Language Processor Systems can also be purchased separately.)

Hewlett-Packard also offers the PC-305 MF/MH/C Vectra CS HP-BASIC Controller which are lower in cost and performance than the PC-308 M/C Vectra Controller. The HP BASIC Language Processor is also included with a built-in HP-IB, and the controllers have access to thousands of solutions available on an IBM PC/XT.

### Vectra System Configurations

- **PC-305MF:** Vectra CS with 640 kilobytes RAM single 1.4 megabyte 3.5" floppy drive, RS232/parallel, BASIC Language Processor with HP-IB, 512 K RAM, BASIC 5.0 ROM, 35731A Monochrome Display, 45981A Multimode Video Adaptor, DOS with PAM.
- **PC-305MH:** Adds 20 megabyte hard disc subsystem to above
- **PC-305C:** Vectra CS with 640 kilobytes RAM single 1.4 megabyte 3.5" floppy drive, 20 megabyte hard disc subsystem, RS232/parallel, BASIC Language Processor with HP-IB, 512K RAM, BASIC 5.0 ROM, 45983A EGA Color Adapter, 35743A EGA Color Display with tilt/swivel base, DOS with PAM.
- **PC-308M:** Vectra PC with 640 kilobytes RAM single 1.2 megabyte floppy drive, RS-232/parallel 20 megabyte hard-disc drive DOS with PAM BASIC Language Processor with HP-IB, 1 megabyte RAM 35731A Monochrome display 45981A Multimode Video Adapter Vectra PC with 640 kilobytes RAM single 1.2 megabyte floppy drive 20 megabyte hard-disc drive DOS with PAM BASIC Language Processor with HP-IB, 1 megabyte RAM 24540A Serial/Parallel interface 45983A EGA adapter 35743A EGA display with tilt/swivel base
- **PC-308C:** Vectra PC with 640 kilobytes RAM single 1.2 megabyte floppy drive 20 megabyte hard-disc drive DOS with PAM BASIC Language Processor with HP-IB, 1 megabyte RAM 24540A Serial/Parallel interface 45983A EGA adapter 35743A EGA display with tilt/swivel base

### Language Processor System Specifications

- System Processing Unit: Motorola 68000, 8 MHz
- Operating System: HP BASIC /HP Pascal
- Memory: 512 kilobytes RAM on main board, expandable to 1 megabyte on main board. Piggyback board with 512K RAM, expandable to 3 megabytes — for maximum system RAM of 4 megabytes.
- I/O Interfaces: Built-in HP-IB. Optional SRM and GP-IO interfaces on separate boards. (Uses host Vectra for display, keyboard, mass storage, real-time clock, serial and printer ports.)
- Size: Standard PC/AT® 8-bit full-length board (4.75" by 13")
- Power Consumption: 1.1 amperes at 5 volts (typical)

### Ordering Information

	Price
• 82314A Vectra PC-308M HP BASIC Controller	\$5760
• 82315A Vectra PC-308C HP BASIC Controller	\$6530
• 82316A Vectra CS PC-305MF HP BASIC Controller	\$3495
• 82317A Vectra CS PC-305MH HP BASIC Controller	\$3995
• 82318A Vectra CS PC-305C HP BASIC Controller	\$4595
• 82300A HP BASIC Language Processor System (with built-in HP-IB, 512K RAM, software, and documentation).	\$1320
• 82301A HP BASIC (software only)	\$505
• 82303A 512K RAM Expansion Kit	\$505
• 82305A RAM Expansion Board	\$605
• 82306A GP-IO Interface	\$505
• 82307A GP-IO Cable	\$195
• 82310A HP Pascal Language Processor System (with built-in HP-IB, 512K RAM, software, and documentation).	\$1320
• 82311A HP Pascal (software only)	\$505
• 50963 SRM Interface	\$845

\* For more information on the Vectra HP BASIC and HP Pascal Controllers, contact your HP sales representative.





The HP Integral Personal Computer is a transportable, HP-UX computer system for solution creators developing workstation-class software for mobile applications.

#### The HP Integral Personal Computer

The HP Integral Personal Computer delivers the performance of an HP-UX operating system in a fully integrated, affordable and easy-to-use package. The HP-UX operating system adheres to AT&T's System V Interface Definition, Issue 1. Everything you need for full computing power—a printer, keyboard, monitor, mass storage, and an optional HP Mouse—is provided in the transportable Integral PC.

The standard 512K bytes of memory is expandable to 7M bytes. And, there's 512K bytes of ROM, containing the HP-UX operating system built in. Also included in ROM is the Personal Applications Manager (PAM), a friendly user interface, and the HP Windows multi-window manager.

PAM simplifies the user approach to the powerful operating system, and has been customized for the Integral PC's multi-tasking environment. For high-end users, the Integral PC also offers traditional UNIX operating system shells.

In addition, an optional Software Engineering ROM Module provides over 150 of the most commonly used HP-UX commands including a complete "C" compiler and symbolic debugger; text editing, formatting, and spelling checker; data communications; maintenance tools; and system utilities. This provides a fast, reliable, truly transportable, low cost, integrated software development solution.

#### The Integral PC Features

- Motorola 68000, 16/32-bit microprocessor, 8 MHz
- 16-bit graphics processor
- 512K byte ROM contains:
  - HP-UX kernel
  - HP Windows
  - Personal Applications Manager (PAM)
- Standard 512K bytes of RAM expands to: 7M bytes
- Microfloppy 3 1/2 inch disc drive, 710K byte
  - Amber/black electroluminescent 9-inch display
  - Two Hewlett-Packard Human Interface Loop (HP-HIL) connectors
- Built-in HP ThinkJet Printer
- Fully functional, typewriter-style keyboard
- HP-IB interface
- Two expansion ports; extendable to ten with bus expander option
- Compatible with HP 9000 family of HP-UX computers

#### HP-UX and the Integral PC

The HP-UX kernel is stored in ROM, providing the Integral PC with on-board power. You can run UNIX-operating-system-based software programs and applications installed on 3 1/2 inch floppy discs, or stored in EPROM or ROM on the EPROM/ROM Module, eliminating the necessity of a Winchester hard disc.

#### UNIX Operating System Software Library

A substantial number of UNIX-based tools are available, especially for software development, text processing, and communications. The library includes Pascal, FORTRAN, and "C" compilers, designed primarily for programming experts. Additionally, a Device Independent Library (DIL) provides high-level language control of instruments through compiled languages. This saves time when programming high-performance computer-aided test solutions.

Real-time extensions are available through HP-UX to provide reliable interrupt handling and priority setting in a multi-tasking instrument control environment.

#### Graphics Display

The Integral PC features a 9-inch, 24-line x 80-column, amber and black electroluminescent (EL) display. The flat panel display is tilt-adjustable, compact, and very readable. The Integral PC's bit-mapped display uses square pixels, which produce excellent, high-quality graphics. It has 255 pixels vertically and 512 pixels horizontally. The 16-bit graphics processor supports high-speed line drawing and can change windows rapidly.

#### Specifications

- Microprocessor/CPU:** Motorola 68000, 16/32-bit processor running at 8 MHz
- Graphics Processor:** 16-bit, with 32K bytes of dedicated RAM
- Operating System:** HP-UX (UNIX System V)
- Memory:** 512K bytes ROM  
512K bytes RAM, expandable to 2.5M bytes in main system and to 7M bytes with I/O expanders
- Mass Storage:** Single 710K byte double-sided, double-density 3 1/2 inch microfloppy
- Display:** 9-inch electroluminescent (EL), 24-line x 80-column screen with adjustable tilt; 256 x 512 pixels
- Keyboard:** Fully spaced, 90-key, full-travel typewriter-style HP-HIL compatible
  - Eight function keys
  - Numeric pad
- Internal Printer:** Built-in ThinkJet
  - 150 cps
  - 1K byte buffer
  - 11 x 12 dot character matrix text print resolution
  - 96 x 96 or 192 x 96 dots per inch graphics resolution
  - Bold and underline print modes
  - Less than 50 dB sound pressure printing noise
- Input/Output:** HP-IB, two HP-HIL, and two expansion ports (can be extended to ten ports using two Bus Extenders)
- Weight:** 25 pounds (11.4 kilograms)
- Dimensions:** 7 x 13 x 16 inches (178 x 330 x 406 mm)

#### How to Order Your Integral Personal Computer

For more information on the Integral PC, contact your HP sales representative or your local HP personal computer dealer.

#### Ordering Information

**HP 9807A** The Integral Personal Computer  
The Integral PC comes complete with the HP-UX operating system, 16/32-bit microprocessor and graphics processor, 512K-byte ROM, 512K-byte RAM, 710K-byte 3 1/2 inch microfloppy disc drive, 9-inch EL display, built-in ThinkJet Printer that includes 50 sheets of paper and a printhead, low-profile 90-key keyboard with numeric keypad, internal clock and speaker, power cable, six applications and utilities discs, and comprehensive documentation.

**Price**  
\$5693

# TECHNICAL COMPUTER SYSTEMS

## HP 9000 Technical Computers

### Languages and Operating Systems



#### HP-UX

Hewlett-Packard supplies industry-recognized languages to give you a broad span of programming capability including: BASIC, FORTRAN 77, Common LISP, PROLOG, Ada\*, Pascal and C. These languages all run on our HP-UX operating system.

HP-UX is an exceptionally powerful, standards-based operating system offering high capacity, high performance, and excellent transportability of applications between systems operating under the UNIX system, including systems from different vendors.

HP-UX is based on AT&T's UNIX System V in compliance with the SVV52 assuring portability of applications developed on other SVID compliant systems. HP-UX B.1 and 5.2, HP's implementation of AT&T's UNIX System V Release 2.0 running on the Series 800 and Series 300 respectively, have been tested using the AT&T System V Verification Suite and conform to the Base System plus Kernel Extension as specified in Issue 2 of the AT&T System V Interface Definition. HP-UX also incorporates features from U.C. Berkeley's 4.2 BSD (Berkeley Software Distribution).

In addition, HP-UX includes many innovations to extend the capabilities of the UNIX system. Those HP-UX features include: real-time enhancements, high performance file access, device I/O libraries, Native Language Support, and the X Window System.

#### HP Pascal

HP Pascal is a software tool for structured application software. Pascal has gained wide acceptance among software professionals as a block-structured, strong-typed language that produces easily read source code.

The system features include:

- a Hierarchical File System (HFS) for tree-structured directories and subdirectories
- Powerful and versatile data and programming structures including program segmentation
- An I/O Procedure Library providing sophisticated device I/O
- A Graphics Library with full peripheral support
- A Librarian allowing the user to create custom procedure libraries.

#### C Language

The C language is the HP-UX system programming tool and a vehicle for transporting software from other UNIX systems. C has a syntax which incorporates certain data and control structures similar to those of Pascal. It also provides very low-level operations and the weak type checking of assembly language. The increased flexibility of the C language offers system programmers a closer, more efficient interface to the hardware than does Pascal.

#### HP FORTRAN 77

The HP 9000 FORTRAN 77 compilers are supersets of the ANSI X3.9-1978 FORTRAN standard commonly referred to as FORTRAN 77 and have been validated by the Federal General Services Administration. These compilers are designed to provide a well-defined language standard for software portability and to feature extensions that enhance the flexibility and power of the FORTRAN language. The result is a modern programming language for the engineer that allows for growth on the large base of available FORTRAN software.

#### Ada\*

Ada\* is a programming language designed in accordance with requirements defined by the U.S. Department of Defense and adopted as an ANSI standard (ANSI/MIL-STD-1815A). Ada is the only programming language approved for DoD mission-critical applications.

A modern programming language, Ada is designed to decrease the development and maintenance costs of large-scale software systems and can be used in commercial, industrial and education environments.

#### Common LISP

HP offers a complete development environment for Common LISP, a software product designed for the development of LISP-based applications. The HP integrated development environment balances the capabilities of symbolic computing with the capabilities of a general purpose workstation.

#### HP PROLOG

The development environment for HP PROLOG allows the programmer to describe problems using symbolic logic in much the same way that humans reason. PROLOG allows the programmer to develop programs that deal with the logical content of a problem without being overly concerned about the manner in which it is solved. The benefits of PROLOG include: integration into the same environment as Common LISP; access to multiple PROLOG dialects; and extensions such as declarative determinism, procedural programming and floating point and rational numbers.

#### HP Technical BASIC

HP Technical BASIC is a BASIC interpreter for the Integral PC, HP 9000 Series 300 and Series 500 HP-UX computer systems. HP Technical BASIC offers an easy to use, interpretive BASIC language and development environment suitable for rapid prototyping, personal programming and program development.

The HP 9000 family of computers is also available on the BASIC or Pascal operating systems. Both are independent of the HP-UX operating system.

#### HP BASIC

HP BASIC 5.0 Language System adds to the inherent simplicity of BASIC the computational power usually found in FORTRAN, ALGOL, and APL. Beyond that, high-performance, I/O intensive constructs are incorporated giving BASIC 5.0 the highest performance found in interactive instrument control systems on the market today.

BASIC 5.0 provides numerous major enhancements: a Hierarchical File System (HFS), complex numbers, and support for the new 32-bit workstations. These features, along with a host of other additions in the areas of human interface, matrix operations and back-up and restore capabilities, are available with the 5.0 release while maintaining compatibility with the previous release.

The Pascal 3.2 Language System gives you all the advantages of a compiled language, a small, tightly controlled execution environment, and more. It offers you high speed and protection from program modification, plus extensive enhancements not found in other Pascal systems.

UNIX is a registered trademark of AT&T in the U.S. and other countries.  
Ada\* is a registered trademark of the U.S. Government (A-JPQ).

## Series 800 Languages and Operating Systems

Hewlett-Packard's Precision Architecture HP 9000 Series 800 is based on HP's HP-UX operating system, which complies with the AT&T System V Interface Definition Issue 2. Each machine in the Series 800 comes standard with an HP-UX operating system. The size of the license included with the hardware depends on the particular Series 800 machine ordered. The Models 825 and 840 come standard with a 16-user HP-UX license. The Model 850 comes standard with a 32-user HP-UX license.

There are four HP-UX operating system products for the Series 800 computers:

<b>92452A</b>	HP-UX 16-user license for the Series 800	\$5,000
<b>#AA0</b>	Software on 1/4" Cartridge Tape	\$0
<b>#AA1</b>	Software on 1/2" 1600 cpi Tape	\$0
<b>#OB0</b>	Delete Manuals	-\$300
<b>#OCC</b>	Revision upgrade for users not on support services	-\$2,900
<b>92453A</b>	HP-UX 1-32 user license for the Series 800	\$10,000
<b>0A0</b>	Upgrade from current 16-user (92452) system (Requires prior or concurrent purchase of 92452A)	-\$5,000
<b>#AA0</b>	Software on 1/4" Cartridge Tape	\$0
<b>#AA1</b>	Software on 1/2" 1600 cpi 9-track tape	\$0
<b>#OB0</b>	Delete Manuals	-\$300
<b>#OCC</b>	Revision upgrade for users not on support services	-\$7,660
<b>92454A</b>	HP-UX 1-64 user license for the Series 800	\$15,000
<b>#0A1</b>	Upgrade from current 16-user (92452) system (Requires prior or concurrent purchase of 92452A)	-\$5,000
<b>#0A2</b>	Upgrade from current 32-user (92453) system (Requires prior or concurrent purchase of 92452A)	-\$10,000
<b>#AA0</b>	Software on 1/4" Cartridge tape	\$0
<b>#AA1</b>	Software on 1/2" 1600 cpi 9-track tape	\$0
<b>#OB0</b>	Delete Manuals	-\$300
<b>#OCC</b>	Revision upgrade for users not on support services	-\$12,600
<b>92455A</b>	HP-UX Unlimited user license for the Series 800	\$15,000
<b>#0A1</b>	Upgrade from current 16-user (92452) system (Requires prior or concurrent purchase of 92452A)	-\$5,000
<b>#0A2</b>	Upgrade from current 32-user (92453) system (Requires prior or concurrent purchase of 92452A)	-\$10,000
<b>#0A3</b>	Upgrade from current 64-user (92454) system (Requires prior or concurrent purchase of 92452A)	-\$15,000
<b>#AA0</b>	Software on 1/4" cartridge tape	\$0
<b>#AA1</b>	Software on 1/2" 1600 cpi 9-track tape	\$0
<b>#OB0</b>	Delete Manuals	-\$300
<b>#OCC</b>	Revision upgrade for users not on support services	-\$22,540
<b>92439A</b>	Native Language I/O and Stick Kanji Font for Series 800	\$2,500
<b>#AA0</b>	Software on 1/4" cartridge tape	\$0
<b>#AA1</b>	Software on 1/2" 1600 cpi 9-track tape	\$0
<b>92433A</b>	Simplex Kanji Font for Series 800. (Requires current version of 92439A)	\$1,200
<b>#AA0</b>	Software on 1/4" cartridge tape	\$0
<b>#AA1</b>	Software on 1/2" 1600 cpi 9-track tape	\$0

The HP-UX Operating System for the Series 800 comes standard with a C compiler. In addition, FORTRAN and Pascal are available for the Series 800 systems.

	Model 825	Model 840	Model 850
<b>FORTRAN/77</b>	<b>92443A</b> \$4,550	<b>92430A</b> \$7,000	<b>92461A</b> \$9,800
<b>Pascal</b>	<b>92444A</b> \$4,550	<b>92431A</b> \$7,000	<b>92462A</b> \$9,800

\*These products are also available on 3 1/2-inch discs for a higher price.

## Series 300 Languages and Operating Systems

### HP-UX Operating System

HP-UX Application Execution Environment. Includes HP-UX Kernel, installation software, HP Windows/9000 and Personal Applications Manager (PAM)

Single-user	<b>HP 98515A</b>	\$350*
1 - 16 multi-user	<b>HP 98595A</b>	\$760*
1 - 32 multi-user	<b>HP 98596A</b>	\$3,200*

HP-UX Programming Environment. Includes commands, C Compiler, MC680X0 assembler, Symbolic Debugger, RS-232 Data Communications, Device I/O and Starbase Graphics Library. Requires 98515A (single-user), 98595A (1 - 16 users) or 98596A (1 - 32 multi-users).

Single-user	<b>HP 98517A</b>	\$900
1 - 16 multi-user	<b>HP 98597A</b>	\$1,200

HP-UX FORTRAN 77 Compiler. Requires 98517A/97A.

Single-user	<b>HP 98518A</b>	\$500
Multi-user	<b>HP 98598A</b>	\$800

HP-UX Pascal Compiler. Requires 98517A/97A

Single-user	<b>HP 98519A</b>	\$500
Multi-user	<b>HP 98599A</b>	\$800

HP-UX DGL/AGP Graphics Library. Requires 98517A/97A.

Single-user	<b>HP 98520A</b>	\$1,000
Multi-user	<b>HP 98600A</b>	\$1,600
SRM Access Utilities for HP-UX	<b>HP 98693A</b>	\$500

RJE Software for HP-UX.

Single-user	<b>HP 98797A</b>	\$1,010
Multi-user	<b>HP 98798A</b>	\$2,525

Ada<sup>®</sup> Software for HP-UX

Single-user	<b>HP 97054A</b>	\$3,125
Multi-user	<b>HP 97055A</b>	\$4,275

### BASIC Language

RAM-based BASIC 5.0 Language System with Hierarchical file system. Includes one system disc set, BASIC 5.0 Utilities and manuals for Series 200 and 300.

BASIC 5.0 Compiler. Includes compiler disc and manual (for Series 200 and 300).

Single-user	<b>HP 98616A</b>	\$875.
-------------	------------------	--------

ROM-based BASIC 4.0 Language System. Includes on ROM board, BASIC 4.0 Manual Kit and BASIC 4.0 Utilities (for Series 200 and 300).

Single-user	<b>HP 98618A</b>	\$505.
-------------	------------------	--------

RAM-based BASIC 4.0 Language System. Includes one system disc set, BASIC 4.0 Utilities and manuals (for Series 200 and 300).

Single-user	<b>HP 98603A</b>	\$1,895.
-------------	------------------	----------

ROM-based BASIC 2.0 Language System. Includes one system ROM board, BASIC 2.0 Manual kit and BASIC 2.0 Utilities

Single-user	<b>HP 98613B</b>	\$875.
-------------	------------------	--------

ROM-based BASIC 2.0 Plus Extensions 2.1 Includes one ROM board, BASIC 2.0 with Extensions Manual Kit and BASIC 2.0 Utilities.

Single-user	<b>HP 98602A</b>	\$3,060
-------------	------------------	---------

### Pascal Language

RAM-based Pascal 3.2 Language System. Includes system disc set and Pascal 3.2 Manual Set (for Series 200 and 300).

Single-user	<b>HP 98617A</b>	\$1,015.
-------------	------------------	----------

RAM-based Pascal 3.1 Language System. Includes system disc set and Pascal 3.1 Manual Set (for Series 200 and 300).

Single-user	<b>HP 98615C</b>	\$1,015.
-------------	------------------	----------

### HPL Language

ROM-based HPL 2.0 Language System. Includes one system ROM board, HPL 2.0 Language Manual Kit and HPL 2.0 Utilities (not available for Models 220 or 236C).

Single-user	<b>HP 98604A</b>	\$1,445.
-------------	------------------	----------

RAM-based HPL 2.1 Language System. Includes system flexible disc, HPL 2.0 Language Manual Kit and HPL 2.0 Utilities (not available for Models 220 or 236C)

Single-user	<b>HP 98614A</b>	\$360.
-------------	------------------	--------

# TECHNICAL COMPUTER SYSTEMS

## HP 9000 Technical Computers

### Networking

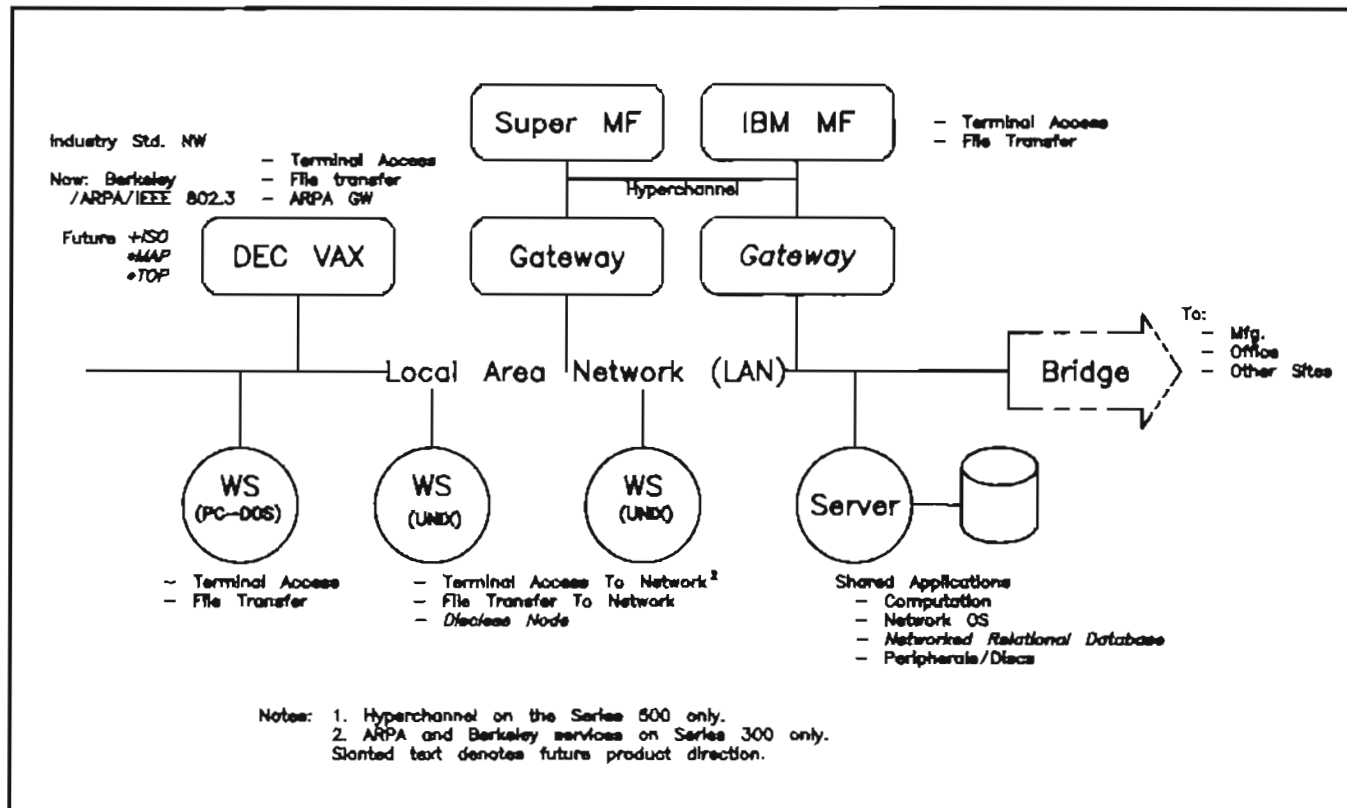

Model Networking Environment

#### HP AdvanceNet: the networking solution

Hewlett-Packard's AdvanceNet is a communications strategy and network architecture designed to provide a broad range of networking alternatives. HP AdvanceNet is a modular, scalable network that improves communication and productivity. To increase productivity, HP AdvanceNet links engineering workstations through a high-speed LAN so engineers can move large design files quickly. We then connect workstations to larger computers by using industry standard protocols.

While the network improves communications, it also lowers costs by allowing everyone to share expensive peripherals, thus minimizing the cost per user.

Using HP AdvanceNet, engineers can share transparent access to files, data bases and sophisticated peripherals like printers, plotters and disks.

In the HP-UX environment, a user on any engineering workstation can access resources on any other network station. A workstation can also act as a dedicated peripheral server for heavy use.

HP AdvanceNet is solidly based on industry standards, which protects your investment. We provide multivendor communications by supporting industry and de facto standards important to the engineering community, including IEEE 802.3 and Ethernet, Transmission Control Protocol and Internet Protocol (TCP/IP), and ARPA and Berkeley networking services.

Hewlett-Packard's membership in standards organizations guarantees that HP AdvanceNet will continue to provide a solution that adheres to new, evolving standards.

In addition, HP AdvanceNet supports other protocols commonly used in mainframe computer centers, such as SNA and HYPERchannel, providing easy access to these essential resources. Additional services provide such capabilities as file and peripheral sharing and the ability to develop customized network protocols.

As a full-range computer supplier, Hewlett-Packard provides network solutions that connect your entire company, including manufacturing and business offices.

#### HP AdvanceNet: a modular, step-by-step implementation

HP AdvanceNet's modular approach makes it easy to implement your network step by step. Each module is designed to help solve a particular networking problem in workgroups, engineering computer centers, site computer center access, companywide access and facility wiring.

##### Workgroup module

HP AdvanceNet connects engineering workstations and personal computers into workgroups. These workgroups can be connected to each other and to other resources.

The module provides strong peer-to-peer capabilities, which connect multivendor equipment through an IEEE 802.3 or an Ethernet LAN. HP AdvanceNet utilizes industry standard TCP/IP, along with ARPA/Berkeley and HP's Network Services, to provide compatibility with a wide range of engineering computer systems.

Files can be shared through Remote File Access. Programs can communicate with other programs using industry-standard Berkeley services.

Since workgroups change as projects are completed and new ones begun, the workgroup modules are easy to modify. Workstations running the HP-UX operating system are connected using IEEE 802.3 and thinLAN cable. This cabling allows easy addition and deletion of stations since workstations are connected to the cable with simple BNC connectors. A peripheral server can be configured as part of the workgroup.

Workstations running BASIC or PASCAL operating systems are connected using the Shared Resource Manager (SRM), which allows users to share peripherals and files among these different operating systems.

The SRM also supports booting of the operating systems over the network, allowing BASIC and PASCAL systems to operate without the need for local disks - further reducing the cost per user.

The HP-UX environment is supported on both the SRM and IEEE 802.3 networks and can serve as a means to tie both networks together.

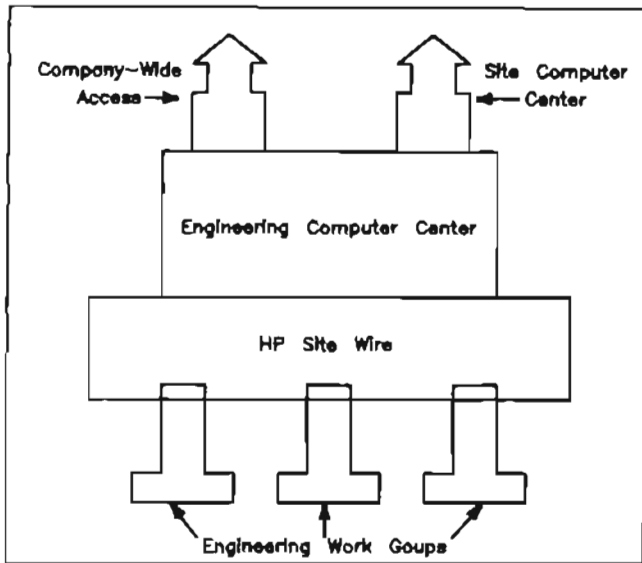

HP AdvanceNet for Engineering

**Engineering computer center module**

HP AdvanceNet provides a flexible and powerful network module for the multiuser systems and workstation servers typically found in engineering computer centers.

Communications with a wide variety of common minicomputers and superminicomputers are provided via standard ARPA networking services. In addition, HP's Network Services can connect with VAX computers through a product that is compatible with DECnet and features file transfers between VAX computers and all HP computer families.

**Site computer center access module**

To handle complex engineering computations, this module provides access to mainframes and supercomputers in the site computer center.

A wide range of network protocols is supported, providing compatibility with most existing computer networks. This minimal impact approach eliminates costly and time-consuming changes inside your computer center.

The module includes a gateway to access IBM mainframes via either SNA or HYPERchannel. Bisync capabilities offer an alternative connection to IBM and many other types of mainframes.

**Company-wide access module**

For remote connections, this module provides standard UNIX communications via uucp and cu. These services are supported over both dial-up asynchronous lines and X.25 packet-switched networks. The module gives engineers access to information located anywhere in the company.

**HP SiteWire module**

HP AdvanceNet uses a flexible and efficient wiring plan to connect workstations and provide access to other computing resources elsewhere in the facility. HP SiteWire is designed to be compatible with the wiring in your existing engineering networks, while establishing a foundation for future growth.

Workstations are wired together into workgroups using thinLAN. Workgroups are connected together and to the rest of the facility with thickLAN.

Both baseband and broadband cabling are available. Repeaters and bridges permit interconnection of multiple LAN segments and extend the LANs to cover longer distances.

**Ordering Information**

**Engineering Work Groups**

Keyboard (ASCII) for Server	HP 46021A	\$225
12-in. Video Monitor for Server	HP 82913A	\$325
Network Services/200	HP 50956A/57A	\$405/1015
Network Services-ARPA Services/300	HP 50952B	\$1015
LAN/300 Link	HP 98643A	\$1325
Network Services/500	HP 50954A/R	\$4080
LAN/500 Link	HP 27125B	\$2600
ARPA Services/840	HP 50980A/R	\$4080
Network Services/840	HP 98195A/R	\$3500
LAN/840	HP 98194A	\$5500
ARPA Services/825	HP 50981A/R	\$2040
NS/825	HP 91787A/R	\$2000
LAN/825 Link	HP 91786A	\$4000
ARPA Services/850	HP 50982A/R	\$7140
NS/850	HP 91789A/R	\$6000
LAN/850 Link	HP 91788A	\$7500
NS for DEC VAX Computer	HP 50950A	\$6120/11,200
ThinMAU	HP 28641A	\$350
MAU	HP 30241A	\$400
Shared Resource Management	HP 50960A/61A/62A/63A	\$5090/2445 \$860/862
NFS	HP 50969A	To be Announced

**Non-HP Products:**

Fusion* From Network Research Corp. for Vectra PC	NRC FNS-PC-TCP	\$350
ARPA/Berkeley Services for Series 500 from Wollongong	WIN/H9000	\$7500

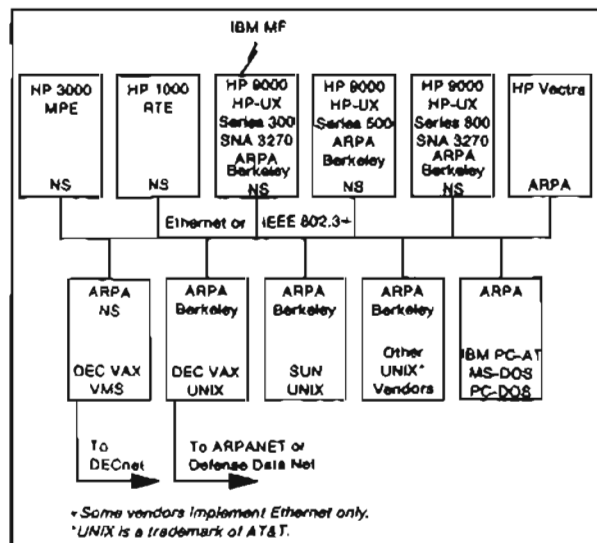

\*Some vendors implement Ethernet only. \*UNIX is a trademark of AT&T.

MISC-CORP 1/0787PD

HP 9000 Series 200, 300, 500 and 800 computers using the HP-UX operating system can connect directly to the Ethernet/IEEE 802.3 local area network (LAN).

# TECHNICAL COMPUTER SYSTEMS

## HP 9000 Technical Computers (cont'd)

### Networking

#### Engineering Computer Center

NS/500	HP 50954A	\$4080
LAN/500 Link	HP 27125B	\$2600
NS for DEC VAX Computer	HP 50950A	\$6120/11,200
ARPA Services/840	HP 50980A	\$4080
LAN/840 Link	HP 98194A	\$5500
NS/840	HP 98195A	\$3500
ARPA Services/825	HP 50981A/R	\$2040
NS/825	HP 91787A/R	\$2000
LAN/825 Link	HP 91786A	\$4000
ARPA Services/850	HP 50982A/R	\$7140
NS/850	HP 91789A/R	\$6000
LAN/850 Link	HP 91788A	\$7500

#### Non-HP Products:

ARPA/Berkeley Services for Series 500 from Wollongong	WIN/H9000	\$7500
---	-----------	--------

#### Site Computer Center Access

3278 Emulator for HP Vectra PC	HP 50920A	\$1195
SNA/Link/3270 (Remote 3270 SNA Terminal Emulator for HP Vectra)	HP 50921A	\$295
Advancelink 2392 for Vectra PC	HP 68333F	\$295
HP-UX SNA3270 for HP 9000 Series 300 Computer Systems	HP 36590A	\$1020
HP-UX Gateway/SNA3270 for HP 9000 Series 300 Computer Systems	HP 36591A	\$1020
HP-UX SNA Link for HP 9000 Series 300 Computer Systems	HP 36592A	\$5610
HP-UX Gateway/ SNA Link for HP 9000 Series 300 Computer Systems	HP 36593A	\$6120
HP-UX Gateway/SNA 3270 for HP 9000 Series 800 Model 825 Computer	HP 36918A/R	\$3000
HP-UX Gateway/SNA 3270 for HP 9000 Series 800 Model 850 Computer	HP 36919A/R	\$10,000
HP-UX Gateway/SNA 3270 for HP 9000 Series 800 Model 840 Computer Systems	HP 36911A/R	\$7140
3278 Display Station Emulator	HP 50955A	\$1500
HP 9000 RJE Emulator for Series 300	HP 50967A	\$1500
RJE Interface for Series 200/300	HP 27122A	\$2115
HP 9000 RJE Emulator for Series 500	HP 50968A	\$2500
RJE Interface for Series 500	HP 98641A	\$1250

#### Non-HP Products:

Network Systems® HYPERchannel® Software	Contact Local HP Sales Office
Host-to-Adapter Interfaces for HYPERchannel®	Contact Local HP Sales Office

ARPA/Berkeley Services for Series 500 Wollongong Network Server/Mitek Systems Corp.	WIN/H9000	\$7500
	M/2030/M2130	\$29,000 \$21,000

#### Company Wide Access

HP-UX Asynchronous Data Communications: cu, uucp, uux X.25 Multiplexer	Bundled with HP-UX HP 2334A PLUS	\$2300
---	--	--------

#### HP SiteWire

LAN/300 Link	HP 98643A	\$1325
LAN/500 Link	HP 27125B	\$2600
LAN/840 Link, LAN/825, LAN/850	HP 98194A	\$5500
Shared Resource Management	HP 50960A/ 61A/62A/63A	\$4995/2395 \$845/845
ThinMAU	HP 28641A	\$350
MAU	HP 30241A	\$400
10 Mbps-10 Mbps LAN Bridge	HP 28648A	\$8000
Scicor® Fiber Optic MAU	Model 10-222	\$750

#### Related Software Products:

Network Services/200	HP 50956A/57A	\$405/1015
Network Services-ARPA Services/300	HP 50952B	\$1015
Network Services/500	HP 50954A/R	\$4000
ARPA Services/840	HP 50980A	\$4080
Network Services/840, NS/825, NS/850	HP 98195A/R	\$3500
ARPA/825, ARPA/850		
Network Services for DEC VAX Computer	HP 50950A	\$6120/11,200
ThinLAN HUB	HP 28645A	\$3010
Repeater Kit	HP 92223A	\$4080

#### Miscellaneous Connections

RS-232C Asynchronous Serial Interface for Series 200 and 300	HP 98626A	\$380
Data Communications Interface for Series 200 and 300	HP 98628A	\$485
4-channel Multiplexer for Series 200 and 300	HP 98642A	\$600
RS-232C Asynchronous Serial Interface for Series 200 and 300	HP 98644A	\$190
HP 2392 and VT100 Terminal Emulator for Series 200 and 300	HP 98791B	\$500
HP-UX Asynchronous Data Communications: cu, uucp, uux	Bundled with HP-UX	
Asynchronous Serial Interface for Series 500	HP 27128A	\$930
Asynchronous 8-channel Multiplexer for Series 500	HP 27130B	\$2100
Asynchronous 6-channel Modem Multiplexer for Series 500	HP 27140A	\$2450
Programmable Data Communication Package	HP 98690A/91A	TBD/650

#### Non-HP Products:

Communications Server/ Terminal Controllers Bridge Communications, Inc.	CS100	\$5400
Asynchronous Terminal Emulator for Series 500 Basic	LS-1	\$16,000
	HP 97056A	\$515

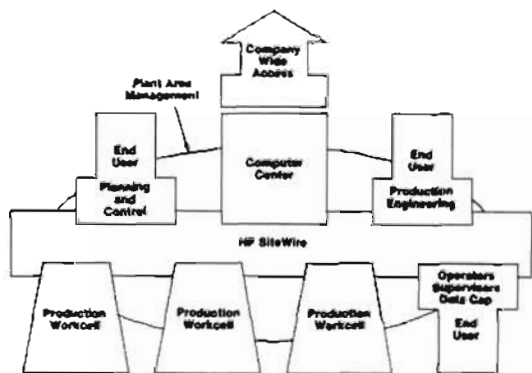

**CIM Networking Modules**

### HP AdvanceNet: The Information Network for Computer Integrated Manufacturing

To lower your operating costs, HP AdvanceNet provides instant information exchange among all your manufacturing functions, including planning and control, financial systems, production processes, production engineering and product design. Computer Integrated Manufacturing (CIM) is the key to gaining the competitive edge by improving quality, productivity and flexibility.

HP AdvanceNet also solves the problem of making terminal connections to a wide range of systems and applications. By keeping terminal transactions separate from system to system communication, the network allows many terminal types to access a variety of computers throughout the site.

Our peer-to-peer services are based on the Open Systems Interconnect model (OSI) developed by the International Standards Organization (ISO). These services overcome one of the principal obstacles to CIM by providing full networking functionality for multivendor information management, no matter where systems are located in the factory. Our Manufacturing Automation Protocol (MAP) products are only one example of our OSI commitment.

HP AdvanceNet's modular approach makes it easy to implement your network step by step. Each module is designed to help solve a particular networking problem in the wiring system, departmental subnets, data centers and plant-wide integration. Like any good CIM plan, HP AdvanceNet lets you implement the network in affordable, manageable steps.

#### HP SiteWire Module

HP AdvanceNet is built on a communications wiring infrastructure called HP SiteWire, which creates a plant-wide network backbone to connect people with information.

Subnetworks gain easy access to the backbone from anywhere in the plant. As your plant configurations change, the network backbone easily accommodates them.

The primary and most versatile HP SiteWire backbone option is based on the IEEE 802.7 broadband standard. This option meets the most demanding needs and allows multiple voice, video and data channels. It lets you mix terminals, point-to-point links, LANs and more on a single backbone cable, and it supports MAP.

An IEEE 802.3 backbone is available for less complex situations that do not require video, voice or specialized data services.

For your subnetwork needs, HP SiteWire offers inexpensive twisted pair solutions for terminals and LANs. Where additional ruggedness is required, IEEE 802.3 ThinLAN is supported on all our factory systems. Our experienced network consultants will custom design HP SiteWire to meet your unique requirements.

#### End-user Modules

HP AdvanceNet offers a wide range of end-user solutions to enhance departmental productivity while providing access to information throughout the plant. Options include multivendor terminal clusters and the latest in industry-standard LANs. Each option solves problems in specific areas like planning and control, the shop floor and production engineering.

HP AdvanceNet helps improve the productivity and effectiveness of your planning and control staff with industry-standard StarLAN,

which connects PCs with information systems over low-cost, unshielded twisted pair.

To provide operators and supervisors with plant-wide information, we connect terminals to systems from different vendors through terminal cluster solutions. Data collection and retrieval are simple when one terminal or bar code reader can access MRP, JIT or quality applications no matter where they're running.

To connect UNIX workstations, we use industry-standard IEEE 802.3 with ARPA and Berkeley networking services. Production engineers can then share files and expensive peripherals. They can also access mainframe resources and product design groups. With tight communications between production engineering and design, new products get to market faster.

#### Production Workcell Module

Before you can achieve CIM, you must establish effective islands of automation. But CIM is easier to accomplish if these islands are initially designed to communicate with the rest of the plant. Planning ahead eliminates the high cost of retrofitting your islands for plant-wide communications.

HP AdvanceNet helps you build effective workcells with extensive connectivity to factory floor devices. For common shop floor devices like PLCs and numerical control equipment, we offer a broad range of EIA RS-232 interfaces, from low-cost to user-programmable.

For the product test and data acquisition, Hewlett-Packard combines its leading position as an instrument supplier with its workcell controllers, connecting instruments via IEEE 488 (HP-IB).

The network also makes it easy to create workcell clusters. Our real-time UNIX and DOS PCs connect easily with IEEE 802.3 ThinLAN. An ideal choice for product test clusters is the Shared Resource Manager (SRM), which connects our popular BASIC and PASCAL systems.

When you're ready, HP AdvanceNet connects your workcells and clusters to the rest of the plant. Even if you have systems from many different vendors, HP AdvanceNet supports MAP, HP Network Services (NS), NS for DECVAX, ARPA, and SNA network links and services.

#### Computer Center Module

For your data center, we provide IEEE 802.3 ThinLAN subnets for Hewlett-Packard and DEC equipment and SNA products for connections to IBM and compatible mainframes. With HP AdvanceNet, you get improved flexibility in application deployment and development, better access to data bases and peripheral sharing.

By connecting your data center to the entire plant, we eliminate isolated subnets. All end-user and workcell subnets gain access through one or more options in our plant area management module to create the complete CIM foundation.

#### Plant Area Management Module

Application integration is CIM's major benefit, and we provide it plant-wide among multiple vendors. We offer a choice of services, including HP Network Services for communications via IEEE 802.3 and TCP/IP protocols across our baseband or broadband backbone.

For industry-standard multi-vendor applications in production engineering and links to product design, we offer industry-standard ARPA and Berkeley services for UNIX systems and workstations.

All HP AdvanceNet services are based on the Open Systems Interconnect model, ensuring that future services and protocols can easily be added to your network, preventing the obsolescence of existing equipment.

If you're currently implementing an effective CIM plan, our new HP precision architecture UNIX systems are the ideal area managers for distributed plant information management systems.

#### Company-wide Access Module

HP AdvanceNet's industry-standard X.25 wide area networking gives you instant communications with headquarters, suppliers and customers. These extensive connections keep you in touch so you don't find out three weeks later what caused you to miss that critical shipment and lose an important account.

You can also improve productivity and lower costs with worldwide electronic mail, even if you have a SNA company network.

**TECHNICAL COMPUTER SYSTEMS****HP 9000 Technical Computers (cont'd)****Networking for Computer Integrated Manufacturing****HP Sitewire**

MAU	HP 30241A	\$400
ThinMAU	HP 28641A	\$350
Repeater Kit	HP 92223A/C	\$4080
ThinLAN Hub	HP 28645A	\$3010
StarLAN Hub	HP 27212A	\$1375
StarLAN Bridge	HP 28647A	\$5000
Buffered Repeater	Ungermann-Bass	
Terminal Server HP Network Planning Design	Ungermann-Bass	Custom Quote

**End User****Operators, Supervisors, Data Capture**

Terminal Servers for HP 3000	Ungermann-Bass	
Advanced Terminal Processor	HP 30273A	\$7660
ATP Direct Connect Package	HP 30145A	\$6720
ATP Direct Port Controller	HP 30144A	\$3240
ATP System Interface Board	HP 30274A	\$9240
ATP Modem Expansion Package	HP 30155A	\$8300
ATP Modem Port Controller	HP 40290A	\$3670
ATP 37/M for HP 1000		
8-Channel Asynch. Multiplexer for HP 9000/200/300	HP 12040D	\$2175
Direct I/O Serial Interface	HP 98642A	\$610
Terminal Emulator for HP 9000/500	HP 98791B	\$510
Channel I/O Asynchronous 6-Channel Multiplexer	HP 27140A	\$2450
Channel I/O Asynchronous 8-Channel Multiplexer	HP 27130B	\$2100
Advancelink 2392 (Terminal Emulator for HP VECTRA)	HP 68333F	\$300

**Planning and Control**

AdvanceLink 2392 (for Vectra/IBM PC)	HP 68333F	\$300
LAN3000/V Link	HP 30242A	\$3085
NS3000/V Network Services	HP 32344A	\$1020
StarLAN Configurator/Diagnostics Software	HP 50906A	\$795
StarLAN/TbinLAN Configurator/Diagnostics Software	HP 50912A	\$1830-\$3665
StarLAN HUB	50912R	\$1280-\$2565
StarLAN Server Kit	HP 27212A	\$1375
StarLAN User Link Kit	HP 50904F	\$1375
StarLAN Bridge	HP 50905F	\$595
Buffered Repeater	HP 28647A	\$595

**Production Engineering**

Buffered Repeater	Ungermann-Bass	
ThinLAN Hub Multipoint Repeater	HP 28645A	\$3010
Network Services-ARPA/300	HP 50952B	\$1015
Network Services for the DEC VAX		\$6120-
Network Services/200	HP 50950A	\$11220
Network Services/500	HP 50956A, 57A	\$405/\$1015
LAN/300 Link	HP 50954A	\$4080
LAN/500 Link	HP 98643A	\$1325
ARPA Services/800	HP 27125B	\$2600
Network Services/9000/800	HP 50980A	\$10200
LAN/9000 Series 800 Link	HP 98195A	\$4080
	HP 98194A	\$6120

**Production Workcell**

For HP 1000 A-Series		
8-Channel Asynch. Multiplexer	HP 12040D	\$2175
Programmable Serial Interface	HP 12042B	\$2070
PSI Firmware Dev. Package	HP 24602A	\$1020
8-Channel Multiuse Asynchronous Multiplexer	HP 12041A/B	\$2730
HP-IB I/O (Series 200/300)	HP 12009A	\$1120
Direct I/O HP-IB Interface	HP 98624A	\$610
Programmable Datacomm I/O	HP 98691A	\$665
VECTRA Prog./Datacomm	HP 98690A	\$415
HP-IB I/O and Command Library for SRM	HP 82990A	\$410
SRM Coax Network for HP 9000 200/300 running BASIC or PASCAL	HP 50960A	\$5090
	61A	\$2445
	62A	\$860
	63A	\$860

**Computer Center**

NS3000/V Network Services	HP 32344A	\$1020-\$5610
NS3000/XL Network Services	HP 36920A	\$3825-\$7650
ThinLAN Hub	HP 28645A	\$3010

ThinLAN 3000/V Link	HP 30240A	\$3085-\$7140
ThinLAN 3000/XL Link	HP 36921A	\$9180
Advanced Terminal Processor ATP for Meridian SL-1 I/O	HP 30276A, 77A	\$8305/\$9240
Distributed Terminal Controller	HP 2345A	\$7240
	2346A/B	\$2775/\$3500
	C	\$2775

Terminal Server	Ungermann-Bass	
Buffered Repeater	Ungermann-Bass	

**Plant Area Management****HP Network Services**

For HP 9000 Systems		
Network Services/800	HP 98195A	\$4080
Network Services/500	HP 50954A	\$2855
Network Services-ARPA/300	HP 50952B	\$1015
Network Services/200 (HP 3000)	HP 50956A, 57A	\$405/\$1015
NS3000/XL Network Services	HP 36920A	\$3825-\$7650
NS3000/V Network Services	HP 32344A	\$1020-\$5610
For HP 1000 A-Series Systems		
Network Services/1000	HP 91790A	\$1530-\$7140

**ARPA/Berkeley Services**

HP NS/ARPA/300	HP 50952B	\$1015
ARPA Services/800	HP 50980A	\$10200

**IBM Connectivity**

HP-UX SNA 3270	HP 36590A	\$1020
HP-UX Gateway SNA/3270	HP 36591A	\$1020
HP-UX SNA Link	HP 36592A	\$5610
HP-UX Gateway/SNA Link	HP 36593A	\$6120
HP-UX Gateway/SNA 3270	HP 36911A	\$7140
3278 Display Station Emulator	HP 50955A	\$1530
HP-UX RJE Emulator 300	HP 50967A	\$1530
RJE Interface	HP 98641A	\$1275
HP-UX RJE Emulator 500	HP 50968A	\$2550
RJE Interface	HP 27122A	\$2155
RJE/1000-II	HP 91781A	\$1630-\$5100
MRJE/1000	HP 91782A	\$2040-\$6120

**Company-wide Access**

Access to an X.25 Company-Wide Network		
NS3000/V Network Services	HP 32344A	\$1020-\$5610
X.25 Link/3000; X.25 Line Concentrator (Dynapac) (for U.S. Only)		
HP 32187A	HP 32187A	\$3630-\$8220
LAN 3000/V Link	HP 30242A	\$3055-\$7140
SNA/IMF	HP 30247A	\$3570-\$8975
SNA/NRJE	HP 30245A	\$2450-\$6120
SNA Link	HP 30246A	\$2090-\$8820

**Access to an SNA Company-Wide Network**

SNA/IMF	HP 30247A	\$3570-\$8980
SNA/NRJE	HP 30245A	\$2450-\$6120
SNA Link	HP 30246A	\$2090-\$8820
HP LU 6.2 Base	HP 30252A	\$3265-\$8160
SNA Server	HP 30254A/55A	\$1020/\$1020
	HP 30256A	\$610-\$1225
HP Office Connect to DISOSS	HP 27515A	\$1430-\$3570
NS 3000/V Network Services	HP 32344A	\$1020-\$5610
LAN 3000/V Link	HP 30242A	\$3085-\$7140
NS Point-to-Point Link/3000	HP 30284A, 85A	\$2140/\$5865
HP Serial Network	HP 50910A	\$300
	HP 50905F	\$605
	HP 50906A	\$810
	HP 50912A	\$3665

**Network Support**

Network Planning & Design/Prepare		Custom Quote
Network Startup/NetAssure		Custom Quote

**Additional Products**

HP 1000 A-Series Async Serial	HP 12005B	\$865
HDLC Network I/F	HP 12007B	\$2295
for DS/1000-IV	12044A	\$2295
HP 1000-A Multiuse Serial	HP 12043A	\$2370
DS/1000-IV Data Link Slave	HP 12072A	\$1450
Binary Synchronous Modem	HP 12073A	\$2275
& Direct Connect Interfaces	12082A	\$2600
HP 1000-A LAP-B Modem	HP 12075A	\$2070
LAN/1000 Link and DDA LAN	HP 12076A	\$3160
Interface Controller	12079A	\$510
Data Link/Multipoint Master	HP 12092A	\$2295
Channel I/O RJE Interface	HP 27122A	\$2155
Channel Asynchronous Serial	HP 27128A	\$930



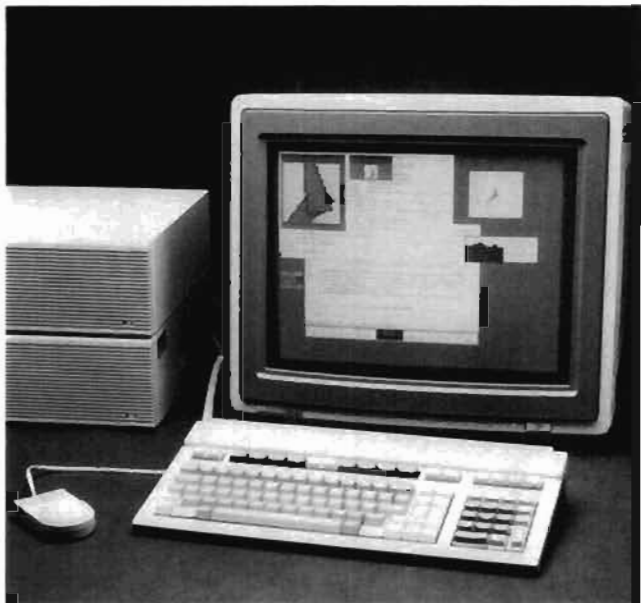

#### The X Window System: Windows for a New Computing Environment

• The X Window system provides HP's Series-300 and HP-825 workstation products with a network-compatible "windowing" system that allows interconnection between HP workstations, and workstations from other vendors.

With the X Window system, you can create multiple windows on your workstation's display to allow you to interact with programs running on your workstation - or another HP workstation, or even workstations from other vendors, connected to your system over a network. Programs compiled on another vendor's workstation to use X ("clients") can use the X windowing software on HP workstations ("servers") for their input and output - and the reverse.

#### Why X?

• X is different from other windowing systems in a number of ways. First, X was developed not by a computer maker, but as part of a research project at the Massachusetts Institute of Technology. This means that X is not the property of a single vendor, but is in the public domain. This ensures that all vendors have equal access to it. Additionally, MIT accepts comments from X users for enhancements.

The second thing that makes X unique is technical features. X offers all of the capabilities that you would expect from any window system. But in addition, X's new architecture offers something no previous commercially-available window system could: network compatibility.

With X, it is possible to have a program "run" on one computer, and use text and graphics display, windowing, and user input on a different computer on the same network. What is significant is that not only is this capability offered on computers from the same maker, but X assures that this will work with computers from other vendors as well that are linked using ARPA networking services. In the multi-vendor, networked systems of computers that are becoming more common every day, this capability is very important.

#### Hewlett-Packard: A Technology Leader

In addition to the standard X Window system, Hewlett-Packard has added powerful new capabilities in the form of a set of user-interface development tools called XrLIB - the first such set of tools commercially available for X.

These tools allow application programmers to significantly reduce the amount of time they spend in creating user interfaces for their programs, allowing them to concentrate on the application itself. With these tools, the time needed to write the user interface for a sophisticated application may be cut in half. And in today's competitive market, every saving is an advantage.

XrLIB offers programmers commonly used tools like:

- pop-up menus
- panels
- message boxes
- scroll bars
- push buttons
- and more.

#### Supporting and Creating Standards

HP supports the current version of X, Version 10, in the form of products for our line 300-Series and Model 825 (HP-PA) engineering workstations. HP is aiding in the development of Version 11 of the X Window System, and is also participating in the development of standard tool technology for X.

Hewlett-Packard's commitment to X is evidence not only of our support for standards, but our technical leadership as well.

#### Technical Details

X runs under HP-UX on HP-300 and HP-825 workstations, using ARPA network services. (Network services are not absolutely necessary for Series-300 workstation, but they are for the Model 825.) The X Window product includes libraries for compiling X applications (featuring graphics and XrLIB tools) under "C", and the following executable programs:

PAM	- HP's Personal Applications Manager
hpterm	- HP TERMO terminal emulator
uwm, xwm	- Window managers
xterm	- VT102 / Tek 4010 terminal emulator
xclock	- X-window analog/digital clock

#### For More Information . . .

. . . please contact your nearest HP technical sales representative.

#### Products & Prices

##### X Window System for Series-300:

82302A X Window System (with XrLIB):	\$715
Option #045 - 3 1/2" disc	
Option #022 - 1/4" cartridge tape	

82320R Right to make one copy:	\$355
Option #100 - right-to-copy, no manuals:	\$255

The X Window system requires a Series 300 SPU with a minimum of 3 megabytes RAM and a 9854x display system, running the HP-UX 5.2 (or later revision) operating system. LAN and ARPA services will be needed for network operation.

##### X Window System for HP Model 825:

92524A X Window System (with XrLIB):	\$2100
Option #AA0 - 1/4" cartridge tape	
Option #AA1 - 1/2" 9-track tape	

92542R Right to make one copy:	\$1470
Option #OB0 - right-to-copy, no manuals:	\$1420

The Model 825 X Window System requires ARPA networking services; it cannot be run as a stand-alone system.

# TECHNICAL COMPUTER SYSTEMS

## HP 9000 Technical Computers

### Artificial Intelligence Development Environments

#### Artificial Intelligence

There are many changes occurring in software development. One of the most significant is that Artificial Intelligence (AI) techniques are moving swiftly out of the laboratory into industry. This is especially true for symbolic, logic and knowledge-based programming.

AI techniques can and will be used in practically all computer applications. These AI techniques are being used to create new applications and can be melded with existing software to increase its scope and usability.

HP has recognized the need for specialized software to help in the design and creation of applications using AI. HP has taken an approach of offering a balance of AI and conventional computing technology in a single system. This offers the application designer the best of both technologies.

#### Symbolic Programming

LISP, LISP Processing language, was developed in the late 50s to aid in the development of computer programs which could replicate human thinking. Common LISP is the dialect of LISP which has become the de facto standard.

LISP provides improved symbolic computing, automatic management of dynamic data structures, ease of language extension, equivalence between data and source code and a combination of features which allow incremental software development.

HP's Development Environment for Common LISP is a software product designed for the development of LISP-based applications. It balances the capability of symbolic computing with the capabilities of a general-purpose workstation. The benefits include:

- An integrated development environment to improve productivity for both LISP and traditional languages
- Common LISP, the standard of LISP dialects, for portability
- An optimized compiler for good performance on a workstation
- A symbolic debugging environment for faster LISP development
- HP-UX access to leverage the tools and libraries of a standard operating system
- Traditional language access to use existing software in FORTRAN, Pascal and C
- A range of workstations and peripherals to tailor the computer system to the application

#### Logic Programming

PROLOG (PROgramming in LOGic), first developed in Europe in the early 1970s, is rapidly gaining in popularity. The Japanese have chosen it as the basic language for their Fifth Generation Computer Project.

Unlike conventional programming languages which force the programmer to write programs that are prescriptions of how to solve a problem, PROLOG lets the programmer describe the problem via symbolic logic in much the same way humans reason.

HP PROLOG resides on top of Common LISP, which lets the user combine the best qualities of both languages. The benefits of HP PROLOG include:

- Ability to blend PROLOG and Common LISP code
- One development environment to learn for both languages
- Combination of Edinburgh C-PROLOG syntax for portability and an s-expression syntax more similar to LISP
- A more powerful implementation for serious applications with extensions including improved I/O, more data types, a package system and a richer set of control structures.

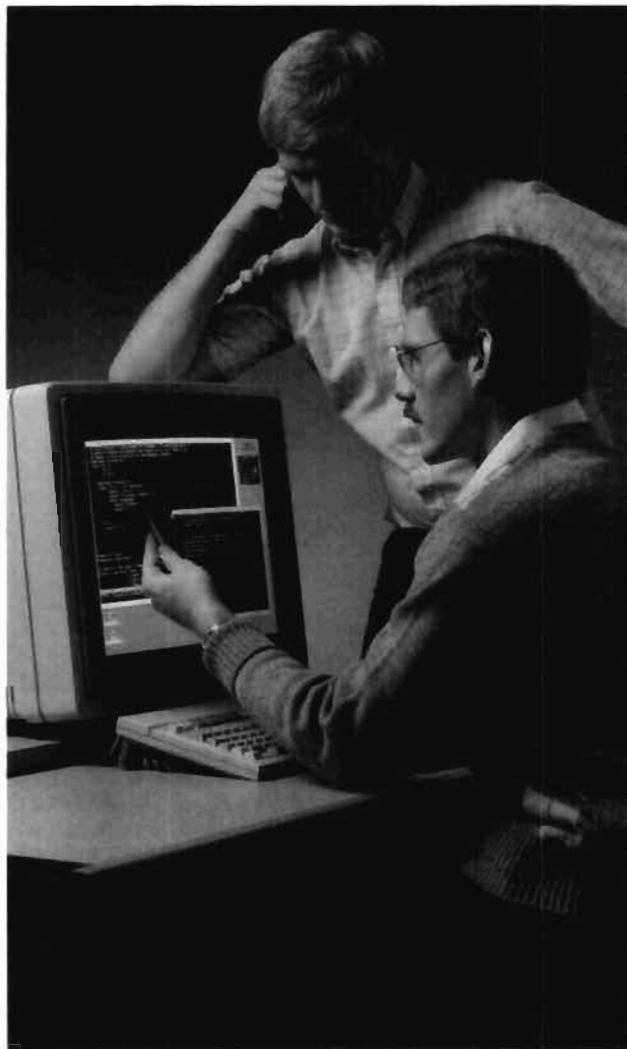

Artificial Intelligence software techniques can and will be used in practically all types of computer applications. AI will, over the coming years, be used to increase the scope and capability of existing applications, and to create whole new applications. HP offers development systems that provide Common LISP and Prolog, combined with the best conventional computing technology.

#### Knowledge Based Programming

The field of Artificial Intelligence has been greatly enhanced by independent software companies. This is especially true in knowledge-based programming and expert system tools. Check the HP Software Supplier Catalog under "AI" and you will find the leading vendors represented (see page 612).

#### Ordering Information

In addition to the software products, HP has created AI Development Systems, which are bundles of hardware (excluding discs) and software tailored to the needs of software developers at a more attractive price.

Development Environment for Common LISP	HP 98678A	\$ 4,000
HP PROLOG	HP 79232U	\$ 4,050
Model 320 AI Monochrome Development System	HP 98584A	\$21,400
Model 320 AI Color Development System	HP 98585A	\$29,800
Model 350 AI Monochrome Development System	HP 98584B	\$31,600
Model 350 Color AI Development System	HP 98585B	\$39,900
Execution License for Common LISP & PROLOG	HP 98679B	\$ 750



#### HP 9000 Graphics Hardware

HP offers a variety of graphics display options for the Model 9000 workstations which allows the user to customize the workstation to provide the desired graphics performance.

#### HP 9000 Series 300 Display Options

The modularity of the Series 300 allows the system to be configured into one of four different display options providing medium and high resolution graphics on either monochrome or color displays. The graphics display options are supported by the BASIC, PASCAL and HP-UX operating systems.

**HP 98542** graphics board provides 512 x 400 pixel resolution on a monochrome display. It operates with the 35731A 12 inch monochrome monitor. \$800

**HP 98543A** graphics board provides 512 x 400 pixel resolution on a color display. It can display 16 simultaneous colors from a color palette of over 16 million colors. The 98543A operates with the 35741A 12 inch color monitor. \$2,400

**HP 98544B** graphics board provides 1024 x 768 pixel resolution on a monochrome display. It operates with the 98781B 17 inch monochrome monitor. \$1,400

**HP 98546B** graphics board provides compatibility with Series 200 displays. It is a 512 x 400 pixel monochrome alpha/graphics video board which operates with the 35731A monitor. \$850

**HP 98547A** graphics board provides a 1024 x 768 pixel resolution on a color display. This board provides a total of 6 graphics memory planes which can be used to display 64 colors from a color palette of over 16 million colors. Alternatively, the board may be used to display 16 colors and provide 2 overlay planes. The 98547A operates with the 98751A and 98785A color monitors or the 98781B greyscale monitor. \$4,500

**HP 98550A** is a high resolution 1280 x 1024 color graphics board for 2-D color applications such as EE physical design and mapping. It contains 10 frame buffer planes which can be configured as 8 color

planes and 2 overlays or 4 color planes double-buffered. It will operate with the 98752A 19 inch color monitor or the 98789A 16 inch color monitor. \$9,800

#### HP 9000 Graphics Subsystems

**HP 98700H** is a 4-plane 3-D wireframe color graphics subsystem which may be used with either the Series 300 or Series 500 systems. An optional graphics accelerator, HP 98710A, provides hardware assist for accelerated transforms and clipping, features especially suitable for 3D wireframe applications requiring interactive response. The 98700H may be further upgraded to a total of 8 color planes to provide 256 colors on a 1024 x 768 resolution display. The HP 98700H comes bundled with a keyboard and 19 inch color monitor. It is connected to the system bus with an interface card which takes one I/O slot. Also part of the CX bundles

<b>HP 98700H</b>	\$15,000
<b>HP 98701A</b>	\$ 2,740
<b>HP 98710A</b>	\$ 7,310

**HP 98720A** is an extensible high-performance 3D Solid Rendering graphics subsystem for the Series 300 workstations and the Series 800 systems. The base system is provided with a 1280 x 1024 resolution 60 Hz noninterlaced color display and 4 independent graphics/alpha overlay planes which will display 16 colors from a palette of over 16 million colors. With the HP 98722 memory upgrade, the system is expandable to 24 image planes, full 16-bit z-buffer, and 4 overlay planes for windowing and text. With the HP 98721A graphics accelerator, the HP 98720A subsystem may be optimized to provide interactive response for such applications as solids modeling, molecular modeling, terrain modeling, high-end AEC, and imaging that need realistic images with interactive response. Also part of the SRX bundles.

<b>HP 98720A</b>	\$11,000
<b>HP 98721A</b>	\$10,000
<b>HP 98722A</b>	\$ 4,500

# TECHNICAL COMPUTER SYSTEMS

## HP 9000 Technical Computers (cont'd)

### HP 9000 Graphics Systems



#### HP 9000 Graphics Software

HP provides a set of software tools which allow the application programmer to interact with, and send graphics output to, a wide variety of graphics display devices and peripherals. They are based on CG-VDI, GKS and other industry standards. The intent of these standards is to provide a common interface to graphics devices.

**Starbase Graphics Library** is a high performance 2-D and 3-D graphics library for the HP 9000 family. It is an extension of the ANSI CGI standard currently under development. Starbase provides procedures to perform basic graphics operations including lines, markers, text, polygons and B-splines. Control functions, inquiry functions and echoing are also supported. Starbase is capable of applying 2-D and 3-D transformations to output primitives, generating high quality text and shaded polygons and providing synchronous and asynchronous input to the application. Starbase provides the interface

#### HP 9000 Graphics Hardware Summary

Graphics Subsystem	98542A	98543A	98544B	98546A	98547A	98550A	98700H	98720A
Resolution	512 x 400	512 x 400	1024 x 768	512 x 400	1024 x 768	1280 x 1024	1024 x 768	1280 x 1024
Color Planes	1	4	1	1	6**	10***	4†	4†
Colors*	1 mono-chrome	16	1 mono-chrome	1 mono-chrome	16 or 64	16 or 256	16-256	16-16M
Monitors/Size	35731A/B 12"	35741A/B 12"	98786A 17"	35731A 12"	98751A 19" 98785A 16" 98786B 17"	98752A 19" 98789A 16"	98751A 19" 98785A 16"	98752A 19" 98789A 16"
Options								
-4 plane graphics memory	N/A	N/A	N/A	N/A	N/A	N/A	98701A	N/A
-8 plane graphics memory	N/A	N/A	N/A	N/A	N/A	N/A	N/A	98722A
-Graphics accelerator	N/A	N/A	N/A	N/A	N/A	N/A	98710A	98721A
Systems Supported								
-Series 300	YES	YES	YES	YES	YES	YES	YES	YES
-Series 500	NO	NO	NO	NO	NO	NO	YES	NO
-Series 825	NO	NO	NO	NO	NO	YES	NO	YES
Operating Systems Supported								
-HP-UX	YES	YES	YES	YES	YES	YES	YES	YES
-BASIC	YES	YES	YES	YES	YES	NO	YES	NO
-PASCAL	YES	YES	YES	YES	YES	NO	Not 98710A YES	NO
							Not 98710A	

\* Displayable colors from a palette of 16 million. When using the 98718B greyscale monitor on a color system, colors pertain to shades of grey.

\*\* 98547A may be used to display 16 colors with two overlay planes or 64 colors with no overlay planes.

† 98700H and 98720A base systems provide 4 color planes and may be upgraded with memory options to provide a total of 8 and 36 planes respectively. See options.

‡ All monitors have switch-selectable 115/230VAC. "B" versions are preset to local power settings and have local product regulatory approval.

\*\*\*98550A may be used to display 256 colors with 2 overlay planes, or 16 colors double buffered with 2 overlay planes.

to the high performance lighting models, shading, non-uniform rational B-splines of the SRX workstations. Starbase is part of the Series 300 HP-UX programming environment, but an option product for the Series 800.

HP 92445A \$2,600

HP 92445R \$1,820

HP 92521A/98672A/98673A HP-GKS graphics library is fully compatible with Level 2b of the ANSI/ISO Graphical Kernel System standard. The library provides application portability and high performance for HP-UX, accessible from FORTRAN, C and Pascal.

Series 300 HP 98672A \$1,000

Series 500 HP 98673A \$3,000

Series 800 HP 92521A \$2,000

HP 92521R \$1,400

HP 92446A/98520A/600A consists of two sets of procedure libraries: DGL (Device-independent Graphics Library) and AGP (Advanced Graphics Package). The libraries must be used in conjunction with the HP-UX operating system.

Series 300 HP 98250A \$1,000

Series 500 HP 98600A \$2,600

Series 800 HP 92446A \$3,750

HP 92446R \$2,625

HP 98674A/98522A is an optional extension to the Starbase library: Starbase Display List. It allows graphics data and commands to be stored and later re-executed and provides the ability to create, modify and manipulate a hierarchy of segments.

Series 300 HP 98784A \$500

Series 800 HP 92522A \$1,000

HP 92522R \$700

HP 97009A Starbase Driver Development Guide is documentation for creating a Starbase driver for devices not supported by HP (PPL).

Series 300 HP 97009-10220 \$250

Series 500 HP 97009-15220 \$250

HP 98053A Versatec Hardcopy Support is a software interface and cable to allow color hardcopy dump from Series 300 bit-mapped displays to Versatec C2500 color plotters.

Series 300 HP 98053A \$1,000

HP 98683X/84X DGL Skeleton Device Handler allows interfacing to non-HP peripherals. The Skeleton Handler is largely a FORTRAN source code template.

Series 300 HP 98603X \$495

Series 500 HP 98684X \$1,000

# TECHNICAL COMPUTER SYSTEMS

## HP 9000 Technical Computers

### Peripherals

851

Description	Product	Series 200		Series 300			Series 800
		B	P	B	P	U	U
ThinkJet printer (HP-IB)	2225A	•	•	•	•	•	•
ThinkJet printer (RS-232C)	2225D	•	•	•	•	•	•
QuietJet printer (RS-232C)	2227/28A	•	•	•	•	•	•
QuietJet Plus printer (HP-IB)	2227B	•	•	•	•	•	†
RuggedWriter printer	2235B/D	†	†	•	•	•	•
X.25 Multi-MUX	2334A					•	•
Alphanumeric terminals	2392/94A					•	•
Graphics terminals	2393/97A					•	•
300 ... 1200 pm line printers	2563B ... 67B	•	•	•	•	•	•
Daisywheel impact printer	2603A	•	•	•	•	•	
LaserJet 2000 printer	2684A/D/P					•	•
LaserJet 500 inter	2686D	•	•	•	•	•	•
LaserJet Series-II printer	33440A	•	•	•	•	•	†
536 Mbyte tape autochanger	35401A	•	•	•	•	•	•
PaintJet color graphics printer	3630A	•	•	•	•	•	•
HP-IB Extender (RS-232C/tw.pr.)	37201A	•	•	•	•	•	•
HP-IB Extender (Coax/Fibre Optic)	37204A	•	•	•	•	•	•
300/1200 baud modem	37212A	•	•	•	•	•	•
Asian printer	41063A	†	†	•	•	•	•
11x11-in. tablet	45911A			•	•	•	•
2/3-button mouse	46060A/B	•	•	•	•	•	•
Control Dial Module	46085A	•	•	•	•	•	•
32 Button Box	46086A	•	•	•	•	•	•
A/B-size digitizers	46087A/B	•	•	•	•	•	•
ColorPro plotter, A-size	7440A	•	•	•	•	•	•
A/B-size 6-pen plotter	7475A	•	•	•	•	•	•
Film recorder	7510A	•	•	•	•	•	•
A/B-size 8-pen autofeed plotter	7550A	•	•	•	•	•	•
DraftPro plotter, C/D-size	7570A	•	•	•	•	•	•
DraftMaster plotter, A-E-size	7595/96A	•	•	•	•	•	•
20/20 Mbyte cartridge disc	7907A	•	•	•	•	•	†
132 Mbyte disc/cartridge tape	7914CT/P/R	•	•	•	•	•	•
132 Mbyte disc/9-track tape	7914ST					•	•
404 Mbyte fixed/pack disc	7933/35H				•	•	•
307/571 Mbyte disc	7936/37H	•	•	•	•	•	•
81/131 Mbyte disc	7957A/58A	•	•	•	•	•	•
1600/800 cpi 9-track tape	7974A					•	•
1600 cpi 9-track autoloader tape	7979A					†	•
6250/1600 cpi 9-trk autoloader tape	7980A					†	•
3 1/2-in. flexible disc	9122D/S	•	•	•	•	•	•
5 1/4-in. flexible disc	9127A	•	•	•	•	•	•
40 Mbyte disc	9133/34L	•	•	•	•	•	
1/4-in. cartridge tape	9144A	•	•	•	•	•	•
10/20 Mbyte winchester discs	9153/54A/B	•	•	•	•	•	
Bar code reader	92916A	•	•	•	•	•	•
Industrial 2397A terminal	9666A					•	•
SRX Graphics controller	98720A					•	•

† Not determined at publication time. Please consult your HP Sales Office for current support status. —

# TECHNICAL COMPUTER SYSTEMS

## HP 9000 Technical Computers

### HP 9000 Interface Summary

#### Series 800 and 500 Interfaces

The following interfaces and memory enhancements are available for HP 9000 Series 800 and Series 500 Technical Computers:

#### 3+5 Mbyte RAM Controller/Array

Series 800 HP 19748A \$20,000

**HP-IB Interface**—Allows communication with as many as 31 HP-IB-compatible device addresses and 15 standard device loads

Series 800 & 500 HP 27110B \$1,010

**GPIO Interface**—Provides 16 bits of latched input and output data for bidirectional information transfer and control of GPIO-compatible devices.

Series 500 HP 27112A 700

**Parallel AFI Interface**—Series 800

HP 27114A 1,600

**HP-CIO Service Extender**—Extender card for out-of-card-cage access to HP-CIO interface card.

Series 800 & 500 HP 27116A 400

**RJE Interface**—Used by HP-UX 50968A/R software for batch transmission to another computer using IBM 2780/378 binary synchronous protocol.

Series 500 HP 27122A 2,115

**LAN Interface**—Provides connection to IEEE 802.3 or Ethernet LAN.

Series 500 HP 27125B 2,550

**ASI Interface**—Single channel asynchronous interface for linking to RS-232C-compatible device.

Series 500 HP 27128A 910

**Eight-channel Multiplexer Interface**—Supports up to eight RS-232C devices.

Series 500 HP 27130B 2,060

**Six-channel Modem Multiplexer Interface**—Supports up to six RS-232C/CCITT-V.22-compatible devices

Series 800 & 500 HP 27140A 2,400

**SRM Interface**—For BASIC and HP-UX access to shared discs, printers and plotters on Shared Resource Management (SRM) system.

Series 500 HP 50961A 2,395

**RGB Interface**—Color video interface to display color graphics on external monitor, used with BASIC 97052, HP-UX 97074/84 and Graphics software 97075/85.

Series 500 HP 97062A 2,520

**I/O Expander—8-slot external card cage**

Series 500 HP 97098A 3,685

**Lan/800 Link and Transport protocols**

Series 800 HP 98194A 6,000

**High-Resolution Graphics Display Station**—Provides four plane color graphics display, 1024 × 768 resolution, 19-in monitor, keyboard and cables.

Series 500 HP 98700H 15,000

**Extra four planes graphics memory for 98700H—**

Series 500 HP 98701A 2,740

**Graphics Accelerator for 98700H**

Series 500 HP 98710A 7,310

#### Series 200 and 300 Interfaces

##### 3278 Display Station Emulator

Series 300 HP 50955A 1,500

**SRM Coax Interface**—Provides connection to Shared Resource Management (SRM) System

Series 200 & 300 HP 50962A 845

**EPROM Programmer Interface**—EPROM programmer card for installation in any HP-DIO backplane slot.

Series 300 HP 98253A 1,500

**EPROM Card**—Contains 16 sockets for EPROMs to allow up to 256 kbytes of storage using INTEL 27128 EPROMs.

Series 200 & 300 HP 98255A 300

**RAM Memory Card, 256 kbyte**

Series 300 HP 98256A 600

**RAM Memory Card, 1 Mbyte**

Series 300 HP 98257A 1,450

**Bubble Memory Interface, 128 kbytes—**Non-volatile memory that appears like flexible disc to operating system

Series 300 HP 98259A 1,900

**Series 300 DOS Coprocessor Hardware**

Series 300 HP 98286A 950

#### Interface to connect 98700H

Series 300 HP 98287A \$655

**Bus Expander**—Provides eight additional DIO card slots with four slots for either memory or I/O and four slots for memory only

Series 300 HP 98568A 1,900

**BASIC 5.0 ROM Card**

Series 300 HP 98605A 1,860

**DMA Controller, 2-channel**

Series 200 & 300 HP 98620B 500

**GPIO Interface**—Provides 16 bits of latched input and output data for bidirectional information transfer, and permits interfacing to GPIO-compatible equipment.

Series 200 & 300 HP 98622A 355

**BCD Interface**—Connects Series 300 with bit-parallel, digit-parallel, binary-coded decimal services for data input.

Series 200 & 300 HP 98623A 385

**HP-IB Interface**—Provides communication with as many as 14 HP-IB-compatible instruments.

Series 200 & 300 HP 98624A 330

**High-Speed Disc Interface**—Connects disc drives and other high-speed HP-IB devices.

Series 200 & 300 HP 98625B 650

**Serial Interface, RS-232C**—Simple, asynchronous serial communications.

Series 200 & 300 HP 98626A/44A 380/190

**RGB Color Video Output**

**Interface**—Graphics output device with programmable display formats up to 512

× 512 resolution Series 200 & 300 HP 98627A 1,010

**Data Communications Interface**—Protocol management and electrical levels for asynchronous serial communications

Series 200 & 300 HP 98628A 485

**Breadboard Interface**—Backplane buffering circuits and dual-inline holes for user-mounted-circuit components.

Series 300 HP 98630A 320

**6844A Multiprogrammer Interface**

Series 300 HP 98633A 350

**Floating Point Math Board**—Provides hardware floating point capability for Series 200 and Model

310 computers. Series 200 & 300 HP 98635A 975

**Analog-to-Digital Card (ADC)**—Provides seven channels of 55,000 readings per second for data acquisition

Series 200 & 300 HP 98640A 990

**RJE Interface**—Emulates IBM 2780/3780 when used with 50967A/R software in an HP-UX system with asynchronous modem.

Series 300 HP 98641A 1,250

**RS-232C MUX Interface, 4-port—**Three direct connect and one modem port.

Series 200 & 300 HP 98642A 600

**LAN 300 Link**—Connects to IEEE 802.3 or Ethernet, 10-Mbyte/second ThinLAN.

Series 300 HP 98643A 1,300

**VME Interface**—Connects Series 200/300 computers to VMEbus card cage.

Series 200 & 300 HP 98646A 1,272

**PC Instrument Bus (PCIB) interface**—provides connection to HP PC Instrument modules.

Series 200 & 300 HP 98647A 850

**Programmable Datacommunication Interface (PDI) Development Package for 98691A**

Series 300 HP 98690A 405

**Programmable Datacommunication Interface (PDI)** Development package for special data communications or serial interfacing.

Series 200 & 300 HP 98691A 650

**HP-DIO Bus Extender**—Provides 16 additional card slots with eight slots for either memory or I/O and eight slots for memory only.

Series 200 & 300 HP 9888A 3,885



HP's new Series 300 DOS Coprocessor bridges the gap between UNIX<sup>®</sup> and MS-DOS<sup>®</sup> operating systems.

### Series 300 DOS Coprocessor

The HP Series 300 DOS Coprocessor System provides IBM PC AT software compatibility for the Series 300. With the addition of the DOS Coprocessor, the Series 300 customer has access to literally thousands of standard, "off-the-shelf", MS-DOS based software applications. Compatible applications include such popular DOS applications as Lotus 1-2-3<sup>®</sup>, WordPerfect<sup>®</sup>, and R:Base System V<sup>®</sup>.

### IBM PC AT on a Plug-in-Card

The DOS Coprocessor System is comprised of an 80286 based Coprocessor DIO card (with socket for an optional 80287 numeric coprocessor) and the DOS Coprocessor Software. The system requires HP-UX version 5.1 or later, with a minimum of the single-user AXE (Application Execution Environment), and works with either the Model 310, 320, 330, or 350 SPU's. At least 2Mb of main system memory and a hard disc of at least 20Mb in size are required. A variety of Series 300 display systems are supported.

The DOS coprocessor software consists of many elements, including a PC-AT compatible version of MS-DOS—configured to emulate IBM's PC-DOS<sup>™</sup> 3.1, Vector's Personal Applications Manager (PAM), an extensive utility set, and utilities to interchange BASIC, Pascal, or HP-UX ASCII files with MS-DOS format. A capability is also provided that allows users of HP portables and HP 150's (with 3 1/2" double-sided discs), and 720K 3 1/2" disc PC compatible machines to interchange files with the DOS Coprocessor System.

### MS-DOS Integration within HP-UX

Running in an HP-UX environment, the HP Series 300 DOS Coprocessor bridges the gap between the world's most popular but otherwise unfriendly operating systems UNIX and MS-DOS. The system allows MS-DOS to function as a true HP-UX task that can operate within or separate from the HP Windows/9000 operating environment.

### BASIC/Pascal Integration

Although the system requires HP-UX, many of the products attributes have been developed so that the system can also be used in BASIC/Pascal environments. The system only requires a minimum of the AXE (Application Execution Environment) portion of the HP-UX system to operate. Using this lost cost version of HP-UX, the system can easily be used in conjunction with another operating system such as Basic/Pascal. With the most recent revisions of the BASIC and Pascal operating systems, the entire HP-UX/DOS/BASIC and/or Pascal system can be placed on a single hard disc where all systems share the same file system. The system can also be easily used using older revisions of BASIC and/or Pascal using hard disc drives which are segmentable into multiple volumes (a ROM upgrade providing this capability is available for older HP 9133H and 9134H hard disc drives).

In order to cope with the steep learning curve usually associated with UNIX systems, the DOS Coprocessor System can be configured

in "Auto-Boot" fashion. Once configured in this fashion the HP-UX system is completely hidden from the user's point of view. When HP-UX is initiated, in "Auto-Boot" mode, DOS is automatically started every time HP-UX is booted. When DOS is exited the system automatically kills the DOS process and properly shuts down the HP-UX system without any HP-UX level user interaction.

### Shared-system Resources

The DOS coprocessor system is designed to take advantage of shared-system resources wherever possible. The following components, for example, are shared between HP-UX and MS-DOS: keyboard, memory, displays, printers and plotters, mouse, file system, and RS-232-C ports. Designing the system in this fashion provides a degree of DOS/UNIX operating systems integration unapproached in the industry.

In fact, the majority of the MS-DOS file system exists entirely within the HP-UX file system. A specialized DOS drive letter, preset at D:, provides a 'view' of the entire resident HP-UX file system. The user can then, using standard DOS commands, manipulate the HP-UX file system. For example, the DOS user could make directories and store and retrieve the majority of his DOS files directly from the HP-UX file system. Since all DOS files that are located on drive D: are visible also from HP-UX, these files could be manipulated using features previously available only to HP-UX files (i.e. networking). Drive C: is configured to appear to DOS as a standard PC AT 20Mbyte hard disc. Using this drive, even applications that directly manipulate DOS's file system are compatible. To HP-UX, this drive appears as a standard file.

The system emulates many IBM PC interface cards using specialized software and existing Series 300 hardware resources. System memory, for example, is shared between DOS and HP-UX and can be allocated to the DOS Coprocessor as Conventional, Extended and Expanded memory (according to the Lotus<sup>®</sup>/Intel<sup>®</sup>/Microsoft<sup>®</sup> Expanded Memory Specification). EMS emulation allows DOS applications that support EMS (i.e. Lotus 1-2-3) running on the DOS Coprocessor System to access memory beyond the Conventional PC memory limitation of 640K. Many PC display adapters are also emulated (MDA, CGA, and Hercules) with multiple window sizes, dithered gray scaling (with CGA emulation on Monochrome monitors), and greatly improved alpha fonts using numerous Series 300 video interfaces and displays. Common PC I/O capabilities are also provided allowing Series 300 interfaces (RS-232, HP-IB, HP-HIL) to emulate standard PC I/O interfaces (RS-232, Centronics Parallel)

### IBM-Compatible Floppy Drive

In order to provide true off-the-shelf IBM PC-AT software compatibility, a 360-Kbyte, 5 1/4-inch, IBM-compatible floppy drive—the HP 9127A—is available. Providing DOS compatibility, the drive is able to read, write and format HP discs as well as provide compatibility to thousands of PC-AT MS-DOS software applications and data.

### Ordering Information

HP Series 300		Price
DOS coprocessor card	HP 98286A	\$950
<b>HP Series 300</b> DOS coprocessor software	HP 98531A	\$495
<b>HP Series 300</b> DOS coprocessor system (includes card and software)	HP 98286S	\$1,295
<b>HP Series 300</b> DOS/Memory Enhancement Kit (includes 1 megabyte of RAM and HP 98286S)	HP 98286T	\$2,195
HP 360 Kbyte 5 1/4-inch IBM-compatible floppy	HP 9127A	\$995
HP numeric coprocessor (80287)	HP 45987A	\$575
ROM Upgrade Kit	HP 09133-89903	\$46*

\*Requires installation by HP Customer Engineer

Lotus and 1-2-3 are U.S. registered trademarks of Lotus Development Corporation.

R:Base System V is a U.S. registered trademark of Microform.

WordPerfect is a U.S. registered trademark of WordPerfect Corporation.

Microsoft and MS are U.S. registered trademarks of Microsoft Corporation.

Intel is a U.S. registered trademark of Intel Corporation.

# TECHNICAL COMPUTER SYSTEMS

## HP 1000 Computers for Real-Time Applications

- Computer-aided manufacturing
- Computer-aided test
- Real-time monitoring and control
- Real-time data acquisition

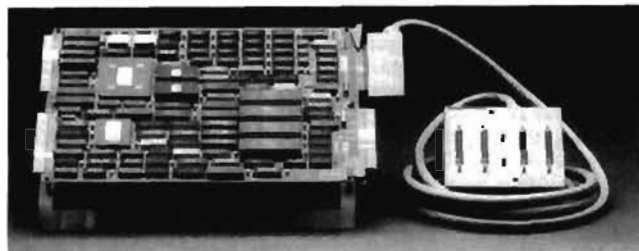

New HP 12100A A400 Minicomputer packs a complete A-Series CPU, 0.5 megabyte of memory, and a four-port serial I/O multiplexer on one card

### Versatile Design for Real-Time Uses

HP 1000 computers are open, modular machines that are designed for real-time multiprogramming, multi-user applications in manufacturing, communications, research, and other fields that require real-time response. A choice of four processors and a wide variety of interfaces and software equips HP 1000 computers to solve many different applications, taking advantage of these HP 1000 real-time performance features:

**Fast, Efficient Handling of I/O.** External sensors, measurement instruments, and other I/O devices connect to HP 1000 systems via I/O interfaces and an I/O system with multi-level, vectored hardware interrupt that expedites I/O. Each I/O channel has its own interrupt priority level, from which interrupts directly initiate service programs. Direct memory access controlled under a distributed intelligence I/O design speeds data transfers to and from memory with minimal involvement of the CPU.

**Fast Processing of Data.** HP 1000 systems can process data at base instruction rates to 1.3 MIPS and floating point processing speeds to 820 KWIPS-BID. This minimizes the time needed to process input data, evaluate results, and initiate real-time action.

**Clocked Operations Timing** is provided by time base generator interrupts that maintain a real-time clock.

**Large Main Memory Capacity.** Up to 32 megabytes of main memory can be provided to keep most critical programs resident and ready to execute quickly, avoiding the delays inherent in moving programs to and from disc.

**A Powerful Real-Time Operating System.** The RTE-A system supports memory-based or disc-based real-time multiprogramming operation with easy, efficient inter-process communication, and priority-based scheduling of programs in response to event interrupt, time-of-day, or program or user request. RTE-A manages sharable memory-resident data arrays up to 2 megabytes and virtual data arrays up to 128 megabytes in main memory and on disc. With its VC+ extension, RTE-A supports execution of programs as large as 7.75 megabytes.

### A Choice of Processors for Diverse Applications

Performance Level	HP 1000 Processor	Base Speed (MIPS)	Floating Point Speed (KWIPS-BID)	I/O B/W (MB/Sec)
1	A400 A600+	0.4	120 110	4.3 4.3
2	A700	0.4	370	4.0
3	A900	1.3	820	3.7

**The new A400 Minicomputer** packs an 0.4 MIPS CPU, double precision floating point firmware, 0.5 megabyte of memory, and a four-port serial I/O multiplexer on a single plug-in board computer (SBC). At a price close to what you'd expect to pay for a personal computer, the A400 SBC delivers full A-Series functionality, including support under the RTE-A real-time executive operating system and complete compatibility with all other members of the A-Series family.

**The A600+ Minicomputer** offers 0.4 MIPS base execution speed and double-precision floating point firmware. Unlike the A400 minicomputer, the A600+ can support ECC memory as well as parity memory. The A600+ processor consists of a CPU card and a memory controller card.

**The A700 Computer** adds floating point hardware with scientific and vector instruction sets to the basic capability of the A400 and A600+ minicomputers, thus offering superior support of computer simulation, graphics, and other computation-intensive uses. The A700 is a five-board computer.

**The A900 Computer** incorporates a pipeline implementation and a cache memory scheme providing three times the performance of an A700 computer. The A900's floating point processor and scientific and vector instruction sets are built-in and 768k bytes of ECC memory is standard for maximum system integrity. The five-board A900 is the ultimate computation machine designed to meet the most demanding needs of OEMs, system designers, and end users.

**Exceptional Applications Flexibility.** Programs can be developed on any member of the A-Series family and executed without change on any other member, from the A400 on up to the A900. Processing power, capacity, and cost can be closely matched to application requirements with the guaranteed ability to grow as and whenever necessary. When upgrading, A400, A600+, and A700 computers can receive trade-in credit toward the purchase of A900 computers.

### Flexible Packaging — from Board Computers to System Processor Units

HP 1000 A-Series processors are available in a variety of packages to meet the requirements of many different applications, as shown in the photo on the next page and as summarized below.

Processor	A400	A600+	A700	A900
Board Computer	12100A	2106CK/DK	Not Avail.	Not Avail.
Micro 14/16 6-Slot Box Computer	2424A	2426G/H	Not Avail.	Not Avail.
Micro 24/26/27/29 14-Slot Box Computer - System Proc. Unit	2434A 2484B	2436G/H 2486B/C	2437B 2487B	2439B 2489B
20-Slot Box Computer	2134A	2156C/D	2137B	2139B
Model 26/27/29 System Proc. Unit	Not Avail.	2196G/H	2197E	2199E





**Board Computers** make the A400 or A600+ processor available to OEMs or system designers in a minimal package for embedded controller applications, or other uses in which custom integration is required to fit into a particular physical package or to meet cost objectives.

**Box Computers** incorporate the CPU card(s) and memory in a fully-powered card cage that can be installed in a rack cabinet. Because a system console and system disc are not prerequisite to purchase, the box computer offers OEMs and system designers more configuration flexibility than the System Processor Unit.

**System Processor Units (SPUs)** include a box computer, interfaces to the system console and system disc, the RTE-A operating system and diagnostics, the system cabinet, site prep consultation and installation/checkout services, and 90-day on-site warranty. The higher level of integration of the SPU simplifies design, ordering, and implementation of systems that use a system console and a system disc. The SPU also complies with FCC and VDE EMI regulations.

**The Micro 14/18 Box Computer** provides the A400 or A600+ processor in a low-cost 6-slot box for low-end systems. Exceptionally efficient cooling makes possible operation in ambient temperatures to 60°C. This and a 1.5G operating shock spec make the Micro 14/16 ideal for use in tough environmental conditions.

**The Micro 24/26/27/29 Box Computer or System Processor Unit** provides the A400, A600+, A700, or A900 processor in the versatile 14-slot Micro/1000 package. The Micro/1000 package can be placed on a table or bench, installed in a space-saving vertical floor mount with roll-about mobility (as shown in the photo above), or rack-mounted in a larger cabinet. In addition to its compactness and convenience, the Micro/1000 package can incorporate integrated mass storage (a 20 megabyte mini Winchester disc and a 630 kilobyte microfloppy disc).

**The 20-Slot Box Computer** provides the A400, A600+, A700, or A900 processor in the largest available package for applications that need more card cage slots than the Micro/1000 package provides.

**The Model 26/27/29 System Processor Unit** provides the A600+, A700, or A900 processor in the 20-Slot box computer that is intended

to be rack mounted in either a tall or a short rack cabinet (HP 29431G or HP 29429A).

### High Density Memory

HP now offers HP 1000 memory using 1M bit RAMs: new 2, 4, and 8 megabyte parity memory boards for the A400, A600+, and A700 computers and an 8 megabyte ECC memory board for the A900 computer. Four of these new memory boards can give 32 megabytes of memory to A-Series computers or SPUs, except for the Micro 27, which has a maximum capacity of only 24 megabytes of parity memory because only three of its card cage slots can be used for memory and Micro 29, which has a maximum capacity of only 16 megabytes of ECC memory because only two of its card cage slots can be used for memory.

Parity checking memory is standard in HP 1000 memory systems for the A400, A600+, and A700. For very large systems in critical applications, Error Correcting Code (ECC) memory, standard in A900 and optional in A600+ and A700, detects and corrects all single-bit errors and detects all double-bit errors to provide the best possible system integrity.

### HP 1000 Software

HP 1000 software products for program development, data base management, graphics, distributed systems networking, quality decision management, programmable controller communications, and process monitoring and control are supported in all HP 1000 A-Series computers. This universality of HP 1000 software helps you to tailor comprehensive, coherent solutions to your specific application needs. Further help is available from a growing array of HP 1000 software products offered by third party suppliers under the HP PLUS software program.

### Program Development

With a hard disc and optional software, HP 1000 systems can be used to develop programs in BASIC, FORTRAN 77, Pascal, Ada, and Macro/1000 Assembly language. Symbolic debug/1000, program profiling, and user microprogrammability of the A700 and A900 processors provide extra capability that can be used to gain extra performance.

# TECHNICAL COMPUTER SYSTEMS

## HP 1000 Computers for Real-Time Applications (cont'd)

### Plant Automation

HP's wide range of hardware and software supports automation of instruments and machines as well as monitoring and control of real-time processes. The HP 1000 can help improve productivity and reduce costs. For low point-count data acquisition, A-Series Measurement and Control Cards provide many analog interfacing functions right in the computer, without the need for an add-on peripheral device. For details, see page 184.

### Computer Networking

HP's AdvanceNet networking software makes it easy to connect HP1000 systems across a city or a continent, sharing vital information throughout the network. LAN link is now available for fast Local Area communications with other HP systems or with DEC VAX systems.

### Data Base Management

Informed management decisions flow easily and confidently from the timely, accurate information maintained in an Image/1000 data base.

### Interactive Graphics

Hewlett-Packard offers a complete line of graphics hardware and software products for simplifying presentation of complex data or de-

veloping product designs. In addition to supporting the traditional graphics displays such as bar charts, pie charts, and histograms, Graphics/1000 software gives you the interactive two- and three-dimensional capability needed for computer-aided drafting, mapping, and design.

### Compatibility with HP 9000 Series 800 Systems

PORT/HP-UX applications migration tools supplied with the HP 1000 A-Series and HP 9000 Series 800 Model 825S, 840S, and 850S systems promote compatibility of HP 1000 systems with HP 9000 Series 800 systems. Multiple HP 1000 systems used as factory floor cell controllers can thus benefit from supervision and support by HP 9000 Series 800 systems used as Area Managers at Level 2 in the CIM hierarchy, or in similar supporting host roles. Also see description of the HP 9000 Series 800, Models 825S, 840S, and 850S on pages 630 through 632.

### Automated Test Systems

HP Automated Test Systems can be configured from HP 1000 A-Series computers and a wide range of electronic instruments to perform virtually any electronic test application.

### HP 1000 System Summary

	Micro 24	Micro 26	Micro 27	Micro 29	Model 26	Model 27	Model 29
Syst. Proc. Unit Product Number	HP 2484A	HP 2486B/C	HP 2487B	HP 2489B	HP 2196G/H	HP 2197E	HP 2199E
Memory cycle time	454 ns	454 ns	500 ns	181 ns*	454 ns	500 ns	181 ns*
I/O Bandwidth	4.3 MB/sec	4.3 MB/sec	4.0 MB/sec	3.7 MB/sec	4.3 MB/sec	4.0 MB/sec	3.7 MB/sec
Operating System	RTE-A	RTE-A	RTE-A	RTE-A	RTE-A	RTE-A	RTE-A
Virtual Code <sup>1</sup> available?	Yes	Yes	Yes	Yes	Yes	Yes, incl.	Yes, incl.
Recommended system console	HP 700/92	HP 700/92	HP 700/92	HP 700/92	HP 700/92	HP 700/92	HP 700/92
I/O Channels available	11 - 46	10 - 45	8 - 42	7 - 41	16 - 48	13 - 48	13 - 45
Maximum parity memory	32 MB	32 MB	24 MB	Not Sup.	32 MB	32 MB	Not Sup.
Maximum ECC memory	Not Sup.	8 MB	8 MB	16 MB	8 MB	8 MB	32 MB
Recommended system discs	HP 12122A built-in 20 MB fixed and 630 kB microfloppy discs				HP 7957A (81 MB)	HP 7957A (81 MB)	HP 7957A (81 MB)
Alternative disc choices	HP 7907A (40 MB, half removable), 7936H/XP (307 MB fixed), 7937H/XP (571 MB fixed), 7957A (81 MB fixed), 7958A (130 MB fixed), 9133L (40 MB fixed + 630 kB microfloppy)				HP 7907A (40 MB, half removable), 7936H/XP (307 MB fixed), 7937H/XP (571 MB fixed), 7957A (81 MB fixed), 7958A (130 MB fixed)		
Software installation/system backup	Microfloppy disc, CS/80 cartridge tape (35401A or 9144A), or 1600 cpi magnetic tape (7974A, 7978B, 7979A, or 7980A)				CS/80 cartridge tape (35401A or 9144A), or 1600 cpi magnetic tape (7974A, 7978B, 7979A, or 7980A)		
Hardware floating point?	No	No	Yes	Yes	No	Yes	Yes
Graphics/1000-II available?	Yes	Yes	Yes	Yes	Yes	Yes	Yes
QDM/1000 available?	Yes	Yes	Yes	Yes	Yes	Yes	Yes
Programmable controller interface available?	Yes	Yes	Yes	Yes	Yes	Yes	Yes
Measurement & control interface available?	Yes	Yes	Yes	Yes	Yes	Yes	Yes
Image/1000-II available?	Yes	Yes	Yes	Yes	Yes	Yes	Yes
LAN/1000 link available?	Yes	Yes	Yes	Yes	Yes	Yes	Yes
AdvanceNet NS/1000 communication with HP 1000, HP 3000, and HP 9000 available?	Yes	Yes	Yes	Yes	Yes	Yes	Yes
Communication with IBM systems available?	Yes	Yes	Yes	Yes	Yes	Yes	Yes

\* Average effective access time, assuming 88% cache hit rate.

**HP 1000 Ordering Information**

**HP 1000 Computers**

	<b>Price</b>
<b>HP 12100A</b> (A400) Single-Board Computer with 512 kB memory	\$ 2,550
<b>HP 2106CK</b> (A600+) Board Computer with 512 kB parity memory	\$ 4,600
<b>HP 2106DK</b> (A600+) Board Computer with 1 MB ECC memory	\$ 8,680
<b>HP 2134A</b> (A400) Computer w/512 kB memory	\$ 8,200
<b>HP 2156C</b> (A600+) Computer w/512 kB parity memory	\$ 9,200
<b>HP 2156D</b> (A600+) Computer w/1 MB ECC memory	\$13,280
<b>HP 2137B</b> (A700) Computer w/FPP	\$13,200
<b>HP 2139B</b> (A900) Computer	\$20,300
<b>HP 2424A</b> (A400) Computer w/512 kB parity memory	\$ 4,895
<b>HP 2426G</b> (A600+) Computer w/512 kB parity memory	\$ 5,900
<b>HP 2426H</b> (A600+) Computer w/1 MB ECC memory	\$ 9,980
<b>HP 2434A</b> (A400) Computer w/512 kB parity memory	\$ 7,040
<b>HP 2436G</b> (A600+) Computer w/512 kB parity memory	\$ 7,300
<b>HP 2436H</b> (A600+) Computer w/1 MB ECC memory	\$11,380
<b>HP 2437B</b> (A700) Computer w/FPP	\$12,300
<b>HP 2439B</b> (A900) Computer	\$16,100

**HP 1000 System Processor Units**

<b>Micro 24</b> System Processor Unit* w/512 kB parity memory	\$ 9,650
<b>Micro 26</b> System Processor Unit* w/512 kB parity memory	\$10,800
<b>Micro 26</b> System Processor Unit* w/1 MB ECC memory	\$14,880
<b>Micro 27</b> System Processor Unit* w/FPP	\$16,500
<b>Micro 29</b> System Processor Unit*	\$20,000
<b>Model 26</b> System Processor Unit* w/512 kB parity memory	\$13,800
<b>Model 26</b> System Processor Unit* w/1 MB ECC memory	\$17,880
<b>Model 27</b> System Processor Unit* w/FPP	\$18,000
<b>Model 29</b> System Proc Unit*	\$26,700

\* Requires system console and system disc for operation; Micro 27 and 29 and Model 27 and 29 will also require one memory array card; Model 26, 27, and 29 System Processor Units are intended to be mounted in an EIA standard 19-inch rack, which is purchased separately.

**HP 1000 Memory Arrays & Other Plug-ins**

<b>HP 12103K</b> 2 MB Parity Memory Array Card for A400, A600+, or A700	\$ 3,500
<b>HP 12103L</b> 4 MB Parity Memory Array Card for A400, A600+, or A700	\$ 6,000
<b>HP 12103M</b> 8 MB Parity Memory Array Card for A400, A600+, or A700	\$10,000
<b>HP 12111B</b> 1 MB ECC Memory Array Card for A600+ or A700	\$ 4,500
<b>HP 12111C</b> 2 MB ECC Memory Array Card for A600+ or A700	\$ 8,000
<b>HP 12154A</b> Battery Backup for 243x computer	\$ 460
<b>HP 12157B</b> Battery Backup for 2137B, 2139B, or 2156C/D computer	\$ 199
<b>HP 12221B</b> 8 MB ECC Memory Array Card for A900	\$16,000

Quantity discounts are available.

A complete list of HP 1000 computer accessories is available from your HP sales office.

178	178	178
179	179	179
180	180	180
181	181	181
182	182	182
183	183	183
184	184	184
185	185	185
186	186	186
187	187	187
188	188	188
189	189	189
190	190	190
191	191	191
192	192	192
193	193	193
194	194	194
195	195	195
196	196	196
197	197	197
198	198	198
199	199	199
200	200	200

## **COMPUTERS, PERIPHERALS & OTHER KEY PRODUCTS**

<b>Solid State Devices .....</b>	<b>660</b>
<b>Analytical Instruments for Chemistry .....</b>	<b>662</b>
<b>Medical Instrumentation .....</b>	<b>664</b>
<b>X-Ray Equipment.....</b>	<b>668</b>
<b>Personal Computers &amp; Calculators.....</b>	<b>688</b>
<b>Business Computer Systems .....</b>	<b>690</b>
<b>Computer Peripherals .....</b>	<b>698</b>

Hewlett-Packard offers other important products for industry, including LED solid-state devices, fiber optic components, analytical instruments for chemical applications, medical electronics, and scientific and industrial x-ray systems.

HP is a major business-computer manufacturer. Our offering includes calculators, portable computers, personal computers and minicomputers. In 1986 HP introduced the first in a series of new, high-performance computers based on HP Precision Architecture, allowing the company to develop a broad range of compatible computers of outstanding price/performance, compared to conventional designs.

**Computers,  
Peripherals &  
Other Key Products**

# SOLID STATE DEVICES

## Components

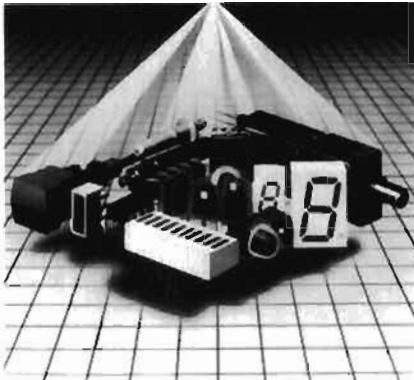

HP's Growing Optoelectronic Family



Fiber Optic Family

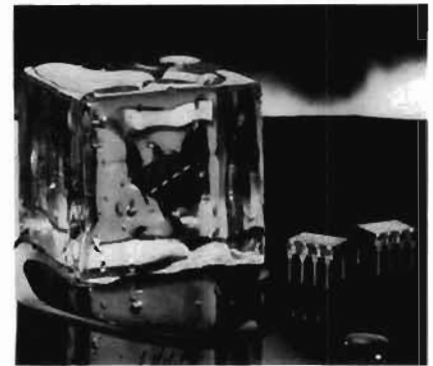

Hermetic Optocouplers

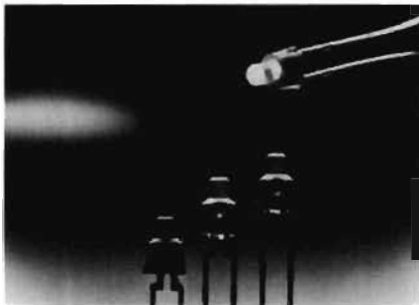

LED Lamps

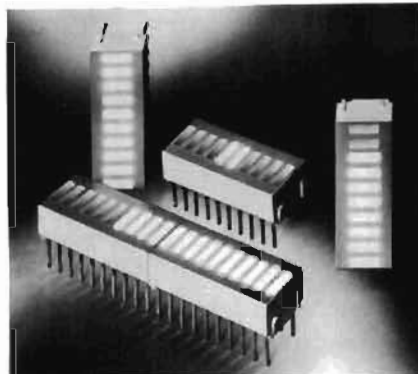

Light Bars

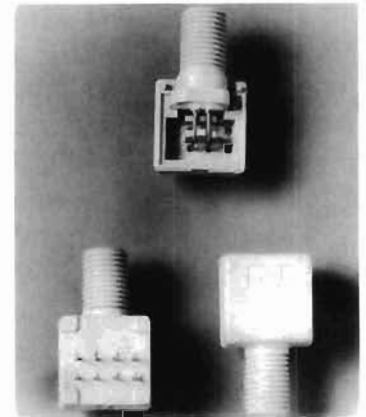

Low-Price Miniature  
Fiber Optic Components

### LED Solid State Lamps, Light Bars & Arrays

Hewlett-Packard is a world leader in the area of LED technology, and offers a broad variety of LED indicator products available in red, high efficiency red, yellow and high performance green. Emphasizing high brightness and superior reliability, Hewlett-Packard's most recent product introductions include a family of high-performance green indicators, ultrabright LED lamps (125 mod at 20mA), and LED bar graph arrays of 10- and 101-elements. Recent advancements in the fundamental semiconductor material have generated new areas of contribution, particularly in sunlight viewability, low power consumption, and brightness.

### Solid State Displays

Hewlett-Packard offers a complete line of seven-segment displays in red, high efficiency red, yellow and high performance green and in a wide variety of package sizes. The newest member is the micro-bright display which has a 0.3-inch character height in a 0.5-inch by 0.3-inch package.

LED alphanumeric displays in monolithic and dot matrix versions are also available. Some of these rugged displays are screened and tested for use in military applications and harsh environments.

The aesthetic appearance and reliable performance of LED displays make them appropriate for use in instruments, point-of-sale,

appliance, automobile, telephone and other high-ambient light front-panel displays.

### Optocouplers

Hewlett-Packard's family of logic compatible, high-performance optocouplers provides solutions to problems caused by ground loops and induced common mode noise for both analog and digital applications in commercial, industrial and military products.

Types of optocouplers available include high-speed and high-gain devices ac/dc to logic interface optocouplers, and optocouplers which interface directly with microprocessors.

### Fiber Optic Components

Hewlett-Packard offers three families of fiber optic components which include transmitters, receivers, cable, connectors and connector assembly tools.

### Plastic Snap-In Link Components

Low cost and ease of use make this family of link components well-suited for applications connecting computers to terminals, printers, plotters and industrial-control equipment. These links use rugged, 1 millimetre diameter plastic fiber cable. Assembling the plastic snap-in connectors onto the cable is extremely easy. The HFBR-0500 evaluation kit contains a complete working link including transmitter, receiver, 5 metres of connected cable, extra connectors, polishing kit and technical literature.

### Miniature Link Components

This family offers a wide range of price/performance choices for computer, industrial-control and military applications. The unique design of the lensed optical coupling system makes this family of components very reliable. The low cost miniature line (HFBR-0400 series) features a Dual-in-line package which requires no mounting hardware or receptacle for use with SMA-style connectors. The standard miniature line (HFBR-0200 series) features a precision metal package for rugged applications. Both HP-style and SMA-style connectors are available for this line. An evaluation kit is available for sampling purposes. The HFBR-0200 kit contains transmitter, receiver, 10 metres of cable and technical literature.

### High Performance Modules

Transparent TTL-TTL link capability and independence from data format restrictions make this family of modules easy to use in a variety of applications. A link monitor on the receiver provides a digital indication of link continuity, independent of the presence of data. The modules are compatible with HP-style connectors and small-diameter glass fiber cable. A transmitter, receiver, 10 metres of connected cable and technical literature are contained in the HFBR-0010 evaluation kit.

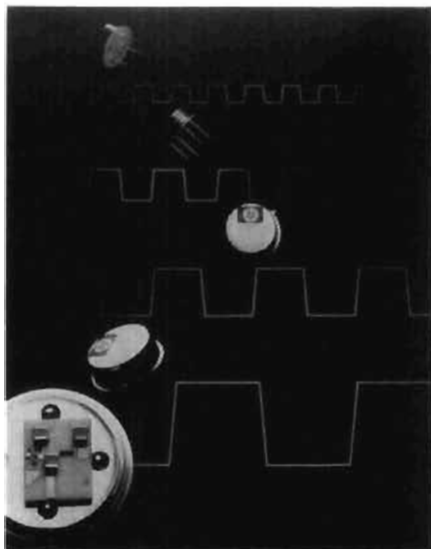

Hybrid Cascadable Amplifiers



Surface Mount Optocouplers



Bar Code Components



Bipolar Transistors

### Silicon Bipolar Transistors

Device-to-device uniformity and superior performance are combined in the HXTR series of microwave transistors which have been individually designed for low noise (HXTR-6000 series), high gain (HXTR-2000 series), low distortion linear power (HXTR-5000 series). With guaranteed RF performance specifications from 1000 to 4000 MHz, these devices are well suited for high-reliability, space military, and industrial applications at frequencies up to 6000 MHz.

### Diodes

Schottky Barrier Diodes combine extremely high rectification efficiency with picosecond switching speeds, low series resistance, and low noise characteristics. This combination makes the Schottky an excellent mixer/detector diode.

**PIN Diodes:** PIN diodes function as variable resistors at microwave frequencies. By controlling the dc bias, the RF resistance of a PIN diode can be varied from 1 ohm to about 10 ohms. This property of the PIN diode makes it extremely useful as a switch attenuator, modulator, phase shifter, limiter or AGC element at all frequencies from 1 MHz to 18 GHz and above.

**Step Recovery Diodes:** The step recovery diode is most graphically described as a

charge-controlled switch. That is, a forward bias stores charge, a reverse bias depletes this stored charge, and when fully depleted the SRD ceases to conduct current.

**Diodes for Hybrid Integrated Circuits:** These circuits are used to achieve circuits with light weight, small size, operation to high frequencies, repeatable characteristics and lower end-product costs. HP offers a wide range of PIN, Schottky and SRD single diodes in beam lead and chip configurations as well as Schottky lead pair and quad diodes.

**Integrated Products:** Hewlett-Packard manufactures a broad line of components for the control, conversion, and generation of RF and microwave signals. This line of integrated products (combinations of chip and beam lead diodes with hybrid thin film circuit technology) includes SPST switches, absorptive modulators, attenuators, limiters, comb generators, double-balanced mixers, and mixer/detectors.

### Bar Code Products

Designed to meet the OEM's bar code needs, Hewlett-Packard's bar code line includes digital bar code wands, two decoder IC's, optical reflective sensors, slot readers, and bar code readers. The expanding line of digital wands contains HP's Low Current Digital Bar Wand, which draws less than 5

mA of current at 5 volts, and the HP Smart Wand, an optical programmable contact bar code reader for the HP-94 Industrial Handheld Computer. The Digital Slot Reader, introduced in 1986 and available in both an infrared (880 nm) and a visible red (660 nm) version, is ideal for use in security or industrial applications. The Multi-Purpose Decoder IC offers a simple and inexpensive solution of adding bar code decoding capabilities to OEM products.

### High Reliability Testing

Many Hewlett-Packard components are space qualified. The reliability of these devices is established by one of the finest high reliability testing facilities in the microwave component industry. Hewlett-Packard's High Reliability Test Group maintains military approved JAN and JANTX parts in stock and can recommend HP standard screening programs, patterned after MIL-S-19500, for any HP component.

### Write For More Information

Specifications of Hewlett-Packard's component products are available in individual data sheets or complete designer catalogs. These are available free of charge from your local HP sales office or authorized distributor, or return the Information Request Card located at the back of this catalog.

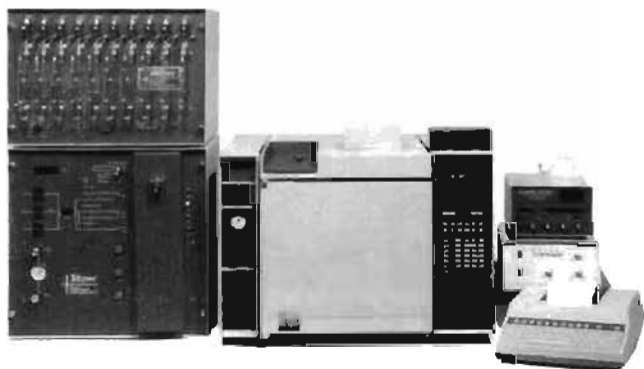

HP 193194B Environmental Analysis System

**Waste Water Analysis** for environmental pollutants has been required since the 1970's, and the number of compounds regulated by the Federal government continues to grow. This system makes it easier for contract and in-house labs to meet their requirement for waste water or other EPA analyses, because it is configured as described in EPA methods 601 and 602. A variety of data handling solutions is available.

**Amino Acid Analysis.** HP AminoQuant, a new amino acid analyzer performs automated analysis of 17 primary and secondary amino acids. Based on the HP 1090 Series M Liquid Chromatograph, it includes extensively tested chemistries and methodologies which provide biochemists with precise, accurate, and sensitive results.



HP AminoQuant Amino Acid Analyzer

**Liquid chromatographs.** The HP 1090 family of HPLC systems splits into two major groups based on the type of system controller used. The HP 1090 Series L systems incorporate a system control panel and handle routine and high-volume analyses with ease. For more demanding applications, HP offers the HP 1090 Series M, which employs the HPLC ChemStation.

Increased confidence in results can be obtained by connecting a sensitive detector to an LC. LC detector options from HP include the HP 1040M diode-array detector and the HP 1046A fluorescence detector.



HP 5890A Gas Chromatograph with HP GC ChemStation

**Gas chromatographs.** The broad line of HP GCs includes the HP 5890A GC for routine analysis, which is fast becoming the standard of the industry. When combined with the HP GC ChemStation analytical workstation for data analysis, the HP 5890A serves as a powerful tool for research and development. Finally, the HP 5880A GC is available in a variety of configurations for special analyses, including simulated distillation and natural gas.



HP 5988A Thermospray LC/Mass Spectrometer

**GC/MS and LC/MS.** You may choose the appropriate mass spectrometer for your needs from among a number of alternatives. In each case, the HP MS ChemStation analytical workstation is available to control the system and process data.

The HP 5970B mass selective detector (MSD) allows gas chromatographers to extend their GC capabilities into the realm of GC/MS. The MSD connects to GCs from many manufacturers. For more capability, HP offers the HP 5995C benchtop GC/MS. At the top of the HP line is the research-grade HP 5988A GC/MS, also available as an LC/MS system.



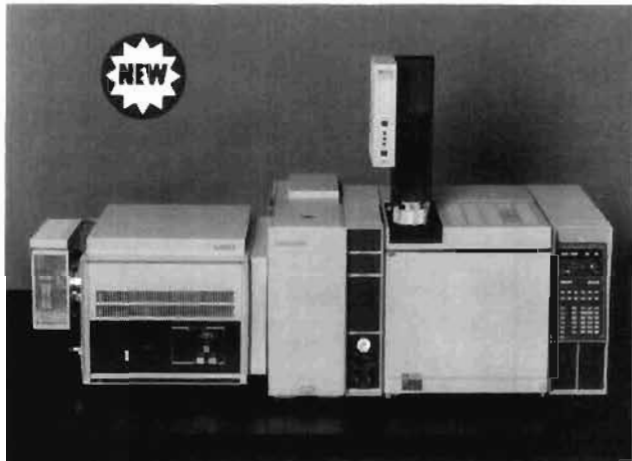

**HP GC/IRD/MSD System**

**Drug Analysis** is only one of the demanding application areas addressed by this powerful, versatile system. It combines three proven HP instruments: the HP 5890A GC, HP 5965A IRD infrared detector, and the HP 5970B Mass Selective Detector (MSD). Therefore it produces three dimensions of data: retention times, infrared spectra, and mass spectra. Data handling is provided by two HP ChemStations.



**HP Lab Automation Systems**

**Laboratory Automation Systems.** Whatever size your laboratory, HP integrators and systems for laboratory information management can help increase your productivity. The HP multi-user, multi-instrument data acquisition and laboratory information management system software products are based on the HP 1000 computer system. They provide easy-to-use, yet sophisticated data reduction and manage the flow of samples, information and materials throughout the lab. The HP family of integrators covers a wide range of capability and includes the HP 3390A reporting integrator, the HP 3392A networking integrator, and the HP 3393A computing integrator.



**HP 8452A UV/Vis Diode-array Spectrophotometer**

**UV/Vis spectrophotometry.** The HP 8451A UV/Vis spectrophotometer is the basis of a growing number of applications packages including simulated dissolution testing for pharmaceuticals. The HP 8452A UV/Vis spectrophotometer, which was introduced in March 1986, makes diode-array technology accessible to laboratories in industry and education where budgets are tight. The HP 8452A works with a variety of controllers, including the HP UV/Vis ChemStation, the HP Vectra PC, and the IBM PC, XT or AT.

**For further information** write to Hewlett-Packard Company, Analytical Products, 1820 Embarcadero Road, Palo Alto, CA 94303.



**HP 89810S Microassay System**

**Innovative Products For Bioscience.** The HP 89810S Microassay System is a complete solution for automating entire microplate methods—from sample preparation, to analysis, to data management. It improves method reliability and repeatability by eliminating much of the tedium and human error from ELISA methods. It also increases daily throughput because it can run unattended overnight. The Microassay System is modular to fit differing lab requirements and includes: fluid handling modules, microplate reader and software, HP Vectra P.C., and a robotic arm for plate manipulation.

# MEDICAL INSTRUMENTATION



## Ultrasound Imaging

- Real-time phased array systems—totally mobile
- Doppler option with advanced analysis capabilities
- Color flow mapping option
- HP 77020AC configured for the cardiologist
- HP 77020AR configured for radiology and shared services: abdominal, ob/gyn, neonatal, peripheral vascular



## Cardiology Instrumentation

- New HP 4765A PageWriter II Interpretive Cardiograph
- ECG Management Systems for computer-aided management of electrocardiograms
- ECG Workstations for PC-based ECG department management



## Obstetrical and Neonatal Instrumentation

- Fetal/maternal monitoring equipment includes antepartum and intrapartum fetal monitors, and central stations
- Telemetry for birthing centers
- Neonatal monitoring includes heart rate, temperature, respiration, pressure, and transcutaneous blood gas

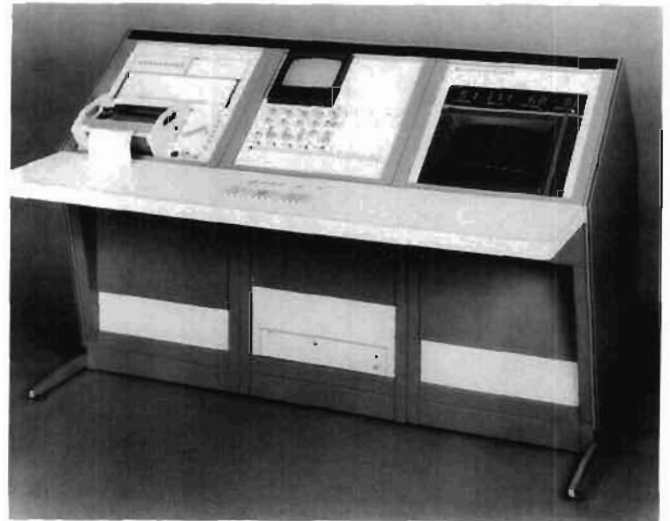

## Cardiovascular Instrumentation

- Computerized catheterization data analysis system automates on-line data collection analysis
- Comprehensive data base for generating both clinical and administrative reports
- Complete choice of plug-in signal conditioners and transducers



**Arrhythmia Monitoring**

- Detection and classification by algorithm
- Advanced information management capabilities
- Patient Information Centers
- Telemetry



**Ambulatory ECG**

- True two-channel analysis and ST-segment measurement
- PC-based system includes two patient analyzers with HP LaserJet printer for reporting
- Optional full disclosure Module

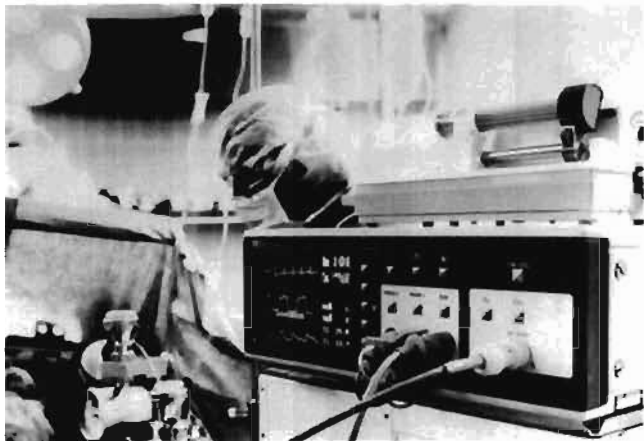

**O.R. Monitoring**

- Compact, inexpensive bedside monitoring for all O.R. levels
- Combinations of up to eight parameters, plus networking capability



**Resuscitation**

- Easy to use, 3-step operation
- Lightweight, reliable design



**Patient Monitoring**

- Monitor/Terminal with overview feature
- Data management
- HP Critical Care Network

For Additional Information on HP Medical instrumentation, request literature in one or more of the following categories.

- Patient Monitoring
- Ultrasound Imaging
- Cardiography Instrumentation
- Cardiovascular Instrumentation
- Obstetrical and Neonatal Instrumentation
- Arrhythmia Monitoring
- OR Monitoring
- Resuscitation
- Healthcare Information Systems
- Healthcare Personal Computers
- Supplies, Consumables, Pressure Transducers

Please use request card at back of catalog.

An Invitation for you to become a subscriber to ADVANCES FOR MEDICINE, the Hewlett-Packard medical products magazine. To receive ADVANCES free of charge, simply fill in and return the request card at the back of this catalog.

# X-RAY EQUIPMENT

## Cabinet X-Ray Systems

Models 43855A, 43855B and 43856A



FAXITRON MODEL 43855A  
WITH OPTION A02



FAXITRON MODEL 43856A



FAXITRON MODEL 43855B

### Faxitron® Cabinet Systems

Radiography, the art and science of making pictures with X-rays, has an important place in modern technology. It is one of the major nondestructive test methods available to industry, provides an indispensable tool in scientific investigations and is a valuable aid to law enforcement agencies. Hewlett-Packard makes a major contribution to these activities with X-ray equipment that offers a "better way" through advanced technology and design. This equipment makes radiographs easier and safer to take.

### Scientific Applications

Oceanography, geology, marine biology, paleontology, pathology, botany, forestry and agricultural research are a few examples of scientific disciplines that use X-rays. Applications range from the study of the interior anatomy of fossils to determining the viability of seeds.

These are among the many applications served by HP Faxitron Cabinet X-ray Systems. They offer a unique combination of high quality radiographic capability, simplicity of operation and convenience of use which is expanding the capabilities of scientific and industrial concerns throughout the world.

### Industrial Inspection

Industrial quality control and inspection procedures, especially in the field of electronics, benefit from nondestructive testing by radiography. The advantages of a testing method which does not harm the test objects are obvious. Radiography, therefore, offers benefits in design engineering, incoming inspection, production quality control, product reliability and failure analysis. X-rays are used to detect misregistration or plate-thru problems in multi-layer P.C. boards; porosity, poor substrate bonding and wiring or lead location in transistors and integrated circuits; voids and other encapsulation problems in potted components; and solder balls or other defects in sealed relays.

Die casting is another industry that benefits from the nondestructive aspects and ability to "see inside" provided by radiography. Porosity, gas void, tramp metal inclusion and other common defects can be easily detected and the cause determined. Expensive machining time can be avoided for castings found to be defective through X-ray inspection. The integrity of welds, alignment of connectors, inspection for proper assembly and mechanical defects are further examples of tests which radiography performs for industry. The benefits of X-ray testing are reduced production costs, better quality assurance and product safety. The results are increased profits.

### Medical Applications

HP Faxitron Cabinet X-ray Systems are used by the medical profession for specimen radiography in support of diagnostic surgical procedures and in biological research. Specimen radiographs of biopsy samples are correlated with preoperative mammograms, for example, and in the evaluation of mastectomy specimens. Typical research applications include microradiography of thin bone specimens and microangiographic studies of vasculature.

# X-RAY EQUIPMENT

## Flash X-ray Systems

Models 43703B, 43710A, 43731A, 43733A, 43734A

MODEL 43731A  
150kV

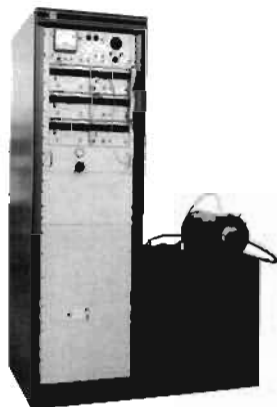

MODEL 43733A  
300kV



MODEL 43734A  
450kV

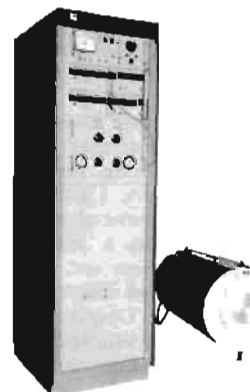

Option 035 - Dual Remote Tubehead

High-speed (flash) radiography is used to record and study dynamic events where interposed material, smoke, flame, debris, or pressure variations exclude the use of high-speed cameras. Typical events include ballistics, shaped charges, explosives, behind-armor studies, shock waves in solids, aerospace phenomena, and crash-injury studies.

The basic performance requirement of a flash X-ray system used for the study of transient mechanisms is to provide high resolution radiographs with exposure times short enough to eliminate motion blur. HP series 43700 Flash X-ray systems produce X-ray pulses of sub-microsecond duration and are designed specifically for "stop motion" radiographic applications. All HP 43700 series systems utilize the same basic components, the same electrical theory, and are modular in concept. Standard systems include 150 kV, 300 kV, 450 kV, 1 MV, and 2.3 MV models.

An HP basic single "channel" flash X-ray system, composed of a pulse generator, high voltage power supply, cold-cathode field emission X-ray tube, and associated controls, provides a single radiograph per event. Additional pulser/X-ray tube sets (add-on channels) may be combined with the initial single-channel system to provide multiple-channel "systems." Multiple channel systems may be of identical output voltage or may use varied output voltage pulser/tube combinations.

For specific information and consultation regarding HP X-ray systems, contact Hewlett-Packard, 1700 S. Baker Street, McMinnville, Oregon 97128. Telephone (800) 952-2212.

**ROCKVILLE (Sales)**  
#2 Choke Cherry Road  
Rockville, Maryland 20850  
Telephone (301) 948-6370

**ALBUQUERQUE**  
7801 Jefferson Street, N.E.  
Albuquerque, New Mexico 87109  
Telephone (505) 823-6100

**IRVINE**  
9800 Muirlands Avenue  
Irvine, California 92718  
Telephone (714) 472-3000

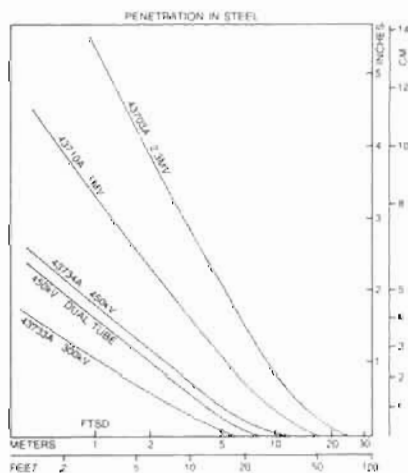
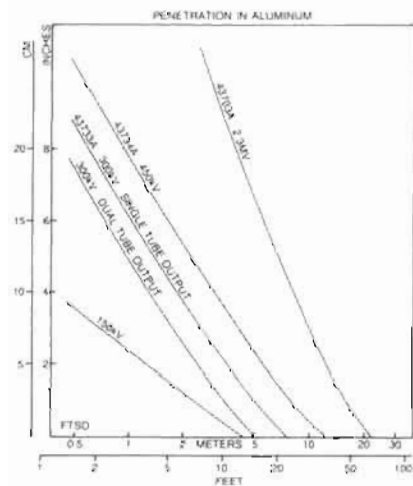

Compression of golf ball when hit with club

# PERSONAL COMPUTERS & CALCULATORS

## Overview and Matrix

Vectra, Touchscreen II, Portable PLUS, Portable Vectra CS PC, HP-94, HP-71

### Advanced Personal Computers

Hewlett-Packard computers were first developed to meet a growing need for complex automatic test systems in industry. In the 20 years since the first HP computer was introduced, we've expanded our product line to include innovative personal computers for professional, business, office, and computation systems.

Sophisticated test and measurement instruments, such as those used today in research and manufacturing, require equally sophisticated controllers. Linking Hewlett-Packard's advanced personal computers to instrumentation creates a practical, cost-effective way to program and perform test procedures, analyze and compare data, and record and plot results. Coupled with powerful software tailored to your specific application, HP computers and instruments provide an integrated single-vendor approach to a wide variety of measurement and computation environments.

Factory automation managers, data processing experts, and professionals in office management, engineering, and scientific environments can find an HP personal computer to fit their needs — as well as one that supports the level of assistance required for successful automation of an instrument system. With many built-in applications and programming aids, plus an unequalled variety of peripherals and accessories, HP computers provide a range of computing power for both novices and experienced users.

**Portable PLUS** — Personal portable computer optimized for solution-oriented applications requiring small size and weight, long battery life, and high durability.

**Portable Vectra CS PC** — IBM PC/XT™ compatible

computer that gives you the functionality of a desktop computer in a battery-powered portable package that communicates with desktops and mainframes.

**Vectra** — Personal computers that have your future in mind. Using a modular design, the Vectra PC lets you configure a system to your requirements, while retaining add-on capabilities that don't penalize your system operation or budget. It's a high-performance personal computer designed for software and hardware compatibility with the IBM® PC/AT\*. The Vectra PC can be ordered in a variety of configurations to meet any technical or business application.

Typical technical configurations include the Vectra Industrial PC, which is designed to handle manufacturing applications such as data collection, report generation, and quality checks. The Vectra/HP BASIC Controller System handles instrument control, computer-aided engineering, and office-automation tasks — all in one system.

In the office environment, the Vectra Office provides a complete, integrated workstation solution with a broad range of software. The Vectra Publisher PC is a bundled desktop publishing solution for producing sophisticated documents using merged text and graphics.



Using the HP PC Instruments Bus (PCIB) and HP's PC Instruments, you can easily create your own automated test and measurement systems.

**Touchscreen II** — Personal computers that offer an easy introduction to office automation and computer-controlled instruments. The HP Touch accessory lets you control your system by simply touching the screen.

**Touchscreen HP-IB Controller and Touchscreen PCIB Controller** — Integrating the Touchscreen II and the test and measurement instruments you use every day. We provide the hardware and software to control instrumentation on the IEEE-488 bus and HP PC Instruments Bus, using the Touchscreen II. See the "Hewlett-Packard Interface Bus" section of this catalog for more information.

**HP-94 and HP-71** — Handheld computers that communicate with desktops and mainframes and that have full-size computing features in a small portable package, which you can take to the field for data collection or to the manufacturing floor for low-cost control.

**PC Instruments** — Personal-computer instrumentation products that form a unique hardware and software system, linking test and measurement instruments with personal computers. You can simultaneously monitor and control as many as eight different instruments per PC Instruments interface card from the screen of your HP Vectra and Touchscreen II PCs and IBM PC/XT/ATs. See the "PC/XT Instruments" section for complete information on these products.

Advanced HP personal computers are also at the heart of IEEE-488-based and other automated measurement systems and computer-aided engineering systems, providing quick solutions to design, simulation, modeling, and test problems. In addition, such products as the Semiconductor Productivity Network, Manufacturing Resource Planning, and the HP Materials, Production, and Management programs combine the efficiency of HP personal computers with the strength of HP mainframes. For complete information on these applications, refer to the "Technical Computer Systems" and "Business Computer Systems" sections of this catalog.

### Computational Tools for Instrument Control and Data Collection

HP's advanced calculators and handheld computers offer portability with the power of a computer. Designed for use in science, engineering, and mathematics, they can stand alone or be used as part of a system. Handheld computers are ideal as system controllers or in remote data collection in field or manufacturing environments.

Advanced calculators and a handheld computer can be enhanced to increase calculating options. And they can become the intelligent center of a system by adding the Hewlett-Packard Interface Loop (HP-IL). HP-IL is a bit-serial interface for battery-operable systems; it provides the link to instruments, peripherals, desktop computers, modems, and terminals. With HP-IL and add-ons, the handheld computer can transfer information collected from remote sites, or monitor and control production operations, processes, and experiments. Applications include those that connect HP-IL systems to RS-232C devices, high-performance HP-IB computers and lab equipment, and control equipment operating with parallel bus structures.

A rugged handheld industrial computer is designed for use in remote data collection and item tracking — applications where it's impossible to use desktop computers and terminals. It can be programmed to collect (with or without a bar-code wand), process, and store data — and then communicate directly to an HP 3000, IBM 8100, or other host computer via built-in serial interface or via modem. Software is developed in BASIC or 8088 assembly language using the HP Vectra PC or IBM PC/XT/AT. A truck-mounted printer is available for mobile applications.

IBM PC/XT is a U.S. trademark of International Business Machines Corporation.

MS-DOS and GW-BASIC are U.S. trademarks of Microsoft Corporation.

IBM and PC/AT are U.S. registered trademarks of International Business Machines Corporation.

DEC is a registered trademark of Digital Equipment Corporation.

Intelligent Mail is a registered trademark of Lattice, Inc.

## Sharing Information and Resources

Networking capabilities provide the links between individual personal computers, mainframes, minicomputers, and associated peripherals. Successful networking, however, is more than just sharing information and peripherals. It is the efficient integration of data; management functions; transparent access to information; management of data and resources; and compatible, reliable storage.

As a leader in developing industry-wide networking and communications standards, HP offers a full range of personal computers, workstations, and host computers that you can configure into fully integrated systems that are exactly suited to your application. The links in such systems are made through the HP AdvanceNet architecture, which encompasses our overall range of networking products.

HP AdvanceNet products address the physical connection (link) and the network services (software) requirements for local area, site-wide, and global-wide networks. HP AdvanceNet has optimized solutions for integrated business systems (office), design (engineering and scientific), and operations (manufacturing), and ties them all together in a total business network. To assist in integrating multi-vendor systems, HP AdvanceNet offers products for both interactive and batch communications between HP systems and IBM systems (mainframes and PCs), and for file transfer to and from DEC® VAX systems.

The broad range of networking alternatives supported by HP AdvanceNet offers the greatest latitude for network design, implementation, and growth. HP AdvanceNet products are based on industry standards, many of which HP has helped create, for

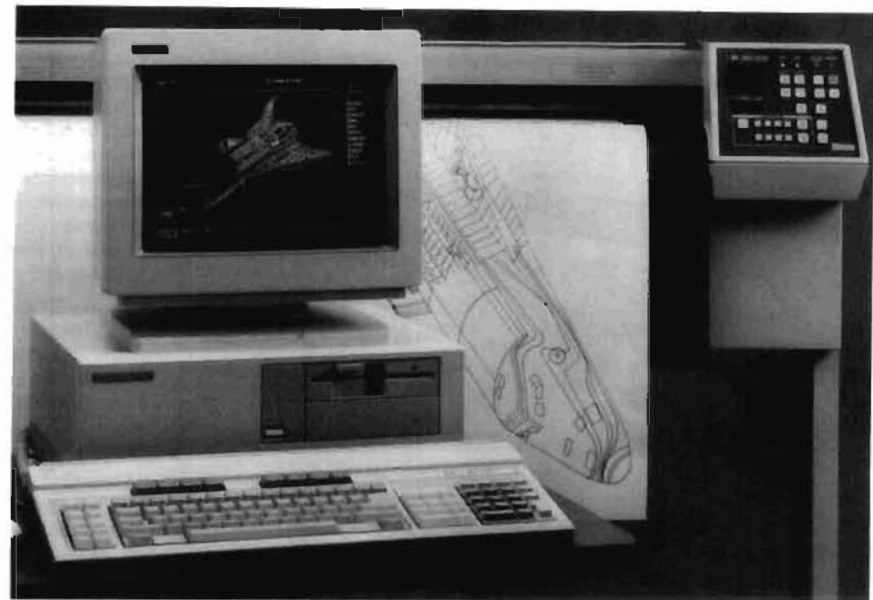

The HP Vectra PC's performance and flexibility make it a natural choice for computer-aided design and engineering.

maximum compatibility, today and tomorrow.

## HP Personal Computers

This chart briefly summarizes HP's wide range of personal computer products. Refer to the "Peripherals" section, page 512, for descriptions of peripherals and accessory products. For more information on each personal computer, see the pages referenced in the matrix, below. Software information is

provided in the "Software Choices" section of this catalog.

If you have more questions about a computer or its usefulness for your application, please call the local Hewlett-Packard Sales and Service Office listed in the telephone directory white pages, or see page 760. Ask for the computer department. For your nearest HP dealer in the U.S., call toll-free 800-752-0900.

## Personal Computer Matrix

Computer	Vectra	Touchscreen II	Portable PLUS	Portable Vectra CS PC	HP-94	HP-71
Microprocessor/CPU	Intel 80286	Intel 8088	Intel 80C86	Intel-80C86-compatible	Intel 80C88-compatible (NRC PD70108)	HP
Coprocessor	Intel 80287	Intel 8087	None	Numeric co-processor slot	None	None
Operating System	MS™-DOS 3.2 PAM	MS-DOS 3.2 PAM	MS-DOS 2.11 PAM	MS-DOS 3.2	HP BASIC Interpreter	HP BASIC (64K ROM-based)
Languages	BASIC, MS-DOS Macro-Assembler, LATTICE® C Compiler	BASIC, COBOL, FORTRAN, GW™-BASIC, C Compiler, Pascal	See "Software Choices," page TBS	MS-DOS Macro-Assembler	BASIC, 80C88 Assembler, Microsoft C	BASIC, Forth, Assembler
Memory	64K ROM, 256K RAM Expands to 3.64M	160K ROM, 256K-640K RAM Expanded memory up to 8M	512K RAM Expands to 2.5M	640K RAM, 2M EMS RAM optional	64K, 128K, or 256K RAM. Expands to 256K	17.5K RAM Expands to 33.5K (129K w/module)
Mass Storage	Multiple configurations	Multiple configurations	Multiple configurations	2 3.5" 1.44M floppy disk drives	None	Multiple configurations
Networking Data Comm. I/O	HP-IB, HP-IL, HP-HIL, RS-232C, RS-422, internal modem, Centronics, OfficeShare LAN	Built-in: 1 HP-IB port, 1 RS-232C/RS-422 port, add'l HP-HIL port, Centronics, OfficeShare LAN	HP-IL, RS-232C, Portable/Desktop Link, internal modem	Built-in: Centronics Options: RS-232C/RS-422 internal modem	Serial	HP-IL, HP-IB, RS-232C, GPIB
I/O Slots	7	4	2	4	1	4
Display	HP Touch, 12-inch monochrome/color 13-inch EGA	HP Touch, 12-inch 27-line x 80-col.	High-contrast flat-panel LCD 25-line x 80-col	25-line x 80-col 32-inch flat panel supertwist LCD	4-line x 20-character LCD with backlight	22-character LCD scroll to 96 char. 25-line x 80-col.
Keyboard	HP HIL device port; Enhanced IBM PC/AT layout	HP-HIL device port; Function keys; 8 screen-labeled, 12 programmable	Full size 8 function keys Shifted numeric keypad	Enhanced IBM PC/XT layout	ABC format Numeric keypad	Block QWERTY Numeric keypad
Refer to Page	672	670	676	678	679	685

# PERSONAL COMPUTERS & CALCULATORS

## The Touchscreen II Personal Computer



The HP Touchscreen II PC, with a Winchester disc drive, is ideal for use with test and measurement instruments.

### The Touchscreen II Personal Computer

The Touchscreen II PC/Terminal is a natural for business and industrial systems. It delivers the processing power, terminal capabilities, and memory space necessary to execute lengthy, complex applications. And with more than 1,000 software packages, you can design office automation or instrument-controller systems using the Touchscreen II and discover solutions you never thought possible with a personal computer.

#### Touchscreen II PC Features

- 8 MHz Intel 8088 microprocessor
- 8 MHz Intel 8087 co-processor (optional)
- HP Touch Accessory (optional)
- MST<sup>™</sup>-DOS 3.2
- Built-in HP 2623 terminal features
- 256K-byte RAM, expandable to 640K bytes
- Four accessory slots
- Up to 8M bytes of expanded memory
- Personal Applications Manager (PAM) and disc utilities
- Support in the U.S. for more than 1,000 software packages
- High-resolution graphics display
- Hewlett-Packard Human Interface Link (HP-HIL)
- Low-profile keyboard
- Flexible data communications features
- Choice of dual microfloppy or Winchester hard disc storage
- 12-inch screen with built-in display tilt

#### Personal Applications Manager (PAM)

The PAM is the primary interface between the user and the MS-DOS 3.2 operating system. PAM is an operating system "shell" that provides an attractive alternative to confusing MS-DOS commands, and has been designed to work harmoniously with HP Touch to facilitate ease of use. For users who want to work directly with the MS-DOS command structure, PAM can easily be bypassed.

#### HP Touch Accessory

Hewlett-Packard's Touchscreen II personal computer encourages "hands-on" interaction. HP Touch is provided as a user-installable accessory. Unlike any other touch-sensitive display available today, HP Touch is totally integrated into the system. Other touch screens use overlays that distort the display; HP Touch does not interfere, either physically or visually, with the display. A matrix of light beams is created using a series of light-emitting diodes (LEDs) embedded along the vertical and horizontal sides of the display.

#### HP-HIL Device Port

The Hewlett-Packard Human Interface Link (HP-HIL) port on the keyboard adds new dimensions for input via the HP Mouse for Graphics Gallery applications or the Graphics Tablet with Drawing Gallery applications. You can install and use HP-HIL devices without reconfiguring the system.

These devices can be used separately or together, and since each device connects to the last one, new devices don't need extra ports on the computer. In addition, the easily transportable input devices can be shared on several different systems: simply unplug a device from one system and plug it into another.

#### Graphics Display

The Touchscreen II's display monitor, a full-size 12-inch screen, provides high-quality resolution for sharp, clear text and graphics. The 27-line by 80-column screen is ergonomically designed for user comfort, and includes built-in display tilt for maximum convenience. Lines 25 and 26 are designated for labeling function keys, and line 27 is reserved for system status and error messages.

#### Keyboard

The low-profile keyboard has 107 sculptured keys with dished home keys, and includes full local editing keys (cursor control, display scroll, next- and previous-page jump, and insert/delete keys for both single characters and lines). An 18-key numeric pad may be used as a graphics keypad for terminal applications. The keyboard includes eight screen-labeled and 12 programmable function keys, and is connected to the terminal by an 8-foot coiled cable.

#### System Expansion

The Touchscreen II comes with four accessory slots to accommodate a number of solutions for expanding your system. The built-in HP-IB interface allows you to add storage space: large-capacity Winchester options of 10M bytes, 20M bytes, and 40M bytes, plus backup tape storage devices. Up to 8M bytes of expanded memory are available. Tailor the Touchscreen II: choose from a full spectrum of Hewlett-Packard printers, plotters, modems, accessories, and software to match your current and future requirements. An Intel 8087 co-processor accessory is available for speedy real-number computation using 1-2-3<sup>®</sup> Release 2.01 from Lotus<sup>®</sup>, FORTRAN, Pascal, and C programming languages and the MS-DOS macroassembler.

#### Ergonomic Design

The Touchscreen II is ergonomically designed for user comfort and convenience. With its small footprint and cable cover system, you can put the Touchscreen II flush against a wall and set a disc drive or printer on top, leaving more space on your desk. The power switch, brightness control, and keyboard connector are located on the front and side panels for easy access.

#### Data Communications

The HP Touchscreen II comes standard with one RS-232C port, an additional RS-232C or RS-422 port, one HP-HIL port on the keyboard, and one HP-IB port. The Touchscreen II, with its built-in terminal capability, can take advantage of HP's powerful networking options to share information with other computer systems ranging from the Portable PLUS to HP, IBM<sup>®</sup>, and DEC<sup>®</sup> mainframes.

Other capabilities include IBM 3278 terminal emulation with file transfer, VT100 terminal emulation, and AdvanceLink. AdvanceLink is a software package that permits ASCII and binary file transfer between Touchscreens, Vectras, other HP computer systems (e.g., the HP 3000), and IBM PCs. Additional data communications capabilities include OfficeShare ThinLAN, the HP AdvanceNet-compatible PC LAN. See the "Networking" section of this catalog for data communications product descriptions.

#### 8087 Co-Processor Accessory

Increased speed and precision in arithmetic, logarithmic, and trigonometric functions are provided by the addition of an Intel 8087 processor as a companion to the Touchscreen II's 8088. The 8087 can multiply 32- and 64-bit floating-point numbers up to 100 times faster than the 8088, depending upon the application. It is supported by the 1-2-3 Release 2.01 from Lotus, and Pascal, Lattice<sup>®</sup> C, and FORTRAN compilers and MS-DOS macroassembler offered on the Touchscreen II. The 8087 co-processor plugs into the Touchscreen II processor board and does not occupy an accessory slot. It must be installed by an HP customer engineer or authorized HP personal computer dealer.



**Software Solutions**

The Touchscreen II is designed to meet the needs of business, industrial, engineering, and manufacturing professionals by managing work through the use of sophisticated, industry-standard and -specific programs. Most of the best-selling software packages now run on the HP Touchscreen II, and have been enhanced to take advantage of such easy-to-use Touchscreen II features as HP Touch, softkeys, and PAM.

In addition to the applications software, there is a wide selection of programming languages and programmer's tools available for the Touchscreen. Such software tools as BASIC, Compiled BASIC, GW™, BASIC, Pascal, COBOL, and Lattice C compiler, as well as assemblers, utilities, and various graphics tools, help you develop custom programs.

Refer to *Software and Accessories for the HP Touchscreen and Portable Personal Computers*, and the "Software Choices" section of this catalog, for up-to-date software information.

**Specifications**

- Microprocessor/CPU:** Intel 8088, 8 MHz
- Operating System:** MS-DOS 3.2
- Memory:** 256K-byte RAM, expandable to 640K bytes; 160K-byte ROM; up to 8M bytes of expanded memory
- Display:** 27-line by 80-column, 12-inch diagonal screen
- Display Enhancements:** Inverse video, underline, blinking, half-bright, or any combination
- Alphanumeric:** 640 x 378 pixels
- Graphics:** 512 x 390 pixels
- Alternate Graphics:** 640 x 400 pixels (not supported by firmware/terminal mode)
- Optional HP Touch Accessory:** User-installable
- Character Set:** Roman8, line-drawing, Math Standard, bold and italics, depending on applications
- Total of 896 characters; local language characters
- 6 x 9 enhanced dot matrix in 8 x 14 dot-character cell
- Keyboard:**
  - Detachable, typewriter-style with 8-ft. (2.43 m) coiled cable
  - One HP-HIL device port
  - Full ASCII code
  - Eight screen-labeled function keys;
    - 12 programmable function keys
  - Auto repeat, N-key rollover, cursor controls
  - 18-key numeric/graphics pad
- Weight:**
  - CPU: 27 pounds (12.27 kg) (without keyboard)
  - Keyboard: 4.7 pounds (2.14 kg)
- Dimensions:**
  - CPU/display: 12.8 x 14.6 x 13.4 inches (325 x 370 x 342 mm)
  - Keyboard, flat: 18 x 8.9 x 1.2 inches (456 x 225 x 30 mm)\*
  - Keyboard, standing: 18 x 8.9 x 2.3 inches (456 x 225 x 58 mm)

\*Home-row height per ZH11618 (German Ergonomic Standard)

**How to Order Your Touchscreen II PC**

For more information on the Touchscreen II, contact your HP sales representative or your local HP personal computer dealer.  
**For the nearest dealer in the U.S., call toll-free: 800-752-0900**

**Ordering Information Price**

<b>Touchscreen II Personal Computer</b>		
HP 45851A	Touchscreen II with PC Kit*	\$2480
HP 35723A	HP Touch Accessory (user-installable option)	\$505
HP 9123D	Dual 3 1/2-inch Microfloppy Disc Drive (710K bytes each drive)	\$915
HP 9153A	10M-Byte Winchester/Microfloppy	\$1940
HP 9153B	20M-Byte Winchester/Microfloppy	\$2740
HP 9133L	40M-Byte Winchester/Microfloppy	\$4450
HP 45632A	384K-Byte Memory Board	\$375
HP 45890 A	512K-Byte Expanded Memory Board	\$710
HP 45885A	8087 Co-Processor Accessory (optional)	\$610
*The Touchscreen II basic system comes with the CPU/terminal (HP 2628 features — block mode with graphics), 256K bytes of memory, one RS-232C port, an additional RS-232C or RS-422 port, one HP-IB port, a system port for the HP Touch accessory, an internal expansion slot for the 8087 co-processor accessory or other custom boards, four accessory slots, and a 12-inch display. The PC kit includes the HP extended keyboard with HP-HIL port and keyboard cable, power cord, and disc drive cable, plus the Operating System Master Disc and Work Master Disc (containing MS-DOS 3.2, PAM, and disc utilities), and full documentation.		
<b>Touchscreen II Terminal</b>		
HP 45850A	Touchscreen II CPU with Terminal Kit	\$2380
The Touchscreen II Terminal includes the Touchscreen II CPU and Terminal Kit. The Terminal Kit includes the HP extended keyboard with HP-HIL port and keyboard cable, power cord, and complete documentation for using the Touchscreen II as a terminal.		
HP 35723A	HP Touch Accessory (user-installable option)	\$505
<b>Reference Documentation</b>		
HP 45849-60202	MS-DOS 3.2 User's Guide	\$75
HP 45625A	Touchscreen Technical Reference Manual	\$62
HP 45624A	HP 150 MS-DOS 2.11 User's Guide	\$50
HP 45953C	MS-Macro Assembler 4.0 for 150/TS	\$100
HP 5061-8971	MS-DOS 3.2 Programmer's Reference	\$50
HP 45849-60204	HP 150 Programmer's Reference	\$75

MS-DOS and GW-BASIC are U.S. trademarks of Microsoft Corporation.  
 IBM is a U.S. registered trademark of International Business Machines Corporation.  
 DEC is a U.S. registered trademark of Digital Equipment Corporation.  
 Lattice is a U.S. registered trademark of Lattice, Inc.  
 1-2-3 and Lotus are U.S. registered trademarks of Lotus Development Corporation.

# PERSONAL COMPUTERS & CALCULATORS

## The Vectra Personal Computer



The powerful HP Vectra Personal Computer, designed to be IBM PC/AT-compatible.

### Versatile and Flexible

Hewlett-Packard's Vectra Personal Computer has been designed to simplify your computing needs. You can select the exact combination of hardware and software that is best for your business today, without restricting your options for the future. The Vectra PC is based on the Intel 80286 microprocessor. You can start with either a 256K-byte or 640K-byte memory, which can be expanded to more than 3M bytes. Add to your system any time, from an almost unlimited range of compatible hardware and software by HP, IBM, and numerous other manufacturers.

The Vectra PC is designed to be compatible with the IBM® PC/AT®. Its MS™.DOS 3.2 operating system lets you run virtually all IBM PC/AT-compatible software, so you can choose from among the most popular programs.

### Vectra PC Features

- 8 MHz Intel 80286 16-bit microprocessor
- Optional 5.33 MHz or 8 MHz Intel 80287 numeric co-processor
- Vectra Disc Operating System (optional):
  - MS-DOS 3.2
  - Personal Applications Manager (PAM)
- Optional BASIC Interpreter and MS-DOS macroassembler
- HP Human Interface Loop (HP-HIL) accessory port
- HP Touch accessory, HP Mouse, graphics tablets, bar-code wand (optional)
- Flexible data communications options
- Supports flexible and hard disc storage
- Hardware and software compatible with IBM PC/AT
- 64K-byte ROM
- Sockets for two additional ROM chips
- 256K-byte and 640K-byte RAM: expandable up to 3.64M bytes
- Three shelves for half-height data-storage cartridges:
  - Two shelves with front access for flexible disc drives
  - One shelf for hard disc drive
- Seven IBM PC/AT-compatible I/O accessory slots
- Detachable keyboard with HP-HIL port
- Choice of monochrome or color display systems
- 3278 terminal emulator
- 20M-byte half-height and 40M-byte half-height internal hard discs (optional)

### Personal Applications Manager (PAM)

HP's PAM is an operating system shell that serves as the primary interface between the user and the MS-DOS operating system. The screen identifies a single function key you press to start any given application. PAM has been designed to work with HP Touch, HP Mouse, or keyboard to facilitate ease of use. For experienced users who want to work directly with the MS-DOS command structure, PAM can easily be bypassed.

### HP Touch Accessory

HP Touch, an optional user-installable accessory, provides an easy-to-use, touch-sensitive display

### Ergonomic Design

The adjustable-tilt Vectra keyboard has 103 step-sculptured keys with tactile feedback and color-coded legends. The keyboard includes 18 function keys, a numeric keypad with cursor control, a separate cursor-control pad, and an HP-HIL port, and is connected to the terminal by an 8-foot coiled cable.

Choose from monochrome or color display systems — whichever best meets your needs. All HP displays feature sharp, clear text and graphics. The screens are ergonomically designed for user comfort.

### System Expansion

The Vectra PC comes with seven IBM PC/AT-compatible accessory slots that accommodate a number of options for system expansion. These options include memory cards, data communications interfaces, and graphics boards.

A full spectrum of Hewlett-Packard printers, plotters, modems, accessories, external storage devices, and software is available to meet your current and future requirements. And the 80287 co-processor accessory is available for fast real-number computation.

### Storage Solutions

To increase Vectra's data storage capacity, you can add up to three internal data storage devices plus external disc and tape drives. You can start with a 360K-byte or 1.2M-byte 5 1/4-inch flexible disc and add more later. There are also 3 1/2-inch internal flexible disc drives, 40M-byte and 20M-byte hard disc drives available.

## Software Solutions

The Vectra PC offers a full range of choices in software, from off-the-shelf IBM PC/AT applications to popular business programs. It runs such business applications as WordStar®, R:Base™ 5000, and 1-2-3® from Lotus®, and will let you access most information-retrieval services. Executive Card Manager is an easy-to-use file manager with a built-in report writer, autodial feature, and more; Executive Card Manager: Templates gives you 21 modifiable formats for various business applications.

HP Graphics Gallery software is also available for the Vectra PC. These software products enable you to create professional-quality presentations and reports. Included in the Graphics Gallery series are Drawing Gallery, Charting Gallery, and Graphics Portfolios. And Gallery graphics can be easily merged with documents created using HP's Executive MemoMaker and AdvanceWrite.

Refer to the *Vectra Software and Accessories Guide* or ask your HP representative or dealer for up-to-date information on software and accessories for the Vectra PC. Also see the "Software Choices" section of this catalog.

## Data and Voice Communications

HP's Vectra PC has many communications options: RS-232C/Centronics ports, RS-232C/422 ports, 1200-baud and 2400-baud modems, HP-IL port, HP-IB communications port, and HP 2392, IBM 3278, and DEC VT100 terminal emulators — more than enough for all your data communications needs. Vectra's sophisticated communications capabilities let you take advantage of HP's powerful networking options to share information with a range of computer systems, including the HP Portable PLUS and Touchscreen II personal computers, IBM personal computers, and HP, IBM, and other host computers.

The OfficeShare family of networking products, ThinLAN, StarLAN, and HP SERIAL, are the HP AdvanceNet-compatible local area network products for personal computers. It will link Vectra PCs for sharing data, data storage, printers, plotters, electronic mail, and so on. See the "Networking and Data Communications" section of this catalog for more information.

OfficeTalk is a sophisticated voice communications product that features a telephone directory, telephone management, voice messaging, an appointments diary, and a memo pad. OfficeTalk consists of a software application and an I/O card. It runs on the Vectra PC and on IBM PC/AT compatibles.

## Specifications

**System Processing Unit (SPU):** Intel 80286, 8 MHz  
**Optional Numeric Co-Processor:** 5.33 MHz or 8 MHz Intel 80287  
**Operating System:** MS-DOS 3.2  
**Memory:** 256K-byte or 640K-byte RAM in 128K-byte increments; expandable to 3.64M bytes

### Keyboard:

- Detachable, with 8-ft. coiled cable
- Adjustable tilt feature
- One HP-HIL port
- Eighteen function keys

### Weight:

- SPU with one flexible disc drive: 26 pounds (11.8 kg)
- Keyboard: 4.2 pounds (1.9 kg)

### Dimensions:

- SPU: 16.7 x 15.4 x 6.3 inches (42.5 x 39.0 x 16.0 cm)
- Keyboard, flat: 20.6 x 8.8 x 1.3 inches (52.5 x 22.0 x 3.5 cm)

## Vectra PC Basic Configurations

The Vectra PC can be purchased in basic configurations for flexibility in assembling specific systems, or as a complete system in several popular preassembled configurations for office, industrial, and technical applications.

### Vectra PC Models 25 and 45

The Vectra PC is available in two basic desktop models designed for flexibility. The Vectra PC Model 25 includes an SPU with 256K bytes of RAM and one 360K-byte internal 5 1/4-inch flexible disc drive, a keyboard, and documentation. The Vectra PC Model 45 includes an SPU with 640K bytes of RAM and one 1.2M-byte internal 5 1/4-inch flexible disc drive, a keyboard, and documentation.

### Ordering Information

HP 72425A Vectra PC Model 25  
 HP 72445A Vectra PC Model 45

### Price

\$2995  
 \$2995

### Vectra PC Models 50 and 60

The Vectra PC Models 50 and 60 are preassembled configurations that feature a bundled hard disc subsystem and serial/parallel interface. The Vectra PC Model 50 includes 640K bytes of RAM with a 1.2M-byte flexible disc drive, a 20M-byte hard disc subsystem, and serial/parallel interface. The Vectra PC Model 60 includes 640K bytes of RAM with a 1.2M-byte flexible disc drive, 40M-byte hard disc subsystem, and serial/parallel interface.

### Ordering Information

HP 72450A Vectra PC Model 50  
 HP 72460A Vectra PC Model 60

### Price

\$3195  
 \$3995

## HP Vectra 3000

The HP Vectra 3000 is Hewlett-Packard's PC workstation for point-to-point connections to an HP 3000 host computer. Compatibility with the IBM PC/AT lets the Vectra run thousands of off-the-shelf business applications plus numerous peripherals and accessories. Connectivity to the HP 3000 provides access to HP's minicomputer-based programs. For convenience, the Vectra 3000 is preassembled for easy installation and includes 640K bytes of RAM, a 1.2M-byte 5 1/4-inch flexible disc drive, a 20M-byte hard disc, a serial/parallel interface, Vectra MS-DOS, AdvanceLink communications software, and your choice of a Monochrome Plus or EGA Color Video subsystem.

### Ordering Information

HP 72458A Vectra 3000 Monochrome Model 58  
 HP 72459A Vectra 3000 EGA Model 59

### Price

\$3930  
 \$4620

# PERSONAL COMPUTERS & CALCULATORS

## The Vectra Personal Computer (cont'd)



The HP Vectra Publisher PC is a complete desktop publishing solution for producing sophisticated documents.

### Vectra Office

The Vectra Office conveniently bundles the Vectra 3000 with either of two complete software packages at a savings of hundreds of dollars. The Vectra Office Professional and Vectra Office Assistant systems include software applications for word processing, graphics, data management, spreadsheets, and electronic mail, and are available with either the Monochrome Plus or EGA Color Video subsystem.

The Vectra Office Professional System bundles a Vectra Office Professional Software Pack with your choice of a Vectra 3000 Monochrome PC or Vectra 3000 EGA PC. The Professional Software Pack includes Executive MemoMaker, AdvanceMail, 1-2-3 from Lotus, Executive Card Manager, the Gallery Collection, and an HP Mouse. The Vectra Office Assistant System bundles a Vectra Office Assistant Software Pack with your choice of a Vectra 3000 Monochrome PC or Vectra 3000 EGA PC. The Assistant Software Pack includes an HP Mouse and the same software as the Professional Software Pack but has AdvanceWrite instead of Executive MemoMaker.

### Additional Ordering Information

	Price
HP 72458A & HP 68300F	Vectra Office Professional Monochrome System with Vectra Office Professional Software Pack. \$5405
HP 72459A & HP 68300F	Vectra Office Professional EGA System with Vectra Office Professional Software Pack. \$6095
HP 72458A & HP 68301F	Vectra Office Assistant Monochrome System with Office Assistant Software Pack. \$5655
HP 72459A & HP 68301F	Vectra Office Assistant EGA System with Office Assistant Software Pack. \$6345

### Vectra Publisher PC

The Vectra Publisher PC conveniently bundles the best hardware and software components needed for desktop publishing. The heart of the system is the Vectra PC with either a monochrome or enhanced color monitor, and PageMaker® from Aldus Corp., the leading page composition software. The system comes preassembled for easy ordering and set-up. When combined with an HP LaserJet printer and HP ScanJet scanner, you'll have a complete, fully supported desktop publishing workstation.

PageMaker and Microsoft® Windows are included with your Vectra Publisher PC. With PageMaker, you can integrate text, graphics, and illustrations created with separate word processing and graphics applications. Word processors supported by PageMaker include HP's Executive MemoMaker and AdvanceWrite, as well as a host of others including Multimate™, Microsoft Word®, WordPerfect™, Windows Write®, and WordStar 3.3®. Chart and graphic files can be created with the leading graphics programs such as HP's Graphics Gallery and Charting Gallery as well as 1-2-3 from Lotus, Symphony®, Windows Paint®, Windows Draw™, In-A-Vision™, AutoCAD®, and others.

HP's enhanced version of Microsoft Windows for the Vectra PC is a graphics-based extension to the MS-DOS operating system, and gives PageMaker a friendly, easy-to-learn user interface. It makes switching between PageMaker and your word processing and graphics programs fast and easy.

Vectra Publisher features include 640K bytes of RAM, a 1.2M-byte flexible disc drive, 20M-byte hard disc subsystem, serial/parallel interface, Vectra MS-DOS, HP Mouse, PageMaker from Aldus, Microsoft Windows, and your choice of a Monochrome Plus or Enhanced Graphics Color Video display with adapter.

### Ordering Information

	Price
HP 72496A	Vectra Publisher PC Monochrome Model 96 \$4626
HP 72497A	Vectra Publisher PC EGA Model 97 \$5316

### Industrial Vectra

The Vectra Industrial PC is a rugged, rack-mounted version of the standard Vectra PC, especially designed for use in manufacturing environments. It includes 640K bytes of RAM, a 1.2M-byte 5 1/4-inch flexible disc drive, and the HP-HIL to connect a wide range of input devices. Other features include an enhanced keyboard with transparent cover, seven internal expansion slots, and support for three internal storage devices. Besides having all the features of the standard Vectra PC, the Industrial Vectra has been enclosed in a rugged casing that allows operation in temperatures of 0° C to 60° C and from 5% to 95% humidity. It can also withstand up to 1.5Gs shock and vibration. Protection against power fluctuation is provided through a special AC power line conditioner.

The Industrial PC is 100 per cent software-compatible with the standard Vectra PC.

### Ordering Information

	Price
HP 72411A	Vectra Industrial PC \$6295

### Vectra HP BASIC Controller System

The Vectra PC has been combined with the HP BASIC Language Processor to make two bundles tailored for the HP measurement automation customer.

The PC-308 HP BASIC Controller is a preconfigured Vectra that includes 640K bytes of RAM, a 1.2M-byte flexible disc, 20M-byte hard disc, HP BASIC Language Coprocessor with 1M-byte RAM, a serial/parallel card, and the Vectra MS-DOS operating system.

The user can buy this system in a monochrome or color version. With this system, the user has access to both the PC and the Series 200/300 worlds through PC-DOS® application software and HP BASIC software.

### Ordering Information

	Price
HP 82314A	Model PC-308M Monochrome System \$5725
HP 82315A	Model PC-308C Color System \$6495

### Vectra CAD/CAE System

The Vectra CAD/CAE system is a preassembled, high-performance bundle ideal for running computer-aided design and other "power-user" applications. It includes 640K bytes of RAM, a 1.2M-byte flexible disc drive, 40M-byte hard disc subsystem, enhanced color graphics (EGA) display system with tilt/swivel base, high-speed (8 MHz) 80287 math coprocessor, serial/parallel card, and Vectra MS-DOS/PAM.

The combination of an EGA display, a fast, high-capacity hard disc, and an 8 MHz coprocessor is a perfect fit for popular CAD packages such as AutoCAD®, VersaCAD®, P-CAD®, and so on. The system is also ideal for getting top performance from business software such as 1-2-3 from Lotus, R:Base, Microsoft Word, or desktop publishing.

### Ordering Information

	Price
HP 82964E	Vectra CAD/CAE System \$6210

**Vectra/StarLAN PC**

Optimized for the HP StarLAN environment with either a Vectra PC or HP 3000 server, this PC is delivered preassembled with customized user documentation to simplify the set-up process. Based on the Vectra PC, the Vectra/StarLAN PC integrates HP StarLAN interface and user software, as well as HP's enhanced terminal emulation software, AdvanceLink. All this makes the HP Vectra/StarLAN PC the right networked office PC and DDP workstation. The Vectra/StarLAN PC includes an SPU with 640K bytes of RAM, 1.2M-byte internal flexible disc drive, 20M-byte internal hard disc drive, serial/parallel interface, your choice of a Monochrome Plus or Enhanced Graphics (EGA) Color monitor and adapter, MS-DOS 3.2, HP StarLAN User Link Kit, AdvancedLink, and customized user documentation.

<b>Ordering Information</b>		Price
HP 72468A	Vectra/StarLAN Monochrome PC Model 68	\$4535
HP 72469A	Vectra/StarLAN EGA PC Model 69	\$5225

<b>Additional Ordering Information</b>		Price
<b>Monitors and Video Adapters</b>		
HP 35731D	12-inch Monochrome Plus Video Display. Compatible with IBM monochrome drivers (HP 35732A Monochrome Plus Video Adapter required).	\$325
HP 35743A	13-inch HP Enhanced Graphics Display (HP 45983A HP Enhanced Graphics Adapter required).	\$845
HP 35745A	13-inch Industrial Enhanced Graphics Display (HP 45983A Enhanced Graphics Adapter required).	\$1495
HP 82959S	Tilt/Swivel Base for the HP 35743A HP Enhanced Graphics Display.	\$95
HP 35732A	Monochrome Plus Video Adapter. Compatible with IBM MDA, Hercules Graphics, and IBM CGA.	\$325
HP 45983A	HP Enhanced Graphics Adapter.	\$495
<b>Data Storage</b>		
HP 45811A	360K-byte, 5 1/4-inch Flexible Disc Drive.	\$225
HP 45812A	1.2M-byte, 5 1/4-inch Flexible Disc Drive.	\$275
HP 45816A	20M-byte, half-height, half-shelf Rugged Hard Disc Subsystem (HP Proprietary Hard Disc Controller Kit included).	\$1395

HP 45816M	20M-byte, half-height, half-shelf Rugged Add-On Hard Disc Drive. Upgrades HP 45816A Hard Disc Subsystem, with serial number prefixes greater than 2552A, to 40M bytes.	\$995
HP 45896A	20M-byte, half-height, full-shelf Hard Disc Subsystem for Vectra PC units with serial number prefixes 2623A and higher (HP 45895A IBM PC/AT-Compatible Hard Disc Controller Kit included).	\$995
HP 45897B	40M-byte, half-height, full-shelf Hard Disc Subsystem for Vectra PCs with serial number prefix 2621A and higher. Prefixes 2621A to 2723A require ROM upgrade HP 45938A. (HP 45895A IBM/AT-Compatible Hard Disc Controller Kit included.)	\$1995
HP 45938A	ROM Upgrade Kit to use HP 45897B 40M-byte Hard Disc Drive Subsystem on Vectra PCs with serial number prefix 2521A to 2723A.	\$150

<b>Accessories</b>		
HP 45973A	1/2M-byte Extended Memory Card for electronic discs.	\$595
HP 45974A	1M-byte Extended Memory Card for electronic discs.	\$995
HP 45987A	Numeric Coprocessor (5.33 MHz Intel 80287).	\$375
HP 82965A	High-Speed Numeric Coprocessor (8 MHz Intel 80287).	\$695
HP 46060A	HP Mouse	\$148

MS-DOS is a U.S. trademark of Microsoft Corporation.  
 RBase is a U.S. trademark of Microrim, Inc.  
 IBM, PC-DOS, and PC/AT are U.S. registered trademarks of International Business Machines Corporation.  
 DEC is a U.S. registered trademark of Digital Equipment Corporation.  
 1-2-3, Symphony, and Lotus are U.S. registered trademarks of Lotus Development Corporation.  
 WordStar is a U.S. registered trademark of MicroPro International Corporation.  
 PageMaker is a trademark of the Aldus Corporation.  
 MultiMate is a U.S. registered trademark of Multimatte International, a subsidiary of Ashton-Tate Corporation.  
 WordPerfect is a trademark of WordPerfect Corp.  
 Windows Draw and In-A-Vision are trademarks of Micrograph, Inc.  
 AutoCAD is a U.S. registered trademark of Autodesk, Inc.  
 P-CAD is a U.S. registered trademark of Personal CAD Systems, Inc.  
 Microsoft Word, Microsoft Windows, Windows Write, and Windows Paint are U.S. registered trademarks of Microsoft Corporation.  
 VersaCAD is a trademark of T & W Systems.

# PERSONAL COMPUTERS & CALCULATORS

## The Portable PLUS PC

### The HP Portable PLUS Personal Computer

More than just a portable computer, the Portable PLUS is a powerful, durable traveling companion that shares information and peripherals with desktops or acts as a terminal to mainframes. And, it's now enhanced with a high-contrast flat-panel liquid-crystal display.

The Portable PLUS is easily tailored to handle varying duties, with the programs and data that you use most often installed directly on the computer as plug-in ROMs. You also have the option of loading disc-based software into the Electronic Disc of the Portable PLUS. In either case, there is no need to carry discs or disc drives.

### Portable PLUS Features

- Full 16-bit CMOS 80C86 microprocessor
- Continuous Memory expands from 512 to 2.5 bytes
- Plug-in ROM software
- Built-in Electronic Disc (E-Disc) drive
- Personal Applications Manager (PAM)
- MS™-DOS 2.11
- Built-in HP-IL, RS-232C, and optional modem interface ports
- HP Link and Portable-Desktop Link for data and peripheral sharing
- Built-in terminal emulation
- Data-compatible with HP and IBM environments
- Full keyboard and numeric keypad
- Full-size 25-line by 80-column high-contrast LCD screen
- Integrated 20-hour power supply
- Two accessory slots

### Big Features in a Small Package

At under ten pounds, and no larger than a three-ring binder, the Portable PLUS is the most durable lap-sized computer for professionals on the go. It offers a full-size high-contrast display and keyboard with numeric keypad for fast field calculations, plus the built-in HP-IL and RS-232C interfaces for fast data transfer to peripherals, desktop computers, or mainframes. And it runs on rechargeable batteries for up to 20 hours.

The Portable PLUS's autostart capability lets you skip over the PAM menu and begin computing sessions in a custom program. And the integrated power supply and Continuous Memory let you return instantly to interrupted work, making it the most convenient portable to use whenever and wherever your work takes you.

### Personal Applications Manager (PAM)

Serving as the main menu on the Portable PLUS, the PAM is the interface between the user and the operating system, providing an alternative to complex MS-DOS command structures, and an easy keystroke format.

### Plug-in ROM Software

The Portable PLUS runs full-feature software in a plug-in ROM, containing everything necessary to complete your work. This ROM-based software offers the reliability and speed of a Winchester disc. Frequently accessed programs can be user-installed into the Portable PLUS, eliminating the need for a separate disc drive. And loading programs is fast (as much as five times faster than floppy discs). You can choose to install your own custom-designed ROM- or EPROM-based applications.

### Built-In E-Disc Mass Storage

The HP Electronic Disc (E-Disc) is a convenient method of temporarily storing data and programs while the Portable PLUS is being used away from an HP 9114B Portable Disc Drive, Touchscreen or Vectra PC, or IBM® PC. With the Portable PLUS's expandable RAM, there is plenty of room for disc-based programs and large data files, and it's fast: E-Disc loads and accepts programs and data up to 10 times faster than a traditional floppy disc drive. The E-Disc is much more durable than a built-in floppy disc, and it extends battery life by requiring much less power.

### Sharing with Desktops

The HP Portable-Desktop Link connects the Portable PLUS with the HP Touchscreen II and HP Vectra personal computers and the IBM PC family. By installing an HP Interface Loop (HP-IL) and software on your desktop computer, you can quickly transfer data or applications software between the Portable PLUS and the desktop model. In addition, printers connected to the desktop computer can be used as output devices for the Portable PLUS.



The HP Portable PLUS PC is a durable, reliable, lap-sized portable computer designed for mobile computing conditions.

### Data Communications and Terminal Emulation

The Portable PLUS built-in Terminal Emulator supports an optional 300/1200-bps modem and a serial interface connection to allow transfer of files with host computers as well as information networks. Using REFLECTION I™ terminal-emulation software, the Portable PLUS supports full block mode terminal communications, emulates the HP 2392 and DEC® VT102 terminals, runs HP DESK and IBM PROFS applications, and supports automated and unattended file transfer using a built-in command language.

**Optional Modem** — This Hayes-compatible internal modem enables communications over normal dial-up telephone lines at speeds up to 1200 bps, cutting the cost of long-distance data communications. The auto-answer and auto-dial features, using either Touch-Tone™ or pulse dialing, make the Portable PLUS a perfect companion for remote-location data communications.

**IBM Terminal Emulation** — With HP's 3270 SNA® emulator for the Portable PLUS, you can connect to an IBM host from almost anywhere. The product (hardware plus software) offers 3270 terminal emulation with file transfer to and from MVS/TSO, VM/CMS, and CICS host files. The emulator, with a synchronous modem and telephone line, gives you the convenience of a portable terminal and the power of a portable PC.

Other methods for data communications with an IBM host are also available. The Portable PLUS running REFLECTION I emulation software can be used in conjunction with an HP 3000 minicomputer to access IBM hosts. Also, the Portable PLUS with REFLECTION I can emulate a full-screen IBM 3278 display station by using IBM or third-party protocol converters. IBM 3278 terminal emulation, including file-transfer capabilities, is supported with YTERM or SIM3278/PC™ software on the Portable PLUS. As with REFLECTION I, these products require protocol converters residing on the IBM host. This terminal emulation capability is the path to accessing most mainframe applications that typically function on IBM 3270-type terminals.

**PPC Access** — The full block mode capability of the Portable PLUS with REFLECTION I allows access to HP's Personal Productivity Center. This permits such operations as full-screen editing within the functions of HP DeskManager.

### Liquid-Crystal Display (LCD)

The Portable PLUS uses advanced LCD technology and a non-glare surface to improve the readability of its 25-line by 80-column display. The flat panel, variable contrast, and tilt features contribute to user comfort. With an optional video interface, a CRT monitor can be connected to duplicate the Portable PLUS's display.

### Keyboard

The full-size keyboard on the Portable PLUS offers the features of a desktop computer: 75 sculptured keys, eight screen-labeled function keys, shifted 10-key numeric keypad, and flexible key mapping. The numeric keypad speeds the work of entering figures into such programs as spreadsheets, test and measurement calculations, and data analysis.

## Memory and Expansion Ports

The Portable PLUS has two expansion ports that can be used for additional memory, plug-in ROM software, or other special-function cards. The Software Drawer holds up to 12 user-installed ROMs of 32K-128K-byte capacity. Memory expansion options include: a 128K-byte Memory Drawer Space to which up to two additional 128K-byte memory cards may be added, and a fully loaded 1-M-byte Memory Drawer. Memory expansion options are continuous random access memory (RAM). Memory (RAM) space is allocated by the user to system memory or E-Disc. System memory is used for program execution and data file operations; the E-Disc is used for program and data storage.

## Battery Power

The Portable PLUS's 20-hour battery life is twice as long as most other portables, providing an average of two weeks of computing time between recharges. And the Portable PLUS can be used during battery recharging. A sophisticated memory-protection scheme ensures that your data will be preserved in the Portable PLUS for approximately one month, and the PAM screen provides a continuous display of power reserves. When the power reserve reaches 5%, the computer automatically turns off until the recharger is connected to it, protecting your data until you get to a power source.

## Software Solutions

The Portable PLUS combines its powerful ROM-based software and E-Disc capability with the fast MS-DOS 2.11 operating system and large-capacity user memory to deliver the computing performance of traditional desktop models. Whenever your work takes you into the field, flies you around the country, or follows you home, your Portable PLUS is packed with software solutions to all your computation problems.

**ROM-Based Applications** — A wide range of high-productivity software is available for the Portable PLUS: choose from such popular core applications as 1-2-3\* from Lotus®, Microsoft® WORD™, Microsoft BASIC, MultiMate™, HP's Executive Card Manager, MemoMaker/Time Management, and REFLECTION I (HP block mode 2392 and VT102 terminal emulator).

**Custom ROM Applications** — Hewlett-Packard's custom ROM program enables you to design software for specific applications. Either programs or data can be installed on industry-standard 32K-byte or 128K-byte custom ROMs, or 32K-byte EPROMs. A maximum capacity of twenty-four 128K-byte ROMs can be achieved using both Software Drawers. The flexible configuration of the ROM disc permits program execution from RAM or ROM.

**Disc-Based Software** — In addition to the plug-in ROM software, there is a wide selection of disc-based software available through HP and third-party vendors. Such tools as GW™-BASIC and Pascal programming languages, and the Lattice® C Compiler, will enhance custom program development. Application software that can be loaded from floppy discs into the E-Disc includes database managers such as dBASE® II, data communications and networking programs, accounting systems, and a variety of personal solution packages, such as The List Manager and The Speller.

Refer to *Software and Accessories for the HP Touchscreen and Portable Personal Computers*, and the "Software Choices" section of this catalog, for up-to-date software information.

## Specifications

**Microprocessor:** 16-bit Intel 80C86, 5.33 MHz

**Operating System:** MS-DOS 2.11

**Memory:** 512K-byte continuous user RAM, expandable to 2.5M bytes; 192K-byte expandable ROM

**Expansion Capability:** Two plug-in ports for 128K RAM Memory Drawer and 12-socket ROM Software Drawer. (Memory Drawer can be expanded to a maximum of 384K bytes by use of additional memory cards.)

**Built-in Mass Storage:** Electronic Disc

### Bundled Software:

PAM — Personal Applications Manager  
 HPLINK — For the Portable-Desktop Link  
 TERM — Terminal link for REFLECTION I emulation  
 SECURE — Password protection utility  
 EDLIN — Low-level MS-DOS text editor  
 Self-diagnostics utility

**Display:** Flat panel, high-contrast, liquid-crystal, anti-glare screen with variable tilt and contrast

**Alphanumeric:** 25-lines by 80-columns

**Graphics:** 200 x 480 pixels

**Display Enhancements:** Inverse video, underline, blinking, half-bright, and all combinations

**Character Set:** Roman8, extended character set, multiple character fonts

**Keyboard:** Full size, 75 sculptured keys, eight screen-labeled function keys, shifted numeric keypad, flexible key mapping

**Data Communications:** Built-in HP-IL and 9-pin RS-232C

**Modem:** Optional 300/1200 bps, direct-connect, pulse and tone dial, Hayes command compatible

**Power Supply:** Three permanently installed lead acid gel D-cell batteries; battery recharger

### Battery:

**Typical Use:** 20 hours on full charge (if used continuously under normal operating conditions).

**Memory Retention:** 6 months on full charge; 1 month from time of low-level indicator (20% charge); 1 week from time of automatic shut-off.

### Weight:

Basic unit — under 9 pounds (4 kg)

Maximum configuration — under 10 pounds (4.5 kg)

**Dimensions:** 13 x 10 x 3 inches (330 x 254 x 76 mm)

## How to Order Your Portable PLUS

For more information on the Portable PLUS, contact your HP sales representative or your local HP personal computer dealer.

**For the nearest dealer in the U.S., call toll-free:**

**800-752-0900.**

## Ordering Information

		Price
HP 45711E	The HP Portable PLUS Personal Computer The HP Portable PLUS basic system comes with 512K bytes of RAM; 192K bytes of ROM; two plug-in ports for RAM and ROM expansion; built-in E-Disc mass storage; MS-DOS 2.11 and PAM with bundled utilities; high-contrast flat-panel LCD display with 25-line by 80-column screen; full-size keyboard; built-in HP-IL, 1200-bps modem, and RS-232C communications ports; integrated power supply and battery recharger; soft carrying case with shoulder strap; and complete documentation.	\$3490
HP 45711F	Same as HP 45711E, but without built-in modem.	\$2995

## Peripherals and Accessories for the Portable PLUS

See the "Peripherals" section, page 698, for product descriptions of peripherals and accessories.

MS-DOS is a U.S. trademark of Microsoft Corporation.

REFLECTION I is a U.S. trademark of Walker Richer & Quinn, Inc.

Touch-Tone is a U.S. trademark of Western Electric.

31M3278/PC is a trademark (pending) of Sirmare, Inc.

Microsoft WORD and GW-BASIC are U.S. trademarks of Microsoft Corporation.

MultiMate is a U.S. trademark of MultiMate International Corporation, a subsidiary of Ashton-Tate Corporation.

IBM and SNA are U.S. registered trademarks of International Business Machines Corporation.

DEC is a U.S. registered trademark of Digital Equipment Corporation.

1-2-3 and Lotus are U.S. registered trademarks of Lotus Development Corporation.

Microsoft is a U.S. registered trademark of Microsoft Corporation.

Lattice is a U.S. registered trademark of Lattice, Inc.

dBASE is a U.S. registered trademark of Ashton-Tate Corporation.

# PERSONAL COMPUTERS & CALCULATORS

## The Portable Vectra CS PC and the HP-94 Handheld Computer



The HP Portable Vectra CS Personal Computer gives you the functionality of a desktop computer in a battery Vectra CS powered portable package.

### The HP Portable Vectra CS Personal Computer

The Portable Vectra PC brings you desktop functionality in a battery-powered package. Now you can take your office with you when you travel, without sacrificing the features you use most in a PC. With the Portable Vectra PC you get the flexibility and power you need to meet your needs today, without restricting your options for the future. It is compatible with the enhanced IBM® PC/XT™, so you can choose from among the most popular software programs.

The Portable Vectra PC comes standard with 640K bytes of system RAM, two built-in 1.44M-byte flexible disc drives, a 12-inch diagonal supertwist LCD display, and a display/printer adapter.

### Portable Vectra CS PC Features

- Enhanced IBM PC/XT compatibility (software, BIOS, and MS™-DOS)
- Vectra MS-DOS 3.2 for the Portable Vectra PC on 3.5-inch media (includes HP extensions: Personal Applications Manager (PAM), four COM ports, and 1.44M-byte format)
- Two 1.44M-byte, 3.5-inch flexible disc drives
- Full size keyboard with 12 function keys and separate numeric keypad
- Caps, Num, and Scroll Lock LED indicators
- 12-inch diagonal, detachable, supertwist LCD display with 640 x 400 pixel resolution
- 7.16 MHz 80C86-compatible processor with 6 MHz, AT-class performance
- 640K-bytes system RAM standard (expandable to 6.6M bytes)
- Numeric coprocessor slot
- User-replaceable battery module with 6-10 hours of battery life and a built-in "fuel" gauge
- Display/printer adapter standard (CGA-compatible RGB and Centronics-compatible parallel connectors) and three additional I/O slots for optional adapters
- Optional adapters:
  - 1200 bps asynchronous modem
  - 2400 bps synchronous/asynchronous modem
  - Dual-serial/EMS adapter (9-pin and 25-pin connectors, RS-232C and RS-422, 1M-byte or 2M bytes of EMS RAM optional)
- Real-time clock with alarm for automatic wake-up
- Software controllable power-off
- Built-in handle
- Worldwide recharger
- Optional battery modules

### Full Desktop Functionality in a Portable Package

You don't have to compromise desktop functionality for portability with the Portable Vectra PC. It has a full size keyboard with a separate numeric keypad. Its high contrast, supertwist LCD is a full 12-inch diagonal display with the same pixel ratio as a CRT. If you prefer to use an external monitor, the display is removable, and a desktop monitor can fit right behind the CPU.

In addition to the slot occupied by the display/printer adapter, which allows connection to a printer and an external monochrome or color monitor, there are three remaining I/O slots for adding optional adapters to fit your specific needs. The dual-serial/EMS adapter allows free data transfer to peripherals, desktop computers, or mainframes.

With 6-10 hours of battery life, you can do a full day's work without recharging the battery. Additional, optional rechargeable battery

modules let you extend your work sessions to 12 or more hours without recharging.

### Supertwist Liquid Crystal Display (LCD)

The Portable Vectra PC uses advanced LCD technology, high-resolution alpha and graphics, and a non-glare surface to improve the readability of its 25-line by 80-column display. The flat panel, variable contrast, and tilt features, as well as the position of the display relative to the keyboard, all contribute to user comfort. The built-in RGB interface enables you to connect an external monochrome or color monitor to replace the Portable Vectra PC's removable display.

### Keyboard

The full-size keyboard on the Portable Vectra PC offers all of the functionality of the IBM Enhanced PC keyboard. Twelve programmable function keys facilitate terminal emulation. The separate numeric keypad provides fast and easy data entry for data analysis, spreadsheets, and financial calculations. Caps, Scroll, and Num Lock LED indicators let you know when you are operating in the locked mode. Full travel keys provide the feel of a desktop keyboard.

### Data Communications and Terminal Emulation

The Portable Vectra PC has several data communications options. The optional dual-serial/EMS adapter provides both RS-232C and RS-422 ports with a 25-pin and a 9-pin connector. Up to three dual-serial/EMS adapters can be installed with a total of 6M bytes of EMS RAM. Two modems are available: a 1200 bps asynchronous modem and a 2400 bps synchronous/asynchronous modem. Both provide Hayes-compatible data communications capabilities.

Terminal emulation is provided with several different software solutions. AdvanceLink provides ASCII and binary file transfers between other PCs (Touchscreens, Vectras, and IBM PCs), and other HP computer systems, such as the HP 3000. Many of the best-selling data communications software packages are on 3.5-inch media for the Portable Vectra PC.

### Battery Power

The Portable Vectra PC has a 6-10 hour battery life. The battery can be charged inside or outside the computer and is user-replaceable. Its fuel gauge lets you know how much charge is left. A low battery warning gives you plenty of time to save files before recharging or exchanging the battery module.

### Operating System and the Personal Applications Manager

The Portable Vectra PC offers a full range of choices in software including off-the-shelf IBM PC/XT versions of popular business programs. A variety of HP software is also available including Executive Memo Maker, a general purpose word processor, and Graphics Gallery, which enables you to create professional quality presentations and reports. HP's Executive Card Manager is an easy-to-use file manager with a built-in report writer and autodial feature. Other available HP software includes AdvanceMail, AdvanceLink, and HP Access.

### Sharing with Desktops/Data Transfer

The Portable Vectra PC can connect with the HP Vectra PC and the IBM PC family via the dual-serial/EMS adapter. Third-party software is available and allows data transfer between the Portable Vectra PC and IBM-compatible PCs. You can use this software to access data or programs on 5.25-inch media that can be transferred to 3.5-inch media for use with the Portable Vectra PC, or you can access data and software stored on a desktop's internal hard disc drive.

### Specifications

**Microprocessor:** Intel 80C86-compatible, 7.16 MHz

**Operating System:** Vectra DOS 3.2

**Memory:** 640K-bytes RAM standard, expandable to 6.6M-bytes

**Built-in Mass Storage:** Two 1.44M-byte, 3.5-inch flexible disc drives

**Display:** 12-inch diagonal, flat panel, high-contrast, supertwist, liquid crystal (LCD), anti-glare, variable tilt and contrast

**Alphanumeric:** 25 lines by 80 columns

**Graphics:** 640 x 400 pixels

**Keyboard:** Full size, IBM Enhanced PC keyboard-compatible, 12 function keys, separate numeric keypad

**Data Communications:** Optional dual-serial/EMS adapter with 25-pin and 9-pin, RS-232C and RS-422

**Modem:** Optional 1200 bps asynchronous modem or 2400 bps synchronous/asynchronous modem, Hayes command compatible

**Battery:** User-replaceable lead acid battery, 6-10 hours of battery life



**Weight:** 17.5 lbs., including battery.

**Dimensions:** 16.4 x 14.0 x 3.4 inches (418 x 355 x 87 mm)

### Ordering Information

		Price
<b>HP D1001A</b>	The HP Portable Vectra CS Personal Computer with 640K-bytes RAM, dual 3.5-inch 1.44M-byte flexible disc drives, U.S. keyboard, display/printer adapter, LCD display, battery, recharger, power cord, and U.S. documentation.	2495
<b>HP D1002A</b>	1200 bps Asynchronous Modem	450
<b>HP D1003A</b>	2400 bps Synchronous/Asynchronous Modem	695
<b>HP D1004A</b>	Dual-Serial/EMS Adapter	220
	Option 001 - 1M-byte EMS RAM	995
	Option 002 - 2M-byte EMS RAM	1795
<b>HP D1006A</b>	Technical Reference Manual	125
<b>HP D1007A</b>	Softcase	145
<b>HP D1008A</b>	1M-byte EMS RAM Kit	795
<b>HP D1001-60009</b>	Battery Module	150
	(Same as included in HP D1001A)	250
<b>HP 5061-4335</b>	Recharger (Same as included in HP D1001A)	150
<b>HP 45951C</b>	Vectra MS-DOS 3.2 (3.5-inch media)	95



### HP-94 Handheld Industrial Computer

The high-quality, rugged, and compact HP-94 Handheld Industrial computer is designed for portable data collection in asset tracking, inventory control, and work-in-process applications. Application software for the HP-94 can be developed in BASIC or 8088 assembly language with the HP 82520A Software Development System and a PC like the HP Vectra or IBM PC/XT/AT® (BASIC) and the Technical Reference Manual and the Microsoft Macro Assembler (assembly language).

Many Value Added Software suppliers have standard application software for the HP-94, and most will write custom applications. See the HP Manufacturing Solutions Catalog (Part No. 5954-6777) or call your local sales office.

Programs are downloaded from the PC development system via a serial interface cable and, depending on the development system computer, a "Level Converter."

The HP-94 has a serial interface that provides RS-232C protocol with 0-5 volt signal levels, a built-in bar code interface, an audio jack, and a backlit display.

The serial interface permits communications with a host computer, software development system, modems, printers, and other peripherals at up to 9600 baud. Data can be entered with any one of three HP Smart Wands, the redefinable keyboard, or the serial port.

### Specifications

**User Memory (bytes):** 64K, 128K, or 256K built-in, 256K maximum battery backed up CMOS RAM

**Read Only Memory (bytes):** 32K built-in operating system

**Memory Options:** With 64K or 128K built-in, add either a 40K ROM card or a ROM/EPROM card; insert a maximum of 128K ROM or EPROM into the card.

**Service Upgrade (bytes):** With 128K RAM built-in, one additional 128K memory board can be installed in the HP-94.

**Maximum RAM Capacity (bytes):** 256K

**Transfer Rate (baud):** 150, 300, 600, 1200, 2400, 4800, 9600

**Programming Languages:** BASIC, 8088 Assembly Language

**Keyboard:** ABC format, redefinable, alphanumeric

**Display:** 4-line x 20-character LCD with backlight

**Power Requirements:** 4.8 volts rechargeable NiCad batteries

**Size:** 14.6 x 16.5 x 3.8 cm. (5.75 x 6.5 x 1.5 inches)

**Weight:** 716 g (1.6 lbs.) with batteries

**Battery Life:** Up to 24 hours continuous use

### Smart Wands (HP 39961D, HP 39963D, HP 39965D)

The HP Smart Wand combines a powerful microcomputer, optimized bar code decoding software, optically programmable configuration options, non-volatile configuration memory, and a high performance contact scanner into a standard industrial wand package. The optics and electronics are designed for lower power consumption and normal operation in a wide range of environments.

The HP Smart Wand automatically recognizes and decodes many of the standard bar code symbologies. In addition to being optimized for the sensing and digitizing electronics in the wand, the decoding software has been designed for very high accuracy when scanning a wide range of real world labels. A built-in power-on memory test option ensures that the decoder is operating properly.

### Specifications

**Codes Decoded:** Code 39, Code 39 full ASCII Conversion, Interleaved 2 of 5, UPC/EAN/JAN, Codebar, and Code 128, Code 11, MSI Plessey

**Operating Voltage:** 5 Volts

**Idle Current:** 9 Milliamps

**Operating Current:** 15 Milliamps

### Datacomm Utilities Pac

The Datacomm Utilities Pac provides data transfer between an HP-94 and an HP 3000 or HP Vectra PC and many other host computers. It supports the XMODEM-CRC standard, allowing XMODEM and XMODEM with improved error checking. Both versions are public domain protocols.

### Ordering Information

		Price
<b>HP-94D</b>	64K-byte Handheld Industrial Computer	\$1395
<b>HP-94E</b>	128K-byte Handheld Industrial Computer	\$2095
<b>HP-94F</b>	246K-byte Handheld Industrial Computer	\$2795
<b>HP 39963D</b>		
Opt. B01	General Purpose Smart Wand (with manual)	\$370
<b>HP 82522A</b>	Datacomm Utilities Pac (includes software on a 5 1/4-inch 360K-byte disc).	\$495
<b>HP 82520A</b>	Software Development System (SDS) (includes software on a 5 1/4-inch 360K-byte disc).	\$795

MS-DOS is a U.S. trademark of Microsoft Corporation.

IBM PC/XT is a U.S. trademark of International Business Machines Corporation.

IBM and PC/AT are registered trademarks of International Business Machines Corporation.

# PERSONAL COMPUTERS & CALCULATORS

## Software Choices

Vectra, Touchscreen II, Portable PLUS, Portable Vectra CS PC



The HP Vectra PC supports a variety of peripherals and runs hundreds of industry-standard software packages.

### Hewlett-Packard: Your Source for Software Solutions

The programs listed in this section are for use on the HP Touchscreen II, HP Vectra, HP Portable PLUS, HP Portable Vectra CS PC, IBM, and IBM-compatible personal computers. Refer to *Software and Accessories for the HP Touchscreen and Portable Personal Computers* for additional information.

The Hewlett-Packard *Software Selection Guide* features listings of HP software products that can be used to automate test and measurement applications. Associated computer-aided engineering software packages are also included.

### Software Package Order Number Designations

The last letter in each software package order number indicates the personal computer(s) that supports the package. (Does not apply to numbers ending with †.)

Order No.	Personal Computer
A	Touchscreen II
C	Portable PLUS
D	Touchscreen II and Portable PLUS
F,E	Vectra, Portable Vectra CS PC, and IBM PC-compatibles
K	Portable PLUS Plug-In ROM
M	Peripherals

Order No.	Description	Price
<b>Programming</b>		
HP 45445D	BASIC by Microsoft®	\$300
HP 82862K†	BASIC by Microsoft, Opt. 400	\$300
HP 45446D	Compiled BASIC by Microsoft	\$395
HP 45450D	GW™ BASIC by Microsoft	\$395
HP 45448A	COBOL by Microsoft	\$750
HP 92248BA	Cross-Reference Utility	\$49
HP 45449D	FORTRAN by Microsoft	\$395
HP 45447D	Pascal by Microsoft	\$350
HP 45435A	Touchscreen Programmer's Tools	\$295
HP 45310A	BASIC Programmer's Library	\$110
HP 45419C	Programmer's Tools	\$325
HP 45452D	Lattice® C Compiler	\$495
HP 45311A	ICON Design System	\$99
HP 45443A	Forms Master	\$295

### Data Communications and Networking

HP 45431A	AdvanceLink	\$190
HP 68333F	AdvanceLink	\$325
HP 68333F	AdvanceLink, Opt. 003	TBS
HP 27534A	AdvanceMail	\$395
HP 82870K	AdvanceMail, Opt. 400	\$295
HP 27535F	AdvanceMail	\$395
HP 45641B†	Touchscreen 3278 Emulation Accessory with File Transfer REFLECTION 1™, Opt. 400	\$1200
HP 82863K	Touchscreen Internal Modem	\$395
HP 45640A	VT100 Terminal Emulator	\$475
HP 45412A	HPMessage	\$180
HP 36569E	HPMessage	\$300
HP 36568A	HPMessage	\$300
HP 35177M	JetStart (for use with ThinkJet personal printer)	\$45
HP 35178M	LaserStart (for use with LaserJet printer)	\$95
HP 82867K	YTERM 3278 Emulation, Opt. 630	\$95

### Data Base Management

HP 36898A	HP Access	\$625
HP 36898F	HP Access	\$625
HP 45421A	Executive Card Manager	\$300
HP 45441D	Executive Card Manager: Templates	\$130
HP 68331F	Executive Card Manager	\$300
HP 68335F	Executive Card Manager: Templates	\$130
HP 45555K	Executive Card Manager, Opt. 400	\$295
HP 68331F	Executive Card Manager	TBS
HP 45563A	R:Base™ 5000	\$495
HP 68336F	R:Base 5000	\$495
HP 68328F	R:Base System V	\$700

### Integrated Solutions

HP 45444A	ExecuDesk	\$100
HP 45498A	Symphony™ from Lotus®	\$695
HP 68339F	Symphony from Lotus	\$695

**Electronic Spreadsheets**

HP 68332F	Executive Spreadsheet	\$260
HP 45482A	1-2-3* from Lotus	\$495
HP 45539K	1-2-3 from Lotus V2.01, Opt. 400	TBS
HP 68340F	1-2-3 from Lotus V2.01	\$495
HP 68340F	1-2-3 from Lotus V2.01, Opt. 003	TBS

**Personal Solutions**

HP 35151D†	The Calendar	\$49.95
HP 35152D†	The List Manager	\$49.95
HP 35153D†	The Writer	\$49.95
HP 35154D†	The Speller	\$49.95
HP 35155D†	The Planner	\$49.95
HP 35156D†	The Personal Correspondence Pack	\$125
HP 35157D†	The Personal Organizer Pack	\$125

**Localization (Translation)**

HP 82866KD	Localization, German—Opt. 400	\$150
HP 82866KF	Localization, French—Opt. 400	\$150
HP 82866KZ	Localization, Italian—Opt. 400	\$150

**Word Processing**

HP 27506F	AdvanceWrite I (Vectra only)	\$295
HP 27507F	AdvanceWrite II (Vectra only)	\$550
HP 27546F	AdvanceWrite PLUS	TBA
HP 45427D	WordStar® Professional*	\$605
HP 45418A	Executive MemoMaker	\$250
HP 68330F	Executive MemoMaker	\$250
HP 68330F	Executive MemoMaker, Opt. 003	TBS
HP 45504K	MemoMaker/Time Management, Opt. 400	\$195
HP 45549K	Microsoft WORD™, Opt. 400	\$375
HP 45474D	Microsoft WORD	\$375
HP 45554K	MultiMate™, Opt. 400	\$495
HP 27505A	HP Word/PC	\$450
HP 27536F	HP Word/PC	\$450
HP 45418A	Executive MemoMaker	\$250
HP 68330F	Executive MemoMaker	\$250
HP 45504K	MemoMaker/Time Management, Opt. 400	\$195
HP 45474D	Microsoft WORD	\$375

**Graphics**

HP 45513A	Charting Gallery	\$295
HP 45411A	Drawing Gallery	\$395
HP 45437A	The Gallery Collection (Charting Gallery, Drawing Gallery, Gallery Picture Library Vol. II)	\$695
HP 68352F	Gallery Collection	\$695
HP 68350F	Charting Gallery	\$295
HP 68351F	Drawing Gallery	\$395
HP 68352F	The Gallery Collection	\$695
HP 68324F	Office Activities Portfolio	\$95
HP 68325F	Chemical/Petrochemical Portfolio	\$150
HP 68326F	Business Management Portfolio	\$95
HP 68327F	HPDraw Figures Portfolio	\$195
HP 45568A	Office Activities Portfolio	\$95
HP 45569A	Chemical/Petrochemical Portfolio	\$150
HP 45570A	Business Management Portfolio	\$95
HP 45571A	HPDraw Figures Portfolio	\$195

**Host Services**

HP 36890F	Print Central	\$180
-----------	---------------	-------

**The following products, available through HP's Direct Marketing Division, are vendor-supported.**

HP 35190J†	LaserControl 100 (for Vectra and LaserJet printer)	\$150
HP 35184A†	Sideways (for Touchscreen and ThinkJet printer)	\$79.95
HP 35188A	Laser Plotter (for Vectra and LaserJet printer)	\$150
HP 35188D	iPrint (for Vectra and LaserJet printer)	\$349.95

**Corporate Site License for Personal Computer Software**

HP's worldwide Corporate Site License Program offers substantial discounts on specified Vectra and Touchscreen PC software, along with the benefit of software standardization, immediate availability, distribution control, and unbundled documentation. Total dollar savings can be estimated by combining the Site License discount percentage and Purchase Agreement discount percentage. For ordering information and savings, contact your local sales office.

GW-BASIC and Microsoft WORD are U.S. trademarks of Microsoft Corporation. REFLECTION I is a U.S. trademark of Walker Richer & Quinn, Inc. R-Base is a U.S. trademark of Micromin, Inc. MultiMate is a U.S. trademark of MultiMate International Corporation, a subsidiary of Ashton-Tate Corporation.

Microsoft is a U.S. registered trademark of Microsoft Corporation. Lattice is a U.S. registered trademark of Lattice, Inc. Lotus, 1-2-3, and Symphony are U.S. registered trademarks of Lotus Development Corporation. WordStar and WordStar Professional are U.S. registered trademarks of MicroPro International Corporation.

# PERSONAL COMPUTERS & CALCULATORS

## Networking/Data Communications



The HP Vectra personal computer helps automate offices by providing access to HP 3000 and DEC minicomputers and IBM mainframes. The Vectra PC can also exchange information with IBM PCs and with the HP Portable PLUS personal computer.

### Personal Computers and Networking

Local area networks (LANs) are the links that connect individual (and sometimes incompatible) personal computers, mainframes, minicomputers, and related peripherals. The network is a data- and resource-sharing system; each individual network node can easily and reliably communicate and exchange information with other nodes.

### Compatibility

HP has been among the leaders in the development of industry-wide standards for networking and communications. Our personal computers, workstations, and host computers communicate via a network based on ISO, IEEE, and other industry standards. **Industry Standards** — HP uses the International Standard Organization (ISO) seven-layer Open Systems Interconnect (OSI) Reference Model as the basis for its HP AdvanceNet architecture. The X.25 standard for public or private data networks and the IEEE 802.3 standard for local area networks represent standards within the OSI Reference Model.

**Communications with Other Vendors** — Both batch and interactive communications in System Network Architecture (SNA®) and bisync environments are supported by HP AdvanceNet, and new product developments will enhance compatibility with SNA,

and will add IBM's DCA/DIA. In addition, HP has products that allow DEC® VAX computers to communicate with HP systems using HP's Network Services (NS) Network File Transfer (NFT).

### HP AdvanceNet

Hewlett-Packard's AdvanceNet is a communications strategy and network architecture designed to provide a broad range of networking alternatives. HP AdvanceNet delivers workable solutions to a multitude of data communications problems in the areas of integrated business systems, engineering and scientific design, and manufacturing operations, and ties them all together with integrated business networks. These capabilities provide you with fast and effective communications that improve the productivity of users and programmers alike.

In developing HP AdvanceNet, HP combined unique products and solutions that focus on cost-efficient yet expandable networking. HP AdvanceNet offers price and performance alternatives for existing and new systems, as well as the flexibility to enlarge and enhance the system as your needs evolve. And your long-term investment in networking is protected by the many alternatives for system upgrades and connections that are supported by HP AdvanceNet.

Hewlett-Packard's network management products enable you to easily design, configure, monitor, and control your network.

### Architecture Interfacing

HP AdvanceNet unites two data processing methods: HP's local interactive access to processing and IBM's centralized batch processing. The SNA approach used by IBM performs the same functions, with different implementations, as the OSI reference model. The HP AdvanceNet strategy interfaces HP equipment with IBM and IBM plug-compatible products for both SNA and bisync environments.

Comprehensive networking architecture integrates the elements of various vendors' hardware and software products to achieve a network that is transparent to the user. This transparency permits interaction within multi-vendor systems, and allows a remote system to operate with the same capabilities as a local system. HP AdvanceNet, which follows the OSI Reference Model and standard protocols, is just such a comprehensive architecture.

The components most suitable for your application can be selected from different vendors without compromising the unique needs of your data communications environment. The chosen components must communicate with the HP products in your network. The compatibility of future hardware and software additions to your HP AdvanceNet system is ensured by HP's commitment to industry standards.

### AdvanceLink

The extensive data communications capabilities of AdvanceLink connect your Touchscreen II to IBM® PCs, to other Touchscreen IIs, to the Vectra personal computer, and to modems. With AdvanceLink, the Touchscreen II can transfer files between most mainframes, public databases, and personal computers.

The powerful command language of AdvanceLink lets you automate such repetitive tasks as modem dialing and logging onto remote computers or public information systems. In addition, the AdvanceLink functions are easily controlled from the Personal Applications Manager (PAM) menu.

You can exchange information with HP 3000s and HP 1000s, and with AdvanceLink running on other Touchscreen II PCs, Vectra PCs, and IBM PCs. Both ASCII and binary files can be transferred using full-duplex modems and phone lines or by a direct cable connection between the Touchscreen IIs and the IBM PC.

### Touchscreen 3278 Emulation

You can gain access to software and databases on an IBM host computer when the Touchscreen 3278 Emulation Accessory with File Transfer is installed on your Touchscreen II. The terminal emulation function offers the advantages of an IBM 3278 terminal plus the convenience of local computing. And the File Transfer feature lets you upload and download files, and use the host computer to transfer data between the Touchscreens and IBM PCs.

### 3270 SNA Emulator for the Vectra PC

HP's 3270 SNA emulator for the Vectra PC lets you connect to an IBM host with multiple simultaneous host sessions. The product (hardware plus software) offers 3270 terminal emulation with file transfer to and from MVS/TSO, VM/CMS, and CICS host files using IBM's 3270 host file-transfer protocols. The 3270 SNA emulator, in conjunction with a synchronous modem and a telephone line, offers the convenience of a 3270 remote terminal and the power of a PC.

### 3270 SNA Emulator for the Portable PLUS

With HP's 3270 SNA emulator for the Portable PLUS, you can connect to an IBM host from almost anywhere. The product (hardware plus software) offers 3270 terminal emulation with file transfer to and from MVS/TSO, VM/CMS, and CICS host files. The emulator, with a synchronous modem and a telephone line, gives you the convenience of a portable terminal and the power of a portable PC.

### Acculink

DEC VT100 and VT52 terminals can be emulated using Acculink™ on the Touchscreen II or Vectra PC. You can run DEC mini-computer-based application software and exchange ASCII and binary files. Acculink supports easy terminal emulation, including error checking and macro file construction.

### Vectra and Touchscreen Internal Modems

Exchanging information over phone lines between Touchscreen IIs and Vectras, or between these and other personal computers, is as easy as plugging in a phone jack. The Internal Modem installed on your Touchscreen II or Vectra offers the capability of tapping into databases and using subscription services. Its 1200-baud operation means fast communications and lower phone bills, while older systems remain compatible with its 300-baud rate. With AdvanceLink and the Internal Modem on your HP personal computer, you can exchange files with a remote HP 3000 computer.

### Portable-Desktop Link

More than a cable and interface card, the Portable-Desktop Link (PDL) connects the HP Portable PLUS personal computer and the Touchscreen II, Vectra, or the IBM PC, creating an efficient data-exchange network. The Portable PLUS is linked to the Touchscreens and Vectras with the HP Extended I/O Accessory and to the IBM PC with the HP-IL Interface Card. The Portable PLUS can take advantage of these links to use printers or disc drives connected to the desktop personal computer.

### HP OfficeShare Networking Family for PCs

The HP OfficeShare networking family for PCs integrates personal computer users into a site network with options for PC servers and HP 3000 servers and communications with HP 1000, HP 9000, and HP 3000 hosts as well as DEC and IBM hosts. The family includes:

- HP StarLAN
- HP ThinLAN FOR PCs
- HP SERIAL Network

These networking products allow PC users to share resources and access HP's distributed processing and Personal Productivity Center services to enhance communications, cut costs, and boost productivity. Additionally, access to DEC and IBM machines is available.

HP StarLAN provides the services to users of the HP Vectra and IBM PC/XT™/AT personal computers using unshielded twisted pair telephone wire meeting the IEEE 802.3 StarLAN specification. HP StarLAN has the additional benefits of lower cost and higher flexibility, often using existing telephone wiring. HP ThinLAN for PCs provides these same services using RG 58 thin coaxial cable to users of the HP Touchscreen, HP Vectra, and IBM PC/XT/AT\* personal computers. The HP SERIAL Network product provides the services to a remote HP Touchscreen, HP Vectra, and IBM PC/XT/AT personal computer user over an asynchronous connection to a remote HP 3000 server or host.

All of the OfficeShare products are MSTM-Net compatible, allowing applications written to the MS-Net interface to function on the network. The products also share a consistent user interface, providing easy user integration into a site-wide LAN. HP StarLAN subnets can be connected to a baseband or broadband backbone cable running through a building to integrate the users in an entire facility. Users in a remote location can access the network services using HP SERIAL Network.

The OfficeShare networking products offer ideal networks for the user requiring information exchange, file transfer to an HP 3000, database access, electronic mail, and sharing of system peripherals such as discs, printers, and plotters. This sharing of information and peripherals provides an efficient exchange of data and use of resources for increased productivity and lower cost.

Acculink is a U.S. trademark of IE Systems, Inc.  
MS-Net is a U.S. registered trademark of Microsoft Corporation.  
SNA and IBM PC/AT are U.S. registered trademarks of International Business Machines Corporation.

IBM PC/XT is a U.S. trademark of International Business Machines Corporation.

DEC is a U.S. registered trademark of Digital Equipment Corporation.

# PERSONAL COMPUTERS & CALCULATORS

## Personal Computation

Models HP-11C, HP-12C, HP-15C, HP-16C, HP-18C, HP-28C



HP-12C



HP-15C

Whether it's a business or scientific calculator, or a handheld computer, Hewlett-Packard products can provide the sense of pride that comes from owning a computational tool that has been designed—in every detail—to be the finest of its kind.

The HP-11C, HP-12C, HP-15C and HP-16C are stand-alone programmable calculators. The Business Consultant and HP-28C professional calculators can be enhanced with an optional cordless printer.

The HP-41 calculator and HP-71 Handheld Computer are expandable and highly customizable. The Custom Products Program provides personalized application solutions. Completely portable systems can be assembled, and communication with instruments and computers is possible using the versatile HP-IL Interface.

### Business Calculators

#### HP-12C Programmable Financial Calculator

The HP-12C is a powerful financial calculator that is a favorite of business professionals in banking, real estate and investment. It features Time Value of Money functions, discounted cash flow functions (NPV and IRR), plus bond functions that calculate yield-to-maturity and price.



HP-18C

#### HP-18C Business Consultant Professional Calculator

This innovative calculator for business professionals sets a new standard in ease of use. Standard business formulas are built in, and menus and softkeys make these functions easy: interest rates, payment schedules, statistics, internal rate of return, markup and margin, interest rate conversions, and time and appointments. A unique formula solver function allows users to enter formulas for personalized business problems in their own words. The calculator has a four-line by 23-character LCD display plus separate alpha and numeric keyboards. Application booklets are available. Features a wireless infrared printer interface.



HP-28C

### Scientific Calculators

#### HP-11C Programmable Scientific Calculator

Scientists, engineers and mathematicians will use these built-in functions: statistics, a random number generator, trigonometrics, hyperbolics and inverses, as well as permutations and combinations. The HP-11C's programmability allows subroutine and indirect addressing plus conditional tests and flags.

#### HP-15C Programmable Scientific Calculator With Matrices

The HP-15C has special functions that help scientists, engineers and mathematicians solve problems involving matrices and complex arithmetic. Built-in matrix functions operate on up to five matrices (a maximum of 64 elements). The HP-15C has SOLVE and integration functions built in for doing derivatives and integrals, plus 448 program lines with insert and delete editing.

#### HP-16C Programmable Calculator for Computer Science

The HP-16C is specifically designed for computer science and digital electronic applications. Number base modes make it easy to convert between binary, octal, decimal and hexadecimal bases. In addition to calling and editing programs, the HP-16C has extensive bit manipulation capability.

#### HP-28C Scientific Professional Calculator

The HP-28C sets a new performance standard for built-in capability in handheld calculators. Equations can be formulated on the calculator and solved using built-in algebra and calculus functions. It easily handles matrices, complex numbers and binary numbers. Using the equation solver, personalized equations can be entered. When the solver function is activated, the HP-28C automatically creates a menu with all the equation variables assigned to softkeys. Additional features include function and data plotting, programming capability and unit conversions. The HP-28C has a 128K-byte operating system, 4-line by 23-character display and wireless infrared printer interface. Application booklets are available.



HP-41CV

HP-41CX



HP-71B



HP 82240A

#### HP-41CV and HP-41CX Advanced Programmable Calculators

The HP-41CV and HP-41CX provide the heart of expandable computational systems. In addition to input/output capability, they provide portability and touch-key simplicity.

In addition to all the built-in functions of the HP-41CV, the HP-41CX features built-in Time and Extended Functions/Memory modules, a text-file editing function and 19 other functions.

A broad range of HP-written Application Packages and Solutions Books is available. A Custom Products program is available for customized software solutions in large quantities (see page 687.)

#### HP-41 Specifications

**User memory (bytes):** 2,233 (319 registers) built into HP-41CV; 6,433 (919 registers) maximum.

**Extended memory (bytes):** 868 (124 registers) built into HP-41CX; HP 82180A Extended Functions/Memory Module, 868 (124 registers) optional for HP-41CV.

**Extended memory modules (bytes):** HP 82181A Extended Memory Module, 1,666 (238 registers) optional for HP-41CX/CV.

**Built-in functions:** Over 200 in HP-41CX; over 128 in HP-41CV.

**Keyboard:** Redefinable, alphanumeric (HP-41CX/CV).

**Display:** LCD, 10 digits; 12 alpha characters (scroll to 24) (HP-41CX/CV).

**Power requirements:** Four 1.5V, size N batteries (HP-41CX/CV)

**Size:** 3.3 x 7.9 x 14.2 cm (1.3 x 3.1 x 5.7 in) (HP-41CX/CV).

#### HP-71 Handheld Computer

The HP-71 Handheld Computer is a powerful computational tool for individuals and is also well suited to manufacturing applications like quality control, portable data acquisition and test instrument control. Its full CMOS CPU has a 4-bit intelligent external bus and 64-bit internal registers.

The HP-71 uses a powerful BASIC language that runs nearly as fast as compiled BASIC and allows structured programming techniques. It supports a sophisticated file management system and an advanced calculator mode (CALC). The operating system can be further enhanced by using FORTH or assembler languages.

Optional HP-IL interfacing provides input/output capability, and four ports accept memory modules or application software. Applications can be customized through the Custom Products program. Documented internal specifications allow development of hardware, software, interfaces and firmware. (See the Custom Products and Programming Development Aids on page 687.)

#### HP-71 Specifications

**User memory (bytes):** 17.5K built in, 33.5K (305.5K using value-added supplier modules) maximum.

**Read only memory (bytes):** 64K built in, 320K maximum.

**Memory modules (bytes):** HP 82420A, 4K (user memory—add a maximum of four); 16K, 32K, 48K or 64K (read only memory—add a maximum of four).

**Transfer rate (bytes/sec):** 8K (copying to a loop, no devices on loop); 6.4K (copying in a file); 4.5K (OUTPUT statement, no formatting (USING)); 4K (ENTER statement, no formatting (USING) and version 1B of the HP-IL module).

**Programming languages:** HP BASIC (built in); FORTH and assembler (optional).

**Keyboard:** Block QWERTY, redefinable, alphanumeric with separate numeric keypad.

**Display:** LCD, 22 characters (scroll to 96).

**Power requirements:** Four 1.5V, size AAA alkaline batteries.

**Size:** 19 x 9.7 x 2.5 cm (7.5 x 3.8 x 1.0 in).

#### Ordering Information

	Price
HP-11C Programmable Scientific Calculator	\$56.00 ☞
HP-12C Programmable Financial Calculator	99.00 ☞
HP-15C Programmable Scientific Calculator with Matrices	99.00 ☞
HP-16C Programmable Calculator for Computer Science	120.00 ☞
HP-18C Business Consultant Professional Calculator	175.00 ☞
HP-28C Scientific Professional Calculator	235.00 ☞
HP-41CV Advanced Programmable Calculator	175.00 ☞
HP-41CX Advanced Programmable Calculator	249.00 ☞
HP-71B Handheld Computer	525.00 ☞

#### Enhancements and HP-IL Peripherals

##### Business Consultant and HP-28C:

##### HP 82240A Infrared Printer

An infrared beam provides a cordless connection with the calculator from up to 18 inches away. Prints 24 characters per line in 5x8 dot matrix using the Roman-8 character set plus 10 additional special math characters. Uses batteries or optional AC adapter.

##### HP-41:

##### HP 82182A Time Module

With this module (built into the HP-41CX), the HP-41CV can become a time-scheduled system controller, alarm clock, appointment reminder, calendar, timer or even an advanced stopwatch.

##### HP 82160A HP-IL Interface Module

Plugs into any one of the four ports in the HP-41, connecting it with HP-IL peripherals and instruments, and to HP-1B, RS-232C and GPIO devices using interface converters. Gives the HP-41 control of up to 30 devices on the loop. Typical HP-41 transfer rate: 150 bytes/second.

##### HP 82183A Extended I/O Module

Provides 59 I/O functions beyond those provided by the HP 82160A HP-IL Module.

##### HP 82104A Card Reader

Allows programs and data to be saved on magnetic cards which contain 32 registers, 16 per side. Adds over 30 control functions to the HP-41.

##### HP 82153A Optical Wand

Easily inputs data or programs into the HP-41 when passed across a printed page of HP-41 bar code.

##### HP 82242A Infrared Printer Interface Module

Provides an interface that allows the HP-41 to be used with the HP 82240A Infrared Printer. Permits numeric, upper- and lower-case alpha, double-wide characters, high-resolution plotting capabilities and intensity control. Allows user-defined special characters to be transmitted to the printer.

##### 00041-15042 Automatic Start and Cassette Duplication Module

Allows programs to be written that automatically set status, configure memory, access peripherals or provide prompts.

##### 00041-15043 HP-IL Development Module

Allows the contents of any control register to be changed, certain status bits to be polled, and the addition of a second HP-41 to monitor the status of the HP-IL loop.

☞ Fast-Ship product — see page 758

# PERSONAL COMPUTERS & CALCULATORS

## Personal Computation

### HP-IL Instruments & Interfaces, HP-IL Interfaces for Other Computers

#### HP-71:

##### HP 82401A HP-IL Interface

Allows direct connection to any HP-IL product, and to HP-IB, RS-232C, and GPIO devices using interface converters. Facilitates simultaneous control of up to 30 devices on the loop.

##### HP 82402A Dual HP-IL Adapter

Allows the HP-71 to have two independent, isolated HP-IL loops simultaneously, using only one port and two HP-IL modules.

##### HP 82400A Card Reader

Provides inexpensive storage for programs and data. Cards can be encoded so they may be executed, but not viewed or edited, to ensure against overwriting. Provides automatic verification.

#### HP-41 and HP-71:

##### HP 82161A Digital Cassette Drive

Uses a digital-quality mini-cassette to store up to 128K bytes of information. Number of tracks, 2; Density, 335 bits/cm (850 bits/inch); format, 256 bytes/record (8 bits/byte); formatted capacity, 512 records (131,072 bytes).

##### HP 82162A Thermal Printer/Plotter

Provides numeric upper- and lower-case alpha, doublewide characters and intensity control.

The chief feature distinguishing the HP 82162A from the HP 82143A dedicated Printer/Plotter is that it has a 101-character buffer for enhanced graphics and bar code printing capabilities and a FORMAT function which automatically centers or justifies copy to the left and right margins.

##### HP 2225B ThinkJet Personal Printer

See numerical index for page number.

##### HP 9114B Disc Drive

See numerical index for page number.

#### Ordering Information

##### HP-18C Business Consultant and HP-28C:

HP 82240A Infrared Printer (110V)

HP 82241A Adapter, U.S. (110V)

##### HP-41:

HP 82240A Infrared Printer (110V)

HP 82242A Infrared Printer Interface Module

HP 82180A Extended Functions/Memory Module

HP 82181A Extended Memory Module

HP 82162A Time Module

HP 82160A HP-IL Interface Module

HP 82183A Extended I/O Module

HP 82104A Card Reader

HP 82153A Optical Wand

00041-15042 Automatic Start and Cassette Duplication Module

00041-15043 HP-IL Development Module

#### Price

135.00 ☞

15.00 ☞

135.00 ☞

65.00 ☞

75.00 ☞

75.00 ☞

75.00 ☞

125.00 ☞

75.00 ☞

195.00 ☞

125.00 ☞

35.00 ☞

75.00 ☞

#### HP-71:

HP 82420A 4K-Byte Memory Module

75.00 ☞

HP 82401A HP-IL Interface

125.00 ☞

HP 82402A Dual HP-IL Adapter

85.00 ☞

HP 82400A Card Reader

165.00 ☞

#### HP-41 and HP-71:

HP 82161A Digital Cassette Drive

550.00 ☞

HP 82162A Thermal Printer/Plotter

450.00 ☞



HP 82169A

### HP-IL Instruments and Interfaces

#### HP-41 and HP-71

##### Instrument Options

See numerical index for page numbers. HP 3468A/B Digital Multimeter; HP 3421A Data Acquisition/Control Unit; HP 5384A/HP 5385A Opt. 003 Frequency Counters; HP 1631A/D Logic Analyzers; HP 4945A Transmission Impairment Measuring Set; HP 8590A Portable Spectrum Analyzer.

##### HP 82164A HP-IL/RS-232C Interface

Translates HP-IL signals into RS-232C signals, and vice versa, for connection of HP-IL systems with RS-232C systems. Provides bit-serial asynchronous data communication. AC adapter included.

##### HP 82169A HP-IL/HP-IB Interface

Permits linkage of HP-IL systems with HP-IB (IEEE 488, 1978) computers and lab equipment. When a controller is used, it can be either an HP-IL or HP-IB device. AC adapter included.

##### HP 82165A HP-IL/GPIO Interface

Allows HP-IL to control equipment operating with parallel bus structures. Contains I/O buffering and a built-in power supply that operates from an HP standard AC adapter that is included.

### HP-IL Interfaces for Other Computers

#### HP 82938A HP-IL/Series 80 Interface

Provides a communication link between portable battery-operable products and larger computers. Allows use of Series 80 built-in graphics.

#### HP 45643A Extended I/O Accessory

Provides a communication link between The PORTABLE and the Touchscreen, Touchscreen MAX and Vectra (and HP-71, using HP 82477A HP-IL Link software) computers via the HP-IL interface.

#### HP 82873A HP-IL Interface Card

Provides a communication link between The PORTABLE and IBM PC/XT (and HP-71, using HP 82477A HP-IL Link software) computers via HP-IL interfacing.

#### HP 82166C HP-IL Interface Kit

A design kit that provides the special components needed to incorporate HP-IL into other devices.

#### Ordering Information

##### HP-41 and HP-71:

HP 82164A HP-IL/RS-232C Interface

#### Price

295.00 ☞

HP 82169A HP-IL/HP-IB Interface

395.00 ☞

HP 82165A HP-IL/GPIO Interface

295.00 ☞

HP 82938A HP-IL/Series 80 Interface

295.00 ☞

HP 45643A Extended I/O Accessory

175.00 ☞

HP 82873A HP-IL Interface Card

150.00 ☞

HP 82166C HP-IL Interface Kit

395.00 ☞

☞ Fast-Ship product—see page 758.



#### Accessories

Accessories such as owner's manuals, programming pads, magnetic cards, thermal paper, battery packs, rechargers and software manuals are readily available for all types of HP calculators.

#### Custom Products and Programming Development Aids

Through customization, the powerful HP-41 and HP-71 can be tailored with personalized software to perform the functions that will increase performance productivity.

Using programs written by customers or value-added suppliers, the HP-41 and HP-71 can be customized using Custom ROMs and EPROMs.

The services of Independent Custom Consultants (ICCs) make the customization process easy. (A list of ICCs is available from your HP Sales Representative.)

#### HP-41:

##### HP-41CV or HP-41CX Opt. 001 Custom Calculator

The shifted function labels are removed from the keys, eliminating unnecessary and possibly distracting nomenclature.

##### HP Bar Code

Provides cost-efficient storage on paper that's easy to use, duplicate and distribute.

#### HP-71:

##### HP 82440A Software Development Utility

Allows development of HP-71 BASIC, FORTH or assembly language source files using an HP-86, HP-87 or IBM PC.

##### HP 82477A HP-IL Link

This software enables transfer, via HP-IL, of most types of files between the HP-71 and MS-DOS personal computers that have HP-IL capability. It allows the PC to be used as a full-sized keyboard and display for the HP-71. 3.5 and 5.25 inch MS-DOS formatted discs are included.

##### HP 82478A FORTH Assembly/Debugger

Provides an extended software development environment for the HP-71. Allows control of the execution, and viewing of status information, of assembly language programs. FORTH routines can be called from BASIC and vice versa.

#### HP-71 Internal Design Specifications (IDS) Documents

##### 00071-90068 Volume I: Detailed Design Description

00071-90069 Volume II: Entry Point and Poll Interfaces (Use with 1BBBB version of HP-71 operating system.)

00071-90070 Volume III: Operating System Source Listings (Use with 1BBBB version of HP-71 operating system.)

00071-90104 Volume II: Entry Point and Poll Interfaces (Use with 2CCCC version of HP-71 operating system.)

00071-90105 Volume III: Operating System Source Listings (Use with 2CCCC version of HP-71 operating system.)

##### 82401-90023 Internal Design Specifications, HP-IL

Provides details on the HP-IL interface, including entry points and source code listing.

##### 00071-90071 Hardware Design Specifications

Provides details on hardware bus specifications.

#### HP-41 and HP-71 Custom ROM Modules

##### HP-41: HP 82508A/B, HP 82509A/B

Provide 4K or 8K bytes of memory with each module, or nearly 21,000 program lines with up to four 8K-byte modules.

##### HP-71: HP 82491A/B, HP 82492A/B, HP 82493A/B, HP 82494A/B

Provide 16K, 32K, 48K or 64K bytes of program storage in a plug-in module. May be used in quantities of one to four for a maximum capacity of 256K bytes of ROM. (Minimum order: 100 modules.)

#### Ordering Information

	Price
HP-41:	
HP-41CV Opt. 001 Custom Calculator	175.00
HP-41CX Opt. 001 Custom Calculator	249.00

#### HP-71:

HP 82440A Software Development Utility	35.00	☞
HP 82477A HP-IL Link	95.00	☞
HP 82478A FORTH Assembly/Debugger	175.00	☞
00071-90068 Volume I: Detailed Design Description	50.00	
00071-90069 Volume II: Entry Point and Poll Interfaces (Use with 1BBBB version of HP-71 operating system.)	50.00	
00071-90070 Volume III: Operating System Source (Use with 1BBBB version of HP-71 operating system.)	200.00	
00071-90104 Volume II: Entry Point and Poll Interfaces (Use with 2CCCC version of HP-71 operating system.)	50.00	
00071-90105 Volume III: Operating System Source (Use with 2CCCC version of HP-71 operating system.)	200.00	
82401-90023 Internal Design Specifications, HP-IL	60.00	
00071-90071 Hardware Design Specifications	200.00	

☞ Fast-Ship product — see page 758.

# PERSONAL COMPUTERS & CALCULATORS

## Personal Computation

### Software, HP-Interface Loop (HP-IL)

#### Software

HP offers software packages as application pacs, solutions books and application booklets. Application pacs come with a manual, plug-in module, and when applicable, prerecorded magnetic cards, a keyboard overlay and quick reference card. Solutions books come with complete documentation. Application booklets stand alone. Available from dealers and HP Representatives.

#### HP-11C:

00011-90009 HP-11C Solutions Handbook

Price  
15.00 ☞

#### HP-12C:

00012-90021 HP-12C Leasing Applications Handbook

15.00 ☞

00012-90015 HP-12C Real Estate Applications Handbook

15.00 ☞

00012-90009 HP-12C Solutions Handbook

15.00 ☞

00012-90022 HP-12C Training Guide

15.00 ☞

#### HP-15C:

00015-90011 HP-15C Advanced Functions Handbook

15.00 ☞

#### HP-18C Business Consultant:

##### Application Booklets

00018-90034 Banking Consultant

7.95 ☞

00018-90035 Business Finance Consultant

7.95 ☞

00018-90038 Direct Sales Consultant

7.95 ☞

00018-90037 Manufacturing Consultant

7.95 ☞

00018-90039 Marketing Consultant

7.95 ☞

00018-90039 Personal Investment Consultant

7.95 ☞

00018-90040 Real Estate Consultant

7.95 ☞

00018-90041 Small Business Consultant

7.95 ☞

#### HP-28C:

##### Step-by-Step Booklets

00028-90041 Algebra and College Math

9.95 ☞

00028-90042 Calculus

9.95 ☞

00028-90043 Probability and Statistics

9.95 ☞

00028-90044 Vectors and Matrices

9.95 ☞

#### HP-41:

##### Application Pacs

00041-15055 HP-41 Advantage

\$49.00 ☞

00041-15024 Clinical Lab & Nuclear Medicine

35.00 ☞

00041-15006 Circuit Analysis

35.00 ☞

00041-15004 Financial Decisions

35.00 ☞

00041-15049 Math/Statistics

45.00 ☞

00041-15022 Games

35.00 ☞

00041-15023 Home Management

35.00 ☞

00041-15016 Real Estate

45.00 ☞

00041-15019 Thermal & Transport Science

35.00 ☞

00041-15039 Petroleum Fluids

75.00 ☞

00041-15026 Securities

35.00 ☞

00041-15001 Standard Applications

35.00 ☞

00041-15002 Statistics

35.00 ☞

00041-15027 Stress Analysis-Mechanical Engineering

35.00 ☞

00041-15021 Structural Analysis-Civil Engineering

45.00 ☞

00041-15005 Surveying

35.00 ☞

00041-15020 Machine Design

35.00 ☞

00041-15042 Auto/Start Duplication ROM

35.00 ☞

00041-15043 HP-41 HP-IL Development Module

75.00 ☞

##### Solutions Books

###### Business:

00041-90094 Business Statistics/Marketing/Sales

15.00 ☞

00041-90096 Home Construction Estimating

15.00 ☞

00041-90086 Lending, Savings, & Leasing

15.00 ☞

00041-90136 Real Estate

15.00 ☞

00041-90137 Small Business

15.00 ☞

#### Engineering:

00041-90093 Antennas

15.00 ☞

00041-90100 Chemical Engineering

15.00 ☞

00041-90089 Civil Engineering

15.00 ☞

00041-90092 Control Systems

15.00 ☞

00041-90088 Electrical Engineering

15.00 ☞

00041-90139 Fluid Dynamics & Hydraulics

15.00 ☞

00041-90140 Heating, Ventilating & Air

15.00 ☞

Conditioning

00041-90090 Mechanical Engineering

15.00 ☞

00041-90138 Solar Engineering

15.00 ☞

00041-90441 Structural Design (cassette based)

35.00 ☞

#### Computation:

00041-90084 Geometry

15.00 ☞

00041-90083 High-Level Math

15.00 ☞

00041-90082 Test Statistics

15.00 ☞

#### Other:

00041-90145 Calendars

15.00 ☞

00041-90102 Chemistry

15.00 ☞

00041-90099 Games I

15.00 ☞

00041-90443 Games II

15.00 ☞

00041-90143 Optometry I (General)

15.00 ☞

00041-90144 Optometry II (Contact Lenses)

15.00 ☞

00041-90142 Physics

15.00 ☞

00041-90141 Surveying

15.00 ☞

00041-90395 Time Module Solutions I

15.00 ☞

#### HP-71:

##### Application Pacs

HP 82481A AC Steady State Circuit Analysis

75.00 ☞

HP 82484A Curve Fitting

95.00 ☞

HP 82479A Data Acquisition

195.00 ☞

HP 82488A Data Communications

95.00 ☞

HP 82482A Finance

75.00 ☞

HP 82480A Math

95.00 ☞

HP 82440A Software Development Utility (with mini-cassette)

35.00 ☞

HP 82489A AMPI (TM) Statistics

95.00 ☞

HP 82483A Surveying

95.00 ☞

HP 82485A Text Editor

75.00 ☞

HP 82490A HP-41 Translator

95.00 ☞

##### Solutions Books

00071-90065 Games

15.00 ☞

00071-90066 General Utilities

15.00 ☞

00071-90064 Math

15.00 ☞

AMPI™ Statistics is a trademark of American Micro Products, Inc.

#### Hewlett-Packard Interface Loop (HP-IL)

The Hewlett-Packard Interface Loop, HP-IL, is a bit-serial interface designed for low cost battery-operable systems. HP-IL allows HP-41 calculators and HP-71, The PORTABLE, HP 150, Vectra and IBM PC and other computers to be used as system controllers, capable of transmitting and receiving data, and performing a wide variety of information management functions. In addition, HP-IL allows the HP-41 and HP-71 to be used for instrument control.

In HP-IL systems, devices are connected by two-wire cables leading from the output port of one device to the input port of the next, until all devices form a closed loop. This loop structure provides a unique capability through: auto address assignment, device capability identification, power ON/OFF control, and error checking.

For additional information or a demonstration of Hewlett-Packard professional calculators and handheld computers, visit your nearest HP sales representative or HP dealer. In the US, for the location and number of the one nearest you call toll-free 1-800-752-0900.

☞ Fast-Ship product — see page 758.

#### HP-IL Products and Applications Summary

Model	Application	See Page
HP-41 Advanced Calculator (with HP 82160A HP-IL Interface Module)	Control: HP-IL bench/field controller Computation: Field data collection	685
HP-71 Handheld Computer (with HP 82401A HP-IL Interface)	Control: HP-IL bench/field controller Computation: Data acquisition, field analysis	685
The PORTABLE PLUS (with HP-IL built in)	Computation and field analysis Remote transaction processing Battery or AC operation	676
The Integral PC (with HP 82924A HP-IL Interface)	HP-IL bench controller; field data analysis control	639
HP 82402A Dual HP-IL Adapter	Allows two HP 82401A HP-IL modules to be plugged into the HP-71 simultaneously.	686
HP 82169A HP-IB Interface	Bench conversion from HP-IL to IEEE-488 computers, peripherals and instruments	686
HP 82164A RS-232C Interface	Bench conversion between HP-IL and RS-232C signals for terminals, modems, computers and peripherals	686
HP 82165A GPIO Interface	Bench conversion between HP-IL and parallel devices Digital data acquisition interface from HP-IL to most computers	686
HP 82938A Series 80 Interface	Bench conversion from HP-IL to Series 80 Personal Computers	686
HP 82166C HP-IL Interface Kit	Components that can be built into a device, providing HP-IL capability	686
HP 45643A Extended I/O Accessory	Driving HP-IL peripherals, including ThinkJet, plus parallel printers Allows communication between The PORTABLE and Touchscreen, and Touchscreen MAX	686
HP 82973A HP-IL Interface Card	Allows communication, using HP-IL, between The PORTABLE and the IBM PC/XT. Driving HP-IL peripherals	686
HP 82161A Digital Cassette Drive	Bench/field program storage Bench/field data storage Bench/field data logging Field data collection	686
HP 82162A Thermal Printer/Plotter	Bench/field hard copy Data logging Simple plotting Computational hard copy	686
ThinkJet Printer (HP-IL option)	Bench/field full-page, hard-copy output Low noise environments Quality graphics and text Battery operation	715

Model	Application	See Page
HP 9114B 3 1/2" Flexible Disc Drive (with HP-IL built in)	Bench/field program storage Bench/field data storage Bench/field data logging Bench/field data collection Bench/field data exchange with Series 80 and Series 200 personal computers Battery or AC operation	706
HP 1631A/D Logic Analyzers	Digital diagnosis and debugging Timing analysis, state analysis, performance analysis, and interactive state/timing analysis	257
HP 3421A Data Acquisition/Control Unit	Bench/field automated measurement, channel selections and control Lab bench experimentation and control Portable experimentation and data collection	554
HP 3468A/B Digital Multimeters	Bench/field automated measurement Scientific experimentation Lab bench experimentation & trouble shooting Bench/field automated service & diagnostic tool	98
HP 4945A Transmission Impairment Measuring Set (TIMS)	Bench testing of voice grade data channels, program channels, and high speed digital channels Master/slave capability for end-to-end testing Automatic gain slope measurement Programmable sweep	497
HP 5384A/HP 5385A Opt. 003 Frequency Counters	Bench, systems, field-automated measurement	179
HP 8590A Portable RF Spectrum Analyzer	Bench/field measurements Design, maintenance and troubleshooting tool for communications equipment, including CATV and telecommunications systems	128

#### HP-IB and HP-IL

HP-IL is a low-cost, low-power alternative below HP-IB in price and performance.

Although HP-IB and HP-IL serve the same basic function—interfacing controllers, instruments and peripherals—they differ in many respects.

1. Because of HP-IL's lower power consumption, it is usable with portable, battery-powered systems. Generally, HP-IB is not.
2. HP-IL system components will generally be low cost and have moderate performance; HP-IB system components are medium- to high-performance and generally cost more.
3. HP-IL systems work at relatively low data rates compared to HP-IB, and relatively high data rates compared to RS-232C. For example, the HP-71 and The PORTABLE can transmit at speeds of 5K to 6K bytes per second via HP-IL (this is equivalent to 50,000 to 60,000 baud on RS-232C). HP-IL maximum data rate is 20K bytes per second; this rate is not dependent on HP-IL cable length.
4. HP-IL allows device separations of up to 100 metres with shielded, twisted pairs (10 metres with zip cord). HP-IB requires extender hardware for long distance connections.

# BUSINESS COMPUTER SYSTEMS

## HP 260 Business Computers



The user-friendly, reliable HP 260 is designed for small businesses requiring a powerful computing system.

### HP 260 Business Computers

HP 260 business computers are multi-user, multi-tasking systems designed to meet the needs of small- to mid-size businesses. They are user-installable, and feature uncomplicated operation — facilitated by softkey-driven processing and the use of full-screen displays that resemble standard business forms. The IMAGE/260 database management system, included with HP 260 computers, provides data accuracy, protection from unauthorized access, and savings in data-storage costs. It also enables information retrieval and reporting by non-programmers.

### HP 260 Series 30 and Series 40

The low-end Series 30 and the high-end, high-performance Series 40 are fully compatible and can each be connected to the same number of peripheral devices. The very affordable Series 30 is recommended for configurations with one to four users. The Series 40 features disc caching, which results in increased system performance, and supports up to 15 concurrent users/tasks. To allow connection with the greatest possible number of peripheral devices, Hewlett-Packard offers an I/O extender that provides slots for additional I/O boards.

### Growth Opportunities

Hewlett-Packard offers a wide range of high-quality peripherals, including mass storage devices, workstations, data-entry terminals, printers, and plotters, that provide an economical way to expand your HP 260 system. Also, both the Series 30 and the Series 40 are upgradable to higher-performance systems. The two series are software-compatible, so it's quick and easy to upgrade from the Series 30 to the more powerful Series 40.

There is also a compatible growth path from the HP 260 computers to HP 3000 systems, because the HP Business BASIC/V language enables HP 260 programs to run on HP 3000 systems. To protect your investment in hardware, HP offers upgrade allowances for any hardware that cannot be integrated into an HP 3000 system.

### PC Integration

The latest release of the HP 260 operating system provides support of terminal emulators running on several popular personal computers, including AdvanceLink on the HP Touchscreen II PC, AdvanceLink 2392 on the HP Vectra PC and IBM® PC/XT™/AT®, and REFLECTION I™ on the HP Portable PLUS.

Any of the personal computers can be used as direct- or modem-connect HP 260 workstations with bidirectional file-transfer capabilities. Hewlett-Packard personal computers are especially easy to use with an HP 260 system, because they include a Personal Applications Manager (PAM) that can initiate HP 260 applications. This makes it easy to incorporate a personal computer's personal productivity capabilities, such as word processing, spreadsheet analysis, and decision-support graphics, into the multi-user HP 260 environment.

### Data Communications

HP 260 systems can communicate with personal computers, HP 3000 systems, HP 250 systems, and other HP 260 systems. They can also emulate IBM 2780/3780 batch terminals.

### Application Software

The friendly yet powerful BASIC/260 programming language makes HP 260 systems very useful tools for program development. Programmer productivity is enhanced by the comprehensive FORMS/260 program and the QUERY/260 database inquiry system.

A wide selection of application software is available from HP Value-Added System Suppliers. Value-Added System Suppliers are independent companies that use their industry expertise to provide innovative HP-260-based solutions. They have applications that address the specific needs of many different types of businesses, from manufacturing plants to medical practices. In addition, the System Suppliers can provide services such as system installation, system management training, application software training, application software maintenance and support, and business consulting.

### Specifications

**Microprocessor:** 16-bit Hewlett-Packard proprietary

**Operating System:** BASIC Operating System

**Memory:** Series 30 standard with 512K bytes; Series 40 standard with 1M byte

**Expansion Capability:** Two integrated RS-232C ports standard on both models; with I/O extender, slots are available for up to 2M-bytes memory, two 4-port video MUX boards, two 5-port ASI boards, one peripheral interface channel (HP-IB parallel interface), and one INP board

**Weight:** Series 30, Series 40, I/O extender (each): 12 kg (approx. 26.5 lbs.)

**Dimensions:** Series 30, Series 40, I/O extender (each): 128(h) x 325(w) x 380(d) mm (approx. 5.0 x 12.8 x 15.0 inches)

### Ordering Information

**HP 45070A** HP 260 Series 30 SPU includes 512K-bytes memory, two RS-232C ports, one peripheral interface channel (HP-IB), system software, and a standard manual set.

**HP 45072A** HP 260 Series 40 SPU includes disc caching, 1M-byte memory, two RS-232C ports, one peripheral interface channel (HP-IB), system software, and a standard manual set.

**HP 45071A** I/O extender: provides five additional board slots.

For more information on HP 260 solutions, contact your HP sales representative or your local HP 260 Value-Added System Supplier.

IBM PC/XT is a U.S. trademark of International Business Machines Corporation. IBM and PC/AT are U.S. registered trademarks of International Business Machines Corporation. REFLECTION I is a U.S. trademark of Walker Richer & Quinn, Inc.



HP 3000 business computers protect your investment in information management systems.

### Integrated Information Systems

Hewlett-Packard pioneered distributed data processing for keeping track of inventories and payables, generating invoices, organizing payrolls, and producing timely reports. Collection, access, and dissemination of data are made easy for any organization, from large corporate headquarters to branch offices and departments. HP also developed business automation systems that meet all the transaction processing demands of today's offices. This includes functions such as word processing, electronic mail, and report writing.

HP's productivity solutions for your office include the HP 3000 family of integrated information systems. The strength of HP communications products along with the flexibility of these systems lets you place cost-efficient, task-oriented computers where you need them.

### The HP 3000 Family

The HP 3000 family of business computers combines hardware, software, communications, and support in one integrated information management system. Over 30,000 HP 3000 systems are used in a wide range of office and manufacturing environments worldwide. Well known for reliability and ease of use, HP 3000s simultaneously manage on-line transaction processing, batch processing, programming, and data communications. HP 3000 systems provide both the performance advantages of leading-edge technology and the security of a fully compatible growth path.

To complement the HP 3000, Hewlett-Packard provides comprehensive networking capabilities, high-quality peripheral devices and workstations, personal computers, and a wide range of ready-to-run software. And because the HP 3000 has been well established for more than a decade, numerous third-party products are available for it.

### The HP 3000 Family Tradition

Hewlett-Packard continues to implement the strategy that has guided the development of the HP 3000 family from its beginning. This strategy integrates:

**Software compatibility.** All members of the HP 3000 family share a common operating environment, so applications can be run on higher-performance models without conversion.

**Expanding product line.** The HP 3000 family continues to expand, providing you with a broad, compatible range of systems from which to choose.

**Easy growth path to higher performance.** HP 3000 systems are always upgradable to higher-performance systems. Software and peripheral compatibility, as well as generous upgrade allowances, make it easy for you to adjust your computing power to handle growing workloads and meet new demands.

**Ease of use.** Among system operators, end users, and programmers, the HP 3000 has a well-deserved reputation of being easy to use. As part of HP's Personal Productivity Center, the HP 3000 extends beyond data processing to increase the productivity of all of your end users. By combining the flexibility of personal computers with the processing power of the HP 3000, Hewlett-Packard allows you to enhance the information-processing capabilities of your entire organization.

**Comprehensive network solutions.** The HP 3000 offers a wide variety of workstation-to-system, system-to-system, and system-to-mainframe communications capabilities.

**Lasting value.** By protecting your investment in software and hardware through compatibility and upgradability, and by maximizing your productivity with easy-to-use systems, Hewlett-Packard ensures that you get a maximum return on your investment in HP 3000 solutions.

To complement its superior software and hardware, HP provides a full range of documentation, training, and consulting programs, ensuring that you get the maximum benefit from your HP 3000.

### HP 3000 Business Computer Systems

The HP 3000 family features a compatible growth path and a wide choice of systems, ranging from small distributed office systems to large database hosts that can handle your company's business computing needs. The HP 3000 family includes the MICRO 3000, MICRO 3000XE, Series 52, Series 58, Series 70, Series 930, and Series 950 systems.

# BUSINESS COMPUTER SYSTEMS

## HP 3000 Business Computers (cont'd)

### MICRO 3000



Specifically designed for an office environment, the MICRO 3000 is ideal for branch offices, departments, and small businesses. As with all HP 3000s, the MICRO 3000 can concurrently handle on-line transaction processing and program development, batch processing, office applications, and data communications. In addition to its stand-alone capabilities, it can serve as a node in a network of computers. The MICRO 3000 can support up to 16 users.

### MICRO 3000XE



The powerful, cost-effective MICRO 3000XE can be the primary computer for a small company, be dedicated to a single application in a large company, or serve as a node in a network of computers. The MICRO 3000XE supports up to 58 users.

### Series 52



Designed as a departmental computer system, the mid-range Series 52 can also meet a small company's data processing needs. In addition to its stand-alone capabilities, it can serve as a node in a network of computers. The Series 52 supports up to 92 users.

### Series 58

A mid-range system supporting up to 152 users, the Series 58 can operate as a stand-alone system or as the central computer (or major node) in a distributed-processing system.

### Series 70

The Series 70 is a high-performance system for large business applications. Suitable for stand-alone operation or as the central computer (or major node) in large distributed networks, the Series 70 will support up to 400 users.

### Series 930



The first of a new generation of high-performance HP 3000s, the Series 930 supports up to 400 users and processes 4.5 million instructions per second (MIPS). Based on a simplified, technologically advanced design, the Series 930 is smaller, consumes less power, and is more reliable than typical systems in its performance class.

### Series 950



The highest-performance system in the HP 3000 family, the Series 950 uses Hewlett-Packard's proprietary NMOS-III VLSI technology. Its single-board processor performance of 7 MIPS is 50% higher than that of the Series 930. The 900 Series systems are based on HP Precision Architecture, a new architecture that represents a fundamental change in computer design: it increases computer performance by simplifying the computer instruction set. HP Precision Architecture is a Reduced Instruction Set Computer (RISC) architecture, in which a simplified, uniform set of frequently processed instructions is executed directly in the hardware. This results in substantially higher levels of performance.

### The MPE Operating System

All members of the HP 3000 family use the MPE (Multi Programming Executive) operating system, a very powerful, multi-user, multi-tasking operating system. MPE V is the version used by MICRO 3000, MICRO 3000XE, and Series 52, 58, and 70 systems. MPE XL, an enhanced version of MPE for the 900 Series systems, has been designed to take advantage of the high-performance capabilities of HP Precision Architecture. The MPE operating system allows easy system management and productive application development.

### Programming Languages

HP 3000 systems are optimized for on-line transaction-processing environments. Programmers can choose from a wide variety of high-level languages, such as COBOL, FORTRAN, RPG, BASIC, and Pascal, to best fit the application requirements.

### Software to Manage Your Information Processing Needs

Hewlett-Packard was the first in the industry to put a database management system on a minicomputer: IMAGE on the HP 3000. With more than 20,000 active installations of IMAGE, HP has the largest installed base of database management systems in the industry. Continuing its leadership role in database technology, HP has developed ALLBASE/XL, a new database management system for the 900 Series systems.

ALLBASE/XL combines both a network and a relational interface in one database management system. HPIMAGE, the network interface, is an enhanced superset of the previous versions of IMAGE.

It provides optimal performance for applications with high-volume, repetitive transactions, such as production planning.

HPSQL, ALLBASE/XL relational interface, is fully compatible with the de facto industry standard, SQL (Structured Query Language). HPSQL provides users with increased flexibility and programmer productivity.

For the MICRO 3000, MICRO 3000XE, Series 52, 58, and 70 systems, the network and relational database management systems are available separately. HP TurboIMAGE, the network model, is included in the fundamental operating-system software; HP SQL/V, the relational model, is available as a separate product.

Hewlett-Packard's database management systems are complemented by and integrated with other tools that combine to form HP's "Information Management Framework":

**System Dictionary** provides a single source for documenting all aspects of the system, from data definitions to configuration information. This makes it easier to develop and maintain applications, and to manage system resources. System Dictionary can be customized to meet your business needs.

**Business Report Writer** allows the development of sophisticated reports through easy-to-use menus, and makes it easy to combine data from several sources in a single report.

**Inform** is an interactive inquiry and report-generation facility designed for managers, purchasers, clerks, and secretaries. It allows easy access to data.

**HPAccess** is a personal computer application that enables users to access information from up to three databases simultaneously. It then automatically translates the data into popular PC applications such as Lotus® 1-2-3® and dBASE® II.

**HPAccess Central** increases the number of databases available to HPAccess users to include IMAGE and TurboIMAGE databases on the HP 3000.

Programming productivity is increased by tools such as VPLUS and HP Toolset. VPLUS is an easy-to-use forms-design and screen-handling tool for programmers. HP Toolset provides a high-productivity, integrated environment for application development. It includes facilities for full-screen editing, symbolic debugging, and version management of source code.

HP also offers **Transact**, a high-level programming language for transaction-processing applications. Transact is a procedural language that provides the functionality of third-generation languages such as COBOL, combined with a comprehensive set of powerful verbs that can perform several functions in a single command.

### Hewlett-Packard Application Software

Hewlett-Packard offers a wide variety of software for your HP 3000, for applications such as manufacturing, accounting and financial planning, and system management.

**HP Financial Accounting** is an on-line, interactive, totally integrated software application composed of eight accounting modules: General Ledger, Accounts Payable, Accounts Receivable, Dual Ledger, Allocator, Report Facility, Interface Facility, and General Accounting. HP Financial Accounting provides you with immediate on-line access to the financial information you need to efficiently run your business.

**HP Financial Budgeting** is an interactive application system for budgeting, financial planning, and expense control. It has been designed specifically to meet the needs of controllers and financial analysts of large companies.

**HP Just-in-Time Manufacturing (HP JIT)** is a customizable, interactive application that manages the planning and control functions of Just-in-Time manufacturers. HP JIT modules are grouped in three categories: Manufacturing Specifications, Materials Planning, and Manufacturing Control. HP JIT is easily customized without programming to meet the specific requirements of your business.

**HP Production Cost Management (HP PCM)** is an easy-to-use cost-accounting system for manufacturing. It provides Work-In-Progress Valuation and Variancing. It also creates General Ledger entries for both material and labor transactions and for the financial variances that it calculates.

**HP Standard Cost Management** is a flexible, powerful tool for setting manufacturing costs. SCM lets you define the costs important to your production process, define the algorithms used to cost products, and provides cost simulation and reporting capabilities. These capabilities will help you better analyze individual product profitability, and improve pricing and resource allocation decisions.

**HP Materials Management/3000** helps manage the materials planning and control functions of a manufacturing operation. This flexible software can be customized for a wide variety of manufacturing environments.

**HP Production Planning/PC** is a Lotus-based production planning product for use with HP Materials Management. Production Planning/PC provides automatic uploading and downloading of information between the HP 3000 and the HP Touchscreen, Vectra, or Vectra-compatible computers. It features Lotus templates for Build-to-Order, Build-to-Stock, and Rate-per-Day environments that offer greater productivity through easy "what-if" analysis and graphical displays.

**HP Production Management/3000** is an interactive application system for managing manufacturing production planning and control. This work-order-based system is ideal for discrete manufacturers who fabricate/assemble multi-part products in lots.

**HP Maintenance Management** provides the tools to better manage your maintenance tasks, including work order control, preventive-maintenance scheduling, and spare-parts inventory.

**HP Purchasing** is a fully integrated system that handles Purchase Order Requests, Purchase Order Management, Vendor Management, Receipts, and Returns. HP Purchasing also posts the appropriate information to HP General Ledger and HP Accounts Payable as transactions occur.

**Silhouette/3000** is HP's most complete high-availability solution for the HP 3000. It automatically duplicates IMAGE and TurboIMAGE databases on multiple HP 3000 systems. Silhouette/3000 is customer-installable and easy to use. It provides high system availability, application availability during system backup, and load balancing across HP 3000 systems.

Hundreds of high-quality software products encompassing a broad range of applications are also available for the HP 3000 from third-party software suppliers.

## Networking and Data Communications

Hewlett-Packard's AdvanceNet is a communications strategy and network architecture designed to provide a broad range of networking alternatives. HP AdvanceNet products enable you to link all of your company's data resources — workstations, minicomputers, and mainframes — in a high-speed, user-transparent network.

HP AdvanceNet unites two data processing methods: HP's local interactive access to processing and IBM's centralized batch processing. The SNA\* approach used by IBM performs the same functions, with different implementations, as the OSI reference model. The HP AdvanceNet approach interfaces HP equipment with IBM and IBM-plug-compatible products for both SNA and Bisync environments.

Local area networks (LANs) are the links that connect individual personal computers, mainframes, minicomputers, and related peripherals. A network is a data- and resource-sharing system; each individual network node can easily and reliably communicate and exchange information with other nodes.

HP 3000 users can increase productivity through high-speed LANs. Hewlett-Packard's LAN/3000 Link and NS/3000 (Network Services) software form a powerful local network that's easy to install, use, maintain, and expand. The LAN/3000 Link includes everything you need to connect your HP 3000 to an industry-standard LAN. And the NS/3000 software provides sophisticated networking capabilities.

The components most suitable for your application can be selected from different vendors without compromising the unique needs of your data communications environment. The compatibility of future hardware and software additions to your HP AdvanceNet system is ensured by HP's commitment to industry-standard modeling.

1-2-3 and Lotus are U.S. registered trademarks of Lotus Development Corporation.  
dBASE is a U.S. registered trademark of Ashton-Tate Corporation.  
SNA is a U.S. registered trademark of International Business Machines Corporation.

	MICRO 3000	MICRO 3000XE	Series 52	Series 58	Series 70	Series 930	Series 950
Technology	NMOS III	NMOS III	TTL	TTL	ECL	TTL	NMOS III
Main Memory (MB)	2 - 4	2 - 8	4 - 8	4 - 8	8 - 16	32 - 96	32 - 128
Workstations	16	56	92	152	400	400*	400*
Disk Storage (GB)	2.2	4.5	4.5	4.5	13.7	13.7*	13.7*
Database Management Systems	TurboIMAGE/V HP SQL	TurboIMAGE/V HP SQL	TurboIMAGE/V HP SQL	TurboIMAGE/V HP SQL	TurboIMAGE/V HP SQL	TurboIMAGE/XL ALLBASE/XL	TurboIMAGE/XL ALLBASE/XL

\*Maximum configuration at first release.

# BUSINESS COMPUTER SYSTEMS

## Personal Productivity Center



HP's Personal Productivity Center offers a variety of powerful business systems to meet your office and data processing needs.

### OFFICE PRODUCTIVITY SOLUTIONS

Hewlett-Packard's Personal Productivity Center (PPC) is a powerful office information system that combines the strengths of personal computing, office applications, distributed data processing, and networking. The PPC allows you to link computers of all sizes into the system that suits you best, from individual workstations to departmental and company-wide networks. At all levels, the PPC provides an integrated solution for accessing, interpreting, and exchanging information. A Personal Productivity Center consists of an HP 3000 running Office Productivity Services software and Personal Productivity Series applications.

PPC hardware includes the HP 3000 family of business computers as well as Hewlett-Packard's Vectra family, Touchscreen, and Portable PLUS computers — and even allows for the integration of IBM® PCs. The Personal Productivity Center also includes a wide range of HP printers and plotters, including the ThinkJet and LaserJet printers, high-volume department printers such as the 2680 laser printer, and a variety of high-quality color plotters.

Personal Productivity Series applications, such as word processing and graphics, are available on each of HP's personal computers. They are also available to users of terminals on HP 3000 systems, and to IBM PC users.

Office Productivity services, such as electronic mail, resource sharing, and information access, are designed to increase the effectiveness of workgroups by linking personal computers, terminals, minicomputers, mainframes, and peripherals in an integrated office information system. These services are available both for small workgroups, using a local area network (LAN), and for the full range of HP 3000 systems — and can even link into IBM mainframes.

The Personal Productivity Center's flexibility is due to its scalable system architecture, which makes it easy to alter, upgrade, and expand the PPC's hardware and software components. Because of this, the Personal Productivity Center is able to meet a wide range of needs, including those of an individual personal computer user, a small workgroup of users sharing databases and



peripherals, a large department, and a corporation with complex data processing and networking needs.

### OFFICE PRODUCTIVITY SERVICES SOFTWARE

Office Productivity Services software, running on the HP 3000, makes data processing integration possible, and puts communications, resource sharing, and information access at your users' fingertips.

#### HP DeskManager

HP DeskManager is the central information distributor and applications integrator of the PPC. It combines all the PPC components — data processing and office software, PCs, terminals, and the HP 3000 — into one

tightly integrated business system.

HP DeskManager manages the flow of information through your network via electronic mail, and lets you integrate data processing applications such as finance, payroll, and order processing. It has a customizable interface so you can tailor the system to work the way you do. It simplifies administration of the electronic mail system with central directory keeping. Also, it provides security features such as password protection, access limitation, and message scrambling.

With HP DeskManager, data processing reports can be sent automatically to predefined distribution lists. Forms can be circulated and returned. Financial data can be collected from multiple locations. All kinds of messages, from simple tax files to complex documents, programs, and data files, can be sent and received — down the hall or around the world.

HP DeskManager also gives terminal users a complete set of office capabilities, including electronic mail, word processing, and electronic filing cabinets.

Two applications that expand the capabilities of HP DeskManager are HP File/Library and HP Schedule.

Office Productivity Services

HP 3000

Terminals

Personal Productivity Series

HP Vectra Office PCs

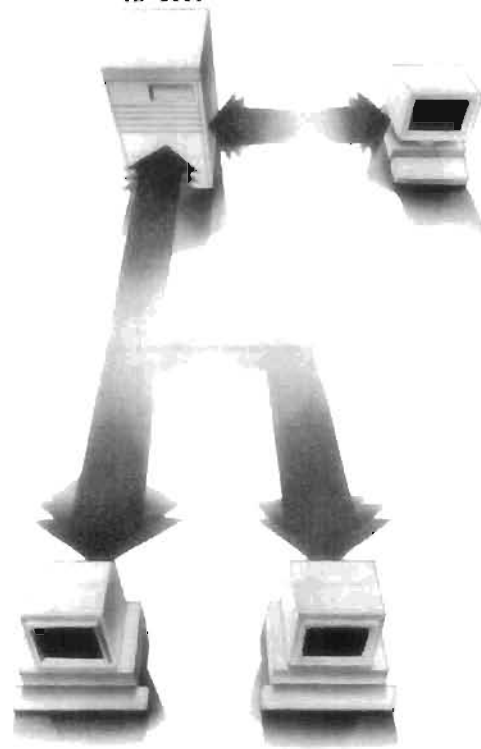



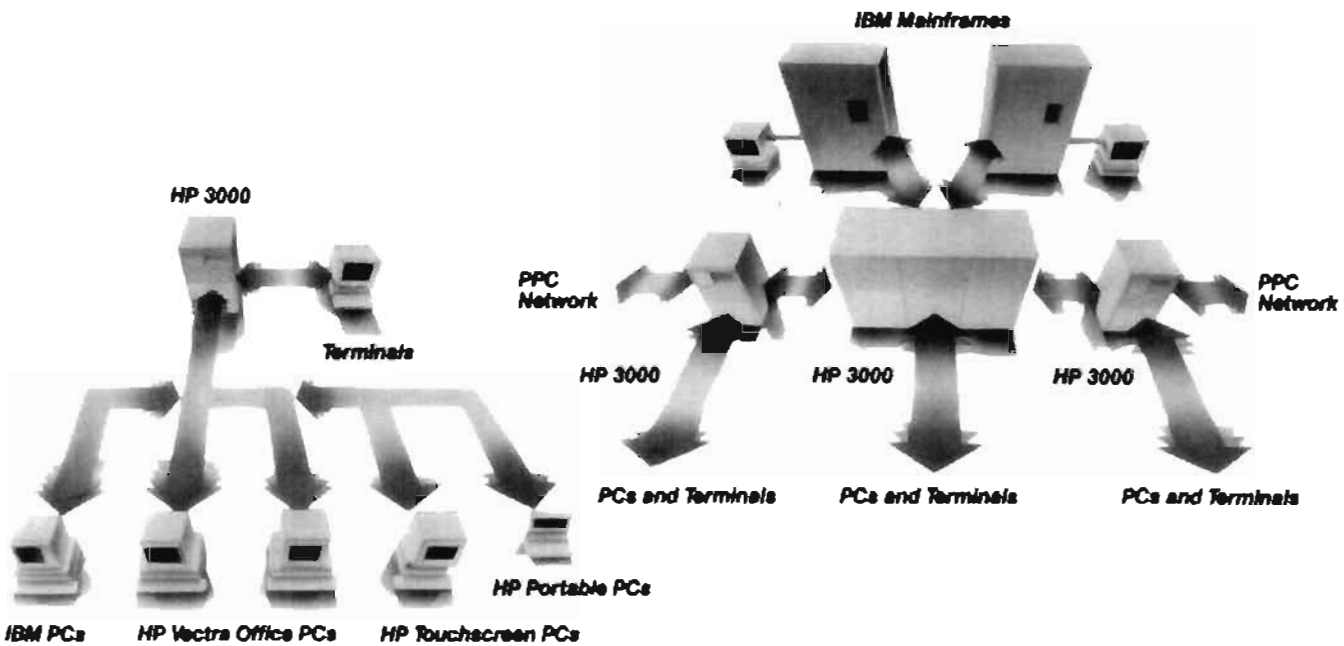

**HP File/Library** is a complete electronic filing solution for the entire department. Any file — even a paper file — can be indexed in the HP File/Library catalog. Users can find documents wherever they are located. With HP File/Library, there is much less need to duplicate files in multiple locations. You'll save valuable disc space by archiving infrequently used documents onto inexpensive cartridge or tape — off the system.

**Print sharing** eliminates the need for a dedicated printer with each PC, and can make the right printer available for every standard job. You can dedicate a standard printer to print drafts quickly, while keeping a high-quality laser printer available to print integrated text and graphics for important documents and presentations. Print sharing also eliminates the work stoppages that result when printing ties up individual PCs.

**Local disc backup** enables users to conveniently schedule central tape backups of hard discs. Controlled by simple PC menus, this Resource Sharing feature automatically consolidates backup requests and can even run unattended.

**HP Schedule** keeps track of schedules and actually coordinates the busy calendars of an entire department or even a group of departments. It sets up meetings and can schedule resources located anywhere on the network — from conference rooms and audio-visual equipment to corporate jets.

**Resource Sharing**  
Resource Sharing software helps you take full advantage of your company's computing resources, with disc sharing, print sharing, and local disc backup capabilities.

**Disc sharing** improves communications and data security while providing optimum allocation of network-wide disc capacity. It can use the disc resources of any HP 3000 on the network — transparently — providing the efficiency of central storage and reducing the number of half-full local hard discs. Files are available for concurrent use, so it lets users share files without shuffling floppy discs.

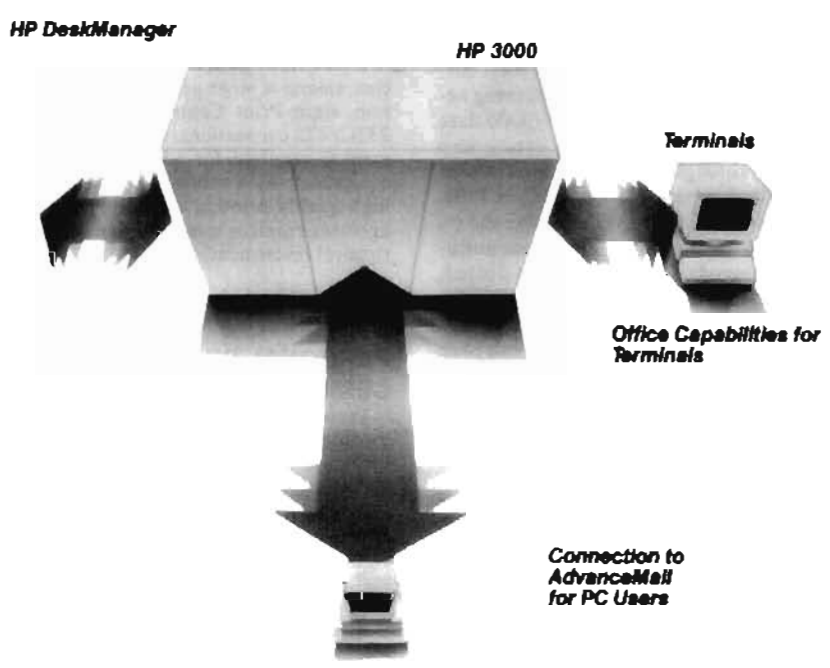

# BUSINESS COMPUTER SYSTEMS

## Personal Productivity Center (cont'd)

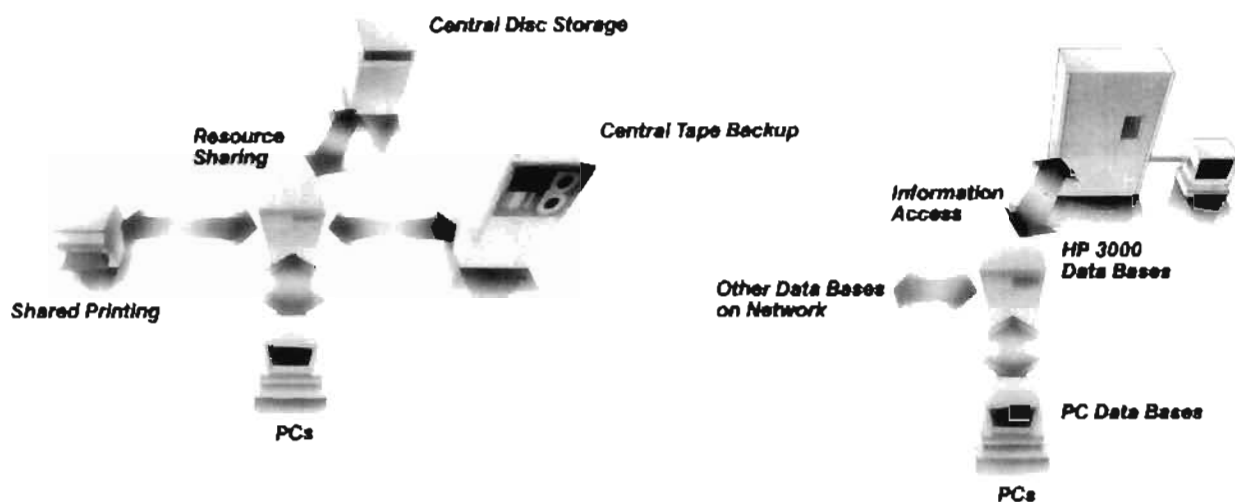

### Information Access

Information Access is unique information management software that provides access to information, reporting and data exchange, and distribution between personal computers, HP 3000 minicomputers, and IBM mainframes. It is an information server that extends the reach of your data processing systems by delivering key business data throughout your organization. Information Access can provide the means for end users to make better decisions based on up-to-the-minute information by providing simple yet secure access to information wherever it resides.

Information Access provides the most current information to PC users by allowing access to host and remote IMAGE/3000 data as well as PC data. Mainframe data is also accessible through Cullinet's Information Center Management System™ (C/ICMS). The user does not need to know where the information is located or any data communications commands. Once data is selected, Information Access helps organize data for better decision making. Results can be output directly to popular PC applications such as Lotus® 1-2-3®, R:Base® 5000, d:Base II®, and the HP Graphics Gallery. The user also has the power to create professional reports with a powerful built-in report writer.

With Information Access, MIS professionals are no longer burdened by requests for custom reports because end users have direct access to the crucial information they require. End users can achieve the best use of their time and resources by choosing either interactive or batch access to information. When used interactively, Information Access

tells a user how long a query will take and keeps the user posted on how the search is progressing. With Information Access the MIS staff is free to be more productive.

### Print Central

Print Central is a low-cost, entry-level shared printing solution for PCs connected to an HP 3000 through basic serial connections. With its Direct Mode, Print Central now provides full access to the capabilities of the LaserJet family of printers and the HP 2932/2934, including graphics.

Print Central allows the customer to invest in high-quality peripherals and leverage their cost among a large group of users. In addition, since Print Central uses existing RS-232C/422 connections, no significant investment is required for additional networking equipment. As a result, users have access to high-quality printing capabilities, and management receives a high return on their peripheral investment.

## PERSONAL PRODUCTIVITY SERIES APPLICATIONS

Personal Productivity Series applications provide PC users with a familiar, high-performance PPC workstation.

AdvanceMail and AdvanceLink integrate standalone capabilities of PCs with Office Productivity Services such as electronic mail, resource sharing, and information access, and provide the ability to work directly with HP 3000 applications.

Personal Productivity Series applications all work together. Executive MemoMaker

and AdvanceWrite PLUS users can exchange documents. Address information from Executive Card Manager can be merged with AdvanceWrite PLUS to customize a mailing. Lotus 1-2-3 files can be converted into Charting or Drawing Gallery graphics. The resulting graphs or the spreadsheets themselves can be merged with text documents.

And any file created with one or all of these applications can be moved anywhere on the network with AdvanceMail.

### Electronic Mail

AdvanceMail integrates the full range of PPC capabilities. It puts a complete set of electronic mail features at every PC user's disposal. Each user has a private In Tray and Out Tray, message filing, and distribution list management. AdvanceMail connects PCs with HP DeskManager on the HP 3000. Messages and files can be distributed across the network to other PCs and terminals.

### Terminal Emulation

AdvanceLink lets PCs emulate terminals on the HP 3000 to run any HP 3000 application. To run these applications, simple time-saving interfaces can be created by collapsing multi-step procedures into single key-stroke operations (macros).

### Integrated Standalone Applications

Integrated standalone applications let personal computer users work off line for word processing, spreadsheet analysis, database management, and graphics.

### Word Processing

**Executive MemoMaker** is the ideal word processor for business professionals and managers who need to create polished letters, memos, and reports. While it offers all the features expected from a word processor, it is as simple to learn and use as a typewriter. Executive MemoMaker provides many screen text editing features such as cut and paste, insert, delete, and copy and merge from other documents. It checks and corrects spelling and features an 85,000-word spelling dictionary. Graphics can be merged with text on the screen. And what you see on the screen is what you will get on paper.

**AdvanceWrite PLUS** is a full function word processor for individuals with sophisticated document production requirements such as integrating text with scanned images or Graphics Gallery pictures. It provides performance and functionality traditionally found only in dedicated word processors. AdvanceWrite PLUS includes such features as line drawing, mail-merge, list management, automatic index and table of contents generation, footnotes, headers and footers, and automatic pagination. It also includes a full-featured spreadsheet, as well as a document search facility (Wordbase Manager).

### Data Management

**Executive Card Manager** keeps up to 64,000 records in an electronic rotating card file for users who need to manage almost any kind of information — from addresses and phone numbers to client contact records and purchase histories. Each card can contain up to 11 screenfuls of information. Executive Card Manager also provides a built-in report writer that lets you present your information in columnar format.

### Spreadsheets

**Lotus 1-2-3** combines spreadsheet, file management, and graphics capabilities in one program. It enables you to gather information from your database, apply it to a spreadsheet, and draw a graph with the results. Any changes you make to the spreadsheet automatically update the graph. Flexible keyboard macros make 1-2-3 from Lotus easy to set up and use. Advanced macro commands reduce complex operations to a few simple steps.

### Graphics

The Graphics Gallery provides professional-quality business graphics. It consists of Charting Gallery, Drawing Gallery, and Portfolios of over 2,000 ready-to-use pictures.

**Charting Gallery** lets you create colorful pie, bar, and line charts. Charts created on Lotus 1-2-3 can be directly read into Charting Gallery.

**Drawing Gallery** lets you create visuals such as text charts, flow charts, organization charts, logos, and presentation slides. Drawing Gallery can be used to enhance and customize charts created in Charting Gallery. Both Charting and Drawing Galleries can integrate with leading desktop publishing applications.

**Portfolios** can provide more than 1,000 ready-made pictures, symbols, and templates for use with Drawing Gallery.

## CORPORATE CONNECTIONS

In addition to supporting IBM PCs as PPC workstations, Hewlett-Packard offers products that connect the PPC with IBM's Distributed Office Support System (DISOSS) and Professional Office System (PROFS).

**HP OfficeConnect to DISOSS** provides a transparent electronic mail link between the PPC and IBM's Distributed Office Support System. Users on either system can communicate with each other using their standard address formats. Distribution lists can be easily accessed by users on both system. Also, PPC users have open access to DISOSS document libraries.

**HP OfficeConnect to PROFS** provides a similarly transparent electronic mail link between the PPC and IBM's Professional Office System. Users can communicate with each other through their own electronic mail systems.

**HP Convert/DCA** enables PPC and DISOSS users to exchange and edit documents in both Final and Revisable Form Text DCA (Document Content Architecture). IBM PC users with DisplayWrite can exchange revisable documents with Vectra PC users with AdvanceWrite and Executive MemoMaker.

## IMPLEMENTATION AND SUPPORT

To help you get the most out of your Personal Productivity Center, Hewlett-Packard offers a consulting service called HP OFFICE-ASSIST. With HP OFFICE-ASSIST, an experienced systems engineer helps you to define your company's goals in implementing office applications.

In the Implementation Analysis phase of HP OFFICE-ASSIST, we help you identify implementation goals and produce a plan of action to meet these goals.

Then, in the Project Implementation Assistance phase, we supply a step-by-step Implementation Handbook, on-site assistance at strategic points in the implementation, and a day of customer education to help you get started with your office application.

IBM, IBM PC/XT, and PC/AT are U.S. registered trademarks of International Business Machines Corporation.  
Lotus and 1-2-3 are U.S. registered trademarks of Lotus Development Corporation.  
A:Base is a U.S. trademark of Microware, Inc.  
d:Base is a U.S. registered trademark of Ashton-Tate, Inc.  
Cullinet's\* and Information Center Management System® are trademarks of Cullinet's Software, Inc.

# COMPUTER PERIPHERALS

## Interactive Terminals

Models 700/92, 700/94

- HP 2392A compatibility
- 80 or 132 column display
- 8 pages of display memory
- 2 RS232C ports

- Local forms cache
- Advanced edit checks
- Modified data tag
- 16 pages of display memory



HP 700/92



HP 700/94

### HP 700/92 Display Terminal

The HP 700/92 Display Terminal performs harmoniously with HP business and technical computer applications. It was designed especially to take advantage of block mode communications in software packages like the popular VPLUS/3000. The 700/92 delivers more power than the HP 2392A terminal it replaces, adding new capabilities to make your work easier and more productive.

The 700/92 offers crisp characters on a 14-inch screen for easy viewing, 8 pages of display memory for increased productivity, and a standard printer port for printing your files locally. The 700/92 also has selectable 80 or 132 column display modes, data transmission rates up to 38.4k baud, and DEC VT100, VT52 and VT220 operating modes.

The 700/92's keyboard has tactile feedback for a responsive touch. Its tilt and swivel mechanism lets you position the screen effortlessly. 72 Hz refresh rate enhances screen readability, especially when displaying black characters on a white background. You can choose soft white, amber, or green phosphor, with a screen-saver function to extend phosphor life.

### HP 700/94 High Performance Terminal

The HP 700/94 Display Terminal incorporates advanced capabilities to help you make the most of your HP computer applications. Like the HP 2394A Data Entry terminal it replaces, the 700/94 provides forms cache and local edit checks optimized to work with software like VPLUS/3000. A superset of the HP 700/92 Display Terminal, the 700/94 makes your work easier and allows you to use your computer system more efficiently.

The 700/94 stores an average of 25 forms locally, circumventing the traditional method of downloading forms repeatedly from the host computer. In addition, the 700/94's local edit checks, modified data tag, and 16 pages of display memory reduce costly host communication traffic. With a printer port standard, selectable 80 or 132 column display modes, and data transmission rates up to 38.4k baud, the 700/94 offers great flexibility for a variety of applications.

The 700/94's keyboard has tactile feedback for a responsive touch. And its tilt and swivel mechanism lets you position the screen effortlessly. 72 Hz refresh rate enhances screen readability, especially when displaying black characters on a white background. You can choose soft white, amber, or green phosphor, with a screen-saver function standard.

### Ordering Information

HP 700/92 Display Terminal  
HP 700/94 High Performance Terminal

### Price

\$895  
\$1095



HP 700/22



#### HP 700/22 DEC VT220 Compatible Terminal

- ANSI terminal compatibility
- 80 / 132 column display
- 4 pages of display memory
- Green, amber or soft white phosphor

The HP 700/22 display terminal is the definitive choice for your ANSI applications. It combines Hewlett-Packard's renowned engineering capabilities with DEC VT220 terminal compatibility. The 700/22 works with programs designed for DEC VT220, VT100 or VT52 terminals, as well as other applications that speak ANSI 3.64 protocol. You don't have to learn a new keyboard to use the 700/22, since its key layout is the same as the DEC VT220 keyboard. The 700/22's keyboard has tactile feedback to give it a responsive touch. With 4 pages of memory, 30 programmable function keys and selectable 80 or 132 column display modes, the 700/22 has the features you need to make your job easier.

The 700/22's crisp characters are displayed on the 14-inch screen — available in soft white, amber and green phosphor. 72 Hz refresh rate enhances screen readability, especially when displaying black characters on a white background. And the tilt and swivel mechanism lets you position the screen effortlessly.



HP 700/41



#### HP 700/41 Entry Level ASCII Terminal

- 9 compatibility modes
- 106-key keyboard with 16 function keys
- 2 serial ports standard
- Green or amber phosphor

The HP 700/41 display terminal breaks the quality barrier in entry level ASCII terminals. The 700/41 offers a broad range of emulations, providing outstanding functionality for users of both HP and non-HP computer systems.

The 700/41's nine emulation modes allow it to work with a variety of computer systems and software. It is compatible with applications designed for the Wyse WY-30, TeleVideo 905/910+/925E, ADDS Viewpoint A2, Lear Siegler ADMJA/ADMS, Qume QVT-101, or Hazeltine 1500 terminal.

The 700/41 has a full-featured keyboard with 16 function keys. Its crisp characters are displayed on a 14-inch green or amber screen. And its tilt and swivel mechanism lets you position the screen effortlessly.



HP 700/71



#### HP 700/71 IBM 3191 Compatible Terminal

- IBM 3191 model A and B display station compatibility
- 102 or 122-key IBM compatible keyboard
- Green or amber phosphor

The HP 700/71 display terminal is your best choice for applications that require IBM 3191 emulation. The 700/71 combines Hewlett-Packard's renowned engineering skills with IBM 3191 display station compatibility.

The 700/71 has features designed for the most demanding user. You can choose for your keyboard either the 122-key layout or the space-saving 102-key version. User controls, including a security keylock, are located on the front panel for easy access.

The 700/71's crisp characters are displayed on a 14-inch screen in either amber or green. Its keyboard has tactile feedback for a responsive touch. The integrated tilt-and-swivel mechanism allows you to position the screen effortlessly. And easy-to-use setup screens simplify terminal configuration. The 700/71 also gives you nonvolatile memory so you can save your setup information.

#### Ordering Information

HP 700/22 DEC VT220 Compatible Terminal	\$575
HP 700/41 Entry Level ASCII Terminal	\$375
HP 700/71 IBM 3191 Compatible Terminal	\$695

#### Price

\$575
\$375
\$695

# COMPUTER PERIPHERALS

## Graphics Terminals

Models 2393A, 2397A

- Supports HP Touch, graphics tablet, mouse, and bar code reader
- High quality graphics  
(two resolution modes; 512x390 and 640x400)
- Complete independent alphanumeric
- Up to 9 pages of memory

- High quality color display
- Supports HP Touch, graphics tablet, mouse and bar code reader
- Graphics software support
- Hardcopy and video interface
- Complete color alphanumeric



HP 2393A



HP 2397A

### HP 2393A Graphics Terminal

The HP 2393A combines bit-mapped vector graphics on a monochrome raster display with comprehensive alphanumeric capabilities. You'll find it a versatile terminal in many applications.

The 2393A's unique HP-HIL (Human Interface Link) interface lets you connect multiple input devices—like HP-Touch, Mouse, Graphics Tablet and Bar Code Reader.

The 2393A also offers a range of output options, so you can connect it to printers, plotters, film recorders and large screen projectors.

Software support for the 2393A includes popular HP packages like DSG/3000, HP DRAW, HP EASYCHART, HP MAP, Graphics 1000/II and Graphics 9000. In addition, you can use the 2393A with many third-party software packages, including Precision Visuals™ DI-3000™ and GRAFMAKER™, ISSCO®'s DISSPLA\* and TELL-A-GRAF®, and SAS Institute's SAS/GRAPH™. The 2393A has ANSI X3.64 and TEKTRONIX® 4010/4014 compatibility too, so you can use it on a variety of computer systems.

The HP 2393A is one of the most flexible graphics terminals in its class, providing quality and reliability at a surprisingly affordable price.

Precision Visuals, DI-3000 and GRAFMAKER are trademarks of Precision Visuals, Inc. ISSCO, DISSPLA and TELL-A-GRAF are registered trademarks of Integrated Software Systems Corporation. SAS/GRAPH is a trademark of SAS Institute, Inc.

### HP 2397A Color Graphics Terminal

The HP 2397A offers a high quality color raster display with fast vector graphics. With all the features and software support of the 2393A monochrome graphics terminal, the 2397A is ideally suited for both business and technical applications.

Eight basic colors can be displayed from a palette of 64 (more using dithering patterns), making user-defined colors easily accessible, including those that match HP plotter pens.

With polyline vectors and local polygonal area fill, the 2397A can be used to create shapes, symbols and typefaces quickly and easily.

The 2397A also provides color alphanumeric. Up to eight color pairs (foreground / background) can be used on a per character basis to differentiate text and identify critical fields.

The 2397A supports a variety of output devices, including printers, plotters, large screen projectors, monitors and film recorders.

### Ordering Information

HP 2393A Graphics Terminal  
HP 2397A Color Graphics Terminal

**Price**  
\$2135 ☒  
\$3360 ☒

☒ Fast-Ship product — see page 758

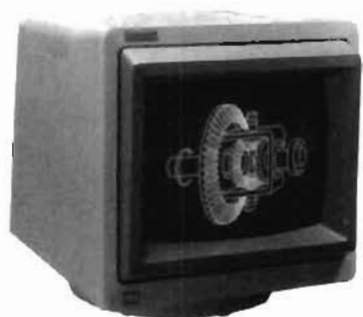

HP 35731

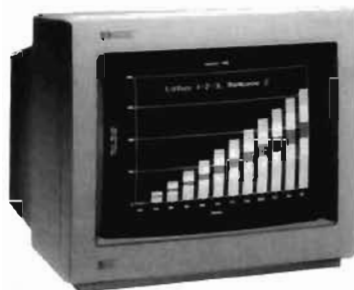

HP 35743

### HP 35731 Monochrome Monitors

The 35731 HP Monochrome Monitor is a 12-inch, medium resolution monochrome video display unit used as an integral component of HP terminals, PCs and workstations.

The monitor features an easy-to-read green phosphor display, as well as compatibility with HP systems that use 512x390 or 640x400 resolutions. It supports the HP Touch Accessory via the HP-HIL interface.

Ergonomic features on the monitor include an anti-glare screen and built-in tilt and swivel for adjusting the screen viewing angle. The monitor also has front panel brightness and contrast controls to make display adjustments more convenient for you.

### HP 35743 Enhanced Graphics Displays

The 35743 HP Enhanced Graphics Display is a medium resolution color CRT display with a 13-inch screen. The Enhanced Graphics Display offers dual resolution modes (640 x 350 and 640 x 200). Designed specifically for use on the HP Vectra Personal Computer, the Enhanced Graphics Display supports a wide range of software products, since it is compatible with the industry standard Enhanced Graphics Adapter.

The Enhanced Graphics Display features TTL video input with up to 16 colors displayable out of a palette of up to 64 colors. The 35743 also has a dual scan input to allow automatic selection between 15.75 and 21.75 scan frequencies.

The 35743 Display offers an optional tilt and swivel mechanism (PN 82959S) for enhancing ease of use.



HP 35741



HP 35723A

### HP 35741 Color Monitors

The 35741 HP Color Monitor provides a 12-inch RGB analog color video display with a 640 x 400 resolution. Like the 35731 Monochrome Monitor, this monitor is used with many HP computer systems, terminals, PCs and workstations.

The color monitor features RGB P22 color phosphor, with analog video inputs capable of providing a continuous spectrum of colors. The HP-HIL interface supports the HP Touch accessory.

With convenient front panel controls, a non-glare screen and integrated tilt and swivel, the color monitor offers state-of-the-art ergonomics.

### HP 35723A Touch Accessory

The 35723A HP Touch Accessory is a 12-inch, user-installable touchscreen bezel. When you add HP touch to your HP computer or terminal that supports the HP-HIL (Human Interface Loop), you transform your ordinary screen into an interactive touchscreen. HP Touch gives you an easy and natural way of communicating with your computer.

HP Touch has a maximum resolution of 43 vertical by 57 horizontal, giving you 2451 touch points. You can define touch areas of varying shapes and sizes, giving you programming flexibility for a wide range of applications.

### Ordering Information

	Price
HP 35731A Monochrome Monitor	\$325
HP 35731B Monochrome (International)	\$340
HP 35741A Color Monitor	\$1195
HP 35741B Color Monitor (International)	\$1195
HP 35743A Enhanced Graphics Display	\$845
HP 35741B Enhanced Graphics Display (International)	\$910
HP 35723A Touch Accessory	\$505

☛ Fast-Ship product — see page 756.

# COMPUTER PERIPHERALS

## Industrial Touch Display Terminal

HP Model 3082A



- Compact
- CIMple
- Rugged

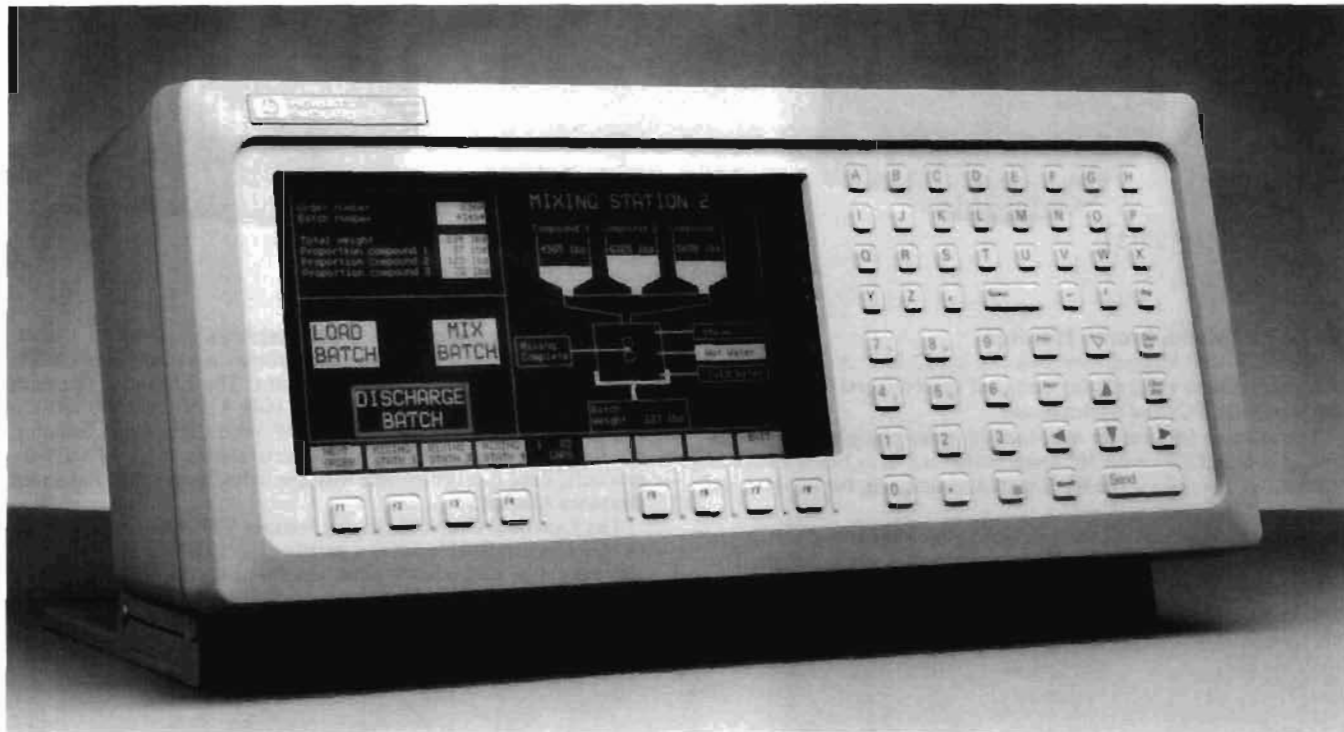

### Features

- **Easy to Use**
  - Touchscreen Input
  - Barcode Input Wand, Slot Reader, Laser Scanner
  - Screen-Labeled Function Keys
  - ABC Keypad Layout
  - On-Line Help
  - Self-Test Capability
  - HP-HIL Interface for a QWERTY Keyboard and Mouse
- **Easy to Install**
  - Plug-Compatible with HP 2392, DEC VT100/51\*
  - Compact Size, 425mm wide x 178mm high x 132mm deep
  - Light in Weight, 8.6 Kg (19 lbs.)
  - Complete with Mounting Bracket
  - Flexible Mounting: Desk, Wall, Pole, Machine, 19" Rack
  - Tilt Adjustment, 0 to 80 Degrees
- **High Quality and Reliability**
  - NEMA 4, 4X, 12, 13 Enclosure (Water-, Dust-, Oil-Resistant)
  - Rugged, Fan-Free, Cast Aluminum Enclosure
  - Designed for Factory Floor
  - Electroluminescent Flat-Panel Display
  - Elastomer Sealed Keypad
- **Easy Application Development**
  - Firmware Based Screen Editors for Forms, Touch, and Character Graphics Design
  - Compatible with WPLUS, FORMS 1000, HP TODAY
  - Offline Screen-Design with an HP Mouse

### Description

HP Industrial Touch is a compact, rugged, and sealed terminal that is plug-compatible with HP 2392 and DEC VT100/52 terminals and designed specifically for factory-floor use.

HP Industrial Touch features a full 28-by-80 character screen with alphanumeric and character graphics capabilities, a built-in sealed alphanumeric keypad, screen-labeled function keys, a variable-volume speaker, and built-in user-friendly screen editors

HP Industrial Touch is also available with touchscreen input and internal decoding for barcode wands, slot readers, and laser scanners.

A local printer, a bar-code wand or scanner, and an HP-HIL keyboard and mouse can be connected directly to the HP Industrial Touch through the sealed rear ports

HP Industrial Touch is compact and rugged enough to be mounted close to the user in almost any factory situation. Its multi-purpose mounting feet allow it to be secured to benches, walls, cabinet doors, poles or machines, and an optional bracket allows it to be mounted in a 19-inch rack. HP Industrial Touch is sealed to meet NEMA 4, 4X, 12, 13 (excluding freezing) specifications and contains no fans or filters.

### Ordering Information

		Price
<b>HP 3082A</b>	Industrial Touch Terminal	\$4300
<b>Option 001</b>	Add Touchscreen	+ \$450
<b>002</b>	Add Barcode Decoding	+ \$300
<b>003</b>	Add Touchscreen and Barcode Decoding	+ \$750
<b>801</b>	Water Tight Option (Canada)	+ \$12
<b>802</b>	Water Tight Option (US)	
<b>803</b>	Water Tight Option (Other Countries)	
<b>908</b>	19" Rack Mount Kit	+ \$109
<b>910</b>	Complete Manual Set	+ \$85
<b>W03</b>	Substitute a 90 day on-site warranty for the standard one (1) year return to HP warranty.	
<b>HP 3082U</b>	Value-Added-Business Development Kit	\$4660
	Includes: 3082A with Option 003, Option 910, 46021A US HP-HIL Keyboard and Cable, 46060A HP-HIL Mouse, HBCS-2300 Plastic Barcode wand	

\*DEC, VT100 and VT52 are registered trademarks of Digital Equipment Corporation.





### Easy to Use

HP Industrial Touch is easy to use for both factory-floor workers and programmers. On the factory floor, its small size makes it possible to put HP Industrial Touch close to the operator without obstructing the job being performed. The ABC keypad, screen-labeled function keys, touchscreen, and barcode capability ensure that even those who have never used a terminal before can enter data quickly and accurately. For those who are more computer-oriented, a QWERTY keyboard and mouse can be attached to the standard HP-HIL interface, enabling the entry of large amounts of data in more complex applications.

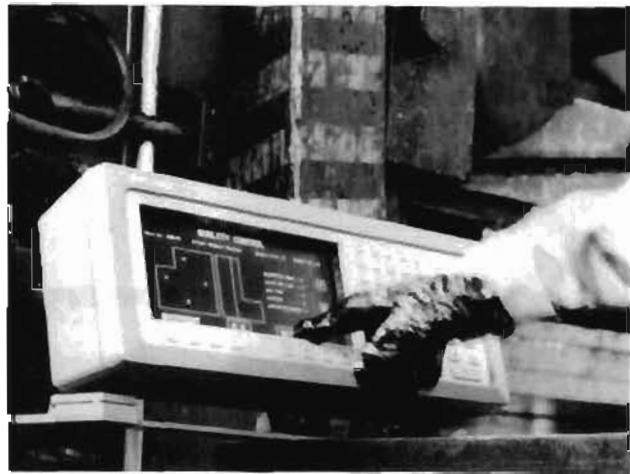

### High Quality and Reliability

HP Industrial Touch is a rugged terminal designed for the factory floor. It has undergone an extensive qualification program to ensure long-term reliability in rugged industrial environments. Quality is reflected in the innovative component design: the sealed elastomer keypad, the EL flat panel display, the abrasion-proof viewing window, the sealed infra-red touchscreen, the cast-aluminum enclosure, and the rugged multiposition mounting bracket. The product is water-resistant, dust-resistant, and oil-resistant and meets NEMA 4, 4X, 12, 13 enclosure specifications (excluding freezing).



### Easy to Install

HP Industrial Touch can be installed in minutes with only a drill, a screwdriver, and a wrench. It comes complete for the factory, ready to install in any industrial environment and requires no additional enclosures, racks, or protective cabinets. A flexible mounting bracket included with HP Industrial Touch makes it easy to install anywhere: on a wall, bench, I-beam, 19-inch rack (Option 908), electrical panel, or machine. And because HP Industrial Touch is plug-compatible with the HP 2392 and DEC UT100/52 terminals, you can have your applications up and running immediately after the terminal is installed.



### Easy Application Development

HP Industrial Touch comes with built-in menu-driven screen editors that make it easy to develop factory-floor applications. Using a standard HP keyboard and mouse, the systems designer develops and tests screens on the terminal that can then be sent to the host computer for integration into the manufacturing application. The Forms Editor includes facilities for drawing lines and boxes, creating protected and unprotected fields, and producing multi-sized text. The Touch Target Editor lets the designer place touch targets of varying size and appearance anywhere on the screen. The Softkey Editor makes it easy to assign user functions to the terminal's function keys. The Graphics Editor lets the designer cut and past ISA graphics characters on the screen. With the Graphics Editor it takes minutes to draw elaborate diagrams that represent the manufacturing process.

# COMPUTER PERIPHERALS

## Terminals—Rugged

Model 9666A

- Rugged (Meets NEMA 12)
- Over Temperature Sensor
- Touchscreen
- High Quality Color Display

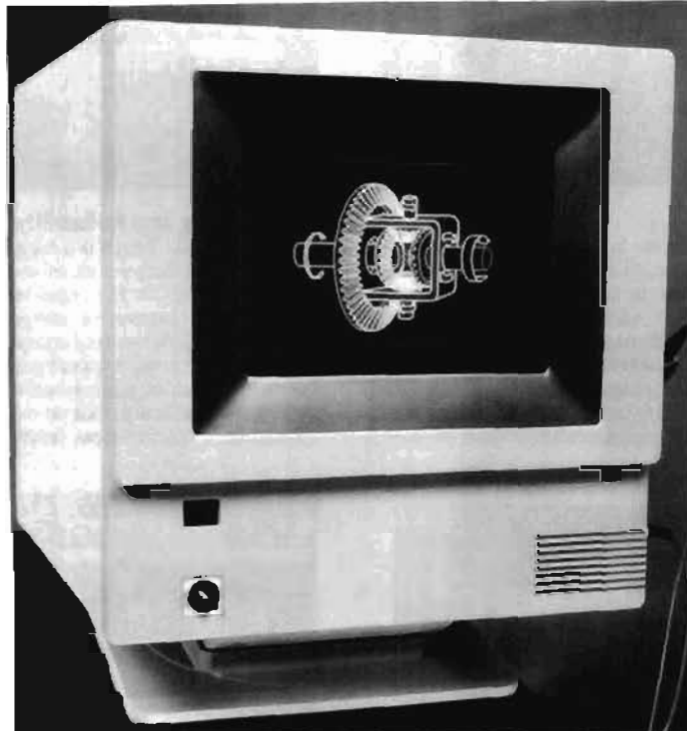

HP 9666A



### HP 9666A Operator Interface Unit (Rugged Terminal)

The HP 9666A OIU is a compact, low-cost, rugged terminal specifically designed for factory floor applications. Its 12" high-resolution color display and state-of-the-art interactive touchscreen is incorporated in a compact dust and drip protected enclosure.

The unique HP-HIL interface lets you connect multiple input devices like HP-Touch, Mouse, Graphics Tablet and Bar Code Reader. Eight basic colors can be displayed from a palette of 64 making user-defined colors easily accessible, including those that match HP plotter pens.

The OIU also provides color alphanumerics. Up to eight color pairs (foreground/background) can be used on a per character basis to differentiate text and identify critical fields.

The terminal can operate at temperatures ranging from 0 to 60 degrees C and its enclosure meets NEMA 12 standards. The OIU is also aided by an over-temperature sensor that prevents equipment loss through automatic shutdown.

The versatility of the OIU is enhanced with the ability to interface with HP 1000, 3000 and 9000 computer systems. In addition, the OIU has ANSI X3.64 and TEKTRONIX 4010/4014 compatibility so that it can be used on a variety of computer systems.

Software support for the OIU includes popular HP packages like DSG/3000, HP DRAW, HP EASYCHART, HP MAP, Graphics 1000/11 and Graphics 9000. In addition, you can use the OIU with many third-party software packages, including Precision Visuals DI-3000 and GRAFMAKER, ISSCO's DISSPLA and TELL-A-GRAF, and SAS Institute's SAS/GRAPH.

The standard OIU offers two RS232 ports. Port 1 moves data at a speed of up to 19.2 kbps with handshaking. For additional flexibility, Port 2 provides a peripheral port for hardcopy output.

Allowing the OIU to be conveniently located on the factory floor, HP features two mounting options: A tilt and swivel base or a 19" rack mounting kit.

#### Ordering Information

HP 9666A Operator Interface Unit  
Opt 001 Bar Code Reader

#### Price

\$5,810  
610

- 2400/1200/300 bps full duplex
- Error correcting (MNP) protocol
- Automatic terminal speed matching up to 9600 bps
- Auto-dial/auto-answer/auto-logon

- PSTN or leased line selection
- Synchronous or Asynchronous
- Alternative control channel for DS applications

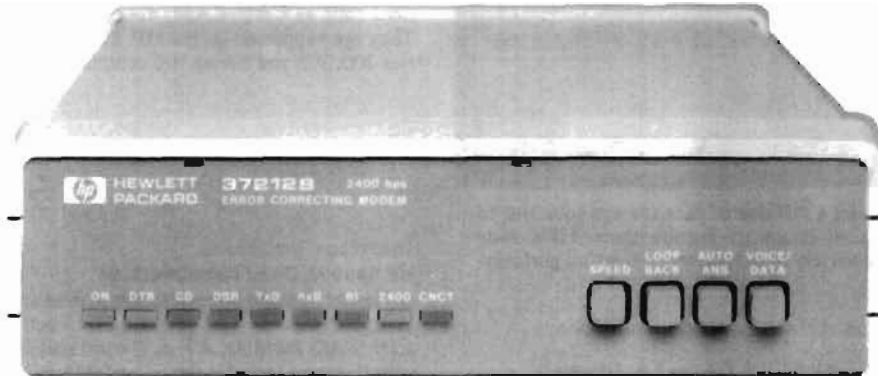

HP37212B



#### Universal V22 Bis Modem

The new HP37212B modem is a high performance multi-function modem offering a wide range of features to suit virtually any application. Numerous configuration options ensure optimum performance for both HP and non-HP systems.

#### For Corruption Free Data Links

Without error control, transmission on a typical 2400 bps line would probably result in an error every minute. The 37212B allows data to be transferred reliably without errors regardless of noisy phone lines. The industry standard MNP error correcting protocol insures reliable data communications by retransmitting lost or incorrectly received data.

Given an error free line, no degradation of speed will result from using error correction. Flow control options allow Hewlett Packards ENQ/ACK protocol to be used with equal efficiency to industry standard XON/XOFF flow control protocols.

With error correction enabled, the 37212B can automatically drop back to transparent communication when connecting to a non-error correcting modem. Alternatively it can be set to lock-out communication with non-error correcting modems.

#### Four Command Modes

Terminal Mode provides a user friendly way to operate the 37212B directly from the keyboard of a terminal or PC. The user is prompted for correct key sequences to obtain particular functions and status information.

Computer mode is optimized to simplify the programming required for a computer to control the modem automatically. Commands are accepted by the modem, but it will not echo or reply unless specifically requested to do so. This ensures that the computer will not receive any unexpected characters from the modem. Status information is represented by a string of eight ASCII characters instead of descriptive text.

Dumb command mode allows the 37212B to be operated manually using front panel control switches.

#### Two Control Channels

Except for manual (dumb) operation, the prime control channel is through the RS232-C (CCITT V.24) data interface. Some computers or devices (eg. DS cards) are unable to output configuration or dialing commands through their data channel. For this reason the 37212B allows a secondary control channel to be selected using the secondary TX/RX pins of the RS-232-C port. A "Y" cable (part number HP15614A) can be used to break out the secondary control channel onto a separate RS-232-C port.

#### Four Modulation Standards

The 37212B supports a variety of transmission speeds and full duplex modulation standards so as to allow communication with a broad spectrum of industry standard modems.

Bell 103 (FSK) at 300 bps	Asynchronous
Bell 212A (DPSK) at 1200 bps	Asynchronous/Synchronous
CCITT V.22 (DPSK) at 1200 bps	Asynchronous/Synchronous
CCITT V.22 bis (QAM) at 2400 bps	Asynchronous/Synchronous

#### Worldwide Regulatory Approvals

The 37212B has been designed to conform to the regulations of telephone approval authorities in many countries. It is FCC, CSA and BABT approved, with many more planned. Approval in many countries allows multi-national customers or systems to standardize on a single modem. The local HP field office will be able to provide up-to-date information on the connection approval status in your country.

#### Flexible Telephone Connection

Both North American and UK style telephone sockets are provided. In addition to sockets for the modem/telephone line, extra sockets are provided for use with an adjacent telephone. This allows telephone communication to take place while the modem is not in use and also enables manual-dial or manual-answer operation. In addition to North American and UK types, a third cable is available with spade terminals for use in other countries.

#### Convenience Features

**NON-VOLATILE MEMORY** stores telephone numbers, log-on strings and modem configuration for speedy operation.

**PULSE OR TONE DIALING** ensures dialing compatibility with most telephone systems.

**LEASED LINE OPERATION** allows a single modem to be used for both leased line and dial back-up.

**INTEGRAL LOUDSPEAKER** monitors call progress without requiring an adjacent telephone.

**DIAGNOSTIC AND SELF TESTS** allow users to verify both line quality and modem operation without the need for special equipment.

**INTEGRAL 120/240V POWER SUPPLY** eliminates the need for an external transformer.

**RACK MOUNT KIT** allows one or two 37212Bs to be mounted in standard 19" equipment racks.

**DC POWER OPTION** simplifies incorporation into systems isolated from a mains (line) supply.

**AUTOMATIC SPEED MATCHING** allows terminal to operate at fixed speeds up to 9600bps, regardless of transmission rate.

#### Ordering Information

HP 37212B Stand Alone Modem

#### Price

\$920

# COMPUTER PERIPHERALS

## Personal Data Storage

Models 9114B, 9122D/S, 9123D, 9127A, 9133H, 9134H, 9133L, 9134L, 9142A, 9154A, 88500A

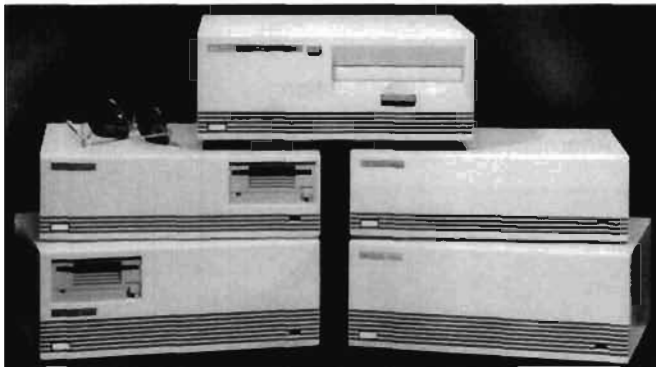

Hewlett-Packard offers you a full line of data storage solutions to fit your personal or technical computer requirements. HP's wide range of disc drives cover a variety of prices, capacities and performance.

### 3.5" Microfloppy Personal Data Storage Solutions

#### HP 9122D Dual 3.5" Drive—HP 9122S Single 3.5" Drive

The HP 9122D is a highly reliable, double-sided 3.5 microfloppy designed for use with HP's desktop and personal computers. Available in both dual and single configurations, the HP 9122D and HP 9122S provide up to 1420 and 710 Kbytes of formatted capacity, respectively. This disc drive is supported on the Series 80, Touchscreen and Touchscreen II personal computer and HP 9000-Series 200, 300, and 500.

#### HP 9114B Portable 3.5" Disc Drive

Designed for HP's Portable computer family as well as, Series 40 and Series 70, the HP 9114B provides up to 710 Kbytes of formatted capacity in a lightweight, battery-operated package. The 3.5" disc drive reads, writes, and initializes double-sided media in both single-sided and double-sided formats. This feature allows data exchange with single-sided drives currently in use.

#### HP 9123D Dual 3.5" Drive (for HP Touchscreen II Personal Computers)

### Hard Disc Personal Data Storage Solutions

#### HP 9153A/9154A 10 Megabyte Winchester Hard Disc

The HP 9153A combines the storage and performance capabilities of HP's 10 Mbyte hard disc with the backup and interchange capabilities of the 3.5" microfloppy in one compact package. The removable media is fully compatible with the HP 9122D/S, HP 9123D and HP 9114B data storage units. The 9154A, hard disc only model, adds Winchester performance and convenience to floppy-based computer systems. These models are supported on the Touchscreen II, HP 9000-Series 200, 300 and 500 and Series 80 computers.

#### HP 9153B/9154B 20 Megabyte Winchester Hard Disc

The storage capabilities of HP's 20 Mbyte hard disc and the backup and interchange capabilities of HP's 3.5" microfloppy are combined in the 9153B. The removable media is fully compatible with the HP 9122D/S, the HP 9123D, and the HP 9114B data storage units.

The high performance HP 9153B and 9154B are well suited for the rugged automated test and measurement market as well as for everyday applications such as word processing, business graphics, and spreadsheets. Two features have been integrated into the HP 20 Mbyte hard disc drives: write protection, and initialize protection. The write protect feature allows you to prevent unauthorized modification of a chosen section of your hard disc. The initialize protect feature insures your data integrity and prevents data loss.

The HP 9153B and 9154B are supported on the Touchscreen II, HP 9000 Series 200 and 300. The HP 9154B is also supported on the HP Vectra PC, AT & T 6300, Olivetti-M24, IBM PC, XT, AT, and COMPAQ Portable with the 88500A Disc/Tape Interface.

### New HP 9133L/9134L 40 Mbyte Winchester Hard Discs

The HP 9133L combines the storage and performance capabilities of the 40 Mbyte hard disc with the backup and interchange capabilities of the 3.5" microfloppy. The removable media is fully compatible with the HP 9122D/S, 9123D, and 9114B data storage units.

The HP 9134L is a stand-alone hard disc Winchester. The HP 9133L and 9134L are ideal for both business and technical applications such as CAD/CAM, data base management, and accounting. They are supported on the HP Touchscreen II and the HP 9000-Series 200, 300 and Series 500 computers.

### Interface Solutions

#### HP 88500A Disc/Tape Interface

Hewlett-Packard provides you with an interface solution to connect your HP tape or disc to your HP Vectra PC, IBM PC/XT/AT, COMPAQ Portable, AT & T 6300 and Olivetti M24. This easy-to-install system includes the powerful Data Manager and Tape Backup software. One short slot interface card allows you to connect up to 7 discs and 1 tape. The HP 88500A supports the 9154A, 9154B, 9134H and 9134L discs as well as the 9142A tape.

### Data Interchange

#### New HP 9127A—Single 5.25" Flexible Disc Drive

The HP 9127A is a single 5.25" disc drive that gives the HP Touchscreen and Touchscreen II data compatibility with the IBM-PC via 5.25" discs. Connected by HP-IB to the Series 300 (via DOS coprocessor card) and Touchscreen computers, the drive can read, write, and initialize discs in IBM-PC format as well as HP format. The discs can be moved between IBM and HP computer systems for easy data exchange. The 9127A can also read copy-protected DOS software with the HP Series 300 DOS coprocessor card.

### Ordering Information

	Price
HP 9114B Double-sided 3.5" Disc Drive	\$ 810
HP 9122D Double-sided 3.5" Dual Disc Drive	\$1420
HP 9122S Double-sided 3.5" Single Disc Drive	\$1110
HP 9123D Double-sided 3.5" Dual Drive	\$ 935
HP 9127A Single-sided 5.25" Flexible Disc Drive	\$1015
HP 9153B 20 Mbyte Hard Disc plus 3.5" Microfloppy	\$2795
HP 9154B 20 Mbyte Hard Disc (Winchester only)	\$2435
HP 9133L 40 Mbyte Hard Disc plus 3.5" Microfloppy	\$4540
HP 9134L 40 Mbyte Hard Disc (Winchester only)	\$4130
HP 9142A 1/4" Tape Backup Subsystem	\$2030
HP 9153A 10 Mbyte Hard Disc plus 3.5" Microfloppy	\$1980
HP 9154A 10 Mbyte Hard Disc (Winchester only)	\$1725
HP 88500A IBM Disc/Tape Interface	\$ 2052
HP 91290A 5.25" HP Qualified Media (Box of 10)	\$ 582
HP 92192A 3.5" Double-sided Microfloppy (Box of 10)	\$ 692

See the Technical Data Sheet #5953-6857, "Data Storage for Personal and Portable Computers" for detailed support information.

Fast ship product! see page 758

# COMPUTER PERIPHERALS

## Data Storage For Technical/Commercial System-Removable

Models 7907A, 7935H, 7935XP

707

- Performance
- Reliability
- Serviceability



HP 7907



- Integral Self Test and Diagnostics
- Internal Microprocessor Controller
- Removability



HP 7935H,  
7935XP



The HP 7907A is a complete peripheral storage product providing user I/O, mass storage, and backup capabilities. The 7907A combines a state-of-the-art fixed/removable disc mechanism with an intelligent controller using the CS/80/HP-IB protocol. The result is a high performance, environmentally rugged disc sub-system providing a cost effective backup and software distribution capability as well as an easy path to data interchange between systems.

### Features

#### Disc Drive

- 41 Mbytes of formatted disc storage
- 20.5 Mbytes of fixed storage/20.5 Mbytes of removable storage in an easy to use front-loading 8" cartridge
- HP standard CS/80/HP-IB protocol
- Average seek time 30 ms
- Ramp-loaded heads for added reliability
- Front panel or system activated image backup/restore in less than 3 minutes
- Environmentally rugged design
- 19" EIA rackmount kit 19507A also available
- Customer installable

#### Description

The HP 7907A is a complete mass storage subsystem featuring 20.5 Mbytes of formatted removable storage in an easy-to-use front loading configuration. Add to this an additional 20.5 Mbytes of formatted fixed storage, a fast 45 ms Total Device Average Transaction Time, a small light-weight package, 19" EIA rackmount capability and an offline backup capability and you have an ideal mass storage system for applications such as Automatic Test, On-Site Data Logging, and Computer Aided Engineering.

#### Electromagnetic Emissions

Radiated and conducted interference:

- HP 7907A-For U.S.A. designed to meet FCC Docket 20780 for Class B computing devices.
- HP 7907A-For Europe, designed to meet applicable VDE 0871 requirements for computing devices.

#### Safety

The HP7907A meets all applicable safety standards of the following:

- IEC 380 and 435
- UL 114 and 478
- CSA C22.2 No. 154

#### HP 7935H Disc Drive

The HP 7935H Disc Drive is a removable media device that provides 404 Mbytes of removable media for increased system flexibility and greater system uptime for private data volume configurations and disc-to-disc backup/restore operations.

#### HP 7935XP Disc Drive

The 7935XP is the same as the disc drive above, but includes one megabyte of controller cache memory for higher performance.

#### Electromagnetic Emissions

Both models of the HP 7935 are designed to meet FCC Docket 20780 for Class A computing devices. For Europe, they are designed to meet VDE 0871 for Level A computing devices and are FTZ licensed on some HP systems.

#### Safety

Both models of the HP 7935 and 7935XP meet all applicable safety standards of the following:

- CSA 22.2 No. 154
- IEC 380 and 435
- UL 114 and UL 478

#### Ordering Information

HP 7907A (41 Mbytes)	\$12,500
Opt 016: 240V/50Hz	N/C
Opt 550: Delete HP-IB Cable	Less 85
HP 7935H (404 Mbytes)	\$28,300
HP 7935XP (404 Mbytes)	\$29,800
Standard Input Power: 208 volts	N/C
Opt 120: For 120-volt operation in U.S.A., Canada	N/C
Opt 210: For 208-volt operation in Canada	N/C
Opt 220: For 220-volt operation in Canada	N/C
Opt 221: For 220-volt operation in continental Europe	N/C
Opt 222: For 220-volt operation in Switzerland	N/C
Opt 223: For 220-volt operation in Denmark	N/C
Opt 241: For 240-volt operation in United Kingdom	N/C
Opt 242: For 240-volt operation in Australia, New Zealand	N/C

# COMPUTER PERIPHERALS

## Data Storage for Technical/Commercial Systems

Models 7942A, 7946A, 7957A, 7958A

- Customer installable
- Convenient desktop packages
- Quiet operation

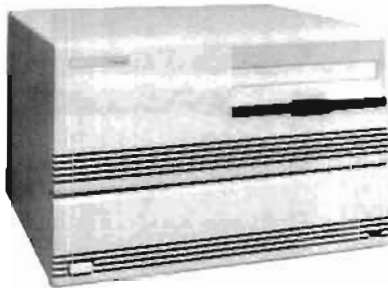

HP 7946A



### HP 7942A 7946A Disc/Tape Drives

The HP 7942A and HP 7946A feature 24 and 55 megabyte capacities and 1/4-inch cartridge tape drives integrated into single units. Both units use the CS/80 and HP-IB interface, as do other HP mass storage units. This command structure allows you to coordinate a wide range of compatible mass storage solutions.

The HP 7942A and HP 7946A are customer installable, contain extensive self-test capabilities, and provide quick access to all replaceable assemblies.

Each drive is quiet enough to operate in an office environment and is small enough for desktop use. Adapter kits allow the drives to fit into 19-inch EIA rack enclosures or in HP's mobile mini-rack.

With average seek time of 30 ms for the disc drives and typical data transfer rate of one megabyte per minute for the tape drives, these disc/tape drives provide the performance needed for entry-level multi-user systems and high-performance work stations.

#### Features

- 24 megabytes - HP 7942A
- 55 megabytes - HP 7946A
- 30 ms average seek time
- 1 megabyte/minute data transfer rate
- Read-after-write capability
- Automatic error detection and reliability
- Compact packaging (208H x 325W x 285mmD)
- Quiet operation (<50 dBa)
- Rack-mountable
- Quick access to all available assemblies
- HP-IB compatible

#### Electromagnetic Emissions

##### Radiated and conducted interference

**For U.S.A.:** meet FCC Docket 20780 for Class B computing peripheral devices.

**For Europe:** meet VDE 0871 for level B computing devices; FTZ licensed in some HP systems.

For more information, contact your local HP office.

#### Safety

The HP 7942A and HP 7946A meet all applicable safety standards of IEC 380 and 435, UL 114 and 478, and CSA 22.2 no. 154.

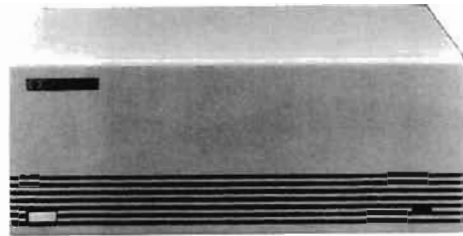

HP 7958A



### HP 7957A, HP 7958A Disc Drives

The HP 7957A (91 megabytes) and HP 7958A (130 megabytes) are 5 1/4" disc drives that offer the capacity and performance demanded by today's commercial and technical multi-user systems and engineering workstations. These disc substations feature average seek times of 29 ms and burst data transfer rates of 1.25 megabytes per second. Combined with efficient low-overhead controllers that accurately and swiftly process each transaction, the HP 7957A and the 7958A offer performance levels previously found only in more expensive 8-inch and 14-inch disc drives.

The compact packaging of the HP 7957A and HP 7958A allows them to be tucked away in HP's attractive mini-rack cabinetry, or placed unobtrusively in desktop applications. There is, of course, a rack-mount kit available for 19" EIA cabinetry, and, with a sound power level of 52 dBa, both drives are suitable for the office or lab environment.

#### Features

- 81 megabytes (formatted), HP 7957A
- 130 megabytes (formatted), HP 7958A
- 29 ms average seek time
- 1.25 megabyte/second burst transfer rate
- Compact packaging (132H x 325W x 285mmD)
- Quiet operation (52 dBa)
- Reliable, sealed media design
- Automatic error correction
- Automatic error logging
- Quick access to all replaceable assemblies
- CS/80 instruction set
- HP-IB compatible

#### Electromagnetic Emissions

##### Radiated and conducted interference

**For U.S.A.:** meet FCC docket 20780 for Class B computing peripheral devices.

**For Europe:** meet EMI level FTZ 1046/84 and provides a Manufacturer's Declaration.

For more information, contact your local HP office.

#### Safety

The HP 7957A and 7958A meet all applicable safety standards of IEC 380 and 435, UL 114 and 478, and CSA C22.2 no. 143 and 154.

#### Ordering Information

	Price
HP 7942A 24 Mbyte Disc/Tape Drive	\$8,500
HP 7946A 55 Mbyte Disc/Tape Drive	\$10,000
HP 7957A 81 Mbyte Fixed Disc	\$5,300
HP 7958A 130 Mbyte Fixed Disc	\$7,850
Opt 015 For non-US shipments, voltage set for 230V operation	\$ 0
Opt 550 Delete 1 metre HP-IB cable	\$ -80
HP 19501A Rack kit for mounting HP 7942A, 7946A in 19-inch EIA rack enclosures	\$ 165
HP 19500B Rack kit for mounting HP 7957A, 7958A in 19-inch rack enclosures	\$ 87

# COMPUTER PERIPHERALS

## Data Storage for Technical/Commercial Systems (cont'd)

Models 7936H, 7937H, 7936XP, 7937XP

709

- High reliability
- Compact size

- Low power consumption
- Choice of controller

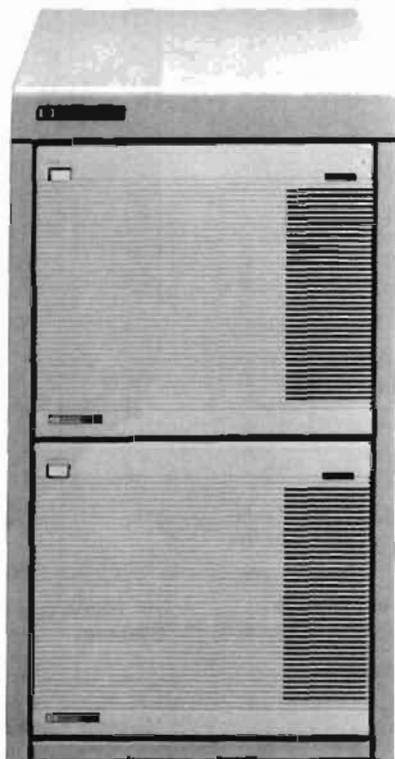

HP 7937A



### HP 7936H and HP 7937H

The HP 7936H and HP 7937H disc drives are fixed media storage devices that provide formatted storage capacity of 307 and 571 megabytes, respectively. These Winchester disc drives incorporate sealed head/disc assembly (HDA), extensive VLSI, and HP-developed sputtered thin film media. As a result, excellent performance, reliability, and floorspace utilization are available at an attractive price.

Designed to meet the performance demands of present as well as future computer systems, the HP 7936H and HP 7937H disc drives offer high density storage and compact size. Ideal for a broad range of multi-user computer systems, these disc drives provide low per-megabyte storage costs and require low power consumption. Compatibility with the basic standard of HP-IB and CS/80 guarantees operations on existing and future HP 3000, HP 9000 and HP 1000 computers.

### HP 7936XP and HP 7937XP

These disc drives are the same as those described above, but contain controller cache as an included feature. The cache contains two megabytes RAM for read cache coupled with a single-instruction write cache. Performance can increase 10-30% on most systems.

#### Features

- High capacity - 307 and 571 megabytes
- 20 ms seek; 8.33 latency; less than 1.0 ms controller overhead
- 2.35 megabytes/second internal burst data transfer rate
- Modular packaging

#### Electromagnetic Emissions

Radiated and conducted interference:

- For U.S.A., designed to meet FCC Docket 20780 for Class A computing peripherals devices.
- For Europe, designed to meet applicable FTZ 1046/84 requirements and provides a Manufacturer's Declaration.

#### Safety

The HP 7936H/7937H and HP 7936XP/7937XP meet all applicable safety standards of the following:

- IEC 380 and 435
- UL 114 and 478
- CSA C22.2 no 143 and 154

#### Ordering Information

HP 7936H (307 megabytes)	\$13,750
HP 7937H (571 megabytes)	17,950
HP 7936XP (307 megabytes + 2 Mbytes cache)	15,800
HP 7937XP (571 megabytes + 2 Mbytes cache)	20,000
HP 97520XP (Controller cache upgrade)	3,315
HP 19511A (Cabinet for 2 HP 7936/37 drives)	815
HP 19512A (Mounting kit for 19" EIA cabinet)	102
Opt 015	N/C
Opt 017	N/C

# COMPUTER PERIPHERALS

## Tape Drives

Models 35401A, 9144A, 7978B, 7974A



HP 9144A 1/4 Inch Cartridge Tape Drive



HP 35401A 1/4-Inch Cartridge Autochanger Tape Drive

The Hewlett-Packard family of tape drives provide a range of solutions to meet your format, capacity, and performance needs. The five major applications for our tape drives are:

- Backup protection against operator error and disc failure
- Archival storage for economical, long term data preservation
- Data exchange with other computers
- Software distribution
- Online mass storage for data logging and tape processing

### 1/4-inch Tape Backup Solutions

#### HP 35401A 1/4-inch Cartridge Autochanger Tape Drive

The HP 35401A provides an unattended backup solution for computer systems with up to 536 megabytes of disc storage. By combining the major components of the HP 9144A tape drive with an autochanger mechanism, the HP 35401A automates cartridge loading and unloading and allows the tape drive to access up to eight cartridges from a removable magazine. The drive's read-while-write and extensive error correction capabilities ensure data integrity. Its small size, quiet operation and ease of use, make it ideal for the office environment.

The 1/4 inch cartridge drive can backup large amounts of data with no operator intervention necessary. In addition to backup, the drive can also be used for software duplication and data exchange. It uses 67 megabyte cartridges and has the same cartridge and data format as the HP 9144A and HP's range of integrated cartridge tape/disc drives (HP 7911/12/14/42/46). This means that you can exchange data between any of these drives configured on similar systems. Support for the HP 35401A is provided by the following HP systems: HP 3000 (MPE/V), HP 9000 Series 200,300,500, HP 1000 A/E/F Series.

#### HP 9144A 1/4-Inch Cartridge Tape Drive

The HP 9144A provides a 1/4-inch tape solution for HP's high performance workstations and small multi-user systems with 15 to 134 megabytes of disc storage. With a data transfer rate of up to 2 megabytes per minute and a cartridge capacity of 67 megabytes, it is a cost effective and convenient backup alternative to multiple floppy discs. The drive offers a read-while-write feature, Media Monitor, and extensive error detection and correction capabilities. It is format compatible with the HP 35401A and HP 7911/12/14/42/46 integrated cartridge subsystems. (HP 9144A cartridges are not compatible with HP 9142A cartridges).

The HP 9144A is supported on the following HP systems: HP 3000 (MPE/V), HP 1000 A/E/F Series, HP 9000 Series 200,300,500, HP Touchscreen PC (HP 150B), Touchscreen II (HP 150C), and HP Vectra.



HP 7980A and HP 7979A 1/2-Inch Magnetic Tape Backup Systems

### 1/2-inch Tape Backup Solutions

#### HP 7980A and HP 7979A 1/2-inch Tape Drives

The HP 7980A is a 1/2-inch reel-to-reel streaming tape drive designed for systems with disc backup requirements of greater than 400 megabytes. Like its predecessor, the HP 7978B, this high-performance drive operates with both 6250 GCR and 1600 PE industry-standard formats. The HP 7979A leverages the same design as the HP 7980A, but is best suited for systems requiring between 100 and 500 megabytes of disc backup by offering the 1600 PE format only. Both drives automatically load and thread any size tape reel ranging from 6 to 10 1/2 inches, freeing the operator to do other things. These tape drives are horizontally-mounted in a waist-high, 19-inch-wide rack for better floorspace utilization, and support IBM/ANSI-compatible formats for software distribution and data interchange between HP and non-HP systems. Both run at 125 ips tape speed to maximize streaming performance. In addition, the new TurboSTORE backup program is available for HP 3000 systems. This program allows simultaneous reading or writing to multiple tape devices, dramatically improving store and restore operations. Support is provided by the HP 3000 (MPE/V), HP 3000 Series 900 (planned), HP 1000A Series (planned) and the HP 9000 Series 300 HP-UX (planned) and Series 800 (planned).

#### Ordering Information

HP 7980A 1/2" tape drive (6250GCR/1600PE)	\$22,400
HP 7979A 1/2" tape drive (1600PE only)	\$13,000
HP 9144A 1/4" tape drive	\$ 2,250
HP 9144A Opt. 150 (for use with HP 150/Touchscreen)	\$ 2,250
HP 35401A 1/4" cartridge autochanger tape drive	\$ 7,620

See technical data sheets #5953-6868, "The HP Family of 1/2-inch and 1/4-inch Tape Drives" and #5953-6892, "The HP 7980A/7979A 1/2-inch Tape Drives" for detailed product information.



- Flatbed design for image source variety
- Hardware scaling prevents image distortion
- Preview scanning makes image cropping easy

- 300 dpi insures high quality output
- Interfaces to both the PC and Macintosh
- Extensive software support broadens applications



### HP ScanJet Desktop Scanner

The HP ScanJet desktop scanner improves the look of your laser printed documents by providing an easy way to include photographs, line art, or graphics from a broad range of original sources such as bound documents or odd-shaped items. The 300 dpi monochrome ScanJet can capture a full page image and store it to your system disc in 20 seconds or less. An optional automatic document feeder also is available for unattended scanning of multiple-page originals. Packaged separately are a choice of two different interface kits enabling the HP ScanJet desktop scanner to operate with either the HP Vectra PC, IBM XT/AT, and compatible personal computers or with the Macintosh Plus and SE. Support also is planned for the Macintosh II.

#### Flatbed Design

Having the ability to scan images from a broad range of original sources such as books, magazines, or odd-shaped items is a must for the serious desktop publisher. That's why the HP ScanJet desktop scanner employs a flatbed design, similar to today's photocopiers. The image is placed on a flat 8.5 X 11-inch glass surface for scanning, giving you the freedom to select the image you want, regardless of the original source.

#### Preview Scanning

The HP ScanJet desktop scanner has the ability to perform a quick, low-resolution preview scan of the entire original. At this point, you can crop any portion of that original by creating a window around the area of interest. When ScanJet does a final scan at 300 dpi, it will only scan and store the area within the window, disregarding everything else. This not only saves time, but also allows you to maximize your disc efficiency by reducing the amount of unnecessary scanned material.

#### Image Enlargement/Reduction

Once the area of interest has been defined, the HP ScanJet using the PC interface kit has the ability to enlarge that area up to 200% or reduce it down to 50% of its original size. Using the Macintosh interface, the image can be scaled from 13% to 200%. This image scaling is performed within the hardware using the original image information. Images that are scaled in various application packages, on the other hand, typically use a dithered pattern of the same information which often creates an unsightly basket-weave pattern across the image. The ScanJet desktop scanner avoids this image distortion to maximize the output quality.

#### Multiple Interfaces

Packaged separately are a choice of two different interface kits enabling the HP ScanJet desktop scanner to operate on the HP Vectra PC, IBM XT/AT, and compatible personal computers as well as the Macintosh Plus and SE. Both kits come complete with interface hardware, scanning software, and all of the necessary documentation.

#### Extensive Software Support

By supporting several of today's most popular file formats, the HP ScanJet desktop scanner is capable of operating with a wide variety of application software packages. The file formats currently supported by ScanJet with the Personal Computer interface include TIFF, MS Paint, PC Paintbrush and GEM, and with the Macintosh interface include TIFF and MacPaint.

#### Ordering Information

HP 9190A ScanJet Desktop Scanner	\$1,495
HP 88290A Personal Computer Interface Kit	\$495
HP 88390A Macintosh Interface Kit	\$595
HP 88190A Automatic Document Feeder	\$595
HP 88400A Optical Character Recognition Software	\$595

# COMPUTER PERIPHERALS

## Tablet—A-size Graphics Tablet

### HP SketchPro, RS-232-C Model

- New technology for unparalleled reliability
- Includes stylus and four-button cursor
- Supported by major PC-CAD software on the HP Vectra PC, IBM AT, IBM PC/XT, and compatibles
- Competitive Price
- Attractive compact design with overlay hold-down
- Superior resolution - up to 1200 lines per inch
- Multifunction softkeys



The HP 7060A SketchPro Graphics Tablet is a small format (11 x 11 in.) tablet for personal CAD systems. It is used for quick menu selection, and rapid cursor movements, as well as tracing and drawing. Primary applications include mechanical, electrical, and electronics CAD, and AEC (Architecture/Engineering/Construction). Secondary applications include business graphics and desktop publishing (DTP).

#### Unparalleled Reliability

Due to a patent-pending Permuted Trace Ordering (PTO) technology, Hewlett-Packard can minimize parts, making the HP SketchPro tablet one of the most reliable tablets on the market. The SketchPro tablet meets HP's standards, at a low price.

#### Supports Top PC CAD Packages

The HP SketchPro tablet is designed to work with the software and hardware you have selected. The HP SketchPro tablet's industry-standard RS-232-C/CCITT V.24 interface enables users to connect the SketchPro tablet to the HP Vectra PC, IBM AT, IBM PC/XT, and compatibles.

The HP SketchPro tablet has four operating modes: Hewlett-Packard, Summagraphics Bit Pad 2 (emulation), Hitachi HDG1111B (emulation), and Microsoft Mouse (emulation). With these modes, the SketchPro tablet supports the most popular CAD and graphics software, such as AutoCAD, VersaCAD, and CADKEY.

#### A Complete Package

The HP SketchPro tablet provides everything you need in the box - For operation, both a comfortable stylus and four-button cursor; for interfacing, an RS-232-C/CCITT V.24 cable for the HP Vectra PC or the IBM AT and compatibles, a cable adapter for the IBM PC/XT and compatibles, and set-up instructions for configuring your software; for tablet menus, a clear anti-static overlay to hold menus securely in place without tape.

#### Intelligent Design

The HP SketchPro has been designed with special attention to ergonomics and aesthetics. The tablet's slope and shape provide maximum user comfort. The anti-static overlay and recessed menu area mean menus without messy tape. Plus the small footprint saves valuable desk space. Both a power on/off LED and a point-digitizing LED provide positive feedback.

#### Superior Resolution

The HP SketchPro tablet has a resolution that is programmatically selectable up to 480 lines per cm (1219 lines per in.), and is accurate up to within 0.5 mm (0.02 in.) of the selected point. The HP SketchPro tablet's resolution meets the most stringent requirements.

#### Multifunction Softkeys

The HP SketchPro tablet includes several softkeys to provide commonly used functions; variable active areas, aspect ratio adjustments, and mouse mode. These softkeys are predefined. Additional, programmable softkeys are provided for future software vendor support.

#### Specifications

**Size:** height, 50 mm (2.0); width, 325 mm (12.8 in.); depth, 343 mm (13.5 in.); tablet tilt, 7 degrees

**Net Weight:** 1.8 kg (4 lbs)

**Power requirements:** source, 110-120 V or 230-240 V (depending on country); frequency, 60 Hz or 50 Hz (depending on country); power, 1.8 Watts

**Resolution:** 480 lines per cm (1219.05 lines per in.)

**Accuracy:**  $\pm 0.5$  mm (0.02 in.); repeatability,  $\pm 0.25$  mm (0.01 in.)

**Proximity:** 2.5 mm (0.01 in.); jitter, 0 pixels

**Stylus tilt:** any degree  $< 90^\circ$

**Active area:** 278 mm x 278 mm (11 in. x 11 in.)

**Technology:** capacitive with Permuted Trace Ordering (PTO)

**Data Rate:** up to 19,200 baud

**Product regulations:** safety, UL Listed, CSA certified; RFI, tested at system level to FCC class B and VDE level B; Acoustics, less than 4.0 Bels sound per A-weighted scale

**Environmental range:** operating temperature,  $0^\circ$  to  $50^\circ$  C; non-operating,  $-55^\circ$  to  $70^\circ$  C; relative humidity, 6% to 95%; shock,  $\frac{1}{2}$  sine shock pulse  $< 3$  msec duration, 140 in./sec delta V, non-operating Trapezoidal pulse, 30 G, 292 in./sec delta V

#### Ordering Information

HP 7060A HP SketchPro Digitizing Tablet

**Price**

**\$649**

AutoCAD is a trademark of Autodesk, Inc. and Microsoft is a registered trademark of Microsoft Corporation.

# COMPUTER PERIPHERALS

## Tablets — A-size Graphics Tablet (cont'd)

### HP 45911A, HP-HIL Model

713

- Low cost: \$499
- Works with HP Vectra, Touchscreen, and HP 9000 Series 300 systems

- High-resolution: up to 1200 lines/inch
- Easy connection using HP-HIL

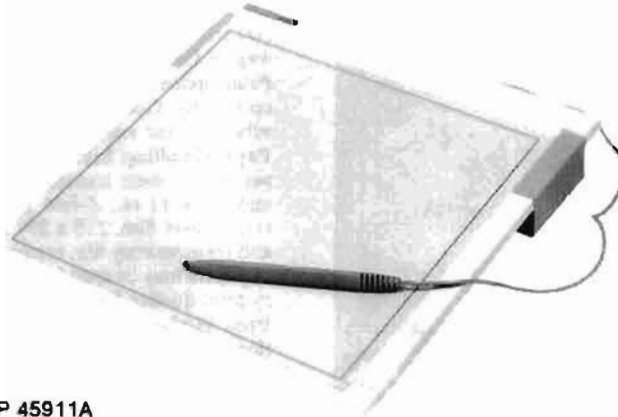

HP 45911A

The HP 45911A is a high-performance, low-cost graphics tablet. When it is installed on a computer supporting the Hewlett-Packard Human Interface Link (HP-HIL), you have a very effective pointing device to increase your productivity with interactive graphics applications such as:

- CAD/CAM
- Presentation Graphics
- Computer Art

The HP Graphics tablet is ideal for tasks such as menu picks, graphics placement, drawing, and tracing. Overlays, like the ones provided with many software packages, can be used on the tablet allowing you to choose menu items conveniently without using screen space. With the tablet's stylus you can make fast movements and create complex drawings as easily as with a pencil and paper. When high accuracy is needed, for tasks such as tracing existing drawings, an optional cursor is available.

#### Unparalleled Reliability

Due to a patent-pending new Permuted Trace Ordering (PTO) technology, Hewlett-Packard can minimize parts, making the HP 45911A one of the most reliable tablets on the market. The tablet meets the reliability standards you expect from Hewlett-Packard, at a low price.

#### Excellent Performance

The HP Graphics tablet has very high resolution, up to 1200 lines per inch. And its fast response time and high accuracy make it easy to use. The tablet is based on capacitive technology and is immune to the effects of magnetic fields.

#### Easy to Install and Use

The stylus is as easy to use as a pencil. Movements of the stylus tip on the tablet surface will be tracked on the computer monitor. The stylus tip can be activated by a gentle push of its tip onto the tablet surface.

The HP Graphics tablet can be used with computers and applications which support the HP-HIL interface. HP-HIL allows you to daisy chain up to 7 input devices (such as a mouse, tablet, bar code reader, keyboard, and others) without using a serial port. Simply plug the HP Graphics tablet into the keyboard, HP-HIL port, or another input device. The HP-HIL interface provides power from the host computer or terminal, eliminating the need for additional power cords.

#### Saves a Serial Port

Since HP-HIL input devices have their own port and they daisy chain together, your serial ports are free so you can use other peripherals, such as plotters and printers. If you want to use input devices

and output devices at the same time, you won't need multiple serial port cards or costly switch boxes.

#### Software Support

The HP Graphics tablet is supported by many popular software packages including ME 10, Graphics Gallery, AutoCAD™ (version 2.52 and above), and Versacad (version 5.1 and above).

#### Superb Design

The HP Graphics tablet has been designed with special attention to ergonomics and aesthetics. The tablet slope and stylus shape have been chosen to make it comfortable in use. And the tablet is so compact in size it uses less desk space than most tablets with equivalent active area.

#### Specifications

**Size:** height, 50 mm (2.0 in.); width, 325 mm (12.8 in.); depth, 343 mm (13.5 in.)

**Active area:** 278 mm x 278 mm (11 in. x 11 in.)

**Tablet tilt:** 7 degrees

**Net Weight:** 1.8 kg (4 lbs)

**Power requirements:** source voltage, 100, 120, 200, 240 V~±10%,

+5%; current 150 mA maximum; power, 1.8 Watts

**Resolution:** 480 lines per cm (1219.05 lines per in.)

**Accuracy:** ±0.5 mm (.02 in.)

**Repeatability:** ±0.25 mm (.01 in.)

**Proximity:** 2.5 mm (.1 in.)

**Stylus tilt:** any angle <90°

**Data output rate:** up to 130 pairs per second

**Document material:** non-conductive

**Product regulations:** safety, UL Listed, CSA certified; RFI, tested at system level to FCC class B and VDE level B; Acoustics, less than 4.0 Bels sound per A-weighted scale

**Environmental range:** operating temperature, 0° to 50° C; non-operating, -55° to 70° C; relative humidity, 6% to 95%; shock, 1/2 sine shock pulse <3 msec duration, 140 in./sec delta V, non-operating Trapezoidal pulse, 30 G, 292 in./sec delta V

#### Accessories Supplied

**Stylus:** 16 cm with .75 m attached cable

**Overlay:** 295 mm x 295 mm (11 1/2 in. x 11 1/2 in.)

HP-HIL Cable

#### Accessories Available

HP 45913A: Four-button cursor

#### Price

\$125

#### Ordering Information

HP 45911A Graphics Tablet  
AutoCAD is a trademark of Autodesk, Inc.

\$499

# COMPUTER PERIPHERALS

## Printers — Versatile Color Graphics and High-Speed NLQ Text Printer

### HP PaintJet Color Graphics Printer

- Color overhead transparencies
- Fast throughput for both text and graphics
- Quiet operation

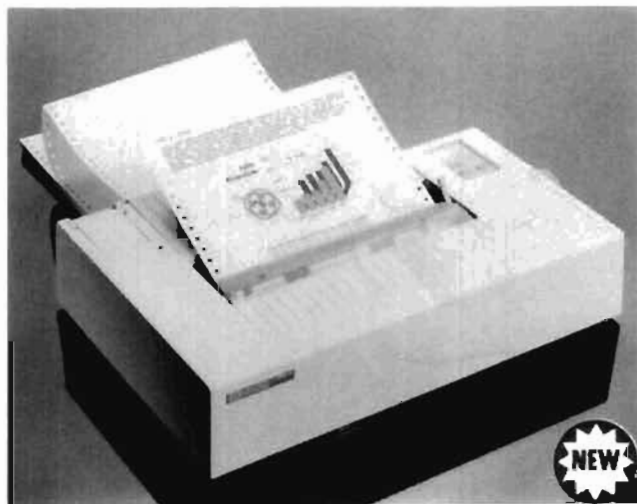

The HP PaintJet (HP 3630A) printer is designed especially for business and PC Engineering professionals who need both high-resolution color graphics and fast NLQ text from a personal printer. The HP PaintJet offers crisp, dark text; merged text and graphics for reports or schedules; and full-page color graphics on either paper or overhead transparency film.

#### High-Resolution Color Graphics

The PaintJet printer has a resolution of 180 dots per inch, so it produces sharp, solid color graphics. With a PaintJet printer, users can create colorful presentation overheads, project schedules, or 3D CAD drawings from the same device that provides their convenience printing.

#### NLQ Text

With a 15 x 30-dot character cell, the PaintJet printer produces clear, sharp near-letter-quality text — perfect for memos, status reports, and project updates. And the PaintJet printer offers a choice of 10-pitch Courier, 12-pitch and 18-pitch Letter Gothic, plus bold, underline, superscript, and color text capability.

#### Fast Throughput

At 167 characters per second, the PaintJet printer can generate a typical page of near-letter-quality text in less than 40 seconds! And a full-page of color graphics takes less than four minutes on paper and under eight minutes on overhead transparency film.

#### Bright Colors in Disposable Cartridges

The PaintJet printer's two disposable print cartridges hold four specially-formulated inks (cyan, yellow, magenta, and black). With these inks, the PaintJet printer produces 330 shades of color. And the same print cartridges work on both paper and overhead transparency film.

#### Multiple Character Sets

The PaintJet printer supports 12 distinct character sets including Roman8, PC-8, US ASCII, Spanish, French, PC-8 (Danish/Norwegian), German, Italian, United Kingdom, Norwegian I, Swedish Names, and ECMA-94.

#### Hardware and Software Compatibility

The PaintJet printer comes with three interface options — Centronics Parallel, RS-232-C/CCITT V.24, and HP-IB (IEEE 488-1/978) — so it works with most popular personal computers. And it is supported by leading business graphics, word processing, productivity, IPC CAD, and utility software.

#### Specifications

**Print Speed (NLQ):** 167 characters per second at 10 pitch; 200 characters per second at 12 pitch; 30–40 seconds per typical page of text; full-page color graphics, 4 minutes or less on paper, 8 minutes or less on transparency film

- Extensive software support
- Three interface options
- High resolution

**Print Resolution:** character structure, 15 x 30-dot print character cells; graphics, 180 x 180 dpi; 330 colors at 90 dpi; 7 colors at 180 dpi  
**Character Sets:** Roman8, PC-8, US ASCII, Spanish, French, PC-8 (Danish/Norwegian), German, Italian, United Kingdom, Norwegian I, Swedish Names, and ECMA-94

**Print Styles:** Courier, 12 point (10 cpi); Letter Gothic, 12 point (12 cpi); Letter Gothic, 8 point (18 cpi); also bold, underline, superscript, subscript, and color text.

**Paper Handling:** friction and sprocket feed; Z-fold and CutSheet paper: single sheet transparency film; CutSheet paper, 210 x 297 mm and 8½ x 11 in.; Z-fold paper, 210 x 304.8 mm and 8½ x 11 in.; single-sheet film, 210 x 297 mm and 8½ x 11 in. HP PaintJet paper and transparency film are recommended for best results. Other printer papers may be used for draft-quality output and provide satisfactory print quality for many applications.

**Print Method:** color inkjet non-impact dot-matrix printing, unidirectional and bidirectional text printing; unidirectional color printing on paper and transparency film

**Print Mechanism:** cartridges, one black, one color; nozzles, total of 60 in two print cartridges (30 black, 10 cyan, 10 magenta, 10 yellow); typical cartridge lifetime, black pen, 1100 text pages (approximately 1.1 million characters); color pen, 180 pages of color graphics (with typical use of solid area fill) or 160 overhead transparencies

**Printable Characters Per Line:** 144 at 18 characters per inch; 96 at 12 characters per inch; 80 at 10 characters per inch

**Controls and Indicators:** power on, paper out, top-of-form, line feed, and form feed

**Interfaces:** Centronics Parallel; RS-232-C/CCITT V.24; HP-IB (IEEE 488-1/978)

**Power Requirements:** supply, 48–66 Hz; 100, 120, 220, 240, VAC + 10%; consumption, 20 W maximum

**Environmental Ranges:** operating temperature, 15° to 30° C (60° to 86° F); non-operating temperature, –40° to 70° C (–40° to 158° F); operating relative humidity (paper), 20% to 80% (at 10° to 30° C); operating relative humidity (transparency film), 20% to 70% (at 10° to 30° C)

**Acoustics:** 5.3 bels(A); typically quoted sound pressure <50 dB (A)  
**Physical Specifications:** height, 98 mm (3.86 in.); width, 442 mm (17.4 in.); depth, 302 mm (11.89 in.); net weight, 5 kg (11 lb); shipping weight, 10.6 kg (23.3 lb)

**Buffer Size:** 8K bytes

**Product Certifications:** CSA approved, CSA C22.2 No. 154; UL Listed, UL-478; TUV Approved, GS Mark, IEC-380; FCC Certified, Class B; FTZ Radio Protection Mark, Level B; VCCI Approved, Class 2

**Estimated Average Usage:** 10 pages per day

#### Supplies and Accessories

	Price
HP 51606A Black print cartridge	27.95
HP 51606C Color print cartridge	34.95
HP 51630P Z-fold paper, 8½ x 11 in., 250 sheets	17.95
HP 51630R Z-fold paper, 210 x 304.8 mm, 250 sheets	17.95
HP 51630Y CutSheet paper, 8½ x 11 in., 250 sheets	22.95
HP 51630Z CutSheet paper, 210 x 297 mm, 250 sheets	22.95
HP 51630Q Single sheet transparency film, 8½ x 11 in., 50 sheets (with plastic sleeves)	64.95
HP 51630S Single sheet transparency film, 210 x 297 mm, 50 sheets (with plastic sleeves)	64.95

#### Ordering Information

	Price
HP 3630A PaintJet Color Graphics Printer	\$1395.00
<b>Options</b>	
001 RS-232-C/CCITT V.24 interface	N/C
002 HP-IB interface (IEEE 488-1/978)	N/C
004 Centronics Parallel interface	N/C

#### ThinkJet Portable Printer HP 2225B/P

- Battery-powered operation
- Quiet, compact 150-cps printing
- Reliable printing convenience
- 200 pages printing between recharges



For desktop or travel, two battery-powered versions (HP-IL and Centronics-type interfaces) allow you to match this very rugged and lightweight printer with the smallest of computers.

#### ThinkJet Desktop Printer HP 2225A/C/D

- Quiet, compact 150-cps printing
- Easy-to-read draft and NLQ printing
- Disposable print cartridges
- Excellent software support

The convenient desktop printer is quiet and unobtrusive, yet quick and efficient, delivering crisp, easy-to-read text and graphics for letters, reports, even spreadsheets.

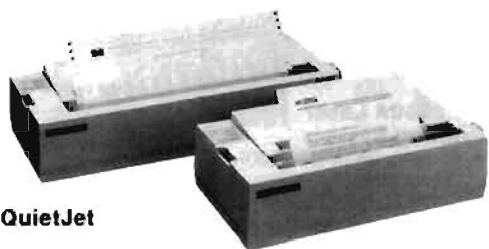

#### QuietJet and QuietJet Plus Printers HP 2228A, HP 2227A/B

- Quiet, quality desktop printing
- 192-cps draft and 48-cps NLQ
- Excellent software support
- Disposable print cartridges

You get exceptionally quiet, quality printing for word processing, data base management, and computer graphics. The narrow-carriage QuietJet Printer is just big enough to handle standard 8 1/2 x 11-inch and A-4 size paper, a real space saver for personal computer and terminal users. The QuietJet Plus Printers have a wide carriage for paper up to 15".

#### HP 2603A Daisywheel Printer 48-cps letter-quality printing

- Triple-bin sheet and envelope feeder accessory
- Easy-to-use drop-in printwheels
- Lower sound rating (58.5 dBA)

The HP 2603A Printer offers fully-formed character printing for office and administrative professionals. Along with the HP 26030E Sheet Feeder and HP 26030A Forms Tractor accessories, the HP 2603A allows you to automate your letter-quality office printing.



#### LaserJet Series II

- Publication-quality print at eight pages/minute
- LaserJet PLUS compatibility—two font cartridge slots; downloadable fonts/forms
- Expandable memory—up to 4.5 megabytes
- Easy-to-use front control panel

The LaserJet Series II printer improves on the features of the popular LaserJet PLUS printer. Printing up to 8 pages per minute on paper sizes including letter, legal, executive, and European A4, the printer is compatible with over 600 of the most popular software packages. The LaserJet Series II prints text and graphics at 300 x 300 dots/inch and provides whisper-quiet operation with virtually all PCs and PC networks. The printer is especially well-suited for desktop publishing.

#### LaserJet 500 PLUS

- Publication-quality print at eight pages/minute
- Two 250-sheet input paper trays
- Ideal for multiple users
- LaserJet PLUS compatibility—downloadable fonts/forms

The LaserJet 500 PLUS printer offers publication-quality printing with several helpful paper handling features. The printer has two 250-sheet input paper cassettes that are available in letter, legal, European A4 and B5 sizes. One size or type of paper can be loaded into one cassette and another in the remaining cassette—providing automatic access to letterhead or legal-size paper. The printer also offers job offset and correct-order output.



See page 716 for LaserJet Fonts, Memory Boards and Tempested products.

# COMPUTER PERIPHERALS

## Departmental and System Printers

Models HP 2684A/D/P, HP 2932/34A, HP 2235A, HP 2563/64/66/67B, HP 2680A, HP 2685C



### LaserJet 2000

- Publication-quality print at up to 20 pages/minute
- LaserJet PLUS compatibility for departmental use
- Optional double-sided (duplex) printing
- Optional 2000-sheet input paper deck

The LaserJet 2000 printer offers high-volume, high-speed printing for the minicomputer and PC network environment. Compatible with the LaserJet PLUS printer, the LaserJet 2000 has upgradeable memory to 5.5 megabytes—ideal for multiple users requiring full-page graphics at 300 × 300 dots/inch and many downloadable fonts. Paper cassettes are available for printing on six paper sizes, including letter, legal, executive, ledger, and European A4 and A3. Includes thirty-four resident fonts and 3 LaserJet font cartridge slots.

### LaserJet Fonts and Memory Boards

A large selection of LaserJet-compatible font cartridges and downloadable soft fonts are available in many typefaces, styles and point sizes. The LaserJet Series II and LaserJet 2000 printers also offer upgradeable memory for increased font downloading and graphics capability. For information about available fonts and printer memory, contact your HP sales representative.

### TEMPEST Printer Family

TEMPEST versions of selected peripherals are available for government applications requiring security protection. International distribution is limited; contact your local HP sales representative for availability and ordering information.



### HP 2932A and HP 2934A Printers

- 200-cps, 136-column impact printing
- Up to 6-part forms
- Handles up to 12,000 pages/month
- Interface flexibility

Speed, reliability, simplicity of operation, and an unlimited duty cycle allow the 2930 Series to meet heavy duty printing needs. The HP 2934A offers all the print features of the HP 2932A plus near-letter quality (NLQ), font cartridges, barcode, OCR, and large character generation.



### RuggedWriter 480 Printer

#### HP 2236 Series

- Fast, 480-cps rugged printing
- 24-wire impact printing
- Three independent paper paths
- Paper handling flexibility
- Built-in dual I/O

The new wide-carriage HP RuggedWriter 480 Printer offers top-quality printing that's fast (480-cps draft and 240-cps letter-quality). It's rugged (unlimited duty cycle and 20,000 hours mean time between failures), designed for use as a shared printer on minicomputers or PC networks, or as an individual PC printer for high-volume applications.



HP 2566/67B

### HP 2563B, 2564B, 2566B, 2567B

#### Line Impact Dot Matrix Printers

- 300, 600, 900, or 1200/1600 lpm
- Bar code and multi-part forms printing
- 16-channel vertical format control
- 55 dBA cabinets for standard HP 2563/64B models

HP 2563/64B



The HP 2563B, 2564B, 2566B, and 2567B are a fully supported line impact dot matrix printer family for minicomputer, microcomputer, or mainframe computer systems. They feature high density and compressed text, graphics, bar code and OCR capabilities, and multiple character sets. High reliability is assured through battery backed-up printer memory, microprocessor control, and few moving parts. Enhanced bar code capabilities are available with the HP Label Card option.

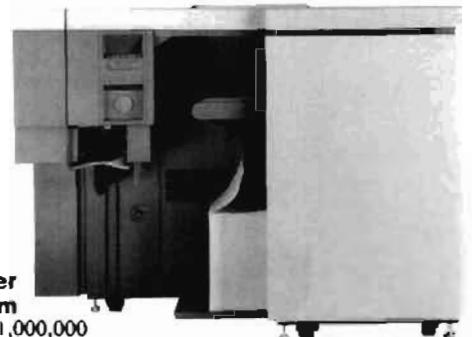

### HP 2680A Laser Printing System

- 45 ppm; up to 1,000,000 sheets monthly
- 8.5 × 11-inch fanfold paper
- Electronic forms and graphics
- High-volume label printing

The HP 2680A Laser Printing System is the solution for HP 3000 and Precision Architecture computer systems. It features continuous paper feed for paper-handling reliability, non-contact fusing, and a data control system that handles variable size characters and up to four pages of print on one sheet of paper. Merged text and graphics are possible using the HP 3000 office applications software (TDP, HPWord, HPDraw), IFS 3000, and IDSF0RM/3000 software and graphics option.



### HP 2685C Laser Print Station

The HP 2685C Laser Print Station is a local or remote solution for large host mainframe computer systems. It consists of the HP 2680A laser printer and a system controller, terminal, disc drive, and magnetic tape.

# COMPUTER PERIPHERALS

## System Printers and Printer Ordering Information

### Model HP 2689A and Output Design Service

#### HP 2689A Laser Printing System

The HP 2689A Laser Printing System provides direct channel connect laser printing on IBM and IBM plug-compatible systems. Communication to the IBM mainframe is made through the HP 26029A Control Unit which drives the HP 2680A laser printer.

#### Output Design Service

The Output Design Service provides custom forms design, logos, and signature-scanning services for all HP laser printers, including the HP 2680A, HP 2685C, and HP 2689A.

### ORDERING INFORMATION FOR HEWLETT-PACKARD PRINTERS

For additional technical information, ask your HP sales representative or your dealer for the following literature:

Product (s)	Part Numbers
Computer Peripherals Selection Guide	5954-9305
PaintJet Color Graphics Printer	5954-8752
ThinkJet Printers	5954-6984
QuietJet Printers	5954-6985
HP 2603A Daisywheel Printer	5953-6296
LaserJet Series II Printer	5954-7330
HP LaserJet 500 PLUS Printer	5954-7330
HP LaserJet 2000 Printer	5954-7331
Tempest LaserJet Family	5954-9482
HP 2932A Printer	5953-6298
HP 2934A Printer	5953-6299
HP 2235 RuggedWriter 480 Printer	5954-6997
HP 256XB Family of Line Impact Dot Matrix Printers	5954-7326
HP Label Card	5954-7327
HP 2680A Laser Printing System	5953-7116
HP 2685C Laser Print Station	5953-2265
HP 2689A Laser Printing System	5954-2252
Output Design Service	5954-8961

Products	Prices
<b>ThinkJet Printers:</b>	
HP 2225A: HP-IB Interface	\$495
HP 2225B: HP-IL Interface, battery power	\$495
HP 2225C: Parallel Interface	\$495
HP 2225D: RS-232 Interface	\$495
HP 2225P: Centronics Interface, battery power	\$495
922197 Cable	+\$49
<b>QuietJet Printers:</b>	
HP 2227A: Dual I/O (Centronics/RS-232)	\$799
HP 2227B: HP-IB Interface	\$799
HP 2228A: Dual I/O (Centronics/RS-232)	\$599

HP 2603A: RS-232 Interface	\$1495
Accessories: HP 26030A (forms tractors)	\$299
HP 26030E (triple-bin sheet feeder)	\$999
HP LaserJet Series II Printer	\$2595
HP LaserJet 500 PLUS Printer	\$4495
HP LaserJet 2000 Printer	\$19,995—\$25,695
HP 2932A: RS-232 Standard	\$2595
Interface options: RS-422 (#035)	+50
Centronics-type (#042)	+50
HP-IB (#046)	+150
HP 2934A: RS-232 standard	\$2995
Interface options: RS-422 (#035)	+50
SNS/Data Link (#039)	+200
Centronics-type (#042)	+50
HP-IB (#046)	+150
Multipoint Asynchronous (#034)	+200
Accessory: HP 293408 Single-bin sheet feeder	+395
<b>RuggedWriter 480 Printers:</b>	
HP 2235A: Dual I/O (Centronics/RS-232)	\$1695
HP 2235B: Dual I/O (HP-IB/RS-232)	\$1895
HP 2235C: Dual I/O (Centronics/RS-232) with sheetfeeder	\$1945
HP 2235D: Dual I/O (HP-IB/RS-232) with sheetfeeder	\$2145
Accessories:	
HP 12239A (sheet feeder-US letter-size tray)	\$250
HP 12239B (sheet feeder-EUR A-4 size tray)	\$250
HP 12235A (font cartridge-4 fonts and 16K RAM)	\$150
HP 2563B Line Impact Dot Matrix Printer	\$5890—\$7490
HP 2564B Line Impact Dot Matrix Printer	\$11,200—\$12,700
HP 2566B Line Impact Dot Matrix Printer	\$22,200
HP 2567B Line Impact Dot Matrix Printer	\$28,600—\$30,640
HP Label Card, Option #024	\$2160
HP 2680A Laser Printing System	\$86,065
HP 2685C Laser Print Station	\$107,193—\$125,042
HP 2689A Laser Printing System	\$101,916

# COMPUTER PERIPHERALS

## Plotters—Scientific Measurement/Business Plotter

### ColorPro Plotter

- 8-pen carousel
- Handles A4/A-size\* paper, transparency film



The HP ColorPro eight-pen plotter is designed to provide quick, presentation-quality color visuals for business and scientific applications. It draws with fiber-tip pens on overhead transparency film and regular and glossy paper.

The ColorPro plotter is designed for professionals who make decisions from numbers and make presentations with numbers. Whether you're drawing overheads for a meeting or recording data from a smart instrument, output quality is important. The exceptional line quality of the ColorPro plotter makes drawings and charts perfect for most professional presentations or reports.

#### High-Quality Output

With an addressable step size of 0.025 mm (0.001 in.), the ColorPro plotter can draw up to 1000 points in a 1-inch line. That means you get ruler-straight lines, even on the diagonal. And when commanded to return to the same point with no pen change, the plotter achieves this repeatability within 0.1 mm (0.004 in.). This precision helps ensure that circles are closed and bar and pie charts are properly aligned.

#### Eight-pen Carousel for Color and Convenience

Once you load the ColorPro plotter's eight-pen carousel, you have access to a spectrum of colors in two different widths — thick pens for headings, thin pens for details. And the pens are capped when not in use to prolong pen life.

#### Programming Features

If you plan on creating your own graphics programs, you can utilize the HP-GL instructions resident in the ColorPro plotter. HP-GL (Hewlett-Packard Graphics Language) is a simple but powerful command set that controls plotting functions such as pen movement, labeling, character set selection, and axis placement. Order the HP ColorPro Programming Manual (Part No. 07440-90001) for complete explanations and examples of the plotter's graphics and interfacing instructions.

\*A4 Size is 210 x 297 mm A Size is 8 1/2 x 11 in.

- High-quality output
- ROM cartridge slot

#### Compatibility

With a choice of two interfaces, RS-232-C/CCITT V.24 or HP-IB (IEEE 488-1978), the HP ColorPro plotter works with virtually all personal computers. It can also be connected to a variety of HP and non-HP minicomputers or mainframes, but does not provide save-drop capability in these environments.

#### ROM Cartridge Slot

To keep up with your expanding needs (such as emerging graphics standards), the ColorPro plotter has a ROM cartridge slot. HP offers a Graphics Enhancement Cartridge as an accessory to the ColorPro plotter. The cartridge adds more advanced capabilities to your ColorPro plotter such as additional HP-GL instructions to draw arcs, circles and polygons; a larger RS-232-C buffer (1024 bytes); and 14 ISO character sets.

#### Graphics Software

The ColorPro plotter is supported by a wide variety of graphics application packages for HP as well as non-HP computer systems. Details are available from any HP sales and support office.

#### Specifications

**Resolution:** smallest addressable step size, 0.025 mm (0.001 in.)

**Repeatability:** with a given pen, 0.1 mm (0.004 in.)

**Pen velocity (each axis):** pen up, approx. 52.0 cm/s (20.5 in./s); pen down, maximum, approx. 40.0 cm/s (15.7 in./s); programmable, 1.0 to 40.0 cm/s in 1.0 cm/s increments

**Acceleration:** approximately 1.2 g's

**Environmental range:** operating, 0°C to 55°C, 5% to 95% Rh (at 40°C), non-operating, -40°C to 75°C

**Maximum plotting area:** pen axis, 191 mm (7.5 in.) for A and A4\*; paper axis, 272 mm (10.7 in.) for A4, 257 mm (10.1 in.) for A

**Interfaces:** HP-IB (IEEE 488-1978) interface which implements IEEE 488-1978 standards; RS-232-C/CCITT V.24, asynchronous serial ASCII with switch selectable baud rates of 75, 110, 150, 200, 300, 600, 1200, 2400, 4800, 9600; 60-byte buffer

**Power requirements:** source, 100, 120, 200, 240 V ~ ±10%, ±5%; frequency, 48-66 Hz; consumption, 20 W maximum

**Size:** height, 125 mm (4.9 in.); width, 460 mm (18.1 in.); depth, 308 mm (12.1 in.)

**Weight:** net, 5.5 kg (12.0 lb); shipping, approx. 8.6 kg (19.0 lb)

**FCC:** FCC certified to conform to limits set for radio frequency interference when used with a class B computing device. Meets or exceeds IEC-380, IEC-435, UL-478

#### Accessories Supplied

HP ColorPro Graphics Plotter Operating Manual

Power supply

An assortment of pens and media are also supplied with the plotter. The media size and appropriate power supply are determined by plotter destination.

NOTE: Interface cables are not supplied with the plotter. They must be ordered separately.

#### Ordering Information

HP 7440A ColorPro Plotter

Price

\$1295.00

HP 17440A Graphics Enhancement Cartridge

\$150.00

#### Options

001 RS-232-C/CCITT V.24 (cable not included)

N/C

002 HP-IB (IEEE 488-1978) (cable not included)

N/C

#### Interface Cables

HP 13242G M-M special RS-232-C cable for use with Option 001, HP D50 Personal Computers, HP Vectra PC with HP 24541A interface

\$69.00

HP 17255D M-F special RS-232-C cable for use with Option 001, IBM PC, AT & T Personal Computers

\$40.00

HP 24542G M-M special RS-232-C cable for use with Option 001, HP Vectra PC with HP 24540A interface, IBM AT

\$50.00

HP 10833A HP-IB 1-metre cable for use with Option 002

\$30.00

☎ Fast-Ship product — see page 758.



# COMPUTER PERIPHERALS

## Plotters—Technical/CAD Professional Plotter

### Model 7475A

719

- High-quality output
- Drafting capability
- Choice of A3/B\*\* and A4/A\* media sizes

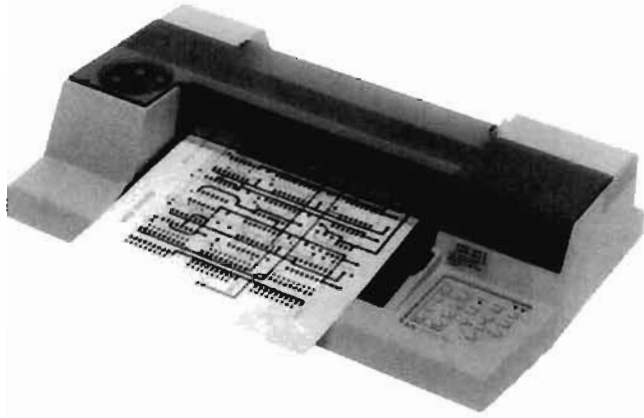

The HP 7475A is a low-cost plotter that provides the kind of graphics excellence and versatility you would expect to find in a much more expensive plotter. The HP 7475A produces fast, high-quality drawings for business, design, and measurement professionals.

With the HP 7475A, you have your choice of two media sizes — A4/A-size\* for colorful report and presentation graphics, and A3/B-size\*\* plots for PERT charts, schematics, engineering drawings, and design applications. You can switch chart sizes with the push of a button.

If you need a vertical format, you can use the front panel keys to rotate the chart 90 degrees. And if you need to digitize, you can do that from the front panel, too.

The HP 7475A accepts four different types of media — chart paper, glossy presentation paper, overhead transparency film and double-matte polyester film. And you have a choice of two different pen types — fiber-tip pens for paper and overhead transparencies and liquid-ink drafting pens for high-quality drawings on polyester film. Fiber-tip pens are available in ten colors and two tip widths. Refillable short-body drafting pens come in three different tip widths.

#### Applications

**Business:** The A3/B-size\*\* capability of the HP 7475A makes it the ideal plotter for PERT charts, organization charts, flow charts, or small flip charts. And the HP 7475A produces colorful A4/A-size\* charts for reports, meetings, and presentations.

**Design:** Perfect as an entry level drafting plotter or an inexpensive companion to your design system, the HP 7475A creates liquid-ink drawings on polyester film for frequently handled archival copies or check plots using fiber-tip pens on paper.

**Measurement:** The HP 7475A adds hardcopy graphics capability to intelligent instruments and instrument systems with an HP-IB (IEEE 488-1978) interface. Many systems (with or without display screens) can have the benefits of high-quality, hardcopy graphics plotted directly from measured data.

#### High-Quality Output

With an addressable step size of 0.025 mm (0.001 in.), the HP 7475A can plot up to 1000 points in a 1-inch line. When commanded to return to the same point with no pen change, the plotter achieves this repeatability within 0.1 mm (0.004 in.). Because of the outstanding resolution and repeatability, the HP 7475A produces straight, professional-quality lines.

\* A4 Size is 210 x 297 mm; A Size is 8½ x 11 in.

\*\* A3 Size is 297 x 420 mm; B Size is 11 x 17 in.

- Six-pen carousel
- Plots on paper, transparency film, polyester film
- Plots using fiber-tip and liquid-ink pens

#### Special Programming Features

If you create your own graphics programs, you'll be glad to learn that the HP 7475A contains over 50 HP-GL (Hewlett-Packard Graphics Language) instructions to control such functions as arc and circle generation, and area fill in pie and bar charts. Plus, the HP 7475A has 19 internal character sets, including ISO European sets, Katakana, ASCII, and Roman 8 extensions.

#### Interface Options

The HP 7475A is easy to interface with most HP and non-HP computers because you have the choice of two interface options — either RS-232-C/CCITT V.24 or HP-IB (IEEE 488-1978). By adding an cavedrop cable you can connect the HP 7475A in series with a computer and a terminal.

#### Graphics Software

The HP 7475A is supported on a wide variety of business and design graphics application packages for HP as well as non-HP computer systems. Details are available from any HP sales and service office.

#### Specifications

**Resolution:** Smallest addressable step size, 0.025 mm (0.001 in.)

**Repeatability:** with a given pen, 0.1 mm (0.004 in.); from pen to pen, 0.2 mm (0.008 in.)

**Pen velocity (each axis):** pen up, 50.8 cm/s (20 in./s); pen down, maximum, 38.1 cm/s (15 in./s); programmable, 1 to 38 cm/s in 1 cm/s increments

**Acceleration:** approximately 2 g's

**Environmental range:** operating, 0°C to 55°C; non-operating, -40°C to 75°C

**Plotting area:** x-axis, 258 mm (10.2 in.), A/B; 275 mm (10.8 in.), A4/A3; y-axis, 198 mm (7.80 in.), A; 192 mm (7.56 in.), A4; 414 mm (16.3 in.), B; 402 mm (15.8 in.), A3

**Interfaces:** HP-IB (IEEE 488-1978) implements the following functions as defined in IEEE 488-1978 — SH1, AH1, T2, TE0, LE0, SR1, RL0, DC1, DT0, L2, PP0 (listen only or address less than 7, otherwise PP2); RS-232-C/CCITT V.24, asynchronous serial ASCII with switch selectable baud rates of 75, 110, 150, 200, 300, 600, 1200, 2400, 4800, 9600. External clock input capabilities with intermediate baud rates of up to 9600 baud; 1024 byte buffer

**Power requirements:** source, 100, 120, 220, 240 V ~ -10%, +5%; frequency, 48-66Hz

**Size:** height, 127 mm (5 in.); width, 568 mm (22.4 in.); depth, 367 mm (14.5 in.)

**Weight:** net, 7 kg (16.0 lb); shipping, approx. 11 kg (24.0 lb)

**FCC:** FCC certified to limits set for radio frequency interface when used with a class B computing device

#### Accessories Supplied

HP 07475-90001 Interfacing and Programming Manual

HP 07475-90002 Operation and Interconnection Manual

HP 07475-90003 Reference Card

Power cords and an assortment of pens and drawing media are also supplied with the plotters. The media size and destination.

NOTE: Interface cables are not supplied with the plotter. They must be ordered separately

#### Ordering Information

##### Options

001 RS-232-C/CCITT V.24 (cable not included)

002 HP-IB (IEEE 488-1978) (cable not included)

HP 7475A Six-pen Graphics Plotter

Available from Instruments Direct 800-523-2121 (U.S. only)

☛ Fast-Ship product — see page 758.

##### Price

N/C

N/C

\$1895 ☛

# COMPUTER PERIPHERALS

## Plotters — High Speed/High Performance Plotter

Model 7550A

- Ideal for high-volume, shared environments
- Requires minimum operator supervision
- Uses drafting media, pens
- High throughput
- 6 g acceleration, 80 cm/s (31.5 in./s)
- Accepts A3/B- and A4/A-size media



HP 7550A



Hewlett-Packard's sheet feed 7550A plotter is an innovative graphics tool for business and technical users alike. Automatic cut sheet feed capability for paper and transparencies makes the HP 7550A ideal for unattended plotting or multiple color copies. With an unmatched 6 g of acceleration, the HP 7550A can produce quick graphs for problem-solving or decision making, or working drawings for drafting or design systems. And the HP 7550A meets Hewlett-Packard's high performance standards, so it creates professional-looking graphs for reports and presentations.

### Fast Throughput

The HP 7550A's fast acceleration and pen speed mean shorter plotting time. The HP 7550A draws in any direction at 80 cm/s (31.5 in./s) and letters at approximately 7-9 characters per second. It uses the powerful MC68000 16-bit microprocessor. The HP 7550A is also equipped with a replot capability so if an entire plot will fit in the replot buffer ( $\approx$  12K bytes), the HP 7550A can produce up to 99 original color copies without rerunning the program, freeing your computer to go on with other tasks.

### Minimum Operator Supervision

The HP 7550A eliminates manual paper handling of A3/B- and A4/A-size sheets of paper, and transparency film. The carousel allows eight pens to be loaded at once, and the plotter caps the pens when not in use to keep ink fresh. The HP 7550A automatically senses the type of carousel loaded, then sets the optimal pen speed and force. It also senses what paper size is being used.

### High Quality Output

With an addressable resolution of 0.025 mm (0.001 in.) and mechanical resolution of 0.006 mm (0.00025 in.), the HP 7550A makes smooth arcs and draws lines that meet precisely. It also has a curved line generator which can be invoked when exceptionally smooth curves are required.

With 20 character sets, the HP 7550A is ideal for international business. Choices include Katakana and ISO European languages for Denmark, France, Germany, Italy, Norway, Portugal, Spain, Sweden, and the United Kingdom. The HP 7550A letters in two fonts: arc font with proportional spacing for maximum readability and stick font with fixed character spacing for speed.

### Features

The front-panel display and function keys guide users through each plotter setup, report plotter status, and give program messages. The HP 7550A rotates graphs 90 degrees for a choice of either horizontal or vertical formats, and aligns graphs to pre-printed forms and grids, all from the front panel.

The HP 7550A accepts standard A4/A- and A3/B-size paper, double-matte polyester film, vellum, and A4/A-size transparency film. Pen choices include liquid-ink, roller-ball, paper, and transparency pens. Because of its complete device control command set and dual interface - HP-IB (IEEE-488) and RS-232-C/CITT V.24, the HP 7550A is adaptable to most system environments.

**Technical Applications**

The drawing quality, media flexibility, automatic sheet feed and fast plotting time of the HP 7550A make it ideal for quick working drawings or small format final drawings in computer-aided design, or for technical graphics in manufacturing, testing, or research and development. The HP 7550A is supported by many technical graphics software packages; the HP 7550A can draw A3/B-size check plots and working drawings to help relieve overburdened drafting plotters, produce quick, problem-solving graphs or engineering analyses, and plot charts and graphs on transparency film for technical presentations. And the HP 7550A does it all quickly and easily.

**Business Applications**

The HP 7550A is suited to business graphics users who appreciate the value of color hardcopy graphics, need quality graphics in quantity, and want a plotter that requires a minimum of operator supervision. Financial graphs, project schedules, forecasts and text charts are typical uses for a HP 7550A in a business environment. And both HP and non-HP graphics software packages make it easy for anyone to use the HP 7550A.

**Software**

Software support is available for the HP 7550A on many HP and non-HP computer systems, as well as HP and non-HP personal computers. In addition to HP's Industry Standard Plotting Package, a variety of graphics packages for nonprogrammers is available. These software packages cover both business and technical applications. Complete information is available from any HP Sales and Support office.

**Specifications**

**Media sizes:** accommodates ISO A4 (210 x 297 mm), ANSI A (8.5 x 11 in.), ISO A3 (297 x 420 mm), and ANSI B (11 x 17 in.)  
**Maximum plotting area:** pen axis, 254 mm (9.97 in.) for A/B, 272 mm (10.65 in.) for A4/A3; paper axis, 411 mm (16.12 in.) for B, 399 mm (15.65 in.) for A3, 196 mm (7.68 in.) for A, 190 mm (7.45 in.) for A4.  
**Resolution:** smallest addressable step size is 0.025 mm (0.001 in.); mechanical resolution is 0.006 mm (0.00025 in.)  
**Repeatability:** with a given pen, 0.1 mm (0.004 in.)  
**Pen Velocity:** pen down, maximum, 80 cm/s (31.5 in./s) in increments of 1 cm/s, from the front panel 10 to 80 cm/s (4 to 31.5 in./s) in increments of 5 cm/s; pen up 80 cm/s (31.5 in./s)  
**Acceleration:** maximum approximately 6 g's; programmable from 1 to 6 g's in increments of 1 g.  
**Pen force:** 15 to 66 grams  
**Power requirements:** source, 100, 120, 220, 240 V, -10%, +5%; frequency, 48 - 66 Hz; consumption, 100 W maximum  
**Interfaces:** HP-IB implements the following HP-IB functions as defined in IEEE 488-1978: SH1, AH1, T6, L3, SR1, RL0, DC1, DT0, C0, PP0, for listen only, PP1 for address greater than 7, and PP2 for address of 7 or less, device address front panel selectable, default value - 5; RS-232-C/CCITT V.24, asynchronous serial ASCII with front panel selectable baud rates of 75, 110, 150, 200, 300, 600, 1200, 2400, and 9600, default value - 2400  
**Buffer size:** default, 1024 bytes; from the program expandable to 12K bytes  
**Character sets:** 20 sets, each in two character fonts, including, the following ISO registered sets: International Reference Version (002); United Kingdom (004), U.S. ASCII (006), Swedish (010), Swedish for Names (011), Katakana (013), JIS ASCII (014), Italian (015), Portuguese (016), Spanish (017), German (021), French (025), Norwegian (060), Norwegian II (061), plus HP 9825 character set.

French/German, Scandinavian, Spanish/Latin America, Special Symbols, and Roman 8 Extensions

**Environmental range:** operating, 0°C to 55°C; nonoperating, -40°C to 75°C; automatic sheet feeder, operating with paper, 10 - 40 C and 0 - 80% RH, with transparency film, 15 - 35°C and 25 - 75% RH

**Size:** height, 215 mm (8.5 in.); width, 670 mm (26.4 in.); depth with A4/A loading tray/no catcher, 432 mm (17.0 in.), A4/A loading tray with catcher, 682 mm (26.8 in.), A3/B loading tray/no catcher, 635 mm (25.0 in.), A3/B loading tray with catcher, 896 mm (35.3 in.)

**Weight:** net approximately 17.3 kg (38.0 lb), shipping approximately 25.0 kg (55.0 lb)

**Pens:** 8 per carousel: fiber-tip, roller-ball, and liquid-ink

**Media:** manual feed, chart paper, high-gloss paper, transparency film, vellum, double-matte polyester mylar film; automatic sheet-feed, chart paper and transparency film.

**Accessories Supplied**

Interfacing and Programming Manual	HP Part Number 07550-90001
Operation and Interconnection Guide	07550-90002
Pocket Guide	07550-90003
A-size Media Loading Tray	17561A
A4 Media Loading Tray	17562A
A4/A Paper Catcher	17563A
Pen carousel for fiber-tip transparency pens	07550-60050
Pen carousel for fiber-tip paper pens	07550-60051

A power cord and an assortment of fiber-tip pens, paper and transparency media are also supplied with the plotter. The media size and appropriate power cord are determined by destination. Drafting pens and drafting media are available; please refer to the Computer Users Catalog for a complete listing.

**Ordering Information**

Interface cables	Price
HP 17355D Male-female RS-232-C/CCITT V.24 cable for use in remote modem environments; pins 1-25 wired end-to-end	\$60 ☛
HP 17255F Female-female RS-232-C/CCITT V.24 cable, adapted for use with IBM personal computer interface	\$40 ☛
HP 17255D Male-female RS-232-C/CCITT V.24 cable, adapted for use with HP 150 personal computer interface	\$40 ☛
HP 17855A RS-422-A adapter cable	\$200 ☛
HP 10833A or 45529A HP-IB 1-metre cable; RFI shielded	\$80 ☛
HP 10833B or 45529B HP-IB 2-metre cable; RFI shielded	\$90 ☛

**Accessories Available**

HP 17526A A3-size Media Handling Kit, including media loading tray, media catcher, 50 sheets A3-size plotter paper	\$160 ☛
HP 17525A B-size Media Handling Kit, including media loading tray, media catcher, 50 sheets B-size plotter paper	17092A \$160 ☛ 17600
HP 17564A B-size Loading Tray	\$110
HP 17565A A3-size Loading Tray	\$110
HP 17566A B-size Media Catcher	\$42

**HP 7550A Graphics Plotter** **\$3900 ☛**  
☛ Fast-Ship product — see page 758.

# COMPUTER PERIPHERALS

## Plotters Low-cost, Eight-pen Drafting Plotter

### HP DraftPro Plotter

- Professional, quality output
- Solid software support
- Pens and media for every application
- A2/C/Architectural C- and A1/D/Architectural D-size media

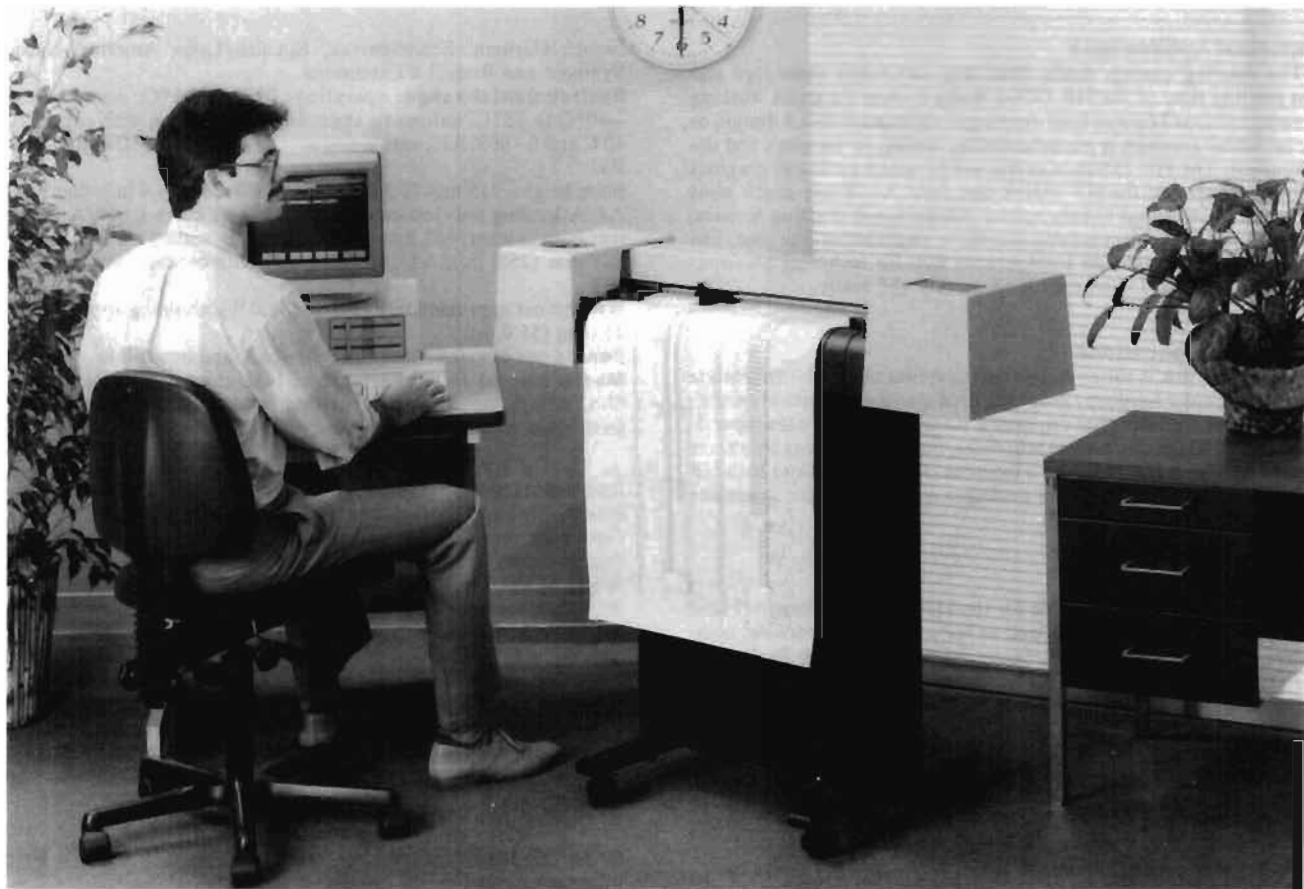

The HP DraftPro plotter is an 8-pen drafting plotter that's been designed especially for you and your personal CAD system. The HP DraftPro plots on single sheets with widths from 550 mm to 640 mm and lengths from 400 mm to 1000 mm. That includes ISO A2 and A3 sizes, ANSI C and D sizes, and Architectural C and D sizes.

Whether you create electrical schematics, floor plans, part renderings, or topographical maps, the DraftPro plotter offers the professional-quality output your work deserves — at a price you can afford.

#### High-Quality Output

When your drawings look good, you look good. So you need high-quality output that reflects the professional nature of your work. The DraftPro plotter provides the high-quality output you expect from a Hewlett-Packard product.

The DraftPro plotter has a mechanical resolution of **0.013 mm** (0.0005 in.) and an addressable resolution of 0.025 mm (0.001 in.) to ensure you get smooth arcs and crisp letters. And with DraftPro's repeatability of 0.10 mm (0.004 in.), your drawings will have precise corners and circles that close.

For applications that require precision plotting, accuracy is an important specification. Accuracy refers to the difference in length between distance the plotter is instructed to draw and the distance it actually draws. The DraftPro plotter is accurate to within 0.5 mm (0.02 in.) or 0.2% of the specified line length, whichever is greater.

#### Media and Pen Flexibility

Different types of media are appropriate for different applications. And for best results, it's important to use pens that are compatible with your media. The DraftPro plotter plots on paper, vellum, and polyester film. And it draws with fiber-tip pens, disposable liquid-ink pens, and refillable liquid-ink pens.

The HP DraftPro also allows you to choose one of eight different plotting speeds right from the front-panel. You can select the speed that is most appropriate for your pen/media combination.

#### Eight-pen Carousel

The DraftPro plotter's eight-pen carousel means you have access to a wide variety of colors and line widths for every drawing. During a plot, pens are changed automatically and they are automatically capped when not in use. Two carousels come with every DraftPro plotter — one for fiber-tip pens, and one for drafting pens.

#### High Throughput

Hewlett-Packard knows that you don't have time to sit around and wait for your plots to finish. In addition to its 2 g acceleration and 40 cm/s (15.7 in./s) velocity, the DraftPro plotter has several features that help minimize plotting time.

The DraftPro plotter has a "pen sorting" feature; the plotter minimizes the number of pen picks by grouping lines of the same color together and drawing them at the same time. In addition, the HP DraftPro has strong communication abilities, and raises and lowers the pen quickly.

### Easy-to-Use

With the HP DraftPro, you can start producing drawings the same day you unpack the plotter. The paper and pen loading procedures are simple, and the front-panel controls can be mastered in minutes. And when you're loading media, the HP DraftPro automatically senses the sheet size and sets the margins accordingly.

The DraftPro plotter is small and lightweight, so it fits almost anywhere. And because it has its own set of wheels, the DraftPro is easy to move and easy to share.

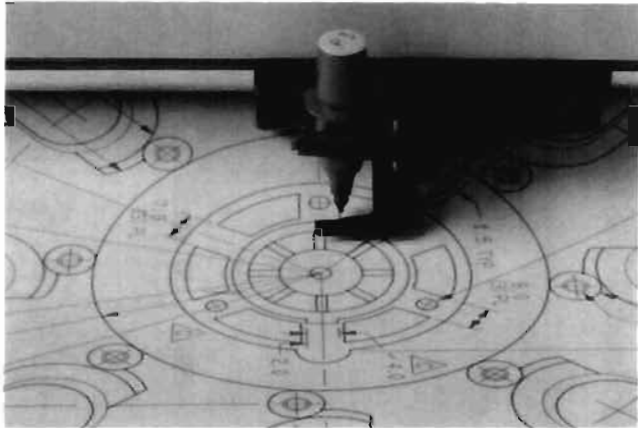

### Powerful Command Set

Programmers will be glad to know the HP DraftPro supports more than 80 HP-GL (Hewlett-Packard Graphics Language) commands. With just a few commands, you can label; draw lines, arcs, and circles; or select one of 20 international character sets.

### Hardware and Software Compatibility

The DraftPro plotter connects easily to almost any HP or other personal computer or workstation. An RS-232-C/CCITT V.24 interface comes standard; HP-IB (IEEE 488-1978) can be ordered as an accessory.

Like all HP drafting plotters, the DraftPro is supported by the leading software vendors. Check with your local HP sales and support office for complete software information. Or contact your current software vendor about their support for the DraftPro.

### Specifications

**Media sizes:** accommodates widths from 550 mm to 640 mm, lengths from 400 mm to 1000 mm. These measurements include A2/C/Architectural C- and A1/D/Architectural D-size media.

**Margins:** Expanded mode, 5 mm (0.2 in.) on three edges, 31 mm (1.2 in.) on the fourth; Normal mode, 15 mm (0.59 in.) on three edges, 39 mm (1.5 in.) on the fourth.

**Resolution:** smallest addressable move, 0.025 mm (0.001 in.); mechanical resolution, 0.013 mm (0.0005 in.)

**Repeatability:** (for the same pen): 0.10 mm (0.004 in.); (pen to pen): 0.20 mm (0.008 in.). These specifications are for 0.08 mm (0.003 in.) polyester film.

**Accuracy:** 0.5 mm (0.02 in.) or 0.2% of the specified line length, whichever is greater. These specifications are for 0.08 mm (0.003 in.) polyester film.

**Pen Velocity:** pen down, 40 cm/s (15.7 in./s); pen up, 50 cm/s (19.7 in./s)

**Acceleration:** 2 g

**Pen Cycle Time:** 100 ms

**Power requirements:** source, 100, 120, 220, 240 V  $\pm$  10%; frequency, 47.5-66 Hz; consumption, less than 80 W maximum.

**Interfaces:** RS-232-C, CCITT V.24, HP-IB (IEEE 488-1978) available as an accessory. HP-IB (IEEE 488-1978), implements the following HP-IB functions as defined in IEEE 488-1978: SH1, AHL, T6, L3, SR1, RL0, DC1, DT0, C0, PP0 for listen-only, PP1 for address greater than 7, and PP2 for address of 7 or less. For more on these codes, refer to the HP-IB section of this catalog.

**Buffer size:** 7448 bytes (to be shared between user-definable I/O, polygon, and pen sort buffers)

**Environmental Range:** operating temperature, 0° C to 55° C; non-operating temperature, -40° C to 75° C; relative humidity, 5% to 95% (in 0° C to 40° C)

**Size:** height, 1030 mm (40.6 in.); width, 1140 mm (44.9 in.); depth, 520 mm (20.5 in.)

**Weight:** 30 kg (66 lb)

**Pens:** 8-pen carousel: fiber-tip, disposable liquid-ink, and refillable liquid-ink drafting pens.

**Media:** Paper, vellum, and double-matte polyester film.

### Accessories Supplied

User's Guide

Power Cord

Media Sampler Kit

5 sheets of architectural D-size paper

Fiber-tip pens (0.3 mm)

Pkg of 5 (black, green, red, and yellow)

Carousels

Fiber-tip pen carousel

Liquid-ink drafting pen carousel

Grit Wheel Brush

Hewlett-Packard Drafting Supplies Catalog

(P/N 5958-9321 (D) or 5958-9322)

### Ordering Information

HP 7570A DraftPro Plotter

HP 17570A HP-IB Cartridge

### Price

\$5,400

\$395

### Accessories Available

Description

HP-IB Installation Instructions

Programmer's Reference (available in English only)

Programmer's Pocket Guide (available in English only)

Hardware Support Manual

Part Number

07570-90014

07570-90001

07570-90003

07570-90000

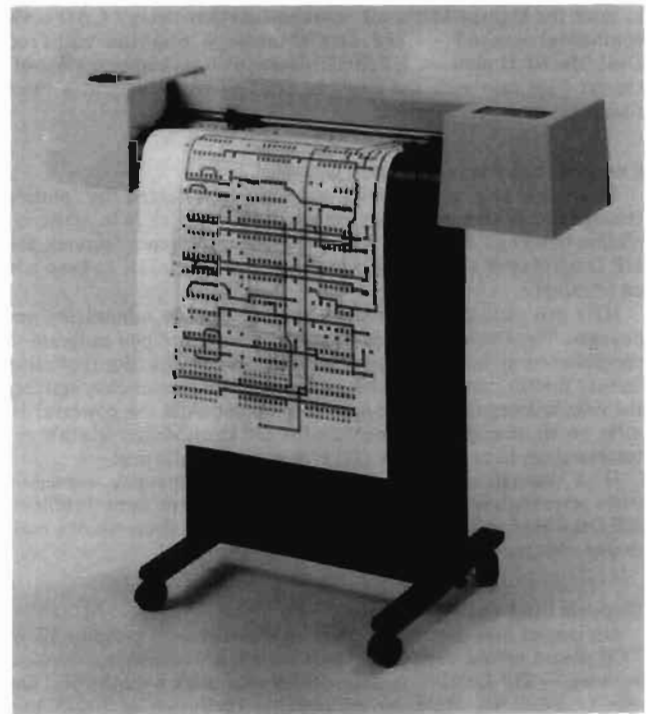

# COMPUTER PERIPHERALS

## Plotters—High Performance, A4/A through A0/E size Drafting Plotters

HP DraftMaster I and DraftMaster II

- High throughput; up to 5.7 g acceleration
- Built-in intelligence
- Superb line quality
- Triple interface: RS-232-C, RS-422-A, HP-IB
- HP 758XB emulation
- Accepts eight standard media sizes



Hewlett-Packard has created a new generation of drafting plotters to meet the high-performance requirements that today's CAD environments demand — the DraftMaster I and the roll-feed DraftMaster II plotters. HP DraftMaster plotters combine state-of-the-art hardware with the latest in drafting technology at a price that's less than you'd expect.

### Exceptional Performance

Your drafting productivity is directly affected by plotter throughput. With a maximum pen speed of 60 cm/s (24 in./s) acceleration of up to 5.7 g, and a host of built-in intelligence features, the HP DraftMaster's plotting power gets the job done fast to keep you on schedule.

HP's pen sorting function trims plotting time by minimizing pen changes. The DraftMaster plotter scans your entire plot program to combine pen-up moves wherever possible. The bi-directional plotting feature further increases drawing efficiency by automatically starting the next line segment at its nearest endpoint. And the powerful 10 MHz 16-bit microprocessor enables the HP DraftMaster to draw numerous short lines quickly, a real advantage for lettering.

High throughput is essential in shared environments, especially when several users who share a plotter are facing the same deadlines. HP DraftMaster is designed to meet the increased demands of a multi-user system.

### Superb Line Quality

No matter how demanding your application — a complex IC or PCB plot, a precise mechanical part design, a detailed architectural drawing — HP DraftMaster showcases your work with the best line quality available. With an addressable resolution of 0.025 mm

(0.00098 in.) and repeatability of 0.10 mm (0.004 in.), you can be sure your design will have a first-class presentation.

### Roll-feed Capability on HP DraftMaster II Plotter

HP DraftMaster II is designed for high-volume, continuous feed, and long-axis plotting. HP DraftMaster II's roll-feed capability keeps productivity humming at peak levels when several users share a plotter. You can store the completed drawings neatly on the take-up roll, or cut them off one at a time with the built-in media cutter.

When your work requires unattended roll-feed plotting, you can use the DraftMaster plotter's "group pen" function. You can plot up to eight times longer on single-color plots (or four times longer on two-color plots) without stopping to reload the pen carousel. After the first pen has plotted a preset distance, the DraftMaster plotter automatically switches to the next pen in that group.

### Simple Operation

HP DraftMaster plotters are designed for fast and convenient operation with easy, common-sense controls. The 32-character liquid crystal display (LCD) presents easy-to-follow command menus in six major languages.

A convenient loading lever makes media handling fast and uncomplicated. Plus, HP DraftMaster senses media size and automatically scales plot size to fit, so there's no worry about pens drawing off the page. DraftMaster's generous eight-pen carousels eliminate time-consuming manual pen changes. And pens are always capped automatically to prevent ink from drying out. You won't have to reset pen speed and force when you change carousels, either — HP DraftMaster senses the type of carousel and automatically adjusts speed and force.

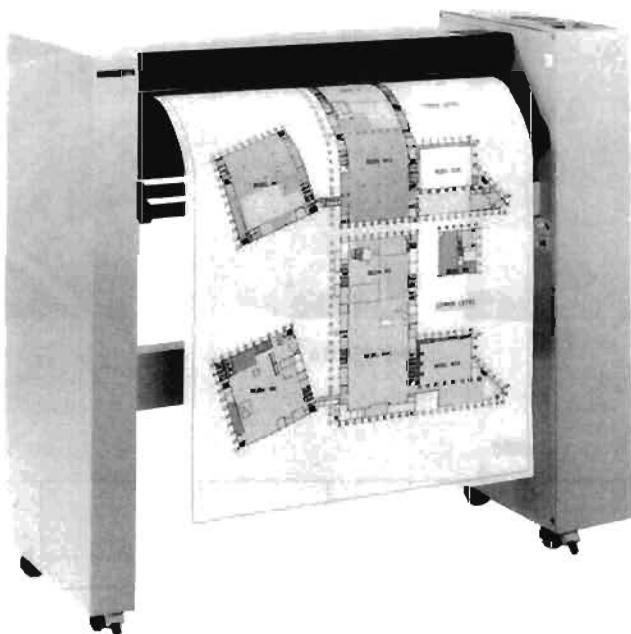

### Pen, Media Flexibility

With the HP DraftMaster Plotter, you can choose from vellum, polyester film, tracing bond, paper, and even transparency film and glossy paper, in A4/A through A0/E-size cut sheets. The HP DraftMaster II also plots on continuous rolls for high-volume, unattended operation, as well as long-axis plotting.

All HP pens and media are carefully designed and tested to give you top-quality results from your HP plotter. HP pens are available in a wide variety of point sizes and colors; the DraftMaster plotter accepts your choice of fiber-tip, roller-ball, and drafting pens (both disposable and refillable).

### Compatibility

Whether you have a personal computer, technical workstation, minicomputer, or mainframe, you can add an HP DraftMaster plotter to your system. For maximum hardware compatibility, all HP DraftMaster plotters come with a triple interface — both RS-232-C/CCITT V.24 and HP-IB (IEEE 488-1978), as well as RS-422-A for longer distance computer connections. And HP DraftMaster plotters have full eavesdrop capability (dual serial I/O for terminal configurations).

### HP 758XB Emulation Mode

There's a tremendous amount of software already available for the DraftMaster plotters because all of the software written for the HP 7585B and 7586B drafting plotters will run on the HP DraftMaster I and II. Just the touch of a button engages HP's proprietary software emulation feature.

### International Design

The LCD menu can prompt in any of six languages: English (default), French, German, Italian, Spanish, and Japanese. The front-panel buttons are labeled with symbols instead of words. And when programming with HP-GL (Hewlett-Packard Graphics Language) commands, users can select from over 20 international character sets in three fonts.

### Specifications

**Media sizes:** ranges include ISO sizes A0 through A4, ANSI sizes A through E, and architectural sizes, as well as oversized media. DraftMaster I (sheets only): acceptable media widths: 207-381 mm (8.15-15 in.), 539-713 mm (21.22-28.07 in.), 753-927 mm (29.65-36.5 in.). DraftMaster II (same sheet sizes as listed above, plus these roll sizes): width, 609.6 mm (24 in.), 914.4 mm (36 in.); length, 46

metres (150 ft). Maximum frame lengths, 609.6 mm (24 in.) rolls, 914.4 mm (36 in.), 938.4 mm (36.9 in.) rolls, 1243.2 mm (48.9 in.)

**Margins (sheets only):** normal mode: three margins approx. 15 mm (0.59 in.) each, fourth margin approx. 39 mm (1.54 in.). Expanded mode: three margins approx. 5 mm (0.2 in.) each, fourth margin approx. 29 mm (1.14 in.)

**Resolution:** smallest addressable step size, 0.025 mm (0.00098 in.)

**Repeatability (for a given pen):** 0.025 mm (0.00098 in.)

**Accuracy:** 0.09% of the move or 0.25 mm (0.0098 in.), whichever is greater.

**Pen velocity:** pen up/down, 60 cm/s (24 in./s) independent of vector direction

**Acceleration:** maximum, 5.7 g (55.6 m/s<sup>2</sup>) on diagonal; 4 g per axis; programmable, 2 or 4 g (19.4 or 39 m/s<sup>2</sup>)

**Pen force:** programmable or front panel selectable; 15-66 grams

**Power requirements:** Source, 100, 120, 220, 240, V $\pm$ 10%; frequency 48-66 Hz; consumption, 105 W maximum.

**Interfaces:** HP-IB (IEEE 488-1978), RS-232-C/CCITT V.24, RS-422-A

**Buffer size:** 26 K (configurable)

**Environmental range:** operating temperature, 0° to 55° C; non-operating temperature, -40° to -75° C; relative humidity, sheets, 5-95%; rolls, 30-70%.

**Size:** height, 120.0 cm (47 in.); width, 134.6 cm (53 in.); depth, 40.8 cm (20 in.)

**Weight:** DraftMaster I, 73 kg (160 lb); DraftMaster II, 75 kg (164 lb)

**Pens:** 8 in carousel; automatic pen changing and capping; automatic setting. Fiber-tip, roller-ball, long-body drafting (refillable or disposable)

**Media:** Vellum, double-matte polyester film, tracing bond, plotter paper, transparency film, and glossy paper.

### Accessories Supplied

Description	HP Part No.
User's Guide	07595-90002
Pocket Guide (available in English only)	07595-90003
Drafting Supplies Catalog	5958-9321D
	5958-9322
Paper sampler, A1 size (5)	9280-9050
Adjustable carousel (2)	5062-1576
Disposable pen adapters (4)	5061-7578
Disposable vellum pens (4)	5061-7566
Roller-ball pens (4)	5061-5037
Fiber-tip pens (10)	17845P
Grit-wheel brush	07595-20085
Power cord (appropriate cord supplies based on destination)	

### Additional Accessories Supplied with DraftMaster II

Description	HP Part No.
914.4 mm (36 in.) paper spool	9300-1069
Paper roll sampler, 914.4 mm (36 in.) wide, 1143 mm (45 ft) long	9280-0736
Media cutters (5)	07596-60008

### Ordering Information

	Price
HP 7595A DraftMaster I plotter (sheet-feed only)	\$9,900
HP 7596A DraftMaster II plotter (sheet-feed and roll-feed)	\$11,900

### Accessories Available

Description	HP Part No.
Programmer's Reference (available in English only)	07595-90001
Roll-feed Upgrade Kit (HP DraftMaster I only; must be installed by qualified serviceperson)	07595-60070
Kanji Retrofit Kit (must be installed by qualified serviceperson)	07595-60104
HP Industry Standard Plotting Package (software)	17580C

# COMPUTER PERIPHERALS

## Plotters — Comparison Guide



ColorPro (HP 7440A)



HP 7475A

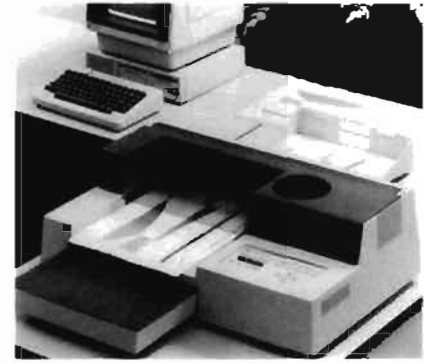

HP 7550A



DraftPro (HP 7470A)

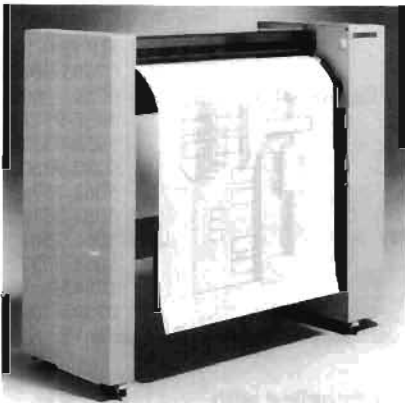

DraftMaster I (HP 7595A)

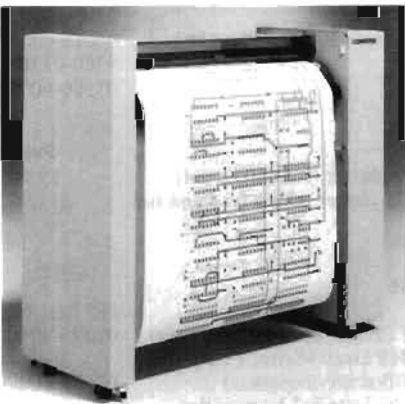

DraftMaster II (HP 7596A)

### HP Pen Plotter Comparison Guide

HP Model	Number of pens	Pen types	Media sizes	Media types	Media load methods	Interfaces	Page
ColorPro (HP 7440A)	8 in carousel	Paper, transparency	A4/A	Paper, transparency film	Manual sheet loading for all media types	RS-232-C/CCITT V.24 or (HP-IB) IEEE-488	718
HP 7475A	6 in carousel	Paper, transparency, liquid-ink	A4/A, A3/B	Paper, transparency film, polyester film	Manual sheet loading for all media types	RS-232-C/CCITT V.24 or (HP-IB) IEEE-488	719
HP 7550A	8 in carousel	Paper, transparency, liquid-ink, roller-ball	A4/A, A3/B	Paper, transparency film, vellum, polyester film	Automatic sheet feed for paper, transparency film Manual sheet loading for all media types	RS-232-C/CCITT V.24 and (HP-IB) IEEE-488	720
DraftPro (HP 7570A)	8 in carousel	Paper, liquid-ink	A2/C, A1/D	Paper, vellum, polyester film	Manual sheet loading for all media types	RS-232-C/CCITT V.24 (standard) (HP-IB) IEEE-488 (optional)	722
DraftMaster I (HP 7595A)	8 in carousel	Paper, transparency, liquid-ink, roller-ball	A4/A, A0/E	Paper, transparency film, vellum, tracing bond, polyester film	Manual sheet loading for all media types	RS-232-C/CCITT V.24, RS-422-A, and (HP-IB) IEEE-488	724
DraftMaster II (HP 7596A)	8 in carousel	Paper, transparency, liquid-ink, roller-ball	A4/A, A0/E, 24" and 36" rolls	Paper, transparency film, vellum, tracing bond, polyester film	Automatic roll feed for all media types except tracing bond and transparency film Manual sheet loading for all media types	RS-232-C/CCITT V.24, RS-422-A, and (HP-IB) IEEE-488	724



- Designer color system



Hewlett-Packard offers a complete line of pens, drawing media, and accessories for both business and technical graphics applications. And all these supplies are manufactured in the HP tradition of quality — quality that you'll see reflected in your work.

### Designer Color System

HP's family of compatible plotter supplies consists of fiber-tip paper pens and transparency pens, plotter paper, glossy plotter paper and transparency plotter film. The fiber-tip pens are available in 10 matching colors so that you can create paper duplicates of your transparencies. Pen colors are black, green, aqua, blue, violet, red-violet, red, orange, yellow and brown. Pens are available in narrow and wide line widths (0.3 mm and 0.7 mm for paper pens; 0.3 mm and 0.6 mm for transparency pens).

Paper pens can be used on all plotters. You can obtain high quality results with HP plotter paper for graphs and large quantities. Use HP glossy paper for reports and presentations. Transparency pens can be used on the HP ColorPro, DraftMaster, 7470, 7475, 7550, 7090, 9872, 7220/7221, and 7225 plotters with HP transparency film for overhead presentations or with HP glossy paper for presentation handouts.

Convenient, economical starter kits are available for the first time plotter use. Each kit contains all the supplies needed to start preparing either paper graphics or overhead transparencies. HP's Paper and Pen Plotter Kit contains all supplies for paper graphics — 15 fiber-tip paper pens in 10 colors and 2 line widths, 250 sheets of plotter paper and HP's "A Personal Guide to Professional Business Graphics". HP's Transparency Plotter Kit contains all supplies for overhead transparencies — 15 fiber-tip transparency pens in 10 colors and 2 line widths, 50 sheets of transparency film and HP's "A Personal Guide to Professional Business Graphics".

- Disposable drafting pens

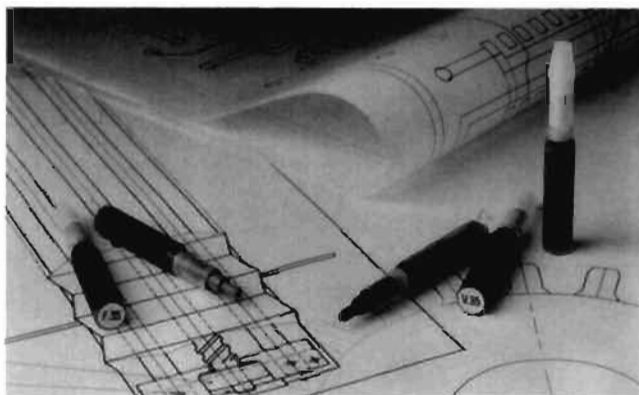

### Technical Drafting Applications

Hewlett-Packard offers three different types of pens and four different types of media so you can select the pen/media combination that's right for your application. Fiber-tip pens are available in ten colors for use on plotter paper. Roller-ball pens come in four colors. In addition to four line widths for disposable drafting pens, HP offers long-body and short-body drafting pens in six line widths.

Sheets of plotter paper, vellum, tracing bond, and polyester film, are available in a range of five sizes, both English (A to E) and metric (A4 to A0). Polyester film, vellum, and plotter paper come in 914.4 mm (36 in.) and 609.6 mm (24 in.) rolls for use with the HP 7586B and DraftMaster 11 roll-feed drafting plotters.

### Disposable Drafting Pens

These pens are designed especially for preliminary drawings and checkplots on plotter paper or final drawings on vellum. Disposable drafting pens come in four line widths and eight colors. Our new pens for use with polyester film produce the same, final plot, archival drawings you've come to expect with a refillable drafting pen but without the messy cleaning or refilling.

### Ordering Information

Plotter supplies may be ordered through HP's direct telephone ordering service, from any HP sales and support office, or from your local retail dealer. The HP Computer User's Catalog (P/N 5953-2450) describes the complete range of plotter supplies and accessories.

### For Best Results

	Paper	Glossy Paper Transparency Film	Tracing Bond	Vellum	Polyester Film
Fiber-tip pens (paper)	HP ColorPro HP 7475 HP 7550 HP DraftPro HP DraftMaster HP 7580 HP 7585 HP 7586				
Fiber-tip pens (transparency)		HP ColorPro HP DraftMaster HP 7475 HP 7550			
Roller-ball pens			HP 7550 HP DraftMaster HP 7580 HP 7585 HP 7586		
Disposable drafting Pens	HP 7550 HP DraftMaster HP 7580 HP 7585 HP 7586			HP 7550 HP DraftPro HP DraftMaster HP 7580 HP 7585 HP 7586	HP 7550 HP DraftPro HP DraftMaster HP 7580 HP 7585 HP 7586
Refillable drafting pens				HP 7550 HP DraftPro HP DraftMaster HP 7580 HP 7585 HP 7586	HP 7550 HP DraftPro HP DraftMaster HP 7580 HP 7585 HP 7586

The undersigned hereby certifies that the foregoing is a true and correct copy of the original as the same appears in the records of the County of [County Name], State of [State Name].

Witness my hand and the seal of the County of [County Name], State of [State Name], this [Day] day of [Month], 20[Year].

Notary Public for the State of [State Name]

My commission expires on [Date]

Case No.	Case Name	Case Type	Case Status
10-12345	John Doe vs. Jane Smith	Personal Injury	Settled
10-23456	ABC Corp vs. DEF Corp	Contract Dispute	On Trial
10-34567	XYZ Inc vs. 123 LLC	Real Estate	Completed
10-45678	456 LLC vs. 789 LLC	Business Dispute	On Trial
10-56789	789 LLC vs. 101 LLC	Business Dispute	On Trial
10-67890	101 LLC vs. 202 LLC	Business Dispute	On Trial
10-78901	202 LLC vs. 303 LLC	Business Dispute	On Trial
10-89012	303 LLC vs. 404 LLC	Business Dispute	On Trial
10-90123	404 LLC vs. 505 LLC	Business Dispute	On Trial
10-01234	505 LLC vs. 606 LLC	Business Dispute	On Trial
10-12345	606 LLC vs. 707 LLC	Business Dispute	On Trial
10-23456	707 LLC vs. 808 LLC	Business Dispute	On Trial
10-34567	808 LLC vs. 909 LLC	Business Dispute	On Trial
10-45678	909 LLC vs. 1010 LLC	Business Dispute	On Trial
10-56789	1010 LLC vs. 1111 LLC	Business Dispute	On Trial
10-67890	1111 LLC vs. 1212 LLC	Business Dispute	On Trial
10-78901	1212 LLC vs. 1313 LLC	Business Dispute	On Trial
10-89012	1313 LLC vs. 1414 LLC	Business Dispute	On Trial
10-90123	1414 LLC vs. 1515 LLC	Business Dispute	On Trial
10-01234	1515 LLC vs. 1616 LLC	Business Dispute	On Trial
10-12345	1616 LLC vs. 1717 LLC	Business Dispute	On Trial
10-23456	1717 LLC vs. 1818 LLC	Business Dispute	On Trial
10-34567	1818 LLC vs. 1919 LLC	Business Dispute	On Trial
10-45678	1919 LLC vs. 2020 LLC	Business Dispute	On Trial
10-56789	2020 LLC vs. 2121 LLC	Business Dispute	On Trial
10-67890	2121 LLC vs. 2222 LLC	Business Dispute	On Trial
10-78901	2222 LLC vs. 2323 LLC	Business Dispute	On Trial
10-89012	2323 LLC vs. 2424 LLC	Business Dispute	On Trial
10-90123	2424 LLC vs. 2525 LLC	Business Dispute	On Trial
10-01234	2525 LLC vs. 2626 LLC	Business Dispute	On Trial
10-12345	2626 LLC vs. 2727 LLC	Business Dispute	On Trial
10-23456	2727 LLC vs. 2828 LLC	Business Dispute	On Trial
10-34567	2828 LLC vs. 2929 LLC	Business Dispute	On Trial
10-45678	2929 LLC vs. 3030 LLC	Business Dispute	On Trial
10-56789	3030 LLC vs. 3131 LLC	Business Dispute	On Trial
10-67890	3131 LLC vs. 3232 LLC	Business Dispute	On Trial
10-78901	3232 LLC vs. 3333 LLC	Business Dispute	On Trial
10-89012	3333 LLC vs. 3434 LLC	Business Dispute	On Trial
10-90123	3434 LLC vs. 3535 LLC	Business Dispute	On Trial
10-01234	3535 LLC vs. 3636 LLC	Business Dispute	On Trial
10-12345	3636 LLC vs. 3737 LLC	Business Dispute	On Trial
10-23456	3737 LLC vs. 3838 LLC	Business Dispute	On Trial
10-34567	3838 LLC vs. 3939 LLC	Business Dispute	On Trial
10-45678	3939 LLC vs. 4040 LLC	Business Dispute	On Trial
10-56789	4040 LLC vs. 4141 LLC	Business Dispute	On Trial
10-67890	4141 LLC vs. 4242 LLC	Business Dispute	On Trial
10-78901	4242 LLC vs. 4343 LLC	Business Dispute	On Trial
10-89012	4343 LLC vs. 4444 LLC	Business Dispute	On Trial
10-90123	4444 LLC vs. 4545 LLC	Business Dispute	On Trial
10-01234	4545 LLC vs. 4646 LLC	Business Dispute	On Trial
10-12345	4646 LLC vs. 4747 LLC	Business Dispute	On Trial
10-23456	4747 LLC vs. 4848 LLC	Business Dispute	On Trial
10-34567	4848 LLC vs. 4949 LLC	Business Dispute	On Trial
10-45678	4949 LLC vs. 5050 LLC	Business Dispute	On Trial
10-56789	5050 LLC vs. 5151 LLC	Business Dispute	On Trial
10-67890	5151 LLC vs. 5252 LLC	Business Dispute	On Trial
10-78901	5252 LLC vs. 5353 LLC	Business Dispute	On Trial
10-89012	5353 LLC vs. 5454 LLC	Business Dispute	On Trial
10-90123	5454 LLC vs. 5555 LLC	Business Dispute	On Trial
10-01234	5555 LLC vs. 5656 LLC	Business Dispute	On Trial
10-12345	5656 LLC vs. 5757 LLC	Business Dispute	On Trial
10-23456	5757 LLC vs. 5858 LLC	Business Dispute	On Trial
10-34567	5858 LLC vs. 5959 LLC	Business Dispute	On Trial
10-45678	5959 LLC vs. 6060 LLC	Business Dispute	On Trial
10-56789	6060 LLC vs. 6161 LLC	Business Dispute	On Trial
10-67890	6161 LLC vs. 6262 LLC	Business Dispute	On Trial
10-78901	6262 LLC vs. 6363 LLC	Business Dispute	On Trial
10-89012	6363 LLC vs. 6464 LLC	Business Dispute	On Trial
10-90123	6464 LLC vs. 6565 LLC	Business Dispute	On Trial
10-01234	6565 LLC vs. 6666 LLC	Business Dispute	On Trial
10-12345	6666 LLC vs. 6767 LLC	Business Dispute	On Trial
10-23456	6767 LLC vs. 6868 LLC	Business Dispute	On Trial
10-34567	6868 LLC vs. 6969 LLC	Business Dispute	On Trial
10-45678	6969 LLC vs. 7070 LLC	Business Dispute	On Trial
10-56789	7070 LLC vs. 7171 LLC	Business Dispute	On Trial
10-67890	7171 LLC vs. 7272 LLC	Business Dispute	On Trial
10-78901	7272 LLC vs. 7373 LLC	Business Dispute	On Trial
10-89012	7373 LLC vs. 7474 LLC	Business Dispute	On Trial
10-90123	7474 LLC vs. 7575 LLC	Business Dispute	On Trial
10-01234	7575 LLC vs. 7676 LLC	Business Dispute	On Trial
10-12345	7676 LLC vs. 7777 LLC	Business Dispute	On Trial
10-23456	7777 LLC vs. 7878 LLC	Business Dispute	On Trial
10-34567	7878 LLC vs. 7979 LLC	Business Dispute	On Trial
10-45678	7979 LLC vs. 8080 LLC	Business Dispute	On Trial
10-56789	8080 LLC vs. 8181 LLC	Business Dispute	On Trial
10-67890	8181 LLC vs. 8282 LLC	Business Dispute	On Trial
10-78901	8282 LLC vs. 8383 LLC	Business Dispute	On Trial
10-89012	8383 LLC vs. 8484 LLC	Business Dispute	On Trial
10-90123	8484 LLC vs. 8585 LLC	Business Dispute	On Trial
10-01234	8585 LLC vs. 8686 LLC	Business Dispute	On Trial
10-12345	8686 LLC vs. 8787 LLC	Business Dispute	On Trial
10-23456	8787 LLC vs. 8888 LLC	Business Dispute	On Trial
10-34567	8888 LLC vs. 8989 LLC	Business Dispute	On Trial
10-45678	8989 LLC vs. 9090 LLC	Business Dispute	On Trial
10-56789	9090 LLC vs. 9191 LLC	Business Dispute	On Trial
10-67890	9191 LLC vs. 9292 LLC	Business Dispute	On Trial
10-78901	9292 LLC vs. 9393 LLC	Business Dispute	On Trial
10-89012	9393 LLC vs. 9494 LLC	Business Dispute	On Trial
10-90123	9494 LLC vs. 9595 LLC	Business Dispute	On Trial
10-01234	9595 LLC vs. 9696 LLC	Business Dispute	On Trial
10-12345	9696 LLC vs. 9797 LLC	Business Dispute	On Trial
10-23456	9797 LLC vs. 9898 LLC	Business Dispute	On Trial
10-34567	9898 LLC vs. 9999 LLC	Business Dispute	On Trial
10-45678	9999 LLC vs. 10100 LLC	Business Dispute	On Trial

[Faint, illegible text in the right column, likely bleed-through from the reverse side of the page.]

Notary Public for the State of [State Name]

My commission expires on [Date]

## **ACCESSORIES, SUPPORT & OFFICES**

<b>Cables &amp; Adapters .....</b>	<b>730</b>
<b>Transit Cases .....</b>	<b>732</b>
<b>Operating Cases .....</b>	<b>736</b>
<b>Cabinet Accessories .....</b>	<b>738</b>
<b>Free Publications.....</b>	<b>744</b>
<b>Ordering Information .....</b>	<b>745</b>
<b>Customer Support.....</b>	<b>746</b>
<b>Sales &amp; Support Offices .....</b>	<b>760</b>

This group includes information on accessories for measurement, shipping, rack mounting and installation for test and measurement instruments and systems. It also includes a description of HP's service and support offering and a list of sales and support offices worldwide. There is also information on placing an order and communicating with HP, as well as descriptions of some of the free publications available.

**Accessories,  
Support & Offices**

# CABLES & ADAPTERS

## Cables, Adapters & Typical SWR Performance

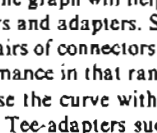
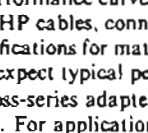
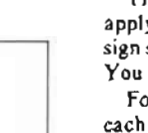
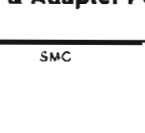
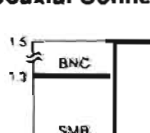
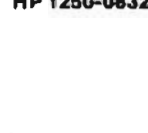
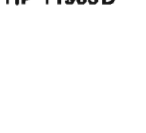
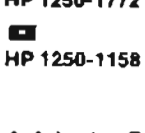
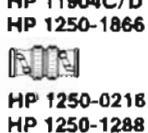
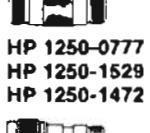
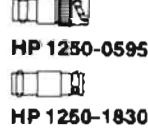
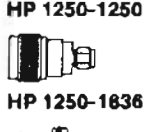
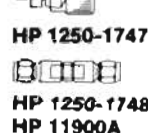
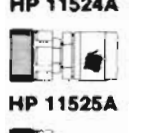
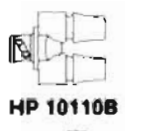
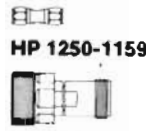
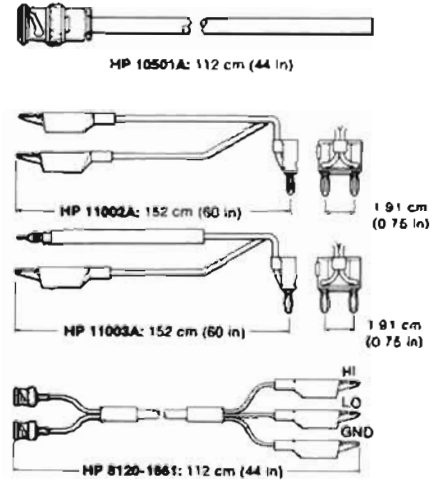
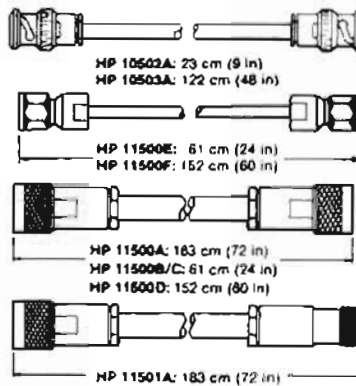
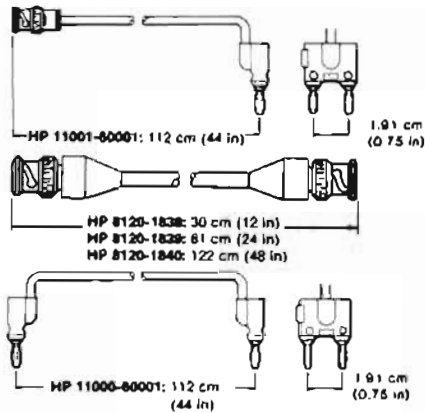

### Coaxial Connector & Adapter Performance

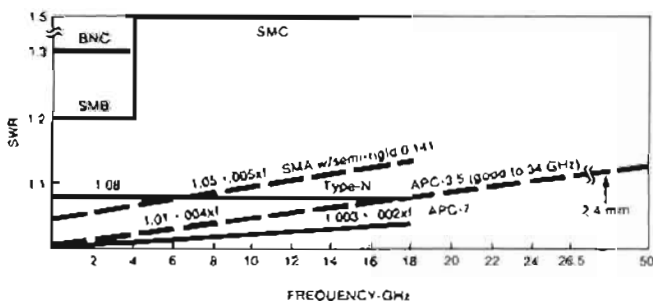

Typical SWR for connector pairs.

The performance curves in the graph will help you in choosing and applying HP cables, connectors and adapters. SWR curves show design specifications for mated pairs of connectors of the type indicated. You can expect typical performance in that range.

For cross-series adapters, use the curve with the highest SWR in each case. For applications of Tee-adapters such as HP 1250-0559, 1250-0846 and 1250-0781, be sure to consider the extra shunt capacitance of the Tee.

Of course when HP mounts various connectors onto RF and microwave products, the product specification predominates and SWR is often far superior to that shown in these utility curves. For example, the HP "precision" Type-N adapters shown on these pages are for high accuracy use dc-1.3 GHz where SWR < 1.03.

For more information on history and performance of various coax connectors, see HP's *Coaxial & Waveguide Measurement Accessories Catalog*. (Lit # 5954-6401).

**HP Part Number**
**Price**
**HP Part Number**
**Price**
**Cable Assemblies**

<b>HP 10601A:</b> 112 cm 50Ω coax with one UG-88C/U BNC (m) connector	\$15.00
<b>HP 10502A:</b> 23 cm 50Ω coax with UG-88C/U BNC (m) connectors	\$20.00
<b>HP 10603A:</b> like HP 10503A, but 122 cm	\$25.00
<b>HP 8120-1838:</b> 30 cm 50Ω coax with two BNC (m) connectors	\$19.50
<b>HP 8120-1839:</b> like HP 8120-1838, but 61 cm	\$20.00
<b>HP 8120-1840:</b> like HP 8120-1838, but 122 cm	\$23.50
<b>HP 11000-80001:</b> 112 cm 50Ω coax with dual banana plugs	\$29.00
<b>HP 11001-80001:</b> 112 cm 50Ω coax, UG-88C/U BNC (m) to dual banana plug	\$26.00
<b>HP 11002A</b> Test Leads: 152 cm, alligator clips to dual banana plug	\$20.00
<b>HP 11003A</b> Test Leads: 152 cm, probe and alligator clip to dual banana plug	\$20.00
<b>HP 8120-1861:</b> 112 cm, dual BNC (m) to alligator clips	\$90.00

**Adapters Type N, Standard 75 Ω<sup>[2]</sup>**

<b>1250-0597</b> N(m) (50Ω) to N(f) (75Ω)	\$18.50
<b>1250-1528</b> N(m) to N(m)	\$55.00
<b>1250-1529</b> N(f) to N(f)	\$38.00
<b>1250-1533</b> N(m) to BNC(m)	\$39.00
<b>1250-1534</b> N(f) to BNC(m)	\$32.00
<b>1250-1535</b> N(m) to BNC(f)	\$36.00
<b>1250-1536</b> N(f) to BNC(f)	\$31.00

**Adapters APC-3.5**

<b>1250-1743</b> APC-3.5(m) to N(m)	\$120.00
<b>1250-1744</b> APC-3.5(f) to N(m)	\$160.00
<b>1250-1745</b> APC-3.5(f) to N(f)	\$115.00
<b>1250-1746</b> APC-3.5(m) to APC-7	\$160.00
<b>1250-1747</b> APC-3.5(f) to APC-7	\$180.00
<b>1250-1748</b> APC-3.5(m) to APC-3.5(m)	\$145.00
<b>1250-1749</b> APC-3.5(f) to APC-3.5(f)	\$175.00
<b>1250-1750</b> APC-3.5(m) to N(f)	\$135.00
<b>1250-1866</b> APC-3.5(mm) to APC-3.5(f)	\$160.00

**Adapters SMA**

<b>1250-1158</b> SMA(f) to SMA(f)	\$18.00
<b>1250-1159</b> SMA(m) to SMA(m)	\$16.50

**Adapters APC-7<sup>Ⓞ</sup>**

<b>11524A</b> APC-7 to N(f)	\$165.00
<b>11525A</b> APC-7 to N(m)	\$165.00
<b>11533A</b> APC-7 to SMA (m)	\$230.00
<b>11534A</b> APC-7 to SMA (f)	\$230.00

**Adapter Banana Plug**

<b>1251-2816</b> Dual banana plug	\$6.00
-----------------------------------	--------

**Adapters BNC, Standard 50 Ω**

<b>1250-0069</b> BNC(m) to UHF(f)	\$30.00
<b>1250-0071</b> BNC(f) to UHF(m)	\$12.50
<b>1250-0076</b> Right angle BNC(UG-306/D)	\$10.75
<b>1250-0080</b> BNC(f) to BNC(f) (UG-914/U)	\$6.50
<b>1250-0216</b> BNC(m) to BNC(m)	\$10.50
<b>1250-0591</b> BNC(f) to WECO Video (m)	\$21.50
<b>1250-0595</b> BNC(f) to BNC Triaxial (m)	\$18.50
<b>1250-0781</b> BNC (cc(m)(f)(f)	\$12.00
<b>1250-1263</b> BNC(m) to single banana plug	\$18.00
<b>1250-1264</b> BNC(m) to dual banana plug	\$27.00
<b>1250-1830</b> BNC(f) to BNC Triaxial (f)	\$95.00
<b>1251-2277</b> BNC(f) to dual banana plug	\$15.50
<b>10110B</b> BNC(m) to dual banana plug	\$77.00

**Adapters BNC, Standard 75 Ω<sup>[3]</sup>**

<b>1250-1286</b> Right angle BNC	\$20.25
<b>1250-1287</b> BNC(f) to BNC(f)	\$10.25
<b>1250-1288</b> BNC(m) to BNC(m)	\$13.25

**Adapters SMB, SMC<sup>[4]</sup>**

<b>1250-0831</b> SMC(m) to BNC(m)	\$26.00
<b>1250-0832</b> SMC(f) to BNC(f)	\$30.00
<b>1250-1023</b> SMC(m) to N(m)	\$37.00
<b>1250-1152</b> SMC(f) to N(m)	\$55.00
<b>1250-1153</b> SMC(f) to N(f)	\$60.00
<b>1250-1236</b> SMB(f) to BNC(f)	\$32.00
<b>1250-1237</b> SMB(m) to BNC(f)	\$34.00

[1] "Precision": typically ≥38 dB return loss to 1.3 GHz

[2] Type N outer conductor; center pin sized for 75 Ω characteristic.

[3] BNC outer conductor; center pin sized for 75 Ω characteristic.

[4] SMB & SMC are used often inside HP instruments for inter-module RF connections.

[5] The K-connector is developed & manufactured by the Wiltron Co, Morgan Hill, CA.

SMB is Snap-on configuration

SMC is Screw-on configuration

Ⓞ APC-7 is a registered trademark of the Bunker Ramo Corporation

🚚 Fast-Ship product—see page 758.

# TRANSIT CASES

## Rugged Protection for Instruments



Typical System II Transit Case

Hewlett-Packard transit cases are rugged protective outer shells for use when instruments must be frequently transported or used away from laboratory conditions. HP cases protect your instruments from hostile environments, shock, vibration, moisture and impact, while providing a secure enclosure for shipping. The cases are molded from a structural composite which is 65% lighter than aluminum, yet provides excellent strength and durability. Tests of the composite show tensile and compressive strength exceeding 33,000 PSI and flexural strength exceeding 45,000 PSI.

### Typical Uses

Transit cases are a necessity whenever equipment is frequently transported from one operating location or test site to another, or is shipped for testing and calibration. Transit cases are particularly valuable for instruments used by service and repair personnel. For example, telephone companies frequently use transit cases for the

instruments they use to repair line faults. Transit cases are also valuable when instruments must be transported over rough roads, or are used in dusty environments or outdoors.

### Product Detail

HP transit cases are pressure molded of an extremely strong and light fiberglass and resin laminate which provides an excellent strength to weight ratio. All cases seal tightly with O-ring gaskets and clamping latches. They are rainproof under the test conditions of MIL-STD-108. Carrying handles are conveniently placed and fold flat when not in use.

Transit cases are typically provided with foam cushions that are designed to cradle the instrument securely. Maximum protection is provided against damage from handling, dropping or crushing. The cushion inserts are typically molded polyurethane, or are fabricated from slabs of polyurethane or polyethylene flexible foams. Each case/cushion unit is designed as its own shock and vibration damping system.

Hewlett-Packard's standard transit cases provide effective protection from all but the most abusive treatment. To ensure maximum protection for your instrument, transit cases are also available in versions that meet the specified requirements of MIL-STD-108, MIL-T-21200, MIL-T-28800, MIL-T-4734 and MIL-C-4150.

Removable swivel casters are available as an option on certain HP transit cases. These cases are identified with an asterisk (\*) in the case selection tables on pages 734 and 735.

### How to Select the Proper Transit Case

Transit cases are available for almost all HP instruments. If you are ordering a case for one of HP's 80 most popular instruments and computation products, you can use the quick cross-reference table below. To order a case for any other instrument, please refer to "Accurate Measurements Assure Proper Fit", and use the tables for ordering System I and System II style cases.

HP Product Number to Transit Case Number Cross-Reference

Product	Transit Case	Product	Transit Case	Product	Transit Case	Product	Transit Case	Product	Transit Case
1417	9211-1294	3582A	9211-2656	438A	9211-2676	59313A	9211-2671	8642A/B	9211-2661
853A	9211-5439	3585A	9211-2663	4145A	9211-2663	59401A	9211-2682	8654A	9211-1895
11713A	9211-2671	3586A/B/C	9211-2650	4191A	9211-2663	82509B	9211-4664	8654B	9211-1290
11729C	9211-2654	3708A	9211-2655	4192A	9211-2663	8340A/B	9211-2662	8656B	9211-2661
1630A	9211-1294	3708A(Opt.1)	9211-2661	4328A	9211-1318	8341A/B	9211-2662	8660A/C	9211-2662
1645A	9211-1289	3709A	9211-2661	4935A	9211-1290	8349A/B	9211-2667	8662A	9211-2662
1725A	9211-2459	3711A	9211-1293	4937A	9211-1289	8350B	9211-2649	8663A	9211-2662
1740A	9211-2459	3712A	9211-1294	4945A	9211-2650	8403A	9211-1292	8671A/B	9211-2661
1741A	9211-2459	3717A	9211-2654	4947A	9211-2650	8405A	9211-1293	8672A	9211-2661
197B	9211-2675	3730E	9211-0839	4948A	9211-2650	8445B	9211-1292	8673B/C	9211-2661
262X Series	9211-4677	3746A	9211-2656	4951C	9211-1290	85B	9211-4620	8673C/D	9211-2663
264X Series	9211-4676	37461A	9211-1298	4952A	9211-1290	8501A	9211-2660	8683A/B/C/D	9211-2649
2671G	9211-2649	3764A	9211-2650	4953A	9211-2644	8505A	9211-2665	8684A/B/C/D	9211-2649
2673G	9211-2649	3776A/B	9211-2650	4954A	9211-2657	8510A <sup>1</sup>	9211-2661	8753A	9211-2656
2816A	9211-1315	3777A	9211-2644	4955A	9211-2668	8511A-8515A	9211-2661	8754A	9211-2661
334A	9211-1289	3779C/D	18054A	4972A	9211-2657	8555A	9211-2671	8756A	9211-2656
339A	9211-2643	3780A	18055A	5061A	9211-1294	8562A/B	9211-5604	8757A	9211-2656
3325A	9211-2655	3781A/B	18055A	5065A	9211-0839	8565A	9211-2656	8770A	9211-2663
3336A/B/C	9211-2655	3782A/B	18055A	5150A	9211-2673	8566A-B <sup>1</sup>	9211-2655	8780A	9211-2662
3421A	9211-2642	3785A/B	18055A	5316A	9211-2681	8566A-B <sup>1</sup>	9211-2661	8901A/B	9211-1293
3455A	9211-2654	3789A/B	9211-2656	5328A	9211-2648	8567A	9211-2665	8970A/B	9211-2649
3456A	9211-2654	3787B	9211-2656	5334A	9211-2642	8568A/B	9211-2655	8971B	9211-2648
3457A	9211-2642	3852A	9211-2657	5335A	9211-2643	8569B	9211-2656	8980A	9211-2661
3478A	9211-2676	3964A	9211-2557	5340A	9211-1292	8570A <sup>1</sup>	9211-2656	8901A/B	9211-1293
3488A	9211-2642	3968A	9211-2557	5342A	9211-2682	8614A	9211-0839	9226A	9211-2662
3561A	9211-2459	432A/B	9211-1318	5343A	9211-2682	8616A	9211-0839	9336A <sup>1</sup>	9211-2652
3562A	9211-2663	435B	9211-1318	5423A	9211-2661	8620C	9211-1289	9336A <sup>1</sup>	9211-2662
3577A	9211-2663	436A	9211-2167	59306A	9211-2667	8640B	9211-0839	9876A	9211-4679

<sup>1</sup>Top half    <sup>2</sup>Bottom half    <sup>3</sup>Instrument requires two cases

**Instrument Cabinet System Styles**

Hewlett-Packard produces two styles of cabinet systems: System I and System II. The most visible difference is handle configuration; the handles on System I instruments are a part of the instrument side frame, and project at 90 degrees from the instrument face. The handles on System II modules also project at 90 degrees from the instrument face, but are not a part of the instrument frame, are easily removable, and are turned outward at the handle grip. Each of the cabinet styles requires a different cushion insert configuration. This difference makes it important to order your case from the correct selection table.

**Transit Case Styles**

Each transit case is coded according to its style in the following tables: Valise (V), hinged with the handle opposite the hinge; Transit (T), a completely removable cover with a handle at each end; and Valise Transit (VT), a hinged transit case with a handle opposite the hinge and a handle at each end. Each case is designed and manufactured in the style that best suits the configuration of its instrument. If a style other than the standard is more appropriate for your application, a special case can be ordered.



Typical transit (T) style case



Typical valise transit (VT) style case



Typical valise (V) style case

**Special or Custom Transit Cases**

When HP began providing standardized cases, it was understood that there would be certain instruments that would not fit into the standard cases. For that reason, special or custom cases are available.

Proper fit is very important in protecting your instrument, and the dimensional measurements of your instrument are critical. It is recommended, when ordering a custom case, that you provide your Hewlett-Packard sales office with the instrument's exact height, width and depth, the serial and model number, and any other pertinent information that may affect the design of the case or cushions. In designing your own case, you may wish to have additional space available for the protected storage of materials necessary for your instrument's on-site operation. Space can be provided for storing power/data cables, operating supplies, accessories, additional printed circuit boards and documentation or manuals. All specifications and measurements should be on hand when discussing your needs with a representative from your local HP sales office.

**Colors**

HP transit cases are produced in "Hewlett-Packard Pearl Gray Cabinet," a standard color used in whole or in part on a majority of the instruments HP produces. Transit cases in any other color must be a special order at additional cost.

**Accurate Measurements Assure Proper Fit**

To assure proper fit, each instrument must be measured carefully. The three measurements necessary are:

**WIDTH:** The distance across the entire body of the instrument, not including rack mounting accessories. Instruments set up to be rack mounted require special cushion designs (custom transit cases).

**DEPTH:** The depth of the instrument from the front panel face to the rearmost projection at the back of the instrument. On a System II instrument add two inches if the instrument has handles.

**HEIGHT:** The actual instrument height from the base to the top of the cabinet.

The selection tables include American standard and metric measurements. The addition of any options, accessories or standoff devices will affect the instrument's overall configuration and must be taken into consideration when ordering a transit case.

# TRANSIT CASES

## Rugged Protection for Instruments (cont'd)



Typical full module System I style cabinet



Typical full module System II style cabinet

### System I Cabinet Style Transit Cases

Full Module Width Instruments					
Instrument Width - 16.75 in. 425.5 mm					
Instrument Depth - 11.25 in. 285.8 mm					
Inst. Height		Style	HP Part Number	Price	
in.	mm			1-4	5-49
3.50	88.9	VT*	9211-1288	\$370	330
5.25	133.4	VT*	9211-1289	\$380	340
7.00	177.8	VT*	9211-1290	\$390	360
8.75	222.3	T*	9211-1291	\$420	380
Instrument Depth - 16.25 in. 412.8 mm					
Inst. Height		Style	HP Part Number	Price	
in.	mm			1-4	5-49
3.50	88.9	VT*	9211-1292	\$400	370
5.25	133.4	VT*	9211-0839	\$420	380
7.00	177.8	VT*	9211-1293	\$430	390
8.75	222.8	VT*	9211-1294	\$430	390
10.50	266.7	T*	9211-1295	\$430	390
12.25	311.2	T*	9211-1313	\$450	410
Instrument Depth - 19.25 in. 489.0 mm					
Inst. Height		Style	HP Part Number	Price	
in.	mm			1-4	5-49
5.25	133.4	VT*	9211-1296	\$440	400
7.00	177.8	VT*	9211-1735	\$450	410
Instrument Depth - 22.25 in. 565.2 mm					
Inst. Height		Style	HP Part Number	Price	
in.	mm			1-4	5-49
12.25	311.2	T	9211-1297	\$480	430

\*Removable casters are an option.

Two-thirds Module Width Instruments					
Instrument Width - 10.50 in. 266.7 mm					
Instrument Depth - 11.00 in. 279.4 mm					
Inst. Height		Style	HP Part Number	Price	
in.	mm			1-4	5-49
6.5	165.1	V	9211-1895	\$330	300

Half Module Width Instruments					
Instrument Width - 7.75 in. 196.9 mm					
Instrument Depth - 8.00 in. 203.2 mm					
Inst. Height		Style	HP Part Number	Price	
in.	mm			1-4	5-49
6.5	165.1	V	9211-1316	\$300	270
Instrument Depth - 11.00 in. 279.4 mm					
Inst. Height		Style	HP Part Number	Price	
in.	mm			1-4	5-49
6.5	165.1	V	9211-1315	\$310	280
Instrument Depth - 16.00 in. 406.4 mm					
Inst. Height		Style	HP Part Number	Price	
in.	mm			1-4	5-49
6.5	165.1	V	9211-1734	\$330	300

One-third Module Width Instruments					
Instrument Width - 5.125 in. 130.2 mm					
Instrument Depth - 8.00 in. 203.2 mm					
Inst. Height		Style	HP Part Number	Price	
in.	mm			1-4	5-49
6.5	165.1	V	9211-1317	\$290	260
Instrument Depth - 11.00 in. 279.4 mm					
Inst. Height		Style	HP Part Number	Price	
in.	mm			1-4	5-49
6.5	165.1	V	9211-1318	\$300	270

### System II Cabinet Style Transit Cases

Full Module Width Instruments					
Instrument Width - 18.75 in. 425.5 mm					
Instrument Depth - 15.25 in. 387.4 mm					
Inst. Height		Style	HP Part Number	Price	
in.	mm			1-4	5-49
3.50	88.9	VT	9211-2642	\$430	390
5.25	133.4	VT	9211-2643	\$430	390
7.00	177.8	VT	9211-2644	\$430	390
8.75	222.3	VT	9211-2645	\$430	390
10.50	266.7	T*	9211-2646	\$430	390
12.25	311.2	T*	9211-2647	\$430	390
Instrument Depth - 18.25 in. 463.6 mm					
Inst. Height		Style	HP Part Number	Price	
in.	mm			1-4	5-49
3.50	88.9	VT	9211-2648	\$480	430
5.25	133.4	VT	9211-2649	\$480	430
7.00	177.8	VT	9211-2650	\$480	430
8.75	222.3	T*	9211-2651	\$480	430
10.50	266.7	T*	9211-2652	\$480	430
12.25	311.2	T*	9211-2653	\$480	430
Instrument Depth - 21.50 in. 546.1 mm					
Inst. Height		Style	HP Part Number	Price	
in.	mm			1-4	5-49
3.50	88.9	VT	9211-2654	\$520	470
5.25	133.4	VT	9211-2655	\$520	470
7.00	177.8	VT	9211-2656	\$520	470
8.75	222.3	T*	9211-2657	\$520	470
10.50	266.7	T*	9211-2658	\$520	470
12.25	311.2	T*	9211-2659	\$520	470
Instrument Depth - 24.50 in. 622.3 mm					
Inst. Height		Style	HP Part Number	Price	
in.	mm			1-4	5-49
3.50	88.9	VT	9211-2660	\$550	500
5.25	133.4	VT	9211-2661	\$550	500
7.00	177.8	T*	9211-2662	\$550	500
8.75	222.3	T*	9211-2663	\$550	500
10.50	266.7	T*	9211-2664	\$550	500
12.25	311.2	T*	9211-2665	\$550	500

\*Removable casters are an option.





Typical System II half module instrument



Typical System II quarter module instrument

## System II Cabinet Style Transit Cases (Continued)

Half Module Width Instruments					
Instrument Width – 8.50 in. 215.9 mm					
Instrument Depth – 9.75 in. 247.7 mm					
Inst. Height In.	mm	Style	HP Part Number	Price	
				1-4	5-49
3.50	88.9	V	9211-2666	\$330	300
5.25	133.4	V	9211-2667	\$330	300
7.00	177.8	V	9211-2668	\$330	300
8.75	222.3	V	9211-2669	\$330	300
10.50	266.7	V*	9211-2670	\$330	300
Instrument Depth – 12.75 in. 323.9 mm					
Inst. Height In.	mm	Style	HP Part Number	Price	
				1-4	5-49
3.50	88.9	V	9211-2671	\$390	350
5.25	133.4	V	9211-2672	\$390	350
7.00	177.8	V	9211-2673	\$390	350
8.75	222.3	V	9211-2674	\$390	350
10.50	266.7	V	9211-2675	\$390	350
Instrument Depth – 15.75 in. 400.1 mm					
Inst. Height In.	mm	Style	HP Part Number	Price	
				1-4	5-49
3.50	88.9	V	9211-2676	\$400	360
5.25	133.4	V	9211-2677	\$400	360
7.00	177.8	V	9211-2678	\$400	360
8.75	222.3	V	9211-2679	\$400	360
10.50	266.7	V	9211-2680	\$400	360
Instrument Depth – 18.75 in. 478.3 mm					
Inst. Height In.	mm	Style	HP Part Number	Price	
				1-4	5-49
3.50	88.9	V	9211-2681	\$400	360
5.25	133.4	V	9211-2682	\$400	360
7.00	177.8	V	9211-2683	\$400	360
8.75	222.3	V	9211-2684	\$400	360
10.50	266.7	V	9211-2685	\$400	360

\* Removable casters are an option.

Quarter Module Width Instruments					
Instrument Width – 4.125 in. 104.8 mm					
Instrument Depth – 9.75 in. 247.7 mm					
Inst. Height In.	mm	Style	HP Part Number	Price	
				1-4	5-49
3.50	88.9	V	9211-2686	\$280	250
5.25	133.4	V	9211-2687	\$280	250
7.00	177.8	V	9211-2688	\$280	250
Instrument Depth – 12.75 in. 323.9 mm					
Inst. Height In.	mm	Style	HP Part Number	Price	
				1-4	5-49
3.50	88.9	V	9211-2689	\$290	260
5.25	133.4	V	9211-2690	\$290	260
7.00	177.8	V	9211-2691	\$290	260
Instrument Depth – 15.75 in. 400.1 mm					
Inst. Height In.	mm	Style	HP Part Number	Price	
				1-4	5-49
3.50	88.9	V	9211-2692	\$350	310
5.25	133.4	V	9211-2693	\$350	310
7.00	177.8	V	9211-2694	\$350	310



Field-installed swivel caster kit. HP part number 1490-0913

# OPERATING CASES

## Rugged Protection for Instruments



Exploded view of an Operating Case with an instrument and drawer ready for mounting.

### Operating Cases

Hewlett-Packard operating cases are rugged protective enclosures, used when instruments are transported and used on-site. They are constructed of the same pressure molded fiberglass/resin laminate as Hewlett-Packard transit cases. Hewlett-Packard's standard hardware provides excellent protection from damage and the elements. Conveniently placed handles fold flat when not in use. Front and back covers seal with O-ring gaskets and clamping latches. All transit cases are rainproof under MIL-STD-108.

### Interior Configuration

Operating cases are equipped with shock mounted aluminum frames that accept any standard 19-inch rack mounting instrument (EIA-RETMA standard) up to the height of the frames. Most full-sized instruments and modular combinations of instruments can be rack mounted in one of our operating cases. The frame arrangement and the ability to remove the front and back covers allows the convenience of operation without removing the instrument. As a result, the instrument can be set up for operation with a minimum of delay. At the same time, environmental protection is afforded. Both Hewlett-Packard System I and System II cabinet styles can be mounted in operating cases (including System I module combining cases).

Rack mounting offers a number of conveniences. Total systems configured of individual instruments and accessories can be combined in one or more operating cases. Patch cable, HP-IB and HP-IL connections can be left in place within the case, so that instruments are ready to be put into use with a minimum of delay.

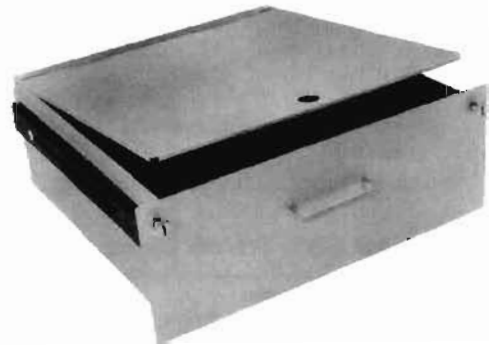

Sturdy drawers that accommodate various HP accessories and operating supplies are available in three sizes and come with smooth-operating ball bearing slides.



Elastomeric shock mounted frames provide outstanding shock and vibration attenuation. A set of standard shock mounts can be provided for any equipment weight and fragility.

### Accessories and Options

A number of accessories and options are available to provide maximum flexibility. Drawers are available in three heights, so that small accessories, supplies and tools can be kept inside the case with the instrument (cut foam cushions can be designed to accommodate any of these items). Aluminum skids, stacking feet, internal power receptacles and many other items are available as options on special orders, or as accessories for customer installation when ordered separately.

### How to Order

Operating cases, like transit cases, are ordered through your local HP sales office. Because of the wide variety of options available and the number of configurations possible, it is recommended that you discuss your needs with an HP representative before you order.

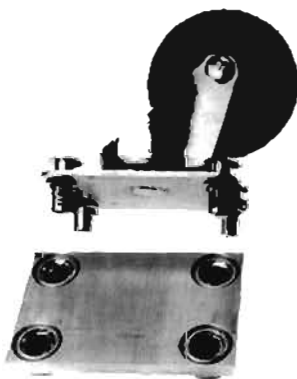

Heavy-duty removable caster and mounting plate

### Operating Case Selection Guide

Case Width = 24.00 in./609.6 mm (standard)

Case Depth = 28.50 in./723.9 mm (standard)

Nominal Rack Height In. ISO	Instrument Weight				Case Height In. mm	HP Part Number	Price	
	maximum lbs	kg	minimum lbs	kg			1-4	5-49
5.25 3U	75	34.0	20	9.1	10.75 273.1	9211-1302	\$1,350	1,080
8.75 5U	75	34.0	20	9.1	15.20 386.1	9211-1303	\$1,450	1,160
10.50 6U	130	59.0	30	13.6	17.00 431.8	9211-2635	\$1,650	1,320
12.25 7U	130	59.0	30	13.6	18.87 479.3	9211-1163	\$1,750	1,400
14.00 8U	130	59.0	30	13.6	20.50 520.7	9211-1241	\$1,800	1,450
15.75 9U	130	59.0	30	13.6	22.25 565.2	9211-1242	\$1,800	1,450
17.50 10U	130	59.0	30	13.6	24.00 612.1	9211-1243	\$1,800	1,450
19.25 11U	130	59.0	30	13.6	25.75 654.1	9211-1244	\$1,800	1,450
21.00 12U	250	113.4	50	22.7	28.00 711.2	9211-1245	\$1,800	1,450
22.75 13U	250	113.4	50	22.7	29.75 755.7	9211-2636	\$1,800	1,450
24.50 14U	250	113.4	50	22.7	31.50 800.1	9211-1911	\$2,200	1,750
26.25 15U	250	113.4	50	22.7	33.25 844.6	9211-2637	\$2,200	1,750
28.00 16U	250	113.4	50	22.7	35.00 889.0	9211-2638	\$2,200	1,750
29.75 17U	250	113.4	50	22.7	36.75 933.5	9211-2639	\$2,200	1,750
31.50 18U	250	113.4	50	22.7	38.50 977.9	9211-2640	\$2,200	1,750
33.25 19U	250	113.4	50	22.7	40.25 1022.4	9211-1713	\$2,200	1,750
47.25 27U	320	145.2	70	31.8	53.88 1368.6	9211-2641	\$2,700	2,150

### Standard Features

Inner rack frame with provision for infinitely adjustable T-bar instrument support bracket. Standard 20" depth.

Inner rack frame with RETMA hole pattern drilled in rear rails.

Standard color: pearl grey cabinet.

Manual pressure relief valve.

### Special Features Available

- A. Mating feet for stacking one case on top of another. \$50
- B. Special color. Please specify. \$40
- C. Modified inner rack frame depth. Standard depth 20" from front panel mounting surface to rear surface of frame. This option includes an appropriate change in the overall depth of the enclosure. Please specify desired inner frame depth. Maximum 23", minimum 12". \$300
- D. Instrument slide pair to mount on either side of inner frame using RETMA hole pattern drilled in front and rear rails. \$90
- E. Special shock mounts for unusual instrument weights. Please specify weights. \$40
- F. Increased front cover depth. Maximum depth 6". Please specify. \$250
- G. Increased rear cover depth. Maximum depth 6". Please specify. \$250
- H. Latches recessed into the surface of the case. \$250
- I. Handles recessed into the surface of the case. \$90
- J. Hermetically-sealed case tested by the hot water method. \$90
- K. MIL-C-4150 certification with the exception of design and preproduction testing. Case will have increased wall thickness, hardware anodized to military specification, and will be hermetically tested using the hot water method. \$290
- L. Automatic pressure relief valve. \$50
- M. Addition of four permanently mounted, 3/4" diameter swivel casters. \$120
- N. Addition of four removable, 3/4" diameter swivel casters. Also available in kit form. \$250
- O. Addition of two aluminum hat-section skids to the case bottom. \$120
- P. Addition of lift rings to either side of the case. \$50
- Q. 3/4" H (88.9 mm) Drawer with ball bearing slides. \$330
- R. 5/4" H (133.4 mm) Drawer with ball bearing slides. \$350
- S. 7 H (177.8 mm) Drawer with ball bearing slides. \$370
- T. Pair of T-Bar instrument support brackets. \$30
- U. AC power receptacle strip with four outlets mounted on bottom rear of inner rack frame. Power cord 1 meter (3' 3") long. NEMA connectors. \$50

### Accessories (when ordered separately)

- 9211-1164 3/4" H (88.9 mm) Drawer with ball bearing slides. \$380
- 9211-1165 5/4" H (133.4 mm) Drawer with ball bearing slides. \$400
- 9211-1166 7 H (177.8 mm) Drawer with ball bearing slides. \$480
- 0950-0122 AC power receptacle strip with four outlets mounted on bottom rear of inner rack frame. Power cord 1 meter (3' 3") long. NEMA connectors. \$50
- 9211-1173 Pair T-Bar instrument support brackets. \$46
- 1490-0913 Caster kit, four removable 3/4" (88.9 mm) swivel casters. For transit cases only. Recommended to be removed before transit. \$210
- 5081-5831 Operating Case Latch. \$7.75 each
- 5081-5832 Aluminum hat section skids (2) for case bottom. \$155
- 5081-5834 Caster kit, four removable 3/4" (88.9 mm) swivel casters. Heavy duty for Transit or Operating Cases. Recommended to be removed before transit. \$300

On request, cases can be fabricated that meet the environmental requirements of Military Specifications. Specifications other than military are subject to change without notice.

# CABINET ACCESSORIES

## System II—Handles and Rack Flanges, Bail Handle Kit

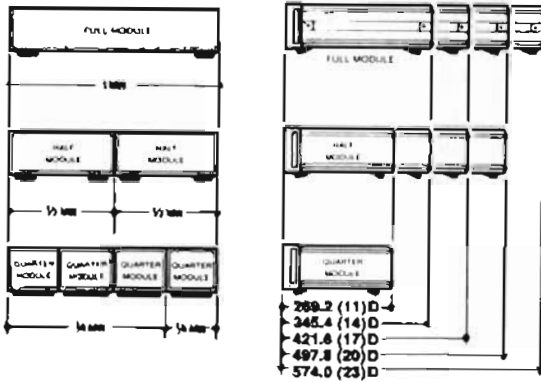
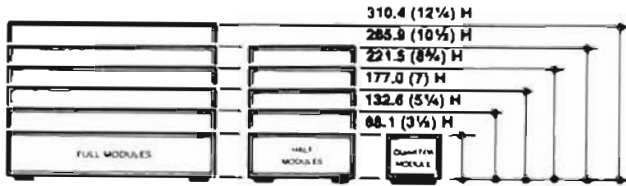

System II Cabinet Design

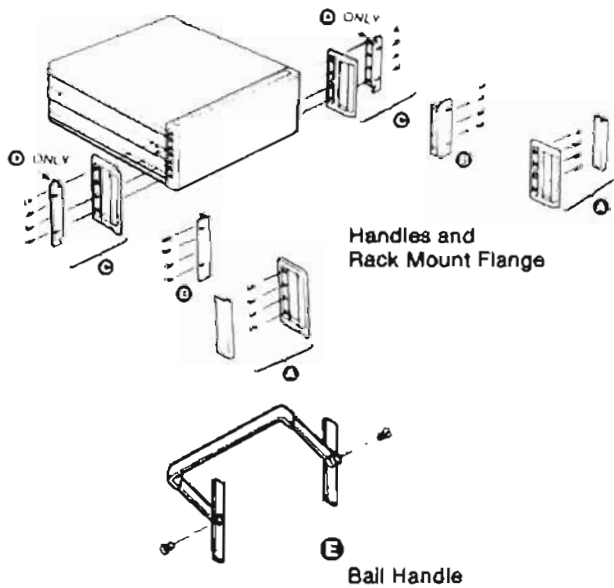

**NOTICE**—Most of the cabinet accessory kits shown on these pages include both inch and metric fasteners to make them compatible with the new metric-fastener-cabinets, as well as the older inch-fastener-cabinets which are still in service. It is most important for the user to be aware of these different fasteners to avoid thread damage when attaching the accessory kits. Metric-fastener-cabinets are identified with a yellow label on the rear which reads "Caution—metric and inch hardware", a "metric" embossment in the front bezel casting under the plastic trim strip, and on the middle of the rear bezel casting.

### System II Cabinet Design

HP's modular cabinet system offers bench-stacking and rack mounting versatility. Many of HP's newer instruments are packaged in this System II frame, easily recognized by the cast aluminum front and rear frames. System II uses optional front corner handles characterized by a slight outward flare.

The family of System II modules is designed for compatibility with EIA and IEC racking standards, both in width and height. Each HP instrument specification contains dimensional information to tell you which module size is used.

### Handles and Rack Mount Flanges

Handles and rack flanges are available for all System II cabinets, although they find most use on full width modules or combinations of narrower modules locked together to form 1 MW (module width).

Certain instruments are supplied with front handles as part of the selling price. Handles and rack flanges can be supplied with most instruments by specifying the appropriate option from the following list, at the time of order. The extra cost of each option is usually specified on the instrument data sheet.

- Option 907 Front Handles
- Option 908 Rack Mount Flanges
- Option 909 Handles with Rack Flanges
- Option 913 Rack Mount Flanges (If handles already furnished) (HP 5061-9769 Version)

The table below describes kits available for use after receipt of equipment. Field installation is very straight-forward. A plastic trim strip is easily removed and the handle or flange attached with screws supplied in the kit. Before rack mounting, bottom feet must be removed.

### Bail Handle Kit

For 1/2 MW cabinets, you can attach this front bail handle for easy portability. Attaching hardware furnished.

HP Part No.	Name	Price
5061-9701	Bail Handle Kit for 88.1 (3 1/2) Module	\$38.00
5061-9702	Bail Handle Kit for 132.6 (5 1/4) Module	35.00
5061-9703	Bail Handle Kit for 177.0 (7) Module	33.00

### Handle and Rack Flanges

Instrument Module Height mm (inch)	A Front Handle Kit		B Rack Mount Flange Kit (3)		C Rack Mount Flange Kits with Handles		D Rack Mount Flange Kit for Instruments With Previously Supplied Handles	
	HP Part No.	Price	HP Part No.	Price	HP Part No.	Price	HP Part No.	Price
88.1 (3 1/2)H	5061-9688	\$ 50.00	5061-9674(1)	\$30.00	5061-9675(1)	\$ 72.50	5061-9769(1)	\$21.00(4)
88.1 (3 1/2)H	—	—	5061-9676(2)	30.00	5061-9682(2)	72.50	5061-9770(2)	36.00(4)
132.6 (5 1/4)H	5061-9689	55.00	5061-9677	32.50	5061-9683	80.00	5061-9771	28.00
177.0 (7)H	5061-9690	65.00	5061-9678	35.00	5061-9684	90.00	5061-9772	32.00
221.5 (8 3/4)H	5061-9691	75.00	5061-9679	40.00	5061-9685	105.00	5061-9773	36.00
265.9 (10 1/2)H	5061-9692	95.00	5061-9680	45.00	5061-9686	120.00	5061-9774	40.00
310.4 (12 1/4)H	5061-9693	140.00	5061-9681	50.00	5061-9687	160.00	5061-9775	49.00
<b>Kit Includes</b>	2 Handles + 2 Trim Strips + Mtg. Screws		2 Flanges + Mtg. Screws		2 Handles + 2 Flanges + Mtg. Screws		2 Flanges + Mtg. Screws	

[1] HP 5061-9674/9675/9769 Kits use standard flanges with 1.75" hole spacing.  
 [2] HP 5061-9676/9682/9770 Kits use special flange with 3.00" hole spacing.

[3] Will not fit onto instruments with previously supplied handles.  
 [4] Option 913 ordered on instruments supplies HP 5061-9769. For 3.00" spacing order HP 5061-9770 instead of Opt. 913.

Fast-Ship product. See page 758

**NOTICE**—Most of the cabinet accessory kits shown on these pages include both inch and metric fasteners to make them compatible with the new metric-fastener-cabinets, as well as the older inch-fastener-cabinets which are still in service. It is most important for the user to be aware of these different fasteners to avoid thread damage when attaching the accessory kits. Metric-fastener-cabinets are identified with a yellow label on the rear which reads "Caution—metric and inch hardware", a "metric" embossment in the front bezel casting under the plastic trim strip, and on the middle of the rear bezel casting.

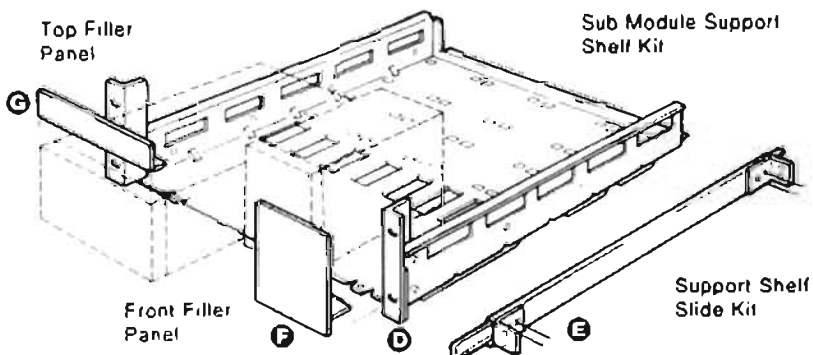
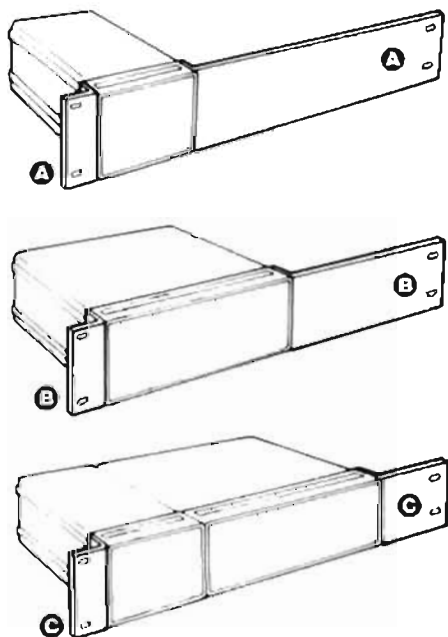

### Rack Mount Adapter Kits

Modules of less than 1 MW can be rack mounted using these kits. Individual 1/4 MW or 1/2 MW modules use the kits shown below directly. Combinations of 1/4 MW and 1/2 MW (of equal depth) are first joined side-by-side with the Lock Link Kit (HP 5061-9694) (following page), then have end flanges applied. Combinations adding to 1 MW use regular rack flange kit (previous page). Kits include attaching screws but not front panel rack mounting screws. Hole patterns conform to EIA and IEC standards.

### Rack Mount Adapter Kits

Module Height mm (Inch)	A Mounts 1/4 MW Module		B Mounts 1/2 MW or 2 ea. 1/4 MW(2) Modules		C Mounts 1/2 MW (3 ea. 1/4 MW)(1) or 1/4 & 1/2 MW side-by-side(2)	
	HP Part No.	Price	HP Part No.	Price	HP Part No.	Price
88.1 (3 1/4)H	5061-9673	\$56.00	5061-9672	\$49.00	5061-9671	\$43.00
132.6 (5 1/4)H	—	—	5061-9657	60.00	5061-9658	50.00
177.0 (7)H	—	—	5061-9660	65.00	5061-9661	70.00
265.9 (10 1/2)H	—	—	5061-9666	77.50	5061-9667	72.50
<b>Kit Includes</b>	1 ea. rack flange 1 ea. 1/4 MW extension adapter flange and screws		1 ea. rack flange 1 ea. 1/2 MW extension adapter flange and screws		1 ea. rack flange 1 ea. 1/2 MW extension adapter flange and screws	

### Support Shelf, Slide, and Filler Panels

Submodules of differing heights, widths, and depths (up to 20 D) may be rack-mounted using these support shelves. Any combination of 1/4 MW and 1/2 MW will fit side-by-side up to 1 MW. Filler panels close up vacant spaces either on top of short modules or side-by-side. The slide kit provides ready access to internal shelf areas and is designed for HP racks with 24-inch depth vertical support rails. Slide kit includes brackets and mounting screws.

HP Part No.	Name	Price
5061-9696	D Support Shelf for 88.1 (3 1/4)H Modules	\$195.00
5061-9697	D Support Shelf for 132.6 (5 1/4)H Modules	195.00
5061-9698	D Support Shelf for 177.0 (7)H Modules	210.00
1494-0015	E Slide Kit (2 ea slides, brackets, hardware)	120.00

### Filler Panels

Description	Size	HP Part No.	Price
G For 88.1 (3 1/4)H support shelf partially filled with instruments, and having the following front panel space to fill:	1/4 MW to fill	5061-9721	\$67.50
	1/2 MW to fill	5061-9722	80.00
	3/4 MW to fill	5061-9723	92.50
E For 132.6 (5 1/4)H support shelf, and having the following front panel space to fill:	1/4 MW to fill	5061-9724	\$80.00
	1/2 MW to fill	5061-9725	87.50
G For 177.0 (7)H support shelf, and having the following front panel space to fill:	1/4 MW to fill	5061-9766	\$75.00
	1/2 MW to fill	5061-9727	110.00
G For 1/4 MW and having the following vertical space to fill.	43.2 (1 3/4)H	5061-2035	\$50.00
	87.6 (3 1/2)H	5061-2036	50.00
G For 1/2 MW and having the following vertical space to fill:	43.2 (1 3/4)H	5061-2037	\$50.00
	87.6 (3 1/2)H	5061-2038	50.00

[1] 1/4 MW can be center mounted using 2 of these kits.  
 [2] Side-by-side modules of equal depth require lock link kit (HP 5061-9694).

Fast-Ship product. See page 758

# CABINET ACCESSORIES

## System II—Lock Link Kits, Rack Mount Slide Kits

**NOTICE**—Some of the cabinet accessory kits shown on these pages include both inch and metric fasteners to make them compatible with the new metric-fastener-cabinets, as well as the older inch-fastener-cabinets which are still in service. It is most important for the user to be aware of these different fasteners to avoid thread damage when attaching the accessory kits. Metric-fastener-cabinets are identified with a yellow label on the rear which reads "Caution—metric and inch hardware", a "metric" embossment in the front bezel casting under the plastic trim strip, and on the middle of the rear bezel casting. Due to design considerations, the slide-mount kits shown on this page are offered in both inch and metric fastener versions.

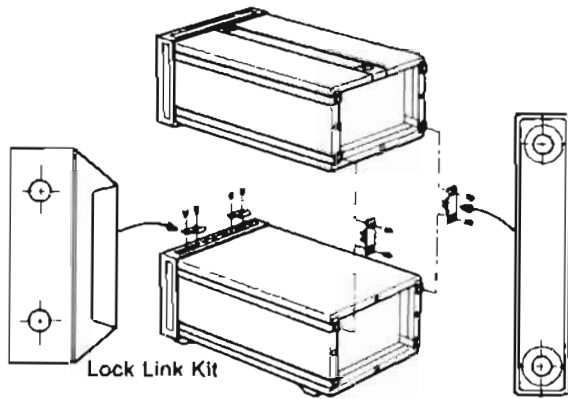

Lock Link Kit

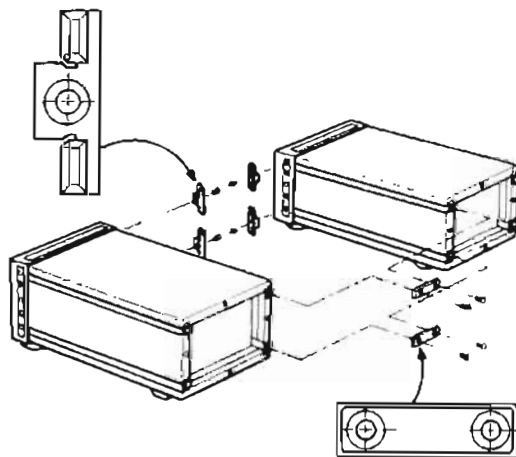

### Lock Link Kits HP 5061-9694 (Includes inch screws)

All sub-module cabinets of equal depths can be linked together over-under or side-by-side with hardware in the lock link kit. Cabinet frames are already pre-threaded to allow quick assembly. For side-by-side connections the kit contains 12 front hooks and six rear links, enough for 3 side-by-side joints. For vertical connections, the kit also contains four front hooks and four rear links enough for two over-under joints. Kit includes screws. Locking cabinets together horizontally in a configuration wider than 1 MW is not recommended.

If the over-under linked combination is to include rear standoff feet (HP 5061-9709), then the over-under locking feet kit HP 5061-9699 (next page) should be used for over-under connection.

The HP 5061-9694 Lock Link Kit is not recommended for full module over/under combinations. Use Kit HP 5061-9699 Locking Feet Kit (next page) to handle those larger weights.

### Slide Kits and Rack Brackets

Rack slides are available for full-width System II cabinets to permit easy access to internal spaces. Each kit consists of two slides which mount directly to System II cabinet side handle recess spaces (after removing side handles). The slides also mount directly to vertical support rails in HP-racks. HP 1494-0060 mounts 345.4D and 421.6D depth System II cabinets. HP 1494-0059; 497.8D and 574.0D.

Standard weight slides carry 38.6 kg (85 lbs) max. load. Tilting versions are available in standard duty only. (HP 1494-0062 and 1494-0063.)

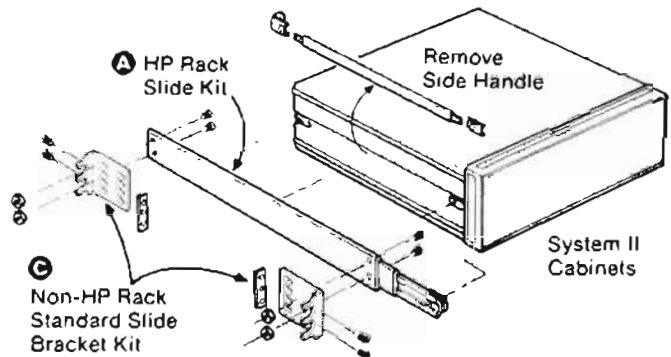

Non-HP Rack Standard Slide Bracket Kit

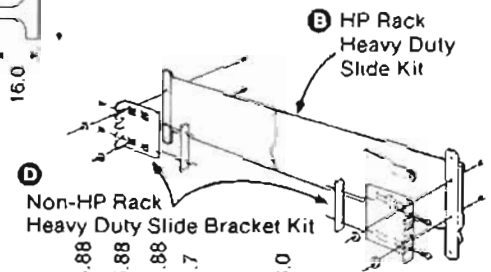
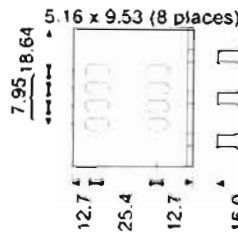

Non-HP Rack Heavy Duty Slide Bracket Kit

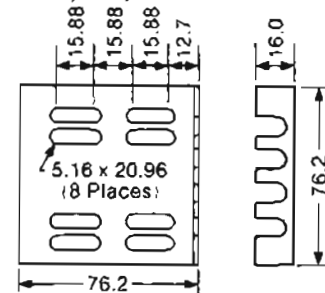

For non-HP-racks, end bracket kits are available for both standard and heavy duty slide kits. Slotted hole arrays in the brackets provide for front-to-back rack rail spacing of 24, 26, and 28-inch nominal centers. They also allow choice of two vertical positions. Each kit of four brackets includes screws and four bar nuts. These general purpose mounting brackets fit most common non-HP-racks such as GE, Honeywell, etc.

HP Part No.	Name	Price
<b>Metric (Inch)</b>		
5061-9694	Lock Link Kit	\$ 25.00
1494-0060 (1494-0018)	A Non-Tilting, Std. Slide Kit, Fits 345.4D & 421.6D Cabinets	100.00
1494-0059 (1494-0017)	A Non-Tilting, Std. Slide Kit, Fits 497.8D & 574.0D Cabinets	100.00
1494-0062 (1494-0025)	Tilting, Std. Slide Kit, Fits 345.4D & 421.6D Cabinets	190.00
1494-0063 (1494-0026)	Tilting, Std. Slide Kit, Fits 497.8D & 574.0D Cabinets	190.00
1494-0058 (1494-0016)	C Non-Tilting, Heavy Duty Slide Kits (497.8D & 574.0D Cabinets Only)	290.00
1494-0061 (1494-0023)	G (4) End Brackets for Non-HP Racks, Std. Slides	46.00
1494-0064 (1494-0042)	D (4) End Brackets for Non-HP Racks, Heavy Duty Slides	70.00

Fast-Ship product. See page 758

**NOTICE**—Most of the cabinet accessory kits shown on these pages include both inch and metric fasteners to make them compatible with the new metric-fastener-cabinets, as well as the older inch-fastener-cabinets which are still in service. It is most important for the user to be aware of these different fasteners to avoid thread damage when attaching the accessory kits. Metric-fastener-cabinets are identified with a yellow label on the rear which reads "Caution—metric and inch hardware", a "metric" embossment in the front bezel casting under the plastic trim strip, and on the middle of the rear bezel casting.

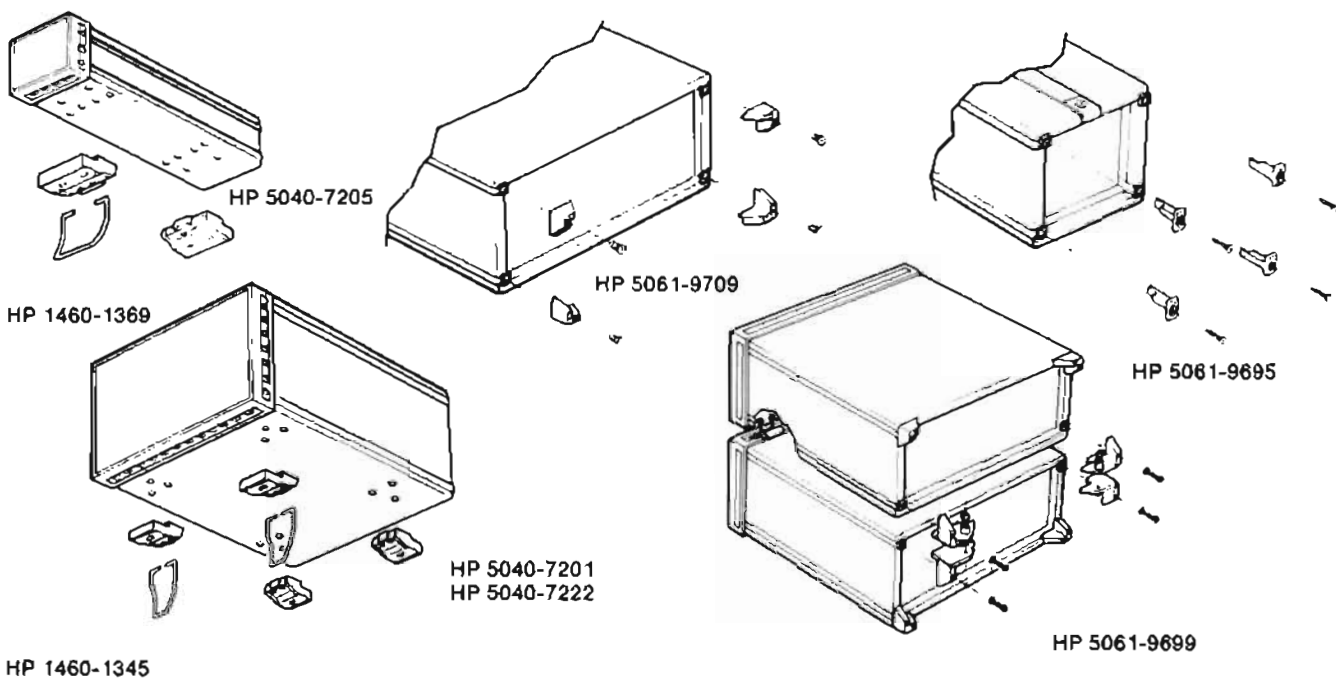

### Bottom and Rear Cabinet Feet

#### Cabinet Rear Standoff Feet HP 5061-9709 (Includes inch screws)

Kit HP 5061-9709 provides four corner feet which give 25.4 mm (1-in.) stand-off protection to the rear panel of instruments. It is used when instruments are to be operated or stored vertically on their rear panels. (Fits all but 1/4 MW by (88.1) 3 1/2 H). Includes mounting screws.

#### Cord Wrap Feet Kit HP 5061-9695 (Includes inch screws)

Kit HP 5061-9695 contains four ribbed corner posts on which you can wrap power cords or signal cables for transport or storage. (Recommended for 1/4 MW and 1/2 MW cabinets weighing less than 11 kg. (24 lbs). Includes mounting screws.

#### Cabinet Bottom Feet and Tilt Stands

The standard foot HP 5040-7201 fits the bottom of full width and 1/2 MW cabinets. It fits front or rear and four are required. HP 5040-7222 foot is a non-skid version. Used in pairs it can prevent bench-top creeping. Tilt-stand HP 1460-1345 fits into the standard or non-skid foot and is used in pairs (front or rear) to tilt the instrument up or down for better viewing.

For 1/4 MW cabinets, foot HP 5040-7205 fits front or rear (two required). Tilt stand HP 1460-1369 fits the standard 1/4 MW foot and can be used front or rear depending on whether you want an upward or downward display.

#### Rear Panel Locking Foot Kit

When full module cabinets are to be linked vertically, and rear standoff feet are planned, use this kit. It consists of right and left foot linking pairs and 2 front hooks, enough for one over-under joint.

Also requires one HP 5061-9709 foot kit to supply the remaining 4 corner feet.

HP Part No.	Name	Price
5061-9709	Rear Standoff Feet Kit (4 Feet)	\$8.75
5061-9695	Cord Wrap Feet Kit (4 Feet)	\$25.00
5040-7201	Standard Foot	\$2.50
5040-7222	Non-Skid Foot	\$6.00
1460-1345	Tilt Stand	\$4.00
5040-7205	1/4 MW Foot	\$6.00
1460-1369	1/4 MW Tilt Stand	\$10.00
5061-9699	1 MW Cabinet Lock-Foot Kit	\$60.00

Fast-Ship product - See page 758

# CABINET ACCESSORIES

## SYSTEM 1—Rack Hardware and Accessories

### System 1 Cabinet Design

System 1 Cabinets are still used on older HP instruments. System 1 can be identified by its front handles being integral with the side casting frame. These two pages describe accessories for use with System 1 Cabinets and small modular instruments.

HP 1051A

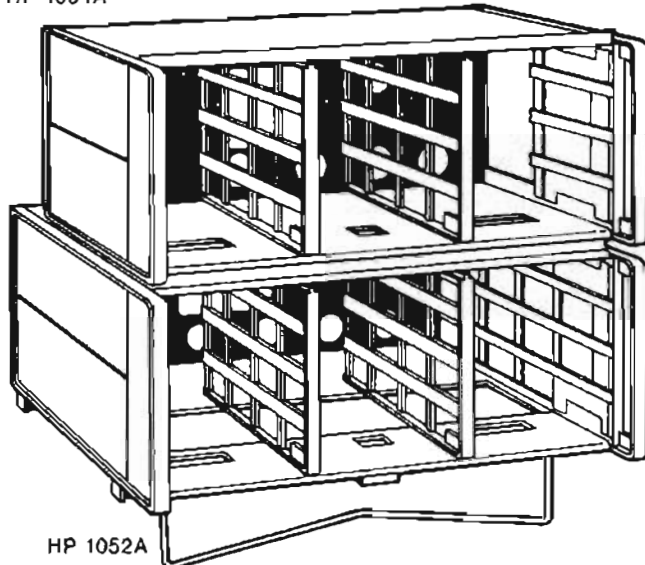

HP 1052A

### Combining Cases, HP 1051A, 1052A

HP 1051A and HP 1052A combining cases conveniently rack or bench mount combinations of small modular Hewlett-Packard SYSTEM 1 instruments. Both cases accept  $\frac{1}{4}$  or  $\frac{1}{2}$  instrument modules, 130mm or 198 mm wide ( $5\frac{1}{8}$  or  $7\frac{7}{8}$  inches). The basic difference is that the HP 1052A is 130 mm ( $5\frac{1}{8}$  in.) deeper and will accept modules up to 416mm deep ( $16\frac{3}{8}$  in.). The HP 1051A accepts instruments up to 286mm deep ( $11\frac{1}{4}$  in.). Each case is furnished with two dividers.

Accessory drawer HP 5060-8756 supplies storage space  $\frac{1}{2}$  width and 77 mm ( $3\text{-}1/32$ " ) high. Use an HP 5060-8758 filler panel above or below.

#### HP 1051A, 1052A, 5060-8756 Specifications

Size	Price
HP 1051A: 178 H x 482.6 W x 337 mm D ( $7$ " x $19$ " x $13\frac{3}{4}$ " )	\$625.00
HP 1052A: 178 H x 482.6 W x 467 mm D ( $7$ " x $19$ " x $18\frac{3}{4}$ " )	\$625.00

#### Weight

HP 1051A: net, 4.5 kg (10 lb). Shipping, 6.7 kg (15 lb).

HP 1052A: net, 5.4 kg (12 lb). Shipping, 8.1 kg (18 lb)

Opt 908: Rack Mount Kit 40.00

Opt 910: Extra Manual 1.00

HP 5060-8756 Accessory Drawer \$215.00

### Rack Mounting Kits, HP 5060-8739 to 5060-8744

With these kits all Hewlett-Packard products in full rack-width cabinets of the integral side frame-handle style (see HP 1051A, 1052A, Combining Cases above) can be easily prepared for rack mounting. Each kit contains two flanges, a filler strip, and mounting screws.

#### Rack Mounting Kit Ordering Information

HP Part Number	Nominal Cabinet Height		Price
	Millimetres	Inches	
5060-8739	88.1	$3\frac{1}{2}$	\$40.00
5060-8740	132.6	$5\frac{1}{4}$	\$40.00
5060-8741*	177	7	\$40.00
5060-8742	221.5	$8\frac{3}{4}$	\$45.00
5060-8743	265.9	$10\frac{1}{2}$	\$45.00
5060-8744	310.4	$12\frac{1}{4}$	\$50.00

\*Also used to rack mount Combining Kits HP 1051A & 1052A shown above.

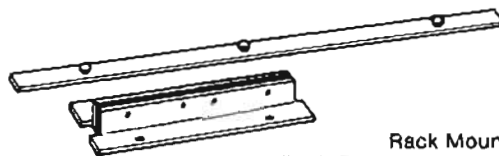

Rack Mounting  
Kits (HP 5060-8739 To 5060-8744)

HP 5040-6678

HP 5060-8764

HP 5060-8762

HP 5040-6680

### Rack Adapter Frames, HP 5060-8762, 5060-8764

These frames can be used to hold combinations of  $\frac{1}{4}$  and  $\frac{1}{2}$  module-width HP instruments. Each frame is furnished with mounting hardware and three dividers. Two models are available for different instrument heights. Adapter frames are for permanent or semi-permanent rack mounting. Where quick removal and reinstallation of instruments is desirable, the HP 1051A and HP 1052A should be used.

HP 5060-8762 is 178 mm (7 in.) high and accepts instruments heights of  $\frac{1}{4}$ H,  $\frac{1}{2}$ H, and 1H. HP 5060-8764 is 89 mm ( $3\frac{1}{2}$  in.) high and accepts instruments of  $\frac{1}{4}$ H and  $\frac{1}{2}$ H.

HP Part No.	Name	Price
5060-8762	Rack Adapter 178mm (7-in)	\$150.00
5060-8764	Rack Adapter 89mm (3½-in)	\$150.00
5040-6678	Extra Vertical Dividers for 5060-8764	\$28.00
5040-6680	Extra Vertical Dividers for 5060-8762	\$12.00

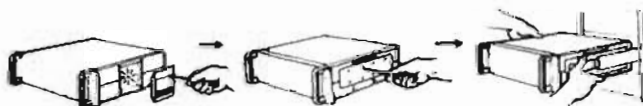

Remove Handles  
and Feet

Attach  
Adapter

Mount  
Slides

### Rack Mount Slide Kits and Cabinet Adapters

By removing the side handle of full width system 1 cabinets, rack mount slides can be attached for easy access to internal space. Both tilt- and non-tilt are available, while max. load factor is 31.7 kg (70 lb). The cabinet adapter plate attaches to the handle recess then to the slide. Slide kits include four angle brackets which mount to rack rails with front-to-back nominal spacings of 24, 26 and 28-inches.

### Cabinet Adapters

HP Part No.	Name	Price
1490-0722	Adapter plate for 88.9mm H( $3\frac{5}{8}$ in.) cabinets	\$135.00
1490-0721	Adapter plate for 133mm H( $5\frac{1}{4}$ in.) and higher cabinets	\$260.00

Fast-Ship product. See page 758



### Rack Mount Slide Kits, HP 1490-0713 to 1490-0720

HP Part Number <sup>1</sup>	Slide Type	Cabinet Depth	Extension Length	Price
1490-0713	fixed	All Sizes	482.6 (19) <sup>2</sup>	\$140.00 ☞
1490-0714	fixed	All Sizes	635.0 (25) <sup>3</sup>	\$160.00 ☞
1490-0715	tilting	279.4 (11)	482.6 (19) <sup>2</sup>	\$220.00 ☞
1490-0716	tilting	406.4 (16)	482.6 (19) <sup>2</sup>	\$230.00 ☞
1490-0717	tilting	279.4 (11)	533.4 (21) <sup>3</sup>	\$240.00 ☞
1490-0718	tilting	406.4 (16)	558.8 (22) <sup>3</sup>	\$240.00 ☞
1490-0719	tilting	482.6 (19)	635.0 (25) <sup>3</sup>	\$240.00 ☞
1490-0720	tilting	558.8 (22)	635.0 (25) <sup>3</sup>	\$240.00 ☞

1. Cabinet Adapters, below, must be added to slides  
 2. Slide's stationary mounting depth: 406.4 (16)  
 3. Slide's stationary mounting depth: 558.8 (22)

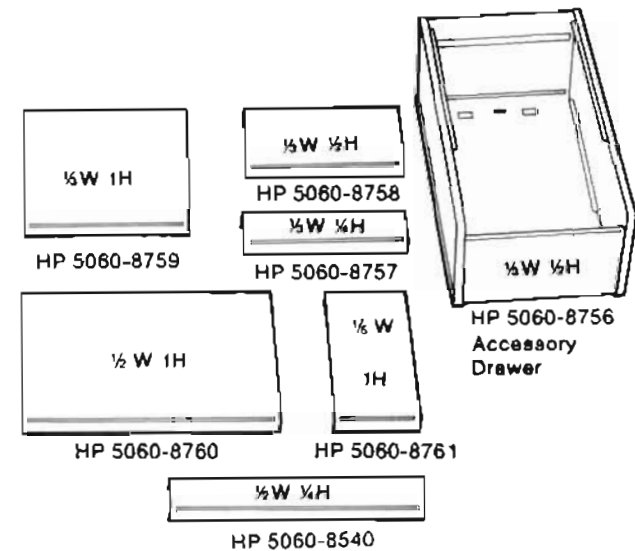
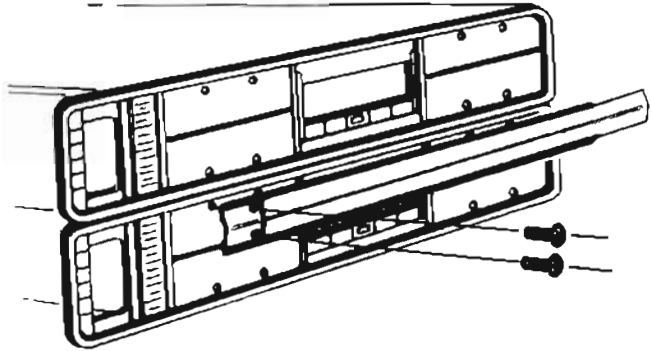

### Joining Bracket Kits, HP 5060-8541 to 5060-8545

These kits join HP System 1 instruments of the same width and length into easily handled single stacks. Each kit consists of two brackets, mounting hardware and trim. They are available to fit the three most common instrument depths:

HP Part Number	Price
5060-8541: 279 mm (11 in.) EIA panel depth	\$160.00 ☞
5060-8543: 406 mm (16 in.) EIA panel depth	\$160.00 ☞
5060-8545: 480 mm (19 in.) EIA panel depth	\$170.00 ☞

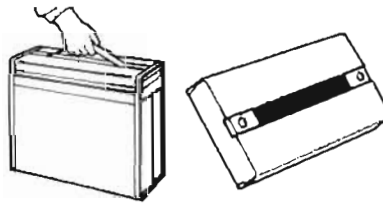

### Control Panel Covers, HP 5060-8766 to 5060-8771

A series of control panel covers equipped with carrying handles are available for full rack width instruments. These covers protect instrument front panels and make rack mounted instruments tamper-proof.

One of these covers, the HP 5060-8768, fits both the HP 1051A and the HP 1052A Combining Case (previous page). Other covers are available to fit the six modular enclosures with front panel heights ranging from 88.1 to 310.4 mm (3 1/2 to 12 1/4 in.). Cover locks securely to front handles.

HP Part Number	Price
5060-8766: 88.1 mm (3 1/2 in.) EIA panel height	\$290.00 ☞
5060-8767: 132.6 mm (5 1/4 in.) EIA panel height	\$270.00 ☞
5060-8768: 177 mm (7 in.) EIA panel height	\$290.00 ☞
5060-8769: 221.5 mm (8 3/4 in.) EIA panel height	\$350.00 ☞
5060-8770: 265.9 mm (10 1/2 in.) EIA panel height	\$350.00 ☞
5060-8771: 310.4 mm (12 1/4 in.) EIA panel height	\$430.00 ☞

☞ Fast-Ship product. See page 758.

### Filler Panels, HP 5060-8540, 5060-8757 to 5060-8761

Filler panels can be used to close off any leftover space after instruments are mounted in combining cases (left) or adapter frames (below). Panels are available in a variety of widths and heights.

HP Part No.	Module Case Height x Width	Filler Panel Dimensions		Price
		Millimetres	Inches	
5060-8540	1/4 x 1/2	38 x 198	1 1/2 x 7 29/32	\$54.00 ☞
5060-8757	1/4 x 1/2	38 x 130	1 1/2 x 5 1/8	\$75.00 ☞
5060-8758	1/2 x 1/3	77 x 130	3 1/2 x 5 1/8	\$43.00 ☞
5060-8759	full x 1/3	155 x 130	6 1/2 x 5 1/8	\$43.00 ☞
5060-8760	full x 1/2	155 x 198	6 1/2 x 7 29/32	\$44.00 ☞
5060-8761	full x 1/3	155 x 63	6 1/2 x 2 9/16	\$70.00 ☞

# FREE PUBLICATIONS

## Aids to Selecting, Using & Maintaining HP Products



### Free aids to selecting, using and maintaining HP products

HP offers a variety of free publications to help you choose the HP products that best fill your needs, to help you benefit from applications knowledge acquired by users inside and outside of HP, and to help you maintain your HP products. These publications range from new-product announcements, catalogs, product family brochures, and single-product technical data through application notes, product notes, and programming aids to service notes and general maintenance periodicals. Because the number and types of free publications vary with product family, a summary of available publications is provided below. Brief descriptions of some of the listed publications follow the summary.

### Instruments and Systems

#### Product Information

Measurement/Computation News

Data sheets and brochures

Catalogs

Test & Measurement Accessories

Catalog (U.S. only)

DC Power Supplies

Recorder Supplies

Coaxial & Waveguide Measurement

Accessories

Digital IC Tester Program

DesignCenter magazine

HP Journal

#### Application Information

Application Notes

Product Notes

Programming Notes

#### Service Information

Service Notes

Bench Briefs

### Computers, Peripherals & Calculators

#### Product Information

Measurement/Computation News

Data sheets & brochures

Selection guides

Catalogs

Computer Users Catalog

Computer Users Documentation Index

Personal Computer Users Catalog

HP Technical Software

HP Vectra Technical Software Guide

Software and Accessories Guide for the

Vectra PC

Software and Accessories Guide for the

Touchscreen PC

Drafting Plotter Supplies

Small Plotter Supplies

Software and Hardware Directory for

Graphics Plotters

LaserJet Print Font Catalog

LaserJet Printer Family Software and

Hardware Solutions

HP Journal

#### Application Information

Application Notes

Application Briefs

Plotter Notes

Set-Up Instructions (for plotters)

### Components

#### Product Information

Catalogs

Microwave and RF Designer's Catalog

Optoelectronics Designer's Catalog

Microwave Integrated Products

Data sheets

HP Journal

#### Application Information

Application Notes

Application Bulletins

### Test & Measurement News

Six times a year *Test & Measurement News* announces HP's latest electronic measuring instruments and accessories; computer/controller, component, and telecom products; and new no-charge literature such as catalogs and application notes.

### HP DesignCenter

*HP DesignCenter* is published for users of HP systems for electronic design, printed circuit board layout, and microprocessor-based development. This full-color magazine features custom application stories, answers to common customer questions, and announcements of new product enhancements.

### Hewlett-Packard Journal

Published six times a year to communicate technical information from the laboratories of HP to all of the fields served by HP, the Journal contains in-depth design descriptions of current hardware and software products as well as research papers and more general information such as advances in technology.

### Application Note Index

The AN index lists and describes the contents of all Application Notes, Programming Notes, and Product Notes on electronic instruments, instrument systems, and solid-state components.

### Application Briefs, Bulletins, and Notes

These aids to solving your measurement, computation, and design problems offer the benefit of the applications research and experience of both HP customers and HP engineers. Some are tutorial, others describe how-to procedures.

### Product Notes

Product Notes augment the Operating and Service Manuals supplied with HP electronic instruments by providing information on various topics that include specifications and characteristics, operation and use, applications and performance.

### Programming Notes

Programming Notes provide product-specific information on the use and operation of instruments in HP-IB systems. Some notes address the needs of inexperienced users and cover basic operation of an HP-IB instrument using a specific HP desktop computer. Others address the needs of experienced users.

### Service Notes

Service Notes contain product-specific service information for HP's electronic products. Subjects include product improvements, modifications, and procedures for troubleshooting, maintenance, and repair. Service Notes are published as appropriate throughout the life of a product. All new Notes are announced in Bench Briefs.

### Bench Briefs

Bench Briefs provides those who maintain HP instruments with timely information that has both specific and general application. Subjects include troubleshooting tips and descriptions of new technologies, components, tools, and equipment. Also, new Service Notes are listed in Bench Briefs as they become available.

### How to Obtain Free Publications

To obtain any of the publications described on this page, contact your nearest Hewlett-Packard office. Locations of HP offices are listed on the back pages of this catalog.

HP offices are also your best source of current information on the topics covered by Application Briefs, Application Bulletins, Application Notes, Product Notes, and Programming Notes.