

---

Test &  
Measurement  
Catalog

---

**1992**



*General categories of products listed in this catalog:*

<b>558</b>	ATE
<b>356</b>	Component Measurement
<b>73</b>	Controllers
<b>618</b>	Data Acquisition
<b>597</b>	Datacom Test
<b>166</b>	Digital Multimeters
<b>182</b>	Electronic Counters
<b>256</b>	EMC Test
<b>480</b>	Function Generators
<b>319</b>	High-Frequency Design Software
<b>377</b>	Lightwave Test
<b>320</b>	Logic Analyzers
<b>650</b>	Measurement Accessories
<b>70</b>	Measurement Systems Architecture
<b>102</b>	Modular Measurement Systems
<b>274</b>	Network Analyzers
<b>401</b>	Noise Figure Measurement
<b>136</b>	Oscilloscopes
<b>633</b>	Personal Computers & Terminals
<b>263</b>	Phase Noise Test
<b>210</b>	Power Meters
<b>520</b>	Power Supplies/Loads
<b>670</b>	Product Support
<b>499</b>	Pulse/Function Generators
<b>558</b>	Semiconductor Test
<b>428</b>	Signal Generators/Synthesizers
<b>218</b>	Signal & Spectrum Analyzers
<b>33</b>	Support Products for Instruments
<b>462</b>	Sweepers
<b>584</b>	Telecom Test
<b>390</b>	Transceiver Test
<b>87</b>	VXI Instruments

*For information on specific products:*

<b>35</b>	Alphabetical Index
<b>53</b>	Numerical Index
<b>1</b>	Table of Contents

*For current prices and support:*

<b>684</b>	HP Test and Measurement sales offices
<b>Inside back cover</b>	Customer information centers

**HP Computer Museum**  
**[www.hpmuseum.net](http://www.hpmuseum.net)**

**For research and education purposes only.**

---

1992



Test &  
Measurement  
Catalog

---

©Hewlett-Packard Company 1991  
Published by the Test & Measurement Sector  
Santa Clara, California  
Developed and produced by The Compage Company  
San Francisco, California  
Composition services by Stibo Datagraphics  
Marietta, Georgia  
Photography by Dave Bjorn/Photo Resource, Hawaii  
*The body of this book is printed on recycled paper*  
5091-3000EUS

# Contents

## **1 Introduction**

- 3 Introduction
- 5 New Products for 1992
- 33 Support Products
- 35 Alphabetical Index
- 53 Model Number Index

## **2 Measurement Systems Architecture**

- 71 Measurement Systems Architecture
- 136 Oscilloscopes
- 165 Waveform Analyzers
- 166 Digital Multimeters
- 182 Electronic Counters
- 210 Power Meters
- 218 Signal Analyzers
- 274 Network Analyzers
- 317 Microwave Receivers
- 319 High-Frequency Design Software
- 320 Logic Analyzers
- 346 Microprocessor Development Systems
- 352 Digital Circuit Testers
- 356 Component Measurement
- 377 Lightwave Test Equipment
- 390 Transceiver Test Equipment
- 401 Noise Figure Meter
- 405 Microwave Test Accessories
- 423 Dimensional Measurements
- 427 Pressure & Temperature
- 428 Signal Generators
- 462 Sweepers
- 476 Amplifiers
- 480 Function Generators & Waveform Synthesizers
- 499 Pulse Generators & Data Generators
- 516 DC Electronic Loads
- 520 Power Supplies
- 552 Frequency & Time Standards

## **3 Board & Semiconductor Test**

- 558 Semiconductor Test Equipment

## **4 Telecommunications & Data Communications Test**

- 584 Telecommunications Test Equipment
- 593 Digital Microwave Radio Test Equipment
- 597 Data Communications Test Equipment

## **5 Controllers, Software, Automated Test**

- 615 Hewlett-Packard Interface Bus
- 618 Data Acquisition Systems
- 630 Technical Computer Systems
- 632 Computer Aided Test

## **6 Accessories & Related Products**

- 633 Personal Computers & Terminals
- 637 Computer Support Products
- 642 Solid State Devices
- 644 Analytical Instruments for Chemical Analysis
- 646 Medical Instrumentation
- 648 X-Ray Equipment
- 650 Cables & Adapters
- 652 Operating Cases
- 654 Transit Cases
- 658 Cabinets & Cabinet Accessories
- 668 Testmobile Carts

## **7 Ordering Information & Customer Support**

- 670 Customer Support
- 680 Instrument Financing
- 682 Ordering Information
- 683 Operating Environments & Warranty
- 684 Sales Offices
- 712 Application & Product Notes
- 728 Free Publications

1

2

3

4

5

6

7

## Customer Services

**Sales** Information on all major HP test and measurement products and services is available through your local Hewlett-Packard Test and Measurement sales office.

### Sales Offices

Worldwide listing 684



### HP DIRECT

Order basic instruments, accessories and rack mounts over the phone for quick off-the-shelf service.

United States 1-800-452-4844

Hours: 9 a.m. to 5 p.m.

Outside of the U.S.

Austria 0222-2-500-350

Belgium 02-761-31-11

Canada (Toronto area) 800-387-8383

(Country wide) 800-671-3154

Denmark 80-30-16-40

France 16-1-60-77-31-08

Germany 30-33-22

Italy 02-95-301-532

Netherlands 06-0501

Spain 91-637-40-13

Sweden 08-750-24-00

Switzerland 057-31-24-90

United Kingdom 0734-441212

### Leasing/Finance

You can "pay as you go" with rental, lease, and finance plans from HP Financing.

HP Easy Rent 680

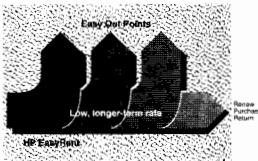

### General Information

Customers can get general information on all Hewlett-Packard sales and services throughout the world at their nearest customer information center.

### Customer Information Centers

United States 1-800-452-4844

Outside of the U.S.

Australia 03-648-1002

Canada (Toronto) 416-678-9430

(Country wide) 800-387-3867

Europe 011-44-344-369369

United Kingdom 0734-696622

Latin America 0052-005-202-0155

### Support

HP offers support that makes it possible for customers to get the most out of their test and measurement equipment. Contact your local HP T&M sales office for more information.

### Service Agreements

Hardware 671

Software 677

### Education

(Classroom and self-paced available) 674

### Consulting services

HP Consultline 679

Since Hewlett-Packard Company (HP) was founded in 1939, the company has designed, manufactured, marketed, and serviced more than 12,000 electronic products and systems used for measurement and computation. Applications for HP products range from science to industry, and from education to engineering.

Headquartered in Palo Alto, California, HP employs more than 91,000 people worldwide, maintains a sales force of 140 offices in the U.S., and has more than 300 sales and support sites and distributors in 100 countries (including Japan, Canada, the Far East, and Latin America).

Part of HP's philanthropy includes contributing both funds and equipment to technical programs at universities. In addition, HP has created a formal policy regarding environmental protection, setting the aggressive goal of eliminating all chlorofluorocarbons (CFCs) from manufacturing by 1994. Evidence of HP's commitment to improving the environment can also be found in this book, which is printed on recycled paper.

### Research and Development

HP is firmly committed to technical innovation, and views research and development as a crucial function. Each year, HP invests approximately 10 percent of its net revenue into this area. The company distributes about 85 percent of its annual research and development budget among 58 divisions for product development. The remaining 15 percent of the budget is allocated to high-risk, long-term research by HP Laboratories, one of the world's leading scientific and technical research centers.

When designing a new product, engineers at HP tap into networks that allow them to communicate with key people working on the same project. In addition, these engineers solicit early input from manufacturing experts to create products that have few parts, are relatively easy to manufacture, and can be made with existing equipment and processes. The end results are high-quality, reliable products that are quickly brought to market.

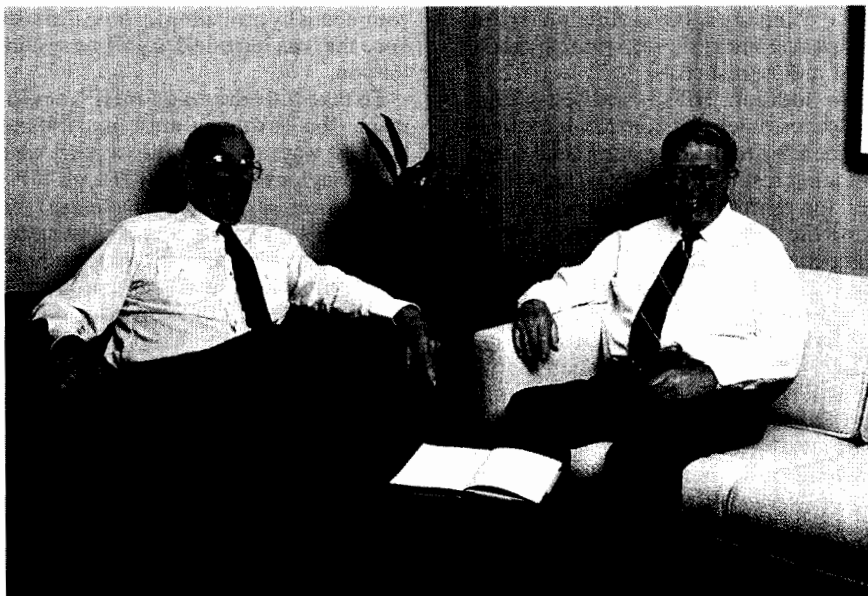

Shown seated are Dave Packard (left) and Bill Hewlett (right), founders of Hewlett-Packard.

### Range of Products

Computers, computer systems, networks, electronic instruments, peripheral devices, medical and analytical instruments, and calculators constitute a major portion of HP products.

HP products support the electronics, telecommunications, aerospace, aircraft, and automotive industries, as well as scientific research programs. The company also manufactures products related to electronics technology, including solid-state components (primarily microwave, semiconductor, and optoelectronic devices).

Through computer technology, most HP instruments incorporate automation and precision unavailable in competing products.

### Open Industry Standards

Computer and instrument consumers want open systems in which different manufacturers' products can work in unison. HP has taken a leadership role in developing industry standards that define interfaces between hardware and software elements—crucial for creating open systems.

In this catalog, HP's commitment to systems development and industry standards can be seen in the new Measurement Systems Architecture (MSA) section, whose products are based on an integrated approach to automatic testing. MSA uses standard commands for

programmable instruments (SCPI), founded on HP's test and measurement systems language (TMSL).

MSA permits engineers to construct instrument sets that work as a unit. In addition, by providing a single set of commands for all types of instruments, SCPI simplifies and encourages software development and increases the compatibility of software as hardware is upgraded. HP intends to implement SCPI in all the company's new systems instruments.

### Test and Measurement Systems

HP's Test and Measurement Organization combines the activities of the Electronic Instruments and Microwave and Communication groups, and includes a sales force dedicated solely to the organization.

Customers use HP's instruments in evaluating the performance of their own equipment, in creating new products, in quality control and manufacturing processes, and in field service applications. Precision electronic equipment is built into interactive systems, providing complete solutions to information needs.

These test and measurement products have solid value to customers. HP's integrated-circuit test system, with its innovative ability to drive devices to their performance limits, enables engineers to detect failures earlier than before.

# HEWLETT-PACKARD: AN OVERVIEW

The company's IC evaluation system helps customers shorten time to market and reduce test costs.

In addition, HP's board-test systems help customers hasten product development by reducing testing time. These systems test both complex digital and analog printed-circuit boards, and provide the first total test solution for surface-mount manufacturing of these boards.

Finally, high-performance companies such as Ferrari S.p.A. use HP test and measurement equipment. Ferrari uses a specially designed system based on HP 1000 minicomputers to test the advanced electronic components and systems of the Ferrari 348.

## Sales and Service

Good customer relationships are a cornerstone of HP's success. In 1990, the company implemented a new selling process that analyzes the structure that underlies a customer's crucial success factors, then uses that knowledge to build information-flow and solution sets that solve particular business problems. This process is backed by industry-specific expertise and by 4,500 third-party solution providers. In the fiscal year 1990, the company's service business achieved 21 percent growth in orders compared to fiscal 1989.

HP takes steps from the beginning of a product's history to ensure that high standards are built into that product. Quality parts are chosen after establishing close working relationships with suppliers.

Consolidation centers have been created by HP to help provide simultaneous and on-time delivery of all the products a customer orders, regardless of how far throughout the world these products must travel to reach that customer.

Through marketing, customer feedback helps to improve products. HP regularly conducts international consumer surveys to understand how to best serve its customers. As a result, on-time delivery of standalone products improved 30 percent in 1990.

## HP's Customer Support Services

Comprehensive support is available from HP in three basic areas: planning/design, implementation, and operation. To further strengthen these services, the customer may also take advantage of HP's software, hardware, consulting, and educational support.

Planning and design are essential to any operation's success, from a single instrument system to a large factory. HP can help you build the best setup for

your needs by providing technical assistance that can include designing a system for you.

To take full advantage of HP's equipment, the customer must understand the best ways to apply it in a particular operating environment. Through HP's installation services, or by using the company's education courses and materials, you can ensure that your equipment is installed quickly and properly.

It is important to keep your equipment in peak condition through maintenance operation—a process that can minimize downtime. To help you in this area, HP has a trained, international staff, supported by a large inventory of replacement parts. In addition, HP provides software updates that may affect your operation.

Hardware is supported through several channels, including onsite and customer-return services. Because HP's Customer Service Centers are highly automated, calibrating and diagnosing problems is an efficient process.

A variety of customer services are available free of charge, including concise hardware and software manuals and other publications. By perusing these manuals, the customer can choose products best suited to particular needs, can benefit from the know-how of engineers and other experts, and can learn how to maintain products. For information about these publications, see page 728 of this catalog.

To further educate its customers in the use of its equipment, HP offers educational courses in operation, application, and software and hardware maintenance for HP products. Classes are taught by highly trained instructors, and are limited to between six and 10 students. For more information, refer to page 674 of this catalog.

## The Structure of This Book

The purpose of this catalog is to give you useful information about HP products in an easy-to-use format. You will find general reference information for HP test and measurement products in the first four pages of the book. Inside the front cover is the Product Category Index. Following the title page is the Description of Terms and, on the facing page, the Table of Contents. The Table of Contents defines the beginnings of major sections and chapters, which are keyed to blue tabs on the outside edges of the pages. On the final page of this introductory section is a listing of customer services available through HP.

Beginning on page 5, you will see this year's New Products for 1992. This is the place to discover exciting new products that HP is offering for the first time.

Immediately following the New Products section are alphabetical and model-number indexes of the products featured in this catalog. Note that a listing printed in boldface in the model number index indicates a new product.

After the product descriptions and information that constitute the bulk of this book, you'll find nearly 40 pages of useful and detailed information regarding customer support, instrument financing, operating environments, warranties, and ordering products. In addition, a comprehensive listing of HP test & measurement sales offices is provided, arranged alphabetically by country. Application and product notes that provide free aids to solving your test and measurement problems are also listed in these 40 pages. More free publications about selecting, using, and maintaining HP test and measurement products are also enumerated at the end of the catalog. Finally, reader service and subscription cards for test and measurement product and application literature have been bound into the back of the book.

## Contacting Hewlett-Packard

For the locations of HP sales and service offices, see page 684. Calls to your local HP office are routed to the person best qualified to help you.

You can also contact HP through toll-free phone numbers at a growing number of international Customer Information Centers (CICs). The listing of HP offices on page 684 includes CIC locations and phone numbers. In addition to providing information, CICs can arrange for you to receive free publications.

## Ordering Products Quickly by Phone

The telephone icon next to the price in the catalog means that the product is available for off-the-shelf shipment through HP DIRECT. The HP DIRECT phone number can be found inside the back cover of this catalog.

## Suggestions Welcome

HP is always interested in hearing comments or suggestions about this catalog. These should be sent to the following address:

Hewlett-Packard Company  
Stu Center, T&M Catalog Manager  
5301 Stevens Creek Boulevard  
MS: 54L AF  
P.O. Box 58059  
Santa Clara, CA 95052-8059  
U.S.A.



### HP E1420B High Performance VXI Universal Counter

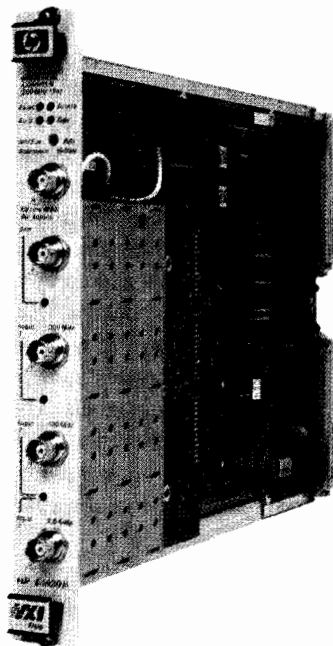

The new HP E1420B high performance VXI universal counter offers several significant improvements over its predecessor, the HP E1420A:

- Switchable  $\times 10$  input attenuators are now standard.
- High-throughput/shared RAM option improves measurement throughput by a factor of 4.

The addition of the  $\times 10$  attenuators allows measurement of higher-voltage signals, covering a dynamic range from 100 mVpp (35 mV rms) to 100 Vpp, with a damage level of 250 V. The shared RAM, Option 040, allows use of shared memory, boosting

the measurement throughput to as much as 200 measurements per second. The HP E1420B is 100% backward-compatible with the HP E1420A, and there is no increase in price.

Specifications—see page 91

For more information, contact your local sales office or use the reply card in the back of this catalog.

\*HP FIRST #1270

### Two-Channel, 250 MHz VXI Oscilloscope Module

The HP E1428A oscilloscope module offers speed, accuracy, and compactness. It is designed to make maximum use of the measurement-throughput capabilities of the VXI platform. It provides a 1-GSa/s digitizing rate, 8-bit vertical resolution, and  $\pm 150$  ps timing accuracy. With 250 MHz real-time bandwidth over 2 simultaneous channels, this compact module fits into a single C-size VXI card slot.

One megabyte of shared RAM with 256K battery backup allows rapid storage and retrieval of measurement results and waveform data. The RAM combines with two built-in automatic tests and 19 automatic pulse-parameter measurements to give the Model E1428A the fastest measurement-throughput rate of any VXI oscil-

loscope module. A choice of two built-in command languages, SCPI or HP 54510-compatible, simplifies programming and reduces test development time.

Specifications—see page 93

For more information, contact your local sales office or use the reply card in the back of this catalog.

\*HP FIRST #1145

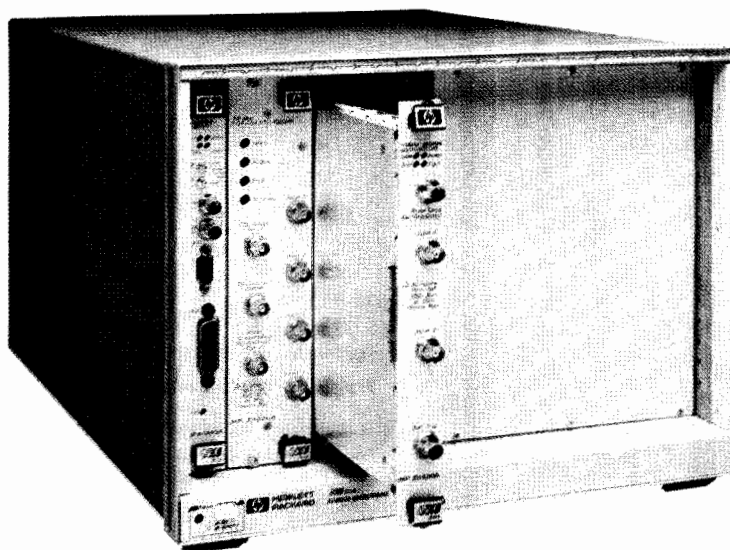

\*For faxed details on these new products, contact HP FIRST at 208-344-4809.  
For detailed instructions on using HP FIRST, see page 35.

## VXI Products (cont'd)

### HP 75000 Model D20 Functional Test System

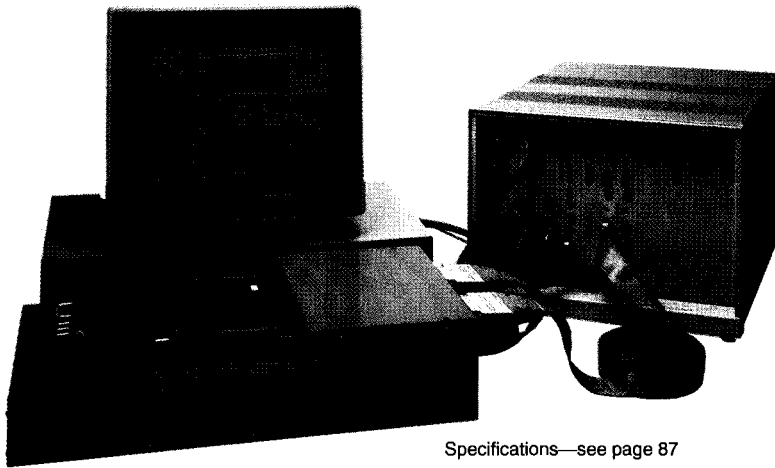

Specifications—see page 87  
For more information, contact your local sales office or use the reply card in the back of this catalog.

\*HP FIRST #1160

The HP 75000 Model D20 digital functional test system is capable of 20 MHz data rates. It includes a timing module, pattern I/O modules, optional pods, and optional software for fast test development.

Model D20 can load multiple tests into its deep, segmentable memory. It provides automatic pin-to-pin deskew and compensation for pod cable delays. Testing capability is improved with on-the-fly timing changes and multiple timing/control signals. The Model D20's comprehensive triggering capability makes it a good match for mixed-signal testing.

### HP E1445A/E1340A/E1446A Arbitrary Function Generators

The HP E1445A is a C-size arbitrary function generator capable of 13-bit resolution and speeds of up to 42 million samples per second. It comes with standard waveforms built in and a deep 256K sample memory.

The HP E1340A provides many of the same features on a B-size card. It has 12-bit resolution and speeds of up to 42 million samples per second. Memory depth is 16K samples.

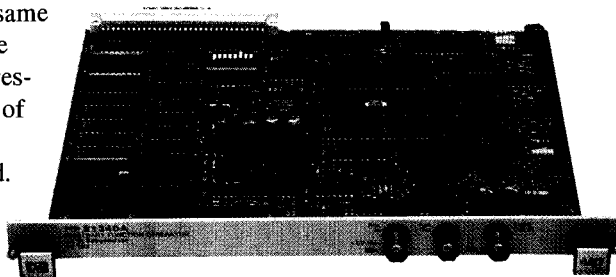

The HP E1446A summing amplifier/DAC gives you higher output power and the ability to sum two signals. It also has a built-in digital-to-analog converter to provide dc offsets.

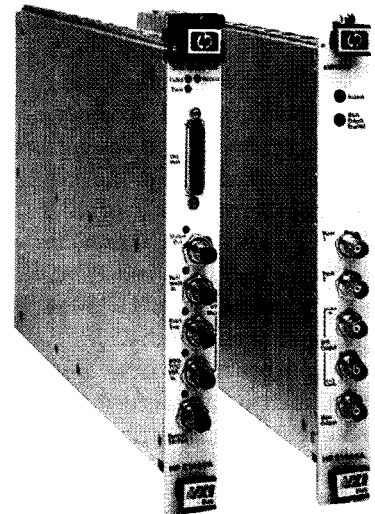

Arbitrary waveform generation software makes the task of generating waveforms easy.

Specifications—see page 92  
For more information, contact your local sales office or use the reply card in the back of this catalog.

\*HP FIRST #1165

\*For faxed details on these new products, contact HP FIRST at 208-344-4809.

6 For detailed instructions on using HP FIRST, see page 35.

### HP 70340A Modular Signal Generator



The HP 70340A modular signal generator is the ideal choice for tomorrow's ATE systems. All the performance of rack-and-stack synthesized sources is now available in half the rack space. Delivering high output power and very low harmonics (-55 dBc) and spurious (-60 dBc), the HP 70340A excels in radar, EW, and communications testing. Its 1 to 20 GHz frequency coverage, 1 Hz resolution, high-performance AM, FM,

and pulse modulation, and excellent spectral purity provide signal-generation flexibility; while its small size, versatile programming (SCPI and CIL), and superior reliability satisfy critical needs in modern ATE systems.

But the HP 70340A is not just for ATE. Take advantage of the power of modular instruments like the HP 70340A in benchtop research and development, leading-edge manufacturing, quality assurance, and metrology. Combine the HP 70340A with other HP modular instruments to produce high-performance, downsized, versatile test stations.

Specifications—see page 103

For more information, contact your local sales office or use the reply card in the back of this catalog.

\*HP FIRST #1560

### HP 71209A Microwave Spectrum Analyzer

The HP 71209A microwave spectrum analyzer is the newest high-performance spectrum analyzer in the HP 70000 MMS family. Its frequency range extends from 100 Hz to 26.5 GHz in coax and to 75 GHz with optional HP 11974 series preselected millimeter mixers. This spectrum analyzer is compatible with HP 8566B programming codes, so you can use existing software. Modularity gives it downsizing and flexibility in your ATS applications.

The sensitivity of the HP 71209A system is similar to that of the HP 71210C, but at a lower price. It also includes a built-in mixer interface, 5 dB step attenuator, and an input protection limiter. An auxiliary 321.4 MHz IF output with constant RF-IF gain and up to 200 MHz band-

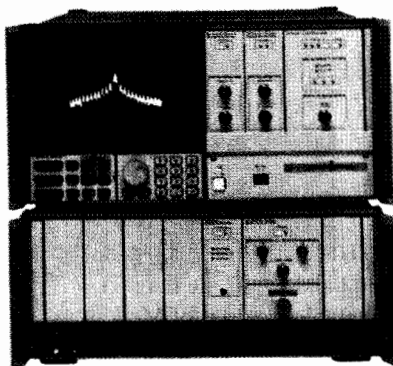

width capability allows you to use the instrument simultaneously as a wide-bandwidth downconverter for demodulating signals and as a spectrum analyzer for measuring signals.

Specifications—see page 253

For more information, contact your local sales office or use the reply card in the back of this catalog.

\*HP FIRST #1485

### HP 71500A Microwave Transition Analyzer

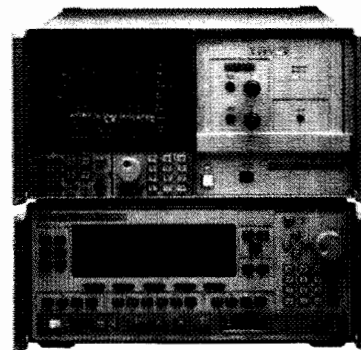

The HP 71500A microwave transition analyzer is a 2-channel, dc to 40 GHz, sampler-based instrument. It is an excellent measurement tool for characterizing nonlinear components in the time, frequency, and power domains.

The microwave transition analyzer makes continuous-wave and pulsed-RF measurements, specializing in fast magnitude and phase transitions. Performance is specified at 1ps delta-time accuracy and 10 ps rise time with internal triggering to 40 GHz. Time and frequency domain measurements include phase settling, rise and fall time, on and off ratio, delay, switching time, peak and average power, and group delay. This instrument is part of the HP 70000 modular measurement system (MMS), combining the new HP 70820A microwave transition analyzer module and the HP 70004A color display/mainframe.

Specifications—see page 104

For more information, contact your local sales office or use the reply card in the back of this catalog.

\*HP FIRST #1480

## General-Purpose Products (cont'd)

### HP 5372A Frequency and Time Interval Analyzer Option 040

The enhanced HP 5372A frequency and time interval analyzer now offers built-in jitter spectrum analysis (Option 040).

This convenient analysis feature assists with jitter or phase-noise characterization in digital communications and other serial data systems. With the new Option 040, complex tasks can be performed

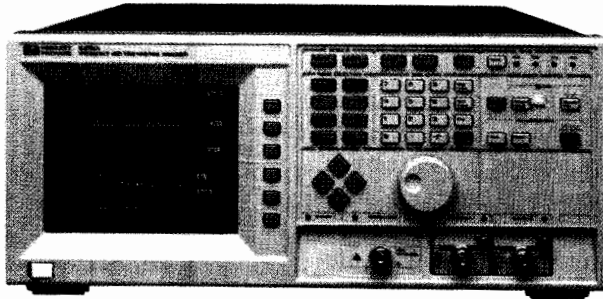

without computer-aided processing.

Specifications—see page 185

For more information, contact your local sales office or use the reply card in the back of this catalog.

\*HP FIRST #1285

### HP 54600 Series Oscilloscopes

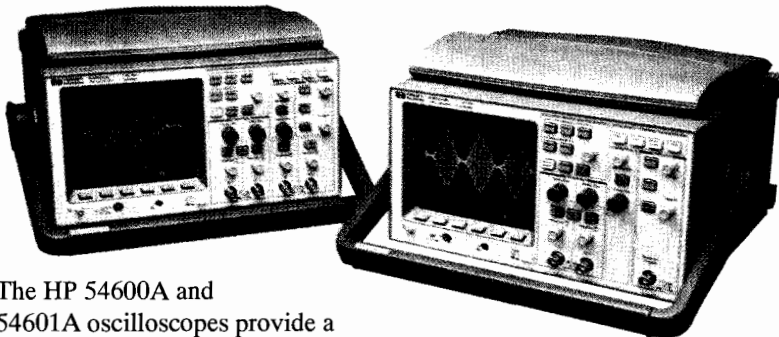

The HP 54600A and 54601A oscilloscopes provide a unique combination of analog look and feel with digital power. The limitations of analog oscilloscopes are overcome by these new products, while maintaining the real-time display and interactive controls that were characteristic of analog technology. HP's advanced integrated-circuit technology brings these new oscilloscopes, with their unique three-processor architecture, to you in a small-size, lightweight package at an affordable price.

The 2-channel HP 54600A is ideally suited for production, field service, and education

applications, where simple controls let you quickly solve your problems. The 4-channel HP 54601A is best suited for research and development labs and applications where more complex digital circuits are being designed and tested.

For even more power, optional interface modules can be added at any time for even more power.

Specifications—see page 154

For more information, contact your local sales office or use the reply card in the back of this catalog.

\*HP FIRST #1140

### 1 GSa/s Oscilloscope and Deep-Memory 100-MHz State and Timing Analysis for the HP 16500A Logic Analysis System

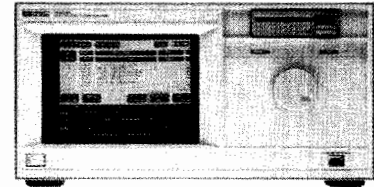

The HP 16500A logic analysis system now includes the optional HP 16532A 1 gigasample-per-second oscilloscope module and the HP 16540D 100 MHz deep-memory state-analysis module.

Each oscilloscope module provides 2 channels of 250 MHz real-time bandwidth with 8-bit vertical resolution and better than 150 ps time-interval resolution. Use the scope with other HP 16500-series modules for a tightly coupled logic analysis system, or configure your system as a multichannel scope with up to 18 channels on as many as 4 time bases.

The HP 16540D/41D state-analysis modules provide from 16 to 208 channels of 100 MHz state and timing analysis with 16K memory per channel.

Both new modules provide you with the performance you need to make highly accurate measurements over many channels for today's fastest CMOS, TTL, and ECL designs.

Specifications—see page 336

For more information, contact your local sales office or use the reply card in the back of this catalog.

\*HP FIRST #1150

## New Products for 1992 General-Purpose Products (cont'd)

### HP 4263A LCR Meter

The HP 4263A LCR meter is HP's best-valued low-end LCR meter, designed for both component evaluation on the production line and fundamental impedance testing for benchtop applications. The instrument can boost throughput with a measurement speed of 25 ms at test frequencies of 100 Hz, 120 Hz, 1 kHz, 10 kHz, and 100 kHz. This ability maximizes the test throughput of electrolytic capacitor, coil, and transformer testing. The HP 4263A's N (turns ratio), M (mutual inductance), and

DCR (dc resistance) measurement capability (with Option 001) relegates time-consuming data calculations and the frustrations of reconfiguring test setups to the past for transformer and coil testing.

Specifications—see page 371

For more information, contact your local sales office or use the reply card in the back of this catalog.

\*HP FIRST #1310

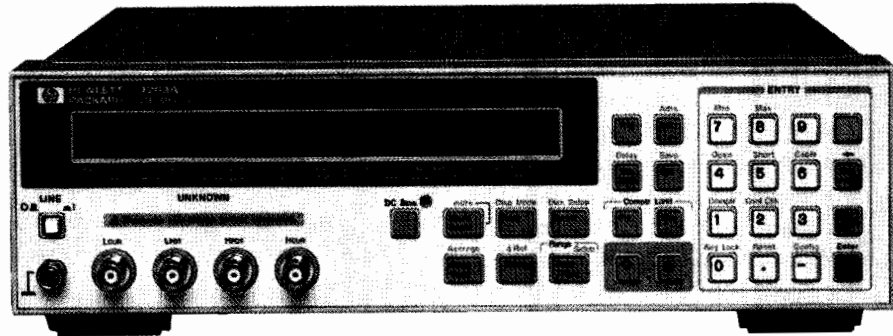

### HP 4338A Milliohmmeter

The HP 4338A milliohmmeter is a precise, reliable, and high-speed test tool for measurements of low resistance. Contact failure of electromechanical components in a low-current circuit is a key issue for component reliability. The HP 4338A offers selectable low ac test signals (1  $\mu$ A to 10 mA). Users can now characterize low resistances of electromechanical components under low-current and dry-contact test conditions. A high resolution of 10  $\mu\Omega$  allows you to determine the slightest differences in contact

resistance testing of relays, switches, connectors, PC board traces, and cables. The 1 kHz test signal eliminates potential errors introduced by thermoelectric effects on the device-under-test contacts.

Specifications—see page 374

For more information, contact your local sales office or use the reply card in the back of this catalog.

\*HP FIRST #1315

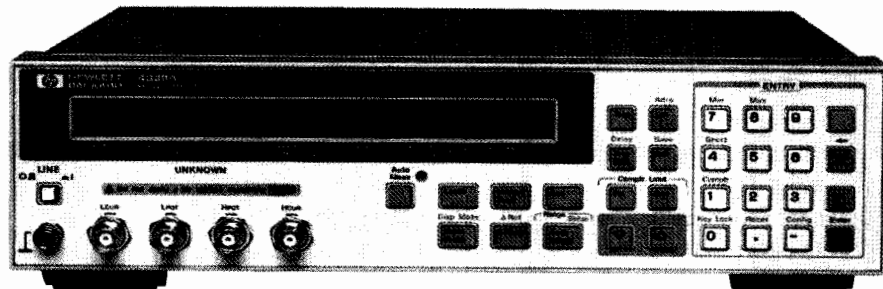

\*For faxed details on these new products, contact HP FIRST at 208-344-4809.

For detailed instructions on using HP FIRST, see page 35.

## General-Purpose Products (cont'd)

### HP 4349A 4-Channel High-Resistance Meter

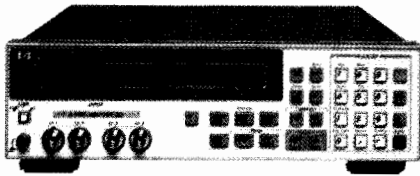

The HP 4349A 4-channel high-resistance meter is HP's highest-throughput high-resistance meter designed for production testing of capacitors. To verify component reliability, capacitor manufacturers need to test capacitor insulation resistance at different test voltages. The 4-channel configuration permits quasi-simultaneous testing of 4 capacitors at 4 different test dc voltages. This testing technique reduces the investment cost for instruments when compared to using 4 single-channel instruments. The HP 4349A's 11 ms 4-channel simultaneous measurement sequence increases the throughput of capacitor testing. The Contact Check function verifies that the signal path between the handler and the device under test is optimal for a measurement.

Specifications—see page 236

For more information, contact your local sales office or use the reply card in the back of this catalog.

\*HP FIRST #1325

### HP 4339A High-Resistance Meter

The HP 4339A high-resistance meter is HP's most advanced tool for making precision high-resistance measurements. The instrument makes benchtop measurements for applications in the laboratory and evaluation engineering environments. The measurement range is from  $10^3 \Omega$  to  $1.6 \times 10^{16}$  with a basic accuracy of 0.6 percent. This wide range allows accurate insulation resistance measurements of materials,

capacitors, relays, switches, connectors, cables, and PC boards. The HP 16008B resistivity cell and the HP 16339A component test fixture are designed for stable and safe measurements of these materials and components. The Test Sequence Program function specifically allows you to control a series of resistance measurements in a sequence (charge-measure-discharge), speeding up critical test time.

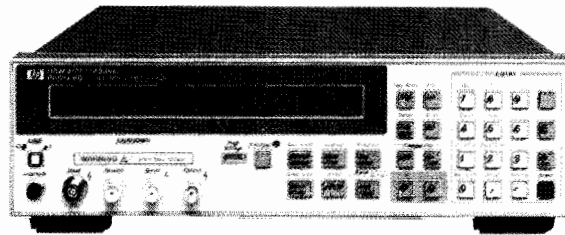

Specifications—see page 373

For more information, contact your local sales office or use the reply card in the back of this catalog.

\*HP FIRST #1320

### HP 3589A Spectrum/Network Analyzer

The HP 3589A spectrum/network analyzer provides complete frequency-domain analysis from audio through IF (10 Hz to 150 MHz) at a price comparable to that of a single dedicated spectrum or network analyzer. Spectrum measurements such as distortion, frequency, and noise level, along with network measurements such as phase, group delay, and attenuation can be made with 50, 75, and 1 M $\Omega$  inputs. Companion 50 and 75 $\Omega$  S-parameter test sets are available for full 2-port network analysis including return loss and impedance. Options include time-gated spectrum

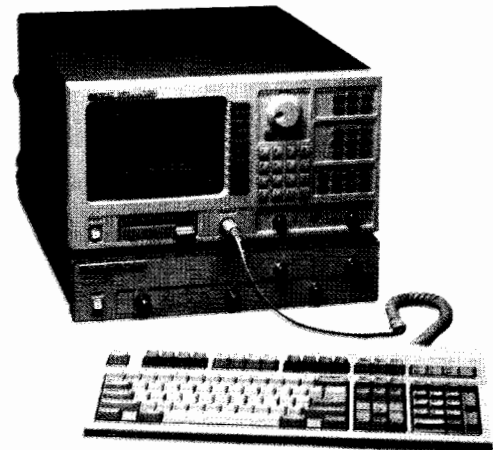

analysis, HP Instrument BASIC, and PC-compatible keyboards.

Specifications—see page 236

For more information, contact your local sales office or use the reply card in the back of this catalog.

\*HP FIRST #1190

\*For faxed details on these new products, contact HP FIRST at 208-344-4809.

For detailed instructions on using HP FIRST, see page 35.

## New Products for 1992 General-Purpose Products (cont'd)

### HP E3610 Series 30 W Bench Power Supplies

The HP E3610 series dc power supplies feature traditional HP performance at an affordable price. The HP E3610A and

E3611A both have output noise less than 200 mV rms. For versatility in benchtop applications, these power supplies feature dual-range outputs and CV/CC operation.

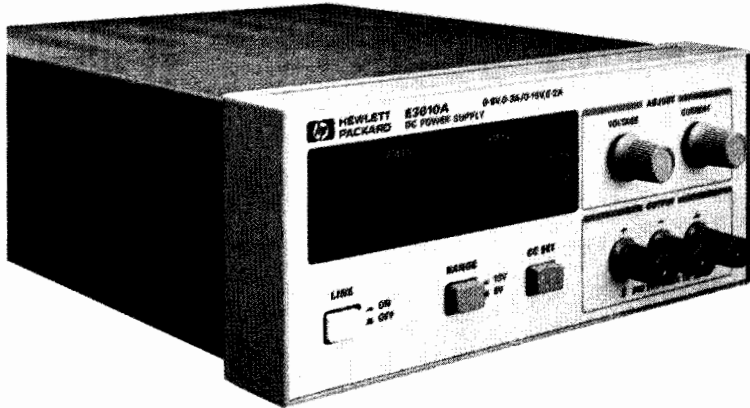

For ease of use, they have separate digital displays for voltage and current readback, a CC-set button for setting the current level without having to short the output, and mode-indicator LEDs to show whether the supply is in CV or CC mode.

Specifications—see page 537

For more information, contact your local sales office or use the reply card in the back of this catalog.

\*HP FIRST #1235

### HP 66000 Modular Power System

The HP 66000 modular power system fits up to eight 150 W programmable dc power modules in just 7 inches of rack space. In addition to their compact size, the

modules have excellent performance, with noise specifications as low as 5 mV peak-to-peak and 0.02% current readback accuracy. Modules can be easily installed or removed from the front of the mainframe, even when the power is on. For manual control of the

power modules during system integration or debugging, an optional keyboard can be plugged into the mainframe.

Specifications—see page 523

For more information, contact your local sales office or use the reply card in the back of this catalog.

\*HP FIRST #1240

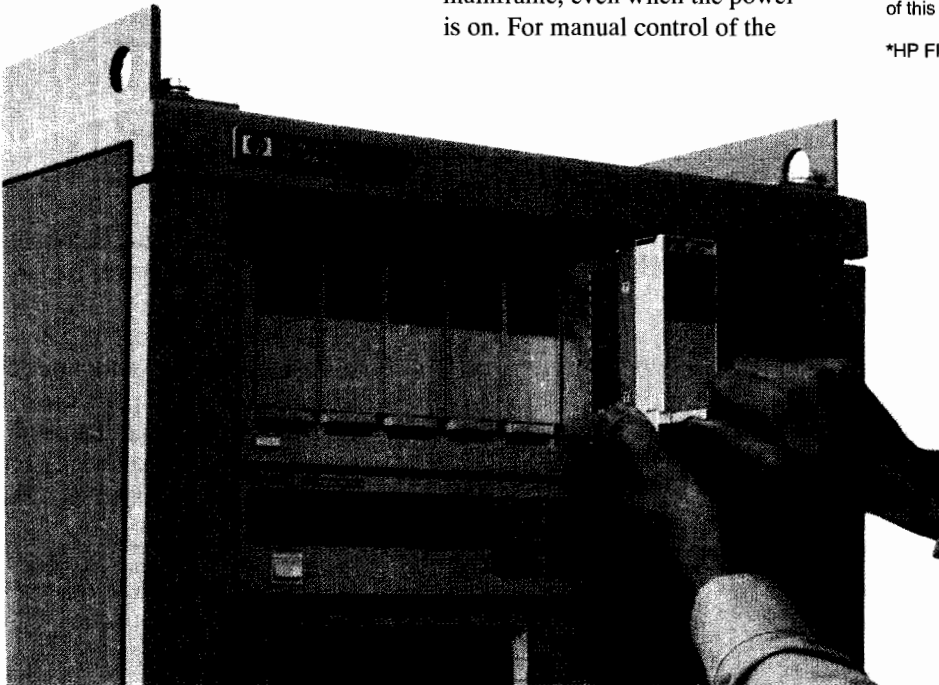

\*For faxed details on these new products, contact HP FIRST at 208-344-4809.  
For detailed instructions on using HP FIRST, see page 35.

## General-Purpose Products (cont'd)

### HP 6670A Series 2 kW System Power Supplies

The HP 6670 series power supplies offer the efficiency and compactness of switching power supplies with performance close to that of linear power supplies. Peak-to-peak noise is less than 5 mV for the HP 6671A. At 2000 watts, these are HP's highest-power HP-IB-programmable power supplies, and have current ratings up to 220 A. For use in ATE systems, the HP 6670 series

power supplies feature SCPI programming and a serial-link interface that allows up to 16 power supplies to be connected to a single HP-IB address.

Specifications—see page 529

For more information, contact your local sales office or use the reply card in the back of this catalog.

\*HP FIRST #1245

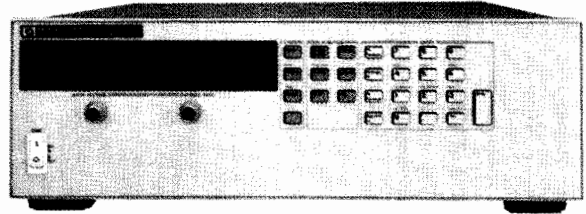

## Lightwave Products

### HP 8153A Lightwave Multimeter

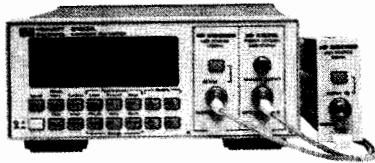

HP now offers two new solutions for optical power and loss measurements by introducing two new modules. The HP 8153A lightwave multimeter can now be configured both as a multimode loss test set and as a return-loss

test set.

The new LED modules, HP 81541MM for 850 nm and HP 81542MM for 1300 nm, offer excellent output power stability. Combined with the appropriate power sensor module, they enable users to perform highly precise insertion loss measurements on multimode optical components.

The return-loss test set consists of the new HP 81534A return-loss module and an appropriate laser

source module. Accessories are available to meet a variety of application requirements. Connector return-loss can be measured with a total uncertainty of  $\pm 0.40$  dB up to 50 dB and  $\pm 0.65$  dB between 50 dB and 60 dB.

Specifications—see page 378

For more information, contact your local sales office or use the reply card in the back of this catalog.

\*HP FIRST #1120

### HP 8146A Optical Time Domain Reflectometer

The HP 8146A is a modular optical time domain reflectometer (OTDR) with plug-in modules for 1310 nm, 1550 nm, and 1310/1550 nm single-mode fiber. It combines a large dynamic range of up to 30 dB with a short attenuation deadzone of 30 m. Multimode modules are also available.

Ease of use is ensured, as the HP 8146A will automatically characterize links in less than 7 seconds. Non-reflective events, such as splices and bends with

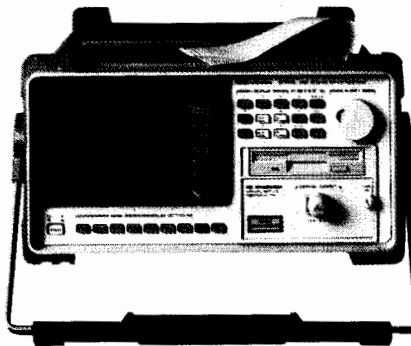

more than 0.05dB loss (selectable threshold), and reflective events are listed in a table.

The HP 8146A's optional features include a printer for immediate hard copies and a disk drive for permanent documentation of measured traces. A software package allows trace analysis on a PC.

Specifications—see page 381

For more information, contact your local sales office or use the reply card in the back of this catalog.

\*HP FIRST #1110



**HP 83440B/C/D Lightwave Converters**

High-speed fiber-optics telecommunication and data communication applications require fast, accurate instrumentation for optical pulse and waveform measurements. The dc-coupled HP 83440 family offers a variety of bandwidth options for converting incoming modulated optical power or optical pulses into electrical current. These fully integrated

hermetic InGaAs photodetectors feature very low noise and pulse aberrations, fast and accurate optical-to-electrical conversion, and a standard user interface compatible with most electrical instrumentation—all in a small, convenient package. They are an excellent choice for optical pulse parameter measurements. The HP 83440s can be used with high-speed digitizing oscilloscopes to accurately measure rise and fall time, overshoot, undershoot, ringing, peak power, pulse width, amplitude noise, and extinction ratio.

Specifications—see page 389  
 For more information, contact your local sales office or use the reply card in the back of this catalog.

\*HP FIRST #1385

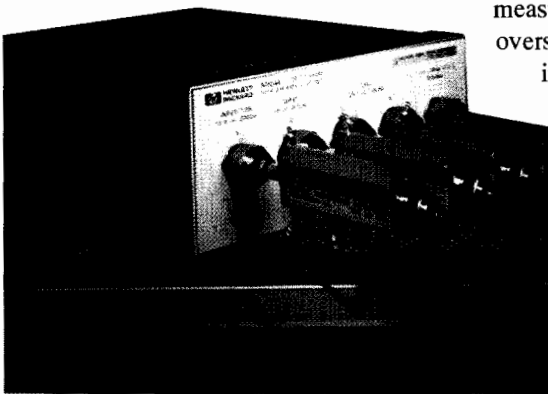

**HP 8509 Lightwave Polarization Analyzer**

The HP 8509 lightwave polarization analyzer brings new capabilities to lightwave designers interested in the polarization of optical signals or their effects on optical components. In real time, the polarization of any optical signal between 1200 and 1600 nm is displayed on a Poincaré sphere and as a Stokes vector. The HP 8509 also automatically determines the polarization dependence of optical components.

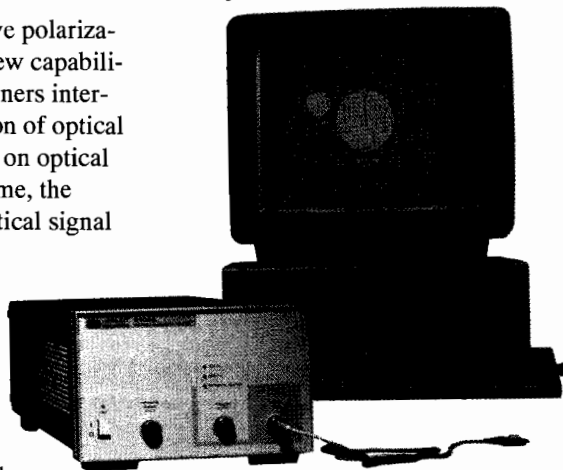

Specifications—see page 384  
 For more information, contact your local sales office or use the reply card in the back of this catalog.

\*HP FIRST #1390

**HP 8504A Precision Reflectometer**

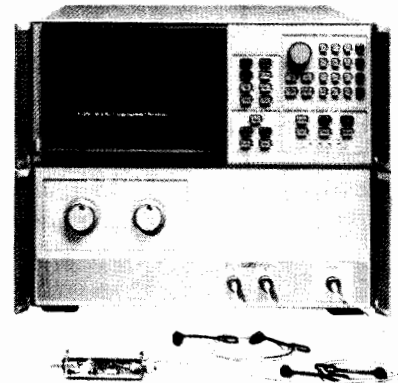

Designers and manufacturers of photodiodes, lasers, connectors, isolators, and other lightwave devices can now precisely characterize both the magnitude and the location of individual reflections within their components. The HP 8504A precision reflectometer provides a dramatic breakthrough in measurement capability with 75 dB of dynamic range and 25-micron 2-event resolution. Measurement spans vary from 40 cm down to 1 mm, and are made in single-mode fiber at either 1300 or 1550 nm.

Specifications—see page 384  
 For more information, contact your local sales office or use the reply card in the back of this catalog.

\*HP FIRST #1395

## Microwave and RF Products

### HP 85301B/C Antenna Measurement Systems

The HP 85301B/C antenna measurement systems are preconfigured measurement systems that can be used either for antenna pattern measurements or for radar cross-section measurements. Both systems provide all the instrumen-

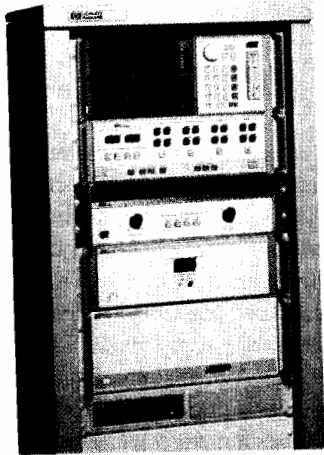

tation necessary for basic measurements. The system's capabilities can be expanded with optional features, and can also be customized for unique measurement applications.

Specifications—see page 317

For more information, contact your local sales office or use the reply card in the back of this catalog.

\*HP FIRST #1400

### HP 8571A and 8572A Microwave EMI Receivers

The new HP 8571A microwave EMI receiver (20 Hz to 22 GHz) makes radiated and conducted emission measurements for testing to international military standards. It offers full RF preselection, peak and average detection, and special impulse bandwidths to meet MIL-STD specifications. The new HP 8572A microwave EMI receiver (20 Hz to 22 GHz) has the same capabilities, but also includes quasi-peak detection and special CISPR bandwidths for EMI compliance testing to CISPR-based commercial standards.

Specifications—see page 378

For more information, contact your local sales office or use the reply card in the back of this catalog.

\*HP FIRST #1475

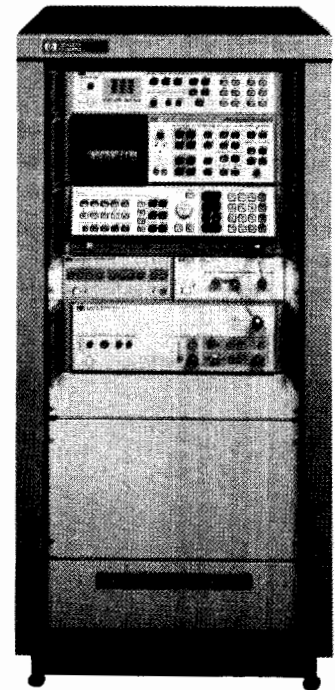

### HP 5373A Modulation Domain Pulse Analyzer

The HP 5373A modulation domain pulse analyzer offers a solution for complex signal modulation analysis. The HP 5373A minimizes the design and testing effort for radar systems and enhances design efforts for EW, ELINT, IFF, and related equipment and components. The analyzer measures modulation and carrier frequency on pulsed RF

signals to 500 MHz. A detector channel can precisely measure envelope parameters such as pulse width and PRT, peak envelope power, percent AM, jitter, and more.

Specifications—see page 185

For more information, contact your local sales office or use the reply card in the back of this catalog.

\*HP FIRST #1255

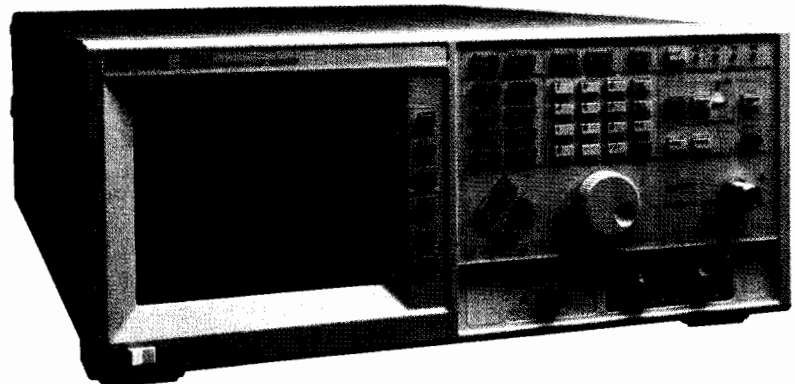

## New Products for 1992 Microwave and RF Products (cont'd)

### HP 83650A Synthesized Sweeper

The HP 8360 series synthesized sweepers set a standard of excellence for applications requiring both the high performance and accuracy of a synthesized source and the speed and versatility of a sweeper.

The newest model in the HP 8360 series, the HP 83650A synthesized sweeper, offers the broadest coaxial output for a synthesized source, 0.01 to 50 GHz. Frequency coverage of the HP 8360 series can be extended to 110 GHz in waveguide when used with an HP 83550 series millimeter-wave source module.

The HP 8360 series synthesized sweepers provide unprecedented swept performance, including list, step, and analog sweeps, precision output power control, comprehensive modulation capability, an optional internal synthesized modulation generator, and an unequaled commitment to quality and reliability. The HP 8360 series sweepers only require calibration every 2

years, and they have over 250 internal diagnostic tests.

Specifications—see page 464

For more information, contact your local sales office or use the reply card in the back of this catalog.

\*HP FIRST #1430

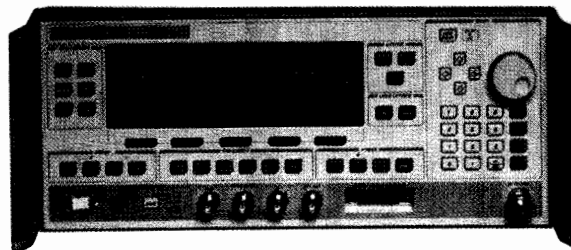

### HP 8920A RF Communications Test Set

The HP 8920A RF communications test set combines all the necessary functions to test and repair RF radios and communication systems up to 1 GHz, including AM/FM/SSB transceivers, pagers, repeaters, filters, duplexers, cellular phones, and combiners. The test set includes the following separate functions: RF signal generator, modulation analyzer, power meter, frequency counter, audio analyzer, duplex generator, digital oscilloscope, function generator, 2 audio sources, and dc-current meter.

An optional signaling encoder/decoder will test digital squelch, digital pagers, and cellular radios. An optional high-performance synthesized spectrum analyzer with 2  $\mu\text{v}$  sensitivity and tracking generator is also available for monitoring interference and intermodulation problems off the air.

An RF probe can be used with the spectrum analyzer to troubleshoot signals within a radio under test.

Radio test software (HP 11807A), encoded on small memory cards, is available to run on the HP 8920A's internal IBASIC controller, allowing the test set to perform automatic tests for AM/FM/European Phi-M and several cellular phones (the test set will drive a printer, providing hard copy of test results), or the user can write custom software on a PC connected to the test set via RS-232.

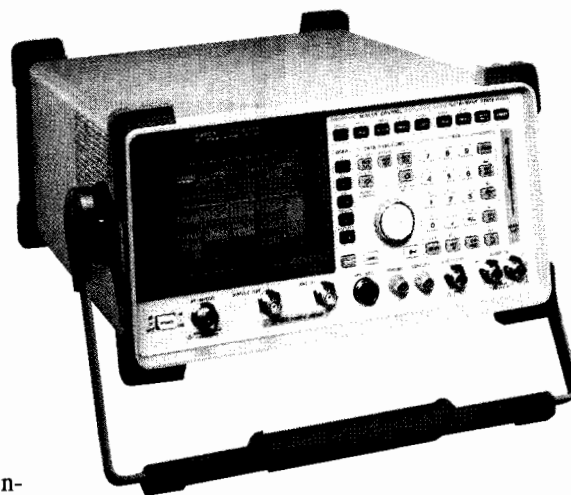

The test set is portable, weighs 35 pounds, comes with an optional battery pack, and meets military-standard ruggedness and environmental specifications.

Specifications—see page 390

For more information, contact your local sales office or use the reply card in the back of this catalog.

\*HP FIRST #1490

## Microwave and RF Products (cont'd)

### HP 8643A and HP 8644B RF Signal Generators

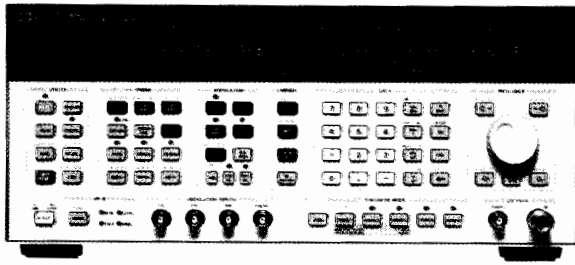

The HP 8643A 1 GHz/2 GHz and HP 8644B 1 GHz/2 GHz RF signal generators are replacements for the HP 8644A. The two new models incorporate all the most popular features and options of the HP 8644A. The HP 8643A has been optimized with the performance necessary for out-of-channel receiver testing while

maintaining a low price. It also comes standard with an electronic attenuator for increased reliability and a variable-modulation oscillator that allows

2-tone testing. The HP 8644B builds on the HP 8643A's performance by lowering the SSB phase noise and spurious for the most demanding applications.

Specifications—see page 437

For more information, contact your local sales office or use the reply card in the back of this catalog.

\*HP FIRST #1520

### HP 11759B RF Channel Simulator

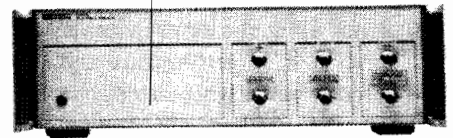

The HP 11759B RF channel simulator provides a precision multipath signal fading environment for North American dual-mode cellular radios as well as other international mobile and cordless communications systems. Each of 6 internal signal paths can simulate combinations of Rayleigh fading with adjustable correlation coefficient or log-normal fading, Doppler conditions to 85 Hz, delays to 170  $\mu$ s, and relative attenuations to 30 dB. It can exercise radios from 40 to 2000 MHz under the complex multipath signal conditions found in a mobile radio environment.

Specifications—see page 400

For more information, contact your local sales office or use the reply card in the back of this catalog.

\*HP FIRST #1540

### HP 11755A RF Simulator WorkSystem Driver

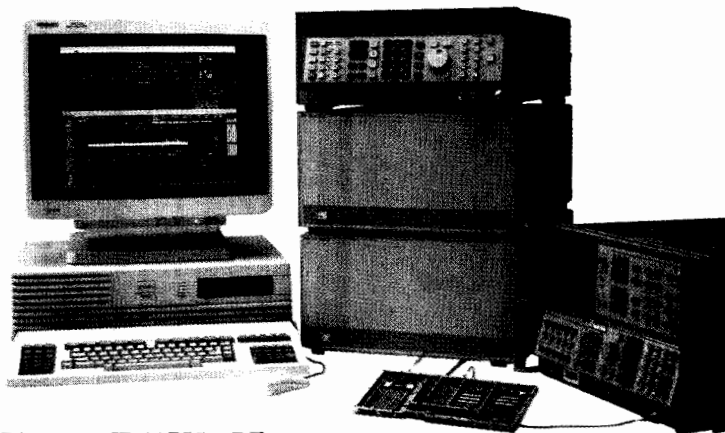

The new HP 11755A RF Simulator WorkSystem Driver links system simulation software from Comdisco Systems, Inc., with an HP signal simulator for complex-modulated signals in the 10 to 3000 MHz frequency range. Together, these products provide computer simulation and RF stimulus for sophisticated communication systems such as digital cellular and satellite networks. By exercising systems before and

after prototyping with ideal signals plus real-life impairments such as multipath fading, distortions, interference, and noise, system integrity can be established early in the design cycle, improving overall time-to-market.

Specifications—see page 453

For more information, contact your local sales office or use the reply card in the back of this catalog.

\*HP FIRST #1550

# New Products for 1992

## Physical and Mechanical Design and Test Products

### HP 10885A PC Axis Board



The HP 10885A PC axis board is a laser interferometer system that can be interfaced with the most popular PC backplanes. Leveraging existing PC/XT, PC/AT, and other IBM-compatible computers significantly lowers startup costs. The HP 10885A provides a 32-bit digital, real-time position output via hardware. Position can also be read over the PC backplane. Combining the high performance of HP laser interferometers with the most popular, lowest-priced, industry-standard backplane speeds system development and integration.

Specifications—see page 423

For more information, contact your local sales office or use the reply card in the back of this catalog.

\*HP FIRST #1260

### HP 10896A Compensation Board

The new HP 10896A compensation board increases the accuracy and repeatability of laser interferometer positioning systems based on the HP 10895A VMEbus laser axis board. With complete, flexible environmental compensation, VMEbus laser positioning systems are suitable in many environments.

Specifications—see page 424

For more information, contact your local sales office or use the reply card in the back of this catalog.

\*HP FIRST #1265

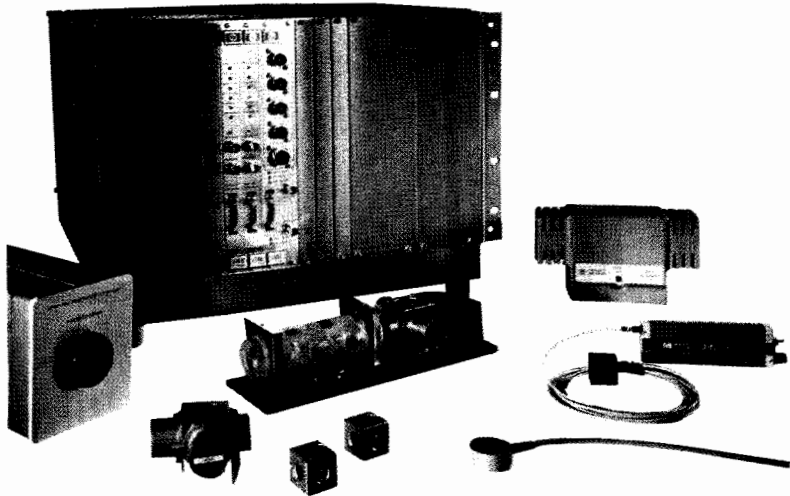

\*For faxed details on these new products, contact HP FIRST at 208-344-4809.  
For detailed instructions on using HP FIRST, see page 35.

## Physical and Mechanical Design and Test Products (cont'd)

### HP 10719A, HP 10721A One-Axis and Two-Axis Differential Interferometers HP 10735A, HP 10736A Three-Axis Interferometers

The optics tailor an interferometer system for the physical layout and measurement requirements of each application. The current list of HP optics includes four new products for improved multi-axis stage positioning and sub-0.5-micron accuracy. The HP 10719A and HP 10721A differential interferometers work together to make highly accurate column-referenced measurements for multi-axis stages. The HP 10735A and HP 10736A three-axis interferometers offer greater accuracy for microlithography and other applications that require up to five degrees of freedom.

Specifications—see page 424

For more information, contact your local sales office or use the reply card in the back of this catalog.

\*HP FIRST #1275

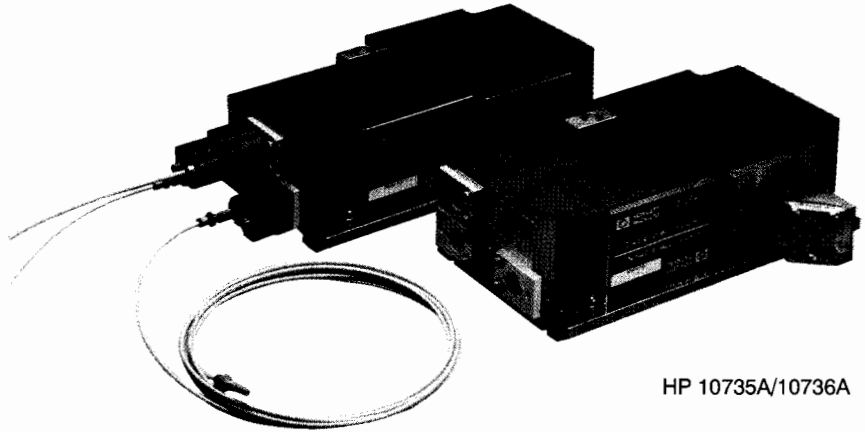

HP 10735A/10736A

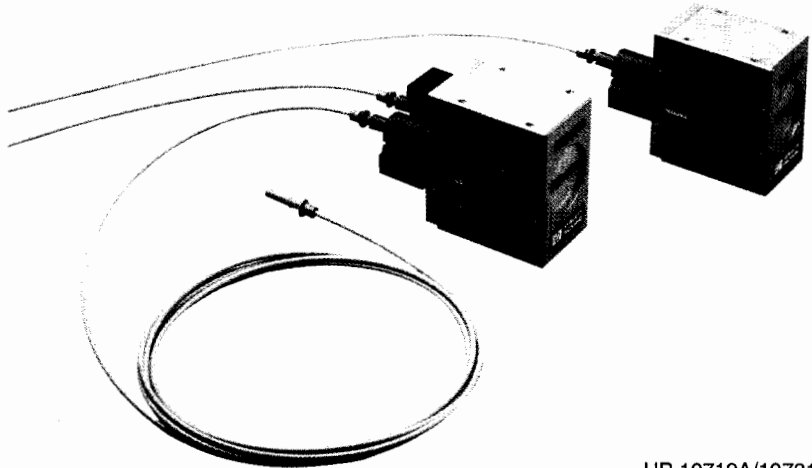

HP 10719A/10721A

## New Products for 1992 Board and Semiconductor Test; ATE Products

### Power Mixed Signal Test System

The HP 9472 is a configurable semiconductor and hybrid test system. It can be used to test smart power, analog, and power mixed-signal devices including motor drivers, disk controllers, switches, voltage regulators, power supply controllers, op-amps, timers, and comparators. It can handle voltages up to  $\pm 2000$  V and currents up

to  $\pm 100$  A, both floating or ground-referenced. The system supports 32 analog channels, 64 digital I/O pins, low leakage measurement capability, inductive load testing, instrument-level diagnostics, time measurement, and menu-driven software with compiled C-language test libraries. An interactive menu-driven software environment

affords an efficient approach to program generation and debug.

The TH-300 Configurable Test Head integrates power, small signal, time measurement, and digital test capability in one compact test head, allowing up to 14 instruments to be located close to the device under test for improved accuracy and high-throughput testing. The test head is designed to allow fast, simple design of load boards, since test head instruments reduce load boards to interconnect circuitry.

Specifications—see page 560

For more information, contact your local sales office or use the reply card in the back of this catalog.

\*HP FIRST #1100



\*For faxed details on these new products, contact HP FIRST at 208-344-4809.  
For detailed instructions on using HP FIRST, see page 35.

## Board and Semiconductor Test; ATE Products (cont'd)

### HP 3078 Board Test System

The HP 3078 is the newest member of the fully upgradeable HP 3070 board test family. It

enhances the combinational test capabilities of HP 3070 products with the addition of functional

test development tools. A result of a joint development effort between HP and Mentor Graphics, the HP 3078 includes an HP 3070 testhead and controller, Mentor Graphics simulation software, and HP simulator-based digital functional test software. A one-year phone-in software support agreement is bundled in with the HP 3078.

Specifications—see page 123

For more information, contact your local sales office or use the reply card in the back of this catalog.

\*HP FIRST #1220

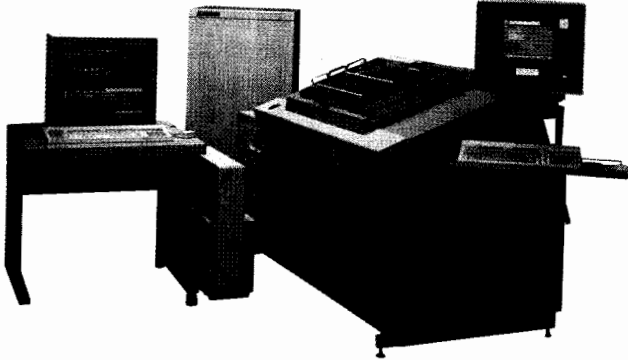

The HP 9490 series mixed-signal LSI test system provides the right solution for a mixed-signal tester from a series of products. The HP 9491A offers higher performance, with greater accuracy and faster data rates; the HP 9492A features mid-range performance at a lower price.

Complex devices with mixed-signal capability need event control and a low-noise environment. Also, reducing test development cost through rapid program generation is very important.

The HP 9490 series addresses these and other key issues associated with advanced mixed-signal device testing.

Specifications—see page 562

For more information, contact your local sales office or use the reply card in the back of this catalog.

\*HP FIRST #1295

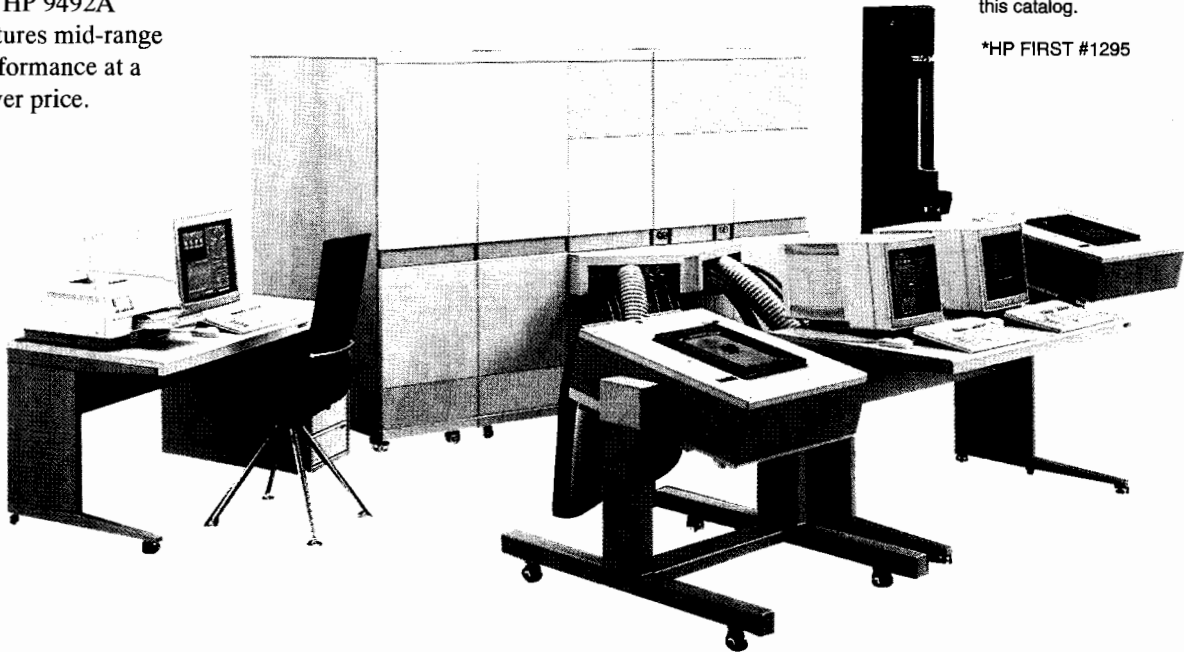



## New Products for 1992 Board and Semiconductor Test; ATE Products (cont'd)

### HP 3070 VXI Board Test System Products

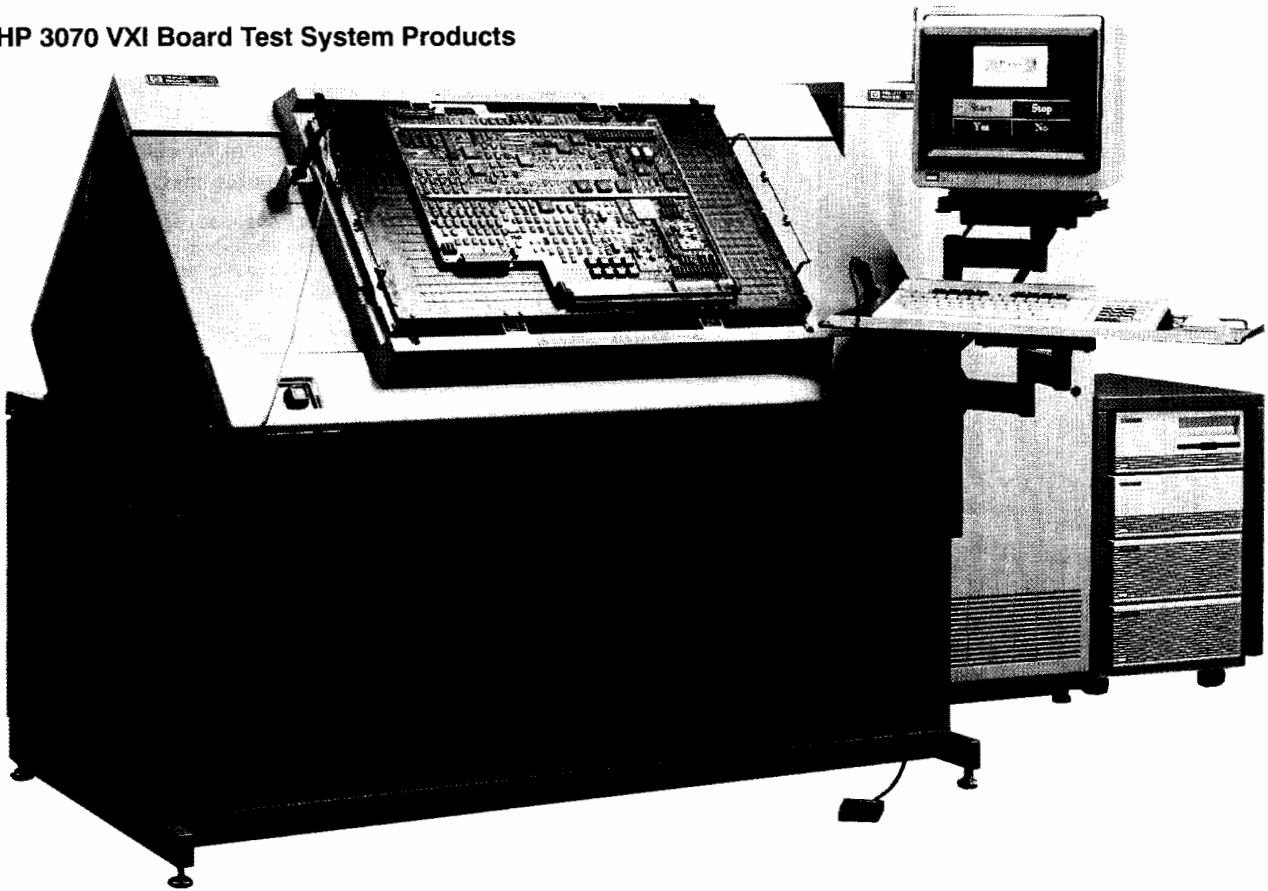

The HP 3070 VXI board test system is a combinational board test solution that adds the capability of VXIbus to the standard analog functional test tools. Both hardware and software are available for a complete VXI system. The HP AccessPlus card and system cabling products provide hardware connections from instruments to the device under test. Standard system software provides extensive SQC tools, opera-

tor interface, and test executive. In addition, HP 3070 VXI integrates HP ITG (Interactive Test Generator) with the standard HP 3070 software, providing virtual instrument front panels to help you develop and debug analog functional tests.

Specifications—see page 124

For more information, contact your local sales office or use the reply card in the back of this catalog.

\*HP FIRST #1225

\*For faxed details on these new products, contact HP FIRST at 208-344-4809.

For detailed instructions on using HP FIRST, see page 35.

## Telecom and Datacom Products

### HP 4990S LanProbe System

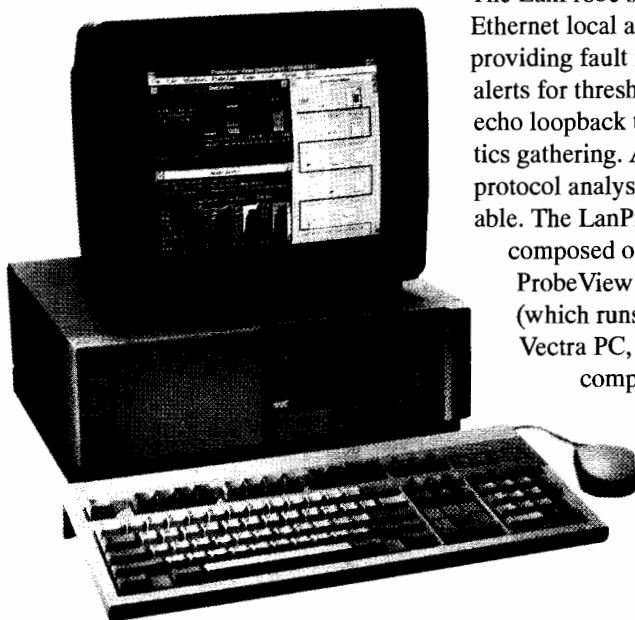

The LanProbe system monitors Ethernet local area networks, providing fault information, alerts for threshold excesses, echo loopback tests, and statistics gathering. An option for protocol analysis is also available. The LanProbe system is composed of HP 4990A ProbeView software (which runs on an HP Vectra PC, IBM PC/AT, or compatible personal computer), one or more HP 4991A

LanProbes attached to the ends of Ethernet network segments, and an optional HP 4992A NodeLocator for automatic node placement for coaxial cables.

Specifications—see page 611

For more information, contact your local sales office or use the reply card in the back of this catalog.

\*HP FIRST #1360

### HP J2201A NEXT Scanner



A new family of hand-held, battery-operated HP local area network (LAN) scanners quickly isolates cabling problems on LANs. These scanners will test virtually any twisted-pair or coaxial LAN wiring system, including token-ring, Ethernet ThinLAN or ThickLAN, 10BASE-T, and Arcnet systems. Built-in time domain reflectometer (TDR) technology instantly detects and locates cable faults, and reports results in plain English—for example: "Short at 53 ft."

The newest member of this family, the HP J2201A NEXT

scanner, provides automatic testing of signal loss and near-end crosstalk (NEXT) from 1 to 0.2 MHz. Cabling installations are quickly evaluated for conformance to one of several networking standards, including token-ring and 10BASE-T. The NEXT scanner automatically reports any deviation from expected results in the measurement data, telling you instantly whether or not the wiring is suitable for data traffic. Optional cable management software provides access to a database with up-to-date records of the physical characteristics of every part of your LAN.

Specifications—see page 606

For more information, contact your local sales office or use the reply card in the back of this catalog.

\*HP FIRST #1355

## New Products for 1992 Telecom and Datacom Products (cont'd)

### HP 4957A and HP 4957PC Protocol Analyzers

The HP 4957A is the latest addition to HP's line of portable WAN protocol analyzers. It provides 64 kbit/s capture performance (256 kbit/s capture performance is optional); built-in RS-232C/V.24, RS-449, and V.35 interfaces; and a 768 Kbyte RAM capture buffer. The HP 4957PC is a full-performance PC card that is functionally identical to the HP 4957A. Designed to transform an IBM-compatible PC into a noncompromised protocol analyzer, the HP 4957PC achieves its high-integrity capture performance through on-board processing and an extensive RAM capture buffer. Both analyzers are supported by a wide range of hardware interfaces and software applications. Hardware interfaces include T1, X.21, and ISDN primary and basic rate at the R, S, T, and U reference points. Software applications include T1.403, frame relay, SNA, X.25, CCS#7, and DDCMP decodes; ISDN, SNA, and X.25 emulation and analysis packages, and layer 2 and 3 statistical packages for X.25 and SNA. Both analyzers are fully

compatible with the HP 18275A Remote Troubleshooter PC software, which sets a new standard for PC-based remote troubleshooting tools.

Specifications—see page 598

For more information, contact your local sales office or use the reply card in the back of this catalog.

\*HP FIRST #1335



### HP 18275A Remote Troubleshooter

The HP 18275A remote troubleshooter software transforms a PC into a powerful central site workstation. Linked to a remote HP 4957A or HP 4957PC, it provides a window into the remote network, allowing a datacom specialist at an escalation center to offer real-time assistance to an on-site CE. This results in

lower downtime for the customer network and reduces repair expenses for the network support organization. The HP 18275A contains a powerful *virtual-mode* remote that reproduces the display and keyboard of the remote analyzer on the PC, allowing an off-site specialist to see how an instrument is operating, and, if

needed, control it. The software package provides for the transfer of data and applications between the PC and the analyzer. It also contains powerful decodes for post-capture analysis of data, and supports a wide range of protocols including SNA, X.25, ISDN, frame relay, X.400, and DASS2/DPNSS.

\*For faxed details on these new products, contact HP FIRST at 208-344-4809.

For detailed instructions on using HP FIRST, see page 35.

## Telecom and Datacom Products (cont'd)

### HP Network Advisor

HP has redefined the protocol analyzer market with the Network Advisor for troubleshooting Ethernet and Token-Ring local area networks (LANs). The Network Advisor helps network managers solve problems caused by misconfigurations, incompatibilities, or defects much faster than traditional tools.

The Network Advisor gives you network performance at a glance. Its protocol transaction analysis far exceeds protocol analyzer capabilities. Its expert-system-based Fault Finder isolates many common LAN problems with little or no user input. By eliminating the tedious, time-con-

suming process of tracking down these often intermittent and evasive problems, the Network Advisor frees network managers to concentrate on more important tasks.

Specifications—see page 609  
For more information, contact your local sales office or use the reply card in the back of this catalog.

\*HP FIRST #1345

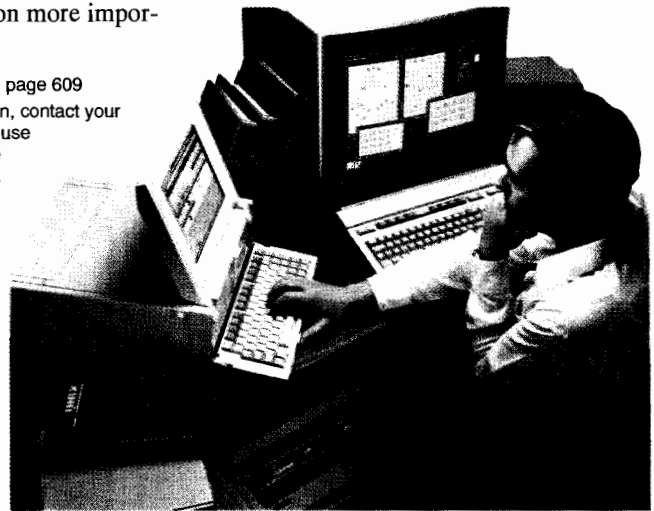

### HP PT502 High-Speed Protocol Tester

The HP PT502 features data triggering, filtering, capture, and analysis at rates up to 2 Mb/s, allowing it to test full bandwidth and fractional DS1/T1 or CEPT/E1 data traffic. The PT502 offers unprecedented ability to examine and generate digital traffic on T1/E1 circuits from a dedicated protocol tester. The HP PT502 features software for frame relay monitoring and simulation, X.25 monitoring and emulation, and SMDS monitoring.



Specifications—see page 601  
For more information, contact your local sales office or use the reply card in the back of this catalog.

\*HP FIRST #1375

### Frame Relay Emulation and Monitoring Software

New frame relay emulation software and enhanced monitoring software are available for the HP PT500, PT502, and PT300 protocol testers. These powerful tools can help you reduce time-to-market and increase the robustness of frame relay products and networks under development. These software packages include full support for automated DTE or DCE emulation of frame relay networks. Multi-port capabilities and a complete end-to-end network simulation feature make this the ideal testing tool for your development lab—simulate entire networks with one tool. A sophisticated programming environment lets you create custom test scripts or device simulations you desire—quickly and efficiently.

Specifications—see page 601  
For more information, contact your local sales office or use the reply card in the back of this catalog.

\*HP FIRST #1370

## New Products for 1992 Telecom and Datacom Products (cont'd)

### HP 37900D Signaling Test Set

The HP 37900D signaling test set has powerful multi-link capabilities that match the test needs of signaling protocols (Signaling System No. 7 and ISDN). Designed to be portable, it offers monitoring of up to 4 bidirectional signaling links or emulation using up to 8 links. The HP 37900D simplifies design verification, installation, or troubleshooting. While displaying real-time activity, message decode, or statistics, the HP 37900D can log specified types of signaling data for later analysis.

A wide range of Signaling System No. 7 variants are built into the product. These include CCITT Red and Blue Books, Bellcore and ANSI, GSM (General System for Mobile

Communications), and many individual national variants. All of these may be decoded according to the individual specification.

Although rugged and portable (13 kg), the HP 37900D offers a full-size keyboard and a large, 80-character by 25-line, electroluminescent screen. It also includes both a double-density 3.5-inch flexible disk drive and a 52-MB hard disk.

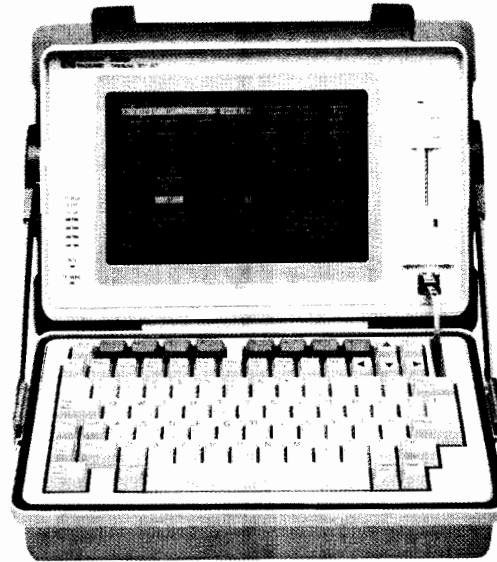

Specifications—see page 605

For more information, contact your local sales office or use the reply card in the back of this catalog.

\*HP FIRST #1445

### HP 37704A SONET Test Set

The HP 37704A SONET test set provides a straightforward approach to SONET testing in the network. It is a comprehensive

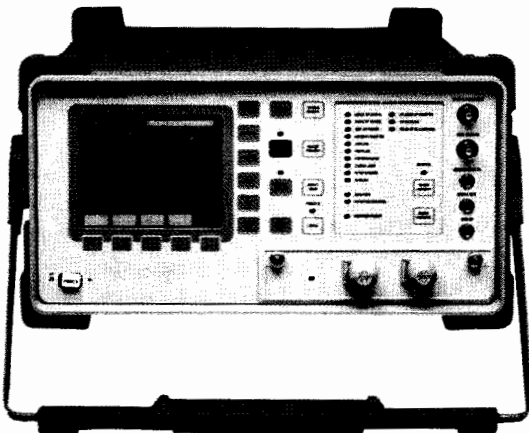

field-portable tester with plug-in modules that cater for electrical- and optical-interface requirements up to 622 Mb/s (STS-12). For installation, commissioning, and maintenance applications, the HP 37704A is easy to use and provides clear graphical measurement results.

The HP 37704A allows thorough functional testing of network equipment to SONET ANSI standards. It checks the

transport of information through a system and verifies the operation of network alarms, error performance monitors, automatic protection switches, and desynchronizing circuits.

Specifications—see page 590

For more information, contact your local sales office or use the reply card in the back of this catalog.

\*HP FIRST #1450

## Telecom and Datacom Products (cont'd)

### HP 37732A Telecom/Datacom Analyzer

The HP 37732A is a portable telecom and datacom analyzer that saves setting-up and testing time with its easy-to-use interface, large clear display, 80-day results

storage, and graphics display. It is designed for installation, fault-finding, and maintenance by PTTs, end users, and service providers.

The HP 37732A measures error performance at 64 kb/s codirectional, 704 kb/s, 2 Mb/s, and 8 Mb/s telecom interfaces and at V.24, V.11/X.21-leased, and V.35 datacom interfaces, at rates from 50 b/s to 2 Mb/s, using a built-in synthesizer.

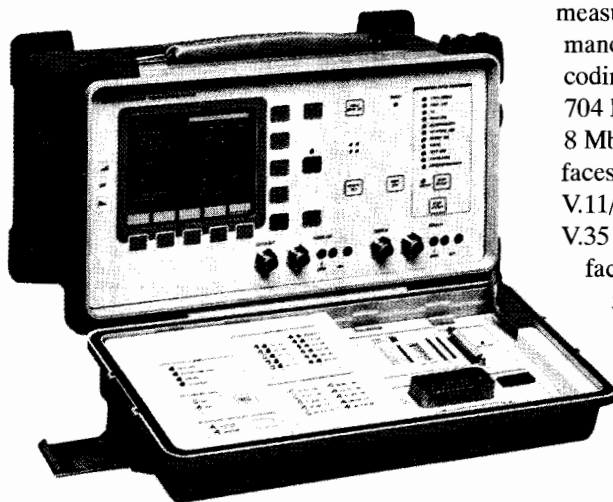

Telecom testing provides analog/digital timeslot access,  $n \times 64$  kb/s testing, sub-64 kb/s testing and ease-of-use features such as auto setup and trouble scan. Datacom testing covers BER/BLER measurements at the datacom interfaces, built-in V.24 breakout, and control-circuit timing analysis to identify interface faults.

Specifications—see page 614

For more information, contact your local sales office or use the reply card in the back of this catalog.

\*HP FIRST #1455

### HP 75000 Series 90 Modular SONET/SDH Analyzer

The HP 75000 Series 90 modular SONET/SDH analyzer is an adaptable, high-performance solution for testing SONET/SDH telecommunication equipment, operating at rates up to 622 Mb/s, according to the relevant North American and international standards.

Designed for use in laboratory and production environments, the HP 75000 Series 90 provides the test functions required to conformance-test a wide range of synchronous

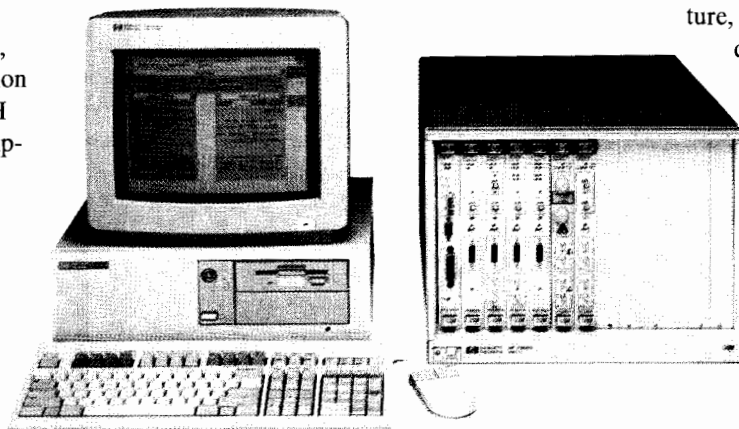

network equipment against the evolving SONET and SDH standards.

Through its modular architecture, based on industry-standard VXI bus hardware, the Series 90 can be tailored exactly to match your test application. The modular construction also ensures that the analyzer can be upgraded easily for future test requirements in a cost-effective way.

Specifications—see page 589

For more information, contact your local sales office or use the reply card in the back of this catalog.

\*HP FIRST #1465

## New Products for 1992 Telecom and Datacom Products (cont'd)

### HP 11757B Multipath Fading Simulator/Signature Test Set HP 11758U Digital Radio Test Set

These two new digital radio test instruments measure the M-Curve signature of a microwave digital radio in the field, without the need for a separate computer. An M-Curve shows how well the radio's equalizers will withstand multipath fading conditions in the transmission path. The HP 11757B multipath fading simulator's internal printer permits the monitoring of changes in the M-Curve as part of the periodic preventative maintenance of the network. The HP 11758U digital radio test set presents the same M-Curve characteristics on its CRT screen, with annotations.

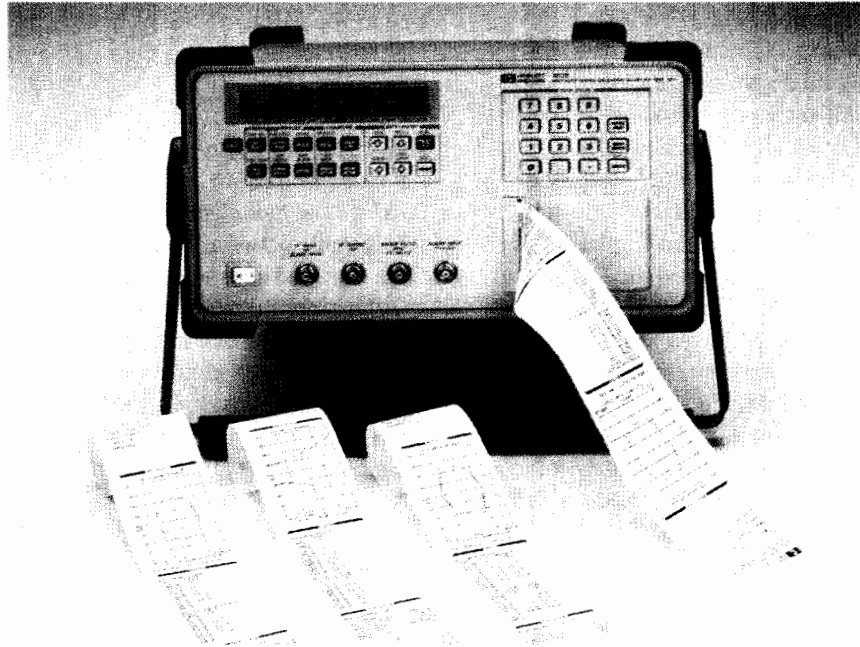

HP 11757B

Specifications—see page 594

For more information, contact your local sales office or use the reply card in the back of this catalog.

\*HP FIRST #1590

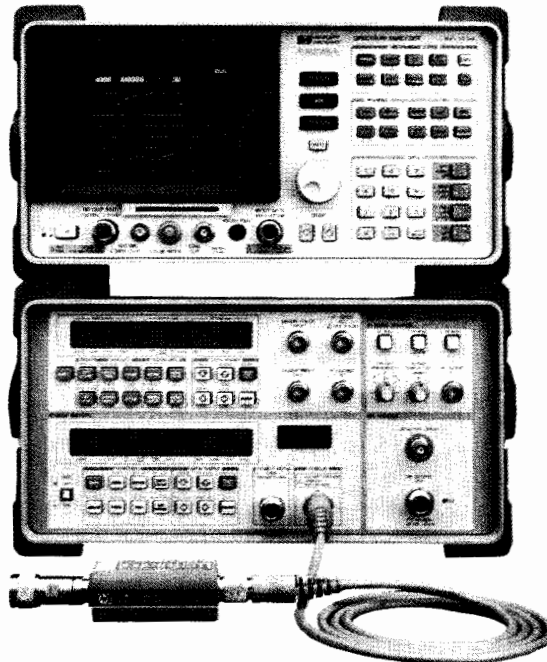

HP 11758B/11758U

\*For faxed details on these new products, contact HP FIRST at 208-344-4809.  
For detailed instructions on using HP FIRST, see page 35.

## Digital Mobile Radio Test Products

### HP 8657D $\pi/4$ DQPSK Signal Generator

The HP 8657D  $\pi/4$  DQPSK signal generator adds the new dimension of  $\pi/4$  DQPSK digital modulation to the HP 8657 family of signal generators. The HP 8657D has two operational modes. The analog mode provides excellent AM, FM, and low residual noise from 0.1 to 1040 MHz. The digital mode provides  $\pi/4$  DQPSK modulation required to test radios for the North American Digital Cellular System and the Japanese Digital Cellular System.

Radios produced for the NADC standard must be capable of operating in both the analog AMPS cellular mode and the new digital cellular mode. The HP 8657D fulfills both requirements, and is thus a single-box solution. Fre-

quency range is limited in the digital mode to 3 bands: 10 to 129.9 MHz, 810 to 965 MHz, and 1420 to 1540 MHz. The HP 8657D accepts serial data and a symbol clock from 20 to 25 kHz. The modulator is selectable between 0.35 and 0.5 root raised cosine filtering.

A high-performance pulse modulator is included in the HP 8657D. Pulse modulation plus  $\pi/4$  DQPSK modulation allows the HP 8657D to fully simulate the properties of TDMA systems.



Specifications—see page 435

For more information, contact your local sales office or use the reply card in the back of this catalog.

\*HP FIRST #1500

### The HP 8922 GSM Test Sets

The HP 8922 GSM test sets are designed to test Pan-European digital cellular phones and their base stations. The new test sets offer a complete set of instrumentation in one box that focuses on critical measurement areas and provides test results quickly, minimizing production test costs.

Three models are currently available. The HP 8922A is a toolbox for testing the RF characteristics of GSM radios. The HP 8922B adds a large memory and state machine for testing base stations. The HP 8922G adds protocol, signaling, and BER measurements to function as a standalone GSM mobile radio tester.

For transmitter testing, the HP 8922 performs complex GSM measurements at the push of a button. It includes a fully synthesized spectrum analyzer to accu-

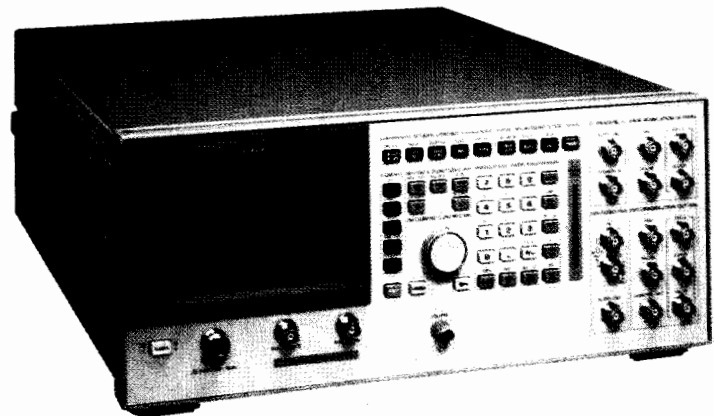

rately measure RF spectrum due to switching and modulation. The global-method analyzer measures phase and frequency error in less than 1 second.

An RF generator provides frequency-agile 0.3 GMSK modulation and pulse modulation for receiver characterization. Programmable generator output,

combined with BERT capability, allows the HP 8922G to test GSM mobile sensitivity.

Specifications—see page 393

For more information, contact your local sales office or use the reply card in the back of this catalog.

\*HP FIRST #1495

\*For faxed details on these new products, contact HP FIRST at 208-344-4809.

For detailed instructions on using HP FIRST, see page 35.



## New Products for 1992 Microprocessor Development System Products

### HP 64700 Series Emulators/Analyzers

The HP 64700 series development tools are extended by a new card cage, emulators, and analyzer. The card cage is of modular design so that you can switch development tools without incurring the cost of a complete emulator. The card cage accepts emulator cards for 8-, 16-, and 32-bit processors, an emulation bus analyzer, and future development tools. A local area network (LAN) card also fits into the card cage, allowing connection to a ThinLAN, ThickLAN, or StarLAN. This LAN card allows connection to HP 9000 and Sun workstations to upload and download files or control an emulation session.

Emulators in the HP 64700 series are enhanced to include real-time, transparent emulation and analysis of Hitachi H8/325, H8/510, H8/536, and PA/10; Intel 80960KA/KB/MC; Motorola 68020/EC020, 68EC030, and

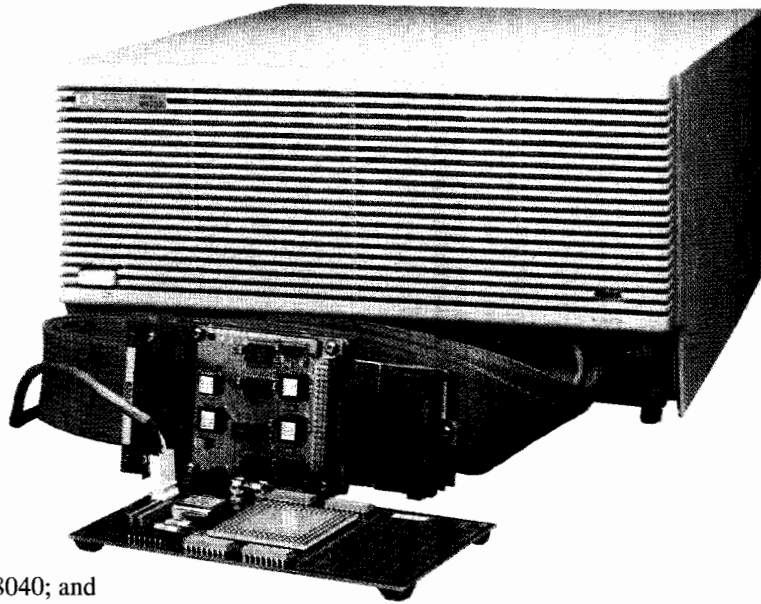

68040; and  
NEC V40 and V50.

The software performance analyzer provides real-time, nonintrusive software measurements that isolate software bottlenecks and identify modules responsible for slow execution times.

Specifications—see page 346

For more information, contact your local sales office or use the reply card in the back of this catalog.

\*HP FIRST #1130



### Hewlett-Packard Support Products

Hewlett-Packard makes a wide range of computer systems, storage devices, and peripherals that can expand the capabilities of HP test and measurement instruments. For specific information on compatibility of these support products with your HP test and measurement instruments, contact your local HP test and measurement sales office (see page 684).

For faxed details on many of these HP support products call HP FIRST at (208) 344-4809. For specific instructions on how to use HP FIRST, turn to page 34.

You can receive a faxed copy of a wide range of product information that includes product data sheets, application notes, and software and hardware compatibility information. Through HP FIRST, specifications are now available on personal computers, peripherals, workstations, and computer systems. For an index of specific product information on workstations and computer systems, dial the HP FIRST phone number (208) 344-4809 and then press 3.

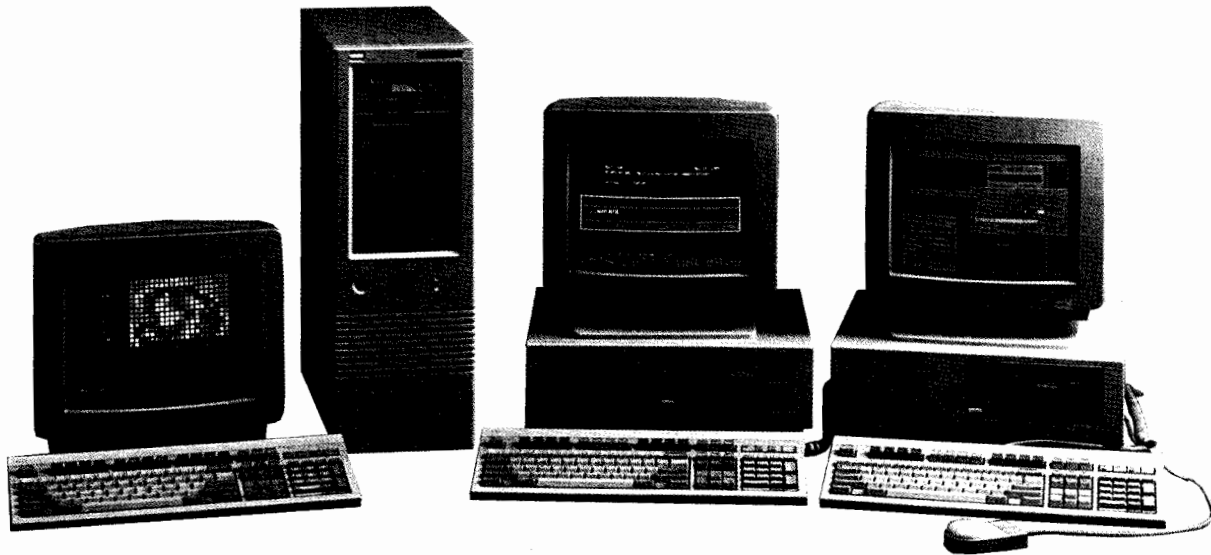
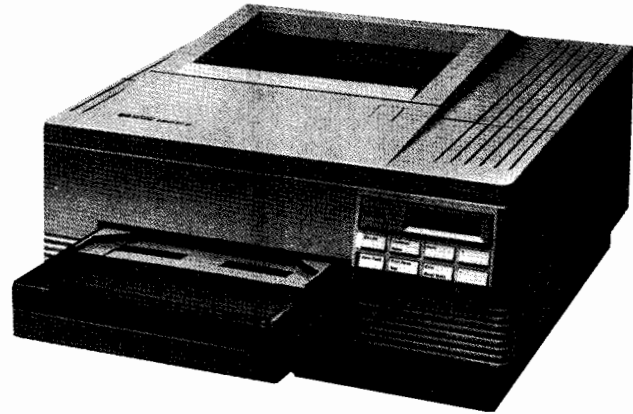
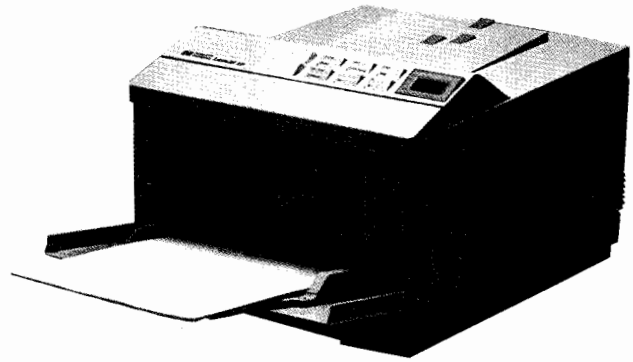

# SUPPORT PRODUCTS

Below is a listing of information available for popular HP peripherals and PCs through HP FIRST.

## Peripherals – General Information

ID No.	Document Name	Document Description
1308	<b>General Peripheral Information</b> HP Peripheral Products Data Sheet	Specifications and comparisons of HP peripherals used in the DOS environment Specifications and comparisons of HP peripherals used on Apple Macintosh computers
8304	HP Peripherals used on Apple Macintosh computers	
1301 1302 1303 1310 1313 2301	<b>Printers and Plotters – DOS Environment</b> HP LaserJet III Data Sheet HP LaserJet IIID Data Sheet HP LaserJet IIP Data Sheet HP LaserJet IIIP Data Sheet HP LaserJet IIISi Data Sheet HP DeskJet 500 Data Sheet	Printer specifications for the HP LaserJet III printer Printer specifications for the HP LaserJet IIID printer Printer specifications for the HP LaserJet IIP printer Printer specifications for the HP LaserJet IIIP printer Printer specifications for the HP LaserJet IIISi printer Printer specifications for the HP DeskJet 500 printer
3100 3301	<b>Scanners – DOS Environment</b> HP ScanJet IIc Product Brief HP ScanJet PLUS Data Sheet	HP ScanJet IIc Scanner features and system requirements HP ScanJet PLUS features and system requirements
2801 3900	<b>Plain Paper Fax – DOS Environment</b> HP FAX-300 Product Brief HP LaserJet FAX Product Brief	Specifications and features for the HP FAX-300 HP LaserJet FAX features and system requirements
8800	<b>Palmtop PC Products</b> HP 95LX Palmtop PC with Lotus 1-2-3	Specifications for the HP 95LX Palmtop PC with Lotus 1-2-3
1304 1305 1317 1319 2302 2303	<b>Printers and Plotters – Apple Macintosh Environment</b> HP LaserJet AppleTalk Data Sheet HP LaserJet IIP PostScript Printer with AppleTalk Data Sheet HP LaserJet IIISi for the Macintosh HP LaserJet PostScript Printers Data Sheet HP DeskWriter with AppleTalk Data Sheet DeskWriter C Data Sheet	Printer specifications for the HP LaserJet family connected to Apple Macintosh computers Printer specifications for HP LaserJet IIP PostScript printers with AppleTalk Printer specifications for the HP LaserJet IIISi for the Macintosh Printer specifications for HP PostScript printers including the HP LaserJet IIP, IIIP, III, IIID, and IIISi Printer specifications for the HP DeskWriter with AppleTalk Printer specifications for the DeskWriter C: 300-dpi black-and-white printer with color capabilities
3100 3301	<b>Scanners – Apple Macintosh Environment</b> HP ScanJet IIc Product Brief HP ScanJet PLUS Data Sheet	HP ScanJet IIc scanner features and system requirements HP ScanJet PLUS features and system requirements

## Personal Computers – DOS Environment

ID No.	Document Name	Document Description
6301	HP Vectra QS/16S Data Sheet	Specifications for the HP Vectra QS/16S personal computer
6302	HP Vectra QS/20 Data Sheet	Specifications for the HP Vectra QS/20 personal computer
6303	HP Vectra 286/12 Data Sheet	Specifications for the HP Vectra 286/12 personal computer
6304	HP Vectra 386/25 Data Sheet	Specifications for the HP Vectra 386/25 personal computer
6305	HP Vectra 486 Data Sheet	Specifications for the HP Vectra 486 personal computer
6306	HP Vectra RS/25C Data Sheet	Specifications for the HP Vectra RS/25C personal computer

Additional information on networking most of these products is also available through HP FIRST.

### How to Use HP FIRST

To receive details on the products listed on pages 5 to 32 of this catalog, dial (208) 344-4809 from a touch tone, group 3 fax machine. HP FIRST will prompt you to select a product category. Press number 4 to receive test and measurement product information. HP FIRST will prompt you to press number 1 to receive a document, or number 2 to receive an index that lists the document titles and HP FIRST numbers. When you press #1 HP FIRST will prompt you to enter the four-digit number of the document you want to receive. Enter the number and press the [START/COPY] or [Receive] button on your fax machine; then hang up the handset. The time required to receive the literature you requested will vary depending on the length and complexity of the document.

### Receive Information on Value-Added Businesses (VABs) Using HP First

For information on application-specific products that, when joined with Hewlett-Packard Test & Measurement products, will help provide a complete measurement system solution, use HP FIRST. When prompted, enter the four-digit number that corresponds with your area of interest.

- 1010** Communications/Networks
- 1020** Component Test
- 1030** Data Acquisition
- 1040** Electronic Functional Test
- 1050** Logic Analysis

### Mechanical Test

- 1061** Acoustics
- 1062** Modal Analysis/Vibration
- 1063** Rotating Machinery/Stress Test

### PC Board Test

- 1071** Fixturing
- 1072** Program Development
- 1073** Software Suppliers
- 1074** General

### RF & MW

- 1081** Antenna Test
- 1082** EMC/EW/Radar Simulation
- 1084** Materials Measurement
- 1085** Microwave Semiconductor Test
- 1086** Network Analysis
- 1087** Radar Cross Section
- 1088** General Test

### 1090 Semiconductor Test

- 1098** Software Productivity

- A**
- AC**
- Probes ..... 179
  - True RMS Voltmeters ..... 178
  - Voltmeters ..... 166–181
  - Power Source ..... 255
- Acceptance Testing ..... 602
- Accessories ..... 307, 313, 665
- Adapters ..... 650–651
  - Analyzers ..... 341, 571
  - Analyzers Upgrade Kits ..... 343
  - Attenuators ..... 109, 380
  - Board Test Systems ..... 129
  - Cabinets ..... 658–659, 662–664, 666–667
  - Cables ..... 587, 650
  - Cables/Connectors ..... 281, 303, 615, 650–651
  - Casters ..... 549
  - Clip Kits ..... 344
  - Coaxial ..... 417
    - Directional Couplers ..... 421
    - Shorts And Opens ..... 420
    - Step Attenuators ..... 410
  - Component Measurement ..... 357
  - Computers ..... 638
  - Connectors ..... 650–651
  - Data Acquisition Systems ..... 626
  - Delay Line ..... 146–147
  - Digital Multimeter ..... 179–181
  - DIP Low Leakage Fixture ..... 561
  - ECL Terminator ..... 146–147
  - Fixtures ..... 129
  - Generators ..... 515
  - Handheld Multimeter ..... 180–181
  - High Frequency Probes ..... 146
  - Kit ..... 146
  - Lightwave Source/Receiver Modules ..... 382
  - Logic Troubleshooting Kits ..... 298
  - Microwave ..... 411, 413–415, 420–421
    - DC, Attenuators ..... 409
    - Network Analyzers ..... 311
    - Test ..... 413–414, 419
  - Modular Measurements ..... 398
  - Modular Power Supply Systems ..... 524
  - Motorized Antenna-Positioning Mast ..... 261
  - Motorized Equipment-Testing Turntable ..... 261
  - Network Analyzers ..... 274, 279–282, 289, 294, 297, 299, 301–304
  - Operating Cases ..... 652–653
  - Oscilloscopes ..... 146, 159, 164, 344
  - Pattern Generators ..... 345
  - Personal Computers ..... 635
  - Plug-in ..... 119
  - Power Supplies ..... 535, 549
  - Printers ..... 344
  - Probes ..... 163, 297
  - Semiconductor Parameter Analyzers ..... 571
  - Semiconductors ..... 561
  - Signal Analyzers ..... 222
  - Single-Output System ..... 531
  - Software ..... 340, 343
  - Spectrum Analyzers ..... 245–249, 255, 258, 261, 292
  - Switches ..... 109
  - Test Equipment ..... 561
  - Testmobile System Cart ..... 669
  - Thermocouple Probe ..... 180
  - Transit Cases ..... 655, 657
  - Trigger ..... 146–147
  - Voltmeter ..... 179–181
  - Waveform Analyzers ..... 147
  - Waveguide ..... 312, 418, 422
  - Waveguide Detectors ..... 418
- Acoustic**
- Analyzers ..... 222–225, 232–233
  - Microphones ..... 222
- Active Probes** ..... 159, 292, 354
- Actuators, Relay** ..... 616
- Adapter**
- Quasi-Peak ..... 258
- Adapters** ..... 258, 365
- APC-3.5 ..... 651
  - APC-7\* ..... 651
  - Bends, Twists, Waveguide ..... 422
  - Cabinets ..... 661
  - Coaxial ..... 422
  - Dielectric Test ..... 375
  - Rackmounts ..... 659
  - Series Loss ..... 375
  - SMA ..... 651
  - Test Port Sets ..... 313
  - Waveguide ..... 422
  - 50-75  $\Omega$  ..... 304, 650
- Adjunct Processor Architecture** ..... 133
- AF**
- Analyzer ..... 391
  - Signal Generators ..... 464
- Agile Signal Generator** ..... 453, 456, 458
- Agile Signal Simulator** ..... 458
- Agile Up-Converter** ..... 458
- AM/FM Signal Generators** ..... 103, 430–433, 435–437, 440–447, 449–451, 456–457
- AM/FM Test Source** ..... 269
- AM/FM/M Modulation Analyzers** ..... 185–189, 268
- AM/FM/M Signal Generators** ..... 436–437, 440–441, 443–446, 456–457, 460–461
- AM/FM/ $\Phi$ M Signal Generators** ..... 442
- Ammeters** ..... 166–181, 372, 576
- Amplified Lightwave Connector** ..... 388
- Amplifiers**
- Broadband ..... 476, 477, 479
  - Distribution ..... 557
  - Microwave ..... 255, 405, 474, 478–479
  - Millimeter ..... 477
  - Noise Figure Measurement ..... 401
  - Power ..... 477, 479, 550
  - Preamplifiers ..... 255
  - RF ..... 255, 476, 478
  - Wideband ..... 479
- Amplitude-Phase Measurement** ..... 360
- Analog**
- Circuit Test Systems ..... 122, 125–128
  - Digital Arbitrary Waveforms ..... 480
  - Feedback ..... 572
  - LSI Test Systems ..... 564, 565
  - Measurements ..... 623
  - Output ..... 577, 626
  - Phase Modulation, Telemetry ..... 460
  - Programmable Power Supplies ..... 520, 522, 540–541
  - Programming, HP-IB ..... 531
  - Source Cards ..... 118
  - Switches ..... 560

## ALPHABETICAL INDEX

- Analog (cont'd)
- Test Functions ..... 562
  - Voltmeter ..... 178
  - VLSI ..... 500
  - Waveforms ..... 335-336
- Analysis ..... 130
- Data ..... 565
  - Emulation Bus ..... 348
  - Flexible ..... 140
  - Logic ..... 348
  - Measurement ..... 184
  - Modulation Domain ..... 184
  - Network ..... 464
  - Single-Shot ..... 335
- Analytical Instruments, Chemical Analysis ..... 644
- Analyzers ..... 231, 270, 347
- Accessories ..... 245, 254-255, 279, 341, 571
  - Attenuator Calibration ..... 272
  - Audio ..... 218-221, 234, 262, 266, 394
  - Audio Spectrum ..... 222-229, 232-233, 262, 289
  - Automatic Network ..... 236-238, 286, 308
  - Automatic Spectrum ..... 106-108, 239-248, 250-253, 255-257, 259-262, 289
  - Bias System ..... 623
  - Burst Signal ..... 236
  - Bus System ..... 615-616
  - Carrier Modulation ..... 265
  - Carrier Phase Noise ..... 221
  - CATV ..... 239-240
  - Constellation ..... 265, 595
  - Control Systems ..... 229
  - Customer Support ..... 675
  - Digital Microwave Radio ..... 593-594, 595
  - Digital Modulation ..... 265
  - Digital Radio ..... 239-240
  - Digital Telecom ..... 585
  - Digital Transmission ..... 265, 585-586, 588, 593-595
  - Distortion ..... 219, 221-229, 232-233, 262, 266-268
  - Dynamic Signal ..... 220, 222-230, 232-233
  - EMC ..... 239-240
  - Error Performance ..... 586, 591
  - Fourier ..... 218-219
  - Fourier (FFT) ..... 222-223, 226-230, 232-233
  - Fourier (FTT) ..... 224-225
  - Frequency ..... 190
  - Frequency and Time Domain ..... 222-230, 232-233, 262
  - Frequency and Time Interval ..... 185
  - Frequency Stability ..... 185-189, 263
  - Gain-Phase ..... 236-238, 286, 288, 358
  - General Purpose ..... 327
  - GSM ..... 239-240
  - GSM Transmitter Tester ..... 108
  - High Performance ..... 331
  - Impedance ..... 291, 356-363
  - Impedance/Gain-Phase ..... 358, 360
  - Jitter ..... 185, 586, 588
  - Lightwave ..... 377
    - Component ..... 383-384
    - Polarization ..... 382
    - Signal ..... 108
  - Logic ..... 320-326, 329-332, 334-341, 343, 345
  - Logic Analyzers ..... 139
  - Microwave ..... 239-248, 250, 252, 265, 287, 312
    - Modulation ..... 185, 188-189, 220, 265, 595
    - Transition ..... 104-105
  - Millimeter Wave ..... 245-248, 250, 252
  - Modular ..... 343, 349-351
  - Modular SONET/SDH ..... 589
  - Modulation ..... 185, 218-222, 227, 229, 265, 268
  - Modulation Domain ..... 184, 188
  - Network ..... 224-229, 274-279, 281-285, 287-288, 292-293, 306, 312, 597
  - Octave ..... 223-225, 232-233
  - Peak Power ..... 210, 218
  - Phase ..... 185, 265
  - Phase Noise ..... 185, 221, 263
  - Portable ..... 239, 241, 243, 248, 326, 329
  - Portable Logic ..... 327-328
  - Probes ..... 345
  - Programmable ..... 232
  - Protocol ..... 597-601, 606
  - Pulse ..... 189
  - Pulsed Phase ..... 265
  - PV ..... 232
  - RF ..... 239-248, 250-251
    - Impedance ..... 362
    - Pulsed Network ..... 315
    - Signal Modulation ..... 265, 268
  - Scalar ..... 275-276, 285
  - Scalar Network ..... 239-240, 277-279, 281-284
  - Selective Level ..... 262, 592
  - Semiconductor Parameter ..... 570-571
  - Signal ..... 218-220, 230, 232, 235, 236, 238, 241, 243, 245-248, 250, 256, 259, 264, 266, 377, 678
  - Signal Generator Test ..... 273
  - Signature ..... 295, 352
  - Software Performance ..... 349
  - Spectrum ..... 106-108, 218-221, 234-235, 238-248, 250-253, 255-262, 391-392, 394
  - Spectrum Networks ..... 233, 236
  - State ..... 334, 346
  - State/Timing ..... 332
  - Time and Frequency Domain ..... 222-230, 232-233, 262
  - Time Interval ..... 185, 190
  - Timing ..... 334, 346
  - Training ..... 675-676
  - Upgrade Kits ..... 341
  - Vector ..... 312
  - Vector Modulation ..... 265
  - Vibration ..... 222-230, 232-233
  - WAN Protocol Analyzer ..... 678
  - Wave ..... 218-219, 221, 262, 592
  - Waveform ..... 106-108, 140, 147, 222-230, 232-233, 253, 265
- Antennas
- EMC ..... 260
  - Measurement System ..... 314-317
  - Positioning Mast ..... 261
  - Systems ..... 464
- AOT 3000 ..... 560
- APC-3.5 Series Adapters ..... 651
- APC-7 Series Adapters ..... 651
- Application Software ..... 311
- Arbitrary Waveform Generators ..... 454, 482, 484, 489, 514
- Armatures ..... 173
- ASIC Test System ..... 558-559
- Atomic Clock/Frequency Standard ..... 552
- ATS 2000 + Automatic Test Systems ..... 134-135
- Attenuation ..... 607
- Attenuators ..... 214
  - Accessories ..... 380
  - Calibration ..... 272

Calibration Data .....	407
Coaxial .....	407-411
Electronic .....	431
Fixed .....	407, 422
High Performance .....	411
High Power .....	407
High Voltage .....	173
MMS .....	412
Optical .....	377, 380
Step, Programmable and Manual .....	409
Switch Driver .....	412
Test System .....	272
Variable .....	422
Waveguide, Fixed, Variable .....	422
Audio Analyzers .....	218-219, 221, 394
Audio Source .....	394
Audio Synthesizer .....	484, 486, 494-495, 498, 592
Auto-Parallel Operation .....	548
Auto-Sequence Program (ASP) .....	358
Auto-Series Operation .....	548
Auto-Tracking Operation .....	548
Automated Spectrum Analysis .....	263-264
Automated Troubleshooting .....	609
Automatic Marker Search .....	329
Automatic Test System .....	134-135, 268, 395
Automation Products .....	259
Automotive Applications .....	132
Autoranging .....	234
Output, Single-Output System .....	531
Power Supplies .....	542
Avalanche Diode Noise Sources .....	404

---

<b>B</b>	
Back Plane Interface .....	323
Bail Handle Kit .....	658
Bar Code Components .....	643
Base Station Test Set .....	393
BASIC	
HP BASIC Systems .....	73
HP Measurement Coprocessor .....	74
Software .....	236, 250
Workstations .....	628
BasicLine Customer Support .....	677
Battery-Operated Analyzers .....	222
Battery-Operated DMM .....	167, 173-175, 178, 180-181
Battery-Operated Microwave Power Meter .....	213
Bench Power Supplies .....	520
BER Test Sets .....	584, 591
Bias Cable .....	405
Bias Current Source .....	367
Bias Networks .....	311
Binary Mode Software .....	625
Bioanalysis Solutions .....	644
Bipolar Modeling System .....	581
Bipolar Transistors .....	561
Bit Error Rate Test Sets .....	393
Bit Error Ratio Test Sets .....	586, 588, 591
Blocking Capacitors .....	407
BNC Series Adapters .....	650
Board Test .....	122-128
Board Test/Semiconductor Test, Training .....	676
Boundary Scan .....	124
Branch Validator .....	349

Breadboard .....	120, 626
Assemblies .....	629
Module .....	118
Bridges, Directional .....	279-280, 284, 298, 406
Broadband Amplifiers .....	477-479
Broadband Detectors .....	275, 417
Broadband Plug-ins, Sweepers .....	470-471
Broadband Preamplifiers .....	478
Burst Noise .....	607
Burst Signal Analysis .....	234, 236
Burst Signals .....	513
Bus Interface .....	323
Bus Preprocessors .....	344
Bus Support .....	323-325
Bus System Analyzer .....	615

---

<b>C</b>	
C Meters .....	369-370, 375, 578
C-V Meter .....	375
C-V Plotter .....	578-579
Cabinets .....	649
Accessories .....	658-664, 666-667
Adapters .....	661
Cases .....	656
X-Ray Systems .....	648
Cables .....	627, 668
Accessories .....	587, 650
Assemblies .....	281, 303, 651
Bias .....	405
Clock .....	587
Connectors .....	650-651
Crocodile Clip .....	587, 613
Dual Banana-BNC .....	651
Extension .....	281
Fiber .....	383
HP-IB .....	615
HP-IL .....	629
Interconnect Kits .....	383
Kits .....	281, 284
LAN .....	607-608
Laser Head .....	426
Master-Slave Operation .....	515
Microwave .....	315
Network Analyzer .....	281, 299-300, 313
Power Sensors .....	205, 213
Precision .....	651
Scanner .....	606
10BASE-T .....	115, 608, 635
CAD Applications, Vectra PCs .....	633
CAD Software .....	319
CAE Links .....	340
CAE Simulator .....	340
CAE Software .....	582
Calibration	
Network Analyzer .....	281, 303, 312
Noise Figure Measurements .....	402
Power Supplies .....	525, 535
Self-Test .....	532
Services .....	672
System, Attenuator .....	272
Calibration Data, Attenuators .....	407-408
Calibrators	
AM/FM (HP 8901A/B) .....	268

## ALPHABETICAL INDEX

- Calibrators (cont'd)
- Power Meters ..... 213, 216
  - Power Sensor System ..... 214
  - Range, for HP 435B Power Meter (HP 11683A) ..... 213
  - Scalar, for HP 8756A/8757A ..... 282
- Capacitance Meters ..... 369-370, 372, 375, 578
- Capacitors
- Auxiliary ..... 375
  - Blocking ..... 407
  - Sets ..... 376
- Cardiography Instrumentation ..... 646
- Cardiovascular Instrumentation, SONOS Imaging System .. 646
- CareVue 9000 Clinical Information System ..... 647
- Carrier Modulation Analyzers ..... 265
- Carrier Noise Test Set ..... 264
- Carrier Phase Noise Analyzers ..... 221
- Carts, Testmobile ..... 668-669
- Cases
- Combining ..... 661-662
  - Custom ..... 657
  - Operating ..... 653-654
  - Transit ..... 655-658
- CAT Software
- HP BASIC Plus ..... 80
- CATV Measurement Personality ..... 239-240
- Cavity Frequency Meters ..... 422
- Cellular Phone Testing ..... 391
- Cellular Radio Interface ..... 397
- Cellular Radio Path Simulator ..... 400, 453
- Cellular Radio Test and Measurement ..... 398, 400, 434, 453
- Cellular Radio Test System ..... 395-396
- Cellular Radio Transmitter Test Software ..... 398
- Centronics Interface Converter ..... 116
- CEPT Digital Network Interconnections ..... 584
- Cesium Beam Frequency Standard ..... 552, 554
- Channel Simulation ..... 400, 493
- Chemical Analysis, Analytical Instruments ..... 644
- Chromatography, Liquid ..... 644
- CIL-MATE Programmed Power Meter ..... 212
- Circuit Analysis ..... 126
- Circuit Modeling ..... 580-581
- Circuit Testers, Digital ..... 122, 125-129, 297, 352, 354-355
- Circuit Testers, SMT ..... 125-126
- Clip Kit Accessories ..... 344
- Clip Leads ..... 357
- Clip, Logic ..... 355
- Clock, Atomic ..... 554
- Clock, Digital ..... 616
- Close-Field Probe ..... 260
- Coaxial
- Accessories ..... 406-410, 414-415, 417-418, 420-422, 651
  - Adapters ..... 422, 650
  - Air Lines ..... 420
  - Attenuators ..... 407-411
  - Blocking Capacitor ..... 420
  - Connector Gages ..... 420
  - Couplers ..... 422
  - Detectors ..... 279, 417-418
  - Directional Couplers ..... 421
  - Dual Directional Coupler ..... 421
  - Fixed Attenuators ..... 407-408, 422
  - Frequency Meters ..... 422
  - Low-Pass Filters ..... 422
  - Matrix Switches ..... 414-415
  - Noise Sources ..... 404
  - Open-Short Circuits ..... 420
- Pad Attenuators ..... 407-408
  - Power Sensors ..... 210, 214, 217
  - Programmable Step Attenuators ..... 411
  - Shorts ..... 420
  - Step Attenuators ..... 409-410
  - Switches ..... 117, 121, 414-416
  - Terminations ..... 420
  - Thermistor Mounts ..... 217
  - Thermocouple Mounts ..... 214
  - Waveguide Adapters ..... 418, 422
- Color Graphics ..... 290
- Color Graphics Terminal ..... 636
- Color Touchscreen ..... 330
- Combining Cases ..... 661-662
- Command Module ..... 97
- Communications ..... 187
- Data ..... 185, 605, 613-614
  - Digital ..... 187
  - FASS ..... 458
  - Signaling ..... 390, 494-495, 498
  - Simulators ..... 453-455
  - Test Equipment ..... 122, 125-128, 218, 234-235, 238-244, 262, 265, 390, 393, 395-396, 430-433, 435, 453, 460-461, 584-595, 605, 606, 612-614
- Comparator, Logic ..... 298, 355
- Comparator, Phase ..... 288
- Comparators ..... 560
- Complex Signal Simulation ..... 453
- Compliance Test Systems ..... 256-257, 259-261
- Component & Semiconductor Measurement
- Digital IC Test System ..... 558-559, 570
  - Impedance, LCR Meters ..... 356-360, 362-366, 368-375
  - Semiconductor Parametric Test ..... 566-570, 572-574, 576-577, 579
- Component Analyzer, Lightweight ..... 384
- Component Monitoring System ..... 647
- Component Testing, Automotive ..... 132
- Components
- Fiber Optic ..... 642
  - Motion Control ..... 642
  - Solid State ..... 642-643
- Computer-Aided Design (CAD) ..... 319, 582
- Computer-Aided Engineering (CAE) ..... 319, 453, 582
- Computer-Aided Software Engineering ..... 346
- Computer-Aided Test ..... 76, 120
- Cabling ..... 115
  - Controllers ..... 73-74
  - HP-IB Interface and Command Library ..... 74
  - Interfacing ..... 115
  - Software ..... 632
  - Switching/Interface Hardware ..... 115
  - Systems ..... 115
- Computers
- Accessories ..... 638
  - Automatic Test Systems ..... 122, 125-128
  - Board Computers ..... 630-631
  - Business ..... 635
  - Furniture ..... 640
  - Instrument Controllers ..... 73-74
  - Measurement Coprocessor ..... 74
  - Network Analyzers ..... 284
  - PC 300 ..... 77
  - Peripherals ..... 73, 76, 637-638
  - Personal ..... 79, 633, 635
  - Real-Time Systems ..... 630-631



SCSI Interface	630
Support Products	640
Technical Computers	630-631
Vectra	426, 635
VXIbus Family	101
Conformance Testers/Testing	602
Connector Gage, 2.4mm and 3.5mm	420
Connectors	408
Adapters	651
Blocks	99, 629
Cables	627, 650
Instrument Grade	409
Interface	98-99, 387
Microwave Precision	651
RS-232-C	639
Constellation Analyzers	265, 595
Consulting Services	
Application Engineering	679
HP ConsultLine	679
HP Project Centers	679
Installation Services	679
Productivity Assistance	679
Startup	679
Support	670, 679
Test and Measurement	679
Control Systems	
Analyzer	229
Measurements	225
Control Unit	121
Controllers	75-76, 97, 632
Bundles	79
HP BASIC Controllers	73-74
HP-IB Interface and Command Library	74
HP-UX Controllers	73
PC Controllers	74, 78
Rackmountable	76, 79
Controllers, PC 300	72, 75, 77, 678
Computer-Aided	73
Digital Signal Processing	396
Disk	560
DOS	73
HP BASIC	79
HP IBASIC	97
HP-IB	625
HP-UX	79
Instrument	73, 81-82
Interconnect System	110
Lightwave Polarization	382
Polarization	383
R-Series Integrated	75
R/332	76
Signal Analyzers	261
Software	76, 79
Stepper Motor	626
Converters	
Arbitrary Waveform	625
Centronics Interface	116
Digital-to-Analog	92-93, 460, 536, 616, 625, 627
Distributed Frequency	315
Frequency	314, 317
Lightwave	377, 389
Millimeter-Wave	314, 317
Thermal	179
4-Channel	92

Counters	100, 205
CW	202, 209
CW Microwave	104-105, 183
Data Acquisition	633
Field Service	182
High Performance	91, 182-183
HP-IB	189
Low-Cost	182
Microwave	204, 266
Portable	182
Power Meters	204, 213
Power Options	193
Precision Time-Interval Measurements	182-183
Pulse	104-105, 183, 266
RF	182, 200
Selection Guide	183
Totalizers	91, 626
Universal	91, 182-183, 192-193, 197, 209
VXI	91
5-Channel Totalizer	625-626
Counters, Electronic	182, 188, 192, 200, 266
Analyzer	185
Digital Multimeter/Counters	627, 629
DVM/DMMs	208
Frequency	191, 194, 198, 208
Low Cost	186-189, 191, 194-195, 198-199
Microwave	185, 202-203, 209
Portable, Battery Operated	191
Pulsed RF	185, 188, 209
Reciprocal	194-195, 202-203, 209, 627
Time Interval	185-189, 191, 194-195, 198-199, 208-209
Timers	191, 194-195, 198, 209
Universal	191, 194-195, 198, 208-209
Couplers, Directional (Coax and Waveguide)	421-422
Create Inc.	231
Cross Point Matrix	560
Crosstalk Attenuation	607
CRT Display, Spectrum Analyzers	250
Crystal Oscillator	556
Current Tracer, Digital	297, 354
Custom Products	130
Custom Switch Matrixes	412-413
Custom Transit Cases	655
Customer Education	670
Customer Support	670, 672, 674-676, 679
BasicLine	677
Software Support	678
CVAWS, Comdisco Vector, Arbitrary Waveform	
Synthesizer	453
CW Microwave Counters	183, 429
CW Synthesized Generators	448

## D

Data Acquisition	
Arbitrary Waveform Generators	625
Control Unit	625
Counters	625
Digital I/O (input/output)	625
Digital-to-Analog Converters	625
HP-IB Controller	625
LVDT Signal Conditioner	625
Manager	628
Measurement and Control Unit	618
Real Time	223, 230-233

## ALPHABETICAL INDEX

- Data Acquisition (cont'd)
- Software ..... 619, 628
  - Stepper Motor Control ..... 625
  - Switches ..... 625
  - System Training ..... 675
  - Systems ..... 618-619, 623-624, 626-629
  - Vibration ..... 223, 230-233
  - Voltmeters/Counters ..... 166-179, 194-195, 208-209, 618, 623-624, 627, 629
- Data Analysis ..... 82, 565, 607, 628
- Brochure ..... 602
  - Buffer ..... 394, 399
  - Communications ..... 185, 187, 605, 613-614
    - Datacom Test Sets ..... 614
    - Digital Data Test Sets ..... 612
    - Equipment ..... 599
    - General Information ..... 612
    - Selective Level Meter ..... 262, 592
    - Spectrum Analyzers ..... 245-248
    - Test Equipment ..... 218, 597-598, 600, 606-607
    - Time Interval Analyzer ..... 185
    - Transmission Impairment Measuring Sets ..... 613
    - Vector Modulation Generator/Analyzer ..... 595
  - Generators . . . 338, 399, 489, 499, 501, 503, 505, 507, 511-513, 515
  - Handling ..... 644
  - Interpretation ..... 323
  - Network Testing ..... 612
  - Pulse Pattern Generator ..... 513
  - Time Interval Analyzer ..... 185
  - Transfer ..... 85
- Datacom Test Sets ..... 614
- DC
- Analog Programmable ..... 547
  - Attenuators ..... 409
  - Current Meter ..... 392
  - Electronic Loads ..... 517-520
  - Source/Monitors ..... 572, 574
  - Voltage Source ..... 576
  - Voltmeters ..... 166-181, 208, 623-624, 627, 629
- DC Power Supplies
- Amplifier/Power Supply ..... 550
  - Analog Programmable ..... 522, 540, 544-546, 548
  - Autoranging ..... 542
  - Bench ..... 537-538
  - Calibration Software ..... 535
  - Dual Tracking ..... 537, 540
  - General Information ..... 520
  - General Purpose ..... 537-538, 540, 542, 544, -546, 548
  - HP-IB Programmable . . . 520-521, 523, 525-530, 532-534, 536
  - Laboratory ..... 520, 522, 536, 538, 540, 550
  - Precision ..... 532, 534
  - Precision Current Sources ..... 551
  - Precision Voltage Sources ..... 484, 551
  - Programmable ..... 520-521, 523, 525-530, 532-534, 536
  - Relay Accessories ..... 535
  - Selection Index ..... 521-522
  - Single Output ..... 528-529
  - Source/Monitors ..... 572
- Debugger
- Microprocessors ..... 336
  - Off-Line ..... 566
- Decade Capacitor ..... 376
- Decoder ..... 391
- Delay Generators ..... 499-503, 505-511
- Delay Line
- Oscilloscopes ..... 146
  - Waveform Analyzers ..... 147
- Demodulator ..... 220, 265
- Depot Repair Applications ..... 123
- Design
- Automation, Microwave ..... 678
  - Course ..... 260
  - Furniture ..... 641
  - Systems, Training ..... 676
  - Tools ..... 123
  - Verification, Signaling Test Set ..... 605
- Design Plus ..... 640
- Designer Color System ..... 638
- Detectors ..... 297, 418
- Adapter ..... 283
  - Bridges ..... 297
  - Broadband ..... 417
  - Coaxial ..... 279, 418
  - Coaxial and Waveguide ..... 417-418
  - Coaxial, Microwave, OEM ..... 417
  - Directional ..... 418
  - Gas Chromatography ..... 645
  - LC ..... 644
  - Low-Barrier Schottky Diode ..... 418
  - Planar-Doped-Barrier Diode ..... 417-418
  - Precision ..... 279, 284
  - Probes ..... 179
  - Scalar ..... 279
  - Waveguide ..... 279-280, 417-418
- Development
- Systems, Logic ..... 346
  - Testing ..... 602
  - Tools ..... 72
- Device Controller, Signal Analyzers ..... 261
- Device Modeling ..... 580-581
- Software ..... 582
- Diagnostics, Cardiology ..... 646
- Diagnostics, EMI ..... 257
- Dielectric Measurement Systems ..... 305
- Dielectric Probe ..... 305
- Differential Interferometer ..... 424
- Digital
- AC Voltmeters ..... 166-181
  - Ammeters ..... 372-373, 576
  - Analog Arbitrary Waveforms ..... 480
  - Analog Signal Generator ..... 490
  - Analyzers
    - Cellular ..... 393
    - FFT ..... 222-233
    - Signature ..... 352
  - Audio Tape (DAT) Backup Solution ..... 637
  - Board Testers ..... 122, 125-129
  - Capacitance Meters ..... 369-370, 375, 578
  - Cellular Test Set ..... 434
  - Circuit Test ..... 122, 125-129, 352, 354-355
  - Circuit Test, SMT ..... 125-126
  - Combinational Board Tester ..... 122, 125-128
  - Communications Board Tester ..... 122, 127-128
  - Communications Measurement ..... 584
  - Constellation Analyzer ..... 595
  - Current Tracer ..... 298, 354
  - D/A Current Converter Cards ..... 627
  - D/A Voltage Converter Cards ..... 627
  - Data Test Equipment ..... 584, 587
  - DC Voltmeter/Counters ..... 208
  - DC Voltmeters ..... 166-181, 623-624, 627, 629

- Digital Generators ..... 434  
 Direct Measurements ..... 226  
 Disk Drive Testing ..... 185  
 Functional Test System ..... 89, 100  
 Handheld Multimeters ..... 180–181  
 High Resistance Meters ..... 372–373  
 High-Speed Test ..... 591  
 IC Test ..... 500  
 IC Testers . . . 122, 125–129, 352, 354–355, 558–559, 564–565, 576  
 Impedance Analyzers ..... 356–360, 362–363  
 In-Circuit Board Test Systems ..... 122, 125–129  
 Input/Output, Switching ..... 626  
 Inputs with Totalize and Interrupt ..... 625  
 IO Modules ..... 118  
 IQ Modulation ..... 434  
 LCR Meters ..... 364–366, 368–375  
 Microprocessor Troubleshooting ..... 352  
 Microwave Radio Test  
   Equipment ..... 593  
   Milliohmmeters ..... 374  
   Modulation ..... 430  
   Modulation Analyzer ..... 265  
   Modulation Signal Generators ..... 434, 460–461  
   Multimeters ..... 90, 166–181, 352, 629  
   Noise Figure Meter ..... 402  
   Oscilloscopes ..... 138–143, 148–153, 158, 335, 394  
   PC Board Test Systems ..... 122, 125–129  
   Phase Modulation ..... 460–461  
   Power Meters ..... 210–212  
   Pressure Gauge ..... 427  
   Programmable Power Supplies ..... 520–521, 523,  
     525–530, 532–534  
   Q Meter ..... 364–365  
   Radio Test ..... 594–595  
   Radio Training Course ..... 596  
   Signal Analyzers ..... 222, 226–229, 232–233, 265  
   Signal Generators ..... 338, 460–461, 514  
   Signal Processing Controller ..... 396  
   Signature Analyzers ..... 352  
   Stimuli ..... 499–503, 505–515  
   Telecom Analyzer ..... 585  
   Test Functions ..... 562  
   Test Unit ..... 135  
   Thermometers ..... 627, 629  
   Time Interval Analyzer ..... 185  
   Transmission Analyzer ..... 585–586, 588  
   Transmission Test Equipment ..... 601  
   Troubleshooting ..... 352, 354–355  
   Voltmeters ..... 166–181  
   VLSI ..... 500  
   Waveforms ..... 335–336  
   16-Channel Output ..... 625  
   32-Channel High Speed ..... 625  
 Digital Cellular Test Set (see Digital) ..... 393  
 Digital Data Source ..... 399  
 Digital Data Test Sets ..... 612  
 Digital Input/Output ..... 627, 630  
 Digital Microwave Radio Test ..... 594–595  
 Digital Oscilloscopes ..... 158  
 Digital Radio Measurement Personalities . . . 239–240, 245–246  
 Digital Radio Test System ..... 393, 593–594  
 Digital Radio Training Course ..... 596  
 Digital Signal Processing (DSP) Simulation ..... 453  
 Digital Transmission Test Equipment ..... 584, 593–594  
   SONET Test Sets ..... 590  
   SONET/SDH Analyzers ..... 589  
   Digital Transmitter Test ..... 398  
   Digital, Oscilloscopes ..... 104–105  
   Digital-to-Analog Converter ..... 92, 460, 537, 616, 627  
   Digitizer, Modular ..... 107  
   Digitizing Oscilloscopes ..... 100, 136, 138–143,  
     147–150, 151–153, 155, 329, 336  
 Dimentional Measurements ..... 425  
 Diodes ..... 643  
 Diodes and Arrays ..... 561  
 Direct Coupled Test Fixture ..... 579  
 Directional Bridges ..... 255, 279–280, 284, 406  
 Directional Couplers ..... 382, 422  
 Disk Controllers ..... 560  
 Distortion Analyzers ..... 219, 221–229, 232–233, 262, 266–267  
 Distributed Frequency Converter ..... 314  
 Distribution Amplifier ..... 557  
 Distribution Expansion Cards ..... 412  
 DOS  
   Controllers ..... 73  
   Interactive Generator ..... 84  
 Double-Sideband Noise Figure Measurements ..... 401  
 Down Converters ..... 265  
 DraftMaster Series Plotters ..... 639  
 DraftPro Series Plotters ..... 639  
 DS3 Transmission Test Set ..... 588  
 Dual Arbitrary Waveform Generator ..... 489, 514  
 Dual Preamplifier ..... 261  
 Dual Tracking Power Supplies ..... 537  
 Dual VHF Switch Module ..... 120  
 Dual-Channel Dynamic Signal Analyzer ..... 222  
 Dual-Output Power Supplies ..... 539–541  
 Dual-Time-Base Windowing ..... 148  
 DUT Wiring ..... 559  
 Dynamic Signals ..... 231, 233  
 Dynamic Signal Analyzers ..... 222–232, 265
- 
- E**  
 Echocardiography ..... 646  
 ECL Pod ..... 515  
 ECL Terminator ..... 146–147  
 Economy Analog Signal Generator ..... 430  
 Economy Microwave ..... 429  
 Economy RF ..... 430–433, 435  
 Education Support ..... 674–676  
 EIA Racks ..... 663–664, 666–667  
 Electrical Interface ..... 590  
 Electronic Attenuators ..... 431  
 Electronic Clocks ..... 552–554  
 Electronic Counters ..... 182, 185–189, 191–192, 194–196,  
   198–204, 208–209, 266  
 Electronic Loads ..... 516–519  
 Electronic Warfare (EW) Simulators ..... 454–455, 458  
 Electrostatic Plotters ..... 639  
 Embedded Controller ..... 78  
 Embedded Microprocessor System Development ..... 346  
 EMC Design Systems ..... 256–257, 259–261  
 EMC Measurement Personality ..... 239–240  
 EMI Measurement Systems ..... 256–261  
 EMI Receiver Functions ..... 258  
 Emulation ..... 605  
   Bus Analyzer ..... 348  
   Memory ..... 347

## ALPHABETICAL INDEX

- Emulators ..... 346-347, 349-351  
 Engineering ..... 131  
 Environments, Operating ..... 683  
 Equivalent Circuit Analysis Function ..... 358  
 Ergonomic Furniture ..... 640  
 Error Analysis ..... 586  
 Error Detectors, Gigabit ..... 591  
 Evaluation Testing ..... 602  
 Event Synchronization Technology ..... 563  
 EW Receiver Test Simulation ..... 458  
 Excess Noise Sources ..... 404  
 Exciters  
   Communication Signal ..... 458  
   Radar Waveform ..... 458  
 Exotic Test Signals ..... 458  
 Extender Chassis ..... 626  
 Extenders ..... 617, 627  
 Extension Cables ..... 281  
 Extractor, Supercritical Fluid ..... 645  
 Eye-Diagram Analyzers ..... 265
- 
- F**  
 Fading Simulator, Cellular ..... 400  
 Fading Simulator, Multipath ..... 453, 593-594  
 Failure Analysis ..... 338  
 Fans ..... 662, 665  
 FASS (*see* Frequency Agile Signal Simulation)  
 Faxitron Cabinet Systems ..... 648  
 FDM Network Monitoring Systems ..... 592  
 Feasibility ..... 131  
 FET Multiplexers ..... 101, 624, 626  
 Fiber Cables ..... 383  
 Fiber Optic Components ..... 643  
 Fiber Optic Test Equipment (*see* Lightwave Test  
 Equipment) ..... 377, 382  
 Fiber Optics  
   Amplified Lightwave Converter ..... 385-388  
   Interferometer ..... 386-387  
   Lightwave Receiver Module ..... 385, 387  
 Filler Panels ..... 659, 661-662  
 Filter Kits ..... 284  
 Filters  
   High Pass ..... 282  
   Low Pass ..... 282, 422  
   Waveguide ..... 422  
 Firmware Enhancement ..... 281  
 Fixed Attenuators ..... 407  
 Fixed Terminations  
   Coaxial ..... 420  
   Waveguide ..... 420  
 Fixtures  
   Automatic ..... 129  
   Board Test System ..... 129  
   Mechanical ..... 129  
   Vacuum Actuated ..... 129  
 Flash X-Ray Equipment ..... 649  
 Flexible Analysis ..... 140  
 Flexible Architecture ..... 621  
 Flexible Configuration ..... 307  
 Flexible Switching ..... 120  
 Flexible Test Program ..... 85  
 Floating  $\pm 36$  V/ $\pm 500$ mA Floating VI ..... 560  
 Floating Time Measurement ..... 560
- Flying Clocks ..... 556  
 FM Modulation Analyzers ..... 185, 268  
 FM Signal Generators ..... 430-433, 435, 449-451, 460-461  
 Four-quadrant Force, Clamp, Measure V/I ..... 560  
 Fourier Analyzers ..... 218-219, 222-233  
 Frames, Racks ..... 661  
 Frequency  
   Analyzers ..... 185, 190  
   Cesium Beam Standards ..... 552  
   Converters  
     Distributed ..... 315  
   Counters ..... 172-173, 185-189, 191, 194-195, 198-199,  
     201-203, 208-209, 627, 629  
   Domain Analysis ..... 223-233, 236, 262  
   Domain Application ..... 389  
   Hopping ..... 456  
   Measurements ..... 207  
   Meters, Coaxial and Waveguide ..... 422  
   Modulation ..... 207, 457  
   Precision ..... 464  
   Response Measurements ..... 228  
   Rubidium Standard ..... 552  
   Sources ..... 552-556  
   Stability Analyzer ..... 185, 263  
   Standards ..... 552, 554-557  
   Sweeps ..... 234, 439, 457  
   Synthesizers ..... 430-433, 435-437, 440-446, 448-451,  
     456-457, 494-495, 498, 552-556  
 Frequency Agile Signal Simulation (FASS) ..... 429, 458, 460  
 Frequency Selective Meter and  
 Tracking Oscillator ..... 262, 592  
 FTM/300 Functional Test Manager ..... 83, 85  
 Function Generators ..... 480-485, 488-498  
 Functional Test Manager ..... 83, 85  
 Furniture ..... 640-641
- 
- G**  
 GaAs Modeling System ..... 581  
 Gage, Connector, 2.4mm and 3.5mm ..... 420  
 Gas Chromatography, Detectors ..... 645  
 General Information ..... 584  
 General Purpose Analyzers ..... 327  
 General Purpose Power Supplies ..... 540-541  
 General-Purpose Instrumentation, Training ..... 675  
 Generators  
   Accessories ..... 515  
   AM-FM Pulse ..... 103, 430-433, 435, 447, 449-450  
   Arbitrary Waveform ..... 454, 482, 484, 489, 514  
   Audio ..... 391  
   AWS Baseband Signal Simulation ..... 454  
   Built-in Tracking ..... 244  
   CW ..... 448  
   Data ..... 338, 499, 501, 503, 505, 507, 511-513, 515  
   Delay ..... 499-503, 505-511  
   Digital ..... 514  
   Digital Modulation ..... 434, 460-461  
   Digital Signal ..... 489  
   Dual Waveform ..... 490  
   Frequency and Time ..... 552-555  
   Function ..... 92, 480-486, 488-498  
   High Performance ..... 438  
   Integrated Program ..... 125  
   Interactive ..... 84

M-Curve Radio Signature Test Set	594
Microwave	450
Multipath Fading Simulator	593-594
Noise	403-404
Pattern	512-513, 586-588, 591
Phase Modulation	460-461
PRBS	514, 586, 588, 591
Programmable	492
Pulse	482, 499-513, 515
Pulse/Function	454, 480-483, 488-497, 499-500
Pulse/Pattern	513
RF	394
Signal	103, 273, 391, 428-458, 460-461, 468, 470, 474, 482-484, 490, 494-495, 514
Signal Simulation	458
Square Wave	480-484, 488-498
Sweep	92, 448, 450, 462-463, 465-475, 480-483, 494-498
Synthesized	92, 103, 430-433, 435, 447-451, 480-481, 484, 486, 494-496
Timing	508
Tracking	234, 240-242, 245, 249, 391, 498
Vector	460-461, 514
Waveform	454, 480-484, 486, 489, 494-498
Word	514, 558-559, 586, 588
Graphics	
Color	290, 636
Human Interface	80
Supplies	638
Grounding Clip	295
GSM Test Sets	393-394
GSM Transmitter Testers	108

## H

Handheld Dynamic Signal Analyzers	222
Handles And Rack Flanges	658
Hardcopy	228
Hardware	565
Board Test Systems	124
Data Acquisition System	619, 622
Support	670-672
VXIbus	87
Harmonic Mixers	254
HDA Simulator	454
Hewlett-Packard Interface Bus (HP-IB)	111-115, 615-617
Hewlett-Packard Multimeter Language	172
High Bandwidth	140
High Performance	
Analyzers	331
Counters	183
Digital Modulation	434
Microwave	429
Modulation	429, 456
Networking	133
Power Supplies	544-545
Pulse Modulation	431
RF Generators	428, 437-438, 441, 443, 446
High Power Attenuators	407
High Reliability Components	646
High Resistance Meters	372-373
High Resolution	140, 424
High Voltage	561
High-Density Memory	631
High-Frequency Probes	146, 255

High-Frequency Relay Multiplexers	118
High-Impedance Signal Probes	265
High-Sensitivity Power Sensors	214
High-Side Switches	560
High-Speed Characterization	500
High-Speed Flash Radiography	649
High-Speed Throughput, Pulsed/CW Microwave	
Frequency Counter	207
High-Test Throughput	565
Histogram, State	339
Holter Monitoring	646
HP BASIC	71-72
BASIC/UX	73
Controllers	79
Interactive Test Generator	84
Measurement Coprocessor	74
Self-Study Course	74
HP BASIC Plus Software	80
HP ConsultLine	679
HP ITG Software	84
HP MSA	71-72
HP PLUS Software	631
HP Project Centers	681
HP SuccessLine	671
HP Test Expert	135
HP Vectra QS/16S PC	633
HP Vectra QS/20 PC	633
HP Vectra RS/25C PC	633
HP Vectra 286/12 PC	633
HP Vectra 386/25 PC	633
HP Vectra 486/25T PC	633
HP Vectra 486/33T PC	633
HP-IB	102, 212, 262, 402
Analog Programming	531
Bus Analyzer	615
Cables	615
Centronics Interface Converter	116
Controller	97, 625
Digital Clock	616
Electronic Counters	201
Extenders	617
Frequency Counters	185-189, 194-195, 198-199, 202-203, 208-209
Functions	523
General Information	110-114
GSM Transmitter Tester	108
Instrumentation	582
Interconnection Cables	615
Interface	637
Command Library	74, 77
Functions	497
Jitter	186
Lightwave Signal Analyzer	108
Logic Analyzers	320
Microwave Transition Analyzer	104-105
Oscilloscopes	335
Power Meters	210-211, 271
Power Supplies	521, 524, 526
Power Supply Programmer	616
Programmable Power Supplies	525, 528, 532
Programming	506
Relay Actuators	117, 616, 627
Remote	459
Signal Sources	430-433, 435, 482, 484, 489-495, 498
Software	307

## ALPHABETICAL INDEX

## HP-IB (cont'd)

- Spectrum Analyzers ..... 106, 108, 218, 223-229, 232-233, 239-248, 250-253, 255-261
- Switch Controller ..... 120
- Switch Test Unit ..... 117
- Switches ..... 414-415
- System Power Supplies ..... 520
- Time Synthesizer ..... 508
- Tracking Sources ..... 249
- Training ..... 113
- VHF Switches ..... 120, 616
- HP-UX Controllers ..... 73, 79
- HP-UX Workstation ..... 628
- HP-UX, Training ..... 676
- HPLC Pumps and Auto Samplers ..... 644
- HPML (see Hewlett-Packard Multimeter Language)
- HPOL (Hewlett-Packard Oscilloscope Language) ..... 143
- Human Interface Graphics ..... 80

**I**

- I-DEAS Mechanical Computer-Aided Engineering Software ..... 231
- IBASIC ..... 293
- IBASIC Programs ..... 296
- IC Design Verification System ..... 558-559
- IC Prototype Verification System ..... 558-559
- IC Test Systems ..... 500
  - Analog ..... 565
  - Digital ..... 558-559
- IC Testers, Digital ..... 122, 125-129, 352, 354, 564-565, 576
- IC-CAP ..... 581-582
- IC-MS ..... 583
- ID (see Instruments on Disk)
- Impedance Analyzers ..... 357-358, 360-363
- Impedance Meter ..... 358
- Impedance Test Kit ..... 291
- Impedance Transformers, 50 to 75  $\Omega$  ..... 255
- Impedance/Gain-Phase Analyzer ..... 358, 360
- In-Process Verification, Automotive ..... 132
- Inductors, Reference ..... 375
- Information Retrieval ..... 132
- Input Adapter ..... 294
- Input Module ..... 295
- Input/Output, Digital ..... 93
- Inputs ..... 140
- Inputs Pods, Oscilloscopes ..... 140
- Installation Kits ..... 100
- Installation Services ..... 679
- Instrumentation
  - HP-IB ..... 72, 582
  - Programmable ..... 72
  - Standalone ..... 72
- Instruments
  - Arbitrary Waveform Digital-to-Analog Converter ..... 625
  - Control ..... 619
  - Controllers ..... 74-76
    - Software ..... 80
  - Data Acquisition System ..... 622
  - Driver Software ..... 84
  - Grade Connectors ..... 407
  - IBASIC ..... 620
  - Measurement and Control ..... 620
  - Measurements ..... 619
  - Protection ..... 654
- Instruments on Disk (ID) ..... 459
- Insulation Resistance Meters ..... 372
  - Ammeters ..... 373
  - Ohmmeters ..... 373
- Integrated Systems ..... 130, 132-135
- Interactive Measurements, Semiconductor Process Control System ..... 566
- Interactive Test Generators ..... 86-87
- Interconnect Cable Kits ..... 383
- Interconnections ..... 323
- Interface ..... 115, 626
  - Back Plane ..... 323
  - Bus ..... 110, 116, 323, 615-616, 618
  - Bus Programming ..... 193
  - Cellular Radio ..... 397
  - Centronics Interface ..... 116
  - Connections ..... 112
  - Connectors ..... 98-99, 387
  - Electrical Optical ..... 597
  - HP-IB Functions ..... 497
  - Microprocessors ..... 344
  - Optical ..... 590
  - Parallel ..... 157
  - Probes ..... 343
  - Proprocessors ..... 344
  - Resource ..... 98
  - RF ..... 382-383, 397
  - RF Kit ..... 385
  - RS-232 ..... 328
  - SCSI Module ..... 230
  - Series ..... 624
  - System ..... 397
  - System Resource ..... 101
  - Transceiver ..... 397
  - User Definer ..... 323, 344
  - VXibus Family ..... 100
- Interference Test Set, Radio ..... 595
- Interferometers
  - Fiber-Optic ..... 386-387
  - Laser ..... 423, 426
- InterModule Bus (IMB) ..... 342
- Internal Disk Drives ..... 88
- Internal Modulation Sources ..... 439
- Internal Programming ..... 394
- Inverters, Pulse ..... 504
- I/Q Tutor Digital Training Program ..... 595-596
- I/Q Vector Modulated Generator ..... 460-461
- I/Q Vector Modulation Analyzer ..... 265
- ISDN Testing
  - BASIC Rate ..... 603
  - Primary Rate ..... 602-603
  - Solutions ..... 597
  - WAN ..... 603
- Isolation Voltage ..... 561
- Isolators, Waveguide ..... 422

**J**

- Jitter
  - Analysis ..... 586
  - Generation & Measurement ..... 292, 586-588
  - Test Sets ..... 584
  - Time Interval Analyzer ..... 185
- Joining Brackets ..... 662

**K**

Kits, Rackmounting ..... 658-659, 661

**L**

Laboratory Bench Power Supplies ..... 522

LAN

  Analysis System ..... 610

  Cable Testing ..... 607-608

  Devices ..... 500

  Protocol ..... 611

  Protocol Analyzer ..... 606

  Servers ..... 633

Language, Waveform Generation (WGL) ..... 459

Languages, Training ..... 675

LANProbe Distributed Analysis System ..... 597

LANProbe Segment Monitor ..... 610-611

Laser

  Head Cable ..... 426

  Interferometers ..... 423, 426

  Machine Tool Calibration ..... 426

  Measurement System ..... 426

  Modular Design ..... 426

  Position Measurement ..... 426

  Position Transducer ..... 423

  Source Modules ..... 377-379

  Transducer System ..... 423

LCR Meters ..... 364-365, 367-368, 370-375

LCZ Meters ..... 370

Lead Sets ..... 345

Leakage Current ..... 564

Leakage Threshold ..... 561

LED Displays and Indicators ..... 642

LED Sources ..... 377, 379

LF Impedance Analyzer ..... 362

Library Systems ..... 637

LIF Utilities ..... 74

Light Sources ..... 379

Lightwave

  Amplified Converter ..... 386-388

  Component Analyzer ..... 310, 382-383

  Converters ..... 377, 389

  CW Source ..... 383

  Directional Coupler ..... 382

  Fiber Optics ..... 385

  Fiber-Optic Interferometer ..... 386

  Modulator ..... 383

  Multimeter ..... 377-379

  Polarization Analyzer ..... 384

  Polarization Controller ..... 382, 385

  Portable ..... 386

  Receiver Modules ..... 382-383, 385, 387

  Selection Chart ..... 377

  Signal Analyzers ..... 377, 385-387

  Source Modules ..... 382-383

  Test Sets ..... 310, 383

  Transmission Systems ..... 584

Lightwave Test Equipment ..... 377, 382

  Attenuating Lens Adapter ..... 380

  Attenuators ..... 380

  Bare Fiber Adapters ..... 380

  Connector Interfaces ..... 380

  Laser Sources ..... 378-379

LED-Sources ..... 378-379

Lightwave Multimeter ..... 378

Loss Test Set ..... 378

Optical Heads ..... 378

Optical Isolators ..... 380

Power Meter ..... 378

Power Splitters ..... 380

Return-Loss Test Set ..... 378

Limiters ..... 255

Line-Impedance Stabilization Network ..... 261

Linear Interferometer ..... 424

Linear Networks ..... 276

Linear Test System ..... 561

Links ..... 642

Liquid Chromatography ..... 644

Local Oscillator Substitution Sources ..... 448

Lock Link Kits ..... 660

Logic

  Analysis ..... 348

  Analysis System ..... 330-331

  Analyzer Training Courses ..... 676

  Analyzers ..... 140, 227, 330, 335, 337-338, 340

    CAE Links ..... 340

    Portable ..... 326, 343

    Preprocessors ..... 96

    Selection Guide ..... 322

    State Analysis ..... 334

    Third-Party Support ..... 340

    Timing ..... 345

    Upgrade Kits ..... 341

    Z-Domain ..... 226, 229

Clip ..... 354

Comparator ..... 298

Current Tracer ..... 354

Development Systems ..... 346

Pattern Generators ..... 338

Probes ..... 298, 338, 354

Pulsar ..... 354

Signal Sources ..... 499, 512-513

Triggering ..... 148

Troubleshooting Kits ..... 355

VXI ..... 96

Low Leakage Measurement ..... 560

Low Resistance Meters ..... 375

Low-Cost Miniature Links ..... 642

Low-Level Signals Measurements ..... 202

Low-Noise Preamplifier ..... 261

Low-Pass Filter Kit ..... 199

LSI Test System ..... 562, 565

Lueven Measurement System (LMS) ..... 231

LV Detectors ..... 644

LVDT Signal Conditioner/Multiplexer ..... 625

**M**

M Signal Generators ..... 464

M-Curve Radio Signature Test Set ..... 593

Mach Zehnder, Interferometer ..... 386-387

Macromodeling ..... 580

Magnetic Disk, Signal Simulation ..... 454-455

Mainframe Systems ..... 100

  Modular ..... 320

  Portable ..... 320

Manufacturing ..... 130-131

## ALPHABETICAL INDEX

- Marker Functions ..... 234
- Mass Memory Module, Spectrum Analyzer ..... 245
- Mass Spectrometry ..... 645
- Mass Storage ..... 228
- Master-Slave Operation Cables ..... 515
- MATE Power Meter ..... 212
- Materials Measurement Software ..... 305
- Matrixes
  - Custom Switch ..... 413
  - Rack and Stack ..... 413
  - Relay ..... 94
  - Switches ..... 94, 117–121, 414–415, 575
- Measurement Personalities
  - CATV ..... 239–240
  - Digital Radio ..... 239–240, 245
  - EMC ..... 239–240
  - GSM ..... 239–240
  - Scalar ..... 239–240, 249
- Measurement Systems
  - Antenna ..... 314
  - Double-Sideband ..... 401
  - Instrument Controllers ..... 73
  - Noise Figure ..... 404
  - Radar Cross-Section ..... 314
  - Single-Sideband ..... 401
- Measurement Systems Architecture .. 102, 104–106, 108–109, 253
- Modular ..... 72
- Switching and Control ..... 115
- Measurements
  - Amplitude-Phase ..... 360
  - Analog ..... 623
  - Analysis ..... 184
  - Components ..... 573
  - Control ..... 629
  - Control Systems ..... 225
  - Coprocessors ..... 77
  - Digital Communications ..... 584
  - Digital Multimeters ..... 166
  - Dimensional ..... 425
  - Dynamic Analog/Digital Signals ..... 226
  - Frequency ..... 207
  - Instruments ..... 619, 681
  - Kits, Straightness ..... 426
  - Limit Test ..... 148
  - Low-Level Signals ..... 202
  - Management ..... 172
  - Modular ..... 398
  - Modules ..... 320, 330
  - Network ..... 238
  - Personalities ..... 244
  - Phase Noise/Software ..... 263
  - Power ..... 269
  - Receivers ..... 271
  - Semiconductors ..... 358, 573
  - Software ..... 398
- Measuring Receiver ..... 220, 270
- Mechanical Engineering Test ..... 223–224, 226–229, 232–233
- Mechanical Engineering Test Equipment. . . . 222, 225, 230–231
- Medical Instrumentation ..... 647, 650
- Memory Cards ..... 626
- Menu-Driven Software ..... 560
- Mercury and Time Domain Analyzers ..... 222
- Meters
  - AC ..... 166–181
  - C-V ..... 375
- Capacitance ..... 370, 375, 578
- Current ..... 392
- DC ..... 392
- Digital ..... 212
- Distortion ..... 262, 266–268, 271
- Frequency ..... 172, 185, 189, 191, 194–195, 198–199, 202–203, 208–209, 422, 627, 629
- Handheld ..... 180–181
- High Resistance ..... 372–373
- Impedance ..... 291, 358, 362–365, 371, 374
- LCR ..... 364–365, 368, 371–375
- Low Resistance ..... 167, 176, 374
- Microwave Power ..... 213
- Millimeter-Wave Subsystems ..... 315
- Millimeters ..... 422
- Milliohmmeters ..... 167, 176, 374
- Modulation ..... 185, 265
- Multifunction ..... 166–181
- Multimeter ..... 100, 166–181, 378–379
- Noise Figure ..... 401–402, 404
- Ohmmeters ..... 166–181, 372–374
- Optical Power ..... 378, 381
- pA Meters ..... 372–373, 576
- Peak Power ..... 210, 217
- Phase ..... 185, 226–229, 236–238, 286, 288
- Picoampere ..... 372–373, 576
- Power ..... 96, 100, 183, 205, 210–217, 271–273, 381
- Q Meter ..... 364, 365, 375
- Reflectometer ..... 381
- Resistance ..... 170–171, 173, 175, 177–178
- RMS ..... 178
- Selective Level ..... 262
- Signature ..... 352
- Susceptance ..... 362, 364
- SWR ..... 283
- Thermistor ..... 216
- Time Interval ..... 185, 191, 194–195, 198, 208–209
- True RMS ..... 166–181
- Universal Counters ..... 195
- Vector Impedance ..... 363
- Metrology, Analysis Software ..... 426
- Microcircuit ..... 419
- Microphones ..... 223
- Microprocessor Development, Training ..... 346, 676
- Microprocessors
  - Debug ..... 333
  - Development Systems ..... 346, 348, 350–351
  - Interfaces ..... 344
  - Operation ..... 320
  - Support ..... 323
  - Troubleshooting ..... 352
- Microwave
  - Accessories ..... 411, 417, 421
  - Amplifiers ..... 255, 405, 474, 477–479
  - Analyzer ..... 312
  - Attenuator Calibration ..... 272
  - Attenuators ..... 409
  - Cables ..... 314–315
  - Communication ..... 220
  - Counters ..... 202–203, 209, 266
  - CW ..... 429
  - Design Automation ..... 678
  - Design System (CAE) ..... 319
  - Digital Radio Test ..... 595
  - Down-Converter ..... 187–189, 271



- Economy ..... 429, 449
- GSM Transmitter Tester ..... 108
- High Performance ..... 429
- Linear Simulator ..... 319
- Mixer/Detector ..... 189
- Modular Measurement System ..... 102
- Network Analyzers ..... 274–279, 281–283, 306
  - Accessories ..... 311
- Noise Figure Test Set ..... 401–403
- Nonlinear Simulator ..... 319
- Power Measuring Equipment ..... 210–217, 270
- Power Sensor ..... 217
- Preamplifiers ..... 107, 261, 478
- Radio Simulation ..... 453
- Receivers ..... 314–315
- Signal Generator Test ..... 273
- Signal Generators ..... 103, 447–451, 460–461
- Signal Simulation ..... 458
- Spectrum Analyzers ..... 106, 108, 239–248, 250, 252–253
- Sweep Oscillators ..... 474–475
- Sweepers ..... 462–463, 466–473
- Swept Signal Generator ..... 448
- Switch Driver ..... 95, 109
- Switches ..... 95, 118, 120–121
- Synthesized Generators ..... 447
- Synthesizers ..... 436–437, 440–446, 448–451, 456–457
  - Test Accessories ..... 409, 413–415, 419
  - Test Equipment ..... 406–408, 417–418, 420, 422
  - Tracking Generators ..... 107
  - Tracking Source ..... 245–246, 249
  - Training ..... 675
  - Transition Analyzer ..... 104–105
  - VXI ..... 95, 101
- Microwave Digital Radio Test System ..... 593–595
- Microwave Linear/Nonlinear Simulator ..... 319
- Microwave Radio
  - Cellular Radio Channel Simulator ..... 400
  - Digital Radio Test System ..... 593–594
  - Fading Test Simulator ..... 593–595
  - M-Curve Signature Test Set ..... 593–594
  - Noise and Interference Test Set ..... 595
  - Portable Counter/Power Meter ..... 204
- Military EMI Compliance Measurement Systems ..... 256
- Millimeter Sources ..... 429
- Millimeter Wave Instrumentation
  - Adapters ..... 422
  - Amplifiers ..... 477
  - Attenuators ..... 422
  - Bends ..... 422
  - Counters ..... 202, 209
  - Detectors ..... 418
  - Directional Couplers ..... 422
  - Frequency Meters ..... 422
  - Harmonic Mixers ..... 254
  - Isolators ..... 422
  - Mismatches, Waveguide ..... 422
  - Mixers ..... 254
  - Network Analyzer ..... 279, 310
  - On-Wafer, 62.5-GHz Network Analyzer System ..... 315
  - Power Sensors ..... 214, 217
  - Preselected Mixers ..... 254
  - Shorts ..... 420
  - Spectrum Analyzers ..... 245–248, 250, 252
  - Straight Sections ..... 422
  - Sweep Oscillator ..... 474
  - Swept Signal Generator ..... 449
  - Synthesized Signal Source ..... 449–450
  - Synthesized Sweeper ..... 450
  - Terminations ..... 420
  - Twists ..... 422
- Millimeter-Wave Source Systems ..... 464, 475
- Millimeter-Wave Subsystems ..... 314–315
- Milliohmmeters ..... 176, 374
- Mismatches, Coaxial Sliding ..... 420
- Mixed Signal ..... 561
- Mixed Signal LSI Test System ..... 562–563
- Mixers
  - Coaxial and Waveguide ..... 407
  - Harmonic ..... 254, 407
  - Millimeter ..... 254
  - Preselected ..... 254
- MMS Interface Box ..... 412
- MMS Modular Power Meter ..... 211
- Mobile Cellular Path Simulator ..... 400
- Mobile Station Test Set ..... 393
- Modems ..... 460–461
- Modular Microcircuit Package ..... 419
- Modular Architecture ..... 565
- Modular DC Source Monitor ..... 573–574
- Modular Logic Analyzers ..... 343
- Modular Measurement System ..... 102, 104–109, 115, 253, 295
  - Signal Generators ..... 103
  - Lightwave Signal Analyzers ..... 385, 387
  - Signal Generators ..... 447
  - Synthesizers ..... 447
  - Vector Voltmeter ..... 295
- Modular Microcircuit Package ..... 311, 419
- Modular Power Meter ..... 211
- Modular Power Supply System ..... 524
- Modular Simulators/Analyzers ..... 350–351
- Modular SONET/SDH Analyzers ..... 589
- Modular System Interface Bus (MSIB) ..... 102
- Modulation
  - Analyzers ..... 219, 221, 265, 268
  - Domain ..... 190
  - Domain Analysis, Selection Guide ..... 184
  - Domain Analyzers ..... 105, 185–188, 190–191
  - Measurement Software ..... 398
  - Test Source ..... 270, 460–461, 595
- Modulator/Demodulator ..... 460–461
- Modulators, I/Q, Vector ..... 460–461
- Monitors, LanProbe Segment ..... 610–611
- Monochrome Graphics Terminal ..... 637
- MOS Modeling System ..... 581
- MOSFET ..... 561
- Motion Control
  - Components ..... 642
  - Systems ..... 188
- Motor Controllers
  - Stepper ..... 626
  - 3-Channel ..... 625
- Motor Drivers ..... 560
- Multiband Signal Generator ..... 449
- Multichannel Measurement System ..... 231–233
- Multichannel Signal Processing System ..... 231–232
- Multifunction Synthesizer ..... 486–487
- Multifunctional Synthesized Waveforms ..... 480
- Multilink Tester ..... 605
- Multimeters ..... 166–181, 352
  - Digital ..... 90, 166, 172

## ALPHABETICAL INDEX

- Multimeters (cont'd)
- Handheld..... 180-181
  - Lightwave..... 377, 379
  - Module..... 119
  - Signature..... 295, 352
- Multipath Fading Simulator, Radio..... 400, 593-595
- Multiple-Output System Power Supplies..... 532-534
- Multiplexers..... 93, 95, 117, 119-120, 122, 172, 623, 625, 627, 629
- Armature Relay..... 173
  - FET..... 101, 624, 626
  - High Frequency Relay..... 118
  - LVDT Signal Conditioner..... 625
  - Probes..... 164
  - Reed Relay..... 173
  - Relay..... 101, 624, 626
  - RF..... 95, 101
  - Solid-State Relay..... 624, 626
  - Strain Gage..... 95
- Multiport Coaxial Switches..... 416
- Multiport Testing..... 602
- Multiprogrammers..... 115, 633
- Multitasking, Semiconductor Process Control System..... 566
- 
- N**
- Narrowband Detection..... 275
- Network
- Advisors, Token Ring..... 609
  - Analysis..... 274, 464
  - Analyzers..... 236-238, 296-297, 306, 314
    - Accessories..... 279-280, 294, 297, 299, 303-304, 313
    - Automatic..... 286, 308
    - Calibration Kits..... 303
    - Frequency and Time Domain..... 222-228, 230-232
    - General Information..... 274
    - Impedance/Gain-Phase..... 358
    - Integrated SCMM Systems..... 316
    - Linear Networks..... 274
    - Microwave..... 288, 306, 318
    - Modular..... 105
    - On-Wafer, 62.5-GHz..... 315
    - Pulsed RF..... 105, 309, 316
    - RF..... 296-301, 304, 317
    - Scalar..... 234-235, 277-279, 281-284
    - Services..... 284
    - Spectrum..... 236-238
    - Test Sets..... 309
    - Upgrade Kits..... 297, 301
    - Vector..... 226-229, 236-238, 286-290, 293, 295, 304, 308-314, 358
    - Vector Voltmeter..... 295
  - Discontinuities..... 307
  - Linear..... 276
  - Measurements..... 238
  - Signaling Equipment..... 605
  - Testing..... 602, 612
  - Wire Testing..... 607-608
- Networking
- High-Performance..... 133
  - Semiconductor Process Control System..... 566
- NewWave Holter System..... 646
- Next Day Support..... 671
- NEXT Scanner..... 606
- NIST Traceable Calibration..... 560
- Noise
- Generator..... 404
  - Measurements..... 263, 401
  - Microwave Noise Figure Test Set..... 401-403
- Noise and Interference Test Set..... 595
- Noise Figure
- Digital Meter..... 402
  - Gain Circles..... 401
  - Measurement System..... 401, 403
  - Meter
    - Noise Sources..... 403
  - Microwave..... 401-403
  - System..... 464
  - Test Set..... 403
  - Noise Sources..... 403, 406
- Nonlinear Device Testing..... 300
- North American Dual-Mode Cellular Radio Test System..... 395-396, 398
- 
- O**
- Obstetrical Information Management System..... 647
- OEM
- Computers..... 630-631
  - Microwave Attenuators..... 407, 409
  - Microwave Detectors..... 417-418
  - Microwave Switches..... 414-415
- Off-Line Debugger..... 566
- $\Omega$  Matching Transformer..... 255
- Ohmmeters..... 166-181, 373-374
- On-Line Control..... 602
- On-Wafer Measurements..... 317
- One-Box Solution..... 522-523
- One-/Two-Axis Differential Interferometer..... 424
- OP-Amps..... 560
- Opens, Coaxial..... 420
- Operating Environments..... 683
- Optical Attenuators..... 377, 380
- Optical Heads..... 378
- Optical Interface..... 590
- Optical Isolators..... 377, 380
- Optical Loss Test Set..... 378, 382
- Optical Power Meter..... 378
- Optical Power Splitters..... 381
- Optical Return-Loss Test Set
  - LED-Sources..... 378
- Optical Storage..... 637
- Optical Time Domain Reflectometer..... 381
- Opto-Coupler..... 561, 642
- Ordering Information..... 682
- Oscillators
- External..... 427
  - Function..... 480-484, 488-498
  - General Information..... 462
  - Low Frequency..... 480-483, 494-497, 592
  - Quartz Crystal..... 552
  - Reference..... 394
  - Sine Wave..... 480-484, 494-498, 592
  - Squarewave..... 482-483, 488-495, 497-498
  - Sweep..... 266, 284, 446, 452, 462, 466-475, 480-483, 494, 498, 592
  - Synthesized Sweep..... 448-450, 480-481, 494-498
- Oscilloscopes..... 136, 155
- Accessories..... 146, 159-164, 344
  - Application..... 137

Digital	158, 394
Digital Waveform Storage	140-143
Digitizing	92-93, 100, 105, 136, 138-154, 156, 329, 336
High Bandwidth	144-145
HP-IB	144-147
Microprocessors	344
Portable	149
Precision	144-147
Probes	140, 159-162, 164, 341
Sampling	105, 144-147
Test Sets	146
Transportation Accessories	163
VXI	92
Waveform	331
2-Channel	149

## P

Pair Scanner	606
Parallel Interface Module	157
Parametric Test Software	583
Parametric Test System, Semiconductors	568, 576, 585
Partial Discharge Detection	561
Patient Monitoring Systems	647
Pattern Generators	
Accessories	345
Digital	339, 489, 514
Error Detector	586
Gigabit	591
Output Drivers	341
Pulse Capability	513
PC Analyzer	232
PC Board Testers	122, 125-129
PC LIF Utilities	77
PC 300 Controllers	77
PC-Based Laser Interferometer System	425
PCM Test Equipment	293, 588
Peak Power Analyzers	210, 218
Peak Power Meters	210, 217
Pen Plotter, Supplies	638
Peripherals, Computers	637-638
Permeability Measurement Systems	306
Permittivity Measurement Systems	305
Personal Computers	633
Accessories	635
Instrument Controller Bundles	78-79
Phase Comparator	288, 556
Phase Meters	185, 226-229, 236-238, 286, 288
Phase Modulation Analyzers	185, 265, 268
Phase Modulation Generator	460-461
Phase Noise Measurement	263
Planar-Doped-Barrier	
Detectors	417-418
Waveguide	417
Plane-Mirror Interferometer	424
Platform Integration	131
Plotters	
Accessories and Supplies	640
C-V	578-579
DraftMaster Series	639
DraftPro Series	639
Electrostatic	639
Pen	638
Plotting Capability, Spectrum Analyzers	250

## Plug-ins

Accessories	119
Broadband	468-470
Cards	621
Modules	117
RF	470, 472-473, 475
Polarity Reversal, Relay Accessory	535
Polarization Controllers Lightwave	382
Portable	
Counter/Power Meter	204
Data Acquisition System	623
Lightwave Signal Analyzer	386-388
Logic Analyzers	326-329, 343
Spectrum Analyzers	222, 239-248
Tracking Generator	245-246, 249
Position Measurement, Laser	426
Positive Pressure Fan	665
Power	
Amplifiers	477-479
Dividers	282, 406
Measurements	269
Meters	
Calibrators	213, 216
MMS Module	108
Modular	108
RF & Microwave	210-212, 214-217, 270
Options, Counters	193
Sensors	
Cables	205
Calibration System	214
High Sensitivity	214
Modules	377-378
RF & Microwave	214
Sources	100, 255
Splitters	282-284, 295, 303, 406
Supplies	
Accessories	549
Analog Programmable	544-545, 547
Controller	560
DC	522, 532, 534, 538, 540, 546, 548
Dual Output	537-539, 541
General Purpose	537-538, 540, 544-548
High Performance	544-545
HP-IB	524, 532
MMS Compatibility	523
Modular	524
Multiple Output	532-534
Probes	160, 382
Programmer	616
Rack Kit	539
Single Output	526-529, 537, 539
Special Purpose	550
Standby	557
Triple Output	538-539
Voltage Rating Index	521-522
VXI Compatibility	523
Sweep, Signal Generators	471
Systems, Uninterruptible	667
Variation, Signal Generators	471
Power, Meters	212-213, 216
Counter	204
Measuring Receiver	270
MMS Module	211
Modular	211
Peak Power Analyzer	105, 210
VXI	96, 211

## ALPHABETICAL INDEX

- Power, Mixed-Signal . . . . . 560  
 Power, Semiconductor . . . . . 561  
 Power Sensors, RF & Microwave . . . . . 210, 214, 217, 271  
 Power, Supplies  
   Amplifier/Power Supply . . . . . 550  
   Bench . . . . . 537-538  
   Calibration Software . . . . . 535  
   Dual Tracking . . . . . 540  
   General Information . . . . . 520  
   HP-IB Programmable . . . . . 520-521, 523, 525-530, 532-534, 536  
   Laboratory . . . . . 520, 522, 536-538, 540, 547, 550  
   Precision . . . . . 532, 534  
   Precision Current Sources . . . . . 484, 551  
   Precision Voltage Sources . . . . . 551  
   Programmable . . . . . 520-521, 523, 525-530, 532-534, 536, 543  
   Relay Accessories . . . . . 535  
   Selection Index . . . . . 521-522  
   Voltage Sources . . . . . 484  
 PRBS Generators . . . . . 514  
 Preamplifiers . . . . . 255, 478  
   Dual . . . . . 261  
   Low-Noise . . . . . 261  
   Microwave . . . . . 261  
   Modular . . . . . 107  
 Precision Coaxial Connectors . . . . . 651  
 Precision Current Sources . . . . . 551  
 Precision Detectors . . . . . 279, 284  
 Precision Frequency Sources . . . . . 552-557  
 Precision Oscillator . . . . . 556  
 Precision Signal Generator . . . . . 458  
 Precision Time Interval Counters . . . . . 183, 185, 198  
 Precision Voltage Sources . . . . . 484, 551  
 Preprocessors  
   Bus . . . . . 344  
   Interfaces . . . . . 344  
   User Defined . . . . . 323  
 Preselected Millimeter Mixers . . . . . 254  
 Preselectors . . . . . 258  
 Pressure Probes, Quartz . . . . . 427  
 Printers . . . . . 344  
 Priority Plus Support . . . . . 671  
 Priority Support . . . . . 671  
 Probes  
   Accessories . . . . . 163, 179-181, 354  
   Active . . . . . 294  
   Active Divider . . . . . 160  
   Analyzers . . . . . 345  
   Current . . . . . 261  
   Detector . . . . . 179  
   Dielectric . . . . . 305  
   Digital Multimeter . . . . . 179-181  
   High Frequency . . . . . 179, 255, 299, 595  
   High Impedance . . . . . 265, 595  
   High Voltage . . . . . 179  
   Impedance . . . . . 358-359  
   Interface . . . . . 343  
   Kelvin . . . . . 179  
   Logic . . . . . 354  
   Mini . . . . . 515  
   Multiplexer . . . . . 164  
   Oscilloscopes . . . . . 140, 146, 159-160, 341  
   Plus-on . . . . . 515  
   Power Supplies . . . . . 160, 382  
   Pressure Quartz . . . . . 427  
   Resistive Divider . . . . . 160  
   Series Current . . . . . 261  
   Spectrum/Network . . . . . 289  
   Temperature . . . . . 179-181  
   Voltage Divider . . . . . 160, 179  
   Waveform Analyzers . . . . . 147  
 ProbeView Software . . . . . 610  
 Process Control System . . . . . 566  
 Productivity Assistance . . . . . 679  
 Program Services . . . . . 131  
 Programmable . . . . . 493  
 Programmable Power Supplies . . . . . 526, 536  
   HP-IB . . . . . 538  
   System . . . . . 543  
 Programmable Pulse/Function Generators . . . . . 492  
 Programmable Signal Analyzer . . . . . 232  
 Programmer Starter Kit . . . . . 454  
 Programmer's Toolkit . . . . . 231  
 Programming  
   Internal . . . . . 394  
   Remote . . . . . 392, 394, 467  
 Protocol  
   Analyzers . . . . . 597-598, 600, 606  
   LAN . . . . . 611  
   Testers . . . . . 601-603  
   WAN Analyzer . . . . . 678  
 PT300 Brochure . . . . . 602  
 PT500 Brochure . . . . . 602  
 Pulse Adder/Splitter . . . . . 504  
 Pulse Bias Noise Clipper . . . . . 579  
 Pulse Counters . . . . . 183, 266  
 Pulse Generators . . . . . 483, 499-511, 513, 515  
   High Power . . . . . 509  
   Programmable . . . . . 501-503, 505-506, 510-511  
 Pulse Inverter . . . . . 504  
 Pulse Modulation  
   High Performance . . . . . 431  
 Pulse Pattern Generator . . . . . 513  
 Pulse Signal Generators . . . . . 449  
 Pulse Width/Duty Cycle Analyzer . . . . . 185  
 Pulsed-RF Network Analyzers . . . . . 309, 314-315  
 Pulse/Function Generators . . . . . 454, 480-484, 488-495, 500  
 Pulsed/CW Microwave Counter . . . . . 207  
 Pulsers, Logic . . . . . 354  
 Pumps and Auto Samplers, HPLC . . . . . 644
- 
- Q**  
 Q Adapter . . . . . 365, 367  
 Q Meter . . . . . 366, 368, 375  
 Q-Star Network . . . . . 128  
 Quartz Crystal Oscillators . . . . . 552  
 Quartz Frequency Standard . . . . . 556  
 Quartz Pressure Probe . . . . . 428  
 Quasi-Peak Adapter . . . . . 258  
 Quick Scanner . . . . . 606
- 
- R**  
 R-Series Integrated Controllers . . . . . 75  
 Rack and Stack Matrixes . . . . . 413  
 Rack Kits, Power Supplies . . . . . 539  
 Rack Mount Kits . . . . . 659, 661

- Rack Slides . . . . . 659–662
- Rackmountable Controller . . . . . 76
- Radar Cross-Section . . . . . 319
- Radar Exciters . . . . . 458
- Radar Signal
- Baseband . . . . . 500
  - Characterization . . . . . 188
  - Simulator . . . . . 454, 458
- Radar Testing . . . . . 185
- Radio Measurement, Digital . . . . . 246
- Radio System Testing . . . . . 185–186
- Radio Test . . . . . 390
- Fading Simulator . . . . . 593–594
  - Microwave Digital . . . . . 593–595
  - Software . . . . . 391–392
  - System . . . . . 393, 395–396
- Radio Test, Microwave, RF Channel Simulator . . . . . 400
- Radiography . . . . . 648
- Range Calibrators . . . . . 213, 216
- Rayleigh Fading Simulator . . . . . 400
- Real-Time Analyzers . . . . . 224–225, 227, 230
- Real-Time DSP Function . . . . . 563
- Receivers
- EMI . . . . . 258
  - Measuring . . . . . 270–271
  - Microwave . . . . . 314–315, 317
  - Modules, Lightwave . . . . . 382, 385
  - Remote . . . . . 423
- Reference Boards . . . . . 298
- Reference Oscillators . . . . . 394
- Reflection/Transmission Test Sets . . . . . 300–301
- Reflectometers, Precision . . . . . 381, 384
- Refurbished Instruments . . . . . 682
- Regulators, Voltage . . . . . 560
- Relay Accessories for Power Supplies . . . . . 536
- Relay Actuators (HP-IB) . . . . . 117, 120, 616, 627
- Relay Devices . . . . . 535
- Relay Matrix Modules . . . . . 118
- Relay Matrixes . . . . . 94, 561
- Relay Multiplexers, VXIbus Family . . . . . 93, 101
- Remote Network Testers . . . . . 604
- Remote Programming . . . . . 291, 392, 394, 439, 467, 548
- Remote Receivers . . . . . 423
- Remote Sensing . . . . . 524, 531
- Remote Test and Analysis (RTA) . . . . . 597, 602–604
- Remote Transparent Monitor (RTM) . . . . . 604
- Remote Troubleshooter Software . . . . . 600
- Repair Services . . . . . 673–674
- Research and Development . . . . . 593
- Resistance Meters . . . . . 166–179, 372–374
- Resistive Divider Probe Kit . . . . . 147
- Resource Interface . . . . . 98
- Resuscitation . . . . . 647
- Return Loss Source Modules . . . . . 377
- Rewritable Optical Disk Drive . . . . . 637
- RF . . . . . 430–433, 435
- Amplifiers . . . . . 476, 478
  - Analyzer . . . . . 315–316, 391, 394
  - Broadband . . . . . 470
  - Channel Simulator . . . . . 400, 402
  - Communications Test Set . . . . . 390
  - Counter . . . . . 182
  - Detectors . . . . . 179
  - Economy . . . . . 430, 432–433
  - Frequency Counters . . . . . 183, 200
  - GSM Transmitter Tester . . . . . 108
  - High Performance . . . . . 428, 436, 441, 443, 446
  - Impedance Analyzer . . . . . 295, 362
  - Interface . . . . . 382–384
  - Interface Kit . . . . . 382–384
  - Modular Measurement System . . . . . 102
  - Multiplexers . . . . . 95, 101
  - Network Analyzer . . . . . 236–238, 286, 297–301, 303–304
  - Network Analyzers . . . . . 296–297, 317
  - Plug-ins, Sweepers . . . . . 471
  - Portable . . . . . 239, 241
  - Preamplifiers . . . . . 107, 478
  - Preselectors . . . . . 258
  - Pulsed Network Analyzers . . . . . 315
  - Signal . . . . . 241
  - Signal Characterization . . . . . 268
  - Signal Generators . . . . . 428–429, 440
  - Spectrum Analyzers . . . . . 106, 108, 239–241, 242, 243–248, 250–251, 253
  - Switches . . . . . 95, 117, 414–415
  - Test Sets . . . . . 393
  - Time and Frequency Analyzers . . . . . 185
  - Tracking Generators . . . . . 107, 239–244, 249
  - Tracking Source . . . . . 245–246, 249
  - VXI . . . . . 95
- RF, Microwave . . . . . 212–213, 216
- RF, Transceiver Test System . . . . . 395–396
- Ring Scanner . . . . . 606
- RISC Support . . . . . 321
- RMS Voltmeters . . . . . 166–179
- Rotary Vane Attenuators, Waveguide . . . . . 422
- RS-232 Interface . . . . . 328
- RS-232-C Connectors . . . . . 639
- RTA Brochures . . . . . 602
- RTA Protocol Testers . . . . . 603
- Rubidium Frequency Standard . . . . . 552, 555
- R/332 Controller . . . . . 76
- 
- S**
- S-Parameter Test Sets . 287, 294, 300–302, 304, 309, 316, 383, 385
- S-Parameters Measurements . . . . . 303
- Scalar Analyzers . . . . . 275–276, 285
- Scalar Measurement Personality . . . . . 239–240, 249
- Scalar Modulation . . . . . 460
- Scalar Network Analyzers . . . . . 278–279, 281–284, 286
- Scalar Transmission/Reflection Measurement Test Set. . . . . 249
- Scanners . . . . . 606
- ScopeLink Software . . . . . 157
- SCPI Programming Commands . . . . . 525
- SCSI Interface Module . . . . . 230
- Secondary Storage, Optical . . . . . 637
- Selective Level Voltmeters . . . . . 262, 592
- Semiconductor Parametric Test System
- CAE Software . . . . . 582
  - Capacitance Meters . . . . . 578
  - Source/Monitor . . . . . 532, 534
  - Test System . . . . . 566–568
- Semiconductors
- Component Measurements . . . . . 577, 580
  - Component Test Systems . . . . . 558–559, 565, 567–570, 574
  - Measurements . . . . . 358
  - Parameter Analyzer . . . . . 572
  - Accessories . . . . . 571

# ALPHABETICAL INDEX

Semiconductors (cont'd)	
Parametric Test System	568, 577, 579, 583
Test Equipment	558-559, 562-570, 572, 575-577, 580-584, 678
Sensors	
High Sensitivity	214-215
Module	214-215, 271
Peak Power	210
Power	214-215, 217, 271-272
Temperature	426
Thermistor	216-217
Serial Link, Capability	525
Series Harmonic Mixers	407
Series Interface	624
Service Kits, Synthesizers	451
Services	
Network Analyzers	284
Repair	673
Servo	189
SHF Signal Generators	460
Shipping	682
Shorts, Coaxial/Waveguide	420
Signal	
Analyzers	
Digital	265
Low Frequency	266
Multichannel	231, 233
Portable Dual-Channel	222
Preselectors	258
Programmable	232
Quasi-Peak Adapter	258
RF	265
Spectrum Analyzers	258
Characterization, RF	268
Generators	
Analog	430
Complex	460
Digital/Analog	490
HF	443, 446, 448, 450, 454, 460
High-Performance RF	437
I/Q	460
SHF	443, 446, 448, 450, 454, 460
UHF	448, 450, 454, 460
Vector	453
VHF	443, 446, 448, 450, 454, 460
Output System	536
Radar	188
Simulator System	458
Sources	
Logic	512
Programmable	447
Signal, Analyzers	218
Attenuator Calibration	272
Audio	222-229, 232-235, 262, 266
Baseband	234-235
Distortion	222-229, 232-233, 262, 266, 268, 270
Frequency and Time Interval	185
Lightwave	108, 385-388
Modulation	185, 222-229, 232-233, 265, 268, 398
Peak Power	210
Phase Noise	185, 263
Signal Generator Test	273
Spectrum	106, 108, 234-235, 253, 255, 263, 289
Spectrum Analyzers	226, 239-248, 250-252, 256-257, 259-261
Time Interval	185
Waveform	106, 222-233, 253, 265
Signal, Generators	434
AM-FM Pulsed	103, 447, 451
CW	448, 482-483, 494-495
Digital	489, 514
Digital Modulation	460-461
General Information	428-429
HF, VHF, UHF, SHF	103, 430-433, 435-437, 440-451, 454, 456-457, 460-461, 494-495, 498
Microwave	103, 447-451
Modular	103, 108, 447
Performance Test System	273
Programmable	430-433, 435-437, 440-446, 448-451, 456-457, 484, 491
Pulsed	103, 447, 449-450
Service Kits	440, 442, 451
Sweep	450, 462-463, 465-475, 480-483, 494-496, 498
Swept	448-450, 482-483, 494-495
Synthesized	103, 429-433, 435-437, 440-451, 456-457, 480-482, 484, 488-490, 492-498
Vector, I/Q	460-461
Signal, Simulation, Radar/EW	458
Signal, Simulation System	453-454
Signal, Sources	103, 430-433, 435-437, 440-448, 452, 456-457, 462-463, 465-475, 480-484, 488-490, 492-498, 500-503, 505-506, 508, 510-514, 516
Signaling	
Encoder	391
RF Radio	390
Test Set	607
Unit	397
Signature	
Analysis	354
Analyzers	295
Multimeter	295
Test Set	594
Silicon Bipolar Transistors	643
SimPlate Fixture Series	129
Simulation	
Signal	454
Vectors	340
Simulators	
Communications Radio	453
Digital Signal Processing (DSP)	453
EW Threat	454-455, 458
Jamming	458
Multipath Fading	400, 402, 593-594
Signal	458
Simulators	
CAE	340
HDA	454
Microwave Nonlinear	319
Radar	454
Rayleigh Fading	402
RF Channel	402
Single Sideband Phase Noise Test System	263
Single-Beam Interferometer	424
Single-Output System	
Accessories	530-531
Autoranging	531
Power Supplies	526, 539-540
Single-Pole Multithrow Switches	416
Single-Shot Analysis	335
Single-Sideband Measurement System	401
Single-Sideband Radio Test System	395-396

- Single-Source Systems . . . . . 111
- Single/Dual Output . . . . . 543
- Slide Kits . . . . . 662
- Slides for Rackmounting . . . . . 660–662, 670
- Sliding Loads (Waveguide) . . . . . 420
- Smart Power . . . . . 560
- SNA Testing . . . . . 600
- Softpanel Interactive Measurement and Analysis Software . . . . . 575
- Software
  - Accessories . . . . . 340
  - Active Device Measurement . . . . . 311
  - Applications Solutions . . . . . 319
  - Attenuator Test . . . . . 272
  - BASIC . . . . . 236, 250
  - BASIC Plus . . . . . 80
  - Binary Mode . . . . . 625
  - Boundary Scan . . . . . 124
  - Branch Validator . . . . . 349
  - Built-in . . . . . 378
  - CAD . . . . . 319, 453
  - CAE . . . . . 453
  - Calibration . . . . . 535
  - Circuit/Device Modeling . . . . . 580
  - Communications . . . . . 602–603
  - Communications System Simulation . . . . . 453
  - Computer-Aided Test . . . . . 632
  - Controllers . . . . . 76, 79
  - DAC/UX Manual . . . . . 626
  - Data Acquisition
    - and Control . . . . . 626
    - Manager . . . . . 627
    - System . . . . . 619, 622
  - Development . . . . . 134, 346, 348–351
  - Digital Signal Processing (DSP) Simulation . . . . . 453
  - Digital Test Development . . . . . 89
  - EMI Measurement . . . . . 259–260
  - EMI Receiver Functions . . . . . 258
  - Express Fixture . . . . . 129
  - Functional Test Manager . . . . . 83
  - HP BASIC . . . . . 71–72
  - HP PLUS . . . . . 631
  - I-DEAS . . . . . 231
  - IC-MS . . . . . 583
  - Instrument Controllers . . . . . 80
  - Integration . . . . . 349
  - Interactive Measurement & Analysis Software . . . . . 574
  - Interactive Test Generator . . . . . 86
  - Logic Analysis . . . . . 339
  - Logic Analyzers . . . . . 323
  - Materials Measurement . . . . . 305
  - Measurement Automation . . . . . 305, 307–308
  - Menu-Driven . . . . . 560
  - Metrology Analysis . . . . . 426
  - Modular Measurements . . . . . 398
  - Network Analyzers . . . . . 284
  - On-Wafer Calibration . . . . . 317
  - Parametric Test . . . . . 583
  - Performance Analysis . . . . . 348–349
  - Phase Noise Measurements . . . . . 263
  - Protocol . . . . . 602–603
  - $\pi/4$  DQPSK Modulation Measurement . . . . . 398
  - Radiated-Emissions Measurement . . . . . 259–260
  - Remote Troubleshooter . . . . . 600
  - Scalar Analyzers . . . . . 285
  - ScopeLink . . . . . 157
  - Semiconductor Parametric Test System . . . . . 568
  - Signal Analyzers . . . . . 236
  - Signal Generator Test . . . . . 273
  - Signaling Tester . . . . . 605
  - SPA . . . . . 333
  - Spectrum Analyzer Measurement Personalities . . . . . 239–240
  - Spectrum Network Analyzers . . . . . 233, 236, 250
  - Support Services . . . . . 670, 677–678
  - Transceiver Test . . . . . 390
  - Updates . . . . . 677
  - VXIbus . . . . . 87
  - Waveform Generator . . . . . 454, 455, 484
  - Windows . . . . . 559
  - 0.3 GMSK Modulation Measurement . . . . . 398
- Solid State
  - Devices . . . . . 643
  - Displays . . . . . 642
  - Relay Multiplexers . . . . . 624, 626
  - Relays . . . . . 642
  - Switching . . . . . 302
- Sonar . . . . . 500
- SONET Test Sets . . . . . 585, 590
- SONET/SDH Analyzers . . . . . 584, 589
- SONOS 1000 Cardiovascular Imaging System . . . . . 646
- Sound Level Meters . . . . . 225–226
- Source Monitor Unit (SMU) . . . . . 571
- Source Monitors, Modular DC . . . . . 572
- Sources, Data . . . . . 399
- Sources, Power . . . . . 100
- Sources, Signal . . . . . 430–433, 435–437, 440–446, 448, 453, 456–457, 462–463, 466–475, 480–483, 489, 491–498, 503, 514
- Spectrum Analysis . . . . . 228, 289
- Spectrum Analyzer Preselector . . . . . 258
- Spectrum Analyzers . . . . . 105–108, 218, 222, 224–225, 232–234, 235, 236–248, 250–253, 256–257, 259–260
  - Accessories . . . . . 245–249, 254, 261
  - HP-IB . . . . . 248
  - Microwave . . . . . 239, 250
  - Optional Equipment . . . . . 251
  - Portable . . . . . 248
  - Telecommunications Test Equipment . . . . . 248
  - Turbo Option . . . . . 250
- Spectrum Network Analyzers . . . . . 233, 236–238
- Splitters, Pulse . . . . . 504
- Stability Analyzer, Frequency . . . . . 185, 264
- Standalone Data Acquisition . . . . . 620
- Standalone HP-IB Instruments . . . . . 72
- Standard Capacitor . . . . . 377
- Standard Commands for Programmable Instruments (SCPI) . . . . . 72
- Standard Repair (STREP) . . . . . 671
- Standards, Frequency and Time . . . . . 552–556, 558
- State Analyzers
  - Logic Analysis . . . . . 334
- State Histogram . . . . . 339
- State/Timing Analyzer . . . . . 332
- Statistical Modeling . . . . . 580
- Step Attenuators
  - Coaxial . . . . . 411
  - High Performance . . . . . 411
  - OEM . . . . . 409
- Step Sweepers . . . . . 465
- Stepper Motor Controller . . . . . 626
- Straightness Measurement Kits . . . . . 426

## ALPHABETICAL INDEX

- Structural Dynamics Research Corp. (DRC) . . . . . 231  
 Structural Measurement System (SMS) . . . . . 231  
 Structural Test . . . . . 222-233  
 Subassembly Testing, Automotive . . . . . 132  
 SuccessLine Selection Guide . . . . . 673  
 SuccessLine Service . . . . . 671  
 Supercritical Fluid Extractor . . . . . 645  
 Support  
   Options . . . . . 673  
   Services . . . . . 677  
   Systems . . . . . 72  
 Support Life . . . . . 671  
 Support, Customer . . . . . 670, 675-676  
 SurePlot Disposable Drafting Pens . . . . . 638  
 Sweep Oscillators . . . . . 284, 446, 452, 473-475,  
   480-483, 494-498, 592  
 Sweep Signal Generators . . . . . 448, 452, 462-463, 465, 467-473,  
   475-476, 480-482, 484, 494-498  
 Sweep Synthesizers . . . . . 452, 481-482, 494-498  
 Sweepers . . . . . 462-463, 465-472  
   Step . . . . . 465  
   Synthesized . . . . . 464  
 Swept Signal Generators . . . . . 448-450  
 Switch Controller, HP-IB . . . . . 120  
 Switch Drivers  
   Attenuators . . . . . 415  
   Modular Measurement System . . . . . 109  
 Switches  
   AC Power Controller . . . . . 623  
   Actuators . . . . . 172, 623, 627, 629  
   Coaxial . . . . . 121, 416  
   Coaxial, Five-Port . . . . . 414-415  
   Coaxial, Microwave OEM . . . . . 414-415  
   Form C . . . . . 93  
   HP-IB . . . . . 616  
   Matrix (HP-IB) . . . . . 117, 120-121  
   Matrixes . . . . . 93  
     Custom . . . . . 413  
   Microwave . . . . . 93, 95, 118, 120-121  
   Relay Multiplexer, Form C . . . . . 94  
   RF . . . . . 95  
   SPDT . . . . . 414-415  
   Switch/Test Unit . . . . . 117  
   Test Unit . . . . . 119  
   VHF, HP-IB . . . . . 117, 120, 616, 623  
   VXIbus Family . . . . . 101  
 Switching  
   Digital Inputs/outputs . . . . . 626  
   Matrix, Semiconductor Test Equipment . . . . . 575  
   Measurement Systems Architecture . . . . . 115  
   Solutions . . . . . 416  
 Switching Time . . . . . 561  
 Synthesized Function Generators . . . . . 92, 454, 481, 484,  
   486, 494-495  
 Synthesized Signal Generators . . . . . 103, 429-433, 435-437,  
   440-448, 450, 452, 456-457, 484, 490, 495-496, 498  
 Synthesized Signal Sources . . . . . 103, 430-433, 435, 447, 449,  
   451-452, 484, 486, 494-495, 498  
 Synthesized Sweepers . . . . . 316, 463-466, 474  
 Synthesizers  
   Arbitrary Waveform . . . . . 454, 482, 484  
   Audio . . . . . 486, 494-495  
   Frequency . . . . . 443, 446, 555  
   Microwave . . . . . 441, 443, 446  
   Multifunction . . . . . 486  
   Signal Generators . . . . . 443, 446  
   Sweep . . . . . 450, 452  
   Time . . . . . 508  
   Two-Channel . . . . . 495  
   Waveform . . . . . 40, 453, 480, 482, 489-491, 493, 496  
 System Performance Analysis (SPA), Software . . . . . 333, 339  
 Systems  
   Analog LSI Test . . . . . 565  
   Antenna Measurement . . . . . 314, 317  
   Attenuator Calibration . . . . . 272  
   Board Test . . . . . 122, 125-129  
   Cable Kits . . . . . 284  
   Combinational Test . . . . . 122, 125-128  
   Communications Test . . . . . 122, 125-128  
   Computer-Aided Engineering (CAE/CAD) . . . . . 319  
   Data Acquisition . . . . . 623, 627, 629  
   Development Tools . . . . . 72  
   Digital IC Test . . . . . 558-559  
   Digital Radio Test . . . . . 593-594  
   EMC Design . . . . . 256-257, 259-261  
   EMC Pre-Productive Evaluation . . . . . 256  
   EMI Measurement . . . . . 256-257, 259-261  
   IC Prototype Verification . . . . . 558-559  
   In-Circuit Test . . . . . 122, 125-128  
   Integrated Network Analyzer Systems . . . . . 316  
   Interface . . . . . 397  
   LSI Test . . . . . 565  
   Microwave Transition Analyzer . . . . . 104-105  
   Military . . . . . 256  
   MMS Synthesizer . . . . . 103, 447  
   Modular Measurement System . . . . . 102, 106-109, 253  
   Modulation Domain Analyzer . . . . . 104  
   Network Analyzers, Modular . . . . . 104  
   Network Analyzers, Pulsed-RF . . . . . 104  
   On-Wafer, 62.5-GHz Network Analyzer System . . . . . 315  
   Oscilloscopes . . . . . 104  
   Power Meter, Peak . . . . . 104  
   Power Supplies . . . . . 525, 527, 529  
   Pulsed-RF Network Analyzer System . . . . . 316  
   Radar Cross-Section Measurement . . . . . 314, 317  
   Real-Time Computer . . . . . 630-631  
   Resource Interface . . . . . 101  
   Semiconductor Test . . . . . 558-559, 565  
   Signal Generator Test . . . . . 273  
   Software . . . . . 250, 285, 308  
   Spectrum Analyzers . . . . . 104  
   Support . . . . . 72  
   Surface Mount Technology Test . . . . . 125-126  
   Vector Voltmeter, microwave . . . . . 104  
   Verification Kits . . . . . 284  
   VXIbus . . . . . 71  
   Waveform Generation . . . . . 454  
 Systems—Transceiver Test . . . . . 395-396  
 Systems, Microprocessor Development . . . . . 352
- 
- T**  
 Tables . . . . . 641  
 TDE (see Test, Development Environment)  
 TECAP Characterization System . . . . . 582  
 Technical Computers and Peripherals  
   Engineering Workstations . . . . . 319  
 Technical Drafting . . . . . 638



- Telecommunications..... 187
- Mask Template..... 151-152
  - Testing..... 128
- Telecommunications Test Equipment..... 218, 298, 590-591
- Bit Error Ratio Measurements..... 586, 588
  - Communication Test Equipment..... 236
  - Constellation Analyzer..... 265, 595
  - Counter/Power Meter..... 204
  - Data Buffer..... 399
  - Datacom Test Sets..... 614
  - Digital Data Test Set..... 587
  - Digital Modulation Analyzer..... 265
  - Digital Modulation Generator..... 460-461
  - Digital Radio Test System..... 593-594
  - Digital Telecom Analyzer..... 585
  - Digital Transmission Analyzer..... 585-586, 588
  - Digital Transmitter Test..... 398
  - DS3 Transmission Test Set..... 588
  - Error Detectors..... 591
  - Error Performance Analyzer..... 586
  - Error Ratio Measurements..... 591
  - FDM Measurements..... 592
  - Frequency Analyzer..... 185
  - GSM Transmitter Tester..... 108
  - Jitter Generator and Receiver..... 586, 588
  - Jitter, Time Interval Analyzer..... 185
  - LAN Protocol..... 611
  - Lightwave Signal Analyzer..... 108
  - M-Curve Signature Test Set..... 593-594
  - Microwave Counters..... 209
  - Microwave Network Analyzers..... 236-238, 286-290, 293, 295, 299-301, 303-304, 308-313
  - Microwave Radio Testing..... 595
  - Microwave Transition Analyzer..... 104-105
  - Modular Measurement System..... 102, 109
  - Modulation Analyzers..... 185, 265, 268
  - Modulator/Demodulator..... 460-461
  - Multipath Fading Simulator..... 593-594
  - Noise and Interference Test Set..... 595
  - Pattern Generators..... 586, 591
  - PCM Testing..... 185, 587
  - Power Meters..... 210-214, 217
  - RF Radio Test..... 390, 395-396
  - Selective Level Meters..... 592
  - Spectrum Analyzers..... 106-108, 222-229, 232-248, 250-253
  - Telecom/Datacom Analyzers..... 614
  - Time Interval Analyzer..... 185
  - Transmission Impairment Measuring Sets..... 613
  - T1 Testing..... 587
  - Vector Modulation Analyzer..... 265, 596
  - Vector Modulation Generator..... 460-461
  - Vector Modulation Training Course..... 596
  - Vector Signal Generator..... 596
  - Voice and Data Testing..... 612
  - Waveform Analyzers..... 106-107, 185, 223, 226-229, 232-233, 253, 265
- Telecommunications Training..... 678
- Telemetry Analog Phase Modulation..... 460
- Temperature
- Measurement..... 624, 627, 629
  - Probes..... 179
  - Sensor..... 426
- Terminals..... 636
- Adaptors..... 357
  - Computers..... 636
- Test
- Accessories, Microwave..... 422
  - and Measurement Assistance..... 679
  - Development Environment..... 134
  - Equipment
    - Data Communications..... 607, 609, 611
    - Parameter Analyzer..... 570
    - Semiconductors..... 568-570, 576, 578, 583
  - Fixtures Products..... 129
  - Kits..... 179
  - Leads..... 579
  - Manager Software..... 83
  - Measurements
    - Cost Reductions..... 71-72
    - Standards..... 71-72
  - Power Devices..... 572
  - Software Development Tools..... 134
  - Software, Pulsed/CW Microwave Frequency Counter..... 207
  - Source..... 269
  - Systems
    - Analog..... 562
    - Digital..... 562
    - Digital Functional..... 100
    - LSI..... 562
    - Mixed Signals..... 562
    - Semiconductors..... 562, 566, 678
  - Transmission Lines..... 285
  - Units..... 118
  - Vectors..... 340
- Test and Adjustment Module..... 245
- Test and Measurement Equipment Support..... 670
- Test Equipment, Telecommunications..... 235
- Test Head..... 560
- Test Sets
- Modules..... 310
  - Oscilloscopes..... 146-147
  - 4-Channel..... 144-145
- Test Systems..... 560
- Board..... 122, 125-128
  - Controllers..... 75
  - IC..... 558-559, 565
- Testers
- Conformance..... 602
  - Protocol..... 602
- Testing
- High Reliability..... 643
  - Surface Mount Technology Boards..... 127
  - Transportable..... 668-669
- Testmobile Carts..... 668
- Tests, Noise Figure..... 403
- Thermal Converters..... 180
- Thermistors
- Assemblies..... 217
  - Power Meters..... 216-217
  - Sensors..... 216-218
- Thermocouple
- Multiplexers..... 93
  - Probe..... 180-181
  - Sensors, Coaxial & Waveguide..... 215
- Threat Simulator, Radar..... 460
- Three-Axis Interferometer..... 424
- Throughput Reduction, Digital Multimeter..... 166
- TIA (Time Interval Analyzer)..... 185, 187
- Tie-Together Kit..... 665
- Time and Frequency Domain Analyzers..... 222-233

## ALPHABETICAL INDEX

Time Converters ..... 402  
Time Domain  
  Analysis ..... 298, 300  
  Analyzers ..... 308  
  Application ..... 389  
  Reflectometry (TDR) ..... 144-145  
  Upgrade Kits ..... 301  
Time Interval Analyzers ..... 185, 190  
Time Interval Calibrator ..... 190, 199  
Time Interval Counters ..... 186  
Time Measurement ..... 560-561  
Time Scale ..... 552  
Time Standards ..... 553-557  
Time Synthesizer ..... 509  
Time Synthesizer, HP-IB ..... 508  
Timers ..... 560  
Timing Analyzers ..... 334  
Timing Cards ..... 337  
Timing Module ..... 89  
TNC Adapters ..... 652  
Token Ring Network Advisors ..... 609  
Top Extractor Fan ..... 665  
Tracking Generators ..... 234, 240-246, 249, 255, 499  
  Built-in ..... 244  
  Modular ..... 108  
Tracking Sources ..... 246-247, 250, 256  
Training Operation ..... 157  
Transceiver  
  Interface ..... 397  
  Test Equipment ..... 392, 394, 397-399  
Transceiver, Cellular Simulator ..... 401  
Transceiver Test Equipment ..... 395, 400  
Transceiver Test System ..... 393, 395-396  
Transient Digitizers ..... 223-233  
Transient Generators ..... 454  
Transient Limiter ..... 260  
Transient Recorders ..... 223-229, 231-233  
Transistor Fixtures ..... 303-304  
Transistor Test Fixtures ..... 312  
Transistors ..... 643  
Transit Cases ..... 654, 656  
Transitional Timing ..... 332  
Transmission Impairment Measuring Sets ..... 613-614  
Transmission/Reflection Test Sets ..... 294, 406  
Transmitter Test ..... 268  
  GSM Cellular ..... 398  
  JDC Cellular ..... 398  
  NADC Cellular ..... 398  
Trigger ..... 146-147  
Trigger-Level Timing ..... 199  
Triggering Logic ..... 148  
Triple Output Power Supplies ..... 539  
Tripod, Signal Analyzers ..... 261  
Troubleshooting  
  Automatic ..... 609  
  Digital Circuit Testers ..... 297  
  Kits ..... 298  
  Microprocessors ..... 352  
  Signaling Test Set ..... 605  
True RMS Voltmeters ..... 167-172, 174-179  
TTL Pod ..... 515  
TV Video Sync Pod ..... 164  
Twisted-Pair Cabling ..... 607-608  
Type N Short ..... 420  
TI Tester ..... 587  
10BASE-T Products ..... 607-608

**U**

UHF Signal Generators ..... 430-431, 433-434, 436-437,  
440-447, 457-458, 460-461  
UL Isolation Voltage Testing ..... 561  
Uninterruptible Power Systems (UPS) ..... 667  
Universal Counters ..... 182-183, 192-193, 197, 209  
Universal Systems Counter and Preamplifier ..... 196  
Universal Time Interval Counter ..... 198  
Upgrade Kits, Network Analyzers ..... 297  
US Government Sales ..... 683  
User-Definable Interface ..... 344  
UV/Visible Spectroscopy ..... 644

**V**

Value Added Business (VAB) ..... 130  
VAWS, Vector Arbitrary Waveform Synthesizer ..... 453  
VDE-0884 Isolation Voltage Testing ..... 561  
Vector Modulation Training Course ..... 605  
Vectors  
  Modulation Analyzer ..... 265-266, 596  
  Network Analyzers ..... 226-229, 287, 295, 311, 313-314  
  Signal Generator ..... 453, 461-462, 596  
  Simulation ..... 340  
  Test ..... 340  
  Voltmeters ..... 276, 295  
    Microwave ..... 105  
    Modular ..... 108  
Vectra Computers ..... 426, 596, 635  
Vectra PC ..... 633  
VEE Engine ..... 81-82  
VEE Test ..... 81-82  
Verification Kits ..... 271, 310, 312  
Versatile Links ..... 642  
VHF  
  Signal Generators ..... 431-432, 460  
  Switch ..... 616  
Vibration Analyzers ..... 222-227, 229-233  
VIS 0600 Testers ..... 561  
VIS 0700 Testers ..... 561  
VIXbus ..... 90  
VMEbus Laser Interferometer System ..... 425  
Voice  
  and Data Testing ..... 612  
  Support ..... 602-603  
Voltage  
  Isolation Tester ..... 561  
  Monitors ..... 571  
  Rating Index ..... 521-522  
  Regulators ..... 560  
  Sources ..... 560  
    DC ..... 576  
    PA Meter ..... 577  
Voltmeters  
  Analog ..... 167, 178  
  Digital ..... 167-172, 174-181  
    Integrating ..... 624  
  Handheld ..... 180-181  
  High Speed ..... 626  
  RMS ..... 167, 170-171, 175-178  
  True RMS ..... 167, 170-171, 175-178  
  Vector, Modular ..... 108

VOR Modulator .....	486	Sliding Loads .....	420
VLSI .....	500	Sliding Shorts .....	420
VXI .....	102, 125	Stands .....	422
Backplane Extension .....	96	Terminations .....	420
Command Module .....	97	Variable Attenuators .....	422
Controller .....	97	Waveguide .....	422
Counter Totalizers .....	91	Wavelength Tracker .....	423
Counters .....	91	WGL (see Waveform, Language, Generation)	
D/A Converters .....	92	Wideband Amplifiers .....	479-480
Data Communications .....	88	Windowing	
Development Tools .....	96-97	Dual-Time-Base .....	148
Digital I/O .....	92	Semiconductor Process Control System .....	566
Digitizing Oscilloscope .....	92	Windows, Software .....	559
Function/Sweep Generators .....	92	Wire Test Instrument .....	607-608
HP IBASIC .....	97	Workstations, Interface .....	347
Logic Analyzer Preprocessor .....	96	Worldwide Training .....	674
Mainframes .....	88, 96		
Matrixes .....	93		
Module Carrier .....	96		
Multiplexers .....	93, 95		
Power Meter .....	96, 211		
Switches .....	93, 95		
Systems .....	87		
Universal Counters .....	91		
VXI Embedded .....	75		
VXIbus Family .....	72, 76, 87-88, 91-93, 95-97, 100-101		

---

<b>W</b>		<b>X</b>	
WAN Protocol Analyzer .....	678	X-Ray Equipment .....	648-649
WAN Test Solutions .....	597		
WAN Testing .....	602-603		
Wave Analyzers .....	219, 221		
Waveform		<b>Z</b>	
Adapters .....	422	- Z-Domain .....	228
Analog .....	335-336		
Analyzers .....	142, 147, 165, 224-231		
Arbitrary .....	484, 514		
Attenuators .....	422		
Converters .....	625		
Digital .....	335-336		
Digitizers .....	223, 226-229, 232-233		
Digitizing Oscilloscopes .....	336		
Generator, Arbitrary .....	454, 482, 514		
Generators .....	165, 484, 489		
Language Generation .....	458-459		
Recorders .....	165		
Software Generation .....	455		
Synthesizers .....	453, 480, 482, 484-491, 493, 496		
Waveguide			
Accessories .....	312		
Bends, Twists .....	422		
Coaxial Adapters .....	422		
Detectors .....	279-280, 417-418		
Directional Couplers .....	422		
Fixed .....	420		
Frequency Meters .....	422		
Holders .....	422		
Isolators Accessories .....	422		
Low-Pass Filters .....	422		
Movable .....	420		
Precision Variable Attenuators .....	422		

# MODEL NUMBER INDEX

New product listings are printed in bold face type

## 100

105B Quartz Frequency Standard ..... 556

## 200

214B Pulse Generator ..... 509  
281 Series Coaxial-Waveguide Adapters ..... 422  
292 Series Waveguide-Waveguide Adapters ..... 422

## 300

306S Board Test Systems ..... 124  
339A Distortion Measuring Set ..... 262  
346A/B/C Broadband Noise Sources ..... 404  
346A/B/C OPT K01 Noise Source ..... 404  
347B Series Waveguide Noise Sources ..... 404  
355 Series Coaxial Step Attenuators ..... 409-410  
362A Series Waveguide Low-Pass Filters ..... 422  
365 Series mm-Wave Waveguide Isolators ..... 422  
370 Series mm-Wave Fixed Attenuators ..... 422  
373 Series mm-Wave Fixed Attenuators ..... 422  
382 Series Waveguide Precision Variable Attenuators ..... 422

## 400

415E SWR Meter ..... 283  
422A/C Series Waveguide Detectors ..... 417-418  
423B Low Barrier Schottky Diode Detector ..... 418  
432A/B Series Power Meters ..... 216  
435B Power Meter ..... 213  
436A Power Meter ..... 212  
437B Power Meter ..... 211  
438A Dual-Channel Power Meter ..... 212  
438A Option 700 MATE — Programmed Power Meter ..... 212  
478A Coaxial Thermistor Mount ..... 217  
486A Series Waveguide Thermistor Mounts ..... 217

## 500

532 Series Waveguide Frequency Meters ..... 422  
537A Coaxial Frequency Meter ..... 422  
545A Logic Probe ..... 298, 354  
546A Logic Pulser ..... 298, 354  
547A Digital Current Tracer ..... 298, 354  
548A Logic Clip ..... 354

## 700

700/32/43/44/92/94 Terminal ..... 636  
722D Dual-Directional Coupler ..... 421  
723D Directional Coupler ..... 421  
752 Series Waveguide Directional Couplers ..... 422  
772-773D Directional Couplers ..... 421  
774-779D Coaxial Dual Directional Couplers ..... 421

## 800

894 Series Waveguide Mismatches ..... 422  
896 Series Waveguide Precision Straights ..... 422

897 Series E-, H-Plane Waveguide Bends ..... 422  
898 Series Waveguide Twists ..... 422  
899 Series Waveguide Straight Sections ..... 422

## 900

908A Coaxial 50- $\Omega$  Termination ..... 420  
909A/C/D/F Coaxial 50- $\Omega$  Terminations ..... 420  
909E Coaxial 75- $\Omega$  Termination ..... 420  
910 Series Waveguide Terminations ..... 420  
914 Series Waveguide Sliding Loads ..... 420  
920 Series Waveguide Moving Shorts ..... 420  
921 Waveguide Fixed Shorts ..... 420

## 0000

0960-0054 SMA-Female Short (50  $\Omega$ ) ..... 420  
0960-0055 SMA-Male Short (50  $\Omega$ ) ..... 420

## 1000

1000 Computers and Systems ..... 630-631  
1008A Testmobile ..... 163  
1050 Series HPLC Modules ..... 644  
1051A/1052A Combining Cases ..... 661  
1090 Series II Liquid Chromatograph ..... 644  
1122A Probe Power Supply ..... 160-161, 163  
1124A Active Divider Probe ..... 160-161, 163  
1133A TV Video Sync Pod ..... 164  
1137A High Voltage Divider Probe ..... 161  
1141A Differential Probe ..... 162  
1142A Probe Control and Power Module ..... 162  
1180A Testmobile Scope Cart ..... 163, 668  
1181A Testmobile ..... 163  
1181A Testmobile System Cart ..... 163, 669  
1182A Testmobile Instrument Cart ..... 668  
1250-1530 N(m) Short (75  $\Omega$ ) ..... 420  
1250-1531 N(f) Short (75  $\Omega$ ) ..... 420  
1250-1737 PC Based Mini Probe Socket ..... 163  
1250-1918 PC Based Mini Probe Socket ..... 163  
1250-XXXX Series Adapters and Connectors ..... 651  
1251-2277 Dual Banana Plug to BNC Female ..... 651  
1251-2816 Dual Banana Plug (for Cable) ..... 651  
1405B Command Module ..... 100  
1460-XXXX Series Cabinet Parts ..... 669  
1490-XXXX Series Slide Kits, Casters ..... 661  
1494-XXXX Series Slide Kits ..... 660  
1496A Digital Test Development Software ..... 89  
1631D Logic Analysis Measurement Techniques Course ..... 675  
**1650 Series Logic Analyzers** ..... 320-326  
**1650B Logic Analyzer, Portable** ..... 322, 327, 328, 342-343  
**1651B Logic Analyzer, Portable** ..... 322, 327, 328, 342-343  
**1652B Logic Analyzer, Portable** ..... 322, 329, 342  
**1653B Logic Analyzer, Portable** ..... 322, 329, 342  
**1654B Logic Analyzer, Portable** ..... 322, 327, 328, 342

## 2000

2106CK/DK Board Computers ..... 630-631  
2134A Computer ..... 630-631  
2139B Computer ..... 630-631

2156C/D Computers	630–631
2196G/H Model 26 Computer Systems	630–631
2199E Model 29 Computer Systems	630–631
2393A Monochrome Graphics Terminal	636
2397A Color Graphics Terminal	636
2424A Micro 14 Computer	630–631
2426G/H Micro 16 Computer	630–631
2434A Micro 24 Computer	630–631
2436G/H Micro 26 Computer	630–631
2439B Micro 29 Computer	630–631
2484B Micro 24 Computer	630–631
2486B/C Micro 26 Computer System	630–631
2489B Micro 29 Computer System	630–631
2804A Quartz Thermometer	427
2813D Quartz Pressure Set	427
2813E Quartz Pressure Probe	427
2816A Pressure Signal Processor	427
2939A Micro 99 Computer	630–631
2959A Computer	630–631
2989A Micro 99 Computer	630–631
2999A Model 29 Computer System	630–631

## 3000

3048A Phase Noise Measurement System	263, 675
3065 Board Test Family	122, 126, 128
3065AT Combinational Board Test System	124
3065CT Communications Technologies Board Test System	128
3065ST Standard Technologies Board Test System	122
<b>3070 VXI Board Test System</b>	122, 123, 124, 125–127
3073ST Series	125
<b>3078 Board Test System</b>	123
3235A Switch/Test Unit	115, 117–119, 678
3245A Universal Source	484–485
3312A Function Generator	483
3314A Function Generator	481, 482–483
3324A Synthesized Function/Sweep Generator	481, 496–497
3325A Synthesizer/Function Generator	494
3325B Synthesizer/Function Generator	481, 494–495
3326A Synthesizer/Function Generator	481, 494–495
3335A Synthesizer/Level Generator	481, 498
3336A/B Synthesizer/Level Generators	481, 498, 592
3336C Synthesizer/Function Generator	262, 498
3365 MS-DOS ChemStation	644
3400A RMS Voltmeter	178
3421A Data Acquisition/Control Unit	618, 629
3437A System Voltmeter	177
3453OT Microwave Switch Terminal Block	413
3455A Digital Voltmeter	177
3456A Systems DVM	176
3457A Multimeter	172–173
3458A Digital Multimeter	170
3466A Digital Multimeter	178
3468A/B Digital Multimeter	174–175
3478A Digital Multimeter	174–175
3488 Switch/Control Unit	115
3488A Switch/Control Unit	120–121
3497A Data Acquisition/Control Unit	618, 627
3498A Extender Cable	627
3561A Dynamic Signal Analyzer	223
3562A Control Systems Analyzer	226–227
3562A Dynamic Signal Analyzer	228–229
3563A Control Systems Analyzer	226–227, 229
3565R Programmer's Toolkit	231
3565S Multichannel Measurement System	230–231

3566A Spectrum/Network Analyzer	230, 231, 232–233
3567A Spectrum/Network Analyzer	230, 231, 232–233
3575A Gain/Phase Meter	288
3577A/B Network Analyzers	286–287, 288
3585B Spectrum Analyzer	234–235
3586A/B Selective Level Meters	498, 592
3586C Selective Level Meter	262, 498
3588A Spectrum Analyzer	236–238
<b>3589A Spectrum/Network Analyzers</b>	236–238
3708A Noise and Interference Test Set	593, 595
3709B Constellation Analyzer	593, 595
3746A/B Selective Level Measuring Sets	498
3764A Digital Transmission Analyzer	586
3784A Digital Transmission Analyzer	586, 588
3787B Digital Data Test Set	587
3789B DS3 Transmission Test Set	588
3852A Data Acquisition and Control Unit	618, 624, 626, 675, 678
3852 HP 3852S User Training Course	675
3853A Extended Chassis	624, 626

## 4000

4061A Semiconductor/Component Test System	569
4062C HP 4062C Operating and Programming Training	676
4062C Semiconductor Parametric Test System	568
4062UX Semiconductor Process Control System	561, 566
4085M Switching Matrix	575
4140B pA Meter/DC Voltage Source	576–577
4142B Modular DC Source/Monitor	572–573
4145B Semiconductor Parameter Analyzer	570–571, 573
4191A RF Impedance Analyzer	362
4192A LF Impedance Analyzer	360–361
4193A Vector Impedance Meter	363
4194A Impedance/Gain-Phase Analyzer	358
4195A Network/Spectrum Analyzer	289–292, 356
<b>4263A LCR Meter</b>	371
4274A Multifrequency LCR Meter	368
4275A Multifrequency LCR Meter	368
4276A LCZ Meter	370
4277A LCZ Meter	370
4278A 1 kHz/1 MHz Capacitance Meter	369
4279A 1 MHz C-V Meter	375
4280A 1 MHz C Meter/C-V Plotter	578–579
4284A Precision LCR Meter	364–365
4285A Precision LCR Meter	364–365
<b>4338A Milliohmeter</b>	374
<b>4339A High-Resistance Meter</b>	372
4342A Q Meter	375
<b>4349A 4-Channel High-Resistance Meter</b>	373
4440B Decade Capacitor	376
4934A Transmission Impairment Measuring Set	613
4935A Transmission Impairment Measuring Set (North American)	613
4935S Data Transmission Test System	613
4936A Transmission Impairment Measuring Set (CCITT)	613
4947A Transmission Impairment Measuring Set	613
4948A In-Service Transmission Impairment Measuring Set	613
4954A WAN Protocol Analyzer	678
4954A/I/AX Protocol Analyzer	597, 600
<b>4957A Protocol Analyzer</b>	597, 606
4957C Protocol Analyzer	597
4957PC Protocol Analyzers	606
4972A LAN Protocol Analyzer	597, 606
4974S Network Analyzer	597

# MODEL NUMBER INDEX

New product listings are printed in bold face type

4980A Combination Ethernet and Token Ring	609
4981A Ethernet Network Advisor	609
4982A Token Ring Network Advisor	609
4990A ProbeView Software	610
<b>4990S LANProbe System</b>	597
4991A LANProbe Segment Monitor	610-611
4992A NodeLocator	611
4993A Probe View Console	611

## 5000

5005B Signature Multimeter	295, 352
5006A Signature Analyzer	295, 352
5011T Logic Troubleshooting Kit	355
5021A Logic Troubleshooting Kit	355
5022A Logic Troubleshooting Kit	355
5023A Logic Troubleshooting Kit	355
5024A Logic Troubleshooting Kit	355
5040-XXXX Series Rack Frames	661
5060-XXXX Control Panel Covers	661
5060-XXXX Filler Panels	661
5060-XXXX Rack Adapter Frames	661
5060-XXXX Rack Mounting Kits	661
5060-XXXX Series Racking Accessories, Covers	661
5061B Cesium Beam Frequency Standard	554
5062-XXXX Series System II Cabinet Parts	661
5065A Rubidium Frequency Standard	555
5087A Distribution Amplifier	557
5089A Standby Power Supply	557
5180A Waveform Recorders	165
5182A Waveform Recorders/Generators	165
5183A Waveform Recorders	165
5227B Laser Interferometer System	425
5314A Universal Counter	182, 191
5315A Electronic Counters	182, 192-193
5316A/B Universal Counters	182, 192-193
5328B Universal Counter	208
5334A/B Universal Counters	182, 194-195, 208
5335A Universal Counter	182, 196-197
5340A Automatic Microwave Counter	208
5342A Microwave Frequency Counter	209
5343A Microwave Frequency Counter	209
5345A Universal Electronic Counter	209
5347A Microwave Counter/Power Meter	204-205
5348A Microwave Counter/Power Meter	204-205
5350B Microwave Frequency Counter	202-203
5351B Microwave Frequency Counter	202-203
5352B Microwave Frequency Counter	202-203
5355A Automatic Frequency Converter	209
5356A, B, C, D Frequency Converter Heads	209
5359A Time Synthesizer	508
5361B Pulse/CW Microwave Counter	206-207
5364A Microwave Mixer/Detector	188-189
5370B Universal Time Interval Counter	182, 198-199
5371A Modulation Domain Analyzer	185, 188, 189
<b>5372A Modulation Domain Analyzer</b>	185, 186, 188, 189
<b>5373A Modulation Domain Pulse Analyzer</b>	185, 188, 189
5384A RF Frequency Counters	182, 200
5385A RF Frequency Counters	182, 200
5386A RF Frequency Counters	182, 200
5501A Laser Transducer System	423
5507B Laser Position Transducer Electronics	423
5508A Measurement Display	426
5517A Laser Head	423
5517B Laser Head	423

5517C Laser Head	423
5518A Laser Head	426
5527B Laser Position Transducer System	423
5528A Laser Measurement System	423, 426
5965B GC/IRD with UNIX ChemStation	644
5971 GC/MS with MS-DOS ChemStation	645
5989 GC/MS with UNIX ChemStation	645

## 6000

6002A 200 W Power Supply	536
6010A 1000 W Autoranging Power Supply	542
6011A 1000 W Autoranging Power Supply	542
6012B 1000 W Autoranging Power Supply	542
6015A 1000 W Autoranging Power Supply	542
6023A 200 W Autoranging Power Supply	542
6024A Autoranging Power Supply	542-543
6030A Single-Output System	525, 530-531
6031A Single-Output System	525, 530-531
6032A Single-Output System	525, 530-531
6033A Single-Output System	525, 530-531
6035A Single-Output System	525, 530-531
6038A Single-Output System	525, 530-531
6050A Electronic Load Mainframe	516-519
6051A Electronic Load Mainframe	516-519
<b>6060B Electronic Load</b>	516-519
6063B Electronic Load	516-519
6114A Precision Voltage Source	551
6115A Precision Voltage Source	551
6177A Precision Current Source	551
6181C Precision Current Source	551
6186C Precision Current Source	551
6200B-6209B DC Power Supplies	537
6205C Dual Output Power Supply	538
6227B Dual Output Power Supplies	540-541
6228B Dual Output Power Supplies	540-541
<b>6234A Dual Output Power Supply</b>	537
6235A Triple Output Power Supply	538
6236B Triple Output DC Power Supply	538
6237B Triple Output DC Power Supply	538
6253A Dual Output Power Supplies	540-541
6255A Dual Output Power Supplies	540-541
6260B DC Power Supply	546-547
6261B DC Power Supply	546-547
6263B DC Power Supply	546-547
6264B DC Power Supply	546-547
6266B-6269B DC Power Supply	546-547
6274B DC Power Supply	546-547
6281A DC Power Supply	540
6282A DC Power Supply	540
6284A DC Power Supply	540
6286A DC Power Supply	540
6289A DC Power Supply	540
6291A DC Power Supply	540
6294A DC Power Supply	540
6296A DC Power Supply	540
6299A DC Power Supply	540
6300 Secondary Storage	637
6400 Secondary Storage	637
6434B-6448B Power Supplies	548-549
6448B DC Power Supply	548
6453A Power Supply	548-549
6456B Power Supply	548-549
6459A Power Supply	548-549

6464C–6483C Power Supplies	548–549
6466C DC Power Supply	548
6469C DC Power Supply	548
6472C DC Power Supply	548
6475C DC Power Supply	548
6477C DC Power Supply	548
6479C DC Power Supply	548
6483C DC Power Supply	548
6541A–6545A 200 W DC Power Supply	544–545
6551A–6555A 500 W DC Power Supply	544
6571A–6575A 2000 W DC Power Supply	544
6621A–6622A Dual-Output System Power Supply	532–533
6623A Triple-Output System Power Supply	532–533
6624A Quadruple-Output System Power Supply	532–533
6625A Precision Dual-Output System Power Supply	532, 534
6626A Precision 4-Output System Power Supply	532, 534
6627A Quadruple-Output System Power Supply	532–533
6628A Precision Dual-Output System Power Supply	532, 534
6629A Precision 4-Output System Power Supply	532, 534
6632A–6634A 100 W System Power Supply	525–526
<b>6641A–6145A 200 W System Power Supply</b>	525, 527
6651A–6655A 500 W System Power Supply	525, 528
<b>6670A Series 2 kW System Power Supplies</b>	529
<b>6671A–6675A 2000 W System Power Supply</b>	525, 529
6825A–6827A DC Power Supply/Amplifier	550
6900 Multiprogrammer I/O	115
6942A Multiprogrammer	632
6944A Multiprogrammer	632
6944S Multiprogrammer System User's Course	675
6954A Multiprogrammer	632

## 7000

7000 Modular Measurement System	72
7000 Vac RMS	561
7550A Plotter	227
7600 Series Electrostatic Plotters	639
7673A Automatic Injector and Sampler	645
7680A Supercritical Fluid Extractor	645

## 8000

8082A Pulse Generator	507
8111A Pulse/Function Generator	488
8112A Pulse Generator	510
8115A 50-MHz Dual-Channel Pulse Generator	511
8116A Pulse/Function Generator	491–492
8118A Pulse Pattern Generator	512–513
8120-XXXX Cables and Adapters	651
8130A Pulse Generator	503–504
8131A Pulse Generator	499, 501, 502
<b>8146A Optical Time Domain Reflectometer</b>	381
<b>8153A Lightwave Multimeter</b>	377–378, 379
8154B LED Source	379
8155A Laser Source	379
8157A Optical Attenuator	380
8158B Optical Attenuator	380
8160A Programmable Pulse Generator	505–506
8161A Programmable Pulse Generator	505–506
8165A Programmable Signal Source	493
8175A Digital Signal Generator	489–490, 514
8200 Introductory Training	676
8328A Scalar Analyzer Software	285
8346A Microwave Amplifier	477
8347A RF Amplifier	476

8349B Microwave Amplifier	474, 479
8350 Sweeper Family	463
8350B Sweep Oscillator Family	466–469, 470–475
8360 Series Synthesized Sweeper	452, 463–464
8444A Option 059 Tracking Generator	255
8447 Series RF Amplifiers	255
8447F Option H64 Dual Preamplifier	261
8449B Microwave Preamplifier	255, 261
8470B Low Barrier Schottky Diode Detector	418
8471D/E Coaxial Detector	417–418
8472B Coaxial Detector	417–418
8473 Series Coaxial Detectors	417–418
8474 Series Coaxial Detectors	417–418
8477A Power Meter Calibrator	216
8478B Coaxial Thermistor Mount	217
8481A/B/D/H Power Sensors	205, 214–215
8482A/B/H Power Sensors	215
8483A Power Sensor	215
8485A/D Power Sensors	215
8487A/D Power Sensors	215
8490D 2.4mm Coaxial Fixed Attenuator	407–408
8491A/B/C Coaxial Fixed Attenuator	407–408
8492A Coaxial Fixed Attenuator	407–408
8493A/B/C Coaxial Fixed Attenuators	407–408
8494A/B/G/H Coaxial Step Attenuators	409–410
8495A/B/D/G/H/K Coaxial Step Attenuators	409–410
8496A/B/G/H Coaxial Step Attenuators	409–410
8497K Coaxial Step Attenuators	409
8498A Coaxial Fixed Attenuator	407–408
<b>8504A Precision Reflectometer</b>	384
8508A Vector Voltmeter	295
<b>8509 Lightwave Polarization Analyzer</b>	384
8510B Basic Measurements Using HP 8510 Network Analyzer System	675
8510C Network Analyzer	308, 316
8511A Frequency Converter	309, 315, 317
8514B S-Parameter Test Set (45 MHz to 20 GHz)	309, 313
8515A S-Parameter Test Set (45 MHz to 26.5 GHz)	309, 313
8516A S-Parameter Test Set (45 MHz to 40 GHz)	309, 313
8517A S-Parameter Test Set (45 MHz to 50 GHz)	309, 313
<b>8530A Microwave Receiver</b>	315, 317
8539A/B/C Microwave Receiver Upgrade Kits	315
<b>8566B with Turbo Option</b>	250, 260
8568B Spectrum Analyzer	250, 260
<b>8571A Microwave EMI Receiver</b>	257
<b>8572A Microwave EMI Receiver</b>	257
8573B EMI Receiver	257
8574B EMI Receiver	257
8590B Portable Spectrum Analyzer	239
8592B Portable Spectrum Analyzer	239
8593A Microwave Spectrum Analyzer	239, 241
8625A Synthesized RF Sweeper	465
8642A/B Synthesized Signal Generators	441–442
<b>8643A Synthesized Signal Generator</b>	437, 438–439
8644A Synthesized Signal Generator	437, 438–439
8644B Signal Generator	438–439
<b>8644B Synthesized Signal Generator</b>	437
8645A Agile Signal Generator	456–457
8657A/B Signal Generators	435
<b>8657D <math>\pi/4</math> DQPSK Signal Generator</b>	435
8660D Synthesized Signal Generator	443, 445
8662A Synthesized Signal Generator	440, 446
8663A Synthesized Signal Generator	436, 440, 446
<b>8664A Synthesized Signal Generator</b>	437, 438–439
<b>8665A/B Synthesized Signal Generators</b>	437, 438–439
8671B Synthesized CW Generator	448
8673B/C/D/E Synthesized Signal Generators	450–451

# MODEL NUMBER INDEX

New product listings are printed in bold face type

8673G Synthesized CW Generator	448
8673H Synthesized Signal Generator	449
8702A/B Lightwave Component Analyzers	382-383
<b>8711A RF Network Analyzer</b>	296-297
8719C Microwave Network Analyzer	306, 307, 313
8720C Microwave Network Analyzer	306, 307, 313
8721A Directional Bridge	255, 406
8722A Microwave Network Analyzer	306, 313
8751A Network Analyzer	293-294
8752A/B RF Network Analyzers	298
8753B HP 8753A RF Network Analyzer Course	675
8753C Network Analyzer	300, 304
8757C Scalar Network Analyzer	258, 280, 284
<b>8757D/E Scalar Network Analyzers</b>	277
8761A/B SPDT Coaxial Switches	414-415
8762A/B/C SPDT Coaxial Switches	414-415
8763A/B/C 4-Port Coaxial Switches	414-415
8764A/B/C 5-Port Coaxial Switches	414-415
8765A/B/C/D/F SPDT Coaxial Switches	414-415
8766/7/8/9K Series Single-Pole Multithrow Switches	414-416
8766C SPMT Coaxial Switch	415
8770A Arbitrary Waveform Synthesizer	453-455
8770S Signal Simulator System	454-455
8780A Vector Signal Generator	453, 460, 593, 596
8782A Vector Signal Generator	461
<b>8782B Vector Signal Generator</b>	596
8791 Model 100 Precision Signal Generator	458
8791 Model 11 Frequency Agile Signal Simulator	458
<b>8791 Model 21 Frequency Agile Signal Simulator</b>	458
8791 Model 200 Radar Simulator	458
8900C/D Peak Power Meters	217
8901A/B Modulation Analyzers	268
8901B RF Level (True RMS)	269
8902A Measuring Receiver	270-271
8902AT Attenuator Calibration System	272
8902S Measuring System	271
8902SG Signal Generator Test System	273
8903B Audio Analyzer	266-267
8903E Distortion Analyzer	266-267
8904A Multifunction Synthesizer	486-487
<b>8920A RF Communications Test Set</b>	390-392
<b>8922A GSM RF Test Sets</b>	393
<b>8922A/B/G GSM RF Test Sets</b>	393-394
<b>8953CT/DT/ST/XT Automated Test Systems</b>	395-396
8954A Transceiver Interface	397
8956A System Interface	397
8958A Cellular Radio Interface	397
8970B Noise Figure Meter	402-403, 464
8970S/U Microwave Noise Figure Measurement Systems	403-404
8971C Noise Figure Test Set	403, 407
8980B Vector Analyzer	265
<b>8981B Vector Modulation Analyzer</b>	265, 596
8990A Peak Power Analyzer	210

## 9000

9000 Series R/332 Controller	78-79
9000 Series V360 Computer	78-79
9000 Series 300 Computers	78
<b>9000 Series 300 Models R/362 and 382 Controllers</b>	74-76
9000 Series 332 Computer	78-79
9000 Series 360 Computer	78-79
9000 Series 375 Computer	79
9144A Cartridge Tape Drive	637

9145A Cartridge Tape Drive	637
9211-708 Series Operating Cases	652
9211-710 Series Transit Cases	654, 656
9420A Interface Connector Assembly (ICA)	98
9421A Interface Test Adaptor (ITA)	98
<b>9460 Testers</b>	561
<b>9464 Testers</b>	561
<b>9470 Testers</b>	561
<b>9472 Power Mixed Signal Test System</b>	560
9480 Analog LSI Test System	564-565
<b>9490 Series Mixed-Signal LSI Test System</b>	562
9491A Mixed Signal LSI Test System	563
9492A Mixed Signal LSI Test System	563

## 10000

10002A 50:1 Voltage Divider Probe	160-161, 163
10020A Resistive Divider Probe Kit	160-161, 163
10024A IC Test Clip	163
10062A Protective Cover	515
10079A Camera	163
10086A ECL Trigger	146-147
10100C 50-Ω BNC Feedthrough	163
10211A IC Test Clip	163
10229A Hook Tip Adapter	163
10240B Blocking Capacitor	160-161
10320C User Definer Interface	323
10349B Upgrade Kit	341
10390A System Performance Analysis Software	333, 339
10430A/31A/32A/33A/34A/35A/36A/37A/38A/39A/40A/41A Passive Oscilloscope Probe	159
10448A Upgrade Kit	341
10449A Upgrade Kit	341
10501A Cable Assembly	651
10502A Cable Assembly	651
10503A Cable Assembly	651
10529A Logic Comparator	355
10541A/B Reference Boards	355
10638A Degausser	556
10702A/B Plane-Mirror Interferometer	424
10705A Single-Beam Interferometer	424
10715A Differential Interferometer	424
10716A High-Resolution Interferometer	424
10717A Wavelength Tracker	423
<b>10719A One-/Two-Axis Differential Interferometer</b>	424
<b>10721A One-/Two Axis Differential Interferometer</b>	424
<b>10735A Three-Axis Interferometer</b>	424
<b>10736A Three-Axis Interferometer</b>	424
10751A Air Sensor	426
10753A Tripod	426
10754A Metrology Software	426
10757A Material Temperature Sensor	426
10777A Optical Square	426
10780C/F Receivers	423
10793A Laser Head Cable	426
10811D/E Oscillators	553
10833A/B/C/D HP-IB Cables	615
10834A HP-IB Cable Adapter	615
10855A Preamplifier	196
10856A Low-Pass Filter Kit	199
10870A Service Kit	199, 508
<b>10885A PC Axis Board</b>	423
<b>10896A Compensation Board</b>	423
11000-60001 Dual Banana-BNC Cable	651
11002A Test Leads	179, 651



11003A Test Leads .....	179, 651	11729C Carrier Noise Test Set .....	264
11049A 3V, 50 $\Omega$ Thermal Converter .....	179	11730A/F Sensor Cables .....	213
11050A 1V, 50 $\Omega$ Thermal Converter .....	179	11736B I/Q Tutor .....	596
11051A 0.5V, 50 $\Omega$ Thermal Converter .....	179	11742A Blocking Capacitor .....	407
11053A Low Thermal Lug-Lug Jumper Set .....	179	11748A High-Impedance Probe Set (HP 8980/81A) .....	265
11058A Low Thermal Banana-Banana Jumper Set .....	179	<b>11755A RF Simulator WorkSystem Driver</b> .....	453
11059A Kelvin Prove Set .....	179	<b>11757B Multipath Fading Simulator</b> .....	594
11060A Surface Mount Device Probe Set .....	179	<b>11758U Digital Radio Test System</b> .....	594
11062A Kelvin Clip Set .....	179	<b>11759B RF Channel Simulator</b> .....	400
11096B High Frequency Probe .....	179	11760S Automatic Power Sensor Calibration System .....	214
11174A Low Thermal Lug-Banana Jumper Set .....	179	11764 A-D Interconnect Cable (for HP 84900 Attenuators) ..	411
11340A/B/C HP-IL Cable Assemblies .....	629	11776A Waveform Generation Software .....	454-455, 675
11500A/B/C/D/E/F Precision Cables .....	651	11776K Waveform Generation Language .....	458
11501A Cable Assembly .....	651	11792A Sensor Module .....	271
11511A Coaxial Short .....	420	11793A Microwave Downconverter .....	271
11512A Coaxial Short .....	420	<b>11798A NMT Cellular Radio Software</b> .....	395-396
11515A Waveguide Adapter .....	422	11799A Signaling Unit .....	397
11516A Waveguide Adapter .....	422	11801A/B/C On-Site Service Kits .....	442
11524A APC-7 to N (female) Adapter .....	651	<b>11805B Transceiver Test Software</b> .....	395-396
11525A APC-7 to N (male) Adapter .....	651	11806B Attenuator Test Software .....	272
11533A APC-7 to SMA (male) Adapter .....	651	11807A Radio Test Software .....	391-392
11534A APC-7 to SMA (female) Adapter .....	651	11808A Signal Generator Performance Test Software .....	273
11536A Probe Tee for HP 8508A .....	295	11812A Verification Kit .....	271
11540A Waveguide Stand .....	422	11823A/B Attenuator Accessory Kits .....	272
11545A-11548A Waveguide Holders .....	422	11823C SWR Accessory Kit .....	272
11549A Power Splitter for HP 8508A .....	295	11835A Data Buffer .....	399
11565A Coaxial Short .....	420	11836A 0.3 GMSK Modulation Measurement Software .....	398
11570A Accessory Kit for HP 8508A .....	295	11845A 2-GHz Retrofit Kit .....	456
11581A Attenuator Set .....	407-408	<b>11847A <math>\pi/4</math> DQPSK Modulation Measurement Software</b> .....	398
11582A Attenuator Set .....	407-408	<b>11847B <math>\pi/4</math> DQPSK Modulation Measurement Software</b>	
11583A/C Attenuator Sets .....	407-408	<b>for JDC</b> .....	398
11590B Bias Network .....	311	11848A Phase Noise Interface .....	263
11600B Transistor Fixture .....	304	11850C/D Three-Way Power Splitters .....	303-304
11602B Transistor Fixture .....	304	11851B RF Cable Kit .....	303-304
11608A Transistor Fixture .....	311	11852B Minimum Loss Pad .....	303-304
11612A/B Bias Network .....	311	11853A Type N Accessory Kit .....	303-304
11613B Calibrator for HP 8756A, 8757A .....	282	11854A BNC Accessory Kit .....	303-304
11614A Firmware Enhancement for HP 8757A .....	281	11855A Type N Accessory Kit .....	303-304
11635A Bias Decoupling Network .....	311	11856A BNC Accessory Kit .....	303-304
11636A/B Power Dividers .....	282, 406	11857B Test Port Extension Cables .....	303-304
11644A Series Waveguide Calibration Kits .....	310, 312	11857D Test Port Extension Cables .....	304
11645A Series Verification Kits .....	310	11858A Transistor Fixture Adapter .....	303-304
11652-60001 BNC (m) 50- $\Omega$ Termination .....	420	11867A RF Limiter .....	255
11661B Frequency Extension Module .....	443	11869A Adapter for HP 86200 Series Sweeper Plug-ins .....	468
11664A/C/D/E Detectors .....	279	11871A/B/C Fiber Cables .....	383
11665B Modulator for HP 8755, 8756 and 8757 .....	282	11876A Upgrade Kit .....	382
11667A/B/C Power Splitters .....	283, 406	11886A Interconnect Cable Kit .....	383
11668A High Pass Filter for HP 8755, 8756, 8757 .....	282	11887A Interconnect Cable Kit .....	383
11672A Service Accessory Kit for HP 8660A/C/D .....	445	11889A RF Interface Kit .....	382-383
11678A Low Pass Filter Kit .....	282	11890A Lightwave Coupler .....	382-383
11679A/B Extension Cables for HP 8755, 8756 and 8757 .....	281	11891A Lightwave Coupler .....	382-383
11683A Range Calibrator .....	213	11894A Polarization Controller .....	383
11684/5/6/8/9A Low Pass Filters .....	282	11940A Close-Field Probe .....	260
11691D Coaxial Directional Coupler .....	421	11941A Close-Field Probe .....	260
11692D Coaxial Dual Directional Coupler .....	421	11945A Close-Field Probe Set .....	260
11693A Microwave Limiter .....	255	11947A Transient Limiter .....	260
11694A Matching Transformer .....	255	11949A Designing for EMC Seminar .....	675
11707A Test Plug-in .....	445	11949A EMC Design Course .....	260
11708A Attenuator (30dB, 50 MHz) .....	214	11950X EMC Design Course .....	260
11713A Attenuator/Switch Driver .....	412-413	11966A/B/C/D/E/F/G/H/K Antennas .....	260
11714A Service Support Kit (for HP 8662A, 8663A) .....	440	11967A/B/C/D Current Probes .....	261
11715A AM/FM Test Source .....	269	11968A/B/C/D/E/F/G/H Positioning Devices .....	261
11716A/B Interconnection Kits .....	409	11970 Series Harmonic Mixers .....	407
11721A Frequency Doubler .....	440	11975A Microwave Amplifier .....	255
11722A Sensor Module .....	271	12016A SCSI Interface Card .....	630-631
11726A Support Kit for HP 8673B/C/D .....	451	12100A A400 Single-Board Computer .....	630-631

# MODEL NUMBER INDEX

New product listings are printed in bold face type

12131A Keyboard Racking Kit .....	662
12679B Rail Kit .....	662
14513A Power Supply Rack Kit .....	541, 545
14515A Rack Kit .....	541
14523A Power Supply Rack Kit .....	541, 545
14525A Rack Kit .....	541
14545A Casters .....	549
14753A Computer-Aided Test Software .....	632
14921A Power Supply Calibration Software .....	535
15104A Pulse Adder/Splitter .....	504
15115A Pulse Splitter/Inverter .....	504
15116A Pulse Inverter .....	504
15408A-15411A Accessories .....	515
15415A Plus-on Miniprobe .....	515
15429A Solder-in Receptacles .....	515
15430A Cable for Master-Slave Operation .....	515
15461A ECL Pod .....	515
15462A TTL/CMOS Pod .....	515
15463A Trisser Pod .....	515
15464A TTL Pod .....	515
15513A 1m WECO 310 - WECO 310 Cable .....	587, 613
15568A Front-Panel DDS Clock Cable .....	587
15569A Rear-Panel DDS Clock Cable .....	587
15680A RF Accessory Kit .....	591
15709A High Impedance Probe .....	595
15710A Soft-Fabric Carrying Case .....	587
15901A Datacom Module .....	585
16005B Kelvin Clip Lead .....	374
16005C Kelvin IC Clip Lead .....	374
16006A Pin-Type Probe Lead .....	374
16007A/B Alligator Clip Leads .....	374
16008A Resistivity Cell .....	372
16014A Series Loss Adapter .....	375
16034E Test Fixture for Chip Components .....	357
16047A/B/C/D Test Fixtures .....	357
16048A/B/C/D/E Test Leads .....	357
16053A Test Leads .....	577
16054A Connection Selector .....	577
16055A Test Fixture .....	577
16056A Current Divider .....	577
16058A Test Fixture .....	571, 573
16060A Transformer Test Fixture .....	371
16061A Test Fixture .....	357
16062A Test Leads .....	357
16063A Test Leads .....	357
16064A Retrofit Kit for Comparator .....	370
16065A External DC Bias Test Fixture .....	357
16065C External Bias Adapter .....	357, 371
16066A Test Fixture Adapter .....	567
16067A 24-Pin DIP Low Leakage Fixture .....	567
16068A 48-Pin DIP Low Leakage Fixture .....	567
16069A Universal Low Leakage Fixture .....	567
16070A General Purpose DIP Fixture .....	567
16071A/B Universal Fixtures .....	567
16072A/B Personality Boards .....	567
16075A Relay Test Adapter .....	567
16076A System Test Module .....	567
16077A Extension Cable Fixture .....	567
16080A Direct Coupled Test Fixture .....	579
16081A Test Leads .....	579
16082A Test Leads .....	579
16083A Pulse Bias Noise Clipper .....	579
16085B Terminal Adapter .....	357
16087A Module Selector .....	573
16088A/B Test Fixtures .....	573
16089A/B/C/D Kelvin Clip Leads .....	357
16091A Coaxial Fixture Set .....	357
16092A Spring Clip Fixture .....	357, 363
16093A/B Binding Post Fixture .....	357, 363
16094A Probe Fixture .....	357
16095A Probe Fixture .....	357, 361
16096A 2-Port Component Test Fixture .....	357, 361
16099A Test Fixture Adapter .....	357, 363
16117B/C/D Low-Noise Test Leads .....	372, 373
16143B Mating Cable .....	374
16276A/B Interactive Measurement & Analysis Software .....	574
16277B Interactive Measurement & Analysis Software .....	574
16278B Interactive Measurement & Analysis Software .....	574
16320B/C Pin Boards .....	567
16334A Test Fixture for Chip Components .....	357
16338A Test Lead Set .....	374
16339A Component Test Fixture .....	372
16355A Relay Test Adapter .....	567
16356A System Test Module .....	567
16370A Test Fixture Adapter .....	567
16371A 24-Pin DIP Low Leakage Fixture .....	567
16372A 48-Pin DIP Low Leakage Fixture .....	567
16373A 64-Pin DIP Low Leakage Fixture .....	567
16374A Universal Low Leakage Fixture .....	567
16375A General Purpose DIP Fixture .....	567
16376A/B Universal Fixtures .....	567
16377A/B Personality Boards .....	567
16378B Extension Cable Fixture .....	567
16380A/C Standard Capacitor Sets .....	376
16451A Dielectric Test Adapter .....	375
16451B Dielectric Test Fixture .....	357
16462A Auxiliary Capacitor .....	375
16470A/B/C Reference Inductors .....	375
<b>16500A Logic Analysis System</b> .....	139, 322, 330-331, 342, 345
<b>16510B State/Timing Analysis Module</b> .....	332
16511B State/Timing Analysis Module .....	332
<b>16515A 1 GHz Timing Card</b> .....	337
<b>16516A 1 GHz Timing Card</b> .....	337
16520A 50 Mb Pattern Generator Master Card .....	338
16521A 50 Mb Pattern Generator Expansion Card .....	338
<b>16530A Digitizing Oscilloscope Card</b> .....	335
<b>16531A Digitizing Oscilloscope Card</b> .....	335
<b>16532A Digitizing Oscilloscope Card</b> .....	139, 336
<b>16540A/16541A 100 MHz State Analyzer</b> .....	334
<b>16541D/16541D 100 MHz State Analyzer</b> .....	334
18107A External Oscillator .....	427
18110A Lab Probe and Cal Module .....	427
18134A Vinyl Carrying Case for 4934A, 4935A .....	613
18182A 1.5 m WECO 310-Crocodile Clip Cable .....	587, 613
<b>18275A Remote Troubleshooter Software</b> .....	600
18347A HP 4951C Protocol Analyzer User's Course .....	675
18587A Barcode Identification System .....	645
19395A Headspace Sampler .....	645
<hr/>	
<b>20000</b>	
22861B ARPA/Berkeley Services for Series 300, Series 800 ..	676
22862A Administration of NFS and Yellow Pages .....	676
28687A Wire Test Instrument .....	607-608
<hr/>	
<b>30000</b>	
31112A Introduction to Pascal .....	675
31113A HP Pascal for Advanced and System Programming ..	675
31124A Introduction to Ada/300 DS .....	675

33311 SPDT Coaxial Switch (OEM) . . . . .	415
33312 4-Port Coaxial Switch (OEM) . . . . .	415
33313 5-Port Coaxial Switch (OEM) . . . . .	415
33314 SPDT Coaxial Switch (OEM) . . . . .	415
33320 Series OEM Coaxial Step Attenuators . . . . .	409-410
33324/6/7 Series . . . . .	411
33330B/C/D/E Coaxial Detectors . . . . .	417-418
33331D/E Coaxial Detector . . . . .	417
33334 Series Coaxial Detectors . . . . .	417-418
33336C Directional Detector . . . . .	417
33340A/B/C/D OEM Coaxial Attenuators . . . . .	407
33363-66 SP Multi-Throw Coaxial Switch (OEM) . . . . .	415
33392/3 Series 2.4 mm Instrument Grade Connectors . . . . .	407
34110A Carrying Case . . . . .	179
34111A High Voltage Probe . . . . .	179
34118B Test Lead Kit . . . . .	179
34119A High Voltage Probe . . . . .	179
34130A Deluxe Test Lead Kit . . . . .	168-169
34161A Accessory Pouch . . . . .	168-169
34300A 40 kV AC/DC High Voltage Probe . . . . .	179
34301A RF Detector Probe . . . . .	179
34302A Clamp-on AC/DC Current Probe . . . . .	179
34303A Temperature Probe . . . . .	179
<b>34401A Multimeter</b> . . . . .	168-169
34520A/B Multimeter Module . . . . .	119
34800A24D Developing Test Plans using FTM/300 . . . . .	675
34806A/B/C/D/E Functional Test Manager Software . . . . .	86
35073A HP-UX System Administration for Series 200 . . . . .	676
35129B HP-UX System Administration for Series 500 . . . . .	676
35130B Programming in C Language . . . . .	675
35199A/B Rack Mounts . . . . .	662
35523 Breadboard Module . . . . .	118
35605A System Rack . . . . .	230
35606A System Rack . . . . .	230
35629A HP 3562A User's Course . . . . .	675
35634A Software . . . . .	233
35635R Programmer's Toolkit . . . . .	230-231
35636A Order Tracking Software . . . . .	233
35637A Swept-Sine Software . . . . .	233
35650A 8-Slot Mainframe . . . . .	230, 233
35650B 4-Slot Portable Mainframe . . . . .	230
35651B Signal Processing Module . . . . .	230-231, 233
35652A/B Input Module . . . . .	230-231, 233
35653A Source Module . . . . .	230-231, 233
35654A/B Signal Processing Modules . . . . .	230-231
35655A/B Input Module . . . . .	230-231, 233
35656A Programmable DAC . . . . .	230-231, 233
35659A SCSI Interface Module . . . . .	230-231
35665A Dual-Channel Dynamic Signal Analyzer . . . . .	224-225, 231
35675A/B Reflection/Transmission Test Kits . . . . .	288
35676A/B Reflection/Transmission Test Kits . . . . .	286, 288
35677A/B S-Parameter Test Set . . . . .	286, 287, 288
35678A/B Calibration Kits . . . . .	288
35679A/B Extension Cables . . . . .	288
35680A Instrument BASIC . . . . .	678
<b>35689A S-Parameter Test Set</b> . . . . .	236, 238
35689B S-Parameter Test Sets . . . . .	238
37050S User and System Manager Course . . . . .	676
37190A HP 37100S Operator and Management Course . . . . .	676
37191A HP 37100S Operator Training . . . . .	676
37204A/B Multipoint HP-IB Extenders . . . . .	617
37701A T1 Tester . . . . .	587
<b>37704A SONET Test Set</b> . . . . .	590
37711A T1/Datacom Test Set . . . . .	614
37721A Digital Transmission Analyzer . . . . .	585
<b>37722A Digital Telecom Analyzer</b> . . . . .	585

<b>37732A Telecom/Datacom Analyzer</b> . . . . .	614
37771A STS-3 Electrical Interface . . . . .	590
37772A 52/155 Mb/s—1310 nm Optical Interface . . . . .	590
37776A Optical Interface 622 Mb/s—1310 nm . . . . .	590
<b>37900D Signaling Test Set</b> . . . . .	597, 605

## 40000

41420A Source/Monitor Unit . . . . .	572-573
41421B Source/Monitor Unit . . . . .	572-573
41422A High Current Source/Monitor Unit . . . . .	572-573
41423A High-Voltage Source/Monitor Unit . . . . .	573
41424A Voltage Source/Voltage Monitor Unit . . . . .	572-573
41425A Analog Feedback Unit . . . . .	572-573
41800A Active Probe . . . . .	292, 294
41802A 1 M Input Adapter . . . . .	294
41941A/B Impedance Probe Kits . . . . .	358-359
41951A Impedance Test Kit . . . . .	291-292
41952A/B Transmission/Reflection Test Sets . . . . .	292
42841A Bias Current Source . . . . .	367
42842A/B/C Bias Current Test Fixture . . . . .	367
42843A Bias Current Cable . . . . .	367
42851A Precision Q Adapter . . . . .	367
43420B NewWave Holter System . . . . .	646
43703B X-Ray Equipment . . . . .	649
43710A X-Ray Equipment . . . . .	649
43731A X-Ray Equipment . . . . .	649
43733A X-Ray Equipment . . . . .	649
43734A X-Ray Equipment . . . . .	649
43855 Cabinet X-Ray Systems . . . . .	648
43855A/B Cabinet X-Ray Systems . . . . .	648
44200S/L SimPlate Express Fixture Kit . . . . .	129
44201S Express Cassette . . . . .	129
44202S/L SimPlate 3070 Fixture Kit . . . . .	129
44203S/D/L SimPlate Fixture Kit . . . . .	129
44458A DACQ/300 Software and Manual . . . . .	626, 628
44458R DACQ/300 Manual and License to Copy . . . . .	626, 628
44459A DACQ/PC Software and Manual . . . . .	626, 628
44459R DACQ/PC Manual and License to Copy . . . . .	626, 628
44460A DACQ/UX Software and Manual . . . . .	626, 628
44460R DACQ/UX Manual and License to Copy . . . . .	628
44461A HP-IB Interface . . . . .	629
44462A 8-Channel Multiplexer Assembly . . . . .	629
44463A Extra Connector Block . . . . .	629
44464A Breadboard Assembly . . . . .	629
44465A 8-Bit In, 8-Bit Out Digital I/O Assembly . . . . .	629
44466A Extra Connector Block . . . . .	629
44469A Seven 10:1 Dividers . . . . .	629
44491A Armature Relay Multiplexer Assembly . . . . .	173
44492A Reed Relay Multiplexer Assembly . . . . .	173
44497A High Voltage Attenuator . . . . .	173
44531A HP 3060A/61A/62A User's Course . . . . .	676
44584 HP 3060 Enhancement Training . . . . .	676
44701A Digital Integrating Voltmeter . . . . .	624
44702A/B 13-Bit High-Speed Voltmeter . . . . .	624
44703A Mainframe Extended Memory Card . . . . .	626
44703B Mainframe Extended Memory Card . . . . .	626
44704A 16-Bit High-Speed Voltmeter . . . . .	624
44714A 3-Channel Stepper Monitor Controllers . . . . .	625
44715A 5-Channel Counter/Totalizer . . . . .	625-626
44721A Digital Inputs with Totalize and interrupt . . . . .	625
44722A Digital Inputs with Totalize and interrupt . . . . .	625
44723A 32-Channel High-Speed Digital Sense/Control . . . . .	625
44724A 16-Channel Digital Output . . . . .	625
44725 Switching . . . . .	625

# MODEL NUMBER INDEX

New product listings are printed in bold face type

44726A Arbitrary Waveform Digital-to-Analog Converter	625
44728 Switching	625
44729 Switching	625
44786A 8-Channel LVDT Signal Conditioner/Multiplexer	625
44788A HP-IB Controller	625
44789A Serial Interface	624
44790A Binary Mode Software	625
44850A HP 3065 Advanced User's Course	676
44851A HP 3065AT User's Course	676
44852A HP 3065 Board Test System User's Course	676
44853A HP 3065 AT Training	676
44990A Express Fixturing System	129

## 50000

50011C HP-IB Instrument Programming Using Series 200/300 BASIC	675
50015A Data Acquisition and Control Fundamentals	675
50698A Programming in FORTRAN 77	675
50710A Programming with HP-UX System Calls	675
50722A HP-UX System Administration for Application Users	676
50740A,B,C Microwave Fundamentals Course	675
50959A Using SRM from BASIC and Pascal	676
51432A HP-UX Fundamentals for General Users	675
51433A Shell Programming for General Users	675
51434B HP-UX for Programmers	675
51435A Advanced HP-UX Tools	675
51436B HP-UX System Administration for Series 300	676
51438A SSCS and make	675
51439A Advanced Editing with VI	675
51440A Document Preparation	675
51482A HP-UX System Administration for Series 800	676
51800A Waveform Measurement Library	165
51820A Waveform Generator Library	165
<b>53310A Modulation Domain Analyzer</b>	185, 186, 188
53700A Continuous Measurement Software	189
54001A 1-GHz Miniature Active Probe Pod	140
54002A 50 BNC Input Pod	140
54003A 1-M 10:1 Probe Pod	140
54006A High Frequency Probe	146-147
54007A Accessory Kit	146-147
54008A Delay Line	146-147
54100A/D Digitizing Oscilloscope	138, 140
54110D Digitizing Oscilloscope	138, 140
54111D Digitizing Oscilloscope	138, 141-142, 143
54112D Digitizing Oscilloscope	138
54118A Trigger	146-147
<b>54120 Series Oscillators</b>	499
54120B Digitizing Oscilloscope Mainframe	144-147
<b>54121A Four-Channel Test Set</b>	144-147
54121T Digitizing Oscilloscope	138, 144-147
<b>54122A Four-Channel Test Set</b>	144-147
54122T Digitizing Oscilloscope	138, 144-147
<b>54123A Four-Channel Test Set</b>	144-147
54123T Digitizing Oscilloscope	138, 144-147
<b>54124A Four-Channel Test Set</b>	144-147
54124T Digitizing Oscilloscope	138, 144-147
54300A Probe Multiplexer	164
<b>54500 Family of Digitizing Oscilloscopes</b>	148-153
<b>54501A Digitizing Oscilloscope</b>	139, 148, 153
<b>54502A Digitizing Oscilloscope</b>	139, 148, 152
<b>54503A Digitizing Oscilloscope</b>	139, 148, 151
<b>54504A Digitizing Oscilloscope</b>	139, 148, 150
<b>54510A Digitizing Oscilloscope</b>	139, 148, 149

<b>54600 Series Oscilloscopes</b>	137, 155, 157
<b>54600A 2-Channel Oscilloscope</b>	154, 155, 156, 158
<b>54601A 4-Channel Oscilloscope</b>	154, 155, 158
54650A HP-IB Interface Module	157
54651A RS-232 Interface Module	157
54652A Parallel Interface Module	157
54653A Operation Training Kit	157
54654A ScopeLink Software	157
54657A Measurement/Storage Module	157
54658A Measurement/Storage Module	157
55280A Linear Measurement Kit	426, 675
55281A Angular Optics Kit	426
55282A Flatness Accessory Kit	426
55283A Straightness Measurement Kit	426, 675
59306A Relay Actuator	616
59307A Dual VHF Switch	616
59309A HP-IB Digital Clock	616
59401A Bus System Analyzer	615-616
59501B HP-IB Power Supply Programmer	536, 616
59510A Relay Accessory for Power Supplies	535
59511A Relay Accessory for Power Supplies	535
59992A-J06 Time Interval Calibrator	198

## 60000

60501B Electronic Load	516-519
60502B Electronic Load	516-519
60503B Electronic Load	516-519
60504B Electronic Load	516-519
<b>60507B Electronic Load</b>	516-519
64000 Series Microprocessor Development Systems	346-351, 676
64120T HP DesignCenter 64000-UX User's Course	676
64121T HP-UX for HP 64000-UX User's Course	676
64620S State/Software Analysis	676
<b>64700 Series Emulators/Analyzers</b>	346, 349-351
64700A Card Cage	347
64708 Software Performance Analyzer	346
<b>66000A Modular Power System</b>	521, 523-524
<b>66001A Modular Power Systems</b>	523-524
<b>66101A-66106A Modular Power Systems</b>	523-524

## 70000

<b>70000 Modular Measurement System</b>	102, 106-109, 253
70004A Color Display	106, 253
70100A MMS Power Meter	108, 211
70138A Vector Voltmeter	108, 295
70300A RF Tracking Generator	107
70301A Microwave Tracking Generator	107
70320A Synthesized Signal Generator	108
70322A Synthesized Signal Generator	108
70325A Agile Signal Generator	108
<b>70340A Modular Synthesized Signal Generator</b>	103, 447
70591A 1/8-Width Module Prototype Kit	106, 253
70592A 3/8-Width Module Prototype Kit	106, 253
70593A 1/2-Width Module Prototype Kit	106, 253
70594A 3/4-Width Module Prototype Kit	106, 253
70595A Module Development Design Guides	106, 253
70596A Module Communication Design Guides	106, 253
70597A MSIB Module Interface Software	106, 253
70611A Attenuator/Switch Driver for MMS	109, 412
70612/13 Series Switch Matrixes	109
70612A MMS Interface Box	415

70613A MMS Interface Box..... 412  
70620B Preamplifier ..... 107  
70621A Preamplifier ..... 107  
70700A Digitizer ..... 107  
**70810B Lightwave Receiver Module** ..... 385  
70820A Microwave Transition Analyzer Module..... 104-105  
70912A/B Down Converter Module..... 398  
71100C Modular Spectrum Analyzer ..... 106, 253  
71150C GSM Transmitter Tester..... 108  
**71200C Modular Spectrum Analyzer** ..... 106, 253  
**71209A Modular Spectrum Analyzer** ..... 106, 253  
71210C Modular Spectrum Analyzer ..... 106, 253  
71250C GSM Transmitter Tester ..... 108  
71400 Signal Analyzers ..... 386  
**71400C Lightwave Signal Analyzer** ..... 108  
**71401C Lightwave Signal Analyzer** ..... 108, 387  
**71500A Microwave Transition Analyzer** ..... 104-105  
**71600 Series Error Performance Analyzers and Pattern Generators** ..... 591  
**71601A 50 Mb/s to 1 Gb/s Error Performance Analyzer** ... 591  
**71602A 50 Mb/s to 1 Gb/s Pattern Generator**..... 591  
**71603A/B 100 Mb/s to 3 Gb/s Error Performance Analyzer** 591  
**71604A/B 100 Mb/s to 3 Gb/s Pattern Generator** ..... 591  
74201A HP Design Capture System Overview ..... 676  
74202A HP Design Verification Interface User's Course ... 676  
74203A Introduction to HILO Modeling ..... 676  
74300A Introduction to HP EGS ..... 676  
74301A PCB Design with HP EGS ..... 676  
74302A Customizing HP EGS..... 676  
74495A Introduction to HP PCD5 ..... 676  
74836T HP DesignCenter ME 30 Users Course ..... 676  
75000 Series B Data Acquisition System ..... 619-622  
**75000 Series 90 Modular SONET/SDH Analyzer** ..... 589  
**75000 VXIbus Family** ..... 87-101  
**75000 Model D20 Digital Functional Test System**..... 89

**80000**

81000 BR Reference Reflector ..... 378  
81210LI Optical Isolator..... 380  
81520A Optical Head ..... 378  
81521B Optical Head ..... 378  
81530A Power Sensor Module ..... 378  
81531A Power Sensor Module ..... 378  
81532A Power Sensor Module ..... 378  
81533A Optical Head Interface Module ..... 378  
81534A Return-Loss Module..... 378  
81536A Power Sensor Module ..... 378  
81541MM LED Source ..... 378  
81542MM LED Source ..... 378  
81551MM Laser Source Module ..... 378  
81552SM Laser Source Module..... 378  
81553SM Laser Source Module..... 378  
81554SM Laser Source Module..... 378  
82000 IC Evaluation System ..... 558-559  
82080A LIF Utilities..... 77  
82300C HP Measurement Coprocessor..... 74  
82300D Measurement Coprocessor ..... 77  
82302A HP BASIC Self-Study Course..... 74  
82314E/15E/19E PC-308 Controllers..... 79  
82323A HP Measurement Coprocessor Upgrade Kit..... 74  
82324B Measurement Coprocessor ..... 77  
82332E/33E PC-312 Controllers ..... 79  
82334E PC-315 Controller ..... 79  
82335A HP-IB Interface and Command Library..... 74, 77

83006A Microwave System Amplifiers ..... 405  
83036C Directional Detector ..... 417, 421  
83040 Series Modular Microcircuit Package ..... 311, 419  
**83211A Digital Signal Processing Controller** ..... 395-396  
83400A/B Lightwave Source Module..... 382  
83401A/B Lightwave Source Module ..... 382  
83402A/B Lightwave Source Module..... 382  
83403A/B Lightwave Source Module..... 382  
83404A/B Lightwave Source Module..... 382  
83410C Lightwave Receiver Module ..... 382  
83411C/D Lightwave Receiver Modules ..... 382  
83412B Lightwave Receiver Module ..... 382  
83420A Lightwave Test Set ..... 310, 383  
83421A Lightwave Source ..... 383  
83422A Lightwave Modulator..... 383  
83423A Lightwave Receiver ..... 383  
83424A Lightwave CW Source ..... 383  
83425A Lightwave CW Source ..... 383  
**83440B/C/D Lightwave Converters** ..... 389  
83500 Series RF Plug-ins ..... 462, 463, 466, 467  
83522A 0.01-2.4 GHz RF Plug-in ..... 468, 472  
83525A/B 0.01-8.4 GHz RF Plug-ins ..... 468, 472  
83540A/B 2-8.4 GHz RF Plug-ins..... 468, 472  
83545A 5.9-12.4 GHz RF Plug-in ..... 468, 472  
83550 Series Source Modules ..... 474  
83550A 8-20 GHz RF Plug-in ..... 468, 472  
83554A 26.5-40 GHz Millimeter-Wave Source Module..... 474-475  
83555A 33-50 GHz Millimeter-Wave Source Module .. 474-475  
83556A 40-60 GHz Millimeter-Wave Source Module .. 474-475  
83557A 50-75 GHz Millimeter-Wave Source Module .. 474-475  
83558A 75-110 GHz Millimeter-Wave Source Module..... 474-475  
83570A 18-26.5 GHz RF Plug-in..... 468, 472  
83572C 26.5-40 GHz RF Plug-in ..... 468, 472  
83590 Series Microwave Amplifier..... 474  
83590A 2-20 GHz RF Plug-in ..... 469  
83592A/B/C 0.01-20 GHz RF Plug-in ..... 469  
83594A 2-26.5 GHz RF Plug-in ..... 469  
83595A/C 0.01-26.5 GHz RF Plug-in ..... 469  
83596A 2.4-40 GHz RF Plug-in..... 471  
83596B 2.4-40 GHz RF Plug-in ..... 468  
83597A 0.01-40 GHz RF Plug-in..... 471  
83597B 0.01-40 GHz RF Plug-in..... 468  
83598A 2.4-50 GHz RF Plug-in ..... 468  
83599A 0.01-50 GHz RF Plug-in..... 468  
**83650A Synthesized Sweeper** ..... 464  
84000 Series EMC Measurement Systems ..... 256  
84100A EMC Pre-Production Evaluation System ..... 256  
84120A EMI Pre-Compliance Measurement System ..... 256  
84130A EMI Commercial Compliance Measurement System..... 256  
84811A Peak Power Sensor ..... 217  
84812A, 84813A, 84814A Peak Power Sensors..... 210  
84851A Power Sensor ..... 205  
84904/6/7 Series Coaxial Step Attenuators ..... 411  
84940A Switch Driver ..... 412  
84941A Distribution Expansion Cards..... 412  
85014B/C Active Device Measurements Application Pac... 311  
85014C Microwave Network Analyzer..... 306  
85015B Scalar Analyzer Software ..... 285  
85016B Scalar Analyzer Software ..... 285  
85020A/B RF Directional Bridges ..... 280  
85022A System Cable Kit..... 281  
85023A/B/C/D/F System Verification Kit ..... 281  
85024A High Frequency Probe..... 255, 288, 292  
85025A/B/C/D/E Detectors ..... 279  
85026A Waveguide Detectors..... 279



**800000**

851162A Measurement Automation Software ..... 307

**A**A1303A/05A/07A Model R/332 Controllers ..... 76  
A1314A, A1319A, A1324A R-Series Controllers ..... 75**C**C1001 - HP 700/92 Terminal ..... 636  
C1002 - HP 700/94 Terminal ..... 636  
C1006 - HP 700/43 Terminal ..... 636  
C1007 - HP 700/44 Terminal ..... 636  
C1017 - HP 700/32 Terminal ..... 636  
C1405A/ABA DIN Keyboard ..... 297**D**D1421B HP Vectra QS/20 PC, Model 1 ..... 634  
D1422B HP Vectra QS/20 PC, Model 46 ..... 634  
D1424B HP Vectra QS/20 PC, Model 47 ..... 634  
D1461C HP Vectra QS/16S PC, Model 1 ..... 634  
D1462C HP Vectra QS/16S PC, Model 40 ..... 634  
D1464C HP Vectra QS/16S PC, Model 40 ..... 634  
D1481C HP Vectra QS/16S PC, Model 1 ..... 634  
D1488C HP Vectra QS/16S PC, Model 80 ..... 634  
D1489C HP Vectra QS/16S PC, Model 80 ..... 634  
D1491B HP Vectra QS/20 PC, Model 1 ..... 634  
D1498B HP Vectra QS/20 PC, Model 86 ..... 634  
D1499B HP Vectra QS/20 PC, Model 87 ..... 634  
D2020A HP Vectra RS/25C PC, Model 1 ..... 634  
D2080A HP Vectra RS/25C PC, Model 1 ..... 634  
D2082A HP Vectra RS/25C PC, Model 170 ..... 634  
D2083A HP Vectra RS/25C PC, Model 330 ..... 634  
D2236A HP Vectra 486/33T PC, Model 1 ..... 634  
D2237A HP Vectra 486/33T PC, Model 1 ..... 634  
D2238A HP Vectra 486/33T PC, Model 170 ..... 634  
D2239A HP Vectra 486/33T PC, Model 670 ..... 634  
D2240A HP Vectra 486/33T PC, Model 1000 ..... 634  
D2360A HP Vectra 386/25T PC, Model 1 ..... 634  
D2361A HP Vectra 386/25T PC, Model 80 ..... 634  
D2362A HP Vectra 386/25T PC, Model 170 ..... 634  
D2363A HP Vectra 386/25T PC, Model 80 ..... 634  
D2364A HP Vectra 386/25T PC, Model 170 ..... 634  
D2371A HP Vectra 386/25T PC, Model 1 ..... 634  
D2460A HP Vectra 286/12 PC, Model 1 ..... 634  
D2461A HP Vectra 286/12 PC, Model 20 ..... 634  
D2462A HP Vectra 286/12 PC, Model 20 ..... 634  
D2463A HP Vectra 286/12 PC, Model 40 ..... 634  
D2464A HP Vectra 286/12 PC, Model 40 ..... 634  
D2467A HP Vectra 286/12 PC, Model 1 ..... 634**E**E21-5061B Flying Clock (Cesium) ..... 554  
E21-5065A Portable Rubidium Time Standard ..... 555  
E1255A 8-Channel Strain Gage Relay Multiplexer ..... 94  
E1256A 8-Channel Strain Gage Relay Multiplexer ..... 94E1300A HP 75000 Series B Mainframe ..... 88, 97  
E1301A HP 75000 Series B Mainframe ..... 97  
E1323A VXI Preprocessor for HP Logic Analyzers ..... 96  
E1326A 5 1/2-Digit Multimeter ..... 90  
E1328A 4-Channel D/A Converter ..... 92-93  
E1330A Quad 8-Bit Digital Input/Output ..... 92, 93  
E1332A 4-Channel Counter/Totalizers ..... 91  
E1333A 3-Channel Universal Counter ..... 91  
**E1340A Arbitrary Function Generator** ..... 92  
E1345A 16-Channel Relay Multiplexer ..... 93  
E1345A Relay Multiplexer ..... 94  
E1346A 48-Channel Single Ended Relay Multiplexer ..... 93, 94  
E1347A 16-Channel Thermocouple Relay Multiplexer ..... 93-94  
E1351A 16-Channel FET Multiplexer ..... 95  
E1352A 48-Channel Single-Ended FET Multiplexer ..... 95  
E1353A 16-Channel Thermocouple FET Multiplexer ..... 95  
E1355A 16-Channel Thermocouple Relay Multiplexer ..... 93  
E1356A 16-Channel Thermocouple Relay Multiplexer ..... 93  
E1357A 8-Channel 120  $\Omega$  Strain Gage Multiplexer ..... 95  
E1358A 8-Channel 350  $\Omega$  Strain Gage Multiplexer ..... 95  
E1361A 4  $\times$  4 Matrix Switch ..... 93  
E1364A 16-Channel Form C Switch ..... 93  
E1366A 50- $\Omega$  RF Multiplexer (2 $\times$ 4:1) ..... 95  
E1367A 50- $\Omega$  RF Multiplexer (2 $\times$ 4:1) ..... 95  
E1368A 18 GHz Microwave Switch ..... 95  
E1369A Microwave Switch Driver ..... 95  
E1370A Microwave Switch Driver ..... 95  
E1400B HP 75000 Series C Mainframe ..... 88  
E1400T VXI Development Mainframe ..... 96  
E1403A A/B-Size VXI Module Carrier ..... 96  
E1405A Command Module ..... 97  
**E1405B Command Module** ..... 97  
E1410A 6 1/2-Digit Multimeter ..... 90  
E1411A 5 1/2-Digit Multimeter ..... 90  
E1416A VXI Power Meter ..... 96, 211  
E1420A Universal Counter ..... 91  
E1426A Digitizing Oscilloscopes ..... 92-93  
E1440A 21-MHz Synthesized Function/Sweep Generator ..... 92  
**E1445A Arbitrary Function Generator** ..... 92  
**E1446A Summing Simplifier/DAC** ..... 92  
**E1450A 160-MHz Timing Module** ..... 89  
**E1451A/E1452A 20-MHz Pattern I/O Modules** ..... 89  
**E1453A/E1454A Pods** ..... 89  
E1460A 64-Channel Relay Multiplexer ..... 93-94  
**E1463A 32-Channel 5-Amp** ..... 94  
**E1465A Relay Matrix** ..... 94  
**E1466A Relay Matrix** ..... 94  
**E1467A Relay Matrix** ..... 94  
E1468A 64-Channel Relay Multiplexer ..... 93-94  
E1469A 64-Channel Relay Multiplexer ..... 93-94  
E1472A 50- $\Omega$  RF Multiplexer (6 $\times$ 4:1) ..... 95  
E1473A 50- $\Omega$  RF Multiplexer Expander (6 $\times$ 4:1) ..... 95  
**E1480A V/360 Controller** ..... 75, 97, 101  
E1482A VXI-MXI Extender ..... 98  
**E1496A Development Software** ..... 89  
E1501A HP 75000 Series B Mainframe ..... 88  
E2000A Interactive Test Generator for HP BASIC ..... 84, 86  
E2001A Instrument Driver Software for HP ITG ..... 84, 86  
E2020A Interactive Test Generator for DOS ..... 84  
E2080A LIF Utilities ..... 74  
**E2100A HP VEE-Engine** ..... 82  
**E2110A HP VEE-Test** ..... 82  
**E2160A HP BASIC Plus Software** ..... 80  
E2301A Surface Thermocouple Probe ..... 180-181

**MODEL NUMBER INDEX**

New product listings are printed in bold face type

E2302A Airflow Thermocouple Probe .....	180-181
E2303A Thermocouple Probe Adapter .....	180-181
E2304A Handheld Multimeter Carrying Case .....	180-181
E2305A Replacement Test Leads .....	180-181
E2306A Test Lead Kit .....	180-181
E2373A Multimeter .....	180-181
E2377A/78A Multimeters .....	180-181
E2500B Model 11 Frequency Agile Signal Simulator .....	458
E2501A Model 200 Radar Simulator .....	458
E2502A Model 100 Precision Signal Generator .....	458
E2505A Model 21 Frequency Agile Signal Simulator .....	458
E3300A IC-CAP Software .....	580-581
E3330A IC-MS Software .....	583
<b>E3610 Series 30 W Bench Power Supplies .....</b>	<b>537</b>
<b>E3610A-E312A DC Power Supplies .....</b>	<b>537</b>
E3660A-62A EIA Racks .....	663, 664, 665-666
E3720A VXI Interface Connector Assembly .....	99
E3722A Hinged Interface Connector Assembly .....	99
E23064A Delux Test Lead Kit .....	181

**H**

H736B I/Q Tutor .....	596
-----------------------	-----

**J**

J06-59992A Time Interval Calibrator .....	190, 199
J2177A Pair Scanner .....	606
J2181A Cable Scanner .....	606
J2187A Quick Scanner .....	606
J2196A Ring Scanner .....	606
<b>J2201A NEXT Scanner .....</b>	<b>606</b>

**K**

K422C Waveguide Detectors .....	418
---------------------------------	-----

**P**

<b>PT500 High-Speed Protocol Tester .....</b>	<b>601</b>
<b>PT502 Protocol Tester .....</b>	<b>601</b>
<b>PT300 Protocol Tester .....</b>	<b>601</b>

**Q**

Q347B Solid State Noise Source .....	403
Q422A Waveguide Detectors .....	418
Q8486A/D Power Sensors .....	214

**R**

R347B Series Solid State Noise Sources .....	404
R422C Waveguide Detectors .....	418
R8486A/D Power Sensors .....	214

**U**

U422A Waveguide Detectors .....	418
---------------------------------	-----





HP Measurement Systems Architecture is Hewlett-Packard's approach to providing products, development tools, and integration and support services that are used in concert to configure cost-effective test and measurement solutions.

## Reduce Cost, Time, and Risk in Test and Measurement

As the world of technology becomes more complex, the demand for faster, more flexible test and measurement systems grows. To meet increasing demands, you must constantly streamline and improve your systems. You need a test strategy that is manageable as well as cost-effective. To answer your concerns, Hewlett-Packard has developed a comprehensive strategy that can help you meet the changing requirements for test and measurement systems. HP Measurement Systems Architecture (HP MSA) is a strategic bridge between the past, present, and future of your test and measurement systems. Hewlett-Packard is working to provide you with flexible solutions featuring integration with existing test systems, higher levels of performance, and the ability to upgrade in the future.

## Open Standards Span Past, Present, and Future of Test Systems

Simply put, HP MSA is a system of open industry standards that allows you to mix and match instrument and controller platforms to build the most effective test system for your application. It's a combination of

products, development tools, and services that will help you realize maximum flexibility in building new systems and integrating them with your existing equipment.

The HP MSA approach to building integrated systems incorporates HP's major instrument platforms, including the HP 75000 VXIbus, the HP 70000 modular measurement system, and HP-IB standalone instruments. MS-DOS and UNIX-based controllers, along with software tools such as HP BASIC, HP ITG, HP Instrument Drivers, and HP VEE, are also part of HP MSA.

## The Benefits of HP MSA

The HP MSA approach allows you to reduce the cost associated with test systems by using scalable products that optimize system throughput and maximize system uptime, and offer scalable performance. You cut your system development time by leveraging hardware and software development tools, compatible products, and integration services. The HP MSA approach minimizes your business risk because it is based on open industry standards, offers worldwide support, and provides a foundation for the future.

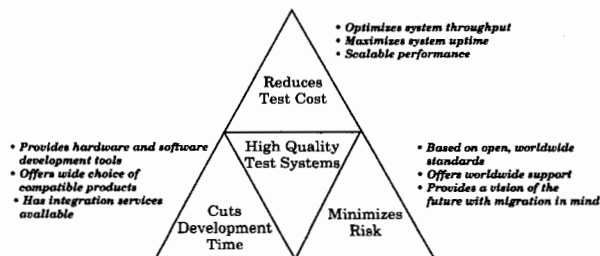

Reduce the cost, time and risk of test. The HP MSA approach helps you build systems that do the best job for you. You can mix and match MMS, VXI, and HP-IB instruments, controllers and powerful software tools to build solid, high-quality test systems.

## Reducing the Cost of Test

Faster system throughput lets you perform more tests, in less time, with fewer systems and lower cost. Hewlett-Packard products are designed for speed with features such as the integrated I/O capability of HP BASIC, optimized firmware such as register-based VXI, measurement coprocessors, and improved technology.

## Cutting Test System Development Time

Hewlett-Packard provides a number of tools to help you design and build new systems faster than ever. Easy-to-use programming languages such as HP BASIC, visual engineering environments such as HP VEE, and HP Instrument Drivers simplify and shorten development time. You can quickly build turnkey systems with HP's wide range of instruments, controllers, software, and development tools.

## Minimizing Your Investment Risk

The use of open industry standards in HP MSA provides you with a solid foundation for your long-term test system strategy. HP test and measurement systems can be configured to be easily upgraded and extended as your needs change and new technologies become available.

Hewlett-Packard's commitment to industry standards like SCPI, MMS, and VXI ensures that your systems and software will continue to be productive in the future — significantly minimizing your risk in test and measurement system investments.

## HP Solutions for Test and Measurement Systems

The following sections highlight the products, development tools, and support services that support the HP MSA approach. More detailed information on each of the products mentioned can be found in the following pages.

## Software

HP MSA includes software products designed to reduce your test development time. HP BASIC is an easy-to-use and highly productive programming language for developing and executing application software. Optimized for instrument control, it is available on a wide range of Hewlett-Packard computers and workstations, including the HP Vectra PC and compatibles.

The HP Visual Engineering Environment (HP VEE) is a problem-solving software environment that lets you select and link visual objects or icons to create complete solutions. HP VEE provides a comprehensive set of visual objects or icons representing functions commonly used in prototyping, experimentation, problem modeling, and test development.

The HP Interactive Test Generator (HP ITG) software is a development tool that accelerates the development of test programs using a windowed, mouse-driven interface designed for automatically generating code and controlling instruments. The HP Functional Test Manager (HP FTM) software provides a versatile, reusable framework for customizing production test systems, including standard forms for a uniform approach to test development, statistical quality control (SQC), and database management.

# MEASUREMENT SYSTEMS ARCHITECTURE

Bridging the Past, Present, and Future of Test

## Controllers

Hewlett-Packard offers a wide range of controllers for test and measurement, including the HP 9000 technical computer and the HP Vectra personal computer solutions. Hewlett-Packard provides desktop as well as rackmount and embedded controllers. Hewlett-Packard's instrument controllers support industry-standard operating systems such as MS-DOS and UNIX, as well as the premiere test environment, HP BASIC. Hewlett-Packard's controllers can easily exchange data with other computers through its networking hardware and software.

## Standard Commands for Programmable Instruments (SCPI)

SCPI provides a universal instrument command set that has been optimized for remote operations and signal oriented measurements. SCPI simplifies software development because you no longer need to learn a different command set for every instrument in your system. Using common instrument mnemonics also minimizes software modifications when upgrading your system hardware.

SCPI is implemented in all of HP's VXI products and many MMS and standalone products. Hewlett-Packard plans to implement SCPI into all new systems products. A new book available from the Hewlett-Packard Press explains the elementary concepts required to program instruments that implement SCPI. To order, call 1-800-333-0088. *A Beginner's Guide to SCPI* is \$29.25.

## Instruments

Hewlett-Packard's MSA includes both modular product families and standalone HP-IB instruments, all optimized for automated test systems. Many new HP instruments include built-in controllers running, HP Instrument BASIC, a subset of HP BASIC.

## VXIbus System

The HP 75000 VXI products allow you to integrate a wide range of switching, analog, and digital measurement capabilities into mainframes that meet the industrywide VXIbus standard. The HP 75000 Series C mainframe delivers high performance while allowing for system downsizing; the HP 75000 Series B mainframe is designed for low-cost computer-aided test applications.

## Modular Measurement System

The HP 70000 modular measurement system provides rugged, reliable instruments for demanding measurements from RF to lightwave that meet the industrywide MMS standard. Systems are configured and reconfigured easily with interchangeable modules. The addition of a color display/mainframe turns your MMS into a microwave workstation.

## Standalone HP-IB Instruments

Standalone HP-IB instruments offer the largest compatible hardware selection for system integrators. HP-IB instruments that feature built-in controllers offer greater

system performance. (HP-IB is HP's implementation of the IEEE-488 standard.)

## System Development Tools

In addition to the software development tools mentioned above, Hewlett-Packard offers the following hardware development tools. The HP 70000 MMS and HP 75000 VXI families offer development tools for the design and integration of today's automated test systems. Choose from a wide array of modules and mainframes. Part kits along with design guides and schematics are also available for creating your own VXI and MMS products.

## System Support

Expert systems consulting, installation, and maintenance programs are all part of the HP MSA approach. Our sales and support people have the expertise you need to help you define requirements, show you how to integrate new technology into existing systems, and keep your system running smoothly. Your investment in Hewlett-Packard products, including those in HP MSA, is protected by our commitment to long-term system support; HP products are backed by excellent warranties and service. And our many training courses help you get the most out of your Hewlett-Packard test and measurement system.

## System Products

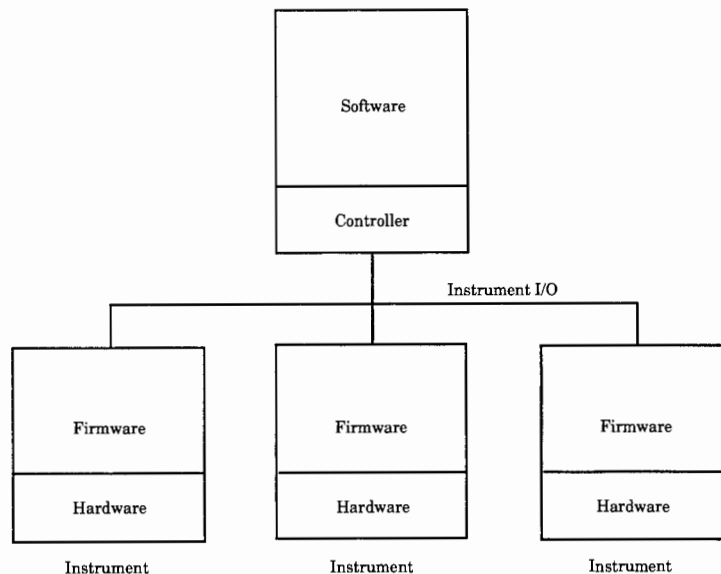

## HP Solution

## See page

HP BASIC, MS-DOS, UNIX	80
HP BASIC, C	80
HP Visual Engineering Environment (HP VEE)	81
HP Instrument Drivers	99
HP Interactive Test Generator (HP ITG)	83
HP Functional Test Manager (HP FTM)	83
HP 9000 Series 300 Workstations	74
PC-300 Controllers	77
HP-IB (IEEE 488)	110
VXIbus	87
MSIB (MMS bus)	99
MXIbus	71
SCPI	110
IEEE 488.2	99, 88
HP Instrument BASIC	110
HP-IB instruments	
VXI cards and mainframes	87
MMS modules, mainframes, and displays	102

<b>System development tools</b>	Software Hardware (including firmware)	See above MMS and VXI development tools
<b>System support</b>	Consulting and service	Hardware support Software support Educational services Consulting services

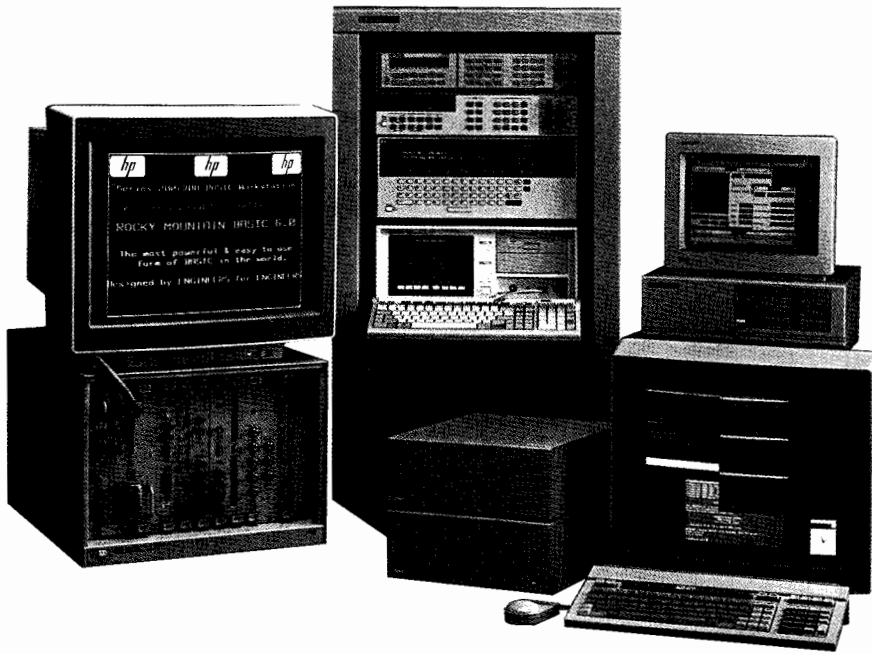

### A Wide Range of Controllers

Hewlett-Packard offers the widest range of instrument controllers available in the industry. Each controller system has been optimized to meet the needs of test and measurement customers.

Controller solutions are available for price-sensitive users as well as for applications requiring the absolute highest performance from the instrument controller. You can choose the operating system, computer hardware platform, and form factor that best meets the requirements for your test systems.

HP offers instrument controllers based on two industry-standard operating systems, MS-DOS and HP-UX, as well as the world's most powerful instrument control environment, HP BASIC (also known as Rocky Mountain BASIC or RMB).

### DOS Controllers

HP offers solutions for those situations where it is desirable to use DOS-based PCs as instrument controllers. These solutions allow the PC to perform simple or sophisticated instrument control tasks while taking advantage of PC standards such as MS-DOS languages and Microsoft Windows.

The HP-IB interface and command library provide a simple way to perform sophisticated instrument control and support many MS-DOS programming languages, as well as Microsoft Windows. The measurement coprocessors turn the PC into a powerful instrument controller running HP BASIC, and allow the test program to run in background and communicate with DOS applications running in the foreground. They can also turn the PC into a multiprocessing controller, saving both time and capital expense.

### HP-UX Based Controllers

High-performance UNIX workstations are quickly becoming the standard platform for computer-aided design and other engineering applications. Hewlett-Packard's HP-UX offering is a complete UNIX System V implementation, with selected enhancements added to provide HP-UX with features necessary for use within the test and

measurement environment. A number of programming languages are available for the development of your instrument control applications. Access to powerful networking and database tools is also readily available within HP-UX.

One enhancement made to HP-UX for instrument control applications is a comprehensive device I/O library. This library gives HP-UX systems the capability of providing very high-performance instrument control. Direct support of DMA hardware and burst mode I/O are available. Interrupt response time is also minimized within HP-UX. Real-time extensions have been added to HP-UX to allow the user to specify which programs are to run with special priority.

A recent addition to Hewlett-Packard's HP-UX-based solutions is the HP Visual Engineering Environment (VEE) (see page 81). This environment allows users to collect, analyze, and present data in a visual manner without programming. With HP VEE, users simply link visual objects, such as instrument panels, waveform displays, and mathematical operators, together graphically, instead of using traditional programming languages, to create complete test solutions.

HP offers a wide range of HP-UX based controllers and HP-UX based engineering workstations. The Model 382 family of controllers, based on the Motorola 68040 microprocessor, provides high computing performance combined with extensive I/O capabilities typically required within T&M (see page 75). The Series 700 family of PA RISC engineering workstations, offer the highest computing power available within the workstation industry today. These products, although not focused on T&M, play a critical role within today's distributed computing environments. The Series 700, Model 720, 730 and 750 workstations offer limited T&M I/O capabilities and are available with an EISA slot(s) for I/O expansion. Based on the HP-UX operating environment, these products support many standard HP-UX applications and languages such as HP VEE (see page 81) and the C language.

### HP BASIC Controllers

A HP controller with the HP BASIC language offers a highly productive environment for development and execution of test and measurement applications including state-of-the-art user interface capabilities.

HP BASIC offers a programming environment unsurpassed in ease of use and user-friendliness. You need not be an expert computer programmer to quickly develop sophisticated instrument control applications. An advanced program editor proof-reads your code to check for syntax errors as you type it in. You need not wait until your program executes to realize that you have made a typing error. Advanced commands for moving and copying program lines are fully integrated into HP BASIC, as well as other features useful in producing very readable, self-documenting programs. Features such as automatic program indentation, string search and replacement, and automatic renumbering of program lines are standard in the HP BASIC environment.

Access to the most advanced device I/O system available is simply a few statements away. Full interrupt processing is supported with 15 levels of user-definable software priorities. Data transfer of various data types is also fully supported. Data formatting is handled automatically for data types such as REAL, INTEGER, STRING, COMPLEX, and arrays of these data types as well.

In addition to supporting multiple data types, the HP BASIC I/O system can determine the optimal data transfer method available based upon system configuration. For example, data transfer will take full advantage of Direct Memory Access (DMA) if DMA hardware is present in the system. No programming changes are required to take advantage of this DMA capability.

Development of test and measurement applications involving sophisticated human interfaces has never been easier. HP BASIC Plus is a new software package that provides single-statement commands to generate a variety of dialog boxes for user interaction. Graphics displays, such as meters, bar charts, text display panels, and stripcharts, are also produced in only a few program statements. HP BASIC Plus also provides an advanced on-line help system.

Support of separate context subprograms within HP BASIC allows you to develop modular, reusable program segments that may be loaded or unloaded during program execution. This helps to increase productivity since modules are easily reused or replaced by new modules.

HP BASIC provides the capability of using compiled subprograms, or CSUBs, that have been developed with standard language compilers. These CSUBs provide increased performance for many applications while still operating within the HP BASIC environment. An HP BASIC compiler is also available to increase performance of HP BASIC programs without having to develop non-HP BASIC code.

The HP BASIC environment is available on three platforms: HP BASIC/DOS for use with HP measurement coprocessors in the DOS environment on personal computers, HP BASIC/UX for use with powerful HP-UX based workstations, and HP BASIC/WS for high-performance operation as a dedicated instrument controller.

# MEASUREMENT SYSTEMS ARCHITECTURE

## Instrument Controllers and Software

### HP 9000 Series 300 Controllers

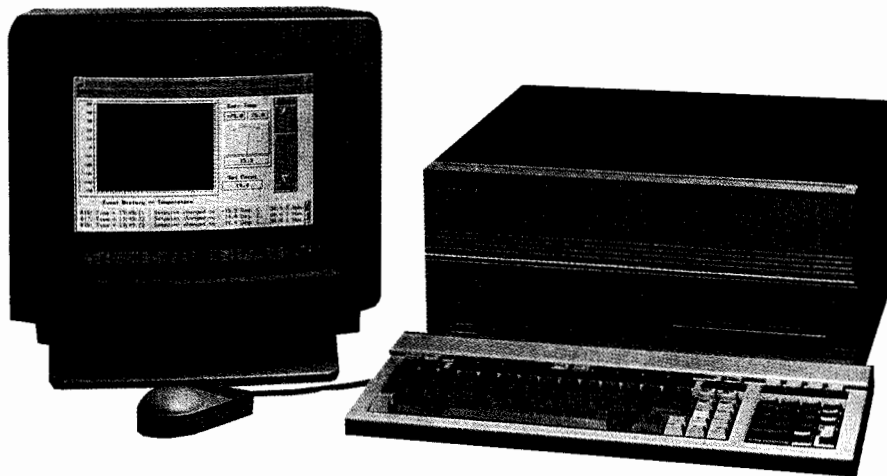

#### HP 9000 Series 300 Controllers

The HP BASIC/WS, HP BASIC/UX, and HP VEE systems are based upon the HP 9000 Series 300 controller systems. HP BASIC/WS incorporates its own operating system with the HP BASIC environment, and is optimized to provide the highest performance HP BASIC platform. The HP BASIC/UX and HP VEE systems are based upon the standard HP-UX operating system, on the same Series 300 hardware platform, and provide the additional benefits associated with multitasking/multi-user operating systems, including an X Windows-based environment and access to HP-UX tools and applications.

The HP 9000 Series 300 family of instrument controllers is available in a variety of configurations with a wide range of performance. HP's latest offerings take full advantage of Motorola MC68030 and MC68040 microprocessors. The HP BASIC/WS and HP-UX operating systems are both supported for use with Series 300 controller systems, and both HP BASIC/UX and HP VEE may be added to HP-UX systems with the Series 300 family to provide the best combination of HP-UX and sophisticated instrument control environments.

A variety of new systems has been introduced this year that have been designed specifically to meet the needs of instrument control customers. The Model 362 and Model 382 are offered in a standard, full-rack-width package including internal flexible disk drive and hard disk options (see page 75). These configurations use external color display systems that are also easily rack-mounted.

The Model 362 offers impressive performance for non-HP-UX applications. This system was designed specifically to execute HP BASIC/WS applications while keeping system cost to an absolute minimum. Standard interfaces include HP-IB, RS-232, HP Parallel, and HP-HIL. Local Area Network (LAN) and SCSI interfaces are also available and require no additional I/O slots. The standard package includes a single DIO interface slot for other Series 300 interfaces, and directly connected I/O expanders are also available. The Model 362 comes standard with 2 MB of parity-checking RAM and is expandable to 16 MB using inexpensive Single Inline Memory Modules (SIMMs).

The Model 382 offers the exceptional performance capabilities of the Motorola MC68040 microprocessor for HP BASIC/WS applications as well as HP-UX-based solutions. The Model 382 includes the same standard interfaces, DIO slots, and expandability as the Model 362. Systems begin with 4 MB of Error-Checking and Correcting (ECC) RAM and are expandable to 32 MB with inexpensive SIMMs.

The same processor technologies are used in the Model R/362 and Model R/382 (see page 75). These systems also offer internal mass storage capabilities in a rack-mountable form factor, but further reduce the amount of rack space required by offering an integrated display system within a single package.

The Model 332 controller provides good I/O performance in a modular Series 300 package, and offers the ability to use a variety of Series 300 display systems, external mass storage units and cabinets designed for the Series 300 ITF form factor. The Model 332 features standard HP-IB, RS-232, and HP-HIL interfaces, with two DIO interface slots available. Direct-connect expanders are also available for this controller. The Model 332 system comes with either 1 MB or 4 MB RAM and is expandable to a total of 8 MB.

The Model 332 is also offered in a standard EIA 19-inch rack-mountable configuration that is very similar to the R/362 and R/382 described above. The Series 300 Model R/332 provides the same performance as the modular Model 332 system, and offers configurations including up to 40 MB hard disk and flexible disk drives in a compact, rack-mountable package.

The Model 380 controller provides performance equivalent to that of the Model 382, listed above, but is offered in a modular Series 300 ITF package. This system also supports higher-resolution display systems, external mass storage, and cabinets designed for the Series 300 ITF form factor. The Model 380 comes standard with HP-IB, RS-232, HP Parallel, LAN, HP-HIL, and either Fast HP-IB or SCSI disk interfaces. This controller starts with 8 MB ECC RAM and is expandable to 32 MB.

An additional Series 300-based controller is the V/360 embedded VXI controller (see page 76). This controller system provides the same performance as the Model 362, but is packaged to fit within the Series C VXI mainframe.

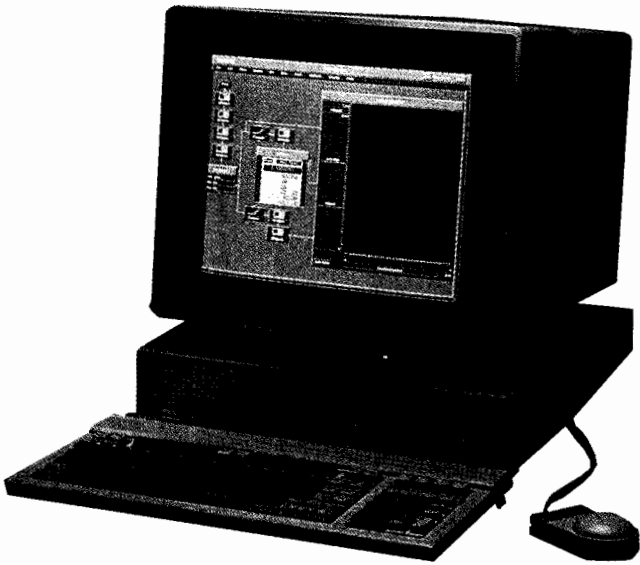

HP 9000 Series Model 362

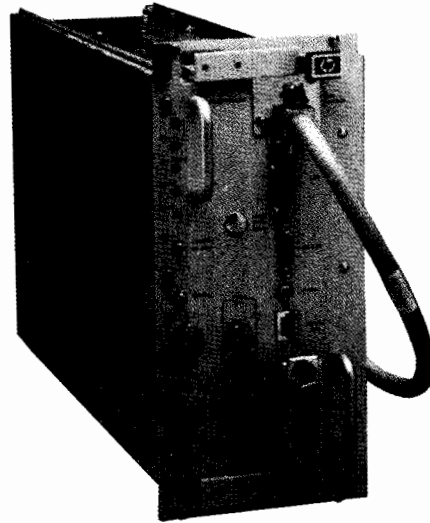

HP V/360 VXIbus Embedded Controller

### HP V/350 VXIbus Embedded Controller

#### Excellent Controller Performance at an Affordable Price

The Series 300 Model 362 and 382 instrument controllers have been designed from the ground up to meet your test engineering needs. These systems offer unprecedented performance, flexibility, and features at an affordable price. As part of the HP 9000 Series 300 family of products, the Model 362 and 382 instrument controllers feature object-code compatibility with existing and future MC68000-based processors. Furthermore, these products also support all your existing I/O interfaces as well as existing DIO and DIO-II interface cards.

As standalone dedicated controllers or as part of a larger network, the Model 362 and 382 are excellent solutions for your growing test and measurement needs.

#### Flexible Configurations and Unprecedented Features

The Model 362 controller is based on Motorola's MC68030 processor, running at 25 MHz, while the Model 382 controller is based on Motorola's MC68040 processor, also running at 25 MHz. The Model 362 offers 6 MIPS performance, ideal for cost-sensitive T&M applications. The Model 382 offers 20 MIPS performance, for the most challenging T&M applications.

The Model 362, which uses standard-parity RAM in SIMM modules, is easily expanded to 16 Mbytes. These SIMM modules are also used in the HP Vectra 486 PCs. The Model 382 uses ECC RAM in SIMM modules, and is easily expanded to 32 Mbytes. RS-232C, HP-IB (IEEE-488) with DMA, LAN (AUI and BNC), SCSI, Centronics, audio, HP-HIL interface, as well as a graphics subsystem and a DIO interface slot are all built in. And the new instrument style package offers internal mass storage as well as a 3.5-inch flexible disk drive and other device options. In addition to the standard internal DIO interface slot, DIO and DIO-II expanders are available.

To better meet the economic and physical requirements of the T&M market, the Model 362 instrument controller features a low-cost rackmountable 14-inch 640 × 480 (256-color) VGA monitor. The Model 382, which supports the same 14-inch monitor as the Model 362, is also available with a 16-inch higher-resolution 1024 × 768 (256-color) monitor.

The Model 362 controller, which has been designed and focused as a low-cost, high-performance HP BASIC controller, supports HP BASIC/WS, HP Pascal Workstation and other environments available from third parties. The Model 382 controller, with its higher-performance processor and larger-RAM capabilities, supports all of the above operating environments as well as the HP-UX operating systems.

The HP BASIC/WS, HP BASIC/UX, HP VEE, and HP-UX operating environments are available in preloaded configurations.

### V/360 VXI Embedded Controller

The V/360 is a VXI embedded controller that provides unparalleled performance, functionality, and flexibility in an integrated package. A wide array of choices in graphics subsystems, RAM capacity, operating systems, and application tools guarantees a perfect fit for your needs, in price, performance, and functionality.

#### Full Series 300 Compatibility and Performance

Because it is a repackaged model 360, the V/360 guarantees full compatibility with operating systems and applications currently available for the Series 300 workstations. As a model 360, the V/360 comes equipped with a Motorola MC68030 processor and floating point coprocessor, both operating at 25 MHz, a two-channel DMA controller and full 32-bit data and address bus to provide excellent performance and faster test program execution. RAM access is optimized by use of the 32-bit bus structures and can be ordered in increments of 4 MB expandable up to 16 MB. The V/360 is also loaded with standard interfaces and several choices in graphics subsystems.

#### Unparalleled VXI Functionality

The V/360 provides all the standard required Slot 0 and command-er functionality as called for by the VXI standard. It, however, goes above and beyond the requirements to provide additional enhancements without sacrificing compatibility and interoperability. Among these enhancements are transparent auto-configuration of Slot0 or non-Slot0, external trigger access, synchronization of VXI CLK10, both word serial and register access through the software, and an extra 256 KB of memory (separate from main memory) for shared memory use.

#### Complete Software and Applications Support

As a complement to the operating system, routines are available for HP BASIC and HP-UX to perform many VXI tasks, provide excellent resource manager capabilities, and aid the user in troubleshooting and diagnosing the entire system. These routines are written so that the user has a choice between interactive and programmatic modes, allowing both automated and user-attended operation.

# MEASUREMENT SYSTEMS ARCHITECTURE

## Instrument Controllers

### R-Series

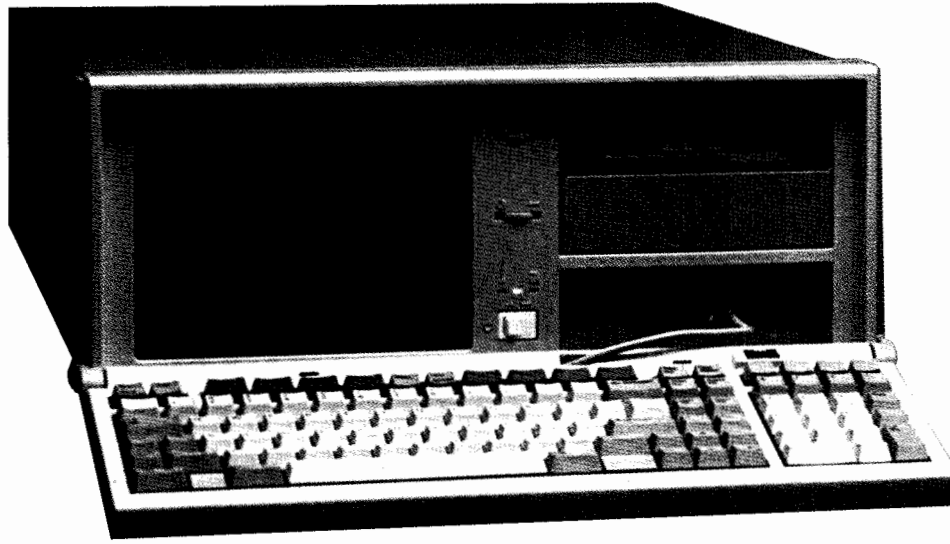

R-Series Controllers minimize rack space

#### HP R-Series Integrated Controllers

For test systems that require integrated controllers, HP offers the new R/362, R/382 and R/382U as well as the already popular R/332. These fully integrated test systems controllers provide the power of the HP 362, HP 382 and HP 332 in a 7-inch package that includes the display, attached keyboard, 3.5-inch floppy, internal hard disk and interfaces.

#### Easy to Rackmount

R-series controllers can be rack mounted into 19-inch test racks as easily as instruments while using the same kind of mounting hardware. They require only 7 inches of space while rack mounted modular controllers require unique, expensive kits for mounting displays and keyboards and 20-25 extra inches of rack space.

#### Easily Transportable

R-series controllers are perfect for systems that perform tests in different locations. They are complete and compact and allow the test system to be moved without having to juggle components or wrestle with cables.

#### Quick to Get Up and Running

R-series controllers are delivered with their operating systems and languages preloaded on an internal hard disk. The only tasks required to get a new test system up and running are connecting the instruments and loading the applications software.

#### Compatible

R-series controllers are fully compatible with other series 300 hardware and software. They provide 4 DIO I/O slots and 1 DIO accessory slot that will accommodate HP's DIO interface and expansion cards. Application software written on other series 300 controllers will run on the R-series.

#### Versatile

R-series controllers can be used for developing test programs as well as running them. There are configurations for HP Basic/WS applications as well as HP-UX applications written in HP Basic/UX or C.

#### Rugged

R-series controllers have been tested extensively to comply with stringent regulatory specifications. They are built to operate in the most difficult testing environments.

#### R-Series Models

**The R/362** provides excellent performance for HP Basic/WS test system applications. The SPU is based on an MC68030 processor providing 6 MIPS. The standard configuration includes an internal 9-inch greyscale display, attached keyboard, 3.5-inch floppy drive, 52 MB internal hard disk and 2 MB of RAM. Standard interfaces include HP-IB, HP-HIL, RS-232C, HP Parallel (printer), external VGA and external audio. Options include a coprocessor, touchscreen, LAN (BNC and AUI), external SCSI interface and additional RAM.

**The R/382** provides the extra power for high speed data handling and analysis as well as excellent performance for HP Basic/WS test system applications. The SPU is based on an MC68040 processor with a built-in coprocessor providing 22 MIPS. The standard configuration includes an internal 9-inch greyscale display, attached keyboard, 3.5-inch floppy drive, 52 MB internal hard disk and 4 MB of RAM. Standard interfaces include HP-IB, HP-HIL, RS-232C, HP Parallel (printer), external VGA and external audio. Options include a touchscreen, LAN (BNC and AUI), external SCSI interface and additional RAM.

**The R/382U** provides the power for HP-UX applications written in HP Basic/UX or C. The same SPU is used on both the R/382U and the R/382. It is based on an MC68040 processor with a built-in coprocessor providing 22 MIPS. Configured for HP-UX, the LAN (BNC and AUI) and a 420 MB hard disk are standard and the floppy is optional. Thus the standard configuration includes an internal 9-inch greyscale display, attached keyboard, 420 MB internal hard disk and 8 MB of RAM. Standard interfaces include HP-IB, HP-HIL, RS-232C, LAN (BNC and AUI), HP Parallel (printer), external VGA and external audio. Options include touchscreen, 3.5-inch floppy, external SCSI interface and additional RAM.

**The R/332** is the senior member of HP's R-series family. The SPU is based on an MC68030 processor providing 4 MIPS. A variety of mass storage and interface options are available. Application software written for the R/332 will migrate easily to the new R-series controllers.



### Measurement Coprocessors

The HP 82300D and HP 82324B measurement coprocessors combine hardware and software in one complete, ready-to-install product. In terms of hardware standpoint, they are I/O cards, designed for an IBM-AT or compatible, that plug into a PC's standard ISA or EISA bus. With their own operating system, processor, HP-IB port, and RAM, they can operate independently of the PC after it is booted.

In terms of software, these measurement coprocessors bring together the power of the HP BASIC language, which is designed specifically for computer-aided test, and the flexibility of the MS-DOS operating system, opening up access to the vast array of MS-DOS application programs that can be used with your test application.

Major features and benefits of HP's measurement coprocessors include:

- **Multi-Com:** Allows bidirectional passing of data or commands between the measurement coprocessor, the MS-DOS application, and the operator. Data being collected by the test program can be automatically placed in an MS-DOS application.
- **Multiprocessing:** Up to 3 coprocessors can be used in a PC simultaneously, for increased throughput and cost savings.
- **HP BASIC Language:** This is fully compatible with the HP BASIC that runs on HP 9000 Series 3000 workstations, and with HP-UX. It is the most powerful and versatile instrument-control language available. A large number of T&M applications that run on it are also available.
- **Foreground/Background:** Allows the HP BASIC program to run independently in background, controlling the instruments while your MS-DOS application is running in the foreground. This improves throughput and allows full use of the PC.
- **Built-in HP-IB Port:** Fully integrated with the features listed above.

	HP 82300D	HP 82324B
Processor	68000	68030
Clock Rate	8 MHz	16 MHz
Maximum Memory	4 MB	8 MB
DMA	No	Yes
Floating Point	No	Optional

The following optional DIO I/O cards are also available: the HP 82306A GPIO, the HP 82307A GPIO Cable 4.6M, and the HP 50963A Shared Resource Manager.

### PC-300 Controllers

A PC-300 controller combines an HP Vectra personal computer with a measurement coprocessor to provide a complete turnkey PC instrument-controller solution.

The HP Vectra PCs cover a wide performance spectrum. The entry-level PC-308 controllers are based on the Vectra 286/12 PC. There are 2 PC-308 models, with a variety of display options. The PC-312CL controller is based on the Vectra QS/16S PC, which uses the 80386SX processor. The PC-312CM controller is based on the Vectra QS/20 PC, which uses the 20 MHz 80386 processor.

Each PC-300 comes standard with a display, a hard disk, a 3.5-inch flexible disk drive, a serial/parallel card, and an installed measurement coprocessor. (The PC-300 can be configured with either a high-performance (HP 82324B) or standard (HP 82300D) measurement coprocessor.) MS-DOS and HP BASIC are also pre-installed to make start-up simple and easy.

### PC LIF Utilities

The HP E2080A LIF utilities provide a convenient way to transfer files between the HP LIF and MS-DOS file formats. It also provides other useful LIF disk utilities for the PC. These utilities are useful if you need to transfer files to MS-DOS computers from HP 9000 Series 200/300 computers or from HP instruments that have been built-in LIF-format disks.

### The HP 82335A HP-IB Interface and Command Library

The HP 82335A HP-IB interface and command library for personal computers provides instrument-control capability for the HP Vectra Series, the IBM PC, PC/XT, and PC/AT, and all true IBM PC compatibles. The HP 82335A command library supports the most popular programming languages. It includes an HP-IB peripheral driver that adds HP-IB printer and plotter support to your software, including MS-DOS and windows applications. The HP-IB command library is also 100% compatible with the IEEE-488.2 specification, and is therefore also 100% compatible with the SCPI (Standard Commands for Programmable Instruments) standard.

The HP-IB command library lets you include commands in your BASIC, Pascal, and C programs to control HP-IB instruments, and allows high-speed string and binary-data transfer using direct memory access (DMA).

The HP 82335A fully supports Microsoft Windows 3.0. With Windows 3.0 and the HP-IB command library, you can create your own Windows T&M applications, and with DDE (dynamic data exchange) capability, you can control your HP-IB devices from inside standard Windows applications, such as Microsoft Excel or Word for Windows.

### Ordering Information

	Price
<b>HP 82300D</b> Measurement Coprocessor	\$1,695
<b>HP 82303A</b> RAM Expansion Kit for HP 82300D (512KB)	\$150
<b>HP 82305A</b> RAM Expansion Board for HP 82300D	\$495
<b>HP 82324B</b> High-Performance Measurement Coprocessor	\$2,795
<b>Opt 102</b> Add 1 MB of RAM (total, 2 MB)	+\$450
<b>Opt 104</b> Substitute 4-MB RAM Board	+\$1,350
<b>Opt 882</b> Floating-Point Unit, Installed	+\$500
<b>HP 82325A</b> 1-MB RAM Board	\$500
<b>HP 82326A</b> 4-MB RAM Board	\$2,000
<b>HP 82327A</b> Floating-Point Unit	\$500
<b>HP E2080A</b> LIF Utilities for the PC	\$525
<b>HP 82335B</b> HP-IB Interface and Command Library for MS-DOS and Windows 3.0	\$525
<b>HP 82335M</b> HP-IB Command Library (software only) for MS-DOS and Windows 3.0	\$310

# MEASUREMENT SYSTEMS ARCHITECTURE

## Instrument Controllers

### Controller Comparison

	HP PC-300 Controllers		HP 9000 Series 300 Controllers							
	286/12 PC-308	QS PC-312	332	R/332	R/362	362	V/360	380	382	R/382 R/382U
<b>Operating System</b>										
MS-DOS	.	.								
HP BASIC/WS			.	.	.	.	.	.	.	.
HP-UX			.	.			.	.	.	.
<b>HP Basic Support</b>										
HP BASIC/DOS	.	.								
HP BASIC/WS			.	.	.	.	.	.	.	.
HP BASIC/UX			.	.			.	.	.	.
<b>Processor</b>										
Main Processor	80286	80386	68030	68030	68030	68030	68030	68040	68040	68040
Clock Speed (MHz)	12	16/20	16.7	16.7	25	25	25	25	25	25
Math Coprocessor	80287 <sup>5</sup>	80387 <sup>5</sup>	68882 <sup>1</sup>	68882 <sup>1</sup>	68882 <sup>1</sup>	68882 <sup>1</sup>	68882			
Clock Speed (MHz)	12	16/20	16.7	16.7	25	25	25			
Measurement Coprocessors	68000 68030 <sup>6</sup>	68000 68030 <sup>6</sup>								
Clock Speed (MHz)	8/16.7	8/16.7								
<b>Memory Capacity</b>										
PC Memory (std)	640 Kbytes	1 Mbyte								
PC Memory (max)	8 Mbytes	16 Mbytes								
680X0 Memory (std)	1 Mbyte <sup>2</sup>	1 Mbyte <sup>2</sup>	1 Mbyte	1 Mbyte	2 Mbytes <sup>6</sup>	2 Mbytes <sup>6</sup>	4 Mbytes	8 Mbytes <sup>4</sup>	4 Mbytes <sup>7</sup>	
680X0 Memory (max)	4/8 Mbytes	4/8 Mbytes	8 Mbytes	8 Mbytes	16 Mbytes <sup>6</sup>	16 Mbytes <sup>6</sup>	16 Mbytes	128 Mbytes <sup>7</sup>	32 Mbytes <sup>7</sup>	
<b>Display Systems<sup>3</sup></b>										
640x480 VGA	M/C	C			G	C			C	G
1024x768			M/C				M/C	M/C	C	
1280x1024			M/C				M/C	M/C		
<b>Available Slots</b>										
PC Cards (std/max)	7/7	7/7								
DIO I/O Cards (std/max)	2/2 <sup>2</sup>	2/2 <sup>2</sup>	2/6	4/4	4/4	1/9	0/0	2/10	1/9	4/4
Expander Support			.			.		.	.	
<b>Computation</b>										
PC (MIPS)	1.5	3								
680X0 (MIPS)	0.6	0.6	4	4	6	6	6	20	20	20

<sup>1</sup> MC68882 math coprocessor available as an option. MC68882 required for HP-UX or BASIC/UX operation.

<sup>2</sup> Only supported from HP Measurement Coprocessors (HP 82324B, HP 82300D). Only available for use with BASIC/DOS.

<sup>3</sup> Resolution specified is in pixels. M=monochrome, C=color, G=gray scale.

<sup>4</sup> ECC RAM standard, expandable to 128 Mbytes using 4-Mbyte chips.

<sup>5</sup> Available as an option.

<sup>6</sup> Uses standard HP Vectra 486 Parity SIMM memory, part no. D2381A, D2156A, D2152A.

<sup>7</sup> Uses standard ECC SIMM memory.



# MEASUREMENT SYSTEMS ARCHITECTURE

Instrument Controllers and Software

Controller Bundles

79

## Bundled Instrument Control Systems

Several bundled systems are available to simplify ordering of the best instrument controller for your application. All bundled systems listed below are localized for a variety of international uses. For more information, contact your local HP sales office.

### PC-300 Instrument Controllers

HP BASIC/DOS	PC-308ML	PC-308CM	PC-312CL	PC-312CM
HP Part Number	82314G	82319F	82332E	82333E
Internal Hard Disk	42 Mbyte	42 Mbyte	42 Mbyte	42 Mbyte
VGA Display Type	Mono	Color	Color	Color
Price <sup>(1)</sup>	\$4,550	\$4,999	\$5,750	\$6,350

<sup>(1)</sup> Option 050 (+\$1,100) substitutes the HP 82324B High-Performance Measurement Coprocessor for the HP 82300D Measurement Coprocessor.

Hewlett-Packard offers four PC-300 instrument controllers based on a range of HP Vectra Personal Computers. Each PC-300 bundle includes an HP Measurement Coprocessor and built-in HP-IB, 1 Mbyte RAM (expandable to 4 Mbyte; 8 Mbyte for the HP 82324B), 3½-inch flexible disk drive, and HP BASIC software pre-installed.

### HP BASIC/WS Controllers<sup>(1)</sup>

HP BASIC/WS	332 MMA	332 CMA	R/332	R/332	R/332	362	R/362	382	R/382
HP Part Number	98580C	98581C	A1303A	A1305A	A1307	A2240A	A1314A	A2241A	A1319A
Internal Hard Disk	none	none	none	20 Mbyte	40 Mbyte	52/210/420	52/420	52/210/420	52/420
Internal Flexible Disk	none	none	3.5 in	3.5 in	3.5 in	3.5 in	3.5 in	3.5 in	3.5 in
Touchscreen	<sup>(2)</sup>	<sup>(2)</sup>	<sup>(3)</sup>	<sup>(3)</sup>	<sup>(3)</sup>		<sup>(3)</sup>		<sup>(3)</sup>
Display Type	Mono	Color	Mono	Mono	Mono	Color	Grey scale	Color	Grey scale
Price	\$6,080	\$8,870	\$8,490	\$10,790	\$11,990	\$5,490	\$9,990	\$7,525	\$11,990

<sup>(1)</sup> Systems for HP BASIC/WS and HP BASIC/UX may be ordered for the V/360. For more information, please contact your local HP sales office.

<sup>(2)</sup> Available as an additional product — HP Part Number 35723A.

<sup>(3)</sup> Available as an option.

Controller bundles are available for HP BASIC/WS operation. These systems provide the highest performance HP BASIC operation with a variety of price and performance choices.

### HP-UX, HP BASIC/UX Controllers<sup>(1)</sup>

HP BASIC/UX	382	R/382U
HP Part Number	A2242A	A1324A
Internal Hard Disk	210/420	420
Internal Flexible Disk	3.5 in.	3.5 in.
Touchscreen		<sup>(2)</sup>
Display Type	Color	Grey scale
Display Resolution	640 × 480 or 1024 × 768	640 × 480
Price	\$9,180	\$16,990

<sup>(1)</sup> Systems for HP BASIC/WS and HP BASIC/UX may be ordered for the V/360. For more information, contact your local HP sales office.

<sup>(2)</sup> Available as an option.

There are two bundled solutions that offer the best of HP-UX and HP BASIC/UX. These bundles include both HP-UX and HP BASIC/UX software. All HP BASIC/UX bundled systems also offer the option of a 210-Mbyte or 420-Mbyte disk drive with HP-UX and HP BASIC/UX installed and optimized for operation. Bundled prices listed do not include disk options.

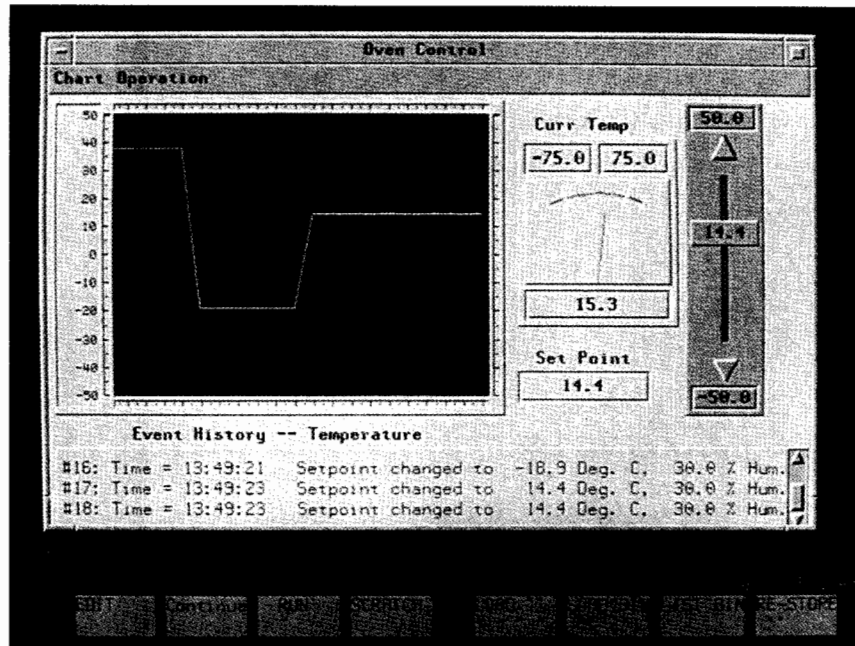

### Human-Interface Graphics Commands and Online Help

HP BASIC Plus adds 2 important new features to HP BASIC: human-interface graphics commands and online help.

HP BASIC Plus provides 29 new commands to help you create crisp, bright human-interface graphics more easily than ever. One HP BASIC Plus command creates a strip chart that would require over 100 lines of code in another language. In addition, with one line of code you can create a wide variety of operator-interface graphics, including:

- Dialog boxes
- Data-display objects
- Text-display objects
- Input devices
- Menu-creation objects

Each of these categories includes a wide range of choices. For example, 7 types of dialog boxes are provided, including boxes for information, questions, warnings, and errors. Data-display objects include an XY graph, a strip chart, a meter, and a bar display.

All of the graphics objects feature a wide range of attribute settings so you can customize them. The core set of attributes includes the object's position on the screen, its background color, and its size. Most of the objects have about 15 core attributes.

In addition to a large set of core attributes, many of the objects have specific attributes of their own. For example, the strip-chart object has over 30 additional attributes, including the number of channels displayed, the color assigned to each channel, the number of points displayed, the number of points in the display buffer, and how the display is updated.

With HP BASIC Plus, it's easy to create a graphical user interface that is more sophisticated than HP BASIC users could ever create before.

It's also easy to integrate these commands into your existing programs. You will need to upgrade your system to HP BASIC 6.2 and you'll need an additional 900 Kbytes of RAM to run HP BASIC Plus. Using the commands is as easy as typing in a new line of HP BASIC. HP BASIC Plus is loaded as a binary and can be stored as a part of your system; once you've loaded and stored HP BASIC Plus, you don't have to include a special set of subprograms in each of your programs.

In addition, since HP BASIC Plus is an HP BASIC binary, you get the advantages of very high-throughput graphics and very responsive menu and dialog box selections.

### Online Help for HP BASIC

HP BASIC Plus also provides online help for all HP BASIC keywords. Now, with the *HP BASIC Quick Reference Guide* information for HP BASIC keywords is at your finger tips, so it's easier than ever to use HP BASIC. You can access information directly by keyword name or find the correct keyword by using the keyword dictionary. In addition, you can copy simple examples from online help directly into the HP BASIC editor.

### System Requirements

HP BASIC Plus requires a Series 300 controller or any controller that supports HP BASIC/UX (i.e., selected Series 300 and Series 400 controllers). It also requires: HP BASIC 6.2 or later; 900 Kbytes RAM (which means you need at least a 2-Mbyte system); and 3 Mbytes space on your hard disk.

### Ordering Information

	Price
<b>HP E2160A</b> HP BASIC Plus License-to-Use	\$350
<b>Opt AA0</b> Media and Manuals for HP BASIC Plus Running on HP BASIC/UX. Includes 1/4-inch Tape and Manual Set.	\$100
<b>Opt AA8</b> Media and Manuals for HP BASIC Plus Running on HP BASIC/WS Controllers or for HP BASIC on the DOS Measurement Coprocessor Products. Includes 3.5-inch Disks and Manual Set.	\$100
<b>Opt AA9</b> Media and Manuals for HP BASIC Plus Running on the DOS Measurement Coprocessor Products. Includes DOS-Format 1.2-Mbyte 5.25-inch Disks and Manual Set.	\$100

HP BASIC Plus is also available as option AGU for many of the HP 9000 Series 300 controller bundles and for many of the PC 300 bundles.

# MEASUREMENT SYSTEMS ARCHITECTURE

Instrument Controllers and Software

HP VEE-Engine, HP VEE-Test

81

- Collect, analyze, and present data without programming
- Iconic-based visual engineering lets you solve problems faster
- A comprehensive set of features allows you to build complete solutions
- Available on HP-UX Workstations

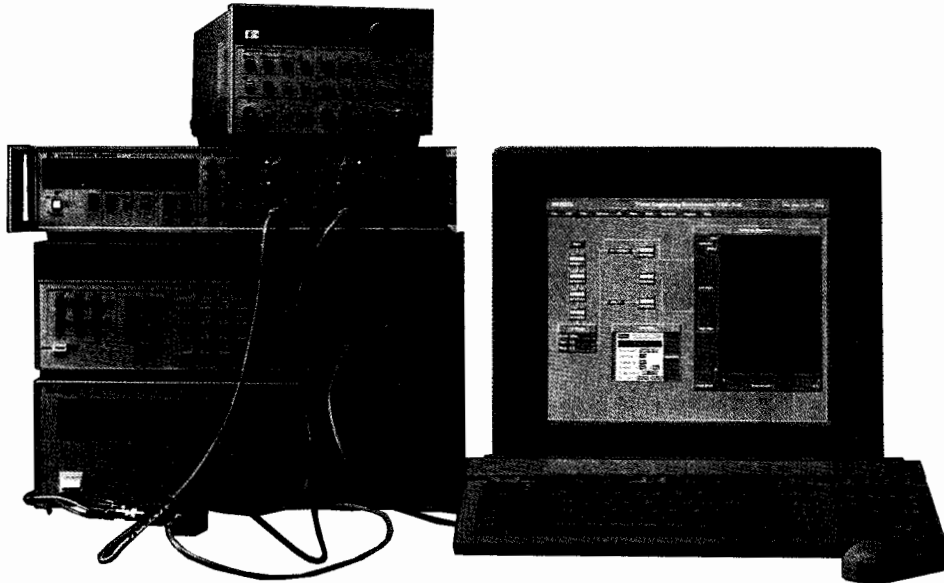

## Solving Problems Faster

HP VEE is a problem-solving environment that lets you create complete engineering solutions without programming, thereby saving you considerable time and effort.

To use, you simply choose any of the extensive set of visual objects, including those for data collection, analysis, or presentation. You then link the objects to define the flow of data through them. The result is a complete graphical solution, similar to a block diagram, which required no programming.

Because the block-diagram approach to defining and solving problems is more intuitive than computer programming, you will be able to create solutions faster and focus on results sooner.

## General Purpose and Test

HP VEE consists of two products: HP VEE-Engine and HP VEE-Test. HP VEE-Engine allows engineers and scientists to analyze and present data already acquired from files or programs, or to generate it mathematically. HP VEE-Test adds specific capabilities for test and measurement applications, including instrument control and device I/O.

From mathematical modeling of engineering problems to complete test and measurement solutions, HP VEE is designed for the programmer and non-programmer alike. HP VEE's ease of use appeals to those who don't have the time for complicated programming rules and time-consuming program coding. In addition to its visual nature, HP VEE shields users from rules of syntax and data types as much as possible, and automatically converts data in some cases. HP VEE's completeness ensures that a wide range of solutions can be successfully created—from simple prototype software to sophisticated models with custom graphical user interfaces.

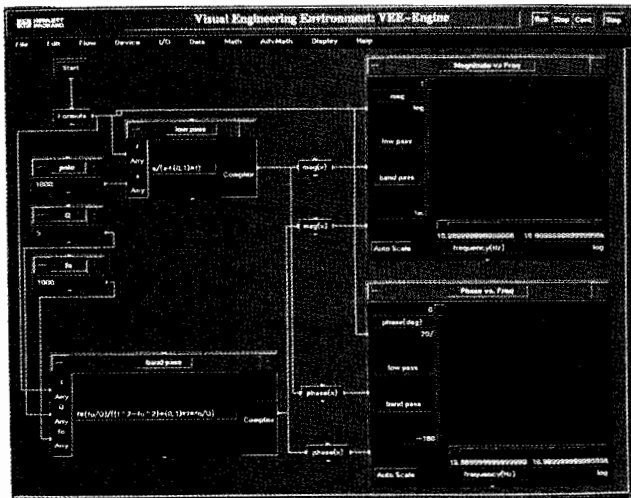

HP VEE-Engine is ideal for the analysis and presentation of resident data.

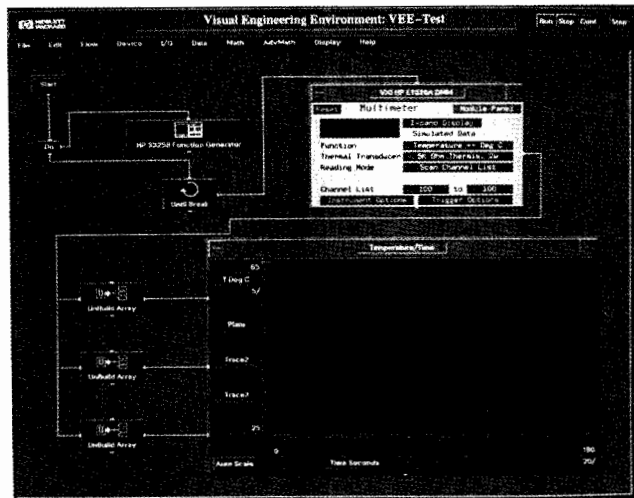

HP VEE-Test allows you to build complete test and measurement solutions.

# MEASUREMENT SYSTEMS ARCHITECTURE

## Instrument Controllers and Software (cont'd)

### HP VEE-Engine, HP VEE-Test

#### Functionally Complete

HP VEE provides visual objects that aid in the collection, analysis, and presentation of data. Further capabilities are provided for data storage, flow, modularity, debugging, documentation, and the creation of custom user interfaces.

#### Data Collection

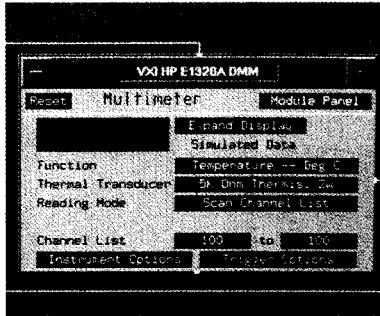

Instrument drivers facilitate the control and data gathering from instruments.

With HP VEE-Test, you have a choice of utilizing any of the over 170 HP instrument drivers (the same as those used with HP ITG), or using direct I/O to any instrument or device on the HP-IB, RS-232, or GPIO bus. The instrument drivers are easy-to-use soft front panels through which you set up and control a specific HP instrument. Direct I/O adds flexibility and throughput by allowing you to define instrument commands and I/O transactions interactively to any device on the supported interfaces.

#### Data Analysis

HP VEE provides a comprehensive set of objects for analyzing and handling data. Objects are available for the most commonly used math operations, as well as for custom formulas, calculus, regression analysis, probability, statistics, and more. The most commonly used engineering functions are also represented in HP VEE as individual objects. Fast Fourier transforms, data filtering, digital signal processing, distributions, and more are provided in easy-to-use and easy-to-access objects to save both time and effort.

#### Data Presentation

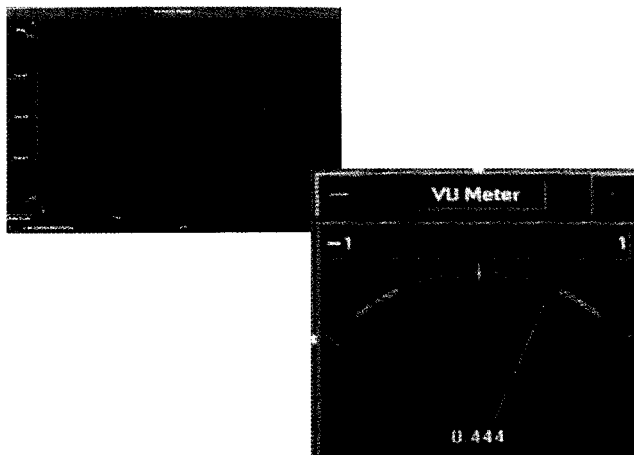

A large number of customizable objects is available for data display and presentation.

Able to display data textually or graphically, HP VEE provides a comprehensive set of objects along with the option to customize them. You can choose from XY plots, Y plots, strip charts, polar plots, complex plane, waveforms, and a number of frequency spectrums.

Each display object is designed to allow clear and accurate readouts of data. Markers are available to mark points on a curve and display their value. Data curves can be zoomed in or out, and a number of panel layouts and grid types can be chosen to display the data effectively.

#### Expanding Your Power

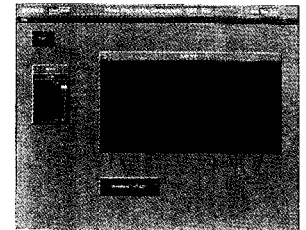
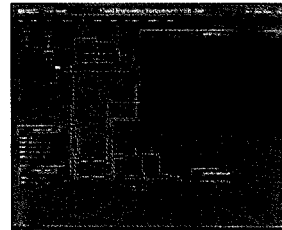

Optional views of the solution allow you to create custom graphical user interfaces.

HP VEE provides additional capabilities to create sophisticated solutions, including:

- Flow control objects and conditionals
- Data manipulation and control objects
- The capability to create custom user interfaces and secure them
- Visual debugging tools
- Documenting objects and features
- Extensive online help

In addition, with the power to bridge into HP-UX applications and programs, HP VEE lets you integrate existing programs, tune your applications when necessary, and access the versatility and power of HP-UX.

#### System Requirements

##### • Computers

HP VEE is supported on HP 9000 series 300, 400, and 700 workstations. Minimum RAM required is 8 MB, recommended is 12-16 MB.

##### • Operating System

HP VEE is supported on the HP-UX platform, version 7.0 or later, running X11 Windows v. 4. Note: some workstations will require HP-UX version 8.0 or later.

##### • Graphics

HP VEE runs on color display systems. Six-plane systems or greater are recommended.

##### • Terminals/Diskless

HP VEE can run on diskless clusters and HP 700/X terminals.

##### • Peripherals

For screen printouts, HP LaserJet with minimum 2 MB RAM or HP PaintJet printers are recommended. Output from display objects may also be sent to a plotter.

#### Ordering Information

**HP VEE-Engine** (HP E2100A for series 300/400; HP E2101A for series 700) is \$895 for the license-to-use. Optional media and documentation may be purchased for \$50 each.

**HP VEE-Test** (HP E2110A for series 300/400; HP E2111A for series 700) is \$4,900 for the license-to-use. Optional media and documentation may be purchased for \$50 each. HP VEE-Test also offers a trade-in allowance of \$800 for prior purchases of HP VEE-Engine.

Note: HP VEE-Engine is not a run-only environment to HP VEE-Test. HP VEE-Test solutions which use I/O objects will NOT run on HP VEE-Engine.

- Available on HP 9000 Series 300 BASIC workstations and HP-UX workstations running HP BASIC/UX, and on HP Vectra PCs with HP Measurement Coprocessor

- Improve functional test processes with statistical analysis
- Substantially reduce your test system development time



HP FTM/300

### HP FTM Functional Test Manager

HP FTM functional test manager software is a test executive that improves the functional test process by reducing time-to-market and reducing test station downtime. HP FTM includes powerful turnkey features, so you write less code. Turnkey user password security and HP-HIL bar-code wand compatibility keep operators from accidentally modifying test programs. Turnkey statistical analysis improves the test process.

HP FTM fits well into the test development process. It provides a standard test development environment. Most programming is done with forms that are very easy to fill out and self-documenting to save time.

### Powerful Turnkey Features

Start functional test system software development with HP FTM, and start out "already finished" with many of your most difficult development tasks. HP FTM provides you with up to 65 percent of your test system software. It does this by taking care of the non-application specific portions of the system software: parts that are typically the same from one test system to another. Develop your next test system quicker using all of HP FTM's powerful turnkey features:

- Turnkey System Security
- Turnkey Test Scheduling
- Turnkey Test Sequencing
- Turnkey Test Debug Mode
- Turnkey Database Management
- Turnkey SQC Data Analysis
- Turnkey Networking

Standardize on the Complete Set of HP FTM Turnkey Features

Use these flexible features to quickly build test systems that do more than most custom-coded systems. Many customers have already standardized on HP FTM turnkey features for all functional test systems.

### Test Development and System Configuration Tools

Using HP FTM's turnkey tools means you can concentrate harder on your application-specific tasks. Application-specific tasks typically include defining tests and test parameters and coupling HP FTM's turnkey features into your overall application environment. HP FTM has system configuration and test development tools to help you in these application-specific areas.

HP FTM development tools are both easy to use and extremely powerful. They combine the friendliness of menus and forms with the ultimate power and flexibility of HP BASIC programming language. Quickly finish the application-specific portion of your functional test software using HP FTM:

#### • Menu of forms

Use HP FTM's forms to conveniently document, access, and modify your test parameter and test system configuration data.

#### • Library of optimized subs

Use these subs and quickly build individual tests tailored to your specific needs.

#### • Full access to HP BASIC

With HP BASIC, add custom test capabilities to HP FTM or use your existing subprograms.

Combining HP FTM's turnkey features with its development tools, you retain all the advantages of writing custom software while substantially reducing your development time and effort.

### Optimized for Test Throughput

While HP FTM provides high-level testing capabilities in real time (for example, HP-IB driver I/O, pass/fail limit testing, data archiving, test sequencing, test progress reporting, and so on), HP FTM still executes HP-IB I/O and test sequencing just as fast as most custom-written test software. However, for even faster program speed or higher flexibility, you can custom code critical test segments using powerful HP BASIC. The structure of HP FTM allows straightforward integration of HP BASIC callable custom code.

Further optimize your overall testing speed by taking advantage of HP FTM's intelligent test sequencer. Set up HP FTM's Test Plan Form so that certain tests are executed only under certain conditions. For example, execute an overall functional test first. Whenever this test fails, then execute a set of troubleshooting tests to gather more information on the cause of the failure. You don't need to execute the troubleshooting tests every time. Or specify a lengthy set of tests as "audit tests" to be executed only on every Nth device under test. With HP FTM's intelligent test sequencer you get more of your product out the door faster.

# MEASUREMENT SYSTEMS ARCHITECTURE

## Instrument Controllers and Software

ITG for BASIC and DOS

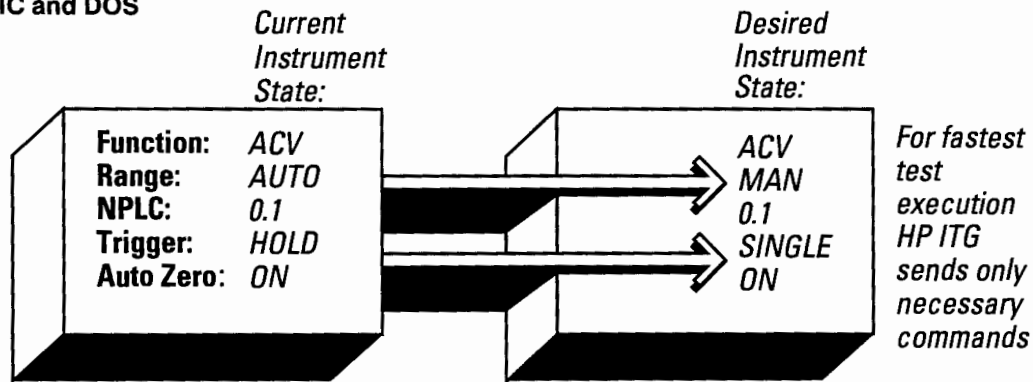

Incremental state programming ensures maximum throughput.

### Powerful Instrument Drivers

HP instrument drivers are designed to give you the full power available in your instrumentation. These drivers contain information on all instrument functions and how to access these functions. Additionally, HP instrument drivers contain the links between functions, assuring that the driver reacts just as the instrument front panel does. This assures that you have all the power of your instruments remotely, and that the software generated in HP ITG will execute with a minimum of errors.

### Wide Variety of Supported Instruments

HP provides quality instrument drivers for many popular HP-IB test and measurement instruments. Although HP-written drivers address most applications, drivers for custom black boxes or non-supported instruments are easily created using any text editor and the tools available with the product. Additionally, the unique structure of HP instrument drivers allows the same instruments to be supported in both HP ITG products.

### Online Help

At the click of a mouse, online help keeps the job moving with information on the operation of HP ITG as well as the specific instruments available. With instruments connected to the HP-IB bus, immediate feedback on an instrument's operation saves time debugging your instrument setups.

### Protected Software Investment

Because software development can easily cost as much as the instrumentation in a test system, protecting that software investment is as important as minimizing it.

The software generated with HP ITG for HP BASIC integrates into your existing HP BASIC test software. Whether you use custom programs or HP Functional Test Manager (HP FTM) software to create new applications, HP ITG serves as an easy and efficient tool for developing the measurement-specific part of your test.

Because HP ITG for DOS supports the full language capabilities of Microsoft QuickC, C, and QuickBASIC, HP ITG/DOS saves development time without abandoning your present software investment.

### Front Panels for VXI and MMS Instruments

HP ITG is particularly well suited for VXI and MMS control. HP ITG gives users interactive front panels that don't exist on the actual instruments. Additionally, full-functionality drivers assure that you can get the most out of your VXI and MMS instrumentation.

### Optimized for Test Development

HP ITG optimizes test throughput by automatically providing incremental state programming. HP ITG tracks the current instrument state and sends only the necessary commands to reach the next state. This eliminates time spent sending superfluous commands over HP-IB, as well as the time required for an instrument to interpret and respond to the command.

### HP ITG for HP BASIC

Code generated in HP BASIC retains the friendliness, power, and high performance that test developers have come to expect for instrument control. Full access to all HP BASIC math, graphics, and I/O capabilities gives HP ITG the edge as a friendly development environment without sacrificing application performance.

### System Requirements

#### HP ITG for HP BASIC

Runs on HP BASIC 5.1 or greater for all HP 9000 Series 300 HP BASIC workstations. Runs on HP BASIC/UX 5.5 or greater. Runs on Vectra-compatible PCs with the HP Measurement Coprocessor.

Additional requirements: HP-HIL or serial mouse, at least 3 MB RAM (4 MB for HP BASIC/UX), and at least 4 MB of available hard disk space.

#### Code generated by HP ITG for HP BASIC

Code developed with HP ITG requires HP BASIC 5.1 or greater and at least 1.5 MB RAM for execution on any HP 9000 Series 300 HP BASIC workstation or Vectra-compatible PC that supports the HP Measurement Coprocessor. Series 300 HP BASIC/UX workstations require at least 4 MB RAM.

### Ordering Information

	Price
<b>E2000A</b> HP Interactive Test Generator (includes software and manuals)	\$995
<b>Opt AA0</b> Software on 1/4-inch tape cartridge	\$0
<b>Opt AA6</b> Software on 5/4-inch LIF disk	\$0
<b>Opt AA7</b> Software on 3/2-inch single-sided LIF disk	\$0
<b>Opt AA8</b> Software on 3/2-inch double-sided LIF disk	\$0
<b>E2001A</b> HP instrument drivers (one set includes all)	\$495
<b>Opt AA0</b> Software on 1/4-inch tape cartridge	\$0
<b>Opt AA6</b> Software on 5/4-inch LIF disk	\$0
<b>Opt AA7</b> Software on 3/2-inch single-sided LIF disk	\$0
<b>Opt AA8</b> Software on 3/2-inch double-sided LIF disk	\$0

### HP ITG for DOS

HP ITG for DOS supports common PC languages and hardware, allowing the code you generate to integrate directly into your current test system. The code generated integrates instrument mnemonics with the proper I/O commands, letting you concentrate on measurements, not methods.

### System Requirements

HP ITG for DOS runs on all HP Vectra PCs, IBM PC-AT and 100 percent compatibles, and the Radisys, VXI controller with at least 80286 CPU, 20 MB hard disk, EGA, VGA, or Hercules displays. Software required includes DOS 3.x or 4.0, Microsoft C version 5.x, QuickC version 2.0, or QuickBASIC version 4.5. Microsoft Windows/286 or Windows/386 can be used, but are not required. Windows 3.0 is also fully supported.

Additional requirements: HP-HIL or serial mouse, at least 640 K system memory and 1 MB expanded memory, compatible HP 82335A or HP 82990A HP-IB interface, or National PCII series GP-IB interface.

#### Code generated by HP ITG for DOS

System requirements to execute software generated with HP ITG for DOS are the same as those for development except that many C applications will not require more than the default 640 K memory. Most QuickBASIC applications will require expanded memory.

### Ordering Information

	Price
<b>E2020A</b> HP Interactive Test Generator for DOS (Includes software and manuals for HP ITG for DOS. Includes the full set of HP instrument drivers. Also includes the HP 82335A HP-IB interface card.)	\$1,995
<b>Opt 335</b> Delete the HP-IB interface card	-\$495
<b>Opt AA6</b> Software on 5/4-inch high-density (1.2 MB) disk	\$0
<b>Opt AA8</b> Software on 3/2-inch high-density (1.44 MB) disk	\$0

### Flexible Test Program Scheduling

Your test system tasks may need to be executed on specific events or at specific times. With HP FTM, schedule your tasks to be executed on the wave of a barcode wand, at specific times of day, or on operator menu selection. At the same time, HP FTM will save important information with your test result data, information such as serial numbers, time of test, operator information, and networked test station number.

For your less-sophisticated operators, use HP FTM's security levels to tailor HP FTM's operator menu to each operator, allowing only specific menus to be seen and executed by specific operators. HP FTM's turnkey security and scheduler features give you flexibility to display, schedule, and initiate tasks the way you want.

### Data Analysis and Report Generation

Analyze and improve your production process in addition to testing your products. Use HP FTM to monitor trends in your process with its turnkey statistical quality control (SQC) analysis features. Improve your process and your profits by monitoring test result trends as you tune your production process. And HP FTM will generate important SQC reports and graphs. Use HP FTM's SQC overview page as your management summary. It lists yield, units passed or failed, and presents information graphically. For more detailed reporting, use HP FTM to produce the following SQC charts and graphs:

- Pareto charts for failure analysis
- Histograms of test results
- Control charts (p, X-bar, and s) as process monitors

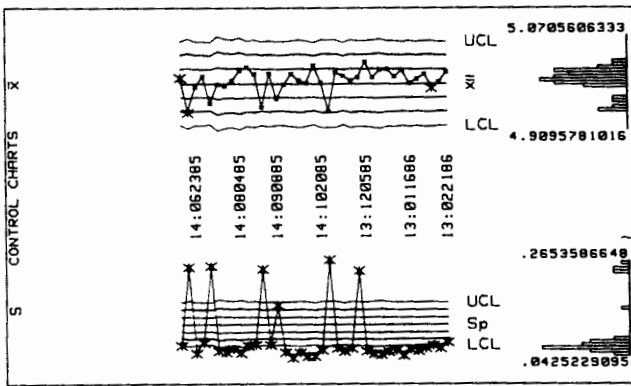

### Networking and Data Transfers to Other Computers

Format your test results and transfer them to other computing environments for further analysis or archiving. HP FTM formats test data files in the standard ASCII formats (CSV and DIF) used by nearly all major software packages.

HP FTM networking features let you use any common file transfer means including RS-232, HP-IB, HP's Shared Resource Manager (SRM), or IEEE 802.3 (using HP's SRM network and a coexisting HP-UX environment). Use HP AdvanceLink and HP FTM for total turnkey transfers of data over RS-232C to DOS computers. The resultant DOS files are ready for access by spreadsheets such as Lotus 1-2-3 and database managers such as dBASE III Plus.

HP FTM software is specially designed to take full advantage of HP's SRM network. Multiple HP FTM systems can be linked to share a common database for data storage and SQC analysis. HP FTM's SRM networking can also be used to transfer test data from HP FTM to HP Q-STATS II area-wide information manager. HP Q-STATS II, working with the HP 306X Board Test Systems and HP FTM at functional and final test, provides a comprehensive "board-test-to-final-test" statistical quality control solution.

### Standardize on HP FTM for All Your Test Systems

Implement just one test system using HP FTM and see the time-saving benefits of reduced software development time, maintenance, and documentation. Standardize on HP FTM and experience the additional effect of having your newer test engineers understand and maintain both new and old systems. Using and training your new test engineers on HP FTM's standard database, data structures, and other turnkey features gives them a big head start in understanding and maintaining all your HP FTM-based systems. Examining the information in HP FTM's forms will complete the picture, making it easy and quick for new engineers to grasp the inner application specific elements of any previously unfamiliar system.

### Summary

HP's Functional Test Manager is a sophisticated, comprehensive, and flexible software package fine tuned for functional test applications in production environments using HP-IB test instrumentation. It provides the set of features most needed to run a modern, versatile production operation. HP FTM has the breadth and depth needed to be considered as your standard test system executive.

Use HP FTM to beat your functional test software development deadlines while simultaneously expanding the functionality and flexibility of your test systems.

### Product Requirements

#### Supported Computers

HP 9000 Series 200\*/300 controllers and HP Vectra (or 100% IBM AT compatible) PC equipped with the HP Measurement Coprocessor.

#### Operating System

HP BASIC 5.X or greater and HP BASIC/UX 5.X or greater. Must order HP BASIC HFS binary (HP 82313A) separately for HP FTM/PC unless using SRM.

#### Memory

Three MB recommended for development system (2.25 MB minimum), 2 MB for run-only. For HP FTM/PC this memory must reside on the HP Measurement Coprocessor.

#### Hard Disk

Local hard disk required unless using SRM. Recommend 20 MB (40 MB for HP FTM/PC if hard disk is shared with DOS applications).

#### Printer

Optional. HP-IB, RS-232, or Centronics (on PC) interfaces with HP Raster Interface Standard capability. For example, HP ThinkJet, HP LaserJet, and HP PaintJet.

#### Plotter

Optional. HP-IB, HPGL (automatic sheet feed desirable).

#### Bar Code Reader

Optional. Use HP 92916A (HP-HIL).

#### 32-Button Box

Optional. Use HP 46086A (HP-HIL).

### Ordering Information

	Price
<b>HP FTM/300</b> (for HP 9000 Series 200/300 computers under HP BASIC 5.X or greater).	
<b>HP 34806A</b> FTM/300 on 3½-inch disk. Includes one seat in training class.	\$5,495
<b>Opt 001</b> Delete training.	– \$900
<b>HP 34806B</b> FTM/300 on 5¼-inch disk. Includes one seat in training class.	\$5,495
<b>Opt 001</b> Delete training.	– \$900
<b>HP FTM/PC</b> (for HP Vectra PCs and compatibles with HP Measurement Coprocessor.)	
<b>HP 34806C</b> HP FTM/PC on 3½-inch disk. Training not included.	\$3,950
<b>HP 34806D</b> HP FTM/PC on 5¼-inch disk. Training not included.	\$3,950
<b>HP FTM/300 for HP-UX</b> (for HP 9000 Series 300 computers with HP BASIC/UX 5.5 or greater).	
<b>HP 34806E</b> HP FTM/300 on ¼-inch tape. Includes one seat in training class.	\$5,495
<b>Opt 001</b> Delete training.	– \$900

### Multiple Copy/Right-to-Use Licenses, Upgrade Kits, Training and Support Materials

Economical multiple copy/right-to-use licenses, upgrade kits for Rev 1.0 and 2.0, user training, and software materials subscription (SMS) are available for HP FTM/300 and HP FTM/PC. For more information on these products ask your local HP sales representative.

Lotus and 123 are registered trademarks of Lotus Development Corporation.

MS-DOS is a registered trademark of Microsoft, Incorporated.

\*HP Models 216 and 220 require display enhancements. HP Model 226 not supported.

# MEASUREMENT SYSTEMS ARCHITECTURE

## HP Interactive Test Generator (HP ITG)

HP ITG for BASIC and HP ITG for DOS

- Accelerates test program development
- Mouse-driven interface to HP-IB instruments
- Full-functionality instrument drivers
- Generates code automatically
- For HP BASIC controllers: Series 300 workstations, HP BASIC/UX controllers, and PCs with the Measurement Coprocessor
- For PCs using Microsoft C, QuickC, or QuickBASIC

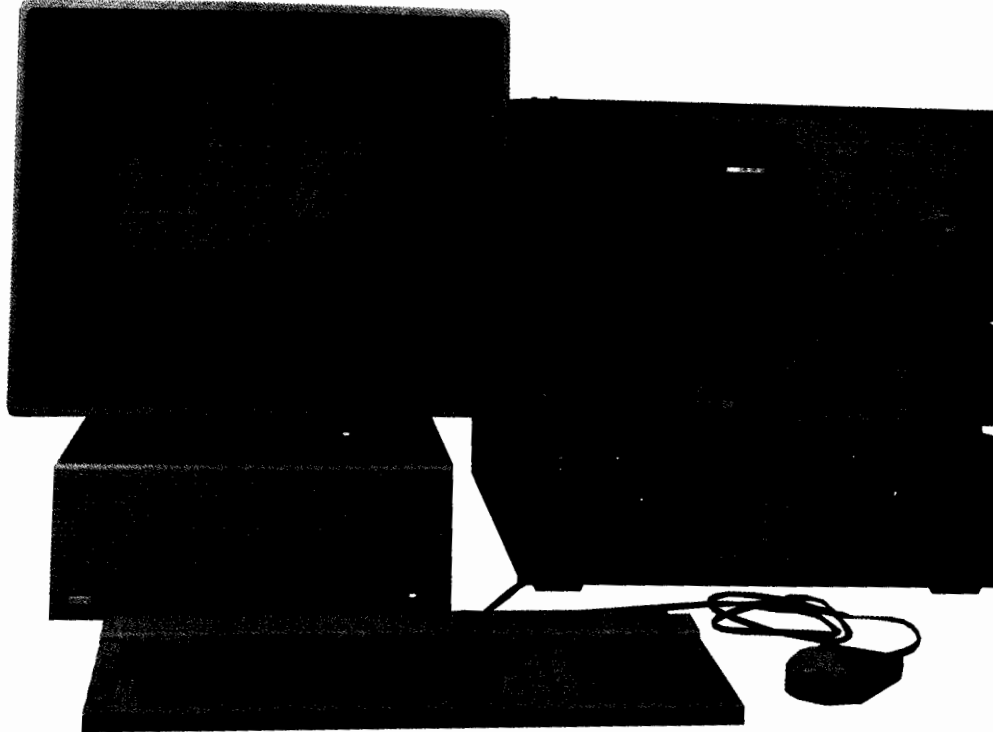

### Software Tools for Reduced Development Time

Hewlett-Packard provides a variety of computer-aided test (CAT) software tools to meet your needs, from general-purpose to specific applications. For general-purpose instrument control, the HP Interactive Test Generator software provides an easy-to-use interactive instrument driver library. For manufacturing test applications, HP's Functional Test Manager software provides a range of features that enable you to generate functional tests quickly and easily, and help you improve control of your manufacturing processes.

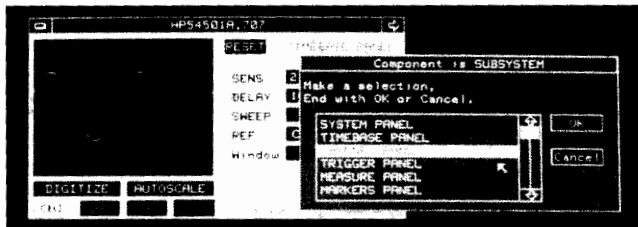

Menu selections expedite instrument setups and reduce costly errors.

### HP Interactive Test Generator (HP ITG)

HP Interactive Test Generator (HP ITG) and HP ITG for DOS (HP ITG/DOS) are software packages that accelerate test development by providing powerful instrument control tools that integrate into your test development environment.

Designed for test engineers, independent of their programming skill, HP ITG reduces test development with onscreen instrument panels. Menu selections made with the click of a mouse prescribe settings of instruments, and initiate and display measurements. HP ITG also automatically generates the code necessary to perform these tasks in your test program.

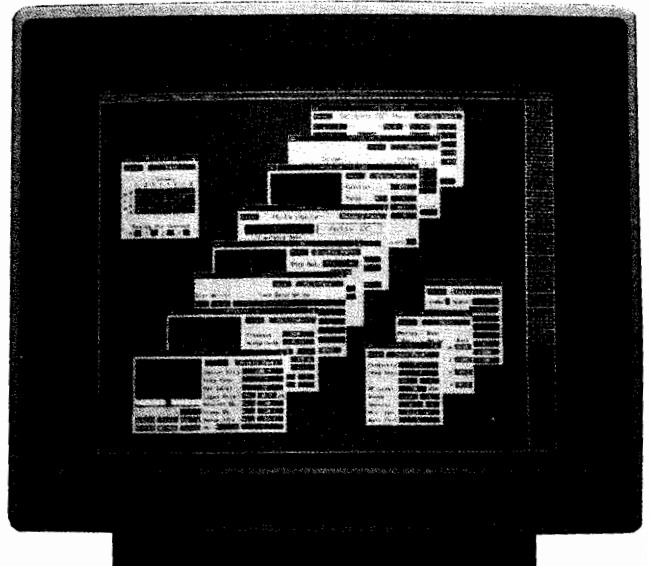

HP instrument drivers are available for a wide variety of popular instruments.



- Two mainframe sizes (Series B and Series C)
- Over 70 modules available
- Core set of test and measurement instruments in VXI
- SCPI language for easy programming
- Instrument Drivers for HP Interactive Test Generator (HP ITG) software and HP Visual Engineering Environment (HP VEE)

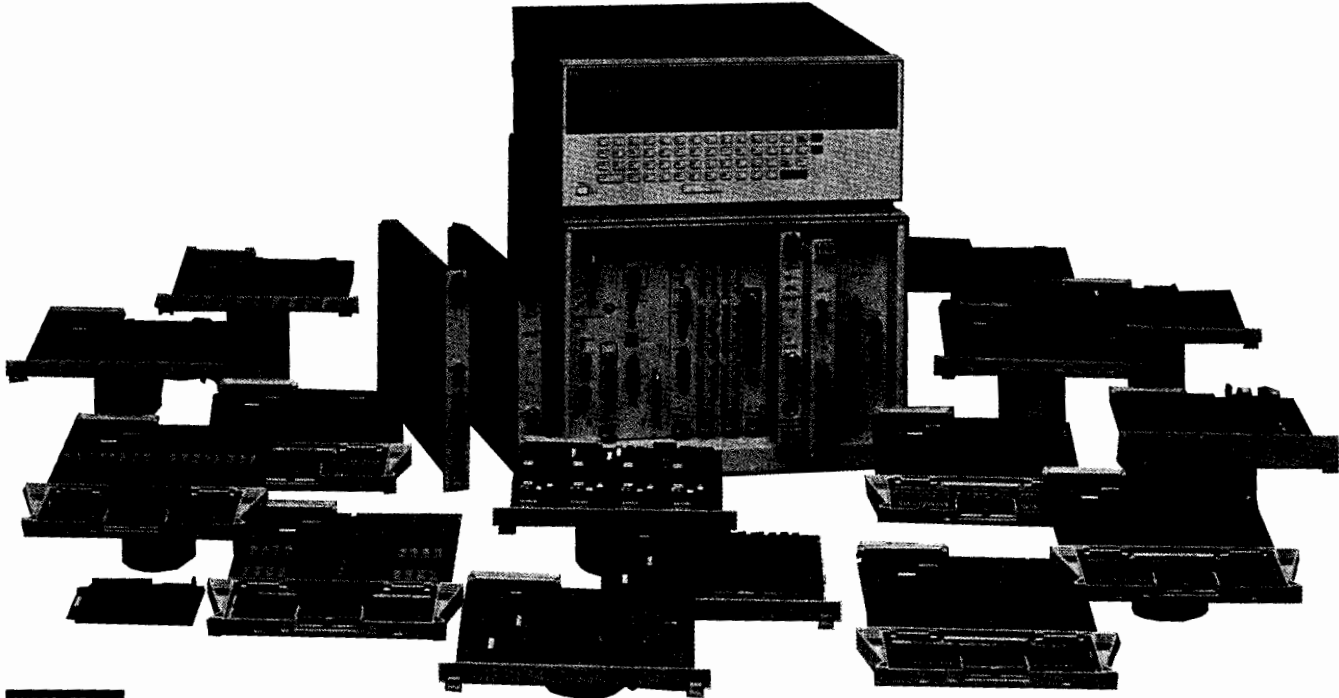

SUPPORTED BY  
**HP ITG**  
SOFTWARE

HP 75000 Family

### HP 75000 Family Reduces Test System Development Time

The HP 75000 family of VXIbus products is part of HP's measurement-systems architecture (MSA), providing benefits such as standardization, downsizing, throughput, and flexibility. Developing a test system involves much more than selecting hardware; it also requires software, systems integration, and support. The HP 75000 family is a fully compatible line of VXI products that reduces the development time for test systems. It includes computers, software, standardized instrument language, and services.

#### Hardware

The HP 75000 family consists of two mainframes and over 70 modules. The HP 75000 Series B Mainframes are designed for low-cost data-acquisition and control applications, and include seven B-size VXI slots. The HP 75000 Series C Mainframe is designed for medium- to high-performance computer-aided test applications, and includes 13 C-size VXI slots. A broad line of HP 75000 B- and C-size modules such as switching, digital multimeters, counters, sources, power meters, and computers are also available.

#### Firmware and Software

HP 75000 products offer compatibility and a broad range of price versus performance. All members of the HP 75000 family use the Standard Commands for Programmable Instruments (SCPI), (formerly TMSL), a new industry standard programming language, to simplify programming. With SCPI, you can send commands to instruments in a consistent, readable form. It conforms to IEEE 488.2. For example, to trigger a reading, you would send the command "\*TRG" to the appropriate instrument. All HP 75000 products support the HP Interactive Test Generator (HP ITG) interface. Hewlett-Packard added these capabilities to the VXI standard to help reduce test system development time.

#### System Support

Because getting a test system running quickly requires a solid base of support, Hewlett-Packard offers support services tailored to your needs. Support services in the U.S. include free 90-day phone-in support and optional 1-year additional support contracts. All HP 75000 Products have a standard 3-year warranty. HP also provides system services such as racking, custom products, and project management.

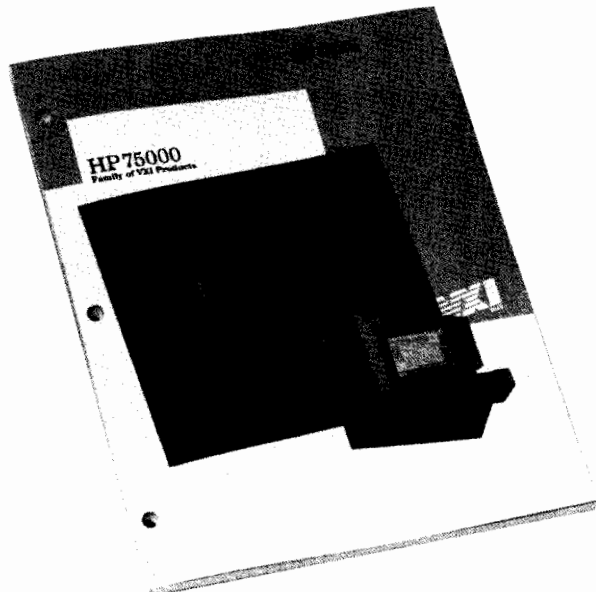

HP VXI Catalog

For full specifications, see the HP 75000 VXI Product Catalog (HP pub. no. 5091-1587).

# MEASUREMENT SYSTEMS ARCHITECTURE

## HP 75000 VXIbus Family

### Series B and Series C Mainframes

#### Series C Mainframe

- High-performance computer-aided test
- Auto-configuring backplane
- Pressurized air channel for independent slot cooling
- Ultra-reliable power supply

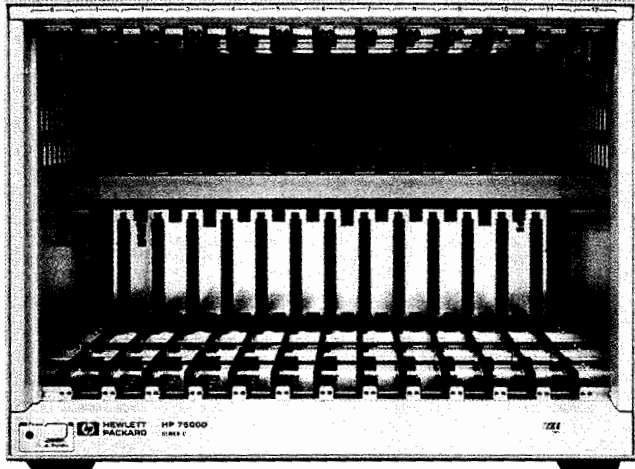

HP 75000 Series C Mainframe



#### Series C Mainframe

The HP 75000 Series C mainframe provides high performance while allowing for system downsizing. The Series C mainframe has 13 C-size VXI slots. It is a high-performance platform that becomes the heart of a computer-aided test system.

With the Hewlett-Packard auto-configuring backplane, all you have to do is plug in a module, and the backplane does the rest. There is no need for jumpers or dip switches to bypass empty slots.

The new Hewlett-Packard power supply has a proven track record of greater than 1 million hours MTBF. It also has a third fan to provide up to 45 watt-per-slot cooling.

With the exclusive Hewlett-Packard pressurized air channel system, each slot is cooled independently. A pressurized plenum with channels delivers air to each slot, ensuring adequate cooling even with empty slots, and with or without faceplates.

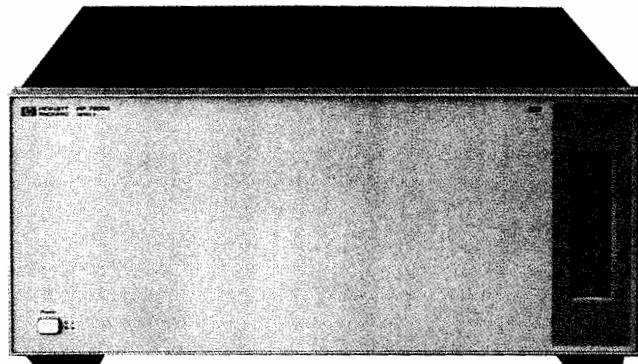

HP 75000 Series B Mainframes

#### Series B Mainframes

- Low-cost switching and measurement
- Built-in command module (no Slot 0 required)
- Flexible, built-in pacer for timing external devices
- SCPI language eases programming

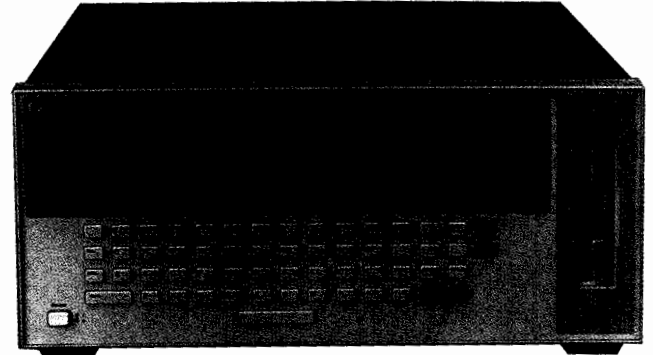

HP 75000 Series B Mainframes



#### Series B Mainframes

The two HP 75000 Series B mainframes provide a flexible, low-cost test system platform. Both include a built-in command module, eliminating the need for Slot 0 and resource manager functions, and providing an HP-IB (IEEE-488) interface. Series B mainframes have seven B-size and three A-size slots. To configure a test system, you plug in the individual instrument and switching modules you want. (The digital multimeter can also be mounted inside the mainframe.) The built-in pacer can generate timing and synchronizing signals by sending a TTL signal from the rear panel connector.

The HP E1300A and E1301A mainframes are identical except that the E1301A also includes a front-panel keyboard/display for direct command entry for troubleshooting wiring and connections, and for programming. You can use the HP E1300A (plain front panel) with turnkey software, such as HP 75000 System 10 software (see page 627). It will further lower the cost of duplicate systems.

#### Optional Internal Disk Drives

When the HP Instrument BASIC (IBASIC) controller is installed in a Series B mainframe, you can also add the Option 005, 3/4-inch flexible disk drive and/or the Option 006, 20-MB hard disk drive. These ruggedized drives provide storage for programs, data, and auto-start routines. Both disk drives can be field-installed later. The 3/4-inch flexible drive supports 256 KB, 720 KB, and 1.4 MB disks. Both LIF and DOS formats are recognized automatically.

#### Optional dc Power Operation

The Series B has the ability to operate on dc voltages from 10 to 30 volts. Using a typical 100 amp-hour auto battery, the operating time can range from approximately 6 to 24 hours, depending on configuration. This option can be used to provide uninterrupted power supply (UPS) capability since the switchover from ac to dc operation is made automatically, without resetting, whenever the ac power drops.

#### Optional RS-232 Ports

The HP E1324A RS-232C/422 Data Comm Module (A size) gives you the ability to control additional RS-232 peripherals at up to 19200 baud or to communicate over longer distances with RS-422. The internal 8-KB buffer reduces computer overhead for managing handshaking. Setup is easy with programmable baud rate, parity, and handshaking protocol.

For full specifications, see the HP 75000 VXI Product Catalog (HP pub. no. 5091-1587).

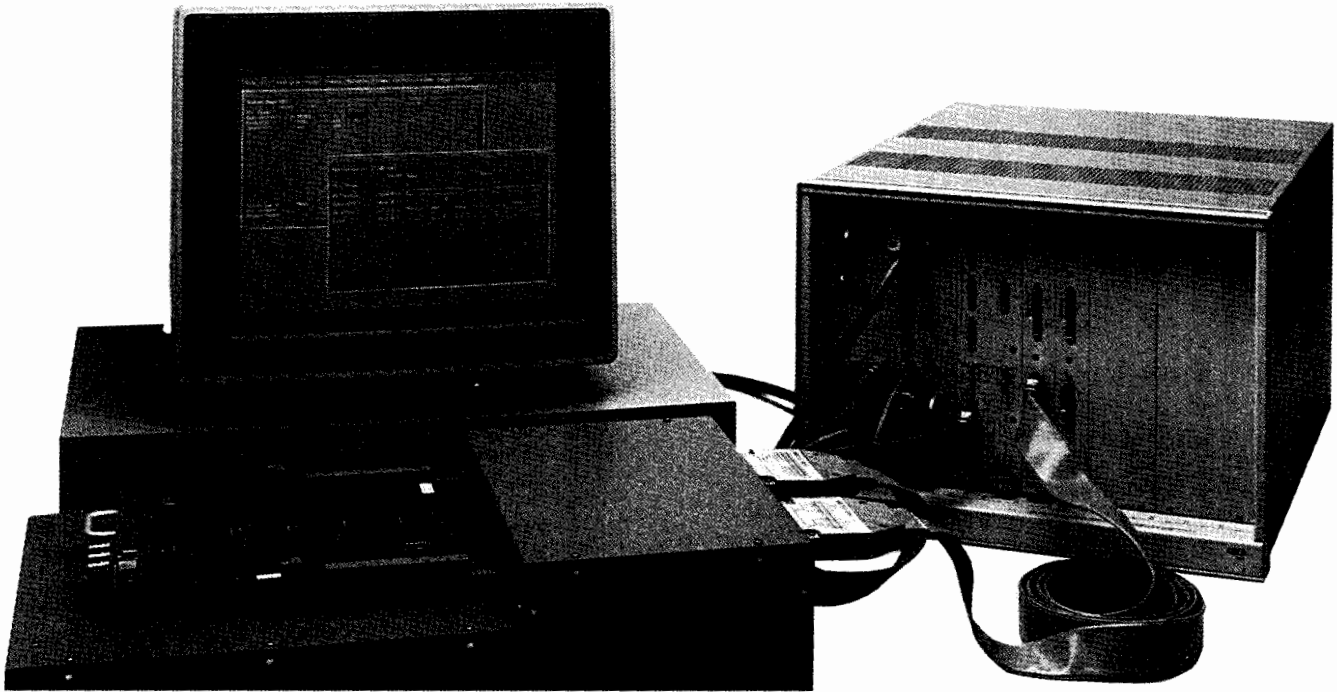

## HP 75000 Model D20 Digital Functional Test System

The HP 75000 Model D20 Digital Functional Test System can be used to functionally test your digital and mixed signal devices under test (DUTs). It has four major components: HP E1450A 160-MHz Timing Module, E1451A/E1452A 20-MHz Pattern I/O Modules, E1453A/E1454A pods, and E1496A Development Software.

### Features

- Scalable architecture for the exact price and performance you need
- On-the-fly timing changes and multiple timing/control signals improve your testing capability
- Bus handshaking and wait-state capability
- Automatic pin-to-pin deskew and compensation for pod cable delays
- Comprehensive triggering for mixed-signal testing
- Optional development software with a menu-driven graphical interface

### 160-MHz Timing Module (HP E1450A)

The HP E1450A Timing Module is used with the HP E1451A/E1452A Pattern Modules to control the digital test. Up to three timing modules can be connected using the master/slave function.

The E1450A has three independent timing generators for controlling the pattern modules and creating bus control signals, strobes, and clocks. The module has up to 256 different timing sets. On-the-fly timing changes allow timing parameters to change from vector to vector. All timing signals can be placed with 6.25-ns resolution and 6-ns accuracy.

The timing module also allows the (DUT) or external instrumentation to drive the test.

### 20-MHz Pattern I/O Modules (HP E1451A/E1452A)

The HP E1451/E1452A Pattern I/O modules are used to send data to and receive data from the DUT at up to a 20-MHz data rate. Each pattern module contains 32 I/O pins arranged in 4 ports of 8 bits. Each port can be programmed to output, record, or perform a real-time compare. Ports can be paralleled for bidirectional data transfers. The pattern module contains 64 K of memory behind each I/O pin. When combined with the HP E1450A Timing Module, pin-to-pin skew is automatically compensated for during power on.

### Timing and Pattern Pods (HP E1453A/E1454A)

The HP E1453A Timing Pod and HP E1454A Pattern Pod are optional active pods with 2-meter cables. One timing pod is used per timing module and each pattern I/O module uses two pods. These pods bring the system accuracy to your DUT. The delay of the pod cable is automatically compensated for by the HP E1450A Timing Module.

### Digital Test Development Software (HP H1496A)

The HP E1496A Digital Test Development Software helps you quickly develop tests for the Model D20. The system software runs on HP-UX workstations and is based on the X Window System, Version 11, and OSF/Motif. It uses pop-up windows and pull-down menus in a mouse-driven environment.

The software can be used standalone to develop the digital test and includes screens for developing timing cycles and editing vector files. In addition, the Model D20 hardware can be connected to the development workstation, providing online debugging of the digital test.

# MEASUREMENT SYSTEMS ARCHITECTURE

## HP 75000 VIXbus Family

### Multimeters

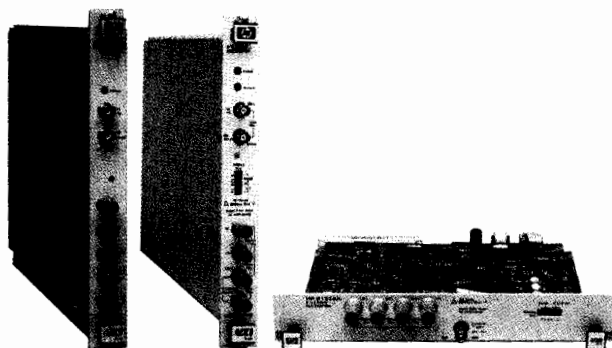

HP E1410A, HP E1411B, and HP E1326B

### 5½-Digit Multimeters (HP E1326B, E1411B)

The HP E1326B and E1411B 5½-digit multimeters are well suited for data acquisition and computer-aided testing. These economical, versatile multimeters meet both high-accuracy scanning and high-speed measurement needs.

These two multimeters differ only in size; they are identical in electrical design. The HP E1326B multimeter is a 2-slot B-size module that can be plugged into the rear of the HP 75000 Series B Mainframe or mounted internally (saving two module slots) with the internal installation kit (HP E1326-80002). The HP E1411B multimeter is a 1-slot C-size module.

#### Features include:

- Dual A/Ds: A 5½-digit/low noise integrating A/D, and a high-speed (14 kHz) sampling A/D
- Balanced differential isolated inputs
- Functions: Vdc, Vac, 2- and 4-wire ohms, offset compensated ohms, thermocouples, thermistors, RTDs
- Autozeroing and autoranging
- Flexible triggering with built-in timer/pacer
- Software calibration

You can use the integrating A/Ds in these multimeters to make 5½-digit, low-noise measurements. Use the sampling A/Ds to make 14-bit readings at rates up to 14 kHz. The multimeters can be combined with any HP 75000 low-frequency multiplexer to create a multichannel scanning multimeter. A single SCPI command from the Series B Mainframe or HP E1405A Command Module can program both the multimeter and multiplexer channels.

### Reading Rates and Resolution

Conditions: Autozero off, fixed range, default trigger delay, sample source "TIMER" for rates >15 readings/s.

Aperture:	320/267 ms	20/16.7 ms	2.5 ms	100 μs	10 μs
Typical reading rates (rdgs/sec)					
Vdc/Ω	3/3.5	49/59	365	3125	13,000
Vac	1.3	1.9	1.9	1.9	1.9
Resolution					
Bits	±22	±20	±18	±15	±14
Digits	6½	6	5½	4½	3½

### Noise Rejection

Conditions: 50/60 Hz ±0.1%, 1 k Ω in both HIGH and LOW leads with 10% imbalance, LOW connected to COMMON at source. Measured with respect to earth ground.

Aperture:	320/267 ms	20/16.7 ms	2.5 ms	100 μs	10 μs
NPLCs	16	1	NA	NA	NA
NMR	84 dB	60 dB	0	0	0
DC CMR	150 dB	150 dB	150 dB	150 dB	150 dB

### 90-Day dc Voltage Accuracy

± (% of reading + volts)

Conditions: Autozero on, 1-hour warm up within ±5° C of cal temp

Aperture:	320/267 ms	20/16.7 ms	2.5 ms	100 μs	10 μs
Range					
125 mV	.023% + 5.0 μV	.023% + 5.0 μV	.023% + 10 μV	.065% + 30 μV	.115% + 60 μV
1 V	.013% + 10 μV	.013% + 15 μV	.013% + 15 μV	.055% + 100 μV	.100% + 200 μV
8 V	.010% + 50 μV	.010% + 50 μV	.010% + 80 μV	.055% + 750 μV	.100% + 1.5 mV
64 V	.015% + 1.0 mV	.015% + 1.0 mV	.015% + 1.0 mV	.055% + 5.0 mV	.100% + 20 mV
300 V	.015% + 5.0 mV	.015% + 5.0 mV	.015% + 5.0 mV	.055% + 30 mV	.100% + 80 mV

### 6½-Digit Multimeter (HP E1410A)

The HP E1410A 6½-Digit Multimeter is a full-function system DMM in a compact, single-slot C-size module. It is similar in design to the popular HP 3457A multimeter, and it is suitable for a wide variety of computer-aided test and manufacturing applications where high accuracy is required.

#### Features include:

- High accuracy/low noise 6½-digit integrating A/D
- 1,450 readings/second at 3½-digits
- Guarded high-impedance inputs
- Functions: Vdc, Vac (dc and ac coupled), 2- and 4-wire ohms, offset compensated ohms, frequency, period
- Autozeroing and autoranging
- Flexible triggering with built-in timer/pacer
- Software calibration

### Reading Rates and Resolution

Conditions: Autozero off, fixed range, delay 0, ac slow filter on, offset compensation off.

Aperture:	200/167 ms	20/16.7 ms	2/1.67 ms	100 μs	10 μs
Reading rates (rdgs/sec)					
Vdc/Ω	4	47	312	1250	1450
Vac	.65	1.0	1.0	1.0	1.0
Resolution					
Bits	±22	±22	±19	±15	±12
Digits	6½	6½	5½	4½	3½

### Noise Rejection

Conditions: 50/60 Hz ±.08%, 1 k Ω imbalance in low lead.

Aperture:	200/167 ms	20/16.7 ms	2/1.67 ms	100 μs	10 μs
NPLCs	10	1	NA	NA	NA
NMR	80 dB	60 dB	0	0	0
dc CMR	140 dB	140 dB	140 dB	140 dB	140 dB

### 90-Day dc Voltage Accuracy

± (% of reading + volts)

Conditions: Autozero on, within ±5° C of cal temp, 1-hour warmup.

Aperture:	200/167 ms	20/16.7 ms	2/1.67 ms	100 μs	10 μs
Range					
30 mV	.0053% + 5.6 μV	.0053% + 6.75 μV	.0053% + 8.8 μV	.0053% + 21 μV	.0053% + 70 μV
300 mV	.0038% + 5.8 μV	.0038% + 6.8 μV	.0038% + 11 μV	.0038% + 50 μV	.0038% + 400 μV
3 V	.0030% + 9.0 μV	.0030% + 9.0 μV	.0030% + 50 μV	.0030% + 400 μV	.0030% + 4 mV
30 V	.0048% + 230 μV	.0048% + 330 μV	.0048% + 800 μV	.0048% + 4 mV	.0048% + 40 mV
300 V	.0063% + 800 μV	.0063% + 800 μV	.0063% + 4 mV	.0063% + 40 mV	.0063% + 400 mV

For full specifications see the HP 75000 VXI Product Catalog (HP pub. no. 5091-1587).

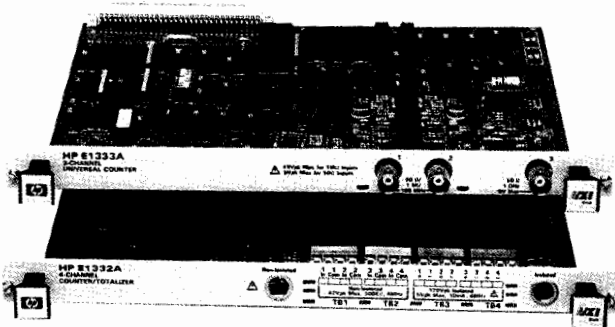

HP E1333A and HP E1332A



### 3-Channel Universal Counter (HP E1333A)

- Frequency, period average, ratio, pulse width, time interval, and totalize to 100 MHz
- 1-GHz frequency measurement available on channel 3
- Occupies only one B-size slot
- 1-ns time-interval resolution with averaging
- Features SCPI command language and ITG panels when used with the HP 75000 Series B mainframe or HP E1405A/B command module

#### Specifications

**Accuracy:**  $\pm$  resolution  $\pm$  time base error  $\pm$  trigger noise error

#### Frequency Measurement

**Range:** 100 MHz (channels 1 and 2)

75 MHz to 1 GHz (channel 3)

**Resolution:**  $1/(\text{gate time})$  (gate time:  $2^n$  ms,  $n = 1$  to 16)

**Period average measurement:** Channels 1 and 2 average  $2^n$  periods of the input signal.

**Range of N:** 1 to 16

**Resolution:**  $1/(10 \times 10^6 \times 2^n)$  seconds

**Time Interval** (with average mode)

**Range:** Up to  $6871/(2^n)$  seconds (where  $2^n$  is the number of intervals to be averaged,  $N = 0$  to 7)

**Resolution:**  $(100 \text{ ns})/(2^n)$  (where  $2^n$  is the number of intervals to be averaged,  $N = 0$  to 7)

#### Pulse Width (with Average Mode)

**Range:** Up to  $6871/(2^n)$  seconds (where  $2^n$  is the number of intervals to be measured,  $N = 0$  to 7)

**Resolution:** 100 ns/ $2^n$

#### Frequency Ratio

**Resolution:**  $1/(2^n)$  ( $2^n$  is the preset number of transitions,  $N = 6$  to 36)

**Totalizing Range:** 1 to  $2^{36} - 1$

#### Time Base

**Frequency:** 10 MHz

**Accuracy:**  $\pm 2$  ppm

**Temperature drift:**  $\pm 5$  ppm ( $0^\circ$  to  $50^\circ$  C)

**Aging:**  $\pm 2$  ppm/yr

**Trigger noise error (RMS) =**

$$\sqrt{(80 \mu\text{V})^2 + (en)^2 / (\text{input slew rate at trigger point in } \mu\text{V/s})}$$

where  $en$  = noise on input signal for 150 MHz bandwidth in  $\mu\text{V}$

### 4-Channel Counter/Totalizer (HP E1332A)

- Totalize, up/down count, gated totalize, pulse width, time interval, period average, and frequency measurement up to 4 MHz
- Programmable direct or isolated inputs
- Programmable digital input filter
- Features SCPI command language and ITG panels when used with the HP 75000 Series B or C mainframe or HP E1405A command module

### Specifications

**Accuracy:**  $\pm$  resolution  $\pm$  time base error  $\pm$  trigger noise error

#### Frequency Measurement (requires 2 channels)

**Range:** 4 MHz

**Resolution:**  $1/(\text{gate time})$  (gate time:  $2^n$  ms,  $N = 1$  to 16)

**Period measurement** (requires 2 channels): Channels 1 and 3 measure  $2^n$  periods of the input signal

**Range of N:** 1 to 16

**Resolution:**  $1/(5 \times 10^6 \times 2^n)$  seconds

#### Time Interval

Measures the time interval between transition from channel 1 to channel 2 or channel 3 to channel 4

**Range:** Up to 858 seconds

**Resolution:** 200 ns

#### Pulse width (requires 2 channels)

**Range:** Up to 858 seconds

**Resolution:** 200 ns

**Totalizing range:** 1 to  $2^{32} - 1$  counts (requires 1 channel)

**Gated totalize range:** 1 to  $2^{16} - 1$  (requires 2 channels)

**Up/down count range:**  $\pm (2^{31} - 1)$  (requires 2 channels)

#### Time Base

**Frequency:** 5 MHz

**Accuracy:**  $\pm 2$  ppm

**Temperature drift:**  $\pm 5$  ppm ( $0^\circ$  to  $50^\circ$  C)

**Aging:**  $\pm 2$  ppm/year

**Trigger noise error (RMS) =**

$$\sqrt{(200 \mu\text{V})^2 + (en)^2 / (\text{input slew rate in } \mu\text{V/s})}$$

where  $en$  = noise on input signal for 5 MHz bandwidth in  $\mu\text{V}$



HP E1420B

### High-Performance Universal Counter (HP E1420B)

The HP E1420B universal counter offers the same exceptional performance as Hewlett-Packard's high-performance rack-and-stack universal counters.

- Full universal counter functionality
- 200-MHz frequency range with 9 digits/second resolution and optional high-frequency channel
- 2-ns time-interval resolution
- High measurement throughput
- Optional shared memory
- X10 attenuator
- Optional TCX0 time base with output for driving VXI CLK10
- Measurement synchronized to VXIbus or external trigger
- 100% backward compatible with E1420A
- Message based
- 1 slot, C-size

#### Specifications

**Frequency range:** .001 Hz to 200 MHz, high-frequency channel optional to 2.5 GHz

**Frequency resolution:** 9 digits in 1 second of measurement time

**Period range:** 5 ns to 1000 s

**Period resolution:** Same as frequency

**Time interval (TI) range:**  $-1$  ns to  $10^3$  s (single-shot)

$-1$  ns to 10 s (averaging)

**Time interval (TI) resolution:** 2 ns single-shot, 200 ps averaging

For full specifications, see the HP 75000 VXI Product Catalog (HP pub. no. 5091-1587).

# MEASUREMENT SYSTEMS ARCHITECTURE

## HP 75000 VXIbus Family

Sources, Digital I/O, Oscilloscope

SUPPORTED BY  
**HP ITG**  
SOFTWARE

HP E1440A



### 21-MHz Synthesized Function/Sweep Generator (E1440A)

The HP E1440A 21-MHz Synthesized Function/Sweep Generator is a 2-slot C-size VXI module that offers five different waveforms with synthesizer accuracy. Frequency resolution down to 1  $\mu$ Hz, 5 ppm frequency accuracy/stability, and outstanding signal purity make this generator the ideal reference source for test equipment. Includes multi-interval sweep and multimarker mode sweep capabilities.

#### Specifications

**Waveforms:** Sine, square, triangle, negative and positive ramps, dc, TTL clock

**Frequency ranges:** Sine: 1  $\mu$ Hz to 21 MHz  
square: 1  $\mu$ Hz to 11 MHz  
triangle/ramps: 1  $\mu$ Hz to 11 kHz  
TTL clock: 1  $\mu$ Hz to 60 MHz

**Frequency resolution:** 11 digits

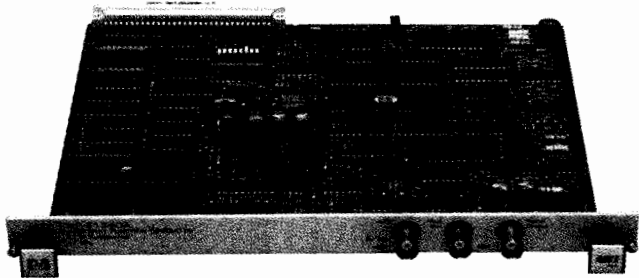

### Arbitrary Function Generator (E1340A)

The E1340A provides standard functions and arbitrary waveforms. It includes sweep, FSK, and wave hop. Its 12-bit resolution produces low distortion ac and good dc accuracy. The register-based B-size format provides an inexpensive architecture for producing analog waveforms.

- Digital synthesis for precise frequency control
- B-size, register-based, SCPI-compatible when using E1300/1301A or E1405A
- HP 9000 Series 300 software E1340A Option 005 Arbitrary Waveform Generation

#### Specifications

**Amplitude resolution:** 12 bits

**Internal time base:** 42.9 MHz

**Waveform memory:** 16K samples

**Built-in waveforms:** Sine, square, ramp, triangle, sin(x)/x, noise, and haversine

**Frequency sweep:** 0.01 Hz to 15 MHz

**dc accuracy:** - + (2% + 100 mV)

**Sine THD (< 100 kHz @ 10 dBm):** - 60 dB

For full specifications, see the HP 75000 Product Catalog (HP pub. no. 5091-1587).

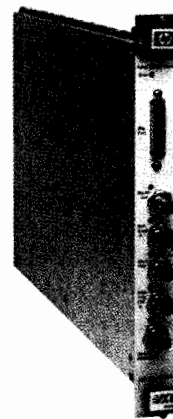

### Arbitrary Function Generator (E1445A)

The E1445A produces arbitrary waveforms and standard analog waveforms with low distortion and high accuracy. The 256-K memory is controlled by a high-speed sequencer that stores waveforms in a very efficient manner. The triggering and clock circuits take advantage of the VXI architecture by connecting to the various VXI backplane lines.

- High resolution D/A converter
- Large memory with sequencer
- Digital synthesis for precise frequency control
- HP 9000 Series 300 software E1445A Option 005 Arbitrary Waveform Generation

#### Specifications

**Amplitude resolution:** 13 bits

**Internal time base:** Synthesizer 0.01 Hz to 10 MHz; 40 and 42.9 MHz crystal with dividers

**Segment memory:** 256K samples

**Sequence memory:** 32K

**Built-in waveforms:** Sine, square, ramp, and triangle

**Frequency sweep:** 0.01 Hz to 10 MHz

**dc accuracy:** 0.1% of full scale

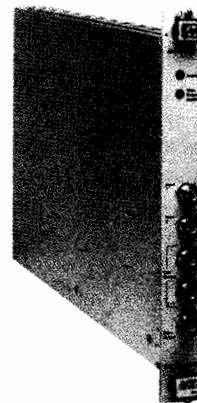

### Summing Amplifier/DAC (E1446A)

The E1446A sums two inputs, provides DC offset, and raises signal power. Each input channel has a 31 dB-attenuator, and the output has a 20 dB-step attenuator. Two outputs drive single-ended and differential loads. The on-board D/A converter provides dc offset independent from the incoming signal. When no signals are attached to the input channels, the E1446A can be used as a power D/A converter.

#### Specifications

**Input impedance:** 50, 75, and 1 M  $\Omega$

**Output impedance:** 50  $\Omega$  single-ended and differential

**Full power bandwidth:** 10 MHz

**Small signal bandwidth:** 50 MHz

**Output level:** 40 V p-p into Hi-Z, 20 V p-p into 50  $\Omega$

**DAC resolution:** 16 bits

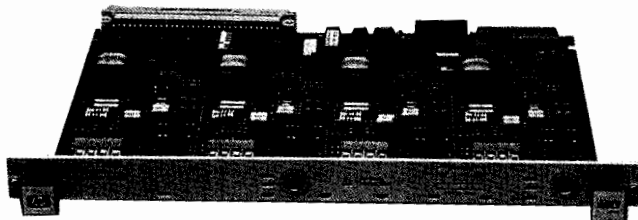

HP E1328A

SUPPORTED BY  
**HP ITG**  
SOFTWARE

#### 4-Channel D/A Converter (E1328A)

The HP E1328A 4-channel D/A converter is a B-size VXI module that provides four independent, isolated channels of voltage or current output. Each channel is individually selectable for maximum flexibility. Software calibration is provided, eliminating the need for mechanical adjustments.

##### Specifications

**Voltage output range:**  $\pm 10.92$  V

**Voltage accuracy:** 24-hour:  $\pm (0.05\% + 3.3 \text{ mV})$   
90-day:  $\pm (0.15\% + 29 \text{ mV})$

**Current output range:**  $\pm 21.8$  mA

**Current accuracy:** 24-hour:  $\pm (0.05\% + 7 \mu\text{A})$   
90-day:  $\pm (0.15\% + 59 \mu\text{A})$

**Settling time:** 750  $\mu\text{s}$

**Isolation:** 120 VRMS, 170 V dc/ac peak

**Programmable resolution:** 333  $\mu\text{V}/667 \text{ nA}$

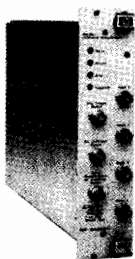

HP E1426A



HP E1428A

SUPPORTED BY  
**HP ITG**  
SOFTWARE

#### 500-MHz Digitizing Oscilloscope (HP E1426A)

The HP E1426A 500-MHz digitizing oscilloscope is a full-function digitizing oscilloscope similar in design to the HP 54503A oscilloscope. High precision and advanced triggering allows repeatable and accurate measurements on simple or complex waveforms.

- HP 54503A equivalent (see page 136)
- 500-MHz bandwidth
- 4 channels
- 8-bit vertical resolution
- 20-Msa/s digitizing rate
- Message-based module (send high-level, ASCII SCPI commands)
- 2-slot, C-size

##### Specifications

**Bandwidth:** dc to 500 MHz ( $-3$  dB, dc-coupled)

**Max sample rate:** 20 Msa/s

**Number of inputs:** 4 (Simultaneous acquisition on two inputs are used; data is alternately acquired by inputs.)

**Vertical sensitivity range:** 1 mV/div to 5 V/div

**Time base range:** 200 ps/div to 5 s/div

#### 1 GSa/s Digitizing Oscilloscope (E1428A)

The HP E1428A 1 GSa/s digitizing oscilloscope is a full-function instrument similar in design to the HP 54510A oscilloscope. Two full-performance channels provide waveform capture confidence.

- 8-bit vertical resolution
- HP 54510A equivalent
- SCPI compatible
- Message-based module
- One-slot C-size

##### Specifications

**Bandwidth:** dc to 250 MHz

**Max sample rate:** 1 GSa/s

**Number of inputs:** 2

**Vertical sensitivity range:** 8 mV to 40 V full scale

**Time base range:** 10 ns to 50 s

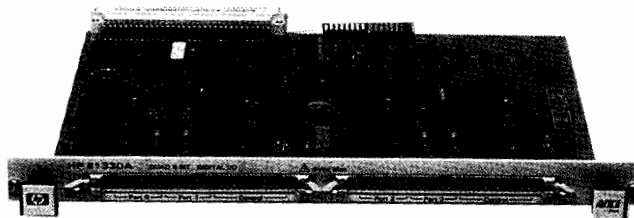

HP E1330A

SUPPORTED BY  
**HP ITG**  
SOFTWARE

#### Quad 8-Bit Digital Input/Output (E1330A)

The HP E1330A digital I/O is a B-size VXI module that provides digital interfacing to special-purpose circuitry or external devices. Each block has dedicated control and handshake lines. The E1330A supports standard GPIO protocols and different data formats such as decimal, hexadecimal, octal, and binary.

##### Specifications

**Data lines:** 4 sets of 8 bidirectional lines, TTL compatible, jumper selectable pull-ups

**Handshake lines:** 4 sets of 3 lines each; Input/Output Status, Control, and Flag

**Handshake modes:** None, Leading Edge, Trailing Edge, Partial, Pulse, and Strobe

\*When used with HP 75000 Series B or HP E1405A command module.

SUPPORTED BY  
**HP ITG**  
SOFTWARE

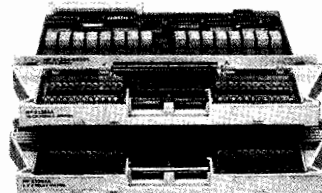

HP E1361A and HP E1364A

#### 4 x 4 Matrix Switch (HP E1361A)

The HP E1361A 4 x 4 matrix switch is a B-size VXI module that provides the 4 x 4 matrix switching capability to connect several instruments at once to several points on a device under test. Each cross point switches two wires with low differential offsets. Larger matrices, such as 4 x 8 or 4 x 12, can be formed by linking 4 x 4 modules.

##### Specifications

**Maximum input voltage:** 250 Vdc or ac rms

**Maximum input current:** 1 A dc or ac rms

**Maximum input power:** 40 W or 40 VA

**Thermal offset:**  $< 7 \mu\text{V}$  per contact

**Bandwidth:**  $-3$  dB @ 10 MHz

**Crosstalk (Ch to Ch):**  $< -80$  dB @  $\leq 100$  kHz  
 $< -30$  dB @  $\leq 10$  MHz

#### 16-Channel Form-C Switch (HP E1364A)

The HP E1364A 16-channel form-C switch is a B-size VXI module that consists of 16 independent form-C relays, allowing a wide variety of devices and signals to be switched. Each channel has Common, Normally Open, and Normally Closed terminals for easy configuration. Power up and -down states can be chosen because the relays are latching.

##### Specifications

**Maximum input voltage:** 250 Vdc or ac rms

**Maximum input current:** 1 A dc or ac rms

**Maximum input power:** 40 W or 40 VA

**Thermal offset:**  $< 7 \mu\text{V}$  per contact

**Bandwidth:**  $-3$  dB @ 10 MHz

**Crosstalk (Ch to Ch):**  $< -80$  dB @  $\leq 100$  kHz  
 $< -30$  dB @  $\leq 10$  MHz

# MEASUREMENT SYSTEMS ARCHITECTURE

## HP 75000 VXibus Family

Switches, Multiplexers, Matrices

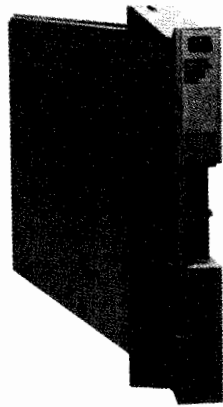

HP E1463A

### 32-Channel 5 Amp, Form-C Switch (E1463A)

The HP E1463A 32-Channel 5-Amp Form-C Switch is a C-size VXI module that is perfect for switching high-power signals. Each channel has Normally Closed, Normally Open, and Common terminals for easy configuration. There is space available on the module for adding varistors (MOVs) for greater relay protection when switching inductive loads. At power up and power down, Common will be connected to Normally Closed because the relays are nonlatching.

#### Specifications

**Maximum input voltage:** 125 Vdc, 250Vac rms

**Maximum current:** 5A dc or ac rms

**Maximum power:**

**Per switch:** 150 W dc, 1250 VA ac

**Per module:** 900 W dc, 7500 VA ac (when plugged into the HP 75000 Series C Cardcage)

**Thermal offset:**  $< 7 \mu\text{V}$  ( $3 \mu\text{V}$  typical) per channel

**Bandwidth (-3 dB):**  $> 10$  MHz (typical)

**Crosstalk (dB) (Ch to Ch):**  $< -63$  dB @  $< 100$  kHz  
 $< -42$  dB @  $< 1$  MHz

### 16-Channel Relay Multiplexer and 48-Channel Single-ended Relay Multiplexer (HP E1345A and E1346A)

The HP E1345A and E1346A relay multiplexers connect multiple analog signals to a DMM or other instrument. The HP E1345A switches three wires per channel with signals up to 170 V peak. The HP E1346A switches one wire per channel. It is designed for applications needing a large number of channels where all signals have a common ground. Both modules feature a removable terminal module for easy wiring.

#### Specifications

**Maximum input voltage:** 120 V dc, 170 V peak ac

**Maximum input current per channel:** 50 mA noninductive

**Maximum power:** 1 VA rms per channel

**Maximum offset voltage per channel:**  $4 \mu\text{V}$  (HP E1345A),  $50 \mu\text{V}$  (HP E1346A)

**Bandwidth (-3 dB):**  $> 10$  MHz



### 16-Channel Thermocouple Relay Multiplexer, 8-Channel 120 $\Omega$ Strain Gage Relay Multiplexer, and 8-Channel 350 $\Omega$ Strain Gage Relay Multiplexer (HP E1347A, HP 1355A, HP 1356A)

These multiplexers connect multiple analog signals to a DMM or other instrument, allowing temperature and strain measurements to be made. Three wires are switched per channel with signals up to 170 V peak. All three modules feature a removable terminal module for easy wiring.

- 16-channel thermocouple measurements with built-in thermistor reference junction.
- 8-channel strain measurements can be made with  $\frac{1}{4}$ -,  $\frac{1}{2}$ -, and full-bridge configurations.

#### Specifications

**Maximum input voltage:** 120 Vdc, 170 V peak ac

**Maximum input current per channel:** 50 mA noninductive

**Maximum power:** 1 VA rms per channel

**Maximum offset voltage per channel:**  $4 \mu\text{V}$

**Bandwidth (-3 dB):**  $> 10$  MHz

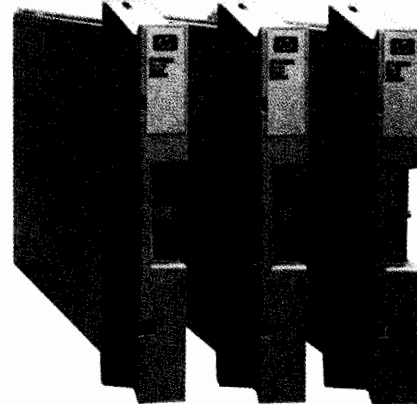

HP E1465A, HP E1466A, HP E1467A

### 16 $\times$ 16 Relay Matrix (E1465A), 4 $\times$ 64 Relay Matrix (E1466A), 8 $\times$ 32 Relay Matrix (E1467A)

The HP E1465A, E1466A, and E1467A Matrix Cards offer the highest switch density available in an HP 75000 Series C plug-in module. The cards feature easy expansion to larger matrices via a chaining cable that allows interconnection of rows on different cards. A full HP 75000 Series C Cardcage can have up to 3072 two-wire crosspoints. These cards provide the best cost-per-cross-point solution for those requiring large matrices.

#### Specifications:

**Maximum input voltage:** 200 Vdc; 170 Vac rms

**Maximum input current:** 1 A dc or ac peak

**Maximum power:** 30 W dc, 62.5 VA ac resistive load

**Thermal offset per channel:**  $< 5 \mu\text{V}$  (differential H-L)

**Bandwidth (-3 dB):**  $> 2.5$  MHz



### 64-Channel Relay Multiplexer, 8 $\times$ 8 Matrix Switch, and 4 $\times$ 16 Matrix Switch (HP E1460A, E1468A, E1469A)

The HP E1460A 64-channel relay multiplexer is a C-size VXI module perfect for switching low-frequency voltage and 2- and 4-wire resistance signals. This module can switch either 64 two-wire or 128 one-wire channels. The HP E1468A 8  $\times$  8 matrix switch and the HP E1469A 4  $\times$  16 matrix switch are C-size VXI modules that provide flexible matrix switching capability required to connect several instruments at once to several points on a device under test.

#### Specifications

**Maximum input voltage:** 220 Vdc, 250 Vac rms

**Maximum input current:** 1 A dc or ac rms (V max  $< 30$  Vdc or rms)

**Maximum power:** 40 VA

**Maximum offset voltage:**  $7 \mu\text{V}$

For full specifications, see the HP 75000 Product Catalog (HP pub. no. 5091-1587).



SUPPORTED BY  
\*  
HP ITG  
SOFTWARE

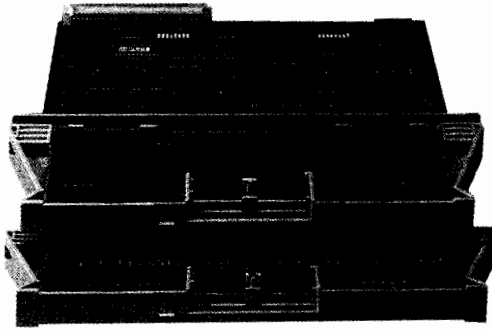

HP E1357A, E1352A

### 16-Channel FET Multiplexer and 48-Channel Single-Ended FET Multiplexer (HP E1351A and E1352A)

The HP E1351A and E1352A FET multiplexers connect multiple analog signals to a digital multimeter (DMM) or other instrument. The HP E1351A switches two wires per channel with the guard terminal common to all channels. The HP E1352A switches one wire per channel and is designed for applications needing a large number of channels where all signals have a common ground. You can use these multiplexers with the HP E1326A as a scanning voltmeter to achieve scanning rates of 10,000 channels/s. Both modules feature a removable terminal module for easy wiring.

#### Specifications

**Maximum input voltage:** 16 V peak

**Maximum input current per channel:** 1 mA noninductive

**Maximum offset voltage per channel:** 25  $\mu$ V (0° to 28° C), 250  $\mu$ V (28° to 50° C)

**Closed channel resistance:** < 3.1 k  $\Omega$  for high or low input  
< 2.1 k  $\Omega$  for guard input

**Bandwidth (-3 dB):** 50  $\Omega$  source, 1 M  $\Omega$ , termination > 200 kHz

SUPPORTED BY  
\*  
HP ITG  
SOFTWARE

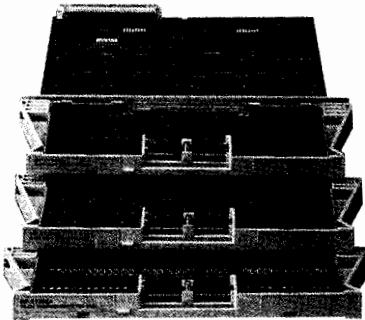

HP E1353A, E1357A, E1358A

### 16-Channel Thermocouple FET Multiplexer, 8-Channel 120 $\Omega$ Strain Gage FET Multiplexer, and 8-Channel 350 $\Omega$ Strain Gage FET Multiplexer (HP E1353A, HP E1357A, HP E1358A)

These multiplexers connect multiple analog signals to a DMM or other instrument, allowing temperature and strain measurements to be made. Two wires are switched per channel with the guard channel common to all channels. All three modules feature a removable terminal module for easy wiring.

- Fast thermocouple measurements: up to 10,000 channels per second
- Dynamic strain measurements: up to 10,000 readings per second

#### Specifications

**Maximum input voltage:** 16 peak

**Maximum input current per channel:** 1 mA noninductive

**Maximum offset voltage per channel:** 25  $\mu$ V (0° to 28° C), 250  $\mu$ V (28° to 50° C)

**Closed channel resistance:** < 3.1 k  $\Omega$  for high or low input  
< 2.1 k  $\Omega$  for guard input

**Bandwidth (-3 dB):** 50  $\Omega$  source, 1 M  $\Omega$ , termination > 200 kHz

SUPPORTED BY  
\*  
HP ITG  
SOFTWARE

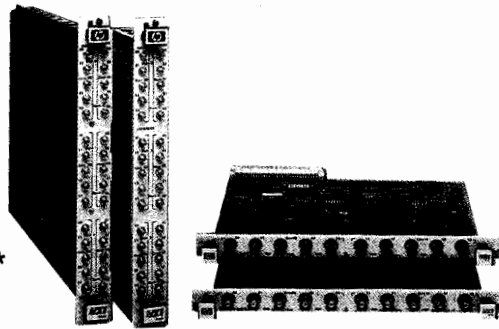

HP E1472A, E1473A, E1366A, E1367A

### 2x4:1 RF Multiplexers (HP E1366A and E1367A)

The HP E1366A and E1367A RF multiplexers are B-size VXI modules that provide broadband switching with two independent 1X4 multiplexers for signals from dc to 1.3 GHz. BNC connectors make configuration easy. These modules are identical except that the HP E1366A is 50-ohm and the HP E1367A is 75-ohm impedance.

#### Specifications

**Maximum input voltage:** 42 V peak

**Maximum input current per channel:** 1 A dc or ac rms

**Maximum power per channel:** 24 W or 24 VA

ac performance:	< 10 MHz	< 100 MHz	< 1.3 GHz
Insertion loss (dB)	< 0.3	< 0.7	< 3.0
Crosstalk (dB)	< -90	< -80	< -40
VSWR	< 1.2	< 1.25	< 1.55

### 6x4:1 RF Multiplexers (HP E1472A and E1473A)

For larger channel 50-ohm RF switching, the HP E1472A and E1473A C-size VXI modules provide six independent 1X4 multiplexers for signals from dc to 3 GHz. Each HP E1472A multiplexer module can support up to two HP E1473A expander modules. Both modules use SMB connectors to assure high performance.

#### Specifications

**Maximum input voltage:** 42 V dc + ac peak

**Maximum input current per channel:** 1 A dc or ac rms

**Maximum power per channel:** 24 W or 24 VA

ac performance:	< 10 MHz	< 100 MHz	< 1.3 GHz	< 3 GHz
Insertion loss (dB)	< .1	< .4	< 1.5	< 8
Crosstalk (dB)	< -90	< -80	< -50	< -20 (typ)
VSWR	< 1.05	< 1.15	< 1.35	< 1.5

SUPPORTED BY  
\*  
HP ITG  
SOFTWARE

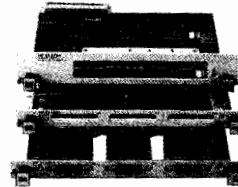

HP E1368A, E1369A, E1370A

### Microwave Switch and Driver (HP E1368A, E1369A, E1370A)

The HP E1368A 18-GHz microwave switch, E1369A microwave switch driver, and E1370A microwave switch/attenuator driver are B-size VXI modules that provide microwave switching and attenuator capability for test systems.

The HP E1368A has three independent SPDT 50  $\Omega$  coaxial switches with excellent performance from dc to 18 GHz. The HP E1369A allows you to mount three HP 3331xx coaxial switches for switching up to 26.5 GHz signals (switches must be ordered separately). The HP E1370A allows you to mount one HP 3336xx microwave switch or one HP 3332xx step attenuator for switching or attenuating signals up to 26.5 GHz (switches and attenuators must be ordered separately).

#### Specifications for the HP E1368A

**Frequency range:** dc to 18 GHz

**Isolation:** > 90 dB

**Characteristic impedance:** 50  $\Omega$

**Insertion loss:** < 0.5 dB

**VSWR:** < 1.4

For full specifications, see the HP 75000 VXI Product Catalog (HP pub. no. 5091-1587).

\*When used with the HP 75000 Series B or C, or the HP E1405A Command Module

# MEASUREMENT SYSTEMS ARCHITECTURE

## HP 75000 VXIbus Family

### Power Meter, Development Tools

SUPPORTED BY  
**HP ITG**  
SOFTWARE



HP E1416A

#### Power Meter (HP E1416A)

The HP E1416A power meter is a full-feature, message-based, single-channel average power meter. It has the capability of the popular HP 437B power meter in a single-slot C-size VXI module. The meter is compatible with HP 8480 thermocouple and diode sensors (see page 214).

#### Features:

- High accuracy
- 100 kHz to 50 GHz
- -70 to +44 dBm

The HP E1416A power meter combines exceptional meter linearity and low sensor SWR to provide outstanding measurement accuracy in demanding situations. Instrumentation accuracy is specified to be  $\pm 0.5$  percent in linear mode or  $\pm 0.02$  dB in logarithmic mode, making instrumentation uncertainty a negligible part of total measurement error. Features include automatic calibration and zeroing, frequency (and cal factor) entry, rel, offset, selectable resolution, duty cycle, range hold setting, save/recall of meter settings, and SCPI compatibility for easy programming.

#### Functions

**Frequency:** Allows entry of test signal frequency for cal factor selection.

**Offset:** Allows power measurement to be offset by  $\pm 99.99$  dB.

**Resolution:** Selectable of 0.1, 0.01, and 0.001 dB or 1 percent, 0.1 percent and 0.01 percent of full scale. Auto filter mode automatically selects the required number of averages for the chosen range and resolution.

**Averaging:** Selectable from 1 to 512 readings (in powers of 2).

**Duty cycle:** Displays peak power representation of measured rms power for rectangular pulses.

**Sensor tables:** Allows entry and editing of up to 10 frequency versus cal factor sensor tables.

**Save/recall states:** Saves and recalls 10 complete HP E1416A operating states.

#### Specifications

**Frequency:** 100 kHz to 50 GHz, sensor-dependent

**Power range:** -70 to +44 dBm (100 pW to 25 W), sensor dependent

**Power sensors:** Compatible with all HP 8480 series sensors.

**Dynamic range:** 50 dB in 10 dB ranges

**Display units:** W, dBm (absolute); %, dB (relative)

#### Accuracy

**Instrumentation:**  $\pm 0.02$  dB or  $\pm 0.5\%$

**Zero set:**  $\pm 0.5\%$  of full scale on most sensitive range. Divide by 10 for each higher range.

For full specifications, see the HP 75000 VXI Product Catalog (HP pub. no. 5091-1587).

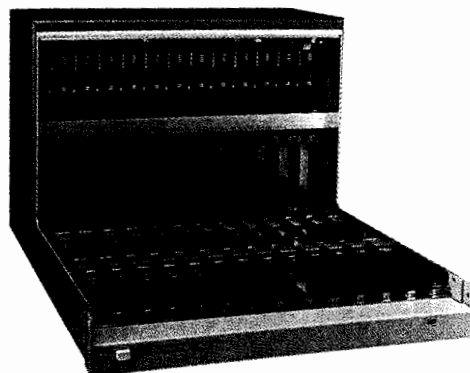

HP E1400T

#### VXI Development Mainframe (HP E1400T)

The HP E1400T development mainframe is a version of the HP E1400B Series C mainframe that can be used as a VXI development or repair station. The mainframe allows easy access to modules being developed or repaired. The HP E1400T mainframe meets all specifications of the HP E1400B mainframe, including power and cooling.

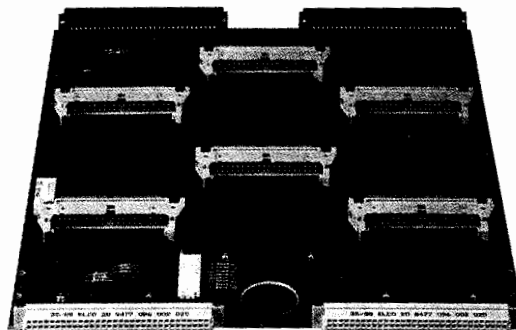

HP E1323A

#### VXI Preprocessor for HP Logic Analyzers (HP E1323A)

The HP E1323A VXI interface provides a complete mechanical and electrical connection between a VXI frame and an HP 16500 or HP 1650 series logic analyzer. With this equipment, you can monitor VXI cycle types and capture bus error conditions using the logic analyzer's state analysis with inverse assembly, or observe timing waveforms and bus handshakes with timing analysis.



HP E1403A

#### A/B-Size Active Module Carrier (HP E1403A)

The HP E1403A A/B-size Active Module Carrier extends the VXIbus backplane (P1 only) so VXIbus A and B-size modules can plug into the backplane of the HP 75000 Series C Mainframe and still mount with their front panels flush with other C-size modules.

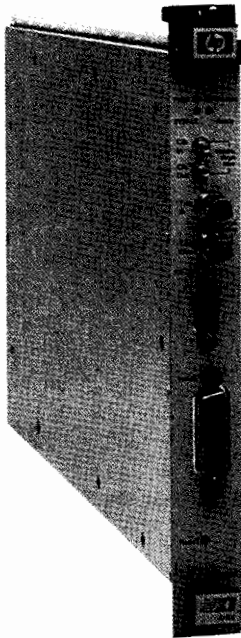

HP E1405B



#### Command Module (HP E1405B)

The HP E1405B command module is a C-size VXI module that has all Slot 0 and resource manager capabilities required by VXI. This module is an HP-IB to VXI interface, and makes both register-based and message-based modules appear as HP-IB instruments to an external computer. Built-in SCPI language makes it easy to program HP register-based cards, including all HP B-size modules. Built-in SCPI also allows ITG to access register-based cards.

SCPI provides consistent commands across different types of instruments. The command module provides a compatible growth path from the low-cost HP 75000 Series B to the high-performance HP 75000 Series C. Users can send high-level IEEE-488.2-compatible commands to program modules instead of sending binary data to and from registers.

#### Features

- HP-IB to C-size VXI interface
- Slot 0 plus resource manager
- Use in the HP 75000 Series C mainframe to provide SCPI capability for all register-based modules
- Optional RAM
- MXI bus protocol support for extending to multiple mainframes
- New SCPI drivers for updating command module to accommodate future register-based products

#### HP IBASIC Controller (HP E1300A Options 020, 021, 022; HP E1301A Options 020,021, 022; HP E1405B Option 020)

Add computing power to your system with more than 150 HP IBASIC commands, a subset of the popular HP BASIC language.

- Use with Series B mainframes or Series C command modules
- Run programs standalone
- Autostart from flexible or hard disk
- Get standard 512 KB non-volatile RAM
- Use optional 1 MB or 2 MB nonvolatile RAM for Series B
- Use optional 512Kbyte RAM for Series C
- Use an RS-232 terminal for development and display
- Control other equipment with RS-232 or HP-IB
- Remotely control Series B mainframes or Series C command modules with RS-232/422

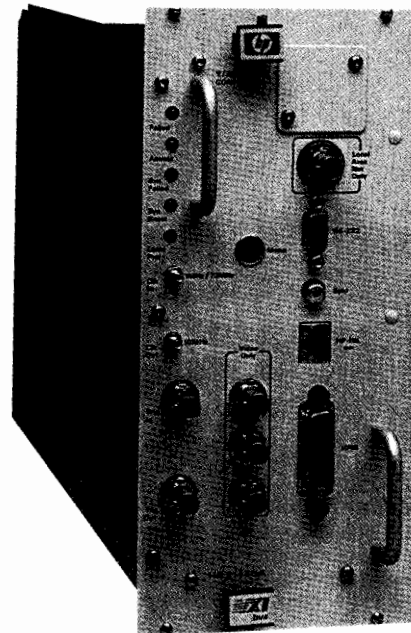

HP E1480A

#### V/360 Controller (HP E1480A)

The HP E1480A V/360 controller occupies four C-size VXI slots and has all Slot 0 and resource manager capabilities required by VXI. It has built-in HP-IB, RS-232, LAN, keyboard, and display ports. This module can access message-based modules on the backplane, or access register-based modules by sending SCPI commands through the HP-IB port on the command module (HP E1405B).

This controller is a Motorola 68030-based computer that can run either the HP BASIC/WS or HP-UX operating systems. With HP BASIC/WS, instrument control for a single-user, single-tasking system is simplified through high-level commands optimized for I/O. With HP-UX, you can use industry-standard networking, windowing systems, and databases with automated test. (Additional specific information on Model 360 can be found on page 98.)

#### Features

- Fast Motorola 68030-based CPU
- Runs either HP BASIC/WS or HP-UX (including HP BASIC/UX)
- Built-in HP-IB, RS-232, LAN, keyboard, and display ports
- HP-ITG compatible
- Disk interface
- 4 slots, C-size

# MEASUREMENT SYSTEMS ARCHITECTURE

## HP 75000 VXIbus Family

Extender, Fixtures

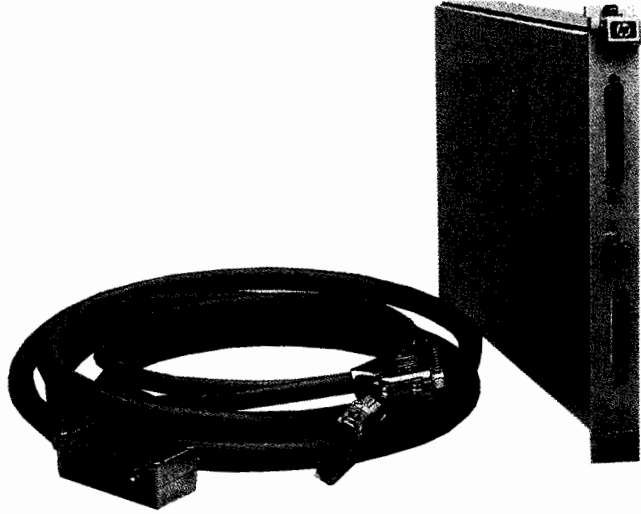

### HP E1482A VXI-MXI Extender (E1482A)

The E1482A is a high-speed MXIbus interface that connects VXI mainframes. It uses the industry-standard MXIbus architecture that allows the system controller to treat all mainframes as a single unit. The trigger and clock lines are extended via the standard INTX connection.

- Extends VXI mainframes and connects to MXIbus computer interfaces
- Has transparent interrupts and triggers
- Provides high-speed data link between computer and VXI mainframes

### Specifications

I/O:	Trigger input/output and external clock via SMB connectors
Connectors:	MXIbus and INTX
VXIbus compliance:	Rev 1.3
Supported devices:	HP E1405B Command Module and E1480A Embedded Computer

### HP 75000 System Resource Interface

The HP 75000 System Resource Interface (SRI) fixtures are designed to offer you high-density modular connections from your devices under test (DUTs) to your HP 75000 System. You can pick from three different versions of the fixture, depending on your configuration. These fixtures are manufactured to meet the requirements of the most demanding test environments. With all gold-plated contacts and a 25,000-plus interconnect cycle durability, they give you dependable connections time and time again. With the standard blocks for general-purpose, high-frequency coax, and power connections, these fixtures can accommodate thousands of possible configurations.

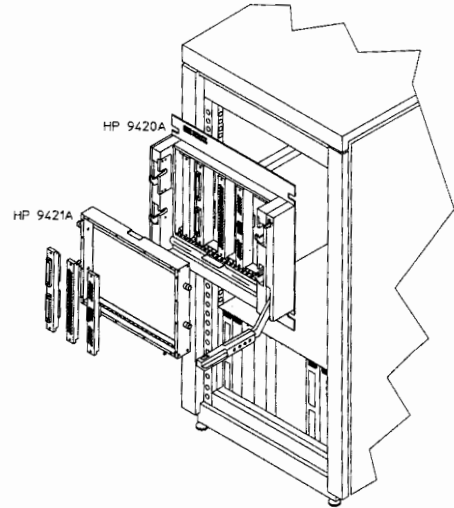

### HP 9420A Interface Connector Assembly (ICA)

The HP 9420A Interface Connector Assembly is mounted in a fixed position onto the test rack. The HP 9421A Interface Test Adapter (ITA) is an interchangeable quick-disconnect panel that interfaces to your DUT. There are 21 slots available on the fixture for standard interchangeable connector blocks. This fixture should be used when the majority of connections come from places other than the VXI mainframe.

### Specifications

#### HP 9420A Interface Connector Assembly (ICA)

Height	40.00 cm (15.75 in)
Width	48.30 cm (19.00 in)
Depth	10.16 cm (4.00 in)
Connector slots	21
Connector spacing	19.05 mm (0.75 in)

#### HP 9421A Interface Test Adapter (ITA) (without customer DUT fixture adapter)

Height	28.58 cm (11.25 in)
Width	41.91 cm (16.50 in)
Depth	3.81 cm (1.50 in)
Connector Spacing	19.05 mm (0.75 in)
Connector Slots	21 (mate with the slots on the HP 9420A and HP E3722A)

The following connector blocks and cable assemblies are used with all three fixtures. Note that the cable assemblies with connectors are not included with the connector blocks (except for the sense pins on the power connector block).

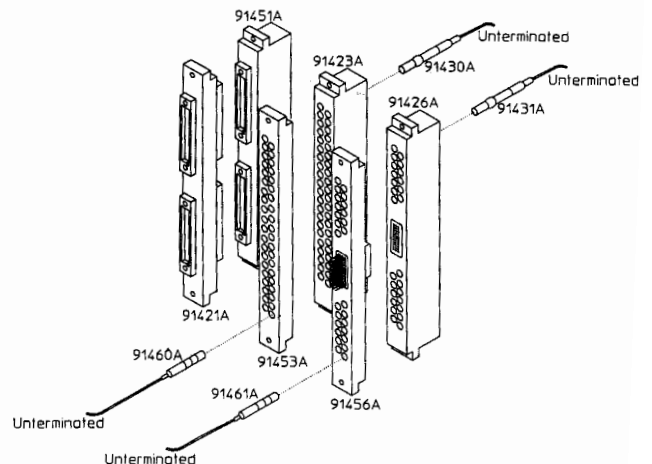

#### Connector Block Specifications

**General-Purpose Connector Blocks:**  
 HP 91421A (for ICA, V/ICA, and H/ICA)  
 HP 91451A (for the ITA, and V/ITA)

No. of pins	192
Voltage	250 VDC max
Current	3 A max
Impedance	40 to 60 $\Omega$
Bandwidth	100 MHz
Durability	25,000 cycles

Connector holes	36
Voltage	250 VAC max
Current	1.5 A max
Impedance	50 $\Omega$
Bandwidth	500 MHz
VSWR	1.2 at 600 MHz
Durability	50,000 Cycles

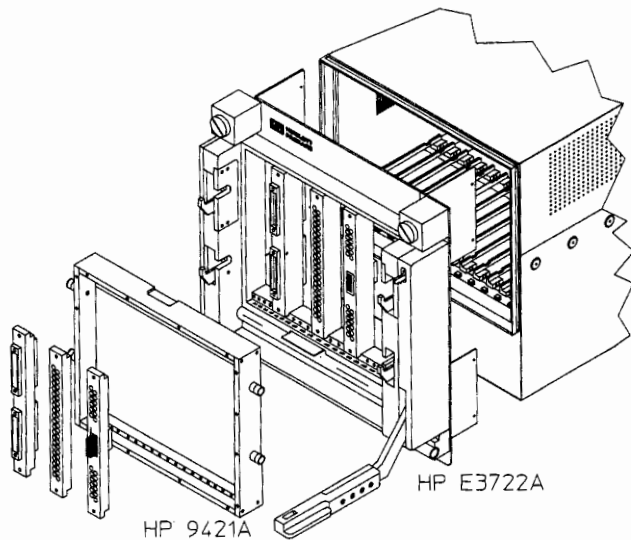
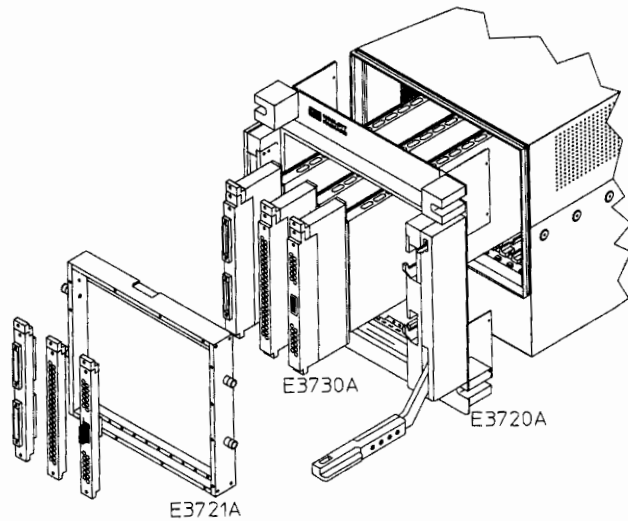

#### HP E3720A VXI Interface Connector Assembly (V/ICA)

The HP E3720A VXI Interface Connector Assembly mounts directly to the front of the HP 75000 Series C Cardcage. Access to the VXI plug-in cards is available without removing the V/ICA. The HP E3721A VXI Interface Test Adapter (V/ITA) is an interchangeable quick-disconnect panel that interfaces to your DUT. There are 13 connector slots available on the fixture for standard interchangeable connector blocks. This fixture should be used when minimum lead lengths are required and the majority of fixtured connections are wired directly to VXI plug-in cards.

#### Specifications

##### HP E3720A VXI Interface Connector Assembly (V/ICA)

Height	40.00 cm (15.75 in)
Width	48.30 cm (19.00 in)
Depth	76.70 cm (30.20 in)
(including cardcage with rear feet)	
Connector slots	13
Connector spacing	30.48 mm (1.20 in)

#### Coax Connector Blocks:

- HP 91423A (for ICA, V/ICA, and H/ICA)
- HP 91430A Coax Terminal Cable Kit (ICA)  
(12 cables with connectors for use with HP 91423A)
- HP 91453A (for ITA and V/ITA)
- HP 91460A Coax Terminal Cable Kit (ITA)  
(12 cables with connectors for use with HP 91453A)

#### Power Connector Blocks w/sense:

- HP 91426A (for ICA, V/ICA, and H/ICA)
- HP 91431A Power Terminal Cable Kit (ICA)  
(12 cables with connectors for use with HP 91431A)
- HP 91456A (for ITA and V/ITA)
- HP 91461A Power Terminal Cable Kit (ITA)  
(12 cables with connectors for use with HP 91461A)

Connector holes	24
Sense pins	36
Resistance	6 m $\Omega$
Voltage	250 VAC max
Current	30 A max per pin
Bandwidth	1 kHz
Durability	50,000 cycles

#### HP E3722A Hinged Interface Connector Assembly (H/ICA)

The HP E3722A Hinged Interface Connector Assembly mounts directly to the HP 75000 Series C Cardcage. The VXI plug-in cards are accessible when the ICA is opened to the horizontal position. The HP 9421A Interface Test Adapter (ITA) is an interchangeable quick-disconnect panel that interfaces with your DUT. There are 21 slots available on the fixture for standard interchangeable connector blocks. This fixture should be used when the majority of connections are wired directly to VXI plug-in cards.

#### Specifications

##### HP E3722A Hinged Interface Connector Assembly (H/ICA)

Height	40.00 cm (15.75 in)
Width	48.30 cm (19.00 in)
Depth	76.70 cm (30.20 in)
(including cardcage with rear feet)	
Connector slots	21
Connector spacing	19.05 mm (0.75 in)

Note: 88.9 mm (3.5 in) cable tray included. Uses HP 9421A ITA

# MEASUREMENT SYSTEMS ARCHITECTURE

## HP 75000 VXibus Family

### Ordering Information

#### Ordering Information

##### Series C Mainframes

**HP E1492B** HP 75000 Series C Starter System. Includes HP E1400B Mainframe with Opt 908 plus HP E1405B Command Module. \$8,750

**HP E1400B** HP 75000 Series C Mainframe \$6,350

**Opt 907** Front Handle Kit +\$170

**Opt 908** Rack Mount Flanges & Rails (includes hardware) +\$180

**Opt 909** Rack Mount Flanges, Handles, & Rails (includes hardware) +\$350

**E1400-80003** Rack Slide kit\* (includes heavy-duty slides, cable tray, hardware, non-tilting)

\*The price of this product was not available at time of printing.

##### Series B mainframes

**HP E1300A** HP 75000 Series B Mainframe (without front panel) \$2,320

**HP E1301A** HP 75000 Series B Mainframe (w/front-panel keyboard/display) \$2,900

##### System Options Installed (choose one):

**Opt 020** HP IBASIC Controller w/512 KB nonvolatile memory +\$1,000

**Opt 021** HP IBASIC Controller w/1 MB nonvolatile memory +\$1,600

**Opt 022** HP IBASIC Controller w/2 MB nonvolatile memory +\$2,400

**Opt 010** 512-KB nonvolatile memory +\$600

**Opt 011** 1-MB nonvolatile memory +\$1,000

**Opt 012** 2-MB nonvolatile memory +\$1,800

##### Disk storage options installed (choose one); requires HP IBASIC):

**Opt 005** 3½-in: flexible disk drive only +\$850

**Opt 006** 20-MB ruggedized hard disk only +\$1,900

**Opt 007** 20-MB ruggedized hard disk plus flexible disk +\$2,100

**Opt 008** External dc power operation installed +\$700

**Opt 009** HP E1326B 5¼-digit multimeter installed internally +\$1,340

**Opt 907** Front Handle Kit +\$80

**Opt 908** Rack Mount Flanges & Rails (includes hardware) +\$130

**Opt 909** Rack Mount Flanges, Handles, & Rails (includes hardware) +\$210

**1494-0059** Rack Slide Kit (includes hardware, non-tilting) \$100

##### Interfaces

**HP E1482A** Series C VXI Extender MXI bus \$2,754

**HP E1324A** RS-232C/422 Data Comm Module \$650

##### Field installation kits

**HP E1300-80001** HP IBASIC (requires at least 512-KB memory) \$700

**HP E1300-80002** 512-KB Nonvolatile Memory for Series B Mainframe (2-MB maximum per mainframe) \$600

**HP E1300-80003** 1-MB Nonvolatile Memory for Series B Mainframe (2-MB maximum per mainframe) \$1,000

**HP E1300-80005** 3½-in Flexible Disk Drive (requires HP IBASIC and disk controller) \$200

**HP E1300-80006** 20-MB Hard Disk (requires HP IBASIC and disk controller) \$1,250

**HP E1300-80011** Disk Controller for Series B Mainframe (only one required per mainframe) \$650

**HP E1300-80008** External dc Power Operation for Series B Mainframe \$700

**HP E1326-80004** Internal Installation Kit for Series B Mainframe for HP E1326B 5¼-Digit Multimeter \$142

#### Price

#### Series C Command Module

**HP E1405B** Command Module \$2,830

**Opt 020** HP IBASIC Controller \$51,000

#### Power meters

**HP E1416A** Power Meter \$2,500

**Opt 915** Service Manual +\$50

**Opt 916** Additional Users' Manual +\$50

**HP 11730A** Accessories supplied: one 1.5-meter (5-ft) sensor cable \$0

#### Multimeters

**HP E1410A** 6½-Digit Multimeter (includes bus cable) \$3,540

**Opt 1BN** MIL-STD-45662A Calibration Certification +\$200

**HP E1411B** 5½-Digit Multimeter, Series C (includes bus cable) \$1,600

**Opt 1BN** MIL-STD-45662A Calibration Certification +\$160

**HP E1326B** 5½-Digit Multimeter, Series B (includes bus cable) \$1,300

**Opt 1BN** MIL-STD-45662A Calibration Certification +\$120

**HP E1326-80004** Internal Installation Kit for HP E1326B 5½-Digit Multimeter \$142

#### Oscilloscopes

**HP E1426A** Digitizing Oscilloscope \$7,950

**HP E1428A** Digitizing Oscilloscope \$12,950

#### Counters

**HP E1420B** High-Performance Universal Counter \$3,450

**Opt 010** TCXO Time Base \$500

**Opt 030** UHF Input Channel \$950

**Opt 040** Shared RAM \$500

**HP E1332A** 4-Channel Counter/Totalizer \$910

**Opt 1BN** MIL-STD-45662A Calibration Certification +\$90

**HP E1333A** 3-Channel Universal Counter \$910

**Opt 1BN** MIL-STD-45662A Calibration certification +\$90

#### Sources

**HP E1440A** 21-MHz Synthesized Function/Sweep Generator \$5,700

**Opt 001** High-Voltage Output \$310

**HP E1445A** Arbitrary Function Generator \$7,000

**HP E1446A** Summing Amplifier/DAC \$2,750

**HP E1340A** Arbitrary Function Generator \$2,500

**HP E1328A** 4-Channel D/A Converter \$1,100

#### Digital

**HP E1493A** HP 75000 Model D20 Digital Functional Test System (includes HP E1450A, HP E1452A, HP E1453A, two HP E1454A, and downloadable SCPI driver) \$11,455

**Opt 001** Add an HP E1451A and two HP E1454As \$4,680

**HP E1494A** Model D20 Digital Test Development System (includes HP E1450A, HP E1452A, HP E1453A, two HP E1454As, HP E1496A, and downloadable SCPI driver) \$14,455

**Opt 001** Add an HP E1451A and two HP E1454As \$4,680

#### The following components are orderable separately:

**HP E1450A** 160 MHz Timing \$6,600

**HP E1451A** 20 MHz Pattern I/O \$3,500

**HP E1452A** Terminating 20 MHz Pattern I/O \$3,500

**HP E1453A** Timing Pod \$675

**HP E1454A** Pattern Pod \$590

**HP E1496A** Digital Test Development Software \$3,500

**HP E1330A** Quad 8-bit Digital Input/Output (includes interface cable) \$610

### Ordering Information

#### Relay Multiplexers

	Price
<b>HP E1345A</b> 16-Channel Relay Multiplexer (includes bus cable)	\$660
<b>HP E1346A</b> 48-Channel Single-Ended Relay Multiplexer (includes bus cable)	\$810
<b>HP E1347A</b> 16-Channel Thermocouple Relay Multiplexer (includes bus cable)	\$760
<b>HP E1460A</b> 64-Channel Relay Multiplexer (includes bus cable)	\$2,420
<b>HP E1355A</b> 8-Channel 120-Ohm Strain Relay Multiplexer	\$925
<b>HP E1356A</b> 8-Channel 350-Ohm Strain Relay Multiplexer	\$925

#### FET Multiplexers

<b>E1351A</b> 16-Channel FET Multiplexer	\$875
<b>E1352A</b> 32-Channel Single-ended FET Multiplexer	\$1,000
<b>E1353A</b> 16-Channel Thermocouple FET Multiplexer	\$975
<b>HP E1357A</b> 8-Channel 120-Ohm Strain FET Multiplexer	\$1,125
<b>HP E1358A</b> 8-Channel 350-Ohm Strain FET Multiplexer	\$1,125

#### RF Multiplexers

<b>HP E1366A</b> 50-Ohm RF Multiplexer (2 × 4: 1)	\$860
<b>HP E1367A</b> 75-Ohm RF Multiplexer (2 × 4: 1)	\$860
<b>HP E1472A</b> 50-Ohm RF Multiplexer (6 × 4: 1)	\$2,530
<b>HP E1473A</b> 50-Ohm RF Multiplexer Expander (6 × 4: 1) (includes cable)	\$1,520
<b>HP E1473-80002</b> Cable Extension Kit for RF Multiplexer Expander (2 cables)	\$66

#### Microwave

<b>HP E1368A</b> 18-GHz Microwave Switch	\$2,120
<b>HP E1369A</b> Microwave Switch Driver (includes cable)	\$510
<b>HP E1370A</b> Microwave Switch/Attenuator Driver	\$500

#### Switches

<b>HP E1465A</b> 16 × 16 Relay Matrix	\$4,950
<b>HP E1466A</b> 4 × 64 Relay Matrix	\$4,950
<b>HP E1467A</b> 8 × 32 Relay Matrix	\$4,950
<b>HP E1463A</b> 32-Channel 5 Amp, Form C Switch	\$1,600
<b>HP E1468A</b> 8 × 8 Relay Matrix	\$2,400
<b>HP E1469A</b> 4 × 16 Relay Matrix	\$2,400
<b>HP E1361A</b> 4 × 4 Relay Matrix	\$660
<b>HP E1364A</b> 16-Channel Form-C Switch	\$660

#### Development Tools

<b>HP E1400T</b> VXI Development Mainframe	\$6,275
<b>HP E1323A</b> VXI Preprocessor for HP Logic Analyzers	\$1,200
<b>HP E1402A</b> VME Module Adapter	\$560
<b>HP E1399A</b> Register-Based Breadboard, Series B	\$400
<b>HP E1490B</b> Register-Based Breadboard, Series C	\$900
<b>HP E1403A</b> A/B-Size Active Module Carrier	\$298
<b>HP E1408A</b> A/B-Size Module Carrier	\$298
<b>HP E1409A</b> Series C Chassis Shield	\$150

### System Computers

**HP E1480A** HP V/360 Controller \$9,950  
 (Includes 4 MB RAM, HP-IB, RS-232, HP-HIL, audio, two-channel DMA, LAN, Slot 0 functionality as well as HP-UX and HP BASIC/UX License-to-Use. Monitor, keyboard and software must be ordered separately. You must also order one of Opts 500 through 550 below. Opts 010 & 011 cannot be ordered concurrently.)

<b>Opt 010</b> 98262A High-Speed HP-IB Disk Interface	+ \$990
<b>Opt 011</b> 98265A SCSI disk interface	+ \$400
<b>Opt 108</b> Add 4 MB RAM for a total of 8 MB RAM	+ \$5,040
<b>Opt 112</b> Add 8 MB RAM for a total of 12 MB RAM	+ \$9,780
<b>Opt 116</b> Add 12 MB RAM for a total of 16 MB RAM	+ \$14,200
<b>Opt 500</b> No graphics subsystem	\$0
<b>Opt 542</b> 98542A Medium-Resolution Monochrome Graphics Board, 512 × 480	+ \$845
<b>Opt 543</b> 98543A Medium-Resolution 4-Plane Color Graphics Board	+ \$1,340
<b>Opt 544</b> 98544A High-Resolution Monochrome Graphics Board, 1024 × 768	+ \$1,610
<b>Opt 549</b> 98549A High-Resolution 6-Plane Color Graphics Board	+ \$2,140
<b>Opt 550</b> 98550A High-Resolution, High-Performance Color Graphics	+ \$4,140

If you plan to communicate directly across the VXI backplane from the V/360, order the following:

<b>HP E1481A</b> V/360 VXIbus Drivers, Media, & Documentation	\$200
<b>HP E1481L</b> V/360 VXIbus Drivers, License-to-Use	\$350
<b>HP E1404A</b> Slot 0/Translator	\$850

### System Resource Interface

<b>HP 9420A</b> Interface Connector Assembly	\$3,425
<b>HP E3720A</b> VXI Interface Connector Assembly (V/ICA)	\$4,500
<b>HP E3722A</b> Hinged Interface Connector Assembly (H/ICA)	\$4,900
<b>HP 91422A</b> General-Purpose Connector Block	\$190
<b>HP 91423A</b> Coax Connector Block	\$122
<b>HP 91430A</b> Coax Terminal Cable Kit: 60 in (ICA) (12 each)	\$389
<b>HP 91426A</b> Power Connector Block w/sense	\$250
<b>HP 91431A</b> Power Terminal Cable Kit: 60 in (ICA) (12 each)	\$313
<b>HP 9421A</b> Interface Test Adapter	\$385
<b>HP E3721A</b> VXI Interface Test Adapter (V/ITA)	\$450
<b>HP E3730A</b> VXI Interface Terminal Module	\$310
<b>HP 91452A</b> General-Purpose Connector Block	168
<b>HP 91453A</b> Coax Connector Block	\$105
<b>HP 91460A</b> Coax Terminal Cable Kit: 36 in (ITA) (12 each)	\$302
<b>HP 91456A</b> Power Connector Block w/sense	\$140
<b>HP 91461A</b> Power Terminal Cable Kit: 36 in (ITA) (12 each)	\$184
<b>HP 91455A</b> Blank Connector Block	\$33
<b>HP 91439A</b> Terminal Extraction Tool Kit	\$207

# MEASUREMENT SYSTEMS ARCHITECTURE

## HP 70000 Modular Measurement System

### General Information

- Optimized for RF and microwave automatic-test systems
- Modular for easier system integration
- Wide variety of products and configurations available

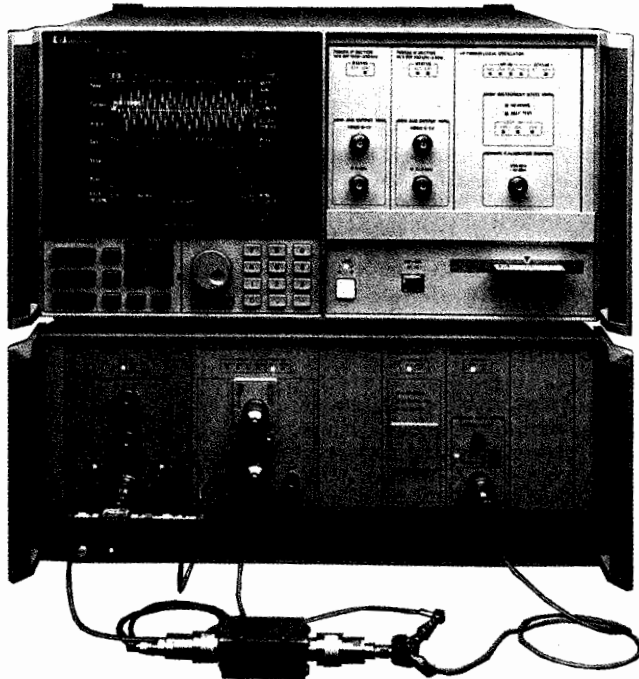

HP 71100A with HP 70300A and 70138A



### HP 70000 Modular Measurement System

The HP 70000 modular measurement system (MMS) is a high-performance instrument system that covers frequencies from RF and microwave to lightwave. It helps you reduce cost, save time, and minimize risk whether you are integrating, using, supporting, or upgrading measurement systems. More than 40 modules, displays, mainframes, and standard systems are available. You can also combine MMS with other systems — such as those in the HP Measurement Systems Architecture — that are based on open, international standards.

#### Designed for Performance

The architecture of the modular measurement system is optimized for RF and microwave instrumentation while meeting industry's need for downsized, modular products. RF and microwave systems require good electromagnetic compatibility (EMC) characteristics to achieve high levels of performance. MMS products meet these critical EMC standards and give you proven performance today.

The fast, internal modular system interface bus (MSIB) allows you to control the HP 70000 system remotely. Instruments can be separated by large distances — up to 1.2 km — and manually operated from one or more locations. A central display, which is also the user interface, can monitor up to four remote instruments simultaneously.

#### Save Time

System integrators can quickly configure modular test systems using numerous off-the-shelf mainframes, components, and software packages. Modularity allows systems of all sizes to be tailored easily to suit your requirements. In addition, a variety of products and services are available to help you customize your entire system or design and build a single custom module.

### Maximize Your Investment

A number of factors reduce the life-cycle costs of the modular measurement system. Modularity provides an easy path for upgrading performance or adding new capabilities. Because the MMS architecture is open (you can build into the system without cost or license requirements) and compatible with other open standards, you can make use of new and existing hardware, software, and engineering expertise. Also, since MMS instruments are smaller than traditional HP-IB instruments and optimized for ATE systems, rack space is reduced. The central display/user interface is shared among instruments, eliminating display and front-panel redundancy. When the display is not needed, it can be excluded from the system, saving even more space and reducing costs.

HP offers many system support alternatives for the MMS. Built-in diagnostics and diagnostic software ensure high system uptime by quickly locating system problems to the module level. You can also make in-house calibrations and repairs using HP documentation and software, or you can return instruments to one of HP's many Customer Service Centers worldwide.

With the modular measurement system, you are assured of the highest performance and best customer support — today and in the years to come.



### Modular Measurement System HP 70000 Family

The complete catalog  
of HP 70000 Modular  
Measurement System  
(MMS) solutions and  
components.  
April 1991

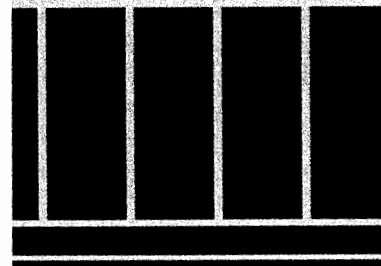

### Free MMS Catalog

The following pages highlight selected components and systems in the HP 70000 family. A complete listing of all MMS products, specifications, and services is also available. For a free copy of the new 140-page HP 70000 Modular Measurement System catalog, contact your local HP sales office, listed on page 684. Ask for HP part number 5952-2170.



(Preliminary Information)



HP 70340A



## HP 70340A Modular Synthesized Signal Generator

### A New Standard of Performance and Value

The new HP 70340A Modular Signal Generator satisfies the demands of tomorrow's ATE for a smaller high-performance signal source. Combining superior reliability, excellent performance, a reduced footprint, and modular flexibility, the HP 70340A sets a new standard with unprecedented value.

### All the Performance of Traditional Rack-n-Stack Sources in Half the Rack Space

Test receivers and subsystems from 1 GHz through 20 GHz with confidence knowing that even at full power (typically  $> +12$  dBm) the HP 70340A provides superior harmonic ( $-55$  dBc) and spurious ( $-60$  dBc) performance. Excellent output power accuracy ( $\pm 1$  dB) and flatness ( $\pm 0.6$  dB) are maintained across the full HP 70340A 100 dB dynamic range. Sweep power linearly and accurately to test power-sensitive devices. Generate real world signals using the FM pulse and logarithmic AM modulations.

The HP 70340A combines superior internal level accuracy and flatness with the flexibility of User Level Correction. This feature allows users to calibrate and program the signal generator output for automatic leveled power at distant test ports. Level correction tables can be stored in memory for quick access as the system is reconfigured for different DUTs or test scenarios. Internal level accuracy is maintained at all output levels by means of pre-programmed correction data.

Other features target more specific applications. The logarithmic amplitude modulation (log AM) can be combined with the fast pulse modulation to simulate antenna scanning patterns of pulsed EW emitters. Log AM also can be used to sweep output power with excellent linearity for use in component testing. The high index FM provides extra capability for testing telemetry and other wide deviation systems.

### Performance, Value and Flexibility to Satisfy Any Application

Designed to meet the demanding requirements of modern ATE systems, the HP 70340A also excels as a benchtop or dedicated test station source. Combine the HP 70340A with other HP modular instruments to provide a high-performance communications test station. The high output power and low phase noise make the HP 70340A an excellent choice as a local oscillator for BER and C/N testing.

The HP 70340A is a natural companion signal source for the HP 71500A Microwave Transition Analyzer. Together, these two modular instruments offer powerful component test capability in a small, easy-to-use package. Test pulsed components with ease using the HP 70340A's fast, clean pulse modulation. Option 1E8 provides the 1 Hz frequency resolution needed for full system capability.

- Broadband frequency coverage: 1 to 20 GHz
- Outstanding output level accuracy and flatness
  - $\pm 1$  dB accuracy
  - $\pm 0.6$  dB flatness
- Versatile programming: SCPI and CIIL
- Superior EMI performance
- High-performance modulation: AM, FM, and pulse
- Excellent spectral purity:  $-55$  dBc harmonics  
 $-60$  dBc spurious

The HP 70340A is also a top performer in bench-top applications. Improve synchronization, eliminate clutter, and increase test flexibility without loss of capability. The high performance and superior EMI shielding of the HP 70340A make it ideal for state-of-the-art research and development, leading edge manufacturing, quality assurance, and metrology applications.

### The Platform for the Future

The HP 70340A is the first in a series of modular, high performance signal sources to come from HP. Proprietary microwave components and a new signal path architecture achieve a combination of output power, spectral purity, modulation, size, and weight unmatched in any other signal source. The extensive use of Surface Mount Technology provides high reliability while minimizing module size. The HP 70340A's built-in functional verification firmware enables a system operator or control program to determine instrument status at any time. In addition, these routines speed fault isolation and repair. The HP 70340A features a mean time to repair of less than 0.75 hours! When required, the time to fully calibrate a unit is less than 6 hours. The estimated MTBF for the HP 70340A is greater than 20,000 hours.

System software longevity and transportability are critical issues in ATE system design. SCPI and CIIL programming compatibility assures that ATE designed around the HP 70340A can realize all the advantages of modular systems in a consistent, fully transportable software environment.

### Abbreviated Specifications

For complete specifications refer to the HP 70340A technical data sheet lit. no. 5091-1593.

- Frequency Range:** 1 to 20 GHz
- Resolution:** 1 kHz, 1 Hz with Option 1E8
- RF Output:**  $+8$  to  $-90$  dBm
- Resolution:** 0.01 dB
- Accuracy:**  $\pm 1$  dB,  $-4$  dBm to maximum power
- Harmonics:**  $-55$  dBc
- Non-Harmonic Spurious:**  $-60$  dBc
- Phase Noise:**  $-86$  dBc/Hz at 10 kHz offset at 6 GHz
- Modulation:** AM, FM, Pulse
- Size:** 4/8 MMS module
- Weight:** Net,  $< 9$  kg (20 lb)

### Ordering Information

Pricing was not final at press time. Please consult your HP sales representative for details.

- HP 70340A** Modular Signal Generator
- Opt 1E1** Add output step attenuator
- Opt 1E8** 1 Hz frequency resolution
- Opt 1E9** 3.5 mm RF output connector



**Digital Design**

Designers of digital integrated circuits and monolithic microwave integrated circuits (MMICs) can use the HP 71500A microwave transition analyzer to model and characterize devices.

Capabilities for high-frequency measurements in the time domain include 1 ps time scale accuracy and internal triggering to 40 GHz. Phase triggering and noise filtering allow you to measure signals as low as -60 dBm (220 μV rms). Viewing events prior to the trigger can be done easily without delay lines. You also have the benefit of viewing simultaneously the time domain waveform and the frequency domain spectrum, including the phase relationship between the signal and its harmonics.

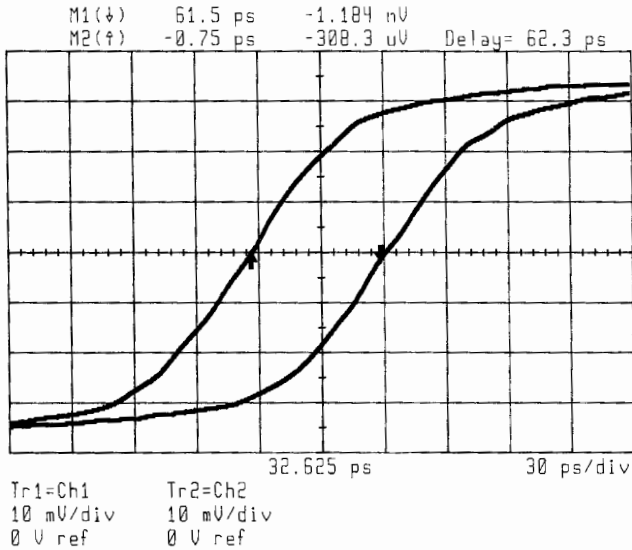

**Communications Test**

In the testing of high-speed communication systems, the microwave transition analyzer can be used with an external controller to measure the group delay of receivers. The system measures the group delay of satellites and other high-speed communication systems that use phase shift keying (PSK), narrowband FM, and other digital modulation techniques.

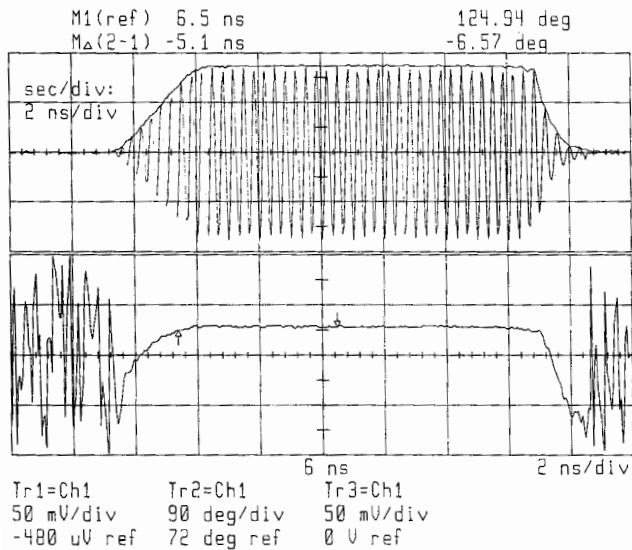

**Radar Test**

You can test synthesized radar systems with measurements such as deviation from linear chirp. The microwave transition analyzer displays amplitude, phase, and frequency versus time for modulation rates to greater than 1 GHz. Maximum frequency deviation is equal to 500 divided by the time span in seconds.

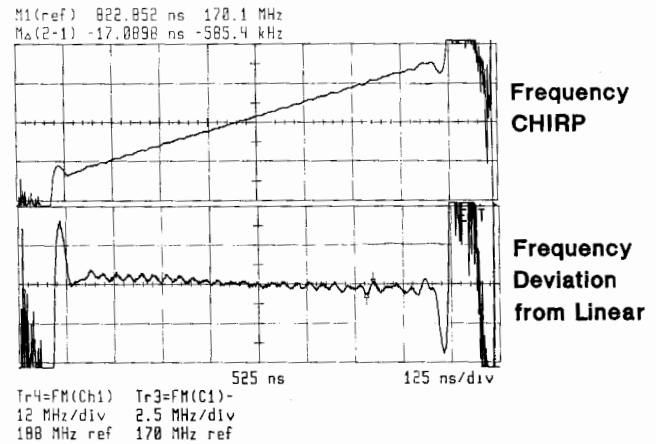

Extensive user math functions allow you to easily characterize your radar system.

**More Information**

Detailed specification and application materials are available in a variety of formats. To order any of the following free of charge, contact your local Hewlett-Packard sales office listed on page 684.

**Color Brochure**

Lit. #5091-0791E

**Videos:**

- Microwave Design in Radar and Communications* P/N 90454T
- Switched and Pulsed RF Component Testing* P/N 90453T

**Product Notes:**

- The Microwave Transition Analyzer: A Versatile Measurement Set for Bench and Test* Lit. #5952-2543
- The Microwave Transition Analyzer: Measure 25 ps Transitions in Switched and Pulsed Microwave Component Testing* Lit. #5952-2546
- The Microwave Transition Analyzer: Picosecond Delta Time Accuracy* Lit. #5952-2545

**Technical Data Sheet**

(Specifications and complete ordering information): Lit. #5091-0792E

**Catalog**

*Modular Measurement System Catalog* Lit. #5952-2170

**Ordering Information**

	<b>Price</b>
<b>HP 71500A</b> Microwave Transition Analyzer System	\$42,900
<b>Opt 003</b> Add Tutorial Kit	+\$2,600
<b>Opt 910</b> Add Extra Set of User's Manuals	+\$250
<b>Opt 915</b> Add Service Manuals	+\$200
<b>HP 70820A</b> Microwave Transition Analyzer Module	\$32,500
<b>Opt 003</b> Add Tutorial Kit	+\$2,600
<b>Opt 910</b> Add Extra Set of User's Manuals	+\$150
<b>Opt 915</b> Add Service Manuals	+\$100
<b>Opt W30</b> Extended Repair Service (see page 671)	+\$815

# MEASUREMENT SYSTEMS ARCHITECTURE

## HP 70000 Modular Measurement System Spectrum Analyzers

- High performance
- Modular flexibility
- HP 8566B code compatibility

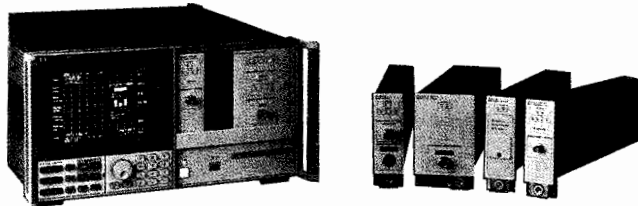

HP 70000 Series



### HP 70000 Series Spectrum Analyzers

Four HP factory-configured spectrum analyzers cover the RF and microwave frequency range. The HP 71100C makes high-performance RF measurements from 100 Hz to 2.9 GHz. The new HP 71209A gives you outstanding performance from 100 Hz to 26.5 GHz at a reasonable cost. The HP 71200C offers maximum flexibility for configuring optional preamplifiers, preselectors, and RF sections — and offers a range of prices. Frequency coverage is 50 kHz to 22 GHz or 26.5 GHz. The HP 71210C provides the ultimate in sensitivity and a dynamic tracking preselector that provides highly repeatable amplitude measurements. Frequency range is 100 Hz to 22 GHz.

All 4 systems include the HP 70004A color display and mainframe, as well as a custom hardkey panel with the most commonly used spectrum analyzer functions. Digital persistence in the color display simulates the variable intensities of an analog display without sacrificing the storage and plotting capabilities of the digital instrument. This allows you to extract information from complex modulation signals such as TV, pulsed RF, and FM.

See the MMS catalog described on page 102 for complete details on MMS instruments and systems.

### Performance Gives You the Competitive Edge

The synthesized performance of HP 70000 spectrum analyzers gives you precise, high-speed tuning for use in the lab and manufacturing and in integrated test systems. Excellent sensitivity, phase noise, and dynamic range allow you to make even the most demanding RF and microwave measurements. Display fidelity of  $\pm 0.7$  dB allows you to accurately measure amplitude anywhere within the

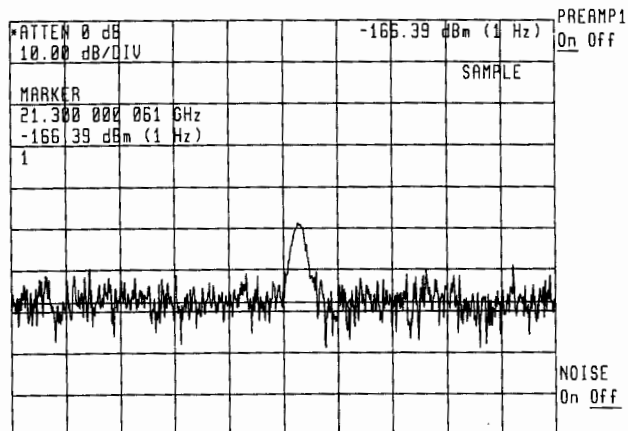

Excellent sensitivity allows you to measure extremely low level signals.

90 dB calibrated display range without using time-consuming IF substitution techniques. An oven-controlled reference oscillator gives 0.1 ppm frequency accuracy and stability over temperature and time. Resolution bandwidths to 10 Hz are standard on all systems.

Selected specifications for these spectrum analyzers are found on page 253. For complete specifications, see the MMS catalog.

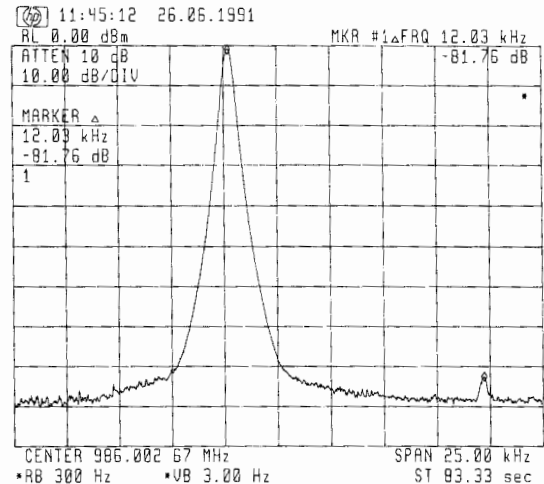

Low phase noise allows you to measure adjacent channel power of high-performance communication systems.

### Code Compatibility with the HP 8566B

To ease the transition to a high-performance ATE analyzer with the support and configuration benefits of modularity, the new HP 71209A spectrum analyzer offers code compatibility with the HP 8566B microwave spectrum analyzer. (See product note 70900-1 for more information.)

### Flexibility for Automated Systems

With the HP 70000 Series spectrum analyzers, you can customize your automated test system and expand it as needed. By combining the analyzers with accessory modules, switch matrixes, and application software, you can build a system with just the right performance. For example, add a digitizer for radar testing, tracking generators and a vector voltmeter for component testing, preamplifiers for spurious testing and surveillance applications, and an external mixer interface (standard on the HP 71209A) for millimeter measurements.

Hewlett-Packard also offers a series of design tools to help you build custom modules. These include MSIB interface software, module development design guides (electrical, mechanical, and EMC), communication design guides (bus protocol and interface, display interface), and four module prototype kits with hardware for 1/8- to 1/4-width modules.

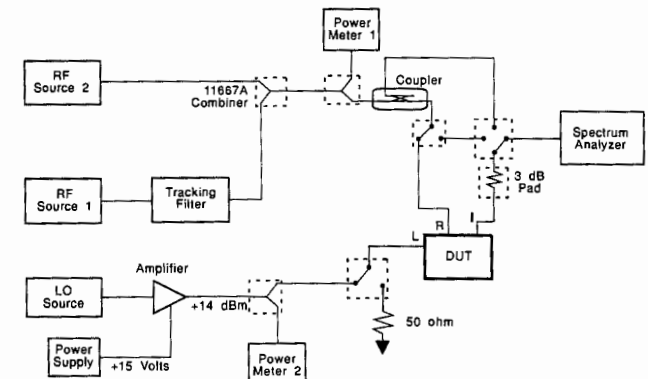

The MMS allowed a 1/4 reduction in rack space for this custom-designed mixer test system.

# MEASUREMENT SYSTEMS ARCHITECTURE

## HP 70000 Modular Measurement System

Preamplifiers, Tracking Generators, Digitizer

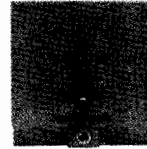
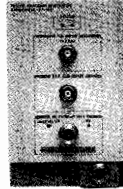
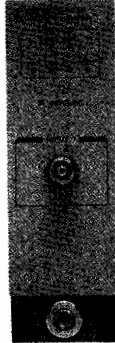
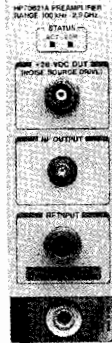
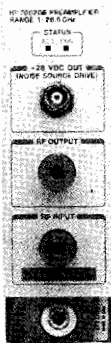

HP 70620B, 70621A, 70700A, 70300A, 70310A

### HP 70620 Series Preamplifiers

Boost the sensitivity of any HP 70000 series spectrum analyzer by 15 to 25 dB using the HP 70621A preamplifier (100 kHz to 2.9 GHz) and the HP 70620B preamplifier (1 to 26.5 GHz; 100 kHz to 26.5 GHz with Option 001). For RF applications, a -134 dBm sensitivity improves to -156 dBm, and for microwave applications, a -133 dBm sensitivity improves to -150 dBm at 22 GHz. See page 253 for sensitivity specifications with individual spectrum analyzers.

System noise figure can be better than 8 dB to 2.9 GHz, 11 dB to 12.8 GHz, and 14 dB at higher frequencies. You can dramatically reduce the test time for spurious measurements because the low system noise figure lets you use a wider-resolution bandwidth, yet achieve the same sensitivity. Sweep times can improve up to a factor of 100 for each decade increase in bandwidth.

The preamplifier modules also provide a drive signal for an external excess noise source, allowing you to measure the noise figures of amplifiers and other devices.

### HP 70700A Digitizer

The HP 70700A digitizer module adds precision digitizing capability to the modular measurement system. Integrated into an HP 70000 series spectrum analyzer, it improves the system's ability to analyze signals in the time domain. A high sampling rate allows recovery of fast pulses, limited only by the bandwidth of the spectrum analyzer signal path.

This module can also be used as a standalone digitizing oscilloscope, transient analyzer, or waveform recorder. Up to 8 digitizers can be operated synchronously without loss in performance. A special feature, Random Event Capture, stores randomly occurring events as they happen, complete with pre-trigger data and timing information.

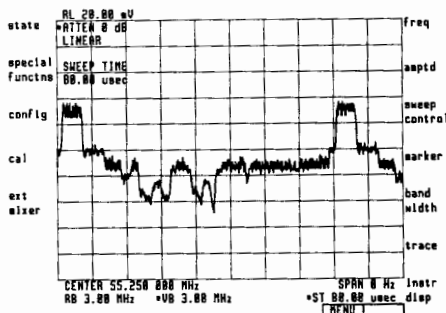

Digitize fast signals with ease.

### HP 70700A Specification Summary

- Maximum sampling rate: 20 Msamples per second
  - Amplitude resolution: 10 bits
  - Harmonic and spurious distortion:  $\geq 50$  dB at 1 MHz;  $\geq 45$  dBc at 10 MHz
  - Bandwidth: 10 MHz single shot;  $> 35$  MHz analog (3 dB)
  - Waveform memory: 262,144 (256K) 10-bit words
  - Data transfer rate: 60 kB/s (nominal)
  - Swept frequency span: 15 ms to 335 s with 800-point trace
  - Fixed frequency (zero span): 80  $\mu$ s to 335 s with 800-point trace
  - Displayed digitizing resolution: 0.12 dB
- Note: Specification changes to HP 70000 spectrum analyzer with HP 70700A

### HP 70300A and 70310A Tracking Generators

The HP 70300A RF and HP 70310A microwave tracking generators add high-performance scalar network analysis capabilities to the modular measurement system for component and sub-assembly testing. They can be combined with HP 70000 series spectrum analyzers, synthesizers, vector voltmeters, and power meters to create a component test workstation for scalar, vector, and signal analysis measurements. The tracking generators give you stimulus-response capability to measure gain, frequency response, and return loss. Use the HP 70301A with an HP 71209A or 71210C spectrum analyzer for a scalar dynamic range of  $> 130$  dB from 2.7 to 18 GHz for high-isolation measurements. Together, the tracking generators provide continuous frequency coverage from 10 MHz to 18 GHz.

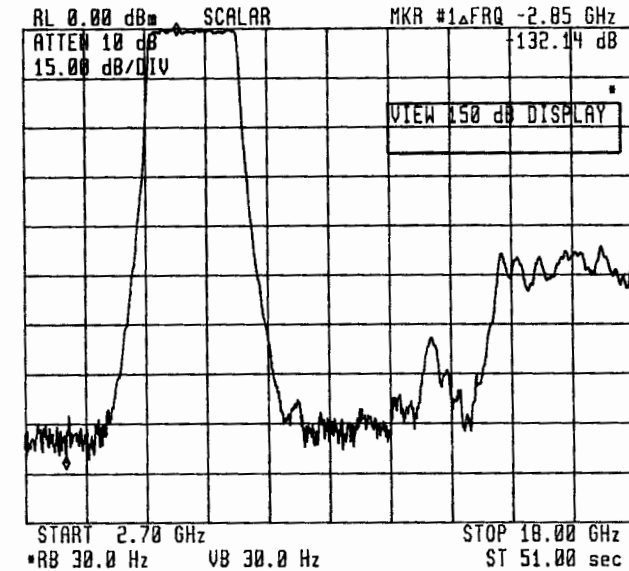

### HP 70300A and 70310A Specification Summary

	HP 70300A	HP 70310A
Frequency range	20 Hz to 2.9 GHz	2.7 to 18 GHz
Frequency accuracy ( $\leq 10$ MHz span)	$\pm[(\text{freq} \times \text{ref}) + 1\% \text{ span} + 15 \text{ Hz}]$	$\pm[(\text{freq} \times \text{ref}) + 1\% \text{ span} + 15 \text{ Hz}]$
Amplitude accuracy (20° - 30° C)		
Absolute	$\pm 0.75$ dB at 300 MHz	$\pm 0.5$ dB at 2.7 GHz
Flatness	$\pm 0.5$ dB	$\pm 1.0$ dB
TG feedthrough with HP 70908A front end	$< -138$ dBm	$< -130$ dBm

### Ordering Information

Module	Price
HP 70300A Tracking Generator Module, 20 Hz to 2.9 GHz	\$12,800
HP 70310A Tracking Generator Module, 2.7 to 18 GHz	\$26,700
HP 70620B Preamplifier Module, 1 to 26.5 GHz	\$8,350
Opt 001 100 kHz to 26.5 GHz	+ \$4,700
HP 70621A Preamplifier Module, 100 kHz to 2.9 GHz	\$5,120
HP 70700A Digitizer Module	\$8,330

# MEASUREMENT SYSTEMS ARCHITECTURE

## HP 70000 Modular Measurement System Instruments and Systems

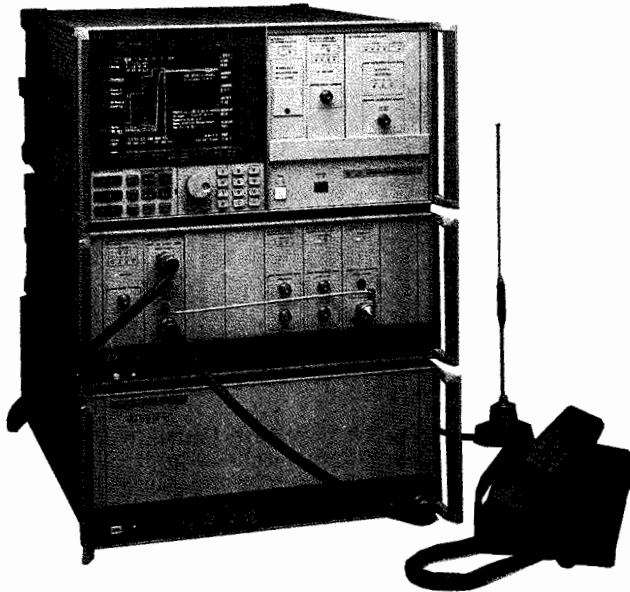

HP 71150C and 71250C



### HP 71150C and 71250C GSM Transmitter Testers

The HP 71150C and 71250C systems are fully configured, high-performance test stations for characterizing Pan-European digital cellular radio transmitters. The systems are based on HP 70000 Series spectrum analyzers and allow time- and frequency-domain testing of base and mobile station transmitters. The HP 71150C has a frequency range of 100 Hz to 2.9 GHz; the HP 71250C of 100 Hz to 22 GHz.

Both systems make all the transmitter tests required by the Groupe Speciale Mobile (GSM) 11.20 and 11.10 specifications. The systems include the HP 11836B GSM personality, a downloadable program that provides the systems with softkeys for making GSM measurements quickly and completely. A patented algorithm accurately measures phase and frequency error of the 0.3 Gaussian minimum shift key (GMSK) modulation signal.

The GSM transmitter testers run all measurement software—an external controller is not required, but can be used in automatic systems. Test data is displayed in graphical, tabular, and swept display formats. For more information, see the MMS catalog described on page 102.

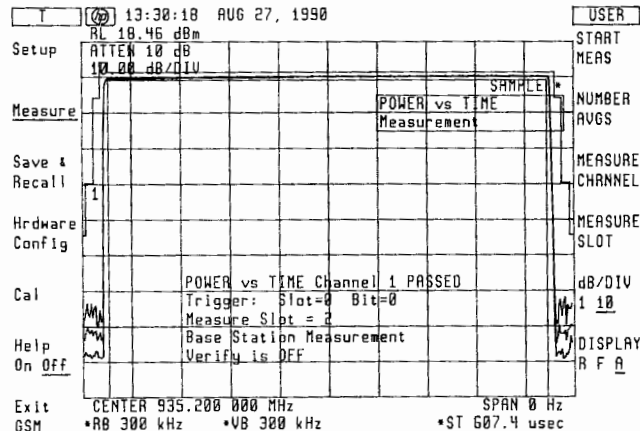

Transmitted RF carrier power versus time of a GMSK signal.

### HP 71600 Series Gigabit Error-Rate Testers

The HP 71600 Series offers a flexible approach to high-speed digital testing. The HP 71601A and 71603A provide complete solutions for error performance analysis to 1 and 3 Gbit/s. They include a pattern generator, error detector, synthesized clock source, and display. The HP 71602A and 71604A are pattern generators operating to 1 and 3 Gbit/s. They include a pattern generator, synthesized clock source, and display. (See page 591.)

### HP 71400C and 71401C Lightwave Signal Analyzers

The HP 71400C and 71401C combine an HP 70000 Series spectrum analyzer with a sensitive, wide-bandwidth optical receiver module. The result is an instrument for analyzing lightwave communication signals and systems. The HP 71400C has a frequency range of 100 kHz to 22 GHz; the HP 71401C of 100 kHz to 2.9 GHz. Displayed average noise level is better than  $-60$  dBm (optical) in a 10 Hz resolution bandwidth. Modules are available for both systems to cover wavelength ranges of 1200 to 1600 nm and 750 to 850 nm. (See page 385.)

### HP 70100A Power Meter

The HP 70100A is a single-channel power meter module. It has features and capability similar to the HP 437B power meter, but uses only half the rack space. Accuracy is specified as  $\pm 0.5\%$  in linear mode and  $\pm 0.02$  dB in logarithmic mode. Features include automatic calibration and zeroing, frequency and calibration factor entry, and selectable resolution. The power meter module is compatible with HP 8480 Series power sensors. (See page 211.)

### HP 70138A Vector Voltmeter

The HP 70138A vector voltmeter module is a two-channel tuned receiver that adds magnitude and phase measurement to the HP 70000 system. A narrowband measuring technique gives this module sensitivity of  $10 \mu\text{V}$  for measurements on very small signals. Inputs are either two high impedance probes with a frequency range of 100 kHz to 1 GHz (standard) or two 50 ohm N-type connectors with a frequency range of 300 kHz to 2 GHz. The vector voltmeter module is similar to the HP 8508A, but uses one-third the rack space. (See page 295.)

### HP 70320 Series Signal Generators

The HP 70320A, 70322A, and 70325A are full-featured, high-performance RF signal generators that offer you the flexibility to choose the right performance for your ATE applications. They are modular measurement system versions of the HP 8644A, 8665A, and 8645A signal generators, respectively. (See page 437.)

### Ordering Information

	Price
<b>HP 70100A</b> Power Meter Module	\$3,080
<b>HP 70138A</b> Vector Voltmeter Module	\$6,190
<b>HP 70320A</b> Synthesized Signal Generator, 252 kHz to 1030 MHz	\$17,750
<b>HP 70322A</b> Synthesized Signal Generator, 100 kHz to 4200 MHz	\$37,200
<b>HP 70325A</b> Frequency-Agile Signal Generator, 252 kHz to 1030 MHz	\$34,150
<b>HP 71150A</b> GSM Transmitter Tester, 100 Hz to 2.9 GHz	\$98,200
<b>HP 71250A</b> GSM Transmitter Tester, 100 Hz to 22 GHz	\$129,400
<b>HP 71400C</b> Lightwave Signal Analyzer, 100 kHz to 22 GHz	\$101,000
<b>HP 71401C</b> Lightwave Signal Analyzer, 100 kHz to 2.9 GHz	\$73,400
<b>HP 71601A</b> Gigabit Error Performance Analyzer, 50 Mbit/s to 1 Gbit/s	\$64,300
<b>HP 71602A</b> Gigabit Pattern Generator, 50 Mbit/s to 1 Gbit/s	\$41,600
<b>HP 71603A</b> Gigabit Error Performance Analyzer, 100 Mbit/s to 3 Gbit/s	\$102,000
<b>HP 71604A</b> Gigabit Pattern Generator, 100 Mbit/s to 3 Gbit/s	\$65,700

# MEASUREMENT SYSTEMS ARCHITECTURE

## Switch Drivers Interface Modules – MMS

HP 70611A, 70612A, 70612C, 70613A, 70613C

109

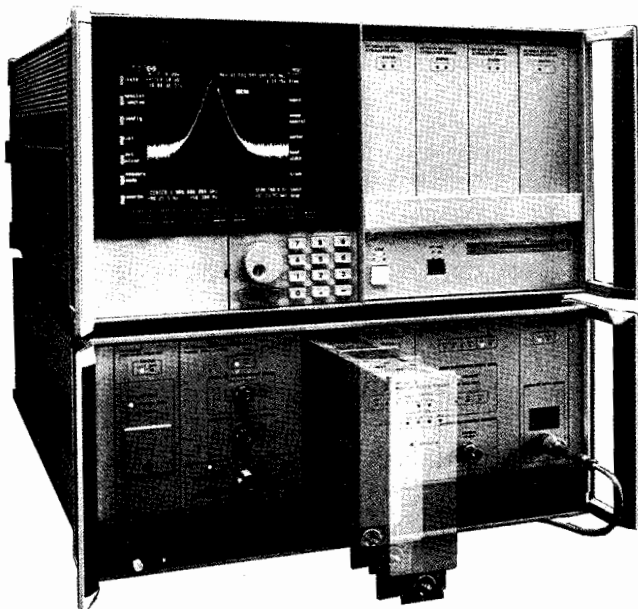

HP 70611A

### HP 70611A Attenuator/Switch Driver

HP now offers designers of modular measurement system products a switch controller in the MMS format. The HP 70611A attenuator/switch driver is ideally suited to drive test-station interface modules that have been designed to include HP 84940A driver cards.

When mated with HP 84940A driver cards, the HP 70611A can control up to 248 (total) RF and microwave devices through either the modular system interface bus (MSIB) or the HP-IB (see Figure 1). One HP 84940A driver card, which has the capacity to drive up to 31 electromagnetic switches or attenuator switch sections, may be incorporated directly within the HP 70611A. Or, up to eight of the driver cards may be located remotely at the end user's test station.

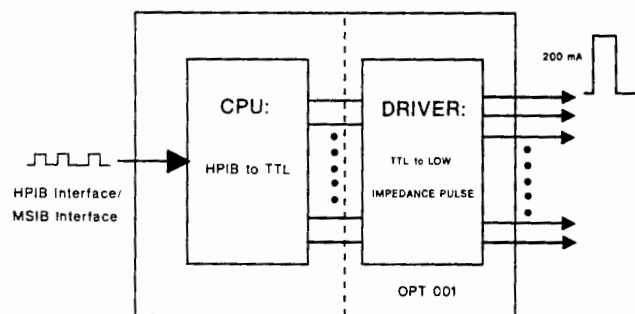
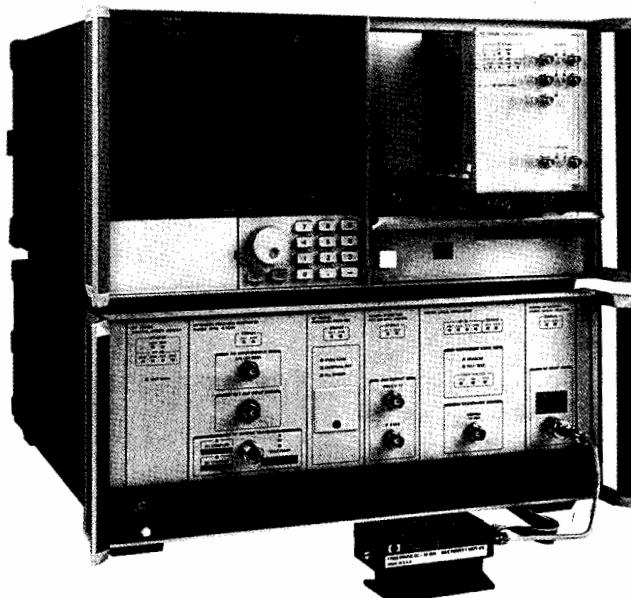

Figure 1

In addition to providing ATE designers with an expandable and convenient remote interface to their test stations, the HP 70611A attenuator/switch driver features a manual interface that can be customized by the user. This manual interface, which is realized through any MMS display, allows the end user to select pulse widths, to enable or disable switch settings, to create custom menus with labels, and to automatically select predefined switch states.

### Accessories

HP offers a full line of switches and attenuators for use with the HP 70611A attenuator/switch driver. Custom switching solutions are also available that incorporate driver controller and microwave hardware into custom rack mounted boxes or MMS modules.



HP 70612A

### HP 70612 and 70613 Series Switch Matrixes

This new family of standard interface modules gives the designer of modular measurement system (MMS) products an off-the-shelf solution to problems of interconnection. The HP 70612 and 70613 are 1 × 6 and 2 × 5 common highway switch matrixes (see Figure 2) available in different frequency bands covering dc to 26.5 GHz. These matrixes come in 1/4-width MMS modules.

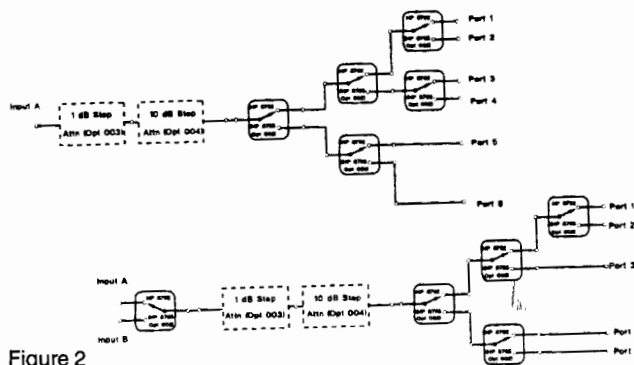

Figure 2

In addition to routing signals between sources and devices under test, the HP 70612 and 70613 feature attenuator options for adjusting signal strengths from 0 to 110 dB in 1 dB steps. Input ports terminated in 50 ohms are standard. Front-panel indicators, which alert the user to current switch status, and front-panel 3.5 mm connectors also are standard. Rear-panel inputs are available.

These switch matrixes can be controlled remotely via the modular system interface bus (MSIB) or the HP-IB. A manual interface that allows users to specify alphanumeric labels for multiple switch states and to recall these predefined states using the labels is created using any MMS display. Up to 217 additional devices can be controlled remotely by an HP 70612 or 70613 using HP 84940A driver cards installed in other interface modules at remote locations. Option 011 for the HP 70612 and 70613 deletes the MSIB/HP-IB interface card (CPU). The resulting module contains only microwave hardware and an HP 84940A driver card. The Option 011 module is designed to be controlled by an HP 70611A.

Along with the standard interface boxes, HP offers the ATE test-set designer custom rack-mount and MMS-compatible interface modules containing hardware such as switches, attenuators, detectors, couplers, indicators, and amplifiers. Additional information on these products can be found on page 412.

# MEASUREMENT SYSTEMS ARCHITECTURE

Hewlett-Packard Interface Bus  
Versatile Interconnect System for Instruments and Controllers

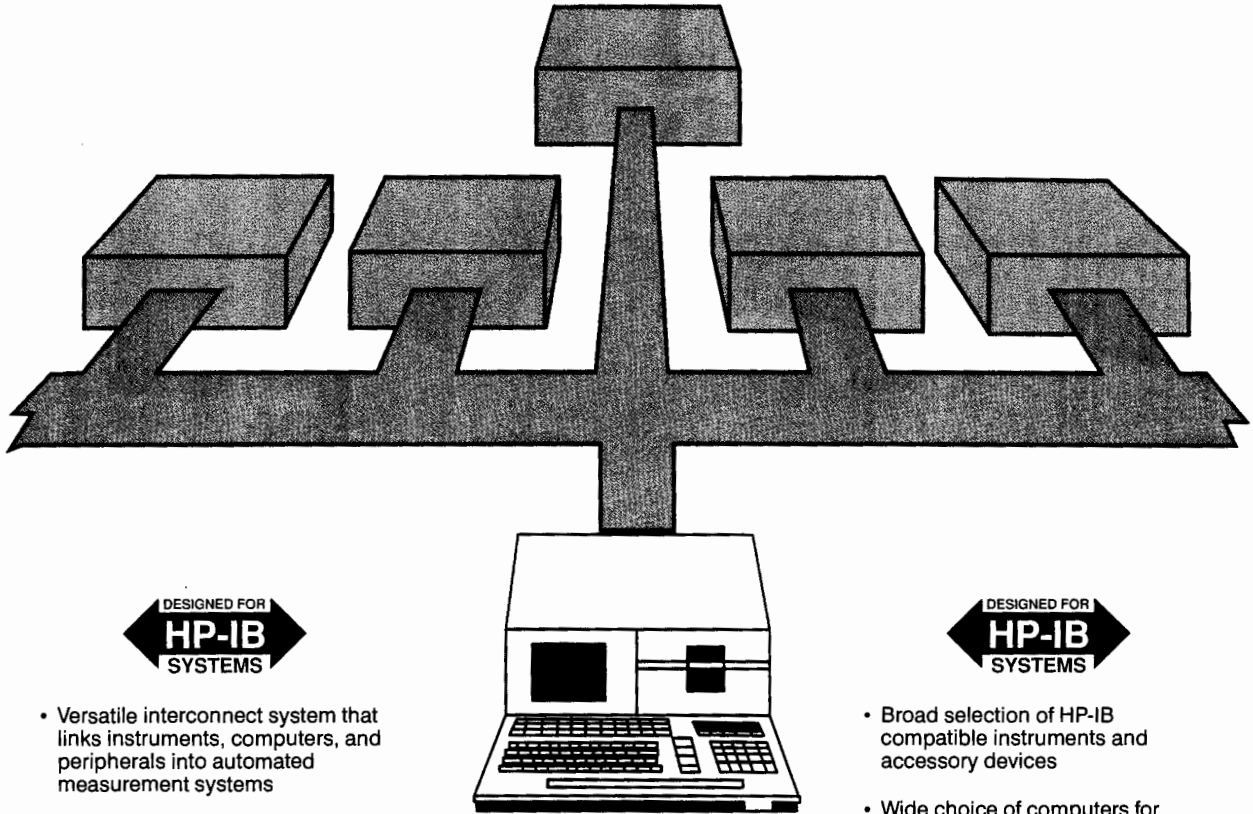

- Versatile interconnect system that links instruments, computers, and peripherals into automated measurement systems
- Hardware, documentation, and support that delivers the shortest path to a measurement system

- Broad selection of HP-IB compatible instruments and accessory devices
- Wide choice of computers for controlling measurement systems and acquiring and managing data

## Advantages of HP-IB Systems

There are many applications where the measurement power of interactive instruments can be further enhanced by desktop computers or minicomputers. Operating in a remote mode can provide more exact, error-corrected results than conventional manual operation techniques.

The following three major parameters combine to reduce significantly the engineering development costs of configuring measurement systems:

1. The Hewlett-Packard Interface Bus, also known as HP-IB.
2. Distributed computing through the growing number of "smart" instruments with internal microprocessors.
3. The broad choice of computers ranging from friendly, easy-to-program desktop computers to more sophisticated computer systems capable of managing multistation instrument clusters and complex databases.

## Relationship Between HP-IB and Other Interface Standards

Hewlett-Packard is committed to the overall advancement of measurement technology and has for some time been working to simplify and standardize instrumentation interfacing. An example of such an effort is the involvement with the HP-IB from its inception at Hewlett-Packard to its present status as a world instrumentation interface standard (IEEE 488.1-1987 and IEC 625-1).

In mid-1972, Hewlett-Packard began to participate in various international standardization bodies. The U.S. Advisory Committee, composed of diverse interests represented by both users and manufacturers, first established initial goals, then adopted the interface concept used by the HP Interface Bus as an appropriate starting point. A draft document was subsequently written and evaluated by members of the committee, then submitted as the U.S. Proposal to the IEC (International Electrotechnical

Commission) Working Group in the autumn of 1972. Since then, the interface definition has undergone a number of minor changes to accommodate various needs at the international level.

In September 1974, the parent technical committee, IEC TC66, approved the main interface draft document for a formal ballot among the member nations of the IEC. Balloting took place in 1976, and IEC recommendation 625-1 was adopted. The IEC recommendation is totally compatible with the present definition of the HP-IB.

Meanwhile, the IEEE Standards Board approved IEEE Standard 488-1975 "Digital Interface for Programmable Instrumentation," first published in 1975 and again published in 1978 with minor editorial changes as IEEE Standard 488-1978. The IEEE standard is also fully compatible with the HP-IB. In January 1976, the American National Standards Institute adopted the IEEE Standard and published it initially as ANSI Standard MC 1.1.



The standardized interface concept is now widely accepted. Hundreds of manufacturers in more than 14 countries offer thousands of products that use the HP-IB concepts articulated in IEEE-488. As more instrumentation interface standards evolve from the HP-IB, we will clearly indicate the relationship of the Hewlett-Packard Interface Bus to those standards, just as we have done with ANSI/IEEE Standard 488 and IEC Publication 625-1.

### Why the HP Interface Bus Name?

As the list of HP products available with the "new digital interface" grew, our customers sought a convenient way to identify those products having the interface capability. In response, in 1974 we adopted the name "Hewlett-Packard Interface Bus" or simply "HP-IB." We will continue to use the identifying name and this symbol:



Both are used with appropriate HP products to identify their interface capabilities.

The Hewlett-Packard Interface Bus fully complies with IEEE Standard 488. As such, it incorporates the mechanical, electrical, and functional specifications of the standard. A fourth and vital element of any interface system is the operational aspect of a product at both the human-machine interface and the machine-machine interface at the HP-IB port. HP-IB capability provides additional user benefits that are beyond the scope of

IEEE Standard 488. Typical user conveniences include high-level language implementation of interface functions, underscored program codes on instrument front panels for easy programming, convenient data output formats, and designed-in learn modes. In addition, we provide complete support documentation in the form of programming and interfacing guides, application notes, and operators' manuals that illustrate the added benefits for users of products with HP-IB capability.

### Single-Source Systems Approach

The decision to use a system instead of conventional manual methods must be based on an engineering evaluation of benefits versus costs. The many benefits associated with a systems approach include the following:

- More consistent results in repeated measurements because a system is not subject to operator fatigue.
- Greater throughput because systems are generally faster.
- More thorough testing because system speed allows more parameters to be measured in a shorter time.
- Results expressed in engineering or scientific units because many systems controllers are capable of online data manipulation.
- Greater accuracy because system errors can be measured automatically, stored, and accounted for in the results.
- Adaptive data acquisition so that a system can be programmed to branch to other measurements to help pinpoint an abnormal condition.
- Measurement results stored in computer memory or on hard copy.



Hewlett-Packard offers a broad range of controllers and software solutions to meet your measurement automation needs.

It is our objective to make the integration of instrumentation systems easier by providing instruments and computers designed for systems applications. Computers are designed with HP-IB options that allow easy hookup to the bus and incorporate easy-to-use bus commands in their software. Hewlett-Packard's policy when designing HP-IB compatible instruments is to eliminate interfacing ambiguities associated with controllers and instruments operating per the ANSI/IEEE and IEC standards by adopting guidelines for consistent interface design.

Proper training on system components is very important for efficient use of any interface system. Therefore, we offer training at sales and service offices worldwide on HP desktop computers, computer systems, and instruments as they relate to the HP-IB. In the area of HP-IB support documentation, we offer general interface technical descriptions, operating and service manuals with programming information, instrument/controller introductory operating guides, quick reference guides, and application notes.

Technical assistance during system development is available at most local HP sales and service offices, from resident systems engineers who specialize in desktop computers, computer systems, and instruments.

### How the HP-IB Operates

All active interface circuitry is contained within the various HP-IB devices, and the interconnecting cable (containing 16 signal lines) is entirely passive. The cable's role is limited to that of interconnecting all devices in parallel so that any one device can transfer data to one or more other participating devices.

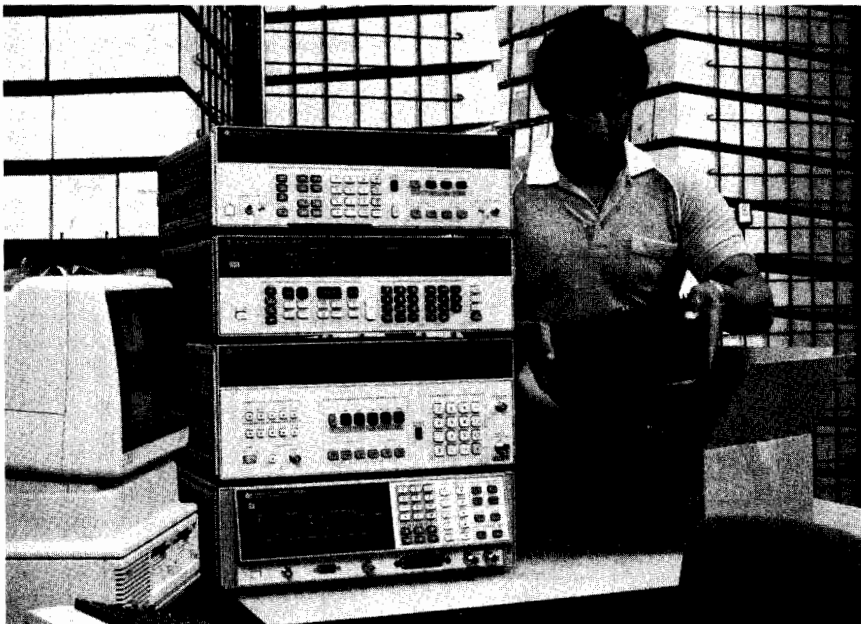

Automation provides the speed needed for production environments. This HP 8957S Cellular Test System produces accurate, hard-copy test results in minutes.

# MEASUREMENT SYSTEMS ARCHITECTURE

## Hewlett-Packard Interface Bus (cont'd)

Versatile Interconnect System for Instruments and Controllers



Every participating device (instrument, controller, accessory module) must be able to perform at least one of the roles of TALKER, LISTENER, or CONTROLLER. A TALKER can transmit data to other devices via the bus, and a LISTENER can receive data from other devices via the bus. Some devices can perform both roles. For example, a programmable instrument can LISTEN to receive its control instructions and TALK to send its measurement results.

A minimum HP-IB system consists of one TALKER and one LISTENER, without a CONTROLLER. In this configuration, data transfer is limited to direct transfer between one device manually set to "talk only" and one or more devices manually set to "listen only" for example, a measuring instrument talking to a printer for semi-automatic data logging).

A CONTROLLER manages the operation of the bus system primarily by designating which devices are to send and receive data, and it can also command specific actions within other devices.

The full flexibility and power of the HP-IB become more apparent, however, when one device that can serve as CONTROLLER/TALKER/LISTENER (e.g., calculator or computer) is interconnected with other devices that may be either TALKERS or LISTENERS, or both (e.g., frequency synthesizers, counters, power meters, relay actuators, displays, printers), depending on the application. An HP-IB controller participates in the measurement by being programmed to schedule measurement tasks, set up individual devices so that they can perform these tasks, monitor the progress of the measurement as it proceeds, and interpret the results of the measurement. Hewlett-Packard offers controllers that can be programmed in high-level languages such as BASIC, FORTRAN, HPL, and Pascal.

### HP-IB Connections and Structure

The HP-IB has a party-line structure. All devices on the bus are connected in parallel. The 16 signal lines within the HP-IB cable are grouped into three clusters according to their functions:

1. Data Bus (8 signal lines)
2. Data Byte Transfer Control Bus (3 signal lines)
3. General Interface Management Bus (5 signal lines)

The Data Bus consists of eight signal lines that carry data in bit-parallel, byte-serial format across the interface. These signal lines carry addresses, program data, measurement data, universal commands, and status bytes to and from devices interconnected in a system. Identification of the type of data present on the DIO signal lines is indicated by the ATN (attention) signal. When the ATN signal is true (asserted), either addresses or universal commands are present on the data bus and all connected devices are required to monitor the DIO lines. When the ATN message is false, device-dependent data (e.g., programming data) is carried between devices previously addressed to talk and listen.

Data transfer uses a set of three signal lines: DAV (data valid), NRFD (not ready for data), and NDAC (not data accepted).

These signals operate in an interlocked handshake mode. Two signal lines, NRFD and NDAC, are each connected in a logical AND (wired OR) to all devices connected to the interface. The DAV signal is sent by the talker and received by potential listeners. The NRFD and NDAC signals are sent by potential listeners and received by the talker.

The General Interface Management Lines manage the bus for an orderly flow of messages. The IFC (interface clear) message places the interface system in a known quiescent state. SRQ (service request) is used by a device to indicate the need for attention or service and to request an interruption of the current sequence of events. REN (remote enable) is used to select between two alternate sources of device program data. EOI (end or identify) is used to indicate the end of a multiple byte transfer sequence or, in conjunction with ATN, to execute a polling sequence.

It is not possible in this limited space to go into detail on each signal line's role. But you should note that every HP-IB device need not be able to respond to all the lines. As a practical and cost-effective matter, each HP-IB device usually responds only to those lines that are pertinent to its typical function on the bus. (Details are covered in each device's operating manual.)

### HP-IB and the New IEEE 488.2

In June of 1987, the IEEE approved a new standard for programmable instruments called IEEE Std. 488.2-1987 Codes, Formats, Protocols, and Common Commands. It works with the IEEE Standard Digital Interface for Programmable Instrumentation, IEEE 488-1978 (now 488.1). HP-IB is Hewlett-Packard's implementation of IEEE 488.1.

As with IEEE 488.1, Hewlett-Packard was active in the development of IEEE 488.2. Many of the new HP instruments introduced this year already follow this new standard, and many more HP instruments to be introduced in the near future will also follow IEEE 488.2.

This new standard addresses issues involved with sending messages between devices on the bus. Its features include:

- A required minimum set of IEEE 488.1 capabilities.
- Reliable transfer of complete messages between a computer and an instrument.
- A precise description of the syntax in those messages.
- A set of commands useful in all instruments.
- Common status reporting capability using serial poll.
- Techniques for guaranteeing synchronization of application programs with instrument functions.
- A way of automatically assigning addresses.

The desired benefit from these features is to make the job of an instrument system designer easier. IEEE 488 standardized the electrical and mechanical interface. This new standard ensures compatibility at the next higher level.

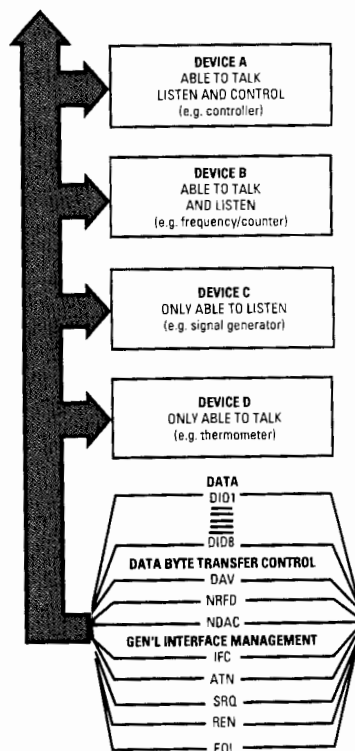

Interface connections and bus structure

**488.1 Requirements**

The IEEE 488.2 Standard requires that each device provide a minimum set of 488.1 interface capabilities. Each device must be able to source and accept bytes, talk and listen, do service request, and respond to device clear.

IEEE 488.2 allows more freedom by making other capabilities optional. However, it requires a minimum capability when these functions are implemented. This applies to the Remote Local, Parallel Poll, Device Trigger, and Controller capabilities.

**Message Exchange**

IEEE 488.1 provides a reliable means of transferring bytes between a talker and a listener. In addition, devices need a reliable means of transferring programming commands and measurement results. IEEE 488.2 provides this means.

**Syntax**

IEEE 488.2 requires that devices listen in a "forgiving" manner. However, the level of forgiveness is precisely defined. The meaning of every data byte is well defined, while several characters sometimes have the same meaning.

Although the listening syntax is forgiving, an instrument is required to talk precisely. Talking precisely greatly increases the chances of a message being accepted by any controller.

**Common Commands**

Certain functions are useful across all types of instruments. IEEE 488.2 defines a set of commands that all instruments must implement. Required commands include identifying the instrument by manufacturer and model number, resetting the instrument to a known state, and performing a self-test.

Other commands that are useful in some instruments are also described in the standard. They are included so that, if the functions are implemented, they will be done in standard ways. For example, there are commands for calibration, triggering, macros, and passing control. There are a total of 13 required commands and 26 optional commands.

**Status Reporting**

IEEE 488.1 exactly describes how the Request Service (RQS) message behaves, but it says very little about the status byte, STB. The meanings of the bits are left to the designer. Some instruments clear the status byte after a serial poll, others do not. Many instruments allow the programmer to configure what causes a service request, but here, too, the techniques for doing so are varied.

IEEE 488.2 describes a hierarchical status reporting model in which the contents of other data structures are summarized in the status byte. It does not specify the exact meaning of all of the bits in the status byte. However, it does describe the meaning of two more of the bits, Message Available (MAV) and Event Status (ESB).

**Synchronization**

Many instruments can accept commands faster than they can execute them. Although this feature can improve system throughput, it also creates a need to know when the instrument actually completes all of its commands. IEEE 488.2 requires three common commands that enable the application program to detect when all pending operations are complete.

**Future**

Codes, formats, protocols, and common commands cover new ground for instrument-to-computer communication. Most of the concepts involved can be used on any physical interface whether HP-IB, RS-232, or VME. If a new physical interface should displace or co-exist with HP-IB, the syntax of messages, the common commands, the status reporting, and the synchronization techniques can all survive.

**HP-IB Training and Support**

To assist you in configuring HP-IB measurement systems, Hewlett-Packard has field salespeople trained in electronic instruments, desktop computers, and computer systems. Also available for technical consultation are computing controller systems engineers and HP-IB instrumentation specialists.

An HP-IB training course on HP-IB controllers and instruments is available. Courses are conducted at a convenient HP location. Some courses can be taught at your site with special arrangements.

**HP-IB Service and Warranty**

Hewlett-Packard has dedicated measurement system servicepeople who perform on-site maintenance of HP instrumentation on customer-configured systems as well as HP-configured systems. Service contract coverage is available to meet your specific measurement system service needs and can be tailored to include extended warranty, calibration, and extended hours of coverage. Contact your local sales and service office for further information on HP-IB service contract information.

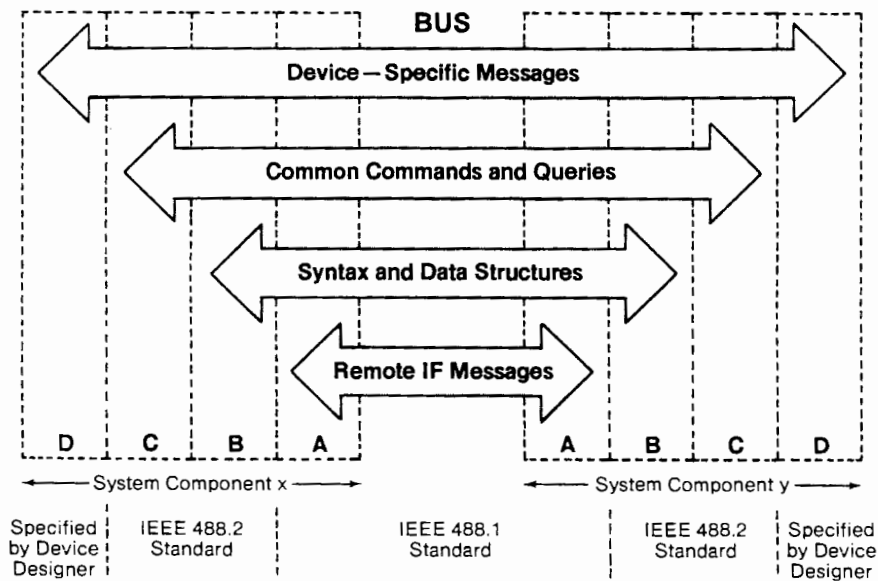

This diagram shows the relationship between the IEEE-488.1 standard and the new IEEE 488.2 standard. The new standard expands and complements IEEE 488.1 by addressing issues involved with sending messages between devices on the bus. Layer D represents device functions, layer C represents common system functions, layer B represents message communications functions, and layer A represents interface functions. Layers D, C and B contain IEEE 488.1 device-dependent messages and layer A contains IEEE 488.1 interface messages.

# MEASUREMENT SYSTEMS ARCHITECTURE

## Hewlett-Packard Interface Bus (cont'd)

Versatile Interface Bus for Instruments and Controllers



Every HP-IB device and HP-configured system carries a standard Hewlett-Packard warranty appropriate to that product. The warranty period for each product will be provided on request at the time of sale and is specified in documentation supplied with the product. Hewlett-Packard takes responsibility for standard HP-IB systems performing as specified. However, software or interfacing that has not been provided by Hewlett-Packard as part of a standard system delivered by Hewlett-Packard is not covered by this warranty.

In all cases, overall operational responsibility for those HP-IB systems assembled by a customer from individual HP-IB devices rests with the customer.

### HP-IB Specifications Summary

#### Interconnect Devices

Up to 15 maximum on one continuous bus.

#### Interconnection Path

Star or linear bus network; total transmission path length 2 meters times number of devices or 20 meters, whichever is less. Operating distances can be extended; see page 617.

#### Message Transfer Scheme

Byte-serial, bit-parallel asynchronous data transfer using locked 3-wire handshake technique.

#### Data Rate

One megabyte per second maximum over limited distance; 250 to 500 KB/s typical over full transmission path (actual data rate depends on individual device characteristics).

#### Address Capability

Primary addresses, 31 TALK and 31 LISTEN; secondary (2-byte) addresses, 961 TALK and 961 LISTEN. Maximum of 1 TALKER and up to 14 LISTENERS at a time.

#### Control Shift

In systems with more than one controller, only one can be active at a time. A currently active controller can pass control to another, but only the designated system controller can assume control over others.

#### Interface Circuits

Driver and receiver circuits are TTL-compatible.

### HP-IB Interface Functions

HP-IB functions are the predefined capabilities that can be designed into an HP-IB device. These capabilities and their alphanumeric codes are summarized in the table. Because the codes completely describe interface capability and are therefore particularly useful to system designers and specifiers, they frequently appear in technical data and on system components. On HP system-ready products the capabilities are listed near the HP-IB connector, and they are included in the specifications for most of the HP-IB products in this catalog.

### HP-IB Reference Publications

- *Tutorial Description of the Hewlett-Packard Interface Bus*. This 118-page reference chronicles the

development of byte-serial, bit-parallel interface system standards, describes their relationship to HP-IB, presents a working overview of HP-IB, and includes useful information. Published by Hewlett-Packard, part number 5021-1927.

- *ANSI/IEEE 488.1-1987, Digital Interface for Programmable Instrumentation, and IEEE Std. 488.2-1987, Codes, Formats, Protocols, and Common Commands*, published by the Institute of Electrical and Electronics Engineers, 345 East 47th Street, New York, NY 10017.
- *IEC 625-1, An Interface System for Programmable Measuring Apparatus (Byte Serial Bit Parallel)*, published by the International Electrotechnical Commission, 1 rue de Varembe, 1211 Geneva 20, Switzerland.

### HP-IB Interface Capability Codes for HP Products

Interface Function	Basic Code	Capability Code
Source Handshake	SH	SH0 No capability SH1 Full capability
Acceptor Handshake	AH	AH0 No capability AH1 Full capability
Talker (Extended Talker)	T(TE)	T(TE)0 No capability T(TE)1 Basic talker, serial poll, talk only T(TE)2 Basic talker, serial poll T(TE)3 Basic talker, talk only T(TE)4 Basic talker T(TE)5 Basic talker, serial poll, talk only, unaddresses if MLA <sup>1</sup> T(TE)6 Basic talker, serial poll, unaddresses if MLA <sup>1</sup> T(TE)7 Basic talker, talk only, unaddresses if MLA <sup>1</sup> T(TE)8 Basic talker, unaddresses if MLA <sup>1</sup>
Listener (Extended Listener)	L(LE)	L(LE)0 No capability L(LE)1 Basic listener, listen only L(LE)2 Basic listener L(LE)3 Basic listener, listen only, unaddresses if MTA <sup>2</sup> L(LE)4 Basic listener, unaddresses if MTA <sup>2</sup>
Service Request	SR	SR0 No capability SR1 Full capability
Remote Local	RL	RL0 No capability RL1 Full capability RL2 No local lockout
Parallel Poll	PP	PP0 No capability PP1 Remote configuration PP2 Local configuration
Device Clear	DC	DC0 No capability DC1 Full capability DC2 Omit selective device clear
Device Trigger	DT	DT0 No capability DT1 Full capability
Driver Electronics	E	E1 Open collector (250Kb/s max) E2 Tri state (1Mb/s max)
Controller <sup>3</sup>	C	C0 No capability C1 System controller C2 Send IFC and take charge C3 Send REN C4 Respond to SRQ C5 Send interface messages, receive control, pass control to self, parallel poll, take control synchronously

<sup>1</sup> MLA: My Listen Address

<sup>2</sup> MTA: My Talk Address

<sup>3</sup> There are 29 controller levels. These are the more significant levels.

Whether you are designing a small, medium, or large test system, Hewlett-Packard's switch family will provide you with long-lasting quality, reliability, and performance. Hewlett-Packard's switch products are used in a variety of testing applications such as switching dc to 26.5 GHz signals. Hewlett-Packard offers dedicated switches and modular systems that include instrumentation. Whatever your application, the ability to make accurate and reliable connections from instruments to test points is critical. Hewlett-Packard's family of switch products integrates easily into any test system.

### Hewlett-Packard Knows Switches!

Hewlett-Packard has been designing and manufacturing switch products for more than 20 years. We understand the special requirements of a switch in a test system. In the design of our products, we have addressed important issues such as signal integrity, automation, fixturing, and ease of use. The result is a wide range of switch products that gives you a choice—all with the quality, reliability, and performance you expect from Hewlett-Packard.

### A Low-Cost System



For many devices, only a few points require testing. Usually, the test system operator connects two or three instruments to different points on the device under test (DUT). By adding an HP 3488A Switch/Control Unit to your test system, you eliminate manual operations in test procedures. This reduces test time and eliminates chances for error. The savings you realize from an automated test procedure makes it easy to justify investing in an HP 3488A.

### A Versatile System of Medium Size

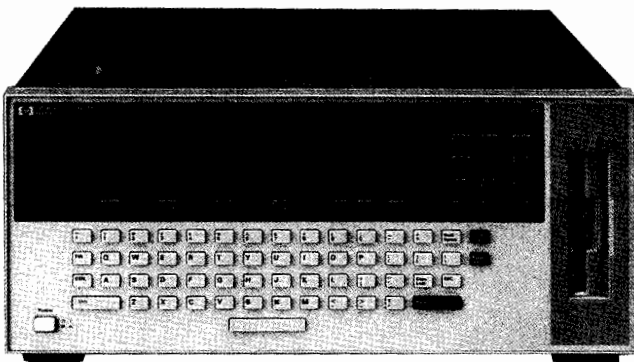

Medium-size systems typically require three to six instruments testing 10 to 100 test points. The instrumentation takes up rack space, and manual tests are difficult to run. The HP 75000 Series B Mainframe reduces your rack space requirements and makes it easy for you to automate your test system. The unit provides instrumentation along with a broad line of switch modules—all in one mainframe. Your costs and development time are reduced with a test system built around the Series B.

### A High-Performance System of Large Size

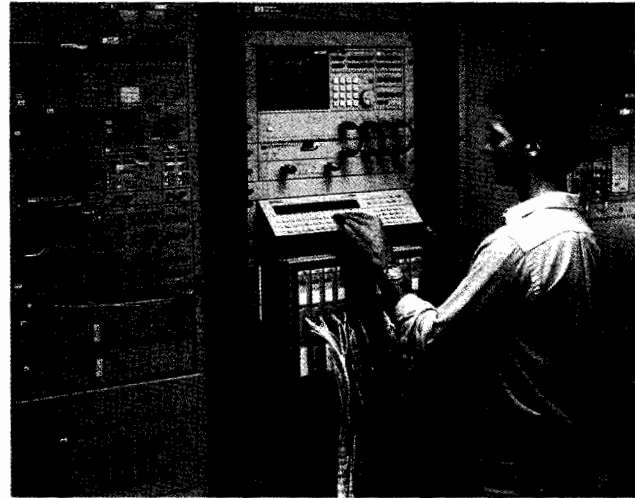

In a large test system, there may be more than one DUT, requiring different test fixtures, instruments, and switches. In addition, a large number of cables and wires are used. Many stimulus and response measurements need to be made, requiring signals to go to and from instruments and the DUT simultaneously. With multiple instruments and multiple points to be tested, you need a dedicated computer to control the test process. The HP 3235A Switch/Test Unit makes it easy for you to integrate large test systems and relieves you of much of the design and documentation effort. The unit includes a multitude of switch modules, high-performance instrumentation, fixturing, and built-in intelligence. The HP 3235A is the right product for applications requiring high-performance switching and a large number of test points.

### Modular Measurement System (MMS)

For ATE configurations that employ the HP 70000 modular measurement system, the HP 70611A MMS attenuator/switch driver module fills a critical need for programmable control of signal switching. The switch module supplies drive power for HP step attenuators and coaxial switches. It controls up to eight HP 84940A driver cards, each of which can drive up to 31 switches. The HP 70611A also extends Hewlett-Packard's custom switch matrix capability from traditional HP-IB rack-and-stack to the versatile, more space efficient MMS.

The HP 70612 and 70613 interface modules give the MMS designer an off-the-shelf solution to the problem of how to connect sources, test equipment, and DUTs. Internal high-performance coaxial switches are configured for 1x6 and 2x5 options with service from dc to 6.5 and 26.5 GHz. Each interface module contains an attenuator/switch driver that can control up to seven additional HP 84940A switch driver cards.

The MMS display provides a powerful manual interface that can be easily customized for the HP 70611, 70612, and 70613 modules. See page 109 for more information.

# MEASUREMENT SYSTEMS ARCHITECTURE

## Hewlett-Packard Interface Bus

HP-IB/Centronics Interface Converter, HP 92203J/K



The Intelligent Interfaces Inc. MicroPrint 45CH is an HP-IB to Centronics interface converter that allows an HP-IB instrument or computer to print data, text, and graphics to HP Centronics parallel printers such as the LaserJet and DeskJet printer families. To operate, connect an HP-IB cable from the instrument to the HP-IB port on the MicroPrint 45CH and the Centronics parallel cable from the printer to the Centronics port on the MicroPrint 45CH, set the desired address, and power up the connector by plugging in its power supply.

### Adapter and Cable Requirements

An ac adapter is included with the HP 92203J for operation in the United States and Canada. An appropriate country ac adapter is required for the HP 92203K international version. An HP-IB cable, HP 10833A, and Centronics parallel peripheral interface cable, HP 92284A, are needed to connect the MicroPrint 45CH to the HP-IB controller and Centronics printer.

### Specifications

#### Connector

**HP-IB:** Standard 24-pin HP-IB connector

**Centronics parallel:** Standard 25-pin to 36-pin

**Directional:** One-way (HP-IB to Centronics), Listen Only

#### Dimensions

**Size:** 28 mm H × 91 mm W × 146 mm D (1.1 in × 3.6 in × 5.75 in)

**Weight:** 0.45 kg (1 lb)

#### Interface

**Input:** HP-IB

**Output:** Centronics (parallel)

#### Hardware compatibility

HP-IB instruments, HP-IB computers/controllers, workstations, Centronics printers

**Data rate:** 15 KB/s

**Power requirements:** 9 vac, 600mA

**Operating temperature:** 10 to 40° C

**Humidity:** 5% to 80% RH, noncondensing

**Safety/regulatory:** ETL, CSA, Germany VFG 1046/1984, FCC Class B. All international ac adapters have appropriate country regulatory approvals.

**Warranty:** A one-year HP replacement warranty is provided.

#### Support

For technical support, please contact Intelligent Interfaces Inc. at: phone: 800-842-0888 or 404-381-9891; fax: 404-925-1172

### Ordering Information

**92203J** HP-IB to Centronics Interface Converter (U.S. and Canada), ac adapter included

**92203K** HP-IB to Centronics Interface Converter (International). Note: When ordering a 92203 K (International), an appropriate ac adapter is needed.

**82241A ABG** Australia

**82241A ABU** United Kingdom

**82241A ABB** Europe

**82241A ABJ** Japan

The MicroPrint 45CH can be ordered directly from HP through HP worldwide sales offices or by calling the HP direct toll-free number 800-452-4844 (in U.S.)

☎ For off-the-shelf shipment, call 800-452-4844.

### Price

**92203J** HP-IB to Centronics Interface Converter \$210 ☎

(U.S. and Canada), ac adapter included

**92203K** HP-IB to Centronics Interface Converter \$200 ☎

(International). Note: When ordering a 92203 K (International), an appropriate ac adapter is needed.

**82241A ABG** Australia \$15

**82241A ABU** United Kingdom \$15

**82241A ABB** Europe \$15

**82241A ABJ** Japan \$15

The MicroPrint 45CH can be ordered directly from HP through HP worldwide sales offices or by calling the HP direct toll-free number 800-452-4844 (in U.S.)

☎ For off-the-shelf shipment, call 800-452-4844.

- For medium to large systems
- 10-slot, intelligent cardcage
- 20-switch modules for dc to 26.5 GHz signals
- DMM, ac/dc source, 4-channel D/A digital I/O, breadboard modules
- Quick interconnect fixture
- Control panel for debugging

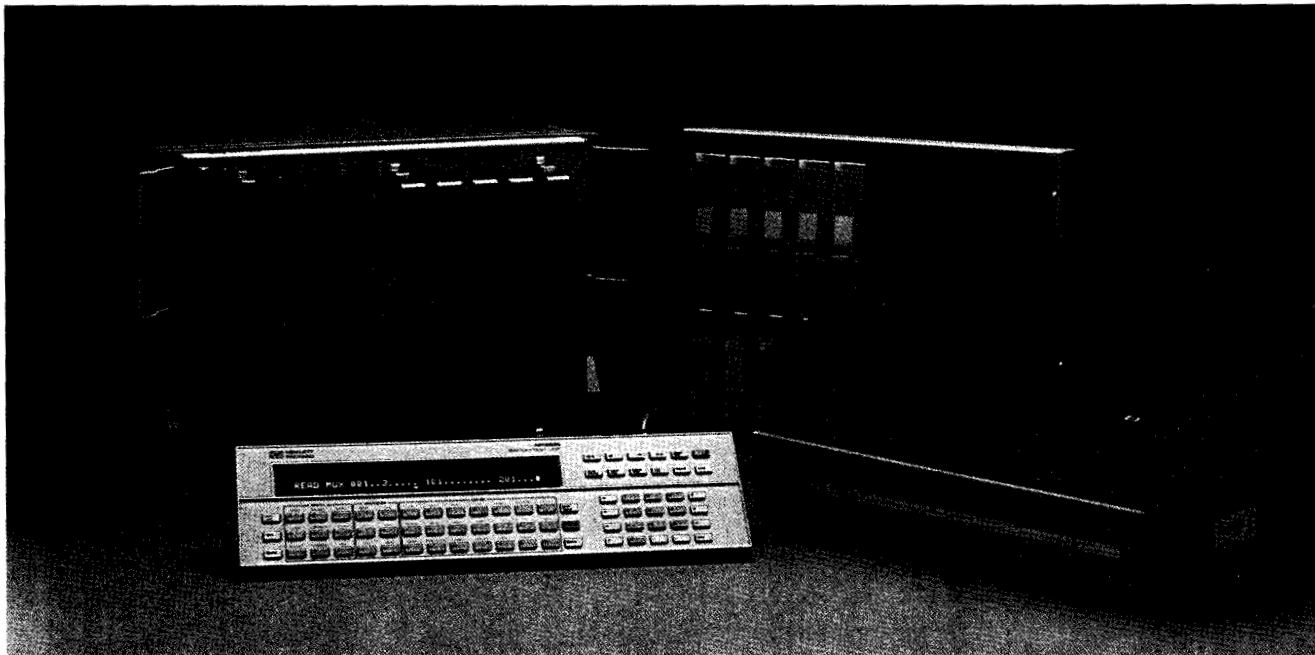

HP 3235A

### Description

The HP 3235A Switch/Test Unit reduces test development of HP-IB test systems by providing high-performance, off-the-shelf switching and interfacing to a wide variety of devices under test (DUT).

The Switch/Test Unit routes signals between the DUT and source/receiver instruments such as digital multimeters, counters, signal sources, and analyzers.

Speed your test system development with:

- off-the-shelf tools
- easy programming
- reduced cabling

Increase your test system throughput with:

- local intelligence
- plug-in digital multimeter module
- internal bus structure
- Quick Interconnect Fixture

### Reconfigurable Architecture

The HP 3235A chassis is a 10-slot cardcage driven by a 16-bit processor backed with 256k of firmware. You control the cardcage over HP-IB using high-level commands for easy programming. Twenty different switch modules in various matrix and multiplexer topologies switch signals up to 10 amperes and from dc to 26.5 GHz. Also available are digital I/O, breadboard, 4-channel D/A, DMM, and ac/dc source modules that are true "instruments on a card."

For applications demanding numerous switch points, up to seven 10-slot HP 3235E Extenders can be slaved to the HP 3235A mainframe. A total of 20,480 two-wire analog points can be controlled from one HP-IB address.

The Quick Interconnect Fixture allows easy reconfiguration of the test system for different devices. Operator errors are also reduced by minimizing the number of connections to be made before starting a new test.

Four analog and two trigger buses link the switch and instrumentation modules. These internal paths provide a "soft-wired" connection that can be redefined by your test software. Analog

signals are routed conveniently from a multiplexer to the digital multimeter (DMM) module during scanning. Or, a trigger generated by the digital I/O module can be routed to the DMM module.

To aid in system setup and debugging, a control panel with a full alphanumeric keypad and electro-luminescent display is available.

### Intelligence of a Computer

The powerful firmware of the HP 3235A instructs the plug-in modules with high-level commands from the host computer. Storage and recall of hundreds of HP 3235A setups saves sending command sequences from the computer. HP BASIC language commands in the mainframe, such as IF . . . THEN and FOR . . . NEXT, plus variables and math functions, keep computer-to-switch interactions to a minimum, thereby increasing throughput. You can use up to 480 Kbytes of mainframe memory for downloaded subroutines and stored values. Downloaded programs, including user-defined data conversions or setups, execute rapidly.

### Complete Modularity Means In-Rack Service

The HP 3235A is completely serviceable in-rack, so you never need to remove the cardcage. All assemblies, including power supply, controller, and HP-IB, remove easily because of the modular design.

### Simple Operational Verification Before Your Test

The HP 3235A offers three levels of internal self-test as well as a fixtured functional test for individual plug-in modules. The fixtured test uses diagnostic terminal blocks that attach to the modules. These diagnostic fixtures, together with the internal DMM module, verify the integrity of the relay contacts in your system.

### HP 3235A Plug-in Modules

A full array of functional plug-in modules is available for the HP 3235A 10-slot mainframe or the HP 3235E 10-slot extender.

# MEASUREMENT SYSTEMS ARCHITECTURE

## Switching and Control (cont'd)

### HP 3235A

#### Low-Frequency Relay Multiplexers

These modules can be used either as input or output multiplexers to switch signals to and from a DUT. The multiplexers are 2-wire, switching both High and Low. They have different voltage- and current-switching capabilities, and use different relay types. The HP 34501T/34502T/34507T can also be used with thermocouples.

	HP 34501	HP 34502	HP 34507	HP 34511	HP 34515
Max Voltage (ac rms)	250 Vdc 250 Vac	125 Vdc 90 Vac	250 Vdc 250 Vac	130 Vdc 130 Vac	1000 Vdc 1000 Vac
Max Current	2 A	25 mA	100 mA	1 A	1 A
No. of Channels	32	32	32	64	10
Relay Type	Armature	Reed	Mercury	Armature	Reed
Thermal Offset	<3 $\mu$ V	<3 $\mu$ V	<20 $\mu$ V	<7 $\mu$ V	<30 $\mu$ V

#### High-Frequency Relay Multiplexers

These multiplexers provide broadband switching of high-frequency analog or digital signals. The HP 34504 switches both the center conductor and the shield. In the HP 34505 and HP 34508, the 3 multiplexer banks are isolated from each other and from ground, preventing ground loops.

#### High-Frequency Relay Multiplexers

	HP 34504	HP 34505	HP 34508
Bandwidth	100 MHz	1.3 GHz	1.3 GHz
Number of Channels	Dual 1 $\times$ 6	Two 1 $\times$ 4 One 1 $\times$ 3	Two 1 $\times$ 4 One 1 $\times$ 3
Impedance	50 $\Omega$	50 $\Omega$	75 $\Omega$
Maximum Voltage (ac rms)	42 Vdc 30 Vac	42 Vdc 30 Vac	42 Vdc 30 Vac
Maximum Current	1 A	1 A	1 A
Switched Shield	Yes	No	No

#### Microwave Switches

These 50-ohm coaxial switches provide excellent electrical performance from dc to microwave frequencies. The HP 34530A goes to 18 GHz, while the HP 34530B goes to 26.5 GHz. The HP 34531A/B 18 GHz multiplexers are configured as 1 $\times$ 6. The HP 34531B has internal 50-ohm terminations for the open channels, while the HP 34531A does not. All of these microwave switches use SMA connectors. A variety of rack-mounting kits are available. Up to four HP 34530A/B 3-port switches can also be mounted in the HP 34530T terminal block kit.

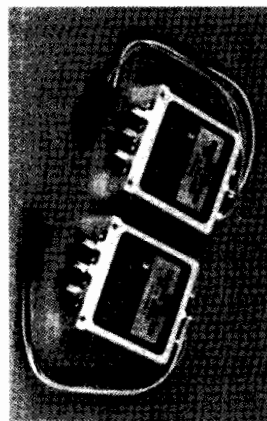

HP 34530A/B

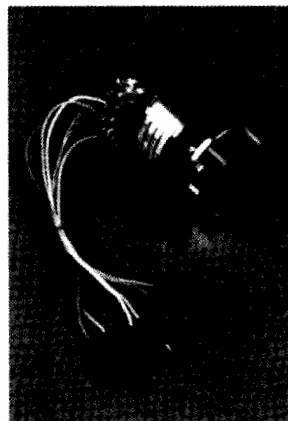

HP 34531A

#### Relay Matrix Modules

These matrix cards come in a variety of configurations, densities, and bandwidths. For the highest density, consider the HP 34511M or the HP 34516M/N. If low leakage is a requirement, the HP 34512C features 10 pA/volt leakage, 2 pA/V typical. For higher bandwidth applications, look at the HP 34506 Switched Shield Matrix. Finally, for very high-frequency applications, consider using the HP 34513C or the HP 34514C General Purpose RF relay modules (described in a later section) to build up your own custom high-frequency matrices. Special cable kits allow many of these modules to expand into larger matrix configurations.

#### Relay Matrix Modules

	HP 34501M	HP 34506	HP 34511M	HP 34512	HP 34516
Crosspoints	32	32	64	32	256
Matrix Configuration	4 $\times$ 8	4 $\times$ 8	8 $\times$ 8 4 $\times$ 16	4 $\times$ 8	8 $\times$ 32 4 $\times$ 64
Bandwidth	1 MHz	30 MHz	1 MHz	30 MHz	1 MHz
Max voltage (ac rms)	42 Vdc 30 Vac	42 Vdc 30 Vac	130 Vdc 130 Vac	250 Vdc 170 Vac	42 Vdc 30 Vac
Max Current	2 A	1 A	1 A	1 A	1 A
Connectors	2-wire	Coaxial	2-wire	Triaxial	2-wire
Switched Shield	No	Yes	No	Yes	No

#### General Purpose Relay Modules

There are several general-purpose modules available for different applications. The HP 34503 has 16 Form C relays. The HP 34510 has 8, but can switch 10 amps per relay. The HP 34513 and HP 34514 are building blocks, allowing you to build up custom-switching topologies to fit your requirements. These cards contain 32 independently operated double-pole/double-throw high-frequency relays. All contacts are brought out to board-mounted SMB connectors. Interconnections between relays are made via coaxial cables.

#### General-Purpose Relay Modules

	HP 34503	HP 34510	HP 34513	HP 34514
Number of relays	16	8	32	32
Contact Config.	SPDT (Form C)	SPDT (Form C)	DPDT	DPDT
Maximum Voltage (ac rms)	250 Vdc 250 Vac	125 Vdc 250 Vac	42 Vdc 30 Vac	42 Vdc 30 Vac
Maximum Current	3A	10 A	1 A	1 A
Bandwidth	1 MHz	1 MHz	1 GHz	300 MHz
Use	General-Purpose	Power Actuator	50 $\Omega$ RF Switching	75 $\Omega$ RF Switching

#### Digital I/O Modules

The HP 34509 has a total of 32 open-drain MOS FET outputs, which can switch voltages up to 42 V and currents up to 0.5 A. This card also contains 2 internal power supplies of 15 V and 28 V, making the module ideal for driving relay coils or other devices. This card is also used in conjunction with the HP 34530 and HP 34531 microwave switches.

The HP 34522 is a 32-bit digital I/O module, featuring 32 bi-directional TTL-compatible data lines, 8 edge-triggered interrupt lines, 16 high-power FET outputs, and a read/write rate > 40 kHz. The 32 data lines are configured as four 8-bit ports, each with its own handshake lines. Each port can be operated independently as a read or write port, or can be combined to handle 16- or 32-bit parallel data.

#### Analog Source Cards

The HP 34521 AC/DC Source Card offers 24-bit (6.5-digit) resolution in the dc voltage mode, highly accurate amplitudes in the ac voltage mode, and versatile high-speed outputs in the arbitrary waveform mode. Maximum voltage output is  $\pm 10$  volts; maximum frequency is 1 MHz. Standard ac outputs include sine, square, and triangle waveforms, with variable duty cycle on both triangle and square waves. AC outputs are generated by direct digital synthesis, which provides high accuracy and resolution down to 0.001 Hz. Arbitrary waveform memory depth is 2048 bytes. Arbitrary waveforms can be generated at a full 1 MHz bandwidth.

The HP 34524 contains 4 completely independent 14-bit plus sign digital-to-analog converters (DAC). In the voltage mode, each DAC can supply  $\pm 10.24$  volts. In current mode, each can provide  $\pm 20.16$  mA. Because the 4 DACs are isolated from each other, they can be connected in series or parallel for greater output voltages or currents.

#### Breadboard Module (HP 34523)

The breadboard module is a convenient way to incorporate special-purpose circuits into your test system. This module lets you interface directly to the HP 3235A's backplane control signals and backplane analog and trigger buses.



### 6.5-Digit Multimeter Module (HP 34520)

With the DMM module, you can integrate a high-performance system multimeter into your test system without extensive cabling and software programming. The DMM module offers 7 functions:

#### dc Voltage (90-day, Tcal ± 5° C)

Range	Best 6.5-Digit Accuracy <sup>1</sup> ± (% of reading + volts)	Input Resistance
30 mV	0.0053% + 5.40 μV	> 10 GΩ
300 mV	0.0038% + 5.7 μV	> 10 GΩ
3.0 V	0.003% + 8 μV	> 10 GΩ
30 V	0.0048% + 220 μV	10 MΩ ± 1%
250 V	0.0063% + 70 μV	10 MΩ ± 1%

#### dc Current (90-day, Tcal ± 5° C)

Range	Best 6.5-Digit Accuracy <sup>1</sup> ± (% of reading + amps)	Max. Burden Voltage at Fullscale
300 μA	0.025% + 15.4 nA	0.35 V
3 mA	0.025% + 15.4 nA	0.35 V
30 mA	0.025% + 1.54 μA	0.35 V
300 mA	0.088% + 25.4 μA	0.6 V
1.5 A	0.088% + 654 μA	1 V

#### Resistance (2- and 4-wire Ω)<sup>2</sup> (90-day, Tcal ± 5° C)

Range	Best 6.5-Digit Accuracy <sup>1</sup> ± (% of reading + Ω)	Current Output
30 Ω	0.0078% + 5.4 mΩ	1 mA
300 Ω	0.0058% + 5.7 mΩ	1 mA
3 k Ω	0.0048% + 9 mΩ	1 mA
30 k Ω	0.0048% + 90 mΩ	100 μA
300 k Ω	0.006% + 1 Ω	10 μA
3 M Ω	0.008% + 15 Ω	1 μA
30 M Ω	0.032% + 830 Ω	100 nA
300 M Ω <sup>3</sup>	2.5% + 100 kΩ	100 nA
3 G Ω <sup>3</sup>	25% + 1 MΩ	100 nA

1 After 1-hour warmup, integration time 100 PLC. Tcal is the temperature of the calibration environment between 18 and 28°C.

2 For 2-wire ohms, add 200 MΩ to count error specifications.

3 For 2-wire ohms, only accuracy is specified following auto-cal (ACAL), under stable conditions (± 1° C).

### AC Voltage (RMS AC and RMS AC + DC)

**ACV bandwidth:** 20 Hz to 1 MHz

**Crest factor:** 3.5 to 1 at fullscale

**Common mode rejection:** With 1 kΩ imbalance in the low lead, dc to 60 Hz.

**Guarded:** > 86dB

**Non-guarded:** > 66dB

**AC Volts (90 day, Tcal ± 5° C)**

Range	(100 Hz to 20 kHz) Best 5½-Digit Accuracy <sup>1</sup> ± (% of reading + % of range)		Input Impedance
	AC Coupled	DC Coupled	
30 mV	0.15% + 0.0441%	0.19% + 0.169%	1 MΩ ± 1% shunted by > 90 pF
300 mV	0.15% + 0.0441%	0.19% + 0.169%	
3.0 V	0.15% + 0.0441%	0.19% + 0.169%	
30 V	0.15% + 0.0441%	0.19% + 0.169%	
300 V	0.21% + 0.053%	0.25% + 0.203%	

<sup>1</sup> Accuracy specified for sine wave inputs, > 10% of range. DC component < 10% of ac component after one-hour warmup and within one week of ACAL. AC band set to < 400 Hz.

### AC Current (RMS AC and RMS AC + DC)

**ACI bandwidth:** 20 Hz to 100 kHz

**Crest factor:** 3.5 to 1 at fullscale

#### Frequency and Period

Measures the frequency or period of the ac component of the ac or dc coupled voltage or current input. The counter uses a reciprocal counting technique to give constant resolution independent of input frequency.

**Frequency range:** 10 Hz to 1.5 MHz (voltage input)  
10 Hz to 100 kHz (current input)

**Period range:** 0.1 s to 667 ns (voltage input)  
0.1 s to 3.33 us (current input)

**Sensitivity:** 10 mV rms or 100 μA rms (sinewave)

**Triggering:** Triggers and counts on zero crossings

### SimPlate Board Test Fixture (HP 34597A)

The HP 34597A SimPlate Board Test Fixture is a vacuum-actuated bed-of-nails test fixture kit for the HP 3235A Switch/Test Unit. SimPlate and the HP 3235A are tools developed for your "rack-and-stack" functional test systems. Unlike an edge connector test, SimPlate gives you access to all component leads to provide more functional test flexibility and improved fault isolation. Because of its unique single-plate design, SimPlate can provide the close-tolerance probing required for interfacing to Surface-mount technology (SMT) boards.

SimPlate is delivered as a kit that you must drill, wire, and assemble. Its components are designed to probe printed circuit boards from a single side, with test pads as small as 0.030-inch diameter on 0.050-inch centers. Probes, receptacles, and additional HP 3235A terminal blocks are ordered separately.

#### General

##### Environmental

**Operating temperature:** 0° to 55° C (32° to 130° F)

**Storage Temperature:** -40° - 75° C (-40° - 165° F)

**Humidity Range:** 95% R.H., 0° to 40° C (32° - 10° F)

##### Power

**Line Voltage:** 90 to 132 V (115 V) or 192 to 264 (230 V) switch-selectable 47 to 66 Hz. Fused at 5A (115 V) or 2.5 A (230 V).

##### Size

**HP 3235 Cardcage:** 310 mm H (without feet) × 426 mm W × 594 mm D (12.2 in × 16.8 in × 23.4 in)

**Height with Feet:** 325 mm (12.8 in)

**Depth with Terminal Blocks:** 693 mm (27.3 in)

##### Weight

HP 3235 Cardcage (max.) 21 kg (46 lb)

Each module (max.) 5.5 kg (12 lb)

##### Net

21 kg (46 lb)

5.5 kg (12 lb)

##### Shipping

28 kg (62 lb)

6.6 kg (14.6 lb)

#### Ordering Information

**HP 3235A** Switch/Test Unit

**Opt 560** Add System Expansion Card

**Opt 580** HP-1B Controller

**Opt 590** Add Quick Interconnect Fixture

**Opt 908** Rack Mount Kit (HP P/N 03235-80908)

**HP 3235E** Switch/Test Unit Extender

**HP 34550A** Control Panel

**HP 34551A** Control Panel Rack Mount Kit

#### Price

\$5,850

\$460

+\$740

+\$970

+\$120

\$4,860

\$780

\$70

**Plug-in Accessories** are supplied with your choice of terminal blocks. "A" suffix designates solder lugs, "B" designates screw terminals, "C" deletes the terminal block, "M" and "N" designate matrices, and "T" is used to measure thermocouples. Prices shown below are for the "B" suffix.

**HP 34501A/B/M/T** 32-Channel Armature Relay Mux/Matrix \$1,600 - 2,000

**HP 34502A/B/M/T** 32-Channel Reed Relay Mux/Matrix \$1,600 - 2,000

**HP 34503A/B** General-Purpose Relay Module \$1,080 - 1,250

**HP 34504A/B/C** Switched-Shield Coax Mux \$1,970 - 1,730

**HP 34505A/B/C** 50-Ω RF Mux \$1,730 - 1,460

**HP 34506A/B/C** Switched-Shield Coax Matrix \$2,000

**HP 34507A/B/M/T** 32-Channel Mercury Relay Mux/Matrix \$1,840 - 2,270

**HP 34508A/B/C** 75-Ω RF Mux \$2,050 - 1,620

**HP 34509A/B/C** 32-Channel Relay Driver Module \$1,430 - 1,160

**HP 34510B** 10-amp, 8-Channel Power Actuator \$960

**HP 34511B/M** 64-Channel Relay Mux/Matrix \$2,710

**HP 34512C** Switched-Shield Triaxial Matrix \$3,220

**HP 34513C** General-Purpose 50-Ω RF Module \$3,220

**HP 34514C** General-Purpose 75-Ω RF Module \$3,560

**HP 34515B** 10-Channel 1000-Volt Mux \$2,330

**HP 34516M/N** 256-Crosspoint Matrix \$5,420

**HP 34520A/B** 6.5-Digit Multimeter Module \$3,190

**HP 34521A/B** AC/DC Source Module \$3,140

**HP 34522A/B** 32-Bit Digital I/O Module \$1,460

**HP 34523A/B** Breadboard Module \$490/670

**HP 34524A/B** 4-Channel D/A Converter Module \$2,050/2,210

**HP 34530A/B** Microwave Switch \$700/810

**HP 34531A/B** 1×6 Microwave Switch \$1,400/1,670

# MEASUREMENT SYSTEMS ARCHITECTURE

## Computer Aided Test

### HP 3488A

- dc-26.5 GHz signal switching
- Matrix, multiplexer, and general purpose relays
- Digital I/O control and actuation
- Up to 50 channels
- 40 configuration storage registers
- 11 switch and control modules



HP 3488A



### HP 3488A Switch/Control Unit

The HP 3488A Switch/Control Unit brings versatile, HP-IB programmable switching to tests requiring multi-channel measurements. The HP 3488A provides signal switching with the integrity and isolation needed for high-performance production test systems. It also offers a flexible, low-cost interconnection for automating experiments on the bench and for developing tests in the lab. The HP 3488A is designed to hold up to 5 of the following switch and control modules:

- 10-Channel Relay Multiplexer
- 10-Channel General Purpose Relay
- Dual 4-Channel VHF Switch
- 4 × 4 Matrix Switch
- 16-Bit Digital Input/Output
- Breadboard
- 3-Channel 18 GHz Switch
- 7-Channel Form-C Relay
- 2-Channel Microwave Switch
- 1.3 GHz 50 and 75 Ω Multiplexers

### Flexible Switching

The HP 3488A is an economical approach to flexible switching through plug-in modules. You can select the right combination of switching functions to meet both performance and budget needs. Testing is simplified by having one solution for connections of low-level DVM inputs, high-level dc and ac power, and microwave signals to 26.5 GHz. Additional devices, such as microwave relays and programmable attenuators, are easily controlled with digital I/O functions. Custom circuitry can also be implemented on breadboard modules.

### Versatile Performance

The HP 3488A can store up to 40 complete switch configurations for convenient recall in automated test programs. Switch operation can be done with multiple relay closures or with selectable channels in a break-before-make mode. Break-before-make and recallable switch configurations can be combined in a programmable scan list. The HP 3488A uses removable screw terminal connectors that provide easily interchangeable wiring for each test. Built-in self-test assures proper operation.

### Multiplexer (Option 010/HP 44470A)

Option 010 is a 10-channel multiplexer for scanning or multiple signal connections. Channels switch 2 wires (Hi and Lo) with 2PST relays for DVM inputs and other signals up to 250V and 2A. This module can also be used to multiplex signals to other switching functions, such as the matrix module.

### General Purpose Relay (Option 011/HP 44471A)

This module consists of 10 SPST independent relays for general signal switching and control of external devices. Quality connections make this module ideal for switching signals when multiplexing is not required, or for supplying switchable power to the device under test.

### VHF Switch (Option 012/HP 44472A)

The VHF module provides broadband switching for high-frequency and pulse signals. The 2 independent groups of bidirectional 1 × 4 switches can be used for signals from dc to 300 MHz. All channels have 50-ohm characteristic impedance and are break-before-make within a group of 4 channels. Each group is isolated from the other and from ground to prevent ground loops. Excellent isolation makes this module ideal for high-frequency signal analyzer measurements requiring a large dynamic range.

### Matrix Switch (Option 013/HP 44473A)

Option 013 offers highly flexible switching with a 4 × 4, 2-wire matrix. Any combination of 4 input channels may be connected to any combination of 4 output channels. Each cross point or node in the matrix uses a 2PST relay to switch 2 lines (Hi and Lo) at a time. Multiple 4 × 4 modules can be connected to form larger matrices. Multiplexers can be used in conjunction with this module to effectively expand the number of inputs and outputs of the matrix.

### Digital I/O (Option 014/HP 44474A)

This module offers 16 very flexible bidirectional I/O lines and 4 TTL-compatible handshake lines for sensing and control of external devices. The digital inputs can be used to sense contact closures to ground. Each channel provides current sinks for remote switching of external relays, such as the HP 33311 series coaxial switches.

### Breadboard (Option 015/HP 44475A)

The breadboard module provides a convenient way to implement custom circuits and special functions that interface directly to the HP 3488A's backplane control signals.

### Microwave Switch (Option 016/HP 44476A)

This microwave switch furnishes 3 independent SPST 50-ohm coaxial switches with excellent performance from dc to 18 GHz. The 3 mm SMA connector allows you to easily connect cables for multiple system configurations.

### Form-C Relay (Option 017/HP 44477A)

This module provides 7 separate SPDT channels for general purpose switching and control of external devices. Using a power supply, the module can drive programmable attenuators and non-HP coaxial switches.

**Microwave Switch (Option 018/HP 44476B)**

The module brings multi-port 50-ohm coaxial switching to your test system. The module can mount any two HP 3331XX coaxial switches. The HP coaxial relays come in 3-, 4-, and 5-port configurations—different switches for a variety of applications. HP coaxial switches that can be used are:

HP Coaxial Switch	Port	Frequency
HP 33311B/Opt 011	3	dc to 18 GHz
HP 33311C/Opt 011	3	dc to 26.5 GHz
HP 33312B/Opt 011	4	dc to 18 GHz
HP 33312C/Opt 011	4	dc to 26.5 GHz
HP 33313B/Opt 011	5	dc to 18 GHz
HP 33313C/Opt 011	5	dc to 26.5 GHz

**1.3 GHz 50-ohm Multiplexer (Option 019/HP 44478A)  
1.3 GHz 75-ohm Multiplexer (Option 020/HP 44478B)**

These modules bring bi-directional switching of signals from dc to 1.3 GHz, with high-channel isolation (> 55 dB @ 1 GHz). Each module consists of 2 groups of 1x4 multiplexers. All test connections are made to BNCs on the module's edge. Off-channels can be resistively terminated.

**Specifications for Option 010/HP 44470A Multiplexer, Option 011/HP 44471A General Purpose Relay, and Option 013/HP 44473A Matrix Switch and Option 017/HP 44477A Form-C Relay Switch Modules**

**Input Characteristics**

**Maximum voltage (terminal-terminal or terminal-chassis):** 250 V dc, 250 Vac rms, 350 Vac peak  
**Maximum current:** 2 A dc, 2 A ac rms  
**Maximum power:** 60 W dc, 500 VA ac  
**Thermal offset:** < 3 μV

**dc Isolation (40°C, 60% RH)**  
**Channel-channel, open channel:** > 10<sup>n</sup> Ω

**ac Isolation/Performance**

(50 Ω termination)	100 kHz	1 MHz	10 MHz
Insertion Loss (dB)	< 0.30	< 0.35	< 0.90
Crosstalk (dB)	< -73	< -53	< -33

**Specifications for Option 012/HP 44472A VHF Switch Module**

**Input Characteristics**

**Maximum voltage**  
 Center-center, center-low: 250 Vdc, 30 Vac rms, 42 Vac peak  
 Low-chassis, low-low: 42 V dc  
**Maximum current (per channel):** 30 mA dc, 300 mA ac rms  
**Thermal offset:** < 15 μV per channel  
**Characteristic impedance:** 50 Ω

**AC Isolation/Performance**

	30 MHz	100 MHz	300 MHz
Crosstalk (dB)			
Channel-Channel	< -100	< -85	< -65
Group-Group	< -85	< -85	< -50
Insertion Loss (dB)	< 0.5	< 0.75	< 1.25
VSWR	< 1.06	< 1.12	< 1.43

All channels break-before-make within a group of 4 channels.

**Specifications for Option 014/HP 44474A Digital I/O Module**

**I/O Lines**  
**Maximum voltage:** +30 Vdc (line-chassis)  
**Output characteristics:** V (high) ≥ 2.4 V; V (low) ≤ 0.4 V  
**I (low) maximum:** 125 mA @ V (low) ≤ 1.25 V; fused at 250 mA  
**Input characteristics:** V (high) ≥ 2 V; V (low) ≤ 0.8 V  
**External increment:** Advances HP 3488A to next programmed configuration on falling edge of TTL pulse  
**Channel closed:** Indicates completion of new configuration; TTL pulse

**Specifications for Option 016/HP 44476A**

**Microwave Switch Module**

**Frequency range:** dc to 18 GHz  
**Isolation:** > 90 dB  
**Impedance:** 50 Ω  
**Insertion loss:** < 0.05 dB  
**SWR:** 1.40

**Specifications for Option 018/HP 44476B**

**Microwave Switch Module**

Refer to HP 3331XX specifications.

**Specifications for Option 019/HP 44478A and Option 020/HP 44478B 1.3 GHz Multiplexers**

**Input Characteristics**

**Maximum voltage:** 42 V DC + AC Peak  
**Maximum current per channel:** 1 A DC or AC rms  
**Maximum power per channel:** 24 W, 24 VA, or 44 dBm  
**Impedance:** 50 Ω (Opt 019/HP 44478A)  
 75 Ω (Opt 020/HP 44478B)

**ac Performance**

	≤ 10 MHz	≤ 100 MHz	≤ 500 MHz	≤ 1.3 GHz
Insertion Loss (dB) ≤ (40° C, 95% RH)	< 0.3	< 0.7	< 1.5	< 3.0
≤ (25° C, 40% RH), (Typ.)	< 0.2	< 0.5	< 1.1	< 1.9
Crosstalk (dB) Channel-Channel Channel-Common	< -90	< -80	< -65	< -55
Group-Group, Module-Module	< -90	< -80	< -70	< -60
VSWR	< 1.2	< 1.25	< 1.35	< 1.55

**General Specifications**

**Environmental**

Temperature: 0° to 55° C (32° to 130° F); humidity: 95%, 0° to 40° C (32° to 105° F)  
**Power:** 86 to 132 V/195 to 250 V, switch-selectable; 48 to 440 Hz; 18 VA.  
**Interface:** HP-IB  
**Size:** 89 mm H (without feet) × 425 mm W × 292 mm D (3.5 in × 16.75 in × 11.5 in). Allow 76 mm (3 in) additional depth for wiring.  
**Weight:** Net: 8.5 kg (18.75 lb); shipping: 16 kg (35.25 lb).  
**Connectors:** Removable screw terminal connector. Each terminal accepts 18 to 26 gauge (16 to 40 mils) wire, with strain relief for wiring.  
 Option 012/HP 44472A VHF Switch: BNC connectors.  
 Option 016/HP 44476A and Option 018/HP 44476B Microwave Switch: SMA connectors.

**Ordering Information**

	Price
<b>HP 3488A</b> Switch/Control Unit	\$1,840
<b>Switch Modules-Includes Terminal Connectors</b>	
<b>Opt 010/HP 44470A</b> 10-Channel Relay Multiplexer Module	+\$520
<b>Opt 011/HP 44471A</b> 10-Channel General Purpose Relay Module	+\$520
<b>Opt 012/HP 44472A</b> Dual 4-Channel VHF Switch Module	+\$740
<b>Opt 013/HP 44473A</b> 4 × 4 Matrix Switch Module	+\$640
<b>Opt 014/HP 44474A</b> 16-Bit Digital Input/Output Module	+\$520
<b>Opt 015/HP 44475A</b> Breadboard Module	+\$210
<b>Opt 016/HP 44476A</b> Microwave Switch Module	+\$2,420
<b>Opt 017/HP 44477A</b> Form-C Relay Module	+\$520
<b>Opt 018/HP 44476B</b> Microwave Switch Module	+\$520
<b>Opt 019/HP 44478A</b> 1.3 GHz 50 Ω Mux	+\$950
<b>Opt 020/HP 44478B</b> 1.3 GHz 75 Ω Mux	+\$1,030

**Rackmounting and Manuals**

<b>Opt 401</b> Side Handle Kit (HP P/N 5061-1171)	+\$50
<b>Opt 907</b> Front Handle Kit (HP P/N 5061-1170)	+\$60
<b>Opt 908</b> Rack Flange Kit (HP P/N 5061-1168)	+\$40
<b>Opt 909</b> Rack Flange with Handles (HP P/N 5061-1169)	+\$90
<b>Opt 910</b> Extra Operating and Service Manuals	+\$100
<b>Opt W30</b> Three-Year Hardware Support	+\$60

# MEASUREMENT SYSTEMS ARCHITECTURE

## Board Test Systems



Technological advances and increased worldwide competition place ever-increasing demands on production managers to cut costs, increase productivity, and improve product quality. The use of advanced technologies, including surface-mount devices (SMDs), application-specific integrated circuits (ASICs), and VLSI circuits, give the manufacturer capability, reliability, and cost advantages. They also present a unique set of process- and test-related problems. Automatic test equipment to solve these problems is no longer a luxury; it is a necessity.

Hewlett-Packard, an innovator in the design and use of advanced technologies, provides a full line of affordable board test systems to meet the diverse needs of the electronics manufacturing industry. From the low cost HP 3065ST Standard Technologies in-circuit tester to the HP 3078 combinational test system, Hewlett-Packard has a system to meet your specific testing requirements.

### The Board Test Advantage

In the manufacturing process, board test is the first stage where the entire fault spectrum, from defective components to process faults, can be detected. Since each production operation is unique, the board test system must have the flexibility to meet your future requirements as well as your current needs. In choosing a test system, the four major factors to consider are software, in-circuit/combinational testing capabilities, fixturing solutions, and reliability/support. Each is of equal importance, similar to the legs of a table. All the legs must be of equal length and long enough to keep the tabletop they support at a usable level. To fall short in any area will throw the entire system out of balance, reducing its overall effectiveness.

### In-Circuit/Combinational Testing

Hewlett-Packard offers analog and digital testing capabilities in both in-circuit and combinational board test systems. Hewlett-Packard's analog in-circuit testing capabilities have been the industry standard for over 12 years. In digital in-circuit testing, the HP vector processing unit (VPU) makes the current RAM-behind-the-probes technique for pattern application obsolete. With the VPU, the theoretical limit to the pattern depth, without reload or dead time, is approximately 535 million test patterns.

Combinational testing has traditionally been defined as the use of both in-circuit and functional test techniques residing in the same system. This implies that it is merely the sum of the two techniques, each with its advantages and disadvantages. However, combinational testing as a whole can be much greater than the sum of the parts. The key to accomplishing this is integration. It requires a single architecture, common hardware, and a flexible software environment to reach its full potential. Every HP combinational test system uses integrated hardware and software resources to provide unsurpassed test coverage and flexibility for analog, digital, and mixed-signal circuits.

### Software Resources

Hardware features and specifications are most often used as points of comparison between board test systems. However, cost of ownership and return on investment depend more on the software resources of the systems. Test program generation times, fixture development, and fault diagnostics are major contributors to the ongoing costs of the production test department. HP board test systems provide software to make the testing process easier, from start to finish.

HP board test systems provide software to automatically transfer valuable programming information from virtually any CAD and CAE system into menu-driven board forms.

Next, the HP Integrated Program Generator (HP IPG) automatically produces a test program, in which typically over 90 percent of the tests work the first time. This includes shorts, opens, digital tests using Hewlett-Packard's 6500 part digital library, and 6-wire guarded analog tests. CAE data is used to generate tests for complex devices such as ASICs.

HP Color Graphical Debug allows programmers to easily debug both analog and digital tests with histograms and built-in logic analyzer-like displays. It provides menu-driven interactive control of all parameters, highlighting failing responses.

All of these test development tools, and more, are managed by the HP IPG Test Consultant, a menu-driven, mouse-supported interface. A programmer's actions are based on recognition, not recollection, with desired actions selected from the available pull-down menus. The software relieves the programmers of time-consuming tasks such as file management, revision archiving, and program scheduling. In addition, programmers choose the levels of flexibility and automation to best match their expertise.

### Fixturing Solutions

HP offers a full line of mechanical and vacuum-actuated test-fixtures and accessories to maximize system performance. In 1986, the HP SimPlate Series was introduced, offering a 10:1 reduction in probing errors over the conventional two-plate design. With the introduction of the HP 3070 family in early 1989, additional vacuum-actuated fixtures and a mechanical fixture and cassette were introduced. These fixtures provide dual-sided and dual-stage probing, short wire lengths, and improved contact reliability. The mechanical fixturing system readily integrates into automated test environments.

The HP Express Fixture Software automatically designs the test-fixture, minimizing wire lengths and close-centered probes, selecting optimum probe locations, and documenting the fixture support automatic drilling, wiring, and receptacle installation of the fixture.

### Reliability/Support

Since 1983, the HP 3065 testers have been the most reliable systems on the market, but now they have been surpassed by the HP 3070 family, with an MTBF of over 2,300 hours. This reliability was achieved through the extensive use of SMT and HP-designed integrated circuits and reduced numbers of electrical parts, cables, connectors, and mechanical parts. Improved diagnostics and board-level repair give the system an MTTR of 2 hours. The standard warranty on the HP 3070 Systems is one year parts and labor.

With over 100 sales and service offices worldwide, trained HP personnel are there when you need them. Expert programming help is available by phone from the HP Response Center, or locally from over 45 offices with trained HP Systems Engineers. In addition, HP qualifies, trains, and supports a worldwide network of Value-added Suppliers. These suppliers provide fast, local, competitively priced fixturing and programming services.

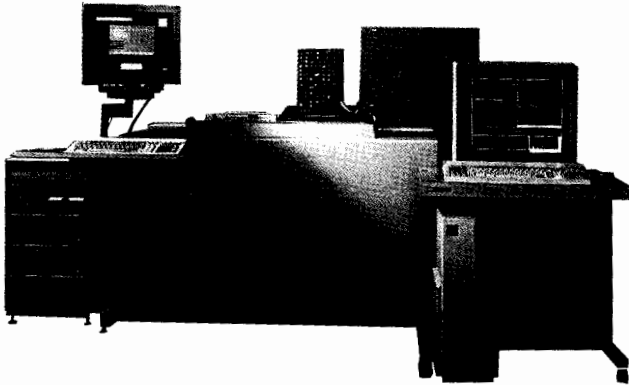

The HP 3078 board test system is designed to help manufacturers shorten time-to-market by reusing design information during the test development process.

The HP 3078 enhances the combinational test capabilities of the HP 3070 family through the addition of simulator-based digital functional test development tools. This product resulted from a joint development effort by HP and Mentor Graphics\*, and is part of a contribution to concurrent engineering that HP calls the concurrent test environment.

Concurrent engineering enables design and test engineers to work in parallel during product development, using the same databases and tools. Utilizing the benefits of concurrent engineering requires a systematic approach to product design, one that integrates all design disciplines, permitting all engineers—whether in research and development, test, quality, components, manufacturing, or packaging—to work on the same product at the same time.

Studies comparing concurrent engineering to the traditional serial approach have shown substantial quality and productivity improvements and significant time-to-market reductions.

### Sharing Design Tools

The HP 3078 board test system provides tight integration of Mentor Graphics\* design and simulation tools with the digital functional test capabilities of the HP 3070 family of board test products. Design engineers can efficiently communicate complex designs to test engineers so that the test development is complete when the design is finished. With this approach, test engineers can reuse schematics, simulation models, stimulus/response data, and test simulation tools. A concurrent engineering approach also enables test engineers to conduct testability reviews while the design can still be changed.

### Design Tools

Using design data from this common tool set, the test engineer can develop digital functional tests concurrent with design development, with the aid of Mentor Graphics' QuickGrade\* and QuickFault\* and HP PreView software.

Mentor Graphics' QuickGrade\* permits rapid grading of test patterns, allowing more "what-if" experiments in a shorter period of time than traditional fault simulators. While its graphical user interface allows new users to become productive quickly, QuickGrade's\* extensive command language is perfect for the advanced user. Undetected stuck-at faults are displayed on the schematic as fault flags, giving engineers a quick visual picture of low fault coverage areas.

Mentor Graphics' QuickFault\* is a thorough deterministic fault simulator that can be distributed over a network to decrease analysis time. The HP 3078 combines fault dictionaries from QuickFault\* with a backtrace algorithm that supports automated measurements using bed-of-nails fixtures and manual measurements using a hand-held probe. These tools minimize diagnostic time while maximizing diagnostic accuracy.

HP PreView software projects real-world test considerations onto a design, making the design easier to test without affecting the design process. Instead of post-processing the simulation results, HP 3078 PreView software simulates the effect of the tester and the fixture on the design during simulation. This approach provides accurate fault coverage that is observable on the tester exactly as simulated. It also produces repeatable test programs that require a minimum of debugging.

### Depot Repair Applications

The HP 3078 is also suitable for use in environments, such as depot repair, where the test development process cannot begin until after the board design is complete. In addition to integrated schematic synthesis and fault simulation tools, the HP 3078 provides a full suite of test debug and diagnostics tools. Standard debug tools include a color graphical logic analyzer display, per-pin programmability, and interactive digital debug facilities. Fault diagnostics tools include a fault dictionary for rapid, accurate diagnosis to the failing node. The fault dictionary can also seed the backtrace routines to further speed failure diagnosis.

### Availability

The HP 3078 board test system includes an HP 307X testhead and controller, an HP Apollo 9000 Series 400 workstation, Mentor Graphics\* CAE software, and HP simulator-based digital functional test capability with concurrent test environment software. A one-year phone-in and software support agreement is included with the HP 3078.

HP board test systems are available in various configurations.<sup>1</sup> The system is available today on Mentor Graphics software revision 7.X with 8.0 to follow.

Because the HP 3078 is built on the HP 307X and Mentor Graphics\* platforms, it is fully compatible with other products in these lines.

HP 3078 simulator-based test capability and concurrent test environment tools can be added to existing HP 3070AT/SMT board test systems and Mentor Graphics Idea Stations\*.<sup>2</sup>

Customers simulating ASICs using Mentor Graphics\* design tools can purchase an in-circuit version of the HP PreView software.<sup>3</sup>

\* Mentor Graphics, Idea Station, QuickGrade and QuickFault are trademarks of Mentor Graphics Corporation in the U.S. and other countries.

<sup>1</sup> Starting at \$383,000.

<sup>2</sup> Starting at \$61,000.

<sup>3</sup> Starting at \$31,000.

# MEASUREMENT SYSTEMS ARCHITECTURE

## Board Test Systems

HP 3065, 3070 Families

### IEEE 1149.1-1990

With the formal acceptance of the IEEE Standard 1149.1-1990, boundary-scan is gaining momentum throughout the electronics industry. The standard is growing in popularity because it cost-effectively addresses the complex problems posed by advanced new technologies such as ASICs and SMDs. Hewlett-Packard, along with other companies, recognized the benefits of boundary-scan and made significant contributions to the development of the IEEE 1149.1 standard. This close involvement allowed Hewlett-Packard to introduce HP boundary-scan software shortly after the standard was formalized.

### HP Boundary-Scan Software

Supported on both the HP 3065AT board test system and on the HP 3070 board test family, HP boundary-scan software automatically creates in-circuit test patterns for individual boundary-scan devices in a matter of minutes. Quite simply, HP boundary-scan software makes test generation easy by accepting de-facto-standard Boundary Scan Description Language (BSDL) files as input and by virtue of its mouse-driven graphical user interface. Users can click on test macros that create more than 20,000 source test vectors per minute (HP 3070 mode). At the same time, the graphical interface allows the user to manipulate the IEEE 1149.1 state diagram. This added flexibility simplifies the task of generating tests for components with non-mandatory features of the IEEE standard.

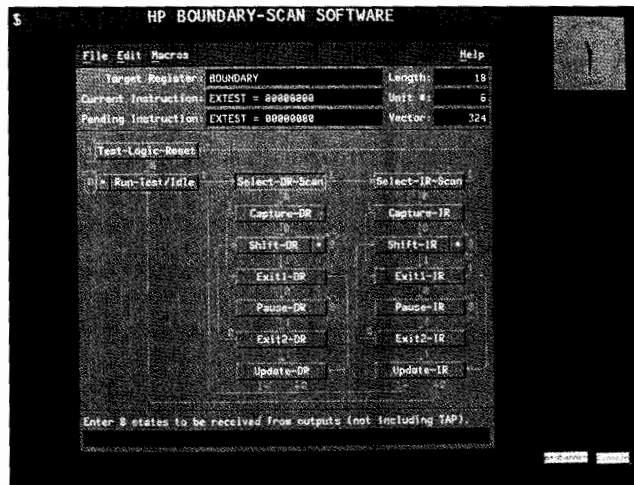

### Complements HP Board Test System Hardware

HP 3070 board test family and HP 3065AT board test system hardware was designed to support boundary-scan testing. The Vector Processing Unit (VPU), standard in all HP 3070 and HP 3065AT systems, can accommodate the very large vector sets necessary to test boundary-scan components. This means that HP boundary-scan software can be added to these existing machines with no tester hardware modifications.

### Continued HP Leadership

HP boundary-scan software was designed for, and has been extensively used by, early adopters of boundary-scan. These are companies that have a few isolated IEEE 1149.1-compliant devices and that see the value of the quick and easy test generation that boundary-scan provides. As these companies gain experience with and confidence in the standard, they will see more boundary-scan devices, many of which will be connected together. HP boundary scan software on the HP 3070 board test family is the base upon which other tools will be built to track the evolving needs of boundary-scan users.

### HP 3070 VXI Board Test Systems

Each member of the 3070 family of combinational board test systems provides several internal instruments for analog functional testing. When the testing requirement exceeds the capability of these instruments, the test engineer is required to use external instruments that meet test needs. Integration of these external instruments often requires custom hardware and software. The HP 3070 VXI board test systems speed combinational test development by reducing the need for custom design.

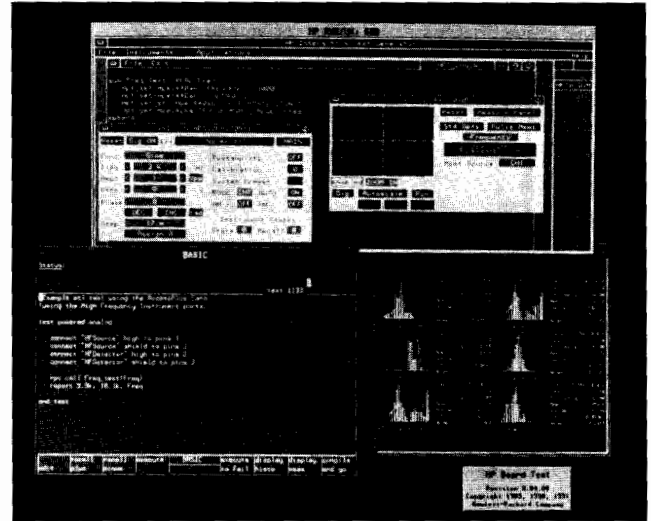

### Engineered System Solution

The HP 3070 VXI board test systems reduce hardware development time through the HP AccessPlus pin card. The card and associated cabling provide an engineered, through-the-system interconnect from the instrument source to the device. This solution speeds test development by providing standard cables and interface for connection to VXI or IEEE-488 instruments. HP AccessPlus resources are controlled with high-level commands that establish measurement paths and automatically reconfigure for either differential or coaxial measurements.

### Speed Analog Functional Test Development

The HP 3070 VXI board test system reduces software test development time with HP Interactive Test Generator (HP ITG). HP ITG provides general-purpose instrument control with its easy-to-use interactive instrument driver library. HP ITG is well suited for control of VXI instruments because it gives users interactive front panels that don't exist on the actual instruments. HP ITG is completely integrated with the standard HP 3070 software. This allows you to fully use HP ITG during development and debug of combinational tests using external analog functional instruments.

### Compatibility

The VXI system is available on all members of the HP 3070 Board Test family.

- In-circuit testers
- Combinational testers
- Surface-mount technology testers

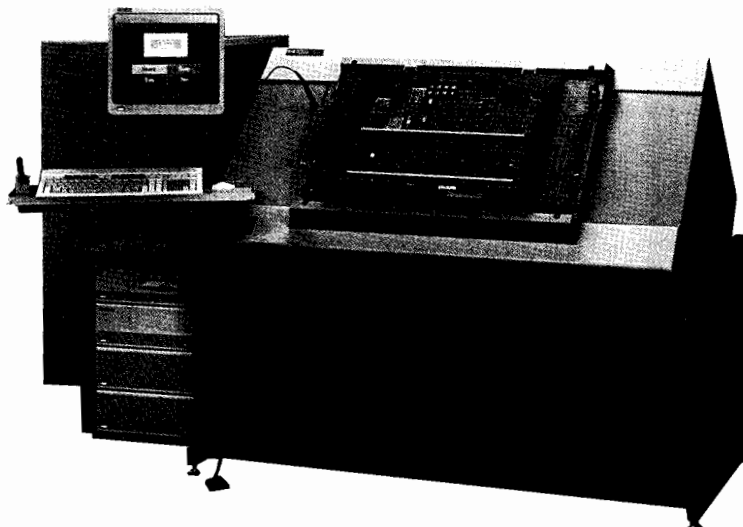

HP 3075

### HP 3070 Board Test Family

HP 3070 board test systems combine high-performance functional and in-circuit test capabilities to solve the most complex test problems faced by the electronics manufacturing industry. All HP 3070 systems provide a completely integrated set of powerful resources for testing digital, analog, and mixed-signal circuits, from surface-mounted, application-specific integrated circuits to state-of-the-art microprocessors. With the latest computational and measurement technologies, the HP 3070 family has the flexibility to effectively test the new technologies you face today . . . and tomorrow.

The family of test systems includes of the HP 3073 advanced in-circuit and HP 3075 combinational testers. The HP 3070 SMT-series includes integral mechanical fixtures that meet the needs of automation and surface-mount technology testing.

### Flexible Architecture

The HP 3070 system architecture is designed to solve test problems into the 21st century. The testhead uses a parallel architecture that supports up to 4 expansion modules. Each module has its own analog and digital control systems and provides up to 648 test nodes. For large node count boards, the modules operate synchronously, providing up to 2,592 total nodes for the HP 3075 and HP 3073, and 1,296 for the HP SMT-Series.

### Compatibility

All HP 3070 systems share a common platform, meaning that test fixtures and programs, as well as programming environments, are compatible across all systems.

Purchase of an HP 3070 system allows for future compatible upgrades, such as combinational test, functional test, dual-sided SMT testing, boundary scan test, and higher pin electronics performance.

### Analog and Mixed-Signal Testing

HP analog testing capabilities are the standard in the electronics industry. These field-proven analog testing techniques, such as the automatic generation of 2-, 3-, 4-, and 6-wire guarded in-circuit tests, built-in sources and detectors, and standard HP-IB (IEEE 488) interface for additional analog functional test instrumentation, are retained in an HP 3070 system. Synchronization of the analog and digital subsystems is added for coordinated mixed-signal testing. In addition, the program generator has been greatly improved through advanced analog simulation techniques to nearly eliminate the need for analog debug.

### Digital Testing

To meet the challenges of testing ASIC, SMT, and VLSI circuitry, test systems must provide better test development tools and improved testing techniques. The HP 3070 Series offers unsurpassed digital test capabilities for these new technologies.

### Vector Processing Unit

Hewlett-Packard pioneered the vector processing unit (VPU) concept in the HP 3065 family, and has continually improved it since that time. The VPU used for digital testing in the HP 3070 family makes obsolete the conventional RAM-behind-the-pins that is used in most other test systems today.

Using the conventional RAM method for pattern application to the device under test, each vector can be used only once before the RAM must be reloaded. Because today's devices require hundreds of thousands of test patterns, the RAM must be reloaded many times. This requires the tests to be segmented and the devices to be re-initialized each time, with dead cycles during reload.

The HP 3070 patented VPU architecture solves this reload problem. It uses a combination of software and hardware for the automatic compression, distributed storage, and application of very deep vector sequences. The theoretical limit to the pattern depth is approximately 535 million vectors before a reload is required.

### Digital Test Capabilities

A variety of pin cards are available to meet different testing requirements. HybridPlus pin electronics provide up to 576 independently programmable digital resources on the system. Each pin can be used for functional or in-circuit, digital, or analog testing. Each pin is independently programmable for drive and receive levels, slew rates, edge placement, pull-up/pull-down loads, and shorts/opens threshold. Digital tests can be applied at 6, 12.5, or 20 million patterns per second with typical edge-placement accuracy of  $\pm 5$  ns. ChannelPlus pin electronics provide up to 1,728 independently programmable digital resources on the system, for applications where high-pin-count ASICs require many tester channels.

### Integrated Program Generator

The HP Integrated Program Generator (HP IPG), combined with a standard digital library of over 6,500 TTL, CMOS, ECL, SMT, ACT, and VLSI devices, automatically generates the digital test program. Typically, over 90 percent of the generated tests work the first time without debug. The HP IPG also provides analog and digital subsystem synchronization for coordinated mixed-signal testing by automatically generating shorts and opens tests, and guarded 6-wire analog tests.

# MEASUREMENT SYSTEMS ARCHITECTURE

## Board Test Systems (cont'd.)

### HP 3070 Board Test Family

#### HP Safeguard In-Circuit Analysis

Every test generated by an HP 3070 system is analyzed by the HP Safeguard In-Circuit Analysis software to minimize the potential for device damage in backdriving testing environments. As each test is created, the software analyzes device parameters such as package type, power dissipation, voltage overshoot, and overdrive currents. If unsafe backdrive conditions are detected, the programmer is notified. In addition, adequate cooldown times are automatically imposed for devices that are being overdriven repeatedly within the test. This is especially important when testing boards with large ASIC and VLSI devices that require many thousands of test vectors.

#### Test Development

Test development is one of the most time-consuming activities in the manufacturing process. HP 3070 test systems provide the software tools needed to shorten your product development cycle.

#### HP IPG Test Consultant

The HP IPG Test Consultant manages the test development on an HP 3070 test system. It is a color, menu-driven, mouse-supported, easy-to-use interface that guides the programmer through the test development cycle. Based on recognition, not recollection, the HP IPG Test Consultant relieves programmers of the burden of remembering the next step. Actions are selected from pull-down menus, and online help is available when needed. Programmers can choose levels of automation or flexibility depending on their expertise with the HP 3070 family.

At the same time, HP IPG Test Consultant relieves programmers of time-consuming tasks such as file management, revision archiving, and program scheduling. This allows them to focus on improving tests for their boards, not trying to remember what comes next.

#### Board Topology Entry

The test development cycle begins by describing the board to the test system. Significant savings in time can be realized if mechanical information about the board (X-Y and connectivity data) can be retrieved from CAD systems. HP 3070 systems come standard with a CAD format translator (CFT). CFT uses templates to structure the data in a format usable by the HP 3070 tester. It has templates for most commercial CAD systems and can be adapted for proprietary systems.

HP 3070 systems include the board forms editor that can be used to enrich the captured CAD data or to enter board descriptions manually. This is a menu-driven editor for entering connectivity and parts information by filling in the blanks on pre-constructed forms.

HP 3070 Series systems capture, compare, and evaluate data created by any simulator and use that information in generating ASIC, cluster, and edge-connector tests. Simulated test patterns and timing information are transferred to the system via the HP Pattern Capture Format for custom test generation.

After the board topology is loaded, the HP Integrated Program Generator develops the test programs. Both in-circuit and functional tests are written in the same high-level languages, such as HP BT-BASIC and Vector Control Language (VCL).

#### State-of-the-Art Fixturing

HP Express Fixture Software automatically designs fixturing for the board to be tested. In addition to minimizing wire lengths, the software minimizes close-centered probes and selects probing locations to reduce areas of high probe density. Each fixture is documented with clear, concise instructions for fixture construction, resulting in higher fixture quality and reduced costs.

During fixture design, the software creates information files to support automated drilling, wiring, and receptacle installation, saving both time and money. After the fixture is completed, the HP fixture verification software is used to ensure that it was properly assembled.

#### Color Graphical Debug

Once the program is generated by HP IPG, typically 90% of the tests work the first time. For those that do not work, HP Color Graphical Debug displays both digital and analog tests using histograms and logic-analyzer-type screens. It is softkey-driven for ease of use.

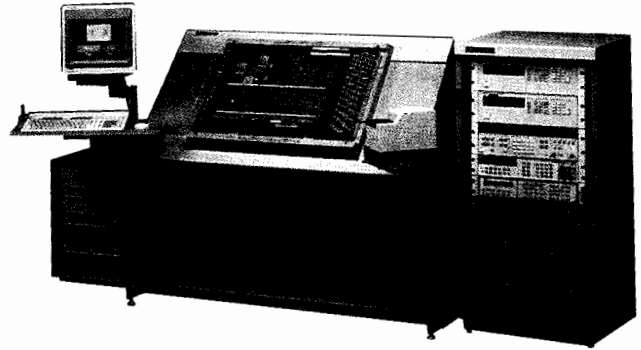

HP 3075

The software provides interactive control of both digital and analog test parameters, including edge placement, slew rates, guard points, drive/receive levels, sources/detectors, and more. Failing responses are highlighted in color. Probing for the debug process can be done through the fixture or via a handheld probe.

#### Production Testing

After a test is released to production, the HP Pushbutton Q-STATS quality management software assists in detecting production process problems. The software uses SQC techniques on actual test data to generate color graphical displays of histograms, production reports, and failure reports, at the touch of a button.

As the need for SQC analysis grows, the HP 3070 family can be integrated into the HP Q-STAR Network, providing access to HP PR PLUS paperless repair management software and HP Q-STATS II advanced quality management software.

#### Protect Your Investment

The HP 3070 family has the flexibility and modularity to grow as your needs grow. It is supported by software, digital/analog combination testing, fixturing solutions, and reliability/support.

The HP 3070 family exceeds the board test industry reliability standards previously achieved by the HP 3065 test system. The HP 3070 design, using SMT and HP integrated circuits, proves an MTBF of over 2,300 hours. The new technologies reduce the number of electronic and mechanical parts required, ensuring unsurpassed system reliability.

When the HP 3070 system fails, its board-level repair strategy simplifies diagnostics and repair. Average mean-time-to-repair (MTTR) is less than 2 hours.

Hewlett-Packard has over 100 board test service offices, which along with the HP Application Engineering Organization (AEO) and Project Centers, can provide complete solutions to your application, hardware, and software needs throughout the world.

#### HP 3070 Board Test Family

For more information on the HP 3070 board test family, contact your local Hewlett-Packard sales and service office. (See page 684.)

#### Ordering Information

Prices depend on system configuration.

HP 3075 Prices start at	\$297,100
HP 3070 SMT-Series: Prices start at	\$332,200
HP 3073 Prices start at	\$205,000



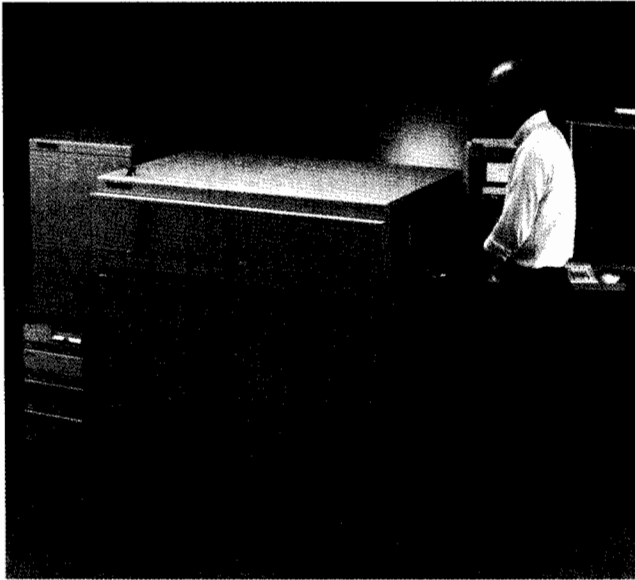

The last five years have seen rapid technological advances in the electronics industry. Device technologies such as application-specific integrated circuits (ASICs) and VLSI circuitry, which were rarely used five years ago, now appear in the design of almost every PC board. However, the greatest impact on the electronics manufacturing industry has been the exponential growth of surface-mount technology (SMT). SMT, ASICs, and VLSI offer greater capabilities and flexibility in much smaller packages. Although they have cost and capability advantages, these new technologies also introduce a unique set of process- and test-related problems that your board test system must solve.

Using SMT in the design of PC assemblies allows higher device densities but results in reduced test pad target size, limited access to test nodes, and dual-sided component placement. Testing these densely packed circuits requires a board test system that has advanced SMT fixturing and test-development tools. That system is the HP 307X SMT-Series tester.

### Testing SMT PC Boards

The primary problems in testing SMT boards are the shortage of reliable probing points access for detailed diagnostics and the high component densities that reduce the size of the test pad to be probed. In an attempt to reduce board geometries even further, manufacturers are placing components on both sides of the PC assembly. This poses problems both for the test system and for the design of the test fixturing.

Testing PC boards with limited access requires a combinational test system with the capability for both in-circuit and cluster functional testing for sections of the board where probe access is impossible. Automatic backtracing for accurate fault isolation within the cluster is also required. To lower the cost of cluster testing, the HP 307X SMT-Series has an integrated program generator, library-generated backtrace trees, and HP Color Graphical Debug.

### SMT Fixturing

Surface-mount technology has had a major impact on test fixture design. The conventional 2-plate vacuum fixture design was adequate for through-hole technology that provided large test pads and single-sided access of every test node. Component densities, reduced access, dual-sided boards, and smaller probing targets have changed the probing process.

Close-center probing is frequently required on SMT boards, making smaller probes a necessity. Smaller probes are more difficult to use because they are more flexible and tend to add to the probing errors of conventional fixturing. In addition, there are few acceptable methods for connecting more than one wire to the 0.050-inch probe. On boards where probes are densely packed, it is sometimes necessary to counteract probe spring tension mechanically because vacuum fixtures cause warping that can introduce failures. The HP SimPlate Series test fixtures, with their single-plate design, solve the problems of close-center probing with a 10:1 reduction in probing errors.

Dual-sided probing is needed when circuit density and component placement make single-side access to test nodes impossible. It requires extremely accurate positioning of the 2 probe plates relative to each other and to the PC board. Longer wires are needed to connect the upper plate to the system interface, affecting signal quality.

To improve signal quality, it is sometimes necessary to use dual-stage probing. This technique easily removes the in-circuit probe loading from the PC board during functional testing on critical nodes. In the past, special probing requirements meant costly, complex fixturing. Hewlett-Packard's automatic fixture generation software and vacuum-actuated and mechanical fixtures provide specialized probing capabilities at affordable prices.

### SMT Testing Solutions

As a major user of SMT, Hewlett-Packard understands the unique demands of testing circuit boards designed with surface-mount devices. Each year, Hewlett-Packard designs approximately 150 new products using SMT, requiring placement of over 450 million surface-mount devices yearly on PC boards. The HP 307X SMT-Series Board Test System combines Hewlett-Packard's expertise in SMT with an extensive background in measurement and computation to provide solutions for SMT test problems.

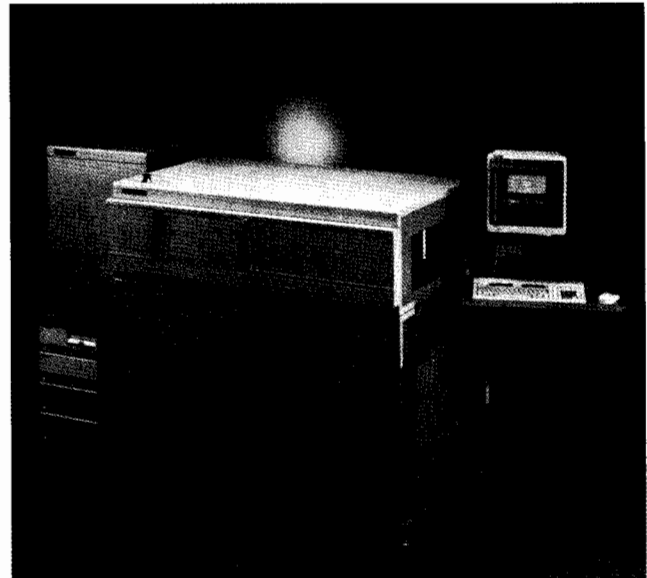

The HP SMT-Series testers provide true combinational test capabilities for testing surface-mount devices with an integral mechanical fixturing system to solve the most complex fixturing problems. The HP Integrated Program Generator (HP IPG) automatically develops analog and digital tests, including cluster testing. HP Express Fixture Software automates the design and construction on the HP SimPlate Express fixtures and HP Express Cassettes for the mechanical fixturing system. The software automatically minimizes top-side probing, fixture wire lengths, and close-center probing.

The HP Express Fixturing System offers the unprecedented mechanical accuracy and reliability required for close-center, dual-sided, and dual-stage probing. With its automatic board-handling capabilities, the system easily integrates into an automated SMT or other high-volume production line.

# MEASUREMENT SYSTEMS ARCHITECTURE

## Board Test Systems

### HP 3065 Board Test Family

- In-circuit test systems
- Combinational test systems

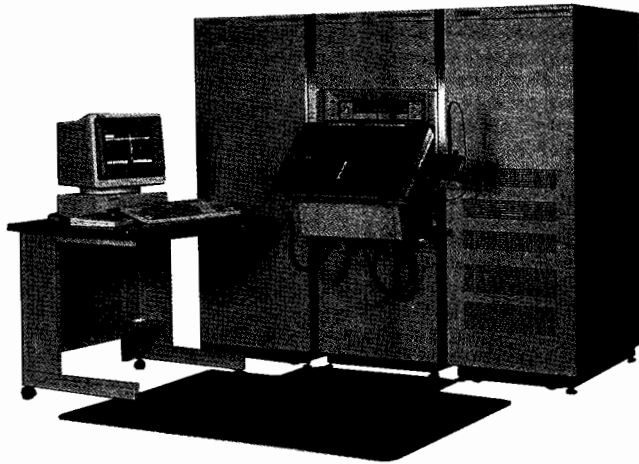

### HP 3065 Board Test Family

Hewlett-Packard offers a complete range of affordable, proven board test products for the electronics manufacturing industry. Building on many years of experience in automatic testing and advanced computer technology, the HP 3065 family provides high-speed digital testing, industry-standard analog in-circuit testing, and analog functional testing. Adding the HP Advanced Technologies hardware and software modules to the L- and X-series testers provides high-speed combinational and IEEE 1149.1-1990 boundary scan testing capabilities.

A distributed intelligence architecture and a true multitasking environment allow a single HP 3065CX PLUS controller to support multiple test stations, multiple programming and repair stations, and a variety of peripherals without sacrificing high throughput in production test. The HP 3065 family consists of two controllers (HP 3065CL/CX PLUS), two test stations (HP 3065HL/HX), the HP 3065ST Standard Technologies tester, the HP 3065AT Advanced Technologies combinational tester, and the HP 3065CT Communications Technologies board test system. The wide selection and varied capabilities of the HP 3065 family allow you to configure a test system to meet the challenge of solving your most complex testing problems . . . in the challenging environment of worldwide competition and rapidly changing technologies.

### New Technologies

Remaining competitive and profitable in today's worldwide marketplace is a problem faced by all electronics manufacturers. To meet these pressures, manufacturers are turning to new technologies and manufacturing processes that promise shorter product development times and increased product flexibility.

The most rapid technological growth is taking place in the use of advanced device technologies, including surface-mount devices (SMDs), application-specific integrated circuits (ASICs), and VLSI, many of which are now designed to meet the IEEE 1149.1 boundary scan standard. These devices place stringent demands on the test system, usually requiring integrated in-circuit and functional (combinational) test capabilities. Surface-mount technology is used to increase device density on PC boards, often placing components on both sides of the boards. In the telecommunications industry, the use of Integrated Services Digital Networks (ISDN) is causing a revolution in the design and testing of new products.

As an innovator in the design and use of these advanced technologies, Hewlett-Packard is a leader in the manufacture of test systems such as the HP 3065 family to address these problems.

### Telecommunications Testing

The telecommunications industry is faced with increased worldwide competition, making product cost and test efficiency major issues. Test managers must reexamine their existing test strategies because existing products and the new ISDN technologies will both be produced and must be tested within the same workcell. The HP 3065CT Communications Technologies test system was designed to solve this problem.

The HP 3065CT is a completely integrated, single-stage test system for the telecommunications industry. It is based on the HP 3065AT combinational tester and the telecommunications software. Additional test instrumentation, new software, and integrated library elements allow the HP 3065CT to perform CCITT specification tests on telecom products. Specification testing on the HP 3065CT requires much less time since production-induced faults are detected with its digital, analog, and combinational test capabilities prior to the CCITT tests.

### Digital Testing of Advanced Devices

Advanced technologies, such as SMDs, ASICs, and VLSI circuits, allow the manufacturer to place greater capabilities into smaller geometries. This poses problems, not only in testing the advanced circuitry, but also in accessing the test nodes on the PC board. HP has the test systems, fixturing, and applications software to solve these problems.

Fast, repeatable digital testing is required to accurately test these advanced devices. HP's digital test capabilities are on a par with its proven analog testing. Microprocessor bus emulation, clock synchronization, and automatic backtrace capabilities make testing the most complex VLSI circuitry a simple task. ASICs require the ability to access data from CAE/CAD systems for accurate test development. The HP 3065 Pattern Capture Format software provides access to over 20 leading design systems and has an open interface to proprietary in-house systems. In addition, HP's Safeguard In-circuit software analyzes every digital test to minimize the potential for device damage. Furthermore, in conjunction with HP Boundary Scan Software (available separately), the HP 3065AT has the capability to test IEEE 1149.1-1990 - compliant devices. The HP Boundary Scan Software automatically generates HP 3065AT tests for boundary scan devices in a matter of minutes.

### HP Q-STAR Network

The HP Q-STAR Test Network offers the basis for implementing SQC in the manufacturing process while providing the optimum solution for your test workcell needs. It provides the HP 3065 user with the tools to implement quality management techniques, paperless repair management, and test program management at minimal incremental cost.

### Protect Your Investment

The modularity and flexibility of the HP 3065 family of test systems allow the user to keep pace with today's rapidly changing technologies. System compatibility, from the low-cost HP 3065ST to the HP 3065AT combinational tester, ensure that programs and fixtures developed on one system are easily transported to others within the family. Therefore, training, test programs, and fixtures are not abandoned when the need for additional capacity arises.

Hewlett-Packard has over 100 board test service offices worldwide, so we are there wherever you are. HP Application Engineering Organization (AEO) and Project Centers can offer complete solutions to your application, hardware, and software support needs anywhere in the world.

### HP 3065 Board Test Family

For more information on the HP 3065 board test family, call your local Hewlett-Packard sales and service office. See page 684.

HP 3065 Series prices start at

**\$100,500**

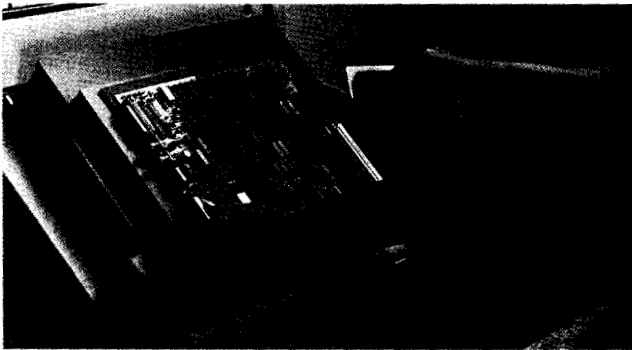

### Test Fixtures

The HP 44203 series of vacuum-actuated test fixtures were introduced in 1986. With only a base plate and a removable support plate, the HP 44203 fixtures offered higher probing accuracy, greater reliability, and easier maintenance than the conventional dual-plate design. The elimination of the top plate and associated hardware reduced the part count of a standard test fixture by 35 percent and reduced the weight by 23 percent.

The newer HP SimPlate 3070 (HP 44202 series) and HP SimPlate Express (HP 44200 series) test fixtures are based on the HP SimPlate design. Solutions for automation and SMT single- and dual-sided access are provided by the mechanical HP Express Fixturing System (HP 44990A) and its HP Express Cassette fixture.

### HP SimPlate Series

The HP 44203S/D/L fixture kits are designed for the HP 306X board test systems. The single-plate design allows the probes and tooling pins to be mounted on the same plane, resulting in improved probing accuracy and repeatability, making these fixtures an excellent choice for testing both conventional and surface-mount technologies. The removable support plate provides immediate probe access without tools for routine maintenance. Testing can continue during maintenance of PC board gaskets and vacuum seals.

### HP SimPlate 307X Series

The HP 44202S/L fixtures bring the proven technology of the single-plate design to the HP 3070 family of board testers. Other features include space for custom fixture electronics, friction hinges to hold lids open during maintenance, and easy upgrade from the HP 3065 to the HP 3070 interface.

### HP SimPlate Express Series

The HP 44200S/L fixtures retain the HP SimPlate top plate interface to the PC board under test. This design supports automatic fixture wiring, lowering the cost while improving the quality of the fixture. Locating grids allow for easy fixture assembly and debug. Average wire lengths of 75 mm (3 in) and wire lengths of 25 mm (1 in) for critical nodes provide the high signal quality necessary to test today's advanced high-speed devices.

### HP Express Fixturing System

The HP 44990A Express Fixturing System provides the exceptional mechanical fixturing accuracy needed for close-center, dual-sided probing for SMT boards. Board flatness is controlled by push rods that oppose areas of high probe density, ensuring accurate probe positioning and contact. Programmable dual-stage probing heights make it easy to remove in-circuit probe loading from the PC board during functional testing of critical circuits.

The system is designed for flexible operation to meet the varying demands of production testing. It can be manually operated in a pass-back mode, partially automated, or fully automated in an in-line mode. The HP Express Fixturing System's light curtains and safety sensors protect the operator from injury and the PC board from accidental damage. Electrostatic charge buildup is reduced because mechanical fixturing eliminates air flow across the board, and automatic loading and unloading minimizes board handling by the operators. The HP 44990A is included with the HP 3070 SMT-Series board test systems.

### HP Express Cassettes

Express Cassettes are built from the HP 44200S SimPlate Express vacuum fixture kit plus either the HP 44201SC or HP 44201SEC Cassette conversion kit. The Express Cassette is a rugged, mechanically operated fixture that is ideal for high-volume testing applications. Its one-piece design makes it easy to handle and store. When the cassette is out of the HP 44990A, the test probes and wiring are fully protected. The cassette can be converted to a vacuum-actuated fixture.

### HP Express Fixture Software

Automatic fixture generation with the HP Express Fixture Software saves time and money in the design and construction of single- and dual-sided test fixtures. The HP Express Fixture Software is a standard part of the HP 3070 Board Test System. The software automatically minimizes fixture wire lengths, selects optimum probe locations, minimizes close-center probe usage, generates to-from wiring guides, positions the board on the fixture, creates files for use in automatic fixture construction, and designs and documents fixture changes to comply with engineering changes to the PC board. For dual-sided fixtures, the software automatically minimizes top-side probing and assigns transfer pins.

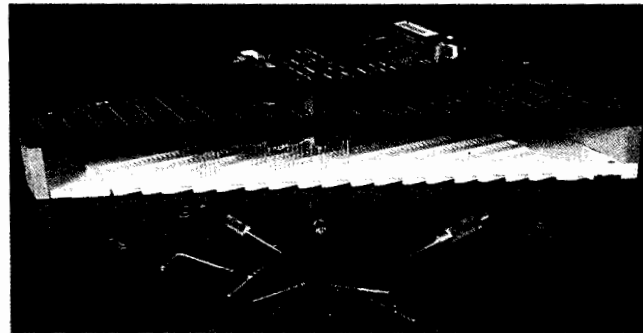

### Accessories

A full line of accessories for fixtures is available from Hewlett-Packard.

### Ordering Information

	Price
<b>HP 44200S</b> Standard HP SimPlate Express Fixture Kit	\$730
<b>HP 44200L</b> Large HP SimPlate Express Fixture Kit	\$1,110
<b>HP 44201SC</b> Bottom-Sided Probing Cassette	\$750
Conversion Kit	
<b>HP 44201SEC</b> Two-Sided Probing Cassette Conversion Kit	\$1,495
<b>HP 44201T</b> Transfer Pin Kit, 20 pins per bag	\$105
<b>HP 44202S</b> Standard HP SimPlate 3070 Fixture Kit	\$710
<b>HP 44202L</b> Large HP SimPlate 3070 Fixture Kit	\$1,090
<b>HP 44202P</b> Interface Pin Block	\$55
<b>HP 44203S</b> HP SimPlate Standard Fixture Kit	\$670
<b>HP 44203D</b> HP SimPlate Dual-well Fixture Kit	\$990
<b>HP 44203L</b> HP SimPlate Large Fixture Kit	\$890
<b>HP E1069A</b> Coaxial Cable Wiring Accessory	\$60
<b>HP E1070A</b> Twisted Pair Wiring Accessory	\$20
<b>HP 44265B</b> Dual-stage Single Point Probes, 10 per bag	\$37
<b>HP 44266B</b> Dual-stage Star Point Probes, 10 per bag	\$37
<b>HP 44274B</b> Dual-stage Receptacles, 10 per bag	\$22
<b>HP 44274S</b> HP SimPlate Receptacles, 100 per bag	\$38
<b>HP 44275P</b> Personality Pins, 100 per bag	\$45
<b>HP 44561L/H</b> Low or High Force Single Point Probe, 100 per bag	\$105
<b>HP 44562L/H</b> LF or HF Serrated Point Probe, 100 per bag	\$105
<b>HP 44563L/H</b> LF or HF Star Point Probe, 100 per bag	\$105
<b>HP 44564L/H</b> LF or HF Spear Point Probe, 100 per bag	\$166
<b>HP 44265F</b> Spear Point Probes-50 mil, 50 per bag	\$110
<b>HP 44265C</b> Chisel Point Probes-50 mil, 50 per bag	\$110
<b>HP 44266F</b> Star Point Probes-50 mil, 50 per bag	\$110
<b>HP 44274F</b> Receptacle-50 mil, 50 per bag	\$59
<b>HP 44990A</b> HP Express Fixturing System	\$67,550

# MEASUREMENT SYSTEMS ARCHITECTURE

## Integrated Systems

### HP Puts It All Together

- 20 years' experience in providing fully integrated systems
- Engineering, manufacturing, support
- Program management
- Systems based on industry standards
- Flexible configurations

### Introduction

Hewlett-Packard doesn't believe in technology for its own sake, but strives to solve tough problems and save you money. And, in today's cost-conscious environment, accountability for the money you spend is more important than ever. HP not only advocates and develops industry standards, but also develops answers to your unique needs. To fully meet your requirements, from individual components to complete turnkey systems, HP offers a variety of services.

### Analysis

To more fully understand what might be the best answer to your needs, an HP team can analyze specific measurement challenges, all the way to analyzing your complete testing philosophy, including:

- Application feasibility studies
- Functional and design specifications
- Mechanical design studies
- Custom hardware and software
- System design and integration
- Project management
- Training, field installation, and support services

### Custom Products and Manufacturing

Throughout this catalog, you can read about individual standard products. Many HP organizations can also modify existing products or, in certain cases, develop products to meet specific customer requirements. On a project basis, HP can also provide manufacturing expertise for your products.

### Integration Services

With a wide breadth of production facilities, HP has a broad spectrum of capabilities, ranging from installing VXI cards in a mainframe, to racking instruments, to complete integrated solutions for your specific applications.

### VABs

As in any industry today, no company makes every kind of product you might need. That's why HP works with "best-in-class" Value-Added-Business associates (VABs) in order to provide for any need you may have.

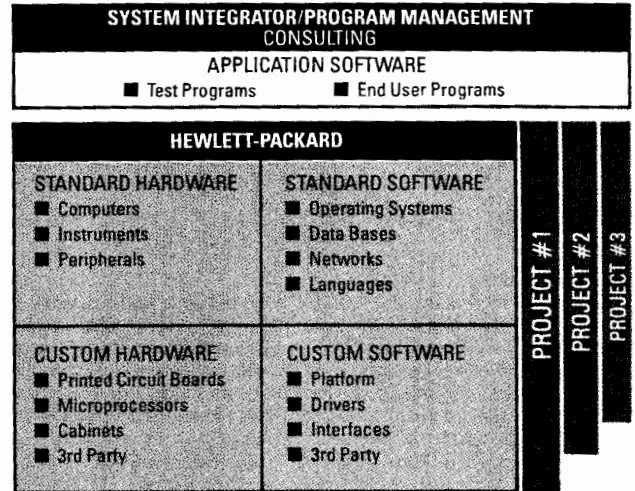

### Integrated Solutions Overview

Large, complex programs depend on the contributions of many companies that draw upon their own unique strengths and capabilities. As shown in the diagram above, HP provides a wide range of standard and customized project components (hardware, software, and integrated systems) that are important to major programs. You can act as the prime contractor on these large projects or we can work with a large systems integrator that handles entire programs of considerable size. There are times when a "do-it-yourself" solution can be just what you're looking for. However, when you need to integrate a sophisticated mix of diverse hardware and software products, HP can provide you with the highest-quality integration services available.

HP can literally put it together for you through extensive engineering, program-management, and manufacturing expertise. Over the last 20 years, HP has developed cost-effective system solutions in many industries, including aerospace/defense, automotive, and telecommunications. This means HP has extensive knowledge of everything from automatic test systems, automotive test systems and dealership information systems, and online technical information systems to product platform systems integration.

Integrating a custom-configured system the right way is more difficult than it looks. To do it successfully, you have to be an expert at cooling and cabling, hardware selection, and ergonomics. HP's open architecture, solidly based on accepted standards such as IEEE 488, UNIX, VXI, and others, means your company is never "locked in" and limited to what is in the box. Instead, your system can grow or adapt to meet your changing requirements.

A truly successful integrated solution must be carefully planned to provide optimum performance. One of the first steps HP takes is to prepare a "scope of work" document that details exactly what the HP team will deliver to your company. HP engineers work closely with your organization to ensure that the right system has been configured to fit your unique applications. This includes determining exactly which products are best suited to your needs—whether standard HP, third-party, or custom products.

## Engineering

When you put HP on your team, you know you'll be working with some of the finest hardware and software engineering talent in the industry. HP has built its international reputation on the quality of its test and measurement instrumentation and its comprehensive families of computers.

Your system has to survive and function in the real world, which means it often has to work in difficult environments. HP never forgets that the systems are created for men and women who must use them every day. We believe that "form follows function" and that the physical design of an object must be appropriate for its use. The human interface is just as important as the equipment we provide.

## Program Services

HP has more to offer than outstanding hardware and software solutions. Here are some of the important services we can provide for your company:

**Complete program management:** When developing and implementing a complex, integrated system, our experienced professionals handle all the crucial details and take the heavy responsibility off your shoulders. A program manager is assigned, who is responsible for coordinating and meeting all HP commitments. The program manager serves as a single, responsible contact point within HP for all project deliverables.

**Full system installation:** A successful installation depends on proper planning. That's why, at the earliest stages of some special projects, we conduct a comprehensive survey of your site to determine the suitability of both floor space and ambient environment.

**Comprehensive training:** First-class user training can help get your new system into full, productive operation in a minimum of time. That's why HP puts so much effort into helping your people get up to speed, quickly!

**Support:** When your company selects HP to develop a unique integrated solution, you know we'll be there to meet your system needs in the future. It's also important to remember that we offer services you can rely on, worldwide.

**Feasibility expertise:** If your company has to develop a custom-designed system, you can draw on our consulting expertise at any time. We can conduct a feasibility study that will help you evaluate which technology and design alternatives are best for your application.

## Manufacturing

Hardware integration is one of our specialties. When you're integrating a number of highly complex components, our experience can save you time and money. When HP integrates a system we make certain that all software works together correctly.

When you're looking for low-volume, custom-tailored solutions, HP can help manufacture exactly what you need, and make sure that it comes up to our own high standards. You can rely on HP for the kind of flexible custom manufacturing that has helped build our reputation for excellence.

## Advanced Platform Integration

If you need custom integration services, HP can help you. For example, when National Car Rental wanted to develop the travel industry's first totally automated rental transaction system, they called on HP. With the new system, preferred travelers can virtually complete their own rental transactions by using National's revolutionary Smart Key machines.

The Smart Key system uses an HP Vectra PC 16S with a video graphics adapter (VGA) color touchscreen to interface with the customer. After inserting a card in the reader, the customer can select a car and receive the car keys and rental agreement from the machine—all without standing in line, filling out forms, or depending on an agent.

The sophisticated software that enables Smart Key to operate was jointly developed by HP and National.

## For More Information

To secure additional information, configuration guidelines, or ordering details, contact your local HP sales office.

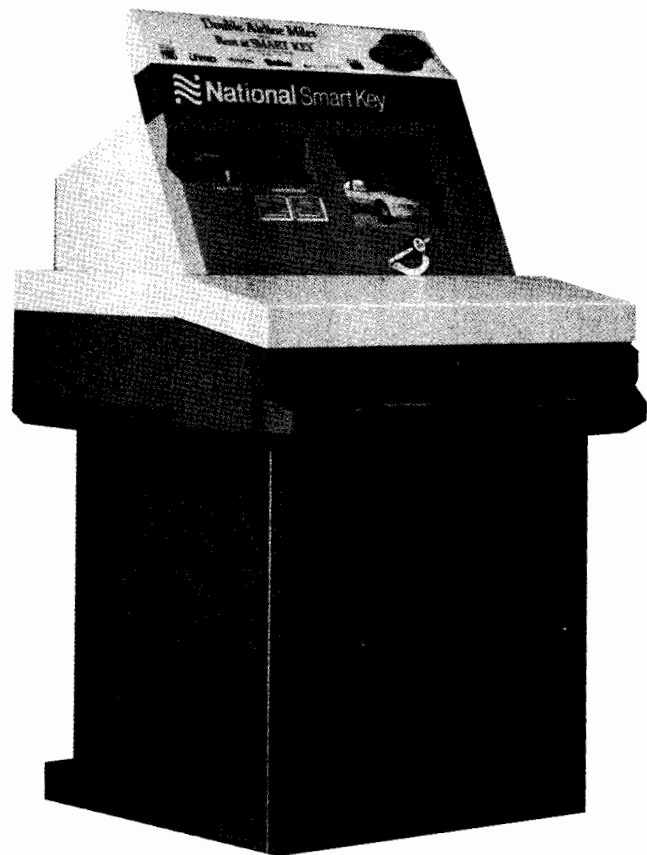

# MEASUREMENT SYSTEMS ARCHITECTURE

## Integrated Systems Automotive Applications

- Hand-held/arm-held systems
- Mobile carts
- Electrical test
- Diagnostics
- Online documentation

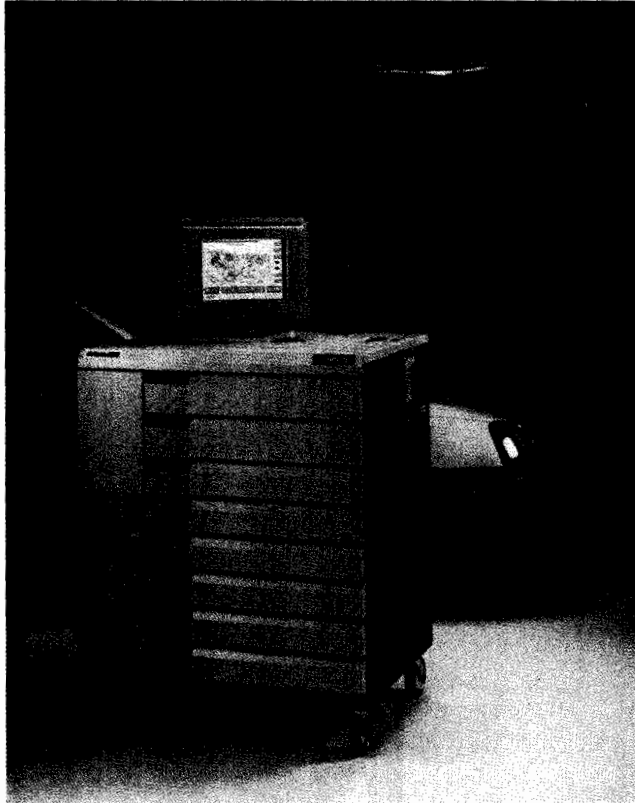

In our years of experience working with automotive manufacturers, HP has developed a wide range of software development tools, and hardware and software platforms that you can build on—from portable information and measurement systems to complete assembly-plant test systems.



### Automotive Applications

Automobile manufacturers worldwide know that competitive success depends on delivering high-quality products and outstanding service. HP has built systems that help improve quality and throughput, whether in the production environment or in the service bay. Solutions include electrical test systems, diagnostic systems, and online documentation systems, available as hand-held portable units. These systems have been built for:

- **Component testing.** Functional testing of “black boxes” such as radios, electronic control units, anti-lock braking systems, and automatic ride control systems.
- **Sub-assembly testing.** Functional test/verification of sub-assemblies such as instrument panels, engines, wire harnesses, and steering columns.
- **In-process verification.** Full functional testing of vehicle (static) roll test, quality-assurance audit testing during the assembly of the vehicle, and end-of-line testing.
- **Service bay systems.** Diagnosis and testing of vehicles in a service-bay environment. Systems can be used by new-car dealers and by independent service agencies. Service bay systems include diagnostic testing of vehicles in the service bay or field environment, as well as graphics-based software tools for development of vehicle diagnostics.
- **Information retrieval.** Electronic distribution and retrieval of service-related information. Platforms include both stationary desktop workstations and portable systems for field and shop use.

## Telecommunications Applications

Unique telecom solutions bridge the gap between HP standard products and platforms tailored to specific customer application requirements.

HP integrates high-performance networking and high-availability HP 9000 UNIX platforms with custom-developed hardware, software, and third-party software into fully supported HP solutions.

## High-Performance Networking

A core element in many telecom solutions is the need for high connectivity to network elements, such as switches and host computers, for network management and adjunct processor applications. HP's telecom networking expertise has evolved the Advanced Communication Controller (ACC), which provides a cost-effective front-end communications gateway. The ACC implements large numbers of X.25, BSC, and SDLC links and custom protocol connections between the Telco network and HP 9000 UNIX processors. The ACC-HP-9000 architecture provides a cost-effective platform that offers scalable performance and high availability to protect the user's investment and to meet increasing needs for assured availability. An example of a solution enabled by the high connectivity capability of the ACC is Dynamically Controlled Network Routing (DCR) of long-distance switch traffic. In this application, ACC supports up to

128 X.25 connections to long-distance switches, which are utilized to download traffic data to a high-availability platform consisting of dual HP 9000 UNIX processors. The DCR platform computes and distributes updated routing tables for the switches every 10 seconds.

## Adjunct Processor Architecture

The figure below shows an ACC adjunct processor architecture, which provides a tightly coupled connection to an Operator Services switch. The ACC provides the ability to manage a large number of terminal connections to support the operator workstations. The ACC can also implement the specialized call-handling protocols between the HP 9000 needed to implement call-processing features not provided by the switch, including message delivery and customized call-intercept.

Telecom solutions components include:

- Scalable high-availability UNIX platforms
- High-connectivity networking solutions
- Customizable protocol support
- -48 Vdc central office CPU power
- DATAKIT switch interfaces
- Audio response unit interfaces
- Third-party software integration and support
- Prototype SMDS interfaces

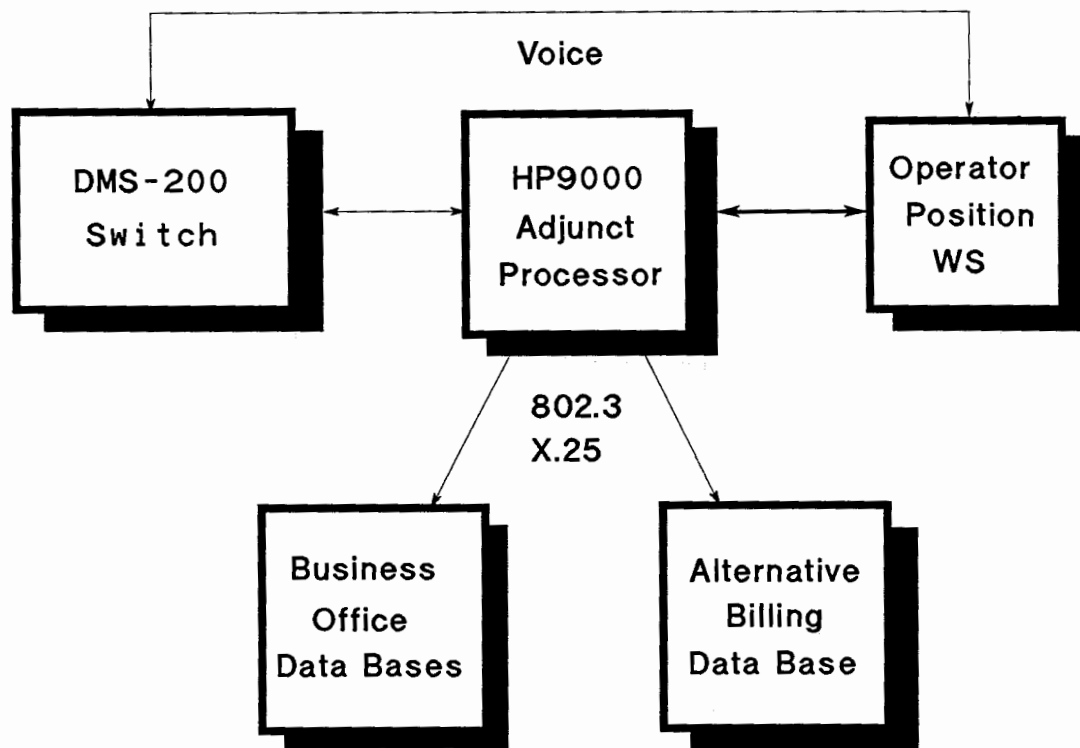

## Adjunct Processor Architecture

# MEASUREMENT SYSTEMS ARCHITECTURE

## Integrated Systems (cont'd)

### HP ATS 2000 + Automatic Test Systems

- Increased productivity
- Improved profitability
- Reduced time to market

#### Aerospace/Defense Applications

HP ATS 2000+ is more than just a collection of sophisticated equipment. It is a cost-effective, dependable, and fully integrated test system. HP ATS 2000+ also enables you to choose from a broad family of instruments, coupled with computers that are specially designed to control complex instrumentation.

HP doesn't believe in technology for its own sake. HP ATS 2000+ is designed to solve tough problems and save you money.

HP works on a fixed-cost, fixed-delivery basis. All costs are established "up front" at the time of purchase, including support, documentation, and training.

#### "Productivity" Is More Than a Buzzword

If you're interested in putting money-saving, high-productivity software to work, HP can help. We provide a growing family of software productivity tools.

**Test development environment (TDE):** This newly released test software development tool has been designed to decrease the development of test software on the HP ATS 2000+ functional test system by up to 50% by eliminating the need to do traditional language-based programming. TDE also serves as the primary test executive for the system.

As shown in the figure to the right, the TDE environment incorporates the HP VEE product and adds a number of modules to adapt and enhance HP VEE for use in the HP ATS 2000+ systems. The result is an easy-to-use graphical development environment.

The TDE run-time or operator environment makes use of the screen-design facility, multi-level security and access, build scheduler, test sequencer, fault information, document retrieval, and system archive to provide a powerful operator environment that is easy to use.

TDE also incorporates the new HP ATS 2000+ digital test unit software and is compatible with HP Test Expert.

**HP Test Expert:** HP Test Expert dramatically speeds up testing and fault diagnosis, and can help detect and isolate faulty modules down to the smallest repair-replaceable unit. Using the power of artificial intelligence, HP Test Expert can help you cut the cost of writing diagnostic software by 50% to 90%. This saving comes from the fact that no one in your organization will have to write diagnostic software. Test times are shortened because redundant testing is eliminated, and highly skilled personnel aren't needed to run the test system.





**HP ATS 2000+ Digital Test Unit**

When fully integrated into the HP ATS 2000+, the new digital test unit (DTU) can perform at a 50 MHz data rate, has 1,024 channels, and can provide simulator- or non-simulator-based testing—all at the board, box, or system level.

For research and development, the DTU helps the HP ATS 2000+ provide functional test capability for testing simulated design and prototype electronic circuits. In production, it provides final functional test of printed-circuit boards and boxes, as well as simulation for certification and quality-assurance testing. For field/depot testing and repair, it provides functional testing for diagnostics and routine maintenance of boards, boxes, and systems.

**Preferred Configuration**

To help facilitate quicker delivery, HP has developed a “preferred configuration” program that contains a specific list of instruments and computer products. This will help reduce the lead time for system deliveries while maintaining an extremely high quality standard and minimizing risk.

**Ordering Information**

To secure additional information, configuration guidelines, or ordering details, contact your local HP sales office.

# HP ATS 2000+ Test Software Development Tools

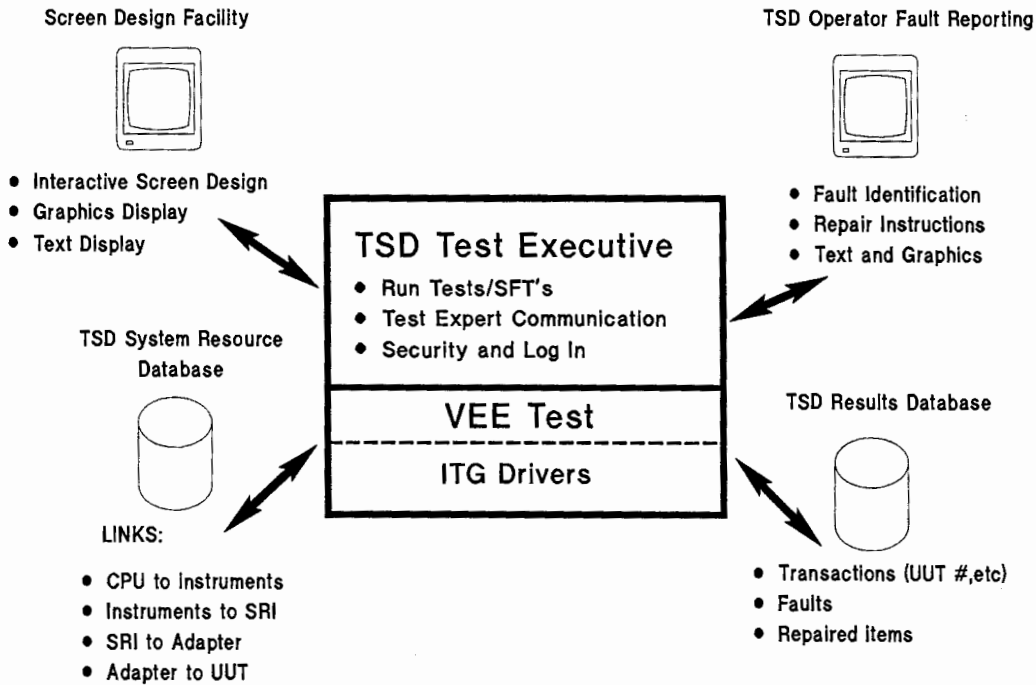

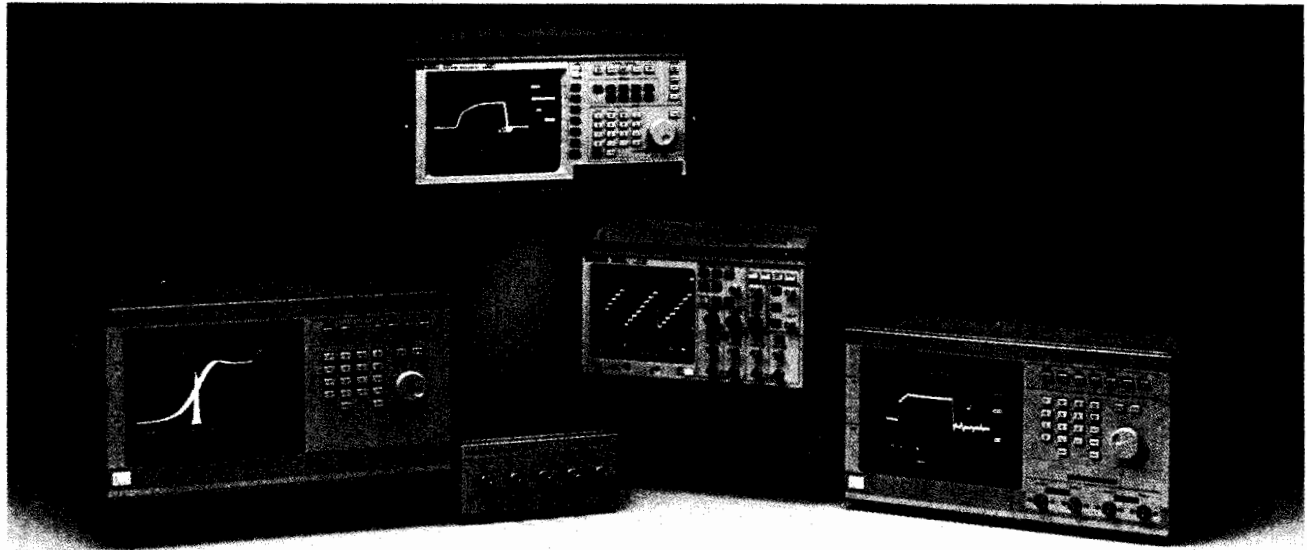

### Oscilloscopes The Beginning of the Digital Scope Era

In the early 1980s, the electronics industry began to discover that analog scopes were often inadequate to analyze signals from modern circuits. Recognizing this, Hewlett-Packard decided to focus its oscilloscope development entirely on digital architectures. The first product arising from this decision was the HP 54100A, the world's first general-purpose, 1-GHz bandwidth digitizing oscilloscope, which was introduced in 1985. Since that time, the electronics world has followed this shift to digital scopes, and the majority of scopes purchased today are digital.

#### Why Digital?

This conversion from analog to digital results in a more productive work environment for you. Digital scopes provide such advantages as:

- Capture and display of transient single-shot signals such as glitches
- Observation of signals occurring before the trigger event
- Automatic measurements with highly repeatable results and accuracy unheard of in analog scopes
- Waveform storage
- Computer I/O and hard-copy printout

These, and other digital scope advantages, provide you with the benefit of better and more quantitative information about your signals. By providing you with a better understanding of your signals, HP digital scopes allow you to enhance and to streamline your design, test, or troubleshooting process.

#### Why Hewlett-Packard?

Since "going digital," HP has continued to develop and to refine the concept of the digital oscilloscope. The HP 54100A/D boasted many firsts in the world of scopes: the first menu-driven user interface, the first pattern and glitch trigger, and the first direct hard-copy mode, among others. This tradition of innovation expanded with the introduction of color displays in 1986, of normalized and calibrated TDR measurements in 1987, and of 2 GSa/s sampling in 1988; it continues today.

HP now offers a complete line of digital scopes that spans the application spectrum from low-cost, general-purpose use to high-performance analysis. HP's focus on meeting your automation and measurement needs results in complete solutions that help you understand your designs and solve problems better than ever before. HP is more than oscilloscopes, too: a complete line of test equipment, application-based seminars and training materials, and the most knowledgeable sales force in the industry give you the security of knowing that your test needs will be met.

#### Choosing the Right Scope: Selection Criteria

In selecting the right HP digital scope for your needs, first consider the signals you're likely to examine.

#### What Is Your Signal's Frequency?

In general, your oscilloscope's bandwidth should be at least 3 times greater than the maximum frequency component of your signal. This maximum component can be estimated with the following formula:

$$\text{frequency} = \frac{.35}{\text{signal rise time (t}_r)}$$

You can then determine how accurate a measurement the scope will provide by comparing the scope rise time and the fastest rise time in your signal, using the following equation:

$$\text{Measured } t_r = \sqrt{(\text{Scope } t_r)^2 + (\text{Signal } t_r)^2}$$

The result of the equation gives you the rise time the scope will display. For example, a 250-MHz scope (rise time of 1.4 ns) should accurately measure a signal with a 4.2 ns rise time with an error of less than 5%. In short, the higher the ratio of scope bandwidth to signal bandwidth, the lower the error.

#### Does the Signal Occur Just Once, or Is the Signal Repetitive?

For single-shot events, a digital scope's sampling rate should typically be at least 10 times faster than the bandwidth of the signal you want to examine. The resulting sample density reduces the possibility of viewing aliased versions of the actual signal, and is usually sufficient for you to recognize the waveform captured. Some HP scopes are specially designed for single-shot applications. These scopes employ digital signal-processing techniques that virtually eliminate the possibility of aliasing, and they provide accurate voltage and timing measurements with sample rates as low as 4 times the signal's bandwidth.

Repetitive signals can be characterized over many acquisition cycles; therefore, the digitizing rate of the scope is often not as important. If your signals are normally repetitive, look at the bandwidth you need instead. It may be that the sample rate of a less expensive digital scope is just right for you.

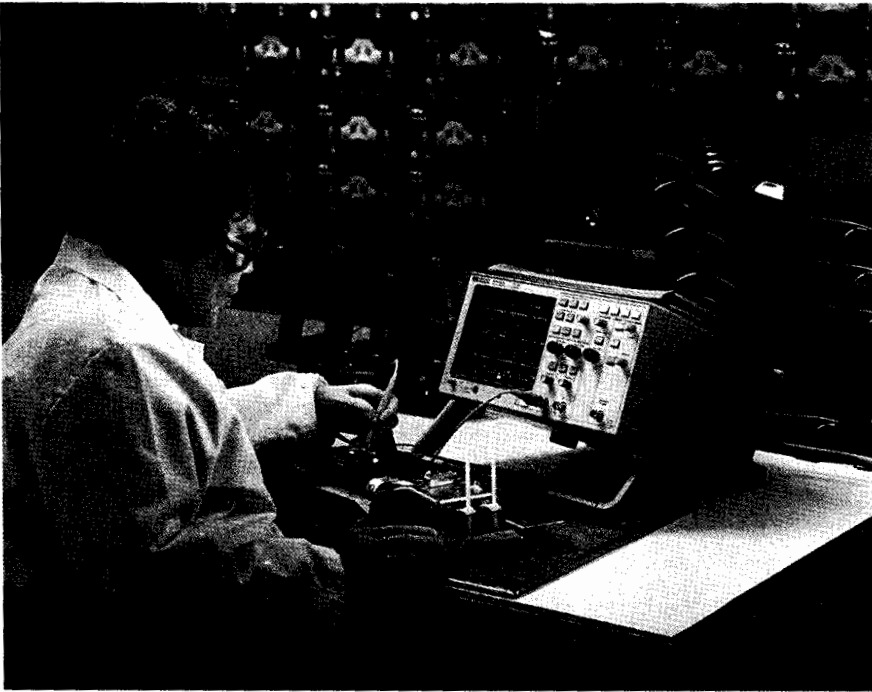

### What's Your Application?

Digital scopes are used in a variety of ways, and HP has a complete line of products to fit your needs. From the troubleshooter working around 100 MHz, to the ATE operator testing at 500 MHz, to the research and development engineer performing microwave component analysis, there's an HP oscilloscope that fits. By providing the right level of price and performance, HP helps you understand your signals better.

Analog scope users have long valued the feel and versatility of analog scopes for troubleshooting, especially for lower-frequency applications. Troubleshooters often look for unusual or unexpected signals, and the ability to quickly set up and adjust the scope to find a signal is crucial. The HP 54600 family of scopes fits into this troubleshooting mold, providing extremely fast update rates, an analog-like human interface, and the digital features needed to quickly find signal problems. If that sounds right for you, find out more about the HP 54600 family on the following pages.

Many engineers find themselves looking for a scope both to capture more complex digital signals and to perform general analysis on those signals. Capturing digital signals and the glitches found with them is a difficult triggering task, but HP has the answer. The HP 54500 family's state-of-the-art digital

triggering capabilities isolate and capture aberrations and glitches on a signal, and the 54500 family has the processing power to measure and analyze the signals found—all at an affordable price. HP 54500 series oscilloscopes provide a broad range of solutions, with up to 1-GSa/s sampling rates and bandwidths of up to 500 MHz. The family also fits well into ATE environments—an HP-IB interface with understandable programming commands is standard.

High-speed signal analysis requires the highest level of performance available. Accuracy and repeatability become primary concerns; you must have confidence in your oscilloscope's ability to capture the signal and analyze the data precisely. HP is acknowledged for leadership in high-frequency measurement technology. This reputation extends to the digital scope market, where the HP 54100-series oscilloscopes offer the ultimate in measurement performance. From 2-GSa/s single-shot performance (the HP 54111D) to 50-GHz repetitive bandwidth (the HP 54124A), the HP 54100 family has the power and accuracy you need to obtain the best possible information about your devices under test.

From troubleshooting to general automated measurement to high-performance analysis, HP has the oscilloscope solution you need to understand your signals better. See the following pages for more information on each of the HP scope families.

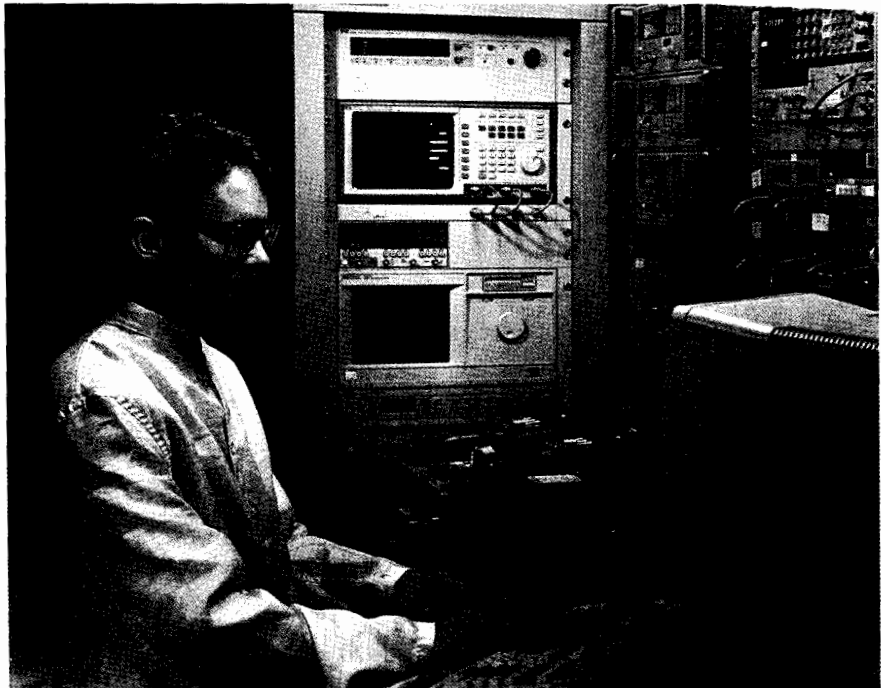

# OSCILLOSCOPES

## HP Digitizing Oscilloscopes (cont'd)

### Compare the Features

Whether you need pinpoint vertical resolution or lightning-fast signal capture, Hewlett-Packard's digitizing oscilloscopes provide a powerful set of features and capabilities in an easy-to-use package.

Here's a look at how the various models compare in terms of features, capabilities, and price.

Model	HP 54100A/D and HP 54110D	HP 54111D (with HP 54114A)	HP 54112D	HP 54121T	HP 54123T	HP 54124T	HP 54122T
<b>Bandwidth: Repetitive Single-Shot</b>	1 GHz 4 MHz <sup>1</sup>	500 MHz 500 MHz	100 MHz 100 MHz	20 GHz not applicable	34 GHz not applicable	50 GHz not applicable	12.4 GHz not applicable
<b>Time Interval Accuracy: Repetitive Single-Shot</b>	100 ps 300 ps	100 ps 300 ps	300 ps 300 ps	10 ps not applicable		10 ps not applicable	
<b>Channels</b>	2	2	4	4		4	
<b>Digitizing Rate</b>	40 MSa/s	1 GSa/s	400MSa/s	not applicable		not applicable	
<b>Memory/ Channel</b>	1k samples	8k samples	64k samples	501 samples		501 samples	
<b>Vertical Resolution</b>	7 bits; 10 bits with averaging	8 bits to 50 MHz 7 bits to 200 MHz 6 bits to 410 MHz	6 bits	12 bits; 14 bits with averaging		12 bits; 14 bits with averaging	
<b>Input Voltage Ranges</b>	7 ranges 80 mV to 8 V full scale	continuously variable 8 mV to 40 V full scale	continuously variable 40 mV to 40 V full scale	continuously variable 1 to 80 mV per division		continuously variable 1 mV to 2.4 V per division	
<b>Input Z, Coupling</b>	50 Ω, 10 kΩ, 1MΩ pods	1 MΩ, 50 Ω internal; ac, dc	1 MΩ, 50 Ω internal; ac, dc	50 Ω		50 Ω	
<b>Pulse Parameter Measure- ments</b>	yes	yes	yes	yes		yes	
<b>Waveform Math</b>	A + B, A - B, A vs B, invert	A + B, A - B, invert	A + B, A - B, invert	A + B, A - B, A vs B, min, max, invert, only		A + B, A - B, A vs B, min, max, invert, only	
<b>Other Analysis Functions</b>	Variable and infinite persistence, averaging, magnify	Variable and infinite persistence, averaging	Variable and infinite persistence, averaging	Variable and infinite persistence, averaging		Variable and infinite persistence, averaging	
<b>Waveform Storage</b>	2 pixel, 4 waveforms	2 pixel, 4 repetitive, 4 single-shot waveforms	2 pixel, 4 repetitive, 4 single-shot waveforms	2 pixel, 4 waveforms		2 pixel, 4 waveforms	
<b>Trigger Enhance- ments</b>	Edge; pattern, state, digital delay by event and time, time-qualified pattern <sup>2</sup>	Edge, pattern, state, digital delay by event and time, time-qualified pattern	Edge, pattern, state, digital delay by event and time	2.5 GHz edge trigger; 18 GHz with HP 54118A		2.5 GHz edge trigger; 18 GHz with HP 54118A	
<b>Instant Hard-Copy and Disk Support</b>	HP printers and HP plotters			HP graphic printers including PaintJet, plotters		HP graphic printers including PaintJet, plotters	
<b>Other</b>	Color display and color hard copy <sup>3</sup>	Color display and color hard copy	Color display and color hard copy	Built-in histograms TDR/TDT color display and color hard copy		Built-in histograms Color display and color hard copy	
<b>For More Information, Order Publication Number</b>	HP 5954-2659 (D)			HP 5952-7084(D)		HP 5952-7084(D) HP 5952-1171 (D)	HP 5952-7084(D)
<b>Page Reference</b>	140	141	143	144	144	144	144
<b>Price</b>	\$16,900 \$21,900 \$23,900	\$29,900	\$24,900	\$30,400	\$36,400	\$44,400	\$32,400

<sup>1</sup> 10 points per period without reconstruction.

<sup>2</sup> D models only.

<sup>3</sup> HP 54110D only.

Model	HP 54501A	HP 54502A	HP 54503A	HP 54504A	HP 54510A	HP 54600A/ HP 54601A	HP 16500A Mainframe with 16532A
<b>Bandwidth: Repetitive Single-Shot</b>	100 MHz 1 MHz <sup>2</sup>	400 MHz 100 MHz	500 MHz 2 MHz <sup>2</sup>	400 MHz 50 MHz	250 MHz 250 MHz	100 MHz 2 MHz <sup>2</sup>	250 MHz 250 MHz
<b>Time Interval Accuracy: Repetitive Single-Shot</b>	1 ns 1 ns	250 ps 500 ps	100 ps 100 ps	250 ps 1 ns	100 ps 150 ps	200 ps 200 ps	± 150 ps ± 150 ps
<b>Channels</b>	4 (2+2)	2	4	2	2	HP 54600A: 2 HP 54601A: 4 (2+2)	2 to 10
<b>Digitizing Rate</b>	10 MSa/s	400 MSa/s	20 MSa/s	200 MSa/s	1 GSa/s	20 MSa/s	1 GSa/s
<b>Memory/ Channel</b>	500 samples 1k samples (HP-IB)	501 samples 2k samples (extended)	501 samples 1k samples (HP-IB)	501 samples 2k samples (extended)	8k samples	4k samples	8000 samples
<b>Vertical Resolution</b>	8 bits; 10 bits with averaging	6 bits; 8 bits with averaging	8 bits; 10 bits with averaging	8 bits; 10 bits with averaging	8 bits; 10 bits with averaging	8 bits	8 bits; 10 bits with averaging
<b>Input Voltage Ranges</b>	Continuously variable 40 mV to 40 V full scale	Continuously variable 16 mV to 40 V full scale	Continuously variable 8 mV to 40 V full scale	Continuously variable 8 mV to 40 V full scale	Continuously variable 8 mV to 40 V full scale	Continuously variable 16 mV to 40 V full scale	16 mV to 40 V full scale in 1: 2: 4: increments
<b>Input Z, Coupling</b>	1 MΩ internal; ac, dc	1 MΩ, 50 Ω internal; ac, dc	1 MΩ, 50 Ω internal; ac, dc	1 MΩ, 50 Ω internal; ac, dc	1 MΩ, 50 Ω internal; ac, dc	1 MΩ internal; ac, dc, ground	1MΩ, 50 Ω internal; ac, dc
<b>Pulse Parameter Measure- ments</b>	yes	yes	yes	yes	yes	yes	yes
<b>Waveform Math</b>	A + B, A - B, A × B, A vs B, invert, only	A + B, A - B, A × B, A vs B, invert, only	A + B, A - B, A × B, A vs B, invert, only	A + B, A - B, A × B, A vs B, invert, only	A + B, A - B, A × B, A vs B, integrate, differentiate, invert, only	A + B, A - B, XY, invert	A + B, A - B
<b>Other Analysis Functions</b>	Variable and infinite persistence, averaging, envelope	Variable and infinite persistence, averaging, envelope	Variable and infinite persistence, averaging, envelope	Variable and infinite persistence, averaging, envelope	Variable and infinite persistence, averaging, envelope	Autostore, peak detect, averaging	Infinite persistence, averaging
<b>Waveform Storage</b>	2 pixel, 4 waveforms	2 pixel, 4 waveforms	2 pixel, 4 waveforms	2 pixel, 4 waveforms	2 pixel, 4 waveforms	2 pixel	Store to built - in disk
<b>Trigger Enhance- ments</b>	Glitch, edge, pattern, state, digital delay by event and time, time-qualified pattern, TV	Glitch, edge, pattern, state, digital delay by event and time, time-qualified pattern, TV	Glitch, edge, pattern, state, digital delay by event and time, time-qualified pattern, TV	Glitch, edge, pattern, state, digital delay by event and time, time-qualified pattern, TV	Glitch, edge, pattern, state, digital delay by event and time, time-qualified pattern, TV	Edge, Autolevel, HF/LF reject, noise reject, TV	Edge, pattern, relay by event, immediate
<b>Instant Hard-Copy and Disk Support</b>	HP graphic printers	HP graphic printers, plotters	HP graphic printers, plotters	HP graphic printers, plotters	HP graphic printers, plotters	HP printers and plotters, Epson-compatible printers, Centronics printers	HP printers including PaintJet, 2 built - in disk drives
<b>Other</b>	Measurement statistics and limit test, dual time- base windowing, scroll mode	Measurement statistics and limit test, dual time- base windowing, scroll mode	Measurement statistics and limit test, dual time- base windowing, scroll mode	Measurement statistics and limit test, dual time- base windowing, scroll mode	Measurement statistics and limit test, segmentable memory via HP-IB, post-acquisition pan and zoom	Super-fast update rate, delayed sweep, roll mode, HP-IB and RS-232 I/O options, Centronics output option	Logic analysis, high-speed timing, pattern generation, multiple time bases (optional)
<b>For More Information, Order Publication Number</b>	HP 5954-2679(D)	HP 5091-0353 EUS	HP 5959-8795(D)	HP 5091-0353 EUS	HP 5952-2404(D)	HP 5091-2221 EUS HP 5091-2222 EUS HP 5091-2223 EUS	HP 5091-2195 EUS
<b>Page Reference</b>	153	152	151	150	149	154	159
<b>Price</b>	\$3,990	\$7,450	\$5,950	\$6,750	\$10,950	HP 54600A: \$2,395 HP 54601A: \$2,895	\$16,700 to \$52,700

# OSCILLOSCOPES

## Digitizing Oscilloscopes

HP 54100A/D, 54110D

- 1-GHz bandwidth
- Auto pulse parameter and time interval measurements
- Digital storage
- Available with color or monochrome display
- Pre-trigger viewing
- Logic triggering capability



HP 54110D



### HP 54100A/D and HP 54110D Digitizing Oscilloscopes

As the speeds of analog and digital logic continue to increase, board and system designers need to pay even closer attention to high-frequency and transmission-line characteristics of their circuits. Design requirements are rigorous. Subnanosecond technology creates narrow and elusive pulses.

When a monochrome display is preferred, for example in a totally automatic test application, choose the HP 54100A or HP 54100D oscilloscope. These units require less rack height (7 in) than the HP 54110D (8.75 in) and have all of the same measurement features and specifications. The HP 54100A has one external trigger input, while the HP 54100D and HP 54110D have two.

#### High Bandwidth

The HP 54100 and 54110 unite a powerful 1-GHz bandwidth with a random repetitive sampling technique for viewing rarely occurring narrow waveforms. These oscilloscopes have 0.002 percent time base accuracy and 10 ps resolution for confident measurements of critical timing parameters in high-speed circuitry.

With random repetitive sampling, you can capture waveforms that occur thousands of screen diameters before the trigger event. This gives an effective memory depth of millions of bytes for finding causes of failures that occur long before the trigger.

#### High Resolution

Analyze perturbations within a waveform with high resolution. With vertical magnification and waveform averaging, small signal details can be viewed and measured with 10 bits of effective resolution.

#### Flexible Analysis

Only the HP 54100A/D and HP 54110D allow the display of either vertical channel versus the other. The 1-GHz bandwidth makes this feature valuable in measuring high-speed I-V device characteristics and transfer functions high-speed converters.

#### A Choice of Input Pods and Probes

The HP 54100 and 54110 inputs are configured with removable pods that can be chosen according to the application. Pods can be changed quickly and easily, and they occupy a minimum of storage space.

- 50- $\Omega$  inputs and probes for a wide variety of environments, without the expense of amplifier plug-ins.
- 1-GHz miniature active probes for densely packed, high-speed logic circuits.
- 1-M  $\Omega$  probes for circuits sensitive to resistive loading.
- 50- $\Omega$  BNC inputs for measurements where terminated lines are important.
- 100:1 probes for extended dynamic range.

For more information on the HP 54100/110 probing system, please refer to page 164.

#### Ordering Information

<b>HP 54100A</b> 1-GHz Digitizing Oscilloscope.	<b>Price</b> \$16,900
<b>Opt W30</b> Extended repair service. See page 671.	+ \$325
<b>HP 54100D</b> 1-GHz Digitizing Oscilloscope.	\$21,900
<b>Opt W30</b> Extended repair service. See page 671.	+ \$440
<b>HP 54110D</b> 1-GHz Digitizing Oscilloscope with Color Display	\$23,900
<b>Opt W30</b> Extended repair service. See page 671.	+ \$550
<b>Input Pods and Probes</b>	
<b>HP 54001A</b> 1-GHz Miniature Active Probe Pod	\$785
<b>HP 54002A</b> 50 $\Omega$ BNC Input Pod	\$140
<b>HP 54003A</b> 1 M $\Omega$ 10:1 Probe Pod	\$680

- 2-Gigasample/second, one channel when used with HP 54114A
- 500 MHz repetitive bandwidth
- 8 k memory depth
- HP PaintJet printer color output



HP 54111D



### HP 54111D: High-Speed General-Purpose Scope

The HP 54111D can be configured as a 2-gigasample/second (Gsa/s), one-channel oscilloscope or as a two-channel 1-gigasample/second oscilloscope with a memory depth of 8 KB samples per channel. The HP 54111D retains all of the key features and user friendliness of the HP 54100/110 oscilloscopes, such as automatic measurements, autoscaling, cursors, and a color display. And the HP 54111D adds features necessary for controlling and managing the added memory depth, such as scroll, zoom, and memory bar.

#### Key Contributions

- 2-gigasamples/second digitizing rate (maximum)
- 500-MHz bandwidth
- 8 KB memory per channel
- Up to 8 bits of vertical resolution with bandwidth limits
- Two channels of simultaneous capture at up to 1 Gsa/s
- Pre-trigger information
- Automatic measurements
- Fully HP-IB programmable
- Advanced logic triggering capabilities
- Instant hard-copy output

#### Memory Bar Simplifies Data Viewing

The HP 54111D provides 8 k samples of memory per channel. This results in a minimum of 16 screens of waveform information in single-shot acquisitions. To simplify management of all this data, the HP 54111D displays a memory bar. The memory bar is displayed along the top edge of the graticule and shows the portion of memory being viewed relative to the entire memory record. In addition, the trigger point is also shown along the memory bar.

#### General-Purpose to Special Applications

With a 2-gigasample/second digitizing rate, the HP 54111D gives you the fastest sampling rate available in a general-purpose digitizing oscilloscope. However, the HP 54111D is much more than an instrument for capturing fast single-shot transients. With random repetitive sampling, this instrument provides a bandwidth of 500 MHz for high-speed circuit design and test.

In addition to its single-shot and repetitive capabilities, the HP 54111D provides flexible input coupling with a wide dynamic range for viewing and analyzing a variety of signals. Use this scope for just about any general-purpose application from very slow to very high-speed repetitive or nonrepetitive waveforms.

#### Ultra-High Digitizing Rate

No longer do you need a manual analog storage oscilloscope to capture high-speed single-shot phenomena found in:

- High-speed pulse analysis
- Nuclear test studies
- Plasma discharge
- High-voltage arcing
- High-frequency bursts

All these single-shot events can be captured easily at 2 Gsa/s, with 4  $\mu$ s of data stored for review and analysis (8  $\mu$ s over HP-IB).

#### High-Speed ECL Design

Nonrepetitive glitches appearing on the clock signal can be captured easily with the 500-MHz single-shot performance of the HP 54111D with the HP 54114A two-gigasample/second test set. Four microseconds of pre-trigger data is invaluable for determining the cause of the glitch.

#### High-Speed Semiconductor Design

Single-shot performance of 500 MHz permits you to measure the outputs from latches (one-time events for multiple clock periods in ECL circuits).

#### Laser and High-Energy Research

Photo detector pulses can be measured with single-shot capture using the 2-GHz sampling rate and built-in automatic measurements. Infinite persistence can also be used to show and measure maximum variations of the waveform to the 500-MHz bandwidth.

The HP 54111D's two simultaneous 1-gigasample/second channels give you the single-shot performance of the most advanced analog storage oscilloscopes, but with all the advantages and ease of use of a digitizing oscilloscope. And with a staggered over-sampling technique, the HP 54111D provides this single-shot performance with up to 8 bits of nonblooming vertical resolution.

# OSCILLOSCOPES

## Digitizing Oscilloscopes (cont'd)

HP 54111D

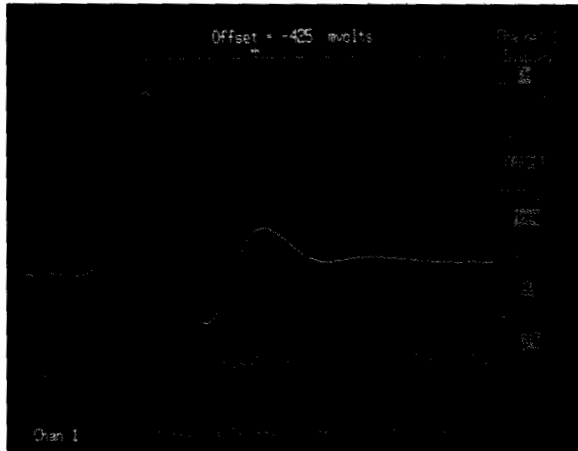

With a 1-gigasample/second digitizing rate, the HP 54111D captured this laser pulse single-shot.

### Data Communications

Combine 2-gigasample/second (Gsa/s) digitizing rate with 8 KB of memory depth per channel, for an invaluable tool for analyzing high-speed serial waveforms such as data communications or radar testing.

### High Bandwidth Applications

Not only is the HP 54111D digitizing oscilloscope useful for single-shot phenomena, but it also samples repetitively, giving you a 500-MHz bandwidth with high signal fidelity. Use this oscilloscope for general-purpose applications, from very slow to very high-speed repetitive or nonrepetitive waveforms.

### Computer-Aided Test

The HP 54111D has many features that make it an excellent tool in computer-aided test. Its repetitive bandwidth and digitizing rate allow it to cover a wide range of automatic measurement applications. In addition, this instrument has many features that enhance test throughput time, such as built-in automatic measurements, fast acquisition cycles, and deep memory.

### Input Range and Conditioning

The HP 54111D has the widest input dynamic range and coupling capabilities of any HP digitizing oscilloscopes. The input sensitivity can be set from 1 mV/div to 5 V/div. All input coupling is internal and programmable. The selections include ac, dc, 1 M $\Omega$ , 50  $\Omega$ , and ground. These input signal conditioning features make the HP 54111D more general purpose for the circuit designer and test engineer.

### HP 54111D Specifications

Vertical (voltage)	Single-Shot		Repetitive
	2 Channel	1 Channel with HP 54114A	
<b>Channels</b>	2	1	2
<b>Bandwidth</b>	250 MHz	500 MHz	500 MHz
<b>Transition time</b>	1.4 ns	700 ps	700 ps
<b>Vertical resolution</b>	8 bits/25 MHz 7 bits/100 MHz 6 bits/250 MHz	8 bits/50 MHz 7 bits/200 MHz 6 bits/500 MHz <sup>1</sup>	6 bits, 8 bits with averaging
<b>Vertical gain accuracy</b>			$\pm 2\%$ of full scale <sup>2</sup>
<b>dc offset accuracy</b>			$\pm 1.5\%$ of setting
<b>Measurement accuracy</b>	single data point $\pm$ gain accuracy $\pm$ offset accuracy $\pm$ resolution		
	between data points on the same waveform $\pm$ gain accuracy $\pm 2 \times$ resolution		
<b>dc offset range:</b>	$\pm 200$ mV (1 mV/div to 4.9 mV/div) $\pm 1$ V (5 mV/div to 49 mV/div) $\pm 10$ V (50 mV/div to 0.49 V/div) $\pm 100$ V (0.5 V/div to 5 V/div)		
<b>Input coupling:</b>	ac/dc/dc-50 $\Omega$ /ground		
<b>Input impedance:</b>	1 M $\Omega$ at 6.5 pF or 50 $\Omega$ (dc)		
<b>Maximum input voltage</b>	1 M $\Omega$ : $\pm 40$ V [dc + peak ac] 50 $\Omega$ : 5 V rms		
<b>Horizontal (time)</b>			
<b>Digitizing rate</b>	1 Gsa/s to 50 Sa/s		
<b>Deflection factor</b>	500 ps/div to 1 s/div		
<b>Memory depth per channel</b>	8 kb (8 $\mu$ s at 1 Gsa/s), single shot only		
<b>Delay range (pre-trigger)</b>	-8 $\mu$ s at 50 $\mu$ s/div and less, increasing to -160 s at 1 s/div		
<b>Delay range (post-trigger)</b>	0.16 s at 0.5 $\mu$ s/div and less, increasing to 10,000 s at 1 s/div		
<b>Time measurement accuracy</b>			
	Single-Shot	Repetitive	
Single channel	$\pm 300$ ps	$\pm 100$ ps	
	$\pm 0.03\%$ of reading	$\pm 0.03\%$ of reading	
Dual channel	$\pm 600$ ps	$\pm 200$ ps	
	$\pm 0.03\%$ of reading	$\pm 0.03\%$ of reading	
<b>Triggering</b>	<b>Internal</b>	<b>External</b>	
<b>Sources</b>	channels 1, 2	inputs 3, 4	
<b>Sensitivity</b>			
dc to 200 MHz	0.1 $\times$ full scale <sup>3</sup>	15 mV (1:1)	
200 MHz to 500 MHz	0.2 $\times$ full scale <sup>3</sup>	45 mV (1:1)	
<b>Trigger level range</b>	$\pm 3 \times$ full scale	$\pm 1$ V (1:1)	
<b>Input resistance</b>	not applicable	1 M $\Omega$	
<b>Maximum input voltage</b>	not applicable	$\pm 10$ V [dc + peak ac]	
<b>Input operating range</b>	not applicable	$\pm 1$ V (1:1) [dc + peak ac]	

<sup>1</sup> Raw data.

<sup>2</sup> When calibrated to probe tip using front-panel calibration source. Applies to major ranges (5 mV/div, 10 mV/div, 20 mV/div, 50 mV/div, 100 mV/div, 200 mV/div, 500 mV/div, 1 V/div, and 2 V/div). All continuous settings between these ranges are  $\pm 3\%$  of full scale.

<sup>3</sup> Applies to settings 5 mV/div and above.

### Ordering Information

**HP 54111D** 2-Gigasample/Second Digitizing Oscilloscope

**Opt W30** Extended repair service. See page 671.

### Price

\$29,900

+ \$675



- 64k memory depth per channel
- Quad 400-megasamples-per-second digitizers
- Four channels

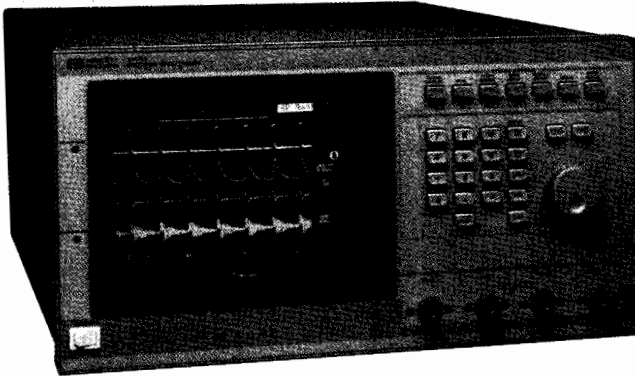

HP 54112D



## HP 54112D Digitizing Oscilloscope

### Four Channels, Deep Memory

The HP 54112D is a 400 megasample-per-second (Msa/s), 4-channel digitizing oscilloscope with 64k samples of memory depth per channel. The HP 54112D retains all the key features and the user-friendliness of the HP 54100 series scopes. These features include automatic measurements, autoscaling, cursors, functional color display, scroll, zoom, and memory bar.

### Key Contributions

- 400-megasamples-per-second digitizing rate
- 100-MHz repetitive and single-shot bandwidth
- 64k-memory per channel
- Four channels of simultaneous capture at the full digitizing rate
- 160  $\mu$ s of pre- or post-trigger information minimum
- Automatic measurements
- Fully programmable
- Advanced logic triggering capabilities
- Instant hard-copy output

### Automatic Test Environment

The English-like commands and the logical structure of the Hewlett-Packard Oscilloscope Language (HPOL) make it easier to program the 54100 Series oscilloscopes in computer-aided test. The learning curve is greatly reduced.

The four channels, built-in automatic measurements, and very deep memory of the 54112D improve the throughput of ATE systems. Data that used to take many acquisition passes can now be captured in one pass.

### General-Purpose Inputs

The fully programmable input impedance and coupling of the four channels allow the user to choose 1 megohm impedance ac- or dc-coupled or 50 ohm dc-coupled on each channel.

- 100 MHz bandwidth (single-shot and repetitive)
- HP PaintJet printer color output

### HP 54112D Specifications

Vertical (voltage)	Single-Shot	Repetitive
<b>Number of channels</b>	4	4
<b>Bandwidth</b>		
dc-coupled	dc to 100 MHz	dc to 100 MHz
ac-coupled	10 Hz to 100 MHz	10 Hz to 100 MHz
<b>Transition time</b> (10% to 90%)	3.5 ns (nominal)	3.5 ns (nominal)
<b>Deflection factor</b> (full scale=8 div)	5 mV/div to 5 V/div continuous	
<b>Vertical resolution</b>	6 bits	6 bits, 8 bits with averaging
<b>Vertical gain accuracy</b>	$\pm 2\%$ of full scale <sup>1</sup>	
<b>dc offset accuracy</b>	$\pm 1.5\%$ of setting $\pm 0.2$ divisions	
<b>Measurement accuracy</b>		
single data point	$\pm$ gain accuracy $\pm$ offset accuracy $\pm$ resolution	
between data points on same waveform	$\pm$ gain acc $\pm 2 \times$ resolution	
<b>dc offset range</b>	$\pm 1$ V (5 mV/div to 49 mV/div) $\pm 10$ V (50 mV/div to 0.49 V/div) $\pm 40$ V (0.5 V/div to 5 V/div)	
<b>Input coupling</b>	ac/dc/dc-50 $\Omega$	
<b>Input impedance</b>	1 M $\Omega$ at 6.5 pF or 50 $\Omega$ $\pm 1\%$	
<b>Maximum input voltage</b>	1 M $\Omega$ : $\pm 40$ V [dc and peak ac] 50 $\Omega$ : 5 V rms	

<sup>1</sup> When calibrated to probe tip using front panel calibration source. Applies to major ranges (5 mV, 10 mV, 20 mV, 50 mV, 100 mV, 200 mV, 500 mV, 1 V and 2 V). All continuous settings between these ranges are  $\pm 3\%$  of full scale.

### Horizontal (time)

<b>Digitizing rate</b>	400 Msa/s to 50 Sa/s
<b>Deflection Factor</b>	2ns/div to 1s/div
<b>Memory depth per channel</b>	either 64k or 8k, single-shot only
<b>Delay range (pre-trigger)</b>	- 160 $\mu$ s at 125 ns/div and less, increasing to - 1200 s at 1 s/div
<b>Delay range (post-trigger)</b>	0.16 s at 0.5 $\mu$ s/div and less, increasing to 10,000 s at 1 s/div
<b>Time measurement accuracy</b>	
single channel	$\pm 500$ ps $\pm 0.002\%$ of reading
dual channel	$\pm 1$ ns $\pm 0.002\%$ of reading

Triggering	Internal	External
<b>Sources</b>	channels 1,2,3,4	input rear-panel
<b>Sensitivity</b>	0.1 $\times$ full scale	20 mV (1:1)
<b>Trigger level range</b>	$\pm 3 \times$ full scale	$\pm 5$ V (1:1)
<b>Input resistance</b>	not applicable	200 k $\Omega$
<b>Maximum input voltage</b>	not applicable	$\pm 40$ V (dc + peak ac)
<b>Input operating range</b>	not applicable	$\pm 5$ V (1:1) [dc + peak ac]

### Ordering Information

	Price
<b>HP 54112D</b> 4 Channel 64k-Memory/Channel Digitizing Oscilloscope	\$24,900
<b>Opt W30</b> Extended repair service; see page 671.	+ \$575

# OSCILLOSCOPES

## Digitizing Oscilloscopes (cont'd)

HP 54121T, 54122T, 54123T, 54124T

- 50 GHz, 34 GHz, 20 GHz, and 12.4 GHz bandwidths
- 0.25 ps timing resolution
- Built-in histograms
- 2.5 GHz edge trigger
- Time domain reflectometry
- HP PaintJet printer output

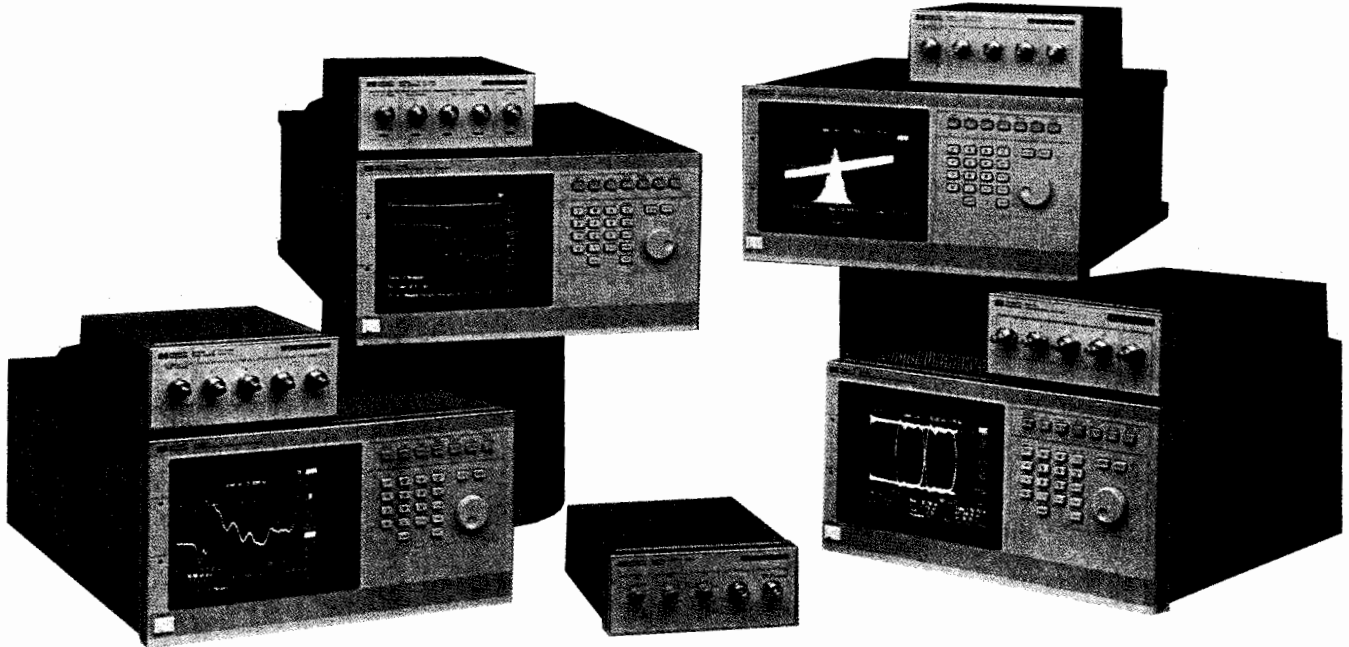

The HP 54120-series of high bandwidth digitizing oscilloscopes featuring digital feedback sampling for repeatable, accurate, and operator-independent measurement results.

### HP 54120 Series High-Bandwidth Digitizing Oscilloscopes

The HP 54120 Series of digitizing oscilloscopes combines high bandwidth, a time domain reflectometer (HP 54121T, HP 54123T, and 54124T only), four input channels, and superb stability in an easy-to-use, fully programmable oscilloscope that needs no manual loop gain adjustment. Whether your application involves high-speed device and circuit characterization, high-speed telecom analysis, or microwave design, the HP 54120 Series of digitizing oscilloscopes gives you a new confidence in state-of-the-art measurements.

#### Key Contributions

- dc - 50 GHz bandwidth (HP 54124T) - 7 ps rise time
- dc - 34 GHz bandwidth (HP 54123T) - 10.3 ps rise time
- dc - 20 GHz bandwidth (HP 54121T) - 17.5 ps rise time
- dc - 12.4 GHz bandwidth (HP 54122T) - 28.2 ps rise time
- 10 ps time interval accuracy
- 0.25 ps time interval resolution
- 10 ps/div to 1 s/div
- 0.4 % vertical accuracy
- 32 microvolt resolution
- 1 mV/div to 80 mV/div (HP 54121T, HP 54123T, and HP 54124T)
- 1 mV/div to 2.4 V/div (HP 54122T)
- Automatic pulse parameter measurements
- Fully HP-IB programmable
- Pushbutton hardcopy documentation

- Four input channels
- Step generator with typically 35 ps rise time and typically 1% flatness (HP 54121T, HP 54123T, and HP 54124T)
- Reflection (TDR)/transmission (TDT) normalization<sup>1</sup> (HP 54121T, HP 54123T, and HP 54124T)
- Time and voltage histograms

#### Picosecond measurements

The 0.25 ps time interval resolution and typically 1 ps time interval accuracy of the HP 54120 family reduce the oscilloscope's contribution to errors in digital pulse parameter measurements in semiconductors and computers.

#### Quantify Noise and Jitter

Time and voltage histograms, which quantify noise and jitter measurements, characterize the eye patterns in telecommunications applications. Eye height and width, location of one and zero, are easily found with histograms. With no loop gain control, you can obtain repeatable results that do not vary between operators or between oscilloscopes over the entire input dynamic range.

#### Eliminate Reflections with TDR

Ringings and waveform distortion can be eliminated by using time-domain reflectometry on the HP 54121T, the HP 54123T, and the HP 54124T to locate and remove discontinuities in transmission line systems.

<sup>1</sup> Normalization uses the Bracewell transform, which is under license from Stanford University.

## HP 54120-Series Specifications Vertical (channels)<sup>1</sup>

	HP 54121T	HP 54122T	HP 54123T	HP 54124T
<b>dc-coupled</b>				
<b>Bandwidth</b> (-3 dB) 2				
High bandwidth				
Chan 1	18.0 GHz	12.4 GHz	20.0 GHz	20.0 GHz
Chan 2	20.0 GHz	12.4 GHz	34.0 GHz	34.0 GHz
Chan 3,4	20.0 GHz	12.4 GHz	34.0 GHz	50.0 GHz
Low bandwidth				
Chan 1	12.4 GHz	10.0 GHz	12.4 GHz	12.4 GHz
Chan 2	12.4 GHz	10.0 GHz	18.0 GHz	18.0 GHz
Chan 3,4	12.4 GHz	10.0 GHz	18.0 GHz	26.5 GHz
<b>Transition time</b> (10% to 90%) (calculated from $T_r = .35/BW$ )				
High bandwidth				
Chan 1	19.4 ps	28.2 ps	17.5 ps	17.5 ps
Chan 2	17.5 ps	28.2 ps	10.3 ps	10.3 ps
Chan 3,4	17.5 ps	28.2 ps	10.3 ps	7.0 ps
Low bandwidth				
Chan 1	28.2 ps	35.0 ps	28.2 ps	28.2 ps
Chan 2	28.2 ps	35.0 ps	19.4 ps	19.4 ps
Chan 3,4	28.2 ps	35.0 ps	19.4 ps	13.2 ps
<b>Noise (rms)</b>				
High bandwidth				
	≤ 2 mV	≤ 2 mV (1:1 attenuation)	≤ 2 mV	≤ 2 mV
Low bandwidth				
	≤ 1 mV	≤ 1 mV (1:1 attenuation)	≤ 1 mV	≤ 1 mV
<b>Scale factor</b> (full-scale is 8 divisions)				
Minimum	1 mV/div	1 mV/div	1 mV/div	1 mV/div
Maximum	80 mV/div	2.4 V/div	80 mV/div	80 mV/div
<b>Attenuation factors</b>				
	N/A	X1, X3, X10, X30	N/A	N/A
<b>Programmable dc offset<sup>3</sup></b>				
	± 500 mV	± 500 mV × atten. factor	± 500 mV	± 500 mV
<b>dc accuracy</b>				
Single Voltage Marker <sup>4</sup>				
Average mode: ± 0.4% of full-scale or marker reading (whichever is greater) ± 2 mV × attenuation factor <sup>5</sup>				
High bandwidth persistence mode: ± 0.4% of full-scale or marker reading (whichever is greater) ± 2 mV × attenuation factor <sup>6</sup> ± 3.0% of <sup>6</sup> (reading - channel offset) <sup>7</sup>				
Low bandwidth persistence mode: ± 0.4% of full-scale or marker reading (whichever is greater) ± 2 mV × attenuation factor <sup>6</sup> ± 1.5% of <sup>6</sup> (reading - channel offset) <sup>7</sup>				
<b>Inputs</b>				
Number	4	4	4	4
Dynamic range	± 320 mV relative to channel offset	± 320 mV × attenuation factor	± 320 mV relative to channel offset	± 320 mV relative to channel offset
Maximum safe input voltage	± 2 V dc + peak ac (+16 dBm)	± 5 V dc + peak ac (+24 dBm)	± 2 V dc + peak ac (+16 dBm)	± 2 V dc + peak ac (+16 dBm)
Nominal impedance	50 Ω	50 Ω	50 Ω	50 Ω
Percent reflection	≤ 5% for 30 ps rise time	≤ 5% for 30 ps rise time	≤ 5% for 30 ps rise time	≤ 5% for 30/20 ps rise time
Connectors	3.5 mm (m)	3.5 mm (m)	3.5 mm (m)	3.5 mm/2.4 mm (m)

<sup>1</sup> When operated within ± 5° C (± 9° F) of the temperature of the last front-panel calibration.

<sup>2</sup> The input samplers are biased differently for increased bandwidth in the high bandwidth mode.

<sup>3</sup> An effective offset of ± 820 mV × attenuation factor can be achieved by using the ± 500 mV attenuation factor mV of channel offset and adding ± 320 mV × attenuation factor of offset with the waveform math offset scaling function.<sup>3</sup>

<sup>4</sup> When driven from a 0 Ω source.

<sup>5</sup> The attenuation factor of the HP 54121T, 54123T, and 54124T is 1.

<sup>6</sup> For the HP 54123T and 54124T, the 3% changes to 5% and the 1.5% changes to 2%.

<sup>7</sup> Performing a vertical software calibration immediately before making a measurement eliminates the final term in the persistence mode dc accuracy specification.

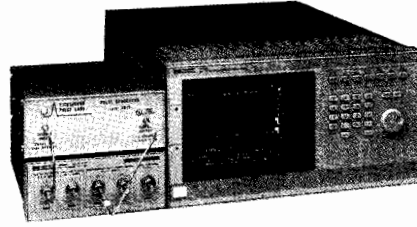

### PicoSecond Pulse Labs 4015B

#### 15-ps, -9 V External TDR or TDT Source

The PicoSecond Pulse Labs model 4015B pulse generator extends the TDR/TDT performance of the HP 54120-Series oscilloscopes. The pulse generator produces a 15-ps fall time with an amplitude of -9 V, which can be triggered by any HP 54120-Series TDR step generator. Contact Dr. Jim Andrews at PSPL, P.O. Box 44, Boulder, CO 80306, (303)443-1249.

### TDR System (HP 54121T, HP 54123T, and HP 54124T only)

	Combined oscilloscope and TDR performance	Normalized characteristics <sup>1</sup>
<b>Rise time<sup>2,3</sup></b>	≤ 45 ps	Adjustable; allowable values based on time base setting Minimum: 10 ps or 0.08 × time/div, whichever is greater Maximum: 5 × time/div
<b>Flatness<sup>2</sup></b>	≤ + 1% after 1 ns from edge; ≤ + 5%, -3% to 1 ns from edge	≤ 0.1%
<b>Levels</b>		
low	0 V ± 2 mV	0 V ± 2 mV
high	+ 200 mV ± 2 mV	+ 200 mV ± 2 mV

<sup>1</sup> Normalized information is a characteristic, not a specification. The information is presented here for comparison purposes only. Normalization characteristics are achieved only with the use of the normalization calibrations and firmware routines.

<sup>2</sup> Measured in the low bandwidth and average display modes.

<sup>3</sup> The rise time of the generator is less than 35 ps, as calculated by  $(Tr \text{ system})^2 = (Tr \text{ generator})^2 + (Tr \text{ scope})^2$

### Horizontal (time base)

<b>Scale factor</b> (full-scale is 10 divisions)	10 ps/division to 1 s/division
<b>Delay</b> (time offset relative to trigger)	16 ns to 10 s or 1000 screen diameters, whichever is smaller
<b>Time interval accuracy</b>	≤ 10 ps ± 0.1% of reading (Dual marker measurement)
<b>Time Interval Resolution</b>	0.25 ps <sup>1</sup> or 0.02 division, whichever is larger

<sup>1</sup> At 10 ps/division, data points are plotted at 0.2 ps intervals to match the display pixel resolution.

### Trigger-external input only

<b>Sensitivity</b>	dc - 100 MHz 100 MHz to 2.5 GHz	40 mV peak-to-peak Increasing linearly from 40 mV at 100 MHz to 200 mV at 2.5 GHz
<b>Pulse width</b>		200 ps, ≥ 200 mV
<b>High-frequency reject</b>		Trigger bandwidth reduced to approximately 100 MHz.
<b>Trigger level range</b>		± 1 V
<b>Jitter</b> (Trigger and time base combined) (one standard deviation)		≤ 2.5 ps + 5E-5 × delay setting (Tested using 2 GHz synthesized source at 200 mV peak-to-peak with High-Frequency Sensitivity ON and High-Frequency Reject OFF.)
<b>Trigger input</b>		
Maximum safe input voltage		± 2 V dc + ac peak (+16 dBm)
Nominal impedance		50 Ω
Percent reflection		≤ 10% for 100 ps rise time
Connector		3.5 mm (m)

# OSCILLOSCOPES

## Accessories for the HP 54120 Series Digitizing Oscilloscopes

HP 54006A, 54007A, 54008A, 54118A, 10086A

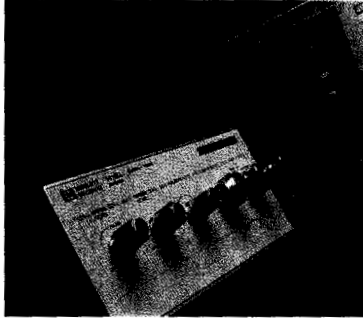

HP 54118A 18 GHz Trigger

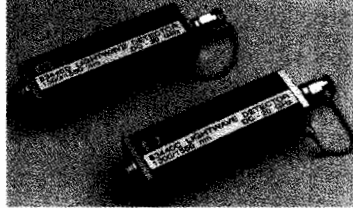

HP 83440C/D Lightwave  
O/E Converters with the HP 54124T Scope

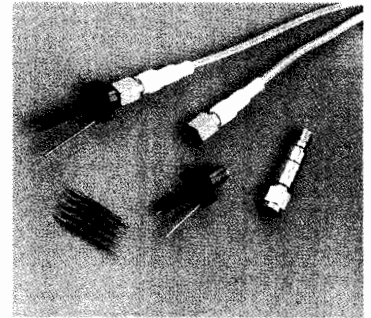

HP 54006A 6 GHz Probe



HP 54008A 20 GHz Delay Line



HP 54007A RF Accessory Kit

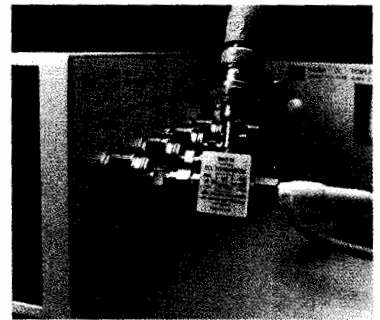

HP 10086A ECL Terminator

Hewlett-Packard has a large number of accessories for use with wideband digital sampling oscilloscopes that will help you build a multi-gigahertz system tailored to your unique needs.

### HP 54118A, 500 MHz to 18 GHz Trigger Simple/Stable Triggering at Microwave Frequencies

For applications requiring more than 2.5 GHz trigger bandwidth, use the HP 54118A 18 GHz Trigger. The HP 54118A gives your HP 54120-series oscilloscope true event triggering from 500 MHz to 18 GHz with less than 1.7 ps of rms jitter at 18 GHz. This powerful and versatile accessory extends the oscilloscope's measurement capabilities to applications in lightwave communications, pulsed RF, gigabit logic, pseudo-random bit stream eye patterns, and other microwave signals.

### HP 83440C/D and HP 11982A Lightwave Converters Optical Oscilloscope Measurements from dc to 32 GHz Bandwidth

Combine an HP 83440C or HP 83440D lightwave converter with an HP 54120-series oscilloscope to create a lightwave oscilloscope. These lightwave systems can be used to measure optical signals in the 1000- to 1600-nm wavelength range with up to 32 GHz of bandwidth. Exceptional pulse response ensures the waveforms that you capture are free of measurement system distortion. For those ultra-low-power optical signals, an HP 11982A lightwave converter provides dc to 15 GHz optical bandwidth at a conversion gain typically better than 300 V/W.

### HP 54006A 6 GHz Probe High Frequency Hand-Held Probing

Probing multi-GHz systems with the HP 54006A, 10:1, 500  $\Omega$  and 20:1, 1 k $\Omega$  resistive divider probes lets you access circuit nodes that do not have a 50  $\Omega$  connector. These probes let you see the signal at specific points, such as the input to a gate. You can also use them to probe circuits that are not nominally 50  $\Omega$ .

### HP 54008A 22 ns Delay Line Viewing the Trigger Signal

The HP 54008A delay line provides 22 ns of delay with a usable frequency response of 20 GHz. By adding this accessory to your HP 54120 oscilloscope system, you will be able to view the trigger event. The HP 54008A has enough delay to view the trigger event with the HP 54118A Trigger installed in the trigger path also.

### HP 54007A Accessory Kit Low-Loss Measurements for the HP 54120 Oscilloscope Systems

The HP 54007A Accessory Kit provides an assortment of parts with 3.5 mm connectors for low-loss measurements. This kit is highly recommended for low-loss reflection and transmission measurements. It also includes semi-rigid coax, formed for use with the HP 11667B power splitter.

#### Contents of HP 54007A Accessory Kit:

17-inch cable, APC 3.5 (f-f)	17-inch cable, APC 3.5 (m-f)
Coaxial short, APC 3.5 (f)	Coaxial short, APC 3.5 mm (m)
50 $\Omega$ termination, APC 3.5 (m)	50 $\Omega$ termination, APC 3.5 (f)
7.5 cm airline, APC 3.5 (m-f)	Power splitter, APC 3.5 mm (f)
6 cm. semi-rigid "L", SMA (m-m)	3 cm. semi-rigid "L", SMA (m-m)
6 dB attenuator, APC 3.5 (m-f)	40 dB attenuator, APC 3.5 (m-f)
Adapter, APC 3.5 mm (m-m)	

### HP 10086A ECL Terminator Safe, Reliable Termination for Measuring ECL Devices

Create a simple high-performance 10 GHz interface between an ECL-compatible output and a 50  $\Omega$  instrument input. The ECL terminator provides bias and termination for your device under test, while presenting an undistorted and level-shifted signal to your measurement equipment. It also provides proper termination to ECL output devices, thereby reducing the risk of destroying sensitive output devices.

# OSCILLOSCOPES

## Ordering Information

HP 54120 Family

147

### HP 54120B includes:

- Color mainframe
- Interface cable
- Service manual for the HP 54120B (HP 54120-90907)
- Power cord

### HP 54121A includes:

- Operating and programming manuals for the HP 54121T
- Service manual for the HP 54121A
- Four channels, switchable step generator, and a trigger input
- Five adapters, APC-3.5 (f-f) (HP 5061-5311)
- Five coaxial shorts, SMA (m) (HP 0960-0055)
- One anti-static mat with wrist strap (HP 9300-1484)
- RF accessories (HP 54121-68701):
  - Five 20 dB attenuators, APC-3.5 (f-m) (HP 33340C Opt 020)
  - Three 50  $\Omega$  cables, SMA (m-m) (HP 8120-4948)
  - Two SMA (m) to BNC (f) adapters (HP 1250-1200)
  - One 50  $\Omega$  termination, SMA (m) (HP 1250-2153)
  - One 50  $\Omega$  termination, SMA (f) (HP 1250-2151)
  - One coaxial short, SMA (f) (HP 1250-2152)

### HP 54121T specific documentation

- HP 54121T Front-panel manual (HP 54121-90903)
- HP 54121T Programming manual (HP 54121-90904)
- HP 54121A service manual (HP 54121-90902)

### HP 54122A includes:

- Operating and programming manuals for the HP 54122T
- Service manual for the HP 54122A
- Four vertical channels, internal attenuators, and a trigger input
- Five adapters, APC-3.5 (f-f) (HP 5061-5311)
- Five coaxial shorts, SMA (m) (HP 0960-0055)
- One anti-static mat with wrist strap (HP 9300-1484)
- RF accessories (HP 54122-68701):
  - One 20 dB attenuator, APC 3.5 (f-m) (HP 33340C Opt. 020)
  - Three 50  $\Omega$  cables, SMA (m-m) (HP 8120-4948)
  - Five SMA (m) to BNC (f) adapters (HP 1250-1200)

### HP 54122T specific documentation

- HP 54122T Front-panel manual (HP 54122-90903)
- HP 54122T Programming manual (HP 54122-90904)
- HP 54122A Service manual (HP 54122-90901)

### HP 54123A includes:

- Operating and programming manuals for the HP 54123T
- Service manual for the HP 54123A
- Four channels, switchable step generator, and a trigger input
- Five adapters, APC-3.5 (f-f) (HP 5061-5311)
- Five coaxial shorts, SMA (m) (HP 0960-0055)
- One anti-static mat with wrist strap (HP 9300-1484)
- RF accessories (HP 54121-68701) See list under HP 54121A above.

### HP 54123T specific documentation

- HP 54123T Front-panel reference manual (HP 54123-90902)
- HP 54123T Programming manual (HP 54123-90903)
- HP 54123A Service manual (HP 54123-90901)

### HP 54124A includes:

- Operating and programming manuals for the HP 54124T
- Service manual for the HP 54124A
- Four channels, switchable step generator, and a trigger input
- Three adapters, APC-3.5 (f-f) (HP 5061-5311)
- Two adapters, 2.4 (f-f) (HP 11900B)
- Three coaxial shorts, SMA (m) (HP 0960-0055)
- Two coaxial caps, 2.4 mm (HP 54124-24101)
- One anti-static mat with wrist strap (HP 9300-1484)
- RF accessories (HP 54121-68701): See list above

### HP 54124T specific documentation

- HP 54124T Front-panel reference manual (HP 54124-90902)
- HP 54124T Programming manual (HP 54124-90903)
- HP 54124A Service manual (HP 54124-90901)

### Ordering Information

<b>HP 54120B</b> Digitizing Oscilloscope Mainframe	\$12,500
<b>Opt 908</b> Rack Mount Kit (HP 5061-9679)	+ \$40
<b>Opt 910</b> One Additional Set of Manuals	+ \$20

### HP 54121T 20 GHz digitizing oscilloscope

The HP 54121T 20 GHz Digitizing Oscilloscope consists of the HP 54120B and the HP 54121A. The HP 54121T is the recommended ordering configuration.

<b>HP 54121T</b> 20 GHz Digitizing Oscilloscope	\$30,400
<b>Opt 090</b> Deletes RF Accessories	- \$1,800
<b>Opt 908</b> Rack Mount Kits (HP 5061-9672)	+ \$89
<b>Opt 910</b> One Additional Set of Manuals	+ \$120
<b>Opt + W30</b> Extended Repair Service. See page 671.	\$695
<b>HP 54121A</b> Four-Channel Test Set	\$17,900
<b>Opt 090</b> Deletes RF Accessories	- \$1,800
<b>Opt 908</b> Rack Mount Kit (HP 5061-9672)	+ \$49
<b>Opt 910</b> One Additional Set of Manuals	+ \$100

### HP 54122T 12.4 GHz digitizing oscilloscope

The HP 54122T 12.4 GHz Digitizing Oscilloscope consists of the HP 54120B digitizing oscilloscope mainframe and the HP 54122A. The HP 54122T is the recommended ordering configuration.

<b>HP 54122T</b> 12.4 GHz Digitizing Oscilloscope	\$32,400
<b>Opt 090</b> Delete RF Accessories	- \$700
<b>Opt 908</b> Rack Mount Kits (1 ea HP 5061-9672)	+ \$89
<b>Opt 910</b> One Additional Set of Manuals	+ \$120
<b>Opt + W30</b> Extended Repair Service. See page 671.	\$695
<b>HP 54122A</b> Four-Channel Test Set	\$19,900
<b>Opt 090</b> Delete RF Accessories	- \$700
<b>Opt 908</b> Rack Mount Kit (HP 5061-9672)	+ \$49
<b>Opt 910</b> One Additional Set of Manuals	+ \$100

### HP 54123T 34 GHz digitizing oscilloscope

The HP 54123T 34 GHz Digitizing Oscilloscope consists of the HP 54120B and the HP 54123A. The HP 54123T is the recommended ordering configuration.

<b>HP 54123T</b> 34 GHz Digitizing Oscilloscope	\$36,400
<b>Opt 090</b> Delete RF Accessories	- \$1,800
<b>Opt 908</b> Rack Mount Kit (HP 5061-9672)	+ \$89
<b>Opt 910</b> One Additional Operating and Programming Manual	+ \$120
<b>Opt + W30</b> Extended Repair Service. See page 671.	+ \$865
<b>HP 54123A</b> Four-Channel Test Set	\$23,900
<b>Opt 090</b> Delete RF Accessories	- \$1,800
<b>Opt 908</b> Rack Mount Kit (HP 5061-9672)	+ \$49
<b>Opt 910</b> One Additional Set of Manuals	+ \$100

### HP 54124T 20 GHz digitizing oscilloscope

The HP 54124T 50 GHz digitizing oscilloscope consists of HP 54120B and the HP 54124A. The HP 54124T is the recommended ordering configuration.

<b>HP 54124T</b> 50 GHz Digitizing Oscilloscope	\$44,400
<b>Opt 090</b> Deletes RF Accessories	- \$1,800
<b>Opt 908</b> Rack Mount Kits (HP 5061-9672)	+ \$89
<b>Opt 910</b> One Additional Set of Manuals	+ \$120
<b>Opt + W30</b> Extended Repair Service. See page 671.	+ \$1,055
<b>HP 54124A</b> Four-Channel Test Set	\$31,900
<b>Opt</b> Delete RF Accessories	- \$1,800
<b>Opt 908</b> Rack Mount Kit (HP 5061-9672)	+ \$49
<b>Opt 910</b> One Additional Set of Manuals	+ \$100

### Accessories

<b>HP 54006A</b> 6 GHz Resistive Divider Probe Kit	\$995
<b>HP 54007A</b> Accessory Kit	\$5,495
<b>HP 54008A</b> 22 ns Delay Line	\$2,600
<b>HP 54118A</b> 18 GHz Trigger	\$9,875
<b>Opt 090</b> Delete RF Accessories	- \$1,250
<b>Opt 908</b> Rack Mount Kit (HP 5061-9672)	+ \$49
<b>Opt 910</b> One Additional Manual	+ \$15
<b>HP 10086A</b> ECL Terminator	\$637

For additional information concerning any high-bandwidth oscilloscope accessory, see HP publication number 5952-7084.

# OSCILLOSCOPES

## Digitizing Oscilloscopes

HP 54501A, 54502A, 54503A, 54504A, 54510A

- Choice of 100 MHz, 250 MHz, 400 MHz, 500 MHz bandwidth
- Single-shot and repetitive signal performance
- Up to 4 channels
- Fully programmable
- Automatic pulse parameter measurements
- Dual-time-base windowing (except HP 54510A)
- Pan and zoom (HP 54510A)
- Automatic limit testing
- Three-year warranty
- Affordable



HP 54501A, 54502A, 54503A,  
54504A, 54510A

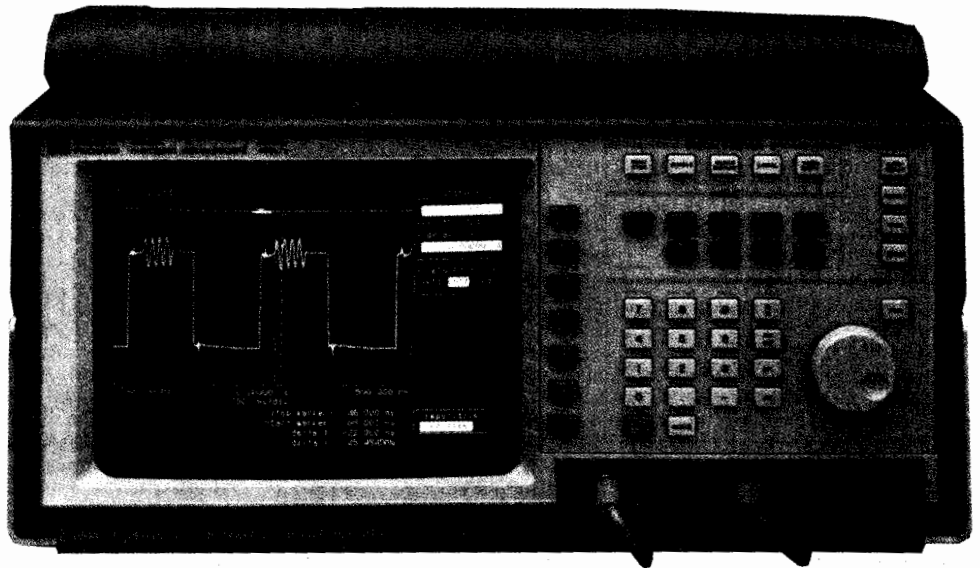

### The HP 54500 Family of Digitizing Oscilloscopes

#### A Family of Affordable Digitizing Oscilloscopes

There are 5 models in the HP 54500 family of digitizing oscilloscopes. For repetitive signals, the HP 54501A and 54503A offer 100 MHz and 500 MHz, respectively, and 4-channel, general-purpose performance. When single-shot capability is important, the HP 54502A and 54504A provide, respectively, 100 MHz and 50 MHz single-shot, and they both provide 400 MHz repetitive signal bandwidths. Using custom ADC design and other custom-integrated circuits, the HP 54510A boosts single-shot performance to 250 MHz as the first 1 gigasample-per-second portable oscilloscope. All these instruments deliver surprising performance at an affordable price.

#### The Digitizing Advantage

The HP 54500 family of oscilloscopes has features and functions that were previously available only on considerably higher-priced instruments. Like the HP 54100 series digitizing oscilloscopes, these instruments include all the digitizing advantages, such as autoscale, pushbutton hard-copy output, automatic measurements, nonvolatile setup and waveform memories, and full HP-IB programmability.

#### Affordable Automation

The HP 54500 family's fully programmable setup and data acquisition capabilities can be used with your HP Vectra PC, IBM PC, or other compatible personal computer. The built-in HP-IB interface, the simplified, self-documenting programming language, and the high data throughput rate provide a modestly priced yet powerful automated test system.

#### Easy to Use

All members of the HP 54500 family have a simplified user interface that makes them easy to operate. Adjustments are made with a single front-panel knob or numeric keypad. Automatic measurements, hard-copy output, and instrument setup are performed with simple keystrokes. Operation is intuitive and straightforward.

#### Advanced Logic and TV Triggering

Hewlett-Packard's advanced logic triggering is a standard feature in the HP 54500 family. Use it to trigger on a wide variety of user-specified conditions. Trigger on edge, pattern, state, or trigger-after-delay to capture such elusive events as timing violations or transient bus phenomena.

Select line and field for a variety of video waveforms. The 54500 family makes it easy to focus on the video information you need to capture.

#### Measurement Limit Test

Using measurement limit test, the HP 54500 family can automatically characterize a circuit or device over temperature or time—without human supervision. Specify upper and lower limits for any 3 of the instrument's automatic measurements, and leave it running unattended. If a measurement exceeds predefined limits, the violating waveform, measurements, and other display data can be automatically stored or transferred to an external printer or controller.

These instruments can automatically calculate maximum, minimum, average, and most recent values for all measurements, making device or circuit characterization even more accurate.

#### Dual-time-base Windowing<sup>1</sup>

Dual-time-base windowing lets you zoom in on fine details of the waveform you are measuring. Similar to the dual-delayed sweep feature found on some analog oscilloscopes, dual-time-base windowing gives you a time-expanded view of a smaller portion of the waveform, defined by you with the instrument's easy-to-use cursors.

#### Lightweight and Portable

Members of the HP 54500 family weigh only 22 pounds and are easily transported. Their small size allows them to fit easily in the trunk of a car, making them ideal for field applications. An optional soft carrying case is also available, as well as a sturdy transit case for safe shipment. See page 163 for accessories.

<sup>1</sup>The HP 54510A has "Pan and Zoom" in place of this feature (see page 149).

### HP 54510A: 1 GSa/s Digitizing Oscilloscope

The HP 54510A is a 1 gigasample/second, 2-channel, portable digitizing oscilloscope with a memory depth of 8 k samples per channel. The HP 54510A retains all of the key features and user friendliness of other 54500 Series oscilloscopes. The HP 54510A adds waveform calculus, memory bar for pan and zoom, faster update rate, and faster throughput over HP-IB. The HP 54510A is an affordable high-performance oscilloscope for applications such as advanced hardware design and troubleshooting, high-energy research, and manufacturing test/ATE.

### HP 54510A Specifications and Characteristics

#### Vertical (voltage)

<b>Bandwidth:</b> dc-coupled <sup>1</sup>	dc to 250 MHz (-3 dB) (300-MHz repetitive mode typical)	
<b>Switchable bandwidth limits</b>	ac-coupled lower -3 dB frequency: 90 Hz LF reject lower -3 dB frequency: 450 Hz Bandwidth limit -3 dB frequency: 30 MHz	
<b>Rise time</b> <sup>2</sup>	1.4 ns	
<b>Number of channels</b>	2 (simultaneous)	
<b>Vertical sensitivity range</b>	1 mV/div to 5 V/div	
<b>Vertical gain accuracy</b> <sup>3,4</sup>	± 1.25% of full scale	
<b>Vertical resolution</b> <sup>4</sup>	8 bits over eight divisions (± 0.4%) 10 bits via HP-IB w/averaging (± 0.1%)	
<b>Maximum sample rate</b>	1 GSa/s (2 ch. simultaneous)	
<b>Waveform record length</b> <sup>5</sup>	8001 points (real time) 501 points (repetitive)	
<b>Input R</b> (selectable)	1 M Ω ± 1% or 50 Ω ± 1%	
<b>Input C</b>	7 pF nominal	
<b>Input coupling</b>	ac, dc	
<b>Maximum input voltage</b>	1 M Ω: ± 250 V [dc + peak ac (< 10 kHz)] 50 Ω: 5 V rms	
<b>Offset range</b>	<b>Vertical Sensitivity</b>	<b>Available Offset</b>
	1 mV to 50 mV/div	± 2 V
	> 50 mV to 250 mV/div	± 10 V
	> 250 mV to 1.25 V/div	± 50 V
	> 1.25 V to 5 V/div	± 250 V
<b>Offset accuracy</b> <sup>4</sup>	± (1.0% of ch offset + 2% of full scale)	
<b>Dynamic range</b>	± 1.5 × full scale from center of screen	
<b>Channel-to-channel isolation</b>	40 dB: dc to 50 MHz 30 dB: 50 MHz to 250 MHz	
<b>Voltage measurement accuracy</b> <sup>3,4</sup>		
<b>Dual cursor</b>	± (1.25% of full scale + 0.032 × V/div)	
<b>Single cursor</b>	± (1.25% of full scale + offset accuracy + 0.016 × V/div)	

#### Horizontal (time)

<b>Time base range</b>	1 ns/div to 5 s/div	
<b>Maximum time base resolution</b>	20 ps	
<b>Delta-t accuracy</b> <sup>6</sup>		
Repetitive	± (0.005% × delta t + 2(10 <sup>9</sup> ) × delay setting + 100 ps)	
Real time	± (0.005% × delta t + 2(10 <sup>9</sup> ) × delay setting + 150 ps)	
(single acquisition)		
<b>Delay range</b> (post-trigger)	10,000 × (s/div)	
<b>Delay range</b> (pre-trigger)	<b>Time/div Setting</b>	<b>Available Delay</b>
	100 ns to 5 s/div	- 160 × (s/div)
	1 ns to 50 ns/div	- 8 μs

#### Triggering

<b>Trigger sensitivity</b> <sup>4</sup>		
<b>Internal</b>		
dc to 50 MHz	0.5 div	
50 MHz to 250 MHz	1.0 div	
<b>External</b>		
dc to 250 MHz	100 mv p-p into 50 Ω	
<b>Trigger pulse width</b> (minimum)		
Internal	1.75 ns	
External	2.8 ns	
<b>Trigger level range</b>		
Internal: ± 1.5 × full scale from center screen		
External: ± 2 V		

Specifications valid for temperature range ± 10° C from software calibration temperature with eight or more averages selected.

<sup>1</sup> Upper bandwidth reduces by 2.5 MHz for each degree above 35° C.

<sup>2</sup> Rise times are calculated from  $t_r = \frac{0.35}{\text{bandwidth}}$

<sup>3</sup> Accuracies decrease 0.08% of full scale per degree C from firmware calibration temperature and are valid for a temperature range ± 10° C from firmware calibration temperature. These accuracies apply to both repetitive and real time (single acquisition modes).

<sup>4</sup> Expansion is used below 7 mV/div range, so resolution and accuracies are correspondingly reduced. Below 7 mV/div, full scale is defined as 56 mV.

<sup>5</sup> Available over HP-IB waveform record length is:  
Real time: 8,000 points  
Repetitive: 500 points

<sup>6</sup> Specification applies at the maximum sampling rate. At lower sampling rates specification should read ± (0.005% × delta t + 2(10<sup>9</sup>) × delay setting + 0.15 × sample interval). For bandwidth limited signals  $t_r = 1.4 \times \text{sample interval}$ . Sample interval is defined as 1/sample rate. Specification also applies to those automatic measurements computing time intervals on similar slope edges (such as pos-pos, neg-neg).

#### Ordering Information

The HP 54510A Digitizing Oscilloscope comes with two HP 10430A 10:1 10 M Ω probes, a front-panel manual, a programming manual, a service manual, a miniature probe to BNC male adapter, a power cord, and a 3-year warranty.

	<b>Price</b>
<b>HP 54510A</b> 1 GSa/s Digitizing Oscilloscope	\$10,950
<b>Opt 908</b> Rackmount Kit (5061-6175)	+ \$250
<b>Opt 910</b> Additional front panel, programming and service manuals	+ \$75
<b>Opt 990</b> Delete probes	- \$200

# OSCILLOSCOPES

## Digitizing Oscilloscopes

HP 54504A

### HP 54504A 400 MHz, 200 MSa/s Digitizing Oscilloscope with 8-bit Vertical Resolution

The HP 54504A is a 400 MHz, 200 MSa/s sample rate, 2-channel digitizing oscilloscope with 8-bit A/Ds designed for both repetitive and single-shot signals. In repetitive mode, the HP 54504A has 400 MHz bandwidth. In real-time mode, its 200 MSa/s sample rate provides a single-shot bandwidth of 50 MHz. Like other members of the HP 54500 family, the HP 54504A has all the digitizing advantages of oscilloscopes that are much higher in price. Its high repetitive/single-shot bandwidth, ease of use, HP-IB programmability, and HP 54500 family general-purpose features make it a powerful tool for both manual and automated test applications.

### HP 54504A Specifications and Characteristics

Vertical (voltage)	Real-Time	Repetitive
<b>Bandwidth</b> (-3 dB) dc-coupled	dc to 50 MHz	dc to 400 MHz <sup>1,5</sup>
<b>Switchable bandwidth limits</b>	ac-coupled lower -3 dB freq.: 10 Hz LF reject lower -3 dB freq.: 450 Hz Bandwidth limit: dc to 30 MHz	
<b>Rise time<sup>2</sup></b>	7.0 ns	875 ps
<b>Number of channels</b>	2 (simultaneous)	
<b>Vertical sensitivity range</b>	1 mV/div to 5 V/div	
<b>Vertical gain accuracy (dc)<sup>3,4</sup></b>	±1.50% of full scale	
<b>Vertical resolution<sup>4</sup></b>	±0.4% of full scale (8 bit A/D) ±0.1% of full scale (10 bits with ≥ 8 averages)	
<b>Maximum sample rate</b>	200 MSa/s	25 MSa/s
<b>Waveform record length<sup>5</sup></b>	Normal: 501 points Extended: 2001 points	Time/div 5 ns to 5 s/div: 501 pts 2 ns/div: 401 pts 1 ns/div: 201 pts
<b>Input R</b> (selectable)	1 MΩ ±1% or 50 Ω ±1%	
<b>Input C</b>	7 pF nominal	
<b>Input coupling</b>	ac, dc	
<b>Maximum input voltage</b>	1 MΩ: ±250 V [dc + peak ac (< 10 kHz)] 50 Ω: 5 V rms	
<b>Offset range</b>	Vertical sensitivity: 1 to 50 mV/div > 50 to 250 mV/div > 250 mV to 1.25 V/div > 1.25 to 5V/div	Available offset: ±2 V ±10 V ±50 V ±250 V
<b>Offset accuracy<sup>4</sup></b>	± (+1.0% of ch. offset + 2% of full scale)	
<b>Dynamic range</b>	±1.5 × full scale from center of screen	
<b>Channel-to-channel isolation</b> (with channels at equal sensitivity)	40 dB: dc to 50 MHz N/A: 50 to 400 MHz	40 dB: dc to 50 MHz 30 dB: 50 to 400 MHz
<b>Voltage measurement accuracy (dc)<sup>3,4</sup></b>		
Dual cursor:	±(1.5% of full scale + 0.032 × V/div)	
Single cursor:	±(1.5% of full scale + offset accuracy + 0.016 × V/div)	

Horizontal (time)	Real-Time	Repetitive
<b>Time base range</b>	1 ns/div to 5 s/div	
<b>Time base reference accuracy</b>	0.01%	
<b>Maximum time base resolution</b>	50 ps	
<b>Delta-t accuracy</b>	±(2% × s/div + 0.01% × delta t + 1 ns)	±(2% × s/div + 0.01% × delta t + 250 ps)
<b>Delay range</b> (post-trigger)	Time/div setting: 50 ms to 5 s/div 100 μs to 20 ms/div 1 ns to 50 μs/div	Available delay: 40 × (s/div) 1 s 10,000 × (s/div)
<b>Delay range</b> (pre-trigger)	All time/div settings: 40 × (s/div)	Time/div setting: 1 μs to 5 s/div 10 ns to 500 ns/div 1 ns to 5 ns/div
		Available delay: -40 × (s/div) -80 μs -10,000 × (s/div)

### Triggering

<b>Internal trigger coupling</b>	Line trigger Low-frequency reject (-3dB 50 KHz)	
<b>Trigger sensitivity<sup>4</sup></b>		
Internal:		
dc to 50 MHz	0.5 div	0.5 div
50 MHz to 100 MHz	not applicable	0.5 div
100 MHz to 400 MHz	not applicable	1.25 div
External:	100 mV peak-to-peak into 50 Ω	
dc to 250 MHz		
<b>Trigger pulse width</b> (minimum):		
Internal:	14.0 ns	1.75 ns
External:	2.8 ns	2.8 ns
<b>Trigger level range</b>	Internal: ±1.5 × full scale from center of screen External: ±2V	

**Power requirements:** Voltage: 115/230 Vac, -25% to +15% 48 to 66 Hz. Power 350 VA maximum.

**Weight:** Net: approximately 10 kg (22 lb). Shipping: approximately 20 kg (44 lb).

**Size:** 194.3 mm H × 422.3 mm W × 355.6 mm D (7.65 in × 16.62 in × 14 in) Does not include front panel protrusions

Specifications valid for temperature range ±10°C from software calibration temperature with 8 or more averages selected.

<sup>1</sup>Upper bandwidth reduces by 2.5 MHz for each °C above +35°C.

<sup>2</sup>Rise times are calculated from:

$$t_r = \frac{0.35}{\text{bandwidth}}$$

<sup>3</sup>Vertical gain accuracy decreases 0.08% per °C from software calibration temperature.

<sup>4</sup>Expansion is used below 7 mV/div range so vertical resolution and accuracies are correspondingly reduced. Below 7mV/div full scale is defined as 56 mV.

<sup>5</sup>On time/div settings 1 μs/div and slower, bandwidth in repetitive mode is 50 MHz.

<sup>6</sup>Available over HP-IB waveform record length is:

Real-time normal: 500 points; extended: 2000 points.

Repetitive 10 ns to 5 s/div: 1024 pts.

5 ns/div: 1000 pts.

2 ns/div: 400 pts.

1 ns/div: 200 pts.

### Ordering Information

The HP 54504A digitizing oscilloscope comes complete with two HP 10430A 10:1 10 MΩ probes, a front panel manual, a programming manual, a service manual, a power cord, and a three-year warranty.

HP 54504A Digitizing Oscilloscope	qty 1	Price
	qty ≥ 2 (each)	\$6,750
<b>Opt 908</b> Rack Mount Kit (5061-6175)		\$6,549
<b>Opt 910</b> Additional Front-Panel, Programming, and Service Manual (54504-90901, 54504-90902)		+ \$250
<b>Opt 090</b> Delete Probes		+ \$75
		- \$200

☎ For off-the-shelf shipment, call 800-452-4844.



### HP 54503A 500 MHz 4-Channel Digitizing Oscilloscope

The HP 54503A is a 500 MHz, 4-channel digitizing oscilloscope designed primarily for repetitive signal applications. All 4 channels have full-featured attenuators. Like all of the HP 54500 family oscilloscopes, the 54503A features 2-channel simultaneous sampling and has the digitizing advantages of oscilloscopes much higher in price. Its 4 channels, 500 MHz repetitive signal bandwidth, ease of use, HP-IB programmability, and HP 54500 family general-purpose features make it a powerful tool for both manual and automated test applications.

### HP 54503A Specifications and Characteristics Vertical (voltage)

<b>Bandwidth: (-3 dB) dc-coupled</b>		
Repetitive: <sup>1</sup>	dc to 500 MHz	
Single-shot:	dc to 2 MHz (based on 10 points per period of input signal)	
<b>Switchable bandwidth limits</b>	ac-coupled lower -3 dB frequency: 10 Hz LF reject lower -3 dB frequency: 450 Hz Bandwidth limit upper -3 dB frequency: 30 MHz	
<b>Rise time</b>	700 ps (calculated from: rise time = 0.35/BW)	
<b>Number of channels<sup>2</sup></b>	4	
<b>Vertical sensitivity range (all channels)</b>	1 mV/div to 5 V/div	
<b>Vertical gain accuracy dc<sup>3,4</sup></b>	± 1.25%	
<b>Vertical resolution<sup>4</sup></b>	± 0.4% (8 bit A/D) ± 0.1% (10 bits via HP-IB with averaging)	
<b>Maximum sample rate</b>	20 MSa/s	
<b>Waveform record length<sup>5</sup></b>	501 points (display) 1024 points (via HP-IB)	
<b>Input R (selectable)</b>	1 MΩ ± 1% or 50 Ω ± 1%	
<b>Input C</b>	7 pF nominal	
<b>Input coupling</b>	ac, dc	
<b>Maximum input voltage</b>	1MΩ: ± 250V [dc + peak ac < 10 kHz] 50 Ω: 5V rms	
<b>Offset range</b>	Vertical sensitivity:	Available offset:
	1mV to 50 mV/div	± 2V
	> 50 mV to 250 mV/div	± 10V
	> 250 mV to 1.25 V/div	± 50V
	> 1.25 V to 5 V/div	± 250V
<b>Offset accuracy<sup>4</sup></b>	± (2% of full scale + 0.5% of offset)	
<b>Dynamic range</b>	(dc + peak ac) ± 1.5 × full scale from center of screen	
<b>Channel-to-channel Isolation</b>	40 dB: dc to 100 MHz 30 dB: 100 to 500 MHz (with channels at equal sensitivity)	
<b>Voltage measurement accuracy</b>		
Dual cursor: <sup>6,7</sup>	± (1.25% of full scale + 0.032 div)	
Single cursor:	± (1.25% of full scale + offset accuracy + 0.016 div)	
<b>Horizontal (time)</b>		
<b>Time base range</b>	200 ps/div to 5 s/div	
<b>Time base reference accuracy</b>	0.005%	
<b>Maximum time base resolution</b>	20 ps	
<b>Delta-t accuracy</b>	± 2% of s/div ± 0.005% × delta t ± 100 ps	
<b>Delay range (post-trigger)</b>	Time/div setting:	Available delay:
	50 ms to 5 s/div	40 × (s/div)
	100μ to 20 ms/div	1 s
	200 ps to 50 μs/div	10,000 × (s/div)
<b>Delay range (pre-trigger)</b>	5 μs to 5s	-39.96 × (s/div)
	10 ns to 2μs	-99.9 μs
	200 ps to 5 ns	-10,000 × (s/div)

Triggering	Real-time	Repetitive
<b>Trigger sensitivity</b>		
≥ 5 mV/div:	dc to 100 MHz	0.063 of full-scale
	100 to 500 MHz	0.156 of full scale
< 5mV/div:	dc to 100 MHz	2.5 mV
	100 to 500 MHz	6 mV
<b>Trigger pulse width (minimum)</b>	1.5 ns	
<b>Trigger level range</b>	± 1.5 × full scale from center of screen	

**Power Requirements:** Voltage: 115/230 Vac, -25% to +15% 48 to 66 Hz. Power 350 VA maximum.

**Weight:** Net: approximately 10 kg (22 lb). Shipping: approximately 20 kg (44 lb).

**Size:** 194.3 mm H × 422.3 mm W × 355.6 mm D (7.65 in × 16.62 in × 14 in); does not include front panel protrusions

Specifications valid for temperature range ± 10° C from software calibration temperature with 8 averages selected and channel(s) in sensitivity range 1, 2, or 5.

<sup>1</sup>Upper bandwidth reduces by 2.5 MHz for each degree centigrade above +35° C.

<sup>2</sup>Simultaneous acquisition on two channels. Channels 1 and 4 are acquired simultaneously. If four channels are used, data is acquired alternately by channels 1 and 4, then 2 and 3.

<sup>3</sup>Accuracy reduces by ± 0.08% for each degree centigrade away from software calibration temperature.

<sup>4</sup>Expansion is used below 7 mV/div range so vertical resolution and accuracies are correspondingly reduced.

<sup>5</sup>For single-shot via HP-IB, waveform record length is 500 points. In repetitive mode: 200 ps/div time base range, waveform record length is 100 points. 500 ps/div time base range, waveform record length is 250 points. 1ns/div time base range, waveform record length is 500 points. ≥ 2 ns/div time base range, waveform record length is 1000 points.

### HP 54503A Telecommunications Mask Template Test Option

Make telecom mask template measurements to ANSI, CCITT, and ISDN standards without using Mylar overlays. HP 54503A Option 001 automates many of the mask measurements that are time-consuming with analog oscilloscopes. Pass-fail accuracy and repeatability are improved through the use of automatic measurements, eliminating human error.

#### HP 54503A Option 001 Features

- 16 standard telecom signal mask templates stored in ROM
- Positive and negative templates
- Automatic triggering on positive "isolated ones" in live traffic for many standard telecom signals
- Automatic best-fit of test signals to positive mask templates
- Automatic pass-fail comparison of mask templates with corresponding input signals
- Automatic storage, printing, or plotting of failed signals
- User-defined pass-fail tolerance
- Memory protection for user mask templates, waveforms, and front panel setups

For more information on this option and a technical data sheet, contact your local HP sales office (see page 684).

<sup>6</sup>For the HP 54503A Option 001, the term "isolated ones" is defined as a pulse sequence of at least two zeroes followed by a one, followed by at least two zeroes.

#### Ordering Information

The HP 54503A digitizing oscilloscope comes complete with two HP 10430A 10:1 10 MΩ probes, a front-panel manual, a programming manual, a service manual, a power cord, and a three-year warranty.

	Price
<b>HP 54503A</b> Digitizing Oscilloscope	qty 1 \$5,950
	qty ≥ 2 (each) \$5,773
<b>Opt 001</b> Telecommunications Mask Template Test Option	+ \$500
<b>Opt 908</b> Rack Mount Kit (5061-6175)	+ \$250
<b>Opt 910</b> Additional Front-Panel, Programming and Service Manual (54503-90901, 54503-90902)	+ \$75
<b>Opt 090</b> Delete Probes	- \$200

☎ For off-the-shelf shipment, call 800-452-4844.

# OSCILLOSCOPES

## Digitizing Oscilloscopes

### HP 54502A

#### HP 54502A 400 MHz, 400 MSa/s Digitizing Oscilloscope

The HP 54502A is a 400 MHz, 400 MSa/s sample rate, 2-channel digitizing oscilloscope designed for both repetitive and single-shot signals. In repetitive mode, the HP 54502A has a 400 MHz bandwidth. In real-time mode, its 400 MSa/s sample rate provides a single-shot bandwidth of 100 MHz. Like other members of the HP 54500 family, the HP 54502A has all the digitizing advantages of oscilloscopes that are much higher in price. Its high repetitive/single-shot bandwidth, ease of use, HP-IB programmability, and HP 54500 family general-purpose features make it a powerful tool for both manual and automated test applications.

#### HP 54502A Specifications and Characteristics

	Real-Time	Repetitive
<b>Bandwidth</b> (-3 dB) dc-coupled	dc to 100 MHz	dc to 400 MHz <sup>1a</sup>
<b>Switchable bandwidth limits</b>	ac-coupled lower -3 dB freq.: 10 Hz LF reject lower -3 dB freq.: 450 Hz Bandwidth limit: dc to 30 MHz	
<b>Rise time<sup>2</sup></b>	3.5 ns	875 ps
<b>Number of channels</b>	2 (simultaneous)	
<b>Vertical sensitivity range</b>	2 mV/div to 5 V/div	
<b>Vertical gain accuracy (dc)<sup>3,4</sup></b>	±2.0% of full scale	
<b>Vertical resolution<sup>4</sup></b>	±1.6% of full scale (6 bit A/D) ±0.4% of full scale (8 bits with ≥ 8 averages)	
<b>Maximum sample rate</b>	400 MSa/s	25 MSa/s
<b>Waveform record length<sup>5</sup></b>	Normal: 501 points Extended: 2001 points	Time/div 5 ns to 5 s/div 2 ns/div 401 pts 1 ns/div 401 pts 201 pts
<b>Input R (selectable)</b>	1 MΩ ±1% or 50 Ω ±1%	
<b>Input C</b>	7 pF nominal	
<b>Input coupling</b>	ac, dc	
<b>Maximum input voltage</b>	1 MΩ: ±250 V [dc + peak ac (<10 kHz)] 50 Ω: 5 V rms	
<b>Offset range</b>	Vertical sensitivity: 2 mV to 50 mV/div > 50 mV to 250 mV/div > 250 mV to 1.25 V/div > 1.25 V to 5V/div	Available offset: ±2 V ±10 V ±50 V ±250 V
<b>Offset accuracy<sup>6</sup></b>	±(2 mV + 2% of ch. offset + 2.5% of full scale)	
<b>Dynamic range</b>	±1.5 × full scale from center of screen	
<b>Channel-to-channel isolation</b>	40 dB: dc to 50 MHz 30 dB: 50 to 100 MHz (with channels at equal sensitivity)	40 dB: dc to 50 MHz 30 dB: 50 to 400 MHz
<b>Voltage measurement accuracy (dc)<sup>3,4</sup></b>	Dual cursor: ±(2.0% of full scale + 0.032 × V/div) Single cursor: ±(2.0% of full scale + offset accuracy + 0.016 × V/div)	
<b>Time base range</b>	1 ns/div to 5 s/div	
<b>Time base reference accuracy</b>	0.01%	
<b>Maximum time base resolution</b>	50 ps (maximum)	
<b>Delta-t accuracy</b>	±(2% × screen diameter + 0.01% × delta t + 500 ps)	±(2% × screen diameter + 0.01% × delta t + 250 ps)
<b>Delay range (post-trigger)</b>	Time/div setting: 50 ms to 5 s/div 100 μs to 20 ms/div 1 ns to 50 μs/div	Available delay: 40 × (s/div) 1s 10 000 × (s/div)

	Real-Time	Repetitive	
<b>Delay range (pre-trigger)</b>	All time/div settings: 40 × (s/div)	Time/div setting: 1 μs to 5 s/div 10 ns to 500 ns/div 1 ns to 5 ns/div	Available delay: -40 × (s/div) -80 μs -10 000 × (s/div)
<b>Internal trigger coupling</b>	Line trigger Low-frequency reject (-3dB 50 KHz)		
<b>Trigger sensitivity<sup>7</sup></b>	Internal dc to 100 MHz 100 MHz to 400 MHz External dc to 250 MHz	0.5 div N/A 1.25 div 100 mV peak-to-peak into 50 Ω	0.5 div 1.25 div
<b>Trigger pulse width (minimum):</b>	Internal: External:	7.0 ns 2.8 ns	1.75 ns 2.8 ns
<b>Trigger level range</b>	Internal: ±1.5 × full scale from center of screen External: ±2V		

**Power requirements:** Voltage: 115/230 Vac, -25% to +15% 48 to 66 Hz. Power 350 VA maximum.

**Weight:** Net: approximately 10 kg (22 lb). Shipping: approximately 20 kg (44 lb).

**Size:** 194.3 mm H × 422.3 mm W × 355.6 mm D (7.65 in × 16.62 in × 14 in); does not include front panel protrusions.

Specifications valid for temperature range ±10° C from software calibration temperature with 8 or more averages selected.

<sup>1</sup>Upper bandwidth reduces by 2.5 MHz for each °C above +35° C.

<sup>2</sup>Rise times are calculated from:

$$t_r = \frac{0.35}{\text{bandwidth}}$$

<sup>3</sup>Vertical gain accuracy decreases 0.08% per °C from software calibration temperature.

<sup>4</sup>Expansion is used below 7 mV/div range so vertical resolution and accuracies are correspondingly reduced. Below 7 mV/div full scale is defined as 56 mV.

<sup>5</sup>On time/div settings 1 μs/div and slower, bandwidth in repetitive mode is 100 MHz.

<sup>6</sup>Available over HP-IB waveform record length is:

Real-time normal: 500 points, extended: 2000 points.	
Repetitive 10 ns to 5 s/div: 1024 pts.	2 ns/div: 400 pts.
5 ns/div: 1000 pts.	1 ns/div: 200 pts.

#### HP 54502A Telecommunications Mask Template Test Option

Make telecom mask template measurements to ANSI, CCITT, and ISDN standards without using Mylar overlays. HP 54502A Option 001 automates many of the mask measurements that are time-consuming with analog oscilloscopes. Pass-fail accuracy and repeatability are improved through the use of automatic measurements, eliminating human error.

#### HP 54502A Option 001 Features

- 16 standard telecom signal mask templates stored in ROM
- Positive and negative templates
- Automatic triggering on positive "isolated ones" in live traffic for many standard telecom signals
- Automatic best-fit of test signals to positive mask templates
- Automatic pass-fail comparison of mask templates with corresponding input signals
- Automatic storage, printing or plotting of failed signals
- User-defined pass-fail tolerance
- Memory protection for user mask templates, waveforms and front panel setups

For more information on this option and a technical data sheet, contact your local HP sales office (see page 684).

<sup>7</sup>For the HP 54502A Option 001, the term "isolated ones" is defined as a pulse sequence of at least two zeroes, followed by a one, followed by at least two zeroes.

#### Ordering Information

The HP 54502A digitizing oscilloscope comes complete with two HP 10430A 10:1 1 MΩ probes, a front panel manual, a programming manual, a service manual, a power cord, and a three-year warranty.

HP 54502A Digitizing Oscilloscope	qty 1	Price
	qty ≥ 2 (each)	\$7,450 \$7,228
<b>Opt 001</b> Telecommunications Mask Template Test Option		+ \$500
<b>Opt 908</b> Rack Mount Kit (5061-6175)		+ \$250
<b>Opt 910</b> Additional Front-Panel, Programming, and Service Manual		+ \$75
<b>Opt 090</b> Delete Probes		- \$200

☎ For off-the-shelf shipment, call 800-452-4844.

### HP 54501A 100 MHz, 4-Channel Digitizing Oscilloscope

The HP 54501A is a 100 MHz, 4-channel digitizing oscilloscope designed primarily for repetitive signal applications. It has all the digitizing advantages of oscilloscopes much higher in price. Ease of use and general-purpose features such as TV trigger, dual-time-base windowing, advanced logic triggering, automatic measurements and full HP-IB programmability make it a powerful tool for both manual and automated test applications.

### HP 54501A Specifications and Characteristics

<b>Vertical (voltage)</b>	
<b>Bandwidth</b>	
dc-coupled	dc to 100 MHz (-3dB)
Repetitive:	dc to 1 MHz
Single-shot:	(Based on 10 points per period of input signal.)
ac-coupled	10 Hz to 100MHz (-3dB)
Repetitive:	10 Hz to 1 MHz
Single-shot:	(Based on 10 points per period of input signal.)
<b>Rise time</b>	
	3.5 ns
Calculated from: Rise time = $\frac{0.35}{\text{bandwidth}}$	
<b>Number of channels</b>	
	4 (2+2) Channels 2 and 3 are limited attenuator inputs, optimized for digital signals.
<b>Simultaneous channels</b>	
	2+2 Channels 1 and 4 are acquired simultaneously. If four channels are used, data is acquired alternately by channels 1 and 4, then 2 and 3.
<b>Vertical sensitivity range</b>	
	5 V/div to 5 mV/div
<b>Vertical gain accuracy (dc)</b>	
	± 1.5%
<b>Vertical resolution</b>	
	± 0.4% - 8 bit A/D (Since expansion is used for 5 mV/div range, A/D resolution is 7 bits 0.8% in that range.) ± 0.1% - 10 bits via HP-IB (with averaging)
<b>Maximum sample rate</b>	
	10 Megasamples/second
<b>Memory depth</b>	
	501 points (display) 1024 points (via HP-IB)
For single-shot via HP-IB, maximum memory depth is 501 points. For 2ns/div time base range, memory depth is 200 points. For 5ns/div time base range, maximum memory depth via HP-IB is 501 points.	
<b>Input RC (nominal)</b>	
	1 MΩ, 16 pF
<b>Input coupling</b>	
	ac, dc
<b>Max input voltage</b>	
	± 250 V [dc + peak ac (<10 kHz)]
<b>Offset range</b>	
	Sensitivity range: Available offset: 5 to 50 mV/div ± 2V 0.1 to 1 V/div ± 20V 1 to 5 V/div ± 200V
<b>Offset accuracy</b>	
	± 2% of offset ± 0.2 X (V/div) ± 0.075 division/Δ° C from calibration temperature
<b>Dynamic range</b>	
	± 16 divisions from center operating range for dc + peak ac input.
<b>Channel-to-channel isolation</b>	
	40 dB dc to 20 MHz 30 dB 20 MHz to 100 MHz (with channels at equal sensitivity)
<b>Voltage measurement accuracy</b>	
Single cursor:	gain accuracy + offset accuracy + A/D resolution
Dual cursor:	gain accuracy + (2 × A/D resolution) (single channel)

### Horizontal (time)

<b>Time base range</b>	2 ns/div to 5 s/div	
<b>Time base accuracy</b>	0.005%	
<b>Maximum time base resolution</b>	100 ps	
<b>Delta-t accuracy</b>	1 ns ± (5E-5) × delta t ± 0.02 × (t/div) Delta-t accuracy for dual-cursor, single-channel measurement, or for channel-to-channel measurement after visual time null calibration has been performed.	
<b>Delay range (post-trigger)</b>	Time base setting	Available delay
	50 ms to 5 s	40 × (s/div)
	100 μs to 20 ms	1 s
	2 ns to 50 μs	10,000 × (s/div)
<b>Delay range (pre-trigger)</b>	10 μs to 5 s	- 40 × (s/div)
	20 ns to 5 μs	- 200 μs
	2 ns to 10 ns	- 10,000 × (s/div)

### Triggering

<b>Trigger sensitivity</b>	dc to 20MHz, 0.1 × full-scale
5mV/div:	20MHz to 100MHz, 0.25 × full-scale
All Other:	dc to 20MHz, 0.05 × full-scale
	20MHz to 100MHz, 0.125 × full-scale
<b>Trigger pulse width (minimum)</b>	7 ns
<b>Trigger level range</b>	± 6 div from center

Specifications valid for temperature range ±10° C from calibration temperature with 8 averages selected and channel(s) in sensitivity range 1, 2, or 5.

**Power requirements:** Voltage: 115/230 V ac, -25% to +15% 48 to 66 Hz. Power 350 VA maximum.

**Weight:** Net: approximately 10 kg (22 lb). Shipping: approximately 20 kg (44 lb).

**Size:** 194.3 mm H × 422.3 mm W × 355.6 mm D (7.65 in × 16.62 in × 14 in). Does not include front panel protrusions.

### Ordering Information

The HP 54501A digitizing oscilloscope comes complete with two HP 10432A 10:1 10 MΩ probes, an operating and programming manual, a service manual, a power cord, and a three-year warranty.

HP 54501A Digitizing Oscilloscope	qty 1	Price
	qty ≥ 2 (each)	\$3,990
<b>Opt 908</b> Rack Mount Kit (5061-6175)		\$3,872
<b>Opt 910</b> One Additional Operating/Programming Manual (54501-90901) and One Additional Service Manual (54501-90902)		+ \$250
<b>Opt 909</b> Delete Probes		+ \$75
		- \$200

☎ For off-the-shelf shipment, call 800-452-4844.

# OSCILLOSCOPES

## Digitizing Oscilloscopes HP 54600-Series Oscilloscopes

- 100 MHz bandwidth
- Analog-like look and feel
- Automatic and cursor measurements of frequency, time, and voltage
- Waveform storage
- Save/recall of 16 setups
- Autoscale
- Optional pass/fail testing
- Optional HP-IB or RS-232 remote control
- Optional hard copy to parallel, RS-232, or HP-IB printers or plotters
- 3-year warranty, optional 5 years
- CSA, IEC 348, and UL 1244 certified

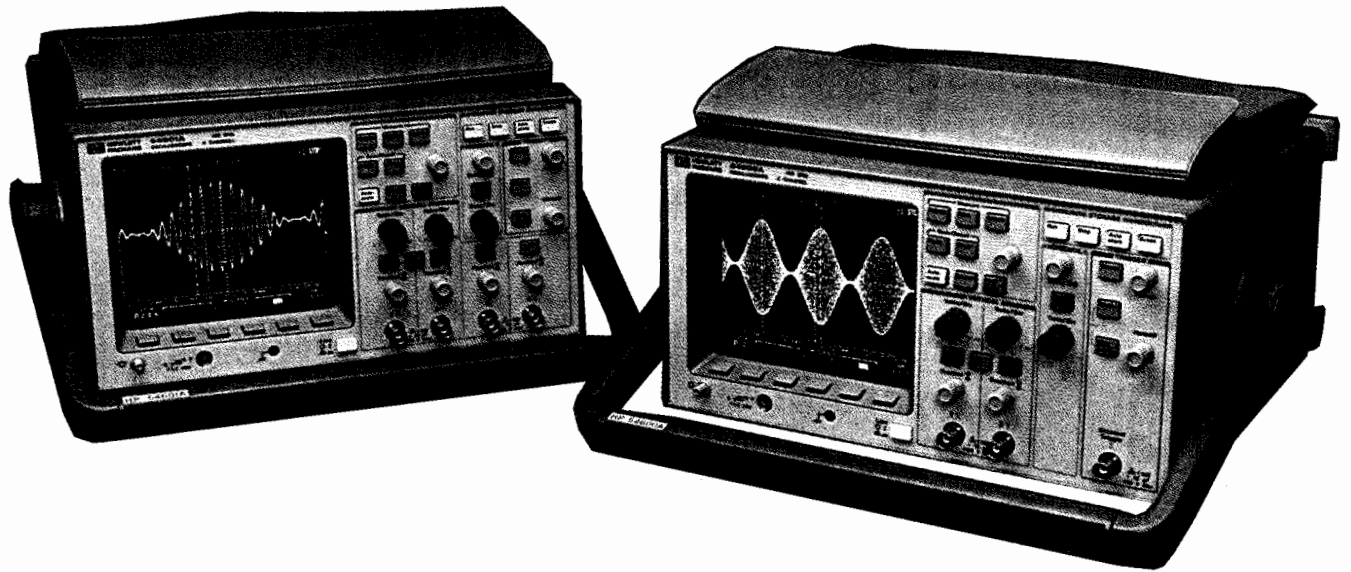

### 54600A 2-Channel and 54601A 4-Channel Oscilloscopes

The HP 54600A and 54601A oscilloscopes offer you the ability to view waveforms that can't be seen with an analog-based product, while maintaining an analog-like, highly interactive display and familiar controls. To solve your most difficult test problems, powerful digital features, such as negative time, storage, measurement, automation, hard-copy, and computer control are provided. This new class of oscilloscopes is made possible through HP's advanced integrated-circuit technology in a small-size, lightweight package at an affordable price.

These oscilloscopes notably enhance your troubleshooting with their unique combination of analog look and feel with digital power. Bright, crisp displays of your most demanding signals are presented at all sweep speeds and delayed sweep magnifications. Storage for glitch and transient analysis is as simple as pressing a button. Negative time lets you view events that would be missed by analog scopes.

The unique 3-processor architecture of these oscilloscopes lets you view waveforms never before visible with a digital oscilloscope. The display speed of 1 million points/s provides a display with unprecedented interactivity. For example, AM-modulated and other rapidly changing signals are displayed as expected.

The 2-channel HP 54600A is ideally suited for production, field-service, and education applications where simple controls let you quickly solve your problems. The 4-channel HP 54601A is best suited for research and development labs and applications where more complex digital circuits are being designed and tested.

These oscilloscopes are produced with HP's advanced SMT production process to give you the reliability you expect of your most critical measurement instrument.

You can increase the power of these oscilloscopes by adding an optional module.

Computer control can be provided with either HP-IB or RS-232 interface modules. Using HP's ScopeLink software, these powerful oscilloscopes can be interfaced to a PC for waveform documentation, analysis, or storage. You can make simple hard copies with either printers or plotters using the parallel module.

The Test Automation Module adds built-in pass/fail testing, 40 masks, 100 sequence steps, and foot-switch control.

The Measurement/Storage Module adds real-time clock, 100 stored traces, and additional automatic measurements to any HP 54600 Series oscilloscope.

#### Performance Characteristics

##### Vertical System (all channels)

<b>Bandwidth (-3dB) (ac-coupled):</b>	dc to 100 MHz, 10 Hz to 100 MHz
<b>Rise time</b>	3.5 ns (calculated)
<b>Math functions</b>	Ch 1 + or - Ch 2
<b>Channels 1 and 2 Accuracy<sup>1</sup></b>	2 mV/div to 5 V/div ±1.5%
<b>Vernier Accuracy<sup>1</sup></b>	Fully calibrated, approximately ±3%
<b>Cursor Accuracy<sup>1,2</sup></b>	
<b>Single cursor:</b>	Vert. Acc. ±1.2% of full scale, ±0.5% of position value
<b>Dual cursor:</b>	Vert. Acc. ±0.4% of full scale
<b>Bandwidth limit</b>	Approximately 20 MHz
<b>Coupling</b>	Ground, ac, and dc
<b>Inversion</b>	Ch 1 and Ch 2
<b>CMRR</b>	Approximately 20 dB at 50 MHz
<b>Input R&amp;C</b>	1 Ω, approximately 13 pf
<b>Maximum input</b>	400 V (dc + peak ac)
<b>Channels 3 and 4 (HP 54601A)</b>	0.1 and 0.5 V/div
<b>Accuracy<sup>1</sup>:</b>	±1.5%
<b>Coupling:</b>	Ground and dc

##### Horizontal System

<b>Sweep speeds</b>	5 s/div to 2 ns/div Main and Delayed
<b>Accuracy</b>	±0.01%
<b>Resolution</b>	100 ps
<b>Vernier accuracy</b>	±0.05%
<b>Cursor Accuracy (Δt &amp; 1/Δt)<sup>3</sup></b>	±0.01% ±0.2% of full scale ±200 ps

<b>Delay Jitter</b>	10 ppm
<b>Pretrigger Delay (Negative time)</b>	≥ 10 div
<b>Posttrigger Delay (Trigger to start of sweep)</b>	At least 2,560 div or 50 ms (not to exceed 100 s)

##### Delayed Sweep Operation

<b>Main Sweep</b>	Delayed Sweep
5 s/div to 10 ms/div	up to 200X main
5 ms/div and faster	up to 2 ns/div

##### Trigger System

<b>Sensitivity</b>	dc to 25 MHz, 0.35 div or 3.5 mV; dc to 100 MHz, 1 div or 10 mV
<b>Sources</b>	Channels 1, 2, 3, and 4 and line (HP 54601A); Channels 1 and 2, line, & Ext. (HP 54600A)
<b>Coupling</b>	ac, dc, LF reject, HF reject, and noise reject LF & HF: - 3 db at approximately 50 kHz
<b>Modes</b>	Auto, Autolevel, Normal, Single, and TV
<b>TV Triggering</b>	TV line and field 0.5 div. of composite sync for stable display (Ch 1 and Ch 2)
<b>Holdoff</b>	Adjustable from 200 ns to approximately 13 s
<b>External Trigger (HP 54600A only)</b>	
<b>Range:</b>	±18 volts
<b>Sensitivity:</b>	dc to 25 MHz, 50 mV dc to 100 MHz, 100 mV



# OSCILLOSCOPES

## Digitizing Oscilloscopes (cont'd)

HP 54600A

### External Trigger (Cont'd.)

<b>Coupling</b>	dc, HF rej., and noise rej.
<b>Input R&amp;C</b>	1 M $\Omega$ , approximately 13 pF
<b>Maximum Input</b>	400 V (dc + peak ac)

### X-Y Operation

<b>Z-Blanking</b>	TTL High blanks trace
<b>Bandwidth</b>	X and Y same as vertical system
<b>Phase Difference</b>	$\pm 3^\circ$ at 100 kHz

### Display System

<b>Display</b>	7-inch Raster CRT
<b>Resolution</b>	255 vertical by 500 horizontal points
<b>Controls</b>	Front-panel intensity control
<b>Graticule</b>	8 $\times$ 10 grid or frame
<b>Autostore</b>	Autostore saves previous sweeps in half-bright display and the most recent sweep in full-bright display

### Acquisition System

<b>Maximum Sample Rate</b>	20 MSa/s
<b>Resolution</b>	8 bits
<b>Simultaneous channels</b>	Channels 1 and 2 or channels 3 and 4
<b>Record length</b>	4,000 points (2,000 single-shot)
<b>Maximum update rate</b>	1,000,000 points/s
<b>Single-shot bandwidth</b>	2 MHz, single-channel 1 MHz, dual-channel
<b>Peak detect</b>	50 ns glitch capture (100 ns dual-channel) at sweep speeds of 50 $\mu$ s/div and greater
<b>Average</b>	Number of averages selectable at 8, 64, or 256

### Advanced Functions

<b>Automatic Measurements</b>	Measurements are continuously updated: Voltage: $V_{avg}$ , $V_{rms}$ , $V_{pp}$ , $V_{top}$ , $V_{base}$ , $V_{min}$ , and $V_{max}$
<b>Time:</b>	Frequency, Period, + Width, - Width, Duty Cycle, Rise Time, and fall time
<b>Cursors:</b>	Manually or automatically placed

### Setup Functions

<b>Autoscale:</b>	Sets the vertical and horizontal deflection and the trigger level
<b>Save/recall:</b>	16 front-panel setups
<b>Trace memory:</b>	Two volatile pixel memories

### Power Requirements

<b>Line voltage range</b>	100 Vac to 240 Vac
<b>Line voltage selection</b>	Automatic
<b>Line frequency</b>	45 Hz to 440 Hz
<b>Max power consumption</b>	220 VA

### General

<b>Size (excluding handle)</b>	172 mm H $\times$ 322 mm W $\times$ 317 mm D (6.8 in $\times$ 12.7 in $\times$ 12.5 in) (excluding handle)
<b>Weight</b>	6.2 kg (14 lb)
<b>Safety</b>	CSA certification and IEC 348, UL 1244

\*Temperature is  $\pm 10^\circ$  C from calibration.

\*Use full scale of 80 mV for 2 mV/div and 5 mV/div ranges.

\*Use full scale of 50 ns for 2 ns/div.

\*Tested to Hewlett-Packard environmental specification section 758 for Class B-1 products.

## Accessories for the HP 54600 Series Oscilloscopes

HP 54650A, 54651A, 54652A, 54653A, 54654A, 54655A, 54656A, 54657A, 54658A

### HP 54650A HP-IB Interface Module

Provides full remote control and hard copy to HP-IB printers and plotters. Programming is in accordance with IEEE 488.2. With the addition of this module, the scope's two pixel trace memories become nonvolatile. An operating and programming manual and a programming-examples disk are supplied.

### HP 54651A RS-232 Interface Module

Provides full remote control and hard copy to RS-232 printers and plotters. With the addition of this module, the scope's two pixel trace memories become nonvolatile. An operating and programming manual and a programming-examples disk are supplied.

### HP 54652A Parallel Interface Module

Provides the lowest-cost hard-copy solution. This module supports printers that are Epson FX-80 or HP-PCL compatible. Remote control is not provided with this module. The scope's two pixel trace memories become nonvolatile with the addition of this module. An operating note is supplied.

### HP 54653A ScopeLink Software

The HP 54653A ScopeLink software package provides a communication link between a personal computer and the HP 54500 and HP 54600 series oscilloscopes. Using the ScopeLink software, you can transfer the waveform image in TIFF or PCX graphic format to the PC for desktop publishing applications. In addition, waveform data can be transferred to the PC in ASCII format for general use. Additional formats can be selected that are compatible with Lotus 1-2-3, DADISP, and HP's Charting Gallery. Instrument setups can be saved to the computer and downloaded to the scope for simple automation applications.

### Equipment Requirements

**Computer:** IBM PC/XT/AT or fully compatible personal computer with serial port (COM1, COM2, or COM3) or an IEEE-488 card (HP 82335A or HP 27209A HP-IB card or National Instruments GP-IB card, part number 181065-01 or 181065-02)

**Disk Drive:** 2 flexible disk drives or 1 flexible disk drive and 1 hard disk drive

**Operating System:** MS-DOS® version 2.0 or later

**Memory:** 512 K of conventional memory

**Graphics Adapter:** CGA, EGA, VGA, or HGC

**Compatible Instruments:** HP 54500 series oscilloscopes, HP 54600 Series oscilloscopes with HP-IB or RS-232 interface module installed, HP 16500A logic analysis system (screen imaging only), and HP 1650 series logic analyzers (screen imaging only)

**Printers:** HP-PCL and Epson FX-80 compatible printers

Supplied with User's Guide, 5/8-inch diskette, and 3/4-inch diskette

### HP 54654A Operator's Training Kit

Consists of a training signal board and lab workbook. After completing these labs, an operator will be able to make measurements and operate the oscilloscope without any additional training. A signal board, manual, and 9 V battery are supplied.

## HP 54655A, 54656A Test Automation Modules

The HP-IB 54655A and RS-232 54656A Test Automation Modules add built-in pass/fail testing with conditional branching to any 54600 series oscilloscope. With the addition of either of these modules, an unskilled operator can perform very exacting oscilloscope measurements by simply connecting the scope probe to the test point and following the instructions on the scope's display. The oscilloscope tests the trace against a template and determines if the trace is passing or not. Failures are indicated to the operator along with instructions as to which action to take.

The test sequence can branch to another test based on the result of the present test. Each step in the sequence has three branching decisions that can be selected. They are the pass condition, the fail upper limit condition, and the fail lower limit condition. Using these three branching conditions, the scope can lead an unskilled operator through a troubleshooting process.

These modules have 100 sequence steps with 40 masks that can be stored in nonvolatile memory. The sequence can be set up from the front panel of the scope without the use of a computer. The Automask function creates a mask template from a known good signal. A built-in mask editor allows the test limits to be precisely adjusted to the exact tolerance for the test. Once the setup has been defined, it can be protected from unintentional change. ScopeLink can be used to copy the setup to other scopes.

The HP-IB 54655A Test Automation Module is designed to improve the productivity of computer-controlled test systems by removing the pass/fail decisions from the computer.

The RS-232 54656A Test Automation Module offers a testing solution that bridges the gap between manual and computer-controlled situations. This version of the Test Automation Module contains a RJ-45 I/O connector that can be connected to a foot switch for operator control and five user-definable output lines. These lines can be used to drive external devices that control a test fixture, or simply external pass/fail indicators.

The HP-IB 54655A is supplied with an operating and programming manual and programming examples on disk. The RS-232 54656A is also supplied with a 9- to 25-pin RS-232 adapter cable and a RJ-45 connector with 10 ft of cable attached for use with the auxiliary I/O connector.

## HP 54657A, 54658A Measurement/Storage Modules

The HP-IB 54657A and RS-232 54658A Measurement/Storage modules add measurement power for R&D, field service, and analysis applications to any 54600 series oscilloscope. Both of these modules add the following:

- Additional automatic measurements of amplitude, channel-to-channel delay, pulse overshoot, pulse preshoot, and phase angle.
- Additional waveform math functions of addition, subtraction, multiplication, differentiation, and integration.
- User-definable measurement thresholds of 10%/90%, 20%/80%, and voltage levels.
- Additional cursor measurements of channel-to-channel delay, phase angle, and percentage.
- Addition of 100 nonvolatile trace memories.
- Addition of a real-time clock for time/date stamping of trace memories and hardcopy outputs.
- Automatic pass/fail testing by use of a mask template.

The automatic pass/fail testing simplifies circuit debugging by comparing a live scope trace to a test mask. If a failure is detected, the failed trace can be time stamped and stored in one of the 100 nonvolatile trace memories, or output to a hardcopy device.

The Automask feature easily creates the test mask from a known good trace, and the mask editor can be used to exactly define the mask to the precise limits of the desired test. Masks can be uploaded to a PC for storage by use of the ScopeLink software package.

Both the HP-IB 54657A and RS-232 54658A are supplied with an operating and programming manual, and programming examples on disk.

# OSCILLOSCOPES

## Digitizing Oscilloscopes (cont'd)

### HP 54600 - Series Oscilloscopes

#### Ordering Information

**HP 54600A** 4-Channel  
100 MHz Oscilloscope  
(Includes two 1.5 meter 10X voltage probes (10071A),  
operating and service manual, and line cord.)

**Volume Discount:**  
2 to 3: Factory base price less 2%  
4 or more: Factory base price less 10%

**HP 54601A** Four-Channel  
100-MHz Oscilloscope  
(Includes two 1.5 Meter 10X voltage probes (10071A),  
operating and service manual, and line cord.)

**Volume Discount:**  
2 to 3: Factory base price less 2%  
4 or more: Factory base price less 10%

- HP 54650A** HP-IB Interface Module \$475
- HP 54651A** RS-232 Interface Module \$475
- HP 54652A** Parallel Interface Module \$275
- HP 54653A** Operator's Training Kit \$200
- HP 54654A** ScopeLink Software \$200
- HP 54655A** Test Automation Module with HP-IB Interface \$750
- HP 54656A** Test Automation Module with RS-232 Interface \$800
- HP 54657A** Measurement/Storage Module with HP-IB Interface \$750
- HP 54658A** Measurement/Storage Module with RS-232 Interface \$750
- HP 10079A** CRT Trace Camera \$595

☎ For off-the-shelf shipment, call 800-452-4844.

- | Price      |   | Opt            |  | Price |
|------------|---|----------------|--|-------|
| \$2,395.00 | ☎ | <b>Opt 101</b> | Accessory Pouch and Front-Panel Cover (HP 10098A)  | \$50  |
|            |   | <b>Opt 102</b> | Two Additional 10071A Probes (HP 54601 only)   | \$90  |
|            |   | <b>Opt 103</b> | Operator's Training Kit (HP 54654A) (Consists of a training signal board and lab workbook. After completing these labs, an operator will be able to make measurements and operate the oscilloscope without any additional training.)   | \$200 |
| \$2,347.50 |   | <b>Opt 104</b> | Carrying Case (HP 5041-9409) (Designed to protect the oscilloscope for shipment or for checking as airline baggage.)   | \$290 |
| \$2,157.50 | ☎ | <b>Opt 105</b> | ScopeLink Software (HP 54653A) (MS-DOS* software that interfaces the scope (with either HP-IB or RS-232 module installed) to a PC for storage analysis or easy integration of waveform data into popular desktop publishing software.) | \$200 |
| \$2,895.00 |   | <b>Opt 090</b> | Delete Probes  | -\$90 |
|            |   | <b>Opt 908</b> | Rackmount Kit (HP 5062-7345) (7-inch EIA standard rack)  | \$255 |
| \$2,837.50 |   | <b>Opt 910</b> | Additional User and Service Guide  | \$15  |
| \$2,607.50 |   |                |  |       |

MS-DOS\* is a U.S. registered trademark of Microsoft Corporation.

#### Educators

These oscilloscopes are ideally suited for classroom use. Contact your local Hewlett-Packard sales office for details on specific education discount programs.





# OSCILLOSCOPES

## Oscilloscope Probes and Accessories (cont'd)

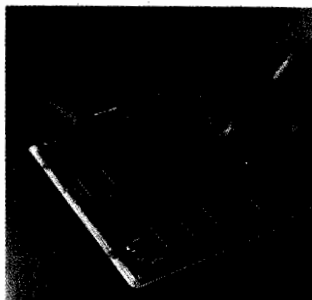

### HP 10400A Family Accessories

Each 10400A family probe is shipped with one general-purpose grabber, one IC grabber, and one ground lead. An accessory package is also included, which contains 4 grounding spanners (for close grounds at the probe tip), 1 probe barrel insulator, 1 adjustment screwdriver, and 8 colored cable markers.

The photo above illustrates use of the IC grabber. This device fits DIPs with 0.1-inch pin spacing (standard) and up to 0.9-inch package width. It is handy for connecting the mini-probe tip to a single DIP pin. Construction prevents shorting adjacent pins during hookup. For applications where several adjacent DIP pins must be probed, the 10024A accessory can be used (see page 163).

#### Replacement Probe Tip Assemblies

Probe	Tip Color	HP Part Number	Price
HP 10430A	white	5061-6145	\$10
HP 10431A	white	5061-6145	\$10
HP 10432A	red	5061-6151	\$10
HP 10433A	blue	5061-6146	\$10
HP 10434A	brown	5061-6147	\$10
HP 10435A	green	5061-6147	\$10
HP 10436A	orange	5061-6152	\$10
HP 10437A	black	5061-6149	\$10
HP 10438A	black	5061-6149	\$10
HP 10439A	black	5061-6149	\$10
HP 10440A	yellow	5061-6148	\$10
HP 10441A	purple	5061-6153	\$10

#### Other HP 10400 Series Probe Accessories

General-purpose grabber/hook tip	\$10
Integrated circuit grabber	\$10
Ground lead	\$5
Accessory package: 4 grounding spanners, 1 probe barrel insulator, 1 adjustment tool, 8 colored wire markers	\$10

### HP 10070A and HP 10071A Probes for HP 54600 Series Oscilloscopes.

The HP 10070A is a 1:1 probe, 1.5 meters in length, that is designed for use with the HP 54600A and HP 54601A oscilloscopes.

The HP 10071A is a 10:1 voltage divider probe, 1.5 meters in length, that can be used with the HP 54600A and HP 54601A oscilloscopes.



HP 10002A

### HP 10002A 1000 V 50:1 Voltage Divider Probe

The HP 10002A voltage divider probe is a general-purpose probe for use with instruments that have a bandwidth of less than 40 MHz with an input impedance of 1 M  $\Omega$  shunted by approximately 15 to 55 pF. The probe is rated at 1000 V peak.

### HP 10020A Resistive Divider Probe Kit

The HP 10020A Resistive Divider Probe Kit is a signal-probing system for measuring fast transition signals in high-impedance systems. It is designed for use with 50  $\Omega$  input oscilloscopes, but may be used with other than 50  $\Omega$  systems if a 50  $\Omega$  feedthrough termination (HP 10100C) is used. The extremely low input RC of the 10020A provides high-fidelity measurements of fast transition signals.

**Probe length (overall):** 1.2 m (4 ft).

**Weight:** Net, 0.45 kg (1 lb); shipping, 1.4 kg (3 lb).

**Accessories supplied:** HP 10240B blocking capacitor, BNC adapter tip, 6-32 adapter tip, alligator tip, probe handle, cable assy's 5.1 cm (2 in) & 15.2 cm (6 in) ground, spanner tip, insulating caps, colored sleeves.

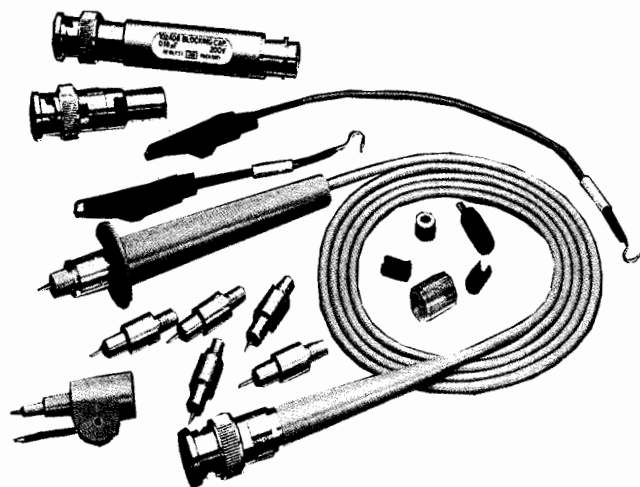

The HP 10020A Resistive Divider Probe Kit (includes HP 10240B)

### HP 10020A Resistive Dividers

Division Ratio	Input R* (ohms)	Division Accuracy	Max V** (rms)	Input C (pF)
1:1	50	—	6	—
5:1	250	$\pm 3\%$	9	<0.7
10:1	500	$\pm 3\%$	12	<0.7
20:1	1000	$\pm 3\%$	15	<0.7
50:1	2500	$\pm 3\%$	25	<0.7
100:1	5000	$\pm 3\%$	35	<0.7

\*When terminated in 50 ohms.

\*\*Limited by power dissipation of resistive element.

### HP 10240B Blocking Capacitor

The HP 10240B blocking capacitor is a probing accessory that provides ac coupling while maintaining a 50  $\Omega$  system. This capacitor is designed for use with the HP 10020A resistive divider probe kit, and it is included with the kit. It can also be used with any probe that must be terminated in 50  $\Omega$ .

### Characteristics

**Capacitance:** 0.18  $\mu$ F

**Maximum voltage:**  $\pm 200$  Vdc

**Reflection:** Under 12% when driven by a 150 ps rise time step in a 50  $\Omega$  system

**Sag:** Approximately 10% per  $\mu$ s (1% in 100 ns)

**Connectors:** BNC

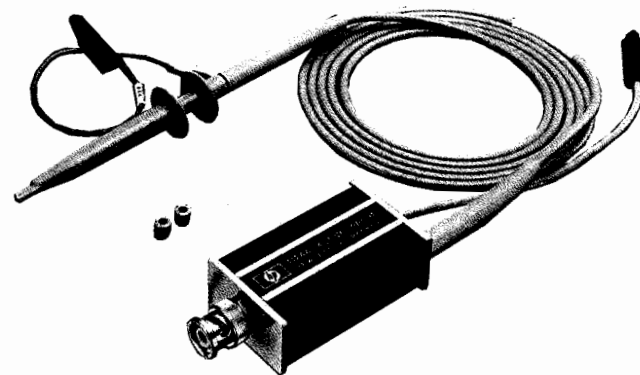

### HP 1124A 100 MHz Active Divider Probe

The HP 1124A active divider probe provides high-voltage, general-purpose probing capabilities for instruments having 50  $\Omega$  inputs without selectable high-impedance inputs. This 10 M  $\Omega$  10 pF probe allows direct measurements of 100 V, in the 100:1 division ratio mode, from dc to 100 MHz. In the 10:1 division ratio mode, input voltage range is  $\pm 10$  V. Power is supplied by instruments with probe power jacks or the HP 11899A probe power supply.

**HP 1124A Specifications**

(measured when connected to a 50  $\Omega$  load)

**Bandwidth:** (measured from a terminated 50  $\Omega$  source) dc-coupled, dc to 100 MHz; ac-coupled, 2 Hz to 100 MHz.

**Pulse response:** (measured from a terminated 50  $\Omega$  source) transition time, <3.5 ns; perturbations, 5% peak-to-peak. Measured with pulse transition time of >2.5 ns.

**Attenuation ratio:** 10:1  $\pm$  5%; 100:1  $\pm$  5%

**Dynamic range:**  $\times$ 10,  $\pm$ 10 V;  $\times$ 100,  $\pm$ 100 V

**Input RC:** 10 M $\Omega$  shunted by  $\approx$  10 pF

**Maximum safe input**

dc-coupled:  $\times$ 10,  $\pm$ 300 V (dc + peak ac)  $\leq$ 100 MHz;  $\times$ 100,  $\pm$ 500 V (dc + peak ac)  $\leq$ 100 MHz

ac-coupled:  $\times$ 10,  $\pm$ 300 V (dc + peak ac)  $\leq$ 100 MHz; dc component must not exceed  $\pm$ 200 V;  $\times$ 100,  $\pm$ 500 V (dc + peak ac)  $\leq$ 100 MHz; dc component must not exceed  $\pm$ 200 V.

**Accessories supplied:** One 20.3 cm (8 in) ground lead, one retractable hook tip, and two probe tip insulating caps

**Power:** Supplied by instruments with probe power jacks or the HP 11899A probe power supply.

**Weight:** Net, 0.2 kg (5 oz); shipping, 0.91 kg (2 lb)

**Length:** 1.5 m (5 ft) overall

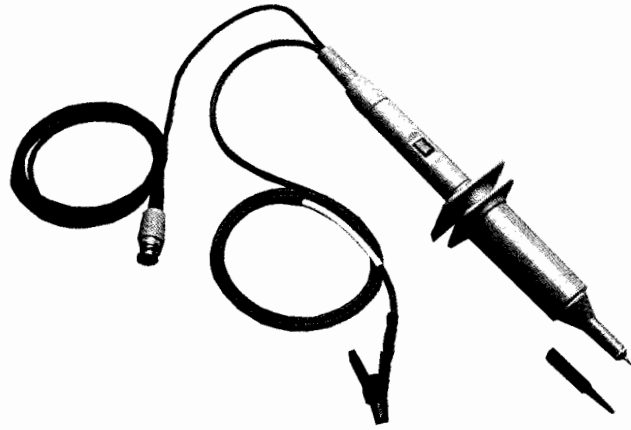
**HP 1137A High-Voltage Divider Probe**

The HP 1137A 1000:1 high-voltage divider probe is designed for use with any oscilloscope having input resistance of 1 M $\Omega$  ( $\pm$ 1%) and nominal input capacitance between 6 and 50 pF. The HP 1137A is a 1000:1 voltage divider probe that extends voltage measurement capability to 5 kV ac or dc.

**Operating Characteristics****Maximum input voltage:**

dc voltage 5 kV

ac voltage 5 kV rms (0 to 250 kHz,) 2.5 kV rms (250 kHz to 1 MHz)

**Input impedance:** 500 M $\Omega$  shunted by 3 pF (approximate)

**Bandwidth:** 1 MHz

**Rise time:** Approximately 350 ns

Calculated from formula:  $t_r = \frac{0.35}{\text{bandwidth}}$

**Temperature coefficient:**  $\pm$  0.02% of reading per degree C

**Division ratio accuracy:**  $\pm$  1.5% of reading (see note)

**Compensation range:** For input capacitance of 6 to 50 pF

**Crest factor:** 2 or less

Note: Characteristic applies for operation between 0° and 55° C, at less than 85% relative humidity. For operation above 40° C, at 85% to 95% relative humidity, add additional 10% of reading.

**General****Operating modes:**

1 M $\Omega$  mode, for oscilloscope impedance of 1 M $\Omega$   $\pm$  1%

10 M $\Omega$  mode (optional), for input impedance of 10 M $\Omega$   $\pm$  1%

**Operating temperature range:** 0° to 55° C

**Storage temperature range:** -20° to 70° C

**Cable length:** 1.5 meters

**Accessories:** Trimmer adjustment tool included

**Ordering Information**

**HP 10002A** 1000V 50:1 Voltage Divider Probe

**HP 10020A** Resistive Divider Probe Kit

**HP 10070A** 1:1 Probe

**HP 10071A** 10:1 Probe

**HP 10240B** Blocking Capacitor

**HP 1124A** 100 MHz Active Probe

**HP 1137A** 1000:1 High Voltage Divider Probe

**Price**

\$290

\$525

\$45

\$45

\$45

\$425

\$150

# OSCILLOSCOPES

## Oscilloscope Probes and Accessories (cont'd)

- dc to 200 MHz probe bandwidth
- $\pm 200$  V (dc + peak ac) maximum voltage without attenuators
- 3000:1 CMRR at 1 MHz
- Low dc thermal drift



HP 1141A, 1142A

### HP 1141A Differential Probe

The HP 1141A is a 1X FET differential probe with 200 MHz bandwidth and 3000:1 CMRR (Common Mode Rejection Ratio). The probe has a high-input resistance of 1 M $\Omega$  and low-input capacitance of 7 pF to minimize circuit loading. The HP 1141A must be used with the HP 1142A probe control and power module. It is designed for use with instruments having 50 ohm inputs.

The HP 1142A probe control and power module controls input coupling modes dc, dc with variable offset, and dc reject. The offset capability allows viewing of very small signals on large dc components without attenuating ac low-frequency components or causing sag from ac coupling. In automated test applications coupling modes and dc offset can be controlled remotely.

Two attenuators, 10X and 100X, are provided to expand the linear differential input range to  $\pm 30$  V.

#### Operating Characteristics

**Bandwidth:** dc to 200 MHz ( $-3$  dB)  
**Rise time:** 1.75 ns (calculated by  $t_r = \frac{0.35}{\text{bandwidth}}$ )

**CMRR:** 3000:1 @ 1 MHz

**dc vertical accuracy:** 2% (1X), 4% (with attenuators)

**Linear differential input range:**  $\pm 0.3$  V (1X)  
 $\pm 3.0$  V (10X)  
 $\pm 30$  V (100X)

#### Common mode operating range:

**dc:**  $\pm 20$  V (1X),  $\pm 200$  V (10X),  $\pm 500$  V (100X)  
**dc to 30 Hz:** Linearly decreased to 30 Hz value  
**30 Hz to 200 MHz:**  $\pm 0.5$  V (1X),  $\pm 5$  V (10X),  $\pm 50$  V (100X) (voltages are peak voltage)  
**dc offset:**  $\pm 20$  V (1X),  $\pm 200$  V (10X),  $\pm 500$  V (100X)  
**Maximum input voltage** (without damage): 200 V dc + peak ac (1X), 500 V dc + peak ac (10X, 100X), common or differential modes

- 10X, 100X attenuators
- dc offset and dc reject
- Remote-control input coupling and offset
- Superior tolerance to ESD
- Rugged construction

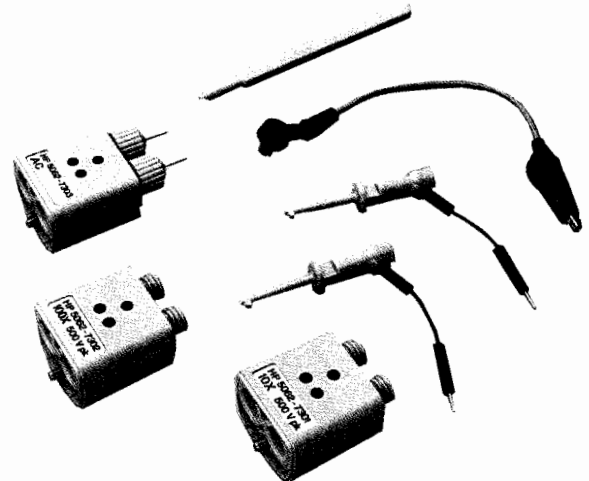

HP 1141A Accessories

**Input coupling:** dc, dc with variable offset, dc reject, and ac (dc and dc reject are selected by pushing buttons on the 1142A; ac coupling is provided via an adapter that attaches to the probe tip).

**ac coupling low-frequency response:** 15 Hz (1X), 1.5 Hz (with attenuators) ( $-3$  dB)

**Input RC:** 1 M $\Omega$  shunted by approximately 7 pF (1X)

**Output:** Designed to drive 50 ohm instruments or high-impedance instruments terminated with a 50 ohm feedthrough termination.

#### General

**Power requirement:** 90 to 132 Vac/198 to 264 Vac, 47 to 440 Hz, 25 VA max

**Temperature:** Non-operating:  $-40^\circ$  to  $70^\circ$  C  
 Operating:  $0^\circ$  to  $55^\circ$  C

**Altitude:** Non-operating: up to 15,300 m (50,000 ft)  
 Operating: up to 4,600 m (15,000 ft)

**Humidity:** Non-operating: 90% relative @  $65^\circ$  C  
 Operating: 95% relative @  $40^\circ$  C

**Cable length:** 1.5 m (5.2 ft)

#### Ordering Information

##### HP 1141A Differential Probe

Includes: 10X and 100X voltage attenuators, ac coupler, 5 probe leads, 2 probe clips, operating and service manual, calibration adapter, ground lead, and one-year warranty.

##### HP 1142A Probe Control and Power Module

Includes: power cord and one-year warranty.

Note: Models HP 1141A and 1142A must be used together.

☎ For off-the-shelf shipment, call 800-452-4844.

#### Price

\$1,675 ☎

\$820 ☎

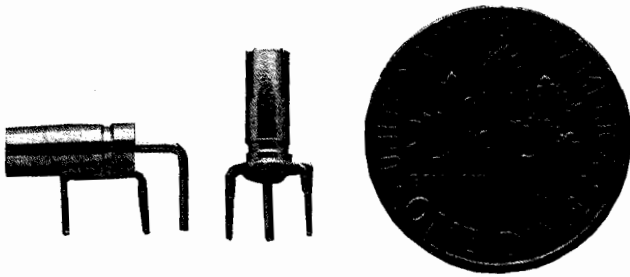

### HP 1250-1737 PC Board Mini Probe Socket

The HP 1250-1737 PC board mini probe socket is ideal for bread-board-circuit applications in which it is desirable to make a reliable circuit connection between the mini probe tip and a test circuit. (Soldering the tip itself into place is not recommended.) The HP 1250-1737 is also useful in production PC-board applications as an oscilloscope test point. The probe plugs into the socket parallel to the PC board.

### HP 1250-1918 PC Board Vertical Mini Probe Socket

The HP 1250-1918 is similar to the 1250-1737 (above), except that it is designed for attaching the probe to the board vertically rather than horizontally.

### HP 10024A/10211A IC Test Clip

The HP 10024A IC test clip provides easy probing of 14- and 16-pin dual in-line packages and includes 4 insulated circuit interface pins. Additional circuit interface pins are available (see Ordering Information) in packages of 12 pins. Each pin has a tip on each end so that probes such as those on HP logic analyzers can be connected for fast, functional checks of circuit operation.

The HP 10211A dip clip is similar in operation to the HP 10024A, but accesses 24-pin dual in-line package IC.

## Probe Accessories

### Terminations

**HP 10100C:** 50  $\Omega$   $\pm$ 1% BNC (male) to BNC (female) feedthrough termination.

### Standard Probe Tip Adapters

**HP 10229A hook tip adapter:** Retractable pincer tip provides firm connection to circuit nodes. Recommended accessory for HP 10020A resistive divider kit.

### Ordering Information

	Price
<b>HP 1250-1737</b> PC Board Mini Probe Socket	\$7
<b>HP 1250-1918</b> PC Board Mini Probe Socket (vertical)	\$8
<b>HP 10024A</b> IC Test Clip (with 4 circuit interface pins)	\$20
<b>HP 10024-69501</b> Interface Pin Kit for HP 10024A (includes 12 interface pins)	\$60
<b>HP 1250-1454</b> BNC-to-Mini Probe Adapter	\$15
<b>HP 10211A</b> Dip Clip	\$85
<b>HP 10229A</b> Retractable Hook Tip Adapter	\$20
<b>HP 10100C</b> 50 Ohm Feedthrough Termination	\$45

### Transportation Accessories

The following transportation accessories are available for the HP 54500 Series and HP 16500 Series:

<b>HP 1540-1066</b> Soft Carrying Case	\$135
<b>HP 9211-2645</b> Transit Case	\$430
<b>HP 5061-6183</b> Front-Panel Cover	\$39

## Testmobiles

Three testmobiles are available for HP oscilloscopes and logic analyzers:

### HP 1180A

This inexpensive testmobile is designed for HP 54500 and HP 54200 Series digitizing oscilloscopes and for HP 1630 and 1650 Series logic analyzers.

### HP 1182A

This new testmobile is similar to the 1180A, but provides 2 more inches of tilt-tray width and 5% more inches of tilt-tray depth.

### HP 1181A

The 1181A testmobile is for larger instruments, such as the HP 54100 Series oscilloscopes. With a tilt-tray that is 22 inches wide and 26 inches long, and a total weight capacity of up to 226.8 kg (500 lb), this cart can handle your large system requirements.

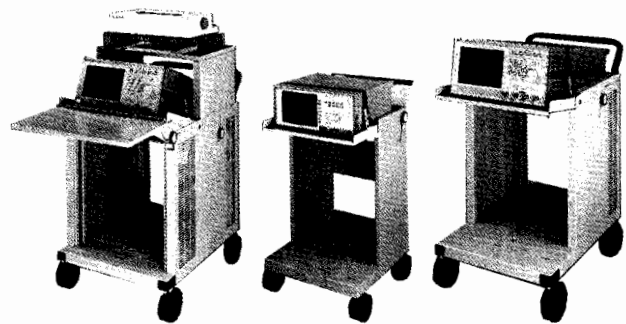

HP 1181A

HP 1180A

HP 1182A

## HP 10079A Camera

The HP 10079A camera is designed for use with HP 54600 Series oscilloscopes. When a printer or plotter is not readily available, or your HP 54600 Series scope is not equipped with a hard-copy interface module, this camera offers a simple solution for recording waveforms. The HP 10079A uses Polaroid Type 667 film.

Polaroid is a U.S. registered trademark of Polaroid Corporation

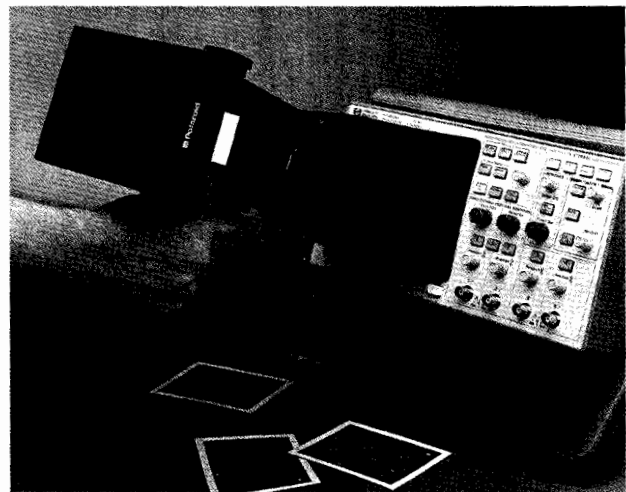

**Ordering Information**  
**HP 10079A** Camera

**Price**  
\$595

# OSCILLOSCOPES

## Oscilloscope Probes and Accessories (cont'd)

- Clamped or unclamped video output
- Trigger output for line and frame
- For most standard broadcast composite video systems
- Compatible with most analog and digitizing scopes



### HP 1133A TV/Video Sync Pod

The HP 1133A TV/video sync pod is an accessory that provides users with TV sync triggering for most analog or digitizing oscilloscopes. It features clamped or unclamped video outputs that can be viewed on the oscilloscope's vertical channels and trigger outputs that can synchronize the oscilloscope to video frame and individual lines.

The pod itself is packaged in a case approximately 14×14×4.5 cm (5.5×5.5×1.75 in) and is powered by a separate ac power module. The pod features a loop-through input (two-female BNC) that can be driven from a 75 ohm source, or, for probing high impedance circuits, from a 1 to 10 megohm probe. The loop-through feature allows a 75 ohm signal to be looped through the TV/video pod, then connected to a video monitor or other 75 ohm device. Clamped or unclamped video outputs are designed to drive a high impedance probe (1 to 10 M $\Omega$ ) connected to the oscilloscope input.

The HP 1133A is compatible with broadcast standards M, N, C, B, G, H, I, D, K, Kl, and L systems.

#### Characteristics

**Video input:** ac coupled with an RC of 1 M $\Omega$  shunted by approximately 10 pF.

**Bandwidth:** Approximately 10 MHz.

**Maximum input voltage:** 40 V (dc plus peak ac).

Frame output is phase locked to the leading edge of the third field synchronizing pulse on field one, to the leading edge of the second pulse on field two. Frame output goes high on field one, and low on field two.

There is a switch for positive or negative sync pulse polarity.

A gain control adjusts for signal amplitude at BNC input.

Gain from input BNC to unclamped output is approximately 2.5 to 50.

#### Ordering Information

Note: The 1133A must be ordered with a power supply option.

<b>HP 1133A TV/Video Sync Pod</b>	\$285
<b>Opt ABA</b> Power Supply for U.S.A., 120 V, nema 515P plug	\$0
<b>Opt ABB</b> Power Supply for Europe, 220 V CEE7-VII plug	\$0
<b>Opt ABG</b> Power Supply for Australia, China	\$0
<b>Opt ABJ</b> Power Supply for Japan, 100 V nema 515P plug	\$0
<b>Opt ABU</b> Power Supply for United Kingdom, 240 V BS1363 plug	\$0

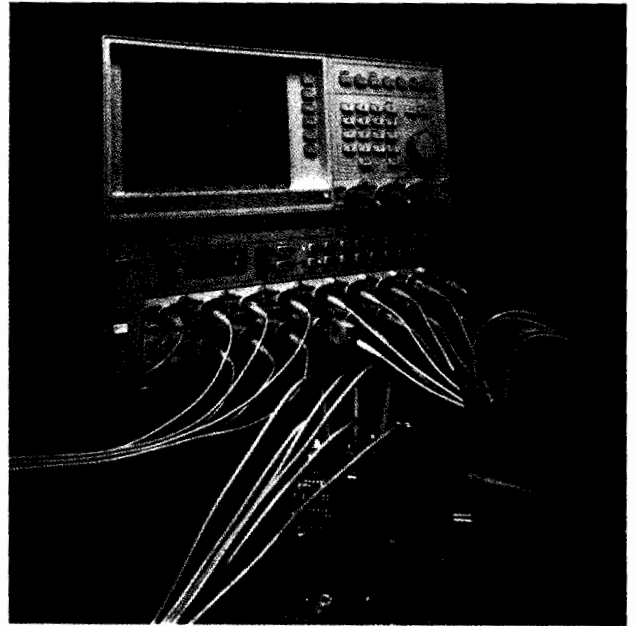

### HP 54300A Probe Multiplexer

#### Multi-Input Tool for 50 $\Omega$ Instrumentation

The HP 54300A is a programmable, dual 8:1 probe multiplexer designed to expand the input capability of instrumentation with 50  $\Omega$  inputs. The unique strength of this multiplexer is its configurability. The user may select from three different input pods: two high-frequency, high-impedance probes, or a 50  $\Omega$  BNC input for terminated line applications.

The HP 54300A features full HP-IB programmability as well as simple front-panel control. It has internal nonvolatile memory for storing lists of switching steps. Switch lists can be advanced step-by-step from a front-panel button, over the HP-IB (i.e., IEEE-488) or, for data logging applications, through a TTL pulse entered at the rear panel.

#### HP 54001A 1 GHz Active Mini-Probe Pod

This pod, with its built-in probe, offers 1 GHz bandwidth with 10 k $\Omega$ /2 pF input loading. It uses HP's mini-tip probe for easy access in compact circuits, and features both high bandwidth and high impedance at the probe tip.

#### HP 54002A 50 $\Omega$ BNC Pod

This pod should be used with terminated 50  $\Omega$  systems. Output from the multiplexer using this pod is <2 dB down at >1 GHz. The 54002A is also useful with divider probes such as the HP 10020A.

#### HP 54003A 300 MHz 1 M $\Omega$ Probe Pod

This pod, with a 10:1 detachable mini-tip probe, has 1 M $\Omega$  resistive and 8 pF capacitive loading. It is valuable when resistance is a more significant loading factor than capacitance, such as in operational amplifier measurements. If desired, the probe can be removed from its pod to provide a 1 M $\Omega$  approximately 10 pF BNC input.

#### Ordering Information

<b>HP 54300A Dual 8:1 Probe Multiplexer</b>	<b>Price</b>
Includes one operating and programming manual. Each HP 54300 accepts up to 16 input pods in any combination. Pods must be ordered separately.	\$8,500
<b>Opt 908</b> Rack Mount Flange Kit	+ \$35
<b>HP 54001A 1 GHz Miniature Active Probe Pod</b>	\$795
<b>HP 54002A 50 <math>\Omega</math> BNC Input Pod</b>	\$145
<b>HP 54003A 1 M<math>\Omega</math> 10:1 Probe Pod</b>	\$690

# WAVEFORM ANALYZERS

## Waveform Recorders, Generator, Generation System

HP 5180A, 51800A, 5182A, 51820A, 5183A

- High measurement throughput
- Measure, modify, play back waveforms
- Simulate complex, real signals

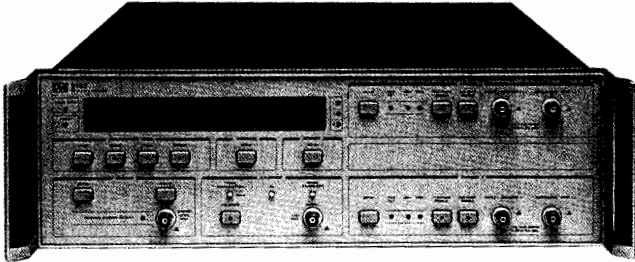

HP 5183A

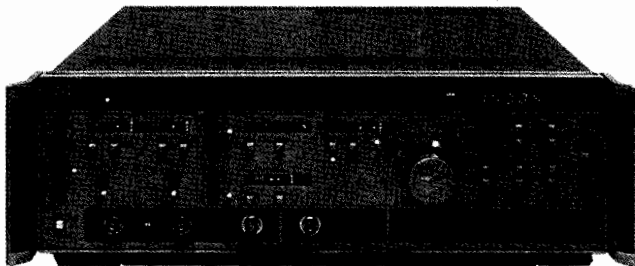

HP 5180A

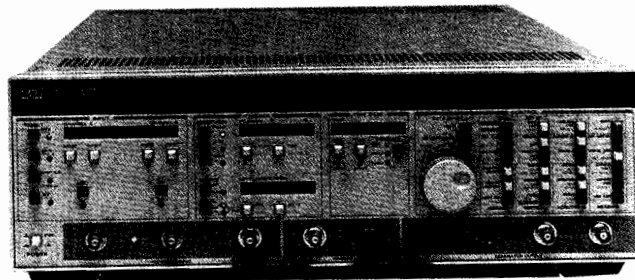

HP 5182A



### HP 5183A Waveform Recorder

The HP 5183A is not a standalone instrument; it functions as a digitizing front end to a computer. HP BASIC driver software, optimized for speed, helps to set up, take measurements, and transfer data at high speeds to an HP 9000 Series 200/300 workstation or HP Vectra PC. The HP 5183A's auto-advance feature can yield up to 70 measurements (1K words) per second with re-arm time as short as 13 ms. Trigger features allow data acquisition that was previously impossible or required complex external trigger circuitry. The optional 512K-word memory allows long continuous records to be acquired. In one-channel operation, channel one can be configured for 512K samples with option 512. Adaptive Sample Rate gives the benefit of catching glitches that would ordinarily escape detection.

### HP 5180A Waveform Recorder

The HP 5180A waveform recorder digitizes and stores single-shot or repetitive signals. Voltage waveforms are digitized at sampling rates up to 20 M sa/s (50 ns/sample). Precise voltages (and times) can be read from the front panel with cursors. The shape of fast attack and decay single-shot waveforms is preserved because the higher frequency components are accurately digitized.

The HP 5180A controls external XYZ displays and hard-copy devices to show the contents of memory records without the need for a computer. Zoom and Gain features expand displayed waveforms horizontally or vertically. There are two methods of transferring data from the HP 5180A to a computer for analysis: HP-IB and DMA.

### HP 5182A Waveform Recorder/Generator

The HP 5182A can re-create single-shot signals or create repetitive signals by playing back a single recording again and again with no time gap between replays. Test your circuits with the actual signal recorded rather than a theoretical one.

Continuous (battery backed-up) waveform memory allows on-site recording of up to 32 waveforms. Carry the HP 5182A back to the lab and play them back. Attach the HP 5182A to an HP Series 200/300 technical computer and you can store the waveforms on disk, process them further, and modify them for "what if" testing.

### HP 51800A and HP 51820A Software Libraries

The HP 51800A Waveform Measurement Library is a collection of programs for measuring signals captured by the HP 5180A. The HP 51820A Waveform Generation Software is a set of tools for creating specialized waveforms.

### Ordering Information

	<b>Price</b>
<b>HP 5183A</b> Waveform Recorder, 2-channel (includes HP 200/300 series cable + s/w). Requires host computer.	\$17,400
<b>Opt 301</b> Adaptive Sample Rate	+ \$3,450
<b>Opt 512</b> 512k-word memory	+ \$5,750
<b>HP 5180A</b> Waveform Recorder	+ \$32,700
<b>Accessories for the HP 5180A</b>	
<b>HP 10871B</b> Service Kit	\$7,700
<b>HP 10873A</b> Rackmount Kit	\$260
<b>HP 10874A</b> Slide-mount Kit	\$320
<b>HP 10875A</b> 4.8 m DMA Cable	\$310
<b>HP 10875B</b> 1.0 m DMA Cable	\$310
<b>HP 5182A</b> Waveform Recorder/Generator	\$38,100
<b>HP 51800A</b> Waveform Measurement Library	\$1,850
<b>Opt 910</b> Additional Manuals	+ \$150
<b>HP 51820A</b> Waveform Generation Software	\$1,850

# DIGITAL MULTIMETERS

## General Information



HP offers a full line of Digital Multimeters.

### Digital Multimeters

Hewlett-Packard offers a wide range of digital multimeters (DMMs) for test and measurement. HP has a DMM with the measurement capability you need for data acquisition, production, test or research.

The combination of precise measurement and versatile configuration in HP DMMs gives you meaningful measurements of your product or process. This allows you to interpret results and make decisions that improve productivity and quality. You can perform dc and ac tests of voltage and current, and measure resistance using two or four terminals. Frequency and period measurements are also available on some models.

Applications in calibration and metrology/standards labs need the accuracy and stability of the HP 3458A. Its digitizing capabilities also allow you to use it in high-resolution digitizing applications.

Computer-aided production testing requires a wide variety of functions, resolutions, and speeds. The HP 3457A fits those needs. Many of your bench measurement problems can be handled by the HP 3468A/B, a high-performance 5½-digit, five-function DMM.

The HP 34401A is a highly cost-effective solution for both bench and system applications, providing high performance and versatility in a 6½-digit DMM. For portable troubleshooting, the HP E2300 series of handheld multimeters offers you HP quality in a 3½-digit handheld.

### Measurement Performance Tradeoffs

In some applications, measurement speed is the most important requirement. Other applications demand high accuracy, high resolution, and excellent noise rejection. Often what you need lies somewhere in between. Innovative integration techniques used in most of HP's DMMs let you trade speed for resolution, which adds measurement flexibility.

HP's integrating DMMs offer the fastest reading rates available with power-line-related noise rejection. Integration selection (number of power-line cycles) is the key to performance tradeoffs. For example, reading rates are maximized by decreasing resolution and the number of power-line cycles. Conversely, accuracy and resolution are improved by increasing the number of power-line cycles. In short, HP allows you to choose the resolution, accuracy, and noise rejection you need, while maximizing measurement speed.

### High Throughput Reduces Test Time

For system applications, you can increase throughput using system DMMs like the HP 3458A. This DMM is HP's throughput leader when you must change functions and ranges often to obtain all of your measurements. The ability to change functions and ranges quickly while taking measurements is a good index of measurement throughput. Several of HP's system DMMs share this strength to help you improve your throughput and your profits.

Most of HP's system DMMs have a Voltmeter Complete pulse output for incrementing channels on external scanners or switches, without the delay of a computer command. An external trigger input is ideal for synchronizing your DMM to your measurement. Interrupt capability allows your system to run more efficiently, since your computer need only provide control when requested by the DMM. Flexible triggering lets you properly synchronize measurements with your device-under-test.

Features such as pass/fail limit testing (in the HP 3457A, HP 34401A, and HP 3458A), program memory, and reading storage minimize computer interaction with the DMM and can help you speed up your system.

### Low Cost of Ownership

In addition to flexibility and multiple functions, HP digital multimeters (DMMs) are noted for reliability. From concept to implementation, every phase of design and manufacture has resulted in extremely reliable products. This reliability is reflected in system uptime and total cost of ownership. We offer electronic no-pots calibration to maximize your uptime. Modular design and self-test capabilities keep repair time and cost to a minimum.

The reliability of HP system DMMs is such that we offer three years of hardware support at a low cost. You can expect HP reliability and support to keep your system up and running for a long time. Because of HP's commitment to quality, you can reduce your total cost of ownership.



HP Model	HP 3458A page 170	HP 3457A page 172	HP 34401A page 168	HP 3478A page 174	HP 3458A page 176	HP 3437A page 177	HP 3455A page 177	HP 3468A/B page 175	HP 3468A page 178	HP E2377A/ E2378A page 180
<b>dc voltage</b>										
Accuracy 1 yr best full scale (parts per million)	24.1 (Opt 002)	27	45	67	25	2300	130	187	350	3667
Resolution (nanovolts)	10	100	100	100	100	100,000	1000	1000	1000	100,000
Maximum reading rate (readings per second)	100,000	1,350	1000	90	330	5700	24	4	4.7	2
Maximum range (volts)	1000	1000 (HP 44497A)	1000	300	1000	10	1000	300	1200	1000
<b>Resistance</b>										
Accuracy 1 yr best full scale (percent)	10.5	52	90	167	86	-	50	167	350	7333
Resolution (microhms)	10	10	100	100	100	-	1	1000	1000	100,000
<b>ac voltage</b>										
Accuracy 1 yr best full scale (percent)	0.009%	0.21%	0.08%	0.22%	0.12%	-	0.14%	0.22%	0.4%	1.0%
Bandwidth	Hz-10 MHz	20 Hz-1 MHz	3Hz-300 kHz	20 Hz-300 kHz	20 Hz-250 kHz	-	30 Hz-250 kHz	20 Hz-300 kHz	20 Hz-100 kHz	40 Hz-1 kHz
<b>Functions</b>	dc & ac V, 2- & 4-wire Ω, offset-compensated Ω, dc & ac I, frequency, period, math, test-sequence storage, ratio, 20 KB reading memory, digitizing, & HP-IB	dc & ac V, 2- & 4-wire Ω, offset-compensated Ω, dc & ac I, frequency, period, math, test-sequence storage, 6 KB reading memory, & HP-IB	dc & ac V, dc & ac I, 2- & 4-wire Ω, frequency, period, continuity, diode test, reading hold, dB, dBm, null, min/max, pass/fail, ratio, 512 rdg. storage, HP-IB, RS-232	dc & ac V, 2- & 4-wire Ω, dc & ac I, & HP-IB	dc & ac V, 2- & 4-wire Ω, offset-compensated Ω, math, ratio, test sequence storage, 64 KB reading memory, & HP-IB.	dc V & HP-IB	dc & ac V, 2- & 4-wire Ω, math & HP-IB	dc & ac V, 2- & 4-wire Ω, dc & ac I & HP-IL	dc & ac V, 2-wire Ω, ohms zero adjust, dc & ac I, diode test, battery/ ac power *	dc & ac V, dc & ac I, 2-wire Ω, diode test, audible continuity, temp (K-type), & data hold
<b>Options</b>	Opt 001 Expanded reading memory to 148 KB Opt 002 High stability (4 ppm/yr) Opt 005 Waveform analysis library Opt 700 CIL language Opt W30 3-yr hardware support	Opt 700 CIL language Opt W30 3-yr hardware support 44497A 1000 V attenuator 44491A Armature relay mux 44492A Reed relay mux	Opt W50 5-yr Hardware Support	Opt W30 3-yr hardware support	Opt 050 Noise rejection for 50 Hz Opt 060 Noise rejection for 60 Hz Opt 401 High ac accuracy Opt W30 3-yr hardware support	Opt W30 3-yr hardware support	Opt 001 Average converter	Opt 001 Rechargeable battery pack Opt W30 3-yr hardware support	Opt 001 ac power only Opt 002 Rack & stack case	E2301A Surface thermocouple probe K-type E2302A Airflow thermocouple probe K-type E2303A Thermocouple probe adapter E2304A Carrying case E2305A Replacement test leads
<b>Digits</b>	8½	6½	6½	5½	6½	3½	6½	5½	4½	3½
<b>Price</b>	\$6,110	\$3,100	\$995	\$995	\$5,695	\$4,395	\$7,295	\$820	\$1,580	\$169/189

# DIGITAL MULTIMETERS

## Low-Cost 6½-Digit Multimeter

HP 34401A

- 11 measurement functions
- 1000 V maximum input
- 20 ppm basic dc accuracy
- 1000 readings per second
- HP-IB and RS-232 standard
- 512-reading memory



DESIGNED FOR  
HP-IB  
SYSTEMS

HP34401A shown with optional pouch.

### A New Performance Standard

The HP 34401A digital multimeter establishes a new price/performance standard by offering such features as 6½ digits of resolution, 1000 readings per second, and 15 ppm basic dc accuracy at a surprisingly affordable price. The HP 34401A has been designed for superior performance and with the flexibility to meet both your present and future needs.

### Great Bench Performance

The clear, logical front panel of the HP 34401A allows you to easily select all primary measurement functions. Traditional "bench" functions, such as continuity and diode test, are included. Math functions, such as NULL, dB, dBm, and min/max/avg are easily selected. A simple menu scheme gives you access to powerful advanced features, such as the ability to store up to 512 readings in internal memory. Measurement results are displayed on a bright, high-visibility readout. A rugged case ensures survival even under the toughest conditions, and the optional accessory pouch makes it easy to pack up and go with the HP 34401A.

### Superior Performance in Your System

The HP 34401A can take up to 1000 readings per second, but throughput is more than just a set of measurements on a fixed range and function. The HP 34401A is designed to make up to 50 range/function changes per second; you won't have to wait for your multimeter to catch up with your test. Both HP-IB and RS-232 are standard, letting you select the interface that best meets your needs. The HP 34401A responds to 3 different command languages. It accepts SCPI commands (Standard Commands for Programmable Instruments), which ensures present and future compatibility. It also responds to commands for the HP 3478A and the Fluke 8840A, and thereby protects your software investment with backward compatibility.

### Specifications

#### dc Voltage Input Characteristics

Range	Maximum Reading (6½ digits)	Resolution in digits			Input Resistance
		6½	5½	4½	
100 mV	120.0000	100 nV	1 µV	10 µV	10 M Ω or > 10 G Ω
1 V	1.200000	1 µV	10 µV	100 µV	10 M Ω or > 10 G Ω
10 V	12.00000	10 µV	100 µV	1 mV	10 M Ω or > 10 G Ω
100 V	120.0000	100 µV	1 mV	10 mV	10 M Ω
1000 V	1050.000	1 mV	10 mV	100 mV	10 M Ω

Input protection: >1000 V on all ranges

Measurement accuracy: ± (% of reading + % of range)

Range	24-Hour 23° C ± 1° C	90-Day 23° C ± 5° C	1-Year 23° C ± 5° C
100 mV	0.0030 + 0.0030	0.0040 + 0.0035	0.0050 + 0.0035
1 V	0.0020 + 0.0006	0.0030 + 0.0007	0.0040 + 0.0007
10 V	0.0015 + 0.0004	0.0020 + 0.0005	0.0035 + 0.0005
100 V	0.0020 + 0.0006	0.0035 + 0.0006	0.0045 + 0.0006
1000 V	0.0020 + 0.0006	0.0035 + 0.0010	0.0045 + 0.0010

Noise rejection: (50 or 60 Hz, 1 k Ω unbalance in LO lead)

DC CMRR: 140 dB

AC CMRR: 70 dB

Normal mode rejection (60 Hz/50 Hz) ± 0.1%:

100 PLC (1.67 s/2.00 s): 110 dB

10 PLC (167 ms/200 ms): 110 dB

1 PLC (16.7 ms/20.0 ms): 60 dB

<1 PLC (3 ms or 800 ms): 0 dB

Maximum reading rate: (readings/s)

Power Line Frequency	Resolution in Digits		
	6½	5½	4½
60 Hz	6	300	1000
50 Hz	5	300	1000

### ac Voltage (true rms) Input Characteristics

Range	Maximum Reading (6½ Digits)	Resolution in Digits		
		6½	5½	4½
100 mV	120.0000	100 nV	1 µV	10 µV
1 V	1.200000	1 µV	10 µV	100 µV
10 V	12.000000	10 µV	100 µV	1 mV
100 V	120.0000	100 µV	1 mV	10 mV
750 V	750.0000	1 mV	10 mV	100 mV

**Input resistance:** 1 M Ω ± 2%, in parallel with 100 pF

**Input protection:** > 750 V rms on all ranges

**Measurement accuracy:** ± (% of reading + % of range);  
1 year, 23° C ± 5° C

Frequency	Ranges	
	100 mV	1, 10, 100, 1000 V
3 to 5 Hz	1.00 + 0.04	1.00 + 0.03
5 to 10 Hz	0.35 + 0.04	0.35 + 0.03
10 Hz to 20 kHz	0.06 + 0.04	0.06 + 0.03
20 to 50 kHz	0.12 + 0.04	0.12 + 0.05
50 to 100 kHz	0.60 + 0.08	0.60 + 0.08
100 to 300 kHz	4.00 + 0.50	4.00 + 0.50

Note: -3 dB frequency typically > 1 MHz

**Volt - Hz Product:** 8 × 10<sup>7</sup>

**Crest factor:** Maximum of 5:1 at full scale

**Maximum reading rate:** 10 readings/s (50 readings/s with default delays defeated)

### Resistance: (2-wire Ω, 4-wire Ω) Input Characteristics

Range	Maximum Reading (6½ Digits)	Resolution in Digits		
		6½	5½	4½
100 Ω	120.0000	100 µΩ	1 mΩ	10 mΩ
1 k Ω	1.200000	1 mΩ	10 mΩ	100 mΩ
10 k Ω	12.000000	10 mΩ	100 mΩ	1 Ω
100 k Ω	120.0000	100 mΩ	1 Ω	10 Ω
1 M Ω	1.200000	1 Ω	10 Ω	100 Ω
10 M Ω	12.000000	10 Ω	100 Ω	1 k Ω
100 M Ω	120.0000	100 Ω	1 k Ω	10 k Ω

**Input protection:** > 1000 V on all ranges

**Measurement accuracy:** ± (% of reading + % of range)

Specs are for 4-wire Ω or 2-wire Ω using Math Null

Range	24-Hour 23° C ± 1° C	90-Day 23° C ± 5° C	1-Year 23° C ± 5° C	Current Source
100 Ω	0.0030 + 0.0030	0.008 + 0.004	0.010 + 0.004	1 mA
1 k Ω	0.0020 + 0.0005	0.008 + 0.001	0.010 + 0.001	1 mA
10 k Ω	0.0020 + 0.0005	0.008 + 0.001	0.010 + 0.001	100 µA
100 k Ω	0.0020 + 0.0005	0.008 + 0.001	0.010 + 0.001	10 µA
1 M Ω	0.002 + 0.001	0.008 + 0.001	0.010 + 0.001	5.5 µA
10 M Ω	0.015 + 0.001	0.020 + 0.001	0.040 + 0.001	550 nA
100 M Ω	0.300 + 0.010	0.800 + 0.010	0.800 + 0.010	550 nA*

\* Measurement is computed from 10 M Ω in parallel with input.

**Maximum reading rate:** Same as DCV

### dc Current Input characteristics

Range	Maximum Reading (6½ Digits)	Resolution in Digits		
		6½	5½	4½
10 mA	12.000000	10 nA	100 nA	1 µA
100 mA	120.000000	100 nA	1 µA	10 µA
1 A	1.20000000	1 µA	10 µA	100 µA
3 A	3.00000000	10 µA	100 µA	1 mA

**Burden voltage:** < 2 V for 3 A input

**Input protection:** Externally accessible 3 A 250 V fuse;

Internal 5 A 500 V fuse

**Measurement accuracy:** ± (% of reading + % of range)

Range	24-Hour 23° C ± 1° C	90-Day 23° C ± 5° C	1-Year 23° C ± 5° C	Shunt Resistance
10 mA	0.005 + 0.010	0.030 + 0.020	0.050 + 0.020	5.0 Ω
100 mA	0.005 + 0.002	0.030 + 0.005	0.050 + 0.005	5.0 Ω
1 A	0.050 + 0.006	0.080 + 0.010	0.100 + 0.010	0.1 Ω
3 A	0.100 + 0.020	0.120 + 0.020	0.120 + 0.020	0.1 Ω

**Maximum reading rate:** Same as DCV

### ac Current (true rms)

**Measurement accuracy:** ± (% of reading + % of range);  
1 year, 23° C ± 5° C

Frequency	Ranges	
	1 A	3 A
3 to 5 Hz	1.00 + 0.04	1.10 + 0.06
5 to 10 Hz	0.30 + 0.04	0.35 + 0.06
10 Hz to 5 kHz	0.10 + 0.04	0.15 + 0.06

**Burden voltage:** < 1.5 V rms for 3 A input

**Input protection:** Externally accessible 3 A 250 V fuse;

Internal 5 A 500 V fuse

**Maximum reading rate:** Same as ACV

### Frequency or Period:

**Range:** 3 Hz to 300 kHz (333 ms to 3.33 µs)

**1-year accuracy:** 0.01% (40 Hz to 300 kHz); 0.05% (3 to 40 Hz)

**Other measurement functions:** Continuity, Diode Test, Ratio dc:dc, Limit Test

**Math functions:** NULL, Min/Max/Avg, dB, dBm, Limit Test

**Memory:** 512-reading internal storage

**Standard Programming Languages:** SCPI, HP 3478A and Fluke 8840A/42A

**Accessories Included:** Test lead kit, Operators Manual, Service Manual, Test Report, and power cord.

### General Specifications

**Power:** 100/120/220/240V, ±10%

**Power Line Frequency:** 45 to 66 Hz, 360 to 440 Hz

**Power Consumption:** 25 VA peak (10 W average)

**Operating Environment:** 0° to 55° C, full accuracy to 80% RH, 30° C

**Storage Environment:** -40° C to 75° C

**Dimensions:** 88.5 mm H × 212.6 mm W × 348.3 mm D (4 in × 8.5 in × 14 in)

**Weight:** Net, 3 kg (6.6 lb); shipping, 5.9 kg (13 lb)

**Safety:** Designed to UL-1244, IEC-348, CSA

**Warranty:** 3 years standard

**Computer Interface:** HP-IB and RS-232C standard

### Ordering Information

**HP 34401A** Multimeter

**Opt 908** Rack Mount Kit

**HP 34130A** Deluxe Test Lead Kit

**HP 34161A** Accessory Pouch

☎ For off-the-shelf shipment, call 800-452-4844.

### Price

\$995

\$51

\$35

\$38

# DIGITAL MULTIMETERS

A System Multimeter with Both High Speed and High Accuracy

HP 3458A

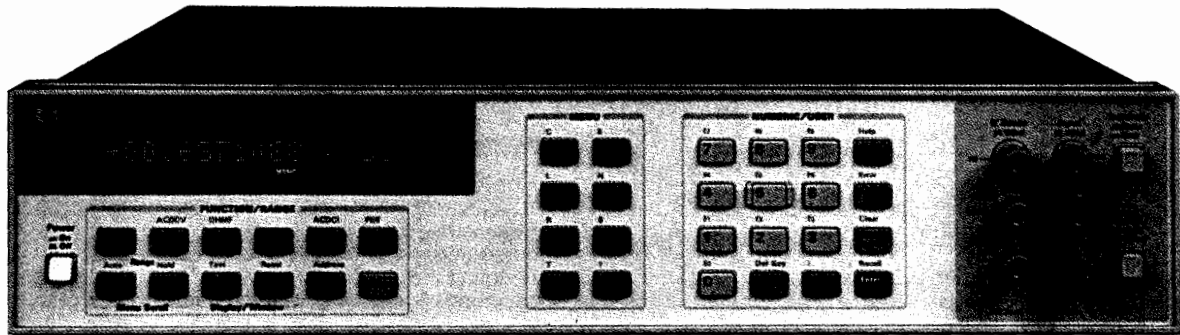

DESIGNED FOR  
MATE  
SYSTEMS



HP 3458A

The HP 3458A multimeter shatters longstanding performance barriers of speed and accuracy on the production test floor, in research and development, and in the calibration lab. The HP 3458A is the fastest, most flexible, and most accurate multimeter offered by Hewlett-Packard. In your system or on the bench, the HP 3458A saves you time and money with unprecedented test system throughput and accuracy, seven-function measurement flexibility, and low cost of ownership.

Select a rate of 100,000 readings per second for maximal test throughput. Or achieve highest levels of precision with up to 8½ digits of measurement resolution and 0.1 part per million transfer accuracy. Add to this programming compatibility through the Hewlett-Packard Multimeter Language (HPML) and the HP 3458A's simplicity of operation, and you have the ideal multimeter for your most demanding applications.

## High-Test System Throughput

### Faster Testing

- Up to 100,000 readings/s
- Internal test setups > 340/s
- Programmable integration times from 500 ns to 1 s

### Greater Test Yield

- More accuracy for tighter test margins
- Up to 8½ digits resolution

### Longer Uptime

- Two-source (10 V, 100 k Ω) calibration, including ac
- Self-adjusting, self-verifying autocalibration for all functions and ranges, including ac

## High-Resolution Digitizing

### Greater Waveform Resolution and Accuracy

- 16 to 24 bits resolution
- 100,000 to 0.2 samples/sec
- 12 MHz bandwidth
- Timing resolution to 10 ns
- Less than 100 ps time jitter
- Over 75,000 reading internal memory

### Flexible Digitizing Software

- Powerful, easy-to-use analysis software for HP 9000 Series 200/300 computers or HP Vectra with measurement coprocessor
- Subprograms for waveform acquisition, data transfer, FFT, IFT, and data presentation

## Calibration Lab Precision

### Superb Transfer Measurements

- 8½ digits resolution
- 0.1 ppm dc volts linearity
- 0.1 ppm dc volts transfer capability
- 0.01 ppm rms internal noise

### Extraordinary Accuracy

- 0.6 ppm for 24 hours in dc volts
- 2.2 ppm for 24 hours in ohms
- 100 ppm mid-band ac volts
- 8 ppm (4 ppm optional) per year voltage reference stability

## HP 3458A Multimeter Performance Features

### dc Volts

- 5 ranges: 0.1 V to 1000 V
- 8½ to 4½ digits resolution
- Up to 100,000 readings/s (4½ digits)
- Maximum sensitivity: 10 nV
- 0.6 ppm 24-hour accuracy
- 8 ppm (4 ppm optional)/year voltage reference stability

### Ω

- 9 ranges: 10 Ω to 1 G Ω
- 2-wire and 4-wire Ω with offset compensation
- Up to 50,000 readings/s (5½ digits)
- Maximum sensitivity: 10 μΩ
- 2.2 ppm 24-hour accuracy

### ac Volts

- 6 ranges: 10 mV to 1000 V
- 1 Hz to 10 MHz bandwidth
- Up to 50 readings/s with all readings to specified accuracy
- Choice of sampling or analog true rms techniques
- 100 ppm best accuracy

### dc Current

- 8 ranges: 100 nA to 1 A
- Up to 1,350 readings/s (5½ digits)
- Maximum sensitivity: 1 pA
- 14 ppm 24-hour accuracy

### ac Current

- 5 ranges: 100 μA to 1 A
- 10 Hz to 100 kHz bandwidth
- Up to 50 readings/s
- 500 ppm 24-hour accuracy

### Frequency and Period

- Voltage or current ranges
- Frequency: 1 Hz to 10 MHz
- Period: 100 ns to 1 s
- 0.01 % accuracy
- ac or dc coupled

## Throughput

### Maximum Reading Rates

- 100,000 readings/s at 4½ digits (16 bits)
- 50,000 readings/s at 5½ digits
- 6,000 readings/s at 6½ digits
- 60 readings/s at 7½ digits
- 6 readings/s at 8½ digits

### Measurement System Speed

- 100,000 readings/s over HP-IB or with internal memory
- 110 autoranges/s
- 340 function or range changes/s
- Postprocessed math from internal memory

## Abbreviated Technical Specifications

### dc Voltage

Range	Full Scale	Maximum Resolution	1-Year* Accuracy	Transfer Accuracy 10 min, Tref ± 0.5° C	Input Impedance
			ppm of reading + ppm of range		
100 mV	120.00000	10 nV	9(5) + 3	0.5 + 0.5	> 10 GΩ
1 V	1.2000000	10 nV	8(4) + 0.3	0.3 + 0.1	> 10 GΩ
10 V	12.0000000	100 nV	8(4) + 0.05	0.05 + 0.05	> 10 GΩ
100 V	120.000000	1 μV	10(6) + 0.3	0.5 + 0.1	10 MΩ ± 1%
1000 V	1050.00000	10 μV	10(6) + 0.1	1.5 + 0.05	10 MΩ ± 1%

One-year specifications for NPLC 100 within 24 hours and ± 1° C of last ACAL, Tcal ± 5° C, MATH NULL, fixed range. Add 2 ppm of reading additional error for HP factory traceability of 10 V dc to US NIST. Traceability error is the absolute error relative to National Standards associated with the source of last external calibration. Transfer specifications for NPLC 100, following 4-hour warm-up. Full scale to 10% of full scale. Measurements on the 1000 V range are within 5% of the initial measurement value and following measurement settling. Tref is the starting ambient temperature. Measurements are made on a fixed range using accepted metrology practices.  
\*High stability (Option 002) ppm of reading in parentheses.

### Noise Rejection (dB)'

	ac NMR <sup>2</sup>	ac ECMR	dc ECMR
NPLC < 1	0	90	140
NPLC ≥ 1	60	150	140
NPLC ≥ 10	60	150	140
NPLC ≥ 100	70	160	140
NPLC = 1000	80	170	140

'Applies for 1 kΩ unbalance in the LO lead and ± 0.1% of the line frequency currently set for LFREQ.

<sup>2</sup> For line frequency ± 1%, ACNMR is 40 dB for NPLC ≥ 1, or 80 dB for NPLC ≥ 100. For line frequency ± 5%, ACNMR is 65 dB for NPLC ≥ 100.

### Maximum Input

	Rated Input	Nondestructive
HI to LO	± 1000 V pk	± 1200 V pk
LO to guard	± 200 V pk	± 350 V pk
Guard to earth	± 500 V pk	± 1000 V pk

### True rms ac Voltage

#### (Synchronous Subsampled Mode)

Range	Full Scale	Maximum Resolution	Accuracy* 24 hour-2 year 40 Hz to 1 kHz % of reading + % of range	Input Impedance
10 mV	12.00000	10 nV	0.02 + 0.011	1MΩ ± 15% with < 140 pf
100 mV	120.00000	10 nV	0.007 + 0.002	1MΩ ± 15% with < 140 pf
1 V	1.2000000	100 nV	0.007 + 0.002	1MΩ ± 15% with < 140 pf
10 V	12.0000000	1 μV	0.007 + 0.002	1MΩ ± 2% with < 140 pf
100 V	120.000000	10 μV	0.02 + 0.002	1MΩ ± 2% with < 140 pf
1000 V	700.00000	100 μV	0.04 + 0.002	1MΩ ± 2% with < 140 pf

\*Specifications apply for full scale to 10% of full scale, dc < 10% of ac, sine wave input, crest factor of 1.4. Within 24 hours and ± 1° C of last ACAL. Peak (ac + dc) input limited to 5 × full scale for all ranges. Add 2 ppm of reading additional error for HP factory traceability of 10 V dc to US NIST.

### Maximum Input

	Rated Input	Nondestructive
HI to LO	± 1000 V pk	± 1200 V pk
LO to guard	± 200 V pk	± 350 V pk
Guard to earth	± 500 V pk	± 1000 V pk
Volt-Hz product	1 × 10 <sup>8</sup>	

### Resistance

Range	Full Scale	Maximum Resolution	Current through Unknown	1-Year Accuracy* (4-wire ohms) ppm of rdg + ppm of range
10 Ω	12.00000	10 μΩ	10 mA	15 + 5
100 Ω	120.00000	10 μΩ	1 mA	12 + 5
1 k Ω	1.2000000	100 μΩ	1 mA	10 + 0.5
10 k Ω	12.000000	1 m Ω	100 μA	10 + 0.5
100 k Ω	120.00000	10 m Ω	50 μA	10 + 0.5
1 M Ω	1.2000000	100 m Ω	5 μA	15 + 2
10 M Ω	12.000000	1 Ω	500 nA	50 + 10
100 M Ω	120.00000	10 Ω	500 nA	500 + 10
1 G Ω	1.2000000	100 Ω	500 nA	0.5% + 10

\*Specifications for 100 NPLC, offset compensation on, within 24 hours and ± 1° C of last ACAL, Tcal ± 5° C. Add 3 ppm of reading additional error for HP factory traceability of 10kΩ to US NIST.

### Memory

	Standard		Option 001	
	Readings	Bytes	Readings	Bytes
Reading storage (16 bit) Non-volatile, for subprograms and/or state storage	10,240	20 k	+65,536	+128 k
		14 k		

**Math Functions:** The HP 3458A performs the following math functions on measurements: NULL, SCALE, OFFSET, RMS FILTER, SINGLE POLE FILTER, THERMISTOR LINEARIZATION, DB, DBM, % ERROR, PASS/FAIL LIMIT TESTING, and STATISTICS. Two math functions may be used at one time.

### General Specifications

**Operating Temperature:** 0° to 55° C

**Warmup Time:** Four hours to all specifications except where noted

**Humidity Range:** 95% RH, 0° to 40° C

**Storage Temperature:** -40° to +75° C

**Power:** 100/120 V, 220/240 V ± 10%, 48 to 66 Hz, 360 to 420 Hz automatically sensed. Fused at 1.5 A @ 115 V or 0.5 A @ 230 V. < 30 W, < 80 VA (peak).

**Size:** 88.9 mm H × 425.5 mm W × 502.9 mm D (3.5 in × 16.75 in × 19.8 in)

**Net Weight:** 12 kg (26.5 lb)

**Shipping Weight:** 14.8 kg (32.5 lb)

### Ordering Information

**HP 3458A** Multimeter (with HP-IB, 20 KB reading memory, and 8 ppm stability) **Price** \$6,595

**Opt 001** Extended Reading Memory (expands total to 148 kB) \$570

**Opt 002** High Stability (4 ppm/year) Reference \$1,080

**Opt 005** Waveform Analysis Library for HP Series \$430

300 computers with BASIC 4.0 or greater and

HP Vectra with Measurement Coprocessor

**Opt 1BN** MIL-STD-45662A Certificate of Calibration \$200

**Opt 1BP** MIL-STD-45662A Certificate of Calibration \$300

with data

**Opt W30** Two additional years return-to-HP \$160

hardware support. See page 671.

**Opt W32** Three-year customer return calibration coverage

**Opt 700** CIIL Language \$1,080

**Opt 907** Front Handle Kit \$60

**Opt 908** Rack Flange Kit \$40

**Opt 909** Rack Flange Kit (with handles) \$90

# DIGITAL MULTIMETERS

3½- to 6½- Digit DMM with Extended Resolution to 7½ Digits

HP 3457A

- Over 1,350 readings/sec at 3½ digits
- Seven functions: dcV, acV, dcl, acl, ohms, frequency, and period

- Three plug-in multiplexer options
- dc sensitivity to 10 nanovolts
- Outstanding combination of performance and price

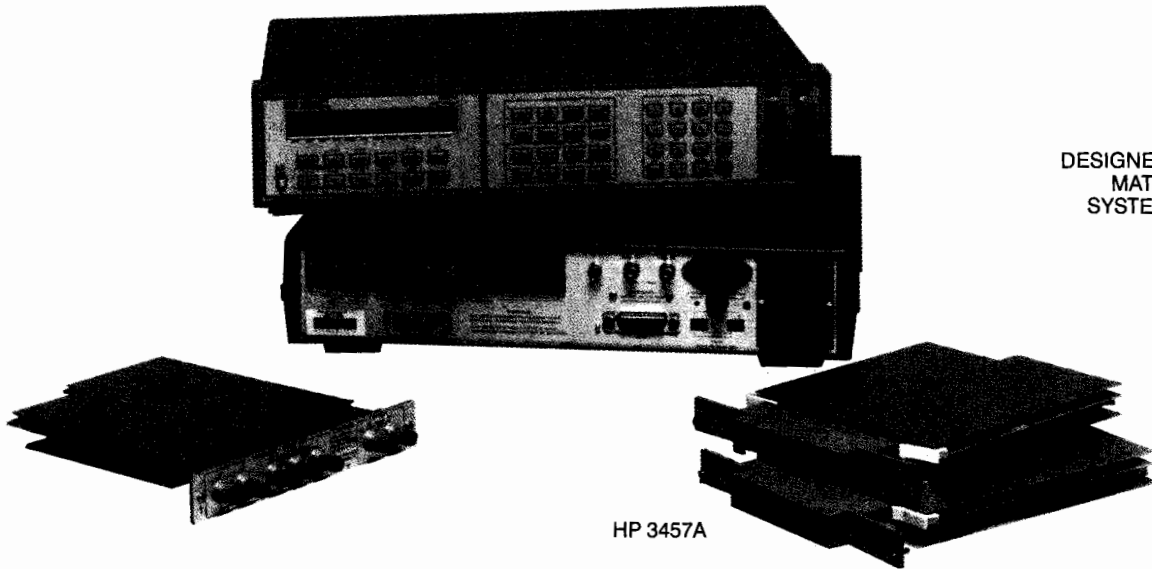

DESIGNED FOR  
MATE  
SYSTEMS

HP 3457A

### HP 3457A Digital Multimeter

The HP 3457A has seven functions with 3½ to 6½ digits of resolution, extendable to 7½ digits. Reading rates vary from 1 reading every 2 seconds to 1350 rds/s and basic dc volts as accurate as 5 ppm. In addition, the input of the HP 3457A can be expanded up to ten channels with either of the optional plug-in multiplexer assemblies. On the bench, the front panel operation is extremely flexible and comprehensive. In systems, the Hewlett-Packard Interface Bus (HP-IB) is standard.

### Powerful Measurement Management

The HP 3457A combines superb analog measuring capability with powerful measurement management. More than 3,000 readings or whole measurement sequences can be stored in the HP 3457A for convenient and fast measurement throughput. The present digital multimeter (DMM) setup can be stored in the non-volatile state memory for convenient reconfiguration.

Additional power from math functions can be obtained by using PASS/FAIL limit testing, NULL, SCALE, THERMISTOR linearization, and others. The power of total electronic calibration, including ac volts, makes it easy to maintain performance.

### System Features

In keeping with HP's long tradition of systems-oriented DMMs, the HP 3457A has all the features you've come to expect plus more to make interfacing to your computer easy—features like flexible formatting of ASCII, 16-bit binary, or 32-bit binary data and buffer memory. In addition, you'll find the VOLTMETER COMPLETE output and EXTERNAL TRIGGER input signals ideal for synchronizing other instruments with the HP 3457A. Finally, programmable front-rear terminal switching lets you measure two separate inputs without a scanner.

### Hewlett-Packard Multimeter Language (HPML)

Another first for the HP 3457A DMM is an easy-to-use DMM language—HPML. Designed to make today's multimeter software fit tomorrow's, HPML asks you only to define the parameters of your measurement. For example, if you want to make a measurement on a 9-volt dc signal with 0.01 percent resolution, the command sequence is "DCV,9,.01".

### Control Interface Intermediate Language (CIIL)

With Option 700, the HP 3457A responds to standardized DMM CIIL commands via HP-IB. Physically and functionally identical to the standard HP 3457A, Option 700 adds the CIIL command set with a built-in test module adapter (TMA) to the DMM's standard HPML.

### Three Rear-Panel Plug-In Options

One of three optional assemblies may be used with the HP 3457A for different measurement capabilities. Using the multiplexer assemblies will allow you to scan up to ten signal channels either sequentially or randomly. All of the capability of the normal front and rear input terminals is available for multiple inputs. Using the high-voltage assembly allows single-channel measurement of either ac or dc voltages at the rear panel.

For measurement flexibility, the HP 44491A Armature Relay Multiplexer Assembly offers eight 2-wire channels and two current/actuator channels. Under software control, the eight 2-wire channels can be reconfigured to four 4-wire ohm channels. The two current channels offer automatic make-before-break switching so that the path for current up to 1.5 A is never broken. In addition, these two channels can be used as external device actuator channels. Each channel can switch up to 150 V.

For higher speed scanning, the HP 44492A Reed Relay Multiplexer Assembly offers ten 2-wire channels. The HP 44492A is useful for switching Vdc, Vac, 2-wire ohms, frequency, and period measurement signals with a maximum amplitude of 125 V.

For measurement of voltages up to 1414 V peak, the HP 44497A High Voltage Assembly offers a 1000:1 attenuator input (channel 1) for the high-voltage measurements. In addition, the other rear terminal input (channel 0) can be used to take conventional Vdc, Vac, 2-wire and 4-wire ohms, period, frequency, dcl, and acl measurements. Using the HP 44497A with HP 3457A in the 6½-digit mode will yield a resolution of 1 mV for a 1000 V input. Implementing the MATH Scale function will cause the HP 3457A LCD to display the measurement results in kilovolts.

### Abbreviated Technical Specifications

90-day, Tcal ± 5° C  
dc Voltage

Range	Maximum Reading	Best 6½-Digit Accuracy ± (% Rdg + Cnts)*		Input Resistance
		% of Reading	Count Error	
30 mV	30.30000 mV	0.0040	365	> 10 GΩ
300 mV	303.0000 mV	0.0025	39	> 10 GΩ
3 V	3.030000 V	0.0017	6	> 10 GΩ
30 V	30.30000 V	0.0035	19	10 MΩ ± 1%
300 V	303.0000 V	0.0050	6	10 MΩ ± 1%

\*After 1-hr warmup, with integration time of 100 power line cycles (PLC). Tcal is the temperature of the calibration environment between 18° and 28° C.

**True rms ac V and (ac + dc)V****Bandwidth:** 20 Hz to 1 MHz**Crest factor:** 3.5:1 at full scale**Common mode rejection:** (1 k $\Omega$  unbalance in LO): > 76 dB, dc-60 Hz  
**Accuracy:** (90 day)

Accuracy specified for sine wave inputs, &gt;10% of range. dc component &lt;10% of ac component after 2-hour warmup and within one week of autocal. Integration time is 10 PLC. ac Band set to &lt;400 Hz.

Range	Maximum Reading	(100 Hz to 20 kHz) Best 5 $\frac{1}{2}$ -Digit Accuracy $\pm$ (% Rdg + Cnts)				Input Impedance
		ac Coupled % of Reading	Count Error	dc Coupled % of Reading	Count Error	
30 mV	32.50000 mV	0.13	116	0.17	364	1M $\Omega$ $\pm$ 1% shunted by <90 pf
300 mV	325.0000 mV	0.13	116	0.17	364	
3 V	3.250000 V	0.13	116	0.17	364	
30 V	32.50000 V	0.13	116	0.17	364	
300 V	303.0000 V	0.19	116	0.23	364	

**Resistance (2- and 4-wire  $\Omega$ )**

Range	Maximum Reading	Best 6 $\frac{1}{2}$ -Digit Accuracy $\pm$ (% Rdg + Cnts)		
		% of Reading	Count Error	Current Output
30 $\Omega$	30.30000 $\Omega$	0.0065	315	1 mA
300 $\Omega$	303.0000 $\Omega$	0.0045	34	1 mA
3 k $\Omega$	3.030000 k $\Omega$	0.0035	6	1 mA
30 k $\Omega$	30.30000 k $\Omega$	0.0035	6	100 $\mu$ A
300 k $\Omega$	303.0000 k $\Omega$	0.0040	7	10 $\mu$ A
3 M $\Omega$	3.030000 M $\Omega$	0.0055	12	1 $\mu$ A
30 M $\Omega$	30.30000 M $\Omega$	0.025	80	100 nA
300 M $\Omega$	303.0000 M $\Omega$	1.6	1000	100 nA
3 G $\Omega$	3.030000 G $\Omega$	16.0	1000	100 nA

For 2-wire  $\Omega$ , add 200 m $\Omega$  to count error specifications. After 1-hr warmup with integration time of 100 power line cycles (PLC). Tcal is the temperature of the calibration environment between 18° and 28° C. For 2-wire  $\Omega$  only, accuracy is specified following autocal (ACAL), under stable conditions ( $\pm$ 1° C).**Maximum Reading Rates (dc V, dc I, and resistance up to 30 k $\Omega$ )**

Power Line Cycles	Maximum No. of Digits	Readings per Second 60 Hz (50 Hz)		NMR
		Auto Zero On	Auto Zero Off	
.0005	3 $\frac{1}{2}$	300	1350	0
.005	4 $\frac{1}{2}$	280	1250	0
.1	5 $\frac{1}{2}$	140 (128)	360 (312)	0
1.0	6 $\frac{1}{2}$	26 (22)	53 (45)	60 dB
10	7 $\frac{1}{2}$	2.5 (2.0)	4.8 (4.0)	80 dB
100	7 $\frac{1}{2}$	.25 (0.2)	0.5 (0.4)	90 dB

Reading rates are specified with zero delay, fixed range, display off, and front panel off. The output is to internal reading memory using single integer format and internal timer. Integration time in PLC. Using Math HIREs mode for 7 $\frac{1}{2}$  digits.**dc Current**

Range	Maximum Reading	Best 6 $\frac{1}{2}$ -Digit Accuracy $\pm$ (% Rdg + Cnts)		Shunt Resistance
		% of Reading	Count Error	
300 $\mu$ A	303.0000 $\mu$ A	0.02	104	1000 $\Omega$
3 mA	3.030000 mA	0.02	104	100 $\Omega$
30 mA	30.30000 mA	0.02	104	10 $\Omega$
300 mA	303.0000 mA	0.07	204	1 $\Omega$
1 A	1.000000 A	0.07	604	0.1 $\Omega$

\*After 1-hr warmup, with integration time of 100 PLC. Tcal is the temperature of the calibration environment between 18° and 28° C.

**Common mode rejection (dB):** 1 k $\Omega$  unbalance in low lead; dc ECMR 140 dB; ac ECMR: <1 PLC, 76 dB; ac ECMR >1 PLC, 156 dB for 50, 60 Hz  $\pm$  .08%.**Memory:** 6235 available bytes that can be partitioned into 3 segments, one devoted to storing measurements, one devoted to storing measurement subprograms, and one devoted to storing instrument states.**Math functions:** The HP 3547A performs the following math functions on measurements: NULL, SCALE, OFFSET, RMS FILTER, SINGLE POLE FILTER, THERMISTOR LINEARIZATION, DB, DBM, % ERROR, PASS/FAIL, LIMIT TESTING, and STATISTICS. Two math functions may be used at one time.**General Specifications****Operating temperature:** 0° to 55° C**Warmup time:** One hour to all specifications except where noted**Humidity range:** 95% RH, 0° to 40° C**Storage temperature:** -40° to +75° C**Power:** 100/120/220/240 V  $\pm$  10%, 48 Hz to 66 Hz, 220 V,  $\pm$  10%, 48 Hz to 66 Hz. Fused at .2 A (115 V) or 0.08 A (230 V). <30 V A.**Size:** 89 mm H (without removable feet)  $\times$  425 mm W  $\times$  292 mm D (3.5 in  $\times$  16.75 in  $\times$  11.5 in). Height (with removable feet): 100 mm (4 in). Allow 76 mm (3 in) additional depth for wiring.**Net weight:** 5.05 kg (11.1 lb)**Shipping weight:** 9.3 kg (20.5 lb)**Plug-in Options****HP 44491A Armature Relay Multiplexer Assembly Input****Characteristics:** Eight 2-wire armature relay channels and two current/actuator channels. Maximum voltage (terminal-to-terminal or terminal-to-chassis) 250 Vrms. Maximum current (per channel) 1.0 A dc or ac rms. Thermal offset <3  $\mu$ V. Closed channel resistance (end of relay life) <2  $\Omega$ . Maximum switching and measurement speed 33 channels/second.**HP 44492A Reed Relay Multiplexer Assembly Input Characteristics:** Ten 2-wire reed relay channels. Maximum voltage (terminal-to-terminal or terminal-to-chassis) 125 V peak. Thermal offset <3  $\mu$ V. Closed channel resistance (end of relay life) <4  $\Omega$ . Specified for <100 kHz ac volts and frequency operation. Maximum switching and measurement speed 300 channels/second.**HP 44497A High-Voltage Attenuator Assembly Input Characteristics:** Two relay channels, channel 1 devoted to high-voltage measurements. Maximum high-to-low voltage of 1000 volts dc or ac rms. Maximum low-to-earth voltage of 350 V peak. Nondestructive overload voltage of 1700 V peak, 1200 volts dc. Attenuator accuracy to be added to HP 3457A range and function accuracy for total accuracy.

dc	0.030% of reading
20 Hz to 1 kHz	2.8% of reading
1 kHz to 10 kHz	12% of reading

Note: One-year accuracy applies to Tcal  $\pm$  5%, NPLC = 1 or greater. Specifications are for low-to-earth voltage less than 0.1 times high-to-earth voltage.**Ordering Information**

<b>HP 3457A</b> Multimeter	\$3,100
* <b>HP 44491A</b> Armature Relay Multiplexer Assembly	\$545
* <b>HP 44492A</b> Reed Relay Multiplexer Assembly	\$545
* <b>HP 44497A</b> High Voltage Attenuator Assembly	\$545
<b>Opt 401</b> Side Handle Kit (5061-1171)	+ \$45
<b>Opt 700</b> CIIL Language	+ \$1,000
<b>Opt 907</b> Front Handle Kit (5061-1170)	+ \$70
<b>Opt 908</b> Rack Flange Kit (5061-1168)	+ \$35
<b>Opt 909</b> Rack Flange and Front Handle Kit (5061-1169)	+ \$85
<b>Opt 910</b> Extra Operating and Service Manual	+ \$110
<b>Opt W30</b> Extended repair service. See page 671.	+ \$80
<b>Opt W32</b> Three-year customer return repair coverage	

**Accessories**

<b>HP 44493A</b> Screw Terminal Connector for HP 44491A (includes strain relief and housing)	\$65
<b>HP 44494A</b> Screw Terminal Connector for HP 44492A (includes strain relief and housing)	\$65
<b>HP 44414A</b> Four Thermistor Pack	\$63

\*Plug-in options may be ordered and shipped separately without a HP 3457A mainframe. Unless otherwise specified, optional plug-in assemblies will be shipped with the HP 3457A mainframe.

☎ For off-the-shelf shipment, call 800-452-4844.

# DIGITAL MULTIMETERS

## High Performance 5½- to 3½- Digit Multimeters

HP 3478A, 3468A/B

- Five functions
- Up to 100 nanovolt resolution
- Electronic calibration



HP 3478A

- Higher accuracy
- Extended ranges
- HP-IB interface
- Front/rear terminals



HP 3468A

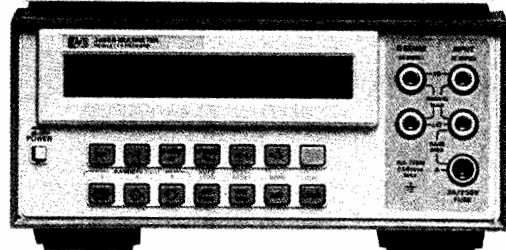

HP 3468B

- Portable
- Battery option
- Low cost
- HP-IL interface

### Description

The HP 3468A/B and the HP 3478A are autoranging 5½ to 3½ digit DMMs, with five functions: dc volts, true rms ac volts, 2- and 4-wire ohms, dc current, and true rms ac current. All three DMMs feature closed-box electronic calibration, which eliminates all adjustments to provide a lower cost of ownership.

### High Performance

All three DMMs offer high performance. The HP 3468A/B are designed with the bench in mind, while the HP 3478A is optimal for system use. The HP 3478A can perform production tests or acquire experimental data at 90 readings per second with 3½ digit resolution, or take 35 readings per second with 130 dB of noise rejection at 4½ digits. The HP 3478A also offers 100 nV and 100 μΩ resolution in the 5½-digit mode.

All three DMMs measure true rms ac voltage to 300 kHz, with crest factors up to 4:1. They measure true rms ac current to 20 kHz.

For even greater performance consider the new HP 34401A digital multimeters. See page 168.

### Battery Operation

Both the HP 3468A and HP 3468B are available with rechargeable battery and battery-charging circuitry for portable measurements (Option 001). This allows for up to five hours of continuous battery operation.

The HP 3468A comes in a streamlined portable package with a handle for convenient carrying; the HP 3468B comes in a plastic system case for easy rack mounting.

### System Operation

The HP 3478A features selectable front/rear inputs for flexible system connections. The Voltmeter Complete output and External Trigger input allow synchronization of the HP 3478A with a scanner for fast multiplexed measurements without the slower software commands. The test program can write prompt messages or results on the alphanumeric display. The operator can respond by pressing the HP 3478A's SRQ key to interrupt the controller and start the next test.

### Reliability/Cost of Ownership

The HP 3468A/B and the HP 3478A all have demonstrated reliability. Mean time between failure (MTBF) rates exceed 100,000 hours of operation. As a result, we offer a three-year extended warranty (Option W30) for less than 4 percent of the purchase price.

### Specifications

#### dc Voltage Input Characteristics

Range*	Maximum Reading (5½ digit)	Resolution		
		5½ digit	4½ digit	3½ digit
30 mV	±30.3099 mV	100nV	1 μV	10 μV
300 mV	±303.099 mV	1 μV	10 μV	100 μV
3 V	±3.03099 V	10 μV	100 μV	1 mV
30 V	±30.3099 V	100 μV	1 mV	10 mV
300 V	±303.099 V	1 mV	10 mV	100 mV

\*30 mV range available on HP 3478A only.

**Input resistance:** 30 mV, 300 mV, 3 V ranges: > 10<sup>10</sup>Ω  
30 V, 300 V ranges: 10 MΩ ± 1%

**Maximum input voltage (nondestructive):** Hi to Lo: 303 Vrms or 450 V peak; Hi or Lo to Earth Ground: 500 V peak

**Measurement accuracy:** ±(% of reading + number of counts). Auto zero ON. 5½ digits.

#### HP 3478A

Range	T <sub>cal</sub> * ± 1° C		T <sub>cal</sub> * ± 5° C	
	24 Hours	90 Days	1 Year	
30 mV	0.025 + 40	0.0275 + 40	0.035 + 40	
300 mV	0.004 + 4	0.005 + 5	0.007 + 5	
3 V	0.003 + 2	0.004 + 2	0.006 + 2	
30 V	0.004 + 3	0.005 + 4	0.007 + 4	
300 V	0.004 + 2	0.005 + 2	0.007 + 2	

#### HP 3468 A/B

Range	T <sub>cal</sub> * ± 1° C		T <sub>cal</sub> * ± 5° C	
	24 Hours	90 Days	1 Year	
300 mV	0.005 + 4	0.009 + 5	0.02 + 5	
3 V	0.0035 + 2	0.0072 + 2	0.0181 + 2	
30 V	0.005 + 3	0.009 + 3	0.02 + 3	
300 V	0.0055 + 2	0.009 + 2	0.02 + 2	

\*T<sub>cal</sub> is the temperature of the environment where the HP 3478A and the HP 3468A/B were calibrated. Calibration should be done with the temperature of the environment between 20° C and 30° C. Twenty-four-hour accuracy is relative to calibration standards.



**Temperature coefficient:** 0° C to 55° C, 5½ digits, auto zero ON.  
± (% of reading + number of counts)° C.

Range	HP 3478A	HP 3468A/B
30 mV	0.0028 + 5.0	-----
300 mV	0.0005 + 0.5	0.0008 + 0.5
3 V	0.0004 + 0.05	0.0007 + 0.05
30 V	0.0006 + 0.5	0.0008 + 0.5
300 V	0.0004 + 0.05	0.0007 + 0.05

**Noise rejection:** in dB with 1 k Ω imbalance in Lo lead; ac rejection for 50, 60 Hz ± 0.1%. Auto zero ON.

Display	ac NMR	ac ECMR	dc CMR
5½ digits	80	150	140
4½ digits	59	130	140
3½ digits	0	70	140

**Maximum Reading Rates (readings/sec.) HP 3478A**

Line Frequency	Auto Zero and Display	Resolution		
		3½ digits	4½ digits	5½ digits
60 Hz	Off	90	35	4.4
	On	60	20	2.3
50 Hz	Off	85	30	3.7
	On	50	17	1.9

**ac Voltage (true rms responding) Input Characteristics**

Range	Maximum Reading (5½ Digit)	Resolution		
		5½ digit	4½ digit	3½ digit
300 mV	303.099 mV	1 μV	10 μV	100 μV
3 V	3.03099 V	10 μV	100 μV	1 mV
30 V	30.3099 V	100 μV	1 mV	10 mV
300 V	303.099 V	1 mV	10 mV	100 mV

**Input impedance:** 1 M Ω ± 1% shunted by <60 pF  
**Maximum Input Voltage** (nondestructive): Hi to Lo: 303 Vrms or 450 V peak; Hi or Lo to Earth Ground: ±500 V peak.  
**Measurement accuracy:** ± (% of reading + number of counts). Auto zero ON. 5½ digit display. Accuracy is specified for sinewave inputs only, >10% of full scale.

**1 Year, T<sub>Cal</sub>\* ± 5° C HP 3478A**

Frequency	Ranges		
	300 mV	3 V, 30 V	300 V
20 to 50 Hz	1.14 + 163	1.14 + 102	1.18 + 102
50 to 100 Hz	0.46 + 163	0.46 + 103	0.50 + 102
100 Hz to 20 kHz	0.20 + 120	0.20 + 70	0.24 + 70
20 to 50 kHz	0.38 + 205	0.26 + 140	0.42 + 140
50 to 100 kHz	1.20 + 840	0.87 + 780	0.98 + 780
100 to 300 kHz	10.1 + 3720 (30 V range only)		

**1 Year, T<sub>Cal</sub>\* ± 5° C HP 3468A/B**

Frequency	Ranges		
	300 mV	3 V, 30 V	300 V
20 to 50 Hz	1.14 + 163	1.14 + 102	1.18 + 102
50 to 100 Hz	0.46 + 163	0.46 + 103	0.5 + 102
100 Hz to 20 kHz	0.29 + 163	0.26 + 102	0.33 + 102
20 to 50 kHz	0.56 + 247	0.41 + 180	0.55 + 180
50 to 100 kHz	1.74 + 882	1.05 + 825	1.26 + 825
100 k to 300 kHz	10.1 + 3720 (30 V range only)		

**Crest factor:** >4:1 at full scale

**Resistance (2-wire Ω, 4-wire Ω) Input Characteristics**

Range*	Maximum Reading (5½ Digit)	Resolution		
		5½ digit	4½ digit	3½ digit
30 Ω	30.3099 Ω	100 μΩ	1 m Ω	10 m Ω
300 Ω	303.099 Ω	1 m Ω	10 m Ω	100 m Ω
3 k Ω	3.03099 k Ω	10 m Ω	100 m Ω	1 Ω
30 k Ω	30.3099 k Ω	100 m Ω	1 Ω	10 Ω
300 k Ω	303.099 k Ω	1 Ω	10 Ω	100 Ω
3 M Ω	3.03099 M Ω	10 Ω	100 Ω	1 k Ω
30 M Ω	30.3099 M Ω	100 Ω	1 k Ω	10 k Ω

**Input protection** (nondestructive): Hi to Lo: ±350 V peak; Hi or Lo to Earth Ground: ±500 V peak.

**Measurement accuracy:** ± (% of reading + number of counts). Auto zero ON. 5½ digit display. 4-wire ohms.

Range*	T <sub>Cal</sub> * ± 1° C		T <sub>Cal</sub> * ± 5° C	
	24 Hours		90 Days	1 Year
30 Ω	0.023 + 35	0.027 + 41	0.034 + 41	
300 Ω	0.0045 + 4	0.012 + 5	0.017 + 5	
3 k to 300 k Ω	0.0035 + 2	0.011 + 2	0.016 + 2	
3 M Ω	0.0052 + 2	0.011 + 2	0.016 + 2	
30 M Ω	0.036 + 7	0.066 + 7	0.078 + 7	

\*30 Ω range available on HP 3478A only.

**Current Through Unknown**

Range*	30 Ω	300 Ω	3 k Ω	30 k Ω	300 k Ω	3 M Ω	30 M Ω
Current	1 mA	1 mA	1 mA	100 μA	10 μA	1 μA	100 nA

\*30 Ω range available on HP 3478A only.

**dc Current Input Characteristics**

Range*	Maximum Reading (5½ Digit)	Resolution		
		5½ digit	4½ digit	3½ digit
300 mA	303.099 mA	1 μA	10 μA	100 μA
3 A	3.03099 A	10 μA	100 μA	1 mA

**Maximum input** (nondestructive): 3 A from <250 V source; fuse protected.

**Measurement accuracy:** ± (% of reading + number of counts). Auto zero ON. 5½ digit display.

Range*	T <sub>Cal</sub> * ± 5° C	
	90 Days	1 Year
300 mA	0.11 + 40	0.15 + 40
3 A (<1 A)	0.14 + 6	0.17 + 6
3 A (>1 A)	1.0 + 30	1.0 + 30

\*300 mA range available on HP 3478A only.

**Maximum burden at full scale:** 1 V (3 A range), 0.1 V (0.3 A range)

**ac Current (true rms responding) Input Characteristics**

Range	Maximum Reading (5½ Digit)	Resolution		
		5½ digit	4½ digit	3½ digit
300 mA	303.099 mA	1 μA	10 μA	100 μA
3 A	3.03099 A	10 μA	100 μA	1 mA

**Maximum input** (nondestructive): 3 A from <250 V source; fuse protected.

**Measurement accuracy:** ± (% of reading + number of counts). Auto zero ON. 5½ digit display. Accuracy specified for sinewave inputs only, >10% of full scale.

**1 Year, T<sub>Cal</sub> ± 5° C**

Frequency	HP 3478A		HP 3468A/B	
	Ranges		Ranges	
	300 mA	3 A	300 mA	3 A
20 to 50 Hz	1.54 + 163	2.24 + 163	1.77 + 163	2.5 + 163
50 to 1 kHz	0.81 + 163	1.50 + 163	1.1 + 163	1.8 + 163
1 k to 10 kHz	0.72 + 163	1.42 + 163	1.0 + 163	1.7 + 163
10 k to 20 kHz	0.86 + 163	1.56 + 163	1.14 + 163	1.84 + 163

**General**

**Operating temperature:** 0 to 55° C  
**Humidity range:** 95% R.H., 0 to 40° C  
**Power:** ac line 48 to 440 Hz; 86 to 250 V, 25 VA max  
**Size:** HP 3468A: 98.4 mm H × 238.1 mm W × 276.2 mm D (3.87 in × 9.37 in × 10.88 in); 3468B: 89 mm H × 213 mm W × 275 mm D (without feet) (3.5 in × 8.39 in × 10.83 in); 3478A: 102 H × 215 W × 356 mm D (4 in × 8.46 in × 14 in)  
**Weight:** HP 3468A/B: 2.1 kg; HP 3468A/B w/Opt 001: 3.1 kg (6.83 lb); HP 3478A: 3 kg (6.61 lb).

**Ordering Information**

Product	Price
HP 3478A DMM with test probes & HP-IB	\$995
HP 3468A DMM in Streamlined Portable Case with HP-IL and test probes	\$910
HP 3468B DMM in Rack and Stack Case with HP-IL and test probes	\$910
<b>Choose one power option (no charge):</b>	
Opt 315 100 V, 50 Hz; Opt 335 220 V, 50 Hz	\$0
Opt 316 100 V, 60 Hz; Opt 336 220 V, 60 Hz	\$0
Opt 325 120 V, 50 Hz; Opt 345 240 V, 50 Hz	\$0
Opt 326 120 V, 60 Hz; Opt 346 240 V, 60 Hz	\$0
HP 3478A Opt W30 extended repair service	\$35
HP 3478A Opt 907 Front Handle Kit (5061-0088)	\$60
HP 3478A Opt 908 Rack Mount Kit (5061-0072)	\$60
HP 3478A Opt 910 Extra Manuals (03478-90008/03478-90009)	\$22
HP 3468A/B Option W30 add 3 year Extended Hardware Support	\$25
HP 3468A/B Option 001, add Rechargeable Battery Pack	\$200
HP 3468B Option 401, add Side Handle Kit (HP P/N 5061-1171)	\$50
HP 3468B Option 907 Front Handle Kit	\$65
HP 3468B Option 908 Rack Mount Kit	\$60
HP P/N 5060-0174 Rack Mount Kit for rackmounting two instruments side-by-side	\$87.50

☎ For off-the-shelf shipment, call 800-452-4844.

# DIGITAL MULTIMETERS

## 6½- to 3½-Digit HP-IB DMM with High Stability

HP 3456A

- Up to 330 readings per second
- 100 nanovolt resolution

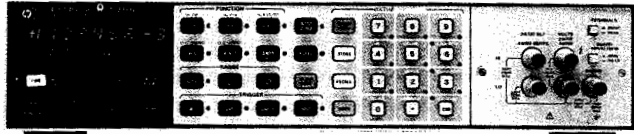

HP 3456A

### Description

This fully guarded, integrating Digital Multimeter (DMM) is designed for bench or systems. The HP Model 3456A measures dc voltage, true rms ac voltage, and resistance.

Measurement speed and accuracy can be enhanced for a specific application by using the HP 3456A's selectable integration time (up to 100 power line cycles). An operator can select up to 330 readings per second for high-speed bursts or one reading every 15 minutes for periodic measurements. Resolution of 100 nanovolts at 48 readings per second (6½ digits) to 10-microvolt resolution at 330 readings per second (3½ or 4½ digits) can be selected.

With good repeatability and 100 nanovolt sensitivity, accuracy on the 10-volt range is ±0.0008% + 2 counts, over a 24-hour period at 23° C ± 1° C.

Four full-scale, true rms ac voltage ranges are provided, with reading speeds up to 12 readings per second over a 10-Hz to 250-kHz range. Best accuracy is 0.05%. Crest factor is greater than seven at full scale.

With the HP 3456A's program memory and reading storage capability, the HP 3456A can take measurements and store them while the computer performs another task.

Another feature of the HP 3456A is its hardware scanner advance for scanned or multiplexed system applications. As soon as the HP 3456A's measurement cycle is complete, a TTL signal can trigger a variety of switching instruments.

### Specifications

#### dc Voltage

Range	Maximum Reading (5½ digit)	Resolution			Input Resistance	Maximum Input Voltage
		6½ digit	5½ digit	4½ digit		
0.1 V	.119999 V	100 nV	1 µV	10 µV	> 10 <sup>10</sup> Ω	± 1000 V peak
1.0 V	1.19999 V	1 µV	10 µV	100 µV	> 10 <sup>10</sup> Ω	
10.0 V	11.9999 V	10 µV	100 µV	1 mV	> 10 <sup>10</sup> Ω	
100.0 V	119.999 V	100 µV	1 mV	10 mV	10 M Ω ± .5%	
1000.0 V	1000.00 V	1 mV	10 mV	100 mV	10 M Ω ± .5%	

Measurement accuracy: ± (% of reading + number of counts)

RANGE	24 hours: 23° C ± 1° C		90 days: 23° C ± 5° C		1 year: 23° C ± 5° C	
	6½ digit (≥ 10 PLC)	6½ digit (1 PLC)	6½ digit (≥ 10 PLC)	6½ digit (1 PLC)	6½ digit (≥ 10 PLC)	6½ digit (1 PLC)
0.1 V	.0022 + 24	0.0024 + 32	0.0026 + 24	0.0027 + 32	0.0034 + 24	0.0035 + 32
1.0 V	0.0009 + 4	0.0012 + 5	0.0016 + 4	0.0017 + 5	0.0024 + 4	0.0025 + 5
10.0 V	0.0008 + 2	0.0011 + 3	0.0015 + 2	0.0016 + 3	0.0023 + 2	0.0024 + 3
100.0 V	0.0011 + 3	0.0014 + 4	0.0018 + 3	0.0019 + 4	0.0026 + 3	0.0027 + 4
1000.0 V	0.0011 + 2	0.0013 + 3	0.0016 + 2	0.0017 + 3	0.0024 + 2	0.0025 + 3

\*Add .02 (Input Voltage) / 1000 % to % of reading.

#### ac True rms Voltage (ac, ac + dc)

Range	Maximum Reading (5½ digit)	Resolution			Input Impedance	Maximum Input Voltage
		6½ digit	5½ digit	4½ digit		
1.0 V	1.19999 V	1 µV	10 µV	100 µV	1 M Ω ± .5% shunted by < 90 pF	± 1000 V peak (700 V rms) 10 <sup>6</sup> VHz
10.0 V	11.9999 V	10 µV	100 µV	1 mV		
100.0 V	119.999 V	100 µV	1 mV	10 mV		
1000.0 V	700.00 V	1 mV	10 mV	100 mV		

- 100 micro-Ω to 1.0 gigaohm

Measurement accuracy: ± (% of reading + number of counts) 90 days: 23° C ± 5° C

Integration Time	Frequency in Hz					
	In Power Line Cycles	10 to 20	Filter Off— 20 to 30	400-20 k 30-20 k	20 k to 50 k 20 k to 50 k	50 k to 100 k 50 k to 100 k
> 1~ (6 digit)*	.47 + 450	.35 + 500	.07 + 730	.17 + 1700	.55 ± 2900	5.0 + 6500
.1~ (5 digit)	.48 + 90	.36 + 53	.08 + 73	.18 + 173	.56 + 293	5.0 + 653
.01~ (4 digit)	.56 + 10	.41 + 7	.13 + 9	.23 + 19	.61 + 31	5.1 + 67

\*Frequencies > 100 kHz are specified for 1.0 V and 10 V ranges only. \*Integration time in power line cycles (PLC). For 5½ digits, multiply counts by 0.1. For 4½ digits, multiply counts by 0.01.

### Resistance (2 W Ω, 4 W Ω, 2 W OC Ω, 4 W OC Ω)

Range	Maximum Reading (5½ digit)	Resolution			Current Through Unknown
		6½ digit	5½ digit	4½ digit	
100 Ω	119.999 Ω	100 µΩ	1 m Ω	10 m Ω	1 mA
1 k Ω	1199.99 Ω	1 m Ω	10 m Ω	100 m Ω	1 mA
10 k Ω	11.9999 k Ω	10 m Ω	100 m Ω	1 Ω	100 µA
100 k Ω	119.999 k Ω	100 m Ω	1 Ω	10 Ω	50 µA
1 M Ω	1199.99 k Ω	1 Ω	10 Ω	100 Ω	5 µA
10 M Ω	11.9999 M Ω	10 Ω	100 Ω	1 k Ω	500 nA
100 M Ω	119.999 M Ω	100 Ω	1 k Ω	10 k Ω	≤ 500 nA <sup>1</sup>
1 G Ω	1000.00 M Ω	1 k Ω	10 k Ω	100 k Ω	≤ 500 nA <sup>1</sup>

<sup>1</sup>Ω source is a 500 nA current source in parallel with a 10 MΩ resistance.

Measurement accuracy: ± (% of reading + number of counts).

RANGE	24 hours: 23° C ± 1° C		90 days: 23° C ± 5° C	
	6½ digit (≥ 10 PLC)	6½ digit (1 PLC)	6½ digit (≥ 10 PLC)	6½ digit (1 PLC)
100 Ω	0.003 + 24	0.003 + 32	0.004 + 24	0.004 + 32
1 k Ω	0.002 + 4	0.003 + 5	0.003 + 4	0.004 + 5
10 k Ω	0.002 + 4	0.003 + 5	0.003 + 4	0.004 + 5
100 k Ω	0.002 + 2	0.003 + 3	0.003 + 2	0.004 + 3
1 M Ω	0.006 + 2	0.006 + 3	0.007 + 2	0.007 + 3
10 M Ω	0.041 + 2	0.041 + 3	0.042 + 2	0.042 + 3
100 M Ω	1.3 + 1	1.3 + 1	1.8 + 1	1.8 + 1
1 G Ω	11 + 1	11 + 1	16 + 1	16 + 1

### Ratio

Type: dc/dc, ac/dc, or (ac + dc)/dc  
 Method: 4-wire with Volts Lo input common  
 Ratio =  $\frac{\text{Signal Voltage}}{\text{Ref. Hi Voltage} - \text{Ref. Lo Voltage}}$

### Reading Rate

Integration Time In Power Line Cycles (PLC)	Rates (rdgs/second)			
	Auto Zero Off		Auto Zero On	
	60 Hz	50 Hz	60 Hz	50 Hz
0.01 (4½ digit)	330	290	210	180
0.10 (5½ digit)	210	180	120	100
1.00 (6½ digit)	48	40	25	20
10.00 (8½ digit)	5.8	4.8	2.9	2.4
100.00 (8½ digit)	57	.47	.29	.24

### Memory

Reading store: Store up to 350 readings  
 Program memory: Can execute an internal program that controls instrument configuration and measurement sequence

### General

Operating temperature: 0 to 50° C  
 Humidity Range: 95% R.H., 0 to 40° C  
 Power: 100, 120, 220, 240 V +5%, -10%, 48 Hz to 400 Hz line operation, 45 VA max  
 Size: 88.9 mm H × 425.5 mm W × 527.1 mm D (3½ in × 16¾ in × 20¾ in)  
 Weight: Net, 10.49 kg (23.13 lb); shipping, 13.35 kg (29.43 lb)

### Ordering Information

HP 3456A Digital Voltmeter \$5,695  
 Opt 050: Noise rejection for 50 Hz \$0  
 Opt 060: Noise rejection for 60 Hz \$0  
 Opt W30: 3-year hardware support. See page 671. +\$120

- 5½/6½-digit DVM with auto cal
- High-speed 3½-digit system voltmeter



HP 3437A

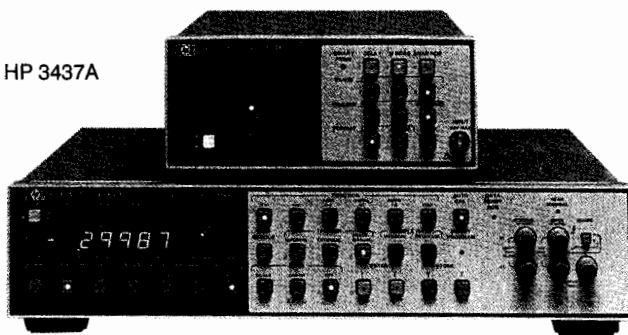

HP 3455A

### HP 3437A Multimeter

The HP 3437A Voltmeter is designed for systems. It is a 3½-digit, high-speed dc voltmeter with sample and hold. The HP 3437A measures dc volts, provides trigger delay, burst reading capability, and the Hewlett-Packard Interface Bus (HP-IB).

There are three dc floating input ranges: 0.1V, 1.0V, and 10.0V full-scale with a maximum display of "1998." Sample and Hold allow the HP 3437A to be an instantaneous reading voltmeter. The trigger delay can be set from 0.1µs to 1.0 second, and the number of readings can be set from 0 to 9999.

#### Specifications

**Static accuracy (90 days, 23° C ± 5° C)**

**10 V range:** ± (0.05% of reading + 1.6 counts)

**Static accuracy temperature coefficient (0° C to 50° C):**  
± (0.002% reading + 0.05 counts) / °C

#### Input Characteristics

**10 V range:** R = 1 M Ω ± 20%; C < 75 pF

**Maximum input voltage high to low on all ranges:** < ± 30 V peak

**Maximum voltage low to chassis:** ± 42 V peak

**Maximum reading rate (remote, N Rdgs. > 1, and a zero delay listener)**

**ASCII:** 3600 readings/sec

**Packed:** 5700 readings/sec

**Input Bandwidth (3 dB) 1 V and 10 V range:** 1.0 MHz

#### General

**Operating temperature:** 0 to 55° C

**Storage temperature:** -40° C to 75° C

**Humidity range:** < 95% R.H., 0° C to 40° C

**Power:** 100 V, 120 V, 220 V, 240 V + 5%, -10%, 48 Hz to 440 Hz line operation, < 42 VA

**Size:** 88.9 mm H × 212.7 mm W × 527.1 mm D (3½ in × 8½ in × 20¾ in)

**Weight:** Net, 5.6 kg (12.3 lb); shipping, 7.6 kg (16.8 lb)

#### Ordering Information

**HP 3437A System Voltmeter**

**Opt W30** Extended repair service. See page 671.

#### Price

\$4,395

+ \$95

### HP 3455A Multimeter

The HP 3455A Digital Voltmeter is a 5½- to 6½-digit integrating voltmeter for bench or systems applications. The HP 3455A measures dc volts, ac volts, and resistance. HP-IB and auto or manual ranging are included.

dc measurements can be made with up to 1µV sensitivity. Resistance can be measured in either a 2-wire or 4-wire mode. The high-resolution (6½-digit) mode gives dc and Ω measurements with more than 1-part-per-million resolution. The standard true rms ac-to-dc converter measures sinusoid and complex signals with crest factors of up to 7:1 at full scale from 30 Hz to 1 MHz.

#### Specifications

##### dc Voltage

**Accuracy** ± (% of reading + counts), 6½-digit mode

24 hours: 23° C ± 1° C		
Range	24 Hours	90 Days
1 V	0.003 + 4	0.006 + 4
10 V	0.002 + 3	0.005 + 3
100 & 1000 V	0.004 + 3	0.007 + 3

**Input resistance:** 0.1 V through 10 V range: > 10<sup>10</sup> Ω; 100 V and 1000 V range: 10 megohm ± 0.1% with Auto Cal. "off"

**Maximum input voltage:** High to low input terminals: ± 1414 V peak; guard to chassis: ± 500 V peak; guard to low terminal: ± 200 V peak

**NMR at 50 or 60 Hz ± 0.1%:** > 60 dB

**ECMR with 1 kΩ unbalance in low lead at dc:** > 160dB

##### ac Voltage (rms converter)

##### Input Impedance

**Front terminals:** 2 M Ω ± 1% shunted by less than 100 pF

**Rear terminals:** 2 M Ω ± 1% shunted by less than 75 pF

##### Maximum input voltage

High to low terminals: ± 1000 volts RMS; 10<sup>7</sup> VHz max

Guard to chassis: ± 500 V peak; guard to low terminal: ± 200 V peak

**Crest factor:** 7:1 at full scale

**Accuracy:** ± [% of reading + counts] (ac coupled)

Fast acV	300 Hz to 20 kHz	20 kHz to 100 kHz	100 kHz to 250 kHz	250 kHz to 500 kHz	500 kHz to 1 MHz
	acV				
90 days					
23° C ± 5° C	0.05 + 50	0.50 + 100	2.00 + 250	5.00 + 500	6.00 + 3100

##### Resistance

**Accuracy** ± (% of reading + counts) 4-wire, 6½-digit mode

24 hours: 23° C ± 1° C		
Range	24 Hours	90 Days
1 k Ω	0.0025 + 4	0.0035 + 5
10 k Ω	0.0045 + 4	0.0060 + 5
100 k Ω	0.0020 + 5	0.0035 + 6
1000 k Ω	0.0120 + 4	0.0135 + 5
10,000 k Ω	0.1000 + 4	0.1000 + 5

##### Maximum Readings per Second for Remote Operations

Function	50 Hz	60 Hz
dcV	22	24
Ω	11	12
acV (rms)	1.1	1.3
Fast acV (rms)	12	13

#### General

**Power:** 100, 120, 240 V + 5% -10%, 48 to 400 Hz; < 60 VA

**Size:** 88.9 mm H × 425.5 mm W × 527.1 mm D (3.5 in × 16.75 in × 20.75 in)

**Weight:** net, 9.38 kg (20.7 lb); shipping, 11.8 kg (26 lb)

#### Ordering Information

**HP 3455A Digital Voltmeter**

**Opt 001** Average converter

#### Price

\$7,295

- \$97

# DIGITAL MULTIMETERS

Bench, General Purpose, and Wide Bandwidth  
HP 3466A/3400A

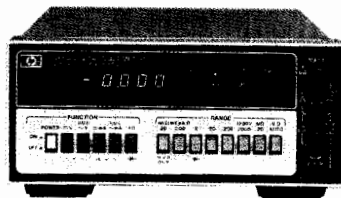

HP 3466A

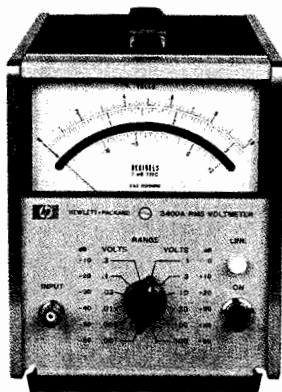

HP 3400A

## HP Model 3466A

The HP 3466A is a 4½-digit autoranging multimeter offering six functions: ACV, DCV, ACI, DCI, Ohms, and Diode Test. ACV and ACI measurements are true rms with selectable ac or dc coupling. Available with rechargeable batteries, it offers 1  $\mu$ volt and 1 mOhm sensitivity with zero adjustment on the lowest ranges to compensate for external offsets.

## Specifications

### dc Voltage

Range	Maximum Display	Accuracy: 1 year. 15 to 30° C $\pm$ (% of reading + # of counts)
20 mV	$\pm$ 19.999	0.05 + 3
200 mV	$\pm$ 199.99	0.04 + 2
2 V	$\pm$ 1.9999	0.03 + 1
20 V	$\pm$ 19.999	0.03 + 1
200 V	$\pm$ 199.99	0.035 + 1
1200 V	$\pm$ 1199.9	0.035 + 1, < 700 V input
1200 V	$\pm$ 1199.9	0.055 + 1 > 700 V input

### ac Voltage (true rms responding, true rms calibrated)

Frequency Range	Accuracy: 1 year. 15 to 30° C $\pm$ (% of reading + # of counts)
20 to 30 Hz	2 + 50
30 to 50 Hz	1 + 30
50 Hz to 10 kHz	0.3 + 20
10 to 20 kHz	1 + 40
20 to 100 kHz	2 + 150

**Maximum Input:** (ac+dc)V:  $\pm$  1200 Vdc, 1700 V (dc + peak ac); acV:  $\pm$  600 V dc, 1700 V (peak ac + dc); 10<sup>7</sup> volt-Hz max  
**Crest Factor:** 4:1 at full scale

### Resistance

**Ranges:** 20  $\Omega$  to 20 M  $\Omega$  in 7 ranges

**Input Protection:** 250 V or 350 V (dc + peak ac)

Range	Accuracy: 1 year. 15 to 30° C $\pm$ (% of reading + # of counts)
20 to 200 $\Omega$	0.08 + 2
2 k to 200 k $\Omega$	0.03 + 1
2000 k $\Omega$	0.04 + 1
20 M $\Omega$	0.15 + 1

### Current

**Maximum Input:** Current: 2 A (fused protected). Voltage: 250 V

### DC Current

Range	Accuracy: 1 year. 15 to 30° C $\pm$ (% reading + # counts)
200 $\mu$ A, 2mA, 20mA	0.07 + 2
200 mA	0.15 + 2
2000 mA	0.5 + 2

### AC Current

Range	Frequency	Accuracy: 1 year. 15 to 30° C $\pm$ (% reading + # counts)
200 $\mu$ A to 200 mA	20 to 30 Hz	2.0 + 50
	30 Hz to 10 kHz	0.9 + 35
2000 mA	20 to 30 Hz	2.0 + 50
	30 Hz to 10 kHz	1.2 + 20

## Ordering Information

**HP 3466A** Digital Multimeter. Standard configuration in a streamlined case with handle, ac-line power, batteries and charger, and test leads.

**Opt 001** Streamlined portable case, ac-line power only

**Opt 002** Rack and Stack case, ac-line power only (Rack mount kit not included)

## Price

\$1,290 ☎

– \$75

– \$10

☎ For off-the-shelf shipment, call 800-452-4844.

## HP Model 3400A

The HP 3400A is a true rms analog voltmeter. Six-decade frequency coverage makes the HP 3400A extremely flexible for audio and RF measurements up to 10 MHz and permits the measurement of broadband noise and fast rise-time pulses.

Pulses or other nonsinusoids with crest factors up to 10:1 can be measured full scale. Plots of measured data and higher resolution measurements can be produced by connecting a DMM to the convenient rear-panel dc output that produces a linear 0 to 1 volt output proportional to the meter deflection.

## Specifications

**Voltage range:** 1 mV to 300 V full scale, 12 ranges

**dB Range:** –72 to +52 dBm (0 dBm = 1 mW into 600  $\Omega$ )

**Frequency range:** 10 Hz to 10 MHz

**Response:** Responds to the RMS value (heating value) of the input signal for all waveforms

**Meter accuracy:** % of full scale (20 to 30° C)\*

10 Hz	50 Hz	1 MHz	2 MHz	3 MHz	10 MHz
5%	1%	2%	3%	3%	5%

**ac to dc converter accuracy:** % of full scale (20 to 30° C)

10 Hz	50 Hz	1 MHz	2 MHz	3 MHz	10 MHz
5%	0.75%	2%	3%	3%	5%

\* Temperature Coefficient: 0.1% from 0 to 20 and 30 to 55° C

**Crest Factor:** (ratio of peak to rms amplitude of input signal): 10:1 at full scale

**Input impedance:** 0.001 V to 0.3 V range: 10 M  $\Omega$  shunted by < 50 pF; 1.0 V to 300 V range: 10 M  $\Omega$  shunted by < 20 pF, ac coupled input.

**Output:** Negative 1 V dc into open circuit at full-scale deflection, proportional to meter deflection from 10 to 100% of full scale. 1 mA maximum; nominal source impedance is 1 k  $\Omega$ . Output noise is < 1 mV rms.

**Accessories furnished:** 10110A adapter, BNC-to-dual banana jack.

## Ordering Information

**HP 3400A** RMS Voltmeter

**Opt 001** Expands the dB scale by placing it on the top of the meter

Rear terminals in parallel with front terminals and linear log scale uppermost on the meter face are available on special order.

**Opt S08** Extends range to 20 MHz

## Price

\$2,195

+ \$60

+ \$200

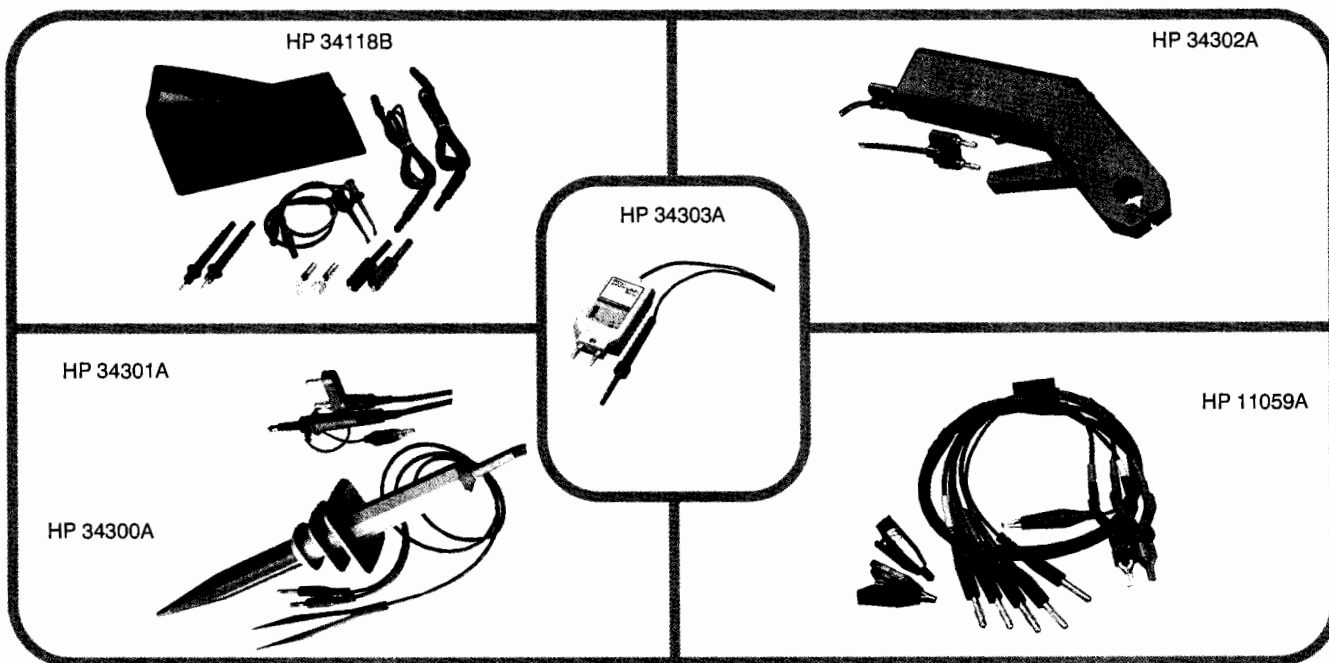

### HP 34301A RF Detector Probe

This probe detects high-frequency signals for voltage measurements. The probe can be used with any DMM having a 10 M  $\Omega$  input.

**Bandwidth:** 100 kHz to 700 MHz

**Voltage range:** 0.25 V to 50 V rms

**Accuracy:** 100 kHz to 500 MHz,  $\pm 1$  dB  
500 MHz to 700 MHz,  $\pm 3$  dB

**Input capacitance:** Approx. 5 pF

**Maximum ac input:** 50 V rms

**Transfer ratio:** 1 Vdc output for 1 V rms input

### HP 34302A Clamp-on ac/dc Current Probe

A clamp-on probe used for measuring ground currents, power supply ripple, or current distribution in systems. This probe allows you to measure ac, dc and ac+dc currents without breaking the circuit.

**Ranges:**  $\pm 10$  A dc or 10 A ac  
 $\pm 100$  A dc or 100 A ac

**Frequency response:** dc to 1 kHz

**Recommended load:**  $> 3.0$  k  $\Omega$

**Rated output:**  $\pm 1.0$  V dc at 10 A  
 $\pm 1.0$  V dc at 100 A

**Aperture size:** 19 mm

**Accuracy:**  $\pm 2\%$  of rated output

### HP 34300A 40 kV ac/dc High-Voltage Probe

A probe for use with any DMM having an input resistance of 10 M  $\Omega$ . Maximum input (at sea level): 40 kV (dc + peak ac), derated 1 percent of voltage rating per 100 meters in rise from sea level.

**Voltage division ratio:** 1000:1

**Bandwidth:** dc to 300 Hz

**Input resistance:** 1 G  $\Omega$

**Division ratio accuracy:**  $\pm 2\%$  (dc, 1000:1, 10 M  $\Omega$  termination)

### HP 11060A Surface Mount Device Test Probe

Designed for SMD testing, the tweezer design of this probe provides an easy method to access and measure SMD-resistive networks. Not to be used over 42 volts peak.

### HP 34303A Temperature Probe

Temperature measurements are read directly in  $^{\circ}$ C or  $^{\circ}$ F on DMMs having a minimum input impedance of 10 k  $\Omega$ . The probe is a temperature-to-voltage transducer with a forward-biased diode providing calibrated linear output. A standard dual banana plug output connector provides universal connection to DMMs. A 9-volt battery is required for operation (not included).

**Temperature range:**  $-58^{\circ}$  to  $302^{\circ}$  F;  
 $-50^{\circ}$  to  $150^{\circ}$  C

**Output:** 10 mV/ $^{\circ}$ C or  $^{\circ}$ F

**Resolution:** 0.01  $^{\circ}$ C or  $^{\circ}$ F

**Accuracy:**  $\pm 3.0^{\circ}$  F;  $\pm 1.7^{\circ}$  C

### HP 11059A Kelvin Probe Set

Works with any DMM with 4-wire ohms. Circuit connection is performed with two gold-plated flat tweezers with special gripping surfaces to ensure precise contact to the components being measured. An alligator clip and lead are provided for either grounding or guarding. Instrument connection is through banana plugs. Not to be used over 42 volts peak.

### Ordering Information

	Price
HP 11002A Test Leads (banana, alligator)	\$22
HP 11003A Test Leads (banana, alligator, and probe)	\$22
HP 11049A 3 V, 5 $\Omega$ Thermal Converter	Contact Factory
HP 11050A 1 V, 50 $\Omega$ Thermal Converter	Contact Factory
HP 11051A 0.5 V, 50 $\Omega$ Thermal Converter	Contact Factory
HP 11053A Low Thermal Lug-Lug Jumper Set	\$29
HP 11058A Low Thermal Banana-Banana Jumper Set	\$29
HP 11059A Kelvin Probe Set	\$135
HP 11060A Surface Mount Device Test Probe	\$24
HP 11062A Kelvin Clip Set	\$26
HP 11096B High-Frequency Probe	\$250
HP 11174A Low-Thermal Lug-Banana Jumper Set	\$29
HP 34110A Carrying Case for 1/2 Rack Size Instruments	\$90
HP 34111A dc High-Voltage Probe	\$280
HP 34118B Test Lead Kit	\$30
HP 34119A High-Voltage Probe	\$130
HP 34300A 40 kV ac/dc High-Voltage Probe	\$90
HP 34301A RF Detector Probe	\$80
HP 34302A Clamp-on ac/dc Current Probe	\$250
HP 34303A Temperature Probe	\$120

☎ For off-the-shelf shipment, call 800-452-4844.

# DIGITAL MULTIMETERS

## 3½-Digit Handheld Multimeters

HP E2373A, E2377A, E2378A

- Excellent standard feature set
- Choice of general-purpose or rugged model
- 0.3% or 0.7% basic DCV accuracy
- 3-year standard warranty on all models
- 3200-count analog/digital display
- All models in stock



HP 2373A, E2377A, and E2378A

### E2300 Series Handheld Multimeters

The HP E2300 Series of handheld multimeters is ideal for portable basic measurements. Standard features on all three models include:

- dc and ac volts, dc and ac current, resistance, audible continuity, and diode test
- Maximum 1 kV dc, 750 V rms, 10 A
- Choice of auto-ranging or manual range hold
- Large 3200-count digital display (samples approx. 2 times/s) with 32-segment analog bar (samples approx 12 times/s)
- Display annunciators for all functions (except temperature on E2377A and E2378A), also for low-battery indication, overload, range hold, and data hold (E2377A and E2378A)
- Built-in tilt stand and three terminal input jacks
- One-year calibration cycle
- Three-year warranty

### Three Models to Choose From

The basic HP E2373A multimeter is ideal for troubleshooting. It offers all the standard features above, along with a basic Vdc accuracy of 0.7 percent. Audible continuity and a choice of auto- or manual ranging make this low-cost meter an excellent choice.

For more exacting tasks, the HP E2377A has a basic Vdc accuracy of 0.3 percent and a 1-kHz bandwidth. It also adds data hold and temperature functions to the solid feature set of the HP E2373A. The temperature function is built in and can be used with any K-type thermocouple probe.

For outside use and rougher applications, the HP E2378A has the same functions and accuracy as the HP E2377A, and is encased in a yellow splash-proof case.

Refer to the following chart to determine which of the three models best suits your needs.

	E2373A	E2377A	E2378A
Basic dc accuracy	0.7%	0.3%	0.3%
Basic ac accuracy	1.2%	1%	1%
Maximum ac bandwidth	500 Hz	1 kHz	1 kHz
Audible continuity and diode test	Yes	Yes	Yes
Data hold function	No	Yes	Yes
Temperature function	No	Yes	Yes
Input protection up to 300 mA range	0.5 A/250 V	0.5 A/250 V	0.5 A/250 V
10 A range	unfused	15 A/250 V	15 A/250 V
Power supply (alkaline batteries)	AA (1.5 V) × 2	AAA (1.5 V) × 2	AAA (1.5 V) × 2
Battery life (minimum)	2500 h	1000 h	1000 h

### Standard Accessories Included

All three meters come with alkaline batteries, spare fuse(s), operating manual, and test leads.

### Always in Stock

All models and accessories are always in stock.

### Additional Accessories

To extend the capability of your handheld multimeter, a variety of accessories are available:

**HP E2301A** Surface Thermocouple Probe, K-type (−130° C to 260° C; accuracy is the greater of ±2.2° C or 0.75 percent of reading.) Note: Must also order E2303A, Thermocouple Probe Adapter.

**HP E2302A** Airflow Thermocouple Probe, K-type (same range and accuracy as E2301A.) Note: Must also order E2303A, Thermocouple Probe Adapter.

**HP E2303A** Thermocouple Probe Adapter (uncompensated, banana to K-type connector). For use with E2377A or E2378A multimeters and any K-type thermocouple probe.

**HP E2304A** Handheld Multimeter Carrying Case (padded, water-resistant nylon case with 2-zipper closing and inside pocket).

**HP E2305A** Replacement Test Leads (right angle), 2-pair.

**HP E2306A** Deluxe Test Lead Kit. Right-angle test leads with four sets of attachable probes: alligator clips, spade lugs, spring-loaded hook tips, and probes. Includes Velcro™-sealed nylon pouch.

For additional multimeter accessories, refer to page 179.

Velcro is a registered trademark of Velcro USA, Intl.

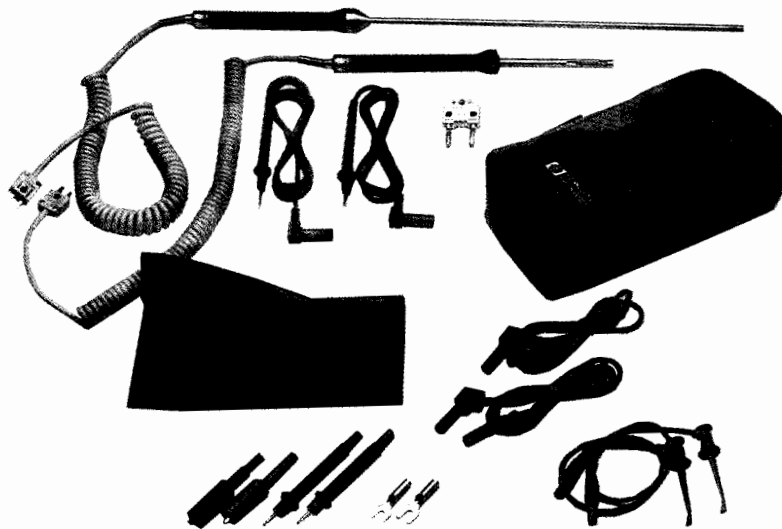

Accessories for handheld multimeters

**Specifications**

23° C ± 5° C, <80% RH

Function	Range	Resolution	Accuracy <sup>1</sup> ± (% rdg + number of digits)	
			E2373A	E2377A E2378A
dc voltage	300 mV	100 μV	0.5% + 2	0.3% + 2
	3 V	1 mV	0.5% + 1	0.3% + 2
	30 V	10 mV	0.5% + 1	0.4% + 1
	300 V	100 mV	0.7% + 1	0.4% + 1
	1000 V	1 V	0.7% + 1	0.4% + 1
ac voltage	3 V	1 mV	1.2% + 4	1.0% + 3 <sup>2</sup>
	30 V	10 mV	1.2% + 4	1.0% + 3 <sup>2</sup>
	300 V	100 mV	1.2% + 4	1.0% + 3 <sup>2</sup>
	750 V	1 V	1.2% + 4	1.0% + 3 <sup>2</sup>
	300 μA	100 nA	—	1.0% + 2
dc current	3 mA	1 μA	—	1.0% + 2
	30 mA	10 μA	1.0% + 2	1.0% + 2
	300 mA	100 μA	1.5% + 2	1.5% + 2
	10 A	10 mA	1.5% + 2	1.5% + 2
	300 μA	100 nA	—	2.0% + 5
ac current	3 mA	1 μA	—	2.0% + 5
	30 mA	10 μA	2.0% + 5	2.0% + 5
	300 mA	100 μA	2.0% + 5	2.0% + 5
	10 A	10 mA	2.0% + 5	2.0% + 5
	Resistance	300 Ω	100 mΩ	0.7% + 2
3 k Ω		1 Ω	0.7% + 1	0.7% + 1
30 k Ω		10 Ω	0.7% + 1	0.7% + 1
300 k Ω		100 Ω	0.7% + 1	0.7% + 1
3 M Ω		1 k Ω	1.5% + 1	0.7% + 1
300 M Ω		10 k Ω	3.0% + 1	2.0% + 1

	E2373A	E2377A	E2378A
Size			
Height	164 mm (6.5 in)	176 mm (6.9 in)	186 mm (7.3 in)
Width	76 mm (3.0 in)	80 mm (3.15 in)	89 mm (3.5 in)
Depth	33 mm (1.3 in)	37 mm (1.4 in)	37 mm (1.4 in)
Net weight	0.27 kg (0.58 lb)	0.34 kg (0.75 lb)	0.45 kg (0.99 lb)

**Ordering Information**

	<b>Price</b>
<b>HP E2373A</b> Multimeter	(1 ea) \$99
	(2 to 5) \$96
	(6 to 9) \$94
	(10+) \$93
<b>HP E2377A</b> Multimeter	(1 ea) \$169
	(2 to 5) \$164
	(6 to 9) \$161
	(10+) \$159
<b>HP E2378A</b> Multimeter	(1 ea) \$189
	(2 to 5) \$183
	(6 to 9) \$180
	(10+) \$178
<b>HP E2301A</b> Surface Thermocouple Probe	\$120
<b>HP E2302A</b> Airflow Thermocouple Probe	\$75
<b>HP E2303A</b> Thermocouple probe Adapter	(1 ea) \$12
	(2+) \$10
<b>HP E2304A</b> Handheld Multimeter Carrying Case	\$19
<b>HP E2305A</b> Replacement Test Leads, 2 pair	\$15
<b>HP E2306A</b> Deluxe Test Lead Kit	0

☎ For off-the-shelf shipment, call 800-452-4844.

**Input resistance (dc voltage):** 300 mV range > 1000 M Ω  
 3 V range 11 M Ω  
 30 to 1 kV ranges 10 M Ω

**Maximum input:** 1000 Vdc or 750 Vac rms

**Continuity check:** 300 Ω range; approx 20 Ω threshold

**Temperature test:** -20° C to 700° C with 1° resolution (not E2373A)

**Diode test:** 0.6 mA test current, ±(3% + 2 mV) accuracy

<sup>1</sup> One digit corresponds to the range's resolution.

<sup>2</sup> 40 to 500 Hz range.

# ELECTRONIC COUNTERS

## General Information

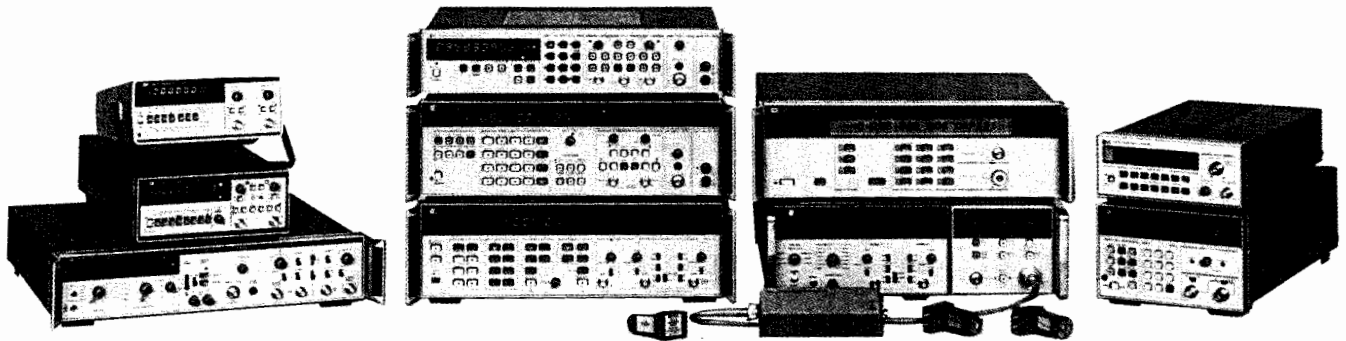

The Hewlett-Packard counter family includes a broad selection of frequency and time-interval measurement options and a selection of Modulation Domain Analyzers for advanced measurement and analysis requirements.

### Electronic Counters

Hewlett-Packard offers the industry's broadest line of electronic counters and counter/timers: 29 models. Starting with the first frequency-measurement projects in the 1940s, Hewlett-Packard has pioneered the major technologies enabling today's electronic counters and modulation domain analyzers.

Electronic counter/timers are used throughout most technical industries for measuring and analyzing frequency, phase, and time-interval signal characteristics. The breadth of the HP offering allows the best product to be selected for each application. An ideal functional and performance fit delivers the greatest value: the best and most cost-effective solution.

HP counter/timers offer:

- High measurement accuracy
- Fast system throughput/HP-IB capability
- Low cost of ownership
- Ease of use
- Data reduction on many models
- Triggering simplicity

### Product Line Additions

Following a tradition of technology innovations, HP adds to the counter/timer product line each year. This year, customers can take advantage of two new modulation domain analyzers.

The HP 53310A combines ease of use and attractive pricing to bring frequency and time measurement capabilities to an expanding range of applications.

The HP 5373A Modulation Domain Pulse Analyzer is tuned for complex signal modulations, especially pulsed and non-repetitive signals. To minimize design and testing efforts for military, air traffic, marine, weather, and space-based radar systems, the HP 5373A analyzes agile carriers, staggered PRI, chirp, phase coding, and similar modulations.

In addition to the new products, an enhanced HP 5372A offers Fast Fourier Transform (FFT) capability. The new HP 5372A option eliminates computer-aided processing to perform these complex tasks.

For more information on the modulation domain analyzer products, see the section starting on page 184.

### Counter Products Basic and High-Performance Universal Counters

Universal counters, also called counter/timers, offer the ability to measure frequency and time intervals. Many models measure period, ratio, statistics, voltage, and totalize. Higher-performance products provide complete, automatic characterization of rise time, pulse width, and other signal parameters. Many options, such as frequency extension, voltage measurement, portable battery operation, higher performance timebases, and systems capability (HP-IB), are also available to customize the product to your specific needs.

- **HP 5314A:** An affordable portable.
- **HP 5315A:** The high-performance portable.
- **HP 5316B:** The low-cost systems counter.
- **HP 5334B:** High performance at a moderate price.
- **HP 5335A:** Top performance in universal counters.

### Precision Time Interval Counter

The HP 5370B universal time interval counter is optimized for precision time-interval measurements and offers time-interval resolution of 100 ps rms. It measures frequency and period (with increased accuracy per unit time compared to other counters) from dc to 100 MHz. Statistics, external trigger, systems interface (HP-IB), and other features are all standard.

- **HP 5370B:** The standard for precision time-interval measurements.

### Basic RF Frequency Counters

These low-cost products provide frequency measurements dc to 3 GHz for bench and systems. HP-IB is standard. The reciprocal (high-accuracy) measurement technique is used; battery and extended-accuracy time-base are available.

- **HP 5384A:** The economical counter for systems and field service.
- **HP 5385A:** The medium-frequency, affordable, systems and field service counter.
- **HP 5386A:** The high-end (3 GHz) compact RF counter.

### Microwave and Millimeter-Wave Frequency Counters

These products provide fundamental high-performance frequency measurements, dc to 110 GHz. Many enhancements—power measurement, battery operation, systems interface (HP-IB), and high-accuracy time bases—are available standard or as options.

Pulse counters add the capability to automatically measure and profile burst or pulsed microwave or millimeter-wave signals.

- **HP 5361B:** Profiles pulsed/CW microwave frequencies.
- **HP 5347A/5348A:** Portable CW microwave counter plus power meter for telecommunications service.
- **HP 5350B/5351B/5352B:** CW microwave, 10 Hz to 46 GHz.

### Mature Products

For information on the mature HP counter products see pages 208 and 209.



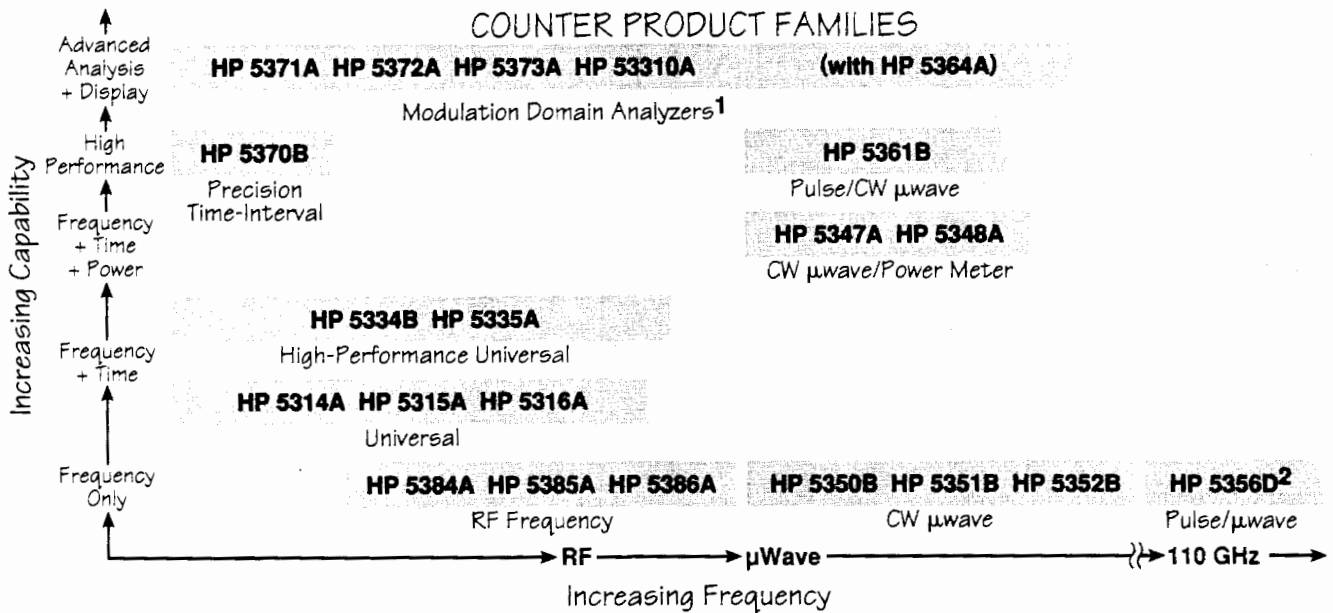

**Counter Selection Guide<sup>3</sup>**

Model	Frequency Range (Extension)	Freq. Resolution (1 s Gate Time)	Sensitivity	Time-Interval Res. (Single-Shot/Averaging)	Additional Features	Page	Price
<b>Universal Counters</b>							
HP 5314A	100 MHz	1 Hz	25 mV	100 ns	Battery optional	191	\$795
HP 5315A	100 MHz (1 GHz)	7 digits	10 mV	100 ns/10 ps	Battery optional	192	\$1,425
HP 5316B	100 MHz (1 GHz)	7 digits	10 mV	100 ns/10 ps	HP-IB standard	192	\$1,755
<b>High-Performance Universal Counters</b>							
HP 5334B	100 MHz (1.3 GHz)	9 digits	15 mV	2 ns/200 ps	HP-IB standard, auto pulse characterization	194	\$2,305
HP 5335A	200 MHz (1.3 GHz)	9 digits	25 mV	2 ns/100 ps	HP-IB standard, dc DVM optional, auto pulse characterization	196	\$5,250
<b>Precision Time-Interval Counter</b>							
HP 5370B	100 MHz	11 digits	35 mV	100 ps/0.3 ps	HP-IB standard, statistics	198	\$16,100
<b>RF Frequency Counters</b>							
HP 5384A	225 MHz	9 digits	15 mV		HP-IB standard, battery optional	200	\$1,650
HP 5385A	1 GHz	9 digits	15 mV		HP-IB standard, battery optional	200	\$2,075
HP 5386A	3 GHz	9 digits	-33 dBm		HP-IB standard	200	\$3,950
<b>CW Microwave Counters</b>							
HP 5350B	20 GHz	1 Hz	-40 dBm		HP-IB standard, MATE optional	202	\$5,700
HP 5351B	26.5 GHz	1 Hz	-40 dBm		HP-IB standard, MATE optional	202	\$6,850
HP 5352B	40 GHz (46 GHz)	1 Hz	-30 dBm		HP-IB standard, MATE optional	202	\$11,000
<b>CW Microwave Counter/Power Meters</b>							
HP 5347A	20 GHz	1 Hz	-32 dBm		HP-IB optional, battery optional, -70dBm to +20 dBm power range	204	\$8,350
HP 5348A	26.5 GHz	1 Hz	-32 dBm		HP-IB optional, battery optional, -70 dBm to +20 dBm power range	204	\$9,375
<b>Pulsed/CW Microwave Counter</b>							
HP 5361B	20 GHz	1 Hz	-32 dBm		HP-IB standard, MATE optional, full microwave pulse measurements, automatic pulse profiling	206	\$11,900

1. Information on the modulation domain analyzers starts on the next page.  
 2. For frequencies above 46 GHz, see the HP 5356D on page 209.  
 3. See pages 208-209 for information about mature products. For modular counters, see the VXI products on page 87.  
 ☎ For off-the-shelf shipment, call 800-452-4844.

# ELECTRONIC COUNTERS

## General Information

### Modulation Domain Analysis: A New View of Complex Signals

As a pioneer of counter/timer technology, Hewlett-Packard recognized a need to expand traditional frequency and time measurement techniques. With modulation domain analyzers, HP offers a unique method for viewing complex signals that is both intuitive and insightful.

Oscilloscopes display amplitude (voltage) versus time: the time domain. Spectrum analyzers show amplitude versus frequency: the frequency domain. The HP 53310A, HP 5371A, HP 5372A, and HP 5373A bring a new dimension to frequency and time-interval analysis with views of the modulation domain:

- Frequency versus time
- Phase versus time
- Time interval versus time

### Improved Measurement Analysis

A wide range of applications benefit from modulation domain analysis. Jitter measurements in digital communication systems, disk and tape drives, and mechanical systems are dramatically improved. Identify the sources of jitter — the first step in improving system performance.

Modulation domain analyzers simplify the study of step response for voltage-controlled oscillators (see Figure 1). They easily characterize the frequency-hopping performance of an agile transmitter. Chirp linearity and phase switching in radar systems are easily understood from displays of frequency or phase versus time.

For more examples of applications that benefit from modulation domain analysis, see the next section which covers the specific HP modulation domain analysis products.

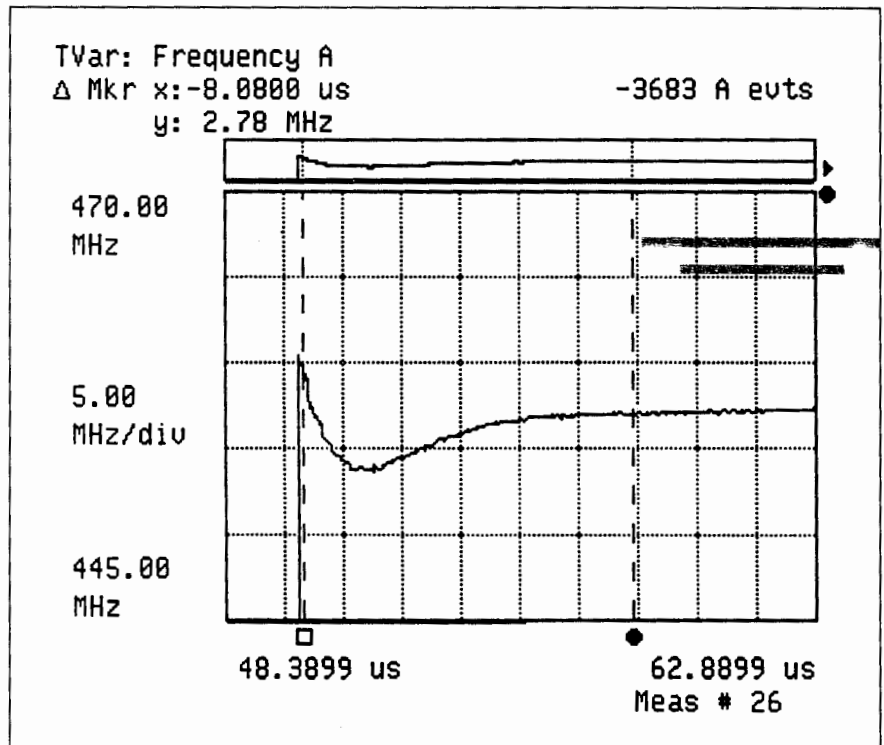

Figure 1. Modulation domain analyzers plot frequency versus time for a range of applications including the simplified, direct characterization of voltage-controlled oscillators. View the step response and analyze ringing and overshoot, settling time, and post-tuning drift.

### Application Details

Discover new ways to view signals — new perspectives for solving elusive problems or fine-tuning product performance. Contact

your local sales office for a demonstration of an HP modulation domain analyzer, or request the application notes that describe this breakthrough measurement technique.

### Modulation Domain Analyzer Selection Guide

Model	Frequency Range (Extension)	Single-Shot Freq. Res. (1s Gate)	Time-Interval Resolution (Single-Shot/Averaging)	Maximum Continuous Meas. Rate (Meas/s)	Memory Size	Output Meas/s	Analysis and Display	Page	Price
HP 5371A	500 MHz (18 GHz) <sup>1</sup>	10 digits	150 ps/1 ps	10×10 <sup>6</sup>	1000	HP-IB: to 20,000	Frequency and time vs. time Software histogram Event timing graph Numeric display	189	\$24,500
HP 5372A	500 MHz (2 GHz) (18 GHz) <sup>1</sup>	10 digits	150 ps/1 ps	14×10 <sup>6</sup>	8000	HP-IB: to 20,000 Fast Port: to 14×10 <sup>6</sup>	As 5371A plus: Hardware histogram Frequency and time vs. time average Pre-triggering Time dev. (jitter) Phase deviation Window Margin Analysis	189	\$30,000
HP 5373A	500 MHz (2 GHz) (18 GHz) <sup>1</sup>	10 digits	150 ps/1 ps	14×10 <sup>6</sup>	8000	HP-IB: to 20,000 FastPort: to 14×10 <sup>6</sup>	As 5372A plus: Frequency, phase, and time vs. time Pulse carrier frequency Chirp deviation Pulse width, PRI, PRF Peak power, % AM	189	\$32,000
HP 53310A	200 MHz (2.5 GHz) (18 GHz) <sup>1</sup>	10 digits	200 ps	2.5×10 <sup>6</sup>	8000 (32,000 w/Opt 001)	HP-IB: to 20,000	Frequency and time vs. time Autoscale (setup) Large display Jitter analysis Softkeys, menus Simple triggering	190	\$9,500

<sup>1</sup> Requires HP 5364A.

# ELECTRONIC COUNTERS

## Modulation Domain Analyzers

HP 5371A, 5372A, 5373A, 53310A

185

- Characterize frequency, phase, and time-interval versus time
- Fast time-interval histogram analysis

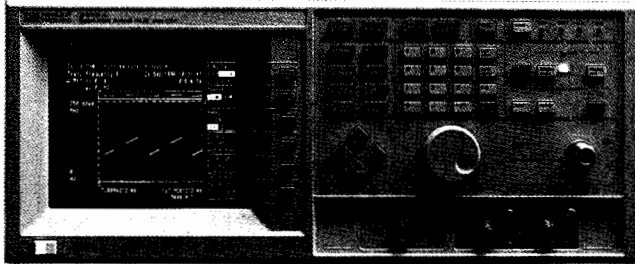

- 150 ps rms single-shot resolution, 2 ps resolution with averaging
- Choice of products to fit project requirements and budgets

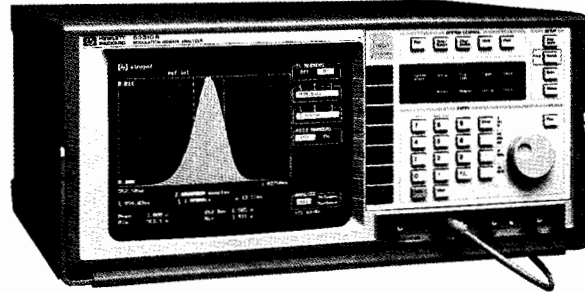

### The Modulation Domain: Viewing Complex Signals

Hewlett-Packard frequency and time-interval analyzers offer a view of information that traditional measurement techniques miss. The modulation domain — mapping frequency, phase, or time-interval vs. time — can more effectively characterize:

- Data storage products
- Radar systems
- Communication systems
- Electromechanical systems
- Frequency stability
- VCOs
- Frequency agile systems

This new view of data is intuitive and offers a direct view of jitter or modulation. The HP modulation domain analyzers provide insight into changes of frequency or time intervals.

### A Choice of Solutions

Choose from four HP modulation domain analyzers based on your project requirements.

### Affordability and Ease of Use

The most affordable modulation domain analyzer, the HP 53310A, includes many innovations for ease of use. Characterization of modulation and jitter is easier with built-in analysis. Parameters such as peak-to-peak deviation, carrier frequency, and modulation rate are all quickly and automatically displayed. Jitter analysis is simplified with automated mean, standard deviation, and probability functions.

### Measurement Versatility

In addition to offering expanded functionality, the HP 5371A and HP 5372A can analyze signals ranging up to 500 MHz, or (with an optional configuration of the HP 5372A) up to 2 GHz. Up to eighteen measurement functions and increased display modes offer the versatility to handle a broad range of situations. With a new hardware option, the HP 5372A can compute and display a spectral presentation of jitter data without the need for an external computer or special processor.

Based on the same technology, the HP 5372A is a superset of the HP 5371A. Choose the lower-priced HP 5371A or more powerful HP 5372A based upon your project constraints.

### Pulsed Systems Design and Analysis

The HP 5373A Modulation Domain Pulse Analyzer minimizes the design and testing effort for radar systems, and enhances design efforts for EW, ELINT, IFF, and related equipment and components. The analyzer measures modulation and carrier frequency on pulsed RF signals to 500 MHz. A detector channel can precisely measure envelope parameters such as pulse width and PRT, peak envelope power, percent AM, jitter, and more. The HP 5373A is easy to use and attractively priced compared to specialized or home-grown test sets used for radar and related advanced systems design.

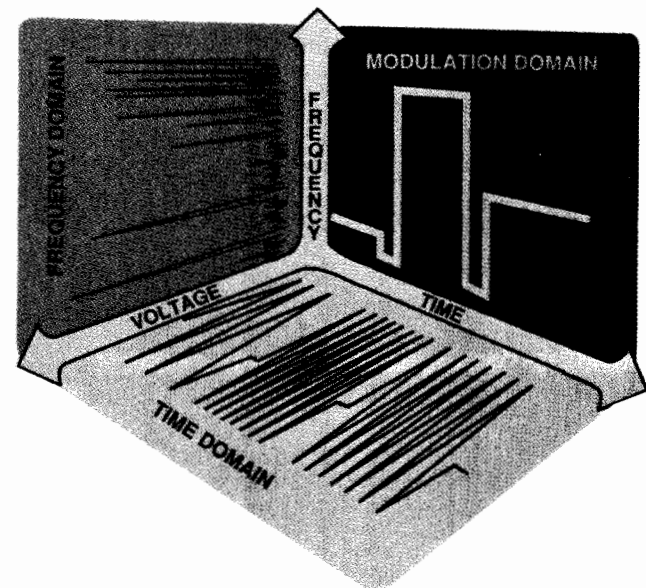

# ELECTRONIC COUNTERS

## Modulation Domain Analyzers

HP 5371A, 5372A, 5373A, 53310A

### Measurement Solutions

#### Window Margin Analysis for Disk and Tape Drive Characterization

The HP 5372A features hardware data reduction to sort time-interval measurements into histograms as fast as 13.3 million measurements per second. Analyze data from a histogram, or have the HP 5372A display window margin information directly. These are fast and accurate methods of viewing a drive's overall timing performance in research and development or in production.

Use the time-interval detect capability of the HP 5372A to monitor for timing errors. An inhibit input can gate out sector header, ECC, and servo fields to measure only in data fields.

The HP 5372A can measure data-to-data as fast as every 75 ns. For faster systems, a random event sampling mode ensures that histogram information is equally sampled across all code spacings.

#### Direct VCO Characterization with Frequency Versus Time Displays

Voltage-controlled oscillators are a key component in many electronic systems. VCO switching and settling characteristics directly affect total system performance. Switching and settling measurements have traditionally been made using discriminators and a storage oscilloscope, but the modulation domain simplifies this characterization by directly showing frequency or phase settling versus time. View the step response and easily characterize ringing and overshoot, settling time, and post-tuning drift. The optional 2-GHz Channel C on the HP 5372A or HP 53310A extends VCO analysis to cover 100-MHz to 2-GHz frequency steps. The HP 5364A Microwave Mixer/Detector lets you analyze VCO's operating between 2 GHz and 18 GHz.

#### Modulation Analysis for Mobile Communications

Mobile communications systems employ a variety of techniques to transmit data over crowded airways. Digital frequency modulation (MSK or GMSK) efficiently encodes data, and time multiplexing (TDMA) techniques increase the number of users on each frequency, but the resulting signals are short bursts with complex characteristics. The HP 53310A simplifies the analysis of these signals in real time and provides a direct profile of modulation in a single TDMA burst. Peak deviation, center frequency, and bit intervals are quickly verified using measurement markers.

Other cellular telephone systems are similarly challenging. They depend on frequency switching to select the correct carrier channel and to minimize multipath fading effects. The HP 53310A can verify switching times and overshoot of the VCOs and frequency synthesizers that control these operations. A direct frequency profile of channel switching is provided on an easy-to-interpret display.

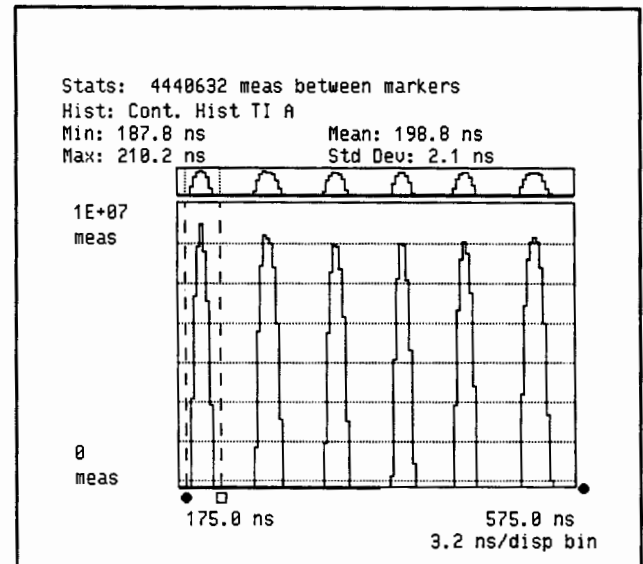

Flexible graphic capabilities let you retrieve statistical information for any single distribution of this RLL (2,7) histogram.

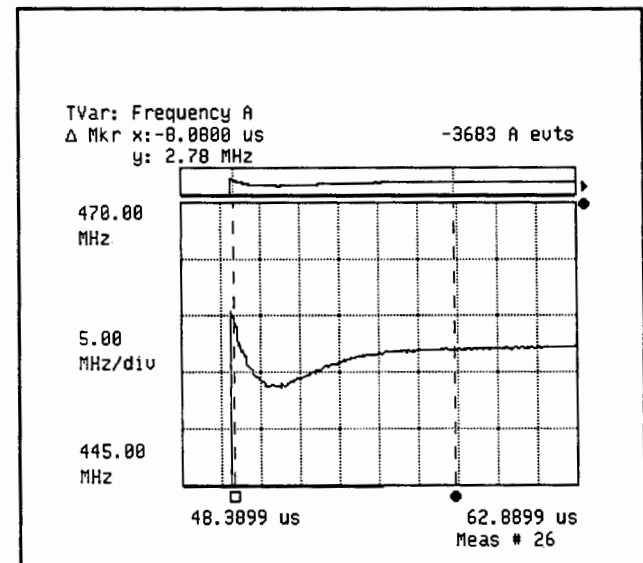

A plot of frequency vs time simplifies VCO switching and post-tuning drift analysis.

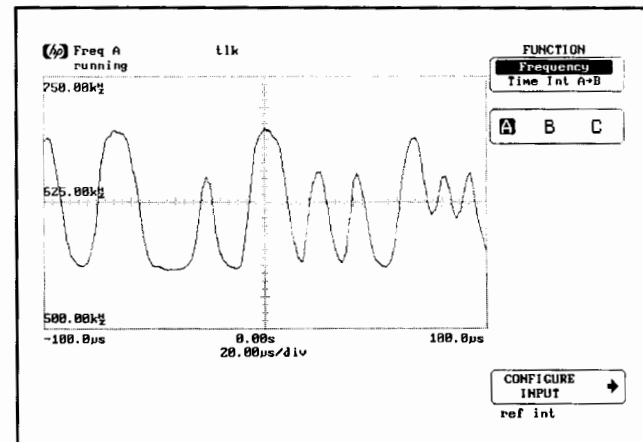

Examine complex modulation in advanced mobile communications systems such as GSM Pan-European Digital Cellular. The HP 53310A provides a direct frequency vs. time profile of GMSK modulation in a single TDMA burst.

## Flexible Jitter Spectrum Analysis for Digital Communications

The HP 5371A and HP 5372A frequency and time-interval analyzers can be used to characterize jitter or phase noise in digital communications, oscillators, and other serial data systems. The HP 5371A measures and displays the variations of period jitter with time or in a histogram. The HP 5372A adds the capability to display jitter as the variation of the significant instants from the ideal timing position (the time deviation function).

With the new Jitter Spectrum Analysis feature (Option 040) of the HP 5372A, jitter spectrum measurements are possible with higher resolution than current jitter test sets. Any clock rate, including nonstandard rates, can be accommodated or measurements made without the presence of a clock. The jitter bandwidth can exceed 2 MHz. The Jitter Spectrum Analysis option is ideal for characterizing the phase noise performance of low-cost oscillators and synthesizers. This new option of the HP 5372A eliminates the need for an external computer for analysis.

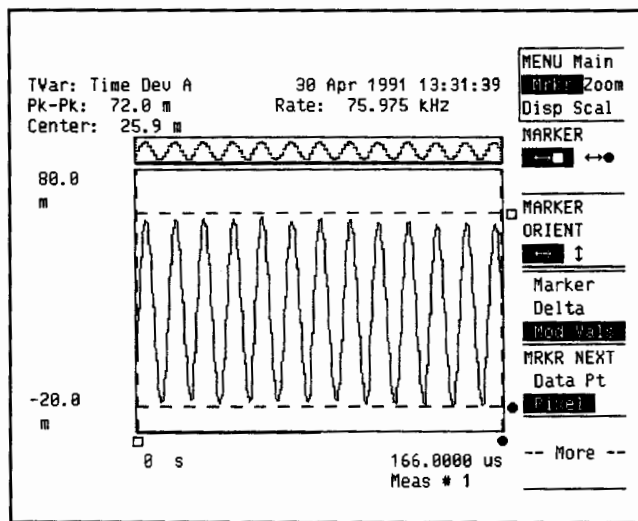

Jitter as a function of time. A strong periodic component is shown in this jitter vs. time graph. The rate of the jitter and the peak-to-peak jitter are displayed in Unit Intervals.

## A Clear Picture of Agile Signals

Characterization of agile transmitters is difficult in the time or frequency domains. Pseudo-random selection of the carrier means repetitive techniques are inadequate to properly characterize an agile radio's performance. "Golden receiver" or back-to-back testing, where transmitters and receivers are tested in pairs, yield little quantitative information about the radio's performance.

The modulation domain provides a clear view of these agile signals. Parameters such as dwell time, hop rate, and carrier settling time can be obtained from the graphic display. Modulation parameters such as peak-to-peak deviation, center frequency, and modulation rate can be easily displayed.

A histogram of frequencies is a clear measure of random usage of the frequency spectrum. Flat histogram characteristics indicate when channels are used with equal probability, providing the highest resistance to jamming and communication security.

- Direct frequency vs. time profiles of agile signals
- Characterize switching time, settling time, and hopping rate
- Examine modulation on agile carriers

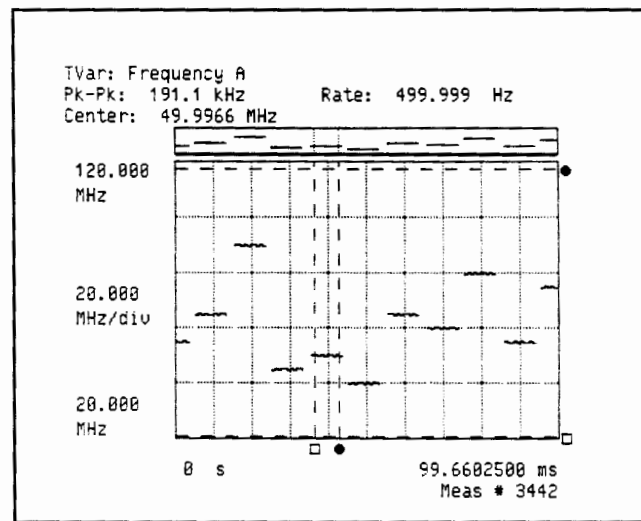

In addition to dwell time and hop sequence, the modulation characteristics on the agile carrier can easily be examined using the HP 5373A time variation graph.

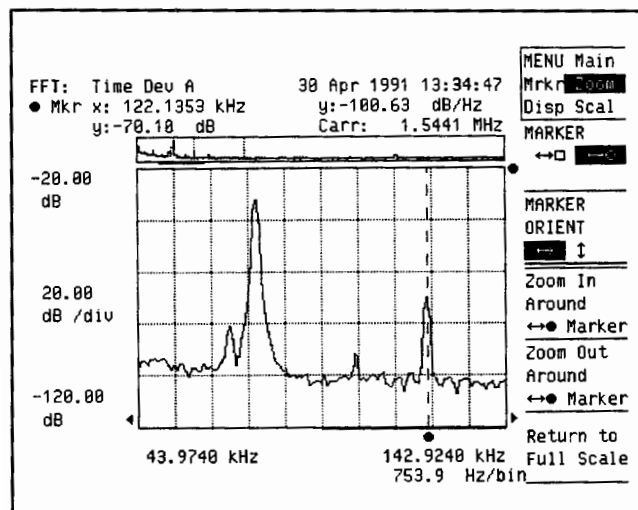

The jitter spectrum shows the large component of jitter as well as a smaller spur. The HP 5372A Jitter Spectrum Analysis (Option 040) enables the viewing of all components of jitter.

# ELECTRONIC COUNTERS

## Modulation Domain Analyzers

HP 5371A, 5372A, 5373A, 53310A

### Powerful Radar Signal Characterization

Combining the HP 5364A microwave mixer/detector with an HP modulation domain analyzer and a local oscillator extends the modulation domain to 18 GHz.

The HP 5364A microwave mixer/detector is designed to ensure downconversion with minimal distortion and group delay over its 500-MHz IF bandwidth. Configure the HP 5364A with your own local oscillator or an HP source such as the HP 8671A synthesized CW generator, the HP 8673C synthesized signal generator, or the HP 8673E synthesized signal generator. In addition to the IF channel, the HP 5364A provides a video detector output to trigger the HP 5373A. The video output can also be used to directly measure pulse width, rise and fall time, and PRF/PRI.

Radar chirp-linearity is easily characterized in the modulation domain. The HP 5364A microwave mixer/detector can be used to downconvert the chirp to baseband, maximizing measurement resolution. A frequency vs. time display clearly shows deviation from linearity. The HP 5373A features display-averaging which dramatically improves the resolution of measurements on repetitive signals.

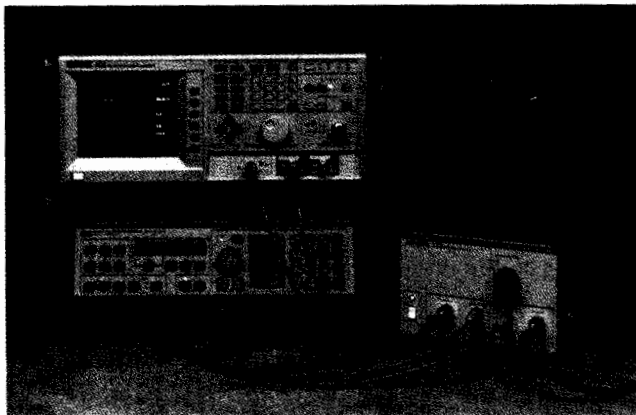

Use the HP 5364A microwave mixer/detector (shown, right, with the HP 5373A) to bring the modulation domain to microwave frequencies between 2 and 18 GHz. The HP 5364A can be used with any modulation domain analyzer.

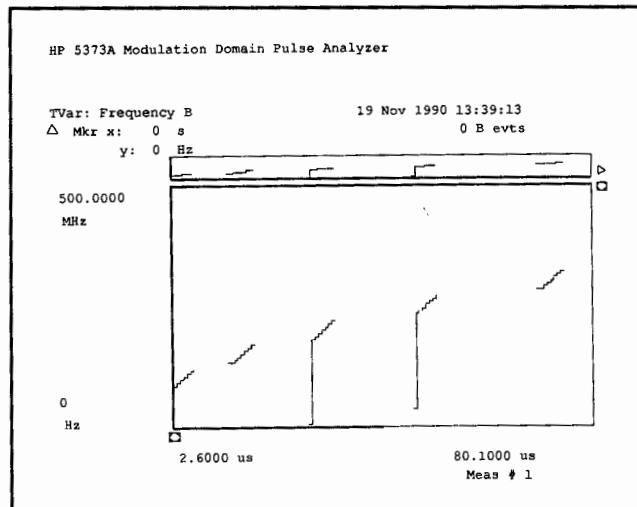

The power of modulation domain analysis can be seen with this HP 5373A frequency vs. time graph of a frequency chirp on an agile carrier with a varying PRI.

### Characterize Motion Control Systems

Pulse encoders for motion control systems deliver pulse streams that correspond to linear or rotary position. Position and velocity can be analyzed by characterizing the timing of pulses delivered by the encoder.

Continuous time-interval and frequency measurements with the HP 53310A give insight about positioning system performance. Variations in velocity or rotational non-linearities can be easily analyzed by viewing the time variation display: a plot of velocity versus time. For closed-loop systems, factors such as system damping, overshoot, and response time can be quickly verified—independently of the system's control.

- Rotational or linear velocity vs. time profiles
- Position control analysis
- Analyze damping, overshoot, and response time

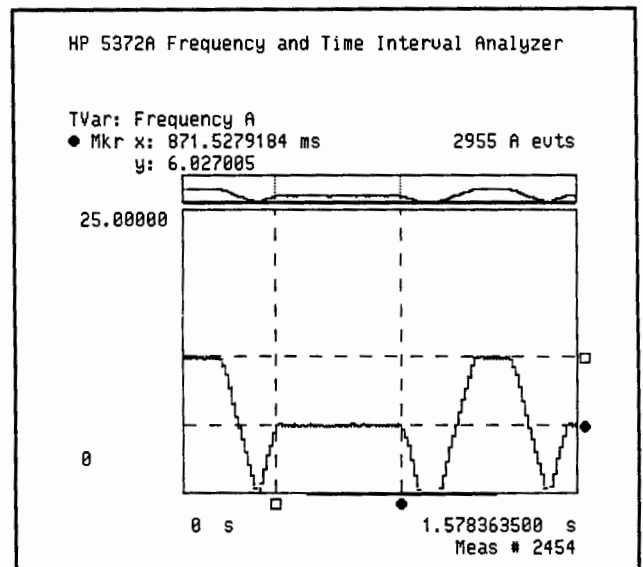

The velocity (frequency) vs. time graph allows easy analysis of the print sweep and double-speed return of a motion-control servo used in a graphics printer.

## HP 5371A, HP 5372A, and HP 5373A Summary

### Basic Performance

- Continuous measurements to a 10 MHz rate (13.3 MHz rate using the HP 5372A or HP 5373A fast-measurement mode)
- 125 mHz to 500 MHz frequency range. 100 MHz to 2 GHz in optional Channel C (HP 5372A or HP 5373A)
- -4.0 to +4.0 s or 10 ns to 8 s time-interval range
- 150 ps rms single-shot time-interval resolution, 10 digits per second frequency resolution
- 1 ns minimum input pulsewidth
- 2 mV trigger level resolution; auto-trigger capabilities
- Selection of input pods: 50  $\Omega$ , 1 M $\Omega$ , or 10 k $\Omega$ , 2 pf active

### Arming and Triggering Capabilities

- Measurement holdoff by time, events, or signal edge
- Measurement sample by time, events, signal edge, or parity
- Arm on any of 3 input channels: external arm, input A, or input B

### Measurements

Function	Range
<b>Frequency A', B'</b>	125 mHz to 500 MHz 8 kHz to 500 MHz <sup>2</sup>
<b>Frequency C' (HP 5372A/73A)</b>	100 MHz to 2 GHz
<b>Frequency A&amp;B, A&amp;C, B&amp;C, A + B, A + C, B - A, C - A, B + C, C - B, A/B, B/A, A/C, C/A, B/C, C/B</b>	250 mHz to 500 MHz (A and B) 16 kHz to 500 MHz (A and B) <sup>2</sup> 100 MHz to 2 GHz (C)
<b>Period A', B'</b>	2 ns to 8 seconds 2 ns to 131 $\mu$ s <sup>2</sup>
<b>Period C' (HP 5372A/73A)</b>	500 ps to 10 ns
<b>Period A&amp;B, A&amp;C, B&amp;C, A + B, A + C, B - A, C - A, B + C, C - B, A/B, B/A, A/C, C/A, B/C, C/B</b>	2 ns to 4.0 s (A and B) 2 ns to 65 $\mu$ s (A and B) <sup>2</sup> 500 ps to 10 ns (C)
<b>Totalize A, B, A&amp;B, A + B, A - B, B - A, A/B, B/A</b>	0 to (2 <sup>32</sup> - 1) events, each channel
<b>Time Interval A, B, A - &gt;, B - &gt; A</b>	10 ns to 8.0 seconds 10 ns to 131 $\mu$ s <sup>2</sup>
<b>Continuous Time Interval A', B'</b>	100 ns to 8.0 seconds 75 ns to 131 $\mu$ s <sup>2</sup>
<b><math>\pm</math> Time Interval A, B, A - &gt; B, B - &gt; A</b>	-4.0 s to +4.0 s including 0 s -65 $\mu$ s to +65 $\mu$ s including 0 s <sup>2</sup>
<b>Rise and Fall Time A<sup>2</sup></b>	1 ns to 100 $\mu$ s (auto-trigger)
<b>Positive and Negative Pulsewidth A<sup>2</sup></b>	1 ns to 1 ms (auto-trigger)
<b>Duty Cycle A<sup>2</sup></b>	0% to 100% for pulsewidths > 1 ns and periods < 1 ms (auto-trigger)
<b>Phase A rel B, B rel A</b>	0° to > $\pm$ 360°
<b>Peak Amplitudes A, B</b>	1 kHz to 200 MHz, 200 mV peak-to-peak to 2 V peak-to-peak

<sup>1</sup> Maximum sample rate for these measurements is 10 MHz (100 ns), and up to 13.3 MHz (75 ns) using the HP 5372A or HP 5373A fast-measurement mode. For all other measurements, maximum sample rate is 5 MHz (200 ns) in the normal measurement mode and 7.7 MHz (135 ns) in the fast-measurement mode.

<sup>2</sup> Requires 8 ns setup time between measurements.

<sup>3</sup> Fast measurement mode values (HP 5372A or HP 5373A).

### HP-IB Performance and Features

- Up to 20,000 measurements/second throughput (HP 5371A), 25,000 for HP 5372A and HP 5373A (binary format)
- Three output formats: ASCII, floating-point, or binary
- Full programmability
- Direct graphics output to printer or plotter

### Analysis Features

- Time variation of measurements: frequency versus time, time interval versus time, and phase versus time. Averaged plots to improve vertical resolution are obtainable using the HP 5372A or HP 5373A.
- Histogram
- Fast time-interval histogram (HP 5372A or HP 5373A; histograms computed at measurement rate)
- Event timing plots
- Limit test
- Statistics: mean, minimum, maximum, standard deviation, variance, rms
- Allan variance, root Allan variance
- Window margin analysis (HP 5372A only)
- Modulation parameters: center frequency, peak-peak deviation, modulation rate
- Frequency deviations from a linear chirp (HP 5373A only)
- Function keys for pulsed signal analysis: PRF, PRI, % AM envelope measurements (HP 5373A only)

### HP 5364A Microwave Mixer/Downconverter

- 2 to 18 GHz input frequency range
- 10 to 500 MHz IF output range
- 2.2 GHz to 18 GHz local oscillator input range
- Built-in manual attenuator
- 73 dB RF input dynamic range for pulse signals, 53 dB for CW signals
- APC 3.5 (m) connectors for RF and LO inputs
- <7.5 ns video output risetime
- Less than 1 ns group delay over 500 MHz IF output range

### HP 53700A Continuous Measurement Software

These compiled subroutines simplify and speed binary programming for the HP 5371A and HP Series 300 computers. Sample programs are included. Software is supported with the HP 5371A only.

### Ordering Information

	Price
<b>HP 5371A</b> Frequency and Time Interval Analyzer	\$24,500
<b>HP 5372A</b> Frequency and Time Interval Analyzer	\$30,000
The HP 5371A and HP 5372A both include 2 HP 54002A 50 $\Omega$ input pods and 1/2-day applications consulting.	
<b>HP 5373A</b> Modulation Domain Pulse Analyzer	\$32,000
Includes 1 HP 53702A 500-MHz envelope detector pod, 1 HP 54002A 50 $\Omega$ input pod, and 1/2-day consulting	

### Options

<b>Opt 060</b> Rear-Panel Inputs (50 $\Omega$ BNC) for channels A and B, 1 M $\Omega$ BNC for external arm. Deletes front panel inputs (HP 5371A, HP5372A only)	\$0
<b>Opt W30</b> Extended Repair Service (see page 671)	
<b>Opt W32</b> Calibration Service (see page 671)	
<b>Additional Options for HP 5372A and HP 5373A</b>	
<b>Opt 001</b> Delete 1/2-day Application Consulting	-\$925
<b>Opt 020</b> FastPort Data Output	+\$1,600
<b>Opt 030</b> 2-GHz Channel C (front-panel input)	+\$2,150
<b>Opt 090</b> Rear Panel Inputs for Channels A, B, and C 1 M $\Omega$ BNC for External Arm, 50 $\Omega$ BNC for channels A and B, type N connector for C. Deletes front panel inputs (HP 5372A only)	+\$2,150

<b>HP 5364A</b> Microwave Mixer/Detector	\$13,650
<b>HP 53700A</b> Continuous Measurement Software (supported with HP 5371A only)	\$1,250

### Accessories

<b>HP 54001A</b> 1-GHz Active Pod (10:1, 10 K $\Omega$ )	\$795
<b>HP 54002A</b> 50 $\Omega$ Pod	\$145
<b>HP 54003A</b> 1 M $\Omega$ Pod (with 10:1 scope probe)	\$690
<b>HP J06-59992A</b> Time Interval Calibrator	\$3,000

# ELECTRONIC COUNTERS

## Frequency and Time Interval Analyzers (cont'd)

### HP 53310A

#### HP 53310A Modulation Domain Analyzer

With the HP 53310A, HP advances modulation domain technology in two directions: affordability and ease of use. Key features of this newest frequency and time-interval analysis product include:

- **Automated setup:** A single button can set up the HP 53310A for measurement. Settings are selected by automatic signal evaluation.
- **Single-touch measurements:** Peak-to-peak deviation, carrier frequency, and modulation rate are easily and quickly measured for quantifying jitter and modulation. The Save/Recall function stores up to 10 measurement steps for fast repeat operations.
- **One-button statistics:** Mean, standard deviation, and probability functions are simplified for easy jitter analysis.
- **Softkey-driven menus:** Measurement parameters and analysis functions are easily selected while measurement data is displayed.
- **Large display:** The expanded screen displays measurement results clearly and aids analysis.
- **Low cost:** The HP 53310A is priced to fit budget-constrained projects and departments.

#### Product Description

The HP 53310A offers powerful analyzer features:

- **Dual timebases:** A main timebase and a window timebase allow data capture while viewing measurement details in the window.
- **Auto or triggered operation:** Select auto, edge-triggering (rising or falling), or a new, unique feature: measurement value triggering (frequency or time-interval). Value triggering can eliminate the need for and expense of external sync signal generation. This can shorten project time and lower costs.
- **Display vs. time or histogram:** Select the appropriate view.
- **Fast histograms:** Up to 16 million measurements/acquisition.
- **Automated measurements:** Autoscale selects appropriate setup parameters; built-in analysis functions eliminate calculations.

#### Specifications

##### Frequency Measurements

**Range:** 10 Hz to 200 MHz (Channel A)  
10 Hz to 100 MHz (Channel B)  
50 MHz to 2.5 GHz (Channel C)

**Maximum Measurement Rate:** 1 MHz (1.5 MHz for fast histograms)

##### Time Interval Measurements

###### + Time interval:

Range: +20 ns to +1 s

Maximum measurement rate: 1.25 MHz (2.5 MHz for fast histograms)

###### ± Time interval:

Range: -0.5 s to +0.5 s

Maximum measurement rate: 1.25 MHz (2.0 MHz for fast histograms)

##### Time Axis in Versus Time

###### Resolution:

Main timebase setting/45 (with panorama off)

Window timebase setting/45 (with panorama on)

##### Inputs

###### Channels A and B

**Sensitivity** (minimum hysteresis): 20 mV rms sinewave to 100 MHz (25 mV rms sinewave for Freq A from 100 to 200 MHz)

**Minimum pulse width:** 5 ns at 60 mV peak-to-peak (2.5 ns at 75 mV peak-to-peak for Freq A  $\geq$  50 MHz)

**Input amplifier noise:** 600  $\mu$ V rms

**Threshold drift:**  $\pm$  3 mV after warmup at 25° C

**Voltage threshold accuracy:**  $\pm$  (25 mV + 1% of threshold value)

**Maximum hysteresis:** Increases the minimum input signal amplitude required by factor of 3 (increased noise immunity)

**Impedance:** 50  $\Omega$  or 1 M $\Omega$  (500 k $\Omega$  in common)

**AC coupling:** 100 Hz cutoff frequency

**Capacitance** (1 M $\Omega$ ): < 20 pF (< 30 pF in common)

**Dynamic range** (ac): 60 mV peak-to-peak to 5 V peak-to-peak

**Signal operating range** (dc):  $\pm$  10 V (1 M $\Omega$ ),  $\pm$  5 V (50  $\Omega$ )

**Damage level:** 5 V rms (50  $\Omega$ ); 40 V rms for < 5 kHz, 5 V rms for > 5 kHz (1 M $\Omega$ )

#### Channel C (Option 030)

**Sensitivity:** -25 dBm to 1.5 GHz, -20 dBm from > 1.5 to 2.0 GHz,

-15 dBm from > 2.0 to 2.5 GHz

**Maximum input level:** +7 dBm

**Damage level:** +15 dBm

#### External Arm

**Impedance:** 1 M $\Omega$

**Delay:** < 10 ns

**Note:** Sensitivity, minimum pulse width, signal operating range and damage level of external input are the same as for Channel B.

#### Frequency Reference

##### Standard Crystal (See page 198)

**Temperature stability:**  $< 8 \times 10^{-6}$ , referenced to 25° C

**Short-term stability:**  $< 4 \times 10^{-9}$  for 1 second average

**Aging rate:**  $< 3 \times 10^{-7}$  per month

##### Option 010: High-stability oven reference (see page 198)

Temperature stability:  $< 7 \times 10^{-9}$  referenced to 25° C

**Short-term stability:**  $< 4 \times 10^{-11}$  for 1 second average

**Aging rate:**  $< 5 \times 10^{-10}$  per day,  $< 1 \times 10^{-7}$  per year

**Warm-up:** Within  $5 \times 10^{-9}$  of final value (frequency 24 hours after turn-on) 10 minutes after turn-on.

#### Rear-Panel Connectors

##### HP-IB

**Full programmability:** All instrument settings and operating modes except specific self-test routines

**Data acquisition and transfer rate:** For 450-point data record, approximately 17 times/sec with an HP 9000 Series 300 (when measuring, for example, a 1-MHz carrier with a timebase setting of 40  $\mu$ s/division)

**Data transfer rate:** Approximately 175 kBytes/sec

**Interface capabilities:** SH1, AH1, T5, TE0, L4, LE0, SR1, RLI, PP0, DC1, DT1, C0, E2

##### Test Limit Output

**Operation:** Goes high when measurements fall outside the display range of the fast histogram

**Operating range:** Low < 0.6 V and high > 1.5 V into 50  $\Omega$

##### Frequency Standard Input

**Frequency:** 5 MHz or 10 MHz

**Operating range:** 1 V peak-to-peak to 5 V peak-to-peak into 1 k $\Omega$

**Damage level:** 10 V rms

##### Frequency Standard Output

**Frequency:** 10 MHz, or External Reference if frequency standard input selected

**Operating range** (ac-coupled): > 1 V peak-to-peak square wave (50  $\Omega$ ), > 2 V peak-to-peak square wave (1 M $\Omega$ )

##### Power Requirements

**Voltage:** 115/230 V ac (-25% to +15%)

**Frequency:** 48 to 66 Hz

**Maximum power:** 300 VA

##### General

**Operating temperature:** 0° to 55° C

**Size:** 425 mm H  $\times$  194 mm W  $\times$  363 mm D (440 mm D, handle extended)

**Weight:** Net, 10 kg; shipping, 18 kg.

#### Ordering Information

	Price
<b>HP 53310A</b> Modulation Domain Analyzer	\$9,500
<b>Opt 001</b> Extended Measurement Memory (4 X)	\$500
<b>Opt 010</b> High-Stability Oven Timebase	\$1,600
<b>Opt 030</b> 2.5-GHz Channel C	\$1,450
<b>Opt W30</b> Extended Repair Service (see page 671)	\$235
<b>Opt W32</b> Calibration Service (see page 671)	\$380
<b>HP 5364A</b> 2 to 18 GHz Mixer/Detector	\$13,650
<b>HP J06-59992A</b> Time Interval Calibrator	\$3,000



# ELECTRONIC COUNTERS

Universal  
HP 5314A

191

- 100 MHz
- 100 ns time interval
- Portable

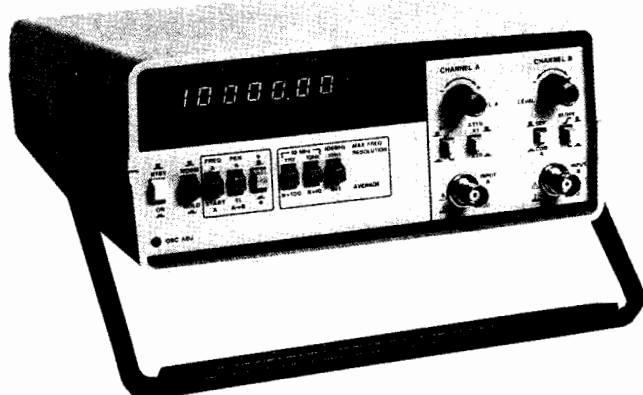

HP 5314A

## HP 5314A Universal Counter

The HP 5314A Universal Counter combines excellent performance and traditional HP quality at a very attractive price. This counter is designed to deliver reliable, high-quality operation in such areas as production test, frequency monitoring, education, training, service, and calibration. A battery (Option 002) makes the HP 5314A especially attractive for field and portable applications.

## Specifications

### Input Channel Characteristics (A and B)

**Range:** Channel A: 10 Hz to 10 MHz direct  
1 MHz to 100 MHz prescaled  
Channel B: 10 Hz to 2.5 MHz

**Sensitivity:** Channel A: 25 mV rms to 100 MHz  
75 mV peak-to-peak at minimum pulse width of 5 ns (100 MHz range)

Channel B: 25 mV rms to 2.5 MHz  
75 mV peak-to-peak at minimum pulse width of 200 ns

**Coupling:** ac

**Impedance:** 1 M  $\Omega$  nominal shunted by less than 30 pF

**Attenuator:**  $\times 1$  or  $\times 20$  nominal (channel A only)

**Trigger level:** Continuously variable  $\pm 350$  mV times attenuator setting around average value of signal

**Slope:** Independent selection of + or - slope

**Channel input:** Selectable SEPARATE or COMMON A

**Dynamic range:** 75 mV peak-to-peak to 4 V peak-to-peak

### Frequency

**Range:** 10 Hz to 10 MHz direct count

1 to 100 MHz prescaled by 10

**Least significant digit (LSD) displayed:** Direct count 0.1 Hz, 1 Hz, 10 Hz switch-selectable. Prescaled 10 Hz, 100 Hz, 1 kHz switch-selectable

**Resolution:**  $\pm$  LSD

**Accuracy:**  $\pm$  LSD  $\pm$  (time base error)  $\times$  freq

### Period

**Range:** 10 Hz to 2.5 MHz

**LSD displayed:**  $\frac{100 \text{ ns}}{N}$  for N=1 to 1000 in decade steps of N

**Resolution:**  $\pm$  LSD  $\pm \frac{(1.4 \times \text{Trigger Error})}{N}$

**Accuracy:**  $\pm$  LSD  $\pm \frac{(1.4 \times \text{Trigger Error})}{N}$

$\pm$  (timebase error)  $\times$  period

### Time Interval

**Range:** 250 ns to 1 s

**LSD displayed:** 100 ns

**Resolution:**  $\pm$  LSD  $\pm$  START trigger error  $\pm$  STOP trigger error

**Accuracy:**  $\pm$  LSD  $\pm$  START trigger error

$\pm$  STOP trigger error  $\pm$  (timebase error)  $\times$  TI

External arming required for START/STOP channels

### Ratio (A to B)

**Range:** 10 Hz to 10 MHz Channel A

10 Hz to 2.5 MHz Channel B

**LSD displayed:** 1/N in decade steps of N for N = 1 to 1000

**Resolution:**  $\pm$  LSD  $\pm$  (B trigger error  $\times$  frequency A)/N

**Accuracy:**  $\pm$  LSD  $\pm$  (B trigger error  $\times$  frequency A)/N

### Totalize

**Range:** 10 Hz to 10 MHz

**Resolution:**  $\pm$  1 count of input

Totalize controlled by front panel switch

### General

**Check:** Counts internal 10 MHz oscillator

**Display:** 7-digit amber LED display with gate and overflow indication

**Max sample rate:** 5 readings per second

**Operating temperature:** 0° to 50° C

**Power requirement:** 115V, +10%, -25%; 230 V, +9%, -17%; 48 to 66 Hz; 10 VA max

**Weight:** 2.0 kg (4.4 lb)

**Dimension:** 238 mm W  $\times$  98 mm H  $\times$  276 mm D (9 3/8 in  $\times$  3 7/8 in  $\times$  10 7/8 in)

**Timebase** (see page 198)

Frequency: 10 MHz

**Aging rate:** < 3 parts in 10<sup>7</sup> per month

**Temperature:** <  $\pm$  1 part in 10<sup>6</sup>, 0° to 50° C

**Line voltage:** <  $\pm$  1 part in 10<sup>7</sup> for  $\pm$  10% variation

### Options

**Option 001:** High-stability timebase (TCXO); see page 198

**Frequency:** 10 MHz

**Aging rate:** < 1 part in 10<sup>7</sup> per month

**Temperature:** <  $\pm$  1 part in 10<sup>6</sup>, 0° to 40° C

**Line voltage:** <  $\pm$  1 part in 10<sup>6</sup> for  $\pm$  10% variation

**Option 002:** Battery

**Type:** Rechargeable lead-acid (sealed)

**Capacity:** Typically 8 hours of continuous operation at 25° C

**Recharging time:** Typically 16 hours to 98% of full charge, instrument non-operating. Charging circuitry included with option. Batteries not charged during instrument operation.

**Battery voltage sensor:** Automatically shuts instrument off when low-battery condition exists.

**Line-failure protection:** Instrument automatically switches to batteries in case of line failure.

**Weight:** Option 002 typically adds 1.5 kg (3.3 lb) to weight of instrument.

### Accessories

Carrying case for half-rack-size instruments

### Definition

**Trigger error:**

$$\frac{\sqrt{(80\mu\text{V})^2 + e_n^2}}{\text{input slew rate at trigger point } (\mu\text{V/s})} \text{ (rms)}$$

where  $e_n$  is the rms noise of the input for a 100 MHz bandwidth in Channel A and 10 MHz bandwidth in Channel B.

### Ordering Information

**HP 5314A** 100 MHz/100 ns Universal Counter

**Opt 001** High-Stability Timebase

**Opt 002** Battery

**Opt W30** Extended Repair Service (see page 671)

**Opt W32** Calibration Service (see page 671)

**HP 34110A** Carrying Case

All orders must include one of these line power options:

**Opt 115** 86 to 127 V

**Opt 230** 190 to 250 V

### Price

\$795

+ \$180

+ \$200

+ \$45

+ \$565

\$90

\$0

\$0

☎ For off-the-shelf shipment, call 800-452-4844.

# ELECTRONIC COUNTERS

## Universal

HP 5315A, 5316B

- Frequency, period, ratio, and totalize to 100 MHz
- Portable and HP-IB models
- 1-GHz capability available
- 100-ns time interval, 10-ps T.I. averaging

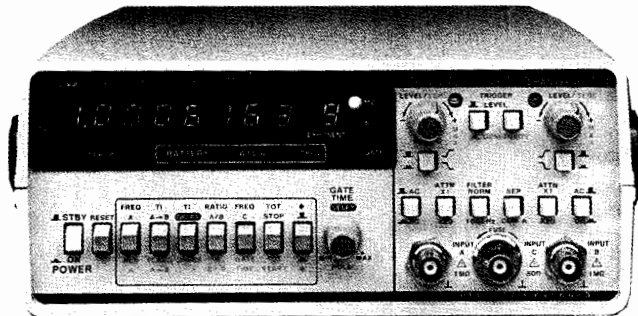

HP 5315A

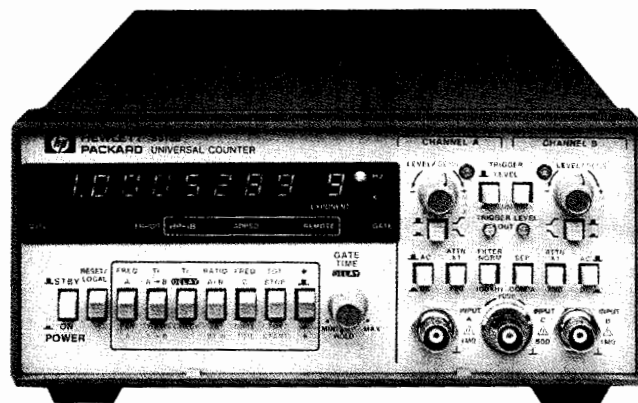

HP 5316B

SUPPORTED BY  
**HP ITG**  
SOFTWARE

DESIGNED FOR  
**HP-IB**  
SYSTEMS

### HP 5315A and HP 5316B Universal Counters

HP's economical HP 5315A and HP 5316B counters offer outstanding performance at affordable prices. A unique custom circuit called the MRC (Multiple Register Counter) packs counting and computing power into this popular counter series. Reciprocal counting techniques provide outstanding frequency resolution of 7 digits per second even at low frequencies. The continuously adjustable gate time allows automatic selection of sample size for easy trade-offs between measurement time and resolution.

### Versatile Measurement Capabilities

The MRC counters measure frequency to 100 MHz—up to 1.0 GHz with the optional Channel C—for CW and pulsed RF signals as narrow as 60 ms. Three time-interval measurements are possible: single-shot (100 ns to 100,000 s), averaging (down to 10 ps resolution), and time-interval delay. The MRC counters also measure/perform: Period A, Ratio A/B, A By B (totalizes A input between 2 events on B), and Totalize (manually gated mode).

Both channels offer input signal conditioning controls:  $\pm$  slope,  $\pm 2.5$  Vdc trigger level, and ac/dc coupling. A Separate/Common switch and 100-kHz low-pass filter for Channel A are included.

### A Choice of Portable or System Models

The HP 5315A, a portable, lightweight unit, includes a carrying handle and optional battery power for up to 4 hours continuous operation. The HP 5316A offers the measurement capabilities of the HP 5315A in a rack-and-stack metal case, built-in HP-IB capabilities, and front-panel access to Channel A and B trigger levels for easy measurement with a DVM.

### HP 5315A, 5316B Specifications

#### Input Characteristics (Channel A and Channel B)

**Range:** dc-coupled, 0 to 100 MHz; ac-coupled, 30 Hz to 100 MHz  
**Sensitivity:** 10 mV rms sine wave to 10 MHz; 25 mV rms sine wave to 100 MHz. 75 mV peak-to-peak pulse at minimum pulse width of 5 ns. Sensitivity can be varied continuously up to 500 mV rms nominal by adjusting sensitivity control. In sensitivity mode, trigger level is automatically set to 0 V nominal.

**Dynamic range:** 30 mV to 5 V peak-to-peak, 0 to 10 MHz; 75 mV to 5 V peak-to-peak, 10 to 100 MHz

**Coupling:** ac or dc, switchable

**Filter:** Low-pass, switchable in or out of Channel A. 3 dB point at 100 kHz nominally.

**Impedance:** 1 M  $\Omega$  nominal shunted by less than 40 pF.

**Signal operating range:** +2.5 Vdc to -2.5 Vdc

**Attenuator:**  $\times 1$  or  $\times 20$  nominal

**Trigger level:** Variable between +2.5 Vdc and -2.5 Vdc

**Slope:** Independent selection of + or - slope

**Common input:** All specifications are the same as A and B except:  
**Sensitivity:** 20 mV rms sine wave to 10 MHz; 50 mV rms to 100 MHz; 150 mV peak-to-peak at a minimum pulse width of 5 ns.

**Dynamic range:** 60 mV to 5 V peak-to-peak to 10 MHz; 150 mV to 5 V peak-to-peak, 10 to 100 MHz.

**Impedance:** 500 k  $\Omega$  nominal shunted by less than 70 pF

#### Frequency and Period (Channel A)

**Range:** 0.1 Hz to 100 MHz; 10 ns to  $10^3$  s (period)

**Resolution:** See Graph 1.

**Accuracy:**  $\pm$  resolution  $\pm$  timebase error (Graph 2)

#### Time Interval

**Range:** 100 ns to  $10^3$  s    **LSD displayed:** 100 ns

**Resolution:**  $\pm$  LSD  $\pm$  noise trigger error (Graph 3)

**Accuracy:**  $\pm$  resolution  $\pm$  timebase error (Graph 2)

#### Time Interval Average

**Range:** 0 ns to  $10^3$  s

**LSD displayed:** 100 ns/ $\sqrt{N}$ , 10 ps max

**Number of intervals averaged (N):** N = Gate Time  $\times$  FREQ

**Minimum dead time (stop to start):** 200 ns

**Resolution:**  $\pm$  LSD  $\pm$  [noise trigger error (Graph 3)]/ $\sqrt{N}$

**Accuracy:**  $\pm$  resolution  $\pm$  timebase error (Graph 2)  $\pm 4$  ns

#### Time Interval Delay (Holdoff)

Front-panel knob inserts a variable delay of nominally 500  $\mu$ s to 20 ms between START (channel A) and enabling of STOP (Channel B). Electrical inputs during delay time are ignored. Delay time may be digitally measured by simultaneously pressing T.I. Averaging, T.I. Delay, and blue key. Other specifications are identical to Time Interval.

#### Ratio

**Range:** 0.1 MHz to 100 MHz, both channels

**LSD:** [(2.5  $\times$  Period A)/gate time]  $\times$  ratio

#### Totalize

**Manual:** 0 to 100 MHz

**A gated by B:** Totalizes input A between two events of B. Instrument must be reset between measurements. Gate opens on A slope, closes on B slope.

#### General

##### Standard Timebase

**Frequency:** 10 MHz

**Aging rate:**  $< 3 \times 10^{-7}$ /mo

**Temperature:**  $\pm 5 \times 10^{-6}$ , 0° to 50° C

**Line voltage:**  $< 1 \times 10^{-7}$  for a  $\pm 10\%$  variation

**Check:** Counts internal 10-MHz reference frequency

**Error light:** LED activated if logic error found during self-check.

**Display:** 8-digit LED display, with engineering units annunciator  
**Overflow:** Frequency and totalize measurements only; 8 least significant digits displayed and front panel LED actuated.

**Gate time:** Continuously variable, nominally from 60 ms to 10 s or 1 period of the input, whichever is longer.

**Sample rate:** Up to 7 readings per second nominal except in time-interval mode, where it is continuously variable nominally from 250 ms to 10 s via gate time control.

**Operating temperature:** 0° to 50° C

**Power:** 100, 120, 220, 240 V (+5%, -10%) 48 to 66 Hz; 15 VA maximum (30 VA maximum, HP 5316B)

**Weight:** Net, 2.2 kg (4 lb 12 oz); shipping, 4.1 kg (9 lb)

**Size:** 98 mm H  $\times$  238 mm W  $\times$  276 mm D (3 7/8 in  $\times$  9 1/2 in  $\times$  10 7/8 in)

**Unique HP 5316B Specifications**

Rack-and-stack metal case; rear-panel, switchable ac power-line module.  
**Rackmount kit:** HP 5062-3972 recommended.  
**Oscillator output:** 10 MHz, 50 mV peak-to-peak into 50 Ω load on rear panel  
**External frequency standard input:** 1, 5, 10 MHz, 1 V rms into 500 Ω, or rear panel  
**Trigger-level output:** ±5%, ±15 mV over ±2.0 Vdc range at front panel connectors  
**Size:** 88 mm H × 212 mm W × 415 mm D (3½ in × 8¼ in × 16½ in)  
**Weight:** Net, 3.7 kg (8 lb 2 oz); shipping, 6.3 kg (14 lb)

**Hewlett-Packard Interface Bus Programming**

**Measurements:** Frequency A and C, Frequency A Armed by B, Period A, Totalize A Gated by B, Ratio A/B, Time Int. A→B, Time Int. Average A→B, Time Int. Delay, Read Gate Time.  
**Controls:** Gate Time Command, which sets long (60 ms to 10 s) or short (500 μs to 30 ms) range; Trigger Level Commands, which set Channel A and/or B slope (±) and Channel A and/or B trigger from -2.50 Vdc to +2.50 Vdc in steps of .01V.  
**HP-IB interface functions:** SH1, AH1, TI, L2, SR1, RL1, PP0, DC1, DT1, C0, E1 (see page 114)

**Options**

**Opt 001:** High-stability timebase (TCXO); see page 198  
**Frequency:** 10 MHz  
**Aging rate:**  $< 1 \times 10^{-7}/\text{mo}$   
**Temperature:**  $\pm 1 \times 10^{-6}$ , 0° to 40° C  
**Line voltage:**  $< 1 \times 10^{-8}$  for a ± 10% variation  
**Opt 002:** Battery (HP 5315A only)  
**Type:** Rechargeable lead-acid (sealed)  
**Capacity:** Typically 4 hours of continuous operation at 25° C  
**Recharging time:** Typically 16 hours to 98% of full charge, instrument non-operating. Charging circuitry included.  
**Low-voltage indicator:** Instrument turns off automatically when battery low. Discharge LED flashes slowly.  
**Line-failure action:** Instrument automatically switches to battery.  
**Weight:** Opt 002 adds 1.4 kg (3 lb) to weight of instrument.  
**Opt 003:** C Channel  
**Input range:** 50 to 1000 MHz, prescaled by 10  
**Sensitivity:** 15 mV rms sinewave (-23.5 dBm) to 650 MHz. 75 mV rms sinewave (-9.5 dBm) to 1000 MHz. Sensitivity can be decreased continuously by up to 20 dB nominal (50 to 500 MHz) and 10 dB nominal (500 to 1000 MHz) by adjusting sensitivity control. Trigger level is fixed at 0 V nominal.  
**Dynamic range:** 15 mV to 1 V rms (36 dB), 50 to 650 MHz, 75 mV to 1 V rms (20 dB), 650 to 1000 MHz  
**Signal operating range:** +5 Vdc to -5 Vdc  
**Coupling:** ac  
**Impedance:** 50 Ω nominal (VSWR, <2.5:1 typical)  
**Damage level:** ±8 V (dc + ac peak), fuse protected  
**Resolution and accuracy:** Same as Frequency A (gate time × 10)

**Opt 004:** High-stability oven timebase (HP 5315A); see page 198.

**Frequency:** 10 MHz  
**Aging rate:**  $< 3 \times 10^{-8}/\text{mo}^*$   
**Temperature:**  $\pm 1 \times 10^{-7}$ , 0° to 50° C  
**Line voltage:**  $< 1 \times 10^{-8}$ , for a 10% variation  
 Oven will operate from fully charged battery for > 24 hours in standby mode.

**Opt 004:** High-stability oven timebase (HP 5316B); see page 198.

**Frequency:** 10 MHz  
**Aging rate:**  $< 3 \times 10^{-8}/\text{mo}^{**}$   
**Temperature:**  $\pm 2 \times 10^{-8}$ , 0° to 50° C  
**Line voltage:**  $< 1 \times 10^{-9}$ , for a 10% variation

\* After 30 days continuous operation (ac power applied, in OFF or ON position).  
 \*\* After 30 days continuous operation.  $< 5 \times 10^{-9}/\text{mo.}$ , after 7 days continuous operation.

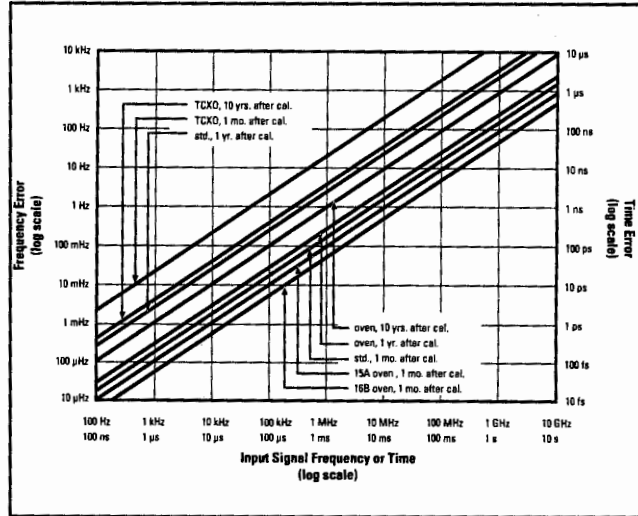

Graph 2. Timebase Error: Environment and aging of the crystal affects all measurements.

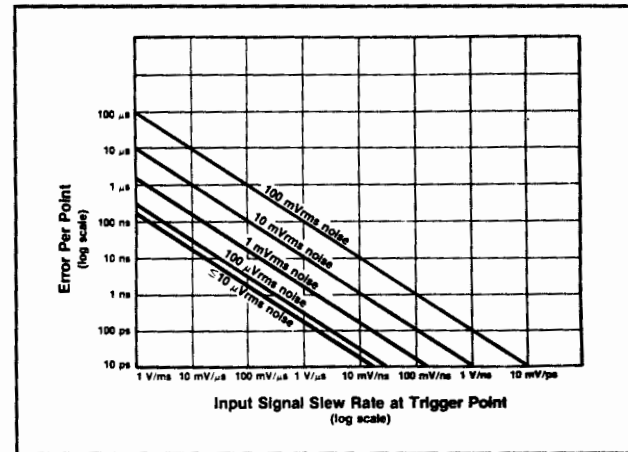

Graph 3. Input Noise Trigger Error: Noise on the input signal affects start/stop points for time-interval measurements.

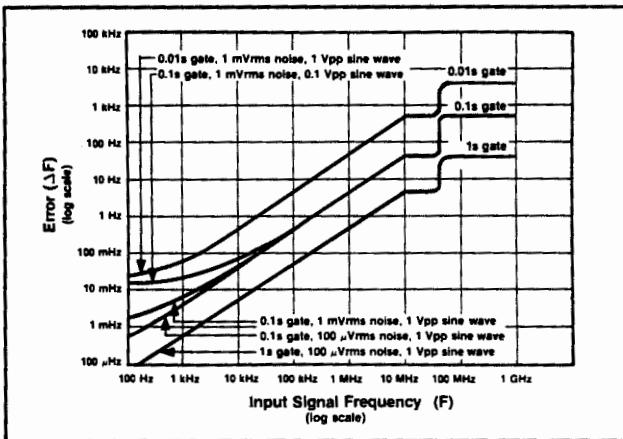

Graph 1. Frequency Resolution Error: Noise on input signal and internal uncertainties affect frequency and period measurements.

**Ordering Information**

**HP 5315A** Universal Counter  
**HP 5316B** Universal Counter

**Price**  
 \$1,425  
 \$1,755

**Options (for HP 5315A and HP 5316B)**

**Opt 001** TCXO Timebase + \$180  
**Opt 002** Battery Pack (HP 5315A only) + \$350  
**Opt 003** C Channel (1.0 GHz) + \$400  
**Opt 004** High-Stability Timebase + \$600  
**Opt W30** Extended Repair Service (see page 671) + \$45  
**Opt W32** Calibration Service (see page 671) + \$565

**HP 5315A Power Options (one option must be selected)**

**Opt 100** 90 to 105 Vac  
**Opt 220** 198 to 231 Vac  
**Opt 120** 108 to 126 Vac  
**Opt 240** 216 to 252 Vac

☎ For off-the-shelf shipment, call 800-452-4844.

# ELECTRONIC COUNTERS

## 100-MHz Universal Counter

HP 5334B

- Two matched 100-MHz input channels; optional C Channel to 1.3 GHz
- 9 digits per second resolution from 1 Hz to 1.3 GHz
- 2 ns time interval resolution, 200 ps with averaging
- Automatic rise/fall time, pulse width, and ac/dc voltage measurements
- Complete HP-IB programmability standard

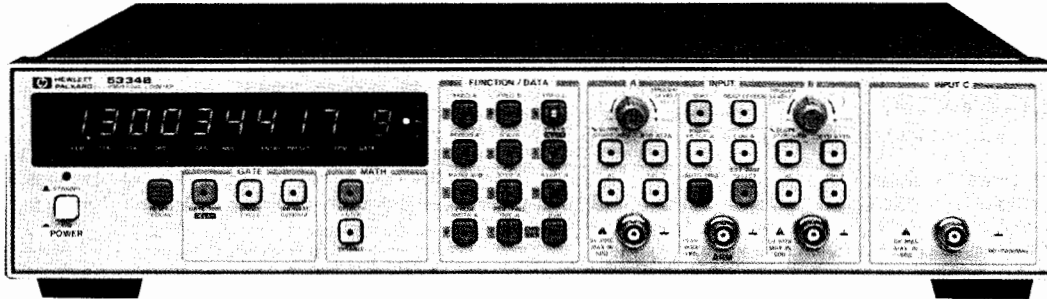

HP 5334B

### HP 5334B Universal Counter

#### Expanded Capabilities for Bench or System

- Rise/fall time, pulse-width measurements at the push of a button.
- ac/dc voltage measurements of the input signal.
- Offset, normalize, and average measurements for greater usability of results.
- Auto triggering and auto attenuation for user convenience.
- 100-MHz frequency and period measurements with resolution of 9 digits per second of gate time.
- Time interval and time-interval delay to 2 ns resolution, 200 ps with averaging.
- Full HP-IB programmability standard with optional rear inputs for system applications. Make up to 140 readings per second.
- 1.3 GHz C Channel and high-stability oven time base options.
- External arming/gating for synchronizing measurements to external events.

#### HP 5334B Specifications

##### Input Characteristics (Channels A and B)

###### Range

**dc-coupled:** 0 to 100 MHz

**ac-coupled:** 1 M $\Omega$ , 30 Hz to 100 MHz; 50  $\Omega$ , 1 to 100 MHz

###### Sensitivity:

15 mV rms sine wave to 20 MHz, 35 mV rms sine wave to 100 MHz

100 mV peak-to-peak at a minimum pulse width of 5 ns

###### Dynamic range (X1):

45 mV to 5 V peak-to-peak, to 20 MHz. 100 mV to 2.5 V peak-to-peak, to 100 MHz

###### Trigger level range

**Manual** (auto trigger off): Continuously adjustable over  $\pm 5.1$  V ( $\times$  attn), displayed in 20 mV steps ( $\times$  attn)

**Preset:** 0V nominal in Sensitivity Mode

###### Auto trigger

**dc-coupled:** 100 Hz to 100 MHz

**ac-coupled:** 1 M $\Omega$ , 100 Hz to 100 MHz; 50  $\Omega$ , 1 to 100 MHz

###### Trigger slope:

Independent selection of + or - slope

###### Impedance:

1 M $\Omega$  or 50  $\Omega$ , nominal, switch-selectable.

###### Attenuator

**Manual:**  $\times 1$  or  $\times 10$  nominal, switch-selectable

**Auto:** Attenuator automatically switched when in auto trigger.

###### Low-pass filter:

100 kHz nominal, Channel A, switchable

###### External arm

**Sensitivity:** 500 mV peak-to-peak at min. pulse width of 50 ns

**Signal operating range:** -5 Vdc to +5 Vdc

**Slope:** Independent selection of START and STOP ARM slopes: +, -, or OFF

##### Frequency A and Frequency B

**Range:** 0.001 Hz to 100 MHz

**Resolution:** See Graph 1.

**Accuracy:**  $\pm$  resolution  $\pm$  time base error (Graph 2)

##### Period A

**Range:** 10 ns to 10<sup>3</sup> s (single gate), 10 s (100 gate average)

**Resolution, accuracy:**  $\Delta$ freq [per]/freq (Graphs 1 and 2)

##### Time Interval A to B

**Range:** -1 ns to 10<sup>3</sup> (single shot), 10 s (100 gate average)

**LSD:** 1 ns (100 ps using 100 gate average)

**Resolution:**  $\pm$  LSD noise trigger error (Graph 3)  $\pm$  1 ns rms

**Accuracy:**  $\pm$  resolution time base error (Graph 2)  $\pm$  trig level timing error (Graph 4)  $\pm$  trig level setting error (Graph 5)  $\pm$  2 ns

##### Time Interval Delay

Selectable delay can be inserted between START and STOP of time interval A to B. Inputs during delay are ignored. Delay range is 1 ms to 99.999 s.

##### Ratio A/B

**Range:** 0.001 Hz to 100 MHz both channels

**LSD:**  $4 \times \text{RATIO}/[\text{FREQ A} \times \text{GATE TIME}]$

**Resolution and accuracy:**  $\pm$  LSD  $\pm$  [B trig error (Graph 3)/GATE TIME]

##### Totalize A

**Range:** 0 to 10<sup>21</sup> -1

**Resolution and accuracy:** 1 count of input signal

##### Pulse Width A

**Range:** 5 ns to 10 ms

**LSD, resolution, accuracy:** Same as time interval A to B except  $\pm 2$  ns in Accuracy deleted

##### Rise/Fall Time A

**Range:** 30 ns to 10 ms

**Minimum amplitude:** 500 mV peak-to-peak

**Dynamic range:** 500 mV to 40 V peak-to-peak

**LSD, resolution, accuracy:** Same as time interval A to B

##### ac/dc Voltage:

**Measurements:** Max. and min. peaks or dc level of Channel A or Channel B input are displayed.

**Frequency range:** dc, 100 Hz to 20 MHz

**Dynamic range:** 0 to 40 V peak-to-peak;  $\pm 51$  Vdc

**Resolution:**  $\times 1$ : 20 mV  $\times 10$ : 200 mV

##### Timebase

**Frequency:** 10 MHz

**Aging rate:**  $< 3 \times 10^{-7}$  per month

**Temperature:**  $5 \times 10^{\circ}$ , 0 to 50 $^{\circ}$  C

##### Math

**Display =** (measurement/normalize) + offset

**Entry range:**  $\pm 1 \times 10^{-30}$  to  $\pm 9.99999999999 \times 10^9$

**Single cycle:** 1 measurement per push of RESET

##### Average

**100 gate average:** 100 measurements accumulated and average value displayed. Adds 1 digit of resolution to measurements and reduces resolution error by 10.

##### Hewlett-Packard Interface Bus

**Programmable controls:** All front-panel controls and functions, except power-on/stby switch.

**Trigger level:** Set Channel A or B in 20 mV steps ( $\times$  attn)

**Data output**

**Normal operation:** 10 readings/s, formatted.  
**High-speed mode:** Up to 140 readings/s (55 readings/s with Option 700), unformatted  
**HP-IB interface functions:** SH1, AH1, T5, TE0, L4, LE0, SR1, RL1, PP0, DC1, C0, E2 (see page 114)

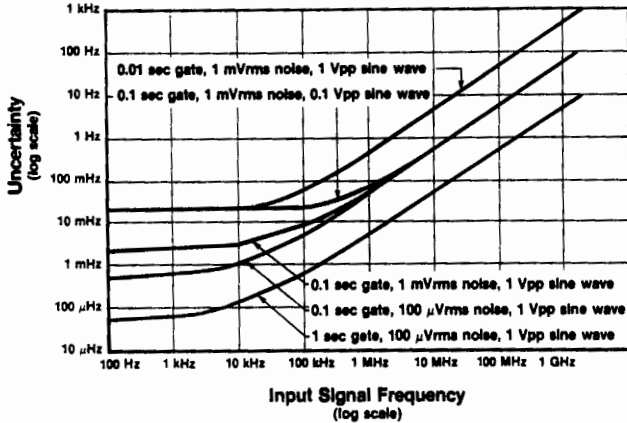

**Graph 1. Frequency Resolution Error:** Noise on the input signal and internal uncertainties affect frequency and period measurements.

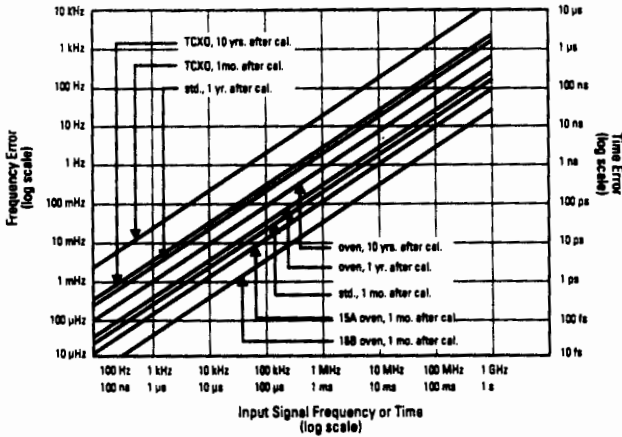

**Graph 2. Time Base Error:** Crystal environment and aging affects all measurements.

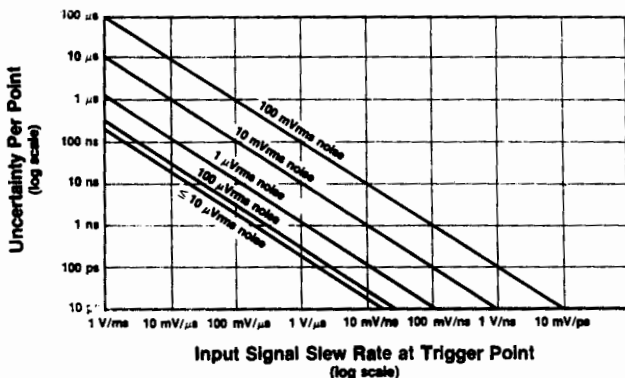

**Graph 3. Input Noise Trigger Error:** Noise on the input signal affects both the start and stop points of all time-interval measurements.

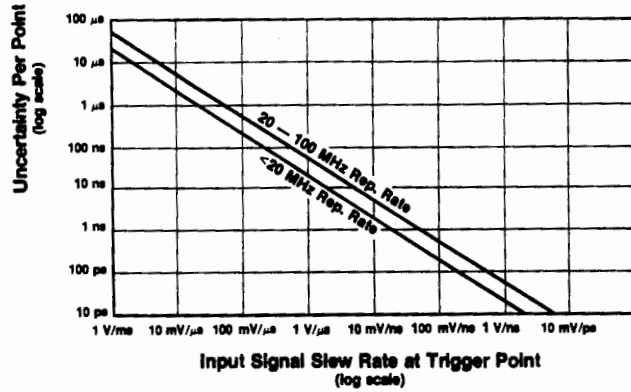

**Graph 4. Trigger Level Timing Error:** Affects the start and stop points of all time-interval measurements. Total error is the larger of the 2 trigger-point errors.

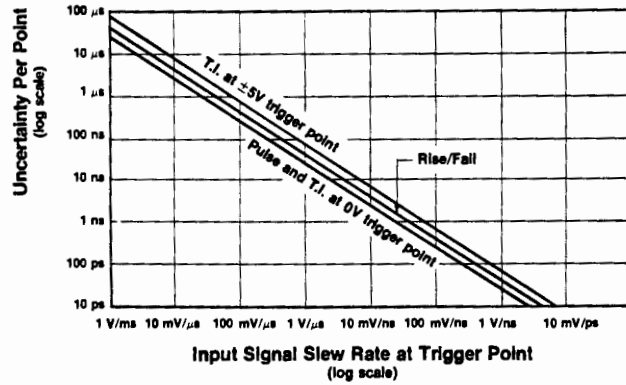

**Graph 5. Trigger Level Setting Error:** Affects both the start and stop points of all time-interval measurements.

**HP 5334A**

See Mature Products (page 208) for information regarding the HP 5334A Universal Counter.

**Options**

**Opt 010: High-Stability Time Base (Oven)**

**Frequency:** 10 MHz  
**Aging Rate:**  $5 \times 10^{-10}$ /day after 24-hour warmup

**Opt 030: 1300 MHz C Channel**

**Range:** 90 to 1300 MHz  
**Sensitivity:** 15 mV rms (-23.5 dBm) sine wave, 90 to 1000 MHz. 75 mV rms (-9.5 dBm) sine wave, 1000 to 1300 MHz  
**Resolution and accuracy:** Same as Frequency A and B

**Ordering Information**

**HP 5334A** Universal Counter

**HP 5334B** Universal Counter

**Opt 010** Oven Oscillator

**Opt 030** Channel C

**Opt 060** Rear Terminals

Channel A, B and ARM in parallel with front inputs.

Option 030 at rear panel only.

**Opt W30** Extended Repair Service (see page 671)

**Opt W32** Calibration Service (see page 671)

☎ For off-the-shelf shipment, call 800-452-4844.

**Price**

\$5,720

\$2,305

+ \$880

+ \$595

+ \$150



# ELECTRONIC COUNTERS

## Universal Systems Counter and Preamplifier HP 5335A, 10855A

- A high-performance 200 MHz/2-ns universal counter
- Built-in automatic rise time, duty cycle, pulse width, slew rate and phase measurements
- Advanced automatic triggering capabilities
- HP-IB plus math and statistics functions standard

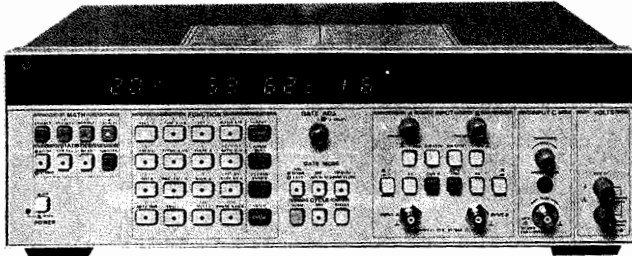

HP 5335A



### Remarkable Automatic Measurement Power

Designed for bench or systems applications, the HP 5335A has 20 measurement functions, all automatically selected by push-button or by HP-IB. These functions, plus greatly expanded arming and triggering capability, make the HP 5335A a powerful universal counter. Math and statistics features, matched Channel A and B input amplifiers, and HP-IB are all included in the standard unit.

The HP 5335A can automatically measure waveform characteristics. With a signal source, rise and fall times, output slew rate, and propagation times can be measured with one test setup. Duty cycle can be measured to see the distortion on a square wave through the amplifier due to different rising and falling slew rates. Phase measurements are push-button selectable and performed automatically.

### Advanced Triggering and Full Measurement Capabilities

The HP 5335A offers several powerful features:

**Manual and Automatic Triggering:** In manual, the  $\pm 5$  Vdc range reduces the need for input attenuators. Two auto trigger modes (front-panel or HP-IB control) select 10 to 90% rise/fall-time trigger points, 50% phase trigger points, or a preset value, then track dc offset to remain on the trigger point.

**Trigger Level DVM:** View both input channel trigger levels.

**Frequency:** Measure to 200 MHz on Channel A, 100 MHz on Channel B, and 1.3 GHz on optional Channel C. Resolution is 9 digits per second over the entire frequency range.

**Time Intervals:** Matched custom input amplifiers reduce trigger errors between Channels A and B. Analog interpolation converts the clock to a 1-GHz-equivalent time base, yielding single-shot time-interval measurements better than 2 ns (100 ps with averaging).

**Math and Statistics:** Averaging can extend resolution for all measurements except phase. Sample sizes are selectable: 100 or 1000. The HP 5335A calculates standard deviation. Built-in math functions (scale, offset, and normalize) simplify conversions for viewing flow, speed, pressure, and temperature parameters, and can be set individually for each measurement function.

### HP 10855A 2-1300 MHz Preamplifier

The HP 10855A Preamplifier enhances measurements of very low-level signals. The  $\pm 1.5$  dB flat response reduces distortion in non-sinusoidal waveforms. The HP 10855A operates with instruments having probe power outlets, or with the HP 1122A Probe Power Supply. The HP 5334A/5335A Option 030 and HP 5328B Option 031 counters support the HP 10855A.

#### HP 10855A Specifications

**Frequency range:** 2 MHz to 1300 MHz  
**Gain (minimum):** 22 dB; 24 dB typical  
**Gain flatness across full frequency range:**  $\pm 1.5$  dB  
**Noise figure:**  $< 8.5$  dB typical  
 Output power for 1 dB gain compression 0 dBm  
**Harmonic distortion:**  $-30$  dB for  $-15$  dBm output, typical;  
 $-25$  dBm for  $< -66$  dB output, typical  
**VSWR:**  $< 2.9$ , typical  
**Impedance:** 50  $\Omega$  nominal  
**Reverse isolation:**  $> 45$  dB  
**Maximum input:** 3.5 V rms ( $+24$  dBm), fuse protected

### HP 5335A Specifications

#### Input Characteristics (Channels A and B)

**Range:** dc-coupled, 0 to 100 MHz  
 ac: 1 M $\Omega$ , 30 Hz to 100 MHz; 50  $\Omega$ , 200 kHz to 100 MHz  
 Note: Channel A range 200 MHz in Frequency A and Ratio modes.

**Sensitivity (X1):** 25 mV rms sinewave.

75 mV peak-to-peak pulse, minimum pulse width of 5 ns  
**Dynamic Range (X1):** 75 mV to 5 V peak-to-peak, to 100 MHz;  
 75 mV to 2.5 V peak-to-peak,  $> 100$  MHz

**Signal Operating Range (X1, DC):**  $-5$  to 5 Vdc

**Trigger Level Range (X1)**

**Auto Trigger OFF**

Preset: Set to 0 Vdc nominal; adjustable:  $-5$  to  $+5$  Vdc

**Auto Trigger ON**

Preset: Set to nominal 50% point of input signal.

Adjustable: Nominally between  $+$  and  $-$  peaks of input signal.

**Auto Trigger (X1), (Requires Repetitive Signal)**

**Range (50% duty cycle):** dc-coupled, 30 Hz to 200 MHz

ac: 1 M $\Omega$ , 30 Hz to 200 MHz; 50  $\Omega$ , 200 kHz to 200 MHz

**Minimum signal:** 100 mV rms

**Duty cycle range:** 10% to 90%

**Response time:** 3 s, typical

**Coupling:** ac or dc, switchable

**Impedance:** 1 M $\Omega$ , nominal, shunted by  $< 35$  pF or 50  $\Omega$  nominal, switchable. In Common A, 1 M $\Omega$  is shunted by  $< 50$  pF.

**Attenuator:**  $\times 1$  or  $\times 10$  nominal, switchable

**Slope:** Independent selection of  $+$  or  $-$  slope

**Channel Input:** Separate or Common A, switchable

#### Frequency A

**Range:** 0 to 200 MHz, prescaled by 2

**LSD Displayed:**  $\frac{1 \text{ ns}}{\text{gate time}} \times \text{freq. (e.g. 9 digits in a second)}$

**Resolution:**  $\pm (2 \times \text{LSD}) \pm 1.4 \times \frac{\text{trigger error}}{\text{gate time}} \times \text{freq}$

**Accuracy:**  $\pm (\text{resolution}) \pm (\text{timebase error}) \times \text{freq}$

#### Period A

**Range:** 10 ns to  $10^7$  s

**LSD Displayed:**  $\frac{1 \text{ ns}}{\text{gate time}} \times \text{PER. (e.g. 9 digits in a second)}$

**Period average:** Select MEAN function, and  $n = 100$  or 1000

#### Time Interval A $\rightarrow$ B

**Range:** 0 ns to  $10^7$  s

**LSD displayed:** 1 ns (100 ps using MEAN)

**Resolution:**  $\pm (2 \times \text{LSD}) \pm (\text{START trigger error}) \pm (\text{STOP trigger error})$

**Accuracy:**  $\pm (\text{resolution}) \pm (\text{timebase error}) \times \text{TI} \pm (\text{trigger level timing error}) \pm (2 \text{ ns})$

**Gate mode:** MIN only

**Time interval average:** Select MEAN function, and  $n = 100$  or 1000

#### Time Interval Delay (Holdoff)

Front panel Gate Adjust control inserts a variable delay between START and enabling of STOP. Electrical inputs during delay are ignored. Delay ranges are same as gate time ranges (100  $\mu$ s to 4 s, nominal) for gate modes of Fast, Norm, and Manual.

#### Inverse Time Interval A $\rightarrow$ B

**Range:**  $10^{-7}$  to  $10^9$  units/second

LSD Displayed, Resolution, and Accuracy are inverse of Time Interval A $\rightarrow$ B specifications.

#### Rise and Fall Time A

**Range:** 20 ns to 10 ms transition with 50 Hz to 25 MHz repetition rates (50% duty cycle)

**Minimum pulse height:** 500 mV peak-to-peak

**Minimum pulse width:** 20 ns

**Duty cycle range:** 20% to 80%

LSD Displayed, Resolution: See Time Interval A $\rightarrow$ B specifications.

#### Pulse Width A

**Range:** 5 ns to  $10^7$  s

**Trigger point range:** 40% to 60% of pulse height

LSD Displayed, Resolution: See Time Interval A $\rightarrow$ B specifications.

**Duty Cycle A** (Constant Duty Cycle Required)**Range:** 1% to 99%, 0 to 100 MHz**Trigger point range:** 40% to 60% of pulse height**LSD displayed:**  $\frac{1 \text{ ns}}{\text{period}} \times 100\%$ **Slew Rate A****Range:** 50 V/s to 10<sup>8</sup> V/s slew rate with 50 Hz to 25 MHz repetition rates (50% duty cycle). Minimum pulse height, width, and duty cycle range are same as Rise and Fall Time A**Input mode:** Automatically set to COMMON A with 10% and 90% trigger levels**Ratio A/B****Range:** Channel A: 0 to 200 MHz (prescaled by 2);  
Channel B: 0 to 100 MHz.**LSD displayed:**  $\frac{\text{Ratio}}{\text{Freq} \times \text{Gate Time}}$  where Freq is higher frequency after prescaling**Totalize A****Range:** 0 to 100 MHz**LSD displayed:** 1 count of input**HP-IB output:** At end of gate**Manual****Count reset:** Via RESET key**HP-IB output:** Totalize data on-the-fly sent if Cycle mode set to Single. Input frequency range in this mode is 0 to 50 Hz nominal.**Gated****Count reset:** Automatic after measurement**Phase A Rel B****Range:** -180° to 360° (Range Hold OFF) or 0° to 360° (Range Hold ON) with signal repetition rates of 30 Hz to 1 MHz.**Minimum signal:** 100 mV rms**LSD displayed:** 0.1°**Gate Time****Range:** 100 μs to 10<sup>7</sup> s**LSD displayed:** Up to 3 digits with Ext. Arm Enable OFF, 100 ns when ON. MIN Gate Mode display zero.**Trigger Level****Range:** ×1, +5 to -5 V; ×10, +50 to -50 V**Resolution:** ×1, 10 mV; ×10, 100 mV**Accuracy (×1):** ±20 mV, ±0.5% of reading**Timebase****Standard Crystal** (see page 198)**Frequency:** 10 MHz**Aging rate:** < 3 × 10<sup>-7</sup>/month**Temperature:** < 5 × 10<sup>-6</sup>, 0 to 50° C**Line voltage:** < 1 × 10<sup>-7</sup> for 10% change**High-stability crystal:** See Option 010**External timebase input:** Rear-panel BNC accepts 5 or 10 MHz, 200 mV rms into 1 kΩ; 5 V rms maximum.**Timebase out:** 10 MHz, > 1 V peak-to-peak into 50 Ω via rear panel.**Statistics****Sample size:** Selectable, n = 100 to 1000 samples**Functions:** Std. dev., mean, and smooth (weighted running average)**Math**

All measurement functions, except GATE TIME, Totalize in Scale Mode, and TRIG LVL, may be operated upon by Math functions. Offset, Normalize, and Scale may be used independently or together:

$$\text{Display} = \frac{\text{measurement} + \text{offset}}{\text{normalize}} \times \text{scale.}$$

**Number value range:** ±1 × 10<sup>-9</sup> to ±9 × 10<sup>9</sup>**Last display:** Causes value of previous display to Offset (negative value), Normalize, or Scale all subsequent measurements**Measurement t-1:** Causes each new measurement to be Offset, Normalized, or Scaled by immediately preceding measurement**Hewlett-Packard Interface Bus (See Option 040)****Programmable controls:** All measurement functions, Math, Statistics, Reset, Range Hold, Ext. Arm Enable/Slope, Check, Gate Adj. (~1 ms to 1 s), Gate Open/Close (gate times to ∞), Gate Mode, Cycle, Preset, Slope, Common A, Auto Trigger**Special functions:** FREQ B, PULSE B, TIME B → A, TOT A-B, LEARN, MIN, MAX, all internal diagnostic routines**Interface functions:** SH1, AH1, T5, TE0, L4, LE0, SR1, RL1, PP0, DC1, DT1, C0 (see page 114)**Data output:** Fixed format consisting of 19 characters plus CR and LF output typically in 8 ms**General****Gate:** Minimum, manual, or continuously variable (NORM/FAST) via Gate Adj. control**NORM:** 20 ms to 4 s nominal**FAST:** 100 μs to 20 ms nominal**MIN:** Minimum gate time. Actual time depends on function.**MANUAL:** Each press opens or closes gate.**Cycle:** Determines delay between measurements**NORM:** No more than a 4 readings per second, nominal**MIN:** Updates display as rapidly as possible (~15 readings per second, depending on function)**SINGLE:** One measurement taken with each press of button.**Arming:** Ext. Arm Enable key allows rear-panel input to determine Start and/or Stop point of a measurement. External gate defined by both Start and Stop armed. All measurements are armable except Manual Totalize, Phase, and Trigger Level.**Start arm:** + or - slope of arm input signal starts measurement.**Stop arm:** + or - slope of arm input signal stops measurement.

When used, Start Arm must occur before Stop Arm.

**Ext. arm input:** Rear-panel BNC accepts TTL into 20 kΩ. Minimum Start to Stop Time: 200 ns.**Trigger level out:** dc output into 1 MΩ via rear panel BNCs for Channel A and B; not adjusted for attenuators.**Accuracy at dc (×1):** ±15 mV ±0.5% of TRIG LVL reading**Gate out:** TTL level into 50 Ω; goes low when gate open; rear panel BNC**Range hold:** Freezes decimal point and exponent of display.**Display:** 12-digit LED; exponent range of +18 to -18**Operating temperature:** 0° to 50° C**Power requirements:** 100, 120, 220, 240 Vac (+5%, -10%), 48 to 66 Hz; 130 VA max**Weight:** Net, 8.8 kg (19 lb 8 oz); shipping, 13.6 kg (30 lb)**Dimensions:** 425.5 mm W × 132.6 mm H × 345.4 mm D (16½ in × 5¼ in × 13½ in), not including removable handles.**Options****Opt 010: High Stability Timebase Oven** (see page 198)**Frequency:** 10 MHz.**Aging rate:** < 5 × 10<sup>-10</sup>/day after 24-hour warmup**Short term:** < 1 × 10<sup>-10</sup> rms for 1s average**Temperature:** < 7 × 10<sup>-9</sup>, 0° to 50° C**Line voltage:** < 1 × 10<sup>-10</sup> for 10% change**Warmup:** within 5 × 10<sup>-9</sup> of final value in 20 minutes**Opt 020: DC Digital Voltmeter****Range:** 4 digits, autoranging, autopolarity, in ±10, ±100, ±1000 V ranges**Sensitivity:** 100 μV, 1 mV, 10 mV, 100 mV for ±1 V, ±10 V, ±100 V, ±1000 V readings**LSD displayed:** Same as sensitivity**Input type:** Floating pair**Input frequency impedance:** 10 MΩ ± 1%**Opt 030: 1.3 GHz C Channel****Input range:** 150 MHz to 1.3 GHz prescaled by 20.**Input sensitivity:** 10 mV rms sinewave (-27 dBm) to 1 GHz; 100 mV rms sine wave (-7 dBm) to 1.3 GHz.**LSD Displayed, Resolution, Accuracy:** Same as Frequency A**Ratio C/A Range:** Channel A, 0 to 200 MHz

Channel C, 150 to 1300 MHz

**Opt 040: Complete Systems Programmability**

Adds remote selection of low-pass filter, ac/dc coupling, attenuator, dc trigger level, and input impedance for Channels A and B.

**Ordering Information**

Ordering Information	Price
<b>HP 5335A</b> Universal Counter (with front handles)	\$5,250
<b>Opt 010</b> Oven Oscillator	+ \$990
<b>Opt 020</b> DVM	+ \$730
<b>Opt 030</b> C Channel	+ \$1,015
<b>Opt 040</b> Expanded HP-IB Control	+ \$950
<b>Opt 908</b> Rack Flange Kit for Use Without Handles	+ \$35
<b>Opt 913</b> Rack Flange Kit for Use With Supplied Front Handles	+ \$70
<b>Opt W30</b> Extended Repair Service (see page 671)	\$110
<b>Opt W32</b> Calibration Service (see page 671)	\$525
<b>HP 10855A</b> 2 MHz to 1300 MHz Preamplifier	\$1,150

# ELECTRONIC COUNTERS

## Universal Time-Interval Counter and Low-Pass Filter Kit

HP 5370B, 10856A

- 20 ps single-shot LSD;  $\pm 100$  ps accuracy
- 11 digits/s frequency resolution
- Up to 8000 measurements/sec
- Built-in statistics functions
- Frequency and period to 100 MHz

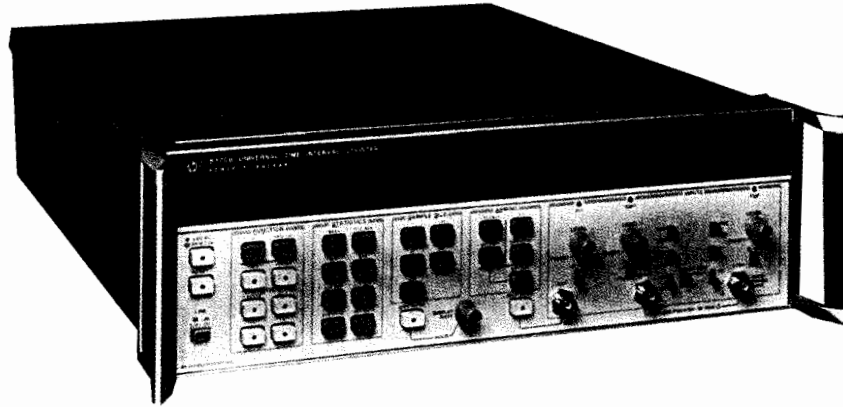

HP 5370B



### Increase Productivity with the HP 5370B's Precision and Measurement Speed

- IC tester performance verification
- Fast IC characterization
- Disk drive manufacture
- Digital communications—jitter analysis
- Radar/laser ranging calibration
- Nuclear systems
- Calibration labs

#### Use the Full Range of Functions

**Time Interval:** Achieve 20 ps single-shot LSD on time intervals from 0 to 10 s, including negative time (in which the STOP channel event occurs before the START channel event).

**Frequency:** Measure up to 100 MHz with 11 digits of resolution in 1 s. Choose gate times down to 1 period; use 1 period with average mode and access the powerful Statistics capabilities.

**Period:** Measure period average from 1 to 100k samples and use Statistics.

**Statistics:** Reduce external computations, reduce random errors, and improve measurement throughput.

**Sample size:** Select 1, 10, 1k, 10k or 100k samples from the front panel, or 1 to 65,536 samples over HP-IB. For the selected sample size, you can compute:

- Mean
- Standard Deviation
- Minimum
- Maximum

**Flexible Arming and Gating:** + TI or  $\pm$  TI with internal or external arming, with or without external hold-off.

#### Full HP-IB Programming and Fast Data Output:

- Up to 8000 readings/s in fast binary mode—125  $\mu$ s dead time.
- 10 to 20 readings/s fully formatted—330  $\mu$ s dead time.

#### Time Interval Measurement Characteristics

##### Range

$\pm$  TI: -10 to +10 s, including zero.

+ TI: 10 ns to 10 s.

##### Resolution

Measurement resolution depends on input signal noise and slew rate. See Graph 3 for characteristic curves.

##### Accuracy

Time-interval measurement accuracy is influenced by internal systematic uncertainties, trigger-level timing error for each trigger edge, and timebase aging in addition to resolution or random uncertainties. Graphs 1 and 2 show characteristic systematic uncertainties for the HP 5370B. These uncertainties may be reduced to less than 10 ps by calibration with the HP J06-59992A time interval calibrator. Careful calibration and averaging will result in accuracies to  $\pm 100$  ps.

#### Frequency and Period Measurement Characteristics

##### Range

Frequency: 0.1 Hz to 100 MHz.

Period: 10 ns to 10 s.

##### Resolution

Measurement resolution depends on input signal noise as well as measurement gate time. Refer to Graph 6 for characteristic curves.

##### Accuracy

Accuracy is influenced by internal uncertainties, timebase aging, and noise on the input signal. Graphs 4 and 5 show the contributions of timebase aging and internal uncertainties to measurement accuracy. Periodic timebase calibration minimizes uncertainty due to timebase aging. Internal uncertainties and noise effects may be reduced by selecting longer gate times, or by averaging results.

#### High-Precision Oscillators

The accuracy of frequency and time-interval measurements is vitally dependent on the timebase or reference element selected. HP has pioneered the field of high-precision crystal oscillators. The current counter product line benefits from HP's leadership in quality and precision oscillator technology.

Three oscillator varieties are standard or optional with the HP counters and counter/timers:

- **RTXO:** Room-temperature crystal oscillators are designed for minimum frequency change over a change in temperature.
- **TCXO:** Temperature-compensated crystal oscillators use external components to offset temperature effects. TCXO temperature characteristics are typically 5 times better than an RTXO, or  $< 5 \times 10^{-7}$  for a  $0^\circ$  to  $50^\circ$  C change.
- **Oven Timebases:** This alternative places the crystal and temperature-sensitive elements within a temperature-controlled environment. A heating element maintains a consistent temperature. The best stability is achieved when the operating point is  $15^\circ$  to  $20^\circ$  C above the highest temperature to which the unit will be exposed. After warmup, the frequency remains very stable, typically  $< 7 \times 10^{-9}$  over a  $0^\circ$  to  $50^\circ$  C variation.

For more information, please request Application Note 200-2, "Fundamentals of Quartz Oscillators," from your local HP office.

#### For More Information

Ask your local HP sales representative for the following literature for more details on the HP 5370B time interval counter and the HP J06-59992A time interval calibrator. (See page 684 for your local HP sales office.)

**HP 5370B** Technical Data Sheet, Literature Number 5952-7915

**HP J06-59992A** Technical Data Sheet, Literature Number 5952-7837

**Product Note 5370B-2:** "Better than 100 ps Accuracy in HP 5370B Time Interval Measurements Through Bias Error Reduction," Literature Number 5952-7834.

**Product Note 5370B-3:** "High Throughput Picosecond Characterization of Pulse Parameters," Literature Number 5952-7769.

**Application Note 191-7:** "High-Speed Timing Acquisition and Statistical Jitter Analysis," Literature Number 5952-7908.



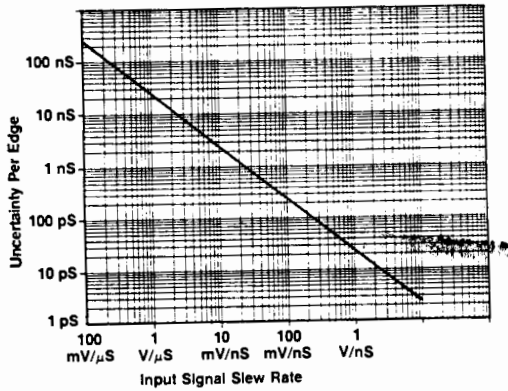

Graph 1. Trigger-level timing error varies with input signal slew rate. Uncertainty is associated with both start and stop edges.

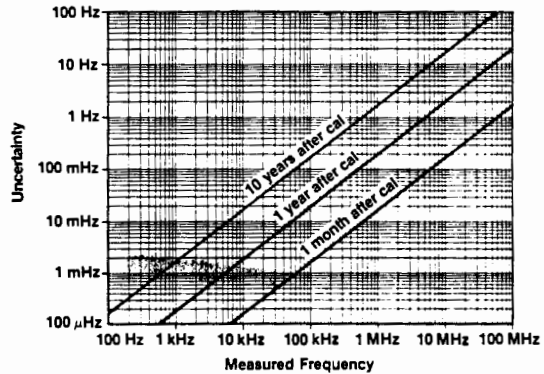

Graph 4. Timebase crystal aging affects frequency and period measurements. You can further reduce the uncertainty by using an atomic frequency standard.

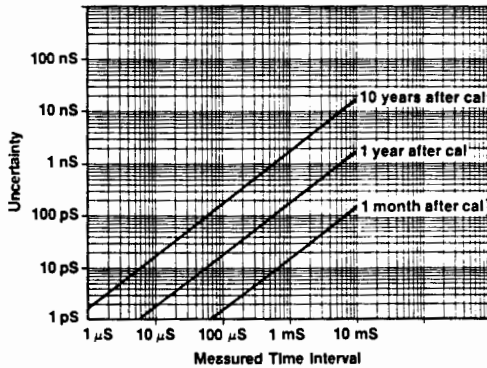

Graph 2. Timebase crystal aging affects a time-interval or pulse-width measurement.

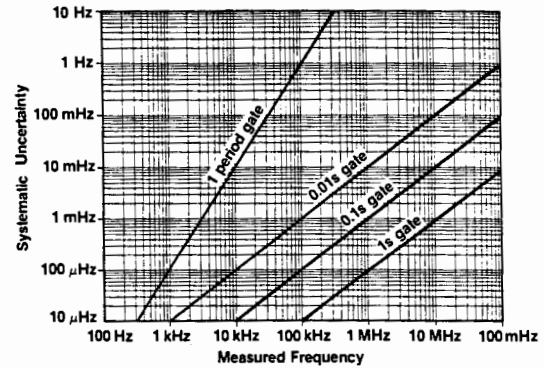

Graph 5. Internal uncertainties affect frequency and period measurements.

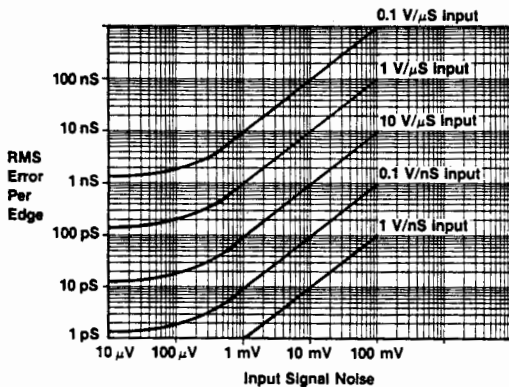

Graph 3. Noise on the input signal will add uncertainty to a time-interval measurement. Averaging will reduce the effects of random noise.

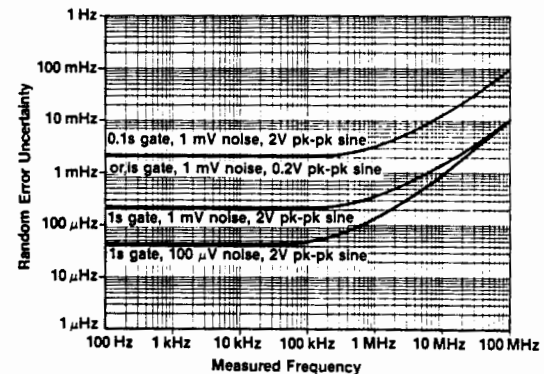

Graph 6. Noise on the input signal will add uncertainty to a frequency or period measurement. Longer gate times and averaging will reduce the effects of random noise.

### HP 10856A Low-Pass Filter Kit

The four low-pass filters of the HP 10856A filter kit are recommended for use with any HP frequency counter to reduce high-frequency noise or unwanted signals that cause frequency or period measurement errors. Further applications for the kit include reducing noise (trace fuzz) in oscilloscope and spectrum analyzer displays.

#### HP 10856A Specifications

Cutoff Frequency (nominal)	5 KHz	50 KHz	500 KHz	15 MHz
Input Impedance (nominal)	1 MΩ	100 kΩ	10 kΩ	50 Ω
Signal Rejection, 100 MHz to 500 MHz	> 40 dB	> 40 dB	> 40 dB	> 20 dB

**Roll-off:** 20 dB per decade

**Attenuation:** × 2, reduces signal voltage by a factor of 2

**Output impedance:** For use with 1 MΩ input instruments

### Ordering Information

HP 5370B Time Interval Counter	\$16,100
Opt 913 Rack Flange Kit for Use with Supplied Front Handles	+ \$30
Opt 908 Rack Flange Kit, No Front Handles	+ \$32.50
Opt W30 Extended Repair Service (see page 671)	\$305
Opt W32 Calibration Service (see page 671)	\$1,345
HP 10856A Low-Pass Filter Kit	+ \$465
HP J06-59992A Time Interval Calibrator	Call HP

# ELECTRONIC COUNTERS

## RF Frequency Counters

HP 5384A, 5385A, 5386A

- Frequency measurements to 3 GHz (HP 5386A)
- Up to 11 digits of resolution, 9 digits per second
- -23.5 dBm sensitivity
- HP-IB standard
- Systems performance and portability

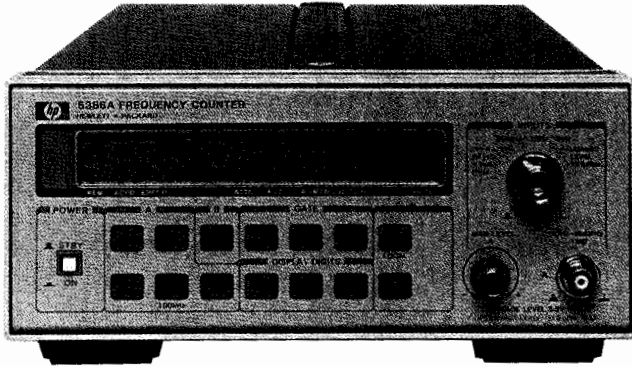

HP 5386A



### HP 5384A/5385A/5386A Frequency Counters

The HP 5384A/5385A/5386A are HP's lowest-priced system frequency counters. They provide outstanding measurement performance for bench, field, and systems applications. Combining wide frequency range, high resolution, high sensitivity, and HP-IB compatibility, these counters are comparable with instruments that cost much more.

#### Portable

The half-rack-width package makes the HP 5384A/5385A/5386A portable and saves rack or bench space.

#### Versatile Display

The 12-digit liquid-crystal display has larger characters than other LED displays and is easier to read in sunlight. The added feature of remote display extends the usefulness of these counters beyond that of simply making and displaying frequency measurements. User-friendly messages, prompts, and measurement units are easily displayed.

#### Low Cost of Ownership

Integrated design and extensive self-tests result in greater reliability, easier serviceability, and ultimately lower cost of ownership.

#### Performance

If your frequency measurement needs are below 3 GHz, HP RF counters provide the basic performance of traditional microwave counters at about half the price. The HP 5386A measures frequencies from 10 Hz to 3 GHz with only two input ports, instead of the three ports found with other counters. The high-frequency input measures frequencies from 100 MHz to 3 GHz with -23.5 dBm sensitivity (15 mV rms). In addition, prescaling techniques offer peak-to-peak FM tolerance of at least 100 MHz for your communications applications. You can select the number of digits displayed from 3-to-11 to blank meaningless digits from an unstable digital source. The HP RF counters also solve systems problems with full remote programmability (via HP-IB standard feature) and remote display capabilities. The high-stability timebase option will lengthen the required calibration period (for kHz accuracy at 3 GHz) from six months to a full year.

#### Applications

The HP RF counters fit well in the following application areas for local oscillator, IF, and radio transmitter frequency measurements:

- Military and private communications
- TACAN, DME, and Identify Friend or Foe
- Global Positioning System
- MDS Television

#### Specifications

**Input channel A (HP 5384A/85A/86A):** 1 M $\Omega$  // 25 pF

**Range:** 10 Hz to 100 MHz

Sensitivity	HP 5384A/5385A	HP 5386A
10 to 50 Hz, sinewave	25 mV rms	15 mV rms
50 Hz to 100 MHz, sinewave	15 mV rms	15 mV rms
5 ns minimum pulse width	45 mV peak-to-peak	45 mV peak-to-peak

**Dynamic range:** 45 mV to 4 V peak-to-peak  $\times$  attenuator setting

**Attenuator:**  $\times 1$  or  $\times 20$  nominal above 50 Hz input

**Low-pass filter:** 100 kHz nominal 3 dB point

**Manual trigger level:** Variable, -0.1 V to +0.1 V  $\times$  attenuator

**Damage level  $\times 1$ :** 10 to 200 Hz: 350 V (dc + ac peak)

0.2 to 420 KHz: 170V (dc + ac peak)

0.42 to 10 MHz: (5 x 10<sup>7</sup> V rms Hz)/freq

> 10 MHz: 5V rms

**$\times 20$ :** < 1 MHz: same as  $\times 1$ ; > 1 MHz: 50 V rms

**Input channel B (HP 5384A):** 50  $\Omega$

**Range:** 50 to 225 MHz

**Sensitivity:** 10 mV rms, 50 to 200 MHz; 15 mV rms, 200 to 225 MHz

**Dynamic range:** 10 mV to 1 V rms

**Manual attenuator:** Variable,  $\times 1$  to  $\times 5$  (0 to 14 dB) nominal

**Damage level:** 350 Vdc + 5 V rms ac

**Input channel B (HP 5385A):** 50 ohm, fused

**Range:** 90 to 1000 MHz

**Sensitivity:** 10 mV rms (-27 dBm), 100 to 1000 MHz, 15 mV rms (-23.5 dBm), 90 to 100 MHz

**Dynamic range:** 10 mV to 7 V rms (-27 to +30 dBm)

**Manual attenuator:** variable,  $\times 1$  to  $\times 18$  (0 to 25 dB) nominal

**Damage level:** ac > 1 MHz: + 30 dBm (7 V rms)

ac < 1 MHz: 2 V rms, dc  $\pm$  5 V

**Input channel B (HP 5386A):** 50 ohm nominal, VSWR 2.5, typical

**Range:** 100 MHz to 3 GHz, prescaled (90 MHz to 3.5 GHz, typical)

**Sensitivity:** 15 mV rms (-23.5 dBm); 5 mV rms (-33.0 dBm) typical

**Dynamic range:** 15 mV rms to .5 V rms (-23.5 dBm to +7 dBm);

5 mV rms to .5 V rms (-33.0 dBm to +7 dBm), typical

Note: Manual attenuator not active for channel B.

#### Frequency A and B

**Range channel A:** 10 Hz to 100 MHz

**Range channel B:** 50 to 225 MHz (HP 5384A); 90 MHz to 1 GHz

(HP 5385A); 100 MHz to 3 GHz (HP 5386A)

**LSD displayed:** 10 Hz to 1 nHz

**Accuracy:**  $\pm$  resolution  $\pm$  time base to error  $\times$  frequency (see Graphs 1 and 3).

#### Period A

**Range:** 10 ns to 0.1 s

**LSD displayed:** .0001 fs to 10 ns

**Accuracy:**  $\pm$  resolution  $\pm$  time base to error  $\times$  period (see Graphs 2 and 3 on the next page)

#### Timebases (see page 198)

**Standard HP 5384A:** RTX0, 10 MHz

**Aging rate:** < 3  $\times$  10<sup>-7</sup>/mo

**Temperature:** < 5  $\times$  10<sup>-6</sup>, 0 $^\circ$  to 50 $^\circ$  C, ref. 25 $^\circ$  C

**Line voltage:** < 1  $\times$  10<sup>-7</sup> for  $\pm$  10% variation

**HP 5384A Opt 001, Standard HP 5385A/5386A:** TCXO, 10 MHz

**Aging rate:** < 1  $\times$  10<sup>-7</sup>/mo

**Temperature:** < 2  $\times$  10<sup>-6</sup>, 0 $^\circ$  to 40 $^\circ$  C, ref. 25 $^\circ$  C

**Line voltage:** < 5  $\times$  10<sup>-8</sup> for  $\pm$  10% variation

#### Oven timebase (Option 004): 10 MHz

**Aging rate:** < 3  $\times$  10<sup>-8</sup>/mo. after 30 days continuous operation

**Temperature:** < 1  $\times$  10<sup>-7</sup>, 0 $^\circ$  to 50 $^\circ$  C, ref. 25 $^\circ$  C

**Line voltage:** < 2  $\times$  10<sup>-9</sup> for  $\pm$  10% variation

**Battery operation with Option 004 (HP 5384A/5385A only)**

**Typical:** 3 hours

**Standby:** 24-hour continuous operation

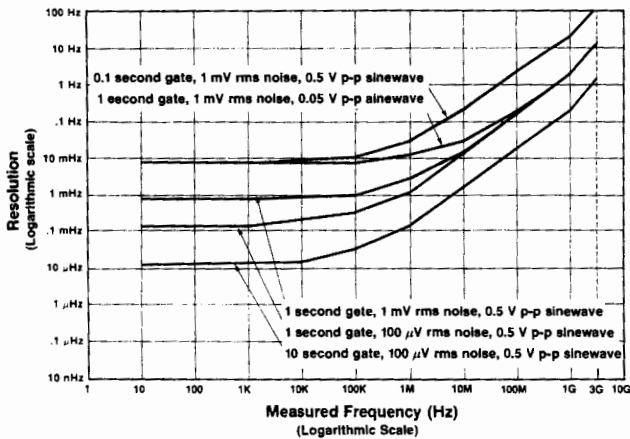

**Graph 1. Frequency Resolution.** Uncertainties that limit resolution can be reduced by increasing the gate time, reducing the noise on the input signal, or increasing the input signal amplitude.

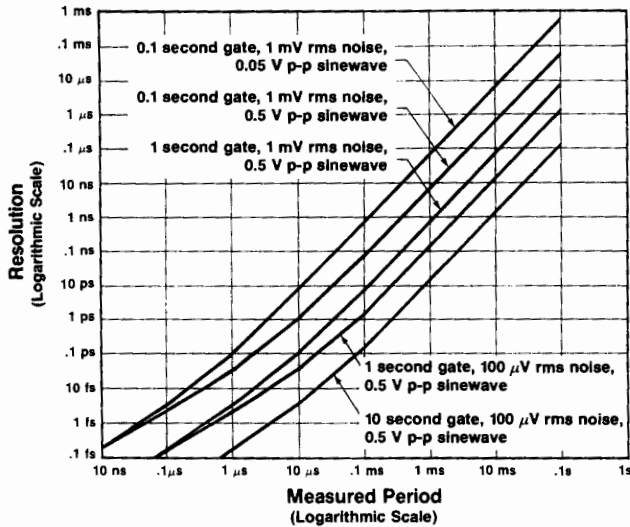

**Graph 2. Period Resolution.** Uncertainties that limit resolution can be reduced by increasing the gate time, reducing the noise on the input signal, or increasing the input signal amplitude.

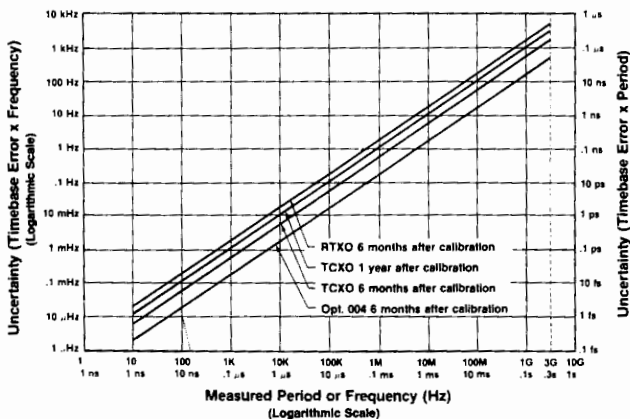

**Graph 3. Frequency and Period Uncertainty Due to Timebase Error.** Timebase error can be reduced by calibrating the timebase more frequently, or by using a timebase with a better aging rate.

**I/O Interface**

**HP-IB Standard**

**Programmable functions:** Frequency A, Frequency B, Period A  
**Programmable controls:** ATTN A, FILTER A, MAN LEVEL A, MAN LEVEL A/B (HP 5384A/85A only), Gate Time  
**Display:** Normal, Increment, Decrement (digits displayed); Remote, Local; any 12-character message can be displayed on the LCD via a system controller.  
**Data output:** Output will be maximum resolution/gate time.  
**Format:** 17 characters plus CR and LF  
**Rate:** 4 readings/s maximum at 0.1 s gate  
**HP-IB interface functions:** SH1, AH1, T5, TE0, L4, LE0, SR1, RL1, PP0, DC1, DT1, C0, E1 (see page 114).  
**Talk Only:** Set with address switch = 31

**Battery Pack (Option 005, HP 5384A/5385A Only)**

**Type:** Sealed lead-acid  
**Capacity:** 4 hours (typ.) at 25° C without Opt 004  
**Recharge time:** 16 hours (typ.) in standby mode  
**Battery-low annunciator:** Enabled 20 min prior to instrument shut-down nominally  
**Battery save switch (rear panel):** Prevents discharge of interval battery by the oven time base, Opt 004, during instrument standby.  
**Line failure protection:** Instrument automatically switches to battery in the event of a line failure.  
**Weight:** Adds 1.4 kg (3 lb) to instrument weight.

**General**

**Check:** 10 MHz self-test  
**Gate times:** 0.1, 1, or 10 seconds (nominal)  
**Display:** 12-digit alphanumeric liquid crystal  
**Display digits (variable):** Frequency 3 to 11; period 3 to 8  
**Timebase output:** 10 MHz, 25 mV peak-to-peak (nominal) into 50 Ω  
**External timebase input:** 10 MHz, 0.5 V rms into 500 Ω; 15 V (dc + ac peak) maximum  
**Operating temperature:** 0° to 50° C  
**Power requirements**  
**ac:** Selectable, 18 VA max (30 VA max., HP 5386A), 115 V + 10%, -25%; 230 V + 10%, -15% (48 to 66 Hz); 115 V ± 10% (380 to 420 Hz)  
**dc (HP 5384A/5385A only):** 9 to 15 Vdc, 1.0 A maximum  
**Weight**  
**HP 5384A/5385A:** Net, 2.2 kg (4.8 lb); shipping, 4.1 kg (9 lb)  
**HP 5386A:** Net, 3.4 kg (7.8 lb); shipping, 5.3 kg (11.9 lb)  
**Size**  
**HP 5384A/5385A:** 212 mm W × 98 mm H × 276 mm D (8 1/4 in × 3 7/8 in × 10 7/8 in)  
**HP 5386A:** 212.3 mm W × 88.1 mm H × 421.6 mm D (8 1/4 in × 3 3/8 in × 16 1/2 in)

**Ordering Information**

<b>HP 5384A</b> Frequency Counter 225 MHz	\$1650
<b>HP 5385A</b> Frequency Counter 1.0 GHz	\$2075
<b>HP 5386A</b> Frequency Counter 3.0 GHz	\$3950
<b>Options for HP 5384A, 5385A, 5386A:</b>	
<b>Opt 004</b> High-Stability Oven Timebase	+ \$575
<b>Opt W30</b> Extended Repair Service (see page 671)	
HP 5384-5385A	+ \$50
HP 5386A	+ \$85
<b>Opt W32</b> Calibration Service (see page 671)	+ \$715
<b>HP 5384A/5385A Only</b>	
<b>Opt 001</b> High-Stability TCXO (HP 5384A only; standard with HP 5385A/5386A).	+ \$160
<b>Opt 005</b> Battery Pack	+ \$315
<b>Side Handle Kit:</b> HP 5061-1171	\$50
<b>Rackmount Kit (single):</b> HP 5060-0173	\$90
<b>Rackmount Kit (dual):</b> HP 5060-0174	\$77.50
<b>Vinyl Carrying/Operating Case:</b> HP 34110A	\$82
<b>HP 5386A only:</b>	
<b>Front Handle Kit:</b> HP 5062-3988	\$50
<b>Rackmount Kit (single):</b> HP 5062-3972	\$51
<b>Rackmount Kit (dual):</b> HP 5062-3974 and 5061-9694	\$55

☎ For off-the-shelf shipment, call 800-452-4844.

# ELECTRONIC COUNTERS

## CW Microwave Frequency Counters

HP 5350B, 5351B, 5352B

- 10 Hz to 46 GHz without an external mixer
- Exceptional sensitivity to  $-40$  dBm
- 1 GHz/s tracking speed
- 60-ms acquisition time
- 100 measurements/s (HP-IB) in automatic mode
- Three years of hardware support with Option W30

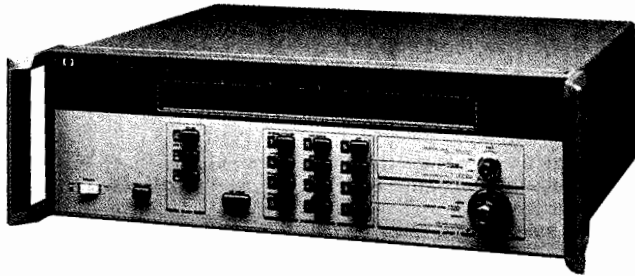

5352B



### HP 5350B/5351B/5352B Microwave Counters

The HP 5350B/5351B/5352B are automatic CW microwave frequency counters that measure to 20, 26.5, and 40 GHz (46 GHz with Option 005), respectively. With resolution as fine as 1 Hz, these counters provide fast and precise frequency measurements.

By integrating all microwave components onto a single hybrid GaAs circuit, these counters offer high performance at low prices. Wide frequency coverage, exceptional sensitivity, fast tracking speed, high measurement throughput, and wide FM tolerance are a few of the high-performance features of these counters.

With a built-in microprocessor, the HP 5350B/5351B/5352B have math capabilities such as measurement scaling and offset. These functions are useful for indirect measurements. Automatic amplitude discrimination automatically measures the frequency of the highest-amplitude signal in a multi-signal environment. Other convenience features include diagnostic routines that perform tests on the counter for general information and troubleshooting.

With high measurement throughput, the HP 5350B/5351B/5352B are ideal components for test systems. Their English-like commands simplify systems integration by reducing programming time and effort. In automatic test systems, the programmable alphanumeric liquid-crystal display (LCD) can serve as a message center; if operational security is a concern, keyboard and display lockout can be activated. In noise-sensitive environments, you can put these counters in SLEEP mode to reduce kickback noise to as low as  $-70$  dBm.

#### Direct Inputs to 46 GHz: Low-Cost, Versatile Solutions

The HP 5350B/5351B/5352B can meet expanding measurement needs. The HP 5350B/5351B measure frequency from 10 Hz to 20 GHz and 26.5 GHz, respectively. The HP 5352B, which extends input capability to 40 GHz (46 GHz with Option 005), measures in the millimeter-wave range directly—without expensive mixers.

#### Exceptional Sensitivity: Direct Measurement of Low-Level Signals

Because these counters have input sensitivity to  $-40$  dBm ( $-30$  dBm for HP 5352B), accurately measuring your low-energy signals becomes a simple task. For example, you no longer need expensive microwave amplifiers to make low-level measurements. Also, you no longer have to worry about signal attenuation by the probe when you make frequency measurements at different nodes within your circuit. These conveniences simplify measurements in applications such as receiver front-end testing.

#### Low Acquisition Time: High Throughput

With acquisition time reduced to 60 ms in automatic, fast-acquisition tracking mode (20 ms in manual mode), these high-speed counters can significantly improve your measurement throughput.

In bench-top applications, this high-speed throughput gives you fast measurement response. The LCD will update measurements rapidly to shorten evaluation time. For applications that require fast response to source tuning, these counters are ideal solutions.

In systems environments, fast measurement throughput contributes to overall system efficiency. Delivering more than 100 measurements/s over HP-IB in automatic mode, these counters save money by reducing test time.

#### 1 GHz/s Tracking: Measuring Fast-Moving Signals

Fast acquisition offers fast tracking speed. With acquisition time below 60 ms, these counters can track source drift to 1 GHz/s effortlessly. For example, when measuring the response of a voltage-controlled oscillator (VCO) to voltage-source tuning, these counters track the changing frequency rapidly to measure transfer characteristics.

### HP 5350B/5351B/5352B Specifications

#### Input 1

**Frequency range:** HP 5350B: 500 MHz to 20 GHz  
 HP 5351B: 500 MHz to 26.5 GHz  
 HP 5352B: 500 MHz to 40 GHz  
 Option 005: 500 MHz to 46 GHz

**Sensitivity:** See Graph 1

**Maximum input:**  $+7$  dBm

**Damage level:**  $+25$  dBm; HP 5350B/5351B Opt 006:  $+39$  dBm (500 MHz to 6 GHz),  $+36$  dBm (6 GHz to 18 GHz),  $+34.8$  dBm (18 GHz to 26.5 GHz)

**SWR** (typical): 500 MHz to 10 GHz: 2:1; Option 002/006, 2.5:1  
 10 GHz to 26.5 GHz: 3:1; Option 002/006, 3.5:1  
 26.5 GHz to 46 GHz: 3.5:1

**Coupling:** dc to  $50 \Omega$  termination, ac to instrument

**Connector:** Precision Type N (female) (HP 5350B)  
 APC-3.5 (male) with collar (HP 5351B/HP 5352B)  
 APC-2.4 (male) with collar (Option 005)

**Accuracy:**  $\pm 1$  LSD  $\pm$  Timebase Error  $\times$  Frequency. See Graph 2, page 193, for timebase error. High-stability timebase (Option 010) has timebase uncertainties that are 1/10 of the values for the oven timebase (Option 001). LSD = least significant digit.

**Residual stability:** Counter and source using common 10-MHz timebase or counter using external higher-stability timebase: .3 LSD rms typical for resolution 1 Hz to 1 kHz at 25°C; HP 5352B: .7 LSD typical 26.5 to 40 GHz.

**Resolution:** Selectable, 1 Hz to 1 MHz

**FM tolerance:** See Graph 2: FM Rate Tolerance

**Maximum deviation:** Auto: 20 MHz p-to-p (HP 5350B/51B),  
 12 MHz p-to-p (HP 5352B),  
 9 MHz p-to-p (Option 005)  
 Manual: 60 MHz p-to-p (HP 5350/51B),  
 55 MHz p-to-p (HP 5352B),  
 55 MHz p-to-p (Option 005)

**Maximum FM rate:** 10 MHz

#### Tracking Speed

**Fast-acquisition track:** 1 GHz/s

**Normal FM rate:** 1 MHz/s

**Low FM rate:** 80 kHz/s

**AM tolerance:** Any modulation index, provided the minimum signal level is not less than the sensitivity specification.

#### Modes of operation

**Automatic:** Counter automatically acquires and displays highest-level signal within sensitivity range

**Manual:** Center frequency must be entered to within  $\pm 20$  MHz or input frequency;  $\pm 3$  MHz worst case below 1 GHz

**Automatic amplitude discrimination:** Measures largest signal present, providing that signal is  $> 6$  dB (typical) above any signal within 500 MHz;  $> 20$  dB (typical) above any signal within 500 MHz to 20 (46) GHz

#### Acquisition time

**Automatic mode:** Fast-acquisition track:  $< 60$  ms

Normal FM rate:  $< 125$  ms

Low FM rate:  $< 1.25$  s

**Manual mode:**  $< 20$  ms

	TCX0	Option 001	Option 010
Aging Rate	$1 \times 10^{-7}$ /month	$5 \times 10^{-10}$ /day	$2 \times 10^{-9}$ /year
Short Term	$1 \times 10^{-9}$ /s	$1 \times 10^{-10}$ /s	$1 \times 10^{-10}$ /s
Temperature 0° to 50° C	$1 \times 10^{-9}$	$1 \times 10^{-9}$	$1 \times 10^{-9}$
Line 10% change	$1 \times 10^{-7}$	$1 \times 10^{-10}$	$1 \times 10^{-10}$
Warmup to <math>5 \times 10^{-9}</math> @ 25° C		10 min	10 min

Table 1. Time Base (10 MHz).

**Input 2**

**Frequency range:** 10 Hz to 525 MHz

50 Ω: 10 MHz to 525 MHz

1 MΩ: 10 Hz to 80 MHz

**Sensitivity:** Full operating environment:

50 Ω: 10 MHz to 525 MHz, 25 mV rms: 15 mV typical @ 25° C

1 MΩ: 10 Hz to 80 MHz, 25 mV rms: 15 mV typical @ 25° C

Gate Time = 1/resolution: 1 ms min

**Maximum input:** 50 Ω: +10 dBm; 1 MΩ: 1V rms

**Damage level:** 50 Ω or 1 MΩ dc to 5 kHz: 250 V (dc + ac peak);

> 5 kHz: 5.5 V rms (+ 28 dBm) +  $1.25 \times 10^6$  V rms/freq

**Coupling:** ac

**Connector:** Replaceable fuse, type BNC (female)

**Accuracy:**

$$\pm 1 \text{ LSD} \pm \left( \frac{1.4 \times \text{Trigger Error}^1}{\text{Gate Time}} \pm \text{Timebase Error} \right) \times \text{Freq}$$

See Graph 2, page 193, for timebase error;

Gate time = 1/resolution = 1 ms minimum

**Impedance:** 1 MΩ nominal shunted by < 70 pF or 50 Ω nominal

**Resolution:** Selectable, 1 Hz to 1 MHz

**High resolution:** 1 MΩ mode: 0.001 Hz for < 100 kHz input; 0.01 Hz

for < 1 MHz input; 0.1 Hz for < 10 MHz input; 1 Hz for > 10 MHz

input: 1-second gate

**Timebase output:** 10 MHz and 1 MHz, 2.4 V square wave ac coupled

into 1 kΩ: 1.5V peak-to-peak into 50 Ω; rear panel BNC connectors

**External timebase:** 1, 2, 5, or 10 MHz, 0.7 V min. to 8 V max.

peak-to-peak sine wave or square wave into > 1 kΩ shunted by

< 30 pF, via rear-panel BNC connector

**General**

**Display:** Segmented 24-character alphanumeric LCD (backlighted)

**Built-in features:** Self-check, diagnostics, display and keyboard lock-

out, overload indicator, HP-IB teach-learn mode

**Data output:** Over HP-IB bus; varies with frequency and resolution

**Auto mode:** > 100 readings/s, 10 kHz resolution, no math func-

tions, "DUMP" mode

**Manual mode:** > 120 readings/s, 10 kHz resolution, no math func-

tions, "DUMP" mode

**Math functions:** Scale, offset, smooth (exponential averaging)

**Sample rate:** Variable from less than 50 ms between measurements

to HOLD, which holds the display indefinitely or until trigger occurs.

**Display rate:** 5/s, variable over HP-IB

**Sleep mode:** Input 1 emissions reduced to < -70 dBm typical when

sleep mode or Input 2 is selected.

**IF output:** Rear-panel BNC provides 30-110 MHz down-converted

microwave signal at > -20 dBm into 50 Ω, ac-coupled.

**HP-IB interface functions:** SH1, AH1, T5, L4, SR1, RL1, PP0, DC1,

DT1, C0, E1 (see page 114)

**Operation temperature:** 0° C to 50° C

**Power requirements:** 100 VA max

**Line select:** 100 V (90 to 105 Vac rms; 47.5 to 440 Hz)

115/120 V (104/126 Vac rms; 47.5 to 440 Hz)

220 V (198 to 231 Vac rms; 47.5 to 66 Hz)

230/240 V (207 to 252 Vac rms; 47.5 to 66 Hz)

**Accessories furnished:** Power cord, manual

**Size:** 133 mm H x 425 mm W x 358 mm D (5¼ in x 16¼ in x 14 in)

**Weight:** 11 kg (24 lb)

$$^1 \text{Trigger error} = \frac{\sqrt{(e_n^2 + e_s^2)}}{\text{Input slew rate in V/S at trigger point}} \text{ s rms}$$

Where  $e_n$  = effective rms noise of counter's input channel (100 μV typical)  
 $e_s$  = rms noise of the input signal for a 500 MHz bandwidth.

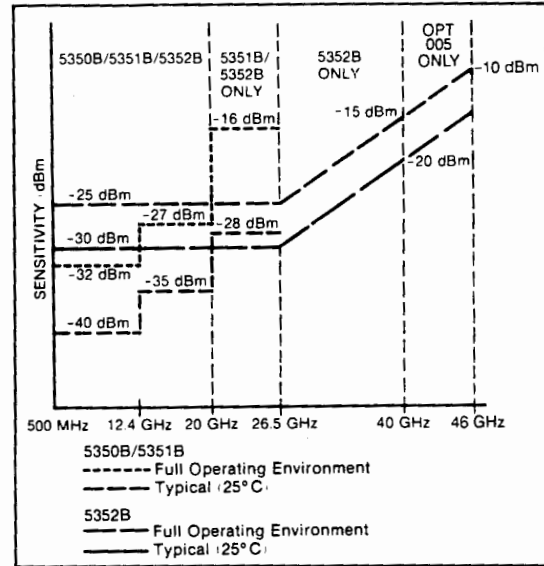

Graph 1. Sensitivity.

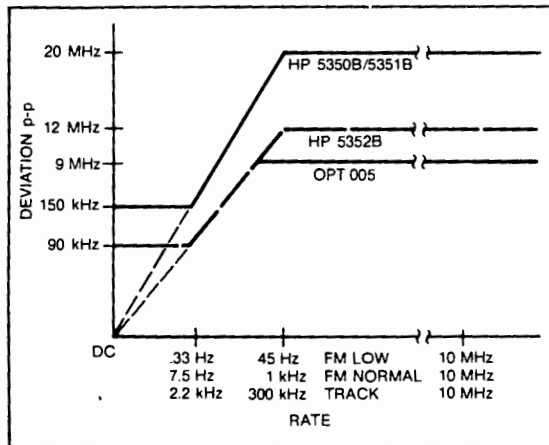

Graph 2. FM rate tolerance.

**Ordering Information**

<b>HP 5350B</b> 20 GHz Microwave Frequency Counter	\$5,700
<b>HP 5351B</b> 26.5 GHz Microwave Frequency Counter	\$6,850
<b>HP 5352B</b> 40 GHz Microwave Frequency Counter	\$4,000

**Options for HP 5350B/5351B/5352B:**

<b>Opt 001</b> Oven Timebase	+ \$780
<b>Opt 002</b> Rear-Panel Inputs (HP 5350B/51B only)	+ \$315
<b>Opt 005</b> Frequency Extension to 46 GHz (HP 5352B only)	+ \$4,050
<b>Opt 006</b> Microwave Level Limiter (HP 5350B/51B only)	+ \$730
<b>Opt 010</b> High-Stability Oven Timebase	+ \$1,560
<b>Opt 700</b> MATE Programming	+ \$520
<b>Opt 910</b> Additional Operating and Service Manual	+ \$78
<b>Opt 908</b> Rack Mount Kit for Use with Front Handles removed	+ \$35
<b>Opt 913</b> Rack Mount Kit for Use with Supplied Front Handles	+ \$37
<b>Opt 1A3</b> Bellcore CLEI Barcode Sticker	+ \$30
<b>Opt W30</b> Extended Repair Service (see page 671)	Call HP
<b>Opt W32</b> Calibration Service (see page 671)	+ \$865

**Additional Equipment Available:**

Transit Case (HP 9211-2643)	\$430
Waveguide (3 in. straight) Adapter WR28-APC3.5 (HP 05356-20217)	\$1,800
Waveguide (3 in. straight) to Coaxial Adapter WR42-APC3.5 (HP 05356-20216)	\$1,900
Adapter: In series APC 3.5 male-to-male (HP 1250-1748)	\$170
Adapter: In series APC 3.5 female-to-female (HP 1250-1749)	\$185

☎ For off-the-shelf shipment, call 800-452-4844.

# ELECTRONIC COUNTERS

## Microwave Counter/Power Meter

HP 5347A, 5348A

- Quick, easy power and frequency measurements
- Portable; battery operation
- Built-in sensor calibration tables
- Supports many HP power sensors



HP 5347A with optional soft carrying case and HP 8485A power sensor

### HP 5347A and HP 5348A Microwave Counter/Power Meters

The HP 5347A and HP 5348A Microwave Counter/Power Meters offer the convenience of a single instrument that meets both your frequency and power measurement needs. The HP 5347A counter/power meter makes these measurements to 20 GHz; the HP 5348A, to 26.5 GHz. Both counter/power meters offer the accuracy and resolution that previously required a standalone counter and a separate power meter. Measurements are easy. The HP 5347A and 5348A are designed for ease of use; they have only 5 function keys. They are rugged, lightweight, and battery powered.

#### True Power Meter Performance

As power meters, the HP 5347A and 5348A offer excellent dynamic range, linearity, and accuracy. They use the same proven power sensors used with Hewlett-Packard's standalone power meters. Power sensors and accurate, wide-range measurements go hand in hand.

Power measurements can be made from  $-70$  dBm to  $+20$  dBm over a 10 MHz to 26.5 GHz frequency range, depending on the sensors used. Exceptional power-meter linearity and low sensor SWR combine to give you outstanding measurement accuracy. The instrumentation accuracy is  $\pm 0.5\%$  in linear mode or  $\pm 0.02$  dB in logarithmic mode, making power-meter uncertainty a negligible part of your total measurement error.

#### Outstanding Frequency Measurements

The frequency counter performance rivals that of HP's highest-performance standalone CW microwave counters. The HP 5347A measures frequency from 10 Hz to 20 GHz; the HP 5348A, from 10 Hz to 26.5 GHz. You can select either 1 Hz or 10 kHz resolution while measuring signals down to  $-35$  dBm.

#### Portable, Easy to Use

The HP 5347A and 5348A come in a rugged, lightweight, and portable package. Several features have been designed in for quick and easy, portable measurements. An internal-battery option, for example, provides up to 2 hours of cordless measurements.

#### Designed for Measurement Ease

How many times have you purchased test equipment only to find that you never use most of the available functionality? The excess functionality only clutters the front panel and makes measurements difficult. Hewlett-Packard recognizes the importance of quick and easy measurements to field service personnel. The HP 5347A and HP 5348A are designed for ease of use.

#### Five Function Keys Simplify Operation

Unnecessary functions were designed out of the HP 5347A and HP 5348A counter/power meters. Only 5 function keys are required to make accurate frequency and power measurements. The chance of getting an incorrect reading due to instrument setup is almost eliminated. Little or no time is required to learn how to use these instruments. A 1-page starter guide is shipped with every instrument.

#### No Need for Calibration Tables

An average calibration table is permanently stored in memory. You no longer need to spend time entering power sensor calibration factors. Using average calibration tables results in only a slight reduction in overall measurement accuracy. With the HP 5347A and 5348A, the press of a single key stores a frequency measurement for use in a power measurement. The stored frequency is then used to access the power sensor calibration factor in the permanently stored calibration-factor-versus frequency tables.

### Internal Battery for Cordless Measurements

An optional internal battery allows you to make cordless measurements for up to 2 hours. In the field, you do not need a power cord. Just walk right up to the output port and make your measurement.

Because at times it might be more convenient to operate the instrument from a dc supply, an external dc input is available for even greater flexibility in choosing a power source.

### A Rugged Package for Tough Environments

These instruments are designed to survive the harsh transportation and operation environments common to portable applications. Their membrane front panels keep dirt and moisture from entering the instruments. An optional soft carrying case stores accessories, protects the unit during transit, and frees your hands to make measurements.

### For Benchtop and ATE Systems Too

Having frequency and true power measurements in a single portable package saves valuable bench space in a manufacturing environment. The ease-of-use features will also be greatly appreciated.

A rackmount kit and HP-IB option are available for using the HP 5347A or HP 5348A in an ATE system.

### Counter Specifications

#### Input 1

##### Frequency range:

HP 5347A: 500 MHz to 20.0 GHz

HP 5348A: 500 MHz to 26.5 GHz

##### Sensitivity:

HP 5347A/48A: 500 MHz to 12.4 GHz: -32 dBm  
(-35 dBm typical)  
12.4 GHz to 20.0 GHz: -27 dBm  
(-32 dBm typical)

HP 5348A: 20.0 GHz to 26.5 GHz: -20 dBm (-27 dBm typical)

##### Maximum input: +7 dBm

##### Damage level: +25 dBm, peak

##### Connector: HP 5347A: N(f); HP 5348A: APC 3.5(m)

##### Coupling: ac

##### Accuracy: $\pm$ LSD $\pm$ timebase error $\times$ frequency

Accuracy specification applies from 0° to 50° C when using internal timebase, 0° to 55° C with external timebase.

##### Resolution: 1 Hz or 10 kHz, selectable

##### Tracking speed: Resolution = 1 Hz, speed = 1 MHz/s Resolution = 10 kHz, speed = 1 GHz/s

##### Acquisition time: Resolution = 1 Hz, time = < 125 ms Resolution = 10 kHz, time < 60 ms

##### Maximum deviation: 20 MHz peak-to-peak, automatic mode

##### Maximum FM rate: 10 MHz

##### AM tolerance: Any modulation index, provided the minimum signal level is not less than the sensitivity specification.

##### TCXO timebase: See page 193 for specifications. See page 198 for a general description of timebases.

##### External timebase: 10 MHz, 0.7 V min. to 8 V max peak-to-peak sine wave or square wave into > 1 K $\Omega$ shunted by < 30 pF, via front-panel BNC connector.

#### Input 2

##### Frequency range: 10 Hz to 525 MHz

##### Sensitivity: 25 mV rms (15 mV rms typical)

##### Impedance: 1 M $\Omega$ nominal shunted by < 70 pF (10 Hz to 80 MHz) or 50 $\Omega$ nominal (10 MHz to 525 MHz)

##### Maximum input: +10 dBm (50 $\Omega$ input), 1 V rms (1 M $\Omega$ input)

##### Connector: BNC (f)

##### Coupling: ac

##### Resolution: 1 Hz or 10 kHz, selectable

### Options

#### Battery (Option 002): 1 to 2 hours of operation (typical); 12 hours to charge (typical)

#### Microwave level limiter (Option 006)

Damage level: 500 MHz to 6 GHz: 39 dBm; 6 GHz to 18 GHz: 36 dBm; 18 GHz to 26 GHz: 34.8 dBm

Sensitivity, reduced by: 500 MHz to 12.4 GHz: 3 dBm; 12.4 GHz to 20 GHz: 4 dBm; 20 GHz to 26 GHz: 5 dBm

### Power Meter Specifications

#### Frequency range: 10 to 26.5 GHz, sensor-dependent

#### Power range: -70 dBm to +20 dBm (100 pW to 100 mW), sensor-dependent

#### Power sensors: HP 8481A, HP 8481D, HP 8484A, HP 8485A (The HP 8481D is a direct replacement for the HP 8484A.)

#### Dynamic range: 50 dB in 10 dB steps

#### Display units: Watts, dBm

#### Resolution: 0.01 dB in log mode, 0.1% of full scale in linear mode

#### Accuracy

##### Instrumentation: $\pm$ 0.02 dB or $\pm$ 0.5%

##### Zero set (digital settability of zero): $\pm$ 0.5% of full scale on most sensitive range

#### Power reference

##### Power output: 1.00 mW. Factory set to $\pm$ 0.7% traceable to U.S. National Institute of Standards and Technology.

##### Accuracy: $\pm$ 1.2% worst case ( $\pm$ 0.9% RSS) for one year.

### General

#### Diagnostics: Rear panel or HP-IB selectable, service diagnostics and user information

#### Data output: Counter: varies with frequency (90 measurements/sec with 10 kHz resol, DUMP mode); Power Meter: 18 measurements/sec

#### HP-IB interface functions: SH1, AH1, T5, L4, SR1, RL1, DC1, DT1, E1 (see page 114)

#### Operating temperature: 0° to 55° C

#### Power requirements: 50 VA maximum

#### Line select: 100V (90 to 105 Vac rms; 47.5 440 Hz)

115/120V (104 to 126 Vac rms; 47.5 to 440 Hz)

220V (198 to 231 Vac rms; 47.5 to 66 Hz)

230/240V (207 to 252 Vac rms; 47.5 to 66 Hz)

#### External dc: 14 to 26 Vdc, 40 W, binding post

#### Accessories supplied: Power cord, operating/programming manual, power sensor cable (HP 11730M)

#### Size: 144 mm H $\times$ 325 mm W $\times$ 456 mm D (5.66 in $\times$ 12.8 in $\times$ 18.0 in)

#### Weight: 9.1 kg (20 lb); with battery, 10.4 kg (23 lb)

### Ordering Information

#### HP 5347A 20 GHz Counter/Power Meter

### Price

\$8,350

#### HP 5348A 26.5 GHz Counter/Power Meter

\$8,950

#### Options for HP 5347A and HP 5348A

##### Opt 002 Battery Pack

+ \$450

##### Opt 006 Microwave Level Limiter

+ \$950

##### Opt 011 HP-IB Interface

+ \$350

##### Opt 070 Soft Carrying Case

+ \$295

##### Opt 913 Rack Mount Kit

+ \$410

##### Opt 915 Service Manual

+ \$150

##### Opt 916 Additional Operating/Programming Manual

+ \$75

##### Opt W30 (HP 5347A) Extended Repair Service (see page 671)

+ \$190

##### Opt W30 (HP 5348A) Extended Repair Service (see page 671)

+ \$215

##### Opt W32 (HP 5347A/48A) Calibration Service (see page 671)

+ \$835

### Power sensors

#### HP 8481A Power Sensor

\$725

#### HP 8481D Power Sensor

\$1,000

#### HP 8485A Power Sensor

1,100

### HP Power sensor cables

#### HP 11730A 1.5-m (5-ft) Sensor Cable

\$100

#### HP 11730B 3.0-m (10-ft) Sensor Cable

\$110

#### HP 11730C 6.1-m (20-ft) Sensor Cable

\$160

#### HP 11730D 15.2-m (50-ft) Sensor Cable

\$210

#### HP 11730E 30.5-m (100-ft) Sensor Cable

\$320

#### HP 11730F 61.0-m (200-ft) Sensor Cable

\$500

### Additional equipment available:

#### Transit Case 9211-2649 (see page 654)

\$480

☎ For off-the-shelf shipment, call 800-452-4844.

# ELECTRONIC COUNTERS

## Pulse/CW Microwave Counter

HP 5361B

- Built-in frequency profiling
- Frequency extensions to 26.5 GHz, 40 GHz
- Measure frequency (pulsed or CW), PRI, PRF, pulse width, offtime, and frequency profiles directly
- 1 Hz resolution on pulsed and CW signals
- Up to +50 dBm pulse level protection (optional)
- 60 ns minimum pulse width
- Measurements down to 1 Hz PRF



HP 5361B

### HP 5361B Pulse/CW Microwave Counter

#### Make All Your Frequency Measurements with One Microwave Counter

The HP 5361B was designed for both high precision pulse and CW performance. It is the only pulse/CW microwave counter with frequency modulation profiling built in. Characterize radar, EW, and communications systems or components. Lower your equipment costs by eliminating the need for a separate CW counter, pulse generator, and computer.

#### Precision Pulse Measurement Provides Accuracy to Spare

The HP 5361B measures 40 GHz pulsed microwave signals with up to 1 Hz resolution. Six separate pulse microwave measurements are available to characterize your signals: frequency, PRF, PRI, pulse width, off-time, and frequency profiling.

#### True CW Performance at No Extra Cost

Count CW signals from 10 Hz to 40 GHz with 1 Hz resolution. Resolution improves to 0.001 Hz at 100 kHz. Other CW counter features include Fast Track and Low FM Rate. Fast Track enables the counter to measure a signal that is sweeping at up to 800 MHz/s. Low FM Rate allows measurements on a signal that is varying slowly in frequency.

#### Frequency Profiling Made Easy and Inexpensive

Intentional or unintentional FM on your carrier, such as a chirp, is easy to measure and plot with the HP 5361B and a printer. The function PROFILE, with a printer, makes it possible to accurately determine the frequency vs. time characteristics of your pulsed or CW signal, replacing a computer, pulse generator, and much software.

Frequency profiling is becoming more important as demands are increased on radar, EW, transponder, and communication equipment. Unwanted frequency perturbations on a switching voltage controlled/digitally tuned oscillator (VCO/DTO) degrade performance. If the linearity of a chirp deviates too much from the desired characteristics, the range side lobes will be out of spec. Characterizing frequency transients, modulation, and linearity is essential to lowering costs and increasing performance in future systems.

Previously, frequency profiling required a microwave counter, a pulse generator, a computer, software, and much interconnection. The PROFILE function allows you to make frequency measurements inside a pulse with no extra equipment, other than a printer. The printer is used to output a plot of frequency versus time.

#### Easy to Use Because It Is Automatic

An external gate is not needed for pulsed signals. Pushing the PROFILE key starts the profiling function. The signal is acquired, the pulse width measured, and frequency profiling started. When the profile is finished, it is sent to the printer for a permanent hard copy.

#### The Most Accurate Method of Frequency Profiling

Gating error is an inherent part of most counter architectures. It can be a small but consistent error of less than 100 ps. The algorithms and hardware associated with PROFILE reduce this gating error to a negligible amount, providing more accurate measurements.

#### Automatic Measurements Simplify Testing

The HP 5361B's suite of automatic features is designed to make your testing easier. The counter performs many automatic operations that must be done manually with other counters. All you need to do is connect your signal and choose the function, and the counter does the rest. Automatic features include:

**Auto-Calibration:** Performs a major calibration internally at power-up, or on command. No external connections are needed.

**Auto-Assess:** Determines whether the signal is pulsed or CW and shifts to the correct measurement routines.

**Auto-Acquire:** Acquires a signal from 500 MHz to 40 GHz.

**Auto-Gate:** Sets the gate width for CW signals (dependent on the selected resolution). Pulsed signals are assigned a gate width calculated to minimize measurement errors.

**Auto-PRF:** Allows you to measure the carrier frequency of signals with stable or changing PRIs, from 2 MHz to 50 Hz. A low-PRF mode allows measurements to 1 Hz PRF.

**Auto-Position:** Positions the gate inside the microwave pulse. Turn-on and turn-off transients do not corrupt the measurement.

**Auto-Track:** Tracks a signal sweeping up to 800 MHz per second in Fast Track (after a CW signal has been acquired).

**Auto-Resolution:** Calculates the number of pulses to average for the true requested resolution. Smoothing improves resolution.

**Auto-Indicate:** Displays the measurement and indicates whether the signal is pulsed or CW.

#### Scope-View Gives You Confidence in Externally Gated Measurements

View the exact position of the measurement on any 100 MHz oscilloscope. For externally gated measurements, there is always a possibility that the gating signal may not coincide with the microwave pulse. Scope-View enables you to easily set up an externally gated measurement because you can see the downconverted pulse with a dc offset at the actual measurement interval.

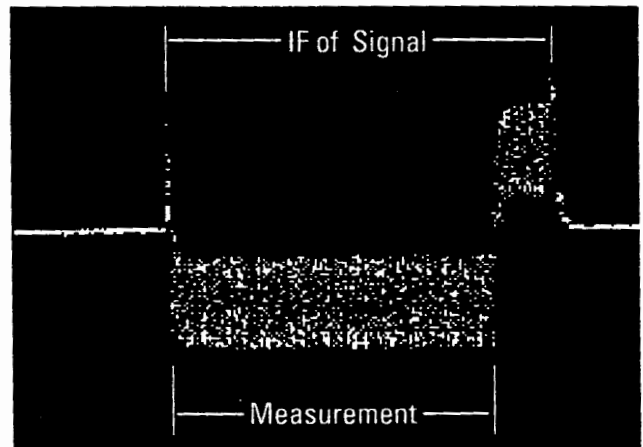

Set up externally gated measurements with confidence using Scope-View.



**A Cost-Effective Choice for Manufacturing and Service**

Test software to control the HP 5361B can be written in 2 different ways. The counter can be controlled by English-like commands, or by Hewlett-Packard's Interactive Test Generator (ITG).

**ITG: The Easiest Way to Generate Test Software – Use a Mouse**

ITG can be used to generate test software for the HP 5361B. This allows the use of a mouse for easy code generation for a rack of instruments. The mouse is used to invoke different functions on graphical panels displayed on a computer. For more information, see page 79.

**High-Speed Throughput Lowers Production Costs**

The counter can also produce results at up to 100 measurements per second. The improved efficiency saves time and money.

**Extended Calibration Cycles Keep the HP 5361B Working and Out of the Calibration Lab**

The only periodic maintenance required for the HP 5361B is time-base calibration. Complete internal calibration is performed at power-up or upon command. To keep the counter out of the calibration lab even longer, Option 001 or 010 can be included. Option 010 extends the calibration cycle to 5 years, and still provides kHz measurement accuracy on a 40 GHz frequency measurement.

**Power for Tomorrow's Radars, VCOs, and DTOs**

The HP 5361B makes frequency, timing, and profiling measurements at the touch of a button. The counter also makes more complex measurements for the carrier frequency of agile signals, staggered PRIs, or the frequency transients in a pulsed or CW signal.

**Frequency Modulation on the Pulse (FMOP) Is Easy and Inexpensive to Quantify**

Frequency-profiling a radar chirp to determine linearity or characterizing the droop when turning on a high-power stage is easy with the HP 5361B's PROFILE function and uses much less equipment.

**One Counter Measures Radar Pulse Parameters and the STALO**

The HP 5361B features state-of-the-art pulse microwave measurements without sacrificing its CW performance. This counter can characterize your radar pulse, and has the needed features for measurements that require high-CW precision, such as testing the Stable Local Oscillator (STALO). The counter measures with 1 Hz resolution up to 40 GHz.

**Resist Input Burnout with a High Damage Level**

Option 006 extends the damage level to +50 dBm for pulses of 1 μs and less, or approximately +40 dBm for CW signals. The standard damage level, and damage level above 26.5 GHz, is +25 dBm, more than enough for lower-power applications.

**The Right Mix of Features Simplifies VCO and DTO Testing**

The HP 5361B has features to accurately and easily test VCOs and DTOs. PROFILE lets you measure the step response with gate widths down to 11 ns. Post-tuning drift and settling time can also be measured in this way. Fast Track is useful for measuring tuning linearity because it tracks a signal that is moving at up to 800 MHz per second. The counter outputs results at up to 100 readings per second.

**Summary Specifications Functions**

Frequency (pulse or CW), frequency profiling, PRF, PRI, pulse width, and offtime

**Input characteristics**

	Input 1 (50 Ω)	Input 2 (1 MΩ)	Input 2 (50 Ω)
<b>Frequency Range</b>	500 MHz to 20, 26.5, 40 GHz	10 Hz to 80 MHz	10 MHz to 525 MHz
<b>Sensitivity</b>		25 mV rms	25 mV rms
0.5 to 12.4 GHz	-28 dBm		
12.4 to 20 GHz	-23 dBm		
0.5 to 26.5 GHz (Opt 026, 040)	-20 dBm		
26.5 to 40 GHz (Opt 040)	0.37 × f(in GHz) to 29.8 dBm		

**Frequency (Input 1)**

**Automatic and manual acquisition:**

500 MHz to 20 GHz; 500 MHz to 26.5 GHz (Opt 026); 500 MHz to 40 GHz (Opt 040)

**Least significant digit:** 1 MHz to 1 Hz for frequency, 0.001 Hz for PRF

**Pulse frequency measurements**

**Pulse width (minimum):** Manual mode, 60 ns; auto mode, 100 ns

**Pulse rep freq:** Minimum 1 Hz; maximum 2 MHz

**Measurement time, resolution, accuracy:** See datasheet

**CW frequency measurements**

**FM tolerance:** 55 MHz peak-to-peak

**Tracking speed (fast acquisition):** 800 MHz/s

**Acquisition time:** Manual mode, <40 ms; automatic mode, fast acq., <100 ms

**Gate times (1 Hz resolution):** 200 to 1000 ms

**Measurement time:** ≥8.5 ms (in Dump Mode)

**Accuracy:** See datasheet

**Pulse parameters (Input 1)**

	Pulse Width	PRI	Offtime	PRF
<b>Min/Max</b>	60 ns/10 ms	500 ns/1 s	400 ns/1 s	1 Hz/2 MHz
<b>LSD</b>	(PW < 1 ms) 1 ns; (PW ≥ 1 ms) 100 ns			to 0.001 Hz
<b>Accuracy (100 Avg.)</b>	± (20 ns + timebase uncertainty × measurement ± LSD			± (20 ns) × (PRF) <sup>2</sup> ± LSD ± timebase uncertainty

**Profile (Input 1)**

**Frequency range (min/max for Y axis):** 500 MHz/40 GHz

**FM chirp tolerance (max span for Y axis):** 50 MHz peak-to-peak

**Time range (min/max span for X axis):** 100 ns/10 ms

**Time resolution:** 1 ns

**Internal gate width:** Minimum: 11 to 23 ns

Typical minimum: 14 ns

**External gate width:** Minimum: Manual acquisition 20 ns

Auto-acquisition 60 ns

**Number of data points:** Up to 100

**Profile frequency measurements**

**Printers supported:** HP 2225A, HP 2227B, HP 3630A Opt 002

**Profile phase measurements:** See Application Note 377-4 for details. Computer required.

**Frequency (Input 2)**

**Range:** 10 Hz to 525 MHz

**Accuracy:** 0.001 to 1 Hz

**Resolution/LSD:** 0.001 to 1 Hz

**Options**

**Option 001 oven timebase:** Aging rate < 5 × 10<sup>-10</sup>/day

**Options 006, increased damage level:** Pulsed, +50 dBm (100 W) peak; CW, +39 dBm (8 W)

**Option 010 high-stability oven timebase:** Aging rate < 7 × 10<sup>-10</sup>/week

(Standard timebase: Aging rate < 1 × 10<sup>-7</sup>/month)

**Option 026:** Frequency extensions for input 1 to 26.5 GHz

**Option 040:** Frequency extensions for input 1 to 40 GHz

**Ordering Information**

HP 5361B Pulsed/CW Microwave Counter	Price
<b>Opt 001</b> Oven Timebase	+ \$950
<b>Opt 006</b> Microwave Limiter	+ \$950
<b>Opt 010</b> High-Stability Timebase	+ \$1,500
<b>Opt 026</b> 26.5 GHz Frequency Extension	+ \$2,600
<b>Opt 040</b> 40 GHz Frequency Extension	+ \$7,000
<b>Opt 700</b> MATE Interface	+ \$750
<b>Opt 908</b> Rack Mount Kit for Use with Front Handles Removed	+ \$34
<b>Opt 910</b> Additional Operating and Programming Manual	+ \$80
<b>Opt 913</b> Rack Mount Kit for Use with Supplied Front Handles	+ \$83
<b>Opt 915</b> Service Manual	+ \$215
<b>Opt W30</b> Extended Repair Service (see page 671)	+ \$315
<b>Opt W32</b> Calibration Service (see page 671)	+ \$525

# ELECTRONIC COUNTERS

## Mature Products

HP 5328B, 5334A, 5340A

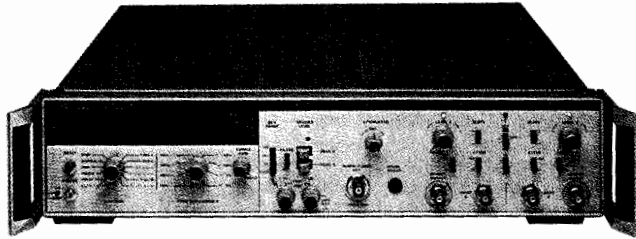

HP 5328B

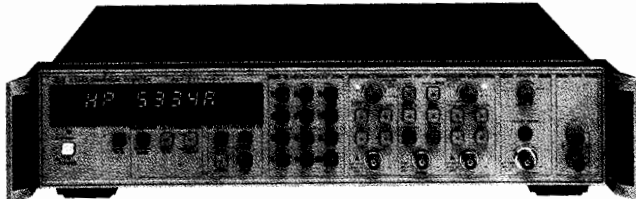

HP 5334A with DVM and C-Channel (Option 050)

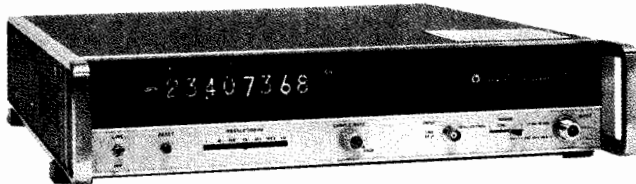

HP 5340A



### Time-Proven Technology

Hewlett-Packard products pass the test of time. As new technology continues to enhance the counter product line, the established products remain viable and in demand. The products listed in this section are examples of HP's commitment to customers that depend on these mature products. If more details are required, please contact your local HP sales office for data sheets and complete product information.

#### HP 5328B Universal Counter

- Frequency measurements to 100 MHz, 1.3 GHz optional.
- 10-ns time-interval resolution, 10 ps with averaging.
- 10-ns period resolution, 1 fs with averaging.
- $\pm 1000$  Vdc DVM and high-stability oven timebase options.
- HP-IB programming and external arming standard.

#### HP 5334A Universal Counter

The HP 5334B (see page 194) is a newer, more affordable version of the HP 5334A. Similar in function and specifications, the HP 5334A has two capabilities not offered with the HP 5334B:

- Front-panel setup memory: stores settings for easy recall.
- Option 020 digital voltmeter:  $\pm 1000$  V autoranging, autopolarity dc DVM with floating input.

#### HP 5340A Automatic Microwave Counter

- Direct measurements from 10 Hz to 18 GHz, 23 GHz optional.
- Single input connector.
- Automatic amplitude discrimination.
- High sensitivity:  $-35$  dBm.
- High AM and FM tolerance.

### Ordering Information

	<b>Price</b>
<b>HP 5328B</b> Universal Counter	\$7,920
<b>Opt 010</b> High-Stability Timebase	+ \$990
<b>Opt 021</b> High-Performance DVM	+ \$940
<b>Opt 031</b> 1300 MHz Channel C	+ \$1,250
<b>Opt 050</b> DVM and Channel C	+ \$2,225
<b>Opt 908</b> Rack Flange Kit, No Handles	+ \$35
<b>Opt 913</b> Rack Flange Kit With Handles	+ \$35
<b>Opt W30</b> Extended Repair Service (see page 671)	+ \$135
<b>Opt W32</b> Calibration Service (see page 671)	+ \$620
<b>HP 5334A</b> Universal Counter	\$5,720
<b>Opt 010</b> Oven Timebase	+ \$990
<b>Opt 020</b> DC Digital Voltmeter	+ \$700
<b>Opt 030</b> 1300 MHz C-Channel	+ \$950
<b>Opt 050</b> DVM and C-Channel	+ \$1,650
<b>Opt 060</b> Rear Panel Input	+ \$125
<b>Opt 908</b> Rack Flange Kit, no handles	+ \$35
<b>Opt 913</b> Rack Flange Kit, with handles	+ \$35
<b>Opt W30</b> Extended Repair Service (see page 671)	+ \$85
<b>Opt W32</b> Calibration Service (see page 671)	+ \$525
<b>HP 5340A</b> Frequency Counter	\$21,900
<b>Opt 001</b> High-Stability Timebase	+ \$1,050
<b>Opt 002</b> Rear-Panel Connectors	+ \$250
<b>Opt 005</b> Frequency Extension to 23 GHz	+ \$760
<b>Opt 006</b> Limiter Input Protection (+ 39 dBm)	+ \$1,050
Incompatible with Opt 002 and Opt 005. Consult factory special to combine these options.	
<b>Opt 011</b> Remote Programming - Digital Output (HP-IB)	+ \$950
<b>Opt 908</b> Rack Flange Kit	+ \$110
<b>Opt W30</b> Extended Repair Service (see page 671)	+ \$415
<b>Opt W32</b> Calibration Service (see page 671)	+ \$1,405



HP 5343A

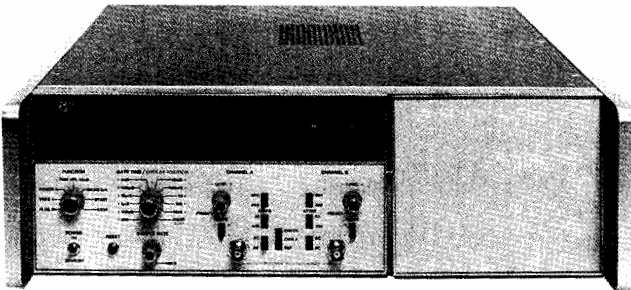

HP 5345A

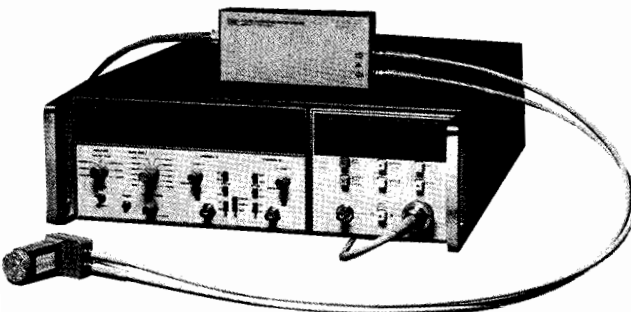

HP 5345A with the HP 5355A and HP 5356D



### HP 5342A and HP 5343A CW Microwave Counters

The HP 5342A and HP 5343A Microwave Counters provide automatic frequency measurements to 18 and 26.5 GHz, respectively. The HP 5342A can be extended to measure up to 24 GHz with Option 005. Other features and capabilities include:

- Highly portable packaging
- Amplitude measurements, 0.1 dBm resolution (Option 002, HP 5342A)
- FM tolerance (peak-to-peak FM deviation to 50 MHz)
- Digital-to-analog conversion (Option 004)

### HP 5345A Universal Systems Counter

The HP 5345A is a full-function universal counter that provides versatile, high-speed measuring capabilities. Measurements can be read out over HP-IB at speeds up to 9000 readings/second. Other features include:

- 500 MHz; extendable with the HP 5355A and HP 5356A/B/C/D
- 2-ns resolution time-interval measurements (jitter analysis)
- 25-mV sensitivity to 500 MHz
- High-throughput frequency, period, ratio, totalize, and scale

### HP 5355A and HP 5356A/B/C/D CW Microwave Counters

The HP 5355A Automatic Frequency Converter, together with the HP 5356A/B/C/D Frequency Converter Heads, increase the pulse and CW frequency measurement capabilities of the HP 5345A to 18, 26.5, 40, and 110 GHz, respectively.

All of these counters characterize pulsed signals, with the 110-GHz version detecting incoming RF bursts as short as 75 ns. All are characterized by sensitivity to  $-25$  dBm and 100-Hz measurement resolution.

### Ordering Information

	Price
HP 5342A Frequency Counter	\$12,700
HP 5343A Frequency Counter	\$14,500

### Options and Accessories (HP 5342A, 5343A)

Opt 001 High-Stability Timebase	+ \$990
Opt 002 Amplitude Measurement (HP 5342A Only)	+ \$2,750
Opt 003 Extended Dynamic Range (HP 5342A Only)	+ \$875
Opt 004 Digital-To-Analog Converter	+ \$440
Opt 005 Frequency to 24 GHz (HP 5342A Only)	+ \$550
Opt 006 Limiter Input Protection (+ 39 dBm)	
HP 5342A	+ \$935
HP 5343A	+ \$825
Opt 011 Digital I/O (HP-IB) (cable not incl)	+ \$605
Opt 908 Rack Flange Kit	+ \$110
HP K70-59992A Rack Mounting Adapter Kit (with slot for access of front connectors from rear)	+ \$450

### HP 10842A Extender Board Kit

\$1,795

### HP 5345A Plug-In Counter

\$17,600

Opt 011 HP-IB Includes remote programming. + \$1,750

Opt 012 HP-IB Similar to Opt 011, but also includes slope and trigger-level controls. + \$1,850

Opt 908 Rack Flange Kit, HP 5060-8740. + \$75

HP 10595A Board Extender Kit: For troubleshooting. \$2,300

HP 5355A Automatic Frequency Converter \$14,500

HP 5356A 18 GHz Frequency Converter \$4,100

HP 5356B 26.5 GHz Frequency Converter \$4,100

HP 5356C 40 GHz Frequency Converter \$4,800

HP 5356D 36 to 110 GHz Harmonic Mixer Driver \$12,800

Options for HP 5356A

Opt 001 High-Pass Filter + \$640

Opt 006 Limiter + \$950

Options for HP 5356B

Opt 001 18 to 26.5 GHz Waveguide (WR-42) + \$1,700

Opt 006 Limiter + \$950

Options for HP 5356C

Opt 001 26.5 to 40 GHz Waveguide (WR-28) + \$1,700

Options for HP 5356D (Requires an HP 5355A

with S/N prefix greater than 2620-xxxx) + \$350

Opt 005 (two HP 5061-5458 parts) 2 cables to connect HP 5356D to HP 1197Q/U/V or W + \$1,950

Opt 050 (HP 11970Q) 36 GHz to 50 GHz Harmonic Mixer + \$1,950

Opt 060 (HP 11970U) 40 GHz to 60 GHz Harmonic Mixer + \$2,100

Opt 075 (HP 11970V) 50 GHz to 75 GHz Harmonic Mixer + \$2,600

Opt 110 (HP 11970W) 75 GHz to 110 GHz Harmonic Mixer + \$2,900

# POWER METERS

Peak Power Analyzer, Peak Power Sensors  
HP 8990A, 84812A, 84813A, 84814A

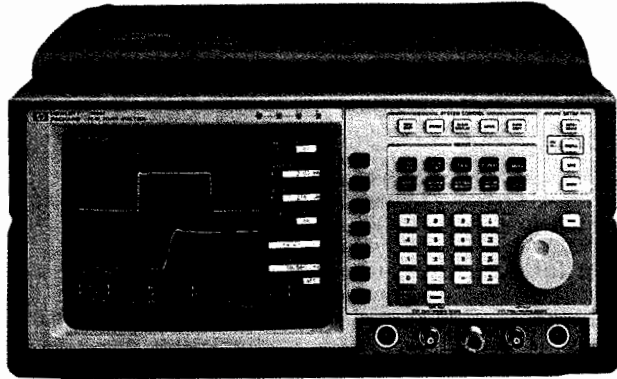

HP 8990A



HP 84814A

HP 84813A

HP 84812A



## HP 8990A Peak Power Analyzer Complete Pulse Power Characterization

The HP 8990A Peak Power Analyzer provides complete and accurate characterization of today's complex pulsed signals. This new peak power analyzer is capable of performing 8 automatic timing measurements (rise time, fall time, pulse width, PRI, PRF, duty cycle, and delay) and 5 automatic power measurements (peak power, average power, pulse top/base amplitude, and overshoot) with pushbutton ease. Front panel operation is intuitive and straightforward. Data entries can be typed in or made with the front panel knob; automatic measurements are made with simple keystrokes.

The HP 8990A offers two sensor channels plus two external triggering/oscilloscope channels, which permits the simultaneous measurement of modulating signals and detected power envelopes. Powerful measurement and display routines put you in control of your most demanding pulse applications. Measurement statistics, high speed/high sensitivity triggering, amplitude and time markers, dual-time-base windowing, measurement limit test, waveform storage, and waveform math are some of the new capabilities featured in the HP 8990A.

The peak power analyzer is compatible with the HP 84812A, 84813A, and 84814A peak power sensors. These sensors and the HP 8990A combine to give you outstanding measurement accuracy in demanding situations:

- Excellent sensor SWR holds over all power levels
- Automatic temperature sensing and correction
- Exceptionally low calibration uncertainty
- Automatic calibration routines for internal gain, offset, and impedance variations
- Superior timebase precision

With state-of-the-art peak power measurement accuracy, fast and complete pulse characterization, high-performance triggering, traceability, and reliability, the HP 8990A lets you measure your test signal with speed, precision, and confidence.

### HP 8990A Specifications

#### Sensor inputs (Channels 1 & 4)

**Frequency range:** 500 MHz to 40 GHz, sensor dependent

**Power range:** -32 to +20 dBm (usable to -40 dBm)

#### Rise/Fall time:

Input Signal Range (dBm)	Rise Time/Fall Time
-16 to +20	< 5 ns
-26 to -16	< 1 $\mu$ s
-32 to -26	< 80 $\mu$ s

#### Instrumentation uncertainty, including noise and offset:

$$\pm \left( 3.5\% + \frac{0.07 \mu\text{W}}{\text{Signal Power}} \times 100\% \right)$$

**Max Pulse repetition rate:** 100 MHz externally triggered, 1 MHz internally triggered

**Linear vertical scale:** 50 nW/div to 20 mW/div in 1-2-5 sequence

**Log vertical scale:** 1, 2, 5 dB/div

#### Video inputs (channels 2 & 3)

**Bandwidth:** dc coupled: dc to 100 MHz (repetitive); dc to 1 MHz (single shot)

ac coupled: 10 Hz to 100 MHz (repetitive); 10 Hz to 1 MHz (single shot)

**Rise time:** < 5 ns

**Vertical sensitivity:** 100 mV/div to 500 mV/div

**Vertical gain accuracy:**  $\pm 1.5\%$

**Available offset range:**  $\pm 20$ V

#### Time Base:

**Range:** 2 ns/div to 5 s/div in 1-2-5 sequence

**Resolution:** 100 ps

**Accuracy:** 0.005%

#### General Characteristics:

**Power requirements:** Voltage: 90-132 or 198-264 Vac; 48-66 Hz. Power: 250 VA max

**HP-IB codes:** SH1, AH1, T5, L4, SR1, RL1, PP1, DC1, DT1, C0, E2

**Size:** 194 mm H  $\times$  422 mm W  $\times$  366 mm L (7.65 in  $\times$  16.62 in  $\times$  14.4 in)

**Weight:** Net, 12.8 kg (28 lb); shipping, 20.1 kg (44 lb)

### HP 84812A/13A/14A Specifications:

**Frequency range:** HP 84812A: 500 MHz to 18 GHz

HP 84813A: 500 MHz to 26.5 GHz

HP 84814A: 500 MHz to 40 GHz

**Power range:** -32 to +20 dBm (usable to -40 dBm)

#### Sensor input SWR (reflection coefficient):

500 MHz to 18 GHz: 1.25 (0.11)

18 GHz to 26.5 GHz: 1.35 (0.15)

26.5 GHz to 40 GHz: 1.60 (0.23)

#### Sensor Calibration Uncertainty:

Frequency	RSS Uncertainty
< 4 GHz	$\pm 3.6\%$
< 12 GHz	$\pm 3.8\%$
< 18 GHz	$\pm 4.3\%$
< 26.5 GHz	$\pm 5.5\%$
< 40 GHz	$\pm 6.5\%$

**Connector type:** HP 84812A: Type-N (m)

HP 84813A: APC-3.5 mm (m)

HP 84814A: 2.4 mm (m)

#### General Characteristics

**Size:** HP 84812A: 27 mm H  $\times$  37 mm W  $\times$  137 mm L (1.05 in  $\times$  1.45 in  $\times$  5.4 in)

HP 84813A: 27 mm H  $\times$  37 mm W  $\times$  127 mm L (1.05 in  $\times$  1.45 in  $\times$  5.0 in)

HP 84814A: 27 mm H  $\times$  37 mm W  $\times$  127 mm L (1.05 in  $\times$  1.45 in  $\times$  5.0 in)

**Weight:** Net, 0.29 kg (0.64 lb); shipping, 0.64 kg (1.4 lb)

### Ordering Information

**HP 8990A Peak Power Analyzer**

**Opt W30** Extended repair service. See page 671.

**HP 84812A Peak Power Sensor**

**Opt W30** Extended repair service. See page 671.

**HP 84813A Peak Power Sensor**

**Opt W30** Extended repair service. See page 671.

**HP 84814A Peak Power Sensor**

**Opt W30** Extended repair service. See page 671.

### Price

\$15,500

\$375

\$1,500

\$45

\$1,650

\$45

\$2,050

\$45

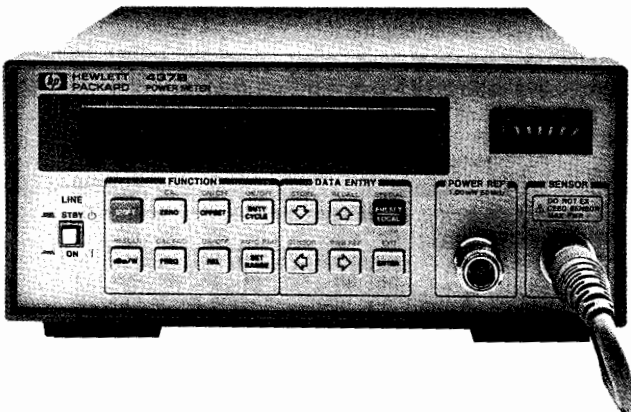

HP 437B  
Power Meter



### HP 437B Power Meter

The HP 437B is a low-cost, high-performance, single-channel, programmable, average power meter compatible with the HP 8480 family of thermocouple and diode power sensors. Depending on which power sensor is used, the HP 437B can measure from -70 dBm (100 pW) to +44 dBm (25 W) at frequencies from 100 KHz to 50 GHz.

Designed for ATE systems and demanding benchtop measurements, the HP 437B Power Meter makes fast, accurate, and reliable average power measurements. Only 3 inches high and half rack wide, the HP 437B minimizes the use of critical rack space in ATE systems. The advanced plastics technology used in the HP 437B cabinet combines the light weight of plastic with the shielding effectiveness of metal, making the HP 437B the only power meter to meet MIL-STD-461C EMI specifications.

A modern and flexible feature set makes this meter easy to use in any application:

- Automatic calibration and zeroing.
- Frequency entry instead of Cal Factor.
- Ten pre-loaded sensor Cal Factor versus frequency tables.
- Selectable resolution to 0.001 dB.
- Offset entry in dB.
- Duty cycle entry for a convenient peak power representation of the measured average power.
- Ten store/recall registers.
- HP-IB is standard.
- Analog meter is a standard feature.

With a measurement speed twice as fast as that of the industry-standard HP 436A, powerful programming capability, state-of-the-art accuracy, and exceptional reliability, the HP 437B lets you measure your test signal with speed, precision, and confidence.

### HP 70100A and E1416A MMS and VXI Power Meters

The HP 70100A is a full-feature single-channel power meter module for the Modular Measurement System (see page 102). It has all the capability of the HP 437B Power Meter in an 1/8th rack-width module. The HP 70100A features the same modern and flexible feature set as the HP 437B, the same state-of-the-art accuracy, and is also fully compatible with the HP 8480 series of power sensors. The HP E1416A power meter is a VXI version of the HP 70100A. For information on the HP E1416A, refer to page 93.

### HP 437B, 70100A, and E1416A Specifications

**Frequency range:** 100 kHz to 50 GHz, sensor dependent.  
**Power range:** -70 to +44 dBm (100 pW to 25 W), sensor dependent.  
**Power sensors:** Compatible with all HP 8480 series Power Sensors.  
**Dynamic range:** 50 dB in 10 dB steps.  
**Display units:** Absolute: Watts, dBm; relative: percent, dB.  
**Resolution:** Selectable resolution of 0.1, 0.01, and 0.001 dB in logarithmic mode; or 1%, 0.1%, and 0.01% of full scale in linear mode.

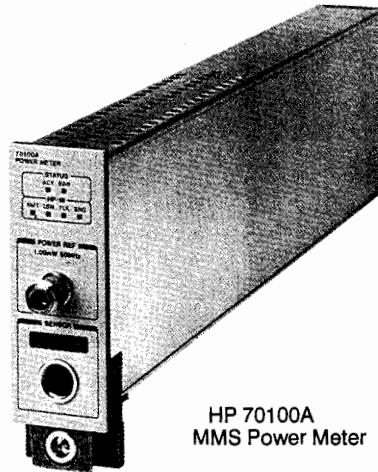

HP 70100A  
MMS Power Meter



HP E1416A  
VXI Power  
Meter

### Accuracy

**Instrumentation:**  $\pm 0.02$  dB or  $\pm 0.5\%$ .

**In REL mode:**  $\pm 0.02$  dB or  $\pm 0.5\%$  within measurement range;  $\pm 0.04$  dB or 1% outside measurement range.

**Zero set:**  $\pm 0.5\%$  of full scale on most sensitive range.

### Power Reference

**Power output:** 1.00 mW, Factory set to  $\pm 0.7\%$  traceable to US National Institute of Standards and Technology.

**Accuracy:**  $\pm 1.2\%$  worst case ( $\pm 0.9\%$  RSS) for 1 year.

### General (HP 437B only)

**EMI:** Radiated and Conducted Emissions and Radiated and Conducted Susceptibility are within the requirements of RE02, CE03, RS01/03 and CS01/03 called out in MIL-STD-461C, and within the requirements of VDE 0871 and CISPR Publication 11.

**Rear-panel output:** Analog 0-1 volt without digital filtering or Cal Factor correction, 1 k $\Omega$  output impedance, BNC connector.

**Line voltage:** 100 and 120 Vac, +5%-10%, 48-66 Hz, 360-440 Hz; 220 and 240 Vac, +5% to 10%, 48 to 66 Hz.

**Power requirement:** 8 watts maximum (10 VA max).

**Weight:** Net 2.6 kg (5.9 lb); shipping 4.5 kg (10 lb).

**HP-IB codes:** SH1, AH1, T5, TE0, L4, LE0, SR1, RL1, PP1, DC1, DT1, C0.

**Dimensions:** 88 mm H  $\times$  212 mm W  $\times$  273 mm D (3.46 in  $\times$  8.35 in  $\times$  10.75 in).

### Accessories

**Furnished:** HP 11730A, 1.5 m (5 ft) cable for power sensors; 2.4m (7.5 ft) power cable. Mains plug shipped to match destination requirements.

**Available:** To select or substitute nonstandard lengths for power sensor cable, see page 212. To rackmount one HP 437B, order part number 5060-0173. To rackmount two HP 437B power meters, order part number 5060-0174.

### Ordering Information

	Price
<b>HP 437B Power Meter.</b>	\$2,625
<b>Opt 002</b> Supplies a parallel rear-panel sensor input.	+ \$75
<b>Opt 003</b> Supplies a parallel rear-panel sensor input and moves reference oscillator to rear-panel.	+ \$75
<b>Opt 004</b> Delete the HP 11730A sensor cable.	- \$75
<b>Opt 401</b> Provides side-carrying handle and standoff feet.	+ \$25
<b>Opt 915</b> Service manual.	+ \$25
<b>Opt 916</b> Extra operating manual (00437-90015).	+ \$25
<b>Opt W30</b> Two additional years of return-to-HP warranty.	+ \$65
<b>HP 70100A Power Meter Module.</b>	\$3,080
<b>Opt 003</b> Moves reference oscillator from front to rear panel.	\$0
<b>Opt 004</b> Delete the HP 11730A Power Sensor Cable.	- \$75
<b>Opt 005</b> Delete reference oscillator.	- \$250
<b>Opt W30</b> Extended repair service. See page 671.	+ \$70

☎ For off-the-shelf shipment, call 800-452-4844.

# POWER METERS

## Power Meters

HP 436A, 438A

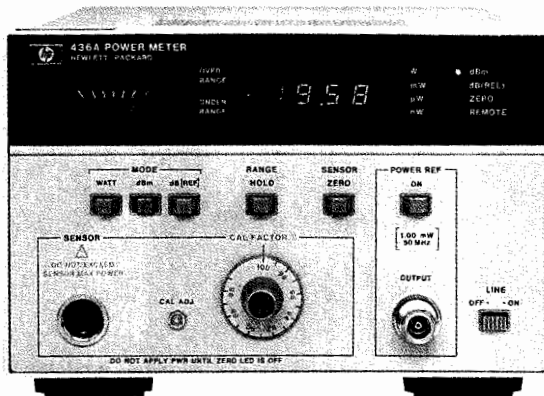

HP 436A



### HP 436A Power Meter

The HP 436A Power Meter is a general-purpose digital power meter intended for manual and automatic radio-frequency (RF) and microwave-power measurements. It is compatible with the entire series of HP 8480 thermocouple and diode power sensors.

The HP 436A measures either absolute or relative power. It displays absolute power in either watts or dBm, and relative power in dB. The HP 436A offers intuitive and straightforward manual operation as well as optional HP-IB programmability (Option 022).

#### Specifications

**Frequency range:** 100 kHz to 50 GHz, sensor dependent

**Power range:** -70 to +44 dBm (100 pW to 25 W), sensor dependent

#### Accuracy

##### Instrumentation

**Watt mode:**  $\pm 0.5\%$

**dBm mode:**  $\pm 0.02$  dB  $\pm 0.001$  dB $^{\circ}$  C

**dB (REL) model:**  $\pm 0.02$  dB  $\pm 0.001$  dB $^{\circ}$  C

**Zero:** Automatic, operated via front panel switch

**Zero set:**  $\pm 0.5\%$  of full scale on most sensitive range, typical

**Zero carry over:**  $\pm 0.2\%$  of full scale when zeroed on the most sensitive range

**Power reference:** Internal 50 MHz oscillator with Type-N female connector on front panel (or rear panel, Opt 003)

**Power output:** 1.0 mW. Factory set to  $\pm 0.7\%$  traceable to the U.S. National Institute of Standards and Technology

**Accuracy:**  $\pm 1.2\%$  worst case ( $\pm 0.9\%$  rss) for one year

#### Supplemental Characteristics

**Recorder output:** Linearly proportional to indicated power with 1 volt corresponding to full scale and 0.316 volts to -5 dB; 1 k $\Omega$  output impedance, BNC connector

**Power consumption:** 100, 120, 220, 240V (+5%, -10%), 48 to 66 Hz, and 360 to 440 Hz; <20 VA (<23 VA with Opt 022)

**HP-IB function codes:** AH1, C0, DC2, DT0, LE0, P0, RL2, SH1, SR0, T3, TE0

**Weight:** Net, 4.5 kg (10 lb); shipping, 5.5 kg (12 lb)

**Size:** 134 mm H  $\times$  213 mm W  $\times$  279 mm D (5.2 in  $\times$  8.4 in  $\times$  11.0 in)

#### Accessories

**Furnished:** HP 11730A, 1.5-m (5-ft) power sensor cable; 2.3-m (7.5-ft) power cable

**Available:** To select and substitute nonstandard lengths for power sensor cables, see page 213. HP 5061-9657 rackmount adapter kit (one HP 436A by itself).

#### Ordering Information

HP 436A Power Meter	Price
Opt 003 Reference oscillator output on rear panel only	\$4,250
Opt 004 Delete power sensor cable	\$25
Opt 022 Digital input/output, fully HP-IB compatible	-\$75
Opt 908 Kit for rackmounting one HP 436A	\$0
Opt 910 Extra operating and service manual (00436-90034)	+\$55
Opt 910 Extra operating and service manual (00436-90034)	+\$25
Opt W30 Extended repair service; see page 671	+\$80
Opt W32 Calibration service; see page 671	\$685

\*Specifications for within range measurements. For range-to-range accuracy add  $\pm 0.02$  dB.

- Ideal for ATE applications
- Dual power sensors
- Innovative ratio & difference measurements



HP 438A



### HP 438A Power Meter

The HP 438A power meter is a dual-channel power meter designed specifically for ATE systems. The compact front panel saves critical rack space, while the dual channel design allows simple and accurate measurements of the ratio and difference of power levels from two separate sensors. This meter is compatible with the HP 8480 series of thermocouple and diode power sensors.

HP-IB capability is standard on the HP 438A. For U.S. Air Force Modular Automatic Test Equipment (MATE) system application, Option 700 provides the HP 438A with the internal capability to be controlled by the MATE Control Interface Intermediate Language (CIIL).

#### Specifications

**Frequency range:** 100 kHz to 50 GHz, sensor dependent

**Power range:** -70 to +44 dBm (100 pW to 25W), sensor dependent.

Uses HP 8480 series power sensors

#### Instrumentation Accuracy

**Single channel:**  $\pm 0.5\%$  (watt mode) or  $\pm 0.02$  dB (dBm mode)

**Dual channel:**  $\pm 1\%$  (watt mode) or  $\pm 0.04$  dB (dBm mode)

**Zeroing:** Automatic,  $\pm 0.5\%$  of full scale on most sensitive range

#### Power Reference

**Power output:** 1.00 mW. Factory set to  $\pm 0.7\%$ , traceable to the U.S. National Institute Standards and Technology

**Accuracy:**  $\pm 1.2\%$  worst case ( $\pm 0.9\%$  rss) for 1 year

**Connector:** front panel Type-N female (also rear panel Opt 002)

#### Supplemental Characteristics

**Recorder output:** Linearly proportional to indicated power in watts. One volt corresponds to full scale; 1 K $\Omega$  output impedance. BNC rear panel female connector

**Line voltage:** 100, 120, 220, or 240 Vac  $\pm 5\%$  -10%. 100 and 120 volts, 48 to 66 Hz and 300 to 440Hz. 220 and 240 volts, 48 to 66 Hz only

**Power requirements:** 65 VA, 35 watts, maximum

**HP-IB interface codes:** SH1, AH1, T5, TE0, L4, LE0, SR1, RL1, PP1, DC1, DT1, C0

**Weight:** Net, 5.9 kg (13 lb). Shipping, 9.1 kg (20 lb)

**Size:** 89 mm H  $\times$  213 mm W  $\times$  418 mm D (3.5 in  $\times$  8.4 in  $\times$  16.8 in)

#### Accessories

**Furnished:** HP 11730A, 2 each, 1.5-meter (5-ft) power sensor cables. Power cable, 1 each, 2.4 meters (7.5 ft). Mains plug matches destination requirements.

**Available:** To select and substitute nonstandard lengths for power sensor cables, see page 213.

#### Ordering Information

HP 438A Dual Channel Power Meter	Price
Opt 002 Rear panel sensor connector (in parallel with front panel) and additional reference oscillator with rear panel output	\$5,300
Opt 700 Internal MATE programming	+\$1250
Opt 004 Delete power sensor cables	-\$150
Opt 910 Additional manual (00438-90015)	+\$25
Opt W30 Extended repair service; see page 671	+\$130
Opt W32 Calibration service; see page 671	\$285

☎ For off-the-shelf shipment, call 800-452-4844.

### HP 435B Power Meter

The HP 435B Power Meter is an analog power meter, compatible with the entire series of HP 8480 Power Sensors. Depending on which sensor is used, the HP 435B can measure power from -65 dBm to +44 dBm, full scale, at frequencies from 100 kHz to 50 GHz. This versatile instrument also features <1 percent instrumentation uncertainty, low noise and drift, auto-zero, recorder output, optional battery operation, and long cable options up to 61 m (200 ft).

### HP 11683A Range Calibrator

The HP 11683A Calibrator is specifically designed for use with the HP 435B, 436A, 437B, 438A, 70100A, and E1416A Power Meters. It allows verification of full-scale meter readings on all ranges, as well as meter tracking. Simply connect the cable between the power meter and calibrator. The CAL ADJ control on the power meter is used to set the meter to full scale on the 1 mW range. The calibrator and meter are then stepped through the other ranges verifying accuracy within ±1 percent plus noise and drift. The HP 11683A also has a polarity switch that tests the auto-zero circuit.

### HP 435B Specifications

**Frequency range:** 100 kHz to 50 GHz (sensor dependent)

**Temperature range:** 0° to 55° C

**Power Range** (calibrated in watts and dB in 5 dB steps)

- With HP 848xB: +5 dBm (3 mW) to +44 dBm (25 W) full scale
- With HP 848xH: -5 dBm (0.3 mW) to +35 dBm (3 W) full scale
- With HP 848xA: -25 dBm (3 μW) to +20 dBm (100 mW) full scale
- With HP 848xD: -65 dBm (300 pW) to -20 dBm (10 μW) full scale

### Accuracy

**Instrumentation:** ±1% of full scale on all ranges

**Zero:** Automatic, operated by front-panel switch

**Zero set:** ±0.5% of full scale on most sensitive range, typical

**Zero carryover:** ±0.5% of full scale when zeroed on the most sensitive range

**Power reference:** Internal 50 MHz oscillator with Type N female connector on front panel (or rear panel, Opt 003 only)

**Power output:** 1.00 mW. Factory set to ±0.7% traceable to the U.S. National Institute of Standards and Technology

**Accuracy:** ±1.2% worst case (±0.9% rss) for one year

### Supplemental Characteristics

**Recorder output:** Linearly proportional to indicated power with 1 volt corresponding to full scale: 1 kΩ output impedance, BNC connector

**RF blanking output:** Provides a contact closure to ground. Used for turning off RF input to sensor during auto-zeroing. BNC connector

**Power consumption:** 110 or 120 V (+5%, -10%), 48 to 66 Hz and 360 to 440 Hz; also 220 or 240 V (+5%, -10%), 48 to 66 Hz only: <20V · A

**Weight:** Net, 2.7 kg (5.9 lb). Shipping, 4.2 kg (9.2 lb)

**Size:** 155 mm H × 130 mm W × 279 mm D (6.3 in × 5.1 in × 11 in)

### Accessories

**Furnished:** HP 11730A, 1.52-m (5-ft) cable for the power sensor; 2.3m (7.5 ft) power cable (mains plug shipped to match destination requirements)

### Available

To select or substitute nonstandard lengths for power sensor cables, see HP 11730A-F Power sensor cables section.

**HP 5060-8762:** Rack adapter frame (holds three instruments the size of the HP 435B)

### HP 11683A Range Calibrator Specifications

**Calibration functions:** Outputs corresponding to meter readings of 3, 10, 30, 100, and 300 μW; 1, 3, 10, 30, and 100 mW

**Calibration uncertainty:** ±0.25% in all ranges

**Power:** 100, 120, 220, or 240 Vac +5%, -10%, 48 - 440 Hz, less than 10 V · A

**Weight:** Net, 1.13 kg (2.5 lb). Shipping, 1.9 kg (4.2 lb)

**Size:** 89 mm H × 133 mm W × 216 mm D (3.5 in × 5.25 in × 8.5 in)

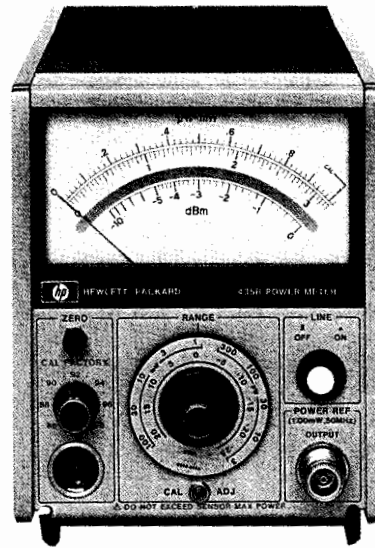

HP 435B

### HP 11730A-F Power Sensor Cables

The HP 11730 series power sensor cables are for use with the HP 435B, 436A, 437B, 438A, 70100A, and E1416A power meters and the HP 8480 series of thermocouple and diode power sensors. These cables are designed to reduce RFI effects on low power readings with an improved shielding design in the cable itself. Cables may be ordered individually or in pairs in any combination desired for single and dual-channel measurements.

The HP 11730A cable is the standard cable for the HP 435B, 436A, 437B, 438A (2 cables shipped), 70100A, and E1416A meters. To order a nonstandard cable, select Option 004 for the meter in question, and order the desired cable from below.

### Ordering Information

	<b>Price</b>
<b>HP 11683A</b> Range Calibrator	\$1,200
<b>HP 435B</b> Power Meter	\$1,825
<b>Opt 001</b> Rechargeable battery installed provides up to 16 hours of continuous operation	+ \$100
<b>Opt 002</b> Input connector placed on rear panel in parallel with front	+ \$25
<b>Opt 003</b> Parallel sensor inputs front and rear panels, reference oscillator output on rear panel	+ \$25
<b>Opt 004</b> Delete power sensor cable	- \$75
<b>Opt 910</b> Extra operating and service manual (P/N 00435-90040)	+ \$7.50
<b>Opt W30</b> Extended repair service; see page 671	+ \$50
<b>Opt W32</b> Calibration service; see page 671	\$475
<b>HP 11730A</b> 1.5 meter (5 ft) sensor cable	\$100
<b>HP 11730B</b> 5.0 meter (10 ft) sensor cable	\$110
<b>HP 11730C</b> 6.1 meter (20 ft) sensor cable	\$160
<b>HP 11730D</b> 15.2 meter (50 ft) sensor cable	\$220
<b>HP 11730E</b> 30.5 meter (100 ft) sensor cable	\$290
<b>HP 11730F</b> 61.0 meter (200 ft) sensor cable	\$475

☎ For off-the-shelf shipment, call 800-452-4844.

# POWER METERS

## Power Sensors

HP 8481A/B/D/H, 8482A/B/H, 8483A, 8485A/D,  
R/Q 8486A/D, W8486A, 8487A/D, 11708A



HP 8481A



HP 8485A

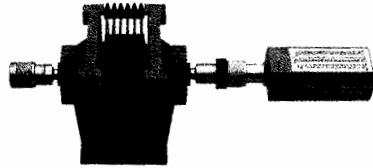

HP 8481B

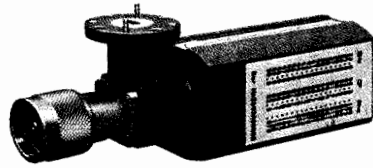

HP Q8486A

### HP 8480 Power Sensor Family

The HP 8480 power sensors are designed for use with the HP 435B, 436A, 437B, 438A, 70100A, and E1416A Power Meters. These thermocouple and diode power sensors provide extraordinary accuracy, stability, and SWR over a wide range of frequencies (100 kHz to 50 GHz) and power levels (-70 to +44 dBm).

#### Best SWR in the Industry

Mismatch uncertainty is usually the largest single source of error in power measurements. The HP 8480 power sensor family gives you extremely low SWR even at mm-wave frequencies. For example, the new HP W8486A power sensor has a specified SWR of less than 1.08:1 over its entire 75 to 110 GHz frequency range. This low SWR translates into minimum mismatch uncertainty and optimum measurement accuracy.

#### Accurate Calibration and Traceability

Each power sensor in the HP 8480 family is individually calibrated and traceable to the U.S. National Institute of Standards and Technology (NIST, formerly NBS). The uncertainty in this calibration factor is your link to NIST. The Cal Factor measurement system used by HP Standards Lab provides you with minimum Cal Factor uncertainty.

#### True-RMS Reading Sensors

HP high-sensitivity diode power sensors (HP 8481D/5D/6D/7D) are always operated inside the square-law region. This means that the sensor will act as a true-RMS reading device over its entire -70 to -20 dBm dynamic range. The benefit to you: HP sensors provide you with accurate readings even if your test signal is subjected to multi-tone environments, modulated carriers, or carriers with high harmonics.

#### mm-Wave Sensor Calibration

A 50 MHz calibration port is included in HP waveguide power sensors for calibration with the power meter. This calibration provides traceability to NIST at millimeter-wave frequencies, and it eliminates the uncertainties due to temperature changes and the variance in making measurements with different meter/sensor combinations.

#### Accurate Accessories Included

With HP power sensors, you can start making measurements right away. No more hunting around for attenuators or adapters. HP sensors include all the accessories you need to optimize accuracy and save time.

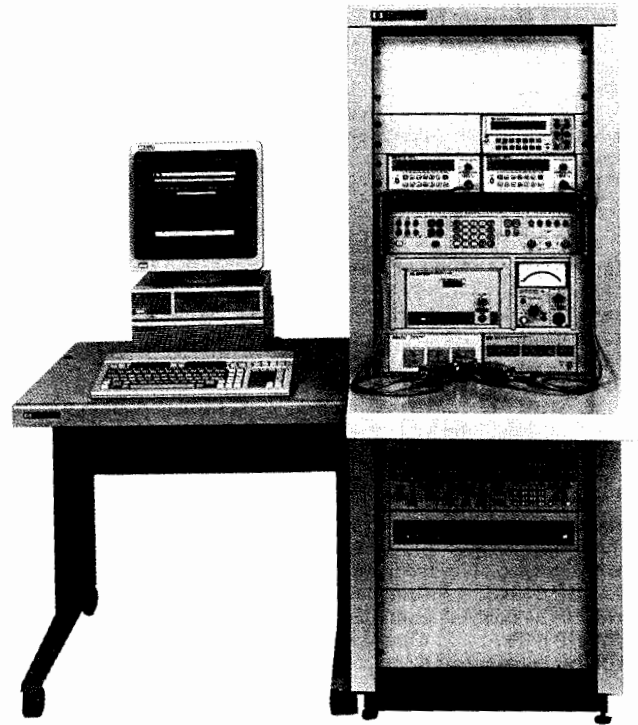

HP 11760S

#### In-House Power Sensor Calibration

Power sensor calibration is now easier than ever with the new HP 11760S calibration system, designed specifically for Metrology and Cal Lab engineers. In less than four minutes, this complete sensor calibration system can measure your sensor's Cal Factor, calculate all measurement uncertainties, generate a permanent record for your files, and plot a new replacement Cal Factor label.

For more information on the HP 11760S Power Sensor Calibration System, please contact your HP Field Engineer.

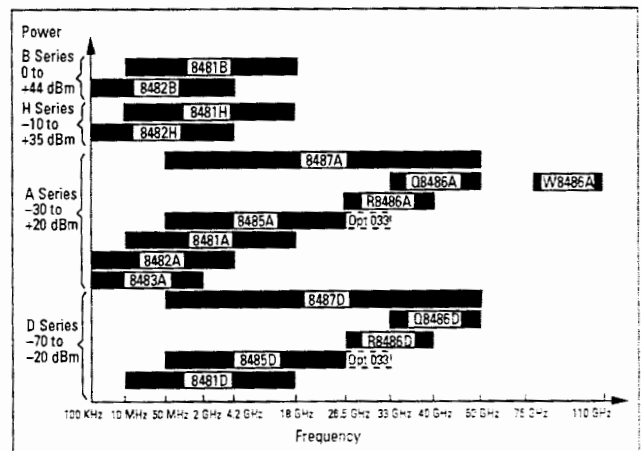

Figure 1. HP 8480 Power Sensor Family frequency and power range coverage.



## HP 8480 Series Specifications

### 25 Watt Sensors 1 mW to 25W (0 to +44 dBm)

HP Model	Frequency Range	Maximum SWR	Power Linearity	Maximum Power <sup>1</sup>	Connector Type	Weight	
8481B	10 MHz – 18 GHz	10 MHz – 2 GHz: 1.10 2 – 12.4 GHz: 1.18 12.4 – 18 GHz: 1.28	+35 to +44 dBm ±4%	0-35° C: 30W avg 35-55° C: 25W avg 0.01-5.8 GHz: 500W pk 5.8-18 GHz: 125W pk 500W·μs per pulse	N(m)	Net 0.8 kg (1.75 lb) Shipping 1.5 kg (3.25 lb)	\$1,700
8482B	100 kHz – 4.2 GHz	100 kHz – 2 GHz: 1.10 2 – 4.2 GHz: 1.18			N(m)		\$1,650

### 3 Watt Sensors 100 μW to 3W (-10 to +35 dBm)

8481H	10 MHz – 18 GHz	10 MHz – 8 GHz: 1.20 8 – 12.4 GHz: 1.25 12.4 – 18 GHz: 1.30	+25 to +35 dBm ±5%	3.5W avg, 100W pk 100W·μs per pulse	N(m)	Net 0.2 kg (0.38 lb) Shipping 0.5 kg (1 lb)	\$875
8482H	100 kHz – 4.2 GHz	100 kHz – 4.2 GHz: 1.20			N(m)		\$850

### 100 mW Sensors 1 μW to 100 mW (-30 to +20 dBm)

8485A	50 MHz – 26.5 GHz	50 – 100 MHz: 1.15 100 MHz – 2 GHz: 1.10 2 – 2.4 GHz: 1.15 12.4 – 18 GHz: 1.20 18 – 26.5 GHz: 1.25	+10 to +20 dBm +2, -4%	300 mW avg, 15W pk 30W·μs per pulse	APC-3.5mm (m)	Net 0.2 kg (0.38 lb) Shipping 0.5 kg (1 lb)	\$1,025
Opt. 033	50 MHz – 33 GHz	26.5-33 GHz: 1.40					+ \$350
8481A	10 MHz – 18 GHz	10 – 30 MHz: 1.40 30 – 50 MHz: 1.18 50 MHz – 2 GHz: 1.10 2 – 12.4 GHz: 1.18 12.4 – 18 GHz: 1.28			N(m)		\$700
8482A	100 kHz – 4.2 GHz	100 – 300 kHz: 1.60 0.3 – 1 MHz: 1.20 1 MHz – 2 GHz: 1.10 2 – 4.2 GHz: 1.30			N(m)		\$700
8483A (75 Ω)	100 kHz – 2 GHz	100 – 600 kHz: 1.80 600kHz – 2 GHz: 1.18		300 mW avg, 10W pk	N(m) 75 Ω		\$700
R8486A	26.5 – 40 GHz	1.4	+10 to +20 dBm +2, -4%	300 mW avg, 15W pk 30W·μs per pulse	Waveguide Flange UG-599/U	Net 0.26 kg (0.53 lb) Shipping 0.66 kg (1.3 lb)	\$2,000
Q8486A	33 – 50 GHz	1.5			Waveguide Flange UG-383/U		\$2,750
W8486A	75-110 GHz	1.08	+1, -3%	200 mW avg 40 W peak	Waveguide Flange UG-387/U	Net 0.4 kg (0.9 lb) Shipping 1.0 kg (2.1 lb)	\$5,925
8487A	50 MHz – 50 GHz	50 – 100 MHz: 1.15 100 MHz – 2 GHz: 1.10 2 – 12.4 GHz: 1.15 12.4 – 18 GHz: 1.20 18 – 26.5 GHz: 1.25 26.5 – 40 GHz: 1.30 40 – 50 GHz: 1.50	+10 to +20 dBm +2, -4%	300mW avg, 15W pk 30W·μs per pulse	2.4 mm (m)	Net 0.14 kg (0.28 lb) Shipping 0.5 kg (1 lb)	\$2,150

### High Sensitivity Sensors 100 pW to 10 μW (-70 to -20 dBm)

8481D <sup>2</sup>	10 MHz – 18 GHz	10 – 30 MHz: 1.40 30 MHz – 4 GHz: 1.15 4 – 10 GHz: 1.20 10 – 15 GHz: 1.30 15 – 18 GHz: 1.35	-30 to -20 dBm ±1%	100 mW avg 100 mW pk	N(m)	Net 0.18 kg (0.41 lb.) Shipping 0.9 kg (2 lb)	\$950
8485D <sup>3</sup>	50 MHz – 26.5 GHz	0.05 – 0.1 GHz: 1.19 0.1 – 4 GHz: 1.15 4 – 12 GHz: 1.19 12 – 18 GHz: 1.25 18 – 26.5 GHz: 1.29	-30 to -20 dBm ±2%	100 mW avg 100 mW pk	APC-3.5 mm (m)	Net 0.2 kg (0.38 lb) Shipping 0.5 kg (1 lb)	\$1,450
Opt. 033	50 MHz – 33 GHz	26.5 – 33 GHz: 1.35					+ \$350
8487D <sup>3</sup>	50 MHz – 50 GHz	0.05 – 0.1 GHz: 1.19 0.1 – 2 GHz: 1.15 2 – 12.4 GHz: 1.20 12.4 – 18 GHz: 1.29 18 – 34 GHz: 1.37 34 – 40 GHz: 1.61 40 – 50 GHz: 1.86	-30 to -20 dBm ±2%	100 mW avg 100 mW pk	2.4 mm (m)	Net 0.2 kg (0.38 lb) Shipping 0.5 kg (1 lb)	\$2,750
R8486D <sup>3</sup>	26.5 – 40 GHz	1.4	-30 dB to -25 dBm ±3%	100 mW avg or pk 40 Vdc max	Waveguide Flange UG-599/U	Net 0.26 kg (0.53 lb) Shipping 0.66 kg (1.3 lb)	\$2,700
Q8486D <sup>3</sup>	33 – 50 GHz	1.4	-25 dB to -dBm ±5%		Waveguide Flange UG-383/U		\$3,600

<sup>1</sup> Negligible deviation except for those power ranges noted.

<sup>2</sup> For pulses greater than 30W the maximum average power (P<sub>avg</sub>) is limited by the energy per pulse (E) in W·μs according to P<sub>avg</sub> = 30-0.02E.

<sup>3</sup> Includes HP 11708A 30 dB attenuator for calibrating against a 0 dBm, 50 MHz power reference. HP 11708A is factory set to 30 dB ±0.05 dB at 50MHz, traceable to NIST.SWR < 1.05 at 50 MHz.

<sup>4</sup> This sensor directly replaces the popular HP 8484A Power Sensor.

☎ For off-the-shelf shipment, call 800-452-4844.

# POWER METERS

## Thermistor Power Meters and Power Meter Calibrator

HP 432A/B, 8477A

- Automatic zero
- High accuracy

- Recorder outputs, analog and digital
- Long cable options



HP 432A



HP 432B

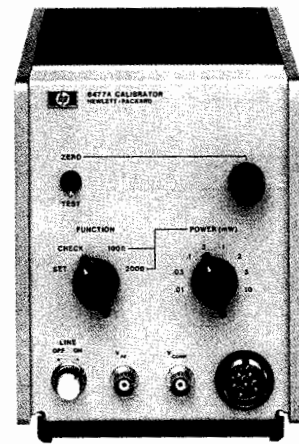

HP 8477A

### HP 432A/B Power Meters

**High accuracy—no thermoelectric error:** High accuracy over a wide temperature range is featured on the HP 432 Power Meters. By measuring the output voltage of the thermistor bridges and computing the corresponding power, even higher accuracy of  $\pm 0.2$  percent  $\pm 0.5 \mu\text{W}$  can be obtained.

Accuracy can be maintained on even the most sensitive range because the error due to thermoelectric effect is reduced to a negligible level.

**Calibrated mounts:** Each thermistor mount is furnished with data stating the calibration factor\* and effective efficiency\* at various frequencies across the operating range. For easy and accurate power measurements, the front panel of the HP 432 contains a calibration factor control, calibrated in 1 percent steps from 88 percent to 100 percent, that compensates for losses in the mount and eliminates the need for calculation.

**Instrument type:** Automatic, self-balancing power meter for use with temperature-compensated thermistor sensor.

\*"Calibration factor" and "effective efficiency" are figures of merit expressing the ratio of the substituted signal measured by the power meter to the microwave power incident on and absorbed by the sensor.

### Specifications (Partial)

#### Power Range

**HP 432A:** 7 ranges with full-scale readings of 10, 30, 100, and 300  $\mu\text{W}$ , 1, 3, and 10 mW; also calibrated in dBm from  $-20$  dBm to  $+10$  dBm full scale in 5 dB steps

**HP 432B:** 4 ranges with full-scale readings of 10 and 100  $\mu\text{W}$ , and 1 and 10 mW

**Noise:** Less than 0.25% of full scale peak (typical)

**Response time:** At recorder output, 35 ms time constant (typical)

**Fine zero:** Automatic, operated by front panel switch

**Zero carryover:** Less than 0.50% of full scale when zeroed on most sensitive range

#### Meter

**HP 432A:** Taut-band suspension, individually calibrated, mirror-backed scales. Milliwatt scale more than 108 mm (4.25 in) long

**HP 432B:** 3 digits with one digit overrange. 20% overrange capability on all ranges

**Calibration factor control:** 13-position switch normalizes meter reading to account for thermistor sensor calibration factor. Range 100% to 88% in 1% steps

**Thermistor sensor:** Thermistor sensors are required for operation of the HP 432A/B. For microwave sensors HP 478B, 8478B, and 486 series, see page 217.

**Recorder output:** Proportional to indicated power with 1 volt corresponding to full scale. 1-k $\Omega$  output impedance

**BCD output:** 8, 4, 2, 1 code: "1" positive. TTL compatible logic. Operates with HP 5150A, Opt 002 (BCD) Digital Recorder. "Print" and "Inhibit" lines available. (HP 432B only)

### Power Consumption

**HP 432A:** 115 or 230 Vac  $\pm 10\%$ , 50 to 400 Hz, 1.5 watts

**HP 432B:** 115 or 230 Vac  $\pm 10\%$ , 50 to 400 Hz, 10 watts

### Weight

**HP 432A:** Net, 2.3 kg (5.5 lb). Shipping, 4.6 kg (10 lb)

**HP 432B:** Net, 3 kg (6.5 lb). Shipping, 4.8 kg (10.5 lb)

**Size:** 130 mm W  $\times$  155 mm H  $\times$  279 mm D (5.2 in  $\times$  6.1 in  $\times$  11.0 in)

### HP 8477A Power Meter Calibrator

The HP 8477A Calibrator is specifically designed for use with the HP 432 Power Meter. It allows you to verify full-scale meter readings on all ranges, and meter tracking. Simply connect three cables between the power meter and calibrator; no charts or additional instruments are required.

**Power:** 115 or 230 Vac  $\pm 10\%$ , 50 to 400 Hz, 3 watts

### Ordering Information

	Price
<b>HP 432A Power meter</b>	\$2,000
<b>Opt W30</b> Extended repair service; see page 671	\$50
<b>Opt W32</b> Calibration service; see page 671	\$565
<b>HP 432B Power meter</b>	\$3,000
<b>Opt 001</b> Rechargeable battery installed, provides up to 20 hours' continuous operation (HP 432A only).	+ \$105
<b>Opt 002</b> Input connector placed on rear panel in parallel with front	+ \$25
<b>Opt 003</b> Input connector on rear panel only	+ \$10
<b>Opt 009</b> 3.1-m (10-ft) cable for 110- $\Omega$ or 200- $\Omega$ sensor	+ \$45
<b>Opt 010</b> 6.1-m (20-ft) cable for 100- $\Omega$ or 200- $\Omega$ sensor	+ \$85
<b>Opt 011</b> 15.2-m (50-ft) cable for 100- $\Omega$ or 200- $\Omega$ sensor	+ \$140
<b>Opt 012</b> 30.5-m (100-ft) cable for 100- $\Omega$ or 200- $\Omega$ sensor	+ \$210
<b>Opt 013</b> 61-m (200-ft) cable for 100- $\Omega$ or 200- $\Omega$ sensor	+ \$350
<b>Opt 100</b> 100 Vac operation, 48 to 66 Hz	\$0
<b>Opt 910</b> Extra operating and service manual (HP432A: P/N 00432-90009; HP432B: P/N 00432-90053)	+ \$5
<b>Opt W30</b> Extended repair service; see page 671	+ \$60
<b>Opt W32</b> Calibration service; see page 671	\$595
<b>HP 8477A Power Meter Calibrator</b>	\$1,700
<b>Opt W30</b> Extended repair service; see page 671	+ \$50
<b>Opt W32</b> Calibration service; see page 671	\$405

☎ For off-the-shelf shipment, call 800-452-4844.

## Thermistor Mounts, Peak Power Sensor, and Peak Power Meters

HP 478A, 8478B, 486 Series, 8900C/D, 84811A



HP 84811A



HP Thermistor Mounts

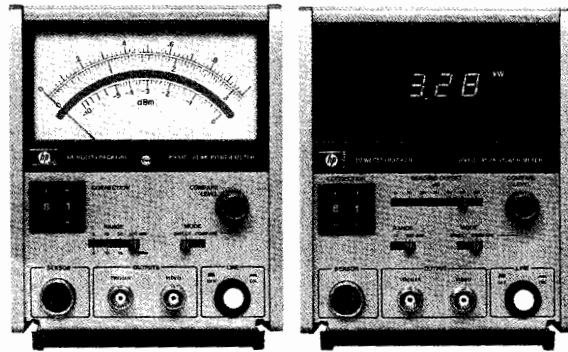

HP 8900C

HP 8900D

### HP 8900C/D Peak Power Meters

The HP 8900C and 8900D Peak Power Meters directly display the peak power of RF pulses over a 100-MHz to 18-GHz frequency range. Measurements can be made on pulses with widths from 1  $\mu$ s (100 ns in Compare mode) to CW, and repetition rates from 100 Hz (0 Hz in Compare mode) to 100 kHz.

The HP 8900C is an economical analog meter calibrated in watts and dBm. The analog display with its large, easy-to-read scale makes it simple to peak or null pulsed power systems. The HP 8900D has a high resolution 3 $\frac{1}{2}$ -digit digital display calibrated in watts. The direct reading display and range annunciators make the digital version a good choice for production and field applications where unambiguous or frequent readings are required.

### HP 8900C/D Peak Power Meters Specifications

**Frequency range:** 100 MHz to 18 GHz

**Dynamic range:** 20 dB (0 to +20 dBm)

**HP 8900C:** 4 ranges of 3, 10, 30, and 100 mW full scale

**HP 8900D:** 2 ranges of 10 and 100 mW full scale

**Pulse Response:**

**Direct Mode**

**Pulse width:** 1  $\mu$ s to CW

**Repetition rate:** 100 Hz to 100 kHz

**Compare Mode**

**Pulse width:** 100 ns (typical) limited by rise time specification

**Repetition rate:** 0 to 100 kHz

**Rise time:** 75 ns

**Fall time:** 125 ns (as measured on video output)

**Power consumption:** 100 and 120 Vac +5, -10%, 48 to 66 Hz and 360 to 440 Hz; 220 and 240 Vac +5, -10%, 48 to 66 Hz

Meter Accuracy	CW	Pulse	Transfer Accuracy CW to Pulse
Direct	$\pm 0.2$ dB	$\pm 0.35$ dB	$\pm 0.2$ dB
Compare	$\pm 0.2$ dB	$\pm 0.25$ dB	$\pm 0.1$ dB

### HP 84811A Peak Power Sensor Specifications

**Power range:** 0 to +20 dBm (1 mW to 100 mW)

**Frequency range:** 100 MHz to 18 GHz

**SWR:** 100 MHz to 12 GHz < 1.5. 12 GHz to 18 GHz < 2.0

**Maximum peak power:** +24 dBm (250 mW) for 5 minutes

**Connector type:** N (male)

**Calibration:** Every 2 GHz from 2 to 10 GHz. Every 1 GHz from 11 to 18 GHz

**Operating temperature:** 0° to +55° C

**Calibration accuracy:** (+10° to +40° C),  $\pm 0.7$  dB 0.1 to 12 GHz  $\pm 1.0$  dB to 18 GHz. 0° to 10° C and 40° to 55° C: add  $\pm 0.2$  dB

### Ordering Information

**HP 8900C** Analog peak power meter \$3,000

**HP 8900D** Digital peak power meter \$3,600

**Opt W30** Extended repair service (for HP 8900C/D); + \$75

See page 681

**Opt W32** Calibration service; see page 671 \$260

**HP 84811A** Peak power sensor \$1,000

**Opt W30** Extended repair service; see page 671 \$50

**Opt W32** Calibration service; see page 671 \$285

☎ For off-the-shelf shipment, call 800-452-4844.

### Temperature-Compensated Thermistor Mounts

High efficiency and good radio frequency (RF) match are characteristic of the HP 478A and 8478B coaxial and 486A series waveguide thermistor mounts. Used in conjunction with the HP 432 Power Meter they provide high accuracy even in routine power measurements. These thermistor mounts are temperature compensated for low drift, even in the presence of thermal shocks, permitting measurement of microwave power as low as 1 microwatt. Each mount contains data showing calibration factor and effective efficiency at six frequencies, directly traceable to the U.S. National Institute Standards and Technology at those frequencies where NIST provides calibration service.

### HP 486, 478, 8478B Specifications

HP Model	Frequency Range, GHz	Maximum SWR	
478A	10 MHz to 10 GHz	1.75, 10 to 25 MHz 1.3, 25 MHz to 7 GHz 1.5, 7 to 10 GHz	\$600
8478B <sup>1</sup>	10 MHz to 18 GHz	1.75, 10 to 30 MHz 1.35, 30 to 100 MHz 1.1, 0.1 to 1 GHz 1.35, 1 to 12.4 GHz 1.6, 12.4 to 18 GHz	\$750
X486A	8.20 to 12.4	1.5	\$900
P486A	12.4 to 18.0	1.5	\$1,050
K486A <sup>2</sup>	18.0 to 26.5	2.0	\$1,050
R486A <sup>2</sup>	26.5 to 40.0	2.0	\$1,050
<sup>1</sup> Opt 011: Furnished with APC-7 RF connector			+ \$25
<sup>2</sup> Circular flange adapters:			
K-band (UG-425/U) HP 11515A			\$325
R-band (UG-381/U) HP 11516A			\$350

### HP 84811A Peak Power Sensor

The HP 84811A Peak Power Sensor works with the HP 8900C/D Peak Power Meters to measure the peak power of RF pulses. It is supplied with a 4-foot flexible cable to easily reach the pulse source being measured. The HP 84811A also conveniently detaches from the meter for storage, recalibration, or replacement.

# SIGNAL ANALYZERS

## General Information



HP offers a complete line of signal analyzers to provide frequency, time, and modulation domain measurement capability. This section is devoted primarily to the frequency domain. It includes spectrum analyzers, distortion analyzers, audio analyzers, modulation analyzers, and measuring receivers. Each type of instrument has distinctive capabilities that make it the preferred instrument for a particular measurement application.

The spectrum analyzer is a swept-tuned, superheterodyne receiver that provides a CRT display of amplitude versus frequency. It is essentially a frequency-selective, peak-responding voltmeter calibrated to display the rms value of a sine wave. The spectrum analyzer can show the individual frequency components that make up a complex signal. (It does not provide phase information about a signal, however.) The swept receiver technique used in Hewlett-Packard spectrum analyzers enables frequency domain measurements to be made over a large dynamic range and a wide frequency range (5 Hz to 325 GHz).

The Fourier analyzer uses digital sampling and mathematical transformation techniques to form a Fourier spectrum of a signal. This method is useful for measuring signals from a few  $\mu\text{Hz}$  to 100 kHz, and provides frequency, amplitude, and phase information. As with the spectrum analyzer, all information is presented on a CRT display. With its real-time signal analysis capability, the Fourier analyzer is able to capture periodic as well as random and transient events.

The wave analyzer uses a tunable filter, which can be visualized as a movable frequency window, to measure both the amplitude and the frequency of individual spectral components. This measurement technique essentially makes the instrument a frequency-selective voltmeter. The wave analyzer employs meters and digital displays to show the amplitude and frequency of the signal within the window. HP wave analyzers provide accurate results from 15 Hz to 32.5 MHz.

Distortion analyzers and audio analyzers employ broadband detectors and notch filters to measure signal properties such as total harmonic distortion. These tunable filters enable the analyzer to selectively display the level and frequency of harmonic and distortion products. Measurement results are shown on a meter or digital display. Audio analyzers include a signal source, making possible measurements such as SINAD, which include signal and distortion levels. The frequency range covered by HP distortion and audio analyzers extends from 5 Hz to 600 kHz.

Modulation analyzers are designed to capture and analyze a fundamental signal and its entire modulation envelope. These analyzers use independent AM and FM detection circuits for simultaneous analysis of complex modulated signals. When a modulation analyzer is combined with a measuring receiver, accurate measurements of frequency, power, and modulation characteristics can be made on signals from 150 kHz to 26.5 GHz. All measurement results are presented on a digital display.

### Spectrum Analyzers

Spectrum analyzers take advantage of the frequency-conversion properties of the swept-tuned heterodyne receiver to make significant contributions to frequency-domain signal analysis. The following are some of the measurements that can be made with spectrum analyzers:

- absolute and relative frequency
- absolute and relative amplitude
- noise
- distortion products
- AM, FM, pulsed RF modulation
- stimulus response
- electromagnetic compatibility (EMC)

These measurements are possible because spectrum analyzers have the following characteristics:

- broad frequency coverage from 5 Hz to 325 GHz
- wide amplitude range from  $-136$  dBm to  $+30$  dBm
- excellent sensitivity for low signal detection
- excellent frequency stability
- high resolution of frequency and amplitude

These capabilities allow spectrum analyzers to provide frequency-domain signal analysis for numerous applications, including the manufacture and maintenance of microwave communications links, radar, telecommunications equipment, CATV systems, and broadcast equipment; mobile communication systems; EMI diagnostic testing; and signal surveillance.

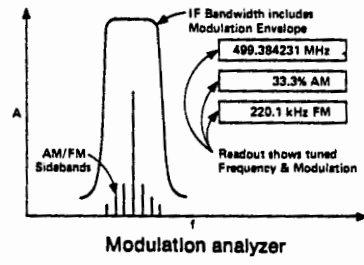
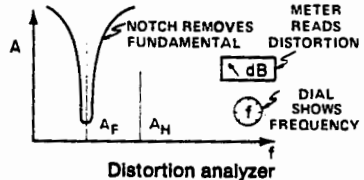
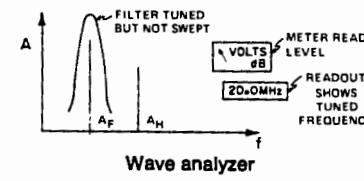
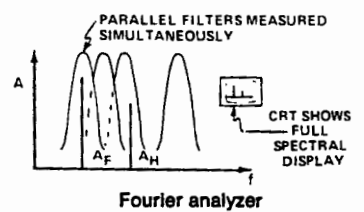
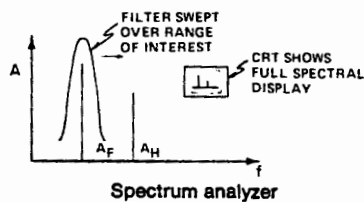
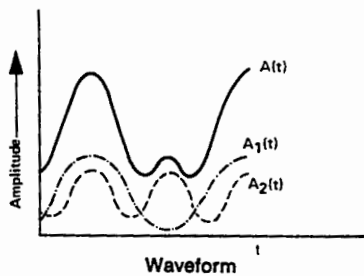

In addition to the swept-tuned frequency mode, spectrum analyzers can also be used in the fixed-tuned mode (zero span) to provide time-domain measurement capability much like that of an oscilloscope.

With the addition of desktop technical computers, the capability of spectrum analyzers can be greatly enhanced. Computers can be used to directly control the operation of spectrum analyzers over HP-IB. Computers can also be used to develop downloadable programs (DLPs) for spectrum analyzers with the capability to store such programs in non-volatile memory. These custom measurement routines are then as easy to use as any of the standard instrument features. Custom measurement "personality" cards are available for many spectrum analyzers.

In addition, spectrum analyzers with HP-IB capability can directly control a plotter or printer, enabling a hard copy of the CRT display to be made without the use of a computer. Application areas that require accurate, high-speed, repetitive routines; physical separation of the operator and the analyzer; unattended operation or operation by personnel with limited technical skills—all are candidates for automation.

Areas that benefit significantly from automated spectrum analysis include:

- EMC testing
- frequency spectrum monitoring
- production testing of RF or microwave components, subsystems, or systems
- remote site testing

The basic measurement capabilities of the spectrum analyzer, combined with its ability to automate and to interface with other HP-IB instruments and peripherals, make this instrument ideal for many general-purpose and specialized applications.

### Fourier Analyzers

Fourier analyzers offer fast, high-resolution spectrum and network analysis. Unlike conventional swept analyzers, Fourier-based analyzers can measure dynamic signals because they measure all frequencies simultaneously, not one at a time.

Fourier analyzers characterize signals using digital signal-processing techniques based on the Discrete Fourier Transform. For a complete description of these techniques, see Application Note 243, "The Fundamentals of Signal Analysis."

Fourier analyzers are especially useful on low-frequency signals (<100 kHz) or where very fast measurements are desired. They can improve measurement speed by a factor of between 10 and 100, and allow accurate measurements on frequencies as low as a few  $\mu$ Hz. Signal components as closely spaced as 20  $\mu$ Hz can be clearly resolved and accurately measured.

Since both the magnitude and this phase of each frequency component are measured, the Fourier analyzer can measure the statistical properties of signals or the joint properties or relationships of two or more signals. Applications include acoustic, modal, vibration, or rotating machine analysis. In addition, various types of modulation can be detected and measured.

Simultaneous measurement of magnitude and phase on two or more channels provides high-quality network measurements. Transfer functions or frequency response can be easily measured, and the use of band-limited or band-translated random noise as the stim-

ulus allows the entire frequency span of interest to be measured at once. Measurement of the coherence function can provide an indication of the validity of many network measurements.

### Wave Analyzers/SLMs

Wave analyzers are known by several different names: frequency-selective voltmeters, carrier-frequency voltmeters, and selective-level meters. A wave analyzer can be thought of as a finite-bandwidth filter which can be tuned throughout a particular frequency range. Signals will be selectively measured as they are isolated within the bandwidth of the filter. For a particular signal, the wave analyzer will indicate both its frequency and its amplitude.

The uses of wave analyzers can be divided into three broad areas: (1) amplitude measurement of a single component of a complex frequency system, (2) amplitude measurement in the presence of noise and interfering signals, and (3) measurement of signal energy appearing in a specified, well-defined bandwidth.

Wave analyzers are most commonly used in communication systems, and have input configurations and measurement bandwidths optimized for these applications. Both balanced and unbalanced inputs are available, and impedances range from 50 to 600 ohms.

### Distortion and Audio Analyzers

The Hewlett-Packard distortion and audio analyzers consist of a narrow-band rejection filter and broadband detector. Before the fundamental is rejected, the analyzer first measures the amplitude of the fundamental, all the harmonic components, and the noise. Then the rejection filter is employed to remove the fundamental. The ratio of the two measurements is total harmonic distortion plus noise.

### Audio Analyzers

The audio analyzer performs several basic low-frequency measurements in addition to distortion, making it a general-purpose audio test set. The audio analyzer includes the SINAD function for testing mobile radio receiver sensitivity. It contains a low-distortion audio oscillator for stimulus-response testing in combination with its distortion analyzer. It has a true rms voltmeter and dc voltmeter for accurate measurement of complex waveform levels. Swept ac level and swept distortion measurements can be made using the internal source and rms voltmeter. A reciprocal frequency counter is included that continuously counts the frequency of the input signal.

### True Harmonic Distortion Measurements

Computer-controlled spectrum analyzers provide a rapid means of measuring true harmonic distortion levels. The fundamental and its harmonic components are rapidly measured one at a time, and the distortion is computed and either stored or printed.

# SIGNAL ANALYZERS

## General Information

### Modulation Analyzers/ Measuring Receivers

A modulation analyzer is a precision receiver designed to detect the entire modulation envelope of a signal under test. It can measure and display the carrier characteristics of RF frequency and power as well as AM, FM, and phase modulation characteristics such as AM depth, peak deviation, residual modulation, and various associated ratios. The modulation analyzer faithfully recovers the actual modulation signal for further analysis such as distortion testing.

In addition to having all the capabilities of the modulation analyzer, the measuring receiver can measure power down to -127 dBm. With very high accuracy, it can look at signals up to millimeter-wave frequencies. This makes it ideal for calibration of signal generators and attenuators.

### Microwave Modulation Analyzers

Most modern microwave communication and radar/EW system designers are turning to the use of complex modulations, which involves the use of quadrature or "vector" modulation formats such as QPSK or 16QAM in the case of communication systems and complex, coded formats in the case of radar/EW systems.

In all these receivers, the signal processing is not handled in the traditional one-channel, amplitude-only mode, but instead is demodulated into in-phase and quadrature-phase signals that provide dynamic phase and amplitude information about the carrier's modulation.

The high bandwidth requirement has led to the introduction of the HP 8980B vector analyzer and the HP 8981B vector modulation analyzer. Both instruments contain a matched dual-channel, sampling oscilloscope with dc to 350 MHz baseband capability.

The HP 8981B contains an internal I/Q demodulator that takes an IF signal from 50 to 200 MHz and demodulates it into I and Q signals for display and analysis. Other demodulation frequency ranges are available up to 1400 MHz. Extensive application information is available in Application Notes 343-2, 343-3, and 343-4, as well as in related data sheets and product notes.

### Peak Power Analysis

For comprehensive measurement and analysis of RF and microwave pulsed power, the HP 8990A peak power analyzer measures eight time parameters and five amplitude parameters. Its powerful waveform math routines can measure ratios and differences and can determine statistics of parameters measured with two RF channels or two video (100 MHz) channels.

### Signal Analyzer Selection Guide Dynamic Signal Analyzers

Frequency Range	Frequency Accuracy ( $\pm$ ) <sup>1</sup>	Resolution Bandwidth Range	Average Noise Level (narrowest RBW)	Optimum Dynamic Range 2nd/3rd Order	Amplitude Accuracy (+) <sup>2</sup>	HP Model Number	Page
0.000125 Hz to 100 kHz	3 Hz	23 $\mu$ Hz to 900 Hz	-120 dBV	85 dB/85 dB	0.15 dB	HP 3561A	223
0.000064 Hz to 100 kHz	4 Hz	12 $\mu$ Hz to 450 Hz	-116 dBV	85 dB/85 dB	0.15 dB	HP 3562A HP 3563A	226 227
0.000244 Hz to 102.5 kHz	3 Hz	244 $\mu$ Hz to 920 Hz	-140 dBV	75 dB/75 dB	0.5 dB	HP 35660A	224, 225
0.0625 Hz to 40 kHz	8 Hz	625 $\mu$ Hz to 1440 Hz	-100 dBV	60 dB/60 dB	0.5 dB	HP 3560A	222
0.000244 Hz to 102.4 kHz	3 Hz	644 $\mu$ Hz to 920 Hz	-110 dBV	78 dB/78 dB	0.5 dB	HP 35665A	224, 225
0.000122 Hz to 102.4 kHz	0.8 Hz	122 $\mu$ Hz to 4096 Hz	-133 dBV	80 dB/80 dB	0.15 dB	HP 3567A	232, 233
0.000122 Hz to 128 kHz	0.1 Hz	122 $\mu$ Hz to 512 Hz	-137 dBV	72 dB/72 dB	0.15 dB	HP 3566A	232, 233

### Spectrum Analyzers

Frequency Range	Frequency Accuracy ( $\pm$ )	Resolution Bandwidth Range	Average Noise Level (narrowest RBW)	Optimum Dynamic Range 2nd/3rd Order	Amplitude Accuracy ( $\pm$ ) <sup>2</sup>	HP Model Number	Page
20 Hz to 40.1 MHz	40 Hz	3 Hz to 30 kHz	-137 dBm	105 dB/86 dB	0.4 dB	HP 3585B	234, 235
10 Hz to 150 MHz	150 Hz	0.004 Hz to 17 kHz	-132 dBm	80 dB/80 dB	0.3 dB	HP 3588A, 3589A	236, 237, 238
10 kHz to 1500 MHz	5 kHz <sup>3</sup>	1 kHz to 3 MHz	-115 dBm <sup>3</sup>	72 dB/83 dB	2 dB	HP 8567A <sup>4</sup>	250
100 Hz to 1500 MHz	260 Hz <sup>3</sup>	10 Hz to 3 MHz	-135 dBm <sup>3</sup>	88 dB/97 dB	2 dB	HP 8588B <sup>3</sup>	250
9 kHz to 1800 MHz	5 MHz <sup>2</sup>	1 kHz to 3 MHz	-115 dBm <sup>3</sup>	70 dB/80 dB	2 dB	HP 8590B <sup>3</sup>	239
9 kHz to 1800 MHz	2 kHz <sup>3</sup> (210 Hz w/PFR)	1 kHz to 3 MHz	-115 dBm <sup>3</sup>	70 dB/80 dB	2 dB	HP 8591A <sup>3</sup>	239
9 kHz to 2.9 GHz	2 kHz <sup>3</sup> (220 Hz w/PFR)	1 kHz to 3 MHz	-112 dBm <sup>3</sup>	70 dB/80 dB	3 dB	HP 8594A <sup>3</sup>	239
50 Hz to 2.9 GHz + mm	2 kHz <sup>3</sup> (150 Hz w/PFR)	10 Hz to 2 MHz	-130 dBm <sup>3</sup>	81 dB/90 dB	2 dB	HP 8560A <sup>3</sup>	245
100 Hz to 2.9 GHz + mm + lightwave	110 Hz <sup>2</sup>	10 Hz to 300 kHz (3 MHz option)	-134 dBm <sup>3</sup> (-156 dBm option)	82 dB/92 dB	1.5 dB (0.9 dB) <sup>4</sup>	HP 71100C <sup>3</sup>	253
9 kHz to 6.5 GHz	2 kHz <sup>3</sup> (220 Hz w/PFR)	1 kHz to 3 MHz	-114 dBm <sup>3</sup>	70 dB/80 dB	3 dB	HP 8595A <sup>3</sup>	239
50 Hz to 6.5 GHz + mm	2 kHz <sup>3</sup> (150 Hz w/PFR)	10 Hz to 2 MHz	-131 dBm <sup>3</sup>	81 dB/90 dB	2 dB	HP 8561B <sup>3</sup>	245
9 kHz to 22 GHz (25 GHz)	10 MHz <sup>2</sup> (1.8 MHz w/COMB)	1 kHz to 3 MHz	-102 dBm <sup>3</sup>	92 dB/71 dB	3 dB	HP 8592B <sup>3</sup>	239
9 kHz to 22 GHz (26.5 GHz)	20 kHz <sup>2</sup> (1.2 kHz w/PFR)	1 kHz to 3 MHz	-102 dBm <sup>3</sup>	92 dB/71 dB	3 dB	HP 8593A <sup>3</sup>	239
9 kHz to 22 GHz (26.5 GHz) + mm	20 kHz <sup>2</sup> (1 kHz w/PFR)	100 Hz to 2 MHz	-110 dBm <sup>3</sup>	100 dB/78 dB	3 dB	HP 8562A <sup>3</sup>	245
9 kHz to 26.5 GHz + mm	1 kHz <sup>3</sup>	10 Hz to 2 MHz	-120 dBm <sup>3</sup>	105 dB/85 dB	3 dB	HP 8563A <sup>3</sup>	245
100 Hz to 22 GHz + mm	2.5 kHz <sup>2</sup>	10 Hz to 3 MHz	-125 dBm <sup>3</sup>	107 dB/86 dB	2.7 dB	HP 8566B <sup>3</sup>	250
50 kHz to 22 GHz (26.5 GHz) + mm	1 kHz <sup>3</sup>	10 Hz to 300 kHz (3 MHz option)	-125 dBm <sup>3</sup> (-109 dBm) <sup>3</sup>	70 dB/88 dB (84 dB/91 dB) <sup>3</sup>	2 dB (0.9 dB) <sup>4</sup>	HP 71200C <sup>3,7</sup>	253
100 Hz to 26.5 GHz + mm	1 kHz <sup>3</sup>	10 Hz to 3 MHz	-139 dBm <sup>3</sup> (-155 dBm option)	99 dB/96 dB	2.5 dB (0.9 dB) <sup>4</sup>	HP 71209A <sup>3</sup>	253
100 Hz to 22 GHz + mm + lightwave	1 kHz <sup>3</sup>	10 Hz to 3 MHz	-136 dBm (-153 dBm option)	96 dB/98 dB	2.5 dB (0.9 dB) <sup>4</sup>	HP 71210C <sup>3</sup>	253

<sup>1</sup>One-year aging; settability and temperature drift included.

<sup>2</sup>Relative accuracy = relative frequency response + lesser of either scale or fidelity or IF gain accuracy.

<sup>3</sup>CF = 1 GHz.

<sup>4</sup> $\pm 0.75$  dB transfer accuracy using HP 70100A-H01 modular power meter.

<sup>5</sup>CF = 10 GHz.

<sup>6</sup>HP 71200C with HP 70600A preselector enabled.

<sup>7</sup>Unpreselected system unless otherwise noted.

## Wave Analyzers/Selective Level Meters

Frequency Range	Selective Bandpass	Dynamic Range		Freq. Readouts	Type of Inputs	Type of Outputs	Modes of Operation	HP Model Number	Page
		Absolute	Relative						
50 Hz to 32.5 MHz	20 Hz 400 Hz 3100 Hz	-130 to +20 dBm	> 80 dB	LED, 0.1 Hz resolution	50/75 Ω, BNC 600 Ω banana jacks	Tracking generator Audio/loudspeaker 1 MHz ref.	Wideband Selective USB/LSB	3586C (3336C*)	502
50 Hz to 32.5 MHz	20 Hz 400 Hz 3100 Hz WTD	-130 to +20 dBm	> 70 dB	LED 0.1 Hz resolution	75 Ω BNC/WECO 124 Ω WECO 135 Ω WECO 150 Ω Siemens 600 Ω WECO/ Siemens	Tracking generator Audio/loudspeaker 1 MHz ref.	Wideband Selective USB/LSB	3586A/B (3336A/B*) (3335A)	599

\*Tracking synthesizers.

## Distortion/Audio Analyzers

Fundamental Frequency Range	Minimum Distortion	Auto Set Level	Auto Nulling	True RMS	AM Detector	Filters	Internal Source	HP-IB	HP Model No.	Page
10 Hz to 110 kHz	0.0018% (-95 dB)	•	•	•	•	•	•	•	339A	262
20 Hz to 100 kHz	0.01% (-80 dB)	•	•	•	Note 1	•	•	•	8903B*	266
20 Hz to 100 kHz	0.01% (-80 dB)	•	•	•	Note 1	•	•	•	8903E**	266

\*The HP 8903B also performs frequency count, signal/noise, SINAD, watts, and ac/dc voltage measurements.

\*\*The HP 8903E also performs frequency count, SINAD, and ac/dc voltage measurements.

Note 1: The HP 8901A modulation analyzer (page XX) provides complete demodulation of AM, FM, and  $\theta$ M signals.

## Modulation Analyzers/Measuring Receivers

Frequency Range	Modulation Measurements	Amplitude Measurement Range	Audio Frequency Count + Distortion Measurement	HP Model Number	Page
dc to 350 MHz 50 to 200 MHz	Baseband, IF, I, Q, AM, mag/phase	5 mV to 5 V -5 to -20 dBm	No	8981B	265
150 kHz to 1300 MHz	AM, FM, $\theta$ M	+30 to 0 dBm	No	8901A	268
150 kHz to 1300 MHz	AM, FM, $\theta$ M	+30 to -20 dBm	Yes	8901B	268
150 kHz to 1300 MHz	AM, FM, $\theta$ M	+30 to -127 dBm	Yes	8902A	270
150 kHz to 18 GHz or 26.5 GHz	AM, FM, $\theta$ M	+30 to -100 dBm	Yes	8902S	271

## Carrier Phase Noise Analysis

Frequency Range	Maximum Sensitivity (depends on offset and method)	Functions Available	HP Model Number	Page
5 MHz to 18 GHz	-170 dBc/Hz (Requires external reference source of equivalent performance)	Fully documented with specified phase detector, frequency discriminator, AM and two port measurements	3048A Phase Noise Measurement System	263

## Peak Power Analysis

Frequency Range	Time Parameters	Amplitude Parameters	Functions Available	HP Model Number	Page
500 MHz to 40 GHz	Rise time, fall time, pulse width, off time, PRI, PRF, delay	Pulse-top amplitude, pulse-base amplitude, peak power, overshoot, average power	2 RF power, 2 video channels, ratios, differences, statistical averages, means, glitch-finding triggering	8990A	210

# SIGNAL ANALYZERS

## Portable Dual-Channel Dynamic Signal Analyzer 31.25 mHz to 40 kHz

HP 3560A

- Frequency response, spectrum, transient analysis in the field
- 6 hr (typical) operation on rechargeable battery pack
- Lightweight (3.2 kg / 7 lbs) and portable
- > 2 kHz, 2 channel real-time bandwidth
- Octave (full and one-third) and spectral map displays
- On-line zoom for greater resolution at high frequencies

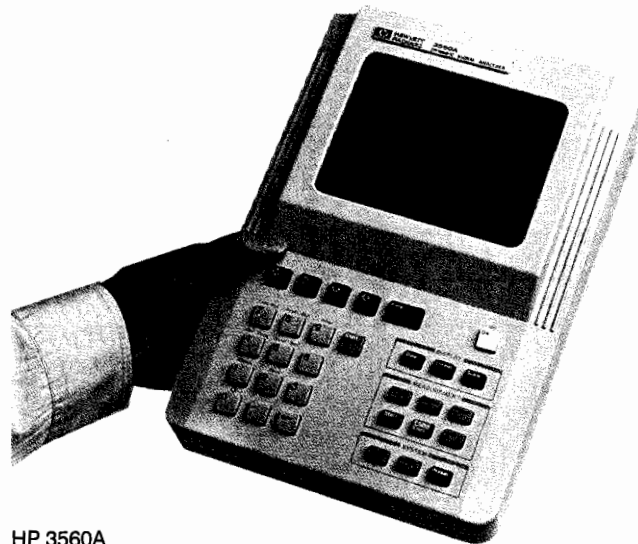

HP 3560A

### HP 3560A Portable Dynamic Signal Analyzer

The HP 3560A portable dynamic signal analyzer is an FFT-based instrument capable of measuring time domain and frequency signals from both steady state and quickly changing signal sources. With two input channels, the HP 3560A provides a variety of frequency response measurements with a frequency range from 31.25 mHz to 40 kHz. Battery power and light weight allow you to bring this broad range of measurements anywhere they are needed with fully portable operation.

The HP 3560A provides more than raw measurements. The ICP input mode directly powers accelerometers, so external signal conditioning hardware is not required. Octave measurements, spectral map displays and marker functions make the HP 3560A a powerful, portable measurement and analysis tool.

#### Ultra-portable dual-channel measurements

The internal, rechargeable battery pack permits the HP 3560A to make spectrum and frequency response measurements in the field. The HP 3560A is built to withstand the harsh environmental conditions normally encountered in portable applications. With a 3.2 kg (7 lb) total weight, the HP 3560A can be taken virtually anywhere.

#### Troubleshoot noise and vibration problems

Analysis features provide the power needed to isolate mechanical noise and vibration signal sources. Octave measurements allow standard acoustic techniques to be used in characterizing the desired signals. The octave measurements comply with ANSI S1.11 standard frequency bands and filter shapes.

Spectral map displays allow you to view your signal and how it changes as a function of time. Spectral map displays are essential for rotating machinery applications where vibration varies as a function of the machine's operating speed.

The spectral map display, combined with the external sampling capability of the HP 3560A, makes it easy to determine which vibration signals are related to the operating speed of the machine and which are fixed frequency signals due to other vibration modes such as structural resonances or oil whirl.

The dual-channel HP 3560A offers structural analysis in the field when used with HP 35207A and 35208A hammer kits. Variable block size, combined with Force/Exponential Windows and on-line zoom, provide the tools for data collection and viewing of FRFs when using impact test techniques. Coherence measurements and real/imaginary trace coordinates allow powerful structural analysis.

#### Documentation and analysis

The HP 3560A measurements can be printed on HP QuietJet or HP LaserJet printers, or HP-GL plotters via RS-232. Stored data can also be transferred to a computer via RS-232 and is compatible with Hewlett-Packard's SDF (Standard Data Format) which allows data transportability to other Hewlett-Packard dynamic signal analyzers such as the HP 3566A/3567A and HP 35665A, and third-party analysis packages for data analysis, comparisons and archiving.

#### Specification Summary

##### Frequency

**Measurement range:** 31.25 mHz to 40 kHz with alias protection  
**Spans:** Baseband 50 Hz to 20 kHz in 1, 2, 5 sequence and 40 kHz.  
**Zoom:** 20 Hz to 10 kHz in 1, 2, 5 sequence.

**Resolution:** Frequency span / lines

**Number of Lines:** Selectable 100, 200, 400, 800, and 1600 lines

**Block size:** 256, 512, 1024, 2048, 4096 points

**Windows:** Hann, Flat Top, Uniform, Force/Exponential

**Amplitude (50 Hz to 20 kHz spans)**

**Accuracy:**  $\pm (0.5 \text{ dB} + 0.025\% \text{ of full scale})$

**Dynamic range:** 60 dB to 10 kHz

**Frequency Response Channel Match (50 Hz to 20 kHz spans)**

0 to 80% of span:  $\pm 0.2 \text{ dB}$ ;  $\pm 5 \text{ deg}$

0 to 50% of span:  $\pm 0.1 \text{ dB}$ ,  $\pm 1 \text{ deg}$  (typical)

##### Input

**Range:** 5 mV to 5 V full scale in 1,2,5 sequence

**Characteristics:** AC/DC coupling, ICP current source, engineering units, single/double integration, differentiation.

**Impedance:** 1 M $\Omega$  (typical)

##### Trigger

**Source:** Internal (Ch 1 or 2), external, free run

**Level:** Variable slope and level with 1% resolution

**Pre-trigger delay:** 0 to 4096 points

**Post-trigger delay:** 0 to 4096 points

**Exterior Sample Signal:** 250 ns minimum low time, 9.75 ns minimum high time, TTL, 102.4 kHz maximum frequency.

**Averaging:** Time, RMS, exponential RMS, peak hold, preview

##### Displays

Time record, power spectrum, power spectral density, frequency response, 1/3 octave, 1/1 octave, CHI-CH2 time, map (2 to 99 traces on display), cross correlation, coherence, differentiated time

##### Display coordinates

Linear magnitude, log magnitude, phase, real, imaginary. Linear x-axis, log x-axis, orders

##### Data storage

Nonvolatile storage of 500 state/trace combinations with 200 line spectra

##### General

**Power:** Internal battery power

**Recharger:** 100/120 Vac + 5%, -10%, 48-66 Hz 220/240 Vac + 5%, -10%, 48-66 Hz.

**Weight:** Approximately 3.2 kg (7 lbs)

**Size:** 300 mm H  $\times$  210 mm W  $\times$  95 mm D (11.75 in  $\times$  8.25 in  $\times$  3.75 in)

**Interface:** EIA-232D

##### Environmental

	Operating	Non-operating
<b>Temperature</b>	0 to +40 $^{\circ}$ C	-20 to +50 $^{\circ}$ C
<b>Relative Humidity</b>	15% to 95%	
<b>Altitude</b>	4600 m (15,000 ft)	15,000 m (50,000 ft)

##### Accessories

###### Microphones

HP 35220A Free field, standard sens., 5 Hz to 40 kHz, 35 to 160 dB

HP 35221A Free field, high sens., 5 Hz to 20 kHz, 20 to 145 dB

HP 35222A Pressure, standard sens., 5 Hz to 20 kHz, 35 to 160 dB

HP 35223A Pressure, high sens., 5 Hz to 10 kHz, 20 to 145 dB

HP 35224A Pre-amplifier, 2 Hz to 200 kHz,  $\pm 0.5 \text{ dB}$

HP 35228A Microphone power supply (battery)

HP 35229A 94 dB/104 dB, 1 kHz calibrator

###### Accelerometers

HP 35200A General vibration; 10 mV/g, 1 Hz to 9 kHz

HP 35201A Machinery vibration; 50 mV/g, 1 Hz to 3 kHz

HP 35205A Handheld velocity probe, 100 mV/in/sec, 2 Hz to 2 kHz

#### Ordering Information

**HP 3560A** Portable dynamic signal analyzer

☎ For off-the-shelf shipment, call 800-452-4844.

#### Price

\$7,500 ☎



# SIGNAL ANALYZERS

## Single-Channel, Dynamic Signal Analyzer 0.000125 Hz to 100 kHz

HP 3561A

223

- Spectrum analysis, FFT-synthesized  $\frac{1}{3}$  and  $\frac{1}{2}$  octave analysis
- Time capture (40 k sample)
- High-speed (7.5 kHz real-time rate)

- High accuracy,  $\pm .15$  dB
- 80 dB dynamic range, to 640  $\mu$ Hz resolution bandwidth
- Non-volatile memory option stores 127 measurements

### Solutions in Spectrum Analysis

The HP 3561A gives you the tools for fast, efficient spectrum analysis. In addition to standard marker features, such as marker-to-peak and peak tracking, it provides harmonic analysis with automatic computation of THD in either percent or dB. Band markers quickly compute rms band level or average band power. Sideband markers make it easy to identify the frequency spacing of modulation sidebands and automatically compute the power.

### Solutions in Vibration and Acoustics

When used with an accelerometer or other motion transducer, the HP 3561A is an excellent diagnostic tool for vibration analysis. By using the display marker capabilities, you can quickly deduce the cause of many machine vibration problems. For acoustics measurements, the octave displays update quickly to indicate short-term changes in noise level. Calibrated sound pressure level measurements are also possible with the simple engineering units feature.

### Specifications

#### Frequency

**Range:** 0.000125 Hz to 100 kHz

**Accuracy:**  $\pm 0.003\%$  of display center frequency

**Resolution:** 0.25% of frequency span

**Window:** Flat top, Hann, uniform, and exponential

**Real-time bandwidth:** (Typical) single display, 3 kHz. Fast average display, 7.5 kHz

#### Amplitude

**Measurement range:** +27 to -120 dBV noise floor (22.4 Vrms to 1  $\mu$ V noise floor)

**Dynamic range:** 80 dB

**Accuracy at the passband center**

$\pm 0.15$  dB  $\pm .015\%$  of input range: +27 to -40 dBV input ranges

$\pm 0.25$  dB  $\pm .025\%$  of input range: -41 to -51 dBV input ranges

#### Input

**Impedance:**  $1 \times 10^6 \Omega \pm 5\%$  shunted by 95 pF maximum

**Isolation:** Input low may be connected to chassis ground or floated up to 30 volts rms (42 volts peak) above ground

**Coupling:** Signal may be ac or dc coupled. Low frequency 3-dB point <1 Hz in ac mode.

**ICP current:** Nominal 4 mA current source provided

#### Output

**Source:** Pseudo-random, random, or impulse

#### Display

**General:** Magnitude, phase, time and math traces can be selected.

Units available are:

**Horizontal:** Hz, seconds, RPM, orders; linear, or log spacing

**Vertical:** dBV, dBm (selectable Z), volts, volts squared, and user-defined units

**Math:** Arithmetic operations can be performed on new or recalled frequency spectra. Add, subtract, multiply, divide, integrate, differentiate and user-defined constants are provided. 1/BW is provided for Power Spectral Density (PSD) computations.

#### Internal Memory

	Non-volatile	Volatile
<b>Standard</b>	2 traces, 6 states	40 time records
<b>Optional</b>	traces + states + (1 + 2x time records) = 127	40 time records

#### General

Weight: net, 15 kg (33 lb); shipping, 21.6 kg (47.5 lb)

Size: 197 mm H  $\times$  335 mm W  $\times$  595 mm D (7.8 in  $\times$  13.2 in  $\times$  23.4 in)

#### Ordering Information

**HP 3561A** Dynamic Signal Analyzer

**Opt 001** Extended Non-volatile Memory

**Opt W30** Extended Repair Service, see page 671.

#### Price

\$13,500

+ \$1,610

+ \$215

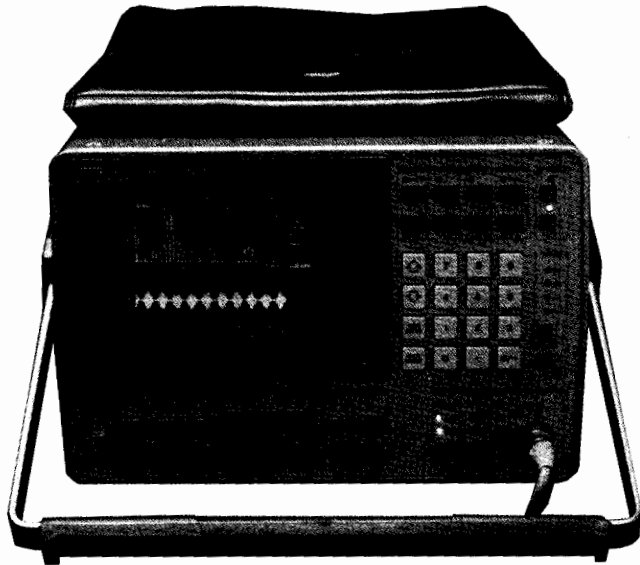

HP 3561A



### Providing High-Performance Signal Analysis

If your test and measurement applications require the performance of a lab instrument with transportable convenience, the HP 3561A is ready to go to work for you. It provides 80 dB dynamic range with  $\pm .15$  dB amplitude accuracy, giving you the precision needed to isolate small components in a signal.

The HP 3561A's set of measurement functions lets you approach problems from several different angles. Spectra can be displayed in a variety of formats and units, including a three-dimensional spectral map. This map displays up to 60 successive spectra and is extremely useful for analyzing transients and monitoring dynamic signals in both electronic and mechanical systems.

In addition to spectrum measurements, the HP 3561A displays time waveforms, and you can observe a signal in both the time and frequency domains simultaneously. A 40 ksample time buffer captures transients for later measurements and analysis. Make acoustics measurements with its FFT-synthesized  $\frac{1}{3}$  and  $\frac{1}{2}$  octave measurements, together with the built-in analog A-weighted filter.

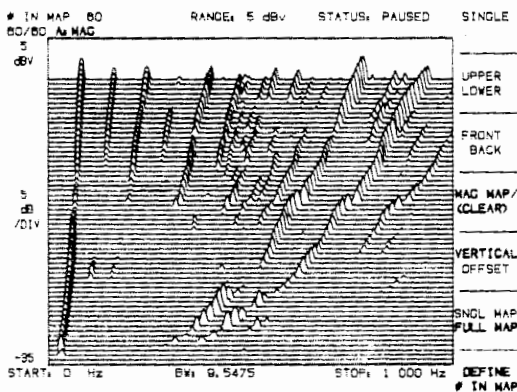

Spectral maps greatly reduce the time required to analyze changes in up to 60 successive measurements.

# SIGNAL ANALYZERS

## Dual-Channel Dynamic Signal Analyzer 122 $\mu$ Hz to 102.4 kHz

HP 35665A

- Network, spectrum, waveform, transient analysis
- Flexible option structure — buy only what you need
- Up to 6.4 Mbytes deep transient capture (optional)
- HP Instrument BASIC (optional)
- 1.44 Mbyte internal LIF/MS-DOS® disk drive
- Fast update rate for interactive measurements
- High-speed processing: 8 traces/second, 12.8 kHz real-time fast average
- Computed order tracking for more stable measurements (optional)
- 31.5 kHz real-time octave measurements (optional)
- Fast swept-sine measurements (optional)

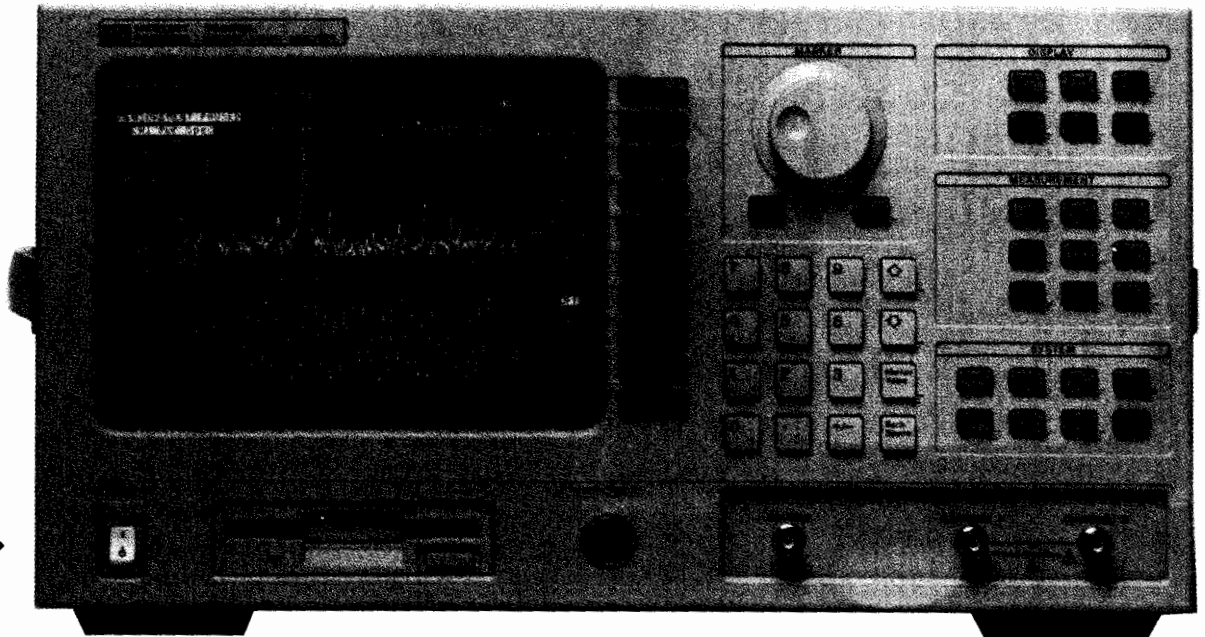

HP 35665A

### HP 35665A Dynamic Signal Analyzer

The HP 35665A is a flexible FFT-based analyzer that provides time, spectrum, network and amplitude domain measurements with a broad range of measurement options applicable in electronics, servo-mechanical and electronic control systems, machinery vibration, and general noise and vibration troubleshooting applications. The measurement options include:

- Computed order tracking measurements
- Real-time octave measurements (complies with ANSI S1.11)
- Swept-sine measurements
- Curve fit/synthesis
- Arbitrary waveform source

Measurement options expand the electronics test capability of the standard HP 35665A into other application areas. With the addition of HP Instrument BASIC programs, even the most complex applications can be reduced to a single keystroke. The multi-faceted measurement modes of the HP 35665A have the measurement functionality of a spectrum analyzer, network analyzer, acoustic sound-level meter, acoustic intensity analyzer, vibration analyzer, audio oscilloscope and amplitude domain analyzer in a single package.

#### Add more options as your needs evolve

Your analysis requirements can change as test needs expand and change. The HP 35665A allows you to configure your own solution to meet both your test requirements and your budget. As your needs evolve, expanding the capability of your analyzer is as easy as ordering the firmware upgrade kit that you can install yourself. Any combination of measurement options is available, with no sacrifice in measurement speed.

#### Computed order tracking eases machinery analysis

The HP 35665A computed order tracking option (Option 1D0) adds HP's order tracking capability to the HP 35665A. This algorithm digitally resamples the incoming signal resulting in extremely stable and repeatable order measurements that were not possible using analog ratio synthesis and filtering. In situations involving quickly varying and fast run up tests, this option provides unprecedented stability. It is only available on Hewlett-Packard measurement hardware.

The internal tachometer input provides a powerful and flexible triggering facility that virtually eliminates the need for external signal-shaping circuitry.

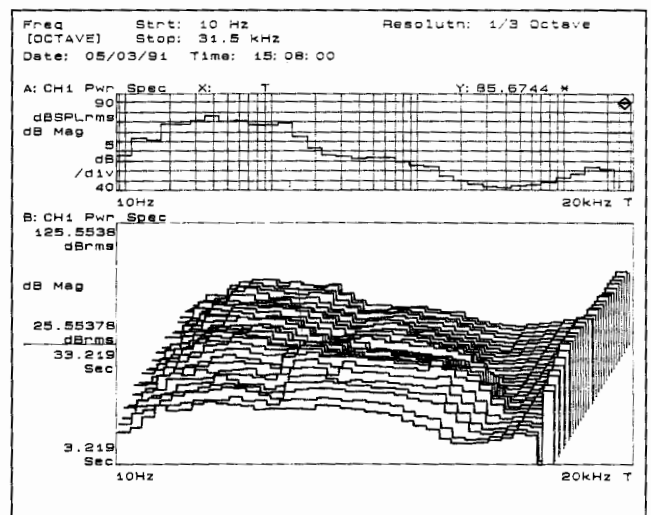

#### Real-time octave for compliance testing

Real-time octave measurements (Option 1D1) provide continuous 1/1, 1/3 and 1/12 octave measurements per ANSI S1.11 (1986, order 3, type 1-D, extended and optional range), ANSI S1.4 and IEC 651-1979 type 0 impulse specifications. These high-performance measurements used to require separate real time analyzers. Now these same high-performance measurements are available at a fraction of the cost of previous solutions.

MS-DOS® is a U.S. registered trademark of Microsoft Corp.

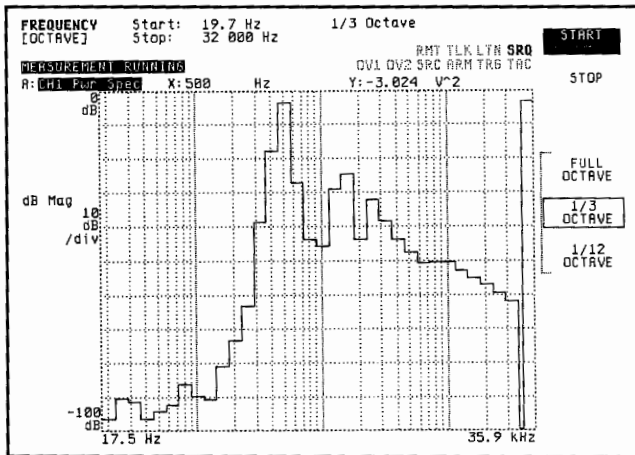

### Fast swept-sine and broadband control systems measurements

Swept-sine measurements typically offer higher signal-to-noise ratios, noise rejection and measurement accuracies than broadband techniques. The optional swept-sine measurements (Option 1D2) add this traditional measurement technique to the HP 35665A, but in an implementation that offers faster measurement results than before. Fast input auto-ranging during the measurement process increases dynamic range to greater than 130 dB.

Fast test time in production settings is even more critical with swept-sine tests since the instrument measurement time is usually the limiting factor in device throughput.

### Advanced modeling and analysis cut design time

The addition of curve fit and synthesis (Option 1D3) allows design engineers to measure real-life devices, compare the actual response to the design goals, model compensation circuits, and predict the end effect of the compensation circuits on the newly modified model. Curve fit and synthesis capability enhances design productivity by reducing the need to build prototypes and by simplifying the design optimization task.

### HP Instrument BASIC for powerful automation

HP Instrument BASIC (Option 1C2), a subset of HP BASIC, provides the test automation power of an external computer inside the HP 35665A. In production applications, HP Instrument BASIC, along with other production oriented features, such as limit lines, enables the HP 35665A to control external HP-IB test equipment, like voltmeters and counters, address external peripherals, like disk drives, printers and plotters, and fully automate a production test procedure with custom graphics and interactive operator prompts.

HP Instrument BASIC is also useful in research and development and field applications. Complex test sequences can be recorded and simplified to a single key press. Tests can be repeated easily by operators not familiar with the measurement problem.

Measurements like electronic filter characterization (Q, 3 dB bandwidth, shape factor), acoustic intensity, Cepstrum displays, Hilbert Transforms and multi-plane balancing can also be derived using HP Instrument BASIC.

### Specification Summary

#### Frequency

**Measurement range:** 244  $\mu$ Hz to 102.4 kHz (1-channel mode); 122  $\mu$ Hz to 51.2 kHz (2-channel mode)

**Spans:** 195.3 mHz to 102.4 kHz (1-channel mode) 97.6 mHz to 51.2 kHz (2-channel mode)

**Measurement Resolution:** 100, 200, 400, and 800 lines.

**Frequency Resolution:** Frequency span/measurement resolution. (minimum 244  $\mu$ Hz 1-channel mode 122  $\mu$ Hz 2-channel mode.)

**Windows:** Hann, flat top, uniform, force, exponential

#### Amplitude

**Range:** 3.99 mVpk to 31.7 Vpk, manual or auto

**Accuracy:**  $\pm 2.92\%$  (0.25 dB) of reading  $\pm 0.025\%$  of full scale.

**Dynamic range:** 72 dB (FFT mode);  
120 dB (swept-sine measurement mode)  
80 dB (octave mode per ANSI S1.11)

**Noise:**  $< -130 \text{ dBV}/\sqrt{\text{Hz}}$  160 Hz to 1.28 kHz  
 $< -140 \text{ dBV}/\sqrt{\text{Hz}}$  1.28 kHz to 102.4 kHz

**Single channel phase:**  $\pm 4.0$  degrees relative to external trigger

### Frequency response channel match

Amplitude:  $\pm 0.04$  dB at full scale

Phase:  $\pm 0.5$  deg at full scale

**Input impedance:** 1 M  $\Omega$   $\pm 10\%$  shunted by  $< 100$  pF

**Coupling:** ac, dc, ICP current source, engineering units, A-weight filter, integration and differentiation via math functions.

**Source types:** Fixed sine, random, chirp, burst random, pink noise, burst chirp, swept-sine (Opt 1D2), arbitrary waveform (Opt 1D4)

**Display results:** Frequency response, power spectrum, linear spectrum, coherence, cross spectrum, power spectral density, time, auto-correlation, cross-correlation, orbit (lissajous), histogram, PDF, CDF

**Trace types:** Log magnitude, linear magnitude, dB magnitude, phase, real, imaginary, Nyquist, Bode, unwrapped phase.

**Trace formats:** Single, upper/lower, front/back, setup, waterfall, waterfall skew, grid on/off, display blanking

**Update-rate:**  $> 8$  traces per second

**Transient capture:** Continuous (real time) data recording to RAM

**Maximum rate:** 262,144 samples/s for 1-channel mode

**Maximum capture length:** 200 ksamples (standard), 1.2 Msamples (Opt 1C1), 3.2 Msamples (opt ANA)

**Saved data and measurement memory:** 400 kbytes (standard), 2.4Mbytes (Opt 1C1), 6.4 Mbytes (Opt ANA)

### Option 1D0 computed order tracking

Computed ratio synthesis, computed tracking filters

**Displays:** Spectral map, order map, order track [mag + phase] or orbit

**Trigger:** Time or RPM, external or free run.

**Tachometer input:** 0.5 to 2048 pulses per revolution

**Trigger level:**  $\pm 20$  Volts maximum, user-selectable level

**Slope:** Positive or negative

User-selectable trigger holdoff

**Option 1D1 real-time octave measurements** (All frequencies in nominal band center frequencies)

**Measurements:** 1/1 Octave (Full), 1/3 Octave, 1/12 Octave

### Real-time frequency range:

1/1 octave measurements: 0.063 Hz to 16 kHz bands

1/3 octave measurements: 0.08 Hz to 31.5 kHz bands

1/12 octave measurements: 0.997 Hz to 12.34 kHz live measurements, 0.997 Hz to 49.35 kHz for post-processed time capture

**Span:** 1 to 12 octaves — all modes

### Option 1D2 Swept-sine measurements

**Sweep types:** Up, down, linear, log, manual

**Input ranging:** Fixed range, or auto-range during measurement

**Resolution:** Selectable frequency resolution during measurement

**Source level control:** Auto-level feature adjusts source level to maintain constant signal level at selected input channel.

### Option 1D3 curve fit/synthesis

20 pole, 20 zero multiple degree of freedom curve fit, auto-order selection, user-selected pole/zero location with fit: table format: polynomial, pole/zero, partial fraction expansion

### Ordering Information

	Price
HP 35665A Dynamic Signal Analyzer	\$13,250
Opt 1D0 Computed order tracking measurements	\$2,500
Opt 1D1 Real-time octave measurements	\$2,000
Opt 1D2 Swept-sine measurement	\$1,000
Opt 1D3 Curve fit/synthesis	\$2,000
Opt 1D4 Arbitrary waveform source	\$500
Opt 1C2 HP Instrument BASIC	\$500
Opt 1C1 Add 2 Mbytes memory	\$1,250
Opt ANA Add 6 Mbytes memory	\$3,000
Opt 1F0 US PC style keyboard (other selected local keyboards are available)	\$170

# SIGNAL ANALYZERS

## Dual-Channel, Control Systems Analyzer 64 $\mu$ Hz to 100 kHz

### HP 3563A

- Measure analog and digital signals
- Apply analog and digital stimulus
- Make swept sine and FFT frequency response measurements
- Measure spectra, waveforms, and transients
- Extract models with s- and z-domain curve fitting
- Model systems using frequency response synthesis

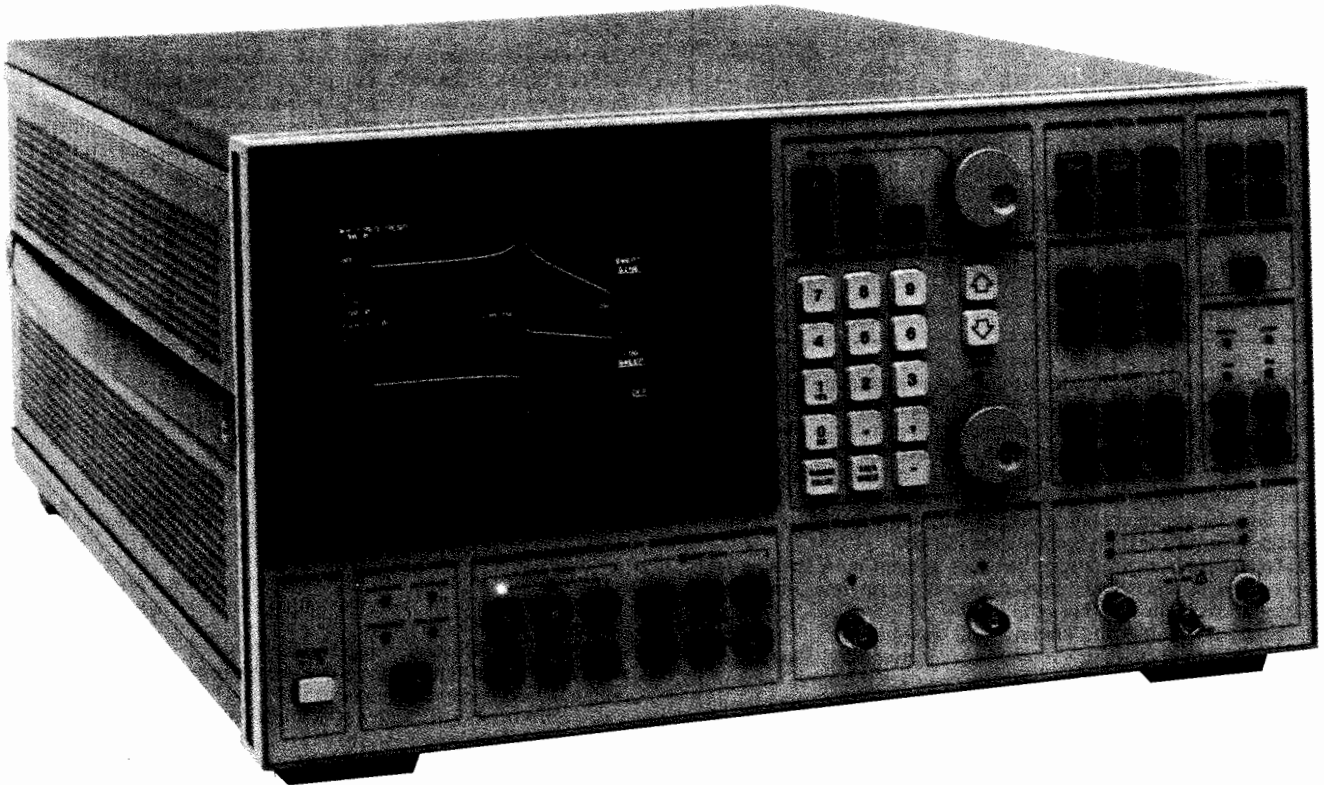

HP 3563A

### Direct Measurement of Dynamic Analog and Digital Signals

The HP 3563A control systems analyzer is the development tool that provides test and analysis of analog, digital, and mixed analog/digital systems. In the world of electronics and control systems, designs are shifting from analog to digital. Products ranging from disk drives to robots to spacecraft use closed-loop control systems containing digital filters and microprocessors rather than analog circuitry.

Hewlett-Packard helps you analyze next-generation systems with the HP 3563A control systems analyzer. A compatible superset of the popular HP 3562A dynamic signal analyzer, this FFT-based analyzer offers the versatility required to make the most difficult spectrum, network, and waveform measurements in both the time and frequency domain. For analog measurements, the analyzer has two differential input channels, a 64  $\mu$ Hz-to-100 kHz frequency range, 150 dB measurement range, 80 dB dynamic range, flexible triggering, and a versatile signal source. The digital inputs accept TTL-level parallel data up to 16-bits wide with data rates as high as 256 kHz and clock rates up to 10 MHz.

### Protect Your HP 3562A Investment

If you develop, design, or test control systems, chances are you own an HP 3562A dynamic signal analyzer. If your designs now call for digital measurements, you can protect your investment in the HP 3562A by converting it to the functionality of the HP 3563A. Because the control systems analyzer is compatible with auto-sequence and computer programs written for the HP 3562A, your programming investment is also protected. For more information regarding HP 3562A, Option 063, please contact your local HP sales representative.

### Test the Performance of Control Systems

Whether a control system is analog, digital, or mixed, you still need to characterize its stability and performance. Characterization of system stability begins with an accurate frequency response measurement. Measure frequency response magnitude and phase quickly using the linear or logarithmic resolution FFT modes. Get a detailed look at the response with the swept sine mode. Linear or logarithmic swept sine frequency response measurements can be made with up to 140 dB dynamic range. With FFT or swept sine tests, frequency response measurements are as accurate as  $\pm 0.1$  dB and  $\pm 0.5^\circ$  (see specifications for details).

Display measurement results in familiar formats such as Bode, Nyquist, and Nichols. Use waveform math to compute the open-loop response from a closed-loop measurement. Activate the special marker function to calculate and display the gain and phase margins.

Key measures of time domain performance such as rise time, overshoot, steady state deviation, and settling time are derived from the system step response. By providing a step stimulus, pre- and post-trigger delay, trace scaling, and separate x- and y-axis markers, the HP 3563A simplifies the measurement of time domain parameters.

The built-in signal source produces the stimuli commonly needed to fully characterize closed-loop control systems. In analog or 16-bit parallel format, the source will output swept sine, fixed sine, sine chirp, step, pulse, ramp, random noise, and arbitrary signals. Data editing combined with waveform math simplifies the creation of arbitrary waveforms such as sine chirps with shaped amplitude.

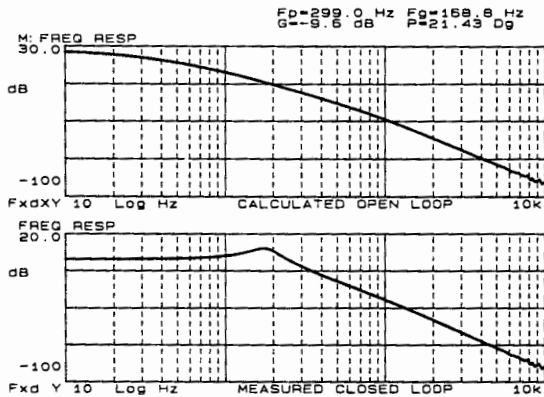

### Turning Data into Information

Plots of the frequency response or step response might not be enough to describe a control system. To quickly develop a proper compensation scheme, you need to know the location of system poles and zeros. If a compensator is being added to the system, its pole/zero model should be added to the system simulation to predict its effect. The HP 3563A addresses these problems with two powerful features: curve fitting and frequency response synthesis.

Identify system poles and zeros by applying the HP 3563A curve fitter to a measured frequency response. Separate s- and z-domain curve fitters are included to handle analog and digital systems. The frequency domain multiple degree of freedom (MDOF) algorithm used in the curve fitters accounts for the interaction of adjacent poles more accurately than single degree of freedom (SDOF) methods. The HP 3563A can fit up to 40 poles and 40 zeros simultaneously. Results are displayed in a table showing the real and imaginary parts of system poles and zeros. If needed, a pole/zero table can be converted to polynomial or pole/residue formats.

Use frequency response synthesis to model s- or z-domain control elements, actuators, and compensators. To create more accurate models, enter a time delay to simulate computational delays. Include a zero-order hold in a z-domain synthesis table to model the effect of a digital-to-analog converter in the control system. Synthesis plus waveform math lets you try a compensator design before it is built. Use waveform math to combine a synthesized response with a measured frequency response and predict the compensator's effect on system stability. If the predicted stability margins do not meet the design criteria, revise the model as many times as needed before building the compensation network.

To handle systems with a mixture of analog and digital subsystems, curve fit and synthesis tables can be transformed between the s- and z-domains. A choice of impulse invariant, step invariant, and bilinear transformations lets you use the method that matches the characteristics of your system.

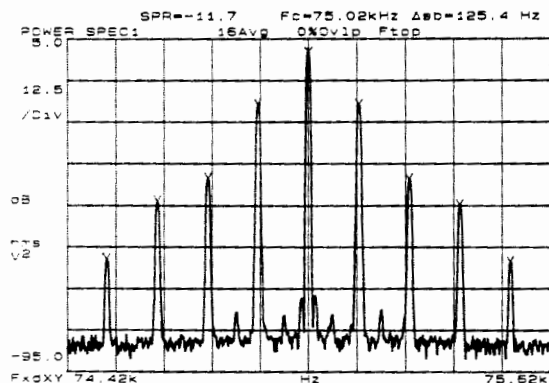

### Characterize Electronic Networks and Signals

Whether you develop digital signal processing ICs and data conversion devices or analyze the processed signals, the HP 3563A can simplify the task. Two inputs that accept analog and digital signals

make the HP 3563A a powerful spectrum and waveform analyzer. Measure frequency spectra with 801 lines of resolution,  $\pm 0.15$  dB accuracy, and 80 dB dynamic range. Special trace markers simplify analysis of distortion, sidebands, and band power. The built-in demodulation capability helps you analyze complex modulated signals in the time and frequency domains.

Perform waveform analysis by capturing signals in the internal 20K-sample capture buffer, or use time throughput to save longer events in an external HP-IB disk drive. Data scrolling and trace expansion help you locate and analyze the important parts of captured waveforms.

With a built-in signal source that generates analog and digital stimulus signals, the HP 3563A is also a versatile network analyzer. Measure the response of analog filters and devices. Test the frequency response of digital filters with a digital-in/digital-out measurement. Test the performance of digital-to-analog converters by applying digital stimulus and measuring the analog output.

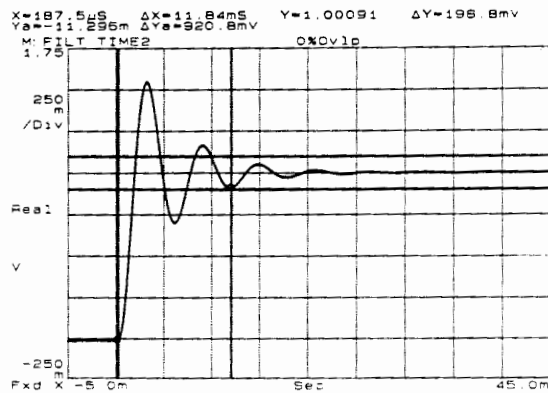

### Troubleshoot Noise and Vibration Problems

Mechanical resonance problems often appear in electromechanical control system designs. The HP 3563A provides the measurements you need to identify structural resonances, analyze motor vibration, and locate noise sources. Improve the quality of frequency response impact testing with functions such as data previewing and automatic overload rejection. Simplify interpretation of vibration measurements by selecting RPM or orders as the frequency axis and by using engineering units scaling to display amplitude in appropriate units such as displacement or velocity.

Test accessories, such as impact hammers, accelerometers, and microphones, are available through the HP test & measurement accessories catalog, and from third-party vendors. For detailed noise and vibration analysis, software solutions are available from third-party software suppliers.

### Automation Makes It Easy

Increase your productivity when automating testing or documenting results with versatile automation capabilities, such as auto sequence programming and direct control of HP-IB disk drives and plotters. Auto-sequence programming (ASP) lets you reduce a series of front-panel operations to a single keystroke. In addition to automating analyzer functions, an ASP can send commands over the HP-IB to control external devices, such as programmable switches and loads. With ASP and a sheet-fed plotter, such as the HP 7550A plotter, the HP 3563A can perform batch plotting of files saved on disk.

For computer-aided testing, the HP 3563A is also HP-IB programmable. If you use a personal computer, the PC file conversion option (Option 921) is useful. This set of utilities runs on a PC and converts HP 3563A and 3562A files to MS-DOS<sup>®</sup> format. Conversion utilities are also included to make analyzer files compatible with MATRIX<sub>x</sub> from Integrated Systems and PC-Matlab from The Mathworks.

Note: See page 229 for specifications. A data sheet with complete specifications is available from your HP sales representative.

MS-DOS is a U.S. registered trademark of Microsoft Corporation.

# SIGNAL ANALYZERS

## Dual-Channel, Dynamic Signal Analyzer 64 $\mu$ Hz to 100 kHz

HP 3562A

- Network, spectrum, waveform, transient analysis
- Linear, logarithmic, swept sine modes

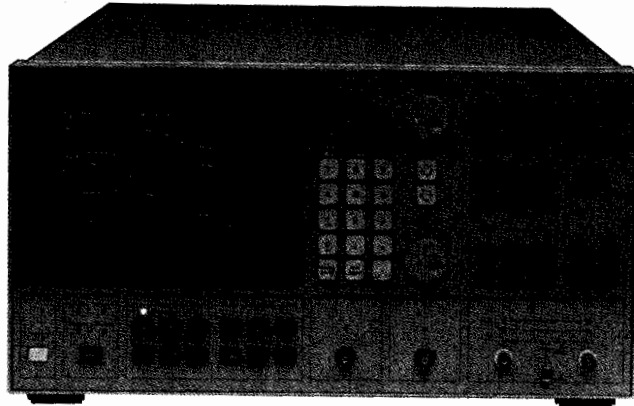

HP 3562A

### HP 3562A Dynamic Signal Analyzer

The HP 3562A dynamic signal analyzer is well suited for design, test, and analysis of electronics, mechanical systems, and electro-mechanical control systems. Two input channels, 64  $\mu$ Hz-to-100 kHz frequency range, 150 dB measurement range, and 80 dB dynamic range in this FFT-based analyzer, offer versatility and performance for even the most difficult spectrum, and waveform measurements, in both time and frequency domains.

The two high-performance input channels and a built-in signal source (noise and sine signals) address network analysis needs on the bench or in a test system. Vector averaging, waveform math, 40-pole/40-zero curve fitter, and frequency response synthesis enhance network measurements with a full range of analysis and modeling capabilities. Zoom analysis, with frequency resolution to 25.6  $\mu$ Hz, plus a powerful AM, FM, and PM demodulation function, make the HP 3562A a versatile spectrum analyzer. For transient or waveform analysis, signals can be sampled, digitized, and then stored in internal memory, or sent via HP-IB to an external disk drive (without a computer). Stored waveforms can be recalled and analyzed in the time, frequency, and amplitude domains (baseband and zoom analysis).

### Frequency Response Measurements

You can make accurate, high-resolution frequency response measurements of electronic and mechanical systems with linear or logarithmic resolution FFT and swept sine analysis. A built-in signal source provides a variety of random noise and sine wave signals to meet the requirements of the system under test.

Linear resolution is the measurement technique common to all dynamic signal analyzers. In the HP 3562A, 2048-point time records are Fourier-transformed into 801-line frequency spectra. For network analysis, frequency response magnitude and phase, as well as input and output power spectra, can be measured with 801 lines of resolution. Accuracy for the frequency response magnitude and phase is  $\pm 0.1$  dB and  $\pm 0.5^\circ$ .

The swept-sine mode configures the HP 3562A as a powerful swept-sine frequency response analyzer. The source can generate linear or logarithmic sweeps with increasing or decreasing frequency; user-selectable sweep rate and resolution are also standard source functions. Input channel functions include user-selectable averaging and integration time; automatic input ranging can be activated to provide over 140 dB of dynamic range for measurements of high performance systems.

### Spectrum Analysis

On-line analysis of distortion, drift, modulation, and phase noise can benefit from the speed and accuracy of the HP 3562A. High-resolution measurements are typically 100 times faster than tuned spectrum analyzers. Because the HP 3562A is an FFT-based analyzer, you can see transient events a tuned analyzer would probably miss.

- 80 dB dynamic range with full alias protection
- High accuracy ( $\pm 0.15$  dB)

The HP 3562A is essentially a dual-channel spectrum analyzer that provides resolution to 25.6  $\mu$ Hz anywhere within the 64  $\mu$ Hz-to-100 kHz measurement range. Amplitude accuracy is  $\pm 0.15$  dB with 80 dB of dynamic range. Modulation analysis can be performed on either or both channels with harmonic and sideband markers as well as with the built-in demodulation capability; zoom measurements can be AM, FM, or PM demodulated with carrier frequencies up to 99.9 kHz.

### Waveform and Transient Analysis

Perform complete analysis of waveforms and transients in the time and frequency domains. Store sampled and digitized waveforms in internal memory (single-channel time capture) or on disk in an external disk drive (single- or dual-channel time throughput). Recall data for time domain analysis as single time records or as a compressed display of up to 10 time records (time capture mode). Data can also be recalled for baseband and zoom analysis in the frequency domain with vector averaging, if needed.

The array of triggering capabilities enhances both waveform recording modes. Pre- and post-trigger delays can be specified to capture the rising edge of a transient or to compensate for delays in the system under test.

### Hardcopy and Mass Storage

When access to prototypes is limited, make your test time more efficient with the time throughput capability; through direct control of external disk drives, the HP 3562A stores time data directly to disk without a computer.

HP-IB is a standard feature to speed and simplify documentation of results with direct control of plotters and disk drives. Anything displayed on the analyzer screen can be plotted or saved on disk, including measurement results, setup state tables, synthesis tables, curve fit tables, and auto-sequence or auto-math program listing.

### Automation for Improved Productivity

As a standalone solution, the analyzer can "learn" a series of keystrokes and then perform them on command (auto-sequence programming). Up to five auto-sequence programs can be stored internally, with additional programs stored on an external disk drive. For networked HP-IB systems, the HP 3562A provides complete HP-IB programmability. Custom display graphics messages can be created with direct programming of the display, and user-defined softkey menus can be created to simplify interactive testing.

### Specifications (HP 3562A, 3563A)

Contact your local HP sales office for more information, including a data sheet with complete specifications.

#### Frequency

**Measurement range:** 64  $\mu$ Hz to 100 kHz. Both channels, single- or dual-channel operation.

**Resolution:** Span/800. Both channels, single- or dual-channel operation, linear resolution mode.

Spans	Baseband	Zoom
# of spans	66	64
min. span	10.24 mHz	20.48 mHz
max. span	100 kHz	100 kHz
time record (sec)	800/span	800/span

**Window functions:** Flat top, Hann, uniform, force, exponential, user-defined

#### Typical real-time bandwidths:

Single-channel, fast averaging	10 kHz
Throughput to CS/80 disk	
Single-channel	12.5 kHz
Dual-channel	6.25 kHz

#### Amplitude

**Accuracy:** Defined as full-scale accuracy at any of the calculated frequency points. Overall accuracy for the linear or logarithmic resolution modes is the sum of the absolute accuracy, window flatness, and noise level. Overall accuracy for swept-sine mode is the sum of absolute accuracy and noise level.

**Absolute accuracy:** Single channel (channel 1 or 2)  
 $\pm 0.15$  dB  $\pm 0.015\%$  of input range (+27 dBV to -40 dBV)  
 $\pm 0.25$  dB  $\pm 0.025\%$  of input range (-41 dBV to -51 dBV)

**Window flatness:**

Flat top +0, -0.01 dB  
 Hann +0, -1.5 dB

**Noise floor:** With flat top window, 50 $\Omega$  source impedance and input set to -51 dBV range  
 20 Hz to 1 kHz (1 kHz span) < -126 dBV (-134 dBV  $\sqrt{\text{Hz}}$ )  
 1 kHz to 100 kHz (100 kHz span) < -115 dBV (-144 dBV  $\sqrt{\text{Hz}}$ )

**Frequency response channel match:**

**Analog/analog:** Input signals at full scale on any pair of ranges, Accuracy is  $\pm 0.1$  dB,  $\pm 0.5$  degree (HP 3562A and HP 3563A).

**Digital/digital:** For simultaneous sampling on channels 1 and 2, accuracy is  $\pm 0.1$  dB,  $\pm 0.5$  degree. (HP 3563A only).

**Mixed analog/digital:** With full-scale inputs on both channels, computational delay between channels corrected for; 1:1 sampling ratio, 16 averages and 256 kHz sample clock; nominal accuracy is  $\pm 0.2$  dB,  $\pm 1.0$  degrees from 64  $\mu\text{Hz}$  to 20 kHz and  $\pm 0.2$  dB,  $\pm 4.0$  degrees from 20 kHz to 100 kHz (HP 3563A only).

**Dynamic range:** All distortion (intermodulation and harmonic), spurious, and alias products are  $\geq 80$  dB below full scale input range (16 averages).

**Analog Input (HP 3563A and 3562A)**

**Input impedance:** 1M $\Omega$   $\pm 5\%$  shunted by < 100 pF

**Input coupling:** Inputs can be ac or dc coupled — ac rolloff is < 3 dB at 1 Hz

**Crosstalk:** -140 dB (50 $\Omega$  source, 50 $\Omega$  input termination, input connectors shielded)

**Common mode rejection:**

0 Hz to 66 Hz 80 dB  
 66 Hz to 500 Hz 65 dB

**External sampling input:** TTL compatible input for signals  $\leq 256$  kHz (nominal maximum sampling rate)

**Digital Input (HP 3563A)**

Measurement data signals can be up to 16 bits wide and must be parallel data in two's complement or offset-binary format. (User selects truncation of unused upper bits or rounding of the three lowest bits for data more than 13 bits wide.) The data qualifier input accepts 8 qualifier lines, a trigger, and 1 clock signal.

**Trigger**

**Trigger modes:** Free run, input channel 1, input channel 2, source and external trigger. Free run applies to all measurement modes. Input channel 1, input channel 2, source and external trigger apply to the linear resolution, time capture, and time throughput measurement modes.

**Trigger delay:** Pre- and post-trigger delay resolution is 1 sample (1/2048 of a time record).

**Pre-trigger:** A measurement can be based on data that starts from 1 to 4096 samples (1/2048 to 2 time records) before trigger conditions are met.

**Post-trigger:** A measurement is initiated from 1 to 65,536 samples (1/2048 to 32 time records) after the trigger conditions are met.

**Analog Source (HP 3563A and 3562A)**

Random noise, burst random, sine chirp, burst chirp, fixed sine, and swept sine are available from the front panel source of the HP 3562A and HP 3563A. The HP 3563A also provides step, pulse, ramp and arbitrary signals from the same front panel source output. Users can select dc offset.

**Output impedance:** 50  $\Omega$  (nominal)

**Output level:** Between +10 and -10 V<sub>peak</sub> (ac + dc) into a  $\geq 10$  k $\Omega$ , < 1000 pF load. Maximum current is 20 mA.

**ac level:**  $\pm 5$  V<sub>peak</sub> ( $\geq 10$  k $\Omega$ , < 1000 pF load)

**dc offset:**  $\pm 10$  V<sub>peak</sub> in 100 mV steps. Residual offset at 0V offset  $\leq 10$  mV

**Distortion:** Including subharmonics

25.6  $\mu\text{Hz}$  to 10 kHz -55 dB

10 kHz to 100 kHz -40 dB

**Pulse:** Nominally 1 sample wide and bandlimited (HP 3563A)

**Digital source (HP 3563A)**

All analog signal types can be output from the digital source connector. Data format is 16-bit parallel in either two's complement or offset binary. Output level is TTL compatible.

**Maximum load:** 8 LSTTL

**Maximum output rate:** 256 kHz

**General**

Specifications apply when AUTO CAL is enabled or within 5°C and 2 hours of last internal calibration

**Ambient temperature:** 0 to 55°C

**Relative humidity:**  $\leq 95\%$  at 40°C

**Altitude:**  $\leq 4570$  m (15,000 ft)

**Storage:**

**Temperature:** -40 to +75°C

**Altitude:**  $\leq 15240$  m (50,000 ft)

**Power:** 86 to 127 VAC, 48 to 66 Hz

196 to 253 VAC, 48 to 66 Hz

450 VA maximum

**Weight:** Net, 27 kg (58 lb); shipping, 36 kg (79 lb)

**Size:** 222 mm H  $\times$  426 mm W  $\times$  578 mm D (8.75 in  $\times$  16.75 in  $\times$  22.75 in)

**Accessories Included**

**HP 3563A:** HP 01650-61607 16-bit probe cable: 3 each

HP 03563-61605 16-bit probe pod: 3 each

HP 03563-61604 8-bit probe cable: 3 each

HP 10347A pattern generator probe lead set: 3 each

HP 5959-0288 grabber (package of 20): 80 each

(4 packages)

Pouch for cables and probes

**HP 3563A/HP 3562A:** Getting started guide, operating manual, programming reference

**Accessories Available**

**HP 3563A:** HP 10346A 8-Channel TTL tristate buffer pod

HP 10348A 8-Channel CMOS tristate buffer pod

HP 01650-63203 termination adapter

**HP 3563A/HP 3562A:** Transit case for one HP 3563A:

HP p/n 9211-2663

**Ordering Information**

**HP 3563A** Control Systems Analyzer

**Price**

\$25,900

**Opt 907** Front Handle kit

+\$77

**Opt 908** Rack Mount kit

+\$41

**Opt 909** Rack Mount and Front Handle kit

+\$102

**Opt 910** Extra Getting Started, Operating,

+\$179

Programming manuals

**Option 915** Add Service manual and kit

+\$100

**Opt 921** PC File Utilities

+\$150

**Opt 922** Delete cables, pods, and pouch

-\$1,400

**Opt W30** Extended Repair Service. See page 681.

+\$625

**HP 3562A** Dynamic Signal Analyzer

\$20,900

**Opt 907** Front Handle kit

+\$77

**Opt 908** Rack Mount kit

+\$41

**Opt 909** Rack Mount add Front Handle kit

+\$102

**Opt 910** Extra Operating manuals

+\$225

**Opt 914** Delete Service manuals

-\$100

**Opt W30** Extended Repair Service. See page 671.

+\$495

# SIGNAL ANALYZERS

## Multichannel Measurement System, 64 $\mu$ Hz to 102.4 kHz

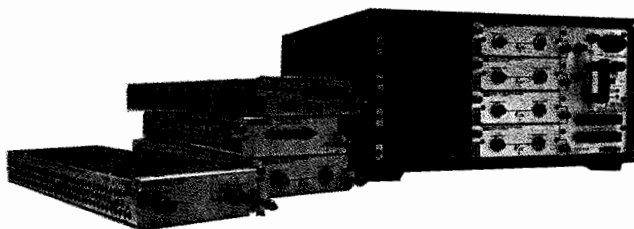

HP 3565S

### HP 3565S Multichannel Measurement System

Looking for a powerful, computer-based, modular measurement platform? The HP 3565S can be configured from 2 to 496 channels, and is optimized for fast signal acquisition and analysis. Using the HP 3565S, systems may be configured for modal analysis, closed-loop vibration control, noise and vibration analysis, signal monitoring, and more. As testing needs change, you can add new modules, new applications software, or enhance the system computer. HP quality, reliability, and service ensure that your system will be ready when critical tests must be performed.

Measurement hardware is modular and consists of one or more mainframes and plug-in modules. There are four types of modules: inputs, sources, signal processors, and a SCSI interface for high-speed data storage. You select the number of inputs, number of sources, and signal processing power desired. Whether you prefer UNIX workstations or DOS-based PCs, the HP 3565S acts as a measurement co-processor, accelerating system performance.

#### Applications Software

System software for the HP 3565S is available from HP (HP 3566A, HP 3567A, HP 3563R), and a variety of respected independent software vendors, such as: Leuven Measurement Systems (LMS), Structural Measurement Systems (SMS), Creare Inc., and Structural Dynamics Research Corp. (SDRC). For further information, see pages 231 through 233, or contact your HP sales representative for configuration assistance.

#### Two Choices of Mainframes

Choose the HP 35650A mainframe for large, expandable systems. It provides power and cooling for up to 8 modules. Up to 8 of these mainframes may be interconnected for a total of 64 available slots.

Choose the new HP 35650B mainframe for small, transportable systems. It provides power and cooling for 4 slots. (This mainframe cannot be connected to additional mainframes).

#### Signal Processing Modules

The signal processing modules perform the following functions for the system:

- Control of all system operations, including commands to control the other modules and flow of data between the modules.
- Transfer of measurement data to the host computer via HP-IB.
- Control of direct throughput to disk.
- Generation of time records to be sent to the HP 35656A source.
- Processing of time data from the input modules.

#### HP 35651B Signal Processing Module

This signal processing module uses an MC 68020 main processor and a MC 56001 DSP processor for computing spectrums. The module includes 1 Mbyte of RAM for data and program space (additional RAM is available as an option). Most application software available for the HP 3565S uses this module.

#### HP 35654A Signal Processing Module

This module is a higher performance version of the HP 35651B, and is used for computation intensive applications such as high speed waterfall displays. In general, the added capability of this module is accessible only through custom programming (as taught in the HP 35635R Programmers Toolkit course).

#### HP 35659A SCSI Interface Module

The HP 35659A SCSI Interface Module provides direct high speed digital recording of signals sampled by HP 3565S Input Modules. The samples can be recorded on an optional internal 440 Mbyte hard disk, Option AMV, or on external HP SCSI-compatible drives such as the HP Series 6300 Removable Optical Disk, the HP C2213A Hard Disk, the HP C1502A DAT Tape Drive, and the HP 7959S. Actual throughput performance depends on the disk drive; however, several HP 35659A modules can be used in parallel to increase system performance. Approximate throughput rates for each disk drive are as follows:

Model Number	Disk Type	Size	Transfer Rate
Series 6300	Removable Optical	325 Mbytes per side	600 kbytes/s
C2213A	Hard Disk	660 Mbytes	1.3 Mbytes/s
C1502A Dat	DAT Tape Drive	1.3 Gbytes	150 kbytes/s
7959S	Hard Disk	325 Mbytes	750 kbytes/s

#### Input Modules

All three input modules use analog-to-digital converters to digitize a signal. In each channel, the A/D converter is preceded by an analog anti-alias filter and followed by a digital filter (with zoom capability) and an 8k FIFO buffer. Time data from the FIFO buffers is sent to the signal processing module to be transformed into spectrums.

#### HP 35652A/B Input Module

The HP 35652A single channel input module has 80 dB dynamic range and DC to 51.2 kHz bandwidth. Preamplifiers for piezoelectric and ICP transducers are built into each module. The ICP mode provides 4 mA of constant current. The HP 35652A module also comes with an option for a buffered analog output. Option 001 provides a 2 volts peak (full scale) analog output.

The HP 35652B is similar to the HP 35652A except with an increased measurement bandwidth to 102.4 kHz. The HP 35652B has 80 dB dynamic range at frequencies below 50 kHz. From 50 kHz to 100 kHz, dynamic range is 75 dB.

#### HP 35655A Input Module

An 8 channel input module, with DC to 12.8 kHz bandwidth for each of the 8 channels, with a dynamic range of 72 dB. All eight channels have their own filtering and trigger detection. Also, all eight channels sample and hold simultaneously to maintain phase match across the channels. Each channel includes a buffered analog output and ICP power.

#### Source Modules

##### HP 35653A Source Module

This module provides the following excitation signals for frequency response measurements:

- Continuous sine wave
- Band-limited random noise
- Burst random noise of variable duration

This module also includes a reference signal for system calibration of input modules.

#### HP 35656A Programmable DAC

This module uses a programmable digital-to-analog converter with 16 bits of resolution to generate arbitrary stimulus signals up to a 51.2 kHz bandwidth. The data buffer size is selectable from 1 to 32768 words.

#### Ordering/Configuration Information

	Price
HP 35605A System Rack (for 2 mainframes)	\$1,860
HP 35606A System Rack (for 4 mainframes)	\$2,375
HP 35650A Eight Slot Mainframe	\$4,650
HP 35650B Four-Slot Portable Mainframe	\$4,650
HP 35651B Signal Processing Module	\$6,200
HP 35652A 51.2 kHz Input Module	\$2,675
HP 35652B 102.4 kHz Input Module	\$3,000
HP 35653A Source Module	\$2,010
HP 35654A Signal Processing Module	\$14,400
HP 35655A 8-Channel Input Module	\$9,800
HP 35656A Programmable DAC	\$4,650
HP 35659A SCSI Interface Module	\$5,500
Opt. AMV 440 Mbyte internal hard disk	\$3,500



## HP 35635R Programmer's Toolkit

The HP 35635R Programmer's Toolkit is a digital signal processing (DSP) development environment and training class for HP 3565S hardware. Custom, high-performance solutions can be created using C programming and the Toolkit library of commands and functions. The Programmer's Toolkit library also provides complete control of the HP 35654A and HP 35651B signal processing modules, the HP 35652A, HP 35652B, and HP 35655A input modules, the HP 35653A and HP 35656A source modules, and the HP 35659A SCSI interface module.

Three levels of programming are provided: Measurement Interface Library (MIL), Signal Processor Interface Library (SPIL), and Motorola 56001 DSP algorithms. MIL commands offer standard measurements such as auto and cross power, PSD, frequency response, auto and cross correlation, and coherence with relatively simple function calls from a C program. When a custom solution cannot be implemented using standard MIL functions, SPIL allows development of custom downloadable C programs that can meet specific measurement needs. Greater expertise is required for programming at the SPIL level than at the MIL level; however, the available level of customization is also greater.

Development environments for MIL-level programming include HP 300 or 400 series host computers running the HP-UX programming environment, the HP Series 700 and 800 series computers, the DEC VMS, and the IBM PC/AT or OS/2 PC compatibles. Successful completion of HP 35635R Programmer's Toolkit training class requires the following skills: ability to create C programs with data structures, ability to edit programs using "vi" or other HP-UX editor, knowledge of measurement parameters such as input range, span, coupling, processing block size, and knowledge of measurement loop concepts such as averaging types, arming, triggering, and cross-channel correction.

## LEUVEN MEASUREMENT SYSTEMS (LMS)

### LMS in the U.S.

The LMS CADA System provides a comprehensive set of tools for the modern test laboratory. The system is organized around four main modules, each focused on a specific application area in Computer-Aided Dynamic Analysis (CADA).

CADA Test is optimized for multi-channel data acquisition and advanced signal processing using HP measurement hardware. Dedicated modules are provided for multiple input/multiple output testing (MIMO), acoustics, closed-loop vibration control, and rotating machinery analysis. A user-programming environment allows seamless integration of customized applications, including specialized processing algorithms embedding HP 35635R Programmer's Toolkit commands, and incorporating Fortran and C sub-programs into the system. Control and data-porting from a variety of HP instruments are available, including the HP 3566A and HP 3567A.

CADA Analysis includes the special-purpose analysis and 3D visualization modules necessary to analyze structural behavior under actual operating conditions.

CADA Modal is a comprehensive package for MIMO modal analysis. Emphasis is on global curve-fitting techniques in both the time and frequency domains.

CADA Link exposes discrepancies between modes of vibration, as derived from FE, and the actual modes measured on the prototype. Design recommendation and model updating packages then help to correct for assumptions by updating the FE model to match the experimental results.

The LMS platform follows the latest standards for user interaction: X-Windows and OSF/MOTIF for the UNIX\* environment, and Microsoft Windows\* 3.0 for the PC environments.

## Structural Measurement Systems (SMS)

SMS offers a comprehensive set of mechanical computer-aided testing (MCAT) software for performing experimental modal analysis, structural dynamics modification, forced response simulation, and acoustic intensity analysis.

The STAR System is a series of software products for testing and analyzing the dynamics of mechanical structures. It runs on HP Vectra, IBM PC AT, PS/2, and compatible computers which support the Microsoft Windows\* operating environment. STAR consists of three structural analysis modules and one module for acoustic analysis. STAR supports the HP 3566/67A, HP 35665A, HP 3562A, HP 3563A and HP 3560A.

STARModal operates on a set of Frequency Response Functions (FRFs) to identify the modal properties of a structure. FRF measurements processed within STARModal estimate the modal parameters of the structure, display its powerful mode shapes in animation and further analysis. STARStruct is a powerful combination of STARModal, Structural Dynamic Modification (SDM), and Forced Response Simulation (FRS).

STARAcoustics is an acoustic intensity analysis system for sound power determination and noise source identification. Crosspower and octave band measurements are supported. Major features include intensity and sound power calculations, noise source ranking, surface contour plots, intensity vector display, octave analysis, microphone calibration capabilities, and A,B,C weighting curves. Links to Microsoft Windows-based applications are provided.

The Modal 3.0 SE Structural Analysis System is a full-capability desktop modal analysis package. It analyzes frequency-response measurements to estimate the modal parameters of a structure under test and displays the resultant mode shapes in animation. Modal 3.0 SE operates on the HP 9000 Series 300 workstations in both RMB and HP-UX operating systems and supports measurements from a variety of HP instruments.

## Creare Inc.

Creare is a highly-regarded systems integrator providing custom solutions for your specific project needs through the integration of hardware, software, and project management services.

As an engineering services and computer systems company, Creare delivers services to an international customer base in mechanical engineering and related fields. Its systems integration services include large-scale testings, model studies, computer software development, problem-solving consulting, and data acquisition systems and software.

Industries served by Creare include aerospace, defense, energy, mining, paper, petrochemical, process control, and rotating machinery. Installations of Creare systems include applications as diverse as turbine condition monitoring, shock and vibration analysis, and speech and signal analysis.

The ability to provide custom data-acquisition and reduction systems for your engineering or scientific application is Creare's strength. Creare consultants have extensive knowledge of HP's computation and instrumentation hardware and the HP 35635R Programmer's Toolkit. Combined with broad application knowledge, Creare has the ability to optimize software performance for your specific hardware configuration, especially in real-time operating environments. Full integration services include instrumentation, signal conditioning, computers, peripherals, software for data acquisition analysis and display, and excellent support. Creare excels at developing custom data acquisition and signal processing software.

## Structural Dynamics Research Corporation (SDRC)

SDRC's I-DEAS is a set of high-functionality Mechanical Computer-Aided Engineering software packages addressing design, structural analysis, testing, NC programming, and engineering data management applications. The I-DEAS testing products include robust capabilities for data acquisition, test data analysis, finite element model correlation, and structural modification.

I-DEAS Data Acquisition provides comprehensive real-time capabilities for collecting data for modal analysis, spectra, and time history streaming applications. The I-DEAS X Windows and unique geometry-based user interface provide ease-of-use. The full signal processing power of the HP 3565S measurement hardware is supported.

I-DEAS Test Data Analysis includes post-processing and graphical display capabilities for time history analysis, spectrum generation, time variant analysis, function math processing, geometry preparation, data display on geometry, modal analysis, statistics, histogram processing, and fatigue applications. Data management, test instrument interfacing (supporting the HP 3562A and the HP 35665A), open architecture, and programmability are available, providing subsets of the above features.

I-DEAS Correlation provides complete capabilities for comparing dynamic finite element analysis and experimental modal analysis results. It shares a common database with I-DEAS Model Solution and includes convenient interfaces to NASTRAN, ANSYS, and ABAQUS. I-DEAS Structural Modification provides capabilities to predict the effects of certain basic changes on a tested structure.

# SIGNAL ANALYZERS

## Multichannel Spectrum/Network Analyzers – 64 $\mu$ Hz to 102.4 kHz

### HP 3566A, 3567A

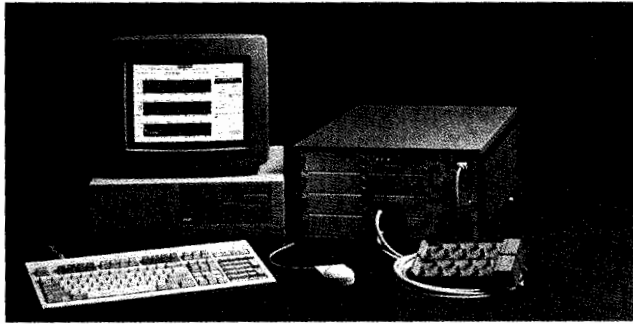

HP 3566A

### Up to 16 Channels of Time and Frequency Measurements

A rich, user-definable measurement set makes the HP 3566A and 3567A excellent for mechanical test, signal characterization, control systems, and production test where signals are below 102.4 kHz. These PC-based dynamic signal analyzers are configurable from 2 to 16 channels, and use modular, HP 3565S hardware (see page 230) to achieve high system performance. Generating test reports is easy since the system software is MS-Windows(\*) based.

The HP 3566A and 3567A have the same measurement feature set but differ in maximum frequency span and hardware configuration (see table below). Each analyzer includes a source for stimulating circuits or systems. An optional programmable DAC module adds arbitrary waveform, swept sine or chirp capability. For fast measurement processing, a powerful hardware signal processor module converts time data to frequency domain data using the latest FFT (Fast Fourier Transform) technology. The measurement hardware (3565S series) is linked to an HP Vectra or IBM PC-AT compatible running MS-DOS, MS-Windows, and HP 35634A measurement software. Optional HP and ISV software packages provide additional measurement and analysis capabilities.

	HP 3566A	HP 3567A
Channel Count	8 or 16	2 to 16
Cross Channel Accuracy	$\pm 0.1$ dB	$\pm 0.1$ dB
Phase	$\pm 0.5^\circ$	$\pm .5^\circ$
Dynamic Range	72 dB	80 dB
Maximum Frequency Span		
Spectrum Measurements	12.8 kHz	102.4 kHz
Network Measurements	12.8 kHz	51.2 kHz <sup>2</sup>
Realtime Bandwidth <sup>3</sup>		
Display Off	12.8 kHz	26.5 kHz
Display On	3.2 kHz	3.2 kHz
Transient Capture Rates		
Max Samples/Sec Per Channel	32,768	262,144
Max Samples/Sec to RAM	1.5 million	1.5 million
Max Time Samples in RAM <sup>4</sup>	7.5 million	7.5 million
Waterfall Display Update <sup>4</sup>	5 per sec	5 per sec
Signal Conditioning	ICP to 2 mA	Charge amp, ICP to 4 mA

<sup>1</sup> 102.4 kHz using an external source.

<sup>2</sup> One channel for 3567, 2 channels for 3566.

<sup>3</sup> With Opt 116.

<sup>4</sup> Rate applies to eight traces, updated simultaneously.

### HP 3566A and 3567A Measurement Capability

- Transient capture to RAM
- Time record
- RPM spectral map
- 1/3 and 1/1 octave
- Auto-correlation
- Cross-correlation
- Frequency response gain phase
- Power spectrum
- Cross spectrum
- Nyquist
- Histogram, PDF, CDF
- Order tracking
- Order ratio map
- Orbit diagram
- Coherence
- Swept-sine
- Record/playback

### Expandable Analyzers for Mechanical Testing

The HP 3566A and 3567A offer features for all types of mechanical testing, including rotating machinery analysis, vibration test, structural analysis, and acoustic noise testing. With an expandable channel count, these analyzers are a solution for applications requiring from 2 to 16 channels. Display up to eight traces of time or frequency data to quickly view accelerometer conditions or input channel ranges. Spectral maps and order-ratio maps provide a picture of machinery behavior during run-up or coast-down operation. From these maps, you can easily identify the important orders of vibration. Analyzer applica-

tions also include sound pressure testing, spatial characterization of radiated noise, and noise source identification. Both the HP 3566A and 3567A provide 1/3 and 1/1 octave displays. Built-in source signals, such as impulse, random, and burst random, are available for stimulating systems.

### Multichannel Characterization of Changing Signals

Use the HP 3566A or HP 3567A to accurately measure fast-changing signals. Applications such as monitoring, underwater acoustic testing, or surveillance require multichannel analyzers to process data in real time. Real-time measurement features ensure that transient events are captured and processed quickly. Eight high-speed displays allow you to monitor changes in the time or frequency domain, with waterfalls and spectrograms showing how signals change with time.

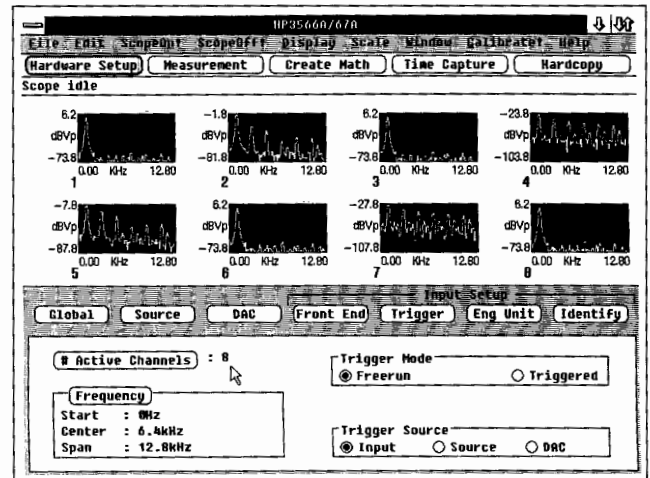

### New Order-Tracking Algorithm (Optional)

Quickly distinguish between order-related and non-order-related rotating machinery signals. This optional software adds order ratio map and order-track measurements to the HP 3566A and 3567A capabilities. With it you can measure an accurate order spectrum independent of changing RPM. Using new HP technology, order ratio maps and order tracks are computed digitally, eliminating the errors and added expense of the ratio synthesizers, tracking filters, and RPM counters required by other FFT analyzers.

### Full-Featured Swept-Sine (Optional)

Swept-sine techniques provide transfer functions with 132 dB dynamic range by changing source levels and input ranges for each frequency point measured. Research and development users can dramatically reduce measurement setup times by using auto-range, auto-level, and auto-resolution. Auto-resolution decreases measurement execution times by optimizing the frequency spacing between measurement points. Gain and phase margins are calculated just by pushing a button, simplifying control system analysis.

Production test users can further increase measurement speed by specifying all measurement parameters by frequency band. Up to ten separate bands allow performance optimization.

### Programmable DAC Provides Arbitrary Waveforms (Optional)

A programmable 16 bit DAC allows custom waveforms to be created and used as stimulus. A DAC editor and waveform calculator simplify their creation using built-in waveform types (sine, square, triangle, exponential, random, and impulse). Mathematical operations such as integration, differentiation, and filtering can be performed on the waveforms before they are output. In production test, chirp waveforms can be used to measure transfer functions extremely fast.

### High-Speed, Multi-Channel Transient Capture

A special transient capture mode allows you to capture transients to RAM at composite sample rates up to 1.5 million samples per second. All channels are simultaneously sampled. With Option 116, 7.5 million samples can be collected. (Option 104 gives 1.5 million samples). Captured signals can be viewed and portions can be selected for analysis using HP 3566A/3567A measurements (except order track, order ratio map, and swept sine). Captured transients can be played back through the DAC module to re-create real-world signals.

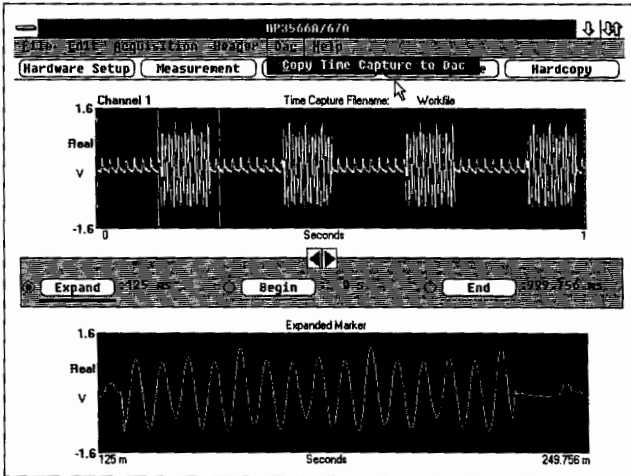

### Documentation of Results

A special Hardcopy Mode lets you document measurement results with up to six displays per page. Each display can include numerous individual annotations and pages can be labeled. Important measurement parameters and a time stamp can be automatically added to each display. Built-in pushbutton computations, such as total harmonic distortion and band power, can be printed on each display. To compare many measured results easily, overlay displays can print many results on a single grid.

Prints and plots can be made to any Microsoft® Windows supported graphics printer or HP-GL plotter (Centronics or RS-232 interface only). In addition, you can write reports using word processors and include HP 3566A and 3567A displays either by using Microsoft Windows "cut and paste" or by importing HP-GL plot files.

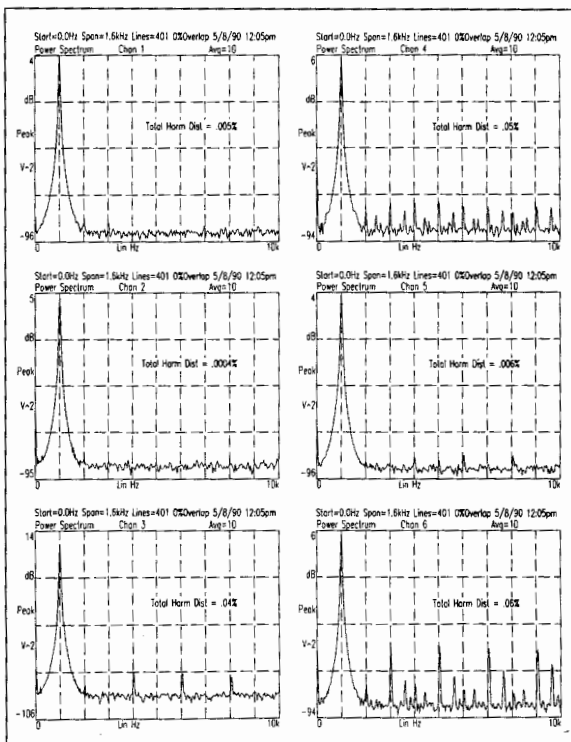

### Create Custom Measurements Easily

A full-function waveform calculator lets you create your own custom measurements and integrate them into the standard user interface. Mathematical functions can be performed on any measurement result, and the result of the operations can be displayed using the full display functionality. Results of math operations can also be output through the programmable DAC.

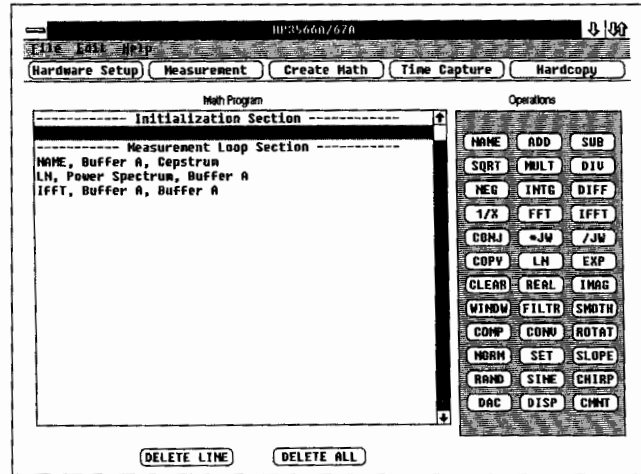

### Ordering Information

**HP 3566A** Spectrum/Network Analyzer **Price**  
\$22,900

Includes 1 HP 35650A mainframe, 1 HP 35655A 8-channel 12.8 kHz input module, 1 HP 35653A source module, 1 HP 35651B signal processor module with 1 Mbyte RAM, 1 HP-IB cable, 90-day onsite hardware warranty, HP time/frequency domain measurement software with 15 months BasicLine and 3 months ResponseLine software support.

- Opt 010** Add 1 HP 35655A 8-channel 12.8 kHz input module (two 8-channel modules is maximum configuration) + \$9,800
- Opt 104** Convert HP 35651B RAM to 4 Mbytes + \$1,500
- Opt 116** Convert HP 35651B RAM to 16 Mbytes + \$4,500
- Opt 056** Add HP 35656A programmable DAC module (required for chirp stimulus, arbitrary waveform and record/playback) + \$4,650
- Opt A16** HP Vectra QS16 with software installed + \$5,950
- Opt 050** Replace HP 35650A Mainframe with portable 4-slot, non-expandable HP 35650B mainframe \$0

**HP 3567A** Spectrum/Network Analyzer **Price**  
\$19,100

Includes 1 HP 35650A mainframe, 1 HP 35652B single-channel 102.4 kHz input module, 1 HP 35653A source module, 1 HP 35651B signal processor module with 1 Mbyte RAM, 1 HP-IB cable, 90-day onsite hardware warranty, HP time/frequency domain measurement software with 15 months BasicLine and 3 months ResponseLine software support.

- Opt 005** Add 1 HP 35650A mainframe (maximum configuration is 3 mainframes) + \$4,650
- Opt 010** Add one 102.4 kHz input module (maximum configuration is 16 input modules) + \$3,000
- Opt 104** Convert HP 35651B RAM to 4 Mbytes + \$1,500
- Opt 116** Convert HP 35651B RAM to 16 Mbytes + \$4,500
- Opt 056** Add HP 35656A Programmable DAC Module (required for chirp stimulus, arbitrary waveform and record/playback) + \$4,650
- Opt A16** HP Vectra QS16 with software installed + \$5,950
- Opt 050** Replace HP 35650A mainframe with portable 4-slot, non-expandable HP 35650B mainframe) \$0

- HP 35636A** Order Tracking (optional software) for HP 3566A and HP 3567A (requires Opt 104 or Opt 116) \$2,575
- HP 35637A** Swept-Sine (optional software) for HP 3566A and HP 3567A (requires Opt 104 or Opt 116) \$1,000
- HP 35634A** Software ONLY for HP 3566A and HP 3567A (order only if you already have hardware) \$4,075

MS-DOS® is a U.S. registered trademark of Microsoft Corp. Microsoft® is a U.S. registered trademark of Microsoft Corp.

# SIGNAL ANALYZERS

## Spectrum Analyzer 20 Hz to 40 MHz

### HP 3585B

- Sweep gating option
- 80 to 100 dB dynamic range
- $\pm 0.25$  dB typical level accuracy

- 50, 75, 1 M  $\Omega$  inputs
- 3 Hz resolution bandwidth
- Automatic limit testing

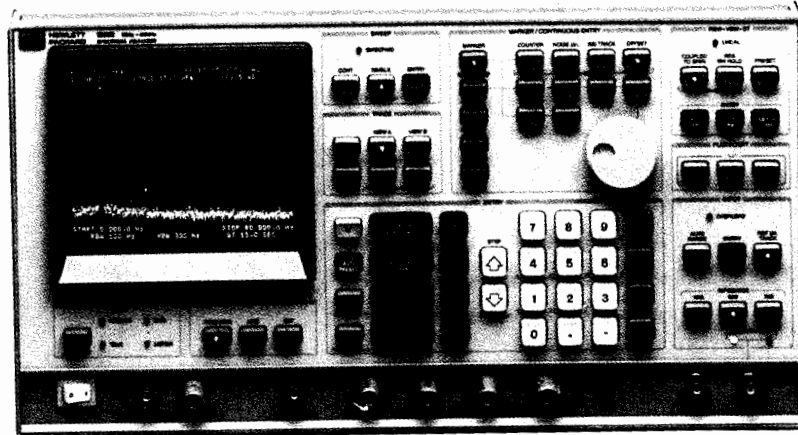

### Uncompromising Baseband Signal Analysis

The HP 3585B spectrum analyzer delivers high performance where it counts — at baseband frequencies. With very high accuracy, resolution, and dynamic range, the HP 3585B is the best solution for signal analysis at the critical frequencies comprising voice, video, or digital information.

In today's high-speed, high-density information processing systems, maintaining the integrity of data signals requires more measurement performance than ever before. The HP 3585B provides 80 to 100 dB of spurious-free dynamic range, a sharp 3 Hz resolution bandwidth, and a 20 Hz to 40.1 MHz frequency range to easily cover most information bandwidths. Fully synthesized tuning (including sweeps) and typical amplitude accuracy to  $\pm 0.25$  dB ensure complete measurement confidence.

### Carefully Chosen Features for Better Measurements

Measurements are faster and easier with the optimized feature set. The automatic limit test function checks all 1000 measurement points against user-defined upper and lower limits in a fraction of a second. Pass/fail results are shown in the display and are available over HP-IB for improved productivity in automated applications.

The automatic peak search and signal track functions speed signal identification and analysis and make examination of drifting signals more convenient. In addition to locating the strongest signal in a display, the peak search function can also find successively smaller signals, or search to the right or left for peaks above a user-defined threshold.

### Fast, Flexible Frequency Sweeps

Well-designed resolution bandwidth filters and a phase-continuous, synthesized local oscillator team up with exceptional dynamic range to give the HP 3585B very fast measurement speeds. A 40 MHz sweep using the 30 kHz resolution bandwidth takes only 200 milliseconds, fast enough for high-resolution spectrum surveillance. A 1 MHz sweep using a 1 kHz bandwidth takes only 2 seconds, yet yields an average noise floor of  $-85$  dBc.

### Powerful Marker Functions

The tunable marker readout of frequency and amplitude can be expressed as an absolute or relative (offset) value. With a single keystroke, the marker value can be entered as the center frequency, reference level, frequency span, or center frequency step size. This improves accuracy and efficiency in manual testing and reduces setup errors.

The built-in frequency counter provides additional accuracy when measuring the frequency of a signal in the display. Results are provided in 0.3 seconds to 0.1 Hz resolution. Because the counter function is combined with the selectivity of the analyzer, it is possible to accurately measure small signals in the vicinity of much larger ones.

For noise measurements, the noise level marker function displays averaged rms noise density at the marker position, normalized to a standard 1 Hz bandwidth and corrected for the analyzer's characteristics. This function can be combined with the relative measurement mode for fast, easy signal-to-noise ratio measurements.

### Measurement Hard Copy

Copying a complete display to a printer or plotter is as easy as pressing a button. The HP 3585B directly controls HP-GL compatible HP-IB plotters and graphics printers such as the HP ThinkJet.

### Tracking Generator

The standard 50  $\Omega$  tracking generator covers the full 40 MHz frequency range of the HP 3585B to provide easy scalar (amplitude-only) network analysis. The signal is fully synthesized in CW measurements and sweeps, and level is adjustable from 0 dBm to  $-11$  dBm from the front panel.

### Flexible Inputs with Autoranging

50, 75, and 1 M $\Omega$  input impedances are all standard and are electronically selectable to match your system. For sensitive circuits, the 50  $\Omega$  and 1 M $\Omega$  inputs and provided probe power, offer maximum compatibility with a variety of passive and active probes. With input autoranging, the HP 3585B automatically chooses the optimum input range for maximum dynamic range and lowest distortion. This eliminates the need to manually adjust attenuation and IF gain.

### Burst Signal Analysis

Spectrum analysis on burst signals using traditional swept measurement techniques include not only the signal of interest but also the signal from the burst repetition period. This raises the effective noise floor of the measurement which masks the signal of interest, making accurate signal-to-noise and carrier-to-noise measurements impossible. The new sweep gating option 001 reveals the signals you have missed.

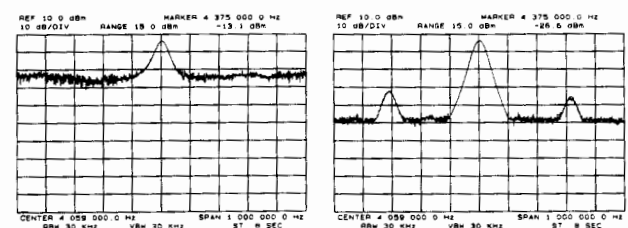

Before sweep gating

After sweep gating

# SIGNAL ANALYZERS

## Spectrum Analyzer 20 Hz to 40 MHz

HP 3585B

235

### Specifications

Specifications describe the warranted performance of the HP 3585B over the temperature range 0° C to 55° C, except where noted. Supplemental characteristics describe typical but non-warranted performance; they are described as "typical" or "approximate" and apply over the temperature range 25 ± 5° C.

#### Frequency

**Measurement range:** Specifications apply 20 Hz to 40.1 MHz  
Start/stop, center, manual frequency range: 0 Hz to 40.1 MHz

**Accuracy:** (Same as frequency ref. accuracy)

**Frequency span:** 0 Hz to 40.1 MHz<sup>2</sup>

**Frequency reference accuracy:** ± 1 × 10<sup>-7</sup>/mo. of frequency

#### Marker frequency:

**Readout accuracy:** ± 0.2% of frequency span ± resolution bandwidth.

**Resolution:** 0.1 Hz

#### Resolution bandwidth:

**Bandwidth:** 3 Hz to 30 kHz (3 dB bandwidth) in 1, 3, 10 sequence.

**Selectivity:** (60 dB / 3 dB) < 11:1

**Video bandwidth:** 1 Hz to 30 kHz in 1, 3, 10 sequence

#### Amplitude

**Display scale:** 10 vertical division graticule with reference level (0dB) at top graticule line

**Calibration:** 1, 2, 5, 10 dB/division

#### Measurement range:

**50/75 Ω input:** -137 dBm to +30 dBm or equivalent level in dBV or volts

**1 MΩ input:** 31 nVrms to 7.08 Vrms

**Input range settings:** Autoranging, -25 dBm to +30 dBm in 5dB steps

#### Amplitude accuracy

Accuracy note: Measurement accuracy is determined by the sum of reference level accuracy, amplitude linearity (if the signal is not at the reference level) and frequency response across the measurement span (if the signal is not at the center or manual frequency). In measurements where the signal is at the reference level and/or at the center or manual frequency, the amplitude linearity and/or frequency response uncertainties will not apply.

#### Reference level

**Range:** -100 dB to +10 dB (relative to input range)

**Accuracy:** 50/75 Ω input (using 1 or 2 dB/div., measured at manual frequency or with sweep rate reduced by a factor of 4):

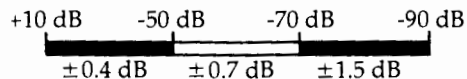

(For 5 or 10 dB/div. add 0.1 dB to the figures above)

Typical accuracy, +10 dB to -50 dB: ±0.25 dB.

**For 1 MΩ input:** Add to above specification ±0.7 dB for 20 Hz to 10 MHz; ±1.5 dB for 10 MHz to 40.1 MHz

#### Amplitude linearity

50/75 Ω input (relative to reference level):

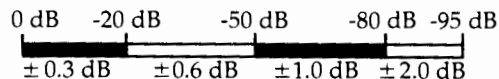

Typical linearity, 0 dB to -20 dB: ±0.2 dB

#### Frequency response

50/75 Ω input (relative to center frequency): ±0.5 dB

(±0.3 dB typ.)

**For 1 MΩ input:** Add to above specification ±0.7 dB for 20 Hz to 10 MHz, ±1.5 dB for 10 MHz to 40.1 MHz

#### Marker amplitude accuracy:

Center or manual frequency at the reference level: Use reference level accuracy from +30 dBm to -115 dBm; add amplitude linearity below -115 dBm.

Anywhere on screen: Add amplitude linearity and frequency response (same as display accuracy)

#### Dynamic range

**Spurious responses:** (Image, out-of-band, and harmonic distortion)

**50/75 Ω input:** < -80 dB relative to a single signal at or below the input range setting.

Typical performance: -84 dB to (1 dB/dB below input range setting)

Example: For a -8 dBm signal on the 0 dBm input range, the spurious responses would be -92 dB.

**1 MΩ input:** < -80 dB, except 2nd harmonic distortion < -70 dB

#### Intermodulation distortion

**50/75 Ω input:** ≤ -80 dB relative to the larger of two signals, each ≥ 6 dB below input range setting except 2nd order IM from 10 MHz to 40 MHz < -70 dB

**1 MΩ input:** < -70 dB for 2nd order, < -80 dB for 3rd order

**Residual responses (no signal at input):** < -120 dBm using -25 dBm range, or 95 dB below input range setting

**Residual phase noise** (typical at 40 MHz, -10 dBm input):

5 kHz offset: -112 dBc/Hz

100 kHz offset: -120 dBc/Hz

**Maximum dynamic range (typical):** 92 dB spurious, harmonic and 3rd order IM; 115 dB signal to noise.

#### Average noise level

**50/75 Ω input:**

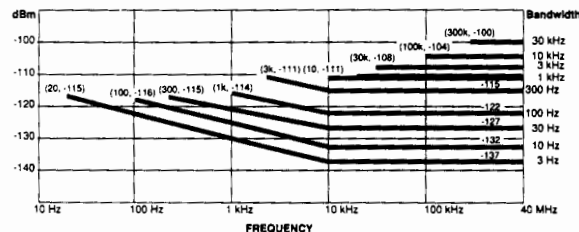

**1 MΩ input:** Below 500 kHz add 12 dB to 50/75 Ω figure

#### Tracking generator

**Level:** 0 dBm to -11 dBm, manual control from front panel

**Frequency accuracy:** ± 1 Hz relative to analyzer tuning

**Frequency response:** ± 0.7 dB; typically: ± 0.5 dB

**Impedance:** 50 Ω, > 14 dB return loss

#### Signal input

**50/75 Ω:** > 26 dB return loss, BNC connectors

**1 MΩ:** ± 3% shunted by < 30 pF, BNC connector

#### Maximum input level

**50/75 Ω:** 13V peak ac plus dc, relay protected for overloads to 42V peak

**1 MΩ:** 42V peak ac plus dc (derated by factor of two for each octave above 5 MHz)

**External trigger:** Negative-going TTL level or contact closure initiates sweep

**External frequency reference:** 10 MHz or subharmonic to 1 MHz, 0 dBm minimum level

#### Option 001 Sweep Gating Mode

**Modes:** Timed (start synch to ext trigger), External gate (start and stop synchronized to ext trigger)

**Programmable gate delay range (typ):** 10 μs-655 ms, 10 μs steps

**Programmable gate length range (typ):** 100 μs, 200 μs-13.1 sec, 200 μs steps

Measurement accuracy dependent on signal set-up time

#### General

**Weight:** 36.7 kg (81 lb)

**Size:** 22.9 cm H × 42.6 cm W × 63.5 cm D (9 in × 16.75 in × 25 in)

#### Ordering Information

**HP 3585B** Spectrum Analyzer

**Opt W30** Extended Repair Service. See page 671.

**Opt 001** Sweep Gating

**Opt 002** Field Installable Sweep Gating Kit

#### Price

\$26,000

+ \$605

+ \$1,500

+ \$2,000

# SIGNAL ANALYZERS

## Spectrum/Network Analyzer, 10 Hz to 150 MHz

HP 3588A, 3589A

- Complete spectrum and vector network measurements (HP 3589A)
- Narrowband measurements hundreds of times faster
- Accuracy to 0.2 dB, spectrum; 0.05 dB, 1 degree network
- Optional time-gated spectrum analysis for burst signals (HP 3589A)
- Companion 2-port 50  $\Omega$ /75  $\Omega$  S-parameter test sets
- 80 to 112 dB dynamic range

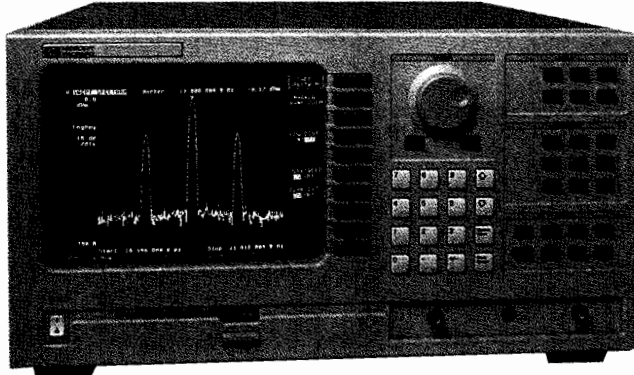

HP 3588A Spectrum Analyzer



### Complete Frequency Domain Analysis

The HP 3588A spectrum analyzer and HP 3589A spectrum/network analyzer provide comprehensive frequency domain measurements and cover the baseband through IF frequency range of 10 Hz to 150 MHz. The HP 3588A offers high performance spectrum measurements and simple scalar network measurements with its fully synthesized tracking generator. The HP 3589A adds complete vector network measurements, support for analysis of RF and microwave downconverted signals, accessory 50  $\Omega$  and 75  $\Omega$  S-parameter test sets, and optional time-gated spectrum analysis.

### Full Network Capability

Because design tasks often require network or impedance measurements along with spectrum analysis, the HP 3589A provides a complete range of features and measurement accessories for comprehensive network analysis. Phase measurement functions include group delay, polar and Smith chart formats, and phase slope or electrical length compensation. All normal transmission measurements can be made in 50  $\Omega$  and 75  $\Omega$  environments by the standard HP 3589A. For audio or broadband analysis, the analyzer also performs log sweeps and adds a 1 M $\Omega$  input.

Both 50  $\Omega$  and 75  $\Omega$  test sets are available for complete two-port network analysis. The test set enables easy, accurate measurement of VSWR, return loss, impedance, directivity, and other transmission and reflection parameters. To ensure optimum accuracy through cables and fixtures, full measurement calibration/error-correction functions are provided, comparable to dedicated network analyzers.

### Unprecedented Speed and Resolution

Narrow resolution measurements with conventional swept-tuned analyzers typically require long measurement times, which can increase development time and test costs. In contrast, the HP 3588A/3589A set new standards in speed while providing much greater frequency resolution.

Faster measurements are made possible with these analyzers' full-digital resolution bandwidth filters. They offer an improved shape factor and sweep characteristics for measurements 4 to 40 times faster than those of conventional analyzers. A unique FFT "Narrowband Zoom" mode provides measurements up to 400 times faster and spans of 1 Hz to 40 KHz anywhere in the 150 MHz frequency range.

The HP 3589A also brings this speed and resolution to narrowband measurements at microwave frequencies, through enhanced features for interfacing with microwave analyzers, receivers, or downconverters.

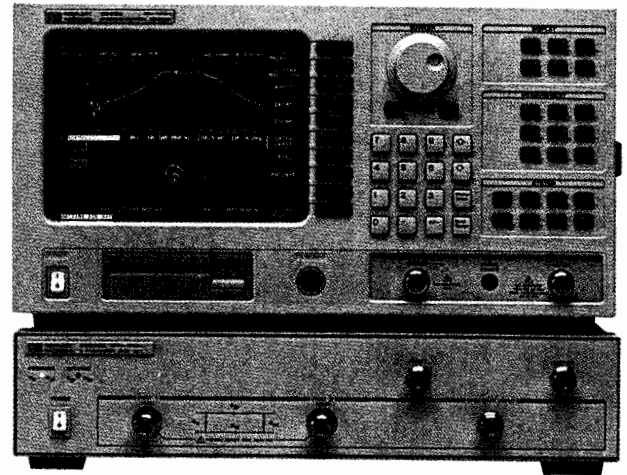

HP 3589A Spectrum/Network Analyzer  
HP 35689A S-Parameter Test Set



### Burst Signal Analysis

Burst or time-varying signals are now found in applications as diverse as communications, disk drives, video, sonar, ultrasound, and optoelectronics. The time-gated spectrum analysis option of the HP 3589A is meant for just these dynamic signals. The analyzer can be triggered to measure only during the "valid" or desired portion of a complex signal, providing standard measurements such as signal-to-noise and distortion. Accurate measurement of these repetitive signal bursts is often impossible with a standard spectrum analyzer.

### Measurement Automation and Convenience Features

Optional HP Instrument BASIC (a subset of HP BASIC) runs inside these analyzers to make repetitive measurements, create custom displays and test sequences, and even to control other instruments in a test system. Automatic programming is available with the "keystroke-recording" feature, which creates complete executable programs by remembering keys pressed during an actual measurement. The HP 3589A includes a set of disk utilities for PC analysis of measurement results and also includes a standard PC-style keyboard interface. Optional PC keyboards are available for the HP 3589A in a variety of languages.

### Specifications Summary

Please see the 3588A and 3589A technical data sheets for full specifications. The following specifications apply from 0° to 55° C and from 10 Hz to 150 MHz.

## Frequency Specifications

**Frequency range:** 0 Hz to 150 MHz; 1 MW input specified from 10 Hz to 40 MHz.

### Frequency accuracy

#### Initial accuracy:

	Without Opt 1D5	With Opt 1D5
20° to 30° C	± 0.5 ppm	± 0.01 ppm
0° to 55° C	± 3.0 ppm	± 0.07 ppm
Aging	± 0.25 ppm/mo.	± 0.125 ppm/mo.

Frequency counter resolution: 0.1 Hz

### Stability

**Spectral purity:** See chart below.

**Noise sidebands:** Less than -105 dBc when measured at a 1 kHz offset from CW signal and normalized to a 1 Hz noise-power bandwidth.

### Drift/residual FM:

The HP 3589A uses a fully synthesized local oscillator and is phase-locked to the frequency reference throughout the sweep. See the frequency accuracy specifications stated earlier.

## Amplitude Specifications

### Amplitude measurement range:

(Maximum without degrading performance)

	50 Ω	75 Ω	1 M Ω
Input dc:	± 3 Vdc	± 3 Vdc	± 25 Vdc
Measured input:	20 dBm	22 dBm	± 7 dBV

**Input range settings** (characteristics only):

**50 Ω input** (in 10 dB steps): +20 dBm to -20 dBm

**75 Ω input** (in 10 dB steps): +21.76 dBm to -18.24 dBm, with included BNC adapter and automatic corrections.

+25.72 dBm to -14.28 dBm, with minimum loss pad (option) and automatic corrections

**1 M Ω input** (in 10 dB steps; HP 3589A only): +7 dBV to -33 dBV

### Spectral Purity (typical)

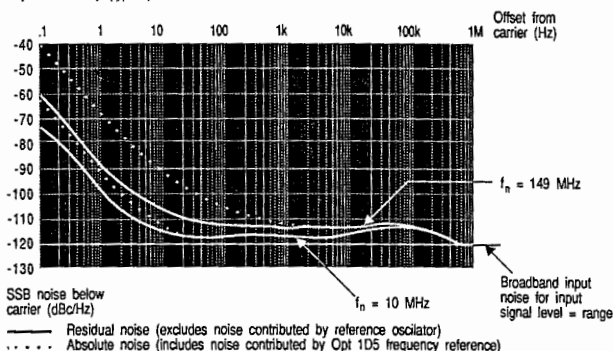

Note: Equivalent noise bandwidth is narrower than 1 Hz for spans below 150 Hz with the narrowband zoom measurement type, providing additional reduction in phase noise from that shown. This maintains good dynamic range, even for extremely small offset frequencies in narrow spans. Noise is reduced by  $10 \cdot \log [1/\text{noise bandwidth}]$  dBc relative to the graph.

**Display resolution:** 0.001 to 100 dB/div

**Marker resolution:** 0.01 dB

**Display units:** dBm, dBV, Vrms

**Input port:** (Type-N connector)

**Return loss:** > 20 dB

**Impedance:** 50 Ω, 1 M Ω, (75 Ω with included adapter or optional minimum-loss pad)

### Source Specifications

**Source port:** (Type-N connector)

**Return loss:** > 20 dB

**Impedance:** 50 Ω (75 Ω with included adapter or optional minimum loss pad)

**Frequency:** 10 Hz to 150 MHz

**Amplitude:** +15 to -54.9 dBm (HP 3588A max. = +10 dBm)

**Absolute amplitude accuracy:** ± 1 dB

**Frequency response:** ± 1 dB

**Spurious:** Harmonic < -30 dBc; Non-harmonic, < -40 dBc

## Spectrum Measurements

### Frequency

#### Frequency span

**Swept:** Range 10 Hz to 150 MHz, and zero span

**Start/stop frequency:** 0 Hz to 150 MHz

**Narrowband zoom:** Range 1.23 Hz to 40 kHz in ×2 steps

#### Resolution bandwidth

**Swept:** 1.1 Hz to 17 kHz

**Narrowband zoom:** (high-accuracy mode): 11 mHz to 360 Hz

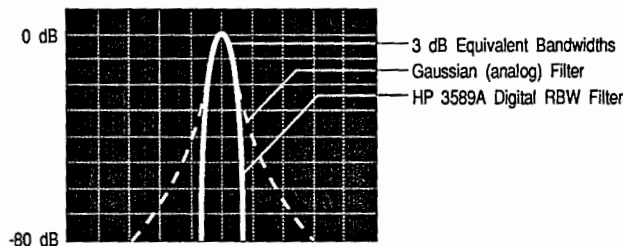

HP 3589A digital RBW filter shape (solid line) compared with a standard (Gaussian) analog RBW filter of equivalent 3 dB bandwidth.

**Video bandwidth:** Entered in frequency values which are coupled to the current RBW and are from  $(1.54 \cdot \text{RBW})$  to  $(0.012 \cdot \text{RBW})$  in seven steps, and off.

### Amplitude

#### Dynamic range

**A/D overload level:** > 2 dB (relative to selected range)

#### 50 Ω Input Noise

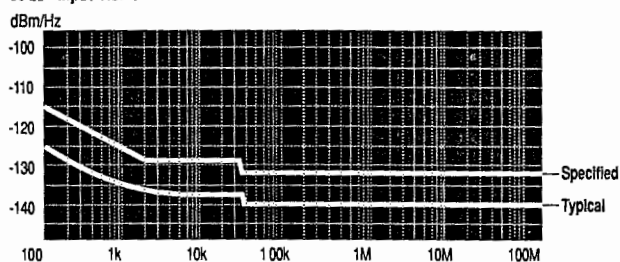

**Noise level:** (dBm/Hz using the marker noise function)

Specified for swept spectrum mode, with 50 W input, range set to -20 dBm and low-distortion mode off.

Note: Equivalent noise bandwidth is narrower than 1 Hz for spans below 150 Hz with the narrowband zoom measurement type, providing additional reduction in noise from that shown.

### Spurious Responses

**General spurious:** Unless specifically mentioned in other spurious specifications, spurious responses are < -70 dBc (< -80 dBc typical) for signal levels equal to input range.

#### Harmonic distortion:

**50 Ω and 75 Ω inputs:** < -80 dBc (< -90 dBc typical)

**1 M Ω input:** < -75 dBc (< -80 dBc typical)

#### Intermodulation distortion:

**50 and 75 Ω inputs:** < -80 dBc (< -90 dBc typical)

**1 M Ω input:** < -75 dBc (< -80 dBc typical)

**Residual Responses:** Below -110 dBm on the -20 dBm range

### Amplitude Accuracy

Measurement accuracy is determined by the sum of full-scale absolute accuracy and scale fidelity (linearity). For measurements made at full-scale (signal level = range), only full-scale accuracy need be considered. Recalibration due to change in center or manual frequency is not required for the accuracy shown.

# SIGNAL ANALYZERS

## Spectrum/Network Analyzer, 10 Hz to 150 MHz (cont'd)

HP 3588A, HP 3589A

### Full-scale absolute accuracy:

(Applies over entire 0° to 55° C temperature range.)

Accuracy is specified for manual frequency or for sweeps in which sweep time is increased by a factor of four. Add  $\pm 0.1$  dB for auto-coupled sweep times.

	10 Hz	100 Hz	30 kHz	300 kHz	40 MHz	150 MHz
50 $\Omega$ Input	$\pm 2.5$ dB	$\pm 1.0$ dB	$\pm 0.5$ dB	$\pm 0.4$ dB	$\pm 0.5$ dB	
50 $\Omega$ Typical	$\pm 1$ dB	$\pm 0.5$ dB		$\pm 0.2$ dB		
75 $\Omega$ Input	$\pm 2.5$ dB	$\pm 1.0$ dB		$\pm 0.8$ dB		
1 M $\Omega$ Input	$\pm 2.5$ dB	$\pm 1.0$ dB		$\pm 0.6$ dB		

**Scale fidelity** (linearity) maximum cumulative error of log scale. Levels are relative to the specified range.

Level	Incremental	Typical
0 to -30 dB	<0.05 dB	0.02 dB
-30 to -40 dB	<0.1 dB	0.03 dB
-40 to -50 dB	<0.3 dB	0.05 dB
-50 to -60 dB	<0.5 dB	0.10 dB
-60 to -70 dB	<0.7 dB	0.10 dB
-70 to -80 dB	—	0.25 dB
-80 to -90 dB	—	0.25 dB
-90 to -100 dB	—	0.40 dB
-100 to -110 dB	—	0.70 dB
-110 to -120 dB	—	4.00 dB

### Sweep Characteristics

**Linear swept spectrum:** The oversweep mode and digital IF filters of the HP 3589A provide sweep times 4 to 40 times faster than those of analog swept analyzers, without increased error.

**Narrowband zoom:**

**Measurement speed:** > 7 measurements/s (for spans  $\geq 10$  kHz)

**Gated sweep:**

(HP 3589A Opt 1D6 only; not available in narrowband zoom mode.) Gate length and trigger delay:

RBW (Hz)	Gate Length Minimum (ms)	Gate Length Maximum (ms)	Edge Trigger Default Delay* (ms)
17000	0.02	131	0.13
9100	0.04	131	0.2
4600	0.08	131	0.38

(For other bandwidths, see HP 3589A Technical Data Sheet.)

### Network Measurements (HP 3588A only)

#### Frequency

**Linear sweep:** For span and RBW, see swept spectrum mode.

**Log sweep:** Start/stop frequency: 10 Hz to 150 MHz.

#### Amplitude

##### Dynamic range

**Sensitivity:** Dynamic range limitation due to noise level and internal crosstalk between the source and receiver.

Impedance	10 Hz-30 KHz	30 kHz-40 MHz	40 MHz-150 MHz
50/75 $\Omega$	80 dB	100 dB	100 dB
50/75 $\Omega$ typical	85 dB	110 dB	110 dB
1 M $\Omega$	75 dB	100 dB	—

### Accuracy – Ratio Amplitude and Phase

**Dynamic accuracy:** At stable temperature following a 2 hour warm-up, and within 5 minutes of normalization. (Typical within one minute of normalization.)

Level (dB)	Accuracy (dB)	Accuracy (deg)	Typical (dB)	Typical (deg)
0 to -5	<0.05	<1.0	<0.05	0.2
-5 to -30	<0.10	<1.5	0.10	0.5
-30 to -40	<0.15	<2.0	0.10	1.0
-40 to -50	<0.35	<3.0	0.10	1.0
-50 to -60	<0.55	<4.0	0.15	1.5
-60 to -70	<0.75	<6.0	0.15	2.5
-70 to -80	—	—	0.30	—
-80 to -90	—	—	0.30	—
-90 to -100	—	—	0.45	—

### Group Delay (not available with log sweep):

**Aperture frequency:** 0.5% to 16% of span in 2x steps

**Accuracy:** Dynamic phase acc./(360\* aperture frequency)  $\pm 1$  ns

### Sweep Characteristics

Linear, log, and gated sweeps are available; see technical data sheet.

### General Characteristics

**Temperature (operating):** 5° to 50° C; Storage: -20° to 60° C

**Calibration interval:** 1 year

#### Power:

115 Vac operation: 90 to 132 Vrms, 47 to 440 Hz

230 Vac operation: 198 to 264 Vrms, 47 to 66 Hz

Max. power dissipation: 450 VA

**Weight:** Net, 28 kg (62 lb); shipping, 38 kg (81 lb)

#### Dimensions:

222 mm H  $\times$  425.5 mm W  $\times$  630 mm D (8.75 in  $\times$  16.75 in  $\times$  24.8 in)

**External keyboard:** Compatible with PC-style 101 key

### HP 35689A/B S-Parameter Test Sets

**Frequency range:** 100 kHz to 150 MHz

**Test port impedance:** HP 35689A, 50  $\Omega$ ; HP 35689B, 75  $\Omega$

**Directivity:** > 40 dB

**Spectrum port insertion loss:** < 0.5 dB typical (HP 35689A)

#### Power:

115 Vac operation: 90 to 132 Vrms, 47 to 66 Hz

230 Vac operation: 198 to 264 Vrms, 47 to 66 Hz

**Weight:** Net, 7.8 kg (17 lb); shipping, 11.5 kg (25 lb)

**Dimensions:** 90 mm H  $\times$  426 mm W  $\times$  584 mm D (3.5 in  $\times$  16.75 in  $\times$  22.75 in)

### Ordering Information

	Price
<b>HP 3588A</b> Spectrum Analyzer	\$19,300
<b>Opt 001</b> High-Stab. Freq. Reference	\$850
<b>Opt 003</b> Add 2 MByte Memory	\$1,500
<b>Opt 1C2</b> HP Instrument BASIC	\$500
<b>HP 3589A</b> Spectrum/Network Analyzer	\$21,750
<b>Opt 1D5</b> High-Stab. Freq. Reference	\$850
<b>Opt 1D6</b> Time-Gated Spectrum Analysis	\$1,500
<b>Opt 1C1</b> Add 2 MByte Memory	\$1,500
<b>Opt 1C2</b> HP Instrument BASIC	\$500
<b>Opt 1D7</b> 50 $\Omega$ to 75 $\Omega$ Minimum Loss Pads	\$900
<b>Opt PC-Style 101-Key Keyboard</b>	\$170
(Available keyboard versions include US, German, Spanish, French, UK, Italian, and Swedish)	
<b>HP 35689A</b> 50 $\Omega$ S-Parameter Test Set	\$3,650
<b>HP 35689B</b> 75 $\Omega$ S-Parameter Test Set	\$4,000



- Easy-to-use portable spectrum analyzers
- Full range of price and performance options

- Expanded memory and trace-storage capability
- Custom measurement personalities

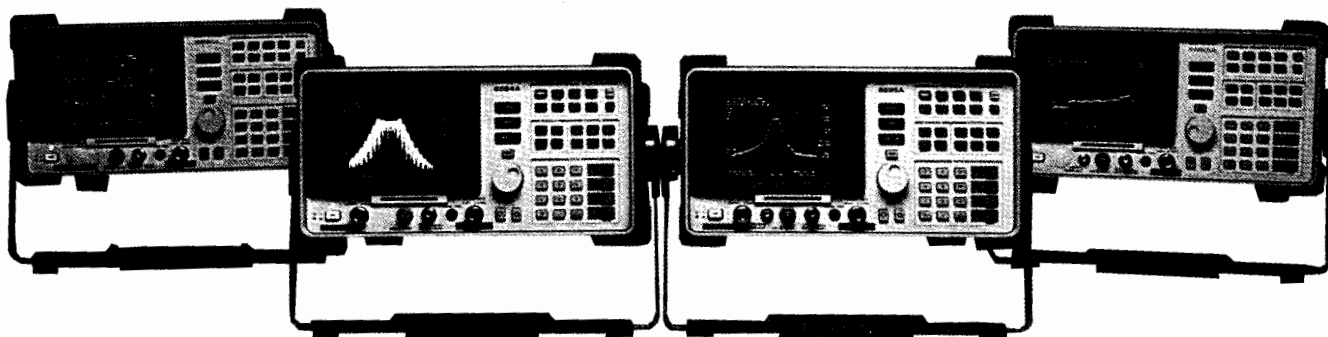

HP 8590 series

### HP 8590 Series Spectrum Analyzers

This family offers a wide range of performance, features, and prices designed to fit your budget. Choose from two low-cost basic performance analyzers or from four higher-performance models with synthesizer accuracy. Whatever your choice, you will find HP 8590 series spectrum analyzers easy to use and reliable. Their expandable feature sets allow them to be easily configured to meet your growing measurement needs.

Many options available for these portable analyzers can be added at the time of instrument purchase or after. These options include application-specific measurement personalities that customize your analyzer for specific tasks such as CATV, digital radio, cellular radio, EMC, and component test measurements (see page 240). You can also add a variety of printers, plotters, and other accessories.

### HP 8590B and 8592B Spectrum Analyzers

These models offer basic RF and microwave measurement performance at a low cost. The HP 8590B has a frequency range of 9 kHz to 1.8 GHz, a 50- or optional 75-ohm input, and a weight of only 13.6 kg (30 lb). Amplitude range is a wide  $-115$  to  $+30$  dBm. The HP 8592B has a frequency range of 9 kHz to 22 GHz (or 25 GHz with Option H25), an internal preselector, and a weight of 15.9 kg (35 lb). Amplitude range extends from  $-114$  to  $+30$  dBm. If ac power is not available, both spectrum analyzers can be operated using the HP 85901A portable ac power source.

### One Spectrum Analyzer for Many Applications

You can change the test capabilities of these spectrum analyzers to fit specific measurement needs. An optional memory card reader enables you to load application-specific measurement personalities. Complex measurement routines are reduced to a keystroke. An optional built-in tracking generator provides the HP 8590B RF analyzer with a synchronously swept signal source for stimulus-response measurements. Operating these analyzers requires only minimal training.

### Easy-to-Use Features

Numerous features make it easier to control your measurements and to analyze the results. Both portable spectrum analyzers have built-in automatic calibration to ensure measurement consistency. Frequency panning lets you quickly reposition signals without repeated sweeps. The internal memory allows 50 traces to be stored, and 24 more can be stored on a RAM card with addition of the optional memory-card reader. Time-and-date stamping come standard. Direct output to printer or plotter are available with either the HP-IB or RS-232 interface option.

### HP 8591A, 8594A, and 8595A RF Spectrum Analyzers

### HP 8593A Microwave Spectrum Analyzer

These portable spectrum analyzers offer frequency accuracy and a wide range of options for applications that demand higher performance. The HP 8591A has a frequency range of 9 kHz to 1.8 GHz and amplitude range of  $-115$  to  $+30$  dBm. The HP 8594A has a frequency range of 9 kHz to 2.9 GHz and an amplitude range of  $-112$  to  $+30$  dBm. The HP 8595A has a frequency range of 9 kHz to 6.5 GHz and an amplitude range of  $-114$  to  $+30$  dBm. And the HP 8593A has a frequency range of 9 kHz to 22 GHz (or to 26.5 GHz with Option 026) and an amplitude range of  $-114$  to  $+30$  dBm.

All four instruments have a standard 7.5 ppm frequency accuracy that can be improved with an optional precision frequency reference to marker count accuracy of  $\pm 230$  Hz at 1 GHz or  $\pm 2.3$  kHz at 18 GHz.

### Standard Features

These analyzers have the ease-of-use features found in the HP 8590B and 8592B. In addition, their built-in memory card reader allows you to load measurement personalities, your own custom programs, and measurement data on 32-Kbyte memory cards. A catalog function allows you to determine the exact content of information stored on your memory cards or within internal memory.

### Option Flexibility

A growing variety of circuit-card options provide even more measurement capability. Circuit cards are installed easily into a built-in cardcage, and most card options are retrofittable.

HP's new circuit-card option for time-gated spectrum analysis lets you characterize burst-modulated or time-multiplexed signals from many sources: digital RF communication systems (including GSM, PCN, and CT-2 formats), video devices, and disk drive read/write heads.

Other circuit-card options include:

- AM/FM demodulator to view and hear signals
- TV sync trigger to select any line of the TV field for measurement
- Fast time-domain sweep to allow zero-span sweep rates to  $20 \mu\text{s}$
- Quasi-peak detector for EMC measurements

A built-in 2.9-GHz tracking generator is available for the HP 8593A, 8594A, and 8595A spectrum analyzers; a 1.8 GHz tracking generator for the HP 8591A. For microwave scalar network measurements, the new HP 85645A microwave tracking source can be used with the HP 8593A (see page 249).

# SIGNAL ANALYZERS

## Spectrum Analyzers, Portable

### HP 8590 Series

- Application-specified measurements
- New component-test, GSM, and CATV personalities

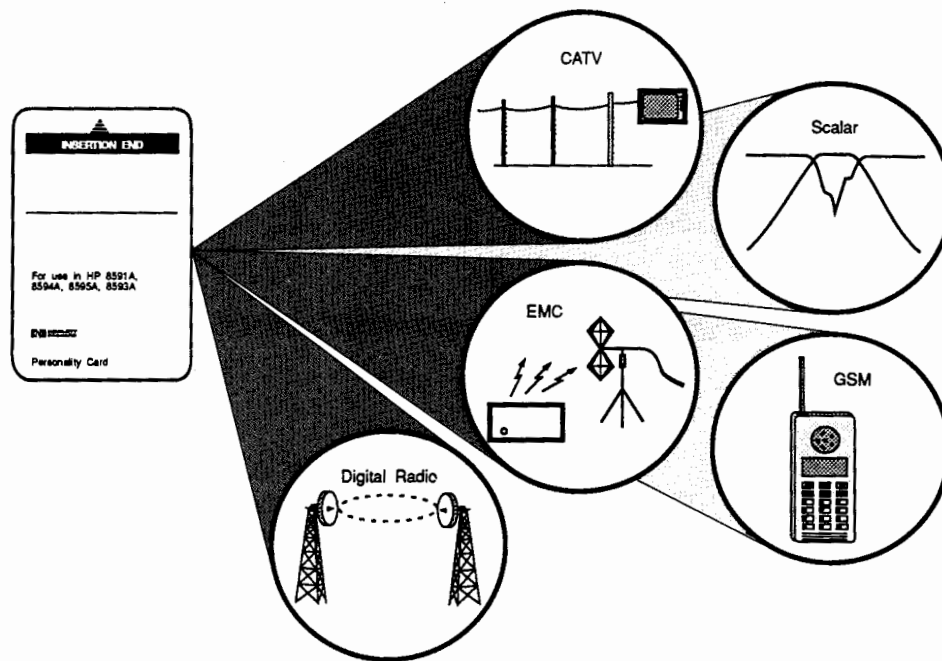

Measurement personalities are available for specialized testing in a variety of fields.

### Measurement Personality Cards

Hewlett-Packard's measurement personality cards are an economical way to customize your HP 8590 series spectrum analyzer for easier, more accurate testing in a number of application areas. The measurement personalities are loaded using the built-in memory card reader (optional on the HP 8590B and 8592B).

### New HP 85714A Scalar Measurement Personality

Add an HP 85714A scalar measurement personality to an HP 8590 series analyzer with optional built-in tracking generator for fast, accurate scalar transmission measurements from 300 kHz to 2.9 GHz. Included are guided "thru" calibration, autoscaling, a transmission coefficient measurement marker, 120-dB extended display, and one-button measurement of CF, insertion loss/gain, bandwidth, and shape factor. For even more power, the scalar measurement personality becomes the interface for the HP 85630A scalar transmission reflection test set, which adds capabilities for reflection measurements as well, including a reflection coefficient measurement marker, a VSWR measurement marker, and simultaneous transmission/reflection display (see page 249).

### New HP 85715A GSM Measurement Personality

This product expands the feature and measurement set of an HP 8590 series spectrum analyzer, customizing it for testing the Pan-European digital cellular radio system. Measurements include those recommended in GSM 11.10 and 11.20 documents: RF carrier power versus time, output RF spectrum, spurious emissions, and more.

### New HP 85716A CATV System Monitoring Personality

The HP 85716A introduces a new concept in CATV testing: data acquisition through system monitoring. Nine automatic noninterfering measurements allow you to continuously monitor headend operation and make faster, easier system proof-of-performance tests. You will locate your system problems—without disrupting service—before they become customer complaints. Automatic measurements include visual carrier frequency, visual carrier level, visual-to-aural frequency difference, visual-to-aural level difference, visual carrier modulation depth, visual carrier powerline hum, visual carrier-to-noise ratio, system composite triple beat, and system composite second order.

### HP 85711A CATV Measurement Personality

This card is recommended for manual headend testing, proof-of-performance measurements, trunk maintenance, and (with a microwave analyzer) CARS-band testing. One-key measurements include channel selection by number and beats identification, carrier level, carrier-to-noise ratio, power-line hum, cross modulation, composite triple beat, video modulation depth, and non-intrusive frequency response. With analyzer Option 301 you can listen to AM and FM signals and measure modulation depth on individual TV lines selected by number. HP 8590 series Option H80 and Option H81 let you view TV pictures on the CRT of the spectrum analyzer.

### HP 85712B EMC Measurement Personality

This card adds capabilities for electromagnetic compatibility (EMC) diagnostic and precompliance measurements. EMC applications include field-strength testing in close fields, peak response measurements weighted for broadband emissions, and identification of narrowband and impulse (broadband) signals. Accessories such as a preamplifier and set of two close-field probes complement the EMC measurement capabilities added by this personality. (See page 243 for more information on EMC test products.)

### HP 85713A Digital Radio Measurement Personality

This measurement card for the microwave spectrum analyzers includes five major agency masks for testing to US, UK, and FRG digital radio specifications. Automatic compare-to-mask and mean power level measurements are made on the modulated signal. Measurement functions include transient analysis monitoring and frequency response measurement. You can create and store your own masks and recall them for later use. More digital radio tests, including multipath fading margin, power measurements, and flatness, are available using the HP 11758T digital radio test system.

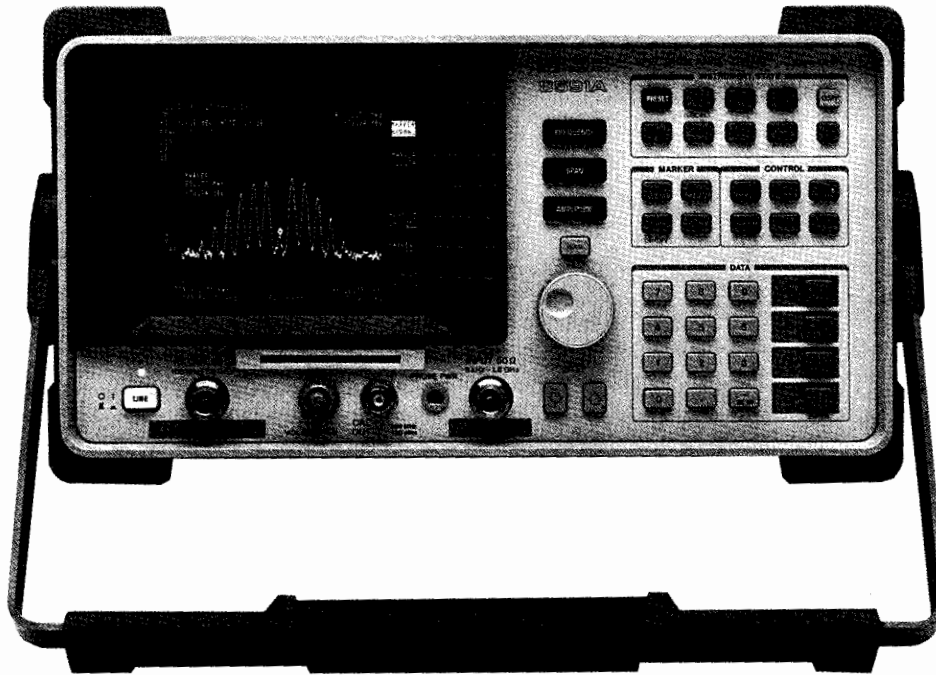

HP 8591A

## Specifications

### HP 8591A, 8593A, 8594A, 8595A

Note: Specifications apply to all four spectrum analyzers unless otherwise noted.

#### Frequency

##### Frequency range

<b>HP 8591A:</b>	50 $\Omega$	9 kHz to 1.8 GHz
	75 $\Omega$ (Opt 001)	1 MHz to 1.8 GHz
<b>HP 8594A:</b>		9 kHz to 2.9 GHz
<b>HP 8595A:</b>		9 kHz to 6.5 GHz
<b>HP 8593A:</b>		9 kHz to 22 GHz; 9 kHz to 26.5 GHz (Opt 026)

##### Frequency readout accuracy (start, stop, center)

**Span  $\leq$  10 MHz:**  $\pm$  (frequency readout  $\times$  freq ref error + 3% of span + 20% of RBW +  $[100 \times N]$  Hz)

**Span  $>$  10 MHz:**  $\pm$  (frequency readout  $\times$  freq ref error + 3% of span + 20% of RBW)

##### Marker count accuracy (S/N $\geq$ 25 dB, RBW/span $\geq$ 0.01)

**Span  $\leq$  10 MHz:**  $\pm$  (marker freq  $\times$  freq ref error + counter res +  $[100 \times N]$  Hz)

**Span  $>$  10 MHz:**  $\pm$  (marker freq  $\times$  freq ref error + counter res + 1 kHz)

**Counter resolution:** Selectable from 10 Hz to 100 Hz

##### Frequency reference error

	Standard	Opt 004 Precision Freq Ref
<b>Aging</b>	$\pm 2 \times 10^{-6}$ /yr	$\pm 1 \times 10^{-7}$ /yr
<b>Settability</b>	$\pm 0.5 \times 10^{-6}$	$\pm 1 \times 10^{-8}$
<b>Temperature</b>	$\pm 5 \times 10^{-6}$	$\pm 1 \times 10^{-8}$

##### Span range

<b>HP 8591A:</b>	0 Hz (zero span), 10 kHz to 1.8 GHz
<b>HP 8594A:</b>	0 Hz (zero span), 10 kHz to 2.9 GHz
<b>HP 8595A:</b>	0 Hz (zero span), 10 kHz to 6.5 GHz
<b>HP 8593A:</b>	0 Hz (zero span), $[10 \times N]$ kHz to 19.25 GHz, $[10 \times N]$ kHz to 23.75 GHz (Opt 026)

##### Span accuracy

**Span  $\leq$  10 MHz:**  $\pm 2\%$  of span

**Span  $>$  10 MHz:**  $\pm 3\%$  of span

##### Sweeptime

###### Range

**Span = 0 Hz or  $>$  10 kHz:** 20 ms to 100 s

**Opt 101:** 20  $\mu$ s to 100 s

###### Accuracy

**20 ms to 100 s:**  $\pm 3\%$

**20  $\mu$ s to  $<$  20 ms, Opt 101:**  $\pm 2\%$

**Sweep trigger:** Free run, single, line, video, external

##### Stability

**Noise sidebands (1 kHz RBW, 30 Hz VBW, Sample)**

**$>$  10 kHz offset from CW signal**

**HP 8591A:**  $\leq -90$  dBc/Hz

**HP 8594A:**  $\leq -85$  dBc/Hz

**HP 8595A:**  $\leq -85$  dBc/Hz

**HP 8593A:**  $\leq -85 + (20 \log N)$  dBc/Hz

**$>$  30 kHz offset from CW signal**

**HP 8591A:**  $\leq -100$  dBc/Hz

**HP 8594A:**  $\leq -95$  dBc/Hz

**HP 8595A:**  $\leq -95$  dBc/Hz

**HP 8593A:**  $\leq -95 + (20 \log N)$  dBc/Hz

##### Residual FM (1 kHz RBW, 1 kHz VBW)

**HP 8591A:**  $<$  250 Hz p-p in 100 ms

**HP 8594A:**  $<$  400 Hz p-p in 100 ms

**HP 8595A:**  $<$  400 Hz p-p in 100 ms

**HP 8593A:**  $<$   $[400 \times N]$  Hz p-p in 100 ms

**System related sidebands:**  $<$  -65 dBc at  $>$  30 kHz offset from CW signal

**Comb generator (HP 8593A only):** 100 MHz fundamental frequency;  $\pm 0.007\%$  frequency accuracy

# SIGNAL ANALYZERS

## Spectrum Analyzers, Portable (cont'd)

### HP 8590 Series

#### Specifications

#### HP 8591A, 8593A, 8594A, 8595A (continued)

##### Amplitude

##### Amplitude range

<b>HP 8591A:</b>	
50 $\Omega$	-115 to +30 dBm
75 $\Omega$ (Opt 001)	-63 to +75 dBm V
<b>HP 8594A:</b>	-112 to +30 dBm
<b>HP 8595A:</b>	-114 to +30 dBm
<b>HP 8593A:</b>	-114 to +30 dBm

##### Maximum safe input

<b>HP 8591A</b>	<b>50 <math>\Omega</math></b>	<b>75 <math>\Omega</math></b>
<b>Avg cont power</b>	+30 dBm (1 W)	+75 dBmW (0.4 W)
<b>Peak pulse power</b>	+30 dBm (1 W)	+75 dBmV (0.4 W)
<b>dc</b>	25 Vdc	100 Vdc

##### HP 8594A, 8595A, 8593A

**Avg cont power:** +30 dBm (1 W, 7.1 V rms) for input atten  $\geq$  10 dB

**Peak pulse power:** +50 dBm (100 W) for  $<$  10  $\mu$ s pulse width,  $<$  1% duty cycle, input atten  $\geq$  30 dB

**dc:** 0 V (dc coupled); 50 V (ac coupled)

**Gain compression ( $>$  10 MHz):**  $\pm$ 0.5 dB (total power at input mixer = -10 dBm)

##### Displayed average noise level

<b>HP 8591A:</b>	$\leq$ -115 to $\leq$ -113 dBm
<b>HP 8594A:</b>	$\leq$ -112 to $\leq$ -107 dBm
<b>HP 8595A:</b>	$\leq$ -114 to $\leq$ -110 dBm
<b>HP 8593A:</b>	$\leq$ -114 to $\leq$ -92 dBm

##### Spurious responses

##### Second harmonic distortion

**HP 8591A:**  $<$  -70 dBc for -45 dBm tone at input mixer ( $>$  5 MHz)

**HP 8594A, 8595A:**  $<$  -70 dBc for -40 dBm tone at input mixer ( $>$  10 MHz)

**HP 8593A:**  $<$  -70 dBc for -40 dBm tone at input mixer (10 MHz to 2.9 GHz);  $<$  -100 dBc for -10 dBm tone at input mixer or below DANL ( $>$  2.75 GHz)

##### Third-order intermodulation

**HP 8591A:**  $<$  -70 dBc for two -30 dBm tones at input and  $>$  50 kHz separation (5 MHz to 1.8 GHz)

**HP 8594A, 8595A, 8593A:**  $<$  -70 dBc ( $>$  10 MHz)

##### Other input-related spurious ( $\geq$ 30 kHz offset)

**HP 8591A:**  $<$  -65 dBc for -20 dBm tone at input mixer ( $\leq$  1.8 GHz)

**HP 8594A, 8595A:**  $<$  -65 dBc

**HP 8593A:**  $<$  -65 dBc (applied freq  $\leq$  18 GHz);  $<$  -60 dBc (applied freq  $\leq$  22 GHz)

##### Display range

**Log scale:** 0 to -70 dB from reference level is calibrated; 0.1 to 20 dB/division in 1 dB steps; 8 divisions displayed

**Linear scale:** 8 divisions

**Scale units:** dBm, dBm V, dB $\mu$  V, volts, watts

##### Marker readout resolution

**Log scale:** 0.05 dB

**Linear scale:** 0.05% of ref level; 0.07% of ref level (Opt 101)

##### Reference Level

##### Range

<b>HP 8591A:</b>	-115 to +30 dBm (50 $\Omega$ )
	-63 to +75 dBm V (75 $\Omega$ )
<b>HP 8594A:</b>	-112 to +30 dBm
<b>HP 8595A, 8593A:</b>	-114 to +30 dBm

**Resolution:** 0.01 dB for log scale; 0.12% of reference level for linear

**Accuracy** (referred to -20 dBm reference level)

**0 to -59.9 dBm:**  $\pm$  (0.5 dB + input attenuation accuracy at 50 MHz)

**-60 to -114 dBm:**  $\pm$  (1.25 dB + input attenuation accuracy at 50 MHz)

##### Frequency response

**Absolute** (referred to 300 MHz CAL OUT)

**HP 8591A, 8594A, 8595A:**  $\pm$  1.5 dB

**HP 8593A:**  $\pm$  2.0 to  $\pm$  3.0 dB (preselector peaked)

**Relative flatness** (referred to midpoint between highest and lowest frequency response deviations)

**HP 8591A, 8594A, 8595A:**  $\pm$  1.0 dB

**HP 8593A:**  $\pm$  1.5 to  $\pm$  2.0 dB (preselector peaked)

##### Calibrator output

**Frequency:** 300 MHz  $\pm$  (300 MHz  $\times$  freq ref error)

**Amplitude:** -20 dBm  $\pm$  0.4 dB

##### Input attenuator

##### Range

**HP 8591A:** 0 to 60 dB in 10 dB steps

**HP 8594A, 8595A, 8593A:** 0 to 70 dB in 10 dB steps

**Accuracy at 50 MHz** (ref 10 dB atten)

**HP 8591A:**  $\pm$  0.5 dB (20 to 50 dB);  $\pm$  0.75 dB (60 dB)

**HP 8594A, 8595A, 8593A:**  $\pm$  0.5 dB (0 to 60 dB);  $\pm$  1.2 dB (70 dB)

**Resolution bandwidth:** 1 kHz to 3 MHz,  $\pm$  20%; 9 kHz and 120 kHz (6 dB) EMI bands

**Switching uncertainty:**  $\pm$  0.4 dB (3 kHz to 3 MHz RBW);  $\pm$  0.5 dB (1 kHz)

**Video bandwidth range:** 30 Hz to 1 MHz

**Log to linear switching:**  $\pm$  0.25 dB at reference level

##### Display scale fidelity

**Log incremental accuracy:**  $\pm$  0.2 dB/2 dB (0 to -70 dB from reference level)

**Log maximum cumulative:**  $\pm$  0.75 dB (0 to -60 dB from reference level) and  $\pm$  1.0 dB (0 to -70 dB from reference level)

**Linear accuracy:**  $\pm$  3% of reference level

##### General Specifications

##### Temperature

**Operating:** 0 $^{\circ}$  C to +55 $^{\circ}$  C

**Storage:** -40 $^{\circ}$  C to +75 $^{\circ}$  C

**EMI compatibility:** Conducted and radiated interference CISPR Pub. 11 and Messempfaenger Postverfuegung 526/527/79

**Audible noise:**  $<$  37.5 dBA pressure and  $<$  5.0 Bels power (ISDP7779)

**Power requirements:** 86 to 127 V rms, or 195 to 250 V rms, 47 to 66 Hz; 103 to 126 V rms, 400 Hz  $\pm$  10%

## Specifications

### HP 8590B and 8592B

Note: Specifications apply to both the HP 8590B and HP 8592B spectrum analyzers unless otherwise noted.

#### Frequency

##### Frequency range

###### HP 8590B:

50  $\Omega$  9 kHz to 1.8 GHz  
75  $\Omega$  (Opt 001) 1 MHz to 1.8 GHz

###### HP 8592B:

9 kHz to 22 GHz

Band	Harmonic mode (n)	Center frequency
0	1-	9 kHz to 2.9 GHz
1	1-	2.75 GHz to 6.4 GHz
2	2-	6.0 GHz to 12.8 GHz
3	3-	12.4 GHz to 19.4 GHz
4	4-	19.1 GHz to 22 GHz

##### Frequency readout accuracy (start, stop, center)

**HP 8590B:**  $\pm(5 \text{ MHz} + 1\%$  of frequency span)

**HP 8592B:**  $\pm[(5 \times N) \text{ MHz} + 0.01\%$  of center frequency + 2% of frequency span]

#### Span

##### Range:

**HP 8590B:** 0 Hz (zero span), 50 kHz to 1.8 GHz

**HP 8592B:** 0 Hz [50  $\times$  N] kHz to 19.25 GHz

##### Accuracy:

**HP 8590B:**  $\pm 3\%$  of indicated span

**HP 8592B:**  $\pm 2\%$  of span for span > 10 MHz and single band spans,  $\pm 5\%$  of span for span  $\leq$  10 MHz and single band spans

#### Sweep time

**Range:** 20 ms to 100 s

**Accuracy:**  $\pm 3\%$  of indicated sweep time

**Sweep trigger:** Free run, single, line, video, external

#### Stability

**Drift:** < 75 kHz/5 minutes after 2-hour warmup and 5 minutes after setting center frequency

##### Noise sidebands

**HP 8590B:** < -95 dBc/Hz at > 30 kHz offset from CW signal

**HP 8592B:** < [-95 + 20 log N] at > 30 kHz offset from CW signal

**System related sidebands:** < -65 dBc at > 30 kHz offset from CW signal

#### Amplitude

##### Amplitude range

###### HP 8590B:

50  $\Omega$  -115 dBm to +30 dBm  
75  $\Omega$  (Opt 001) -63 dBm V to +75 dBm V

###### HP 8592B:

-114 dBm to +30 dBm

**Maximum safe input level:** 50  $\Omega$  75  $\Omega$

**Avg. continuous power** +30 dBm (1 W) +75 dBm V (0.4 W)

**Peak pulse power** +30 dBm (1 W) +75 dBm V (0.4 W)

**dc** 25 Vdc 100 Vdc

**Gain compression (> 10 MHz):**  $\leq 0.5$  dB (total power at input mixer = -10 dBm)

**Displayed average noise level (input terminated, 0 dB atten, 1 kHz RBW, 30 Hz VBW)**

**HP 8590B:** < -115 dBm to < -113 dBm

**HP 8592B:** < -114 dBm to < -92 dBm

#### Spurious responses

##### Second harmonic distortion (> 5 MHz)

**HP 8590B:** < -70 dBc for -45 dBm tone at input mixer

###### HP 8592B:

**10 MHz to 2.9 GHz:** < -70 dBc for -40 dBm tone at input mixer

**> 2.75 GHz:** < -100 dBc for -10 dBm tone at input mixer (or below DANL)

#### Third-order intermodulation

##### HP 8590B

**Distortion > 5 MHz:** < -70 dBc for two -30 dBm tones at input mixer

**Other input-related:** < -65 dBc for  $\geq 30$  kHz offset from CW signal

##### HP 8592B

**Distortion > 10 MHz:** < -65 dBc for two -30 dBm tones at input mixer and > 50 kHz separation

**Other input-related:** < -65 dBc for applied freq  $\leq 18$  GHz; < -60 dBc for applied freq  $\leq 22$  GHz

#### Display range

**Log scale:** 0 to -70 dB from reference level is calibrated; 1 to 20 dB/division in 1 dB steps; 8 divisions displayed

**Linear scale:** 8 divisions

**Scale units:** dBm, dBm V, dBm  $\mu$ V, volts, watts

**Marker readout resolution:** 0.05 dB for log scale; 0.05% of reference level for linear

#### Reference level

##### Range

**HP 8590B:** -115 dBm to +30 dBm (50  $\Omega$ )

-63 to +75 dBm V (75  $\Omega$ )

**HP 8592B:** -114 dBm to +30 dBm

**Resolution:** 0.01 dB for log scale; 0.12% of reference level for linear

**Accuracy (referred to -20 dBm reference level)**

**0 to -59.9 dBm:**  $\pm(0.5 \text{ dB} + \text{input attenuation accuracy at } 50 \text{ MHz})$

**-60 to -114 dBm:**  $\pm(1.25 \text{ dB} + \text{input attenuation accuracy at } 50 \text{ MHz})$

#### Frequency response (10 dB input atten)

##### HP 8590B

**Absolute:**  $\pm 1.5$  dB, ref to 300 MHz CAL OUT

**Relative:**  $\pm 1.0$  dB, referred to midpoint between highest and lowest frequency response deviations

##### HP 8592B - preselector peaked

**Absolute:**  $\pm 2.0$  to  $\pm 3.0$  dB (300 MHz CAL OUT)

**Relative:**  $\pm 1.5$  to  $\pm 2.0$  dB

#### Calibrator output

**Frequency:** 300 MHz  $\pm 30$  kHz

**Amplitude:** -20 dBm  $\pm 0.4$  dB (50  $\Omega$  - HP 8590B/92B)

+28.75 dBm V  $\pm 0.4$  dB (75  $\Omega$ , Opt 001)

#### Input attenuator

**Range:** 0 to 60 dB, 10 dB steps

**Accuracy:**  $\pm 0.5$  dB at 50 MHz (ref 10 dB atten, 0 to 50 dB)  
 $\pm 0.75$  dB at 50 MHz (ref 10 dB atten, 60 dB)

**Resolution bandwidth:** 1 kHz to 3 MHz, -3 dB nominal

**Switching uncertainty, referred to 3 kHz RBW:**  $\pm 0.4$  dB for 3 kHz to 3 MHz RBW;  $\pm 0.5$  dB for 1 kHz

**Video bandwidth range:** 30 Hz to 1 MHz

**Log to linear switching:**  $\pm 0.25$  dB at reference level

#### Display scale fidelity

**Log incremental accuracy:**  $\pm 0.2$  dB/2 dB, 0 to -70 dB from reference level

**Log maximum cumulative:**  $\pm 0.75$  dB, 0 to -60 dB from reference level

**Linear accuracy:**  $\pm 3\%$  of reference level

#### General

##### Temperature range

**Operating:** 0° to +55° C

**Storage:** -40° to +75° C

**EMI compatibility:** CISPR Pub 11 and FRZ 526/527/79

**Audible noise:** < 37.5 dBA pressure and < 5.0 Bels power (ISODP7779)

**Power requirements:** 86 to 127 or 195 to 250 V rms, 47 to 66 Hz; 103 to 126 V rms, 400 Hz  $\pm 10\%$

# SIGNAL ANALYZERS

## Spectrum Analyzers, Portable (cont'd)

### HP 8590 Series

#### Options

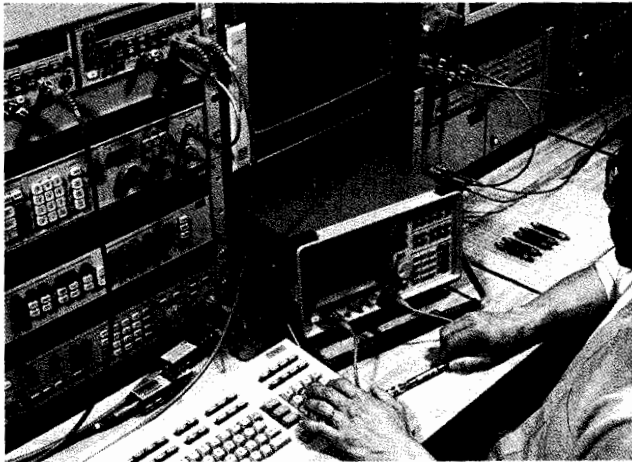

HP 8590 series RF spectrum analyzers have built-in tracking generator option.

#### Option 010 and 011 Built-in Tracking Generators

Option 010 (50 ohms) is available for all HP 8590 series spectrum analyzers except the HP 8592B. Option 011 (75 ohms) is available for the HP 8590B and 8591A only.

<b>Frequency range:</b>	<b>50 Ω</b>	<b>75 Ω</b>
<b>HP 8590B, 8591A</b>	100 kHz to 1.8 GHz	1 MHz to 1.8 GHz
<b>HP 8594A, 8595A, 8593A</b>	300 kHz to 2.9 GHz	
<b>Tracking drift (nominal, 30-min warmup)</b>		
<b>HP 8590B</b>	1.5 kHz/5 min (10 kHz RBW)	
<b>HP 8591A, 8594A, 8595A, 8593A</b>	1 kHz/5 min (1 kHz RBW)	
<b>Output power level</b>		
<b>Range:</b>	<b>50 Ω</b>	<b>75 Ω</b>
<b>HP 8590B</b>	0 to -15 dBm	+42.8 to +27.8 dBmV
<b>HP 8591A</b>	0 to -70 dBm	+42.8 to -27.2 dBmV
<b>HP 8594A, 8595A, 8593A</b>	+1 to -10 dBm	
<b>Resolution:</b>	0.1 dB	0.1 dB
<b>Absolute accuracy:</b>	<b>HP 8590B</b>	±1.5 dB
	<b>HP 8591A</b>	±1.0 dB
	<b>HP 8594A, 8595A, 8593A</b>	±0.75 dB

#### Output vernier accuracy

<b>HP 8590B</b>	±1.0 dB
<b>HP 8591A</b>	±0.75 dB
<b>HP 8594A, 8595A, 8593A</b>	±0.50 dB

#### Output flatness (referred to 300 MHz):

<b>HP 8590B</b>	±1.75 dB
<b>HP 8591A (10 dB attenuator)</b>	±1.75 dB
<b>HP 8594A, 8595A, 8593A (0 dBm)</b>	±2.0 dB

#### Output attenuator (HP 8591A only)

**Range:** 0 to 60 dB in 10 steps  
**Switching accuracy (at 30 MHz):** ±0.8 dB or 2.5% of attenuator setting, whichever is greatest, for maximum of 1.5 dB (referred to 10 dB source attenuator setting)

#### Tracking generator feedthrough

<b>HP 8590B, 8591A:</b>	< -106 dBm (50 Ω); < -57.24 dBmV (75 Ω)
<b>HP 8594A, 8593A:</b>	< -107 dBm (400 kHz to 5 MHz); < -112 dBm (5 MHz to 2.9 GHz)
<b>HP 8595A:</b>	< -110 dBm (5 MHz to 2.9 GHz)

#### Output VSWR (nominal)

<b>HP 8591A:</b>	< 2.5:1 (0 dB attenuation)
	< 1.6:1 (10 dB attenuation)
<b>HP 8594A, 8595A, 8593A:</b>	< 2.0:1

#### Ordering Information

<b>HP 8590B</b> Spectrum Analyzer (9 kHz to 1.8 GHz)	\$9,985
<b>HP 8592B</b> Spectrum Analyzer (9 kHz to 22 GHz)	\$21,650
<b>Opt 001</b> 75 Ω Input (HP 8590B only)	+ \$0
<b>Opt 003</b> Card Reader	+ \$620
<b>Opt 010</b> Tracking Generator 50 Ω (HP 8590B only)	+ \$4,300
<b>Opt 011</b> Tracking Generator 75 Ω (HP 8590B only)	+ \$4,300
<b>Opt 021</b> HP-IB Interface	+ \$650
<b>Opt 023</b> RS-232 Interface	+ \$650
<b>HP 8591A</b> Spectrum Analyzer (9 kHz to 1.8 GHz)	\$12,825
<b>HP 8594A</b> Spectrum Analyzer (9 kHz to 2.9 GHz)	\$14,995
<b>HP 8595A</b> Spectrum Analyzer (9 kHz to 6.5 GHz)	\$20,750
<b>HP 8593A</b> Spectrum Analyzer (9 kHz to 22 GHz)	\$27,255

#### Options

<b>Opt 001</b> 75 Ω Input (HP 8591A only)	+ \$0
<b>Opt 004</b> Precision Frequency Reference	+ \$2,200
<b>Opt 010</b> 50 Ω Built-in Tracking Generator	+ \$4,900
<b>Opt 011</b> 75 Ω Built-in Tracking Generator (HP 8591A only)	+ \$4,900
<b>Opt 021</b> HP-IB Interface	+ \$650
<b>Opt 023</b> RS-232 Interface	+ \$650
<b>Opt 026</b> 26.5 GHz Frequency Extension (HP 8593A only)	+ \$3,415
<b>Opt 101</b> Fast Time Domain Sweeps	+ \$1,050
<b>Opt 102</b> AM/FM Demodulator and TV Sync Trigger	+ \$1,575
<b>Opt 103</b> Quasi-Peak Detector/AM-FM Demodulator	+ \$1,700
<b>Opt 105</b> Time-gated Spectrum Analysis	+ \$2,075
<b>Opt 301</b> TV Sync Trigger (HP 8591A, 8594A, 8595A)	+ \$2,625

#### Measurement Personalities

<b>HP 85700A</b> Blank 32-Kbyte Memory Card	\$105
<b>HP 85711A</b> CATV Measurement Personality	\$620
<b>HP 85712B</b> EMC Measurement Personality	\$860
<b>HP 85713A</b> Digital Radio Measurement Personality	\$880
<b>HP 85714A</b> Scalar Measurement Personality	\$985
<b>HP 85715A</b> GSM Measurement Personality	\$2,080

#### Selected Accessories

<b>HP 85901A</b> Portable ac Power Source	\$1,290	☐
<b>HP 11758T</b> Digital Radio Test Set	\$61,000	
<b>HP 11945A</b> Opt E51 Close-Field Probe Set	\$2,720	☐
<b>HP 11946A</b> Quasi-Peak Adapter/AM-FM Demodulator Upgrade Kit	\$1,910	
<b>HP 8447D</b> Broadband Preamplifier (100 kHz to 1.3 GHz)	\$1,650	☐
<b>HP 41800A</b> Active Probe (5 Hz to 500 MHz)	\$1,740	☐
<b>HP 85024A</b> High-Frequency Probe (300 kHz to 3 GHz)	\$2,100	☐
<b>HP 2225A/B</b> ThinkJet Printer	\$595	☐
<b>HP 7440A</b> ColorPro Plotter	\$1,295	☐

☐ For off-the-shelf shipment, call 800-452-4844.

- Synthesized tuning
- Frequency counter
- Digital bandwidths
- AM/FM demodulator
- Adjacent channel power and occupied bandwidth

- Meets all MIL-T-28800C specifications for ruggedness
- Optional precision frequency reference, tracking generator, mass memory
- One-year calibration cycle

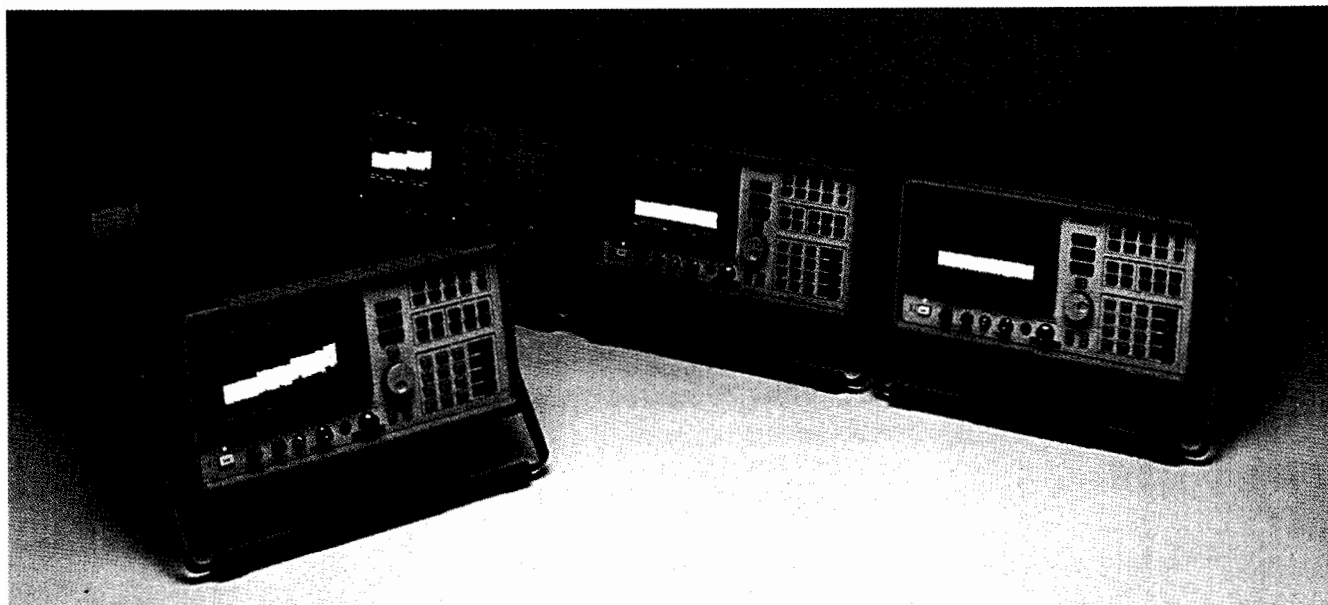

HP 8560 Series



## HP 8560 Series Spectrum Analyzers

These portable spectrum analyzers are HP's highest-performing portables. They combine MIL-rugged packaging, synthesized tuning, and HP's traditional ease of use as standard features.

The HP 8560A has a frequency range of 50 Hz to 2.9 GHz. A built-in tracking generator is optional. The HP 8561B has a frequency range of 50 Hz to 6.5 GHz. For higher, preselected frequency coverage, the HP 8562A and 8563A operate from 9 kHz to 22 GHz and 26.5 GHz, respectively. Using HP 11974 series millimeter mixers, preselected coverage reaches 75 GHz, and with other mixers, unpreselected coverage can be extended to 325 GHz. (See page 254 for information on HP millimeter mixers.)

### Rugged for Field Service

The HP 8560 series meets all MIL-T-28800C requirements, including those for temperature, pulse shock, and transit drop. These analyzers are warmed up and running in only 5 minutes. They fully meet specifications at temperatures from  $-10^{\circ}$  to  $+55^{\circ}$  C, and can withstand 30 g's of shock.

### Narrow Digital Resolution Bandwidths

For fast, accurate measurements of closely spaced signals, the HP 8560A, 8561B, and 8563A feature digital 10 Hz, 30 Hz, and 100 Hz resolution bandwidths. These bandwidths allow the analyzers to sweep as much as 20 times faster than do conventional analog bandwidths. Digital bandwidths also provide the spectrum analyzer CRT with a calibrated measurement range of 100 dB.

### Improved Frequency Accuracy

An optional precision frequency reference improves frequency accuracy to less than  $\pm 150$  Hz at 1 GHz after a 15-minute warmup (1-year aging). This capability comes standard on the HP 8563A.

### Specified Pulse Response

These portables easily capture and accurately display short-duration radar pulses. Specified pulse-digitization uncertainty is less than 1.25 dB and typical repeatability is less than 0.2 dB.

### Occupied Bandwidth and Adjacent Channel Power

The HP 8560A, 8561B, and 8563A help you characterize radio transmitters with easy-to-use occupied bandwidth and adjacent channel power functions. Use the occupied bandwidth function to determine the 99% power bandwidth of the signal. The total transmitted power and the adjacent channel power are determined by the adjacent channel power measurement.

### Scalar Network Analysis Capability

Two new tracking sources allow the HP 8560 series to make high-performance scalar network analysis measurements at microwave frequencies. The frequency range of the new HP 85644A is 300 kHz to 6.5 GHz, and the new HP 85645A extends to 26.5 GHz. (See page 249.) For RF testing, the HP 85640A tracking generator and the optional built-in tracking generator for the HP 8560A both cover a frequency range of 300 kHz to 2.9 GHz.

### HP 85620A Mass Memory Module

This plug-in module adds extra memory and computer capability to the HP 8560 series. It allows you to create complex measurement routines that can be saved as single-key measurements using downloadable programming. Your DLPs can be stored on 32-Kbyte memory cards or in the 128-Kbyte battery-backed RAM of the mass memory module. You can also store traces with state information, and create and store limit lines. A clock/calendar and automatic save and execute functions let you set the analyzer for unattended, automatic measurements when specified criteria are met. This module comes standard with the HP 8563A.

### HP 85629B Test and Adjustment Module

This accessory creates a whole new approach to servicing your spectrum analyzer. The module plugs into the rear panel of an HP 8560 series analyzer and automates high-level diagnostics, self-tests, and adjustment procedures. It performs more than 1000 troubleshooting measurements. Readjustments are fast and accurate because the module controls internal analyzer settings as well as external test equipment.

# SIGNAL ANALYZERS

## Spectrum Analyzers, High-Performance Portable (cont'd)

HP 8560A, 8561B, 8562A, 8563A



HP 8563A



### HP 8560A and 8561B RF Spectrum Analyzers

The HP 8560A and 8561B offer excellent performance for RF design and service applications. The HP 8560A has a frequency range of 50 Hz to 2.9 GHz, and the HP 8561B extends this range up to 6.5 GHz. Both have synthesized tuning for drift-free, accurate measurements. They also have a sensitivity of  $-130$  dBm and digital bandwidths of 10, 30, and 100 Hz. Both analyzers meet MIL-T-28800C specifications for ruggedness.

Manual control is simple with an easy-to-use combination of hard-keys and softkeys that minimizes the number of keystrokes required to make measurements. Other measurement features include advanced marker capability and built-in AM and FM demodulators. Hard copies of results are easily obtained using the analyzers' direct print and plot functions or by using a computer.

Scalar measurement capability is made available by adding an optional built-in tracking generator to the HP 8560A or by using the HP 85640A tracking generator or a new HP 85644A or 85645A tracking source with either analyzer. For millimeter applications that don't require full microwave coverage, the HP 8560A and 8561B provide lower-cost solutions. Both are compatible with HP 11970 series harmonic mixers and HP 11974 series preselected mixers. For very precise measurements, consider adding an optional precision frequency reference. It gives frequency accuracy of less than  $\pm 150$  Hz at 1 Gz.

### HP 8562A and 8563A Microwave Spectrum Analyzers

The HP 8562A and 8563A extend the features and capabilities of the RF members of the HP 8560 series into the microwave frequency range. In addition, both the HP 8562A and the 8563A have standard,

preselected frequency ranges of 9 kHz to 22 GHz and 26.5 GHz, respectively. (The frequency range of the HP 8562A can be extended to 26.5 GHz with Option 026.) Their internal preselector requires no adjustment after 30 minutes at room temperature. This means faster measurements, which can be especially important in automated testing. For millimeter-wave measurements, preselection can be extended to 75 GHz using the HP 11974 series millimeter mixers. Unpreselected frequency range can be extended to 110 GHz using the HP 11970 series mixers and to 325 GHz using mixers from other manufacturers. (See page 254 for more information on HP millimeter mixers.)

The HP 8562A has a sensitivity of  $-110$  dBm. The HP 8563A has a sensitivity of  $-120$  dBm and digital resolution bandwidths of 10, 30, and 100 Hz. The HP 8563A also features 128 Kbytes of battery-backed RAM that stores up to 100 traces and states; limit-line capability for defining test criteria; and a built-in clock/calendar for time- and date-stamping traces and other output data. (These features can be added to the HP 8562A with the mass memory module accessory.) Scalar measurement capability to 6.5 GHz or 26.5 GHz can be added using a new HP 85644A or 85645A tracking source.

### HP 85710A Digital Radio Measurement Personality

This measurement program, stored on a memory card, customizes the HP 8562A and 8563A microwave spectrum analyzers for digital radio measurements. It contains five agency masks for testing to U.S. FCC, UK, and FRG specifications. A compare-to-mask function allows you to characterize spectral emissions. Other functions include mean power level, transient analysis monitoring, and frequency response measurements. You can also create and store your own custom masks.



## Specifications

### Frequency

#### Frequency range

**HP 8560A:** 50 Hz to 2.9 GHz (dc-coupled); 100 kHz to 2.9 GHz (ac-coupled)

**HP 8561B:** 50 Hz to 6.5 GHz (dc-coupled); 100 kHz to 6.5 GHz (ac-coupled)

**HP 8562A:** 9 kHz to 22 GHz; 9 kHz to 26.5 GHz (Opt 026)

**HP 8563A:** 9 kHz to 26.5 GHz

Harmonic mode (n)	Center frequency
1	9 kHz to 2.9 GHz
1	2.75 to 6.46 GHz
2	5.86 to 13 GHz
3	12.4 to 19.7 GHz
4	19.1 to 22 GHz
4	19.1 to 26.5 GHz

**Frequency readout accuracy** (start, stop, center, or marker):  $\pm$ (freq readout  $\times$  freq ref acc'y + 5%  $\times$  span + 15%  $\times$  RBW + 10 Hz)

**Counter resolution:** 10 Hz to 1 MHz (HP8562A, selectable); 1 Hz to 1 MHz (HP 8560A, 8561B, 8563A, selectable)

**Marker counter accuracy** (S/N  $\geq$  25 dB):  $\pm$ (marker freq  $\times$  freq ref acc'y + 50 Hz  $\times$  n + 1 LSD)

**Delta counter accuracy** (S/N  $\geq$  25 dB):  $\pm$ (delta freq  $\times$  freq ref acc'y + 100 Hz  $\times$  n + 2 LSD)

**Frequency reference accuracy** (after 5-min warmup)

**HP 8560A, 61B, 62A standard:**  $< 4 \times 10^{-6}$ /yr (includes aging, temp drift, settability)

**Opt 003 precision frequency reference** (standard on HP 8563A):  $< 0.13 \times 10^{-6}$ /yr (includes aging, temp drift, settability, 15-min. warmup)

**Residual FM** (zero span)

**HP 8560A and 8561B:**  $< 10$  Hz peak-to-peak in 20 ms ( $< 2$  Hz peak-to-peak w/Opt 003)

**HP 8562A:**  $< 50$  Hz  $\times$  N peak-to-peak in 100 ms ( $< 2$  Hz  $\times$  N peak-to-peak w/Opt 003)

**HP 8563A:**  $< 2$  Hz  $\times$  N peak-to-peak in 20 ms

**Spectral purity**

**Noise sidebands:**  $< (-100 + 20 \log n)$  dBc/Hz at 30 kHz offset

**Frequency span**

**Range**

**HP 8560A:** 0 Hz, 100 Hz to 2.9 GHz

**HP 8561B:** 0 Hz, 100 Hz to 6.5 GHz

**HP 8562A:** 0 Hz, 2.5 kHz  $\times$  N to 19.25/23.75 GHz (Opt 026)

**HP 8563A:** 0 Hz, 100 Hz  $\times$  N to 23.75 GHz

**Accuracy:**  $< \pm 5\%$

**Resolution bandwidth** (-3 dB)

**Range**

**HP 8560A, 8561B, and 8563A:** 10 Hz to 1 MHz in a 1, 3, 10 sequence, and 2 MHz

**HP 8562A:** 100 Hz to 1 MHz in a 1, 3, 10 sequence, and 2 MHz

**Accuracy**

**HP 8560A, 8561B, and 8563A:**  $\pm 10\%$  (10 Hz to 300 kHz);  $\pm 25\%$  (1 MHz, 2 MHz)

**HP 8562A:**  $\pm 30\%$  (100 Hz);  $\pm 10\%$  (300 Hz to 300 kHz);  $\pm 25\%$  (1 MHz, 2 MHz)

**Selectivity** (-60 dB/-3 dB)

**HP 8560A, 8561B, and 8563A:**  $< 5:1$  (RBW  $\leq$  100 Hz);  $< 15:1$  (RBW  $>$  100 Hz)

**HP 8562A:**  $< 15:1$

**Video bandwidth**

**Range:** 1 Hz to 3 MHz in a 1, 3, 10 sequence

**Amplitude**

**Amplitude range:** +30 dBm to displayed average noise level

**Maximum safe input**

**Average continuous power:** +30 dBm (1W) with input atten  $> 10$  dB

**Peak pulse power:** +50 dBm (100 W) with input atten  $\geq 30$  dB for  $< 10 \mu$ s pulse width and  $< 1\%$  duty cycle

**DC:** 0 V

**Display range**

**Display:**  $10 \times 10$  division graticule

**Calibration:** Log = 10, 5, 2, and 1 dB per division; linear = 10% of reference level/division

**Reference level range:** Log = -120 to +30 dBm in 0.1 dB steps; linear = 2.2  $\mu$ V to 7.07 V in 1% steps

**Input attenuation range:** 0 to 70 dB in 10 dB steps

**Dynamic Range**

**Maximum dynamic range**

**Compression to noise**

**HP 8560A:** 125 dB

**HP 8561B and 8563A:** 128 dB

**HP 8562A:** 118 dB

**Signal to distortion, harmonic**

**HP 8560A:** 81 dB

**HP 8561B and 8563A:** 81 dB ( $< 2.9$  GHz), 110 dB ( $\geq 2.9$  GHz)

**HP 8562A:** 76 dB ( $< 2.9$  GHz), 105.5 dB ( $\geq 2.9$  GHz)

**Signal to distortion, intermodulation**

**HP 8560A:** 90 dB

**HP 8561B and 8563A:** 90 dB ( $< 2.9$  GHz), 92 dB ( $\geq 2.9$  GHz)

**HP 8562A:** 83 dB ( $< 2.9$  GHz), 86 dB ( $\geq 2.9$  GHz)

**Displayed average noise level** (minimum RBW, 0 dB input attenuation, 1 Hz video BW, no signal at input)

Frequency	HP 8560A	HP 8561B	HP 8562A	HP 8563A
10 kHz	-103 dBm	-103 dBm	-90 dBm	-103
100 kHz	-110 dBm	-110 dBm	-100 dBm	-110
1 MHz to 2.9 GHz	-130 dBm	-130 dBm	-120 dBm	-130
2.75 to 6.46 GHz		-131 dBm	-121 dBm	-131
5.86 to 13.0 GHz			-110 dBm	-120
12.4 to 19.7 GHz			-105 dBm	-115
19.1 to 22.0/ 26.5 GHz			-100 dBm	-110

**1 dB gain compression:** -5 dBm at input mixer (10 MHz to 2.9 GHz); -3 dBm at input mixer ( $> 2.75$  GHz)

**Spurious responses** (signals generated by analyzer due to input signals): For mixer level  $< -40$  dBm,  $> 60$  dB below input signal for frequencies  $< 6.46$  GHz

**Second harmonic distortion**

Frequency	Mixer Level	HP 8560A	HP 8561B	HP 8562A/8563A
50 Hz to 10 MHz	-40 dBm	-60 dBc	-60 dBc	
10 MHz to 2.9 GHz	-40 dBm	-72 dBc	-72 dBc	-72 dBc
$> 2.75$ GHz	-10 dBm		-100 dBc	-100 dBc

**Third-order intermodulation** (two -30 dBm signals at mixer): -64 dBc, 50 Hz to 10 MHz (HP 8560A and 8561B); -70 dBc, 10 MHz to 2.9 GHz; -75 dBc,  $> 2.75$  GHz (HP 8561B, 8562A, 8563A)

**Image, multiple, and out-of-band responses:**  $< -70$  dBc, 10 MHz to 22 GHz;  $< -60$  dBc, 10 MHz to 22 GHz

**Residual responses** (no signal at input, 0 dB input atten):

$< -90$  dBm,  $> 200$  kHz

**Amplitude Accuracy**

**Frequency response** (relative)

**HP 8560A:**  $\pm 1.0$  dB (dc-coupled)

**HP 8561B:**  $\pm 1.0$  dB (dc-coupled, 50 Hz to 2.9 GHz);  $\pm 1.5$  dB (dc-coupled, 2.75 to 6.5 GHz)

**HP 8562A/8563A**

Frequency Range	HP 8562A/8563A
9 kHz to 2.9 GHz	$\pm 1.0$ dB
2.75 to 6.46 GHz	$\pm 1.5$ dB
5.86 to 13.0 GHz	$\pm 2.0$ dB
12.4 to 19.7 GHz	$\pm 3.0$ dB
19.1 to 22.0 GHz	$\pm 3.0$ dB
19.1 to 26.5 GHz	$\pm 3.0$ dB



# SIGNAL ANALYZERS

## Accessories for Scalar Measurements (cont'd)

HP 85630A, 85640A, 85644A, 85645A, 85714A

**Calibrator accuracy:**  $\pm 0.3$  dB

**IF gain uncertainty:**  $\pm 1$  dB for 0 dBm to  $-80$  dBm reference level

**Scale fidelity:**  $\pm 0.4$  dB/4 dB to a maximum of  $\pm 1.5$  dB over 0 to 90 dB range; linear,  $\pm 3\%$  of reference level

**Input attenuator switching accuracy** (with 20 to 70 dB settings referenced to 10 dB):  $< 2.9$  GHz  $\pm 0.6$  dB/10 dB step,  $\pm 1.8$  dB max

**Resolution bandwidth switching uncertainty:**  $\pm 0.5$  dB referenced to 300 kHz BW

**Pulse digitization uncertainty** (pulse-response mode, PRF  $> 720$ /sweep time)

**Log** (peak-to-peak): 1.25 dB (RBW  $\leq 1$  MHz), 3 dB (RBW = 2 MHz)

**Linear** (peak-to-peak): 4% of ref level (RBW  $\leq 1$  MHz); 12% of ref level (RBW = 2 MHz), nominal standard deviation 0.2 dB

### Sweep

#### Sweep time

**Range:** 50  $\mu$ s to 60 s (zero span); 50 ms to 100 s (span  $> 0$ )

**Sweep trigger:** free run, line, single, video, external

### Demodulation

**Modulation type:** AM and FM

**Audio output:** Speaker and phone jack with volume control

### Inputs and Outputs (all values are nominal)

#### Front-panel connectors

**RF input:** Precision type N (female), impedance 50 ohms

**VSWR:**  $< 1.5:1$  for  $< 2.9$  GHz and  $\geq 10$  dB input atten;  $< 2.3:1$  for  $> 2.9$  GHz and  $\geq 10$  dB input atten

**LO emission level** (average): with 10 dB input atten,  $< -80$  dBm

**Second IF input:** SMA (female), frequency 310.7 MHz; NF 7 dB

**First LO output:** SMA (female), impedance 50 ohms; freq range 3.0000 to 6.8107 GHz; amplitude  $+16.5$  dBm  $\pm 2$  dB ( $20^\circ$  to  $30^\circ$  C);  $+14.5$  dBm  $\pm 2$  dB (HP 8560A Opt 002)

**Calibrator output:** BNC (female), impedance 50 ohms

#### Rear-panel connectors

**10 MHz reference (input/output):** BNC (female), impedance 50 ohms; input range  $-2$  to  $+10$  dBm

**Video output:** BNC (female), impedance 50 ohms (dc-coupled)

**LO sweep/0.5 V per GHz output:** shared BNC (female), impedance 2,000 ohms (dc-coupled); LO sweep output 0 to  $+10$  V (no load)

**External trigger input:** BNC (female), impedance  $> 10,000$  ohms; trigger level, rising edge of TTL level

#### HP-IB

**Interface functions:** SH1, AH1, T6, TE0, L4, LE0, SR1, RL1, PP1, PC1, DT1, C1, C28

**Direct plotter outputs:** HP 7440A, 7470A, 7475A, 7550A

**Printers:** HP 3630A PaintJet, HP 2225A ThinkJet; other printers with IEEE 488 interface may work

### General Specifications

#### Environmental

**Military specifications:** Meets MIL-T-28800C, Type III, Class 3, Style C

**Calibration interval:** 1 year

**Warmup:** 5 minutes from ambient conditions

**Temperature:**  $-10^\circ$  to  $+55^\circ$  C, operating;  $-62^\circ$  to  $+85^\circ$  C, not operating

**Humidity:** 95% at  $40^\circ$  C for 5 days

**Altitude:** 15,000 ft, operating; 50,000 ft, not operating

**Rain resistance:** Drip-proof at 16 liters/hour/ft<sup>2</sup>

**Vibration:** 0.059 inch peak-to-peak excursion (5 to 15 Hz); 0.039 inch peak-to-peak excursion (15 to 25 Hz); 0.020-inch peak-to-peak excursion (25 to 55 Hz)

**Pulse shock:** Half sine, 30 g's for 11 ms duration

**Transit drop:** 8-inch drop on 6 faces and 8 corners

**Electromagnetic compatibility:** Conducted and radiated interference in compliance with CISPR Publication 11 (1985) and FTZ 526/527/79. Meets MIL-STD 461B, Part 4, with exceptions noted below.

**Conducted emissions:** CE01 (narrowband), 1 to 15 kHz only; CE03 (narrowband), full limits; CE03 (broadband), 20 dB relaxation from 15 to 100 kHz

**Conducted susceptibility:** CS01, full limits; CS02, full limits; CS06, full limits

**Radiated emissions:** RE01, 15 dB relaxation to 28 kHz and exceptioned from 28 to 50 kHz; RE02, full limits  $< 1$  GHz

**Radiated susceptibility:** RS01, full limits; RS02, exceptioned; RS03, limited to 1 V/meter from 14 kHz to 1 GHz with 20 dB relaxation at IF frequencies

#### Power requirements

**115 Vac operation:** Voltage 90 to 140 V rms; current 3.2 A rms max; frequency, 47 to 440 Hz

**230 Vac operation:** Voltage 180 to 250 V rms; current 1.8 A rms max; frequency 47 to 66 Hz

**Maximum power dissipation:** 180 W

**Nominal audible noise:** 5.0 Bels power at room temp (ISO DP7779)

#### Nominal weight

**HP 8560A:** 18.2 kg (40 lb)

**HP 8561B, 8562A and 8563A:** 20 kg (44 lb)

**Size:** 163 mm H  $\times$  325 mm W  $\times$  427 mm D (nominal, without handle, feet, or cover)

### Option 002 Built-in Tracking Generator (HP 8560A only)

#### Frequency

**Frequency range:** 300 kHz to 2.9 GHz

**Tracking drift:** Usable in 1 kHz RBW after 5-minute warmup; usable in 300 Hz RBW after 30-minute warmup

**Minimum usable RBW:** 300 Hz

#### Amplitude

**Output level:**  $-10$  to  $+1$  dBm

**Resolution:** 0.1 dB

#### Accuracy

**Vernier:**  $\pm 0.20$  dB/dB,  $\pm 0.5$  dB max ( $25^\circ$  C  $\pm 10^\circ$  C)

**Absolute:**  $\pm 0.75$  dB

**Level flatness:**  $\pm 2.0$  dB

**Return loss:** 10 dB

**Dynamic range:** 96 dB at 300 kHz to 1 MHz; 116 dB at 1 MHz to 2.7 GHz; 111 dB at 2.7 to 2.9 GHz

**Power sweep:** 10 dB range, 0.1 dB resolution

#### Input/output

**RF output (front panel):** type N (female), 50 ohm nominal

**Ext ALC input (rear panel):** BNC (female); use with negative detector

### Ordering Information

Model	Price
HP 8560A RF Spectrum Analyzer	\$24,995
HP 8561B RF Spectrum Analyzer	\$31,000
HP 8562A Microwave Spectrum Analyzer	\$38,995
HP 8563A Microwave Spectrum Analyzer	\$35,600

#### Options

Opt 001 Second IF Output (standard on HP 8563A)	+ \$850
Opt 002 Built-in Tracking Generator (HP 8560A only)	+ \$6,400
Opt 003 Precision Frequency Reference (standard on HP 8563A)	+ \$2,400
Opt 026 Extended Frequency Coverage to 26.5 GHz (HP 8562A)	+ \$3,500
Opt T01 TEMPEST-compliant (HP 8562A only)	
Opt 908 Rack Mount Kit Without Handles	+ \$400
Opt 909 Rack Mount Kit With Handles	+ \$450
Opt 915 Add Service Manuals	+ \$425
Opt W30 Extended Repair Service (See page 671)	
For HP 8560A	+ \$625
For HP 8561B	+ \$735
For HP 8562A	+ \$835
For HP 8563A	+ \$1,050
Opt W32 Calibration Service (See page 671)	
For HP 8560A	+ \$835
For HP 8561B	+ \$930
For HP 8562A	+ \$1,050
For HP 8563A	+ \$1,195
HP 41800A Active Probe	\$1,740
HP 85024A High-Frequency Probe	\$2,100
HP 85620A Mass Memory Module	\$2,200
Opt T01 TEMPEST-Compliant	
HP 85629B Test and Adjustment Module	\$2,200
HP 85640A Tracking Generator	\$8,000
HP 85644A Tracking Source	\$18,000
HP 85645A Tracking Source	\$30,000
HP 85700A 32-Kbyte RAM Memory Card	\$100
HP 85710A Digital Radio Measurement Personality	\$850
HP 85901A Portable AC Power Source	\$1,230

☎ For off-the-shelf shipment, call 800-452-4844.

- New high-performance tracking sources
- New scalar measurement personality
- New scalar test set for transmission/reflection measurements

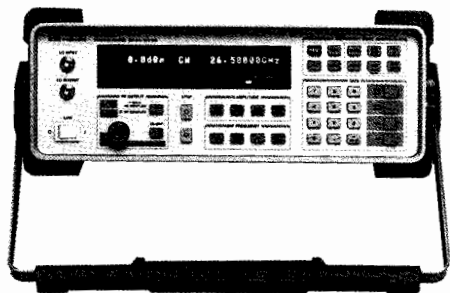

HP 85645A



### Accessories for Scalar Network Analysis

A variety of accessories are designed to enhance Hewlett-Packard spectrum analyzers by adding scalar measurement capability. These powerful solutions allow you to meet both your scalar network analysis and spectrum analysis needs.

#### HP 85644A and 85645A Tracking Sources

These new tracking sources add high-performance scalar network analysis capability to a variety of HP spectrum analyzers. The HP 85644A has a frequency range of 300 kHz to 6.5 GHz; the HP 85645A extends this range to 26.5 GHz. Both sources have leveled output power of up to +10 dBm, providing up to 140 dB of dynamic range. They are housed in a portable, rugged package for bench and field applications; a System II cabinet is also available.

#### Measurement Applications

Because these sources can track many different hosts, including spectrum analyzers and sweepers, they are suited to a number of applications. High dynamic range enables you to measure components and subsystems with the most demanding specifications. Synthesized offset tracking, typically greater than 1 GHz, lets you characterize frequency translation devices. You can measure third-order intermodulation faster than ever before — with no gaps in frequency — using two tracking sources to make the measurement in a swept mode.

For electromagnetic compatibility testing from circuit design through product qualification, use the tracking sources for shield effectiveness and susceptibility measurements.

To generate continuous-wave (CW) signals, use an HP 85644A or 85645A as a portable, standalone source. In standalone mode, frequency accuracy is typically better than  $\pm 5$  MHz, and synthesized frequency can be obtained by locking the source to the LO of an HP spectrum analyzer.

#### Compatibility

The tracking sources are compatible with the following spectrum analyzers: HP 8566A/B; HP 8560 series; HP 71209A; and HP 8593A, 8594A, and 8595A with Option 009. The tracking sources are compatible with the following sweepers: HP 8340A/B, HP 8341B, and HP 8350 series RF plug-ins.

#### Other Features

These include power sweep capability, built-in 70 or 60 dB attenuation, external amplitude modulation capability, external ALC, and HP-IB control.

#### HP 85640A Portable Tracking Generator

Similar in capability to the built-in tracking generator for the HP 8560A, this portable model provides the HP 8560 series spectrum analyzers with scalar measurement capability from 300 kHz to 2.9 GHz. It is ideal for testing and adjusting transceiver components in the field. The spectrum analyzer and tracking generator combined have a dynamic range greater than 100 dB.

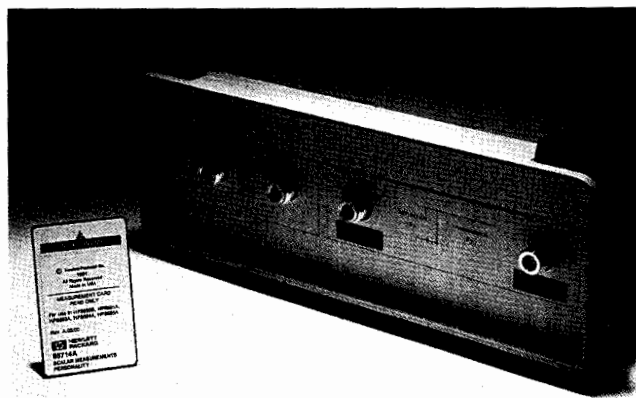

HP 85630A and HP 85714A



#### HP 85714A Scalar Measurement Personality

This downloadable program enhances an HP 8590 series spectrum analyzer and tracking generator for transmission measurements. With the addition of the HP 85630A scalar test set, it provides the user interface for a transmission/reflection measurement system.

#### Features

The scalar measurement personality adds a number of useful features to the scalar/spectrum analyzer system. These include guided OPEN/SHORT and THRU calibration, pass/fail limit line testing, an enhanced 120 dB display for high dynamic range measurements, a tabular display format, and one-button measurements for 3 or 6 dB bandwidth, insertion loss/gain, shape factor, Q, and center-frequency measurements.

#### HP 85630A Scalar Transmission/Reflection Test Set

This new 50-ohm test set adds reflection capability to an HP 8590 series spectrum analyzer with a built-in tracking generator (Option 010) and an HP 85714A scalar measurement personality. The result is a powerful yet economical solution for your scalar network analysis and spectrum analysis needs.

#### Features

The many capabilities of this combined scalar/spectrum analyzer system include guided calibration, pass/fail limit-line testing, a 120 dB display for high dynamic range measurement, and a tabular display format. One-button measurements provide onscreen results for 3 or 6 dB bandwidth, Q factor, shape factor, and insert loss/gain measurements.

In addition, the scalar test set allows you to view transmission and reflection data simultaneously on the screen, so you can make adjustments on a device under test while monitoring the results. You can also make calibrated transmission and reflection measurements on a device using a single setup, without the usual requirement of spectrum-analyzer-based systems to recalibrate and reconfigure.

Other capabilities provided by the test set include a reflection coefficient measurement marker, VSWR measurement markers, return loss measurement, automatic switching between transmission and reflection mode, and source attenuation.

#### Ordering Information

	Price
HP 85630A Scalar Transmission/Reflection Measurement Test Set	\$4,995
HP 85640A Portable Tracking Generator	\$8,000
HP 85644A Tracking Source	\$18,000
HP 85645A Tracking Source	\$30,000
HP 85714A Scalar Measurement Personality	\$950

# SIGNAL ANALYZERS

Spectrum Analyzers, Bench, 100 Hz to 325 GHz  
HP 8566B, 8567A, 8568B

- 100 Hz to 325 GHz coverage with synthesizer accuracy
- 10 kHz to 1.5 GHz coverage at a lower price
- 100 Hz to 1.5 GHz coverage with counter accuracy
- 2 to 22 GHz preselected range
- Trace markers with amplitude and frequency readout
- 16 Kbytes of user RAM for trace data or custom routines

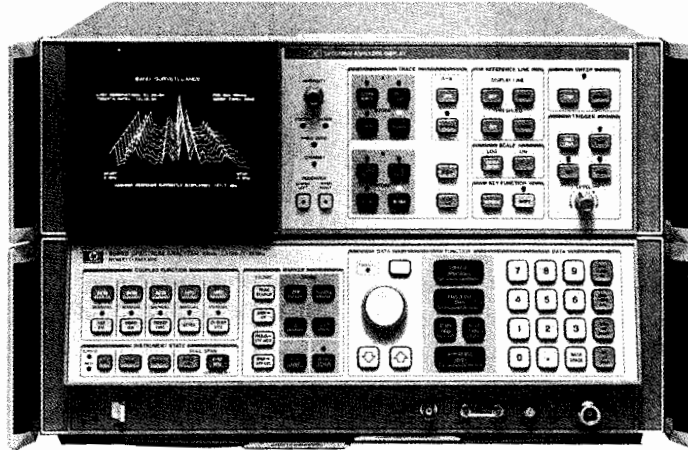

SUPPORTED BY  
**HP ITG**  
SOFTWARE

HP 8566B

DESIGNED FOR  
**HP-IB**  
SYSTEMS



with Turbo Option

## HP 8566B, 8567A, 8568B Spectrum Analyzers

The HP 8566B, 8567A, and 8568B are high-performance spectrum analyzers for bench and ATE system use. The HP 8566B has the highest performance of the three, with a frequency range from 100 Hz to 22 GHz that can be extended to 325 GHz using external mixers. (HP 8566B Option 1BH is available for general export.) The HP 8567A and 8568B are RF spectrum analyzers with frequency coverage to 1500 MHz. See pages 251 and 252 for specification summaries on all analyzers.

Each analyzer is designed around its own internal bus and controlled by its own microcomputer to yield significant improvements in operational and data processing features as well as flexibility under computer control. Each analyzer has 16 Kbytes of user RAM for storing trace data, instrument states, or custom downloadable programs (DLPs).

### New HP 8566B Turbo Option

Increase the measurement speed of your HP 8566B spectrum analyzer. A new turbo option (Option 002) nearly doubles the analyzer's processing rate, so your measurements can be made up to 50% faster, with 25% improvement typical. If you already own an HP 8566B, a turbo retrofit kit is available as Option R02.

### Performance

The exceptional frequency stability of both the HP 8566B and the HP 8568B makes it possible to measure with 10 Hz resolution bandwidths. This narrow resolution bandwidth yields sensitivities to  $-135$  dBm in both instruments. Excellent frequency stability, sensitivity, and frequency-reference accuracy combine to allow very accurate measurement of small signals in the presence of large ones.

For applications that don't require the high performance of the HP 8568B, the HP 8567A offers the same speed, versatility, and automatic operation capability at a lower price. Resolution bandwidths as narrow as 1 kHz yield sensitivities as low as  $-115$  dBm.

### Flexibility

These spectrum analyzers fit into many applications, such as EMC testing (see page 256), broadband signal surveillance, and component stimulus-response testing. The HP 8444A Option 059 tracking generator adds stimulus-response capabilities to the RF models for a minimal cost. The HP 85644A and 85645A tracking sources add 6.5 GHz and 22 GHz high-performance scalar capability to the HP 8566B.

### Usability

The instrument control settings are conveniently shown on the CRT for easy reference. Functions are activated by pressing a front-panel key, then selecting the function value using the knob, step keys, or numeric keyboard. To maintain a calibrated display, certain functions are automatically coupled in the analyzer. For example, resolution bandwidth, video bandwidth, and sweep time are automatically adjusted by the instrument when the frequency span is reduced.

Up to four tunable display markers are available to aid in measuring and analyzing signals. Two markers can be used to make relative measurements by displaying their amplitude and frequency differences. Marker information allows you to step between evenly spaced portions of a spectral display (such as signal harmonics) or "zoom in" on a selected portion of the spectrum. Analyzer control settings can be saved in the non-volatile memory of the analyzer.

### Versatile CRT Display and Plotting Capabilities

All displayed information resides in the analyzer's digital memory, which refreshes the CRT at a flicker-free rate. Multiple traces can be displayed to measure residual FM or drift, or to conduct real-time surveillance over a wide frequency range.

By adding an HP-IB plotter, hard copy of all information on the display of the analyzer can be made for analysis, documentation, or presentation. Plots can be produced directly or with the aid of a controller.

### Custom Softkey Programming

Custom measurement routines can be created to meet your specific requirements. These programs can be created on an external controller or from the front-panel controls of the instrument, then stored in the non-volatile memory of the analyzer. Custom programming allows you to create complex measurement routines that can be stored and later executed using a single softkey.

### System Software

BASIC system software for the HP 8566B, 8567A, and 8568B spectrum analyzers provides high-level routines to aid in developing custom programs for specific measurement applications. Capabilities include automatic computation and setting of analyzer functions to ensure optimum measurement performance.

# SIGNAL ANALYZERS

## Spectrum Analyzers, Bench, 100 Hz to 1500 MHz

HP 8568B, 8567A

251

### Specification Summary

FREQUENCY	HP 8568B	HP 8567A
Frequency Range	100 Hz to 1500 MHz (dc-coupled) 100 kHz to 1500 MHz (ac-coupled)	10 kHz to 1500 MHz
Frequency Span	100 Hz to 1500 MHz + zero span	100 Hz to 1500 MHz + zero span
Frequency Reference Accuracy		
Aging Rate	$< 2.5 \times 10^{-7}$ /year	$< 5 \times 10^{-8}$ /year
Temperature Stability	$< 7 \times 10^{-8}$ (0° to 55° C)	$< 1 \times 10^{-8}$ (5° to 55° C)
Resolution Bandwidth (-3 dB)	10 Hz to 3 MHz in 1,3,10 sequence	1 kHz to 3 MHz in 1,3,10 sequence
Video Bandwidth	1 Hz to 3 MHz in 1,3,10 sequence	1 Hz to 3 MHz in 1,3,10 sequence
Residual FM (peak-to-peak, < 100 kHz span)	< 3 Hz (res BW $\leq$ 30 Hz)	< 100 Hz (res BW 1 kHz)
Drift (per minute of sweep time, after 1-hour warmup)	< 10 Hz (freq span $\leq$ 100 kHz)	< 100 Hz (freq span $\leq$ 100 kHz)
Phase Noise (30 kHz offset, 1 Hz res BW)	-107 dBc	-105 dBc
<b>AMPLITUDE</b>		
Amplitude Range	-135 to +30 dBm	-115 to +30 dBm
Log Display Range	1, 2, 5, or 10 dB/div for 10, 20, 50, or 90 dB display	1, 2, 5, or 10 dB/div for 10, 20, 50, or 90 dB display
Scale Fidelity—incremental	$\pm 0.1$ dB/dB; 0 to 90 dB	$\pm 0.1$ dB/dB; 0 to 80 dB
cumulative (20° to 30° C)	$\leq \pm 1.0$ dB; 0 to 80 dB $\leq \pm 1.5$ dB; 0 to 90 dB	$\leq \pm 1.0$ dB; 0 to 80 dB $\leq \pm 1.5$ dB; 0 to 90 dB
Calibrator Uncertainty	$\pm 0.3$ dB	$\pm 0.3$ dB
Frequency Response (input atten $\geq$ 10 dB)	$\pm 1.5$ dB, 100 Hz to 1500 MHz/ $\pm 1$ dB, 100 kHz to 1500 MHz	$\pm 1$ dB, 10 kHz to 1500 MHz
Spurious Responses (< -40 dBm at mixer)	< -70 dBc (< 10 MHz input sig) < -75 dBc (> 10 MHz input sig)	< -70 dBc
Second Harmonic Distortion (-30 dBm at mixer)	< -70 dBc (sig $\geq$ 10 MHz) < -60 dBc (sig < 10 MHz)	< -70 dBc (sig $\geq$ 10 MHz) < -60 dBc (sig < 10 MHz)
Third Order Intercept (TOI)	+10 dBm (sig > 10 MHz)	+10 dBm (sig > 10 MHz)
Residual Responses (at 1 MHz) (0 dB attn, no input signal)	< -105 dBm	< -100 dBm
Gain Compression ( $\leq$ 10 dBm at mixer)	< 0.5 dB	< 1.0 dB
Displayed Average Noise Level (0 dB attn, 1 Hz Video BW)	< -112 dBm, 500 Hz to 1 MHz (10 Hz res BW) < -135 dBm, > 1 MHz (10 Hz res BW)	< -92 dBm, 50 kHz to 1 MHz (1 kHz res BW) < -115 dBm, > 1 MHz (1 kHz res BW)
Sweep Time: Zero Span	1 $\mu$ s to 1500 s	1 $\mu$ s to 1500 s
Swept	20 ms to 1500 s	20 ms to 1500 s

### General Specifications (apply to both HP 8568B and 8567A unless noted)

#### Environmental

**Temperature:** Operation: 8568B, 0° to 55° C; 8567A, 5° to 55° C  
Storage: -40° to +75° C

**EMI:** Conducted and radiated interference is within the requirements of MIL-STD461B, CE03/part 2 and RE02/part 7, and the requirements of CISPR Pub. 11 and FTZ 526/1979

**Power requirements:** 100, 120, 220, or 240 Vac (+5%, -10%), 50 to 60 Hz or 400 Hz with Op 400

#### Warmup Time

**Operation:** 30 min from cold start

#### Frequency reference

**8568B:** Frequency within  $1 \times 10^{-8}$  of final stable freq within 30 min

**8567A:** Frequency within  $5 \times 10^{-8}$  of final stable freq within 30 min

**Size** (w/out handles): 279.4 mm H  $\times$  425.5 mm W  $\times$  558.8 mm D (11 in  $\times$  16.75 in  $\times$  22 in)

**Weight:** Net, 45 kg (100 lb)

#### Inputs

RF in (Type N), RF in (BNC, 8568B only), ext freq ref in, ext sweep trig in

**Quasi-peak:** Video in, IF in

#### Outputs

Cal out, display X, Y, and Z out, horiz sweep out, video out, penlift out, 21.4 MHz IF, 1st LO, freq ref, probe power out (8568B only)

**Quasi-peak:** Video out, IF out

### Ordering Information

**HP 8568B** Spectrum Analyzer

**HP 8567A** Spectrum Analyzer

**Opt 001** 75 ohm (BNC) RF input

**Opt 016** Installed EMI Receiver Functions

**Opt 044** Add HP 8444A Opt 059 Tracking Generator (8567A only)

**Opt W30** Extended Repair Service (see page 671)

8568B

8567A

**Opt W32** Calibration Service (see page 671)

8568B

8567A

**Opt 400** 400 Hz Power Line Frequency Operation

8568B

8567A

**Opt 010** Rackmount Slide Kit

**Opt 908** Rack Flange Kit (instrument w/out handles)

8568B

8567A

**Opt 913** Rack Flange Kit (instrument w/handles)

8568B

8567A

**Opt 910** Add Extra Set of User's Manuals

**Opt 915** Add Service Manuals

8568B

8567A

**Opt 462** Impulse Bandwidths for EMI Measurements (8568B only)

**Opt 080** 8568B Information Card in Japanese

**Opt 081** 8568B Information Card in French

### Price

\$38,765

\$29,680

+ \$204

+ \$255

+ \$7,600

+ \$1,060

+ \$670

+ \$3,610

+ \$2,860

+ \$410

+ \$715

+ \$460

+ \$66

+ \$153

+ \$71

+ \$153

+ \$355

+ \$825

+ \$825

+ \$2,040

\$0

\$0

# SIGNAL ANALYZERS

## Spectrum Analyzer, Bench, 100 Hz to 325 GHz HP 8566B

### HP 8566B Specification Summary

#### Frequency

**Frequency range:** 100 Hz to 22 GHz with internal mixer; extendable to 110 GHz with HP 11970 external mixers, to 75 GHz with HP 11974 series preselected mixers, and to 325 GHz with mixers from other suppliers

**Frequency span:** 0 Hz, 100 Hz to 22 GHz, variable in approximately 1% increments

**Frequency reference accuracy:** Aging rate,  $<1 \times 10^{-9}$ /day,  $<2.5 \times 10^{-7}$ /year

**Temperature stability:**  $<7 \times 10^{-9}$ , 0° to 55° C

**Resolution bandwidth:** 3 dB bandwidths of 10 Hz to 3 MHz in a 1, 3, 10 sequence

**Bandwidth selectivity, 60 dB/3 dB ratio:**  $<11:1$ , 30 Hz to 3 kHz;  $<13:1$ , 10 kHz and 30 kHz;  $<15:1$ , 100 kHz to 3 MHz

**Bandwidth shape:** synchronously tuned, 4- or 5-pole filters, approximately Gaussian shape

**Video bandwidth:** 1 Hz to 3 MHz in a 1, 3, 10 sequence

**Residual FM (typical peak-to-peak, fundamental mixing mode):**  $<0.2$  Hz, frequency span  $<5$  kHz;  $<5$  Hz, frequency span  $<100$  kHz;  $<200$  Hz, frequency span  $<5$  MHz

**Drift (typical, after 1-hour warmup at stabilized temperature):**  $<10$  Hz/min of sweep time, frequency span  $\leq 100$  kHz;  $<500$  Hz/min of sweep time, frequency span 100 kHz to 5 MHz;  $<5$  kHz/min of sweep time, frequency span  $\geq 5$  MHz

#### Spectral Purity

**Noise sidebands (center frequency 100 Hz to 5.8 GHz):** 320 Hz offset,  $<-80$  dBc/Hz; 1 kHz offset,  $<-85$  dBc/Hz; 10 kHz offset,  $<-90$  dBc/Hz; 100 kHz offset,  $<-105$  dBc/Hz

#### Amplitude

**Amplitude range (dBm):**  $-134$  to  $+30$ , 1 MHz to 2.5 GHz;  $-132$  to  $+30$ , 2 to 5.8 GHz;  $-125$  to  $+30$ , 5.8 to 12.5 GHz;  $-119$  to  $+30$ , 12.5 to 18.6 GHz;  $-114$  to  $+30$ , 18.6 to 22 GHz

**Log display range:** 1, 2, 5, or 10 dB/division for 10, 20, 50, or 90 dB displays, respectively

**Scale fidelity:**  $\pm 0.1$  dB/dB over 0 to 80 dB display (20° to 30° C);  $\pm 1.0$  dB max over 0 to 80 dB display;  $\pm 1.5$  dB max over 0 to 90 dB display

**Calibrator uncertainty:**  $\pm 0.3$  dB

**Frequency response (10 dB input atten):** 100 Hz to 2.5 GHz,  $\pm 0.6$  dB; 2 to 12.5 GHz,  $\pm 1.7$  dB; 12.5 to 20 GHz,  $\pm 2.2$  dB; 20 to 22 GHz,  $\pm 3.0$  dB

#### Dynamic range

**Spurious responses:**  $<-70$  dBc for mixer levels  $\leq -40$  dBm

#### Second harmonic distortion

**Unpreselected, mixer levels  $\leq -40$  dBm:**  $<-70$  dBc, 100 Hz to 2.5 GHz;  $<-80$  dBc, 50 to 700 MHz

**Preselected, mixer levels  $\leq -10$  dBm:**  $<-100$  dBc, 2 to 22 GHz

**Third order intercept (TOI):**  $> +5$  dBm, 100 Hz to 5 MHz;  $> +7$  dBm, 5 MHz to 5.8 GHz;  $> +5$  dBm, 5.8 to 18.6 GHz

**Image responses:**  $<-70$  dBc, 100 Hz to 18.6 GHz;  $<-60$  dBc, 18.6 to 22 GHz

**Multiple responses:**  $<-70$  dBc, 100 Hz to 22 GHz

**Out-of-band responses:**  $<-60$  dBc, 2 to 22 GHz

**Residual responses (0 dB input atten, no input signal):**  $<-100$  dBm, 100 Hz to 5.8 GHz;  $<-95$  dBm, 5.8 to 12.5 GHz;  $<-85$  dBm, 12.5 to 18.6 GHz;  $<-80$  dBm, 18.6 to 22 GHz

**Gain compression ( $\leq -5$  dBm at mixer):**  $<1.0$  dB, 100 Hz to 22 GHz

**Displayed average noise level (0 dB input atten, 10 Hz res BW)**

**Unpreselected:**  $<-95$  dBm, 100 Hz to 50 kHz;  $<-112$  dBm, 50 kHz to 1 MHz;  $<-134$  dBm, 1 MHz to 2.5 GHz

**Preselected:**  $<-132$  dBm, 2 to 5.8 GHz;  $<-125$ , 5.8 to 12.5 GHz;  $<-119$  dBm, 12.5 to 18.6 GHz;  $<-114$  dBm, 18.6 to 22 GHz

#### Sweep Time

**Zero span:** 1  $\mu$ s to 1500 s

**Swept:** 20 ms to 1500 s

**Accuracy:**  $\pm 10\%$   $\leq 200$  s sweep times;  $\pm 30\%$   $> 200$  s sweep times

**Trigger:** Free run, line, video, external, continuous, and single

### General Specifications

#### Environmental

**Temperature:** Operation, 0° to 55° C; storage,  $-40$  to  $+75$  °C

**Humidity:** Operating  $<95\%$  RH, 0° to 40° C.

**EMI:** Conducted and radiated interference is within the requirements of MIL-STD-461C, Part 7, REO2 and CEO3 (Air Force), and the requirements of CISPR Pub. 11 and Messemphaenger-postferfuegun 526/527/79

**Power requirements:** 100, 120, 220, or 240 Vac ( $+5\%$ ,  $-10\%$ ), 50 to 60 Hz or 400 Hz with Opt 400

**Warmup time operation:** 30 min from cold start (0° to 55° C)

**Frequency reference:** frequency within  $1 \times 10^{-8}$  of final stable frequency within 30 min

**Size (w/out handles):** 279.4 mm H  $\times$  425.5 mm W  $\times$  598.5 mm D (11 in  $\times$  16.75 in  $\times$  23.56 in)

**Weight:** net, 50 kg (112 lb)

#### Inputs

RF in (Type N), ext freq ref in, ext sweep trig in

**Quasi-peak:** Video in, IF in

#### Outputs

Cal out, 1st LO out, IF out, sweep + tune out, display X, Y, Z out, horiz sweep out, video out, penlift out, 21.4 MHz IF out, freq ref, 10 MHz

**Quasi-peak:** Video out, IF out

### Ordering Information

	Price
<b>HP 8566B</b> Spectrum Analyzer	\$64,500
<b>Opt 002</b> Turbo Option	\$2,500
<b>Opt R02</b> Turbo Retrofit Kit	\$3,000
<b>Opt 016</b> Installed EMI Receiver Functions	+ \$255
<b>Opt 400</b> 400 Hz Power-Line Frequency Operation	+ \$410
<b>Opt W30</b> Extended Repair Service (see page 671)	+ \$1,150
<b>Opt W32</b> Calibration Service (see page 671)	+ \$3,900
<b>Opt 462</b> Impulse Bandwidths for EMI Measurements	+ \$2,040
<b>Opt 010</b> Rackmount Slide Kit	+ \$460
<b>Opt 908</b> Rack Flange Kit (instrument w/out handles)	+ \$66
<b>Opt 913</b> Rack Flange Kit (instrument w/handles)	+ \$71
<b>Opt 910</b> Add Extra Set of User's Manuals	+ \$355
<b>Opt 915</b> Add Service Manuals	+ \$825
<b>Opt 031</b> German Operating Manual	\$0
<b>Opt 080</b> Information Card in Japanese	\$0
<b>Opt 081</b> Information Card in French	\$0
<b>Opt E69</b> Internal MATE Test Module Adapter	+ \$4,500

# SIGNAL ANALYZERS

## HP 70000 Series Spectrum Analyzers

### HP 71100C, 71200C, 71209A, 71210C

253

- Highest performance (100 Hz to 26.5 GHz)
- Automated, reconfigurable systems
- HP 8566B code compatibility

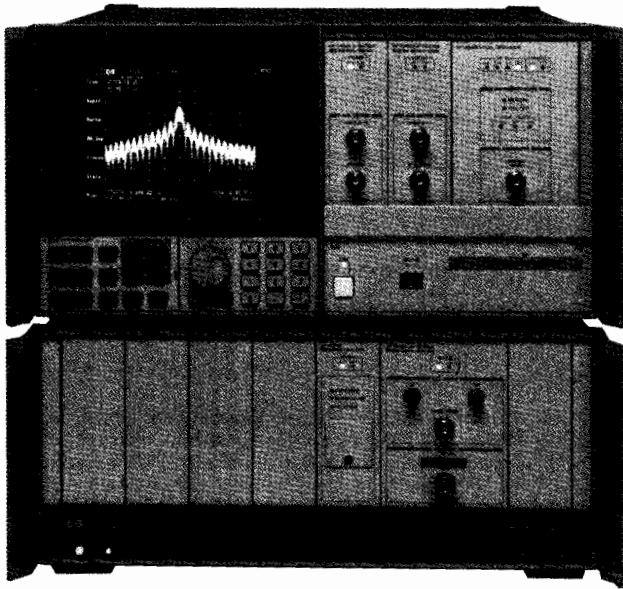

HP 71209A



### HP 70000 Series Spectrum Analyzers

The HP 70000 Series spectrum analyzers are part of HP's growing modular measurement system (MMS) family. Four factory-configured spectrum analyzers combine high performance, ease of use, and the benefits of modularity for RF and microwave applications:

- HP 71100C RF spectrum analyzer, 100 Hz to 2.9 GHz
- HP 71200C microwave spectrum analyzer, 50 kHz to 22 GHz, with optional preselection and 26.5 GHz frequency coverage
- New HP 71209A microwave spectrum analyzer, 100 Hz to 26.5 GHz, with an outstanding set of performance features
- HP 71210C microwave spectrum analyzer, 100 Hz to 22 GHz, with ultimate sensitivity and a dynamic tracking preselector

Measurement capabilities can be extended to 325 GHz using external mixers. The HP 71209A has a built-in mixer interface, and the HP 70907B external mixer interface module adds millimeter capability. Preselected coverage is available to 75 GHz with HP 11974 series mixers, and unpreselected coverage to 110 GHz with HP 11970 series harmonic mixers. See page 254.

All four spectrum analyzers feature a color display with color editor, a custom hardkey panel with the most commonly used spectrum-analyzer functions, downloadable programming capability, and a memory card reader. You can copy data directly to a printer, plotter, or external disk or store data internally. Compatible MMS modules add other capabilities to the systems, including scalar analysis, CW phase, power-meter measurements, and waveform analysis. You can also build custom modules. See page 102 for selected details on the HP 70000 system and products. For complete information, call your local HP sales office for a free copy of the MMS catalog, described on page 102.

### New HP 71209A Microwave Spectrum Analyzer

The HP 71209A is the MMS standard for microwave spectrum analysis, offering exceptional performance for a new lower price. Special features include a built-in mixer interface for completely preselected coverage from 100 Hz to 75 GHz (using HP 11974 Series mixers), programming code compatibility with the HP 8566B spectrum analyzer, similar performance to that of the HP 71210C, an adjustable IF gain amplifier, a 5 dB step attenuator, a built-in base-band limiter, and compatibility with the new HP 85644A and 85645A tracking sources.

### Ordering Information

	Price
<b>HP 71100C</b> Spectrum Analyzer, 100 Hz to 2.9 GHz	\$48,500
<b>HP 71200C</b> Spectrum Analyzer, 50 kHz to 22 GHz (not preselected)	\$53,800
<b>Opt 001</b> Extended Frequency to 26.5 GHz	+ \$1,980
<b>Opt 002</b> Preselection to 22 GHz	+ \$8,610
<b>Opt 003</b> Extended Frequency and Preselection to 26.5 GHz	+ \$14,610
<b>HP 71209A</b> Spectrum Analyzer, 100 Hz to 26.5 GHz	\$67,700
<b>HP 71210C</b> Spectrum Analyzer, 100 Hz to 22 GHz	\$84,100

### HP 70000 Series Spectrum Analyzer Specification Summary

	HP 71100C	HP 71200C (without preselection)	HP 71200C (with preselection)	HP 71209A	HP 71210C
Frequency Range (tunable in 1 Hz increments)	100 Hz to 2.9 GHz (dc-coupled) 100 kHz to 2.9 GHz (ac-coupled)	50 kHz to 22 GHz	50 kHz to 22 GHz/ 50 kHz to 26.5 GHz	100 Hz to 26.5 GHz	100 Hz to 22 GHz
With external mixers	75 GHz with HP 11974 preselected mixers; 110 GHz with HP 11970 harmonic mixers; 325 GHz with other mixers				
Resolution Bandwidth Range	10 Hz to 300 kHz; 3 MHz option			10 Hz to 3 MHz	
Phase Noise	-108 dBc/Hz at 10 kHz offset	-108 dBc/Hz at 10 kHz offset, to 6.2 GHz			
Optimum Dynamic Range 2nd/3rd order	82 dB/92 dB	70 dB/88 dB	84 dB/91 dB	99 dB/96 dB	96 dB/98 dB
Amplitude Accuracy (relative frequency + lesser of scale fidelity or IF gain accuracy)	± 2 dB (± 0.9 dB) <sup>1</sup>	± 2 dB (± 0.9 dB) <sup>1</sup>		± 2 dB (± 0.9 dB) <sup>1</sup>	± 2.5 dB (± 0.9 dB) <sup>1</sup>
Displayed Average Noise Level, 10 Hz RBW at 2.9 GHz at 22 GHz at 26.5 GHz	-131 dBm	< -129 dBm < -116 dBm < -115 dBm	Bypassed < -127 dBm < -111 dBm < -109 dBm Filtered < -119 dBm < -96 dBm < -95 dBm	-136 dBm -128 dBm -126 dBm	-139 dBm -133 dBm
Displayed Average Noise Level With HP 70620 Series Preamplifiers at 2.9 GHz at 22 GHz at 26.5 GHz	-156 dBm	-140 dBm -119 dBm -115 dBm		-155 dBm -148 dBm -145 dBm	-155 dBm -150 dBm

<sup>1</sup> ± 0.9 dB transfer accuracy using the HP 70100A - H01 modular power meter.

# SIGNAL ANALYZERS

## Millimeter Mixers

### HP 11970 Series and 11974 Series

- Preselected mixers to eliminate signal identification
- State-of-the-art technology
- Easier automated measurements

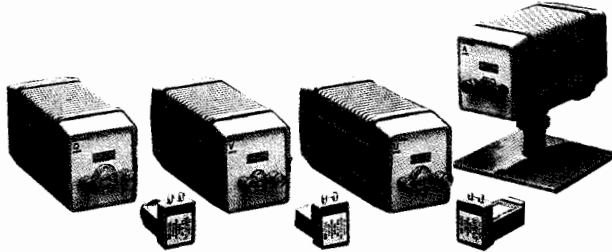

HP 11970, 11974 Series Mixers

### HP 11974 Series Preselected Millimeter Mixers

Eliminate the need for signal identification at millimeter frequencies. The HP 11974 series mixers are preselected from 26.5 to 75 GHz for faster, easier testing of millimeter devices and systems. Preselection reduces mixer overload from broadband signals and reduces radiation of local oscillator harmonics back to the device under test. Equipment operators can quickly locate true signals, and software development for automated measurements is greatly simplified.

HP 11974 series preselected mixers are available in four bands:

HP Model <sup>1</sup>	Frequency range (GHz)	Sensitivity (displayed avg. noise level/10 Hz) (dBm)	Calibration Accuracy (dB)	Image Rejection (dB)	1 dB Gain Compression (dBm)
HP 11974A	26.5 to 40	-111	< ±2.3	-54	+6
HP 11974Q	33 to 50	-106	< ±2.3	-50	+0
HP 11974U	40 to 60	-109	< ±2.6	-50	+0
HP 11974V	50 to 75	-100	< ±4.5	-50	+3

<sup>1</sup>Specifications apply when connected to the HP 8566B or 70000 series spectrum analyzers.

These mixers feature advanced barium-ferrite technology and come with a standalone power supply. They are particularly useful for broadband millimeter signal analysis, millimeter electromagnetic-interference (EMI) measurements, and unattended monitoring of millimeter signals.

### Compatibility

Upgrade kits are available to assure the compatibility of HP 8560A, HP 8561A/B, HP 8562A/B, and HP 8566A/B spectrum analyzers and the HP 70907A external mixer interface module. Consult your HP sales representative to determine requirements. All versions of the HP 8563A spectrum analyzers and HP 70907B external mixer interface modules are fully compatible with the HP 11974 series.

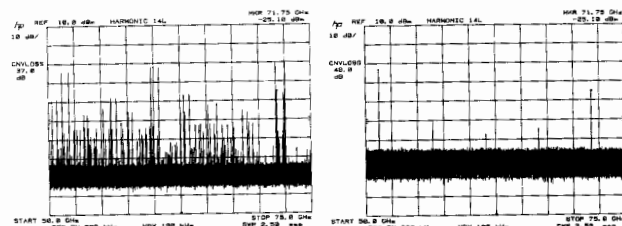

50 to 75 GHz Sweep Without Preselection

50 to 75 GHz Sweep Using HP 11974 Series Mixer

### HP 11970 Series Harmonic Mixers

The HP 11970 series waveguide mixers are general-purpose harmonic mixers. They employ a dual-diode design to achieve flat frequency response and low conversion loss. These are achieved without external dc bias or tuning stubs. Manual operation and computer-controlled hardware operation are simplified because mixer bias and tuning adjustment are not required.

- Low conversion loss
- Individually amplitude-calibrated
- No bias or tuning adjustments
- High 100 mW safe input level

HP 11970 series harmonic mixers are available in six bands:

HP Model	Frequency Range (GHz)	LO Harm Number	Conversion Loss (dB)	Noise Level (dB) 1 kHz RBW	Freq' Response (dB)	Gain Compression (dBm)
HP 11970K	18 to 26.5	6+	24	-105	±1.9	-3
HP 11970A	26.5 to 40	8+	26	-102	±1.9	-5
HP 11970Q	33 to 50	10+	28	-101	±1.9	-7
HP 11970U	40 to 60	10+	28	-101	±1.9	-7
HP 11970V	50 to 75	14+	40	-92	±2.1	-3
HP 11970W	75 to 110	18+	46	-85	±3.0	-1

<sup>1</sup>Frequency of the mixers is reduced by 1 dB for LO range of 14 to 18 dBm.

### Compatibility

The HP 11970 series mixers extend the frequency range of the HP 8561B, 8562A, and 8563A portable spectrum analyzers; of the HP 8566B spectrum analyzer (used with the HP 11975A amplifier); and of the HP 70000 modular measurement system (used with the HP 70907A/B external mixer interface modules).

### HP 11970 and 11974 Series Specifications

**IF range:** dc to 1.3 GHz

**LO amplitude range:** +14 to +16 dB; +16 optimum

**Calibration accuracy:** +2 dB for HP 11970 series with optimum LO amplitude

**Typical RF input SWR:** < 2.2:1, < 3.0:1 for HP 11974 series

**Bias requirements:** None

**Typical odd-order harmonic suppression:** > 20 dB (does not apply to HP 11974 series)

**Maximum CW RF input level:** +20 dBm (100 mW), +25 dBm for HP 11974 series

**Maximum peak pulse power:** 24 dBm (250 mW) with < 1 μs pulse (avg. power = +20 dBm)

**Bandwidth:** 100 MHz minimum (HP 11974 series only)

**Environmental:** Meets MIL-T-28800C, Type III, Class 3, Style C

**IF/LO connectors:** SMA (female)

**TUNE IN Connector:** BNC

**LO range:** 3 to 6.1 GHz

### Ordering Information

<b>HP 11974A</b> 26.5 to 40 GHz Preselected Mixer	<b>Price</b>
<b>HP 11974Q</b> 33 to 50 GHz Preselected Mixer	\$14,100
<b>HP 11974U</b> 40 to 60 GHz Preselected Mixer	\$14,800
<b>HP 11974V</b> 50 to 75 GHz Preselected Mixer	\$15,500
<b>Opt 003</b> Delete Power Supply (HP 11974 series only)	\$16,500
<b>HP 11970K</b> 18 to 26.5 GHz Mixer	-\$500
<b>HP 11970A</b> 26.5 to 40 GHz Mixer	\$1,990
<b>HP 11970Q</b> 33 to 50 GHz Mixer	\$2,050
<b>HP 11970T</b> 18 to 40 GHz Mixers, Hardwood Case,	\$2,200
Cables, Tools	\$3,600
<b>Opt 001</b> Add 40 to 60 GHz Mixers (HP 11970 series only)	+ \$2,200
<b>Opt 002</b> Add 33 to 50 GHz Mixers (HP 11970 series only)	+ \$1,950
<b>HP 11970U</b> 40 to 60 GHz Mixers	\$2,460
<b>HP 11970V</b> 50 to 75 GHz Mixers	\$2,920
<b>HP 11970W</b> 75 to 110 GHz Mixers	\$3,270
<b>HP 11970</b>	
<b>Opt 009</b> Mixer Connection Set adds three 1-meter low-loss SMA cables, wrench, Allen driver for any HP 11970 series mixer.	+ \$475
<b>HP 11969A</b> Carrying Case for 1 to 5 HP 11970 series mixers. Includes SMA cables and tools as in Opt 009.	\$670
<b>HP 11975A</b> 2 to 8 GHz Amplifier	\$4,990
<b>HP 281A/B</b> Coaxial-to-Waveguide Adapters	
<b>R281A</b> 26.5 to 40 GHz, 2.4 mm (f)	\$850
<b>R281B</b> 26.5 to 40 GHz, 2.4 mm (m)	\$800
<b>Q281A</b> 33 to 50 GHz, 2.4 mm (f)	\$850
<b>Q281B</b> 33 to 50 GHz, 2.4 mm (m)	\$800



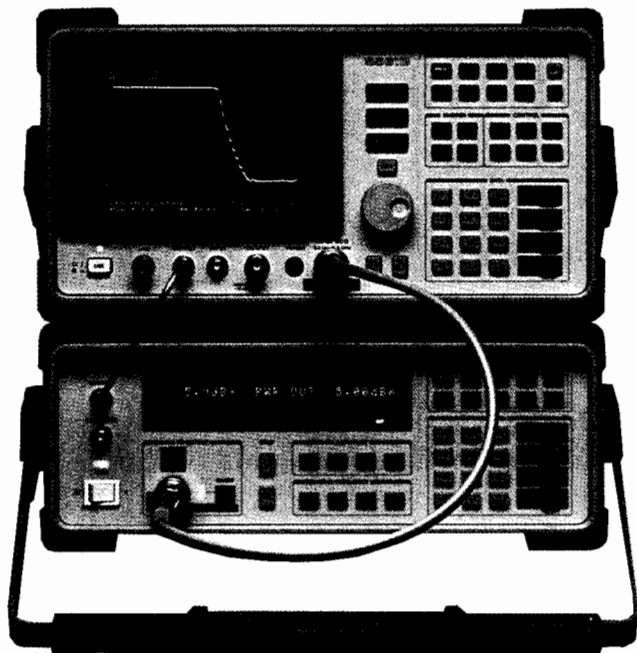

HP 85644A



### HP 85644A and 85645A Tracking Sources

New portable tracking sources add versatile, high-performance scalar network analysis capability to a variety of HP spectrum analyzers. The HP 85644A has a frequency range of 300 kHz to 6.5 GHz; the HP 85645A, 300 kHz to 26.5 GHz. Features include:

- Leveled output range of +10 to -80 dBm
- Offset tracking, typically > 1 GHz
- Up to 140 dB dynamic range
- Swept intermodulation-distortion measurement capability
- Rugged, portable package or optional system cabinet

Compatible spectrum analyzers are the HP 8566A/B; the HP 8560 series; the HP 71209A; and the HP 8593A, the 8594A, and 8595A Option 009. Tracking sources are also compatible with the HP 83590 series, HP 8340, and HP 8341 sweepers. See page 249.

### HP 85640A Portable Tracking Generator

This portable, rugged tracking generator adds scalar analysis capability from 300 kHz to 2.9 GHz to an HP 8560 series portable spectrum analyzer. Measure gain, frequency response, compression, flatness, and return loss on components and subsystems. A built-in attenuator gives an output power range of -80 to 0 dBm. See page 249.

### HP 8444A Option 059 Tracking Generator

Used with the HP 8568B RF spectrum analyzer, this model adds stimulus response-response capability for a minimal cost. It allows swept-frequency testing of components and subsystems. Frequency range is 500 kHz to 1.5 GHz.

### HP 8447 Series RF Amplifiers

These amplifiers, with a frequency range of 9 kHz to 1.3 GHz, have low noise and wide bandwidths. They improve spectrum analyzer sensitivity and noise figure while providing input isolation. Broad frequency coverage, flat frequency response, and low distortion assure accurate measurements. See page 478.

### HP 8449B Preamplifier

This high-gain, low-noise preamplifier has a frequency range of 1 to 26.5 GHz. It increases the sensitivity of any microwave spectrum analyzer for detection and analysis of very low-level signals. Its improved sensitivity can also dramatically reduce measurement time. See page 478.

### HP 11975A Microwave Amplifier

This general-purpose, leveled microwave amplifier has a frequency range of 2 to 8 GHz and an adjustable output of +6 to +16 dBm. It has an adjustable bias current output port that supplies a maximum of +11 mA at +3 V. This bias current is needed by some external harmonic mixers. The amplifier has automatic leveling control (ALC) that can be switched on and off. An "unleveled" light indicates that ALC is off. Use the HP 11975A as an LO driver for the HP 11970 and 11974 series harmonic mixers to achieve maximum performance.

### HP 85901A Portable ac Power Source

This easy-to-carry power source can be used as a standalone battery for over 1 hour of operation at 100 W continuous load, or can be connected to an external 12 Vdc source for longer use. It shuts off automatically when the charge gets low, and can be recharged in 6 hours or less. Over-voltage, short-circuit, and overload protection on the inverter output are built in. Also included are over-voltage protection on the inverter input and over-charge and over-discharge protection on the internal battery.

### HP 11867A and 11693A Limiters

Protect the input circuits of spectrum analyzers, counters, amplifiers, and other instruments from high power levels with minimal effect on measurement performance. The HP 11867A RF limiter (dc to 1.8 GHz) reflects signals up to 10 W average power and 100 W peak power. Insertion loss is less than 0.75 dB. The HP 11693A microwave limiter (100 MHz to 12.4 GHz, usable to 18 GHz) guards against input signals over 1 mW up to 1 W average power and 10 W peak power.

### HP 11694A 75 Ohm Matching Transformer

From 3 to 500 MHz, this transformer allows measurements in 75 ohm systems while retaining amplitude calibration with a 50 ohm spectrum analyzer input. VSWRs are less than 1.2; insertion loss is less than 0.75 dB.

### HP 8721A Directional Bridge

Frequency range is 100 kHz to 100 MHz. This bridge is used in return-loss measurement made with a swept source, such as a tracking generator and spectrum analyzer. It has 6 dB insertion loss and is 6 dB coupled to the auxiliary arm. Frequency response is +0.5 dB (0.1 to 110 MHz); directivity is greater than 40 dB (1 to 110 MHz); load-part return loss is less than 0.03; maximum input power is +20 dBm. The standard model is 50 ohm with a 75 ohm option.

### HP 85024A High-Frequency Probe

In-circuit measurements are easy with this probe. Input capacitance of only 0.7 pF shunted by 1 megohm resistance permits high-frequency probing without adverse loading of the circuit under test. Excellent frequency response and unity gain guarantee highly accurate swept measurements. High sensitivity and low distortion levels allow measurements taking advantage of full analyzer dynamic range. This probe is directly compatible with many HP RF spectrum and network analyzers.

### Ordering Information

	Price
HP 85644A Tracking Source	\$18,000
HP 85645A Tracking Source	\$30,000
HP 85640A Portable Tracking Generator	\$8,000
HP 8444 Opt 059 Tracking Generator	\$8,300
HP 8447A Preamplifier	\$1,550
HP 8447D Preamplifier	\$1,650
HP 8447E Power Amplifier	\$1,850
HP 8447F Preamplifier-Power Amplifier	\$2,720
HP 8449B Preamplifier	\$7,310
HP 11975A Microwave Amplifier	\$4,990
HP 85901A Portable AC Power Source	\$1,230
HP 11867A RF Limiter	\$490
HP 11693A Microwave Limiter	\$670
HP 11694A 75 Ohm Matching Transformer	\$205
HP 8721A Directional Bridge	\$400
HP 85024A High-Frequency Probe	\$2,100

☎ For off-the-shelf shipment, call 800-452-4844.

# SIGNAL ANALYZERS

## EMC Measurement Systems

### HP 84000 Series



HP 84110A EMC Pre-Production Evaluation System

### HP 84000 Series EMC Measurement Systems

The best way to eliminate problems of electromagnetic compatibility is to attack them at all states of product development. For this you need the right test equipment. HP now offers a full line of EMC measurement systems to help you with all aspects of this task—from testing of initial designs through formal compliance measurements. Whether you need simple EMC design tools or a fully automated EMI compliance test system, you will find a solution to improve your productivity. All HP 84000 series EMC measurement systems reflect HP's extensive knowledge and experience of EMC testing and are backed by our proven quality and worldwide support.

#### HP 84100A EMC Design Development System

The sooner you consider the EMC performance of a new product design, the fewer EMC problems you will encounter later in the product-development cycle. The HP 84100A system gives you the right tools for quickly locating EMC problems at the breadboard and prototype levels. The heart of the system is a portable spectrum analyzer with a 9-kHz to 1.8-GHz frequency range. The analyzer has a built-in tracking generator for making quick immunity and shielding-effectiveness measurements. An EMC measurement "personality" installed in the system makes EMC measurements easy for beginners and supplies advanced capabilities for experienced troubleshooters. Two calibrated magnetic-field probes are included for locating emission hot spots on printed circuit boards, cables, and power supplies. And the system has an HP-IB interface for one-button output to printers and plotters.

To further enhance your design-development skills, HP offers a two-day course on "Designing for EMC." See page 260 for details.

#### HP 84110A EMC Pre-Production Evaluation System

If you send your products to consultants or independent test facilities for final compliance measurements, pre-compliance testing can save you time and money at final compliance test time. The HP 84110A takes the mystery out of finding the right equipment for this job. The system includes an easy-to-use portable spectrum analyzer with built-in quasi-peak detection to measure device emissions. The analyzer is enhanced with EMC diagnostic capabilities as well as capabilities for making conducted and radiated measurements. Accessories include a line impedance stabilization network (LISN), a transient limiter, two calibrated magnetic-field probes, two antennas, and a tripod. An HP-IB interface allows one-button output to printers and plotters.

While not intended for formal compliance testing, the HP 84110A offers impressive pre-test capabilities for a fraction of the price of a full EMC compliance test system.

#### HP 84120A EMI Pre-Compliance Measurement System

This pre-compliance measurement system has all the capabilities of the HP 84110A plus two more. First, the HP 84120A adds automation software that runs on a variety of computers available for the system. This allows you to collect data, correct for antenna factors and cable losses, analyze data and store it on disk, and output data and reports to printers and plotters—all automatically.

Second, the pre-compliance measurement system can be upgraded to a complete final compliance test system. The HP 84120A comes with a 10-kHz to 1.5-GHz spectrum analyzer and a quasi-peak adapter. These can be combined with our RF preselector to make an EMI test system that meets all CISPR Publication 16\* EMI receiver requirements.

In addition to measurement hardware and software, the HP 84120A system includes antennas for commercial radiated EMI measurements and a LISN for conducted EMI measurements. A low noise preamplifier (9 kHz to 1.3 GHz) provides additional sensitivity, and a portable antenna tower and turntable are also included.

#### HP 84130A EMI Commercial Compliance Measurement System

This test system has the accuracy and capabilities you need to be confident of your EMI compliance measurement results. Built around the HP 8574B EMI receiver, it meets the requirements of CISPR Publication 16\*. This high performance system offers outstanding capabilities not available in conventional EMI receivers.

Frequency range of the HP 84130A is 9 kHz to 1.5 GHz. The EMI receiver has full RF preselection; peak, quasi-peak, and average detection; and specialized bandwidths that meet or exceed CISPR specifications. Two powerful software programs automate the system for conducted-emission and radiated-emission measurements made inside shielded enclosures and radiated-emission measurements made at open-area test sites. The automated system tests to specifications of the FCC, VDE, FTZ, VCCI, DOC, and other international regulatory agencies.

Accessories include antennas, automatic antenna-positioning mast, automatic turntable, LISN, transient limiter, coaxial cables and adapters, HP-IB cables, and power cords. An optional site-attenuation package gives you the hardware needed to characterize an outdoor range or semi-anechoic chamber.

#### Ordering Information

	Price
<b>HP 84100A</b> EMC Design Development System	\$22,325
<b>Opt 103</b> Quasi-Peak Detection and AM/FM Demodulation	+ \$1,700
<b>HP 84110A</b> EMC Pre-Production Evaluation System	\$26,945
<b>Opt 010</b> Tracking Generator	+ \$4,700
<b>HP 84120A</b> Commercial EMI Pre-Compliance Measurement System	\$59,970
<b>HP 84130A</b> Commercial EMI Compliance Measurement System	\$121,440
<b>Opt 657</b> Site-Attenuation Kit	+ \$16,590

\* CISPR Publication 16 is the Comite International Special des Perturbations Radioelectrique specification for radio interference measuring apparatus and measurement methods.

- Built to CISPR Publication 16\* recommendations
- Automatic or manual commercial and military compliance testing
- Diagnostic EMI measurements

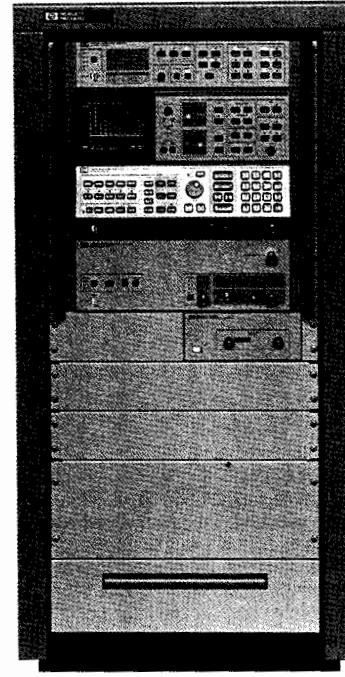
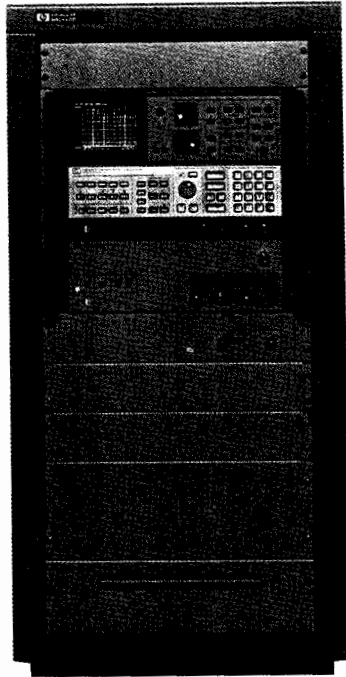

HP 8571A and 8572A



### New HP 8571A and 8572A Microwave EMI Receivers

These EMI receivers are capable of making your most demanding measurements over a wide (20 Hz to 22 GHz) frequency range. They are specifically designed to make essential military and commercial EMI measurements easily and quickly. The HP 8571A receiver includes an HP 8566B spectrum analyzer with Options 002 and 462, an HP 85685A RF preselector, and an HP 8449B preamplifier. The HP 8572A includes the same equipment, but adds an HP 85650A quasi-peak adapter for CISPR-based commercial EMI tests. Both receivers are completely configured and verified by HP and come with an individual calibration sheet to ensure  $\pm 2$  dB amplitude accuracy. They are shipped in a system cabinet.

### HP 8573B and 8574B EMI Receivers

For EMI compliance testing that requires less frequency range, these CISPR 16\* receivers have everything you need to make fast, accurate measurements to 1.5 GHz in accordance with commercial and military regulations. Each includes an HP 85650A quasi-peak adapter, an HP 85685A RF preselector, and an HP 8567A or 8568B spectrum analyzer. For easy startup, each receiver is completely configured and verified at the factory and shipped to you in a system cabinet.

### EMI Diagnostics

In addition to final compliance measurements, all HP EMI receivers are excellent for diagnostics. You can quickly identify problem areas using the swept frequency features of the spectrum analyzer in the system.

### Automated EMI Measurements

Optional HP 85869A and 85879A EMI measurement software turns your receiver into a fast, easy-to-operate, automatic test system. The software automates conducted-emission and radiated-emission measurements made inside chambers and at open test sites. Test setups for common compliance measurements, typical antenna factors, and many test limits are included. You can easily modify any of these parameters to customize tests for specific applications. The HP 85874B combined EMI software package includes both the HP 85869A and the HP 85879A.

### Accessories and Optional Configurations

Complete your EMI receiver system by choosing from a full line of accessories for conducted and radiated measurements: line impedance stabilization networks (LISN), antennas, positioning equipment, and transducers (see page 261). Or order the HP EMI measurement system for commercial compliance. It offers a complete measurement setup that includes all accessories and transducers required for designated EMI compliance tests (see page 256).

### Ordering Information

	Price
<b>HP 8571A</b> EMI Receiver (with HP 8566B Opt 002 and 462 spectrum analyzer)	\$102,500
<b>HP 8572A</b> EMI Receiver (with HP 8566B Opt 002 and 462 spectrum analyzer)	\$108,000
<b>HP 8573B</b> EMI Receiver (with HP 8567A spectrum analyzer)	\$61,485
<b>HP 8574B</b> EMI Receiver (with HP 8568B spectrum analyzer)	\$70,455
<b>Opt 630</b> HP 85869A EMI Measurement Software (3.5-in. disk)	\$5,000
<b>HP 85869A</b> EMI Measurement Software	\$7,000
<b>HP 85879A</b> Radiated-Emission Measurement Software	\$8,000
<b>HP 85874B</b> Combined EMI Measurement Software	\$11,000

\*CISPR Publication 16 is the Comité International Spécial des Perturbations Radioélectriques specification for radio interference measuring apparatus and measurement methods.

# SIGNAL ANALYZERS

## RF Preselector, 20 Hz to 2 GHz/Quasi-Peak Adapter/EMI Receiver Functions

HP 85685A, 85650A, 85867A

- Automatic filter tracking
- Input overload protection
- Low system noise

- Quasi-peak detection
- CISPR-specified bandwidths
- Bypass for regular spectrum analyzer operation

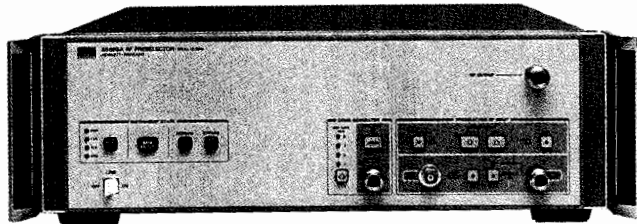

HP 85685A

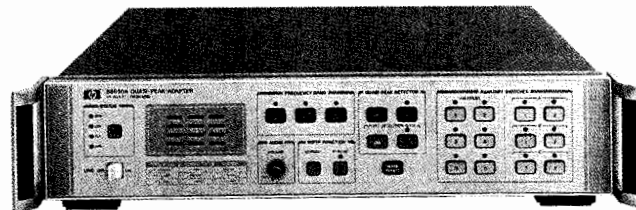

HP 85650A



### HP 85685A RF Preselector

This instrument turns an HP 8566B, 8567A, or 8568B spectrum analyzer into a test receiver for specialized applications. The RF preselector has tracking filters and preamplifiers covering the 20 Hz to 2 GHz range. This improves spectrum analyzer measurement sensitivity while providing overload protection from out-of-band signals. The resulting test receiver system, operated in the presence of high-level interference, has a measurement range 30 dB greater than that of a spectrum analyzer alone.

Together the preselector and spectrum analyzer measure signals within the filter passband of the preselector and reject out-of-band interference by 40 dB. This enables low-level signals to be monitored in the presence of high-level ambients. The preselector decreases input overload from out-of-band signals, thereby increasing the range for measuring low-level signals. Fast, wideband measurements mean a reduction in measurement time.

Combining the HP 85685A RF preselector with an HP 8566B, 8567A, or 8568B spectrum analyzer and the HP 85650A quasi-peak adapter gives you an EMI receiver that meets the recommendations of CISPR Publication 16\*.

The RF preselector adds the measurement sensitivity and overload protection needed for FCC, VDE, and VCCI radiated emission testing. For commercial and MIL-STD conducted EMI tests, the low-frequency input withstands large impulses and line impedance stabilization network (LISN) transients. A built-in calibrator ensures  $\pm 2.0$  dB absolute-amplitude accuracy as required by the regulatory agencies and a convenient linearity check tests for system overload.

Operating the test receiver is easy. Use only the spectrum analyzer controls—the RF preselector automatically adjusts input-filter tracking, and the spectrum analyzer reports preselector operating conditions on the CRT. The receiver system is fully HP-IB programmable, and the HP 85685A comes equipped with the hardware needed to connect it to any compatible spectrum analyzer.

### HP 85650A Quasi-Peak Adapter

The HP 85650A quasi-peak adapter works with the HP 8566B, 8567A, and 8568B spectrum analyzers and with the 85685A RF preselector to complete an EMI test receiver system. The quasi-peak adapter adds the special bandwidth filters and quasi-peak detection capability specified in CISPR Publication 16\*. These bandwidth filters (200 Hz, 9 kHz, and 120 kHz) have 6 dB resolution and may be selected using either peak or quasi-peak detection.

A bypass switch enables the spectrum analyzer to bypass the quasi-peak adapter, and a normal mode allows use of the three CISPR bandwidths whether or not the quasi-peak detector is being used. The HP 85650A is fully programmable over the HP-IB for automated measurements, and it has both an internal speaker and an audio output jack (for external headphones) for monitoring signals.

### HP 85867A EMI Receiver Functions

This set of softkey programs simplifies commercial EMI measurements performed manually using HP EMI receivers (see page 257). An external computer is not needed after the softkeys are downloaded into spectrum analyzer nonvolatile RAM. You can select a CISPR\* band, make automatic quasi-peak measurements at up to six discrete frequencies, and directly print or plot measurement data using front-panel softkeys.

Features of the EMI Receiver Functions include a quasi-peak softkey that automatically chooses resolution bandwidths, video bandwidths, CISPR bandwidths, and sweeptimes for fast, accurate quasi-peak measurements. Up to six quasi-peak markers and numeric values can be displayed at the same time. This lets you simultaneously view a wide frequency span and the quasi-peak values of up to six signals. A numeric keypad overlay for the spectrum analyzer is included to help you select the right softkey, and a help function gives the purpose of each softkey. Options are available for factory installation of this product.

### Ordering Information

	Price
<b>HP 85685A</b> RF preselector	\$23,190
<b>Opt 010</b> Rackmount Slide Kit	+ \$395
<b>Opt 908</b> Rack Flange Kit Without Handles	+ \$33
<b>Opt 910</b> Extra Manual	+ \$51
<b>Opt 913</b> Rack Flange Kit with Handles	+ \$36
<b>HP 85650A</b> Quasi-peak Adapter	\$5,820
<b>Opt 908</b> Rack Flange Kit Without Handles	+ \$26
<b>Opt 910</b> Extra Manual	+ \$10
<b>Opt 913</b> Rack Flange Kit with Handles	+ \$31
<b>HP 85867A</b> EMI Receiver Functions	
<b>Opt 630</b> 3/4-inch Media	\$300
<b>Opt 655</b> 5/8-inch Media	\$300

\*CISPR Publication 16 is the Comité International Spécial des Perturbations Radioélectriques specification for radio interference measuring apparatus and measurement methods.

- EMC design evaluation tools
- Automated EMI compliance testing

- Test libraries for major regulatory agencies
- Complete, customized test reports

### HP 85712C EMC Measurement Personality Card

This memory card customizes the HP 8590 series portable spectrum analyzers for electromagnetic compatibility testing. Evaluation capabilities include limit lines, antenna-factor correction, quasi-peak measurements,\* average measurements, narrowband and broadband discrimination, EMC diagnostic keys, and EMC pre-compliance measurement keys. The EMC-measurement-enhanced analyzer works with the HP 11945A set of close-field probes to quickly locate EMI hot spots in your product, allowing you to read magnetic-field strength in dB $\mu$ A/m at the probe tip. (For more information on the HP 8590 series portable spectrum analyzers, see page 239.)

### HP 85869A EMI Measurement Software

The EMI measurement software is a general-purpose program for making radiated- and conducted-emission measurements automatically according to commercial and military regulations. The program is designed for use with the HP 8571A, 8572A, 8573B, and 8574B EMI receivers. A friendly menu structure leads you through an EMI measurement from the initial setup to the final plotting of the test results. The HP 85869A has an easy setup procedure, so you're ready to run even if you have never programmed before.

### Automate MIL-STD and Commercial EMI Measurements

The HP 85869A EMI measurement software automates military and commercial EMI measurements made in shielded enclosures. The program takes advantage of the ability of the spectrum analyzer to quickly measure wide frequency spans and locate device emissions using peak detection. For commercial measurements, quasi-peak and average data need be taken only at selected hot spots. Save time and effort in your MIL-STD measurements by using the software to automatically discriminate between narrowband and broadband signals.

### Design Your Own Tests

Design your own tests or choose from the examples given in the software. These examples reside in the test library and include MIL-STD, FCC, VDE, and FTZ emission tests. Transducer factors, test limits, and receiver parameters are easily changed and stored. Once you have designed a test, it is stored away and can be executed repeatedly at the press of a key.

### HP 85879A Radiated Emissions Measurement Software

Automate your commercial EMI compliance testing with the radiated-emissions measurement software. This program, designed for use with the HP 8572A, 8573B, and 8574B EMI receivers, simplifies radiated-emission measurements made in the presence of ambient signals. Results are accurate, repeatable, and fully documented.

### Separate Ambient Signals From EUT Emissions

The software generates a list of signal frequencies and amplitudes (along with antenna positions). This enables you to quickly identify and catalog ambient signals in the test environment. A pre-compliance scan feature helps you locate EUT emissions by scanning a selected frequency band and identifying potential emissions. Positioning equipment, such as the antenna tower and EUT turntable, is adjusted automatically by the software to maximize the signals. The software then creates a list of the suspect signals that require testing for final EMI compliance.

### Test to Regulatory Agency Specifications

The radiated emissions measurement software includes a library of test limits for all major regulatory agencies—FCC, FTZ, and VCCI. This eliminates the need to create a set of limits before final compliance testing. Also, the software allows you to verify test results manually and then return to program control just by pressing a key.

### Customize Tests and Measurement Reports

You can reconfigure tests easily by defining measurement routines that will automatically execute commands in the order you establish. The software also allows you to test to your own limits and to set receiver parameters to meet specific needs. An automated report generator records test results in graphic and tabular formats. Text can be integrated to produce concise, professional-looking reports. Storage libraries allow you to save, update, and reprint your reports.

### Use Selected PCs

The radiated-emissions measurement software runs on HP personal computers with HP BASIC language processors and 3 Mbytes of RAM. It also operates with selected IBM-compatible PCs using HP BASIC language processors and 3 Mbytes of RAM.

### Compatibility

The HP 85869A and 85879A are compatible with the following equipment. Compatible firmware datecodes vary. See data sheets for details.

**Spectrum analyzers:\*\*** HP 8566B, 8567A, 8568B

**RF preselector:** HP 85685A

**Quasi-peak adapter:** HP 85650A

**EMI receivers:** HP 8571A, 8572A, 8573B, 8574B

**Antenna towers:** HP 11968A (HP-IB), 11968B

**Turntables:** HP 11968D (HP-IB), 11968E

**Transducers:** HP 11966 Series

**Computers:\*\*** HP 9000 Series 200 Models 236, 236C; HP 9000 Series 300 Models 310, 319, 320, 330, 332, 340, 350, 360, 370, 375; and other personal computers. See data sheet for more information.

**Memory requirements:\*\*** 3 Mbytes

**Mass Storage:\*\*** HP 9122C, 9153C

**Plotters:** HP 7440A, 7475A, 7550B

**Printers:** HP 2225A ThinkJet, HP 2227B QuietJet Plus, HP C2106A DeskJet 500, HP 33471A LaserJet II P, HP 33449A LaserJet Series III

\*Quasi-peak measurements available by adding Opt 103 to HP 8591A, 8593A, 8594A, or 8595A spectrum analyzers.

\*\*Minimum equipment required.

### Ordering Information

	Price
<b>HP 85712C</b> EMC Measurement Personality Card	\$1,210
<b>HP 11946A</b> Quasi-Peak Detector/AM-FM Demodulator Upgrade Kit	\$1,910
<b>HP 85869A</b> EMI Measurement Software	\$0
<b>Opt 630</b> 3½-inch Disks	\$7,000
<b>Opt 655</b> 5¼-inch Disks	\$7,000
<b>Opt 830</b> Upgrade Kit for HP 85864A/B/C Software, 3½-inch Disks	\$500
<b>Opt 855</b> Upgrade Kit for HP 85864A/B/C Software, 5¼-inch Disks	\$500
<b>HP 85879A</b> Radiated Emissions Measurement Software	\$0
<b>Opt 630</b> 3½-inch Disks	\$8,000
<b>Opt 655</b> 5¼-inch Disks	\$8,000
<b>Opt 830</b> Upgrade Kit for HP 85870A Software, 3½-inch Disks	\$850
<b>Opt 855</b> Upgrade Kit for HP 85870A Software, 5¼-inch Disks	\$850

# SIGNAL ANALYZERS

## EMC Development Products and Accessories

### Various Models

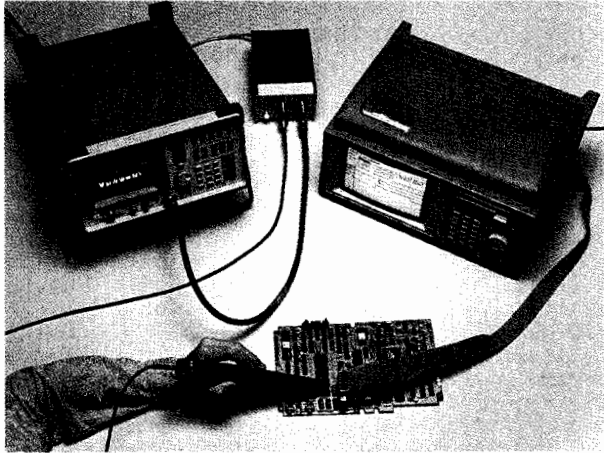

HP can show you how to design for electromagnetic compatibility.

### HP 11949A EMC Design Course

"Designing for EMC" is a two-day course for engineers who face issues of electromagnetic compatibility. Emphasis is placed on evaluating and solving EMC problems early in the design phase of a product, rather than during final EMC compliance testing. Expert instruction and many demonstrations provide EMC fundamentals, methods of measuring EMC, and principles of incorporating proven EMC design into products.

The course covers the following topics: overview of EMC design, non-conducted coupling, common impedance coupling, radiation from digital circuits, cables, advanced cables, conducted emissions, susceptibility, electrostatic discharge, shielding, and diagnostics. The 11-chapter handbook used in class becomes a permanent reference. To register, call 1-800-HP CLASS in the U.S. or contact your nearest HP Education Center (listed on page 675).

### HP 11950X EMC Design Course

This custom version of the HP 11949A EMC design course described above is offered for a fixed fee at the site of your choice. For more information, contact your local HP sales office (listed on page 684).

### HP 8566B/68B Option 462 Impulse Bandwidths

Option 462 for the HP 8566B and 8568B spectrum analyzers provides impulse bandwidths for making MIL-STD and DEF STAN EMI measurements. Standard HP 8566B and 8568B models have 12 resolution bandwidth filters (10 Hz to 3 MHz in a 1, 3, 10 sequence), specified in terms of their 3 dB bandwidth. Option 462 modifies the 1 kHz to 3 MHz resolution bandwidth filters to correspond to their impulse bandwidths instead.

In addition to enhancing instrument capability for MIL-STD 461A/B/C and 462 EMI measurements, spectrum analyzers with Option 462 can still make all commercial EMI and general-purpose measurements. Option 462 spectrum analyzers are compatible with the HP 85650A quasi-peak adapter, HP 85685A RF preselector, HP 85869A EMI measurement software, HP 85879A radiated emissions measurement software, and HP 85867A EMI receiver functions program. Existing HP 8566B and 8568B spectrum analyzers can be modified to include this option. For more information, contact your local HP sales office (listed on page 684).

### EMC Accessories Catalog

More complete descriptions and specifications for HP's growing line of accessories and transducers can be found in the EMC Accessories Catalog, HP literature number 5952-1791. This free catalog is available from your HP local sales office (listed on page 684).

### HP 11940A and 11941A Close-Field Probes

These hand-held probes are designed to measure magnetic-field radiation from surface currents, slots, cables, and ICs for EMC diagnostic and troubleshooting measurements. Their unique design results in a high level of electric-field rejection. This significantly reduces errors, thus allowing calibrated and repeatable measurements.

The HP 11941A operates from 9 kHz to 30 MHz; the HP 11940A, from 30 MHz to 1 GHz. Five antenna factors appear on each probe for calculating absolute magnetic-field strength ( $\text{dB}\mu\text{A}/\text{m}$ ) from the  $\text{dB}\mu\text{V}$  reading of a spectrum analyzer. Each probe is calibrated and comes with a 2-meter RG-223 coaxial cable, an SMA(f)-to-type-N(m) adapter, and an SMA(f)-to-BNC(m) adapter.

### HP 11945A Close-Field Probe Set

The close-field probe set includes both the HP 11940A and 11941A probes for full coverage from 9 kHz to 1 GHz. Option E51 adds the HP 8447F Option H64 dual preamplifier, a 36-in (914-mm) Type N cable, and a carrying bag for storage and protection of the entire set.

### HP 11947A Transient Limiter

This limiter protects a spectrum analyzer input from damage caused by high-level transients from line impedance stabilization networks (LISNs) during EMI testing for conducted emissions. Frequency range is 9 kHz to 200 MHz and insertion loss is 10 dB. The transient limiter can withstand inputs as high as 10 kW for 10  $\mu\text{s}$ , or 2.5 W of average power. The built-in high-pass filter helps reduce 60 Hz line feedthrough that could impede conducted-emission measurements. This limiter is not required for HP 8573B and 8574B EMI receivers or other systems employing the HP 85685A RF preselector.

### HP 11966 Series Antennas

These antennas are individually calibrated and shipped with a calibration certificate showing actual performance data. The series includes the following products:

HP Model	Frequency Range
HP 11966A Active Loop H-Field Antenna	10 kHz to 30 MHz
HP 11966B Active Rod E-Field Antenna	30 Hz to 50 MHz
HP 11966C Biconical Antenna	30 to 300 MHz
HP 11966D Log Periodic Antenna	200 MHz to 1 GHz
HP 11966E Double-Ridged Waveguide Horn Antenna	1 to 18 GHz
HP 11966F Conical Log Spiral Antenna	200 MHz to 1 GHz
HP 11966G Conical Log Spiral Antenna	1 to 10 GHz
HP 11966H Dipole Antenna Set	28 MHz to 1 GHz
HP 11966K Magnetic Field Pickup Coil	20 Hz to 50 kHz

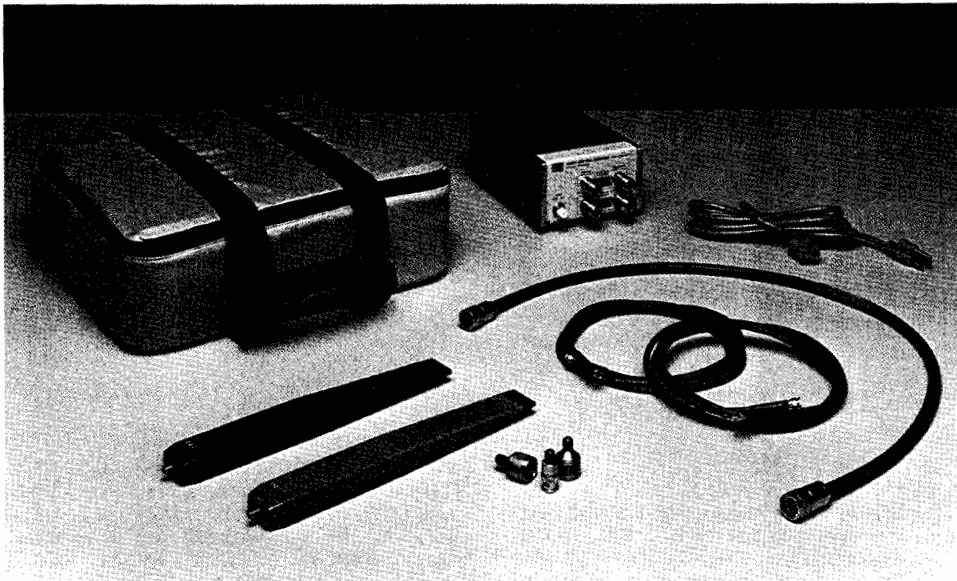

#### HP 11967 Series Current Probes

This series is designed for MIL-STD 461/462 conducted-emission measurements on power and interconnecting leads. Used with 10  $\mu$ F capacitors, HP part number 0160-6683.

HP Model	Frequency Range
11967A Current Probe	15 kHz to 50 MHz, dc to 60 Hz powerlines
11967B Current Probe	20 Hz to 2 MHz, dc to 400 Hz powerlines

#### HP 11967C Line Impedance Stabilization Network

Used for commercial, CISPR-based conducted emission measurements, this single-phase unit meets the requirements of the FCC and VDE for conducted emission testing. Includes color-coded pin plugs for constructing a power cord to connect with the LISN.

#### HP 11968 Series Positioning Devices

This series includes motorized and manually operated antenna masts and turntables.

HP Model	Description
11968A	Motorized, HP-IB programmable antenna-positioning mast; includes controller
11968B	Manually operated antenna-positioning mast
11968C	Non-metallic antenna tripod; minimizes unwanted reflections in the test environment
11968D	Motorized, HP-IB programmable equipment-testing turntable; includes controller
11968E	Manually operated turntable

#### 11729-60014 Low-Noise Preamplifier

This amplifier provides the sensitivity needed for MIL-STD 461C CE-06 receiver/transmitter key-up testing. Frequency range is 10 Hz to 25 MHz.

#### HP 8447F Option H64 Dual Preamplifier

Improve receiver and spectrum analyzer sensitivity for more accurate radiated-emission measurements. This dual preamplifier is ideal for use with the HP 11940A and 11941A close-field probes to detect low-level signals from a device under test. Frequency range is 9 kHz to 1.3 GHz. See page 478.

#### HP 8449B Microwave Preamplifier

This high-gain, low-noise preamplifier adds sensitivity for MIL-STD radiated measurements. Frequency range is 1 to 26.5 GHz. See page 478.

#### Ordering Information

HP Model	Description	Price
HP 11949A	"Designing for EMC" Course (per person)	\$750
HP 11950X	"Designing for EMC" Course (per site)	\$12,500
HP 8566B/8568B	Opt 462 Impulse Bandwidths	\$2,040
HP 11940A	Close-Field Probe, 30 MHz to 1 GHz	\$690
HP 11941A	Close-Field Probe, 9 kHz to 30 MHz	\$690
HP 11945A	Close-Field Probe Set, 9 kHz to 1 GHz	\$1,185
Opt 001	Rotary Joints	+ \$790
Opt 003	Delete Cables and Adapters (2 sets)	- \$210
Opt E51	Add HP 8447F Option H64 Preamplifier, Carrying Bag, 36-in Type N Cable	+ \$2,720
HP 11947A	Transient Limiter, 9 kHz to 200 MHz	\$500
HP 11966A	Active Loop H-Field Antenna, 10 kHz to 30 MHz	\$2,475
HP 11966B	Active Rod E-Field Antenna, 30 to 50 MHz	\$2,180
HP 11966C	Biconical Antenna, 30 to 300 MHz	\$1,610
HP 11966D	Log Periodic Antenna, 200 MHz to 1 GHz	\$1,875
HP 11966E	Double-Ridged Waveguide Horn Antenna, 1 to 18 GHz	\$3,230
HP 11966F	Conical Log Spiral Antenna, 200 MHz to 1 GHz	\$1,920
HP 11966G	Conical Log Spiral Antenna, 1 to 10 GHz	\$1,770
HP 11966H	Dipole Antenna Set, 28 MHz to 1 GHz	\$3,850
HP 11966I	Double-Ridged Waveguide Horn Antenna, 200 MHz to 2 GHz	TBA
HP 11966J	Double-Ridged Waveguide Horn Antenna, 18 to 40 GHz	TBA
HP 11966K	Magnetic Field Pickup Coil, 20 Hz to 50 kHz	\$570
HP 11966N	Log Periodic Antenna, 200 MHz to 5 GHz	TBA
HP 11967A	Current Probe, 15 kHz to 50 MHz	TBA
HP 11967B	Current Probe, 20 Hz to 2 MHz	TBA
HP 11967C	Line Impedance Stabilization Network	\$2,810
HP 11968A	Motorized Antenna-Positioning Mast	\$18,575
HP 11968B	Manual Antenna-Positioning Mast	\$3,005
HP 11968C	Antenna Tripod	\$755
HP 11968D	Motorized Equipment-Testing Turntable	\$11,400
HP 11968E	Manual Equipment-Testing Turntable	\$1,555
0160-6683	10 $\mu$ F capacitor	TBA
11729-60014	Low-Noise Preamplifier, 10 Hz to 25 MHz	\$525
HP 8447F	Option H64 Dual Preamplifier, 9 kHz to 1.3 GHz	\$2,720
HP 8449B	Microwave Preamplifier, 1 to 26.5 GHz	\$7,310

☎ For off-the-shelf shipment, call 800-452-4844.

# SIGNAL ANALYZERS

## Selective Level Meter and Distortion Measurement Set

HP 3586C, 339A

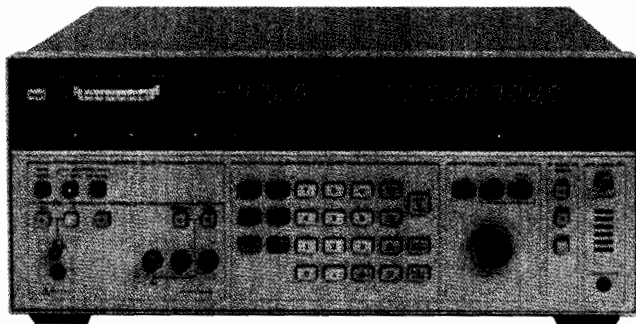

HP 3586C



### HP 3586C Selective Level Meter

The HP 3586C Selective Level Meter is designed for general-purpose wave analysis applications in the design, manufacture, and maintenance of electronic systems. The HP 3586C is fully HP-IB programmable and covers the frequency range of 50 Hz to 32.5 MHz, allowing measurement of audio, sonar, and other low-frequency systems, as well as high-frequency communications subsystems. Input impedances of 50, 75, and 600  $\Omega$  are provided with 10 k $\Omega$  bridging for maximum measurement flexibility in a wide variety of applications. Signal levels are measured with up to  $\pm 0.2$  dB accuracy down to  $-80$  dB, with 0.01 dB resolution and bandwidth choices of 20, 400, or 3100 Hz. The built-in counter and narrow-resolution bandwidths allow harmonic and intermodulation measurements to be made with ease. Frequency can be set or measured with 0.1 Hz resolution and  $\pm 10$  ppm stability ( $\pm 0.2$  ppm optional).

For frequency response measurement of high-Q filters and other selective networks, the companion HP 3336C synthesizer/level generator functions as a full-featured, HP-IB programmable tracking generator. Frequency range for the HP 3336C is 10 Hz to 21 MHz, with precise output levels from  $-70$  to  $+8$  dBm.

### HP 3586C Specifications (abbreviated)

#### Frequency

**Range:** 50/70  $\Omega$  unbalanced input, 50 Hz to 32.5 MHz; 600  $\Omega$  balanced input, 50 Hz to 108 kHz

**Resolution:** 0.1 Hz

**Center frequency accuracy:**  $\pm 1 \times 10^{-3}$ /year ( $\pm 2 \times 10^{-7}$ /year with option 004).

#### Selectivity

**3dB bandwidth:**  $\pm 10\%$ : 20 Hz, 400 Hz, 3100 Hz

**Pass band flatness:**  $\pm 0.3$  dB

#### Level accuracy (+20 to -80 dB):

$\pm 0.20$  dBm, 20 kHz to 18 MHz

$\pm 0.25$  dBm, 18 MHz to 32.5 MHz

### Ordering Information

	<b>Price</b>
<b>HP 3586C</b> Selective Level Meter	\$12,700
<b>Opt 004</b> High-Stability Frequency Reference	+ \$775
<b>Opt 907</b> Front Panel Handles	+ \$68
<b>Opt 908</b> Rack Flange Kit	+ \$37
<b>Opt 909</b> Rack Flange & Handle Combination Kit	\$95
<b>Opt W30</b> Extended repair service. See page 671.	\$280

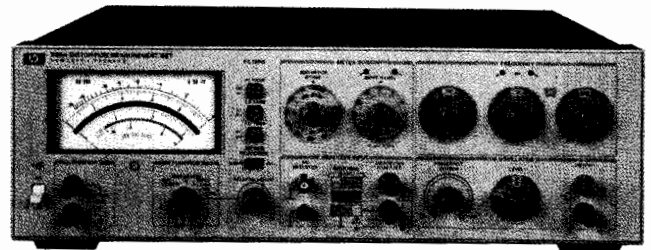

HP 339A

### HP 339A Distortion Measurement Set

The HP 339A Distortion Measurement Set is an ultralow distortion measuring system complete with total harmonic distortion (THD) analyzer, true rms voltmeter, and sinewave oscillator. This lightweight bench instrument allows you to make THD measurements over the 10 Hz to 110 kHz frequency band, including harmonics to 330 kHz.

With the built-in tracking oscillator in the HP 339A, you only need to tune one instrument instead of two. Input filters are included to speed test time. The 30 kHz low-pass filter provides the band limiting required by FCC proof-of-performance broadcast testing. An 80 kHz low-pass filter and 400 Hz high pass filter reduce high frequency noise and line frequency hum.

### Distortion Measurements

The fundamental frequency range is 10 Hz to 110 kHz with continuous frequency coverage with 2-digit resolution. The distortion analyzer and oscillator are tuned simultaneously. Distortion measurement range is 100% to 0.01%, (0 dB to  $-80$  dB).

### Specifications

#### Distortion measurement accuracy

20 Hz to 20 kHz:  $\pm 1$  dB

10 Hz to 50 kHz:  $+1, -2$  dB

50 kHz to 110 kHz:  $+1.5, -4$  dB

#### Distortion introduced by instrument (input > 1V rms)

10 Hz to 20 kHz <  $-95$  dB (0.0018%) THD

20 kHz to 30 kHz <  $-90$  dB (0.0056%) THD

30 kHz to 50 kHz <  $-85$  dB (0.01%) THD

50 kHz to 110 kHz <  $-70$  dB (0.032%) THD

#### Oscillator

Frequency range is 10 Hz to 100 kHz with 2-digit resolution. Output level is variable from 1 V rms to  $> 3$  V rms.

#### Oscillator distortion (> 600 ohm load, < 3 Vrms)

10 Hz to 20 kHz <  $-93$  dB (0.0022%) THD

20 kHz to 30 kHz <  $-85$  dB (0.0056%) THD

30 kHz to 50 kHz <  $-80$  dB (0.01%) THD

50 kHz to 80 kHz <  $-70$  dB (0.032%) THD

80 kHz to 110 kHz <  $-65$  dB (0.056%) THD

#### Voltmeter

Range is 1 mV rms full scale to 300 V rms full scale ( $-60$  dB to  $+50$  dB with the meter calibrated in dBV to 600 ohms). Option 001 provides increased sensitivity to 0.1 mV rms ( $-80$  dBV).

#### Voltmeter accuracy

1 mV to 300 V Ranges .1 mV and .3 mV ranges

20 Hz to 20 kHz:  $\pm 2\%$  20 Hz to 20 kHz:  $\pm 2\%$

10 Hz to 110 kHz:  $\pm 4\%$  10 Hz to 30 kHz:  $\pm 4\%$

30 kHz to 80 kHz:  $+10\%$  to  $-30\%$

#### General

**Power:** 100/120/220/240 V  $+5\%$ ,  $-10\%$ , 48 Hz to 66 Hz line operation, 200 mA maximum.

**Size:** 146 mm H  $\times$  426 mm W  $\times$  375 mm D (5.75 in  $\times$  16.75 in  $\times$  14.75 in)

**Weight:** Net, 8.2 kg (18 lb); shipping, 11.3 kg (25 lb)

### Ordering Information

	<b>Price</b>
<b>HP 339A</b> Distortion Measurement Set	\$4,875
<b>Opt 001</b> Increased Sensitivity	\$290
<b>Opt W30</b> Extended Repair Service. See page 671.	\$105



### Calibrated, Automated Phase Noise Measurements with

- Specified amplitude accuracy of  $\pm 2$  dB
- Offset frequency range of 0.01 Hz to 40 MHz
- Carrier frequency range from 5 MHz to beyond 18 GHz
- Spurs separated from noise spectra

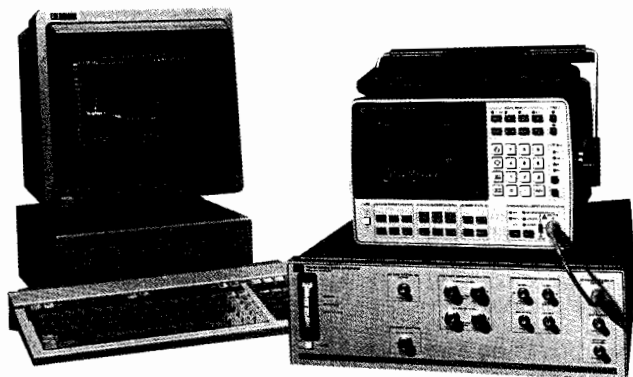

HP 3048A Phase Noise Measurement System controlled by an HP 98580C Desktop Computer.

### HP 3048A Phase Noise Measurement System

The HP 3048A Phase Noise Measurement System uses the power of a flexible software program to automate phase noise carrier measurements. The basic HP 3048A system includes the HP 11848A Phase Noise Interface containing the phase detectors and phase-lock loop circuitry, the HP 3561A Dynamic Signal Analyzer, measurement software, and a comprehensive operator training course. Using the HP 98580C desktop computer (or PC-compatible, with Option 301), the basic system measures carrier frequencies from 5 MHz to 1.6 GHz (to 18 GHz with Option 201) and characterizes the demodulated phase noise over an offset range of 0.01 Hz to 100 kHz. Adding an RF spectrum analyzer such as the HP 3585A/B provides automated measurements to offsets of 40 MHz. A variety of signal generators such as the HP 8662A, HP 8663A, or HP 8642A/B can also be added to the system to provide a low-noise reference signal up to a frequency of 2.56 GHz.

### Measurements Above 1.6 GHz

Adding an HP 11729C Carrier Noise Test Set in combination with an HP 8662A or HP 8663A provides a low-noise reference signal for measuring carrier signals up to 18 GHz. The local oscillator is gener-

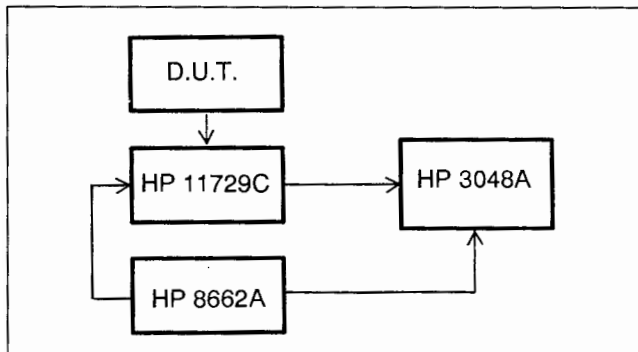

HP 3048A Phase Noise Measurement System extended to 18 GHz

ated from the 640 MHz rear-panel auxiliary output of the HP 8662A (or HP 8663A). Using this reference, a step recovery diode (internal to the HP 11729C) generates a series of harmonics up to approximately 18 GHz that are used to down-convert the microwave signal. The HP 11729C down converts microwave signal sources to an intermediate frequency between 5 and 1280 MHz, a range where tunable, low noise references are available. A bandpass filter is used to apply the correct harmonic to the mixer for down-conversion of the microwave input signal. With the down-converted microwave signal and a reference oscillator, a fully calibrated phase noise measurement of the microwave signal can be made.

To extend the frequency range of the HP 3048A to millimeter wave frequencies (up to 110 GHz), there are special options available for both the HP 3048A and the HP 11729C. For complete information regarding millimeter-wave extensions to the HP 3048A, consult Application Note 385, *Millimeter Measurements Using the HP3048A Phase Noise Measurement System* (P/N 5951-6749) or contact your local Hewlett-Packard sales office.

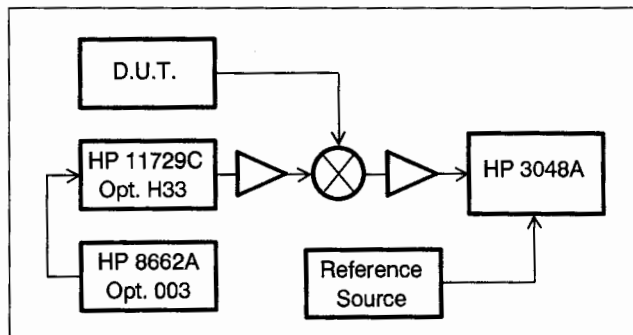

HP 3048A extended to 110 GHz

In both the microwave and millimeter down-conversion setups, the random phase noise contribution of the HP 11729C/HP 8662A combination is dominated by the multiplied absolute noise of the HP 8662A auxiliary 640 MHz rear-panel output.

### Phase Noise Measurement Software

The HP 3048A system software uses the HP 11848A interface to demodulate the phase noise of a carrier in the frequency range of 5 MHz to 18 GHz (and beyond with external, user-supplied mixers) and measures the resulting baseband signal with the analyzers. Measurement menus allow the operator to specify the measurement process, including the calibration of the system. Several output formats are available to the user, including plots of the single sideband phase noise power of a signal, integrated noise power, or the calculated Allen variance. A real-time measurement mode is available to monitor the level of phase noise and discrete spurs as changes are made to the device under test. The phase noise measurement software is available in both RMB workstation or MS-DOS® PC-compatible formats.

As measured by the HP 3048A, the term *phase-noise* includes all forms of a signal's frequency and phase instabilities. Randomly occurring frequency and phase modulation, as well as discrete sidebands resulting from power-line phase modulation and phase jitter, are detected and accurately measured. Coherent signals are displayed at the power level that was detected while random phase signals are normalized for a 1 Hz bandwidth. The recommended phase noise measurement technique is the phase detector method which requires a reference oscillator with adequate noise performance and tuning capability.

MS-DOS is a U.S. registered trademark of Microsoft Corp.

# SIGNAL ANALYZERS

## Automated Spectrum Analysis (cont'd)

### HP 3048A

#### Specifications Summary

##### Sensitivity

The following graph indicates the sensitivity of the HP 3048A system as limited by its own internally generated noise for a signal under test at +15 dBm. Also plotted is the phase noise that would limit the measurement sensitivity for a 1 GHz signal using the phase detector measurement method and the HP 8662A or HP 8663A as a reference source.

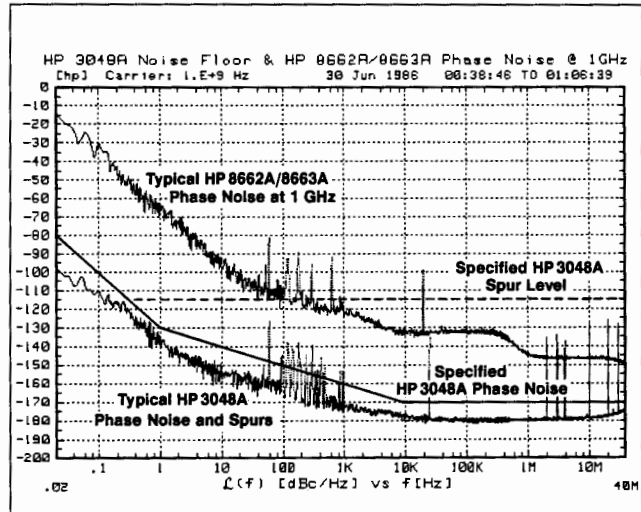

#### Carrier frequency range

**Internal mixer:** 5 MHz to 1.6 GHz, optional to 18 GHz

**External (user-supplied) mixer:** The frequency range of the carrier is limited only by the frequency range of the external mixer.

**Offset frequency range:** 0.01 Hz to 100 kHz, extended to 40 MHz with an optional spectrum analyzer such as the HP 3585B

**Amplitude accuracy:**  $\pm 2$  dB to 1 MHz offsets;  $\pm 4$  dB for offsets greater than 1 MHz. This accuracy is verified by the system at the time of the measurement. If there are any accuracy degradations, the system will advise the user during the measurement.

#### Ordering Information

**HP 3048A Phase Noise Measurement System** \$38,500

Includes the HP 11848A Phase Noise Interface, HP3561A Dynamic Signal Analyzer, RMB workstationbased measurement software and operator training.

#### Reference oscillator options

**Opt 001** Adds HP 8662A Opt 003 Synthesized Signal Generator (0.01 to 1280 MHz) +\$42,525

**Opt 002** Adds HP 8663A Opt 003 Synthesized Signal Generator (0.1 to 2560 MHz) +\$58,475

**Opt 003** Adds HP 11729C Carrier Noise Test Set (1.28 to 18 GHz) +\$28,035

**Opt 004** Adds HP 11729C Opt 130 Carrier Noise Test Set +\$30,015

**Opt 006** Adds HP 8642B Opt 001 Synthesized Signal Generator (0.1 to 2114 MHz) +\$44,240

#### Software option

**Opt 301** Replaces standard RMB workstation phase noise software w/MS-DOS PC-compatible phase noise software. A graphics dump utility comes w/this option. \$0

#### System computers

**HP 3048A Standard:** HP 98580C Opt 104 and HP-HIL Knob (HP 46083A)

**HP 3048A Opt 301:** IBM PC/AT/XT and true compatibles with 640 Kbytes RAM; MS-DOS 3.0 or later; EGA or compatible video card with 128 Kbytes video RAM; EGA or compatible color display; HP-IB card (recommend HP 82335A HP-IB card<sup>1</sup>)

For full details on available system options and ordering information, see the HP 3048A Phase Noise Measurement System technical data (5953-8462).

- Down-converts 1.28 to 18 GHz signals
- Low noise floor

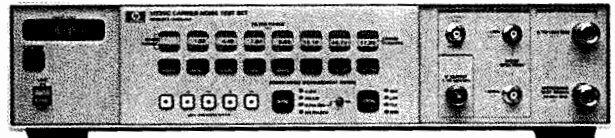

HP 11729C



#### HP 11729C Carrier Noise Test Set

The HP 11729C is a fully programmable microwave down-converter used primarily as an accessory to the HP 3048A Phase Noise Measurement System. The input frequency range of the HP 11729C is 1.28 to 18 GHz and IF bandwidth is 5 to 1280 MHz. With option 130, the HP 11729C can be used as an AM noise demodulator for carriers from 10 MHz to 18 GHz. The baseband demodulated signal is input to the HP 3048A for calibrated AM noise measurements.

#### Specifications Summary

##### Downconverter

**Frequency range:** 1.28 to 18 GHz in 8 bands

**Amplitude:** +7 dBm minimum  
+18 dBm maximum

##### IF output

**Bandwidth:** 5 to 1280 MHz

**Level:** +7 dBm minimum

##### AM noise detection (Option 130)

**Frequency range:** 10 MHz to 18 GHz

**Input level:** 0 dBm minimum  
+18 dBm maximum

##### AM noise floor (at +10 dBm input level, dBc/Hz):

Offset from carrier	Typical	Specified
1 kHz	-147	-138
10 kHz	-152	-145
100 kHz	-161	-155
1 MHz-165	-160	

#### General

**Operating temperature range:** 0° to +55° C

**Power:** 100, 120, 220, 240 V, +5%, -10%; 48 to 66 Hz; <75 VA max.

**Weight:** Net, 10.4 kg (23 lb); shipping, 13.6 (30 lb)

**Size:** 99 mm H x 425 mm W x 551 mm D (16.8 in x 21.7 in x 3.9 in)

1MW x 3' H x 20 D System II module

#### Ordering Information

**HP 11729C Carrier Noise Test Set (10 MHz to 18 GHz)<sup>2</sup>** \$28,035

Note: Each of options 003 through 027 (only one may be ordered) also includes 0.005 to 1.28 GHz coverage which is not used for downconversion.

**Opt 003** (1.28 to 3.2 GHz) - \$8,500

**Opt 007** (3.2 to 5.76 GHz) - \$8,500

**Opt 011** (5.76 to 8.32 GHz) - \$8,500

**Opt 015** (8.32 to 10.88 GHz) - \$8,500

**Opt 019** (10.88 to 13.44 GHz) - \$8,500

**Opt 023** (13.44 to 16.0 GHz) - \$8,500

**Opt 027** (16.0 to 18.0 GHz) - \$8,500

**Opt 130** AM noise detection +\$1,980

**Opt 140** Rear panel connectors +\$570

**Opt 907** Front handle kit (5062-3988) +\$57

**Opt 908** Rack flange kit (5062-3974) +\$36

**Opt 909** Rack flange kit with front handles (5062-3975) +\$82

**Opt 910** A total of two sets of operation and service manuals (11729-90017) +\$36

**Opt W30** Extended repair service, see page 671 +\$140

<sup>1</sup> Also operates with National Instruments PC-II and PC-III GP-IB cards

<sup>2</sup> Extends to 10 MHz for AM detection only

☎ For off-the-shelf shipment, call 800-452-4844.

- Displays phase and amplitude modulation vs. time
- 350 MHz I, Q baseband signal analysis
- Markers for measuring phase, amplitude, and time
- 12-bit digitizing for HP-IB measurements

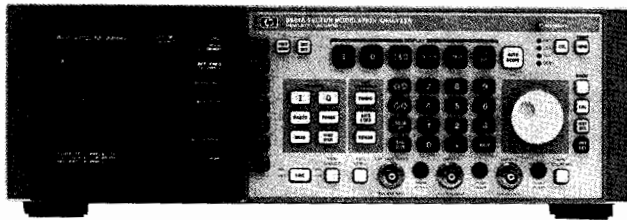

HP 8980B

- 50 to 200 MHz modulated IF input frequency range
- Other bands available to 1400 MHz
- 35 MHz baseband bandwidth with I/Q filters and 35 MHz with internal filters
- I,Q BWs up 40 to 250 MHz with higher IF bands
- Automatic internal/external demodulator calibration

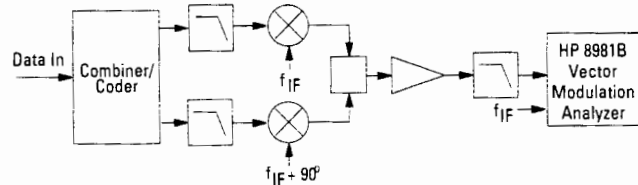

Fig. 2. I/Q Modulator Measurement with HP 8981B

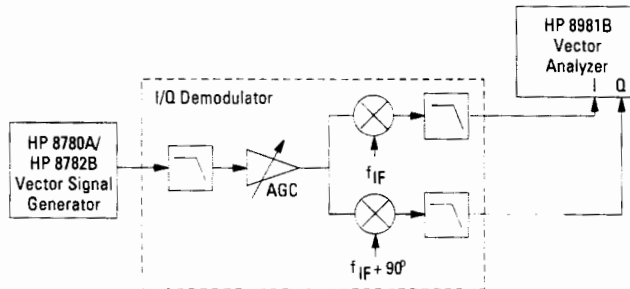

Fig. 1. I/Q Demodulator Measurement with HP 8980/81 B

The HP 8980B vector analyzer and HP 8780A/8782B Vector Signal Generators can be used to adjust and troubleshoot an I/Q demodulator directly. The I/Q outputs of the demodulator are connected directly to the HP 8980B. The HP 8980B vector analyzer can display the constellations of high-rate modulation schemes such as QPSK, 16QAM, 49PRS, 64QAM, and 256QAM. It also makes statistical measures of system quality such as closure, lock angle error, and quadrature error.

### HP 8981B Vector Modulation Analyzers

The HP 8981B vector modulation analyzer analyzes analog I and Q signals, because it contains a calibrated demodulator it can be connected to the IF of the modulator. This gives you the flexibility to examine changes in modulation down through the receiver chain and isolate faults quickly.

#### Specifications

##### HP 8981B I/Q Mode Specifications

###### I and Q channels

**Bandwidth** (–3dB): 350 MHz dc-coupled

**DC vector accuracy using internal ADC:** ±1% of full scale

**Input termination:** 50 ohms or 75 ohms

**Input coupling:** Each channel independently: ac, dc, or ground

###### Power Requirements

**Voltage:** 100, 120, 220, 240 Vac, –10% to 10%; 48 to 66 Hz

**Power:** 245 W, 320 VA maximum

**Dimensions:** 5½-inch rack height, one module width 23D HP

System II cabinet

**Weight:** Net, approximately 20 kg (45 lb); shipping, approximately 24 kg (53 lb)

##### HP 8981B Demod Mode Specifications

**Modulated IF input frequency range:** 50 to 200 MHz.

**Modulated IF input level range:** –5 to –20 dBm.

**Coherent reference input frequency range:** 50 to 200 MHz.

**Coherent reference input level range:** +10 to –20 dBm.

**Baseband bandwidth** (3 dB): 100 MHz with external filters. Supplemental characteristic of 35 MHz with internal filters.

**Corrected vector dc accuracy at 70 MHz:** (typical from 50 to 200 MHz) <2% of full scale IF input.

###### Supplemental Characteristics

**Quadrature error:** Corrected: < ±0.5°; uncorrected: < ±1°.

**I/Q gain imbalance** (dc to 10 kHz): Corrected, < ±0.1 dB; uncorrected, < ±0.25 dB.

	Frequency Range	RF BW	Calibrated Modulation Analysis	Calibrated I/Q Outputs
HP8981B	50 to 200 MHz	70 MHz	Yes	No
Opt H20	200 to 350 MHz	100 MHz	Yes	No
Opt H32	321.4 MHz	200 MHz	Yes	Yes
Opt H35	350 to 500 MHz	150 MHz	Yes	No
Opt H36	360 to 550 MHz	200 MHz	Yes	No
Opt H50	500 to 900 MHz	300 MHz	Yes	No
Opt H75	750 to 1250 MHz	500 MHz	Yes	No
Opt H85	850 to 1400 MHz	500 MHz	Yes	No

#### Ordering Information

**HP 8981B** Vector Modulation Analyzer

**HP 11748A** Active Probe System

#### Price

\$32,000

\$4,000



UMOP (Unintentional Modulation on Pulse) is identified by quantitatively measuring and displaying the phase and amplitude transients on a radar pulse.



Display of vector-demodulated SAW chirp signals. The spiraling phase response indicates the changing chirp frequency and amplitude.

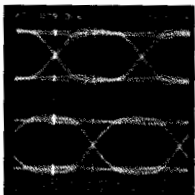

**I & Q Display:** Each I and Q channel is displayed vs. time on a separate grid, one above the other.

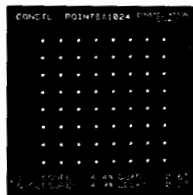

**Constellation Display:** Displays Q vs. I at the instant defined by the time marker.

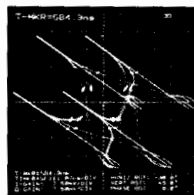

**3D Display:** Useful for visual, or intuitive, analysis of Q vs. I vs. time waveforms. Signal can be rotated about any of 3 axes for optimal viewing.

# SIGNAL ANALYZERS

## Audio Analyzer, 20 Hz to 100 kHz; Distortion Analyzer, 20 Hz to 100 kHz

### HP 8903B, 8903E

- Measures distortion, SINAD, signal-to-noise
- Measures true-rms ac volts, dc volts, frequency
- Low-distortion programmable source
- rms, average, and quasi-peak detection

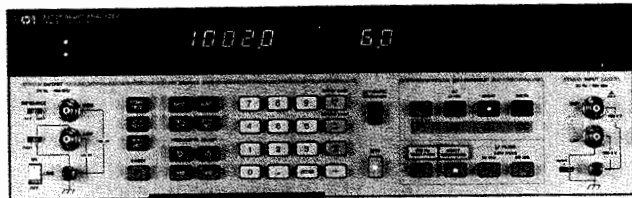

HP 8903B



### HP 8903B Audio Analyzer and HP 8903E Distortion Analyzer

The HP 8903B audio analyzer and HP 8903E distortion analyzer provide unparalleled versatility and performance for audio measurements from 20 Hz to 100 kHz. The HP 8903B combines the functionality of a low-distortion audio source, high-performance distortion analyzer, frequency counter, ac voltmeter, dc voltmeter, and SINAD meter into one compact package. With microprocessor control of source and analyzer, the HP 8903B can perform stimulus-response measurements, such as signal-to-noise ratio and swept distortion, automatically with no additional equipment. The HP 8903E distortion analyzer is the analyzer portion of the HP 8903B audio analyzer. (The HP 8903E has no source.)

For ease of use, most measurements on the HP 8903B and HP 8903E are made with only one or two keystrokes. Both instruments automatically tune and autorange for maximum accuracy and resolution. For quick identification of input signals, the analyzer counts and displays the input frequency in all ac measurement modes.

#### Low-Frequency Applications

The HP 8903B/E have many features that make difficult audio measurements easy. These include flexible data display formats, a selectable balanced or unbalanced input, plug-in filters, and automatic notch filter tuning. With the ratio key, you can establish a reference in % or dB and directly make frequency-response and 3 dB bandwidth measurements without computation. A fully balanced analyzer input allows testing of the bridged power amplifiers found in many radios and car stereos, as well as professional balanced audio equipment.

With 2 internal plug-in filter slots and 6 optional filters to choose from, we simplify your audio measurements by providing the filter networks required by international standards. (See the next page for a complete list of filters.) The HP 8903B and HP 8903E both use true-rms detection (for all signals with crest factor 3) for accurate measurement of complex waveforms and noise. Average and quasi-peak detectors are also available. (Quasi-peak is selectable only via HP-IB on the HP 8903E.) Accurate distortion measurements typically can be made down to less than  $-90$  dB (0.003%) from 20 Hz to 20 kHz.

For receiver testing, both instruments have a tunable SINAD notch filter. On the HP 8903B, the filter is automatically tuned to the source frequency. With the HP 8903E, a front-panel key allows the operator to lock the notch filter at any given input frequency.

- Measures distortion, SINAD
- Measures true-rms ac volts, dc volts, frequency
- rms, average, and quasi-peak detection

SUPPORTED BY  
**HP ITG**  
SOFTWARE

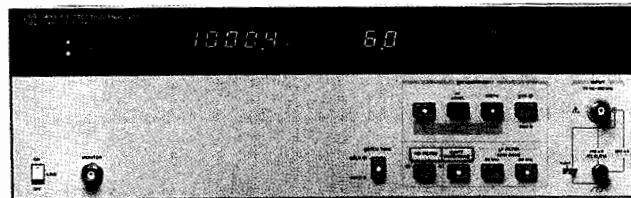

HP 8903E



### HP 8903B and HP 8903E Specifications

#### System Specifications

(HP 8903B only, source and analyzer combined)

#### Distortion

Residual distortion and noise (the higher of):

- 80 kHz BW:  $-80$  dB (0.01%) or  $17 \mu\text{V}$ , 20 Hz to 20 kHz
- 500 kHz BW:  $-70$  dB (0.032%) or  $50 \mu\text{V}$ , 20 Hz to 50 kHz
- $-65$  dB (0.056%) or  $50 \mu\text{V}$ , 50 kHz to 100 kHz

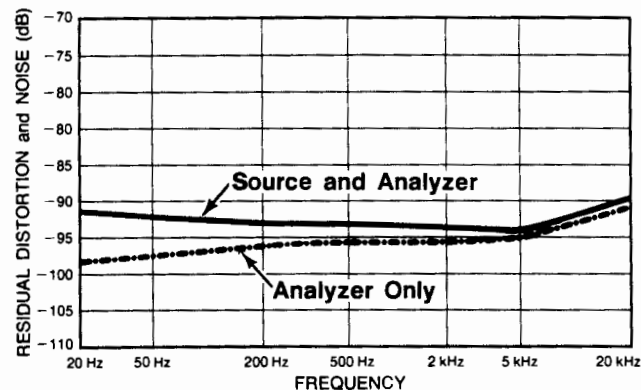

Typical residual THD + noise for source and analyzer combined (source voltage set to 1.5 V, 80 kHz BW). Dashed line represents typical residual THD + noise for the analyzer only.

#### Signal-to-Noise

Frequency range: 50 Hz to 100 kHz

Display range: 0 to 99.99 dB

Accuracy:  $\pm 1$  dB

Input voltage range: 50 mV to 300 V

Residual noise (the higher of):  $-85$  dB or  $17 \mu\text{V}$ , 80 kHz BW;  $-70$  dB or  $50 \mu\text{V}$ , 500 kHz BW

#### Source Specifications (HP 8903B only)

##### Frequency

Range: 20 Hz to 100 kHz

Resolution: 0.3%

Accuracy: 0.3% of setting

##### Output Level

Range: 0.6 mV to 6 V open circuit

Resolution: 0.3% or better

Accuracy (open circuit): 2% of setting 60 mV to 6 V, 20 Hz to 50 kHz; 3% of setting 6 mV to 6 V, 20 Hz to 100 kHz; 5% of setting 0.6 to 6 mV, 20 Hz to 100 kHz.

**Flatness** (1 kHz reference):  $\pm 0.7\%$  ( $\pm 0.06$  dB), 20 Hz to 20 kHz;  $\pm 2.5\%$  ( $\pm 0.22$  dB), 20 Hz to 100 kHz

**Distortion and noise** (the higher of):

**80 kHz BW:**  $-80$  dB (0.01%) or  $15 \mu\text{V}$ , 20 Hz to 20 kHz

**500 kHz BW:**  $-70$  dB (0.032%) or  $38 \mu\text{V}$ , 20 Hz to 50 kHz  
 $-65$  dB (0.056%) or  $38 \mu\text{V}$ , 50 to 100 kHz

**Impedance:**  $600 \Omega \pm 1\%$  or  $50 \Omega \pm 2\%$ , front-panel selectable (HP-IB programmable)

**Sweep mode:** Log sweep with up to 500 points per decade or 255 points total between entered start and stop frequencies.

## Analyzer Specifications

### Distortion

**Fundamental frequency range:** 20 Hz to 100 kHz

**Display range:** 0.001% to 100% ( $-99.99$  to 0 dB)

**Accuracy:**  $\pm 1$  dB, 20 Hz to 20 kHz;  $\pm 2$  dB, 20 kHz to 100 kHz

**Input voltage range:** 50 mV to 300V

**Residual distortion and noise** (the higher of):

**80 kHz BW:**  $-80$  dB (0.01%) or  $15 \mu\text{V}$ , 20 Hz to 20 kHz

**500 kHz BW:**  $-70$  dB (0.032%) or  $45 \mu\text{V}$ , 20 Hz to 50 kHz  
 $-65$  dB (0.056%) or  $45 \mu\text{V}$ , 50 kHz to 100 kHz

### Supplemental Characteristics

**3 dB measurement bandwidth:** 10 Hz to 500 kHz

**Detection:** true rms or rms calibrated average

### SINAD

**Fundamental frequency range:** 20 Hz to 100 kHz.

**Display range:** 0 to 99.99 dB.

**Residual distortion and noise:** Same as listed under Distortion.

**Accuracy:**  $\pm 1$  dB, 20 Hz to 20 kHz;  $\pm 2$  dB, 20 to 100 kHz.

**Input voltage range:** 50 mV to 300 V.

### Supplemental Characteristics

**Detection:** True rms or rms-calibrated average.

**Tuning:** HP 8903B: Notch filter is tuned to the internal source frequency. HP 8903E: Notch filter is tuned to the counted input frequency. Notch filter hold function available on front panel.

### AC Level

**Full range display:** 300 V, 30 V, 3 V, 0.3 V, 30 mV, 3 mV, 0.3 mV

**Overrange:** 33%, except on 300 V range

**Accuracy:**  $\pm 2\%$ , 50 mV to 300 V, 20 Hz to 20 kHz;  $\pm 4\%$ , 0.3 to 50 mV, 20 Hz to 100 kHz;  $\pm 4\%$ , 50 mV to 300 V, 20 to 100 kHz

### Supplemental Characteristics

**AC converter:** True-rms responding for signals with crest factor up to 3, rms-calibrated average detection and quasi-peak

**3 dB measurement bandwidth:**  $> 500$  kHz

### DC Level

**Full range display:** 300 V, 48 V, 16 V, 4 V.

**Overrange:** 33%, except on 300 V range

**Accuracy:**  $\pm 1.0\%$  of reading, 600 mV to 300 V  
 $\pm 6$  mV,  $V_{in} < 600$  mV.

### Frequency Measurement

**Measurement range:** 20 Hz to 150 kHz (20 Hz to 100 kHz in distortion and SINAD modes)

**Resolution:** 5 digits (0.01 Hz for input frequencies  $< 100$  kHz)

**Accuracy:**  $\pm (0.004\% + 1 \text{ digit})$

**Sensitivity:** 50 mV in distortion and SINAD modes, 5.0 mV in ac level and signal-to-noise (HP 8903B only) modes

### Standard Audio Filters

#### 30 kHz Low-Pass Filter

**3 dB cutoff frequency:** 30 kHz  $\pm 2$  kHz

**Rolloff:** Third-order Butterworth; 18 dB/octave or 60 dB/decade

#### 80 kHz Low-Pass Filter

**3 dB cutoff frequency:** 80 kHz  $\pm 4$  kHz

**Rolloff:** Third-order Butterworth; 18 dB/octave or 60 dB/decade

## Internal Plug-in Filter Options

Both the HP 8903B and HP 8903E have 2 internal plug-in filter slots, each of which will accept one of 6 optional filters. The standard HP 8903B/E come with 30 kHz and 80 kHz low-pass filters, but with no plug-in filters. The appropriate filter options must be ordered for the analyzers to have any of the filters listed below. Each filter option has 2 option numbers: the 010 series for the left filter slot and the 050 series for the right filter slot. Each filter option ordered (maximum of 2) adds additional cost to the instrument.

Filters	Option Numbers Filter Position	
	Left Slot	Right Slot
400 Hz High-Pass	010	050
CCITT Weighting Filter	011	051
CCIR Weighting Filter	012	052
C-MESSAGE Weighting Filter	013	053
CCIR/ARM Weighting Filter	014	054
"A" Weighting Filter	015	055

## Analyzer Input

**Input type:** Balanced (full differential).

**Input impedance:**  $100 \text{ k} \Omega \pm 1\%$  shunted by  $< 300$  pF, each side to ground. (In dc-level mode the input resistance is  $101 \text{ k} \Omega \pm 1\%$ ).

**Max input** (maximum peak input voltage, any combination of ac/dc):  
**HP 8903B:** 425 V peak, applied differentially or between either input to ground.

**HP 8903E:** 42 V peak, low side to ground.

425 V peak, differentially or high side to ground.

**CMRR:**  $> 60$  dB, 20 Hz to 1 kHz,  $V_{in} < 2$  V;  $> 45$  dB, 20 Hz to 1 kHz;  $> 30$  dB, 20 Hz to 20 kHz.

## General

**Temperature:** Operating,  $0^\circ$  to  $55^\circ$  C; storage,  $-55^\circ$  to  $75^\circ$  C

**Power:** 100, 120, 220, or 240 V (+5,  $-10\%$ ); 48 to 66 Hz. 100 or 120 V (+5,  $-10\%$ ); 48 to 440 Hz. 100 VA maximum

**Weight:** HP 8903B: Net, 12.3 kg (27 lb); shipping, 16.4 kg (36 lb).  
 HP 8903E: Net, 11.8 kg (26 lb); shipping, 15.9 kg (35 lb)

**Dimensions:** 146 mm H  $\times$  425 mm W  $\times$  462 mm D (5.75 in  $\times$  16.8 in  $\times$  18.2 in)

## Ordering Information

### Analyzer Mainframes

	Price
<b>HP 8903B</b> Audio Analyzer <sup>1</sup>	\$6,720
<b>Opt 001</b> Input/Output Connectors on Rear Panel Only	+ \$115
<b>Opt 910</b> 2 sets of Operation/Calibration (08903-90079) and Service Manuals (08903-90062)	+ \$285 ☎
<b>Opt 915</b> Service Manual (08903-90062)	+ \$120 ☎
<b>Opt W30</b> Extended Repair Service (see page 671)	+ \$150
<b>Opt W32</b> Calibration Service (see page 671)	+ \$765

### HP 8903E Distortion Analyzer<sup>1</sup>

<b>Opt 001</b> Input/Output Connectors on Rear Panel Only	+ \$225
<b>Opt 910</b> Additional Operation and Calibration Manual (08903-90053) and Two Service Manuals (08903-90065)	+ \$295 ☎
<b>Opt 915</b> Add Service Manual (08903-90065)	+ \$132 ☎
<b>Opt W30</b> Extended Repair Service (see page 671)	+ \$95
<b>Opt W32</b> Calibration Service (see page 671)	+ \$405

### Options for both HP 8903B and HP 8903E

<b>Opt 010</b> or <b>050</b> 400 Hz High-Pass Filter	+ \$235
<b>Opt 011</b> or <b>051</b> CCITT Weighting Filter	+ \$235
<b>Opt 012</b> or <b>052</b> CCIR Weighting Filter	+ \$235
<b>Opt 013</b> or <b>053</b> C-Message Weighting Filter	+ \$235
<b>Opt 014</b> or <b>054</b> CCIR/ARM Weighting Filter	+ \$235
<b>Opt 015</b> or <b>055</b> "A" Weighting Filter	+ \$235
<b>Opt 907</b> Front Handle Kit (5061-9689)	+ \$55
<b>Opt 908</b> Rack Flange Kit (5061-9677)	+ \$32.50
<b>Opt 909</b> Rack Flange Kit (5061-9683) with Front Handles	+ \$80 ☎

<sup>1</sup>HP-IB cables not included. For description and price, see page 615.

☎ For off-the-shelf shipment, call 800-452-4844.

# SIGNAL ANALYZERS

## Modulation Analyzer, 150 kHz to 1300 MHz, AM/FM Test Source

HP 8901A, 8901B, 11715A

- Measures AM and FM to 1% accuracy
- Measures RF frequency
- Measures RF power

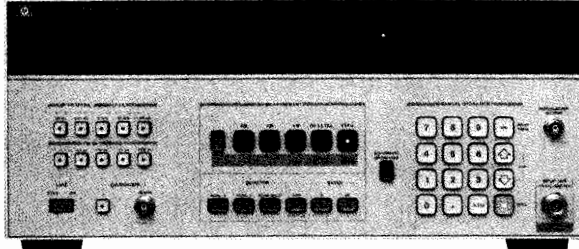

HP 8901A



- Low internal noise
- Completely automatic

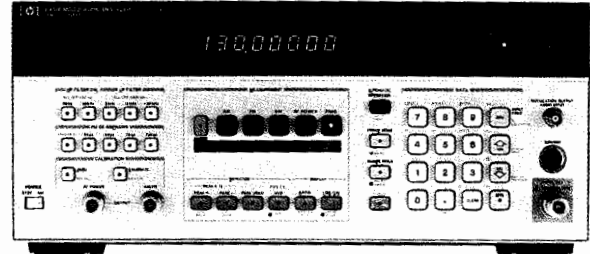

HP 8901B



### HP 8901A and HP 8901B Modulation Analyzers

The HP 8901A and HP 8901B modulation analyzers combine the capabilities of several RF instruments to give complete, accurate characterization of modulated signals in the 150 kHz to 1300 MHz frequency range. Both instruments very accurately measure modulation and recover the modulation signal. They determine RF frequency and measure RF power. The major additional capabilities of the HP 8901B are its improved power-meter accuracy, its ability to use external power sensors, its ability to make adjacent-channel power measurements or carrier-noise measurements (with Options 030 through 037), and its ability to count audio frequencies and measure distortion on 400 Hz and 1 kHz signals. Both instruments are fully automatic and make all major measurements at the press of a key or under HP-IB control.

#### Transmitter Testing

The HP 8901A/B have the features required to perform standard transmitter measurements. They measure transmitter power, count frequency, and measure the signal modulation very accurately. The HP 8901B also characterizes the demodulated audio signal's frequency, level, and distortion. With Option 030 the HP 8901B can quickly and accurately make adjacent-channel power measurements to CEPT standards.

#### RF Signal Characterization

The HP 8901A/B are excellent lab & production tools for accurately characterizing RF signals.

Use the HP 8901A/B to make accurate AM/ $\Phi$ M and FM/AM conversion measurements of phase- and amplitude-sensitive devices such as bandpass filters and multiple-channel receivers. Excellent isolation between AM and FM make it simple to separate the AM and  $\Phi$ M of AM stereo, the incidental AM of FM transmitters, and the AM, FM, and  $\Phi$ M components of complex signals.

#### Automatic Test Systems

The HP 8901A/B are important components of automatic RF test systems. All functions are fully automatic and easily programmed. With these measurements combined into one instrument, interfacing requirements, hardware costs, and software-development time are reduced.

### HP 8901A and HP 8901B Specifications

#### RF Input

**Frequency range:** 150 kHz to 1300 MHz

**Operating level:** 12 mV rms to 7 V rms

**Input impedance:** 50  $\Omega$  nominal

**Tuning:** Manual frequency entry, automatic, or track

**Acquisition time (automatic operation):** ~1.5 s

**Maximum safe input level (typical):** 35 V rms (25 W for source SWR < 4), ac; 40 V, dc

#### Frequency Modulation

**Rates:** 20 Hz to 200 kHz

**Deviations:** To 400 kHz

#### Accuracy:

$\pm 2\%$  of reading  $\pm 1$  digit, 20 Hz to 10 kHz rates, 250 kHz to 10 MHz;

$\pm 1\%$  of reading  $\pm 1$  digit, 50 Hz to 100 kHz rates, 10 to 1300 MHz

**Demodulated output distortion:** < 0.1% THD

**AM rejection** (for 50% AM at 400 Hz and 1 kHz rates): < 20 Hz peak deviation measured in a 50 Hz to 3 kHz BW

**Residual FM** (50 Hz to 3 kHz BW): < 8 Hz rms @ 1300 MHz, decreasing linearly with frequency to < 1 Hz rms for 100 MHz and below

**Maximum deviation resolution:** 1 Hz

**Stereo separation** (50 Hz to 15 kHz): > 47 dB typical

#### Phase Modulation

**Carrier frequency:** 10 to 1300 MHz

**Rates:** 200 Hz to 20 kHz; typically usable from 20 Hz to 100 kHz with degraded performance

**Deviation:** To 400 radians

**Maximum deviation resolution:** 0.001 radian

**Accuracy:**  $\pm 3\%$  of reading  $\pm 1$  digit

**Demodulated output distortion:** < 0.1% THD

**AM rejection** (for 50% AM at 1 kHz rate): < 0.03 radian peak deviation (50 Hz to 3 kHz BW)

#### Amplitude Modulation

**Rates:** 20 Hz to 100 kHz

**Depth:** To 99%

**Accuracy:**

$\pm 2\%$  of reading  $\pm 1$  digit, 50 Hz to 10 kHz rates, 150 kHz to 10 MHz;

$\pm 1\%$  of reading  $\pm 1$  digit, 50 Hz to 50 kHz rates, 10 to 1300 MHz

**Flatness** (variation in indicated AM depth for constant depth on input signal):  $\pm 0.3\%$  of reading  $\pm 1$  digit

**Demodulated output distortion:** < 0.3% THD

**FM rejection** (at 400 Hz and 1 kHz rates, 50 Hz to 3 kHz BW): < 0.2% AM

**Residual AM** (50 Hz to 3 kHz BW): < 0.01% rms

**Maximum depth resolution:** 0.01%

#### Frequency Counter

**Range:** 150 kHz to 1300 MHz

**Accuracy:**  $\pm 3$  counts of least significant digit  $\pm$  reference accuracy

**Internal reference**

**Frequency:** 10 MHz

**Aging rate:**  $< 1 \times 10^{-6}$ /month (optional:  $1 \times 10^{-9}$ /day)

**Maximum resolution**

**HP 8901A:** 10 Hz for frequencies < 1 GHz; 100 Hz for frequencies  $\geq 1$  GHz

**HP 8901B:** 1 Hz

#### HP 8901A RF Level (Peak Voltage Responding, RMS Sine Wave Power Calibrated)

**Range:** 1 mW to 1 W

**Instrumentation accuracy:**  $\pm 1.5$  dB

**SWR:**  $\leq 1.3$ , 150 kHz to 650 MHz;  $\leq 1.5$ , 650 to 1300 MHz

**Maximum resolution:** 0.001 mW for levels < 0.01 W

**HP 8901B RF Level (True RMS)****Frequency range with HP 11722A:** 100 kHz to 2.6 GHz**Power range:** -20 to +30 dBm**RF range-to-range change error:**

±0.02 dB/RF range change from reference range

**Input SWR:** <1.15, using HP 11722A sensor module**Zero set** (digital settability of zero):

±0.5% ±1 digit of full scale on lowest range (decrease by a factor of 10 for each high range)

**RF power resolution:**

0.1% of full scale in watts or volts mode

0.001 in dBm or dB relative mode

**HP 8901B Selective Power Measurements (Options 030 Through 037)****Frequency range:** 10 MHz to 1.3 GHz**Carrier power range:** +30 to -20 dBm, 12.5, 25 and 30 kHz filters; +30 to -10 dBm, carrier noise filter**Dynamic range:** 115 dB**Carrier rejection** (temp. ≤35° C): >90 dB for offsets ≥1 channel spacing or 5 kHz, whichever is larger**Relative accuracy:** ±0.5 dB, levels ≥-95 dBc or levels ≥-129 dBc/Hz**Power Reference****Power output:** 1.00 mW, factory set to ±0.7%, traceable to the U.S. National Institute of Standards and Technology**Accuracy:** ±1.2% worst case (±0.9% rss) for one year (0° to 55° C)**Audio Filters****High-pass** (3 dB cutoff frequency): 50 Hz and 300 Hz**Low-pass** (3 dB cutoff frequency except >20 kHz filter): 3 kHz, 15 kHz, >20 kHz**De-emphasis filters:** 25 μs, 50 μs, 75 μs, and 750 μs**Calibrators (Standard HP 8901B, Option 010 HP 8901A)****AM calibrator depth and accuracy:** 33.33% depth, nominal; internally calibrated to an accuracy of ±0.1%**FM calibrator deviation and accuracy:** 34 kHz peak deviation, nominal; internally calibrated to an accuracy of ±0.1%**General Characteristics****Operating temperature range:** 0° to 55° C**Power requirements:** 100, 120, 220, or 240V (+5%, -10%); 48 to 66 Hz; 200 VA max**Weight:** HP 8901A: Net, 20 kg (44 lb); shipping, 25 kg (55 lb)

HP 8901B: Net, 23 kg (52 lb); shipping, 31 kg (69 lb)

**Size:** HP 8901A: 190 mm H × 425 mm W × 468 mm D (7.5 in × 16.8 in × 18.4 in). HP 8901B: 190 mm H × 425 mm W × 551 mm D (7.5 in × 16.8 in × 21.7 in)**Ordering Information****HP 8901A/HP 8901B****HP 8901A Modulation Analyzer<sup>1</sup>****Opt 001** RF Connectors on Rear Panel Only \$11,045**Opt 002** 1×10<sup>-9</sup>/Day Internal Reference +\$260**Opt 003** Connections for External Local Oscillator +\$880**Opt 004** Operation from 48 to 440 Hz Power +\$490

(temp. &lt;40° C) +\$330

**Opt 010** AM and FM Calibrators +\$730**Opt 907** Front Handle Kit (5061-9690) \$67**Opt 908** Rack Flange Kit (5061-9678) \$36**Opt 909** Front Handle & Rack Flange Kit (5061-9684) \$93**Opt 910** a total of 2 sets of Operating (08901-90135) +\$255

and Service Manuals (08901-90136)

**Opt 915** Service Manual (08901-90136) +\$103**Opt W30** Extended Repair Service (see page 671) +\$235**Opt W32** Calibration Service (see page 671) +\$475**HP 8901B Modulation Analyzer<sup>1</sup>** \$15,475**Opt 021** Add HP 11722A Sensor Module +\$2,480**Opt 030** High Selectivity (select only 2 filter options) +\$2,860

(Options 032 through 037 require Option 030; Option 030 includes Option 003 connections for external local oscillators.)

**Opt 032** 12.5 kHz Filter \$0**Opt 033** 20.0/25.0 kHz Filter \$0**Opt 035** Cellular Radio Filter \$0**Opt 037** Carrier Noise Filter \$0**Opt 910** 2 sets of Operation/Calibration (08901-90113) +\$370

and Service Manuals (08901-90114)

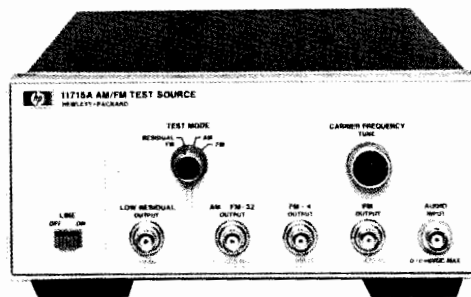
**Opt 915** Service Manual (08901-90114) +\$155**Opt W30** Extended Repair Service (see page 671) +\$335**Opt W32** Calibration service (see page 671) +700

HP 11715A

**HP 11715A AM/FM Test Source**

The HP 11715A AM/FM test source provides very flat, wide-bandwidth, and low-distortion amplitude- or frequency-modulated RF signals. Designed primarily for performance tests and adjustments of the HP 8901A/B modulation analyzer and HP 8902A measuring receiver, it will also serve as a high-quality modulated test oscillator where its frequency ranges apply.

The major components of the HP 11715A are a low-noise voltage-controlled oscillator (VCO), 2 digital dividers, and a double-balanced mixer. The VCO is the primary signal source, with a typical frequency range of 330 to 470 MHz at the FM output. FM is produced by directly coupling the external modulation source to the VCO's tune input, providing very wide bandwidth modulation with low phase shift. This design also ensures very little incidental AM.

The HP 11715A can also be used in conjunction with an HP 8901A/B and an HP 8902A as a calibrated signal source for special applications. In particular, the U.S. commercial FM broadcast band of 88 to 108 MHz is covered by the FM ÷ 4 output of the HP 11715A.

**HP 11715A Specifications****FM Outputs****Frequency range:**

11 to 13.5 MHz, AM FM ÷ 32 output

88 to 108 MHz, FM ÷ 4 output

352 to 432 MHz, FM output

**Peak deviation:**

&gt;12.5 kHz, 11 to 13.5 MHz carrier

&gt;100 kHz, 88 to 108 MHz carrier

&gt;400 kHz, 352 to 432 MHz carrier

**Distortion:** <0.025% THD (<-72 dB) for

Carrier Frequency	Peak Deviation	Modulation Rate
12.5 MHz	12.5 kHz	<10 kHz
100 MHz	100 kHz	<100 kHz
400 MHz	400 kHz	<100 kHz

**Flatness:**

±0.1%, dc to 100 kHz rates ±0.25%, dc to 200 kHz rates

**Stereo separation** (88 to 108 MHz carrier, 75 kHz peak deviation, 1 kHz rate): >60 dB typical**AM Output****Frequency range (AM/FM ÷ 32 output):** 11 to 13.5 MHz**Depth:** To 99%**Distortion:**

&lt;0.05% THD (&lt;-66 dB), 50% AM, 20 Hz to 100 kHz rates

&lt;0.1% THD (&lt;-60 dB), 95% AM, 20 Hz to 100 kHz rates

**Flatness:** ±0.1%, 50 Hz to 50 kHz rates;

±0.25%, 20 Hz to 100 kHz rates

**Linearity:** ±0.1%, <95% AM; ±0.2%, <99%**Ordering Information****HP 11715A AM/FM Test Source****Opt 910** a total of 2 sets of Operating and Service Manuals (11715-90004) +\$25

☎ For off-the-shelf shipment, call 800-452-4844.

<sup>1</sup>HP-IB cables not included. For description and prices, see page 615.

# SIGNAL ANALYZERS

## Measuring Receiver, 150 kHz to 1300 MHz HP 8902A

- RF power: digital power meter accuracy
- Tuned RF level: 0 to -127 dBm dynamic range
- Carrier noise: AM and phase noise measurements to -140 dBc/Hz

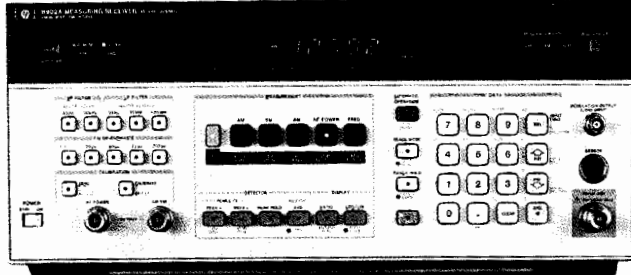

HP 8902A



### HP 8902A Measuring Receiver

The HP 8902A measuring receiver combines 6 precise measurement functions into one fully automatic, HP-IB programmable instrument. It accurately measures RF power, tuned RF level, carrier noise/adjacent channel power, modulation, and RF frequency, and characterizes audio signals. For precise signal analysis, the HP 8902A measuring receiver provides the performance you need.

#### Metrology and Calibration

The HP 8902A measuring receiver makes signal generator and attenuator calibration easier than ever before. As the main component in the HP 8902AT attenuator calibration system and the HP 8902SG signal generator test system, the HP 8902A provides exceptional accuracy, wide dynamic range, and a broad range of measurements.

The HP 8902A quickly and accurately measures your signal generator's RF frequency, RF level flatness, output level accuracy to -127 dBm, AM and FM with 1% accuracy, incidental and residual AM, FM and phase modulation, and carrier noise down to -140 dBc/Hz, and characterizes the demodulated audio signals.

For attenuator calibration and other relative measurements, the HP 8902A gives you great accuracy and dynamic range. Option 050 provides  $\pm(0.015 \text{ dB} + 0.005 \text{ dB/10 dB})$  relative power accuracy to test attenuators to the most stringent specifications.

#### RF Signal Characterization

The HP 8902A measuring receiver is an excellent lab and production tool for accurately characterizing RF signals from 150 kHz to 1300 MHz.

Level measurements down to -127 dBm with superb accuracy make the HP 8902A ideal for testing devices such as antennas, multiplexers, log/linear amplifiers, filters, and mixers. Unlike diode detectors, the HP 8902A's power meter accurately measures signals with harmonics and spurious.

The HP 8902A makes accurate AM-to- $\emptyset$ M and FM-to-AM conversion measurements of phase- and amplitude-sensitive devices, such as bandpass filters and multiple-channel receivers. Excellent isolation between AM and FM makes it simple to separate the AM and  $\emptyset$ M of AM stereo, the incidental AM of FM transmitters, and the AM, FM, and  $\emptyset$ M components of complex signals.

#### Automatic Test Systems

The HP 8902A is an important component of automatic RF test systems. All functions—power, level, frequency count, carrier noise, modulation, audio analysis—are fully automatic and easily programmed. With these measurements combined in one instrument, interfacing requirements, hardware costs, and software development time are reduced.

- AM and FM: 1% accuracy;  $\emptyset$ M: 3% accuracy
- RF frequency: 1 Hz resolution
- Audio: level, frequency, and distortion

### HP 8902A Specifications

#### RF Power (with HP 11722A Sensor Module)

**Range:** +30 dBm (1W) to -20 dBm ( $10 \mu\text{W}$ )

**Frequency range:** 0.1 MHz to 2.6 GHz

**Linearity:**  $\pm 0.02 \text{ dB}$  (within range)  $\pm 0.02 \text{ dB}$  per range change from reference range  $\pm 1$  count LSD

**Input SWR:** <1.15

#### Tuned RF Level

**Range:** 0 to -127 dBm

**Frequency range:** 2.5 to 1300 MHz

**Relative accuracy:**  $\pm 0.02 \text{ dB} \pm 0.02 \text{ dB}$  per IF range change  $\pm 0.04 \text{ dB}$  per RF range change  $\pm 1$  digit

**Worst-case cumulative relative power accuracy** (with Opt 050<sup>1,2</sup>):

$\pm 0.005 \text{ dB/10 dB}$  step (0 to -100 dBm)

$\pm 0.050 \text{ dB/10 dB}$  step (-100 to -120 dBm)

$\pm 0.015 \text{ dB} \pm 1$  digit

#### Selective Power Measurements (Carrier Noise, Options 030 to 037)

**Frequency range:** 10 to 1300 MHz

**Carrier power range:**

+30 dBm to -20 dBm: 12.5 kHz, 25 kHz and 30 kHz filters

+30 dBm to -10 dBm: carrier noise filter

**Relative measurement accuracy:**

$\pm 0.5 \text{ dB}$ ; levels > -95 dBc: 12.5 kHz, 25 kHz and 30 kHz filters

$\pm 0.5 \text{ dB}$ ; levels > -129 dBc/Hz: carrier noise filter

**Filter bandwidths:** 2.5 kHz, carrier noise filter; 8.0 kHz, 12.5 kHz filter; 16.0 kHz, 25 kHz filter; 30.0 kHz, cellular radio filter

#### RF Frequency

**Range:** 150 kHz to 1300 MHz

**Maximum resolution:** 1 Hz

#### Amplitude Modulation

**Rates:** 20 Hz to 100 kHz

**Depths:** To 99%

**Accuracy:**  $\pm 1\%$  of reading  $\pm 1$  digit, for rates 50 Hz to 50 kHz and depths  $\geq 5\%$

#### Frequency Modulation

**Rates:** 20 Hz to 200 kHz

**Deviations:** To 400 kHz

**Accuracy:**  $\pm 1\%$  of reading  $\pm 1$  digit, for rates 50 Hz to 100 kHz

#### Phase Modulation

**Rates:** 200 Hz to 20 kHz

**Deviations:** To 400 radians

**Accuracy:**  $\pm 3\%$  of reading  $\pm 1$  digit

#### Audio Level, Frequency, and Distortion Capability

**Audio level accuracy:**  $\pm 4\%$  of reading, 100 mV to 3V

**Audio frequency display resolution:** 6 digits, to 250 kHz

**Audio distortion accuracy:**  $\pm 1 \text{ dB}$ , 400 Hz and 1 kHz

<sup>1</sup>Specifications are warranted when using a Hewlett-Packard synthesized source with less than 100 Hz peak residual FM measured in a 3 kHz post-detection bandwidth over a 30-second period.

<sup>2</sup>Accuracy specifications do not include mismatch uncertainty.



# SIGNAL ANALYZERS

Measuring Receiver, Sensor Module, Verification Kit  
HP 8902A, 11812A, 11722A, 8902S, 11793A, 11792A

271

## Ordering Information

<b>HP 8902A</b> Measuring Receiver <sup>1</sup>	<b>Price</b>	
<b>Opt 001</b> Rear Panel Instead of Front Panel Connections for Input, Modulation Output, and Calibrators	\$28,985	
<b>Opt 002</b> 1×10 <sup>-9</sup> /Day Internal Reference Oscillator	+\$260	
<b>Opt 003</b> RF Connectors on Rear Panel Only	+\$880	
<b>Opt 004</b> Operation from 48 to 400 Hz Power Line (temp. < 40°C)	+\$490	
<b>Opt 021</b> Add HP 11722A Sensor Module	+\$330	
<b>Opt 030</b> High Selectivity (select only two filter options)	+\$2,480	
(Options 032 to 037 require Option 030. Option 030 includes Option 003 connections for external local oscillator.)	+\$2,860	
<b>Opt 032</b> 12.5 kHz Filter	\$0	
<b>Opt 033</b> 25.0 kHz Filter	\$0	
<b>Opt 035</b> Cellular Radio Filter	\$0	
<b>Opt 037</b> Carrier Noise Filter	\$0	
<b>Opt 050</b> Increased Power Measurement Accuracy	+\$4,160	
<b>Opt 907</b> Front Handle Kit (5061-9690)	+\$67	☎
<b>Opt 908</b> Rack Flange Kit (5061-9678)	+\$36	☎
<b>Opt 909</b> Rack Flange Kit (5061-9684) with Front Handles	+\$93	☎
<b>Opt 910</b> Additional Operation and Calibration Manual (08902-90029) and 2 Service Manuals (08902-90031)	+\$370	☎
<b>Opt 915</b> Add Service Manual (08902-90031)	+\$155	☎
<b>Opt W30</b> Extended Repair Service (see page 671)	\$380	
<b>Opt W32</b> Calibration Service (see page 671)	\$475	

☎ For off-the-shelf shipment, call 800-452-4844.  
HP-IB cables not included. For description and prices, see page 615.



HP 11812A

## HP 11812A Verification Kit

The HP 11812A verification kit is available to verify the performance of the HP 8902A Option 050 tuned RF level function to ±(0.015 dB + 0.010 dB/10 dB step). The kit consists of a step attenuator, two 10 dB pads semi-permanently attached, a cable, and a case.

## HP 11812A Specifications

**Frequency:** 30 MHz  
**HP 11812A accuracy:** ±(0.003 dB + 0.003 dB/10 dB step)  
**Option 050 worst-case cumulative tuned RF level accuracy verified with the HP 11812A:**  
±0.010 dB/10 dB step (0 to -100 dBm)  
±0.050 dB/10 dB step (-100 to -120 dBm)  
±0.015 dB ±1 digit

**Ordering Information**  
**HP 11812A** Verification Kit

**Price**  
\$2,315

## HP 11722A Sensor Module (100 kHz to 2.6 GHz)<sup>1</sup>

The HP 11722A sensor module was designed for use with the HP 8901B modulation analyzer and the HP 8902A measuring receiver. The HP 11722A contains a silicon monolithic thermocouple as a power-sensing element.

With the HP 11722A sensor module, you get all the performance of the HP 8901B or HP 8902A, plus superb power-measurement accuracy, at a single connector. You can characterize a signal without switching back and forth between the power sensor and the analyzer's RF input.

## Ordering Information

**HP 11722A** Sensor Module (100 kHz to 1300 MHz) **Price**  
\$2,480

## Extend the HP 8902A to Microwave with the HP 8902S Measurement System

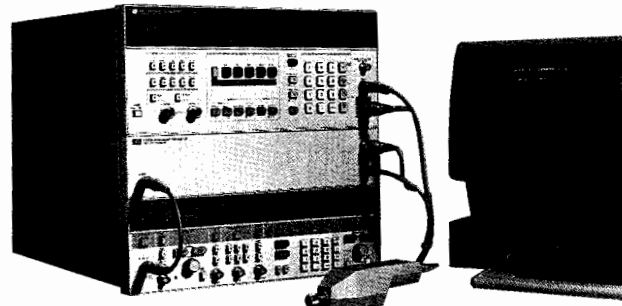

HP 8902S System

The HP 8902S system extends the frequency range of the HP 8902A by adding the HP 11793A microwave converter and a local oscillator. With the HP 11792A sensor module, the system delivers the accuracy and resolution of a high-performance power meter to 26.5 GHz from +30 to -100 dBm. The extended system counts signals to 26.5 GHz with 10 Hz resolution and excellent long-term frequency stability.

## HP 11793A Microwave Converter

The HP 11793A microwave converter downconverts microwave signals to the frequency range of the HP 8902A measuring receiver. For signals above 1.3 GHz, the HP 11793A routes the signal through its internal mixer. Below 1.3 GHz, signals are routed directly to the input of the HP 8902A.

The HP 11793A requires +8 dBm leveled output from the local oscillator. For LOs with insufficient power above 18 GHz, the HP 11793A offers an optional 18 to 26.5 GHz amplifier.

## HP 11792A Sensor Module (50 MHz to 26.5 GHz)<sup>1</sup>

The HP 11792A sensor module gives you all the performance of the HP 8902S system, plus superb power-measurement accuracy, at a single connector. You can characterize a signal without manually switching between the power sensor and the receiver input.

## Ordering Information

**HP 8902S** Measuring System **Price**  
(For complete ordering information see HP 8902S Measurement System Ordering Information guide, or call your HP sales office.)

<b>HP 11793A</b> Microwave Downconverter	\$8,585
<b>Opt 001</b> Add 18 to 26.5 GHz Amplifier	+\$11,635
<b>Opt 010</b> Front Right LO input Connector	+\$230
<b>Opt 011</b> Amplifier and front right LO Connector	+\$11,850
<b>Opt 020</b> Rear Panel Connector	+\$230
<b>Opt 021</b> Amplifier and Rear Panel Connector	+\$11,850
<b>Opt 907</b> Front Handle Kit (5062-3988)	+\$50
<b>Opt 908</b> Rack Mount Flange Kit (5062-3974)	+\$31
<b>Opt 909</b> Handles w/Rack Mount Flange Kit (5062-3975)	+\$73

**HP 11792A** Sensor Module (50 MHz to 26.5 GHz) **Price**  
\$4,440

<sup>1</sup>Each HP 11722A and HP 11792A sensor module is individually calibrated, traceable to the U.S. National Institute of Standards and Technology. The calibration factors are printed on the sensor module for fast reference. Enter these factors into the HP 8902A's non-volatile memory and the instrument automatically compensates for the power sensor's efficiency and mismatch loss at each frequency.

# SIGNAL ANALYZERS

## Attenuator Calibration System

HP 8902AT, 11806B, 11823A/B/C

- Exceptional accuracy:  $\pm 0.015 \text{ dB} \pm 0.005 \text{ dB}/10 \text{ dB}$
- 100 dB dynamic range

- Tests fixed, manual, and programmable attenuators
- 10 MHz to 26.5 GHz



HP 8902AT

### HP 8902AT Attenuator Calibration System

The HP 8902AT offers a total solution for attenuator calibration. It is configured for optimal performance from 10 MHz to 18 GHz. Option 026 extends its performance to 26.5 GHz. The HP 8902AT combines the exceptional accuracy of the HP 8902A Option 050 with HP 11806B attenuator test software to give you precise results with the speed provided by automation.

The HP 8902AT minimizes measurement uncertainty by specifying 0.005 dB/10 dB attenuation accuracy, monitoring the output power of the attenuator source, and automatically adjusting for any amplitude instabilities. This provides you with state-of-the-art accuracy, simply and repeatably.

The HP 8902AT includes the HP 11806B attenuator test software, the HP 8902A Option 050 measuring receiver, the HP 11793A microwave converter, a local oscillator, an attenuator source, a power splitter, a power sensor, an attenuator accessory kit, and an SWR accessory kit. For a detailed list of equipment, see the HP 8902S Ordering Guide.

#### Accessory Kits

The HP 8902AT attenuator calibration system includes an attenuator accessory kit and an SWR accessory kit. The HP 11823A/B attenuator accessory kit includes 10 dB matching attenuators and adapters to test attenuators, with Type N, APC-3.5, and APC-7 connectors. The HP 11823C SWR accessory kit includes precision SWR bridges, opens, shorts, and terminations.

### HP 11806B Attenuator Test Software

The HP 11806B attenuator test software provides the efficiency and repeatability of automation for attenuator calibration. By entering a table of frequencies, levels, and specification limits, you can test any RF or microwave attenuator—fixed, manual or programmable—quickly and accurately.

The HP 11806B offers flexibility and ease of use with user-selectable averaging, various output formats, and flexible hardware configurations. With additional features such as statistical analysis, multiple test frequencies, and support of multiple attenuator sources, the HP 11806B is the ideal software for all your attenuator-calibration needs.

### HP 8902AT Specifications

#### Frequency Range

10 MHz to 18 GHz

10 MHz to 26.5 GHz, Opt 026

#### Dynamic Range

+10 to -117 dBm, 10 to 1300 MHz

0 to -100 dBm, 1300 MHz to 18 GHz

0 to -95 dBm, 18 GHz to 26.5 GHz

#### Attenuation Accuracy<sup>1</sup>

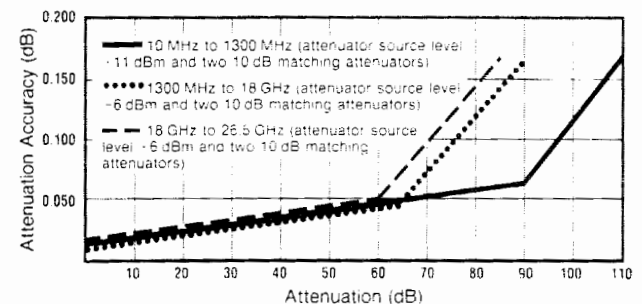

For optimal dynamic range, the attenuator source level can be increased to -11 dBm and smaller matching attenuators can be used. This results in 0.1 dB uncertainty for frequencies of 1300 MHz to 26.5 GHz.

#### Ordering Information

**HP 8902AT** Attenuator Calibration System

**Opt 026** 26.5 GHz Coverage

**HP 11806B** Attenuator Test Software

**HP 11823A** Attenuator Accessory Kit

**HP 11823B** Attenuator Accessory Kit

**HP 11823C** SWR Accessory Kit

#### Price

\$148,170

+ \$44,520

+ \$3,500

+ \$6,210

+ \$7,340

+ \$22,055

<sup>1</sup>Accuracy specifications do not include mismatch uncertainty.

- Frequency coverage to 26.5 GHz
- Powerful software for ease of test modification

- Fully automated system: more thorough testing in less time
- Fast, accurate, and repeatable measurements

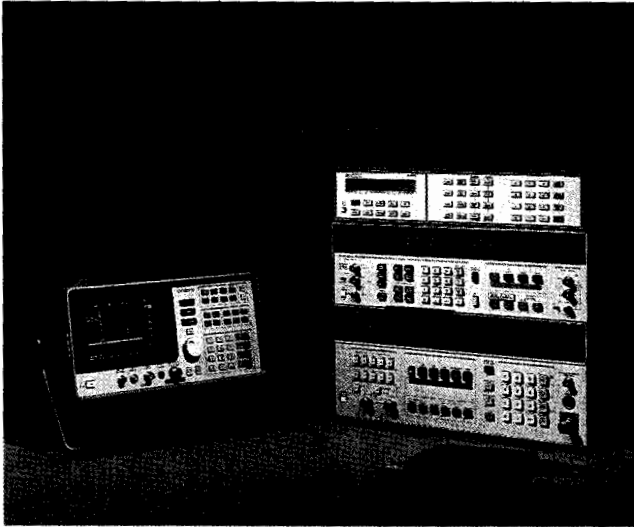

HP 8902SG

### HP 8902SG Signal Generator Test System

The HP 8902SG signal generator test system provides a versatile and powerful solution for testing RF and microwave signal generators. System hardware provides accurate measurements and complete automation; dedicated software adds flexibility, speed, and ease of use.

The standard system includes an HP 8902A measuring receiver, an HP 8903B audio analyzer, an HP 8562B spectrum analyzer, and an HP 3488A switch control unit to provide complete automation. The HP 11808A signal generator performance test software is included, as are all cables and adapters required to complete the system. Options 018 and 026 add the HP 11793A microwave converter and a synthesized local oscillator to extend measurement capabilities to microwave frequencies.

Many common signal-generator performance tests can be run with the HP 8902SG. Tests such as Output Level Accuracy, Output Flatness, and AM and FM Accuracy are but a few of those available. The system can be expanded to offer additional tests, such as Pulse Rise/Fall Time and Third Order Intermodulation Distortion. The system software is easily updated to reflect changes in the test equipment used.

### HP 8902SG Specifications

#### RF Frequency

**Range:** 150 kHz to 1300 MHz, standard system  
150 kHz to 18 GHz, Opt 018  
150 kHz to 26.5 GHz, Opt 026

#### RF Power

**Range:** +30 dBm to -20 dBm, standard system  
+30 dBm to -20 dBm, Opts 018 and 026

**Frequency range:** 100 kHz to 2600 MHz, standard system  
50 MHz to 18 GHz, Opt 018  
50 MHz to 26.5 GHz, Opt 026

#### Tuned RF Level

**Frequency range:** 2.5 to 1300 MHz, standard system  
2.5 MHz to 18 GHz, Opt 018  
2.5 MHz to 26.5 GHz, Opt 026

**Range:** +10 to -117 dBm, 2.5 to 1300 MHz,  
0 to -100 dBm, 1300 MHz to 18 GHz (Opts 018 and 026)  
0 to -95 dBm, 18 to 26.5 GHz (Opt 026)

**Relative accuracy:**  $\pm 0.02$  dB per IF range change  $\pm 0.04$  dB per RF range change  $\pm 1$  digit.

#### Amplitude Modulation

**Rates:** 20 Hz to 100 kHz

**Depths:** To 99%

**Accuracy:**  $\pm 1\%$  of reading  $\pm 1$  digit, for rates 50 Hz to 50 kHz and depths  $\geq 5\%$

#### Frequency Modulation

**Rates:** 20 Hz to 200 kHz

**Deviations:** To 400 kHz

**Accuracy:**  $\pm 1\%$  of reading  $\pm 1$  digit, for rates 50 Hz to 100 kHz

#### Phase Modulation

**Rates:** 200 Hz to 20 kHz

**Deviations:** To 400 radians

**Accuracy:**  $\pm 3\%$  of reading  $\pm 1$  digit

#### Audio Source

**Frequency range:** 20 Hz to 100 kHz

**Frequency accuracy:** 0.3% of setting

#### Audio Analyzer

**Distortion frequency range:** 20 Hz to 100 kHz fundamentals

**Distortion accuracy:**  $\pm 1$  dB, 20 Hz to 20 kHz

#### General

**Temperature:** Operating, 0° to 55° C; storage, -25° to 75° C

**Power:** 100, 120, 220, or 240V (+5%, -10%); 48 to 66 Hz

### HP 11808A Signal Generator Performance Test Software

The HP 11808A software provides 29 common performance tests for RF and microwave signal generators. The software is structured so that tests are defined by data files; data files for HP signal generators are included with the software and others can be created easily through simple screen entries.

The software supports the equipment in the HP 8902SG configurations as well as other types, such as digital scopes, digital voltmeters, and function generators. Instruments in the system can be indicated quickly in the program through the use of softkeys and the configuration can be stored for later use.

#### Ordering Information

**HP 8902SG** Signal Generator Test System

**Opt 018** Extension to 18 GHz Operation

**Opt 026** Extension to 26.5 GHz Operation

**HP 11808A** Signal Generator Performance Test

Software

#### Price

\$92,350

+ \$43,650

+ \$70,450

\$6,255

# NETWORK ANALYZERS

## Complete Characterization of Linear Networks

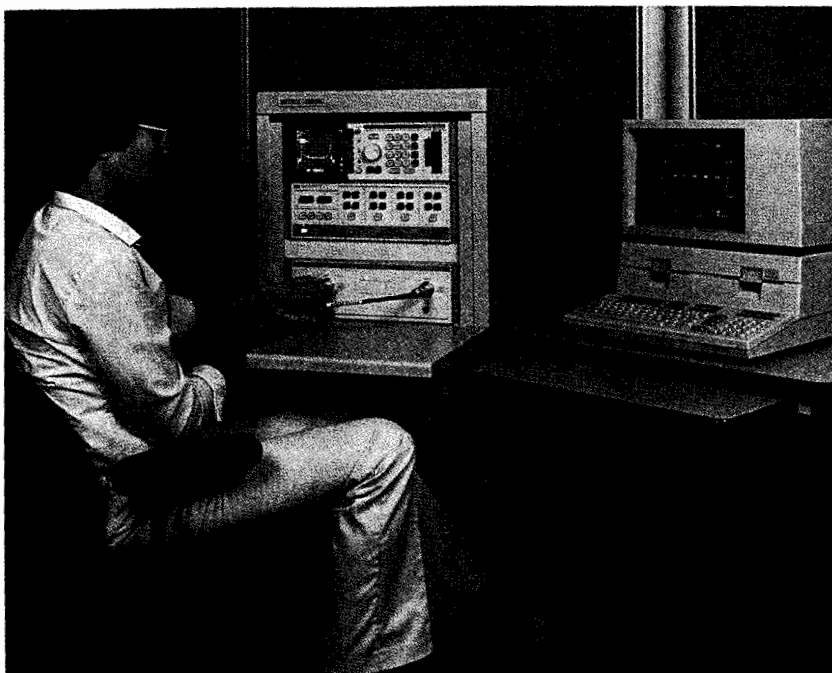

### Why Network Analysis?

Characterizing the behavior of linear networks that will be stimulated by arbitrary signals and interfaced with a variety of other networks is a fundamental problem in both synthesis and test processes. For example, the engineer designing a multi-component network must predict with some certainty the final network performances from knowledge of the individual components. Similarly, a production manager must know allowable tolerances on the products manufactured and whether the final products meet the specified tolerances. Network analysis offers a solution to these problems through complete description of linear network behavior in the frequency domain. Additionally, some network analyzers offer the capability to transform measurement data, taken in the frequency domain, to the time domain providing further insight into the behavior of linear networks.

Network analysis accomplishes the description of both active and passive networks by creating a data model of such component parameters as impedances and transfer functions. However, these parameters not only vary as a function of frequency but are also complex variables in that they have both magnitude and phase. Swept network analyzers now measure magnitude and phase (the total complex quantity) as a function of frequency with less difficulty than conventional CW measurements. Impedance and transfer functions can then be conveniently displayed on a swept CRT, as in Figure 1, X-Y recorder, or peripherals such as a printer and/or a plotter.

Thus, network analysis satisfies the engineering need to characterize the behavior of linear networks quickly, accurately, and completely over broad frequency ranges. Hewlett-Packard manufactures a full line of scalar network analyzers (magnitude only) and vector network analyzers (both magnitude and phase).

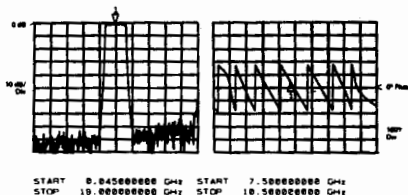

Figure 1. 45 MHz to 18 GHz measurement of magnitude and phase in a single sweep.

### What is Network Analysis?

Network analysis is the process of creating a data model of the transfer and/or impedance characteristics of a linear network through stimulus-response testing over the frequency range of interest. All network analyzers in the HP product line operate according to this definition.

At frequencies above 1 MHz, lumped elements actually become "circuits" consisting of the basic elements plus parasitics like stray capacitance, lead inductance, and unknown absorptive losses. Since parasitics depend on the individual device and its construction they are almost impossible to predict. Above 1 GHz component geometries are comparable to a signal wavelength, intensifying the variance in circuit behavior due to device construction.

Network analysis is generally limited to the definition of linear networks. Since linearity constrains networks stimulated by a sine wave to produce a sine wave output, sine wave testing is an ideal method for characterizing magnitude and phase response as a function of frequency. For non-linear measurements, refer to the sections on spectrum analyzers, wave analyzers (signal analyzers) and vector modulation products in this catalog.

### Network Analyzers

Hewlett-Packard network analyzers are instruments that measure transfer and/or impedance functions of linear networks through sine wave testing. A network analyzer system accomplishes these measurements by configuring its various components around the device under test. The first requirement of the measurement system is a sine wave signal source to stimulate the device under test. Since transfer and impedance functions are ratios of various voltages and currents, a means of separating the appropriate signals from the measurement ports of the device under test is required. Finally, the network analyzer itself must detect the separated signals, form the desired signal ratios, and display the results.

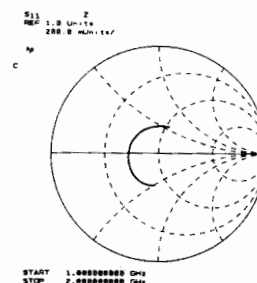

Figure 2. Input impedance of microcircuit amplifier is read directly with Smith Chart overlay for Polar Display.

### Signal Sources and Signal Separation

In the general case, any sine wave source meeting the network analyzer's specifications can be used to stimulate the device under test. If the analyzer is capable of swept

measurements, great economies in time can be achieved by stimulating the device under test with a sweep oscillator or synthesized sweeper. This allows quick and easy characterization of devices over broad frequency ranges.

At high frequencies the problem of signal separation usually involves traveling waves on transmission lines and becomes correspondingly more difficult. Hewlett-Packard manufactures test sets applicable for separating the appropriate traveling waves in a variety of high frequency measurements.

**Broadband and Narrowband Detection**

After the desired signals have been obtained from the test set they must be detected by the network analyzer; HP network analyzers can use one of two detection methods. Broadband detection accepts the full frequency spectrum of the input signal while narrowband detection involves tuned receivers that convert CW or swept RF signals to a constant IF signal. There are certain advantages to each detection scheme.

Scalar analyzers usually employ broadband detection techniques. Broadband detection reduces instrument cost by eliminating the IF section required by narrowband analyzers but sacrifices noise and harmonic rejection. However, noise is not a factor in many applications. Finally, broadband systems can make measurements where the input and output signals are not of the same frequency, as in the measurement of the insertion loss of mixers and frequency doublers. Narrowband systems cannot make these measurements.

Vector network analyzers normally employ narrowband detection techniques. Narrowband detection makes a more sensitive low noise detection of the constant IF possible. This allows increased accuracy and dynamic range for frequency selective measurements (as compared to broadband systems).

**Signal Processing and Display**

Once the RF has been detected, the network analyzer must process the detected signals and display the measured quantities. All HP network analyzers are multi-channel receivers utilizing a reference channel and at least one test channel; absolute signal levels in the channels, relative signal levels (ratios) between the channels, or relative phase difference between channels can be measured depending on the analyzer.

Relative ratio measurements are usually made in dB, which is the log ratio of an unknown signal (Test Channel) with a chosen reference signal (Reference Channel). This allows the full dynamic range of the instrumentation to be used in measuring variations of both high and low level circuit responses. For example, 0 dB implies the two signal levels have a ratio of unity while  $\pm 20$  dB implies a 10:1 voltage ratio between two signals.

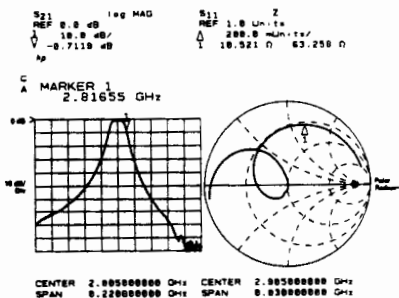

Figure 3. Simultaneous measurement of transmission response and passband reflection coefficient.

All network analyzer phase measurements are relative measurements with the reference channel signal considered to have zero phase. The analyzer then measures the phase difference of the test channel with respect to the reference channel.

Phase information complements amplitude data in the measurement of low frequency parameters. Phase is more sensitive to network behavior and it is a required component of complex impedance and transfer functions.

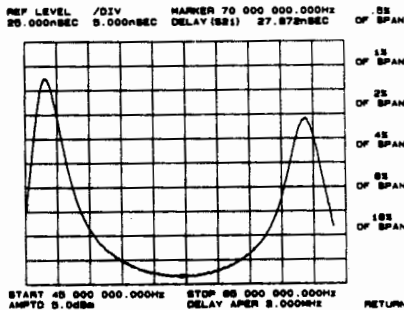

Figure 4. Direct measurement of group delay with digital readout at marker.

Phase data is also required to measure delay distortion or group delay of networks. Delay distortion occurs when different frequency components of a complex waveform experience nonlinear phase shifts as they are transmitted through a network. Group delay is a measure of this distortion and is defined as:

$$T_g = - \frac{d\theta}{d\omega}$$

An alternative method for measuring phase distortion is deviation from linear phase or differential phase. Deviations from linear phase can be measured by introducing enough electrical length in the network analyzer's reference channel to linearize a device's phase shift.

Scattering parameters, or S-parameters, were developed to characterize linear networks at high frequencies. S-parameters define the ratios of reflected and transmitted traveling waves measured at the network ports. A two-port device is modeled with S-parameters in Figure 5.  $S_{11}$  is the complex

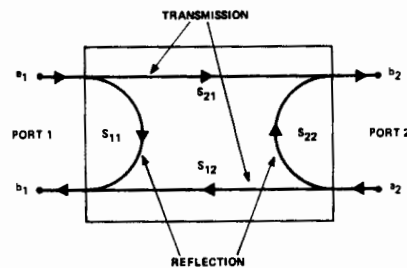

Figure 5. S-parameter model for a two-port linear network.

reflection coefficient at port 1 and is the ratio of  $b_1/a_1$ , if  $a_2 = 0$  (port 2 terminated in its characteristic impedance).  $S_{21}$  is the complex transmission coefficient from port 1 to port 2,  $b_2/a_1$ , if  $a_2 = 0$ . The "a" and "b" signals represent the amplitude and phase of the incident and emerging or reflected traveling waves. By reversing the ports and terminating port 1 in its characteristic impedance,  $S_{22}$  and  $S_{12}$  can be similarly defined.

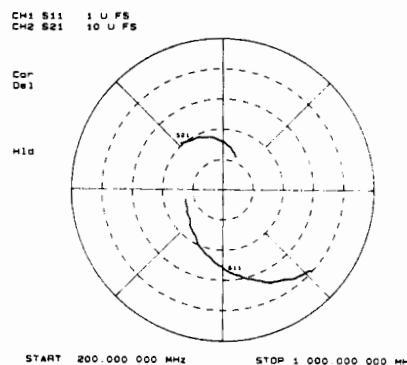

Figure 6. Simultaneous measurement of transistor S-parameters.

**Additional Capabilities**

Precision design work and manufacturing tolerances demand highly accurate measurements, but most errors in network measurements are complex quantities that vary as a function of frequency. By characterizing and virtually removing these systematic errors, measurement accuracies are improved by several orders of magnitude. Hewlett-Packard now offers network analyzers with built-in, high-speed computational hardware that can perform the complex mathematics required for sophisticated error correction.

Computer controlled network analyzers can be programmed to set up and make many measurements automatically. The measurement process is further accelerated by the computer's ability to store, transform, summarize, and output data in a variety of formats to a number of peripherals. These capabilities make the computer controlled network analyzer ideal for both computer aided design or automatic production testing.

# NETWORK ANALYZERS

## Complete Characterization of Linear Networks (cont'd)

### Network Analyzer Product Line Summary

HP Model	Frequency Range	Source	Measurement Capabilities
HP 3562A Dual-Channel Dynamic Signal Analyzer (page 226)	64 $\mu$ Hz to 100 kHz	Swept and fixed sine, chirp, burst chirp, random noise, and burst random noise	Transfer functions, magnitude/phase, 40-pole/40-zero curve fitter, frequency-response synthesis, time-domain functions, and spectrum analysis. HP-IB programmable.
HP 3563A Dual-Channel Control Systems Analyzer (page 228)	64 $\mu$ Hz to 100 kHz	Analog and digital swept and fixed sine, chirp, burst chirp, random noise, burst random noise, step, pulse, ramp, and arbitrary	Transfer functions, magnitude/phase, 40-pole/40-zero curve fitter (S- and Z-domains), frequency-response synthesis (S- and Z-domains), time-domain functions, and spectrum analysis with analog or digital input signals. HP-IB programmable.
HP 3577B Network Analyzer (page 286)	5 Hz to 200 MHz	Integrated synthesized source	Transfer functions, magnitude/phase, group delay, S-parameters, insertion loss, gain/attenuation, electrical length, gain compression, SWR, impedance, HP Instrument BASIC optional. HP-IB programmable.
HP 4195A Network/Spectrum/ Impedance Analyzer (page 289)	10 Hz to 500 MHz	Integrated synthesized source	Transfer functions, magnitude/base, insertion loss/gain, attenuation, group delay, S-parameters, return loss, SWR, complex impedance, accuracy enhancement. HP-IB programmable.
HP 8751A Network Analyzer (page 293)	5 Hz to 500 MHz	Integrated synthesized source	Transfer functions, magnitude/phase, insertion loss/gain, attenuation, gain compression, S-parameters, electrical length, group delay, deviation from linear phase. Impedance-magnitude/phase: return loss, $R + jX$ . Full accuracy enhancement. HP Instrument BASIC capability. Built-in 3.5-in flexible disk (LIF/DOS format). HP-IB capability.
HP 8752A Network Analyzer (page 298)	300 kHz to 1.3/3.0 GHz	Integrated synthesized source, test set and receiver	Transfer functions - magnitude/phase, insertion loss/gain, attenuation, gain compression, S-parameters, electrical length, group delay, deviation from linear phase. Impedance-magnitude/phase, return loss, $r + jx$ , accuracy enhancement, time-domain capability. HP-IB programmable.
HP 8753C Network Analyzer (page 300)	300 kHz to 3 GHz/6 GHz	Integrated synthesized source	Transfer functions - magnitude/phase, insertion loss/gain, attenuation, gain compression, S-parameters, electrical length, group delay, deviation from linear phase. Impedance - magnitude/phase - Return Loss, $r + jx$ . Full accuracy enhancement. Time-domain capability. Harmonic measurement capability. HP-IB programmable.
HP 8719A/8720B Network Analyzers (page 306)	130 MHz to 13.5 GHz (8719A) 130 MHz to 20 GHz (8720B)	Integrated synthesized source (1 Hz resolution optional)	Transfer functions - magnitude/phase, insertion loss/gain, attenuation, S-parameters, electrical length, group delay, deviation from linear phase. Impedance - magnitude/phase - Return Loss, $r + jx$ . Full accuracy enhancement. Time-domain capability. HP-IB programmable.
HP 8510 Series Network Analyzers (page 309)	45 MHz to 110 GHz	HP 8350 Series Sweep Oscillators HP 8340B, 8341B Synthesized Sweepers HP 8360 Synthesized Sweepers	Transfer functions - magnitude/phase, insertion loss/gain, attenuation, S-parameters, electrical length, group delay, deviation from linear phase, impedance, return loss, $R + jx$ . Active device characterization. Full accuracy enhancement. Time-domain capability. HP-IB programmable.

### Vector Voltmeter

HP Model	Frequency Range	Source	Measurement Capabilities
HP 3575A Gain Phase Meter (page 288)	1 Hz to 13 MHz	None	Gain, phase, and amplitude
HP 8508A Vector Voltmeter (page 295)	0.1 MHz to 1 GHz 0.3 MHz to 2 GHz	None	Voltage, impedance Transfer functions, phase and amplitude HP-IB programmable

### Scalar Analyzer

HP Model	Frequency Range	Source	Measurement Capabilities
HP 8575C Scalar Network Network Analyzers (page 277)	10 MHz to 10 GHz	HP 8350 Series Sweep Oscillator, HP 8340B or 8341B HP 8360 Series Synthesized Sweepers	Scalar transmission/reflection measurements 50 $\Omega$ coax measurements 10 MHz to 50 GHz 75 $\Omega$ coax measurement 10 MHz to 2.4 GHz Waveguide measurements 26.5 to 110 GHz Open/short averaging, normalization, averaging, limit testing Storage registers, HP-IB programmable
HP 8711A RF Network Analyzer Network Analyzer (page 296)	300 kHz to 1.3 GHz	Integrated synthesized source, I/R test set and receiver	Transmission/reflection measurements 50 $\Omega$ and 75 $\Omega$ measurements HP Instrument BASIC (IBASIC) Narrowband/broadband receivers Internal calibration, averaging, limit testing, internal disk and storage registers

# NETWORK ANALYZERS

## Scalar Network Analyzers, 10 MHz to 110 GHz

HP 8757D/E

277

- 76 dB dynamic range
- Optional power calibrator
- 40 dB directivity bridges
- 40 GHz in coax, 110 GHz in waveguide

- Buffered plotter/printer output
- External disk and internal register save/recall
- Limit testing built in
- Color display

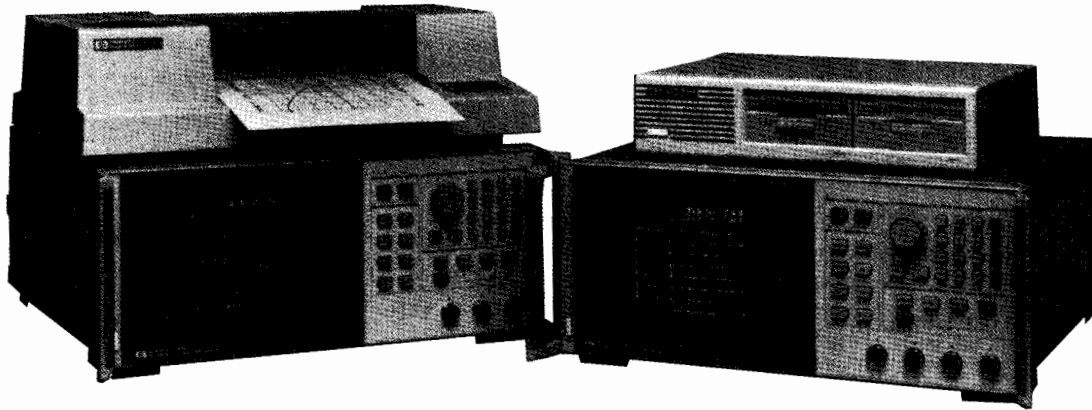

HP 8757E and HP 8757D Option 001

Measure insertion loss, gain, return loss, SWR, and power quickly and accurately with either the HP 8757D or HP 8757E Scalar Network Analyzers. With high-performance detectors and directional bridges, and a companion HP source and digital plotter, the HP 8757D and 8757E become the basis of a complete measurement system with superb performance.

### A Choice of Two Analyzers

For an economical measurement solution, choose the HP 8757E Scalar Network Analyzer. The HP 8757E features three detector inputs and two independent display channels, allowing simultaneous ratioed or non-ratioed measurement of your device's transmission and reflection characteristics, 76 dB dynamic range (+16 to -60 dBm) for measuring high rejection devices, and a choice between ac (square wave modulated) or dc detection techniques. The internal plotter/printer buffer allows you to send your measurement data directly to a plotter and then proceed to the next measurement, typically in less than 5 seconds. The HP 8757E includes a user-friendly interface, and menu-driven, direct-access softkeys, which simplify its operation.

When your application demands maximum system versatility, choose the HP 8757D Scalar Network Analyzer. It offers all of the performance of the HP 8757E, plus more standard features, limit testing, external disk save/recall, and a color display. Limit testing reduces test time by letting the analyzer make quick and objective pass/fail decisions. External disk save/recall allows your measurement state to be preconfigured by an engineer or skilled specialist and then automatically recalled by production technicians. The result is reduced setup time and greater test integrity at each production station. The precision color display simplifies the separation of measurement information while providing a pleasant display for the technician.

### Increase Absolute Power Measurement Accuracy

For near power meter measurement accuracy, configure a system which includes the HP 8757D Option 002 and the HP 85037 series precision detectors. Option 002 on the HP 8757D adds an internal power calibrator used to characterize the HP 85037 series detectors' accuracy versus power. In addition, each HP 85037 series precision detector incorporates a dual diode detector to improve power measurement accuracy when harmonics are present, plus internal frequency correction factors, read by the HP 8757D, for more accurate power versus frequency measurements. The result is a system optimized for swept absolute power measurements.

### Systems from 10 MHz to 110 GHz

You can conveniently obtain a 20 GHz or 40 GHz coaxial measurement system by ordering the HP 8757XA (10 MHz to 20 GHz) or HP 8757XB (10 MHz to 40 GHz) scalar measurement system. Or, you can configure your own system to 50 GHz in coax or 110 GHz in waveguide.

The HP 8350B sweep oscillator family offers the benefits of a modular system with choices in source frequency range and output power. When testing narrowband, frequency-selective devices, choose a synthesized sweeper from the HP 8360 series or an HP 8340B or 8341B. The HP 8360 series, 8340B, and 8341B provide excellent frequency stability and up to 1 Hz frequency resolution.

Feature	HP 8757D			HP 8757E
Display	Color			Monochrome
Display channels	4			2
Detector inputs	3 standard 4 with Option 001			3
Dynamic range	76 dB			76 dB
AC/DC detection mode	Yes			Yes
Measurement points: Selectable values	101, 201, 401, 801, 1601			101, 201, 401
Channels displayed	3 or 4	2	1	1 or 2
Max points per channel	401	801	1601	401
Plotter/printer buffer	Yes			Yes
Noise figure display capability	Yes			Yes
External disk save/recall	Yes			No
Internal save/recall registers	9			9
Limit testing (channels 1 and 2)	Yes			No
Adaptive normalization	Yes			No
Cursor search functions	Max, Min, bandwidth, n dB			Max, min
SWR display mode	Yes			Yes
Non-standard sweep mode	Yes			Yes
Auxiliary voltage display mode	Yes			Yes
Optional power calibrator	Yes			No

# NETWORK ANALYZERS

## System Specifications

HP 8757

### System Accuracy

#### Transmission loss or gain measurement accuracy

Transmission loss or gain measurements are made relative to a 0 dB reference point established at calibration.

Transmission measurement uncertainty  
= dynamic power accuracy + mismatch uncertainty

Dynamic power accuracy is the measurement uncertainty due to the change in power level between calibration and the measurement. Mismatch uncertainty is the uncertainty due to reflections in the measurement setup. The frequency response errors of the source, detectors, bridge, and power splitter are removed via calibration.

#### Transmission measurement uncertainty examples

Assumptions:

- Measurement frequency = 10 GHz
- DUT input/output SWR = 1.5
- Change in power after calibration < 35 dB (+0 to -35 dBm range)

Uncertainty Component	HP 85037B precision detector	HP 85025E detector	HP 11664E detector
Dynamic accuracy ( $\pm$ dB)	0.06	0.40	0.30
Mismatch ( $\pm$ dB)	0.45	0.33	0.61
Uncertainty Total ( $\pm$ dB)	0.51	0.73	0.91

#### Absolute power measurement accuracy:

This specification is useful for determining the accuracy of power measurements in dBm when using the HP 85037 series precision detectors or the HP 85025 series precision detectors in DC mode.

Absolute power uncertainty = absolute power accuracy at 50 MHz  
+ frequency response + mismatch uncertainty

#### Absolute power measurement uncertainty examples

Assumptions:

- Measurement frequency = 10 GHz
- DUT input/output SWR = 1.5
- Measured power = 0 dBm

Uncertainty Component	HP 85037B detector	HP 85025E detector
Absolute power accuracy at 50 MHz ( $\pm$ dB)	0.11	0.40
Frequency response ( $\pm$ dB)	0.20	0.50
Mismatch ( $\pm$ dB)	0.18	0.10
Uncertainty Total ( $\pm$ dB)	0.49	1.00

#### HP 8757D Option 002 Power Calibrator

The HP 8757D's internal power calibrator provides a 50 MHz reference standard for characterizing the absolute power accuracy and dynamic power accuracy of the HP 85037 series precision detectors.

Frequency: 50 MHz  $\pm$  0.2 MHz  
Accuracy at 0 dBm:  $\pm$  0.05 dB  
Linearity:  $\pm$  0.08 dB (+20 to +10 dBm)  
 $\pm$  0.04 (+10 to -30 dBm)

### Reflection Measurement Accuracy

Uncertainties due to calibration error and the frequency response of the source, detectors, and bridges are removed via open/short averaging. The remaining uncertainties are primarily the sum of directivity uncertainty, effective source match uncertainty, and dynamic power accuracy. As shown in the graphs below, directivity is the dominant error term when measuring small reflected signals (high return loss) and source match is dominant when measuring large reflected signals (low return loss).

Effect of effective source match on reflection uncertainty:

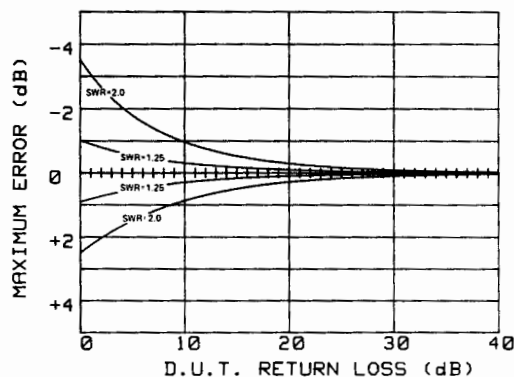

Effect of directivity on reflection uncertainty:

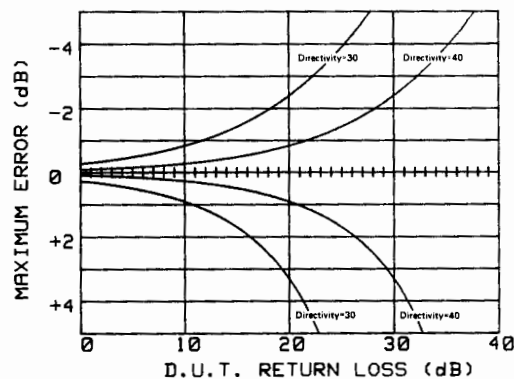

Dynamic power accuracy (HP 85027/20 bridges, 50 MHz, 25  $\pm$  5°C, +7 dBm input):

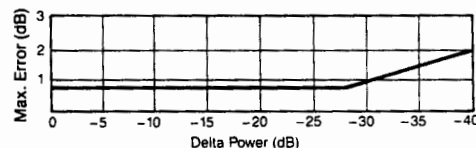



# NETWORK ANALYZERS

## 8757 System Accessories

HP 85037A/B, 85025A/B/C/D/E, 11664A/C/D/E, R/Q/U85026A

279

### HP 85037 Series Precision Detectors (ac/dc)

The HP 85037 Series precision detectors are designed specifically for operation with the HP 8757D scalar network analyzer and may be used in either ac or dc detection modes. When used in conjunction with the HP 8757D's internal power calibrator (Option 002), these detectors provide the maximum absolute power measurement accuracy.

### HP 85025 and 85026 Series Detectors (ac/dc)

The HP 85025 and 85026 Series detectors are designed specifically for operation with the HP 8757 scalar network analyzer and are not compatible with either the HP 8756 or the 8755. The HP 85025/26 detectors detect either a modulated (ac) or an unmodulated (dc) microwave signal.

### 11664 Series Detectors (ac only)

The HP 11664 Series detectors are designed to operate with the HP 8757, 8756, and 8755 scalar analyzers in ac mode only.

### Detector Adapters

The HP 85025C and 11664C detector adapters match the scalar analyzer display to most standard crystal, silicon, and gallium arsenide detectors. This enables the user to operate up to 110 GHz with the HP 8757 and 8756. The HP 85025C detector adapter is designed for use with the HP 8757 only, and can operate in either ac or dc detection modes. The HP 11664C detector adapter is designed for use with the HP 8757, 8756, and 8755 scalar analyzers.

### Precision Detector Summary, HP 85037 Series

For use with the HP 8757D in either ac or dc detection modes

Model	Frequency Range	Connector Type	Dynamic Range	Frequency	Return Loss	Frequency Response	Power (@ 50 MHz)	Dynamic Accuracy <sup>1</sup>	Absolute Accuracy <sup>2</sup>
HP 85037A <sup>1</sup>	10 MHz to 18 GHz	Type-N (m) 7 mm <sup>2</sup>	ac mode	0.01 to 0.04 GHz	10 dB	±0.3 dB	20 dBm	±0.20 dB	±0.25 dB
			+20 to -55 dBm	0.04 to 18.0 GHz	20 dB	±0.2 dB	10 dBm	±0.06 dB	±0.11 dB
HP 85037B <sup>1</sup>	10 MHz to 26.5 GHz	3.5 mm (m)	dc mode	0.01 to 0.04 GHz	10 dB	±0.3 dB	20 dBm	±0.20 dB	±0.25 dB
			+20 to -50 dBm	0.04 to 18.0 GHz	20 dB	±0.2 dB	10 dBm	±0.06 dB	±0.11 dB
HP 85037B <sup>1</sup>	10 MHz to 26.5 GHz	3.5 mm (m)	dc mode	18 to 26.5 GHz	18 dB	±0.3 dB	-35 dBm	±0.06 dB	±0.11 dB
			+20 to -50 dBm				-50 dBm	±0.50 dB	±0.50 dB

### Coaxial Detector Summary, HP 85025 and 11664 Series

For use with the HP 8757 only in either ac or dc detection modes

Model	Frequency Range	Connector Type	Dynamic Range	Frequency	Return Loss	Frequency Response	Power (@ 50 MHz)	Dynamic Accuracy <sup>1</sup>	Absolute Accuracy <sup>2</sup>
HP 85025A <sup>3</sup>	10 MHz to 18 GHz	Type-N (m) 7 mm <sup>2</sup>	ac mode	0.01 to 0.04 GHz	10 dB	±0.8 dB	16 dBm	±0.8 dB	±0.8 dB
			+16 to -55 dBm	0.04 to 4 GHz	20 dB	±0.5 dB	6 dBm	±0.4 dB	±0.4 dB
			dc mode	4 to 18 GHz	17 dB	±0.5 dB	-35 dBm	±0.4 dB	±0.4 dB
			+16 to -50 dBm				-50 dBm	±1.3 dB	±1.3 dB
HP 85025B <sup>3</sup>	10 MHz to 26.5 GHz	3.5 mm (m)	ac mode	0.01 to 0.04 GHz	10 dB	±0.8 dB	16 dBm	±0.8 dB	±0.8 dB
			+16 to -55 dBm	0.04 to 4 GHz	20 dB	±0.5 dB	6 dBm	±0.4 dB	±0.4 dB
			dc mode	4 to 18 GHz	17 dB	±0.5 dB	-35 dBm	±0.4 dB	±0.4 dB
			+16 to -50 dBm	18 to 26.5 GHz	12 dB	±2.0 dB	-50 dBm	±1.3 dB	±1.3 dB
HP 85025D <sup>3</sup>	10 MHz to 50 GHz	2.4 mm (m)	ac mode	0.01 to 0.1 GHz	10 dB	±0.8 dB	16 dBm	±1.0 dB	±1.0 dB
			+16 to -55 dBm	0.1 to 20 GHz	20 dB	±0.5 dB	6 dBm	±0.4 dB	±0.4 dB
			dc mode	20 to 26.5 GHz	20 dB	±1.0 dB	-35 dBm	±0.4 dB	±0.4 dB
			+16 to -50 dBm	26.5 to 40 GHz	15 dB	±2.5 dB	-50 dBm	±1.3 dB	±1.3 dB
HP 85025E <sup>3</sup>	10 MHz to 26.5 GHz	3.5 mm (m)	ac mode	0.01 to 0.1 GHz	10 dB	±0.8 dB	16 dBm	±1.0 dB	±1.0 dB
			+16 to -55 dBm	0.1 to 18 GHz	25 dB	±0.5 dB	6 dBm	±0.4 dB	±0.4 dB
			dc mode	18 to 25 GHz	25 dB	±0.5 dB	-35 dBm	±0.4 dB	±0.4 dB
			+16 to -50 dBm	25 to 26.5 GHz	23 dB	±1.4 dB	-50 dBm	±1.3 dB	±1.3 dB

### For use with the HP 8757, 8756, or 8755 in ac detection mode only

HP 11664A	10 MHz to 18 GHz	Type-N (m) 7 mm <sup>2</sup>	+16 to -60 dBm	0.01 to 0.04 GHz	10 dB	±0.5 dB	16 dBm	±0.4 dB
				0.04 to 4 GHz	20 dB	±0.5 dB	6 dBm	±0.3 dB
				4 to 12 GHz	18 dB	±0.5 dB	-35 dBm	±0.3 dB
				12 to 18 GHz	16 dB	±0.5 dB	-60 dBm	±1.2 dB
HP 11664E	10 MHz to 26.5 GHz	3.5 mm (m)	+16 to -60 dBm	0.01 to 0.04 GHz	10 dB	±0.5 dB	16 dBm	±0.4 dB
				0.04 to 6 GHz	20 dB	±0.5 dB	6 dBm	±0.3 dB
				6 to 18 GHz	16 dB	±0.5 dB	-35 dBm	±0.3 dB
				18 to 26.5 GHz	12 dB	±1.0 dB	-60 dBm	±1.2 dB

<sup>1</sup>The HP 85037A/B specifications are applicable when used with the HP 8757D scalar network analyzer. The absolute power accuracy and dynamic power accuracy specifications apply after a calibration via the HP 8757D Option 002's internal power calibrator.

<sup>2</sup>Option 001 changes to 7 mm connector.

<sup>3</sup>The HP 85025 and 85026 series detectors and the HP 85025C detector adapter require HP 8757A firmware revision 2.0 or higher. To upgrade previous revisions, order the HP 11614A Firmware Enhancement.

<sup>4</sup>Dynamic accuracy refers to measurement accuracy as power varies (in dB) from a 0 dBm reference. 25 ± 5°C, 50 MHz.

<sup>5</sup>DC mode, 25 ± 5°C

# NETWORK ANALYZERS

## 8757 System Accessories

85025C, 11664A/C/D/E, R/Q/U85026A, HP 85020A/B, HP 85027A/B/C/D/E

### Waveguide Detectors and Detector Adapters Summary

For use with the HP 8757 only in either ac or dc detection modes

Model	Frequency Range	Connector Type	Dynamic Range	Return Loss	Frequency Response	Dynamic Accuracy
HP R85026A <sup>1</sup>	26.5 to 40 GHz	WR-28	+10 to -50 dBm (ac mode) +10 to -45 dBm (dc mode)	12 dB	±1.5 dB	±(0.3 dB + 0.03 dB/dB)
HP Q85026A <sup>1</sup>	33 to 50 GHz	WR-22	+10 to -50 dBm (ac mode) +10 to -45 dBm (dc mode)	12 dB	±2.0 dB	±(0.3 dB + 0.03 dB/dB)
HP U85026A	40 to 60 GHz	WR-19	+10 to -50 dBm (ac mode) +10 to -45 dBm (dc mode)	12 dB	±2.0 dB	±(0.3 dB + 0.03 dB/dB)
HP 85025C Opt K57 <sup>2</sup>	50 to 75 GHz	WR-15	+10 to -45 dBm (typical)	9.5 dB (typical)		
HP 85025C Opt K71 <sup>3</sup>	75 to 110 GHz	WR-10	+10 to -45 dBm (typical)	9.5 dB (typical)		
HP 85025C <sup>1</sup>	<sup>2</sup>	SMA (m)	<sup>2</sup>	<sup>2</sup>	<sup>2</sup>	<sup>2</sup>

### For use with the HP 8757, 8756, or 8755 in ac detection mode only

HP 11664D	26.5 to 40 GHz	WR-28	+10 to -50 dBm	12 dB	±1.5 dB	±0.5 dB @ 10 dB ±0.2 dB @ 0 to -35 dB
HP 11664C	<sup>2</sup>	SMA (m)	<sup>2</sup>	<sup>2</sup>	<sup>2</sup>	<sup>2</sup>

#### HP 85020A/B Direction Bridges (ac only)

The HP 85020A/B directional bridges offer high directivity and excellent test port match to 4.3 GHz. These bridges may be used with the HP 8757, 8756, or 8755 scalar network analyzers in ac detection mode. The HP 85020A is designed for 50 ohm environments while the HP 85020B is designed for 75 ohm environments.

#### HP 85027 Series Directional Bridges (ac/dc)

The HP 85027 series directional bridges are designed to operate with either the HP 8757 in ac or dc detection modes or with the HP 8756 or 8755 in ac detection mode. These bridges offer high directivity, excellent test port match, and a measurement range of up to 50 GHz in coax.

### Directional Bridge Summary

For use with the HP 8757, 8756, or 8755 in ac detection mode only

Model	Frequency Range	Nominal Impedance	Connector		Directivity (dB)		Test Port Match (SWR)	
			Input	Test Port				
HP 85020A	10 MHz to 4.3 GHz	50 ohms	Type-N (f)	Type-N (f)	0.01 to 3 GHz 3 to 4.3 GHz	40 dB 34 dB	0.01 to 3 GHz 3 to 4.3 GHz	<1.20 <1.25
HP 85020B	10 MHz to 2.4 GHz	75 ohms	Type-N (f)	Type-N (f)	40 dB		0.01 to 1.3 GHz 1.3 to 2.4 GHz	<1.25 <1.39

### For use with the HP 8757 in ac or dc detection mode or with the 8756 or 8755 in ac detection mode only

Model	Frequency Range	Nominal Impedance	Connector		Directivity (dB)		Test Port Match (SWR)	
			Input	Test Port				
HP 85027A	10 MHz to 18 GHz	50 ohms	Type-N (f)	7 mm	40 dB		0.01 to 8.4 GHz 8.4 to 12.4 GHz 12.4 to 18 GHz	<1.15 <1.25 <1.43
HP 85027B	10 MHz to 26.5 GHz	50 ohms	3.5 mm (f)	3.5 mm (f)	0.01 to 20 GHz 20 to 26.5 GHz	40 dB 36 dB	0.01 to 8.4 GHz 8.4 to 20 GHz 20 to 26.5 GHz	<1.15 <1.43 <1.78
HP 85027C	10 MHz to 18 GHz	50 ohms	Type-N (f)	Type-N (f)	0.01 to 12.4 GHz 12.4 to 18 GHz	36 dB 34 dB	0.01 to 8.4 GHz 8.4 to 12.4 GHz 12.4 to 18 GHz	<1.15 <1.25 <1.43
HP 85027D	10 MHz to 50 GHz	50 ohms	2.4 mm (f)	2.4 mm (m)	0.01 to 20 GHz 20 to 26.5 GHz 26.5 to 40 GHz 40 to 50 GHz	36 dB 32 dB 30 dB 25 dB	0.01 to 16 GHz 16 to 30 GHz 30 to 40 GHz 40 to 50 GHz	<1.18 <1.27 <1.4 typically <1.85
HP 85027E	10 MHz to 26.5 GHz	50 ohms	3.5 mm (f)	3.5 mm (m)	0.01 to 20 GHz 20 to 26.5 GHz	40 dB 36 dB	0.01 to 8.4 GHz 8.4 to 20 GHz 20 to 26.5 GHz	<1.15 <1.43 <1.78

<sup>1</sup> The HP 85025 and 85026 series detectors and the HP 85025C detector adapter require HP 8757A firmware revision 2.0 or higher. To upgrade previous revisions, order the HP 11614A Firmware Enhancement.

<sup>2</sup> Depends upon the particular detector being used

<sup>3</sup> Must be used with the HP 85025C or 11664C detector adapter



HP 11679A

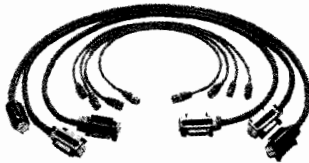

HP 85022A

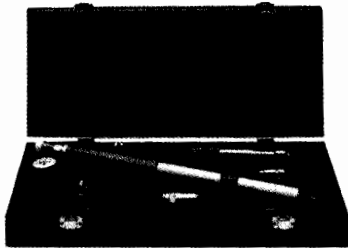

HP 85028A



HP 85023C



HP 11668A



HP 11678A

### HP 11679A/B Extension Cables

**Function:** These cables extend the distance between the scalar network analyzer and the detector or bridge to a maximum of 200 feet without degradation of performance.

HP 11679A: 7.6 m (25 ft) extension cable

HP 11679B: 61 m (200 ft) extension cable

### HP 85023A/B/C/D/F Verification Kits

The HP 85023 Series system verification kits each contain a set of precision components used to perform a system verification procedure for the HP 8757 scalar network analyzer system. This procedure, which is in the HP 8757/56 Operating and Service Manuals, checks system installation and can be used as a daily functional test.

Choose a system verification kit to match your device under test. For 7mm applications, select the HP 85023A. If you are measuring SMA or 3.5mm devices, choose the HP 85023B. For 50 ohm, Type-N applications, select the HP 85023C. These kits (HP 85023A/B/C) all include an open, short, 10 dB fixed attenuator, 50 ohm termination, and a source to directional bridge adapter of the corresponding connector type. The HP 85023D verification kit, for 75 ohm Type-N measurements, consists of a short, a 75 ohm termination, a 50 ohm 10 dB fixed attenuator, and two HP 11852B 50 to 75 ohm minimum loss pads (for 50/75 ohm impedance conversion).

The HP 85023F verification kit includes 2.4 mm standards for verifying performance of the HP 8757 system to 50 GHz. Included are a 2.4 mm female open, short and 50 ohm load, a 10 dB attenuator, and female to female adapter.

**Frequency range:** HP 85023A/C, dc to 18 GHz  
 HP 85023D, dc to 1.3 GHz  
 HP 85023B, dc to 26.5 GHz  
 HP 85023F, dc to 50 GHz

**Connector type:** HP 85023A, 7mm  
 HP 85023B, 3.5mm  
 HP 85023C, Type-N, 50 ohm  
 HP 85023D, Type-N, 75 ohm  
 HP 85023F, 2.4mm, 50 ohm

**Characteristic impedance:** HP 85023A/B/C/F, 50 ohm  
 HP 85023D, 75 ohm

**Weight:** Net, 0.5 kg (1.2 lb); shipping, 1.2 kg (2.9 lb)

### HP 85022A System Cable Kit

The HP 85022A contains all the BNC and HP-IB cables to connect an HP 8350B sweep oscillator (or the HP 8360 series, HP 8340B/41B synthesized sweepers), an HP Series 200 or 300 computer, and a printer to the HP 8757 or 8756. This kit contains 3 one-meter HP-IB cables (HP 10833A), 3 two-foot BNC cables (HP 11170B), and 1 four-foot BNC cable (HP 11170C).

**BNC connectors:** N-Male, N-Male

**BNC impedance:** 50 ohm

**Weight:** Net, 0.5 kg (1.2 lb); shipping, 1.2 kg (2.9 lb)

### HP 85028A 7mm Directivity Verification Standards for HP 85021A/85027A

The HP 85028A allows on-site verification of the 40 dB directivity of the HP 85021A and 85027A directional bridges. For frequencies below 2 GHz, a precision 52 dB return loss load is used. For frequencies from 2 to 18 GHz, a sliding mismatch is used to establish a ripple pattern from which the directivity can be calculated. The HP 85028A includes a precision 50 ohm termination, a high-performance sliding mismatch, a 7 mm open/short, a 7 mm connector gage kit, and a torque wrench.

**Weight:** Net, 2.0 kg (4.5 lb); shipping, 3.5 kg (8.0 lb)

### HP 11614A Firmware Enhancement

The HP 11614A firmware enhancement updates the HP 8757A scalar network analyzer to firmware revision 2.1. (HP 8757As with serial number prefix 2802A or higher already have revision 2.1 firmware.) Firmware revision 2.1 added several new features to previous versions of the HP 8757A. These include the ability to display and plot reflection traces in units of standing wave ratio (SWR), tabular listings of numerical data on an HP ThinkJet printer, full calibration and operation with the HP 85025C detector adapter and R/Q/U85026A waveguide detectors, and the ability to display and plot an external voltage applied to a rear panel input. All revision 2.1 features are HP-IB programmable.

### HP 8757C/E Firmware Update

Update the HP 8757C (serial prefix 3004A and below) to revision 3.2 or the HP 8757E (serial prefix 3004A and below) to revision 4.2 with a firmware update kit. These kits enhance the operation of the HP 8757C/E by adding:

- Synthesized step sweep measurements with the HP 8360 series synthesized sweepers.
- Plotter buffer on/off selection.
- Cursor format selection, SWR or dB, while displaying device match in dB.

All 3.2 and 4.2 revision features are HP-IB programmable.

HP 8757C firmware update kit: 08757-60099

HP 8757E firmware update kit: 08757-60098

# NETWORK ANALYZERS

## 8757 System Accessories (cont'd)

HP 11613B, 11636A/B, 11665B, 11668A, 11852B

### HP 11668A High Pass Filter

The HP 11668A high pass filter accessory is recommended when making measurements on active devices that have gain below 50 MHz. Use of the HP 11668A, placed after the HP 11665B, reduces the modulator drive feedthrough from 8 mV to 1 mV and prevents possible amplifier saturation. Use of the HP 11668A filter is not necessary for passive measurements since the feedthrough from the HP 11665B is  $-65$  dBm and causes no degradation in system performance.

**Frequency range:** 50 MHz to 18 GHz

	Insertion Loss	Return Loss
50 to 100 MHz	$\leq 2.5$ dB	$\geq 12$ dB
100 MHz to 8 GHz	$\leq 1.0$ dB	$\geq 16$ dB
8 to 12 GHz	$\leq 1.0$ dB	$\geq 14$ dB
12 to 18 GHz	$\leq 1.5$ dB	$\geq 14$ dB

**Maximum input:** +27 dBm

**Connectors:** N-female, N-male

**Weight:** Net, 0.13 kg (5 oz); shipping, 0.28 kg (10 oz)

### HP 11678A Low Pass Filter Kit

**Description:** The HP 11678A low pass filter kit contains five filters. Low pass filters reduce harmonics generated by the RF source when making precision measurements.

**Frequency Range** (low pass filters, cutoff frequency fc)

HP 11688A: 2.8 GHz

HP 11689A: 4.4 GHz

HP 11684A: 6.8 GHz

HP 11685A: 9.5 GHz

HP 11686A: 13.0 GHz

**Insertion loss:**  $< 1.1$  dB at 0.95 fc

**Rejection** (at 1.25 fc): Greater than 40 dB

**Impedance:** 50  $\Omega$  normal

**Connectors:** N-Female, N-Male

**Weight:** Net, 0.44 kg (1 lb); shipping, 1.2 kg (2.9 lb)

### HP 11613B Calibrator

HP 8757 and 8756 verification/calibration is recommended every 12 months. This can be accomplished at an HP service center or on-site using the HP 11613B calibrator and an HP 9000 series 200 or series 300 computer.

The HP 11613B is a dedicated transfer standard for calibration of the HP 8757 and 8756. The HP 11613B provides the standard a 27.778 kHz source and a series of precision attenuators. The calibrator includes software (both 3.5 and 5.25 inch formats) that operates on an HP 9000 series 200 or series 300 computer, the BASIC operating system (BASIC 2.0, and above) and a GP-IO cable for use when calibrating the HP 8756. The software verifies (and adjusts if necessary) the internal calibration parameters stored in the non-volatile memory of the HP 8757 and 8756. All HP 8757 and 8756 detector inputs can be calibrated in a matter of minutes. Re-calibration of the HP 11613B is recommended every two years.

**Memory Requirement:** 1/2M byte, including BASIC

**Hardware Requirement:** HP 98622A 16-bit GP-IO interface card for use with HP 8756

**Dimensions:** 40 H  $\times$  185 W  $\times$  203 mm D (1.5 in  $\times$  7.3 in  $\times$  8.0 in)

**Cable length:** 1.22 m (48 in)

**Weight:** Net, 0.91 kg (2 lbs); shipping, 1.4 kg (3 lbs)

HP 11665B

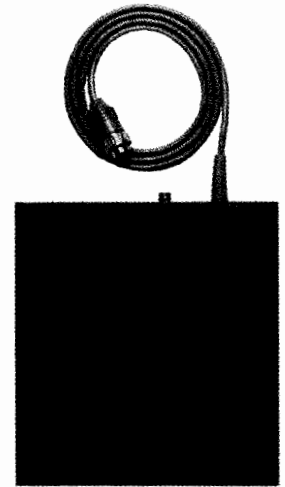

HP 11613B

### HP 11636A/B Power Dividers

The HP 11636A/B power dividers/combiners are recommended when making wideband comparison measurements without ratioing, and in fault location measurements with the HP 8757/85016. Detailed specifications are on page 406.

### Other Signal Separation Devices

Many other signal separation devices are available from HP for use with the HP 8757, 8756, and 8755. Coaxial couplers from 0.1 to 18 GHz are available with the HP 770 series, the 790 series, and the HP 11692. Higher directivity HP 752 series waveguide couplers can also be used with the HP 8757, 8756, or 8755 with the addition of appropriate HP 281 series waveguide-to-coax adapters.

### 11665B Modulator

**Function:** Absorptive on-off modulator designed for and powered by the HP 8757, 8756, or 8755 scalar network analyzers

Frequency Range	Return Loss On and Off	Insertion Loss On Off
15 to 40 MHz	$\geq 10$ dB	$\leq 7.0$ dB $\geq 35$ dB
40 MHz to 4 GHz	$\geq 15$ dB	$\leq 3.2$ dB $\geq 35$ dB
4 to 8 GHz	$\geq 12$ dB	$\leq 4.3$ dB $\geq 45$ dB
8 to 12.4 GHz	$\geq 8$ dB	$\leq 3.8$ dB $\geq 40$ dB
12.4 to 18 GHz	$\geq 8$ dB	$\leq 5.0$ dB $\geq 45$ dB

**Modulator drive feedthrough:**  $\leq 8$  mV (peak) at 27.8 kHz at either port when powered by the HP 8757, 8756, or 8755. Reduced to  $\leq 1$  mV (peak) using the HP 11668A. (See HP 11668A High Pass Filter.)

**Drive current:** Nominally +50 mA in On condition,  $-50$  mA Off condition

**Weight:** Net, 0.17 kg (6 oz); shipping, 0.9 kg (2 lb)

### HP 11852B 50 $\Omega$ /75 $\Omega$ Minimum Loss Pad

The HP 11852B is a low SWR minimum loss pad required between 75  $\Omega$  devices and 50  $\Omega$  sources and detectors. For more information, see page 303.



HP 11667A

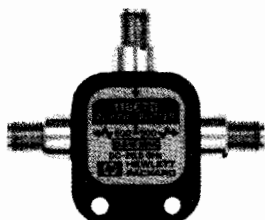

HP 11667B

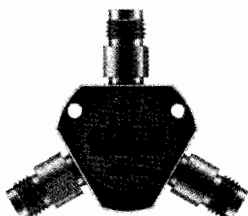

HP 11667C

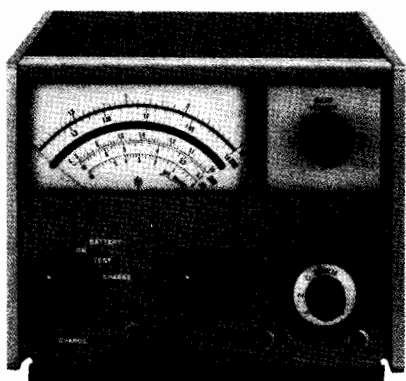

HP 415E

**HP 415E SWR Meter**

HP 415E SWR Meter is a low noise, 1000 Hz tuned amplifier and voltmeter, calibrated in dB and SWR. Designed for use with square law detectors, it measures SWR, attenuation, and gain directly from metered scales, or drives an X-Y recorder for RF substitution measurements. Front-panel INPUT switch selects unbiased low (50 to 200 Ω) or high (2500 to 10,000 Ω) impedance crystal, biased crystal (1 V into 1 kΩ), or low or high current bolometer (4.5 or 8.7 mA ± 3% into 200 Ω).

An internal precision 60 dB attenuator allows the HP 415E to operate over a 70 dB range in 10 or 2 dB steps, with ±0.05 dB accuracy for a 10 dB step; maximum cumulative error between any two 10 dB steps is ±0.1 dB. Sensitivity is 0.15 μV rms for full scale deflection at maximum bandwidth (1 μV rms on high impedance crystal input).

Continuously adjustable bandwidth can be adjusted from 15 Hz for maximum sensitivity at CW frequencies to 130 Hz for swept frequency uses. An optional rechargeable battery pack provides up to 36 hours of continuous operation for portable use.

**Weight:** Net, 4 kg (9 lb); shipping, 5.8 kg (13 lb)

**Power:** 115 to 230 V ±10%, 50 to 400 Hz, 1 VA

**Dimensions:** 155 mm H × 190 mm W × 279 mm D (6½ in × 7¾ in × 11 in)

**HP 11667A/B/C Power Splitters**

The HP 11667A/B/C power splitters are recommended when making wideband ratio measurements using the HP 8757, 8756, or 8755 scalar network analyzer. These two-resistor type splitters provide excellent output SWR at the auxiliary arm when used for source leveling or ratio measurement applications. The tracking between output arms over a frequency range from dc to 50 GHz allows wideband measurements to be made with a minimum of uncertainty.

**Frequency Range:**

**HP 11667A** dc to 18 GHz

**HP 11667B** dc to 26.5 GHz

**HP 11667C** dc to 50 GHz

**Impedance** 50 ohms nominal

**Insertion Loss**

**HP 11667A/B:** 6 dB nominal

**HP 11667C:** 8.5 dB nominal

HP 11667A	dc to 4 GHz	dc to 8 GHz	dc to 18 GHz
<b>Input SWR:</b>	≤ 1.15	≤ 1.25	≤ 1.45
<b>Equivalent Output SWR:</b> (leveling or ratio measurements)	≤ 1.10	≤ 1.20	≤ 1.33
<b>Output Tracking (dB):</b> (between output arms)	≤ 0.15	≤ 0.20	≤ 0.25
<b>Typical Phase Tracking (deg):</b> (between output arms)	0.5	1.5	3.0

HP 11667B/C	dc to 18 GHz	dc to 26.5 GHz	dc to 40 GHz	dc to 50 GHz
<b>Input SWR:</b>				
HP 11667B	≤ 1.22	≤ 1.29		
HP 11667C	≤ 1.22	≤ 1.38	≤ 1.50	≤ 1.65
<b>Equivalent Output SWR:</b> (leveling or ratio measurements)				
HP 11667B	≤ 1.22	≤ 1.22		
HP 11667C	≤ 1.29	≤ 1.29	≤ 1.50	≤ 1.65
<b>Output Tracking (dB):</b> (between output arms)				
HP 11667B	≤ 0.25	≤ 0.40		
HP 11667C	≤ 0.30	≤ 0.35	≤ 0.40	≤ 0.40
<b>Typical Phase Tracking (deg):</b> (between output arms)				
HP 11667B	1.5	2.5		
HP 11667C	2.0	2.5	3.0	3.0
<b>Typical Insertion Loss (dB):</b>				
HP 11667C	6.0	7.0	8.0	8.5

**Maximum Input Power:** +27 dBm

**Connectors**

HP 11667A N-female on all ports

HP 11667B 3.5 mm female on all ports

HP 11667C 2.4 mm female on all ports

**Dimensions**

HP 11667A 46 mm H × 52 mm W × 19 mm D (1.8 in × 2.0 in × 0.7 in)

HP 11667B 40 mm H × 47 mm W × 10 mm D (1.6 in × 1.9 in × 0.4 in)

HP 11667C 36 mm H × 36 mm W × 10 mm D (1.4 in × 1.4 in × 0.4 in)

**Weight**

HP 11667A net, 0.14 kg (0.31 lb); shipping, 0.22 kg (0.5 lb)

HP 11667B net, 0.06 kg (0.13 lb); shipping, 0.14 kg (0.3 lb)

HP 11667C net, 0.06 kg (0.13 lb); shipping, 0.14 kg (0.3 lb)

# NETWORK ANALYZERS

## Ordering Information

HP 8757

### Ordering Information

The HP 8757 Scalar Network Analyzer is ordered with multiple line items to give you maximum flexibility in specifying a system that meets your needs. Consult your local HP Sales Office if you would like assistance.

	Price		
<b>Complete measurement systems</b>			
<b>HP 8757XA</b> 20 GHz Coaxial Scalar System	\$39,510		
<b>Includes:</b>			
<b>HP 8757D</b> Scalar Network Analyzer			
<b>HP 8350B</b> Sweep Oscillator			
<b>HP 83592C</b> RF Plug-in (0.01 to 20 GHz)			
<b>HP 85027E</b> Directional Bridge (3.5 mm)			
<b>HP 85025E</b> Detector (3.5 mm)			
<b>HP 85022A</b> Cable Kit			
<b>HP 8757XB</b> 40 GHz Coaxial Scalar System	\$54,175		
<b>Includes:</b>			
<b>HP 8757D</b> Scalar Network Analyzer			
<b>HP 8350B</b> Sweep Oscillator			
<b>HP 83597A</b> RF Plug-in (0.01 to 40 GHz)			
<b>HP 85027D</b> Directional Bridge (2.4 mm)			
<b>HP 85025D</b> Detector (2.4 mm)			
<b>HP 85022A</b> Cable Kit			
<b>Analyzer</b>			
<b>HP 8757D</b> Scalar Network Analyzer	\$9,100		
<b>Opt 001</b> Fourth detector input	+ \$1,600		
<b>Opt 002</b> Internal Power Calibrator	Contact Your HP Office		
<b>Opt 802</b> HP 9122C Disk Drive and an HP 10833A HP-IB cable	+ \$1,745		
<b>Opt W03*</b> 90 day On-site Warranty Conversion	\$0		
<b>Opt W30</b> 2-year Extended Service	+ \$215		
<b>HP 8757E</b> Scalar Network Analyzer	\$7,600		
<b>Opt W03*</b> 90-day On-site Warranty Conversion	\$0		
<b>Opt W30</b> 2-year Extended Service	\$190		
<b>Sweep oscillators</b>			
(choose either HP 8350B with an RF Plug-in, 8360 Series, 8340B, or 8341B)			
<b>Precision Detectors</b>			
<b>HP 85037A</b> 0.01 to 18 GHz, Type-N(m)	Contact Your HP Office		
<b>Opt 001</b> 7mm Connector			
<b>HP 85037B</b> 0.01 to 26.5 GHz, 3.5mm(m)			
<b>Directional bridges</b>			
<b>HP 85027A</b> 0.01 to 18 GHz, 7mm, 50 Ω	\$2,600		
<b>HP 85027B</b> 0.01 to 26.5 GHz, 3.5mm (f), 50 Ω	\$3,100		
<b>HP 85027C</b> 0.01 to 18 GHz, Type-N (f), 50 Ω	\$2,600		
<b>HP 85027D</b> 0.01 to 50 GHz, 2.4mm (m), 50 Ω	\$3,500		
<b>HP 85027E</b> 0.01 to 26.5 GHz, 3.5mm (m), 50 Ω	\$3,100		
<b>HP 85020A</b> 0.01 to 4.3 GHz, Type-N (f), 50 Ω	\$1,250		
<b>HP 85020B</b> 0.01 to 2.4 GHz, Type-N (f), 75 Ω	\$1,400		
<b>Detectors</b>			
<b>HP11664A</b> 0.01 to 18 GHz, Type-N (m)	\$565		
<b>Opt 001</b> 7mm connector	+ \$50		
<b>HP 11664E</b> 0.01 to 26.5 GHz, 3.5mm (m)	\$725		
<b>HP 11664D</b> 26.5 to 40 GHz, WR-28 Waveguide	\$1,300		
<b>HP 11664C</b> Detector Adapter	\$350		
<b>HP 85025A</b> 0.01 to 18 GHz, Type-N (m)	\$900		
<b>Opt 001</b> 7mm Connector	+ \$50		
<b>HP 85025B</b> 0.01 to 26.5 GHz, 3.5mm (m)	\$950		
<b>HP 85025D</b> 0.01 to 50 GHz, 2.4mm (m)	\$1,550		
<b>HP 85025E</b> 0.01 to 26.5 GHz, 3.5mm (m)	\$1,200		
<b>HP R85026A</b> 26.5 to 40 GHz, WR-28 Waveguide	\$1,600		
<b>HP Q85026A</b> 33 to 50 GHz, WR-22 Waveguide	\$1,800		
<b>HP U85026A</b> 40 to 60 GHz, WR-19 Waveguide	\$1,800		
<b>HP 85025C</b> Detector Adapter	\$600		
<b>System verification kits</b>			
<b>HP 85028A</b> 7mm Directivity Verification Standards	\$5,300		
<b>HP 85023A</b> 7mm, 50 Ω	\$725		
<b>HP 85023B</b> 3.5mm, 50 Ω	\$950		
<b>HP 85023C</b> Type-N, 50 Ω	\$650		
<b>HP 85023D</b> Type-N, 75 Ω	\$1,000		
<b>HP 85023F</b> 2.4mm, 50 Ω	\$2,200		
<b>Filter kits</b>			
<b>HP 11668</b> High Pass Filter Kit	\$700		
<b>HP 11678</b> Low Pass Filter Kit	\$2,300		
<b>System cable kit</b>			
<b>HP 85022A</b> System Cable Kit	\$375		
<b>Computer</b>			
<b>HP 98580C Option 102</b> Series 300, Model 332	\$6,780		
<b>Disk drive</b>			
<b>HP 9122</b> 3.5 inch Dual Flexible-disk Drive	\$1,465		
<b>Software</b> (choose one option)			
<b>HP 85015B</b> System Software for HP 8757	\$2,000		
<b>Opt 630</b> for Computer with HP 9121/22 Disc Drive	\$0		
<b>Opt 655</b> for Either HP 9826 or 9836 Computer	\$0		
<b>HP 85016B</b> Transmission Line Test Software for HP 8757	\$4,500		
<b>Opt 630</b> for Computer with HP 9121/22 Disk Drive	\$0		
<b>Opt 655</b> for Either HP 9826 or 9836 Computer	\$0		
<b>HP Part No. 86399-10001</b> Amplifier Test Software	\$250		
<b>Recommended accessories</b>			
<b>Printer</b>			
<b>HP 2225A</b> ThinkJet Printer	\$595		
<b>HP 2227B</b> QuietJet Printer	\$849		
<b>HP 3630A Option 002</b> PaintJet Color Graphics Printer	\$1,395		
<b>Plotter</b>			
<b>HP 7440A Opt 002</b> Eight-pen Graphics Plotter (8.5 in × 11 in)	\$1,295		
<b>HP 7550B</b> Eight-pen Vector Plotter (11 in × 17 in)	\$3,995		
<b>Optional accessories</b>			
(for ratio and/or modulation measurements)			
<b>HP 11636A</b> Power Divider dc to 18 GHz	\$550		☎
<b>HP 11636B</b> Power Divider dc to 26.5 GHz	\$995		
<b>HP 11665B</b> Modulator	\$1,000		☎
<b>HP 11667A</b> Power Splitter dc to 18 GHz	\$930		
<b>Opt 001</b> N-male on Input Port; N-female on Output Ports:	\$0		
<b>Opt 002</b> N-female on Input Port; 7mm on Output Ports:	+ \$75		
<b>HP 11667B</b> Power Splitter dc to 26.5 GHz	\$995		
<b>HP 11667C</b> Power Splitter dc to 50 GHz	\$1,500		
<b>HP 11679A</b> Detector Extension Cable, 7.6m (25 ft)	\$125		
<b>HP 11679B</b> Detector Extension Cable, 61m (200 ft)	\$375		
<b>HP 11852B</b> 50 to 75 Ω Minimum Loss Pad	\$400		
<b>Service and support products</b>			
<b>HP 11613B</b> Calibrator	\$995		
<b>HP 415E</b> SWR Meter	\$3,500		
<b>Opt 001</b> Rechargeable Battery Installed	+ \$200		
<b>Opt 002</b> Rear panel Output Connector	+ \$50		

\*Only where available

☎ For off-the-shelf shipment, call 800-452-4844.

# NETWORK ANALYZERS

## Scalar Analyzer Software, Transmission Line Test System

HP 85015B, 85016B, 8328A

285

- Custom tests without programming
- Friendly menu operation
- Measure insertion loss and return loss

- Plot or store data
- Test coax and waveguide
- Locate faults in transmission lines

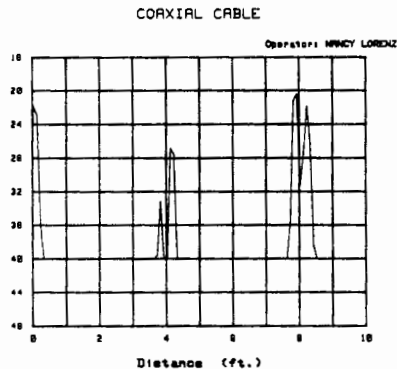

### HP 85015B System Software

Using the HP 85015B system software for the HP 8757, you can create and run complete scalar measurements without programming. The software guides you all the way from setup to output making all the necessary settings on the scalar analyzer and source to provide fast, accurate measurements that can be stored for later reference.

### Easy to Learn

Use the BASIC mode to get up to speed quickly on the software's operation. It prompts you with a few simple questions, then sets up your source and analyzer automatically. The software prompts you to make all the connections necessary for calibration and measurement sequences, then automatically plots the data on the CRT display. For a permanent record, send the plot to a graphics plotter with a single keystroke.

### Customized Measurement Setups

Use the GENERAL and ADVANCED modes to access more of the software's powerful features. Define up to 4 measurements in one sequence. Specify particular power levels for your test device and enter your specifications limits as point, line, or sloped limits. These limit lines allow simple pass/fail testing, or real time adjustment to within the specified limits. Finish by outputting the data using your own customized format with labels, limit lines, and "out-of-spec" indicators. Store the data on computer disc for archival purposes, then recall it later for further analysis.

### Compatible Sources

The HP 85015B and 85016B software are compatible with HP 8757 scalar network analyzer systems configured with an HP 8350B sweep oscillator and HP 83500 series RF plug-in or an HP 8340B or 8341B synthesized sweeper. The HP 85015B is not compatible with the HP 8360 series synthesized sweeper. For HP 8360 compatibility with the HP 85016B, order HP 85016B Option H01.

### Test Transmission Lines with the HP 85016B

The HP 85016B transmission-line test software provides all the capability of the HP 85015B plus fault location for complete testing of coax and waveguide of transmission lines. Test frequency response (insertion and return loss), the find faults (mismatches) that affect the signals in your frequency range. Troubleshoot your ECM, radar, or communication system quickly and without guesswork.

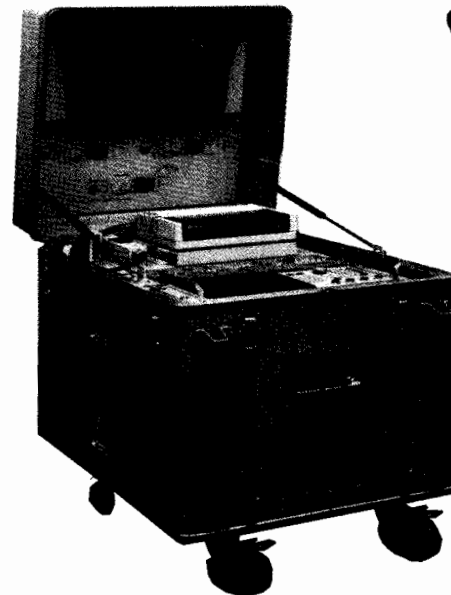

HP 8328A

### HP 8328A Transmission Line Test System

The HP 8328A transmission line test system tests the performance of waveguide runs and coaxial cables with swept frequency measurement of insertion loss and return loss. Additionally the HP 8328A system can make fault location tests to fine impedance mismatches as a function of distance, quickly and without guesswork.

The HP 8328A is a dedicated transmission line test system for tests from 10 MHz to 18 GHz. It is configured in a rugged, transportable container. The system is self-contained for ease of use and is ideal for accessing transmission lines in difficult-to-reach installations such as aircraft. Although all testing can be done automatically, full manual capability is available.

### Measurement Capability

- Measurements versus distance: return loss (dB), SWR, or reflection coefficient.
- Resolution (distance between data points as a percentage of the transmission line length): 1% (101 pts), 0.5% (201 pts), 0.25% (401 pts)
- Measurements versus frequency: insertion loss, gain, return loss, SWR, reflection coefficient, and power in dBm, dBW, or mW.
- Resolution: user selectable up to 1024 points for swept measurement or stepped CW measurements.

### Ordering Information

Each HP 85015B and 85016B software package comes with 5 discs, including a data disk. Order the option that corresponds to your computer configuration. The HP 85015B/85016B can run on BASIC 4.0 or greater and requires 2 MB of RAM memory.

	<b>Price</b>
<b>HP 85015B</b> system software	\$2,000
<b>Opt 630</b> 3.5 in disks	\$0
<b>Opt 655</b> 5.25 in disks	\$0
<b>HP 85016B</b> transmission line test software	\$4,500
<b>Opt 630</b> 3.5 in disks	\$0
<b>Opt 655</b> 5.25 in disks	\$0
<b>Opt H01</b> HP 8360 series compatibility	+ \$1,000
<b>HP 8328A</b> transmission line test system	\$68,000
<b>Opt 001</b> 10 MHz to 8.4 GHz only	- \$4,300
<b>Opt 100</b> Adds support software	+ \$250
<b>Opt W30</b> Two years extended service	+ \$1,600
<b>Opt 043</b> Add floppy disk drive	+ \$500



# NETWORK ANALYZERS

## Audio/Video/Baseband/IF Network Analyzer, 5 Hz to 200 MHz

HP 3577B

- High-speed/high-accuracy measurements
- .001 dB, .005 degree, 1 ps, and .001 Hz resolution
- Discrete sweep and limit lines
- Optional HP Instrument BASIC

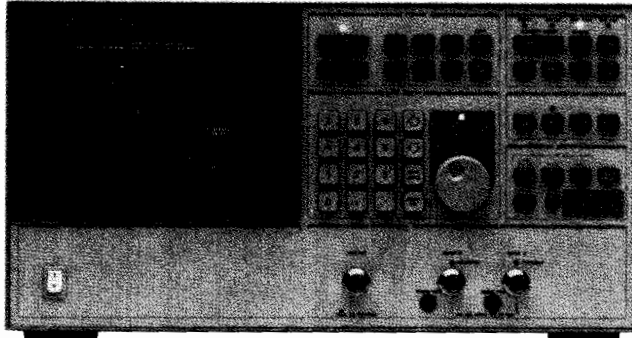

HP 3577B



### HP 3577B Network Analyzer

The HP 3577B is a high-performance, yet economical, two-channel network analyzer for use in both research and development and manufacturing. It is used to measure magnitude/phase, insertion loss, group delay, SWR, electrical length, and gain compression from 5 Hz to 200 MHz. When used with the HP 35676A/B reflection/transmission kit, it can also measure return loss, reflection coefficient, and impedance.

An optional third channel is available for use with the HP 35677A/B s-parameter test set or for measuring two devices simultaneously. When used with the HP 35677A/B, the HP 3577B can measure all four s-parameters and any of the parameters listed above without having to manually alter the test configuration. The HP 35677A is used for 50 ohm systems and the HP 35677B is used for 75 ohm systems.

When equipped with optional HP Instrument BASIC, the HP 3577B can execute user-written programs designed to automate measurement systems, compute parameters (such as pass band ripple and 3 dB bandwidth) or customize the user-interface. This includes system control of other HP-IB instruments and peripherals, such as plotters and printers, via the HP-IB. A programmable I/O port, located on the rear panel, extends HP Instrument BASIC control to non-HP-IB devices, such as device handlers, environmental chambers, and even the device-under-test itself.

Of course, the HP 3577B is fully programmable, either internally with HP Instrument BASIC, or externally via the Hewlett-Packard Interface Bus (HP-IB).

An optional high-stability frequency reference oven is available for those users not having an in-house frequency standard.

### Unprecedented Measurement Precision

This network analyzer has the accuracy and resolution required to characterize the most demanding narrowband devices and the flexibility to quickly characterize wideband devices. Dynamic magnitude and phase accuracy are 0.02 dB and 0.2 degree, respectively. Device response can be examined in fine detail with 0.001 dB, 0.005 degree, and 1 ps resolution. A built-in synthesized LO and tracking generator provide superb frequency accuracy with 0.001 Hz resolution. The 100 dB plus dynamic range and -130 dBm noise floor meet the needs of the most demanding measurements.

Built-in three-term error correction removes errors due to directivity, frequency response, and source mismatch for one-port measurements. Similarly, vector normalization enhances the accuracy of two-port measurements.

### High-Throughput for Manufacturing

The HP 3577B brings high-throughput network analysis to manufacturing without compromising accuracy. Using discrete sweep, the sweep time is typically reduced by a factor of twenty when compared to a traditional linear sweep. Operators select from 2 to 51 frequency points for measurement. High-frequency resolution is used only in important regions of the device response; less important regions are measured with few points or skipped completely. Sweep time is further reduced by selecting the optimum resolution bandwidth and settling time for each frequency point.

Evaluation of test results is completed in a tenth of a second using the limit test feature. Any combination of upper and lower limits, with up to 20 operator-defined segments, is allowed. Test results are compared to the limits at the end of each sweep, and PASS/FAIL is indicated both on the display and on the FAIL line of programmable I/O port.

Optional HP Instrument BASIC completes the high-throughput picture by providing fast, error-free instrument/test system configuration and control of non-HP-IB devices, such as device handlers.

### Specifications Summary

#### Source

##### Frequency

Range: 5 Hz to 200 MHz

Resolution: 0.001 Hz

Stability (Opt 1 only/instrument on  $\geq$  48 hrs):  
 $\pm 5 \times 10^{-8}$ /day, 0 to 55° C

#### Amplitude

Range: +15 dBm to -49 dBm (1.26 Vrms to 793 $\mu$  Vrms: 2dBV to -62 dBV) into a 50  $\Omega$  load

Resolution: 0.1 dB

Accuracy:  $\pm$  1 dB at +15 dBm and 100 kHz. Below +15 dBm, add the greater of  $\pm$  0.02 dB/dB or 0.2 dB

Flatness: 1.5 dBp-p from 5 Hz to 200 MHz

Impedance: 50  $\Omega$ ; > 20 dB return loss at all levels

RF output connector: 50  $\Omega$  Type N female

Sweep types: Linear, discrete, alternate, cw and log frequency; log amplitude

Sweep time: 100 ms/span to 6553 sec/span for frequency sweep; 1 ms/step to 16 s/step for amplitude sweep.

Sweep modes: Continuous, single, manual

Trigger modes: Free run, immediate, line, external

#### Input Characteristics

Frequency range: 5 Hz to 200 MHz

Inputs: Two receiver inputs (A,R); third receiver input (B) is optional

Input impedance: Selectable 50  $\Omega$  with > 25 dB return loss, or 1 M $\Omega$  in parallel with approximately 30 pF.

Input connectors: 50  $\Omega$  Type N female.  
Full scale input level: -13 dBV from 10 kHz to 200 MHz with internal 20 dB attenuators ON (0 dBm at 50  $\Omega$ ).

Resolution bandwidth: Selectable 1 kHz, 100 Hz, 10 Hz, or 1 Hz.

Sensitivity (Due to noise and internal crosstalk between source and receiver inputs):

Resolution Bandwidth	30 kHz-200 MHz (50 $\Omega$ ) 300 kHz-20 MHz (1 M $\Omega$ )	
	Internal 20 dB Attenuator ON	Internal 20 dB Attenuator OFF
10 Hz	-110 dBm	-130 dBm
100 Hz	-105 dBm	-125 dBm
1 kHz	-95 dBm	-115 dBm

Crosstalk: > 100 dB isolation between inputs.  
For 1 M  $\Omega$  inputs, add 5 dB to table.

#### Magnitude characteristics

Range: Full scale input to sensitivity

Display units: dB, dBm, dBV, V, and linear ratio

Accuracy (at 100 kHz, 25° C, and full scale input)

Absolute (A, B, R):  $\pm$  0.2 dB

Ratio (A/R, B/R, A/B):  $\pm$  0.15 dB (50  $\Omega$ );  $\pm$  0.2 dB (1 M  $\Omega$ )



### Dynamic Accuracy

Error		Input Level Relative to Full Scale Input
Resolution Bandwidth	1 Hz	
1 kHz, 100 Hz, 10 Hz	1 Hz	
±.04 dB	±.04 dB	0 dB to -10 dB
±.02 dB	±.02 dB	-10 dB to -50 dB
±.05 dB	±.05 dB	-50 dB to -60 dB
±.15 dB	±.25 dB	-60 dB to -80 dB
±.75 dB	±.75 dB	-80 dB to -90 dB
±.75 dB	± 3.00 dB	-90 dB to -100 dB

**Frequency response:** (when driven from a 50 Ω source and with 50 Ω receiver input impedance)

Absolute (A,B,R): 0.3 dBpp from 20 Hz to 20 MHz; 0.6 dBpp from 5 Hz to 200 MHz.

Ratio (A/R, B/R, A/B): 0.3 dBpp from 20 Hz to 20 MHz; 0.4 dB from 5 Hz to 200 MHz.

### Stability

**Temperature:** Typically  $< \pm 0.02$  dB/°C

**Time:** Typically  $\pm 0.05$  dB/hour at 25° C

### Phase characteristics (A/R, B/R, A/B)

**Range:**  $\pm 180$  degree

**Accuracy:** At 100 kHz, 25° C, and Full Scale Input:  $\pm 2.0^\circ$

### Dynamic Accuracy

Error	Input Level Relative to Full Scale Input
±.4 degree	0 dB to -10 dB
±.2 degree	-10 dB to -50 dB
±.5 degree	-50 dB to -60 dB
± 1.5 degree	-60 dB to -80 dB
± 7.5 degree	-80 dB to -100 dB

**Temperature stability:** Typically  $< \pm 0.05$  degree/°C

**Time stability:** Typically  $< \pm 0.05$  degree/hr at 25° C

### Delay characteristics

**Range:** 1 ps to 20,000s

**Resolution:** 0.01 ns/div to 1000s/div

**Normalized accuracy:**  $\frac{\text{Dynamic Phase Accuracy}}{360 \times \text{Aperture [Hz]}} + 2 \text{ ns}$

**Aperture range:** 0.5% to 16% of frequency span

**Reference level:**  $\pm 10^3$  s

**Limit test:** Twenty segments for each trace per limit test. Delay between sweeps approximately 10 to 120 ms.

### General Characteristics

#### Traces

**Number of traces:** Two simultaneous traces may be present with a rectangular graticule. One trace with polar or Smith graticules.

**Markers:** Each trace has one main marker and an offset marker.

#### Graticules

**Rectangular graticule:** 0% to 100% full scale deflection in 0.05% increments. Logarithmic and linear.

**Polar/Smith chart graticule:**  $\pm 500$  degree in 0.001 degree increments.

#### Limit test

Twenty segments for each trace per limit test. Delay between sweeps approximately 10 to 120 ms.

#### Noise averaging

**Type:** Exponentially weighted vector averaging on successive sweep data.

**Averaging factor:** Selectable 1 (off), 4, 8, 16, 32, 64, 128, 256.

**Linear phase slope compensation:** Provides linear phase slope offset of  $-72,000$  degree/span to  $+72,000$  degree/span.

### Calibration

**Transmission:** Both traces can be normalized to measured data with full accuracy and resolution.

**Reflection:** Corrects for directivity, frequency response, and source match errors.

### Programming

**Remote programming:** Via the Hewlett-Packard Interface Bus (HP-IB). The HP 35677A/B S-parameter test sets are programmable through the HP 3577A interface only.

**Plotter control:** Directly compatible with HP-IB graphics plotters that use Hewlett-Packard Graphics Language (HP-GL) with listen-only capability.

**Save/recall:** Front-panel setups can be stored in non-volatile memory locations 1 through 5. Last state is saved when power is removed.

### Operating conditions

**Temperature:** 0° C to +55° C.

**Relative humidity:**  $< 95\%$  at 40° C.

**Altitude:**  $< 4,572$  m (15,000 ft).

### Non-operating conditions

**Temperature:**  $-40^\circ$  C to  $+75^\circ$  C.

**Altitude:**  $< 15,240$  m (50,000 ft).

**Power:** 115 V  $+ 10\%$ ,  $-25\%$  (47 Hz to 440 Hz), or 230 V  $+ 10\%$ ,  $-15\%$  (47 Hz to 66 Hz), 450 VA maximum.

**Weight:** 31 kg (67 lb) net; 41 kg (90 lb) shipping.

**Size:** 222 mm H  $\times$  426 mm W  $\times$  578 mm D (8.7 in  $\times$  16.75 in  $\times$  22.75 in).

### HP 35677A/B S-Parameter Test Set

The HP 35677A/B test set is used to make transmission and reflection measurements in both the forward and reverse directions. The only setup required is to connect the device-under-test to the two measurement ports. Even reverse measurements can be made without changing device connections. The HP 35677A is used for 50-ohm systems and the HP 35677B is used for 75-ohm systems.

### HP 35677A/B S-Parameter Test Set Specifications

**Frequency range:** 100 kHz to 200 MHz

**Test port impedance**

HP 35677A: 50 Ω; HP 35677B: 75 Ω

**Directivity:**  $> 40$  dB

**Frequency response**

**Transmission (S21, S12):**  $\pm 1$  dB,  $\pm 5$  degrees

**Reflection (S11, S22):**  $\pm 1$  dB,  $\pm 5$  degrees

#### Port match

**Test ports 1, 2:** HP 35677A,  $> 26$  dB; HP 35677B,  $> 24$  dB

**Test ports 1, 2 open/short ratio:** HP 35677A,  $< \pm 0.75$  dB magnitude and  $< \pm 5$  degrees phase; HP 35677B,  $< \pm 1$  dB magnitude and  $< \pm 7.5$  degrees phase

**Input port:**  $> 20$  dB return loss

**Output ports A, B, and R:**  $> 26$  dB return loss

**Test port isolation:**  $> 100$  dB

#### Connectors

**Input port and output ports A, B, and R:** 50 Ω Type N female. Test Ports 1 and 2: HP 35677A, 50 Ω Type N female; HP 35677B, 75 Ω Type N female.

**dc bias inputs:** BNC female, rear panel

**dc bias range:** Typically  $\pm 30$  Vdc and  $\pm 20$  mA with some degradation of RF specifications; 200 mA damage level.

### Accessories Supplied

4 ea. 190-mm (7.5 in) 50 Ω cables with type N male connectors for connection to HP 3577B (HP 8120-4387)

1 ea. test set interconnect cable to HP 3577B (HP 35677-61620)

1 ea. rear-panel lock foot kit (HP 5061-0099).

1 ea. service manual (HP 35677-90010).

# NETWORK ANALYZERS

Audio/Video/Baseband/IF Network Analyzer, 5 Hz to 200 MHz

HP 35676A/B, 3575A

## General Characteristics

**Power:** All power is obtained through the HP 35677A interconnect cable.

**Weight:** Net, 6 kg (13 lb); shipping, 122 kg (25 lb)

**Size:** 90 mm H × 425 mm W × 584 mm D (3.5 in × 16.75 in × 22.75 in). Add 1½ inch to depth for front panel connectors.

## HP 35676A/B Reflection/Transmission Test Kits

Operating in conjunction with internal calibration routines in the HP 3577B, the HP 35676A/B test kit provides measurements of reflection, transmission and impedance from 5 Hz to 200 MHz. Each test kit contains a precision resistive divider, a reference load, a coaxial short, a carrying case, and miscellaneous cables and hardware.

## HP 35676A/B Operating Characteristics\*

**Frequency range:** 5 Hz to 200 MHz.

**Test port impedance:** 50Ω ± 2% typical (HP 35676A) 75 Ω ± 2% typical (HP 35676B).

**Equivalent directivity:** 40 dB typical.

**Equivalent source match:** 30 dB typical (HP 35676A); 25 dB typical (HP 35676B).

\*Typical, assuming proper calibration with accessories supplied.

## Ordering Information

	<b>Price</b>
<b>HP 3577B</b> Network analyzer	\$19,750
<b>Opt 001</b> Frequency reference	+ \$850
<b>Opt 002</b> Third receiver	+ \$3,450
<b>Opt 1C2</b> HP Instrument BASIC/ 640 Kbytes RAM	+ \$950
<b>Opt 907</b> Front handle kit	+ \$79
<b>Opt 908</b> Rack Mount kit	+ \$42
<b>Opt 909</b> Rack Mount and front handle kit	+ \$105
<b>Opt 910</b> Extra operating and service manual	+ \$250
<b>Opt 911</b> Extra HP Instrument BASIC manual	+ \$10
<b>Opt W30</b> Extended repair service. See page 671.	+ \$450
<b>HP 35676A</b> 50 Ω reflection/transmission test kit	\$1,465
<b>Opt W30</b> Extended repair service. See page 671.	+ \$45
<b>HP 35676B</b> 75 Ω Reflection/transmission test kit	\$1,750
<b>HP 35677A</b> 50 Ω S-parameter test set	\$4,300
<b>HP 35677B</b> 75 Ω S-parameter test set	\$4,300
<b>Opt 907</b> Front handle kit	+ \$52
<b>Opt 908</b> Rack Mount kit	+ \$27
<b>Opt 909</b> Rack Mount and front handle kit	+ \$63
<b>Opt 910</b> Extra operating and service manuals	+ \$47
<b>HP 35678A</b> 50 Ω type N calibration kit	\$825
<b>HP 35678B</b> 75 Ω type N calibration kit	\$1,575
<b>HP 35679A</b> 50 Ω type N port extension cables	\$550
<b>HP 35679B</b> 75 Ω type N port extension cables	\$1,850
<b>HP 85024A</b> high-frequency probe	\$2,300



HP 3575A

## HP 3575A Gain-Phase Meter

The HP 3575A gain-phase meter is a broadband two-channel analyzer typically used to measure transfer functions such as amplifier gain/loss or the frequency response of filters. It can be used to measure the ratio and relative phase of any two signals on its two-channel inputs and for absolute measurements of signals on each channel. A wide range of input waveforms can be measured, including sine, square, and triangular waveforms. A three-digit display can be selected to read amplitude level/ratio or phase of the input signals. An optional three-digit readout and analog output is available for simultaneous amplitude and phase measurements.

## Specifications Summary

**Frequency:** 1 Hz to 13 MHz

**Level:** 200 μV rms to 20 V rms

**Number of channels:** 2

**Impedance:** 1 MΩ in parallel with 30 pF

**Protection:** ± 40 V dc, 20 V rms

**Nominal amplitude accuracy:** ±1 dB (See data sheet for complete accuracy specifications.)

**Amplitude functions:** A dBV, B dBV, or B/A dB

**Range:** A dBV, B dBV: -74 dBV to +26 dBV (in two ranges)

B/A dB: -100 to +100 dB

**Resolution:** 0.1 dB

**Nominal phase accuracy:** ±0.5 degrees (See data sheet for complete accuracy specifications.)

**Range:** ±180° with 12° of overrange

**Resolution:** 0.1°

## General

**Power:** 115 V / 230 V ±10%, 48 Hz to 440 Hz, 40 VA

**Weight:** net, 8.3 kg (18.4 lb); shipping, 11.3 kg (25.8 lb)

**Size:** 88 mm H × 425 mm W × 337 mm D (3.47 in × 16.75 in × 13.25 in)

Contact your local HP sales office for more information including a data sheet containing complete specifications.

## Ordering Information

	<b>Price</b>
<b>HP 3575A</b> Gain/Phase Meter	\$7,180
<b>Opt 001</b> Dual readouts/dual outputs	+ \$670
<b>Opt 002*</b> BCD programming (negative true)	+ \$1,135
<b>Opt 003*</b> BCD programming (positive true)	+ \$1,135
<b>Opt 908</b> Rack flange kit	+ \$37
<b>Opt 910</b> Extra manual	+ \$53
<b>Opt W30</b> Extended repair service. See page 671.	+ \$145

\*Note: Includes Option 001

# NETWORK ANALYZERS

## Combined Network/Spectrum Analysis, 10 Hz to 500 MHz

### HP 4195A

289

- Linear and nonlinear device measurement and analysis
- High accuracy and resolution
- User functions
- Color graphics, graphics analysis, and direct copy capability
- Direct save/recall with internal disk drive

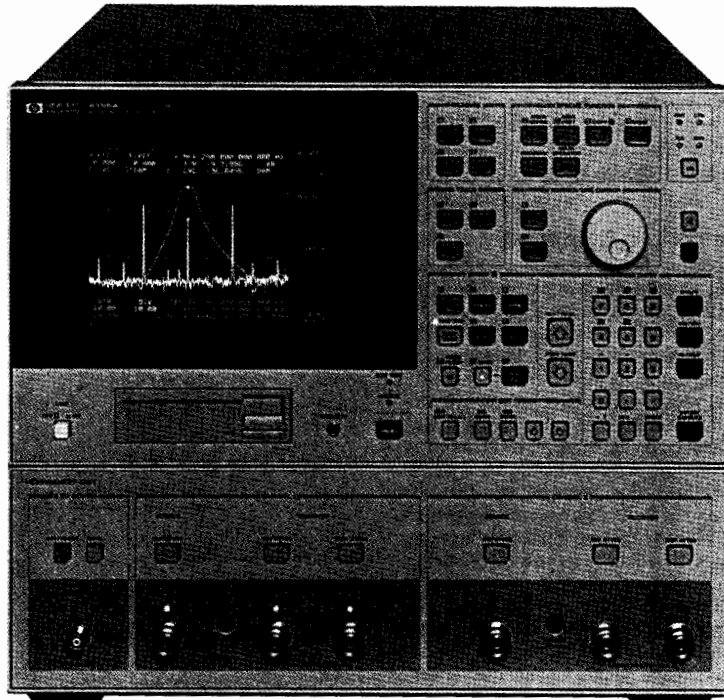

HP 4195A



### Description

The HP 4195A is a high-performance, cost-effective and intelligent analyzer with combined vector network and spectrum analysis capabilities. The frequency is covered from 10 Hz through 500 MHz with an excellent 0.001 Hz resolution for audio, baseband, HF, VHF, and IF applications. It directly measures amplitude ratio, phase, group delay, and spectrum level needed for characterizing linear/non-linear analog circuits or components used in communications, telecommunications, consumer electronics, and other equipment.

The HP 4195A's excellent accuracy and resolution meet the severe measurement requirements for developing advanced equipment. A color display allows you to readily differentiate among multiple traces. Convenient softkey operation and marker functions make deriving device parameters quick and easy. Measurement results can be directly copied to printer or plotter without an external computer. Furthermore, the HP 4195A has internal user functions for computing and a self-controlling capability. User Program, User-Defined Function and User Math allow you to quickly customize the setups most suited to your application without using an external computer. A built-in 3.5-inch disk drive can save the instrument state, data, and user functions.

### Combined Vector Network and Spectrum Analysis

Network analyzers and spectrum analyzers have become essential tools for evaluating subsystems or components used in electronic equipment. Phase and group delay measurements in particular are rapidly increasing in importance. The HP 4195A offers full network and spectrum analysis from 10 Hz to 500 MHz at half the price. It has very wide applications. Network analysis functions include characterizing the gain/group delay ripple of filters and amplifiers. Spectrum

analysis functions include the harmonic, intermodulation distortion of amplifiers or IF subsystems in communications and telecommunications. S-parameters can also be measured by using 2 transmission/reflection test sets, without changing the device's direction.

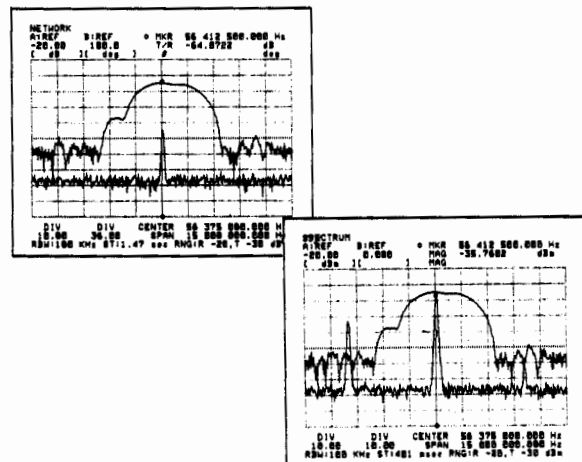

# NETWORK ANALYZERS

## Combined Network/Spectrum Analysis, 10 Hz to 500 MHz (cont'd)

### HP 4195A

#### High Accuracy and Resolution Measurement

The HP 4195A measures amplitude ratio and phase with an accuracy of  $\pm 0.05\text{dB}/\pm 0.3\text{ deg}$  and a resolution of  $0.001\text{dB}/0.01\text{ deg}$ . The amplitude and phase distortion of transmission devices, such as filters, amplifiers, delay lines, and cables, affect the quality of information and create bit errors in PSK or QAM systems. The HP 4195A can evaluate distortion with high accuracy and resolution. For accuracy enhancement, 1 Port Full Cal, 1 Port Partial Cal, Normalization and Port Extension capabilities are available. For spectrum analysis, high level accuracy of  $\pm 0.1\text{dB}$  and fully synthesized pure local OSC, typically  $-100\text{ dBc/Hz}$  (100 Hz offset), allow you to obtain stable and reliable C/N, harmonic distortion or intermodulation distortion measurements. In addition the high shaped digital IF filter technique makes discrimination of closely spaced signals easy, so 50/60 Hz power-line sidebands can be measured using the 10Hz RBW.

#### User Functions for Easy Customized Operation

The HP 4195A has three user functions for customizing operations for your applications without using an external computer. The User Program gives you a one-key solution for performing your application. You can program a sequence from measurement and marker control, through to computing and printing a hard copy. This function is very useful and improves efficiency for C/N (Carrier Noise ratio), THD (Total Harmonic Distortion) measurements or automatic device parameter extraction, such as an amplifier's gain, group delay, gain compression, or harmonic distortion. The User Math function helps you put the result in the form you need by using the built-in math operators and arithmetic functions. For example, you can display level in volt peak-to-peak instead of volts rms or perform differentiation of gain or max hold. The User-Defined Function lets you define functions that can be called with softkeys as you like, such as input of step size, signal tracking, transmission/reflection alternate sweep, or gain/level spectrum alternate sweep. In addition, the HP 4195A has the Program Sweep function, which can arbitrarily sweep the points programmed in the table. This increases measurement efficiency by reducing excessive points in the Lin or Log sweep. Also, the resolution bandwidth can be independently set for each programmed point. The above user functions and program sweep table can be saved into the built-in 3.5-inch disk, so you can start your application at any time.

```

SPECTRUM          C/N-MEASUREMENT
PROGRAM EDITOR
FILE NAME: CNI

1  C/N-MEASUREMENT
10 MCF2
20 DELT1
30 MKACT1
40 MKMX
50 DMK=1 MHZ;R1=0
60 FOR R0=1 TO 10
70 SWTRC
80 R1=DMKRA+R1
90 R2=R1/R0
100 DISP "C/(CDB)=",R2
110 NEXT R0
120 CRT "C/N-MEASUREMENT"
130 END
  
```

User Program for C/N Measurement

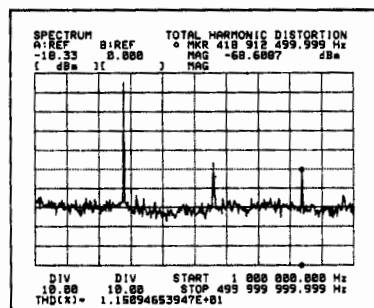

THD Measurement by Using User Define Function

#### Advanced Marker Action on Color Graphics

The application-oriented marker functions are very useful for both network and spectrum measurements. You can quickly obtain the desired results from the easy-to-see color graphics CRT. The Next Peak is convenient for searching harmonic or spurious signals. The marker target is used for extraction of SAW filter's 3 dB bandwidth or an amplifier's  $-1\text{ dB}$  gain compression point. The delta marker is used for C/N measurement, and the noise marker is used for noise measurements. A maximum of four traces can be simultaneously displayed on the CRT, so it is easy to compare the data. The smith/polar chart is convenient for impedance matching in circuit design. In addition, the results can be directly copied to a compatible plotter or printer without an external computer.

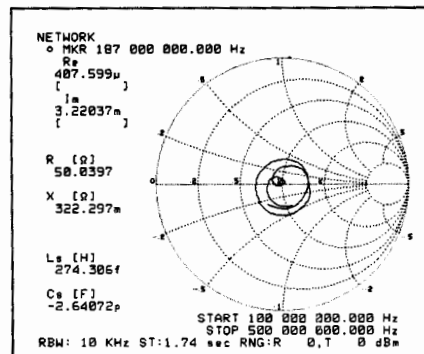

#### Specifications

##### Network Measurement

###### Source

**Frequency:** 10Hz to 500MHz, 1 mHz resolution  
**Power:**  $-50\text{ dBm}$  to  $+15\text{ dBm}$ ,  $0.1\text{ dB}$  resolution  
**Sweep Parameters:** Frequency, power, and dc bias level  
**Sweep Types:** Linear, log, cw, program, and partial  
**Output:** 2 outputs  
**dc bias level:**  $\pm 40\text{V}$ ,  $10\text{ mV}$  resolution

###### Receiver

**Frequency:** 10Hz to 500MHz  
**Input:** 4 inputs,  $50\ \Omega$  nominal  
**Resolution Bandwidth:** 3Hz to 300 kHz, 1 or 3 step  
**Input Crosstalk:**  $\leq -100\text{ dB}$

###### Magnitude Ratio

**Dynamic Range:**  $> 100\text{ dB}$   
**Resolution:**  $0.001\text{dB}$   
**Dynamic Accuracy ( $23 \pm 5^\circ\text{C}$ ),  $-30\text{dBm}$  R input:**  $\pm 0.05\text{dB}$  @  $-70\text{dBm}$  to  $-30\text{dBm}$  T input

###### Phase

**Range:**  $\pm 180^\circ$   
**Resolution:**  $0.01^\circ$   
**Dynamic Accuracy ( $23 \pm 5^\circ\text{C}$ ,  $-30\text{dBm}$  input):**  $\pm 0.3^\circ$  @  $-70$  to  $-30\text{dBm}$  T input

###### Delay

**Range:** 10 ps to 500 s  
**Resolution:** 10ps @ 3.6 MHz aperture  
**Accuracy:** Depends on phase accuracy

###### Error Compensation

**Mode:** Normalization, 1 port partial cal, 1 port full cal and port extension

##### Spectrum Measurement

###### Frequency

**Measurement Range:** 10 Hz to 500 MHz

###### Resolution:

**RBW:** 3 Hz to 300 kHz, 1 or 3 step  
**Selectivity (60/3dB):** 4.5 for 3 Hz to 30 Hz, 9 for 100 Hz to 10 kHz, 8.5 for 30 kHz to 300 kHz.

**Noise Sideband:**  $< -100\text{ dBc/Hz}$  @ 1 kHz offset  
 $< -90\text{ dBc/Hz}$  @ 100 Hz offset

**Amplitude**

**Measurement Range:** -135 dBm to +20 dBm  
**Accuracy:** ±1.0 dB @ 50 MHz  
**Linearity** (23 ± 5° C): ±0.1 dB @ -40 to 0 dB; ±0.2 dB @ -60 to -40 dB  
**Frequency Response:** ±1.5 dB

**Dynamic Range** (23 ± 5° C)

**Second Harmonic Distortion:** ≤ -70 dBc @ ≥ 2 MHz  
**T.O.I Distortion:** ≤ -80 dBc @ ≥ 2 MHz  
**Residual Response:** -110 dB @ ≥ 100 kHz.  
**Average Noise Level:** Typically -140 dBm @ 10 Hz RBW, ≥ 2 MHz

**Sweep**

**Sweep Type:** Linear, log, cw, program and partial  
**Sweep Mode:** Continuous, single and manual  
**Sweep Time:** Approximately 3.5 sec @ 500 MHz span, 300 kHz RBW

**Input**

**Number of inputs:** 4 inputs  
**Impedance:** 50 Ω nominal  
**Damage level:** +30 dBm  
**Attenuator:** 0 to 50 dB, 10 dB step

**Display and Analysis**

**Display:** 7.5 inch color CRT  
**Display Format:** Rectangulars, Table, Smith and Polar  
**Traces:** 4 traces max  
**Scale Type:** Linear, log  
**Autoscale**  
**Phase Display Expansion:** Display phase continuously more than ±180 deg.  
**Video Filter:** Digital video filtering reduces random noise  
**Comment Entry:** Display a comment using text, numbers, and special characters ( , , % , etc).  
**Marker:** MKR → Max (Min, Ref, Center, Start and Stop), Next Peak, Width, and Delta reading mode.

**User Functions**

**User Math:**  
Puts the result in the form needed for your application by using built-in math operators, arithmetic functions, and editing capability.  
**User Defined Function:**  
Provides one-key solution for a specific application without an external computer. 6 user functions can be created and soft-keys can be labeled as you like.  
**User Program (Auto Sequence Program):**  
Allows to program the control or measurement, analysis, copy and other sequence without an external computer.

**Hardcopy**

Hardcopy of traces, measurement data, results of analysis and annotations are produced by the HP 4195A and HP plotters or printers with LISTEN only capability.  
**Color Dump Mode:** Copy the traces, graticules, and annotations to a color graphics printer. Colors are fixed.  
**Dump Mode:** Copy the CRT display to a graphics printer  
**Plot Mode:** Copy the traces, graticule, and annotations to an HP-GL compatible digital plotter  
**Print Mode:** Copy measurement data in tabular form to a printer

**Storage**

Instrument state, trace data, table of Program Sweep and User Program can be independently saved or recalled from the built-in 3.5 inch floppy disk memory via SAVE/GET function.  
Instrument state includes active control setting of measurement, active calibration data, active display format, active scale setting, User Math and User Defined Function.

**Remote Programming**

HP-IB interface operates according to IEEE 488-1987 and IEC 625 standards and IEEE 628-1982 recommended practices  
**Interface Function:** SH1, AH1, T5, TE0, L4, LE0, SR1, RL1, PP0, DC1, DT1, C0, E1  
**Transfer Formats:** ASCII  
32/64 bit IEEE 754 floating point format

**General Characteristics:**

**Operating Conditions:**  
**Temperature:** 0° C to +45° C  
**Humidity:** 95% RH at 40° C  
**Non-Operating Conditions:**  
**Temperature:** -40° C to +70  
**Safety:** Based on IEC-348, UL-1244  
**Power:** 100, 120, 220V ±10%, 240V -10% +5%, 48Hz to 60Hz, 500VA (max)  
**Dimensions:** 425 mm W × 375 mm H × 620 mm D (16.75 in × 14.8 in × 24.4 in)  
**Weight:** Approximately 41 kg (90.4 lb)

**41951A Impedance Test Kit**

The HP 4195A and HP 41951A Impedance Test Kit, which is designed to use with the HP 4195A, can be used to perform impedance analysis from 100 kHz to 500 MHz. The direct reading of impedance parameters, error compensation, variable test signal/dc bias level, and dedicated analysis functions are all convenient for evaluating components, such as crystal/SAW resonators, coils, and varicap diodes. The equivalent circuit function is very useful for modeling and evaluating components under actual operating conditions to improve the quality and reliability of circuit design.

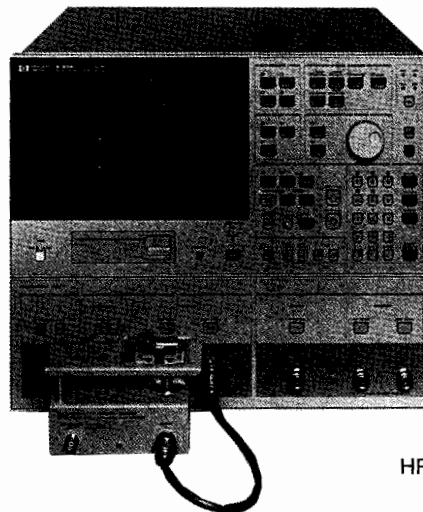

HP 4195A with HP 41951A



HP 41951A

# NETWORK ANALYZERS

## Combined Network/Spectrum Analysis, 10 Hz to 500 MHz (cont'd)

### HP 4195A

#### HP 41951A Impedance Test Kit

The HP 41951A can be used for impedance measurements from 100 kHz to 500 MHz when used with the HP 4195A.

**Measured Parameters:**  $|Z|$ ,  $|Y|$ ,  $\theta$ , L, C, R, X, G, B, D, and Q

**Error Compensation:** 1 port cal, open/short offset, and port extension

**Equivalent Circuit Analysis:** Circuit constants approximation and simulation of frequency characteristics

**Available Accessories:** Refer to page 357.

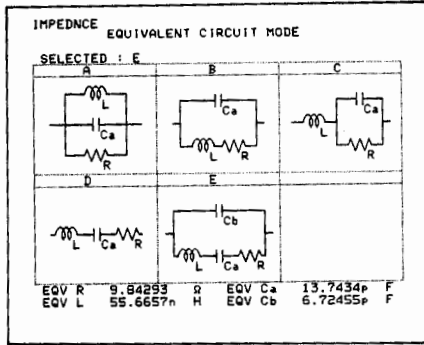

#### HP 41952A/B Transmission/Reflection Test Sets

The HP 41952A/B Transmission/Reflection Test Sets provide a neat solution to the HP 4195A Network/Spectrum Analyzer to measure both transmission and reflection characteristics. The HP 41952A/B are directly connected to the HP 4195A and include a power splitter and a directional coupler in each compact box. Furthermore, two test sets of the HP 41952A or 41952B (Option 009) allow the HP 4195A to perform full S-parameters measurement without having to remove and reverse the device. The HP 41952A is used for 50  $\Omega$  application, and the HP 41952B is used for 75  $\Omega$  application.

#### Specifications

	HP 41952A	HP 41952B
Impedance:	50 $\Omega$	75 $\Omega$
Frequency Range:	100 kHz to 500 MHz	100 kHz to 500 MHz
Directivity:	40 dB @ 300 kHz to 200 MHz	35 dB @ 800 kHz to 200 MHz
Frequency Response: *1		
Transmission Magnitude, Phase (@ $\geq$ 300 kHz):	$\pm 1$ dB, $\pm 5$ deg	$\pm 1$ dB, $\pm 5$ deg
Reflection Magnitude, Phase (@ $\geq$ 1 MHz):	$\pm 1$ dB, $\pm 5$ deg	$\pm 1$ dB, $\pm 5$ deg
Effective Source Match:		
Test Port:	> 20 dB @ $\geq$ 300 kHz	> 20 dB @ $\geq$ 300 kHz
Connector:		
Test Port:	50 $\Omega$ type N-(f)	75 $\Omega$ type N-(f)
Accessories Furnished:	50 $\Omega$ N cable Operating Note Carrying Case	50 $\Omega$ N cable HP 11852B M. L. Pad Operating Note Carrying Case

Note: HP 41952B Opt. 009 deletes 50  $\Omega$  N cable and HP 11852B.

\*1: Typical



HP 4195A with HP 41952A

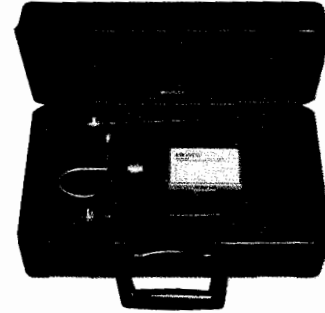

HP 41952A

#### HP 41800A Active Probe

The HP 41800A Active Probe is a high-input impedance probe that covers the frequency from 5 Hz to 500 MHz, and makes it easy to perform signal analysis of circuits in audio, video, HF, and VHF band. For both spectrum and network analysis, the HP 41800A presents a great value by its low distortion and low noise characteristics. The HP 41800A is directly compatible with HP analyzers, such as the HP 4195A, HP 3577A, HP 3585A, or HP 8568B, which supply probe power from the front panel.

#### Specifications

**Bandwidth:** 5 Hz to 500 MHz

**Input R, C (nominal):** 100 k  $\Omega$ , 3pF (probe alone)

**Average Noise Level (typical):** 10 nV/ $\sqrt{\text{Hz}}$  300 kHz to 500 MHz

**2nd Harmonic Distortion:** < -50 dBc -20 dBc input

**Output Connector:** 50  $\Omega$  type N male

**Accessories Furnished:** 10:1 divider, hook tip, ground leads, spare tips, BNC male adaptor, and so on

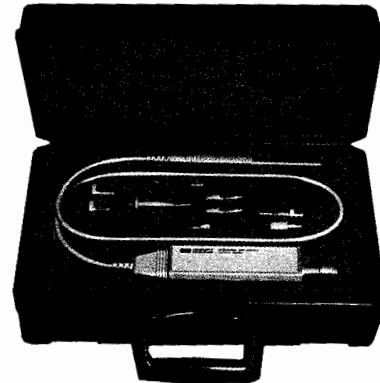

HP 41800A

#### Accessories Available

**HP 85044A/B** Transmission/Reflection Test Set

Refer to page 302.

**HP 85024A** High Frequency Probe

Refer to page 279.

#### Ordering Information

**HP 4195A** Network/Spectrum Analyzer

**Opt W30** Extended repair service. See page 671.

**Opt 001** High Stability Frequency Reference.

Improve the stability of frequency for evaluating such high Q devices as crystal filters, oscillators, or resonators.

Frequency Accuracy:  $\pm 1$  ppm ( $23^\circ\text{C} \pm 5^\circ\text{C}$ )

Frequency Stability:  $\pm 1 \times 10^{-8}$  ( $23^\circ\text{C} \pm 5^\circ\text{C}$ )

**HP 41951A** Impedance Test Kit

**HP 41952A** 50  $\Omega$  Transmission/Reflection Test Set

**HP 41952B** 75  $\Omega$  Transmission/Reflection Test Set

**Opt 009** Delete 50  $\Omega$  N Cable and 11852B

**HP 41800A** Active Probe

#### Price

\$25,000

+ \$550

+ \$850

\$1,530

\$2,245

\$2,765

-\$500

\$1,740

# NETWORK ANALYZERS

## Baseband, IF and RF Network Analyzer, 5 Hz to 500 MHz

HP 8751A

293

- 5 Hz to 500 MHz
- 0.001 Hz, 0.001 dB, 0.001 degree, 10 ps resolution
- Full 2-port and interpolative calibration
- Conjugate matching analysis
- Built-in 1.44 Mbyte disk drive for save/ recall
- Crisp color display with RGB output
- 10 updates of 201 sweep points per second
- 0.4 ms/point fast list sweep
- Up to 4 traces simultaneous measurement/display
- 8 active trace markers per channel
- HP Instrument BASIC for customization
- HP 41802A 1 M  $\Omega$  input adapter



HP 8751A  
with HP 87511A

### HP 8751A Network Analyzer

The HP 8751A network analyzer is a high-throughput instrument with lab precision that covers 5 Hz to 500 MHz. The 8751A provides resolution of 0.001 Hz, 0.001 dB, 0.001 degree, and 10 ps for characterizing the linear behavior of either passive or active networks, devices, or components in the lab and the production test areas. The built-in 1.44 Mbyte disk drive is for direct save/recall of instrument state, calibration data, and application programs for your customization. Dedicated 50/75  $\Omega$  S-parameter test sets, 50/75  $\Omega$  T/R test kits, and the 1 M  $\Omega$  input adaptors are all available.

### Lab Precision

Versatile display format and built-in accuracy enhancement (2-port full cal, 1-port full cal, and interpolative calibration) are provided for high-precision measurement in lab environments. The 8751A's unique conjugate matching capability gives you the optimum power transfer to make designing easier.

### Production Throughput

Unprecedented total throughput is a key feature of the HP 8751A. 0.4 ms/point measurement time is now applicable not only to linear sweep, but also to list sweep (programmable with IFBW and OSC output power) and to log sweep. The 8751A can also simultaneously measure/display up to four parameters with simple softkey operations. GO/NO-GO limit testing with an I/O handler control capability and HP Instrument BASIC are available to enhance total production test throughput.

### Data Storable in LIF/DOS formatted floppy disk

A 1.44 Mbyte disk drive is standard with the HP 8751A for easy save/recall of the instrument states, measurement data, calibration data, and application programs. Both HP LIF and DOS formats are supported. Saving data in DOS format enables you to see and manipulate data on a PC.

### HP Instrument BASIC

HP Instrument BASIC (IBASIC) is available as an option. IBASIC enables you to easily create application programs for a measurement on the HP 8751A without using an external computer. IBASIC increases the productivity of a measurement, and reduces additional investment.

### HP 8751A Specifications

#### Source

##### Frequency characteristics

**Range:** 5 Hz to 500 MHz

**Resolution:** 1 mHz

**Accuracy:**  $\pm 20$  ppm,  $\pm 1.0$  ppm (Opt. 001)

**Stability:**  $\pm 2.5 \times 10^{-9}$ /8 hours (typical  $23 \pm 5^\circ$  C with Opt. 001)

#### Output characteristics

**Power range:**  $-50$  to  $+15$  dBm

**Resolution:** 0.1 dB

**Flatness:**  $\pm 2.0$  dB @  $5 \text{ Hz} \leq \text{freq.} \leq 500 \text{ MHz}$  ( $23 \pm 5^\circ$  C,  $+0$  dBm, relative to 50 MHz)

**Level accuracy:**  $\pm 0.5$  dB (50 MHz, 0 dBm)

**Level linearity:**  $\pm 0.5$  dB @ Output level  $\geq -35$  dBm  
 $\pm 1.5$  dB @ Output level  $< -35$  dBm

(50 MHz, relative to 0 dBm)

**Impedance:** 50  $\Omega$

# NETWORK ANALYZERS

## Baseband, IF and RF Network Analyzer, 5 Hz to 500 MHz (cont'd)

### HP 8751A

#### Receiver

**Frequency range:** 5 Hz to 500 MHz

**Input range:** 0 dBm @ ATT = 20 dB  
-20 dBm @ ATT = 0 dB

**IF Bandwidth:** 2 Hz, 20 Hz, 200 Hz, 2 kHz, 4 kHz

**Noise level:** -130 dBm @ IFBW=20 Hz, ATT=0 dB,  
frequency  $\geq$  100 kHz

**Maximum input level:** 0 dBm

**Impedance:** 50  $\Omega$

**Crosstalk:** < -100 dB

**Dynamic accuracy:**  $\pm 0.05$  dB,  $\pm 0.3^\circ$  (Input level -10 to -60 dB,  
20 Hz IFBW)

**Delay characteristics:**

**Aperture frequency:** 0.5 to 20%

**Display range:** 10 ps to 500 s

**Accuracy:** (Phase accuracy)/(360  $\times$  aperture)

**Size:** 425 mm W  $\times$  235 mm H  $\times$  553 mm D (16.75 in  $\times$  9.25 in  $\times$   
21.77 in)

**Weight:** 28 kg (61.6 lb)

### HP 8751A Accessories

#### HP 87511A 50 $\Omega$ S-parameter Test Set

#### HP 87511B 75 $\Omega$ S-parameter Test Set

The HP 87511A/B S-parameter test sets provide the capability to measure reflection and transmission characteristics (including S-parameters) of 2 port devices in either direction with a single connection. The frequency range of the HP 87511A/B test sets is 100 kHz to 500 MHz. The test sets are controlled from the HP 8751A.

#### HP 87511A/B Specifications

	HP 87511A	HP 87511B
Impedance	50 $\Omega$	75 $\Omega$
Frequency range	100 kHz - 500 MHz	100 kHz - 500 MHz
Directivity	$\geq 35$ dB from 300 kHz to 500 MHz	33 dB from 300 kHz to 500 MHz
Typical tracking S <sub>21</sub> , S <sub>12</sub> S <sub>11</sub> , S <sub>22</sub>	$\pm 1$ dB, $\pm 5^\circ$ $\pm 1$ dB, $\pm 5^\circ$	$\pm 1$ dB, $\pm 5^\circ$ $\pm 1$ dB, $\pm 5^\circ$
Nominal insertion loss RF input to Port 1,2 RF input to R,A,B Port 1,2 to A,B	13 dB 19 dB 6 dB	19 dB 31 dB 6 dB
Max operating level	+20 dBm	+20 dBm
Damage level	+23 dBm	+23 dBm
Size	90H $\times$ 426W $\times$ 553mmD	90H $\times$ 426W $\times$ 553mmD
Weight	5.7 kg	5.7 kg

#### HP 87512A 50 $\Omega$ Transmission/Reflection Test Kit

#### HP 87512B 75 $\Omega$ Transmission/Reflection Test Kit

The HP 87512A/B transmission/reflection test kits provide the capability to measure transmission and reflection characteristics. The frequency range of the HP 87512A/B test kits is 5 Hz to 500 MHz.



#### HP 87512A/B Specifications

	HP 87512A	HP 87512B
Impedance	50 $\Omega$	75 $\Omega$
Insertion loss	10 $\pm$ 1 dB typical	
Equivalent directivity	>40 dB typical	
Equivalent source match	>30 dB typical	>25 dB typical

#### HP 41802A 1 M $\Omega$ Input Adaptor

The HP 41802A 1 M  $\Omega$  input adaptor provides the capability to perform high-impedance measurement using HP network and spectrum analyzers. The frequency range of the HP 41802A input adaptor is 5 Hz to 100 MHz. Passive probe is required for measurement (probing).

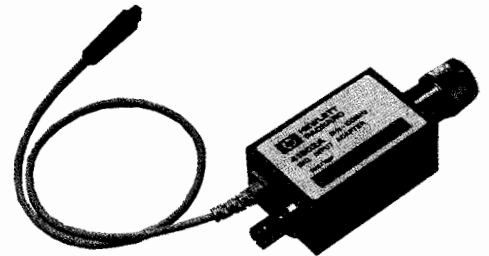

#### HP 41802A Specifications

**Frequency range:** 5 Hz to 100 MHz

**Adaptor gain:** 0 dB  $\pm$  0.5 dB @1 MHz

**Input R, C (typical):** 1 M  $\Omega$ , 12 pF

**1dB Gain compression:** 0.32 Vrms (+ 3dBm, 50  $\Omega$  terminated)

**Damage level:** 2 Vrms,  $\pm$  50 Vdc

**Size:** 28 mm H  $\times$  42 mm W  $\times$  100 mm D (1.1 in  $\times$  1.65 in  $\times$  3.94 in)

**Weight:** 400 g (0.88 lb)

#### Other Accessories

**HP 85031B** Precision 7 mm calibration kit

**HP 85032B** 50  $\Omega$  type-N calibration kit

**HP 85033C** Precision 3.5 mm calibration kit

**HP 85036B** 75  $\Omega$  type-N calibration kit

**HP 11850C** 50  $\Omega$  power splitter

**HP 11850D** 75  $\Omega$  power splitter

**HP 11853A** 50  $\Omega$  type-N accessory kit

**HP 11854A** 50  $\Omega$  BNC accessory kit

**HP 11855A** 75  $\Omega$  type-N accessory kit

**HP 11856A** 75  $\Omega$  BNC accessory kit

#### Ordering Information

**HP 8751A** Network analyzer

**Opt 001** High-stability frequency reference

**Opt 002** HP Instrument BASIC and 1 Mbyte RAM

**Opt 907** Front handle kit

**Opt 908** Rack Mount kit

**Opt 909** Rack flange and handle kit

**Opt 910** Extra operating manual

**Opt 915** Add service manual

**HP 87511A** 50  $\Omega$  S-parameter test set

**Opt 001** N-type port

**HP 87511B** 75  $\Omega$  S-parameter test set

**Options (common for the HP 87511A/B)**

**Opt 907** Front handle kit

**Opt 908** Rack Mount kit

**Opt 909** Rack flange and handle kit

**Opt 910** Extra operating manual

**HP 87512A** 50  $\Omega$  transmission/reflection test kit

**HP 87512B** 75  $\Omega$  transmission/reflection test kit

**HP 41802A** 1 M  $\Omega$  input adaptor

**HP 41800A** Active probe

#### Price

\$22,500

+ \$850

+ \$1,000

+ \$75

+ \$40

+ \$105

+ \$160

+ \$140

\$5,000

\$0

\$5,000

+ \$50

+ \$31

+ \$72.50

+ \$50

\$2,000

\$2,500

\$900

\$1,740



# NETWORK ANALYZERS

## Vector Voltmeter and Input Modules

HP 8508A, 70138A, 85081B, 85082A

295

- RF voltage and phase measurements
- 100 kHz to 1 GHz high-impedance probe inputs
- 300 kHz to 2 GHz 50 ohm inputs

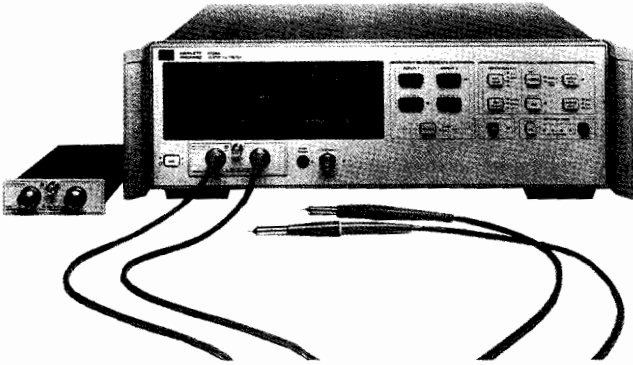

HP 8508A Option 001

### HP 8508A and HP 70138A Vector Voltmeters

The HP 8508A and HP 70138A vector voltmeters are fully automatic tuned receivers that make RF voltage and phase measurements easy. Their narrowband measuring technique gives a dynamic range of over 90 dB and a sensitivity of  $10 \mu\text{V}$  to trace even the smallest signal. These vector voltmeters also measure the phase difference between their two input channels with at least 0.1 degree resolution over a full  $+180$  to  $-180$  degree range, so they can be used for another complete set of measurements—such as electrical length, phase distortion, or impedance. The standard unit is supplied with the HP 85081B Input Module, which has two high-impedance probe inputs that operate from 100 kHz to 1 GHz. Its ability to store a reference and use it in later measurements means individual circuit sections can be characterized and adjusted independently. Any CW source can be used as a stimulus—even a source that is part of the device being tested—so measurements can be made under normal operating conditions. To adapt the probe inputs for measurements in a  $50 \Omega$  environment, the HP 11570A Accessory Kit provides two HP 11536A Probe Tees, an HP 11549A Power Splitter, and two HP 908A  $50 \Omega$  Terminations. Option 050 is supplied with the HP 85082A Input Module. Its  $50 \Omega$  inputs operate from 300 kHz to 2 GHz, and provide the accuracy and dynamic range to make measurements on active and passive components.

### HP 8508A and 70138A with HP 85081B High-Impedance Input Module

#### Specifications Summary

(\*Specifications apply to HP 85082A  $50 \Omega$  Input Module only.)

**Frequency range:** 100 kHz to 1 GHz (300 kHz to 2 GHz\*)

**Maximum input:** 2V peak ac ( $+16 \text{ dBm}^*$ ),  $\pm 50\text{V}$  dc

**A (ref) channel minimum:**  $10 \text{ mV}$  ( $-47 \text{ dBm}^*$ ), 100 kHz to 300 kHz  $1 \text{ mV}$  ( $-47 \text{ dBm}^*$ ), 300kHz to 3MHz  $300 \mu\text{V}$ , 3MHz to 1GHz ( $-57 \text{ dBm}$ , 3MHz to 2GHz\*)

**B channel noise level:**  $10 \mu\text{V}$  ( $-87 \text{ dBm}^*$ )

**Input crosstalk:**  $> 100 \text{ dB}$ , 1 MHz to 500 MHz  $> 80 \text{ dB}$ , 500 MHz to 1 GHz ( $> 70 \text{ dB}$ , 1 GHz to 2 GHz\*)

#### Magnitude Accuracy

##### Absolute accuracy

(A, B 100 mV,  $15^\circ$  to  $30^\circ \text{ C}$ ):

- $\pm 1/-1.5 \text{ dB}$ , 100 kHz to 300 kHz
- $\pm 0.5 \text{ dB}$ , 300 kHz to 1 MHz
- $\pm 0.3 \text{ dB}$ , 1 MHz to 100 MHz
- $\pm 0.6 \text{ dB}$ , 100 MHz to 300 MHz
- $\pm 1 \text{ dB}$ , 300 MHz to 1 GHz
- ( $\pm 1 \text{ dB}$ , 300 MHz to 1.5 GHz\*)
- ( $+1/-2 \text{ dB}$ , 1.5 GHz to 2 GHz\*)

##### Ratio accuracy

(A, B 100mV,  $15^\circ$  to  $30^\circ \text{ C}$ ):

- $\pm 1 \text{ dB}$ , 100 kHz to 300 kHz
- $\pm 0.4 \text{ dB}$ , 300 kHz to 1 MHz
- $\pm 0.2 \text{ dB}$ , 1 MHz to 100 MHz
- $\pm 0.4 \text{ dB}$ , 100 MHz to 300 MHz
- $\pm 0.6 \text{ dB}$ , 300 MHz to 1 GHz
- ( $\pm 0.6 \text{ dB}$ , 300 MHz to 1.5 GHz\*)
- ( $\pm 1 \text{ dB}$ , 1.5 GHz to 2 GHz\*)

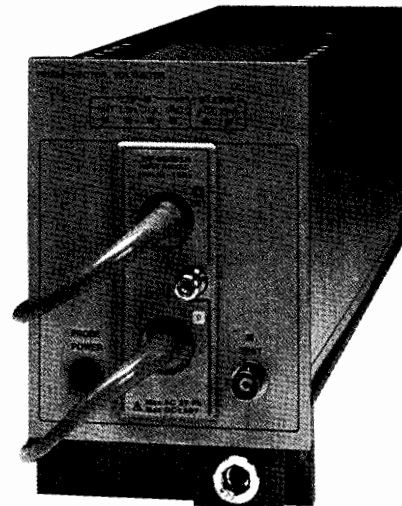

HP 70138A



#### Phase Accuracy

(A, B 100mV,  $15^\circ$  to  $30^\circ \text{ C}$ )

- $\pm 4$ , 300 kHz to 1 MHz
- $\pm 1$ , 1 MHz to 100 MHz
- $\pm 4$ , 100 MHz to 300 MHz
- $\pm 6$ , 300 MHz to 1 GHz
- ( $\pm 6$ , 300 MHz to 1.5 GHz\*)
- ( $\pm 12$ , 1.5 GHz to 2 GHz\*)

**Search and lock time:** Lockup (within one range): 40ms, frequencies up to 3 MHz, 20 ms, frequencies greater than 3MHz.

#### General: HP 8508A only

**Power:** 100, 120, 220, or 240V  $+5\%/-10\%$ , 48 to 440Hz, 40VA.

**Size:** 133 mm H  $\times$  425.5 mm W  $\times$  473.3 mm D (5.25 in  $\times$  16.75 in  $\times$  18.65 in) Opt. 001: 158.8 mm H  $\times$  524.5 mm W  $\times$  524.5 mm D (6.25 in  $\times$  19.75 in  $\times$  20.65 in).

**Weight:** Net, 8.1 kg (18 lb); shipping, 11 kg (24 lb). Option 001: net, 9.4 kg (21 lb); shipping 12.5 kg (28 lb).

#### HP 11570A Accessory Kit

**$50 \Omega$  Tee:** For monitoring signals on  $50 \Omega$  transmission line. Kit contains two each with Type N female connectors.

**$50 \Omega$  Power Splitter:** All connectors Type N female.

**HP 908A  $50 \Omega$  Termination:** For terminating  $50 \Omega$  coaxial systems in their characteristic impedance. Kit contains two each with Type N male connectors.

**HP 11512A Short:** Type N male.

#### HP 85089A Grounding Clip

The HP 85089A grounding clip fits over the probe tip of the HP 85081B to provide a ground return when making in-circuit measurements. It also acts as a shorting bar when the probe is not in use to reduce susceptibility to electrostatic damage.

#### Ordering Information

**HP 8508A Vector Voltmeter** (includes HP 85081B) \$6,200 ☎

**Opt 001:** Add bail handle and front protective cover. +\$250

**Opt 801:** Add 2 each HP 11576A 10:1 Divider and +\$630

HP 10216A Isolators.

**HP 70138A Vector Voltmeter** \$5,930

**Opt 050:** Replace HP 85081B Input Module with HP 85082A Input Module. \$0

**Opt 100:** Delete Input Module. -\$1,500

**HP 85081B Input Module** (100 kHz to 1 GHz, high impedance probe inputs) \$1,500

**HP 85082A Input Module** (300 kHz to 2 GHz,  $50 \Omega$  Type N inputs) \$1,500

**HP 11570A Accessory Kit** (measurement in  $50 \Omega$  systems with standard HP 8508A and 70138A) \$1,100

**HP 85089A Grounding Clip** \$10

☎ For off-the-shelf shipment, call 800-452-4844.

# NETWORK ANALYZERS

RF Network Analyzer, 300 kHz to 1300 MHz  
HP 8711A

- 300 kHz to 1300 MHz
- Internal 3.5 in disk drive (LIF/DOS)
- Narrowband/broadband detection
- "Real time" sweep speed (50 ms/sweep)
- Integrated transmission/reflection test set
- Synthesized 1 Hz resolution source
- Internal HP Instrument BASIC
- 90 dB of system dynamic range
- Simple and easy to use

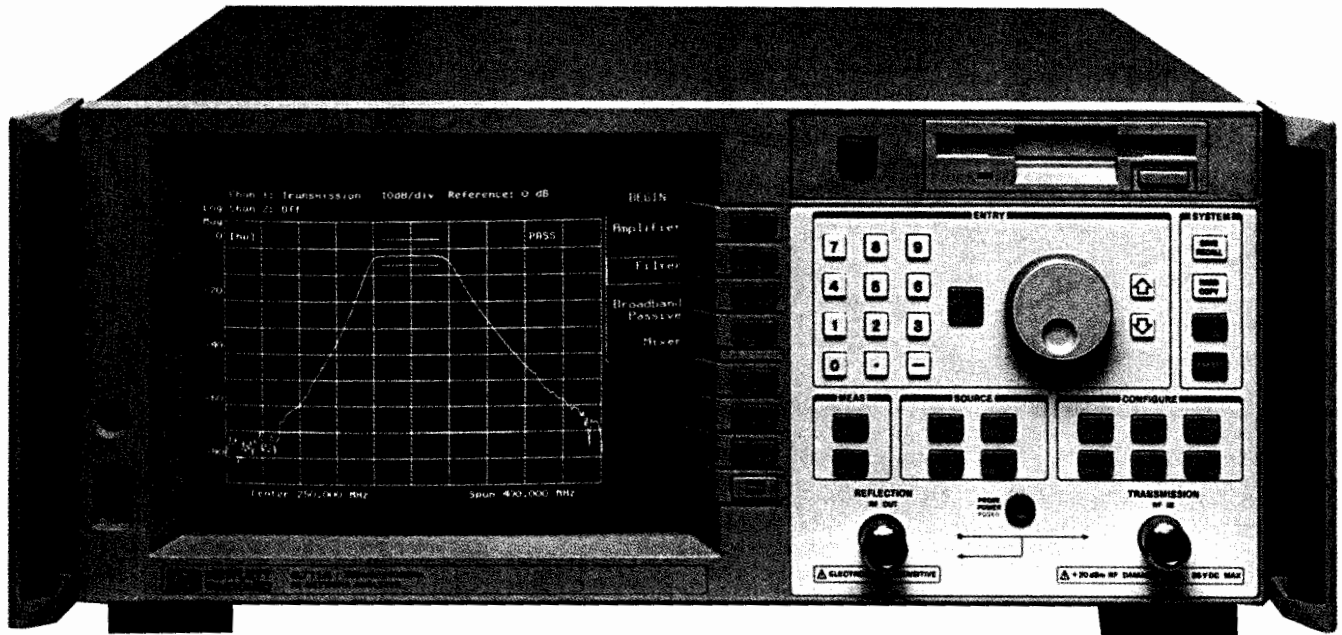

## HP 8711A RF Network Analyzer

The HP 8711A provides speed, accuracy, and measurement versatility at a price that makes it ideal for RF manufacturing. Characterize the transmission/reflection frequency response or measure the insertion loss, gain, return loss, conversion loss, power, or SWR of a variety of RF components. The HP 8711A is a compact, integrated network analyzer that provides fast, simple, and accurate RF testing.

Integrated synthesized source and transmission/reflection test set enable the complete swept frequency characterization of RF components with a single connection. The internal synthesized source is a fast (50 ms/sweep) and stable (1 Hz resolution) stimulus for testing narrowband devices. The HP 8711A's sensitive receivers have both narrowband and broadband detection, which makes the instrument ideal for testing linear and non-linear components that make up RF systems. Broadband detection allows characterization of frequency translation devices, while narrowband detection provides greater than 90 dB of dynamic range for testing high rejection, narrowband devices.

Optional HP Instrument BASIC (IBASIC) puts computer automation capabilities inside the instrument, simplifying measurement setups and testing. A built-in LIF/DOS format 3.5 inch floppy disk drive allows unlimited storage of instrument states, measurement and calibration data, and IBASIC programs.

Integrated source, receiver, test set, display, and disk drive result in a network analyzer that is easy to use, ideal for manufacturing, incoming inspection, and maintenance applications.

## Designed for Manufacturing

Simplicity, ease of use, and automated functions save device test time. The time saving features of the HP 8711A were designed with high volume manufacturing in mind.

The HP 8711A is capable of displaying multiple measurement parameters simultaneously on the CRT, such as insertion loss and return loss characteristics. Nine internal save/recall registers are available to speed device testing. Storing and recalling complete instrument states internally saves time and reduces operating errors.

Powerful marker functions speed the final test of components by calculating and displaying specified device characteristics (maximum, minimum, 3 dB bandwidth and marker search) in real time, along with measurement data.

Limit testing allows comparison of measured data to user defined test limits and displaying the results on the instrument's display. This feature ensures your devices are aligned and tested to the same specifications at all production test stations.

HP Instrument BASIC and built-in disk drive simplify measurement automation and reduce system cost. IBASIC's unique keystroke recording capability enables automation of manual measurements without the need for any programming. The HP 8711A is PC compatible, use an IBM compatible personal computer and the analyzer's DOS disk format to control your measurement system and transfer data directly to popular MS-DOS programs. Peripherals are supported (printers and plotters) through both RS-232 and HP-IB interfaces.

## Specifications Summary

### Source characteristics

#### Frequency

**Range:** 300 kHz to 1300 MHz

**Resolution:** 1 Hz

**Accuracy:** < 5 ppm

#### Output

**Power range:** 0 to 16 dBm

w/ attenuator -60 to 13 dBm

75  $\Omega$  reduces output by 3 dB

#### Resolution

**Port flatness:** +/-1.0 dB

w/attenuator +/-2.0 dB

w/meter correction +/-0.3 dB

#### Signal purity

**Harmonics:** < -30 dBc

**Spurious:** < 30 dBc

**Phase noise:** < 67 dBc/Hz, at 10 kHz (typical)

### Receiver characteristics

#### Frequency range

**Narrowband:** 300 kHz to 1300 MHz

**Broadband:** 10 MHz to 1300 MHz

#### Dynamic range

**50  $\Omega$  Narrowband:** > 90 dB

**Broadband:** > 66 dB

**75  $\Omega$  Narrowband:** > 87 dB

**Broadband:** > 63 dB

#### Maximum input (0.1 dB compression)

**Narrowband:** 10 dBm

**Broadband:** 16 dBm

#### Input damage level: 20 dBm

### Test set characteristics

**Test port match:** 20 dB

**System directivity:** 40 dB

### RF Connectors

**Test Ports:** 50  $\Omega$  Type N(f)

75  $\Omega$  Type N(f)

### Physical characteristics

**Size:** 180 mm H  $\times$  430 mm W  $\times$  480 mm D (7 in  $\times$  17 in  $\times$  18.75 in)

**Weight:** Net, 20.5 kg (45 lbs); shipping, 25 kg (55 lbs)

## Detectors/Bridges

External detectors (50 and 75  $\Omega$ ) and bridge are available for remote device measurements. An unmodulated dc detection mode measures the microwave power directly without using modulation techniques.

### HP 86200A 50 $\Omega$ Scalar Detector

An external scalar detector for use when measuring external 50  $\Omega$  devices.

### HP 86201A 75 $\Omega$ Scalar Detector

An external scalar detector for use when measuring external 75  $\Omega$  devices.

### HP 86205A 50 $\Omega$ Bridge

An external directional bridge which offers high directivity and excellent port match designed for 50  $\Omega$  device measurements.

## Upgrade Kits

The following upgrade kits add optional measurement capability to existing HP 8711A network analyzers.

### HP 86223A Attenuator Upgrade Kit

Provides the necessary components to retrofit an HP 8711A with a 60 dB step attenuator (Option 1E1). Includes installation at an HP service center. Also available as HP Part Number 08711-60060.

### HP 86224A IBASIC Upgrade Kit

Provides the necessary components to retrofit an HP 8711A with IBASIC capabilities (Option 1C2). Includes installation at an HP service center. Also available as HP Part Number 08711-60061.

### HP C1405A/ABA DIN Keyboard

PC keyboard to enhance editing capability (Option 1CL).

## Calibration Kits

Accuracy enhancement characterizes the systematic errors by measuring known devices (standards) over the frequency range of interest. Kits for the HP 8711A contains standards to characterize these errors.

### HP 85032E 50 $\Omega$ Calibration Kit

Contains 50  $\Omega$  Type N standards used to calibrate the HP 8711A for measurements of devices with 50  $\Omega$  Type N connectors. Standards include fixed termination, open circuit and short circuit.

### HP 85036E 75 $\Omega$ Calibration Kit

Contains 75  $\Omega$  Type N standards used to calibrate the HP 8711A for measurements of devices with 75  $\Omega$  Type N connectors. Standards include fixed termination, open circuit, and short circuit.

## Accessories

### HP 11852B 50/75 $\Omega$ Minimum Loss Pad

A low SWR minimum loss pad required when measurements are made on 75  $\Omega$  devices using a 50  $\Omega$  measurement system.

### HP 11853A Type N Accessory Kit

Accessory kit which provides the RF components required for measuring devices having 50  $\Omega$  Type N connectors.

### HP 11854A BNC Accessory Kit

Accessory kit which provides the RF components required for measuring devices having 50  $\Omega$  BNC connectors.

### HP 11855A Type N Accessory Kit

Accessory kit which provides the RF components required for measuring devices having 75  $\Omega$  Type N connectors.

### HP 11856A BNC Accessory Kit

Accessory kit which provides the RF components required for measuring devices having 75  $\Omega$  BNC connectors.

### HP 86211A Type N/Type F Adapter Kit

Adapter kit which provides Type N to Type F adapters necessary when measuring Type F devices on a network analyzer with Type N ports.

### HP 86212A Type N/TNC Adapter Kit

Adapter kit which provides Type N to TNC adapters necessary when measuring TNC devices on a network analyzer with Type N ports.

## Test Port Cables

Replacement test port cables are available as HP part numbers. The analyzer ships with the BNC type cable as standard.

### HP 8120-1839 BNC Test Port Cable, 50 $\Omega$

### HP 5063-0061 BNC Test Port Cable, 75 $\Omega$

### HP 8120-4781 50 $\Omega$ Type N Cable

### HP 8120-2408 75 $\Omega$ Type N Cable

## Ordering Information

	Price
HP 8711A Network Analyzer	\$13,500
Opt 1EC 75 System Impedance	\$0
Opt 1E1 60 dB Attenuator	\$800
Opt 1C2 IBASIC Capability	\$1,350
Opt 1CL DIN Keyboard	\$210
Opt 1CF Soft Carrying Case	\$250
Opt 1CM Rack Mount	\$75
HP 86223A Attenuator Upgrade Kit	\$1,150
HP 86224A IBASIC Upgrade Kit	\$1,550
HP C1405A DIN Keyboard	\$150
HP 85032E 50 $\Omega$ Calibration Kit	\$650
HP 85036E 75 $\Omega$ Calibration Kit	\$650
HP 11853A Type N Accessory Kit	\$500
HP 11854A BNC Accessory Kit	\$500
HP 11855A Type N Accessory Kit	\$500
HP 11856A BNC Accessory Kit	\$500
HP 86200A 50 $\Omega$ Scalar Detector	\$600
HP 86201A 75 $\Omega$ Scalar Detector	\$600
HP 86205A 50 $\Omega$ Bridge	\$1,300
HP 86211A Type N/Type F Adapter Kit	\$300
HP 86212A Type N/TNC Adapter Kit	\$700
HP 8120-1839 BNC Test Port Cable, 50 $\Omega$	\$20
HP 5063-0061 BNC Test Port Cable, 75 $\Omega$	\$75
HP 8120-4781 50 $\Omega$ Type N Cable	\$280
HP 8120-2408 75 $\Omega$ Type N Cable	\$800

☎ For off-the-shelf shipment, call 800-452-4844.

# NETWORK ANALYZERS

RF Network Analyzer, 300 kHz to 3 GHz  
HP 8752A/B

- 300 kHz to 1.3 or 3 GHz
- Integrated 1 Hz resolution synthesized source
- Integrated transmission/reflection test set
- 50  $\Omega$  or 75  $\Omega$  system impedance
- Direct save/recall to an external disk drive
- Execute complex test procedures with the test sequence function
- 100 dB of dynamic range
- Group delay and deviation from linear phase
- Superb uncorrected performance

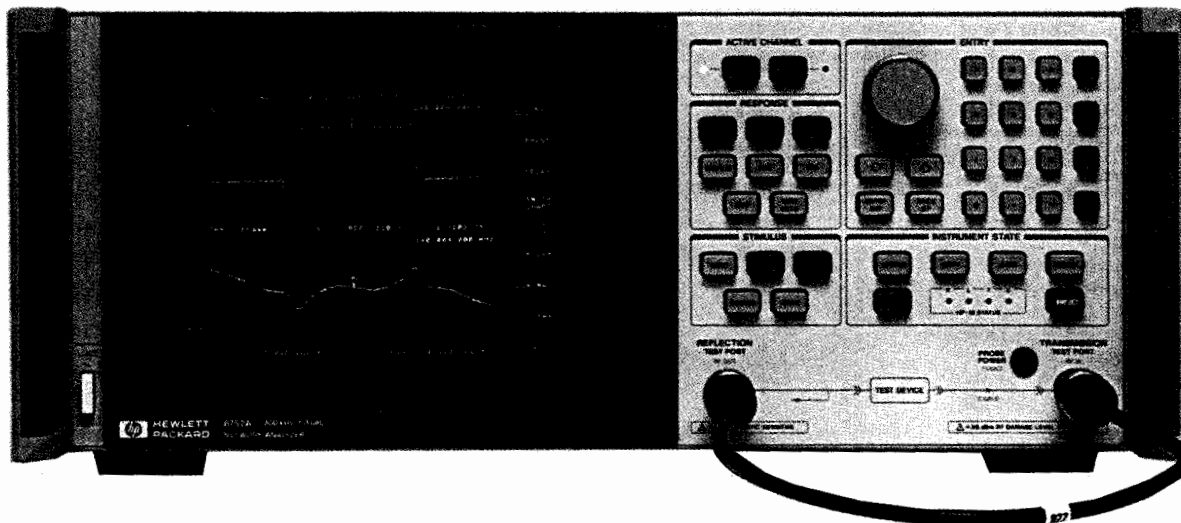

HP 8752A



## HP 8752A/B RF Network Analyzers

The HP 8752A/B RF network analyzers provide simple and complete vector network measurements in a compact and fully integrated RF network analyzer. Characterize your RF components and networks accurately and economically with the HP 8752A/B RF network analyzers in the 300 kHz to 1.3 or 3 GHz frequency range. Integration of the swept synthesized source, test set, and receiver results in a network analyzer that is easy to set up and use, which is ideal for service, incoming inspection, production, and final test measurements.

The integrated synthesized source provides measurement port power level of +5 to -20 dBm with linear, log, list, power, and CW sweep types. The sensitive tuned receivers provide 100 dB of dynamic range.

With two independent display channels available, you can simultaneously measure the reflection and transmission characteristics of the device under test on the crisp color display. Data can be displayed in log magnitude, linear magnitude, SWR, phase, group delay, polar, real, or Smith chart formats. The easy-to-use softkey measurement functions allow you to quickly measure the desired characteristic of your device under test.

### Designed for Manufacturing

The productivity features of the HP 8752A/B increase your throughput in production. The test sequence function provides rapid and consistent execution of complex, repetitive tests with a single keystroke. In sequencing mode, you make the measurement once from the front panel and the instrument automatically saves the keystrokes without an external computer.

The HP 8752A/B offers excellent uncorrected performance, allowing simple and accurate measurements of your device under test without the need for measurement calibration. Other productivity enhancements include a plot/print buffer, limit testing, arbitrary frequency testing, and marker tracking functions. Up to four on-screen markers per channel are available for hardcopy outputs or for tuning at specific frequencies.

### Time Domain Analysis

The HP 8752A/B with Option 010 has the capability of displaying the time domain response of a network, obtained by computing the inverse Fourier transform of the frequency domain response. Two time domain modes are offered with the HP 8752A/B. The low-pass mode provides traditional time domain reflector (TDR) measurement capability and gives the response of a mathematically simulated step or impulse response. The bandpass mode, which has only the impulse stimulus, provides the time domain response of frequency-selective devices such as SAW filters and antennas.

### Specifications Summary

#### Source

##### Frequency Characteristics

**Range:** 300 kHz to 1.3 GHz  
(Opt 003: 300 kHz to 3 GHz)

**Resolution:** 1 Hz

**Accuracy:**  $\pm 10$  ppm

##### Output Characteristics

**Power range:** -20 to +5 dBm

**Resolution:** 0.1 dB

**Flatness:** < 2 dB peak-to-peak

**Level accuracy (50 MHz, -5 dBm):**  $\pm 0.5$  dB

**Level linearity (relative to -5 dBm):**

-20 to -15 dBm:  $\pm 0.5$  dB

-15 to 0 dBm:  $\pm 0.2$  dB

0 to +5 dBm:  $\pm 0.5$  dB

**Impedance:** 50  $\Omega$  (HP 8752A), 75  $\Omega$  (HP 8752B)

#### Receiver

**Frequency range:** 300 kHz to 1.3 GHz

(Opt 003: 300 kHz to 3 GHz)

**Noise level:** Reflection -85 dBm (typical), Transmission -110 dBm (typical) @ 10 Hz bandwidth

**Maximum input level:** 0 dBm

**Impedance:** 50  $\Omega$  (HP 8752A), 75  $\Omega$  (HP 8752B)

**Crosstalk:** (300 kHz to 1.3 GHz) 100 dB

(1.3 to 3 GHz) 90 dB

**Dynamic accuracy:**  $\pm 0.05$  dB,  $\pm 0.3^\circ$  over a 50 dB input range

##### Delay characteristics

**Range:**  $\frac{1}{2}$ \* (minimum aperture)

**Aperture (selectable):** frequency span/(# points - 1) to 20% of the frequency span

**Accuracy:** (phase accuracy)/(360\* aperture in Hz)

**RF Connectors**

**Test Ports:** 50  $\Omega$  Type N (female) (HP 8752A)  
75  $\Omega$  Type N (female) (HP 8752B)

**Physical Characteristics**

**Size:** 178 mm H  $\times$  425 mm W  $\times$  498 mm D (7.0 in  $\times$  16.75 in  $\times$  20.0 in)  
**Weight:** Net, 25 kg (56 lb); shipping, 28 kg (63 lb)

**Upgrade Kits**

The following upgrade kits add optional measurement capability to existing HP 8752A/B network analyzers.

**HP 11885A 3 GHz Frequency Upgrade Kit**

The HP 11885A upgrade kit extends the operating frequency range (Option 003) of the HP 8752A/B from 1.3 GHz to 3 GHz. Installation at an HP service center is included.

**HP 85019C Time Domain Upgrade Kit**

The HP 85019C upgrade kit adds time domain analysis capability (Option 010) to an existing HP 8752A/B network analyzer. This kit is user installable.

**Accessories****HP 11878A 3.5 mm Adapter Kit**

The HP 11878A Adapter Kit provides the RF components generally required when an SMA or 3.5 mm device needs to be measured with the HP 8752A standard Type N configuration. The kit includes four Type N to 3.5mm adapters to accommodate both male and female connectors.

**HP 11853A 50  $\Omega$  Type N Accessory Kit**

The HP 11853A Accessory Kit furnishes the RF components required for measurement of devices with 50  $\Omega$  Type N connectors.

**HP 11854A 50  $\Omega$  BNC Accessory Kit**

The HP 11854A Accessory Kit furnishes the RF components required for measurement of devices with 50  $\Omega$  BNC connectors.

**HP 11855A 75  $\Omega$  Type N Accessory Kit**

The HP 11855A Accessory Kit furnishes the RF components required for measurement of devices with 75  $\Omega$  Type N connectors.

**HP 11856A 75  $\Omega$  BNC Accessory Kit**

The HP 11856A Accessory Kit furnishes the RF components required for measurement of devices with 75  $\Omega$  BNC connectors.

**Test Port cables**

Hewlett-Packard supplies test port cables with each HP 8752A/B. Additional or replacement cables can be ordered separately:

HP Part Number 8120-4781 Type N 50  $\Omega$  - HP 8752A

HP Part Number 8120-2408 Type N 75  $\Omega$  - HP 8752B

**HP 11852B 50  $\Omega$ /75  $\Omega$  Minimum Loss Pad**

The HP 11852B is a low SWR minimum loss pad required when measurements are made on 75  $\Omega$  devices with the HP 8752A network analyzer. Measurements on two port devices require two HP 11852B pads and one 50  $\Omega$  Type N barrel.

**Frequency range:** dc to 2.0 GHz

**Insertion loss:** 5.7 dB

**Return loss:** 75  $\Omega$  typically  $>$  30 dB, 50  $\Omega$  typically  $>$  26 dB

**Connectors:** 50  $\Omega$  Type N (female) and 75  $\Omega$  Type N (male)

**Calibration Kits**

Accuracy enhancement procedures characterize the systematic errors of the measurement system by measuring known devices (standards) on the system over the frequency range of interest. The calibration kits in the HP 8752A/B family contain precision standards with which to characterize the systematic errors of an HP 8752A/B measurement system.

**HP 85032B 50  $\Omega$  Type N Calibration Kit**

Contains precision 50  $\Omega$  Type N standards used to calibrate the HP 8752A for measurements of devices with 50  $\Omega$  Type N connectors. This kit can also be used to perform system verification. Option 001 removes the precision phase-matched 7mm to Type N adapters. Standards include fixed terminations, open circuits, and short circuits.

**HP 85036B 75  $\Omega$  Type N Calibration Kit**

Contains precision 75  $\Omega$  Type N standards used to calibrate the HP 8752B for measurements of devices with 75  $\Omega$  Type N connectors. This kit can also be used to perform system verification. Standards include fixed terminations, open circuits, and short circuits.

**HP 85033C 3.5 mm Calibration Kit**

Contains precision 3.5 mm standards used to calibrate the HP8752A network analyzer for measurements of devices with 3.5 mm or SMA connectors. Option 001 removes the precision phase-matched 7mm to 3.5mm adapters. Standards include fixed terminations, open circuits, and short circuits.

**Ordering Information**

	Price
<b>HP 8752A/B</b> Network Analyzer	\$23,000
<b>Opt 003</b> 3 GHz Frequency Extension	+ \$4,000
<b>Opt 010</b> Time Domain Capability	+ \$5,300
<b>Opt 802</b> Add Dual Disk Drive and Cable	+ \$1,745
<b>Opt 908</b> Rack Mount Kit (w/o handles 5062-3978)	+ \$35
<b>Opt 910</b> Extra Manual (08752-90001)	+ \$150
<b>Opt 913</b> Rack Mount Kit (w/handles 5062-4072)	+ \$40
<b>HP 11885A</b> 3 GHz Frequency Upgrade	\$4,500
<b>HP 85019C</b> Time Domain Upgrade	\$5,300
<b>HP 85032B</b> 50 $\Omega$ Type N Calibration Kit	\$1,600
<b>Opt 001</b> Deletes 7mm to Type N adapters	- \$500
<b>HP 85036B</b> 75 $\Omega$ Type N Calibration Kit	\$2,000
<b>HP 85033C</b> 3.5 mm Calibration Kit	\$2,500
<b>Opt 001</b> Deletes 7mm to 3.5 mm adapters	- \$500
<b>HP 11878A</b> 3.5 mm Adapter Kit	\$550
<b>HP 11853A</b> 50 $\Omega$ Type N Accessory Kit	\$400
<b>HP 11854A</b> 50 $\Omega$ BNC Accessory Kit	\$400
<b>HP 11855A</b> 75 $\Omega$ Type N Accessory Kit	\$500
<b>HP 11856A</b> 75 $\Omega$ BNC Accessory Kit	\$500
<b>HP 11852B</b> 50 $\Omega$ /75 $\Omega$ Minimum Loss Pad	\$400
<b>HP 8120-4781</b> 50 $\Omega$ Type N Test Port Cable	\$350
<b>HP 8120-2408</b> 75 $\Omega$ Type N Test Port Cable	\$800
<b>HP 85024A</b> High Frequency Probe	\$2,100

☎ For off-the-shelf shipment, call 800-452-4844.

**HP 85024A High Frequency Probe**

The HP 85024A High Frequency Probe makes it easy to perform in-circuit measurements. An input capacitance of only 0.7 pF shunted by 1 megohm of resistance permits high frequency probing without adversely loading the circuit under test. Excellent frequency response and unity gain guarantee high accuracy in swept measurements with this probe. High probe sensitivity and low distortion levels allow measurements to be made while taking advantage of the full dynamic range of HP RF analyzers. Spectrum analyzers that supply probe power from the front panel include the HP 8568B, 8590B, 8591A, 8560A, 8561B, 8562A/B, and 71100A. RF network analyzers such as the HP 8753C, 8752A, 8751A, 3577A, and 4195A are also directly compatible. You can use the HP 85024A with other instruments by using the HP 1122A Probe Power Supply or any dual  $\pm$  15V, 130 mA supply.



HP 85024A

**Specifications Summary**

**Input capacitance** (@ 500 MHz):  $<$  0.7 pF (nominal)

**Input resistance:** 1 M $\Omega$  (nominal)

**Bandwidth:** 300 kHz to 3 GHz

**Gain** (@ 500 MHz): 0 dB  $\pm$  1 dB

**Average noise level** (10 Hz to 10 MHz):  $<$  1 mV

**Frequency response:**  $\pm$  1.25 dB (300 kHz to 1 GHz)  
 $\pm$  2, -3 dB (1 GHz to 3 GHz)

**Input voltage for 1 dB compression:** 0.3 V

**Maximum safe RF voltage:** 1.5V peak (with 10:1 divider 15V peak)

**Noise figure:**  $<$  50 dB ( $<$  100 MHz)

$<$  24 dB (100 MHz to 3 GHz)

**Distortion** (@ 0.3 V):  $<$  -30 dBc

**Includes:** Type N male adapter, 10:1 divider, spare probe tips, 2.5-inch ground lead, hook tip, spanner tip, and probe tip nut driver.

# NETWORK ANALYZERS

RF Network Analyzer, 300 kHz to 6 GHz  
HP 8753C

- 300 kHz to 6 GHz
- Integrated 1 Hz resolution synthesized source
- Direct save/recall to an external disk drive
- Time domain analysis
- Execute complex test procedures with the test sequence function
- 100 dB of dynamic range
- Group delay and deviation from linear phase
- 0.001 dB, 0.01 deg, 0.01 nanosec marker resolution
- Built-in accuracy enhancement
- Swept harmonic measurements

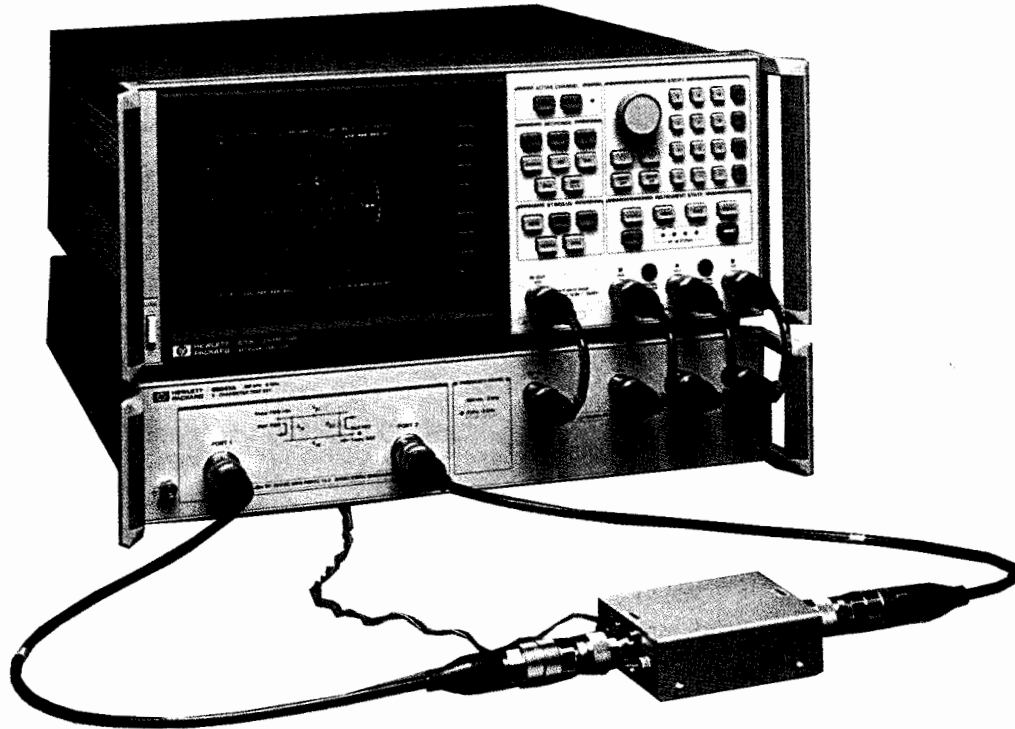

HP 8753C with HP 85047A



## HP 8753C Network Analyzer

The HP 8753C network analyzer provides excellent RF network measurements for lab and production test areas. When combined with a test set, it provides a complete solution for characterizing linear behavior of either active or passive networks, devices, or components from 300 kHz to 6 GHz. With two independent display channels available, you can simultaneously measure and view the reflection and transmission characteristics of the device under test in overlay or split-screen format on the crisp color display. The easy-to-use softkey selection of measurement functions allows you to measure the magnitude, phase, or group delay characteristics of your device under test.

The test sequence function allows rapid and consistent execution of complex repetitive tests with a single keystroke. In sequencing mode, you make the measurement once from the front panel, and the instrument stores the keystrokes so that no additional programming expertise is required. You can even set other HP-IB instruments with a test sequence. Other productivity enhancements include a plot/print buffer, limit testing, arbitrary frequency testing, and marker tracking functions. Segmented calibration and interpolative error correction allow you to apply vector accuracy enhancement over a subset of the frequency range that you initially calibrated the HP 8753C.

The integrated synthesized source provides >100 mW of output power, 1 Hz frequency resolution, and linear, log, list, power, and CW sweep types. Three tuned, 300 kHz to 3 GHz (Option 006 extends to 6 GHz) receivers allow versatile independent power measurements or simultaneous ratio measurements over a 100 dB dynamic range. By using the HP 85047A Test Set with the HP 8753C, the reflection and transmission characteristics of the device under test can be investigated from 300 kHz to 3 GHz or from 3 MHz to 6 GHz with the test set's frequency doubler enabled.

## Non-linear Device Testing

Non-linear device characterization is possible with the HP 8753C. Swept second- and third-harmonic levels of an amplifier can be displayed directly or relative to the fundamental carrier (dBc) when employing the optional harmonic measurement capability (Option 002). Amplifier harmonics up to 40 dBc can be measured quickly and conveniently on a swept-frequency basis for fundamental signals as low as 16 MHz, using the same test configuration used to measure gain. Power meter calibration provides leveled absolute power to devices that are sensitive to absolute input or output levels. The HP 8753C automatically controls an HP 436A, 437B, or 438A Power Meter to set the power anywhere in the test configuration with power meter accuracy.

The HP 8753C has the capability to perform mixer tracking and conversion loss measurements. These are possible because the tuned receiver can be offset from its synthesized source by the LO frequency of the mixer. Both fixed and swept IF measurements can be made.

## Time Domain Analysis

Time domain responses can be displayed by the HP 8753C with Option 010. The instrument computes the inverse Fourier transform of the frequency domain data to display the reflection or transmission coefficient versus time. The HP 8753C offers two time domain modes. The low-pass mode provides the traditional Time Domain Reflectometer (TDR) measurement capability and gives the response of the network to a mathematically simulated step or impulse response. This mode gives information of the type of impedance (R, L, C) at the discontinuity. The bandpass time domain mode, which has only the impulse stimulus, has no frequency restrictions and provides the time domain response of frequency selective devices such as SAW filters or antennas. Gating may be used to selectively isolate a single response to view the frequency domain response of individual portions of a component without disturbing the circuit itself.

**Specifications Summary**

**Source**

**Frequency Characteristics**

**Frequency range:** 300 kHz to 3 GHz

**Frequency resolution:** 1 Hz

**Frequency accuracy:** ±10 ppm

**Output characteristics**

**Power range:** -5 to +20 dBm

**Power accuracy:** (50 MHz, +10 dBm) ±0.5 dB

**Power linearity** (relative to +10 dBm):

0.5 to 0 dBm: ±0.5 dB

0 to +15 dBm: ±0.2 dB

+15 to +20 dBm: ±0.5 dB

**Impedance:** 50 ohms

**Harmonics:** ≤ -25 dBc (20 dBm output level)

≤ -50 dBc (0 dBm output level)

**Nonharmonics:**

**Mixer-related:** ≤ -32 dBc (20 dBm output level)

≤ -55 dBc (0 dBm output level)

**Other spurious:**

f < 135 MHz: -60 dBc

f ≥ 135 MHz: -60 dBc + 20\*log(f/135 MHz) dBc

**Phase noise** (10 kHz offset in 1 Hz BW):

f < 135 MHz: -90 dBc

f ≥ 135 MHz: -90 dBc + 20\*log(f/135 MHz) dBc

**Receiver**

**Frequency range:** 300 kHz to 6 GHz

**Inputs:**

A, B 100 dB dynamic range < 3 GHz

95 dB dynamic range 3 to 6 GHz

**Sensitivity** (noise level):

3 kHz BW: -90 dBm < 3 GHz, -85 dBm 3 to 6 GHz

10 Hz BW: -100 dBm < 3 GHz, -95 dBm 3 to 6 GHz

**Maximum input level:** 0 dBm

**Impedance:** 50 Ω

**Input crosstalk:**

300 kHz to 1 GHz: -100 dB

1 GHz to 3 GHz: -90 dB

3 GHz to 4.5 GHz: -85 dB

4.5 GHz to 6 GHz: -75 dB

**Dynamic accuracy:** ±0.05 dB, ±0.3° over a 50 dB input range

**Delay Characteristics**

**Range:** ½\* (1/minimum aperture)

**Aperture (selectable):** frequency span/(# points -1) to 20% of the frequency span

**Resolution:** 27.8/(aperture in Hz)

typically 0.01 nanoseconds

**Accuracy:** (phase accuracy)/(360\*aperture in Hz)

**RF Connectors:** 50 Ω Type N (female)

**Physical Characteristics**

**Size:** 178 mm H × 425 mm W × 498 mm D, (7.0 in × 16.75 in × 20.0 in).

**Weight:** Net, 22 kg (48 lb); shipping, 25 kg (55 lb).

**Upgrade Kits**

The following upgrade kits retrofit the latest operating systems or add optional measurement capability to existing HP 8753A/B/C network analyzers.

**HP 11882A Upgrade Kit for the HP 8753A**

This kit upgrades an HP 8753A to an HP 8753B with revision 3.0 firmware. New measurement capabilities include mixer measurements, support of 6 GHz and solid-state test sets, interpolative error correction, and the test sequencing function (for built-in automatic measurements). Options for 6 GHz receiver and harmonic measurements can also be added to an HP 8753A after the HP 11882A kit has been installed. This kit includes installation at an HP service center.

**HP 11883A Harmonic Measurements Upgrade**

This upgrade kit adds harmonic measurement capability (Option 002) to an HP 8753B/C network analyzer. This kit includes installation at an HP service center.

**HP 11884A 6 GHz Receiver Upgrade**

This kit extends the operating frequency range of the HP 8753B/C receiver from 3 GHz to 6 GHz. To make transmission/reflection measurements above 3 GHz, the HP 85047A S-parameter test set is required. This kit includes installation at an HP service center.

**HP 85019A Time Domain Upgrade Kit**

This upgrade kit adds time domain analysis capability (Option 010) to an existing HP 8753A network analyzer. This kit is user installable.

**HP 85019B Time Domain Upgrade Kit**

This upgrade kit adds time domain analysis capability (Option 010) to an existing HP 8753B/C network analyzer. This kit is user installable.

**HP 86387A Mixer Measurement Upgrade for HP 8753B**

This upgrade adds mixer measurement capability to an existing HP 8753B. Phase lock hardware and firmware revision 3.0 is included. This kit includes installation at an HP service center.

**HP 86387B Mixer Measurement Upgrade for HP 8753C**

This upgrade adds mixer measurement capability to an existing HP 8753C. Phase lock hardware and firmware revision 4.1 is included. This kit includes installation at an HP service center. Not required for HP 8753Cs at revision 4.02 or higher.

**HP 86388A Upgrade Kit for the HP 8753B**

This kit adds the latest firmware revision to an existing HP 8753B. Significant enhancements include diskfile compatibility with HP 8753C network analyzers and support of solid-state switching test sets. This kit is user installable.

**Transmission/Reflection Test Sets**

The transmission/reflection test sets provide the capability to simultaneously measure the reflection and transmission characteristics of two port devices. The device must be physically turned around to measure its reverse direction characteristics.

**HP 85044A/B Transmission/Reflection Test Sets**

The HP 85044A/B test sets provide the capability to measure the reflection and transmission characteristics of 50 Ω and 75 Ω devices, respectively.

**Specifications Summary**

	HP 85044A	HP 85044B
<b>Impedance:</b>	50 Ω	75 Ω
<b>Frequency range:</b>	300 kHz to 3 GHz	300 kHz to 2 GHz
<b>Directivity<sup>1</sup>:</b>	35 dB to 1.3 GHz 30 dB to 3.0 GHz	35 dB to 1.3 GHz 30 dB to 2.0 GHz

**Typical Tracking**

**Transmission magnitude, phase<sup>1,2,3</sup>:**

0.3 MHz to 2.0 MHz ±1.5 dB, ±10° ±1.5 dB, ±10°

2.0 MHz to F max ±1.5 dB, ±10° ±1.5 dB, ±10°

**Reflection magnitude, phase<sup>1,2,3</sup>:**

0.3 MHz to 2.0 MHz ±1.5 dB, ±25° ±1.5 dB, ±25°

2.0 MHz to F max ±1.5 dB, ±10° ±1.5 dB, ±10°

**Effective source match<sup>2,3</sup>: (Test Ports):**

0.3 MHz to 2.0 MHz 14 dB 14 dB

2.0 MHz to 1.3 GHz 20 dB 17 dB

1.3 GHz to F max 16 dB 16 dB

**RF Connectors**

**Test ports:** Precision 7 mm 75 Ω Type N (female)

**All others:** 50 Ω Type N (female) 50 Ω Type N (female)

**Physical Characteristics**

**Size:** 615 mm H × 101 mm W × 204 mm D (2.44 in × 7.5 in × 8.0 in)

**Weight:** Net, 1.7 kg (3.8 lb); shipping, 2.0 kg (4.4 lb)

<sup>1</sup>Degrees, specified as deviation from linear phase.

<sup>2</sup>F<sub>max</sub> is the upper frequency limit of the associated test set.

<sup>3</sup>Can be improved through Accuracy Enhancement.

# NETWORK ANALYZERS

## S-Parameter Test Sets

### HP 8753C Series

#### S-Parameter Test Sets

The S-parameter test sets provide the capability to measure reflection and transmission characteristics (including S-parameters) of two port devices in either direction with a single connection. The test sets are controlled from the HP 8753C and include programmable step attenuators.

#### HP 85046A/B S-Parameter Test Sets

The HP 85046A/B test sets provide the capability to simultaneously measure the transmission and reflection characteristics of 50  $\Omega$  and 75  $\Omega$  devices, respectively.

#### Specifications Summary

	HP 85046A	HP 85046B
<b>Impedance:</b>	50 $\Omega$	75 $\Omega$
<b>Frequency Range:</b>	300 kHz to 3 GHz	300 kHz to 2 GHz
<b>Directivity:</b>	35 dB to 1.3 GHz 30 dB to 3.0 GHz	35 dB to 1.3 GHz 30 dB to 2.0 GHz

#### Typical tracking

##### Transmission magnitude, phase<sup>1,2,3</sup>:

0.3 MHz to 2.0 MHz	$\pm 1.5$ dB, $\pm 20^\circ$	$\pm 1.5$ dB, $\pm 20^\circ$
2.0 MHz to Fmax	$\pm 1.5$ dB, $\pm 10^\circ$	$\pm 1.5$ dB, $\pm 10^\circ$

##### Reflection magnitude, phase<sup>1,2,3</sup>:

0.3 MHz to 2.0 MHz	$\pm 1.5$ dB, $\pm 25^\circ$	$\pm 1.5$ dB, $\pm 25^\circ$
2.0 MHz to Fmax	$\pm 1.5$ dB, $\pm 10^\circ$	$\pm 1.5$ dB, $\pm 10^\circ$

#### Effective source match<sup>3</sup> (Test Ports):

0.3 MHz to 2.0 MHz	14 dB	14 dB
2.0 MHz to 1.3 GHz	20 dB	17 dB
1.3 GHz to Fmax	16 dB	16 dB

#### RF connectors

<b>Test Ports:</b>	Precision 7 mm	75 $\Omega$ Type N (female)
<b>All others:</b>	50 $\Omega$ Type N (female)	50 $\Omega$ Type N (female)

**Includes:** Four 190 mm (7.5 in) cables with Type N (male) connectors for connection to the HP 8753C. One HP 8753C test set interconnect cable.

#### Physical Characteristics

**Size:** 90 mm H  $\times$  426 mm W  $\times$  553 mm D (3.5 in  $\times$  16.75 in  $\times$  21.5 in)  
**Weight:** Net, 9.1 kg (20 lb); shipping, 10 kg (22 lb).

#### HP 85047A S-Parameter Test Set

The HP 85047A test set includes a frequency doubler that can be switched in to measure 3 MHz to 6 GHz in a single sweep or switched out to measure 300 kHz to 3 GHz in a single sweep. The HP 8753C controls the frequency doubler. HP 8753C Option 006 (6 GHz receiver) is required to activate the HP 85047A.

#### Specifications Summary

**Impedance:** 50  $\Omega$   
**Frequency ranges:** 300 kHz to 3 GHz  
3 MHz to 6 GHz

**Directivity:** 300 kHz to 1.3 GHz: 35 dB  
1.3 GHz to 3 GHz: 30 dB  
3 GHz to 6 GHz: 25 dB

#### Typical tracking

##### Transmission magnitude, phase:

300 kHz to 3 GHz:  $\pm 1.5$  dB,  $\pm 10^\circ$   
3 GHz to 6 GHz: +0.5, -2.5 dB,  $\pm 20^\circ$

##### Reflection magnitude, phase:

300 kHz to 3 GHz:  $\pm 1.5$  dB,  $\pm 10^\circ$   
3 GHz to 6 GHz:  $\pm 1.5$  dB,  $\pm 20^\circ$

#### Effective source match:

300 kHz to 1.3 GHz: 20 dB  
1.3 GHz to 3 GHz: 16 dB  
3 GHz to 6 GHz: 14 dB

#### RF connectors

**Test ports:** Precision 7 mm

**All others:** 50  $\Omega$  type N (female)

**Includes:** Four 190 mm (7.5 in) cables with Type N (male) connectors for connection to the HP 8753C, one HP 8753C test set interconnect cable

#### Physical Characteristics

**Size:** 90 mm H  $\times$  426 mm W  $\times$  533 mm D (3.5 in  $\times$  16.75 in  $\times$  21.5 in)  
**Weight:** Net, 10 kg (22 lb); shipping, 11.5 kg (25.3 lb)

#### Solid-State Switching

Solid-state switching allows for simultaneous measurement of forward and reverse parameters and continuous update of all 4 S-parameters as required for 2-port error correction (used to achieve best possible measurement accuracy). Option 009 replaces the standard solid-state RF test port switch with a mechanical RF switch. HP 8753 systems specifications for standard and Option 009 test sets are identical. Nominal insertion loss of the solid-state switch is less than 2 dB (@ 3 GHz) or 3dB (@ 6 GHz), relative to a mechanical switch.

The solid-state switch can be retrofitted into any existing HP 85046A/B or 85047A test set using the HP 86389A or 86389B solid-state switch upgrade kit. Solid-state switching test sets are supported on HP 8753C and HP 8753B network analyzers with firmware revision 3.0 or higher. For HP 8753A/B network analyzers with firmware revision 2.01 or lower, upgrade kits are available, which add support for solid-state test switching test sets.

#### HP 86389A/B Solid-State Switch Upgrade Kits

The HP 86389A/B kits retrofit any existing HP 85046A/B and HP 85047A S-parameter test set by replacing the mechanical RF test port switch with a solid-state RF switch. This solid-state switch allows for simultaneous measurement of forward and reverse parameters and continuous measurement of all 4 S-parameters (required for 2-port error correction).

The HP 86389A retrofits HP 85046A/B test sets, and the HP 86389B retrofits HP 85047A test sets. HP 8753B/C network analyzers with firmware revision 3.0 or higher support solid-state test sets. HP 8753A/B network analyzers with firmware revision 2.01 or lower must be upgraded (HP 11882A for the HP 8753A, HP 86388A for the HP 8753B). These kits include installation at an HP service center.

<sup>1</sup>Degrees, specified as deviation from linear phase.

<sup>2</sup>F max is the upper frequency limit of the associated test set.

<sup>3</sup>Can be improved through Accuracy Enhancement.



## Accessories

### HP 11850C/D Three-Way Power Splitters Specifications Summary

	HP 11850C	HP 11850D
<b>Impedance:</b>	50 $\Omega$	75 $\Omega$
<b>Frequency range:</b>	dc to 3 GHz	dc to 2 GHz
<b>Tracking:</b>	$\pm .25$ dB, $\pm 3^\circ$	$\pm .2$ dB, $\pm 2.5^\circ$
<b>Equivalent source match</b> (ratio or leveling):	30 dB @ 1.3 GHz	30 dB @ 1.3 GHz
<b>Nominal insertion loss:</b>	20 dB @ 3 GHz	20 dB @ 3 GHz
<b>Input port match:</b>	9.5 dB +1 dB/GHz	7.8 dB
<b>Input port match:</b>		
dc to 1.3 GHz	20 dB	20 dB
1.3 GHz to F max	10 dB	10 dB
<b>RF connectors</b>		
<b>RF input:</b>	50 $\Omega$ Type N (female)	50 $\Omega$ Type N (female)
<b>All others:</b>	50 $\Omega$ Type N (female)	75 $\Omega$ Type N (female)

### HP 11851B RF Cable Kit

This kit includes three 610 mm (24 in) 50  $\Omega$  cables phase matched to 4° at 1.3 GHz and one cable 860 mm (34 in). Connectors are Type N (male). Recommended for use with HP 85044A/B Transmission/Reflection Test Set and HP 11850C/D Power Splitter.

### HP 11852B 50 $\Omega$ /75 $\Omega$ Minimum Loss Pad

The HP 11852B is a low SWR minimum loss pad required for measurements on 75  $\Omega$  devices with the HP 8753C receiver.

**Frequency range:** dc to 2.0 GHz

**Insertion loss:** 5.7 dB

**Return loss:** 75  $\Omega$  typically  $\geq 30$  dB, 50  $\Omega$  typically  $\geq 26$  dB

**Maximum input power:** 250 mW (+24 dBm)

**RF Connectors:** 50  $\Omega$  Type N (female) and 75  $\Omega$  Type N (male)

### Type N Accessory Kits

Each kit contains a Type N (female) short, a Type N (male) short, two Type N (male) barrels, two Type N (female) barrels, and a storage case.

### HP 11853A 50 $\Omega$ Type N Accessory Kit

The HP 11853A accessory kit furnishes the RF components required for measurement of devices with 50  $\Omega$  Type N connectors using the HP 11850C, 85044A, 85046A, or 85047A.

### HP 11855A 75 $\Omega$ Type N Accessory Kit

The HP 11855A accessory kit furnishes the RF components required for measurement of devices with 75  $\Omega$  Type N connectors using the HP 11850D or 85044B. This kit also contains a 75  $\Omega$  Type N (male) termination.

\* F max is the upper frequency limit of the associated power splitter.

### BNC Accessory Kits

The BNC accessory kit contains two Type N (male) to BNC (female) adapters, two Type N (male) to BNC (male) adapters, two Type N (female) to BNC (female) adapters, two Type N (female) to BNC (male) adapters, a BNC (male) short, and a storage case.

### HP 11854A 50 $\Omega$ BNC Accessory Kit

The HP 11854A accessory kit furnishes the RF components required for measurement of devices with 50  $\Omega$  BNC connectors using the HP 11850C, 85044A, 85046A, or 85047A.

### HP 11856A 75 $\Omega$ BNC Accessory Kit

The HP 11856A furnishes RF components required for measurement of devices with 75  $\Omega$  BNC connectors using the HP 11850D, 85044B, or 85046B. This kit also contains a 75  $\Omega$  BNC (male) termination.

### HP 11857D 50 $\Omega$ APC-7 Test Port Cables

The HP 11857D includes two precision 61 cm (24 in) cables, phase matched to 2° at 1.3 GHz for use with the HP 85046A S-parameter test set. Connectors are 50  $\Omega$  APC-7.

### HP 11857B 75 $\Omega$ Type N Test Port Cables

The HP 11857B includes two precision 61 cm (24 in) cables, phase matched to 2° at 1.3 GHz for use with the HP 85046B S-parameter test set. One cable has 75  $\Omega$  Type N (male) connectors on both ends; the other has one Type N (male) and one Type N (female) connector.

### HP 11600B/11602B Transistor Fixtures

**Function:** Mounts on front of HP 85046A and 85047A S-Parameter Test Sets, holds devices for S-parameter measurements in a 50  $\Omega$  coax circuit.

### Transistor base patterns

**Model 11600B:** Accepts TO-18/TO-72 packages

**Model 11602B:** Accepts TO-5/TO-12 packages

**Calibration references:** short circuit termination and a 50  $\Omega$  through-section

**Frequency range:** dc to 2 GHz

**Impedance:** 50  $\Omega$  nominal

**Reflection coefficient:** <0.05, 100 MHz to 1.0 GHz: <0.09, 1.0 to 2 GHz

**Connectors:** Hybrid APC-7; Option 001, Type N (female)

### HP 11858A Transistor Fixture Adapter

The HP 11858A adapts the HP 11600B and 11602B transistor fixtures (vertical test port configuration) to the HP 85046A or 85047A S-parameter test set. Connectors are APC-7.

### HP 85043B Systems Cabinet

The HP 85043B systems cabinet has been ergonomically designed specifically for the HP 8753C and the HP 85046A/B or 85047A S-parameter test sets. The 122 cm (48 in) system cabinet includes a bookcase, a drawer, and a convenient work surface.

### Calibration Kits

Accuracy enhancement procedures characterize the systematic errors of the measurement system by measuring known devices (standards) on the system over the frequency range of interest. The calibration kits in the HP 8753C family contain precision standards with which to characterize the systematic errors of an HP 8753C measurement system.

### HP 85031B 7 mm Calibration Kit

The HP 85031B Calibration Kit contains a set of precision 7 mm fixed terminations, an open circuit, and a short circuit used to calibrate the HP 8753C and its 50  $\Omega$  test sets for measurement of devices with precision 7 mm connectors.

# NETWORK ANALYZERS

## Accessories (cont'd)

### HP 8753C Series

#### HP 85032B 50 $\Omega$ Type N Calibration Kit

The HP 85032B Calibration Kit contains precision 50  $\Omega$  Type N standards used to calibrate the HP 8753C and its 50  $\Omega$  test sets for measurement of devices with 50  $\Omega$  Type N connectors. Precision phase-matched 7 mm to 50  $\Omega$  Type N adapters are included for accurate measurements of non-insertable devices. Standards include fixed terminations, open circuits, and short circuits.

Option 001 is intended solely for use with the HP8752A network analyzer. Option 001 removes the precision phase-matched 7 mm to Type N adapters.

#### HP 85033C 3.5 mm Calibration Kit

The HP 85033C Calibration Kit contains precision 3.5 mm standards used to calibrate the HP 8753C and its 50  $\Omega$  test sets for measurement of devices with 3.5 mm and SMA connectors. Standards include fixed terminations, open circuits, and short circuits. Precision 7 mm to 3.5 mm adapters are included for accurate measurements of non-insertable devices.

Option 001 is intended solely for use with the HP 8752A network analyzer. Option 001 removes the precision phase-matched 7 mm to 3.5 mm adapters.

#### HP 85036B 75 $\Omega$ Type N Calibration Kit

The HP 85036B Calibration Kit contains precision 75  $\Omega$  Type N standards used to calibrate the HP 8753C and its 75  $\Omega$  test sets for measurement of devices with 75  $\Omega$  Type N connectors. Standards include fixed terminations, open circuits, and short circuits. Precision phase-matched adapters are included for accurate measurements of non-insertable devices.

#### Verification Kits

Measuring known devices, other than the calibration standards, is a convenient way of verifying that the HP 8753C measurement system is operating properly.

#### HP 85029B 7 mm Verification Kit

The HP 85029B Verification Kit contains a set of precision 7 mm devices, with data traceable to NIST, used to verify the calibrated performance of an HP 8753C measurement system. The devices have precision 7 mm connectors and include a 20 dB pad, a 50 dB pad, and a mismatch attenuator. The verification process requires only an HP 85031B calibration kit, an HP 85029B verification kit, and an external 3.5-inch disk drive connected to the HP 8753C.

Option 001 is intended solely for use with the HP 8702B Lightwave Component Analyzer. Option 001 adds verification data that is compatible with the HP 8702B.

#### Software

Software operates with a BASIC operating system, using an HP Series 300/400 computer (2 MB of memory required).

#### HP 85160A Measurement Automation Software

Measurement automation software simplifies device measurements by providing guided measurements, limit testing, sequencing to test all four S-parameters, data formatting flexibility (data files can be formatted to be compatible with Touchstone® linear circuit simulation programs), and complete save/recall capability to a floppy disk. After it is configured, you simply recall a test file and calibration data, connect the device under test, and output the results.

#### HP 85165A Resonator Measurement Software

Resonator measurement software performs complete characterization of crystals, SAWs, and other resonant devices using the HP 8753C. The software guides the user through the measurement process and calculates key parameters of the device under test according to the EIA-512 resonator measurement standard.

#### Systems

Two measurement systems are available that will increase measurement efficiency in research and development and production.

#### HP 8753C Option E02 S-Parameter/Noise Figure Measurement System

Combining the capabilities of the HP 8753C Network Analyzer, the HP 8970B Noise Figure Meter, and a specially designed S-Parameter Test Set, this system allows your key amplifier measurements of gain, phase/linearity, and noise figure to be made through a single RF test port connection.

#### HP 8753C Option E20 Frequency Converter Measurement System

The HP 8753C Option E20 test system combines the capabilities of the HP 8753C Network Analyzer and a specially designed test set to characterize frequency converter performances with a single RF connection. Make measurements of:

- Conversion loss
- Compression
- Group delay
- Amplitude/phase tracking
- RF and IF port SWR
- IO feedthrough
- Isolation (RF/IF and IF/RF)
- Output power

#### Ordering Information

	Price
<b>HP 8753C</b> Network Analyzer	\$26,500
<b>Opt 002</b> Harmonic Measurement Capability	+ \$3,500
<b>Opt 006</b> 6 GHz Receiver Option	+ \$3,500
<b>Opt 010</b> Time Domain Capability	+ \$5,300
<b>Opt 802</b> Add Dual Disk Drive and Cable	+ \$1,745
<b>Opt 908</b> Rack Mount Kit (w/o handles 5062-3978)	+ \$35
<b>Opt 910</b> Extra Manual (08753-90153)	+ \$150
<b>Opt 913</b> Rack Mount Kit (w/handles 5062-4072)	+ \$40
<b>Opt E02</b> S-Parameter-Noise Figure Measurement System	+ \$37,650
<b>Opt E20</b> Frequency Connector Measurement System	+ \$40,115
<b>HP 85047A</b> 50 $\Omega$ S-Parameter Test Set—6 GHz	\$10,800
<b>Opt 009</b> Mechanical Test Port Switch	- \$1,000
<b>Opt 913</b> Rack Mount Kit (5062-4069)	+ \$40
<b>HP 85046A</b> 50 $\Omega$ S-Parameter Test Set—3 GHz	\$9,000
<b>Opt 009</b> Mechanical Test Port Switch	- \$1,000
<b>Opt 913</b> Rack Mount Kit (5062-4069)	+ \$40
<b>HP 85046B</b> 75 $\Omega$ S-Parameter Test Set—3 GHz	\$9,000
<b>Opt 009</b> Mechanical Test Port Switch	- \$1,000
<b>Opt 913</b> Rack Mount Kit (5062-4069)	+ \$40
<b>HP 85044A</b> 50 $\Omega$ Transmission/Reflection Test Set	\$3,200
<b>HP 85044B</b> 75 $\Omega$ Transmission/Reflection Test Set	\$3,700
<b>HP 85029B</b> Precision 7 mm Verification Kit	\$1,600
<b>Opt 001</b> Data for HP 8702B	\$0
<b>HP 85031B</b> Precision 7 mm Calibration Kit	\$1,200
<b>HP 85032B</b> 50 $\Omega$ Type N Calibration Kit	\$1,600
<b>Opt 001</b> Deletes 7 mm to Type N adapters	- \$500
<b>HP 85033C</b> Precision 3.5 mm Calibration Kit	+ \$2,500
<b>Opt 001</b> Deletes 7 mm to 3.5 mm adapters	- \$500
<b>HP 85036B</b> 75 $\Omega$ Type Calibration Kit	\$2,000
<b>HP 85043B</b> Systems Rack	\$3,200
<b>HP 85160A</b> Measurement Automation Software	\$1,550
<b>HP 85165A</b> Resonator Measurement Software	\$5,000
<b>HP 11882A</b> Upgrade Kit for HP 8753A	\$3,400
<b>HP 11883A</b> Harmonic Measurements (Opt 002) Upgrade	\$3,500
<b>HP 11884A</b> 6 GHz Receiver (Opt 006) Upgrade	\$3,500
<b>HP 85019A</b> Time Domain (Opt 010) Upgrade (HP 8753A)	\$5,300
<b>HP 85019B</b> Time Domain (Opt 010) Upgrade (HP8753B/C)	\$5,300
<b>HP 86388A</b> Upgrade Kit for HP 8753B (Rev. 3.00)	\$300
<b>HP 86389A</b> Solid-State Switch Upgrade Kit (for HP 85046A/B test sets)	\$1,500
<b>HP 86389B</b> Solid-State Switch Upgrade Kit (for HP85047A test sets)	\$1,500
<b>HP 11850C</b> 50 $\Omega$ Power Splitter	\$950
<b>HP 11850D</b> 75 $\Omega$ Power Splitter	\$1,500
<b>HP 11851B</b> 50 $\Omega$ /Type N RF Cable Kit	\$950
<b>HP 11852B</b> 50 $\Omega$ /75 $\Omega$ Minimum Loss Pad	\$400
<b>HP 11853A</b> 50 $\Omega$ Type N Accessory Kit	\$400
<b>HP 11854A</b> 50 $\Omega$ BNC Accessory Kit	\$400
<b>HP 11855A</b> 75 $\Omega$ Type N Accessory Kit	\$500
<b>HP 11856A</b> 75 $\Omega$ BNC Accessory Kit	\$500
<b>HP 11857B</b> 75 $\Omega$ Type N Test Port Extension Cables	\$1,455
<b>HP 11857D</b> 50 $\Omega$ APC-7 Test Port Extension Cables	\$1,050
<b>HP 11600B/11602B</b> Transistor Fixtures	\$1,800
<b>HP 11858A</b> Transistor Fixture Adapter	\$980

☎ For off-the-shelf shipment, call 800-452-4844.

- Two accessories to complete turnkey systems for characterizing materials
- Determines permittivity (dielectric constant) or permeability
- Fast, convenient, wide frequency range
- Compatible with most RF and microwave network analyzers



HP 85070A

### Materials Measurements

Materials have two properties that determine how they interact with electromagnetic fields:

- Permittivity or dielectric constant (including loss factor)
- Permeability (including magnetic losses)

There are several reasons for measuring these properties at high frequencies:

Materials are used in state-of-the-art RF/microwave components, such as substrates, capacitors, ferrites, insulators, resonators/filters, radomes, absorbers, shielding, etc. Materials should be characterized or inspected to achieve best performance while minimizing scrap.

High-power microwave processing offers unique advantages over conventional heating. A material's dielectric loss factor should be determined in order to correctly apply and optimize dielectric heating processes.

Dielectric measurements are useful analysis tools because dielectric properties correlate directly with other material properties, such as moisture content, phase transitions, molecular structure, polarizability, and relaxation constants.

### HP 85070A Dielectric Probe Kit

Measure dielectric properties of materials quickly and conveniently with the HP 85070A dielectric probe kit. The measurement is nondestructive and requires no sample preparation, saving you time, trouble, and material. Dip the probe into liquids and semi-solids; there is no need for special containers. For solid materials, press the probe against a single flat face.

The system yields permittivity, dielectric constant, loss factor, loss-tangent, or Cole-Cole diagrams—versus frequency—from 200 MHz to 20 GHz (depending on network analyzer and material). Accuracy is typically 5%.

The HP 85070A kit includes its own software dedicated to the probe.

### HP 85071A Materials Measurements Software

The HP 85071A software calculates materials properties from S-parameter measurements of samples loaded in a transmission line. This fixture can be either coaxial (inherently broadband) or rectangular waveguide (banded, but with simpler sample shapes).

Choose from several different models in the software to suit your material:

- The traditional method (described in Product Note 8510-3) measures both dielectric and magnetic materials (such as ferrites and absorbers), and yields both  $\epsilon_r^*$  and  $\mu_r^*$ .
- Two other methods determine  $\epsilon_r^*$  of nonmagnetic materials, but eliminate spurious data at periodic frequencies. One is also insensitive to the location of the sample in the fixture, so you do not need to know or carefully control position.
- A simpler 1-port method measures  $\epsilon_r^*$  using only reflection data.

The method yields 1% to 2% accuracy (typical) from 100 MHz to 110 GHz, depending on the material, fixture, and network analyzer.

### Complete Systems

A complete broadband system includes the HP 85070A or 85071A, with a network analyzer and controller. (The HP 85071A also requires a fixture, in coax or waveguide.)

Both the HP 85070A and 85071A are compatible with all the leading RF/microwave network analyzers: HP 8752, 8753, 8719, 8720, and 8510. Choose the analyzer to match your frequency range needs and budget.

The software from both is available for either HP Vectra PCs (or other 100%-compatible PC-AT computers with MS-DOS) or HP 9000 series 300 BASIC controllers (with Option 300).

### Other Solutions

Many other techniques, based on RF or microwave network analyzers, offer unique advantages. For example, free space methods are non-contacting and suitable to temperature extremes.

Resonator (cavity) methods provide the highest accuracy and sensitivity to low-loss materials. Contact HP with your special needs.

At frequencies below 15 MHz, the HP 16451B dielectric test fixture (coupled with an LCR meter or impedance analyzer) provides accurate measurements of materials.

### Ordering Information

	<b>Price</b>
<b>HP 85070A</b> Dielectric Probe Kit (with its software)	\$3,950
<b>Opt 300</b> Substitute HP BASIC Software	\$0
<b>HP 85071A</b> Materials Measurement Software	\$4,000
<b>Opt 300</b> Substitute HP BASIC Software	\$0
<b>HP 85075A</b> Extra Probe	\$500

# NETWORK ANALYZERS

Microwave Network Analyzers, 50 MHz to 40 GHz

HP 8719C, 8720C, 8722A, 85014C, 85162A

- 50 MHz to 13.5, 20, or 40 GHz frequency range
- Fast-sweeping synthesized source built in
- Integrated switching S-parameter test set
- Vector receiver, error correction, time domain
- Direct save/recall to an external disk drive
- Up to 103 dB dynamic range

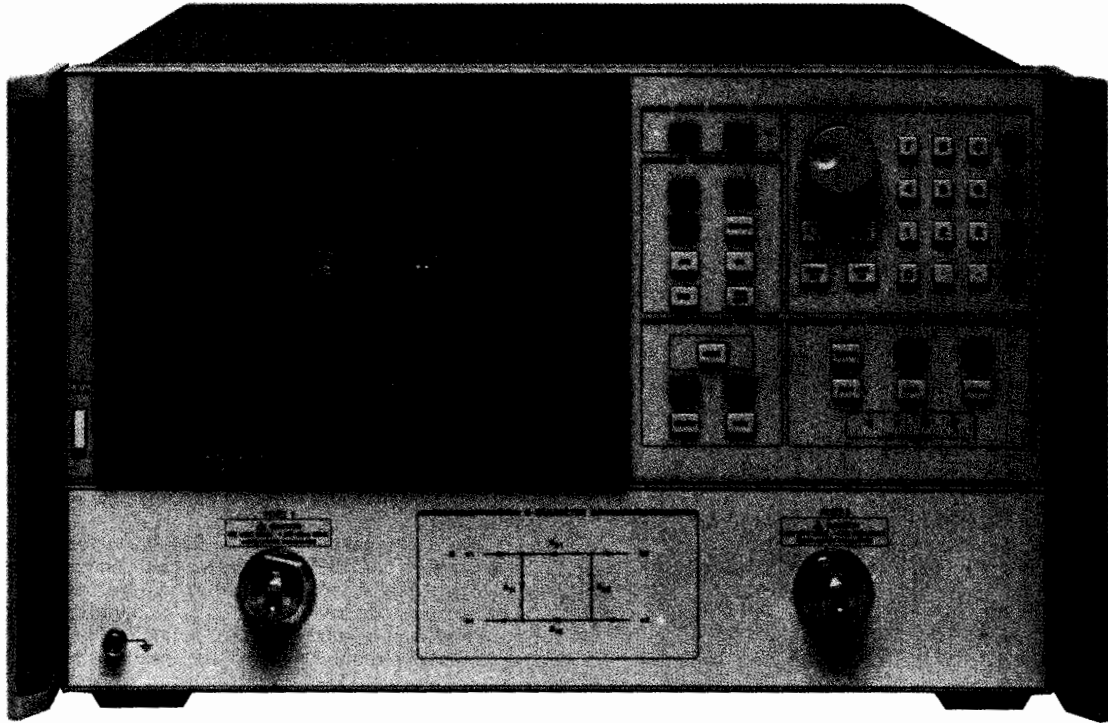

HP 8722A

## HP 8720 Series Network Analyzers

The HP 8719C, 8720C, and 8722A vector network analyzers characterize RF/microwave components down to 50 MHz and up to 40 GHz. These network analyzers include a fast-sweeping source, S-parameter test set, tuned receiver, and large color display in a single package. Their integrated design makes the HP 8720 series compact, economical, and easy to use. They are ideal choices for cost- or space-conscious engineers in research and development, manufacturing, incoming inspection, or quality assurance.

### Affordable Analyzers with Excellent Performance

Despite their affordable price, the HP 8720 series network analyzers offer remarkable performance. The integral source is fully synthesized, even while sweeping, and provides stability and accuracy within 10 ppm (typical). Yet the sweep rate is extremely fast: measurement update times are typically about 1 ms per point. Frequency resolution is 100 kHz standard; Option 001 provides 1 Hz resolution for narrow-band or long-delay devices.

The tuned receivers with variable-bandwidth IF filters provide up to 103 dB of dynamic range. A built-in switching test set measures all 4 S-parameters (both forward and reverse) with a single connection.

Two independent channels can simultaneously display two measurements, such as reflection and transmission responses. The receiver detects both magnitude and phase, and displays results in a variety of useful formats, including group delay, deviation from linear phase, complex impedance, and SWR—on rectangular, polar, or Smith charts.

Built-in vector accuracy enhancement provides excellent error-corrected accuracy in all common coaxial connectors. A user kit supports user-defined standards, and allows calibration in waveguide (including effects of dispersion). Choose from a simple response normalization to full 2-port error correction. Or use TRL\* to measure non-coaxial devices (e.g. microstrip) in a fixture. In addition, the frequency subset feature lets you zoom in on a response without recalibrating.

### Powerful Features for Active Devices

With +10 dBm at their test ports, the HP 8719C and 8720C have plenty of power for testing amplifiers. For sensitive small-signal devices, the built-in step attenuator can cut power back to -65 dBm. Absolute power levels can be set accurately anywhere in the system, using the power meter calibration feature. Power sweep capability and power resolution of 0.1 dB make it easy to test the gain-compression characteristics of active components. In addition, there are 2 internal tees for biasing transistors through the test ports.

### In-Fixture Device Characterization

Use TRL\* calibration to minimize fixture errors, which would otherwise dominate the measurement of non-coaxial devices (such as microstrip). Or combine the network analyzer with a wafer-probing station, to measure devices while still on the wafer. Electronic port extensions and gating are also available to enhance accuracy.

### Time Domain and Fault Location

Time domain capability (Option 010) computes and displays the response versus time or distance (instead of frequency) of the device under test (DUT). Use time domain to locate and quantify individual faults or discontinuities in a network. Apply the gating feature to remove the effects of unwanted reflections (separated in time), then view the DUT's true response versus frequency.

### Time-Saving Productivity Features

Limit test capability makes pass/fail decisions quantitative and decisive. Define up to 22 test limits per channel, based on the specifications of your components. Tuning is faster, and testing is more consistent.

To document results without a computer, the copy feature sends the entire display to a compatible plotter or printer. A built-in buffer controls the peripheral while you continue with the next measurement.

Annotate specific trace features with markers — up to 5 per channel, all displayed at once. Advanced marker functions track a maximum or minimum point (while tuning), or compute the delta between 2 markers. For bandpass filters, markers automatically calculate center frequency, bandwidth, and Q.

With save/recall capability, an experienced user can define and save test configurations for each DUT. Other users can recall identical conditions later, and align or test each DUT consistently. Use 5 internal non-volatile memory registers, or save/recall directly to an external CS80 disk drive.

### Flexible Configuration for Systems

Option 011 deletes the couplers and transfer switch, providing direct access to the source output and 3 inputs. Build your own test set or switch matrix for high power, tracking, or multi-port devices. Or create an economical system with excellent sensitivity for RCS and near-field antenna test. Use the external TTL trigger to acquire over 300 points per second with precise timing.

### Accessories

Configure a complete measurement system with test port cables, calibration kits, verification kits, and adapters. Waveguide calibration kits are available in X, P (Ku), K, and R (Ka) bands, covering 8.2 to 40 GHz. The HP 8720 family network analyzers use the same precision calibration standards and rugged flexible cables as the industry-standard HP 8510.

### Software Enhances Measurement Capability

Automate these network analyzers with a desktop computer via HP-IB. The HP 85162A measurement automation software guides you through measurements and simplifies test configurations. With the HP 85014C active device measurement software, you can measure transistors quickly and completely. This software includes models to de-embed the HP 85041A transistor fixture, and also controls the bias supply.

Measure the dielectric properties of materials quickly and non-destructively with the HP 85070A dielectric probe kit (including software). For greater accuracy and flexibility, use the HP 85071A materials measurement software, for samples loaded into waveguide or coaxial fixtures.

### Specifications Summary

Data applies at  $23^{\circ} \pm 3^{\circ}$  C. See product literature for total measurement uncertainty after error correction.

Model	HP 8719C	HP 8720C	HP 8722A
Minimum frequency	50 MHz	50 MHz	50 MHz
Maximum frequency	13.5 GHz	20 GHz	40 GHz
Frequency resolution (std)	100 kHz	100 kHz	100 kHz
With Opt 001	1 Hz	1 Hz	1 Hz
Frequency accuracy	10 ppm	10 ppm	10 ppm
Maximum power	+10 dBm	+10 dBm	-15 dBm
Minimum power	-65 dBm	-65 dBm	-65 dBm
Power resolution	0.1 dB	0.1 dB	0.1 dB
Power flatness	$\pm 2.0$ dB	$\pm 2.0$ dB	$\pm 3.0$ dB
Power sweep range	20 dB	20 dB	10 dB
Receiver sensitivity (> 2 GHz)	-93 dBm	-93 dBm	-91 dBm
With Opt 011	-113 dBm	-113 dBm	-113 dBm
System dynamic range (> 2 GHz)	103 dB	103 dB	75 dB
With Opt 003	N/A	N/A	84 dB
Test port connector	3.5 mm	3.5 mm	2.4 mm

Measurement rate (typical, 201-point sweep): <2 ms/point (1-port) to <5 ms/point (full 2-port)

HP-IB functions: SH1, AH1, T6, TE0, L4, LE0, SR1, RL1, PP0, DC1, DT0, C0, C1, C10, E2

Size: 267 mm H  $\times$  425 mm W  $\times$  533 mm D (10.5 in  $\times$  16.75 in  $\times$  19.75 in), excluding connectors

Weight: Net, 34 kg (75 lb); shipping, 40 kg (88 lb)

### Ordering Information

HP 8719C Network Analyzer (50 MHz to 13.5 GHz) \$45,500

HP 8720C Network Analyzer (50 MHz to 20 GHz) \$57,000

HP 8722A Network Analyzer (50 MHz to 40 GHz) \$75,000

The following options apply to all 3 network analyzers:

Opt 001 1 Hz Frequency Resolution +\$9,500

Opt 003 High Forward Dynamic Range \$0

Opt 010 Time Domain Capability +\$9,000

Opt 011 Direct-Access Receiver Configuration -\$4,000

Opt 802 Add HP 9122C Dual Disk Drive +\$1,545

Opt 913 Rack Mount Kit (#5062 - 4071) +\$40

Opt W30 Extended Repair Service (see page 671)

Opt W31 On-Site Repair Service (see page 671)

Opt W32 Calibration Service (see page 671)

HP 85014C Active Device Measurement Software (see page 311)

HP 85162A Measurement Automation Software \$1,500

One media option must be selected:

Opt 630 for 3.5-inch disk media \$0

Opt 655 for 5.25-inch disk media \$0

# NETWORK ANALYZERS

## Microwave Network Analyzers, 45 MHz to 110 GHz

### HP 8510 Series

- 45 MHz to 110 GHz frequency range
- Real-time error-corrected measurements
- 60 dB effective directivity and source match

- 80 dB to 100 dB dynamic range
- 0.001 dB, 0.01 degree, 0.01 nanosecond measurement resolution
- Time domain analysis

HP 8510C

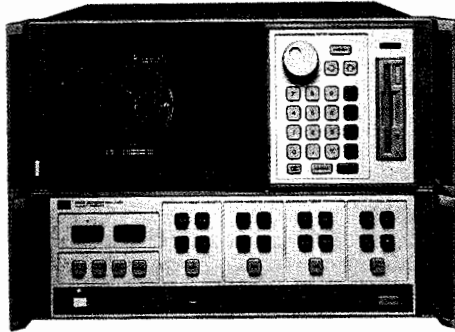

### HP 8510 Series Microwave Network Analyzers

The HP 8510 series microwave vector network analyzers provide a complete solution for characterizing the linear behavior of either active or passive networks over the 45 MHz to 50 GHz frequency range. A complete system comprises the HP 8510C network analyzer, an S-parameter test set, and a compatible RF source. For millimeter-wave measurement needs, complete systems operating to 110 GHz can be configured. For compatible lightwave measurement products, see page 383.

Measurement results can be displayed on a large, color CRT on one of two independent, yet identical, channels. The channels may be displayed individually, or simultaneously, with results presented in either log/linear magnitude, phase, or group delay format on rectangular or polar coordinates. Direct measurement of impedance is possible with the Smith chart format. The value and frequency of the data can be read with one of five independent markers. The CRT display can be copied directly to a plotter, such as the HP 7440A, 7475A, or 7550A. For increased productivity a plotter buffer is available. Also, a list of measurement data can be sent to an external printer such as the HP 2225A.

Powerful measurement enhancement functions are also available. Data averaging can be employed to narrow the effective receiver IF bandwidth, extending dynamic range and increasing signal-to-noise ratio. Trace smoothing aids in the interpretation of measurement results and is used to control the aperture of group delay measurements. Electrical length measurements are accomplished with the electrical delay function.

Built-in storage provides the capability to save and recall up to eight different front-panel states, eight separate calibrations, and eight separate measurements in nonvolatile memory. Extension of the internal storage capacity is possible via the built-in 3½-inch disc drive or an external disc drive.

### High Performance

Along with the capability to completely characterize a microwave network with a single connection over the extremely broad 45 MHz to 50 GHz frequency range, the HP 8510 system offers wide dynamic range. Depending on the test set used, 80 dB to 100 dB of dynamic range is available. The precision IF processing and detection system contributes as little as  $\pm 0.05$  dB and  $\pm 0.5$  degree measurement uncertainty at a level of 50 dB below the reference. Meaningful resolutions of 0.001 dB, 0.01 degree, and 0.01 nanosecond are easily available.

### Real-Time Error Correction

The HP 8510's built-in, high speed computer provides the capability to characterize and effectively remove the impact of systematic errors through accuracy enhancement techniques. Effective directivity and source match can be improved to as much as 60 dB. The data processing speed of the system is such that a fully error-corrected, 401 point trace of data is updated in under one second. This virtual "real-time" display of error-corrected data means that you can easily adjust your test device while it's being measured, with the assurance that you are viewing the data at the highest possible accuracy.

### Time Domain Analysis

The HP 8510 (with Option 010) has the capability of displaying the time domain response of a network, obtained by computing the Inverse Fourier Transform of the frequency domain response. The time domain response displays the reflection coefficient of the network versus time, which displays the magnitude and location of each individual discontinuity, or else the transmission coefficient versus time, which displays each individual transmission path.

### Pulsed-RF Measurement Capability.

For the measurement of pulsed-RF devices the HP 8510C can be equipped with wideband IF detectors (Option 008). When configured with a compatible test set (HP 85110A), the system can measure pulse widths as narrow as 1 usec on devices with output power up to 20 W (CW). Measurement formats include magnitude and phase versus frequency or time (pulse profile).

### RF Sources

The recommended system source for the HP 8510C is the HP 8360 synthesized sweeper. It provides 1 Hz frequency resolution, phase-locked narrowband sweeps, and fully synthesized start frequencies for broadband ramp sweeps. All HP 8360-series synthesized sweepers are compatible with the HP 8510C. However, the HP 83621A (20 GHz), 83631A (26 GHz), and 83651A (50 GHz) models are optimized for HP 8510C system operation. Both the HP 8340-series synthesized sweeper and HP 8350B-series sweep oscillators are also compatible with the HP 8510C.

### System Rack

#### HP 85043A System Rack Kit

The HP 85043A system rack stands 128 cm (50.5 in) high, 60 cm (23.6 in) wide, and 80 cm (31.5 in) deep. Complete with support rails and ac power distribution (suitable for 50 to 60 Hz, and 110 to 240 Vac), it includes rack mounting hardware for all instruments. Thermal design is such that no rack fan is needed.

### System Software

#### HP 85161B measurement automation software

The HP 85161B measurement automation software provides a more simplified and flexible user interface to the HP 8510C system. The program leads the operator through the measurement sequence one step at a time, from system setup and calibration, to device measurement and hardcopy output. Complete measurement configurations can be saved to disc for later recall. Also, data printout formats can be customized by the operator.

The HP 85161B software is designed for use with HP 9000 Series 200 or 300 computers and the BASIC operating system (5.0 or higher).

### Ordering Information

	Price
HP 8510C Network Analyzer	\$34,900
Opt 008 Pulsed-RF Measurement Capability	+ \$10,230
Opt 010 Time Domain Capability	+ \$10,000
Opt W31 On-Site Repair Service, see page 671	+ \$1,150
HP 85043A System Rack Kit	\$3,130
HP 85161B Measurement Automation Software	\$1,550

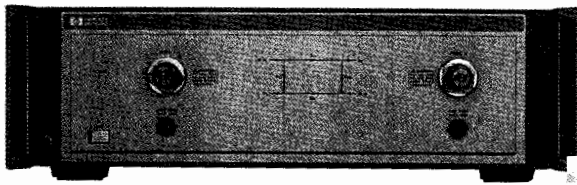

HP 8517A

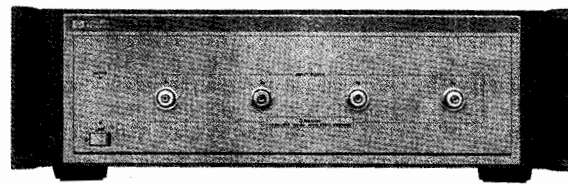

HP 8511B

### S-Parameter Test Sets

Several S-parameter test sets are available for the HP 8510C network analyzer for broadband coaxial measurements from 45 MHz to 50 GHz. The HP 8514B, 8515A, 8516A, and 8517A test sets have an architecture that develops a separate reference channel for each incident port. RF switching is done with a built-in electronic switch. For active device measurements, the test sets include the ability to apply dc bias (external) to the test port center conductors. Also available are two 90 dB step attenuators (60 dB in the HP 8516A/8517A) which allow control of the port 1 and port 2 signal levels.

### Pulsed-RF Measurement Test Set

The HP 85110A test set is specially configured for operation in pulsed-RF measurement systems (HP 85108). Four 90 dB step attenuators protect each input of the fundamentally-mixed down converter to allow measurement of test devices with output power of 20 watts CW.

### Test Set General Information

	HP 8514B	HP 8515A	HP 8518A	HP 8517A	HP 85110A
Frequency range (GHz)	0.045 to 20	0.045 to 26.5	0.045 to 40	0.045 to 50	2 to 20
Test ports (port 1 or 2): Nominal Operating Power Level (dBm)	0 to -5	-5 to -25	-10 to -18	+3 to -13	0 to -3
Test Port Connector Type	3.5 mm (M)		2.4 mm (M)		3.5 mm (M)
Impedance DC Bias	50 ohm nominal 500 mA, 40 Vdc maximum				
Attenuation Range (incident signal)	0 to 90 dB, in 10 dB steps (0 to 60 dB for HP 8516A and 8517A)				

### Frequency Converters

With the HP 8511A (26.5 GHz) and 8511B (50 GHz) frequency converters, the HP 8510 becomes a general-purpose four-channel magnitude/phase receiver. Add your own power splitters for transmission measurements, and bridges or directional couplers for reflection measurements. Since one input is used for system phase-lock, the other three inputs are available for measurements of multi-port devices, subsystems, and antennas. All four inputs have precision 3.5 mm (HP 8511A) or 2.4 mm (8511B) connectors.

### Multiple Test Set Operation

A single HP 8510C system may be configured with two test sets. In this configuration the test sets have different addresses, and the user may select between them from the front panel of the HP 8510 without reconnections. This capability is useful, for example, when combining a microwave coaxial test set with a millimeter-wave test set in the same HP 8510 system.

IF switching (Option 001): In the multiple test set configuration, the 20 MHz IF signal is daisy-chained from the test sets to the HP 8510. This capability requires test set Option 001 in one of the two test sets.

The RF signal must be routed to the desired test set using a coaxial RF switch and an HP 11713A switch driver. The switch driver is controlled automatically by the HP 8510C over the 8510 system interface bus.

### Ordering Information

<b>HP 8511A Frequency Converter</b>	\$19,700
Opt 001 Add IF Switching	+ \$2,600
Opt W31 On-Site Repair Service (see page 671)	+ \$1,150
<b>HP 8511B Frequency Converter</b>	\$23,000
Opt 001 Add IF Switching	\$2,500
Opt W31 On-Site Repair Service (see page 671)	+ \$860
<b>HP 8514B S-Parameter Test Set</b>	\$28,300
Opt 001 Add IF Switching	+ \$2,600
Opt 002 Delete Step Attenuators and Bias Tees	- \$6,500
Opt 003 High Forward Dynamic Range	\$0
Opt W31 On-Site Repair Service (see page 671)	+ \$1,270
<b>HP 8515A S-Parameter Test Set</b>	\$39,400
Opt 001 Add IF Switching	+ \$2,600
Opt 002 Delete Step Attenuators and Bias Tees	- \$7,000
Opt W31 On-Site Repair Service (see page 671)	+ \$1,595
<b>HP 8516A S-Parameter Test Set</b>	\$41,200
Opt 001 Add IF Switching	+ \$2,600
Opt 002 Delete Step Attenuators and Bias Tees	- \$7,000
Opt 003 High Forward Dynamic Range	\$0
Opt W31 On-Site Repair Service (see page 671)	+ \$1,395
<b>HP 8517A S-Parameter Test Set</b>	\$41,000
Opt 001 Add IF Switching	+ \$2,600
Opt 002 Delete Step Attenuators and Bias Tees	- \$7,500
Opt W31 On-Site Repair Service (see page 671)	+ \$1,350
<b>HP 85110A Pulsed-RF S-Parameter Test Set</b>	\$55,000
Opt 001 Add IF Switching	+ \$2,500
Opt W31 On-Site Repair Service (see page 671)	+ \$1,935

# NETWORK ANALYZERS

## Millimeter-Wave and Lightwave Test Sets Measurement System

### HP 8510 Series

The HP 8510C system can easily be configured for making measurements at millimeter-wave frequencies. Hewlett-Packard offers hardware for configuring systems in the 33 to 50 GHz, 40 to 60 GHz, 50 to 75 GHz, and 75 to 110 GHz waveguide bands. These S-parameter configurations allow both forward and reverse measurements to be made with a single connection to the device under test. The greatest convenience and highest accuracy is assured through the TRL (Through-Reflect-Line) calibration technique.

#### HP 85106C Millimeter-Wave Network Analyzer Subsystem

The HP 85106C millimeter-wave network analyzer subsystem includes an HP 8510C network analyzer, an HP 85105A millimeter-wave controller, an HP 83621A synthesized source, and an HP 8350B/83540A source (LO), all mounted in a single bay rack with extendable worksurface. The system setup disk makes the retrieval of system states fast and easy. System installation at your facility and one year of on-site service are included with the HP 85106C at no additional cost. Two HP 85104A series test set modules are required to complete the system. Precision calibration kits and verification kits are also available for these waveguide bands.

The HP 85106C can be configured as a combination microwave/millimeter-wave S-parameter system with Option 001. This option adds an HP 851A microwave test set, 50 GHz source (83651A), HP 85133D test port return cable set, HP 85056A calibration kit, and appropriate cabling for convenient switching between millimeter-wave operation and microwave operation with no re-connections required.

The HP 8510C's external phase-locked control allows the use of the economical HP 8350B sweep oscillator as the local oscillator (LO) source. However, a synthesizer can also be used as the LO source when faster measurement speeds are desired. Option 002 substitutes an HP 83621A synthesized source for the HP 8350B/83540A source as the LO.

Option 010 adds time domain capability to the HP 8510C for transferring frequency domain data to the time domain for observing the effects of impedance discontinuities as a function of distance or time.

#### HP 85104A Series Test Set Modules

An HP Q/U/V/W 85104A test set module contains all of the necessary waveguide hardware (frequency multiplier, isolators, directional couplers, and harmonic mixers) compactly integrated into one box. Any pair of the test set modules can be connected to the HP 85105A millimeter-wave controller for S-parameter millimeter-wave measurement capability. These modules are easy to maneuver and make the system extremely simple to set up.

#### HP 11644A Series Calibration Kits

Each HP Q/U/V/W 11644A precision calibration kit contains two straight waveguide test port sections with precision flanges, a flush short circuit, a precision quarter-wavelength shim, and a sliding or fixed load termination. In addition to providing the "offset" for the offset short and offset load, the shim is also used as the "line" standard for a TRL calibration. The standards in the kit allow you to take full advantage of the built-in accuracy enhancement and data processing features of the HP 8510C.

#### HP 11645A Series Verification Kits

Each HP Q/U/V/W 11645A verification kit contains a standard section, a mismatch section, and a 20 dB and 50 dB attenuator. The devices in the kit are shipped with nominal data and uncertainties traceable to the US National Institute of Standards and Technology (NIST).

#### Ordering Information

	Price
<b>HP 85106C</b> Millimeter-Wave Network Analyzer Subsystem	\$122,500
<b>Opt 001</b> Add Microwave Test Set (HP 8517A), 50 GHz source (83651A), and 2.4 mm Accessories	+ \$71,000
<b>Opt 002</b> Synthesized LO (HP 83621A) for the fastest measurement speed	+ \$18,900
<b>Opt 010</b> Add Time Domain Capability to the HP 8510C	+ \$10,000

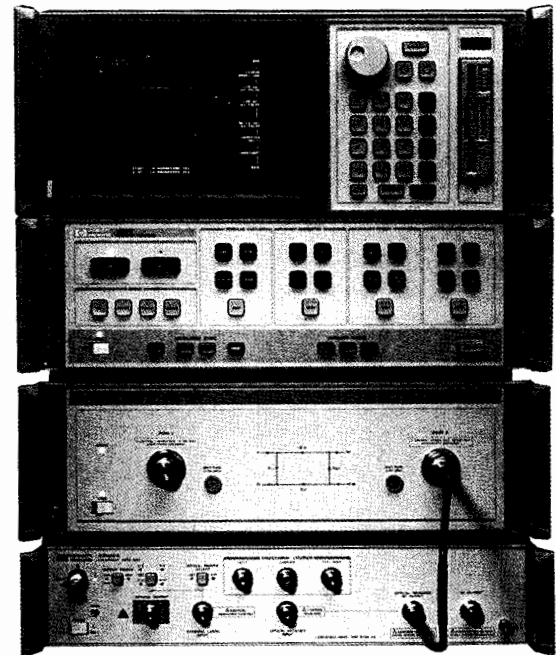

HP 8510C/83420A Lightwave Component Analyzer System

#### Test Set Modules (order 2 each)

<b>HP Q85104A</b> WR-22 (33 to 50 GHz) Test Set Module	\$28,000
<b>HP U85104A</b> WR-19 (40 to 60 GHz) Test Set Module	\$29,000
<b>HP V85104A</b> WR-15 (50 to 75 GHz) Test Set Module	\$32,000
<b>HP W85104A</b> WR-10 (75 to 110 GHz) Test Set Module	\$35,000
<b>Calibration Kits</b>	
<b>HP Q11644A</b> WR-22 (33 to 50 GHz) Calibration Kit	\$3,850
<b>HP U11644A</b> WR-19 (40 to 60 GHz) Calibration Kit	\$4,200
<b>HP V11644A</b> WR-15 (50 to 75 GHz) Calibration Kit	\$4,200
<b>HP W11644A</b> WR-10 (75 to 110 GHz) Calibration Kit	\$4,400
<b>Verification Kits</b>	
<b>HP Q11645A</b> WR-22 (33 to 50 GHz) Verification Kit	\$4,750
<b>HP U11645A</b> WR-19 (40 to 60 GHz) Verification Kit	\$4,750
<b>HP V11645A</b> WR-15 (50 to 75 GHz) Verification Kit	\$4,750
<b>HP W11645A</b> WR-10 (75 to 110 GHz) Verification Kit	\$4,750

#### HP 83420A Lightwave Test Set

The HP 8510 microwave network analyzer can be extended to calibrated, lightwave measurements using the 20 GHz HP 83420A lightwave test set.

The HP 83420A contains a 1300 nm or 1550 nm lightwave source (Fabre Perot or DFB laser), receiver and lightwave directional coupler (for reflection measurements). It combines with existing HP 8510 analyzers for swept 130 MHz to 20 GHz optical and electrical testing of small-signal-sinusoidal transmission and reflection characteristics. Lightwave devices like lasers, photodiodes, optical modulators and optical amplifiers can be tested for modulation bandwidth, optical return loss and differential phase response. Data can be displayed in appropriate frequency and distance-time domain formats.

The HP 8510/83420 system is easy to operate since step-by-step measurement instructions can be provided when the HP 83420A test set program is run on an appropriate computer.

#### Ordering Information

	Price
<b>HP 83420A</b> Lightwave Test Set	\$47,500
<b>Opt 01X</b> Select optical connector	\$0
<b>Opt 100</b> External lightwave source input	\$2,800
<b>Opt 210</b> 1550 nm DFB laser	\$15,000
<b>Opt 220</b> 1300 nm DFB laser	\$10,500



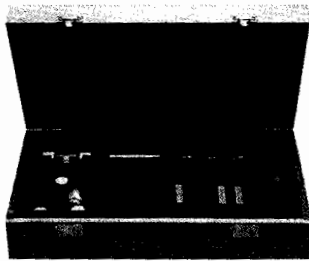

HP 85041A



HP 83040A

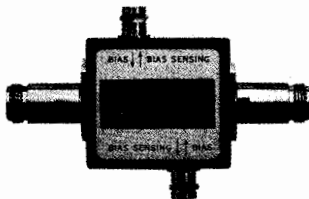

HP 11590B



HP 11612A

### Active Device Test

Hewlett-Packard offers an extensive array of accessories designed for the needs of active device test and measurement, including fixtures, bias supplies, bias networks, and application software.

#### HP 85041A Transistor Test Fixture Kit

The HP 85041A transistor test fixture (TTF) kit is a comprehensive measurement system for testing and characterizing stripline packaged microwave transistors. It is useful only when used with the HP 85014BC active device measurement software.

**Frequency range:** dc to 18 GHz

**Transistor package inserts:** 70 mil and 100 mil

**Verification devices:** Short and through circuits

**Connectors:** Precision 7 mm

**Accessories supplied:** Fixture stand, torque tool, tweezers, and lid opening tool

#### HP 83040 Series Modular Microcircuit Package

The new HP 83040 system bridges the gap between custom microcircuit packages and precision test fixtures. This versatile design tool provides a flexible, modular platform for breadboard design and test. Characterize and store circuit modules for easy integration into CAE models. Immediate availability eliminates mechanical design and fab queues, streamlining design cycle times.

- Compatible with many vector network analyzer calibration methods
  - 0.254-mm (0.010-in) and 0.635-mm (0.025-in) substrates
  - Excellent performance to 26.5 GHz (0.254-mm substrates)
- (See page 419 for complete description and ordering information.)

#### HP 11608A Transistor Fixture

**Function:** Provides the capability of completely characterizing strip-line transistors. A through-line microstrip and bolt-in grounding structure, machineable by customer, is included.

**Frequency range:** dB to 12.4 GHz

**Reflection coefficient:** <0.05, dc to 4 GHz; <0.07, 4.0 to 8.0 GHz; >0.15, 8 to 12.4 GHz

**Package styles:**

**Opt 003:** 0.205-in diameter packages

**Calibration references:** Opt 003 only, short circuit termination and a 50-ohm through-section

**Connectors:** APC-7 hybrid

**Weight:** Net, 0.9 kg (2 lb); shipping, 1.4 kg (3 lb)

**Size:** 25 mm H x 143 mm W x 89 mm D (1 in x 5.63 in x 3.5 in)

### Bias Networks

Bias networks are available for applying dc bias to the center conductor of a coaxial line which can be connected to a device under test. The bias network also provides a dc block to the RF input port.

Bias Network	HP 11590B	HP 11590B Opt 001	HP 11612A	HP 11612B
Frequency Range (GHz)	0.1 to 12.4	0.1 to 18	0.045 to 26.5	0.045 to 50
Connectors	Type N (f) RF Input Type N (f) RF Output BNC (f) dc Bias	7 mm 7 mm BNC (f)	3.5 mm (f) 3.5 mm (m) SMB snap-on (m)*	2.4 mm (f) 2.4 mm (f) SMB snap-on (m)*
Insertion Loss (max)	0.8 dB	0.8 dB, 0.1 to 12.4 GHz 1.2 dB, 12.4 to 18 GHz	0.8 dB, 0.045 to 12.4 GHz 1.3 dB, 12.4 to 26.5 GHz	0.8 dB, 0.045 to 12.4 GHz 1.3 dB, 12.4 to 26.5 GHz 26.5 to 50 GHz
Return Loss (min)	19 dB	19 dB, 0.1 to 12.4 GHz 14 dB, 12.4 to 18 GHz	20 dB, 0.045 to 8 GHz 18 dB, 8 to 18 GHz 14 dB, 18 to 26.5 GHz	20 dB, 0.045 to 8 GHz 18 dB, 8 to 18 GHz 14 dB, 18 to 26.5 GHz 10 dB, 26.5 to 50 GHz
Bias Current (max)	500 mA	500 mA	500 mA**	500 mA
Bias Voltage (max)	100 V	100 V	40 V	40 V

\* Cable included. SMB(f) to BNC(m).

\*\*Option 001 provides for 2 amps maximum bias current over the 400 MHz to 26.5 GHz frequency range. Higher bias currents may be applied with pulsed operation.

#### HP 11635A Bias Decoupling Network

The HP 11635A bias decoupling network is a recommended accessory for prevention of bias oscillations when biasing microwave bipolar transistors with any HP bias network or S-parameter test set. Installing the HP 11635A between the bias supply and the base bias network prevents low-frequency oscillations.

### Application Software

Hewlett-Packard offers application software packages that complement these network analyzer systems provide automated calibration and measurement capability. Software is available for HP Series 200/300 desktop computers using BASIC 2.0, 3.0, 4.0, or 5.0 operating systems on both 3½-inch and 5¼-inch disc media.

#### HP 85014B/C Active Device Measurement Application Pacs

The HP 85014B/C software pacs provide the capability for measurement of RF and microwave transistors (HP 85014B for the HP 8510C and HP 85014C for the HP 8719C/8720C/8722A). Features include automated device biasing with the HP 6626A precision power supply, system calibration, and de-embedding of S-parameters when using the HP 85041A transistor test fixture. They are also usable with other HP transistor fixtures as well as with user-designed fixtures. Plotted and listed output of device S, H, Y, and Z parameters, as well as the device amplifier summary and termination summary, are provided. Also available is the capability to store and retrieve S-parameter data in formats suitable for computer-aided-design applications.

#### Ordering Information

<b>HP 85041A</b> Transistor Test Fixture	\$6,000
<b>HP 11590B</b> Bias Network	\$700
<b>HP 11612A</b> Bias Network	\$825
<b>Opt 001</b> 2 amps maximum bias current	+ \$175
<b>HP 11612B</b> Bias Network	\$1,025
<b>HP 11635A</b> Bias Decoupling Network	\$275
<b>HP 85014B/C</b> Active Device Measurement Software	\$3,100
<b>HP 11608A</b> Transistor Fixture, Customer-Machineable	\$2,000
<b>Opt 003</b> 0.205-in Diameter Package Style	+ \$500

# NETWORK ANALYZERS

## Microwave Network Analyzer Accessories

### HP 8510, 8720 Series

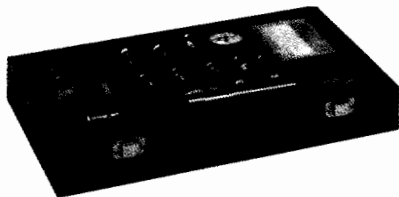

HP 85050C

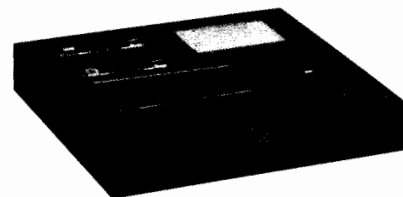

HP 85053B

### Microwave Network Analyzer Accessories

A wide range of accessories is available for both the HP 8720C and the HP 8510C series network analyzers, including calibration kits, verification kits, cables, and adapters for 7 mm, 3.5 mm, Type N, and 2.4 mm connector interfaces. The standards used in the 3.5 mm, Type N, and 2.4 mm connectors use precision slotless connectors (PSC-3.5, PSC-N, and PSC-2.4).

#### Calibration Kits

Error-correction procedures require that the systematic errors in the measurement system be characterized by measuring known devices (standards) on the system over the frequency range of interest. All network analyzer calibration kits contain precision standard devices to characterize the systematic errors of the HP 8720C or 8510C network analyzer system.

Each calibration kit also contains adapters to change the sex of the test port, connector gages for verifying and maintaining the connector interface, and a torque wrench for proper connection. Each kit contains standards definitions on disk for the HP 8510C. (These definitions are already included in the HP 8720C.)

#### Calibration Kit Summary

Calibration Kit	Connector Type	Frequency Range (GHz)	Performance Summary		Description	Price
			Directivity/Source Match at Fmax w/8720C	w/8510C		
85050B	7 mm	0.045 to 18	45/30	52/41	Contains open and short circuits and fixed and sliding terminations.	\$5,500
85050C	7 mm	0.045 to 18	n/a	60/60	Contains standards for TRL calibration on HP 8510B, including precision airline. Also contains open and short circuit and fixed termination.	\$6,000
85050D	7 mm	0.045 to 18	36/30	40/35	Economy kit. Contains open and short circuits and precision-fixed termination. No gages included.	\$2,050
85052B	3.5 mm	0.045 to 26.5	40/30	44/31	Contains open and short circuits (m and f) and fixed and sliding terminations (m and f), and in-series adapters.	\$7,700
85052C	3.5 mm	0.045 to 26.5	n/a	50/50	Contains standards for TRL calibration on HP 8510, including precision airlines. Also contains open and short circuits and fixed terminations. No gages included (see HP 11752D).	\$8,500
85052D	3.5 mm	0.045 to 26.5	36/29	36/30	Economy kit. Contains open and short circuits (m and f) and precision fixed termination (m and f), and in-series adapters. No gages included.	\$4,100
85054B	Type N	0.045 to 18	40/30	42/32	Contains open and short circuits (m and f) and fixed and sliding terminations (m and f), in-series adapters, and 7 mm to type N (m and f) adapters.	\$8,900
85054D	Type N	0.045 to 18	34/28	34/28	Contains open and short circuits (m and f) and broadband fixed terminations, in-series adapters, and 7-mm-to-type-N (m and f) adapters.	\$5,400
85056A	2.4 mm	0.045 to 50	38/33	38/33	Contains open and short circuits (m and f) and fixed and sliding terminations (m and f), in-series adapters, and 7-mm-to-type-N (m and f) adapters.	\$9,200
85056D	2.4 mm	0.045 to 50	26/24	26/24	Contains open and short circuits, broadband terminations, and in-series adapters. No gages included.	\$5,000
85056K	2.92 mm (K-connector)	0.045 to 40	22/19	22/19	Contains 2.4 mm open and short circuits, fixed terminations and 2.4 mm to 2.92 mm adapters. Adds 2.4 mm sliding loads and gages	\$7,000
Option 001			27/24 (typical)	27/24 (typical)		+ \$4,500
K11644A	WR-42	18.0 to 26.5	50/45	50/50	Contain flush short circuit, a precision shim, and a sliding (R) or fixed (X/P/K) termination.	\$3,600
X11644A	WR-90	8.2 to 12.4	50/45	50/50		\$4,000
P11644A	WR-62	12.4 to 18.0	50/45	50/50		\$4,000
R11644A	WR-28	26.5 to 40	50/45	50/50		\$4,000

### Verification Kits

Measuring known devices, other than the calibration standards, is a straightforward way of verifying that the network analyzer system is operating properly. Hewlett-Packard offers verification kits that include precision airlines, mismatch airlines, and precision fixed attenuators. Traceable measurement data for all devices is shipped with each kit on disk.

Verification kits may be recertified by Hewlett-Packard. This recertification includes a new measurement of all standards, as well as new data and uncertainties. Certification in compliance with MIL-STD 45662A is also available.

#### Verification Kit Summary

Verification Kit	Connector Type	Frequency Range (GHz)	Price
85051B	7 mm	0.045 to 18	\$4,000
85053B	3.5 mm	0.045 to 26.5	\$4,000
85055A	Type N	0.045 to 18	\$4,000
85057B	2.4 mm	0.045 to 50	\$4,600
R11645A	WR-28	26.5 to 40	\$4,750

### Test Port Return Cables and Adapters

Test port cables and adapter sets are available for various connector types. The cable/adapter configurations are described below. All cables are designed with one end that connects directly to the special ruggedized ports of the network analyzer test set, and one end that connects to the device under test.

Special test port adapter sets are also available to convert the ruggedized ports of the network analyzer test set to the desired connector interface. Each kit contains two adapters, one male and one female.

Both the cables and the special adapters have one special female connector which is designed to connect directly to the 3.5 mm test port (2.4 mm for HP 8516A/8517A and 8722A). This side of the cable or adapter can only be connected to the test set port, and cannot be mated to a standard 3.5 mm (or 2.4 mm) male connector. The male test set ports, however, can be mated to a standard 3.5 mm (or 2.4 mm) female connector.

Choose one of the configurations shown.

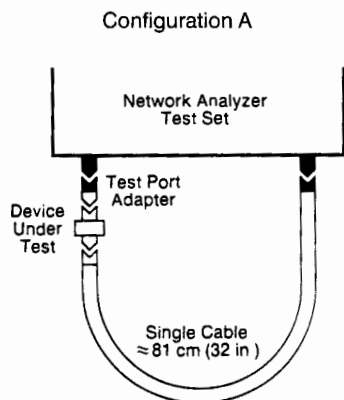

**Configuration A**  
For HP 8719C/8720C Network Analyzer or HP 8514B/8515A Test Sets (3.5 mm test port)

	Cables/Adapters	Connector Type (on device side of cable/adapter)	Price
For 3.5 mm devices	HP 85131C Semi-rigid Cable or HP 85131E Flexible Cable	3.5 mm (f)	\$750
	HP 85130D Adapter Set <sup>a</sup>	3.5 mm (m or f)	\$1,090
	HP 85132C Semi-rigid Cable or HP 85132E Flexible Cable	7 mm	\$1,650
For 7 mm devices	HP 85130B Adapter Set	7 mm	\$1,090
	Use 7 mm cables and the 7 mm to N adapters included in the HP 85054B/D calibration kit.		-
For Type N devices	HP 85130C Adapter Set	Type N (m or f)	\$1,090

<sup>a</sup> Recommended but not required

**Configuration A**  
For HP 8722A Network Analyzer or HP 8516A/8517A Test Sets (2.4 mm test port)

	Cables/Adapters	Connector Type (on device side of cable/adapter)	Price
For 2.4 mm devices	HP 85133C Semi-rigid Cable or HP 85133E Flexible Cable Set	2.4 mm (f)	\$950
	HP 85130G Adapter Set <sup>a</sup>	2.4 mm (m or f)	\$1,090
	HP 85134C Semi-rigid Cable or HP 85134E Flexible Cable	3.5 mm (f)	\$1,850
For 3.5 mm devices	HP 85130F Adapter Set	3.5 mm (m or f)	\$1,090
	HP 85135C Semi-rigid Cable or HP 85135E Flexible Cable	7 mm	\$1,650
For 7 mm devices	HP 85130E Adapter Set	7 mm	\$1,090

<sup>a</sup> Recommended but not required

**Configuration A.** This cable arrangement is for applications where the device under test is connected directly to the test set port. This setup offers the best mechanical rigidity for device connection. To adapt the test set port (port 1) to the device under test, choose the appropriate special adapter set. Besides converting the test port to the desired interface, these adapters also function as “test port savers” which protect the test set from damage and wear due to heavy use.

**Configuration B.** This cable arrangement is for applications where the device under test is connected between cable ends. This setup offers more flexibility when connecting to the device under test. Choose semi-rigid or flexible cables

The cables for 3.5 mm and 7 mm devices are available as semi-rigid cables, offering excellent performance and suitable for applications where the connectors of the device under test are in-line, or as super-flexible cables which are more rugged and have a tighter bending radius, ideal for manufacturing environments. The semi-rigid cables carry a 90-day warranty, whereas the flexible cables are warranted for one full year.

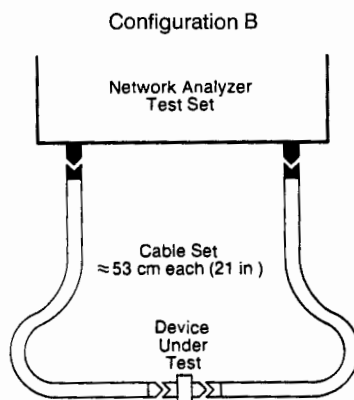

**Configuration B**  
For HP 8719C/8720C Network Analyzer or HP 8514B/8515A Test Sets (3.5 mm test port)

	Cable Set	Connector Type (on device side of cable/adapter)	Price
For 3.5 mm devices	HP 85131D Semi-rigid Cable Set or HP 85131F Flexible Cable Set	3.5 mm (one male, one female)	\$1,300
		3.5 mm (one male, one female)	\$2,900
For 7 mm devices	HP 85132D Semi-rigid Cable Set or HP 85132F Flexible Cable Set	7 mm	\$1,100
		7 mm	\$2,700
For Type N devices	Use 7 mm cables and the 7 mm to N adapters in the HP 85054B/D calibration kit.		-

**Figure B**  
For HP 8722A Network Analyzer or HP 8516A/8517A Test Sets (2.4 mm test port)

	Cable Set	Connector Type (on device side of cable/adapter)	Price
For 2.4 mm devices	HP 85133D Semi-rigid Cable Set or HP 85133F Flexible Cable Set	2.4 mm	\$1,700
		(one male, one female)	\$3,990
For 3.5 mm devices	HP 85134D Semi-rigid Cable Set or HP 85134F Flexible Cable Set	3.5 mm (one male, one female)	\$1,300
		3.5 mm (one male, one female)	\$2,900
For 7 mm devices	HP 85135D Semi-rigid Cable Set or HP 85135F Flexible Cable Set	7 mm	\$1,100
		7 mm	\$2,700

# NETWORK ANALYZERS

## Pulsed-RF Network Analyzer

HP 85108A

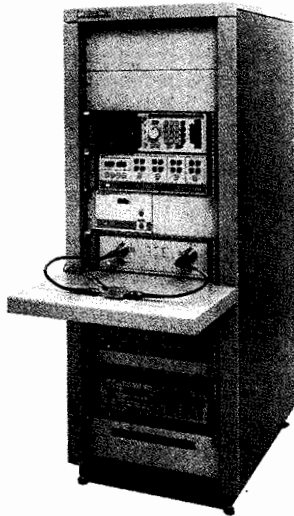

### Magnitude and Phase Characterization

The HP 8510 has become a standard measurement tool for the microwave design engineer. It provides a highly accurate, easy-to-use way to completely characterize the S-parameters of microwave components. This same tool now makes the characterization of pulsed-RF devices as simple as the press of a button. This dynamic characterization allows you to evaluate the magnitude and phase response inside the pulse as a function of time.

### The HP 85108A Pulsed-RF Network Analyzer System

The HP 85108A is a factory-integrated system that provides the entire instrument configuration required to make pulsed-RF measurements. Simply add the desired measurement accessories for a complete system.

The system is built around the HP 8510C with the pulsed-RF measurement capability option (Option 008) already installed. The system also includes the HP 85110A S-parameter test set. An HP 83622A and an HP 83624A synthesized sweeper provide, respectively, the RF and LO signals needed to operate the fundamentally mixed test set.

The system also includes on-site installation, and a one-year on-site warranty insures that the system remains up and running.

### The HP 8510C Option 008

The HP 8510C pulsed-RF measurement capability option (Option 008) consists of an additional receiver subsystem for the HP 8510. This pulsed-RF measurement capability, which exists in parallel with the standard HP 8510C operation, provides you with the ability to measure and display the relative magnitude and phase shift of the component as a function of time with an equivalent bandwidth of 1.5 MHz. This allows the evaluation of the dynamic pulsed-RF characteristics for pulse widths down to 1 microsecond. Using the repetitive sampling method, point-to-point display resolution of 100 nanoseconds is available.

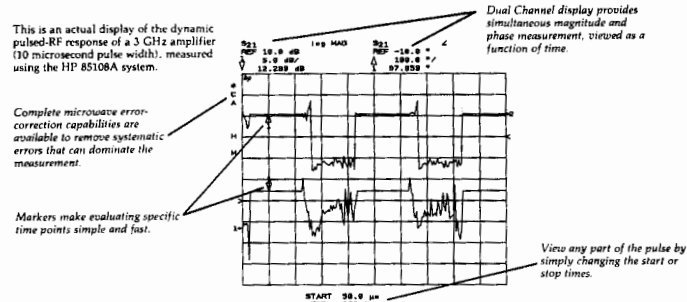

### The HP 85110A S-Parameter Test Set

The HP 85110A S-parameter test set is a required system component for the HP 8510C pulsed-RF measurement capability. The figure below shows a simplified block diagram of this test set.

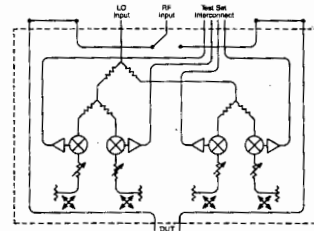

Key to the performance of the test set are the fundamental mixers used to provide the low noise IF necessary to make accurate, pulsed-RF measurements with the pulsed-RF receiver subsystem. Two external synthesizers act as the RF and LO sources for the four-channel downconverter. This approach eliminates the need to dedicate one channel for phase-lock, making full two-port, pulsed-RF S-parameter measurements available. Also, the internal pulse modulator of the RF synthesizer can be used to pulse the device-under-test.

The block diagram also provides some distinct advantages, whether using the HP 8510C for pulsed-RF or standard S-parameter measurements. Because of the coupler-based measurement path and attenuators, the test set can handle high powers, up to 20 W. And the connections available on the rear panel provide access to the measurement path, making it easy to configure test systems that use a single measurement connection. Special versions of the HP 85110A test set are available for even higher power applications or other frequency ranges.

### Ordering Information

#### HP 85108A Pulsed-RF Network Analyzer System

The HP 85108A Pulsed-RF Network Analyzer system is a factory-integrated system that includes the instruments required to make dynamic pulsed-RF measurements. Installation and one-year, on-site warranty included.

This system consists of: HP 8510C Network Analyzer with Option 008 Pulsed-RF Measurement Capability  
HP 83622A Synthesized Sweeper with Options: 001 Add Step Attenuator, 003 Delete Front Panel Keyboard/Display, 004 Rear Panel RF Output and 008 1 Hz Frequency Resolution.

HP 83624A Synthesized Sweeper with Options: 003 Delete Front Panel Keyboard/Display, 004 Rear Panel RF Output and 008 1 Hz Frequency Resolution.

HP 85110A S-Parameter Test Set

System Rack

#### HP 85110A S-Parameter Test Set

Requires one HP 83622A 2 to 20 GHz synthesized sweeper and one HP 83624A 2 to 20 GHz (high power) synthesized sweeper for system operation.

The HP 85110A is a 2 to 20 GHz S-Parameter Test Set that provides the low noise IF required by the HP 8510C Option 008 Pulsed-RF Measurement Capability.

#### To upgrade an existing HP 8510C System for Pulsed-RF Measurements

Your existing HP 8510 system can also be upgraded to perform pulsed-RF measurements. This upgrade can be performed on-site or integrated into a full system at the factory. The following additional equipment will be required:

#### HP 85110A S-Parameter Test Set

\$55,000

#### HP 83624A Synthesized Sweeper

\$39,900

The HP 83624A Synthesized Sweeper should be used as the system LO source and the HP 8340B or 8341B you already own should be used as the system RF source.

#### HP 85111A Pulsed-RF Measurement Capability Upgrade Kit for the HP 8510B.

\$12,750

The HP 85111A Pulsed-RF Detector Upgrade Kit provides the hardware to upgrade an existing HP 8510B (Rev 4.0 or later) to an HP 8510B with Option 008.

#### HP 85111B Pulsed-RF Measurement Capability Upgrade Kit for the HP 8510C

\$12,750

The HP 85111B Pulsed-RF Detector Upgrade Kit provides the hardware to upgrade an existing HP 8510C to an HP 8510C with Option 008.



# NETWORK ANALYZERS

## Integrated Single Connection Multiple Measurement Systems

- Hardware
- Software
- Support

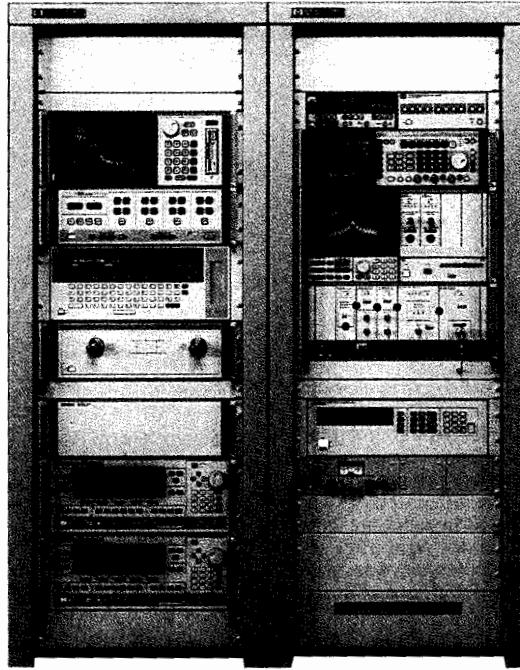

HP 85108A F56

### Test Systems for MMICs, Hybrids, or Modules

Hewlett-Packard can design and integrate customized test systems for your microwave component and sub-system testing application. By employing the single connection multiple measurement (SCMM) approach facilitated by open-architecture S-parameter test sets such as the HP 85110A, a variety of stimulus/response measurements are possible, all through a single RF connection to the device under test. Your existing HP 8510 and related hardware can be integrated into these types of systems.

With your HP test system, you will be able to measure the entire range of performance specifications required by MMIC chips or hybrids such as amplifiers, oscillators, mixers, attenuators, switches, or a combination of these—all with a single touchdown of the wafer probes or a single fixture insertion. Also, be assured that your HP system will provide the optimum in test performance and accuracy, and will be backed by the best service support in the industry.

### Benefits of Integrated Test Systems

Examples of applications that can benefit from the SCMM approach are high-volume T/R module test, on-wafer MMICs, packaged hybrid devices, or even multi-port subsystems.

#### Lower Your Test Time

Integrated systems reduce test times by at least a factor of 2 over the same testing with multiple wafer passes or fixture insertions on separate test systems.

#### Increase Your Test Accuracy

Complete test data, taken at the same time under the same dc bias and temperature conditions, provides for the highest accuracy and consistency in product characterization.

#### Increase Your Product Yield

Reduced handling decreases wafer breakage, and yields increase due to reduced pad or connector damage.

#### Increase Your Product Reliability

Reduced pad damage results in better bonding, and single-pass testing decreases the chances of ESD damage.

#### Maximize Your System Up-Time

You get responsive, single vendor support from HP, worldwide.

Added together, these benefits will mean a substantial reduction to your microwave component costs!

### System Integration and Support

Each system is fully integrated at HP, then installed at your facility. Integration can include customized system functional test software, acceptance test procedures, and system specifications (at additional cost). This frees your resources for more effective product development and manufacturing. Once your system is installed, local systems support from HP assures that it will continue to perform.

### Experience Counts

Numerous test systems similar to the one shown above have already been supplied to customers around the world to cover a variety of MMIC, T/R module, and TWT testing applications. In producing these integrated systems, HP has combined 50 years of experience in producing the very best in test instrumentation and computation tools with over 15 years of experience designing, fabricating, and testing our own world-class GaAs devices, MMICs and hybrid assemblies. When you choose HP you get a test system supplier that can understand and relate to your testing needs.

If the capabilities of a completely integrated approach to component test interest you, contact your nearest local HP sales representative for more information on how such a system can be configured and delivered to you.

# MICROWAVE RECEIVERS

Antenna/RCS Measurement Systems, 45 MHz to 110 GHz

HP 8530A and HP 85301B/C

317

- Fast data acquisition speeds
- Excellent microwave performance

- Multiple parameters (channels)
- Manual and automated measurements

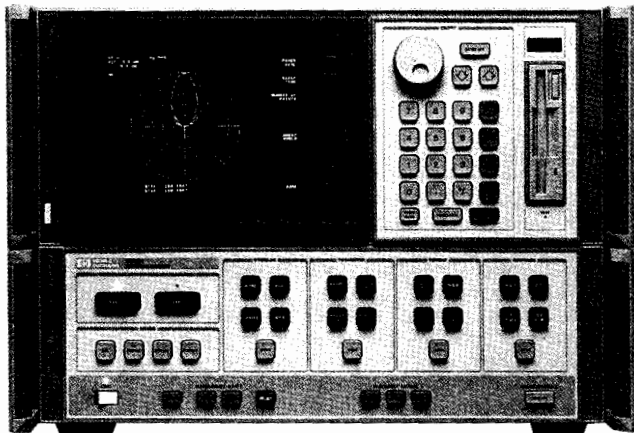

HP 8530A



## HP 8530A Microwave Receiver

The HP 8530A is a fast, accurate, microwave receiver designed to address both manual and automated antenna and radar cross-section measurement applications. It features fast data acquisition speeds, excellent sensitivity, wide dynamic range, multiple test channels, and fast frequency agility speeds, without compromising measurement accuracy. The receiver provides broad frequency coverage from 45 MHz to 26.5 GHz with extensions to 110 GHz.

The receiver's features are designed to increase productivity. For manual measurements, antenna patterns are displayed on a large color display, with on-screen active markers providing quick data analysis. For permanent data storage, measured data can be archived to the built-in disk drive, or sent to a plotter or printer. The internal serial plotter/printer buffer allows the next measurement to proceed while data is being output. Built-in antenna/RCS calibrations complete the manual measurement capability.

For automated systems, the HP 8530A provides exceptional speed. Features are designed to improve measurement throughput: from fast data acquisition speeds up to 5,000 points per second and multiple test channel capability to a large 100,000 point internal data buffer. All designed to increase productivity.

To increase the utility of the HP 8530A Microwave Receiver, an optional network analyzer capability is available. By loading a new set of firmware, the HP 8530A is transformed into an HP 8510C network analyzer, which with an S-parameter test set, can be used to make traditional network analysis measurements on components and materials.

The HP 8530A provides versatility and flexibility for the unique requirements of antenna/RCS testing, with designed-in quality and reliability, all at an economical price.

## HP 8530A Data Acquisitions Speeds

	Without data transfer	With Immediate data transfer
Fast CW	0.2 msec/data point	0.3 msec/data point
Auto-ranging Fast CW	0.4 msec/data point	0.4 msec/data point

## HP 85301B/C Antenna Measurement System

Hewlett-Packard's antenna and RCS measurement systems are pre-configured antenna/RCS measurement systems based on the high-performance HP 8530A microwave receiver. Both systems provide all the instruments necessary for a basic measurement system. The HP 85301B utilizes external mixers for best microwave performance and the HP 85301C uses a harmonic down-converter. Additional options are available to increase the capability of the systems. Both systems provide a system rack, cables, system integration, installation, performance verification, two-day system engineer consulting, and one-year on-site support. Additionally, customized systems to meet unique requirements can be configured. Contact your local HP sales representative for additional assistance with customized systems.

## HP 85301C Antenna Measurement System (.045 to 26.5 GHz)

The HP 85301C Antenna Measurement System is a pre-configured antenna/RCS measurement system utilizing the HP 8530A, HP 8511A frequency converter, and HP 83631A transmit source as the heart of the system. A standard option extends the frequency coverage to 50 GHz by substituting an HP 8511B frequency converter and HP 83651A transmit source.

## HP 85301B Antenna Measurement System (2 to 20 GHz)

The HP 85301B is a pre-configured antenna/RCS measurement system using the HP 8530A microwave receiver, HP 85310A distributed frequency converter, and a 20 GHz HP 8360 Series synthesizer. The HP 85301B system provides the best microwave performance, highest measurement sensitivity, and greatest measurement flexibility. It also features good immunity to spurious signals, the ability to locate mixers at the test antenna, up to three test channels (plus a reference), and the ability to extend frequency coverage up to 110 GHz using the HP 85325A millimeter-wave sub-systems. Standard options allow for additional test channels, transmit amplifiers, a 26.5 GHz source, remote LO capabilities, time domain, and network analysis capability.

## HP 85310A Distributed Frequency Converter

The HP 85310A distributed frequency converter provides a high sensitivity frequency converter which can be remotely located from the HP 8530A microwave receiver. The HP 85310A consists of an HP 85309A LO/IF distribution unit, one HP 85320A test mixer module, and one HP 85320B reference mixer module. The standard converter provides one phase-lock reference channel and one test channel. Optional second or third test channels are also available. Standard frequency coverage is 2 GHz to 26.5 GHz, extendable to 110 GHz.

## HP 8511A and B Frequency Converters

The HP 8511A and B frequency converters are alternate frequency converters for use with the HP 8530A microwave receiver. The HP 8511A and B provide good microwave performance at an economical price. The HP 8511A operates from 45 MHz to 26.5 GHz, and the HP 8511B operates from 45 MHz to 50 GHz. Both have three test channels. Since the HP 8511 is a harmonic converter, it is susceptible to RFI; hence it is usually used in indoor ranges where RFI is not a concern. The fast ramp-frequency sweep mode of the HP 8511 of 230 microseconds per frequency (or 4,347 frequency points per second), makes it an ideal downconverter for applications requiring fast swept-frequency measurements such as RCS measurements.

# MICROWAVE RECEIVERS

## Antenna/RCS Measurement Systems, 45 MHz to 110 GHz (cont'd)

### HP 8530A and HP 85301B/C

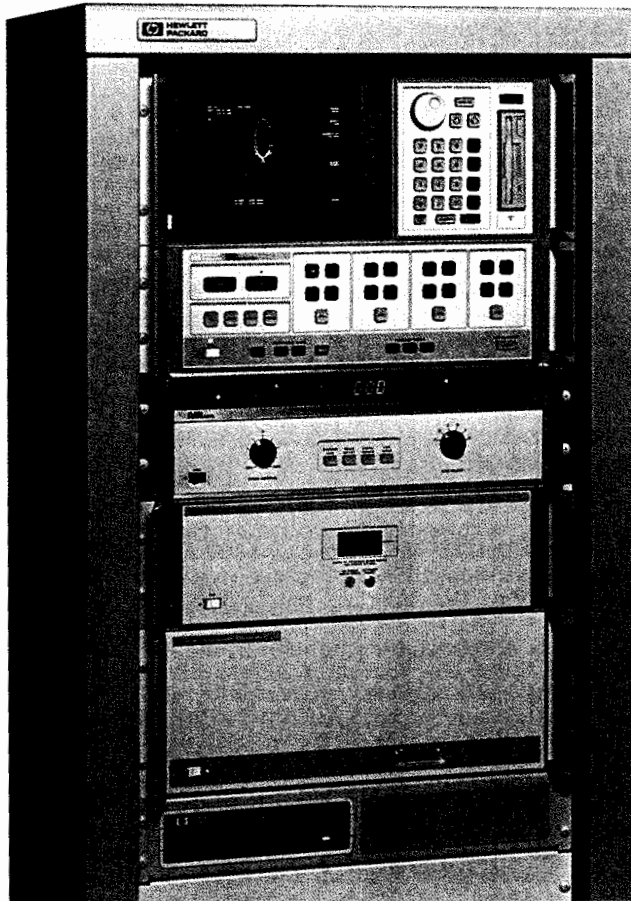

HP 85301B Antenna Measurement System

#### HP 85381A/C/D Microwave Cables

The HP 85381 series of microwave cables is used to connect the HP 8530A, LO source, HP 85310A, and HP 85320A/B mixer modules. Refer to the HP 8530A ordering guide for detailed information.

#### HP 85325A Millimeter-Wave Subsystems

The HP 85325A subsystems extend the HP 85301B to millimeter-wave frequencies by including the hardware needed for coverage from 26.5 to 110 GHz in five waveguide bands. These subsystems provide excellent sensitivity and performance at millimeter-wave frequencies. Up to three test channels (plus a reference) can be configured. One HP 85326A millimeter-wave interface kit is required to interface the HP 85325A subsystem to the HP 85301B.

#### HP 85395A/B/C and HP 85396A Microwave Receiver Upgrade Kits

All HP 8510s can be upgraded to the HP 8530A microwave receiver, the receiver optimized for antenna and RCS measurements. Upgrading will improve the measurement speed and throughput of current antenna/RCS measurement systems and provides additional features. For automated measurements, data acquisition speed will be significantly faster. The large data buffer contributes to greater measurement productivity. Upgrading also provides manual measurement capability, allowing patterns to be displayed directly on the screen of the receiver. On-screen markers make data analysis quick and easy. Manually measured data can be archived to the built-in disk drive, or sent to a plotter or printer. Built-in antenna and RCS calibrations provide complete manual measurement capability.

#### Ordering Information

	Price
<b>HP 85301B</b> Antenna Measurement System (2 to 20 GHz)	\$178,000
<b>Opt 001</b> Add One Additional Test Channel	+ \$10,490
<b>Opt 002</b> Add Two Additional Test Channels	+ \$19,680
<b>Opt 003</b> Substitute 26.5 GHz Transmit Source	+ \$10,100
<b>Opt 004</b> Add 2 to 26.5 GHz Power Amplifier	+ \$13,300
<b>Opt 005</b> Remote LO Downconverter Operation	+ \$3,100
<b>Opt 010</b> Add Time Domain Capability to HP 8530A	+ \$10,000
<b>Opt 011</b> Add HP 8510C Firmware Operating System	+ \$3,500
<b>Opt 360</b> Delete HP 85360A Antenna Software	- \$19,500
<b>HP 85301C</b> Antenna Measurement System (45 MHz to 26.5 GHz)	\$138,800
<b>Opt 001</b> Extend Frequency Coverage to 50 GHz	+ \$13,400
<b>Opt 010</b> Add Time Domain Capability to HP 8530A	+ \$10,000
<b>Opt 011</b> Add HP 8510C Firmware Operating System	+ \$3,500
<b>Opt 360</b> Delete HP 85360A Antenna Software	- \$19,500
<b>HP 8530A</b> Microwave Receiver	\$37,400
<b>Opt 010</b> Time Domain Capability	+ \$10,000
<b>Opt 011</b> Add HP 8510C Firmware Operating System	+ \$3,500
<b>HP 85310A</b> Distributed Frequency Converter (2 to 26.5 GHz operation; includes two mixers)	\$32,175
<b>Opt 001</b> Add One Additional Test Channel	+ \$9,000
<b>Opt 002</b> Add Two Additional Test Channels	+ \$16,750
<b>HP 8511A</b> Frequency Converter (to 26.5 GHz)	\$19,700
<b>Opt 001</b> Add IF Switching	+ \$2,600
<b>HP 8511B</b> Frequency Converter (to 50 GHz)	\$23,000
<b>Opt 001</b> Add IF Switching	+ \$2,600
<b>HP 85309A</b> LO/IF Distribution Unit	\$25,750
<b>Opt 001</b> Adds One Additional Channel Capability	+ \$5,875
<b>Opt 002</b> Adds Two Additional Channel Capability	+ \$10,500
<b>HP 85320A</b> Test Mixer Module (2 to 26.5 GHz)	\$3,125
<b>HP 85320B</b> Reference Mixer Module (2 to 26.5 GHz)	\$3,300
<b>HP 85381A</b> Microwave Cable	\$500.00
<b>Opt Cxx</b> Replace xx with Cable Length in Meters	+ \$20/meter
<b>HP 85381C</b> Microwave Cable	\$650.00
<b>Opt Cxx</b> Replace xx with Cable Length in Meters	+ \$120/meter
<b>HP 85381D</b> Microwave Cable	700.00
<b>Opt Cxx</b> Replace xx with Cable Length in Meters	+ \$130/meter
<b>HP 85325A</b> Millimeter-Wave Subsystem (26.5 to 40 GHz)	\$19,915.00
<b>Opt 001</b> Add One Additional Channel	+ \$2,950.00
<b>Opt 002</b> Add Two Additional Channels	+ \$5,900.00
<b>HP 85325A</b> Millimeter-Wave Subsystem (33 to 50 GHz)	\$19,305.00
<b>Opt 001</b> Add One Additional Channel	+ \$3,290.00
<b>Opt 002</b> Add Two Additional Channels	+ \$6,580.00
<b>HP 85325A</b> Millimeter-Wave Subsystem (40 to 60 GHz)	\$20,450.00
<b>Opt 001</b> Add One Additional Channel	+ \$3,735.00
<b>Opt 002</b> Add Two Additional Channels	+ \$7,470.00
<b>HP 85325A</b> Millimeter-Wave Subsystem (50 to 75 GHz)	\$27,290.00
<b>Opt 001</b> Add One Additional Channel	+ \$4,495.00
<b>Opt 002</b> Add Two Additional Channels	+ \$8,990.00
<b>HP 85325A</b> Millimeter-Wave Subsystem (75 to 110 GHz)	\$28,535.00
<b>Opt 001</b> Add One Additional Channel	+ \$5,270.00
<b>Opt 002</b> Add Two Additional Channels	+ \$10,540.00
<b>HP 85326A</b> Millimeter-Wave Interface Kit	\$5,500.00
<b>Opt 001</b> Add One Additional Test Channel	+ \$2,250.00
<b>Opt 002</b> Add Two Additional Test Channels	+ \$4,500.00
<b>HP 85395A</b> Upgrade Kit (HP 8510A to HP 8530A) Retains Network Analyzer Capability	\$25,000.00
<b>HP 85395B</b> Upgrade Kit (HP 8510B to HP 8530A) Retains Network Analyzer Capability	\$20,000.00
<b>HP 85395C</b> Upgrade Kit (HP 8510C to HP 8530A) Retains Network Analyzer Capability	\$6,000.00
<b>Opt 111</b> Deletes Network Analyzer Capability (valid for HP 85395A/B/C Upgrade Kits)	- \$3,500.00
<b>HP 85396A</b> Upgrade Kit Adds Network Analyzer Capability to HP 8530A	\$4,000.00
<b>HP 85043A</b> System Cabinet	\$3,130.00
<b>HP 85380A</b> Weatherproof Enclosure	\$3,250.00



# HIGH-FREQUENCY DESIGN SOFTWARE

Circuit Simulator, Electromagnetic Simulator

HP 85150B, 85180A

319

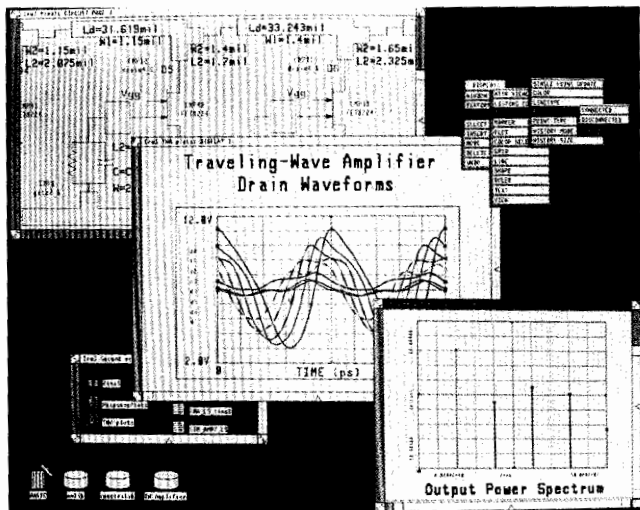

The HP 85150B microwave-design system integrates subsystem design, schematic capture, simulation, artwork generation, and documentation to speed the high-frequency design process.

## HP 85150B Microwave Design System

- Available on HP, Apollo, Sun, DEC, IBM, and 386/486 workstations.
- Interacts with schematic, simulation, artwork, and documentation simultaneously.
- Minimizes prototyping with advanced linear and nonlinear simulators.
- Eases documentation chores with automatic links to schematics and simulation results.
- Generates artwork from the schematic automatically.

### Integrated Solution for High Frequency Design

The HP 85150B microwave design system is an integrated CAE package for microwave and RF engineers. It provides extensive modeling, analysis, and layout capabilities to take a design from its conception to physical representation. It is particularly well suited for developing monolithic microwave integrated circuits (MMICs), hybrid microwave and RF circuits, and RF and microwave subsystems.

The HP microwave design system integrates the design capture system, the microwave linear simulator, the microwave nonlinear simulator, and the microwave artwork generator, with an exceptionally convenient documentation facility. Switching from one application to another is as easy as clicking a mouse button.

With the design capture system, you can enter circuit schematics as easily and intuitively as you would draw them on paper. These schematics are used by the microwave linear or nonlinear simulator for analysis, optimization, or manual tuning. When satisfied with the circuit performance, you invoke the microwave artwork generator to generate the mask layouts automatically.

The information you create with the microwave design system is easily consolidated for immediate documentation. Generate engineering notebooks, reports, proposals, and production forms with minimum overhead. By preserving and leveraging the knowledge of the R&D environment, you can design circuits of increasing complexity.

### Ordering Information

**HP 85150B** Microwave Design System

**Price**  
\$38,000

The HP 85150B includes the following:

**HP 85157A** Design-Capture System

**HP 85151A** Microwave Linear Simulator

**HP 85155A** Microwave Nonlinear Simulator

**HP 85156A** Simulator Interface

**HP 85152A** Microwave-Artwork Generator

(Please call your local HP sales representative for more detailed information.)

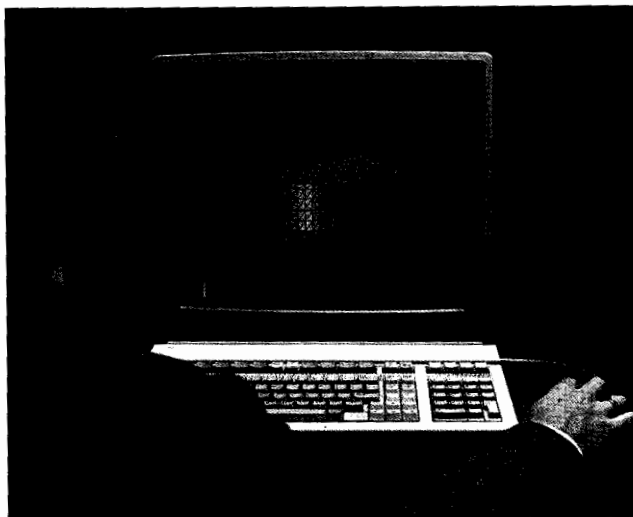

The HP 85180A High-frequency Structure Simulator creates S-parameters and electromagnetic field plots for passive structures, such as machined components and circuit models.

## HP 85180A High-frequency Structure Simulator

- Available on HP, Apollo, Sun, DEC, and IBM workstations.
- Calculates S-parameters for multiport structures.
- Unrestricted geometries with unlimited number of dielectrics and conductors.
- Conductor and dielectric loss
- Analysis is based solely on Maxwell's equations and includes dispersion.
- Complete solution for electric and magnetic fields, energy densities, and more.

### Electromagnetic Field Solutions for Non-Experts

The HP 85180A high-frequency structure simulator computes S-parameters for passive, three-dimensional structures. Although the simulator performs complete electromagnetic solutions, users need only minimal background in electromagnetic field theory to operate it. It requires only geometric and material parameters.

The high-frequency structure simulator has many applications, including: microwave machined component design; microwave, RF, and high-speed digital circuit modeling; and production refinement. Machined component designers can simulate complex designs before investing in a custom-machined prototype. High-frequency circuit designers can create model libraries of transmission line structures and other circuit elements for use with their circuit simulators. Production engineers can use the high-frequency structure simulator to study the effect of tolerance variations on quality and manufacturing yield.

Links to other systems enhance design productivity. Mechanical descriptions of components can be transferred from HP ME Series 30 mechanical design software. S-parameters computed by the high-frequency structure simulator can be used in the HP microwave-design system or in other circuit simulators.

### Ordering Information

**HP 85180A** High-Frequency Structure Simulator

### Price

\$41,000

(Please call your local HP sales representative for more detailed information.)

# LOGIC ANALYZERS

## General Information

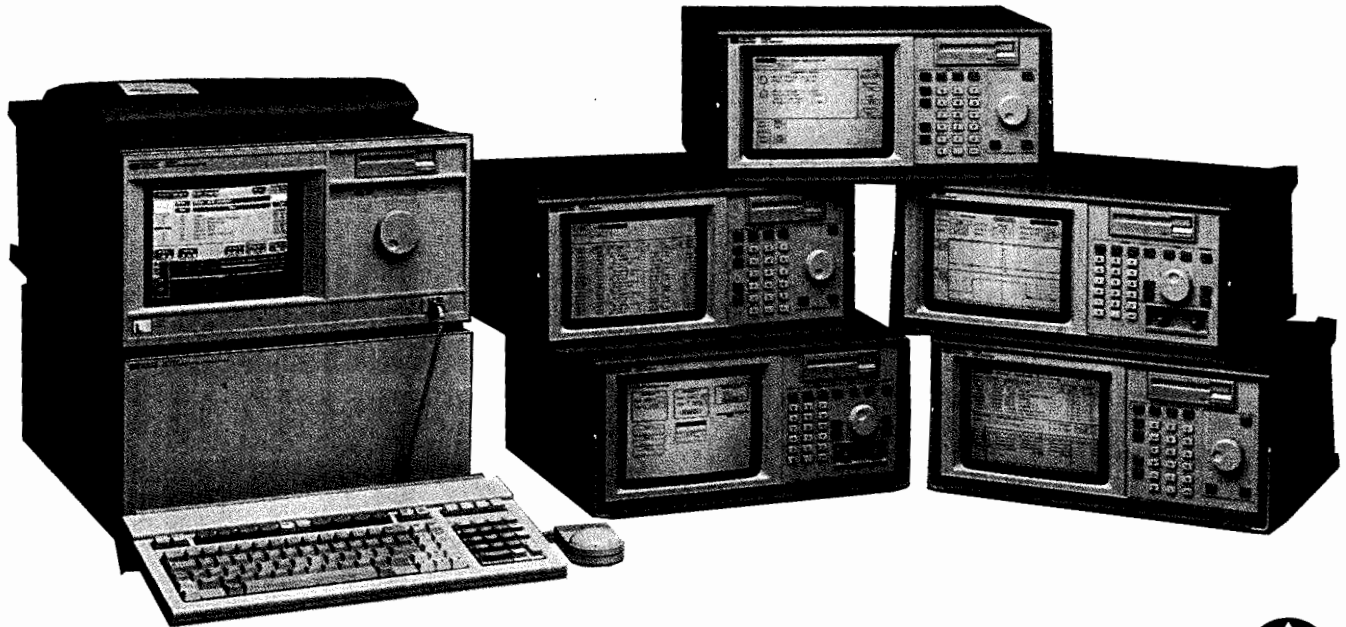

HP Family of Logic Analyzers



### The HP Family of Logic Analyzers

HP logic analyzers support such diverse applications as hardware troubleshooting, hardware/software integration, software performance analysis, hardware characterization, prototype verification, low-volume manufacturing tests, and failure analysis. These tools provide you with everything you need to solve your toughest measurement problems, including troubleshooting and characterizing your digital designs.

### Choose from Portables or Modular Mainframe System

You can choose from five portable models in the 1650 Series, or the 16500 Series modular logic analysis system. A selection guide appears on page 322. The 1650 Series offers standalone performance while the 16500 Series adds a color touchscreen, an additional floppy drive, and the availability of high-performance measurement modules in a five-slot mainframe. With the HP 16501A you can combine up to nine measurement cards in one system.

### Unparalleled Ease of Use

All instruments have menu-driven interfaces, and can be automatically configured from files on a built-in disk drive. Set up measurements quickly using the touchscreen of the HP 16500A, or using disk-based configurations. To change a parameter on the HP 16500A, simply point to the field you need to change and then enter the value using the popup keypad or knob. A mouse, trackball, and keyboard are available as control options for the instrument.

### Find the Problem by Combining Measurement Modules

When you can capture symptoms but have not yet identified the underlying problem, the intermodule bus lets you trigger other measurement modules in connection with the module where the symptom appears. For example, you might find a glitch connected with the timing analyzer, but not know what is causing it. By triggering the integrated oscilloscope module, you can identify its cause quickly by triggering a timing analyzer from a state analyzer. You can also see timing relationships which only occur when a certain portion of code is executed.

### See Analog Phenomena with a Built-In Scope

HP logic analyzers offer digitizing oscilloscopes with the performance you need to solve the toughest measurement problems. Now you can get full 250 MHz analog bandwidth with a 1 GSa/s, 8-bit digitizing scope in the 16500A mainframe. Or, get a full 100 MHz analog bandwidth, 400 MSa/s, 6-bit digitizing oscilloscope in either the 1650 Series or the 16500 Series. All oscilloscope modules have the digitizing advantages of waveform storage and recall, automatic measurements and markers, and powerful logic triggering, for much less than the instruments would cost separately.

### Understand Microprocessor Operation with the Widest Range of Accessories in the Business

HP offers the broadest support for buses, standard interfaces, and microprocessors of any logic analyzer vendor. Support includes inverse assembler software and quick-connection probes for virtually any microprocessor-based design. You can even create your own inverse assemblers for proprietary processors, or have HP design a custom solution for you.

### Quality and Reliability

In addition to their measurement value, HP logic analyzers offer our traditional quality and reliability. HP operates a worldwide support network to provide the assistance you need to get the most out of your logic analyzer investment.

Option W30 adds to the product warranty by providing three years (from the time of initial delivery) of customer return repair service. If you purchase option W30, HP provides all labor, parts, and materials necessary to maintain your product in good operating condition, and performs preventive maintenance and necessary factory improvements or modifications.



### Full-Featured RISC Support

The new HP 16540D and HP 16541D provide full featured 100 MHz state analysis with 16K memory depth. HP provides full support for most RISC and CISC processors. Up to 208 channels can be probed simultaneously.

### Unmatched Compatibility

Compatibility protects your investment because you can use any of Hewlett-Packard's analyzers to make your measurement. Most preprocessors are compatible with every HP analyzer, as are configuration files and data files.

All HP logic analyzers use the same user interface concepts. If you are familiar with one instrument, you will find the same functions in the same places on other models.

Programmability is the same for all models. You do not need to learn new commands or constructs when changing models. Programs written for the HP 1650B run on the HP 16510B.

Many analyzers can be upgraded to include more powerful measurement features. For example, the HP 1651B 32-channel 35 MHz state/100 MHz timing analyzer can be upgraded to the HP 1653B state/timing analyzer with a 100 MHz bandwidth oscilloscope. (See page 341 for upgrade kit information.)

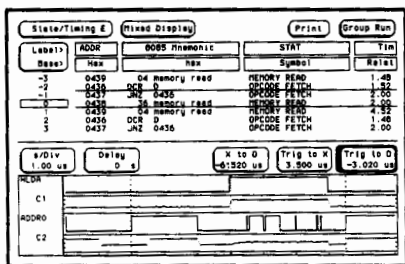

State, timing, and oscilloscope data time correlated on the same display.

All state and timing analyzer data can also be translated and transferred to many popular simulators and testers—automatically. The data you capture with your HP logic analyzer can be automatically transferred to popular workstations and analyzed, or it can be transferred to ASIC verification, board, and IC testers.

### A Computer in Each Analyzer

Compact, portable analyzers mean that you have measurement power where you need it. At the heart of each HP analyzer is a powerful 16-bit processor dedicated to quickly making and displaying measurements. You do not need to tie up a personal computer in order to make measurements, and portability is increased.

If you need to put measurement data into your personal computer memory, HP provides the documentation to make it easy. Ask your HP sales representative for HP's Logic Analyzer and Personal Computer Programming Series (HP Pub. No. 5952-4241).

### Powerful State Triggering

HP logic analyzers have complex state triggering to filter unnecessary data and provide you with only the data you need for your measurement. Up to five clocks or qualifiers can be used to determine exactly when to sample. Up to eight full-featured sequence levels, each with storage qualification, branching, and complex pattern triggering, allow you to store only the data you need. Up to eight pattern recognizers and a range term offer the flexibility to extract data from complex code. Tag time or states to keep track of how and when your code is executed.

### Quickly Store or Recall Setups and Data

Store measurements and configurations to the built-in disk drive(s). Use auto-load to recall a specific configuration when turning on the instrument. Use the disk to store information captured from a remote location, then examine the error in more detail on another HP logic analyzer in the lab.

### HP-IB and RS-232: Standard on Every Analyzer

Both HP-IB and RS-232 ports are standard on each instrument. You can program any analyzer from either interface, while using the other interface to control a printer. Upload measurement data to your computer quickly for additional analysis.

### Complete Package

The price of each HP logic analyzer includes all you need to start making measurements, including general-purpose probing, grabbers, and software. Your preprocessor also includes everything you need to make measurements on your processor, including probing and inverse assembly software.

### Instant Documentation

With the push of a button, you can document results professionally with the standard hardcopy feature. Full-color printouts are available using the HP PaintJet printer with the HP 16500A. Documentation helps you trace your steps and communicate your findings to others. Either the HP-IB or RS-232 port can be assigned to control a printer. The HP 16500A supports the HP DeskJet, LaserJet, PaintJet, ThinkJet, and QuietJet, and Epson printers (such as the RX-80, RX-100, MX-80 and MX-100).

### Links to Simulation, Manufacturing Test

Transfer and translate simulation vectors to the HP 16500A pattern generator and state analyzer to perform functional prototype analysis. Or capture data from known good boards and transfer that information to board testers, or transfer the information back to the simulator.

### Lightweight, Flexible Probes

Lightweight, flexible passive probes make connection to the target system easier than ever. There are no heavy active pods to dislodge the probing scheme at the wrong time. Cooling is not a problem because the passive probes do not generate heat.

Passive probing provides excellent impedance over a wide frequency range. And the low-capacitance loading means that critical edges are not affected by probing. HP's complete general-purpose probing solution comes standard with each analyzer. See page 323 for information on connectors that make it easy to interface to your design.

### Identify Performance Bottlenecks

The HP 10390A system performance analysis software adds three measurements to HP state analyzers. The state histogram and state overview measurements display the intensity of activity in specific areas of memory or identify modules that are prime targets for optimization. The time interval measures execution time of a module, time between calls to a module, or time between two different modules.

### Logic Analyzer Section Highlights

Selection Guide	322
Microprocessor/Bus Support	323
HP 1650B, HP 1651B	327
HP 1652B, HP 1653B	329
HP 16500A and Modules	330
Accessories	341
Upgrade Kits	341
Ordering Information	343

# LOGIC ANALYZERS

## Selection Guide

HP's selection of logic analyzers consists of the HP 1650 series of portable logic analyzers and the HP 16500A logic analysis system. The following application reference guide provides a quick overview of HP analyzers, key measurement needs, and features. More information on logic analyzers is provided on the following pages.

### Application Reference Guide

	1650B	1651B	1652B	1653B	1654B	16500A
<b>Microprocessor Support</b>						
8-bit	Y	Y	Y	Y	Y	Y
16-bit	Y		Y		Y	Y
32-bit	Y		Y			Y
RISC						Y
DSP	Y	Y	Y	Y	Y	Y
Multiple Microprocessor Support	Y		Y		Y	up to 10
Bus	Y	Y	Y	Y	Y	Y
Custom	Y	Y	Y	Y	Y	Y
<b>Hardware Analysis</b>						
Timing						
100 MHz/All Channels	Y	Y	Y	Y	Y	Y
1 GHz						Y
Glitch Detection	5 ns	5 ns	5 ns	5 ns	5 ns	2 ns
Maximum Channels	80	32	80	32	64	400 @ 100 80 @ 1 GHz
Digitizing Oscilloscope						
400 MSa/s-100 MHz BW			Y	Y		Y
1 GSa/s-250 MHz BW						Y
50 MBit/s Pattern Generation						Y
Cross-Domain Measurements						
Timing/State	Y	Y			Y	
Timing/State/Scope			Y	Y		Y
<b>Software Analysis</b>						
State Speed (MHz)	35	35	35	35	35	35/100
Channel Count	80	32	80	32	64	400/208
Sequencer Speed (MHz)	35	25	35	25	35	35/100
Correlated State Listings	Y	Y	Y	Y	Y	Y (100 MHz)
System Performance Analysis	Y	Y	Y	Y	Y	Y
Compare/Run Until	Y	Y	Y	Y	Y	Y
Chart Mode	Y	Y	Y	Y	Y	Y
<b>System Features</b>						
Portable	Y	Y	Y	Y	Y	
Modular						Y
Programmability			HP-IB/RS-232 on all			
Hard Copy Output			Variety of HP-IB or RS-232 printers			
Setup Storage/Auto Load	Y	Y	Y	Y	Y	Y
Data Storage			compatible disk files			
Color						Y
Keyboard/Mouse						Y
<b>Page Reference</b>	<b>327</b>	<b>327</b>	<b>329</b>	<b>329</b>	<b>327</b>	<b>330</b>

### Logic Analysis Systems

HP 16500A	HP 16510B	HP 16515/516A	HP 16530/531A
5-slot mainframe	80 channels/card	1 GHz timing analysis	Oscilloscope time base and acquisition cards
9-inch color display	Up to 5 cards/16500A	16 channels/card	Up to 8 input channels per 16500A
Touch screen or mouse control	100 MHz sampling for timing analysis	Up to 80 channels with full capability/16500	Can be triggered by state or timing analysis
Two 3.5-inch disk drives	35 MHz maximum input clock in state analysis	1 ns resolution	400 Msamples/s for 100 MHz bandwidth for single-shot and repetitive signal analysis
Inter-card triggering via intermodule bus	Detects glitches as small as 5 ns	8 kbit/channel memory	Automatic measurements and statistics
Screen hard copy via RS-232 + HP-IB	Simultaneous state/timing analysis	<b>HP 16520/521A</b>	
Programmability via RS-232 + HP-IB		50 Mbit/s pattern generator	
Simultaneous display of state, timing, and oscilloscope traces	<b>HP 16511B</b>	Up to 204 channels/16500A	
Links to CAE and manufacturing testers	Combines two HP 16510B systems	ECL and TTL output	
	Triggers up to 160 channels wide	Can be combined with 16510B or 16515/516A for stimulus/response testing	
	<b>HP 16540/541</b>		<b>HP 16532A</b>
	100 MHz state/timing analysis		1-Gigasample/s oscilloscope
	4 kbit or 16 kbit/channel memory		250 MHz single-shot bandwidth
	Up to 208 channels per 16500A		2 channels per card
			Up to 10 channels per 16500A
			Automatic measurements and statistics

### Simplified Data Interpretation and Interconnections

Hewlett-Packard offers broad support for microprocessors, microcontrollers, interfaces, buses, and digital signal processors. Support includes inverse assemblers, which display target system activity in easy-to-understand mnemonics, and single-probe connection schemes for most processors. If your design includes a custom processor or ASIC, you can use the user-definable inverse assembler and microprocessor interface kit to develop your own support package.

Additional software tools enable you to identify software bottlenecks in your system. The system performance analysis (SPA) package can help you find out where your system is spending its time.

### Quick, Reliable, Complete Connections Between Target Systems and HP's Logic Analyzers

HP microprocessor support offers you a quick, reliable connection to your target system. The HP preprocessor is the mechanical and electrical connection between your target system and the HP logic analyzer. It provides reliable, correct, fast and convenient connections to your system. HP preprocessors are engineered to provide low-capacitance probing, so your target system will not be disturbed. HP provides all clocking and demultiplexing circuits to correctly capture your system operation. Additional status lines are provided to further decode the operation of your processor.

### Microprocessor Support: The Window to System Behavior

Analyze the code in your microprocessor-based system while operating at full clock speed. HP microprocessor support allows you to follow the path of your software without intrusion, from power-up through interrupt to fatal system crashes.

Inverse assembly software translates logic levels captured by the logic analyzer into microprocessor mnemonics that are already familiar to you. The resulting display can easily be compared to original assembly language listings to track down software defects.

Most preprocessors include an inverse assembler disk. When loaded into the logic analyzer from the internal disk drive, this software configures the instrument for use with your microprocessor and transforms the acquired address, data, and status of each state into microprocessor mnemonics.

### HP Support for the Newest Processors

Hewlett-Packard has the resources and commitment to support the newest microprocessors. Hewlett-Packard works with semiconductor vendors to ensure that as processors become available for development, you can use your HP logic analyzer to integrate them into your new system. If your processor is not listed in the support table, contact your HP sales representative to determine its support status.

### Additional Microprocessor Support Through Third Parties

Hewlett-Packard has teamed up with a number of third-party hardware and software vendors to provide complete solutions to your microprocessor and bus analysis needs. Contact your HP field engineer for details on support for the following, as well as various other package types for popular microprocessors.

- EISA bus
- MCA bus
- PC XT/AT bus
- MIL STD 1750 processor
- MIPS R3000
- FDDI
- National DP 8344 BCP

### Backplane and Bus Interfaces

Backplane and bus interface standards are becoming more common. They minimize hardware design effort while increasing the complexity of systems that designers can assemble. This has created a need for better system integration tools. Hewlett-Packard has led the way in providing tools for bus and interface analysis with support for standards such as MIL-STD-1553A/B, SCSI, VME, and RS-232C.

### Design Your Own Preprocessor with the HP 10320C

The HP 10320C user-definable interface allows you to build a custom preprocessor. Use the HP 10320C when you need any of the following:

- An interface for analyzing custom or proprietary devices with your logic analyzer
- A semi-custom test fixture for using your logic analyzer in a manufacturing test environment
- A link for ribbon cables or connections to your logic analyzer

The HP 10320C provides a breadboard that fits inside the HP 10269C general-purpose probe interface. In addition, the kit includes mechanical hardware to mount the breadboard in place and connectors for sending your signals to the HP 10269C. The accompanying manual discusses the interface design process, including what to look for in your target system, how to design so that setup and hold requirements are met, and tips on power supply distribution.

### Display Mnemonics Match Your Custom Interface

Just as the HP 10320C user-definable interface allows you to design custom hardware, the HP 10391B inverse assembler development package allows you to design a custom inverse assembler for your logic analyzers. This software package allows you to write an inverse assembler that will display your system operation in familiar mnemonics across up to 160 channels. The HP 10391B is a macro assembler that runs on HP Vectra personal computers or IBM PC compatibles. The HP 10391B includes Pascal-like instructions such as CASE and IF-THEN statements, strong bit-manipulation capabilities for extraction of single bits or conditional branching on a few bits within a word, and assembly-language constructs including AND, ROTATE, and INCREMENT/DECREMENT instructions.

### Required Equipment

The HP 10391B requires the following equipment:

- HP Vectra PC, IBM PC\* or PC-compatible with a minimum of 256K of memory and MS-DOS\*\* 2.1 or above.
- One floppy disk drive and an internal hard disk (recommended configuration) for the PC, or two floppy disk drives.
- RS-232C port and cable. Recommended card: HP 24540A Serial/Parallel Card or HP 24541A Dual Serial card. For 25-pin ports, use HP 13242G cable or equivalent. For 9-pin ports, use HP 24542G cable.
- HP 1650A/B, 1651A/B, 1652B, or 1653B Logic Analyzer, or HP 16500A Logic Analysis System with an HP 16510B/16511B State/Timing card installed.

\* IBM PC is a trademark of International Business Machines

\*\* MS-DOS is a U.S. registered trademark of Microsoft Corporation

# LOGIC ANALYZERS

## Microprocessor and Bus Support

### Selection Guide

Microprocessor or Device	Package Type	Logic Analyzers Supported			Termination Adapter Included	# of Pods Used	Max. Clock Rate (MHz) [13]	Hardware Style Type [6]	Order No.	U.S. List Price [12]	
		1651 1653 [10]	1650 1652 16510	16540 16541 [11]							
<b>Actel FPGA</b>											
ACT1010,1020	PGA	NO	YES	YES			B	[15]	\$895		
ACT1010,1020	PLCC	NO	YES	YES			B	[15]	\$950		
ACT1010,1020	JQCC	NO	YES	YES			B	[15]	\$950		
A1280	PGA	NO	YES	YES			B	[15]	\$995		
<b>Altera EPLD</b>											
EPM5064	JLCC	NO	YES	YES		4	35	B	[15]	\$845	
EPM5128-J,L	PLCC	NO	YES	YES		4	35	B	[15]	\$895	
EPM5128-P	PGA	NO	YES	YES		4	35	B	[15]	\$845	
EPM5192-J,L	PLCC	NO	YES	YES		5	35	B	[15]	\$950	
EPM5192-	PPGA	NO	YES	YES		5	35	B	[15]	\$895	
<b>AMD</b>											
AM29000	PPI	PGA	NO	YES	YES	5	5,8,9	50	B	E2417A	\$1,600
AM29030	PPI	PGA	NO	YES	YES				B	[15]	\$2,950
<b>Analog Devices</b>											
ADSP2100/2101		[5]	NO	YES	YES	0	3		N/A	[8]	N/C
<b>GTE</b>											
65816		[5]	NO	YES	YES	0	3	ALL	N/A	[7,8]	N/C
<b>Hitachi</b>											
6301/6303	PPI	DIP	YES	YES	YES	3	2	ALL	B	10335G	\$700
64180	PPI	DIP	NO	YES	YES	3	3	ALL	B	10336G	\$700
64180	PPI	PLCC	NO	YES	YES	2	3	ALL	B	10336H	\$1,300
<b>INMOS Transputer</b>											
T414,425		[5]	NO	YES	YES	4	33	N/A	[8]		N/C
T800,801,805		[5]	NO	YES	YES	4	33	N/A	[8]		N/C
<b>Intel</b>											
8080		[5]	YES	YES	YES	0	2	ALL	N/A	[7,8]	N/C
8085	PPI	DIP	YES	YES	YES	0	2	12	A	10304B	\$1,000
MCS-51	PPI [1]	DIP	YES	YES	YES	0	2	16	A	E2415A	\$1,400
8031/51	PPI	DIP	NO	YES	YES	2			B	[15]	\$235
8031/51	PPI	PLCC	NO	YES	YES	2			B	[15]	\$285
8031/51	PPI	PQFP	NO	YES	YES	2			B	[15]	\$885
MCS-96	PPI [2]	PGA	NO	YES	YES	0	3	12	A	E2416A	\$850
MCS-96(Adaptor)		PLCC	NO	YES	YES	0	3	12	A	[15]	
8086/8088	PPI	DIP	NO	YES	YES	0	3	10	A	10305B	\$1,400
80186	PPI	PGA	NO	YES	NO	0	3	25	B	10306G	\$700
80186(Adaptor)		PLCC	NO	YES	NO	3	3	25	N/A	[15]	\$150
80186(Adaptor)		PLCC	NO	YES	NO	3	3	25	N/A	[15]	\$180
80186/188		PGA	NO	YES	NO	3	3	25		[15]	\$335
80286	PPI	PGA	NO	YES	YES	0	3	32	A	E2409B	\$1,700
80286(Adaptor)		LCC	NO	YES	YES	0	3	32	N/A	#1CA	\$700
80286(Adaptor)		PLCC	NO	YES	YES	0	3	32	N/A	#1CB	\$285
80386DX	PPI	PGA	NO	YES	YES	0	5	66	A	10314D	\$2,200
80386SX	PPI	PQFP	NO	YES	NO	5			B	[15]	\$1,085
80486	UI	PGA	NO	YES	YES	7	5	33	B	E2403A	\$1,400
80486	PPI	PGA	NO	NO	YES	0	7	33	C	E2411A	\$2,400
80860	UI	PGA	NO	YES	YES	8	5 to 8	35	B	E2405A	\$1,500
80960CA	UI	PGA	NO	YES	YES	0	5 to 8	40	B	E2410A	\$1,200
80960KA	UI	PGA	NO	YES	YES	4	5 to 6	25	C	E2402A	\$1,000
80960KA	PPI	PGA	NO	YES	YES	[3]	5 to 6	25	C	E2425A	\$2,400
<b>LSI Logic</b>											
LR33000	PPI	PGA	NO	YES	YES		5	40	B	[15]	\$2,950
SPARC64901	PPI	PGA	NO	YES	YES		5		B	[15]	\$950
<b>MIPS</b>											
R3000	PPI	PGA	NO	NO	YES	[3]	7	33	C	E2401A	\$3,500
R3000		[9]	NO	YES	NO		5	ALL		[15]	
R3000		PGA	NO	YES	YES		5			[15]	\$1,890

## Selection Guide (continued)

Microprocessor or Device	Package Type	Logic Analyzers Supported			Termination Adapter Included	# of Pods Used	Max. Clock Rate (MHz) [13]	Hardware Style Type [6]	Order No.	U.S. List Price [12]	
		1651 1653 [10]	1650 1652 16510	16540 16541 [11]							
<b>Motorola</b>											
146805E2	[5]	YES	YES	YES	0	2	ALL	N/A	[7,8]	N/C	
56000	[5]	NO	YES	YES	0	3	ALL	N/A	[8]	N/C	
6800/6802	PPI	DIP	YES	YES	YES	0	2	2	A	10307B	\$1,110
6803	[5]	YES	YES	YES	0	2	ALL	N/A	[7,8]	N/C	
6809	PPI	DIP	YES	YES	YES	0	2	2	A	10308B	\$1,110
68000/010	PPI	DIP	NO	YES	YES	0	3	12.5	A	10311B	\$1,600
68000/010	PPI	PGA	NO	YES	YES	3	3	16	B	10311G	\$600
68000/010		PLCC	NO	YES	YES		3			[15]	\$335
68008		DIP	NO	YES	YES		3			[15]	\$643
68020	PPI	PGA	NO	YES	YES	5	5	33	B	10313G	\$850
68020	PPI	PGA	NO	YES	YES	0	5 to 6	33	C	E2426A	\$2,250
68020	PPI	PQFP	NO	YES	YES		5			[15]	\$1,050
68030	PPI	PGA	NO	YES	YES	5	5	33	B	10316G	\$875
68030	PPI	PGA	NO	YES	YES	0	5	50	C	E2406A	\$2,000
68030		PQFP	NO	YES	YES		5			[15]	\$1,050
68040	UI	PGA	NO	YES	YES	7	5	25	B	[8]	N/C
68040	PPI	PGA	NO	YES	YES	0	5	25	C	E2420A	\$3,300
68HC001	PPI	PGA	NO	YES	YES		4		B	[15]	\$385
68HC001	PPI	PLCC	NO	YES	YES		4		B	[15]	\$385
68HC11	PPI	DIP	YES	YES	NO	4	2	8.4	B	10315G	\$900
68HC11	PPI	PLCC	YES	YES	NO	4	2	8.4	B	10315H	\$1,800
68302 ADS	[9]	NO	YES	YES	0	5 to 10	ALL		D	E2414A	\$400
68302		PGA	NO	YES	YES		5			[15]	\$360
68302		PQFP	NO	YES	YES		5			[15]	\$1,050
68331/332 EVS	[9]	NO	YES	YES	0	5	ALL		E	E2413A	\$750
68332		PQFP	NO	YES	YES		5			[15]	\$1,050
68340 EVS	[9]	NO	YES	YES	0	5	ALL		E	E2424A	\$750
88100	PPI	PGA	NO	YES	YES	10	5	35	B	E2404A	\$1,700
88200	PPI	PGA	NO	YES	YES	5	5 to 10	35	B	E2400A	\$1,200
<b>National</b>											
NS32016	[5]	NO	YES	YES	0	3	ALL	N/A	[8]	N/C	
HPC16003/4/64		NO	YES	YES	0	3	ALL	N/A	[8,14]	N/C	
DP8344 BCP		NO	YES	YES						[15]	
<b>Nec</b>											
7810/11	[5]	NO	YES	YES	0	3	ALL	N/A	[8]	N/C	
V20/30	PPI	DIP	NO	YES	YES	0	3	10	A	10337B	\$1,785
V33	PPI	PGA	NO	YES	YES	0	3	10	A	E2428A	\$1,265
V33	PPI	PLCC	NO	YES	YES	0	3	10	A	#001	\$200
V40/50	PPI	DIP	NO	YES	YES	0	3	10	A	10338B	\$2,670
V53	PPI	PGA	NO	YES	YES	0	3	10	A	E2429A	\$1,450
V60	PPI	PGA	NO	YES	YES	4	4	16	B	10339G	\$1,200
V70	PPI	PGA	NO	YES	YES	5	5	20	B	E2407A	\$1,300
<b>Performance</b>											
PACE 1750A		PGA	NO	YES	YES		5	40	B	[15]	\$2,950
<b>Rockwell</b>											
6502	[5]	YES	YES	YES	0	2	ALL	N/A	[7,8]	N/C	
<b>Texas Instruments</b>											
34010	[5]	YES	YES	YES	2	ALL	N/A	[8]		N/C	
32020/C25	PPI	NO	YES	YES	3	3	40	B	E2418A	\$800	
370C050	[5]	YES	YES	YES	0	2	20	N/A	[8]	N/C	
320C10/14	[5]	YES	YES	NO	0	2	ALL	N/A	[8]	N/C	
<b>Xilinx LCA</b>											
XC2018		PGA	NO	YES	YES		5	35	B	[15]	\$895
XC2018		PLCC	NO	YES	YES		5	35	B	[15]	\$950
XC2064		PGA	NO	YES	YES		5	35	B	[15]	\$895
XC2064		PLCC	NO	YES	YES		5	35	B	[15]	\$895

# LOGIC ANALYZERS

## Microprocessor and Bus Support (cont'd)

### Selection Guide (continued)

Microprocessor or Device	Package Type	Logic Analyzers Supported			Termination Adapter Included	# of Pods Used	Max. Clock Rate (MHz) [13]	Hardware Style Type [6]	Order No.	U.S. List Price [12]	
		1651 1653 [10]	1650 1652 16510	16540 16541 [11]							
<b>Xilinx LCA (continued)</b>											
XC3020	PGA	NO	YES	YES		5	35	B	[15]	\$895	
XC3020	PLCC	NO	YES	YES		5	35	B	[15]	\$950	
XC3030	PGA	NO	YES	YES		5	35	B	[15]	\$895	
XC3030	PLCC	NO	YES	YES		5	35	B	[15]	\$950	
XC3042	PGA	NO	YES	YES		5	35	B	[15]	\$950	
XC3042	PLCC	NO	YES	YES		5	35	B	[15]	\$950	
XC3064	PGA	NO	YES	YES		5	35	B	[15]	\$950	
XC3064	PLCC	NO	YES	YES		5	35	B	[15]	\$950	
XC3090	PGA	NO	YES	YES		5	35	B	[15]	\$995	
XC3090	PLCC	NO	YES	YES		5	35	B	[15]	\$950	
<b>Zilog</b>											
Z80	PPI	DIP	YES	YES	YES	0		ALL	A	10300B	\$1,200
Z80		DIP	NO	YES	YES					[15]	\$235
Z80		PLCC	NO	YES	YES					[15]	\$285
Z180	PPI	DIP	NO	YES	YES		3	ALL	B	10336G	\$700
Z180	PPI	PLCC	NO	YES	YES		3	ALL	B	10336H	\$1,300
Z180		PLCC	NO	YES	YES		3			[15]	\$320
Z8001/8002		[5]	NO	YES	YES	0	3	ALL	N/A	[7,8]	N/C
<b>Bus/Interface Preprocessors</b>											
Bus or Interface Name											
HPIB/RS232	PPI	YES	YES	YES	0	2		A	10342B	\$1,500	
HPIB	PPI	YES	YES	YES	2	2		B	10342G	\$600	
SCSI-I/II	PPI	YES	YES	YES	0	2		D	E2423A	\$2,000	
MILSTD 1553A/B	UI	YES	YES	YES	0	2		D	10341B	\$4,500	
VME A-size	PPI	NO	YES	YES	0	5		D	10344A	\$1,200	
VME VXI B/C	PPI	NO	YES	YES	0	5		D	E1323A	\$1,200	
IBM PC AT/XT BUS		NO	YES	YES		5		D	[15]	\$1,950	
EISA Bus		NO	YES	YES		10		D	[15]		
IBM MCA Bus		NO	YES	YES		7		D	[15]		
FDDI LAN		NO	YES	YES		2 to 3		D	[15]		
IBM MCA Bus		NO	16515/516			N/A	N/A	D	[15]	\$500	

Notes: "PPI" stands for Preprocessor Interface, which includes an Inverse Assembler. The "UI," or Universal Interface, does not.

[1] Includes 8031/8033, 8051/8052, and CMOS versions.

[2] Includes 8096/7-90, -AH, BH, 80C196KA-KB.

[3] Termination adaptors not needed; all necessary termination modules included.

[5] Available as Inverse Assembler with Operating Note only. No interfacing hardware provided.

[6] Hardware Style Types:

A: Requires 10269C to operate (other styles do not).

B: Interface board with connectors for termination adapters.

C: Low-profile probe with cables for termination modules.

D: Special bus interface hardware.

E: Only termination adapters are provided.

N/A - Not applicable; no interfacing hardware provided.

[7] 10320C and 10322A recommended, but not required.

[8] Factory-supplied.

[9] Requires vendor-supplied evaluation board.

[10] The 1654B analyzer supports preprocessors needing 4 or fewer probes at speeds up to 35 MHz.

[11] The 16540A master supports one 16-channel probe; each 16541A expander adds 48 channels or 3 probes.

[12] Factory Base Price is \$15 less than U.S. list price.

[13] Speed listed as of this printing.

[14] Designed to work with the National Microcontroller Development System.

[15] Interface provided by third-party vendor. Contact your Hewlett-Packard sales representative for more information.

### How to Calculate Your System's Bus Rate

The logic analyzer state speed required to capture data from a microprocessor system depends on its bus rate. Bus rate is a function of microprocessor clock speed, which varies for different microprocessors. Complex instruction set computers (CISC) typically require 2 to 4 clock cycles per bus cycle. Many reduced instruction set computers (RISC) require 1 clock cycle per bus cycle. Data showing the minimum clock cycles per bus cycle is shown for each HP-supported processor listed in the table above.



# LOGIC ANALYZERS

## Portable Logic Analyzers

HP 1650B, 1651B, 1654B

327

- HP 1650B: 80 channels of 35 MHz state/100 MHz timing
- HP 1651B: 32 channels of 35 MHz state/100 MHz timing
- HP 1654B: 64 channels of 35 MHz state/100 MHz timing

- Broad support for microprocessors, buses and interfaces
- Simultaneous state/state or state/timing measurements

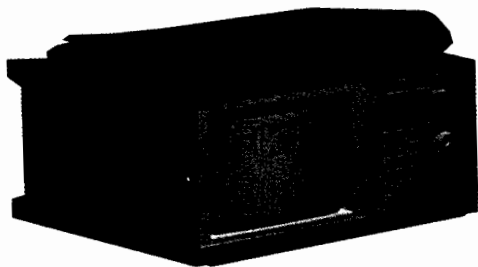

HP 1650B

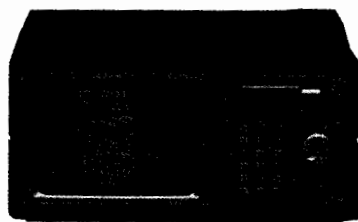

HP 1651B

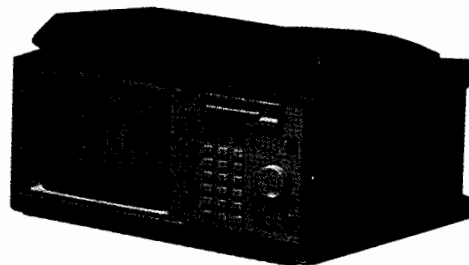

HP 1654B



### HP 1650B, HP 1651B, HP 1654B: Best Value In General-Purpose Logic Analyzers

For microprocessor analysis or general-purpose state and timing-debug, the HP 1650B, HP 1651B, and HP 1654B logic analyzers offer the best value. Each analyzer can be configured as a one- or two-state analyzer, a state analyzer/timing analyzer, or a timing analyzer. Data captured by each analyzer can be displayed with full time correlation. Lightweight, flexible, passive probing is included.

### Support for Most Microprocessors, Buses, and Interfaces

The HP 1650B, 1651B and 1654B support a broad range of microprocessors, buses, and interfaces. Each support package turns your analyzer into a powerful debugging tool dedicated to the task at hand. Most support packages include a 3½-inch disk that configures the analyzer and translates captured data into mnemonics. See pages 324-326 for details on support for your system.

### Powerful State Analysis Helps You Focus on Needed Information

The HP 1650B's powerful state triggering filters out unnecessary data and provides a listing of the crucial data:

- Clocks and clock qualifiers allow your system to determine when the analyzer takes a sample.
- Storage qualification allows you to specify which states are stored in memory.
- Eight sequence levels determine the sequence of states required for trigger and help you to focus on a specific area of code execution.
- Eight pattern recognizers, one range recognizer, or logical combinations of these are used to identify stored states.
- Tagging keeps track of the amount of time or the number of states between stored states.
- Enable/disable can be used to restrict storage to the activity of a specific routine.

### Transitional Timing on All Channels Extends the Measurement Range

Each analyzer provides 10 ns timing resolution on every channel. The analyzer stores data only when there is a transition, thus avoiding redundant data storage. 100 MHz transitional timing on all channels effectively extends the memory by lengthening the time covered by the acquisition. Because timing analyzer samples at full speed, events that are seconds or minutes apart are captured with 10 ns resolution. You can use pattern, edge, or duration triggering across all 80, 64, or 32 channels when you need to see what is happening around a hardware interrupt or handshake.

### Glitch Capture on All Channels

With glitch capture on all channels, you no longer need to move probes around your system to detect intermittent problems. You can trigger on and capture 5 ns glitches on all channels of your HP 1650B, 1651B, and 1654B analyzers. Glitches are displayed as vertical dashed lines, so you can easily distinguish legitimate system activity from glitches.

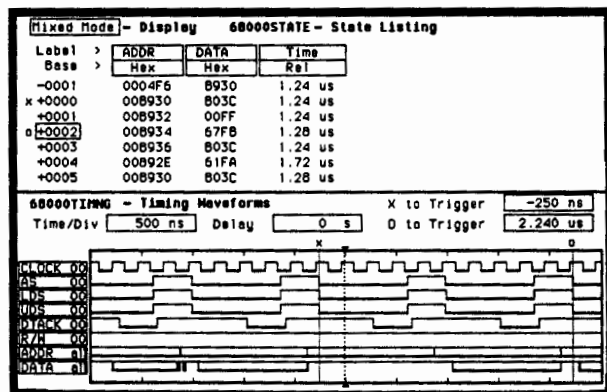

Time Correlated State and Timing Displayed on the Same Screen

# LOGIC ANALYZERS

## Portable Logic Analyzers (cont'd)

HP 1650B, 1651B, 1654B

### Capture the Data You Want to See

You can trigger on a pattern across the full number of channels, or qualify a pattern by specifying a duration, glitch, or edge. Or you can specify a pattern duration to capture error conditions indicated by a pattern that exceeds a specified limit. When you need to see what is happening around a troublesome glitch or hardware interrupt signal, use glitch or edge triggering. Use postprocessing to determine statistical variance of edge placement, or to detect propagation delays that fall outside specified values.

### Flexible Data Display Modes Decrease Debugging Time

Display state acquisitions in one of five forms:

- State listing, which displays your acquisition as a binary, hexadecimal, octal, decimal, or ASCII listing
- Symbolic/inverse assembler, which displays your data in easy-to-interpret mnemonics
- State waveform mode, which displays the data in waveform diagram format
- X-Y chart mode, which displays the value of a data label versus acquisitions or other labels
- State compare mode, which enables you to compare an acquisition to previously acquired state data

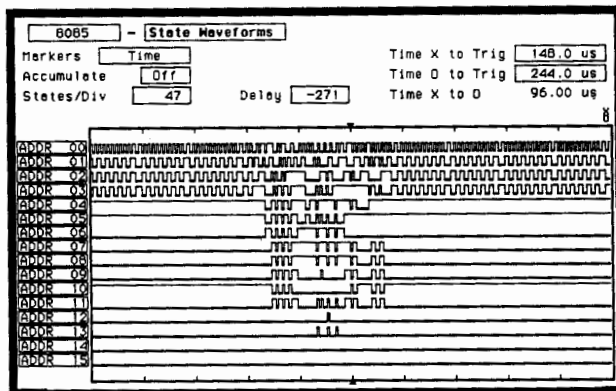

View an entire state acquisition at a glance to examine bus activity or processor control, fully correlated with state listing, X-Y chart, and compare modes.

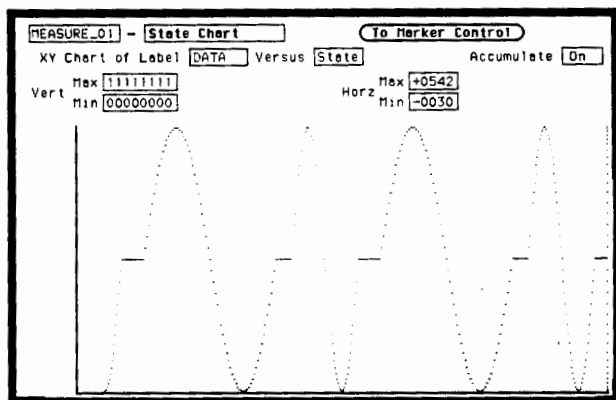

Plot label versus states to check A/D converters or memory coverage. Plot label versus label to obtain a circuit or routine "signature." Correlate chart display with inverse assembled listing.

MEASURE_01 - State Compare		Specify Stop Measurement	
Show	Difference Listing	Find Difference	0
Mask	> *****	Full Compare	
Label	> DATA	STROBE	
Base	> Bin	Hex	
+0006	00010111	1	
+0007	00011110	1	
+0008	00100101	1	
+0009	00101110	1	
+0010	00110111	1	
+0011	01000000	1	
+0012	01001010	1	
+0013	01010100	1	
+0014	01011111	1	
+0015	01101010	1	
+0016	01110101	1	
+0017	10000000	1	
+0018	10000000	1	
+0019	10000000	1	
+0020	10000000	1	
+0021	10000000	1	

Compare state acquisitions with previously acquired state data. Select channel and range masks to "zoom in" on important data. Repetitively capture data until compare is equal or not equal.

### Lightweight, Flexible Probing

Like all HP logic analyzers, the HP 1650B, 1651B, and 1654B feature lightweight, flexible, passive probing. Passive probing means lower cost and increased reliability, because no active circuitry is needed at the probe tip. Measurement quality is not sacrificed; each probe only loads your digital system with 100 K $\Omega$  and 8 pF.

### Compact and Portable

With their small footprint, the HP 1650B, 1651B, and 1654B fit easily on your workbench, within your field of vision along with the device you're working on. At only 22 pounds, these analyzers can be carried easily with the built-in handle or soft carrying case. The case allows you to keep all the probes and cables conveniently stored on top of the instrument.

### Measurement Compatibility

Save setup time by transferring state and timing configurations or measurements made with one instrument to another. Make measurements in the field with confidence that the setups and data can be reproduced later in the lab. Use a 3/4-inch disk to transfer data from one analyzer to another. Use the HP 10392A state-to-pattern generator link to transfer activity captured in the field to the HP 16500A digital pattern generator to duplicate failure modes in the lab.

### Programmability Over HP-IB or RS-232

Both HP-IB and RS-232 interface ports are standard equipment on the HP 1650B, HP 1651B, and 1654B. You can program front-panel functions from either interface, or send hardcopy output to HP-IB or RS-232 printers.

### Built-in Upgrade Path

The HP 1650B/1651B feature a built-in upgrade path to the HP1652B/1653B logic analyzers with built-in oscilloscopes. You can get a 32- or 80-channel analyzer now and upgrade with a 400 MSa/s oscilloscope when you need to.

### The HP 1651B and 1654B - for 8- and 16-Bit Microprocessor Applications

The HP 1651B and 1654B offer all the features of the HP 1650B, except channel count (and state speed on the HP 1651B). For debugging most 8-bit processors, or to monitor timing activity across up to 32 channels, the HP 1651B is the ideal tool. For debugging 16-bit processors, or to monitor 8-bit processors with extra channels for timing analysis, the HP 1654B is the perfect match.

### Key Specifications and Characteristics

Model Number	HP 1650B	HP 1651B	HP 1654B
Timing	100 MHz all 80 channels	100 MHz all 32 channels	100 MHz all 64 channels
State	35 MHz all 80 channels	35 MHz all 32 channels	35 MHz all 64 channels
Memory	1 Kbit/channel	1 Kbit/channel	1 Kbit/channel
Microprocessor Support	Most 8-, 16-, and 32-bit microprocessors	Most 8-bit microprocessors	Most 8-, 16-bit microprocessors

See page 343 for ordering information.



- 80 channels of state/timing
- 2 channels of 400 MSA/s digitizing oscilloscope
- More measurement power at a lower cost than separate instruments

### Logic Analyzers with a Digitizing Oscilloscope

The HP 1652B and HP 1653B Logic Analyzers have all of the features of the HP 1650B and HP 1651B plus two 400 MSA/s digitizing oscilloscope channels, automatic pulse parameter measurements, and time-correlated state, timing, and oscilloscope displays. You still can completely analyze your 8-, 16-, or 32-bit microprocessor while getting better definition on system signals with the 2-channel oscilloscope.

You can characterize critical timing parameters with time interval measurements to better than 1 ns accuracy or examine glitches in your system with the built-in scope to determine if noise or loading is the problem. Or, you can use the scope to enhance your troubleshooting capabilities.

### Two Simultaneous 400 MSA/s Analog Channels

Each scope channel is a full-featured, 400 MSA/s, 100 MHz bandwidth oscilloscope. Both channels simultaneously capture nonrepeating events with a full 2,048 samples per channel. The built-in scope is based on the same technology used in the popular HP 54502A 100 MHz Single-Shot BW Oscilloscope. The scope features include precision voltage and time-interval measurements, autoscale, waveform math, auto-calibration, infinite persistence, and averaging display modes.

### Time-Correlated State, Timing, and Oscilloscope Measurements

System debugging becomes easier when you display time-correlated state, timing, and analog displays on the same screen. You can see how hardware and software interact, while getting an accurate view of how your system sees the signal.

### Cross-Trigger Measurement Modules

You can use the state analyzer's powerful triggering capabilities to determine when the oscilloscope should trigger. Glitch triggering on all channels makes the timing analyzer another great tool for triggering the scope. Simply set up the timing analyzer to trigger on a glitch, then trigger the oscilloscope to capture the activity around the glitch. By getting an analog display of the signal, you can determine whether the glitch is really a problem.

- See analog events with a general-purpose 100 MHz single-shot BW digitizing scope for viewing analog events
- Automatic pulse parameter measurements

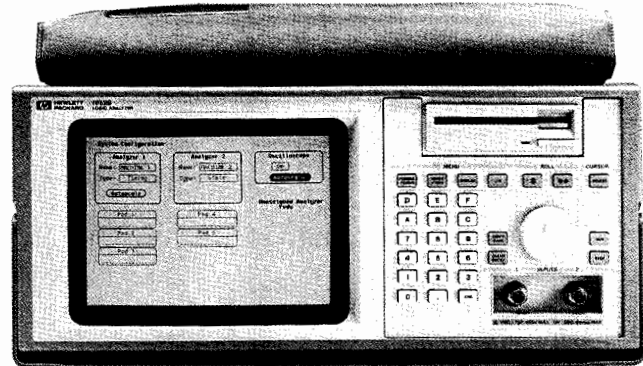

### See Pre-Trigger Events

2 K sample memory per oscilloscope channel lets you view events up to 5 s before the trigger, while maintaining better than 1-ns time-interval accuracy.

### Automatic Pulse Parameter Measurements

Quickly analyze a signal's analog properties without having to count gratitudes. Choose automatic measurements or time markers to measure voltage and timing relationships. The HP 1652B/1653B automatically measures the following pulse parameters:

- |                      |               |
|----------------------|---------------|
| + pulse width        | - pulse width |
| frequency            | period        |
| rise time            | fall time     |
| peak-to-peak voltage | overshoot     |
| prebush              |               |

### Automatic Marker Search

Using the automatic marker search, you can examine waveforms for specific patterns that could be the cause of a system crash. Or use the automatic marker search statistics to reveal setup and hold-time violations as you make repeated measurements on the system. After each run, the markers are placed on specified patterns, and statistics are compiled on the mean, minimum, and maximum marker placement times, so you can see how often a specific event occurs.

### Hardcopy Output

After using the built-in oscilloscope to find an elusive problem, use either an HP-IB or RS-232 printer to obtain a permanent record. The HP 1652B and 1653B support over 10 printers.

### All Other Features of the HP 1650B/1651B

All of the other features of the HP 1650B/1651B logic analyzers are included in the HP 1652B/1653B. These features include 80/32 channels of state and timing analysis, full-featured triggering, built-in disk drives, and support for most popular processors and bus interfaces. And the data and configuration files of the HP 1652B/1653B are compatible with the HP 1650B/1651B/1654B and with the HP 16510B. You can transfer information from one analyzer to another.

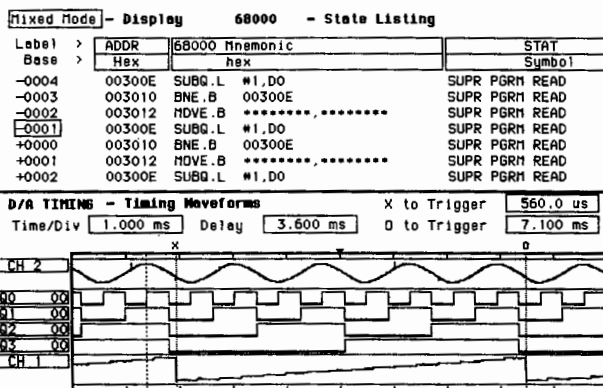

### Portable Analyzers

The HP 1652B/1653B Portable Analyzers are ideal for service applications. Their small size and light weight (just 24 lb) make them easy to carry to test sites. With the built-in scope, you have two complete instruments in one small package.

### Key Specifications and Characteristics

	HP 1652B	HP 1653B
Timing	100 MHz all 80 channels	100 MHz all 32 channels
State	35 MHz all 80 channels	35 MHz all 32 channels
Analog	2 - 400 MSA/s 100 MHz BW Simultaneous acquisition channels	2 - 400 MSA/s 100 MHz BW Simultaneous acquisition channels
Glitch capture	80 channels	32 channels
Microprocessor support	Most 8-, 16-, and 32-bit microprocessors, buses	Most 8-bit microprocessors, buses

See page 343 for ordering information.

# LOGIC ANALYZERS

## Logic Analysis Systems

### HP 16500A and Measurement Modules

- Modular, configurable logic analysis system
- Expandable, up to nine different measurement modules
- Powerful cross-module triggering



HP 16500A

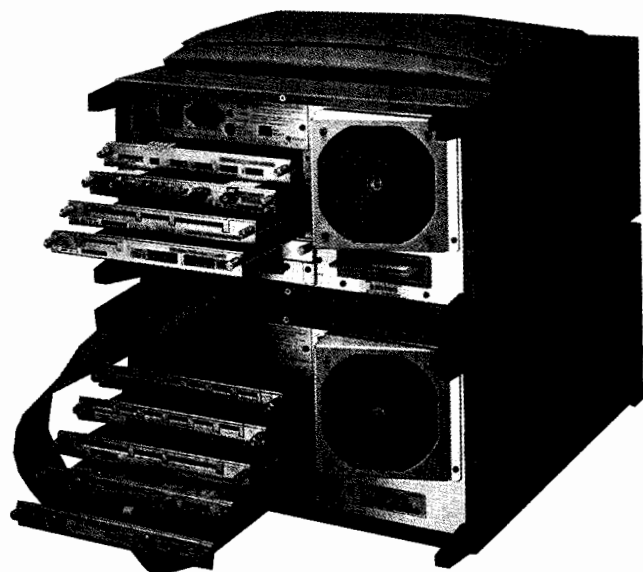

The HP 16500A supports six different measurement modules.

- 100-MHz state analysis
- Support for most microprocessors
- 1-GHz timing and pattern generation modules

### HP 16500A Modular Logic Analysis System

The HP 16500A logic analysis system can be configured for a wide range of measurement tasks, including microprocessor debug, hardware design verification and debug, software performance analysis, characterization, and functional pass/fail testing. Start with a focused system, then expand as your needs evolve.

The HP 16500A logic analysis five card slots accept six different measurement modules. With the HP 16500A, you can do the following:

- Customize your own system by adding cards to the five card slots.
- Make time-correlated measurements between cards using the intermodule bus.
- Compare hardware measurement data with design simulation data.
- Program the HP 16500A with easily understood commands through HP-IB or RS-232C built-in interfaces.
- Store setups and measurement results in either of two built-in disk drives for fast recall or permanent record.
- Generate report-quality documentation with pushbutton ease.

### HP 16501A Logic Analysis System Expansion Frame

The expansion frame provides an additional four\* slots to your HP 16500A Logic Analysis System, giving you control of up to nine measurement modules from your HP 16500A's interface. With the expansion frame you can now cross-trigger up to nine measurement modules and then view your results on the same screen with 10 ns time correlation.

### Color Touchscreen, Mouse, and Keyboard

Save time and reduce errors with the HP 16500A color touch screen. Simply point to the field you want to change; the touchscreen eliminates the need to search a front panel for the right button. Pop-up menus offer all choices at a glance, and the software does not allow you to make an incorrect choice. Front-panel operations can also be executed via mouse and/or keyboard providing complete user-interface flexibility.

Color discriminates between overlapped traces and emphasizes important points. In addition, you can customize for personal preference and environmental considerations. Even infrequent users spend less time making measurements and more time analyzing the results.

Data display areas are not touch-sensitive, so there is no need to worry about losing your latest acquisition.

### Use Cross-Domain Triggering for Complex Measurements

Use state to arm timing, or use timing to arm state when the symptom of a problem is best isolated with one analyzer and the cause is best isolated with the other. For example, track a microprocessor program flow around a hardware interrupt. Find the edge of the interrupt signal with the timing analyzer. After the signal is found, the timing analyzer can arm the state analyzer to start acquiring data.

\*The HP 16501A interfaces with the HP 16500A via an expansion frame interface card that occupies one of the HP 16500A's five module slots. The expansion frame has five slots, providing a total of nine measurement module slots when combined with the HP 16500A.

### Perform Time-Correlated State Analysis of Multiple Microprocessors

In multiple microprocessor environments, systems are driven by multiple clocks. The HP 16500A/16510B provides simultaneous capture of separately clocked systems while time-tagging all states. You can capture the states from several microprocessors, then analyze their flow with interleaved, time-correlated state displays. You can monitor up to 10 independently clocked microprocessor systems with five HP 16510B modules while monitoring the activity with state-to-state time-correlated listings or monitor multiple RISC systems at speed with the HP 16540A/D and HP 16541A/D.

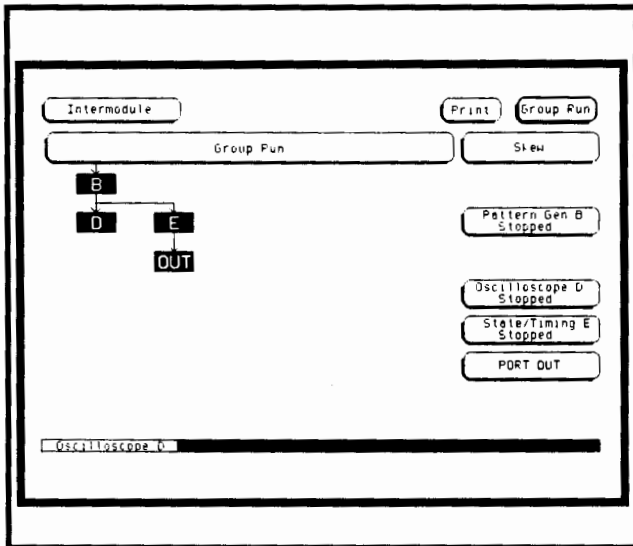

With the HP 16500A intermodule bus, you can arm or trigger one measurement module from another.

### Configure Your System

The HP 16500A Logic Analysis System can be configured for your debug, characterization, systems integration, or pass/fail testing applications. Start with a focused system, then expand it as your needs evolve. For example, start with an 80-channel logic analyzer and a 2-channel oscilloscope, then add more capability as needed.

### High-Performance System

Verify or analyze the performance of circuits through combined analog, state, and timing measurements. The five card slots hold state/timing cards, timing cards, pattern generator cards, and digitizing oscilloscope cards. Use these cards in combination to make measurements that could not be made with separate instruments. For example, state can arm both oscilloscope and timing waveform capture, allowing you to display a mixture of timing and scope waveforms on screen to measure time relationships between events.

### Store Setups and Data Quickly

It is easy to store and retrieve measurement results and setups with the two built-in 3½-inch disk drives. Use the back disk drive for the operating system, leaving the front disk free for measurement files.

### Correlate 1-GHz Timing with Oscilloscope Waveforms

Connect several 1-GHz timing lines while probing simultaneously with oscilloscope channels. For example, configure 32 channels of 1-GHz timing with four oscilloscope channels to provide time correlation from a single trace point. This procedure allows you to capture the number of channels you need while simultaneously capturing parametric information.

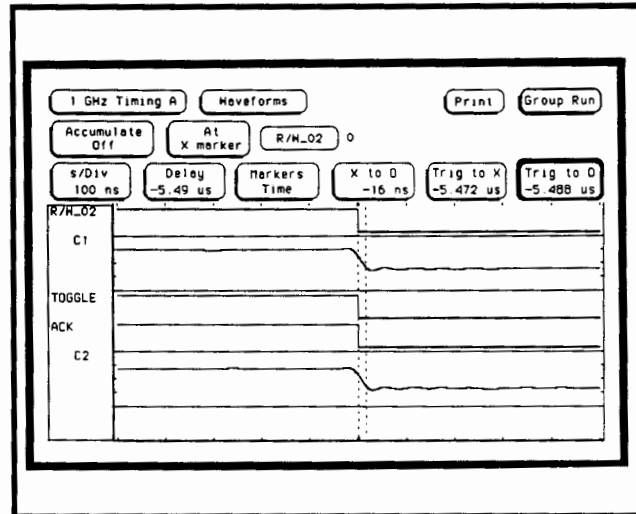

1-GHz timing waveforms time correlated with 1-GSa/s digitizing oscilloscope waveforms.

### Application Driven Trigger Selection

Select the trigger mode that best suits your application. Use glitch, state, analog, or timing triggers to capture state, analog, and/or timing data. To analyze interrupt handling in a microprocessor system, use the oscilloscope to arm timing, state, and analog on the asynchronous interrupt. Then capture microprocessor program flow with state, capture control lines with timing, and capture the interrupt line with the scope. The HP 16500A Logic Analysis System connects state, timing, analog, and pattern generation trigger qualification serially or in parallel in any order to meet your needs.

### Generate Patterns Interactively

Generate patterns triggered by the intermodule bus or by the pattern generator's external qualification. The intermodule bus provides state, analog, timing, and/or pattern generator program flow qualification. Test your circuit's response to patterns derived from simulation, for rigorous functional analysis of prototypes. You can quickly generate pattern generator programs using the HP 10392A state-to-pattern generator link.

See page 343 for ordering information.

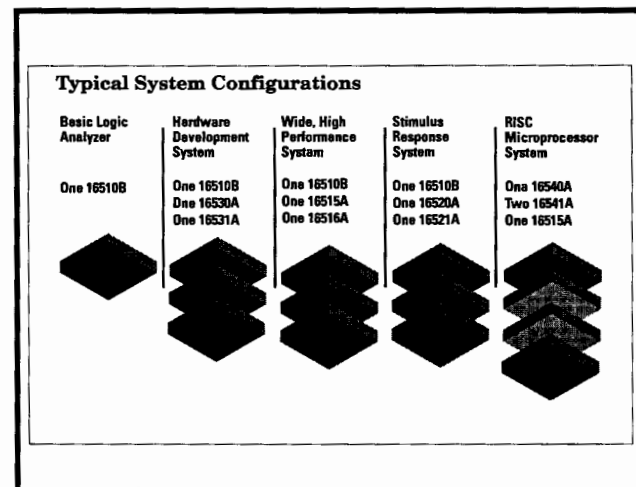

# LOGIC ANALYZERS

## State and Timing Analysis Modules

### HP 16510B, 16511B



#### HP 16510B, HP 16511B State/Timing Module

##### Full-Featured State Analysis

The HP 16510B offers 80 channels of full-featured state and timing analysis. You can configure up to 400 channels of state and timing in the HP 16500A frame, or examine up to 10 processors at the same time. Each HP 16510B can operate as a separate state/timing analyzer, while time correlation is available over the HP 16500A intermodule bus (IMB).

#### Trigger Across 160 Channels

Simplify data tracking through pipelined architectures with the use of the HP 16511B 160-channel 35-MHz state/100-MHz timing module. You can trigger across all 160 channels, making the flow through the pipeline easier to follow.

Trigger on complex handshaking routines across several synchronous processors and display all of the data on the same screen to debug multiprocessor systems. RISC, wide bus, and ASIC integration tasks become easier when you can look at all of the data with one state or timing analyzer. Data correlation across all 160 channels is automatic.

#### View Activity of Two Parts of a System

The HP 16510B and 16511B can be configured into two independent state analyzers or a single state and one timing analyzer. Measurements that would normally require two instruments can now be made with a single instrument.

For example, by using the state analyzer to focus on a specific I/O routine, you can watch both the program execution and the activity on the I/O lines with a time-correlated display. Or when you need to examine the interaction of two microprocessors, the HP Logic Analyzers can display time-correlated state listings.

#### Use the State Analyzer as a Window to the System

When a trigger sequence is too complex for the scope, use the state analyzer's powerful 8-level, 8-resource term trigger to locate the problem; then use another measurement module to get a detailed picture of the fault. The state and timing analyzer can be used together to define when a problem occurs and then either arm or trigger the HP 16532A oscilloscope or HP 16515A/16516A 1 GHz Timing Analyzer to capture data. This approach saves time and helps avoid the extra work of finding a problem with a scope alone.

Label	HPMDATA	Time
Base	Binary	Relative
29	11101111	400 ns
30	11101111	1.00 us
31	11101111	400 ns
32	11101111	400 ns
33	11101111	1.00 us
34	11101111	400 ns
35	11101111	400 ns
36	11101111	1.00 us
37	11101111	400 ns
38	11101111	400 ns
39	11101111	1.00 us
40	11101111	400 ns
41	11101111	400 ns
42	11101111	1.00 us
43	11101111	400 ns
44	11101111	400 ns

Time tagging measures the time between states. You can get an accurate picture of the time it takes your system to make the transition from one state to another.

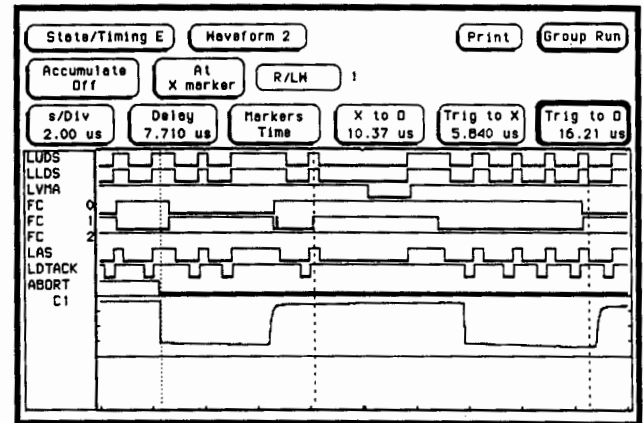

Transitional timing on every channel gives a wide view of system activity (shown here with a time-correlated oscilloscope channel).

#### Measure the Time Between States

With time tagging turned on, you can measure the time it takes your system to make the transition between one state or another. The time information is displayed along with the state data, so you can get a clear picture of an event's duration. Combine state tagging with storage qualification to confirm the length of an information transfer without actually storing all of the data.

#### Transitional Timing on All Channels

The HP 16510B and 16511B logic analyzers store timing data only when there is a transition, thus avoiding redundant data. This effectively extends the memory by lengthening the time covered by an acquisition. Because the timing analyzer samples at full speed, events that are seconds or even minutes apart are captured with 10 ns resolution. Use transitional timing for analysis of asynchronous data busses, where activity often occurs in bursts, followed by long periods of dead time.

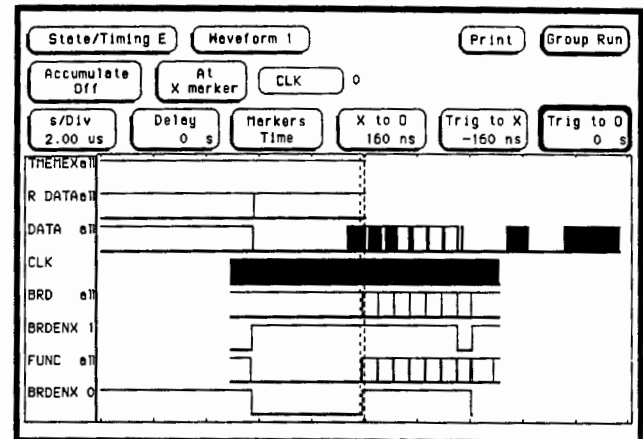

Transitional timing captures 20  $\mu$ s of data with 10-ns resolution.

### Use Postprocessing to Snare Elusive Timing Faults

Use the timing analyzer's postprocessing to find setup and hold violations. Use the specify-stop-measure feature to acquire data until the time interval between two patterns violates a specified condition. Transitional timing can supply a long pre-trigger record length, so you can look back in time to discover the cause of the problem.

### System Performance Analysis

The HP 10390A System Performance Analysis software (SPA) provides an overview of system activity. It can be used with another state machine in the same analyzer to find the activity of interest in order to make time-interval measurements. Or, it can be used in state overview mode to help identify execution segments as prime targets for optimization.

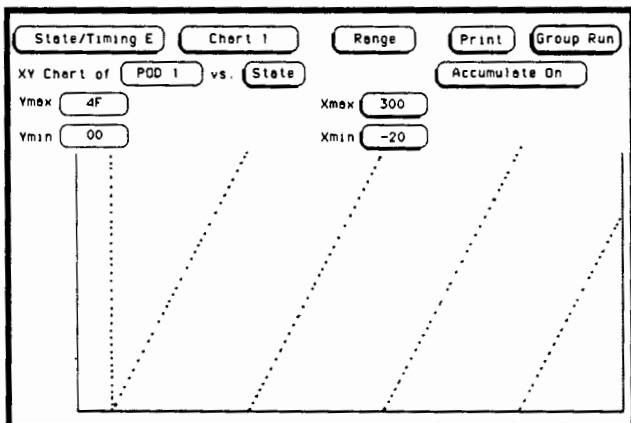

Chart mode shows characteristic signature of a memory read cycle.

### Debug Microprocessors

HP preprocessors tailor the HP 16510B and 16511B to microprocessors from Intel, Motorola, Zilog, National, Hitachi, AMD, MIPS, and NEC. These preprocessors simply plug directly into the CPU socket. Companion software converts the acquired state data to microprocessor mnemonics, making it easy to monitor program execution. See pages 324 through 326 for microprocessor and bus interface support details.

For designs that use custom or proprietary CPUs, use the HP 10320C user-definable interface to connect HP logic analyzers to your system. The HP 10391B inverse assembler development package can be used to develop custom software that converts the acquired state data to CPU mnemonics.

### Key Specifications and Characteristics

Model	HP 16510B	HP 16511B
Channel count	80	160
Maximum state input clock rate*	35 MHz	35 MHz
Setup time*	10 ns	10 ns
Hold time*	0 ns	0 ns
Maximum timing speed*	100 MHz	100 MHz
Memory depth per channel	1024	1024
Minimum detectable glitch width*	5 ns	5 ns
Input R	100 K ohm ± 2%	100 K ohm ± 2%
Input C	~ 8 pF	~ 8 pF

\* Specifications

See page 324 for microprocessor support.  
See page 343 for ordering information.

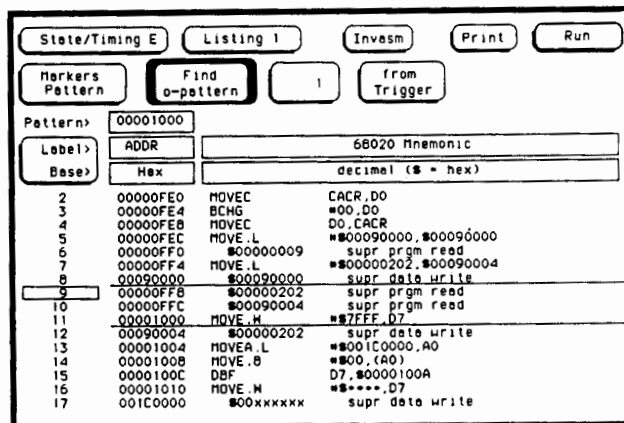

A Motorola 68020 inverse assembly listing.

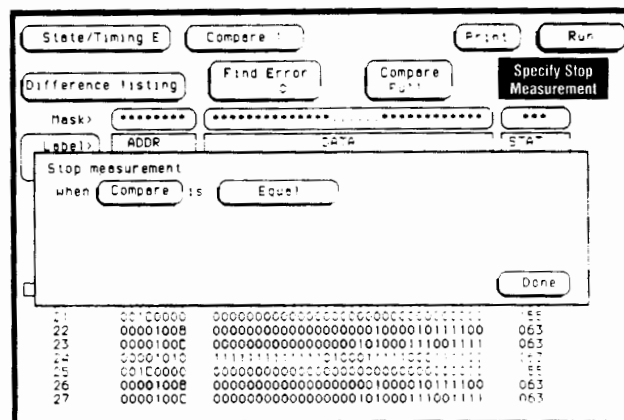

Use the state analyzer compare mode to identify faulty states. See page 343 for ordering information.

# LOGIC ANALYZERS

## 100 MHz State and Timing Modules

### HP 16540A/D, 16541A/D



### HP 16540A/16541A, 16540D/16541D 100-MHz State/Timing Analyzers

The HP 16540/16541 100-MHz State/Timing Analyzer offers full-featured 100-MHz data capture and analysis. You can configure up to 208 100-MHz channels with either 4K deep memory on the HP 16540A/541A, or 16K deep memory on the HP 16540D/541D. Powerful four-level sequencing, with pattern and range recognizers, storage qualification, and per-level branching, helps you find elusive system errors. Adjustable setup and hold time enable the HP 16540/16541 to capture data reliably, even from ECL systems.

The HP 16540/16541 also offers all of the software features found in the 35-MHz model 16510B, including chart mode, compare, and system performance analysis (SPA). The HP 16540/16541 is fully programmable.

When you use the HP 16540/16541 as part of a complete logic analysis system, you can correlate 100-MHz state measurements with other modules, such as the HP 16515A/16516A 1-GHz timing, or the HP 16532A 1-GSa/s digitizing oscilloscope module, to speed debug.

#### 100-MHz State Gives You the Margin You Need

Today's RISC processors already operate at bus rates up to 70 MHz. Because clock rate increases are one of the fastest ways to increase processor performance, there is no doubt that bus rates will increase. The HP 16540/16541 has full performance up to 100 MHz, giving you the margin you need for today's and tomorrow's systems.

#### Full Support for Popular RISC and CISC Processors

The HP 16540/16541 brings you the broadest RISC processor support available. RISC/CISC processors supported include the following:

AMD AM2900  
Intel 80860, 80960, 80386, 80486  
MIPS R2000/3000/4000  
Motorola 88000 (88100 and 88200), 68030, 68040



HP E2406A

Each microprocessor or bus support package includes a preprocessor interface, which gives you quick and easy connection to your target system. Inverse assembly software translates acquired states into processor-specific mnemonics.

#### Post-Processing Reduces Debug Time

Detect processing errors by comparing measured and expected results while running your system at speed. Compare mode allows you to compare just the section of code you are interested in. Compare images can be edited from the front panel or by program control.

System performance analysis (SPA) software (HP 10392A Option 003) helps you characterize the performance of your system. Use SPA to determine where system bottlenecks occur or to optimize I/O routines or data transfer times.

State histogram mode lets you break your system into small ranges that correspond to natural boundaries in your system. A trace shows you the operations on which your system spends its time.

Time interval mode helps you characterize activities such as data requests and packet transfers, or detect error recovery procedures that take too long.

#### Monitor Time Between Events

When optimizing high-performance systems, you need to keep track of what happened when. Time tagging allows you to measure the time between critical system events such as interrupt handling, subroutine calls, or secondary memory accesses. With the HP 16540/16541, you can track these events to the full 100-MHz speed of the analyzer.

#### Compatibility Protects Your Investment

The HP 16540/16541 probes are compatible with HP 1650 family and HP 16510A/B Series probes. Most preprocessors used with the other 16500 family products can be used with the HP 16540/41. The HP 16540/16541 user interface is nearly identical to the HP 16510B, so you can set up measurements quickly.

#### Key Specifications and Characteristics

Model Number/Type	HP 16540A/D Master Card	HP 16541A/D Expansion Card
Channel count	16	48
Maximum state input clock rate*	100 MHz	
Maximum sequencer speed	100 MHz	
Setup time*	0 ns, 2 ns, or 4 ns	
Hold time*	4 ns, 2 ns, or 0 ns	
Maximum timing speed*	100 MHz	100 MHz
Memory depth per channel	4 K (A version) 16 K (D version)	4 K (A version) 16 K (D version)
Input R	100 K $\Omega$ $\pm$ 2%	100 K $\Omega$ $\pm$ 2%
Input C	$\sim$ 8 pF	$\sim$ 8 pF

\* Specifications

See page 323 for microprocessor support.  
See page 343 for ordering information.



### HP 16530A Timebase Card, HP 16531A 2-Channel Acquisition Card

#### Built-in Full Featured Scope

The HP 16530A/16531A offers the advantages of a full-featured digitizing oscilloscope, integrated into your logic analyzer. You get a full 100-MHz analog-equivalent bandwidth scope with digitizing advantages such as autoscale, automatic measurements, powerful triggering, and negative time viewing.

Arm or trigger the oscilloscope from any other module in the HP 16500A logic analysis mainframe. You can capture and display the analog events that affect the digital system. Correlate the oscilloscope to state listings and timing waveforms to identify cause-and-effect relationships.

#### Correlate Single-Shot Events with Precision Time-Interval Measurements

Make time-interval measurements with markers at better than 1-ns accuracy single-shot (after deskewing). Accuracy at probe tip is ensured by a front-panel calibration routine that reduces channel-to-channel skew. You can also calibrate for delays caused by uneven probe lengths, to ensure that the measurement is correct.

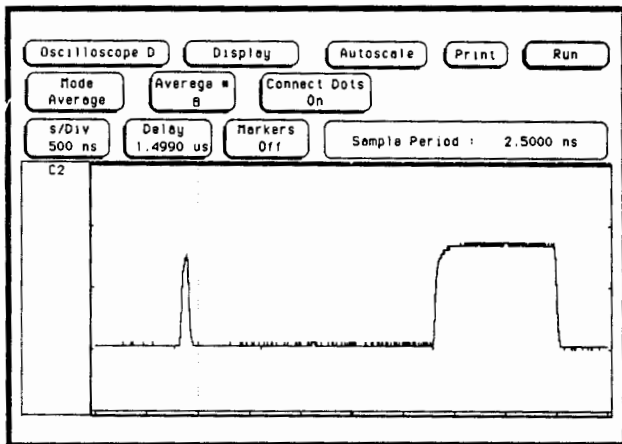

The HP 16530A/16531A Digitizing Oscilloscope finds a glitch.

#### Single-Shot Analysis

The HP 16531A 2-channel, 400-Msa/s digitizing oscilloscope captures 100-MHz bandwidth signals single-shot. You can capture up to eight channels simultaneously to determine relationships between infrequent events. A high-resolution color display and postcapture scroll and zoom allow detailed examination of waveforms.

#### Capture Many Waveforms Simultaneously

Run up to four HP 16531A oscilloscope cards with a single HP 16530A time-base card for simultaneous acquisition. The HP 16530A/16531A oscilloscope module can be configured to acquire from two to eight signals simultaneously. Save time when debugging and characterizing systems by observing multiple test points during each test.

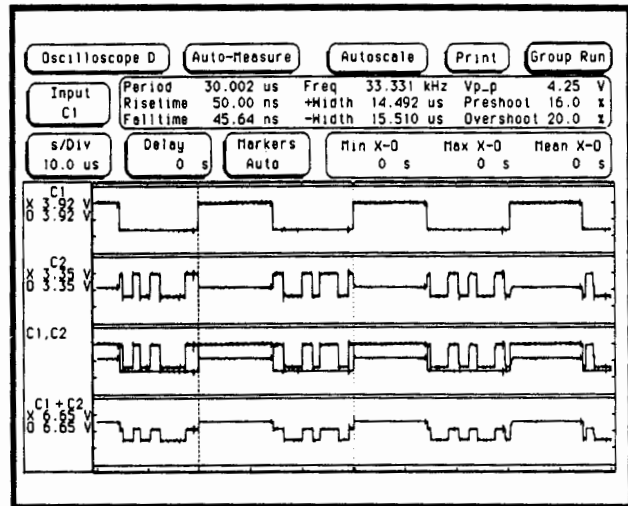

Waveform match functions are available.

#### Measure Slow and Fast Events Simultaneously

Use the 4 K sample depth to measure periods and time intervals. Then zoom in for rise-time measurements. Add a second oscilloscope module to create a dual time base digitizing oscilloscope, and to display events with different time bases on the same screen.

#### Find the Causes of Errors

Each channel has 4 K memory depth for capturing events before or after the trigger event. View events up to 10  $\mu$ s before the trigger event with greater than 1 ns accuracy.

#### View Analog and Digital Waveforms – and More

Capture random signal variations with the Accumulate mode. Filter out noise with Average mode. Show true single-shot events with Single mode. Scan many periods of the waveform easily with the Connect-the-Dots feature. View analog-like waveforms with 6-bit vertical resolution. Analyze differential waveforms with the A-B mode. The HP 16530A/16531A gives you all of the features of a digitizing oscilloscope plus the power of a logic analyzer in one frame.

#### Automatic Measurements

Automatic pulse parameters allow fast analysis without having to count gratitudes. Parameters such as frequency, period, pulse width, peak-to-peak voltage, maximum voltage, minimum voltage, rise time, fall time, preshoot, and overshoot require just one keystroke. Measure voltage and timing relationships by placing the markers and reading the results on the display. Display the time between markers, acquire until capture specified time between markers, or perform statistical analysis on the time between markers. Setup is easy with automatic waveform scaling, TTL and ECL presets, and automatic marker placement on specified edges.

#### Key Specifications and Characteristics

Model Numbers	HP 16530A, HP 16531A
Bandwidth*	dc to 100 MHz (real time, dc coupled)
Maximum sample rate	400 MSA/s
Channel count	2, 4, 6, or 8 simultaneous channels. Maximum of 14 channels with the HP 16501A expansion frame.
Rise time**	3.5 ns
Vertical resolution	6 bits over 4 div ( $\pm 1.6\%$ )
Waveform record length	4096 points
Time-interval measurement accuracy	$\pm (0.02\% \times \text{time interval} + 750 \text{ ps})$
Input coupling	dc
Input resistance	1 M $\Omega$ , 50 $\Omega$
Input capacitance	13 pF (nominal)

\*Specifications

\*\*Rise time is calculated from: rise time = 0.35/bandwidth

See page 343 for ordering information.

# LOGIC ANALYZERS

## Digitizing Oscilloscope Modules

### HP 16532A



#### HP 16532A 1 GSa/s Digitizing Oscilloscope Card

The HP 16532A 1GSa/s Digitizing Oscilloscope Module provides two channels of simultaneous single-shot (real-time) waveform capture. Each channel uses an 8-bit 1-gigasample/s analog-to-digital converter providing a 250-MHz single-shot bandwidth. This high-performance instrument reveals more detail on a waveform, instantly uncovering problems that might be masked by lower bandwidth single-shot scopes. The HP 16532A also lets you measure critical timing margins with  $\pm 150$ -ps accuracy.

#### Capture Many Waveforms Simultaneously with 1-ns Resolution

If you need more scope channels, up to four HP 16532As can be operated using the same time base setting to provide up to eight channels. Since each HP 16532A card has its own time base, you can also operate each pair of channels independently. Up to 18 channels, with a maximum of nine independent time bases, can be configured in an HP 16500A with an HP 16501A expansion frame.

#### Tackle Your Toughest Debugging Problems with $\pm 150$ -ps Time-Interval Accuracy

Quickly characterize the effects of slow rise times, propagation delays, and marginal setup times with time-interval measurement accuracy of  $\pm 150$  ps. Accurate and repeatable measurements give you the confidence you need when evaluating the narrow timing margins found in today's high-speed microprocessor-based systems.

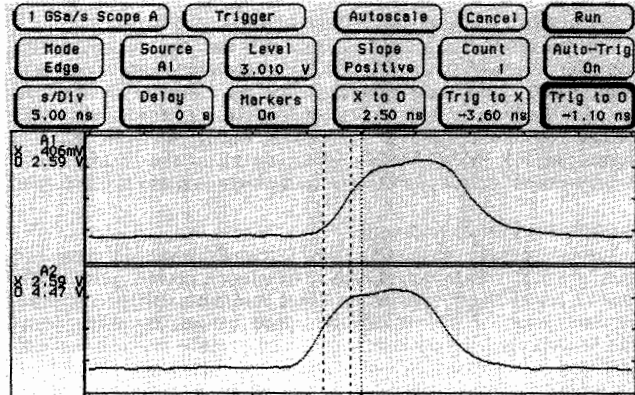

Propagation delay through a logic gate.

#### Intermodule Triggering Shows You the Complete Picture

Inter-module triggering lets you trigger the HP 16532A at a particular time of interest by using the sophisticated triggering capabilities of any state or timing analyzer present in your HP 16500A. Once you've acquired them, you can view state and timing data and oscilloscope waveforms simultaneously on one screen, with 10-ns time correlation.

#### View Analog and Digital Waveforms – and More

Capture random signal variations with the Accumulate mode. Filter out noise with the Average mode. Show true single-shot events with the Single acquisition mode. View analog-like waveforms with 8-bit vertical resolution. Analyze differential waveforms with the A-B mode. The HP 16532A gives you the features of a digitizing oscilloscope plus the power of a logic analyzer in one frame.

#### Automatic Measurements

Automatic pulse parameter measurements allow fast analysis without having to count graticules. Parameters such as frequency, period, pulse width, peak-to-peak voltage, rise time, fall time, preshoot, and overshoot require just one keystroke. Maximum voltage and minimum voltage are available over HP-IB or RS-232C. Measure voltage and timing relationships by placing the markers and reading the results on the display. Display the time between markers, acquire until capturing specified time between markers, or perform statistical analysis on the time between markers. Setup is easy with automatic waveform scaling, TTL and ECL presets, and automatic marker placement on specified edges.

#### Key Specifications and Characteristics

Model number	HP 16532A
Bandwidth *	dc to 250 MHz (real time, dc coupled)
Maximum sample rate	1 GSa/second
Channel count	2, 4, 6, or 8 simultaneous channels using the same time base setting or up to 10 channels with independent time bases for each pair of channels. Maximum of 18 channels with the HP 16501A expansion frame.
Rise time **	1.4 ns
Vertical resolution	8 bits over 4 div ( $\pm 0.4\%$ )
Waveform record length	8,000 points
Time-interval measurement accuracy *	$\pm [(0.005\% \times \text{time interval}) + (2 \times 10E - 6 \times \text{delay setting}) + 150 \text{ ps}]$
Input coupling	1 M $\Omega$ : ac, dc 50 $\Omega$ : dc only
Input resistance *	1 M $\Omega \pm 1\%$ , 50 $\Omega \pm 1\%$
Input capacitance	$\sim 7$ pF (nominal)

\* Specifications.

\*\* Rise time is calculated from rise time = 0.35/bandwidth.

See page 343 for ordering information.

### HP 16515A/16516A Timing Analyzers Affordable 1-GHz Timing

Measure precise time relationships to 1-ns resolution with the HP 16515A/16516A 1-GHz timing analyzer. Make time-interval measurements or view the order of events in your high-speed system with 1-ns single-shot resolution on every channel. There is no need to compromise channel count for sample speed. Every channel runs to the full 1-GHz sample rate.

Debug quickly with up to 80 channels of 1-GHz timing in one HP 16500A Logic Analysis Mainframe. More channels means that you can avoid having to move probes in order to find the problem. 16 channels of 1-GHz timing complements the HP 16510B 100-MHz timing to help you get a clearer picture of critical timing behavior.

### Find the Cause of Problems with 8 Kb/Channel Memory Depth

Find and analyze events that occur before or after the trigger event. Each channel stores eight K samples to allow 8  $\mu$ s of negative time capture with 1-ns resolution for pre-trigger applications. Deep memory stores data over many clock cycles while retaining precise edge placement information. Deep memory also helps you find elusive problems more quickly when you're not sure exactly where to trigger.

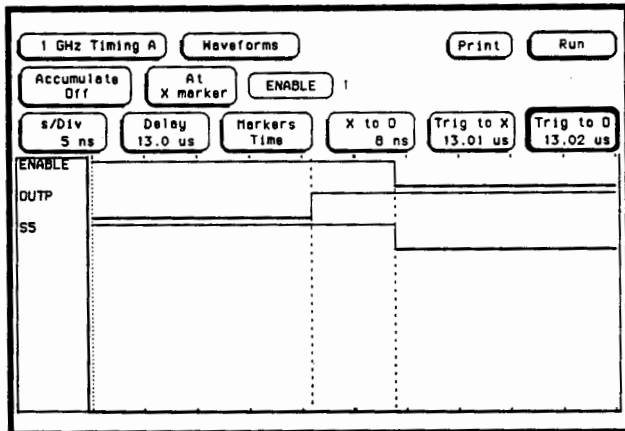

Make time-interval measurements with 1ns resolution.

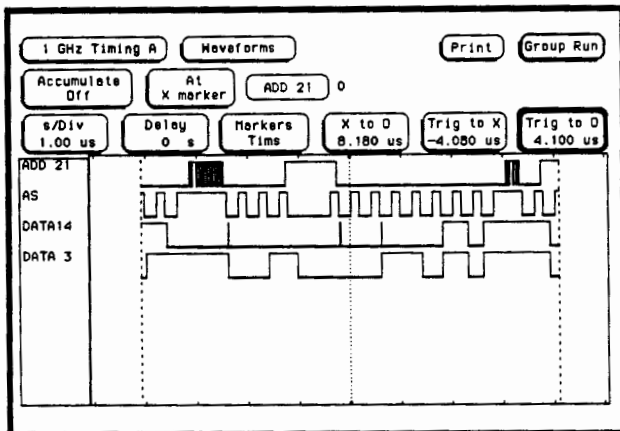

Capture 8  $\mu$ s of circuit activity with a 1ns sample period.

### Hook Up Easily to Your Circuit with Lightweight Probes

Lightweight 10 k $\Omega$ , 3 pF passive probes are easy to connect. These probes can be connected with probe tips or plugged directly into any 0.1 inch grid with .026-to-.033-inch-diameter round pins or .025-inch square pins. Individual grounds are provided for each channel to shorten ground loops.

### Correlate 1-GHz Timing with Other Modules

Use the state analyzer to find the problem, then examine events around it with 1-ns resolution. Display state, timing, and analog activity on the same screen. Use the automatic pattern search and specify stop-measurement to determine if timing violations occurred.

### Time-Interval Accuracy

Time-interval accuracy is more than just channel skew. The HP 16515A/16516A's time-interval accuracy is specified, and includes all parameters that affect your critical time-interval measurements—the only high-performance logic analyzer that does.

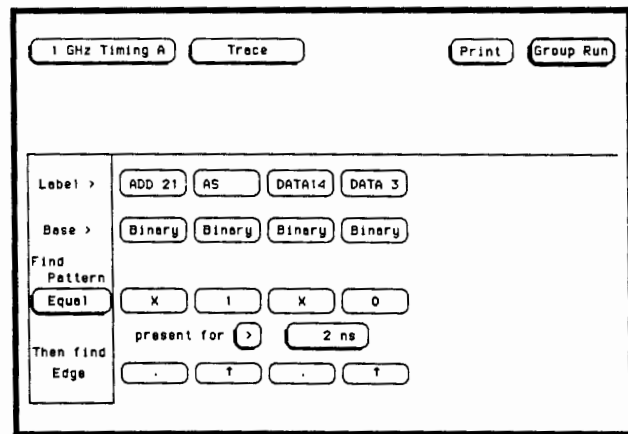

Use the pattern duration trigger feature to filter unwanted triggers.

### Key Specifications and Characteristics

Model Number	HP 16515A	HP 16516A
Maximum sample rate	1 GHz	
Channel count	16	
Memory depth per channel	8K	
Time-interval accuracy	$\pm$ (sample period + 0.01% of time interval reading + value below)	
	<b>Within 1 Pod</b>	<b>Across Pods</b>
	1ns	1.5ns
Minimum input voltage swing*	500 mV peak-to-peak	
Input dynamic range*	$\pm$ 7 volts	
Input resistance	10 k $\Omega$ $\pm$ 2%	
Input capacitance	~3 pF	

\*Specifications

See page 343 for ordering information.

# LOGIC ANALYZERS

## Pattern Generator Modules

HP 16520A, 16521A



### Functionally Test Your System

The HP16520A/16521A digital Pattern Generator Modules are the perfect tools for functional test of a digital design. Standard 3M<sup>1</sup> connectors eliminate the need to design custom test points onto your PC board. With the HP 16520A/16521A providing the stimulus, you can use any of the HP 16500A acquisition modules to determine whether the system is responding correctly.

### Pattern Generator Benefits

During the prototype debug phase of design, digital pattern generators offer several benefits. Pattern generators can simulate signals from not-yet-completed parts of the system, such as backplane buses, other PC boards, or peripherals. Pattern generators allow you to check the functional characteristics of your system and also allow you to see how your system responds to unanticipated signals. You can perform margin testing to determine exactly when your system fails.

### Easy Pattern Development

Eliminate the painful process of developing test patterns by hand. Use the HP 10392A state-to-pattern generator link to obtain patterns from a known good system or from the interface you want to simulate. The HP 10392A translates these patterns to the pattern generator. You can specify which control lines you want assigned to the pattern generator's return-to-zero (RZ) lines, and simulate complex data sequences by using the state analyzer's time-tagging information.

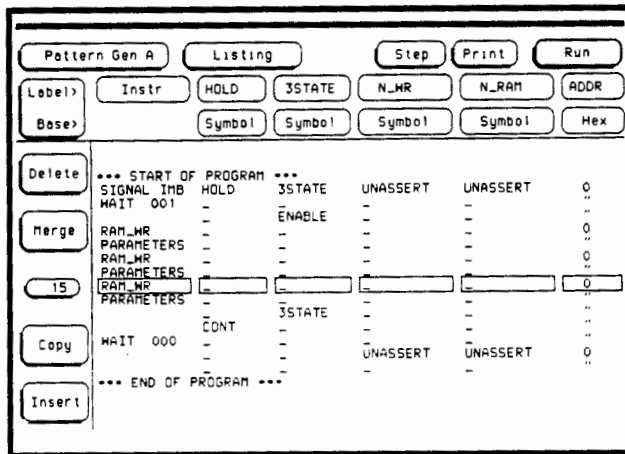

Symbols can be used to display data in your system's mnemonics, making debug and documentation easier.

### Get the Patterns You Need from Simulation

If the patterns you need were developed as a result of a simulation, you can now transfer this information to the HP 16500A pattern generator and state analyzer. To speed your design confirmation efforts, the HP 16520/16521A digital pattern generator can accept data from most popular commercial simulators.

### Digital Stimulus and Response

Configure the HP 16500A to provide both stimulus and response in one instrument. The pattern generator runs the device under test through an initialization sequence, then tells the state analyzer to begin making measurements. During the measurements, use State Compare to determine if the device is functioning properly.

Up to 108 channels of stimulus and 160 channels of response can be installed in one frame, or 208 channels of stimulus and 320 channels of response can be installed in a 16500A/16501A system.

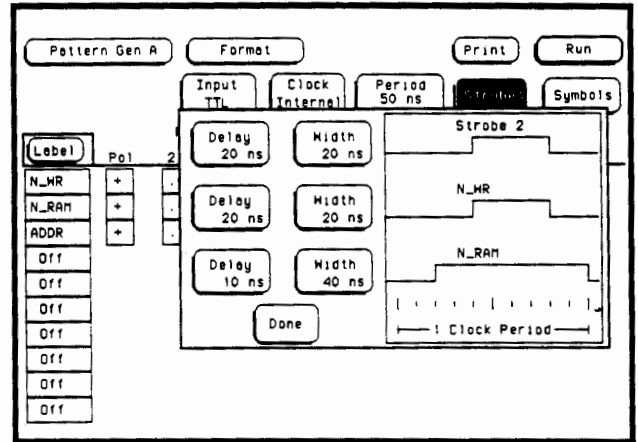

Three return-to-zero channels can be adjusted via pop-up windows.

### Low-Volume Manufacturing Test

Use the HP 16500A with digital pattern generation and state response as a low-volume manufacturing test system. The standard 3M<sup>1</sup> connectors make hook-up easy. The user interface, learn string capability, and standard HP-IB/RS-232 interfaces support fast test development.

### Failure Analysis

Use the HP 16520A/16521A digital pattern generator to track down and repeat failures, then use state or timing analysis to transfer data on the failure back to a computer for more analysis. The data can be transferred to many popular testers in order to enhance test program development.

### Easy Operation

Only two menus are needed for complete data entry: a format menu and a listing menu. The format menu allows you to group data channels together for easy data entry. Enter data in hex, octal, binary, decimal, or symbols. Editing is enhanced with delete, insert, and copy functions. You can merge stored programs to create more complex data files quickly. Macros allow you to repeat portions of code quickly. Symbols can be generated to replace complex data patterns.

To allow pattern generation when complex trigger conditions occur, derive run control for the pattern generator from the screen, external sources, or intermodule bus.

### Quick Circuit Connection

Easily attach to boards through probe tips or 2 × 10, 0.1-inch center connectors on your circuit board. Standard connectors eliminate the need to purchase special connectors or to build custom fixtures to hook into your DUT. The lightweight and passive probing system provides ECL or TTL patterns through 50-ohm connections. Series termination eliminates the need for external 50-ohm terminations. Generate ECL Differential, TTL, or CMOS Tristate patterns with the 10345A ECL Differential Driver, the HP 10346A TTL Tristate Pod, or the 10348A CMOS Tristate Pod.

### Key Specifications and Characteristics

	HP 16520A	HP 16521A
Channel count	12 NRZ, 3 RZ	48 NRZ
Memory depth	4095	4095
Maximum data rate	50 Mb/s	50 Mb/s
Output levels	ECL, TTL CMOS <sup>2</sup>	ECL, TTL, CMOS <sup>2</sup>

<sup>1</sup> 3M is a registered trademark of Minnesota Mining and Manufacturing.

<sup>2</sup> CMOS voltage levels require an HP 10348A, CMOS buffer pad.

See page 343 for ordering information.

### HP 10390A System Performance Analysis Software

#### Optimize Your System

See an overall picture of your system to find the routines that are slowing performance. The HP 10390A system performance analysis software (SPA) converts your HP logic state analyzer into a powerful tool for finding bottlenecks in your system. SPA can help you find the routines that are called most often, identify inefficient use of disks and peripherals, and find processes that use too much CPU time.

The state analyzer repetitively samples your target system as it operates. The analyzer takes a sample of your system, sorts the captured data into ranges, then delays a random amount of time before starting again. The random delay ensures that the measurement won't sync on only a small portion of your system's code. After each acquisition, the captured information is translated into histograms and bar charts to present an overall picture of your system's operation.

SPA performs three kinds of measurements: state overview, state histogram, and time interval measurements.

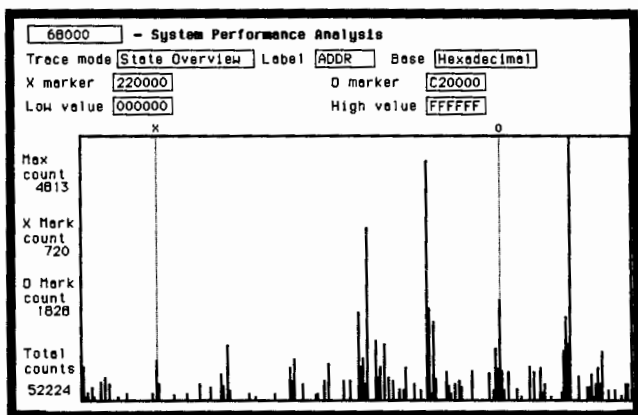

State overview mode on the address lines of microprocessor.

#### State Overview: A Macro View

The state overview measurement shows an overview of system activity. Set the state overview to look at address lines; the display shows how many times the process accesses each address. This measurement quickly tells you which addresses have activity and which addresses are never used. Use this as a coverage test for diagnostic software or to verify that there are no accesses to protected segments of memory.

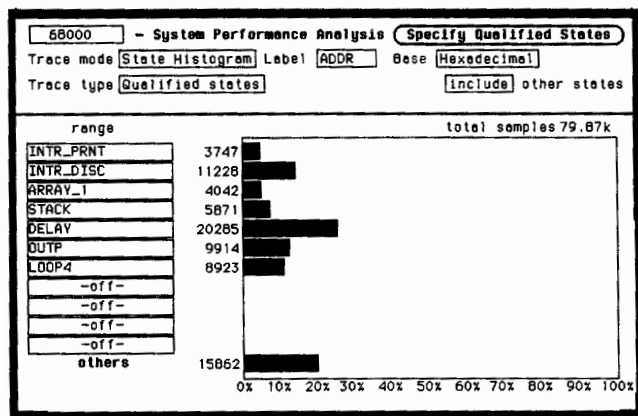

State histogram of system activity.

#### State Histogram: Software Use

State histograms allow you to break your measurement into small ranges that correspond to the natural boundaries in your system. A trace shows you the percentage of all operations that occur in a specific range. How often does your system access a disk drive or a printer? Use the state histogram mode to characterize use of peripherals to optimize your system.

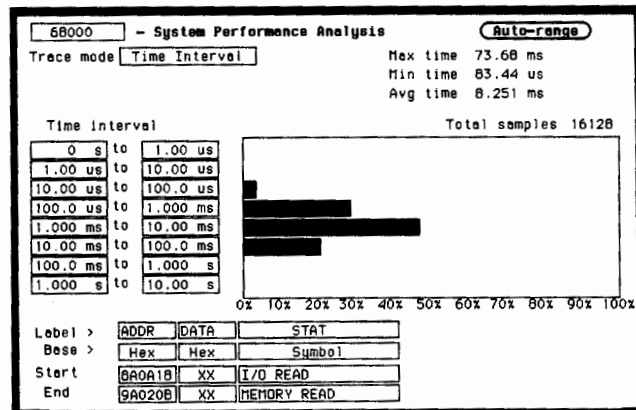

Time interval mode measures the time spent between two events in your system.

#### Time Interval: Real-Time Performance

When characterizing the speed of your software, use the time interval measurement. Time interval mode measures the time between two events in your system. Now you can find I/O routines that reduce system performance by spending too much time in wait loops, or you can identify error recovery procedures that sometimes take too long.

The time interval mode produces a histogram of time intervals, divided into as many as eight user-definable time ranges. In addition, the average, minimum, and maximum times captured between system events, plus the total number of time interval samples taken, can be read directly off the display.

#### Operating Characteristics

**State overview:** Bar chart of all possible values of a label versus number of occurrences of each value, available on any label setup in the state format specification. X-axis is all possible values for a label. (Example: for a label with 16 bits, the x-axis can range from 0 to FFFFH.)

**State histogram:** Histogram of states that occur within specified values of a label. Available on any label setup in the state format specification. User may specify up to 11 ranges of values.

**Time interval:** histogram of the time intervals between user-specified start and stop events. 40 ns time resolution, 60 ns minimum sample period.

**Time interval size:** 10 ns to 999,000 seconds.

Calculated statistics: maximum time, minimum time, average time, total number of time intervals sampled. Start and stop can be qualified from another machine in the logic analyzer.

System performance analysis features are NOT programmable via HP-IB or RS-232.

# LOGIC ANALYZERS

## CAE Links

### Simulation Vectors for Hardware Verification

Perform functional verification of your simulated design by transferring and translating simulation vectors to the HP 16500A logic analysis system. You can compare actual circuit behavior with simulation results to detect and isolate design faults. By using simulation vectors as the basis for your prototype verification, you can develop just the tests you need to verify that your design works.

### CAE Link Benefits

Links between simulation and prototype test save you time. For functional prototype verification you can quickly and easily transfer and translate just the test vectors you need. CAE links eliminate manual reentry of test vectors and make the development of test suites easy. As a result, products get to market sooner.

An added benefit of CAE links is the ability to transfer prototype test vectors to manufacturing test. You can develop a core set of test vectors, make sure that they fully test your product's functionality in the lab, then hand the completed design and test vectors to manufacturing.

### Acquire Test Vectors from Known Good Boards

Reduce the time spent on tedious entry of zeros and ones while creating manufacturing tests. Use the HP 16500A state and timing modules to gather the data for you from a known good board. With the 1-ns resolution of the HP 16515A/16516A, you can develop tests for the most demanding designs and most complex testers.

Connect the HP 16500A acquisition modules to the known good board and make successive data acquisitions. You can then modify complete test programs!

### Begin Your ASIC Design Cycle with Real-World Test Vectors

Before beginning your next ASIC design, capture test vectors from the systems that it will be designed to replace. Use the HP 16500A to acquire a representative sample of data from key nodes in the system. Then transfer the test vectors back to the simulation environment for use as behavioral test data. This process lets you verify that your ASIC design behaves properly in your system before you send it to the foundry.

### Analyze and Correlate Production Tester Behavior with Simulation

You can correlate the behavior of your device under test with simulated behavior by using the HP 16500A state and timing modules. These permit you to monitor behavior of the device while it is in the test fixture. In turn, the captured data can be compared to simulated data to determine if the test, tester, or design is at fault.

### Protect Your Test Development Investment

Protect your test development investment by using the HP 16500A to transfer tests developed on one tester to another. The HP 16500A can capture your test program with 1-ns resolution. This information can be used to reconstruct test programs for another tester.

### HP and TSSI: Working Toward Your Third-Party Support Productivity

The HP 16500A is supported by Test Systems Strategies, Inc., (TSSI) of Beaverton, Oregon (USA). TSSI markets software that links design and test. TSSI supports most simulators in addition to supporting many popular ASIC Verification, IC, and board testers. For more information on TSSI, contact your HP sales representative.

TSSI software supports the HP 16500A pattern generator modules and all HP state and timing analyzers. You can capture system behavior with any of these analyzers, and then transfer that information to TSSI's proprietary waveform database where it can then be transferred to testers or simulators.

TSSI also supports the compare mode found in all HP state analyzers. This means that you can compare simulation results with acquisitions to detect system faults.

TSSI software runs on DEC VAX, Apollo 3000 and 4000 Series, HP 9000 Series 300, and SUN 3/3 Series computer systems.

### CAE Simulators Supported by TSSI

Most popular commercial simulators and many proprietary simulators are supported by TSSI. The list of supported commercial simulators includes: Calma TEGAS/TEXOUT/TEXSIM; Daisy Logician DLS; Gateway Verilog; HP EDS; HHB Systems CADAT; LSI Logic, Lattice Logic Expert; Logic Modeling Systems; Mentor Graphics QuickSim; QuickTurn; Silicon Compiler Systems LSim; Silvar-Lisco Logix/Helix; SimuCad SILOS; Teradyne LASAR; Valid Logic ValidSIM; Vantage; Viewlogic ViewSim; and ZyCad ZILOS.

### Popular Testers Supported by TSSI

Many ASIC verification, board, and IC testers are supported, including the HP 82000 ASIC Evaluation System, HP 3065/3070 series board testers, and the HP 9480 Analog LSI Test System. For more information on tester support, contact your HP sales representative.

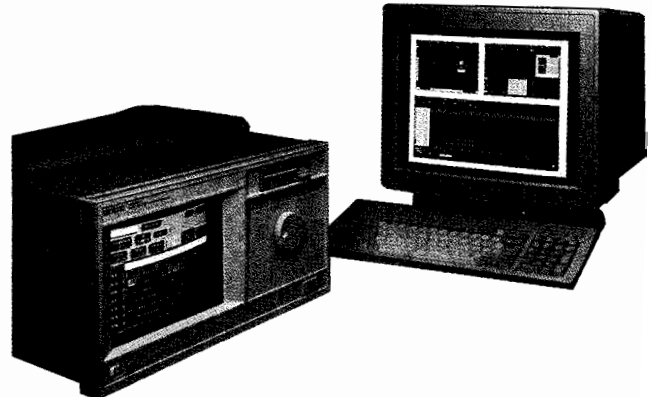

CAE Link between an HP 16500A and a workstation

### Accessories for HP Logic Analyzers

Logic analyzer accessories make your measurement tasks easier. Probing accessories such as HP termination adaptors allow you to connect to your target system with industry standard 3M\* connectors. With the wide range of HP oscilloscope probes you can choose the impedance that best matches your measurement.

### Easy and Quick Connection to Your Circuit

HP offers a wide range of probing solutions. You can use the general-purpose probes, which consist of flying lead sets and grabbers, to make measurements while you are debugging a circuit. HP offers two types of grabbers. A general-purpose grabber is shipped with the HP 165X family of logic analyzers and the HP 16510B. A surface mount grabber is shipped with the HP 16540/41 100-MHz State Analyzer. A complete set of general-purpose probes comes with each analyzer.

For a more permanent connection to your target system, you can use the 01650-63203 termination adaptor or the 16515-63202 high-speed timing termination adaptor. The termination adaptor connects the logic analyzer's probe cable to your target system via a flexible 3M connector. The connection to your device under test consists of a 2 × 10, 0.1-inch center female header. Any 3M-type connector can be used as the interface to your system. The termination adaptor contains the passive network needed to properly terminate the logic analyzer's probes. It provides a 100-k Ω, 8-pF termination to your system.

If you want to have the termination closer to the active components on your board, you can use the 1810-1278 termination dip package to provide the logic analyzer's termination. The 18-pin dip package consists of nine termination networks. Each IC is designed to provide a signal path for eight data channels and a clock line.

### Oscilloscope Probes

Selecting the right probe for your particular measurement involves many choices. While the oscilloscope modules in each analyzer come with probes that meet most measurement needs, you may require a probe with other characteristics.

The HP 1652B/1653B are shipped with HP 10430A probes. The HP 16530A/16531A oscilloscopes are shipped with the HP 10433A mini-probes.

If you require more information on HP oscilloscope accessories, refer to *Oscilloscope Probes and Accessories* (HP part number 5954-2678). This guide includes information on probe selection, and lists other oscilloscope accessories.

### Capture Patterns with Your State Analyzer

The HP 10392A translates state analyzer data into pattern generator data. You can use the state-to-pattern generator link to help develop test vectors for simulation of missing boards or modules, functional verification, or regeneration of patterns captured at a remote site.

Functional test with the pattern generator and state analyzer is easier when you can obtain test vectors from a known good source. You can obtain test vectors from a number of sources, then merge them into the pattern generator to create just the test you need.

The HP 10392A state-to-pattern generator link software runs on the HP 16500A logic analysis system without the use of an external controller. This software lets you translate state analyzer data files from your HP 1650B/1651B/1652B/1653B/1654B or HP 16510B state analyzer to the HP 16520A/16521A pattern generator.

You can choose automatic or manual label generation and channel assignments to best meet your test setup needs. Automatic translation of symbols from the state analyzer to the pattern generator makes data interpretation easier. When the state analyzer's time tagging feature is turned on, the pattern generator's clock rate is automatically set and repeat statements are used to duplicate as closely as possible the data rates of your system.

### HP Testmobiles and Carrying Cases

Make your logic analysis system a portable one with the HP testmobile. Each testmobile is designed to withstand rugged use. Drawers for storing your accessories are included. The HP 1181A testmobile is designed for the HP 16500A logic analysis system. The HP 1180A is designed for the HP 1650 Series logic analyzers.

The 1540-1066 soft carrying case for the HP 1650 Series logic analyzers allows you to easily carry your logic analyzer and its accessories to remote sites.

### Pattern Generator Output Drivers

The HP 10345A 8-channel ECL differential output driver pod translates the HP 16520A/16521A ECL signals into ECL differential output levels. The HP 10346A 8-channel TTL tristate buffer pod allows you to tristate groups of pattern generator channels. The HP 10346A is useful when you are driving bidirectional buses such as backplane buses. The HP 10348A CMOS tristate buffer pod provides CMOS voltage levels and will allow you to tristate channels in the same manner as the HP 10346A.

For ordering information see page 343.

### Logic Analyzer Upgrade Kits

Upgrade kits for logic analyzers include software, hardware, or both, to enhance the performance of your logic analyzer. The text below summarizes the upgrade options available for the HP logic analyzers listed. See page 343 for prices.

#### HP 1650A and 1651A Upgrades

You can upgrade the software capabilities of your HP 1650A or HP 1651A logic analyzer with the HP 10449A software upgrade kit. This kit includes RAM, ROM, software, and manual inserts to add the following features to the HP 1650A or HP 1651A:

- State Compare mode
- State waveforms
- State Chart mode

The HP 10449A upgrade kit does *not* include the HP-IB interface or 35-MHz state analysis features present on the HP 1650B. HP Service Center installation is highly recommended and is not included in the price.

#### HP 16510A Upgrade

The 16510-68703 adds the following software features to your HP 16510A logic analyzer:

- State Compare mode
- State waveforms
- State Chart mode

This upgrade kit contains software only, and you can install it yourself. The software in this kit is compatible with all HP 16500A modules.

#### HP 16500A Frame Upgrades

The 16500-68704 CPU board allows you to upgrade your frame to 2.5 MB of operating system memory. This kit is suggested for customers who own frames shipped before January 1990, who are using four or more measurement modules. Frames purchased after January 1990 offer 2.5 MB of operating system memory standard.

#### HP 16510A to HP 16510B Upgrade

The HP 10448A 35-MHz state hardware upgrade kit for the HP 16510A logic analyzer provides an upgrade to 35-MHz state analysis as well as state Compare, state waveforms, and state Chart mode. This kit includes the following:

- 80-channel 35-MHz state/100-MHz timing card with no probe assemblies (requires transfer of probe assemblies from the HP 16510A to the new HP 16510B 35-MHz state card)
- Software for the new card
- Manual inserts

You can install this upgrade kit yourself. It is compatible with all HP 16500A modules. The new card also includes connectors to allow installation of the HP 16511B 160-channel 35-MHz state/100-MHz timing conversion kit. See page 332 for a description of the HP 16511B logic analyzer.

#### HP 1650B to HP 1652B and HP 1651B to HP 1653B Upgrades

The HP 10349B oscilloscope upgrade kit converts the HP 1650B or HP 1651B logic analyzer to a HP 1652B or HP 1653B, respectively. The upgrade kit includes the following:

- 2-channel 400 MSa/s digitizing oscilloscope board
- Software
- Manual inserts

HP Service Center installation is highly recommended, and is not included in the price.

\* 3M is a registered trademark of Minnesota Mining and Manufacturing Co.

# LOGIC ANALYZERS

## General Characteristics

HP 1650B, 1651B, 1652B, 1653B, 1654B, 16500A

### Characteristics

#### Disk Drives/Files

**Built-in disk drives file types:** System software, configuration (contains instrument configuration, data, pointer to inverse assembler file), inverse assembler, auto-configuration.

**Autoload designation:** A predefined configuration file can be loaded at powerup.

**Disk operations:** Store, load, copy, duplicate disk, pack disk, re-name, purge, format disk.

#### Programmability/IO Ports

Instrument settings and operating modes can be remotely programmed for *all* logic analyzer models with either RS-232C or HP-IB (IEEE-488). Both ports are standard on all analyzers. Either port can be used for hard-copy output.

#### Hard-Copy Output

**Printers supported:** HP ThinkJet, HP QuietJet, HP LaserJet series, HP PaintJet, HP DeskJet, Epson and Epson-compatible (such as Epson RX-80, RX-100, MX-80, MX-100) printers via RS-232C or HP-IB

**HP-IB interface functions:** SH1, AH1, T5, TE0, L3, LE0, SR1, RL1, PP1, DC1, DT1, C0, and E2

#### RS-232C Configurations

**Protocols:** XON/XOFF, ENQ/ACK, none, data

**Bits:** 8

**Stop bits:** 1, 1½, 2

**Parity:** None, odd, even

**Baud rates:** 110, 300, 600, 1200, 4800, 9600, 19200

#### Input/Output Rear-Panel BNCs

**Input BNC:** Labeled port-in (HP 16500A) or external trigger input (HP 1650B/1651B/1652B/1653B/1654B). Input signal must drive 6.1 mA ( $I_{in}$ ) @ 0.5 V ( $V_{in}$ )

**Output BNC:** Labeled port-out (HP 16500A) or external trigger output (HP 1650B/1651B/1652B/1653B/1654B). Output signal is active high, TTL output level, high > 2 V into 50 Ω, < 0.4 V into 50 Ω.

#### Auxiliary Power Available

Each cable is capable of providing 1/3 A maximum at 5 V. The primary use of the auxiliary power is as a source for preprocessors.

#### HP 16500A InterModule Bus (IMB)

**Run control:** Analog, timing, state, and pattern generation can be armed by group run. Modules can run concurrently or be armed in series. Each module can arm one or more modules.

**Mixed display modes:** Any timing or oscilloscope waveform displays can be mixed. State listings can be included with waveforms in the state/timing Mixed Mode display.

**Acquiring data for mixed displays:** To obtain a mixed display, multiple modules must be armed through the IMB. To include a state listing(s) in Mixed Mode Display, State Time Tagging must be on.

**Time-interval accuracy between modules:** Equals the sum of the channel-to-channel time-interval accuracies of each module used in the measurement, for a deskewed measurement.

#### Operating Environment

**Temperature:** Instrument, 0° to 50° C (+32° to 122° F). Disk media, 10° to 40° C (+50° to 104° F). Probes and cables, 0° to 65° C (+32° to 149° F)

**Humidity:** Instrument, up to 95% relative humidity at +40° C (+104° F). Disk media, 8% to 80% relative humidity.

**Altitude:** to 4,600 m (15,000 ft)

**Vibration-operating:** Random vibration 5 to 500 Hz, 10 minutes per axis, ~ 0.3 g (rms)

**Vibration-nonoperating:** Random vibration 5 to 500 Hz, 10 minutes per axis, ~ 2.41 g (rms); and swept sine resonant search, 5 to 500 Hz, 0.75 g (0 to peak), 5-minute resonant dwell @ 4 resonances per axis

#### Weight

**HP 1650B/1651B/1654B:** Net, 10.0 kg (22 lb); shipping 18.2 kg (40 lb)

**HP 1652B/1653B:** Net, 11.0 kg (24 lb); shipping 19.0 kg (42 lb) shipping

**HP 16500A (max):** Net, 18.1 kg (40 lb) + (.7 kg (1.6 lb) × number of cards); shipping 25.9 kg (57 lb) + (3.6 kg (8 lb) × number of cards)

#### Power

**HP 1650B/1651B/1652B/1653B/1654B:** 115 V/230 V, 48 to 66 Hz, 200 W max

**HP 16500A:** 115 V/230 V, 48 to 66 Hz, 475 W max

#### Size

**HP 1650B/1651B/1652B/1653B/1654B:** 194.3 mm H × 425.4 mm W × 355.6 mm D (7.65 in × 16.62 in × 14.0 in) including rear feet, excluding bottom feet

**HP 16500A:** 222.2 mm H × 425.7 mm W × 548.6 mm D (8.75 in × 16.76 in × 21.6 in), including rear feet, excluding bottom feet



### Portable Logic Analyzers

<b>HP 1650B</b> 80-Channel Log Analyzer	Price	\$8,200
<b>Opt 908</b> Rack Mount Tray		+ \$300
<b>Opt 910</b> Extra operating and programming manual		+ \$100
<b>Opt W30</b> Extended repair service. See page 671.		+ \$190
<b>HP 1651B</b> 32-Channel Logic Analyzer		\$4,100
<b>Opt 908</b> Rack Mount Tray		+ \$300
<b>Opt 910</b> Extra operating and programming manual		+ \$100
<b>Opt W30</b> Extended repair service. See page 671.		+ \$100
<b>HP 1652B</b> 80-Channel Logic Analyzer with Oscilloscope		\$11,800
<b>Opt 908</b> Rack Mount Tray		+ \$300
<b>Opt 910</b> Extra operating and programming manual		+ \$100
<b>Opt W30</b> Extended repair service. See page 671.		+ \$285
<b>HP 1653B</b> 32-Channel Logic Analyzer with Oscilloscope		\$7,700
<b>Opt 908</b> Rack Mount Tray		+ \$300
<b>Opt 910</b> Extra operating and programming manual		+ \$100
<b>Opt W30</b> Extended repair service. See page 671.		+ \$185
<b>HP 1654B</b> 64-Channel Logic Analyzer		\$6,950
<b>Opt 908</b> Rack Mount Tray		+ \$300
<b>Opt 910</b> Extra operating and programming manual		+ \$100
<b>Opt W30</b> Extended repair service. See page 671.		+ \$165

### Modular Logic Analyzers

<b>HP 16500A</b> Logic Analysis System Mainframe	\$7,700
<b>Opt 908</b> Rack Mount Kit (8 $\frac{1}{4}$ -in EIA rackmount)	+ \$40
<b>Opt 910</b> Extra operating and programming manual	+ \$100
<b>Opt W30</b> Extended repair service. See page 671.	+ \$180
<b>HP 16501A</b> Logic Analysis System Expansion Frame	\$4,500
<b>Opt 908</b> Rack Mount Kit (8 $\frac{1}{4}$ -in EIA rackmount)	+ \$40
<b>Opt W30</b> Extended repair service. See page 671.	+ \$115
<b>HP 16510B</b> 80-Channel 35-MHz State/100-MHz Timing	\$6,000
<b>Opt 910</b> Extra operating and programming manual	+ \$100
<b>Opt W30</b> Extended repair service. See page 671.	+ \$130
<b>HP 16511B</b> 160-Channel Logic Analyzer 35-MHz State/100-MHz Timing Conversion Kit (2 HP 16510Bs needed)	\$500
<b>HP 16515A</b> 16-Channel 1-GHz Timing Master Card	\$8,300
<b>Opt 910</b> Extra operating and programming manual	+ \$75
<b>Opt W30</b> Extended repair service. See page 671.	+ \$190
<b>HP 16516A</b> 16-Channel 1-GHz Timing Expansion Card	\$7,500
<b>Opt W30</b> Extended repair service. See page 671.	+ \$165
<b>HP 16520A</b> 12-Channel 50-Mb/s Pattern Generation Card	\$4,500
<b>Opt 910</b> Extra operating and programming manual	+ \$100
<b>Opt W30</b> Extended repair service. See page 671.	+ \$95
<b>HP 16521A</b> Pattern Generator Expansion Card	\$5,000
<b>Opt W30</b> Extended repair service. See page 671.	+ \$95

<b>HP 16530A</b> 400-MSa/s Oscilloscope Time-Base Card	\$1,650
<b>Opt 910</b> Extra operating and programming manual	+ \$100
<b>Opt W30</b> Extended repair service. See page 671.	+ \$50
<b>HP 16531A</b> 2-Channel 400-Msa/s Scope Acquisition Card	\$4,500
<b>Opt W30</b> Extended repair service. See page 671.	+ \$100
<b>HP 16532A</b> 2-Channel 1-GSa/s Oscilloscope Card	\$9,000
<b>Opt 910</b> Extra operating and programming manual	+ \$100
<b>Opt W30</b> Extended repair service. See page 671.	+ \$225
<b>Opt W32</b> Calibration service. See page 671.	+ \$445
<b>HP 16540A</b> 16-Channel 100-MHz State/Timing Master Card	\$7,000
<b>Opt 910</b> Extra operating and programming manual	+ \$100
<b>Opt W30</b> Extended repair service. See page 671.	+ \$165
<b>Opt W32</b> Calibration service. See page 671.	+ \$445
<b>HP 16541A</b> 48-Channel 100-MHz State/Timing Expansion Card	\$8,500
<b>Opt W30</b> Extended repair service. See page 671.	+ \$200
<b>Opt W32</b> Extended calibration service	+ \$445
<b>HP 16540D</b> 100-MHz 16K Deep State/Timing Master Card	\$8,400
<b>HP 16541D</b> 100-MHz 16K Deep State/Timing Expansion Card	\$9,900

### Upgrade Kits

<b>HP 10449A</b> Software Upgrade Kit for HP 1650A/51A	\$500
<b>HP 16510-68703</b> Software Upgrade Kit for HP 16510A	\$95
<b>HP 10448A</b> 35-MHz State Upgrade Kit for HP 16510A	\$3,800
<b>HP 10349B</b> Scope Upgrade Kit for HP 1650B or HP 1651B.	\$4,200
<b>HP 16500-68704</b> CPU Upgrade Kit for HP 16500A Mainframe	\$895
<b>HP 16500-68703</b> Current Operating Software Version (16500A)	\$25
<b>HP 01650-68703</b> Current Operating Software Version (1652B/53B)	\$25
<b>HP 01652-68703</b> Current Operating Software Version (1652B/53B)	\$25

Price for upgrade kits does not include installation.

### Accessory Software

<b>HP 10390A</b> System Performance Analysis Software	
<b>Opt 001</b> For the HP 1650 Series	\$550
<b>Opt 002</b> For the HP 16510A/B	\$550
<b>Opt 003</b> For the HP 16540A/41A	\$500
<b>HP 10391B</b> Inverse Assembler Development Package	\$1,000
<b>HP 10392A</b> State-to-Pattern Generator Link	\$550

### Probe Interface

<b>HP 10269C</b> General-purpose probe interface (required with many microprocessor support packages, see "Microprocessor and Interface Support," page 324.	\$470
---	-------

# LOGIC ANALYZERS

## Ordering Information

### Interfaces for Microprocessors

<b>HP E2417A</b> AMD AM29000/050 Preprocessor (PGA)	\$1,600
<b>HP 10335G</b> Hitachi 6301/6303 Preprocessor (DIP)	\$700
<b>HP 10336G</b> Hitachi 64180 Preprocessor (DIP)	\$700
<b>HP 10336H</b> Hitachi 64180 Preprocessor (PLCC)	\$1,300
<b>HP 10304B</b> Intel 8085 Preprocessor (DIP)	\$1,000
<b>HP E2415A</b> Intel MCS-51 Preprocessor (DIP)	\$1,400
<b>HP E2416A</b> Intel MCS-96 Preprocessor (PGA)	\$850
<b>HP 10305B</b> Intel 8086/8088 Preprocessor (DIP)	\$1,400
<b>HP 10306G</b> Intel 80186 Preprocessor (PGA)	\$700
<b>HP E2409B</b> Intel 80286 Preprocessor (PGA)	\$1,700
<b>Opt 1CA</b> Intel 80286 (Adapter) (LCC)	\$700
<b>Opt 1CB</b> Intel 80286 (Adapter) (PLCC)	\$285
<b>HP 10314D</b> Intel 80386DX Preprocessor (PGA)	\$2,200
<b>HP E2403A</b> Intel 80486 Universal Interface (PGA)	\$1,400
<b>HP E2411A</b> Intel 80486 Preprocessor (PGA)	\$2,400
<b>HP E2405A</b> Intel 80860 Universal Interface (PGA)	\$1,500
<b>HP E2410A</b> Intel 80960CA Universal Interface (PGA)	\$1,200
<b>HP E2432A</b> Intel 80960CA Preprocessor (PGA)	\$2,300
<b>HP E2402A</b> Intel 80960KA Universal Interface (PGA)	\$1,000
<b>HP E2425A</b> Intel 80960KA Preprocessor (PGA)	\$2,400
<b>HP E2401A</b> MIPS R3000 Preprocessor (PGA)	\$3,500
<b>HP 10307B</b> Motorola 6800/6802 Preprocessor (DIP)	\$1,110
<b>HP 10308B</b> Motorola 6809 Preprocessor (DIP)	\$1,110
<b>HP 10311B</b> Motorola 68000/010 Preprocessor (DIP)	\$1,600
<b>HP 10311G</b> Motorola 68000/010 Preprocessor (PGA)	\$600
<b>HP 10313G</b> Motorola 68020 Preprocessor (PGA)	\$850
<b>HP E2426A</b> Motorola 68020 Preprocessor (PGA)	\$2,250
<b>Opt 1CC</b> Motorola 68020 Adapter (PQFP)	\$1,300
<b>HP 10316G</b> Motorola 68030 Preprocessor (PGA)	\$875
<b>HP E2406A</b> Motorola 68030 Preprocessor (PGA)	\$2,000
<b>Opt 1CC</b> Motorola 68030 Adapter (PQFP)	\$1,300
<b>HP E2420</b> Motorola 68040 Preprocessor (PGA)	\$3,300
<b>HP 10315G</b> Motorola 68HC11 Preprocessor (DIP)	\$900
<b>HP 10315H</b> Motorola 68HC11 Preprocessor (PLCC)	\$1,800
<b>HP E2419A</b> Motorola 68HC16Z1 Preprocessor (PQFP)	\$2,400
<b>HP E2414A</b> Motorola 68302 ADS Support	\$400
<b>HP E2413A</b> Motorola 68331/332 EVS Support	\$750
<b>HP E2413B</b> Motorola 68331/332 Preprocessor (PQFP)	\$2,400
<b>HP E2424A</b> Motorola 68340 EVS Support	\$750
<b>HP E2404A</b> Motorola 88100 Preprocessor (PGA)	\$1,700
<b>HP E2400A</b> Motorola 88200 Preprocessor (PGA)	\$1,200
<b>HP 10337B</b> NEC V20/30 Preprocessor (DIP)	\$1,785
<b>HP E2428A</b> NEC V33 Preprocessor (PGA)	\$1,265
<b>Opt 001</b> NEC V33 Preprocessor (PLCC)	\$200
<b>HP 10338B</b> NEC V40/50 Preprocessor (DIP)	\$2,670
<b>HP E2429A</b> NEC V53 Preprocessor (PGA)	\$1,450
<b>HP 10339G</b> NEC V60 Preprocessor (PGA)	\$1,200
<b>HP E2407A</b> NEC V70 Preprocessor (PGA)	\$1,300
<b>HP E2418A</b> TI 32020/C25 Preprocessor	\$800

<b>HP E2431A</b> TI 32020/C30/31 Preprocessor	\$2,100
<b>HP 10300B</b> Zilog Z80 Preprocessor (DIP)	\$1,200
<b>HP 10336G</b> Zilog Z180 Preprocessor (DIP)	\$700
<b>HP 10336H</b> Zilog Z180 Preprocessor (PLCC)	\$1,300

### Bus and Interface Preprocessors

<b>HP 10342B</b> HP-IB, RS-232C and RS-449 buses	\$1,550
<b>HP 10342G</b> HP-IB bus	\$600
<b>HP 10341B</b> MIL-STD 1553A/B bus	\$4,500
<b>HP E2423A</b> SCSI I/II bus	\$2,000
<b>HP 10344A</b> A-size VME bus	\$1,200
<b>HP E1323A</b> B-size VME; B- & C-Size VXIbus	\$1,200

### User-Definable Interface Products

<b>HP 10320C</b> User-definable interface	\$300
<b>HP 10321A</b> Microprocessor interface parts kit	\$360
<b>HP 10322A</b> 40-pin DIP interface cable	\$480
<b>HP 10323A</b> 48-pin DIP interface cable	\$550
<b>HP 10324A</b> 64-pin DIP interface cable	\$670
<b>HP 10391B</b> Inverse assembler development package	\$1,000

### Miscellaneous Accessories

<b>HP E2421A</b> Pomona 5514 SOIC Clip Kit	\$54.50
<b>HP E2422A</b> Pomona 5515 QUAD clip kit	\$197.50

### Printers and Accessories

<b>HP 3630A</b> PaintJet color graphics printer	\$1,395
<b>Opt 001</b> with RS-232C/V.24 interface	\$0
<b>Opt 002</b> with HP-IB interface	\$0
<b>HP 2225A</b> ThinkJet printer with HP-IB interface	\$495
<b>HP 2225D</b> ThinkJet printer with RS-232C/V.24 interface	\$495
<b>HP 92261A</b> ThinkJet print cartridges	\$10.95
<b>HP 92261N</b> paper (2500 Sheets, for ThinkJet, DeskJet)	\$64.95
<b>HP 92261S</b> Mini-printer stand	\$49
<b>HP 2276A</b> DeskJet printer, Centronics/RS-232C/v.24 Interface	\$795
<b>HP 10833A</b> HP-IB cable, 1m	\$80
<b>13242-60010</b> RS-232C cable, 3m	\$69

### Oscilloscope Accessories

<b>HP 10503A</b> BNC-to-BNC cable, 1.2m	\$35
<b>HP 10240B</b> BNC-to-BNC blocking capacitor	\$45
<b>HP 10211A</b> IC probe clip	\$81
<b>HP 10024A</b> 16-pin IC test clip	\$20

### Oscilloscope Probes

<b>HP 10020A</b> 1:1-100, 50-500 Ω, <1 pF resistive divider probe set, 1.2m	\$525
<b>HP 10430A</b> 10:1, 1 MΩ, 6.5 pF mini-probe, 1m	\$135
<b>HP 10433A</b> 10:1, 10 MΩ, 10 pF mini-probe, 2m	\$135
<b>HP 10435A</b> 10:1, 1 MΩ, 7.5 pF mini-probe, 1m	\$125
<b>HP 10437A</b> 1:1, 50 Ω mini-probe, 2m	\$90
<b>HP 10438A</b> 1:1, 1 MΩ, 40 pF mini-probe, 1m	\$100
<b>HP 10439A</b> 1:1, 1 MΩ, 64 pF mini-probe, 2m	\$105
<b>HP 10440A</b> 100:1, 10 MΩ, 2.5 pF mini-probe, 2m	\$135

### State and Timing Analyzer Replacement

#### Probes and Lead Sets

<b>HP 01650-61607</b> 16-channel woven probe cable for 1650B, 1651B, 1652B, and 1653B	\$125
<b>HP 16510-61601</b> 16-channel woven probe cable for HP 16510B	\$160
<b>HP 16510-61602</b> 16-channel woven probe cable for HP 16510B	\$155
<b>HP 5959-9333</b> 5 probe leads for HP 1650 B series	\$25
<b>HP 5959-9334</b> 5 short ground leads for HP 1650B, 1651B, 1652B, 1653B, and 16510B	\$20
<b>HP 5959-9335</b> 5 long ground leads for HP 1650B, 1651B, 1652B, 1653B, and 16510B	\$20
<b>HP 01650-61608</b> 16-channel probe lead set for HP 1650B/1651B/1652B/1653B/16510B	\$180
<b>HP 01650-63203</b> Termination adaptor for HP 1650B/1651B/1652B/1653B/16510B	\$100
<b>HP 1810-1278</b> 9-channel IC termination adaptor	\$5
<b>HP 1251-8106</b> 2 × 10, 0.1-in center header (similar to 3-M <sup>1</sup> p/n 3592-6002)	\$7.50
<b>HP 5090-4356</b> Surface-mount grabbers (package of 20)	\$25
<b>HP 5959-0288</b> Throughhole grabbers (package of 20)	\$20
<b>HP 16515-61604</b> 1-channel coax probe cable for HP 16515A/16516A	\$72.50
<b>HP 16515-69502</b> 8 1-channel lead set for HP 16515A/16516A	\$145
<b>HP 16515-68703</b> Grounding kit for HP 16515A/16516A	\$150
<b>HP 16515-68705</b> Probe pins for HP 16515A/16516A	\$120
<b>HP 16515-63202</b> 1 GHz Timing Termination Adaptor	\$120

### Pattern Generator Accessories; Replacement

#### Probes and Lead Sets

<b>HP 10392A</b> State-to-pattern generator link	\$550
<b>HP 16520-61601</b> Input qualifier probe cable	\$120
<b>HP 16520-69501</b> Input qualifier probe kit	\$180
<b>HP 16520-61602</b> 8-channel data probe cable	\$200
<b>HP 16520-61603</b> Clock/strobe probe cable	\$205
<b>HP 10347A</b> Pattern generator probe lead set	\$200
<b>HP 10345A</b> 8-channel ECL differential driver pod	\$120
<b>HP 10346A</b> 8-channel TTL tristate buffer pod	\$120
<b>HP 10348A</b> 8-channel CMOS tristate buffer pod	\$120
<b>HP 5959-0288</b> Grabbers (package of 20)	\$20

#### Other Accessories for

##### HP 1650B/1651B/1652B/1653B

<b>HP 1180A</b> Testmobile for HP 1650B/1651B/1652B/1653B	\$290
<b>HP 92199B</b> Power strip	\$36
<b>HP 1540-1066</b> Soft carrying case for HP 1650B/1651B/1652B/1653B	\$135
<b>HP 92192A</b> Blank double-sided 3.5-in diskettes (box of 10)	\$29
<b>HP 5061-6175</b> Rackmount kit for HP 1650B/1651B/1652B/1653B	\$300
<b>HP 1494-0015</b> Rackmount slide tray for HP 1650B/1651B/1652B/1653B	\$120
<b>HP 9211-2645</b> Transit Case HP 1650B/1651B/1652B/1653B	\$430
<b>HP 5061-6183</b> Front Cover for HP 1650B/1651B/1652B/1653B	\$35

#### Other Accessories for the HP 16500A

<b>HP 92192A</b> Blank double-sided 3.5-in diskettes (box of 10)	\$29
<b>HP 1181A</b> Testmobile for the HP 16500A	\$970
<b>HP E2427A</b> Keyboard Kit	\$300
<b>HP 46060A</b> HP Mouse	\$155
<b>HP M1309A</b> Trackball	\$302
<b>HP 5061-9679</b> Rackmount kit for HP 16500A	\$40
<b>HP 9211-2658</b> Transit case for HP 16500A	\$520

For off-the-shelf shipment, call 800-452-4844.

<sup>1</sup> 3-M is a registered trademark of Minnesota Mining and Manufacturing Corporation.

# MICROPROCESSOR DEVELOPMENT SYSTEMS

Emulators, Analyzers, and Software Development  
HP 64000 Series

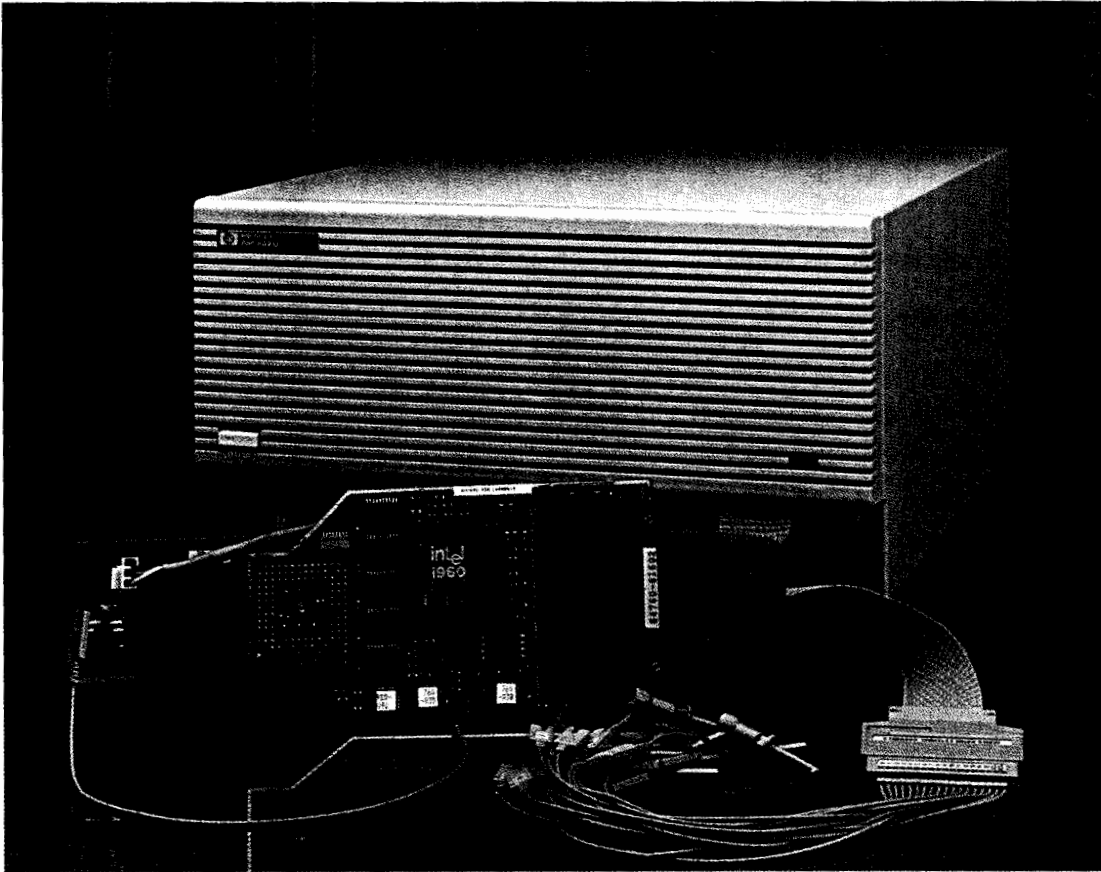

## HP 64700 Series Emulators/Analyzers

### Real-Time, Transparent Emulation and Analysis

HP 64700 Series emulators/analyzers provide real-time, transparent emulation and analysis for popular microprocessors. The HP 64700 Series is made up of modular emulation and analysis tools that can be controlled from a terminal, an optional HP 9000 or Sun Motif-style interface, PC-hosted interface, or an optional LAN card for workstations. This choice of interfaces, plus high-speed program download, makes for efficient microprocessor-based system development.

### High Performance

- Real-time, transparent emulation at full processor speeds
- Triggering capabilities in an emulation bus analyzer support eight-level sequencing, time tags, prestore analysis for establishing software interrelationships
- Software performance analyzer card available for evaluating and improving code performance and efficiency
- A 64-channel emulation bus analyzer includes a 16-channel external analyzer that can function as an independent 100-MHz timing analyzer as well as a 25-MHz state analyzer
- Synchronized operation and cross-triggering between multiple emulators for multiple processor designs
- Real-time code coverage analysis for efficient, thorough software testing and design
- A high-speed RS-422 interface greatly improves emulator download and upload times when used with PCs
- LAN card available for fast download and host independence in a workstation environment
- Dual-bus architecture and dual-port emulation memory to ensure nonstop, real-time emulation
- Fully tested to rugged electrical, temperature, and shock standards to ensure continued reliability and performance
- Meets international requirements for RFI/EMI emissions

### Choice of Design Environments

HP 64700 Series emulators/analyzers offer several flexible configuration options. These host-independent emulation and analysis vehicles can be controlled from a simple terminal, or the emulator can be hosted on an IBM PC compatible such as the HP Vectra PC. For large team-oriented or complex designs, the HP 64700 integration environment hosted on HP 9000 or Sun workstations offers powerful development solutions.

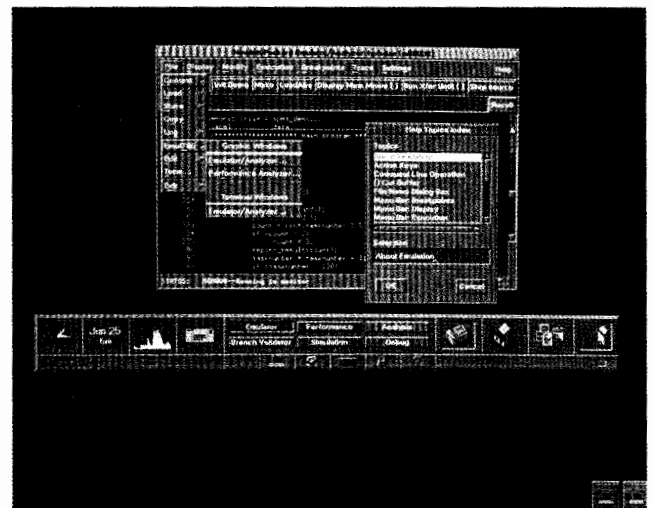

With the X/Motif interface it's easy to access the HP 64700 Series development tools. Command entry is quick and accurate with a click of a mouse button. Multiple windows can be displayed simultaneously for comparing different fields.

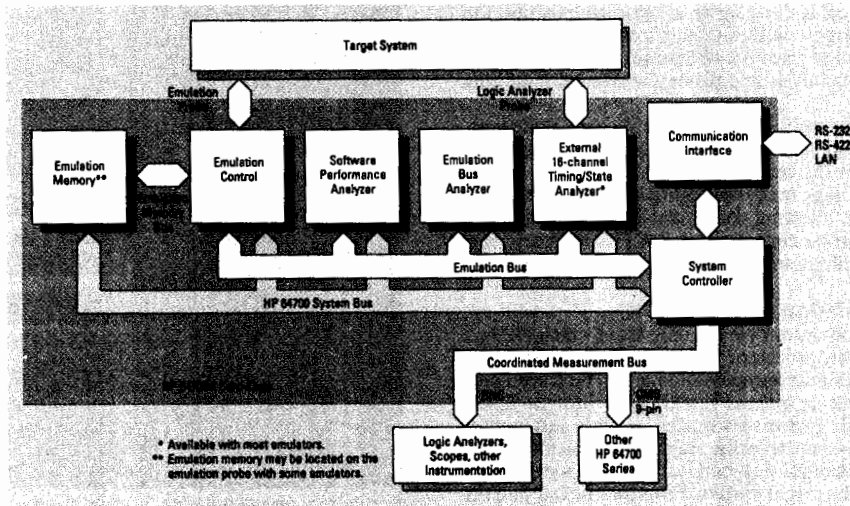

HP 64700 Series emulators/analyzers have a dual-bus architecture with a foreground or background monitor to permit you to control the microprocessor emulation in the target system. This dual-bus architecture gives you maximum transparency by allowing traces to be executed and displayed without halting processor execution.

### HP 64700A Card Cage

The HP 64700A card cage is the basis for modular emulators and analyzers. It can be disassembled and reassembled easily for cost-saving reconfiguration to support other 8-, 16-, and 32-bit processors.

The card cage has six and one-half card slots. One slot is dedicated to a card cage host control card, one to an emulation bus analyzer card, and the one-half card slot is for a LAN card. The remaining four slots are available for emulator card sets, a flash EPROM card, a software performance analyzer card, and future products. The flash EPROM card offers easy software and firmware updates without the need to install new ROMs.

A host computer can communicate with the card cage via LAN, RS-232-C, or RS-422, which allows the HP development tools to operate in a variety of design environments. The card cage contains two independent RS-232-C serial ports, each with standard 25-pin female connectors. There is an RS-422 capability embedded in one of the ports, which can be programmed to operate at rates of up to 460 kB and is available for IBM PC compatibles.

When using these emulators with HP or Sun workstations, the LAN card allows connection to Ethernet networks via ThinLAN, Thick-LAN, or StarLAN. TCP/IP protocols, LAN gateways, and ARPA/Berkeley standards are supported.

### Terminal Operation

A firmware-resident ASCII terminal interface is embedded in the emulator, supplying commands for all emulation and analysis features. Commands are ASCII strings; file transfers using industry-standard formats are accepted. Since a terminal can access these commands, host independence is realized. This interface is ideal for remote field applications, and for use of portable computers, field service, or other applications where a host is impractical or unavailable.

### PC-Hosted Environment

A PC user interface for MS-DOS-based computers makes these emulation systems one of the easiest to use in the industry. Visually self-explanatory screens give you simplified access to best-of-class emulation and analysis features for any level of measurement complexity. Hierarchical command trees lead you quickly through your tasks.

A PC-based development environment provides the solution for the microprocessor software development and analysis needs of individual engineers and small design teams. High-performance tools include an IBM PC compatible, HP 64700 Series emulator, and windowed user interface, combined with software development tools. These tools constitute a development environment tailored for small design teams and those desiring personal development systems.

HP MS-DOS-based PC interface windows provide views of several areas of interest at once, eliminating time wasted in repeatedly switching contexts or running commands. The interface supports color and monochrome displays and uses directed syntax with menus and submenus for quick selection of commands.

### Workstation Interface

Easy-to-use interfaces are available on HP and Sun workstations. These interfaces are Motif-style, including terminal window operation, 3-D look and feel, pull-down menus, point and click, cut and paste, and pop-up recall buffers and help screens. This interface makes it very easy to move about an emulation session with pop-up windows, recall commands, specifications, and file history, reducing the need to remember many commands or file names.

### Emulation Memory

Dual-ported emulation memory in the HP 64700 Series emulators runs at maximum processor speeds with no wait states for accurate duplication of target system performance. The dual-port memory allows emulation displays and modifications of emulation memory without halting the processor during emulation. Memory can be mapped in 256-byte, 512-byte, or 1-Kbyte blocks, depending on the processor and can be configured as either emulation or target RAM, emulation or target ROM, or guarded memory. The emulator checks for writes to ROM or guarded memory.

### Popular File Formats

Popular absolute file formats are accepted by the HP 64700 Series emulators, including Intel OMF-86, OMF-51, OMF-286, OMF-386, and IEEE-695.

# MICROPROCESSOR DEVELOPMENT SYSTEMS

## Emulators, Analyzers, and Software Development (cont'd)

### HP 64000 Series

#### Advanced Probe Technologies

For quick, sure plug-in capability, 8- and 16-bit processors are probed with slim, flexible cables ending in a low-profile probe for accessing hard-to-reach targets without sacrificing signal fidelity. Signal fidelity is maintained at maximum-rated processor speeds so that you know your system analysis and processor control functions are accurate.

Multiple package types are supported where applicable. For example, both PGA and DIP packages for the Motorola 68000, along with LCC and PGA packages for the Intel 80186, are supported.

HP's active probe technology makes plugging into complex 32-bit designs significantly easier, allowing you to design *with* emulation, not around it. An active probe contains target CPU, memory, and high-speed circuitry for both functional and electrical transparency.

#### 8-, 16-, and 32-Bit Emulation

High-quality, real-time emulators are the core from which HP has evolved support for the microprocessor software development process. Full-speed execution of microprocessor code can be traced and analyzed nonintrusively with or without functional prototype hardware. Emulation of multiple processors makes possible interactive measurements and coordinated execution starts of complex designs.

Emulators provide an essential link between the software development environment and the target system. Programs developed on the HP 64700 development environment are run on the emulation subsystem for real-time debug and analysis. The emulation bus analyzer provides the displays and triggering conditions for the emulator and is the access point for interactive emulation analysis. Processor run controls in the emulator allow you to single step, display, and modify memory. Modifications and improvements to software are made quickly and easily in the early design phases; emulation gives you the flexibility to experiment before committing a product to firmware.

#### Comprehensive Logic Analysis Emulation Bus Analysis

Each HP 64700 Series emulator includes an emulation bus analyzer for tracing microprocessor code flow. Based on the same "logic-analyzer-on-a-chip" used in the HP 1650A/1651A Logic Analyzers and the HP 16500A Logic Analysis System, the analyzer has abundant resources for solving the most complex system problems. Up to eight hardware resources, each consisting of address, data, and status event comparators, can be combined in several fashions. Those resources can be grouped to establish complex sequential trace specifications using "find A, followed by B . . ." constructs up to eight levels deep. A range comparator can be applied to address or data events at any one of the levels. Each event is tagged with an execution time for easy measurement of code execution times. A dual-bus architecture allows all traces to be set up and reviewed without breaking processor execution. A prestore function allows tracking of relationships between a given software element and one or more other software events that influence that element. For example, prestore helps pinpoint which of several different tasks accessing a variable is responsible for corrupting it.

Emulation bus analyzer features include:

- Eight levels of sequencing for complex program flow tracking
- Address, data, or status range resources
- Prestore queue for variable access tracking
- Time tagging for instruction execution measurements
- 1,024-state-deep memory (512 states with time tagging)
- Store qualification resources
- Code coverage memory for reliability metrics



Emulation and emulation bus analysis cards provide debug, run control, source-line referencing, and real-time trace capability.

#### Software Coverage Analysis

HP 64700 Series emulators have code coverage analysis implemented in hardware. Code coverage analysis is valuable during initial coding and software test. Coverage analysis provides a history of the memory addresses that are either written to or read from during program execution. For example, you can quickly determine how exhaustive a test suite is by using coverage analysis to measure what percentage of code is being accessed. Since the coverage analyzer is built into hardware, it does not rely on statistical sampling of code space and allows running in real time.

#### Logic Analysis

The 64-channel emulation bus analyzer includes a 16-channel state/timing analyzer. The analyzer can be configured as a 100-MHz timing analyzer with 5-ns glitch detection or as a 25-MHz state analyzer. In state mode, the analyzer can be clocked by the microprocessor clock or by an independent synchronous source.

Based on the same logic analyzer chip as the emulation bus analyzer, the logic analyzer also has full triggering and qualification capabilities. The analyzer can serve as a standalone logic analyzer or can be coupled with the emulation bus analyzer for correlation of microprocessor activity with other target system activity. The two analyzers can cross-trigger or arm each other on the basis of hardware or software events that one analyzer detects. Target system probing is through a 1.4 meter cable with 18 probe leads (16 data channels and two clock channels). There are 36 miniature probe tips included for easy connection of both signal and ground lines of each lead to target system ICs or test points.

#### Software Performance Analysis

Software performance analysis verifies and benchmarks both high-level and assembly-level code, even when they are mixed. The software performance analyzer (SPA) can measure activity generated by your entire program (activity), find the most active modules and determine if they are being called too often (linkage), and measure how long any subroutine takes to execute (duration). These measurements show where your optimization effort will yield the greatest benefit.

An additional advantage of SPA is its ability to show convergence when measuring, for example, the duration of a process. SPA calculates a measurement error tolerance level each time additional data is acquired. Best of all, SPA lets you make software performance benchmarks and predictions before any costly hardware is produced.

SPA is closely coupled to the emulation/analysis environment by such features as cross-triggering and an enable/disable window. You can control when data is collected and filter out irrelevant activity.

The software performance analyzer provides overview measurements to aid in evaluating total system effectiveness of programs operating in real time. Global measurements let software designers determine where resources are being used in terms of execution times, memory usage, and interaction traffic. Software performance measurements aid in determining where to focus optimization efforts for maximum effect on system performance.

- Monitors up to 254 specified simultaneous events during activity measurements
- Monitors up to 84 simultaneous events in real time for duration measurements
- Supports 8-, 16-, and 32-bit processors
- Graphical user interface that is compatible with X11/Motif
- Histogram or statistical data list displays
- Statistical data list includes mean, percentage, standard deviation, and maximum and minimum times by either state or time counts
- Automatically reads and loads symbols from the data base used by the emulator/analyzer

### Software Development

For C programmers, source code syntax is checked against draft ANSI standard C and compiled into highly space- and time-efficient executable code by HP's optimizing Advanced C Cross Compilers. Each microprocessor-specific compiler makes full use of the microprocessor's instruction set and address modes with features not available in most native compilers.

The quality and reliability of these compilers is ensured through a comprehensive process emphasizing object-oriented design and exhaustive testing with four independent test suites. Working tightly with corresponding assemblers and linkers, HP compilers generate symbolic code that is directly usable by debuggers and integration and test tools in the succeeding phases of the development cycle.

### Software Integration

HP's Advanced Cross Debug System provides clear insight into microprocessor programs from the beginning of coding through system integration. C and assembly code can be debugged simultaneously. In either view of the program, the code, stack, and variables are displayed and updated at every step or break in execution.

Using the simulator, programs can be run and debugged without any hardware external to the host computer. When using the debugger with an emulator, your program runs full speed on the real microprocessor with real memory. With in-circuit emulation, prototype memory is also available.

A powerful software test environment can be built using command files to run the debugger (in background) and using a journaling feature to record all input and capture the resulting output.

### HP Branch Validator

HP Branch Validator is a software verification tool that is easy to use in the software verification process. HP Branch Validator, working through HP SoftBench, provides a complete environment for branch analysis that supports rapid reiteration of the compile-test-analyze loop. Comprehensive reports provide detailed feedback on the thoroughness of test suites. There are native and embedded versions of HP Branch Validator that are hosted on HP 9000 and Sun workstations.

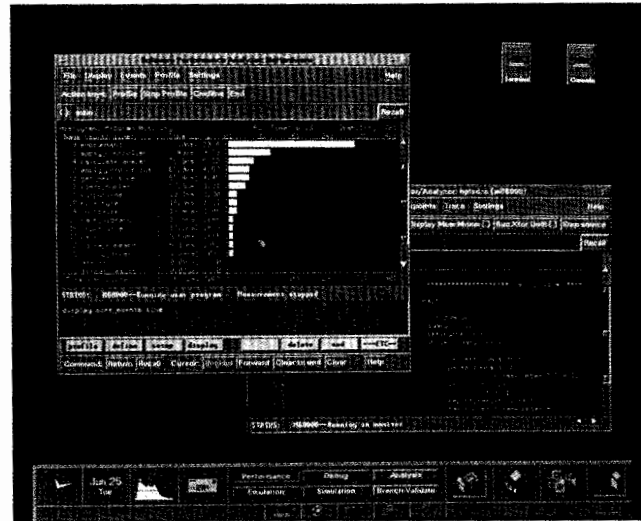

Optimize your code using the software performance analyzer and real-time, nonstatistical measurements. With this analyzer you can measure program activity, locate the most active modules and determine if they are being called too often, and measure how long any subroutine takes to execute.

A mouse-driven OSF/Motif interface allows for a rapid learning curve with minimal reference to manuals. The HP SoftBench environment provides a user with familiarity, which contributes to efficient use of tools and programmer satisfaction in creating a custom environment for software test. The convenient use of menus and windows enables you to quickly focus the test suite on relevant sets of files and measure against the criteria for successful branch validation.

### Native Development

As an integrated part of HP CASEdge, the native version of HP Branch Validator takes advantage of the HP SoftBench engineering environment to support development of HP-UX C language products. Both ANSI and non-ANSI versions of the HP-UX C compiler are supported.

### Embedded Development

As an integrated part of the HP AxCASE environment, HP Branch Validator supports AxLS C language for embedded microprocessor development applications. HP Branch Validator can use the actual prototype hardware with an emulator, running the program under test, to produce test metrics. This tool can also be used with an emulator running out of circuit or with a debugger/simulator to develop software before the hardware is available.

### Ordering Information

The HP 64700 modular analyzers/emulators are a dynamic family of software and hardware development tools for embedded microprocessor-based systems. With development support for over sixty 8-, 16-, and 32-bit microprocessors, there are many combinations of solutions available. It is recommended that an HP field engineer be contacted for a suggested system configuration that will fit your application. For a copy of our latest brochure, in the U.S. call 1-800-477-3282 (please call between 8:00 am and 5:00 pm mountain time). Outside the U.S., please call your local HP sales office.

# MICROPROCESSOR DEVELOPMENT SYSTEMS

## Emulators, Analyzers, and Software Development (cont'd)

### HP 64000 Series

#### HP 64700 Modular Emulators/Analyzers

The following are examples of emulation/analyzer systems with PC interface software and the processors currently supported. These are basic systems that do not include the software performance analyzer, interfaces, or LAN card for HP 9000 and Sun workstations, or software available from VABs.

Microprocessor	Card Cage HP 64700A	Emulator Card Model Number	Emulation Memory	Emulation Memory Model Number	Emulation Bus Analyzer Model Number	PC Interface Software	Price
<b>Advanced Micro Devices (AMD)</b>							
Am29000	●	64774G	0		64704A	●	\$22,712
			512 KB	64774Y			\$25,997
			1 MB	64774Z			\$29,282
<b>AT&amp;T</b>							
AT&T DSP32C	●	64773G	64 KB		64704A	●	\$29,214
<b>Hitachi</b>							
H8/510	●	64732A	128 KB	64726A	64703A	●	\$16,868
			512 KB	64727A			\$19,268
			1 MB	64728A			\$16,233
H8/325	●	64734F	128 KB	64725A	64706A	●	\$11,823
647180X	●	64735F	128 KB	64725A	64706A	●	\$12,173
H8/330	●	64736F	128 KB	64725A	64706A	●	\$11,823
H8/532	●	64737F	128 KB	64725A	64706A	●	\$12,173
H8/520	●	64738F	128 KB	64725A	64706A	●	\$12,033
H8/536	●	64739A	128 KB	64725A	64706A	●	\$12,313
<b>Intel</b>							
8086/8087	●	64762G	128 KB		64706A	●	\$12,532
		64762H	512 KB				\$17,432
8088/8087	●	64763G	128 KB		64706A	●	\$12,532
80C186	●	64764H	128 KB		64706A	●	\$13,284
		64764J	512 KB				\$18,432
80C188	●	64765J	512 KB		64703A	●	\$20,912
80C286	●	64766H	128 KB		64704A	●	\$20,628
80C196	●	64771G	64 KB		64704A	●	\$14,484
80960KA/KB/KC	●	64760G	0		64705A	●	\$21,591
			256 KB	64171A			\$22,671
			1 MB	64171B			\$27,990
8051, DIP	●	64788G	128 KB		64704A	●	\$14,536
8051, PLCC	●	64788H	128 KB		64704A	●	\$14,536
<b>Mitsubishi</b>							
MELPS 7700	●	64145F	128 KB	64726A	64706A	●	\$14,543
			512 KB	64727A			\$16,943
<b>Motorola</b>							
68000, DIP 12.5 MHz	●	64742G	128 KB		64706A	●	\$12,532
		64742J	512 KB				\$17,132
68000, PGA 12.5 MHz	●	64742H	128 KB		64706A	●	\$12,532
		64742K	512 KB				\$17,132
68000, DIP 16 MHz	●	64743G	128 KB		64706A	●	\$14,132
		64743J	512 KB				\$18,632
68000, PGA 16 MHz	●	64743H	128 KB		64706A	●	\$14,132
		64743K	512 KB				\$18,632
68010, DIP	●	64745J	512 KB		64706A	●	\$17,432
68010, PGA	●	64745K	512 KB		64706A	●	\$17,432
68302, PGA	●	64746G	128 KB		64703A	●	\$15,592
		64746H	512 KB				\$23,072



Microprocessor	Card Cage HP 64700A	Emulator Card Model Number	Emulation Memory	Emulation Memory Model Number	Emulation Bus Analyzer Model Number	PC Interface Software	Price
<b>Motorola</b>							
68EC020 (ABG board req)	●	64748A	0		64704A	●	\$20,061
		(64748B)	256 KB	64171A			\$21,141
			1 MB	64171B			\$23,661
68EC030 (ABG board req)	●	64747A	0		64704A	●	\$20,061
		(64748B)	256 KB	64171A			\$21,141
			1 MB	64171B			\$23,661
68332	●	64749G	0		64703A	●	\$18,872
		64749H	512 KB				\$28,840
68331	●	64749J	512 KB		64703A	●	\$28,840
68040	●	64750A	512 KB		64704A	●	\$41,382
<b>National Semiconductor</b>							
NS32532/32GX32	●	64772G	512 KB		64704A	●	\$26,010
NS32GX320	●	64778G	0		64704A	●	\$28,000
NS32FX16	●	64779G	2 MB		64703A	●	\$25,072
NS32CG16	●	64779H	2 MB		64703A	●	\$25,072
NS32CG160	●	64779J	2 MB		64703A	●	\$25,072
HPC16003/16083	●	64775G	128 KB		64706A	●	\$18,632
HPC16004/16064	●	64775H	128 KB		64706A	●	\$18,632
HPC16400E	●	64775J	128 KB		64706A	●	\$18,632
<b>NEC</b>							
V25, PLCC	●	64731F	128 KB	64726A	64706A	●	\$13,493
			512 KB	64727A			\$15,893
V25 +	●	64754F	128 KB	64726A	64706A	●	\$13,493
			512 KB	64727A			\$15,893
V35 +	●	64755F	128 KB	64726A	64706A	●	\$13,493
			512 KB	64727A			\$15,893
V33	●	64756F	128 KB	64726A	64703A	●	\$16,793
			512 KB	64727A			\$19,193
			1 MB	64728A			\$19,643
V40	●	63791A	128 KB	64726A	64703A	●	\$16,343
			512 KB	64727A			\$18,743
			1 MB	64728A			\$19,193
V50	●	64792A	128 KB	64726A	64703A	●	\$16,343
			512 KB	64727A			\$18,743
			1 MB	64728A			\$19,193
V53	●	64757F	128 KB	64726A	64703A	●	\$17,318
			512 KB	64727A			\$19,718
			1 MB	64728A			\$20,168
V70 20 MHz	●	64758G	512 KB		64706A	●	\$23,391
		64758H	1 MB				\$28,161
782XX series	●	64759F	128 KB	64725A	64706A	●	
7821X probe cable	●	64759F/001					\$11,809
7822X probe cable	●	64759F/002					\$11,907
7823X probe cable	●	64759F/003					\$11,907
<b>Texas Instruments</b>							
TMS320C25, PGA	●	64787G	128 KB		64706A	●	\$15,232
<b>Zilog</b>							
Z80	●	64753F	64 KB		64706A	●	\$9,905

# DIGITAL CIRCUIT TESTERS

## Signature Multimeter and Analyzer

HP 5005B, 5006A

- Digital and analog measurements
- Single-probe measurements of logic signals, voltage, frequency
- 25-MHz multiple logic family signature analysis

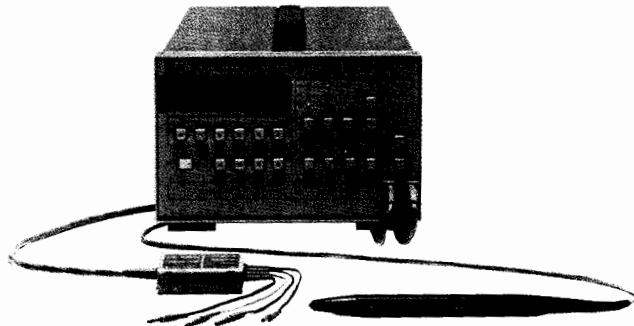

HP 5005B

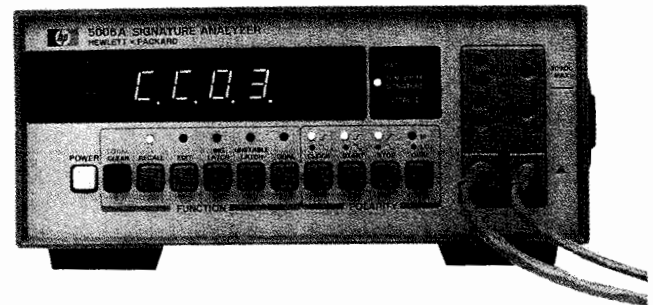

HP 5006A



### HP 5006A and HP 5005B Digital Troubleshooting

#### Signature Analysis

Signature analysis is a fast and accurate method for troubleshooting digital circuits. Finding faults is reduced to tracing signal flow and comparing measured signatures to printouts or computer-stored signatures. A signature is a 16-bit cyclic redundancy code (CRC) generated for blocks of data. Instead of entire bit streams, only signatures are compared to detect errors.

HP's patented signature analysis technique enables the HP 5005B or HP 5006A to generate a compressed, four-digit "fingerprint" or signature of a digital data stream at a logic node. Any fault associated with a device connected to the node will force a change in the data stream and produce an erroneous signature.

#### The Technique

Troubleshoot with signature analysis by probing a circuit, reading the display, and comparing to the known-good signature. Reference signatures can be generated by probing an operational circuit, or by external stimulation.

Many features of the HP 5005B and HP 5006A simplify troubleshooting procedures:

- Compatibility with multiple logic families: preset threshold levels (TTL, CMOS, and ECL for the HP 5005B; TTL and CMOS for the HP 5006A) and adjustable thresholds (+12.5 V to -12.5 V) simplify use with a wide variety of logic devices.
- 25-MHz clock frequency: signature analysis is possible for high-speed circuits such as CRT controllers.
- Qualified signature mode: fault isolation in complex products can be done quickly by windowing the signature collection to specific modules or devices with no major test setup changes.
- HP-IB programmability: every HP 5005B and HP 5006A measurement and control function can be programmed through HP-IB.

#### Time Savers

Two features save time when troubleshooting without a computer-aided system: composite signatures, and signature memory. A composite signature is the binary sum of individual signatures. The HP 5005B and HP 5006A compute composite signatures for any grouping of digital signals (such as bus or IC). Only the composite signature need be compared to a documented reference signature if all signals for that group are good.

Signatures are stored in memory after the probe switch is pushed. The memory stores the last 32 readings. Signatures can be compared in groups, not after every probe, by reviewing memory in the RECALL mode.

- Full at-speed testing of digital products
- Composite signatures
- Signatures compared with signature memory

### HP 5005B Signature Multimeter

Total checkout of a digital system often requires characterizing both digital data activity and analog signal parameters. The HP 5005B Signature Multimeter offers, in a single instrument, a measurement set optimized for digital troubleshooting applications. Digital multimeter functions for checking power supplies and circuit board integrity, universal counter features for measuring clock frequencies and time intervals between signals, and a means for verifying the analog integrity of active digital signals are all included in the HP 5005B Signature Multimeter.

#### Digital Multimeter

Certain digital problems result from analog circuit failures: a low power supply voltage, an open or shorted circuit path, a faulty A/D or D/A converter. Each may contribute to a system failure. The HP 5005B contains a 4 1/2-digit dc voltmeter, ohmmeter, and differential voltmeter. Performance is tuned for analog measurements necessary for digital troubleshooting.

#### Frequency Counter

The HP 5005B counter functions provide totalize and frequency measurements to 50 MHz and time interval measurements with 100 nanosecond resolution. Intended to extend digital troubleshooting capabilities, the counter functions can characterize one-shots and timers (time interval measurement), test interrupt lines, reset lines and RS-232 asynchronous interfaces (totalize), and verify clock and clock driver circuitry (frequency measurement).

#### Voltage Threshold

Logic level degradation is a common and troublesome malfunction in digital products. The HP 5005B's peak voltage measurement mode provides a simple, direct method for measuring the logic high and logic low voltages of active digital signals.

When in peak voltage measurement mode, the HP 5005B characterizes and displays either the greatest (positive peak) or lowest (negative peak) voltage probed. Selection of positive peak or negative peak modes displays the appropriate measured threshold for comparison against the specifications of the logic family.

#### Multifunction Probe

The HP 5005B multifunction probe automates access to the signature analyzer, multimeter, and counter functions through a single probe. Signal multiplexing to the appropriate function is internal to the HP 5005B. A switch located on the side of the probe allows the operator to trigger automatic measurement. The analog parameters and functional digital operation can be characterized by probing the same point.

## HP 5005B and HP 5006A Specifications

### Common Signature Specifications

**Display:** 4 digits. Characters 0-9, ACFHPU

**Probe:** Logic level lamps: high, low, open, pulsing; minimum pulse width: 10 ns

**Fault detection:** 100% of single-bit errors; 99.998% of multiple-bit errors

**Minimum gate length:** 1 clock cycle (1 data bit) between START and STOP

**Maximum gate length:** No limit

**Minimum timing between gates:** 1 clock cycle between STOP and START

#### Data Probe Timing

**Setup time:** 10 ns (data to be valid  $\approx$  10 ns before clock edge)

**Hold time:** 0 ns (data held until clock edge)

#### START, STOP, QUAL Timing

**Setup time:** 20 ns (signals valid  $\approx$  20 ns before clock edge)

**Hold time:** 0 ns (data held until clock edge)

#### CLOCK Timing

**Maximum clock frequency:** 25 MHz

**Minimum pulse width:** 15 ns in high or low state

### HP 5006A Unique Specifications

#### Input Impedance

**Probe:** 50 k  $\Omega$  to ground nominal

**Pod:** 100 K  $\Omega$  to ground nominal

#### Overload Protection

**Probe:**  $\pm$ 150 V continuous  $\pm$ 250 V intermittent  
**Pod:**  $\pm$ 20 V continuous  $\pm$ 140 V intermittent  
 250 Vac for 1 minute  $\pm$ 140 Vac for 1 minute

**CMOS sense:** 20 Vdc maximum

#### TTL Thresholds

**Probe:** Logic one: 2 V + .2 - .3; logic zero: 0.8 V + .3 - .2

**Pod:** 1.4 V  $\pm$  .6

#### CMOS Thresholds

**Logic one:** 70% of sensed voltage

**Logic zero:** 30% of sensed voltage

#### Other

**Lamps:** Key status: recall, edit, signature latch, unstable latch, qualify mode, timing polarities. Programmable (Option 040): remote, talk, listen, SRQ. Status: composite signature, gate, unstable

**Selectable Power:** 115 V + 10-25% ac line, 48-440 Hz, 230 V + 10-15% ac line, 48-66 Hz, 25 VA maximum

**Operating environment:** Temperature: 0-55° C, humidity: 95% RH at +40° C; altitude: 4600 m (15,000 ft)

**Size:** 89 mm H  $\times$  216 mm W  $\times$  279 mm D (3.5 in  $\times$  8.5 in  $\times$  11 in)

**Weight:** Net 2.4 kg (5.3 lb); shipping: 4.1 kg (9 lb)

### HP 5005B Unique Signature Specifications

**Qualify mode:** Data clock qualified by external signal. DATA probe input impedance  $\approx$  50 k  $\Omega$  to the average value of "0" and "1" threshold settings ( $\pm$  6 V max.); 15 pF.

**Front panel indicators:** Flashing GATE light indicates detection of valid START, STOP, CLOCK conditions. Flashing UNSTABLE light indicates a difference between 2 successive signatures and possible intermittent faults.

#### Logic Thresholds

**Preset Thresholds:** TTL, ECL, CMOS.

**Adjustable thresholds:** Each threshold can be adjusted to  $\pm$ 12.5V in 50 mV steps, accuracy is  $\pm$  .2 V.

**Logic threshold circuitry:** Operative during NORM, QUAL, kHz, TOTLZ and ms measurements.

### HP 5005B Multimeter Specifications

#### Frequency

**Display:** 5 digits

**Ranges:** 100 kHz, 1 MHz, 10 MHz, 50 MHz, autoranged

**Resolution:** 1 LSD (1 Hz on 100 kHz range)

**Accuracy:**  $\pm$ 0.01% of reading  $\pm$ 1 count

Minimum pulse width  $\approx$  10 ns in high or low state

Gate time  $\approx$  1 s, fixed

Input impedance  $\approx$  50 k  $\Omega$  to the average value of "0" and "1" threshold settings ( $\pm$  6 V max.); 15 pF

#### Totalizing

**Display:** 5 digits

**Range:** 0 to 99,999 counts

**Resolution:** 1 count

Maximum input frequency  $\approx$  50 MHz with a minimum pulse width of 10 ns and a minimum pulse separation of 10 ns

Minimum START/STOP pulse width  $\approx$  20 ns

DATA input impedance  $\approx$  50 k  $\Omega$  to the average value of "0" and "1" threshold settings (+6 V max.); 15 pF

START/STOP input impedance  $\approx$  100 k  $\Omega$ ; 15 pF

#### Time Interval

**Display:** 5 digits

**Ranges:** 10 ms, 100 ms, 1 s, 10 s, 100 s, autoranged

**Resolution:** 1 count (100 ns on 10 ms range)

**Accuracy:**  $\pm$ 0.01% of reading  $\pm$ 2 counts

Minimum START/STOP pulse width  $\approx$  20 ns

START, STOP input impedance  $\approx$  100 k  $\Omega$

#### Resistance

**Display:** 4 or 5 digits, depending on range

**Ranges:** 30 k  $\Omega$ , 300 k  $\Omega$ , 1 M  $\Omega$ , 3 M  $\Omega$ , 10 M  $\Omega$ , autoranged

**Accuracy:** (at 15°C-30°C)

Range	Full Scale	Accuracy	Display Resolution
30 k $\Omega$	29,999 k $\Omega$	$\pm$ 1% of reading $\pm$ 2 $\Omega$	1 $\Omega$
300 k $\Omega$	299,99 k $\Omega$	$\pm$ 1% of reading	10 $\Omega$
1 M $\Omega$	999.9 k $\Omega$	$\pm$ 1% of reading	100 $\Omega$
3 M $\Omega$	2999. k $\Omega$	$\pm$ 10% or reading	1 k $\Omega$
10 M $\Omega$	10000. k $\Omega$	$\pm$ 10% of reading	10 k $\Omega$

Input impedance  $\approx$  20 k  $\Omega$  to  $\pm$ 2 V

#### DC Voltage

**Display:** 4½ digits

**Ranges:**  $\pm$ 25 V,  $\pm$ 250 V, autoranged; referenced to earth ground

**Accuracy:** (at 15°C-30°C)

Range	Accuracy	Resolution
25 V	$\pm$ 0.1% of reading $\pm$ 2 mV	1 mV
250 V (< 100 V)	$\pm$ 0.25% of reading $\pm$ 20 mV	10 mV
250 V ( $\geq$ 100 V)	$\pm$ 0.25% of reading $\pm$ 20 mV	100 mV

Input impedance  $\approx$  10 M  $\Omega$

#### Differential Voltage

**Reading:** reads voltage at probe; displays difference between reading and voltage at the time  $\Delta$ V key was depressed.

**Specifications:** See DC Voltage. Range is determined by the larger of the two compared voltages.

#### Peak Voltage

**Display:** 3½ digits

**Range:** 0- $\pm$ 12 Vp

**Resolution:** 50 mV

**Accuracy:**  $\pm$ 2% of reading  $\pm$ 5% of p-p signal  $\pm$ 100 mV

Minimum peak duration  $\approx$  10 ns

Maximum time between peaks  $\approx$  50 ms

Input impedance  $\approx$  100 k  $\Omega$ ; 15 pF

#### Other

**Data Probe Protection:**

**Continuous overload**

DCV,  $\Delta$ V, k  $\Omega$  modes only:  $\pm$ 250 V ac/dc

All other modes:  $\pm$ 150 V ac/dc, 20 V rms at input frequencies > 2 MHz

**Intermittent overload:**  $\pm$ 250 V ac/dc (up to 1 min), all modes

**Timing Pod Protection:**

**Continuous overload:**  $\pm$ 100 V ac/dc, 20 V rms (input frequencies > 2 MHz)

**Intermittent overload:**  $\pm$ 140 V ac/dc (up to 1 min)

**Operating temperature:** 0° C to +55° C

**Power:** selectable 100 V, 120 V, 220 V or 240 V ac line (+5%-10%), 48-66 Hz, 35 VA maximum

**Weight:** Net: 5.5 kg (12.0 lb); shipping: 8.7 kg (19 lb)

#### Ordering Information

**HP 5005B** Signature Multimeter

**Opt 910** Additional Manual

**HP 5006A** Signature Analyzer

**Opt 40** HP-IB Interface

**Opt 910** Additional Manual

**HP 5060-0173** Half Rack Mount Kit, HP 5006A

#### Price

\$8,000

+ \$75

\$2,700

+ \$300

+ \$16.50

\$95

☎ For off-the-shelf shipment, call 800-452-4844.

# DIGITAL CIRCUIT TESTERS

## Logic Troubleshooting Components

HP 545A, 546A, 547A, 548A

### HP 545A TTL/CMOS Logic Probe

The HP 545A Logic Probe contains all the features built into other HP probes, plus switch-selectable, multi-family operation and built-in pulse memory. Employing straightforward one-lamp display, the HP 545A operates from 3 to 18 volts in CMOS applications or from 4.5 to 15 Vdc in the TTL mode while maintaining standard TTL thresholds.

The probe's independent, built-in pulse memory and LED display help you capture hard-to-see intermittent pulses. Connect the probe tip to a circuit point, reset the memory, and wait for the probe to catch hard-to-find glitches.

The hand-held HP 545A is light, rugged, overload protected, and very fast: 80 MHz in TTL, 40 MHz in CMOS. Handy power supply connectors easily hook up to supply voltage almost anywhere in the unit under test.

#### HP 545A Probe Specifications

**Input Current:**  $\leq 15 \mu\text{A}$  (source or sink)

**Input capacitance:**  $\leq 15 \text{ pF}$

#### Logic thresholds

\*TTL: Logic one  $2.0 + 0.4$ ,  $-0.2 \text{ V}$ . Logic zero  $0.8 + 0.2$ ,  $-0.4 \text{ V}$

**CMOS:** 3–10 Vdc supply

Logic one:  $0.7 \times V_{\text{supply}} \pm 0.5 \text{ Vdc}$

Logic zero:  $0.3 \times V_{\text{supply}} \pm 0.5 \text{ Vdc}$

**CMOS:**  $\geq 10$ –18 Vdc supply

Logic one:  $0.7 \times V_{\text{supply}} \pm 1.0 \text{ Vdc}$

Logic zero:  $0.3 \times V_{\text{supply}} \pm 1.0 \text{ Vdc}$

**Input minimum pulse width:** 10 ns using ground lead (typically 20 ns without ground lead)

**Input maximum pulse repetition frequency:** TTL, 80 MHz. CMOS, 40 MHz

**Input overload protection:**  $\pm 120 \text{ V}$  continuous (dc to 1 kHz);  $\pm 250$  for 15 seconds (dc to 1 kHz)

**Pulse memory:** Indicates first entry into valid logic level; also indicates return to initial valid level from bad level for pulse  $\geq 1 \mu\text{s}$  wide

#### Power Requirements

**TTL:** 4.5 to 15 Vdc\*

**CMOS:** 3 to 18 Vdc

**Maximum current:** 70 mA

**Overload protection:**  $\pm 25 \text{ Vdc}$  for one minute

**Accessory included:** Ground clip

\*  $\pm 5 \pm 10\%$  Vdc power supply; usable to  $+15 \text{ Vdc}$  with slightly increased logic low threshold.

### HP 546A Logic Pulser

The Logic Pulser solves the problem of how to pulse IC's in digital circuits. Touch the Pulser to the circuit under test, press the pulse button and all circuits connected to the node (outputs as well as inputs) are briefly driven to their opposite state. No unsoldering of IC outputs is required. Pulse injection is automatic, high nodes are pulsed low and low nodes high each time the button is pressed.

Several features of the HP 546A—automatic polarity pulse output, pulse width, and amplitude—simplify multi-family operation. To deliver a continual or specific-length pulse stream, the Pulser is programmable. Choose from several output patterns: single pulses; pulse streams of 1, 10, or 100 Hz; bursts of 10 or 100 Hz; or bursts of 10 or 100 pulses. Used with HP multi-family IC Troubleshooters, the HP 546A can be a voltage and current source for digital troubleshooting applications.

#### HP 546A Pulser Specifications

##### Output

Family	Output Current	Pulse Width	Typical Output Voltage	
			HIGH	LOW
TTL/DTL	$\leq 650 \text{ mA}$	$\geq 0.5 \mu\text{s}$	$\geq 3 \text{ Vdc}$	$\leq 0.8 \text{ Vdc}$
CMOS	$\leq 100 \text{ mA}$	$\geq 5.0 \mu\text{s}$	$\geq (V_{\text{supply}} - 1 \text{ Vdc})$	$\leq 0.5 \text{ Vdc}$

**Power supply requirements:** TTL; 4.5 to 5.5 Vdc at 35 mA, CMOS; 3 to 18 Vdc at 35 mA, protected to  $\pm 25 \text{ Vdc}$  for 1 min

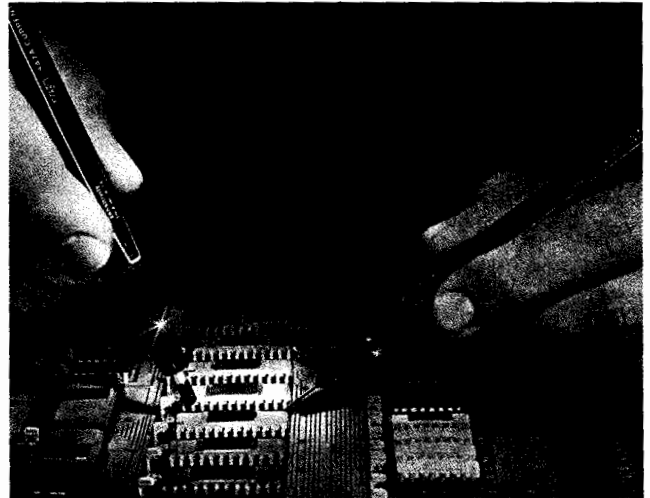

HP 547A/546A

### HP 547A Digital Current Tracer

The HP 547A Current Tracer precisely locates low-impedance faults in digital circuits by locating current sources or sinks. On a bad node, the Tracer can verify that the driver is functioning and locate problems by tracing current flow to the source or sink causing the node to be stuck. The Tracer is designed to troubleshoot circuits carrying fast rise-time current pulses. The Tracer displays transitions, single pulses, and pulse trains using a simple one-light indicator. Because it is not voltage sensitive, the Tracer operates on all logic families having current pulses exceeding 1 mA, including CMOS where even lightly-loaded outputs can have up to 2 to 3 mA of instantaneous charging current.

#### HP 547A Current Tracer Specifications

##### Input

**Sensitivity:** 1 mA to 1 A

**Frequency response:** Light indicates single-step current transitions; single pulses  $\geq 50 \text{ ns}$  in width; pulse trains to 10 MHz (typically 20 MHz for current pulses  $\geq 10 \text{ mA}$ )

**Risetime:** Light indicates current transitions with risetime  $\leq 200 \text{ ns}$  at 1 mA

##### Power Supply Requirements

**Voltage:** 4.5 to 18 Vdc

**Input current:**  $\leq 75 \text{ mA}$

**Maximum ripple:**  $\pm 500 \text{ mV}$  above 5 Vdc

**Overvoltage protection:**  $\pm 25 \text{ Vdc}$  for one minute

### HP 548A Logic Clip

The HP 548A Logic Clip is an extremely handy service and design tool which clips onto dual-inline package (DIP) ICs and instantly displays the states of up to 16 pins simultaneously. The 16 LEDs independently follow level changes at the associated pins. Lit diodes are logic high; extinguished diodes are logic low. The Logic Clip needs no power connections and has its own gating logic for locating ground and  $V_{cc}$  pins. Buffered inputs reduce circuit loading.

#### HP 548A Specifications

**Input threshold:**  $(\geq 0.4 \pm 0.06 \times \text{Supply Voltage}) = \text{Logic High}$

**Input impedance:** 1 CMOS load per input

**Input protection:** 30 Vdc for 1 minute

**Supply voltage:** 4-18 Vdc across any two pins

**Auxiliary supply input:** 4.5 to 20 Vdc applied via connector. Supply must be  $\geq 1.5 \text{ Vdc}$  more positive than any pin of IC under test.

**Supply current:**  $< 55 \text{ mA}$

# DIGITAL CIRCUIT TESTERS

## Logic Comparator and Troubleshooting Kits

HP 10529A, 5011T, 5021A, 5022A, 5023A, 5024A

355

- Stimulus-response capability
- In-circuit fault finding

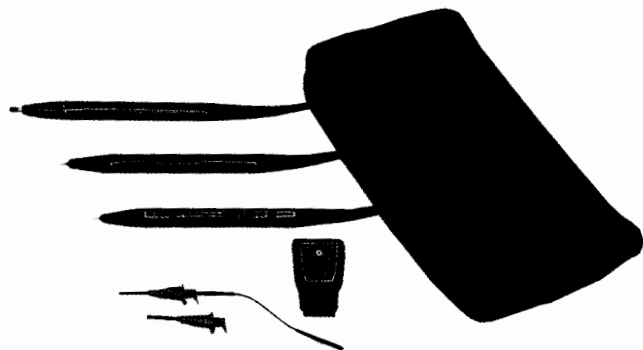

HP 10529A

### HP 10529A Logic Comparator

The HP 10529A Logic Comparator clips onto powered TTL or DTL ICs and detects functional failures. In-circuit ICs are compared with a known-good reference IC inserted in the Comparator. Pins are identified as output or input by setting 16 miniature switches. Any logic state difference between the test and reference ICs is indicated by a lighted LED. Intermittent errors as short as 300 ns are detected using the socket board and indicated visually. A test board is supplied to confirm correct operation of all Comparator circuitry, test leads, and display elements.

Additional blank reference boards are available separately (HP 10541A). Twenty pre-programmed reference boards are available (HP 10541B) to support testing for 7400, 7402, 7404, 7408, 7410, 7420, 7430, 7440, 7451, 7454, 7473, 7474, 7475, 7476, 7483, 7486, 7490, 7493, 74121, and 9601 ICs.

#### HP 10529A Specifications

**Input threshold:** 1.4 V nominal (1.8 V nominal with socket board), TTL or DTL compatible

**Test IC loading:** Outputs driving Test IC inputs are loaded by 5 low-power TTL loads plus input of Reference IC. Test IC outputs are loaded by 2 low-power TTL loads.

**Input protection:** Voltages < -1 V or > 7 V must be current limited to 10 mA

**Supply voltage:** 5 V ±5%, at 300 mA

**Supply protection:** Supply voltage must be limited to 7 V.

**Maximum current consumption:** 300 mA

#### Sensitivity

**Error sensitivity:** 200 ns with reference board or 300 ns with socket board. Errors greater than this are detected and stretched to at least 0.1 second

**Delayed variation immunity:** 50 ns. Errors shorter than this value are considered spurious and ignored

**Frequency range:** Maximum operational frequency varies with duty cycle. An error existing for a full clock cycle will be detected if the cycle rate is less than 3 MHz.

**Accessories included:** 1 test board; 10 blank reference boards; 1 programmable socket board; 1 carrying case

- Dynamic and static testing
- Multi-pin testing

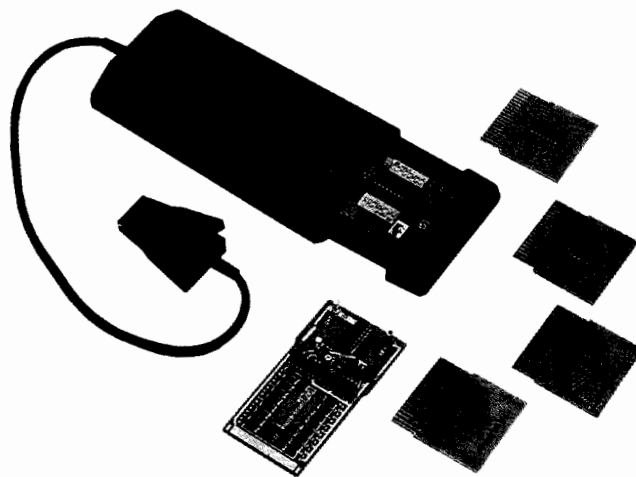

HP 5022A

### Logic Troubleshooting Kits

Each of HP's IC Troubleshooters provide their own unique and important troubleshooting function. Together they become invaluable stimulus-response testing partners that help pinpoint faults and ensure fast non-destructive repair of digital circuits.

HP has packaged the IC Troubleshooters into kits which offer ordering convenience and cost savings. Applications information is available, such as AN 163-2, "New Techniques of Digital Troubleshooting," to help users derive maximum benefit from these instruments.

FAULT	STIMULUS	RESPONSE	TEST METHOD
Shorted Node <sup>1</sup>	Pulser <sup>2</sup>	Current Tracer	<ul style="list-style-type: none"> <li>• Pulse shorted node</li> <li>• Follow current pulses to short</li> </ul>
Stuck Data Bus	Pulser <sup>2</sup>	Current Tracer	<ul style="list-style-type: none"> <li>• Pulse bus line(s)</li> <li>• Trace current to device holding the bus in a stuck condition</li> </ul>
Internally Open IC	Pulser <sup>2</sup>	Probe	<ul style="list-style-type: none"> <li>• Pulse device input(s)</li> <li>• Probe output for response</li> </ul>

<sup>1</sup>A node is an interconnection between two or more IC's.

<sup>2</sup>Use the Pulser to provide stimulus or use normal circuit signals, whichever is most convenient.

#### Ordering Information

HP 545A Logic Probe	Price
HP 546A Logic Pulser	\$290
HP 547A Digital Current Tracer	\$380
Accessories (HP 545A, 546A, 547A)	\$700
HP 00545-60104 Tip Kit for HP 546A, 545A	\$80
HP 10526-60002 Multi-Pin Stimulus Kit	\$100
HP 1250-1948 Adapter, Coax Str.	\$25
HP 548A Logic Clip	\$350
HP 10529A Logic Comparator	\$1,350
Accessories (HP 10529A)	
HP 10541A Twenty Blank Reference Boards	\$250
HP 10541B Twenty Pre-programmed Boards	\$490

#### IC Troubleshooter Kits Selection and Ordering

HP MODEL	545A TTL/CMOS Probe	546A TTL/CMOS Pulser	547A TTL/CMOS Current Tracer	548A TTL/CMOS Clip	10529A TTL Comparator	PRICE
5011T Kit	X	X		X	X	\$2,340
5021A Kit	X	X		X		\$1,000
5022A Kit	X	X	X	X		\$1,690
5023A Kit	X	X	X	X	X	\$3,010
5024A Kit	X	X	X			\$1,350

☎ For off-the-shelf shipment, call 800-452-4844.

# COMPONENT MEASUREMENT

## General Information Impedance Measurement

Application Area	Component/Material Manufacturer		Component User	
	R&D and QA	Production	Incoming Inspection	R&D
Major Requirements	Verify that device has sufficient performance	Perform GO/NO-GO testing based on MIL, IEC, etc.		Evaluate devices/circuits under actual working conditions
Required Measurement Functions	Multi-function/General Purpose Wide freq. range Auto freq. sweep Variable signal level & DC Bias Multi-parameter High accuracy and resolution	High Speed/Single Function High Speed Fixed frequency level & DC Bias Single parameter		Multi-function/General Purpose High frequency resolution Auto freq. sweep Variable signal level & DC Bias Multi-parameter High accuracy and resolution
HP 4195A				
HP 4194A				
HP 4192A				
HP 4191A				
HP 4193A				
HP 4284A/4285A				
HP 4274A/4275A				
HP 4278A				
HP 4276A/4277A				
HP 4279A				
HP 4263A				
HP 4342A				
HP 4338A				
HP 4339A/4349A				

Table 1. Component measurement applications and HP products

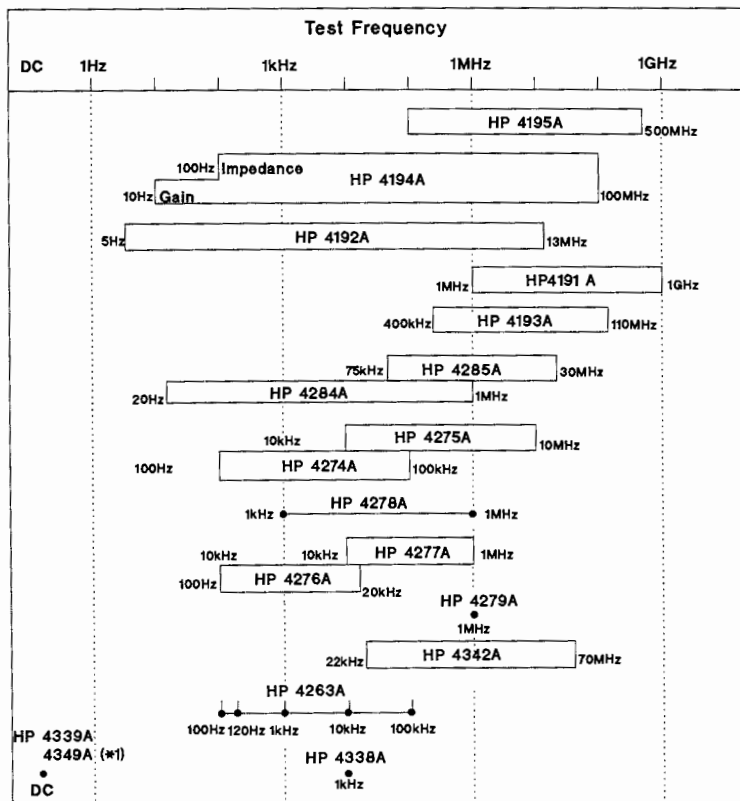

(\*) : Use an external power source.

Table 2. HP component measurement products versus test frequency

Note: Refer to page 289 for complete information of the HP 4195A.

### Component Measurement

An impedance-measuring instrument measures impedance characteristics of electronic components, materials, and circuits. HP impedance instruments provide:

1. A broad product line, to fit each application.
2. Full evaluation of impedance characteristics under conditions of varying frequency, test-signal level, and DC bias.
3. High-precision, high-resolution impedance measurement, with error correction for test-lead or test-fixture effects.

Impedance-measuring instruments can be divided into two general categories: LCR meters and impedance analyzers. The LCR meter primarily measures the inductance, capacitance, and resistance of a test device. The impedance analyzer, in addition to all of the functions of the LCR meter, measures the impedance and phase of the test device, and makes detailed analysis of the impedance measurement.

The major applications of impedance-measurement instruments are in electronic-component materials manufacture and electronic equipment manufacture (electronic component users).

Table 1 shows the type of evaluation and the functions required according to instrument application.

Impedance measurements can be divided into two general categories:

1. Tests of whether the test device functions properly under application conditions.
2. Tests under conditions stipulated by MIL or IEC standards.

When type 1 measurements are conducted in a research and development department, the purpose is to shorten development time through careful evaluation. Therefore, a multi-function, general-purpose instrument for the measurement of many characteristics is required, such as an impedance analyzer or high-resolution LCR meter.

Type 2 measurements are conducted for go/no-go tests in manufacturing or incoming inspection. The measurement data are fed back to vendors or manufacturing processes for correction and improvement. Because of volume, test costs must be minimized. Therefore, a high-speed, single-function instrument may be used. Sorting and interpreting test results may be required, so an LCR meter with a comparator option can be used.

Table 2 shows Hewlett-Packard's line of instruments arranged according to measurement frequency and performance. Test frequencies of these instruments range from 5 Hz to 1 GHz, and some have fixed MIL/IEC standard frequencies between 1 kHz and 1 MHz.

Since Hewlett-Packard introduced the first digital LCR meter, the company has continued to create high-performance impedance-measurement instruments. Because of this effort, it is now possible for virtually anyone to make the most difficult impedance measurements with ease and great accuracy.

### Variety of Available Test Fixtures and Cables

A variety of test fixtures and cables is available for the HP LCR meters for many applications. Figure 1 is a compatibility chart for the test fixtures and cables and HP's LCR meters. Refer to the individual LCR meter data sheet for details.

- \* 1: Information given with cable length; connector type; recommended frequency for use; max. applicable dc voltage.
- \* 2: Information given with recommended frequency for use; max. applicable dc voltage.
- \* 3: Information given with cable length; recommended frequency for use; max. applicable dc voltage; (shape of UNKNOWN terminals).
- \* 4: A cable with 7 mm connectors required.

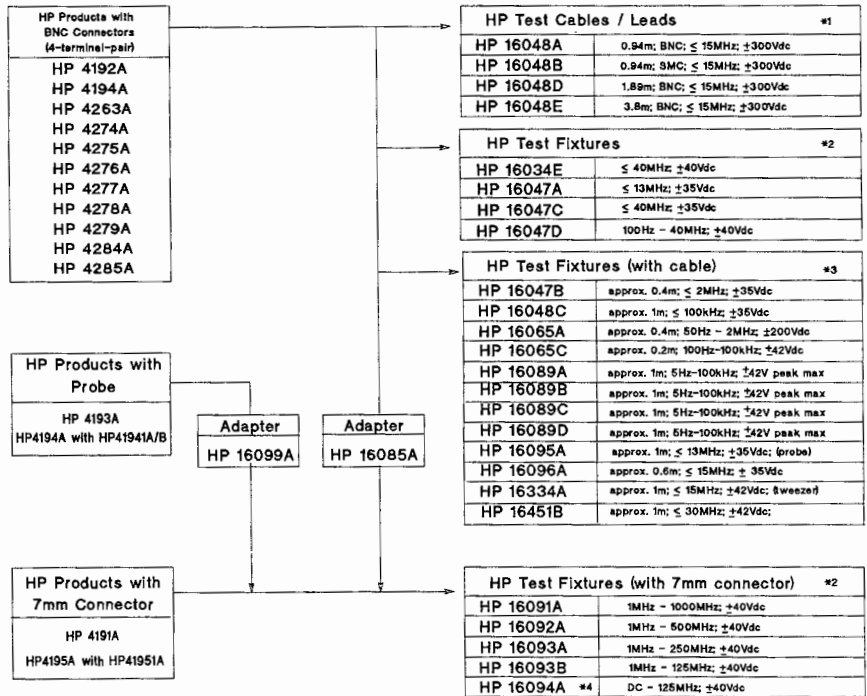
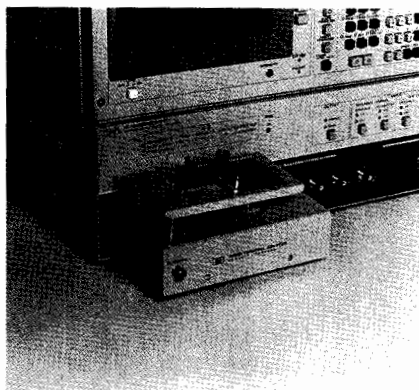
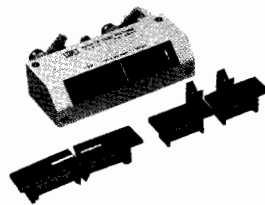

Figure 1. HP instruments versus accessories



HP 16092A with HP 16085B



HP 16047A

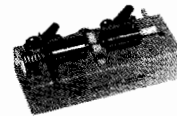

HP 16034E

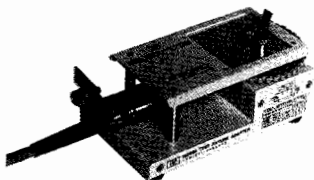

HP 16093A with HP 16099A

Note: Refer to the sections of the HP 41941A/B and 41951A for more information.



16047C



HP 16048A

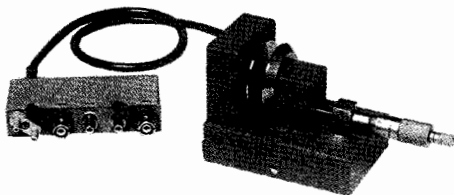

HP 16451B

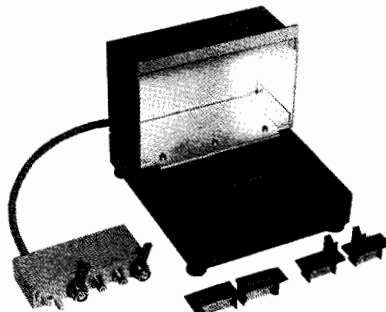

HP 16065A



HP 16334A

# COMPONENT MEASUREMENT

## Impedance/Gain-Phase Analyzer

HP 4194A

- High accuracy and wide range  
Impedance measurement:  
100 Hz to 40 MHz, 0.1 m $\Omega$  to 1.6 M $\Omega$ , 0.17%  
10 kHz to 100 MHz, 0.1  $\Omega$  To 1 M $\Omega$ , 1.5% when used with the HP 41941A/B
- Gain-phase measurement:  
10 Hz to 100 MHz, -107 dBm to +15 dBm, 0.1 dB resolution
- Flexible measurement, computation, and analysis capabilities on a color graphic display
- Fully programmable

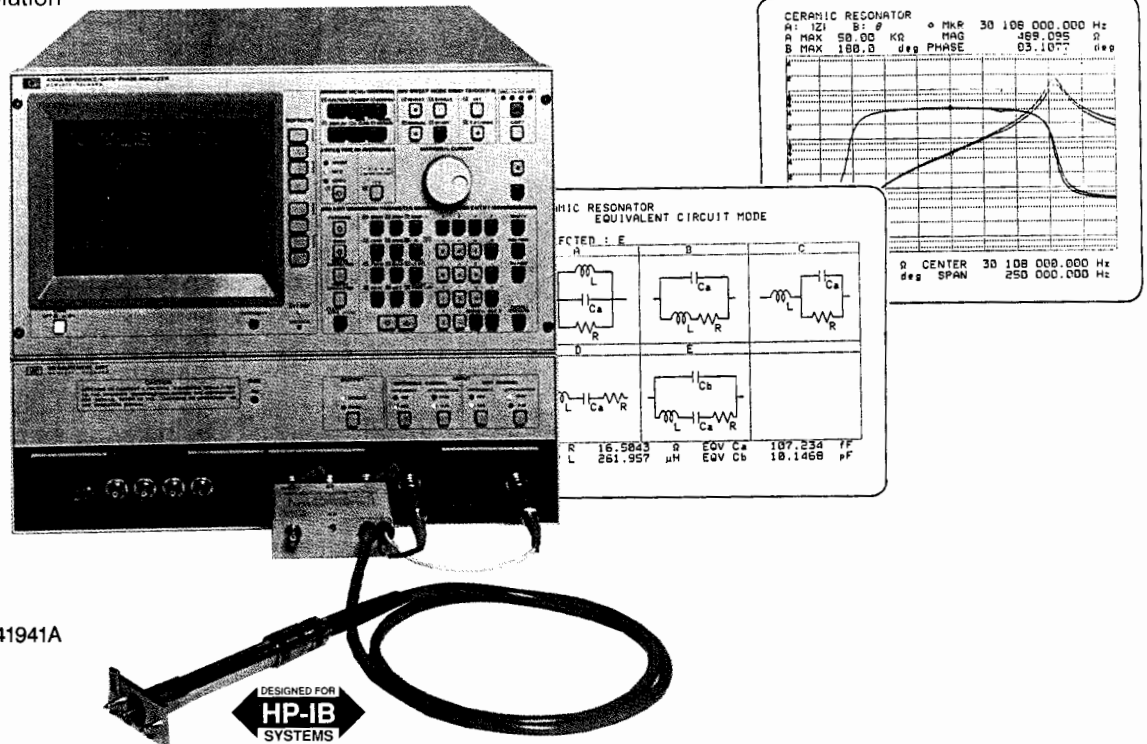

HP 4194A with HP 41941A



### Description

The HP 4194A Impedance/Gain-Phase Analyzer is an integrated solution for efficient measurement and analysis or go/no-go testing of components and circuits. Detailed impedance and transmission characteristics, including secondary parameter derivations, can be simply and quickly evaluated or tested. The HP 4194A can contribute to improving engineering productivity and reducing test cost. The analyzer is flexible and has wide measurement capabilities in both impedance and transmission measurements. It is also fully programmable using Auto Sequence Programming (ASP). Desired measurements and computations, including graphics analysis, can be programmed simply by storing front-panel keystroke operations, allowing you to customize measurement, computation, and analysis functions. The HP 4194A also features high accuracy and error elimination functions to ensure reliable measurements.

### Wide Range Accurate Measurement

Featuring a wide test frequency range — 100 Hz to 40 MHz for impedance measurements (10 kHz to 100 MHz when using the HP 41941A/B Impedance Probe Kit) and 10 Hz to 100 MHz for gain-phase measurements — the HP 4194A satisfies a wide spectrum of needs. Realistic device characteristics can be analyzed under actual operating conditions by varying the test frequency, test signal level, and dc bias. The HP 4194A's high degree of measurement accuracy — 0.17 percent for impedance measurements (1.5 percent when using the HP 41941A/B) with an amplitude ratio of 0.1 dB — ensures that you'll improve the quality of your test devices.

### Quick Analysis

The HP 4194A makes high-speed measurements, (approximately 3.7 ms per point), displays results on a color CRT, and performs parameter analysis of components and circuits quickly and efficiently, substantially reducing development and evaluation time. The analysis function not only provides you with impedance and transmis-

sion characteristics, but also allows you to determine secondary parameters. Using the marker and line cursor functions, you can obtain the resonating frequency of resonators and the pass band width of band pass filters quickly.

### Equivalent Circuit Analysis Function

Using the HP 4194A's Equivalent Circuit Analysis Function, you can easily and quickly obtain those equivalent circuit constants that, until now, required a number of time-consuming, complicated calculations. By using measured values, this unique function can approximate the circuit constant values of five circuit models. For example, a resonator's equivalent circuit elements or a coil's self inductance, lead resistance, and stray capacitance can be easily obtained.

The Equivalent Circuit Analysis Function also simulates the frequency characteristics of components by using derived circuit values or values you specify. By using approximation and simulation, you can compare design values to measurement values, and thereby improve component design efficiency.

### Auto Sequence Program (ASP)

The HP 4194A's ASP function, an internal programming feature, allows you to control all HP 4194A operations (measurement, display, and analysis) without the need for an external computer. By using ASP and actual measurement values, you can readily calculate many secondary parameters that you may need to evaluate. You can use the HP 4194A's powerful analysis functions to analyze these calculated parameters.

You can also use ASP to enhance such HP 4194A functions as alternate sweep, sweep timing control, and marker tracking. Because ASP eliminates the need for external controller, thereby eliminating data transfer time, the HP 4194A can quickly and efficiently perform production line go/no-go testing of components such as resonators and filters. All these features combine to increase your engineering and manufacturing productivity.



## Increased Capabilities with the HP 41941A/B Impedance Probe Kit

When using the HP 4194A with the HP 41941A/B Impedance Probe Kit, you can perform reliable impedance evaluations up to 100 MHz. Measurement errors due to residual impedance and stray admittance are eliminated by using the calibration standards furnished with the HP 41941A/B and the HP 4194A's automatic calibration function. This makes it possible to make highly accurate measurements (basic measurement accuracy 1.5 to 3 percent) over a wide measurement range of 100 m $\Omega$  to 1 M $\Omega$ . Calibration accuracy is guaranteed to the tips of the HP 41941A (1.5 m) and HP 41941B (3 m) impedance probes.

The HP 41941A/B can be used as a grounded probe to evaluate the impedance of in-circuit components such as printed circuit patterns, and the input/output impedance of circuits. In addition, you can connect an external dc bias source directly to the HP 41941A/B to perform dc biased measurements up to  $\pm 150$  V/0.5 A, to measure the dc characteristics of inductors, capacitors, materials, and semiconductors. To perform swept dc bias measurements, use the HP 4194A's  $\pm 40$  V internal dc bias source.

## Specifications

### Impedance Measurements

**Measurement Parameters:**  $|Z|$ ,  $|Y|$ ,  $\theta$ , R, X, G, B, L, C, D, Q. Twenty parameter combinations are available.

**Test Frequency:** 100 Hz to 40 MHz (CABLE LENGTH: 0m), 100 Hz to 15 MHz (CABLE LENGTH: 1 m), 1 mHz resolution.

**OSC Level:** 10 mV - 1 Vrms ( $\leq 10$  MHz), 10 mV - 0.5 Vrms ( $> 10$  MHz) (UNKNOWN terminal open), 3 digit resolution

**DC Bias:** 0 to  $\pm 40$  V, 10 mV resolution

**Measurement terminal:** 4 - terminal pair configuration

**Measurement Range and Maximum Resolution:**

Measurement Parameter	Range	Max Resolution
$ Z , R, X$	10 m $\Omega$ to 100 M $\Omega$	100 $\mu\Omega$
$ Y , G, B$	10 nS to 100 S	1 nS
$\theta$	$\pm 180^\circ$	0.01 $^\circ$
L	1 nH to 100 kH	10 pH
C	10 fF to 0.1 F	0.1 fF
D	0.001 to 10	0.0001
Q	0.1 to 1000	0.1

**Basic Measurement Accuracy:** 0.17%

**Level Monitor:** 1 mV - 1 Vrms, 1  $\mu$ A @20 mA

### Gain-Phase Measurements

**Measurement Parameters:** Tch/Rch (dB, Linear Ratio), Tch, Rch (V, dBm, dBV),  $\theta$  (degree, rad),  $\tau$

Tch = Test Channel, Rch = Reference Channel,  $\tau$  = Group Delay

**Measurement Frequency:** 10 Hz - 100 MHz, 1 mHz resolution

**Aperture Frequency Range (Group Delay Measurements):** 0.5% to 100% of frequency span

**OSC Level:** -65 dBm - +15 dBm, 0.1 dB resolution

**Measurement Range:**

**Tch/Rch:** 0 to  $\pm 120$  dB, 0.001 dB resolution

**Tch, Rch:** -107 dBm - -5 dBm (0 dB Attenuator)

-87 dBm - +15 dBm (20 dB Attenuator)

0.001 dB resolution

$\theta$ :  $\pm 180^\circ$  (can display phase continuously with the phase scale expansion function), 0.01 $^\circ$  resolution

$\tau$ : 0.1 ns to 1 s, 0.1 ns resolution

**Basic Measurement Accuracy:**

**Tch/Rch:** 0.1 dB, 0.5 $^\circ$

**Tch, Rch:** 0.35 dBm

**Level Monitor** Monitor the input level of the Reference and Test channels in units of dBm, dBV and Volts.

### Impedance Measurements Using the HP 41941A/B

The specifications listed below are for the HP 4194A when used with the HP 41941A/B.

**Frequency Range:** 10 kHz - 100 MHz, 1 mHz resolution

**OSC Level:** Opt. 350: 10 mV - 1.28 Vrms

Opt. 375: 10 mV - 1.54 Vrms

**DC Bias:** Internal:  $\pm 40$  V,  $\pm 20$  mA

External:  $\pm 150$  V,  $\pm 500$  mA, max 25 W

**Measurement Range:** 100 m $\Omega$  to 1 M $\Omega$

**Basic Measurement Accuracy:**

$\pm 1.5\%$  to  $3\%$  ( $\geq 100$  kHz),  $\pm 3\%$  to  $6\%$  ( $< 100$  kHz)

**Cable Length:** HP 41941A: 1.5 m, HP 41941B: 3 m

## Common Specifications

**Trigger Mode:** Internal, External, and Manual

**Sweep Capability:**

**Sweep Parameter:** Frequency, OSC Level, DC Bias (impedance measurements only)

**Entry:** START/STOP or CENTER/SPAN

**Sweep Type:** LIN, LOG, ZERO SPAN (DC Bias: LIN or ZERO SPAN only)

**Number of Measurement Points:** 2 to 401 points

**Sweep Functions:** Partial Sweep, Expand Markers Sweep, Program Points Measurement

## Display

**CRT:** 7.5-inch color CRT

**Display Mode:** Rectangular (X- A & B), Rectangular (A - B), Table

**Display Control:** Autoscale, Superimpose, and Storage

## Analysis

**Marker:** Single, Delta, Double Markers

**Line-Cursor:** Line-Cursor, Delta-Line Cursor

**Equivalent Circuit Function:** Approximation, Simulation

**Arithmetic Operation**

**Data Register Manipulation:** Use arithmetic operations and functions to manipulate data registers

**Go/No-Go Limits**

## Programming

**Auto Sequence Program (ASP):** Control the HP 4194A's operation with an internal program language. ASP can be entered using the front panel keys or downloaded from HP-IB.

**Program Memory Size:** 20 kBytes of nonvolatile memory

**Copy:** Dump, Plot, Print Mode

## General Specifications

**Operating Temperature and Humidity:** 0 $^\circ$  C to 40 $^\circ$  C (HP 41941A/B: -20 to +65 $^\circ$  C),  $\leq 95\%$  RH at 40 $^\circ$  C

**Storage Temperature:** -30 $^\circ$  C to +60 $^\circ$  C (HP 41941A/B: -40 to +65 $^\circ$  C)

**Safety:** Based on IEC - 348, UL - 1244

**Power:** 100, 120, 220V  $\pm 10\%$ , 240 V -10% + 5%, 48 to 66 Hz, 400 VA (max)

**Dimensions:** 425 mm W  $\times$  375 mm H  $\times$  620 mm D (16.73 in  $\times$  14.76 in  $\times$  24.41 in)

**Weight:** Approximately 37 kg (net) (81.4 lb)

## Reference Data

**Typical Measurement Speed:**

**Impedance:** Approximately 3.7 ms/point

**Gain-Phase:** Approximately 3.5 ms/point

**Impedance when used with the HP 41941A/B:** Approximately 6 ms/point

## Accessories Furnished

**HP 16047D:** Direct Coupled Test Fixture

**HP 8120-1838:** 30 cm BNC Cable (2 ea) (Opt. 350)

**HP 04194-61640:** 30 cm BNC Cable (2 ea) (Opt. 375)

**HP 8120-1839:** 60 cm NNC Cable (Opt. 350)

**HP 04194-61641:** 60 cm NNC Cable (Opt. 375)

**HP 1250-0080:** BNC Adapter

## Accessories Available

Refer to page 357.

## Ordering Information

**HP 4194A Impedance/Gain-Phase Analyzer**

**Opt 350\*:** 50  $\Omega$  System

**Opt 375\*:** 75  $\Omega$  System

**Opt W30:** Extended repair service. See page 671.

**Opt 001:** High Stability Frequency Reference

**HP 41941A\* Impedance Probe Kit (1.5 m)**

**HP 41941B\* Impedance Probe Kit (3 m)**

\*Must select either Opt. 350 or 375

**Price**

\$23,800

\$0

\$0

+ \$455

+ \$850

\$1,770

\$1,770

# COMPONENT MEASUREMENT

## LF Impedance Analyzer (5 Hz to 13 MHz)

HP 4192A

- 5 Hz to 13 MHz variable measuring frequency
- Gain-phase measurement: amplitude, phase, group delay
- Floating or grounded devices
- Impedance measurement:  $|Z| \cdot |Y| \cdot \theta \cdot R \cdot X \cdot G \cdot B \cdot L \cdot C \cdot D \cdot Q \cdot \Delta \cdot \Delta\%$
- Standard HP-IB

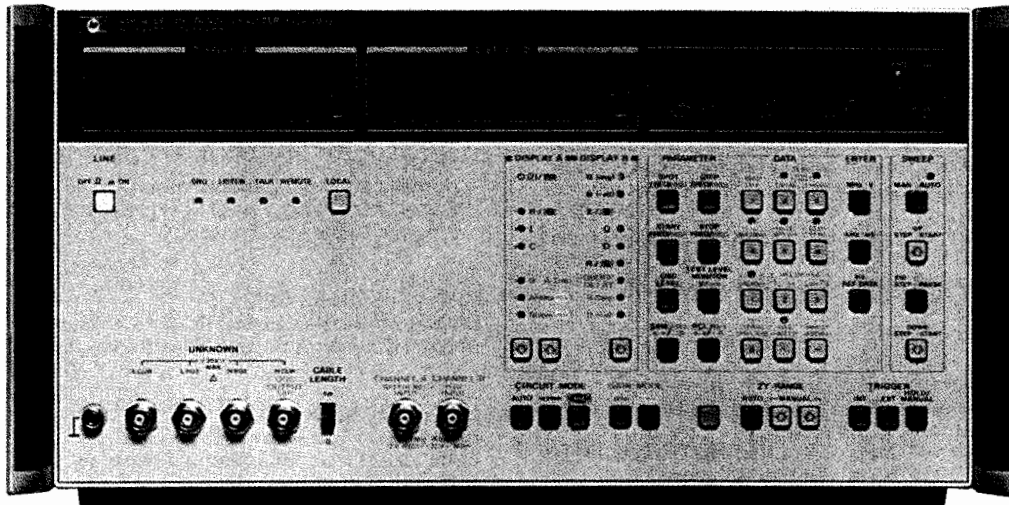

HP 4192A (shown with Opt. 907 handles)



### Description

The HP 4192A LF Impedance Analyzer performs both network analysis and impedance analysis on such devices such as telecommunication filters, audio/video electronic circuits, and basic electronic components. Both floating and grounded devices can be tested.

### Automatic Swept Frequency Measurement of All Impedance Parameters

The HP 4192A can measure 11 impedance parameters ( $|Z|$ ,  $|Y|$ ,  $\theta$ ,  $R$ ,  $X$ ,  $G$ ,  $B$ ,  $L$ ,  $C$ ,  $D$ ,  $Q$ ) over a wide range  $|Z|$ : 0.1 m $\Omega$  to 1 M $\Omega$ ;  $|Y|$ : 1 nS to 10 S).

The built-in frequency synthesizer can be set from 5 Hz to 13 MHz with a maximum resolution of 1 mHz. This feature allows accurate characterization of such high Q devices as crystals. Test signal level is variable from 5 mV to 1.1 V with 1 mV resolution. Also, an internal dc bias voltage source provides  $\pm 35$  V at 10 mV increments. Thus, the HP 4192A can evaluate components and entire circuits at near actual operating conditions.

### Specifications (complete specifications on data sheet)

#### Measuring signal (23 $\pm 5^\circ$ C)

**Frequency range:** 5 Hz to 13 MHz

**Frequency step:** 0.001 Hz (5 Hz to 10 kHz), 0.01 Hz (10 kHz to 100 kHz), 0.1 Hz (100 kHz to 1 MHz), 1 Hz (1 MHz to 13 MHz).

**Frequency accuracy:**  $\pm 50$  ppm

**OSC level:** 5 mV to 1.1 Vrms variable into 50  $\Omega$  (amplitude-phase measurement) or open circuit (impedance measurement).

**OSC level step:** 1 mV (5 mV to 100 mV), 5 mV (100 mV to 1.1 V).

**OSC level accuracy:** 5 Hz to 1 MHz:  $\pm((5 + 10/f)\%$  of setting + 2 mV) where f is in Hz. 1 MHz to 13 MHz:  $\pm((4 + 1.5 \times F)\%$  of setting + 2 mV) where F is in MHz.

**Level monitor** (impedance measurement): Current through or voltage across sample can be monitored

**Control:** Spot and sweep via front panel or HP-IB

#### Measuring mode

**Spot measurement:** At specific frequency (or dc bias)

**Swept measurement:** Manual or automatic sweep from START to STOP frequency (or dc bias) at selected STEP frequency (or dc bias) rate

**Sweep mode:** Linear or logarithmic (frequency only)

**Recorder outputs:** Output dc voltage proportional to each measured value, and frequency or dc bias.

**Maximum output voltage:**  $\pm 1$  V

**Output voltage accuracy:**  $\pm(0.5\%$  of voltage + 20 mV)

**Key status memory:** Five sets of measuring conditions can be stored and recalled at any time.

**HP-IB data output and remote control:** Standard

**Self-test:** Automatic introspective testing

**Trigger:** Internal, external, manual, or HP-IB

### Amplitude-Phase Measurement

**Parameter measured:** Relative amplitude B-A (dB) and phase  $\theta$  (degrees or radians), B-A and group delay, absolute amplitude A (dBm or dBV) or B (dBm or dBV), and deviation ( $\Delta$ ,  $\Delta\%$ ) of all parameters

**Reference amplitude:** 0 dBV = 1 Vrms, 0 dBm = 1 mW (with 50  $\Omega$  termination)

**OSC output resistance:** 50  $\Omega$

**Channels A and B:** input impedance: 1 M $\Omega \pm 2\%$ , shunt capacitance: 25 pF  $\pm 5$  pF

#### Display range and resolution

**B-A:** 0 to  $\pm 100$  dB, 0.001 dB (0 to  $\pm 20$  dB), 0.01 dB ( $\pm 20$  to  $\pm 100$  dB)

$\theta$ : 0 to  $\pm 180^\circ$ , 0.01 $^\circ$

**Group delay:** 0.1 ns to 19 s, max. resolution 4 $\frac{1}{2}$  digits

**A or B:** +0.8 to -100 dBV, 0.001 dB ( $> -20$  dB), 0.01 dB

( $\leq -20$  dB), +13.8 to -87 dBm, 0.001 dB ( $> -20$  dBm), 0.01 dB ( $\leq -20$  dBm)

**Measuring accuracy (23  $\pm 5^\circ$  C):** Specified at BNC unknown terminals after 30 minute warmup (test speed: normal or average)

**B-A (relative amplitude) and  $\theta$  (phase) Measurement:** Determined by sum of channel A and B accuracies given below (accuracy of each channel changes according to absolute input level)

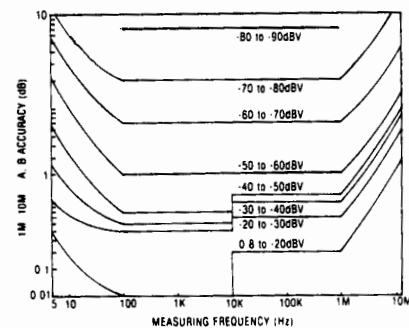

FIGURE 1 : GAIN MEASUREMENT ACCURACY

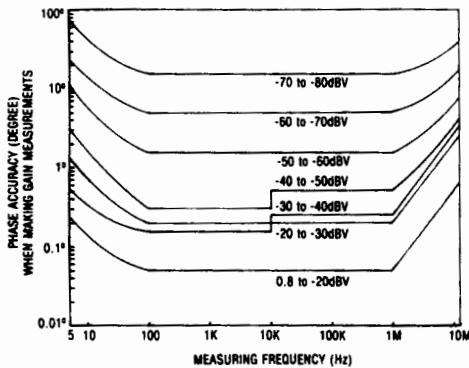

FIGURE 2 : PHASE ACCURACY WHEN MAKING GAIN MEASUREMENT

**Impedance Measurement**

**Parameter measured:**  $|Z| - \theta$ ,  $|Y| - \theta$ , R-X, G-B, L-D · Q · R · G, C-D · Q · R · G and deviation ( $\Delta$ ,  $\Delta\%$ ) of all parameters

**Display:** 4½ digits, max. display 12999 counts, 19999 for L & C.

**Circuit mode:** series equivalent circuit (—□—) and parallel equivalent circuit (—□—). Automatic selection available.

**Auto ZERO adjustment:** Automatic normalization of the readout offset due to residuals of the test fixture by pushbutton operation (at spot frequency)

**Measuring range and accuracy (23 ± 5° C):** Specified at BNC unknown terminals after 30 minute warmup when OSC level is more than 0.1 V and when auto ZERO adjust is performed (test speed: normal or average). Accuracy given below is only valid when the measured value is equal to full scale of each range.

**|Z| -  $\theta$ , R - X measurement:** Range: |Z|, R, X: 0.1 m  $\Omega$  to 1.2999 M $\Omega$ ;  $\theta$ : -180.00° to +180.00°. Accuracy: R accuracy (D ≥ 10); X accuracy (D < 1)

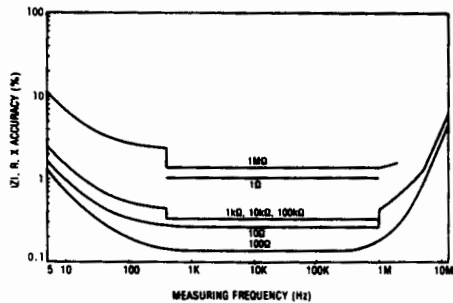

FIGURE 3 : |Z|, R, X ACCURACY

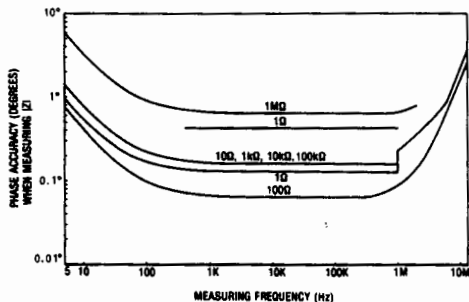

FIGURE 4 : PHASE ACCURACY WHEN MEASURING |Z|

**|Y| -  $\theta$ , G - B measurement:** range: |Y|, G, B: 1 nS to 12.999 S;  $\theta$ : -180.00° to +180.00°. Accuracy: G accuracy (D > 1); B accuracy (D ≤ 0.1).

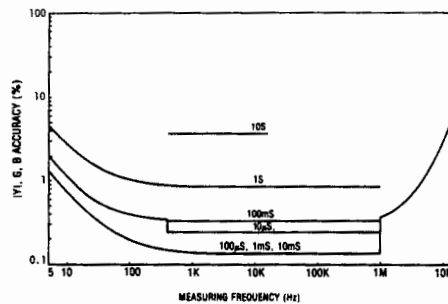

FIGURE 5 : |Y|, G, B ACCURACY

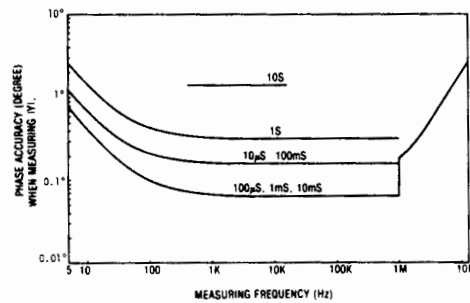

FIGURE 6 : PHASE ACCURACY WHEN MEASURING |Y|

**L - D · Q, C - D · Q measurement:** (automatically calculated from measured Z/Y values)

Parameter	Measuring Range*	Basic Accuracy
L	0.01 nH to 1000 H	0.27%
C	0.1fF to 199** mF	0.15%
D(1/Q)	0.0001 to 19.999	0.001 (C-measurement) 0.003 (L-measurement)

\*Varies with measuring frequency except for D(1/Q)  
\*\*Accuracy of C ranges over 100 mF is not specified.

**Internal dc bias:** Standard (impedance measurement only)  
**Voltage range:** -35 V to +35 V, 10 mV step  
**Setting accuracy (23 ± 5° C):** 0.5% of setting + 5 mV  
**Bias control:** Spot and swept, using front panel controls or HP-IB

**General**

**Measuring time (high speed mode)**  
**B-A and  $\theta$ , A or B:** 88 to 127 ms (≥ 400 Hz)  
**Impedance parameters:** 58 to 91 ms (≥ 1 kHz)  
**Test level monitor range (impedance measurement)**  
**Voltage:** 5 mV to 1.1 V  
**Current:** 1  $\mu$ A to 11 mA  
**Operating temperature:** 0 to 55° C, ≤ 95% RH at 40° C  
**Power:** 100, 120, 220 V ± 10%, 240 V + 5% to -10%, 48 to 66 Hz, 150 VA max.  
**Size:** 425.5 mm W × 235 mm H × 615 mm D (16.75 in × 9 in × 22.6 in).  
**Weight:** Approx. 19 kg (41.9 lb)  
**Furnished accessories and parts:** HP 16047A test fixture, HP 11048C 50  $\Omega$  feed thru terminations (2 ea), power splitter, HP 11170A BNC cables (2 ea), BNC adapter

**Ordering Information**

- HP 4192A LF Impedance Analyzer
  - Accessories
  - HP 16095A Probe Fixture
  - HP 16096A 2-port Component Test Fixture
  - HP 16097A Accessory Kit
  - HP 16047C Test Fixture
  - HP 16048A Test Leads (BNC connector)
  - HP 16048C Test Leads with alligator clip
- Refer to page 357 for accessories.

**Price**  
\$16,400

\$840  
\$1,425  
\$2,280  
\$315  
\$330  
\$440



☎ For off-the-shelf shipment, call 800-452-4844.

# COMPONENT MEASUREMENT

## RF Impedance Analyzer

HP 4191A

- 1 to 1000 MHz variable test frequency with sweep capability
- Direct reading of  $|Z| - \theta$ ,  $|Y| - \theta$ ,  $|\Gamma| - \theta$ ;  
 $L \cdot C - R \cdot G \cdot D \cdot Q$   
 $R - X, G - B, \Gamma_x - \Gamma_y$

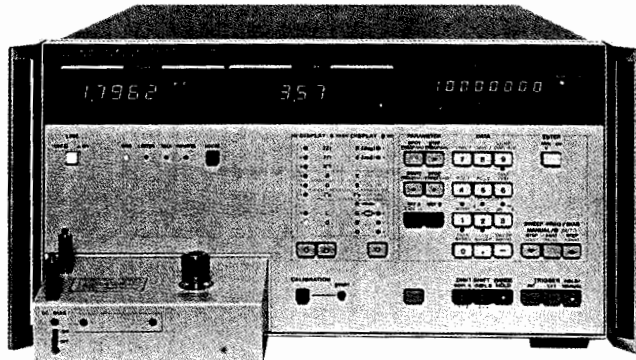

HP 4191A (Shown with Opt 907 Handles)



### Description

The HP 4191A RF Impedance Analyzer measures 14 parameters with a maximum resolution of 4½ digits. The internal synthesizer provides variable frequencies from 1 MHz through 1000 MHz covering the UHF, VHF, and video bands with automatic sweep capability. An internal dc bias supply with auto sweep function covers the voltage range of  $\pm 40$  V in 10 mV steps.

The HP 4191A permits reliable measurements over a wide measuring range. Its outstanding repeatability, frequency response, and accuracy are made possible by a unique error-correction capability and specially designed test fixtures. These features allow the HP 4191A to be used in evaluating electronic materials, components, and circuitry.

The internal synthesizer provides a maximum resolution of 100 Hz (Option 002) with an accuracy of 3 ppm, allowing small changes in the resonant frequency of the device under test to be easily detected. The swept frequency capability aids in the analysis of frequency characteristics of the device.

Two complete front-panel settings (parameter selection and the sweep control) can be stored in a non-volatile memory and recalled at any time with a single key operation. This, together with the standard HP-IB interface, makes the HP 4191A extremely efficient as either a standalone or a systems instrument.

These unique features permit very wide applications in: (1) semiconductor testing such as surface state evaluation at high frequencies (C-V/G-V and conductance (G/ $\omega$ - $\omega$ ) characteristics), and the input/output impedance evaluation of diodes and transistors, (2) resonator, filter, and magnetic and dielectric materials testing, (3) evaluation of LCR components such as high-frequency chip and leaded components, and (4) testing of communications-related components such as cables, connectors, etc.

### Specifications (Refer to data sheet for complete specifications)

**Parameter measured:**  $|Z| - \theta$ ,  $|Y| - \theta$ ,  $|\Gamma| - \theta$ ,  $R - X$ ,  $G - B$ ,  $\Gamma_x - \Gamma_y$   
 $L - R \cdot G \cdot D \cdot Q$ ,  $C - R \cdot G \cdot D \cdot Q$

**Display:** 4½ digit, max display 19999 counts

**Deviation measurement** (deviation from stored reference)

$\Delta$ : -19999 to +19999 counts  $\Delta\%$ : -1999.9 to +1999.9%

**Measuring signal** ( $23 \pm 5^\circ$  C)

**Frequency range:** 1 MHz to 1000 MHz

**Frequency step:**

Standard: 100 kHz, 1 to 500 MHz 200 kHz, 500 to 1000 MHz

Opt 002: 100 Hz, 1 to 500 MHz 200 Hz, 500 to 1000 MHz

**Frequency accuracy:**  $\pm 3$  ppm

**Signal level (Into 50 $\Omega$ ):**  $-20 \pm 3$  dBm

**Frequency control:** spot and swept

- High resolution—4½ digit max
- Wide measuring range—1 m - 100 k ( $|Z|$ )
- Versatile, easy-to-use test fixtures

### Measuring mode

**Spot measurement:** At specific frequency (or dc bias)

**Swept measurement:** Manual or automatic sweep from start to stop frequency (or dc bias) at step frequency (or dc bias) rate in linear or logarithmic form

**Auto calibration:** Automatic error compensation referenced to connected terminations (0  $\Omega$ , 50  $\Omega$ , 0 S), 51 frequencies including start and stop frequencies

**Electrical length compensation:** Automatic compensation for electrical length of test fixtures (Range: 0 to 99.99 cm)

**Internal dc bias:** Voltage range:  $-40$  to  $+40$  V, 10 mV step

Setting accuracy: 0.1% of setting + 10 mV

Bias control: spot and swept

**External dc bias:** Voltage range:  $-40$  to  $+40$  V

Max allowable current: 100 mA

**Key status memory:** Two sets of measuring conditions can be stored and recalled at any time. These conditions are kept in storage even when LINE is turned off.

**Ranging:** Auto/Range hold

**Trigger:** Internal, External, or Manual

**Self-test:** Automatic internal program test

**HP-IB data output and remote control:** standard

**$|\Gamma| - \theta / \Gamma_x - \Gamma_y$  Measurement**

**Measuring range:**  $|\Gamma|$ ,  $\Gamma_x$ ,  $\Gamma_y$ : 0.0001 to 1.0000

$\theta$ :  $0^\circ$  to  $\pm 180.00^\circ$  (0 to  $\pm \pi$  rad.)

$|\Gamma|$ ,  $\Gamma_x$ ,  $\Gamma_y$  resolution: 0.0001

### Reference Data (Not Specified)

**Temperature coefficient for  $|\Gamma|$ :**  $0.0001^\circ$  C ( $23 \pm 5^\circ$  C)

**Measuring time:**  $< 800$  ms or  $< 250$  ms (high speed mode)

**Frequency switching time:**  $\leq 200$  ms

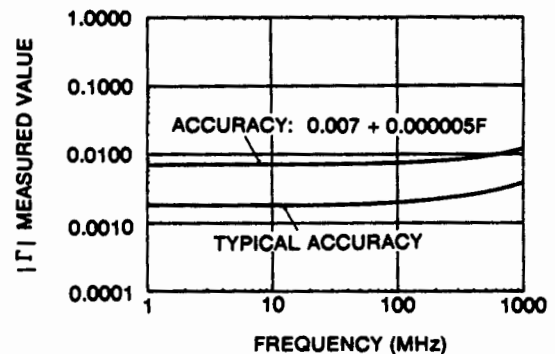

### General

**Temperature:** 0 - 55° C,  $< 95\%$  RH

**Power:** 100, 120, 220 V  $\pm 10\%$ , 240 V + 5% - 10%, 48 - 66 Hz, 150 VA max

**Size:** 425.5 mm W  $\times$  230 H  $\times$  574 mm D (16.75 in  $\times$  9 in  $\times$  22.6 in)

**Weight:** Approx 24 kg (52.8 lb)

**Accessories furnished:** Accessory case (with reference terminations included)

### Accessories Available

Accessory	Price
HP 16091A Coaxial Test Fixture	\$570
HP 16092A Spring Clip Test Fixture	\$555
HP 16093A Binding Post Test Fixture	\$225
HP 16093B Binding Post Test Fixture	\$240
HP 16094A Probe Fixture	\$207

Refer to page 357 for accessories.

### Ordering Information

HP 4191A RF Impedance Analyser	\$20,450
Opt W30 Extended repair service. See page 671.	+ \$465
Opt 002 100 Hz/200 Hz resolution synthesizer	+ \$2,190
Opt 004 Recorder Outputs	+ \$560

- 400 kHz to 110 MHz spot or swept frequency
- Measure impedance magnitude (10 m  $\Omega$  to 120 k  $\Omega$ ) and phase ( $-180.0^\circ$  to  $+180.0^\circ$ )
- Test components in-circuit and out-of-circuit

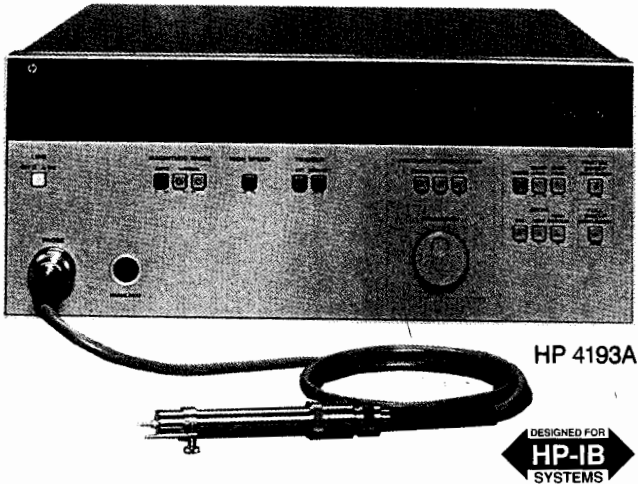

HP 4193A



### HP 4193A Vector Impedance Meter

The HP 4193A Vector Impedance Meter measures impedance magnitude and phase. An internal oscillator provides test signals from 400 kHz to 110.0 MHz. The test signal is a constant current between 10  $\mu$ A and 100  $\mu$ A, depending on  $|Z|$  range.

#### Reliable and Accurate Impedance Measurement

The HP 4193A can measure and display impedance magnitudes from 10 m  $\Omega$  to 120 k  $\Omega$ . Impedance phase is displayed from  $+180.0^\circ$  to  $-180.0^\circ$ . Accuracy is as good as 3.0 percent of reading (magnitude) and  $3.2^\circ$  (phase).

Also, the HP 4193A's 3 $\frac{1}{2}$ -digit resolution makes it easy to see small changes in measurement results during adjustment procedures, for example.

#### Frequency Sweep for Complex Component Testing

When you're testing complex components such as ceramic resonators, it's useful to sweep frequency to get the big picture, and to identify such critical impedance points as the series resonant point. This requires both swept measurement and measurements at individual "spot" frequencies. The HP 4193A can do both.

The HP 4193A can be tuned to any individual frequency from 400 kHz to 110.0 MHz with a maximum resolution of 1 kHz. If a greater frequency resolution is required, it can be provided by connecting an external synthesized source such as the HP 3335A or HP 8656B to the HP 4193A EXT OSC input.

Flexible internal frequency sweep is an exciting HP 4193A feature. Frequency can be swept linearly over any portion of the HP 4193A frequency range or swept logarithmically over the entire 400 kHz to 110.0 MHz range.

#### Test In-Circuit and Out-of-Circuit Components

Several test fixtures help adapt the HP 4193A to your device under test. For example, the handy L-ground probe is useful for in-circuit testing. The HP 16099A Test Fixture Adapter and three associated fixtures help connect to out-of-circuit devices of various sizes and shapes.

#### Specifications (Refer to data sheet for complete specifications.)

##### Test Signal Output Specifications

Test signal is output from the furnished low-ground probe.

**Frequency range:** 400 kHz to 110.0 MHz

##### Frequency resolution

**400 kHz to 9.999 MHz:** 1 kHz resolution

**10.00 MHz to 99.99 MHz:** 10 kHz resolution

**100.0 MHz to 110.0 MHz:** 100 kHz resolution

**Frequency accuracy:**  $\pm 0.01\%$  of setting after calibration.

**Frequency stability:**  $\pm 100$  ppm per month (0 to  $55^\circ$  C)

##### Frequency control

**Spot:** Spot frequency is set using coarse, medium and fine controls

**Full sweep:** Logarithmic sweep at 43 points over full range of 400 kHz to 110 MHz

- Fixtures include low-grounded probe, spring clip fixture, and binding post fixture
- Standard HP-IB and analog outputs

**Partial sweep:** Linear sweep from selected START to STOP frequency. Number of steps is selected as 100, 1000 or "HIGH RESOLN." When "HIGH RESOLN" steps are selected, the operator must also select "coarse," "medium," or "fine" resolution.

**EXT OSC:** increase frequency resolution by connecting an external frequency synthesizer

#### Impedance Measurement Specifications

**Input configuration:** low-grounded probe (furnished)

**Digital display of impedance:** 3 $\frac{1}{2}$  digits

$|Z|$ : 0 to 1999 counts (0 to 120 counts on 100 k  $\Omega$  range)

$\theta$ :  $-1800$  to  $+1800$  counts ( $-180$  to  $+180$  counts on 100 k  $\Omega$  range)

**Measurement trigger:** Internal, external, and manual

**Measurement range control:** Auto, hold, and manual

##### Measurement Range

$|Z|$ : Five decade ranges: 10  $\Omega$ , 100  $\Omega$ , 1 k  $\Omega$ , 10 k  $\Omega$ , 100 k  $\Omega$

**minimum  $|Z|$  (sensitivity):** 10 m  $\Omega$

**maximum  $|Z|$ :** 120 k  $\Omega$

$\theta$ : One range:  $-180.0^\circ$  to  $+180.0^\circ$

#### Reference Data

##### Test Signal Output

**Frequency settling time:** 5 ms to 400 ms. Best case is when  $(\Delta f/f)\%$  is less than 10% (below 10 MHz) and less than 1% (above 10 MHz).

##### Signal purity

**Spurious:**  $-60$  dBc (dBc is dB below carrier)

**Harmonics:**  $-30$  dBc

**Residual FM:** Measured in a 100 Hz band centered on the carrier

**1 MHz to 110 MHz:** 100 Hz p-pFM

**Test level:** Constant current source

#### Impedance Measurement

**Residual Impedance of Probe (at probe tip)**

**Resistance:**  $\leq 0.55 \Omega$

**Inductance:**  $\leq (4.9 + 10/f)$  nH where f is measuring frequency in MHz

**Parallel capacitance:**  $\leq 0.11$  pF

**Measuring speed:** Assumes range is fixed; recorder output is OFF

**HI SPEED:** Approximately 150 ms per measurement

**NORMAL:** Approximately 1 s per measurement

**Ranging time:** Approximately 1.2s

**Temperature coefficient at  $23^\circ$  C  $\pm 5^\circ$  C**

$|Z|$ : 2 m  $\Omega/^\circ$  C,  $\theta$ :  $0.02^\circ/^\circ$  C

#### General

**Operating temperature/humidity:** 0 to  $55^\circ$  C,  $\leq 95\%$  RH @  $40^\circ$  C.

Note that measurement error in  $0^\circ$  C to  $55^\circ$  C temperature range is typically double the error in the  $23^\circ$  C  $\pm 5^\circ$  C range.

**Power:** 100/120/220 V  $\pm 10\%$ , 240 V  $-10\%$  to  $+5\%$ , 48 to 66 Hz, 150 VA max

**Size:** 426 mm W  $\times$  178 mm H  $\times$  498 mm D (16.75 in  $\times$  7 in  $\times$  19.6 in)

**Weight:** 18 kg (40 lb)

**Accessories furnished:** The low-ground probe kit includes a probe, spare pins, spare clips, BNC adapter, component mounting adapter, probe socket, and accessory case.

#### Ordering Information

**HP 4193A** Vector Impedance Meter

**Price**

\$12,120

##### Accessories

**HP 16099A** Test Fixture Adapter (used with HP 16092A and HP 16093A/B)

\$505

**HP 16092A** Spring Clip Fixture (used with HP 16099A)

\$555

**HP 16093A** Binding Post Fixture (used with HP 16099A)

\$225

**HP 16093B** Binding Post Fixture (used with HP 16099A)

\$240

Refer to page 357 for accessories.

☎ For off-the-shelf shipment, call 800-452-4844.

# COMPONENT MEASUREMENT

## Precision LCR Meters

HP 4284A, 4285A

- 20 Hz to 1 MHz, with over 8,600 test frequencies
- 0.05% basic accuracy, 6-digit resolution
- Test signal level (Option 001): 5 mV to 20 Vrms, 50  $\mu$ A to 200 mArms
- 10-bin component sorting-comparator
- 75 kHz to 30 MHz in 100 Hz steps
- 0.1% basic accuracy
- High-speed measurements: 30 ms/meas
- List sweep measurement capability

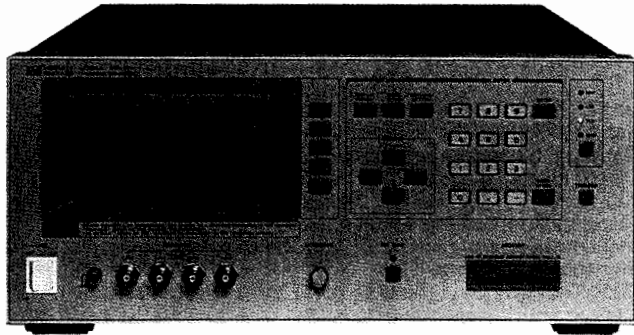

HP 4284A

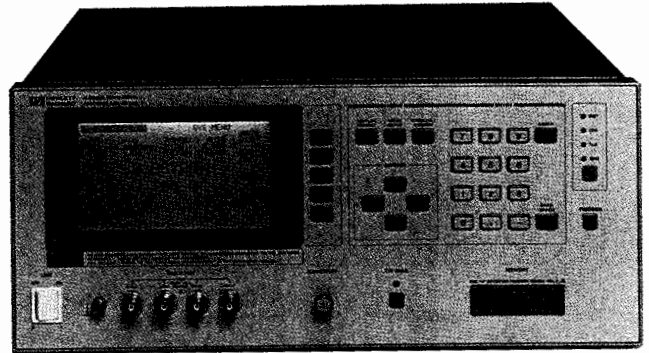

HP 4285A



### HP 4284A, HP 4285A Precision LCR Meters

The HP 4284A and HP 4285A precision LCR meters are cost-effective solutions for component and material measurement. They can be used to improve component quality by providing an accurate, high-throughput test solution. The wide 20 Hz to 1 MHz test frequency range and superior test signal performance allow the HP 4284A to test components to the most commonly used test standards, such as IEC/MIL standards, and under conditions that simulate the intended application. For demanding RF component tests, the HP 4285A offers a higher test frequency range, from 75 kHz to 30 MHz. Whether in research and development, production, quality assurance, or incoming inspection, the HP 4284A and HP 4285A will meet all of your LCR meter test and measurement requirements.

### Wide Range of Test Signal and dc Bias

The test signal (voltage/current) is variable from 5 mVrms to 2 Vrms, and from 50  $\mu$ Arms (100  $\mu$ Arms on the HP 4285A) to 20 mArms. The constant test signal level feature guarantees that the applied test signal level will remain constant for demanding tests. Option 001 of HP 4284A will allow you to vary the test signal level from 5 mVrms to 20 Vrms and from 50  $\mu$ Arms to 200 mArms, offering a convenient method of testing components over a wide range of working conditions. The dc bias is selectable from  $\pm 1$ mV to  $\pm 40$ V with an accuracy of 0.1% for applications that require accurate bias control, such as measuring the C-V characteristics of semiconductors.

### High Accuracy, Resolution, and Test Throughput

The HP 4284A's wide impedance measurement range covers from 1  $\Omega$  to 100 M  $\Omega$  full scale with 0.01 m  $\Omega$  minimum resolution and with an unmatched basic accuracy of 0.05% to 1 MHz. The HP 4285A covers a wide impedance range up to 10 M  $\Omega$  with a basic accuracy of 0.1%, permitting more accurate component tests at RF frequencies than previously available LCR meters. Six full digits of resolution for all measurement parameters allow you to determine even the smallest differences in materials or component performance. A dissipation factor measurement resolution of 0.000001 is very useful when developing low loss capacitors and inductors used in high-performance

electronic equipment. The measurement time needed to obtain the optimum accuracy is only 190 ms/meas. (1 kHz). A selectable integration time permits high-throughput testing with a measurement time of only 40 ms/meas (1 kHz) for a slight tradeoff in accuracy.

### High Current Biasing for Power Inductor Evaluation

Combining the HP 4284A precision LCR meter, HP 42841A current source, and HP 42842A/B current fixture gives you a high-performance power inductor and transformer test system, which enables the testing of inductors up to 1MHz and at high dc current levels, up to 20 A (40 A with two HP 42841A and the HP 42842B) demanded for components used in advanced switching power supplies. To evaluate the inductors at higher frequencies, the HP 4285A precision LCR meter, HP 42841A current source, and HP 42842C current fixture make measurements up to 30 MHz and 10 A.

### High Q Measurements of RF Components

The HP 4285A precision LCR meter together with the HP 42851A precision Q adapter permits fast and accurate Q factor measurements up to 999.999 with the resonant measurement method. The automatic tuning, 5-digit display, and variable test level allow you to measure Q factors of RF components and materials in a fraction of the time previously required.

### Flexibility and Ease of System Integration

The HP 4284A's built-in comparator, advanced compensation, and optional handler and scanner interfaces permit easy integration with automatic component handling equipment. The 10-bin comparator allows for error-free Go/No-Go testing by comparing a component's measured value with user-selected test limits. The scanner interface provides control and compensation for up to 128 (HP 4284A) or 90 (HP 4285A) multiplexed measurement channels. The list sweep feature permits up to ten frequencies, test signal levels, or bias level points to be automatically measured. The high-speed HP-IB interface and SCPI programming language are excellent for data logging and system applications.

### Simple Operation for Error-Free Measurement Setup

The large, easy-to-read LCD screen displays the instrument settings and the measurement results. The new softkey and cursor operation provides easy front-panel operation. The memory card allows storing and retrieving of up to ten entire instrument setups, including bin-limit information. It improves operator efficiency and minimizes setup errors.

### Specifications

(Refer to data sheet for complete specifications.)

**Parameters measured:**  $|Z|$ ,  $\theta$ ,  $|Y|$ ,  $\theta$ , R-X, G-B

C-D, Q, ESR, G, Rp

L-D, Q, ESR, G, Rp

Deviation and % deviation

**Measurement circuit modes:** Series and parallel

**Ranging:** Auto and manual

**Trigger:** Internal, external and manual

**Delay time:** 0 to 60.000s in 1ms steps

**Measurement terminals:** Four-terminal pair

**Test cable length:**

HP 4284A: Standard: 0 and 1 m

With Option 006: 0, 1, 2 and 4 m

HP 4285A: 0, 1 and 2 m

**Integration time:** Short, medium, and long

**Averaging:** 1 to 256, programmable

**Test Signal:**

HP 4284A: 20Hz to 1 MHz  $\pm$  0.01%, 8610 selectable frequencies

HP 4285A: 75kHz to 30 MHz  $\pm$  0.01%, 100 Hz steps

**Test signal modes:**

**Normal:** Programs selected voltage or current at the measurement terminals open or shorted, respectively, and not at the device under test

**Constant:** Maintains selected voltage or current at the device under test independent of changes in the device's impedance

**Test signal level**

#### HP 4284A Standard

		Range	Accuracy
Normal	V	5 mVrms to 2 Vrms	$\pm$ (10% + 1 mVrms)
	I	50 $\mu$ Arms to 20 mArms	$\pm$ (10% + 10 $\mu$ Arms)
Constant	V	10 mVrms to 1 Vrms	$\pm$ (6% + 1 mVrms)
	I	100 $\mu$ Arms to 10 mArms	$\pm$ (6% + 10 $\mu$ Arms)

#### HP 4284A with Option 001:

		Range	Accuracy
Normal	V	5 mVrms to 20 Vrms	$\pm$ (10% + 1 mVrms)
	I	50 $\mu$ Arms to 200 mArms	$\pm$ (10% + 10 $\mu$ Arms)
Constant	V	10 mVrms to 10 Vrms	$\pm$ (10% + 1 mVrms)
	I	100 $\mu$ Arms to 100 mArms	$\pm$ (10% + 10 $\mu$ Arms)

#### HP 4285A

		Range	Accuracy
Normal	V	5 mVrms to 2 Vrms	$\pm$ (8% + 0.4 fm% + 1 mVrms)
	I	200 $\mu$ Arms to 20 mArms	$\pm$ (8% + 1 fm% + 40 $\mu$ Arms)
Constant	V	10 mVrms to 1 Vrms	$\pm$ (6% + 0.2 fm% + 1 mVrms)
	I	100 $\mu$ Arms to 20 mArms	$\pm$ (6% + 0.2 fm% + 40 $\mu$ Arms)

fm: test frequency (MHz)

#### dc bias

HP 4284A standard : 0V, 1.5V and 2V

HP 4284A/4285A Option 001 : 0V to  $\pm$ 40V

Range	Resolution	Accuracy
$\pm$ (0.000 to 4.000)V	1 mV	$\pm$ (0.1% + 1 mV)
$\pm$ (4.002 to 8.000)V	2 mV	$\pm$ (0.1% + 2 mV)
$\pm$ (8.005 to 20.000)V	5 mV	$\pm$ (0.1% + 5 mV)
$\pm$ (20.01 to 40.00)V	10 mV	$\pm$ (0.1% + 10 mV)

### Measurement Display Range

Parameter	Range
$ Z $ , R, X	0.01 m $\Omega$ to 99.9999 M $\Omega$
$ Y $ , G, B	0.01 nS to 99.9999 S
C	HP 4284A: 0.01 fF to 9.9999 F HP 4285A: 0.01 fF to 999.999 $\mu$ F
L	HP 4284A: 0.01 nH to 99.9999 kH HP 4285A: 0.001 nH to 99.9999 H
D	0.000001 to 9.99999
Q	0.01 to 99999.9
$\theta$	$-180.000^\circ$ to $180.000^\circ$
$\Delta$ %	$-999.999\%$ to $999.999\%$

### Display

LCD dot-matrix display: Displays measured values, control settings, comparator limits and decisions, list sweep tables, self-test messages, and annunciations.

### Correction function

**Zero OPEN/SHORT:** Eliminates measurement errors due to the test fixture's stray parasitic impedance

**Load:** Improves measurement accuracy by using a calibrated device as reference

### List sweep function

A maximum of ten frequencies or test signal levels can be programmed. Single or sequential testing can be performed. When Option 001 is installed, dc voltage bias testing can also be performed

### Comparator

Ten-bin sorting for the primary measurement parameter. IN/OUT for the secondary measurement parameter

**Bin count:** 0 to 999999

**List sweep comparator:** HIGH/IN/LOW decision output for each measurement point in the list sweep table

### Other functions

**STORE/LOAD:** Ten instrument setups can be stored/ loaded from the internal non-volatile memory. Ten additional setups can also be stored/loaded from a memory card.

**HP-IB:** All instrument control settings, measured values, comparator limits, list sweep table, and self-test results. The memory buffer can store a maximum of 128 measurement results and output the data over HP-IB. ASCII and 64-bit binary data formats.

### Options

**Opt 001:** HP 4284A: Increases the ac test signal to 20 Vrms/ 200 mArms. Variable  $\pm$ 40 Vdc bias

HP 4285A: Variable  $\pm$ 40 Vdc bias

**Opt 002:** HP 4284A: Allows the HP 4284A to control the HP 42841A bias current source

HP 4285A: Allows the HP 4285A to control the HP 42841A bias current source and the HP 42851A precision Q adapter

**Opt 006 (HP 4284A only):** Increases test cable length capability. Adds 2 and 4 m operation

**Opt 109:** Delete HP-IB interface

**Opt 201:** Handler interface

**Opt 202:** Handler interface

**Opt 301:** Scanner interface. Provides control interface for operation with a scanner. OPEN/SHORT/LOAD correction data for each scanner channel is stored in non-volatile memory.

HP 4284A: 128 channels at three frequencies

HP 4285A: 90 channels at seven frequencies

# COMPONENT MEASUREMENT

## Precision LCR Meters (cont'd)

### HP 4284A, 4285A

#### General

**Power requirements:** 100/120/220 V ± 10%, 240 V + 5%/-10%, 47 to 66Hz

**Power consumption:** 200VA max

Operating temperature and humidity: 0 to 55° C, ≤95% RH at 40° C

**Size:** 177 mm H × 426 mm W × 498 mm D (6.97 in × 16.77 in × 19.61 in)

**Weight:** Approximately 16 kg (35.2 lb)

#### HP 4284A Measurement Accuracy

The following measurement accuracy is specified when all of the following conditions are satisfied:

1. Warm up time: ≥ 30 minutes
2. Ambient temperature: 23 ± 5° C
3. Test signal voltage: 0.3 Vrms to 1 Vrms
4. Test cable length: 0 m
5. OPEN and SHORT corrections have been performed
6. D ≤ 0.1 for C, L, X and B measurements

Q ≤ 0.1 for R and G measurements

Accuracies are relative to calibrated standards. Absolute accuracies are given as: (HP 4284A's relative accuracy + calibration uncertainty of standards).

|Z|, C, L and D accuracies are shown in Figure 1.

The accuracies are represented as:

|Z|, C and L: ± (% of reading)

D: ± (D value)

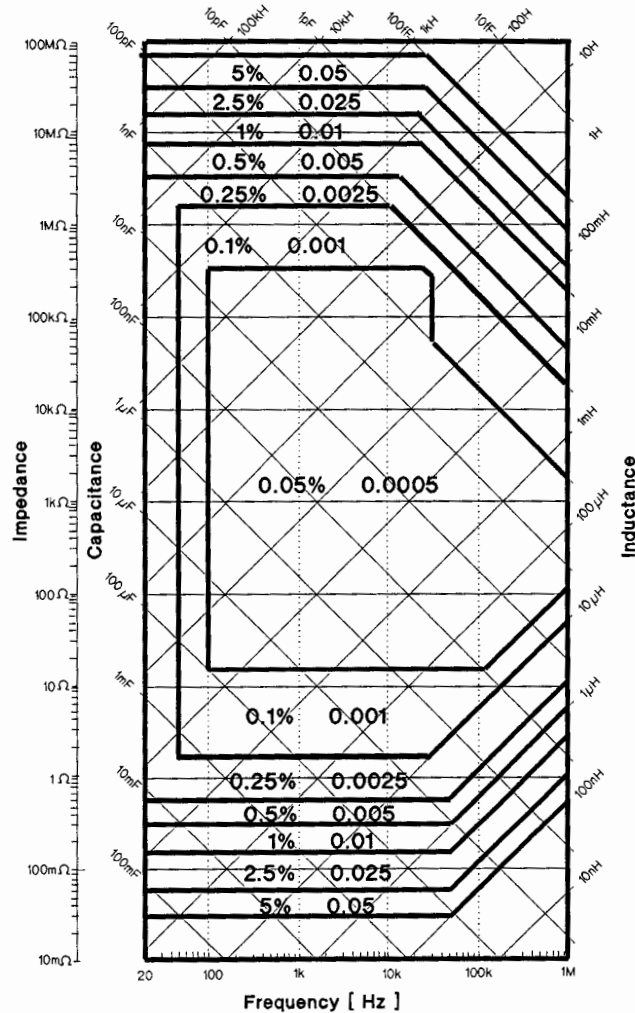

Figure 1. HP 4284A Measurement Accuracy

#### HP 4285A Measurement Accuracy

The following measurement accuracy is specified when all of the following conditions are satisfied:

1. Warm up time: ≥ 30 minutes
2. Ambient temperature: 23 ± 5° C
3. Test signal voltage: 0.2 Vrms to 1 Vrms
4. Test cable length: 0 m
5. OPEN and SHORT corrections have been performed
6. D ≤ 0.1 for C, L, X and B measurements

Q ≤ 0.1 for R and G measurements

|Z|, C, L and D accuracies are shown in Figure 2.

The accuracies are represented as:

|Z|, C and L: ± (% of reading)

D: ± (D value)

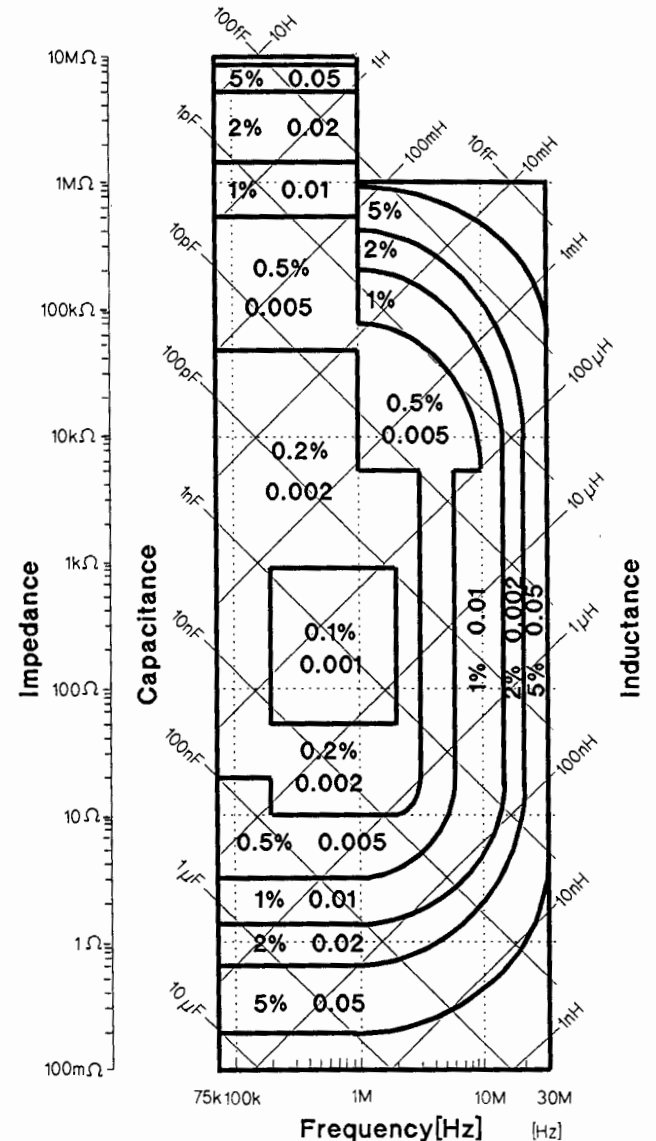

Figure 2. HP 4285A Measurement Accuracy



**Supplemental Characteristics**

**Measurement time:** Typical measurement time from the trigger command to the EOM (End of Measurement) output at the handler interface connector.

**HP 4284A**

	20 Hz	100 Hz	1 kHz	10 kHz to 1 MHz
SHORT	1,100 ms	270 ms	40 ms	30 ms
MEDIUM	1,320 ms	400 ms	190 ms	180 ms
LONG	1,320 ms	1,040 ms	830 ms	820 ms

**HP 4285A**

	75 kHz to 30 MHz
SHORT	30 ms
MEDIUM	65 ms
LONG	200 ms

**Option 001 dc Bias current output:** 100 mA max

**Accessories**

**HP 42841A Bias Current Source**

**Bias current output:** (23 ± 5° C)

Range	Resolution	Accuracy
0.00 A to 1.00 A	0.01 A	± (1% of setting + 5 mA)
1.1 A to 5.0 A	0.1 A	± (2% of setting)
5.1 A to 20.0 A	0.1 A	± (3% of setting)

**Output Voltage:**

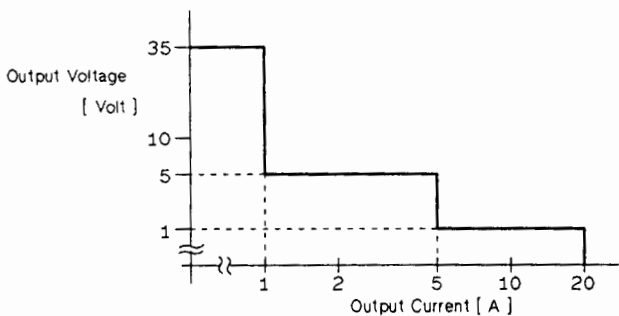

**Basic impedance accuracy:** 1% when used with the HP 4284A/4285A

**Interface:** Custom, directly controllable by the HP 4284A/4285A with Option 002

**HP 42842A/B bias current test fixture**

Used with the HP 4284A and HP 42841A for high dc bias current measurements

HP 42842A: 20A max

HP 42842B: 40A max

**HP 42842C bias current test fixture**

Used with the HP 4285A and HP 42841A for high dc bias current measurement. 10 A max

**HP 42843A bias current cable**

Used with the HP 4284A, HP 42841A (2 units) and HP 42842B for 40A maximum applications

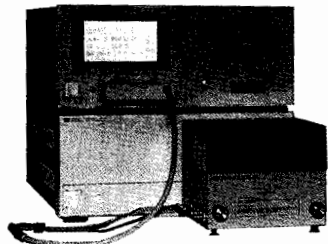

HP 4284A with HP 42841A and HP 42842A

**HP 42851A Precision Q Adapter**

Used with the HP 4285A for resonant Q measurements

**Parameters measured:** Q-L, Q-C

**Q measurement range:** 5.00 to 999.99

**Basic Q accuracy:** 5%

**Measurement time:** 75 ms to 1.5 s

**Interface:** Custom, directly controllable by the HP 4285A with Option 002

**Opt 001:** SMD Test Fixture

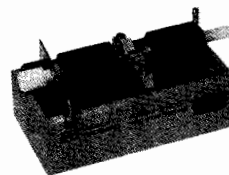

SMD Test Fixture

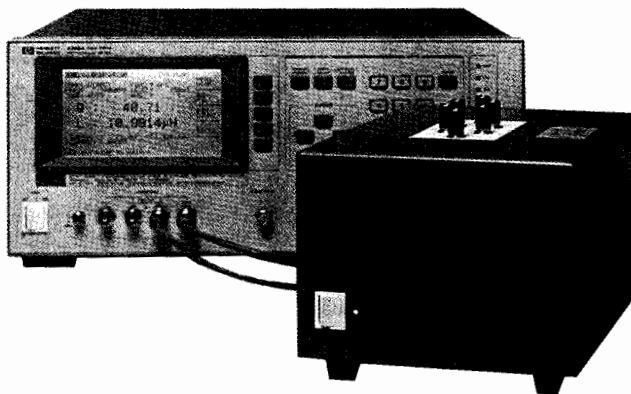

HP 4285A with HP 42851A

**Ordering Information**

	<b>Price</b>
<b>HP 4284A</b> Precision LCR Meter	\$10,450
<b>HP 4285A</b> Precision LCR Meter	\$13,530
<b>Opt 001</b> Power Amplifier/DC Bias (HP 4284A) DC Bias (HP 4285A)	+ \$1,210 + \$920
<b>Opt 002</b> Bias Current Interface (HP 4284A) Accessory Control Interface (HP 4285A)	+ \$280 + \$280
<b>Opt 006</b> 2m/4m Cable Length Operation (HP 4284A only)	+ \$176
<b>Opt 009</b> Delete Operation Manual	- \$77
<b>Opt 109</b> Delete HP-IB Interface	- \$248
<b>Opt 201</b> Handler Interface	+ \$280
<b>Opt 202</b> Handler Interface	+ \$310
<b>Opt 301</b> Scanner Interface	+ \$600
<b>Opt W30</b> Extended repair service. See page 671. (HP 4284A) (HP 4285A)	+ \$190 + \$215
<b>HP 42841A</b> Bias Current Source	\$6,970
<b>HP 42842A</b> Bias Current Test Fixture (20 A max)	\$1,640
<b>HP 42842B</b> Bias Current Test Fixture (40 A max)	\$2,050
<b>HP 42842C</b> Bias Current Test Fixture (10 A max)	\$2,500
<b>Opt 001</b> SMD Test Fixture (HP 42842C only)	+ \$430
<b>HP 42843A</b> Bias Current Cable	\$1,000
<b>HP 42851A</b> Precision Q Adapter	\$4,850
<b>Opt 001</b> SMD Test Fixture	+ \$430

Refer to page 357 for accessories.

# COMPONENT MEASUREMENT

## Multi-Frequency LCR Meters

HP 4274A, 4275A

- Test frequencies – HP 4274A: 100 Hz to 100 kHz  
HP 4275A: 10 kHz to 10 MHz
- Test signal level – HP 4274A: 1 mV to 5 Vrms  
HP 4275A: 1 mV to 1 Vrms
- 0.1% basic accuracy
- High resolution – 5½ digit; D=0.00001
- Measure L/C – D/Q/ESR/G; IZI – e,  
R-X/B/L/C; ΔLCRZ, Δ%

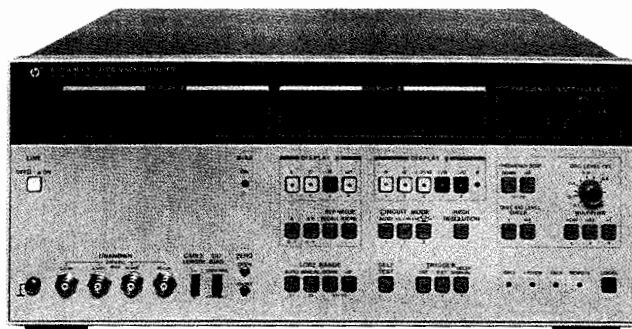

HP 4274A

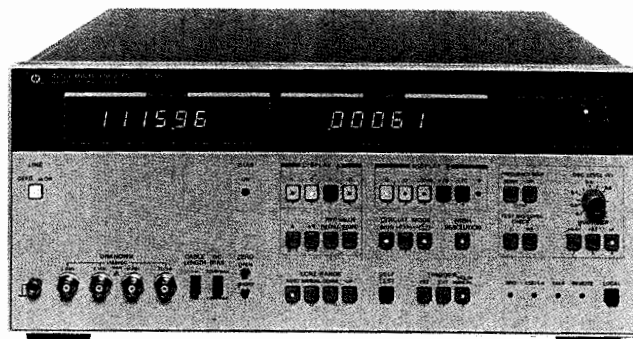

HP 4275A



### Description

The HP 4274A and HP 4275A Multi-frequency LCR Meters are microprocessor-based impedance measuring instrumentation. Both instruments offer LCR components, complex components, electronic circuits "tested under actual working conditions," and semiconductor materials. A measurement under conditions similar to the intended use contributes to the improvements in quality and reliability of electronic components, devices, and circuits.

### Specifications

(Refer to the HP 4274A & HP 4275A data sheet for details.)

#### Measurement Parameters and Range

	HP 4274A	HP 4275A
L	100.00 nH to 1000.0 H	100.00 nH to 10.00 H
C	1.0000 pF to 1.00 F	1.0000 pF to 100.00 μF
R, IZI, ESR, & X	100.00 mΩ to 10.000 MΩ	1.0000 Ω to 10.000 MΩ
D	0.00001 to 9.9999	0.00001 to 9.9999
Q (1/D)	0.01 to 9900	0.01 to 9900
G & B	1.0000 μS to 100.00 S	1.0000 μS to 10.00 S
e	0 to ±180°	0 to ±180°

#### Measurement Accuracy

	C-D/Q	L-D/Q
	D-range: 0.00001 to 9.9999 Q-range: 0.01 to 9900 (=1/D) (C & D accuracy apply only when C: full scale and D: ≤ 0.1)	D-range: 0.00001 to 9.9999 Q-range: 0.01 to 9900 (=1/D) (L & D accuracy apply only when C: full scale and D: ≤ 0.1)
HP 4274A	C: 0.1% + 2 D: 0.32% + 0.0007 + 1	L: 0.1% + 3 D: 0.31% + 0.0011 + 1
HP 4275A	C: 0.1% + 2 D: 0.32% + 0.0007 + 1	L: 0.1% + 3 D: 0.31% + 0.0011 + 1

**Range:** full scale range, accuracy: % of reading + counts (D accuracy: % of reading + absolute D value + count).

(Conditions: Warm-up time ≥ 30 minutes, environment temperature: 23° C ± 5° C).

Refer to technical data sheet for accuracy details.

#### Measurement frequencies

HP 4274A: 100 Hz to 100 kHz, 11 spots (100 Hz, 120 Hz, 200 Hz, 400 Hz, 1 kHz, 2 kHz, 4 kHz, 10 kHz, 20 kHz, 40 kHz, 100 kHz; ±0.01%)

HP 4275A: 10 kHz to 10 MHz, 10 spots (10 kHz, 20 kHz, 40 kHz, 100 kHz, 200 kHz, 400 kHz, 1 MHz, 2 MHz, 4 MHz, 10 MHz; ±0.01%)

#### Test signal level:

HP 4274A: 4-ranges (1 mVrms to 5 Vrms) continuously variable

HP 4275A: 3-ranges (1 mVrms to 1 Vrms) continuously variable

**Test signal level monitor:** Standard.

**Displays:** Dual 5½-digit and single 3-digit; maximum display 199999 (full scale and overrange in high resolution mode), and 4½-digit; maximum display 19999 in normal mode. (Number of digits depends on measurement frequency, test level, and range.)

**Circuit modes:** Series, parallel, AUTO mode.

**Deviation measurement:** Difference between recallable stored reference and displayed is deviation value (count or percent)

**Ranging:** AUTO or MANUAL (UP/DOWN).

**Trigger:** Internal, external, or manual

**Measurement terminals:** Four-terminal pair with guard

**Auto zero adjustment:** Automatic normalization of the readout offset due to residuals of the test fixture by pushbutton operation

**Normalization range:** C < 20 pF, L < 2000 nH, R < 0.5 Ω, G < 5 μS

**Self test:** Automatic operational verification check indicates pass or fail condition

#### General Information

**Operating temperature and humidity:** 0° C - 55° C,  
≈95% RH at 40° C

**Power:** 100, 120, 220V ±10%, 240V + 5% to 10%, 48 to 66Hz,  
135VA max. (HP 4274A); 165VA max. (HP 4275A)

**Size:** 177 mm H × 425 mm W × 574 mm D (7 in × 16.75 in × 22.6 in)

**Weight:** 18 kg (39.6 lb)

#### Accessory Furnished

HP 16047A: Direct coupled test fixture

#### Special Options

One or two arbitrary test frequencies for each instrument are available. For more details, please contact the nearest HP sales office

#### Selectable Frequency Range

HP 4274A: 100 Hz to 100 kHz to ±0.1%. If two frequencies are added, at least one frequency must satisfy the following equation:  $f = 1200/N$  kHz where N is an integer from 12 to 12000

HP 4275A: 10 kHz to 10.7 MHz ±0.1%.

#### Ordering Information

HP 4274A Multi-Frequency LCR Meter \$11,755

Opt W30: Extended repair service. See page 671. + \$260

HP 4275A Multi-Frequency LCR Meter \$14,100

Opt W30: Extended repair service. See page 671. + \$260

Opt 001: 0 to ±35 internal dc bias, max resolution; 1 mV steps + \$1,045

Opt 002: 0 to ±99.9 V internal dc bias, resolution: 100 mV steps. + \$965

Opt 004: Frequency steps in 1-3-5 sequence \$0

#### Accessory Available

HP 16023B: dc Bias Controller, for control of dc bias \$350 ☎

Opt 001 or 002 Internal Bias Supply.

☎ For off-the-shelf shipment, call 800-452-4844.

# COMPONENT MEASUREMENT

## 1 kHz / 1 MHz Capacitance Meter

HP 4278A

369

- Measurement Speed: 6.5 ms/10 ms/21 ms
- Measurement Parameters: C-D•Q•ESR•G
- C-D Measurement Accuracy:
  - 0.07%, 0.0005(1 kHz, 21 ms)
  - 0.05%, 0.0002(1 MHz, 21 ms)
- High Resolution: 6 digit, D:0.00001
- Intelligent Built-in Comparator: 10-bin Sorting

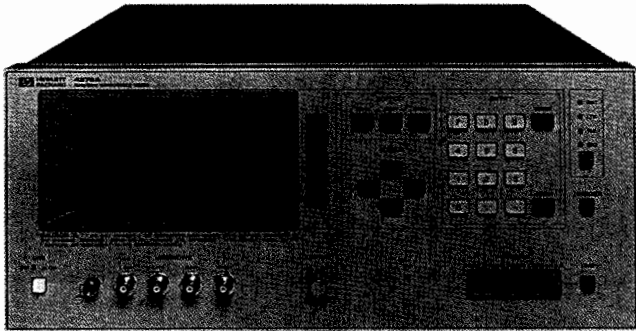

HP 4278A



### Description

The HP 4278A 1kHz/1MHz Capacitance Meter is a high-speed, highly reliable, precision test instrument aimed at incoming/outgoing capacitor inspection applications on the production line and in quality control. The HP 4278A will improve test efficiency by performing comparative measurements of low to medium value capacitors (up to 200  $\mu\text{F}$ —a range that covers most ceramic and film capacitors).

The HP 4278A's standard measurement frequencies and oscillator output levels are 1kHz/1MHz and from 0.1 V to 1 V in 0.1 V steps, respectively.

The built-in comparator function of the HP 4278A gives you the ability to sort parts into ten bins. A high-speed HP-IB interface and an optional handler interface are available for combining the HP 4278A with an automatic handler and an external computer, to build a total solution for automatic testing and data acquisition and analysis.

### Specifications

(Refer to data sheet for complete specifications.)

**Measurement parameters:** C-D•Q•ESR•G

**Display:** Dot-matrix LCD, 4, 5, 6 digits, selectable

**Measurement circuit modes:** Parallel and Series

**Test signals:**

**Frequency:** 1 kHz and 1 MHz,  $\pm 0.02\%$

**Signal Level:** 0.1 to 1 Vrms,  $\pm 10\%$  ( $C \leq 20 \mu\text{F}$ ), in 0.1 Vrms steps

**Measurement time modes:** SHORT, MEDIUM, and LONG

**Measurement Times:**

Mode	SHORT	MEDIUM	LONG
Time*	6.5 ms	10 ms	21 ms

\* Measurement time includes Settling, Integration (analog measurements), Calculation, and Comparison times.

### Measurement Range

Measurement Parameter	1 KHz	1 MHz Normal Mode
		1 MHz High Accuracy
C	0.001 pF to 200.000 $\mu\text{F}$	0.00001 pF to 1280.00 pF 0.00001 pF to 2663.00 pF
DF	0.00001 to 9.99999	0.00001 to 9.99999 .000001 to .999999

- 1 kHz Normal Mode: 7 decade ranges 100 pF to 100  $\mu\text{F}$  full scale. 100% overranging on all ranges, (max. 200000 counts) when  $D \leq 0.5$ .
- 1 MHz Normal Mode: 11 binary ranges, 1 pF to 1024 pF full scale. 25% overranging on all ranges, when  $D \leq 1$ .
- 1 MHz High Accuracy Mode: Measurement range is  $\pm 30\%$  of the user defined nominal value, maximum 2048 pF. When  $D \leq 0.05$ .

### Measurement Accuracy

It is specified at the UNKNOWN terminals and at the end of standard 1 or 2 meter test leads under the following conditions.

1. Warm Up Time:  $\geq 10$  minutes.
2. Ambient Temperature is  $23 \pm 5^\circ\text{C}$  and variance is less than  $0.2^\circ\text{C}/\text{minute}$ .
3. Test signal level is set to 1 Vrms.
4. Zero OPEN/SHORT compensation has been performed.
5.  $D \leq 0.05$  for 1 MHz High Accuracy Mode.  
 $D \leq 0.1$  for 1 kHz and 1 MHz Normal Modes.
6. Accuracies are only valid when the measured value is equal to the full scale of each range.
7. Accuracy stated in the tables is given for LONG integration time.
8. Accuracy equations are read as follows:  
C:  $\pm$  (% of reading + % of full scale)  
D:  $\pm$  (% of reading + absolute D value)  
(C:  $\pm$  (% of reading + absolute C value) for Table 3)

Table 1: 1 kHz Measurement Accuracy

C range	C	D
100 $\mu\text{F}$	0.07% + 0.025%	0.065% + 0.0025
100 pF to 10 $\mu\text{F}$	0.05% + 0.025%	0.05% + 0.0005

Table 2: 1 MHz Normal Mode Measurement Accuracy

C range	C	D
256 to 1024 pF	0.1% + 0.02%	0.1% + 0.0005
4 to 128 pF	0.05% + 0.02%	0.1% + 0.0005
2 pF	0.05% + 0.03%	0.1% + 0.0005
1 pF	0.05% + 0.06%	0.1% + 0.001

Table 3: 1 MHz High Accuracy Mode Measurement Accuracy

Nominal C + Open Circuit C	C	D
1024 to 2048 pF	0.11%	0.0004
256 to 1024 pF	0.07%	0.0003
4 to 256 pF	0.05%	0.0002
2 to 4 pF	0.06% + 0.0004 pF	0.0003
0 to 2 pF	0.08% + 0.0004 pF	0.0006

**Trigger modes:** Internal, External, or Manual

**Measurement terminals:** Four-terminal pair, guarded

**Cable Length compensation:** 0, 1, or 2 m

**Compensation function:** Zero OPEN/SHORT, Standard, Offset

**Comparator:** Ten-bin sorting for capacitance, and go/no-go testing for D, Q, ESR, and G.

**Self test:** Checks the HP 4278A's basic operation.

**Memory card:** External memory for storing and recalling control settings and comparator limits.

### General Specifications

**Operating temperature and humidity:** 0–55° C, 95% RH @ 40° C

**Power:** 100, 120, 220VAC  $\pm 10\%$ , 240VAC +5 –10%, 48 to 66 Hz, 200VA max.

**Size:** Approximately 426 mm W  $\times$  177 mm H  $\times$  498 mm D (16.77 in  $\times$  6.97 in  $\times$  19.61 in)

**Weight:** Approximately 10 kg (22 lb, standard)

### Accessories Available

<b>HP 16270A:</b> Memory Card Set	\$285
<b>HP 16334A:</b> Tweezer-type Test Fixture for Chip Components	\$450
<b>HP 16047A:</b> Direct-coupled Test Fixture	\$275
<b>HP 16047C:</b> Test Fixture	\$315
<b>HP 16048A:</b> Test Leads, BNC (1 m)	\$330
<b>HP 16048B:</b> Test Leads, SMC (1 m)	\$330
<b>HP 16048D:</b> Test Leads, BNC (2 m)	\$440

### Ordering Information

<b>HP 4278A 1kHz/1MHz Capacitance Meter</b>	\$8,230
<b>Opt W30</b> Extended repair service. See page 681	+ \$180
<b>Opt 001</b> 1 kHz test frequency only	– \$865
<b>Opt 002</b> 1 MHz test frequency only	– \$370
<b>Opt 003</b> 1% frequency shift: prevents possible test signal interference when component test contacts are located close to those of other test units	\$0
<b>Opt 009</b> Delete Manual	– \$28
<b>Opt 101</b> HP-IB compatibility	+ \$248
<b>Opt 201</b> Handler Interface	+ \$280
<b>Opt 202</b> Handler Interface	+ \$310
<b>Opt 301</b> Scanner Interface	+ \$600

☎ For off-the-shelf shipment, call 800-452-4844.

# COMPONENT MEASUREMENT

## LCZ Meters

HP 4276A, 4277A

- 3-digit frequency setting:
  - 100 Hz to 20 kHz (801 spots)
  - 10 kHz to 1 MHz (701 spots)
- High-speed measurements
- Measure L/C-D/Q/ESR/G,  $|Z| - \theta$ , high speed L/C
- 10-bin component sorting-comparator (Opt 002)
- 0.1% basic accuracy over impedance range of 100 m  $\Omega$  to 10 M  $\Omega$  (HP 4276A), 10  $\Omega$  to 1 M  $\Omega$  (HP 4277A)

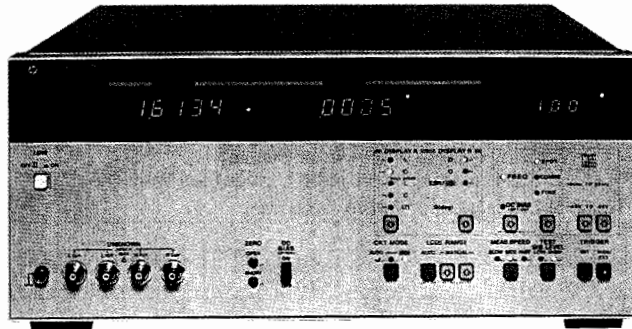

HP 4276A

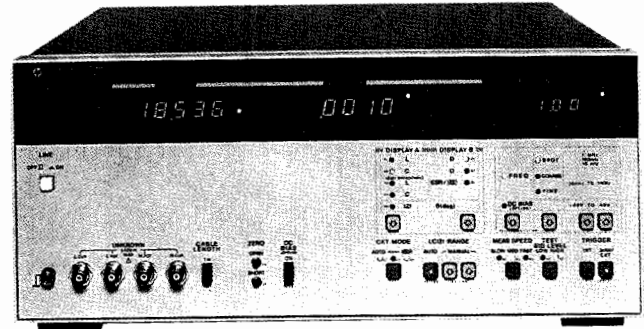

HP 4277A



### Description

HP's 4276A and 4277A LCZ Meters are general-purpose impedance-measuring instruments designed to measure circuit components such as capacitors and inductors using frequency and dc bias conditions identical to those of the intended application. Both HP 4276A and HP 4277A feature variable test frequency (100 Hz to 20 kHz and 10 kHz to 1 MHz respectively), optional dc bias variable from 0 to  $\pm 40$  V, multiple parameters ( $L \cdot C \cdot |Z| \cdot D \cdot Q \cdot ESR \cdot G \cdot \theta$ ) with fully automatic high speed measurements, and  $\frac{1}{4}$  digit resolution. The HP 4276A has an impedance range of 100 m  $\Omega$  to 10 M  $\Omega$  and the HP 4277A 10  $\Omega$  to 1 M  $\Omega$ .

Both instruments are ideal for production line, quality control, and circuit design applications, and are versatile enough for standalone use or systems use under HP-IB control (standard). An optional comparator for 10-bin sorting with measurement time of less than 100 ms makes the HP 4276A/4277A a good choice for production line testing of discrete components.

**Specifications** (Refer to data sheet for complete specifications.)  
Common to HP 4276A and HP 4277A:

**Parameters measured:** C-D • Q • ESR • G • L-D • Q • ESR • G  
high speed L, high speed C  
 $|z| - \theta$  and  $\Delta$  (deviation for any parameter)

**Display:**  $\frac{1}{4}$  digits (max), maximum display 19999

**Measurement circuit modes:** Auto, Parallel, and Series

**Frequency control modes:** SPOT, COARSE (10 freq./decade), and FINE (max. freq. resolution).

**Test Signal Level** (Unknown terminal open)

	HIGH	LOW
HP 4276A	1 Vrms $\pm 10\%$ @ 1kHz	50 mV $\pm 20\%$ (CP only) @ 1 kHz
HP 4277A	1 Vrms $\pm 10\%$	20 mV $\pm 15\%$

### Test frequencies:

**HP 4276A** - 100 Hz to 20 kHz  $\pm 0.01\%$  (801 points)

**HP 4277A** - 10 kHz to 1 MHz  $\pm 0.01\%$  (701 points)

**Measurement accuracy and range:** Specified at the front panel unknown connectors when all of the following conditions are satisfied:

- (1) warmup time  $\geq 30$  min.
- (2) test signal level is set to HIGH (1 Vrms)
- (3) measurement speed mode: MED or SLOW
- (4) ambient temperature is 23° C  $\pm 5^\circ$  C
- (5) cable length switch is set to 0 m (HP 4277A)
- (6) OPEN and SHORT adjustments have been made
- (7)  $D \leq 0.1$

### C measurement basic accuracy:

**HP 4276A:** 0.1% + 17 counts to 3% + 2 counts

**HP 4277A:** 0.1% + 17 counts to 3% + 4 counts

### dc bias

**Internal dc bias (opt.):** 0 to  $\pm 40$  V

### Reference Data

**Measurement speed (typical):** (Circuit mode: AUTO, test signal level: HIGH, display digit: 3 digits, FAST mode)

Measurements	HP 4276A @ 1 kHz	HP 4277A @ 1 MHz
C-D • ESR • G	65 ms	75 ms
L-D • ESR • G	75 ms	65 ms
Z- $\theta$	80 ms	75 ms
High Speed C	35 ms	40 ms

### General Specifications

**Operating temperature and humidity:** 0° to 55° C,  $\leq 95\%$  RH at 40° C.

**Power requirements:** 100/120/220 Vac  $\pm 10\%$ , 240 V + 5% - 10%; 48 to 66 Hz.

**Power consumption:** 65 VA max (HP 4276A);

75 VA max (HP 4277A).

**Size:** 188 mm H  $\times$  426 mm W  $\times$  422 mm D (7 $\frac{1}{2}$  in  $\times$  16 $\frac{1}{2}$  in  $\times$  16 $\frac{1}{2}$  in).

**Weight:** approx. 8.5 kg (18.7 lb).

### Special Options

**HP 4276A Opt H05:** 1 kHz C-D measurement only (1V/100mV)

**HP 4276A Opt H06:** 1 kHz C-D measurement only (1V/300mV)

**HP 4276A Opt H07:** 1 kHz C-D measurement only (1V/500mV)

**HP 4277A Opt H03:** Programmable dc bias for high speed C-V measurement (1V/20mV, 1 MHz only)

**HP 4277A Opt H04:** Programmable dc bias for high speed C-V measurement (500mV/20mV, 1 MHz only)

**HP 4277A Opt H07:** High accuracy dc bias

Contact your nearest HP sales office for more information.

### Accessories

**Furnished accessories:** HP 16047A Direct Coupled Test Fixture

### Accessories Available

**HP 16064A:** Retrofit Kit for Comparator (HP 4276A/HP 4277A, Option 002)

### Ordering Information

**HP 4276A LCZ Meter** \$5,660

**HP 4277A LCZ Meter** \$7,770

**Opt 001** Internal dc bias, 0 to  $\pm 40$  V + \$241

**Opt 002** 10-bin sorting for L/C/|Z| and go/no-go + \$840

testing for D/Q, interfaceable with component handler.

**Opt W30** Extended repair service. (HP 4276A) See + \$135

page 671. **Opt W30** Extended repair service (HP 4277A) See + \$185

page 671.

- 0.1% basic accuracy
- 100 Hz, 120 Hz, 1 kHz, 10 kHz, 100 kHz test frequencies
- 50 m, 100 m, 250 m, 500 m, 1 V rms test levels
- High-speed measurement: 25 ms
- High-speed contact check
- Quick test recovery
- Wide capacitance test range
- Front-end protection
- Built-in comparator
- Transformer parameter measurements (optional)

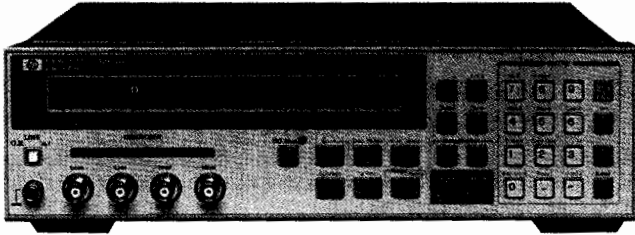

#### HP 4263A LCR Meter

The HP 4263A LCR Meter is HP's most cost-effective low-end LCR meter, designed for both component evaluation on the production line and fundamental impedance testing for bench-top applications.

#### Selectable Test Frequencies

The HP 4263A has 5 test frequencies that allow you to simulate testing under the correct conditions: 100 Hz, 120 Hz, 1 kHz, 10 kHz, and 100 kHz.

#### High-Speed Measurements

The HP 4263A can boost throughput with a measurement speed of 25 ms at any test frequency. This ability improves the throughput of electrolytic capacitor and transformer testing. The 4263A can check the contact condition between the test terminals and the device under test (DUT). This function ensures the reliability of PASS/FAIL testing with automatic handlers in production. The quick recovery system of the 4263A improves throughput. Normal operation is resumed the instant a faulty DUT is removed from the handler, so the handler can always be operated at its full speed while only good DUTs are retained.

#### Electrolytic Capacitor Measurements

The 4263A's accuracy and wide measurement range are the right tools to make precise measurements of electrolytic capacitors. Charged capacitors can discharge through the front end and destroy an instrument. The 4263A's front end is designed for protection and maintains test integrity.

#### Transformer Parameter Measurements

With the 4263A's ability to make turns ratio (N), mutual inductance (M), and dc resistance (DCR) measurements, data calculations and changing test setups are no longer time-consuming tasks.

#### Specifications (See data sheet for complete specifications.)

##### Measurement Functions

**Measurement parameters:**  $|Z|$ ,  $|Y|$ ,  $\theta$  [°], R, X, G, B, L, C, Q, D, ESR

**Option 001:** Add DCR (dc resistance), N (turns ratio), and M (mutual inductance) measurement

**Measurement circuit mode:** Series and parallel

**Mathematical functions:** Deviation and percent deviation

**Ranging:** Auto and manual

**Trigger:** Internal, external, manual, and HP-IB

**Delay time:** 0 to 9999 ms in 1 ms steps

**Test cable lengths:** 0 m, 1 m, 2 m, 4 m (freq = 100 Hz, 120 Hz, 1 kHz); 0 m, 1 m, 2 m (freq = 10 kHz); 0 m, 1 m (freq = 100 kHz)

**Measurement time:** Short, medium, and long

**Averaging:** 1 to 256

##### Test Signal Information

**Test frequency:** 100 Hz, 120 Hz, 1 kHz, 10 kHz, and 100 kHz

**Frequency accuracy:**  $\pm 0.01\%$  (freq = 100 Hz, 1 kHz, 10 kHz, 100 kHz),  $\pm 1\%$  (freq = 120 Hz)

**Output impedance:**  $100 \Omega \pm 10\%$ ,  $25 \Omega \pm 10\%$  ( $\leq 1 \Omega$  range)

**AC test signal level:** 50 mV, 100 mV, 250 mV, 500 mV, and 1 V rms

**Accuracy:**  $\pm 10\% + 10$  mV

##### Internal dc bias

**Level:** 1.5 and 2 V **Accuracy:**  $\pm (5\% + 2$  mV)

**External dc bias:** 0 to +3 V

##### Measurement Range

Parameter	Measurement Range
$ Z $ , R, X	1 m $\Omega$ to 100 M $\Omega$
$ Y $ , G, B	10 nS to 1000 S
C	1 pF to 1 F
L	10 nH to 100 kH
D	0.0001 to 9.9999
Q	0.1 to 9999.9
$\theta$	-180° to +180° C
DCR	1 m $\Omega$ to 100 M $\Omega$
N	0.9 to 200 (unspecified)
L, M	1 $\mu$ H to 100 H (unspecified)
$\Delta \%$	-999.99% to 999.99%

**Measurement accuracy:**  $\pm 0.1\%$  (basic) (for  $|Z|$ , R, X,  $|Y|$ , G, B, C, L)

**Measurement time:** Time interval from a trigger command to the EOM (end of measurement) signal output at the handler interface port (range: hold; display: off).

Mode	Time (typical)
Short	25 ms
Medium	65 ms
Long	500 ms

**Front-end protection:** Internal circuit protection when a charged capacitor is connected to the input terminals. The maximum capacitor voltage is:  $V_{max} = \sqrt{(8/C)}$  typical @  $V_{max} \leq 250$  V;  $V_{max} = \sqrt{(2/C)}$  typical @  $V_{max} \leq 1000$  V C is in Farads

**Display:** 24 digits LCD display. Capable of displaying: measured values, control settings, comparator limits and decisions, self-test messages, and annunciations.

##### Correction Function

**Zero OPEN/SHORT:** Eliminates measurement errors due to stray parasitic impedances in the test fixtures.

**Load:** Improves measurement accuracy by using a calibrated device as a reference. Available only via HP-IB.

**Comparator function:** HIGH/IN/LOW for each primary measurement parameter and secondary measurement parameter.

**Contact check function:** Contact failure between the test fixture and device can be detected. Additional time for contact check: 5 ms.

##### Other Functions

**Save/recall:** Ten instrument setups can be saved/recalled from the internal nonvolatile memory.

**Continuous memory capability:** If the instrument is turned off, or if a power failure occurs, instrument settings (except dc bias on/off) are automatically memorized ( $\geq 72$  hours at  $23^\circ \pm 5^\circ$  C).

**HP-IB interface:** All control settings, measured values, and comparator information.

**Handler interface:** All output signals are negative-logic, optically isolated open collectors. Output signals include: HIGH/IN/LOW, no contact, index, end of measurement, and alarm. Input signals include: keylock and external trigger.

##### General Specifications

**Power requirements:** 90 to 132 V or 198 to 264 V, 47 to 66 Hz, 45 VA max.

**Operating temperature:** 0 to 55° C

**Dimensions:** 320 mm W  $\times$  100 mm H  $\times$  300 mm D (12.6 in  $\times$  3.94 in  $\times$  11.81 in)

**Weight:** 4.5 kg (9.9 lb)

##### Ordering Information

	Price
HP 16060A Transformer Test Fixture	\$540
HP 16065C External Bias Adapter (up to 40 Vdc)	\$450
HP 16089A Kelvin Clip Leads (1 m, 2 large clips)	\$490
HP 16089B Kelvin Clip Leads (1 m, 2 medium clips)	\$480
HP 16089C Kelvin Clip Leads (1 m, 2 IC clips)	\$580
HP 16089D Alligator Clip Leads (1 m, 4 medium)	\$410
HP 16064B LED Display/Trigger Box (pass/fail display and trigger)	\$330
HP 4263A LCR Meter	\$3,800
Opt 001 Add N/M/DCR Measurement Function	\$660
Opt 009 Delete Operation Manual	
Opt W30 Extended Repair Service (see page 671)	

# COMPONENT MEASUREMENT

## High-Resistance Meter

HP 4339A

- Wide measurement range:  $1 \times 10^3 \Omega$  to  $1.6 \times 10^6 \Omega$
- Stable test fixtures: resistivity cell, component test fixture
- High-speed measurement: 10 ms
- Test sequence programming
- Resistivity calculations
- Grounded DUT measurement

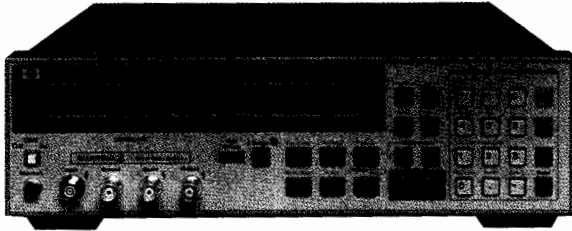

### HP 4339A High-Resistance Meter

The HP 4339A high-resistance meter is HP's most advanced tool for making precision high-resistance measurements.

#### Precise and Stable Measurement

The measurement range is from  $1 \times 10^3 \Omega$  to  $1.6 \times 10^6 \Omega$ , with a basic accuracy of 0.6%. This wide range allows accurate high-resistance measurement of capacitors, relays, switches, connectors, materials, cables, and PC boards. The grounded device-under-test (DUT) measurement capability of the HP 4339A gives you the ability to evaluate cables and transformers under grounded conditions. The HP 16008B resistivity cell and the HP 16339A component test fixture are designed for stable and safe measurements of materials or components.

#### Ease of Use

The Test Sequence Program function allows you to control a series of resistance measurements in a sequence (charge-measure-discharge). You can set the charge time, measurement interval time, and number of measurements in a sequence through the front panel. Surface resistivity ( $\rho_s$ ) and volume resistivity ( $\rho_v$ ) functions can be called to act upon measurement data. Calculated results are then automatically displayed, saving you time and effort.

#### High Test Throughput

The 10 ms measurement time, 2 ms high-speed contact check function, built-in comparator and HP-IB/handler interfaces deliver high-speed test throughput for production environments.

#### Specifications

(See data sheet for complete specifications.)

##### Measurement functions

##### Measurement parameters:

R (dc resistance), I (dc current),  $\rho_s$  (surface resistivity),  $\rho_v$  (volume resistivity)

**Mathematical functions:** Deviation and percent deviation.

**Ranging:** Auto and manual

**Trigger:** Internal, external, manual, and HP-IB

**Delay time:** 0 to 9999 ms in 1 ms steps

**Test cable lengths:** 2 m maximum

**Measurement time:** Short, medium, and long

**Averaging:** 1 to 256

**Test voltage:** 0 to 1000 Vdc, 100 mV steps @ 0 to 200 V, 1 V steps @ 200 to 1000 V

**Voltage accuracy:** (0.16% + 100 mV) @  $\leq 200$  V,  
(0.16% + 500 mV) @  $> 200$  V

**Maximum current:** 10 mA @  $\leq 100$  V, 5 mA @  $\leq 250$  V,  
2 mA @  $\leq 500$  V, 1 mA @  $\leq 1$  kV

**Current compliance setting:** 0.5 mA, 1 mA, 2 mA, 5 mA, 10 mA

**Output resistance:**  $1 \text{ k}\Omega \pm 10\%$

#### Measurement Range/Accuracy

Parameter	Measurement Range	Basic Accuracy
I	60 fA to 100 $\mu$ A	$\pm 0.4\%$
R ( $\Omega$ )	$1 \times 10^3$ to $1.6 \times 10^6$	$\pm 0.6\%$

**Measurement time:** Time interval from a trigger command to the EOM (end of measurement) signal output at the handler interface port (range: hold, display: off).

Mode	Time (typical)
Short	10 ms
Medium	30 ms
Long	1850 ms

**Display:** 24 digits LCD display. Capable of displaying: measured values, control settings, comparator limits and decisions, self-test messages, and annunciators.

#### Correction function

**Zero OPEN:** Eliminates measurement errors due to stray parasitic resistance in the test fixtures.

**Test sequence program:** Controls a series of resistance measurements. Charge time, measurement interval time and number of measurement can be programmed.

**Comparator function:** HIGH/IN/LOW for the measurement parameter.

#### Contact check function

Contact failure between the test fixture and device can be detected.

**Available DUT type:** Capacitive DUT's only

**DUT capacitance:**  $\geq 0.5$  pF + 5% of residual stray capacitance

**Residual stray capacitance of the fixture:**  $\leq 50$  pF

**Additional measurement time for contact check:** 2 ms

#### Other functions

**Save/recall:** Ten instrument setups can be saved/recalled from the internal nonvolatile memory.

**Continuous memory capability:** If the instrument is turned off, or if a power failure occurs, instrument settings are automatically memorized ( $\geq 72$  hours at  $23 \pm 5^\circ \text{C}$ ).

**HP-IB interface:** All control settings, measured values, and comparator information.

**Handler interface:** All output signals are negative-logic, optically isolated open collectors. Output signals include: HIGH/IN/LOW, no contact, index, end of measurement, and alarm. Input signals include: high voltage off, keylock, and external trigger.

#### General Specifications

**Power requirements:** 90 to 132 V or 198 to 264 V, 47 to 66 Hz, 45 VA maximum

**Operating temperature:** 0 to  $55^\circ \text{C}$

**Dimensions:** 320 mm W  $\times$  100 mm H  $\times$  450 mm D (12.6 in  $\times$  3.94 in  $\times$  17.72 in)

**Weight:** 6.5 kg (14.3 lb)

#### Ordering Information

	Price
HP 16339A Component Test Fixture	\$1,960
HP 16008B Resistivity Cell (50 mm Diameter Electrode)	\$2,280
Opt 001 Add 26/76 mm Diameter Electrodes	+\$540
Opt 002 Add 26 mm Diameter Electrode	+\$250
Opt 003 Add 76 mm Diameter Electrode	+\$420
HP 16117B Low-Noise Test Leads (1 m, 2 Clips)	\$460
HP 16117C Low-Noise Test Leads (1 m, Connectors)	\$390
HP 16064B LED Display/Trigger Box	\$330
HP 4339A High-Resistance Meter	\$4,500
Opt 009 Delete Operation Manual	
Opt W30 Extended Repair Service (see page 671)	

# COMPONENT MEASUREMENT

## 4-Channel High-Resistance Meter

373

HP 4349A

- Designed for capacitor measurements
- 4-channel input
- High-speed measurement: 11 ms
- Fast settling time
- High-speed contact check
- Comparator function

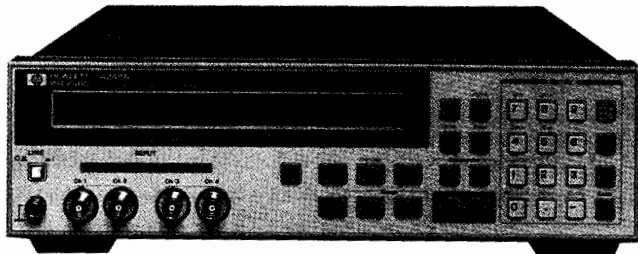

### HP 4349A 4-Channel High-Resistance Meter

The HP 4349A 4-channel high-resistance meter is HP's highest-throughput high-resistance meter for production testing of capacitors.

#### High Throughput

To verify component reliability, capacitor manufacturers need to test capacitor insulation resistance at different voltages. The 4-channel configuration permits simultaneous testing of 4 capacitors with different test voltages. This configuration reduces the investment cost when compared to a single-channel instrument. The HP 4349A's 11 ms 4-channel simultaneous measurement improves the test throughput in a capacitor production line. For insulation resistance testing for capacitor manufacturers, capacitor charge time is a key factor in slowing down measurement time. The HP 4349A's front end has a 1 k  $\Omega$  input impedance that allows the instrument to reduce the capacitor's charge time, and thus increases test throughput. The Contact Check function verifies that the signal path between the handler and the device under test (DUT) is optimal for a measurement. Contact Checking maintains automatic handler/DUT integrity while keeping system throughput high.

#### System Integration

The built-in comparators for all 4 channels and the HP-IB/handler interface make system integration with automatic handlers and computers a fast and clean process.

#### Specifications

(See data sheet for complete specifications.)

#### Measurement functions

**Measurement parameters:** I (dc current), R (dc resistance)

**Note:** The HP 4349A has no test voltage source. It needs an external voltage source for resistance measurements. (The HP 4349A converts current measurement data into resistance with the test voltage data entered into memory.)

**Number of test channels:** 4 channels (Option 001: 2 channels). Each channel measures simultaneously by the trigger.

**Test voltage data entry:** 0.1000 to 1000.0 V (5 digits)

**Ranging:** Auto and manual

**Trigger:** Internal, external, manual, and HP-IB

**Delay time:** 0 to 9999 ms in 1 ms steps

**Test cable lengths:** 2 m maximum

**Measurement time:** Short and long

**Averaging:** 1 to 256

#### Measurement Range/Accuracy

Parameter	Measurement Range	Basic Accuracy
I	1 pA to 100 $\mu$ A	2%
R (in ohms)	$1 \times 10^3$ to $1 \times 10^{15}$	2% + voltage source accuracy

**Measurement time:** Time interval from a trigger command to the EOM (end of measurement) signal output at the handler interface port.

Mode	Time (typical)
Short	11 ms
Long	31 ms

**Display:** 24 digits LCD display. Capable of displaying: measured values, control settings, comparator limits and decisions, self-test messages, and annunciations.

#### Correction function

**Zero OPEN:** Eliminates measurement errors due to leakage current in the test fixture for each test channel.

**Comparator function:** HIGH/IN/LOW for the measurement parameter of each test channel.

#### Contact check function

Contact failure between the test fixture and device can be detected.

**Available DUT type:** Capacitive DUT only

#### Required condition

**DUT capacitance:**  $\geq 0.5$  pF + 5% of residual stray capacitance

**Residual stray capacitance of the fixture:**  $\leq 50$  pF

**Additional time for contact check:** 2 ms

#### Other functions

**Save/recall:** Ten instrument setups can be saved/recalled from the internal nonvolatile memory.

**Continuous memory capability:** If the instrument is turned off, or if a power failure occurs, instrument settings (except dc bias) are automatically memorized ( $\geq 72$  hours at  $23 \pm 5^\circ$  C).

**HP-IB interface:** All control settings, measured values, and comparator information.

**Handler interface:** All output signals are negative-logic, optically isolated open collectors. Output signals include: HIGH/IN/LOW and no contact for each channel, index, end-of-measurement and alarm. Input signals include: keylock and external trigger.

#### General Specifications

**Power requirements:** 90 to 132 V or 198 to 264 V, 47 to 66 Hz, 45 VA maximum

**Operating temperature:** 0 to  $55^\circ$  C

**Dimensions:** 320 mm W  $\times$  100 mm H  $\times$  450 mm D (12.6 in  $\times$  3.94 in  $\times$  17.72 in)

**Weight:** 6.5 kg (14.3 lb)

#### Ordering Information

**HP 16117D** Low-Noise Test Lead (1 m, Triax Connector)

**HP 4349A** 4-Channel High-Resistance Meter

**Opt 001** 2 Test Channels

**Opt 009** Delete Operation Manual

**Opt W30** Extended Repair Service (see page 671)

#### Price

\$146

\$6,450

– \$650

# COMPONENT MEASUREMENT

## Milliohmmeter

HP 4338A

- Low and selectable test signal current: 1  $\mu$ A to 10 mA
- Wide measurement range: 10  $\mu\Omega$  to 100 k $\Omega$
- 10  $\mu\Omega$  resolution
- 1 kHz ac measurement
- High-speed measurement: 34 ms
- Built-in comparator
- Auto-measurement mode

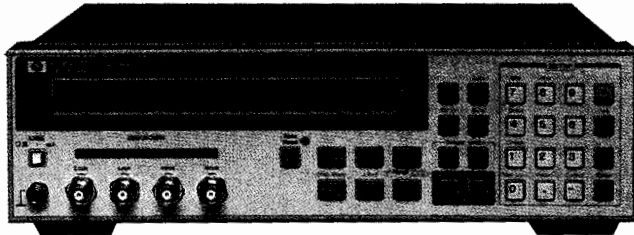

### HP 4338A Milliohmmeter

The HP 4338A milliohmmeter is a precise, reliable, high-speed test tool for measurements of low resistance.

#### Precise Low-Resistance Measurement

Contact failure of electromechanical components in a low-current circuit is a key issue for component reliability. The HP 4338A offers selectable low ac test signals (1  $\mu$ A to 10 mA). Users can now characterize low resistances of electromechanical components under low-current conditions. A high resolution of 10  $\mu\Omega$  allows you to determine the slightest differences in contact resistance testing of relays, switches, connectors, PC board traces and cables. The 1 kHz test signal eliminates potential errors introduced by thermoelectric effects on the device-under-test (DUT) contacts. The 1 kHz ac test signal is the best solution to evaluate the internal resistance of batteries, because it avoids dc energy consumption.

#### High-Speed Measurements

The high-speed (34 ms), built-in comparator and HP-IB/handler interfaces make it possible to construct a measurement system using an automatic handler and external computer to minimize production test time.

#### Auto-Measurement Mode

When performing gross continuity testing where the test signal level is not a significant factor in the test, the auto-measurement function allows the instrument to select an appropriate test signal and measurement range setting.

#### Specifications

(See data sheet for complete specifications.)

##### Measurement function

**Measurement parameters:** R (ac resistance), X (reactance), L (inductance), |Z| (impedance),  $\theta$  (phase [°])

**Combinations:** R, R-X, R-L, |Z|- $\theta$  (series mode only)

**Mathematical functions:** Deviation and percent deviation

**Ranging:** Auto and manual

**Trigger:** Internal, external, manual, and HP-IB

**Delay time:** 0 to 9999 ms in 1 ms steps

**Measurement time:** Short, medium, and long

**Averaging:** 1 to 256

#### Test Signal Characteristics

**Test frequency:** 1 kHz

**Frequency accuracy:**  $\pm 0.1\%$

**Test signal level:** 1  $\mu$ A, 10  $\mu$ A, 100  $\mu$ A, 1 mA, 10 mA rms

**Level accuracy:**  $\pm 10\% + 0.2 \mu$ A

**Maximum voltage across sample:** 20 mV peak in any case

#### Measurement Range

Parameter	Measurement Range
R	10 $\mu\Omega$ to 100 k $\Omega$
X,  Z	10 $\mu\Omega$ to 100 k $\Omega$ (typical)
L	10 nH to 10 H (typical)
$\theta$	-180° to +180° C (typical)

**Measurement accuracy:**  $\pm 0.4\%$  Basic for R

**Measurement time:** Time interval from a trigger command to the EOM (end of measurement) signal output at the handler interface port.

Mode	Time (typical)
Short	34 ms
Medium	70 ms
Long	900 ms

**Display:** 24 digits LCD display. Capable of displaying: measured values, control settings, comparator limits and decisions, self-test messages, and annunciations.

#### Correction Function

**Zero SHORT:** Eliminates measurement errors due to parasitic impedances in the test fixture.

#### Comparator Function

HIGH/IN/LOW for each primary measurement parameter and the secondary measurement parameter.

#### Other Functions

**Superimposed dc:**  $\pm 42$  Vdc maximum may be present on measurement terminals.

**Save/recall:** Ten instrument setups can be saved/recalled from the internal nonvolatile memory.

**Continuous memory capability:** If the instrument is turned off, or if a power failure occurs, instrument settings are automatically memorized ( $\leq 72$  hours at  $23 \pm 5^\circ$  C)

**HP-IB interface:** All control settings, measured values, and comparator information.

**Handler interface:** All output signals are negative-logic, optically isolated open collectors.

Output signals include: HIGH/IN/LOW, index, end of measurement, and alarm. Input signals are keylock and external trigger.

#### General Specifications

**Power requirements:** 90 to 132 V or 198 to 264 V, 47 to 66 Hz, 45 VA max.

**Operating temperature:** 0° to 55° C

**Dimensions:** 320 mm W  $\times$  100 mm H  $\times$  300 mm D (12.6 in  $\times$  3.94 in  $\times$  11.81 in)

**Weight:** 4.5 kg (9.9 lb)

#### Ordering Information

	Price
HP 16338A Test Lead Set	\$770
HP 16143B Mating Cable (0.6 m)	\$320
HP 16005B Kelvin Clip Lead (0.4 m, with large clip)	\$100
HP 16005C Kelvin IC Clip Lead (0.4 m, with IC clip)	\$140
HP 16006A Pin-Type Probe Lead (0.4 m)	\$53
HP 16007A Alligator Clip Leads (0.4 m, with 2 red clips)	\$25
HP 16007B Alligator Clip Leads (0.4 m, with 2 black clips)	\$25
HP 16064B LED Display/Trigger Box	\$330
HP 4338A Milliohmmeter	\$3,450
Opt 009 Delete Operation Manual	
Opt W30 Extended Repair Service (see page 671)	



# COMPONENT MEASUREMENT

Q Meter/1 MHz C-V Meter

HP 4342A, 4279A

375

- Frequency range: 22 kHz to 70 MHz
- Q range: 5 to 1000

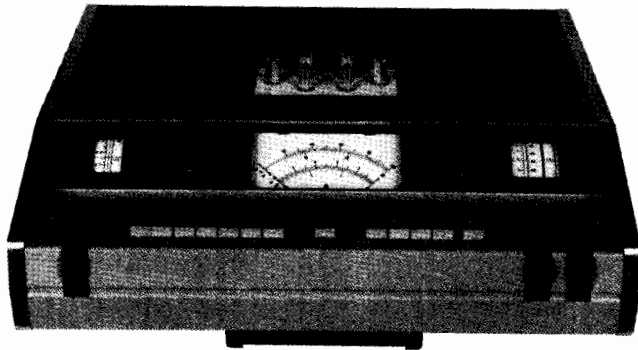

HP 4342A

## Description

The direct-reading expanded scale of the HP 4342A permits measurement of Q from 5 to 1000 and reading of very small changes in Q resulting from variation in test parameters. The HP 4342A will measure the dissipation factor and dielectric constant of insulating materials. The Q meter can measure the coefficient of coupling, mutual inductance, and frequency response of transformers.

## Specifications

### Test frequency

**Range:** 22 kHz to 70 MHz (HP 4342A Opt 001: 10 kHz to 32 MHz)  
**Accuracy:** ±1.5% from 22 kHz to 22 MHz; ±2% from 22 MHz to 70 MHz; ±1% at "L" point on frequency dial (HP 4342A Opt 001: ±1.5% from 10 kHz to 10 MHz; ±2% from 10 MHz to 32 MHz; ±1% at "L" point on frequency dial)  
**Increments:** Approximately 1% resolution

### Q measurement characteristics

**Q range:** 5 to 1000 in 4 ranges  
**Q accuracy:** % of indicated value: (@ 25° C)

Q	22 kHz to 30 MHz	30 MHz to 70 MHz
5 to 300	±7	±10
300 to 600	±10	±15
600 to 1000	±15	±20

**Q increments:** 1 from 20 to 100; 0.5 from 5 to 10

**ΔQ range:** 0 to 100 in 4 ranges: 0 to 3, 0 to 10, 0 to 30, 0 to 100

**ΔQ accuracy:** ±10% of full scale

**ΔQ increments:** 0.1 from 0 to 10; 0.05 from 0 to 3

### Inductance measurement characteristics

**L range:** 0.09 μH to 1.2 H, direct reading at 7 specific frequencies

**L accuracy:** ±3% after substitution of residuals (approx. 10 nH)

## General

**Temperature range:** 0° C to 50° C

**Power:** 115 or 230 V ±10%; 50 to 400 Hz; approx. 40 VA

**Size:** 138 mm H × 425 mm W × 414 mm D (5.4 in × 16.8 in × 16.3 in)

**Weight:** Net 14 kg (31 lb); shipping 18.45 kg (41 lb)

## Options and Accessories

Opt 001 Frequency Range (10 kHz to 32 MHz)	+ \$360
HP 16014A Series Loss Test Adapter	\$168
HP 16451A Dielectric Test Adapter	\$720
HP 16462A Auxiliary Capacitor	\$670
HP 16470A Reference Inductors, set of 20	\$3,145
HP 16470B Stable Inductors, set of 4	\$1,750
HP 16470C Complete set of 24 Inductors (HP 16470A + HP 16470B)	\$4,920
HP 4342A Q Meter	\$7,915

- Built-in programmable dc bias sweep source with a voltage accuracy of 0.1%
- High-speed C-V measurements: 10 ms, 20 ms, and 30 ms/meas point
- 0.1% basic accuracy and six-digit resolution
- Automatic dc bias polarity control

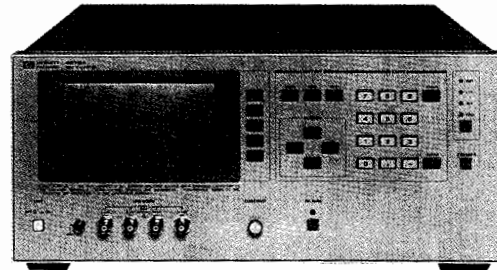

HP 4279A



## Description

The HP 4279A 1MHz C-V meter offers the optimal solution for increasing quality and throughput when measuring the capacitance versus bias voltage characteristics of varactor diodes, MOS diodes, and the like. The HP 4279A measures capacitance over a range of 0.00001 pF to 1280.00 pF with a basic accuracy of 0.1% and a six-digit display resolution, while sweeping the accurate dc bias voltage. The automatic bias polarity control feature allows quick selection of the correct polarity bias voltage for the device under test.

## Specifications

**Parameters measured:** C-D, Q, ESR, G

**Display:** 4,5,6 digits, selectable, maximum display 999999

**Measurement frequency:** 1MHz ±0.02%

**Test signal level:** 20 mV, 50 mV, 100 mV, 200 mV, 500 mV, and 1 Vrms

**Measurement terminals:** 4-terminal pair

**Test cable length compensation:** 0 m, 1 m and 2 m

**Error-correction:** OPEN/SHORT/LOAD and temperature compensation

**Measurement time:** 10ms/20ms/30ms selectable

**Measurement accuracy (@23° C ±5° C) and range**

**Basic measurement accuracy:** ±0.1% (@ D ≤ 0.1)

**Range:** C: 0.00001 pF - 1280.00 pF, D: 0.00001 - 9.99999

**Internal dc bias:** 0V to ±38V, up to 51 sweep points are programmable via HP-IB

Bias voltage	Voltage step	Accuracy (@23° C - 5° C)
± (0.000 to 4.000) V	1 mV	± (0.1% of setting + 1 mV)
± (4.002 to 8.000) V	2 mV	± (0.1% of setting ± 2 mV)
± (8.005 to 20.000) V	5 mV	± (0.1% of setting + 3 mV)
± (20.01-38.00) V	10 mV	± (0.1% of setting + 10 mV)

**Bias polarity control:** Automatically performed

**External dc bias:** 0V to ±100V via rear panel connector

## General

**Operating temperature and humidity:** 0° C to 55° C, ≤95% RH at 40° C

**Power:** 100/120/220 V ±10%, 240 V +5% -10%; 48 to 66 Hz; 200 VA maximum

**Size:** 177 mm H × 426 mm W × 498 mm D (7 in × 16.8 in × 19.6 in)

**Weight:** Approximately 15 kg (33 lb)

**Accessories available:** Refer to page 357

## Ordering Information

HP 4279A 1MHz C-V meter	\$10,150
Opt W30 Extended repair service - see page 671	\$215
Opt 003 1% frequency shift	\$0
Opt 009 Delete manual	-\$36

# COMPONENT MEASUREMENT

## Standard Capacitor Set and Decade Capacitor

HP 16380A, 16380C, 4440B

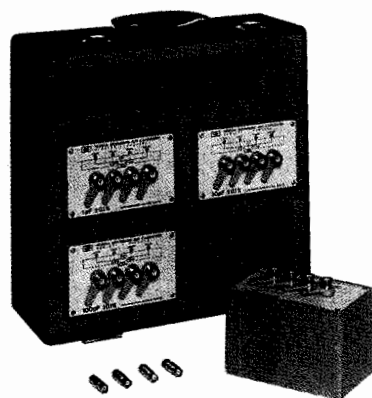

HP 16380A

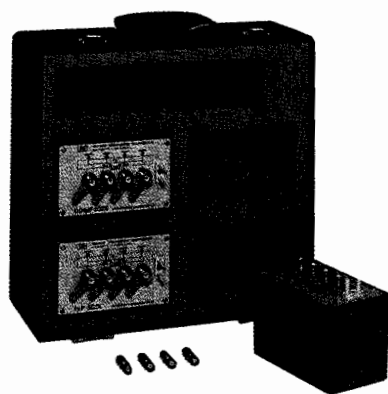

HP 16380C

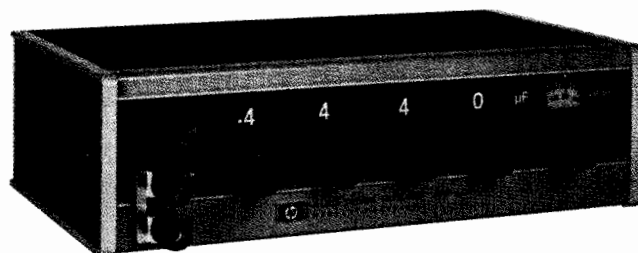

HP 4440B

### HP 16380A, HP 16380C Description

The HP 16380A and HP 16380C are precision standard capacitor sets that cover the range of 1 pF to 1 μF in decade steps. The HP 16380A consists of four discrete air-dielectric capacitors with nominal values of 1 pF, 10 pF, 100 pF, and 1000 pF. Similarly, the HP 16380C consists of four discrete capacitors, but with solid dielectrics and with nominal values of 0.01 μF, 0.1 μF, 1 μF, and 1 μF.

Both the HP 16380A and HP 16380C are furnished with test certification of 0.01% calibration accuracy. Capacitance stability with respect to time varies from capacitor to capacitor but is in the range of ±50 or ±300 ppm/year.

The HP 16380A and HP 16380C both have the four-terminal pair configuration to allow direct connection to any of Hewlett-Packard's many four-terminal pair impedance measuring instruments. The HP 16380A/C can be easily adapted to two-, three-, and five-terminal configurations.

### HP 16380A, 16380C Specifications (valid at 1 kHz, 23 ± 5° C)

#### HP 16380A

Capacitance	1 pF	10 pF	100 pF	1000 pF
Nominal Accuracy	±0.1%			
Calibration Accuracy	±0.01%			
Stability	≤300 ppm/yr*			
Dissipation Factor	≤0.0001			
Dimensions	112 mm H × 142 mm W × 88 mm D			
Weight	8.0 kg (includes case)			

\*Supplemental performance characteristics.

#### HP 16380C

Capacitance	0.01 μF	0.1 μF	1 μF
Nominal Accuracy	±0.1%		
Calibration Accuracy	±0.01%		
Stability	≤50 ppm/yr		
Dissipation Factor	≤0.0004	≤0.0005	≤0.0007
Dimensions	117 mm H × 142 mm W × 88 mm D		
Weight	6.3 kg (includes case)		

### HP 4440B Description

The HP 4440B Decade Capacitor is a high accuracy instrument providing usable capacitances from 40 pF to 1.2 μF. Its 0.25% accuracy makes it an ideal aid for circuit design or as a working standard.

The use of silvered-mica capacitors in all four decades provides higher accuracy, lower dissipation factor, and good temperature coefficient. An air capacitor vernier provides 100 pF (from 40 pF to 140 pF) with resolution of 1 pF. Capacitors are housed in a double shield in such a way that increased capacitance from two terminals to three terminals is held to 1 pF.

### 4440B Specifications

**Capacitance:** 40 pF to 1.2 μF in steps of 100 pF with a 40 pF to 140 pF variable air capacitor providing continuous adjustment to better than 2 pF between steps

**Direct reading accuracy:** ±(0.25% + 3 pF) at 1 kHz for three-terminal connection

**Resonant frequency:** Typical values of the resonant frequency are 450 kHz at 1 μF, 4 MHz at 0.01 μF, and 40 MHz at 100 pF

**Dissipation factor:** for C ≥ 1040 pF, 0.001 max. at 1 kHz  
for C < 1040 pF, 0.005 max. at 1 kHz

**Temperature coefficient:** < +70 ppm/°C

**Insulation resistance:** 5 GΩ minimum, after 5 minutes at 500 V dc

**Maximum voltage:** 42 Vdc or 30 Vrms

**Weight:** net, 2.5 kg (5½ lb); shipping, 3.6 kg (8 lb)

**Size:** 76 mm H × 264 mm W × 152 mm D (3 in × 11 in × 6 in)

### Ordering Information

**HP 16380A** Standard Capacitor Set (1 pF, 10 pF, 100 pF, 1000 pF) \$3,095

**HP 16380C** Standard Capacitor Set (0.01 μF, 0.1 μF, 1 μF) \$4,660

**HP 4440B** Decade Capacitor \$1,975

# LIGHTWAVE TEST EQUIPMENT

## General Information

377

### Lightwave Selection Chart

<b>Lightwave Multimeter</b>	<b>HP 8153A</b>		
<b>Power Sensor Modules</b> Wavelength Range Power Range Accuracy (at ref. cond.)	450 to 1700 nm + 10 to - 110 dBm ± 2.2%		
<b>Laser Source Modules</b> Wavelengths Stability (6 h)	1300, 1550, 1300/1550 nm ± 0.03 dB		
<b>LED Source Modules</b> Wavelengths Stability (6 h)	850, 1300 nm ± 0.03 dB		
<b>Return Loss Module</b> Wavelength Range Return Loss Range	1250 to 1600 nm 0 to 70 dB		
<b>Sources</b>	<b>HP 8154B</b>	<b>HP 8155A</b>	
Wavelengths Output Power Stability (12 h)	850, 1300, 1550 nm - 17 to - 23 dBm ± 0.02 dB	1300, 1550 nm > - 4 dBm ± 0.03 dB	
<b>Optical Attenuators</b>	<b>HP 8158B</b>	<b>HP 8157A</b>	
Wavelength Range Linearity (single-mode) Return Loss	600 to 1650 nm ± 0.4 dB 14 dB	1200 to 1650 nm ± 0.2 dB 45 dB	
<b>Optical Isolators</b>	<b>HP 81210LI</b>	<b>HP 81310LI</b>	
Wavelength Range Peak Isolation	1290 to 1330 nm 60 dB	1530 to 1570 nm 60 dB	
<b>Lightwave Converters</b> Wavelength Range Bandwidth (optical) Conversion Gain	<b>HP 11982A</b> 1200 to 1600 nm dc to 15 GHz 300 V/W nominal	<b>HP 83440B/C/D</b> 1200 to 1600 nm dc to 6/20/34 GHz 35/35/25 V/W nominal	
<b>Lightwave Signal Analyzers</b>	<b>HP 71400C</b>	<b>HP 71401C</b>	<b>HP 83810A</b>
Wavelength Range Modulation Bandwidth Sensitivity (optical)	750 to 870, 1200 to 1600 nm 100 kHz to 22 GHz - 62/ - 66 dBm	750 to 870, 1200 to 1600 nm 100 kHz to 2.9 GHz - 62/ - 66 dBm	1200 to 1600 nm 9 kHz to 22 GHz - 4 dBm
<b>Lightwave Component Analyzers</b>	<b>HP 8702B</b>	<b>HP 8703A</b>	<b>HP 83420A</b>
Wavelengths Modulation Bandwidth	850, 1300, 1550 nm 300 kHz to 6 GHz	1300, 1550 nm 130 MHz to 20 GHz	1300, 1550 nm 130 MHz to 20 GHz
<b>Lightwave Precision Reflectometer</b>	<b>HP 8504A</b>		
Wavelengths Return Loss Range Measurement Span Two-Event Resolution	1300, 1550 nm 0 to 70 dB 1 mm to 40 cm (air) 50 μm (air)		
<b>Lightwave Polarization Analyzer</b>	<b>HP 8509A</b>		
Wavelength Range	1200 to 1600 nm		
<b>Optical Time Domain Reflectometer</b>	<b>HP 8146A</b>		
Wavelengths Dynamic Range Attenuation Deadzone	1310, 1550, 1310/1550 nm up to 30 dB 30 m		
<b>Hand-Held Optical Loss Test Set</b>	<b>HP 8140A</b>		
<b>Power Sensor Modules</b> Wavelength Range Power Range Accuracy (at ref. cond.)	400 to 1700 nm + 10 to - 70 dBm ± 5%		
<b>LED Source Modules</b> Wavelengths Stability (15 min)	850, 1300, 1550 nm ± 0.03 dB		

# LIGHTWAVE TEST EQUIPMENT

## Lightwave Multimeter HP 8153A

- User-exchangeable plug-in modules for tailor-made measurements
- Traceable to NIST and PTB for accurate absolute power measurements
- Installed application software for standard measurements without external controller
- Dump-to-printer and dump to plotter for easy documentation
- Measures absolute power, insertion loss, and return loss
- Solutions for parallel-beam, unpackaged-chip, connectorized, and bare-fiber measurements



### High Flexibility Through Modular Design

The HP 8153A lightwave multimeter mainframe offers 2 slots for plug-in modules. Since modules can be combined in any configuration, the instrument can be used as a 1/2-channel power meter, as a 1/2-channel light source, as a loss test set, or even as a return-loss test set.

### Power Sensor Modules Offer High Accuracy and Sensitivity

Four different power sensor modules, with different sensitivities from  $-70$  dBm down to  $-110$  dBm, cover the 450 nm to 1700 nm wavelength range. Each is individually calibrated over its entire wavelength range and is traceable to NIST and PTB for precise optical power measurements. Their excellent linearity and the high stability of the source modules provide the basis for precise determination of optical insertion loss for both single-mode and multimode components.

### Stabilized Laser- and LED-Source Modules

The source modules offer very good short-term and long-term stability. The high output power can be internally attenuated by up to 6 dB for accurate adjustment to meet the measurement requirements. The HP 81554SM laser-source module incorporates 2 lasers for easy component loss testing at both 1310 nm and 1550 nm. All sources output CW or pulse-modulated light (internal modulation at 270 Hz, 1 kHz, or 2 kHz).

### Return-Loss Measurements with Unsurpassed Accuracy

By calibrating directly at the connector under test using the HP 81000BR reference reflector, an exceptional accuracy is achieved: 0.4 dB for return-loss measurements over a dynamic range of 50 dB ( $\pm 0.65$  dB between 50 dB and 60 dB). The reference reflector is a gold-plated connector capable of providing a 96% reflection

with just  $\leq 2\%$  uncertainty. Unwanted reflections in front of the DUT can also be calibrated and compensated for. Both steps require just the push of a button. Combine a laser-source module with the return-loss module in the HP 8153A lightwave multimeter mainframe to configure a return-loss test set.

### Built-In Software for Advanced Applications

Without the need for an external controller, long-term power, insertion loss, or return-loss monitoring up to 100 hours can be performed. For easy documentation, the measured curves can be dumped to the HP ThinkJet or to any HPGL plotter. Automatic loss measurements can be made simultaneously at 2 wavelengths. Procedures to maximize the amount of coupled light are supported as well.

### Optical Heads Feature Large-Area Detectors

The HP 81520A and HP 81521B optical heads and their various accessories offer elegant solutions for every sophisticated measurement. They can be used for high-precision power measurements in both parallel-beam and connectorized applications. Together with the HP 81220FL attenuating lens adapter, they can easily be used to perform calibrated absolute power measurements on unpackaged laser chips or LED chips. The HP 81000BA bare-fiber adapter facilitates interfacing to a fiber pigtail with a typical repeatability of less than 0.02 dB. For A/B relative power measurements or power monitoring during a bit error rate test, the HP 81000XS optical power splitters offer both low insertion loss and low polarization sensitivity. For more detailed information about accessories, please see the lightwave catalog.

Sensor Module Specifications

	HP 81530A	HP 81536A	HP 81531A	HP 81532A	HP 81533A + 81520A	HP 81533A + 81521B
Sensor Element	Si	InGaAs			Si	Ge
Wavelength Range	450 to 1020 nm	800 to 1700 nm			450 to 1020 nm	900 to 1700 nm
Power Range	+3 to $-110$ dBm	+3 to $-70$ dBm	+3 to $-90$ dBm	+3 to $-110$ dBm	+10 to $-100$ dBm	+3 to $-80$ dBm
Display Resolution (dB)	0.001 dBm, 0.001 dB					
Display Resolution (W)	0.01 pW	100 pW	1 pW	0.01 pW	0.1 pW	10 pW
Applicable Fiber Type	9/125 to 100/140 $\mu$ m, (NA < 0.3)				parallel beam, 9/125 to 100/140 $\mu$ m (NA < 0.3)	
Accuracy (at ref. cond.)	$\pm 2.5\%$ (600 to 1020 nm)	$\pm 2.5\%$ (1000 to 1650 nm)			$\pm 2.2\%$ (600 to 1020 nm)	$\pm 2.2\%$ (1000 to 1650 nm)
Total Uncertainty	$\pm 5\% \pm 0.5$ pW (600 to 1020 nm)	$\pm 5\% \pm 50$ pW (1000 to 1650 nm)	$\pm 5\% \pm 1.5$ pW (1000 to 1650 nm)	$\pm 5\% \pm 0.5$ pW (1000 to 1650 nm)	$\pm 4\% \pm 0.5$ pW (600 to 1020 nm)	$\pm 4\% \pm 50$ pW (1000 to 1650 nm)
Linearity 18° to 28° C, const. temp. 0° to 55° C, const. temp.	$\pm 0.015$ dB $\pm 0.3$ pW (0 to $-90$ dBm) $\pm 0.05$ dB $\pm 0.5$ pW (0 to $-90$ dBm)	$\pm 0.015$ dB $\pm 30$ pW (0 to $-50$ dBm)	$\pm 0.015$ dB $\pm 1$ pW $\pm 0.05$ dB $\pm 1.5$ pW (0 to $-70$ dBm)	$\pm 0.015$ dB $\pm 0.3$ pW $\pm 0.05$ dB $\pm 0.5$ pW (0 to $-90$ dBm)	$\pm 0.15$ dB $\pm 0.5$ pW (+10 to $-80$ dBm)	$\pm 0.15$ dB $\pm 0.5$ pW (+3 to $-60$ dBm)

Source Module Specifications

	81551MM	81552SM	81553SM	81554SM	81541MM	81542MM	81542MM Opt 001
Diode Type	Laser	Laser	Laser	Laser	LED	LED	LED
Central Wavelength (nm)	850 $\pm 10$	1310 $\pm 20$	1550 $\pm 20$	1310/1550 $\pm 20$	850 $\mu$ m $\pm 30$ $\mu$ m	1300 $\mu$ m $\pm 40$ $\mu$ m	1300 $\mu$ m $\pm 40$ $\mu$ m
Fiber Type	50/125 $\mu$ m	9/125 $\mu$ m	9/125 $\mu$ m	9/125 $\mu$ m	50/125 $\mu$ m	50/125 $\mu$ m	62.5/125 $\mu$ m
Spectr. Bandwidth	< 1.5 nm	< 2.5 nm	< 4 nm	< 2.5/4 $\mu$ m	< 90 $\mu$ m	< 90 $\mu$ m	< 90 $\mu$ m
Output Power (dBm)	> $-2$ dBm	> 0 dBm	> 0 dBm	> $-1$ dBm	> $-17$ dBm	> $-20$ dBm	> $-20$ dBm
CW Stability (15 min, T-const.)	$\pm 0.01$ dB	$\pm 0.003$ dB	$\pm 0.003$ dB	$\pm 0.005$ dB	$\pm 0.003$ dB	$\pm 0.002$ dB	$\pm 0.002$ dB

# LIGHTWAVE TEST EQUIPMENT

## Lightwave Multimeter/Light Sources

HP 8153A, 8154B, 8155A

379

### Ordering Information

<b>HP 8153A</b> Lightwave Multimeter Mainframe	<b>Price</b>	\$2,800
<b>Power Sensor Modules<sup>1</sup></b>		
<b>HP 81530A</b> Si, +3 to -110 dBm, 450 to 1020 nm		\$2,850
<b>HP 81531A</b> InGaAs, +3 to -90 dBm, 800 to 1700 nm		\$2,950
<b>HP 81532A</b> InGaAs, +3 to -110 dBm, 800 to 1700 nm		\$4,600
<b>HP 81536A</b> InGaAs, +3 to -70 dBm, 800 to 1700 nm		\$2,400
<b>Optical heads<sup>2</sup></b>		
<b>HP 81533A</b> Optical Head Interface Module <sup>3</sup>		\$1,050
<b>HP 81520A</b> Optical Head, Si, +10 to -100 dBm, 450 to 1020 nm		\$2,300
<b>HP 81521B</b> Optical Head, Ge, +3 to -80 dBm, 900 to 1700 nm		\$2,650
<b>Laser Source Modules<sup>1</sup></b>		
<b>HP 81551MM</b> 850 nm, Multimode		\$5,950
<b>HP 81552SM</b> 1310 nm, Single-Mode		\$5,950
<b>HP 81553SM</b> 1550 nm, Single-Mode		\$9,200
<b>HP 81554SM</b> 1310/1550 nm, Single-Mode		\$11,700
<b>LED Source Modules<sup>1</sup></b>		
<b>HP 81541MM</b> 850 $\mu$ m, 50 $\mu$ m Multimode Fiber Output		\$3,250
<b>HP 81542MM</b> 1300 $\mu$ m, 50 $\mu$ m Multimode Fiber Output		\$4,550
<b>HP 81542MM Opt 001</b> 62.5 $\mu$ m fiber instead of 50 $\mu$ m fiber output		\$320
<b>Return Loss Module<sup>4</sup> and Accessories</b>		
<b>HP 81534A</b> Return Loss Module		\$5,650
<b>HP 81102BC</b> Patch-cord HRL, bare fiber		\$420
<b>HP81109AC</b> Patch-cord HRL, Diamond HMS-10/HP		\$700
<b>HP 81000UM</b> Universal Through Adapter		\$95
<b>HP 81000BR</b> Reference Reflector		\$230

<sup>1</sup>One connector interface (HP 81000xl) required per module.  
<sup>2</sup>For required lenses and adapters, see lightwave catalog.  
<sup>3</sup>Required to connect the optical head to the mainframe.  
<sup>4</sup>Two connector interfaces (HP 81000xl) required per module.

### Light Sources

- High stability
- User-exchangeable connector interfaces
- External modulation up to 850 MHz (HP 8155A)

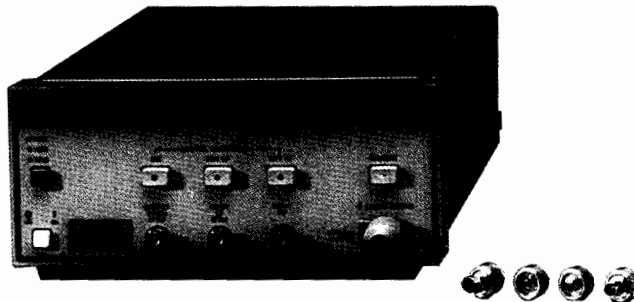

HP 8155A, Option 002



### HP 8154B, 8155A Light Sources

The HP 8154B high-performance LED source is the ideal stimulus for every precise measurement on multimode fibers and components. It offers internal modulation at 270 Hz and can be externally modulated up to 1 MHz.

The HP 8155A is a highly stable laser source with external digital modulation capabilities up to 850 MHz for performance tests on fast telecommunication links.

### HP 8154B LED Source Specifications

	Option 001	Option 002	Option 003
<b>Wavelength</b>	850 $\pm$ 30 nm	1300 $\pm$ 40 nm	1550 $\pm$ 40 nm
<b>Fiber Type</b>	50/125 $\mu$ m	50/125 $\mu$ m	50/125 $\mu$ m
<b>Output Power</b>	> -17 dBm	> -20 dBm	> -23 dBm
<b>Stability (12 h)</b>	$\pm$ 0.03 dB	$\pm$ 0.02 dB	$\pm$ 0.02 dB

### HP 8155A Laser Source Specifications

	Option 002	Option 003
<b>Wavelength</b>	1300 $\pm$ 30 nm	1550 $\pm$ 40 nm
<b>Fiber Type</b>	9/125 $\mu$ m	9/125 $\mu$ m
<b>Output Power</b>	> -4 dBm	> -4 dBm
<b>Stability (12 h)</b>	$\pm$ 0.03 dB	$\pm$ 0.03 dB

### Ordering Information

<b>HP 8154B</b> LED-Source Mainframe*	<b>Price</b>	\$2,950
<b>Opt 001</b> 850 nm Central Wavelength		+ \$1,500
<b>Opt 002</b> 1300 nm Central Wavelength		+ \$3,450
<b>Opt 003</b> 1550 nm Central Wavelength		+ \$4,850
<b>Opt W30</b> Extended Repair Service (see page 671)		+ \$50
<b>Opt W32</b> Calibration service (see page 671)		+ \$115
<b>HP 8155A</b> Laser-Source Mainframe*		\$3,450
<b>Opt 002</b> 1300 nm Central Wavelength		+ \$9,650
<b>Opt 003</b> 1550 nm Central Wavelength		+ \$11,800
<b>Opt W30</b> Extended Repair Service (see page 671)		+ \$65
<b>Options for Both Instruments</b>		
<b>Opt 907</b> Front Handle Kit		+ \$50
<b>Opt 908</b> Rack Flange Kit		+ \$50
<b>Opt 914</b> Extra Operating and Service Manual		+ \$110
<b>Opt 916</b> Add. Operating and Programming Manual		+ \$30

\*One connector interface (HP 81000xl) per mainframe required.

# LIGHTWAVE TEST EQUIPMENT

## Optical Attenuators

### HP 8157A, 8158B

- High resolution (0.01 dB)
- Short settling time (typical 80 ms)
- For multimode and single-mode fibers (8158B)
- > 45 dB return loss (8157A)

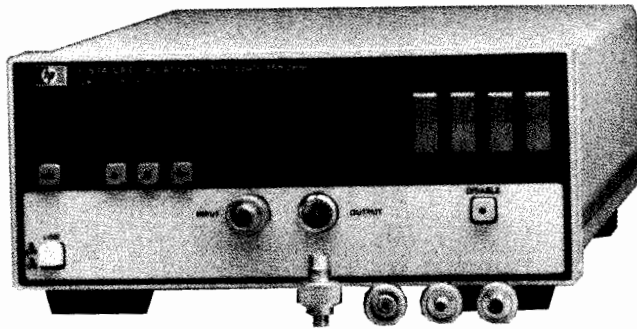

### HP 8157A Attenuator

The HP 8158B is a programmable optical attenuator for single-mode and multimode optical fibers with a numerical aperture up to 0.3. Options are available for the short- and the long-wavelength range.

The HP 8157A is a high-performance single-mode attenuator for the 1200 to 1650 nm wavelength window. Its excellent linearity, very high return loss, and polarization-insensitivity make it the ideal attenuator for bit error rate measurements on optical systems for high data rates.

### Specifications

	HP 8158A Option 001	HP 8158B Option 002	HP 8157A
<b>Wavelength Range</b>	600 to 1200 nm	1200 to 1650 nm	1200 to 1650 nm
<b>Fiber Type</b>	all with NA <0.3	all with NA <0.3	single-mode
<b>Attenuation Range</b>	60 dB	60 dB	60 dB
<b>Insertion Loss (typical)*</b>	1 dB	2 dB	2 dB
<b>Linearity (typical)</b>	+0.05 dB	+0.05 dB	+0.05 dB
<b>Return Loss*</b>	14 dB	14 dB	45 dB

\* depending on connector type.

**Size:** 89 mm H × 212 mm W × 345 mm D (3.5 in × 8.36 in × 13.6 in)  
**Weight:** Net, 5.3 kg (11.7 lb); shipping, 9.6 kg (21.2 lb)

### Ordering Information

	Price
<b>HP 8158B</b> Optical Attenuator Mainframe	\$2,650
<b>Opt 001</b> 600 to 1200 nm	\$4,300
<b>Opt 002</b> 1200 to 1650 nm	\$4,300
<b>Opt 011</b> HMS-10/HP Connector	\$710
<b>Opt 012</b> FC/PC Connector (multimode only)	\$1,020
<b>Opt 013</b> DIN 47256 Connector	\$1,020
<b>Opt 014</b> ST Connector (multimode only)	\$1,020
<b>HP 8157A</b> Optical Attenuator	\$9,550
<b>HP 81000AI/FI/GI/KI/SI/VI/WI</b> Connector Interface (each)	\$155

### Accessories

#### Optical Isolators

Optical isolators from HP offer very high peak-isolation (> 60 dB) as well as very high return loss (> 60 dB). Polarization dependence is less than 0.2 dB, and insertion loss less than 3 dB. They are available either with pigtailed (standard version) or with connectors (see Options).

#### Optical Power Splitters for HP 81520A/81521B

The optical power splitters are mode- and polarization-insensitive, and offer a split ratio of approximately 10:1. The HP 81000AS/BS accept single-mode and multi-mode fibers with a maximum numerical aperture of NA = 0.3 and have factory-installed connector options. The HP 81101BS accepts single-mode fibers only and offers high return loss for physical-contact connectors. Typical values are 36 dB for Diamond HMS-10/HP, 33 dB for DIN 47256, and 30 dB for PC.

#### High-Performance Bare-Fiber Adapter for 81520A/81521B Optical Heads

The HP 81000BA for fibers with 125- $\mu$ m cladding diameter and the HP 81000CA for fibers with 140  $\mu$ m cladding diameter are capable of interfacing fiber pigtailed to the 81520A/81521B with 0.02 dB repeatability. Its sophisticated design makes it very easy to use and ensures not only high accuracy but also high throughput in serial testing.

#### Attenuating Lens Adapter for Direct Chip Measurements

With the HP 81220FL mounted on an HP 81521B optical head, the output power of LED or laser chips up to 20 mW can be measured precisely, before the pigtail is attached. Anti-reflection coating on all optical surfaces guarantees minimum back-reflections. The maximum acceptable numerical aperture is NA=0.5 in the wavelength range from 1200 nm to 1650 nm.

#### Connector Interfaces for Both Easy Cleaning and Easy Adaptation

User-exchangeable connector interfaces permit easy cleaning of the instrument's front end connector, and also allow the use of different connector types with the same instrument. They are available for Diamond HMS-10, FC/PC, D4, SMA, SC, DIN, and Biconic.

#### A Variety of Other Accessories Help Solve Your Measurement Problems

Patch cords and adapters enable users to interface virtually every connector type to the instruments. Filters and filter holders extend the measurement range to higher power levels. For more detailed information about accessories, please see the lightwave catalog.

### Ordering Information\*

	Price
<b>Optical Isolators</b>	
<b>HP 81210LI</b> 1310 nm $\pm$ 20 nm Wavelength Range	\$4,500
<b>HP 81310LI</b> 1550 nm $\pm$ 20 nm Wavelength Range	\$4,500
<b>Opt 001</b> Input: Bare Fiber, Output: Diamond HMS-10/HP	\$440
<b>Opt 010</b> Input: Diamond HMS-10/HP, Output: Bare Fiber	\$440
<b>Opt 011</b> Input and Output: Diamond HMS-10/HP	\$890
<b>Opt 002</b> Input: Bare Fiber; Output: PC	\$440
<b>Opt 022</b> Input and Output: PC	\$890

### Connector Interfaces

<b>HP 81000AI</b> Diamond HMS-10/HP	\$155
<b>HP 81000FI</b> FC/PC	\$155
<b>HP 81000GI</b> D4	\$155
<b>HP 81000JI</b> SMA (lensed interface only)	\$155
<b>HP 81000UI</b> SC	\$155
<b>HP 81000SI</b> DIN 47256	\$155
<b>HP 81000VI</b> ST	\$155
<b>HP 81000WI</b> Biconic	\$155

\*For more information please see the lightwave catalog.

# LIGHTWAVE TEST EQUIPMENT

## Optical Time Domain Reflectometer – Optical Loss Test Set/Power Meter

HP 8146A, 8140A

381

- High-resolution and long-range capability in one module
- Automatic link characterization in less than 7 seconds
- Optional built-in printer and floppy disk drive



HP 8146A

### HP 8146A Optical Time Domain Reflectometer

The HP 8146A is a high-performance optical time domain reflectometer for installation, field maintenance, and bench applications. Plug-in modules are available for all common wavelengths and single-mode fibers.

Each module can be used as a high-resolution or long-range module (switch-selectable). With 30 dB dynamic range and 3 m event deadzone in one module (HP 81462SM), the complete link can be tested. In less than 7 seconds the HP 8146A will automatically characterize the link with up to 100 reflective and non-reflective events. The minimum detectable splice loss is 0.05 dB.

For documentation purposes, the HP 8146A features an optional built-in printer and 3.5-inch floppy disk drive.

#### Specifications

Module	HP 81462SH	HP 81463SH	HP 81465SH
Central Wavelength	1310 ± 20 nm	1550 ± 20 nm	1310/1550 ± 20 nm
Dynamic Range	30 dB	27 dB	30/27 dB
Event Deadzone	3 m	3 m	3 m
Attenuation Deadzone	30 m	40 m	30/40 m

Span: 1 to 200 km

Read-out resolution: 0.1 m, 0.0001 mi, 0.1 ft

Distance accuracy: ±0.5 m ± sample spacing ± meas. distance × 10<sup>-4</sup>

Compare mode: Two waveforms can be compared on screen

Laser safety class: 21 CFR class 1, Cenelec 3A

Dimensions: 190 mm H × 340 mm W × 465 mm D (7.5 in × 13.4 in × 18.3 in)

Weight: Net, 15 kg (33 lb), including one module

#### Ordering Information

HP 8146A Optical Time Domain Reflectometer	Price
Opt 001 Additional DC Input	\$770
Opt 003 3.5-inch Floppy Disk Drive	\$250
Opt 002 Thermal Printer	\$1,100
HP 81462SH 1310 nm, Single-Mode Module	\$14,250
HP 81463SH 1550 nm, Single-Mode Module	\$17,500
HP 81465SH 1310/1550 nm, Single-Mode Module	\$23,750
HP 81460SA MS-DOS PC-Based OTDR Emulation Software	\$1,050
HP 81000AI/FI/GI/KI/SI/VI/WI Connector Interface (each)	\$155

- Modular design
- Sources and sensors for all common wavelength ranges
- Standalone LED source, power meter and loss test set



HP 8140A with 81401A sensor module and 81412A LED source module

### HP 8140A Optical Loss Test Set/Power Meter

The HP 8140A is a compact, lightweight instrument for hand-held operation in the installation and maintenance of optical links and component characterization. It may be configured as a power meter, a stand-alone source, or a loss test set.

As a power meter, it is an ideal tool for the measurement of the output power of transmitter modules and of power levels at the fiber end, and for the check for "dark" fibers.

The HP 8140A, in a standalone source or loss test set configuration, covers all wavelengths commonly used in datacom LANs and telecommunications networks. Its main applications include the insertion loss of optical passive components and the total link loss to check for power budgets.

#### Specifications

Power Meter/Sensor	HP 81400A	HP 81401A
Wavelength Range:	400 to 1100 nm	750 to 1700 nm
Fiber Type:	up to 100/140 μm	up to 100/140 μm
Measurement Range:	+10 to -70 dBm 1 pW to 10 mW	+3 to -70 dBm 1 pW to 2 mW
Noise Floor:	<3 pW pp	<3 pW pp
Measurement Uncertainty:	±5%	±5%
Calibrated Wavelength:	660/780/820/850 nm	820/850/1300/1550 nm
Sensor Element:	Si	InGaAs

Loss Test Set/Source	HP 81411A	HP 81412A	HP 81413A
Wavelength (μm):	850 ± 10	1300 ± 20	1550 ± 20
Spectral Bandwidth (μm) (FWHM):	<50 nm	<140 nm	<200 nm
Output Power (Into 50/125 μm):*	> -17 dBm	> -20 dBm	> -25 dBm
Dynamic Range (Into 50/125 μm):*	>53 dB	>50 dB	>45 dB
Stability (15 min, cons. temp, 0° to 40° C):**	±0.03 dB	±0.03 dB	±0.03 dB

\* Typically 20 dB less into single-mode fiber.

\*\* After 5-min. warmup.

Size: 185 mm H × 81 mm W × 41 mm D (7.2 in × 3.2 in × 1.6 in)

Weight: Net, 600 g (incl. source, sensor, 4 batteries and 2 connector interfaces)

#### Ordering Information

HP 8140A Optical Loss Test Set (mainframe)	Price
HP 81400A Optical Sensor 400 to 1100 nm	\$580
HP 81401A Optical Sensor 750 to 1700 nm	\$370
HP 81411A LED Module 850 nm	\$770
HP 81412A LED Module 1300 nm	\$790
HP 81413A LED Module 1550 nm	\$1,350
HP 81000AI/FI/GI/JI/KI/SI/VI/WI Connector Interface	\$1,900
HP 8140CC Carrying Case	\$155 each
	\$110

# LIGHTWAVE TEST EQUIPMENT

## Lightwave Component Analyzer HP 8702B, 8703A

- 300 kHz to 20 GHz modulation frequency
- Calibrated measurements of high-speed optical, electro-optical, and electrical components

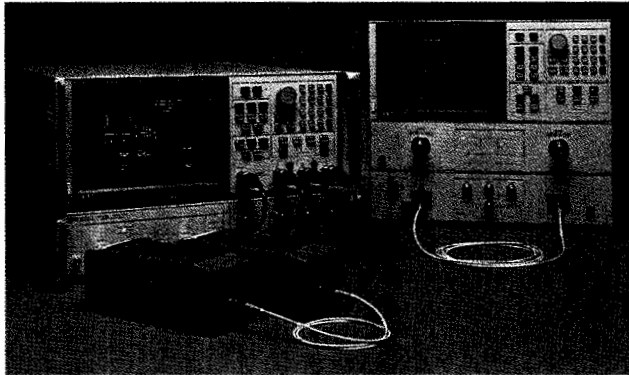

HP 8702B & 8703A

### Lightwave Component Analyzer

As the transmission rate or bandwidth of fiber optic systems is pushed upward, high frequency design considerations become key. Both the HP 8702B and 8703A measure each of the elements that transmit these wide bandwidths. They make calibrated measurements of lasers or LED transmitters, photodiode receivers, optical fibers, and the electrical components they work with. The lightwave component analyzers operate with a swept modulation frequency to precisely characterize how these components operate on the high-speed, information-bearing signal. Information on how each component responds independent of the others provides insight into how systems can be predicted and improved.

Both the HP 8702B and 8703A operate at a fixed wavelength and sweep the frequency of the intensity modulation signal over the bandwidth you select. The HP 8702B has transducers (lightwave source and receivers), which allow it to operate at 850, 1300, and 1550 nm. The HP 8703A can operate at 1300 and 1550 nm. These sources and receivers come with calibration data to allow calibrated measurements of the electro-optical components.

### Measure Optical Components

Measurements can be made of such components as connectors, splitters, couplers, and lenses, as well as fiber itself. This yields modulation bandwidth, insertion loss, length, and optical return loss. In the distance-time domain, reflections can be located without the dead zone typical of OTDR type measurements. Transmission measurements can also be displayed in the distance-time domain to view the impulse or step response of the component. Delay and dispersion are easily viewed in this manner.

### Measure Electro-Optical Components

Often the limiting elements in a fiber optic system are the electro-optical components (for example, lasers, APD's, PIN photodiodes, and modulators), which convert the electrical information to optical or vice versa. The conversion efficiency or responsivity of these devices is a function of many variables. The characterized lightwave source and receiver in the lightwave component analyzer allows each of these devices to be uniquely tested. Data can be displayed in the frequency domain as the modulation frequency response or in the time domain as the step response.

### Measure Electrical Components

When used to measure linear electrical components such as amplifiers, filters, and transmission lines, the lightwave component analyzers have the full measurement capability of a microwave network analyzer. Typical measurements are bandwidth, insertion loss/gain, phase, impedance, match, and group delay.

### Measure Both Transmission and Reflection Characteristics

Complete characterization of component behavior depends on knowing how the signal is transmitted through it and how it is reflected back. For optical reflections, the lightwave component analyzers use a lightwave directional coupler to make the reflection measurements. Data can be presented in the modulation frequency domain or in the distance-time domain to locate and measure the

- 850, 1300, or 1550 nm operation
- Reflection measurements with < 1mm resolution up to 50 dB optical dynamic range

source of the reflection. Because of the wide measurement bandwidth, single reflections can be located with < 1mm of resolution and up to 50 dB optical dynamic range and 100 dB electrical dynamic range. For electrical reflection measurements, the analyzer uses a test set to perform the measurement. Results, such as impedance, can then be displayed.

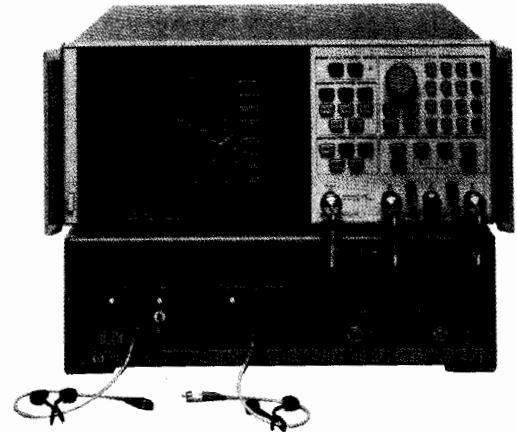

HP 8702B

### HP 8702B Lightwave Component Analyzer

Standard configuration requires an HP 8702B, an RF interface kit, a lightwave source, lightwave receiver, and fiber cable. All HP 8340xB sources have built-in optical isolators for reduced reflection sensitivity and improved optical source match compared to the A models. A lightwave directional coupler is required for reflection measurements.

### HP 8702B Accessories Lightwave Source Modules

All with directly modulated Fabry-Perot lasers.  
 HP 83400A/B, 300 kHz to 3 GHz, 1300 nm, 9/125  $\mu$ m fiber  
 HP 83401A, 300 kHz to 3 GHz, 1300 nm, 50/125  $\mu$ m fiber  
 HP 83402A/B, 300 kHz to 6 GHz, 1300 nm, 9/125  $\mu$ m fiber  
 HP 83403A/B, 300 kHz to 3 GHz, 1550 nm, 9/125  $\mu$ m fiber  
 HP 83404A/B', 300 kHz to 3 GHz, 850 nm, 50/125  $\mu$ m fiber

### Lightwave Receiver Modules

All with PIN photodiodes.  
 HP 83410C, 300 kHz to 3 GHz, 1300/1550 nm, 62.5/125  $\mu$ m fiber  
 HP 83411C, 300 kHz to 6 GHz, 1300/1550 nm, 9/125  $\mu$ m fiber  
 HP 83411D, 300 kHz to 6 GHz, 1300/1550 nm, 9/125  $\mu$ m fiber  
 HP 83412B, 300 kHz to 3 GHz, 850 nm, 62.5/125  $\mu$ m fiber

### Lightwave Directional Couplers

A three-port, directional coupler for making reflection measurements and monitoring transmission signals. The couplers have a nominal 3 dB coupling factor.

HP 11890A 9/125  $\mu$ m fiber  
 HP 11891A 50/125  $\mu$ m fiber

### RF Interface Kit

HP 11889A

This kit contains the RF accessories required to operate the HP 8702 when a test set is not used. Contains a power splitter, a 20 dB pad, SMA accessories and adapters for the analyzer.

### Probe Power Supply

HP 11899A

This power supply provides regulated dc power to a number of Hewlett-Packard products. Compatible products include: HP 1124A, HP 85024A, HP 41800A probes as well as the HP 8340x and HP 8341x lightwave sources and receivers.

\*The following sticker applies to the HP 83404A:





# LIGHTWAVE TEST EQUIPMENT

## Lightwave Component Analyzer (cont'd)

HP 8702B, 8703A

383

### S-Parameter Test Set

HP 85046A 300 kHz to 3 GHz  
HP 85047A 300 kHz to 6 GHz

These test sets provide the capability to measure impedance and transmission characteristics of two-port electrical devices in either forward or reverse direction with a single connection. The HP 85047A is required for 6 GHz operation.

### Calibration Kit

HP 85033C 3.5 mm

Contains precision 3.5 mm standards used to calibrate the HP 8702 for electrical measurements of components with 3.5 mm or SMA connectors.

### Polarization Controller

HP 11894A

The polarization of light can be easily and precisely adjusted using this general-purpose instrument. It offers a full range of polarization control via three polarization paddles.

### Workspace Cabinet

HP 11895A

This cabinet fits beneath an HP 8702 system making the system easier to use and reducing required bench space.

### Ordering Information

**HP 8702B** Lightwave Component Analyzer

**Opt 006** 6 GHz Receiver Operation + \$3,000  
**Opt 011** Delete Time Domain - \$5,300  
**Opt 802** Add Disk Drive & Cable + \$1,545

<b>HP 83400A</b> Lightwave Source	\$13,000
<b>HP 83400B</b> Lightwave Source	\$17,500
<b>HP 83401A</b> Lightwave Source	\$13,000
<b>HP 83402A</b> Lightwave Source	\$15,000
<b>HP 83402B</b> Lightwave Source	\$19,500
<b>HP 83403A</b> Lightwave Source	\$13,000
<b>HP 83403B</b> Lightwave Source	\$17,500
<b>HP 83404A</b> Lightwave Source	\$12,700
<b>HP 83404B</b> Lightwave Source	\$17,500
<b>HP 83410C</b> Lightwave Receiver	\$6,150
<b>HP 83411C</b> Lightwave Receiver	\$4,600
<b>HP 83411D</b> Lightwave Receiver	\$12,000
<b>HP 83412B</b> Lightwave Receiver	\$6,000
<b>HP 11890A</b> Lightwave Coupler	\$3,900
<b>HP 11891A</b> Lightwave Coupler	\$3,900
<b>HP 11889A</b> RF Interface Kit	\$1,500
<b>HP 11894A</b> Polarization Controller	\$1,500
<b>Opt 01X</b> Add Connectors	+ \$1,400
<b>HP 11895A</b> Workspace Cabinet	\$450
<b>HP 85046A</b> S-parameter Test Set	\$9,000
<b>HP 85047A</b> S-parameter Test Set	\$10,800

### HP 8703A Lightwave Component Analyzer

- 130 MHz to 20 GHz Modulation Frequency
- 1300 and 1550 nm operation
- FP and DFB lasers

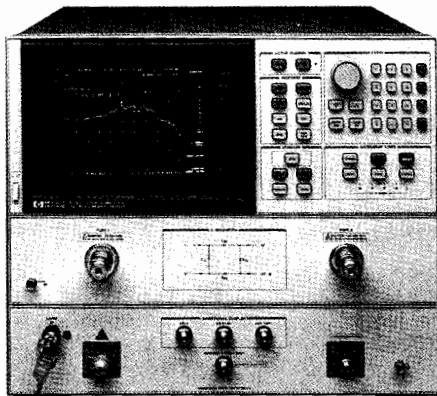

HP 8703A

### HP 8703A Lightwave Component Analyzer

Standard configuration includes an internal 1300 nm Fabry-Perot (FP) laser and one 1300/1550 nm receiver. Optional 1300 or 1550 nm DFB internal laser sources are also available. The external lightwave source input (Option 100) is used with the HP 83424A or 83425A<sup>1</sup> Lightwave CW Sources for additional 1550 or 1300 nm DFB wavelength flexibility.

### 20 GHz Lightwave Test Set, Source, Modulator, and Receiver

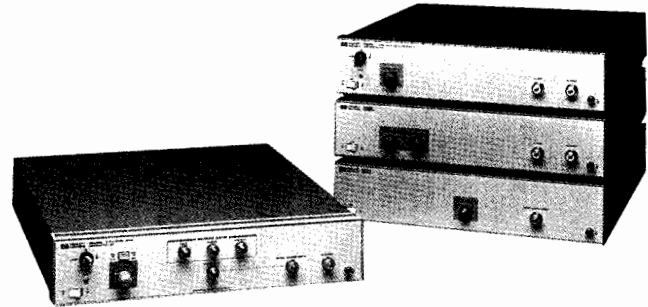

HP 83420A, 83421A, 83422A, 83423A

### HP 83420A Lightwave Test Set

Includes a 1300 nm FP laser, modulator, receiver, and directional coupler. Basic lightwave component analyzer tests from 130 MHz to 20 GHz can be made when the HP 83420A is combined with an external controller and an HP 8510, HP 8720/H80, HP 8719/H80, or HP 8757 microwave analyzer system.

### 20 GHz Lightwave Sources and Receivers

HP 83421A Lightwave Source  
HP 83422A Lightwave Modulator  
HP 83423A Lightwave Receiver

For standalone applications, these instruments have modulation frequency ranges of 130 MHz to 20 GHz.

### Ordering Information

<b>HP 8703A</b> Lightwave Component Analyzer	\$108,500
<b>Opt 01X</b> Select Optical Connector	\$0
<b>Opt 100</b> External Lightwave Source Input	+ \$2,800
<b>Opt 210</b> 1550 nm DFB Laser	+ \$15,000
<b>Opt 220</b> 1300 nm DFB Laser	+ \$10,500
<b>Opt 300</b> Additional Lightwave Receiver	+ \$10,900
<b>Opt 802</b> Add Disk Drive & Cable	+ \$1,545
<b>Opt 830</b> Add HP 3.5 mm Cal Kit & Cable	+ \$5,100
<b>HP 83424A</b> Lightwave CW Source-1550 nm	\$27,500
<b>Opt 100</b> External Lightwave Source Input	+ \$2,800
<b>HP 83425A</b> Lightwave CW Source-1300 nm	\$24,100
<b>Opt 100</b> External Lightwave Source Input	+ \$2,800
<b>HP 83420A</b> Lightwave Test Set	\$47,500
<b>Opt 01X</b> Connector Option	\$0
<b>Opt 100</b> External Lightwave Source Input	+ \$2,800
<b>Opt 210</b> 1550 nm DFB laser	+ \$15,000
<b>Opt 220</b> 1300 nm DFB laser	+ \$10,500
<b>HP 83421A</b> Lightwave Source	\$29,500
<b>Opt 01X</b> Connector Option	\$0
<b>Opt 100</b> External Lightwave Source Input	+ \$2,800
<b>Opt 210</b> 1550 nm DFB Laser	+ \$15,000
<b>Opt 220</b> 1300 nm DFB Laser	+ \$10,500
<b>HP 83422A</b> Lightwave Modulator	\$20,000
<b>Opt 01X</b> Connector Option	\$0
<b>HP 83423A</b> Lightwave Receiver	\$13,500
<b>Opt 01X</b> Connector Option	\$0
<b>Opt 300</b> Additional Lightwave Receiver	+ \$10,900

<sup>1</sup>The following sticker applies to the HP 83425A:



# LIGHTWAVE TEST EQUIPMENT

## Precision Reflectometer and Polarization Analyzer

HP 8504A, 8509A/B

- Reflection measurement range from 0 to 75 dB
- 25-micron 2-event distance resolution (in air)
- 1300 and 1550 nm wavelengths

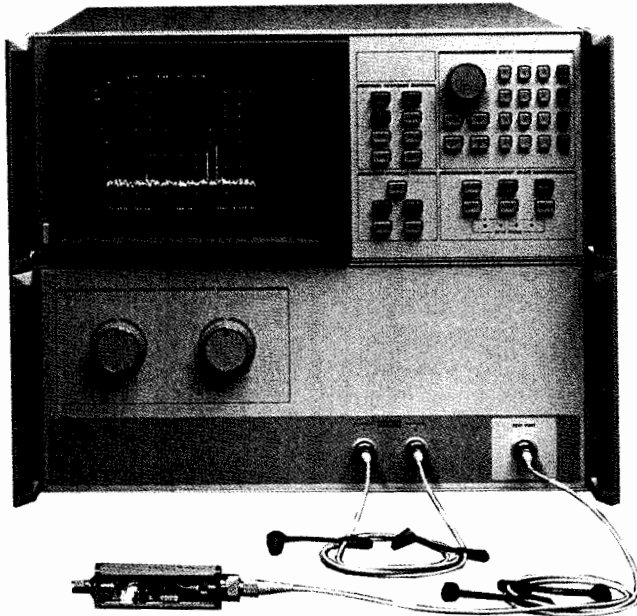

HP 8504A

### HP 8504A Precision Reflectometer

The HP 8504A precision reflectometer provides state-of-the-art lightwave reflection measurements with very high dynamic range and spatial resolution. This allows engineers and scientists involved in the development and evaluation of lightwave components to precisely locate, identify, and quantify the individual reflections within a device. Calibrated measurements are performed in seconds using a simple user interface and a rapid scan rate.

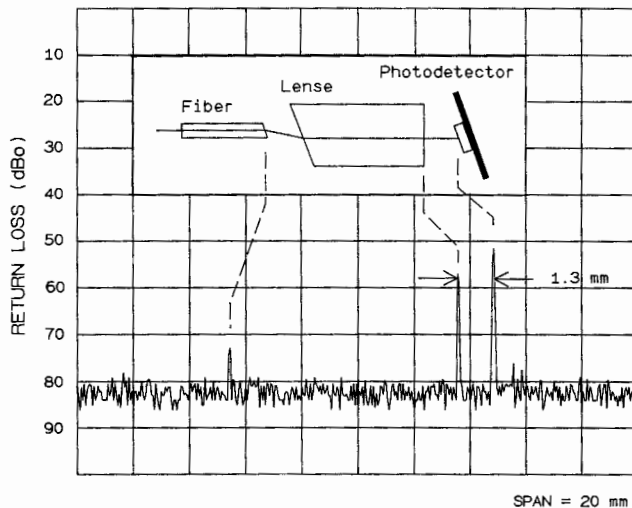

Multiple reflection measurement made on an HP 8504A

The HP 8504A precision reflectometer measures connectorized components in single-mode fiber (9/125  $\mu$ m). The measurement span can be varied from 1 mm to 40 cm (in air). The location of the 40 cm measurement window can be offset by adding the appropriate length of extension cable. Measurements are made using internal 1300 nm and 1550 nm light sources.

### Ordering Information

HP 8504A Precision Reflectometer	Price
Opt 011-015 Connector Options	\$0
Opt 210 Delete 1300 nm Source	-\$5,500
Opt 220 Delete 1550 nm Source	-\$6,500

- Conveniently measures state (Stokes parameters) and degree of polarization
- Displays on Poincare sphere in real time
- Automatically determines polarization-dependent loss or gain of optical components

### Lightwave Polarization Analyzers

The HP 8509A is used to view an optical signal's state, degree of polarization, and its power. The HP 8509B adds internal laser sources and a polarizer to determine the polarization transformation or polarization dependence of an optical component. An HP Vectra 386 PC with Windows 3.0 graphical environment is included to control the measurement and display the results. Special PC hardware interface and measurement software is included.

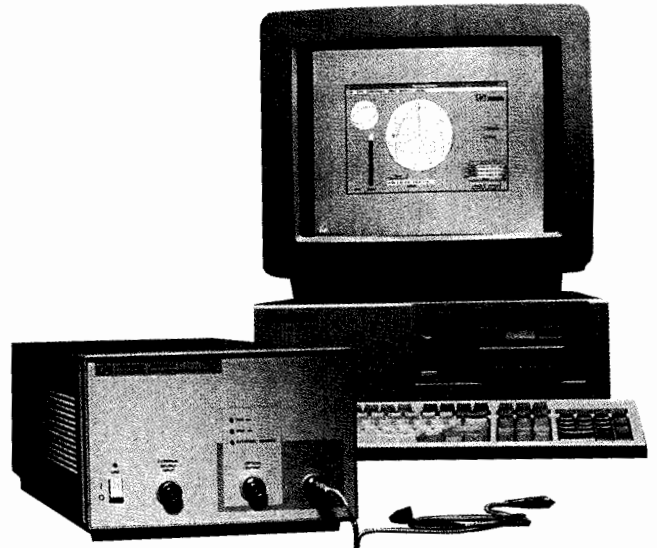

HP 8509 lightwave polarization analyzer

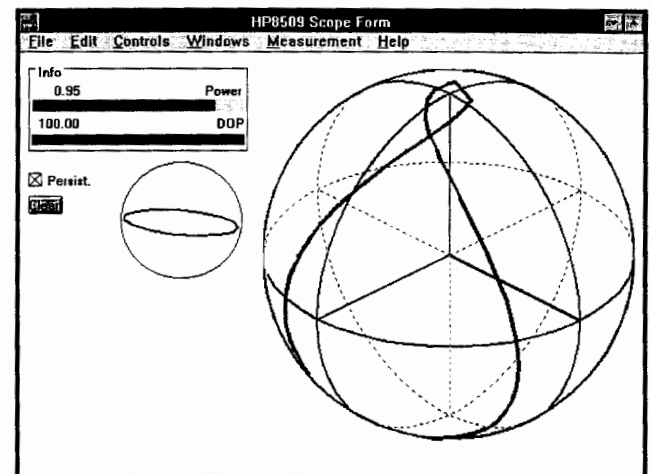

HP 8509 Poincare sphere and polarization ellipse display

### Specification summary

Internal sources:	1300 and 1550 nm
Measurement range:	1200 to 1600 nm
Compatible fiber:	9/125 $\mu$ m
Operation:	Windows 3.0

### Ordering Information

HP 8509A Polarization Analyzer	\$36,000
HP 8509B Polarization Analyzer	\$52,000
Opt 210 Delete 1300 nm source	-\$2,000
Opt 220 Delete 1550 nm source	-\$2,000
For both HP 8509A and 8509B:	
Opt 011-015 Connector options	\$0
Opt 1FF Delete Computer	-\$3,000

# LIGHTWAVE TEST EQUIPMENT

## Lightwave Signal Analyzers for 850, 1300, 1550 nm

HP 71400C, 71401C, 70810B

385

- Calibrated measurement of intensity modulation
- 100 kHz to 22 GHz bandwidth
- Single-mode fiber-optic input

- Reference-receiver capability
- Customer-exchangeable connector adapters
- High-performance electrical spectrum analyzer
- RIN measurements to  $-165$  dB/Hz

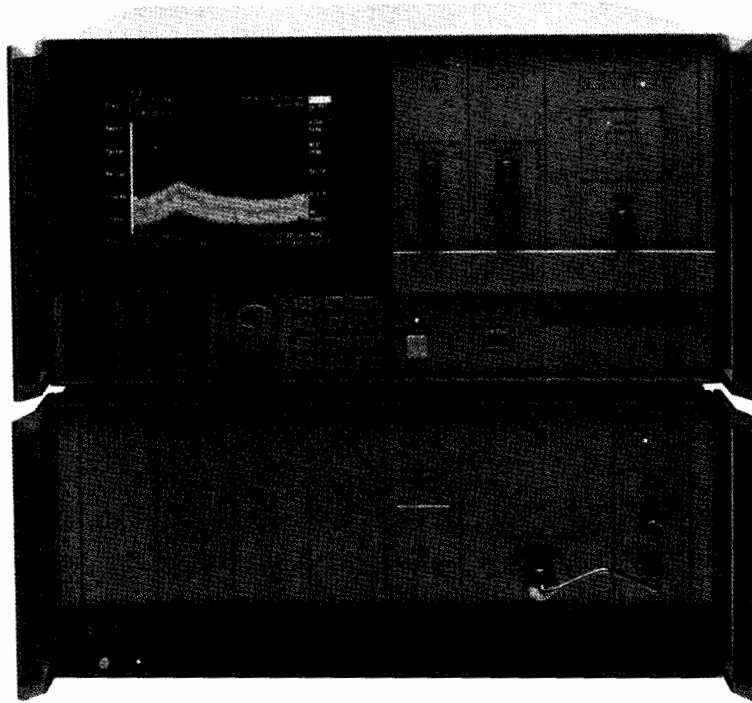

HP 71400C  
with HP 70810B



### Calibrated Measurement of Intensity Modulation to 22 GHz

The HP 71400C combines a high-performance microwave spectrum analyzer with a wideband, highly sensitive optical receiver. This system measures modulated light on single-mode optical fibers simply and accurately from 100 kHz to 22 GHz. Optical modulation, noise, and average power are presented on a fully calibrated display. The system characterizes semiconductor lasers, laser transmitters, optical modulators, and detectors. With the addition of the HP 11980A fiber-optic interferometer, the system measures linewidth. Together the lightwave signal analyzer, interferometer, and a gated source measure chirp and FM characteristics of distributed-feedback (DFB) and other single-line lasers.

In addition to being a lightwave signal analyzer, this system also functions as a microwave spectrum analyzer with all the capability of the HP 71210C. Because the lightwave signal analyzer is part of the HP 70000 modular measurement system, its measurement capabilities can also be expanded easily. For example, you can add a tracking generator module for modulation response measurements to 18 GHz. (See pages 102 to 108 for more information.)

The HP 71400C system measures intensity modulation up to 22 GHz and operates over the wavelengths from 1200 to 1600 nm or, with Option 850, from 750 to 870 nm. It can achieve an optical sensitivity of better than  $-60$  dBm. The analyzer also offers average-power measurement, displayed both as a real-time vertical power bar and as a digital readout. Full calibration of both average power and modulation power makes this system a reference receiver for measuring and characterizing optical detectors and receivers.

For lower-frequency applications, the HP 71401C has an upper frequency limit of 2.9 GHz and the same functions and features as the HP 71400C. Both models provide lightwave optical or electrical units in watts or decibels, and microwave units for electrical spectrum analysis.

### Lightwave Measurement with the HP 70810B Module

The HP 70810B lightwave section is a one-eighth-width lightwave-receiver module for the HP 70000 modular measurement system. The HP 70810B has a built-in average power meter and an attenuator. It has a wavelength range of 1200 to 1600 nm, a detected modulation bandwidth of 100 kHz to 22 GHz, and a built-in RF amplifier of 32 dB that provides an optical sensitivity of  $-60$  dBm in a 10-Hz bandwidth. The module also features both optical- and electrical-input capability.

The HP 70810B may be used in standalone applications as a lightwave receiver housed in an HP 70000 mainframe. In this configuration, the electrical output is the detected intensity modulation in its amplified and uncorrected state.

For high-speed measurements in the 850 nm range, the HP 70810B Option 850 has a wavelength range of 750 to 870 nm and all the capabilities of the standard module. It can be ordered for an existing system or as a standalone module.

If the lightwave module is ordered for an existing HP 70000 system that includes the HP 70908 or 70904 RF (input) section, Option 20 offers extended system calibration and adjustment. In this case, the two modules are mated, tested, and calibrated together at the factory for optimum optical and electrical specification and amplitude flatness.

### Relative Intensity Noise

A downloaded program (DLP) for relative intensity noise (RIN) measurement has been included with the HP 70810B lightwave module. The DLP subtracts thermal noise and shot noise components of a measurement and calculates the RIN of only the laser to  $-165$  dB/Hz.

# LIGHTWAVE TEST EQUIPMENT

Lightwave Signal Analyzer, 1200 to 1600 nm  
HP 83810A, 11980A Accessory

- Portable
- 9 kHz to 22 GHz bandwidths
- Calibrated measurement of optical modulation power
- Optical marker function
- Interferometer for laser chirp measurements
- Exchangeable connector adapters

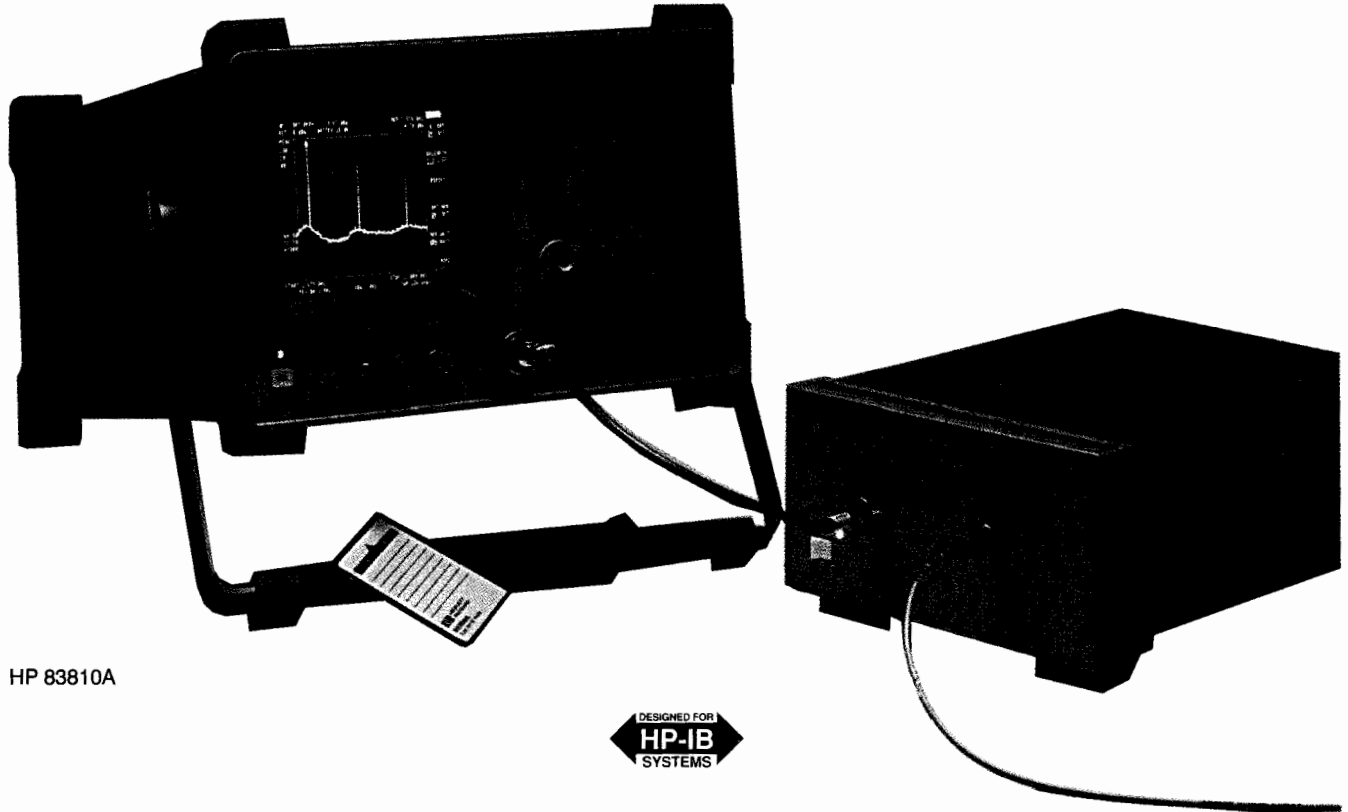

HP 83810A



## HP 83810A Portable Lightwave Signal Analyzer

This low-cost system has a wavelength range of 1200 to 1600 nm and bandwidths of 9 kHz to 22 GHz. It displays optical modulation power as a function of frequency and also measures and displays intensity modulation, distortion, and laser intensity noise. Maximum optical sensitivity is  $-54$  dBm at 100 MHz and  $-39$  dBm at 22 GHz. Frequency response is  $\pm 2.2$  dB at 100 MHz and  $\pm 3.2$  dB at 22 GHz. An optical marker function allows measurements to be expressed in optical or electrical units, logarithmic or linear. Frequency-response corrections and optical power are calculated automatically.

The HP 83810A consists of a fully functional HP 8593A portable microwave spectrum analyzer, the HP 11982A amplified lightwave converter, the HP 11982A Option 001 lightwave frequency-response corrections and menus, an interface cable, and a type-N-to-SMA adapter.

The amplified lightwave converter combines a PIN photodetector with a low-noise preamplifier to improve the sensitivity of the measurement system. Conversion gain is 300 v/w and input optical reflections are 0.05%. The frequency response corrections included allow you to observe and measure changes in noise floor and distortion products when a laser is modulated, thus enabling you to predict the effects of laser noise.

Adding the HP 11980A fiber-optic Mach Zehnder interferometer to the lightwave signal analyzer allows you to make linewidth, chirp, and frequency modulation (FM) measurements of single-line lasers.

## Input Connectors

An important feature of HP lightwave analyzers and accessories is their versatile input-connector system. A variety of optical screw-on connector interface adapters and patch cords for other connector systems are available. See ordering information on page 387.

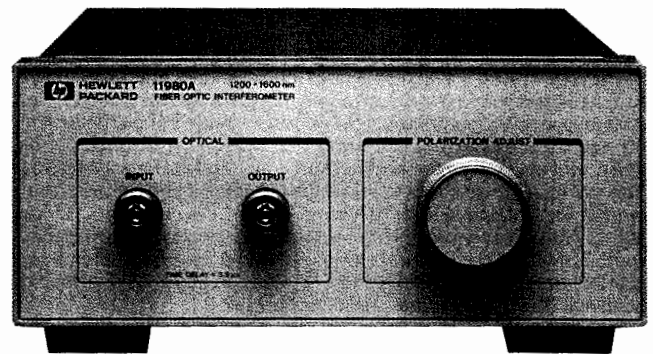

HP 11980A  
Option 005

## HP 11980A Fiber-Optic Interferometer

This accessory, for use with any of the HP lightwave signal analyzers, is a Mach Zehnder interferometer of fixed delay for measuring and characterizing single-linewidth lasers. Using a technique developed by Hewlett-Packard, the HP 11980A and an HP 71400 series or 83810A lightwave signal analyzer measure chirp and FM components on DFB lasers. They also make traditional measurements of laser linewidth. Together, the interferometer, lightwave signal analyzer, and a gateable RF source permit the display of a true power spectrum of single-frequency lasers, including intensity modulation linewidth and components of chirp caused by the intensity modulation.

Option 005 replaces the standard 0.76 km of delay with 5.2 km to measure laser linewidth down to 30 kHz.

# LIGHTWAVE TEST EQUIPMENT

## Lightwave Signal Analyzers and Interferometer

HP 71400C, 71401C, 70810B, 83810A, 11980A

387

### Specifications

#### HP 71400C

(For general analyzer and electrical-mode specifications, refer to data sheets for the HP 71210C.)

**Wavelength range:** 1200 to 1600 nm

**Input return loss** (characteristic): > 27 dB

#### Frequency

**Frequency range:** 100 kHz to 22 GHz

**Span:** 1 Hz to 22 GHz plus 0 Hz

#### Amplitude (at 25° C)

**Maximum input average power:** +30 dBm (optical)

**Modulated power:** +15 dBm (optical)

**Average power accuracy** (at 1300 or 1550 nm): ±0.65 dB (optical), ±0.5 nW, ± connector losses

**Modulated power accuracy (relative to average power) at 100 MHz:** ±1.0 dB (optical)

**Frequency response** (relative to 100 MHz): 100 kHz to 22 GHz, ±1.0 dB (optical)

**Displayed average optical noise level, optical dB** (10 Hz Res BW, 0 dB input attenuation): -51 dBm, 100 kHz to 1 MHz; -57 dBm, 1 to 10 MHz; -62 dBm, 10 to 100 MHz; -66 dBm, 100 MHz to 8 GHz; -64 dBm, 8 to 16 GHz; -60 dBm, 16 to 22 GHz

#### Inputs

**Optical:** Choice of single-mode fiber optic input connectors (see Ordering Guide)

**Electrical:** SMA for optical bypass, 100 Hz to 22 GHz (see HP 71210C data sheet for other system inputs)

#### HP 71401C

Specifications for the HP 71401C are identical to those of the HP 71400C with the following exception:

**Frequency range:** 100 kHz to 2.9 GHz

#### HP 71400C/71401C Option 850

Specifications for these systems are identical to those of the standard systems with the following exceptions.

**Wavelength range:** 750 to 850 nm

**Noise equivalent power:** Exactly 4 dB greater range than standard system

#### HP 83810A

##### Optical

**Wavelength range:** 1200 to 1600 nm

**Input return loss** (characteristic): > 33 dB

**Frequency range:** 9 kHz to 22 GHz

##### Amplitude

**Optical frequency response, absolute, 10 dB attenuation, 20-30 C**

9 kHz to 12.8 GHz	+2.2 dB
12.4 to 19.4 GHz	+3.0 dB
19.1 to 22.0 GHz	+3.2 dB

**Displayed average optical noise level, characteristic, 1 kHz RBW, 30 Hz VBW, 0 dB attenuation**

400 kHz to 6.4 GHz	-54 dBm
6.0 to 12.8 GHz	-48 dBm
12.4 to 19.4 GHz	-44 dBm
19.1 to 22 GHz	-39 dBm

**Harmonic distortion:** > 70 dB below fundamental with modulated power < -30 dBm

**Maximum safe optical input power, average:** 10 mW

**Maximum operating optical input power, peak:** 1.5 mW

**Optical input connectors:** Single-mode fiber connectors such as Diamond HMS-10/HP, FC/PC, ST, Biconic, DIN

#### HP 70810B

##### Optical

**Wavelength range:** 1200 to 1600 nm

**Responsivity:** Determined for each instrument to ±20%; typical value: 1200 V/W

**Input return loss** (characteristic): > 27 dB (optical)

##### Frequency

**Frequency range:** 100 kHz to 22 GHz

##### Amplitude

**Maximum input average power:** +30 dBm (optical)

**Modulated power:** +15 dBm (optical)

**Frequency response, corrected, relative to 100 MHz:** 100 kHz to 2.9 GHz, ±2.0 dB; 2.9 to 22 GHz, ±5.0 dB

**Uncorrected:** Typically < 25 dB roll-off 100 kHz to 22 GHz

**Noise equivalent power** (optical dBm/√Hz): -55, 100 kHz to 10 MHz; -66, 10 to 100 MHz; -70, 100 MHz to 8 GHz; -68, 8 to 16 GHz; -64, 16 to 22 GHz

##### Inputs

**Optical:** Choice of single-mode fiber optic input connectors (see Ordering Guide)

**Electrical:** SMA for optical bypass

#### HP 70810B Option 850

Specifications for this module are identical to those of the standard HP 70810B with the following exceptions:

**Wavelength range:** 750 to 870 nm

**Responsivity, characteristic:** 500 V/W nominal value at 100 MHz

##### Amplitude

**Noise equivalent power** (optical dBm/√Hz): -51, 100 kHz to 10 MHz; -62, 10 to 100 MHz; -66, 100 MHz to 8 GHz; -64, 8 to 16 GHz; -60, 16 to 22 GHz

#### HP 11980A

This accessory is a Mach Zehnder interferometer for use with the HP 71400C, 71401C, and 83810A.

**Wavelength range:** 1250 to 1600 nm

**Optical insertion loss:** < 8 dB (optical) at 1300 and 1550 nm

**Delay time:** Typically 3.5 μsec; Option 005, 25 μsec

##### Inputs

**Optical:** Choice of Diamond®, PC/FC, ST, Biconic, or DIN single-mode fiber connectors (see Ordering Information)

#### Ordering Information

**HP 71400C** Lightwave Signal Analyzer, 100 kHz to 22 GHz **Price** \$102,100

Order must also include one of the connector options, 011 to 015, listed below.

**Opt 850** 750 to 870 μm Wavelength \$0

**HP 71401C** Lightwave Signal Analyzer, 100 kHz to 2.9 GHz \$73,400

**Opt 850** 750 to 870 μm Wavelength \$0

**HP 83810A** Lightwave Signal Analyzer, 9 kHz to 22 GHz \$39,230

**Opt 001** Frequency Response Correction/Menus +\$800

**Opt 004** Precision Frequency Reference +\$2,050

**Opt 301** AM/FM Demod/TV Sync Trigger/Fast Time Domain Sweep +\$2,300

**HP 70810B** Lightwave Section, 100 kHz to 22 GHz \$19,900

Order must also include one of the connector options, 011 to 015, listed below.

**Opt 850** 750 to 870 Wavelength \$0

**Opt 020** System Adjustment and Calibration (use HP 71400A specifications) +2,000

**Opt 098 or 099** System LO Firmware Upgrade \$0

**HP 70810AB** Upgrade Kit \$1,000

**HP 11980A** Fiber-Optic Interferometer \$6,720

Order must also include one of the connector options, 011 to 015, listed below.

**Opt 005** 25 μsec Delay \$3,020

**Connector Options for the HP 71400C, 70810B, and 11980A**

**Opt 011** Diamond HMS-10/HP Connector Interface \$0

**Opt 012** FC/PC Connector Interface \$0

**Opt 013** DIN 47256 Connector Interface \$0

**Opt 014** ST Connector Interface \$0

**Opt 015** Biconic Connector Interface \$0

#### Additional Interface Connectors

**HP 81000AI** Diamond® HMS-10/HP \$155

**HP 81000FI** FC/PC \$155

**HP 81000SI** DIN 47256 \$155

**HP 81000WI** Biconic \$155

**HP 81000VI** ST \$155

**HP 15475A** Cleaning Kit for Optical Surfaces \$160

☎ For off-the-shelf shipment, call 800-452-4844.

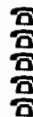

# LIGHTWAVE TEST EQUIPMENT

## Amplified Lightwave Converter, 1200 to 1600 nm

### HP 11982A

- Optical-to-electrical converter
- Bandwidths from dc to 15 GHz
- High sensitivity
- Frequency- and time-domain measurements

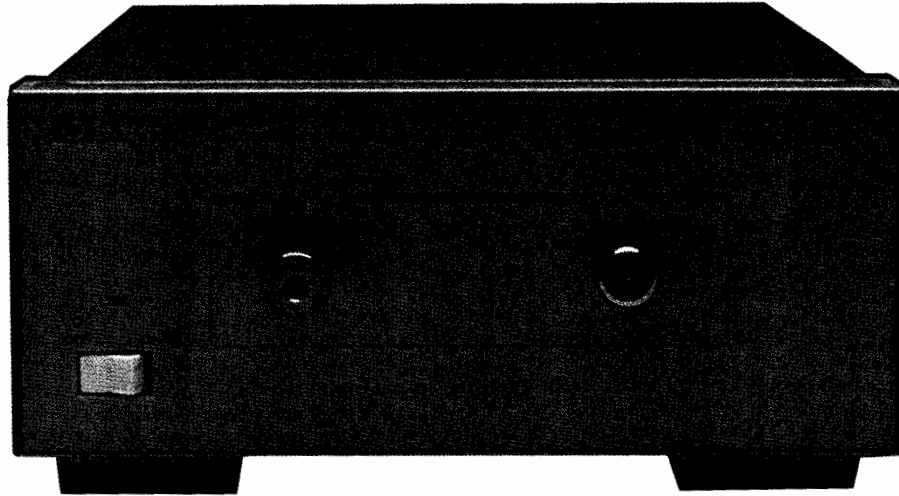

HP 11982A

### HP 11982A Amplified Lightwave Converter

This wide-bandwidth, sensitive optical-to-electrical converter is ideal for characterizing lightwave systems and components. The converter combines a PIN photodetector with a low-noise dc-coupled preamplifier to create a general-purpose front end. It can be used with oscilloscopes, spectrum analyzers, and network analyzers. Measurements can be made in both the lightwave time and frequency domains.

The HP 11982A covers wavelengths from 1200 to 1600 nm and bandwidths from dc to 15 GHz. With 300 V/W conversion gain and 0.05% input optical reflections, it significantly improves the sensitivity of the measurement system. Each converter comes with a calibration chart of instrument-specific data for frequency response and responsivity. This enables you to make corrected, accurate measurements.

### Frequency Domain Measurements

Used with an electrical spectrum analyzer, the HP 11982A displays optical modulation power as a function of frequency. Intensity modulation, distortion, and laser intensity noise can also be displayed and measured. Using frequency-response corrections, you can predict and observe the effects of laser modulation on a system.

The Option 001 memory card for the HP 11982A programs an HP 8591A, 8594A, 8595A RF or 8593A microwave spectrum analyzer with the frequency-response corrections and menus of the lightwave converter. This allows you to make easy, accurate, and corrected measurements to 22 GHz. A complete lightwave signal analyzer, containing the lightwave converter and an HP 8593A spectrum analyzer is available. See page 386 for details.

Using this lightwave signal analyzer and an HP 11980A interferometer, you can measure linewidth with a gateable modulation source. Measurements of chirp and frequency modulation of single-line lasers can also be made. See page 386.

### Time Domain Measurements

Combining the dc-coupled HP 11982A with an HP 54120 series digitizing oscilloscope gives you the ability to make optical eye-pattern and impulse-response measurements. Use the results to verify optical and opto-electronic components and optical system level performance. The HP 11982A provides dc coupling with 20 dB electrical gain and 15 GHz bandwidth. The HP 54120 series has a wide range of bandwidths, low jitter, and the averaging and persistence features needed for time domain measurements.

### Specifications

**Wavelength** (characteristic): 1200 to 1600 nm  
**Bandwidth** (characteristic): dc to 15 GHz (optical)  
**Full width half maximum:** 29.4 ps  
**Conversion gain** (dc responsivity): 300 V/W, nominal  
**Noise equivalent power** (characteristic): 30 pW/√Hz  
**Input return loss** (characteristic with HMS 10/HP connector): > 26 dB  
**Aberrations (characteristic):** < 20% peak-to-peak  
**Corrected frequency response, dc to 22 GHz:** ± 2.2 dB at 20° to 30° C  
**Harmonic distortion** (output < -10 dBm): > 41 dB below fundamental  
**Maximum safe optical input power, average:** 10 mW  
**Maximum operating optical input power, peak:** 1.5 mW  
**Output voltage range** (into 50 ohms): > 700 mV  
**Output offset voltage** (into 50 ohms): < 1 mV

### Ordering Information

	<b>Price</b>
<b>HP 11982A</b> Amplified Lightwave Converter	\$13,020
<b>Opt 001</b> Frequency Response Correction/Menus	+ \$850
Connector Options	\$0
<b>Opt 011</b> Diamond HMS-10	\$0
<b>Opt 012</b> FC/PC Conn. Interface	\$0
<b>Opt 013</b> Din. Conn. Interface	\$0
<b>Opt 014</b> St. Conn. Interface	\$0
<b>Opt 015</b> Biconic Connector Interface	\$0
<b>Opt 910</b> Extra User Manual	+ \$90

# LIGHTWAVE TEST EQUIPMENT

## Lightwave Converter: dc to 6, 20, 32 GHz 1000 to 1600 nm

HP 83440B/C/D

389

- Fast 14, 22, or 74 ps Full Width Half Max (FWHM) pulse response
- Low pulse aberrations
- Small, convenient package
- Ideal for high-speed digitizing oscilloscopes

### HP 83440 Unamplified Lightwave Converters

High-speed fiber-optics telecommunication and data communication applications demand fast, accurate instrumentation for optical pulse and waveform measurements. The dc-coupled HP 83440 family offers a variety of bandwidth options for converting incoming modulated optical power or optical pulses into electrical current. Ideal for optical pulse parameter measurements, these fully integrated hermetic InGaAs photodetectors feature very low noise and pulse aberrations; fast, accurate optical-to-electrical conversion; small, convenient packaging; and a standard user interface compatible with most electrical instrumentation. The HP 83440 converters mount directly to test-instrument front panels to simplify system integration and to ensure minimum output signal distortion from unnecessary cables, connectors, and signal conditioning components. A very simple internal structure ensures very low signal distortion for improved output-signal fidelity. The HP 83440's novel optical launch ensures low optical reflection for demanding DFB laser applications, and integral dc bias regulation ensures stable frequency response performance.

### Time-Domain Applications

Ideal for laser and modulator testing, the dc-coupled 83440 family faithfully reproduces incoming optical signals for accurate pulse parameter measurements. Several bandwidth options, nearly Gaussian response characteristics, and low pulse aberrations make these detectors an excellent choice for demanding optical time-domain measurements. Use the HP 83440 with high-speed digitizing oscilloscopes to accurately measure rise and fall time, overshoot, undershoot, ringing, peak power (pulse amplitude), pulse width, amplitude noise, and extinction ratio. The 83440 family also makes excellent mask measurements in applications in which sufficient optical power is available.

### Frequency-Domain Applications

The frequency domain allows users to measure, quantify, and model modulation characteristics such as spectral purity, harmonic content, and noise spectral density. The HP 83440 family allows frequency-domain instruments such as network and spectrum analyzers to accept optical input signals for basic lightwave measurements.

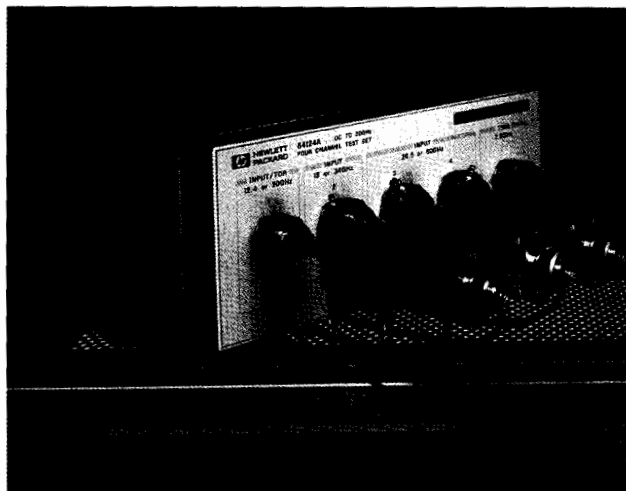

### General Specifications

**Wavelength** (spectral response): 1000 to 1600nm

(Stated specifications apply at 1300 and 1550 nm.)

**Noise equivalent power:** <18 pW  $\sqrt{\text{Hz}}$

**Max operating optical power** (saturation): 2 mW peak

**Max safe optical power** (damage): 10 mW peak

**Input optical reflection:** <0.05% (>33 dB)

**DC bias<sup>2</sup>:** +10 to +15 Vdc

**Packaging:** Hermetic

**RF Output Connector**

HP 83440B/C: 3.5 mm (m)

HP 83440D: 2.4 mm (m)

**Compatible Optical Fiber**

HP 83440B/C/D: 9/125 single mode

**Optical Input Connector**

Opt 011: HMS - 10/HP

Opt 012: FC/PC

Opt 013: DIN 47256

Opt 014: ST

Opt 015: Biconic

### Product Specifications

Model	Band-Width <sub>opt</sub>	FWHM <sup>1</sup> Pulse Width	Conversion Gain	Price
HP 83440B	6 GHz	74 ps	35 V/W	\$4,500
HP 83440C	20 GHz	22 ps	35 V/W	\$7,500
HP 83440D	32 GHz	14 ps	15 V/W	\$12,500

<sup>1</sup>Full Width Half Max is the pulse width at 1/2 the maximum deflection.

<sup>2</sup>Power supplied by HP 54120 oscilloscope or HP 87421A power supply with HP 83440-60009 cable.

# TRANSCEIVER TEST EQUIPMENT

## RF Communications Test Set

### HP 8920A



#### HP 8920A RF Communications Test Set

The HP 8920A is a full-feature, one-box test set designed to meet the communication test needs of both service and manufacturing environments. Combining 22 complete instruments, the HP 8920A offers the full functionality needed in testing land mobile radios, cellular phones, and communications systems.

#### Test and Troubleshoot Faster

The HP 8920A decreases standard test and troubleshooting time by simplifying standard measurement tasks and providing more needed capability in one box. Transmitters and receivers are simply characterized with single-key RX, TX, and duplex tests. All measured results are displayed on a single screen as either digital measurements or analog bar graphs. All settings and measurements are easily accessed and changed using the front-panel knob, and all settings can be saved in nonvolatile save/recall register for future access.

#### Minimize Production Test Costs

The HP 8920A's Built-in I-BASIC Computer combined with the HP 11807A Radio Test Software provides a complete solution for automated radio test in the production environment. Production costs are lowered by increasing throughput with decreased test times and automating measurements without the added expense of an external controller. Test equipment costs are also reduced as the HP 8920A allows you to replace several individual instruments with one.

#### Standard Features Summary

- Synthesized AM/FM signal generator to 1 GHz
- AM/FM modulation analyzer
- Duplex offset generator
- SSB demodulator
- RF power meter
- RF frequency counter/frequency error meter
- Audio frequency counter
- AF power meter
- AC/DC voltmeter
- SINAD meter
- Distortion meter
- Two variable audio sources
- Digital oscilloscope
- Built-in I-BASIC controller
- $2\mu\text{V}$  sensitivity (typically  $<1\mu\text{V}$ )

#### Optional Features Summary

- Spectrum analyzer and tracking generator
- Signaling source and analyzer
- Cellular-phone test capability
- Function generator
- DC current meter
- HP-IB/RS-232 interface buses for remote programming
- Radio test software
- Radio interface card



## Spectrum Analyzer with Tracking Generator

The HP 8920A's optional synthesized spectrum analyzer measures signals from 400 kHz to 1 GHz with variable spans from 5 kHz to 1 GHz (full span). The tuneable marker provides automatic readout of frequency and amplitude, or of relative frequency or amplitude from a reference. The tracking generator included with the spectrum analyzer allows for swept characterization of devices with fully settable amplitude and sweep spans (to 1 GHz).

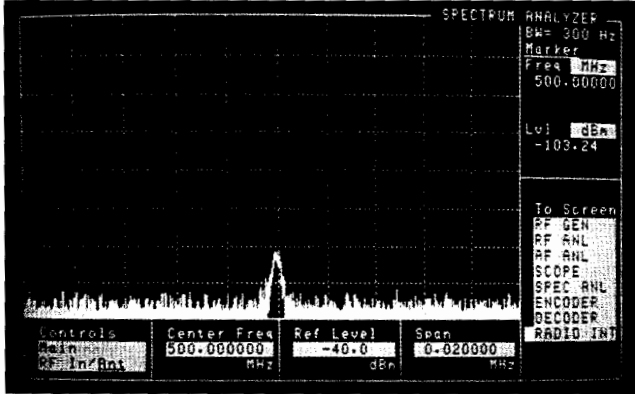

**Sensitive Receiver:** 2  $\mu\text{V}$  sensitivity (typically <math><1 \mu\text{V}</math>), available through the ANT IN port, allows for off-the-air monitoring of low-level signals. For measuring high-power signals, the HP 8920A can accept 100 W intermittently (for 10 seconds) or 60 W continuous.

## Signaling Encoder and Decoder

The optional signaling encoder and decoder support all common signaling formats, including tone sequential, digital paging, DTMF, and cellular signaling. Common standards are list-selectable and easily modified for different user formats. The decoder displays the tone or digital sequence transmitted, and the duration of the tone or tone pair. For digital paging transmitters, the decoder will display the address/code, the message, and the transmission rate.

## HP 11807A Radio Test Software

The HP 11807A is an easy-to-use software solution for automatic testing of radio receivers and transmitters. Running on the HP 8920A's built-in I-BASIC computer, the HP 11807A offers a complete selection of tests for land mobile radios, cellular phones, and communication systems. Its flexibility and modularity allow you to select and change test sequences, test parameters, and pass/fail limits without programming expertise. All test results are displayed on the screen and can be documented with hard-copy printouts when an external printer is added.

The HP 11807A system support tests (Option 100) give technicians automated test capability for commonly performed tasks on communications systems. System support tests include cable-fault location, intermodulation-products calculation, frequency scanning, and field-strength measurement.

## Cellular-Phone Testing

The HP 8920A tests the most common cellular phones when the signaling option (Option 004) is combined with the HP 11807A software for cellular tests. Three levels of phone testing are available: manual phone troubleshooting, quick functional checkout, and full parametric testing to system specifications. Cellular formats supported include AMPS, TACS, NMT 450, NMT 900, and JTACS. In addition to phone testing, the features and performance of the HP 8920A make it an ideal solution for base station. Test channels are easily characterized using the duplex test function, and duplexers and combiners are easily tuned using the spectrum analyzer with the tracking generator.

## Specifications Summary

### Signal Generator

#### RF Frequency

**Range:** 250 kHz to 1 GHz

**Accuracy and stability:** Same as reference oscillator  $\pm 0.015$  Hz

#### Output

**Range:**  $-137$  to  $-19$  dBm into 50  $\Omega$  (RF in/out)

$-127$  to  $+7$  dBm into 50  $\Omega$  (duplex out)

**Level accuracy:**  $\pm 1.8$  dB (RF in/out)

$\pm 1.5$  dB (duplex out)

Typically  $\pm 1.0$  dB for all levels

### Modulation

#### FM (ac/dc-coupled)

**FM deviation:** 100 kHz; 0.25 to 250 MHz

(Rates > 25 Hz) 50 kHz; 250 to 500 MHz

100 kHz; 500 to 1000 MHz

**FM rate:** DC to 75 kHz (3 dB BW)

**FM accuracy:**  $\leq 10$  kHz dev:  $\pm 7.5\%$  of setting  $\pm 50$  Hz

$> 10$  kHz dev:  $\pm 7.5\%$  of setting  $\pm 500$  Hz

#### AM

**AM depth:** 0% to 90%

**AM rate:** 20 Hz to 25 kHz (3 dB BW)

**AM accuracy:**  $\leq 10\%$  AM:  $\pm 5\%$  of setting  $\pm 1.0\%$  AM

$> 10\%$  AM:  $\pm 5\%$  of setting  $\pm 1.5\%$  AM

### Audio Generator

**Frequency range:** DC to 25 kHz

**Output level range:** 0.1 mV to 4 V rms

**Output impedance:**  $< 1 \Omega$

### RF Analyzer

#### RF Frequency Measurement

**Measurement range:** 400 kHz to 1 GHz

**Accuracy:**  $\pm 1$  Hz plus timebase accuracy

#### RF Power Measurement

**Measurement range:** 1 mW to 60 W continuous

100 W for 10 s/min

**Accuracy:**  $\pm 10\%$  of reading  $\pm 1$  mW (for inputs  $\geq 200$  mW)

#### FM Measurement

**Frequency range:** 5 to 1000 MHz

**Deviation:** 20 Hz to 75 kHz

**Sensitivity:** 2  $\mu\text{V}$  (typically  $< 1 \mu\text{V}$ )

**Accuracy:**  $\pm 4\%$  of reading plus residual FM and noise contribution

**Residual FM and noise:**  $< 20$  Hz (0.3 to 3 kHz rms)

#### AM Measurement

**Frequency range:** 10 to 1000 MHz

**Depth:** 0% to 95%

**Accuracy:**  $\pm 5\%$  of reading  $\pm 1.5\%$  AM

#### SSB Measurement

**Frequency range:** 400 kHz to 1 GHz

**Bandwidth (3 dB):** 20 Hz to 70 kHz

### AF Analyzer

#### Frequency Measurement

**Measurement range:** 20 Hz to 400 kHz

# TRANSCEIVER TEST EQUIPMENT

## RF Communications Test Set (cont'd)

HP 8920A

**Accuracy:**  $\pm 0.02\%$  plus resolution plus reference oscillator accuracy

### AC/DC Voltage Measurement

**AC Range:** 0 to 30 Vrms

**AC Accuracy:**  $\pm 3\%$  of reading  $\pm 150 \mu\text{V}$  rms

**DC Range:** 100 mV to 42V

**DC Accuracy:**  $\pm 1.0\%$  of reading  $\pm 45$  mV

### SINAD/Distortion Measurement

**Fundamental frequency:** 1 kHz  $\pm 5$  Hz

**Distortion range:** 0.1% to 100%

**Accuracy:**  $\pm 1$  dB (0.5 to 100% distortion)

**SINAD range:** 0 to 60 dB

**Accuracy:**  $\pm 1$  dB (0 to 46 dB SINAD)

### Audio Filters

**Standard:** 50 Hz HPF, 300 Hz HPF, 300 Hz LPF, 3 kHz LPF, 15 kHz LPF, 750  $\mu\text{s}$  de-emphasis, 1 kHz notch

**Optional:** C-Message, CCITT, 400 Hz HPF, 4 kHz BPF, 6 kHz BPF

### Oscilloscope Specifications

**Bandwidth (3 dB):** 2 Hz to 50 kHz

**Scale/Division:** 10 mV to 10V

**Time/Division:** 10  $\mu\text{s}$  to 100 ms

### Spectrum Analyzer Specifications (Option 002)

**Frequency range:** 400 kHz to 1 GHz

**Frequency span/resolution bandwidth (coupled):**

Span	Bandwidth
$\leq 50$ kHz	300 Hz
$\leq 300$ kHz	1 kHz
$\leq 5$ MHz	3 kHz
$\leq 50$ MHz	30 kHz
$> 50$ MHz	300 kHz

Plus full span capability

**Display range:** 80 dB

### Tracking Generator

(Included with Option 002)

**Frequency range:** 400 kHz to 1 GHz

**Frequency offset:** Frequency span endpoints  $\pm$  frequency offset cannot be  $< 400$  kHz or  $> 1$  GHz

**Output level range:** Same as signal generator

**Sweep modes:** Normal and inverted

### Signaling Encode/Decode (Option 004)

CDCSS, DTMF, 1 TONE, 2 TONE, 5/6 TONE SEQUENTIAL (EIA, CCITT, CCIR, ZVEI, EEA, Euro, NATEL), RPC1 (Pocsag), GOLAY, AMPS, TACS, NMT-450, NMT-900

### DC Current Meter (Option 003)

**Measurement range:** 0 to 10 A (usable to 15 A)

**Accuracy:** The greater of:  $\pm 10\%$  of reading or  $\pm 30$  mA

### Reference Oscillator Specifications

**TCXO (Standard)**

**Temperature:** 1 ppm (0 to  $+55^\circ\text{C}$ )

**Aging:**  $< 2$  ppm/year

### OCXO (Option 001)

**Temperature:** 0.05 ppm (0 to  $+55^\circ\text{C}$ )

**Aging:**  $< 0.5$  ppm/year ( $< 1$  ppm in 1st year)

### Remote Programming (Option 003)

**HP-IB:** Hewlett-Packard's implementation of IEEE Standard 488.2

**RS-232:** Three-wire RJ-11 connector used for serial data in and out

**Baud Rates:** 300, 1200, 2400, 4800, 9600, and 19200 selectable

### General Specifications

**Size:** 188 mm H  $\times$  330 mm W  $\times$  456 mm D

**Weight:** 15.9 kg (35 lbs)

**CRT Size:** 7  $\times$  10 cm

**Operating Temperature:** 0 to  $+55^\circ\text{C}$

**AC:** 100/120/220/240 V, 48 to 440 Hz, approx. 80 watts

**DC:** 11 to 28 V, approx 120 watts

**Leakage:** At Signal Generator output frequency and level  $< 40$  dBm typical leakage is  $< 0.5 \mu\text{V}$  induced in a resonant dipole antenna 1 inch from any surface except the rear panel. Spurious leakage levels are typically  $< 1 \mu\text{V}$  in a resonant dipole antenna.

### Ordering Information

HP 8920A RF Communications Test Set	Price
HP 8920A RF Communications Test Set	\$13,800
Opt 001 High stability timebase	\$600
Opt 002 Spectrum analyzer with tracking generator	\$1,500
Opt 003 HP-IB/RS-232/current measurement	\$600
Opt 004 Tone/digital signaling	\$600
Opt 005 256 k RAM memory	\$500
Opt 010 400 Hz high-pass filter	\$300
Opt 011 CCITT weighting filter	\$300
Opt 012 4 kHz bandpass filter	\$300
Opt 013 C-Message weighting filter	\$300
Opt 014 6 kHz bandpass filter	\$600
Opt 020 Radio interface card	\$2,000
Opt 908 Rack flange kit (5061-9677)	\$400
Opt 910 Extra operating/quick reference manual (08920-90010 and 08920-90012)	\$100
Opt W30 Three-year warranty	\$335

### HP 11807A Radio Test Software

(requires Option 005 on HP 8920A)

Opt 001 North American FM tests	\$500
Opt 002 European PM tests	\$500
Opt 003 AM tests	\$500
Opt 004 AMPS/EAMPS cellular tests	\$1,500
Opt 005 TACS/ETACS cellular tests	\$1,500
Opt 006 NMT cellular tests	\$1,500
Opt 007 JTACS cellular tests	\$1,500
Opt 100 System support tests	\$75

### Optional Accessories

08920-61060 Antenna	\$30
08920-61059 Microphone	\$50
08920-80027 DC Battery Pack (24 V)	\$150
08920-80028 Battery Charger	\$250
08920-90034 IBASIC Reference/HP 8920A Programming Manual	\$113
08920-90036 Service Kit	\$250
08920-61061 Connector Kit	\$50
HP 85700A 32 Kbyte SRAM memory card	\$100
HP 85702A 128 Kbyte SRAM memory card	\$175
HP 85704A 256 Kbyte SRAM memory card	\$350
HP 85705A 512 Kbyte SRAM memory card	\$525

### Available Literature

	Ref #
HP 8920A Technical Data Sheet	5952-2799
Service Applications/Brochure	5952-2797
Manufacturing Application/Brochure	5952-2796
Cellular Applications/Brochure	5091-0902
HP 11807A Technical Data Sheet	5091-0903

☎ For off-the-shelf shipment, call 800-452-4844.

# TRANSCEIVER TEST EQUIPMENT

GSM Test Sets

HP 8922A/B/G

393

- Complete, one-box GSM mobile-station tester
- Designed to minimize production costs
- Full-featured "tool kit" of instruments
- GSM base-station tester
- Fast, one-key GSM measurements
- Built-in I-BASIC controller

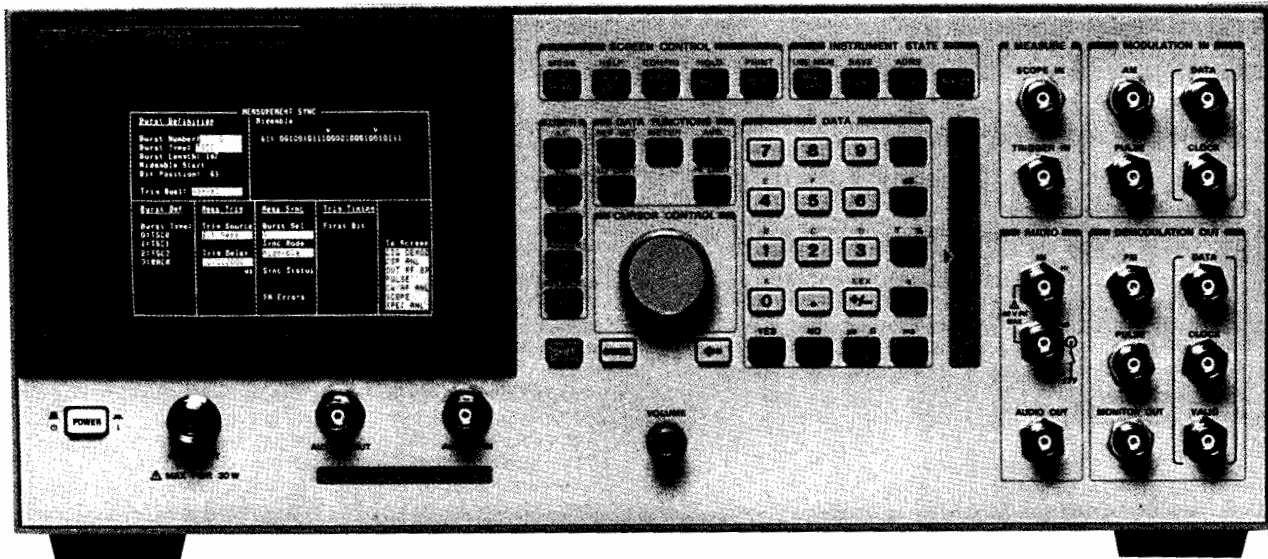

## HP 8922A/B/G GSM Test Sets

The HP 8922A, 8922B, and 8922G are integrated test solutions for the production of GSM radios. These test sets are based on a common, expandable platform. Hewlett-Packard is working on new test sets based on this platform to meet your expanding digital radio measurement needs. The HP 8922A is a toolbox with the necessary hardware to test the RF characteristics of GSM radios. For base-station testing, the HP 8922B builds on this platform by adding a large memory and reference section to provide baseband data patterns for bit-error-rate (BER) testing. The HP 8922G is a stand-alone GSM mobile station tester. It adds bit-error-rate testing and signaling capability to the performance of the HP 8922A to fully test GSM mobile radios without additional equipment.

## Minimize Production Testing Costs

Fast, accurate testing is crucial to producing competitive GSM radios. Because testing is a critical success item, the cost associated with testing a high-quality radio is a substantial component of the final production cost. The HP 8922 is carefully tuned to provide optimal measurement speed without sacrificing performance. Key measurements, such as phase and frequency error, utilize dedicated digital signal-processing hardware for high throughput. To facilitate measurements, the coherent data demodulation mode recovers and outputs the transmitted data from a timeslot every frame (1 timeslot/frame). In addition, the HP 8922G adds bit-error-rate capability. All measurements in the HP 8922 have been crafted in a similar manner to address the speed requirements of the GSM radio production market.

## GSM Radio Test Solutions

The HP 8922A contains a complete set of instrumentation for testing the RF sections of GSM radios. In addition to the frequency-agile 0.3 GMSK RF generator, the RF analyzer has an agile local oscillator, coherent data demodulator, pulse demodulator, FM demodulator, global method analyzer for phase and frequency error, synthesized spectrum analyzer, and pulsed power meter. The HP 8922B adds a large programmable RAM and phase-lock-loop timing generator for generating long GSM data patterns. The HP 8922G adds a bit-error-rate tester (BERT) for performing GSM receiver measurements, channel CODEC for speech encoding and decoding, and call control protocol to set up a phone call and maintain the link while performing measurements. Echo mode is facilitated by the voice CODEC for functional testing of a mobile, and the electrical man-machine interface (EMMI) is implemented for controlling the mobile and supporting the digital audio interface (DAI).

## Complete Tool Set

Besides this complement of GSM-specific instruments, the HP 8922 contains general-purpose tools useful for module test, troubleshooting, and debugging activities. These tools include a digital oscilloscope, a CW RF frequency counter, a CW RF power meter, an ac voltmeter, a dc voltmeter, a 1 kHz distortion/SINAD meter, an audio frequency counter, and a synthesized audio source. The combination of these capabilities makes the HP 8922 an extraordinarily powerful tool for the manufacture and installation of GSM radio equipment.

# TRANSCEIVER TEST EQUIPMENT

## GSM Test Sets (cont'd)

HP 8922A/B/G

### HP 8922A/B/G Specifications

#### RF Generator

**Frequency range:** 10 to 1000 MHz  
**Frequency resolution:** 1 Hz  
**Switching speed:** 577  $\mu$ s  
**0.3 GMSK modulation:** External clock and data  
**Pulse modulation:** External  
**30 dB pulse modulation:** External  
**Reverse power:** 30 W continuous, 100 W for 10 s/min (RF input)

#### RF Analyzer

**Frequency range:** 10 to 1000 MHz  
**Frequency resolution:** 1 Hz (100 kHz in hop mode)  
**Switching speed:** 577  $\mu$ s  
**Coherent data demodulation:** 0.3 GMSK at 270.833 Kbits/s, 1 time-slot/frame  
**FM analog demodulation:** 0.3 GMSK  
**Global method:** RMS and peak phase error, frequency error  
**Amplitude envelope:** Rise, fall, and burst flatness over useful bits  
**Peak transmitter power:** +10 to +45 dBm  
**Output RF spectrum measurements:** Due to modulation and switching transients  
**CW frequency counter:** 10 to 1000 MHz

#### Spectrum Analyzer

**Frequency range:** 10 to 1000 MHz  
**Frequency accuracy and stability:** Same as timebase  
**Display range:** 80 dB  
**Other features:** External trigger, marker

#### Digital Oscilloscope

**Frequency range:** 2 Hz to 50 kHz  
**Sweep times:** 10  $\mu$ s to 100 ms in 1, 2, 5, 10 steps

#### Audio Analyzer

**Frequency range:** 20 Hz to 400 kHz  
**AC voltage range:** 0 to 30 V<sub>rms</sub>  
**DC voltage range:** 100 mV to 42 V  
**THD + noise:** 1 kHz  $\pm$  5 Hz  
**SINAD:** 1 kHz  $\pm$  5 Hz

#### Audio Source

**Frequency range:** dc to 25 kHz  
**Output level range:** 0.1 mV<sub>rms</sub> to 4 V<sub>rms</sub>

#### Reference Oscillator

**External reference input frequency:** 13, 10, 5, 2, or 1 MHz  
**External reference output:** 10 and 13 MHz

#### Remote Programming

**HP-IB:** IEEE 488.2  
**RS-232:** 300, 1200, 2400, 4800, 9600, and 19200 baud

#### Internal Programming

**Programming language:** Hewlett-Packard Instrument BASIC  
**Program storage:** 32 Kbyte to 256 Kbyte external memory cards

#### General Specifications

**Size:** 177 mm H  $\times$  426 mm W  $\times$  574 mm D (7 in  $\times$  16.75 in  $\times$  23 in)  
**Weight:** 32 kg (70 lb)  
**Operating temperature:** 0° to +55° C  
**Storage temperature:** -40° to +75° C  
**Power:** 100, 120, 220, 240 Vac, 48 to 440 Hz,  $\pm$ 10% of line voltage

### HP 8922B Additional Specifications

#### Data Buffer

**Frame control RAM:** Memory for 102 unique GSM frames  
**Data RAM:** 64 Kbyte FIFO for active timeslot data (load via GPIO while clocking data)  
**Hop RAM:** 32 Kbytes for controlling HP 8922B frequency hopping

#### GSM Reference

**External reference input frequencies:** 13, 10, 5, 2, 1 MHz, bit clock, or frame clock

### HP 8922G Additional Specifications

**Broadcast channel capability:** BCCH + CCCH or BCCH + CCCH + SDCCH/4

**Control channels (SDCCH, FACCH, SACCH):** BCCH + CCCH, BCCH + CCCH + SDCCH/4, SDCCH/8 (non-hopped), SACCH/FACCH

**Traffic channels:** TCH/FS

**Call control capabilities:** BS originated call (FS), MS originated call (FS), MS camp on, BS call disconnect, MS call disconnect

**Encryption:** On, off, user supplied key

**Timing:** Auto, manual, uplink-downlink offset measurement

**Hopping:** Cyclic only, 2 independent MA tables with offsets

**Digital audio interface (DAI):** Normal operation and test of acoustic devices and A/D & D/A (according to GSM recommendation 11.10 section III.1.4)

**Electrical man-machine interface:** Control via HP-IB

**Speech encoding/decoding:** Full rate speech (FS)

**Echo mode:** User-selectable delay, 0 to 5 s

**Bit/Frame-error-rate measurements:** Class Ia, Ib, and II bits in both raw and residual form

**MS power output level control:** 0 to 15 with RF analyzer auto adjust

**Measurement coordination:** Flexible control of burst and ARFCN

**SACCH MEAS results:** RXLEV, RXQUAL, timing advance

### Ordering Information

	<b>Price</b>
<b>HP 8922A GSM RF Test Set</b>	\$61,350
<b>Opt 001</b> High-Stability Timebase (08922-61062)	+ \$1,775
<b>Opt 002</b> Transit Protection (front panel cover, and extended rear feet) (08922-61070)	+ \$675
<b>Opt 910</b> Total of Two Sets of Operation Manuals (08922-90009) and Service Manuals (08922-90006)	+ \$500 ☎
<b>Opt 913</b> Rack Mount Flange Kit (5062-4072)	+ \$32 ☎
<b>Opt 915</b> Add Service Manual (08922-90006)	+ \$250 ☎
<b>Opt W30</b> Extended Repair Service (see page 671)	+ \$1,180
<b>HP 8922B GSM BS Test Set</b>	\$71,750
<b>Opt 001</b> High-Stability Timebase (08922-61062)	+ \$1,775
<b>Opt 002</b> Transit Protection (front-panel cover, and extended rear feet) (08922-61070)	+ \$675
<b>Opt 910</b> Total of Two Sets of Operation Manuals (08922-90010) and Service Manuals (08922-90006)	+ \$500 ☎
<b>Opt 913</b> Rack Mount Flange Kit (5062-4072)	+ \$32 ☎
<b>Opt 915</b> Add Service Manual (08922-90006)	+ \$250 ☎
<b>Opt W30</b> Extended Repair Service (see page 671)	+ \$1,380
<b>HP 8922G GSM MS Test Set</b>	\$82,150
<b>Opt 001</b> High-Stability Timebase (08922-61062)	+ \$1,775
<b>Opt 002</b> Transit Protection (front-panel cover, and extended rear feet) (08922-61070)	+ \$675
<b>Opt 003</b> Protocol Logging (adds data output port and firmware for use with HP IDACOM PT-300 or PT-500 protocol analyzers)	+ \$935
<b>Opt 910</b> Total of Two Sets of Operation Manuals (08922-90011) and Service Manuals (08922-90006)	+ \$600 ☎
<b>Opt 913</b> Rack Mount Flange Kit (5062-4072)	+ \$32 ☎
<b>Opt 915</b> Add Service Manual (08922-90006)	+ \$250 ☎
<b>Opt W30</b> Extended Repair Service (see page 671)	+ \$1,957

☎ For off-the-shelf shipment, call 800-452-4844.



# TRANSCEIVER TEST EQUIPMENT

Automated Test Systems

HP 8953XT/CT/DT/ST, 11805B, 11798A, 83211A

395



- High-performance radio testing
- Test AM, FM,  $\phi$ M, cellular, NADC, SSB radios
- Automated measurements

- Fast, repeatable results
- Flexible configurations for changing needs
- Expandable for future needs

## Transceiver Test Systems

Hewlett-Packard offers a full line of transceiver test systems. The HP 8953 Series of transceiver test systems are designed to offer maximum performance, flexibility, and expandability for the mobile communications market. All systems are based on 3 "designed-for-systems" instruments: the HP 8656B/8657A synthesized signal generator, the HP 8903B audio analyzer, and the HP 8901A/B modulation analyzer. These 3 basic building blocks, together with software and a programmable interface for system integration, create an automated solution flexible enough to meet your needs today and tomorrow.

These systems and their options are designed to perform the majority of in-channel and out-of-channel tests on AM, FM,  $\phi$ M analog and digital cellular, and SSB radios. The performance inherent in these systems gives you the margin you need to measure your radio without being limited by your test equipment.

## HP 11805B Transceiver Test Software

- Repeatable test routines based on industry standards
- Menu-driven to tailor software to the radio under test
- User graphics for system-interconnection verification
- Calibration routines for measuring/correcting path losses
- Electronic data storage

## Transceiver Test Made Easy

The Hewlett-Packard 11805B transceiver test software is an easy-to-use, comprehensive solution for automatically testing land mobile, analog cellular, and single-sideband transceivers. It supports all instruments in the HP 8953S configuration guide (publication number 5952-1988). The HP 11805B software package provides quick and easy testing with full menu-driven operation, concise graphics, and easy-to-read test results.

The HP 11805B transceiver test software consists of a main executive interface program combined with at least one of three options. Option 001 includes test procedures for AM, FM, and  $\phi$ M radios derived from EIA/TIA standards for AM and FM transceivers and CEPT/ETSI standards for  $\phi$ M transceivers. Option 002 performs test over-the-air and via the AMPS test bus on both AMPS and TACS radios. Tests are derived from EIA/TIA standards for AMPS radios and Mobile Station Compatibility standards for TACS/ETACS radios. Option 003 tests single-sideband suppressed carrier radios with procedures derived from IEC standards.

## Operating Environment

The HP 11805B is compatible with the HP 9000 Series 300 computers with 2 Mbytes user RAM, BASIC 6.0 operating system, printer, and disk drive. The display compatibility interface card should be used with series 300 controllers to eliminate display flicker. System software is shipped on 3 1/2-inch, double-sided diskettes.

## Ordering Information<sup>1</sup> (data sheet p/n 5952-1987)

<b>HP 11805B</b> Transceiver Test Software	<b>Price</b>
<b>Opt 001</b> AM, FM, and $\phi$ M Radio Tests	\$3,675
<b>Opt 002</b> Cellular Radio Tests	+ \$525
<b>Opt 003</b> Single-Sideband Radio Tests	+ \$525

<sup>1</sup> For additional ordering information, contact your local Hewlett-Packard sales representative.

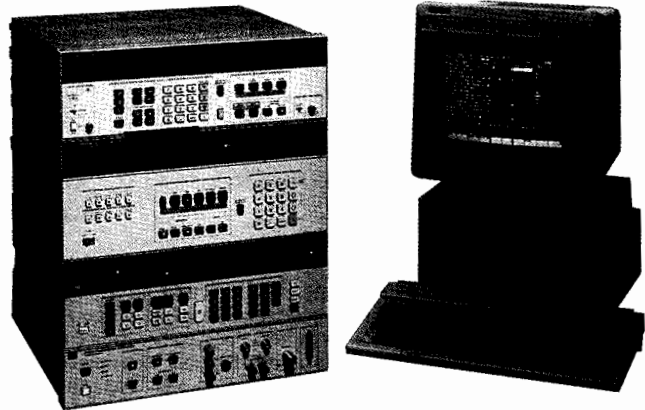

## HP 8953XT AM, FM and $\phi$ M Radio Test

The HP 8953XT is a high-performance system for testing land mobile radios. It has the capability to test two-way AM, FM, and  $\phi$ M transceivers, both single-channel and multi-channel, with or without continuous tone-controlled squelch systems (CTCSS) signaling formats. Radios with digital coded squelch (DCS) signaling can also be tested with additional equipment. The HP 11805B software, included with the HP 8953XT system, provides test routines derived from EIA/TIA standards for AM and FM transceivers and CEPT/ETSI standards for  $\phi$ M transceivers.

**Ordering Information<sup>1</sup>** (data sheet p/n 5952-1987) **Price**  
**HP 8953XT** Transceiver Test System \$41,465

HP 8953XT Components:

<b>HP 8656B Opt 002</b> Synthesized Signal Generator	
<b>HP 8903B Opts 001, 010, 051</b> Audio Analyzer	
<b>HP 8901A Opts 001, 002</b> Modulation Analyzer	
<b>HP 8954A</b> Transceiver Interface	
<b>HP 437B Opt 003</b> Power Meter	
<b>HP 8482A</b> Power Sensor	
<b>HP 11805B Opt 001</b> Transceiver Test Software	
All Necessary Cables and Adapters	
<b>Opt 100</b> Extended Transceiver Test System	+ \$74,230
(adds equipment for out-of-channel testing)	

## HP 8953ST Single-Sideband Radio Test System

The HP 8953ST single-sideband test system is specially configured to test single-sideband suppressed-carrier transceivers (A3J). This system uses 2 signal generators for receiver tests and a high-performance spectrum analyzer for transmitter characterization. All test procedures are derived from IEC standards for A3J radios.

**Ordering Information<sup>1</sup>** (data sheet p/n 5952-1987) **Price**  
**HP 8953ST** Single Sideband Test System \$100,995

HP 8953ST Components:

<b>HP 8656B Opts, 001, 002</b> Synthesized Signal Generator
<b>HP 8644A Opts, 003, 007</b> Synthesized Signal Generator
<b>HP 8903B Opts, 001, 010, 051</b> Audio Analyzer
<b>HP 8568B</b> Spectrum Analyzer
<b>HP 8956A</b> System Interface
<b>HP 6652A</b> System DC Power Supply
<b>HP 11805B Opt 003</b> Transceiver Test Software
All necessary Cables and Adapters

# TRANSCEIVER TEST EQUIPMENT

## Automated Test Systems (cont'd)

HP 8953XT/CT/DT/ST, 11805B, 11798A, 83211A

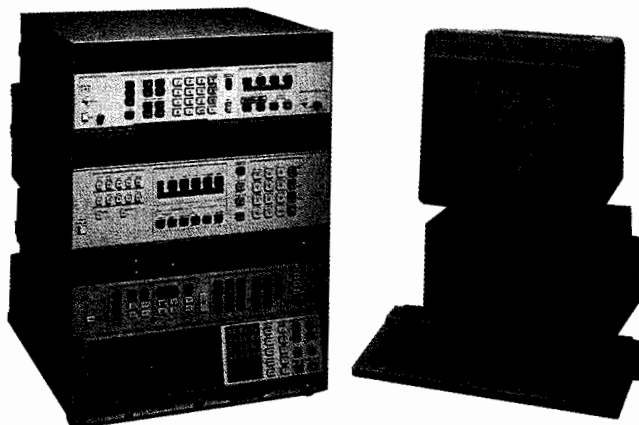

### HP 8953CT Analog Cellular Radio Test

The HP 8953CT cellular radio test system is configured for testing AMPS, TACS, and ETACS cellular radios. NMT radios can be tested with a modified HP 8953CT configuration.<sup>1</sup> Flexible instrument connections and signal paths, coupled with digital signaling, give the HP 8953CT system the ability to automate complex cellular radio measurements. The HP 8953CT can be expanded to perform digital tests on North American dual-mode cellular radios.

Testing can be performed over-the-air on both AMPS and TACS radios. The HP 11805B software performs cellular radio tests derived from EIA/TIA standards for AMPS radios and Mobile Station Compatibility standards for TACS/ETACS radios.

#### Ordering Information<sup>1</sup> (data sheet p/n 5952-1987)

##### HP 8953CT Cellular Test System

**Price**  
\$50,865

HP 8953CT Components:

**HP 8656B Opt 002** Synthesized Signal Generator

**HP 8903B Opts 001, 013, 051** Audio Analyzer

**HP 8901B Opts 001, 002** Modulation Analyzer

**HP 8958A** Cellular Radio Interface

**HP 8482A** Power Sensor

**HP 11805B Opt 002** Transceiver Test Software

All Necessary Cables and Adapters

**Opt 100** Extended Cellular Radio Test System

+ \$61,100

(adds equipment for out-of-channel testing)

### HP 11798A NMT Radio Test Software

The HP 11798A cellular radio test software provides the comprehensive RF and signaling required for testing cellular mobile radios conforming to the 450 and 900 MHz standards of the Nordic Mobile Telephone (NMT) system. With user-written software, a system can also be configured to simulate a mobile station for base-station signaling tests.

#### Ordering Information<sup>1</sup> (data sheet p/n 5953-8431)

##### HP 11798A NMT Software Application Pac

**Price**  
\$1,220

### HP 8953DT Digital Cellular Radio Test System

The HP 8953DT North American dual-mode cellular (NADC) radio test system provides a high-performance solution for testing NADC radios. It adds digital signaling and measurement capability to the HP 8953CT to test both the digital and the analog modes of NADC radios. All test routines are derived from EIA/TIA IS-54 and IS-55 and are performed automatically under the control of the HP 83211A NADC digital signal-processing controller, which is included.

The HP 8953DT NADC radio test system is based on the HP 8953CT. The components from the HP 8953CT test the radio for AMPS compatibility. For digital receiver measurements, the HP 8657D signal generator provides  $\pi/4$  DQPSK modulated signals while the HP 83211A generates data streams and performs BER/ WER, (bit error-rate and word error-rate) measurements. Digital transmitter measurements such as phase and frequency error are performed by the HP 83211A digital signal processor.

#### Ordering Information<sup>1</sup> (data sheet p/n 5091-1701)

##### HP 8953DT NADC Radio Test System

**Price**  
\$142,550

HP 8953DT Components:

**HP 8657A Opt 002** Synthesized Signal Generator

**HP 8903B Opts 001, 010, 053** Audio Analyzer

**HP 8901B Opts 001, 002, 030, 033, 035** Modulation Analyzer

**HP 8958A Opt 003** Cellular Radio Interface

**HP 8657D  $\pi/4$  DQPSK** Synthesized Signal Generator

**HP 11835A Opt 002** Data Buffer

**HP 83211A Opt 002** NADC Digital Signal Processing Controller

**Opt 001** Adds Second Digital Source

+ \$34,200

(8657D and 11835A Opt 002)

### HP 83211A NADC Digital Signal Processing Controller

The HP 83211A NADC digital signal processing controller is a digital analyzer and system controller for the HP 8953DT NADC radio test system. It automates NADC radio testing, and also codes and generates digital data streams and performs digital analysis. Menu-driven software included in the HP 83211A runs in the MS-DOS<sup>\*</sup> environment and allows complex NADC radio measurements to be performed quickly and easily. In addition to the HP Vectra RS-25 personal computer, the HP 83211A consists of a high-performance, floating-point digital signal processor; a 10 MHz, 12-bit digitizer; an HP-IB board, a GPIO board, and DSP software.

#### Ordering Information<sup>1</sup> (data sheet p/n 5091-1701)

##### HP 83211A NADC Digital Signal Processing Controller

**Price**

\$53,350

**Opt 001** Adds Second GPIO Card for Second Digital Source

+ \$1,525

**Opt 002** Accessory Kit

+ \$2,850

(HP 8482A power sensor, cables, attenuators, and terminations for HP 8953DT)

<sup>1</sup> For additional ordering information, contact your local Hewlett-Packard sales representative.

MS-DOS<sup>\*</sup> is a U.S. registered trademark of Microsoft Corporation.

# TRANSCEIVER TEST EQUIPMENT

RF Interfaces

HP 8954A, 8956A, 8958A, 11799A

397

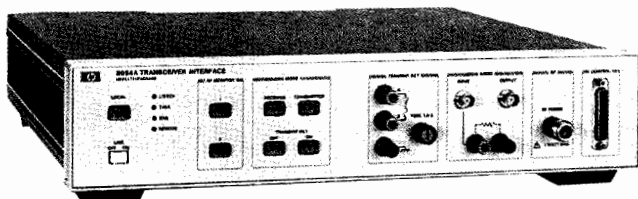

HP 8954A

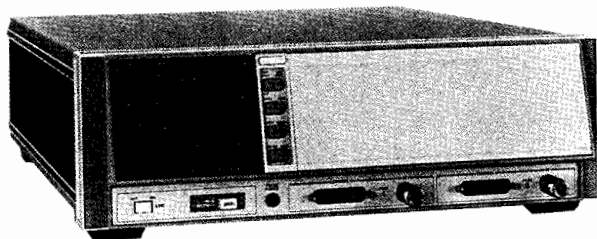

HP 8956A

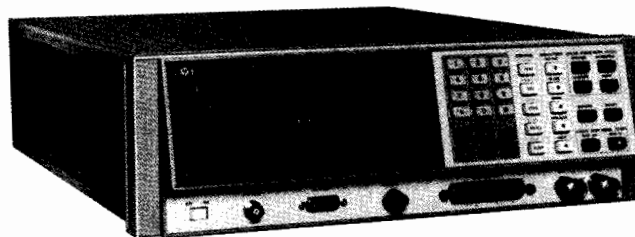

HP 8958A

## HP 8954A Transceiver Interface

The HP 8954A is Hewlett-Packard's lowest priced transceiver test interface. It is fully programmable and uses microwave switches and hardware in all RF paths. Designed for dc to 18 GHz measurements, the HP 8954A Transceiver Interface provides the flexibility needed for most AM, FM, and SSB receiver and transmitter testing.

## HP 8954A-H03 Transceiver Interface

The HP 8954A Option H03 Transceiver Interface is a full-duplex version of the standard HP 8954A. The standard RF switching hardware is replaced with a power divider network that is designed for 10 MHz to 1500 MHz use. The HP 8954A Option H03, when used with the HP 11799A Signaling Unit, is part of the recommended configuration for testing NMT (Nordic Mobile Telephone) cellular radios.

## HP 8956A System Interface

The HP 8956A System Interface, with its multiple paths and connections, provides added flexibility in the designing of systems in the frequency range from dc to 1000 MHz. It has two RF test ports for duplex testing, stimulus/response testing, and reduced connect/disconnect times. A built-in, switchable 120 watt 30 dB attenuator can be inserted for transmitter testing and removed for receiver testing, increasing receiver measurement range.

Additional functions of the HP 8956A include current drain and timing measurements.

## HP 8958A Cellular Radio Interface

The HP 8958A Cellular Radio Interface gives your system the capability to fully test a cellular radio. With the flexible Channel Simulator, you can simulate cell-site operation, verify signaling protocol, or perform highly complex and sophisticated tests using an external controller to generate and analyze data content.

## HP 11799A Signaling Unit

For testing cellular radios compatible with the 450 and 900 MHz protocols of the Nordic Mobile Telephone (NMT) system, HP supplies the HP 11799A Signaling Unit.

When used with the three basic transceiver test instruments and a duplex interface, the HP 11799A simulates a base station and mobile exchange for over-the-air RF and signaling tests of cellular mobile radios.

## Ordering Information

	Price
<b>HP 8954A</b> Transceiver Interface	\$4,815
<b>Opt 907</b> Front Handle Kit (5061-9688)	+ \$52
<b>Opt 908</b> Rack Flange Kit (5061-9674)	+ \$32
<b>Opt 909</b> Front handle w/Rack Flange Kit (5061-9675)	+ \$75
<b>Opt 910</b> Extra manual (08954-90010)	+ \$15
<b>HP 8954A-H03</b> Transceiver Interface	Consult your HP representative
<b>HP 8956A</b> System Interface	\$15,975
<b>Opt 001</b> Rear Panel Connectors	+ \$110
<b>Opt 907</b> Front Handle Kit (5061-9689)	+ \$57
<b>Opt 908</b> Rack Flange Kit (5061-9677)	+ \$33
<b>Opt 909</b> Front handle & Rack Flange Kit (5061-9683)	+ \$82
<b>Opt 910</b> Extra manual (08956-90020)	+ \$21
<b>HP 8958A</b> Cellular Radio Interface	\$13,365
<b>Opt 002</b> Diversity Switch	+ \$855
<b>Opt 003</b> Frequency/Dynamic Range Extension	+ \$1,650
<b>Opt 907</b> Front panel Handles (5061-9689)	+ \$57
<b>Opt 908</b> Rack Mount Flanges (5061-9677)	+ \$33
<b>Opt 909</b> Front handles & Rack Mount Kit (5061-9683)	+ \$82
<b>Opt 910</b> Extra Manual (08958-90002)	+ \$52
<b>HP 11799A</b> Signaling Unit	\$15,575

## System Interface Comparison

	HP 8954A	HP 8954A-H03	HP 8956A	HP 8958A
Frequency range	DC to 18 GHz	10 to 1500 MHz	DC to 1000 MHz	10 to 1500 MHz
Number of RF ports	4	4	6	6
Number of audio ports	2	2	4	2
Number of UUT ports	1	1	2	1
Duplex capabilities	NO	YES	YES	YES
Typical applications	AM, FM, $\varnothing$ M, SSB	AM, FM, $\varnothing$ M, SSB, NMT*	AM, FM, $\varnothing$ M, SSB	AMPS, TACS, NMT*

\*Requires the HP 11799A signaling unit

# TRANSCEIVER TEST EQUIPMENT

## 0.3 GMSK and $\pi/4$ DQPSK Modulation Measurement Software

HP 11836A, HP 11847A/B

- Global measurement of GSM and PCN digital cellular radio transmitters
- Characterization of North American dual-mode cellular and Japanese digital cellular (JDC) transmitters
- Measurements on I-Q baseband drive signals

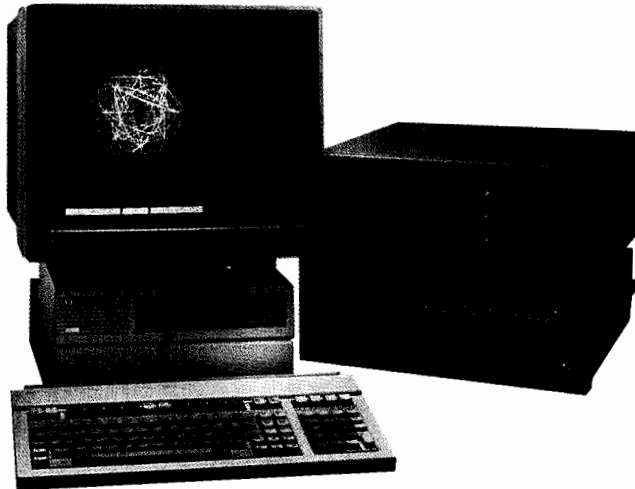

HP 11847A display of I-Q Constellation



### 11836A 0.3 GMSK Modulation Measurement Software

The HP 11836A software package is an easy-to-use, accurate solution for testing transmitters designed for PCN and the Global System for Mobile Communications (GSM), Pan-European Digital Cellular Radio System. By downconverting the transmitter to an IF of 700kHz and digitizing 1 time slot, the HP 11836A recovers the transmitted data and measures the spectrum of the signal. The software performs mathematical calculations to measure the transmitter carrier, frequency accuracy, amplitude envelope, and modulation phase error (peak and rms). This technique is known as the global method.

The software digitally reconstructs the actual transmitted data, from which is computed the ideal phase trajectory of a theoretically perfect 0.3 Gaussian minimum shift keying modulator. It also uses the recovered data to very precisely regenerate the data clock, which is used to synchronize the data stream. By subtracting the actual phase trajectory from the calculated ideal trajectory, the phase error is obtained. The frequency error, rms phase error, and peak phase error are then determined from the phase-error data.

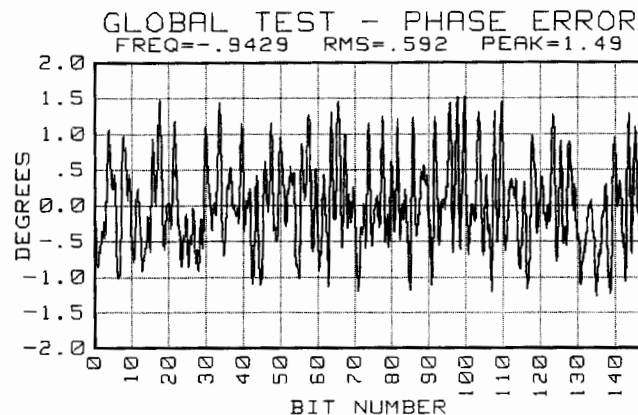

Sample software output (HP 11836A)

### Modulation Measurement Software for $\pi/4$ DQPSK Systems: HP 11847A for NADC and HP 11847B for JDC Systems

The HP 11847A/B  $\pi/4$  DQPSK modulation measurement software builds on the successful algorithms used in the HP 11836A 0.3 GMSK software. The design was adapted for the Japanese and North American dual-mode systems that use the  $\pi/4$  DQPSK format.

The HP 11847A software is designed to make measurements specified in the TIA/EIA standards IS-54 and IS-55 for North American dual-mode systems. These include transmitter frequency error, burst amplitude droop, modulation phase, magnitude error, and error vector magnitude. The software has a filter factor of 0.35 and is designed for symbol rates of 24.3 kHz and bit rates of 48.6 kHz.

The HP 11847B software is designed to make measurements on JDC system transmitters that use the  $\pi/4$  DQPSK modulation. These differ from the NADC system transmitters because the channel spacings in Japan are 25 kHz. The resulting symbol rate is 21 kHz and the Nyquist filter factor is 0.5.

In both versions, the menu-driven software offers a selection of many graphs and displays of the demodulated signal. These graphs include I and Q channel eye diagrams, the I-Q constellation diagram, phase and magnitude vs. time, and error vector magnitude vs. time for one complete burst. The test option menu allows the user to choose to test mobile or base-station bursts, using internal or external triggers, and allows synchronizing to appropriate synch words. The software runs on an HP 9000 Series 300 computer using BASIC 6.0, and requires 4 Mbytes of memory.

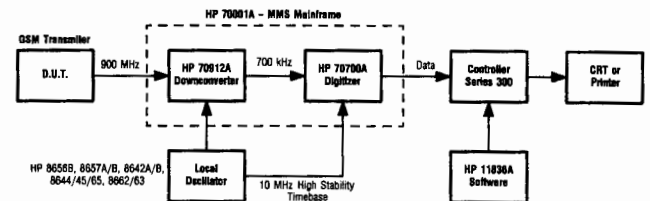

Modulation Measurement System Block Diagram.

#### Ordering Information

	Price
HP 11836A 0.3 GMSK Modulation Measurement Software	\$10,660
HP 11847A/B $\pi/4$ DQPSK Modulation Measurement Software	\$10,300

#### Associated Equipment Required:

HP 70001A System Mainframe	\$7,050
HP 70700A Digitizer Module	\$8,330
HP 70912A Downconverter Module	\$3,735
Local Oscillator (one of the following): HP 8642A/B, HP 8644A, HP 8645A, HP 8656B, HP 8657A/B, HP 8662A, HP 8663A, or HP 8665A	Contact HP

**Controller:** The software requires BASIC 6.0 on an HP 9000 Series 300 instrument controller. However, due to the extensive computations by the software, the HP 9000 Model 345 (50 MHz 68030 with 68882 coprocessor) or equivalent is recommended.

**Memory:** 4 Mbytes RAM (11847A/B)  
3 Mbyte RAM (11836A)

#### Optional Equipment:

**Printers:** HP-IB Printers such as HP QuietJet Plus  
**Modular Measurement System Graphics Displays:**

HP 70205A Graphics Display	\$5,980
HP 70206A System Graphics Display	\$8,690



# TRANSCEIVER TEST EQUIPMENT

Data Buffer, GSM, NADC, JDC

HP 11835A

399

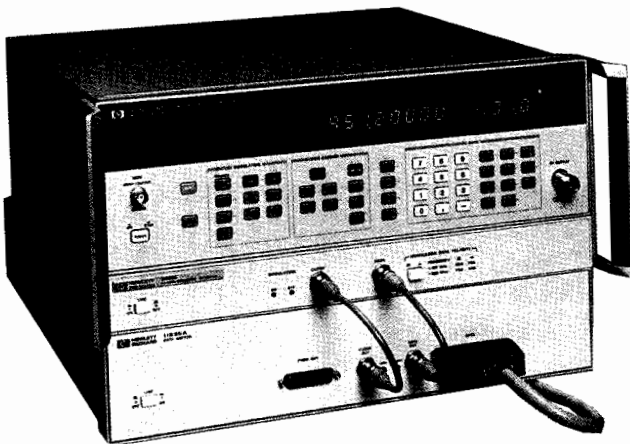

The HP 11835A Data Buffer with HP 8657A Option 022

The HP 11835A Data Buffer is a configurable data output device. Its primary function is to buffer data from a computer and output the data as a serial stream. It can output the serial data at rates from dc to 4 MHz with a user-supplied clock. Optionally, an internal reference board will provide the bit clock used in the GSM system (Option 001) or the bit and symbol clock used in the North American and Japanese digital cellular systems (Option 002).

The HP 11835A contains a large memory which can be configured as a programmable state machine. This is useful in generating the data streams to test the new digital mobile communications systems. The memory is divided into four locations. There are two first-in, first-out (FIFO) RAMS each with a capacity of 1024 Mbits. One FIFO can be loaded via the GPIO interface while the active data is clocked out the other. This allows continuous data streams to simulate digital radio transmissions. In addition to FIFO memory, a frame control RAM (128 K × 16 bits) controls the operation of the HP 11835A. It determines when to output data and sends internal clock signals as well as external trigger signals for timing control. The fourth RAM is a hop control RAM, used to drive a fast-hopping source such as the HP 8662A-H25 to simulate frequency hopping in GSM radios, for example.

#### Option 001 GSM Reference

The Option 001 GSM reference board provides synchronization of the HP 11835A with clock frequencies used by the Pan-European Digital Cellular Radio System. This option permits the use of the 1, 2, 5, or 10 MHz instrumentation references and the 216.67 Hz frame clock, the 270.833 kHz bit clock, or 13 MHz GSM clock as reference inputs. From these inputs, 10 MHz, 13 MHz, 270.833 kHz (bit clock), and 216.67 Hz (frame clock) signals are output.

#### Option 002 NADC and JDC Reference

The Option 002 reference board provides similar capabilities as Option 001 but for the North American (NADC) and Japanese digital cellular (JDC) systems. When configured for the NADC system, the HP 11835A Option 002 can input 1, 2, 5, or 10 MHz instrumentation references, as well as the 48.6 kHz bit clock and the 24.3 kHz symbol clock. From these inputs the Option 002 outputs the bit clock (48.6 kHz), the symbol clock (24.3 kHz), and the frame clock (25 Hz). For the JDC system, Option 002 provides the same inputs and outputs, but uses the Japanese system frequencies. These include the 42 kHz bit clock, the 21 kHz symbol clock, and the 50 Hz frame clock.

## HP 11835A Specifications

### Inputs (TTL Levels)

**Bit clock input:** BNC, rear panel

**GPIO input:** 50-pin, front panel

**Trigger input:** BNC, rear panel

### Outputs (TTL Levels)

**Data output:** BNC, front panel

**Clock output:** BNC, front panel

**Program outputs:** 25-pin, front panel

**Parallel bus outputs:** 25-pin, rear panel

**Hop control bus:** 50-pin, rear panel

**Programmable outputs:** 3 BNCs, rear panel

### Option 001 Specifications (for use with the GSM System)

**Reference modes:** Reference Lock, Bit Clock Lock, Frame Clock Lock, or Free Run.

**Inputs:** (rear panel BNCs)

Reference: 1, 2, 5, 10, 13 MHz, >0 dBm (50 Ω nominal)

Frame clock: 216.67 Hz, TTL levels

Bit clock: 270.833 kHz, TTL levels

**Outputs:** (rear panel BNCs)

10 MHz, 13 MHz, 270.833 kHz (bit), 216.67 Hz (frame)

### Option 002 Specifications (for use with NADC or JDC systems)

**Reference modes:** Reference Lock, Bit Clock Lock, Frame Clock Lock, or Free Run.

**Inputs:** (rear panel BNCs)

Reference: 1, 2, 5, 10 MHz, >0 dBm (50 Ω nominal)

Frame clock: 21 kHz (JDC), 24.3 kHz (NADC) TTL levels

Bit clock: 42 kHz (JDC), 48.6 kHz (NADC) TTL levels

**Outputs:** (rear panel BNCs)

Reference: 10 MHz (50 Ω nominal)

Symbol clock: 21 kHz (JDC), 24.3 kHz (NADC) TTL levels

Bit clock: 42 kHz (JDC), 48.6 kHz (NADC) TTL levels

Frame clock: 25 Hz or 50 Hz, TTL levels

Note: For bit and symbol clocks, rates can be varied ±10ppm.

### General Information

Power: 90 to 264 volts from 48 to 66 Hz; 75 VA maximum

Size: 88.1 mm H × 425 mm W × 346 mm D (3.5 in × 16.75 in × 13.6 in)

Weight: Net, 6 kg (14 lb); shipping, 11 kg (24 lb)

**Cables included:** The HP 11835A includes a GPIO cable to connect to the host computer and a ribbon cable to connect to a HP 8662-H25 Fast Hop Signal Generator.

### Recommended computer and operating system:

HP Model 9000 Series 300 with 4 Mbyte of RAM.

Requires a GPIO card, HP 98622A.

HP Vectra PC with the HP 82300C or HP 82324A Measurement Coprocessor and 4 Mbytes of RAM. Requires GPIO card, HP 82306C.

Operating System is HP BASIC 5.0 or later version.

### Ordering Information

(only one option can be ordered)

	Price
<b>HP 11835A Data Buffer</b>	\$9,360
<b>Opt 001</b> GSM Reference	\$1,040
<b>Opt 002</b> NADC and JDC Reference	\$1,250
<b>Opt 907</b> Front Handle Kit (5062-3988)	\$50
<b>Opt 908</b> Rack Mount Flange Kit (5062-3974)	\$31
<b>Opt 909</b> Handles w/Rack Mount Flange Kit (5062-3975)	\$73

# TRANCEIVER TEST EQUIPMENT

## RF Channel Simulator, 40 MHz to 2000 MHz HP 11759B

- Two channels of three paths each
- Rayleigh, Rice, or Log-normal fading
- Doppler to 85 Hz
- Delay intervals to 170  $\mu$ s
- RF bandwidth > 1.9 MHz
- PC controlled

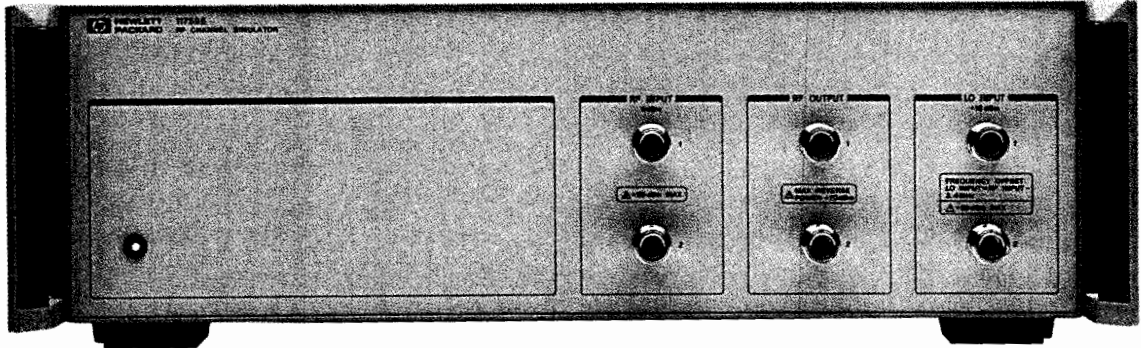

### The HP 11759B RF Channel Simulator

With the HP 11759B RF Channel Simulator it is easy to simulate the fast and slow fading, time dispersion, and Doppler shifts experienced in a mobile radio environment. Designed to test digital cellular radios under RF multipath conditions, the HP 11759B is also suitable for testing many other analog and digital wireless communications systems with RF bandwidths to 1.9 MHz under RF multipath fading conditions.

The HP 11759B consists of the applications software and the RF processing hardware. To complete the RF multipath simulation system, two other user-supplied components are necessary — a personal computer acting as a front panel and controller for the HP 11759B, and a synthesized local oscillator used to determine the RF operating frequency and to supply a 10-MHz timebase for the system clock.

### Two Multipath Channels Equal Test Flexibility

The HP 11759B contains two independent 40 MHz to 2000 MHz RF channels of three paths each. Each path can be Rayleigh or Log-normal faded, delayed, Doppler shifted (with or without Rayleigh spectrum spreading), and attenuated relative to the others. In addition, under Rayleigh fading conditions, the correlation factor for path pairs in the two channels is adjustable from 0 to 1.

With two separate three-path channels available, the HP 11759B can be easily configured for all the various multipath test requirements of mobile radio development, manufacturing, and type acceptance. With an external power divider and/or power combiner, one HP 11759B can be configured for single-channel six-path multipath tests, co-channel interferer tests, adjacent and alternate channel tests, and space and/or frequency diversity tests. Even duplex tests are possible, with one channel assigned for forward transmission and the second for reverse transmission. Independent local oscillator inputs for each channel allow the freedom to select any combination of RF channels required to completely test a radio under multipath fading conditions.

### Easy to Use Manually or Remotely

Simple on-screen menus guide the user through the potentially complex task of creating RF multipath signals for testing a mobile or base-station radio.

Remote control is accomplished just as easily by installing a serial interface card in the PC controller and accessing the menus over a serial (RS-232) communications link.

### HP 11759B Partial Specifications

(See technical data sheet for complete specifications.)

#### RF Channel Specifications

**Number of independent RF channels:** 2  
**RF input/output frequency range:** 800 to 2000 MHz  
 (usable 40 to 2000 MHz)

**RF bandwidth (1 dB):** > 1.9 MHz typically  
**Path insertion loss:** Typically 20 dB  $\pm$  3.5 dB, 800 to 1000 MHz;  
 25 dB  $\pm$  4.0 dB, 1400 to 2000 MHz

**LO input frequency range:** RF input frequency less 3.4 MHz

#### Channel Simulation Specifications

**Number of independent paths per channel:** 3  
 Independent Rayleigh fading, Delay, Doppler, and level available on each path

**Path attenuation range:** 0 to 30 dB, in 0.1 dB steps

**Path delay interval range:** 0 to 170  $\mu$ s, in 0.1  $\mu$ s steps

**Simulated vehicle speed range (at 900 MHz):** 0 to  $\pm$  100 km/h

**Simulated doppler range:** 0 to  $\pm$  85 Hz, in 0.1 Hz steps

**Rayleigh amplitude distribution:** Available on all paths for vehicle speeds from 1 to 100 km/h (at 900 MHz)

**Repetition interval:** > 30 seconds

**Deviation from Rayleigh CPDF (typical):**

<  $\pm$  1.0 dB from +10 to -20 dB of the mean power

<  $\pm$  3.0 dB from -20 to -30 dB of the mean power

**Deviation from Rayleigh LCR (typical):**

< 5% of the vehicle speed, +10 to -30 dB of the mean power

Correlation coefficient range between CH1 and CH2 paths:

0-1 in 0.1 steps

### Remote Control

Available through optional serial (RS232) interface card installed in PC controller.

### General

**Operating Temperature Range:** 0° C to +55° C

Specifications warranted +15° C to +35° C

**EMI:** VDE 0871/1978, CISPR Pub. 11 (1975)

**Power:** 90 to 132/190 to 264 V; 48 to 64 Hz; 185 VA maximum

**Size:** 146 mm H  $\times$  425 mm W  $\times$  620 mm D (5.7 in  $\times$  16.8 in  $\times$  24.4 in)

**Weight:** Net, 13.6 kg (30 lb); shipping, 19 kg (42 lb)

### Ordering information

HP 11759B RF Channel Simulator	Price
HP 11759B RF Channel Simulator	\$52,500
Opt 907 Front-Panel Handle Kit (5062-3989)	+\$55
Opt 908 Rack Mount Flange Kit (5062-3997)	+\$34
Opt 909 Rack Mount Flange Kit with Handles (5062-3983)	+\$83
Opt 910 Extra Operating and Service Manual	+\$50
Opt W30 Two Additional Years of Return-to-HP Service	+\$995



### What is Noise Figure?

Modern receiving systems must often process very weak signals. Noise added by the receiving system components often determines whether or not an input signal can be processed properly. Unlike other ways to measure receiver noise (minimum discernible sensitivity, tangential sensitivity, etc.) noise figure is an objective measure: it does not depend on the judgment of the person measuring. In addition, noise figure is universal; it may be determined for transistors, amplifiers, and mixers as well as for entire systems.

Noise figure can be expressed as the ratio of total output noise power (at a source temperature of 290K) to the output noise power if there were no noise added by the device under test (DUT).

Noise figure is typically measured by applying two noise powers to the test device input and measuring the corresponding output powers. Assuming the device is linear, it can then be characterized with respect to total output noise power for all values of input noise power. Noise figure is calculated (ratio of total output noise power to output noise power, assuming no device noise) assuming an input noise power generated from a 290K thermal noise source.

To learn more about noise figure basics and measurement, read HP Application Note 57-1 (see the Literature section on this page).

### Single- and Double-Sideband Noise Figure Measurements

There are both advantages and disadvantages to single- and double-sideband measurements.

Double-sideband microwave measurements are easy. The most basic setup requires only a mixer and a local oscillator. However, the resulting noise figure is the average of the test device performance at the two down-converted frequencies. If the device characteristics vary rapidly with frequency, as with

transistors or amplifiers with narrow passbands, double-sideband measurement can introduce significant error. In addition, spurious and harmonically related signals can also render double-sideband measurement data invalid.

Single-sideband measurements eliminate double-sideband problems. Double-sideband problems such as image, spurious, and harmonic signals are removed by pre-selecting the desired noise sideband before mixing. Single-sideband measurements, however, require accurately designed filtering systems (such as temperature-compensated YIG filters), which are difficult to design and maintain. In spite of its difficulties, single-sideband is the only way to make a standard, down-converted noise figure measurement: its measured value does not depend on the device characteristics.

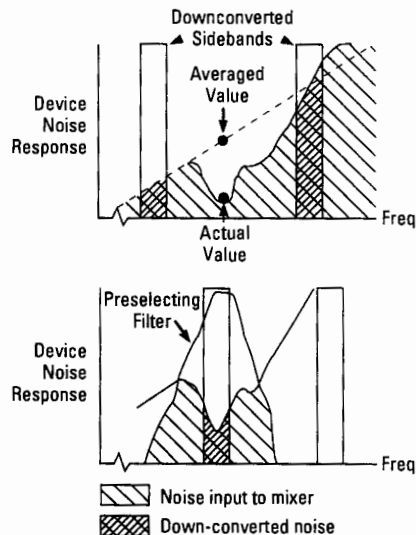

### Noise Figure Measurement Applications

Hewlett-Packard's noise figure measurement equipment is exceptional in applications like these:

**Amplifiers:** 1) Simultaneous noise figure and gain measurement; 2) results automatically corrected for ENR variations, ambient temperature, and mixer, LO, and IF noise contributions; 3) real-time, swept, corrected output to oscilloscope for easy tuning (display is digitally stored); 4) single-test-port calibration and measurement from 10 MHz to 26.5 GHz (with HP 8970 S/U systems).

**Transistors:** All the benefits of measuring amplifiers plus: 1) easy real-time tuning for best noise figure and gain; 2) real-time tuning to actual transistor  $F_{min}$  without second stage effects; 3) broadband (10 MHz to 26.5 GHz) single-sideband measurement (with the HP 8970S/U system); 4) low mismatch effects (the HP 346A features virtually identical impedance for  $T_h$  and  $T_c$ ); 5) ease of programming for automatic systems.

**Receivers and mixers:** 1) Simultaneous measurement of gain (conversion loss) and noise figure; 2) tunable and swept IF from 10 to 1600 MHz (with the HP 8970B) and 10 MHz to 26.5 GHz (with the HP 8970S/U); 3) no external IF gain needed; 4) automatic ENR correction, even for broadband sweeps; 5) effects of LO power, IF power, and IF frequency changes on noise figure easily observed; 6) ease of programming.

### Literature

**Product Note 8970B/S-2, Applications and Operation of the HP 8970B Noise Figure Meter**, describes the HP 8970B and many of its applications in more detail. It is both an introduction to the HP 8970B and a summary reference manual.

**Product Note 8970B/S-3, Noise Parameter Measurement Using the HP 8970B Noise Figure Meter and the ATN NP4 Noise Parameter Test Set**, describes noise parameter measurement on transistors.

**Application Note 57-1, Fundamentals of RF and Microwave Noise Figure Measurements**, explains the theory behind noise figure and its measurement. This note includes an extensive glossary of noise-related terms.

**Application Note 57-2, Noise Figure Measurement Accuracy**, discusses considerations for making accurate noise figure measurements and for determining the accuracy of noise figure measurements.

**Product Note 8970B/S-4, Displaying HP 8970B Noise Figure Meter Measurements on the HP 8757 Scalar Network Analyzer**, shows how to use a single display for noise and scalar parameters in production test situations.

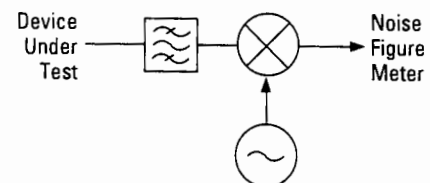

Single-sideband noise measurement system.

# NOISE FIGURE METER

## Automatic Noise Figure Meter

HP 8970B

- 10 to 1600 MHz
- Accurate and simple, swept or CW measurements
- Second-stage correction
- Displays both noise figure and gain
- Calibrated display on oscilloscope, recorder, or plotter
- Powerful special function enhancements

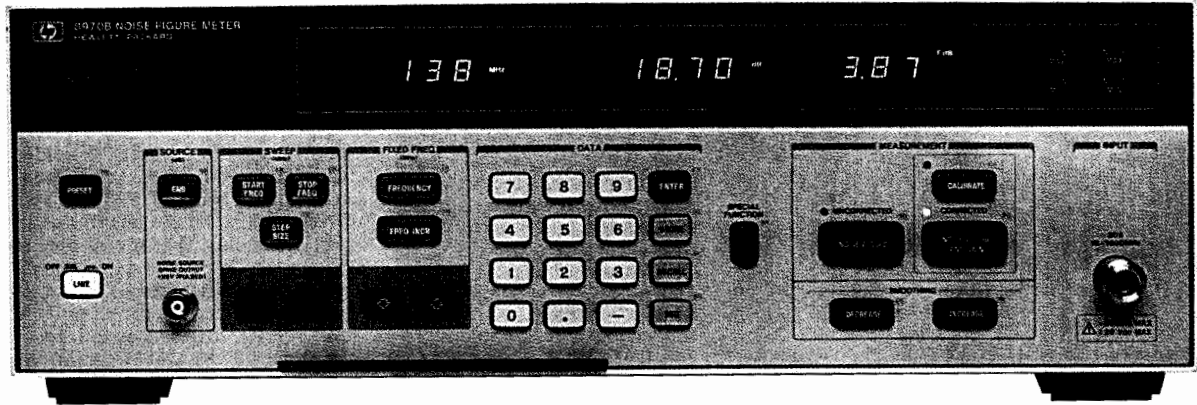

HP 8970B



### HP 8970B Noise Figure Meter

With the HP 8970B Noise Figure Meter, noise figure measurements are easy, accurate, and repeatable. Automatic second-stage correction makes accurate noise figure readings possible even for low-gain devices. The HP 8970B's dynamic range allows gain measurements of at least 40 dB (higher in some cases) or loss measurements to  $-20$  dB, with no external attenuation or amplification. The HP 8970B can store up to 4 ENR (Excess Noise Ratio) noise source calibration tables. It also properly interpolates ENR values at each measurement frequency.

### Microprocessor and Controller Functions

The HP 8970B takes the mystery out of noise figure measurements. It uses a microprocessor to make the calculations and corrections necessary for truly accurate, convenient, and flexible noise figure measurements. The meter also controls external local oscillators (such as the HP 8671/73 series synthesizers, the HP 8340 or HP 8360 series synthesized sweepers, or the HP 8350 sweep oscillator) and the HP 8971B Noise Figure Test Set. This makes accurate, broadband microwave measurements of amplifiers, mixers, and transistors as simple as RF measurements.

Virtually all of the HP 8970B's front panel keys and functions are accessible over HP-IB, Hewlett Packard's enhanced version of IEEE-488. The meter has an independent System Interface Bus (SIB) to control the HP 8971B and local oscillator. This additional bus frees you from having to write computer code to control an instrument on the SIB (such as the local oscillator) when used in an automated setup. Pass-through capability allows other instrument controllers to send messages through the meter to any other instrument on the SIB.

### Simple Calibration and Second-Stage Correction

Noise figure measurement accuracy is enhanced because the meter measures its own noise figure (and that of the rest of the measurement system) at up to 181 points. It stores this information, interpolates where necessary, and corrects for it when displaying the device-under-test noise figure. The HP 8970B also measures the test device gain.

### Display

The HP 8970B's front-panel LEDs display frequency, gain, and noise figure. Rear-panel BNC connectors allow swept display of noise figure and gain versus frequency on an oscilloscope or x-y recorder. You can also have the noise figure and gain vs. frequency display sent to a digital plotter over the HP 8970B's SIB. All display modes are easily and accurately scaled to the desired resolution from the meter's front panel. The swept oscilloscope display allows you to optimize your test device in real time for both noise figure and gain. You can

easily change the noise figure display from noise figure to effective noise temperature ( $T_e$ ) or Y factor.

### Front Panel and Special Functions

The HP 8970B front-panel keys control the number entry, calibration, and measurement functions. STORE, RECALL, and SEQ keys allow up to 9 front panel settings to be stored and sequenced automatically or manually to save setup time. Smoothing INCREASE and DECREASE keys are used to average up to 512 readings before display. This increases accuracy and eliminates display flicker.

For those who need greater measurement power than that provided by the HP 8970B's simple front panel, more than 200 special functions can be selected by pressing a numerical code and special function key. Two examples are hot-cold measurements and automatic compensation for losses at the input of the test device. One of the special functions is a catalog that quickly shows you the current special functions being used. Three pull-out cards serve as a mini-reference manual for the instrument. They include most of the special functions, the HP-IB formats and codes, error messages, and typical measurement setups.

### HP 8970B Partial Specifications

(See technical data sheet for complete specifications.)

**Noise figure (gain) measurement range:** 0 to 30 dB ( $-20$  to at least 40 dB)

**Noise figure (gain) instrumentation uncertainty:**  $\pm 0.1$  dB for  $0^\circ$  to  $55^\circ$  C ( $\pm .15$  dB)

**Noise figure resolution:** 0.01 dB (0.001 dB over HP-IB)

**Gain resolution:** 0.01 dB (0.001 dB over HP-IB)

**Frequency range:** Tunable from 10 to 1600 MHz

**Tuning accuracy** (from  $10^\circ$  to  $40^\circ$  C):  $\pm (1\text{MHz} + 1\%$  of frequency), 6 MHz maximum

**Frequency resolution:** 1 MHz

**Noise figure** (for input power levels below  $-60$  dBm):  $< 7$  dB + 0.003 dB/MHz

**Maximum operating input power:**  $-10$  dBm

**Maximum net external gain:**  $> 65$  dB between noise HP 8970B RF input

**Noise source drive:**  $28.0 \pm 0.1$  V

**Operating temperature:**  $0^\circ$  to  $55^\circ$  C

**Storage temperature:**  $-55^\circ$  to  $75^\circ$  C

**Power:** 100, 120, 220, or 240 V ( $+5\%$ ,  $-10\%$ ); 48–66 Hz; 150 VA maximum

**Dimensions:** 143 mm H  $\times$  425 W  $\times$  476 mm D (5.68 in  $\times$  16.75 in  $\times$  18.38 in)

**Weight:** Net, 15.5 kg (34 lb); shipping, 18.5 kg (40 lb)

# NOISE FIGURE METER

## Noise Figure Measurement System

HP 8970S/U, 8971C

403

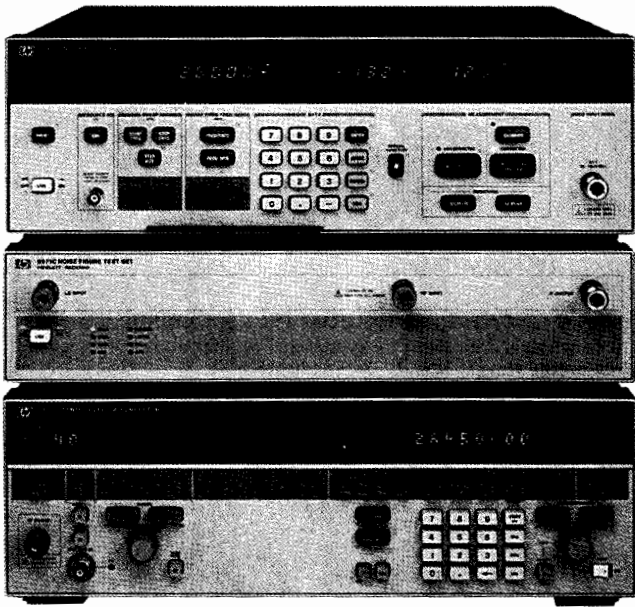

HP 8970S/U



### HP 8970S/U Microwave Noise Figure Measurement Systems

Until now, there was no standardized way to make microwave noise figure measurement, so users had to design and support their own microwave systems. Measurements crossing from RF to microwave were difficult because they required multiple system configurations.

Hewlett-Packard's answers to these problems are the HP 8970S and HP 8970U noise figure measurement systems. Each system consists of the HP 8970B Noise Figure Meter, the new HP 8971C Noise Figure Test Set, and a synthesized local oscillator. (The recommended LOs for the HP 8970S are listed in the HP 8970S Partial Specifications; the HP 8970U uses the HP 8673G Synthesized CW Generator as its local oscillator.)

The HP 8970S/U systems eliminate the tedious job of designing the measurement system and selecting components. The HP 8970B acts as the controller, so all system operation is transparent to the user. To ensure specified performance, the HP 8970S/U systems are given specifications just like an RF noise figure meter (i.e., the HP 8970B).

#### HP 8970S/U Partial Specifications

(See HP 8970S technical data sheet for complete specifications.)

**Frequency range:** 10 MHz to 26.5 GHz

**Noise figure measurement range:** 0 to 30 dB

**Noise figure instrumentation uncertainty** (for a 14 to 16 dB ENR noise source in a 10° to 40° C environment and for device under test noise figure plus gain greater than 10 dB):

10 MHz to 18 GHz: ±0.2 dB (plus typical drift of ±0.015 dB/° C)

18 to 26.5 GHz: ±0.4 dB (plus typical drift of ±0.08 dB/° C)

**Gain instrumentation uncertainty:** ±0.28 dB (plus typical drift of ±0.05 dB/° C, 10 MHz to 18 GHz  
±0.07 dB/° C, 18 to 26.5 GHz)

**Noise figure (max):**

10 to 30 MHz: 18 dB

30 to 100 MHz: 13 dB

0.1 to 12 GHz: 10 dB

12 to 18 GHz: 11.5 dB

18 to 26.5 GHz: 14 dB

**Input SWR:** 10 MHz to 18 GHz: 2.25

18 to 26.5 GHz: 2.7

**Recommended local oscillators:** HP 8671B, 8672A, 8673B/C/E/G, 8340B, 8341B, 83620A, 83622A, 83640A, and 83642A

- 10 MHz to 26.5 GHz
- Fully specified system
- Removes double-sideband inaccuracies
- As easy to operate as the HP 8970A or B

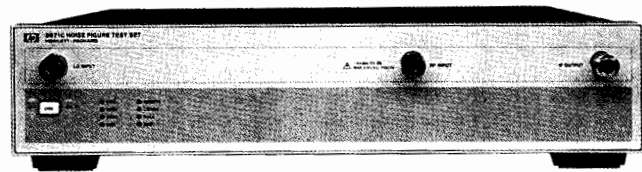

HP 8971C



### HP 8971C Noise Figure Test Set

The HP 8971C Noise Figure Test Set brings the simplicity of double-sideband measurements and the accuracy of single-sideband measurements together in one package. Careful design and high performance components, including a stable YIG filter, allow broadband single-sideband measurements from 10 MHz to 26.5 GHz with a single calibration and sweep. A low-noise preamplifier built into the Noise Figure Test Set lowers the second-stage noise figure, thereby reducing a major source of measurement uncertainty.

Measurement modes in the HP 8970B allow for double down-conversion using the HP 8971C as the second down-converter. These modes can be used for millimeter-wave measurements of amplifiers and transistors and measurements of receivers and mixers with IFs above 1.6 GHz.

#### HP 8971C Partial Specifications

(See HP 8970S technical data sheet for complete specifications.)

**Frequency range:** 10 MHz to 26.5 GHz

**Input SWR:**

10 MHz to 18 GHz: 2.25

18 to 26.5 GHz: 2.7

**Image and odd-harmonic rejection:** 20 dB

**Accessories supplied:**

1 LO-to-HP 8971B cable — SMA(female), 300 mm

1 HP 8971B-to-HP 8970B cable — N(male), 190 mm

1 N(male)-to-SMA(male) adapter

2 HP-IB cables — .5 m

# NOISE FIGURE METER

## Noise Sources

Models HP 346 A/B/C, R/Q347B



HP 346A, HP 346B, HP 346C

### HP 346A/B/C Broadband Noise Sources

The ideal companion to the HP's noise figure meter and systems is the HP 346 family of noise sources. Since they are broadband (10 MHz to either 18 or 26.5 GHz), they eliminate the necessity for several sources at different frequency bands. Each source has individually calibrated ENR values at specific frequencies. The calibration is printed on its label (see illustration) for easy loading into the HP 8970B. The low SWR of each noise source reduces a major source of measurement uncertainty—re-reflections of test signals. In addition, the variety of available connectors reduces the need for degrading accuracy with connector adapters.

The HP 346 family of noise sources are designed for a broad range of measurement applications. The HP 346C covers the broadest frequency range, 10 MHz to 26.5 GHz. The HP 346B's high ENR, low SWR, and variety of connectors make it a general-purpose noise source. The HP 346A is designed especially for accurate characterization of input-impedance-sensitive devices (like GaAsFETs and many UHF amplifiers). Its very small change in reflection coefficient (<0.01) from ON to OFF minimizes errors when measuring noise figure and gain as a function of input impedance.

### HP 346A/B/C Partial Specifications

(See technical data sheet for complete specifications.)

**Frequency range:** 10 MHz to 18 GHz for HP 346A/B; 10 MHz to 26.5 GHz for HP 346C.

**Excess noise ratio (ENR) limits:** HP 346A: 5 to 7 dB; HP 346B: 14 to 16 dB; HP 346C: 12 to 16 dB (10 MHz to 12 GHz) and 14 to 17 dB (12.0 to 26.5 GHz).

**Maximum SWR (reflection coefficient) on and off:**

**HP 346A/B:** 10 to 30 MHz — 1.3 (0.13); 30 to 5000 MHz — 1.15 (0.07); 5 to 18 GHz — 1.25 (0.11).

**HP 346C:** 10 MHz to 18 GHz — 1.25 (0.11); 18 to 26.5 GHz — 1.35 (0.15).

**Power required:**  $28 \pm 1$  Vdc.

**Dimensions:** 140 mm H  $\times$  21 mm W  $\times$  30 mm D (5.5 in  $\times$  0.8 in  $\times$  1.2 in)

**Weight:** Net, 0.108 kg (3.5 oz); shipping, 0.5 kg (1 lb)

**Standard connector:** APC-3.5 (male)

### HP 346C Option K01 Broadband Noise Source

This new coaxial noise source features coverage from 1 to 50 GHz with the 2.4 mm coaxial connector. ENR is nominally 20 dB at 1 GHz and 7dB at 50 GHz. Contact HP for technical specifications.

### HP R & Q347B Solid-State Noise Sources

The performance and reliability you have come to expect from Hewlett-Packard RF and microwave solid-state noise sources is now extended to millimeter-wave frequencies with the HP R347B (26.5 to 40 GHz) and HP Q347B (33 to 50 GHz) noise sources. A new GaAs avalanche diode specifically designed for high noise output and long-term reliability was developed for the HP R/Q347B noise sources. This results in excellent ENR stability over time. In turn, this ensures long recalibration cycles and very accurate noise figure measurements.

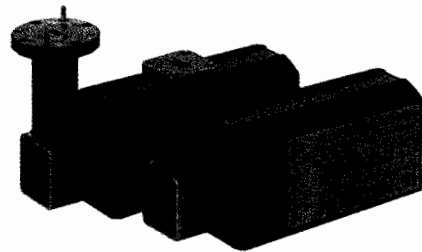

HP R/Q347B

### HP R & Q347B Noise Sources Partial Specifications

(See technical data sheet for complete specifications.)

**Frequency range:** R347B: 26.5 to 40 GHz  
Q347B: 33 to 50 GHz

**Excess noise ratio (ENR) range:**

HP R347B: 10 to 13 dB

HP Q347B: 10 to 13 dB (33 to 42 GHz)

6 to 12.5 dB (42 to 50 GHz)

**Max. SWR (reflection coefficient):**

HP R347B: <1.42 (0.17)

HP Q347B: <1.57 (0.22)

**Supplemental Characteristics**

**ENR Variation with temperature:** <0.009 dB/C

**ENR Variation with time:**

R347B: 0.15 dB typ. (over 2000 hrs.)

Q347B: 0.15 dB typ. (over 2000 hrs.)

### Ordering Information

	<b>Price</b>
<b>HP 8970B</b> Noise Figure Meter	\$ 12,700
<b>Opt H18</b> Increases Upper Frequency from 1600 to 1800 MHz	+ \$500
<b>Opt 907</b> Front Panel Handle Kit (5061-9689)	+ \$55.00
<b>Opt 908</b> Rackmounting Flange Kit (5061-9677)	+ \$32.50
<b>Opt 909</b> Both Options 907 and 908 (5061-9683)	+ \$80.00
<b>Opt 915</b> Service Manual (08970-90023)	\$35.00
<b>Opt 916</b> Additional Operating Manual (08970-90048)	\$30.00
<b>Opt 700</b> External Mate Translator	+ \$7,055.00
<b>Opt W30</b> Extended Repair Service	\$140.00
<b>Opt W32</b> Calibration Service	\$525.00
<b>HP 8971C</b> Noise Figure Test Set	\$21,000.00
<b>Opt 001</b> Add L.O. Power Amplifier	+ \$5,000.00
<b>Opt 002</b> Delete RF Preamp	- \$3,500.00
<b>Opt 907</b> Front Panel Handle Kit (5062-3988)	\$43.00
<b>HP 8970S</b> Noise Figure Measurement System	See HP 8970S Ordering Guide
<b>HP 8970U</b> Noise Figure Measurement System (10 MHz to 26.5 GHz)	\$68,600
<b>Opt W30</b> Extended Repair Service	\$1,200
<b>Opt W32</b> Calibration Service	\$4,050
<b>HP 346A</b> Noise Source	\$1,750
<b>Opt 001</b> Type N (male) Connector	\$0
<b>Opt 002</b> APC-7 Connector	\$25
<b>Opt 004</b> Type N (female) Connector	\$0
<b>Opt 910</b> Extra Operating Manual	\$2
<b>Opt W30</b> Extended Repair Service	\$55
<b>Opt W32</b> Calibration Service	\$285
<b>HP 346B</b> Noise Source	\$1,650
<b>Opt 001</b> Type N (male) Connector	\$0
<b>Opt 002</b> APC-7 Connector	\$25
<b>Opt 004</b> Type N (female) Connector	\$0
<b>Opt 910</b> Extra Operating Manual	\$2
<b>Opt W30</b> Extended Repair Service	\$55
<b>Opt W32</b> Calibration Service	\$285
<b>HP 346C</b> Noise Source	\$2,200
<b>Opt 910</b> Extra Operating Manual	\$2
<b>Opt W30</b> Extended Repair Service	\$55
<b>Opt W32</b> Calibration Service	\$305
<b>HP 346 Opt K01</b> Noise Source	\$3,600
<b>HP R347B</b> Noise Source	\$2,500
<b>HP Q347B</b> Noise Source	\$3,100

☎ For off-the-shelf shipment, call 800-452-4844.

# MICROWAVE TEST ACCESSORIES

## Microwave System Amplifiers

HP 83006A, 83017A, 87421A, 87400A, 87415A

405

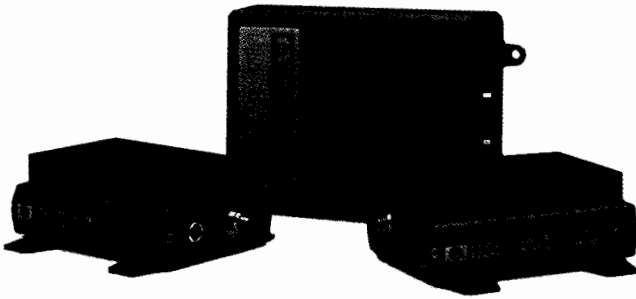

HP 83006A/17A and 87421A

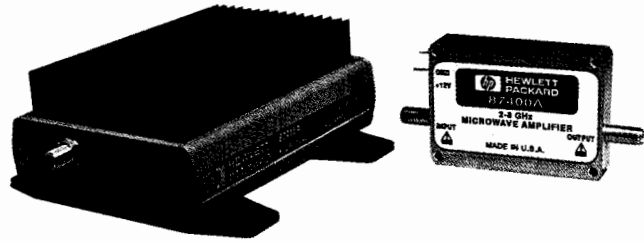

HP 87400A/415A

These Microwave System Amplifiers are targeted specifically for systems designers and integrators to speed and simplify the task of adding microwave gain and power blocks to measurement systems. The amplifiers are designed to provide microwave power where it is needed to recover systematic power losses within a test set or at the end of a cable run.

The HP 87400A Microwave Component Amplifier provides 30 dB minimum gain and over 23 dBm output power over the 2 to 8 GHz range in a small component style package that includes bias regulation. The HP 87415A offers the same performance in a package that includes integral heat sinking, bias port cabling, and standalone packaging for use in test system applications.

The HP 83006A and the HP 83017A Microwave System Amplifiers cover the frequency ranges of 10 MHz to 26.5 GHz with 20 dB gain and 0.5 to 26.5 GHz with 25 dB gain, respectively. The HP 83017A includes an internal directional detector at the output for use in external leveling applications. Both amplifiers come ready-to-use in a package

that includes a heatsink, bias regulation, and a mounting bracket. A 2 meter long dc bias cable with 3 wire leads is included with each amplifier.

The HP 87421A Power Supply is designed to power these amplifiers if a separate bias supply is not available within the system. The power supply is housed in a small separate package and, with the cable supplied, may be placed in any convenient location up to 2 meters away from the amplifier.

Developed to simplify the gain block needs of microwave systems integrators, this family of compact, integrated amplifiers offers power recovery wherever it is needed. Increase dynamic range or drive test devices into compression; these amplifiers make signal strength recovery easy. They are also ideal for use in external leveling, as preamplifiers in spectrum analyzers and frequency counters to increase instrument sensitivity and dynamic range. Other applications include use as a benchtop amplifier, in antenna subsystems, and production test systems.

### Specifications

(+20 to +30° C)

(HP 87400A specifications apply from +45 to +55° C case temperature.)

HP Model	Frequency Range (GHz)	Gain (dB min)	1 dB Comp Output Power (dBm min)	Noise Figure (dB typ)	SWR Input/Output	Price
87400A	2 to 8	30	+23	<13	2.0:1 3.6 2 to 2.5 2.6 2.5 to 8	\$1,900
87415A	2 to 8	30	+23	<13	2.0:1 3.6 2 to 2.5 2.6 2.5 to 8	\$2,400
83006A	0.01 to 26.5	20	+13 0.01 to 20 +10 20 to 26.5	<13 10 to 200 MHz <8 0.2 to 18 GHz <13 18 to 26.5 GHz	2.6:1 2.8:1 0.01 to 18 -3.2:1 18 to 26.5	\$3,950
83017A	0.5 to 26.5	25	+18 0.5 to 20 +13 20 to 26.5	<8 0.5 to 18 <13 18 to 26.5	2.6:1 2.6:1	\$4,950

**Bias voltage:** +12 V dc nominal (+11 to +13 V dc) for HP 87400A, HP 87415A, HP 83006A, and HP 83017A  
-12 V dc nominal (-11 to -13 V dc) for HP 83006A, HP 83017A

**RF connectors:** 3.5 mm (f) on RF input and output for all amplifiers  
BNC (f) on Detector Out on HP 83017A

**Weight:** Net 0.64 kg (1.5 lb); shipping 1.32 kg (3 lb) HP 87415A, HP 83006A, and HP 83017A

**Size:** Approx 51 mm H × 127 mm W × 102.5 mm D (2 in × 5 in × 4 in) for HP 87415A, HP 83006A, and HP 83017A amplifiers

Approx 12.2 mm H × 86.4 mm W × 44 mm D (0.5 in × 3.4 in × 1.72 in) for HP 87400A

**Bias cable:** HP Part Number 83006-60004 is a 2 meter cable with a 3-pin connector on one end and 3 wire leads on the other end.  
(supplied with HP 87415A, HP 83006A, and HP 83017A)

	dc Output Voltage/Current	Output Power	ac Input Voltage	Price
87421A	Output V1: +12 V at 2.0A Output V2: -12 V at 200 mA	25 W max	100 to 240 VAC 50/60 Hz	\$395

**Bias cable:** HP Part Number 83006-60004 is a 2 meter cable with a 3-pin connector on one end and a D-subminiature connector on the other end.  
(supplied with HP 87421A)

# MICROWAVE TEST ACCESSORIES

Transmission Reflection Test Sets, Power Splitters, Power Dividers  
HP 8721A, 85044A/B, 11850C/D, 11667A/B/C, 11636A/B

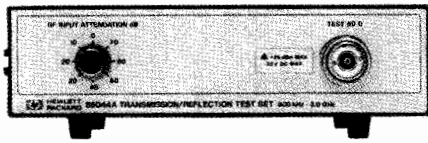

HP 85044A

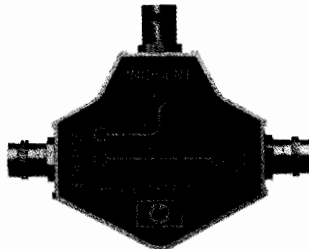

HP 8721A



HP 11850C



HP 11667A

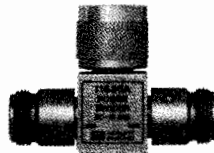

HP 11636A

## Description

Accurate broadband measurements of transmission and reflection parameters are highly dependent on the device used to separate signals for the measurement. Some devices separate the reflected and transmitted signals and some split power for ratio and comparison measurements.

### HP 8721A Directional Bridge

#### HP 8721A Option 008 75 $\Omega$ Version

**Frequency range:** 0.1 to 110 MHz

**Directivity:** > 40 dB, 1 to 110 MHz, typically > 30 dB, 0.1 to 1 MHz

**Load port match:** > 30 dB (VSWR < 1.07)

**Transmission arm:** Nominal loss, 6 dB. Frequency response, < 0.2 dB.

**Coupling arm:** Nominal coupling, 6 dB. Frequency response, < 0.6 dB.

**Maximum input power:** +20 dBm

**Weight:** Net, 0.55 kg (0.25 lb); shipping, 1.1 kg (0.5 lb)

**Size:** 59 mm H x 39 mm W x 123 mm D (1.5 in x 1 in x 3.13 in)

### HP 85044A 50 $\Omega$ Transmission Reflection Test Set

#### HP 85044B 75 $\Omega$ Transmission Reflection Test Set

The HP 85044 contains a power splitter and directional bridge that permits simultaneous transmission and reflection measurements with over 30 dB directivity from 300 kHz to 3.0 GHz. Detailed specifications on the HP 85044A and HP 85044B appear on page 301.

### HP 11850C 50 $\Omega$ Power Splitter

#### HP 11850D 75 $\Omega$ Power Splitter

These three-way power splitters are designed for ratio measurements from dc to 3.0 GHz (11850C) or 2 GHz (11850D). One output port provides the reference and the other two output ports can be used for independent transmission measurements. They provide 0.25 dB tracking and > 20 dB output match. Detailed specifications are on page 303.

### HP 11667A Power Splitter (Type N)

#### HP 11667B Power Splitter (3.5 mm)

#### HP 11667C Power Splitter (2.4 mm)

These two-way, two-resistor splitters provide good input and output source match in ratio measurement and source leveling applications. The HP 11667A operates from dc to 18 GHz with output match > 17 dB and tracking < 0.25 dB. The HP 11667B operates from dc to 26.5 GHz and has output source match > 18 dB and tracking < 0.4 dB. The HP 11667C operates from dc to 50 GHz and has an output source match > 12 dB and tracking < 0.4 dB. Detailed specifications are on page 283.

### HP 11636A/B Power Dividers/Combiners

The HP 11636A/B are two-way, three-resistor power dividers for nonratio measurements. They can also be used as power combiners for combining two independent signals. They are ideal for fault location measurements with HP 8757S and HP 85016A software.

**Frequency range:** HP 11636A: dc to 18 GHz

HP 11636B: dc to 26.5 GHz.

**Impedance:** 50  $\Omega$  nominal

**Insertion loss:** 6 dB nominal

	DC to 10 GHz	DC to 18 GHz	DC to 26.5 GHz
<b>Input SWR</b>			
HP 11636A	< 1.25	< 1.35	
HP 11636B	< 1.22	< 1.29	< 1.29
<b>Output SWR</b> (nonratio measurements)			
HP 11636A	< 1.25	< 1.35	
HP 11636B	< 1.22	< 1.29	< 1.29
<b>Output Tracking</b> (between output arms)			
HP 11636A	< 0.4 dB	< 0.5 dB	
HP 11636B	< 0.25 dB	< 0.25 dB	< 0.5 dB
<b>Typical Phase Tracking</b> (between output arms)			
HP 11636A	2°	2°	
HP 11636B	2°	2.5°	3°

### Maximum Input Power

HP 11636 A +30 dBm

HP 11636B +27 dBm

### Connectors

HP 11636A: Type N male input port, female output ports

HP 11636B: APC-3.5 female on all ports

### Dimensions

HP 11636A: 42 mm H x 45 mm W x 18 mm D (1.64 in x 1.75 in x 0.69 in)

HP 11636B: 40 mm H x 47 mm W x 10 mm D (1.6 in x 1.9 in x 0.4 in)

### Weight

HP 11636A: Net, 0.14 kg (0.31 lb); shipping, 0.45 kg (1 lb)

HP 11636B: Net, 0.06 kg (0.13 lb); shipping, 0.14 kg (0.3 lb)

### Ordering Information

HP 8721 Directional Bridge

Opt 008 75  $\Omega$  Version

HP 85044A 50  $\Omega$  Transmission Reflection Test Set

HP 85044B 75  $\Omega$  Transmission Reflection Test Set

HP 11850C 50  $\Omega$  Power Splitter

HP 11850D 75  $\Omega$  Power Splitter

HP 11667A Power Splitter (dc to 18 GHz)

Opt 001 Type N Male Input, Type N Female Outputs

Opt 002 Type N Female Input, APC-7 On Outputs

HP 11667B Power Splitter (dc to 26.5 GHz)

HP 11667C Power Splitter (dc to 50 GHz)

HP 11636A Power Divider (dc to 18 GHz)

HP 11636B Power Divider (dc to 26.5 GHz)

☎ For off-the-shelf shipment, call 800-452-4844.

### Price

\$400

+ \$50

\$3,200

\$3,700

\$950

\$1,500

\$990

\$0

+ \$75

\$1,070

\$1,570

\$600

\$1,050





# MICROWAVE TEST ACCESSORIES

Coaxial Fixed Attenuators, Blocking Capacitor, 2.4 mm Instrument Grade Connectors, Harmonic Mixers

407

HP 8490 Series, 11581/2/3, 11742A, 11970 Series, 33392/3 Series

## HP 8490D, 8491A/B, 8492A, 8493A/B/C Fixed Attenuators

Hewlett-Packard coaxial fixed attenuators provide precision attenuation, flat frequency response, low SWR over broad frequency ranges (dc to 50.0 GHz) at low prices. Attenuators are available in nominal attenuations of 3 dB and 6 dB, also 10 dB increments from 10 dB to 60 dB. These attenuators are swept-frequency tested to ensure they meet specifications at all frequencies. Calibration points are provided on a nameplate chart attached to each unit.

## HP 8491C Economy Fixed Attenuators

The new HP 8491C series general-purpose fixed attenuators feature precision attenuation, flat frequency response, and low SWR from dc to 18 GHz. Available with precision Type-N connectors, the HP 8491C family is available in 3, 6, 10, 20, and 30 dB attenuation values. Please specify attenuation value (option) when ordering.

## HP 11581A, 11582A, 11583A/C Attenuator Sets

A set of four Hewlett-Packard attenuators—3, 6, 10, and 20 dB—are furnished in a handsome walnut accessory case. The HP 11581A set consists of HP 8491A Attenuators; the HP 11582A set, HP 8491B Attenuators; the HP 11583A set, HP 8492A Attenuators; and the HP 11583C set, HP 8493C Attenuators. The set includes calibration reports certified traceable to the National Institute of Standards and Technology, containing both the attenuation and the reflection coefficients for each attenuator at the frequencies indicated under "Option 890" calibration data on the next page. Thus it is not required to specify Option 890.

These sets are ideal for calibration labs or where precise knowledge of attenuation and SWR is desired.

## HP 8498A High Power Attenuator

The HP 8498A Option 030 is designed to meet the needs of high power attenuation applications in the RF and microwave frequency range. It is specified from dc to 18 GHz at 25 watts average, 500 watts peak, from dc to 5.8 GHz and 125 watts peak from 5.8 to 18 GHz. Available only in a 30 dB model (Option 030), the unit offers low SWR (<1.30 at 18 GHz) and good accuracy ( $\pm 1$  dB at 18 GHz). The unit also features "human engineered" cooling fins that prevent operator burns even under continuous maximum input power conditions.

## Option 890 Calibration Data

Extensive calibration data is available on HP attenuators at low cost. When Option 890 is specified for the fixed attenuators or microwave step attenuators, standardized calibration data in frequency steps no larger than 500 MHz is provided over the frequency range of the units. This data is generated from measurements made on an HP 8510 Automatic Network Analyzer and features excellent accuracy (traceable to NIST) and low cost. Data is given for attenuation and the SWR (reflection coefficient for the HP 8493C) of each port and is provided in a protective plastic envelope.

## HP 11742A Blocking Capacitor

The HP 11742A is a high performance outside blocking capacitor. It features broadband performance, low SWR (1.2 from .01 to 26.5 GHz) and low insertion loss (.6 dB from .01 to 26.5 GHz). The HP 11742A comes with 3.5 mm connectors. It is ideal for use with high frequency oscilloscopes and in bias circuits for the attenuation of low frequencies and blocking dc voltages up to 50V.

## 2.4 mm Instrument Grade Connectors

The 2.4 mm coaxial connector family allows mode free operation from dc to 50 GHz in coax. Designed to offer a very repeatable, low return loss coaxial interface rugged enough for repeated connect-disconnect cycles, the 2.4 mm draws upon many years of connector development experience and incorporates the best features of many different designs. These precision-instrument-grade connectors and connector parts offer designers very repeatable, low return loss connectors for test equipment and demanding breadboard design applications.

## Typical 2.4 mm Performance (return loss):

	dc to 18 GHz	18 to 26.5 GHz	26.5 to 50 GHz
Connector pair	30 dB	28 dB	22 dB
Launch connectors	28 dB	26 dB	20 dB

## 2.4 mm Male (plug) Connector Parts & Assemblies:

HP Model	Description	Price (per 10)
33392A	Male outer conductor	\$320.00
33392B	Male center conductor	\$115.00
33392C	Snap ring	\$20.00
33392D	Coupling nut	\$32.50
33392E	Bead/ring assembly	\$145.00
33393A	Male barrel launch	
33392H	Cable end connector	\$75.00
33393C	Cable assy (0.086 dia)	\$150.00

## 2.4 mm Female (jack) Connector Parts & Assemblies:

33392F	Female outer conductor	\$350.00
33392G	Female center conductor	\$100.00
33392E	Bead/ring assembly	\$145.00
33393B	Female barrel launch	

## HP 11970 Series Harmonic Mixers

Although designed for operation with HP spectrum analyzers, these broadband mixers also serve a wide variety of general-purpose uses for the frequency bands from 18 to 110 GHz. Such uses include down-conversion for noise figure and network analysis measurements.

As down-conversion mixers for test receivers, the HP 11970s offer flat response, low SWR, and low conversion loss without requiring bias. These mixers can also serve as harmonic generators with input signals from 2 to 6.1 GHz. Outputs are at the band specified, and each mixer is individually calibrated for conversion loss over its complete band.

## HP 11970 Series Specifications

HP Models	Frequency Range (GHz)	Frequency Response (dB)	Waveguide and Equivalent Flange	Price
11970K	18 to 26.5	$\pm 1.9$ $\pm 2.1$	WR-42 UG-595/U	\$1,990
11970A	26.5 to 40	$\pm 1.9$ $\pm 2.1$	WR-28 UG-599/U	\$2,050
11970Q	33 to 50	$\pm 1.9$ $\pm 2/3$	WR-22 UG-383/U	\$2,200
11970U	40 to 60	$\pm 1.9$ $\pm 2.3$	WR-19 UG-383/U (mod)	\$2,460
11970V	50 to 75	$\pm 2.1$ $\pm 2.5$	WR-15 UG-385/U	\$2,920
11970W	75 to 110	$\pm 3.0$	WR-10 UG-385/U (mod)	\$3,270

# MICROWAVE TEST ACCESSORIES

Coaxial Fixed Attenuators, Blocking Capacitor, 2.4 mm Instrument, Grade Connectors, Harmonic Mixers (cont'd)

HP 8490 Series, 11581/2/3, 11742A, 11970 Series, 33392/3 Series



HP 8490 Series



HP 8492 Series



HP 8493A/B/C Series

### Ordering Example

Include appropriate frequency range/connector and attenuation designations from the ordering example below with every attenuator order.

#### 8491B Option 010

#### Connectors and Frequency Range

- 0D: 2.4 mm (m,f), dc to 50.0 GHz
  - 1A: Type N (m,f), dc to 12.4 GHz
  - 1B: Type N (m,f), dc to 18 GHz
  - 1C: Type N (m,f), dc to 18 GHz
  - 2A: APC-7, dc to 18 GHz
  - 3A: SMA (m,f), dc to 12.4 GHz
  - 3B: SMA (m,f), dc to 18 GHz
  - 3C: 3.5 mm (m,f), dc to 26.5 GHz
  - 8A: Type N (m,f), dc to 18 GHz
- 8498 is available in a 30-dB model only  
 \*Not available for HP 8493A/B  
 \*\*Not available for HP 8493A/B/C and HP 8490D

#### Attenuation

- 003: 3 dB
- 006: 6 dB
- 010: 10 dB
- 020: 20 dB
- 030: 30 dB
- 040: 40 dB\*
- 050: 50 dB\*\*
- 060: 60 dB\*\*

### Ordering Information

- HP 11581A 3, 6, 10, 20 dB HP 8491A set
- HP 11582A 3, 6, 10, 20 dB HP 8491B set
- HP 11583A 3, 6, 10, 20 dB HP 8492A set
- HP 11583C 3, 6, 10, 20 dB HP 8493C set

### Price

- \$450
- \$550
- \$1,050
- \$950

### HP 8490D, 8491A/B/C, 8492A, 8493A/B/C, 8498A, Option 890 Specifications

Freq Range (GHz)	Conn (m,f)	Model	SWR (max)	Power	Attenuation Accuracy									Price
					3 dB Opt 003	6 dB Opt 006	10 dB Opt 010	20 dB Opt 020	30 dB Opt 030	40 dB Opt 040	50 dB Opt 050	60 dB Opt 060		
dc to 12.4	Type N Type N SMA	8491A 8491A 8493A	dc to 8 GHz: 1.2 8 to 12.4 GHz: 1.3	2 W avg 100 W peak	dc to 12.4	±0.3	±0.4	±0.6	±0.6	±1.0	±1.5	±1.5	±2	\$125
						Opt 003	Opt 006	Opt 010	Opt 020	Opt 030	Opt 040	Opt 050	Opt 060	\$175
						Opt 003	Opt 006	Opt 010	Opt 020	Opt 030				\$120
dc to 18	Type N Type N Type N Type N SMA	8491B 8491B 8491C 8491C 8493B	dc to 8 GHz: 1.2 8 to 12.4 GHz: 1.3 12.4 to 18 GHz: 1.5	2 W avg 100 W peak	dc to 12.4 12.4 to 18	±0.3	±0.4	±0.6	±0.6	±1.0	±1.5	±1.5	±2	\$150
						±0.4	±0.5	±0.6	±1.0	±1.0	±1.5	±1.5	±2	\$210
						Opt 003	Opt 006	Opt 010	Opt 020	Opt 030	Opt 040	Opt 050	Opt 060	\$95
						Opt 003	Opt 006	Opt 010	Opt 020	Opt 030	Opt 040	Opt 050	Opt 060	\$95
dc to 18 High Power	Type N	8498A Opt 030	dc to 8 GHz: 1.15 8 to 12.4 GHz: 1.25 12.4 to 18 GHz: 1.35	25 W avg 500 W peak (dc to 5.8 GHz) 125 W peak (5.8 to 18 GHz) 500 μs max per pulse					Opt 030					\$340
														Opt 003
dc to 26.5	3.5 mm	8493C	dc to 8 GHz: 1.1 8 to 12.4 GHz: 1.15 12.4 to 26.5 GHz: 1.25 1.27 (Opt 006 only)	2 W avg 100 W peak	dc to 18 18 to 26.5	±0.5	±0.3	±0.5	±0.7	±1.0				
						±0.6	±0.5	±0.6	±1.0	±1.3				\$250
dc to 50	2.4 mm	8490D	dc to 26.5 GHz: 1.15 (1.08 Opt 040 only) 26.5 to 40 GHz: 1.25 (1.15 Opt 040 only) 40 to 50 GHz: 1.45 (1.25 Opt 040 only)	2 W avg 100 W peak	dc to 26.5 26.5 to 50	+0.9	+0.9	+0.09	+1.3	+1.3	+1.5			
						-0.5	-0.6	-0.6	-0.8	-0.8	-0.8			\$375
Opt 890 Calibration Data		HP Models		Calibration Frequencies (MHz)									Opt 890 Price	
		8490D		0.4 GHz to 50 GHz in 400 MHz steps									+ \$50	
		8491A, 8493A		.2 GHz to 12.4 GHz in 200 MHz steps									+ \$20	
		8491B, 8492A, 8493B, 8498A		.2 GHz to 18.0 GHz in 200 MHz steps									+ \$25	
				1.5 GHz to 26.5 GHz in 250 MHz steps									+ \$40	

☎ For off-the-shelf shipment, call 800-452-4844.

# MICROWAVE TEST ACCESSORIES

## Coaxial Step Attenuators

HP 355 Series, 8494/5/6/7 Series, 11716 Series, 33320 Series

409

- Excellent repeatability
- Manual and programmable

- Calibration data available
- Five million cycles per section reliability

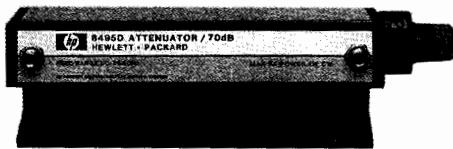

HP 8495D

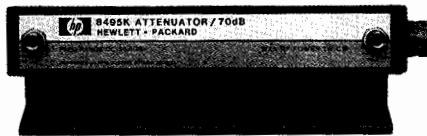

HP 8495K

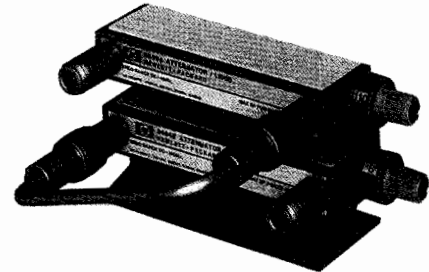

HP 11716A



### DC to 1000 MHz Programmable and Manual Step Attenuators. HP 355C/D/E/F

- Precision attenuation from DC to 1000 MHz
- 355C/E provide 0 to 12 dB in 1 dB steps
- 355D/F provide 0 to 120 dB in 10 dB steps
- All standard models use standard BNC RF connector
- Programmable models (E/F) use 7-pin connector

### DC to 4, 18, and 26.5 GHz Programmable and Manual Step Attenuators

HP 8494A/B/G/H (0 to 11 dB, 1 dB steps)

HP 8495A/B/D/G/H/K (0 to 70 dB, 10 dB steps)

HP 8496A/B/G/H (0 to 110 dB, 10 dB steps)

HP 8497K (0 to 90 dB, 10 dB steps)

Hewlett-Packard attenuators offer exceptional repeatability and reliability in a wide range of attenuation, frequency, and connector options.

- SMA (f), Type N (f), APC-7 mm (f), and 3.5 mm RF connectors.
- DC to 4 GHz, dc to 18 GHz, and dc to 26.5 GHz models.
- Permanent magnet latching design and automatic DC current interrupts simplify programmable model drive circuit design.

Each attenuator contains three or four cascaded attenuator sections; edge-line contacts insert and remove attenuator sections as needed. Precision gold-plated leaf springs ensure long life (over 5 million cycles) and very high attenuator repeatability (typically 0.01 dB). Programmable models (G, H, and K suffixes) feature fast-switching solenoids; attenuation programming is done through a 12-pin connector.

To improve measurement accuracy in manual and automated test systems, NIST traceable calibration data (SWR and attenuation) is available as Option 890. Generated on an HP 8510 network analyzer, this option offers swept data for each attenuator step in 250 MHz steps from 1500 MHz to 26.5 GHz (upper frequency varies by model).

To simplify connecting programmable attenuators to the drive circuit, each unit is supplied with a 5-ft cable assembly. With an HP 11713A Attenuator Driver, or an HP 70611 Driver for MMS-based systems, the attenuators are easily integrated into a Hewlett-Packard Interface Bus (HP-IB) automated system.

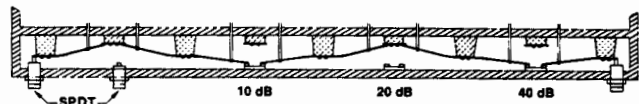

Figure 1. 70 dB plus SPDT.

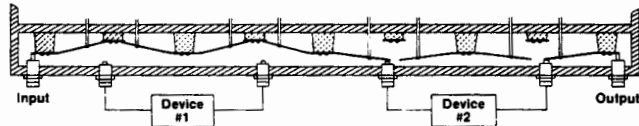

Figure 2. Dual transfer switch showing device #2 inserted in signal path.

### Custom Attenuator and Switch Combinations

Custom step attenuator/switch combinations are possible with the HP 8494/5/6/7 attenuator family. Examples can be as simple as adding a SPDT switch section to a standard 70 dB attenuator (figure 1) or creating a dual transfer switch (figure 2). See the HP Microwave Test Accessories Catalog for more information.

### HP 11716A/B Attenuator Interconnect Kits

Quickly and conveniently connect 1 dB step and 10 dB step attenuators together to achieve greater dynamic range with 1 dB steps. The 11716A/B interconnect kits contain a rigid RF cable, mounting bracket, and necessary hardware to connect any pair of HP 8494/5/6/7 attenuators in series (see photo above). Attenuators must be ordered separately.

### Ordering Information

HP 11716A Interconnect Kit (Type N)

HP 11716B Interconnect Kit (7mm)

### Price

\$220

\$300

### HP 33320 Series OEM Step Attenuators

The HP 33320 series step attenuators are compact versions of the HP 8495/6/7 benchtop attenuators. They offer the same specifications, but are configured to fit easily into microwave systems and instruments. Both manual and programmable versions are available; the manual version occupies less than 1.5 square inches of panel space. OEM quantity discounts are available for the HP 33320 series; the HP 33320 series has a five-million-cycles-per-step reliability guarantee.

Programmable models are supplied with a 5-ft cable, fitted with a round 12-pin Viking connector that mates with the HP 11713 Attenuator/Switch Driver. A flat ribbon cable with a DIP-type connector, compatible with a standard 14-pin DIP IC socket, is also available.

### How to Order the HP 8494/5/6/7 Series Attenuators

Each order must include basic model number, suffix letter, and connector option.

Optional calibration data

#### HP 8494 A Option 001 Option 890

4 (1 dB step, 11 dB max)  
5 (10 dB step, 70 dB max)  
6 (10 dB step, 110 dB max)  
7 (10 dB step, 90 dB max)

A (Manual, dc to 4 GHz)  
B (Manual, dc to 18 GHz)  
D (Manual, dc to 26.5 GHz)\*  
G (Programmable, dc to 4 GHz)  
H (Programmable, dc to 18 GHz)  
K (Programmable, dc to 26.5 GHz)\*

001 (N female)  
002 (SMA female)  
003 (APC-7)  
004 (3.5 mm female)\*

\* Option 004 is only available on D and K models.

### HP 355 Series, 8494/5/6/7 Series Specifications

HP Model (Switching Mode) (OEM Model No.)	Frequency Range (GHz)	Incremental Attenuation (dB)	SWR Maximum (50 Ω Nominal)	Insertion Loss (0 dB setting)	Attenuation Accuracy	Power Rating, Minimum Life	Solenoid Voltage Speed Power	Size, Shipping Weight	Connector Options Available	Price
355C (Manual)	dc to 1	0 to 12 1 dB steps	dc to 0.25 GHz: 1.2 dc to 0.5 GHz: 1.3 dc to 1.0 GHz: 1.5	0.11 dB + 1.39 dB/GHz	±0.1 dB @ 1000 Hz ±0.25 dB: dc to 0.5 GHz ±0.35 dB: dc to 1.0 GHz	0.5 W avg 350 W peak 0.3 million cycles per section	—	67 mm H × 70 mm W × 152 mm D (2.6 in × 2.75 in × 6 in)	BNC (f) See Note 1	\$700
355E (Programmable)							15 to 18 V < 65 ms 3.0 W	1.4 kg (3 lb)		\$1,050
355D (Manual)	dc to 1	0 to 120 10 dB steps	dc to 0.25 GHz: 1.2 dc to 0.5 GHz: 1.3 dc to 1.0 GHz: 1.5	0.11 dB + 1.39 dB/GHz	±0.3 dB @ 1000 Hz ±1.5 dB to 90 dB, and ±3 dB to 120 dB @ 1 GHz	0.5 W avg 350 W peak 0.3 million cycles per section	—	67 mm H × 70 mm W × 152 mm D (2.6 in × 2.75 in × 6 in)	BNC (f) See Note 1	\$700
355F (Programmable)							15 to 18 V < 65 ms 3.0 W	1.4 kg (3 lb)		\$1,050
8494A (Manual) (33320A)	dc to 4	0 to 11 1 dB steps	1.5	0.6 dB + 0.09 dB/GHz	±0.2 dB: 1 to 2 dB ±0.3 dB: 3 to 6 dB ±0.4 dB: 7 to 10 dB ±0.5 dB: 11 dB	1 W avg 100 W peak 10 μs max 5 million cycles per section	—	43 mm H × 73 mm W × 159 mm D (1.7 in × 2.9 in × 6.2 in)	001 002 003 See Note 2	\$620
8494G (Programmable) (33320G)							20 to 30 V < 20 ms 2.7 W	43 mm H × 73 mm W × 142 mm D (1.7 in × 2.9 in × 5.6 in)		\$845
8494B (Manual) (33320B)	dc to 18	0 to 11 1 dB steps	dc to 8 GHz: 1.5 dc to 12.4 GHz: 1.6 dc to 18 GHz: 1.9	0.6 dB + 0.09 dB/GHz	dc to 12.4 GHz ±0.3 dB: 1 to 2 dB ±0.4 dB: 3 to 4 dB ±0.5 dB: 5 to 6 dB ±0.6 dB: 7 to 10 dB ±0.7 dB: 11 dB dc to 18 GHz ±0.7 dB: 1 to 5 dB ±0.8 dB: 6 to 9 dB ±0.9 dB: 10 to 11 dB	1 W avg 100 W peak 10 μs max 5 million cycles per section	—	43 mm H × 73 mm W × 159 mm D (1.7 in × 2.9 in × 6.2 in)	001 002 003 See Note 2	\$915
8494H (Programmable) (33320H)							20 to 30 V < 20 ms 2.7 W	43 mm H × 73 mm W × 142 mm D (1.7 in × 2.9 in × 5.6 in)		\$1,220
8495A (Manual) (33320A)	dc to 4	0 to 70 10 dB steps	1.35	0.4 dB + 0.07 dB/GHz	±1.7% of setting or ±0.4 dB, whichever is greater	1 W avg 100 W peak 10 μs max 5 million cycles per section	—	43 mm H × 73 mm W × 130 mm D (1.7 in × 2.9 in × 5.1 in)	001 002 003 See Note 2	\$515
8495G (Programmable) (33320G)							20 to 30 V < 20 ms 2.7 W	43 mm H × 73 mm W × 114 mm D (1.7 in × 2.9 in × 4.5 in)		\$720
8495B (Manual) (33321B)	dc to 18	0 to 70 10 dB steps	dc to 8 GHz: 1.35 dc to 12.4 GHz: 1.5 dc to 18 GHz: 1.7	0.4 dB + 0.07 dB/GHz	±3%: dc to 12.4 GHz ±4%: dc to 18 GHz % in dB from Atten. Setting	1 W avg 100 W peak 10 μs max 5 million cycles per section	—	43 mm H × 73 mm W × 130 mm D (1.7 in × 2.9 in × 5.1 in)	001 002 003 See Note 2	\$670
8495H (Programmable) (33321H)							20 to 30 V < 20 ms 2.7 W	43 mm H × 73 mm W × 114 mm D (1.7 in × 2.9 in × 4.5 in)		\$920
8495D (Manual) (33321D)	dc to 26.5	0 to 70 10 dB steps	dc to 6 GHz: 1.25 6 to 12.4 GHz: 1.45 12.4 to 18.0 GHz: 1.6 18.0 to 26.5 GHz: 1.8	0.6 dB + 0.09 dB/GHz	±0.3 dB at 6 GHz 10 dB attenuation to ±2.8 dB at 26.5 GHz 90 dB attenuation. See Data Sheet 5952-8278 for details.	1 W avg 100 W peak 10 μs max 5 million cycles per section	—	43 mm H × 52 mm W × 159 mm D (1.7 in × 2.1 in × 6.2 in)	004 3.5 mm See Note 2	\$875
8495K (Programmable) (33321K)							20 to 30 V < 20 ms 2.7 W	43 mm H × 52 mm W × 168 mm D (1.7 in × 2.1 in × 6.6 in)		\$1,170
8496A (Manual) (33322A)	dc to 4	0 to 110 10 dB steps	1.5	0.6 dB + 0.09 dB/GHz	±1.7% of setting or ±0.4 dB, whichever is greater	1 W avg 100 W peak 10 μs max 5 million cycles per section	—	43 mm H × 73 mm W × 159 mm D (1.7 in × 2.9 in × 6.2 in)	001 002 003 See Note 2	\$620
8496G (Programmable) (33322G)							20 to 30 V < 20 ms 2.7 W	43 mm H × 73 mm W × 142 mm D (1.7 in × 2.9 in × 5.6 in)		\$845
8496B (Manual) (33322B)	dc to 18	0 to 110 10 dB steps	dc to 8 GHz: 1.5 dc to 12.4 GHz: 1.6 dc to 18 GHz: 1.9	0.6 dB + 0.09 dB/GHz	±3%: dc to 12.4 GHz ±4%: dc to 18 GHz % in dB from Atten. Setting	1 W avg 100 W peak 10 μs max 5 million cycles per section	—	43 mm H × 73 mm W × 159 mm D (1.7 in × 2.9 in × 6.2 in)	001 002 003 See Note 2	\$915
8496H (Programmable) (33322H)							20 to 30 V < 20 ms 2.7 W	43 mm H × 73 mm W × 142 mm D (1.7 in × 2.9 in × 5.6 in)		\$1,220
8497K (Programmable) (33323K)	dc to 26.5	0 to 90 10 dB steps	dc to 6 GHz: 1.25 6 to 12.4 GHz: 1.45 12.4 to 18.0 GHz: 1.6 18.0 to 26.5 GHz: 1.8	0.6 dB + 0.09 dB/GHz	±0.3 dB at 6 GHz 10 dB attenuation to ±2.8 dB at 26.5 GHz 90 dB attenuation. See Data Sheet 5952-8278 for details.	1 W avg 100 W peak 10 μs max 5 million cycles per section	5 V or 24 V	43 mm H × 52 mm W × 143 mm D (1.7 in × 2.1 in × 5.6 in)	004 3.5 mm See Note 2	\$1,320
Option 890 Calibration Data	Option 890 Frequency List (MHz) DC to 4 GHz Models: 100, 300, 500, 700, 900, 1000, 1250, 1500, 1750, 2000, 2500, 3000, 3500, 4000. DC to 18 GHz Models: Same as above to 4000 MHz, every 500 MHz to 16000 (plus 12400 MHz), every 250 MHz from 16000 to 18000.						Models 8494A/G, 8496A/G, 33320A/G, 33322A/G 8495A/G, 33321A/G 8494B/H, 8496B/H, 33320B/H, 33322B/H 8495B/H, 33321B/H 8495D/K, 8497K		Option 890 add \$25 add \$25 add \$35 add \$35 add \$50	
Note 1: 355C/D/E/F connector options (BNC (f) standard): Option 001 N(f) Option 005 TNC(f) Option 007 Transistor protection (355E/F only)				Price add \$25 add \$10 add \$55	Note 2: 8494/5/6/7 orders must specify connector option. See ordering example above. Option 001 N(f) Option 002 SMA(f) Option 003 APC-7 Option 004 3.5 mm (HP 8495D/K, 8497K only)				Price N/C N/C add \$50 N/C	

☎ For off-the-shelf shipment, call 800-452-4844.

# MICROWAVE TEST ACCESSORIES

## High Performance Programmable Step Attenuators

HP 84904/6/7 K, L, and M

411

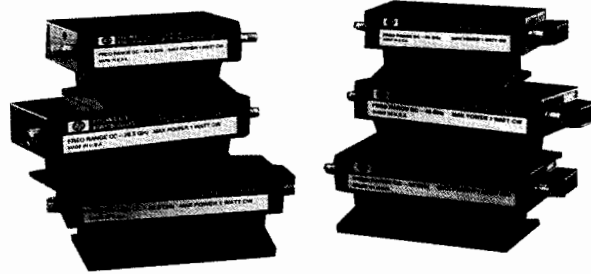

HP 84904/6/7 K, L, and M

### High Performance Coaxial Attenuators

The HP 84904/6/7 family of programmable step attenuators offers unmatched attenuation performance to 50 GHz. The new K family brings superior accuracy and reliability to 26.5 GHz, while the L and M families offer unparalleled performance to 40 and 50 GHz respectively.

These families offer the selection, performance, and reliability expected from HP attenuators: attenuation range of 11, 70, or 90 dB; 1 dB and 10 dB step sizes; 5 million cycles per section; better than 0.03 dB repeatability; connector size options; and now the choice of male (plug) or female (jack) connectors. Connector choices include precision 3.5 mm or 2.92 mm on the 26.5 GHz K model, and precision 2.4 mm or 2.92 mm on the L model. *While the 2.92 mm connector format is compatible with both 3.5 mm and SMA connectors, Hewlett-Packard recommends the more rugged 2.4-mm and 3.5-mm connectors.*

#### Other Features

- Same drive circuits and solenoids as HP 8494/5/6/7 family.
- Switching time under 20 milliseconds (includes settling time).
- Permanent magnet latching design; attenuators will withstand over 10 g shock without performance degradation.
- Automatic dc circuit interrupts cut power consumption and simplify drive circuit design.
- Equipped with 10-pin DIP plugs (m). Optional cables with 10-pin DIP socket (f) connectors are available; see below.
- Attenuation and SWR calibration data (Option 890).

Drive options include the HP 11713A Attenuator/Switch driver, which permits users to easily integrate the attenuator into HP-IB-compatible automatic test systems and the new HP 70611 MMS Attenuator/Switch Driver. Cabling options include 8- or 16-inch rib-

bon cables (HP 11764C/D) with a 10-pin DIP socket (f) and a 14-pin DIP plug for easy connection to standard 14-pin DIP IC sockets, a 5-foot Interconnect Cable (HP 11764A) with 10-pin DIP socket (f), and a "Viking" cable for the HP 11713 driver, and a 5-foot Interconnect Cable (HP 11764 B) with a 10-pin DIP socket (f) and bare leads for custom applications.

#### Ordering Information

##### Attenuators

Attenuator Model	Price
HP 84904M 0 to 11 dB, 1 dB steps, 50 GHz	\$3,500
HP 84904L 0 to 11 dB, 1 dB steps, 40 GHz	\$2,400
HP 84904K 0 to 11 dB, 1 dB steps, 26.5 GHz	\$1,850
HP 84906M 0 to 90 dB, 10 dB steps, 50 GHz	\$3,500
HP 84906L 0 to 90 dB, 10 dB steps, 40 GHz	\$2,400
HP 84906K 0 to 90 dB, 10 dB steps, 26.5 GHz	\$1,850
HP 84907M 0 to 70 dB, 10 dB steps, 50 GHz	\$3,300
HP 84907L 0 to 70 dB, 10 dB steps, 40 GHz	\$2,200
HP 84907K 0 to 70 dB, 10 dB steps, 26.5 GHz	\$1,675
Opt 100 Male 2.4-mm Connector	+ \$75
Opt 104 Male 3.5-mm Connector (K models only)	+ \$75
Opt 106 Male 2.92-mm Connector (L models only)	+ \$125
Opt 006 Female 2.92-mm Connector (L models only)	+ \$75
Opt 890 Atten and SWR data	+ \$65

##### Attenuator Accessories

HP 11764A Interconnect Cable with 10-pin Socket (f) to "Viking" Connector for HP 11713A	\$35
HP 11764B Interconnect Cable with 10-pin DIP Socket (f) and Bare Leads	\$10
HP 11764C Interconnect Cable- with 203-mm (8 in) Ribbon Cable, 10-pin DIP Socket, 14-pin DIP Plug	\$5
HP 11764D Interconnect Cable- with 406-mm (16 in) Ribbon Cable, 10-pin DIP Socket, 14-pin DIP Plug	\$5

### HP 84904/6/7K/L Specifications

HP Model	Frequency Range	Incremental Attenuation	SWR Maximum (50 nominal) Std Opt 006	Insertion Loss 0 dB setting	Shipping Weight
HP 84904L (33324L)	dc to 40 GHz	0 to 11 dB 1 dB steps	dc to 12.4 GHz: 1.3 (1.5)	0.8 dB + 0.04 dB/GHz	291 g (10.3 oz)
HP 84904M	dc to 50 GHz		12.4 to 34 GHz: 1.7 (1.9)		
HP 84904K (33324K)	dc to 26.5 GHz		34 to 40 GHz: 1.8 (2.0)		
			40 to 50 GHz: 2.2 (3.0)		
HP 84906L (33326L)	dc to 40 GHz	0 to 90 dB 10 dB steps	dc to 12.4 GHz: 1.3 (1.5)	0.8 dB + 0.04 dB/GHz	291 g (10.3 oz)
HP 84906M	dc to 50 GHz		12.4 to 34 GHz: 1.7 (1.9)		
HP 84906K (33326K)	dc to 26.5 GHz		34 to 40 GHz: 1.8 (2.0)		
			40 to 50 GHz: 2.2 (3.0)		
HP 84907L (33327L)	dc to 40 GHz	0 to 70 dB 10 dB steps	dc to 12.4 GHz: 1.25 (1.4)	0.6 dB + 0.03 dB/GHz	229 g (8.1 oz)
HP 84907M	dc to 50 GHz		12.4 to 34 GHz: 1.5 (1.7)		
HP 84907K (33327K)	dc to 26.5 GHz		34 to 40 GHz: 1.7 (1.9)		
			40 to 50 GHz: 2.1 (3.0)		

Attenuation Accuracy	
dc to 26.5 GHz	26.5 to 40 GHz
0.4 dB: 1 dB	0.6 dB: 1 dB
0.5 dB: 2 dB	0.6 dB: 2 dB
0.7 dB: 3 dB	0.7 dB: 3 dB
0.7 dB: 4 dB	0.7 dB: 4 dB
0.7 dB: 5 dB	0.7 dB: 5 dB
0.7 dB: 6 dB	0.8 dB: 6 dB
0.8 dB: 7 dB	0.9 dB: 7 dB
0.8 dB: 8 dB	0.9 dB: 8 dB
0.85 dB: 9 dB	1.0 dB: 9 dB
0.9 dB: 10 dB	1.1 dB: 10 dB
1.10 dB: 11 dB	1.2 dB: 11 dB
	0.5 dB: 10 dB
	0.6 dB: 20 dB
	0.7 dB: 30 dB
	1.0 dB: 40 dB
	1.2 dB: 50 dB
	1.6 dB: 60 dB
	1.9 dB: 70 dB
	2.3 dB: 80 dB
	2.7 dB: 90 dB

Sensitivity power dB/dB/watt (temperature dB/dB/°C): 0.001 (0.0001)  
 Power rating: 1 W ave, 50 W peak, 10 μS max pulse width  
 Minimum life: 5 million cycles per section  
 Solenoid voltage/speed/power: 20-30 V / <20 ms / 2.7 W

# MICROWAVE TEST ACCESSORIES

## Custom Switch Matrixes

HP 11713A, 70611/12/13, 87130A, 84940A

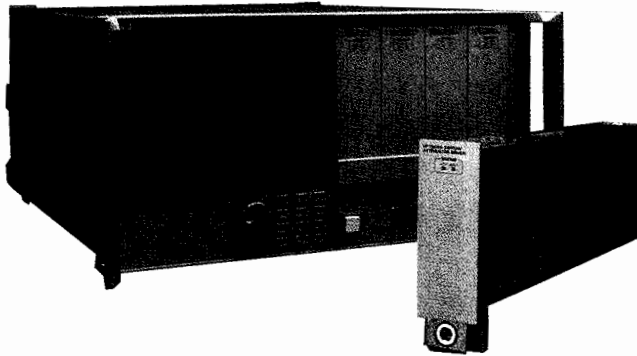

### HP 11713A Attenuator/Switch Driver

The HP 11713A attenuator/switch driver provides simple HP-IB control of up to 10 bistatic 24 V solenoid-activated switches or attenuator sections. It can drive up to 2 programmable attenuators of the HP 8494/5/6/7, HP 84904/6/7, or HP 33320 series and, concurrently, up to 2 electromechanical switches. The HP 11713A can also supply +24 V common and 10 pairs of current sinking contacts (total current less than 1.25 A) to control up to 10 relays. No external power supply is required. The integral power supply (with short-circuit protection) can provide 125 mA at 24 V to all contacts for control of the attenuators and switches. Each HP 11713A is provided with 2 plug-in drive cables for the programmable attenuators. Other cables are also available for driving switches and attenuators with the HP 11713A. The convenient front-panel controls allow manual control of individual attenuation sections and switches in local mode.

### HP 70611A Attenuator/Switch Driver for MMS

The HP 70611A is a 1/8 MMS module capable of driving up to 248 electromechanical switches or attenuator switch sections. The HP 70611A is MSIB-, SCPI-, and HP-IB-compatible. In addition to being programmable, the HP 70611A features an extremely user-friendly manual interface via the HP 70004 color display. The highlight of the manual interface is the operator's ability to custom configure groups of switch control lines and their settings, then identify these switch configurations with a user-defined alphanumeric label. In this manner, end-users of the HP 70611A can define custom menus with their own identification labels for simplified manual control. The 70611A controls switches or attenuator sections in banks of 31 (8 banks total) through individual HP 84940A I/O cards which are, in turn, directly wired to the switches or attenuators. Option 001 for the HP 70611A includes one HP 84940A I/O driver card. The HP 70611A, Option 001, is capable of driving 31 switches or attenuator sections. Additional drive capacity can be added with additional HP 84940A I/O driver cards.

### HP 70612 and HP 70613: MMS Interface Boxes

In addition to custom interface boxes, HP offers off-the-shelf interface solutions in MMS-compatible modules. The HP 70612 (1X6) and HP 70613 (2X5) are common-highway switch matrixes available in 2/8s MMS modules, with integrated controllers. They are equipped with front-panel indicators to facilitate manual use and an internal controller with all the capabilities of the HP 70611A attenuator/switch driver. A variety of options is available for both of these products, including performance to 26.5 GHz, terminated or unterminated ports, on-board attenuation, and choice of port locations. For more detailed descriptions of these products, see the Modular Measurement System section of this catalog. Custom MMS interface solutions are also available from Hewlett-Packard. Please call your local HP sales representative for more information.

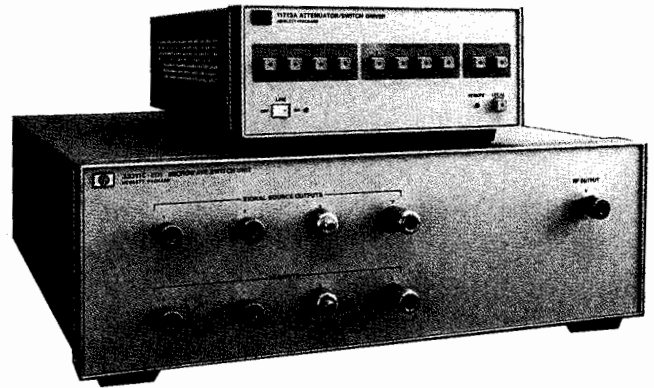

### HP 87130A Attenuator/Switch Driver

The HP 87130A is a 3/4-inch, full-width System II attenuator/switch driver, capable of driving up to 248 bi-stable electromechanical switches or attenuator sections. The HP 87130A is controlled over HP-IB via industry-standard Standard Commands for Programmable Instruments (SCPI) commands. The HP 87130A has been designed for use primarily as an ATE switching or test-set controller or on a bench top with a computer. Control and programming are accomplished via user-written programs (IBASIC, RMB, C, or Pascal) or the HP 87130A Instrument Test Generator (ITG) Driver.

### Expandable Versatility

A standard HP 87130A has the ability to drive up to 31 switches or attenuator sections. The cabinet has been designed to allow the driver to be customized, either by the customer or by HP for the customer, with internal components, making for very compact, integrated switching solutions. Rear-panel connections allow up to 31 switches to be connected externally. By adding expansion modules or additional HP 84940A driver cards, up to 248 switches can be controlled externally. A distribution board (which attaches to the rear switch driver connector) and accessory cables simplify connection of switches and attenuators.

### Set and Forget

The HP 87130A can store up to 256 user-defined switching paths. A path is a switch configuration stored in the HP 87130A's EEPROM memory, which defines a set of switches and their states (open or closed). Many paths can also be saved under a group heading, allowing the user to store paths in "subdirectories" for later recall. In addition to configuring paths, the user also has complete control over signal pulse widths. When required, the user can also instruct the HP 87130A to query the switches to verify that they are in the commanded switch state; if not, the operator is notified of the error by the front panel or software. For applications that must "wake up" in a predetermined state, a power-up state can be programmed into the HP 87130A.

### HP 84940A Switch Driver and HP 84941 Distribution Expansion Cards

The HP 84940A is an add-on switch driver card for the HP 70611/2/3 family of MMS switch controller/drivers and the HP 87130A switch controller. This switch driver card gives the switching system design the flexibility to locate the switching matrix or test set away from the switch driver, allowing remote control over distances up to 150 ft (45 m). The HP 84940A is designed to control up to 31 24 Vdc bi-static latching solenoid-controlled switches or attenuator sections, each drawing up to 200 mA. Sensing of switch position is also enabled through the use of the HP 84940A, giving the user the ability to run diagnostics on the switching system. Connection to switches and attenuators is made through 31 four-pin output connectors, allowing for easy connection and disconnection of devices. The HP 84941A is a distribution card to facilitate easy hookup of switches or attenuators external to the HP 70611A Option 001 and HP 87130A. It converts between the 68-pin dc control connector on the attenuator/switch drivers, to 31 four-pin single in-line connectors.

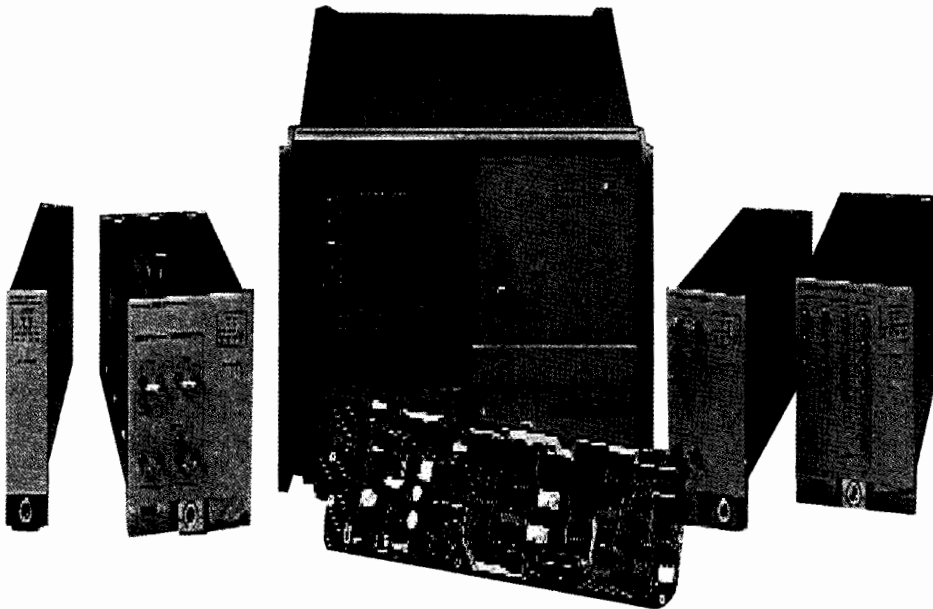

MMS Custom Matrixes

### Ordering Information

	<b>Price</b>
<b>HP 11713A</b> Attenuator/Switch Driver	\$1,750
<b>HP 11717A</b> Attenuator/Switch Driver Rackmount Kit	\$55
<b>HP 11761A</b> (HP 8765/HP 11713A Adapter Cable)	\$35
<b>HP 11764A</b> (HP 84904/6/7 to HP 11713A Drive Cable)	\$35
<b>HP 11764B</b> (HP 84904/6/7 5-ft Ribbon Cable with 14-Pin DIP Connector)	\$10
<b>HP 34530T</b> Microwave Switch Terminal Block for HP 3235A (holds up to 4 HP 8762/3/4 switches)	\$325
<b>HP 44476B</b> Microwave Switch Module for HP 3488A (holds up to 3 HP 8762/3/4 Opt 011 switches)	\$520
<b>HP 70611A</b> MMS Attenuator/Switch Controller	\$3,600
<b>Opt 001</b> Add Switch Driver Card	+ \$1,000
<b>HP 70612A</b> MMS 1X6 Switching Module 18 GHz with Controller and Terminated Switches	\$8,400
<b>HP 70613A</b> MMS 2X5 Switching Module, 18 GHz with Controller and Terminated Switches	\$8,400
<b>Opt 001</b> Delete Controller Card	- \$2,100
<b>Opt 003</b> Replace with Unterminated Switches	- \$1,000
<b>Opt 004</b> Add 0 to 11 dB Step Attenuator	+ \$825
<b>Opt 005</b> Add 0 to 110 dB Step Attenuator	+ \$825
<b>Opt 007</b> Rear-Panel Output Connector	+ \$250
<b>HP 70612C</b> MMS 1X6 Switching Module 26.5 GHz with Controller and Terminated Switches	\$9,400
<b>HP 70613C</b> MMS 2X5 Switching Module, 26.5 GHz with Controller and Terminated Switches	\$9,400
<b>Opt 001</b> Delete Controller Card	- \$1,200
<b>Opt 003</b> Replace with Unterminated Switches	- \$1,000
<b>Opt 004</b> Add 0 to 11 dB Step Attenuator	+ \$1,800
<b>Opt 005</b> Add 0 to 90 dB Step Attenuator	+ \$1,300
<b>Opt 007</b> Rear-Panel Output Connector	+ \$250
<b>HP 87130A</b> System Attenuator/Switch Driver	\$3,500
<b>HP 84940A</b> Attenuator/Switch Driver Expansion Card	\$1,000
<b>HP 84941A</b> Distribution Expansion Card	\$250

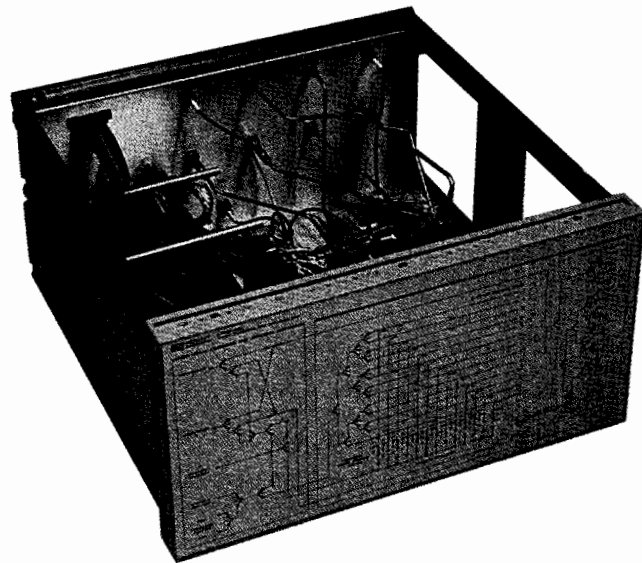

System II Rack-and-stack matrix

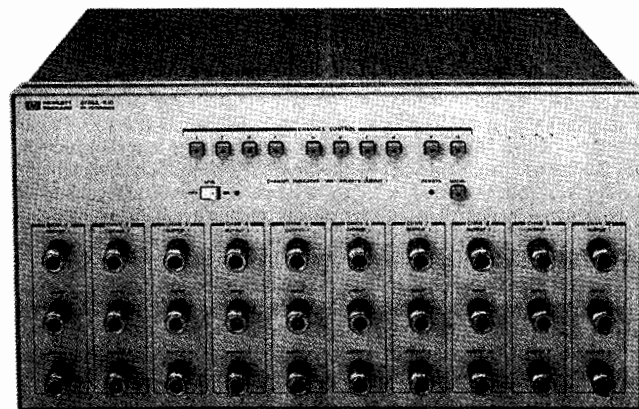

System II Rack-and-stack matrix

### Custom Switch Matrixes and Test Sets

HP microwave switch matrixes will custom-configure a switch matrix or test set for your specific measurement and signal-routing requirements. Featuring automated or manual control, these matrixes and test sets can be configured in System II rack-and-stack, MMS, or VXI platforms. Depending upon your particular needs, components other than switches, such as step attenuators, mixers, couplers, power splitters, detectors, power sensors, and noise sources can be included. Each HP matrix is fully documented with a general description, RF and dc schematics, interior-parts identifier photos, parts list drive logic, and operating instructions.

More information on how to specify and order a custom matrix from Hewlett-Packard is available in Product Note 8760-1 (HP Literature Number 5959-7860).

# MICROWAVE TEST ACCESSORIES

## Switching Solutions – Coaxial Switches

HP 8761A/B, 8762/3/4, 8765 Series

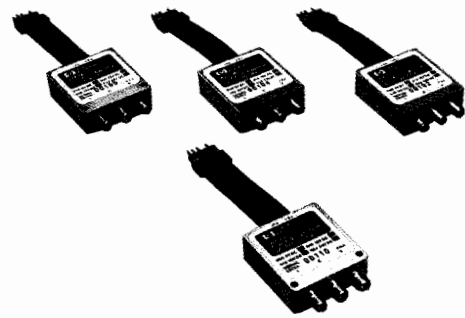
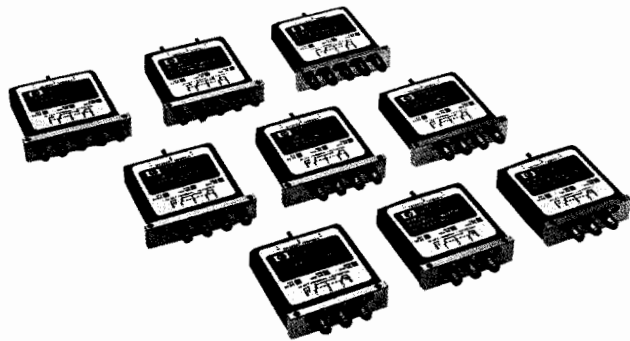

### Coaxial Switches

HP coaxial switches feature low SWR, low insertion loss, and excellent isolation. All HP switches feature  $\mu$ s latching solenoids and break-before-make switching circuits.

#### HP 8761A/B Switches

The HP 8761A/B are single-pole double-throw (SPDT) switches for dc to 18 GHz use. Each port has 6 connector options plus a 50  $\Omega$  termination, making these switches useful for switching between components with different connector types or for making switch "trees."

#### HP 8762 Switches

The HP 8762A/B/C switches (dc to 4 GHz, dc to 18 GHz and dc to 26.5 GHz) are also SPDT type. They feature exceptional isolation (90 dB to 18 GHz) and internally switched 50  $\Omega$  loads so that all ports maintain a 50  $\Omega$  match. The internal loads are rated for 1 W average or 100 W peak (10  $\mu$ s pulse width).

#### HP 8763 Switches

The HP 8763A/B/C switches (dc to 4 GHz, dc to 18 GHz and dc to 26.5 GHz) are used for transfer switching. They can be used to insert or remove a component from a signal path. They can also be used as the intersection switching elements in a larger microwave matrix. They include 1 internal 50  $\Omega$  switched load.

#### HP 8764 Switches

The HP 8764A/B/C switches (dc to 4 GHz, dc to 18 GHz and dc to 26.5 GHz) are 5-port switches with essentially the same internal structure as the HP 8762 switches. Elimination of the internal load makes it possible to utilize the extra ports for a variety of purposes, such as adding external high-power loads to extend power handling capability or reversing signal path.

The HP 8762/3/4 switches all use latching solenoids and have dc circuit interrupts to cut off solenoid current when switching is complete.

#### HP 8765A/B/C/D

These are SPDT switches that offer outstanding performance with a life of 5 million cycles (HP 8765A, dc to 4 GHz; HP 8765B, dc to 20 GHz; HP 8765C, dc to 26.5 GHz; HP 8765D, dc to 40 GHz). They are designed for long life and high repeatability. Unlike the HP 8762 switches, they do not have internally switched loads or dc-current interrupts. Voltage options cover the complete range from 4.5 to 32 Vdc. The standard HP 8765 comes with a ribbon cable and 0.025 in<sup>2</sup> pins in a single inline connector for convenient connection to the HP 11761A adapter cable or to any other Berg single inline connector package. Solder terminals are also available. Other features include magnetically latching solenoids and configuration solenoid control.

#### HP 8765F Switch

The HP 8765F switch is a 75  $\Omega$  switch designed around the proven reliability of the HP 8765 family of 50  $\Omega$  switches. The HP 8765F offers a subminiature 75  $\Omega$  SMB(m) snap-on connector and gives you the long life and high repeatability expected of this family. Ideal for use in ATE switching systems and test equipment destined for video, television, and cable television applications, the HP 8765F offers a new standard of quality in 75  $\Omega$  switching (dc to 2 GHz).

### HP-IB Compatible

All the HP 8760 series switches can be remotely controlled by the HP-IB interface bus with the HP 11713A attenuator/switch driver, the HP 3235A, the HP 3488A, or the HP E1700A. For the HP 70000 modular measurement system, the HP 70611A is available to drive up to 31 switches.

### Ordering Information

#### HP 8761A/B Coaxial Switch

Specify voltage and connectors (including built-in 50  $\Omega$  terminations) by alphabetic suffix on the switch model number and the appropriate 3-digit option number. Specify all connectors.

HP 8761A 12 to 15 V Solenoids

\$360

HP 8761B 24 to 30 V Solenoids

\$360

#### Connector options (Port 1, Port 2, Port C)

Option Code	Connector Type	Option Code	Connector Type
0	N(f)	4	APC-7 for UT-250 coax
1	N(m)	5	SMA(f)
2	APC-7	6	SMA(m)
	w/threaded sleeve		
3	APC-7	7	50 $\Omega$ termination
	w/coupling nut		

#### HP 8762A/B/C, HP 8763A/B/C, HP 8764A/B/C Coaxial Switches

Specify the frequency and voltage by the alphabetic suffix and option number. The standard model has 24 V solenoids.

HP 8762A SPDT, dc to 4 GHz

\$430

HP 8762B SPDT, dc to 18 GHz

\$480

HP 8762C SPDT, dc to 26.5 GHz

\$555

HP 8763A 4-Port, dc to 4 GHz

\$480

HP 8763B 4-Port, dc to 18 GHz

\$530

HP 8763C 4-Port, dc to 26.5 GHz

\$605

HP 8764A 5-Port, dc to 4 GHz

\$480

HP 8764B 5-Port, dc to 18 GHz

\$530

HP 8764C 5-Port, dc to 26.5 GHz

\$605

Opt 011, 5 Vdc Solenoids

\$0

Opt 015, 15 Vdc Solenoids

\$0

#### HP 8765A/B/C/D Coaxial Switches

A voltage option must be ordered with the mainframe. Specify frequency, voltage, dc connectors, and ribbon cable extension options by alphabetic suffix and option number.

HP 8765A SPDT, dc to 4 GHz

\$190

HP 8765B SPDT, dc to 20 GHz

\$220

HP 8765C SPDT, dc to 26.5 GHz

\$270

HP 8765D SPDT, dc to 40 GHz

\$600

HP 8765F SPDT, dc to 2 GHz, 75  $\Omega$

\$350

Opt 005 5 Vdc Solenoids

\$0

Opt 010 10 Vdc Solenoids

\$0

Opt 015 15 Vdc Solenoids

\$0

Opt 024 24 Vdc Solenoids

\$0

Opt 100 Solder Terminals

\$0

Opt 108 8-in Ribbon Cable Extension

+\$10

Opt 116 16-in Ribbon Cable Extension

+\$10

Opt 890 Calibration data

+\$25

For HP 8765A

+\$35

For HP 8765B

+\$25

For HP 8765C

+\$50

For HP 8765D

+\$75

For HP 8765F

+\$25

☎ For off-the-shelf shipment, call 800-452-4844.



# MICROWAVE TEST ACCESSORIES

## Switching Solutions – Coaxial Switches

### HP 8760 Series Product Specifications

415

#### HP 8761A/B, 8762/3/4A/B/C, 8765A/B/C/D/F, 8766/7/8/9K Specifications

HP Model (OEM Model)	Frequency Range (GHz)	SWR 50 Ω Nominal	Insertion Loss	Isolation	Switching Speed	RF Connectors	Dimensions HxWxD (mm)	Shipping Weight (g)	Price
HP 8761A SPDT (33311A)	dc to 18	<1.2 to 12.4 GHz <1.25 to 18 GHz	0.8 dB @ 18 GHz	> 50 dB to 12.4 GHz > 45 dB to 18 GHz	35 to 50 mS	See table on page 414	41 × 38 × 38	300	\$360
HP 8761B SPDT (33311B)	dc to 18	<1.2 to 12.4 GHz <1.25 to 18 GHz	0.8 dB @ 18 GHz	> 50 dB to 12.4 GHz > 45 dB to 18 GHz	35 to 50 mS	See table on page 414	41 × 38 × 38	300	\$360
HP 8762A SPDT (33311A)	dc to 4	<1.1 to 2 GHz <1.2 to 4 GHz	<0.2 dB @ 2 GHz <0.25 dB @ 4 GHz	> 100 dB to 4 GHz	< 30 mS	SMA (f)	14 × 53 × 54	220	\$430
HP 8762B SPDT (33311B)	dc to 18	<1.10 to 2 GHz <1.2 to 12.4 GHz <1.3 to 18 GHz	<0.2 dB @ 2 GHz <0.5 dB @ 18 GHz	> 90 dB to 18 GHz	< 30 mS	SMA (f)	14 × 53 × 54	220	\$480
HP 8762C SPDT (33311C)	dc to 26.5	<1.15 to 2 GHz <1.25 to 12.4 GHz <1.4 to 18 GHz <1.8 to 26.5 GHz	<0.2 dB @ 2 GHz <0.5 dB @ 18 GHz <1.25 dB @ 26.5 GHz	> 90 dB to 18 GHz > 50 dB to 26.5 GHz	< 30 mS	3.5 mm (f)	14 × 53 × 54	220	\$555
HP 8763A 4-port (33312A)	dc to 4	<1.1 to 2 GHz <1.2 to 4 GHz	<0.2 dB @ 2 GHz <0.25 dB @ 4 GHz	> 100 dB to 4 GHz	< 30 mS	SMA (f)	14 × 53 × 54	220	\$480
HP 8763B 4-port (33312B)	dc to 18	<1.10 to 2 GHz <1.2 to 12.4 GHz <1.3 to 18 GHz	<0.2 dB @ 2 GHz <0.5 dB @ 18 GHz	> 90 dB to 18 GHz	< 30 mS	SMA (f)	14 × 53 × 54	220	\$530
HP 8763C 4-port (33312C)	dc to 26.5	<1.15 to 2 GHz <1.25 to 12.4 GHz <1.4 to 18 GHz <1.8 to 26.5 GHz	<0.2 dB @ 2 GHz <0.5 dB @ 18 GHz <1.25 @ 26.5 GHz	> 90 dB to 18 GHz > 50 dB to 26.5 GHz	< 30 mS	3.5 mm (f)	14 × 53 × 54	220	\$605
HP 8764A 5-port (33313A)	dc to 4	<1.1 to 2 GHz <1.2 to 4 GHz	<0.2 dB @ 2 GHz <0.25 dB @ 4 GHz	> 100 dB to 4 GHz	< 30 mS	SMA (f)	14 × 53 × 54	220	\$480
HP 8764B 5-port (33313B)	dc to 18	<1.10 to 2 GHz <1.2 to 12.4 GHz <1.3 to 18 GHz	<0.2 dB @ 2 GHz <0.5 dB @ 18 GHz	> 90 dB to 18 GHz	< 30 mS	SMA (f)	14 × 53 × 54	220	\$530
HP 8764C 5-port (33313C)	dc to 26.5	<1.15 to 2 GHz <1.25 to 12.4 GHz <1.4 to 18 GHz <1.8 to 26.5 GHz	<0.2 dB @ 2 GHz <0.5 dB @ 18 GHz <1.25 dB @ 26.5 GHz	> 90 dB to 18 GHz > 50 dB to 26.5 GHz	< 30 mS	3.5 mm (f)	14 × 53 × 54	220	\$605
HP 8765A SPDT (33314A)	dc to 4	<1.2 to 4 GHz	<0.3 dB @ 4 GHz	> 110 dB to 4 GHz	< 15 mS	SMA (f)	14 × 33 × 45	200	\$190
HP 8765B SPDT (33314B)	dc to 20	<1.2 to 4 GHz <1.35 to 12.4 GHz <1.45 to 18 GHz <1.7 to 20 GHz	<0.3 dB @ 4 GHz <0.7 dB @ 20 GHz	> 110 dB to 4 GHz > 75 dB to 20 GHz	< 15 mS	SMA (f)	14 × 33 × 45	200	\$220
HP 8765C SPDT (33314C)	dc to 26.5	<1.25 to 4 GHz <1.45 to 18 GHz <1.7 to 26.5 GHz	<0.3 dB @ 4 GHz <0.75 dB @ 20 GHz <1.0 dB @ 26.5 GHz	> 110 dB to 4 GHz > 68 dB to 20 GHz > 50 dB to 26.5 GHz	< 15 mS	3.5 mm (f)	14 × 33 × 45	200	\$270
HP 8765D (33314D)	dc to 40	<1.25 to 4 GHz <1.45 to 18 GHz <1.7 to 40 GHz	<0.2 dB @ 4 GHz <0.5 dB @ 20 GHz <1.0 dB @ 40 GHz	> 110 dB to 4 GHz > 90 dB to 20 GHz > 50 dB to 40 GHz	< 15 mS	2.4 mm (f) 2.92 mm Opt 292	14 × 33 × 45	200	\$600
HP 8765F 75 Ω	dc to 2	<1.5 to 2 GHz	<0.3 dB to 2 GHz	> 90 dB to 2 GHz	< 20 mS	SMB (m)	14 × 33 × 45	200	\$350
HP 8766K SP3T (33363K)	dc to 26.5 or dc to 18 for Opt 002	<1.3 to 8 GHz <1.5 to 12.4 GHz <1.6 to 18 GHz <1.8 to 26.5 GHz	Port 1: 0.2 dB + 0.05 dB/GHz	Consult Technical Data Sheet	< 20 mS	3.5 mm (f)	23 × 45 × 82	178	\$630
HP 8767K SP4T (33364K)	dc to 26.5 or dc to 18 for Opt 002	<1.3 to 8 GHz <1.5 to 12.4 GHz <1.6 to 18 GHz <1.8 to 26.5 GHz	Port 2: 0.2 dB + 0.06 dB/GHz		< 20 mS	3.5 mm (f)	23 × 45 × 105	235	\$690
HP 8768K SP5T (33365K)	dc to 26.5 or dc to 18 for Opt 002	<1.3 to 8 GHz <1.5 to 12.4 GHz <1.6 to 18 GHz <1.8 to 26.5 GHz	Port 3: 0.2 dB + 0.08 dB/GHz		< 20 mS	3.5 mm (f)	23 × 45 × 133	292	\$750
HP 8769K SP6T (33366K)	dc to 26.5 or dc to 18 for Opt 002	<1.3 to 8 GHz <1.55 to 12.4 GHz <1.8 to 18 GHz <2.05 to 26.5 GHz	Port 4: 0.25 dB + 0.095 dB/GHz		< 20 mS	3.5 mm (f)	23 × 45 × 160	349	\$900
			Port 5: 0.25 dB + 0.108 dB/GHz						
			Port 6: 0.25 dB + 0.12 dB/GHz						

☎ For off-the-shelf shipment, call 800-452-4844.

# MICROWAVE TEST ACCESSORIES

## Switching Solutions — Multiport Coaxial Switches

87104/6A/B Series, 8766/7/8/9 Series

### 87104/6A/B Multiport Coaxial Switches

Hewlett-Packard now offers the new HP 87104/6 multiport 50  $\Omega$  coaxial switches, with the quality and high reliability you've come to expect Hewlett-Packard electromechanical switches. Long life, high performance, and exceptional repeatability are the hallmark of these new multiport switches. Available in 4 GHz and 20 GHz versions, with SMA (f) connectors, the HP 87104/6 switches are available with or without internal 50  $\Omega$  terminations. Adaptability to your applications has led to a wide range of configurations, including a choice of switching voltage: 5, 10, 15 or 28 Vdc or TTL control with 28 Vdc drive, along with a choice of dc connectors: either solder terminals or ribbon cable connectors. Internal switching logic assures that only one section is activated at a time; electronic interrupts and indicators cut off solenoid current after switching is completed to reduce power consumption and give positive indication of switch position. Other available options include dc solder terminals or ribbon connectors, and calibration data. These switches are well suited for ATE switching matrixes, test sets, precision test equipment, and any application requiring long, reliable life and high repeatability.

### HP 8766/7/8/9K Series Single-Pole Multi-Throw Switches

The HP 8766/7/8/9K Series switches are modified versions of the coaxial edgeline design (dc to 26.5 GHz) for applications requiring single-pole, 3-throw, 4-throw, 5-throw, or 6-throw coaxial switches.

These compact switches offer the same reliability, repeatability (typically 0.01 dB), and long life (5 million switching cycles per section) as the HP 8494/5/6/7K series step attenuators from which they are derived.

The switches are also available with flat ribbon cables and DIP-type connectors compatible with standard 14-pin DIP IC sockets.

Isolation and insertion loss vary with frequency and depend on the port selected on the HP 8766/7/8/9 switch. For applications in which isolation and insertion loss are critical, it is suggested that you obtain a copy of the data sheet for further application information. Ask your Hewlett-Packard Sales Representative for the data sheet "HP 8766,7,8,9K Microwave Single-Pole Multi-Throw Switches" (PN 5959-7831). See the table on page 415 for product specifications.

Specify the switch by model number, solenoid voltage, optional extension cables or solder terminals, and calibration data. A standard model comes with an 8-inch ribbon cable and connector for dc control signals.

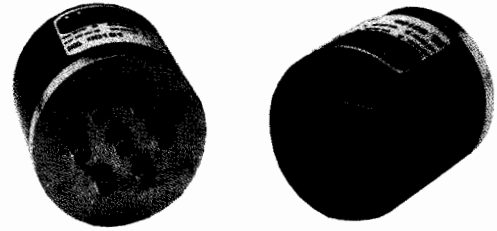

### Ordering Information

	Price
HP 87104A SP4T, dc to 4 GHz	\$950
HP 87104B SP4T, dc to 20 GHz	\$1350
HP 87106A SP6T, dc to 4 GHz	\$1100
HP 87106B SP6T, dc to 20 GHz	\$1500
Opt 005 5V solenoids	\$0
Opt 010 10V solenoids	\$0
Opt 015 15V solenoids	\$0
Opt 024 24V solenoids	\$0
Opt 050 TTL Control, 28V drive	\$25
Opt 100 solder terminals	\$0
Opt 116 16 inch ribbon cable extension	\$0
Opt 890 Calibration Data:	\$40

### HP 8766K, HP 8767K, HP 8768K, HP 8769K Coaxial Switches

Specify RF connectors (and frequency), solenoid voltages, dc connectors by option number. Standard unit is 24 Vdc, 3.5 mm(f) RF connectors (dc to 26.5 GHz), and Viking-type dc connector.

HP 8766K SP3T Multi-Port Switch	\$630
HP 8767K SP4T Multi-Port Switch	\$690
HP 8768K SP5T Multi-Port Switch	\$750
HP 8769K SP6T Multi-Port Switch	\$900
Opt 002 Replace 3.5 mm (f) w/ SMA(m) Connectors	-\$25
Opt 008 8-in. Ribbon Cable w/DIP Connector	-\$50
Opt 011 5 Vdc Solenoids	\$0
Opt 015 15 Vdc Solenoids	\$0
Opt 016 16-in. Ribbon Cable w/DIP Connector	-\$50
Opt 890 Calibration Data	\$35

☎ For off-the-shelf shipment, call 800-452-4844.

HP Model	Frequency Range (GHz)	SWR 50 $\Omega$ Nominal	Insertion Loss dB	Isolation	Switching Speed	RF Connectors	Dimensions H×W×D (mm)	Shipping Weight (g)	Price
HP 87104A SP4T	dc to 4	<1.2 to 4 GHz	<0.3 dB to 4 GHz	>110 dB to 4 GHz	<20 ms	SMA(f)	80×65×65	360	\$ 950
HP 87104B SP4T	dc to 20	<1.2 to 4 GHz <1.35 to 12.4 GHz <1.45 to 18 GHz <1.7 to 20 GHz	<0.3 dB to 4 GHz <0.7 dB to 20 GHz	>110 dB to 4 GHz >75 dB to 20 GHz	<20 ms	SMA(f)	80×65×65	360	\$1,350
HP 87106A SP6T	dc to 4	<1.2 to 4 GHz	<0.3 dB to 4 GHz	>110 dB to 4 GHz	<20 ms	SMA(f)	80×65×65	360	\$1,100
HP 87106B SP6T	dc to 20	<1.2 to 4 GHz <1.35 to 12.4 GHz <1.45 to 18 GHz <1.7 to 20 GHz	<0.3 dB to 4 GHz <0.7 dB to 20 GHz <1.0 dB to 26.5 GHz	>110 dB to 4 GHz >75 dB to 20 GHz >55 dB to 26.5 GHz	<20 ms	SMA(f)	80×65×65	380	\$1,500



HP 8474 Series



HP 8471 D/E

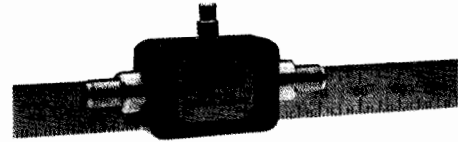

HP 83036C

### Low-Barrier Schottky Diode Detectors

#### HP 423B, HP 8472B, HP 8473B/C

These low-barrier Schottky diode (LBSD) detectors have been widely used for many years in a variety of applications, including leveling and power sensing. They offer good performance and ruggedness. Matched pairs (Option 001) offer very good detector tracking. A video load option (Option 002) extends the square-law region to at least 0.1 mW ( $-10$  dBm).

#### Planar-Doped Barrier Detectors

##### HP 8471D/E

The HP 8471D and HP 8471E are economy detectors based on the planar-doped barrier (PDB) diodes. The PDB diodes give them superior frequency response, square-law response, and temperature performance. The HP 8471D has a BNC (m) input connector and a frequency range of 100 kHz to 2 GHz, making it ideal for use in RF and low microwave applications. The HP 8471E has an SMA (m) input connector and an SMC (m) output connector. Its frequency range is 10 MHz to 12 GHz. Both models come standard with a negative output; a positive output can be specified as an option (Option 103).

##### HP 8473D/E Planar-Doped Barrier Detectors

The HP 8473D and 8473E detectors were the first gallium arsenide PDB diodes introduced. They feature broadband performance and excellent flatness vs. frequency, along with superior temperature stability. The HP 8473D is available with a 3.5 mm (m) RF connector and a BNC output connector. The HP 8473E features a 2.4 mm (m) RF connector with a BNC output connector.

##### HP 8474A/B/C/D/E High-Performance Planar-Doped Barrier Detectors

These detectors are the newest addition to the HP family of high-performance detectors. Utilizing a gallium arsenide PDB diode as the detecting element, these detectors offer superior performance when compared to earlier detector designs. They feature extremely flat frequency response over their entire band of operation (typically better than  $\pm 1$  dB to 50 GHz) and very good frequency response stability versus temperature. For applications where broadband frequency coverage is not required, octave band options are available in specific bands, usually with improved frequency response specifications.

The HP 8474 detectors are available with APC-7 (0.01 to 18 GHz), Type N (0.01 to 18 GHz), 3.5 mm (mates with SMA, 0.01 to 33 GHz), 2.92 mm (0.01 to 40 GHz), or 2.4 mm (0.01 to 50 GHz) connectors. These detectors are offered with options for optimal square-law loads (Option 102) and for positive polarity output (Option 103). Because the unit-to-unit frequency response tracking of these devices is typically better than  $\pm 0.3$  dB, no matched response option is offered.

### Waveguide Detectors

In addition to coaxial detectors, Hewlett-Packard offers a line of waveguide detectors that cover a portion of the millimeter frequency band. The HP Q422A (33 to 50 GHz) and HP U422A (40 to 60 GHz) are silicon, low-barrier Schottky diode detectors. The HP K422C (18 to 26.5 GHz) and the HP R422C (26.5 to 40 GHz) are GaAs PDB diode detectors. All four models have a negative output polarity as the standard; the HP Q422A and HP U422A are also available in a positive-polarity option.

### Broadband Directional Detector

#### HP 83036C

The HP 83036C is a broadband microwave power sampler, which operates in much the same way as a directional coupler and detector combination. The HP 83036C is composed of a resistive bridge and PDB diode, which yields a very broadband device with excellent frequency response, superior temperature response, and square-law response characteristics. With a 10 MHz to 26.5 GHz frequency range, a single HP 83036C can be used in many applications where two directional couplers and detectors were once required, such as in broadband power monitoring and source leveling.

The HP 83036C has a maximum SWR of 1.7 above 50 MHz on both the input and output ports. Directivity of 14 dB matches that of most miniature couplers currently available. The maximum insertion loss is 2.2 dB.

The HP 83036C can be used as the monitoring element inside an instrument's ALC loop, as the monitoring element for external leveling of a microwave source, or for forward and reverse power monitoring.

# MICROWAVE TEST ACCESSORIES

## Coaxial and Waveguide Detectors

HP 8470 Series, 420 Series, 83036C

### Planar-Doped Barrier Diode Detectors (OEM Equivalent Model No.)

HP Model	Frequency Range (GHz)	Frequency Response (dB)	SWR Maximum (50Ω Nom.)	Low-Level Sensitivity	Maximum Input (Peak or Average)	Short-Term Maximum Input (<1 Min.)	Option 002/102 Optimum Square-Law Load	Option 003/103 Positive Polarity Output	Other Options	Input/Output Connector	Price
HP 8471D (HP 33331D)	0.0001 to 2	±0.2 to 1 GHz ±0.4 to 2 GHz	<1.23 to 1 GHz <1.46 to 2 GHz	>0.5 mV/μW	100 mW	0.7 W	Yes	Yes		BNC(m) BNC(f)	\$135
HP 8471E (HP 33331E)	0.01 to 12	±0.23 to 4 GHz ±0.6 to 8 GHz ±0.85 to 12 GHz	<1.2 to 4 GHz <1.7 to 8 GHz <2.4 to 12 GHz	>0.4 mV/μW	100 mW	0.7 W	No	No		SMA(m) SMC(m)	\$185
HP 8473D (HP 33330D)	0.01 to 33	±0.25 to 12.4 GHz ±0.40 to 26.5 GHz ±1.25 to 33 GHz	<1.2 to 14 GHz <1.36 to 26.5 GHz <2.96 to 33 GHz	>0.4 mV/μW	200 mW	1 W	Note 2	Note 3		3.5mm(m) SMC(m)	\$450
HP 8473E (HP 33330E)	0.01 to 50	±0.25 to 12.4 GHz ±0.40 to 26.5 GHz ±0.6 to 40 GHz ±1.0 to 50 GHz	<1.4 to 26.5 GHz <1.9 to 40 GHz <2.3 to 50 GHz	>0.4 mV/μW	200 mW	1 W	Note 2	Note 3		2.4mm(f) SMC(m)	\$650
HP 8474A	0.01 to 18	±0.25 to 12.4 GHz ±0.35 to 18 GHz	<1.3 to 15 GHz <1.4 to 18 GHz	>0.4 mV/μW	200 mW	.75 W	Note 2	Note 3	Octave Bands (See Data Sheet)	APC-7 BNC(f)	\$350
HP 8474B (HP 33334B)	0.01 to 18	±0.35 to 18 GHz	<1.3 to 18 GHz	>0.4 mV/μW	200 mW	.75 W	Note 2	Note 3	Octave Bands (See Data Sheet)	Type N(m) BNC(f)	\$315
HP 8474C (HP 33334C)	0.01 to 33	±0.45 to 26.5 GHz ±0.70 to 33 GHz	<1.4 to 26.5 GHz <2.2 to 33 GHz	>0.4 mV/μW	200 mW	.75 W	Note 2	Note 3	Octave Bands (See Data Sheet)	3.5mm(m) SMC(m)	\$300
HP 8474D (HP 33334D)	0.01 to 40	±0.35 to 26.5 GHz ±0.6 to 40 GHz	<1.3 to 26.5 GHz <1.8 to 40 GHz	>0.4 mV/μW	200 mW	.75 W	Note 2	Note 3	Octave Bands (See Data Sheet)	2.92mm(m) SMC(m)	\$450
HP 8474E (HP 33334E)	0.01 to 50	±0.4 to 26.5 GHz ±0.6 to 40 GHz ±1.0 to 50 GHz	<1.2 to 26.5 GHz <1.6 to 40 GHz <2.8 to 50 GHz	>0.4 mV/μW	200 mW	.75 W	Note 2	Note 3	Octave Bands (See Data Sheet)	2.4mm(m) SMC(m)	\$460

### Directional Detector

HP Model (OEM Equivalent No.)	Frequency Range (GHz)	Frequency Response (dB)	Input SWR Maximum (50 Nom.)	Output SWR Maximum (50 Nom.)	Maximum Thru Line Loss (dB)	Low Level Sensitivity	Minimum Directivity (dB)	Maximum Input (Into 50-Ohm Load) with a 2:1 Source Match	Maximum Input (Into Open)	Input/Output Connector	Price
HP 83036C (HP 33336C)	0.01 to 26.5	±1.0	1.7	1.7	2.2	18 uV/μW	14	32 dBm	21 dBm	3.5 mm(f)	\$785

### Low-Barrier Schottky Diode Detectors

HP Model	Frequency Range (GHz)	Frequency Response (dB)	SWR Maximum (50Ω Nom.)	Low-Level Sensitivity	Maximum Input (Peak or Average)	Short-Term Maximum Input (<1 Min.)	Option 001 Matched Response	Option 002 Optimum Square-Law Load	Option 003 Positive Polarity Output	Input/Output Connector	Price
HP 423B	0.01 to 12.4	±0.2/octave to 8 GHz ±0.3 overall	<1.15 to 4 GHz <1.3 to 12.4 GHz	>0.5 mV/μW	200 mW	1 W (typical)	±0.2 dB to 12.4 GHz	Yes	Yes	N(m) BNC(f)	\$265
HP 8470B HP 8470B Opt 012	0.01 to 18	±0.2/octave to 8 GHz ±0.3 to 12.4 GHz ±0.6 to 18 GHz	<1.15 to 4 GHz <1.3 to 15 GHz <1.4 to 18 GHz	>0.5 mV/μW	200 mW	1 W (typical)	±0.2 dB to 12.4 GHz ±0.3 to 18 GHz	Yes	Yes	APC-7 BNC(f) N(m) BNC(f)	\$380 \$330
HP 8472B	0.01 to 18	±0.2/octave to 8 GHz ±0.3 to 12.4 GHz ±0.6 to 18 GHz	<1.2 to 4.5 GHz <1.35 to 7 GHz <1.5 to 12.4 GHz <1.7 to 18 GHz	>0.5 mV/μW	200 mW	1 W (typical)	±0.2 dB to 12.4 GHz ±0.3 to 18 GHz	Yes	Yes	SMA(m) BNC(f)	\$330
HP 8473B (33330B)	0.01 to 18	±0.2/octave to 8 GHz ±0.3 to 12.4 GHz ±0.6 to 18 GHz	<1.2 to 4 GHz <1.5 to 18 GHz	>0.5 mV/μW	200 mW	1 W (typical)	±0.2 dB to 12.4 GHz ±0.3 to 18 GHz	No	Yes	3.5mm(m) BNC(f)	\$335
HP 8473C (33330C)	0.01 to 26.5	Same as 8473B to 8 GHz ±1.5 from a -3.3 dB slope from 18 to 26.5 GHz	<1.2 to 4 GHz <1.5 to 18 GHz <2.2 to 26.5 GHz	>0.5 mV/μW	200 mW	1 W (typical)	±0.2 dB to 12.4 GHz ±0.3 to 18 GHz ±0.5 to 26.5 GHz	No	Yes	3.5mm(m) BNC(f)	\$360

### Waveguide Detectors

HP K422C	18 to 26.5	±0.6	<1.78	>0.42 mV/μW	100 mW	1 W (typical)	Note 1	Note 2	Note 3	UG-595/U MIL-W-85/1-102 (EIA WR-42) (MIL-F-3922/54C-001)	\$800
HP R422C	26.5 to 40	±0.6	<1.78	>0.42 mV/μW	100 mW	1 W (typical)	Note 1	Note 2	Note 3	UG-599/U MIL-W-85/3-008 (EIA WR-28) (MIL-F-3922/54-003)	\$800
HP Q422A	33 to 50	±1.5	<2.0	>0.25 mV/μW	100 mW	0.5 W	Note 1	Note 2	Yes	UG-383/U MIL-W-85/3-010 (EIA WR-22) (MIL-F-3922/67B-006)	\$1,200
HP U422A	40 to 60	±1.5	<2.0	>0.20 mV/μW	100 mW	0.5 W	Note 1	Note 2	Yes	UG-383/U (mod.) MIL-W-85/3-014 (EIA WR-19) (MIL-F-3922/67B-007)	\$1,500

Note 1: Not applicable for HP K422C and R422C. Available as a special option for Q/U422A. Consult an HP representative.

Note 2: Available as a special option on request. Consult your HP representative.

Note 3: Available as a special option on request. Consult your HP representative.

☎ For off-the-shelf shipment, call 800-452-4844.

# MICROWAVE TEST ACCESSORIES

## Modular Microcircuit Package

### HP 83040 Series

419

- Microcircuit design and test package
- Streamline design cycles
- Off-the-shelf delivery, convenience
- Excellent repeatability
- Flexible modular design
- 0.635 and 0.254-mm (0.010 and 0.025-in) thick substrates

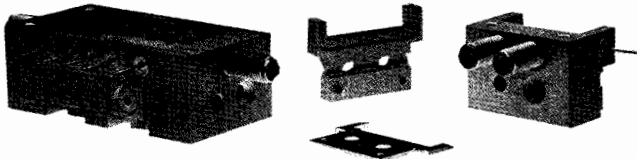

HP 83040 series

### HP 83040 Series Modular Microcircuit Package

This unique new package bridges the gap between custom model shop microcircuit packages and chip test fixtures. It offers flexibility and delivery not normally available with model shop packages, calibration methods usually associated with test fixtures, and prices to beat both. Off-the-shelf availability and modular design mean no model shop lead times or setup charges. Pre-designed launches and package parts let you spend time designing circuits.

The HP 83040 series is compatible with many of the HP vector network analyzer calibration techniques, such as Adapter Swap, Adapter Removal, Port Extension, Normalization, Gating, De-embedding, and TRL, each fully described in Product Note 83040-2. Typical performance: 0.5 dB insertion loss (through 1 launch), 20 dB return loss, 30 dB repeatability, and 40 dB source match to 26.5 GHz.

Unlike most test fixtures, this is a microcircuit package. Build circuits, test them, then seal them up for use as stand-alone components. No bulky vises or complex spring-loaded pins to worry about and keep track of.

### Applications

- Breadboard design package
- Combine circuit modules; build sub-circuit libraries
- Sample test MMIC devices
- "Connectorize" chips and circuit components for use as stand-alone components in microwave chains

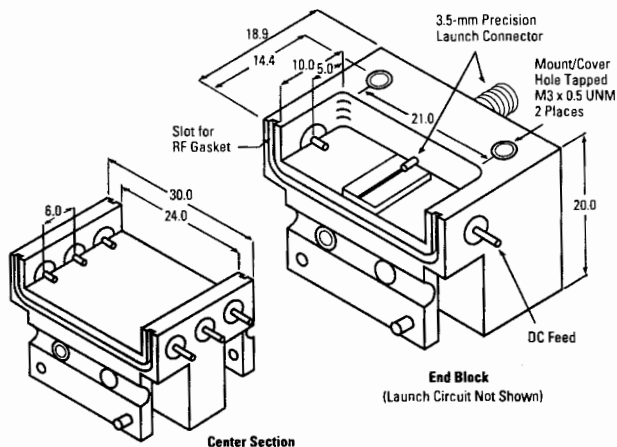

- Support literature available:
  1. Data sheet, HP Lit. No. 5952-1418
  2. Product Note 83040-1 (Assembly Instructions), HP Lit. No. 5952-1906
  3. Product Note 83040-2 (Calibration and Modeling Techniques), HP Lit. No. 5952-1907
  4. Product Note 83040-3 (Pre-assembled MMIC Devices), HP Lit. No. 5091-0531

0.635-mm (0.025-in)		
Substrates	Model Number	Price
<b>Starter Kit</b>	HP 83040B	\$975
<b>Evaluation Kit</b>	HP 83040B Opt 001	\$500
<b>Reorder Kits</b>		
Single end blocks (w/circuit)	HP 83041B	\$375
Double end blocks	HP 83042B	\$200
Center sections		
1 of each length	HP 83043B Opt 100	\$350
1-mm center section	HP 83043B Opt 001	\$125
2-mm center section	HP 83043B Opt 002	\$125
5-mm center section	HP 83043B Opt 005	\$175
10-mm center section	HP 83043B Opt 010	\$225
20-mm center section	HP 83043B Opt 020	\$250
Through line circuits		
1 of each length	HP 83045B Opt 100	\$175
1-mm through line	HP 83045B Opt 001	\$75
2-mm through line	HP 83045B Opt 002	\$75
5-mm through line	HP 83045B Opt 005	\$100
10-mm through line	HP 83045B Opt 010	\$125
20-mm through line	HP 83045B Opt 020	\$125
Launch circuit	HP 83046B	\$100

0.254-mm (0.010-in)		
Substrates	Model Number	Price
<b>Starter Kit</b>	HP 83040C	\$1250
<b>Evaluation Kit</b>	HP 83040C Opt 001	\$500
<b>Reorder Kits</b>		
Single end blocks (w/circuit)	HP 83041C	\$450
Double end blocks	HP 83042C	\$300
Center sections		
1 of each length	HP 83043C Opt 100	\$350
1-mm center section	HP 83043C Opt 001	\$125
2-mm center section	HP 83043C Opt 002	\$125
5-mm center section	HP 83043C Opt 005	\$175
10-mm center section	HP 83043C Opt 010	\$225
20-mm center section	HP 83043C Opt 020	\$250
Through line circuits		
1 of each length	HP 83045C Opt 100	\$175
1-mm through line	HP 83045C Opt 001	\$85
2-mm through line	HP 83045C Opt 002	\$85
5-mm through line	HP 83045C Opt 005	\$125
10-mm through line	HP 83045C Opt 010	\$150
20-mm through line	HP 83045C Opt 020	\$150
Launch circuit	HP 83046C	\$100
Both substrate thicknesses		
Cover	HP 83044X	\$65
Clamp kit	HP 83047X	\$65
<b>Calibration Short</b>	HP 83048A Opt 001	\$75

Starter Kit Contents		Evaluation Kit Contents	
Quantity/Pkg		HP 83040B Opt 001 0.635-mm (0.025-in) Substrates	HP 83040C Opt 001 0.254-mm (0.010-in) Substrates
Single end blocks (with circuits)	2	2 Single launch end blocks (with circuits)	2 Single launch end blocks (with circuits)
Double end block	1	1 20-mm center section	1 10-mm center section
1-mm center section	1	1 20-mm center through line	1 10-mm center through line
2-mm center section	1	2 Clamps	2 Clamps
5-mm center section	1		
10-mm center section	1		
20-mm center section	1		
Cover	1		
1-mm through line	1		
2-mm through line	1		
5-mm through line	1		
10-mm through line	1		
20-mm through line	1		
Launch circuits	2		
Clamp kit	4		

For off-the-shelf shipment, call 800-452-4844.

# MICROWAVE TEST ACCESSORIES

## Coaxial and Waveguide Terminations, Coaxial Shorts and Opens

HP 908A, 909A/C/D/E/F, 910A/B/C, 914B/C, 920C, 921A, 11511A, 11512A, 11565A, 8513A/B, 85140A/B, 85141A/B



HP 909C



HP 909D



HP X910B

### HP 908A, 909A/C/D/E/F, 85138A/B Coaxial Fixed Terminations (50 and 75 Ω)

The HP 908A, 909A and 909D terminations are low-reflection loads for terminating 50 Ω coaxial systems in their characteristic impedance. The HP 909C (50 Ω) and HP 909E (75 Ω) are precision ultra-low-reflection terminations intended for use as calibration standards.

#### HP 908A, 909A/C/D/E/F, 85138A/B Specifications

HP Model	Frequency Range (GHz)	Impedance (ohms)	SWR	Power Rating	Connector	Price
HP 908A	dc to 4	50	1.05	0.5 W avg 1 kW pk	N (m)	\$160
HP 909A	dc to 18	50	1.05: 0 to 4 GHz 1.1: 4 to 12.4 GHz 1.25: 12.4 to 18 GHz	2W avg 300 W pk	APC-7	\$235
HP 909A Opt 012 Opt 013			1.06: 0 to 4 GHz 1.11: 4 to 12.4 GHz 1.3: 12.4 to 18 GHz		Opt 012 N (m) Opt 013 N (f)	-\$15
HP 909C	dc to 2	50	1.005	0.5W avg 100 W pk	APC-7	\$355
HP 909C Opt 012 Opt 013			1.01		Opt 012 N (m) Opt 013 N (f)	-\$25
HP 909C Opt 200	dc to 0.2	50	52 dB to 200 MHz	0.5 W avg 100 W pk	Must be ordered with Opt 012 N (m) or Opt 013 N(f)	\$0
HP 909C Opt 201			1.01		Must be ordered with Opt 012 N(m)	-\$20
HP 909D	dc to 26.5	50	1.02: dc to 3 GHz 1.036: 3 to 6 GHz 1.12: 6 to 26.5 GHz	2 W avg 100 W pk	3.5 mm (m)	\$230
HP 909D Opt 011					Opt 011 3.5 mm (f)	\$0
HP 909D Opt 040			1.02: dc to 4 GHz 1.036: 4 to 6 GHz 1.12: 6 to 26.5 GHz		3.5 mm (m)	+\$15
HP 909E	dc to 2	75	1.01	0.5 W avg 100 W pk	N(m)	\$300
HP 909E Opt. 011					N(f)	
HP 909E Opt. 201	dc to 0.2				N(m)	-\$35
HP 909F	dc to 6	50	1.005: dc to 5 GHz 1.01: 5 to 6 GHz	0.5 W 100 W pk	APC-7	\$430
HP 909F Opt 012	dc to 6	50	1.007: dc to 2 GHz 1.01: 2 to 3 GHz 1.016: 3 to 6 GHz	0.5 W 100 W pk	N(m)	-\$25
HP 909F Opt 013					N(f)	-\$25
HP 85138A	dc to 50	50	1.07: dc to 26.5 GHz 1.12: 26.5 to 40 GHz 1.22: 40 to 50 GHz	0.5 W	2.4 mm (m)	\$475
HP 85138B					2.4 mm (f)	\$525

### HP 920C, 921A Waveguide Shorts

The HP R920C, Q920C and U920C are low-loss movable shorts for waveguide systems operating from 26.5 to 60.0 GHz.

The HP R921A, Q921A and U921A are fixed shorts for waveguide systems.

#### HP 920C, 921A Specifications

HP Model	Frequency Range (GHz)	Type	Waveguide Size EIA	Price
R920C	26.5 to 40.0	movable	WR28	\$800
Q920C	33.0 to 50.0	movable	WR22	\$800
U920C	40.0 to 60.0	movable	WR19	\$810
R921A	26.5 to 40.0	fixed	WR28	\$85
Q921A	33.0 to 50.0	fixed	WR22	\$75
U921A	40.0 to 60.0	fixed	WR19	\$75

### HP 910A/B/C, 914B/C Waveguide

#### Fixed and Movable Terminations

The HP 910A/B/C are fixed terminations for waveguide systems. The HP 914A/B are similar to the HP 910A/B/C, except that their absorptive elements are movable and locking plungers control the position of the elements. HP 914C models use micrometer adjustment.

#### HP 910A/B/C, 914A/B/C Specifications

HP Model	Frequency Range (GHz)	SWR	Power Rating	Type	Waveguide Size (EIA)	Price
X910B	8.2 to 12.4	1.015	1 watt	fixed	WR90	\$400
P910A	12.4 to 18.0	1.02	1 watt	fixed	WR62	\$400
R910A	26.5 to 40.0	1.03	1 watt	fixed	WR42	\$325
Q910A	33.0 to 50.0	1.03	1 watt	fixed	WR22	\$275
U910A	40.0 to 60.0	1.04	1 watt	fixed	WR19	\$325
V910C	50.0 to 75.0	1.025	0.3 watt	fixed	WR15	\$650
W910C	75.0 to 110.0	1.03	0.2 watt	fixed	WR10	\$650
X914B	8.2 to 12.4	1.01	1 watt	sliding	WR90	\$1000
P914A	12.4 to 18.0	1.01	0.5 watt	sliding	WR62	\$1250
K914B	18.0 to 26.5	1.01	0.5 watt	sliding	WR42	\$900
R914C	26.5 to 40.0	1.01	0.5 watt	sliding	WR28	\$800
Q914C	33.0 to 50.0	1.01	0.5 watt	sliding	WR22	\$825
U914C	40.0 to 60.0	1.01	0.5 watt	sliding	WR19	\$900

### HP 11511A, 11512A, 11565A Coaxial Shorts and Opens

These shorts and opens are used for establishing measurement planes for known reflection phase and magnitude in 50 Ω and 75 Ω coaxial systems for various connectors.

#### Ordering Information

HP 11511A N-(f) Short (50 Ω)	\$60
HP 1250-1531 N-(f) Short (75 Ω)	\$44
HP 11512A N-(m) Short (50 Ω)	\$60
HP 1250-1530 N-(m) Short (75 Ω)	\$55
HP 11565A APC-7 Short (50 Ω)	\$110
HP 0960-0054 SMA-(f) Short (50 Ω)	\$22.50
HP 0960-0055 SMA-(m) Short (50 Ω)	\$11
HP 11652-60001 BNC (m) 50 Ω Termination	\$120
HP 85138A 2.4 mm (m) 50 Ω Termination	\$475
HP 85138B 2.4 mm (f) 50 Ω Termination	\$525
HP 85140A 2.4 mm (m) Short	\$250
HP 85140B 2.4 mm (f) Short	\$275
HP 85141A 2.4 mm (m) Open	\$275
HP 85141B 2.4 mm (f) Open	\$300

☎ For off-the-shelf shipment, call 800-452-4844.

# MICROWAVE TEST ACCESSORIES

Coaxial Single- and Dual-Directional Couplers, 90° Hybrid Coupler  
HP 770 Series, 11691D, 11692D, 87300B/C, 87301D, 87310B

421

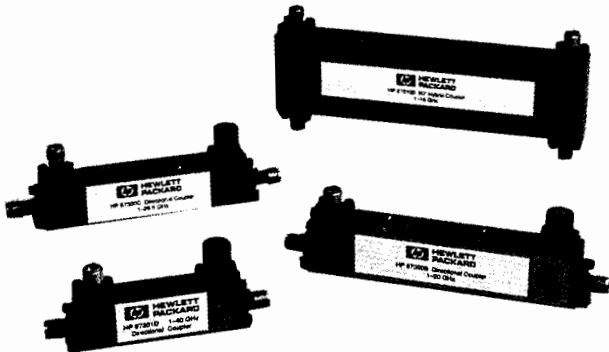

HP 87300B, 87301D, 87310B

## HP 87300 Series Directional Couplers

Hewlett-Packard offers a line of compact, broadband directional and hybrid couplers that are designed for signal monitoring or, when combined with a coaxial detector, signal leveling. The HP 87300B is supplied with SMA (f) connectors, the HP 87300C has 3.5 mm (f) connectors, and the HP 87301D has 2.4 mm (f) standard or optional 2.92 mm (f) connectors.

The HP 87310B is a 3 dB hybrid coupler intended for applications requiring a phase difference of 90 degrees between signals. The HP 87310B features SMA (f) connectors.

## HP 87300 Series Specifications

HP Model	Frequency Range (GHz)	Nominal Coupling & (dB) Variation	Minimum Directivity (dB)	SWR Maximum	Insertion Loss (dB)	Price
HP 87300B	1 to 20	10 ± .5	16	1.35	< 1.4	\$495
HP 87300C	1 to 26.5	10 ± 1	> 14	1.40	1 to 12.4: < 1.1 12.4 to 26.5: < 1.6	\$925
HP 87301D	1 to 40	13 ± 1	1 to 20: 14 20 to 40: 10	1 to 20: 1.5 20 to 40: 1.7	1 to 20: < 1.1 20 to 40: < 1.8	\$1,350
HP 87310B	1 to 18	3 dB ± .5		1.35	< 1.8	\$1,100

## HP 773D Directional Coupler & HP 772D Dual-Directional Coupler

The HP 772D and 773D are high-performance couplers designed for broadband swept measurements in the 2 to 18 GHz range. The HP 773D is ideal for leveling broadband sources when used with an HP 8474B detector. (See also the HP 83036C directional detector.) For reflectometer applications, the HP 772D is the best coupler to use with HP power sensors and power meters (such as the HP 438A dual power meter). Forward and reverse power measurements on transmitters, components, or other broadband systems are made simpler by using the HP 772D. The broadband design allows the use of a single test setup and calibration for tests spanning the entire 2 to 18 GHz frequency range.

## HP 774D - 778D Dual-Directional Couplers

The economical HP 774D-778D couplers cover frequency spreads of more than 2:1, each centered on one of the important VHF/UHF bands. With their high directivity and mean coupling accuracy of ± 0.5 dB, these are ideal couplers in reflectometer applications. The close tracking of the auxiliary arms makes these couplers particularly useful for reflectometers driven by sweep oscillators such as the HP 8350B with its appropriate plug-in. Power ratings are 50 W average, 10 Kw peak.

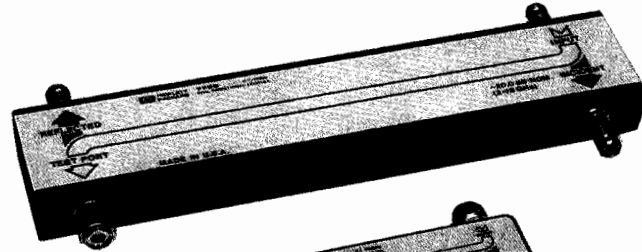

HP 772D

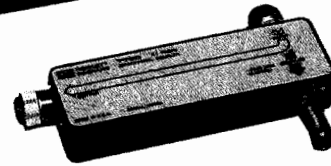

HP 773D

## HP 772-779D, 11691D, 11692D Specifications

HP Model	Frequency Range (GHz)	Nominal Coupling (dB)	Maximum Coupling Variation (dB)	Minimum Directivity (dB)	SWR Primary Line Maximum (50 Ω Nom.)	Price
HP 772D	2 to 18	20	± 0.9	2 to 12.4: 30 12.4 to 18: 27	2 to 12.4: 1.3 12.4 to 18: 1.4	\$2,800
HP 773D	2 to 18	20	± 0.9	2 to 12.4: 30 12.4 to 18: 27	1.2*	\$1,450
HP 774D	0.215 to 0.450	20	± 1	40	1.15	\$1,450
HP 775D <sup>1</sup>	0.450 to 0.840	20	± 1	40	1.15	\$1,450
HP 776D <sup>1</sup>	0.940 to 1.90	20	± 1	40	1.15	\$1,450
HP 777D	1.90 to 4.0	20	± 0.4	30	1.2	\$1,600
HP 778D	0.10 to 2.0	20	± 1.5	0.1 to 1 GHz: 36 <sup>2</sup> 1 to 2 GHz: 32	1.1	\$1,550
HP 779D	1.7 to 12.4	20 ± 0.5	± 0.75	1.7 to 4 GHz: 30 4 to 12.4 GHz: 26	1.2*	\$1,550
HP 11691D	2 to 18	22	± 1.0	2 to 8 GHz: 30 8 to 18 GHz: 26	1.2*	\$2,550
HP 11692D	2 to 18	22	± 1 incident to test port	2 to 8 GHz: 30 8 to 18 GHz: 26 <sup>1</sup>	2 to 12.4 GHz: 1.3 12.4 to 18 GHz: 1.4	\$3,900
<b>HP 772D Standard Connectors</b>						
Primary Line: APC-7, APC-7; Auxiliary Arms: N(f)						
Opt 001 Primary Line: N(f), N(f)						
-						
<b>HP 774D-777D Standard Connectors</b>						
Primary Line: N(m), N(f)						
Auxiliary Arm: N(f), N(f)						
NA						
<b>HP 778D Standard Connectors</b>						
Primary Line: N(m), N(f); Auxiliary Arms: N(f), N(f)						
Opt 011 Primary Line: APC-7, N(f)						
Opt 012 Primary Line: N(m), N(f)						
+ \$25						
\$0						
<b>HP 779D Standard Connectors</b>						
Primary Line: N(m) input, N(f) output; Auxiliary Arm N(f)						
Opt 010 Primary Line: N(f) input, N(m) output; Auxiliary Output N(f)						
Other options: APC-7 on any or all ports						
\$0						
Contact HP						
<b>HP 11691D and 773D Standard Connectors</b>						
Primary Line: APC-7, APC-7; Auxiliary Arm: N(f)						
Opt 001 All N(f)						
Opt 005 (11691D only) All APC-7						
-						
+ \$25						
<b>HP 11692D Standard Connectors</b>						
Primary Line: N(f), APC-7; Auxiliary Arms: N(f), N(f)						
Opt 001 Primary Line: N(f), N(f)						
Opt 002 Primary Line: N(f), N(m)						
-						
+ \$15						
-						

<sup>1</sup>Maximum auxiliary arm tracking: 0.3 dB for HP 776D; 0.5 dB for HP 777D

<sup>2</sup>30 dB, 0.1 to 2 GHz, input port

<sup>3</sup>24 dB with Type N connector on the test port

<sup>4</sup>Apparent SWR at the output port of a coupler when used in a closed-loop leveling system

# MICROWAVE TEST ACCESSORIES

## Waveguide and Millimeter Waveguide Accessories

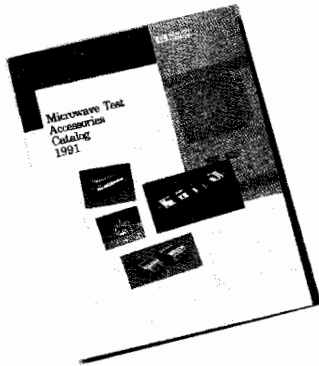

### Microwave Test Accessories Catalog

Hewlett-Packard offers a wide variety of waveguide accessories to help solve your test and measurement problems.

For more detailed descriptions of all of HP's waveguide accessories, as well as general-purpose microwave and RF test and measurement accessories, please order the 1991 Microwave Test Accessories Catalog (HP Lit. No. 5952-2843).

The following represents a brief description of many of the waveguide accessories available.

### HP 752 Series Waveguide Directional Couplers

The HP 752 series couplers are specified to meet a wide variety of microwave applications. Every coupler has a minimum directivity of 30 dB over its entire frequency range. Each coupler is swept-frequency-tested to ensure that the main guide SWR and directivity specifications are accurate. Performance characteristics are unaffected by humidity, temperature, time, making these units especially useful in microwave standards measurements.

The HP R752AS/CS/DS, Q/U752A/C/D, and V/W752C/D use a split block design, allowing for very close control of critical dimensions, which results in the high performance of these couplers.

The HP 752 couplers cover frequencies from 8.2 to 110 GHz in the following bands: X, P, K, R, Q, U, V, and W.

### HP 281A/B/C, 292A/B, 11515A/16A Coax and Waveguide Adapters

HP 281A/B/C rugged waveguide-to-coax adapters cover frequencies from 2.6 to 60 GHz. Coaxial connector types include Type N, APC-7, 3.5 mm, 2.4 mm, and 1.85 mm.

HP 292A/B waveguide-to-waveguide adapters connect waveguide sizes with overlapping frequency ranges.

HP 11515A/16A adapt circular waveguide flanges to rectangular flanges in K-band and R-band.

### HP 532 Series, 537A Frequency Meters

These direct-reading frequency meters measure frequencies from 33.0 to 60.0 GHz in waveguide, and from 3.7 to 12.4 GHz in coax quickly and accurately. Their long scales and numerous calibration marks provide high resolution, which is particularly useful when measuring frequency differences or small frequency changes. Frequency is read directly in GHz, so neither interpolation nor charts are required.

The instruments make up a special transmission section with a high-Q resonant cavity, which is tuned by a choke plunger. A 1 dB or greater dip in output indicates resonance; virtually full power is transmitted off resonance. Overall accuracy of each frequency meter includes allowance for 0 to 100% relative humidity and temperature variation from 13° to 33° C.

### HP 362 Series Waveguide Low-Pass Filters

These low-pass filters facilitate microwave measurements by eliminating undesirable signals (such as harmonics) from the measurement system. Suppression of such signals is particularly important in applications such as broadband reflection and transmission measurements or slotted line measurements, where harmonics generated by the signal source could otherwise impair measurement accuracy. The HP 362 low-pass filters cover the frequency range from 8.2 to 40 GHz in the X, P, K, and R bands.

### HP 11540 Series Waveguide Stand, Waveguide Holders

The HP 11540A waveguide stand locks HP waveguide holders at any height from 70 to 133 mm (2.75 in to 5.25 in). The waveguide holders are offered in 5 sizes to hold waveguide covering frequencies from 22 to 40 GHz.

### HP 382 Series Waveguide Attenuators

Operation of these HP 382 series rotary-vane, continuously variable attenuators depends on a mathematical law rather than on the resistivity of the attenuator card. They are direct-reading and provide accurate attenuation from 0 to 50 dB regardless of temperature and humidity. The HP 382 attenuators cover the frequency range from 8.2 to 60 GHz in the X, P, K, R, Q, and U bands.

### HP 370A/B/C Millimeter-Wave Fixed Attenuators

The HP Q and U 370 fixed attenuators offer precise attenuation, flat frequency response, and low SWR. Their ruggedness, reliability, and small size make them ideal for bench systems applications. They are also useful for general-purpose applications, such as reduction of power levels to sensitive components and systems.

### HP 373D/G Millimeter-Wave Fixed Attenuators

The HP R, Q, U, V, and W 373 precision fixed attenuators offer very precise attenuation, flat frequency response, very low SWR, and low attenuation drift with age. The split block design offers this excellent performance in a rugged, reliable package. Intended for use on the bench in applications requiring very precise signal reduction, or where a precise attenuation standard is needed. Available in 20 and 50 dB values.

### HP 365A Millimeter-Wave Waveguide Isolators

The HP Q and U365A isolators use a Faraday-rotation-type design consisting of a section of waveguide containing low-loss ferrite material and impedance-matching elements. A permanent magnet supplies the external magnetic bias field to the ferrite core. This results in excellent broadband isolation ratios of at least 25 dB, along with low SWR and insertion loss. Models in the R, V, and W bands are also available.

### HP 894, 896, 897, 898, 899

#### Millimeter-Wave Waveguide Accessories

Waveguide accessories, such as E- and H-plane bends, twists, and straight sections, are necessary and useful for assembling waveguide measurement systems.

HP offers HP R/Q/U/V/W 897A/B E-plane and H-plane bends of 90 degrees. HP R/Q/U/V/W 898A/B twists can be specified for either right rotation (A-Model) or left rotation (B-Model) of 90 degrees. And, finally, several HP R/Q/U/V/W 899A/B straight sections are available in 2.5 and 5.0 cm lengths to fill out the proper dimensions of complicated test setups.

Network analysis calibration is verified by measuring a precise and traceable reference impedance. HP's R/Q/U/V/W 896 standard sections and R/Q/U/V/W 894 standard mismatches are these kinds of references.

They have very low SWR, less than 1.016. Impedance is NIST-traceable, using laser interferometry to accurately measure waveguide dimensions.

The HP Q/U896 has a unique precision flange design. When mating with a standard MIL-spec flange, this design improves repeatability by about a factor of 2 (when mating 2 HP precision flanges, repeatability is improved by a factor of 5).



# DIMENSIONAL MEASUREMENTS

## Laser Interferometer Positioning Systems

HP 5527B, VMEbus, PC-Compatible

423

- High accuracy (sub-0.5 micron), resolution, and repeatability
- Industry-standard electronics
- Choice of laser head, optics, and electronics

- Fast axis velocity (350 mm/s)—plane mirror optics
- Automatic wavelength-of-light compensation
- Remote sensing with fiber optic receivers

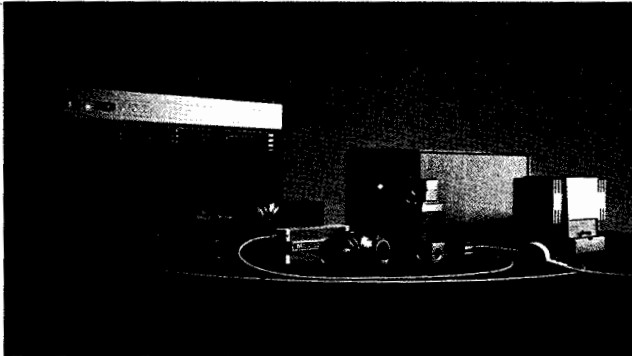

HP 5527B Laser Interferometer Positioning System

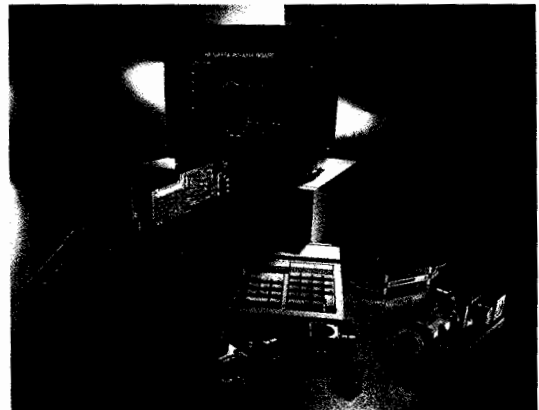

PC-Compatible Laser Interferometer Positioning System with the HP 10885A PC Axis Board

### Precision Positioning Products

Laser interferometer precision positioning systems — composed of electronic and optical components — provide very precise position or distance information for dimensional measurements and motion control. When built into manufacturing and inspection processes, a laser interferometer system reports the position of a probe or controls the motion of a product platform with more accuracy than any other method.

Precision laser positioning systems improve product quality and reliability, increase manufacturing consistency for increased production yields, and allow the production of precision products that would otherwise be impossible to manufacture. Laser interferometer positioning systems are vital in many applications:

- Integrated-circuit fabrication, inspection, and repair
- Manufacture of high-capacity disk drives
- Precision machine tools
- Manufacture or calibration of other measurement scales
- Mechanical parts inspection/measurement
- Custom test and measurement
- Precise plotting
- Mechanical vibration analysis
- Antenna testing

Many of HP's innovations have resulted in products that are unavailable from any other vendor. VME electronics and digital programmable servo-control electronics for closed-loop positioning are offered only by HP.

### System Components

Hewlett-Packard precision positioning systems combine Michelson interferometry with a two-frequency HeNe laser. HP's patented two-frequency design provides greater stability and reduced noise sensitivity, and extends the measurement range — up to 80 meters (260 ft.). Three subsystems make up a laser interferometer system:

- **Laser:** Supplies a monochromatic light source (or beam).
- **Optics:** Direct the beam and generate the interference pattern.
- **Electronics:** Detect and count the light and dark interference fringes, process the data, and output distance information.

### Improving Accuracy and Repeatability

Maximum accuracy and repeatability require compensation for certain parameters. HP laser interferometer systems depend on the high accuracy of the laser's wavelength. However, the wavelength of light in air varies with the air's refractive index which is a function of air temperature, pressure, and composition. In addition to the wavelength-of-light effects, errors can result from thermal expansion of the workpiece. To take full advantage of Hewlett-Packard's high wavelength stability, the HP 10717A Wavelength Tracker compensates for changes in the air's refractive index. The HP 10780F Remote Receiver eliminates thermal effects due to the receiver electronics by using a remote, fiber-optic pickup. The new HP 10896A, with wavelength-of-light compensation, increases accuracy and repeatability for VMEbus systems. Product Note 5527A/B-2 describes in detail how to achieve maximum accuracy and repeatability.

### HP Laser Interferometer Products

HP offers the components needed to configure laser interferometer positioning systems for a broad range of applications and other requirements. All systems support the same laser sources and optics. The differences are determined by the electronics.

### Interferometer Electronics

HP interferometer electronics offer a choice of: backplane (interfacing characteristics), output formats, and environmental compensation options. Table 1 on the next page summarizes the HP products based on these differentiators.

The HP product line offers interferometer electronics tailored for a variety of customer needs. For interfacing to industry-standard backplanes, the VMEbus provides a high-performance alternative and PC products provide the lowest-cost solution. Both are popular industry standards and offer system configuration flexibility. In addition to the standard 32-bit measurement output, the HP 5527B offers a broader choice of output formats compared with the VMEbus and PC electronics.

Each of the electronics alternatives supports the complete range of lasers and optics. In addition, the HP 10780C Receiver and HP 10780F Remote Receiver work with all electronics.

# DIMENSIONAL MEASUREMENTS

## Laser Interferometer Positioning Systems (cont'd)

HP 5527B, VMEbus, PC-Compatible

**Table 1. Key Characteristics of HP Interferometer Electronics**

System	Electronics	Backplane	Output Formats	Other Differentiators
HP 5527B	HP 5507B	Proprietary	32-bit digital, GPIO, HP-IB, motor drive (in $\pm 10$ Vdc, 16-bit digital, and pulse-width modulated), A-Quad-B, up/down pulse.	High-performance, complete package Servo-axis board Fully compensated A-Quad-B for high-precision machine tools Complete compensation for environmental effects
VMEbus	HP 10895A HP 10896A	VMEbus	32-bit digital (hardware output and backplane output)  VME compensation board	High-performance, robust, industry-standard 32-bit backplane Fast system development Wavelength-of-light compensation
PC Axis	HP 10885A	ISA (PC/AT, PC/XT, and IBM compatibles)	32-bit digital (hardware output and backplane output)	Lowest-cost, most-popular, industry-standard backplane Fast system development

### Optics

The optics tailor each interferometer system for the physical layout and measurement requirements of each application. The current list of HP optics includes four new products for improved multi-axis stage positioning and sub-0.5-micron accuracy.

- **HP 10702A Linear Interferometer:** The basic for linear measurements.
- **HP 10706A/B Plane-Mirror Interferometers:** Commonly used with multi-axis stages.
- **HP 10716A High-Resolution Interferometer:** A plane-mirror interferometer with twice the resolution of the HP 10706A/B.
- **HP 10715A Differential Interferometer:** A plane-mirror interferometer for differential measurements.
- **HP 10705A Single-Beam Interferometer:** Physically smaller for confined spaces or low-mass, non-contact measurements.
- **HP 10719A\*, HP 10721A\* One- and Two-Axis Differential Interferometers:** For optimized accuracy and repeatability with IC fabrication equipment; the position of the wafer stage is directly referenced to the optics column.
- **HP 10735A\*, HP 10736A\* Three-Axis Interferometers:** Can be used in pairs to make 5 precise measurements (x, y, pitch, roll, and yaw) simultaneously for IC fabrication.

See Table 2 for a summary of HP reflector products and the configurations supported with HP optics.

\* New products.

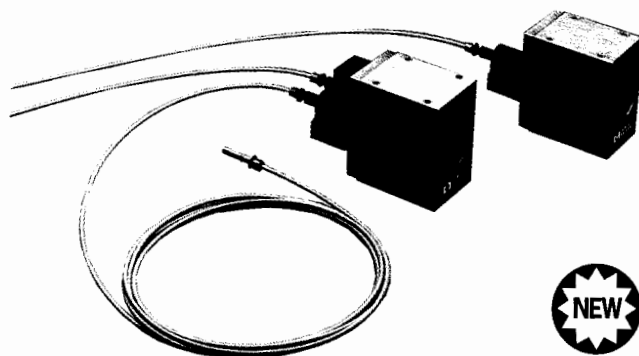

The HP 10719A and 10721A Differential Interferometers work together to make highly accurate column-referenced measurements for multi-axis stages.

**Table 2. HP Reflectors and Optics: Supported Combinations**

Optics	Reflectors/Mirrors			
	HP 10703A	HP 10704A	HP 10724A	Custom Mirrors
HP 10702A	✓			
HP 10705A		✓		
HP 10706A/B			✓	✓
HP 10716A			✓	✓
HP 10715A			✓	✓
HP 10719A, HP 10721A				✓
HP 10735A, HP 10736A				✓

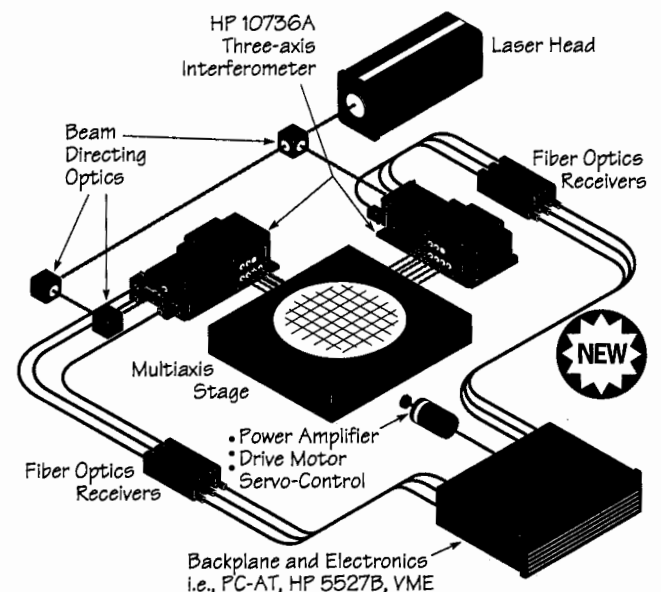

The new HP 10735A and HP 10736A Three-Axis Interferometers offer greater accuracy for microlithography and other applications that require up to five degrees of freedom.

### Laser Heads

Three laser heads are available for HP interferometer systems: The HP 5517A, HP 5517B (500-mm/second axis velocity for linear optics), and HP 5517C (700 mm/sec for linear optics).

The total accuracy of an interferometer system is the sum of the errors from the laser head, the optics, and the effects of the environment. All HP laser heads have a vacuum wavelength accuracy of  $\pm 0.1$  ppm ( $\pm 0.02$  ppm with factory calibration to MIL-STD 45662) and a demonstrated MTBF greater than 20,000 hours.

### Interferometer System Configurations HP 5527B Laser Interferometer System

The HP 5527B offers improved system performance with finer resolution, faster axis velocities, remote sensing receivers, and complete servo-control capability. It can be configured for closed- or open-loop control, multiaxis capabilities, automatic compensation for environmental effects, and special prototyping abilities for custom electronics.

The HP 5507B system electronics for the HP 5527B combine superior performance with greater ease of use and full EMC compliance. The system is controlled with HP-IB. Five outputs are available depending on the boards used:

- **HP 10932B Axis Board:** Open-loop measurements or position data for custom closed-loop positioning. Outputs are in 32-bit digital format, and are available directly and over HP-IB.
- **HP 10934A A-Quad-B Board:** Provides high-resolution, A-Quad-B and Up/Down pulse outputs with full environmental compensation.
- **HP 10936B Servo-Axis Board:** Closed-loop motor drive outputs for a range of motor amplifiers. Motor-drive outputs are  $\pm 10$  V analog, 16-bit digital, and pulse-width modulated for precision positioning. The HP 10936B is a programmable digital servo with built-in motion control algorithms; custom algorithms can be down-loaded. A trace function speeds and simplifies servo-loop characterization and position control.
- **HP 10941A Prototyping Board:** Capabilities for custom electronic designs.
- **HP 10946C Automatic Compensation Board:** With HP 10717A wavelength tracker and/or HP 10751A air sensor and HP 10757A material temperature sensor, automatically compensates for wavelength-of-light and material temperature effects.
- **HP 10780C/F Receiver:** Supports up to 6 measurement axes.

### PC-Based Laser Interferometer Positioning System

The HP 10885A PC Axis Board offers a laser interferometer system that can be interfaced with the most popular PC backplanes. Leveraging existing PC/XT, PC/AT, and other IBM-compatible computers significantly lowers start-up costs. The HP 10885A provides a 32-bit digital, real-time position output via hardware. Position can also be read over the PC backplane. Combining the high performance of HP laser interferometers with the most popular, lowest-priced, industry-standard backplane speeds system development and integration and reduces system cost.

### VMEbus Laser Interferometer Positioning System

The HP 10895A Laser Axis Board, compatible with VME Rev. C.1, provides capability similar to that of the HP 10932B Axis Board. Position data is output in 32-bit format for closed-loop positioning systems. Position can also be read over the VMEbus backplane. This VME solution permits easy, cost-effective integration of laser electronics into VMEbus systems, and can also be used in VXI backplanes.

The new HP 10896A Compensation Board increases the accuracy and repeatability of positioning systems using the HP 10895A. With wavelength-of-light compensation, laser-positioning systems based on the VMEbus are suitable in many environments.

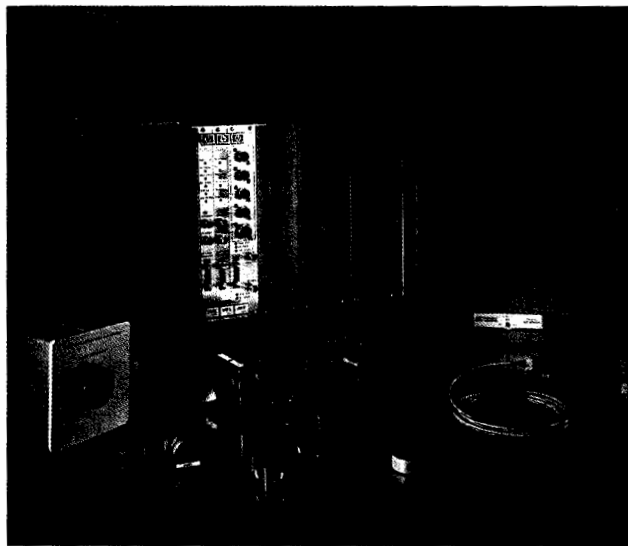

The HP 10895A VMEbus Laser Axis Board and HP 10896A VMEbus Compensation Board permit easy, cost-effective integration of high-speed laser electronics into this popular industry-standard backplane.

### Ordering Information

To configure and order an HP laser interferometer positioning system, please request the appropriate data sheets and ordering information from your local Hewlett-Packard sales office:

- Introduction to Laser Systems Brochure**, 5091-2507E
- Laser Head and Optics Technical Data Sheet**, 5091-0728E
- HP 5527B Technical Data Sheet**, 5091-2508E
- VMEbus Technical Data Sheet**, 5091-0727
- PC Axis Technical Data Sheet**, 5091-1265
- Systems Ordering Information**, 5091-1641

### System Specifications

	HP 5527B	VMEbus	PC Axis
<b>Accuracy</b>			
Vacuum	0.1 ppm	0.1 ppm	0.1 ppm
With MIL STD 45662A	0.02 ppm	0.02 ppm	0.02 ppm
<b>Maximum Resolution</b>			
Linear optics	10 nm	10 nm	10 nm
Plane mirror optics	5 nm	5 nm	5 nm
High-res. optics	2.5 nm	2.5 nm	2.5 nm
<b>Maximum Axis Velocity</b>			
Linear optics	700 mm/s	700 mm/s	700 mm/s
Plane mirror optics	350 mm/s	350 mm/s	350 mm/s
High-res. optics	175 mm/s	175 mm/s	175 mm/s
<b>Maximum Range</b>	40 m	40 m	40 m
<b>Maximum Data Output Rates</b>			
Position/position error	3.0 MHz	3.0 MHz	3.0 MHz
A-quad-B (transition rate)	5.2 MHz	N/A	N/A
Up-down pulse	5.2 MHz	N/A	N/A
Motor-drive	8 kHz	N/A	N/A
<b>Atmospheric Compensation</b>	Yes	Yes	(available spring 1992)

# DIMENSIONAL MEASUREMENTS

## Laser Interferometer Measurement Systems

### HP 5528A

- Transportable
- Standalone
- Easy to use
- PC-compatible software
- Optimized for machine-tool calibration
- Acceptance testing of new machines
- Multiple measurements
- Long-distance measurements

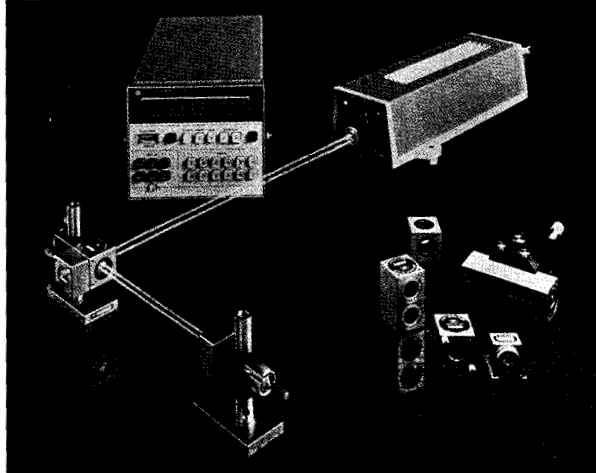

HP 5528A

### HP 5528A Laser Measurement System

The HP 5528A Laser Measurement System quickly detects and easily measures critical errors in positioning and geometry of precision machines. These measurements include distance and velocity, pitch and yaw, flatness, straightness, squareness, and parallelism. The system can be used for machine tools, and also to calibrate coordinate-measuring machines, printed-circuit-board fabrication equipment, and other precision equipment. Because it does not degrade from wear or aging, the HP 5528A system makes an ideal reference length standard for metrology labs and various research and development applications.

Using the HP 5528A Laser Measurement System to completely characterize machines provides the following benefits:

- Ensures that new machines meet their specifications.
- Reduces scrap, rework, and inspection cost by increasing the ability to produce parts repeatably and accurately.
- Reduces preventative maintenance cycles.

### Measurement Versatility Through Modular Design

The basic HP 5528A measures distance and velocity. Additional measurement optics are available for pitch, yaw, flatness, straightness, squareness, and parallelism. The basic system consists of the HP 5508A Measurement Display, HP 5518A Laser Head, HP 10793A Laser Head Cable, and applicable measurement optics. The following measurement optic kits are available:

- HP 55280A Linear Measurement Kit (distance and velocity)
- HP 55281A Angular Optics Kit (pitch and yaw)
- HP 55282A Flatness Accessory Kit (surface-plate flatness)
- HP 55283A Straightness Measurement Kit (straightness and parallelism)
- HP 10777A Optical Square (squareness)

This design allows the HP 5528A system to be configured to meet present needs while offering economical expansion in the future.

### Measurement and Analysis

The addition of a personal computer and metrology software greatly enhances the capabilities of the HP 5528A system. HP 10754A Dimensional Metrology Analysis Software provides complete data collection, storage, analysis, and printout for system measurements. This software operates on the HP Vectra PC family of computers and other IBM PC-XT and AT compatibles.

### Improved Accuracy and Repeatability

With automatic and manual compensation, the HP 5528A system provides increased measurement accuracy and repeatability. The manual compensation consists of measuring air temperature, pressure, and relative humidity, finding the compensation factor that corresponds to these measurements in a look-up table, and then entering this number into the HP 5508A Measurement Display. Automatic compensation is provided by the HP 10751A Air Sensor.

This device measures air temperature and pressure, calculates the compensation factor, and automatically updates the HP 5508A Measurement Display. Automatic compensation assures maximum measurement accuracy and repeatability in changing environments.

Material temperature compensation is available to correct errors induced by thermal expansion of the measured object. Material temperature can be manually entered or automatically monitored and updated by one to three HP 10757A Material Temperature Sensors.

### Specifications

#### General

- Laser:** Two-frequency HeNe, 1.0 mW maximum power output
- Power:** 100, 120, 220, 240 Vac (+5%, -10%); 48 to 66 Hz, 175 VA max
- Display update rate:** 20 Hz nominal

#### Distance

- Accuracy:**  $\pm 0.1$  ppm in vacuum;  $\pm 0.02$  ppm in vacuum with factory calibration to MIL-STD 45662;  $\pm 1.7$  ppm with HP 10751A air sensor (15° to 25° C)
- Resolution:** 0.01  $\mu\text{m}$  (1.0  $\mu\text{in}$ )
- Measurement range:** 40 m (130 ft); 80 m (260 ft) with C01-5518A Long-Range Special
- Measurement velocity:** 27.4 m/min (1080 in/min)

#### Pitch and Yaw

- Resolution:** 0.1 arc-sec
- Measurement range:**  $\pm 36000^\circ$  arc-sec ( $\pm 10^\circ$ )

#### Straightness

- Resolution:** 0.01  $\mu\text{m}$  (1.0  $\mu\text{in}$ ) using short-range optics; 0.1  $\mu\text{m}$  (10.0  $\mu\text{in}$ ) using long-range optics
- Measurement range:**  $\pm 1.5$  mm (0.060 in)
- Axial range:** 0.1 to 3.0 m (0.3 to 10 ft) using short-range optics; 1.0 to 30 m (3.0 to 100 ft) using long-range optics

### Ordering Information

Ordering Information	Price
HP 5508A Measurement Display	\$7,040
HP 5518A Laser Head	\$7,040
HP C01-5518A Long Range Special	\$1,500
HP 10751A Air Sensor	\$4,400
HP 10753A Tripod	\$1,430
HP 10754A Dimensional Metrology Analysis Software	\$1,200
HP 10757A Material Temperature Sensor	\$970
HP 10777A Optical Square	\$4,500
HP 10793A Laser Head Cable	\$240
HP 55280A Linear Measurement Kit	\$4,400
HP 55281A Angular Optics Kit	\$4,900
HP 55282A Flatness Accessory Kit	\$2,900
HP 55283A Straightness Measurement Kit	\$7,400

For detailed information, ask for the following literature:

HP 5528A Data Sheet (5952-7935); HP 10754A Data Sheet (5952-7990); Application Note 325-2 Machine Tool Calibration with the Laser Measurement System (5952-7708)

# PRESSURE & TEMPERATURE

## Quartz Pressure Probe and Thermometer

HP 2813D/E, 2804A

427

- 0.001 psi resolution (6,9 Pa)
- Rugged and reliable
- Simple operation

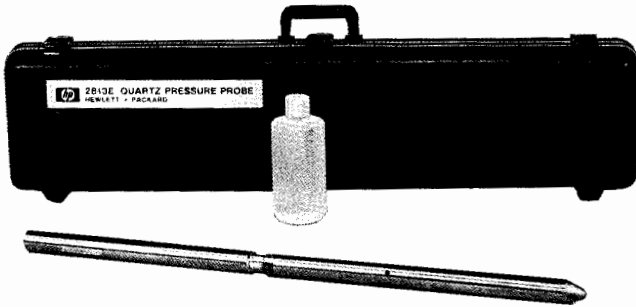

HP 2813E



HP 2813D

### HP 2813E Quartz Pressure Probe

The quartz technology from Hewlett-Packard is the standard for pressure measurement applications requiring extremely high accuracy, resolution, and repeatability. With its rugged construction, the 2813E probe is ideal for petroleum applications, oceanographic research and subterranean hydrodynamic studies. The simplicity of the HP 2813E's mechanical design makes it easy to use and service in the field.

Capable of sensing wellbore pressure changes as small as 0.001 psi, the probe's measurements can be instantly observed and recorded on the surface. With accuracy better than  $\pm 1.0$  psi plus  $\pm 0.01\%$  of the pressure reading, the HP 2813E/D gives confidence in precision measurements. With repeatability of 0.4 psi over the full calibrated pressure range (200 - 11,000 psia) at constant temperature, be confident that changes in successive measurements are due to changes in the well, not probe measurement error.

Though a precision instrument, the HP 2813E is rugged and reliable in an oil field environment. Housed in a 1-inch OD case made of Nitronic 50 stainless steel, the probe can withstand pressures of up to 12,000 psia and temperatures of up to 350°F (177°C)

### HP 2813D Quartz Pressure Set

The reference crystal, sensor crystal and electronics pc board are available as matched components in the HP 2813D Quartz Pressure Set. Design the essential pressure-measuring components of the HP 2813E into your own downhole instrumentation package.

### HP 2813E/D Specifications

#### Operating Environment

**Calibrated pressure range:** 200 to 11,000 psi (1,38 to 75,8 MPa).

**Calibrated temperature range:** 95 to 350°F (35 to 177°C)

#### Static Measurement (pressure and temperature are constant)

**Accuracy:**  $\pm [1.0 \text{ psi (6,9 kPa) (due to curve fit error) } + 0.01\% \text{ of actual pressure (due to calibration system error)}]$

**Repeatability:**  $\pm 1.0$  psi (6,9 kPa) over the entire calibrated pressure and temperature range; or  $\pm 0.4$  psi (2,76 kPa) over the pressure range with temperature held to a single value

**Aging:** Error due to aging of sensor and reference crystal pair is typically less than  $\pm 0.5$  psi (3,45 kPa) per year.

**Temperature uncertainty error:**  $(\Delta T) \cdot (0.28 \text{ psi} + 0.02\% \text{ of actual pressure in psi})$  for temperature in degrees F

**Resolution:** 0.001 psi (6,9 Pa) when sampling for 1 second

**Sensitivity:** 1.4583 Hz/psi (15,2 Hz/kPa) nominal

#### Non-Operating Characteristics (HP 2813E)

**Outside diameter:** 1 1/8 in. (37 mm)

**Length:** 39.3 in. (998 mm)

**Weight:** 11 lb (5 kg)

**Static tensile pull strength:** > 20,000 lb (9070 kg)

**Steel case material:** Nitronic 50 high strength

- Display of absolute or differential temperature
- Variable resolution analog output
- Easy ice-point or triple-point adjustment

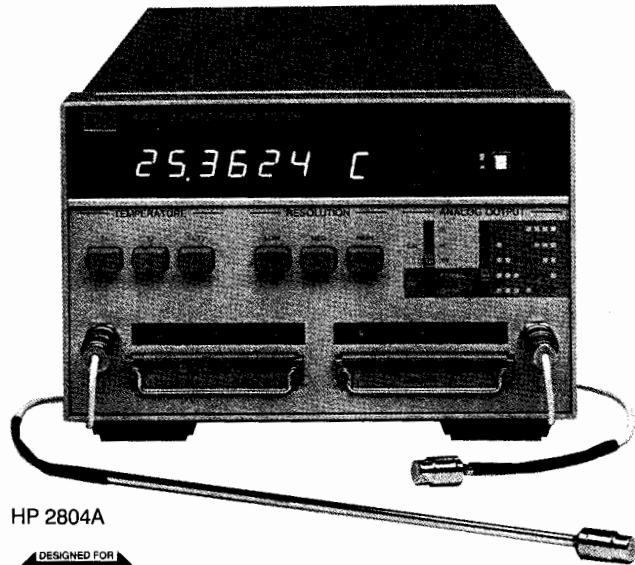

HP 2804A



### HP 2804A Quartz Thermometer

The HP 2804A Quartz Thermometer lets you easily measure temperature with exceptionally high accuracy and resolution. The useable resolution of 0.0001°C allows you to measure temperature changes that could not be detected by other digital thermometers.

The HP 2804A can be used with one or two temperature sensing probes. The temperature of either probe, or their difference, can be measured and displayed under pushbutton control. Display resolution is selectable.

The HP-IB (standard) offers you a simple, yet flexible, way to connect the Quartz Thermometer to either an HP computing controller or printer. The analog output (standard) converts any three consecutive digits to a voltage between 0 and +10 volts to drive a chart recorder.

### HP2804A Specifications

**Range:** -80 to 250°C

**Absolute Accuracy:** HP 2804A with HP 18110A, or HP 18111A

#### Quartz Probe:

$\pm 0.040^\circ\text{C}$  from  $\pm 50$  to  $150^\circ\text{C}$

$\pm 0.075^\circ\text{C}$  from  $\pm 80$  to  $250^\circ\text{C}$

NIST traceable to ITS-90

**Resolution:** three levels can be selected:

Level of selection	Resolution		Nominal time between readings in seconds	
	°C	°F	T1 or T2	T1-T2
Low	0.01	0.1	0.1	0.2
Medium	0.001	0.01	1	2
High	0.0001	0.001	10	20

#### General

**Display:** 7-digit LED, polarity, decimal, and °C or F annunciator

**Probes:** Laboratory probes are available. See data sheet.

#### Power Required

100, 120, 220, or 240 Vac, +5% -10%, 48 to 66 Hz, <30 VA

#### Ordering Information

**HP 2813E** Quartz Pressure Probe

**HP 2813D** Quartz Pressure Set

**HP 2804A** Quartz Thermometer

#### Accessories and Probes for the HP 2804A

**HP 18107A** External Oscillator

**HP 18110A** Lab Probe and Cal Module, 25 mm (1 in.)

**Opt 001** Extra Prom

**HP 18111A** Lab Probe and Cal Module, 230 mm (9.1 in.)

**Opt 001** Extra PROM

**Opt 002** Threaded Probe Connector

#### Price

\$27,700

\$21,600

\$9,600

\$1,400

\$2,600

+\$150

\$2,600

+\$150

+\$130

# SIGNAL GENERATORS

## Signal Generators to 110 GHz

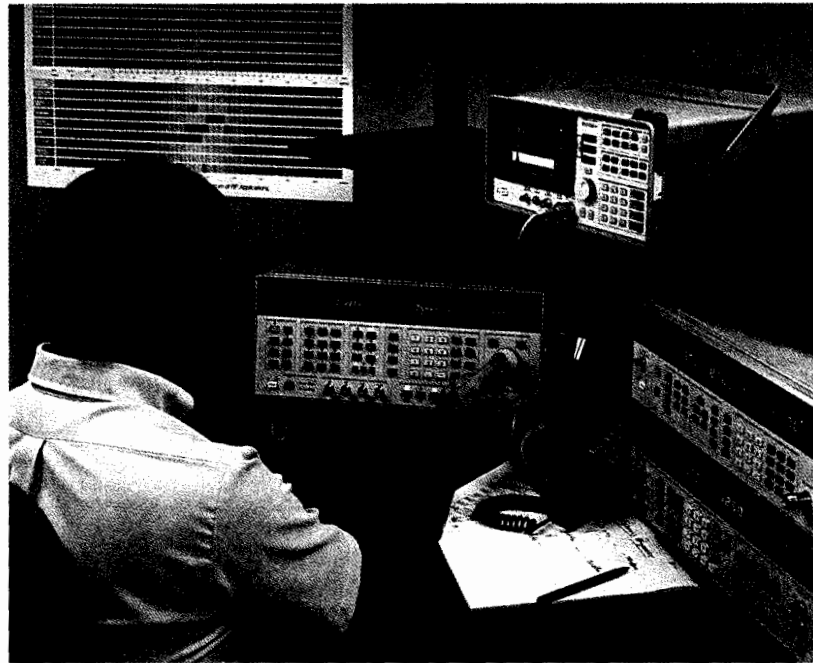

Hewlett-Packard offers the widest selection of high-performance signal sources from dc to 110 GHz. They cover every application range from low-frequency navigation

signals, through cellular mobile radio, to millimeterwave satellite systems. Each offers synthesized frequency accuracy and stability as well as calibrated level and remote pro-

grammability. Modulation capabilities range from general purpose AM, FM,  $\Phi$ M, pulse, and I-Q modulation to more specific formats such as QPSK, 16-QAM, 64-QAM, 0.3 GMSK, and  $\pi/4$  DQPSK.

### Signal Generator Summary Economy RF

Frequency	Model	Characteristics	Page
0.1 to 990 MHz	HP 8656B	<b>Economically priced signal generator.</b> $\pm 1.0$ dB absolute level accuracy from +13 to -127 dBm in 0.1 dB steps. Calibrated AM and FM. Frequency resolution of 10 Hz. Timebase aging rate of $\pm 2$ ppm/year.	430
0.1 to 1040 MHz	HP 8657A	<b>Spectral purity and electronic attenuator at an economical price.</b> $< -130$ dBc/Hz @ 500 MHz SSB phase noise. $< -60$ dBc spurious. Electronic attenuator. $\pm 1$ dB level accuracy. AM and FM.	432
0.1 to 2060 MHz	HP 8657B	<b>Spectral purity and pulse to 2 GHz at an economical price.</b> $< -130$ dBc/Hz @ 500 MHz SSB phase noise. $< -60$ dBc spurious. $\pm 1$ dB level accuracy. AM, FM, and pulse with $> 90$ dB on/off at 1030 MHz.	434

### Digital/I-Q Modulation

Frequency	Model	Characteristics	Page
0.1 to 1040 MHz GSM bands	HP 8657A Opt 022	<b>0.3 GMSK for GSM radio testing.</b> Analog performance of the HP 8657A plus 0.3 GMSK from 10 to 130 MHz and 520 to 1040 MHz. $< 3^\circ$ rms phase error.	430
0.1 to 2060 MHz GSM and PCN bands	HP 8657B Opt 022	<b>0.3 GMSK for GSM and PCN radio testing.</b> Analog performance of the HP 8657B plus 0.3 GMSK from 10 to 130 MHz and 520 to 2060 MHz. $< 3.5^\circ$ rms phase error. Baseband I/Q outputs.	430
0.1 to 1030 MHz NADC and JDC bands	HP 8657D	<b>Analog and digital modulation for North American and Japanese digital cellular.</b> Analog performance of the HP 8657B to 1030 MHz. $\pi/4$ DQPSK from 10 to 129.9 MHz, 810 to 965 MHz, and 1420 to 1540 MHz. $< 4\%$ error vector magnitude, baseband I/Q outputs.	430
0.01 to 3 GHz	HP 8780A	<b>Precision wideband analog and digital modulation source for digital microwave communications and radar.</b> Synthesized signal generator for wideband and complex modulation formats. Digital formats from BPSK to 64 QAM. Vector (quadrature) bandwidths dc to 350 MHz. +10 to -100 dbm.	460
1 to 250 MHz	HP 8782B	<b>Economy digital modulation source.</b> Synthesized signal generator for digital modulations BPSK through 256 QAM. DC to 100 MHz symbol rates. +7 to -100 dBm. Analog I/Q inputs.	461

### High-Performance RF

Frequency	Model	Characteristics	Page
0.252 to 1030 MHz 0.252 to 2060 MHz	HP 8643A, HP 8644B	<b>Performance signal generator for RF design.</b> $< -130$ dBc/Hz @ 1 GHz SSB phase noise HP 8643A; $< -137$ dBc/Hz HP 8644B. $< -100$ dBc spurious. AM, FM, $\Phi$ M, and pulse modulation. Advanced modulation source. Lowest specified leakage. Avionics option available (Opt 009).	437
0.1 to 1057.5 MHz 0.1 to 2115 MHz	HP 8642A HP 8642B	<b>Broadband spectral purity and FM for phase noise testing.</b> High spectral purity. 1 Hz frequency resolution. $\pm 1$ dB absolute output level accuracy. AM, FM, $\Phi$ M, and pulse. Sweep. Two-hour on site repair.	441
0.01 to 110 MHz 1 to 1300 MHz 1 to 2600 MHz	HP 8660D	<b>Plug-in modules for high-rate/wide-deviation modulation.</b> 1 Hz frequency resolution, $3 \times 10^{-10}$ /day stability. Calibrated and leveled output from +13 to -146 dBm. HP-IB and BCD programmable. AM, FM, $\Phi$ M, pulse modulation. Plug-ins determine frequency range and modulation capability.	443
0.01 to 1280 MHz	HP 8662A	<b>Low close-in noise.</b> 0.1 Hz frequency resolution, $5 \times 10^{-10}$ /day stability. Calibrated and leveled output from +13 to -140 dBm. Digital sweep. Completely HP-IB programmable. AM/FM modulation. Fast switching.	446
0.1 to 2560 MHz	HP 8663A	<b>Low close-in noise with complex modulation.</b> 0.1 Hz frequency resolution, $5 \times 10^{-10}$ /day stability. Calibrated and leveled output from +16 to -130 dBm. Digital sweep. Completely HP-IB programmable. AM, FM, $\Phi$ M, pulse modulation. Fast switching.	446
0.1 to 3.0 GHz 0.1 to 4.2 GHz 0.1 to 6.0 GHz	HP 8664A HP 8665A HP 8665B	<b>Performance signal generators for 3.0 GHz, 4.2 GHz and 6 GHz testing.</b> Excellent spectral purity. AM and FM. High Performance pulse modulation. Advanced modulation source.	437

### CW Microwave

Frequency	Model	Characteristics	Page
2 to 18 GHz	HP 8671B	<b>Precision CW signals, pure and simple.</b> 1 to 3 kHz frequency resolution, $5 \times 10^{-10}$ /day stability. +8 to -120 dBm output. Completely HP-IB programmable.	448
2 to 26 GHz	HP 8673G	<b>Digital sweep and mm-wave capability add powerful flexibility in CW applications.</b> 1 to 4 kHz frequency resolution, $5 \times 10^{-10}$ /day stability, 0 to -100 dBm output (+8 dBm with Opt 008), digital sweep, millimeter capability. Completely HP-IB programmable.	448

### Economy Microwave

Frequency	Model	Characteristics	Page
2 to 12.4 GHz 5.4 to 18 GHz	HP 8673H	<b>High-performance, multiband synthesizers for cost-sensitive applications.</b> 1 to 3 kHz frequency resolution, $5 \times 10^{-10}$ /day stability. +8 to -100 dBm output, AM, FM and pulse modulation, digital sweep, millimeter capability. Completely HP-IB programmable.	449

### High-Performance Microwave

Frequency	Model	Characteristics	Page
2 to 18 GHz	HP 8673E	<b>Exceptional value in a full-feature synthesizer.</b> 1 to 3 kHz frequency resolution, $1.5 \times 10^{-9}$ /day stability. +8 to -120 dBm output. Pulse, amplitude, and frequency modulation. Digital sweep. Completely HP-IB programmable.	450
0.05 to 18 GHz 0.05 to 26 GHz	HP 8673C HP 8673D	<b>State-of-the-art spectral purity for demanding applications in wideband receiver test.</b> Harmonics and sub-harmonics < -60 dBc. 1 to 3 kHz resolution, C-model; 1 to 4 kHz, D-model; +2 to -100 dBm output, C-model; +5 to -100 dBm, D-model. Pulse, amplitude, and frequency modulation. Digital sweep. Completely HP-IB programmable.	450
2 to 26 GHz	HP 8673B	<b>Optimum choice for high-performance microwave receiver and subsystem test.</b> 1 to 4 kHz frequency resolution, $5 \times 10^{-10}$ /day stability. +8 to -100 dBm output. Pulse, amplitude, and frequency modulation. Digital sweep. Completely HP-IB programmable.	450
0.01 to 50 GHz	HP 8360 Series	<b>Programmable, general-purpose sweeper with full network analyzer compatibility.</b> 1 Hz frequency resolution, $1 \times 10^{-9}$ /day stability. +20 to -110 dBm output. Pulse, frequency, and amplitude modulation. Continuous analog sweep with spans from 100 Hz to 49.99 GHz. Completely HP-IB programmable. Complete analog, list, and step sweep capability.	452

### High-Performance Modular

Frequency	Model	Characteristics	Page
0.252 to 1030 MHz 0.252 to 2060 MHz 0.1 to 4.2 GHz	HP 70320A, 70325A HP 70322A	<b>High-performance full-rack-width instruments with HP-IB and MSIB control for Modular Measurement System (MMS).</b> Excellent spectral purity. AM, FM, and pulse modulation. Advanced modulation source.	437
1 to 20 GHz	HP 70340A	<b>Modular signal generator for Modular Measurement System (MMS).</b> Full-performance signal source in half-rack-width (4/8 MMS). AM, FM pulse modulation. > +8 to -90 dBm output power. 1 Hz (Option) frequency resolution. < 10 s pulse rise/fall times. HP-IB, SCPI and CIL programming. Ideal for general-purpose ATE as well as radar, EW, and communications tests.	103

### Frequency-Agile/Complex Signal Simulation

Frequency	Model	Characteristics	Page
10 to 3000 MHz	HP 11755A	<b>Comdisco/Vector arbitrary waveform synthesizer.</b> Computer-aided engineering for modeling block diagram level design simulations for communications system modules and subsystems. Creates complex software signal formats for testing on the block model, then downloads the complex signal to the HP VAWS simulator for testing hardware with real-life signals with precision impairments.	453
dc to 50 MHz	HP 8770A/S	<b>High-performance arbitrary waveform source for baseband simulation and advanced modulation.</b> Simulates highly complex baseband and modulated carriers for radar/EW, communications, disk drive, and other applications. 12-bit resolution, excellent spectral purity. 125 MHz clock rate. HP 11776A waveform generation software runs on HP Technical Desktop Computer.	454
0.252 to 1030 MHz 0.252 to 2060 MHz	HP 8645A	<b>Performance signal generator for testing frequency-agile radios and surveillance receivers.</b> 15 $\mu$ s switching speed. Spectral purity. AM, FM, pulse modulation. FM deviation to 20 MHz. Flexible control of frequency.	456
0.01 to 3 GHz	HP 8791 Model 11	<b>Reconfigurable agile-signal simulator for radar, EW, and spread-spectrum simulation.</b> Advanced frequency-agile signal simulation for EW, radar, and communication receiver test. 250 ns frequency-hopping over 3 GHz. Arbitrary control over AM, FM, $\Phi$ M, pulse modulation and agile carrier. 40 MHz modulation bandwidth. Easy-to-use application-specific instrument-on-a-disk software. Optional upconversion available to 18 GHz.	458
0.05 to 18 GHz	HP 8791 Model 21	<b>Microwave-agile simulator.</b> Same as Model 11 (above), but uses state-of-the-art microwave-agile upconverter with 100 ns (typical) switching time for the entire range from 50 MHz to 18 GHz. Intended for "exotic" modulation requirements in radar/EW and secure communication applications.	458

### Millimeter Sources

Frequency	Model	Characteristics	Page
26.5 to 40 GHz 33 to 50 GHz 40 to 60 GHz 50 to 75 GHz 75 to 110 GHz	HP 83554A HP 83555A HP 83556A HP 83557A HP 83558A	<b>Efficient frequency multipliers.</b> Effectively extends the performance of an 11 to 20 GHz microwave source HP 8673B/C/D, 8340, 8341, 8350B, or 8360 to the millimeter-wave frequency ranges.	474

# SIGNAL GENERATORS

Economy RF  
HP 8656B, 8657A/B

## The HP 8656/57 Series Synthesized Signal Generators

The HP 8656/57 series is a collection of economical synthesized signal sources that support a variety of communications test requirements. Six models are included: 3 for general-purpose analog and 3 specialized for digital modulation. All 6 units offer capabilities ideal for research and development, manufacturing, and support applications.

The series offers high value in meeting your communications test needs. Ease-of-use features, such as store/recall memory and sequencing, help automate and speed tests. High-performance areas, such as good spectral purity and accurate output levels, ensure accurate test results. With the wide range of features and performance levels available, one of the HP 8656/57 series is sure to meet your requirements.

### Economy Analog Signal Generators

HP 8656B	<ul style="list-style-type: none"> <li>• 100 kHz to 990 MHz</li> <li>• AM and FM modulation</li> <li>• Lowest cost of family</li> <li>• In-channel performance</li> </ul>
HP 8657A	<ul style="list-style-type: none"> <li>• 100 kHz to 1040 MHz</li> <li>• AM and FM modulation</li> <li>• Low SSB phase noise</li> <li>• Electronic attenuator for ATE</li> <li>• In- and out-of-channel performance</li> </ul>
HP 8657B	<ul style="list-style-type: none"> <li>• 100 kHz to 2060 MHz</li> <li>• AM, FM and optional pulse modulation</li> <li>• Low SSB phase noise</li> <li>• In- and out-of-channel performance</li> </ul>

### Digital Modulation

HP 8657A Option 022	<ul style="list-style-type: none"> <li>• 100 kHz to 1040 MHz</li> <li>• 0.3 GMSK modulation</li> <li>• Low phase error</li> </ul>
HP 8657B Option 022	<ul style="list-style-type: none"> <li>• 100 kHz to 2060 MHz</li> <li>• 0.3 GMSK modulation</li> <li>• Low phase error</li> <li>• Optional pulse modulation</li> </ul>
HP 8657D	<ul style="list-style-type: none"> <li>• 100 kHz to 1030 MHz</li> <li>• <math>\pi/4</math> DQPSK modulation</li> <li>• Low error vector magnitude</li> <li>• Pulse modulation</li> </ul>

For more details on the 6 signal generators in the HP 8656/57 series, please see the catalog pages of this section. For full performance and specification information, see the documents listed below.

### Available Literature

Economical Signal Generator Brochure  
Economical Signal Generator Technical Data  
Signal Generator Selection Guide

### Reference No.

5091-1555  
5091-1556  
5951-6745

- 100 kHz to 990 MHz
- AM and FM modulation
- $\pm 1$  dB absolute level accuracy
- Amplitude offset and phase adjust

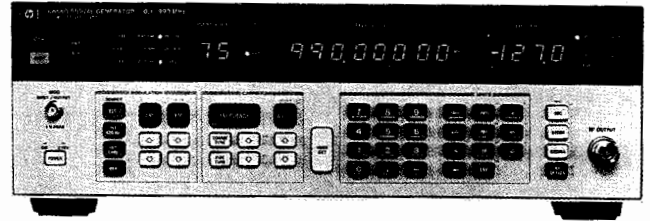

SUPPORTED BY  
**HP ITG**  
SOFTWARE

DESIGNED FOR  
**HP-IB**  
SYSTEMS

## HP 8656B Synthesized Signal Generator

The 8656B is a programmable synthesized signal generator that offers exceptional value through a powerful combination of performance, quality, and economy.

### Communication Band Frequency Coverage

The HP 8656B provides frequency coverage from 0.1 to 990 MHz (with under-range to 10 kHz). This wide range covers the IF and LO frequencies, as well as the RF frequencies of most receivers. Frequency resolution of 10 Hz allows convenient setting of increments including narrow channel spacings, while characterization of phase-sensitive devices is made easier with the help of the phase increment/decrement feature.

### Precise Output Control

The 8656B also features  $\pm 1.0$  dB absolute level accuracy and 0.1 dB resolution for accurate receiver sensitivity tests, circuit characterization, and research and development applications. The output levels are calibrated from +13 dBm (over-range to +17 dBm) to -127 dBm and may be set and displayed in any one of 14 convenient units, including dBm, volts, dB $\mu$ V or  $V_{\text{emf}}$ . The output level can also be offset to compensate for cable and/or other losses external to the generator, or turned on or off with a dedicated key. Shielding keeps leakage at  $< 1.0 \mu\text{V}$  for testing RFI-susceptible devices, and standard resettable reverse power protection for up to 25 W guards against accidental damage from transmitters.

### Versatile Modulation

The HP 8656B's modulation capabilities include simultaneous and mixed modulation modes (AM/AM, FM/FM, and AM/FM) from internal (1 kHz and 400 Hz) and external sources. AM is ac-coupled, while FM can be either ac- or dc-coupled. The patented dc-coupling technique used in the HP 8656B provides exceptional long-term stability ( $< 10$  Hz/hour drift) and center frequency accuracy ( $\pm 500$  Hz), eliminating the need for retuning in the dc FM mode. For calibrated external modulation, a 1 V peak signal is required, and HI/LO annunciators on the HP 8656B indicate when the external signal is within 5% of the correct amplitude.

### Ease of Operation for Improved Productivity

Up to 100 complete front-panel setups can be stored in the HP 8656B's memory for recall during testing. These setups can be accessed sequentially by pushing one front-panel key or by using the rear-panel SEQ port. The SEQ port can be connected to a foot switch or other operator-controlled device.



- 100 kHz to 1040 MHz
- AM and FM modulation
- Electronic attenuator for ATE
- $\pm 1.0$  dB level accuracy (typically  $\pm 0.5$  dB)
- 50 W reverse power protection

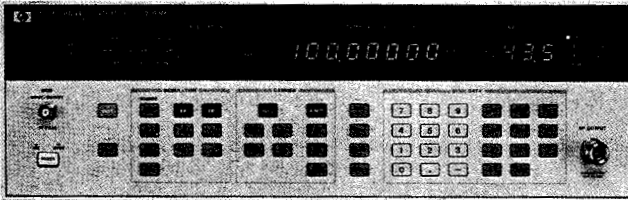

SUPPORTED BY  
**HP ITG**  
SOFTWARE

DESIGNED FOR  
**HP-IB**  
SYSTEMS

### HP 8657A Synthesized Signal Generator

The 8657A is a 100 kHz to 1040 MHz synthesized signal generator that offers truly outstanding performance at an affordable price. The HP 8657A gives enhanced performance above the HP 8656B signal generator to form a complementary set of low-cost/high-performance RF signal generators from Hewlett-Packard.

#### Spectral Purity for Demanding Applications

The HP 8657A provides excellent phase noise performance across its full 100 kHz to 1040 MHz range. When characterizing an RF receiver, the SSB phase noise of the HP 8657A ( $-130$  dBc/Hz at 500 MHz) provides the performance for almost all measurements requiring test signals at adjacent or out-of-channel offsets.

#### RF Output with Electronic Attenuator

The HP 8657A's patented solid-state attenuator provides accurate output levels to  $\pm 1$  dB (typically  $\pm 0.5$  dB). Highly reliable PIN diodes replace mechanical relays to provide an extended switching lifetime. The HP 8657A is backed with a 5-year warranty against attenuator failure, providing you with the highest level of insurance for trouble-free performance.

The HP 8657A provides high RF output power (+13 dBm with over-range to +17 dBm) for driving mixers and overcoming cable losses without the use of external amplifiers. The unique RF leveling loop design also lowers intermodulation distortion to typically better than  $-50$  dBc. Reverse power protection is provided standard for protection up to 50 W and 50 Vdc.

#### Versatile Modulation

The HP 8657A can combine modulation modes for AM/AM, FM/FM, and AM/FM from both internal and external modulation sources. Like the HP 8656B, the HP 8657A has ac-coupled AM and ac/dc coupling for FM.

The patented dc-coupling technique provides excellent long-term stability ( $<10$  Hz/hour drift) as well as center frequency accuracy ( $\pm 500$  Hz worst-case). When dcFM is enabled, SSB phase noise and residual FM performance are not degraded as with other generators. dcFM allows the HP 8657A to be used as an ideal VCO in a design application, or to be used to faithfully reproduce digital squelch tones when modulating the carrier signal.

Pulse modulation for this frequency range is available, and can be ordered as HP 8657B Option H60.

- 100 kHz to 2060 MHz
- AM, FM, and optional pulse modulation
- $\pm 1$  dB absolute level accuracy (typically  $\pm 0.5$  dB)
- 1 Hz frequency resolution
- 50 W reverse power protection

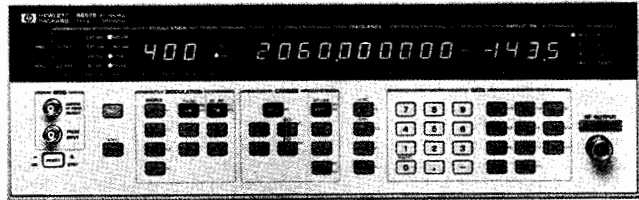

SUPPORTED BY  
**HP ITG**  
SOFTWARE

DESIGNED FOR  
**HP-IB**  
SYSTEMS

### HP 8657B Synthesized Signal Generator

The 8657B is an L-Band synthesized signal generator offering excellent performance at an affordable price. The HP 8657B is ideal for radio-receiver and radar system and subsystem design and testing.

#### Spectral Purity for Radar and Satellite

The low residual FM and low SSB phase noise make the HP 8657B excellent as a local oscillator, low-noise VCO, or test source with AM, FM, and pulse modulation. In addition to great noise performance, features such as carrier phase adjust allow you to characterize phase-sensitive devices such as phase detectors or phase interferometers, using precise 1-degree phase offsets with respect to another signal source. Display blanking and nonvolatile memory-clear are also available for operation in secure environments.

#### Advanced Performance

The 8657B offers wide dynamic output range, from +13 to  $-143.5$  dBm, with unparalleled accuracy of  $\pm 1$  dB. The HP 8657B also has extremely low radiated emissions for making sensitivity measurements on your receiver or for design work on extremely sensitive circuitry. High-stability dcFM keeps center frequency drift below 10 Hz/hour, which allows accurate VCO simulation or low-rate FM modulation.

#### High-Performance Pulse Modulation

The HP 8657B has a GaAs FET pulse modulator (Option 003) for fast rise time and high isolation pulse. The HP 8657B has 35 to 50 ns rise times (typically 10 to 18 ns) and 70 to 90 dB on/off ratios. For pulse modulation coverage to 1040 MHz only, order the HP 8657B Option H60.

#### Ease of Operation for Improved Productivity

Up to 100 complete front-panel setups can be stored in the HP 8657B's memory for recall during testing. These setups can be accessed sequentially by pushing one front-panel key or by using the rear-panel SEQ port. The SEQ port can be connected to a foot switch or other operator-controlled device.

# SIGNAL GENERATORS

## Economy RF (cont'd)

HP 8656B, 8657A/B

Specifications	HP 8656B	HP 8657A	HP 8657B
<b>Frequency</b> Range: Resolution: Timebase aging rate: Option 001: Switching Speed (w/in 100 Hz of carrier):	100 kHz to 990 MHz 10 Hz $\pm 2$ ppm/year $1 \times 10^{-9}$ parts/day after 45 days <35 ms (25 ms typ. at 25° C)	100 kHz to 1040 MHz 10 Hz $\pm 2$ ppm/year $1 \times 10^{-9}$ parts/day after 45 days <35 ms (30 ms typ. at 25° C)	100 kHz to 2060 MHz 1 Hz $\pm 2$ ppm/year $1 \times 10^{-9}$ parts/day after 45 days <35 ms (30 ms typ. at 25° C)
<b>Spectral Purity</b> $f_c = 500$ MHz SSB Phase Noise (20 kHz offset): Nonharmonics (> 5 kHz offset, CW mode): Harmonics:  Subharmonics:  Residual FM (0.3 to 3 kHz, CW mode):	< -114 dBc/Hz < -60 dBc < -30 dBc, output $\leq +7$ dBm  None < 4 Hz rms	< -130 dBc/Hz < -60 dBc < -30 dBc, output $\leq +10$ dBm  None < 4 Hz rms	< -130 dBc/Hz < -60 dBc, < 1030 MHz, < -54 dBc, $\geq 1030$ MHz < -30 dBc, output $\leq +7$ dBm, < 1030 MHz < -25 dBc, output $\leq +7$ dBm, > 1030 MHz None, 100 kHz to 1030 MHz < -25 dBc, 1030 to 2060 MHz < 3 Hz rms
<b>Output Level</b> Range:  Resolution: Absolute Accuracy:  Reverse Power Protection:	+13 to -127 dBm into 50 $\Omega$  0.1 dB < $\pm 1$ dB, 123 to 990 MHz, +7 to -124 dBm < $\pm 1.5$ dB, 0.1 to 123.5 MHz, and < -124 dBm or < +7 dBm at 0.1 to 990 MHz 25 W	+13 to -143.5 dBm into 50 $\Omega$ , +10 dBm, 100 kHz to 1 MHz 0.1 dB < $\pm 1$ dB, output $\geq -127$ dBm < $\pm 1.5$ dB, > +7 dBm 50 W	+13 to -143.5 dBm into 50 $\Omega$ , +10 dBm, < 1030 MHz 0.1 dB < $\pm 1$ dB, output +3.5 to -127 dBm < $\pm 1.5$ dB, output $\geq +3.5$ dBm 50 W
<b>Amplitude Modulation</b> Depth:  Resolution: Bandwidth (1 dB): Accuracy: (internal rates) Distortion: (0 to 30% AM, internal rates, level < +7 dBm)	0 to 99%, output < +7 dBm, 0.1 to 990 MHz 1% 20 Hz to 40 kHz < $\pm (2\% + 4\%$ of setting), < 90% AM < 1.5%	0 to 99%, output $\leq +7$ dBm, $f_c \geq 400$ kHz 1% 20 Hz to 40 kHz < $\pm (2\% + 6\%$ of setting), < 90% AM, levels < +7 dBm < 1.5%	0 to 100%, output $\leq +7$ dBm 1% 20 Hz to 40 kHz < $\pm (2\% + 6\%$ of setting), < 90% depth, internal rates < 1.5%, < 1030 MHz < 4%, > 1030 MHz
<b>Frequency Modulation</b> Maximum Peak Deviation <sup>1</sup> :  Resolution:  Bandwidth (1 dB): Indicator Accuracy: Distortion: (internal rates, $\geq 3$ kHz peak deviation)	99 kHz, $f_c < 123.5$ and > 247 MHz 50 kHz, $f_c 123.5$ to 247 MHz 100 Hz, deviations < 10 kHz,  1 kHz, deviations $\geq 10$ kHz  dc to 50 kHz < $\pm 5\%$ of setting < 0.5% THD + noise	99 kHz, $f_c < 130$ and > 260 MHz 50 kHz, $f_c 130$ to 260 MHz 100 Hz, deviations < 10 kHz,  1 kHz, deviations $\geq 10$ kHz  dc to 50 kHz < $\pm 5\%$ of setting < 0.5% THD + noise	50 kHz, $f_c 130$ to 260 MHz to 400 kHz, $f_c 1040$ to 2060 MHz 100 Hz, < 1040 MHz, dev < 100 kHz 200 Hz, > 1040 MHz, dev < 100 kHz dc to 50 kHz < $\pm 5\%$ of setting < 0.5% THD + noise, $\geq 6$ kHz peak deviation for $f_c \geq 1040$ MHz

Specifications	HP 8656B	HP 8657A	HP 8657B
Pulse Modulation On/Off Ratio:  Rise/Fall Time, 10% to 90%:  Repetition Rate: Duty cycle:	Not applicable	Not applicable	Opt 003 > 70 dB, $f_c \geq 130$ MHz, > 95 dB, $f_c \geq 1030$ MHz < 35 ns, $f_c \geq 130$ MHz, < 50 ns, $f_c \geq 1030$ MHz dc to 30 MHz, typical 0% to 100%
Remote Programming Interface: IEEE-488 Functions:	HP-IB (HP's implementation of IEEE-488) SH0, AH1, T0, L2, SR0, RL1, PP0, DC1, DT0, C0, E1		
General Save/Recall/Sequence Registers: Operating Temperature: Power Requirements:  Dimensions:  Weight:	100 nonvolatile registers to save front-panel settings 0° to 55° C 100 V, 120 V, 220 V or 240 V (+5, -10%); 48 to 440 Hz HP 8656B: 125 VA maximum HP 8657A: 175 VA maximum HP 8657B: 200 VA maximum HP 8656B, 8657A: 133 mm H x 425 mm W x 520 mm D (5.25 in x 16.75 in x 20.5 in) HP 8657B: 133 mm H x 425 mm W x 574 mm D (5.25 in x 16.57 in x 22.6 in) HP 8656B: 18.1 kg (40 lb) HP 8657A: 18.2 kg (40 lb) HP 8657B: 20.5 kg (45 lb)		
*Deviations reduced for low-rate modulation; not specified for $f_c - (f_m) < 100$ kHz.			

**Ordering Information**

Base Price	HP 8656B	\$6,720	HP 8657A	\$9,425	HP 8657B	\$13,660
<b>Options</b>						
001 High-Stability Timebase		+\$1,050		+\$1,050		+\$1,050
002 RF Connectors on Rear Panel Only		+\$275		+\$275		+\$275
003 Pulse Modulation		N/A		N/A		+\$890
H60 Pulse Modulation, Frequencies to 1040 MHz		N/A		N/A		-\$2,000
907 Front Handle Kit (5061-9689)		\$57 ☎		\$57 ☎		\$57 ☎
908 Rack Flange Kit (5061-9677)		\$33 ☎		\$34 ☎		\$34 ☎
909 Combined Front/Rack Flange Kit(5061-9683)		\$82 ☎		\$82 ☎		\$82 ☎
910 Extra Operation/Calibration and Two Service Manuals		\$360 ☎		\$360 ☎		\$360 ☎
915 Add Service Manual	(08656-90205)	\$154 ☎	(08657-90004)	\$154 ☎	(08657-90007)	\$154 ☎
+ W30 3-year Repair Service		\$155		\$190		\$310
+ W32 3-year Calibration Service		\$405		\$450		\$500

☎ For off-the-shelf shipment, call 800-452-4844.

# SIGNAL GENERATORS

## Digital/I-Q Modulation

### HP 8657A/B Option 022

- 100 kHz to 1040 MHz
- Standard AM and FM modulation
- 0.3 GMSK for GSM cellular system
- $<3^\circ$  rms phase error
- 100 kHz to 2060 MHz
- Standard AM and FM modulation
- 0.3 GMSK for GSM and PCN cellular systems
- $<3.5^\circ$  rms phase error
- Optional pulse modulation

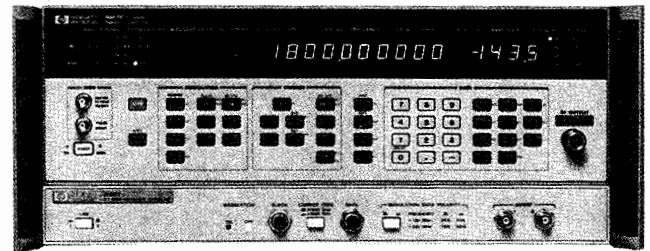
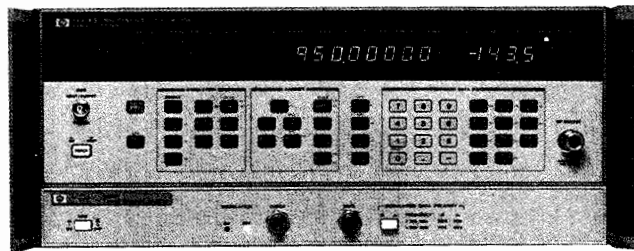

#### HP 8657A Option 022 0.3 GMSK Modulation

The HP 8657A Option 022 generates 0.3 Gaussian Minimum Shift Keying (GMSK) modulation, required to simulate transmitters or to test receivers designed for the Groupe Speciale Mobile (GSM) Pan-European digital cellular radio system. Option 022 contains the necessary premodulation filtering and signal-processing circuitry to generate precise 0.3 GMSK modulation over the entire 520 to 1040 MHz and 10 to 130 MHz frequency bands.

#### High-Performance Digital Modulation

The precision of the digital premodulation filter and I/Q modulator yield a phase error specification of 3 degrees rms and 8 degrees peak for frequencies below 960 MHz. This precision reduces errors during testing of receivers by providing accurate, dependable test signals. A modulation polarity key is provided to invert the sense of the modulation relative to the data. This can be used when modulating with inverted data, when substituting into a receiver's IF (when an inversion may already have taken place), or when using Option 022 in its heterodyne band (10 to 130 MHz). Option 022 provides a high-performance yet cost-effective solution for the design and manufacture of GSM radios.

#### HP 8657B Option 022 0.3 GMSK Modulation

Option 022 for the HP 8657B signal generator adds the same 0.3 GMSK modulation function as the corresponding option on the HP 8657A, only for the 8657B the frequency range is extended to 2060 MHz. This provides a cost-effective solution for generating the signals needed to test receivers of the GSM system, at the same time covering the frequency range of the new Personal Communications Network (PCN).

#### Operation of 0.3 GMSK Modulation

To activate 0.3 GMSK modulation on the 8657A/B Option 022, simply connect framed and channel-coded data to the data input connector and a clock to the clock input. When the 0.3 GMSK modulator senses that a valid clock (270.833 kHz) is present, it locks to the clock signal and enables the data input port. Once input, the data is digitally filtered and modulated onto the RF output of the signal generator. A front-panel switch is used to select 0.3 GMSK modulation when operating above or below 1030 MHz.

#### Specifications

##### Analog Modulation Mode:

When the 0.3 GMSK modulator is turned off or a clock signal is absent, these instruments perform as standard HP 8657A and 8657B models. Please refer to the HP 8657A or 8657B specifications for analog mode performance.

##### Frequency

###### Range:

HP 8657A Opt 022	520 to 1040 MHz
HP 8657B Opt 022	520 to 2060 MHz
Both, data inverted	10 to 130 MHz

##### Spectral Purity

###### Harmonics:

	$< -30$ dBc
	$< -25$ dBc, $f_c > 1030$ MHz
	(HP 8657B only)
	$< -50$ dBc, $> 150$ kHz offsets
<b>Non-harmonic spurious:</b>	$< -100$ dBc
<b>Noise floor:</b>	$< -100$ dBc

##### Modulation

**Modulation format:** 0.3 Gaussian Mean Shift Keying

**Pre-modulation filter:** Gaussian LPF

**Bandwidth  $\times$  data rate (BT):** 0.3

**Data rate:** 270.833 kHz ( $\pm 1$  kHz)

##### Modulation phase error:

890 to 960 MHz and 10 to 130 MHz:  
 $3^\circ$  rms, typically  $1^\circ$   
 $8^\circ$  peak, typically  $5^\circ$

1030 to 2060 MHz (HP 8657B only):  
 $3.5^\circ$  rms, typically  $1.5^\circ$   
 $9^\circ$  peak, typically  $1.5^\circ$

##### Frequency error:

10 Hz,  $f_c < 1030$  MHz  
 20 Hz,  $f_c > 1030$  MHz (HP 8657B only)

##### Inputs:

Serial data and clock

##### Outputs (HP 8657B only):

Baseband 0.3 GMSK I and Q signals

##### General

0.3 GMSK Modulator only

##### Dimensions:

44 mm H  $\times$  425 mm W  $\times$  422 mm D  
 (1.75 in  $\times$  16.75 in  $\times$  17 in)

##### Weight:

Net, 4 kg (9 lb); shipping, 9 kg (20 lb)

- 100 kHz to 1030 MHz
- Standard AM and FM modulation
- $\pi/4$  DQPSK modulation for NADC and JDC
- Pulse modulation
- < 4% error vector magnitude

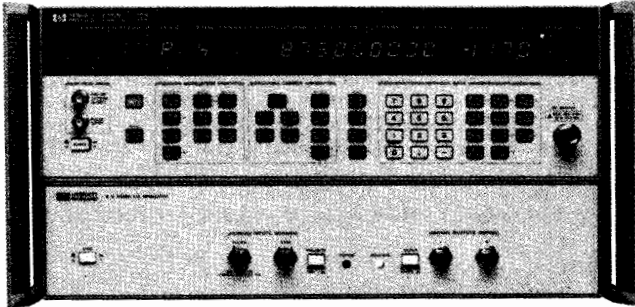

### HP 8657D $\pi/4$ DQPSK Signal Generator

The HP 8657D signal generator adds  $\pi/4$  DQPSK digital modulation capability to conventional AM, FM, and pulse modulation formats. The HP 8657D builds on the excellent performance of the HP 8657B synthesized signal generator, adding the digital modulation capability needed to test the most recent cellular radios for the North American Digital Cellular (NADC) and the Japanese Digital Cellular (JDC) radio systems.

#### Traditional Source

The HP 8657D is ideal for in-channel testing of analog receivers. Excellent level accuracy ( $\pm 1$  dB), low radiated emissions, low residual noise, and minimal distortion make the HP 8657D an ideal choice. The HP 8657D makes system integration easy by being front panel and HP-IB compatible with the HP 8656B/8657A/8657B family of economy signal generators.

#### $\pi/4$ DQPSK Modulation

Radios produced for the NADC standard must be capable of operating in the analog AMPS cellular mode as well as in the new digital cellular mode. The HP 8657D provides test equipment to fulfill both requirements, making it a single-box solution. When it is operating in the  $\pi/4$  DQPSK mode, the frequency range is limited to the following 3 bands: 10 to 129.9 MHz, 810 to 965 MHz, and 1420 to 1540 MHz. The attached  $\pi/4$  DQPSK modulator accepts serial data and a symbol clock from 20 to 25 kHz. Modulator filtering is selectable to either 0.35 or 0.5 root raised cosine filtering. AM and FM modulation are not available in the  $\pi/4$  DQPSK modulation mode.

#### Pulse Modulation

A high-performance pulse modulator is included in the HP 8657D, which can be used in both the analog and digital modulation modes. This pulse modulator offers < 35 ns rise/fall times and better than 70 dB on/off ratios below 1030 MHz. Pulse modulation, combined with  $\pi/4$  DQPSK modulation capability, allows the HP 8657D to fully simulate the TDMA properties of these systems.

### Specifications

#### Analog Modulation Mode:

In the analog modulation mode, specifications are the same as those for the HP 8657B up to 1030 MHz. Please see the HP 8657B specifications for analog mode performance.

#### $\pi/4$ DQPSK Modulation Mode

- Frequency range:** 10 to 129.9 MHz  
810 to 965 MHz  
1420 to 1540 MHz, data inverted
- Switching speed:** < 50 ms to be within 100 Hz of final frequency
- Modulation:**  $\pi/4$  DQPSK
- Modulation Data Clock Frequency Range**  
Symbol clock: 20 to 25 kHz  
Bit clock: 40 to 50 kHz
- Pre-modulation filter:** Square-root raised cosine
- Filter shape factor:**  $\alpha = 0.35$  or  $\alpha = 0.50$
- Error vector magnitude (15° C to 35° C):**  
< 4.0%, 10 to 129.9 MHz and 1420 to 1540 MHz, level < +3 dBm  
< 3.5%, 810 to 965 MHz, level < +7 dBm
- I/Q origin offset (15° to 35° C):** -35 dB, RF output only
- Pulse Modulation**  
**On/off ratio:** > 70 dB,  $f_c \leq 1030$  MHz  
> 50 dB,  $1420 \text{ MHz} \leq f_c \leq 1540 \text{ MHz}$ ,  $\pi/4$  DQPSK mode
- Rise/fall time (10% to 90%):** 35 ns (typically 10 ns)

### Ordering Information

### Price

<b>HP 8657A</b> Synthesized Signal Generator	\$9,425
<b>Opt 022</b> 0.3 GMSK Modulation	+ \$6,055
<b>Opt W30</b> Three-year Repair Service	+ \$190
<b>Opt W32</b> Three-year Calibration Service	+ \$450
<b>HP 8657B</b> Synthesized Signal Generator	\$13,660
<b>Opt 022</b> 0.3 GMSK Modulation	+ \$7,345
<b>Opt W30</b> Three-year Repair Service	+ \$310
<b>Opt W32</b> Three-year Calibration Service	+ \$500
<b>HP 8657A and HP 8657B</b>	
<b>Opt 001</b> High-Stability Reference	+ \$1,050
<b>Opt 002</b> Rear Panel Input/Output Connectors	+ \$275
<b>Opt 003</b> Pulse Modulation	+ \$845
(not available on 8657A, order HP 8657B H60)	- \$2,000
<b>Opt 907</b> Front Handle Kit (5061-9689)	+ \$57
<b>Opt 908</b> Rack Flange Kit (5061-9677)	+ \$34
<b>Opt 909</b> Rack Flange Kit with Handles (5062-3983)	+ \$82
<b>Opt 910</b> Extra Op/Cal and Two Service Manuals	+ \$360
<b>Opt 915</b> Add Service Manual (does not come standard) (HP 8657A: 08657-90004; HP 8657B: 08657-90007)	+ \$154
<b>HP 8657D</b> $\pi$ DQPSK Signal Generator	\$23,625
<b>Opt 001</b> High-Stability Reference	+ \$1,050
<b>Opt 910</b> Total of Two Sets of Operating/Calibration (08657-90107) and Service (08657-90126) Manuals	+ \$600
<b>Opt 913</b> Rack Mount Flange Kit (5062-4073)	+ \$36
<b>Opt 915</b> Add Service Manual (does not come standard) (08657-90126)	+ \$275
<b>Opt W30</b> Three-year Repair Service	+ \$565
<b>Opt W32</b> Three-year Calibration Service	+ \$810

☎ For off-the-shelf shipment, call 800-452-4844.

# SIGNAL GENERATORS

## High-Performance RF (cont'd)

HP 8662A, 8663A

**SSB broadband noise floor in 1 Hz BW at 3 MHz offset from carrier:**  $< -146$  dBc for  $f_c$  between 120 and 640 MHz at output levels above  $+10$  dBm.

### Spurious signals

	Frequency Range (MHz)				
	0.01 to 120	120 to 160	160 to 320	320 to 640	640 to 1280
Spurious non-harmonically related <sup>1,2</sup>	-90 dBc	-100 dBc	-96 dBc	-90 dBc	-84 dBc
Sub-harmonically related ( $\frac{1}{2}, \frac{3f}{2}$ , etc.)	none	none	none	none	-75 <sup>3</sup> dBc
Power-line (60 Hz) related or microphonically generated (within 300 Hz) <sup>4</sup>	-90 dBc	-85 dBc	-80 dBc	-75 dBc	-70 dBc
Harmonics	$< -30$ dBc				

### Output

**Level range:**  $+13$  to  $-139.9$  dBm (1V to  $0.023 \mu V_{rms}$  into  $50 \Omega$ )

**Resolution:** 0.1 dB

**Absolute level accuracy** ( $+15^\circ$  to  $+45^\circ$  C):  $\pm 1$  dB between  $+13$  and  $-120$  dBm,  $\pm 3$  dB between  $-120$  and  $-130$  dBm

**SWR:** Typically from 1.5 to 1.8, depending on output level and frequency

**Reverse power protection:** Typically up to 30 W or  $\pm 8$  Vdc

### Amplitude Modulation

**Depth:** 0 to 95% at output levels of  $+8$  dBm and below ( $+10$  dBm in uncorrected mode). AM available above these output levels but not specified.

**Resolution:** 1%, 10 to 95% AM; 0.1%, 0 to 9.9% AM.

**Incidental PM** (at 30% AM): 0.15 to 640 MHz,  $< 0.12$  radian peak; 640 to 1280 MHz,  $< 0.09$  radian peak.

**Incidental FM** (at 30% AM): 0.15 to 640 MHz,  $< 0.12 \times f_{mod}$ ; 640 to 1280 MHz,  $< 0.09 \times f_{mod}$ .

**Indicated accuracy:**  $\pm 5\%$  of reading  $\pm 1\%$  AM. Applies for rates given in table below, internal or external mode, for depths  $\leq 90\%$ .

### Rates and distortion with internal or external modulating signal:

Frequency Range	AM Distortion			
	AM rate	0 to 30% AM	30 to 70% AM	70 to 90% AM
0.15 to 1 MHz	dc to 1.5 kHz	2%	4%	5.75%
1 to 10 MHz	dc to 5 kHz	2%	4%	5.75%
10 to 1280 MHz	dc to 10 kHz	2%	4%	5.75%

### Frequency Modulation

**FM rates** (1 dB bandwidth): External ac, 20 Hz to 100 kHz; external dc, dc to 100 kHz.

**FM deviation:** 25 to 200 kHz, depending on carrier frequency.

**Indicated FM accuracy:**  $\pm 8\%$  of reading plus 10 Hz (50 Hz to 20 kHz).

**FM resolution:** 100 Hz for deviations  $< 10$  kHz, 1 kHz for deviations  $\geq 10$  kHz.

**Incidental AM** (AM sidebands at 1 kHz rate and 20 kHz deviation):  $< -72$  dBc,  $f_c < 640$  MHz;  $< -65$  dBc,  $f_c \geq 640$  MHz.

**FM distortion:**  $< 1.7\%$  for rates  $< 20$  kHz,  $< 1\%$  for rates  $< 1$  kHz.

**Center frequency accuracy and long-term stability in AC mode:** Same as CW mode.

### Supplemental Characteristic

**Frequency-switching speed:**<sup>5</sup> From  $420 \mu s$  to 12.5 ms, depending on the programming mode.

### HP 8663A Specifications

The HP 8663A Signal Generator is related to the HP 8662A in both concept and structure. The HP 8662A concept of an extremely low phase noise signal source, incorporating signal generator modulation capabilities and output characteristics, is carried even further by the HP 8663A. While maintaining high spectral purity, the HP 8663A offers increased frequency range to 2560 MHz, increased output level to  $+16$  dBm, and the addition of phase and pulse modulation. The result is a highly flexible and powerful signal generator that utilizes and extends the proven circuitry of the HP 8662A. Thus, the HP 8662A and HP 8663A share many of the same specifications.

### Frequency

**Range:** 100 kHz to 2560 MHz (2559.9999996 MHz)

**Resolution:** 0.1 Hz ( $f_c < 640$  MHz)

0.2 Hz ( $640 \text{ MHz} \leq f_c < 1280 \text{ MHz}$ )

0.4 Hz ( $f_c \geq 1280 \text{ MHz}$ )

**Accuracy, stability, and internal reference oscillator:** Identical to HP 8662A.

### Spectral Purity

(see HP 8662A specifications)

**Spurious signals:** Identical to HP 8662A, except that for  $f_c$  between 1280 and 2560 MHz the spurious non-harmonics are  $-78$  dBc; the sub-harmonically related ( $f/2, 3f/2$ , etc.) between 640 and 1280 MHz are  $-70$  dBc and between 1280 and 2560 MHz are  $-40$  dBc; and the power-line (60 Hz) or microphonically generated spurious are  $-65$  dBc.

**Harmonics:**  $< -30$  dBc,  $\leq +13$  dBm output,  $< -25$  dBc,  $+13$  dBm to  $+16$  dBm output,  $f_c < 1280$  MHz;  $< -25$  dBc,  $f_c \geq 1280$  MHz.

### Output

**Level range:**  $+16$  dBm to  $-129.9$  dBm

**Resolution:** 0.1 dB

**Absolute level accuracy** ( $+15^\circ$  to  $+45^\circ$  C):  $\pm 1$  dB,  $+16$  dBm to  $-119.9$  dBm;  $\pm 3$  dB,  $-120$  dBm and below

**SWR:**  $< 1.5$

### Amplitude Modulation

**Depth:** 0 to 95% at levels of  $+10$  dBm and below

**Resolution:** 0.1%

**Incidental FM** (at 30% AM): Identical to HP 8662A except:  $< 0.3 \times f_{mod}$  for  $1280 \leq f_c < 2560$  MHz

**Indicated accuracy:**  $\pm 6\%$  of reading  $\pm 1\%$  AM (400 Hz and 1 kHz, depth 90%)

**AM bandwidth** (1dB):

DC to  $> 1.5$  kHz,  $0.15 \text{ MHz} \leq f_c < 1 \text{ MHz}$ ; dc to  $> 5$  kHz,  $1 \text{ MHz} \leq f_c \leq 10 \text{ MHz}$ ; dc to  $> 10$  kHz,  $f_c > 10 \text{ MHz}$ ; external dc coupling.

External ac coupling or internal; low-frequency coupling is 20 Hz. **Distortion** (400 Hz and 1 kHz):  $< 2\%$  (0 to 30% AM);  $< 4\%$  (30 to 70% AM);  $< 6\%$  (70 to 90% AM).

### Frequency Modulation

**FM rates** (1 dB bandwidth): External ac, 20 Hz to 100 kHz, external dc, dc to 100 kHz.

**Maximum allowable peak deviation:** Identical to HP 8662A for  $f_c$  between 100 kHz and 1280 MHz. Up to 400 kHz for  $f_c$  between 1280 and 2560 MHz.

**Indicated FM accuracy** (50 Hz to 20 kHz):  $\pm 9\%$  of setting  $+10$  Hz.

**FM resolution:** 100 Hz to 1 kHz, depending on  $f_c$  and deviation setting.

**Incidental AM** (AM sidebands at 1 kHz rate and 20 kHz deviation):  $< -72$  dBc ( $10 \leq f_c < 640$  MHz);  $< -65$  dBc ( $640 \leq f_c < 2560$  MHz).

**FM distortion:**  $< 1.25\%$  (400 Hz and 1 kHz rates);  $< 1.75\%$  (rates less than 20 kHz).

### Phase Modulation (Option 002)

**Maximum peak phase deviation:** From  $\pm 25^\circ$  for  $f_c$  between 120 and 160 MHz to  $\pm 400^\circ$  for  $f_c$  between 1280 and 2560 MHz.

**Maximum rate:** From 10 kHz for  $f_c$  between 0.15 and 10 MHz to 10 MHz for  $f_c$  between 250 and 2560 MHz.

**Phase deviation resolution:**  $1^\circ$  ( $0.1 \leq f_c < 640$  MHz);  $2^\circ$  ( $640 \leq f_c < 1280$  MHz);  $4^\circ$  ( $1280 \leq f_c < 2560$  MHz).

**Phase modulation distortion:** 10% at maximum rate.

### Biphase Modulation

Biphase modulation is available on the standard HP 8663A for  $f_c$  less than 640 MHz and available for all  $f_c$  with Option 002.

**Deviation:**  $\pm 90^\circ$ .

**Carrier null when modulated with 1 MHz, 50% duty cycle square wave:**  $> 25$  dBc.

**Modulation input required:** TTL positive true. The internal modulation oscillator can be used for 50% duty-cycle modulation. External input is on rear panel.

<sup>1</sup> In the remote mode it is possible to have microprocessor clock-related spurious signals spaced 3 MHz apart at an absolute level of typically less than  $-145$  dBm.

<sup>2</sup> Spurious signals can be up to 3 dB higher in the dc FM mode.

<sup>3</sup>  $f/2$  spurs not specified for carrier frequencies above 850 MHz.

<sup>4</sup> At a 50 Hz line frequency, power-line or microphonically related spurious signals may be up to 3 dB higher and appear at offsets as high as 1 kHz from the carrier.

<sup>5</sup> Due to automatic leveling loop bandwidth changes, brief (30 ms) level inaccuracies may occur when switching through 150 kHz and 1 MHz RF output frequencies.

# SIGNAL GENERATORS

High-Performance RF

HP 8643A, 8644B, 8664A, 8665A, 8665B

437

- Frequency ranges of 1 GHz, 2 GHz, 3 GHz, 4.2 GHz, or 6 GHz
- Lowest overall noise and spurious
- AM, FM, and pulse modulation
- Lowest specified leakage (optional)
- Internal modulation source for complex waveforms
- Onsite repair and calibration



SUPPORTED BY  
**HP ITG**  
SOFTWARE

DESIGNED FOR  
**HP-IB**  
SYSTEMS

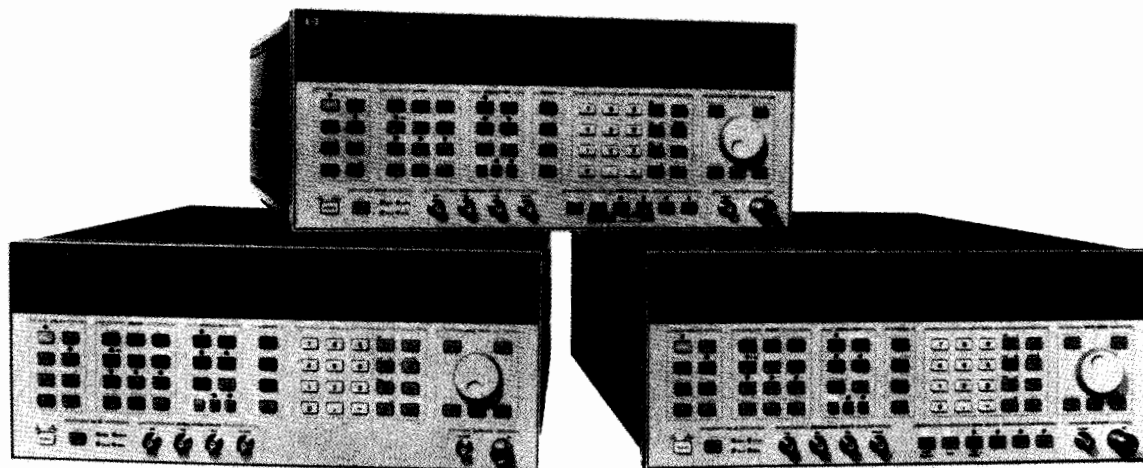

These signal generators offer the RF designer/manufacturer a selection of frequency range and high performance. The HP 8643A, HP 8644B and HP 8664A are for traditional out-of-channel receiver test applications. The HP 8665A/B are for high performance applications up to 6 GHz, particularly radar, telemetry and spurious testing of UHF receivers. All signal generators within this performance family have options that allow them to be configured to meet specific application needs.

## HP 8643A 1 GHz/2 GHz Signal Generator

HP has optimized the HP 8643A's configuration with the performance necessary for out-of-channel receiver tests while maintaining a low price. Options have been limited on the HP 8643A, but many performance/feature capabilities have been included as standard. The HP 8643A combines the most common options that have been purchased with the cost savings of consolidation.

## Standard Electronic Attenuator and Advanced Modulation Source

Reliability is enhanced by the use of an electronic attenuator on the 1 GHz version. Instead of using mechanical relays for setting levels, the HP 8643A uses solid-state components accurate to within  $\pm 1.0$  dB. The HP 8643A comes standard with an advanced internal modulation synthesizer that provides coverage to 400 kHz and 2-tone capability with the selection of sine, square, sawtooth, and white Gaussian noise waveforms.

## HP 8644B 1 GHz/2 GHz High-Performance Signal Generator

The HP 8644B represents the highest overall performance in HP's line of 1 GHz and 2 GHz signal generators. The HP 8644B builds on the HP 8643A's performance by lowering SSB phase noise ( $-136$  dBc/Hz vs.  $-130$  dBc/Hz) and lowering spurious ( $-105$  dBc vs.  $-100$  dBc). The HP 8644B should be used either for a specific test that requires the lowest SSB phase noise or an application with diversified requirements in which it is hard to identify what signal-generator performance is required.

## HP 8664A 3 GHz, HP 8665A 4.2 GHz and HP 8665B 6 GHz High-Performance Signal Generators

These three signal generators are virtually identical in performance, except for frequency coverage and price. Your application will dictate which instrument is required. The HP 8664A and HP 8665A/B are suited for out-of-channel receiver measurements through the use of Option 004 (low-noise enhancement) and for such applications as radar testing through the use of Option 008 (pulse modulation).

## Wideband FM and Optional Pulse Modulation

FM rates of up to 2 MHz and deviations to 20 MHz peak allow use in many applications such as the new higher-rate digital communications. An optional pulse modulator with on/off ratio of  $> 80$  dB and rise/fall times of  $< 5$  ns is available. Pulse width and delay can be internally adjusted between 50 ns and 999 ms, eliminating the need for an external pulse generator.

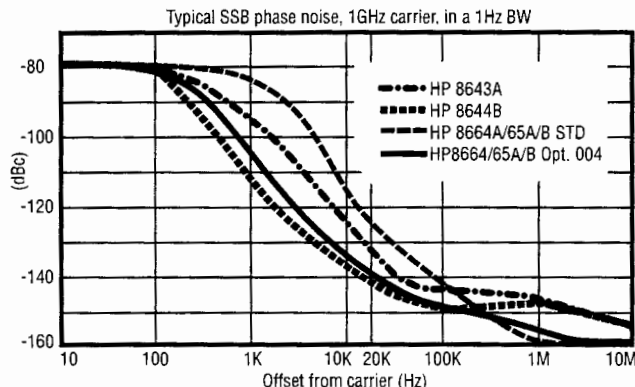

TYPICAL SSB PHASE NOISE  
AT 1 GHz CARRIER

# SIGNAL GENERATORS

## High-Performance RF (cont'd)















HP 8643A, 8644B, 8664A, 8665A, 8665B

Specifications	HP 8643A	HP 8644B	HP 8664A HP 8665A/B
<b>Frequency</b> Range:  Resolution: Stability: Switching Speed (typ.):	0.252 to 1030 MHz 0.252 to 2060 MHz (Opt 002)  0.01 Hz $5 \times 10^{-10}$ /day (Opt 001) <90 ms <200 ms with FM on	0.252 to 1030 MHz 0.252 to 2060 MHz (Opt 002)  0.01 Hz $5 \times 10^{-10}$ /day (Opt 001) <350 ms	0.1 to 3000 MHz (HP 8664A) 0.1 to 4200 MHz (HP 8665A) 0.1 to 6000 MHz (HP 8665B) 0.01 Hz $5 \times 10^{-10}$ /day (Opt. 001) <100 ms
<b>Spectral Purity</b> SSB Phase Noise @ 1 GHz (20 kHz offset): Nonharmonics:  Harmonics: Subharmonics:  Residual FM @ 1 GHz: 0.3 to 3 kHz Post Det. BW	-130 dBc/Hz  < -100 dBc, > 10 kHz offset, 0.252 to 1030 MHz < -84 dBc, > 10 kHz offset, 1030 to 2060 MHz  < -25 dBc, output $\leq$ +8 dBm None, 0.252 to 515 MHz < -60 dBc, 515 to 1030 MHz < -40 dBc, 1030 to 2060 MHz < 2 Hz rms	-136 dBc/Hz  < -105 dBc, > 10 kHz offset, 0.252 to 1030 MHz < -100 dBc, > 10 kHz offset, 1030 to 2060 MHz  < -30 dBc, output $\leq$ +10 dBm None, 0.252 to 515 MHz < -60 dBc, 515 to 1030 MHz < -40 dBc, 1030 to 2060 MHz < 1 Hz rms	-117 dBc/Hz -134 dBc/Hz (Opt 004) < -100 dBc, > 10 kHz offset, 187.5 to 2060 MHz < -90 dBc, > 10 kHz offset, 2060 to 6000' MHz, 0.1 to 187.5 MHz < -30 dBc, output $\leq$ +10 dBm < -75 dBc, 0.1 to 1500 MHz < -40 dBc, 1500 to 3000 MHz < -50 dBc, 3000 to 6000' MHz < 15 Hz rms < 2.5 Hz rms (Opt 004)
<b>Output Level</b> Range:  Resolution: Absolute Accuracy:  Reverse Power Protection:	+13 to -137 dBm  0.01 Hz $\pm 1$ dB, output $\geq$ -127 dBm  50 W	+16 to -137 dBm, +13 dBm (Opt 002) 0.01 Hz $\pm$ dB, output $\geq$ -127 dBm  50 W	+13 to -139.9 dBm +9 dBm (Opt 008) 0.01 Hz $\pm 1$ dB, output $\leq$ -119.9 dBm, 1 to 3000 MHz $\pm 1.5$ dB, output $\leq$ -119.9 dBm, > 3000' MHz, < 1 MHz 25 W <sup>2</sup> , 0.1 to 2060 MHz 1 W, > 2060' MHz
<b>Amplitude Modulation</b> Depth: Resolution: Bandwidth (3 dB): Accuracy: 1 kHz rate Distortion: 30% depth, 1 kHz rate	0 to 100%, output $\leq$ +7 dBm 0.1% dc to > 100 kHz, $\leq$ 128 MHz $\pm$ (7% of setting + 1%) up to 80% depth < 3%; < 4% (Opt 002)	0 to 100%, output $\leq$ +7 dBm 0.1% dc to > 100 kHz, > 128 MHz $\pm$ (7% of setting + 1%) up to 80% depth < 3%; < 4% (Opt 002)	0 to 100%, output $\leq$ +7 dBm 0.1% > 10 kHz for > 10 MHz $\pm$ (6% of setting + 1%) up to 90% depth < 4%
<b>Frequency Modulation</b> Maximum Peak Deviation:  Resolution: Bandwidth (3 dB): Carrier Accuracy in FM: Indicator Accuracy:  Distortion:	2 MHz, 1030 to 2060 MHz 1 MHz, 515 to 1030 MHz Deviation halves per lower octave 2.5% of setting dc to 100 kHz $\pm 0.5\%$ of setting < 5%, < 30 kHz rate < 10%, < 100 kHz rates < 5%	20 MHz/200 kHz <sup>3</sup> , > 1030 MHz 10 MHz/100 kHz <sup>2</sup> , > 515 MHz Deviation halves per lower octave 2.5% of setting dc to 100 kHz $\pm 0.5\%$ of setting < 5%, < 30 kHz rates < 10%, < 100 kHz rates < 5%	20 MHz, 3000 to 6000' MHz 10 MHz, 1500 to 3000 MHz Deviation halves per lower octave 2.5% of setting dc to 800 kHz $\pm 0.4\%$ of setting $\pm 9\%$ , < 20 kHz rates < 1%



Specifications	HP 8643A <sup>1</sup>	HP 8644B <sup>1</sup>	HP 8664A <sup>1</sup> HP 8665A/B <sup>1</sup>
<b>Pulse Modulation</b> On/Off Ratio: Rise/Fall Time, 10 to 90%: Repetition Rate: Internal Width/Delay:	> 35 dB > 80 dB, > 1030 MHz < 100 ns dc to 1 MHz N/A	> 35 dB > 80 dB, > 1030 MHz < 100 ns dc to 1 MHz N/A	Opt 008 > 80 dB < 5 ns dc to 10 MHz Yes
<b>Internal Modulation Source</b> Waveforms and Rates:  Frequency Accuracy: Output Level (into 600 Ω): Output Resolution:	Sine, white Gaussian noise: 0.1 Hz to 400 kHz Triangle, sawtooth, square: 0.1 Hz to 50 kHz Same as timebase 1 V pk 2 mV pk		
<b>Frequency Sweep</b> Digital Sweep: Markers/Z-Axis Output: Phase Continuous Sweep:	Digitally stepped sweep over entire frequency range. Linear/log selection. 0.5 to 1000 s sweeps. 3 markers available/Z-axis output nominally +5 V/X-axis output nominally 0 to 10 V. 40 MHz of span available depending on carrier frequency. 20 ms to 10 s sweep times.		
<b>Remote Programming</b> Interface: Control Language: IEEE-488 Functions:	HP-IB (IEEE 488.2-1987) Hewlett-Packard Systems Language (HP-SL). All functions controlled except power. SH1, AH1, T6 TEO, L4, LEO, SR1, PPO, DC1, DTO, CO, E2		
<b>General</b> Power Requirements: Operation Temperature: Leakage: Calibration Interval: Weight: Dimensions:	± 10% of 100 V, 120 V, 220 V, or 240 V; 48 to 440 Hz; 500 VA (except HP 8643A/44B: 400 VA) 0° to 55° C Conducted and radiated interference meets MIL STD 461B REO2 and FTZ 1046. Recommended 3 years (MTBC) HP 8643A: 23 kg (50 lb). HP 8644B: 30 kg (67 lb). HP 8664A/65A/B: 35 kg (78 lb). 177 mm H × 426 mm W × 624 mm D (7 in × 16.8 in × 24.6 in). (Opt 010 adds 35 mm (1.4 in) to D.)		
<sup>1</sup> 3000 MHz for HP 8664A, 4200 MHz for HP 8665A, 6000 MHz for HP 8665B. <sup>2</sup> N/A to HP 8665B. <sup>3</sup> Low-noise mode 3.			

### Ordering Information

Base Price	HP 8643A	\$15,000	HP 8644B	\$22,655	HP 8664A	\$28,890
					HP 8665A	\$38,315
					HP 8665B	\$39,200
<b>Options:</b>						
001 High-Stability Timebase		\$1,650		\$1,650		\$1,650
002 2 GHz Doubled Output		\$5,000		\$7,625		N/A
003 Rear-Panel Input/Output		\$430		\$430		\$430
004 Low-noise Option		N/A		Standard		\$4,375
005 Electronic Attenuator (N/A with Opt 002)		Standard		\$535		N/A
008 Pulse Modulation		N/A		N/A		\$3,835
009 Specified VOR/ILS		\$1,600		\$1,600		N/A
010 Reduced-Leakage Configuration		\$1,600		\$1,600		\$1,600
011 2 GHz Internal Frequency Counter		\$1,065		\$1,065		N/A
907 Front-Handle Kit (5061-9690)		\$65 		\$65 		\$65 
908 Rack Flange Kit (5061-9678)		\$35 		\$35 		\$35 
909 Combined Front/Rack Flange Kit (5061-9684)		\$90 		\$90 		\$90 
910 Extra Manual Set (includes service manual)		\$190 		\$190 		\$190 
915 Add Service Manual		\$65 		\$65 		\$65 
<b>Service Kit</b>						
W30 Add 3 Years to Return Warranty.	(08645-61116)	\$650	(08645-61116)	\$650	(08665-61116)	\$1,250
		\$425		\$425		\$875

<sup>1</sup>HP-IB Cables

 For off-the-shelf shipment, call 800-452-4844.

# SIGNAL GENERATORS

## High-Performance RF (cont'd)

HP 8662A, 8663A, 11721A



### Pulse Modulation<sup>1</sup>

- Pulse on/off ratio:** >80 dB (50 to 2560 MHz)
- Pulse rise/fall time:** <250 ns (50 to 120 MHz); <800 ns (120 to 640 MHz); <100 ns ( $f_c \geq 640$  MHz)
- Pulse repetition frequency** (50% duty cycle):
  - Internal:** 10 Hz to 99.9 kHz
  - External:** 10 Hz to 2 MHz, 50 MHz <  $f_c$  < 640 MHz; 10 Hz to 5 MHz,  $f_c > 640$  MHz
- Internal Modulation Oscillator**
- Rates:** 10 Hz to 99.9 kHz
- Frequency resolution:** 3 digits
- Frequency accuracy:** Same as reference oscillator
- Output level** (available on rear panel): 1 V peak into 600  $\Omega$
- Output impedance:** 600  $\Omega$
- Flatness** (referenced to 1 kHz): <  $\pm 1\%$
- Distortion:** <1%

### Other HP 8662A and HP 8663A Information

- Remote programming:** The HP-IB interface is standard on the HP 8662A and HP 8663A signal generators. All functions controlled from the front panel, with the exception of the line switch, are programmable with the same accuracy and resolution as in manual mode.
- Operating temperature range:** 0° to +55° C
- Leakage:** Meets radiated and conducted limits of MIL STD 461A methods RE02 and CE03 as well as VDE 0871
- Power requirements:** 115 (90 to 126) V or 230 (198 to 252) V; 48 to 66 Hz; 450 VA max
- Weight:** HP 8662A: net, 30 kg (65.5 lb); shipping, 36 kg (80 lb); HP 8663A: net, 33.8 (74 lb); shipping, 40 kg (88 lb)
- Size:** HP 8662A: 178 mm H  $\times$  425 mm W  $\times$  572 mm D (7 in  $\times$  16.75 in  $\times$  22.5 in). HP 8663A: 178 mm H  $\times$  425 mm W  $\times$  642 mm D (7 in  $\times$  16.75 in  $\times$  25.3 in). Note: depth includes front panel depth of 45 mm (1.75 in).

### Ordering Information

	<b>Price</b>
<b>HP 8662A</b> 1280 MHz Signal Generator <sup>2</sup>	\$41,890
<b>Opt 001</b> RF Connectors on Rear Panel Only	+ \$435
<b>Opt 003</b> Specified SSB Phase Noise for 640 MHz Output	+ \$625
<b>Opt 700</b> External MATE Translator	+ \$11,295
<b>Opt 907</b> Front Handle Kit (5061-9690)	+ \$67
<b>Opt 908</b> Rack Flange Kit (5061-9678)	+ \$36
<b>Opt 909</b> Rack Flange Kit with Front Handles (5061-9684)	+ \$93
<b>Opt 910</b> Two Sets of Operating and Service Manuals (08662-90069)	+ \$139
<b>Opt W30</b> Extended Repair Service (see page 671)	+ \$900
<b>Opt W32</b> Calibration Service (see page 671)	+ \$740
<b>Opt 1BN</b> MIL STD 45662A Calibration Certificate	+ \$200
<b>Opt 1BP</b> MIL STD 45662A Calibration with Data Provided	+ \$750

### HP 8663A 2560 MHz Signal Generator<sup>2</sup>

<b>Opt 001</b> RF Connectors on Rear Panel Only	+ \$435
<b>Opt 002</b> Wideband Linear Phase Modulation	+ \$6,300
<b>Opt 003</b> Specified SSB Phase Noise for 640 MHz Output	+ \$625
<b>Opt 700</b> External MATE Translator	+ \$7,830
<b>Opt 907</b> Front Handle Kit (5061-9690)	+ \$67
<b>Opt 908</b> Rack Flange Kit (5061-9678)	+ \$36
<b>Opt 909</b> Rack Flange Kit with Front Handles (5061-9684)	+ \$93
<b>Opt 910</b> Additional Operation and Calibration Manual (08663-90069) and Service Manuals (08663-90071)	+ \$360
<b>Opt 915</b> Add Service Manual (08663-90071)	+ \$155
<b>Opt W30</b> Extended Repair Service (see page 671)	+ \$1,220
<b>Opt W32</b> Calibration Service (see page 671)	+ \$860
<b>Opt 1BN</b> MIL STD 45662A Calibration Certificate	+ \$200
<b>Opt 1BP</b> MIL STD 45662A Calibration with Data Provided	+ \$800

### HP 11714A Service Support Kit (required for servicing HP 8662A/8663A)

\$1,800

<sup>1</sup> Pulse modulation is available for  $f_c < 50$  MHz but is unspecified.  
<sup>2</sup> HP-IB cables not supplied. For description and price, see page 615.

☎ For off-the-shelf shipment, call 800-452-4844.

### HP 11721A Frequency Doubler

The HP 11721A Doubler is an ideal accessory for extending the usable frequency range of signal generators, frequency synthesizers, or other signal sources. Operating on input frequencies of 50 MHz to 1300 MHz, it provides a doubled output in the range of 100 MHz to 2300 MHz. The HP 11721A will work well with any RF source with an output in the range 50 to 1300 MHz.

The 50  $\Omega$  passive circuit of the HP 11721A offers low conversion loss, low spurious, and excellent flatness over its entire frequency range when operated above +10 dBm.

### HP 11721A Specifications

- Input frequency range:** 50 to 1300 MHz
- Output frequency range:** 100 to 2600 MHz
- Conversion loss (+13 dBm input, 50 to 1280 MHz):** <15 dB
- Spurious referenced to desired output frequency f (+13 dBm input with harmonics < -50 dBc, 50 to 1280 MHz):**  $f/2$ , -15 dB;  $3f/2$ , -15 dB
- Input SWR:** 1.5 typical
- Input/output impedance:** 50  $\Omega$  nominal
- Operating temperature range:** 0° to +50° C
- Connectors:** Input, type N male; output, type N female
- Size:** 161 mm L  $\times$  30 mm W  $\times$  20.5 mm H (6 1/4 in  $\times$  1 1/8 in  $\times$  3/8 in)
- Weight:** Net, .02 kg (0.5 lb); shipping, 0.4 kg (1 lb)

### Ordering Information

<b>HP 11721A</b> Frequency Doubler	<b>Price</b>
<b>Opt W30</b> Extended repair service. See page 671	\$800
	+ \$50

# SIGNAL GENERATORS

High-Performance RF

HP 8642A, 8642B

441

- 100 kHz to 2.115 GHz
- < -134 dBc/Hz SSB phase noise at 20 kHz offset
- -100 dBc nonharmonic spurious

- +20 dBm maximum output level
- AM, FM,  $\Phi$ M and pulse modulation
- On-site repair and calibration

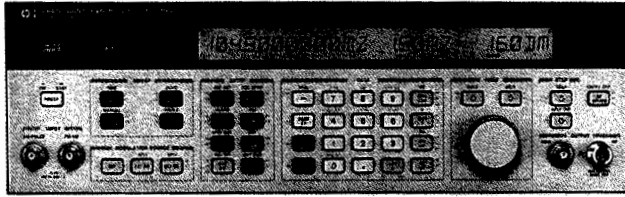

HP 8642A

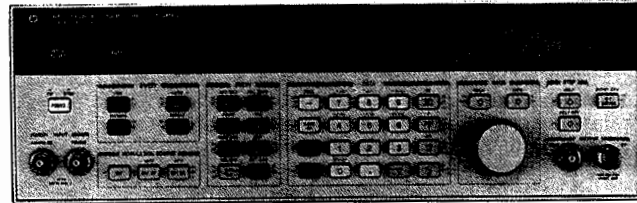

HP 8642B



## HP 8642A/B Synthesized Signal Generators

The HP 8642A and HP 8642B synthesized signal generators are high-performance programmable signal generators intended for the most demanding out-of-channel RF receiver measurements and other stringent RF applications. The HP 8642A covers the frequency range from 100 kHz to 1057.5 MHz; the HP 8642B, to 2115 MHz.

### Low SSB Phase Noise

The HP 8642A/B provide state-of-the-art in SSB phase noise at 20 kHz offsets of -134 dBc/Hz at 1 GHz.

### -100 dBc Spurious

Nonharmonic spurious are held to below -100 dBc up to 1 GHz on the HP 8642A/B and to below -94 dBc above 1 GHz. These 2 generators allow receiver spurious rejection tests to be fully automated with the utmost confidence in test results.

### Repeatability and Level Accuracy

In addition to a high-reliability attenuator, absolute output level accuracy is  $\pm 1$  dB down to -127 dBm (0.1  $\mu$ V). In research and development or on the production line, the HP 8642A/B will accurately measure receiver sensitivities.

### Up to +20 dBm Output Level

Up to +20 dBm is available from the HP 8642A/B to perform a variety of high-level measurements, often eliminating the need for external amplifiers. This extra power can be used to overcome cabling losses. With the relative amplitude feature, the display can be offset to show correct output level at the end of the cable.

### AM, FM, $\Phi$ M, and Pulse Modulation

The HP 8642A/B offer AM, FM,  $\Phi$ M, and pulse modulation across their full frequency ranges.

A low distortion internal modulation oscillator can be used to modulate the HP 8642A/B up to 100 kHz rates. The internal audio oscillator can also be used as a standalone audio source with variable rates and levels.

## HP 8642A/B Specifications

### Frequency

**Range:** 100 kHz to 1057.5 MHz, HP 8642A; 100 kHz to 2115 MHz, HP 8642B.

**Bands:** Both generators cover their ranges in one continuous span. However, many other specifications are dependent on carrier frequency. To simplify such specifications, the HP 8642A and 8642B carrier frequency ranges are divided into bands as shown in the table below.

Band	Carrier Frequency (MHz)	Band	Carrier Frequency (MHz)
10	1057.500001 to 2115 (HP 8642B)	4	16.523438 to 33.046875
9	528.750001 to 1057.5	3	8.261719 to 16.523437
8	284.375001 to 528.75	2	4.130680 to 8.261718
7	132.187501 to 284.375	1	0.1 to 4.130680
6	86.093751 to 132.1875	HET	0.1 to 132.1875
5	33.046876 to 86.09375		

**Resolution:** 1 Hz, 0.1 Hz with special function

**Stability:** Same as reference oscillator

### Internal Reference Oscillator

**Standard:** Aging rate:  $\pm 2$  ppm/year

**Option 001:** <10<sup>-9</sup>/day aging rate after 8 days warmup

### Spectral Purity

**Residual FM** (in CW, AM or Angle Modulation < 1/2 Max. Dev.):

**500 MHz:** <1.2 Hz (0.3 to 3 kHz BW), <2 Hz (0.05 to 15 kHz BW)

**1000 MHz:** <2 Hz (0.3 to 3 kHz BW), <5 Hz (0.05 to 15 kHz BW)

**2000 MHz:** <5 Hz (0.3 to 3 kHz BW), <9 Hz (0.05 to 15 kHz BW)

**SSB Phase Noise at 20 kHz offset** (CW, AM or FM/ $\Phi$ M < 1/2%

Maximum deviation):

**125 MHz:** -144 dBc/Hz

**250 MHz:** -141 dBc/Hz

**500 MHz:** -137 dBc/Hz

**1000 MHz:** -134 dBc/Hz

**2000 MHz:** -125 dBc/Hz

**Residual AM:** <0.01% AM rms, 0.3 to 3 kHz BW

**Spurious**

**Harmonics:** -30 dBc, level  $\leq$  +10 dBm, -25 dBc  $f_c$  > 1057.5 MHz

**Subharmonics:** None,  $f_c \leq$  1057.5 MHz; -45 dBc,  $f_c$  > 1057.5 MHz

**Nonharmonics** (>10 kHz offsets): -100 dBc,

(-94 dBc  $f_c$  > 1057.5 MHz)

Typical SSB Phase Noise at 1 GHz

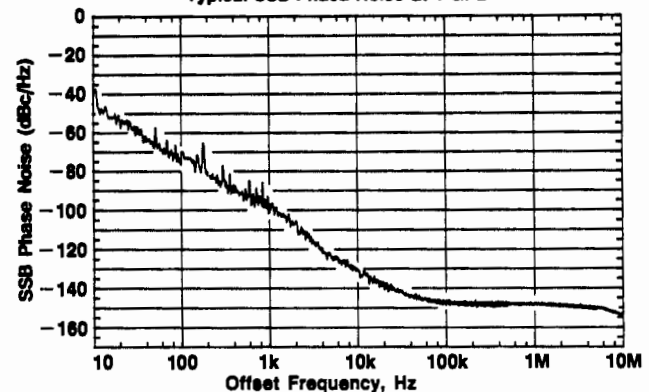

# SIGNAL GENERATORS

## High-Performance RF (cont'd)

HP 8642A, 8642B

### Output

**Level range:** from maximum available to  $-140$  dBm ( $0.023 \mu\text{V}$ ).

**Maximum level available:**

	HP 8642A	HP 8642B
+20 dBm (2.24 V)	bands 1 thru 7	bands 1 thru 7
+19 dBm (2.00 V)	n/a	band 8
+18 dBm (1.78 V)	bands 8 & HET	HET
+17 dBm (1.58 V)	n/a	band 9
+16 dBm (1.41 V)	band 9	band 10

**Resolution:** 0.1 dB.

**Absolute accuracy:**  $\pm 1$  dB, output level  $\geq -127$  dBm

**Flatness:**  $\leq \pm 0.75$  dB, +10 dBm output level

**Impedance:**  $50 \Omega$  nominal

**SWR:**  $< 1.5:1$ , level  $< 0$  dBm;  $< 2.0:1$ , level  $\geq 0$  dBm

**Reverse power protection:** 50 W, from a  $50 \Omega$  source 25 Vdc (HP 8642A); 25W, 50 Vdc (HP 8642B)

**Third order intermodulation:**  $< -50$  dBc at +10 dBm, 2 generators 25 kHz apart into a resistive combiner. Typically decreases 10 dB for every 5 dB of combined level decrease.

### Amplitude Modulation

**AM depth:** 0 to 99.9%, output level  $\leq +10$  dBm

**AM resolution:** 0.1%

**AM indicator accuracy at 1 kHz rate and up to 90% AM:**

$\pm (3.5\%$  of setting  $+1\%$  AM),  $f_c \leq 528.75$  MHz (8642A),  $f_c \leq 1057.5$  MHz (8642B)

$\pm (5\%$  of setting  $+1\%$  AM),  $f_c > 528.75$  MHz (8642A),  $f_c > 1057.5$  MHz (8642B)

**AM distortion at 1 kHz rate:**

Depth	Distortion	
	8642A; $f_c \leq 528.75$ MHz 8642B; $f_c \leq 1057.5$ MHz	8642A; $f_c > 528.75$ MHz 8642B; $f_c > 1057.5$ MHz
0 to 30% AM	$< 1\%$	$< 2\%$
30 to 70% AM	$< 2\%$	$< 4\%$
70 to 90% AM	$< 4\%$	$< 6\%$

**AM 3 dB bandwidth, depth  $\leq 90\%$ :**

**External dc/ac coupling:** dc/20 Hz to 100 kHz,  $f_c$ : 01 to 4.13 MHz, 33.04 to 2115 MHz, HET; dc/20 Hz to 20 kHz,  $f_c$ : 4.13 to 33.04 MHz

**Internal:** Same as external ac

**Incidental  $\Phi\text{M}$  at 1 kHz rate and 30% AM:**  $< 0.2$  radians peak

### Frequency Modulation

**Maximum FM deviation:**

Carrier Frequency Band	Maximum Deviation DC-Coupled	Maximum Deviation AC-Coupled or Internal
10	3 MHz	(the smaller of) 3 MHz or $f_{\text{mod}} \times 2160$
9	1.5 MHz	1.5 MHz or $f_{\text{mod}} \times 1080$
8	750 kHz	750 kHz or $f_{\text{mod}} \times 540$
7	375 kHz	375 kHz or $f_{\text{mod}} \times 270$
6	187 kHz	187 kHz or $f_{\text{mod}} \times 135$
5	93.8 kHz	93.8 kHz or $f_{\text{mod}} \times 67.5$
4	46.9 kHz	46.9 kHz or $f_{\text{mod}} \times 33.75$
3	23.4 kHz	23.4 kHz or $f_{\text{mod}} \times 16.88$
2	11.7 kHz	11.7 kHz or $f_{\text{mod}} \times 8.44$
1	93.8 kHz	93.8 kHz or $f_{\text{mod}} \times 67.5$
HET	1.5 MHz	1.5 MHz or $f_{\text{mod}} \times 1080$

**FM resolution:** 0.7% of setting or 0.0004% of maximum deviation, whichever is larger

**FM indicator accuracy, rates  $\leq 100$  kHz:**  $\pm (5\%$  of setting  $+10$  Hz)

**FM distortion, rates 20 Hz to 100 kHz:** 4% for max. dev., 2% for  $\frac{1}{2}$  max. dev., 0.4% for  $\frac{1}{4}$  maximum dc-coupled deviation

**FM 3 dB bandwidth (dc/ac coupling):** dc/20 Hz to 200 kHz

**Incidental AM:** 0.3%, 20 kHz peak dev., 1 kHz rate,  $f_c > 400$  kHz

### Phase Modulation

**Maximum phase deviation:**

Carrier Frequency 1Band	Maximum Deviation (Radians)
10	200
9	100
8	50
7	25
6	12.5
5	6.25
4	3.13
3	1.56
2	0.78
1	6.25
HET	100

**$\Phi\text{M}$  accuracy:**  $\pm (5\%$  of setting  $+0.09$  radians), 1 kHz rate

**$\Phi\text{M}$  resolution:** Greater of 0.7% of setting or 0.0004% of max. dev

**$\Phi\text{M}$  distortion:**  $< 0.4\%$ , 1 kHz rate

**$\Phi\text{M}$  3 dB bandwidth:** dc/20 Hz to 15 kHz

**Pulse Modulation (for output levels  $\leq +15$  dBm)**

**Pulse on/off ratio:**  $> 40$  dB;  $> 80$  dB,  $f_c > 1057.5$  MHz

**Rise/fall time:**  $< 400$  ns, 10% to 90%

**Maximum repetition frequency:** 100 kHz

**Minimum pulse width:** 2  $\mu\text{s}$

**Internal Modulation Oscillator**

**Rates:** 20 Hz to 100 kHz

**Frequency resolution:** 1% of setting

**Frequency accuracy:** 2% of setting

**Output level range:** 0 to 3 V peak into  $600 \Omega$

**Output level resolution:** 4 mV

**Distortion:**  $< 0.02\%$ , 0.02 kHz to 15.8 kHz;  $< 0.15\%$ ,  $> 15.8$  kHz

**Output level accuracy:**  $\pm (4\% + 15$  mV) within 1 second

**Output impedance:**  $600 \Omega \pm 10\%$

**Frequency Sweep**

**Modes:** Start-Stop, Span, and Phase continuous

**X-axis output:** 0 to 10 Vdc,  $\pm 10\%$

**Z-axis output:** TTL positive true for display blanking during retrace

**Remote Programming**

**Interface:** HP-IB (IEEE-488-1978)

**HP-IB functions:** Listener, talker, and controller. SH1, AH1, T5, TE0, L3, LE0, SR1, RL1, PP1, DC1, DT1, C1, C3, C28, E2

**General**

**Operating temperature range:**  $0^\circ$  to  $55^\circ$  C

**Storage temperature:**  $-55^\circ$  to  $+75^\circ$  C

**Leakage:** Conducted and radiated interference is within the requirements of MIL-STD-461B method RE02. Interference is also within the standards set by FTZ-1046. Also, RF leakage of  $< 0.5 \mu\text{V}$  is induced in a 2 turn loop 2.5 cm in diameter, held 2.5 cm away from any surface for output levels  $\leq 0$  dBm.

**Power requirements:** 100, 120, 220, or 240 V;  $+5\%$ ,  $-10\%$ ; 48 to 440 Hz; 300 VA max

**Size:** 133 mm H  $\times$  425 mm W  $\times$  617 mm D (5.25 in  $\times$  16.75 in  $\times$  24.3 in)

**HP System II module size:**  $5\frac{1}{4}$  H  $\times$  1W  $\times$  23 D

**Weight:** Net, 32.7 kg (71.5 lb); shipping, 43 kg (95 lb)

**Ordering Information**

**HP 8642A** Synthesized Signal Generator<sup>1</sup> \$30,340

**HP 8642B** Synthesized Signal Generator<sup>1</sup> \$41,680

**Opt 001** High-Stability Time Base +\$2,560

**Opt 002** Input/Output Connectors on Rear Panel Only +\$185

**Opt 1BN** Mil Std 45662A Certificate of Calibration +\$200

**Opt 1BP** Mil Std 45662A Calibration w/Test Data +\$750

**Opt 710** Onsite Repair Manual (08642-90020) +\$74

**Opt 907** Front Handle Kit (5061-9689) +\$57

**Opt 908** Rack Flange Kit (5061-9677) +\$33

**Opt 909** Rack Flange Kit (5061-9683) with Front Handles +\$82

**Opt 910** Additional Operation and Calibration Manual (08642-90224) and 2 Service Manuals (08642-90226) +\$565

**Opt 915** Add Service Manual (08642-90226) +\$255

**HP 8642A Opt W30** Extended Repair Service +\$615

(see page 671)

**HP 8642B Opt W30** Extended Repair Service +\$845

(see page 671)

**HP 11801A** On-site repair kit for HP 8642A +\$22,930

**HP 11801B** On-site repair kit for HP 8642B +\$30,210

**HP 11801C** On-site repair kit for HP 8642A/B +\$31,900

<sup>1</sup>HP-IB cables not supplied. For description and price, see page 615.

☎ For off-the-shelf shipment, call 800-452-4844.

- 10 kHz to 2600 MHz
- Synthesizer stability and accuracy
- 1 Hz resolution (2 Hz above 1300 MHz)

- Ten-digit display
- Calibrated output over > 140 dB range
- AM, FM,  $\Phi$ M, or pulse modulation



HP 8660D (with HP 86633B and HP 86603A plug-ins)

## HP 8660D Synthesized Signal Generator

### System Concept

The HP 8660 is a modular, solid-state, plug-in system. Each system includes: 1) A programmable, synthesized signal generator mainframe; 2) an RF section plug-in; and 3) a modulation section. Synthesized accuracy and stability, along with complete programmability, make the HP 8660 ideal for automated receiver, subsystem, and component testing.

### Mainframes

The HP 8660D offers front-panel and HP-IB or BCD control of center frequency and frequency sweep. An external reference may be used to replace the internal high-stability reference oscillator.

### Plug-In RF Sections

The HP 86601A (0.01 to 110 MHz), HP 86602B (1 to 1300 MHz), and HP 86603A (1 to 2600 MHz) are the three RF-section choices. The HP 11661B frequency extension module (mainframe Option 100) must be used with the HP 86602B and HP 86603A and is installed internally to an HP 8660 mainframe. (If you are using the HP 8660A mainframe, the HP 86603A plug-in must be ordered with Option 003.)

### Plug-In Modulation

There are 5 modulation sections from which to choose. The HP 86631B auxiliary section provides external AM and pulse modulation. The HP 86632B offers AM and FM and utilizes a free-running VCO to provide high FM deviations and rates, while the HP 86633B provides AM and phase-locked FM. The HP 86634A offers high-performance phase modulation with rates to 10 MHz, while the HP 86635A provides both FM and phase modulation. (The HP 86634A and HP 86635A must be used with the Option 002 RF section.)

## HP 8660D Mainframe Specifications

**Frequency accuracy and stability:** CW frequency accuracy and long-term stability are determined by an internal reference oscillator, or by an external reference.

### Reference Oscillator

**Internal:** 10 MHz quartz oscillator. Aging rate less than  $\pm 3$  parts in  $10^6$  per 24 hours.

**External:** Rear panel switch allows operation from 5 MHz or 10 MHz frequency standard at a level between 0.5 and 2.5 V rms into 170  $\Omega$ .

**Reference output:** Rear-panel BNC connector provides output of the selected reference signal at a level of at least 0.75 V rms into 170  $\Omega$ .

**Digital sweep:** Auto, single, or manual. Selectable speeds of 0.1, 1, or 50 s

### Remote Programming

#### Functions

**HP 8660D:** CW frequency, frequency stepping (STEP  $\uparrow$ , STEP  $\downarrow$ ), output level, and most modulation functions are programmable.

#### Programming Input

**Connector type:** 36-pin Cinch type 57 (mating connector supplied). 24-pin Cinch type 57 for HP-IB control. BCD and HP-IB control internal-jumper-selectable.

**Logic:** TTL-compatible (negative true).

**Switching time:** Less than 10 ms to be within 100 Hz of any new frequency selected. (Less than 175 ms to be within 10 Hz.)

### General

**Operating temperature range:** 0° to +55° C

**Power:** 100, 120 V (+5%, -10%), 48 to 400 Hz; 220, 240 V (+5%, -10%), 48 to 66 Hz; approximately 350 W

**Weight** (mainframe only): Net, 23.8 kg (53 lb); shipping, 29.6 kg (65 lb)

### Supplemental Characteristics

#### Typical Single-Sideband Phase Noise

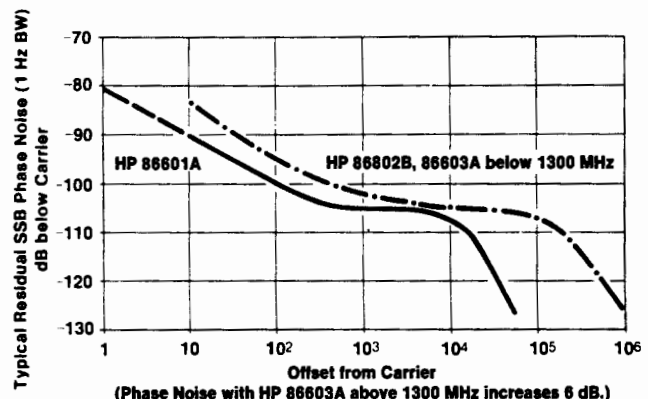

# SIGNAL GENERATORS

High-Performance RF  
HP 86601A, 86602B, 86603A

10 kHz to 110 MHz

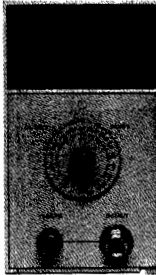

HP 86601A

1 MHz to 1300 MHz

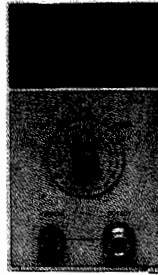

HP 86602B (HP 11661B required)

1 MHz to 2600 MHz

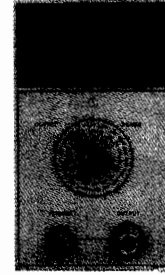

HP 86603A (HP 11661B required)

## RF Section Specifications (installed in HP 8660D mainframe)

		HP 86601A	HP 86602B (requires HP 11661B)	HP 86603A (requires HP 11661B)			
FREQUENCY CHARACTERISTICS	Frequency Range	0.01 to 110 MHz (109.999999 MHz)	1 to 1300 MHz (1299.999999 MHz)	1 to 2600 MHz (2599.999998 MHz)			
				CF < 1300 MHz	CF ≥ 1300 MHz		
	Frequency Resolution	1 Hz	1 Hz		2 Hz		
	Harmonics	≤ -40 dBc	≤ -30 dBc (< -25 dBc above +3 dBm)		≤ -20 dBc <sup>1</sup>		
	Spurious Non-Harmonically Related (greater than 10 kHz offsets) Power-Line Related (CW, AM, $\emptyset$ M only) <sup>2</sup>	≤ -76 dBc	≤ -80 dBc below 700 MHz ≤ -60 dBc above 700 MHz within 45 MHz of carrier ≤ -70 dBc above 700 MHz > 45 MHz from carrier ≤ -50 dBc on +10 dBm range ≤ -80 dBc		≤ -74 dBc within 45 MHz of carrier <sup>1</sup> ≤ -64 dBc > 45 MHz from carrier ≤ -60 dBc		
Signal-to-Phase-Noise Ratio (CW, AM, $\emptyset$ M only, offsets > 300 Hz)	> 50 dB	> 45 dB		> 39 dB			
OUTPUT CHARACTERISTICS	Output Level (into 50 $\Omega$ )	± 13 dBm to -146 dBm	+10 to -146 dBm	+10 to -136 dBm	+7 to -136 dBm <sup>4</sup>		
	Output Accuracy (local and remote)	± 1 dB, +13 to -66 dBm ± 2 dB, -66 to -146 dBm	± 1.5 to -76 dBm ± 2.0 to -146 dBm	± 2.5 dB to -76 dBm <sup>3</sup> ± 3.5 dB to -136 dBm			
	Flatness (output-level variation with frequency)	< ± 0.75 dB	< ± 1.0 dB	< ± 2.0 dB			
	Impedance	50 $\Omega$					
MODULATION CHARACTERISTICS	AM	AM Modulation Depth	0 to 95%	0 to 90% <sup>4</sup>		0 to 50% <sup>4</sup>	
		3 dB Bandwidth: 0 to 30%	200 Hz, CF < 0.4 MHz	10 kHz, CF < 10 MHz	100 kHz, CF ≥ 10 MHz		5 kHz
			10 kHz, 0.4 ≤ CF < 4 MHz	100 kHz, CF ≥ 4 MHz	100 kHz, CF ≥ 10 MHz		
	0 to 70%	125 Hz, CF < 0.4 MHz	6 kHz, CF < 10 MHz	60 kHz, CF ≥ 10 MHz		N/A	
	0 to 90%	6 kHz, 0.4 ≤ CF < 4 MHz	60 kHz, CF ≥ 4 MHz	5 kHz, CF < 10 MHz		N/A	
		100 Hz, CF < 0.4 MHz	100 Hz, CF < 0.4 MHz	50 kHz, CF ≥ 10 MHz			
		5 kHz, 0.4 ≤ CF < 4 MHz	50 kHz, CF ≥ 4 MHz				
		50 kHz, CF ≥ 4 MHz					
		Distortion, <sup>5</sup> THD at 30% AM at 70% AM at 90% AM	< 1%, 0.4 to 110 MHz < 3%, 0.4 to 110 MHz < 5%, 0.4 to 110 MHz	< 1% < 3% < 5%		< 5% N/A N/A	
	FM	FM Rate	dc to 1 MHz with HP 86632B and HP 86635A 20 Hz to 100 kHz with HP 86633B	dc to 200 kHz with HP 86632B and HP 86635A 20 Hz to 100 kHz with HP 86633B			
Maximum Deviation (peak)		1 MHz with HP 86632B and HP 86635A 100 kHz with HP 86633B	200 kHz with HP 86632B and HP 86635A 100 kHz with HP 86633B		400 kHz with HP 86632B, 86635A 200 kHz with HP 86633B		
Distortion, THD (at rates up to 20 kHz)		< 1% up to 200 kHz dev. < 3% up to 1 MHz dev.	< 1% up to 200 kHz dev.		< 1% up to 400 kHz dev.		
PULSE	Pulse Rise/Fall Time	200 ns	50 ns				
	On/Off Ratio (with pulse level control at max.)	> 50 dB	> 40 dB		> 60 dB		
$\emptyset$ M	$\emptyset$ M Rate	N/A	dc to 1 MHz with HP 86635A dc to 1 MHz for CF < 100 MHz dc to 10 MHz for CF ≥ 100 MHz with HP 86634A				
	Maximum Peak Deviation	N/A	0 to 100° C		0 to 200° C		
	Distortion, THD	N/A	< 5% up to 1 MHz rates < 7% up to 5 MHz rates < 15% up to 10 MHz rates				
GENERAL	Weight	Net, 5 kg (11 lb) Shipping, 6.8 kg (15 lb)	Net, 4.1 kg (9 lb) Shipping, 5.5 kg (12 lb)	Net, 5 kg (11 lb) Shipping, 6.4 kg (14 lb)			
		HP 11661B: Net, 2.3 kg (5 lb); shipping, 2.7 kg (6 lb)					

<sup>1</sup>For output levels +3 dBm and below; slightly higher +3 to +7 dBm.

<sup>2</sup>Measured in a 30 kHz band centered on the carrier excluding a 1 Hz band centered on the carrier.

<sup>3</sup>For +3 to +7 dBm output levels, output accuracy and flatness will be slightly degraded (above 1300 MHz only).

<sup>4</sup>For RF output level meter readings from +3 dB to -6 dB and only at +3 dBm and below.

<sup>5</sup>Applies only at 400 Hz and 1 kHz rates with output meter set between 0 and +3 dB. At -6 dB meter setting the distortion approximately doubles.

<sup>6</sup>Phase modulation is only possible with Option 002 RF Sections.

# SIGNAL GENERATORS

High-Performance RF

HP 86631B, 86632B, 86633B, 86634A, 86635A

445

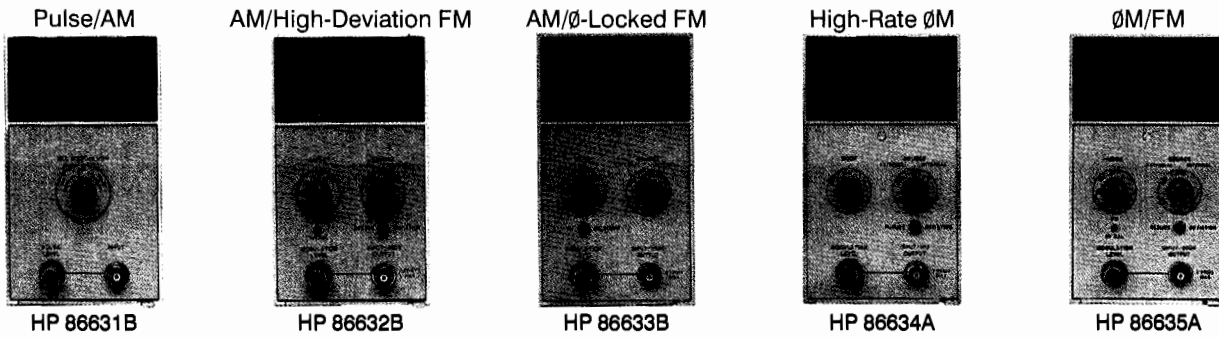

## Modulation Section Specifications

		HP 86631B	HP 86632B	HP 86633B	HP 86634A	HP 86635A
	Functions	Ext. Only	Int. and Ext.	Int. and Ext.	—	—
AM	Indicated Accuracy (at 400 and 1000 Hz rates)	—	± 5% of full scale With HP 86601A RF Section: ± 7% center frequency ≥ 100 MHz. With HP 86603A RF Section: ± 10%, center frequency ≥ 1300 MHz.		—	—
FM	Functions	—	Int. and Ext., FM CF CAL	Int. and Ext.	—	Int. and Ext., FM CF CAL
	Center Frequency Long-Term Stability	—	Typically less than 1 kHz/hr	Same as in CW Mode (3 x 10 <sup>-4</sup> /day)	—	Typically less than 1 kHz/hr
	Indicated Accuracy (up to 20 kHz rates)	—	± 5% of full scale		—	± 5% of full scale
Pulse	Functions	Ext. Only	—	—	—	—
øM	Functions	—	—	—	Int. and Ext.	Int. and Ext.
	Indicated Accuracy (15° to 35° C)	—	—	—	± 5% of full scale up to 100 kHz rates ± 8% of full scale up to 2 MHz rates ± 15% of full scale up to 10 MHz rates	
Meter		—	0 to 100% AM 0 to 10, 100, 1000 kHz FM Pk. Dev. (0 to 20, 200, 2000 kHz FM for CF ≥ 1300 MHz)	0 to 100% AM 0 to 10, 100 kHz FM Pk. dev. (0 to 20, 200 kHz FM for CF ≥ 1300 MHz)	0 to 100° Peak øM (0 to 200° for CF ≥ 1300 MHz)	0 to 10, 100, 1000 kHz FM, 0 to 100° Pk, øM (0 to 20, 200, 2000 kHz FM, 0 to 200° Pk. øM for CF ≥ 1300 MHz)
Internal Modulation Source: Output:		None —	400 Hz and 1 kHz ± 5% 200 mV minimum into 10 k Ω. Available at front panel BNC connector			
Input Impedance		500 Ω Pulse 600 Ω AM	600 Ω	600 Ω	50 Ω	600 Ω
Weight		Net, 1.4 kg (3 lb); shipping, 23 kg (5 lb)	Net, 2.7 kg (6 lb); shipping, 4.1 kg (9 lb)	Net, 2.7 kg (6 lb); shipping, 4.1 kg (9 lb)	Net 1.6 kg (4 lb); shipping, 3.2 kg (7 lb)	Net, 2.7 kg (6 lb); shipping, 4.1 kg (9 lb)

## Ordering Information

**HP 8660D** Synthesized Signal Generator mainframe<sup>1</sup>  
**Opt 001** ± 3 × 10<sup>-9</sup>/Day Internal Reference Oscillator  
**Opt 002** No Internal Reference Oscillator — \$300  
**Opt 003** Operation from 48 to 440 Hz Line \$0  
**Opt 005** Factory-Configured for HP-IB \$0  
**Opt 100** HP 11661B Factory Installed Inside Mainframe + \$7,550  
**Opt 908** Rack Flange Kit (08660-60347) \$113 ☎  
**Opt 910** Additional Operation and Calibration Manual (08660-90103) and Two Service Manuals (08660-90104) + \$255 ☎  
**Opt 915** Add Service Manual (08660-90104) + \$103 ☎  
**Opt W30** Extended Repair Service (see page 671) + \$355  
**HP 86601A** 0.01 to 110 MHz RF Section \$9,250  
<sup>1</sup>HP-IB cables not supplied. For description and price, see page 615.  
☎ For off-the-shelf shipment, call 800-452-4844.

## Price

**HP 86602B** 1 to 1300 MHz RF Section<sup>2</sup> \$10,465  
**HP 86603A** 1 to 2600 MHz RF Section<sup>2</sup> \$12,960  
**Opt 002** Add Phase Modulation Capability + \$2,865  
 (HP 86602B, 86603A only)  
**Opt 003** Allows Operation of HP 86603A with HP 8660A Mainframe + \$281  
**HP 86607A** Field Retrofit for HP 8660A/C to HP 8660D \$5,400  
**HP 86631B** AM/Pulse Auxiliary Section \$910  
**HP 86632B** AM/FM Modulation Section \$4,360  
**HP 86633B** AM/FM Modulation Section \$4,360  
**HP 86634A** øM Modulation Section \$3,475  
**HP 86635A** øM/FM Modulation Section \$4,800  
 Note: Opt 910, 2 sets of operation and service manuals, is available for each plug-in section. Contact your HP sales representative for part numbers and prices.  
**HP 11661B** Frequency Extension Module \$7,550  
**HP 11672A** Service Accessory Kit \$1,650  
**HP 11707A** Test Plug-In \$3,210  
<sup>2</sup>HP 86602B and HP 86603A RF sections require an HP 11661B for operation.

# SIGNAL GENERATORS

## High-Performance RF

HP 8662A, 8663A

- 10 kHz to 1280 MHz frequency range
- < -147 dBc/Hz SSB phase noise at 10 kHz offset
- 0.1 Hz frequency resolution

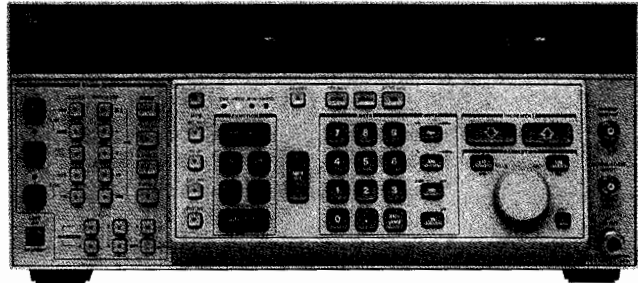

HP 8662A



- 100 kHz to 2560 MHz frequency range
- AM/FM/ØM/pulse in one generator
- Internal variable modulation oscillator

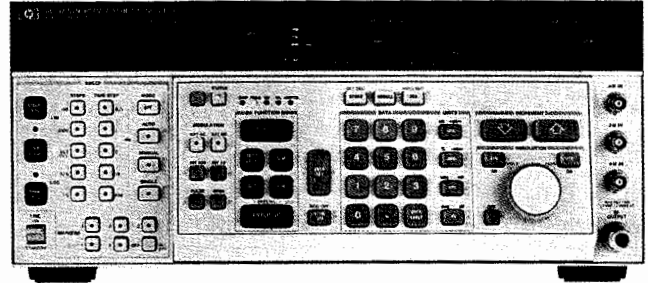

HP 8663A



### HP 8662A/HP 8663A Synthesized Signal Generators

Spectral purity is the key contribution of both the HP 8662A and HP 8663A, making them ideal for many radar, satellite communication, and phase noise measurement applications. Typical absolute phase noise performance of these generators at a 1 kHz offset is as low as -135 dBc/Hz, depending on the band of operation.

The frequency range of the HP 8662A is 10 kHz to 1280 MHz. It offers versatile AM/FM, using either internal 400 Hz and 1 kHz rates or externally applied modulating signals which can be either ac- or dc-coupled. It also has simultaneous modulation capability.

The HP 8663A and the HP 8662A provide the U.S. Air Force MATE (Modular Automatic Test Equipment) capability, Option 700. This option is an external translator that allows the HP 8663A to be controlled by the MATE language CIIL (Control Interface Intermediate Language).

### HP 8662A Specifications

#### Frequency

**Range:** 10 kHz to 1280 MHz (1279.999998 MHz)

**Resolution:** 0.1 Hz (0.2 Hz above 640 MHz)

**Accuracy and stability:** Same as reference oscillator

**Internal reference oscillator:** 10 MHz quartz oscillator. Aging rate < 5 × 10<sup>-10</sup>/day after 10-day warmup (typically 24 hrs in normal operating environment).

#### Spectral Purity

**Front-panel absolute SSB phase noise (dBc/Hz):**

	Frequency Range (MHz)					
	0.01 to 119.9 <sup>1</sup>		120 to 159.9 <sup>2</sup>		160 to 319.9 <sup>2</sup>	
	spec	typ	spec	typ	spec	typ
1 Hz	-68	-78	-66	-76	-60	-70
10 Hz	-98	-108	-96	-106	-90	-100
100 Hz	-116	-126	-115	-125	-109	-119
1 kHz	-126	-132	-129	-135	-124	-130
3 kHz	-126	-135	-129	-138	-124	-133
5 kHz	-128	-138	-131	-141	-126	-136
10 kHz	-132	-138	-142	-148	-136	-142
100 kHz	-132	-139	-142	-148	-136	-142

	Frequency Range (MHz)					
	320 to 639.9 <sup>3</sup>		640 to 1279.9 <sup>3</sup>		1280 to 2559.9 <sup>4</sup>	
	spec	typ	spec	typ	spec	typ
1 Hz	-54	-64	-48	-58	-42	-52
10 Hz	-84	-94	-78	-88	-72	-82
100 Hz	-103	-114	-97	-108	-92	-102
1 kHz	-118	-125	-112	-119	-106	-113
3 kHz	-118	-127	-112	-121	-106	-115
5 kHz	-120	-130	-114	-124	-108	-118
10 kHz	-131	-136	-124	-130	-118	-124
100 kHz	-131	-136	-124	-130	-118	-124

### Residual SSB phase noise (dBc/Hz):

	Frequency Range (MHz)					
	0.01 to 119.9 <sup>1</sup>		120 to 159.9 <sup>2</sup>		160 to 319.9 <sup>2</sup>	
	spec	typ	spec	typ	spec	typ
10 Hz	-108	-114	-112	-119	-106	-113
100 Hz	-121	-126	-122	-129	-118	-124
1 kHz	-128	-133	-131	-138	-127	-134
3 kHz	-128	-136	-131	-139	-127	-135
5 kHz	-129	-138	-133	-141	-129	-136
10 kHz	-132	-137	-142	-147	-136	-142
100 kHz	-132	-137	-142	-147	-136	-142

	Frequency Range (MHz)					
	320 to 639.9 <sup>3</sup>		640 to 1279.9 <sup>3</sup>		1.28 to 2559.9 <sup>4</sup>	
	spec	typ	spec	typ	spec	typ
10 Hz	-100	-107	-93	-101	-88	-95
100 Hz	-112	-119	-105	-112	-100	-106
1 kHz	-121	-128	-115	-122	-109	-116
3 kHz	-121	-129	-115	-123	-109	-117
5 kHz	-123	-130	-117	-124	-111	-118
10 kHz	-131	-136	-124	-130	-118	-124
100 kHz	-131	-136	-124	-130	-118	-124

<sup>1</sup> HP 8663A band begins at 0.1 MHz; specifications extend up to and including 119.999999 MHz.

<sup>2</sup> Specifications extend up to and including 0.1 Hz less than the starting frequency of the next band.

<sup>3</sup> Specifications extend up to and including 1279.999998 MHz.

<sup>4</sup> This band available on HP 8663A only; specifications extend up to and including 2559.999996 MHz.

### Option 003 specified SSB phase noise for rear-panel 640 MHz output:

	spec	typ
1 Hz	-54	-64
10 Hz	-84	-94
100 Hz	-104	-114
1 kHz	-121	-126
3 kHz	-121	-127
5 kHz	-129	-138
10 kHz	-145	-149
100 kHz	-157	-159



# SIGNAL GENERATORS

## Modular Measurement System

HP 70340A  
(Preliminary Information)

447



HP 70340A



### HP 70340A Modular Synthesized Signal Generator All the Performance of Traditional Rack-n-Stack Sources in Half the Rack Space

Test receivers and subsystems from 1 GHz through 20 GHz with confidence knowing that even at full specified power (typically  $> +12$  dBm) the HP 70340A provides superior harmonic ( $-55$  dBc) and spurious ( $-60$  dBc) performance. Excellent output power accuracy ( $\pm 1$  dB) and flatness ( $\pm 0.6$  dB) is maintained across the full HP 70340A 100 dB dynamic range. Sweep power linearly and accurately to test power sensitive devices. Generate real world signals using the FM pulse and logarithmic AM modulations. The HP 70340A Modular Signal Generator satisfies the demands of tomorrow's ATE for a downsized, high performance modular signal source.

### Performance, Value, and Flexibility to Satisfy Any Application

Designed to meet the demanding requirements of modern ATE systems, the HP 70340A also excels as a benchtop or dedicated test station signal source. Combine the HP 70340A with other HP modular instruments to provide a high-performance communications test station. The high output power and low phase noise make the HP 70340A an excellent choice as a local oscillator for BER and C/N testing.

The HP 70340A is a natural companion signal source for the HP 71500A Microwave Transition Analyzer. Together these two modular instruments offer powerful component test capability in a small, easy to use package. Test pulsed components with ease using the HP 70340A clean, fast pulse modulation. Option 1E8 provides the 1 Hz frequency resolution needed for full system capability.

The HP 70340A is also a top performer in benchtop applications. The high performance and superior EMI shielding of the HP 70340 made it ideal for leading edge research and development, manufacturing, quality assurance, and metrology applications.

### The Platform for the Future

The HP 70340A is the first in a series of modular, high performance signal sources to come from HP. Proprietary microwave components and a new signal path architecture achieve a combination of output power, spectral purity, modulation, size, and weight unmatched in any other signal source. The extensive use of Surface Mount Technology provides high reliability while minimizing module size. Built-in functional verification routines ensure the HP 70340A delivers full performance and speed servicing. SCPI programming assures that ATE designed around the HP 70340A can realize all the advantages of modular systems in a consistent, fully transportable software environment.

- Broadband frequency coverage: 1 to 20 GHz
- High-performance modulation: AM, FM and Pulse
- Excellent spectral purity:  $-55$  dBc harmonics  
 $-60$  dBc spurious
- Outstanding output level accuracy and flatness
- Industry standard programming: SCPI

### Abbreviated Specifications

(For complete specifications refer to the HP 70340A technical data sheet, lit. no. 5091-1593.)

#### Frequency:

**Range:** 1.0 to 20 GHz

**Resolution:** 1 kHz; 1 Hz with Option 1E8

#### RF Output:

**Leveled Output Power:**  $+8$  dBm to  $-90$  dBm ( $0^\circ$  to  $35^\circ$  C)

**Resolution:** 0.01 dB

**Accuracy:**  $\pm 1$  dB ( $-4$  dBm to maximum power)

**Flatness:**  $\pm 0.6$  dB

#### Spectral Purity:

**SSB Phase Noise (10 kHz offset):**  $-86$  dBc/Hz @ 6 GHz  
 $-76$  dBc/Hz @ 18 GHz

**Harmonics:**  $< -55$  dBc

**Sub-Harmonics:** None

**Non-Harmonic Spurious:**  $< -60$  dBc

#### External Pulse Modulation

**On/Off Ratio:**  $> -80$  dB

**Minimum Pulse Width:**  $< 25$  nSec

**Max. Rise/Fall:**  $< 10$  nSec

#### External Frequency Modulation:

**Rates:** 1 kHz to 1 MHz

**Flatness:**  $\pm 2$  dB referenced to 100 kHz

**Maximum Deviation:** 10 MHz

**Maximum Modulation Index:**  $> 300$

#### External Amplitude Modulation

**Type:** Logarithmic AM (Scan Mod)

**Depth:** 0 to 60 dBc

**Sensitivity:**  $-10$  dB/Volt

**Step Response:**  $< 5 \mu$  sec (50 dB step)

#### General

**Environmental:** ( $0^\circ$  to  $55^\circ$  C)

Mil Std 461 (RE02, CE03, CS02, RS03)

Meets requirements for MMS hardware. See Prod. Note 70000-1, HP 70000 System Design System Overview for details.

**Weight:**  $< 9$  kg (20 lbs.) (module only)

**Size:** 4/8 wide MMS module

**Power:**  $< 80$  Watts

### Ordering Information

(Pricing was not final at press time. Please consult your HP sales representative for details.)

**HP 70340A** Modular Signal Generator

**Opt 1E1** Add Output Step Attenuator

**Opt 1E8** 1 Hz Frequency resolution

**Opt 1E9** 3.5 mm RF Output Connector

**Opt 0B2** Extra Operation Manual

**Opt 0B2** Service Manual

**Opt W30** 2 Add'l Years HP Service Warranty

# SIGNAL GENERATORS

## CW Microwave HP 8671B/HP 8673G

- 2 to 18 GHz and 2 to 26 GHz frequency range
- + 8 dBm calibrated output power
- Low spurious signals
- Low phase noise
- 128 dB dynamic range
- Digital sweep (HP 8673G only)

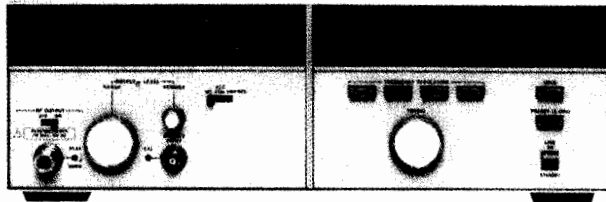

HP 8671B

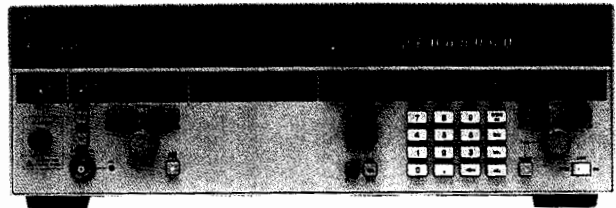

HP 8673G



### HP 8671B / HP 8673G Synthesized CW Sources

The HP 8671B and HP 8673G are value-packed synthesized CW generators that meet all the requirements for clean CW sources. The HP 8671B features 128 dB dynamic range, + 8 dBm calibrated output power, full programmability, low phase noise and low spurious signals. The HP 8673G adds features including synthesized sweep, mm-drive capability and programming compatibility with other HP 8673 series synthesized sources.

### Performance, Measurement Flexibility and Value

These synthesized CW generators are ideal solutions for applications requiring a microwave local oscillator. In up and down conversion applications, the low harmonics (to -40 dBc) and low phase noise provide plenty of dynamic range. The high output power (+10 dBm to 26 GHz with the HP 8673G Option 008) provides extra margin in ATE systems. When making component measurements, the HP 8673G synthesized sweep capability allows you to make quick swept measurements with synthesizer accuracy.

### Specifications

#### Frequency Characteristics

**Range:** HP 8671B 2.0 to 18.0 GHz (18.6 GHz overrange).

HP 8673G 2.0 to 26.0 GHz.

**Resolution:**

2.0 to 6.6 GHz: 1 kHz	Band 1
6.6 to 12.3 GHz: 2 kHz	Band 2
12.3 to 18.6 GHz: 3 kHz	Band 3
18.6 to 26.0 GHz: 4kHz	Band 4 (HP 8673G only)

#### Spectral Purity

**Single-sideband phase noise (1 Hz BW, CW mode):**

F <sub>c</sub>	Offset from F <sub>c</sub>				
	10 Hz	100 Hz	1 kHz	10 kHz	100 kHz
Band 1	-58 dBc	-70 dBc	-78 dBc	-86 dBc	-110 dBc
Band 2	-52 dBc	-64 dBc	-72 dBc	-80 dBc	-104 dBc
Band 3	-48 dBc	-60 dBc	-68 dBc	-76 dBc	-100 dBc
Band 4	-46 dBc	-58 dBc	-66 dBc	-74 dBc	-98 dBc

**Harmonics** (<0 dBm; +15° C to +35° C): HP 8673G < -40 dBc; HP 8671B: < -25 dBc

**Subharmonics and multiples thereof:** 2.0 to 18.6 GHz: < -25 dBc, 18.6 to 26 GHz: < -20 dBc (HP 8673G only)

**Spurious (non-harmonically related):** 2.0 to 18.6 GHz: < -60 dBc, 18.6 - 26.0 GHz: < -58 dBc (HP 8673G only)

**Spurious (power line and fan rotation related):** 2.0 to 18.6 GHz: < -40 dBc; 18.6 to 26.0 GHz: < -38 dBc (HP 8673G only)

### Output Characteristics

**Output Level: HP 8671B/HP 8673G:** 2.0 to 18.0 GHz: + 8 dBm

**HP 8673G only:** 18.0 to 22.0 GHz + 4 dBm

22.0 to 26.0 GHz + 1 dBm

**Opt 008: (HP 8673G only)** 2.0 to 8.0 GHz: + 8 dBm, 8.0 to 26.0 GHz: + 10 dBm

### General

**Digital Sweep Characteristics: (HP 8673G only)** Identical to HP 8673B

**Operating temperature range:** 0 to +55° C

**Power:** 100, 120, 220, 240V, +5%, -10%; 48-66 Hz; < 400 VA max

**Weight:** net, 29kg (64lb); shipping, 34.5kg (76lb)

**Size: HP 8673G:** 146 mm H × 425 mm W × 620 mm D (5.7 in × 16.8 in × 24.4 in)

**HP 8671B:** 133 mm H × 425 mm W × 603 mm D (5.25 in × 16.75 in × 23.75 in)

### Ordering Information

	Price
<b>HP 8673G</b> Synthesized CW Generator	\$29,900
<b>Opt 004</b> Rear Panel RF Output	+ \$75
<b>Opt 006</b> Chassis Slide Kit	+ \$75
<b>Opt 008</b> +10 dBm output power	+ \$5,000
<b>Opt 907</b> Front-panel Handle Kit (5062-3989)	+ \$55
<b>Opt 908</b> Rack Mounting Flange Kit (5062-3977)	+ \$33
<b>Opt 909</b> Front-panel & Rack Mounting Kits (5062-3983)	+ \$80
<b>Opt 910</b> Service Manual and Extra Operating Manual (08673-90105) (08673-90106) (08673-60097)	+ \$80
<b>Opt 915</b> Service Manual (08673-90106) (08673-60097)	+ \$65
<b>Opt W30</b> Extended Repair Service. See page 671.	+ \$725
<b>HP 8671B</b> Synthesized CW Generator	\$24,500
<b>Opt 907</b> Front-panel Handle Kit (5062-3989)	\$55
<b>Opt 908</b> Rack Mounting Flange Kit (5062-3977)	+ \$33
<b>Opt 909</b> Front-panel Handle Kit Plus Rack Mounting Flange Kit (5062-3983)	+ \$80
<b>Opt 910</b> Extra Operating and Service Manual (08671-90023) (08671-90026) (08672-60024)	+ \$60
<b>Opt W30</b> Extended Repair Service. See page 671.	+ \$600

☎ For off-the-shelf shipment, call 800-452-4844.

# SIGNAL GENERATORS

Economy Microwave

HP 8673H

449

- 2 to 12.4 GHz or 5.4 to 18 GHz
- +8 to -100 dBm calibrated output
- 0.1 dB resolution, digitally displayed

- AM/FM/Pulse Modulation
- Low spurious and phase noise
- Digital sweep

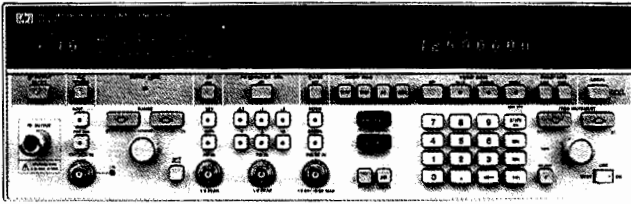

HP 8673H



## HP 8673H Multiband Synthesized Signal Generator

### Low Price, High Performance

When full 2.0 to 26.0 GHz frequency coverage is not needed, you can choose the HP 8673H Synthesized Signal Generator with the same reliability and performance at nearly half the cost of a 2 to 26 GHz synthesizer. Choose between Option 212 (2 to 12.4 GHz) and Option 618 (5.4 to 18.0 GHz) for the frequency coverage you need. What does high performance mean? Standard on either option of the HP 8673H is AM, FM, and pulse modulation, digital sweep, millimeter-drive capability and +8 dBm output power.

### Multiband Frequency Coverage for Multiple Applications

Whether your application is receiver test, component test, or frequency translation, the HP 8673H has the performance you need. For pulsed sensitivity testing of radar receivers, you can be confident that pulse shape fidelity will be maintained under all specified output power levels and pulse widths. Leveled output power to -100 dBm provides great dynamic range for sensitivity testing. Digital sweep and high output power make swept frequency component tests simple and easy. The HP 8673H allows measurement flexibility with variable sweep dwell and span. Low phase noise and wide FM deviations to 10 MHz allow for accurate signal substitution in communication systems. With the addition of the HP 83550 millimeter source modules, the HP 8673H gives you the capability to reach 110 GHz.

### Drop-in Confidence

The HP 8673H is ideal for automated test systems. Minimum output power of +8 dBm (see typical output power graph on page 450) means sufficient power at the device under test even after losses through switches and cables. For systems that use proven software for an HP 8673 synthesizer, the HP 8673H is a drop-in replacement.

### Reliability You Can Count On

Acquisition cost is an important factor in any purchase decision. But what about cost-of-ownership? As a member of the field-proven HP 8673 family, the HP 8673H comes to you with an estimated 20,000 hours mean time between failure (based on component warranty failure rates). To guarantee that the first three years of your HP 8673H are worry-free, Option W30 provides three years of return-to-HP service.

## HP 8673H Specifications

### Frequency Characteristics

**Range:** 2.0 to 12.4 GHz (Option 212)  
5.4 to 18.0 GHz (Option 618)

**Resolution:** 2.0 to 6.6 GHz: 1 kHz (Band 1)  
6.6 to 12.3 GHz: 2 kHz (Band 2)  
12.3 to 18.0 GHz: 3 kHz (Band 3)

### Spectral Purity

Single-sideband phase noise (1 Hz BW, 1 kHz offset, CW mode):

F <sub>c</sub>	Offset from F <sub>c</sub>				
	10 Hz	100 Hz	1 kHz	10 kHz	100 kHz
Band 1	-58 dBc	-70 dBc	-78 dBc	-86 dBc	-110 dBc
Band 2	-52 dBc	-64 dBc	-72 dBc	-80 dBc	-104 dBc
Band 3	-48 dBc	-60 dBc	-68 dBc	-76 dBc	-100 dBc

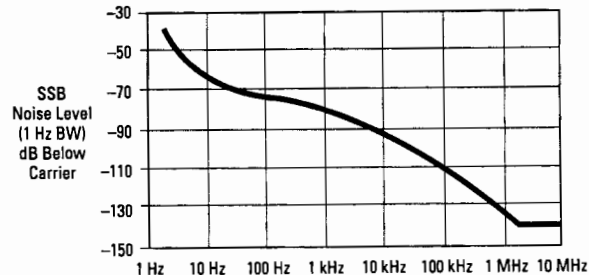

Typical HP 8673H single-sideband phase noise performance using the internal high stability time base, Band 1.

**Harmonics (< 0 dBm; +15° C to +35° C):** < -40 dBc  
**Subharmonics and multiples thereof:** ≤ -25 dBc

### Output Characteristics

**Output level (+15° C to +35° C):** +8 to -100 dBm  
**Resolution:** 0.1 dB

### Pulse Modulation

**ON/OFF ratio:** > 80 dB  
**Rise/fall times:** < 35 ns  
**Pulse repetition frequency:** 50 Hz to 1 MHz  
**Minimum duty cycle:** < 0.0001 for leveled performance

### Amplitude Modulation

**Depth:** 0 to 75%, at 0 dBm maximum carrier level, +15° C to +35° C  
**Rate (30% depth):** 10 Hz to 100 kHz, ± 3 dB  
**Sensitivity:** 30%/Volt and 100%/Volt ranges

### Frequency Modulation

Deviation Range	Rate (± 3 dB BW, typical)	Maximum Peak Deviation
30, 100 kHz/V	100 Hz to 10 MHz	The smaller of 10 MHz or:
0.3, 1, 3 MHz/V	1 kHz to 10 MHz	fmod × 5, Band 1
10 MHz/V	1 kHz to 10 MHz	fmod × 10, Band 2
		fmod × 15, Band 3

### General

**Digital sweep characteristics:** Identical to HP 8673B  
**Remote programming:** All functions HP-IB programmable except line switch.  
**Operating temperature range:** 0 to +55° C  
**Power:** 100, 120, 220, 240V, +5%, -10%: 48 to 66 Hz; 400 VA max  
**Weight:** Net, 29 kg (64 lb); shipping, 34.5 kg (76 lb)  
**Size:** 146 H × 425 W × 620 mm D (5.7 in × 16 in × 24.4 in)

### Ordering Information

HP 8673H Synthesized Signal Generator

	Price
Opt 212 or Option 618	\$24,500
Opt 004 Rear Panel RF Output	+ \$75
Opt 006 Chassis Slide Kit	+ \$75
Opt 907 Front Panel Handle Kit (5062-3989)	+ \$55
Opt 908 Rack Mounting Flange Kit (5062-3977)	+ \$33
Opt 909 Front Panel & Rackmounting Kits (5062-3983)	+ \$80
Opt 915 Service Manual (08673-90114), (08673-09116), (08673-60097)	+ \$65
Opt 916 Extra Operating Manual (08673-90119)	+ \$20
Opt W30 Extended Repair Service. See page 671.	+ \$575

☎ For off-the-shelf shipment, call 800-452-4844.

# SIGNAL GENERATORS

## High-Performance Microwave

HP 8673B, 8673C, 8673D, 8673E

- 10 MHz to 26.5 GHz frequency range
- $< -60$  dBc harmonics/subharmonics
- Low spurious and phase noise

- +8 to -100 dBm calibrated output
- Internally leveled AM/FM/pulse modulation
- Frequency extension capability to 110 GHz

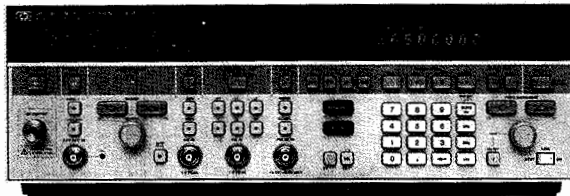

HP 8673B

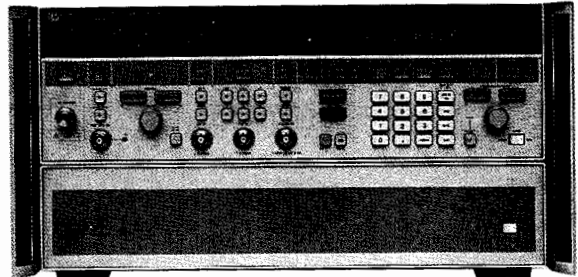

HP 8673D



### HP 8673B, 8673C, 8673D, and 8673E Synthesized Signal Generators

The HP 8673B/C/D/E Synthesized Signal Generators are full-performance synthesizers designed to generate precise microwave signals over the 50 MHz to 26.5 GHz frequency range. These generators offer calibrated and leveled power, AM, FM, pulse modulation, digital sweep, programmability, and frequency extension capability to 110 GHz. The HP 8673B covers 2.0 to 26.5 GHz. The HP 8673C/D pair cover 50 MHz to 18.6 GHz and 26.5 GHz respectively and the HP 8673E covers 2.0 to 18.6 GHz.

#### Excellent Spectral Purity

A variety of applications ranging from microwave radar to communications systems require the frequency stability available from the HP 8673B/C/D/E. The broadband frequency coverage is derived from multiplying a fundamental 2.0 to 6.6 GHz YIG-tuned oscillator. This technique provides the wide frequency coverage in a single instrument. Indirect synthesis phase-locks the YIG-tuned oscillator to a 10 MHz quartz crystal reference to provide excellent long term and short term stability (frequency drift  $< 5 \times 10^{-10}$  per day), (HP 8673B/C/D). Phase locked loops are optimized for lowest possible single-sideband phase noise. The HP 8673C and HP 8673D include an internal tracking YIG-filter to further reduce unwanted harmonic, subharmonic, and nonharmonic spurious signals above 1.2 GHz to  $< -60$  dBc.

#### Wide Dynamic Output Range

For broadband component and receiver testing applications, the HP 8673B/C/D/E deliver exceptionally flat power output across the full frequency ranges. For receiver sensitivity measurements, power is internally (or externally) leveled to -100 dBm (-120 dBm for the HP 8673E). Maximum available power varies with frequency as shown in the figure below.

#### Internally Leveled Pulse Modulation

The HP 8673B/C/D/E features an internal pulse modulator that provides high-quality pulse modulation over the entire 50 MHz to 26.5 GHz range. Since the modulation is done before the frequency multiplication, the peak pulsed power can be leveled and calibrated to within typically +1.5/-1.0 dBm of the set level referenced to CW. External TTL level pulse rates up to 1 MHz and pulse widths as narrow as 100 ns can be easily accommodated by the HP 8673B/C/D/E to provide ON/OFF ratios in excess of 80 dB.

#### Calibrated AM/FM Modulation

AM and FM capability is included in the HP 8673B/C/D/E to expand the versatility in receiver testing applications. AM depth at rates up to 100 kHz can be accurately set using the front panel meter. Six ranges of metered FM are available at rates and peak deviations up to 10 MHz. The HP 8673E features unlocked mode which allows up to 10 MHz deviation at rates as low as 50 Hz. Both AM depth and FM deviation are linearly controlled by varying the externally supplied modulating input voltage up to 1V peak. Simultaneous modulation of AM, FM, and pulse is possible to simulate complex environments.

#### Frequency Extension to 110 GHz

The HP 8673B/C/D can be used as microwave drivers for the HP 83550-series millimeter-wave source modules. This combination (with the addition of the HP 8349B Microwave Amplifier) can provide leveled output signals up to 110 GHz with the "System Leveling" mode. The resultant output frequency can be displayed on the HP 8673B/C/D front panel by entering the multiplication factor of the source module.

#### Full Programmability and Digital Sweep

The HP 8673B/C/D/E provide full programmability of all front panel functions for automatic test applications. Output level can be controlled in steps as fine as 0.1 dB. An internal microprocessor is used to simplify HP-IB program code generation and follow front-panel keystroke sequences. This design allows the implementation of digital sweep. Sweep spans can be set over the entire frequency range with variable rates, step sizes, and selectable markers available.

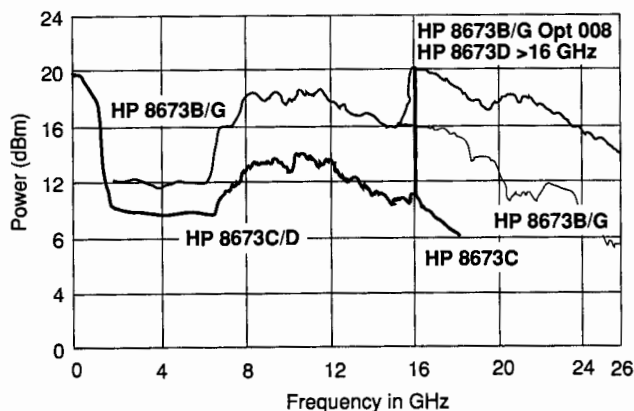

Maximum power typically available from HP 8673B/C/D/G and HP 8673B/G Option 008 at 25° C. HP 8673E and HP 8673H Option 212 and Option 618 typical maximum power is the same as HP 8673B/G over 2.0 to 18.0 GHz.



# SIGNAL GENERATORS

## Synthesized Sweepers 10 MHz to 50 GHz (or 110 GHz)

### HP 8360 Series

- 1 Hz frequency resolution (Option 008)
- Low spurious and phase noise
- +20 dBm to -110 dBm calibrated output

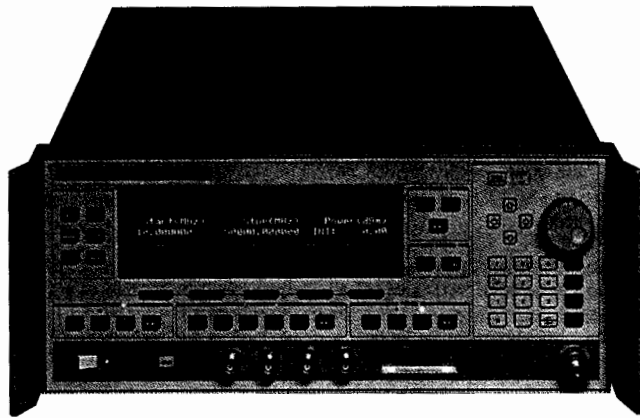

### HP 8360 Series Synthesized Sweepers

The HP 8360 series synthesized sweepers are the standard of excellence for applications requiring the high performance and accuracy of a synthesized source and the speed and versatility of a sweep oscillator. The HP 8360 series synthesized sweepers offer the same standard of commitment to quality and reliability that was inherent in the previous industry standard HP 8340/8341.

#### Frequency Precision and Spectral Purity

The synthesized broadband frequency coverage and precise 1 Hz frequency resolution (Option 008) are generated by indirect synthesis, enabling the HP 8360 to achieve the same low single-sideband phase noise performance as the HP 8671B, the HP 8672A, and the HP 8673 series synthesized signal generators.

#### < -50 dBc Harmonics

The HP 8360 delivers excellent harmonic performance with harmonics at least 50 dB below the carrier from 1.8 to 20 GHz, and at least 35 dB below the carrier above 20 GHz.

#### Pulse, Scan, Amplitude, and Frequency Modulation

High-performance pulse modulators with >80 dB on/off ratio, and rise/fall times <10 ns (Option 006), make the HP 8360 suitable for the most demanding pulse modulation applications.

In addition to its linear AM mode (100%/V), the HP 8360 offers a scan modulation mode (10 dB/V). Both modes have dc-coupled amplitude modulation capability with a 3 dB bandwidth of 100 kHz, and 99.7% (50 dB) of modulation depth. Pulse and amplitude modulation capabilities can be used independently and simultaneously.

The HP 8360 also offers dc-coupled frequency modulation capabilities with rates up to 10 MHz.

#### Specifications

(See technical data sheet for complete specifications.)

#### Frequency

Range (by model):

HP 83620A	10 MHz to 20 GHz
HP 83622A	2 to 20 GHz
HP 83623A	10 MHz to 20 GHz (High Power)
HP 83624A	2 to 20 GHz (High Power)
HP 83630A	10 MHz to 26.5 GHz
HP 83640A	10 MHz to 40 GHz
HP 83650A	10 MHz to 50 GHz

Resolution: 1 kHz standard, 1 Hz optional.

Time base: Internal 10 MHz time base. Aging rate: less than  $5 \times 10^{-10}$ /day,  $1 \times 10^{-7}$ /year after 30-day warm-up.

#### RF Output

Range: +20 to -110 dBm

Resolution: 0.02 dB

Maximum leveled power (by model):

HP 83620A	+10 dBm	HP 83630A	+4 dBm
HP 83622A	+10 dBm	HP 83640A	+2 dBm
HP 83623A	+17 dBm	HP 83650A	0 dBm
HP 83624A	+20 dBm		

#### RF output connector:

3.5 mm on 20 GHz models, 2.4 mm on 40 and 50 GHz models; nominal 50  $\Omega$  output impedance.

- Pulse, amplitude, and frequency modulation
- Complete analog sweeper
- < -50 dBc harmonics 1.8 to 20 GHz

#### Spectral Purity

##### Harmonics and subharmonics:

- < -50 dBc at output frequencies < 20 GHz
- < -40 dBc at output frequencies < 40 GHz
- < -35 dBc at output frequencies > 40 GHz

##### Non-harmonically related spurious:

- < -60 dBc at output frequencies > 20 GHz
- < -52 dBc at output frequencies < 20 GHz

##### Single-sideband phase noise (dBc/1 Hz BW, CW Mode):

Frequency Range (GHz)	Offset from Carrier			
	100 Hz	1 kHz	10 kHz	100 kHz
0.01 to 7.0	-70	-78	-86	-107
7.0 to 13.5	-64	-72	-80	-101
13.5 to 20.0	-60	-68	-76	-97
20.0 to 26.5	-58	-66	-74	-95
26.5 to 33.4	-54	-62	-70	-91
33.4 to 40.0	-54	-62	-70	-91
40.0 to 50.0	-52	-60	-68	-89

#### Modulation

##### Pulse Modulation

On/off ratio: > 80 dB

Rise and fall times: < 50 ns (< 10 ns optional)

Minimum internally leveled RF pulse width: < 1  $\mu$ s

Minimum unleveled RF pulse width: < 100 ns (20 ns with Opt 006)

##### Scan and Amplitude Modulation

Rates (3dB BW): dc to 100 kHz

Depth: 0 to 90% (20 dB) and 0 to 99.7% (50 dB) above 10 Hz

Sensitivity: 100%/V and 10 dB/V

##### Frequency Modulation

###### Locked mode

Modulation rate (6 dB BW, 1 MHz deviation): 50 kHz to 10 MHz

Maximum deviations: 8 MHz

###### Unlocked mode

Modulation rate (6 dB BW, 1 MHz deviation): dc to 10 MHz

Maximum deviations: At rates  $\leq$  100 Hz:  $\pm$  75 MHz

At rates > 100 Hz:  $\pm$  8 MHz

Sensitivity: 1 MHz/V or 10 MHz/V, user-selectable

#### Internal Modulation Generator (Opt 002)

##### AM, FM

Waveforms: Sine, square, triangle, ramp, noise

##### Rate

Range: Sine: 1 Hz to 1 MHz

Square, triangle, ramp: 1 Hz to 100 kHz

Resolution: 1 Hz

##### Depth, deviation

Range and Accuracy: same as base instrument

Resolution: 0.1%

##### Pulse

Modes: Free-run, gated, triggered, delayed

Period range: 300 ns to 400 ms

Resolution: 25 ns

Width range: 25 ns to 400 ms

Accuracy: 5 ns

##### Video delay

Internal sync pulse: 0 to 400 ms

Externally supplied sync pulse: 225 ns to 400 ms

#### Ordering Information

##### HP 8360 Models

HP 83620A Synthesized Sweeper	\$37,000
HP 83622A Synthesized Sweeper	\$32,900
HP 83623A Synthesized Sweeper	\$44,000
HP 83624A Synthesized Sweeper	\$39,900
HP 83630A Synthesized Sweeper	\$46,000
HP 83640A Synthesized Sweeper	\$52,000
HP 83650A Synthesized Sweeper	\$56,000

Opt 001 Add Step Attenuator \$2,000/\$3,800

Opt 002 Internal Modulation Generator \$3,500

Opt 003 Delete Front Panel Keyboard/Display -\$1,500

Opt 004 Rear Panel RF Output \$200

Opt 006 Fast Pulse Modulation \$4,000

Opt 008 1 Hz Frequency Resolution \$2,500

Opt 700 Mate System Compatibility \$4,000

Opt W30 Extended Repair Service (See page 671)

##### Dedicated HP 8510 Synthesized Sweepers

HP 83621A Synthesized Source \$33,900

HP 83631A Synthesized Source \$44,000

HP 83651A Synthesized Source \$49,900

Opt W30 Extended Repair Service (See page 671)

- CAE system design and hardware verification
- Comdisco SPW-compatible
- 100-MHz modulation bandwidth

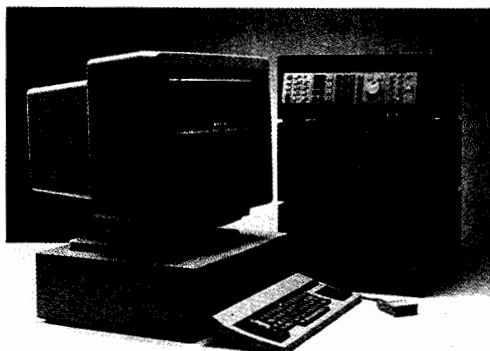

### The RF Simulator WorkSystem

Use Comdisco's Signal Processing WorkSystem (SPW) to design sophisticated communications systems, then verify your hardware performance with radio frequency (RF) signals generated by an HP Vector Arbitrary Waveform Synthesizer (VAWS). Dramatically reduce your design cycle times with the RF Simulator WorkSystem by doing "what-if" analysis on your system designs before committing to a specific system topology.

The RF Simulator WorkSystem combines the power of system simulation and the reality-check of complex RF simulation by linking SPW and HP VAWS into a self-contained design and verification system.

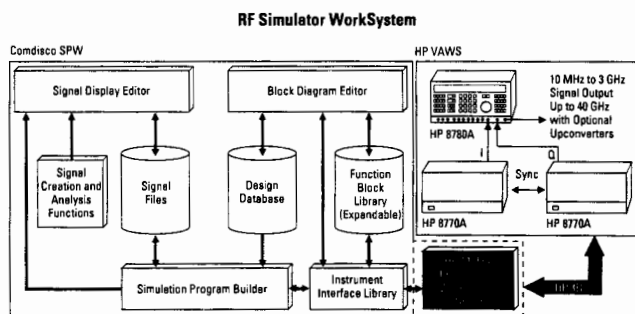

### Signal Processing WorkSystem (SPW)

Comdisco Systems' SPW is a fully integrated UNIX-based software package that provides you all the tools you need to graphically and interactively capture, simulate, test, and implement a broad range of RF system and digital signal processing (DSP) designs. Using standard library blocks, the Block Diagram Editor (BDE) lets you graphically prototype elements such as modulators, digital filters, transmitters, receivers, and even full satellite channels. Once designed, you can simulate the entire block diagram in software. You can even capture signals from the real world or use mathematically defined waveforms constructed with the Signal Display Editor (SDE) to inject into your simulation. Then use the SDE to analyze signals at any point in a simulated block diagram by displaying Fast Fourier transforms (FFTs), bit error rate, eye diagrams, and more. The applications are limitless. For more details on SPW and a complete list of blocks available, please refer to the SPW datasheet from Comdisco Systems.

### HP Vector Arbitrary Waveform Synthesizer (VAWS)

HP VAWS combines two high-performance HP 8770A Arbitrary Waveform Synthesizers (AWS) driving the I and Q modulation inputs of an HP 8780A Vector Signal Generator. The extremely clean AWS outputs and calibrated vector modulator synergistically provide complex modulated signals to 3 GHz with up to 100 MHz instantaneous bandwidth. Signals up to 40 GHz and beyond are yours for the asking with standard and custom HP upconverters. The availability of I/Q baseband outputs, in addition to a wideband modulated carrier and coherent reference, make the HP VAWS an excellent RF test generator for many modern communications applications.

- Upconversion to 40 GHz
- Exceptional I/Q performance
- Integrated design and verification

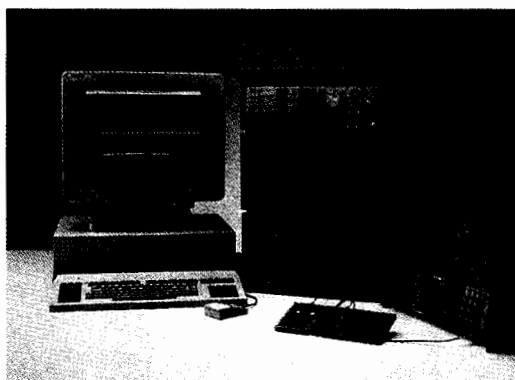

### RF Simulator WorkSystem Driver

The HP 11755A RF Simulator WorkSystem Driver brings the power of Comdisco's SPW and HP VAWS together. Select from a palette of SPW blocks to merge HP VAWS into your system block diagram. Then, with just a click of the mouse, you can produce the actual RF signal at that node. To achieve unprecedented image rejection, take advantage of the powerful built-in I/Q compensation algorithm that virtually eliminates quadrature error, gain imbalance, and carrier leakage. With 512-K, 12-bit word pairs (clocked at 125 MHz) HP VAWS can produce a broad range of signals with up to a 100-MHz arbitrary bandwidth and a playback time of at least 4 ms. To put that in perspective, that's over four times the memory required to simulate a 2<sup>15</sup>-1 sequence at a 36-MHz symbol rate. Much longer scenarios are possible using sequencing techniques or lower clock rates. For example, in certain cellular Rayleigh fading applications, you can achieve a 12-second scenario with a 30-kHz bandwidth.

### HP VAWS Specifications

Summarized below are some significant characteristics of an HP VAWS system. Please consult the HP 11755A data sheet for further details.

- Output frequency:** 10 MHz to 3 GHz (upconverters available to 40 GHz and beyond)
- Modulation bandwidth:** > 100 MHz
- Output level:** -100 to +4 dBm
- Memory length:** 512 K I/Q word pairs
- Clock rate:** 125 Msamples/sec (internal)  
10 to 130 MHz (external)  
2, 4, 8, ..., 256 rate dividers
- Image rejection:** > 45 dB after compensation (25 dB without)
- Carrier leakage:** < -45 dB after compensation (-20 dB without)

### Computer Platforms

The HP 11755A RF Simulator WorkSystem Driver is supported on the HP/Apollo 425S, DN3500, DN4500, and Sun-4 platforms. For details on other platforms, contact Comdisco.

### Ordering Information

- A complete RF Simulator WorkSystem is composed of:
- A workstation equipped with HP-IB running Comdisco's Signal Processing WorkSystem
  - HP 11755A RF Simulator WorkSystem Driver
  - 2 HP 8770A Arbitrary Waveform Synthesizers
  - 1 HP 8780A Vector Signal Generator
  - BNC and HP-IB cables and other accessories (see the HP 11755A datasheet for details)

For Signal Processing WorkSystem ordering information, contact Comdisco at:

Comdisco Systems, Inc.  
919 E. Hillsdale Blvd.  
Foster City, CA 94404  
(415) 574-5800, FAX: (415) 358-3601

**HP 11755A RF Simulator WorkSystem Driver**

**Price**  
\$5,000

# SIGNAL GENERATORS

## Frequency Agile/Complex Signal Simulation

### HP 8770S, 8770A, 11776A

- Unmatched spectral purity
- Source of "real-life" signals to 50 MHz
- A software reconfigurable modulation source
- Simulate very complex baseband and IF signals
- Outstanding reliability (> 100,000 hrs MTBF)
- 125-MHz sample rate
- 12-bit resolution, 512K word memory

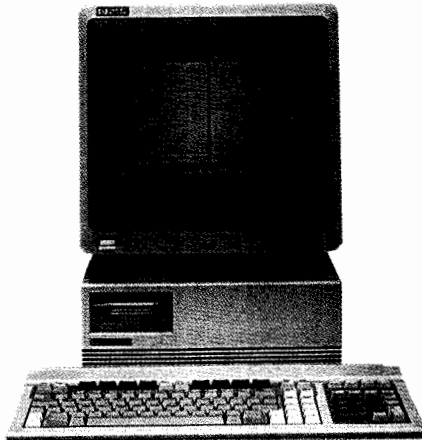

HP 11776A

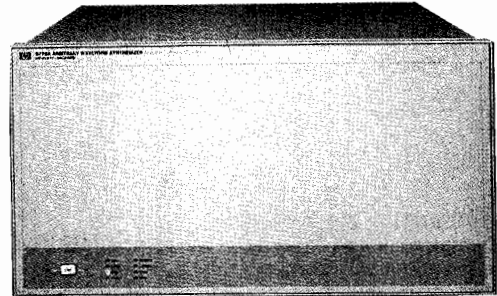

HP 8770A

## HP 8770S Signal Simulator System, dc–50 MHz

### Simulate Signals for Radar, EW, Communications, Magnetic Disk, and Other Applications

Today's sophisticated electronic systems require "real-life" functional testing to ensure that they will perform properly under their intended operating conditions. The HP 8770S helps you answer critical questions: "Will this radar accurately detect and decode multiple targets? Will my EW receiver correctly identify advanced threats? Will this digital communications receiver properly reconstruct transmitted signals in the presence of fading or jamming? Will this magnetic disk read circuit respond properly to a missing bit?"

#### Description

The HP 8770S Signal Simulator System consists of the:

- HP 8770A Arbitrary Waveform Synthesizer
- HP 9000 Series 300 Technical Computer
- HP 11776A Waveform Generation Software

You design waveforms with the software, then generate the waveforms with the HP 8770A. Use this advanced simulation system to generate complex baseband and IF signals from dc to 50 MHz. Add precise amounts of distortion and noise to test the operating margins of your system early in the development cycle. All signal parameters are under complete software control, allowing quick changes to meet new test demands. The HP 8770A has a complete HP-IB command set for full automatic control and easy downloading of waveform data previously defined by the HP 11776A, or by other means. Regardless of your application, the use of precise, complex test signals improves the evaluation of your circuits and systems.

The HP 8770A Arbitrary Waveform Synthesizer (AWS) forms the heart of the HP 8770S. Advanced digital synthesis techniques ensure precise waveform generation.

#### Features

- 8-ns sample update rate
- 12-bit words
- 125-MHz internal clock (phase-locks to crystal osc.)
- Special "deglitching" circuits
- 110-dB RF attenuator
- 512-K memory

#### Benefits

- Rapid signal parameter changes
- High-amplitude resolution
- Time base with synthesizer accuracy
- Low harmonic and spurious distortion levels
- 12-bit resolution even at low signal levels
- Highly complex waveforms, longer waveform sequences

The HP 11776A Waveform Generation Software operates on the HP 9000 Series 300 technical computers. It consists of the Waveform Generation Language (WGL), an HP BASIC 5.13 operating system, and application disks for powerful waveform development. Use over 100 easy commands and math functions to create and manipulate waveforms as desired. Add noise or spurs to generate real-life test signals. Add waveforms together to create harmonically-distorted waves, or multiply waves to create complex modulated signals. Create waves in either the frequency or time domain and quickly convert from one to the other. Capture data from other instruments such as spectrum analyzers and oscilloscopes. Once waveforms have been developed, you can download them into the HP 8770A for immediate generation, or store them on a disk for later use in multiple stations. Thus, WGL makes "what if" testing to determine a device's performance easy and affordable.

### Build Waveform Libraries for Complete Tests

Any HP-IB computer can control the HP 8770A and download previously defined waveform data. Generate a library of test waveforms with the HP 11776A software or your own BASIC program. Then download them to the HP 8770A from the computer in your ATE system for use in your applications.

### Stretch Memory with Sequencing

Certain parts of waveforms often repeat themselves and quickly fill up even the largest memory. This leaves less memory to define the rest of the desired test signal. The HP 8770A avoids this problem by allowing sections of memory (packets) to be repeated any number of times and in any order. This sequencing capability and the large 512-K word memory free large amounts of memory for greater flexibility when defining complex waves. Many test signals can also be stored simultaneously in the memory and accessed at any time with the sequencer. In a production ATE environment, this substantially decreases download time, reducing costs.

## Applications Overview

### Radar

The HP 8770S simulates multiple targets for more effective radar testing. Simulate complex radar video and IF signals. Add noise, pulse jitter, and clutter. Shape radar chirps to exact specifications. Stagger multiple radar pulses. Vary the PRF as a function of time. Control radar pulse parameters with extremely precise resolution. Finally, manipulate Doppler shift and range or superimpose multiple targets together, resulting in complex, demanding test signals.



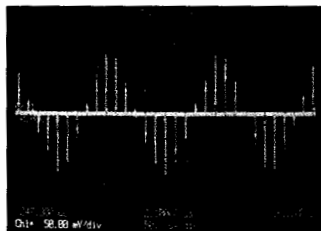

Doppler-shifted return of moving target

**Electronic Warfare**

Simulate MOP, exotic threats, and other complex modulated signals to test next-generation EW receivers and signal processors. Vary pulse amplitudes, rise and fall times, pulse width, PRI, and stagger of individual radars.

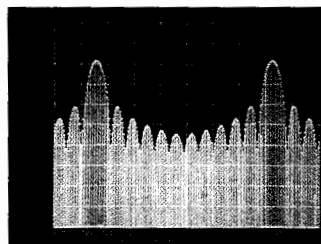

Antenna scan pattern

**Communications**

The HP 8770S is an excellent signal simulator for conventional analog communication systems, digital microwave radios, and satellite communications systems. Design and generate amplitude-, frequency-, and phase-modulated communications signals with digital precision. Exploit memory sequencing to hop from one frequency to the next with fast frequency switching speed and phase continuity. Simulate Nyquist filter responses in software to eliminate time-consuming and costly hardware filters.

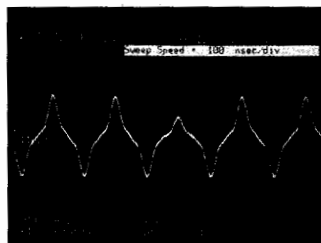

Missing bit

**Magnetic Disk**

The signal simulation system continues to be extremely successful in magnetic disk applications. Replace the head disk assembly to test read/servo channel boards for design integrity, calibrate disk media certifiers, or verify board operation in production test. Test bit shift susceptibility to less than 50-ps shift resolution. The Programmer's Starter Kit (P/N 08770-60064) interactively creates seven common disk-test waveforms.

**Other Applications**

- Video and Imaging
- Component Test

**HP 8770A Performance Characteristics**

**Frequency**

**Range:** dc to 50 MHz

**Frequency Switching Speed:** 8 ns, phase continuous

**RF output**

**Power range:** +10 dBm to -110 dBm

**Attenuator:** 110 dB in 10 dB steps

**Max Output Voltage:** 2 V peak-to-peak into 50 or 75 ohms

**Number of DAC bits:** 12 true bits, monotonic

**Amplitude Resolution:** .024% of full scale

**Amplitude Flatness:** < ±0.65 dB (<0.1 dB w/predistortion)

**Phase Linearity (dc - 50 MHz):** ±5° (< ±1° w/predistortion)

**Output Impedance:** 50 Ω (75 Ω for Option 002)

**Output SWR:** <1.2:1

**Connector:** Type N (female)

**Spectral Purity**

**Harmonic Distortion (output level = +10 dBm):**

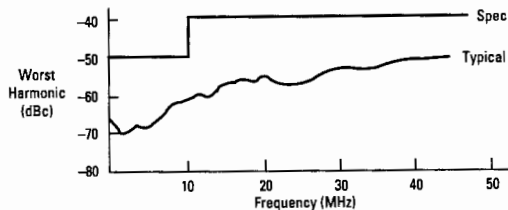

**Inband Spurious and Nonharmonic Distortion:**

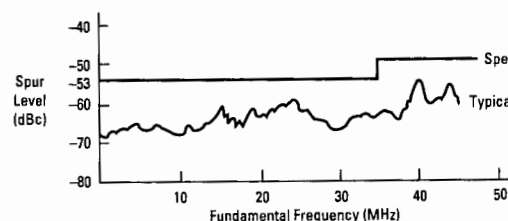

**Two-Tone Intermodulation Distortion:** < -65dBc for a 10.000 MHz and 10.124 MHz signal at +4 dBm each

**SSB Phase Noise @ 10MHz:** < -120 dBc/Hz @ 10 kHz offset.

**Modulation Capabilities**

AM, FM, ΦM, Chirp, Pulse, Digital (BPSK, QPSK, BPSK, QAM), Antenna Scan, I/Q

**External System Triggering:** Repetitive, Single-Shot, Gated

**Outputs:** Scan Start, Packet Start, Sequence Start, Equal Address, Packet Advance Ready

**Inputs:** Packet Advance Trigger, System Start Trigger, System Stop Trigger

**Clock**

**Sampling Clock Rate:** 125 MHz (externally variable)

**Reference Oscillator:** 10MHz quartz crystal. Aging rate < 5×10<sup>-10</sup>/day after a 24-hour warm-up and an oscillator time-off of less than 24 hours.

**Remote Operation**

HP-IB and 16-bit GPIO parallel port

**General**

**Operating Temperature:** 15° to 40° C

**Power:** 445 VA

**Weight:** Net, 23.6 kg (52 lb); shipping, 29.5 kg (65 lb).

**Size:** 235 mm H × 425.5 mm W × 622 mm D (9.25 in × 16.75 in × 24.5 in)

**Ordering Information**

**HP 8770S** Signal Simulator System

**Price**

\$0

To ensure coordination of shipments and compatibility of instruments, computers, and software, use the system model number when ordering individual components. Obtain the HP 8770A and HP 11776A Data Sheet and an HP 8770S Ordering Guide from your local sales office.

**HP 8770A** Arbitrary Waveform Synthesizer

\$26,000

**Opt 907** Front-Panel Handles (5062-3991)

\$75

**Opt 908** Rack Mount Flange Kit (5062-3979)

\$40

**Opt 909** Rack Flange Kit with Front Handles (5062-3985)

\$105

**Opt 915** Add Service Manual (08770-90019)

\$40

**Opt 916** Extra Operating Manual (08770-90036)

\$25

**Opt 002:** 75 ohm Output Impedance

\$0

**Opt H12:** Digital Data Output

\$500

**Opt W30** Extended Repair Service. See page 671.

\$595

**Opt W32** Calibration Service.

\$285

**HP 11776A** Waveform Generation Software (5¼-in Diskettes Standard)

\$7,000

**Opt 630:** 3½-in Diskettes Only

\$0

**HP P/N 08770-60064** Programmer Starter Kit

\$75

Other software to control HP 8770A

Contact HP

# SIGNAL GENERATORS

## Frequency Agile/Complex Signal Simulation

HP 8645A

- 252 kHz to 1030 MHz frequency range with optional coverage to 2060 MHz
- 15  $\mu$ s frequency switching
- Standalone control of frequency agility

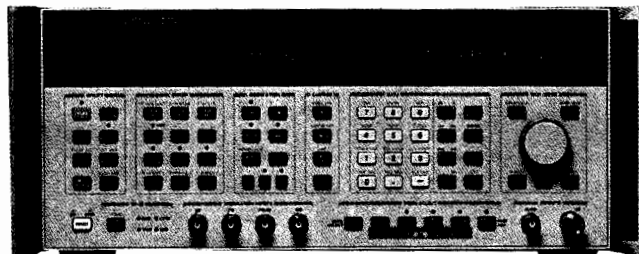

HP 8645A



### HP 8645A Agile Signal Generator

The HP 8645A Agile Signal Generator combines high performance with frequency agility for new fast-switching test requirements. These capabilities are important for performance testing of such devices as frequency agile radios and surveillance receivers. Besides extending traditional receiver testing to agile applications, the HP 8645A can be used to create complex signal simulations involving several modulation types and frequency agility. These complex RF signals can quantitatively exercise a receiver's vulnerability to a jamming transmission. The HP 8645A can also be a fast-switching stimulus needed to decrease production test times. The high performance and frequency agility of the HP 8645A provide capability for both static and agile test requirements with just one calibrated signal generator.

### Specified Agile Performance

The HP 8645A provides specified signal performance in both static and agile operation. Fully-synthesized outputs with high timebase accuracy are standard when not frequency hopping. The Fast Hop mode activates a frequency-lock loop to allow frequency switching as fast as 15  $\mu$ sec from 128 to 2060 MHz. Over the frequency range of 8 to 2060 MHz, the fastest switching time is 85  $\mu$ sec and outputs below 8 MHz require 500  $\mu$ sec. Frequency accuracy of each output is better than  $\pm 2$  ppm while in Fast Hop mode. At each frequency, a specific amplitude can be assigned within a 20 dB range for performance tests versus amplitude while frequency hopping. For a full test of a receiver, up to 8000 frequencies can be entered and sequences of up to 8000 frequency settings can be specified. Performance parameters such as phase noise, spurious, amplitude accuracy, and modulation remain high quality and are completely specified while fast hopping to insure confident test results.

### Flexible, High-Performance Modulation

For receiver measurements the HP 8645A offers independent or simultaneous FM and AM for both static and hopped frequency tests. The modulating signal can be the internal 0.1 Hz to 400 kHz synthesizer or an external input that allows FM deviations up to 20 MHz at rates up to 10 MHz. In Fast Hop operation, maximum deviation is 3.5 MHz with 10 MHz rates. AM is available with up to 100 kHz rates and 99% depth. Pulse modulation allows a 35 dB on/off ratio with 100 nsec rise/fall times.

### Complete Control of Frequency Hopping

The HP 8645A offers flexible and comprehensive control of the frequency hopping output. Parameters can be entered from the front panel, through the HP-IB port or using TTL inputs on the rear panel. Extensive hopped frequency simulations including hop frequencies, amplitude, dwell times, hop rate, modulation, and so forth can be entered into nonvolatile memory from the front panel. Activating a hop sequence requires only a press of the Hop key. Agile control is available by a computer with the added advantage of using the new Hewlett-Packard Systems Language (HP-SL). For real-time control, rear-panel inputs accept TTL signals for triggering, dwell time, and frequency selection to allow direct connection with the hardware

- Specified performance while fast hopping
- FM rates to 10 MHz, deviations to 20 MHz
- Low spurious and phase noise

under test. With this wide choice of control, use of the HP 8645A can be readily customized to a wide variety of test situations from bench-top use to ATE systems.

### HP 8645A Specifications

#### Frequency

**Range:** 251.46485 kHz to 1030 MHz; 251.46485 kHz to 2060 MHz with Option 002 or with HP 11845A 2 GHz Retrofit Kit installed

**Frequency bands:** The exact endpoints of each frequency band can be determined by dividing the 1030 to 2060 MHz band by two for each band decrease. The specifications use approximate endpoints.

**Phase offset:** Adjustable in 1 degree increments

**Reference oscillator stability, Option 001:**  $< 5 \times 10^{-10}$ /day aging

#### Fast Hop Operation

**Frequency switching time:** 128 to 2060 MHz:  $< 15 \mu$ sec, 8 to 2060 MHz:  $< 85 \mu$ sec, 0.25 to 2060 MHz:  $< 500 \mu$ sec. Opt. 002: add 5  $\mu$ sec.

**Frequency hop range:** 0.25 to 2060 MHz. With FM on, limited to any three consecutive frequency bands.

**Frequency accuracy:**  $\pm 2$  ppm of carrier frequency

**Amplitude accuracy:**  $\pm 1$  dB,  $> -127$  dBm output ( $\pm 1.5$  dB,  $> -127$  dBm output when amplitude level is varied up to  $-5$  dB from the constant learned value during Fast Hop)

**Channel and sequence tables:** In Fast Hop, each specific frequency and amplitude to be output is entered into a Channel Table. The order of channels to be output is entered into a Sequence Table.

**Maximum number of channels:** 8000

**Maximum number of channels in sequence table:** 8000

**Hop rate range:** Fixed rates from 8 Hz to 50 kHz using internal timer. An external input allows more range and variable rates.

**Dwell time range:** Fixed times of 6.4  $\mu$ sec to 99 msec using the internal timer. External input allows longer and variable dwell.

**Learn cycle time:** Typically, 10 sec. to 3.5 min., depending on sequence size

**Fast Hop bus:** Allows real-time selection of any channel for output. Typically, frequency switching time increases by 5  $\mu$ sec.

**Modulation:** Internal or external AM, FM, or simultaneous AM/FM  
**Output level:** Allowed amplitude variation of all channels entered is 0 to 20 dB. Output level is reduced by  $> 60$  dB while switching between channels. External dc AM can be used to shape the output.

#### Spectral Purity

##### SSB phase noise (CW, AM, or FM<sup>2</sup> operation):

Carrier Frequency (MHz)	Standard Operation		Fast Hop 20 kHz (dBc/Hz)
	20 kHz (dBc/Hz)	100 kHz (dBc/Hz)	
1030 to 2060	-120	-127	-116
515 to 1030	-127	-134	-123
257 to 515	-132	-137	-128
128 to 257	-136	-140	-133
64 to 128	-139	-141	-137
32 to 64	-141	-141	-139
16 to 32	-142	-142	-141
8 to 16	-143	-143	-142
4 to 8	-144	-144	-143
Less than 4 MHz	-144	-144	-144

**Harmonics:**  $< -30$  dBc, output  $\leq 10$  dBm. Opt 002, output  $> 8$  dBm:  $< -30$  dBc, 0.25 to 1030 MHz;  $< -25$  dBc, 1030 to 2060 MHz.

**Subharmonics:** none,  $< 515$  MHz.  $< -60$  dBc, 515 to 1030 MHz.  $< -40$  dBc,  $> 1030$  to 2060 MHz.

**Nonharmonics:**  $> 20$  kHz offset<sup>3</sup>:  $< -100$  dBc,  $< 2060$  MHz.

$< -94$  dBc,  $> 1030$  to 2060 MHz.

<sup>1</sup>Typically,  $\pm 2$  ppm of carrier frequency multiplied by the temperature change in  $^{\circ}$ C must be added if ambient temperature changes occur between the learn operation and the conclusion of frequency hopping. FM at minimum deviation.

<sup>2</sup>FM at minimum deviation.

<sup>3</sup>Typically, nonharmonic spurs at all offsets are  $< 30$  dB above the instrument's phase noise level as measured in a 1 Hz bandwidth.

**Residual FM<sup>1</sup> (CW, AM, FM<sup>2</sup> operation):**

Carrier frequency (MHz)	Post detection bandwidth	
	0.3 to 3 kHz (Hz rms)	0.05 to 15 kHz (Hz rms)
0.25 to 257	< 1	< 1.2
257 to 515	< 1.2	< 2
515 to 1030	< 2	< 4
1030 to 2060	< 4	< 8

**Typical SSB phase noise and spurs at 1 GHz:**

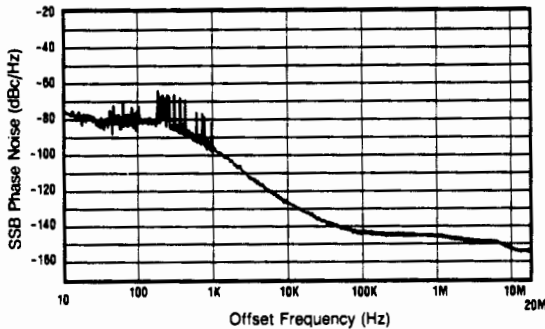

**Residual AM:** < 0.01% AM rms, 0.3 to 3 kHz post detection BW  
**Typical SSB AM noise floor, offsets > 100 kHz:** < -157 dBc/Hz at +16 dBm output, 0.25 to 1030 MHz. < -150 dBc/Hz at +13 dBm output, 1030 to 2060 MHz.

**Output**

**Maximum level:** +16 dBm, 0.25 to 1030 MHz; Opt 002: +14 dBm, 0.25 to 1030 MHz. +13 dBm, above 1030 MHz.  
**Minimum level:** -137 dBm  
**Absolute accuracy:** ± 1 dB, output ≥ -127 dBm  
**Reverse power protection:** 50 watts from a 50 Ω source, 25 Vdc  
**Typical third order intermodulation:** < -50 dBc, outputs < 8 dBm  
**Typical output level overrange:** 2 dB more than maximum level  
**Typical SWR and output impedance:** < 1.7:1, 50 Ω

**Modulation**

**External modulation input:** Coupling is ac or dc for AM, FM, and phase modulation. Pulse modulation input is dc coupled. Displayed deviation or depth corresponds to ±1V external input.  
**Simultaneous modulation:** AM/FM, AM/Phase, AM/Pulse, FM/Pulse, Phase/Pulse, AM/FM/Pulse, AM/Phase/Pulse  
**Simultaneous internal/external modulation:** FM and Phase

**Amplitude Modulation**

**Depth:** 0 to 99.9%, for output ≤ 7 dBm  
**AM indicator accuracy:** ± (6% of setting + 2%, AM), up to 90% depth and 1kHz rate for carrier frequencies > 1 MHz. When amplitude level is varied up to -5 dB from the constant learned value during Fast Hop: ± (7% of setting + 1% AM) up to 80% depth, 1 kHz rate)

**Distortion, at 400 Hz and 1 kHz rates:**

Depth	Carrier frequency	
	0.25 to 1030 MHz	1030 to 2060 MHz
0 to 30%	< 2%	< 5%
30 to 70%	< 3%	< 5%
70 to 90%	< 5%	< 8%

**3 dB bandwidth<sup>3</sup>:** > 5 kHz, 0.25 to 8 MHz. > 50 kHz, 8 to 128 MHz. > 100 kHz, 128 to 2060 MHz.

**Incidental phase modulation:** < 0.2 rad peak, at 30% depth and 1 kHz

**Typical external input impedance:** 600 Ω

<sup>1</sup>Specified for 48 to 63 Hz power line. Typical for 400 Hz power line and Fast Hop operation.  
<sup>2</sup>Deviation < 0.1% of maximum available  
<sup>3</sup>Lower 3 dB bandwidth limit is 0 Hz for dc coupling and typically 20 Hz for ac coupling.

**Frequency Modulation**

**FM deviation and rate:** In the highest frequency band of 1030 to 2060 MHz, the maximum FM peak deviation is 20 MHz for standard operation and 3.52 MHz for Fast Hop. Maximum FM rate (3 dB bandwidth) in the 515 to 1030 MHz band and above is 10 MHz. Divide rate and deviation by two for each frequency band decrease.  
**FM indicator accuracy:** ± 10%, < 50 kHz rate and < 10% of maximum deviation (< 50% of maximum deviation in Fast Hop)  
**FM distortion:** Rates 20 Hz to 100 kHz: < 2.7%, deviation < 2% of maximum available (Fast Hop: < 10% of maximum deviation)  
**Carrier frequency accuracy in FM:** ± 0.4% of deviation setting, ac or dc coupled. Typically add 1% of deviation in Fast Hop.  
**Incidental AM:** < 0.5%, deviation limited to < 6% of max. or 20 kHz  
**Typical external FM group delay:** 30 μs for rates 20 Hz to 20 kHz, decreases to < 1 μs at rates > 200 kHz. Fast Hop: < 1 μs.  
**Typical external FM input impedance:** 50 or 600 Ω

**Pulse Modulation**

**On/off ratio:** > 35 dB  
**Rise/fall time:** < 100 nsec, between 10% and 90% response points  
**Maximum pulse repetition frequency:** 1 MHz  
**Minimum pulse width:** 0.5 μs  
**Typical output level accuracy:** ± 2 dB  
**Typical external input levels and impedance:** on: > 3.0V peak; off: < 0.8V peak. Damage level: ≥ ± 10V peak. 600 Ω.

**Internal Modulation Source**

**Waveforms:** Sine, square, sawtooth, and white Gaussian noise  
**Frequency range:** Sine, white Gaussian noise: 0.1 Hz to 400 kHz. Square, sawtooth: 0.1 Hz to 50 kHz  
**Frequency accuracy:** Same as internal reference oscillator  
**Output level:** Typically, 1 V<sub>pk</sub> max. into 600 Ω. Accuracy: ± 20 mV.  
**Output level resolution:** 2 mV. Typical impedance: 600 Ω.  
**Distortion:** < 0.1%, output at 1V peak and ≤ 15 kHz

**Frequency Sweep**

**Phase continuous sweep:** Linear sweep with times from 10 ms to 10 s, not dependent on span. Maximum span is 40 MHz from 1030 to 2060 MHz frequency band, divided by two for each band decrease.  
**Fast Hop sweep:** Linear or log stepped with times from 10 msec to 100 sec. Number of steps varies with time selected. Typical time per step is 30 μs for outputs within 128 to 2060 MHz, 170 μs for 8 to 2060 MHz, and 650 μs for 0.25 to 2060 MHz.  
**Sweep control and markers:** X-axis: 0 to +10V. Z-axis: +5V retrace, +1V trace, 0V markers. Three markers available.

**General**

**Remote control:** HP-IB (IEEE-488.2-1987). The control language used is the Hewlett-Packard Systems Language (HP-SL). All front-panel functions except power switch and knob. A unique Fast Hop bus interface accepts TTL levels for frequency agile control.  
**Operating temperature range:** 0 to +55° F  
**Leakage:** Meets Mil Std 461B RE02 and FTZ 1046  
**Storage registers:** 10 full function and 40 freq./ampl. locations  
**Memory erasure:** All memory contents according to Mil Std 380-380  
**Weight:** Net, 31 kg (69 lbs); shipping, 42 kg (95 lbs)  
**Size:** 177 mm H × 426 mm W × 624 mm D (7 in × 16.8 in × 24.6 in)

**Ordering Information**

	<b>Price</b>
<b>HP 8645A Agile Signal Generator<sup>4</sup></b>	\$36,195
<b>Opt 001</b> High stability timebase	+ \$1,670
<b>Opt 002</b> 2 GHz output	+ \$7,695
<b>Opt 003</b> RF connectors on rear panel only	+ \$430
<b>Opt 907</b> Front handle kit (5061-9690)	+ \$65
<b>Opt 908</b> Rack flange kit (5061-9678)	+ \$35
<b>Opt 909</b> Rack flange kit with front handles (5061-9684)	+ \$90
<b>Opt 910</b> Provides an additional operation/calibration manual (08645-90023) and 2 service manuals (08645-90025)	+ \$190
<b>Opt 915</b> Add service manual (08645-90025)	+ \$65
<b>Opt W30</b> Extended repair service. See page 671.	+ \$800
<b>08645-61116</b> Service kit	\$500
<b>9211-2662</b> Transit case	\$550
<b>1490-0913</b> Transit case wheels	\$210
<b>1494-0059</b> Non-tilting rack slide kit	\$100
<b>1494-0063</b> Tilting rack slide kit	\$190

<sup>4</sup>HP-IB cables not included. For description and price, see page 615.  
 ☎ For off-the-shelf shipment, call 800-452-4844.

# SIGNAL GENERATORS

## Frequency Agile/Complex Signal Simulation

HP 8791 Models 11, 21, 100, 200, 2000

- Advanced dynamic control
- 100-ns frequency agility
- 40-MHz instantaneous modulation bandwidth
- Arbitrary control over AM, FM,  $\Phi$ M, pulse, and frequency hop



HP 8791 Model 21

**Model 21 Frequency Agile Signal Simulator (0.05 to 18 GHz)**

**Model 11 Frequency Agile Signal Simulator (10-3000 MHz)**

**Model 100 Precision Signal Generator (Instrument-on-a-Disk software)**

**Model 200 Radar Simulator (Instrument-on-a-Disk software)**

### Exotic Test Signals for EW, Radar, and Communications

The new HP 8791 Model 21 Frequency Agile Signal Simulator (FASS) system generates exotic, agile test signals for advanced EW threat simulation, radar-target simulation, and secure communications test. Covering 0.05 to 18 GHz with 100-ns agility and a 40-MHz instantaneous modulation bandwidth, the system is capable of generating advanced spread-spectrum formats like chirps, Barker-coded pulses, maximal-length sequences, QAM, and FSK. Comprehensive application software on a 44-MB removable disk harnesses the power of FASS, giving the system an easy-to-use, mouse-driven front panel.

The application-specific Instrument-on-a-Disk (ID) software includes the HP 8791 Model 200 Radar Simulator, which features various intrapulse modulations and antenna scans, and the HP 8791 Model 100 Precision Signal Generator, which gives easy access to FASS's agile carrier, AM, FM,  $\Phi$ M, and pulse modulation functions. Optional upconversion extends FASS coverage to 40 GHz.

### Description

The Frequency Agile Signal Simulator uses high-speed memory, signal processing, digital-to-analog conversion, and direct digital and analog synthesis for precise signal simulation with unprecedented flexibility.

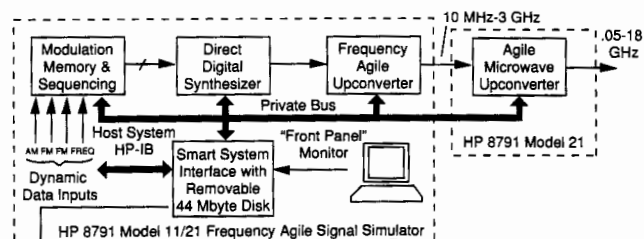

HP 8791 Model 200 Radar Simulator  
Instrument-on-a-Disk

- Easy-to-use application-specific software
- Precise synthesized signal control
- Standalone or subsystem operation
- 40-GHz operation with optional upconverters
- Phase-coherent hopping

The modulation data source's digital memory and sequencers store signal characteristics, namely carrier frequency hop patterns, amplitude, frequency, phase, and pulse modulation data. This data is supplied to the agile carrier synthesizer, where it is processed and converted to an analog signal made up of a carrier and its modulation. This 13.5- to 58-MHz signal is then translated to anywhere between 10 and 3000 MHz by the agile upconverter. A second agile upconverter, used in the HP 8791 Model 21 FASS, translates the signal between 0.05 and 18 GHz. The smart interface manages data flow and signal generation functions within FASS, as specified by inputs from its front panel or over HP-IB.

### System Contributions

The Frequency Agile Signal Simulator is characterized by:

- High performance modulation and agility
- Instrument-grade, repeatable, accurate
- Easy-to-use, software reconfigurable user interface
- Low cost of ownership
- Off-the-shelf instrumentation

### Application Overview

#### Electronic Warfare

FASS is ideal for simulating advanced threats with intrapulse modulation, PRI stagger, frequency agility, and antenna scan modulation. Being fully synthesized, FASS is especially well suited for pulse Doppler radar simulation.

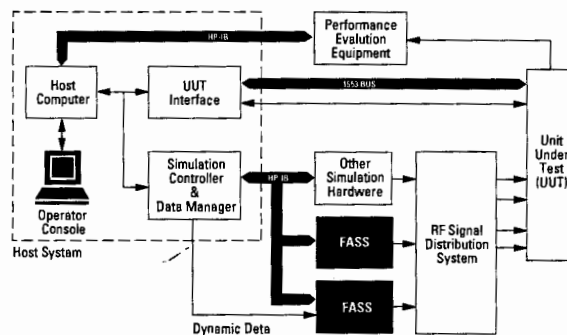

#### Radar

FASS can simulate target returns for testing and calibrating radar receivers. FASS can also be used as a major subsystem for instrumentation radars, serving as a complex waveform exciter or a frequency agile STALO for coherent systems.

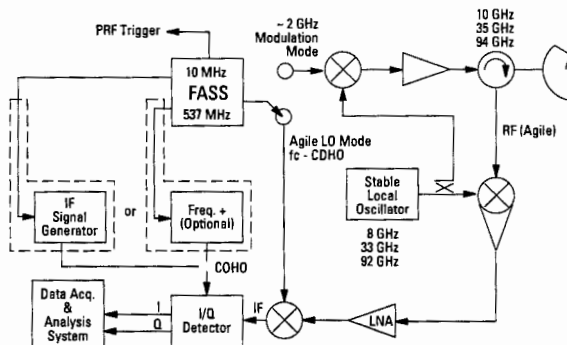

#### Communications

FASS can produce a variety of sophisticated agile signals useful for testing secure communication systems. Margin and tolerance testing can be accomplished by precisely adding distortion to ideal signals. In addition, common signals for testing sensitivity, bandwidth, frequency accuracy, selectivity, intermodulation, and distortion are readily available.

## Modes of Operation

### Instruments on a Disk (IDs)

Instruments-on-a-Disk (IDs) make this otherwise complex system easy to use and give FASS the front panel personality of specific applications. By clicking clearly labeled softkeys with the mouse, users can select sophisticated signal characteristics like PRI stagger and antenna scan patterns.

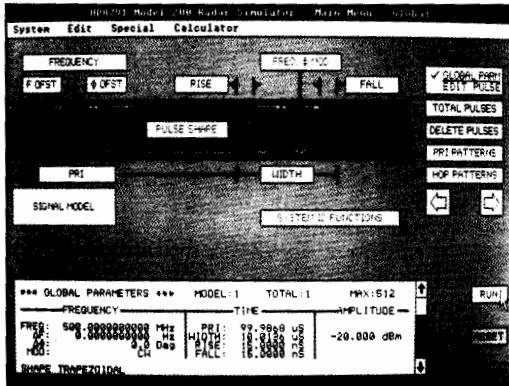

HP 8791 Model 200 screen

### Remote HP-IB

Remote HP-IB commands in FASS come in two varieties. There are the commands that simply mimic front-panel keystrokes of an ID and the general-purpose commands that give access to all the functions of FASS. Whichever set of standard HP-IB commands is used, integrating FASS's high-integrity, advanced signal simulation capability into an existing simulation system is very convenient.

### Waveform Generation Language (WGL)

For advanced applications where existing ID software is insufficient, users can program FASS with the Waveform Generation Language (WGL) software. WGL could be used to generate a non-standard signal such as a nonlinear chirp or a pulse with droop.

### Dynamic Data/Dynamic Sequence

Dynamic data mode allows selective, external control of instantaneous frequency, FM,  $\Phi$ M, and AM, as well as pulse modulation and level. In dynamic data mode, data maps are downloaded to the modulation data source's frequency and modulation memories. Dynamic data supplied at rates of up to 33 MHz addresses desired locations in memory. The output of FASS is determined by the values mapped at that location. Dynamic sequence allows external real-time selection of up to 1024 unique waveform sequences.

### Performance Characteristics

#### HP 8791 Model 21 Frequency Agile Signal Simulator

##### Frequency

**Range:** 0.05 to 18 GHz (to 40 GHz with upconversion)

**Resolution:** 0.125 Hz

**Switching speed:** < 100 ns typical over full 18 GHz BW

##### Amplitude

**Fast level control switching speed:** < 100 ns typical in 6.02 dB steps

**Output power:** +10 to -107 dBm

##### Modulation capabilities

**Instantaneous bandwidth:** 40 MHz

**Formats:** Arbitrary FM,  $\Phi$ M, AM, Pulse, Frequency Hopping

##### Spectral purity

**Spurious response:** -55 dBc, typical

**Phase noise:** < -110 dBc/Hz @ 10 kHz offset, 9.77 GHz, typical

##### Remote Operation

HP-IB compatible

**Dynamic data:** AM, FM,  $\Phi$ M, carrier frequency, pulse

**Dynamic data rates:** Up to 33 megawords/sec/channel

##### General

**Dimensions:** Rack 1237 mm H  $\times$  600 mm W  $\times$  803 mm D (48.7 in  $\times$  23.6 in  $\times$  31.6 in) consol 1064 mm H  $\times$  754 mm W  $\times$  756 mm D (41.9 in  $\times$  29.7 in  $\times$  29.8 in)

**Weight:** Shipping, rack 319 kg (700 lb); consol 75 kg (165 lb)

#### HP 8791 Model 11 Frequency Agile Signal Simulator

##### Frequency

**Range:** 0.01 to 3 GHz (to 18.5 GHz with upconversion)

**Resolution:** 0.125 Hz

**Switching speed:** < 100 ns typical over full 3 GHz BW

##### Amplitude

**Fast level control switching speed:** < 100 ns typical in 6.02 dB steps

**Output power:** +10 to -107 dBm

##### Modulation capabilities

**Instantaneous bandwidth:** 40 MHz

**Formats:** Arbitrary FM,  $\Phi$ M, AM, Pulse, Frequency Hopping

##### Spectral purity

**Spurious response:** -55 dBc, typical

**Phase noise:** < -125 dBc/Hz @ 10 kHz offset, 2 GHz, typical

##### Remote Operation

HP-IB compatible

**Dynamic data:** AM, FM,  $\Phi$ M, carrier frequency, pulse

**Dynamic data rates:** Up to 33 megawords/sec/channel

##### General

**Dimensions:** Rack 1237 mm H  $\times$  600 mm W  $\times$  803 mm D (48.7 in  $\times$  23.6 in  $\times$  31.6 in) consol 1064 mm H  $\times$  754 mm W  $\times$  756 mm D (41.9 in  $\times$  29.7 in  $\times$  29.8 in)

**Weight:** Shipping, rack 295 kg (650 lb); consol 75 kg (165 lb)

#### HP 8791 Model 100 Precision Signal Generator

The HP 8791 Model 100 Precision Signal Generator Instrument-on-a-Disk (PSID) software configures HP 8791 Model 11/21 FASS to be a precise signal generator with the modulation capabilities of an advanced waveform generator.

**Carrier:** Amplitude, phase, frequency

**AM:** Modulation index: 0 to 9999% (80 dB DSB-SC)

Modulation frequency: 0.0625 Hz to 20 MHz

**PM:** Peak phase deviation: 0° to 180°

Modulation frequency: 0.0625 Hz to 10 MHz

(upper limit dictated by 40-MHz modulation bandwidth)

**FM:** Frequency deviation: 0.125 Hz to 20 MHz

Modulation frequency: 0.0625 Hz to 10 MHz

(upper limit dictated by 40-MHz modulation bandwidth)

**Modulation Waveforms:** Sine: AM, PM, FM

Rectangle: 0 to 100% duty cycle AM (allows for pulse modulation)

Arbitrary user-defined:  $\leq$  8192 points

#### HP 8791 Model 200 Radar Simulator

The Model 200 Radar Simulator Instrument-on-a-Disk (RSID) software configures HP 8791 Model 11/21 FASS to simulate advanced pulsed radar emitters.

**Frequency hopping:** Constant, linear, scheduled, user-defined

**Intrapulse modulation:** Coherent, noncoherent, chirp, Barker, user-defined

**Pulse width:** 29.8 ns to 100 ms

**Rise and fall:** 29.8 ns to 230 ns

**Pulse shapes:** Trapezoidal, Gaussian, exponential, user-defined

**Pulse repetition frequency:** 1 Hz to 625 kHz

**PRF patterns:** Constant, burst, stagger, jitter, wobble, user-defined

**Antenna scan rate:** 4 to 100,000 RPM

**Main beam width:** 0.1 to 360°

**Antenna scan patterns:** Circular, conical, raster, sector, user-defined

**Antenna radiation patterns:** Rectangular, Hamming, Hanning, Blackman, 3-term, cosn, programmable

#### Ordering Information

##### HP 8791

Model	Price
Model 21 Frequency Agile Signal Simulator (E2505A)	\$360,000
Model 11 Frequency Agile Signal Simulator (E2500B)	\$220,000
Model 100 Precision Signal Generator (E2502A)	\$6,500
Model 200 Radar Simulator (E2501A)	\$11,500

Contact HP for additional configurations such as the dc-50 MHz

"Baseball FASS."

# SIGNAL GENERATORS

## Digital/I.Q. Modulation

### HP 8780A

- High performance, versatile modulation source
- Analog phase modulation for telemetry signals
- BPSK, QPSK, 8PSK, 16QAM, 64QAM, digital modulation, and pulse
- Direct-sequence spread spectrum modulation with chip widths to 7ns

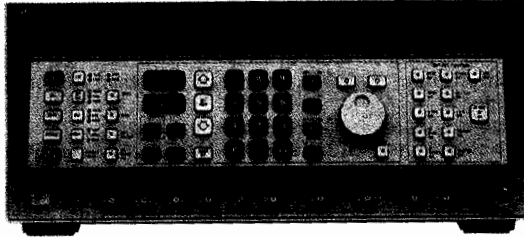

HP 8780A



### HP 8780A Vector Signal Generator

The HP 8780A Vector Signal Generator is a synthesized IF source with exceptional modulation for modern receiver and component testing. It is capable of modulation bandwidths almost 100 times wider than previous synthesizer and has built-in DACs (digital-to-analog-converters) to simplify generation of common digital modulations. Its extra-wide modulation bandwidth comes from a vector modulator that effectively doubles baseband modulation bandwidths for 700 MHz of output modulation. The vector signal generator's wide-band modulation is complemented with an unmodulated coherent carrier output for demodulation of test signals.

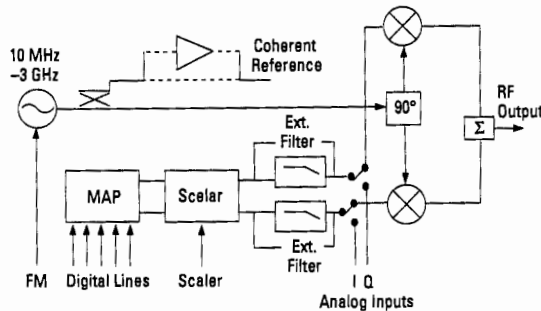

HP 8780A Block Diagram

The HP 8780A Vector Signal Generator offers a wide variety of modulation using both digital and analog inputs. It generates many standard digital modulations like QPSK and 16QAM and traditional modulations like FM, AM, and pulse. By combining the different modulation types, signals as diverse as Barker-coded radar pulses and Doppler-shifted satellite signals can be simulated.

### Applications

The HP 8780A Vector Signal Generator is well suited for receiver measurements where wideband or complex modulations are required. It can be used as a calibrated transmitter to test modern radar EW receivers or communication receivers using vector I/Q modulation techniques. It provides a stable, coherent carrier for phase measurement. It can also be upconverted if receivers operate at frequencies higher than 3 GHz.

### Analog Phase Modulation for Telemetry

HP 8780A option H02 offers analog modulation capability, which can be used in the tracking and data relay satellite system (TDRSS). The ground station needs linear phase modulation to communicate with the satellite and establish command and control. The HP 8780A with option H02 can generate the signals used during both on-ground and in-orbit testing.

- Wideband FM: over 200 MHz p-p deviations
- 700 MHz modulation bandwidth using I/Q or vector
- 10 MHz or 3 GHz IF testing
- Pulse modulation with 1-ns rise times
- Coherent carrier output

### HP 8780A Specifications

#### Frequency

**Range:** 10 MHz to 3 GHz

**Resolution:** 1 Hz

#### Output

**Level range:** +10 to -100 dBm <2.5 GHz

+4 to -100 dBm ≥2.5 GHz

(+12 dBm ≤3 GHz with Option 064)

#### Coherent Carrier Output

Unmodulated (except for FM) and unlevelled version of front panel RF output available at rear panel

#### AC Coupled Frequency Modulation

**Rates** (3 dB frequencies): 20 Hz to 12 MHz

**Deviation ranges:** 50 kHz to 50 MHz peak-to-peak (up to >200 MHz p-p possible with slightly higher distortion by overdriving FM input)

#### DC Coupled Frequency Modulation

**Maximum rate** (3 dB frequency): 10 kHz

**Deviation ranges:** 150 Hz to 150 kHz peak-to-peak

#### Digital Modulation

**Modulation types:** BPSK, QPSK, 8PSK, 16QAM (64QAM with Opt 064), Arbitrary 2-State, Burst (except 64QAM)

**Parallel data rates:** 0 to 150 MHz clocked (except 64QAM), 0 to 100 MHz clocked 64QAM with Opt 064, 0 to 50 MHz asynchronous

**Serial data rates** (only with Option 064): 0 to 150 MHz clock and data line for 0 to 25 MHz 64QAM symbol rate

#### Analog Phase Modulation (Only with Option H02)

**Modulation frequency range:** dc to 10 MHz

**Modulation level:** 0 to 1.5 V peak into 50 ohms

**Modulation sensitivity:** 1 radian/volt

**Modulation Index:** Variable by changing drive level over the range from 0.2 to 1.5 radians

#### Scalar Modulation/AM

Traditional AM modulation requires a dc offset of 0.5 V to be added to the scalar input

**Sensitivity:** 0 to +1 volt for 0 to full-scale envelope modulation

#### General

**Operating temperature range:** 0° C to +55° C

**Power:** 100, 120, 220, 240 V, +5%, -10%, 48 to 440 Hz; 500 VA max

**Weight:** Net, 31.5 kg (70 lb); shipping, 35.5 kg (78 lb)

**Size:** 177 mm H × 425 mm W × 637 mm D (7.0 in × 16.7 in × 25.1 in)

#### Ordering Information

HP 8780A Vector Signal Generator	Price
HP 8780A Vector Signal Generator	\$64,000
Opt 001 Rear panel output and modulation inputs	+\$450
Opt 002 +10 dBm Coherent Carrier output	\$3,000
Opt 064 64 QAM modulation	\$2,000
Opt H02 Analog Phase Modulation	\$2,500

# SIGNAL GENERATORS

Digital I/Q Modulation

HP 8782B

461

- 1 MHz to 250 MHz covers 70 and 140 MHz IFs
- Calibrated 100 MHz BW I/Q vector modulation inputs
- BPSK, QPSK, 8PSK, 16QAM, 256QAM digital modulation and burst

- Internal pseudo-random binary sequence generator
- AM/SCALAR modulation to simulate flat fading
- Coherent carrier output
- Optional 1 GHz LO for up conversion to 750 MHz to 1.25 GHz

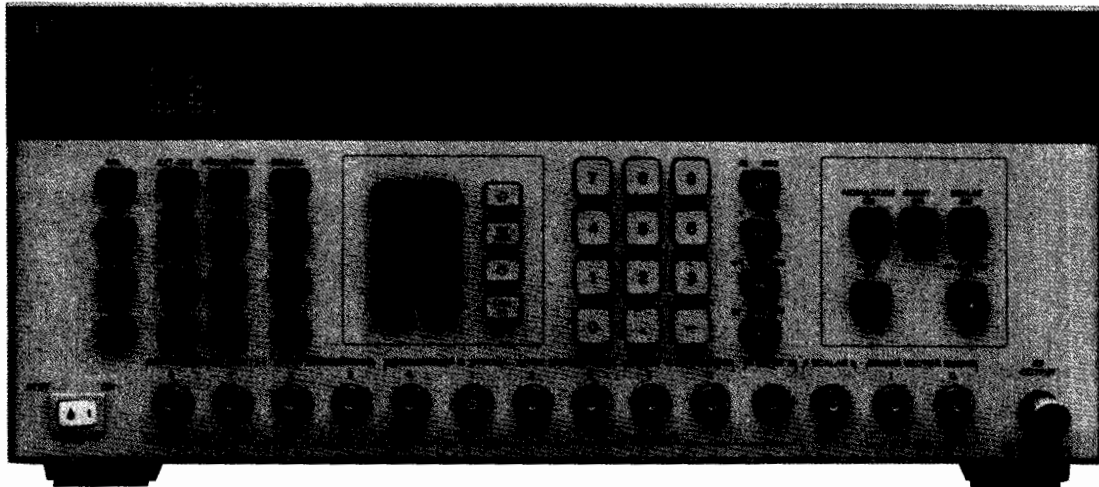

HP 8782B

## HP 8782B Vector Signal Generator

The HP 8782B vector signal generator is a second-generation synthesized generator providing IF signal generation for research and development and manufacturing. It supports a wide range of built-in digital modulation from BPSK to 256QAM for RF and microwave terrestrial and satellite communications applications. Its 1 MHz to 250 MHz frequency range, covers most of the IF frequencies in commercial receivers. An internal pseudo-random bit sequence (PRBS) generator makes all digital modulation possible without using external digital data sources. The HP 8782B also provides an unmodulated coherent carrier output for testing receivers and sub-systems before carrier recovery circuits are working. Its cost is substantially lower than that of the HP 8780A vector signal generator.

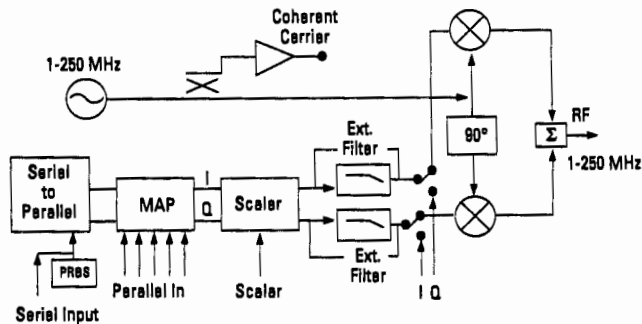

HP 8782B Simplified Block Diagram

The HP 8782B offers a wide variety of digital modulation using either the internal PRBS generator or a user data source. It generates calibrated test signals as well as specified modulation impairments such as quadrature errors, I/Q imbalance, carrier leakage, and flat fading.

## Applications

Using the HP 8782B to align digital radios in manufacturing can improve radio quality. Instead of relying on a golden standard modulator from Research and Development, the HP 8782B can provide calibrated constellations with extremely low quadrature error and amplitude imbalance. Customers can also simulate transmitter impairments by using the HP 8782B to test receiver performance margins.

## HP 8782B Specifications

### Frequency

**Range:** 1 to 250 MHz

**Resolution:** 1 Hz

**RF output level:** +7 to -100 dBm for all formats

### Coherent Carrier Output

Typically +10 dBm up to 140 MHz

Typically +8.5 dBm at >150 MHz

### Digital Modulation

**Modulation types:** BPSK, QPSK, 8PSK, 16QAM, 64QAM, 256QAM, 9PRS, 25PRS, 49PRS, 81PRS

**Parallel data rates:** 0 to 100 MHz clocked, 0 to 50 MHz asynchronous

**Serial data rates:** 0 to 200 MHz clock and data lines for drive signal rise times <1.0 μs

### Analog I/Q Inputs:

**Frequency response:** dc to 40 MHz (-0.5 dB)

**Vector dc accuracy:** <1.5% of full scale

**Vector dc residual:** <1.0% of full scale

**Sensitivity:** ±0.5 V

### Burst Modulation

**Burst rates:** 0 to 50 MHz

**Burst dc on/off ratio:** >50 dB at 70 MHz carrier typical >50 dB from 1 to 250 MHz

**Burst rise/fall time:** <2.2 ns

**PRBS:** Internal pseudo-random binary sequence generator with  $2^m - 1$  sequence length

### AM/SCALAR Modulation

**Sensitivity:** 0 to +1 V for 0 to full-scale output power

**Frequency response:** dc to 50 kHz at 70 MHz carrier frequency

### General

**Operating temperature range:** 0° C to +55° C

**Power:** 100, 120, 220, or 240 Vac, 48 to 66 Hz; 100 or 120 Vac 360 to 440 Hz; 360 VA typical

### Ordering Information

**HP 8782B** Vector Signal Generator



**Price**

\$35,000

# SWEEPERS

## General Information

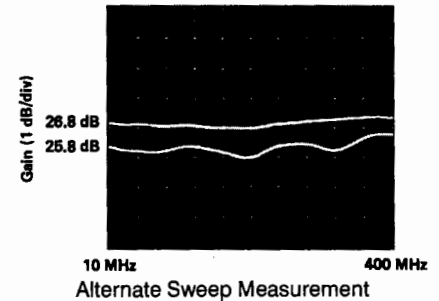
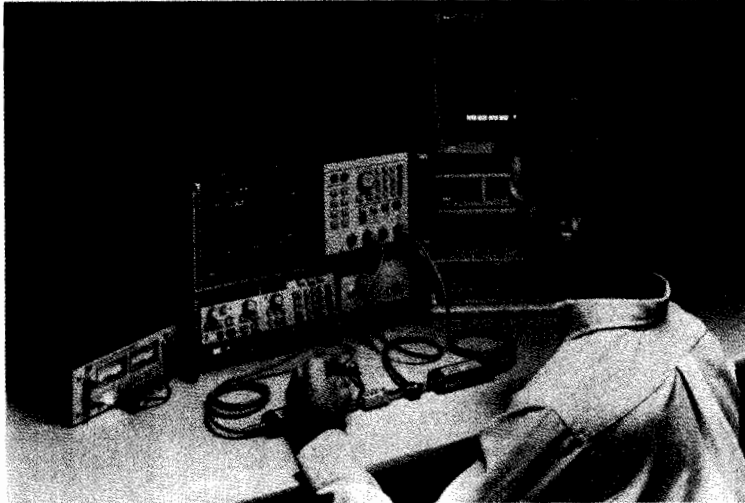

### Sweepers

Sweepers are important in a number of applications where the characteristics of a device or system must be determined over a continuous range of frequencies. By replacing laborious point-by-point techniques, swept measurements increase the speed and convenience of broadband testing. The continuous frequency characterization of the unknown device or system also eliminates the chance of missing important information between frequency points.

Hewlett-Packard sweepers cover the entire frequency spectrum from dc to 110 GHz. The HP 8350 family of solid state oscillators provide a versatile choice of configurations—single-band, straddle-band, or very-wide-band plug-ins. The HP 8360 series of broadband synthesizers combine the excellent stability, frequency accuracy, and phase noise of a synthesizer with the versatile characteristics of a sweeper. For coverage in the millimeter-wave frequency range, the HP 83550-series frequency multipliers effectively extend the excellent performance of Hewlett-Packard's sweeper family to 110 GHz.

A chart of the complete frequency coverage of Hewlett-Packard's line of sweepers is shown on page 463.

#### Sweep flexibility

Every HP sweeper has several different sweep modes available for setting the frequency limits of the instrument. A full band or independently adjustable start/stop frequency sweep can be selected. Alternately, a marker sweep or a symmetrical  $\Delta F$  sweep about the desired center frequency can be chosen. Sweep times from 0.01 to more than 100 seconds are possible.

Marker capability, both Z-axis intensity dots and RF pips, are available on HP sweepers to note important measurement frequencies. Up to five independent markers are offered on all sweepers, the HP 8360 series and the HP 8350 mainframe. Crystal markers are also offered on the HP 86222B, 83522A, and 83525A/B RF plug-ins.

Another powerful feature available on the HP 8360 series and 8350 sweeper mainframe is the Save/Recall Mode, where up to nine (eight on the 8360 series) complete front-panel states can be stored in memory and later recalled when the measurement is repeated.

The HP 8360 series, 8350 sweeper mainframe, and 83500 series RF plug-ins offer total HP-IB control of all front-panel functions.

#### Power Output and Leveling

Power output is continuously adjustable at the front panel with built-in attenuators available on most plug-ins for greater power control. Internal or external leveling capability ensures high accuracy when making swept measurements.

For applications that require high power, the HP 83623A (.01 to 20 GHz) synthesized sweeper offers +17 dBm leveled output power, while the HP 83624A (2 to 20 GHz) synthesized sweeper provides +20 dBm. Also the HP 83550A with the HP 8350 sweeper mainframe offers at least +20 dBm of leveled output power from 2 to 18.6 GHz and +18 dBm to 20 GHz.

When higher output power is required from an existing source, the HP 8349B microwave amplifier (2 to 20 GHz) can be driven by the RF output of the sweeper to provide a full +20 dBm of output power from 2 to 18.6 GHz. The amplifier can be easily leveled via its built-in directional detector and the automatic level control (ALC) circuitry of the sweeper.

Power as well as frequency can be swept with the HP 8360 series or the HP 8350 and 83500 series plug-ins using the Power Sweep function. This means that both the frequency response and the power response of level-sensitive devices like transistors and amplifiers can be measured using the same test setup. Using the power sweep function, the 1-dB gain compression can easily be measured at a CW frequency. Also, the ability to alternate between two successive sweeps allows a swept measurement of the 1-dB gain compression point.

### Modulation

Modulation capabilities further extend the sweeper's usefulness both as a sweeper and as a signal generator for signal simulations. The sweepers described here offer versatile pulse, FM, and AM modulation capabilities.

The HP 8360-series synthesized sweeper, as well as all HP 83500 and most 86200 series plug-ins (when used with the HP 8350 sweeper mainframe) are capable of directly producing the 27.8-kHz square wave modulation required by the HP 8757 family of scalar network analyzers, eliminating the need for an external modulator.

#### Low Harmonics

For those measurements requiring low harmonics from a swept source there are a number of choices available. The HP 83592C and HP 83595C RF plug-ins for the HP 8350 sweeper mainframe offers -55 dBc and -50 dBc harmonic suppression (respectively), from 2.4 to 20 GHz. The HP 83599A/83598A and HP 83597B/83596B RF plug-ins also provide -45 dBc from 1.5 to 20 GHz, -40 dBc up to 40 GHz, and -35 dBc from 40 to 50 GHz (HP 83599A/83598A only). The HP 83620A and HP 83640A synthesized sweepers provide -50 dBc up to 20 GHz. The HP 83640A also specifies -40 dBc from 20 to 40 GHz.

#### Covering Millimeter-Wave Frequencies

The HP 83550-series millimeter-wave source modules answer the growing need for high-performance sweepers in the millimeter-wave frequency ranges. The source modules are frequency multipliers that effectively extend the excellent performance of HP sweepers covering the 11 to 20 GHz range to the 26.5 to 40 GHz (HP 83554A), the 33 to 50 GHz (HP 83555A), the 40 to 60 GHz (HP 83556A), the 50 to 75 GHz (HP 83557A), and the 75 to 110 GHz (HP 83558A) millimeter-wave frequency ranges.



### Sweeper Applications

Sweepers are an integral part of many kinds of test applications. Their versatility and extensive feature set make them the perfect choice for scalar/vector network analysis, noise figure measurements, frequency translation measurements, signal simulation, and many other applications. The sweepers described here are designed to be compatible with all relevant measurement solutions from Hewlett-Packard.

Sweepers are used extensively with swept scalar network analyzers to characterize the amplitude responses of broadband devices or with vector network analyzers when the amplitude and phase characteristics of the device (i.e., s-parameters) are needed. Examples of such analyzers are the HP 8757C/E scalar network analyzers and the HP 8510 vector network analyzer. The HP 8360 series and HP 8350B sweepers can be controlled by these analyzers via a private "system interface bus." This makes use of the sweepers' full programmability and creates synergistic performance.

For scalar measurements requiring more dynamic range, the HP 8349B microwave amplifier can be used to extend the dynamic range from 76 dB to typically > 90 dB.

For measurements that require an entirely spurious-free environment and phase information, sweepers may be used with vector network analyzers such as the HP 8510. Extremely high performance vector measure-

ments can be made with the HP 8360 series and the HP 8510.

Noise figure measurements above 1,600 MHz can be made using the HP 8970 noise figure meter with either the HP 8360 series or the HP 8350 serving as the local oscillator. With this equipment, noise figure and gain measurements can be made on microwave components such as amplifiers,

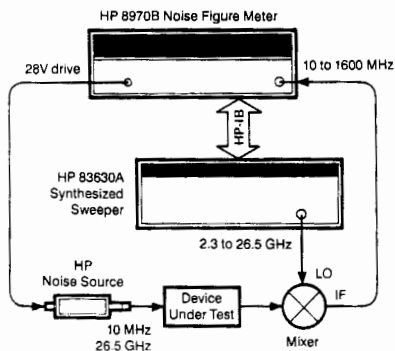

transistors, or mixers. The HP 8360 series and can also be used as a microwave LO in HP 8902S and 8952S measurement systems that make several important measurements on microwave sources.

Two-tone sweep testing of devices such as mixers and receiver front ends require two

signals offset from each other by the IF. This is accomplished by phase-locking the difference frequency of two sweepers to a very stable source. The sweepers may then be swept across the band of interest.

In communications applications where up-converter simulation is required in conjunction with the HP Microwave Link Analyzer, several of the HP 86200 series plug-ins are compatible (as an option) with such a system to permit very accurate RF to RF, RF to IF, and RF to BB distortion measurements.

The modulation and built-in attenuator features of Hewlett-Packard sweepers make them useful in many traditional CW signal generator applications. The excellent stability, phase noise, frequency range, and modulation capability of the HP 8360 series, make them well suited for most of these applications. In addition, the accuracy, linearity, and flatness of the HP 83500/86200 series broadband plug-ins make them more than adequate in many applications requiring a general-purpose CW generator. For wideband applications these RF plug-ins feature performance that rivals octave band oscillators in the areas of frequency purity and accuracy, harmonics, flatness, and power.

A Product Line Summary of Swept Microwave Sources (HP Part No. 5091-0897E), as well as specific data sheets, application notes, and product notes are available from your local Hewlett-Packard sales office.

### Sweeper - Summary Chart

Frequency Range*	Model Number			Frequency Range (GHz)													
	8350 Series	8620 Series**	Other Sweepers	10 MHz	100 MHz	1 GHz	2 GHz	4 GHz	8 GHz	12 GHz	18 GHz	26.5 GHz	40 GHz	50 GHz	60 GHz	75 GHz	110 GHz
10 MHz to 2.4 GHz 10 MHz to 8.4 GHz 10 MHz to 20 GHz 10 MHz to 26.5 GHz 10 MHz to 40 GHz 10 MHz to 50 GHz	HP 83522A HP 83525A/B HP 83592A/B/C HP 83595A/C HP 83597B HP 83599A	HP 86222A/B	HP 83620A/23A HP 83630A HP 83640A HP 83650A	→	→	→	→	→	→	→	→	→	→	→	→	→	→
1.7 to 4.3 GHz 2 to 8.4 GHz 3.6 to 8.6 GHz 2 to 18.6 GHz 2 to 20 GHz 2 to 22 GHz 2 to 26.5 GHz 2.4 to 40 GHz 2.4 to 50 GHz	HP 83540A/B  HP 83590A  HP 83594A HP 83596B HP 83598A	HP 86235A HP 86240A HP 86240C HP 86290B/C  HP 86290B Opt H08	HP 83622A/24A	→	→	→	→	→	→	→	→	→	→	→	→	→	→
5.9 to 12.4 GHz 7 to 11 GHz 8 to 12.4 GHz 8 to 20 GHz	HP 83545A  HP 83550A	HP 86245A HP 86250D Opt H08 HP 86250D		→	→	→	→	→	→	→	→	→	→	→	→	→	→
10 to 15.5 GHz 12.4 to 18 GHz 18 to 26.5 GHz 26.5 to 40 GHz	HP 83570A HP 83572C	HP 86260B HP 86260A		→	→	→	→	→	→	→	→	→	→	→	→	→	→
26.5 to 40 GHz*** 33 to 50 GHz*** 40 to 60 GHz***			HP 83554A HP 83555A HP 83556A	→	→	→	→	→	→	→	→	→	→	→	→	→	→
50 to 75 GHz*** 75 to 110 GHz***			HP 83557A HP 83558A	→	→	→	→	→	→	→	→	→	→	→	→	→	→

\*Other special frequency ranges can be provided upon request.  
 \*\*HP 86200 series RF plug-ins are usable with the HP 8350B mainframe via the HP 11869A adapter.  
 \*\*\*The HP 83550 series millimeter-wave source modules are frequency multipliers that require a +17 dBm microwave input. See page 462.

# SWEEPERS

## Synthesized Sweepers, 10 MHz to 50 GHz (or 110 GHz)

### HP 8360 Series

- 1 Hz frequency resolution (Option 008)
- Low spurious and phase noise
- +20 dBm to -110 dBm calibrated output
- Pulse, amplitude, and frequency modulation
- Complete analog sweeper
- $\leq 50$  dBc harmonics 1.8 to 20 GHz

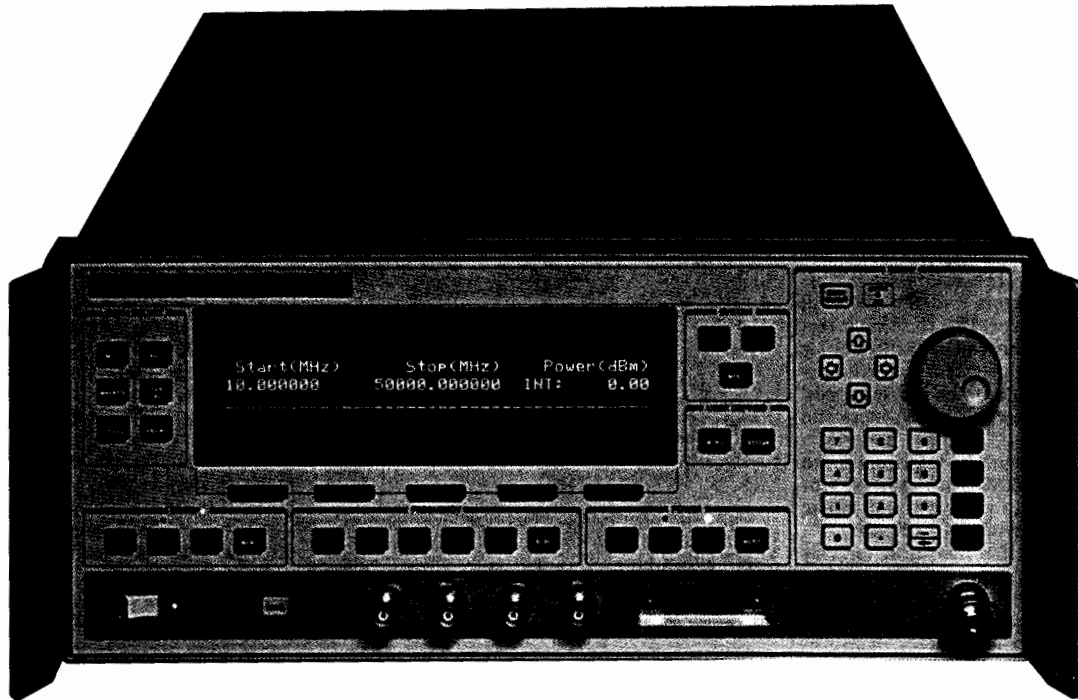

HP 83650A

### HP 8360 Series Synthesized Sweepers

The HP 8360 series synthesized sweepers are the standard of excellence for applications requiring the high performance and accuracy of a synthesized source and the speed and versatility of a sweep oscillator. The HP 8360 series synthesized sweepers offer the same standard of commitment to quality and reliability that was embodied in the previous industry-standard HP 8340/8341.

### Frequency Precision and Spectral Purity

The synthesized broadband frequency coverage and precise 1 Hz frequency resolution (Option 008) are generated by indirect synthesis, enabling the HP 8360 to achieve the same low single-sideband phase noise performance as the HP 8671B, the HP 8672A, and the HP 8673 series synthesized signal generators.

The HP 8360 provides list and stepped frequency switching times as fast as 5 ms. In addition, the HP 8360 provides arbitrary CW switching times less than 50 ms.

### Output Power

The HP 8360 provides output power between +20 dBm and -110 dBm (Option 001) with 0.02 dB resolution, and features power sweep capability with >20 dB dynamic range for complete characterization of level-sensitive devices.

### $\leq 50$ dBc Harmonics

The HP 8360 delivers excellent harmonic performance, with harmonics at least 50 dB below the carrier from 1.8 to 20 GHz, and at least 35 dB below the carrier above 20 GHz.

### Pulse, Scan, Amplitude, and Frequency Modulation

High-performance pulse modulators with >80 dB on/off ratio and rise/fall times <10 ns (Option 006) make the HP 8360 suitable for the most demanding pulse modulation applications.

In addition to its linear AM mode (100%/V), the HP 8360 offers a scan modulation mode (10 dB/V). Both of these modes provide dc-coupled amplitude modulation capability with a 3 dB bandwidth of 100 kHz, and 99.7% (50 dB) of modulation depth. Pulse and amplitude modulation capabilities can be used independently and simultaneously. The HP 8360 also offers dc-coupled frequency modulation capabilities with rates up to 10 MHz.

### System Compatibility

#### Network Analyzers

The HP 8360 series includes 3 dedicated HP 8510 models that are preconfigured as the recommended sources for the HP 8510 vector network analyzer (Rev. 4.0+). They have rear-panel outputs, 1 Hz resolution, and no front panel. The ability of these sources to produce both narrow and broadband, analog, list, and step sweeps makes them the optimum sources for fast and comprehensive device characterization.

The HP 8360 is also compatible with the HP 8757C/E scalar network analyzers, and produces an internal 27.8 kHz square-wave signal for use with the HP 8757C/E AC detection mode.

In addition, 5 flexible markers, along with useful marker functions such as marker sweep, marker to center frequency, and marker delta, simplify swept device testing.

#### HP 8970 Noise Figure Systems

High output power and low broadband noise make the HP 8360 the optimum source for the HP 8970 noise figure systems.

#### Millimeter-Wave Source Systems

When driven by an HP 8360, the HP 8355X series millimeter-wave source modules provide millimeter-wave test signals from 26.5 to 110 GHz.

#### HP 85301 Antenna Systems

The broadband frequency coverage and 5 ms/point switching speed of the HP 8360 make it the ideal source for the HP 85301A antenna measurement systems.

- Broad 300 kHz to 3 GHz frequency coverage
- +20 dBm output power available to 3 GHz
- 1-Hz frequency resolution
- Synthesized ramp and step sweep modes

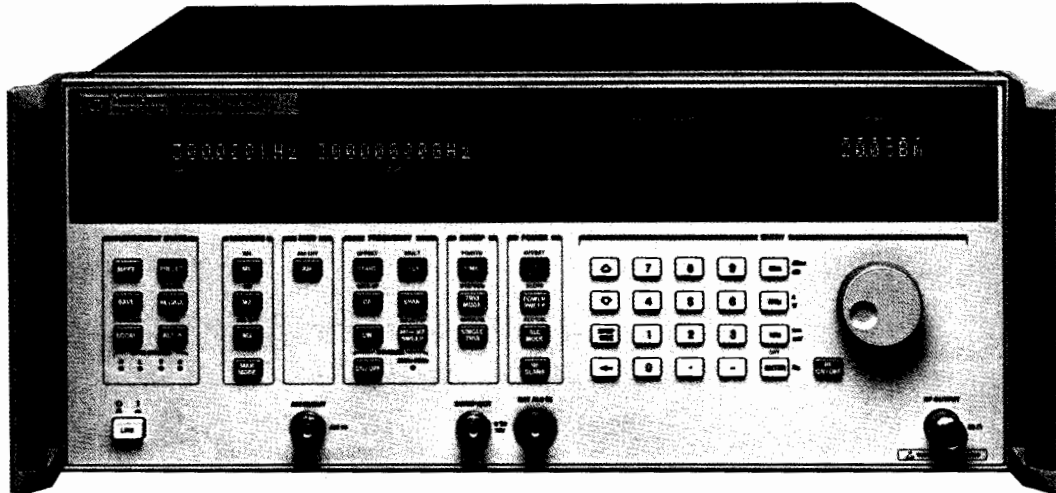

### The HP 8625A Synthesized RF Sweeper

The HP 8625A synthesized RF sweeper is a powerful general-purpose source for research & development and production test areas. With broad 300 kHz to 3 GHz frequency coverage, extendable to 6 GHz with Option 1EG, the HP 8625A is an excellent stimulus for RF component tests.

Precise measurements can be achieved with synthesized frequency accuracy, resolution, and stability in analog, stepped sweep, or CW measurement modes. High-level mixers and amplifiers can easily be driven with +20 dBm output power. The power may also be reduced to -75 dBm for power-sensitive devices with Option 1E1.

The HP 8625A is particularly suited for frequency translation device characterization. Fully compatible with the HP 8753C (rev. 4.1 or higher) vector network analyzer, the HP 8625A/8753C use a dedicated source/analyzer interface to provide synergistic performance for frequency converter measurements. This interface allows the HP 8625A to track the internal source of the HP 8753C, and provides direct control of the source's parameters from the front panel of the analyzer. To upgrade existing HP 8753C systems, order the HP 86387B mixer measurement upgrade kit.

The HP 8625A is also an excellent stimulus for scalar detector/display type measurement systems, such as those based on an oscilloscope or scalar analyzer. Sweep out and blanking control lines are provided for analog and step sweep measurements. Five versatile markers can be used to quickly identify critical test frequencies. Two HP 8625As can also track one another to provide two signals with a fixed or swept offset.

#### Specifications

##### Frequency Characteristics

**Range:** 300 kHz to 3 GHz  
3 MHz to 6 GHz (with Option 1EG)  
**Resolution:** 1 Hz

##### CW Mode

**Accuracy:** ±10 ppm  
**Stability:** ±7.5 ppm, ±3 ppm/year; typical (0° to 55° C)

##### Sweep Modes: Start/Stop, CF/Span, Marker Sweep

**Linearity:** ±1% of frequency span  
**Width:** 100 Hz to full span  
**Time:** 20 ms to 100 s

##### Stepped Sweeps:

**Number of points:** 5 to 1601  
**Switching time/point:** ≤ 5 ms for sweeps within a band

##### Output Power

**Maximum Levelled Power:** +20 dBm  
+5 dBm (with Option 1EG)  
**Minimum Settable:** -5 dBm, -75 dBm with Option 1E1  
**Power Sweep:** 0 to 25 dB/sweep (300 kHz to 3 GHz)  
**Slope Compensation:** 0 to +2 dB/GHz (300 kHz to 3 GHz)  
**Source Match:** 1.38:1, typical

##### Spurious Signals

###### Harmonics and Subharmonics:

< -20 dBc at +20 dBm  
< -40 dBc at 0 dBm

###### Nonharmonically related:

< -25 dBc at +20 dBm  
< -50 dBc at 0 dBm

###### Single-Sideband Phase Noise (at 10 kHz offset):

< -90 dBc ≤ 100 MHz  
< -63 dBc at 3 GHz

###### Residual FM: < 100 Hz peak at 100 MHz

(50 Hz to 15 kHz bandwidth)

###### Signal Purity with Option 1EG enabled (doubler mode):

**Harmonics:** < -8 dBc

**Subharmonics:** < -18 dBc

###### Single-Sideband Phase Noise (at 10 kHz offset):

< -83 dBc ≤ 100 MHz  
< -65 dBc at 6 GHz

##### General

**Internal AM:** 1 kHz sine wave  
**External AM (3 dB BW):** DC to 10 kHz  
**Weight:** Net 18.5 kg (41 lb); shipping 22 kg (48 lb)

##### Ordering Information

**HP 8625A** Synthesized RF Sweeper  
**Opt 1E1** Add Step Attenuator \$1,000  
**Opt 1E4** Rear-Panel RF Output \$500  
**Opt 1EG** 6 GHz Operation \$3,000  
**Opt W30** Extended Repair Service (see page 671) \$525  
**Opt W32** Calibration Service (see page 671) \$160

##### Price

\$22,500  
\$1,000  
\$500  
\$3,000  
\$525  
\$160

# SWEEPERS

## Model 8350 Series: 10 MHz to 50 GHz

### HP 8350 Series

- Versatile microprocessor-controlled mainframe
- Single-band, straddle-band, and broadband plug-ins
- 10 MHz to 50 GHz from a single plug-in
- 10 mW output power to 26.5 GHz
- Total HP-IB programmability

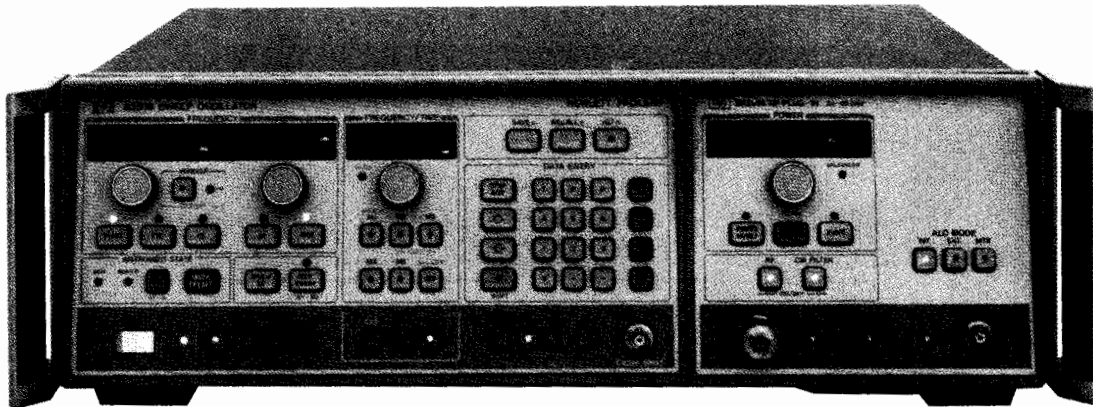

HP 8350B



### HP 8350 System

The HP 8350 is a powerful general-purpose source for swept microwave measurements, wideband CW signal generation, and automatic testing. It incorporates the efficiency of microprocessor control with state-of-the-art YIG-tuned oscillators and GaAs FET amplifiers to produce a high-performance sweeper system ideally suited for either manual or automatic measurements.

You can easily configure a source to meet your application's frequency coverage and power requirements. Just combine the versatile HP 8350 mainframe with any of the 31 standard RF plug-ins (see table on page 468) and you are ready to make measurements. Both the advanced HP 83500 series plug-ins and the existing HP 86200 series plug-ins (via the HP 11869A adapter) are accepted by the HP 8350 mainframe.

### HP 8350 Mainframe

The HP 8350 has been designed to include many features that not only speed up and simplify measurements but also improve accuracy. In addition, it is compatible with HP network analyzers, counters, noise figure meters, power meters, and microwave link analyzers to provide complete solutions.

All function values (sweep limit frequencies, marker frequencies, and so on) are indicated on high-resolution digital displays. Function values are easily modified using the appropriate knob, step keys, or data-entry keyboard.

Five independent, continuously variable markers are available to note your measurement frequencies. The active marker frequency or the frequency difference between any two markers is read easily from a high-resolution digital display. You can also use marker sweep to zoom in on a particular frequency span while retaining your original sweep limits.

Another particularly useful feature in making repetitive measurements is the HP 8350's Save/Recall Mode. Once the sweeper has been set for a particular measurement, all front-panel settings (HP 8350 and HP 83500 series plug-ins) can be saved and later recalled to repeat the measurement by accessing one of nine internal storage registers.

In the past, HP-IB programming of sweepers was limited to a series of CW frequencies. With the HP 8350, all front-panel functions, for example, sweeps, markers, sweep time, even output power (HP 83500 series plug-ins) can be programmed. This means there are no limitations in designing your own customized test systems. Utilizing the Learn Mode function, the HP 8350 becomes a "talker" as well as a "listener" on the bus, transferring all manually entered front-panel controls to the computer.

The HP 8350 provides full compatibility with the HP 8510 network analyzer and the HP 8757 scalar network analyzers for convenient vector and scalar measurements. The HP 5343A counter can be combined with the HP 8350 to measure start, stop, or marker frequencies with up to 100-kHz accuracy while sweeping. Microwave noise figure measurements may be made using the HP 8350 with the HP 8970 noise figure meter. In addition, the HP 8350B, with an appropriate plug-in driving the HP 8349B microwave amplifier, provides up to +20 dBm of output power across a 2 to 18.6 GHz range.

### HP 83500 Series Plug-Ins

Broadband frequency coverage from 10 MHz to 50 GHz with high output power is provided in the HP 83500-Series RF plug-ins. One plug-in, the HP 83599A, covers the entire 10 MHz to 50 GHz frequency range, offering +10 dBm output power with -45 dBc harmonics from 1.5 to 20 GHz and 0 dBm output power with -35 dBc harmonics at 50 GHz. The HP 83595A/C operate from 10 MHz to 26.5 GHz without sacrificing frequency accuracy ( $\pm 12$  MHz at 26.5 GHz). The HP 83595C also provides -50 dBc harmonics and subharmonics from 1.5 to 26.5 GHz with +13 dBm to 20 GHz. The HP 83592C 10 MHz to 20 GHz RF plug-in has -55 dBc harmonics and subharmonics from 2 to 20 GHz. The HP 83550A provides +20 dBm of output power from 8.0 to 18.6 GHz, +18 dBm from 18.6 to 20.0 GHz, and also has a built-in source module interface to drive the HP 83550-Series millimeter-wave source modules. The 18 GHz to 26.5 GHz band is filled by the HP 83570A RF plug-in and boasts a 10 dBm power level (comparable to most BWOs). The millimeter-wave bands are covered by the HP 83550-Series millimeter-wave source modules, frequency multipliers that provide coverage in the 26.5 to 40 GHz (HP 83554A), 33 to 50 GHz (HP 83555A), 40 to 60 GHz (HP 83556A), 50 to 75 GHz (HP 83557A), and 75 to 110 GHz (HP 83558A) bands by effectively extending the characteristics of an 11 to 20 GHz microwave source to the millimeter frequency range.

The HP 83500 Series plug-ins offer output power level control previously unavailable on a swept source. Power level control is calibrated with 0.1 dB resolution and up to 80 dB range (with Option 002 attenuator). Calibrated power sweeps are available for characterizing device performance as a function of power. Slope and internal leveling controls are standard on all units. The HP 83500 Series plug-ins (except the HP 83572C) are also capable of power meter leveling with the HP 432A/B/C, 436A, 437A, and 438A power meters.

All HP 83500-Series front-panel functions are HP-IB programmable including power level, so automatic test systems can characterize a device as a function of frequency and of input power level.

### HP 86200 Series Plug-Ins

Combining HP 86200 Series plug-ins (including one you might already own) with an HP 11869A adapter makes all the convenient digital controls, markers, and HP-IB capability of the HP 8350 immediately available. The HP 86200 Series plug-ins are an attractive choice for economical single-band operation with the HP 8350. For measurements with HP microwave link analyzers, use specially characterized HP 86200 series plug-ins with the HP 8350 to create an upconverter for communications distortion measurements.

The HP 86290B/C plug-ins cover the 2 to 18 GHz frequency range with 10 dBm and 13 dBm of output power, respectively. Frequency accuracy at 18 GHz is 30 MHz, exceeding that available on most single-band plug-ins. Both HP 83500 Series and HP 86200 Series plug-ins compatible with the HP 8350 mainframe are summarized in the table on page 468. Note that the HP 11869A adapter is required with all HP 86200 Series plug-ins.

- Accurate, high-resolution digital displays
- Five markers with marker  $\Delta$  and marker sweep
- Save/Recall 9 complete front-panel states

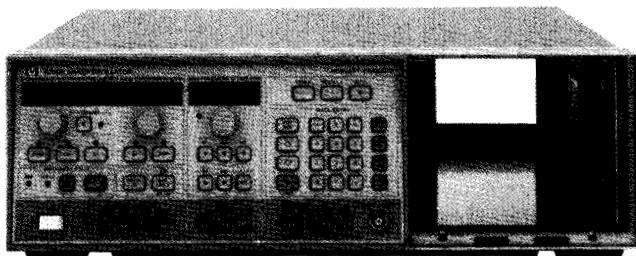

HP 8350B



### HP 8350B

Sweeper applications are greatly enhanced by the features of the HP 8350B. Along with the traditional swept and CW frequency functions, the HP 8350B adds extensive marker capabilities, versatile data entry, and complete HP-IB programmability. Besides the popular HP 83500 Series RF plug-ins, the HP 8350B also accepts the HP 86200 Series plug-ins via the HP 11869A adapter. And the HP 8350B is directly compatible with such measurement systems as the HP 8510 vector network analyzer and the HP 8757 scalar network analyzers. Frequency accuracy is easily enhanced by using the HP 5343A counter to count the start, stop, or active marker frequencies.

The HP 8350B has three methods of changing function values: control knobs, keyboard entry, or step key entry.

Five markers are available with the HP 8350B. These markers, combined with the high-resolution digital readout, make the accurate location of important frequency responses easy. A key marker feature, marker  $\Delta$ , computes the difference between any two markers. The markers can also modify the center frequency (marker  $\rightarrow$  CF) or the start/stop frequency (marker sweep).

A necessity in making repetitive measurements or automatic tests is the Save/Recall feature. This feature supplies nine memory locations, each storing a complete front-panel setup. Nonvolatile memory is included so that all memories are retained even when line power is removed.

The HP 8350B makes "simultaneous" comparison of two separate frequency ranges or power levels easy via the alternate sweep mode. When the alternate sweep mode is activated, the HP 8350B alternates between the current front-panel setting and any stored memory setting on successive sweeps. The output from this function may be processed through a network analyzer such as the HP 8757 and viewed on a two-channel display.

All front-panel controls (except the ac line switch) may be programmed or controlled via the HP-IB. The HP 8350B may interact as a listener or as a talker on the HP-IB.

A self-test is performed at turn on or whenever the instrument preset function is activated. This function verifies that the HP 8350B is functioning properly. If there is a problem, error codes are displayed on the front panel to help locate the problem quickly to the board and component level.

### HP 8350B Specifications

#### Frequency Control Functions

Refer to RF plug-in for frequency range, linearity, and accuracy specifications.

**Start/Stop Sweep:** Sweeps up from the start frequency to the stop frequency

**CF/ $\Delta$ F Sweep:** Sweeps symmetrically upward, centered on CF

**$\Delta$ F:** Frequency width of sweep continuously adjustable from zero to 100% of frequency range

- Accepts all HP 83500 Series plug-ins
- Total HP-IB programmability
- Compatible with HP network analyzers

**CF Resolution:** 0.00038% (262,144 points across band)

**$\Delta$ F Resolution:** 0.1% of full band (1,024 points across band), 0.012% of band for  $\frac{1}{2}$  of band or less, 0.0015% of band for  $\frac{1}{4}$  of band or less

**Display Resolution:** 5 digits

**CW Operation:** Single frequency RF output

**CW Resolution:** Same as CF

**Vernier:** Adjusts CW frequency or swept center frequency up to 0.05% of RF plug-in band being swept

**Vernier Resolution:** 4 ppm (64 points between each CW point; 262,144 points across band)

**Offset:** Allows the CW frequency or center frequency to be offset by any amount up to the full range of the plug-in

**Frequency Markers:** Five frequency markers are independently adjustable and fully calibrated over the entire sweep range. Amplitude or intensity markers available

**Resolution:** 0.4% of selected sweep width (256 points/sweep)

#### Sweep and Trigger Modes

**Internal:** Sweep recurs automatically

**Line:** Sweep triggered by ac power line frequency

**External Trigger:** Sweep is actuated by external trigger signal

**Single:** Selects mode and triggers a single sweep

**Sweep Time:** Continuously adjustable from 10 ms to 100 seconds

**Manual Sweep:** Continuous manual adjustment of frequency between end frequencies

**External Sweep:** Sweep is controlled by external signal applied to SWP OUTPUT/SWP INPUT connector

**Sweep Output:** Direct-coupled sawtooth, zero to approximately +10 volts, concurrent with swept RF output

#### Instrument State Storage

**Save n/Recall n:** Nine different front-panel settings can be stored

**Alt n:** Causes the RF output to alternate on successive sweeps between the current front panel setting and a setting stored in memory

#### Modulation

**External AM:** Refer to RF plug-in specifications

**Internal AM:** Selectable to 27.8 kHz or 1 kHz. On/off ratio, refer to RF plug-in specifications.

**External FM:** Refer to RF plug-in specifications

#### Remote Programming (HP-IB)

The HP 8350B has both input and output capability. All front-panel controls except the ac line power switch are programmable.

**Frequency Resolution:** Same as CF/ $\Delta$ F plus vernier

**Power Resolution:** See HP 83500 series plug-ins

**HP-IB Interface Functions:** SH1, AH1, T6, L4, SR1, RL1, PPO, DC1, DT1, CO, E1

#### General Specifications

**Nonvolatile Memory:** Continuous memory that retains the contents of all instrument state storage registers, the HP-IB address, and current instrument state when ac line power is off

**Operating Temperature range:** 0° C to +55° C

**Power:** 100, 120, 220, or 240 volts  $\pm$ 10%, 50 to 60 Hz (Opt 400, 60 to 400 Hz). Approximately 375 volt-amps including RF plug-in.

**Weight (not including RF unit):** Net 16.5 kg (36.4 lb); shipping 22.7 kg (50 lb)

**Dimensions:** 133.3 mm H  $\times$  425 mm W  $\times$  422 mm D (5.25 in  $\times$  16.75 in  $\times$  16.6 in)

#### Ordering Information

**HP 8350B** Sweep Oscillator Mainframe

**Opt 400:** 60 - 400 Hz Fan

**Opt 803:** HP 5343A Interface Cables

**Opt 910:** Extra Manual

**Opt W30:** Extended Repair Service (see page 671)

**Opt W32:** Calibration Service (see page 671)

#### Price

\$5,400

+ \$200

+ \$60

+ \$80

+ \$125

+ \$305

For transit cases see page 654.

# SWEEPERS

## HP 8350 Series: RF Plug-Ins

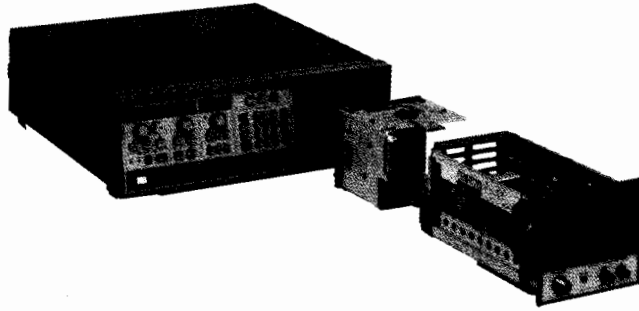

### HP 11869A Adapter

The HP 11869A adapter provides the electrical and mechanical interface between the HP 8350 and 86200 Series plug-ins. All of the HP 8350's standard operating features, including HP-IB remote programming, are available. However, specific plug-in functions (output power level, RF on/off, and so on) cannot be controlled or remotely programmed by the HP 8350 mainframe.

See page 473 for HP 86200 Series plug-in specifications.

### Plug-Ins Compatible with The HP 11869A Adapter

The HP 11869A adapter attaches to the back of the HP 86200 Series plug-in and is equipped with a switch for setting the specific interface code for the plug-in being used.

The following plug-ins will operate in the HP 8350 by using the

HP 11869A:

HP 86220A <sup>1,2</sup>	HP 86240A/B <sup>3</sup> /C	HP 86250A <sup>1,2</sup> /B <sup>1,2</sup> /C <sup>2</sup> /D
HP 86222A/B	HP 86241A <sup>1,2</sup>	HP 86251A <sup>2,3</sup>
HP 86230B <sup>1,2</sup>	HP 86242A <sup>1</sup> /C/D <sup>2</sup>	HP 86260A <sup>1</sup> /B <sup>1,3</sup> /C <sup>1,2,3</sup>
HP 86235A	HP 86245A	HP 86290A <sup>2</sup> /B/C

### Ordering Information

#### HP 11869A Adapter

**Opt 004** Extension cables for plug-ins with rear-panel RF output

**Opt 006** Type N aux out interface connector for HP 86251A and 86290A<sup>2</sup>/B/C

**Opt W30** Extended repair service (see page 671)

#### Price

\$800

+ \$200

+ \$200

+ \$45

<sup>1</sup>Not compatible with 27.8-kHz square wave modulation.

<sup>2</sup>Models HP 86220A, 86230B, 86290A, 86250A/B/C, 86242A/C/D, 86240B, 86241A, 86251A, and 86260C are obsolete.

<sup>3</sup>Requires a special PROM for the HP 11869A, which is shipped with every HP 86251A and 86260B/C.

### RF Plug-In Summary

	HP Model Number	Frequency Range (GHz)	Leveled Power Output	CW Frequency Accuracy (MHz)	Complete Specifications on Page
<b>Broad-Band Plug-Ins</b>	HP 83599A	0.01 to 50	10 mW/1 mW <sup>1</sup>	±25	471
	HP 83598A	2.4 to 50	10 mW/1 mW <sup>1</sup>	±25	471
	HP 83597B	0.01 to 40	10 mW/2 mW <sup>1</sup>	±20	471
	HP 83596B	2.4 to 40	10 mW/2 mW <sup>1</sup>	±20	471
	HP 83595A	0.01 to 26.5	2.5 mW	±12	469
	HP 83595C	0.01 to 26.5	20 mW/10mW <sup>2</sup>	±12	469
	HP 83594A	2 to 26.5	2.5 mW	±12	469
	HP 83592A/B	0.01 to 20	20 mW/10 mW <sup>2</sup>	±10	469
	HP 83592C	0.01 to 20	4 mW/2.5 mW <sup>3</sup>	±10	469
	HP 83590A	2 to 20	10 mW	±10	469
	HP 83525A/B	0.01 to 8.4	20 mW/10 mW	±15/12	472
	HP 83522A	0.01 to 2.4	20 mW	±5	472
	HP 86222A/B	0.01 to 2.4	20 mW	±10	473
	HP 86290B	2 to 18.6	10 mW	±30	473
HP 86290C	2 to 18.6	20 mW	±30	473	
<b>Straddle-Band Plug-Ins</b>	HP 83540A/B	2 to 8.4	40 mW/20 mW	±12	472
	HP 86240A	2 to 8.4	40 mW	±25	473
	HP 86240C	3.6 to 8.6	40 mW	±25	473
	HP 83550A	8.0 to 20.0	100 mW/63 mW <sup>4</sup>	±20	473
<b>Single-Band Plug-Ins</b>	HP 86235A	1.7 to 4.3	40 mW	±20	473
	HP 83545A	5.9 to 12.4	50 mW	±20	472
	HP 86245A	5.9 to 12.4	50 mW	±40	473
	HP 86250D	8.0 to 12.4	10 mW	±40	473
	HP 86260B	10 to 15.5	10 mW	±50	473
	HP 86260A	12.4 to 18	10 mW	±50	473
	HP 83570A	18 to 26.5	10 mW	±30	472
	HP 83572C	26.5 to 40	4 mW (Opt 001)	±100	472

Note: The HP 11869A adapter is required to interface HP 86200 Series plug-ins with the HP 8350B mainframe.

<sup>1</sup> HP 83599A/83598A and HP 83597B/83596B: 10 mW to 20 GHz.

<sup>2</sup> 20 mW to 18 GHz (HP 83592B) and 20 mW to 20 GHz (HP 83595C).

<sup>3</sup> HP 83592C: 4 mW to 18.6 GHz.

<sup>4</sup> HP 83550A: 100 mW to 18.6 GHz.

## Model 8350 Series: Broadband RF Plug-Ins HP 83595A/C, 83592A/B/C, 83594A, 83590A

- Calibrated output power with 0.1-dB resolution
- +13 dBm from 0.01 to 20.0 GHz
- 12-MHz frequency accuracy at 26.5 GHz

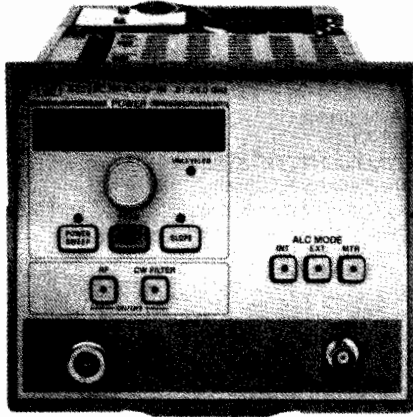

HP 83592C



- -55 dBc harmonics and subharmonics from 3.5 to 20 GHz
- Internal leveling and slope standard
- HP-IB

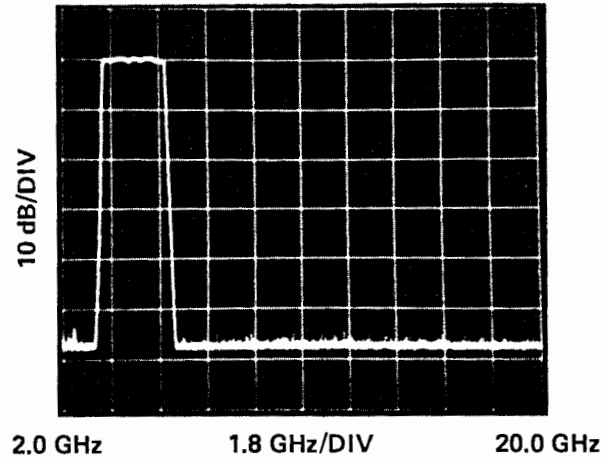

The HP 83590 Series plug-ins feature wideband frequency coverage, while maintaining narrowband precision, with excellent frequency accuracy and stability. At 26.5 GHz, the HP 83595A/C maintain an accuracy of  $\pm 12$  MHz. The HP 83595C does not sacrifice excellent performance for broadband high-frequency coverage; the output power is internally leveled for a minimum of +13 dBm to 20 GHz and +10 dBm to 26.5 GHz, with  $< -50$  dBc harmonics and subharmonics from 1.5 to 26.5 GHz. The 83592B offers +13 dBm internally leveled output power to 18.6 GHz, while maintaining  $\pm 0.9$  dB flatness. The HP 83592C provides a clean test signal with  $-55$  dBc harmonic and subharmonic levels (3.5 to 20 GHz) to maximize dynamic range. Power output capabilities have been expanded to provide power sweep and slope control. In addition, the HP 83590 Series plug-ins are completely HP-IB programmable.

The most outstanding feature of the HP 83590 Series plug-ins is their broad frequency range. Innovative technology is used to create this precision frequency range. The principle behind this technology is the Switched YIG Tuned Multiplier circuit (SYTM). The YTM circuit uses the output of a fundamental oscillator to drive a high-efficiency multiplier that has been integrated with a tracking YIG filter in order to create and select high-order harmonics to be used as output frequencies.

A figure of merit for the HP 83590 Series is its flat output power over the entire frequency range. The output power is internally leveled within 0.9 dB with a displayed resolution of 0.1 dB. The power level may be controlled to a minimum settable power level of  $-5$  dBm ( $-2$  dBm for the HP 83592B and HP 83595C). This level may be extended to  $-75$  dBm on the HP 83592A and HP 83590A or to  $-72$  dBm on the HP 83592B with Option 002 (70 dB Step Attenuator), or to  $-60$  dBm on the HP 83592C, the HP 83595A, and HP 83594A with Option 002 (55 dB Step Attenuator), or to  $-62$  dBm on the HP 83595C with Option 002 (60 dB Step Attenuator).

Since power parameters are critical to high-frequency measurements, the HP 83590 Series (along with all HP 83500 Series plug-ins) offers many modes of power output. In addition to a single power output, the HP 83590 Series offers a Power Sweep function. The Power Sweep function sweeps a power range for characterizing level sensitive devices like amplifiers and transistors. The Slope mode is supplied to provide compensation for cable or test set losses. In all these modes the power output is internally monitored and leveled. If preferred, the power may be externally leveled. The HP 83590 Series plug-ins are capable of power meter leveling with the HP 432A/B/C, 436A, and 438A power meters.

HP-IB programmability is an essential feature when one of the HP 83590 Series is used in automatic test systems. For example, the automated tests of amplifiers for gain compression are possible. These plug-ins are completely programmable, which means the power mode may be selected and the power level may be set with .01 dB resolution.

### Output Characteristics

#### Output Power Resolution

**Displayed:** 0.1 dB

**Programmable/Settable:** 0.01 dB

**Power Sweep** (with Opt 002 Power Sweep cannot cross an attenuator step)

**Calibrated Range:**  $> 9$  dB

**Accuracy** (including linearity), typical:  $\pm 1.5$  dB

**Power Slope** (with Opt 002 Power Slope cannot cross an attenuator step)

**Calibrated Range:** Up to 5 dB/GHz; up to 15 dB for full sweep.

**Linearity**, typical:  $< 0.2$  dB

**Residual AM In 100 kHz Bandwidth**, typical:  $< -50$  dBc

**Source Output VSWR** (50 ohm nominal) typical:  $< 1.9$

### Modulation Characteristics

#### External AM

**Frequency Response**, typical: 100 kHz

**Range of Amplitude Control**, typical: 15 dB

**Sensitivity**, typical: 1 dB/V

#### Internal Square Wave Modulation

1 kHz or 27.8 kHz square wave modulation selectable by internal jumper in HP 8350B. The 27.8 kHz modulation ensures operation with all Hewlett-Packard scalar network analyzers.

**On/Off Ratio:**  $> 30$  dB

**Symmetry:** 40/60

#### External Pulse Modulation

(HP 83592A/B/C, 83595A specifications only)

**Pulse Input:** TTL compatible

**Rise/Fall Time**, typical:  $< 50$  nsec

#### Minimum RF Pulse Width:

**Internally Leveled**, typical:  $< 5$   $\mu$ sec

**Unleveled**, typical: 200 nsec (0.01 to 2.5 GHz)

100 nsec (2.5-20 GHz or 26.5 GHz)

#### External FM

##### Maximum Deviations for Modulation Frequencies:

DC to 100 Hz:  $\pm 75$  MHz

100 Hz to 1 MHz:  $\pm 7$  MHz

1 MHz to 2 MHz:  $\pm 5$  MHz

2 MHz to 10 MHz:  $\pm 1$  MHz

**Sensitivity** (switch selectable), typical

FM Mode:  $-20$  MHz/V

Phase-Lock Mode:  $-6$  MHz/V

# SWEEPERS

## Model 8350 Series: Broadband RF Plug-Ins (cont'd)

HP 83595A/C, 83592A/B/C, 83594A, 83590A

### General Specifications

#### Minimum sweep time:

- 10 msec for single band
- HP 83590A, 83592A/B: 25 msec for full sweep
- HP 83594A, 83595A/C: 30 msec for full sweep
- HP 83592C: 35 msec for full sweep

#### Auxiliary output:

(rear-panel fundamental oscillator output, nominally 0 dBm):

- HP 83590A, 83594A: 2.0 to 7.0 GHz
- HP 83592A/B/C, 83595A: 2.3 to 7.0 GHz

#### Frequency reference output:

(rear panel BNC output, switch selectable):

- 1 V/GHz  $\pm$  25 mV (<18 GHz) or
- 0.5 V/GHz  $\pm$  25 mV (< 20 GHz or <26.5 GHz)

#### RF output connector:

- HP 83590A, 83592A/B/C: Type N (female)
- HP 83594A, 83595A: Type APC 3.5 (male)

#### Weight:

Net 6.0 kg (13.2 lb); shipping 9.2 kg (20 lb)

### Ordering Information

	Price
<b>HP 83590A</b> 2.0 to 20 GHz RF Plug-In	\$16,000
<b>HP 83592A</b> 0.01 to 20 GHz RF Plug-In	\$18,400
<b>HP 83592B</b> 0.01 to 20 GHz (high power) RF Plug-In	\$20,400
<b>HP 83592C</b> 0.01 to 20 GHz (low harmonics) RF Plug-In	\$20,400
<b>HP 83594A</b> 2.0 to 26.5 GHz RF Plug-In	\$22,500
<b>HP 83595A</b> 0.01 to 26.5 GHz RF Plug-In	\$24,300
<b>HP 83595C</b> 0.01 to 26.5 GHz RF Plug-In (high power, low harmonics)	\$27,000
<b>Opt 002</b> 70 dB Step Attenuator (HP 83590A, 83592A/B)	+ \$1,500
55 dB Step Attenuator (HP 83592C, 83594A, 83595A)	
60 dB Step Attenuator (HP 83595C)	+ \$1,800
<b>Opt 004</b> Rear-Panel RF Output	+ \$200
<b>Opt W30</b> Extended Repair Service	See HP 8350B
<b>Opt W32</b> Calibration Service	Data Sheet

	Band 0	Band 1	Band 2	Band 3	Band 4	Full Band
<b>Frequency Characteristics</b>						
<b>Range</b>						
HP 83590A	-	2 to 7	7 to 13.5	13.5 to 20	-	2 to 20
HP 83592A/B/C	.01 to 2.4	2.4 to 7	7 to 13.5	13.5 to 20	-	.01 to 20
HP 83594A	-	2 to 7	7 to 13.5	13.5 to 20	20 to 26.5	2 to 26.5
HP 83595A/C	.01 to 2.4	2.4 to 7	7 to 13.5	13.5 to 20	20 to 26.5	.01 to 26.5
<b>Accuracy (MHz, 25° C)</b>						
CW Mode	$\pm 5$	$\pm 5$	$\pm 10$	$\pm 10$	$\pm 12$	
All Sweep Modes (sweep time > 100 ms)	$\pm 15$	$\pm 20$	$\pm 25$	$\pm 30$	$\pm 35$	$\pm 50$
<b>Linearity (MHz), typical</b>						
	$\pm 2$	$\pm 2$	$\pm 4$	$\pm 6$	$\pm 10$	$\pm 10 (\pm 15)^1$
<b>Stability, typical</b>						
With Temperature (MHz/° C)	$\pm 0.2$	$\pm 0.2$	$\pm 0.4$	$\pm 0.6$	$\pm 0.8$	
With 10 dB Power Change (kHz)	$\pm 200$	$\pm 200$	$\pm 400$	$\pm 600$	$\pm 800$	
With 3:1 Load SWR (kHz)	$\pm 100$	$\pm 100$	$\pm 200$	$\pm 300$	$\pm 400$	
With Time* (kHz)	$\pm 100$	$\pm 100$	$\pm 200$	$\pm 300$	$\pm 400$	
<b>Residual FM (kHz peak, 10 Hz to 10 kHz bandwidth)</b>						
	<5	<5	<7	<9	<12	
<b>Output Characteristics</b>						
<b>Maximum Leveled Power (mW, 25° C) with Option 002</b>						
	10 (20 <sup>3/9</sup> ) 10 (16 <sup>2/20</sup> )	10 (20 <sup>3/4</sup> ) 7 (14 <sup>2/8</sup> , 16 <sup>6</sup> )	10 (20 <sup>3/4</sup> ) 6.3 (13 <sup>2/5</sup> , 16 <sup>6</sup> )	10 (2.5 <sup>4</sup> , 20 <sup>6</sup> ) 5 (1.4 <sup>4</sup> , 16 <sup>6</sup> )	2.5 (10 <sup>6</sup> ) 1.25 (6 <sup>6</sup> )	10 (2.5 <sup>1/1</sup> ) 5 (1.25 <sup>1/1</sup> , 1.4 <sup>4</sup> , 6 <sup>6</sup> )
<b>Power Level Accuracy (dB)</b>						
Internally Leveled	$\pm 1.5$	$\pm 1.3$	$\pm 1.3$	$\pm 1.4$	$\pm 1.7$	$\pm 1.5 (\pm 1.8)^9$
<b>Power Variation (dB, max specified power)</b>						
Internally Leveled	$\pm 0.9$	$\pm 0.7$	$\pm 0.7$	$\pm 0.8$	$\pm 0.9$	$\pm 0.9 (\pm 1.0)^9$
Externally Leveled <sup>8</sup>	$\pm 0.2 (0.3)^8$	$\pm 0.2 (0.25, 0.3)^8$	$\pm 0.2 (0.25, 0.3)^8$	$\pm 0.2 (0.25, 0.3)^8$	$\pm 0.2 (0.25, 0.3)^8$	
<b>Minimum Settable Power (dBm)</b>						
With Option 002	-5 (-2 <sup>3/9</sup> ) -60 (-62 <sup>6</sup> , -72 <sup>2</sup> , -75 <sup>6</sup> )	-5 (-2 <sup>3/4</sup> ) -60 (-62 <sup>6</sup> , -72 <sup>2</sup> , -75 <sup>6</sup> )	-5 (-2 <sup>3/4</sup> ) -60 (-62 <sup>6</sup> , -72 <sup>2</sup> , -75 <sup>6</sup> )	-5 (-2 <sup>3/9</sup> ) -60 (-62 <sup>6</sup> , -72 <sup>2</sup> , -75 <sup>6</sup> )	-5 (-2 <sup>3/9</sup> ) -60 (-62 <sup>6</sup> , -72 <sup>2</sup> , -75 <sup>6</sup> )	
<b>Spurious Signals (dBc, max specified power)</b>						
<b>Harmonically Related</b>						
	< -25 (< -20 <sup>6</sup> , < -45 <sup>7</sup> ) < -25 (< -40 <sup>1</sup> )	< -25 (< -50 <sup>6</sup> , < -55 <sup>7</sup> ) < -50 (< -55 <sup>1</sup> )	< -25 (< -50 <sup>6</sup> , < -55 <sup>7</sup> ) < -50 (< -55 <sup>1</sup> )	< -25 (< -50 <sup>6</sup> , < -55 <sup>7</sup> ) < -50 (< -55 <sup>1</sup> )	< -20 (< -50 <sup>6</sup> ) < -50	
<b>Non-Harmonics</b>						

<sup>1</sup> HP 83594A, 83595A specifications only.

<sup>2</sup> 10-minute period after one-hour warmup at same frequency.

<sup>3</sup> HP 83592B specifications only.

<sup>4</sup> HP 83592C specifications only.

<sup>5</sup> Negative crystal detector (sweep time > 100 msec) or HP 432A/B/C, 436A, or 438A Power Meter (sweep time  $\geq$  100 sec); excludes coupler/detector variation.

<sup>6</sup> HP 83590A, HP 83592A specifications only.

<sup>7</sup> HP 83592C only: < -25 dBc (0.1 to 1.4 GHz)

< -45 dBc (1.4 to 2.4 GHz)

< -50 dBc (2.4 to 3.5 GHz)

< -55 dBc (3.5 to 20 GHz)

<sup>8</sup> HP 83594A specifications only.

<sup>9</sup> HP 83595C specifications only.



## Model 8350 Series: Broadband RF Plug-ins

HP 83597A, 83596A

- 10 MHz to 50 GHz frequency coverage with the 2.4 mm coaxial connector
- -45 dBc harmonics and subharmonics from 1.5 to 26.5 GHz, -40 dBc from 26.5 to 40 GHz, -35 dBc to 50 GHz

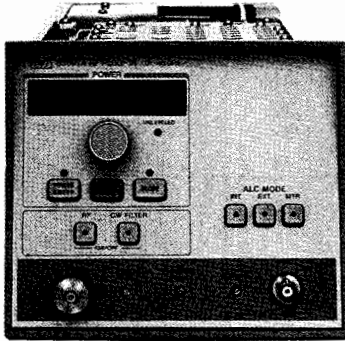

HP 83597A

The HP 83599A/83598A and 83597B/83596B RF plug-ins provide the highest performance and reliability available up to 50/40 GHz (respectively) from a swept source. They feature high output power, as well as excellent harmonic performance. They also incorporate the 2.4 mm connector that makes high performance broadband coaxial measurements possible. The superiority of the 2.4 mm connector lies in its ruggedness, repeatable performance, and excellent match over the entire frequency range.

A 50 GHz broadband swept scalar measurement system is easy to configure with the HP 83599A/8350B and the HP 8757A/C/E Scalar Network Analyzers with the appropriate 2.4 mm scalar network analyzer accessories. With -45 dBc of harmonic and subharmonic suppression from 1.5 to 20 GHz, and < -35 dBc above 20 GHz, these plug-ins are the ideal choice for scalar network analysis.

The broadband frequency coverage and high output power of these plug-ins make them ideal as local oscillators for down-converting high-frequency signals to a lower intermediate frequency. They provide the broadest frequency coverage for mixer measurement systems or coaxial noise figure measurements with the HP 8970B Noise Figure Meter.

The outstanding performance of the HP 83599A/83598A and 83597B/83596B plug-ins makes them especially attractive as stand-alone sources for various signal generation and simulation applications. Frequency accuracies of better than ±5 to ±25 MHz are specified depending on the frequency of operation. These plug-ins also have very flexible amplitude, frequency, and pulse modulation capabilities.

### Output Characteristics

#### Output Power Resolution

Displayed: 0.1 dB Programmable/Settable: ±0.01 dB

**Minimum settable power:** -12 dBm

#### Power variation:

Externally leveled (excluding coupler/detector variation)

Negative crystal detector<sup>2</sup> or HP 432A/B/C, 436A or 438A

Power meter<sup>3</sup>: ±0.2 dB, typical

### Power sweep

Calibrated range: > 20 dB (<20 GHz), >12 dB (> 20 GHz)

Accuracy (including linearity): ±1.5 dB, typical

Resolution (displayed): 0.1 dB, typical

### Power slope

Calibrated range: up to 5 dB/GHz, up to 12 dB for full sweep

Linearity: 0.2 dB, typical

Resolution (displayed): 0.01 dB/GHz, typical

**Residual AM in 100 kHz bandwidth:** -50 dBc, typical

**Source output VSWR** (50 Ω, nominal impedance): <2.0:1, typical

### Modulation Characteristics

#### External AM

Frequency response: 100 kHz, typical

Maximum input: 15V

Range of amplitude control: 15 dB, typical

Sensitivity: 1 dB/V, typical

Input impedance: approximately 25 kΩ

#### Internal square-wave modulation

1 kHz or 27.778 kHz square-wave modulation selectable by internal jumper in HP 8350B. The 27.778 kHz modulation ensures operation with all Hewlett-Packard scalar network analyzers.

On/off ratio: > 30 dB

#### External pulse modulation:

Rise/fall time (neglecting overshoot): < 50 nsec, typical

Minimum RF pulse width: Internally leveled: <1.5 μsec, typical

Unleveled: <1 μsec, typical

On/off ratio: > 60 dB, typical

#### External FM

Maximum deviations for modulation frequencies:

DC to 100 Hz: ±75 MHz (cross-over coupled),

±12 MHz (direct coupled)

100 Hz to 1 MHz: ±7 MHz

1 to 2 MHz: ±5 MHz

2 to 10 MHz: ±1 MHz

Sensitivity (switch-selectable):

FM mode: -20 MHz/V, typical

Phase-lock mode: -6 MHz/V, typical

### General Specifications

**Minimum sweep time:** 30 ms for a single band, 75 ms for <20 GHz sweep width, 150 ms for > 20 GHz sweep width.

**Auxiliary output:** Rear panel 2.3 to 7.0 GHz fundamental oscillator output, nominally 0 dBm.

**Frequency reference output:** Switch-selectable 0.5 V/GHz (0.01 to 38 GHz) or 0.25V/GHz (0.01 to 40 GHz).

±25 mV (<2.4 GHz)

±100 mV (>2.4 GHz)

**RF output connector:** Type 2.4 mm (male).

**Weight:** Net 7.1 kg (15.7 lb), Shipping 10.2 kg (22.5 lb).

### Ordering Information

**HP 83599A** 10 MHz to 50 GHz RF Plug-In

**HP 83598A** 2.4 GHz to 50 GHz RF Plug-In

**HP 83597B** 10 MHz to 40 GHz RF Plug-In

**HP 83596B** 2.4 GHz to 40 GHz RF Plug-In

**Opt 002** 60 dB Step Attenuator

**Opt 004** Rear-Panel RF Output

**Opt W30** Extended Repair Service (see page 671) See HP 8350B

**Opt W32** Calibration Service (see pg 671)

### Price

\$37,000

\$33,500

\$34,000

\$30,500

+ \$2,700

+ \$200

See HP 8350B

Data Sheet

	Band 0	Band 1	Band 2	Band 3	Band 4	Full Band
<b>Frequency Characteristics</b>						
<b>Range</b>						
HP 83599A	0.01 to 2.4 GHz	2.4 to 7.0 GHz	7.0 to 14.0 GHz	14.0 to 26.5 GHz	26.5 to 50.0 GHz	0.01 to 50.0 GHz
HP 83598A		2.4 to 7.0 GHz	7.0 to 14.0 GHz	14.0 to 26.5 GHz	26.5 to 50.0 GHz	2.4 to 50.0 GHz
HP 83597B	0.01 to 2.4 GHz	2.4 to 7.0 GHz	7.0 to 14.0 GHz	14.0 to 26.5 GHz	26.5 to 40.0 GHz	0.01 to 40.0 GHz
HP 83596B		2.4 to 7.0 GHz	7.0 to 14.0 GHz	14.0 to 26.5 GHz	26.5 to 40.0 GHz	2.4 to 40.0 GHz
<b>Accuracy<sup>1</sup></b>						
CW Mode:	±5 MHz	±5 MHz	±10 MHz	±20 MHz	±25 MHz	
All Sweep Modes: <sup>2</sup>	±15 MHz	±20 MHz	±25 MHz	±50 MHz	±65 MHz	±75 MHz
<b>Residual FM (peak):<sup>3</sup></b>	<5 kHz	<5 kHz	<7 kHz	<14 kHz	<24 kHz	
<b>Output Characteristics</b>						
<b>Maximum Leveled power<sup>1,4</sup></b>	10 mW	10 mW	10 mW	10 mW (3 mW > 20 GHz)	3 mW <sup>5</sup>	
[High Power] <sup>6</sup>		[30 mW]	[30 mW]	[30 mW]		
<b>Power Level Accuracy<sup>1,7,8</sup></b>	±1.5 dB	±1.3 dB	±1.3 dB	±1.4 dB	±2.2 dB	±2.2 dB
<b>Power Variation<sup>1,8</sup></b>	±0.9 dB	±0.7 dB	±0.7 dB	±0.8 dB	±1.4 dB	±1.5 dB
<b>Spurious Signals<sup>9</sup></b>						
Harmonics and Subharmonics	< -25 dBc (<1.5 GHz)	< -45 dBc	< -45 dBc	< -40 dBc	< -40 dBc	< -40 dBc
[High Power] <sup>6</sup>	< -50 dBc (>1.5 GHz)	[< -20 dBc]	[< -20 dBc]	[< -20 dBc]	[< -35 dBc > 40 GHz]	
Non-Harmonics:	< -25 dBc	< -50 dBc	< -50 dBc	< -50 dBc	< -50 dBc	

<sup>1</sup> 25° C ± 5° C.

<sup>2</sup> For sweep times ≥ 100 ms.

<sup>3</sup> 10 Hz to 10 kHz bandwidth, CW mode with CW filter on.

<sup>4</sup> Typically degrades 0.1 dB/° C above 25° C.

<sup>5</sup> Includes power level variations.

<sup>6</sup> Degrades typically ±0.05 dB/° C outside the 20° C to 30° C range.

<sup>7</sup> At specified maximum leveled power.

<sup>8</sup> High-power operating-mode performance is given in brackets []. Activating it increases power from 2.4 to 20 GHz and degrades harmonics.

<sup>9</sup> For sweep times ≥ 10 sec and ≥ 2.5 sec/GHz.

<sup>10</sup> HP 83599A/83598A provide +2 mW from 26.5 to 40 GHz.

# SWEEPERS

## Model 8350 Series: RF, Plug-Ins

### HP 86200 Series

HP 83500 Series Plug-Ins: Specifications Summary	Broadband			Straddle-Band			Single-Band		
	HP 83522A <sup>1</sup>	HP 83525A <sup>1</sup>	HP 83525B <sup>1</sup>	HP 83540A	HP 83540B	HP 83550A	HP 83545A	HP 83570A <sup>2</sup>	HP 83572C <sup>2</sup>
<b>Frequency Characteristics</b>									
Range (GHz)	0.01 to 2.4	0.01 to 8.4	0.01 to 8.4	2 to 8.4	2 to 8.4	8 to 20	5.9 to 12.4	18 to 26.5	26.5 to 40
Accuracy (MHz, 25° C)									
CW Mode	± 5	± 15 <sup>4</sup>	± 12 <sup>4</sup>	± 12	± 12	± 20	± 20	± 30	± 100
All Sweep Modes (sweep time > 100 ms)	± 15	± 20 <sup>4</sup>	± 20 <sup>4</sup>	± 20	± 20	± 50	± 35	± 55	± 150
Residual FM (kHz peak, 10 Hz to 10 kHz bandwidth)	< 5	< 9 <sup>4</sup>	< 7 <sup>4</sup>	< 7	< 7	< 25 <sup>3,5</sup>	< 15	< 30	< 60
<b>Output Characteristics</b>									
Maximum Levelled Power (mW, 25° C)	> 20	> 20	> 10	> 40	> 20	> 100 <sup>6</sup>	> 50	> 10	> 5 <sup>6</sup>
Power Level Accuracy (dB)									
Internally Levelled	± 1	± 1.5	± 1.5	± 1.5	± 1.5	± 1.5	± 1	± 1.8	± 1.5 <sup>7</sup>
Power Variation (dB, at max specified power)									
Internally Levelled	± 0.25	± 1	± 1	± 1	± 1	± 1.25	± 0.6	± 1.4	± 3 <sup>8</sup>
Externally Levelled, Typical (excluding coupler/detector variations)	± 0.1	± 0.1	± 0.1	± 0.1	± 0.1	± 0.1	± 0.1	± 0.1	± 0.2
Spurious Signals (dBc, at max specified power)									
Harmonically Related	< -25	< -20	< -45 <sup>9</sup>	< -20	< -45	< -20 <sup>9</sup>	< -30 <sup>10</sup>	< -25	< -20
Non-Harmonics	< -25	< -60 <sup>9</sup>	< -60 <sup>9</sup>	< -60	< -60	< -50	< -60	< -50	< -50
Source SWR, Typical (50 ohms nominal, internally levelled)	< 1.5	< 1.6 <sup>8</sup>	< 1.6 <sup>8</sup>	< 1.6	< 1.6	< 2.5	< 1.6	< 2.5	< 1.5 <sup>7</sup>
<b>Modulation Characteristics</b>									
External Pulse, Typical									
Rise/Fall Time (ns)	n/a	20 <sup>4</sup>	20 <sup>4</sup>	20	20	25	15	20	300/50 <sup>11</sup>
Minimum RF Pulse Width									
Levelled (µs)	n/a	1 <sup>4</sup>	5 <sup>4</sup>	1	5	1	1	1	n/a
Unlevelled (ns)	n/a	100 <sup>4</sup>	100 <sup>4</sup>	100	100	100	100	100	500 <sup>11</sup>
External FM									
Maximum Deviation (MHz)									
DC to 100 Hz Rates	± 75	± 75	± 75	± 75	± 75	± 75	± 75	± 75	± 150
100 Hz to 200 kHz Rates	± 7	± 7	± 7	± 7	± 7	± 12	± 7	± 7	± 7
200 kHz to 1 MHz Rates	± 7	± 7	± 7	± 7	± 7	± 12	± 7	± 7	± 7
1 to 2 MHz Rates	± 5	± 5	± 5	± 5	± 5	± 12	± 5	± 5	n/a
2 to 6 MHz Rates	± 1	± 1	± 1	± 1	± 1	± 12	± 1	± 1	n/a
6 to 10 MHz Rates	± 1	± 1	± 1	± 1	± 1	± 1	± 1	± 1	n/a
Sensitivity (MHz/volt), Typical	-20/-6	-20/-6	-20/-6	-20/-6	-20/-6	-20/-6	-20/-6	-20/-6	-20/-6
External AM									
Frequency Response (kHz), Typical	100	100	100	100	100	100	100	100	10
Range (dB), typical	> 15	> 15	> 15	> 15	> 15	> 20	> 15	> 11	> 11 <sup>7</sup>
Sensitivity (dB/volts)	+ 1	+ 1	+ 1	+ 1	+ 1	+ 1	+ 1	+ 1	+ 1 <sup>7</sup>
Internal AM (1 kHz/27.8 kHz square wave)									
On/Off Ratio (dB)	> 30	> 30	> 30	> 30	> 30	> 30	> 40	> 25	> 20 <sup>11</sup>
<b>Prices</b>									
Plug-in	\$8,400	\$13,100	\$14,300	\$9,900	\$10,750	\$16,500	\$10,100	\$13,000	\$19,200
With Opt 001 (Calibrated External Leveling)	n/a	n/a	n/a	n/a	n/a	n/a	n/a	n/a	+\$1,600
With Opt 002 (70 dB Attenuator)	+\$1,005	+\$1,105	+\$1,105	+\$1,105	+\$1,105	+\$1,305 <sup>12</sup>	+\$1,105	n/a	n/a
With Opt 004 (Rear Panel RF Output)	+\$200	+\$200	+\$200	+\$200	+\$200	+\$200	+\$200	n/a	n/a
With Opt 006 Int. Sq. Wave Mod. & Ext. Pulse Mod.	n/a	n/a	n/a	n/a	n/a	n/a	n/a	n/a	+\$1,800
With Opt W30 (Two Years Extended Service)	+\$190	+\$285	+\$285	+\$215	+\$215	+\$380	+\$250	+\$320	+\$425
With Opt W32 Calibration Service (See Pg 671)	+\$1,300	+\$1,265	+\$1,420	+\$1,135	+\$970	+\$1,405	+\$1,215	+\$800	+\$895

<sup>1</sup> Enhanced frequency accuracy is provided by internal crystal markers of 10 MHz and 50 MHz (over full range for HP 83522A, and below 2 GHz for HP 83525A/B). 1 MHz harmonic markers are available below 1 GHz.

<sup>2</sup> WR42 waveguide RF output connector type.

<sup>3</sup> WR28 waveguide RF output connector type.

<sup>4</sup> Specifications apply from 2 to 8.4 GHz only. 0.01 to 2 GHz specifications are the same as for the HP 83522A plug-in.

<sup>5</sup> 63 mW from 18.6 to 20 GHz.

<sup>6</sup> Unlevelled output power.

<sup>7</sup> Externally levelled (requires Option 001 which consists of a calibrated crystal detector, external coupler, and BNC cable).

<sup>8</sup> Specifications apply only from 2 to 8.4 GHz; below 2 GHz non-harmonics are < -30 dBc and SWR is < 2.0.

<sup>9</sup> -15 dBc from 8 to 11 GHz.

<sup>10</sup> -17 dBc from 5.9 to 7 GHz.

<sup>11</sup> Requires Option 006, which provides internal square-wave modulation and external pulse and square-wave modulation capabilities.

<sup>12</sup> 50 dB step attenuator.

<sup>13</sup> 20 Hz to 15 kHz bandwidth.

HP 86200 Series Plug-Ins: Specifications Summary	Broadband		Straddle-Band		Single-Band				
	HP 86222B <sup>1</sup>	HP 86290B <sup>2</sup>	HP 86240A	HP 86240C	HP 86235A	HP 86245A	HP 86250D	HP 86260B	HP 86260A
<b>Frequency Characteristics</b>									
<b>Range (GHz)</b>	0.01 to 2.4	2.0 to 18.6	2.0 to 8.4	3.6 to 8.6	1.7 to 4.3	5.9 to 12.4	8.0 to 12.4	10.0 to 15.5	12.4 to 18.0
<b>Accuracy (MHz, 25° C)</b>									
CW Mode	± 10	± 80	± 25	± 25	± 20	± 40	± 40	± 50	± 50
Remote Programming, Typical	± 6		± 3.5	± 3.5	± 3.5	± 20	± 20	± 25	± 25
All Sweep Modes (sweep time > 100 ms)	± 15	± 80	± 40	± 35	± 30	± 50	± 50	± 70	± 70
<b>Residual FM</b> (kHz peak, 10 Hz to 10 kHz bandwidth)	< 5	< 30	< 9	< 9	< 7	< 15	< 15	< 25	< 25
<b>Output Characteristics</b>									
<b>Maximum Leveled Power</b> (mW, 25° C)	> 20	> 10	> 40	> 40	> 40	> 50	> 10	> 10	> 10
<b>Power Variation (dB, at max specified power)</b>									
Internally Leveled	± 0.33	± 0.9	± 1	± 0.8	± 0.8	± 0.6	± 0.5	± 0.7	± 0.7
Externally Leveled (excluding coupler and detector variations)	± 0.1	± 0.15	± 0.1	± 0.1	± 0.1	± 0.1	± 0.1	± 0.1	± 0.1
<b>Spurious Signals (dBC, at max specified power)</b>									
Harmonically Related	< -25	< -25	< -16	< -16	< -20	< -17	< -40	< -25	< -25
Non-Harmonics	< -25	< -50	< -60	< -60	< -60	< -60	< -60	< -50	< -50
<b>Source SWR</b> (50 ohms nominal, internally leveled)	< 1.5	< 1.9	< 1.6	< 1.6	< 1.6	< 1.6	< 1.6	< 2.0 Unleveled	< 2.0 Unleveled
<b>Modulation Characteristics</b>									
<b>External Pulse</b>									
Rise/Fall Time, Typical (ns)	n/a	n/a	20	20	20	n/a	n/a	n/a	n/a
On/Off Ratio (dB)			40	40	40				
For Input (volts)			+ 6	+ 6	+ 6				
<b>External FM<sup>3</sup></b>									
Maximum Deviation (MHz)									
DC to 100 Hz Rates	± 75	± 75	± 75	MLA <sup>3</sup>	± 75	± 150	± 150		
100 Hz to 1 MHz Rates	± 5	± 5	± 5		± 5	± 5	± 5		
1 to 2 MHz Rates	± 2	± 5	± 2		± 2	± 5	± 5		
DC to 200 Hz Rates								± 75	± 75
200 Hz to 200 kHz Rates								± 3.5	± 3.5
Sensitivity, Nominal (MHz/volt)	-20/-6	-20/-6	-20/-6	+ 20	-20/-6	-20/-6	-20/-6	-20/-6	-20/-6
<b>External AM</b>									
Linear Mode									
Frequency Response, Typical (kHz)	150	300	125	125	125	30	30	500	500
Attenuation (dB), Typical, For Input (volts)	> 30 + 6	> 30 + 5	> 30 + 5	> 30 + 5	> 30 + 5	> 20 + 6	> 20 + 8	> 25 - 10	> 25 - 10
Square Wave Mode									
On/Off Ratio (dB), For Input (volts)	n/a	> 30 + 5	n/a	n/a	n/a	> 40 + 1	> 40 + 1	n/a	n/a
Compatible with HP 8757/8756 Mod Drive Signal	Yes	Yes	Yes	Yes	Yes	Yes	Yes	No	No
<b>Internal AM</b>									
1 kHz Square Wave									
On/Off Ratio (dB)	> 30	> 25	> 40	> 40	> 40	> 40	> 40	> 25	> 25
<b>Prices</b>									
Plug-In	\$7,900 (86222A: \$6,900)	\$16,500 (86290C: \$20,500)	\$7,400	\$8,200	\$7,000	\$9,100	\$7,500	\$8,900	\$8,700
With Opt 002 (70 dB Attenuator)	+ \$750	n/a	+ \$905	+ \$905	+ \$850	n/a	n/a	n/a	n/a
With Opt 004 (Rear Panel RF Output)	+ \$200	+ \$200	+ \$200	+ \$200	+ \$200	+ \$200	+ \$200	+ \$200	+ \$200
With Opt H80 or 008 (MLA Upconverter)	+ \$1,505	n/a	n/a	standard	+ \$1,005	+ \$1,005	+ \$1,005	n/a	+ \$1,505
With W30 Extended Repair Service	+ \$180(B)	+ \$390(B)	+ \$170	+ \$195	+ \$155	+ \$205	+ \$160	+ \$190	+ \$190
Return to HP Support	+ \$155(A)	+ \$500(C)							
With W32 Calibration	+ \$525(B)	+ \$690(B)	+ \$405	+ \$500	+ \$405	+ \$405	+ \$405	+ \$405	+ \$405
Service (see page 671)	+ \$525(A)	+ \$810(C)							

<sup>1</sup> HP 86222A specifications identical to HP 86222B, except that the HP 86222B has 1, 10, and 50 MHz crystal markers that allow enhancement of frequency accuracy to better than ± 200 kHz.

<sup>2</sup> HP 86290C specifications identical to HP 86290B, except that the HP 86290C has maximum leveled power > 20 mW. HP 86290B specifications listed apply to frequencies 6 to 12.4 GHz.

<sup>3</sup> The HP 86240C has Microwave Link Analyzer (MLA) compatibility as a standard feature.

# SWEEPERS

## HP 83550 Series Millimeter-Wave Source Modules

HP 83554A, 83555A, 83556A, 83557A, and 83558A

- 26.5 to 110 GHz frequency range
- Leveled high output power
- Can be driven by many HP microwave sources

- Source module remotable up to one meter length
- Low entry cost

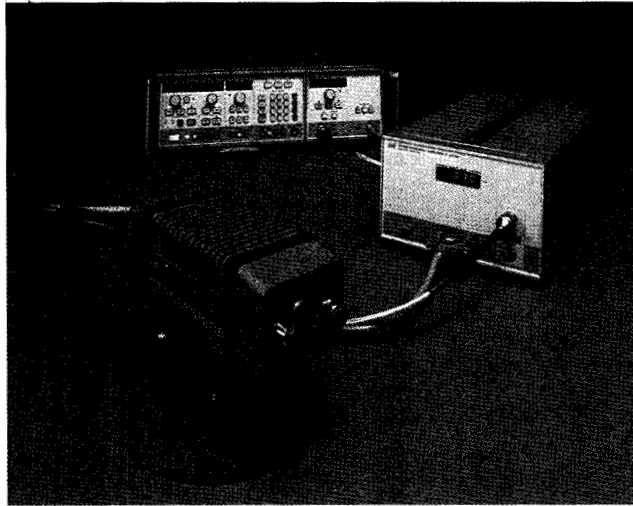

The five HP 83550 series millimeter-wave source modules provide a simple approach to extend the frequency range of 11 to 20 GHz sources to cover 26.5 to 40 GHz (HP 83554A), 33 to 50 GHz (HP 83555A), 40 to 60 GHz (HP 83556A), 50 to 75 GHz (HP 83557A), and 75 to 110 GHz (HP 83558A) bands. The HP 83550 series source modules offer leveled high output power, full waveguide band frequency coverage, and the high frequency accuracy and resolution of the driving microwave source.

As shown in the figure in the right column, there are three basic ways of configuring a millimeter-wave source to best suit your specific needs. Your choice can range from a sophisticated synthesized sweeper (HP 83623A or HP 83624A) to a sweep oscillator (HP 8350B/8359x) with an HP 8349B amplifier.

### Pulse, AM, and FM Modulation

The high-performance pulse modulators of the HP synthesized sources offer  $> 80$  dB on/off ratio and  $< 50$  ns rise and fall times. Pulse amplitudes are leveled for pulse widths as narrow as  $1 \mu\text{s}$ .

The HP 8340B/8341B also feature dc-coupled AM with a 3 dB bandwidth of 100 kHz. Pulse and amplitude modulation can be used to simultaneously simulate antenna scan patterns.

FM rates between 100 Hz and 10 MHz may be applied to the HP 8673B/C/D synthesizer input to achieve deviations up to 20 MHz (HP 83554A) and 30 MHz (HP 83555A, 83556A), 40 MHz (HP 83557A), and 60 MHz (HP 83558A) at millimeter-wave frequencies.

### High Output Power

Leveled output power from the source modules is rated at +8 dBm for the HP 83554A, +3 dBm for the HP 83555A, +3 dBm for the HP 83556A, +3 dBm for the HP 83557A, and -1 dBm for the HP 83558A. This high output power can permit the source module to serve as a mixer LO in some applications, and also expands the available dynamic range in frequency response measurements.

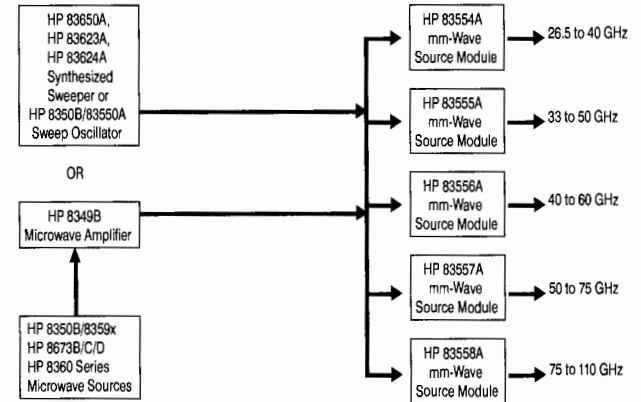

### All at a Lower Cost

The HP 83550-series source modules combine performance and quality with a low cost of entry. This is possible because the source modules are backward-compatible with existing HP microwave sources. Thus you can generate a full waveguide band of millimeter-wave frequencies for just the cost of a source module and an HP 8349B amplifier (where required). Also, the cost of ownership to you is reduced even further by the two-year warranty on the microcircuits of the HP 83550-series source modules and the HP 8349B microwave amplifier.

### HP 83554A Output Characteristics

	HP 8350B/83550A	HP 8350B/ 83590 Series/8349B	HP8360 Series/8349B, HP83623A, 83624A, 83650A	HP 8673B/C/D/8349B
<b>Maximum Leveled Power</b> (25° C ± 5° C)	+8 dBm, 26.5 to 37.2 GHz +7 dBm, 37.2 to 40.0 GHz	+8 dBm, 26.5 to 37.2 GHz +7 dBm, 37.2 to 40.0 GHz	+8 dBm, 26.5 to 37.2 GHz +7 dBm, 37.2 to 40.0 GHz	+8 dBm, 26.5 to 37.2 GHz +7 dBm, 37.2 to 40.0 GHz
<b>Minimum Settable Power:</b>	-5 dBm	-5 dBm	-5 dBm	-5 dBm
<b>Power Level Accuracy<sup>2</sup></b> (25° C ± 5° C)	±2.00 dB	±2.00 dB	±2.00 dB	±2.00 dB
<b>Power Flatness</b> (at max leveled power)	±1.50 dB	±1.50 dB <sup>3</sup>	±1.50 dB <sup>3</sup>	±1.50 dB <sup>3</sup>
<b>Source Output SWR</b>	<2.0	<2.0	<2.0	<2.0
<b>Spurious Signals<sup>4</sup></b> Harmonically related spurious:				
26.5 to 26.7 GHz	< -25 dBc	< -25 dBc	< -25 dBc	< -25 dBc
26.7 to 40.0 GHz	< -50 dBc	< -20 dBc <sup>4</sup>	< -40 dBc	< -20 dBc <sup>5</sup>

## HP 83550 Series Millimeter-Wave Source Modules (cont'd)

HP 83555A, 83556A, 83557A, and 83558A

### HP 83555A Output Characteristics<sup>1</sup>

	HP 8350B/83550A	HP 8350B/ 83590 Series/8349B	HP8360 Series/8349B, HP83623A, 83624A, 83650A	HP 8673B/C/D/8349B
<b>Maximum Leveled Power</b> (25° C ± 5° C)	+3 dBm	+3 dBm	+3 dBm	+3 dBm
<b>Minimum Settable Power</b>	-5 dBm	-5 dBm	-5 dBm	-5 dBm
<b>Power Level Accuracy<sup>2</sup></b> (25° C ± 5° C)	±2.00 dB	±2.00 dB	±2.00 dB	±2.00 dB
<b>Power Flatness</b> (at max leveled power)	±1.50 dB	±1.50 dB <sup>3</sup>	±1.50 dB <sup>3</sup>	±1.50 dB <sup>3</sup>
<b>Source Output SWR</b>	<2.0	<2.0	<2.0	<2.0
<b>Spurious Signals<sup>4</sup></b> Harmonically related spurious: 33.0 to 37.5 GHz 37.5 to 49.5 GHz 49.5 to 50.0 GHz	< -20 dBc < -50 dBc < -20 dBc	< -20 dBc < -20 dBc <sup>4</sup> < -20 dBc	< -20 dBc < -40 dBc <sup>5</sup> < -20 dBc	< -20 dBc < -20 dBc <sup>5</sup> < -20 dBc

### HP 83556A Output Characteristics<sup>1</sup>

	HP 8350/83550A	HP 8350B/ 83590 Series/8349B	HP 8360 Series/8349B, HP 83623A, 83624A, 83650A	HP 8673B/C/D/8349B
<b>Maximum Leveled Power</b> (25° C ± 5° C)	+3 dBm	+3 dBm	+3 dBm	+3 dBm
<b>Minimum Settable Power:</b>	-5 dBm	-5 dBm	-5 dBm	-5 dBm
<b>Power Level Accuracy<sup>2</sup></b> (25° C ± 5° C)	±2.25 dB	±2.25 dB	±2.25 dB	±2.25 dB
<b>Power Flatness</b> (at max leveled power)	±1.75 dB	±1.75 dB <sup>3</sup>	±1.75 dB <sup>3</sup>	±1.75 dB <sup>3</sup>
<b>Source Output SWR</b>	<2.0	<2.0	<2.0	<2.0
<b>Spurious Signals<sup>4</sup></b> Harmonically related spurious: 40.0 to 45.0 GHz 45.0 to 60.0 GHz	< -20 dBc < -50 dBc	< -20 dBc < -20 dBc <sup>4</sup>	< -20 dBc < -40 dBc <sup>5</sup>	< -20 dBc < -20 dBc <sup>5</sup>

### HP 83557A Output Characteristics

	HP 8350B/83550A	HP 8350B/83592C/ 83595C/8349B	HP8360 Series/ 8349B, HP 83623A, 83624A, 83650A	HP 8673C/D/8349B
<b>Maximum Leveled Power</b> (25° C ± 5° C)	+3 dBm	+3 dBm	+3 dBm	+3 dBm
<b>Minimum Settable Power</b>	-2 dBm	-2 dBm	-2 dBm	-2 dBm
<b>Power Level Accuracy</b> (25° C ± 5° C)	±2.5 dB	±2.5 dB	±2.0 dB	±2.5 dB
<b>Power Flatness</b> (at max leveled power)	±2.0 dB	±2.0 dB	±1.5 dB	±2.0 dB
<b>Source Output SWR</b> Leveled: Unleveled:	<2.0 <3.0	<2.0 <3.0	<2.0 <3.0	<2.0 <3.0
<b>Spurious Signals<sup>4</sup></b> Harmonically related spurious:	< -20 dBc	< -20 dBc	< -20 dBc	< -20 dBc

### HP 83558A Output Characteristics

	HP 8350B/83550A	HP 8350B/83592C/ 83595C/8349B	HP 8360 Series/ 8349B, HP 83623A, 83624A, 83650A	HP 8673C/D/8349B
<b>Maximum Leveled Power</b> (25° C ± 5° C)	0 dBm	0 dBm	0 dBm	0 dBm
<b>Minimum Settable Power</b>	-5 dBm	-5 dBm	-5 dBm	-5 dBm
<b>Power level accuracy</b> (25° C ± 5° C)	±2.5 dB	±2.5 dB	±2.0 dB	±2.5 dB
<b>Power flatness</b> (at max leveled power)	±2.0 dB	±2.0 dB	±1.5 dB	±2.0 dB
<b>Source Output SWR</b> Leveled: Unleveled:	<2.0 <3.0	<2.0 <3.0	<2.0 <3.0	<2.0 <3.0
<b>Spurious Signals<sup>4</sup></b> Harmonically related spurious:	< -20 dBc	< -20 dBc	< -20 dBc	< -20 dBc

<sup>1</sup>All specifications apply to internally leveled operation only.  
<sup>2</sup>Specified with respect to HP 83550A or HP 8349B power display. Includes power level flatness.  
<sup>3</sup>Must have 0.5 V/GHz modification on microwave source  
<sup>4</sup>Except for the HP 83592C/95C which are -45 dBc  
<sup>5</sup>Except for the HP 8673C/D, which are -50 dBc  
<sup>6</sup>Expressed in dB relative to the carrier level (dBc)

### General Specifications

#### Waveguide Output Connector

- HP 83554A:** EIA size WR 28 waveguide; JAN UG-599 flange
- HP 83555A:** EIA size WR 22 waveguide; JAN UG-383 flange
- HP 83556A:** EIA size WR 19 waveguide; JAN UG-383 (mod.) flange
- HP 83557A:** EIA Size WR 15 waveguide; JAN UG-385 flange
- HP 83558A:** EIA Size WR 10 waveguide; JAN UG-387 flange

**Weight:** Net, 1.7 kg (4 lb)

**Dimensions:** Module, 80 mm W × 80 mm H × 210 mm D (3.15 in × 3.15 in × 8.27 in)

**Furnished with each source module:** Operating and Service Manual, Modification Procedures for 0.5 V/GHz output, Type N RF Cable, Module Base Assembly, Synthesizer Interface Cable

### Ordering Information

	<b>Price</b>
<b>HP 83554A</b> 26.5 to 40.0 GHz mm-Wave Source Module	\$10,000
<b>HP 83555A</b> 33.0 to 50.0 GHz mm-Wave Source Module	\$10,000
<b>HP 83556A</b> 40.0 to 60.0 GHz mm-Wave Source Module	\$10,000
<b>HP 83557A</b> 50.0 to 75.0 GHz mm-Wave Source Module	\$15,000
<b>HP 83558A</b> 75.0 to 110.0 GHz mm-Wave Source Module	\$15,000
<b>Opt 910</b> Extra Manual	+ \$40
<b>Opt W30</b> Extended Repair Service (see page 671)	
<b>HP 83554/5/6</b>	+ \$225
<b>HP 83557/8</b>	+ \$375
<b>Opt W32</b> Calibration Service (see page 671)	
<b>HP 83554/5/6</b>	+ \$1,050
<b>HP 83557/8</b>	+ \$1,315

# AMPLIFIERS

## RF Amplifier

HP 8347A

- Broadband 100 kHz to 3 GHz coverage
- +20 dBm output power
- Low harmonics
- 25 dB gain
- Internally leveled

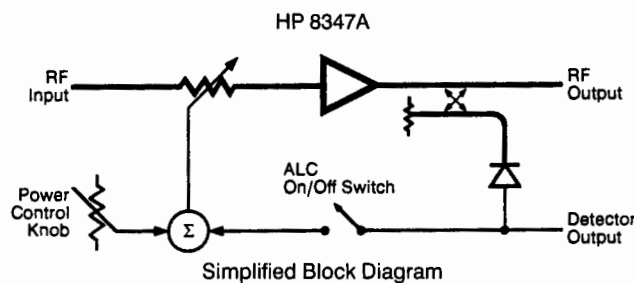

### Specifications

**Frequency range:** 100 kHz to 3 GHz

**Maximum leveled output power:**  $\geq +20$  dBm

**Output power leveling range** ( $\geq 300$  kHz):  $+2$  to  $+20$  dBm

**Power flatness** (internally leveled,  $\pm 300$  kHz):  $\pm 1.5$  dB

**Gain:**  $\geq 25$  dB

**Harmonics** (at  $+20$  dBm output)

**Internal leveling off (ALC off):**  $\leq -25$  dBc

**Internal leveling on (ALC on):**  $\leq -20$  dBc

**Reverse Isolation:** 60 dB

**Noise Figure**

**10 MHz to 3 GHz:** 15 dB

**Below 10 MHz:** 20 dB

### General

**RF input and output connectors:** Type N female

**Size:** 102 mm H  $\times$  213 mm W  $\times$  298 mm D (4.0 in  $\times$  8.4 in  $\times$  11.8 in)

**Weight:** Net, 4 kg (8 lb); shipping, 5 kg (11 lb)

### Supplemental Characteristics

**Maximum input for minimum internally leveled output:**  $-14$  dBm

**1 dB compression point:**  $+22$  dBm

**Third-order intercept:**  $+30$  dBm

**RF input and output impedances:** 50 ohms

### VSWR

**Input:** 2.0:1

### Output

**Internally leveled:** 1.5:1

### Unleveled:

Below 2 GHz: 2.0:1

2 to 3 GHz: 3.0:1

### Ordering Information

**HP 8347A** RF Amplifier

### Price

\$4,250

### HP 8348A

- Broadband 2.0 to 26.5 GHz coverage
- > 23 dB gain
- > +25 dBm (> 300 milliwatts) across 2 to 20 GHz
- < 13 dB typical noise figure

### HP 8346A

- Broadband 26.5 to 40 GHz coverage
- +17 dBm output power to 38 GHz
- Low harmonics
- 2.4 mm coaxial connectors

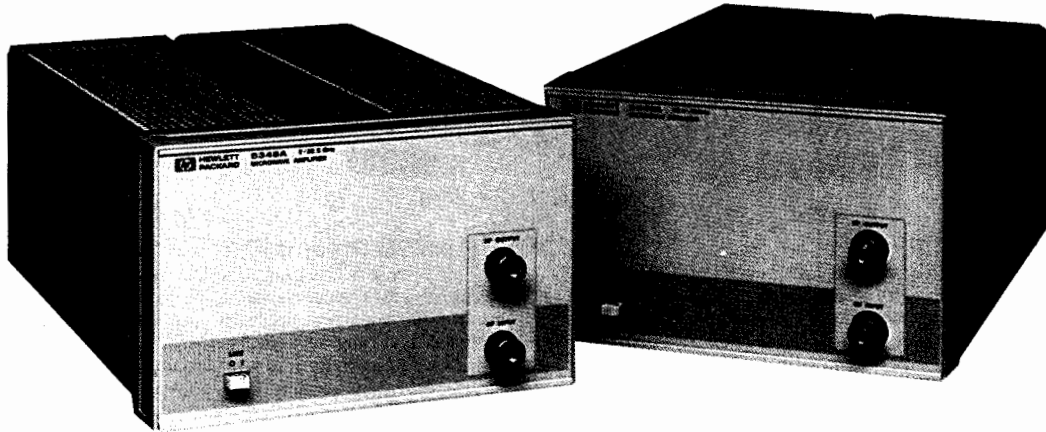

HP 8348A and HP 8346A

### HP 8348A

#### Specifications

<b>Frequency range:</b>	2.0 to 26.5 GHz
<b>Maximum output power</b> (at 0 dBm input):	
1.0 to 2.0 GHz:	≥ +20 dBm (typical)
2.0 to 20.0 GHz:	≥ +25 dBm
20.0 to 26.5 GHz:	≥ +23 dBm
<b>Power flatness:</b> (at 0 dBm input)	± 4 dB (typical)
<b>Minimum small signal gain</b> (at -15 dBm input):	
1.0 to 2.0 GHz:	≥ 20 dB (typical)
2.0 to 20.0 GHz:	≥ 25 dB
20.0 to 26.5 GHz:	≥ 23 dB
<b>Spectral Purity</b>	
<b>Harmonics:</b> typical (at maximum specified output power)	
1.0 to 2.0 GHz:	< -20 dBc
2.0 to 26.5 GHz:	> -15 dBc
<b>Third-order intercept</b>	
2.0 to 20.0 GHz:	+36 dBm, nominal
20.0 to 26.5 GHz:	+31 dBm, nominal
<b>Maximum continuous input</b>	
<b>Microwave Power:</b>	+22 dBm
<b>DC Voltage:</b>	±10 V
<b>Input and output impedance:</b> 50 Ω, nominal	
<b>Input SWR:</b>	3:1 (typical)
<b>Output SWR:</b> (typical)	
1.0 to 2.0 GHz:	6:1
2.0 to 20.0 GHz:	4.5:1
20.0 to 26.5 GHz:	2:1
<b>Reverse isolation:</b>	> 50 dB (typical)
<b>Noise figure</b> (typical):	
1.0 to 20 GHz:	< 10 dB
20 to 26.5 GHz:	< 13 dB

#### Pulse transmission capability

<b>Rise/fall time:</b>	< 5 ns (typical)
<b>Delay time:</b>	< 5 ns (typical)

#### General

**Input and output connectors:** 3.5 mm male  
**Power requirement:** 50 to 400 Hz, 100, 120, 200, or 240 volts AC (±10%); 85 VA maximum  
**Size:** 133 mm H × 214 mm W × 366 mm D (5.2 in × 8.4 in × 14.4 in).  
**Weight:** Net 7 kg (15 lb); shipping, 14 kg (31 lb)

### HP 8346A

#### Specifications

<b>Frequency range:</b>	26.5 to 40.0 GHz
<b>Maximum output power</b> (at +7 dBm input):	
25.0 to 26.5 GHz:	≥ +17 dBm (typical)
26.5 to 38.0 GHz:	≥ +17 dBm
38.0 to 40.0 GHz:	≥ +13 dBm
<b>Power flatness</b> (at +7 dBm input):	
26.5 to 38 GHz:	± 3 dB (typical)
38 to 40.0 GHz:	± 4 dB (typical)
<b>Minimum small signal gain</b> (at -5 dBm input):	
25.0 to 26.5 GHz:	≥ 10 dB (typical)
26.5 to 38.0 GHz:	≥ 10 dB
38.0 to 40.0 GHz:	≥ 8 dB

#### Spectral Purity

<b>Harmonics</b> (at maximum specified output power):	< -30 dBc (typical)
--	---------------------

#### Maximum continuous input

Microwave Power:	+22 dBm
DC Voltage:	±10 V

#### Input and output impedance: 50 Ω, nominal

<b>Input SWR:</b>	4:1 (typical)
<b>Output SWR:</b>	3:1 (typical)
<b>Reverse isolation:</b>	
26.5 to 38.0 GHz:	> 35 dB (typical)
38.0 to 40.0 GHz:	> 25 dB (typical)
<b>Noise figure:</b>	< 13 dB (typical)

#### Pulse Transmission Capability

<b>Rise/fall time:</b>	< 10 ns (typical)
<b>Delay time:</b>	< 10 ns (typical)

#### General

**Input and output connectors:** 2.4 mm male  
**Power requirement:** 50 to 400 Hz, 100, 120, 200, or 240 Volts AC (±10%); 85 VA maximum  
**Size:** 133 mm H × 214 mm W × 366 mm D (5.2 in × 8.4 in × 14.4 in)  
**Weight:** Net, 7 kg (15 lb); shipping, 14 kg (31 lb)

# AMPLIFIERS

## RF and Microwave Amplifiers

HP 8447A/D/E/F, HP 8449B



HP 8447D



HP 8449B

### HP 8447 Series Amplifiers

These low-noise, high-gain amplifiers have many general-purpose uses. They improve the sensitivity of spectrum analyzers, counters, RF voltmeters, EMI meters, power meters, and other devices. They will also increase the maximum power available from a signal generator or sweeper.

Standard connectors are BNC (f). Other options are:  
 Option 010: Single-Channel Amplifier, N (f) Connectors  
 Option 001: Dual-Channel Amplifier, BNC (f) Connectors  
 Option 011: Dual-Channel Amplifier, N (f) Connectors

Dual-channel, 50 ohm (nominal) amplifiers are ideal for dual-channel systems such as oscilloscopes or network analyzers. Channels may also be cascaded for increased small-signal gain.

#### General Specifications (all models)

**Weight:** Net, 1.56 kg (3.4 lb); shipping, 2.3 kg (5.1 lb)

**Size:** 85.8 mm H × 130 mm W × 216 mm D (3.4 in × 5.1 in × 8.5 in)

**Power:** 110 or 230 Vac + 10%, 48 to 440 Hz, 15 W

#### Ordering Information

HP 8447A Preamplifier

HP 8447D Preamplifier

HP 8447E Power Amplifier

HP 8447F Preamplifier-Power Amplifier

☎ For off-the-shelf shipment, call 800-452-4844.

#### Price

\$1,550

\$1,650

\$1,850

\$2,720

### HP 8449B Preamplifier

This 1 to 26.5 GHz high-gain, low-noise preamplifier is ideal for many general-purpose applications. It increases the sensitivity of any microwave spectrum analyzer, enabling you to detect and analyze very low-level signals in dramatically reduced measurement time. Its improved sensitivity lets you widen bandwidths and measure low-level signals using much shorter sweep times.

#### General Specifications

Displayed average noise level, 0 dB attn, 10 Hz RBW (char)

HP 8563A:

1.0 to 2.9 GHz

2.75 to 6.46 GHz

5.86 to 13.0 GHz

12.4 to 19.7 GHz

19.1 to 26.5 GHz

HP 8566B:

1.0 to 2.5 GHz

2.0 to 5.8 GHz

5.8 to 12.5 GHz

12.5 to 18.6 GHz

18.6 to 22 GHz

-153 dBm

-154 dBm

-146 dBm

-141 dBm

-136 dBm

-155 dBm

-154 dBm

-150 dBm

-144 dBm

-140 dBm

**Weight:** Net, 4 kg (8.8 lb) nominal

**Size:** 102 mm H × 213 mm D (4.0 in × 8.4 in × 11.74 in)

**Power:** 100, 120, 220, or 240 V, ±10%; 47 to 63 Hz

#### Ordering Information

HP 8449B 1 to 26.5 GHz Preamplifier

Opt 907 Front Handle Kit

Opt 908 Rack Mount Kit (half-rack width)

#### Price

\$7,310

\$65

\$50

### Specifications

	HP 8447A Preamp	HP 8447D Preamp	HP 8447E Power Amp	HP 8447F Preamp-Power Amp	HP 8449B Preamp												
Frequency Range	0.1 to 400 MHz	100 kHz to 1.3 GHz	100 kHz to 1.3 GHz	100 kHz to 1.3 GHz	1.0 GHz to 26.5 GHz												
Typical 3 dB Bandwidth	50 kHz to 700 MHz	75 kHz to 1.7 GHz	75 kHz to 1.4 GHz	50 kHz to 1.4 GHz													
Gain (mean, per channel)	20 dB ± 1.0 dB at 10 MHz (20° to 30° C)	> 25 dB (20° to 30° C)	22 dB ± 1.5 dB (20° to 30° C)		≥ 26 dB (20° to 30° C)												
Gain Flatness Across Full Frequency Range	± 1.8 dB (0° to 55° C) ± 0.7 dB (20° to 30° C) characteristic	± 1.5 dB	± 1.5 dB		1 to 26.5 GHz ± 4.5 dB (0° to 55° C) 2 to 22 GHz ± 2.4 dB (20° to 30° C, typ.)												
Noise Figure	< 7 dB	< 8.5 dB	< 11 dB typical		<table border="1"> <thead> <tr> <th>Band</th> <th>Specified</th> <th>Typical</th> </tr> </thead> <tbody> <tr> <td>1.0 to 12.7 GHz</td> <td>≤ 8.5 dB</td> <td>7 dB</td> </tr> <tr> <td>12.7 to 22.0 GHz</td> <td>≤ 12.5 dB</td> <td>9 dB</td> </tr> <tr> <td>22.0 to 26.5 GHz</td> <td>≤ 14.5 dB</td> <td>12 dB</td> </tr> </tbody> </table>	Band	Specified	Typical	1.0 to 12.7 GHz	≤ 8.5 dB	7 dB	12.7 to 22.0 GHz	≤ 12.5 dB	9 dB	22.0 to 26.5 GHz	≤ 14.5 dB	12 dB
Band	Specified	Typical															
1.0 to 12.7 GHz	≤ 8.5 dB	7 dB															
12.7 to 22.0 GHz	≤ 12.5 dB	9 dB															
22.0 to 26.5 GHz	≤ 14.5 dB	12 dB															
Output Power for 1 dB Gain Compression	> +6 dBm	> +7 dBm typical	> +12.5 dBm 100 MHz to 1 GHz		≤ +7 dBm (characteristic)												
Harmonic Distortion	-32 dB for 0 dBm output	-30 dB for 0 dBm output (typical)	-30 dB for + dBm output		-30 dB for 0 dBm output (characteristic)												
Output for < -60 dB Harmonic Distortion	-25 dBm (characteristic)	-30 dBm	-20 dBm		-30 dBm (characteristic)												
VSWR	< 1.7	< 2.0 input < 2.2 output 1 to 1300 MHz	< 2.2 input < 2.5 output 1 to 1300 MHz		<table border="1"> <thead> <tr> <th>Input:</th> <th>Output:</th> </tr> </thead> <tbody> <tr> <td>1.0 to 2.0 GHz</td> <td>1.0 to 26.5 GHz</td> </tr> <tr> <td>2.0 to 12.5 GHz</td> <td></td> </tr> <tr> <td>12.5 to 26.5 GHz</td> <td></td> </tr> </tbody> </table>	Input:	Output:	1.0 to 2.0 GHz	1.0 to 26.5 GHz	2.0 to 12.5 GHz		12.5 to 26.5 GHz					
Input:	Output:																
1.0 to 2.0 GHz	1.0 to 26.5 GHz																
2.0 to 12.5 GHz																	
12.5 to 26.5 GHz																	
Reverse Isolation	> 30 dB	> 40 dB	> 40 dB		> 75 dB												
Maximum dc Voltage Input	± 10 V	± 10 V	± 10 V		± 20 V												
Options Available	001	001, 010, 011	010	010													
Option Prices	+ \$700	+ \$750, \$102, \$1,150	+ \$120	+ \$395													

HP 8447D AND 8447E COMBINED IN A SINGLE PACKAGE



- Continuous 2 to 20 GHz coverage
- 15 dB gain to 18.6 GHz
- 100 milliwatts across 2 to 18.6 GHz
- < 13 dB typical noise figure



HP 8349B

### Frequency Specifications

Range: 2 to 20 GHz

### Output and Input Specifications (25° C ± 5° C)

Minimum output power (at + 5 dBm input):

Frequency Range (GHz)	Output	
	Leveled	Unleveled
2.0 to 18.6	19 dBm (80 mW)	20 dBm (100 mW)
18.6 to 20.0	17 dBm (50 mW)	18 dBm (63 mW)

1 dB compression point: + 21 dBm, nominal

Power flatness (Leveled): ± 1.25 dB

Minimum small signal gain (at - 5 dBm input):

2.0 to 18.6 GHz: 15dB

18.6 to 20.0 GHz: 13dB

Noise figure: < 13 dB, typical

Impedance (Input and Output): 50 ohms, nominal

VSWR:

Frequency Range (GHz)	Input	Output	
		Leveled	Unleveled (typical)
2.0 to 5.0	≤ 2.8	≤ 2.5	≤ 4.8
5.0 to 11.0	≤ 2.8	≤ 2.5	≤ 3.8
11.0 to 18.0	≤ 2.8	≤ 2.5	≤ 3.2
18.0 to 20.0*	≤ 2.8	≤ 2.5	≤ 3.2

\*VSWR from 18.0 to 20.0 GHz is typical

Maximum continuous input, to the input or output ports:

+ 27 dBm (RF), ± 10V (DC)

### Spectral Purity

Harmonics (at + 20 dBm output):

2.0 to 11.0 GHz: < - 20 dBc

11.0 to 20.0 GHz: < - 30 dBc typical

Non-harmonic spurious: ≤ - 55 dBc

Third-order intercept: + 33 dBm, nominal

### Pulse Transmission Capability

Rise/fall time: < 10 ns typical

### General

Reverse isolation: > 50 dB, typical

RF input/output connectors: Type N female

Size: 133 mm H × 214 mm W × 366 mm D (5.2 in × 8.36 in × 13.6 in)

Weight: Net, 7 kg (15 lb); shipping, 14 kg (31 lb)

### Ordering Information

HP 8349B 2 to 20 GHz Microwave Amplifier

Opt 001 Rear Panel RF Input/Output

Opt 002 Rear Panel RF Input with Front Panel RF

Output

Opt W30 Extended Repair Service (see page 671)

☎ For off-the-shelf shipment, call 800-452-4844.

### Price

\$8,500

+ \$100

+ \$100

+ \$165

# FUNCTION GENERATORS & WAVEFORM SYNTHESIZERS

## General Information

### Introduction

Hewlett-Packard offers a wide variety of signal sources for almost any application, including function generators and frequency or waveform synthesizers. Output frequencies range from 1  $\mu$ Hz to 80 MHz.

For higher frequency applications, refer to the "Signal Generators" and "Sweep Oscillators" sections of this catalog.

### Standard

Standard function generators typically offer a variety of waveforms, such as sine-wave, square, triangle, and ramp.

The HP 8111A also offers pulse capabilities, and the HP 3312A has modulation and sweeping capabilities. Both generators can be used only in manual operation.

### Multi-Functional

Functionality describes function generators that are capable of more than generating a variety of waveforms. For example, up to 150 vectors can be defined with the HP 3314A for the generation of arbitrary signals.

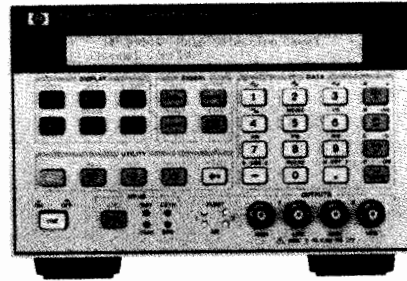

### Analog/Digital Arbitrary Waveforms

The HP 8175A Digital Signal Generator is a data generator, which provides, with the Option 002, arbitrary signals on two analog channels. Digital pattern and analog signals can also be generated simultaneously.

### Synthesized Arbitrary Waveforms

The HP 8770A, in conjunction with an HP 9000 Series 300 Desktop Computer and the HP 11776A Waveform Generation Software, is a complete system for the generation of most complex arbitrary waveforms with synthesizer accuracy. Waveforms can be created in both the time and frequency domain.

### Multifunction Synthesized Waveforms

The HP 8904A Multifunction Synthesizer digitally creates a multitude of complex signals from six simple waveforms. It begins



with a Synthesizer/Function generator offering standard waveforms, DC, and noise. Option 001 adds three channels that can modulate the first synthesizer; option 002 adds a second independent synthesizer output. Modulation capabilities include AM, FM, PM, DSB, and pulse.

### Fast

These instruments offer all of the standard waveforms over the full frequency range up to 50 MHz. The HP 8116A and HP 8165A combine these features with different modes, modulation, and sweep capabilities. Both instruments can be used as pulse generators. The HP 8165A, with its frequency stability of 1 ppm/day, has synthesizer quality.

## HP Function Generators Summary I

HP Models	Standard		Multifunctional					Fast	
	HP 8111A	HP 3312A	HP 3245A	HP 3314A	HP 8904A	HP 8175A	HP 8770A	HP 8118A	HP 8165A
Sine Wave Min. Frequency Max. Frequency	1 Hz 20 MHz	0.1 Hz 13 MHz	0 Hz 1 MHz	1 mHz 20 MHz	0 Hz 600 kHz	dc 25 MHz	dc 50 MHz	1 mHz 50 MHz	1 mHz 50 MHz
Waveforms Square Triangle Ramp Pulse Arbitrary	1 Hz to 20 MHz 1 Hz to 20 MHz 1 Hz to 20 MHz 1 Hz to 20 MHz	0.1 Hz to 13 MHz 0.1 Hz to 13 MHz 0.1 Hz to 13 MHz 0.1 Hz to 20 MHz	0 Hz to 1 MHz 0 Hz to 1 MHz	1 mHz to 20 MHz 1 mHz to 20 MHz	0.1 Hz to 50 kHz 0.1 Hz to 50 kHz 0.1 Hz to 50 kHz	Full Arbitrary Waveform	Full Arbitrary Waveform	1 mHz to 50 MHz 1 mHz to 50 MHz 1 mHz to 50 MHz 1 mHz to 50 MHz	1 mHz to 50 MHz 1 mHz to 50 MHz 1 mHz to 50 MHz 1 mHz to 20 MHz
Modes Trigger Gate Counted Burst	ext ext 1 to 1999	int/ext int/ext	int/ext int/ext int subroutine	int/ext int/ext 1 to 1999	Creates signals from six basic Waveforms	Full Arbitrary Waveform	Full Arbitrary Waveform HP 11776A	ext ext 1 to 1999	ext ext 1 to 1999
Modulation AM FM PM PWM		int/ext int/ext	int subroutine Arbitrary	ext ext	int int int	Full Arbitrary Waveform	Full Arbitrary ext HP 11776A	ext ext	ext ext
Sweep Lin. Log. VCO		int/ext int/ext	int int int subroutine	int int ext	int none int	Full Arbitrary Waveform	Full int/ext Waveform	ext int/ext ext	ext
Output (into 50 $\Omega$ ) Amplitude (p-p) dc Offset Output Impedance- $\Omega$	16 V $\pm 8$ V 50	10 V $\pm 4.5$ V 50	10 V $\pm 5$ V 0150	10 V $\pm 5$ V 50	10 V $\pm 5$ V 50	16 V $\pm 8$ V 50	2 V 50	16 V $\pm 8$ V 50	20 V $\pm 10$ V 50/1000
Programmability			HP-IB	HP-IB	HP-IB	HP-IB	HP-IB	HP-IB	HP-IB
Notes			2 independent channels, also AC current and 6-digit precision dc voltage or current.	also $\frac{1}{2}$ cycle bursts, phase lock	4 internal channels. One is modulated or sequenced	2 analog outputs dig./analog signals simultaneously	HP Series, 300 Controller, plus HP 11776A software recommended		
Catalog page	488	482 483	484 485	482 483	486 487	489 490	454	491 492	493

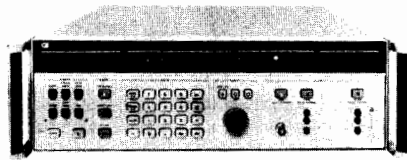

### Synthesizers

Synthesizers provide sinewaves with the focus on a very high frequency stability and excellent level accuracy. You can choose among different output impedances. The HP 3335A generates sinewaves up to 81 MHz and the HP 3336A/B/C has modulation capabilities.

### Synthesized Function Generators

Synthesized function generators combine the frequency stability of a synthesizer with the feature set of the function generator. The HP 3324A has good synthesizer performance and versatile sweep modes that are phase continuous over the full frequency range. In addition, the HP 3325B provides various modulation capabilities and excellent synthesizer performance. The HP 3326A plays a special part because of its two channels, which can be combined in various ways to produce two-tone signals or calibrated two-phase signals.

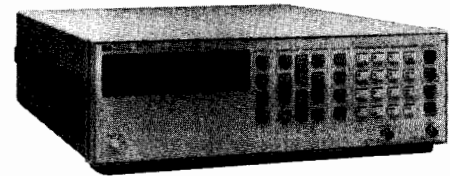

### Which Function Generator Do You Need?

HP's function generators and synthesizers are the best solution for most applications. The tables shown on these two pages will help you determine the right one for your application. The instruments are split into categories, depending on their main specifications. For an explanation of the instrument's full range of capabilities, see the following information.

### HP Function Generators Summary II

HP Models	SYNTHESIZED FUNCTION GENERATORS			SYNTHESIZERS	
	3324A	3325B	3326A	3335A	3336A/B/C
Sinewave					
Min. Frequency	1 mHz	1 μHz	DC	200 Hz	10 Hz
Max. Frequency	21 MHz	21 MHz	13 MHz	81 MHz	21 MHz
Frequ. Stability	10 <sup>-7</sup> /month	10 <sup>-7</sup> /month	10 <sup>-7</sup> /month	10 <sup>-9</sup> /day	1.5x10 <sup>-9</sup> /day
Frequ. Resolution	1 mHz	1 μHz	1 μHz	1 MHz	1 μHz
Waveforms					
Square	1 mHz to 11 MHz	1 μHz to 11 MHz	dc to 13 MHz		
Triangle	1 mHz to 11 kHz	1 μHz to 11 kHz			
Ramp	1 mHz to 11 kHz	1 μHz to 11 kHz			
Pulse			dc to 13 MHz		
Modulation					
AM		int/ext	int/ext		ext
FM					
PM		int/ext	int/ext		ext
PWM			ext		
Sweep					
Lin.	int	int	int	int	int
Log.	int	int	int		
Discrete	int	int	int		
VCO					
Level Range - 50 Ω	10 V (p-p)	10 V (p-p)	10 V (p-p)	-87 to +13 dBm	-71 to +8 dBm
Level Resolution	4 digits	4 digits	4 digits	0.01 dB	0.001 dB
Level Accuracy	± 0.9 dB	± 0.9 dB	± 1.0 dB	± 0.1 dB	± 0.08 dB
DC Offset-50Ω	± 5 V	± 5 V	± 5 V		
Output impedance-Ω	50	50	50	50/75/124/135	50/75/124/135/150/600
Spurious	-55 dBc	-70 dBc	-70 dBc	-75 dBc	-70 dBc
Phase noise	-50 dBc	-60 dBc	-66 dBc	-58 to -70 dBc	-64 dBc
Notes	60 MHz TTL clock, multi-interval and multi-marker sweep	Modulation source can be used separately	2 channels, two-tone and two phase signals		
Catalog page	496 497	494 495	494 495	498	498

### Broad Application Range

If your applications involve a large variety of measurements, one of HP's standard function generators is the right solution.

### Simulating Real Life Signals

HP's Arbitrary Function Generators are dedicated for the simulation of real-life signals, ranging from disk drive or video test signals to mechanical vibration simulation. Applications such as VOR, FM stereo, and communications signalling are covered by the Multifunction Synthesizer HP 8904A.

### Versatility and Speed

Many applications require standard waveforms over the full frequency range up to 50 MHz and with versatile operating modes. These requirements can be fulfilled with the HP 8116A and HP 8165A. The HP 8165A can be recommended especially for those applications requiring 50 MHz in conjunction with good frequency stability.

### Highly Accurate Reference Sources

Applications such as PLL-testing, calibration of measurement instruments, and testing of Frequency Division Multiplex equipment are ideally suited for HP's synthesizers. The very stable frequency source and the excellent level accuracy make these synthesizers the right choice if a reference source is required.

### Accuracy and Versatility

Synthesized function generators are for those applications that require a combination of an accurate frequency source and a versatile function generator. Sweeping over the entire frequency range without any phase discontinuity makes these generators ideal for such applications as simulation of rotation signals and filter testing. Even the calibration of phase measuring instruments is possible by programming a certain phase offset between two generators or using the HP 3326A's two outputs.

# FUNCTION GENERATORS & WAVEFORM SYNTHESIZERS

## Function Generator HP 3314A

- Lin/Log sweeps, gate, counted burst, AM/FM/VCO
- Arbitrary waveform generator
- Phase lock  $\times N$  and  $\div N$  modes, 1/2-cycle mode

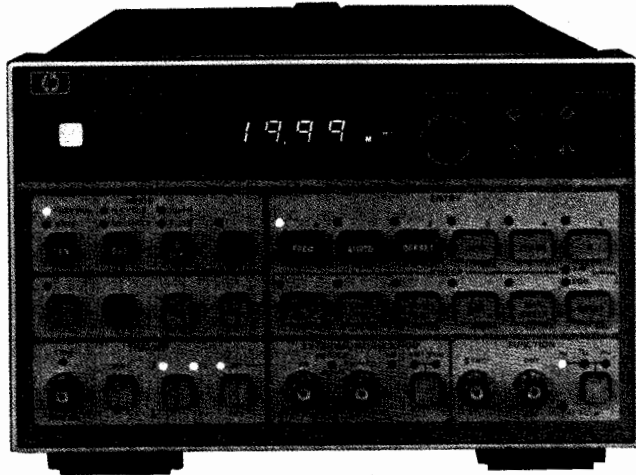

HP 3314A



### HP 3314A Multi-Waveform Generator

The HP 3314A Function/Waveform Generator has the precision and versatility to produce numerous waveforms. Its feature set includes accurate sine, square, and triangle waves, with ramps and pulses available using variable symmetry. Additional features include counted bursts, gate, lin/log sweeps, AM, FM/VCO, dc offset, and phase lock. For increased versatility, the arbitrary waveform mode allows a countless number of user-defined waveforms. Because complete programmability is provided, all of these capabilities are available for ATE systems, as well as bench applications.

### Precise Functions

The HP 3314A provides sine, square, and triangle waveforms from 0.001 Hz to 19.99 MHz with an amplitude range of 0.01 mV to 10Vp-p into 50  $\Omega$  with optional 30 Vp-p into  $> 500 \Omega$ .

Continuous waveforms are provided with high accuracy and low distortion, with frequency accuracy on the upper range of 0.01 percent and sine distortion  $< -55$  dBc to 50 kHz.

Pulses and ramps are provided to 2 MHz using the variable symmetry control over the full 5 percent to 95 percent symmetry range. This provides narrow pulses with 9 ns rise/fall times for digital circuit testing, and positive or negative ramps for amplifier testing and process control.

Independent dc offset to  $\pm 5$  V (into 50  $\Omega$ ) can be added to any ac signal. A post-attenuator summing technique is used to provide large ac signals with small offsets and vice versa.

### Burst and Gate

The N cycle burst mode generates an integer number of complete cycles at each trigger. Bursts of 1 to 1999 cycles are possible for use in applications ranging from sonar testing to digital circuits. Variable symmetry and start/stop phase can be used to produce single ramps and haversines.

Like burst mode, gate mode can be triggered internally or externally. In gate, the HP 3314A output consists of complete cycles, pulses, or arbitrary waveforms which start when the trigger is true, and stop after the trigger goes false. In gate and burst modes, the full frequency range applies for sine, square, triangle, pulse, and ramp waveforms.

### 1/2 Cycle and Integer Phase Lock Modes

The 1/2 cycle burst mode allows simulation of specialized signals found in electronics. At each trigger, alternating 1/2 cycles of sines or triangles are produced. With the addition of variable start/stop phase and symmetry, pulses with variable rise/fall time and overshoot can be produced. Repetition rate, 1/2 cycle frequency, symmetry, and phase can be set independently to produce a variety of waveforms.

The  $\text{Fin} \times N$  and  $\text{Fin} \div N$  modes provide powerful phase locking capability. With integer phase lock, fractions or multiples of the

reference signal can be provided, and  $\pm 200$  deg of phase offset is available. The HP 3314A phase locks to the plus or minus edge of the trigger signal; it can lock to a variety of signals such as sines, squares, pulses, ramps, and others, with complete control of output function, symmetry, N, phase, amplitude and offset.

### Modulation and Sweep

Complete AM, FM/VCO modulation give the HP 3314A versatile signal modifying capabilities. With 100 kHz bandwidths, AM and FM/VCO can be used separately or simultaneously to produce many waveforms.

Multi-frequency measurements can be made with HP 3314A sweep capabilities. Linear, logarithmic, and manual sweep make measurements of filters, amplifiers, and other networks convenient and accurate. X drive, marker, and trigger output signals are also provided.

### Arbitrary Waveforms

For specialized low frequency applications, you can use the HP 3314A arbitrary (ARB) waveform mode to create custom waveforms as a series of voltage ramps or vectors. Values are easy to enter from the front panel, using the modify knob as a pencil and an oscilloscope as a pad. For remote programming, use a desktop or mainframe computer to calculate the values, then program them using the HP-IB. Arbitrary waveforms are automatically stored in non-volatile memory for quick recall.

### Two Sources in One

A square-wave trigger source is included for generation of complex waveforms with a single HP 3314A. The 0.5 MHz to 500 kHz internal trigger is useful in gated, burst, and phase locked waveforms. This signal is provided as an output for synchronizing the HP 3314A to other devices.

### Specifications

#### Frequency

**Range:** 0.001 Hz to 19.99 MHz—sine, square, and triangle waveforms, 0.001 Hz through 2 MHz range when symmetry  $\neq 50\%$

**Resolution:** 3 1/2 digits

#### Accuracy

Autorange	Range Hold	Accuracy
0.001 Hz to 19.99 Hz	0.001 Hz to 19.99 Hz	$\pm (0.4\% \text{ setting} + 0.2\% \text{ range})$
15 Hz to 199.9 kHz	0.1 Hz to 199.9 kHz	$\pm (0.2\% \text{ setting} + 0.1\% \text{ range})$
150 Hz to 19.99 MHz	1 kHz to 19.99 MHz	$\pm (0.01\% \text{ setting} + 50 \text{ ppm/yr})$

#### Amplitude

**Range:** 0.01 mVp-p to 10 Vp-p into 50  $\Omega$

**Resolution:** 3 1/2 digits

**Absolute Amplitude Accuracy:** 10 kHz, 1.00-10.00 Vp-p, Autorange ON

$\pm (1\% \text{ of display} + 0.035 \text{ Vp-p})$ , sine and square wave

$\pm (1\% \text{ of display} + 0.06 \text{ Vp-p})$ , triangle

**Flatness-sinewave:** Relative to 10 kHz, 1.00V to 10.0V (range 4)

20Hz	50 kHz	1 MHz	19.99 MHz
$\pm .07$ dB	$\pm .33$ dB	$\pm 1.5$ dB	

#### Frequency Sweep

**Linear:** 0 to 2 decades, 7.2 ms to 1999 s/sweep

**Log:** 1 to 7 decades (integer only), 40 ms to 1999 s/decade

**Manual sweep:** Modify knob tunes between start and stop frequencies. X drive follows sweep.

#### Modulation Inputs:

Bandwidth	Sensitivity	Range	Z
AM: dc to 100 kHz	2 Vp-p for 100% - 1 Vdc for suppressed carrier	$> 100\%$	10 k $\Omega$
FM: 100 Hz to 100 kHz	$\pm 1$ Vp for 1% of range deviation	$\pm 1\%$ of freq. range	10 k $\Omega$
VCO: dc to 100 kHz	10%/volt	+1 to -10V	10 k $\Omega$

### Waveform Characteristics

**Sine harmonic distortion:** individual harmonics will be below these levels, relative to the fundamental.

20 Hz	50 kHz	1999 KHz	19.99 MHz
-55 dB	-40 dB	-25 dB	

**Square wave rise/fall time:**

< 9 ns, 10% to 90% at 10 Vp-p output

**N integer:**

N = 1 to 1999, Preset to 1  
For Phase-lock  $Fin \div N$ ,  $Fin \times N$   
or N CYCLE (counted burst)

**Function invert:** Inverts ac portion of signal outputs

### Phase

**Phase offset-phase lock modes**

**Resolution:** 0.1°  
**Range:**  $\pm 199.9^\circ$

**Start/stop phase-burst modes**

**Resolution:** 0.1°  
**Range:**  $\pm 90.0^\circ$  for frequencies to 19.99 MHz

### Trigger

**Internal trigger**

**Range:** .002 ms (500 kHz) to 1999 s (0.5 mHz) square wave  
**Period accuracy:**  $\pm (0.01\% + 50 \text{ ppm/year})$  of displayed interval (excluding sweep intervals)  
**Trigger output:** Low < 0.5 V, high > 2.5 V; output resistance 1 k $\Omega$

**External trigger**

For Gate, N Cycle,  $\frac{1}{2}$  Cycle,  $Fin \times N$ ,  $Fin \div N$ , and external sweep triggers

**Frequency range:** 50 Hz to 20 MHz  
**Trigger slope:** Selectable, positive or negative

### Symmetry

**Symmetry range:** 5% to 95% of period, 2 Hz to 2 MHz ranges

### Arbitrary waveforms

Output consists of a series of voltage ramps called vectors. Arbitrary waveforms can be composed of 2 to 150 vectors. A maximum of 160 vectors can be stored in six available storage registers with a minimum of 2 vectors per waveform. Features include MARKER and SYNC outputs and a GATE mode. Practical frequencies are 0.002 Hz to 2.5 kHz.

### Option 001 - Voltage Multiplier

Simultaneous X3 amplitude output on rear panel (into > 500  $\Omega$ , 30 Vp-p max, dc to 1 MHz).

### General

**Power:** 100, 120, 220, 240 V + 5% -10%, 48 to 66 Hz 95 VA maximum

**Weight:** Net, 7.3kg (16lb); shipping, 10.5kg (23lb)

**Size:** 132.6 mm H  $\times$  212.3 mm W  $\times$  419.0 mm D (5.22 in  $\times$  8.36 in  $\times$  16.50 in)

### HP-IB

IEEE Standard 488-1978 abbreviated definition.  
SH1 AH1 T6 TE0 L3 LE0 SR1 RL1 PP0 DC1 DT1 C0 E2.

### Ordering Information

**HP 3314A** Function Generator

**Opt 001** Simultaneous X3 Output

**Opt W30** Extended Repair Service. See page 671.

### Price

\$4,950

+ \$265

+ \$115

- Two function generators in one instrument
- AM-FM, sweep, trigger, gate and burst (int & ext)

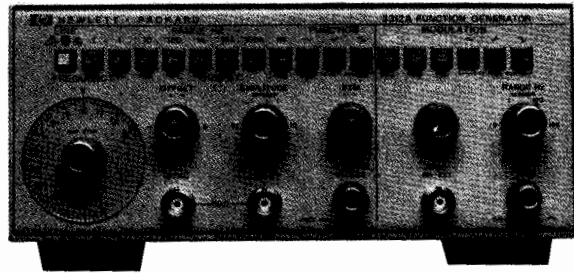

HP 3312A

### HP 3312A Function Generator

The HP 3312A Function Generator combines two separate, independent function generators with a modulator section in one compact instrument. The main generator can, via pushbutton control, be triggered by the modulation generator to provide sweep functions, AM, FM, or tone burst, and includes dc offset up to 10 volts p-p into 50  $\Omega$ .

### Specification Summary

**Output waveforms:** Sine, square, triangle,  $\pm$  ramp, pulse, AM, FM, sweep, triggered, and gated

### Frequency characteristics

**Range:** 0.1 Hz to 13 MHz in 8 decade ranges  
**Dial accuracy:**  $\pm 5\%$  of full scale. Unspecified in Uncal Mode

**Square wave rise or fall time (10% to 90%):** < 20 ns

**Variable symmetry:** 80:20:80 to 1 MHz

**Sine wave distortion:** < 0.5% (-46 dB) THD from 10 Hz to 50 kHz. (10 kHz range maximum). (> 30 dB below fundamental from 50 kHz to 13 MHz, at full-rated output.)

### Output characteristics

**Impedance:** 50  $\Omega \pm 10\%$

**Level:** 20 Vp-p into open circuit, > 10 Vp-p into 50  $\Omega$  at 1 kHz

**Level flatness (sine wave):**  $< \pm 3\%$  from 10 Hz to 100 kHz at full rated output (1 kHz reference).  $< \pm$  from 100 kHz to 10 MHz

**Sync output:** Impedance: 50  $\Omega \pm 10\%$  > 1 Vp-p square wave into open circuit. Duty cycle varies with symmetry control

**dc offset:** Variable up to  $\pm 10$  volts. Instantaneous ac voltage + Vdc offset cannot exceed  $\pm 10$  V (open circuit) or  $\pm 5$  V (50  $\Omega$ )

### Modulation characteristics

**Types:** Internal and external AM, FM, sweep, trigger, gate, or burst  
**Waveforms:** Sine, square, triangle, ramp, or variable symmetry pulse

**Frequency range:** 0.01 Hz to 10 kHz

### Amplitude and frequency modulation

**Depth:** 0 to 100% (AM), 0 to 5% (internal FM)

**Modulation frequency:** 0.01 Hz to 10 kHz (internal), dc to > 1 MHz (AM external), dc to > 50 kHz (FM external)

### Sweep characteristics

**Sweep width:** > 100:1 on any range

**Sweep rate:** 0.01 Hz to 10 kHz, 90:10 ramp

### Gate characteristics

**Start/stop phase range:**  $+90^\circ$  to  $-80^\circ$

**Frequency range:** 0.1 Hz to 1 MHz (useful to 10 MHz)

### External frequency control and FM

**Range:** 1000:1 on any range

**Linearity:** 0.5% of Fmax for Fmax  $\leq$  1 MHz, freq. span  $\leq$  100:1

### General

**Power:** 100, 120, 220, 240 V, +5%, -10%, switchable; 48 Hz to 440 Hz;  $\leq 30$  V A

**Size:** 102 mm H  $\times$  213 mm W  $\times$  377 mm D (4 in  $\times$  8.4 in  $\times$  14.8 in)

**Weight:** Net, 3.8 kg (8.4 lb); shipping, 5.9 kg (13 lb)

### Ordering Information

**HP 3312A** Function Generator

**Opt W30** Extended Repair Service. See page 671.

☎ For off-the-shelf shipment, call 800-452-4844.

### Price

\$1,800

\$50

# FUNCTION GENERATORS & WAVEFORM SYNTHESIZERS

## Universal Source HP 3245A

- Precision dc outputs with 6½ digits of resolution
- Synthesized ac with 0.4% amplitude accuracy
- Sine, Square, Triangle, and ARB to 1 MHz
- Floating outputs
- New 100-Volt option
- Nonvolatile storage of up to 14 setups
- Second-channel output available
- Phase-continuous frequency changes
- Optional software for waveform modification
- Downloadable subroutines

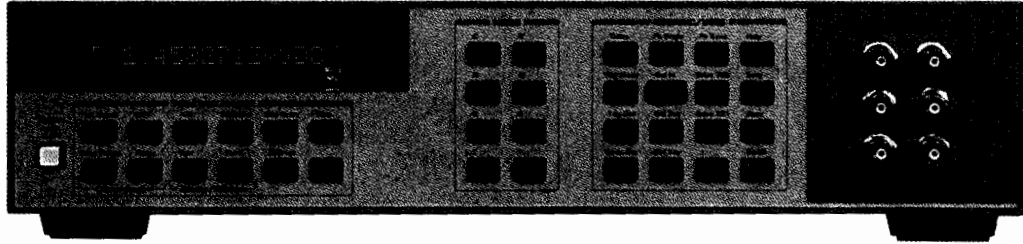

HP 3245A



### Description

The HP 3245A Universal Source combines precision dc capabilities with versatile ac performance, including arbitrary waveform generation. This creates versatility on the bench, where the HP 3245A may be all the source you ever need. The HP 3245A can also fit into your Computer-Aided Test System, providing the capabilities of ac, dc, ARB, and second-channel options in a single 3.5" tall instrument.

### Precision dc

The HP 3245A provides precision dc outputs of both voltage and current. In the high-resolution mode, you get 24-bit resolution with 60-ppm, 90-day accuracy. The low-resolution mode provides 12-bit resolution with 100  $\mu$ sec settling times. This type of precision means you can use the HP 3245A to test A/D converters, Voltage to Frequency converters, VCOs, transducers, and other equipment needing highly accurate dc voltage or current. There are two output ranges in the high-resolution mode:  $\pm 1$  volt and  $\pm 10$  volts. In the low resolution mode, there are seven ranges. In current, there are four ranges of output, from 0.1 mA to 100 mA. Output impedance is selectable as either zero ohms or 50 ohms.

### Accurate AC

The HP 3245A can generate ac voltage outputs, including sine, triangle, and square waves, at frequencies of up to 1 MHz. Variable duty-cycle pulse and ramp outputs can be generated at up to 100 kHz. In the ac mode, the HP 3245A can make phase-continuous frequency changes "on-the-fly." All ac waveforms are synthesized and have 0.001-Hz resolution and 50-ppm frequency accuracy. Ninety-day amplitude accuracy for sine, ramp, and ARB is 0.35% of output + 0.41% of range.

### Arbitrary Waveform

The HP 3245A offers arbitrary waveform operation at a full 1-MHz bandwidth. This is accomplished by a sampling technique in which the values loaded into RAM are sampled at approximately 4.3 MHz and then run through a 1.25-MHz 5-pole low-pass filter. This allows full 1-MHz repetition rate while maintaining 0.001-Hz resolution at any frequency. The HP 3245A can also store multiple arrays that can be accessed for arbitrary waveform generation. Array depth is 2048 bytes.

### Second Channel Option

The addition of a second channel allows you to generate two waveforms, either independent or phase related to each other. The second channel output can be phase synchronized to the first channel or to an external input. Such capabilities are especially useful if you are doing modem testing, tone-sequence generation, DTMF generation, FSK generation, or other operations where two outputs are required.

### Waveform-Generation Software

A powerful software package for creating specialized waveforms is available as an option to the HP 3245A. This menu-driven software facilitates the capture of a waveform using a separate hardware digitizer, such as the HP 3458A. The waveform can then be modified, if desired, and played back via the HP 3245A. The use of a graphics tablet makes it easy to modify waveforms. The software also contains a library of standard waveforms that can be used as is or mixed with other waveforms to generate complex outputs.

### NEW! Option 002 High-Voltage Output

Option 002 is a precision voltage amplifier that increases the output voltage 10-fold. Maximum voltage is now  $\pm 100$  volts, or 200 volts peak-to-peak in ac mode. The second channel slot is used for the high-voltage option. It is not possible to have both second channel and high-voltage options in the same instrument.

### System Operation

The HP 3245A includes features that make it especially powerful in system applications. Because it contains many BASIC-like constructs, such as IF..THEN and FOR..NEXT, the HP 3245A can do much of the work that normally falls to the host computer. Now, subroutines can be downloaded to the HP 3245A and run standalone, minimizing host interaction. Built-in math capabilities add to the power of the HP 3245A. Electronic calibration is both easy and accurate and does not require the instrument to be removed from a rack or opened to perform a calibration.

All these features combine to make the HP 3245A a universal source, combining precision dc outputs, accurate ac waveforms, and arbitrary waveform capabilities in a single instrument.

**dc Volts Output****High-resolution (24-bit) mode**

Range	0 $\Omega$ Mode Resolution	50 $\Omega$ Mode Resolution
1 V	1 $\mu$ V	0.5 $\mu$ V
10 V	10 $\mu$ V	5 $\mu$ V

**Low-resolution (12-bit) mode**

Range	0 $\Omega$ Mode Resolution	50 $\Omega$ Mode Resolution
0.078125 V	–	40 $\mu$ V
0.15625 V	79 $\mu$ V	79 $\mu$ V
0.3125 V	157 $\mu$ V	157 $\mu$ V
0.625 V	313 $\mu$ V	313 $\mu$ V
1.25 V	625 $\mu$ V	625 $\mu$ V
2.5 V	1250 $\mu$ V	1250 $\mu$ V
5 V	2.5 mV	2.5 mV
10 V	5.0 mV	–

**Current compliance:** 100 mA on all ranges

**Settling time (Delay 0):****High-resolution mode:**

0.1% of step: 20 ms

0.001% of step: 40 ms

(1 s if function changed)

**Low-resolution mode:**

0.1% of step (0  $\Omega$  Mode): 100  $\mu$ s

(50  $\Omega$  Mode): 25  $\mu$ s

0.5% of step (50  $\Omega$  Mode): 5  $\mu$ s

**Overshoot:**

High-resolution mode: <5% of step + 0.15% of range

Low-resolution mode: <30% of step + 2% of range

**dc Volts Accuracy** (<10 Hz noise):  $\pm$  (% of programmed output + volts), impedance mode, >1 M  $\Omega$  load. Tcal is the temperature of calibration from 18° C to 28° C. One hour warm-up.

**24 Hour:** T<sub>cal</sub>  $\pm$  1° C

Range	High-Resolution Mode	Low-Resolution Mode
10 V	0.0007% + 85 $\mu$ V	0.09% of Output + 0.02% of range
1 V	0.0008% + 15 $\mu$ V	(for all ranges)

**90 Day:** T<sub>cal</sub>  $\pm$  5° C

High-Resolution Mode		Low-Resolution Mode	
Range	Accuracy	Range	Accuracy
10 V	0.0038% + 180 $\mu$ V	10 V	0.17% + 37 mV
1 V	0.0042% + 31 $\mu$ V	5 V	0.17% + 19 mV
		2.5 V	0.17% + 9.2 mV
		1.25 V	0.17% + 4.6 mV
		0.625 V	0.17% + 2.5 mV
		0.3125 V	0.17% + 1.3 mV
		0.15625 V	0.17% + 0.73 mV

**dc Volts Accuracy** with Option 002: Ninety-day accuracy in the low-resolution mode is  $\pm$ (0.2% of output + 370 mV) for 10-volt range. (10x amplifier; 100 volts output)

**dc Current Output Resolution**

Range	High Resolution	Low Resolution
0.1 mA	0.1 nA	50 nA
1 mA	1 nA	500 nA
10 mA	10 nA	5 $\mu$ A
100 mA	100 nA	50 $\mu$ A

**90 DAY:** T<sub>cal</sub>  $\pm$  5° C. After one hour warm-up.

High-Resolution Mode		Low-Resolution Mode	
Range	Accuracy	Range	Accuracy
100 mA	0.0202% + 3.3 $\mu$ A	100 mA	0.32% + 400 $\mu$ A
10 mA	0.0074% + 220 nA	10 mA	0.30% + 52 $\mu$ A
1 mA	0.0052% + 20 nA	1 mA	0.25% + 3.7 $\mu$ A
0.1 mA	0.0052% + 3.3 nA	0.1 mA	0.25% + 0.38 $\mu$ A

**ac Volts Output Characteristics**

(sine, square, ramp, arbitrary)

**Frequency range:**

0 to 1 MHz for sine, arbitrary, and square (at 50% duty cycle)

0 to 100 kHz for ramp

0 to 100 kHz for square w/duty cycle not equal to 50%

**Amplitude and/or offset resolution**

Range (Peak-Peak)	50 $\Omega$ Mode Resolution	0 $\Omega$ Mode Resolution
.15625 V	79 $\mu$ V	–
.3125 V	157 $\mu$ V	157 $\mu$ V
.625 V	313 $\mu$ V	313 $\mu$ V
1.25 V	625 $\mu$ V	625 $\mu$ V
2.5 V	1250 $\mu$ V	1250 $\mu$ V
5 V	2.5 mV	2.5 mV
10 V	5.0 mV	5.0 mV
20 V	–	10.0 mV

Amplitude can be set from 10% to 100% of range.

**ac Amplitude Accuracy (sine, ramp, arbitrary):**

24 Hour: T<sub>cal</sub>  $\pm$  1C 0.16% of output + .25% of range

90 Day: T<sub>cal</sub>  $\pm$  5C 0.29% of output + .36% of range

**ac Amplitude Accuracy with Option 002:** Ninety-day accuracy is  $\pm$ (0.32% of output + 3.6% of range) for 10-volt range. (10x amplifier; 100 volts output)

**Sinewave characteristics (50  $\Omega$  Mode)**

Frequency	Harmonic and Spurious Levels (amp1 $\geq$ 50%) of range)*	THD (amp1 $\geq$ 50% of range)	Flatness In reference to 1 kHz
<3 kHz	< -62 dB	< -56 dB	.07 dB
to 10 kHz	< -62 dB	< -50 dB	.07 dB
to 30 kHz	< -52 dB	< -48 dB	.07 dB
to 100 kHz	< -46 dB	< -46 dB	.20 dB
to 300 kHz	< -40 dB	–	.60 dB
to 1 MHz	< -37 dB	–	2.00 dB

\*Additional fixed spurious response > 4 MHz: 500  $\mu$ Vrms.

**Squarewave characteristics (50  $\Omega$  Mode):**

Rise time: < 250 ns, 10% to 90%

Settling time: < 1  $\mu$ s to 1% of amplitude

Overshoot: < 5% of peak-to-peak amplitude

Duty cycle range: 5% to 95%, 0 to 100 kHz

50% above 100 kHz

Duty cycle accuracy:  $\pm$ (0.8% of period + 120 ns)

**Frequency resolution:** 0.001 Hz

**Frequency accuracy:**  $\pm$  50 ppm, 18 to 28° C

**Frequency temperature Coefficient:**  $\pm$  1 ppm/° C

**Phase offset:**

Range: -360 to +360° C

Resolution: < 0.001° C

**Ramp linearity to 1 kHz (50  $\Omega$  Mode):**

0.3% of peak-to-peak value measured @ 50% duty cycle from 10% to 90% point

**Ramp duty cycle range:** 5% to 95% with < 0.1% resolution

**Ordering Information**

**HP 3245A** Universal Source

**Opt 001** Second Channel Output

**Opt 002** High-Voltage Amplifier

**Opt 005** Waveform Generation Software

**Opt 907** Front Handle Kit

**Opt 908** Rack Flange Kit

**Opt 909** Rack Flange and Handle Combination Kit

**Opt W30** Extended Warranty

**Price**

\$4,550

+ \$2,690

+ \$1,500

+ \$410

+ \$60

+ \$40

+ \$90

+ \$126

# FUNCTION GENERATORS & WAVEFORM SYNTHESIZERS

## Multifunction Synthesizer

HP 8904A

- Sine to 600 kHz, square, ramp, triangle to 50 kHz
- 12 bit direct digital synthesis
- Tone, DTMF, digital, Hop Ram sequence modes
- One or two outputs

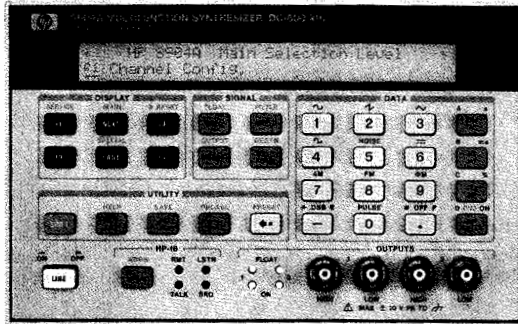

HP 8904A



### Function Synthesizer

The standard HP 8904A Multifunction Synthesizer generates accurate sinewaves from 0 Hz to 600 kHz with 0.1 Hz resolution. The HP 8904A also has five other standard functions: square, triangle, ramp, from 0 Hz to 50 kHz plus dc, and Gaussian white noise. All waveform values in the HP 8904A are DIGITALLY calculated in real time by Hewlett-Packard's Digital Waveform Synthesis IC yielding 12 bit digital accuracy. Full HP-IB programmability is also included standard on the HP 8904A.

### Two Outputs

Option 002 adds a second, identical synthesizer and floating 50  $\Omega$  output section to the HP 8904A. Frequency, amplitude, waveform, and phase can be independently set for the two sources. Either synthesizer can be precisely varied in phase relative to each other from 0 degrees to 359.9 degrees with a resolution of 0.1 degree.

### Complex Signal Generation

Option 001 adds internal synthesizers (for a total of four) which can modulate channel A or be summed to give complex waveform generating capabilities to the HP 8904A. All four synthesizers are independent with precise phase offset capabilities. These synthesizers can be DIGITALLY summed before being output. In addition to summing, Option 001 allows channels B, C, and D to modulate channel A with AM, FM,  $\Phi$ M DSBSC, or pulse modulation.

### FM Stereo Composite Mode

Option 001 also includes a mode for generating FM Stereo composite signals. Test signals in this mode include Left=Right, Left=-Right, Left Only, and Right Only. Single keystrokes select test tone frequency, composite level, test signal mode, and pilot tone level. Stereo separation is typically greater than 65 dB.

### Communication Signaling

Option 001 also adds four sequence modes to the HP 8904A: tone, DTMF, digital, and hop ram sequence modes. These modes make the HP 8904A a powerful tool for use in communications signaling. Tone and DTMF modes allow creation of single or dual tone sequences up to 750 states in length. Digital sequence mode can generate bit streams up to 3000 bits in length with 100  $\mu$ s resolution. Hop ram sequence mode allows sequencing of 16 tones, each with an associated amplitude, frequency, and phase value.

- One to four internal channels
- AM, FM,  $\Phi$ M, DSBSC, and pulse modulation
- Unit to unit phase synchronization
- Optional 600  $\Omega$  high power, balanced output

### Fast Hop

Option 003 adds the ability to externally hop channel A in frequency, phase, or amplitude. Up to 16 frequency/phase/amplitude states can be entered into the "HOP RAM" memory. To hop, an external device must address the four-bit wide, TTL-level address bus provided on the rear panel. Phase continuous switching can be done in as little as 20  $\mu$ s.

### Unit to Unit Phase Synchronization

With Option 005, multiple HP 8904A's can be phase synchronized to provide more than two phase related outputs. In the synchronous mode, one unit is specified to be the master clock unit and all others are designated slaves. Two signals are then routed from the clock master unit to all slave units through external low-loss power splitters. To synchronize the units, a phase reset command is given to the master HP 8904A via HP-IB or from the front panel. The total phase error between units will be the larger of  $\pm 0.1$  degree or 60 ns for frequencies from 0.1 Hz to 100 kHz. Up to eight HP 8904A's may be synchronized.

### 600 $\Omega$ Balanced Output

Option 006 changes output 1 from a 50  $\Omega$  electronically floating output to a transformer coupled, 600  $\Omega$  balanced output. Option 006 provides high power, balanced signals into 600  $\Omega$  loads. Maximum output is 10 volts rms into 600  $\Omega$ . The Option 006 output restricts the frequency range of output 1 to 30 Hz to 100 kHz. In addition, complex waveforms such as square, ramp, and triangle waveforms are degraded and DC cannot be passed through the Option 006 output. In many applications, however, the HP 8904A Option 006 is a direct replacement for the HP 200CD Wide Range Oscillator.

### HP 8904A Specifications (for 50 $\Omega$ output only)

#### Frequency

**Range:** Sinewave: 0 Hz to 600 kHz  
Square, triangle, ramp: 0 Hz to 50 kHz

**Resolution:** 0.1 Hz

**Accuracy** (internal 10 MHz timebase): 50 ppm

#### AC Amplitude (sinewave only)

**Range:** 0 to 10 V p-p into a 50  $\Omega$  load

**Accuracy (> 40 mV p-p into 50  $\Omega$ ):**

1%, 0.1 Hz to 100 kHz; 3%, 100 kHz to 600 kHz

**Flatness (> 630 mV p-p into 50  $\Omega$ ):**

$\pm 0.1\%$  ( $\pm 0.009$  dB), 0.1 Hz to 100 kHz

#### DC Amplitude

**Range:** 0 to  $\pm 10$  V p-p open circuit

**Accuracy:** Larger of  $\pm 20$  mV or  $\pm 2.1\%$

#### Spectral Purity (sinewave only)

**THD + N (including spurs, amplitude > 50 mV rms into 50  $\Omega$ ):**

-63 dBc rms (0.07%), 20 Hz to 7.5 kHz, 30 kHz BW

-63 dBc rms (0.07%), 7.5 kHz to 20 kHz, 80 kHz BW

#### Gaussian Noise

**Spectral characteristic:** Equal energy per unit bandwidth ("white")

**Time domain characteristic:** Gaussian distribution

**Flatness (> 100 mV p-p):** Typically  $\pm 0.5$  dB, 0.1 Hz to 100 kHz



**Option 001 Specifications**

Modulation is for channel A only, and specified for sinewave carrier and modulation. External modulation is NOT possible.

**Amplitude Modulation (with Option 001)**

**Rate:** 0 to 600 kHz

**Depth range:** 0% to 100 % of carrier amplitude

**Frequency Modulation (with Option 001)**

**Rate:** 0 to 600 kHz

**Deviation range:** 0 to 600 kHz

**Phase Modulation (with Option 001)**

**Rate:** 0 to 600 kHz

**Deviation range:** 0° to 179.9°/channel

**Pulse or DSBSC Modulation (with Option 001)**

**Rate:** 0 Hz to 50 kHz (up to 600 kHz for DSBSC)

**Summation (with Option 001)**

Two, three, or four channels may be summed.

**Channel to channel phase accuracy (equal amplitude sinewaves):** Larger of  $\pm 0.1^\circ$  or 30 ns, 0.1 Hz to 100 kHz

**FM Stereo Composite Mode (with Option 001)**

**Test modes:** Left=Right, Left = - Right, Left Only, Right Only

**Composite signal level:** Up to 10  $V_{pp}$  into 50  $\Omega$

**Pre-emphasis modes:** Off, 25  $\mu s$ , 50  $\mu s$ , and 75  $\mu s$

**Channel separation:** Typically > 65 dB, 20 Hz to 15 kHz rates

**Tone Sequence Mode (with Option 001)**

**Number of frequencies:** 16 tones each with user-definable frequency, on-time and off-time

**On/Off time duration range:** 0 ms, 0.80 ms to 655.35 ms

**Timing accuracy:**  $\pm 0.02$  ms ( $\pm 20 \mu s$ )

**Sequence length:** 750 steps, user-definable

**DTMF Sequence Mode (with Option 001)**

**Number of tone pairs:** 16 standard DTMF tone pairs (0-9, A-D, #, \*) with user-definable on-time and off-time

**On/Off time duration range:** 0 ms, 1.00 ms to 655.35 ms

**Timing accuracy:**  $\pm 0.02$  ms ( $\pm 20 \mu s$ )

**Sequence length:** 750 steps, user-definable

**Digital Sequence Mode (with Option 001)**

**User definable:** On level, off level, and bit period

**Bit period duration range:** 0.10 ms to 655.35 ms

**Timing accuracy:**  $\pm 0.02$  ms ( $\pm 20 \mu s$ )

**Sequence length:** Up to 3000 bits, user-definable

**Hop Ram Sequence Mode (with Option 001)**

**Number of frequencies:** 16 tones each with user-definable frequency, phase, and amplitude

**Sequence clock frequency range:** 0.1 Hz to 10 kHz

**Sequence length:** 750 steps (all 16 tones used) or 3000 steps (tones 0 and 1 used), user-definable

**Option 002 Specifications (50  $\Omega$  outputs)**

**Output 1 to output 2 phase accuracy (sinewaves at the same frequency):**  $\pm 0.1^\circ$  or 30 ns, 0.1 Hz to 100 kHz, whichever is greater

**Option 003 Specifications (Fast Hop)**

**Direct hopping of channel A:** 16 phase-frequency-amplitude states may be addressed with four TTL-compatible inputs.

**Switching speed (via digital port):** Typically < 20  $\mu s$

**Option 005 Specifications (50  $\Omega$  outputs)**

**Unit to unit phase accuracy (sine waves only):** Larger of  $\pm 0.1$  degree or 60 ns, 0.1 Hz to 100 kHz

**Maximum number of synchronized units:** 8 units

**Option 006 Specifications (sine wave)**

All specifications for the standard 50  $\Omega$  output HP 8904A are degraded by the accuracy, flatness, and distortion specifications of the Option 006, 600  $\Omega$  transformer coupled output.

**Output type:** Fully floating/balanced transformer coupled output

**Usable frequency range:** Typically 30 Hz to 200 kHz

**AC amplitude range:** 0 to 10 Vrms into 600  $\Omega$

**AC amplitude accuracy (> 40 mVrms into a balanced 600  $\Omega$  load):**

6% (0.5 dB), 30 Hz to 20 kHz

12% (1.0 dB), 30 Hz to 100 kHz

**Flatness (> 40 mVrms into a balanced 600  $\Omega$  load):**

+0.15 dB, -0.75 dB, 30 Hz to 100 kHz

**THD + Noise (including spurs, > 140 mVrms into a balanced 600  $\Omega$  load):** -63 dB (0.07%), 7.5 kHz to 20 kHz, 80 kHz BW

**General**

**Store recall:** 35 nonvolatile registers

**Output type (standard unit):** 50  $\Omega$  electronic floating or grounded output, HP-IB programmable

**Maximum float voltage (50  $\Omega$  output, signal + float):** 10 V peak maximum from high or low output to chassis ground

**External timebase input:** 10 MHz accepted at a nominal level of 0.1 to 5 V peak, automatic switching

**Operating temperature range:** 0° C to 50° C

**Storage temperature range:** -20° C to 70° C

**Remote operation:** HP-IB

**Weight:** Net, 5.9 kg (12.8 lb); shipping, 13 kg (28.6 lb)

**Size:** 133 H  $\times$  213 W  $\times$  513 mm D (5.25 in  $\times$  8.36 in  $\times$  20.2 in)

**Ordering Information**

	<b>Price</b>
<b>HP 8904A</b> Multifunction Synthesizer <sup>1</sup>	\$3,175
<b>Opt 001</b> Adds three (two when ordered with Opt 002) internal channels, Channel A modulation, summation, FM stereo mode, and sequence capability	+ \$1,835
<b>Opt 002</b> Adds second internal synthesizer and output	+ \$1,345
<b>Opt 003</b> Adds fast hop and digital modulation	+ \$570
<b>Opt 004</b> Connectors on rear panel only (not available with Opt 005 or 006)	+ \$60
<b>Opt 005</b> Adds unit to unit phase synchronization	+ \$540
<b>Opt 006</b> Changes Output 1 from a 50 $\Omega$ output to a transformer coupled, 600 $\Omega$ balanced output	+ \$860
<b>Opt 910</b> Provides an additional operation and calibration manual (08904-90007) and two service manuals (08904-90008)	+ \$123 ☎
<b>Opt 915</b> Adds service manual (08904-90008)	+ \$36 ☎
<b>Opt W30</b> Extended repair service. See page 671	+ \$95
<b>Opt W32</b> Calibration service. See page 671	+ \$210
<b>08904-61024</b> Rack mount kit for a single HP 8904A	+ \$125
<b>08904-61025</b> Rack mount kit for mounting two HP 8904A's side by side	+ \$90

**HP 8904A Retrofit kits (customer retrofittable):**

<b>HP 11816A</b> Retrofit kit for Opt 001	+ \$2,055
<b>HP 11817A</b> Retrofit kit for Opt 002	+ \$1,640
<b>HP 11818A</b> Retrofit kit for Opt 003	+ \$675
<b>HP 11827A</b> Retrofit kit for Opt 005 <sup>2</sup>	+ \$645
<b>HP 11837A</b> Retrofit kit for Opt 006 <sup>2</sup>	+ \$1,040

<sup>1</sup>HP-IB cables not included. For description and price see page 615.

<sup>2</sup>Not available for units with serial prefix less than 2948A.

☎ For off-the-shelf shipment, call 800-452-4844.

# FUNCTION GENERATORS & WAVEFORM SYNTHESIZERS

## 1 Hz to 20 MHz Pulse/Function Generator

HP 8111A

- Sine, triangle, square, and haversine functions
- 20 MHz, 32 Vpp for all waveforms
- Variable duty cycle or pulse width
- Trigger, gate, VCO, and optional burst
- Digital display for all parameters
- Error recognition

HP 8111A with  
Option 001,  
Counted Burst

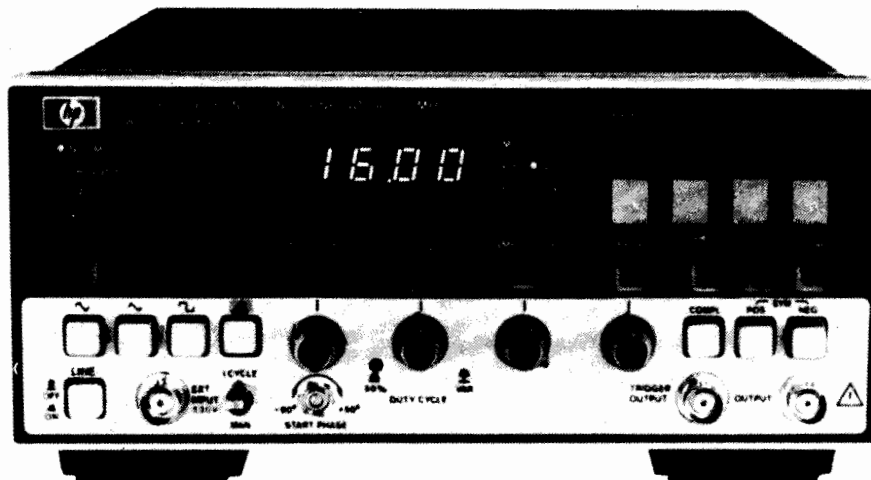

The HP 8111A combines pulse generator and function generator capabilities in a single, compact unit. Triggered operation for all waveforms, and the ability to define rectangular waveforms in terms of pulse width or duty cycle, are examples of the HP 8111A's versatility.

### Saves Space and Equipment

Small size and manifold capability make the HP 8111A an ideal source for service and bench. Digital display, error detector, and good repeatability assure high operating confidence. This reduces the need for output monitoring and consequently saves equipment.

### Flexible

Operating modes include VCO which permits frequency-shift keying and dc-to-frequency conversion as well as sweep and FM applications. Option 001's Burst mode simplifies tone burst generation and digital preconditioning by generating a precise number of waveform cycles. An "extra cycle" feature activated after a burst allows critical events to be examined.

Pulse mode's variable width down to 25 ns and clean 10 ns transitions provide useful digital test capability. High analog flexibility is assured because all waveforms can be generated in trigger, gate and burst modes. Adjustable duty cycle up to 999 kHz means that CRT sawtooth waveforms and rectangular signals for dc motor control can be simulated.

### Specifications (50-Ω load resistance)

#### Waveforms

Sine, triangle, ramp, square, pulse, haversine functions

#### Timing Frequency

**Range:** 1.00 Hz to 20.0 MHz (3-digit resolution)  
**Accuracy (50% duty cycle):** 5% ( $\pm 10\%$  below 10 Hz)  
**Jitter:**  $< 0.1\%$  + 50 ps  
**Stability:**  $\pm 0.2\%$  (1 hour),  $\pm 0.5\%$  (24 hours)

#### Duty cycle (sine, triangle, square, haversine functions):

	Calibrated	Variable (below 1 MHz)
Range:	50% nominal	10% to 90%
Resolution:	2 digits	2 digits
Accuracy:	$\pm 1$ digit	$\pm 6$ digits ( $\pm 3$ in range 20 to 80%)

#### Pulse width

**Range:** 25.0 ns to 100 ms (3-digit resolution)  
**Accuracy:**  $\pm 5\%$   $\pm 2$  ns

#### Output Characteristics (Voltages double into high impedance) Amplitude

**Range:** 1.60 mVpp to 16.00 Vpp (3 $\frac{1}{2}$ -digit resolution)  
**Accuracy:**  $\pm 5\%$  (at 1 kHz for sine and triangle)  
**Flatness (sine, triangle):**  $\pm 3\%$  (+10%, -15% above 1 MHz)

#### Offset

**Range:** 0.00 mV to  $\pm 8.00$  V (3-digit resolution)  
**Accuracy:**  $\pm 5\%$  setting  $\pm 2\%$  amplitude  $\pm 20$  mV  
(ampl  $\geq 160$  mVpp),  
 $\pm 5\%$  setting  $\pm 2\%$  amplitude  $\pm 1$  mV  
(ampl  $< 160$  mVpp)

**Distortion:** THD (1 Hz-1 MHz)  $< 3\%$  (-30 dB); harmonics (1 MHz-20 MHz)  $< -26$  dB. Distortion may increase by 3 dB below 10° C and above 45° C

**Linearity (triangle):**  $< \pm 3\%$  ( $< \pm 1\%$  below 1 MHz)

#### Pulse and squarewave performance

**Transitions:**  $< 10$  ns  
**Perturbations:**  $< \pm 5\%$  ( $< \pm 10\%$  below 0.16 Vpp)  
**Output impedance:**  $\pm 50 \Omega \pm 5\%$

#### Modes

Normal, trigger\*, gate\*, VCO and (Option 001) burst\*  
**VCO range:** 2 decades, ext. signal 0.1 V to 10 V (dc to 1 kHz)  
**Burst length:** 1 to 1999 periods for all waveforms

#### General

**Repeatability:** Factor 2.5 better than accuracy

#### Environmental

**Storage temperature:** -40° C to +75° C  
**Operating temperature:** 0° C to 55° C  
**Humidity:** 95% RH, 0° C to 40° C

**Power:** 100/120/220/240 V rms; +5% - 10%; 48 to 440 Hz; 70 VA max

**Weight:** Net, 4.6 kg (10 lb); shipping, 6.6 kg (15 lb)

**Size:** 89 mm H  $\times$  212.3 mm W  $\times$  345 mm D (3.5 in  $\times$  8.36 in  $\times$  13.6 in)

\*Adjustable start-phase for haversine, haverstriangle

#### Ordering Information

**HP 8111A** Pulse/Function Generator \$2,700  
**Opt 001** Burst + \$530  
**Opt 910** Extra Operating and Service Manual + \$39  
**Opt W30** Extended Repair Service (see page 671) \$65  
**HP 5062-4001:** Bail Handle Kit \$40  
**HP 5062-3972** Rack Mount Kit (single HP 8111A) \$60  
**HP 5062-3974** Rack Mount Kit (two instruments) \$35  
**HP 5061-9694** Lock Link Kit (for use with HP 5062-3974) \$45

☎ For off-the-shelf shipment, call 800-452-4844.

# FUNCTION GENERATORS & WAVEFORM SYNTHESIZERS

## Dual Arbitrary Waveform Generator

HP 8175A Option 002

489

- Two analog channels / 1 kpoints ea / 50 MHz ea
- Individual datapoint durations 20 ns to 9.99 s
- Ten-bit amplitude resolution
- Digital and analog signals simultaneously
- Four waveform entry modes; calculator, graphical editing, abs. and rel. levels, various codings
- Up to 32 Vp-p output voltage (into open), separately programmable offset (max  $\pm 16$  V)



HP 8175A, Option 002; Data Page:  
Waveform Setup

With the Option 002, the Dual Arbitrary Waveform Generator, the HP 8175A offers the new Arbitrary Waveform mode in addition to the existing Parallel and Serial modes. The Arbitrary Waveform mode gives you dual arbitrary waveform channels and simultaneous equivalent digital signals. This means you have the ideal source for such difficult applications as:

- simulation of two dependent variables, such as force and distance, at the same time.
- digital and analog simulation of such devices as programmable filters.
- stimulus and compare signals at the same time for DACs or ADCs.

The arbitrary outputs are 50 Mpoints/s, synchronous, but independent in shape and amplitude (max 16 V peak-to-peak into 50 ohm and max 32 V peak-to-peak into open). The waveforms can be set up by means of algorithms (a fundamental set of mathematical functions are available, including noise); interpolations (linear and spline); graphic or tabular entry of instantaneous level (or amplitude and offset), or tabular entry of equivalent digital pattern. Additionally, any existing waveform can be modified, simply by tabular or graphical editing. A more powerful alternative method is using the Combine feature. This allows you to combine an algorithm arithmetically with any desired part of the current waveform.

### Application Examples

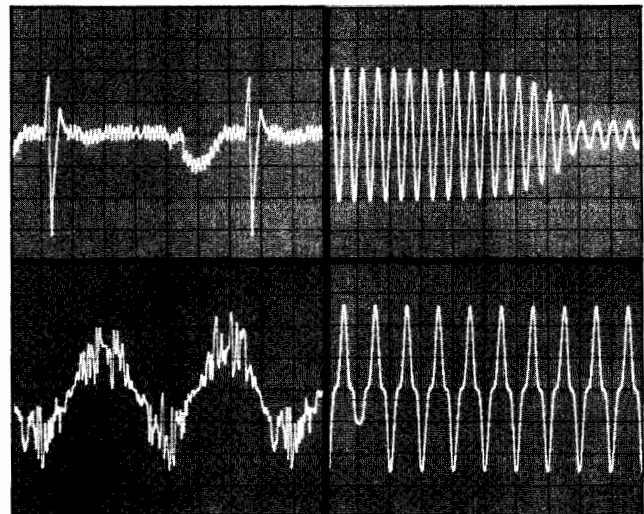

The comprehensive feature set, together with the outstanding memory management and interaction capability, mean that "real-life" simulation for the most exacting circuits is within your grasp.

# FUNCTION GENERATORS & WAVEFORM SYNTHESIZERS

## Dual Arbitrary Waveform Generator (cont'd)

HP 8175A Option 002

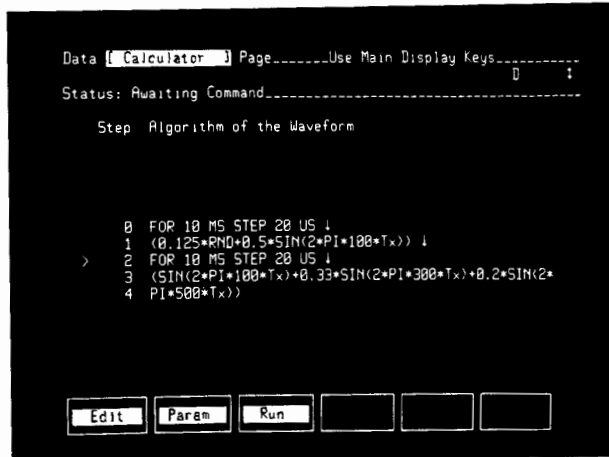

### Data Page: Calculator

The built-in calculator provides a comfortable method of setting up very complex, mathematically definable waveforms by simply entering the formula. Softkeys support most of the fundamental mathematical functions. The Combine capability allows any previously generated function to be combined with the current calculated function. By this means, noise can be introduced into any desired parts of the waveform.

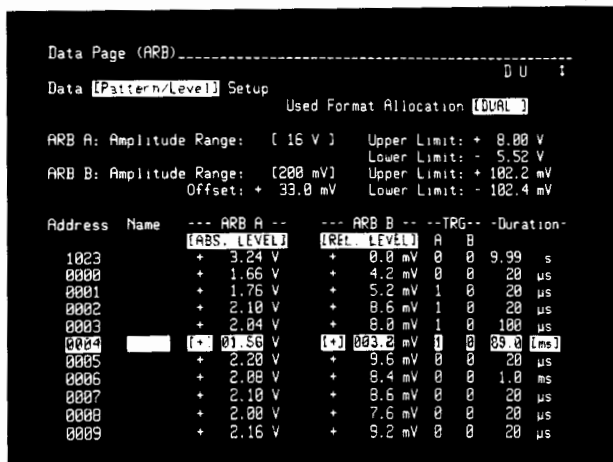

### Data Page: Pattern/Level Set-Up

Data Points of a waveform can be entered and displayed in absolute or relative levels or in various codes. Comprehensive waveform editing support is provided. For instance, segments of data points can be moved or copied to other memory locations, or waveform segments can easily be exchanged between the two analog channels. In this way, it's easy to produce phase shifted signals. Graphical editing of the waveform, including interpolation between data points, is possible on this menu.

### Specifications

Apply for operating temperatures from 0° to 55° C

#### Option 002 Dual Arbitrary Waveform Generator (can be retrofitted in HP service office)

Number of analog outputs: 2

Number of bits: 10

Number of data points:

Horizontal: 1024 points

Vertical: 1000 points with additional 24 points override

800 points for 16 V p-p Output Voltage Range

640 points for 32 V p-p Output Voltage Range

Differential non-linearity:  $\leq 1$  LSB (monotonic)

Output impedance: 50  $\Omega$   $\pm 5\%$

#### Output Levels

Load impedance: 50  $\Omega$ :

7 output voltage ranges: 0.2 V to 16 V, Res. 0.2 mV to 20 mV

2 offset ranges:  $\pm 0.8$  V and  $\pm 8$  V (Output Volt. Range > 1 V)

Load impedance:  $\geq 50$  k  $\Omega$

7 output voltage ranges: 0.5 V to 32 V, Res. 0.5 mV to 50 mV

2 offset ranges:  $\pm 1.6$  V and  $\pm 16$  V (Output Volt. R. > 2V)

#### Accuracy (Output A and Output B)

Amplitude accuracy:  $\pm 4\%$   $\pm 4$  LSB

Offset accuracy:  $\pm 1\%$  of programmed value

$\pm 2\%$  of (progr. High Level of p-p Output Volt. +  
progr. Low Level of p-p Output Volt.) (If High and  
Low Level are identical in magnitude, but opposite in sign; this  
error will be zero).

plus:

into 50  $\Omega$ :  $\pm 10$  mV for 0.2 V, 0.5 V and 1 V ranges

or:  $\pm 25$  mV for 2 V and 5 V range

or:  $\pm 50$  mV for 10 V and 16 V range

into  $\geq 50$  k  $\Omega$ :  $\pm 20$  mV for 0.5 V, 1 V and 2 V ranges

or:  $\pm 50$  mV for 5 V and 10 V range

or:  $\pm 100$  mV for 20 V and 32 V range

#### Timing (for Output A and B)

The maximum sample update rate is 50 MHz.

The Data Point Duration is 20 ns to 9.99 s.

#### Trigger output characteristics:

Number of trigger output channels: 2

Trigger output impedance: 50  $\Omega$   $\pm 5\%$

Trigger output levels: ECL into 50  $\Omega$

TTL into 50  $\Omega$  and  $\geq 50$  k  $\Omega$

Trigger pulse width: The trigger can be set for each individual data point to High Level or Low Level. The trigger width depends on the programmed Data Point Duration.

#### Ordering Information

HP 8175A Digital/Analog Signal Generator

Note: HP 8175A must be ordered with at least option #002 or one of the digital options (refer to page 520).

Opt. 002 Dual Arbitrary Waveform Generator

Opt. 908 Rack Flange Kit (P/N 5062-3978)

Opt. 910 Additional Operating/Programming/Service

Manual

Opt. 916 Additional Programming Manual

W30 Extended repair service (see page 671)

☎ For off-the-shelf shipment, call 800-452-4844.

Price

\$12,900

\$3,950

\$36

\$290

\$72

\$280

# FUNCTION GENERATORS & WAVEFORM SYNTHESIZERS

1 MHz to 50 MHz Pulse/Function Generator

HP 8116A

491

- Sine, triangle, square, haversine, and dc
- 1 MHz to 50 MHz, 32 Vpp for all waveforms
- Variable (10 ns min) pulse width, 6 ns transitions

- Modulation
- Self-prompting operating concept
- Error recognition and self test



HP 8116A with Option 001, Burst and Logarithmic Sweep

SUPPORTED BY HP ITG SOFTWARE

The fully programmable HP 8116A features pulse as well as function generator capabilities in one small unit. A broad 1 MHz to 50 MHz band for all waveforms and a wide choice of operating and modulating modes assure high flexibility. These factors, plus good repeatability, make the HP 8116A a sound, long-term investment.

## Unique Operating Concept Saves Engineering Time

HP's custom IC's have made it feasible to put the many HP 8116A capabilities into such a small volume. Handling is simplified by a unique, microprocessor-controlled, operating concept that ensures a clear overview of the compact front panel at all times. When the mode and waveform have been selected, illuminated labels show which parameters must be set. There's no clutter, and no confusion.

**Auto-vernier.** In normal mode, the HP 8116A's auto-vernier increments any desired parameter continuously until a stop signal is applied. This means that thresholds can be measured automatically, without a controller.

**Level or amplitude programming.** The HP 8116A's output can be programmed in terms of high and low levels or in terms of amplitude and offset. Consequently, a direct, automatic, conversion is always feasible, so that the HP 8116A can be programmed in the same terms as the device is specified.

**Safe limit.** Devices can be protected by the limit feature. This prevents the output from exceeding a given magnitude.

## Rectangular Waveforms

For such applications as laser diodes or dc motors, square waves can be programmed for constant duty cycles from 10 percent to 90 percent. For digital test, or for simulating very low duty-cycle events, pulse width can be programmed down to 10 ns. Square wave and Pulse modes provide clean 6 ns edges that are ideal for many technologies. Pulse width modulation and pulse recovery capability are available in Pulse mode.

## Sine and Triangle Functions

A ten percent to 90 percent duty cycle, programmable in one percent steps, provides ramps and asymmetrical sine waves for testing VCOs, servos, amplifier linearity, and industrial process-control systems. Haversine functions, available in External Trigger, Gate, and Burst modes, extend the applications to such areas as telephone line and vibration testing.

## Modulation

All waveforms can be amplitude or frequency modulated. VCO operation allows frequency variation over two decades with an external voltage; consequently, transducer output can be conditioned for mag tape recording, or frequency-shift keying or linear sweep can be carried out.

## Option 001

**10 1/2-decade log sweep.** Sweep mode covers the wide 1 MHz to 50 MHz band in a single up sweep. Test setups require no more than an X-Y recorder or scope because all necessary control signals are available. The HP 8116A sweeps can be internally triggered, if desired.

**Accurate, counted bursts.** A preprogrammed number of cycles of any waveform can be generated in Burst mode. With sine, triangle, and square functions, bursts can be triggered internally as well as externally.

**Hold capability.** For material stress testing, low-frequency functions can be held at instantaneous levels. Hold is controlled by an external signal.

## Low-Cost Automation for Bench and Systems

Powerful capability, small size, and wide specified temperature range make the HP 8116A a good choice for automatic test systems. Also, the low cost means that it's now realistic to automate those routine bench jobs and leave more time for design. Comfortable software features such as easy syntax and flexible format contribute to rapid system design.

## Operating Confidence

There's reliability in the HP 8116A's output because proper operation is always ensured by the instrument's error detector. This helps you to recover from an incorrect front panel or programming operation by indicating the offending parameter. Also, the built-in test and diagnosis feature verifies correct function each time the instrument is switched on.

# FUNCTION GENERATORS & WAVEFORM SYNTHESIZERS

## 1 MHz to 50 MHz Pulse/Function Generator (cont'd)

HP 8116A

### Specifications

Specifications apply with 50-Ω load and temperatures in the range 0° C to 55° C.

### Functions

Sine, triangle, ramp, square, pulse, haversine, havertriangle, and dc

### Timing

#### Frequency

**Range:** 1 MHz to 50 MHz (3-digit resolution)

**Accuracy<sup>1</sup>** (pulse mode, 50% d/c):  $\pm 3\% \pm 0.3$  mHz below 100 kHz,  $\pm 5\%$  above 100 kHz

**Jitter** (Pulse mode, 50% d/c):  $< 0.1\% + 100$  ps

**Stability:**  $\pm 2\%$  (1 hour),  $\pm 5\%$  (24 hours)

**Duty cycle:** (Sine, triangle, square, haversine, and havertriangle)

**Range:** 10% to 90% (20% to 80% above 1 MHz, 50% above 10 MHz), 2-digit resolution

**Accuracy<sup>1</sup>:**  $\pm 0.5$  digits ( $\pm 3$  digits above 1 MHz)

#### Pulse width

**Range:** 10.0 ns to 999 ms (3-digit resolution)

**Accuracy<sup>1</sup>:**  $\pm 5\% \pm 2$  ns

**Jitter:**  $< 0.1\%$  ( $0.2\% + 200$  ps for width  $\leq 10$  μs)

### Output Characteristics

(Voltages double into high impedance)

#### Amplitude

**Range:** 10.0 mVpp to 16.0 Vpp (3-digit resolution)

**Accuracy<sup>1</sup>:**  $\pm 5\%$  (at 1 kHz for sine and triangle)

**Flatness (sine):**  $\pm 3\%$  ( $\pm 5\%$  above 1 MHz,  $+5$ – $15\%$  above 10 MHz)

**Flatness (triangle):**  $\pm 3\%$  ( $\pm 5\%$  above 1 MHz,  $+5$ – $25\%$  above 10 MHz)

#### Offset and dc mode

**Range:** 0.00 to  $\pm 7.95$  V (0 to  $\pm 795$  mV for amplitude  $< 100$  mVpp)

**Resolution:** 3 digits

**Accuracy<sup>1</sup>:** 0.5% of setting  $\pm 1\%$  of ampl  $\pm 40$  mV ( $+2$  mV if ampl  $< 100$  mVpp,  $\pm 20$  mV in dc mode)

**Distortion** (Sine, normal mode, 50% duty cycle)

**Total harmonic distortion (10 Hz - 50 kHz):**  $< 1\%$  ( $-40$  dB)\*

**Harmonic related signals (50 kHz - 1 MHz):**  $< -34$  dB  
(1 MHz - 50 MHz):  $< -23$  dB\*

\*May increase by 3 dB below 10° C and above 45° C.

**Non-linearity** (Triangle, ramp, 100 mHz–1 MHz):  $< \pm 3\%$

#### Pulse and square wave characteristics

**Transitions:**  $< 7$  ns

**Pulse perturbations:**  $< \pm 5\% \pm 2$  mV

**Output impedance:** 50 Ω  $\pm 5\%$

### Operating Modes

Normal, trigger\*, gate\*, and external width

### Additional Modes in HP 8116A Option 001

**Logarithmic up sweep** (for all waveforms)

**Range:** Start and stop frequencies selectable up to full range (1 MHz to 50 MHz)

**Sweep time:** Selectable in 1-2-5 sequence from 10 ms to 500 seconds per decade

**Sweep repetition:** Continuous sweeps (internal sweep) or externally triggered

**Counted burst\*** (For all waveforms)

**Burst length:** 1 to 1999 cycles

**Burst repetition:** Internally triggered at selectable intervals from 100 ns to 999 ms (except in Pulse mode), or externally triggered, up to 40 MHz

\*Selectable ( $-90^\circ$ ) start-phase for haversine, havertriangle.

### Control Modes

**Frequency modulation:**  $\pm 5\%$  max deviation

**Sensitivity:** 1 V for 1% deviation

**Modulating frequency:** dc to 20 kHz

#### Amplitude modulation

**Sensitivity:**  $\pm 2.5$  V for 100% mod. ( $+2.5$  V to  $-7.5$  V for DSBSC)

**Modulating frequency:** dc to 1 MHz

<sup>1</sup>Applies from 15° C to 35° C, %-error increases 0.05 per °C outside this range.

### Pulse width modulation

**Range:** 10 ns to 1 s in 8 non-overlapping decade ranges  
Max. width ratio: 10:1

**Sensitivity:**  $\pm 9$  V for 1:10 ratio

### Voltage-controlled oscillator

**Range:** 2 decades in range 1 MHz to 50 MHz

**Sensitivity:** 0.1 V to 10 V for 2 decades

**Modulating frequency:** dc to 1 kHz

### Auxiliary Modes

**Manual:** Simulates external input

**1 cycle (Option 001):** Triggers single output cycle in Trigger, Gate and Ext Burst modes

**Auto vernier:** Continuous vernier that can be remotely or manually stopped

**Limit:** Programmable maximum output levels to protect DUT

**Complement:** Selectable normal/complement output

**Disable:** Relay disconnects output

### Auxiliary Inputs and Outputs

#### External input

**Threshold:**  $\pm 10$  V adjustable

**Max input voltage:**  $\pm 20$  V

**Sensitivity:** 500 mVpp

**Min pulse width:** 10 ns

**Input impedance:** 10 k Ω typ

**Trigger slope:** Positive, negative, and off

#### Control input

**Max input voltage:**  $\pm 20$  V

**Input impedance:** 10 k Ω typ

#### Trigger output

**Output levels:** 0/2.4 V typ

**Output impedance:** 50 Ω typ

**X-Output (Option 001)** for sweep X-Y recording (rear panel)

**Output levels:** 0 V (= start frequency) to 10 V max

**Slope:** 1.5 V per sweep decade

**Marker output (Option 001)** for sweep (rear panel)

**Output levels:** TTL

**Leading edge:** Positive at selected marker frequency

**Hold input (Option 001)**, rear panel

**Input levels:** TTL

**Leading edge:** Positive transition causes HP 8116A output ( $f < 10$  Hz) to hold at instantaneous level. Output droop 0.01% per second

**Max input voltage:**  $\pm 20$  V

### HP-IB Capability

All manual key operations are programmable. Talk mode provides learn, status byte, and error report capabilities

### Memory

Battery-backup RAM retains current operating state

### General

**Repeatability:** Factor 4 better than accuracy

### Environmental

**Storage temperature:**  $-40^\circ$  C to  $+70^\circ$  C

**Operating temperature:**  $0^\circ$  C to  $55^\circ$  C

**Humidity:** 95% RH,  $0^\circ$  C to  $40^\circ$  C

**Power:** 100/120/220/240 V rms;  $+5\%$ ,  $-10\%$ ; 48 to 440 Hz; 120 VA max

**Weight:** net, 5.9 kg (13 lb); shipping, 8.0 kg (18 lb)

**Size:** 89 mm H  $\times$  212.3 mm W  $\times$  422 mm D (3.5 in  $\times$  8.36 in  $\times$  16.6 in)

### Ordering Information

**HP 8116A** Programmable Pulse/Function Generator\* \$4,150

**Opt. 001:** Burst and Logarithmic Sweep + \$550

**Opt. 910:** Extra Operating & Service Manual + \$41

**Opt. W30:** Extended Repair Service. See page 681 \$95

**HP 5062-4001:** Bail Handle Kit \$40

**HP 5062-3972:** Rack Mount Kit (single HP 8116A) \$60

**HP 5062-3974:** Rack Mount Kit (two instruments) \$35

**HP 5061-9694:** Lock Link Kit (for use with HP 5062-3994) \$45

\*HP-IB cables not supplied, see page 615.

☎ For off-the-shelf shipment, call 800-452-4844.

# FUNCTION GENERATORS & WAVEFORM SYNTHESIZERS

50 MHz Programmable Signal Source

HP 8165A

493

- Pulse/function capability
- Sine, triangle, and square to 50 MHz
- Pulses and ramps to 20 MHz
- Trigger, gate, and counted burst
- Synthesizer stability, precision amplitude
- Storage of operating parameters

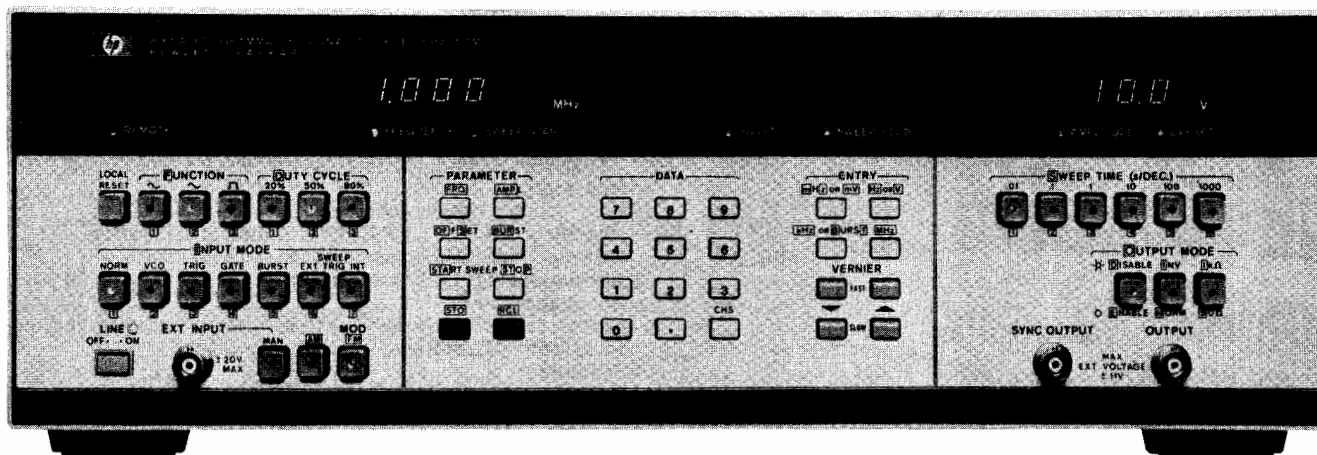

HP 8165A with Option 002, AM, and Logarithmic Sweep

## Versatility and Simplicity for Systems and Bench

The HP 8165A Programmable Signal Source is a versatile function generator with good accuracy and many trigger features. Microprocessor control assures rapid, accurate setup whether you're programming locally or via HP-IB.

## Operating Set Storage

Ten complete sets of operating information can be stored and recalled. In the event of power failure, battery back-up retains all data plus the active settings.

## Stability and Resolution

Stable frequency is ensured with an internal crystal. The four-digit frequency display provides a 1  $\mu$ Hz resolution in the 1 to 9.999 MHz range. In Normal mode, the accuracy is 0.001% with a stability of  $\pm 1 \times 10^{-6}$ .

## Specifications

### Waveforms and Frequency Range

**Sine, square, and triangle** (50% duty cycle): 1.000 mHz to 50.00 MHz

**Pulse/ramp** (20, 80% symmetry): 1.000 mHz to 19.99 MHz

**Haversine/havertriangle**: Please inquire for special option

### Output Characteristics

**Range**: Amplitude and offset independently variable within  $\pm 10$  V window

**Source impedance**: selectable 50  $\Omega \pm 1\%$  or 1 k  $\Omega \pm 10\%$

**Amplitude**: 10.0 mVpp to 10.0 Vpp (50  $\Omega$  into 50  $\Omega$ )

2.00 Vpp to 20.0 Vpp (1 k  $\Omega$  into 50  $\Omega$ )

Accuracy	Sine V Vrms	Square	Triangle (50%)	Ramp (20%–80%)	Pulse (20%–80%)
< 1 kHz	$\pm 3\%$	$\pm 2\%$	$\pm 3\%$	$\pm 3\%$	$\pm 2\%$
1 kHz–4.99 MHz	$\pm 3\%$	$\pm 2\%$	$\pm 3\%$	$\pm 5\%$	$\pm 2\%$
5 MHz–19.9 MHz	$\pm 8\%$	$\pm 5\%$	$\pm 10\%$	$\pm 10\%$	$\pm 5\%$
20 MHz–50 MHz	$\pm 8\%$	$\pm 5\%$	+5% to –20%	—	—

**Offset**: 0  $\pm 10$  mV to  $\pm 5.00$  V (50  $\Omega$  into 50  $\Omega$ )

0  $\pm 20$  mV to  $\pm 10.0$  V (1 k  $\Omega$  into 50  $\Omega$ )

**Accuracy**:  $\pm 1\%$  programmed value  $\pm 1\%$  signal Vpp  $\pm 20$  mV

## Sine characteristics

**Distortion**: Total harmonic distortion (THD) for fundamental up to 1 MHz: 38 dB

**Harmonic signals**: (Fundamental above 1 MHz):  $\leq -30$  dBc

## Square/pulse characteristics

**Transition times**: (10% to 90%):  $\leq 5$  ns (50  $\Omega$  into 50  $\Omega$ ),  $\leq 7$  ns (1 k  $\Omega$  into 50  $\Omega$ )

**Preshoot/overshoot/ringing**:  $\leq \pm 5\%$  (50  $\Omega$  into 50  $\Omega$ ),  $\pm 10\%$  (1 k  $\Omega$  into 50  $\Omega$ )

## Triangle/ramp characteristics

**Linearity**: (10% to 90%):  $\leq \pm 1\%$  ( $\leq \pm 5\%$  above 5 MHz)

## Operating Modes

**Norm** (Continuous phase locked), **VCO** (external sweep voltage)

**Trig** (Ext or man. one-shot), **Gate**, **Burst** (1 to 9999 counted cycles)

## Frequency modulation

**HP-IB**: Control and learn capability for all modes and parameters

**Interface functions\***: SH1, AH1, T6, L4, SR1, RL1, PP0, DC0, DT1, C0, E1

## General

**Memory**: Nonvolatile. 10 addressable locations plus one for active operating state. Each location can store a complete set of operating parameters and modes.

**Power**: 100/120/220/240 Vrms;  $\pm 5\%$ ,  $-10\%$ ; 48 to 66 Hz, 200 VA max

**Operating temperature**: 0° to 50° C

**Weight**: Net 12 kg (26.5 lbs); shipping 16 kg (35.3 lbs)

**Size**: 133 mm H  $\times$  426 mm W  $\times$  422 mm D (5.2 in  $\times$  16.8 in  $\times$  16.6 in)

## Ordering Information

**HP 8165A** Programmable Signal Source\*\*

**Opt. 002** AM and logarithmic sweep

**Opt. 003** Rear Panel Connectors

**Opt. 907** Front Handle Kit (Part No HP 5062-3989)

**Opt. 908** Rack Mount Flange Kit

(Part No HP 5062-3977)

**Opt. 909** Opt 907, 908 combined

(Part No HP 5062-3983)

**Opt. 910** Additional Operating and Service Manual

**Opt. W30** Extended repair service see page 671.

**Price**

\$9600

\$1200

\$0

\$56

\$33

\$82

\$71

\$210

\*For more on these codes, refer to the HP-IB section of this catalog.

\*\*HP-IB cables not supplied; see page 615.

☎ For off-the-shelf shipment, call 800-452-4844.

# FUNCTION GENERATORS & WAVEFORM SYNTHESIZERS

## Synthesizer/Function Generator 1 $\mu$ Hz to 21 MHz

HP 3325B, 3326A

- Fully synthesized microhertz resolution
- Functions—sine, square, triangle, ramps, dc offset
- Internal programmable modulation source
- Log, lin, discrete sweep
- Excellent signal purity
- dc to 60 MHz SYNC output

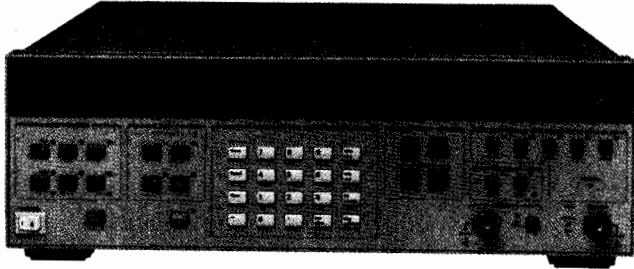

HP 3325B

DESIGNED FOR  
MATE  
SYSTEMS

### HP 3325 Synthesizer/Function Generator

The HP 3325B is a 1  $\mu$ Hz to 21 MHz synthesizer/function generator with high performance, exceptional versatility and value. Testing is made fast and efficient in general purpose applications whether on the bench or in ATE systems.

#### Synthesizer Precision

HP 3325B frequency accuracy is determined by a precision frequency reference and can be set with a resolution of 1  $\mu$ Hz. It has up to -65 dBc harmonic and -70 dBc spurious levels for precision measurements. The phase of the output signal can be precisely controlled  $\pm 719.9$  deg with 0.1 deg resolution, and multiple HP 3325Bs can be locked together for multi-phase applications.

#### Function Generator Versatility

Precision squarewaves to 10.999,999 MHz have 20 ns rise times with synthesizer accuracy and precision. Triangle and ramp waveshapes are also available with .05 percent linearity up to 10.999,999 kHz. DC and phase offset can be added to these waveshapes. The modulation source can be used as an arbitrary function generator via HP-IB, providing user-defined waveshapes. These features make the HP 3325B one of the most versatile sources for bench or ATE system applications. Save-recall memory includes 10 nonvolatile memory locations for simple and rapid access to frequently used test setups.

#### Discrete Sweep

The enhanced feature set of the HP 3325B includes 100-segment discrete sweep capability which allows arbitrarily defined multi-segment linear or stepped sweeps and tone sequences. This complements its linear and log, phase continuous sweep capability.

#### Internal Modulation Source

A built-in programmable modulation source provides sine, square, and arbitrary waveshapes for internal amplitude or phase modulation, or for use as a second source. In addition, a rear panel sync output provides a TTL compatible dc to 60 MHz signal with 1  $\mu$ Hz resolution for use as a precision, high-resolution clock signal, and extended frequency coverage.

#### ATE Systems Compatibility

All functions, including frequency, amplitude, phase, modulation, sweep, and waveshapes, are programmable via HP-IB or RS-232 interface. The HP 3325B is fully compatible in form, fit, and function with the HP 3325A. All HP-IB programs written for the HP 3325A are fully compatible with the HP 3325B.

### Specifications

#### Waveforms

Sine, square, triangle, negative, and positive ramps

#### Frequency

##### Range

**Sine:** 1  $\mu$ Hz to 20.999 999 999 MHz

**Square:** 1  $\mu$ Hz to 10.999 999 999 MHz

**Triangle/ramps:** 1  $\mu$ Hz to 10.999 999 999 kHz

**Resolution:** 1  $\mu$ Hz, < 100 kHz  
1 mHz  $\geq$  100 kHz

**Accuracy:**  $\pm 5 \times 10^{-6}$ , 20° to 30° C at time of calibration

**Warm-up time:** 20 minutes to within specified accuracy

#### Main signal output (all waveforms)

**Impedance:** 50  $\Omega$

**Connector:** BNC; switchable to front or rear panel, nonswitchable with Option 002, except by internal cable change.

#### Amplitude

**Range:** 1 mV to 10 Vp-p in 8 amplitude ranges, 1-3-10 sequence (10 dB steps), into 50  $\Omega$  load

Function	Sine		Square		Triangle/Ramps	
	min	max	min	max	min	max
Units Displayed						
peak-peak rms	1.000 mV	10.00 V	1.000 mV	10.00 V	1.000 mV	10.00 V
dBm (50 $\Omega$ )	0.354 mV	3.536 V	0.500 mV	5.000 V	0.289 mV	2.887 V
	-56.02	+23.98	-53.01	+26.99	-57.78	+22.22

**Resolution:** 0.03% of full range or 0.01 dB (4 digits)

#### Amplitude accuracy

(without dc offset, relative to programmed amplitude and accuracy)

#### Sine wave amplitude accuracy

1 mHz to 100 kHz:  $\pm 0.1$  dB,  $\geq 3$  Vpp;  $\pm 0.2$  dB, < 3 Vpp

100 kHz to 20 MHz:  $\pm 0.4$  dB,  $\geq 3$  Vpp;  $\pm 0.6$  dB, 0.1 to 3 Vpp

#### Sine wave spectral purity

**Phase noise:** -60 dB for a 30 kHz band centered on a 20 MHz carrier (excluding  $\pm 1$  Hz about the carrier) with high-stability Option 001 installed.

**Spurious:** All non-harmonically related output signals will be more than 70 dB below the carrier (60 dB with dc offset) or less than -90 dBm, whichever is greater.

**Sine wave harmonic distortion:** Harmonically related signals will be less than the following levels (relative to the fundamental) at full output for each range:

0.1 Hz	50 kHz	200 kHz	2 MHz	15 MHz	20 MHz
-65 dB	-60 dB	-40 dB	-30 dB	-25 dB	

#### Square wave characteristics

**Rise/fall time:**  $\leq 20$  ns, 10% to 90% at full output

**Overshoot:**  $\leq 5\%$  of peak-to-peak amplitude, at full output

**Settling time:** < 1  $\mu$ s to settle to within .05% of final value

#### DC offset

**Range:** dc only (no ac signal): 0 to  $\pm 5.0$  V/50  $\Omega$

**dc + ac:** Maximum dc offset  $\pm 4.5$  V on highest range, decreasing to  $\pm 4.5$  mV on lowest range.

**Resolution:** 4 digits

#### Sine wave amplitude modulation

**Modulation depth at full output for each range:** 0 to 100%

**Modulation frequency range:** dc to 400 kHz (0 to 21 MHz carrier frequency)

**Sensitivity:**  $\pm 5$  V peak for 100% modulation

#### Sine wave phase modulation

**Range:**  $\pm 850^\circ$ ,  $\pm 5$  V input

**Modulation frequency range:** dc - 5 kHz



# FUNCTION GENERATORS & WAVEFORM SYNTHESIZERS

Two-Channel Synthesizer, DC to 13 MHz

HP 3325B, 3326A

495

## Frequency sweep

### Sweep time

**Linear:** 0.01 s to 1000s

**Logarithmic:** 1 s to 1000s single, 0.1 s to 1000s continuous

### Discrete sweep

**Number of segments:** 100 maximum

**Time/Segment:** 0.01 s to 1000s, 0.01 s resolution

**Maximum sweep width:** Full frequency range of the main signal output for the waveform in use, except minimum log start frequency is 1 Hz.

**Phase continuity:** Sweep is phase continuous over the full frequency range of the main output.

## Modulation source

**Frequency range:** Sine 0.1 Hz to 10 kHz, square 0.1 Hz to 2 kHz

**Frequency accuracy:** 0.1%, typical

**Impedance:** Drives 10 kΩ or greater load

**Sinewave purity:** -34 dBc or better, typical

**Waveforms:** Sine, square, arbitrary

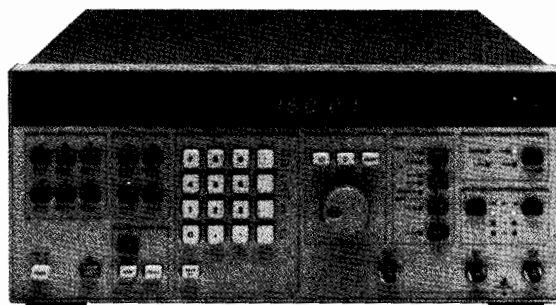

HP 3326A



## Auxiliary inputs and outputs

**Auxiliary frequency output:** 21 MHz to 60.999 999 999 MHz, under range coverage to 19.000 000 001 MHz, frequency selection from front panel; 0 dBm; output impedance 50 Ω.

**Sync output:** Square wave with V (high) ≥ 1.2 V, V (low) ≥ 0.2 V into 50 Ω. Frequency range is the same as main signal for front panel sync and dc to 60 MHz for rear panel sync.

**X-Axis drive:** 0 to > +10 V dc linear ramp proportional to sweep frequency, linearity, 10-90%, ± 0.1% of final value

## MATE/CIIL Compatibility

For MATE system applications, Option H05 provides internal CIIL compatibility.

## Option 001 high stability frequency reference

**Aging rate:** ± 5 × 10<sup>-9</sup>/week (72 hr warm up); ± 1 × 10<sup>-7</sup>/month (after 15 days continuous operation).

**Ambient stability:** ± 5 × 10<sup>-8</sup> (0° C to +55° C)

**Warm-up time:** Reference will be within ± 1 × 10<sup>-7</sup> of final value 15 minutes after turn-on for an off time of less than 24 hours.

## Option 002 high voltage output

**Frequency range:** 1 μHz to 1 MHz

### Amplitude

**Range:** 4.00 mVpp to 40.00 Vpp (≥ 500 Ω, ≤ 500 pF load)

**Accuracy:** ± 2% of full output for each range at 2 kHz

**Output impedance:** < 2 Ω at dc, < 10 Ω at 1 MHz

**dc offset range:** 4 times the specified range of the standard instrument.

## General

### Operating environment

**Temperature:** 0° C to 55° C

**Relative humidity:** 95%, 0° C to 40° C

**Altitude:** ≤ 15,000 ft

**Power:** 100, 120, 220, 240 V, +5%, -10%, 48 to 66 Hz; 90 VA, 120 VA with all options; 10 VA standby

**Weight:** 9 kg (20 lb) net; 14.5 kg (32 lb) shipping

**Size:** 132.6 mm H × 425.5 mm W × 497.8 mm D (5.25 in × 16.75 in × 19.63 in)

## Ordering Information\*

**HP 3325B** Frequency Synthesizer

**Opt 001:** High Stability Frequency Reference

**Opt 002:** High Voltage Output

**Opt H05:** Internal MATE Programming

**Opt W30:** Extended Repair Service. See page 671.

**Price**

\$4,800 ☎

+ \$805

+ \$270

(call HP)

+ \$115

\*HP-IB cable not supplied.

☎ For off-the-shelf shipment, call 800-452-4844.

## HP 3326A Two-Channel Synthesizer

The HP 3326A Two-Channel Synthesizer combines two independent synthesizers, flexible modulation, and control circuitry into a single, powerful package. This instrument provides precise phase offset, two-tone sweep, fast frequency switching, internal amplitude and phase modulation, and pulse signals for bench or systems use.

With multiple channels and modes, the HP 3326A does the job of several sources. An internal switch selected signal combiner sums both source outputs into a single ultra-low IMD signal source. Phase continuous sweeps are available in linear and multielement discrete modes. DC offset is available in all modes, and all outputs are floating. Frequency resolution is 11 digits, with flexible triggering for frequency, amplitude, and phase changes and sweeps.

## Specifications Summary

For complete specifications, refer to the HP 3326A data sheet.

**Frequency** (waveforms are sine, square, pulse, and dc)

**Range:** 0 Hz to 13 MHz

**Resolution:** 1 μHz below 100 kHz, 1 mHz at and above 100kHz.

**Stability:** ± 5 × 10<sup>-9</sup>/year, 20° C to 30° C

**Output amplitude** (sine mode)

**Range:** 1 mVpp to 10 Vpp in 8 ranges without DC offset

**Accuracy:** Relative to programmed value after self-calibration

	0.001 Hz	100 KHz	1 MHz	13 MHz
+23.98 dBm	±0.1 dB	±0.3 dB	±0.6 dB	±0.6 dB
+3.98 dBm	±0.2 dB	±0.5 dB	±0.8 dB	±0.8 dB
-36.02 dBm	±0.2 dB	±0.5 dB	±1.0 dB	±1.0 dB
-56.02 dBm				

**Phase offset** (channel A vs B in two-phase mode)

**Range/Resolution:** ± 720 degrees range, 0.01 degree resolution

**Accuracy:** After self-calibration, for equal-level sinewaves 1 V to 10

0.1 Hz	10 Hz	100 kHz	1 MHz	13 MHz
±0.5	±0.2	±0.3	±2.0	

## Frequency sweep

**Sweep types:** Linear, discrete (2 to 63 discrete elements)

**Sweep time:** 5 ms to 1000 s, linear or per element

Option 001 High Stability Frequency Reference

**Stability:** ± 5 × 10<sup>-9</sup>/week after 72 hours continuous operation.

± 1 × 10<sup>-7</sup>/month after 15 days continuous operation.

Option 002 High Voltage Output

**Frequency range:** dc to 1 MHz

**Amplitude range:** 4 mV to 40 Vpp into > 1k Ω, < 200 pF load

**dc offset:** ± 20 V, independent of amplitude range. dc + ac peak must not exceed 20V

## General

**Power:** 100, 120, 220, 240 V, +5%, -10%, 48 to 66 Hz; 290 VA max

**Weight:** Net, 2 kg (60 lb); shipping, 37 kg (81 lb)

**Size:** 177 mm H × 425.5 mm W × 497.8 mm D (7 in × 16 3/4 in × 19 3/4 in)

## Ordering Information

**HP 3326A** Two-Channel Synthesizer

**Opt 001** High Stability Frequency Reference

**Opt 002** High Voltage Output

**Opt 003** Rear Terminal Outputs (Rear only)

**Opt W30** Extended Repair Service. See page 671.

**Price**

\$11,100

+ \$690

+ \$315

\$0

+ \$250

# FUNCTION GENERATORS & WAVEFORM SYNTHESIZERS

## 1 MHz to 21 MHz Synthesized Function/Sweep Generator

HP 3324A

- Multi-interval sweep
- Master/slave capability
- $\pm 719.9^\circ$  variable phase
- Additional 60 MHz output
- Outputs and HP-IB isolated
- HP3325B-software compatible

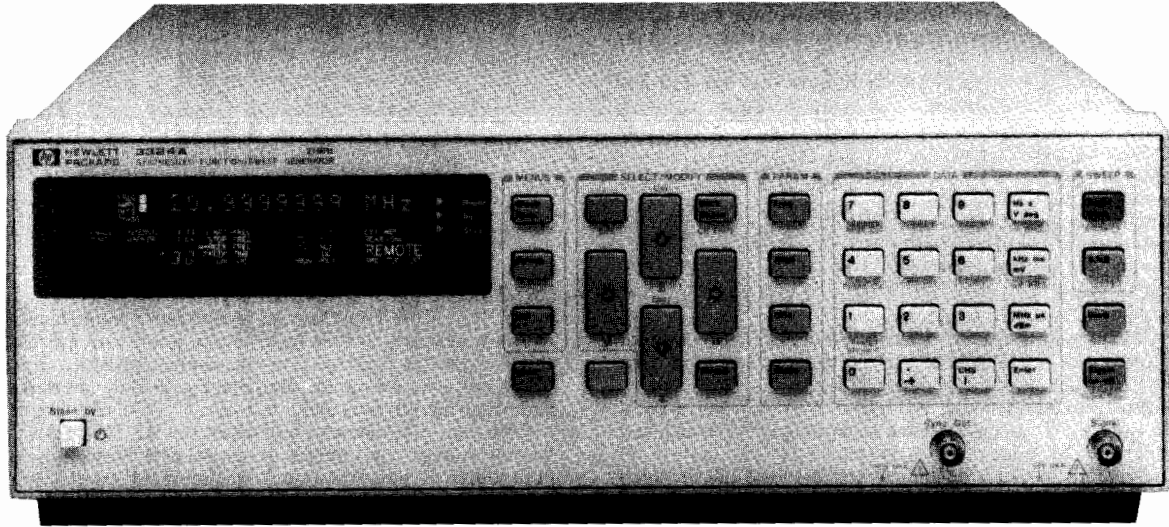

HP 3324A



### The HP 3324A Synthesized Function/Sweep Generator

The HP 3324A complements HP's family of synthesized function generators. It combines good synthesizer quality with extended sweep capabilities, at a moderate price.

#### Multi-Interval Sweeping

The 3324A offers the capability to define up to 50 different sweep intervals, each containing its individual sweep parameters, such as start and stop frequency, sweep time, linear or logarithmic sweep, and marker frequency. Up to 100 intervals can be sequenced, because the repetition of intervals is possible.

The following example shows four different intervals of a sequence of five. Interval one is a linear up-sweep followed by interval two, which has the same start-frequency and stop-frequency. Interval three represents a logarithmic sweep; it is repeated at the end of the sequence. Interval four is linear down-sweep. The complete sequence is generated once in single mode or continuously in continuous mode.

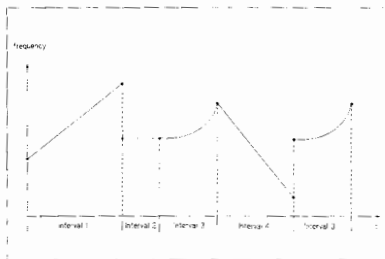

The sweep is performed phase-continuous, even if stop-frequency and start-frequency of succeeding intervals aren't equal.

#### The Reference Source

Many applications, such as PLL testing and calibration of measurement instruments, require a frequency reference that can be accurately tuned and that is stable over a long period of time. The accuracy and stability of the HP 3324A fulfill this requirement.

For those applications requiring a stability better than 5 ppm/year, a high-stability frequency reference oven provides a stability of 0.05 ppm/week (optional).

#### Good Spectral Purity

In addition to the highly stable frequency the HP 3324A provides good sinewave spectral purity with  $-50$  dBc phase noise and  $-55$  dBc spurious signals.

#### System Clock Applications Up to 60 MHz

An auxiliary TTL output provides synthesizer stability over the range 1 MHz to 60 MHz.

#### Multi-Channel Applications

Master/slaving is simplified with the Automatic Phase Calibration options, which eliminate time-consuming phase adjustments. A single keystroke or HP-IB command initiates auto-cal. Thereafter, any phase difference up to  $719.9$  degrees can be entered. If more than two channels are needed, a VHF switch is required to connect the master reference in each slave in turn.

#### High Output Voltage

If more than 10 V (p-p) amplitude is required, the High Voltage Option will enhance the amplitude range up to 40 V (p-p) (limited for frequencies up to 1 MHz).

#### Structured Front Panel

The HP 3324A's front panel is clearly structured and is supported by an alphanumeric fluorescent display. The status of the instrument can be seen immediately, as all of the selected parameters and functions are displayed.

#### Waveforms

Sine, square, triangle, negative and positive ramps, DC, and TTL clock



### Specifications

For more information, please request the data sheet and also the product information sheets "3324A Sweep Parameters" and "Multi-Channel Setups."

### Frequency Range

- Sine: 1 mHz to 21,000,000.0 MHz
- Square: 1 mHz to 11,000,000.0 MHz
- Triangle/Ramps: 1 mHz to 11,000,000.0 kHz
- Auxiliary TTL clock: 1 mHz to 60,000,000.0 MHz

### Resolution

1 mHz for up to 999,999,999 kHz, 100 mHz for 1 MHz up to 21,000,000.0 MHz

Accuracy: ± 5 ppm of selected value, 20° to 30° C

### Stability

± 5 ppm/year, 20° to 30° C, standard (see also Option 001)

### Main Signal Output

Impedance: 50 Ω

### Amplitude (all waveforms except Auxiliary TTL clock)

Range: 1 mV to 10 V (p-p) in 8 amplitude ranges, 1-3-10 sequence

Resolution: 4 digits (0.03% of full range)

Accuracy (without DC offset)

#### Sine

- 1mHz to 100kHz: ≥ 3 V (p-p) ± 0.2 dB
- > 100kHz to 21MHz: ≥ 3 V (p-p) ± 0.4 dB

#### Squarewave

- 1mHz to 100kHz: ≥ 3 V (p-p) ± 1.5%
- 100kHz to 10MHz: ≥ 3 V (p-p) ± 5%

#### Triangle

- 1mHz to 2kHz: ≥ 3 V (p-p) ± 1.5%
- 2kHz to 10kHz: ≥ 3 V (p-p) ± 5%

### Sinewave Spectral Purity

#### Phase Noise

-50 dB for a 30 kHz band centered on a 20 MHz carrier (excluding ± 1 Hz about the carrier)

#### Spurious

All non-harmonically related output signals will be more than 55 dB below the carrier

#### Sinewave harmonic distortion

Harmonically related signals will be less than the following levels relative to the fundamental:

Frequency Range	Harmonic Level
.1 Hz to 199 kHz	- 60 dBc
200 kHz to 1.99 MHz	- 40 dBc
2 MHz to 14.9 MHz	- 30 dBc
15 MHz to 20 MHz	- 25 dBc

### Waveform Characteristics

#### Squarewave characteristics

Rise/Fall time: (10% to 90% at full output) = < 20 ns  
Overshoot: 5% of peak-to-peak amplitude at full output

#### Triangle/ramp characteristics

Linearity (10%-90%, 10 kHz): ± 0.05% of full p-p output voltage

### DC Offset

Range: dc only (no ac signal): 0 to ± 5 V/50 Ω

Resolution: 4 digits

### Phase Offset

#### Range

± 719.9° with respect to arbitrary starting phase or assigned zero phase. See also Options 003 and 004

Resolution: 0.1°

### Frequency Sweep

Sweep sequence modes: Single, continuous

Sweep function modes:

Multi-Interval: Up to 50 different intervals can be sequenced and repeated in a sequence which can contain up to 100 intervals

Multi-Marker: One marker frequency can be set in each interval or up to 9 marker frequencies can be set if only one interval is used

Sweep time (settable for each interval): Linear, 10 ms to 10<sup>5</sup>s;  
Log., 100 ms to 10<sup>5</sup>s

Maximum sweep width (settable for each interval): Full frequency range of the main signal output for the waveform in use, except that the minimum log start frequency is 1 Hz.

Phase continuity: Sweep is phase continuous over the full frequency range of the main output.

### Auxiliary Outputs

#### SYNC output

Phasesynchronous squarewave with same frequency as main signal output, output impedance: 50 Ω

Auxiliary freq. output: Square, freq. range: 21 MHz to 60 MHz

X-Axis drive output: Linear ramp proportional to sweep time

Z-Axis blank output: Output signal depending on sweep state

Sweep marker output: Pulses (TTL and CMOS compatible) at selected marker frequencies

#### 1 MHz reference output

1 MHz squarewave for phase locking additional instruments to the HP 3324A, output impedance: 50 Ω, output amplitude: 0 dBm

### Auxiliary Input

Reference input: For phase locking the HP 3324A to an external frequency reference. Signal from 0 dBm to 20 dBm into 50 Ω

### HP-IB Interface Functions

Interface functions: SH1,AH1,T6,L3,SR1,RL1,PP0,DC1,DT0,C0,E2

### Option 001, High Stability Frequency Reference

#### Aging rate

- ± 5 × 10<sup>-8</sup>/week after 72 hours continuous operation
- ± 1 × 10<sup>-7</sup>/month after 15 days continuous operation

#### 10 MHz oven output

10 MHz squarewave for phaselocking additional instruments to the HP 3324A, output impedance: 50 Ω, output level: > 4.5 dBm

### Option 002, High Voltage Output

Frequency range: 1 mHz to 1 MHz

#### Amplitude

4 mV to 40 V (p-p) in 8 ranges, 4-12-40 sequence into 500 Ω, < 500 pF load

Accuracy: ± 2% of full output for each range at 2 kHz

Flatness: ± 10% relative to programmed amplitude

#### Waveform characteristics

##### Sinewave harmonic distortion

Harmonically related signals will be the same as the standard instrument up to 1 MHz

Squarewave characteristics (typical, 500 Ω, 500 pF load)

Rise/Fall Time: (10% to 90% of p-p output voltage) ≤ 125 ns

Overshoot: ≤ 10% of p-p output voltage

Output impedance: < 3 Ω at dc, < 10 Ω at 1 MHz

DC Offset: 4 times the specified range of the standard instrument

### Options 003 and 004, Automatic Phase Calibration

Calibration: Refers to slave phase to master. Interconnect cables are supplied. If there are two or more slaves, a VHF switch HP 59307A is required. Master/slaving doesn't apply to sweep mode.

### General

Power: 100/120/220/240 V, 48 to 66 Hz, max. 100 VA

Weight: 11 kg net

Dimensions: 132.6 mm H × 425.5 mm W × 497.8 mm D

### Ordering Information

	Price
HP 3324A Synthesized Function/Sweep Generator	\$3,850
Opt 001 High Stability Frequency Reference	+ \$800
Opt 002 High Voltage Output	+ \$270
Opt 003 Automatic Phase Calibration, slave	+ \$475
Opt 004 Automatic Phase Calibration, master	+ \$285
Opt 907 Front Handle Kit (5062-3989)	+ \$55
Opt 908 Rack Flange Kit (5062-3977)	+ \$33.50
Opt 909 Rack Flange and Handle Combination Kit (5062-3983)	+ \$82.50
Opt W30 Extended repair service. See page 671.	+ \$90

☎ For off-the-shelf shipment, call 800-452-4844.

HP

# FUNCTION GENERATORS & WAVEFORM SYNTHESIZERS

## Synthesizer/Function Generator HP 3335A, 3336C

- 200 Hz to 81 MHz
- High spectral purity
- Precision amplitude control
- 1 mHz resolution

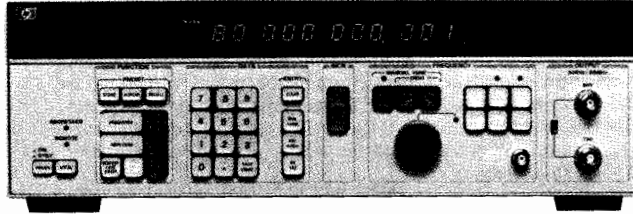

HP 3335A

### HP 3335A Synthesizer/Level Generator

The HP 3335A Synthesizer/Level Generator has performance characteristics that make it ideally suited for the telecommunications industry as well as for traditional synthesizer applications, including testing of Frequency Division Multiplex (FDM) equipment and research and development and production testing of communications systems.

#### Precision Amplitude, Frequency

The HP 3335A incorporates a state-of-the-art attenuator with accuracies of up to  $\pm 0.025$  dB over the 81 MHz frequency range. Frequency stability up to  $\pm 1 \times 10^{-8}$ /day is provided by an internal temperature-controlled oscillator.

#### Frequency Sweep, Tracking Generator

The HP 3335A combines the frequency, accuracy and stability of a synthesizer with the time-saving convenience of a digital sweeper. In addition, the HP 3335A operates as a tracking generator with the HP 3746A/B Selective Level Measuring Set (SLMS) or the HP 3586A/B/C Selective Level Meter for automatic or semi-automatic testing of FDM systems.

#### Specifications

Contact your local HP Sales Office for more information including a data sheet with complete specifications.

#### Frequency

**Standard range:** 200 Hz to 81 MHz    **Resolution:** .001 Hz  
**Option 002/004 range:** 75  $\Omega$ , 200 Hz to 81 MHz; 124  $\Omega$ , 10 kHz to 10 MHz; 135/150  $\Omega$ , 10 kHz to 2 MHz  
**Option 003 range:** 75  $\Omega$ , 200 Hz to 81 MHz; 150  $\Omega$ , 10 kHz to 2 MHz

**Option 001:** (high stability frequency reference)  
 Stability, long term:  $\pm 1 \times 10^{-10}$ /day;  $\pm 1 \times 10^{-7}$ /month  
 Aging rate:  $\pm 5 \times 10^{-8}$ /day;  $\pm 2 \times 10^{-8}$ /month

#### Spectral purity

**Harmonic distortion:** 200 Hz to 10 MHz:  $< -45$  dBc; 10 MHz – 80 MHz:  $< -40$  dBc  
**Phase noise:** (30 kHz band, excluding  $\pm 1$  Hz, centered on the carrier): 9.9 MHz:  $< -63$  dBc; 20 MHz:  $< -70$  dBc; 40 MHz:  $< -64$  dBc; 80 MHz:  $< -58$  dBc

**Spurious:** Nonharmonically related signals: the greater of  $-75$  dBc or  $-125$  dBm (50/75  $\Omega$ ),  $-97$  dBm (124  $\Omega$ ),  $-68$  dBm (135/150  $\Omega$ )

#### Amplitude range

$-88.74$  dBm to  $+13.01$  dBm depending on option and impedance.  
**Resolution:** 0.01 dB

**Absolute level accuracy** (Max. output at 100 kHz,  $10^\circ$  C to  $35^\circ$  C): 50/75  $\Omega$   $\pm 0.05$  dB; 124/135/150  $\Omega$ :  $\pm 0.1$  dB.

**Flatness** (Relative to 100 kHz, full amplitude): 50/75  $\Omega$ : 1 kHz to 25 MHz:  $\pm 0.07$  dB, 200 Hz to 80 MHz:  $\pm 0.15$  dB; 124  $\Omega$ : 50 kHz to 10 MHz:  $\pm 0.15$  dB, 10 kHz to 10 MHz  $\pm 0.4$  dB; 135/150  $\Omega$ : 10 kHz to 2 MHz:  $\pm 0.18$  dB.

#### Ordering Information

	<b>Price</b>
<b>HP 3335A</b> Synthesizer/Level Generator	\$12,800
<b>Opt 001</b> High-stability reference $\pm 5 \times 10^{-10}$ /day	+ \$1,280
<b>Opt 002</b> Connector (75/124/135 $\Omega$ )	+ \$575
<b>Opt 003</b> Connector (75/150 $\Omega$ )	+ \$365
<b>Opt 004</b> Connector (75 $\Omega$ , miniature WECO on 124/135 $\Omega$ )	+ \$575
<b>Opt C01</b> Rack Slide Mount	Contact HP

- 10 Hz to 20.999 MHz
- 11 digit resolution
- Excellent amplitude accuracy
- 1 mHz resolution

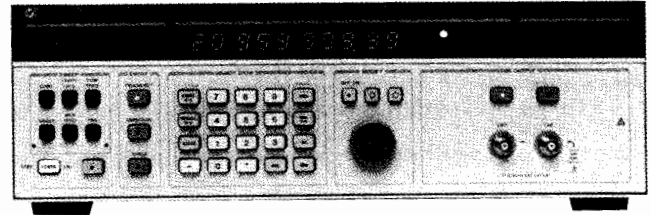

HP 3336C

### HP 3336C Synthesizer/Function Generator

The HP 3336C is designed for traditional synthesizer applications as well as R&D and production testing of systems or components. It features precision level control, high spectral purity, optional frequency stability of  $\pm 5 \times 10^{-8}$ /week, internal frequency sweep and numerous other user conveniences.

#### Precision Frequency Measurements, Amplitude Accuracy

A single loop fractional-N synthesis technique allows synthesizer accuracy with 11 digits of resolution, with completely phase continuous frequency sweep over any of the instruments' frequency ranges. HP attenuator technology coupled with custom designs in leveling loops and thermal converters produce amplitude accuracies of up to  $\pm 0.05$  dB. The fast leveling loop makes extremely flat sweeps possible at high sweep speeds.

Models HP 3336A and B are also available for the telecommunications industry (see page 599).

#### Specifications

Contact your local HP Sales Office for more information including a data sheet with complete specifications.

#### Frequency

**Range:** 10 Hz to 20.999 999999 MHz  
**Resolution:** 1  $\mu$ Hz for frequencies  $< 100$  kHz, 1 mHz for frequencies  $\geq 100$  kHz  
**Aging rate:**  $\pm 5 \times 10^{-8}$ /year ( $20^\circ$  to  $30^\circ$  C)

#### Amplitude

**Range:** 50  $\Omega$ :  $-71.23$  to  $+8.76$  dBm; 75  $\Omega$ :  $-72.99$  to 7.00 dBm  
**Absolute accuracy:**  $\pm 0.05$  dB,  $20^\circ$  to  $30^\circ$  C (for the top 9.99 dB of amplitude range at 10 kHz),  $\pm .08$  dB,  $0^\circ$  to  $55^\circ$  C  
**Flatness:** 50/75  $\Omega$ ,  $\pm 0.1$  dB ( $\pm 0.07$  dB with Option 005) referenced to 10 kHz

#### Amplitude modulation

**Modulation depth:** 0 to 100%  
**Modulation frequency range:** 50 Hz to 50 kHz

#### Phase modulation

**Range:**  $0^\circ$  to  $\pm 850^\circ$   
**Linearity:**  $\pm 0.5\%$  from best fit straight line  
**Modulation frequency range:** dc to 5 kHz

#### Frequency sweep

**Sweep time:** Linear; 0.01 s to 99.99 s. Single Log: 2 s to 99.99 s  
 Continuous Log: 0.1 s to 99.99 s

#### Dimensions

**Size:** 132.6 mm H  $\times$  425.5 mm W  $\times$  497.8 mm D (5.2 in  $\times$  16.8 in  $\times$  19.6 in)  
**Weight:** Net, 10 kg. (22 lb); shipping, 15.5 kg. (34 lb)

#### Ordering Information

	<b>Price</b>
<b>HP 3336C</b> Synthesizer/Level Generator	\$5,640
<b>Opt 004</b> High Stability Frequency Reference	+ \$685
<b>Opt 005</b> High Accuracy Attenuator	+ \$685
<b>Opt 907</b> Front Handle Kit	+ \$58
<b>Opt 908</b> Rack Flange Kit	+ \$34
<b>Opt 909</b> Rack Flange and Handle Kit	+ \$84
<b>Opt W30</b> Extended Repair Service. See page 671.	+ \$130

# PULSE GENERATORS & DATA GENERATORS

## General Information

499



A typical stimulus-response test setup. The HP 8131A pulse generator in the foreground generates 500 MHz pulses with typically 120 ps transitions (20 to 80% of amplitude). The HP 54120 Series oscilloscope measures device response.

### Stimulus Selection Guide — (Refer to page 504 for pulse adders and inverters)

Application	Advanced IC development				General electronic evaluation				Digital - communications - radar - automotive					
Stimulus type	Fast pulse generators				General-purpose pulse generators				Data generators	Arbitrary	Pulse/function generators			
HP Model	8131A	8130A	8082A	8161A	8160A	214B	8112A	8115A	8118A	8175A	8175A#002	8111A	8116A	8165A
Special features				MATE option 511	MATE option 511	High-voltage 514			Pulse patterns 517	Data patterns and arbitrary waveforms 519				
Page	506	508	512	511	511	514	515	516	517	519	493	492	495	497
<b>Timing</b>														
Max rate (MHz/Mbit/s)	500	300	250	100	50	10	50	50	50 (RZ)	50 (NRZ)	50 M samples/s	20	50	50
Min transition time (ns)	0.2	1	1	1.3	6	15	5	6.5	100 (NRZ)	6.5	12	10	6	5
Variable delay	●	●	●	●	●	●	●	●	●	●	See pod specs	●	●	●
Min width (ns)	0.5	1	2	4	10	25	10	10	10	10	Opt 001	20	25	10
Best resolution (ns)	0.01	0.01		0.1	0.1		0.1	0.1	0.1	0.1	20	0.1	0.1	1 mHz
<b>Outputs</b>														
Channels	2 (Opt)	2 (Opt)	1	2 (Opt)	2 (Opt)	1	1	2	2	24	2	1	1	1
Vpp into 50 Ω	5	5	5	5	20	100	16	16	16	See pod specs	16	16	16	20
Best resolution (mV)	10	10		10	10		10	10	10		0.2	0.1	0.1	0.1
Vwindow into 50 Ω	±5	±5	±5	±5	±20	0/100	±8	±8	±8		±8	±8	±8	±10
Normal/complement	Both	Both	Both	Select.	Select.	Pos/neg	Select.	Select.	Select.	Normal	Select.	Select.	Select.	Select.
<b>Modes</b>														
Trigger, gate modes	●	●	●	●	●	●	●	●	●	●	●	●	●	●
Burst mode	●	●		●	●	Opt 001	●	●	Memory	Memory	Memory	Opt 001	●	●
Modulation/control									●	High-level	Algorithm	VCO	●	●
Sweep	Shaper								●		Algorithm		Option	Option
<b>Waveforms</b>														
Pulse, square	●	●	●	●	●	●	●	●	●	●	●	●	●	●
Ramp, triangle		●	●	●	●		●	●	●		●	●	●	●
Sine, Gauss' pulses					●		●	●	●		●	●	●	●
Multi-level									●		●			●
<b>Data patterns</b>														
Depth (kbit)									16	1	1			
Segments/ loops/jumps									1//	255/255/2	255/255/2			
<b>Programmability</b>														
HP-IB	●	●		CIIL/●	CIIL/●		●	●	●	●	●		●	●
HP ITG driver available	●	●					●					●		
<b>Suggested oscilloscope or logic analyzer</b>	HP54120	HP54120	HP54120	HP54110D	HP54110D	HP54501A	HP54503A	HP54503A	HP16530A	HP16510B	HP16530A	HP54501A	HP54503A	HP54503A
									HP16530B	HP1651B	HP1653B			

# PULSE GENERATORS & DATA GENERATORS

## General Information (cont'd)

### Compact HP Solutions

Verify your design under real conditions with HP stimulus-response setups. With programmable sources and instruments, you achieve resolution and accuracy for repeatable measurements. When you add the statistical and documentation possibilities of digitizing oscilloscopes, you turn measurements into credible results.

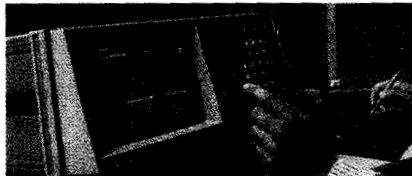

### Digital IC Test

Trigger levels, timing, and output drive, for example, can be measured using an HP 54503A oscilloscope and an HP 812A pulse generator. Source resolution is 100 ps/10 mV and the measurement accuracy is 1.5% voltage and 50 ps timing. For dynamic devices, dual-channel sources are available.

### Analog and Digital VLSI and Boards

Serial data devices can be function- and parametric-tested by the HP 8118A pulse patterns. Parallel data is the domain of the HP8175A, which tests interactively, and can create arbitrary waveforms at the same time.

Combining these with the HP 165x or 165xx logic analyzer/oscilloscopes makes universal testing for analog, digital, and mixed circuits an economic reality.

### High-Speed Characterization

The HP 813x pulse generators provide nano- and subnano-second edges that can be positioned in 10 ps steps. Together with the GHz bandwidths of the HP 54120 Series oscilloscopes, they address some of today's fastest logic. These features are discussed in application note AN 381 (GaAs flip-flop test), and application note AN 381-1 (200 MHz Schmitt trigger test).

### IC Test Head, Computer Backplanes

The HP 8131A with sub-nanosecond filter accessories provides a very smooth calibration pulse. The HP 8130A's variable transitions are ideal for bandwidth and crosstalk tests.

### LAN Devices

The HP 8118A can generate any 2-, 3-, or 4- level code, has plenty of memory for super-messages, variable parameters for waveform mask, and can drive lines direct.

### Automotive Applications

Magnetic sensor pulses can be simulated by several pulse and pulse/function generators with external rate modulation. The HP 8175A arbitrary waveform option allows

the signal to be entered as an algorithm, and can also emulate tacho signals. Complex tacho profiles can be simulated by the HP 3324As segmented sweep (see previous section).

### Radar Baseband Signals, Sonar

Delayed pulse bursts, amplitude, and frequency modulated pulse trains are among the very individual signals that pulse and pulse/function generators can generate. Complex bursts can be managed by data sources. Modulation can be real-time on the HP 8118A, or created with the HP 8175A arbitrary waveform.

### Physical Research

As examples, scintillator signals can be simulated by pseudo-random data, and bio and mechanical signals by loading either algorithms or a digitized oscilloscope captures to the HP8175A.

### Analog Circuits and Components

Such measurements as amplifier bandwidth, filter performance, servo step response, and diode reverse recovery time are performed quickly using rectangles or trapezoids from the HP 812A. For spike immunity or stressing, the HP 214B generates 100 V pulses. Programmable filters, DACs, and ADCs can obtain input and control or compare signals simultaneously from the HP 8175A.

## Pulse Parameter Definitions of Terms Used in Instrument Specifications

**Time Reference Point:** Median (50% amplitude point on pulse edge).  
**Pulse Period:** The time interval between the leading edge medians of consecutive trigger output pulses.

**Trigger Delay:** Interval between trigger point of input signal and the trigger output pulse's leading edge median. Applies in trigger, external width, gate and burst modes.

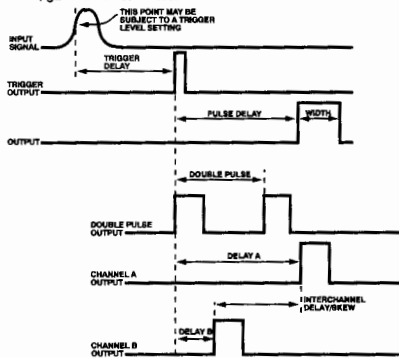

**Pulse Delay:** Interval between leading edge medians of trigger output pulse and output pulse.

**Double Pulse:** Interval between leading edge medians of the double pulse.

**Interchannel Delay/Skew:** Interval between corresponding leading edge medians.

**Pulse Width:** Interval between leading- and trailing-edge medians.

**Additional Information for Pulse Generators with Variable Transition Times**

**Pulse Width:** The specified and displayed value is that obtained with fastest edges; essentially equal to the interval from the start of the leading edge to the start of the trailing edge.

By designing so that the pulse edges turn about their start points, the interval from leading edge start to trailing edge start stays unchanged\* when transition times are varied. This is more convenient for programming and the width display is easy to interpret.

\*In practice, start points may shift with changes in transition time.

**Delay:** The specified and displayed value is that obtained with the fastest leading edge. For a slower edge, the actual delay exceeds the displayed delay by the combined shift of start-point and median.

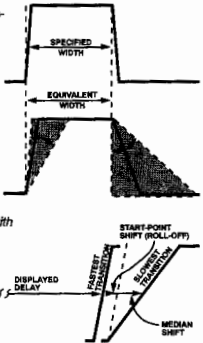

**Transition Time:** Interval between the 10% and 90% amplitude points on the leading/trailing edge.

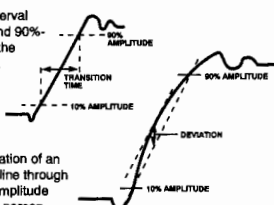

**Linearity:** Peak deviation of an edge from a straight line through the 10% and 90% amplitude points, expressed as percentage of pulse amplitude.

**Jitter:** Short-term instability of one edge relative to a reference edge. Usually specified as rms value, which is one standard deviation or "sigma." If distribution is assumed Gaussian, six sigma represents 99.74% of the peak-peak jitter.

The reference edge for period jitter is the previous leading edge. That for delay jitter is the leading edge of the trigger output. Width jitter is the stability of the trailing edge with regard to the leading edge.

**Stability:** Long-term average instability over a specific time, for example, hour, year.

Jitter is excluded.

Pulse output is specified as pulse top and pulse base (usually referred to as high level and low level), or as peak-to-peak amplitude and median offset. A "window" specification shows the limits within which the pulse can be positioned.

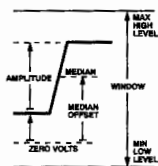

**Preshoot, Overshoot, Ringing:** Preshoot and overshoot are peak distortions preceding/following an edge. Ringing is the positive peak and negative peak distortion, excluding overshoot, on pulse top or base. A combined preshoot overshoot, ringing specification of e.g. ±5% implies:

- Overshoot/undershoot <math>\pm 5\%</math>
- Largest pulse-top oscillation <math>\pm 5\%</math>, of pulse amplitude.

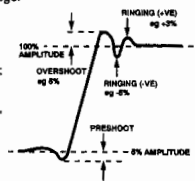

**Settling Time:** Time taken for pulse levels to settle within level specification, measured from 90% point on leading edge.



**Duty Cycle:** Percentage ratio of pulse width to period. In pulse/function generators, this term is also used to define sine and triangle symmetry. Note that, in pulse generators, this is a secondary parameter derived from period and width settings. The duty cycle achieved is therefore subject to width and period accuracies.

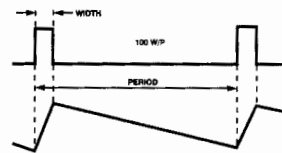

**Output Impedance/Resistance:** Effective pulse source impedance/dc resistance.

**Reflection Coefficient:** Reflection at pulse generator output expressed in percent of incident pulse amplitude. (Test pulse edges correspond to generator's fastest transitions).

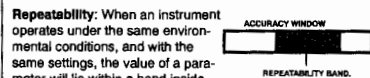

**Repeatability:** When an instrument operates under the same environmental conditions, and with the same settings, the value of a parameter will lie within a band inside the accuracy window. Repeatability defines the width of this band.

### HP-IB Programming Times

**Listen Time:** The time an instrument occupies the bus to receive and verify a message. The NRFD signal is active during this period.

**Setting Time:** The time taken by the instrument to execute an HP-IB message, and for the output to settle within the accuracy specification. NRFD inactive.

**Execution Time:** The sum of Listen Time and Settling Time.

**Talk Time:** The time an instrument occupies the bus to output a specified string. Output data is typically instrument error status, or current or stored parameters.

# PULSE GENERATORS & DATA GENERATORS

## 500 MHz High-Speed Pulse Generator

HP 8131A

501

- <200 ps fixed transitions
- Suitable for BICMOS, ECL, and GaAs technologies
- 10 ps 10 mV best case resolution
- Optional second channel
- Simulates data/clock signals
- 1 GHz Transducer Mode

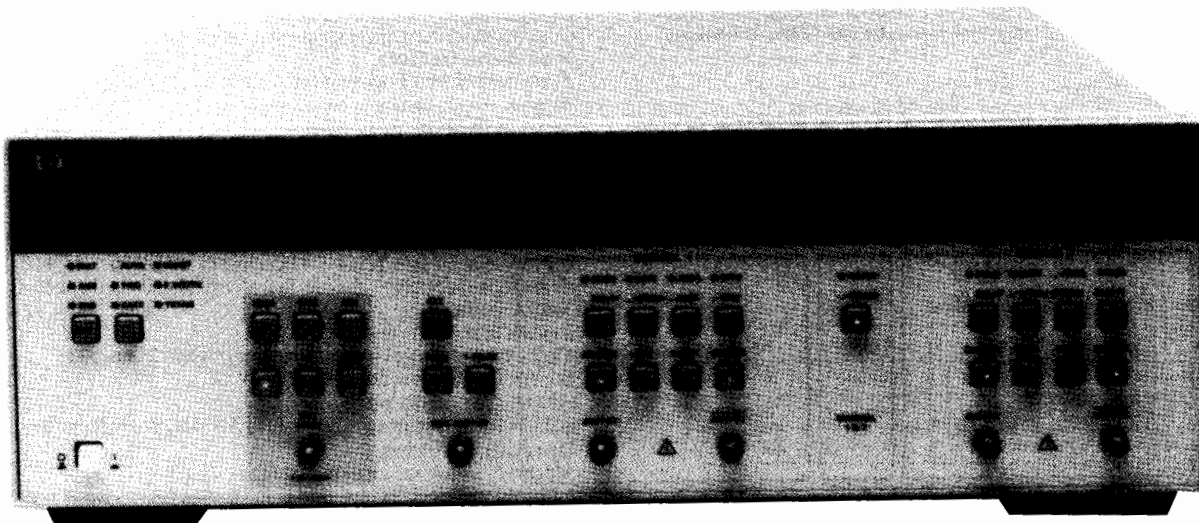

HP 8131A with Option 020, second channel



### 200 ps Transition Times

The HP 8131A delivers excellent performance to help you solve high-speed measurement problems. Transition times of less than 200 ps from the 10% to 90% amplitude (20% to 80% of amplitude: typical 150 ps) enable repeatable and reliable timing measurements on high-speed digital circuits. Since compromises in edge speed directly affect your measurement accuracy, the clean and sharp edges offered by the HP 8131A minimize errors due to threshold uncertainties. Matching the requirements of the most advanced ECL and GaAs devices, you now can characterize components and circuits with repetition rates up to 500 MHz (in Transducer Mode up to 1 GHz). The HP 8131A is the first product that offers 200 ps edge speed in a fully programmable product, which makes it extremely useful not only in research and development environments but also in high-speed production test applications.

### 10 ps Timing Resolution

The high timing resolution allows precise measurement of timing parameters, such as setup and hold times. Especially in the two-channel version, the ability to exactly position sharp pulses through independent delay and width makes the HP 8131A a very useful tool in evaluating fast digital circuits. With a timing resolution that is about one order of magnitude higher than the typical gate delay of ECL devices, it is easy to detect trends when varying a critical pulse parameter without losing a required timing relation. Spikes can be simulated with 500 ps small pulses, and, in combination with the 10 ps width resolution, timing and energy-related failures can be examined.

### 5 V Amplitude and 10 mV Resolution

The 5 V amplitude makes it possible to stimulate high-speed circuits such as ECL, GaAs, or BICMOS devices. In addition, you can now test the excess-voltage immunity of your high-speed components and evaluate crosstalk caused by 5 V, 200 ps transitions. The 10 mV resolution helps to slowly approach the threshold levels of digital circuits. The minimum amplitude of 100 mV is enough to check for minimum signal swing up to a 500 MHz (1 GHz in Transducer Mode) repetition rate. In combination with the full programmability, you can now do detailed analysis of critical level conditions in an automated test routine.

### 500 MHz Repetition Rate

The 500 MHz repetition rate of the HP 8131A establishes a new class of high-speed programmable pulse generator, which allows testing at the maximum toggle rate of your ECL, CMOS, and complex GaAs devices. Now it is possible to perform functional and parametric tests of fast digital circuits under program control. In research and development, this means more reliable tests under repeatable conditions and easy documentation of test results. In production, the programmability opens new possibilities to functionally test high-speed digital components with significantly higher throughput under well-defined conditions.

### 1 GHz Transducer Mode

If you need to functionally test your component at frequencies beyond 500 MHz, the 1 GHz transducer mode allows for shaping an externally provided sinewave into a squarewave with transition times of 200 ps. Especially if you need a very fast, programmable clock source, the combination of the HP 8131A and a microwave signal generator is ideal. This way, you can test maximum toggle frequency with a true digital 1 GHz signal.



# PULSE GENERATORS & WAVEFORM GENERATORS

## 500 MHz High-Speed Pulse Generator (cont'd) HP 8131A

### Transition Time Converters (HP 15432/3/4A)

HP 8131A's fast edges are ideal for testing some of today's fastest digital ICs. But what happens when a practical circuit — through unavoidably long ground connections, for example — is reactive?

It doesn't take much inductance to cause violent ringing when shot at with edges faster than 200 ps. It's unlikely that a reduction in repetition rate will improve circuit performance, unless accompanied by an increase in switching time. The transition time converters allow the edges to be slowed to nominal values of 300, 500 and 1000 ps.

### Flexibility

You can thus test not only fast digital ICs, but also test heads and mainframes where, at high frequencies, the quality of cables, connectors, and terminations can influence the transition times significantly. Always think of the route from the HP 8131A to the device as a transmission line, and the transition time converter as simply a filter that removes some of the highest frequencies, slowing the edges, damping reflections, and reducing overshoot and ringing.

### Typical Performance Characteristics:

	15432A	15433A	15434A
Output Transition Times	300 ps	500 ps	1000 ps
Intrinsic Transition Times	260 ps	480 ps	990 ps
3 dB Corner Frequency	1120 MHz	660 MHz	330 MHz
Input Voltage	< 10.0 V peak-to-peak		
Insertion Loss	< 0.2 dB		
Overshoot and Ringing	< 5%		
VSWR	< 2.0		

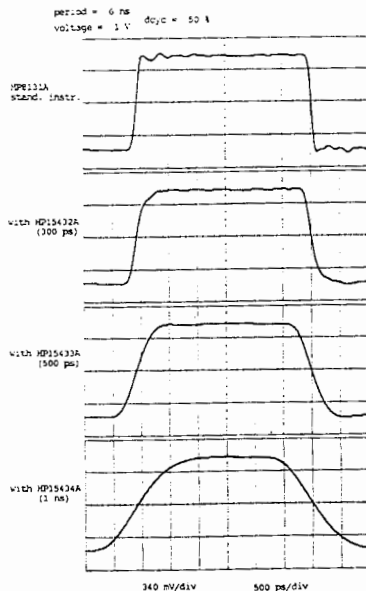

Waveforms are plotted from the HP 54121T Digitizing Oscilloscope

### Specifications

Specifications describe the instrument's warranted performance (30 minutes warm-up, 50  $\Omega$  load) at 0° C to 55° C ambient temperature.

### Timing Parameters (Measured at 50% of amplitude)

#### Common Specification

Resolution: 3 digits (best case: 10 ps)

Period: 2 ns to 99.9 ms

#### Delay

**Fixed:** 20 ns

**Variable range:** from 0 ns to 99.9 ms (max < Period) measured between trigger out and main out.

**Double pulse:** 2 ns to 99.9 ms (period  $\geq$  5.00 ns)

Double Pulse and Delay are mutually exclusive.

**Width:** 500 ps to 99.9 ms (max < Period)

**Transition times:** (for leading and trailing edges)

10%-90% of amplitude: < 200 ps, 300mV to 3V range, period  $\leq$  1 us.

20%-80% of amplitude: < 200 ps, 100mV to 5V range

### Differential Outputs

**Output Levels:** (Into 50  $\Omega$ , output levels double when driving into open circuits, instrument disables outputs if levels exceed  $\pm 6.5$ V, or ampl. exceeds 6.5V)

**High level:** -4.90V to +5.00V **Low level:** -5.00V to +4.90V

Resolution: 3 digits (best case: 10 mV)

Settling Time: 10 ns

### Operating Characteristics

(Values describe typical, non-warranted performance)

#### Inputs and Outputs

**External input:** (Trigger, Gate, Burst, Ext. Width)

Trigger slopes can be selected pos/neg.

Input impedance: 50  $\Omega \pm 2.5 \Omega$

Threshold: -5 V to +5 V

Input frequency: dc to 500 MHz

Min. pulse width: 1 ns

Input sensitivity:  $\geq$  300 mV (peak-to-peak)

#### Transducer input:

Impedance: 50  $\Omega \pm 2.5 \Omega$  Frequency: 10 MHz to 1 GHz

Transition: < 50 ns

Sensitivity:  $\geq$  600 mV (peak-to-peak)

#### Trigger output:

Levels: high 0V, Low 0.6 V

Delay from external input to trigger output: 16 ns

Source impedance: 50  $\Omega \pm 5 \Omega$

### HP-IB Capabilities

All modes and parameters are fully HP-IB programmable

### Operating Modes

**Manual:** Simulates an external input signal

**1 Pulse:** in Trigger, Gate, and Burst mode, one pulse or double pulse is generated.

**Auto:** Continuous pulse stream

**Trigger:** Each active input transition generates a single output pulse or double pulse

**Gate:** External signal enables period generation. First output pulse is synchronous with active edge. Last pulse is always completed. Width and period of first pulse may deviate from subsequent pulses.

**E. Width:** Restoration of external signal with selectable output levels

**E. Burst:** Each active input transition generates a preprogrammed number of pulses (1 to 9999); min burst period is 5 ns. Width and period of first pulse may deviate from subsequent pulses.

**Transducer:** External sinewave (up to 1 GHz) toggles output. Output levels are selectable

**Limit:** Max. high and low levels into 50 Ohm can be limited to protect the device under test. Pushing the limit key declares present levels as limits, which then can not be exceeded as long as the mode is active.

**Complement:** Normal/complement selectable

**Disable:** Relays connect/disconnect outputs

**Set:** Sets parameters to fixed ratio relative to period

**Store:** Stores complete setting in displayed location

**Recall:** Recalls complete setting from displayed location

### General

**Storage temperature:** -40° C to +65° C

**Operating temperature:** 0° C to 55° C

**Power:** 100/120/220/240 Vrms,  $\pm 10\%$ , 400 VA max., 48 to 66 Hz

**Weight:** 20 kg (44.4 lb)

**Sizes:** 145 mm H  $\times$  426 mm W  $\times$  525 mm D (5.7 in  $\times$  16.75 in  $\times$  20.65 in)

**Recalibration period:** 1 year recommended

### Ordering Information

**HP 8131A 500 MHz Pulse Generator**

**Price**

\$16,000

#### Options

**Opt 001** Rear-Panel Connectors

\$0

**Opt 020** Second channel (not retrofittable)

\$8,250

**Opt 908** Rack Mount Flange Kit (P/N 5062-3977)

\$36

**Opt 910** Additional Manual Set

\$230

**Opt 915** Additional Service Manual

\$200

**Opt 916** Additional Operating and Programming

\$32

Manual (P/N 08131-90011)

**Opt H01** Preparation for rack slides (requires rack

\$0

slide kit)

**Opt W30** Extended repair service. See page 671

\$360

#### Accessories

**HP 15432A** 300 ps Transition Time Converter

\$240

**HP 15433A** 500 ps Transition Time Converter

\$240

**HP 15434A** 1 ns Transition Time Converter

\$240

**HP 8493A** Option 010; 10 dB Attenuator

\$145

**HP 8493A** Option 020; 20dB Attenuator

\$145

**P/N 8120-4948** Cable, Coax (SMA)

\$210

☎ For off-the-shelf shipment, call 800-452-4844.



# PULSE GENERATORS & DATA GENERATORS

## 300 MHz Pulse Generator, Variable Transitions

HP 8130A

503

- One ns variable transitions
- 300 MHz repetition rate
- 5V peak-to-peak amplitude

- Minimum resolution: 10 ps; 10 mV
- One channel (two optional)
- Fully HP-IB programmable

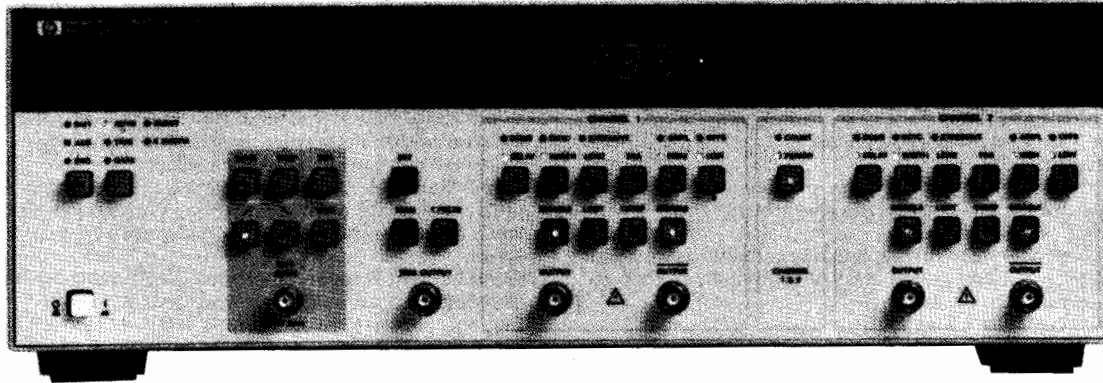

HP 8130A with Option 020, second channel



### 300 MHz Pulse Generator

The 300 MHz repetition rate of the HP 8130A Pulse Generator establishes a new class of high-speed programmable pulse generators with variable transition times. In many cases, the HP 8130A will perform parametric and function tests up to 300 MHz, because delay and width have a degree of adjustment at this speed. This increases your confidence in the device, because measurements can be performed at a higher speed, and even at-speed measurements are feasible.

### Variable Transition Times

Clean edges down to 1 ns mean repeatable, reliable measurements on fast digital ICs such as BiCMOS, ECL and ECLips\*. Variable transition times mean you can optimize switching speed and thus reduce the effects of ringing and reflection when driving reactive or unmatched loads. In addition, the variable transitions open a wide range of analog and digital applications, such as measuring operational amplifiers slew rate, or comparator threshold uncertainty, because trapezoidal and triangular waveforms can be generated.

### 5 V Peak-to-Peak Amplitude and 10 mV Resolution

With 5 V peak-to-peak pulse amplitude into 50 ohms, you can cover the level requirements of all high-speed semiconductor technologies, such as BiCMOS, ECL, and ECLips. Minimum signal sensitivity down to 100 mV can be tested using a direct connection to the HP 8130A. Attenuators can be inserted for smaller signal amplitudes; for example, with a 20 dB attenuator, the minimum amplitude is 10 mV with 1 mV resolution.

### 10 ps Timing Resolution

A timing resolution of an order of magnitude higher than typical gate-delays eliminates time-window uncertainties, allowing for more accurate and reliable measurements.

### Data and Clock Simulation

Two signals—data and clock—are needed in order to characterize flip-flops. The HP 8130A with Option 020, second channel, is a convenient way of generating two different but synchronized signals. Double-pulse can be selected in one channel to simulate a clock; the other channel then appears to produce a series of binary ones and zeroes in NRZ (non-return-to-zero) format. Data rates up to 280 Mbit/s can be simulated.

### Rapid ATE Integration

The HP 8130A is the first fully programmable product to offer full pulse performance flexibility up to 300 MHz. Even the input trigger level can be programmed to automate your measurements. This makes it an extremely useful instrument not only for research and development and production engineering environments, but also in incoming component inspection, and for high-speed functional test applications in production test. A new standardized programming language (HP-SL) enables you to program, upload, and download new parameters or complete settings for future requirements; for example, you can rapidly acquire setups that you have previously set manually.

### Fast and Convenient Manual Operation

The proven design of Hewlett-Packard's pulse generators has been adapted to the requirements of the HP 8130A. Your training is reduced, and you're able to concentrate on your measurement task.

### Specifications

Specifications describe the warranted performance. Non-warranted values are described as "typical." All specifications apply after a 30 minute warmup phase with 50 ohms load resistance at all outputs, and are valid at 0° C to 55° C ambient temperature.

#### Timing Parameters

##### Common Specifications

**Measurement conditions:** Normal mode, measured at 50% of amplitude and fastest transitions

**Resolution:** 3 digits, best case: 10 ps

##### Period

**Range:** 3.33 ns to 99.9 ms

##### Width

**Range:** 1.5 ns to 99.9 ms (max < Period)

\*Registered trademark of Motorola Inc.

# PULSE GENERATORS & DATA GENERATORS

## 300 MHz Pulse Generator, Variable Transitions (cont'd)

HP 8130A

### Delay

(Measured between trigger out and main out)

**Fixed delay** 18 ns

**Variable range:** From 0 ns to 99.9 ms (max < Period)

**Double pulse** (Period  $\geq$  7.20 ns)

**Range:** 3.33 ns to 99.9 ms (max < Period). Double pulse and delay are mutually exclusive

**Transition Times** (Measured at 10% to 90% of amplitude)

**Range:** 1 ns to 100  $\mu$ s leading and trailing edges common in range 1 ns to 2 ns, max leading/trailing ratio 1:20 (1:5 from 2 to 5 ns).

**Linearity:**

Transitions 1.00 ns to 1.99 ns:  $\leq \pm 20\%$  of amplitude

Transitions 2.00 ns to 49.9 ns:  $\leq \pm 10\%$  of amplitude

Transitions > 50 ns:  $\leq \pm 3\%$  of amplitude

### Under-Programmability

Period, width, and transitions are under-programmable to ensure that the specified minimum values can always be obtained

### Output Levels

Output levels double when driving into open circuits. Instrument disables outputs if levels exceed  $\pm 6.5$  V, or amplitude exceeds 6.5 V peak-to-peak

**High level:** -4.90 V to +5.00 V

**Low level:** -5.00 V to +4.90 V

**Resolution:** 3 digits, best case: 10 mV

**Level accuracy:**  $\pm 1\%$  of programmed value  $\pm 3\%$  of amplitude  $\pm 40$  mV

**Settling time:** 20 ns (at fastest transition time)

### Operating Characteristics

Operating Characteristics describe typical, non-warranted performance.

#### Duty cycle

(Width and duty cycle are mutually exclusive)

**Range:** 1% to 90%

**Resolution:** 1%

Subject to width and period specifications

#### Input and output

BNC connectors on the front panel. Rear panel connectors are optional

#### Main outputs (differential outputs)

**Amplitude:** 100 mV peak-to-peak to 5 V peak-to-peak into 50  $\Omega$

**Offset:** -4.95 V to 4.95 V into 50  $\Omega$

**Source impedance:** 50  $\Omega \pm 1 \Omega$

**Maximum external voltage:**  $\pm 5$  V

**Short circuit current:** 200 mA

#### External input

Trigger, Gate, Burst, and External width mode

Trigger slopes can be selected positive or negative

**Input impedance:** 50  $\Omega \pm 2.5 \Omega$

**Threshold:** -5 V to +5 V

**Resolution:** 100 mV

**Maximum input voltage:**  $\pm 10$  V

**Input transition:** < 50 ns

**Input frequency:** dc to 300 MHz

**Minimum pulse width:** 1.5 ns

**Input sensitivity:**  $\geq 300$  mV peak-to-peak

#### Trigger output

**Levels:** High at 2.4 V, low at 0.3 V into 50  $\Omega$

**Trigger pulse width:**

Period (PER)	Pulse width
3.33 ns to 99.9 ns	50% of PER
100 ns to 999 ns	95% of PER
1.00 $\mu$ s to 9.99 $\mu$ s	99.5% of PER
10.0 $\mu$ s to 99.9 ms	99.95% of PER

**Transition times:** < 1 ns

**Source impedance:** 50  $\Omega \pm 2.5 \Omega$

**Delay from external input to trigger output:**

**In Trigger and External Width mode:** 16 ns

**In Gate and Burst mode:** 18.5 ns

**Max/Min external voltage:** +7/-2 V

### Operating Modes

**Manual:** Simulates an external input signal

**1 Pulse:** In Trigger, Gate, and Burst mode, one pulse to double pulse is generated

**Auto:** Continuous pulse stream

**Trigger:** Each active input transition generates a single output pulse or double pulse

**Gate:** External signal enables period generator. First output pulse is synchronous with active edge. Last pulse is always completed. Width and period of first pulse may deviate from subsequent pulses.

**External burst:** Each active input transition generates a preprogrammed number of pulses (1 to 9999); minimum burst period is 5 ns. Width and period of first pulse may deviate from subsequent pulses

**External width:** Pulse recovery (external edges toggle output). Output levels and transition times are selectable.

**Limit:** Maximum high and low levels into 50  $\Omega$  can be limited to protect the device under test. Pushing the limit key declares present levels as limits which then cannot be exceeded as long as the mode is active.

**Complement:** Normal/complement is selectable per output

**Disable:** Relays connect/disconnect outputs.

**Set:** Sets parameters to fixed ratio relative to period (delay = 0 ns, width = 50% of period, transitions = 10% of period, limited to min 1 ns; period, high level and low level = current values)

### HP-IB capabilities

All modes and parameters are programmable, downloadable and uploadable. ASCII and binary formats are supported.

### Nonvolatile Memory

Current settings are saved on power-down. Additionally, 19 complete set-ups can be stored.

### General

**Storage temperature:** -40° C to +65° C

**Operating temperature:** 0° C to 55° C

**Power:** 100/120/220/240 Vrms,  $\pm 10\%$ , 250 VA max, 50 to 60 Hz

**Weight:** 20 kg (44.4 lb)

**Size:** 145 mm H  $\times$  426 mm W  $\times$  525 mm D (5.7 in  $\times$  16.75 in  $\times$  20.65 in)

**Recalibration period:** 1 year recommended

### Ordering Information

Ordering Information	Price
HP 8130A 300 MHz Pulse Generator	\$12,700
Opt 001 Rear-Panel Connectors	\$0
Opt 020 Second Channel (not retrofittable)	\$6,800
Opt 908 Rackmount Flange Kit (P/N 5062-3977)	\$36
Opt 910 Additional Manual Set	\$230
Opt 915 Additional Service Manual	\$200
Opt 916 Additional Operating/Programming Manual (P/N 08130-90011)	\$32
Opt W30 Extended Repair Service. See page 681.	\$360
Opt H01 Preparation for rack slides (rack slide kit required)	\$0

### Pulse Generator Accessories



HP 15104A/15115A



HP 15116A

HP 15104A Pulse Adder/Splitter dc to 2 GHz \$120

HP 15116A Pulse Inverter 3 MHz to 2 GHz \$230

HP 15115A Pulse Splitter/Inverter 3 MHz to 2 GHz \$230

☎ For off-the-shelf shipment, call 800-452-4844.

# PULSE GENERATORS & DATA GENERATORS

MATE-Approved Stimuli

HP 8160A, 8161A

505

- HP 8160A: 6 ns variable edges/20 V pp
- Hp 8161A: 1.3 ns variable edges/5 V pp
- One-to-three percent basic accuracy

The HP 8160A and 8161A are fully programmable pulse generators designed for high-performance applications on the bench and in automatic test systems. Operation is easy because the pulse parameters are controlled independently and do not inter-react. Dual channel options permit synchronous or complex waveforms to be generated. With its 50 MHz repetition rate, 20 V output, and 6 ns variable transition times, the HP 8160A is a general-purpose pulse generator. The HP 8161A covers the high end of technology with its 100 MHz, 5 V, and 1.3 ns variable transition times. Measured between the 20 percent to 80 percent amplitude points, these transitions are faster than 1 ns and meet ECL requirements.



HP 8161A output

ECL memory output

Combining high programming accuracy with microprocessor-based control capabilities, pulses can be set up without a measuring instrument. Pulse parameters are entered and displayed numerically, and generated with a basic timing accuracy of one-to-three percent, depending upon parameter.

An easy-to-use HP-IB interface brings high-accuracy pulses to automatic test. All parameters and operating modes are remotely programmable using straightforward command sequences. Faster, easier program generation and reduced software costs are direct benefits.

## Precision Pulse Generation

Both models provide precision control over all parameters of their output pulses. The HP 8160A's leading and trailing edge transition times may be independently programmed down to 6 ns. The HP 8161A's transitions have a common control from 1.3 ns to 5 ns, and are independent above 5 ns. Variable transition times are indispensable when digital ICs need to be characterized: either the ICs data sheeted input transition time is required, or the ICs functioning range with various transitions needs to be evaluated.

Direct entry of the high and low levels of the output pulse enables easy adjustment to the logic levels concerned. Pulse width is variable from 4 ns (HP 8161A) or 10 ns (HP 8160A) to 1 s, giving a wide range of duty cycle programmability. Delay shifts the output pulse in relation to the trigger output or, in double pulse mode, defines the pulse spacing.

In the dual-channel versions, double pulse can be selected in either or both channels. This means, for example, that simultaneous clock and data signals can be generated.

## Counted Burst

Using Burst Mode, a predetermined number of pulses is generated independent of frequency. Bursts from 0 to 9999 pulses in length may be produced, and can be triggered via an external signal manually or with an HP-IB command.

- Variable transitions
- Dual channel (Option 020)

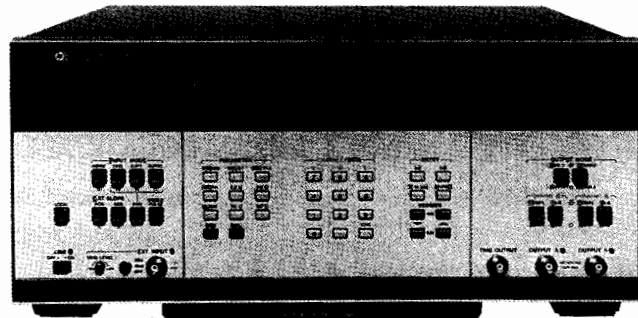

HP 8160 with Options 020, 700

DESIGNED FOR  
MATE  
SYSTEMS



## Complex Signals

Independent pulse parameters plus individual programmability of the Option 020's dual outputs are augmented by the A ADD B mode. Summation allows complex signals to be precisely and easily set up. Here are some examples:

Applications such as radar coincidence circuits and special codes in communications require 3- and 4-level signals. These are conveniently generated by combining channel A and channel B pulses.

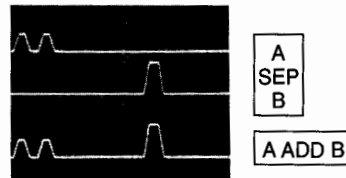
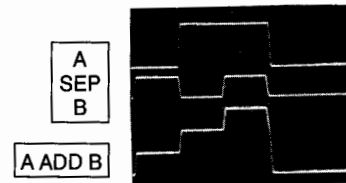

Transponder circuits need accurate delays, often with respect to a double-pulse interrogation signal. This is arranged by operating one channel in double pulse mode and setting up the transponder delay in the other.

A critical test for digital circuits and ICs is its glitch and noise sensitivity, which can be easily performed with the A ADD B mode.

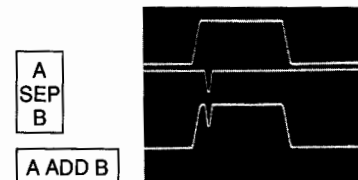

# PULSE GENERATORS & DATA GENERATORS

## MATE-Approved Stimuli

HP 8160A, 8161A

### User Features

#### Fast, Reliable Setup

Microprocessor control promotes highly accurate pulses. Parameters are directly entered via the instrument's keyboard, and are then displayed on numeric LEDs with three-digit resolution.

In bench applications, the vernier controls give a fine adjust capability to "tweak-in" any pulse parameter. You can increment or decrement the selected parameter either in single steps or at speed.

Error detection by the microprocessor further simplifies pulse set-up by solving the old problem of incompatible settings. Should pulse width exceed pulse period, for example, the microprocessor indicates a TIMING error. All possible mis-settings are detected and the type of error is indicated to aid rapid correction.

#### HP-IB Programming

Microprocessor control over all interface functions makes remote programming as easy and straightforward as manual control. The instruments employ keystroke programming so that data entry via the HP-IB is an exact simulation of manual entry. Bus commands for each front panel key simply replace manual keystrokes.

#### Specifications

Specifications apply over the temperature range 20° C to 40° C, with an output load of 50 ohms. More detailed specifications are available in the product data sheets.

##### Period

**Range:** 20 ns to 999 ms (HP8161A: 10 ns to 980 ms)

**Basic accuracy:** ± 3%

**Basic jitter:** 0.1% pp

##### Delay/double pulse, width

**Range:** 0.0 ns to 999 ms (HP8161A: 0 ns to 990 ms)

**Basic accuracy:** ± 1%.

##### Transition times (10 to 90% of amplitude)

**Range:** 6.0 ns to 9.99 ms (HP8161A: 1.3 ns to 900 us)

**Basic accuracy:** ± 3% (HP8161A: ± 10%)

##### Output (50 ohms into 50 ohms)

**Amplitude:** 0.10 to 9.99 V (HP8161A: 0.06 to 5.00 V)

**Window:** ± 9.99 V (HP8161A: ± 5.00 V)

**Basic accuracy:** ± 1%

**Source resistance:** 50 Ω (HP8160A: 50 ohm / 1 k Ω selectable)

Output voltages double when 1 k Ω is selected)

**Normal/complement:** Selectable (HP8161A without Option 020 has normal and complement outputs)

**Channel addition:** Selectable with Option 020,3- and 4-level signals feasible. Maximum output: 20 V pp (HP8161A, 5 Vpp)

**Operating modes:** Normal, trigger, gate, ext burst (0 to 9999 pulses), double pulse.

**HP-IB capability:** All modes and parameters can be programmed  
Talk mode for status, error messages, stored parameters

**Memory:** 9 programmable locations\*

1 location for active operating state\*

1 location with fixed parameter set

**Capacity:** 1 complete operating state per location

\*Battery back-up for power-off storage

#### Parameter Storage

Complete parameter and mode information for nine independent instrument setups can be stored. Waveforms may be stored and recalled either manually or via the HP-IB.

By utilizing a single command to recall an entire instrument setup, controller time is saved. In simple repetitive testing applications, storage of test waveforms gives a high degree of convenience without an external controller.

#### Learn Mode

When interrogated by the system controller, the instruments output a character string to the interface bus. This string completely describes the pulser's current setup or any one of its stored parameter sets. Using Learn Mode, you can enter and try out waveforms manually and then automatically transfer them via the HP-IB to the controller for storage in a program.

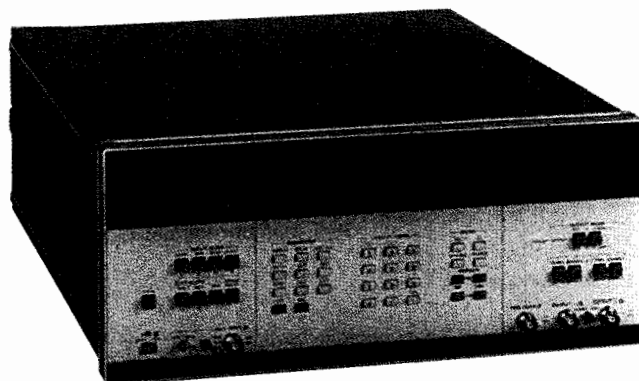

HP 8161A

#### General

**Recalibration period:** 1 year

**Repeatability:** Factor 2 better than specified accuracy

**Operating temperature:** 0° C to 50° C (Specifications apply from 20° C to 40° C. Accuracy derating factors for 0° C to 20° C and 40° C to 50° C)

**Power:** 115/230 V ac + 10%, -22%, 48-66 Hz; 675 VA max

**Weight:** Net 20.8 kg (46 lbs), shipping 25 kg (55 lbs)

**Size:** 178 mm H × 426 mm W × 530 mm D (7 in × 16.8 in × 20.9 in)

#### Ordering Information

	Price	
	HP 8160A	HP 8161A
<b>HP 8160A/8161A</b> Programmable Pulse generator*	\$17,900	\$20,400
<b>Opt 001</b> Rear-panel inputs and outputs	\$0	\$0
<b>Opt 020</b> Second channel (Rate common)	\$8,350	\$8,750
<b>Opt 700</b> Built-in MATE/CIIL compatibility	\$3,060	\$3,060
<b>Opt 907</b> Front handle kit (HP 5062-3990)	\$66 ☎	\$66 ☎
<b>Opt 908</b> Rack flange kit (HP 5062-3978)	\$36 ☎	\$36 ☎
<b>Opt 909</b> Opt 907, 908, combined (HP 5062-3984)	\$92 ☎	\$92 ☎
<b>Opt 910</b> Set of operating/programming and service manuals	\$122	\$153
<b>Opt W30</b> Extended repair service. See page 671.	\$380	\$310

\* HP-IB cables not supplied, see page 615.

☎ For off-the-shelf shipment, call 800-452-4844.

# PULSE GENERATORS & DATA GENERATORS

250 MHz Fast Pulse Source

HP 8082A

507

- <1 ns variable transition times
- Ultra-clean 50 ohm source
- Switch-selectable ECL levels
- Dual  $\pm 5$  V outputs

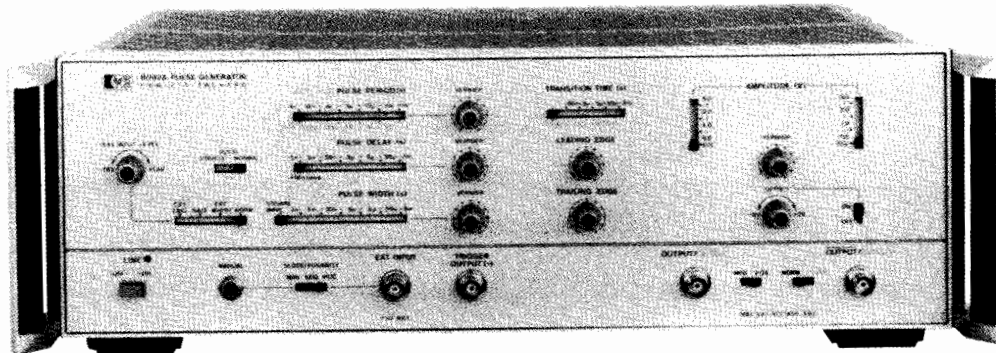

HP 8082A

The HP 8082A is a fast pulse generator with all pulse parameters variable. With repetition rates to 250 MHz, transition times down to 1 ns, and amplitudes to 5 V, the HP 8082A is ideally suited for state-of-the-art TTL and ECL logic designs. Using the HP 8082A, you can rapidly test logic circuits under all operating conditions by simply varying pulse parameters.

Hybrid ICs, manufactured by Hewlett-Packard, are used extensively in the design of the HP 8082A. These ICs eliminate the need for fans, reduce power consumption, and enable a low reactance 50 ohm source impedance to be used. This source impedance absorbs 98% of reflections from signals up to 4 V amplitude.

## Specifications

### Pulse Characteristics (50 $\Omega$ source and load impedance)

**Transition times:** (10% to 90%): 1 ns to 0.5 ms in 6 ranges at amplitudes >1.8 V and >4.5 V respectively in the two upper output ranges. Minimum value may increase to 1.2 ns at other amplitudes. Leading/trailing times are common on fastest range, and independently variable over 1:10 ratio on other ranges.

**Overshoot and ringing:**  $\leq \pm 10\%$  of pulse amplitude may increase to  $\pm 10\%$  with amplitude vernier CCW.

**Preshoot:**  $\leq \pm 5\%$  of pulse amplitude

**Linearity:** Linearity aberration for both slopes  $\leq 5\%$  for transition times >5 ns

**Output:** Maximum amplitude is 5 V from 50  $\Omega$  into 50  $\Omega$ . Maximum output voltage is  $\pm 5$  V (amplitude + offset).

**Offset:**  $\pm 2$  V, into 50  $\Omega$

**DC-source impedance:** 50  $\Omega$  +5% -10%

**Reflection coefficient:** 5% in ECL setting, increasing to 15% in 5 V range

**Output protection:** Cannot be damaged by open or short circuits or application of ext.  $\leq \pm 6$  V or  $\pm 200$  mA independent of control settings

**Attenuator:** Two separate three step-attenuators reduce the outputs to 1 V. Vernier is common for both outputs and reduces the output to 0.4 V minimum. A further position provides ECL-compatible outputs ( $-0.9$  V to  $-1.7$  V typ. open circuit).

### Timing

**Repetition rate:** 250 MHz to 1 kHz in 6 ranges

**Period jitter:** <0.1% of setting +50 ps

**Delay:** 2 ns to 0.5 ms in 6 ranges plus typ. 17 ns fxd. with respect to trigger output. Duty cycle >50%

**Delay jitter:** <0.1% of setting +50 ps

**Double pulse:** Up to 125 MHz max. (simulates 250 MHz)

**Pulse width:** 2.4 ns to 0.5 ms in 6 ranges

**Width jitter:** <0.1% of setting +50 ps

**Width duty cycle:** >50%

**Square wave:** Delay and double pulse are disabled, max. Rep. Rate 250 MHz. Duty cycle is 50%  $\pm 10\%$  up to 100 MHz, 50%  $\pm 15\%$  for >100 MHz.

**Trigger output:** Negative going Square Wave (50% duty cycle typ.) >500 mV from 50  $\Omega$  into 50  $\Omega$ . Internal 50  $\Omega$  can be switched off by slide-switch on PC-board. Amplitude up to 1 V into 50  $\Omega$  up to 200 MHz

**Trigger output protection:** Cannot be damaged by short circuit or application of external  $\pm 200$  mA

## External Operating Modes

### External Input

**Input impedance:** 50  $\Omega$   $\pm 10\%$ , dc coupled

**Maximum input:**  $\pm 6$  V

**Trigger level:** Adjustable  $-1.5$  V to  $+1.5$  V

**Slope control:** Positive, negative, or manual selectable. In the manual position all ext. functions can be controlled by push button. Button pushed in simulates an "on-signal."

**Sensitivity:** Sine-wave >200 mV p-p pulses >200 mV

**Repetition rate:** 0 to 250 MHz

### External-Controlled Modes

**External trigger:** There is approximately 7 ns delay between the external input and the trigger output. Rep. rate is externally controlled (is triggered by external signal). Trigger output provides the pulse-shaped input signal.

**Synchronous gating:** Gating signal turns rep. rate generator on. Last pulse normal width even if gate ends during pulse.

**External width:** Output pulse width determined by width of drive input. Rep. rate and delay are disabled. Trigger output provides shaped input signal.

## General

**Operating temperature:** 0° C to 55° C

**Power:** 100/120/220/240 Vrms; +5%, -10%; 48 to 440 Hz.

85 VA max

**Weight:** Net, 7.9 kg (17.44 lb); shipping, 8.9 kg (19.63 lb)

**Size:** 133 mm H x 426 mm W x 345 mm D (5.2 in x 16.75 in x 13.6 in)

## Ordering Information

**HP 8082A** Pulse Generator

**Opt 907** Front Handle Kit (HP 5062-3989).

**Opt 908** Rack Flange Kit (HP 5062-3977).

**Opt 909** Opt 907, 908 Combined (HP 5062-3983).

**Opt 910** Additional Operating and Service Manual

**Opt W30** Extended Repair Service. See page 671.

## Price

\$6,650

+ \$56

+ \$33

+ \$82

+ \$28

+ \$195

☎ For off-the-shelf shipment, call 800-452-4844.

# PULSE GENERATORS & DATA GENERATORS

## High-Resolution Time Synthesizer

HP 5359A

- Precise digital delays, 0-160 ms
- 50 ps increments
- Jitter < 100 ps
- Programmable
- Fully synchronous to external trigger
- Automatic calibration

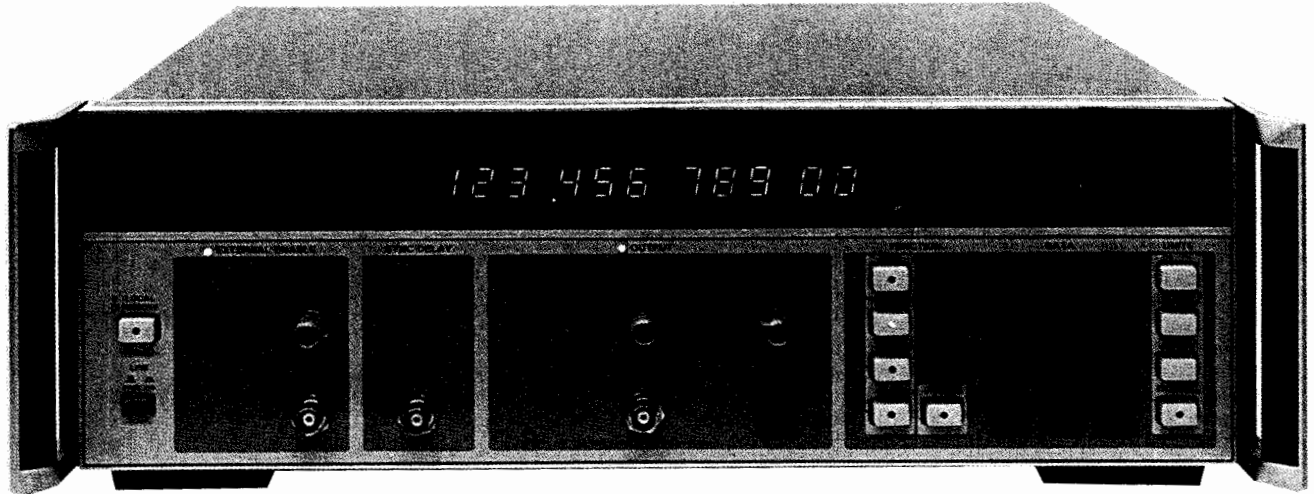

HP 5359A



### HP 5359A Time Synthesizer

The HP 5359A Time Synthesizer produces two extremely-precise low-jitter time delays. These delays,  $T_d$  and  $T_w$ , are individually selectable using the keyboard. Step values of 50 ps or greater set  $T_d$  or  $T_w$  to be delays of up to 160 ms.

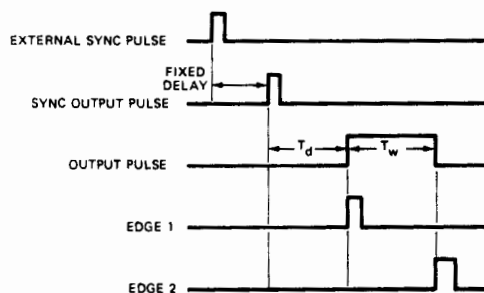

The HP 5359A has many applications. It can be used for the calibration of Radar, Loran, DME, and Tacan Systems, for precision generation of delayed sweeps in oscilloscopes, and for extremely accurate "time positioning" control of external gates on frequency counters. In component and circuit test, the instrument can be used for extremely accurate delay line simulation.

### Condensed Specifications

#### Modes

**External trigger mode:** Selects the delays from the sync out to the beginning of the output pulse, and the width of the output pulse.

**Internal trigger mode:** Selects the "period" or "frequency" and the width of the output pulse.

**Events mode:** Substitutes external input (to 100 MHz) for the internally counted clock (delay and width must both be specified in terms of events instead of time).

**Triggered frequency mode:** The same as internal frequency mode except the output is a burst beginning in synchronism with an external trigger signal, and continuing for the duration of this signal.

**Calibrate mode:** Performs an internal calibration to remove the effects of internal delay differences.

#### Range

**Delay  $T_d$ :** 0 ns to 160 ms

**Width  $T_w$ :** 5 ns to 160 ms (width & delay  $\leq$  160 ms)

**Period:** 100 ns (or width + 85 ns) min; 160 ms max

**Frequency:** Same as corresponding "period"

**Repetition rate:** 10 MHz max

**Accuracy:**  $\pm 1$  ns  $\pm$  time base error ( $\pm 100$  ps  $\pm$  time base error after external calibration)

**Insertion delay:** Fixed at < 150 ns; selectable as < 50 ns for delays > 100 ns

**Jitter:** Typical 100 ps rms; maximum 200 ps rms (delays to 10 ms)

**External trigger input:** -2 V to +2 V, slope selectable

**Sync output:** 1 V at 50  $\Omega$ ; 5 V at 1 M $\Omega$ . Width 35 ns nominal

#### Output Pulse

**Amplitude:** 0.5 V to 5 V, into 50  $\Omega$

**Polarity:** Positive or negative

**Offset:** -1 V to 1 V, or OFF

**Transition time:** < 5 ns

**Note:** External voltage must not be applied. Offset and Amplitude voltage into 50  $\Omega$  may be displayed.

**EDGE 1 & 2 OUTPUTS (rear panel):** Occur in Sync with leading edge of output pulse (same specification as Sync out)

**HP-IB:** All controls except trigger levels are programmable.

#### Time Base

High Stability Oven Oscillator

**Frequency:** 10 MHz

**Aging rate:**  $< 5 \times 10^{-10}$ /day

**Temperature:**  $< 4.5 \times 10^{-9}$ , 0° C to 50° C

**Line voltage:**  $< 1 \times 10^{-10}$ ,  $\pm 10\%$  from nominal

**Size:** 133 mm H  $\times$  426 mm W  $\times$  521 mm D (5.25 in  $\times$  16.75 in  $\times$  20.50 in)

**Weight:** 13.6 kg (30 lb)

**Power requirements:** 100, 120, 220, or 240 Vac +5% -10%, 48 to 66 Hz, less than 250 VA

**Front handles:** Supplied with instrument

#### Ordering Information

**HP 5359A** Time Synthesizer

**Opt 908** Rack Flange Kit (without handles)

**Opt 910** Additional Manual

**Opt 913** Rack Flange Kit (with handles)

**Opt W30** Extended Repair Service. See page 671

**Opt W32** Calibration Service. See page 671

**HP 10870A** Service Kit

**Price**

\$16,500

+ \$35

+ \$75

+ \$40

\$1,600

# PULSE GENERATORS & DATA GENERATORS

Fast, High Power Pulse Generator

HP 214B

509

- High power 100 V, 2 A output into 50  $\Omega$
- 10 MHz repetition rate
- Constant duty cycle
- Counted pulse burst option

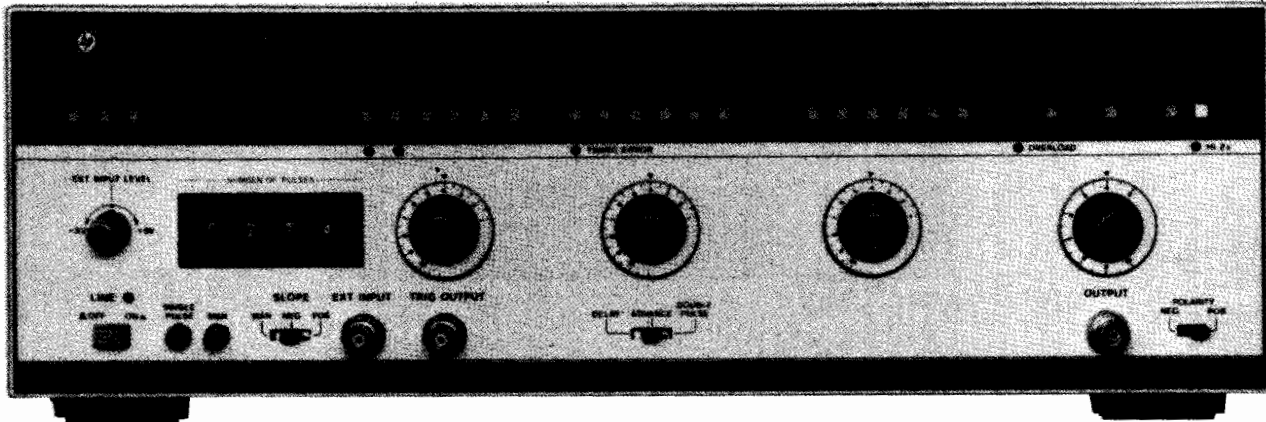

HP 214B with Option 001, Counted Burst.

The HP 214B pulse generator employs semiconductor technology for high power pulse generation at up to 10 MHz repetition rate. Delivering 100 V pulses with 15 ns risetimes, the HP 214B meets the speed demands of today's applications.

State-of-the-art VMOS FETS used as current sources for the output amplifier tubes enable pulse width to be specified down to 25 ns. The HP 214B is thus well-equipped for low duty cycle applications such as laser diode pulsing or transient simulation.

Where changing duty cycle threatens destruction to the device under test, the HP 214B Constant Duty Cycle (CDC) mode provides device protection. In CDC operation the duty cycle, hence power, remains constant as frequency is varied. The HP 214B is itself protected against excessive duty cycles via an overload protect circuit.

Easy operation is assured by the timing error indication. Calibrated dials enable fast accurate adjustments. Operating into unmatched loads, clean pulse shape is guaranteed by the low reactance 50  $\Omega$  source impedance. Pulse distortions such as preshoot and overshoot are specified as 5% at all amplitudes.

## Specifications

### Timing

**Repetition rate:** 10 Hz to 10 MHz in 6 ranges. In 30 V to 100 V amplitude range, maximum rep. rate is 4 MHz. Calibrated vernier provides continuous adjustment within ranges. **Vernier accuracy:**  $\pm$  (10% of setting + 1% full scale). **Period Jitter:**  $\leq$  0.1% + 300 ps.

**Pulse delay/advance:** Pulse can be delayed/advanced with respect to the trigger output from 10 ns to 10 ms ( $\pm$  fixed delay of 45 ns) in 5 ranges. Calibrated vernier provides continuous adjustment within ranges. **Vernier accuracy:**  $\pm$  (10% of setting + 1% full scale) + fixed delay. **Position Jitter:**  $\leq$  0.1% + 500 ps.

**Maximum pulse position duty cycle:**  $\geq$  50%

**Double pulse:** 5 MHz maximum in all ranges except 30 V to 100 V range which is max. 2 MHz. Minimum separation is 100 ns.

**Pulse width:** 25 ns to 10 ms in 6 decade ranges. Calibrated vernier provides continuous adjustment within ranges. **Accuracy:**  $\pm$  (10% of setting + 1% full scale) + 5 ns. **Width Jitter:**  $\leq$  0.1% + 500 ps.

**Max. duty cycle:**  $\geq$  10% for 30 to 100 V range.  $\geq$  50% all other ranges. **Constant duty cycle mode (disabled in ext. trigger mode):** Duty cycle of output pulse remains constant as the period is varied. The duty cycle limits in this mode are typically 8% fixed for the 10 MHz to 1 MHz range (max. 4 MHz); 2.5% to 10% for 1 MHz to 0.1 MHz range; 0.25% to 10% for 0.1 MHz to 10 kHz range; 0.1% for all other ranges. Calibrated vernier provides continuous adjustment within ranges.

**Accuracy:**  $\pm$  (15% of setting + 1% of full scale)

### Trigger Output

**Amplitude:**  $\geq$  +5 V (50 ohm into open circuit)

**Pulse width:** 10 ns typical

## External Operating Modes

### External input (impedance 10 k ohm, dc coupled)

**Repetition rate:** dc to 10 MHz. **Sensitivity:** 500 mV<sub>pp</sub>, dc coupled.

**Slope:** pos. or neg. **Trigger level:** +5 V to -5 V adjustable.

**Maximum input level:**  $\pm$ 100 V. **Trigger pulse width:**  $\geq$  10 ns.

**EXT TRIG mode:** An output pulse is generated for each input pulse.

**GATE mode:** Gate signal turns on rep. rate generator synchronously. Last pulse always completed.

**BURST mode (optional):** Preselected number of pulses generated on receipt of trigger signal. **Number of pulses:** 1 to 9999. Minimum spacing between bursts: 200 ns.

**Manual:** Pushbutton can be used for triggering single pulses (EXT TRIG mode), generating gate signals (GATE mode), or triggering pulse bursts (BURST mode).

## Output

**Amplitude:** 0.3 V to 100 V in 5 ranges. Calibrated vernier provides adjustment within ranges. **Vernier accuracy:**  $\pm$ 10% of setting.

**Source impedance:** Fixed 50  $\Omega$  nominal on ranges up to 10 V. Selectable 50  $\Omega$  nominal or HI-Z on 10 - 30 - 100 V ranges (with 50  $\Omega$  / 50  $\Omega$  impedance, amplitude decreases to 5 - 15 - 50 V).

**Polarity:** Pos. or neg. selectable

**Transition times:**  $\leq$  15 ns for leading and trailing edges

**Pulse top perturbations:**  $\leq$   $\pm$  5% of amplitude

## General

**Operating temperature:** 0° C to 55° C

**Power:** 100/120/220/240 Vrms; +5%, -10%, 48 to 66 Hz, 360 VA max

**Size:** 133 mm H x 426 mm W x 422 mm D (5.2 in x 16.8 in x 16.6 in)

**Weight:** Net, 13.6 kg (30 lb); shipping, 15.6 kg (34.3 lb)

## Ordering Information

	Price
<b>HP 214B</b> Pulse Generator	\$5,500
<b>Opt 001</b> Counted Burst	\$860
<b>Opt H04</b> 48-440 Hz Line	on request
<b>Opt 907</b> Front Handle Kit (part number HP 5061-9689)	\$56
<b>Opt 908</b> Rackmount Kit (part number HP 5061-9677)	\$33
<b>Opt 909</b> Opt 907, 908 Combined (part number HP 5061-9683)	\$82
<b>Opt 910</b> Set of Operating/Progr. and Service Manuals	\$34
<b>Opt W30</b> Extended repair service. See page 671.	\$120

☎ For off-the-shelf shipment, call 800-452-4844.

# PULSE GENERATORS & DATA GENERATORS

## Versatile 50 MHz Source

HP 8112A

- Full pulse capability
- Modulation
- Ramps and haversines
- Width/duty cycle
- Device protection
- Error recognition and self test

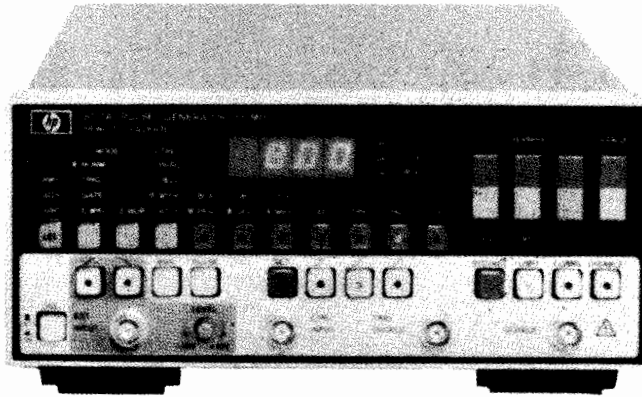

HP 8112A

### HP 8112A Pulse Generator

The HP 8112A is a fully programmable 50 MHz pulse generator with 5 ns transitions and 32 V<sub>pp</sub> (into open circuit) max output amplitude. All pulse parameters are variable including delay and double pulse spacing.

Besides the comprehensive trigger modes, external modulation capabilities extend applicability. Three-level signals and upper level, width, period, and delay-modulated signals are available. These can be combined with the trigger modes so that complex real-life signals like modulated bursts are simulated easily.

Step response and trigger hysteresis measurements require fast transitions or sawtooth signals as obtained in the HP 8112A's linear transition model—either fixed 5 ns or variable from 6.5 ns. The new cosine transitions, also variable from 6.5 ns, mean that band-filtered signals are now just as simple to obtain.

Sensitive devices are protected by programming output limits and the upper level can be controlled by the device supply. Also, constant energy or constant width can be programmed.

Dual channel operation is feasible by operating HP 8112A's in a master/slave combination. Refer also to HP 8115A.

For really easy operation a green button gives error-free settings. A new softkey operating concept plus detailed error recognition make the HP 8112A's powerful versatility easy to handle.

### Specifications

Specifications apply with 50-ohm load, and temperatures in the range 0° C to 55° C.

**Timing** (Specifications apply for min transition times.)

**Period:** 20.0 ns to 950 ms

**Delay:** 75.0 ns to 950 ms

**Double pulse:** 20.0 ns to 950 ms

**Width:** 10.0 ns to 950 ms

**Accuracy:** ± 5% of progr value ± 2 ns (delay: ± 4 ns)

**Duty cycle:** 1% to 99% (Min: 10 ns. Max: period -10 ns)

**Accuracy:** ± 10% of progr value

**Pulse Characteristics** (Voltages double when driving into open circuit.)

#### Levels

High level: -7.90 V to 8.00 V

Low level: -8.00 V to 7.90 V

Accuracy: ± 1% of progr value ± 3% amplitude ± 40 mV

Settling time: 100 ns + transition time

### Transition times

Fixed: 5 ns typical

Linear and cosine: 6.5 ns to 95.0 ms (max edge ratio 1:20 within a 1.5-decade range. Ranges overlap by 0.5 decade)

Accuracy: ± 5% of programmed value ± 2 ns

**Preshoot, overshoot, ringing:** ± 5% ± 10 mV (variable transitions), ± 10% ± 10 mV (fixed transitions)

**Output resistance:** 50 ohm ± 5%

**Operating modes:** Normal, Trigger, Gate, Ext Width (pulse restoration), Ext Burst (1 to 1999 pulses)

### Control (Modulation) Modes

**Period, delay, width:** Covered in 8 non-overlapping decades (max input frequency 8 kHz).

**High level:** -8 V to +8 V, independent of progr low level (min input transition 200 μs)

### General

**HP-IB:** All keys programmable. Learn, status, and error reporting capability. HP-IB interface functions: SH1, AH1, T6, L4, SR1, RL1, PP0, DC1, DT1.

**Memory:** Retains current operating state. Nine store/recall locations, 1 fixed set of parameters.

**Repeatability:** Factor 4 better than accuracy

### Environmental

Storage temperature: -40° C to +65° C

Operating temperature: 0° C to 55° C

Humidity: 95% RH, 0° C to 40° C

**Power:** 100/120/220/240 V rms; +5%; -10%; 48 to 440 Hz; 120 VA max

**Weight:** Net, 5.9 kg (13 lb); shipping, 8.0 kg (18 lb)

**Size:** 89 mm H × 212.3 mm W × 450 mm D (3.5 in × 8.36 in × 17.7 in)

### Ordering Information

**HP 8112A** Programmable Pulse Generator\* \$6,400

**Opt 910** Extra Operating and Service Manual \$49

**Opt W30** Extended Repair Service. See page 671. \$150

**HP 5062-4001** Bail Handle Kit \$40

**HP 5062-3972** Rackmount Kit (single HP 8112A) \$60

**HP 5062-3974** Rackmount Kit (two instruments) \$35

**HP 5061-9694** Lock Link Kit (for use with \$45

HP 5062-3974)

\*HP-IB cables not supplied, see page 615

☎ For off-the-shelf shipment, call 800-452-4844.



# PULSE GENERATORS & DATA GENERATORS

## 50 MHz Dual-Channel Pulse Generator

HP 8115A

511

- "Two HP 8112As in one"
- Simulates data/clock signals

- Displays both channels
- Multilevel signals

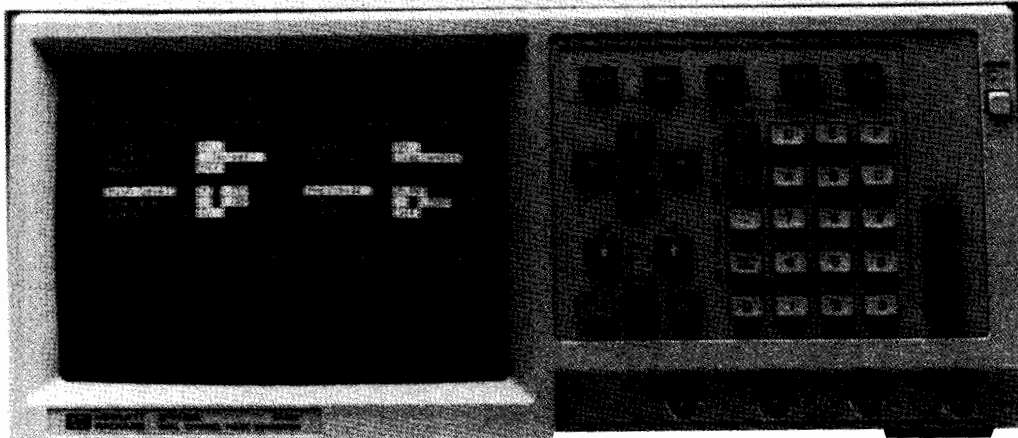

HP 8115A



### Bench and ATE-System Suitable

The HP 8115A is a fully programmable 50 MHz dual channel pulse generator, which delivers pulse trains with up to 32 V peak-to-peak into high impedance and variable transitions from 6.5 ns up to 95 ms.

The HP 8115A is suitable to operate as a standalone instrument or in an ATE-System. The specifications are for a wide temperature range, 0° C to 55° C, useful for ATE-Systems. Much higher accuracy is achieved in the limited temperature range 20° C to 30° C; this is useful for bench-top applications which require higher accuracy. The high and low level for each channel is independently programmable. The output voltages can also be programmed as amplitude and offset.

### Two Channels / Channel Addition

Two channels are available; they are designed as parameter-independent but synchronous outputs. With the delay capability, phase-shifted signals can be achieved. The two channels can be added, thus 3-level, 4-level signals or spikes can be created.

### Specifications

Specifications describe the instrument's warranted performance (30 minutes warm-up, 50  $\Omega$  load) at 0° C to 55° C [20° C to 30° C] ambient temperature.

#### Timing Parameters

(measured at 50% of amplitude with fastest edges)

#### Common Specifications:

**Resolution:** 3 digits (best case 100 ps)

**Repeatability:** Factor 4 better than accuracy

**RMS-jitter\*:** 0.05% of programmed value + 30 ps

**Period (PER):** 20 ns to 950 ms

**Accuracy:**  $\pm 5\%$  of progr. value  $\pm 2$  ns [ $\pm 2\%$   $\pm 1$  ns]

**Delay (DEL):** 75 ns to 950 ms (max: PER + 55 ns)

**Accuracy:**  $\pm 5\%$  of progr. value  $\pm 4$  ns [ $\pm 2\%$   $\pm 4$  ns]

\*See page 500.

**Double pulse (DOUB):** 20 ns to 950 ms (max: PER - WID)

**Accuracy:**  $\pm 5\%$  of progr. value  $\pm 2$  ns [ $\pm 2\%$   $\pm 2$  ns]

DEL and DOUB are mutually exclusive

**Width (WID):** 10 ns to 950 ms (max: PER - 10 ns)

**Accuracy:**  $\pm 5\%$  of progr. value  $\pm 2$  ns [ $\pm 2\%$   $\pm 2$  ns]

**Linear transitions** (between 10% and 90% of ampl)

**Range:** 6.5 ns to 95 ms

**Accuracy:**  $\pm 5\%$  of progr. value  $\pm 2$  ns [ $\pm 5\%$   $\pm 2$  ns]

**Output** (voltages double when driving into open)

**High Level:** -7.90 V to +8.00 V

**Low Level:** -8.00 V to +7.90 V

**Resolution:** 3 digits (best case 10 mV)

**Level-accuracy:**  $\pm 1\%$  of progr. value  $\pm 3\%$  of ampl.

$\pm 40$  mV [ $\pm 1\%$   $\pm 1\%$   $\pm 20$  mV]

**Repeatability:** Factor 4 better than accuracy

### Supplemental Specifications

**Trigger Mode:** Manual, Auto, Trigger, Gate

**Addition:** Adds up channel 2 to channel 1

**Control modes:** High level, Period, Delay, Width

#### General

**Storage temperature:** -40° C to +65° C

**Operating temperature:** 0° C to 55° C

**Power:** 100 to 120/220 to 240 Vrms,  $\pm 10\%$ , 450 VA max., 48 to 66 Hz

**Weight:** 16 kg (35.5 lb)

**Size:** 190 mm H  $\times$  426 mm W  $\times$  584 mm D (7.5 in  $\times$  16.75 in  $\times$  23 in)

**Recalibration period:** 1 year recommended

### Ordering Information

**HP 8115A** 50 MHz Dual Channel Pulse Generator \$11,100

**Opt 908** Rack Flange Kit (P/N 5062-3978) \$35

**Opt 910** Set of Operating/Programming and Service Manuals \$220

**Opt 915** Service Manual (P/N 08115-90001) \$190

**Opt 916** Additional Operating and Programming Manual (P/N 08115-90011) \$32

**Opt W30** Extended repair service. See page 671. \$140

#### Accessories

**HP 1494-0059** Rack Slide Kit \$115

☎ For off-the-shelf shipment, call 800-452-4844.

# PULSE GENERATORS & DATA GENERATORS

## 100 Mbit/s Pulse Pattern Generator HP 8118A

- 2 channels / 16 kbit each / 100 Mbit/s each
- Strobe channel (bit, word, or frame trigger)
- Variable word and frame length

- Variable width and delay
- Rise/fall time separately programmable
- Variable high and low level, channel addition

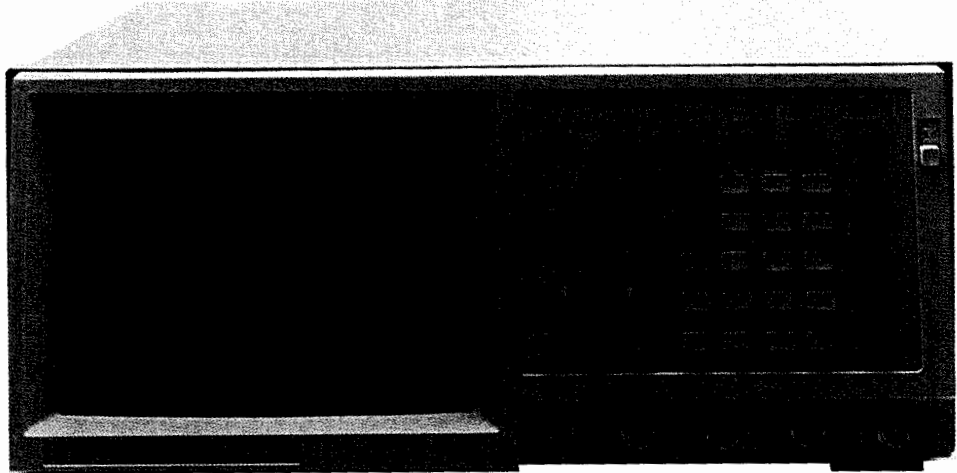

HP 8118A

### HP 8118A Pulse Pattern Generator

#### Parametric and Functional Test

The HP 8118A is a two-channel pulse and serial data generator. It provides full control over voltage levels, timing, and transition times in all operating modes, and in its pattern mode offers patterns of up to 16 kbits with programmable word and frame lengths, and up to 100 Mbit/s data rate, NRZ, 50 Mbit/s RZ.

The HP 8118A is an excellent combination of a fully programmable serial data generator and a pulse generator in one package. It offers functional test capabilities for testing ICs, modules, and boards. With the built-in parametric capabilities, it is possible to combine the digital information with the signal degradation that occurs in practice, allowing evaluation of the effect of worst-case conditions on your device-under-test.

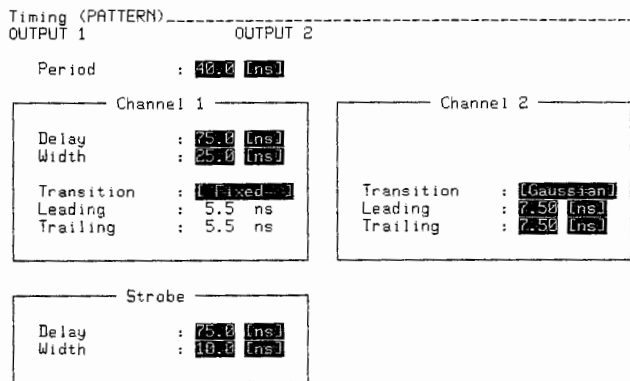

Timing parameter display of both channels and the additional strobe channel

#### Powerful Editor

The HP 8118A offers a convenient and comprehensive set of editing capabilities, making creation of the serial data pattern required for your application quick and easy. The digital patterns you create can also be combined with PRBS (pseudo-random-binary-sequence) capability to make segments of random data or a complete PRBS pattern. Word- and frame-oriented data patterns can be created using the "Word" mode of the HP 8118A, with up to 3640 words and word lengths of up to 256 bits allowable. With these features, protocols with preamble-data-postamble structure and defined word and frame lengths, as used for data transmission in serial data networks, can be rapidly created.

#### Serial Data Transmission - ISDN

The Integrated Services Digital Network provides all forms of communication, including voice, data, video and so forth. Specific line codes are used for transmitting this serial data. In the United States the four-level line code 2B1Q, is about to become standard. In Europe, the three-level code AMI is used. With the HP 8118A's channel addition capability, and the help of the HP 8118A Coder<sup>1</sup> program running on a Series 200/300 controller, you can enter ASCII data and convert it to the line code you require, such as 2B1Q, AMI, HDB3, Manchester II, NRZ, or RZ. Because the HP 8118A allows you to vary pulse parameters on your data pattern, you can then simulate signal degradation by changing voltage or timing parameters of the pattern output.

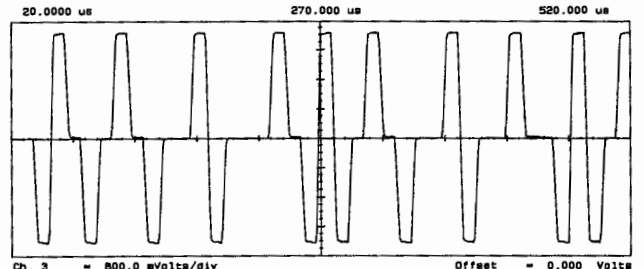

3- and 4-level signals produced by HP 8118A's internal channel addition feature  
a) HDB3 signal  
b) 2B1Q signal

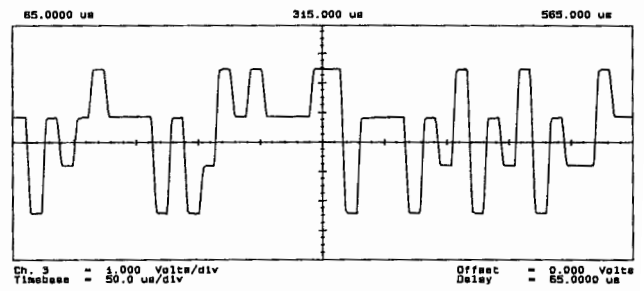

<sup>1</sup>Unsupported program available on request. Uses HP BASIC 5.1 platform.

## Burst Signals

Complex burst signals with up to 16384 pulses can be generated with the HP 8118A in its pattern mode. Burst signals are often used for testing sequential devices such as counters and shift registers. Bursts are also used in radar and navigation applications such as baseband signal injection, simulation, and tracking circuits, tests of phase comparators, and transmitters. Cosine edges allow near-Gaussian pulses to be set up.

Both channels are time-synchronous and have the same period, but all other parameters—data, timing, and voltage—are independently programmable. With data on one channel, the second channel can also be added to the first to create spikes, glitches, or three- and four-level signals.

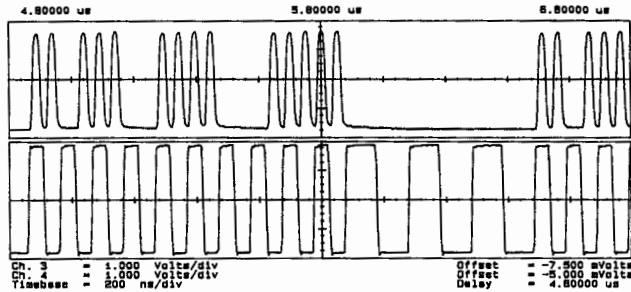

Complex burst patterns and independent second channel

## Specifications

Specifications describe the instrument's warranted performance (30 minutes warm-up, 50-ohm load) at 0° C to 55° C [20° C to 30° C] ambient temperature.

### Timing parameters

(measured at 50% of amplitude with fastest edges)

#### Common specifications

**Resolution:** 3 digits (best case, 100 ps)

**Repeatability:** Factor 4 better than accuracy

**RMS-jitter<sup>1</sup>:** 0.05% of programmed value + 30 ps

**Period (PER):** 20 (10)<sup>3</sup> ns to 950 ms

**Accuracy:** ± 5% of progr. value ± 2 ns [± 2% ± 1 ns]

**Delay:** 75 ns to 950 ms (max: PER + 55 ns)

**Accuracy:** ± 5% of progr. value ± 4 ns [± 2% ± 4 ns]

**Double pulse<sup>2</sup>:** 20 ns to 950 ms (max: PER - WID)

**Accuracy:** ± 5% of progr. value ± 2 ns [± 2% ± 2 ns]  
Delay and Double pulse are mutually exclusive.

**Width (WID):** 10 ns to 950 ms (max: PER - 10 ns)

**Accuracy:** ± 5% of progr. value ± 2 ns [± 2% ± 2 ns]

**Linear transitions** (between 10% and 90% of amplitude)

**Range:** 6.5 ns to 95 ms

**Accuracy:** ± 5% of progr. value ± 2 ns [± 5% ± 2 ns]

<sup>1</sup>See page 500

<sup>2</sup>10 ns with NRZ data format

<sup>3</sup>Available in Pulse Generator mode

**Output** (voltages double when driving into open)

**High level:** -7.90 V to +8.00 V

**Low level:** -8.00 V to +7.90 V

**Resolution:** 3 digits (best case 10 mV)

**Level-accuracy:** ± 1% of progr. value ± 3% of amplitude  
± 40 mV [± 1% ± 1% ± 20 mV]

**Repeatability:** Factor 4 better than accuracy

### Pattern

**Data capacity:** 16384 bits per channel (in bit mode: maximum numbers of bits)

**Data formats:** RZ with programmable Delay and Width up to 50 Mbit/s, DNRZ with programmable Delay up to 50 Mbit/s, NRZ up to 100 Mbit/s

**Word length:** 3 to 256 bits, common for both channels (word mode only)

**No of words:** Number of words × word length < 16384 bits, common for both channels (word mode only)

**Random pattern:** Up to 16384 bits long, PRBS sequence if block-length is 2<sup>n</sup> - 1

## Supplemental Specifications

**Trigger mode:** Manual, Auto, Trigger, Gate

**Addition:** Adds up channel 2 to channel 1 levels

**Operating modes:** Bit Mode, Word Mode, Break, Start/Stop, Continue, Autocycle, Single Cycle

**Strobe output:** Fixed TTL levels; Delay, Width independently programmable; bit, word, of frame trigger

**Control modes:** High level, Period, Delay, Width

### General

**Storage temperature:** -40° C to +65° C

**Operating temperature:** 0° C to 55° C

**Power:** 100 to 120/220 to 240 V rms, ± 10%, 450 VA max., 48 to 66 Hz

**Weight:** 17 kg (38.8 lb)

**Size:** 190 mm H × 426 mm W × 584 mm D (7.5 in × 16.75 in × 23 in)

**Recalibration period:** 1 year recommended

## Ordering Information

**HP 8118A 100 Mbit/s Pulse Pattern Generator**

**Price**

\$13,500

**Opt 908 Rack Flange Kit (P/N 5062-3978)**

+ \$35

**Opt 910 Set of Operating/Programming and Service Manuals**

+ \$220

**Opt 915 Service Manual (P/N 08118-90001)**

+ \$190

**Opt 916 Additional Operating and Programming Manual (P/N 08118-90011)**

+ \$32

**Opt W30 Extended Repair Service. See page 671.**

+ \$140

## Accessories

**HP 1494-0059 Rack Slide Kit**

\$115

☎ For off-the-shelf shipment, call 800-452-4844.

# PULSE GENERATORS & DATA GENERATORS

## Interactive Digital/Analog Stimulus

HP 8175A

- 24 data channels
- 2 arbitrary channels

- Agile memory
- Interactive Test

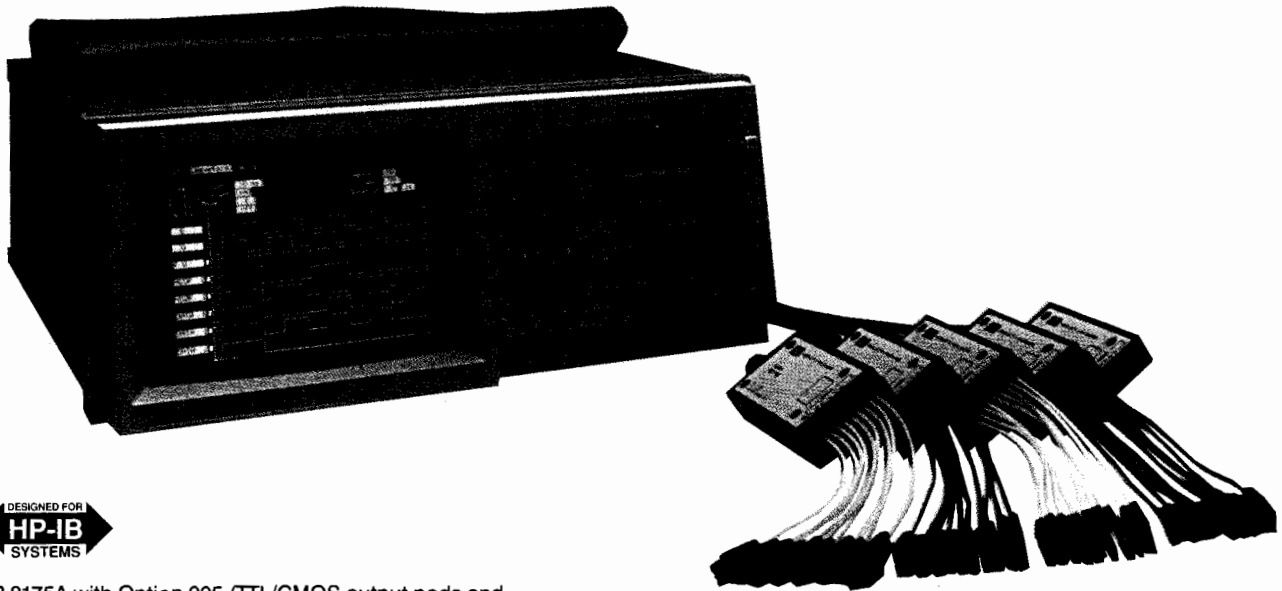

HP 8175A with Option 005 (TTL/CMOS output pods and trigger input pod)

### HP 8175A Digital Signal Generator

#### Test Under Real, Repeatable Conditions

Whether your device needs analog or digital signals or—like programmable filters—both, the HP8175A helps you emulate the real environment. This is because programmable data patterns and arbitrary waveforms can be made available at the same time. Repeatable timing and voltage settings let you test the device's limits with confidence.

#### Signal Quality at the Device

The HP8175A's 24 data outputs are connected to your device or test head by active pods. This reduces distortion because the connections between pod and device can be kept very short.

Each pod supports 8 channels so, if you are working with mixed logic, you can use any combination of the available ECL, TTL, or variable-level TTL/CMOS pods.

The two analog channels of the Option 002 arbitrary waveform generator have 50-ohm outputs.

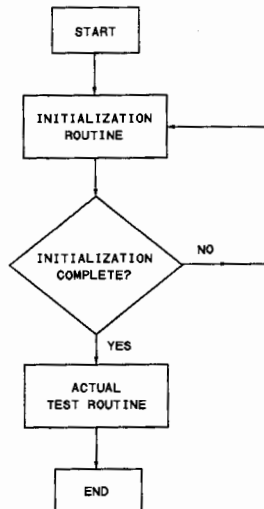

#### Interactive Test

An agile, segmentable memory makes it possible for the HP 8175A to jump to different routines as needed by a test procedure. In the example on the left, an initial data pattern or waveform is output until the DUT changes state. This change is sensed by the HP 8175A's 8-line trigger pod, which then implements a user-defined jump.

Start, stop, continue, and tri-state can also be implemented from the DUT in this way.

#### Designed for Stimulus-Response Test

In addition to the 24 data outputs, there are also 8 flag outputs. These depend directly on DUT status, and so can make sure that a measuring device captures the right information.

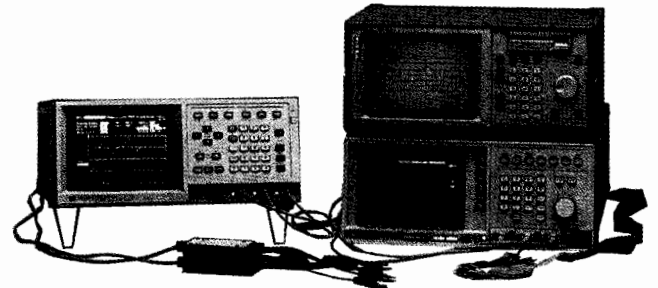

HP 8175A starts HP 1650A logic analyzer and HP 54110D oscilloscope signal capture.

#### Capture/Playback Applications

Data patterns or analog signals captured by your HP logic analyzer can be read into the HP 8175A's memory. Thus critical once-in-a-while occurrences that cause device problems are available for detailed evaluation. To help you move captured information into the HP 8175A, a program<sup>1</sup> is available that converts HP 165x(x) files to HP 8175A-readable form. The transfer can take place online via HP-IB, or offline with 3½ inch disks.

#### Convenient Bench and System Implementation

Internal storage plus support of external disk drive and printer make manual setups very convenient. For automation, binary learn strings speed updates over HP-IB from the computer. In racked systems, temperatures can get fairly high; to ensure reliable results under these conditions, the HP 8175A is fully specified up to 55° C.

<sup>1</sup>This and other HP 8175A programs are available to users on request. The programs run on HP Basic 5.1 or HP Pascal 3.1 platforms. The programs are not supported.

**Built-in Editor**

The HP 8175A's internal processor lets you set up counter and random patterns in a few keystrokes. It offers copy, insert, and cursor editing on tables and graphics plus special features for arbitrary waveforms<sup>2</sup>.

**Memory Segments Sequenced in Real Time**

For long data sequences with repeating elements, the memory can be segmented so that only unique data need be entered. The menu below shows how the segments are set up: the first four lines produce a continuous data stream, reusing areas of memory with common data. A command from the device can cause a real-time jump to the line "TEST 2."

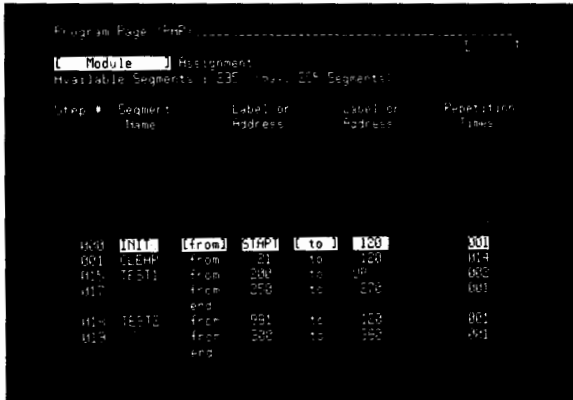

User-defined memory segments

**Flexibility Through Bit-by-Bit Timing**

Long wait periods in a data stream or constant levels in an arbitrary waveform can use many k of memory. This is seldom a problem for the HP 8175A because each data pattern or sampling point can be given its own unique duration, from 0.02 μs up to 9.99 s.

Variable Pattern timing gives the user flexibility when programming long, asynchronous data systems. Note that the long, unchanging pattern in this example is implemented by a single 10 μs duration, thus saving 9 addresses.

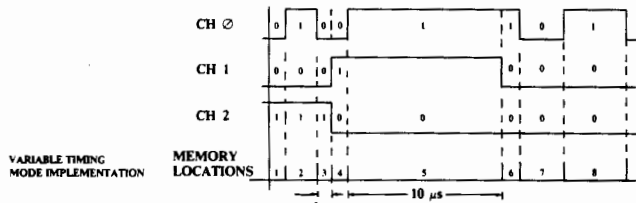

Each memory location has its own individual duration.

**Extra Clock Output for Dynamic Devices**

Devices that need a continuous clock do not force you to abandon the HP 8175A's variable timing feature because a clock with independent frequency is available. It is locked to the HP 8175A master crystal so that clock and data remain synchronized.

**High-Resolution Edge Placement**

All edges can be placed with 20 ns resolution. For critical clock/data or data/data adjustment, option 001 provides 100 ps resolution delay on four channels.

<sup>2</sup>More information about the Option 002 arbitrary waveform generator is available on page 489.

**Specifications**

(Please request data sheet for complete specifications.)

**Outputs**

**Data channels:** 24, each 1024 bits

**Max data rate:** 50 Mbit/s, NRZ format

(If Serial Mode is selected, two 8-kbit channels are available, max data rate 100 Mbit/s, NRZ format.)

**Levels:** ECL, TTL, or variable-level TTL/CMOS pods. Different pods can be installed for mixed logic applications (each pod handles 8 channels). Variable level from 2.4 V to 9.9 V, programmable from HP8175A or external pod input. Fanout: 5 ECL/ 15 LSTTL/10/LSTTL loads, depending on pod. Transitions: 3/6/9 ns into 22 pF, depending on pod. Tristate: implemented from HP8175A or by external signal to each pod.

**Analog channels (Option 002):** 2 arbitrary waveform channels, each 10-bit vertical resolution with 1024 sample points. Max sample rate: 50 MHz.

**Level ranges:** 7. From 0.2 Vpp max (0.2 mV resolution) to 16 Vpp max (20 mV resolution), into 50 Ω

**Source resistance:** 50 Ω

**Flag and clock channels:** 8 flags, or 7 flags and one clock. Flags are set by external status, see Trigger Pod. Clock period can be set from 20 ns to 99 μs, independent of bit duration. Levels: depends on pods, see data channels.

**Timing**

**Bit duration:** 0.02 μs to 9.99 s, individual or global

**Resolution:** 3 digits

**Option 001:** 100 ps independent edge positioning on four channels in a 20.0 to 40.0 ns window

**Memory**

**Size:** 24 × 1024 bit

**Segments:** As required up to 255

**Capabilities:** Start, stop, continue, restart, jump A, jump B, and loop

**Inputs**

**Trigger pod:** 8 lines to set flags and/or implement start, jump, output disable, stop and continue

**BNC inputs:** For external clock, external 1 MHz reference and start/stop

**Ordering Information**

**HP 8175A** Digital/Analog Stimulus Price \$12,900

Note: HP 8175A must be ordered with at least one of the following options: 002, 003, 004, or 005—or with individual pods.

**Opt 001** Fine Timing, 100 ps Resolution on 4 Channels + \$1,500

**Opt 002** Dual Arbitrary Waveform Generator + \$3,950

**Opt 003** 4 ECL Pods Model HP 15461A and 1 Trigger Pod Model HP 15463A + \$5,020

**Opt 004** 4 TTL Pods Model HP 15464A and 1 Trigger Pod Model HP 15463A + \$3,420

**Opt 005** 4 TTL/CMOS Pods Model HP 15462A and 1 Trigger Pod Model HP 15463A + \$7,620

**Opt 908** Rack Flange Kit (PN 5062-3978) + \$36

**Opt 910** Operating/Programming and Service Manual + \$290

**Opt 916** Additional Operating/Programming Manual + \$72

**Opt W30** Extended Repair Service. See page 671. + \$280

**Supplied Accessories**

**HP 15429A** set of 5 double receptacles with each output pod for soldering into printed circuit boards. \$55

Set of leads and clips with each Trigger Pod HP 15463A for replacements, order:

**HP 15463-63201** Set of 11 Leads \$125

**HP 5959-0288** Set of 20 Clips \$20

**Available Accessories**

**HP 15408A** Set of 5 Grabbers \$100

**HP 15409A** Set of 5 BNC Adapters \$100

**HP 15410A** Set of 5 SMB Adapters \$100

**HP 15411A** 5 Open Coax Adapters \$65

**HP 15415A** Set of 5 Mini-Probes \$100

**HP 15430A** Cable, for Master/slave Operation of 2 HP 8175As + \$85

**HP 10062A** Cover, for Protecting Front Panel + \$75

☎ For off-the-shelf shipment, call 800-452-4844.

# DC ELECTRONIC LOADS

## Electronic Load Family

HP 6050A - 6063B, 60501B - 60507B

- HP-IB control of current, voltage, and resistance
- HP-IB readback of current, voltage, and power
- Built-in pulse waveform generation with programmable amplitude, frequency, duty cycle, and slew rate.
- Continuous and pulse modes.
- Full protection from overpower, overtemperature, overcurrent, overvoltage, and reverse polarity
- Software calibration
- Trigger for external synchronization
- Can be controlled by an analog voltage in constant current mode
- Can be paralleled in constant current mode
- Remote voltage sense in constant voltage mode
- High voltage loads now available
- Standard three-year warranty

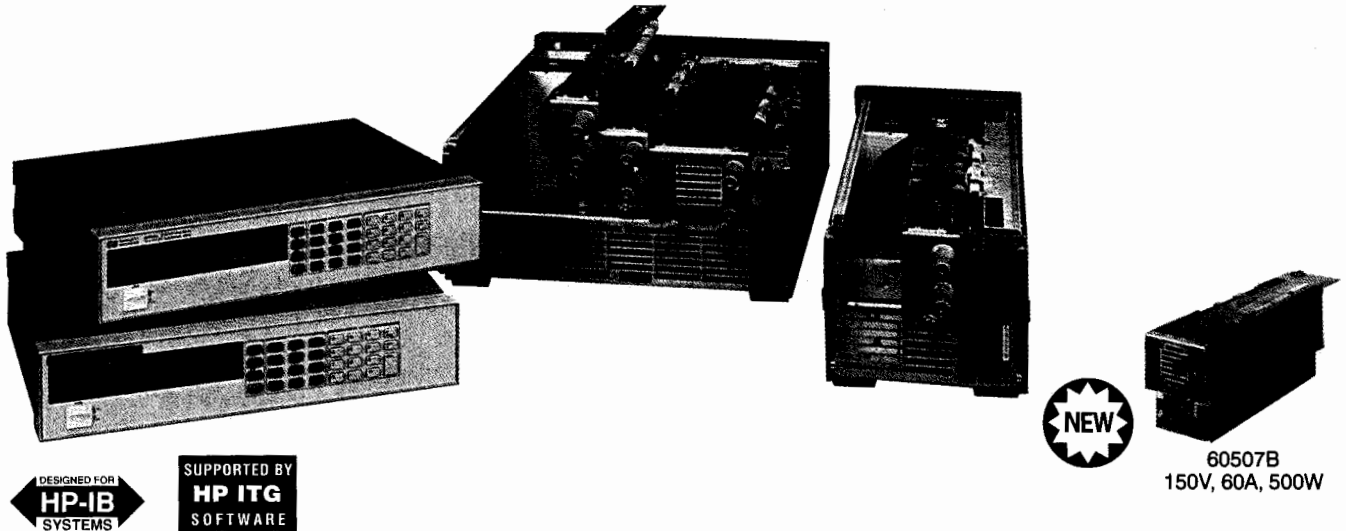

### HP dc Electronic Loads

HP dc electronic loads are ideal for the test and evaluation of dc power sources and power components and are well suited for applications in areas such as research and development, production, and incoming inspection.

#### The Hewlett-Packard One-Box Solution

HP single-input loads and load mainframes are equipped with standard HP-IB interfaces. The built-in IEEE-488 interface allows complete control of all load functions as well as readback of input voltage, current, power, and detailed operating status. Each HP standalone load or load module also includes programming inputs that allow control of load current via an analog control voltage. Other system features contributing to the one-box solution concept are internal voltage and current monitors and an internal transient generator with programmable amplitudes, frequency, duty cycle, and slew rate. The HP one-box solution saves space, cost, and time while making HP dc electronic loads easy to integrate into automated test systems.

Hewlett-Packard dc electronic loads have been recently enhanced to optimally address a broader range of dynamic loading applications. This new family of loads are form, fit, and functional equivalents to the previous "A models" (HP 6060A, HP 6063A, and HP 60500A modules). Your existing software will run on these new modules, thus preserving previous resource investment in HP loads. In fact, the HP 60500B modules can be operated in the 6050A or 6051A mainframe with HP 60500A load modules.

The "B models" (HP 6060B, HP 6063B, and HP 60500B modules) accommodate a limited set of operating conditions where minimal load current overshoots could occur at maximum slew rate settings. This dynamically enhanced load family can achieve zero percent overshoot (typical specification) when slewing current up to 100 percent of full scale.

The HP load family's programmable slew rate feature can be used to further tailor load performance for specific application needs. These enhanced models also include circuitry to optimize load operation when testing dc power supply output startup characteristics.

#### New Model for 1991!

A broader range of application requirements can be met with a new dc load module from Hewlett-Packard, the HP 60507B. The HP 60507B (150V, 60 A, 500 W) offers all of the advantages in performance, reliability, and quality as the existing HP Electronic Load family in a dual slot-width package, and it includes all of the dynamic performance enhancements of the new 6060B and 60500B models.

#### Fully Compatible Operation

The features and SCPI instruction set of all HP dc electronic loads are fully compatible with one another. For example, test programs developed for an HP 6060B 300-watt single-input electronic load or an HP 60502B 300-watt single-input load module are interchangeable.

The HP dc electronic load family is also fully compatible with the HP 59510A relay accessory (see page 535). The HP 59510A provides physical isolation of the HP dc electronic load from the device under test or any other test instrument by switching power and sense leads. Capable of switching up to 60 amperes and 200 volts dc, the HP 59510A can be controlled by rear panel signals on the HP electronic load.

**Constant Current**

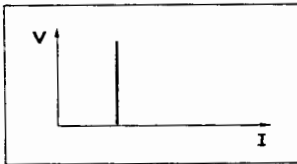

- Power Supply Load Regulation Testing
- Battery Capacity Testing
- Capacitor Discharging

**Constant Voltage**

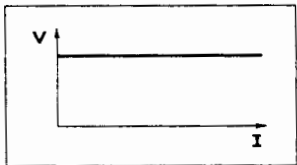

- Current Source Testing
- Current Limit Testing
- Shunt Regulator

**Constant Resistance**

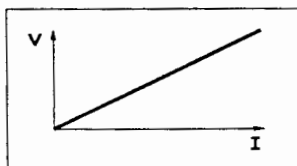

- Characterizing Power Supply Crossover
- Power Supply Start-Up Delay
- Power Resistor Emulation

**Pulse and Dynamic Loading**

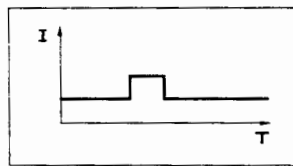

- Power Supply Load Transient Response
- Power Component Testing
- Pulse Electroplating

**Programmable Slew Rate**

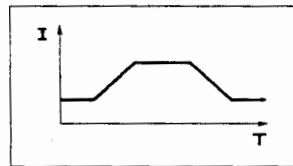

- Power Supply Testing
- Power Component Testing
- Power Supply Load Transient Response

**Analog Programming**

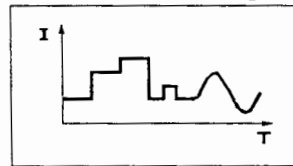

- Battery Capacity Testing
- "Real-life" Load Simulation

**dc Electronic Load Applications**

**System or Manual Applications**

HP dc electronic loads are equally suitable for manual use on the bench. The front panel LCD meters indicate voltage, current, and power readings. The full-function front-panel keypad allows easy, repeatable, and reliable control of the load when it is used manually. Six volatile user-definable states allow you to easily save settings for later recall. An additional user-definable power-up state allows you to define settings that are remembered when the unit is switched off and then recalled when it is switched on again.

**Specifying System Performance**

Because Hewlett-Packard electronic loads feature an integrated HP-IB programmer, pulse generator, current shunt, DMM, and cabling, their performance is specified as a system. Our specifications cover all the integrated functions as one unit, which eliminates the need to calculate the actual performance of the automated test system based on each component's specification. The HP one-box solution makes the integration and documentation of your test system fast and easy.

**Single-Input Products**

The HP 6060B and HP 6063B are single-input loads with standard rear-panel inputs. They are also available with optional front-panel inputs in addition to the rear-panel inputs. Front-panel inputs (Option 020) make input connections to the HP electronic load convenient for bench applications. These front-panel terminals are capable of handling the entire current rating of the load and can accept wire gauges up to AWG #4 (22 sq mm). They require no tools to tighten, making the connections quick and easy.

**Mainframe Products**

The HP 6050A 1800-watt and HP 6051A 600-watt electronic load mainframes accept the user-installable HP load modules for easy system configuration and future reconfiguration, if desired. The HP 6050A holds up to six HP 60501B, 60502B, and 60503B load modules or three HP 60504B and HP 60507B load modules, allowing up to 1,800 watts total maximum power. The HP 6051A holds up to two HP 60501B, 60502B, 60503B modules or one HP 60504B or HP 60507B module allowing up to 600 watts total maximum power. One HP-IB address is all you need for complete control and readback of all load modules within a single mainframe.

**Operating HP Loads Below the Minimum Input Voltage Specification**

HP electronic loads meet all specifications when operated above 3.0 volts; however, the dc operating characteristics also extend below this minimum input voltage for static tests. Because of the FET technology used in the power input circuits, HP electronic loads have a low minimum input resistance allowing them to sink high currents even at low voltages.

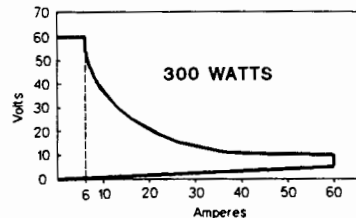

**HP 60502B INPUT CHARACTERISTICS**

The figure above shows the operating range of a typical HP dc electronic load. Notice that low-voltage operation, completely down to zero volts, is possible at correspondingly reduced current levels, depending on the minimum resistance of the load. HP electronic loads, therefore, can be used in many applications that previously required zero volt loads.

**Why Not Make Your Own Load?**

Many load users have resorted to building their loads in-house when a commercially available electronic load with the right combination of features, power rating, performance, and purchase price could not be found. By making these loads in-house, users incur many hidden costs that can easily be overlooked. There are cost components associated with product development, parts procurement, manufacturing, product documentation, training, and product failure, maintenance, or replacement. In addition, the cost components increase as the design complexity changes from simply using resistors to more sophisticated designs addressing application needs for HP-IB programming, readback, and triggering schemes for measurement synchronization.

Equipment buyers with electronic load needs have realized that the purchase price of commercially available electronic loads can be relatively insignificant when compared to the overall cost of designing, manufacturing, and maintaining them in-house.

The HP electronic load family reduces your total cost of ownership by providing superior performance, features, reliability, and complete product documentation at a reasonable purchase price. These loads allow you to use fewer resources for your electronic load test system development, and more resources to remain successful and competitive in your particular industry. The standard three-year warranty can further reduce your maintenance costs.

The quality, performance, price, and Hewlett-Packard support will help you make an intelligent and economical purchase decision.

# DC ELECTRONIC LOADS

## Specifications

### Specifications (Data Subject to Change)

Amperes	0 to 60 A	0 to 10 A	0 to 30 A	0 to 120 A	0 to 60 A
Volts	3 to 60 V	3 to 240 V	3 to 60 V	3 to 60 V	3 to 150 V
Maximum Power (at 40°C)	300 W	250 W	150 W	600 W	500W
Hewlett-Packard Model	HP 6060B, 60502B	HP 6063B, 60503B	HP 60501B	HP 60504B	HP 60507B
<b>Constant current mode</b>					
Ranges	0 to 6 A, 0 to 60 A	0 to 1 A, 0 to 10 A	0 to 3 A, 0 to 30 A	0 to 12 A, 0 to 120 A	0 to 6 A, 0 to 60 A
Accuracy	0.1% ± 75 mA	± 0.15 ± 10 mA	0.1% ± 40 mA	0.12% ± 130 mA	0.1% ± 75 mA
Resolution	60 A range: 16 mA 6 A range: 1.6 mA	10 A range: 2.6 mA 1 A range: 0.26 mA	30 A range: 8 mA 3 A range: 0.8 mA	120 A range: 32 mA 12 A range: 3.2 mA	60 A range: 1.6 mA 6 A range: 1.6 mA
Temperature coefficient	100 ppm/°C ± 5 mA/°C	150 ppm/°C ± 1 mA/°C	100 ppm/°C ± 3 mA/°C	120 ppm/°C ± 8 mA/°C	120 ppm/°C ± 5 mA/°C
Regulation	± 10 mA	± 8 mA	± 10 mA	± 10 mA	± 10 mA
<b>Constant voltage mode</b>					
Accuracy	0.1% ± 50 mV	± 0.12% ± 120 mV	0.1% ± 50 mV	0.1% ± 50 mV	0.1% ± 125 mV
Resolution	16 mV	64 mV	16 mV	16 mV	40 mV
Regulation	± 10 mV	± 10 mV	± 5 mV	± 20 mV	± 10 mV
Temperature coefficient	100 ppm/°C ± 5 mV/°C	120 ppm/°C ± 10 mV/°C	100 ppm/°C ± 5 mV/°C	100 ppm/°C ± 5 mV/°C	100 ppm/°C ± 5 mV/°C
<b>Constant resistance mode</b>					
Ranges	0.033 to 1.0 Ω 1 Ω to 1 KΩ 10 Ω to 10 KΩ	0.20 to 24.0 ohm 24 to 1000Ω 240 to 5000Ω	0.067 to 2 Ω 2 Ω to 2 K Ω 20 Ω to 10 KΩ	0.017 to 0.5 Ω 0.5 Ω to 2 K Ω 5 Ω to 5 KΩ	0.033 to 2.5 Ω 2.5 Ω to 2.5 KΩ 25 Ω to 10 KΩ
Accuracy	1 Ω: 0.8% ± 8 mΩ (with ≥ 6A at input) 1 K Ω: 0.3% ± 8 mS (with ≥ 6V at input) 10 K Ω: 0.3% ± 8 mS (with ≥ 6V at input)	24Ω: 0.6% ± 200 mΩ (with ≥ 1A at input) 10 KΩ: 0.3% ± 0.3 mS (with ≥ 24V at input) 50 KΩ: 0.3% ± 0.3 mS (with ≥ 24V at input)	2 Ω: 0.8% ± 16 mΩ (with ≥ 3A at input) 2 KΩ: 0.3% ± 5 mS (with ≥ 6V at input) 10 KΩ: 0.3% ± 5 mS (with ≥ 6V at input)	0.5 Ω: 0.8% ± 5 mΩ (with ≥ 12A at input) 500 Ω: 0.3% ± 16 mS (with ≥ 6V at input) 5 KΩ: 0.3% ± 16 mS (with ≥ 6V at input)	2.5 Ω: 0.8% ± 16 mΩ (with ≥ 6A at input) 2.5 KΩ: 0.3% ± 5 mSΩ (with ≥ 15V at input) 10 KΩ: 0.3% ± 5 mSΩ (with ≥ 15V at input)
Resolution	1 Ω: 0.27 mΩ 1 KΩ: 0.27 mS 10 KΩ: 0.027 mS	24Ω: 6 mΩ 10 KΩ: 0.011 mS 50 KΩ: 0.001 mS	2 Ω: 0.54 mΩ 2 KΩ: 0.14 mS 10 KΩ: 0.014 mS	5 Ω: 0.14 mΩ 500 Ω: 0.54 mS 5 KΩ: 0.054 mS	2.5 Ω: 0.57 mΩ 2.5 KΩ: 0.10 mS 10 KΩ: 0.01 mS
Regulation	1 Ω: 10 mV 1 KΩ: 10 mA 10 KΩ: 10 mA	24Ω: 10 mV 10 KΩ: 8 mA 50 KΩ: 8 mA	2 Ω: 10 mV 2 KΩ: 10 mA 10 KΩ: 10 mA	5 Ω: 20 mV 500 Ω: 10 mA 5 KΩ: 10 mA	2.5 Ω: 10 mV 2.5 KΩ: 10 mA 10 KΩ: 10 mA
Temperature coefficient	1 Ω: 800 ppm/°C ± 0.4 mΩ/°C 1 KΩ: 300 ppm/°C ± 0.6 mS/°C 10 KΩ: 300 ppm/°C ± 0.6 mS/°C	24 Ω: 800 ppm/°C 800 ppm/°C ± 10 mΩ/°C 10 KΩ: 300 ppm/°C 300 ppm/°C ± 0.03 mS/°C 50 KΩ: 300 ppm/°C 300 ppm/°C - 0.03 mS/°C	2 Ω: 800 ppm/°C ± 0.8 mΩ/°C 2 KΩ: 300 ppm/°C ± 0.5 mS/°C 10 KΩ: 300 ppm/°C ± 0.5 mA/°C	0.5 Ω: 800 ppm/°C ± 0.2 mΩ/°C 500 Ω: 300 ppm/°C ± 1.2 mS/°C 5 KΩ: 300 ppm/°C ± 1.2 mS/°C	2.5 Ω: 800 ppm/°C ± 0.8 mΩ/°C 2.5 KΩ: 300 ppm/°C ± 0.3 mS/°C 10 KΩ: 300 ppm/°C ± 0.3 mS/°C
<b>Transient generator</b>					
Frequency range	0.25 Hz to 10 kHz	0.25 Hz to 10 kHz	0.25 Hz to 10 kHz	0.25 Hz to 10 kHz	0.25 Hz to 10 kHz
Resolution	4% or less	4% or less	4% or less	4% or less	4% or less
Accuracy	3%	3%	3%	3%	3%
Duty cycle range	3 to 97% (0.25 Hz to 1 kHz) 6 to 94% (1 kHz to 10 kHz)	3% to 97% (0.25 Hz to 1 kHz) 6 to 94% (1 kHz to 10 kHz)	3 to 97% (0.25 Hz to 1 kHz) 6 to 94% (1 kHz to 10 kHz)	3 to 97% (0.25 Hz to 1 kHz) 6 to 94% (1 kHz to 10 kHz)	3 to 97% (0.25 Hz to 1 kHz) 6 to 94% (1 kHz to 10 kHz)
Resolution	4%	4%	4%	4%	4%
Accuracy	6% of setting ± 2%	6% of setting ± 2%	6% of setting ± 2%	6% of setting ± 2%	6% of setting ± 2%
<b>Current level high range</b>					
Resolution	60 A range: 260 mA	10 A range: 43 mA	30 A range: 130 mA	120 A range: 520 mA	60 A range: 260 mA
Accuracy	0.1% ± 350 mA	0.18% ± 50 mA	0.1% ± 200 mA	0.15% ± 700 mA	0.15% ± 350 mA
<b>Current level low range</b>					
Resolution	6 A range: 26 mA	1 A range: 4 mA	3 A range: 13 mA	12 A range: 52 mA	6 A range: 26 mA
Accuracy	0.1% ± 80 mA	0.18% ± 13 mA	0.1% ± 40 mA	0.15% ± 160 mA	0.15% ± 85 mA
Current temperature coefficient	100 ppm/°C ± 7 mA/°C	180 ppm/°C ± 1.2 mA/°C	100 ppm/°C ± 5 mA/°C	150 ppm/°C ± 10 mA/°C	150 ppm/°C ± 5 mA/°C
Voltage level	3 to 60 V	3 to 240 V	3 to 60 V	3 to 60 V	3 to 150 V
Voltage level resolution	260 mV	1 V	260 mV	260 mV	650 mV
Voltage level accuracy	0.1% ± 300 mV	0.15% ± 1.1 V	0.1% ± 300 mV	0.15% ± 300 mV	0.15% ± 750 mV
Voltage temperature coefficient	150 ppm/°C ± 5 mV/°C	120 ppm/°C ± 10 mV/°C	150 ppm/°C ± 5 mV/°C	150 ppm/°C ± 5 mV/°C	150 ppm/°C ± 5 mV/°C
Programmable slew rate	80 A range: 1 A/ms - 5 A/μs 6 A range: 0.1 A/ms - 0.5 A/μs	10 A range: 0.17 A/ms - 0.83 A/μs 1 A range: 17 A/ms - 83 A/μs	30 A range: 0.5 A/ms - 2.5 A/μs 3 A range: 0.05 A/ms - 0.25 A/μs	120 A range: 2 A/ms - 10 A/μs 12 A range: 200 A/ms - 1 A/μs	60 A range: 1 A/ms - 5 A/μs 6 A range: 0.1 A/ms - 0.1 A/μs
Rise/fall time	12 μs to 8 ms	16 μs to 8 ms	12 μs - 8 ms	12 μs - 8 ms	36 μs - 8 ms

#### HP 6050A, 6051A weight

Net weight: 6050A: 9.5 kg (21 lb)

6051A: 5.5 kg (12 lb)

Shipping weight: 6050A: 13.6 kg (30 lb)

6051A: 7.5 kg (17 lb)

#### HP-IB Interface Capabilities

The following HP-IB functions are implemented: SH1, AH1, L4, SRI, DC1, DT1, and RLI.

#### Safety Agency Compliance

Hewlett-Packard Electronic Loads are designed to comply with the following regulatory standards: IEC 348, VDE 0411, UL 1244, and CSA Electrical Bulletin 556B.



Specifications (continued)

Hewlett-Packard Model	HP 6060B, 60502B	HP 6063B, 60503B	HP 60501B	HP 60504B	HP 60507B
Analog programming bandwidth	10 kHz (-3 dB frequency)	10 kHz (-3 dB frequency)	10 kHz (-3 dB frequency)	10 kHz (-3 dB frequency)	10 kHz (-3 dB frequency)
Analog programming accuracy					
Current (low range)	4.5% ± 75 mA	3% ± 8 mA	4.5% ± 40 mA	4% ± 200 mA	4% ± 75 mA
Current (high range)	4.5% ± 250 mA	3% ± 12 mA	4.5% ± 130 mA	4% ± 400 mA	4% ± 200 mA
Temperature coefficient	100 ppm/°C ± 6 mA/°C	150 ppm/°C ± 1 mA/°C	100 ppm/°C ± 3 mA/°C	100 ppm/°C ± 12 mA/°C	150 ppm/°C ± 6 mA/°C
Voltage	0.8% ± 200 mV	0.5% ± 150 mV	0.8% ± 200 mV	0.8% ± 200 mV	0.8% ± 375 mV
Temperature coefficient	100 ppm/°C ± 1 mV/°C	120 ppm/°C ± 10 mV/°C	100 ppm/°C ± 1 mV/°C	100 ppm/°C ± 1 mV/°C	120 ppm/°C ± 12.5 mV/°C
Analog programming voltage	0 to 10 V	0 to 10 V	0 to 10 V	0 to 10 V	0 to 10 V
Readback specifications					
Current readback resolution	17 mA (via HP-IB) 20 mA (front panel)	2.7 mA (via HP-IB) 10 mA (front panel)	9 mA (via HP-IB) 10 mA (front panel)	32 mA (via HP-IB) 100 mA (front panel)	17 mA (via HP-IB) 20 mA (front panel)
Current readback accuracy	0.05% ± 65 mA	0.12% ± 10 mA	0.06% ± 40 mA	0.1% ± 110 mA	0.1% ± 65 mA
Temperature coefficient	50 ppm/°C ± 5 mA/°C	100 ppm/°C ± 1 mA/°C	85 ppm/°C ± 3 mA/°C	100 ppm/°C ± 8 mA/°C	100 ppm/°C ± 5 mA/°C
Voltage readback resolution	17 mV (via HP-IB) 20 mV (front panel)	67 mV (via HP-IB) 100 mV (front panel)	17 mV (via HP-IB) 20 mV (front panel)	16 mV (via HP-IB) 20 mV (front panel)	40 mV (via HP-IB) 100 mV (front panel)
Voltage readback accuracy	0.05% ± 45 mV	0.1% ± 150 mV	0.05% ± 45 mV	0.1% ± 45 mV	0.1% ± 90 mV
Temperature coefficient	50 ppm/°C ± 1.2 mV/°C	100 ppm/°C ± 8 mV/°C	50 ppm/°C ± 1.2 mV/°C	100 ppm/°C ± 2 mV/°C	100 ppm/°C ± 5 mV/°C
Power readback accuracy	0.2% ± 4 W	0.2% ± 3 mV	0.2% ± 2 W	0.2% ± 6 W	0.2% ± 8 W
Analog monitor accuracy					
Current monitor (0 to 10 V out)	4% ± 85 mA	3% ± 10 mA	4% ± 40 mA	4% ± 170 mA	3% ± 85 mA
Temperature coefficient	50 ppm/°C ± 6 mA/°C	100 ppm/°C ± 1 mA/°C	60 ppm/°C ± 3 mA/°C	100 ppm/°C ± 10 mA/°C	100 ppm/°C ± 6 mA/°C
Voltage monitor (0 to 10 V out)	0.25% ± 40 mV	0.4% ± 240 mV	0.25% ± 40 mV	0.4% ± 60 mV	0.4% ± 120 mV
Temperature coefficient	50 ppm/°C ± 0.2 mV/°C	70 ppm/°C ± 1.2 mV/°C	50 ppm/°C ± 0.2 mV/°C	100 ppm/°C ± 2 mV/°C	100 ppm/°C ± 5 mV/°C
Remote sensing	5 Vdc maximum between sense and load input				
Minimum operating voltage	2 volts (typical 1.2 V)	2 volts (typical 1.2 V)	2 volts (typical 1.2 V)	2 volts (typical 1.4 V)	2 volts (typical 1.4 V)
Programmable short	0.033 Ω (0.020 typical)	0.20 Ω (0.10 typical)	0.066 Ω (0.040 typical)	0.017 Ω (0.012 typical)	0.033 Ω (0.025 Ω typical)
Programmable open (typical)	20 KΩ (typical)	80 KΩ (typical)	20 KΩ (typical)	20 KΩ (typical)	20 KΩ (typical)
Drift (over 6-hour interval)					
Current	0.03% ± 10 mA	0.03% ± 15 mA	0.03% ± 5 mA	0.03% ± 20 mA	0.03% ± 10 mA
Voltage	0.01% ± 10 mV	0.01% ± 20 mV	0.01% ± 10 mV	0.01% ± 10 mV	0.01% ± 25 mV
PARD (20 Hz to 10 MHz noise)					
Current	4 mA rms 40 mA peak-peak	1 mA rms 10 mA peak-peak	2 mA rms 20 mA peak-peak	6 mA rms 60 mA peak-peak	4 mA rms 40 mA peak-peak
Voltage	6 mV rms	6 mV rms	5 mV rms	8 mV rms	10 mV rms
dc solution voltage	± 240 Vdc, between any input and chassis ground				
Digital inputs	V <sub>ih</sub> = 0.9 V max at I <sub>ih</sub> = -1 mA V <sub>il</sub> = 3.15 V min (pull-up resistor on input)				
Digital outputs	V <sub>oh</sub> = 0.72 V max at I <sub>oh</sub> = 1 mA V <sub>ol</sub> = 4.4 V min at I <sub>ol</sub> = -20 Ω				
Net weight (approx.)	6060A: 6.4 kg (14 lb) 60502A: 3.2 kg (7 lb)	6063A: 6.4 kg (14 lb) 60503A: 3.2 kg (7 lb)	3.2 kg (7 lb)	5.8 kg (13 lb)	5.9 kg (13 lb)
Shipping weight	6060A: 7.5 kg (17 lb) 60502A: 4.5 kg (10 lb)	6063A: 7.5 kg (17 lb) 60503A: 4.5 kg (10 lb)	4.5 kg (10 lb)	7.3 kg (16 lb)	7.3 kg (16 lb)

- Notes:  
 1. Operating temperature range is 0 to 55°C. All specifications apply for 25°C ± 5°C, except as noted.  
 2. Maximum continuous power available is derated linearly from 40°C to 75% of maximum at 55°C.  
 3. dc current accuracy specifications apply 30 seconds after input is applied.

Ordering Information

Model	Price	Options							
		Front Panel Inputs	ac Input			Rackmount Kit			Extra Manuals
			100 Vac Japan Only	220 Vac	240 Vac	800	908	909	
HP 6050A	\$1,920	—	\$0*	\$0*	\$0*	—	+\$37†	+\$98†	+\$52*
HP 6051A	\$1,700	—	\$0*	\$0*	\$0*	+\$67†	+\$67†	—	+\$50*
HP 6060B	\$2,100	+\$82*	\$0*	\$0*	\$0*	—	+\$32*	+\$75*	+\$35*
HP 6063B	\$2,500	+\$82*	\$0*	\$0*	\$0*	—	+\$32*	+\$75*	+\$35*
HP 60501B	\$1,315	—	—	—	—	—	—	—	+\$32*
HP 60502B	\$1,620	—	—	—	—	—	—	—	+\$32*
HP 60503B	\$1,950	—	—	—	—	—	—	—	+\$32*
HP 60504B	\$2,275	—	—	—	—	—	—	—	+\$32*
HP 60507B	\$2,500	—	—	—	—	—	—	—	+\$32*

- † Options 908 and 909 for the HP 6050A, and Options 800 and 908 for the HP 6051A, require either the slide kit (P/N 1494-0059) or slide rails to support the weight of the load mainframe. Slide kits can be purchased using the above part number.  
 \* This feature is available as an option.  
 — This feature is not available.

Option Descriptions

- Opt 020** Front panel inputs (for HP 6060B and 6063B only)  
**Opt 100** 87 to 106 Vac, 47 to 66 Hz (for Japan only)  
**Opt 220** 191 to 233 Vac, 47 to 66 Hz  
**Opt 240** 209 to 250 Vac, 47 to 66 Hz  
**Opt 800** Rackmounting kit for two units (for 6051A) mounted side by side (HP part numbers 5062-3994 and 5062-3978)  
**Opt 908** Rackmounting kit includes (HP P/N 5062-3978 with an HP 6050A, HP P/N 5062-3960 with HP 6051A, and HP P/N 5062-3974 with an HP 6060B and 6063B)  
**Opt 909** Rackmounting kit with handles (HP P/N 5062-3984 when mounting an HP 6050A and HP P/N 5062-3975 when mounting an HP 6060B and 6063B)  
**Opt 910** Extra manual set, including one each of the operating manual, programming reference manual, and service manual. The programming manual is available with the mainframe, and therefore not individual modules (operating manuals and programming manuals only are shipped with standard units)

# POWER SUPPLIES

## General Information

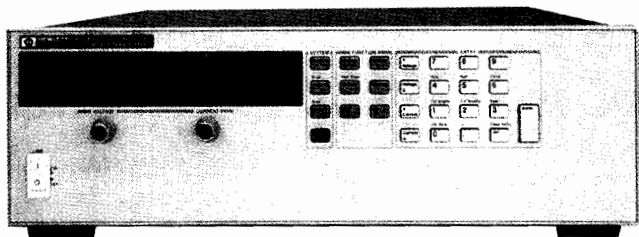

### HP-IB System Power Supplies (pages 523 through 536)

- Multiple-output
- Precision multiple-output
- Modular power system
- Single-output
- Accessories and options
- Selection table on page 521



### Bench Power Supplies (pages 537 through 539)

- Single-output
- Dual-output
- Triple-output
- Selection table on page 522

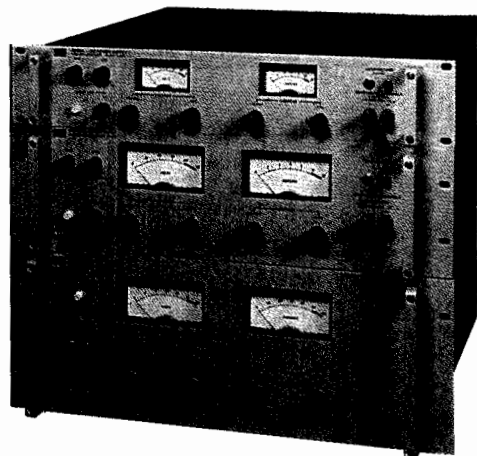

### Analog Programmable Power Supplies (pages 540 through 551)

- General-purpose
- Bipolar/amplifier
- Precision voltage and current sources
- Selection table on page 522

### DC Power Supply Catalog with Electronic Loads

For more detailed information on dc power products refer to the DC Power Supply Catalog. To obtain the DC Power Supply Catalog, check the box on the card included with this catalog, call 1-800-452-4844, ext. 2722, or ask your HP sales representative.



### Power Products Modification Service

If you don't find the power supply you need, or if you require a completely integrated power system, ask your local HP sales representative for information on HP's Power Products Modification Service.



### HP-IB Programmable Supplies

All models listed in the tables on this page feature built-in HP-IB for direct voltage and current programming, as well as actual voltage and current readback.

#### Single Output HP-IB Power Supplies – 100 W to 1000 W

Max. Volts (dc)	Max. Amps (dc)	Type	HP Model Number	Page
6.7	30	Autoranging	HP 6033A	530
7	120	Autoranging	HP 6031A	530
8	20	Linear	HP 6641A	527
8	50	Linear	HP 6651A	528
8	220	High-Performance Switching	HP 6671A	529
± 10	0.01	DAC Programmer*	HP 59501B	536
20	5	Linear	HP 6632A	526
20	10	Linear	HP 6642A	527
20	10	Autoranging	HP 6033A	530
20	10	Autoranging	HP 6038A	530
20	10	High-Performance Autoranging	HP 6002A†	536
20	25	Linear	HP 6652A	528
20	50	Autoranging	HP 6031A	530
20	50	Autoranging	HP 6032A	530
20	100	High-Performance Switching	HP 6672A	529
35	6	Linear	HP 6643A	527
35	15	Linear	HP 6653A	528
35	60	High-Performance Switching	HP 6673A	529
50	2	Linear	HP 6633A	526
50	4	High-Performance Autoranging	HP 6002A†	536
60	3.3	Autoranging	HP 6038A	530
60	3.5	Linear	HP 6644A	527
60	9	Linear	HP 6654A	528
60	17	Autoranging	HP 6030A	530
60	17.5	Autoranging	HP 6032A	526
60	35	High-Performance Switching	HP 6674A	529
100	1	Linear	HP 6634A	526
120	1.5	Linear	HP 6645A	527
120	4.5	Linear	HP 6655A	528
120	18	High-Performance Switching	HP 6675A	529
200	5	Autoranging	HP 6030A	530
200	5	Autoranging	HP 6035A	530
500	2	Autoranging	HP 6035A	530

\* No readback. † Must be ordered with Option 001 for HP-IB control; no readback.

#### Precision Multiple Output HP-IB Power Supplies 25 W to 50 W

Low Range		High Range			Number of each output type per HP Model Number				Page
Max. Volts (dc)	Max. Amps (dc)	Max. Volts (dc)	Max. Amps (dc)	Power	HP 6625A	HP 6626A	HP 6628A	HP 6629A	
7	15 mA	50	500 mA	25 W	1	2	—	—	534
16	200 mA	50	1 A	50 W	1	2	2	4	534

#### Multiple Output HP-IB Power Supplies 40 W to 80 W

Low Range		High Range			Number of each output type per HP Model Number					Page
Max. Volts (dc)	Max. Amps (dc)	Max. Volts (dc)	Max. Amps (dc)	Power	HP 6621A	HP 6622A	HP 6623A	HP 6624A	HP 6627A	
7	5	20	2	40	—	—	1	2	—	533
7	10	20	4	80	2	—	1	—	—	533
20	2	50	0.8	40	—	—	1	2	4	533
20	4	50	2	80	—	2	—	—	—	533

#### HP 66000 Modular Power System

Max. Volts (dc)	Max. Amps (dc)	Power	HP Model Number	Page
8	16	128	HP 66101A	523
20	7.5	150	HP 66102A	523
35	4.5	150	HP 66103A	523
60	2.5	150	HP 66104A	523
120	1.25	150	HP 66105A	523
200	0.75	150	HP 66106A	523

# POWER SUPPLIES

## Voltage Rating Index (cont'd)

### Analog Programmable Supplies

All models listed in this table are programmable either with an analog voltage or a resistance signal. For lab bench applications where analog programming is not required, also consider the Lab Bench Power Supplies listed below.

Max. Volts (dc)	Max. Amps (dc)	Type	HP Model Number	Page
6.7	30	Autoranging	HP 6023A	542
7	120	Autoranging	HP 6011A	542
7.5	5	CV/CC	HP 6281A	540
8	20	Linear	HP 6541A	544
8	50	Linear	HP 6551A	544
8	220	High Performance Switching	HP 6571A	544
8	1000	CV/CC	HP 6464C	548
10	10	CV/CC	HP 6282A	540
10	100	CV/CC	HP 6260B	546
15	200	CV/CC	HP 6453A	548
16	600	CV/CC	HP 6466C	548
18	500	CV/CC	HP 6466C	548
20	0.6	Dual Output (20V, 20V)	HP 6205C	537
20	2	Precision Voltage	HP 6114A	539
± 20	± 2	Bipolar PSA	HP 6825A	550
20	3	CV/CC	HP 6284A	540
20	3	Dual Output (20V, 20V)	HP 6253A	540
20	10	Linear	HP 6542A	544
20	10	Autoranging	HP 6023A	542
20	10	Autoranging	HP 6024A	542
20	10	CV/CC	HP 6263B	546
20	10	CV/CC	HP 6286A	540
20	20	CV/CC	HP 6264B	546
20	25	Linear	HP 6552A	544
20	50	Autoranging	HP 6011A	542
20	50	Autoranging	HP 6012B	542
20	50	CV/CC	HP 6261B	546
20	100	High Performance Switching	HP 6572A	544
25	2	Dual Output (25V, 25V)	HP 6227B	540
35	6	Linear	HP 6543A	544
35	15	Linear	HP 6553A	544
35	60	High Performance Switcher	HP 6573A	544
36	100	CV/CC	HP 6456B	548
36	300	CV/CC	HP 6469C	548
40	0.3	Dual Output (40V, 40V)	HP 6205C	537
40	1	Precision Voltage	HP 6114A	539
40	1.5	CV/CC	HP 6289A	540
40	1.5	Dual Output (40V, 40V)	HP 6255A	540
40	5	CV/CC	HP 6266B	546
40	5	CV/CC	HP 6291A	540

Max. Volts (dc)	Max. Amps (dc)	Type	HP Model Number	Page
40	5.7	Autoranging	HP 6024A	542
40	10	CV/CC	HP 6267B	546
40	25	CV/CC	HP 6434B	548
40	30	Autoranging	HP 6012B	542
40	30	CV/CC	HP 6268B	546
40	50	CV/CC	HP 6269B	546
50	0.5	Precision Current	HP 6177C	539
50	0.8	Precision Voltage	HP 6115A	539
50	1	Dual Output (50V, 50V)	HP 6228B	540
± 50	± 1	Bipolar PSA	HP 6826A	550
60	1	CV/CC	HP 6294A	540
60	3	CV/CC	HP 6296A	540
60	3.3	Autoranging	HP 6024A	542
60	3.5	Linear	HP 6544A	544
60	9	Linear	HP 6554A	544
60	15	CV/CC	HP 6274B	546
60	17	Autoranging	HP 6010A	542
60	17.5	Autoranging	HP 6012B	542
60	35	High Performance Switcher	HP 6574A	544
64	50	CV/CC	HP 6459A	548
64	150	CV/CC	HP 6472C	548
100	0.25	Precision Current	HP 6181C	539
100	0.4	Precision Voltage	HP 6115A	539
± 100	± 0.5	Bipolar PSA	HP 6827A	550
100	0.75	CV/CC	HP 6299A	540
110	100	CV/CC	HP 6475C	548
120	1.5	Linear	HP 6545A	544
120	4	Linear	HP 6555A	544
120	18	High Performance Switcher	HP 6575A	544
200	5	Autoranging	HP 6010A	542
200	5	Autoranging	HP 6015A	542
220	50	CV/CC	HP 6477C	548
300	0.1	Precision Current	HP 6186C	539
300	35	CV/CC	HP 6479C	548
320	0.1	CV/CC	HP 6209B	537
440	25	CV/CC	HP 6483C	548
500	2	Autoranging	HP 6015A	542
500	20	CV/CC	HP 6483C	548
600	1.5	CV/CC	HP 6448B	548
600	15	CV/CC	HP 6483C	548

### Lab Bench Power Supplies

Type	Max. Volts (dc)	Max. Amps (dc)	HP Model Number	Page
Single Output Dual Range	8/15	3/2	HP E3610A	537
	20/35	1.5/0.85	HP E3611A	537
	60/120	0.5/0.25	HP E3612A	537
Dual Output	25 V	0.2	HP 6234A	537
	25 V	0.2		
Triple Output	6 V	1	HP 6235A	537
	± 18 V	0.2		
	6 V	2.5	HP 6236A	537
	± 20 V	0.5		
18 V	1	HP 6237A	537	
± 20 V	0.5			

# POWER SUPPLIES

## HP 66000 Modular Power System

HP 66000A, HP 66001A, and HP 66101A - 66106A

523

- High density: eight slots in seven inches of rack space
- Output sequencing
- Low ripple and noise
- High-accuracy readback of voltage and current
- SCPI (Standard Commands for Programmable Instruments)
- Optional keyboard/display unit

- Serial link connects two mainframes at one HP-IB address
- Optional isolation and polarity reversal relays
- Built-in self-test
- Five nonvolatile storage states per output
- Three-year warranty

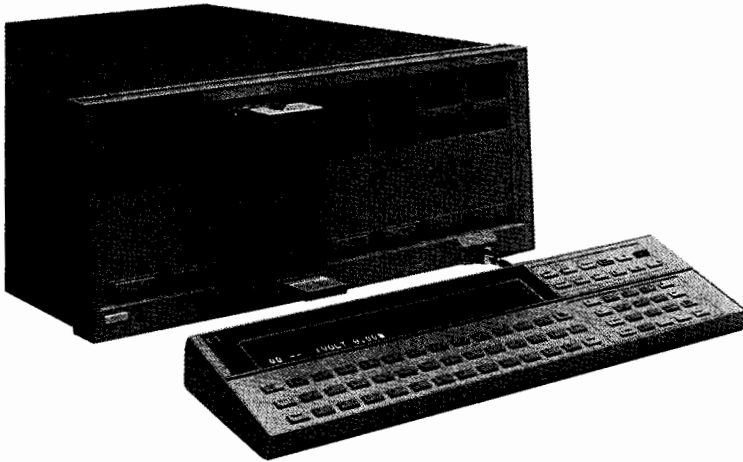

### HP 66000 Modular Power System

The Hewlett-Packard Modular Power System is the newest addition to the HP family of "One-Box" solution system power products. This power system simplifies test system assembly, cabling, programming, debugging, and operation. It is ideal for ATE and production test environments, where it can be used to provide bias power and stimulus to sub-assemblies and final products.

The HP Modular Power System saves rack space. The seven-inch high mainframe can accommodate up to eight dc power modules. The following single-slot width dc power modules are available:

HP 66101A	8 V	16 A	128 W
HP 66102A	20 V	7.5 A	150 W
HP 66103A	35 V	4.5 A	150 W
HP 66104A	60 V	2.5 A	150 W
HP 66105A	120 V	1.25 A	150 W
HP 66106A	200 V	0.75 A	150 W

Through the HP Serial Link, up to 16 power modules can be controlled. Applications ranging from 150 watts to 2000 watts can be addressed by configuring up to eight HP 6640, HP 6650, HP 6670, or HP 6030 system power supplies with one HP 66000A MPS Mainframe—all at one HP-IB address.

### Programmable Features

As a "One-Box" solution, the HP 66000 Modular Power System offers full programmability and measurement over the HP-IB. For local or manual control, the HP 66001A MPS Keyboard allows full access to all programmable features, and is available as a tool for test system development and debugging.

Through its SCPI command set, the HP Modular Power System is compatible with HP-IB, VXI, and MMS test and measurement solutions. To increase application flexibility, this new system features output sequencing, a new capability for HP system supplies. Up to 20 voltage, current, and dwell time parameters can be downloaded to each output, allowing highly synchronized output sequences to be executed without controller intervention.

### Output Connections

System assembly is simplified thanks to a quick-disconnect connector assembly on each module.

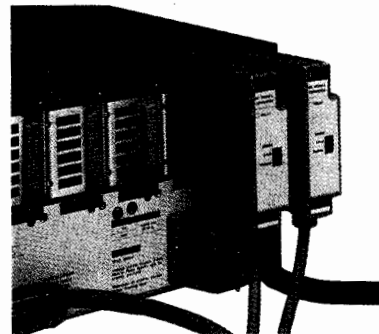

These connectors permit modules to be removed from the front of the mainframe, without disconnecting cabling or removing the mainframe from the rack.

### Isolation/Polarity Reversal Relays (dc Power Module Option 760)

Optional relays provide output connect/disconnect and polarity reversal. These relays are assembled as part of the module connector, thereby providing a truly compact solution.

### HP-IB Functions

The following functions can be programmed via the HP-IB:

#### Programmable Functions

Voltage Output  
Current Output  
Output Sequencing  
Output Enable/Disable  
Fault Interrupt  
OVP and OCP  
Software Calibration  
Self-test

#### Readback Functions

Actual Measured Voltage  
Actual Measured Current  
Present Module Status  
Accumulated Module Status  
Programming Error Codes  
Fault Codes  
Service Request

# POWER SUPPLIES

## HP 66000 Modular Power System

HP 66000A, HP 66001A, and HP 66101A - 66106A

### Specifications (at 0° C to 55° C unless otherwise specified)

Hewlett-Packard Model		HP 66101A	HP 66102A	HP 66103A	HP 66104A	HP 66105A	HP 66106A
Output Ratings (at 40° C)	Output Voltage	8 V	20 V	35 V	60 V	120 V	200 V
	Output Current	16 A	7.5 A	4.5 A	2.5 A	1.25 A	0.75 A
	Output Power	128 W	150 W	150 W	150 W	150 W	150 W
Programming Accuracy (at 25° C ± 5° C)	Voltage	0.03% + 3 mV	0.03% + 8 mV	0.03% + 13 mV	0.03% + 27 mV	0.03% + 54 mV	0.03% + 90 mV
	Current	0.03% + 6 mA	0.03% + 3 mA	0.03% + 2 mA	0.03% + 1.2 mA	0.03% + 0.6 mA	0.03% + 0.4 mA
Readback Accuracy (via HP-IB or Keyboard Display at 25° C ± 5° C)	Voltage	0.02% + 2 mV	0.02% + 5 mV	0.02% + 8 mV	0.02% + 16 mV	0.02% + 32 mV	0.02% + 54 mV
	Current	0.02% + 6 mA	0.02% + 3 mA	0.02% + 2 mA	0.02% + 1 mA	0.02% + 0.5 mA	0.02% + 0.3 mA
Ripple and Noise (20 Hz to 20 MHz)	Constant Voltage rms	2 mV	3 mV	5 mV	9 mV	18 mV	30 mV
	Constant Voltage peak-peak	5 mV	7 mV	10 mV	15 mV	25 mV	15 mV
	Constant Current rms	5 mA	3 mA	2 mA	1 mA	1 mA	1 mA
Line Regulation	Voltage	0.5 mV	0.5 mV	1 mV	2 mV	3 mV	5 mV
	Current	0.75 mA	0.5 mA	0.3 mA	0.1 mA	30 μA	30 μA
Load Regulation	Voltage	1 mV	1 mV	1 mV	2 mV	4 mV	7 mV
	Current	0.2 mA	0.2 mA	0.2 mA	0.1 mA	50 μA	30 μA

**Transient response time:** Less than 1 msec for the output voltage to recover within 100 mV of its previous level following any step change in load current up to 10% of rated current.

**Isolation:** Output terminals can be up floated to ±240Vdc from chassis ground

### Supplemental Characteristics

Hewlett-Packard Model		HP 66101A	HP 66102A	HP 66103A	HP 66104A	HP 66105A	HP 66106A
Average Resolution	Voltage	2.4 mV	5.9 mV	10.4 mV	18.0 mV	36.0 mV	60.0 mV
	Current	4.6 mA	2.3 mA	1.4 mA	0.75 mA	0.38 mA	0.23 mA
	OVP	50 mV	120 mV	200 mV	375 mV	750 mV	1.25 mV
OVP Accuracy		250 mV	500 mV	800 mV	1 V	1.5 V	2.5 V

**Remote sensing:** Up to half the rated output voltage can be dropped in each load lead. Add 2 mV to the voltage load regulation specification for each 1 volt change in the negative output lead due to load current change.

**Command processing time:** Average time required for the output voltage to change following receipt of HP-IB commands is 20 msec.

**Output programming response time:** The rise and fall time (10%/90% and 90%/10%) of the output voltage is less than 20 ms. The output voltage change settles within 1 LSB (0.025% × rated voltage) of the final value in less than 120 ms.

**Downprogramming:** An active downprogrammer sinks approximately 10% of the rated output current.

**Calibration interval:** One year

#### AC input of MPS mainframe:

Voltage	100 Vac	120 Vac	200 Vac	220 Vac	240 Vac
Current (max)	29 A	25 A	16 A	16 A	15 A

#### Input power of MPS mainframe:

3200 VA (max) 1800 W (max) 1600 W (typ)

**HP-IB capabilities:** SH1, AH1, T6, L4, SR1, RL1, PPO, DC1, DT1, EI, and CO, and IEEE 488.2 and SCPI compatible command set.

**RFI suppression:** Designed to comply with VDE 0871/6.78 level B.

**Safety agency compliance:** Designed to comply with IEC 348, VDE 0411, UL 1244, and CSA 556B.

**Warranty period:** Three years

### Ordering Information

**HP 66000A MPS Mainframe**

### Price

\$1,900

**Opt 908:** Rack Mount Kit

\$37

**Opt 909:** Rack Mount Kit with Handles

N/C

For the HP 66000A, one of the following line cord options must be specified when ordering. Order according to local electrical codes. All line cords are 2.5 meters long.

**Opt 831** 12 AWG wire size; UL listed, CSA certified;

\$0

unterminated line cord (200-400 Vac connections)

**Opt 833** 1.5 sq mm wire size; Harmonized cordage;

\$0

unterminated line cord (200-240 Vac connections)

**Opt 834** 10 AWG wire size; UL listed, CSA certified;

\$0

unterminated line cord (100-120 Vac connections)

**Opt 841** Line cord with NEMA 6-20P, 20A/250V plug

\$15

(suggested for use in North and South America)

**Opt 843** Line cord with JIS C8303 appended fig 6(2),

\$35

20A/250V plug (suggested for use in Japan)

**Opt 845** Line cord with IEC 309, 16A/220V plug

\$35

(suggested for use in Denmark, Switzerland, Austria,

China and other countries not listed)

**Opt 846** Line cord with NEMA L5-30P, 30A/120V

\$55

locking plug (suggested for use in North America)

**Opt 847** Line cord with CEE 7/7, 16A/220V plug

\$35

(suggested for use in continental Europe)

**Opt 848** Line cord with BS 546, 15A/240V plug

\$35

(suggested for use in India and South Africa)

**HP 66001A MPS Keyboard** (Order HP 34551A to rack

\$750

mount)

**HP 34551A** (rack kit for HP 66001A keyboard)

\$65

**HP 66101A** DC Power Module 8 volt, 16 amperes

\$1,750

**HP 66102A** DC Power Module 20 volt, 7.5 amperes

\$1,750

**HP 66103A** DC Power Module 35 volt, 4.5 amperes

\$1,750

**HP 66104A** DC Power Module 60 volt, 2.5 amperes

\$1,750

**HP 66105A** DC Power Module 120 volt, 1.25 amperes

\$1,750

**HP 66106A** DC Power Module 200 volt, 0.75 amperes

\$1,750

**Opt 760:** Open/close and polarity reversal relays

\$180

### Shipping Information

**Net weight:**  
**Shipping weight:**  
**Shipping carton:**

**HP 66000A**  
33 lbs/15 kgs  
41 lbs/41 kgs  
29 in × 23 in × 12 in

**HP 66001A**  
2.3 lbs/1.05 kgs  
2.95 lbs/1.34 kgs  
19 in × 7 in × 3 in

**HP 66101A - 66106A**  
6 lbs/2.8 kgs  
9 lbs/4.1 kgs  
29 in × 12 in × 8 in

The features and capabilities described below are applicable to many, but not all, of the Hewlett-Packard single-output system power supplies described on the following pages. Please refer to the page that describes a specific model to determine whether a feature is actually available for a specific model.

### Single-Output System Power Supplies

System power supplies are designed primarily for use in automatic test systems, where a computer programs the power supply to the initial voltage or current for the component, subassembly, or product under test, and may vary the voltage and current throughout the test to simulate worst-case operating conditions. Front-panel controls are provided to simplify setup and debugging of the test system. System power supplies are often used as lab bench supplies until they are needed as system components.

### "One-Box" Solution

Hewlett Packard's HP-IB system power supplies integrate the functions of a power supply, voltage and current programmers, voltage and current readback, status readback, and SRQ interrupts all into a single package. These HP "One-Box" Solution power supplies offer the following inherent advantages:

- **Fully specified performance:** One set of specifications covers the complete power supply, from the HP-IB input to the output.
- **Ease of integration:** The power supply, programmer, current shunt, and DMM are in one box; no additional cabling is required.
- **Reduced system cost:** Everything is in one box so there is no long list of extras to buy, and less rack space is required.
- **Ease of use:** Outputs are programmed directly in volts and amps. Extensive system features like status readback and electronic calibration lead to faster program development and less maintenance time.
- **Load protection:** Overcurrent and overvoltage protection features can be used to shut down the output when dangerous conditions occur, as well as sending SRQ interrupts to the computer.
- **Reliability:** Hewlett Packard's advanced design techniques combined with the integrated "One-Box" approach mean increased reliability backed with a three-year warranty.

### Protection for the Unit Under Test

In addition to programmable overvoltage, overcurrent, and over-temperature protection, HP system power supplies offer Discrete Fault Indicator (DFI) and Remote Inhibit (RI). Typically used for emergency shutdown of the test system independent of the HP-IB and controller, these hardware signals allow a group of power supplies to be connected together so that a user-defined fault condition anywhere in the system can trigger an alarm or shut down the system.

Almost any change of state in power supply operation can be used to generate a Service Request (SRQ) to interrupt the controller.

Because inadvertent misconnections or failures elsewhere in your system can occur, HP system power supplies are protected against reverse bias voltage imposed across the output terminals, and the unit under test is protected against open sense leads.

Local lockout can be programmed via the HP-IB to disable the front-panel controls, preventing unauthorized operators from changing a power supply setting.

### SCPI Programming Commands

HP-IB commands for all single output system models except the HP 6630 series are implemented with SCPI, the new language standard for programmable test instruments. This standard means that all

instruments performing the same function use the same instruction. For example, reading the output voltage directly from the power supply is done with the same commands as for an external multimeter.

The example below shows the self-documenting nature of SCPI instructions. First the power supply is programmed to 15 volts, and then the resultant output voltage and current are read back.

```
VOLT 15
MEAS:VOLT?:CURR?
```

### Serial Link Capability

Rather than use two or more HP-IB addresses in systems that require more than one power supply, all single-output system supplies (except the three models in the 6630 series) can use HP's serial link to operate up to 16 power supplies on one HP-IB address. Plus, the low-cost telephone-type cables that interconnect the units can be up to 30 meters long.

### Relay Connect/Disconnect and Polarity Reversal

Relays for connecting the power supply to the load and reversing the polarity of the voltage at the load are available on most single-output system models. The HP 6630 Series 100-watt models can be ordered with Option 760 to provide built-in relays. All other higher-power models up to 200 volts and up to 60 amps require external relay accessories, HP Model 59510A Isolation Relay, or HP Model 59511A Isolation and Reversal Relay. The relay accessories allow seamless programming (through the power supply's own HP-IB port) of all sense and load lead connections with controlled sequencing to prevent open sense leads under all conditions.

### Down-Programming (Current Sinking) Capability

All single-output system supplies except the HP 6030 series have circuitry that allows sinking (pulling current into the more positive terminal of the supply) to either change or maintain the output voltage. This capability helps the output capacitor on the power supply (or on the unit under test) discharge quickly, even when there is little or no load on the power supply. This can be an important feature in systems that require outputs to be quickly discharged before the UUT is removed from the fixture, preventing arcing and contact degradation in the system test head fixture.

### Calibration

Calibration can be accomplished on many models without removing the power supply from the rack, and it can be done with or without a computer. A user-specified password minimizes accidental access to the calibration routines, which coordinate the entry of calibration constants derived from measurements of voltage, current, and over-voltage settings with an external reference voltmeter.

### Store/Recall States

Most single-output system supplies have the ability to store and recall five complete power supply operating states in nonvolatile memory to save programming time. One of these five states is automatically recalled at power-on so that the supply can be initialized to any desired state. Each state specifies voltage and current settings, overvoltage and overcurrent protection settings, output protection delay time, external relay position and polarity, and the digital output port data.

### Fan Speed Control

The HP 6650 and 6670 series protect nearby users from unnecessary acoustic noise by automatically slowing down the power supply's internal cooling fan when loading and ambient temperature permit.

# POWER SUPPLIES

## Single-Output System: 100 W

### HP 6632A, 6633A, 6634A

- Linear output regulation
- Low ripple and noise
- "One-Box" solution: includes V and I readback
- Fast up- and down-programming

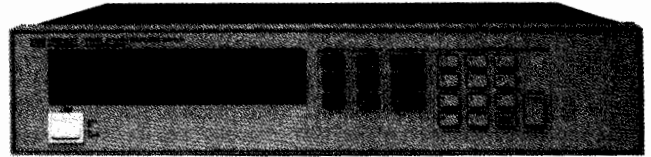

#### Specifications (at 0° C to 55° C unless otherwise specified)

Hewlett-Packard Model		6632A	6633A	6634A
Output Ratings	Output Voltage	0 to 20 V	0 to 50 V	0 to 100 V
	Output Current	0 to 5 A	0 to 2 A	0 to 1 A
Programming Accuracy at 25°C ± 5°C	Voltage	0.05% + 5 mV	0.06% + 20 mV	0.05% + 20 mV
	+ Current	0.15% + 7 mA	0.15% + 2 mA	0.15% + 1 mA
Ripple and Noise from 20Hz to 20MHz	Voltage (rms/p-p)	normal mode	0.3mV/3 mV	0.5mV/3 mV
		fast mode	1mV/10 mV	1mV/15 mV
	Current	rms	2 mA	2 mA
Readback Accuracy at 25°C ± 5°C	Voltage	0.07% + 15 mV	0.07% + 30 mV	0.06% + 70 mV
	+ Current	0.18% + 9 mA	0.17% + 3 mA	0.15% + 2 mA
	- Current	0.50% + 15 mA	0.50% + 7 mA	0.50% + 6 mA
Load Regulation	Voltage	2 mV	4 mV	5 mV
	Current	1 mA	1 mA	1 mA
Line Regulation	Voltage	0.5 mV	1 mV	1 mV
	Current	0.5 mA	0.25 mA	0.25 mA

**Transient response time:** Less than 100  $\mu$ s (50  $\mu$ s in fast mode) for the output voltage to recover to its previous level (within 0.1% of the voltage rating of the supply) following any step change in load current of up to 50% of rated current.

**Isolation:** Output terminals can be floated up to  $\pm$ 240 Vdc from chassis ground.

#### Supplemental Characteristics

Hewlett-Packard Model		6632A	6633A	6634A
Programming Resolution	Voltage	5 mV	12.5 mV	25 mV
	Current	1.25 mA	0.5 mA	0.25 mA
	OVP	100 mV	250 mV	500 mV
OVP Accuracy		2.4% + 240 mV	2.4% + 600 mV	2.4% + 1.2 V
Sink Current		5 A	2 A	1 A
Minimum Current in Constant Current Mode		20 mA	8 mA	4 mA

**Remote sensing:** Up to 2 volts can be dropped in each load lead. Add 5 mV to the voltage load regulation specification for each 1 volt change in the negative output lead due to load current change.

**Command processing time:** Average time required for the output voltage to begin to change following receipt of digital data is 10 ms for power supplies connected directly to the HP-IB.

**Output programming response time:** The rise and fall time (10/90% and 90/10%) of the output voltage is less than 15 ms (400  $\mu$ s in fast mode). The output voltage change settles within 1 LSB (0.025%  $\times$  rated voltage) of final value in less than 60 ms (2 ms in fast mode).

**Input power:** 350 VA, 250 W, at full load

**HP-IB interface capabilities:** SH1, AH1, T6, L4, SR1, RL1, PP1, DC1, DT0, E1 and C0

**RFI suppression:** Designed to comply with VDE 0871/6.78 level B

**Safety agency compliance:** Designed to comply with IEC348, VDE 0411, and CSA 556B. Meets UL 1244

**Size:** 88.1 mm H  $\times$  425.5 mm W  $\times$  346 mm D (3.5 in  $\times$  16.75 in  $\times$  13.6 in)

**Weight:** net, 10.5 kg (23 lb); shipping, 12.3 kg (27 lb)

**Warranty period:** Three years

#### Key Features

- HP-IB programming of voltage and current
- Measured voltage and current readback over the HP-IB
- Programmable overvoltage and overcurrent protection\*
- Selftest at power-on or from an HP-IB command
- Electronic calibration via HP-IB\*
- Option 760 for built-in relays and DFI/RI\*
- Fast/normal mode operation selected via rear-panel switch
- Option 020 provides front panel binding posts

\* For more information on these features, see page 525.

#### Ordering Information

HP Model	Output ratings	Price
HP 6632A	20 volts, 5 amperes	\$1,750
HP 6633A	50 volts, 2 amperes	\$1,750
HP 6634A	100 volts, 1 ampere	\$1,750

#### Option descriptions

Opt 020 Front binding posts	\$79
Opt 760 Isolation and reversal relays; includes discrete fault indicator and remote inhibit	\$405
Standard AC Input: 104 to 127 Vac, 48 to 63 Hz, 3.3 A	N/C
Opt 100 87 to 106 Vac, 48 to 63 Hz, 2.9 A (Japan Only)	N/C
Opt 220 191 to 233 Vac, 48 to 63 Hz, 1.7 A	N/C
Opt 240 209 to 250 Vac, 48 to 63 Hz, 1.6 A	N/C
Opt 908 Rack Mount Kit (HP p/n 5061-9674)	\$32
Opt 909 Rack Mount Kit with handles (HP p/n 5061-9675)	\$75
Opt 910 Extra operating manual (HP p/n 5957-6360) and service manual (HP p/n 5957-6365). Standard unit is shipped with operating manual only.	\$32
Accessory rack slide kit (HP p/n 1494-0059)	\$100



# POWER SUPPLIES

## Single-Output System: 200 W

HP 6641A, 6642A, 6643A, 6644A, 6645A

527

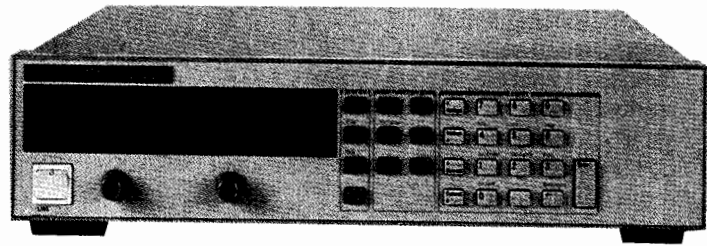

- Linear output regulation
- Low ripple and noise
- "One-Box" solution: includes V and I readback
- Fast up- and down-programming
- SCPI (Standard Commands for Programmable Instruments)

### Specifications (at 0° C to 55° C unless otherwise specified)

Hewlett-Packard Model		6641A	6642A	6643A	6644A	6645A
Output ratings	Output voltage	0 to 8 V	0 to 20 V	0 to 35 V	0 to 60 V	0 to 120 V
	Output current (40° C)	0 to 20 A	0 to 10 A	0 to 6 A	0 to 3.5 A	0 to 1.5 A
	Maximum current (50° C)	18.0 A	9.0 A	5.4 A	3.2 A	1.4 A
	Maximum current (55° C)	17.0 A	8.5 A	5.1 A	3.0 A	1.3 A
Programming accuracy at 25° C ± 5° C	Voltage	0.06% +	5 mV	10 mV	15 mV	26 mV
	Current	0.14% +	26 mA	13 mA	6.7 mA	4.1 mA
Ripple and noise from 20 Hz to 20 MHz	Constant voltage	rms	300 μV	300 μV	400 μV	500 μV
		peak-peak	3 mV	3 mV	4 mV	5 mV
	Constant current	rms	10 mA	5 mA	3 mA	1.5 mA
Readback accuracy at 25° C ± 5° C	Voltage	0.07% +	6 mV	15 mV	25 mV	40 mV
	+ Current	0.10% +	18 mA	9.1 mA	5 mA	3 mA
	- Current	0.35% +	40 mA	20 mA	12 mA	6.8 mA
Load regulation	Voltage	1 mV	2 mV	3 mV	4 mV	5 mV
	Current	1 mA	0.5 mA	0.25 mA	0.25 mA	0.25 mA
Line regulation	Voltage	0.5 mV	0.5 mV	1 mV	1 mV	2 mV
	Current	1 mA	0.5 mA	0.25 mA	0.25 mA	0.25 mA

**Transient response time:** Less than 100 μs for the output voltage to recover to its previous level (within 0.1% of the voltage rating of the supply or 20 mV, whichever is greater) following any step change in load current of up to 50% of rated current.

**Isolation:** Output terminals can be floated up to ±240 Vdc from chassis ground.

### Supplemental Characteristics

Hewlett-Packard Model		6641A	6642A	6643A	6644A	6645A
Average programming resolution	Voltage	2 mV	5 mV	10 mV	15 mV	30 mV
	Current	6 mA	3 mA	2 mA	1.2 mA	0.5 mA
	OVP	13 mV	30 mV	54 mV	93 mV	190 mV
OVP accuracy		160 mV	400 mV	700 mV	1.2 V	2.4 V
Downprogramming current		5.8 A	2.5 A	1.5 A	0.9 A	0.75 A

**Remote sensing:** Up to half the rated output voltage can be dropped in each load lead. The drop in the load leads subtracts from the voltage available for the load. Add 3 mV to the voltage load regulation specification for each 1 volt change in the positive output lead due to load current change.

**Command processing time:** Average time required for the output voltage to begin to change following receipt of digital data is 20 ms for power supplies connected directly to the HP-IB.

**Output programming response time:** The rise and fall time (10/90% and 90/10%) of the output voltage is less than 15 ms. The output voltage change settles within 1 LSB (0.025% × rated voltage) of final value in less than 60 ms.

**Modulation:** (Analog programming of output voltage and current)  
Input signal: 0 to -5 V  
Input impedance: 10 K ohms nominal

#### AC input:

voltage	100 Vac	120 Vac	220 Vac	240 Vac
current	4.4 A	3.8 A	2.2 A	2.0 A

**Input power:** 480 VA, 400 W, at full load; 60 W at no load.

**HP-IB interface capabilities:** SH1, AH1, T6, L4, SR1, RL1, PP0, DC1, DT1, E1, and CO. IEEE 488.2 and SCPI compatible command set

**RFI suppression:** Designed to comply with VDE 0871/6.78 level B.

**Safety agency compliance:** Designed to comply with IEC 348, VDE 0411, UL1244, and CSA 556B

**Size:** 88.1 mm H × 425 mm W × 439 mm D (3.5 in × 16.75 in × 17.3 in)

**Weight:** Net, 14.2 kg (31.4 lb); shipping, 16.3 kg (36 lb)

**Warranty period:** Three years

### Key Features

- HP-IB programming of voltage and current
- Measured voltage and current readback over the HP-IB
- SCPI (Standard Commands for Programmable Instruments)\*
- Serial link connects up to 16 outputs to one HP-IB address\*
- Auto-parallel up to 3 units
- Outputs can be connected in parallel or in series
- Programmable overvoltage and overcurrent protection\*
- Overtemperature protection
- Discrete Fault Indicator/Remote Inhibit (DFI/RI)\*
- Selftest at power-on or from an HP-IB Command
- Electronic calibration via HP-IB or front panel\*
- Five nonvolatile store/recall states\*
- User-definable power-on state\*
- Digital I/O controls external relay accessories\*
- Fan speed control minimizes acoustic noise\*

\* For more information on these features, see page 525.

### Ordering Information

HP Model	Output ratings	Price
HP 6641A	8 volts, 20 amperes	\$2,400
HP 6642A	20 volts, 10 amperes	\$2,300
HP 6643A	35 volts, 6 amperes	\$2,300
HP 6644A	60 volts, 3.5 amperes	\$2,300
HP 6645A	120 volts, 1.5 amperes	\$2,350

#### Option descriptions:

Opt 100	87 to 106 Vac, 47 to 63 Hz	N/C
Opt 220	191 to 233 Vac, 47 to 63 Hz	N/C
Opt 240	209 to 250 Vac, 47 to 63 Hz	N/C
Opt 908	Rack Mount Kit (HP p/n 5062-3974)	\$32
Opt 909	Rack Mount Kit with handles (HP p/n 5062-3975)	\$75

# POWER SUPPLIES

## Single-Output System: 500 W

HP 6651A, 6652A, 6653A, 6654A, 6655A

- Linear output regulation
- Low ripple and noise
- "One-Box" solution: includes V and I readback
- Fast up- and downprogramming
- SCPI (Standard Commands for Programmable Instruments)

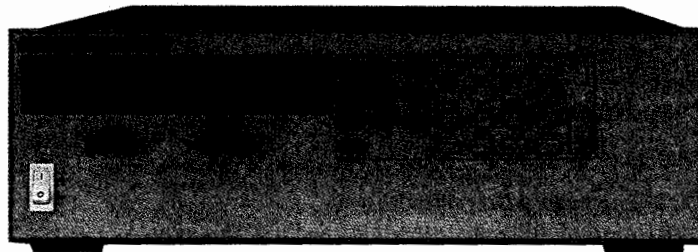

### Specifications

Hewlett-Packard Model		6651A	6652A	6653A	6654A	6655A
Output ratings	Output voltage	0 to 8 V	0 to 20 V	0 to 35 V	0 to 60 V	0 to 120 V
	Output current (40° C)	0 to 50 A	0 to 25 A	0 to 15 A	0 to 9 A	0 to 4 A
	Maximum current (50° C)	45.0 A	22.5 A	13.5 A	8.1 A	3.6 A
	Maximum current (55° C)	42.5 A	21.3 A	12.8 A	7.7 A	3.4 A
Programming accuracy at 25° C ± 5° C	Voltage	0.08% +	5 mV	10 mV	15 mV	26 mV
	Current	0.15% +	60 mA	25 mA	13 mA	8 mA
Ripple and noise from 20 Hz to 20 MHz	Constant voltage	rms	300 μV	300 μV	400 μV	500 μV
		peak-peak	3 mV	3 mV	4 mV	5 mV
	Constant current	rms	25 mA	10 mA	5 mA	3 mA
Readback accuracy at 25° C ± 5° C	Voltage	0.07% +	6 mV	15 mV	25 mV	40 mV
	+ Current	0.15% +	67 mA	26 mA	15 mA	7 mA
	- Current	0.35% +	100 mA	44 mA	24 mA	15 mA
Load regulation	Voltage		1 mV	2 mV	3 mV	4 mV
	Current		2 mA	1 mA	0.5 mA	0.5 mA
Line regulation	Voltage		0.5 mV	0.5 mV	1 mV	1 mV
	Current		2 mA	1 mA	0.75 mA	0.5 mA

**Transient response time:** Less than 100 μs for the output voltage to recover to its previous level (within 0.1% of the voltage rating of the supply or 20 mV, whichever is greater) following any step change in load current of up to 50% of rated current.

**Isolation:** Output terminals can be floated up to ±240 Vdc from chassis ground.

### Supplemental Characteristics

Hewlett-Packard Model		6651A	6652A	6653A	6654A	6655A
Average programming resolution	Voltage	2 mV	5 mV	10 mV	15 mV	30 mV
	Current	15 mA	7 mA	4 mA	2.5 mA	1.25 mA
	OVP	12 mV	30 mV	54 mV	93 mV	190 mV
OVP accuracy		180 mV	400 mV	700 mV	1.2 V	2.4 V

**Remote sensing:** Up to half the rated output voltage can be dropped in each load lead. The drop in the load lead subtracts from the voltage available for the load. Add 3 mV to the voltage load regulation specification for each 1 volt change in the positive output lead due to load current change.

**Command processing time:** Average time required for the output voltage to begin to change following receipt of digital data is 20 ms for power supplies connected directly to the HP-IB.

**Output programming response time:** The rise and fall time (10/90% and 90/10%) of the output voltage is less than 15 ms. The output voltage change settles within 1 LSB (0.025% × rated voltage) of final value in less than 60 ms.

**Downprogramming:** An active downprogrammer sinks approximately 20% of the rated output current.

**Modulation:** (Analog programming of output voltage and current)  
Input signal: 0 to -5 V  
Input impedance: 10 K ohms nominal

#### AC input:

voltage	100 Vac	120 Vac	220 Vac	240 Vac
current	12 A	10 A	5.7 A	5.3 A

**Input power:** 1380 VA, 1100 W, at full load; 120 W at no load

**HP-IB interface capabilities:** SH1, AH1, T6, L4, SR1, RL1, PP0, DC1, DT1, EI, and C0. IEEE 488.2 and SCPI compatible command set

**RFI suppression:** Designed to comply with VDE 0871/6.78 level B

**Safety agency compliance:** Designed to comply with IEC 348, VDE 0411, UL1244, and CSA 556B

**Size:** 132.6 mm H × 425.5 mm W × 497.8 mm D (5.22 in × 16.75 in × 19.6 in)

**Weight:** Net, 25 kg (54 lb); shipping, 28 kg (61 lb)

**Warranty period:** Three years

### Key Features

- HP-IB programming of voltage and current
- Measured voltage and current readback over the HP-IB
- SCPI (Standard Commands for Programmable Instruments)\*
- Serial link connects up to 16 outputs to one HP-IB address\*
- Auto-parallel up to 3 units
- Outputs can be connected in parallel or in series
- Programmable overvoltage and overcurrent protection\*
- Overtemperature protection
- Discrete Fault Indicator/Remote Inhibit (DFI/RI)\*
- Selftest at power-on or from an HP-IB command
- Electronic calibration via HP-IB or front panel\*
- Five nonvolatile store/recall states\*
- User-definable power-on state\*
- Digital I/O controls external relay accessories\*
- Fan speed control minimizes acoustic noise\*

\* For more information on these features, see page 525.

### Ordering Information

HP Model	Output ratings	Price
HP 6651A	8 volts, 50 amperes	\$2,950
HP 6652A	20 volts, 25 amperes	\$2,750
HP 6653A	35 volts, 15 amperes	\$2,750
HP 6654A	60 volts, 9 amperes	\$2,750
HP 6655A	120 volts, 4 amperes	\$2,800

### Option descriptions

Opt 100:	87 to 106 Vac, 47 to 63 Hz	N/C
Opt 220:	191 to 233 Vac, 47 to 63 Hz	N/C
Opt 240:	209 to 250 Vac, 47 to 63 Hz	N/C
Opt 908:	Rack Mount Kit (HP p/n 5062-3977)	\$35
Opt 909:	Rack Mount Kit with handles (HP p/n 5062-3983)	\$85
Opt 910:	Service manual (HP p/n 5959-3321) and extra operating manual (HP p/n 5959-3348). Standard unit is shipped with operating manual only.	\$30

# POWER SUPPLIES

## Single-Output System: 2000W

### HP 6671A, 6672A, 6673A, 6674A, 6675A

529

- Low ripple and noise
- "One-Box" Solution: includes V and I readback
- Fast up- and downprogramming
- SCPI (Standard Commands for Programmable Instruments)

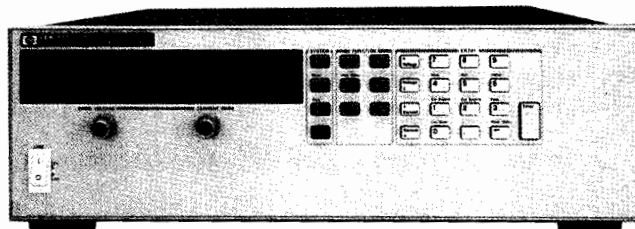

#### Specifications (at 0° C to 55° C unless otherwise specified)

Hewlett-Packard Model		6671A	6672A	6673A	6674A	6675A
Output ratings	Output voltage	0 to 8 V	0 to 20 V	0 to 35 V	0 to 60 V	0 to 120 V
	Output current	0 to 220 A	0 to 100 A	0 to 60 A	0 to 35 A	0 to 18 A
Programming accuracy: at 25°C ± 5°C	Voltage	0.04% +	8 mV	20 mV	35 mV	60 mV
	Current	0.1% +	125 mA	60 mA	40 mA	25 mA
Ripple and noise: from 20 Hz to 20 MHz	Constant voltage	rms	650 μV	750 μV	800 μV	1.25 mV
		peak-to-peak	5 mV	9 mV	9 mV	11 mV
	Constant current	rms	200 mA	100 mA	40 mA	25 mA
Readback accuracy: at 25°C ± 5°C	Voltage	0.05% +	12 mV	30 mV	50 mV	90 mV
	± Current	0.1% +	150 mA	100 mA	60 mA	35 mA
Load/line regulation:	Voltage	0.002% +	300 μV	650 μV	1.2 mV	2 mV
	Current	0.005% +	10 mA	7 mA	4 mA	2 mA

**Transient response time:** Less than 900 μsec for the output voltage to recover within 100 mV following a change in load from 100% to 50% or 50% to 100% of the output current rating of the supply.

**Isolation:** Output terminals can be floated up to ± 240 Vdc maximum from chassis ground.

#### Supplemental Characteristics

Hewlett-Packard Model		6671A	6672A	6673A	6674A	6675A
Average programming resolution:	Voltage	2 mV	5 mV	9 mV	15 mV	30 mV
	Current	55 mA	25 mA	15 mA	8.75 mA	4.5 mA
	OVP	15 mV	35 mV	65 mV	100 mV	215 mV
Output voltage programming response time: (excluding command processing time)	Full-load programming rise/fall time (10% to 90% or 90% to 10%)*	30 ms	60 ms	130 ms	130 ms	195 ms

\* With full resistive load equal to rated output voltage/rated output current

**Output common mode noise current:** (to signal ground binding post) 500 μA rms, 4 mA peak-peak

**Remote sensing:** Up to half the rated output voltage can be dropped in each load lead. The drop in the load leads subtracts from the voltage available for the load.

**Command processing time:** Average time required for the output voltage to begin to change following receipt of digital data is 20 ms for power supplies connected directly to the HP-IB.

**Modulation:** (Analog programming of output voltage and current) Input signal: 0 to -4 V for voltage 0 to 7 V for current

Input impedance: 30 KΩ or greater

See operating manual for exact values.

**AC input current:** (AC input frequency 47 to 63 Hz) 19A

**Input power:** 3800 VA, 2600 W at full load; 170 W at no load

**HP-IB interface capabilities:** SH1, AH1, T6, L4, SR1, RL1, PP0, DC1, DT1, E1, and C0. IEEE 488.2 and SCPI compatible command set

**RFI suppression:** Complies with FTZ 1046/84, Level B

**Safety agency compliance:** Designed to comply with VDE 0411 and UL1244. Complies with CSA 22.2 No. 231 and IEC 348.

**Size:** 132.6 mm H × 425.5 mm W × 640.0 mm D (5.22 in × 16.75 in × 25.2 in)

**Weight:** Net, 28.2 kg (62 lb); shipping, 31.8 kg (70 lb)

**Warranty period:** Three years

#### Key Features

- HP-IB programming of voltage and current
- Measured voltage and current readback over the HP-IB
- SCPI (Standard Commands for Programmable Instruments)\*
- Serial link connects up to 16 outputs to one HP-IB address\*
- Auto-parallel up to 5 units
- Outputs can be connected in series
- Programmable overvoltage and overcurrent protection\*
- Overtemperature protection
- Discrete Fault Indicator/Remote Inhibit (DFI/RI)\*
- Selftest at power-on or from an HP-IB command
- Electronic calibration via HP-IB or front panel\*
- 5 non-volatile store/recall states\*

- User-definable power-on state\*
- Digital I/O controls external relay accessories\*
- Fan speed control minimizes acoustic noise\*

\* For more information on these features, see page 525.

#### Ordering Information

HP Model	Output ratings	Price
HP 6671A	8 volts, 220 amperes	\$4,450
HP 6672A	20 volts, 100 amperes	\$4,400
HP 6673A	35 volts, 60 amperes	\$4,350
HP 6674A	60 volts, 35 amperes	\$4,300
HP 6675A	120 volts, 18 amperes	\$4,400

#### Option descriptions:

**Opt 200** 174-220 Vac, 47-63 Hz (Japan only) N/C

If option 200 is not ordered, the power supply will be configured to operate at 191-250 Vac, 47-63 Hz

One of the following line cord options must be specified when ordering. Order according to local electrical codes. All line cords are 2.5 meters long.

**Opt 831** 12 AWG wire size; unterminated line cord N/C

**Opt 841** Line cord with NEMA 6-20P, 20A/250V plug \$15

Option 831 or 841 suggested for use in North and South America, except for Canada. These options are for use on a dedicated branch circuit

**Opt 832** 4 mm<sup>2</sup> wire size; unterminated line cord N/C

**Opt 842** Line cord with IEC 309, 32A/220V plug \$75

Option 832 or 842 suggested for use in Europe and other countries not listed.

**Opt 843** Line cord with JIS C8303 appended fig 6(2), 20A/250V plug \$35

Option 843, 831 or 834 suggested for use in Japan.

**Opt 834** 10 AWG wire size, unterminated line cord N/C

**Opt 844** Line cord with NEMA L6-30P, 30A/250V locking plug \$55

Option 834 or 844 suggested for use in North and South America.

**Opt 908** Rack Mount Kit (HP p/n 5062-3977) \$35

**Opt 909** Rack Mount Kit with handles (HP p/n 5062-3983) \$85

# POWER SUPPLIES

## Single-Output System: 200 to 1000 W Autoranging

### HP 6030A, 6031A, 6032A, 6033A, 6035A, 6038A

- Autoranging output
- "One-Box" Solution: includes V and I readback
- SCPI (Standard Commands for Programmable Instruments)

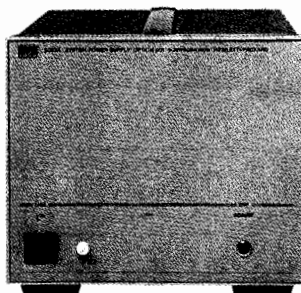
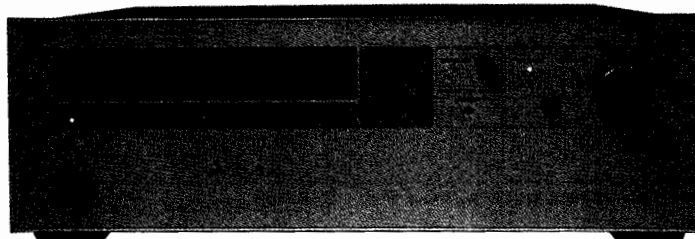

HP 6033A, and 6038A

HP 6033A and 6038A  
with Opt 001.

HP 6030A, 6031A, 6032A, and 6035A

### Specifications (at 0° C to 50° C unless otherwise specified)

Hewlett-Packard Model			6033A	6031A	6038A	6032A	6030A	6035A
Output ratings	Output voltage		0 to 20 V	0 to 20 V	0 to 60 V	0 to 60 V	0 to 200 V	0 to 500 V
	Output current		0 to 30 A	0 to 120 A	0 to 10 A	0 to 50 A	0 to 17 A	0 to 5 A
Autoranging Output*	V1		20 V	20 V	60 V	60 V	200 V	500 V
	P1		200 W	1000 W	200 W	1000 W	1000 W	1000 W
	V2		14 V	14 V	40 V	40 V	120 V	350 V
	P2		242 W	1064 W	240 W	1200 W	1200 W	1200 W
	V3		6.7 V	7 V	20 V	20 V	60 V	200 V
	P3		200 W	840 W	200 W	1000 W	1020 W	1000 W
Programming accuracy at 25° C ± 5° C	Voltage		0.035% + 9 mV	0.035% + 15 mV	0.035% + 40 mV	0.035% + 40 mV	0.035% + 145 mV	0.25% + 400 mV
	Current		0.15% + 20 mA	0.25% + 250 mA	0.085% + 10 mA	0.2% + 85 mA	0.2% + 25 mA	0.3% + mA
Ripple and noise from 20 Hz to 20 MHz	Constant voltage	rms	3 mV	8 mV	3 mV	8 mV	22 mV	50 mV
		peak-to-peak	30 mV	50 mV	30 mV	40 mV	50 mV	160 mV
	Constant current	rms	15 mA	120 mA	5 mA	25 mA	15 mA	50 mA
Readback accuracy at 25° C ± 5° C	Voltage		0.07% + 6 mV	0.08% + 7 mV	0.07% + 50 mV	0.08% + 20 mV	0.08% + 80 mV	0.5% + 200 mV
	Current		0.3% + 25 mA	0.4% + 100 mA	0.2% + 11 mA	0.36% + 35 mA	0.36% + 15 mA	0.5% + 50 mA
Load regulation	Voltage		0.01% + 2 mV	0.01% + 3 mV	0.01% + 3 mV	0.01% + 5 mV	0.01% + 5 mV	0.01% + 13 mV
	Current		0.01% + 9 mA	0.01% + 15 mA	0.01% + 5 mA	0.01% + 10 mA	0.01% + 10 mA	0.03% + 34 mA
Line regulation	Voltage		0.01% + 1 mV	0.01% + 2 mV	0.01% + 2 mV	0.01% + 3 mV	0.01% + 5 mV	0.01% + 13 mV
	Current		0.01% + 6 mA	0.01% + 25 mA	0.01% + 2 mA	0.01% + 10 mA	0.01% + 5 mA	0.03% + 17 mA
Transient Response Time 10% step change	Time		1 ms	2 ms	1 ms	2 ms	2 ms	5 ms
	Level		50 mV	100 mV	75 mV	100 mV	150 mV	200 mV

\*See the generalized autoranging output characteristic curve.

**Isolation:** Either terminal may be grounded, or may be floated up to  $\pm 240\text{V}$  ( $\pm 550\text{V}$  for the HP 6030A and 6035A) from chassis ground.

### Supplemental Characteristics

Hewlett-Packard Model		6033A	6031A	6038A	6032A	6030A	6035A
Average Programming Resolution	Voltage	5 mV	5 mV	15 mV	15 mV	50 mV	125 mV
	Current	7.5 mA	30 mA	2.5 mA	12.5 mA	4.25 mA	1.25 mA
	OVP	100 mV	100 mV	100 mV	200 mV	600 mV	1 V
AC Input Current:	100 Vac	6.0 A	24 A	6.0 A	24 A	24 A	24 A
	120 Vac	6.5 A	24 A	6.5 A	24 A	24 A	24 A
	220 Vac	3.8 A	15 A	3.8 A	15 A	15 A	15 A
	240 Vac	3.6 A	14 A	3.6 A	14 A	14 A	14 A
Weight (kg(lb)):	Net	9.6(21)	17.2(38)	9.6(21)	16.3(36)	16.3(36)	16.3(36)
	Shipping	11.4(25)	22.7(50)	11.4(25)	21.8(48)	21.8(48)	21.8(48)

**Remote sensing:** Remote sensing can be used to maintain the CV load effect specification at the load with up to 0.5 V drop per load lead, and sense wires that are less than 0.2  $\Omega$  per lead. Operation is possible with up to 2.0 V drop per lead; however, the load effect specification may be degraded.

**Modulation** (analog programming of output voltage and current): Analog programming inputs and monitoring terminals are provided on the rear panel in addition to the HP-IB programming capabilities. Zero to full-scale voltage or current can be programmed with either 0 to 5 V voltage signals, or 0 to 4000  $\Omega$  resistance signals. The monitoring terminals present 0 to 5 V buffered signals, which are proportional to the output voltage and current.

**Inductive load:** HP models 6030A, 6031A, 6032A, 6035A, and 6038A are stable when operating in CC into inductive loads up to 100 mH, and the HP 6033A and 6038A can handle up to 1 H. A special modification is available for HP Models 6030A, 6031A, and 6032A to ensure stable operation when operating into inductive loads up to 10 H.

**HP-IB interface capabilities:** SH1, T6, AH1, L4, SR1, RL1, PP1, DC1, DT1, IEEE 488.2 and SCPI compatible command set.

**RFI suppression:** Meets VDE 0871/6.78 Level B and FCC class B.

### Supplemental Characteristics (continued)

**Safety agency compliance:** Designed to comply with IEC 348 and VDE 0411, CSA 556B, ANSI C39.5 Part 0, Draft 8.

**Size:** HP 6033A and 6038A: 177.0 mm H × 212.3 mm W × 443.6 mm D (6.97 in × 8.36 in × 17.872 in) HP 6030A, 6031A, 6032A, and 6035A: 132.6 mm H × 425.5 mm W × 503.7 mm D (5.2 in × 16.75 in × 19.83 in)

**Warranty period:** Three years

### Key Features

- HP-IB programming of voltage and current
- Measured voltage and current readback over the HP-IB
- SCPI (Standard Commands for Programmable Instruments)\*
- Serial link connects up to 16 outputs to one HP-IB address\*
- Auto-parallel up to 2 units
- Outputs can be connected in series
- Overtemperature protection
- Discrete Fault Indicator/Remote Inhibit (DFI/RI)\*
- Selftest at power-on or from an HP-IB command
- 16 store/recall states
- Digital I/O controls external relay accessories\*

\* For more information on these features, see page 525.

### Autorangeing Output

As autorangeing power supplies, these models can provide a wide and continuous range of voltage and current combinations at the maximum rated power. This often allows both present and future requirements to be satisfied with fewer supplies, also reducing the number of instruments in the system.

### Optional Blank Front Panel

Often, control and monitoring via the front panel is very useful during system development, but is not needed afterwards. If the system is reproduced without further development, power supplies without front-panel controls and meters (Option 001) can be used (except with the HP 6035A). Ordering your power supplies with Option 001 significantly decreases the cost.

### Overvoltage and Overcurrent Protection

Because of the delicate nature of most loads, these system power supplies provide several different types of protection. Since they are CV/CC supplies, both the output voltage and the current will be automatically limited to the programmed values. If reaching programmed value indicates an undesirable condition, the power supply can be instructed to automatically downprogram to zero output. For example, if the programmed current limit is reached while testing a PC board assembly, it may indicate a shorted component. In this case, the FOLDBACK feature, if enabled, would be able to serve as an overcurrent protection circuit and downprogram the power supply automatically. FOLDBACK can be enabled and reset over the HP-IB. The built-in overvoltage protection circuit is adjustable with a front-panel control. The set trip level can be displayed on the front-panel meter and can also be read back over the HP-IB, thus making it easy to adjust the level. The OVP circuit, once tripped, can be reset over the HP-IB.

Production procedures sometimes require the operator to adjust the output voltage or current of a power supply locally with the front-panel controls. If this is done, programmed levels can be set to limit the available adjustment range to a safe margin.

Potentially harmful conditions, such as overtemperature and high or low ac input, will trigger the power supply to automatically downprogram to zero output. When these conditions occur, or the FOLDBACK or OVP circuits trip, LEDs on the front panel light to indicate the failure. This status can also be read back to the computer over the HP-IB and can be used to generate interrupts.

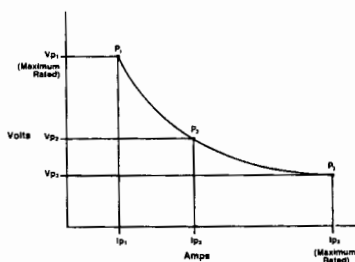

Generalized autorangeing output characteristic curve

### Ordering Information

HP Model	Output ratings	Price
HP 6030A	200 volts, 17 amperes, 1000 watts	\$3,850
HP 6031A	20 volts, 120 amperes, 1000 watts	\$3,850
HP 6032A	60 volts, 50 amperes, 1000 watts	\$3,850
HP 6033A	20 volts, 30 amperes, 200 watts	\$2,750
HP 6035A	500 volts, 5 amperes, 1000 watts	\$4,100
HP 6038A	60 volts, 10 amperes, 200 watts	\$2,750

### Option Descriptions:

**Opt 001** Front panel which has only line switch, line indicator, and OVP adjust – \$300

Standard unit is configured to operate at 104 to 127 Vac, 48 to 63 Hz. To operate at other input voltages, order one of the following line voltage options.

- Opt 100** 87-106 Vac, 48-63 Hz. This option is for use in Japan only. The power supply output power is 75% of the output power available with the other line voltage options. \$0
- Opt 220** 191-233 Vac, 48-63 Hz \$0
- Opt 240** 208-250 Vac, 48-63 Hz \$0

For HP models 6030A, 6031A, 6032A, and 6035A, one of the following line cord options must be specified when ordering. Order according to local electrical codes. All line cords are 2.5 meters long.

- Opt 831** 12 AWG wire size; UL listed, CSA certified; unterminated line cord (200-240 Vac connections) \$0
- Opt 833** 1.5 mm<sup>2</sup> wire size; Harmonized cordage; unterminated line cord (200-240 Vac connections) \$0
- Opt 834** 10 AWG wire size; UL listed, CSA certified; unterminated line cord (100-120 Vac connections) \$0
- Opt 841** Line cord with NEMA 6-20P, 20A/250V plug (suggested for use in North and South America) \$15
- Opt 843** Line cord with JIS C8303 appended fig 6(2), 20A/250V plug (suggested for use in Japan) \$35
- Opt 845** Line cord with IEC 309, 16A/220V plug (suggested for use in Denmark, Switzerland, Austria, China and other countries not listed) \$35
- Opt 846** Line cord with NEMA L5-30P, 30A/120V locking plug (suggested for use in North America) \$55
- Opt 847** Line cord with CEE 7/7, 16A/220V plug (suggested for use in continental Europe) \$35
- Opt 848** Line cord with BS 546, 15A/240V plug (suggested for use in India and South Africa) \$35

- Opt 800** Rack mount kit for two units side by side. This applies to HP 6033A and 6038A only. \$79
- Opt 908** Rack mount kit for a single unit. A blank filler panel is supplied when this option is ordered with HP 6033A and 6038A.
  - HP 6033A and 6038A \$84
  - HP 6030A, 6031A, 6032A and 6035A \$35
- Opt 909** Rack mount kit with handles for HP Models 6030A, 6031A, 6032A, 6035A \$85
- Opt 910** One extra operating and service manual shipped with each power supply. \$32

### Accessory

HP 5080-2148 serial link cable, 2m (6.6') \$6  
 Up to 16 power supplies can share one HP-IB address, while still providing full independent control. This feature requires programming in SCPI mode. To use this feature you will need to order one HP 5080-2148 serial link cable for each unit to be added to the chain, with the first unit connected directly to HP-IB.

# POWER SUPPLIES

## Multiple-Output System Power Supplies: Descriptions of Key Features

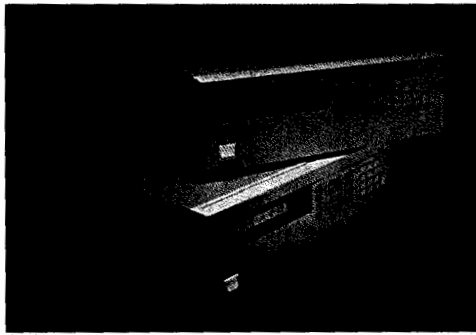

Most of the features and capabilities of the Hewlett-Packard single-output system power supplies, described on page 525 are also present in the multiple-output products described on the following pages. To determine which features are available with a specific model, please see the page on which it is described.

### Multiple-Output "One-Box" Solution

The HP 6620 Series are complete power supply systems, combining the functions of several power supplies and programmers, a scanner, precision current shunts, and a DVM in one box. One set of complete specifications covers the entire system from the HP-IB input to the output. These products allow substantial savings in purchase price, space, and cabling and integration costs.

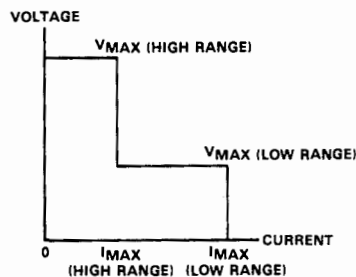

Figure 1 Output Characteristic Curve for HP 662XA Series Power Supplies

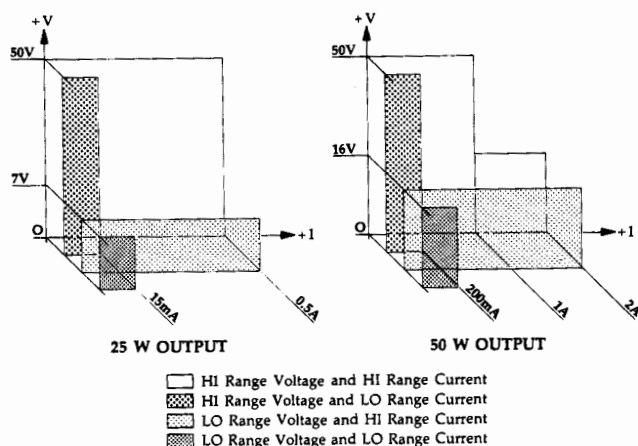

Figure 2

Each model packs up to 200 W in a 5/4-inch high rack-width package, providing 2, 3, or 4 independent isolated outputs. Each output provides extra flexibility by supplying power in both a high and a low range. (See Figures 1 and 2.) This feature can provide extended operating ranges and increased resolution to meet unique application requirements. The output range is selected according to the programmed values of voltage and current.

HP Models 6625A, 6626A, 6628A, and 6629A provide both precision programming and readback of measured voltage and current output. Their expanded resolution of up to 0.5 mV or 1  $\mu$ A in programming and readback makes them especially suitable for component evaluation and sub-assembly testing.

### Protection for the Unit Under Test

Programmable overvoltage and overcurrent protection are provided for each output. If the overvoltage setting is exceeded, a crowbar circuit is activated, which shorts the output. Terminals on the rear panel can be strapped together so that a fault on one output disables all outputs. Overtemperature conditions, or a drop in line voltage that would cause an unregulated output condition, will disable all outputs. Fault trips which disable the output can be reset over the HP-IB.

Local lockout capability enables the programmer to disable all front-panel controls over the HP-IB except the channel select (to allow display of the output voltage and current of any channel).

Option 750 is available on all units providing control of external relays, such as Models 59510A and 59511A. This allows the load to be physically disconnected from the power supply and provides for programmable polarity reversal. Also included are Discrete Fault Indicator (FLT) and Remote Inhibit (INH) lines, which can be used to implement additional protection for the device under test.

### Store/Recall States

These models allow up to 11 sets of voltage and current settings for all outputs to be stored or recalled with a single command. This reduces programming time by eliminating the separate processing time for up to 7 commands for each output.

In addition, Models 6625A, 6626A, 6628A, and 6629A provide 4 sets of non-volatile states, one of which can be programmed to provide predetermined output settings at turn-on.

### Downprogramming (Current Sinking Capability)

All outputs can source or sink the full rated output current, which speeds downprogramming of capacitive loads. This capability can significantly increase throughput of sub-assembly testing, and prevent the possibility of contact arcing or degradation in the system test head fixture. It also facilitates connection of the outputs in a bipolar mode of operation for component test applications requiring more than one output voltage.

### Calibration and Self-Test

With this series of power supplies, calibration is performed by computer without removing the instrument's cover. All that is required is a shunt, a DVM, a controller, and a few lines of code. Simple commands are used to cycle the power supply through adjustment points and to store calibration information in the supplies memory. Calibration is maintained through line-voltage cycling. An internal jumper can be removed to prevent the supply from accepting calibration commands.

The considerable self-test capability is exercised at power-on and upon receipt of the self-test command over the HP-IB. Running self-tests will not cause the outputs to change.

# POWER SUPPLIES

## Multiple-Output System Power Supplies: 40 to 80 W

HP 6621A, 6622A, 6623A, 6624A, 6627A

533

- 2, 3, or 4 independent isolated outputs
- Dual-range linear outputs
- Low ripple and noise
- Fast up- and down-programming

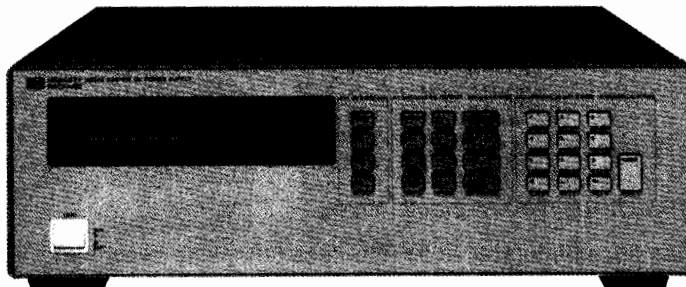

### Specifications (at 0° to 55° C unless otherwise specified)

		40 W Output	40 W Output	80 W Output	80 W Output	
Output Power	Low Range Volts, Amps	0 to 7 V, 0 to 5 A	0 to 20 V, 0 to 2 A	0 to 7 V, 0 to 10 A	0 to 20 V, 0 to 4 A	
	High Range Volts, Amps	0 to 20 V, 0 to 2 A	0 to 50 V, 0 to 0.8 A	0 to 20 V, 0 to 4 A	0 to 50 V, 0 to 2 A	
Output Combinations (total number of outputs)	HP 6621A (2)	—	—	2	—	
	HP 6622A (2)	—	—	—	2	
	HP 6623A (3)	1	1	1	—	
	HP 6624A (4)	2	2	—	—	
	HP 6627A (4)	—	4	—	—	
Programming Accuracy (at 25° C ± 5° C)	Voltage	19 mV + 0.06%	50 mV + 0.06%	19 mV + 0.06%	50 mV + 0.06%	
	Current	50 mA + 0.16%	20 mA + 0.16%	100 mA + 0.16%	40 mA + 0.16%	
Ripple and Noise (peak-to-peak, 20 Hz to 20 MHz; rms, 20 Hz to 10 MHz)	Constant Voltage	rms	3 mV	3 mV	3 mV	
		peak-to-peak	500 μV	500 μV	500 μV	
	Constant Current	rms	1 mA	1 mA	1 mA	1 mA
Readback Accuracy (at 25° C ± 5° C)	Voltage	20 mV + 0.05%	50 mV + 0.05%	20 mV + 0.05%	50 mV + 0.05%	
	+ Current	10 mA + 0.1%	4 mA + 0.1%	20 mA + 0.1%	8 mA + 0.1%	
	- Current	25 mA + 0.2%	8 mA + 0.2%	50 mA + 0.2%	20 mA + 0.2%	
Load Regulation	Voltage	2 mV	2 mV	2 mV	2 mV	
	Current	1 mA	0.5 mA	2 mA	1 mA	
Load Cross Regulation	Voltage	1 mV	2.5 mV	1 mV	2.5 mV	
	Current	1 mA	0.5 mA	2 mA	1 mA	
Line Regulation	Voltage	0.01% + 1 mV	0.01% + 1 mV	0.01% + 1 mV	0.01% + 1 mV	
	Current	0.06% + 1 mA	0.06% + 1 mA	0.06% + 1 mA	0.06% + 1 mA	

**Transient Response Time:** Less than 75 μs for the output to recover to within 75 mV of nominal value following a load change within specifications.

**Isolation:** All outputs can be floated up to ± 240 Vdc from chassis ground.

### Supplemental Characteristics

		40 W Output	40 W Output	80 W Output	80 W Output
Average Programming Resolution	Voltage	6 mV	15 mV	6 mV	15 mV
	Current	25 mA	10 mA	50 mA	20 mA
	OVP	100 mV	250 mV	100 mV	250 mV
Output Programming Response Time (time to settle within 0.1% of full scale output, after Vset command has been processed)		2 ms	6 ms	2 ms	6 ms

### General Specifications

**Remote sensing:** Up to 1 V drop per load lead. The drop in the load leads is subtracted from the voltage available for the load.

**Command processing time:** 7 ms typical with front-panel display disabled

**Downprogramming:** Current sink limits are fixed approximately 10% higher than source limits for a given operating voltage above 2.5 V.

**Input power:** 550 W max.

**HP-IB interface capabilities:** SH1, AH1, T6, L4, SR1, RL1, PP1, DC1, DT0

**Safety agency compliance:** Designed to comply with IEC 348, VDE 0411, UL 1244, ANSI C39.5, and CSA 556B.

**Size:** 132.6 mm H × 425.5 mm W × 497.8 mm D (5.22 in × 16.75 in × 19.6 in)

**Weight:** Net, 17.4 kg (38 lb); shipping, 22.7 kg (50 lb)

**Warranty period:** Three years

### Key Features

- HP-IB programming of voltage and current
- Measured voltage and current readback over the HP-IB
- Two outputs can be connected in parallel or in series
- Automatic selection of operating voltage/current range\*\*
- Programmable overvoltage and overcurrent protection\*
- Overtemperature protection
- Discrete Fault Indicator/Remote Inhibit (DFI/RI)\*

- Selftest at power-on or from an HP-IB command
- Electronic calibration via HP-IB\*
- 10 store/recall states\*
- Option 750 for relay control and DFI/RI\*\*

\* For more information on these features, see page 525.

\*\* For more information on these features, see page 532.

### Ordering Information

HP 6621A Dual-Output System Supply	\$4,000
HP 6622A Dual-Output System Supply	\$4,000
HP 6623A Triple-Output System Supply	\$4,450
HP 6624A Quad-Output System Supply	\$4,950
HP 6627A Quad-Output System Supply	\$4,950

### Option Descriptions

<b>Standard:</b> 104 to 127 Vac, 47 to 66 Hz, 5.4A	
<b>Opt 100:</b> 87 to 106 Vac, 47 to 66 Hz Input, 6.3A, (Japan only)	\$0
<b>Opt 220:</b> 191 to 233 Vac, 47 to 66 Hz, 3.0A	\$0
<b>Opt 240:</b> 209 to 250 Vac, 47 to 66 Hz, 3.0A	\$0
<b>Opt 750:</b> Protection Features and Relay Control	\$265
<b>Opt 908:</b> Rack Mount Kit (HP p/n 5062-3977)	\$35
<b>Opt 909:</b> Rack Mount Kit with Handles (HP p/n 5062-3983)	\$85
<b>Opt 910:</b> Service Manual and Extra Operating Manual. (Standard unit is shipped with operating manual only.)	\$32

# POWER SUPPLIES

## Precision Multiple-Output System Power Supplies: 25 to 50 W

HP 6625A, 6626A, 6628A, 6629A

- 14-bit programming and readback of voltage and current
- 2 or 4 independent isolated outputs
- Dual-range linear outputs
- Low ripple and noise
- Fast up- and down-programming

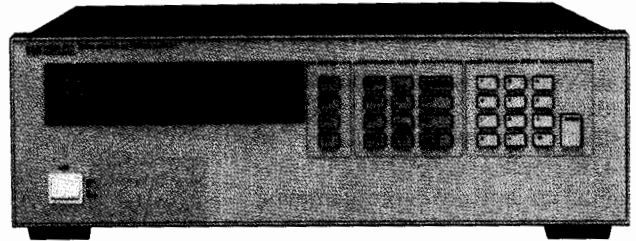

### Specifications (at 0° to 55° C unless otherwise specified)

Output Power	Output Range	25 Watt Output		50 Watt Output	
		Low Range	High Range	Low Range	High Range
	Output Volts	0 to 7 V	0 to 50 V	0 to 16 V	0 to 50 V or 0 to 16 V
	Output Amps	0 to 15 mA	0 to 500 mA	0 to 200 mA	0 to 1 A or 0 to 2 A
Output Combinations (total number of outputs)	HP 6625A (2)	1		1	
	HP 6626A (4)	2		2	
	HP 6628A (2)	0		2	
	HP 6629A (4)	0		4	
Programming Accuracy (at 25° C ± 5° C)	Voltage	1.5 mV + 0.016%	10 mV + 0.016%	3 mV + 0.016%	10 mV + 0.016%
	Current	15 μA + 0.04%	100 μA + 0.04%	185 μA + 0.04%	500 μA + 0.04%
Ripple and Noise (peak-to-peak, 20 Hz to 20 MHz; rms, 20 Hz to 10 MHz)	Constant Voltage	rms	3 mV	3 mV	3 mV
		peak-to-peak	500 μV	500 μV	500 μV
	Constant Current	rms	0.1 mA	0.1 mA	0.1 mA
Readback Accuracy (at 25° C ± 5° C)	Voltage	2 mV + 0.016%	10 mV + 0.016%	3.5 mV + 0.016%	10 mV + 0.016%
	Current	15 μA + 0.03%	130 μA + 0.03%	250 μA + 0.04%	550 μA + 0.04%
Load Regulation	Voltage	0.5 mV	0.5 mV	0.5 mV	0.5 mV
	Current	0.005 mA	0.005 mA	0.01 mA	0.01 mA
Load Cross Regulation	Voltage	0.25 mV	0.25 mV	0.25 mV	0.25 mV
	Current	0.005 mA	0.005 mA	0.01 mA	0.01 mA
Line Regulation	Voltage	0.5 mV	0.5 mV	0.5 mV	0.5 mV
	Current	0.005 mA	0.005 mA	0.01 mA	0.01 mA

**Transient Response Time:** Less than 75 μs for the output to recover to within 75 mV of nominal value following a load change from 0.1 A to full current.

**Isolation:** All outputs can be floated up to ±240 Vdc from chassis ground.

### Supplemental Characteristics

Average Programming Resolution	Voltage	25 W Low Range	25 W High Range	50 W Low Range	50 W High Range
		Current	460 μV	3.2 mV	1 mV
Output Programming Response Time (time to settle within 50 mV of programmed value after Vset command has been processed)	OVP	1 μA	33 μA	13 μA	131 μA
		230 mV	230 mV	230 mV	230 mV
		6 ms	6 ms	6 ms	6 ms

### General Specifications

**Remote sensing:** Up to 10 V total drop in the load leads. The drop in the load leads subtracts from the voltage available for the load.

**Command processing time:** 7 ms typical with front-panel display disabled.

**Current sink limits:** 25 W output: 0.5 A  
50 W output: 1 A (2 A below 16 V)

**Input power:** 550 W max

**HP-IB interface capabilities:** SH1, AH1, T6, L4, SR1, R1, PP1, DC1, DT0, C0, E1

**Safety agency compliance:** Designed to comply with IEC 348, VDE 0411, UL 1244, ANSI C39.5, and CSA 556B.

**Size:** 132.6 mm H × 425.5 mm W × 497.8 mm D (5.22 in × 16.75 in × 19.6 in)

**Weight:** HP 6625A and 6628A: Net, 15.5 kg (34 lb); shipping, 20.8 kg (46 lb)

HP 6626A and 6629A: Net, 17.7 kg (39 lb); shipping, 23.0 kg (51 lb)

**Warranty period:** Three years

### Key Features

- HP-IB programming of voltage and current to .5mV or 15 μA
- 14-bit measured voltage and current readback over the HP-IB
- Two outputs can be connected in parallel or in series
- Automatic selection of operating voltage/current range\*\*
- Programmable overvoltage and overcurrent protection\*
- Overtemperature protection
- Discrete Fault Indicator/Remote Inhibit (DFI/RI)\*
- Selftest at power-on or from an HP-IB command
- Electronic calibration via HP-IB\*

- 11 store/recall states: 4 nonvolatile\*
- User-definable power-on state\*
- Option 750 for relay control and DFI/RI\*\*

\* For more information on these features, see page 525.

\*\* For more information on these features, see page 532.

### Ordering Information

HP 6625A Dual-Output System Supply	\$4,850
HP 6626A Quad-Output System Supply	\$7,950
HP 6628A Dual-Output System Supply	\$4,850
HP 6629A Quad-Output System Supply	\$7,950

### Option Descriptions

Standard: 104 to 127 Vac, 47 to 66 Hz, 5.7A	\$0
Opt 100 87 to 106 Vac, 47 to 66 Hz Input, 6.3A	\$0

Opt 220 191 to 233 Vac, 47 to 66 Hz, 3.0A	\$0
Opt 240 209 to 250 Vac, 47 to 66 Hz, 3.0A	\$0
Opt 750 Relay Control and DFI/RI	\$265
Opt 908 Rackmount Kit (HP p/n 5062-3977)	\$35
Opt 909 Rackmount Kit with Handles (5062-3983)	\$85
Opt 910 Service Manual and Extra Operating Manual. (Standard unit is shipped with operating manual only.)	\$32

### Accessories

14852A Bias cable to connect either the HP 6626A or the HP 6629A to a 3-terminal device test fixture. (See Application Note 376-1, "Biasing Three-Terminal Devices for Test.")	\$300
--	-------



- Relay Accessories Isolate load from dc output
- Switch and sequence power and sense leads
- DC output polarity reversal (HP 59511A only)

- Power Supply Calibration Software
- Test and calibrate HP 6600 Power Supplies
- Quick menu-driven operation

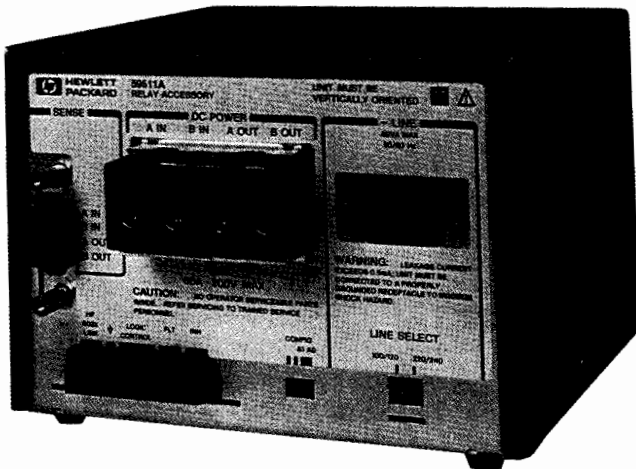

HP 59511A

### Relay Devices

The HP 59510A and 59511A are remote-controllable relay devices. These power supply accessories can be configured to switch dc power to multiple test fixtures or can be used to provide extra protection when a fault condition requires emergency shutdown. Each unit switches one power supply output. These relays can be used with any dc power supply within the voltage and current limits. The HP 59511A has all of the features of the HP 59510A and also provides relays for polarity reversal.

An internal microprocessor sequences the switching of power and sense leads. This protects the load by minimizing possible voltage overshoots. When used with HP system power supplies that are configured appropriately (see table on this page), the relays can be controlled through the power supply HP-IB port. For other applications, the HP 59510A and 59511A are controlled through a TTL signal port.

Both relay accessory models can be mounted on any one of three sides to a flat surface with the PEM fasteners provided. The rack-mount kit (Option 850) eases mounting behind the power supply or toward the front of the equipment rack.

The following table shows the HP power supplies that can be ordered with rear panel connections for direct control of the HP 59510A and 59511A.

HP Power Supply	Power Supply Option	Relay Devices Controlled
HP 6621A-6629A	750	4 HP 59510A relays or 2 HP 59511A relays
HP 6632A-6634A	760	This option includes built-in relay devices
HP 6651A-6655A	std	1 HP 59510A or 59511A
HP 6030A-6038A	std*	1 HP 59510A or 59511A

\* Models manufactured before May 1, 1988, do not have this capability. Contact your HP sales office for retrofit information.

### Specifications

**Operating ranges:** 200 V at 20A, or 120 V at 30A, or 48 V at 60A

**Isolation:** Input to output: 200 Vdc

Input/output to ground: 500 Vdc

TTL control to ground: 240 Vdc

**Settling time (TTL control):** Connect 440 ms, disconnect 160 ms, polarity reversal 600 ms

**dc voltage drop (at 60A):** 0.5 volts maximum on each relay

**ac Input:** equipped with a line module settable to nominal 100, 120, 220, or 240 Vac (-13% +6%), 48 to 63 Hz

### Weight:

**HP 59510A:** net, 2.3 kg (5 lb); shipping, 3.6 kg (8 lb); shipping with Option 850, 4.1 kg (9 lb)

**HP 59511A:** Net, 3.6 kg (8 lb); shipping, 5.0 kg (11 lb); shipping with Option 850, 5.5 kg (12 lb)

**Mounting orientation:** Within  $\pm 10^\circ$  from vertical

**Size:** 130.6 mm H  $\times$  185.4 mm W  $\times$  198.6 mm D (5.14 in  $\times$  7.26 in  $\times$  7.81 in)

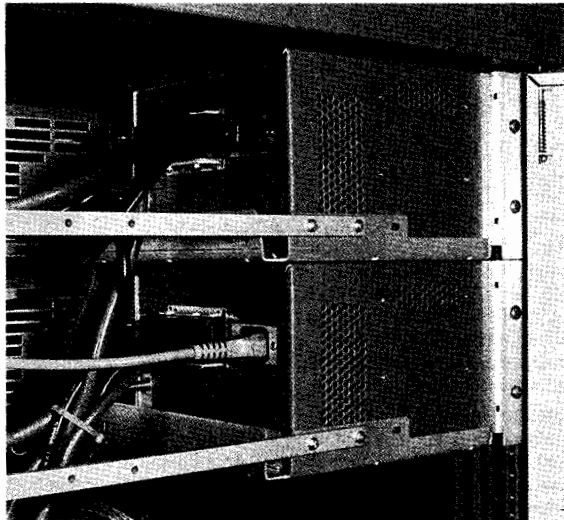

### Options

**Option 850** is a rackmount kit to facilitate mounting relay accessories. Side-by-side mounting of two devices requires two kits. For side-by-side mounting, adequate clearance is required so that the rear-exiting cables fit inside the rear wall or door of the rack. The clearance needed varies according to the flexibility of the user-supplied cables. Approximately 4 inches from the relay accessory panel is usually adequate.

**Option 910** is one extra operating and service manual.

### Power Supply Calibration Software

The HP 14921A power supply calibration software, together with the specified HP test equipment, automates the performance testing and alignment of HP 6600 Series System Power Supplies. It is especially valuable in large installations where regular calibration cycles are performed.

Tests include line and load regulation, programming accuracy, readback accuracy, ripple and noise, programming speed, and transient recovery time.

Required equipment includes HP 9000 Series 300 workstation; HP 3458A DMM; HP 3488A switch control unit; HP 44471 relay actuator; HP 44472A VHF switch; HP 6030A dc power supply; HP 6050A, 60503A, 60504A electronic loads; HP 59510A relay accessories; an AC source; and precision current shunts.

### Ordering Information

Item	Price
HP 59510A Output Isolation Relay Accessory	\$1,150
HP 59511A Output Isolation/Polarity Reversal Relay Accessory	\$1,550
Opt 850 Rack Mount Kit	+\$77
Opt 910 Extra Operating and Service Manual	+\$26
HP 14921A Power Supply Calibration Software	\$1,200

# POWER SUPPLIES

## Other HP-IB Programmable Products

HP 6002A, 59501B

- 200-watt autoranging dc output
- HP-IB option for either voltage or current control
- Built-in overvoltage protection

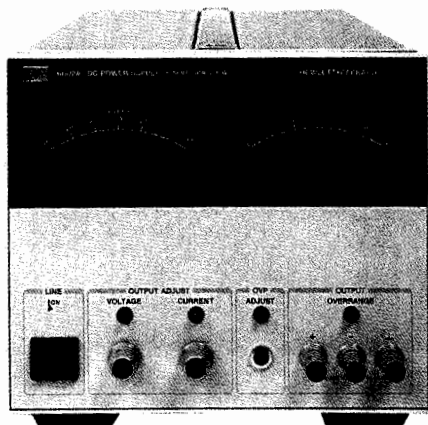

HP 6002A

### Description

The HP 6002A 200-watt autoranging power supply is recommended only for use in existing systems. For new systems, the HP Model 6653A or 6654A 500-watt supplies, or the HP Model 6642A, 6643A, or 6644A 200-watt supplies offer significant advantages in price and performance. The HP Models 6033A and 6038A 200-watt autorangers are also excellent alternatives to the HP Model 6002A.

### HP-IB Option

Option 001 is required for HP-IB control of either voltage or current. Selection of the controlled parameter is made via rear-panel manual switches. A 59501B digital-to-analog converter may be used to program current limit, while the internal HP-IB option programs the voltage.

### Specifications

**DC output:** Voltage and current output can be adjusted from 0 to 50 V, 0 to 10 A, 200 W maximum, by front-panel controls, analog programming, or an optional HP-IB interface

**Load regulation:** Voltage, 0.01% + 1 mV; current, 0.01% + 1 mA

**Line regulation:** voltage, 0.01% + 1 mV; current, 0.01% + 1 mA

**Ripple and noise:** 20 Hz to 20 MHz; voltage, 1 mV rms, 10 mV p-p; current, 5 mA rms

**Load transient recovery time:** 100  $\mu$ s for output voltage to recover within 15 mV of nominal voltage setting following a load current change of 50% to 100% or 100% to 50% of full load current

**Programming response time:** Maximum time for output voltage to change between 0 to 99.9% or 100% to 0.1% of maximum rated output voltage. Up-programming: 100 ms. Down-programming: 400 ms at no load, 200 ms at full load.

**DC output isolation:** 150 Vdc

**AC power:** 100, 120, 220, or 240 Vac (-13%, +6%), 48 to 63 Hz

**Temperature rating:** 0° C to 55° C operating, 40° C to 75° C storage. Supply is fan cooled.

**Size:** 180 mm H  $\times$  212 mm W  $\times$  422 mm D (6.97 in  $\times$  8.36  $\times$  16.6 in)

**Weight:** Net, 14.5 kg (32 lb); shipping, 15.9 kg (35 lb)

### HP-IB Option Specifications

Output	Range	Voltage	Current
Output ranges	hi	0 to 50 V	0 to 10 A
	lo	0 to 10 V	0 to 2 A
Accuracy	hi	0.2% + 25 mV	0.2% + 25 mA
	lo	0.2% + 10 mV	0.2% + 25 mA
Resolution	hi	50 mV	10 mA
	lo	10 mV	2 mA

### Ordering Information

**HP 6002A** Autoranging dc Power Supply

**Opt 001:** HP-IB interface

**Opt 800:** Rack flange kit for two units

**Opt 908:** Rack mounting kit for one unit

**Opt 910** Extra operating and service manual

**Price**

\$3,450

\$585

\$79

\$84

\$10

- HP-IB control for analog-programmable power supplies
- Unipolar/Bipolar HP-IB digital to analog converter
- Programmable 10-volt dc output



HP 59501B

### Description

The HP 59501B is an isolated digital-to-analog converter designed to provide a convenient interface between the Hewlett-Packard Interface Bus and those HP power supplies that are not equipped with built-in HP-IB control but are capable of being analog voltage controlled. With proper wiring, the built-in isolation devices protect other instrumentation on the HP-IB from damage that could be caused by power supply outputs. A programmable high/low range control improves resolution by ten to one.

The HP 59501B also can be used directly as a low power dc signal source.

### Digital to Analog Converter Specifications

**DC output voltage:** Programmable in high or low ranges within the voltage limits shown below. Output mode is unipolar or bipolar and is selected by a rear-panel switch.

Unipolar: 0 to 9.99 V (low range, 0 to 0.999 V)

Bipolar: -10 to +9.98 V (low range, -1 to +0.998 V)

**DC output current:** 10 mA maximum

**Ripple and noise:** 2 mV rms/10 mV p-p

**Resolution:** unipolar: 10 mV (low range, 1 mV)

bipolar: 20 mV (low range, 2 mV)

**Accuracy:** Specified at 23° C  $\pm$  5° C

unipolar: 0.1% + 5 mV (low range, 0.1% + 1 mV)

bipolar: 0.1% + 10 mV (low range, 0.1% + 2 mV)

### Power Supply Programmer Specifications

In the following specifications, M represents the calibrated full-scale value of the supply being programmed, and P is the actual programmed output. The full-scale value M can be any value within the supply's output range and is calibrated with the HP 59501B programmed to its maximum high-range output.

**Accuracy:** Specified at 23° C  $\pm$  5° C

Unipolar: 0.05% M + 0.25% P (low range, 0.01% M + 0.25% P)

Bipolar: 0.1% M + 0.25% P (low range, 0.02% M + 0.25% P)

**Isolation:** 600 Vdc between HP-IB data lines and output terminals  
Power: 100, 120, 220, or 240 Vac (-13%, +6%), 47 to 63 Hz, 10 VA (selectable on rear panel)

**Size:** 101.6 mm H  $\times$  212.9 mm W  $\times$  294.6 mm D (4 in  $\times$  8.38 in W  $\times$  11.6 in D)

**Weight:** Net, 1.82 kg (4 lb); shipping, 2.27 kg (5 lb)

### Ordering Information

**HP 59501B** HP-IB Isolated D/A Power Supply Programmer

**Opt 910** Extra operating and service manual

**HP p/n 5060-0173** rack kit for one unit

**HP p/n 5060-0174** rack kit for two units

☎ For off-the-shelf shipment, call 800-452-4844.

**Price**

\$1,100

\$5.35

\$85

\$75

# POWER SUPPLIES

Laboratory: Single and Multiple Output, 10W to 38W  
HP E3610A-E3612A, 6209B, and 6234A-6237B

537

- HP E3610A-E3612A . . . 30-watt output
- Dual ranges
- Digital voltage and current meters
- HP 6209B . . . 32-watt output
- 320 volts
- Remote sensing

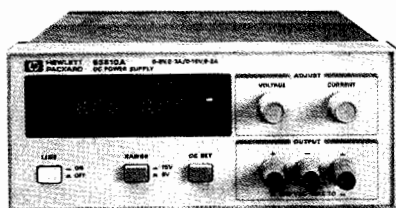

Single Output HP E3610A-E3612A



Single Output: HP 6209B

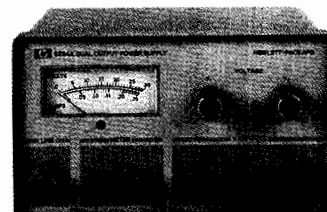

Dual Output: HP 6234A

## Description – Single Output Models

### HP E3610A-E3612A

These popular low-cost CV/CC bench supplies are designed for general laboratory use.

The constant voltage/constant current output allows operation as either a voltage source or current source, with the changeover occurring automatically based on the load. This characteristic also provides an adjustable current limit, so that an electronic engineer can set the safest current limit level for any particular DUT. And the CC Set button allows the current limit to be set without having to short the output.

Each model has two ranges to choose from, allowing more current at a lower voltage. Either the positive or negative terminal may be connected to ground, providing a positive or negative voltage output. Power supplies may be connected in series, to provide a higher output voltage. Either terminal may be floated up to  $\pm 240$  volts from ground.

The dual digital meters allow you to easily monitor current and voltage simultaneously, adjusting as needed with the 10-turn voltage control and the 1-turn current control.

These supplies measure 88 mm H, 212 mm W, and 318 mm D (3.5 in  $\times$  8.4 in  $\times$  12.5 in). They weigh 3.8 kg (8.4 lb).

### HP 6209B

This CV/CC power supply covers a range up to 320 volts. It is equipped with 10-turn voltage and current controls, and front- and rear-panel terminals.

Units may be bench operated or rack mounted individually or in pairs using accessory rack mounting hardware. They measure 89 mm H  $\times$  216 mm W  $\times$  317 mm D (3.5 in  $\times$  8.5 in  $\times$  12.5 in) and weigh 4.5 kg (10 lb).

## Description – Dual Output Models

### HP 6234A

The HP 6234A is a low-cost, dual-output bench power supply with two independently adjustable and isolated power sources in one compact unit. Both of the dc power sources are of the constant voltage/current limit type with each output voltage being adjustable continuously over a 0 to 25 V range. The maximum current available per output is 0.2 A and is limited automatically to prevent overload.

The HP 6234A offers considerable flexibility to the user with output voltages that can be arranged to provide identical or different voltages in any polarity combination with respect to 0 or other common positive or negative voltage points. The outputs can also be connected in series to provide up to 50 V at 0.2 A. Both sources are fully isolated to permit either of the output terminals to be grounded.

With push-button switches, users can select either voltage or current for each output to be monitored on the unit's meter. Other features include two multiple-turn controls for precise voltage setting, regulation to 0.01 percent, and in ripple and noise of less than 200 microvolts rms.

With dimensions of only 93 mm H  $\times$  157 mm W  $\times$  210 mm D (3.64 in  $\times$  6.17 in  $\times$  8.25 in), the HP 6234A supply takes up a minimum amount of bench space. Its weight is 2.3 kg (5 lb). The unit can be powered from a 115 V or an optional 230 V, 47 to 63 Hz ac input (Option 028).

### HP 6205C

This low-cost bench supply is equipped with 10-turn output voltage controls, volt/ampere meter, meter function/range switch, and front and rear output terminals. In addition, an output range switch permits the selection of either a high or low output voltage range.

The HP 6205C combines the versatility of a dual power supply with the flexibility of auto-parallel and auto-series operation to extend the output ratings of this supply to 20 V/1.2 A, 40 V/0.6 A, and 80 V/0.3 A. In addition, using the supply's auto-tracking capability, opposite polarity voltages ( $\pm 20$  V,  $\pm 40$  V) can conveniently be obtained from this one supply.

# POWER SUPPLIES

Laboratory: Single & Multiple Output, 10W to 38W (cont'd)

HP 6200B – 6218C and 6234A – 6237B

- Dual output to 24 watts
- Short-circuit proof
- Independent voltage controls

- Triple output to 38 watts
- Short-circuit proof
- Tracking  $\pm 20$  volt outputs

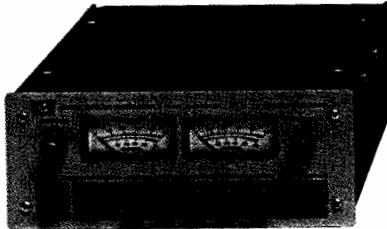

Dual Output: HP 6205C



Triple Output: HP 6235A

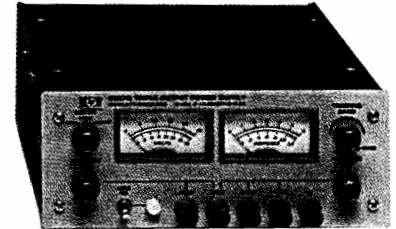

Triple Output: HP 6236B, 6237B

This constant voltage/current limiting supply is short-circuit protected by a fixed current limiting circuit that is activated at approximately 110 percent of rated load current. The current-limit point can be reduced by changing the value of a single internal resistor. Units may be bench operated or rack mounted individually or in pairs using accessory rack mounting hardware.

## Description – Triple Output Models

### HP 6235A

This compact, low-cost, three-in-one power supply is a handy addition to the lab bench where single or multiple voltages are needed for designing and testing breadboards and prototypes. The HP 6235A delivers three adjustable dc output voltages: 0 to +6 V at 1 A, 0 to +18 V at 0.2 A, and 0 to –18 V at 0.2 A. A single 0 to 36 volt output at 0.2 A can also be obtained by connecting across the +18 V and –18 V terminals.

The controls, meter, and binding posts are conveniently arranged on the front panel. One voltage control simultaneously adjusts the +18 V and –18 V outputs, which track one another and can be used to power additional amplifiers and other circuits requiring balanced positive and negative voltages. The supply's dual outputs have added versatility with an adjustable tracking ratio control (TRACK) that can set the negative output to a lower voltage than the positive output. Once the tracking ratio control has established a voltage ratio between the positive and negative outputs, the ratio remains constant as the +18 V voltage control is adjusted. A third control sets the 0 to +6 V output voltage.

The supply is a constant voltage/current limit type with each output voltage continuously adjustable over its range, while the maximum current available is automatically limited to prevent overloading. The power supply's outputs share a common terminal and are isolated from chassis ground so that any output terminal can be grounded, if desired. Each output voltage or current can be quickly selected and monitored with the push-button meter switches.

Model 6235A measures 89 mm H  $\times$  157 mm W  $\times$  210 mm D (3.5 in  $\times$  6.17 in  $\times$  8.25 in) and weighs 2.3 kg (5 lb).

### HP 6236B and 6237B

Microprocessors, digital and linear integrated circuits, and displays used in lab development frequently requires triple output power supplies for operating prototypes. The HP 6236B and 6237B are valued additions to the design bench due to their multiple output voltages, small size, ease of operation, and application-related performance.

These compact constant voltage/current limiting supplies combine 0 to  $\pm 20$  V tracking outputs rated at 0.5 A with a single output rated at 0 to +6 volts at up to 2.5 A in the HP 6236B, and 0 to +18 volts at 1 A in the HP 6237B.

Controls, meters, and binding posts are logically arranged on a neatly laid out front panel. One voltage control simultaneously adjusts the 20 V and –20 V outputs, which track within 1 percent to power operational amplifiers and circuits requiring balanced voltages. A tracking ratio control can disable the 1:1 tracking feature and set the negative output to a lower voltage than that of the positive output. Once the tracking ratio control has established a voltage ratio between the positive and negative outputs, the ratio remains constant as the  $\pm 20$  V voltage control varies both outputs. Another voltage control sets the 0 to +6 V (HP 6236B) or 0 to +18 V (HP 6237B) output.

All outputs are protected against overload and short-circuit damage by fixed current limiting circuits. For any overload condition, the +20 V and –20 V outputs in both models are limited to 0.55 A and the +18 V output in the HP 6237B is limited to 1.1 A. The overload protection circuit for the +6 V output in the HP 6236B has a current foldback characteristic that reduces the maximum available current from about 2.75 A at a 6 V terminal voltage to 1 A at zero volts (or short circuited). This foldback-limiting characteristic maximizes the available current in the important 5 to 6 volt range while minimizing dissipation during overloads.

Another protective feature safeguards sensitive load circuitry by preventing an output voltage overshoot when the supply is turned on or off.

Separate dual-range panel meters allow both the voltage and current of any output to be monitored simultaneously. A three-position switch selects the output that the meters will monitor.

Both models measure only 89 mm H  $\times$  216 mm W  $\times$  319 mm D (3.5 in  $\times$  8.5 in  $\times$  12.5 in) and weigh 4.3 kg (9.5 lb).

### Specifications

RATINGS		PERFORMANCE							GENERAL	
dc output		HP Model	Load Effect	Source Effect	PAR rms/p-p	Control Mode and Resolution	Remote Control Coefficients	Power 115 Vac ± 10%	Options	Price
Volts	Amps									
<b>SINGLE OUTPUT - UP TO 30 WATTS - DUAL RANGE</b>										
0 to 8/0 to 15	0 to 3/0 to 2	HP E3610A	0.01% + 2 mV	0.01% + 2 mV	200 μV/2 mV	CV/CC	**	47 to 63 Hz 0.8A, 70 W	0E3, 0E9	\$300
0 to 20/0 to 35	0 to 1.5/0 to 0.85	HP E3611A	0.01% + 2mV	0.01% + 2 mV	200 μV/2 mV	CV/CC	**	47 to 63 Hz 0.8A, 70 W	0E3, 0E9	\$300
0 to 60/0 to 120	0 to 0.5/0 to 0.25	HP E3612A	0.01% + 2 mV	0.01% + 2 mV	200 μV/2 mV	CV/CC	**	47 to 63 Hz 0.8A, 70 W	0E3, 0E9	\$300
<b>SINGLE OUTPUT - UP TO 32 WATTS - 320 VOLTS</b>										
0 to 320	0 to 0.1	HP 6209B	0.02% + 2 mV	0.02% + 2 mV	1 mV/40 mV	CV/CC 40 mV/200 μA	3000 Ω/V ± 1% 150 kΩ/A ± 10%	48 to 63 Hz 1 A, 60 W	28 910	\$1,270
<b>DUAL OUTPUT - 10 WATTS</b>										
Dual output 0 to 25 and 0 to 25	0.2 0.2	HP 6234A	0.01% + 1 mV	0.01% + 1 mV	200 μV/1 mV	CV/CL	**	104 to 127 Vac 47 to 63 Hz 0.26A, 35 W	28 910	\$640
<b>DUAL OUTPUT - 24 WATTS - DUAL RANGES</b>										
Two dual ranges 0 to 20/0 to 40 and 0 to 20/0 to 40	0 to 0.6/0.3 0 to 0.6/0.3	HP 6205C	0.01% + 4 mV	0.01% + 4 mV	200 μV/1 mV	CV/CL 10 mV/*	200 Ω/V ± 1%	48 to 440 Hz 0.5 A, 50 W	910 11, 28 40	\$1,150
<b>TRIPLE OUTPUT - 13 WATTS</b>										
Triple output 0 to 6 and 0 to 18 and 0 to -18	0 to 1 0 to 0.2 0 to 0.2	HP 6235A	8 mV 10 mV 10 mV	8 mV 15 mV 15 mV	1 mV/5 mV 1 mV/5 mV 1 mV/5 mV	CV/CL	** ** **	47 to 63 Hz 0.26 A, 35 W	910 28	\$700
<b>TRIPLE OUTPUT - 35 WATTS</b>										
Triple output 0 to +6 and 0 to +20 and 0 to -20	2.5 0.5 0.5	HP 6236B	0.01% + 2 mV	0.01% + 2 mV	350 μV/1.5 mV	CV/CL 70 mV/*	**	104 to 127 Vac 47 to 63 Hz 1.2 A, 112 W	100, 220 240, 910	\$930
<b>TRIPLE OUTPUT - 38 WATTS</b>										
Triple Output 0 to +18 and 0 to +20 and 0 to -20	1 0.5 0.5	HP 6237B	0.01% + 2 mV	0.01% + 2 mV	350 μV/1.5 mV	CV/CL 70 mV/*	**	104 to 127 Vac 47 to 63 Hz 1.2 A, 112 W	100, 220 240, 910	\$930

\* fixed current limit.

\*\* remote control not available.

### Option Descriptions

- Opt 0E3** 230 Vac ± 10%, 47 to 63 Hz input. Factory installable only. \$0
- Opt 0E9** 100 Vac ± 10%, 47 to 63 Hz input. Factory installable only. Intended for use in Japan. \$0
- Opt 011** Internal overvoltage protection crowbar. Protects delicate loads against power supply failure or operator error. Dual output model has dual crowbar. HP 6205C +\$210
- Opt 028** 230 Vac ± 10%, single phase input. Consists of reconnecting power transformer taps, and other components where necessary. \$0
- Opt 040** Multiprogrammer interface. Prepares HP 6205C power supplies for resistance programming by the HP 6942A, 6944A, or 6954A Multiprogrammer. +\$80

- Opt 100** 87 to 106 Vac, 47 to 63 Hz, single phase input. \$0
- Opt 220** 191 to 233 Vac, 47 to 63 Hz, single phase input \$0
- Opt 240** 208 to 250 Vac, 47 to 63 Hz, single phase input \$0
- Opt 910** One additional operating and service manual is shipped with each power supply. (HP 6209B-6237B) +\$5.35

### Accessories

- HP 14513A** Rack kit for one HP 6209B, 6236B, or 6237B supply \$100 ☎
  - HP 14523A** Rack kit for two of the above power supplies \$60 ☎
- ☎ For off-the-shelf shipment, call 800-452-4844.

# POWER SUPPLIES

## General Purpose: 25 to 200 W Output

### HP 6227B-6299A

- Constant voltage/constant current operation
- Remote sensing and programming
- Auto-series, -parallel, and -tracking operation
- Front and rear output terminals
- Floating output—use as positive or negative source
- Bench or rack mounting



HP 6281A, 6284A, 6289A,  
6294A, 6299A

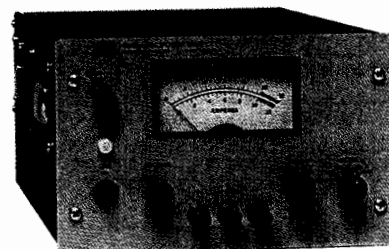

HP 6282A, 6286A,  
6291A, 6296A

### Description

#### HP 6281A-6299A Single Output

This series of medium-power constant voltage/constant current power supplies is available in two power ranges: 37 to 75 watts (packaged in 3/4-inch high half-rack cases) and 100 to 200 watts (packaged in 5/4-inch high half-rack cases). All models except HP 6294A and 6299A have separate coarse and fine voltage and current controls that allow the voltage and current outputs to be varied from zero to the maximum rated values. The latter two models have 10-turn voltage controls. Crossover from constant voltage to constant current operation occurs automatically when the load current exceeds the value established by the current control settings. A four-position meter function switch selects either of two output voltage or output current ranges (X1, X0.1) for display on the panel meter.

The 37 to 75 watt models are of the series-regulated type. They have excellent regulation and ripple characteristics and include a special output-capacitor discharge circuit for improved programming speed. The 100 to 200 watt models employ a series-regulator/SCR-preregulator configuration to achieve the high efficiency necessary for a convection-cooled package of this size. They also have excellent regulation, low ripple and noise, and moderate programming speeds.

#### HP 6253A and 6255A Dual Output

These versatile dual-output models each contain two identical, independently adjustable 60-watt power supplies in a full-rack width case. The regulator, voltage, and current control, and the metering circuits of each section of the supply, are electrically identical to those of the individual 37 to 75 watt models described above.

By combining the versatility of a dual power supply with the flexibility of auto-series and auto-parallel operation, twice the maximum rated output voltage or current of each section can be obtained from the one supply. In addition, using the supply's auto-tracking capability, opposite-polarity voltages ( $\pm 20$  V for HP 6253A or  $\pm 40$  V for HP 6255A) are possible.

#### HP 6227B and 6228B Dual Output

These versatile lab supplies each house two identical 50-watt regulated power supplies. A convenient front-panel switch selects either independent or tracking operation. In the track mode, the right supply tracks the left within  $0.2\% \pm 2$  mV. The tracking mode is especially useful for powering operational amplifiers, push-pull stages, deflection systems, or any application where plus and minus voltages must track with insignificant error. The independent mode permits operation of the two supplies individually, in auto-parallel or in auto-series.

### Specifications

RATINGS			PERFORMANCE							
DC Output		HP Model	Load Effect		Source Effect		Ripple & Noise (PARD) (rms/p-p)		Drift (stability)	
Volts	Amperes		Voltage	Current	Voltage	Current	Voltage	Current	Voltage	Current
0 to 7.5	0 to 5	6281A	5 mV	0.01% + 250 $\mu$ A	0.01% + 2 mV	0.01% + 250 $\mu$ A	200 $\mu$ V/1 mV	4 mA rms	0.1% + 2.5 mV	0.1% + 12.5 mA
0 to 10	0 to 10	6282A	0.01% + 1 mV	0.05% + 1 mA	0.01% + 1 mV	0.05% + 1 mA	500 $\mu$ V/25 mV	5 mA rms	0.1% + 2.5 mV	0.1% + 25 mA
0 to 20	0 to 3	6253A*	0.01% + 4 mV	0.01% + 250 $\mu$ A	0.02% + 2 mV	0.01% + 250 $\mu$ A	200 $\mu$ V/1 mV	2 mA rms	0.1% + 2.5 mV	0.1% + 7.5 mA
0 to 20	0 to 3	6284A	0.01% + 4 mV	0.01% + 250 $\mu$ A	0.01% + 2 mV	0.01% + 250 $\mu$ A	200 $\mu$ V/1 mV	2 mA rms	0.1% + 2.5 mV	0.1% + 7.5 mA
0 to 20	0 to 10	6286A	0.01% + 1 mV	0.05% + 1 mA	0.01% + 1 mV	0.05% + 1 mA	500 $\mu$ V/25 mV	5 mA rms	0.1% + 2.5 mV	0.1% + 25 mA
0 to 25	0 to 2	6227B*	0.01% + 1 mV	0.01% + 250 $\mu$ A	1 mV	100 $\mu$ A	250 $\mu$ V/4 mV	250 $\mu$ A/2 mA	0.2% + 2 mV	0.2% + 3 mA
0 to 25	0 to 2				1 mV	100 $\mu$ A	250 $\mu$ V/4 mV	250 $\mu$ A/2 mA	0.2% + 2 mV	0.2% + 3 mA
0 to 40	0 to 1.5	6255A*	0.01% + 2 mV	0.01% + 250 $\mu$ A	0.01% + 2 mV	0.01% + 250 $\mu$ A	200 $\mu$ V/1 mV	500 $\mu$ A rms	0.1% + 2.5 mV	0.1% + 4 mA
0 to 40	0 to 1.5				0.01% + 2 mV	0.01% + 250 $\mu$ A	200 $\mu$ V/1 mV	500 $\mu$ A rms	0.1% + 2.5 mV	0.1% + 4 mA
0 to 40	0 to 1.5	6289A	0.01% + 2 mV	0.01% + 250 $\mu$ A	0.01% + 2 mV	0.01% + 250 $\mu$ A	200 $\mu$ V/1 mV	500 $\mu$ A rms	0.1% + 2.5 mV	0.1% + 4 mA
0 to 40	0 to 5	6291A	0.01% + 1 mV	0.05% + 1 mA	0.01% + 1 mV	0.05% + 1 mA	500 $\mu$ V/25 mV	3 mA rms	0.1% + 2.5 mV	0.1% + 12.5 mA
0 to 50	0 to 1	6228B*	0.01% + 1 mV	0.01% + 250 $\mu$ A	1 mV	100 $\mu$ A	250 $\mu$ V/4 mV	250 $\mu$ A/2 mA	0.2% + 2 mV	0.2% + 1.5 mA
0 to 50	0 to 1				1 mV	100 $\mu$ A	250 $\mu$ V/4 mV	250 $\mu$ A/2 mA	0.2% + 2 mV	0.2% + 1.5 mA
0 to 60	0 to 1	6284A	0.01% + 2 mV	0.01% + 250 $\mu$ A	0.01% + 2 mV	0.01% + 250 $\mu$ A	200 $\mu$ V/1 mV	500 $\mu$ A rms	0.1% + 2.5 mV	0.1% + 2.5 mA
0 to 60	0 to 3	6289A	0.01% + 1 mV	0.05% + 1 mA	0.01% + 1 mV	0.05% + 1 mA	500 $\mu$ V/25 mV	3 mA rms	0.1% + 2.5 mV	0.1% + 7.5 mA
0 to 100	0 to 0.75	6299A	0.01% + 2 mV	0.01% + 250 $\mu$ A	0.01% + 2 mV	0.01% + 250 $\mu$ A	200 $\mu$ V/1 mV	500 $\mu$ A rms	0.1% + 2.5 mV	0.1% + 2 mA

\*Models 6227B, 6228B, 6253A, and 6255A contain two identical, independently adjustable power supplies.

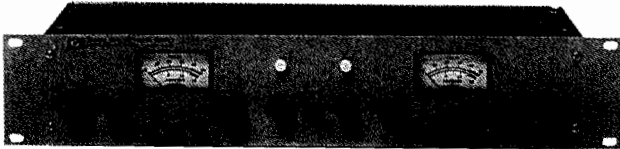

HP 6253A, 6255A

Each side of the dual supply can be operated as a constant voltage or constant current source, and each has its own crowbar for overvoltage protection. In the tracking mode, an overvoltage condition in either supply trips both crowbars. The power supply outputs are isolated up to 300 V from output to chassis or output to output.

**Specifications – General**

**Load effect transient recovery:** Time, 50  $\mu$ s; level, 15 mV  
**Meter accuracy:** 3% of full scale  
**Power:** Standard input voltage is 115 Vac  $\pm$  10%. Order Option 028 for 230 Vac  $\pm$  10% operation. Input power frequency, maximum input current, maximum power consumption are:  
 HP 6227B, 6228B—48 to 63 Hz, 2.7 A, 260 W;  
 HP 6253A—48 to 440 Hz, 2.6 A, 235 W; HP 6255A—48 to 440 Hz, 2.6 A, 235 W; HP 6281A—48 to 440 Hz, 1.3 A, 118 W; HP 6282A—57 to 63 Hz, 3.5 A, 200 W; HP 6284A—48 to 440 Hz, 1.5 A, 128 W; HP 6286A—57 to 63 Hz, 5.5 A, 320 W; HP 6289A—48 to 440 Hz, 1.3 A, 110 W; HP 6291A—57 to 63 Hz, 5.5 A, 280 W; HP 6294A—48 to 440 Hz, 1.3 A, 114 W; HP 6296A—57 to 63 Hz, 4.5 A, 250 W; HP 6299A—48 to 440 Hz, 1.5 A, 135 W.  
**Size:** 6227B, 6228B: 155 mm H  $\times$  197 mm W  $\times$  309.55 mm D (6 $\frac{1}{2}$  in  $\times$  7 $\frac{1}{2}$  in  $\times$  12 $\frac{1}{16}$  in)  
 HP 6253A, 6255A: 87 mm H  $\times$  483 mm W  $\times$  403 mm D (3 $\frac{1}{16}$  in  $\times$  19 in  $\times$  15 $\frac{1}{16}$  in)  
 HP 6281A, 6284A, 6289A, 6294A, 6299A: 87 mm H  $\times$  209 mm W  $\times$  398 mm D (3 $\frac{1}{16}$  in  $\times$  8 $\frac{1}{32}$  in  $\times$  15 $\frac{1}{16}$  in)  
 HP 6282A, 6286A, 6291A, 6296A: 131 mm H  $\times$  210 mm W  $\times$  435 mm D (5 $\frac{1}{8}$  in  $\times$  8 $\frac{1}{4}$  in  $\times$  17 $\frac{1}{16}$  in)

**Option Descriptions**

See the Options listing in the table below for availability.  
**Opt 005** 50-Hz ac input: Optimizes power supplies that require adjustment/modification for 50-Hz operation. \$0  
**Opt 010** Chassis slides. Enable convenient access to rack-mounted power supply for maintenance. + \$90

**Specifications (continued)**

REMOTE CONTROL FEATURES								GENERAL						
Resistance Coefficient		Voltage Coefficient		Speed, UP*		Speed, DOWN*		Overvoltage		Weight			Options	Price
Voltage	Current	Voltage	Current	NL	FL	NL	FL	Range	Margin	Net	Shipping			
200 $\Omega$ /V $\pm$ 1%	200 $\Omega$ /A $\pm$ 10%	1 V/V $\pm$ 1%	0.2 V/A $\pm$ 10%	1 ms	2 ms	10 ms	8 ms	2.5 to 10 V	4% + 2 V	6.4 kg/14 lb	7.2 kg/16 lb	11, 28, 40	\$1,210	
200 $\Omega$ /V $\pm$ 1%	100 $\Omega$ /A $\pm$ 10%	1 V/V $\pm$ 1%	100 mV/A $\pm$ 10%	70 ms	200 ms	9 s	40 ms	1 to 13 V	7% + 1 V	11.3 kg/25 lb	13.6 kg/30 lb	5, 11, 28, 40	\$1,520	
200 $\Omega$ /V $\pm$ 1%	500 $\Omega$ /A $\pm$ 10%	1 V/V $\pm$ 1%	0.33 V/A $\pm$ 10%	30 ms	80 ms	400 ms	100 ms	2.5 to 23 V	4% + 2 V	12.7 kg/28 lb	17.7 kg/39 lb	10, 11, 28, 40	\$2,100	
200 $\Omega$ /V $\pm$ 1%	500 $\Omega$ /A $\pm$ 10%	1 V/V $\pm$ 1%	0.33 V/A $\pm$ 10%	30 ms	80 ms	400 ms	100 ms	2.5 to 23 V	4% + 2 V	6.4 kg/14 lb	7.2 kg/16 lb	11, 28, 40	\$1,100	
200 $\Omega$ /V $\pm$ 1%	100 $\Omega$ /A $\pm$ 10%	1 V/V $\pm$ 1%	100 mV/A $\pm$ 10%	150 ms	150 ms	9 s	70 ms	2 to 22 V	7% + 1 V	10.8 kg/26 lb	13.1 kg/29 lb	5, 11, 28	\$1,590	
200 $\Omega$ /V $\pm$ 1%	500 $\Omega$ /A $\pm$ 10%	1 V/V $\pm$ 1%	.5 V/A $\pm$ 10%	40 ms	200 ms	400 ms	75 ms	5 to 28 V	7% + 1.5 V	11 ka/24 lb	12.9 kg/28 lb	40	\$2,470	
200 $\Omega$ /V $\pm$ 1%	500 $\Omega$ /A $\pm$ 10%	1 V/V $\pm$ 1%	0.66 V/A $\pm$ 10%	15 ms	45 ms	200 ms	40 ms	2.5 to 44 V	4% + 2 V	12.7 kg/28 lb	17.7 kg/39 lb	10, 11, 28, 40	\$2,100	
200 $\Omega$ /V $\pm$ 1%	500 $\Omega$ /A $\pm$ 10%	1 V/V $\pm$ 1%	0.66 V/A $\pm$ 10%	15 ms	45 ms	200 ms	40 ms	2.5 to 44 V	4% + 2 V	6.4 kg/14 lb	7.2 kg/16 lb	11, 28, 40	\$1,100	
200 $\Omega$ /V $\pm$ 1%	200 $\Omega$ /A $\pm$ 10%	1 V/V $\pm$ 1%	200 mV/A $\pm$ 10%	275 ms	275 ms	13 s	275 ms	6 to 43 V	7% + 1 V	11.3 kg/25 lb	12.7 kg/28 lb	5, 11, 28	\$1,590	
200 $\Omega$ /V $\pm$ 1%	1 k $\Omega$ /A $\pm$ 10%	1 V/V $\pm$ 1%	1 V/A $\pm$ 10%	50 ms	350 ms	1 s	50 ms	5 to 55 V	7% + 1.5 V	11 ka/24 lb	12.9 kg/28 lb	40	\$2,470	
300 $\Omega$ /V $\pm$ 1%	1 k $\Omega$ /A $\pm$ 10%	1 V/V $\pm$ 1%	1 V/A $\pm$ 10%	25 ms	80 ms	2 s	175 ms	5 to 65 V	4% + 2 V	5.9 kg/13 lb	6.8 kg/15 lb	11, 28, 40	\$1,160	
300 $\Omega$ /V $\pm$ 1%	500 $\Omega$ /A $\pm$ 10%	1 V/V $\pm$ 1%	333 mV/A $\pm$ 10%	600 ms	600 ms	5 s	200 ms	9 to 68 V	7% + 1 V	11.3 kg/25 lb	12.7 kg/28 lb	5, 11, 28	\$1,590	
300 $\Omega$ /V $\pm$ 1%	1 k $\Omega$ /A $\pm$ 10%	1 V/V $\pm$ 1%	1.3 V/A $\pm$ 10%	25 ms	200 ms	1.5 s	200 ms	20 to 108 V	4% + 2 V	5.9 kg/13 lb	6.8 kg/15 lb	11, 28, 40	\$1,160	

\*UP = Increasing output voltage. NL = No output load current. FL = Full rated output load current.

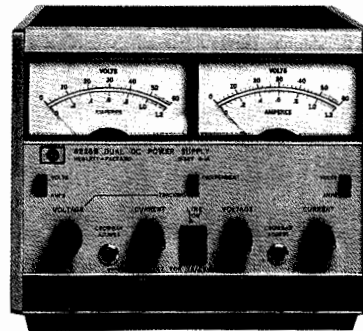

HP 6227B, 6228B

**Opt 011** Internal overvoltage protection crowbar. Protects sensitive loads against power supply failure or operator error. Monitors the output voltage and places a virtual short circuit (conducting SCR) across load after preset trip voltage is exceeded. + \$132  
 HP 6281A, 6284A, 6289A, 6294A, 6299A  
 HP 6253A, 6255A, 6282A, 6286A, 6291A, 6296A + \$215  
**Opt 028** 230 Vac  $\pm$  10%, single-phase input. Factory modification reconnects the multitap input power transformer for 230 V operation.  
**Opt 040** Interfacing for Multiprogrammer operation. Prepares standard HP power supplies for resistance programming by the HP 6942A, 6944A, or 6954A.  
**Single-output models** + \$80  
**Dual-output models** + \$158  
**Opt 910** One additional operating and service manual shipped with the power supply  
 HP 6227B + \$10  
 HP 6253A, 6255A, 6228B + \$7.88  
 HP 6281A, 6282A, 6284A, 6286A, 6289A, 6291A, 6294A, 6296A, 6299A + \$5.35

**Accessories**

**HP 14513A** 3.5 in high rack kit for one HP 6281A, 6284A, 6289A, 6294A, 6299A \$100   
**HP 14523A** 3.5 in high rack kit for two above supplies \$60   
**HP 14515A** 5.25 in high rack kit for one HP 6282A, 6286A, 6291A, 6296A \$120   
**HP 14525A** 5.25 in high rack kit for two above supplies \$60   
**HP 5060-8760** Blank filler panel for HP 6227B, 6228B \$44   
**HP 5060-8762** Adapter frame for rack mounting one or two HP 6227B, 6228B \$150

# POWER SUPPLIES

## Autorangeing Power Supplies

HP 6010A, 6011A, 6012B, 6015A, 6023A, and 6024A

- Complete front-panel control/display
- Constant voltage/constant current operation
- Remote programming and sensing
- Autorangeing output
- High efficiency, compact, and light weight
- Ten-turn voltage and current controls

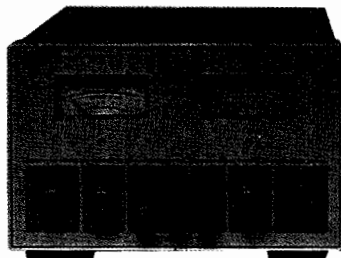

HP 6024A

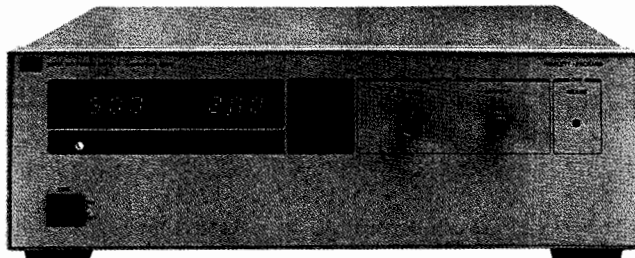

HP 6010A, 6011A, 6012B, and 6015A

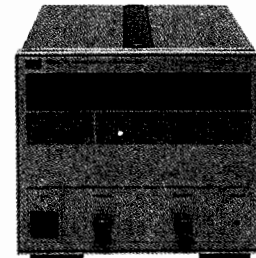

HP 6023A

### Description

#### HP Models 6010A, 6011A, 6012B, 6015A, and 6023A

This versatile family of dc power supplies provides laboratory grade performance along with many features to meet both laboratory and system needs.

Ten-turn front panel controls provide the means to precisely adjust the output voltage and current. The settings of these controls can be observed on the front panel meters by pressing the Display Settings button. This allows the current limit to be set when operating in the CV mode without shorting the output terminals and the voltage limit to be set when operating in the CC mode without opening the load leads.

Three and one-half digit front-panel meters provide a convenient means for monitoring the output voltage and current. The accuracy of these meters allows them to replace external DVMs and monitor resistors in many applications that require monitoring of the power supply output.

The overvoltage protection (OVP) trip level can also be displayed on the front-panel meters, allowing the trip level to be accurately adjusted without actually activating the OVP circuitry or disconnecting loads. In addition to the protection provided to the power supply and load by the OVP, these supplies also have protection against operating under excessive ac line or thermal conditions.

As autorangeing power supplies, these units can operate at their maximum rated power over a wide and continuous range of voltage and current combinations. This often allows both present and future requirements to be satisfied with fewer supplies.

HP Model 6023A is stable when operating in the CC mode into inductive loads up to 1 henry. HP Models 6010A, 6011A, 6012B, and 6015A are stable when operating in the CC mode into inductive loads up to 100 mH, and a special modification is available for these three models to assure stability with loads up to 10 henries.

### System Features

The output voltage and current of these supplies can be remotely controlled with either 0 to 5 volt or 0 to 4000 ohm analog programming signals. The actual output levels can be monitored without complicated external circuitry by connecting DVMs to the buffered 0 to 5 volt monitor outputs. All programming and monitoring signals are referenced to the same common and are accessed through the rear panel barrier strip.

Either terminal may be grounded, or floated up to  $\pm 240$  volts from chassis ground for the HP 6011A, 6012B, and 6023A, and  $\pm 550$  volts for the HP 6010A and 6015A.

If more output voltage or current is needed than a single unit can provide, auto-series or auto-parallel configurations can be used. Up to four 1,000-watt units, or up to two 200-watt units can be connected in auto-parallel, and any combination can be used in auto-series providing up to 240 volts total (550 Vdc for HP 6010A and 6015A) from chassis ground including output voltage. Remote sensing can be used to maintain the CV load effect specification at the load with up to 0.5 volt drop per load lead and sense wires that are less than 0.2 ohm per lead. Operation is possible with up to 2.0 volts per lead; however, load effect specification may be degraded. For more system control and monitoring capabilities, see Option 002.\*\*

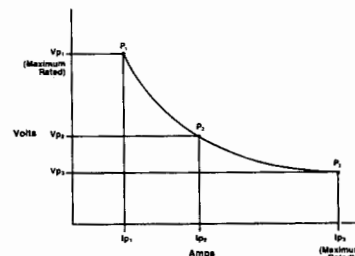

Generalized autorangeing output characteristic curve

### Specifications (at 0° C to 50° C unless otherwise specified)

Ratings*		Autorangeing Output*				HP Model	Regulation				10% Change Transient Recovery		
Volts	Ampere	$V_1$	$P_1$	$V_2$	$P_2$		$V_3$	$P_3$	Load Effect			Source Effect	
								Voltage	Current	Voltage	Current	Time / Level	
0 to 20	0 to 30	20 V	200 W	14 V	242 W	6.7 V	200 W	6023A	0.01% + 2 mV	0.01% + 9 mA	0.01% + 1 mV	0.01% + 5 mA	1 ms / 50 mV
0 to 20	0 to 120	20 V	1000 W	14 V	1064 W	7 V	840 W	6011A	0.01% + 3 mV	0.01% + 15 mA	0.01% + 2 mV	0.01% + 25 mA	2 ms / 100 mV
0 to 80	0 to 10	60 V	200 W	40 V	240 W	20 V	200 W	6024A	0.01% + 3 mV	0.01% + 3 mA	0.01% + 5 mV	0.01% + 5 mA	1 ms / 75 mV
0 to 80	0 to 50	60 V	1000 W	40 V	1200 W	20 V	1000 W	6012B	0.01% + 5 mV	0.01% + 10 mA	0.01% + 3 mV	0.01% + 10 mA	2 ms / 100 mV
0 to 200	0 to 17	200 V	1000 W	120 V	1200 W	60 V	1020 W	6010A	0.01% + 5 mV	0.01% + 10 mA	0.01% + 5 mV	0.01% + 5 mA	2 ms / 150 mV
0 to 500	0 to 5	500 V	1000 W	350 V	1050 W	200 V	1000 W	6015A	0.01% + 13 mV	0.03% + 34 mA	0.01% + 13 mV	0.03% + 17 mA	5 ms / 200 mV

\*See the generalized autorangeing output characteristic curve.

\*\*Option 002 not available with HP model 6015A.



### HP Model 6024A

As an autoranging dc power supply, the HP 6024A can provide 200 watts over a wide and continuous range of voltage and current combinations, with maximums of 60 volts and 10 amperes. This provides greater flexibility than traditional power supplies that have only one maximum power point.

Ten-turn potentiometers provide precise control of the output voltage and current. The output levels can be observed on the separate front-panel voltage and current meters. Terminals are available on both the front and rear panel for load connections.

The built-in OVP is adjustable from the front panel. Other protection features include over-temperature and high ac line detection.

The HP 6024A has many system-oriented features. It can be remotely programmed with 0 to 5 volt or 0 to 2500 ohm analog signals. The output current can be easily monitored without an external shunt with the proportional 0 to 5 volt buffered monitor output. Remote sensing can be used to eliminate the effects of voltage drops in the load leads, and either terminal may be floated up to  $\pm 240$  volts from chassis ground. Several units can be combined in auto-series, auto-parallel, and auto-tracking configurations, further increasing the HP 6024A's flexibility.

For more system features, see Option 002.

### General Specifications

#### Dimensions

**HP 6010A, 6011A, 6012B and 6015A:** 132.6 mm H  $\times$  425.5 mm W  $\times$  516.4 mm D (5.2 in  $\times$  16.75 in  $\times$  20.33 in)

**HP 6023A:** 177.0 mm H  $\times$  212.3 mm W  $\times$  443.6 mm D (6.97 in  $\times$  8.36 in  $\times$  17.872 in)

**HP 6024A:** 133.4 mm H  $\times$  212.3 mm W  $\times$  415.33 mm D (5.25 in  $\times$  8.36 in  $\times$  16.35 in)

### Ordering Information

#### Option Descriptions

**Opt 002** provides extra programming and monitoring capabilities for system use. A card inserted into the power supply is accessible through a 37-pin connector on the rear panel. It provides easy access to the control and monitor signals available on standard units, as well as these additional features:

- OVP trip and reset
- power supply inhibit
- status bits indicating CV mode, CC mode, unregulated output, OVP tripped, overtemperature condition, and ac line drop-out
- remote programming via a 0 to 2 mA current sink
- bias supplies for your circuitry: +5 volts at 100 mA, +15 volts at 75 mA, and -15 volts at 75 mA
- buffered 0 to 5 volt outputs representing both the output voltage and the output current. (HP 6010A, 6011A, 6012B, 6015A, and 6023A provide this feature standard, but HP 6024A provides only a scaled 0 to 5 volt output to represent output current, not output voltage.)
- programmable remote/local for use when programming with a current sink

These features can all be taken advantage of with an HP 6942A, 6944A, or 6954A Multiprogrammer instrument subsystem configured with an HP 69709A Power Supply Programming Card. The Multiprogrammer provides a cost-effective solution for controlling a

group of power supplies, and it also can provide many other digital and analog monitoring and control functions, all on the HP-IB. The voltage and current programming resolution available with this card is 1/1000th of full scale.

The features available with Option 002 can also be interfaced to your own external circuitry rather than an HP Multiprogrammer.

### Price

Standard unit is configured to operate at 104 to 127 Vac, 48 to 63 Hz. To operate at other input voltages, order one of the following line voltage options.

**Opt 100** 87 to 106 Vac, 48 to 63 Hz. HP 6024A Only! \$0

This option is for use in Japan only. The power supply output power is 75% of the output power available with the other line voltage options. For HP 6024A only.

**Opt 220** 191 to 233 Vac, 48 to 63 Hz \$0

**Opt 240** 208 to 250 Vac, 48 to 63 Hz \$0

For HP models 6010A, 6011A, 6012B, and 6015A, one of the following line cord options must be specified when ordering. Order according to local electrical codes. All line cords are 2.5 meters long.

**Opt 831** 12 AWG wire size; UL listed, CSA certified; \$0

unterminated line cord (200-240 Vac connections)

**Opt 833** 1.5 mm<sup>2</sup> wire size; Harmonized cordage; \$0

unterminated line cord (200-240 Vac connections)

**Opt 834** 10 AWG wire size; UL listed, CSA certified; \$0

unterminated line cord (100-120 Vac connections)

**Opt 841** Line cord with NEMA 6-20P, 20A/250V plug \$15

(suggested for use in North and South America)

**Opt 843** Line cord with JIS C8303 appended fig 6(2), \$35

20A/250V plug (suggested for use in Japan)

**Opt 845** Line cord with IEC 309, 16A/220V plug \$35

(suggested for use in Denmark, Switzerland, Austria,

China and other countries not listed)

**Opt 846** Line cord with NEMA L5-30P, 30A/120V \$55

locking plug (suggested for use in North America)

**Opt 847** Line cord with CEE 7/7, 16A/220V plug \$35

(suggested for use in continental Europe)

**Opt 848** Line cord with BS 546, 15A/240V plug \$35

(suggested for use in India and South Africa)

**Opt 800** Rack Mount kit for two units side by side. For

HP 6023A and 6024A only.

HP 6023A \$63

HP 6024A \$69

**Opt 908** Rack Mount kit for a single unit. A blank filler panel is supplied when ordered for half rack width units.

HP 6010A, 6011A, 6012B, 6015A \$36

HP 6023A \$84

HP 6024A \$64

**Opt 909** Rack Mount kit with handles for HP 6010A, \$85

6011A, 6012B, and 6015A

**Opt 910** One extra operating and service manual

shipped with each power supply.

HP 6024A \$10

HP 6010A, 6011A, 6012B, 6015A, 6023A \$21

PARD (rms/p-p) 20H to 20MHz		Programming Response Time							General						Price
		Setting Band	UP		DOWN			AC Input Current				Weight kg (lbs)			
			Full Load	No Load	Full Load	Light Load		100 Vac	120 Vac	220 Vac	240 Vac	Net	Shipping		
3 mV 30 mV	15 mA —	5 mV	100 ms	100 ms	200 ms	500 ms	50 $\Omega$	—	6.5 A	3.8 A	3.6 A	6.6 (19)	10.5 (23)	\$2,100	
8 mV 50 mV	120 mA —	30 mV	300 ms	300 ms	500 ms	1.5 s	50 $\Omega$	—	24 A	15 A	14 A	16.8 (37)	22.2 (49)	\$3,250	
3 mV 30 mV	5 mA —	60 mV	200 ms	200 ms	300 ms	600 ms	Open	5.3 A	5.3 A	2.9 A	2.7 A	5.4 (12)	7.3 (16)	\$2,100	
8 mV 40 mV	25 mA —	90 mV	300 ms	300 ms	2.0 s	3.0 s	100 $\Omega$	—	24 A	15 A	14 A	15.9 (35)	21.3 (47)	\$3,250	
22 mV 50 mV	15 mA —	300 mV	300 ms	300 ms	600 ms	3.5 s	Open	—	24 A	15 A	14 A	16.3 (36)	21.7 (48)	\$3,250	
50 mV 160 mV	50 mA —	750 mV	350 ms	250 ms	600 ms	7.0 s	Open	—	24 A	15 A	14 A	16.3 (36)	21.7 (48)	\$3,500	

# POWER SUPPLIES

## General Purpose: 200–2000 W Output

### HP 6541A–6575A

- Complete front-panel control/display
- Low ripple and noise
- Constant voltage/current operation
- Remote programming and sensing

- Overvoltage and overcurrent protection
- Front-panel calibration
- Fan-speed control minimizes acoustic noise

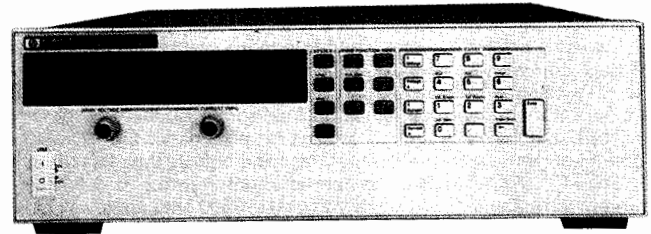
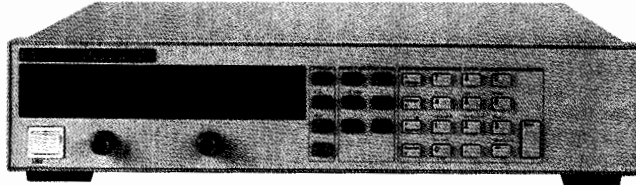

This series of high-performance constant voltage/constant current power supplies includes 15 models with output ratings of up to 120 volts and current ratings of up to 220 amps. All models have excellent regulation and low ripple and noise.

Front-panel control of the output can be accomplished three ways. By using the numeric keypad, precise voltage and current levels can be set. Using the output up/down keys makes it easy to increment and decrement the voltage and current settings in small steps. Finally, rotary pulse generators respond to speed of rotation, setting voltage and current quickly and conveniently.

Output voltage and current are displayed on the front panel, along with the operating mode and state of various power supply features.

Nonvolatile state storage allows for storage of up to five sets of frequently used voltage, current, and protection settings for quick recall. The power supply will recall a state upon power-on (or recovery from power failure).

Calibration of the power supply can be accomplished from the front panel without removing the supply from the rack. A user-specified password minimizes accidental access to the calibration routines. Self-test occurs automatically at turn-on, providing an extra measure of protection for the system.

The high performance of the 200-watt models (HP 6541A–6545A) and the 500-watt models (HP 6551A–6555A) are a result of the linear design. The low output noise of the 2000-watt models (HP 6571A–6575A) has been achieved through controlled-slope switching, extensive filtering, and careful component layout. Normal mode noise voltage and common mode noise currents have been kept to low values through careful attention to the design. The result is that these switching power supplies can be used in most noise-sensitive applications where linear supplies were once the only solution. The low noise has been achieved while still preserving the efficiency and compactness of a switching supply.

The output of these supplies can be controlled remotely with an analog voltage programming signal. Both the voltage and current can

be programmed. All dc output, ac input, remote sensing, and programming connections are made to rear-panel terminals.

All models have active down-programming circuits to speed up the test process by discharging the supply's output capacitor quickly, even under no-load conditions.

If more output current or voltage is needed than a single unit can provide, auto-parallel or series configurations can be used. Up to three 200-watt models, up to three 500-watt models, or up to five 2000-watt models can be connected in auto-parallel. Power supply outputs of models with the same power rating can be connected in series up to the limit of 240 volts total.

An automatic fan speed control circuit protects nearby users from unnecessary acoustic noise by automatically slowing down the power supply's internal cooling fan when loading and ambient temperature permit.

These power supplies offer a variety of protection features for both the power supply and the load. Overvoltage protection (OVP) circuits continuously compare the actual output voltage to the OVP level set from the front-panel controls. For the HP 6541A–6555A models, when the actual output exceeds the OVP level, an SCR crowbar is triggered to short the output of the supply, protecting the load from damage due to overvoltage. Similarly, with HP 6571A–6575A models, the power supply output is turned off and the downprogrammer circuit is activated to protect the load when an overvoltage condition occurs.

Overcurrent protection can be set to disable the output of the supply in the event of a transition from CV to CC operating mode, which happens when the current setting is reached. The output is disabled by setting the voltage to zero and the current to a small value. This can be used to protect a shorted load from continuing to draw more than the intended maximum current.

Overtemperature protection automatically disables the power supply's output if an over-temperature situation exists.

### Specifications (at 0° C to 55° C unless otherwise specified)

Output Volts	Ratings Amps*	HP Model	PARD (rms/p-p)		Load Regulation		Line Regulation		Keypad Programming Accuracy (25° C ± 5° C)	
			Voltage	Current	Voltage	Current	Voltage	Current	Voltage	Current
0 to 8	0 to 20	6541A	300 $\mu$ V/3 mV	10 mA rms	1 mV	1 mA	0.5 mV	1 mA	0.06% + 5 mV	0.14% + 26 mA
0 to 20	0 to 10	6542A	300 $\mu$ V/3 mV	5 mA rms	2 mV	0.5 mA	0.5 mV	0.5 mA	0.06% + 10 mV	0.14% + 13 mA
0 to 35	0 to 6	6543A	400 $\mu$ V/4 mV	3 mA rms	3 mV	0.25 mA	1 mV	0.25 mA	0.06% + 15 mV	0.14% + 7 mA
0 to 60	0 to 3.5	6544A	500 $\mu$ V/5 mV	1.5 mA rms	4 mV	0.25 mA	1 mV	0.25 mA	0.06% + 26 mV	0.14% + 4 mA
0 to 120	0 to 1.5	6545A	700 $\mu$ V/7 mV	1 mA rms	5 mV	0.25 mA	2 mV	0.25 mA	0.06% + 51 mV	0.14% + 2 mA
0 to 8	0 to 50	6551A	300 $\mu$ V/3 mV	25 mA rms	1 mV	2 mA	0.5 mV	2 mA	0.06% + 5 mV	0.15% + 60 mA
0 to 20	0 to 25	6552A	300 $\mu$ V/3 mV	10 mA rms	2 mV	1 mA	0.5 mV	1 mA	0.06% + 10 mV	0.15% + 25 mA
0 to 35	0 to 15	6553A	400 $\mu$ V/4 mV	5 mA rms	3 mV	0.5 mA	1 mV	0.75 mA	0.06% + 15 mV	0.15% + 13 mA
0 to 60	0 to 9	6554A	500 $\mu$ V/5 mV	3 mA rms	4 mV	0.5 mA	1 mV	0.5 mA	0.06% + 26 mV	0.15% + 8 mA
0 to 120	0 to 4	6555A	700 $\mu$ V/7 mV	2 mA rms	5 mV	0.5 mA	2 mV	0.5 mA	0.06% + 51 mV	0.15% + 4 mA
0 to 8	0 to 220	6571A	650 $\mu$ V/5 mV	200 mA rms	0.002% + 300 $\mu$ V	0.005% + 10 mA	0.002% + 300 $\mu$ V	0.005% + 10 mA	0.04% + 8 mV	0.1% + 125 mA
0 to 20	0 to 100	6572A	750 $\mu$ V/9 mV	100 mA rms	0.002% + 650 $\mu$ V	0.005% + 7 mA	0.002% + 650 $\mu$ V	0.005% + 7 mA	0.04% + 20 mV	0.1% + 60 mA
0 to 35	0 to 60	6573A	800 $\mu$ V/9 mV	40 mA rms	0.002% + 1.2 mV	0.005% + 4 mA	0.002% + 1.2 mV	0.005% + 4 mA	0.04% + 35 mV	0.1% + 40 mA
0 to 60	0 to 35	6574A	1.25 mV/11 mV	25 mA rms	0.002% + 2 mV	0.005% + 2 mA	0.002% + 2 mV	0.005% + 2 mA	0.04% + 60 mV	0.1% + 25 mA
0 to 120	0 to 18	6575A	1.9 mV/16 mV	12 mA rms	0.002% + 4 mV	0.005% + 1 mA	0.002% + 4 mV	0.005% + 1 mA	0.04% + 120 mV	0.1% + 16 mA

\* For models 6541A–6555A only, derate output current 1% per ° C from 40° to 55° C.

### Transient Response Time:

**HP 6541A–6555A:** Less than 100  $\mu$ s for the output voltage to recover to its previous level (within 0.1% of the voltage rating of the supply or 20 mV, whichever is greater) following any step change in load current of up to 50% of rated current.

**HP 6571–6575A:** Less than 900  $\mu$ s for the output voltage to recover within 100 mV following a change in load from 100% to 50% or 50% to 100% of the output current rating of the supply.

**Isolation:** Output terminals can be floated up to  $\pm$  240 Vdc maximum from chassis ground.

**Supplemental Characteristics**

**Remote Sensing:** Up to half the rated output voltage can be dropped in each load lead. The drop in the load leads subtracts from the voltage available for the load.

**Maximum Reverse Diode Current:** With ac power applied, the supply will continuously withstand reverse diode current equal to the output current rating of the supply without damage.

**Analog Programming of Output Voltage and Current:**

**HP 6541A-6555A:**

**Input signal:** 0 to -5V  
**Input impedance:** 10 K Ω nominal

**HP 6571A-6575A:** Model dependent. See operating manual for exact values.

**Input signal:** 0 to -4V for voltage  
 0 to 7V for current

**Input impedance:** 30 K Ω or greater

**Output Common Mode Noise Current** (to signal ground binding post):

**HP 6671A-6675A:** 500 μA rms, 4 mA peak-peak

**AC Input (ac input frequency 47 to 63 Hz):**

**HP 6541A-6545A                      HP 6551A-6555A**

Voltage	Current	Voltage	Current
100 Vac	4.4 A	100 Vac	12 A
120 Vac	3.8 A	120 Vac	10 A
220 Vac	2.2 A	220 Vac	5.7 A
240 Vac	2.0 A	240 Vac	5.3 A

**HP 6571A-6575A Line Current:** 19 A maximum

**RFI Suppression:** Complies with FTZ 1046/84, Level B

**Safety Agency Compliance:** Designed to comply with VDE 0411 and UL1244. Complies with CSA 22.2 No. 231 and IEC 348.

**Size:**

**HP 6541A-6545A:** 88.1 mm H × 425.5 mm W × 439 mm D  
 (3.5 in × 16.75 in × 17.3 in)

**HP 6551A-6555A:** 132.6 mm H × 425.5 mm W × 497.8 mm D  
 (5.22 in × 16.75 in × 19.6 in)

**HP 6571A-6575A:** 132.6 mm H × 425.5 mm W × 640.0 mm D  
 (5.22 in × 16.75 in × 25.2 in)

**Weight:**

**HP 6541A-6545A:** Net, 14.2 kg (31.4 lb); shipping, 16.3 kg (36 lb)

**HP 6551A-6555A:** Net, 25 kg (54 lb); shipping, 28 kg (61 lb)

**HP 6571A-6575A:** Net, 28.2 kg (62 lb); shipping, 31.8 kg (70 lb)

**Warranty period:** Three years

**Option Descriptions**

**HP 6541A-6555A:**

**Opt 100** 87 to 106 Vac, 47 to 63 Hz

**Opt 220** 191 to 233 Vac, 47 to 63 Hz

**Opt 240** 209 to 250 Vac, 47 to 63 Hz

If no line input option is ordered, the power supply will be configured to operate at 104 to 127 Vac, 47 to 63 Hz

**HP 6571A-6575A:**

**Opt 200** 174 to 220 Vac, 47 to 63 Hz (Japan only)

If Option 200 is not ordered, the power supply will be configured to operate at 191 to 250 Vac, 47 to 63 Hz

**HP 6541A-6545A:**

**Opt 908** Rack Mount Kit (HP p/n 5062-3974)

**Opt 909** Rack Mount Kit with handles  
 (HP p/n 5062-3975)

**HP 6551A-6575A:**

**Opt 908** Rack Mount Kit (HP p/n 5062-3977)

**Opt 909** Rack Mount Kit with handles  
 (HP p/n 5062-3983)

Line cords are included with HP 6541A-6555A.

Line cords must be ordered for HP 6571A-6575A.

Line cord options (for HP 6571A-6575A only): Order according to local electrical codes. All line cords are 2.5 meters long.

**Opt 831** 12 AWG wire size; UL listed, CSA certified; unterminated.

**Opt 841** 12 AWG wire size; UL listed, CSA certified; with NEMA 6-20P, 20A/250V plug.

Opt 831 or 841 suggested for use in North and South America, except for Canada. These options are for use on a dedicated branch circuit.

**Opt 832** 4 mm<sup>2</sup> wire size; Harmonized cordage meeting CENELEC publication HD-22; unterminated.

**Opt 842** 4 mm<sup>2</sup> wire size; Harmonized cordage meeting CENELEC publication HD-22; with IEC 309, 32A plug.

Option 832 or 842 suggested for use in Europe and other countries not listed.

**Opt 843** 12 AWG wire size; UL listed, CSA certified; with JIS C8303 appended fig 6(2) 20A/250V plug.

Option 843, 831, or 834 suggested for use in Japan.

**Opt 834** 10 AWG wire size; UL listed, CSA certified; unterminated.

**Opt 844** 10 AWG wire size; UL listed, CSA certified; with NEMA L6-30P, 30A/250V locking plug.

Option 834 or 844 suggested for use in North and South America.

**Price**

N/C

N/C

N/C

N/C

\$32

\$75

\$35

\$85

N/C

\$15

N/C

\$75

\$35

N/C

\$55

**Supplemental Characteristics**

HP Model	Average Resolution			OVP Accuracy	Output Voltage Response Time*				Price
	Voltage	Current	OVP		Tr NL	Tr FL	Tf NL	Tf FL	
6541A	2 mV	6 mA	13 mV	160 mV	3 ms	3 ms	15 ms	15 ms	\$1,750
6542A	5 mV	3 mA	30 mV	400 mV	3 ms	3 ms	15 ms	15 ms	\$1,650
6543A	10 mV	2 mA	54 mV	700 mV	3 ms	3 ms	15 ms	15 ms	\$1,650
6544A	15 mV	1.0 mA	93 mV	1.2 V	3 ms	3 ms	15 ms	15 ms	\$1,650
6545A	30 mV	0.5 mA	190 mV	2.4 V	3 ms	3 ms	15 ms	15 ms	\$1,700
6551A	2 mV	15 mA	12 mV	160 mV	3 ms	3 ms	15 ms	15 ms	\$2,300
6552A	5 mV	7 mA	30 mV	400 mV	3 ms	3 ms	15 ms	15 ms	\$2,100
6553A	10 mV	4 mA	54 mV	700 mV	3 ms	3 ms	15 ms	15 ms	\$2,100
6554A	15 mV	2.5 mA	93 mV	1.2 V	3 ms	3 ms	15 ms	15 ms	\$2,100
6555A	30 mV	1.25 mA	190 mV	2.4 V	3 ms	3 ms	15 ms	15 ms	\$2,150
6571A	2 mV	55 mA	15 mV	200 mV	30 ms	30 ms	130 ms	30 ms	\$3,800
6572A	5 mV	25 mA	35 mV	500 mV	60 ms	60 ms	250 ms	60 ms	\$3,750
6573A	9 mV	15 mA	65 mV	900 mV	130 ms	130 ms	350 ms	130 ms	\$3,700
6574A	15 mV	8.75 mA	100 mV	1.15 V	130 ms	130 ms	600 ms	130 ms	\$3,650
6575A	30 mV	4.5 mA	215 mV	3.0 V	195 ms	195 ms	600 ms	195 ms	\$3,750

\* No load (NL) and full load (FL) 10/90% rise time, 90/10% fall time when using analog programming.

# POWER SUPPLIES

General Purpose: 200 to 2000 W Output

HP 6260B-6274B

- Built-in overvoltage protection
- Constant voltage/constant current operation
- Remote programming
- Remote sensing
- Auto-series, -parallel, and -tracking operation
- $\leq 50 \mu\text{s}$  load transient recovery



HP 6263B, 6266B

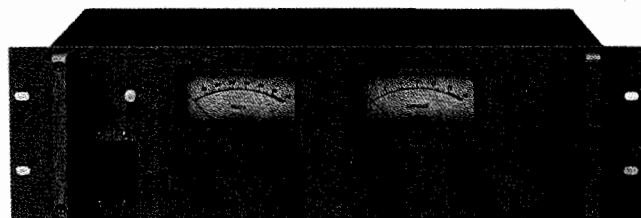

HP 6274B

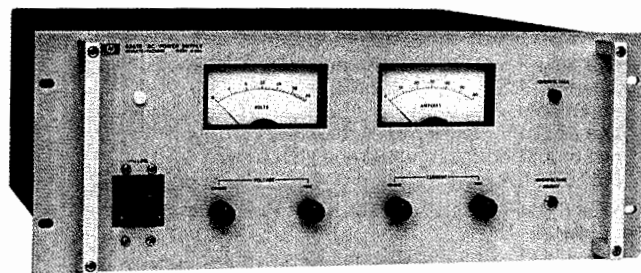

HP 6260B, 6261B, 6268B, 6269B

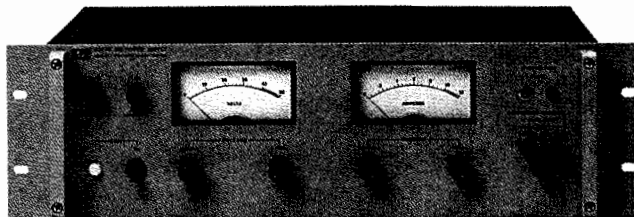

HP 6264B, 6267B

## Description Models 6260B-6274B

This series of high-performance constant voltage/constant current supplies includes nine models with output rating from 10 to 60 V. All models employ a transistor series-regulator/triac-preregulator circuit to achieve high efficiency, excellent regulation, low ripple and noise, and moderate programming speeds in a compact full-rack width package.

Separate coarse and fine voltage and current controls allow the voltage and current outputs to be varied from zero to the maximum rated value; crossover from constant voltage to constant current operation occurs automatically when the load current exceeds the value established by the current control settings.

Additional features include built-in overvoltage crowbar protection; remote error sensing; and auto-series, auto-parallel, and auto-tracking operation. The crowbar trip point adjustment and associated overvoltage indicator are conveniently located on the front panel.

Auto-series, auto-parallel, and auto-tracking connections should ordinarily include no more than three supplies. If a specific application requires the use of more than three supplies in any of the three connections, consult your local HP Field Engineer for additional information.

All dc output, ac input, sensing, control, and programming connections are made to rear-panel terminals. Either the positive or negative output terminal may be grounded or the supplies may be operated floating at up to 120 volts above ground. Models 6263B, 6264B, 6266B, and 6267B are convection cooled. All other models in this series employ cooling fans. Models that output more than 200 watts are equipped with terminal blocks for ac input and are not shipped with line cords.

## Specifications

RATINGS			PERFORMANCE							
DC Output		HP Model	Load Effect		Source Effect		PAR (rms/p-p)		Drift (stability)	
Volts	Ampers		Voltage	Current	Voltage	Current	Voltage	Current	Voltage	Current
0 to 10	0 to 100	6260B	0.01% + 200 $\mu\text{V}$	0.02% + 2 mA	0.01% + 200 $\mu\text{V}$	0.02% + 2 mA	500 $\mu\text{V}/5 \text{ mV}$	50 mA rms	0.03% + 2 mV	0.03% + 20 mA
0 to 20	0 to 10	6263B	0.01% + 200 $\mu\text{V}$	0.02% + 500 $\mu\text{A}$	0.01% + 200 $\mu\text{V}$	0.02% + 500 $\mu\text{A}$	200 $\mu\text{V}/10 \text{ mV}$	3 mA rms	0.03% + 500 $\mu\text{V}$	0.03% + 6 mA
0 to 20	0 to 20	6264B	0.01% + 200 $\mu\text{V}$	0.02% + 500 $\mu\text{A}$	0.01% + 200 $\mu\text{V}$	0.02% + 500 $\mu\text{A}$	200 $\mu\text{V}/10 \text{ mV}$	5 mA rms	0.03% + 500 $\mu\text{V}$	0.03% + 6 mA
0 to 20	0 to 50	6261B	0.01% + 200 $\mu\text{V}$	0.02% + 1 mA	0.01% + 200 $\mu\text{V}$	0.02% + 1 mA	500 $\mu\text{V}/5 \text{ mV}$	25 mA rms	0.03% + 2 mV	0.03% + 10 mA
0 to 40	0 to 5	6266B	0.01% + 200 $\mu\text{V}$	0.02% + 500 $\mu\text{A}$	0.01% + 200 $\mu\text{V}$	0.02% + 500 $\mu\text{A}$	200 $\mu\text{V}/10 \text{ mV}$	3 mA rms	0.03% + 500 $\mu\text{V}$	0.03% + 3 mA
0 to 40	0 to 10	6267B	0.01% + 200 $\mu\text{V}$	0.02% + 500 $\mu\text{A}$	0.01% + 200 $\mu\text{V}$	0.02% + 500 $\mu\text{A}$	200 $\mu\text{V}/10 \text{ mV}$	3 mA rms	0.03% + 2 mV	0.03% + 3 mA
0 to 40	0 to 30	6268B	0.01% + 200 $\mu\text{V}$	0.02% + 2 mA	0.01% + 200 $\mu\text{V}$	0.02% + 2 mA	1 mV/5 mV	20 mA rms	0.03% + 2 mV	0.03% + 5 mA
0 to 40	0 to 50	6269B	0.01% + 200 $\mu\text{V}$	0.02% + 2 mA	0.01% + 200 $\mu\text{V}$	0.02% + 2 mA	1 mV/5 mV	25 mA rms	0.03% + 2 mV	0.03% + 10 mA
0 to 60	0 to 15	6274B	0.01% + 200 $\mu\text{V}$	0.02% + 500 $\mu\text{A}$	0.01% + 200 $\mu\text{V}$	0.02% + 500 $\mu\text{A}$	200 $\mu\text{V}/20 \text{ mV}$	5 mA rms	0.03% + 2 mV	0.03% + 5 mA

**Specification – General**

**Load effect transient recovery:** Time, 50  $\mu$ s; Level, 10 mV  
**Resolution:** Voltage control, less-than 0.02%; current control, less than 0.15%

**Temperature coefficient per °C:** 0.01% of output plus 200  $\mu$ V  
**Temperature ratings:** Operating, 0 to 55° C; storage, –40 to 75° C  
**Remote control programming:** These power supplies are capable of being programmed in constant voltage and constant current operation by using an external resistance or dc voltage with coefficients as shown in the table below.

Rear terminal wiring configurations for remote control operation are specified in the operating and service manual supplied with the power supply. For remote control programming procedures and timing considerations, contact your local HP Field Engineer.

**Power:** Input voltage tolerance is  $\pm$ 10%, 57 to 63 Hz. For other input voltage and frequency options available, see the Options listing in the specifications table below. Standard input voltage, maximum input current, and maximum power are: HP 6260B—230 Vac, 12 A, 1600 W; HP 6263B—115 Vac, 4.5 A, 350 W; HP 6266B—115 Vac, 4 A, 325 W; HP 6268B—230 Vac, 12 A, 1600 W; HP 6261B—230 Vac, 12 A 1500 W; HP 6264B—115 Vac, 8 A, 600 W; HP 6267B—115 Vac, 8 A, 550 W; HP 6269B—230 Vac, 18 A, 2500 W; HP 6274B—115 Vac, 15 A, 1200 W.

**AC line connections:** 3-wire, 5-foot ac power cord included—HP 6263B and 6266B.

Three-terminal barrier strip provided on power supply for ac power connections—HP 6260B, 6261B, 6264B, 6267B, 6268B, 6269B and 6274B.

**Size:** HP 6263B, 6266B: 83.7 mm H  $\times$  483 mm W  $\times$  479.4 mm D (3.296 in  $\times$  19 in  $\times$  18.875 in)  
 HP 6264B, 6267B, 6274B: 127 mm H  $\times$  483 mm W  $\times$  479.4 mm D (5.00 in  $\times$  19 in  $\times$  18.875 in)  
 HP 6260B, 6261B, 6268B, 6269B: 173 mm H  $\times$  483 mm W  $\times$  479.4 mm D (6.812 in  $\times$  19 in  $\times$  18.875 in)

**Option Descriptions**

- |  |                   |
|--|-------------------|
| <b>Opt 005</b> 50-Hz ac input: Optimizes power supplies that require adjustment/modification for 50-Hz operation.  | Price<br>\$0      |
| <b>Opt 010</b> Chassis slides. For access to rack mounted power supplies: HP 6263B, 6264B, 6266B, 6267B HP 6274B, 6260B, 6261B, 6268B, 6269B   | + \$91<br>+ \$168 |
| <b>Opt 016</b> 115 Vac $\pm$ 10% single phase input. Consists of replacing power transformer and circuit breaker, and reconnecting bias transformer, RFI choke, and fans.  | + \$126           |
| <b>Opt 022</b> Voltage and current programming adjust. Allows the V and I programming coefficients and zero output to be conveniently adjusted to 0.1% accuracy via access holes in the rear panel. Consists of four potentiometers and resistors located inside the rear panel. | + \$64            |
| <b>Opt 026</b> 115 Vac $\pm$ 10%, single phase input. Consists of replacing the input circuit breaker and reconnecting the power transformer, bias transformer, RFI choke, and fans. Models 6261B and 6268B only.  | \$0               |
| <b>Opt 027</b> 208 Vac, $\pm$ 10%, single phase input. Consists of reconnecting power transformer taps, and other components where necessary.  | \$0               |
| <b>Opt 028</b> 230 Vac $\pm$ 10%, single phase input. Consists of reconnecting power transformer taps, and other components where necessary.   | \$0               |
| <b>Opt 040</b> Multiprogrammer interface. Prepares standard HP power supplies for resistance programming by the HP 6942A, 6944A, or 6954A Multiprogrammers. This option includes Option 022, special calibration, and protection check-out procedures (where required).          | + \$80            |
| <b>Opt 910</b> One additional operating and service manual shipped with each power supply: HP 6260B–6274B.   | + \$7.88          |

**Specifications (continued)**

REMOTE CONTROL FEATURES								GENERAL					
Resistance Coefficient		Voltage Coefficient		Speed, UP*		Speed, DOWN*		Overvoltage		Weight		Options	Price
Voltage	Current	Voltage	Current	NL	FL	NL	FL	Range	Margin	Net	Shipping		
200 $\Omega$ /V $\pm$ 1%	2 $\Omega$ /A $\pm$ 10%	1 V/V $\pm$ 1%	5 mV/A $\pm$ 10%	70 ms	70 ms	200 ms	75 ms	2 to 12 V	5% + 2 V	43.9 kg/97 lb	48 kg/106 lb	5, 10, 16, 22, 27, 40	\$3,360
200 $\Omega$ /V $\pm$ 1%	100 $\Omega$ /A $\pm$ 10%	1 V/V $\pm$ 1%	50 mV/A $\pm$ 10%	150 ms	150 ms	7 s	350 ms	2 to 23 V	5% + 1 V	15.4 kg/34 lb	18.6 kg/41 lb	5, 10, 22, 27, 28, 40	\$2,130
200 $\Omega$ /V $\pm$ 1%	10 $\Omega$ /A $\pm$ 10%	1 V/V $\pm$ 1%	25 mV/A $\pm$ 10%	140 ms	140 ms	10 s	150 ms	2.5 to 23V	5% + 1 V	21.3 kg/47 lb	24.5 kg/54 lb	5, 10, 22, 27, 28, 40	\$2,200
200 $\Omega$ /V $\pm$ 1%	4 $\Omega$ /A $\pm$ 10%	1 V/V $\pm$ 1%	10 mV/A $\pm$ 10%	150 ms	160 ms	250 ms	250 ms	2 to 23 V	5% + 2 V	35.3 kg/78 lb	39.4 kg/87 lb	5, 10, 22, 26, 27, 40	\$3,200
200 $\Omega$ /V $\pm$ 1%	200 $\Omega$ /A $\pm$ 10%	1 V/V $\pm$ 1%	100 mV/A $\pm$ 10%	275 ms	275 ms	13 s	1.5 s	2.5 to 45 V	5% + 1 V	15.4 kg/34 lb	18.6 kg/41 lb	5, 10, 22, 27, 28, 40	\$2,150
200 $\Omega$ /V $\pm$ 1%	100 $\Omega$ /A $\pm$ 10%	1 V/V $\pm$ 1%	50 mV/A $\pm$ 10%	275 ms	275 ms	13 s	750 ms	2.5 to 45 V	5% + 1 V	17.7 kg/39 lb	20.8 kg/46 lb	5, 10, 22, 27, 28, 40	\$2,200
200 $\Omega$ /V $\pm$ 1%	6 $\Omega$ /A $\pm$ 10%	1 V/V $\pm$ 1%	16.7 mV/A $\pm$ 10%	300 ms	300 ms	1 s	650 ms	4 to 45 V	5% + 1 V	34.4 kg/76 lb	38.1 kg/84 lb	5, 10, 22, 26, 27, 40	\$3,050
200 $\Omega$ /V $\pm$ 1%	4 $\Omega$ /A $\pm$ 10%	1 V/V $\pm$ 1%	10 mV/A $\pm$ 10%	350 ms	350 ms	1 s	800 ms	4 to 45 V	5% + 1 V	40.3 kg/89 lb	44 kg/98 lb	5, 10, 22, 27, 40	\$3,150
300 $\Omega$ /V $\pm$ 1%	67 $\Omega$ /A $\pm$ 10%	1 V/V $\pm$ 1%	33.3 mV/A $\pm$ 10%	600 ms	600 ms	40 s	800 ms	6 to 66 V	5% + 1 V	21.7 kg/48 lb	24.5 kg/54 lb	5, 10, 22, 27, 28, 40	\$2,450

\*Up = increasing output voltage. NL = No output load current. FL = Full rated output load current.

# POWER SUPPLIES

General Purpose: 300 to 11,000 W Output

HP 6434B-6483C

- Outstanding value—low cost/watt
- Up to 75% efficiency at full output
- Constant voltage/constant current operation

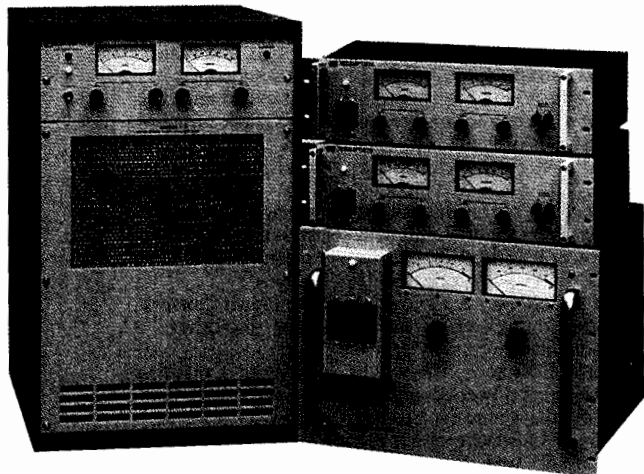

HP 6434B-6483C

## Description

This series of SCR-regulated power supplies is designed for medium- to high-power applications requiring a fixed or variable dc source with moderate regulation and ripple. For supplies with better regulation, faster response time, and lower ripple, see Models HP 6571A-6575A on page 544.

## Operating Features

All supplies in this series are of the constant voltage/constant current type. Large easy-to-read panel meters continuously monitor output voltage current.

Input and output power; remote sensing; remote programming; and auto-series, -parallel, and -tracking connections are made to bus bars and terminal blocks on the rear panel.

## Protective Features

In addition to the overload protection inherent in constant voltage/constant current operation, there are many other built-in protective features included in these supplies. The features vary within the three model classifications as follows:

**HP 6434B-6448B:** (1) Reverse voltage protection. (2) Fused ac input.

**HP 6453A, 6456B, 6459A:** (1) ac line loss protection circuit monitors 3-phase input and cuts off SCR's and opens output bus if a phase drops out; operation resumes when ac input returns to normal. (2) three-phase input circuit breaker. (3) Optional internal crowbar (Option 006) protects load from overvoltage condition.

**HP 6464C-6483C:** (1) High-temperature protection thermostat opens input to power transformer and lights front-panel indicator if supply overheats. (2) Prolonged overload protection circuit is activated and lights front-panel indicator if output current exceeds approximately 115 percent of maximum rating. (3) Optional internal crowbar (except on HP 6464C) protects load from overvoltage condition. (4) Turn-on circuit limits peak line current during startup into low impedance loads. (5) Phase-balance circuit permits operation with line-to-line input voltage imbalance up to 8 percent. (6) Overcurrent and overvoltage circuits of master-slave supplies used in auto-series, -parallel, or -tracking operation can be interlocked.

## Auto-Series, -Parallel, -Tracking Operation

Supplies may be connected in auto-series or auto-tracking (except HP 6448B and 6483C, which cannot be connected in auto-series).

Up to three lower-power models (HP 6434B-6448B) may be connected in any of the above configurations. Higher-power model (HP 6453A/6483C) interconnection should ordinarily include no more than two supplies.

## Remote Programming

The voltage and current outputs of the supplies can be programmed by a remote resistance, or for most models, a remote voltage source. Programming speeds and coefficients are detailed in the specifications table.

## AC Power Requirements

The ac power requirements vary with the three model classifications (see Options listing). When powered from a 50-Hz source (possible with Option 005), the rms ripple and transient response specifications increase by 50 percent. The peak-to-peak ripple specification is unchanged by line frequency.

## Line Cords

Line cords are not supplied with Models 6434B, 6448B and 6453A-6483C.

## Specifications

RATINGS			PERFORMANCE						
DC Output		HP Model	Load Effect		Source Effect		PARD <sup>Δ</sup> rms/p-p	Temperature Coefficient	Drift
Volts <sup>‡</sup>	Ampere <sup>‡</sup>		Voltage	Current	Voltage	Current			
0 to 8	0 to 1000	HP 6464C	0.05% + 5 mV	0.1% + 1 A	0.05% + 5 mV	0.1% + 1 A	80 mV/1 V	0.03% + 100 μV	0.03% + 1 mV
0 to 15	0 to 200	HP 6453A	0.2% + 10 mV†	1% or 2 A†	0.2% + 10 mV†	1% or 2 A†	150 mV rms	0.05% + 2 mV	0.25% + 10 mV
0 to 16 or 18	0 to 600 or 500*	HP 6486C	0.05% + 5 mV	0.1% + 0.6 A	0.05% + 5 mV	0.1% + 0.6 A	180 mV/1 V	0.03% + 200 μV	0.2% + 1 mV
0 to 36	0 to 100	HP 6456B	0.2% + 10 mV†	1% or 1 A†	0.2% + 10 mV†	1% or 1 A†	180 mV rms	0.05% + 2 mV	0.25% + 10 mV
0 to 36	0 to 300	HP 6469C	0.05% + 5 mV	0.1% + 0.3 A	0.05% + 5 mV	0.1% + 0.3 A	180 mV/1 V	0.03% + 400 μV	0.15% + 1 mV
0 to 40	0 to 25	HP 6434B	40 mV	200 mA	18 mV	200 mA	40 mV/500 mV	0.03% + 5 mV	0.1% + 20 mV
0 to 64	0 to 50	HP 6459A	0.2% + 10 mV†	1% or 0.5 A†	0.2% + 10 mV†	1% or 0.5 A†	180 mV rms	0.05% + 2 mV	0.25% + 10 mV
0 to 64	0 to 150	HP 6472C	0.05% + 100 mV	0.1% + 0.15 A	0.05% + 100 mV	0.1% + 0.15 A	160 mV/2 V	0.03% + 4 mV	0.15% + 16 mV
0 to 110	0 to 100	HP 6475C	0.05% + 100 mV	0.1% + 0.1 A	0.05% + 100 mV	0.1% + 0.1 A	200 mV/2 V	0.03% + 5 mV	0.15% + 20 mV
0 to 220	0 to 50	HP 6477C	0.05% + 100 mV	0.1% + 50 mA	0.05% + 100 mV	0.1% + 50 mA	330 mV/2 V	0.03% + 8 mV	0.15% + 35 mV
0 to 300	0 to 35	HP 6479C	0.05% + 100 mV	0.1% + 35 mA	0.05% + 100 mV	0.1% + 35 mA	330 mV/3 V	0.03% + 11 mV	0.15% + 45 mV
0 to 440, 500 or 600	0 to 25, 20, 15*	HP 6483C	0.05% + 100 mV	0.1% + 35 mA	0.5% + 100 mV	0.1% + 35 mA	600 mV/5 V	0.03% + 20 mV	0.15% + 60 mV
1 to 600	5 mA to 1.5 A	HP 6448B	1 V	40 mA	600 mV	15 mA	600 mV/2 V	0.03% + 100 mV	0.1% + 300 mV

† Specified for combined line and load regulation.

Δ For operation with a 50-Hz input (possible only with Option 005), the rms ripple and transient response specifications are increased by 50%.

\* The output current rating is given in the same order corresponding with the voltage rating.

‡ Under light loading conditions, power supply may not meet all published specifications. The graph on the next page defines the permissible operating regions for CV and CC modes of operation.

For operation with a 50-Hz input (possible only with Option 005), output current is linearly derated from 100% at 40° C to 80% at 50° C.

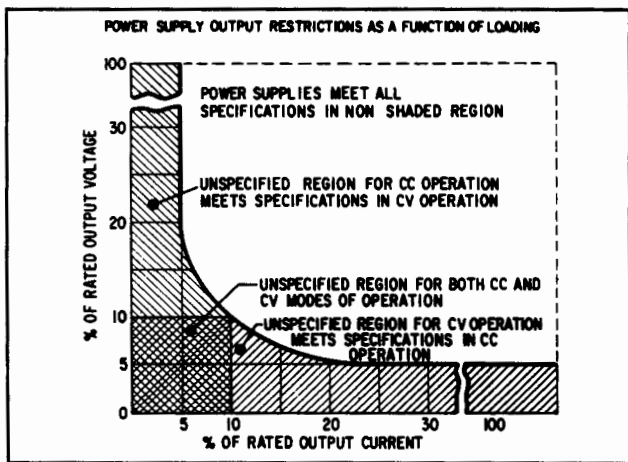

**Site Evaluation**

Higher power units (HP Models 6464C-6483C) most likely will require installation of a dedicated electrical branch service. It is suggested that a site evaluation be conducted by a qualified electrician or engineer prior to ordering. At that time, the electrician can help determine the correct line voltage option to order.

**Size**

**Models 6434B 6448B:** 133 mm H × 483 mm W × 432 mm D (5.25 in × 19 in × 17 in)

**Models 6453A, 6456B, 6459A:** 356 mm H × 483 mm W × 500 mm D (14 in × 19 in × 19.7 in)

**Models 6464C, 6466C, 6469C, 6472C, 6475C, 6477C, 6479C, 6483C:** 705 mm H × 483 mm W × 715 mm D (27.75 in × 19 in × 28.12 in)

**Option Descriptions**

**HP 6434B-448B**

**Standard:** 115 Vac, ± 10%, single phase, 57 to 63 Hz

**Opt 005:** Realignment for 50-Hz operation

**Opt 010:** Chassis slides

**Opt 027:** 208 Vac, ± 10%, single phase, 57 to 63 Hz

**Opt 028:** 230 Vac, ± 10%, single phase, 57 to 63 Hz

**Opt 910:** One extra operating and service manual shipped with each power supply

**Price**

\$0

\$0

+ \$168

\$0

\$0

+ \$10

**HP 6453A, 6456B, 6459A**

An ac input option must be specified when ordering.

Three-phase voltages are phase-to-phase.

AC input connections are by means of a 4-conductor connector at rear of unit. Low voltage (208 V, 230 V) models are furnished with an Arrow Hart and Hageman plug (HP 1251-6896). High voltage (380 V, 400 V, 460 V) models are furnished with an Arrow Hart and Hageman plug (HP 1251-6897).

**Opt 001** 208 Vac, ± 10%, 3-phase, 15.5 A/phase, 57 to 63 Hz \$0

**Opt 002** 230 Vac, ± 10%, 3-phase, 14 A/phase, 57 to 63 Hz \$0

**Opt 003** 460 Vac, ± 10%, 3-phase, 7 A/phase, 57 to 63 Hz + \$105

**005:** Realignment for 50-Hz operation \$0

**Opt 006** Overvoltage protection crowbar for HP 6453A, 6459A + \$520

HP 6456B + \$685

**Opt 010** Chassis slides + \$270

**Opt 031** 380 Vac, ± 10%, 3-phase, 8.5 A/phase, 57 to 63 Hz + \$158

**Opt 032** 400 Vac, ± 10%, 3-phase- 8.0 A/phase, 57 to 63 Hz + \$158

**Opt 910** One extra operating and service manual shipped with each power supply. + \$10

**HP 6464C-6483C**

An ac input option must be specified when ordering.

Three phase voltages are phase-to-phase.

ac input connections are by means of an enclosed 4-wire terminal block.

**Opt 001** 208 Vac, ± 10%, 3-phase, 55 A/phase, 57 to 63 Hz \$0

**Opt 002** 230 Vac, ± 10%, 3-phase, 50 A/phase, 57 to 63 Hz \$0

**Opt 003** 460 Vac, ± 10%, 3-phase, 25 A/phase, 57 to 63 Hz + \$270

**Opt 005** Realignment for 50 Hz operation \$0

**Opt 006** Internal overvoltage protection crowbar for HP 6477C, 6479C, 6483C + \$420

HP 6466C + \$605

HP 6469C + \$540

HP 6472C, 6475C + \$490

**Opt 023** Rack mounting attachments for standard 19-in rack + \$137

**Opt 031** 380 Vac, ± 10%, 3-phase, 30 A/phase, 57 to 63 Hz + \$270

**Opt 032** 400 Vac, ± 10%, 3-phase, 28.5 A/phase, 57 to 63 Hz + \$270

**Opt 040** Prepares power supply to be programmed with resistance by an HP 6942A, 6944A, or 6954A + \$105

**Opt 910** One extra operating and service manual shipped with each power supply. + \$15

**Accessory**

**HP 14545B:** Casters for HP 6464C-6483C—set of four \$103

**Specifications (continued)**

REMOTE CONTROL								GENERAL						
Resolution V	C	Load Transient Recovery <sup>Δ</sup>	Resistance Coefficient		Voltage Coefficient†		Up		Down		Net Weight		Options	Price
			Voltage	Current	Voltage	Current	NL	FL	NL	FL	Kg	lb		
8 mV	1 A	100 ms, 500 mV	200 Ω/V ± 2%	1 Ω/A ± 2%	1 V/V ± 1%	6.2 mV/A ± 7%	1.6 s	0.6 s	6 s	0.1 s	235	518	1, 2, 3, 5, 23, 31, 32, 40	\$18,500
65 mV	1 A	50 ms, 150 mV	200 Ω/V ± 2%	1 Ω/A	0.4 V/V	30 mV/A	1 s	0.5 s	20 s	0.2 s	108	238	1, 2, 3, 5, 6, 10, 31, 32	\$7,600
18 mV	0.5 A	100 ms, 500 mV	200 Ω/V ± 2%	1.66 Ω/A ± 2%	1 V/V ± 1%	10.3 mV/A ± 7%	1.6 s	0.6 s	15 s	0.2 s	226	500	1, 2, 3, 5, 6, 23, 31, 32, 40	\$15,500
90 mV	0.5 A	50 ms, 300 mV	200 Ω/V ± 2%	2 Ω/A	166 mV/V	60 mV/A	1 s	0.5 s	60 s	0.5 s	108	238	1, 2, 3, 5, 6, 10, 31, 32	\$7,600
36 mV	0.3 A	100 ms, 500 mV	200 Ω/V ± 2%	3.33 Ω/A ± 2%	1 V/V	20.6 mV/A ± 7%	1.6 s	3 s	20 s	0.5 s	226	500	1, 2, 3, 5, 6, 23, 31, 32, 40	\$15,000
10 mV	12.5 mA	200 ms, 200 mV	200 Ω/V ± 2%	12 Ω/A	1 V/V	**	0.3 s	1.2 s	75 s	1.2 s	30.4	67	5, 10, 27, 28	\$2,900
100 mV	0.25 A	50 ms, 600 mV	300 Ω/V ± 2%	4 Ω/A	94 mV/V	120 mV/A	1 s	0.5 s	45 s	0.7 s	108	238	1, 2, 3, 5, 6, 10, 31, 32	\$7,600
64 mV	0.15 mA	100 ms, 750 mV	300 Ω/V ± 2%	6.7 Ω/A ± 2%	1 V/V ± 3%	41.2 mV/A ± 7%	1.4 s	2.5 s	55 s	0.7 s	226	500	1, 2, 3, 5, 6, 23, 31, 32, 40	\$15,000
22 mV	0.1 A	100 ms, 1 V	300 Ω/V ± 2%	10 Ω/A ± 2%	1 V/V ± 3%	62 mV/A ± 7%	1.5 s	2 s	80 s	0.7 s	226	500	1, 2, 3, 5, 6, 23, 31, 32	\$15,000
44 mV	50 mA	100 ms, 2 V	300 Ω/V ± 2%	20 Ω/V ± 2%	1 V/V ± 3%	124 mV/A ± 7%	1.5 s	2 s	95 s	1 s	226	500	1, 2, 3, 5, 6, 23, 31, 32	\$15,000
80 mV	35 mA	100 ms, 3 V	300 Ω/V ± 2%	28.6 Ω/A ± 2%	1 V/V ± 3%	177 mV/A ± 7%	1.5 s	2 s	75 s	1.6 s	226	500	1, 2, 3, 5, 6, 23, 31, 32	\$15,000
60 mV	25 mA	100 ms, 5 V	300 Ω/V ± 2%	40 Ω/A ± 2%	1 V/V ± 3%	0.25 V/A ± 7%	1.5 s	2 s	120 s	2 s	226	500	1, 2, 3, 5, 6, 23, 31, 32	\$15,500
80 mV	0.75 mA	200 ms, 3 V	300 Ω/V ± 2%	600 Ω/A	1 V/V	**	0.2 s	1 s	45 s	2 s	27.8	61	5, 10, 27, 28	\$2,900

<sup>Δ</sup> For operation with a 50-Hz input (possible only with Option 005), the rms ripple and transient response specifications are increased by 50%.

\*\*This feature is not available.

\* An ac input option must be specified when ordering these 3-phase models.

† Special Option J30 must be ordered with Models 6434B-6448B and 6466C-6483C to be programmed with an HP 59501B Power Supply Programmer. Contact your local HP Field Engineer for ordering instructions.

# POWER SUPPLIES

## Special Purpose: DC Power Supply/Amplifiers

HP 6825A-6827A

- High-speed remote programming
- Overload protection
- Wide-band response
- Bipolar voltage
- Current sink or source

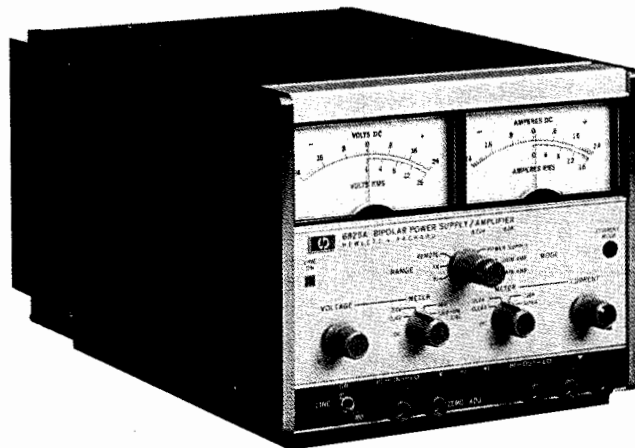

HP 6825A-6827A

### Power Supply/Amplifiers

The Power Supply/Amplifier is a general-purpose instrument useful in any laboratory engaged in research and development of electronic systems, circuitry, or components. The unit can be operated in one of two basic operating modes: power supply or amplifier. Terminals at the rear permit access to various internal control points to further expand the operational capabilities of the instrument. The resulting flexibility lends the Power Supply/Amplifier to an almost unlimited number of applications.

### Models 6825A-6827A

These models feature dual-range output and constant-voltage/constant-current operation. Output voltage and current as a dc supply, or gain as a power amplifier, are remotely controllable and are compatible with Hewlett-Packard Multiprogrammer Systems.

The unit can furnish a bipolar, constant-voltage, or constant-current output. It can be remotely programmed with a resistance, voltage, or current, and its high speed programming characteristics adapt it to a wide variety of laboratory and production testing applications. The unit can sink, as well as source, current, permitting it to serve as a variable load device.

As a direct-coupled power amplifier, each unit offers a signal-to-noise ratio of approximately 80 dB at full output with low distortion and a frequency response up to 40 kHz in the fixed gain mode.

### General Specifications

**Temperature:** operating, 0 to 55° C; storage, -40 to +75° C

**Power:** HP 6825A, 6826A, 6827A, switchable, 100, 120, 220, or 240 Vac, -13% +6%, 48 to 63 Hz, 150 W

**Size:** HP 6825A, 6826A, 6827A — 155 mm H × 198 mm W × 316 mm D (6<sup>1</sup>/<sub>2</sub> in × 7<sup>7</sup>/<sub>8</sub> in × 12<sup>1</sup>/<sub>8</sub> in)

**Weight:** 6825A, 6826A, 6827A — 8.2 kg (18 lb)

### Specifications

RATINGS		POWER SUPPLY PERFORMANCE						POWER AMPLIFIER PERFORMANCE						Options	Price	
dc Output		HP Model	PARD (rms/p-p)		Transient Recovery		Resolution		Voltage Gain		Frequency Response, +1, -3 dB		Distortion at Full Output			
Volts	Amperes		Voltage	Current	Time	Level	Voltage	Current	Fixed	Variable	Fixed Gain	Variable Gain	100 Hz	10 kHz		
-5 V to +5 V/ -20 V to +20 V	0 to 2.0 A Both Ranges	6825A	10/30 mV	5/15 mA	100 μs	20 mV	40 mV	6 mA	1X 4X	0-2X 0-8X	dc to 40 kHz	dc to 15 kHz	0.1% THD	0.5%	910	\$3,100
-5 V to +5 V/ -50 V to +50 V	0 to 1.0 A Both Ranges	6826A	6/35 mV	0.8/5 mA	100 μs	50 mV	100 mV	3 mA	1X 10X	0-2X 0-20X	dc to 40 kHz	dc to 15 kHz	0.1% THD	0.5%	910	\$3,100
-10 V to +10 V/ -100 V to +100 V	0 to 0.5 A Both Ranges	6827A	10/50 mV	0.4/5 mA	100 μs	100 mV	200 mV	1.5 mA	2X 20X	0-4X 0-40X	dc to 30 kHz	dc to 15 kHz	0.1% THD	1%	910	\$3,100

### Options Descriptions

**Opt 910** One additional manual shipped with each power supply

### Price

+ \$15

### Accessories

**HP 5060-8762** Adapter frame for rack mounting one or two HP 6825A-6827A units

**HP 5060-8760** Blank filler panel to be used with above units

☎ For off-the-shelf shipment, call 800-452-4844.

### Price

\$150 ☎

\$44 ☎



# POWER SUPPLIES

## Precision Voltage and Current Sources

HP 6114A, 6115A, 6177C, 6181C, and 6186C

551



- Manually operated voltage sources
- 0.025% output voltage accuracy
- Continuously variable current control

- Manually operated current sources
- Useful to  $\mu\text{A}$  region
- High output impedance—no output capacitor

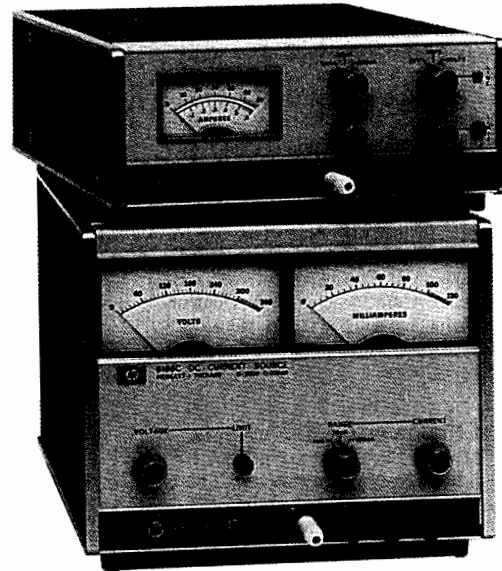

### HP 6114A and 6115A Voltage Sources

These highly accurate, stable, and easy-to-use voltage sources are intended for use as low-cost calibrators, working voltage standards, system reference supplies, and high-performance lab supplies. The supplies automatically switch between their 2 voltage ranges. They can be remotely programmed with analog techniques.

The 4-digit push-button voltage control, with a fine-adjust knob, provides voltage resolution of  $200 \mu\text{V}$ . The front-panel current control provides 2 mA resolution.

A built-in overvoltage protection circuit (SCR crowbar) monitors the output and reduces output voltage and current to zero whenever the preset voltage limit is exceeded. The overvoltage limit is adjustable from 0.5 V to 10% over the output rating of the power supply, using the front-panel control.

#### Specifications

##### DC Output

**HP 6114A:** 0 to 20 V, 0 to 2 A

20 to 40 V, 0 to 1 A

**HP 6115A:** 0 to 50 V, 0 to 0.8 A

50 to 100 V, 0 to 0.4 A

**Load Regulation:** CV: 0.0005% +  $100 \mu\text{V}$

CC: 0.01% +  $500 \mu\text{A}$

**Line Regulation:** CV: 0.0005% +  $100 \mu\text{V}$

CC: 0.005% +  $40 \mu\text{A}$

**Ripple and Noise:** rms/peak-to-peak 20 Hz to 20 MHz

CV:  $40 \mu\text{V}/200 \mu\text{V}$

CC:  $200 \mu\text{A}/1 \text{ mA}$

**AC Input:** 104 to 127 or 208 to 254 Vac (switchable), 48 to 440 Hz

### HP 6177C, 6181C, and 6186C Current Sources

These constant current/voltage limit power supplies offer exceptional regulation and stability. Typical applications include resistivity measurements, semiconductor characterization, and applications in electrochemistry and electromagnetics.

The output current is continuously variable from zero to full scale with the 10-turn control, while the decadal counts turns. Each model has 3 current ranges, providing resolution of 0.03% of range full scale. These sources can be remotely-programmed with analog techniques.

#### Specifications

##### DC Output

	Full Scale Current	Max. Voltage Compliance
HP 6177C	0 to 500 mA	0 to 50 V
HP 6181C	0 to 250 mA	0 to 100 V
HP 6186C	0 to 100 mA	0 to 300 V

**Range A:** 1% full scale current

**Range B:** 10% full scale current

**Range C:** 100% full scale current

**Load regulation:**  $0.0025\% + (5 \times 10^{-6} \times \text{range full scale current})$

**Line regulation:**  $0.0025\% + (5 \times 10^{-6} \times \text{range full scale current})$

##### Ripple and noise

###### HP 6117C and 6181C

(rms):  $0.00032 \times \text{range full scale current}$

(peak-to-peak):  $0.008 \times \text{range full scale current}$

###### HP 6186C

(rms):  $0.0002 \times \text{range full scale current}$

(peak-to-peak):  $0.005 \times \text{range full scale current}$

**AC input:**  $115 \pm 10\%$  Vac, 48 to 63 Hz (for 230 Vac, see Option 028)

#### Ordering Information

	Price
<b>HP 6114A, 6115A</b> Precision Voltage Source	\$2,500
<b>HP 6177C, 6181C</b> Precision Current Source	\$2,250
<b>HP 6186C</b> Precision Current Source	\$3,050
<b>Opt 028</b> $230 \pm 10\%$ Vac Input (6177C, 6181C, 6186C)	N/C
<b>Opt 910</b> Extra Operating and Service Manual (HP 6177C, 6181C, 6186C)	\$7.88
(HP 6114A, 6115A)	\$10
<b>HP 5060-8764</b> Rack Adapter for rack-mounting one or two HP 6177/81C Sources	\$150
<b>HP 5060-8530</b> Blank Filler Panel to be used with HP 5060-8764 for one power supply	\$100
<b>HP 5060-8762</b> Rack Adapter for rack mounting one or two HP 6186C, 6114A, or 6115A units	\$150
<b>HP 5060-8760</b> Blank Filler Panel to be used with 5060-8762	\$44

# FREQUENCY & TIME STANDARDS

## General Information

Hewlett-Packard offers frequency standards and clocks that provide accurate frequency, time-interval and timekeeping capabilities. Hewlett-Packard standards provide means for comparing these quantities against national standards such as those of the U.S. National Institute of Standards and Technology (NIST) and the U.S. Naval Observatory (USNO).

A range of Hewlett-Packard source products and systems components can be integrated into high-quality frequency and time applications. A choice of standards technologies match desired accuracy and capabilities to varying tasks.

Frequency sources and systems manufactured by Hewlett-Packard are used for control and calibration at observatories, national centers for measurement standards, physical research laboratories, missile and satellite tracking stations, communication systems, radio navigation systems, manufacturing plants, and radio monitoring and transmitting stations.

### Types of Frequency Standards

At the present time, three types of frequency standards are in common use. These are:

1. The cesium atomic beam controlled oscillator
2. The rubidium gas cell controlled oscillator
3. The quartz crystal oscillator

Hewlett-Packard manufactures all three types of frequency standards. Of these three standards, the first is a primary frequency standard and the last two are secondary frequency standards. A primary standard does not require any other reference for calibration; the secondary standards require calibrations both during manufacturing and at intervals during use depending on the accuracy desired.

### Cesium Beam Frequency Standard

Cesium beam standards are in use wherever the goal is a very high-accuracy primary frequency standard. In fact, the NIST frequency standard itself is of the cesium-beam type. The cesium beam standard is an atomic resonance device that provides access to one of nature's invariant frequencies.

### Rubidium Frequency Standard

Rubidium frequency standards feature a high order of both short-term and long-term frequency stability. These are both important in certain fields such as deep-space communications, satellite ranging, and Doppler radar.

The rubidium gas cell is dependent upon gas mixture and gas pressure in the cell. It must be calibrated and is subject to a small degree of drift. The drift is typically 100 times less than that of the best quartz-crystal standard.

### Quartz-Crystal Oscillators

Quartz oscillators are used in virtually every frequency control application, including atomic standards. The excellent short-term stability and spectral purity of the quartz oscillators used in Hewlett-Packard atomic standards contribute to the high quality of the output signal of these standards. For less demanding applications where some long-term drift can be tolerated, quartz oscillators are used as independent frequency sources.

### Frequency Standards and Clocks

Frequency standards and clocks have no fundamental differences—they are based upon dual aspects of the same phenomenon. The basic unit of time, the second, is defined as the duration of 9,192,631,770 periods of transition within the cesium atom. Frequency is determined by counting the number of cycles over the period of a second.

### Time Scale and Standards

The time interval of the atomic time scale is the International Second, defined in October 1967 by the Thirteenth General Conference of Weights and Measures. Since January 1972, the frequency offset between UTC and Atomic Time has been zero and the UTC time scale is kept in synchronism with the rotation of the earth to within  $\pm 0.9$  second by step-time adjustments of exactly 1 second, when needed (see Hewlett-Packard Application Note 52-2).

The USNO provides the official basis for Standard Time for the United States. The UTC signal is broadcast from the NIST stations WWV and WWVB and by several other stations throughout the world. (See Hewlett-Packard Applications Note 52-1, Fundamentals of Time and Frequency Standards, for a list of stations broadcasting time signals.)

The Master Clock at the USNO, one of the world's most accurate clocks, is made of an ensemble of more than a dozen Hewlett-Packard cesium-beam frequency standards. Hewlett-Packard portable cesium standards, "flying clocks," are used periodically to check the synchronization between these stations and the Master Clock.

### System Components

Hewlett-Packard standby power supplies ensure continued operation despite line interruptions, and operate over a range of ac line voltage to supply regulated dc to operate frequency standards and frequency dividers and clocks. The batteries in the supplies assume the full load immediately when ac power fails.

Low distortion, excellent isolation and versatile configurations of the Hewlett-Packard distribution amplifier allow the outputs of high-quality frequency standards to be delivered to multiple channels. Modular construction tailors this component for a variety of system requirements.

### Hewlett-Packard House Standard

The Hewlett-Packard House Standard at the Santa Clara Division consists of an ensemble of five Hewlett-Packard cesium-beam standards, each with the Option 004 high-performance tube.

Time is maintained relative to the USNO and NIST master clocks to an accuracy of better than  $\pm 1.0$  microseconds. This accuracy is verified with flying clock trips from the Naval Observatory to both Hewlett-Packard, Santa Clara Division, and Hewlett-Packard, Geneva. Both locations have been designated U.S. Naval Observatory Time Reference Stations.

Comparison of Frequency Standards

Standard	Principal Construction Feature	Principal Advantage
Cesium atomic beam resonator controlled oscillator	Beam of free cesium atoms, spatially state selected, is subjected to a microwave signal at resonance frequency.	High intrinsic reproducibility and long-term stability. Designated as primary standard for definition of time interval.
Rubidium gas cell resonator controlled oscillator	Gas-buffered resonance cell with optically pumped state selection.	Compact and lightweight. High degree of short-term stability.
Quartz crystal oscillator	Piezoelectrically active quartz crystal with electronic stabilization.	Very compact, light and rugged. Inexpensive.

# FREQUENCY & TIME STANDARDS

Frequency Standards  
HP 5061B, 5065A, 105B, 10811D/E

553

## Specifications – Frequency Standards

Instrument:	HP 5061B (Option 004)	HP 5065A	HP 105B	HP 10811D/E
Type of Standard:	Cesium	Rubidium	Quartz	Quartz
Accuracy: Maintained in a dc magnetic field up to 2 gauss over a temperature range of 0° to 50° C	$\pm 5 \times 10^{-12}$ ( $\pm 3 \times 10^{-12}$ )	Set to $\pm 1 \times 10^{-11}$ of UTC at factory		
Accuracy: Limited temp. range <sup>(1)</sup>	$\pm 3 \times 10^{-12}$ ( $\pm 2 \times 10^{-12}$ )			
Reproducibility	$\pm 3 \times 10^{-12}$ ( $\pm 1.5 \times 10^{-12}$ )			
Retrace	$\pm 3 \times 10^{-12}$ ( $\pm 5 \times 10^{-13}$ )			
Settability (frequency)	$\pm 7 \times 10^{-13}$ ( $\pm 1 \times 10^{-13}$ )	$\pm 2 \times 10^{-12}$	1 ppm (coarse); $5 \times 10^{-6}$ (fine)	$> \pm 1 \times 10^{-6}$ (10 Hz)
Long-Term Stability	$\pm 2 \times 10^{-12}$ ( $\pm 2 \times 10^{-12}$ ) <sup>(4)</sup>	$\pm 1 \times 10^{-11}$ /month	$5 \times 10^{-10}$ /day	$5 \times 10^{-10}$ /day
DC Magnetic Field Stability, freq. charge, any orientation in a 2-gauss field	$< \pm 2 \times 10^{-12}$ ( $< \pm 2 \times 10^{-13}$ )	$< \pm 5 \times 10^{-12}$ (1 gauss field)		$< -90$ dBc (1 gauss field)
Time Constant, quartz OSC, control loop	1 s			
Warmup Time at 25° C	45 min (30 min)	$5 \times 10^{-11}$ /4 hrs <sup>(2)</sup>	$1 \times 10^{-9}$ /30 min	$5 \times 10^{-9}$ /10 min
Tube Warranty	5 yrs (3 yrs)	3 yrs	Not applicable	
Sinusoidal Outputs	1/5/10 MHz, 100 kHz	5 MHz, 1 MHz, 100 kHz	5M, 1M, 100k, Clock (1M)	10 MHz
Output Voltage	1 volt into 50 $\Omega$			1 V into 1000 $\Omega$ , or 0.55 V into 50 $\Omega$
Harmonic Distortion (from rated output)	$< -40$ dBc			$< -25$ dBc
Non-Harmonic Distortion (from rated output)	$< -80$ dBc			$< -100$ dBc
Temperature, Operating	0 to 50° C		0° to 50° C	0° to 71° C
Temperature, Non-Operating	$-40$ to 70° C <sup>(3)</sup>		$-40$ to 50° C	$-55$ to 85° C
Power, ac	50/60/400 Hz $\pm 10\%$ , 115/230V $\pm 10\%$ 44(Ce)/49(Rb)W		19 W (71 W warmup)	Not applicable
Power, dc	22 to 30 V, 30 W	23 to 30 V, 35 W	7 W (11 W warmup)	2.5W (10 W warmup)
Power, ac/dc with options – add	5 to 16 W	0 to 16 W	Not applicable	0W
Dimensions (H×W×D): mm:	221×425×416	133×425×416	88.2×425×286	72×52×62
inches:	8.7×16.7×16.4	5.2×16.7×16.4	3 $\frac{3}{8}$ ×16 $\frac{3}{4}$ ×11 $\frac{1}{4}$	2.8×2×2.4
Weight (lb/kg) Option 001 Option 002 Option 003	64/29.1 (68/30.9)  6/2.7	34/15.4 2/0.9 3.5/1.6	24/10.9	0.69/0.31
Standby Power Supply-Capacity at 25° C w/clk	45 min	10 min	6 hrs	
Recharge	Automatic	Switch	Automatic	
Time Standard (Clock option)				
1 PPS Outputs: Connectors	Front and rear BNC	Front BNC		
	Amplitude	10 V peak into 50 $\Omega$ load		
	Width	20 $\mu$ s min		
	Rise Time	$< 50$ ns		
	Fall Time	$< 50$ ns		
Jitter, Pulse-to-Pulse	$< 1$ ns, rms			
Synchronization	Automatic, 100 $\pm$ 100 ns delay			
Clock Pulse Adjustment				
Range	0.1 $\mu$ s to 1 s			
Clock Display:	LCD	LED		
(1) Static mechanical and atmospheric and electromagnetic environment $\pm 2.5^\circ$ C range at any temperature between 15° and 35° C.				
(2) After 24 hours off at 25° C.				
(3) If options are installed in the HP 5065A, The non-operative temperature TS $-40^\circ$ to $+50^\circ$ C.				
(4) For life of cesium beam tube.				
NOTE: Tubes are intrinsically capable of meeting these specifications when installed in HP 5061Bs currently in production.				

### HP 10811D/E Oscillators

The HP 10811D/E crystal oscillators are oven-controlled, high-performance component oscillators. Both offer unmatched quality, high performance, and low cost. The low aging rate and fast warmup time reduce maintenance costs and downtime. Low power consumption gives the HP 10811D/E oscillators longer battery-backup time. Low phase noise translates to lower system phase noise when using HP oscillators.

The HP 10811D has a PCB connector for all external connections; the HP 10811E uses filter feed-through terminals for power connections and oven monitor. The HP 10811E also has SMB snap-on RF connectors for the 10 MHz output and EFC input, and provisions for shock mounting.

### Ordering Information

**HP 10811D** 10 MHz Oscillator, PCB/Edge Connector

**HP 10811E** 10 MHz Oscillator, SMB Connectors

**Options for HP 10811D or HP 10811E**

**Opt 001** Low Aging Rate

**Opt 002** Low Phase Noise

**Opt 003** Integrated Opt 001 and Opt 002

**Opt 023** 10.23 MHz (for GPS applications), standard stability, and aging performance

**Opt 100** Reduced Specifications

Note: Options are mutually exclusive; no mixing.

### Price

\$1,000

\$1,200

+ \$500

+ \$750

+ \$2,500

+ \$100

– \$200

# FREQUENCY & TIME STANDARDS

## Primary Standards

### HP 5061B

- HP 5061B
- Accuracy  $\pm 3 \times 10^{-12}$
- Primary standard
- Proven reliability



HP 5061B (shown with Option 003)

### HP 5061B Cesium Beam Standard

The first Hewlett-Packard Cesium Beam Standard, the HP 5060A, was introduced in 1964. This was followed in 1967 with the improved HP 5061A, in 1973 with the high-performance beam tube option for the HP 5061A and in 1986 with the 5061B. Since this time the accuracy and reliability of Hewlett-Packard cesium beam standards continues to be demonstrated and these standards have become the worldwide standard for frequency and time keeping. The HP 5061B has provision for an optional digital divider and reliable, easy-to-read LCD clock and for a battery with 3/4-hour standby power capacity with automatic charging (Option 003).

### Reliability and Warranty

Over 200-million operation hours have proven the performance and reliability of Hewlett-Packard cesium beam standards in various worldwide applications. The units have provided dependable micro-second accuracy in aircraft, ships, and fixed environments.

A five-year warranty on the HP 5061B standard cesium beam tube is further testimony of its proven field reliability. This warranty includes replacement of the cesium beam tube if it should fail within the warranty period.

### HP 5061B with Option 003, Time Standard and Standby Power Supply

The HP 5061B has provision for an optional digital divider and reliable, easy-to-read LCD, time-of-day, 24-hour digital clock (Option 003). By including this option, the number of applications and the versatility of the cesium standard is increased. The one-pulse-per-second output can simplify the comparison with other standards (such as portable and secondary standards) as well as GPS and Loran Systems. The techniques for such comparisons are described in Application Note AN 52-2. Option 003 also includes an internal battery power supply which will provide at least 45 minutes of standby power if the line power should fail. This will prevent phase and frequency interruptions due to intermittent or an extended power failure. Battery power also enables moving the cesium beam standard to locations of other secondary standards without losing time.

### HP 5061B, Opt 004

- Improved accuracy  $\pm 2 \times 10^{-12}$
- Settability  $\pm 1 \times 10^{-13}$
- Time domain stability  $5 \times 10^{-12}$  (1 s avg)

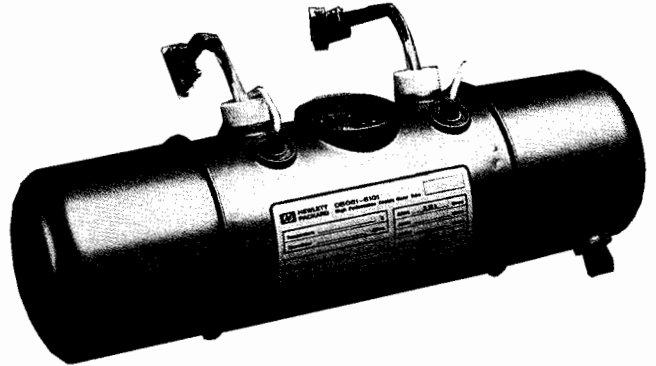

Option 004, High Performance Cesium Beam Tube with three-year warranty

### HP 5061B with Opt 004, High Performance Cesium Beam Tube

The Hewlett-Packard 5061B primary frequency standard with the Option 004 Cesium Beam Tube offers increased stability and accuracy in the instrument which has become the worldwide standard of frequency and time keeping since its introduction in 1967. Improvements in magnetic shielding, ruggedization, and environmental performance permit improved performance and expansion of navigation and communication systems.

The design concept of the new high-performance beam tube includes unique HP designed single-beam optics with higher beam intensity to accomplish better short-term stability and greater immunity to effects of shock and vibration. A 50-percent increase in resonance cavity length contributes to better accuracy and settability because of the high Q of the narrower resonant line width. This tube retains the unique cesium standard feature of virtually no long-term instability or aging.

The intrinsic accuracy is improved to  $\pm 2 \times 10^{-12}$  which provides an excellent reference standard without need of calibration. If desired, as in many time keeping applications, two or more units may be calibrated to determine the difference in rate or may be adjusted to the same frequency. With the improved settability specifications of  $1 \times 10^{-13}$ , small changes in frequency are accomplished rapidly and accurately. A provision for degaussing the tube without adversely affecting the instrument operation allows removal of any residual magnetic field in the tube. This is important in achieving the settability performance.

The short-term stability specification is improved by a factor of ten with this tube. The  $5 \times 10^{-12}$  (1 s avg.) performance compares very favorably with that of rubidium type standards which are noted for their excellent short-term stability. An important advantage of the better short-term stability is the capability to make measurements to 1 sigma precision of  $1 \times 10^{-12}$  in about one minute compared to the two hours required previously. The HP 5061B with the Option 004 High Performance Tube has the same high reliability as the HP 5061B with the standard tube. The new high-performance tube is warranted for three years.

### Ordering Information

	Price
HP 5061B Cesium Frequency Standard	\$46,600
Opt 003 Clock and Standby Power Supply	\$5,000
Opt 004 High Performance Beam Tube	\$8,500
Opt 908 Rack Flange Kit	\$80

- Compact
- Long-term drift rate  $< 1 \times 10^{-11}$ /month
- Time domain stability  $< 5 \times 10^{-13}$  (100 s, avg)
- High reliability
- Proven performance

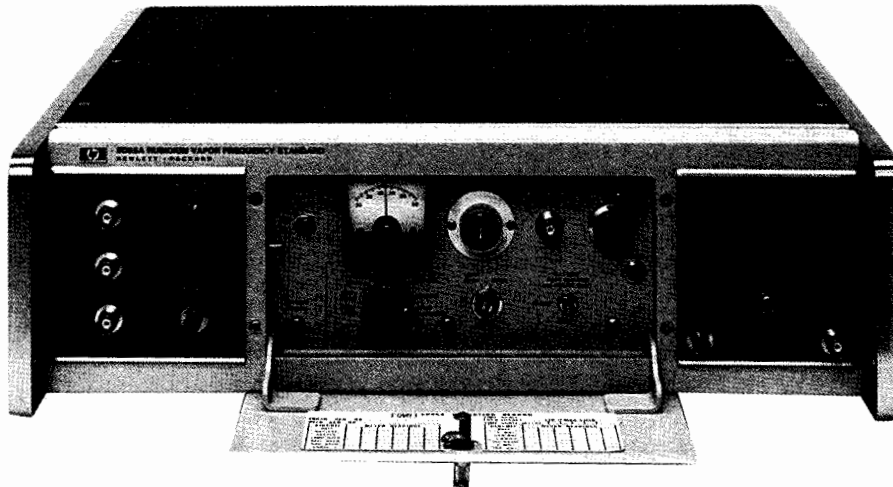

HP 5065A

### HP 5065A Rubidium Frequency Standard

The HP 5065A is an atomic-type secondary frequency standard which uses a rubidium vapor resonance cell as the stabilizing element. As a result, it has long-term stability of better than  $1 \times 10^{-11}$  per month which exceeds that of high quality quartz oscillator frequency standards by 50 to 100 times. Furthermore, it has excellent short-term stability. These features contribute to its desirability as a coherent signal source, as a master oscillator for radio and radar systems where special requirements for stability and/or narrow bandwidth must be met, as a precision time keeper where the better performance of a cesium beam primary standard is not required, and as a house frequency standard for improved accuracy with fewer NIST calibrations compared to that required with quartz standards.

Front panel controls and circuit check meter of the HP 5065A are protected by a panel door. The magnetic field control provides fine frequency adjustment with which the frequency can be set to a precision of better than  $2 \times 10^{-12}$  without reference to a chart. The low noise quartz oscillator is phase-locked to the atomic frequency and provides the standard 5 MHz, 1 MHz, and 100 kHz outputs. The circuit check meter with selector switch monitors key voltages and currents for routine maintenance readings, calibration procedures, and fault finding.

The HP 5065A is designed for assured operation to give the user confidence that the standard output signals are correct and locked to the atomic frequency. Logic within the unit maintains power to a "continuous" operation light on the front panel. If operation is interrupted, even momentarily, for any reason, the light goes out and stays out until manually reset. An integrator limit light warns when the frequency correcting servo loop is approaching the limit of its dynamic range.

The HP 5065A is contained in a small-size package and is light-weight in comparison to a cesium beam standard. Additionally the rubidium resonance cell is much more frequency stable than quartz oscillators while subjected to shock and vibration, EMC, humidity, and magnetic field effects.

### Reliability and Warranty

The most significant module in the HP 5065A in terms of performance is the Rubidium Vapor Frequency Reference (RVFR). This temperature controlled, magnetically shielded unit includes the Rb gas cell and a photo sensitive detector designed for maximum possible reliability. Field experience, including several million hours of operation, have demonstrated this reliability and the RVFR is now warranted for a period of three years. This increased warranty protects the owner in the event of random failure.

### Options and Accessories

The Option 001 Digital Clock has an easy to read LED time-of-day display. The olive black upper panel provides a dark background around the readout for excellent contrast and readability. Initial clock setting is accomplished by means of pushbuttons easily accessible by removing the top cover. The LED display offers high reliability, freedom from errors due to mechanical shock, and performance over the full environmental range of the HP 5065A. A sync button on the digital divider permits automatic synchronization of this 1 PPS pulse to an external pulse. The clock 1 PPS is adjustable in decade steps from 0.1  $\mu$ sec to 1 s, with respect to the synchronized reference, with 7 thumbwheel switches.

To conserve battery power, the display is not illuminated when ac power is not available. A STANDBY READ pushbutton below the display is used for readout when operating on the internal battery or external dc.

The Option 002 Standby Battery provides the HP 5065A with a minimum of 10 minutes standby power at 25°C. Switchover from line to battery is automatic so there is no interruption of operation if ac line power should fail. A front panel ac interruption light warns when ac power has failed or has been disconnected. Fast or float charging rates may be selected when ac power is available.

The Option 003 combines the Option 001 Clock and Option 002 Battery and should be specified if both Options 001 and 002 are required.

### Ordering Information

	<b>Price</b>
<b>HP 5065A</b> Rubidium Frequency Standard	\$42,000
<b>Opt 001</b> Digital Clock	+ \$5,000
<b>Opt 002</b> High Performance Beam Tube	+ \$2,400
<b>Opt 003</b> Clock and Standby Power Supply	+ \$7,000
<b>Opt 908</b> Rack Flange Kit	+ \$100

# FREQUENCY & TIME STANDARDS

## Secondary Standards, Special Products, Accessories

HP 105B, E21-5061B/5065A, J45-5061, K34-59991A, 10638A

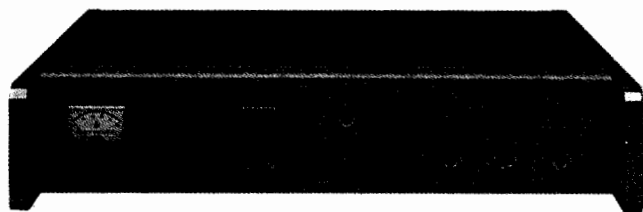

HP 105B

### HP 105B Quartz Frequency Standard

The HP 105B Quartz Frequency Standard provides excellent long- and short-term stability characteristics, spectrally pure output, unexcelled reliability, and the ability to operate under a wide range of environmental conditions. The HP 105B fills a need for a small and economical yet highly stable precision reference for frequency and time standards. The HP 105B can be operated from the ac line. It also has a built-in 6-hour standby battery for uninterrupted operation. The 5 MHz, 1 MHz, and 100 kHz buffered sinusoidal outputs have excellent short-term stability (1 part in  $10^{11}$  rms for 1 s averaging time) and aging rate ( $< 5$  parts in  $10^{10}$  per day).

The HP 105B features rapid warm-up. Typically, the standard will be within 5 parts in  $10^6$  of the final frequency in 15 minutes after an "off" period of less than 24 hours. The basis of this standard is an extremely stable quartz crystal oscillator. The crystal, oscillator and AGC circuit are all enclosed in a proportional oven for reduced temperature effects on these components and circuits.

A spectrally pure 5 MHz output, when multiplied high into the microwave region, provides signals with spectra only a few Hz wide. Spectra less than 1 Hz wide can be obtained in X-band (8.2 to 12.4 GHz). The 5 MHz output is suitable for doppler measurements, microwave spectroscopy, and similar applications where the reference frequency must be multiplied by a large factor.

### HP 105B Specifications

**Outputs:** 5 MHz, 1 MHz, 100 kHz; 1 V rms into 50  $\Omega$  front and rear connectors

**Clock output:** 1 MHz; 0.5 V rms into 1 k  $\Omega$  rear connector

#### Frequency Stability

**Aging rate:**  $< 5 \times 10^{-10}$  per 24 hours

**Short-term stability:** For 5 MHz output only

$\tau$ (sec)	$\sigma_{\Delta f/f}(2,\tau)$
$10^{-2}$	$1.5 \times 10^{-10}$
$10^{-1}$	$1.5 \times 10^{-11}$
100	$1 \times 10^{-11}$

**Temperature:**  $< 5 \times 10^{-9}$  total change  $0^\circ\text{C}$  to  $50^\circ\text{C}$

**Load:**  $< \pm 9 \times 10^{-11}$  open to short, 50  $\Omega$  R, L, or C load change

**Supply voltage:**  $\pm 5 \times 10^{-11}$  for 22 to 30 V dc from 26 V dc reference and for 115/230 V  $\pm 10\%$

**Warm-up (at  $25^\circ\text{C}$ ):** To within  $1 \times 10^{-7}$  in 15 min.,  $1 \times 10^{-8}$  in 20 min.,  $1 \times 10^{-9}$  in 30 min. of final value (24 hours after turn-on) if off less than 24 hours.

### Distortion (5 MHz, 1 MHz, 100 kHz) below rated output

**Harmonic:**  $> 40$  dB; **Non-harmonic:**  $> 80$  dB

### Frequency adjustments

**Fine:**  $\pm 5 \times 10^{-8}$  range with digital dial reading parts in  $10^0$

**Coarse:**  $1 \times 10^{-6}$  front-panel screwdriver control

**Phase locking:** External +5 V to -5 V allows  $> 2 \times 10^{-8}$  frequency control for locking to external source.

**Temperature:**  $0^\circ\text{C}$  to  $+50^\circ\text{C}$  operating;  $-40^\circ\text{C}$  to  $+50^\circ\text{C}$  ( $+75^\circ\text{C}$  without standby battery storage)

**Altitude:** 15.24 km (50,000 ft.)

**Standby supply capacity:** 6 hours at  $25^\circ\text{C}$  ambient temperatures.

**Power requirements:** 115/230 V  $\pm 10\%$ , Hz at 19 W (71 W warmup), 22-30 V dc at 16 W (8 W warmup)

**Size:** 88 mm H  $\times$  425 mm W  $\times$  286 mm D ( $3\frac{1}{2}$  in  $\times$   $16\frac{1}{4}$  in  $\times$   $11\frac{1}{4}$  in)

**Weight:** 105B—net, 11 kg (24 lb); shipping, 14 kg (31 lb)

### Ordering Information

**HP 105B** Quartz Frequency Standard

**Opt 908** Rack Flange Kit

**Opt 910** Extra manual

### Price

\$9,500

+ \$80

+ \$30

## Special Products and Accessories

### HP E21-5061B/5065A Flying Clocks

A wide range of operating power capabilities enable the HP E21-5061B and E21-5065A to operate on local power in virtually any country in the world. The standby capability makes it possible to travel where there is no power available and allows transportation between power sources. These special products can be operated in almost any air or surface vehicle as "flying clocks" (see Hewlett-Packard Journal, August 1966 and December 1967).

The HP E21-5061B consists of an HP 5061B Cesium Beam Standard with Option 003 LCD Clock and Special Option E21, all fastened to an HP 5089A Standby to form a portable unit. The power supply, which can be operated from 11 to 30 V dc, 85 to 255 V ac, will provide approximately 10-hours standby power.

The Option 004 tube, because of the improved shielding, offers a significant increase in accuracy under the varying earth's magnetic field conditions experienced by flying clocks and is a desirable addition to the HP E21-5061B.

HP E21-5065A Portable Time Standard consists of the HP 5065A Rubidium Standard with digital clock and divider (Option 001) and the HP 5089A Power Supply with 6 or more hours standby capability. The component units are held together by side bars, and the interconnecting cables are protected by a back cover.

### HP J45-5061B Certified Stability of $1 \times 10^{-13}$

The HP J45-5061B will certify that the Model HP 5061B with standard Options 003 and 004 has stability performance of better than or equal to  $1 \times 10^{-13}$  in a day, when measured on any five consecutive days. This means that the cesium standard's absolute deviation from the HP Santa Clara Division House Standard is less than or equal to 8.64 ns per day on each of the five consecutive days during the certification. The certification applies only to original shipments and is performed under calibration laboratory conditions.

### HP K34-59991A Phase Comparator

The HP K34-59991A Broadband Linear Phase Comparator accurately compares the phase relationship of the output signals of two frequency standards having the same nominal frequency. This will enable resolving extremely small differences between precision frequency sources. The Phase Comparator operates over a frequency range of 10 kHz to 50 MHz and input levels between 100 mV and 10 V rms. A linear dc output voltage, proportional to the phase differences between the two standards, is available at both the front and rear panels, and is suitable for driving a stripchart recorder.

### HP 10638A Degausser

The HP 10638A Degausser is designed for use with the HP 5061B Option 004 High Performance Cesium Beam Tube without interrupting normal operation. The degausser removes residual magnetism in the shields of the beam tube which can cause a frequency offset. Relaxation of the residual magnetism insures a settability of  $\pm 1 \times 10^{-13}$ , allowing stable precise changes in output frequency and a reproductibility of  $\pm 1.5 \times 10^{-13}$ . The degausser should be used when initially setting up the HP 5061B with Option 004 or after the instrument has been moved or adjusted.

### Ordering Information

**Special Option HP E21-5061B** Flying Clock +\$9,050

(Includes HP 5089A; requires HP 5061B, Opt 003)

**Weight:** 64 kg (141 lb)

**Size:** 425 H mm  $\times$  405 mm W  $\times$  546 mm D (16.7 in  $\times$  15.9 in  $\times$  21.5 in) including handles

**Opt 003** Digital Clock +\$5,000

**Special Option HP E21-5065A** Flying Clock +\$9,175

(Includes HP 5089A; requires HP 5065A, Opt 001)

**Weight:** 50 kg (141 lb.)

**Size:** 314 mm H  $\times$  425 mm W  $\times$  546 mm D (8.4 in  $\times$  16.7 in  $\times$  21.5 in) including handles

**Opt 001** Digital Clock +\$5,000

**Special Option HP J45-5061B** Certified Stability \$950

(Requires Option 004)

**Special Option HP K34-59991A** Phase Comparator \$2,700

**HP 10638A** Degausser \$5,000

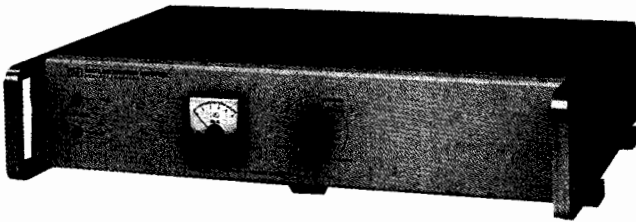

HP 5087A

## HP 5087A Distribution Amplifier

The Hewlett-Packard 5087A distribution amplifier provides the isolation and flexibility required for distribution of the output of high-quality frequency standards. The distribution amplifier features plug-in modular construction, short-circuit isolation, exceptional phase stability, low noise and cross-talk, and switchover to standby dc if ac power fails.

Several configurations are available and special combinations of input and output modules can be supplied. Amplifiers can be added or the configuration easily changed with the HP 10812A options

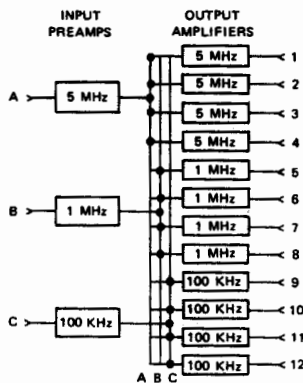

Figure 1. HP 5087A with Option 031.

## HP 5089A Standby Power Supply

The HP 5089A standby power supply furnishes dc power to keep frequency or time standard systems operating during extended interruptions of ac line power. This unit is designed for use with Hewlett-Packard cesium-beam standards, rubidium vapor standards, quartz standards, and other equipment that will operate from 22 to 28 Vdc. No switching is used in transferring power from line to battery operation and back again, thus assuring uninterrupted operation.

The HP 5089A is an extremely versatile unit. It was designed both as a portable power supply for the HP 5061B and HP 5065A "flying clocks," and as a standby supply for stationary applications.

### HP 5087A Specifications

**Inputs:** up to three, rear panel BNC

**Frequencies:** 10 MHz, 5 MHz, 1 MHz, or 100 kHz

**Level:** 0.3 to 3.0 V rms, 50 ohms

**Outputs:** up to 12 rear panel BNC

**Frequencies:** 10 MHz, 5 MHz, 1 MHz, or 100 kHz

**Level:** 0 to 3 V into 50 ohms (screwdriver adjustment)

**Harmonic distortion:** > 40 dB below rated output

**Non-harmonic distortion:** > 80 dB below rated output

#### Isolation

**Load** (open or short on any other channel):

Amplitude change: 0.1%

Phase change: < 0.1 ns at 5 or 10 MHz

< 0.5 ns at 1 MHz

< 5.0 ns at 100 kHz

**Injected signal:** 1 V signal up to 50 MHz applied to any output except 10 MHz, will be down > 60 dB in all other outputs; 10 MHz output channel will be down > 50 dB.

**SSB phase noise (5 MHz):** > 145 dB below signal in 1 Hz BW for frequencies > 1 kHz from carrier.

**Short-term stability degradation (5 MHz):** <  $1 \times 10^{-12}$  in 10 kHz bands (1 s average).

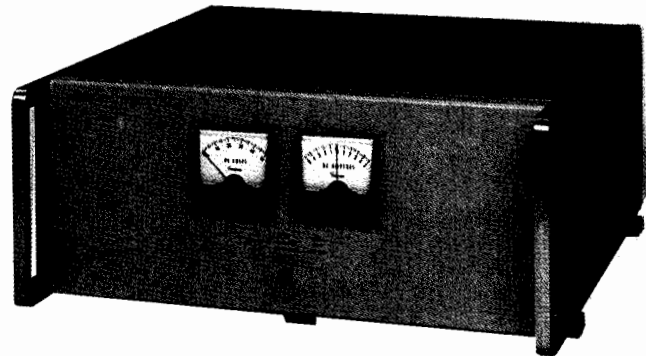

HP 5089A

### Environmental

**Temperature:** MIL-E-16400, Class 4

**Operating:** 0° to 50° C

**Storage:** -62° to +75° C

### Stability

**Amplitude:** ± 0.5 dB, 0° to 50° C

**Phase:** < 0.1 ns/° C, 5 and 10 MHz

**Humidity:** 95% at 40° C

**Altitude:** Up to 30,000 ft

### General

**Power:** 115 or 230 V ± 10%, 48 to 440 Hz, 20 VA, max, or 22 to 30 V dc, 500 milliamperes, max

**Size:** 88 mm H × 425 mm W × 286 mm D (3.5 in × 16.7 in × 11.3 in)

**Weight:** Typical, Opt 031: net 7 kg (15 lb)

## HP 5089A Specifications

### Input Voltage

**AC charging:** 85 V to 130 V ac rms, 48 to 440 Hz, 300 VA max

85 V to 255 V ac rms, 48 to 66 Hz, 300 VA max

**DC operation:** 11 V to 30 V dc, 110 W max

**Output voltage:** 22 V to 28 V dc (nominal), 2 A maximum

**Standby capacity:** 15 AH at +25° C when fully charged

**Recharge:** Complete recharge in 24 hours from ac line

**External low battery voltage alarm:** Visible LED or audible

### Environmental

**Temperature:** 0 to 50° C operating; -40° to +65° C storage

**Humidity:** Up to 95% at 40° C (with no internal condensation)

**Altitude:** 12,000 m (40,000 ft), operating; 15,000 m (50,000 ft) storage

**Size:** 177 mm H × 425 mm W × 416 mm D (7 in × 16.7 in × 16.4 in)

**Weight:** Net weight 30.5 kg (67 lb)

### Ordering Information

**HP 5087A Distribution Amplifier Mainframe** \$3,100

**Opt 908 Rack Flange Kit** + \$80

### Normal Configurations (input and output amplifiers)

**Opt 031** 5, 1, 0.1 MHz inputs; 4 outputs at each + \$2,600

**Opt 032** Single 5 MHz Input and 12 Outputs + \$2,300

**Opt 033** Single 10 MHz Input and 12 Outputs + \$2,300

**Opt 034** Single 5 MHz Input, 4 each Outputs at 5, 1, and 0.1 MHz + \$2,700

### Special HP 5087A Configurations

#### Input Preamplifiers (up to 3 total)

**Opt 004** Input Preamplifier (0.1 to 10 MHz) + \$120

**Opt 005** 5 to 1 MHz Input Divider + \$200

**Opt 006** 1 to 0.1 MHz Input Divider + \$340

**Opt 011** 5 to 10 MHz Input Doubler + \$350

**Opt 013** 10 to 5 MHz Input Divider + \$390

**Opt 014** 10 to 1 MHz Input Divider + \$350

#### Output Amplifiers (up to 12 total)

**Opt 001** 5 MHz Output Amplifier + \$190

**Opt 002** 1 MHz Output Amplifier + \$190

**Opt 003** 0.1 MHz Output Amplifier + \$220

**Opt 012** 10 MHz Output Amplifier + \$190

**HP 5089A Standby Power Supply. Includes ac and dc input power cables, dc output cable, and extender board.** \$7,500

**Opt 001** Spare Board (HP 05089-60001). + \$1,400

**Opt 908** Rack Mounting Adapter Kit. + \$800

**Opt 910** Extra Operating and Service Manual. + \$250

# SEMICONDUCTOR TEST EQUIPMENT

## IC Evaluation System

HP 82000 Models D400, D200, D100, D50

- Up to 400 MHz vector rate
- Up to  $\pm 200$  ps edge placement accuracy
- Up to 768 channels
- Tester-per-pin architecture
- Automatic functional test generation
- Automatic ac/dc characterization

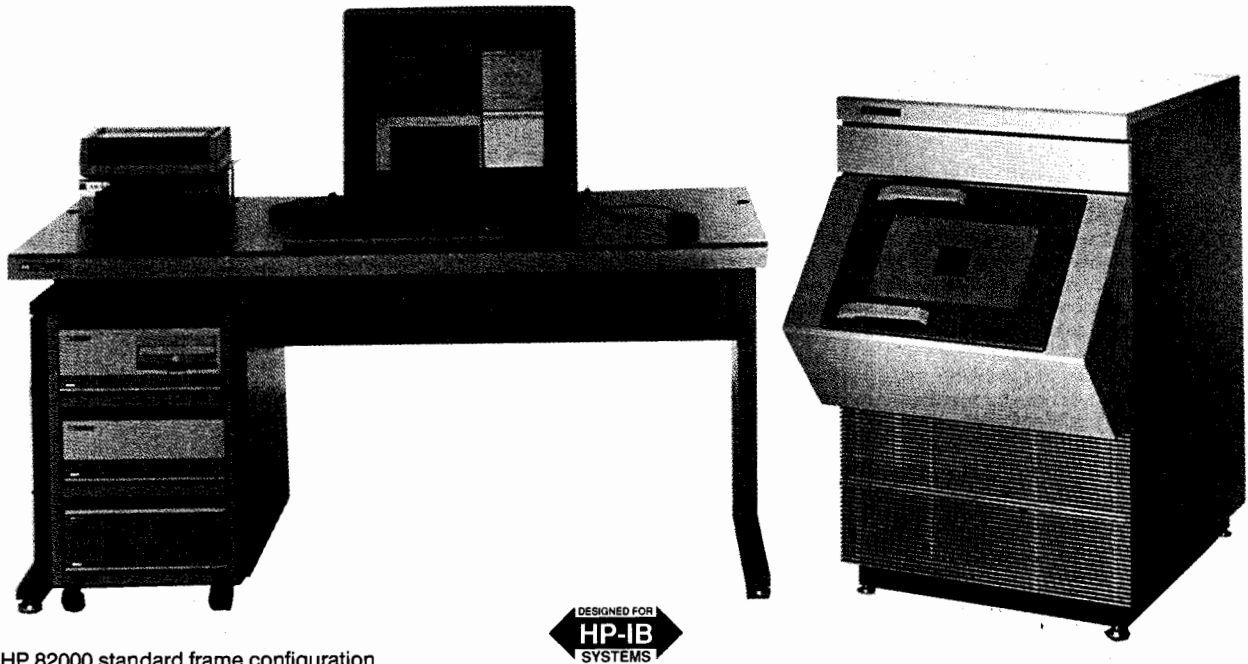

The HP 82000 standard frame configuration

### A Family of Compatible Systems

With the HP 82000, Hewlett-Packard offers systems to satisfy the IC evaluation requirements of both IC manufacturers and end users. To address a wide range of applications, 4 models are available: Model D400 for a maximum vector rate of 400 MHz, and Models D200, D100, and D50 for maximum rates of 200 MHz, 100 MHz and 50 MHz respectively.

#### Model D50

The HP 82000 Model D50 is the ideal choice to test mainstream CMOS devices. ASICs with up to 768 bidirectional signal pins can be verified and characterized with up to  $\pm 500$  ps accuracy. Critical turnaround times are reduced with the Model D50's automated characterization software, which is also compatible with the other models.

#### Model D100

The HP 82000 Model D100 is designed to test BiCMOS and fast CMOS devices of up to 100 MHz. The edge placement accuracy is  $\pm 350$  ps on up to 512 I/O channels.

#### Model D200

The HP 82000 Model D200 offers 200 MHz speed and  $\pm 250$  ps edge placement accuracy on up to 512 I/O channels. It is designed for manufacturers, design centers, and ASIC system designers with fast BiCMOS and bipolar devices.

#### Model D400

The HP 82000 Model D400 is intended for applications with the most demanding speed requirements. These are typically high-speed bipolar and GaAs devices. The D400 I/O boards can also be mixed and used with D200 boards, thus allowing great application flexibility.

### Application Examples

#### Prototype verification

Unlike large and complicated production ATE, the HP 82000 is a personal tester dedicated to your verification requirements. The ability to create a functional test program from the EDA (electronic design automation) workstation database means faster time-to-market in prototype verification.

The earlier design problems are detected, the lower the overall product development cost. This system enables you to analyze IC function and parameters at the prototype stage of the design cycle. The risk of ASIC problems in later board-level integration is minimized.

#### IC characterization

To optimize design throughput, Hewlett-Packard developed automatic characterization functions as standard with every system. There are numerous test functions, which provide test patterns and appropriate system setups, and automatically sweep test parameters for complete characterization tests. Measurements of ac and dc characteristics, such as hold time or leakage current, are started quickly from menus and are completed instantly.

Engineering testing of prototype ICs is the main application area of the characterization functions. Other applications include incoming inspection and failure analysis of parts rejected by production ATE. For the latter, the HP 82000 can be used as a dedicated system to diagnose the process problems that caused rejection.

#### Production testing

For low-volume production testing, the HP 82000 can be a cost-effective solution because its high timing and level accuracies allow tight guardbands for higher test yield. Test programs can also be optimized for throughput by using HP-IB commands and firmware-stored test setups. The high pincounts typically required in production testing are provided for by the maxiframe, which can house up to 512 D400, D200, or D100 channels, or 768 D50 channels (see page 559). Third-party products can be integrated with the system to access wafer prober stations and device handlers. With systems in production and in the engineering department, test programs can be shared over a LAN (local area network) without extra effort.

#### Tester-per-Pin Architecture

Timing and level capabilities are provided for every channel without sharing resources. Each channel also has dedicated memory for masking information and can have its own data format (RZ, R1, DNRZ, and so on). All tester channels can be calibrated individually at the device-under-test (DUT) pin. For best results, you can calibrate using the actual test parameter set—giving an edge placement accuracy of  $\pm 200$  ps for Model D400,  $\pm 250$  ps for Model D200,  $\pm 350$  ps for the Model D100, and  $\pm 500$  ps for Model D50. This is useful when performing fast go/no-go tests, for example, in production.



### Best Time-to-Test with Windows Software

Productivity is increased by a highly interactive user interface based on the X Window standard. The mouse-operated software is used to enter and modify parameters for pin timing and levels, and to modify the vector data. Thanks to the tester-per-pin architecture, parameters can be defined and changed for each channel individually without limitations through shared resources. Error maps, timing diagrams and shmoo plot displays show results in a graphic form familiar to the engineer. Simultaneous access to different windows lets you see immediately the results of changes made in the setup. "Change-and-see" avoids recompilation of test programs and gives you the shortest possible debug cycle.

### Automatic Test Program Generation

The LAN provides fast access to design workstations from vendors such as Daisy, Mentor, Valid, and HP, and to FACTOR and VERILOG files. Other formats can be adapted by the user during the translation process or with the EDA programming toolkit. The computing power of a 32-bit workstation, and translation programs optimized for speed, maintain high throughput in the automatic test program generation.

Software fully supporting the testers' hardware resources generates a functional device test without user programming. Test vectors, timing setup, and pin setup are generated automatically.

### Test Control Includes Scan-Path Testing

To support "design for testability," a scan-path testing mode is integral to the system. The memory of up to 256 tester channels can be serialized via a software command, increasing vector depth on user-selected channels. A programmable vector sequencer has functions such as vector repeat, looping and branching on real-time test results or external events.

### Minimum DUT Wiring

"Instant-wired" DUT boards for the popular pin layouts reduce the time for I/O wiring to zero and are available in various sizes to allow you to optimize board size and cost for the pin count of your DUT. A controlled impedance environment from the testers' I/O circuits to the DUT provides excellent signal fidelity up to 400 MHz. To cover special IC packages, HP also offers boards that provide maximum flexibility for user wiring.

### Cost-Efficient Configurations

For applications requiring a maximum of 80 I/O pins (160 I/O pins on the model D50), there is a compact benchtop alternative to the standard and maxiframe systems. The system components, including DUT boards, are compatible for upgrades to higher channel counts. With built-in self-test and calibration, on-site board exchange is easy. Expansion to maximum-channel-count systems with uncompromised speed and accuracy is made possible by adding extra mainframes.

For ordering and technical information, technical data sheets and application notes, please contact your nearest HP sales office.

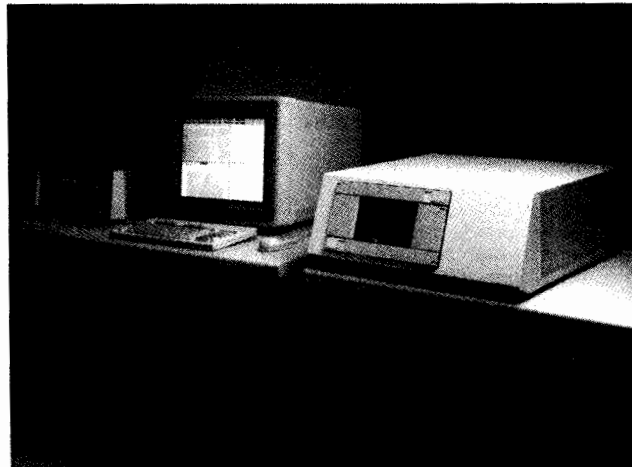
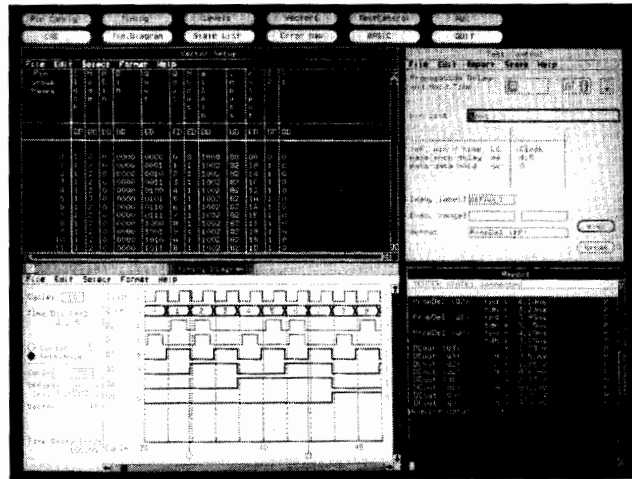

### HP 82000 System Characteristics

	Model D400	Model D200	Model D100	Model D50	
<b>Vector Rate</b>	400 MHz	200 MHz	100 MHz	50 MHz	<b>Architecture:</b> Tester-per-pin with individual timing and level resources, including per-pin formatting, compare mode (edge/window), tristate, masking, and channel modes. <b>PMUs:</b> Available as plug-in boards, 1 pair per mainframe. <b>Software:</b> interactive X Window environment, automatic tests and ac/dc characterization, color graphics result windows.
<b>Vector Depth</b>	1024/K	2048/K	1024/K	1024/K	
<b>Max. I/O Pin Count</b>	512	512	512	768	
<b>Timing Resolution</b>	50 ps	50 ps	50 ps	100 ps	
<b>Edge Placement Accuracy</b>					
at standard calibration	± 500 ps	± 500 ps	± 600 ps	± 800 ps	
at calibrated user settings	± 200 ps	± 250 ps	± 350 ps	± 500 ps	
<b>Level Range</b>	-4...+8 V	-4...+8 V	-4...+8 V	-2...+7 V	
	-4...+5 V (400 MHz RZ channels)				

# SEMICONDUCTOR TEST EQUIPMENT

## Power Mixed Signal Test

HP 9472 and 9470 Series (AOT 3000 and 2000)

- Menu-driven software
- "C" program development environment
- $\pm 1500$  V,  $\pm 100$  A
- 32-channel analog cross point matrix 2 A/1000 V
- 64 Digital I/O with  $\pm 600$  V Protection at 20 MHz
- Low-level measurement capability ( $< 5 \mu\text{V}$ ,  $< 1 \text{ pA}$ )
- Time  $\pm 1$  ns (100 ps resolution)

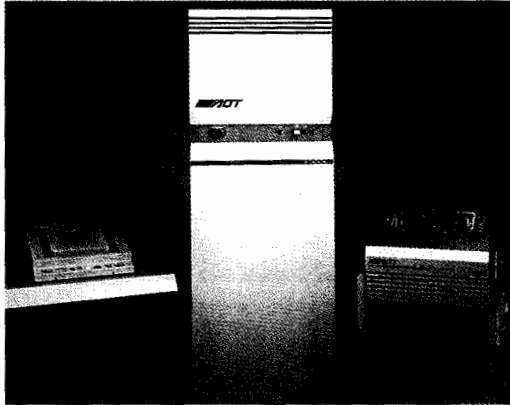

HP 9472 Test System with TH-200 and TH-300 Test Heads



### HP 9472 Test System

The HP 9472 is a general-purpose modular and field-configurable test system. It can be configured to test a host of smart power, hybrid, analog, and power mixed-signal devices including motor drivers, disk controllers, high-side switches, voltage regulators, power-supply controllers, analog switches, op-amps, timers, and comparators. It can handle voltages up to  $\pm 2000$  V and currents up to  $\pm 100$  A. The system supports up to 32 analog channels, 64 digital I/O pins, and features low leakage measurement capability, inductive load testing, instrument-level diagnostics, networking, time measurement and menu-driven software with compiled "C" language test libraries.

#### Benefits

Immediate production • Versatile, reconfigurable • High throughput, fast program development

#### Features

The HP 9472 is designed to provide quality production testing at a low cost. The system controller, a 25 MHz 80386 PC with a high-speed instrument control bus, is complemented by RS232C and optional HP-IB and Ethernet interfaces. The mainframe houses 4-quadrant, 16-bit V/I resources, an NIST traceable calibration standard and a high-voltage relay matrix. All mainframe resident voltage/current sources are 3-wire Kelvin-connected (force, sense, and driven guard) through a 1000 V/2 A matrix to 1 or 2 test heads. If needed, the system may easily be expanded with a second bay.

#### Configurable Test Head

The TH-300 test head integrates power, small signal, time measurement and flexible digital test capability together in one compact test-head environment, allowing up to 14 test-instrument modules to be located close to the DUT for improved accuracy and high-throughput, single-pass testing. Both precision analog and digital options are available. The test head is designed to allow straightforward interfacing to external instruments that may be needed to provide high-power pulses, RF stimulus and measurements, and capacitance measurements. Signals of all types can be connected to the DUT via a modular interface that may be configured as required by the application.

#### Menu-Driven Software

An interactive menu-driven environment affords an efficient approach to program generation and debugging. The primary menu allows the user to quickly select operating modes such as Program Generation, Program Debug, System Operation, System Diagnostics, Real Time Report Generation, Utilities, and context-sensitive help.

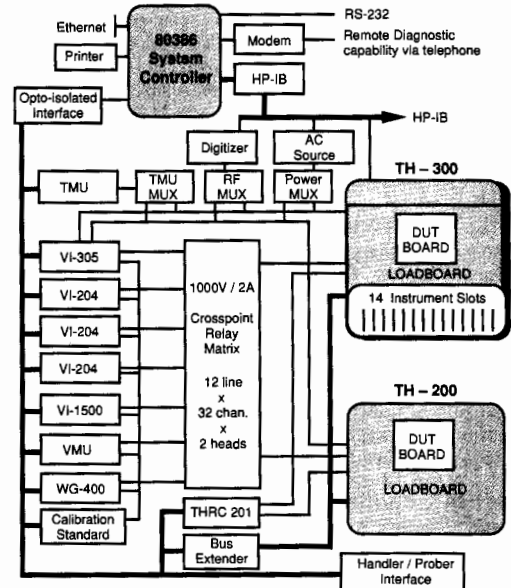

HP 9472 system architecture shown with available options

### HP 9472 Basic Components

Single bay cabinet • 80386 system controller • 80387 math coprocessor • Printer • Color monitor • 84-Mbyte hard disk • Floppy disk • Opto-isolated interface • Handler interface • System interface • Test head control (32 relay drivers, 32 static digital driver/receivers per test head) • Differential voltmeter (16-bit, 1000 volt Range) • NIST traceable calibration standard • Diagnostic board • Documentation • Installation and training

### Optional Mainframe Resources

- VI-204** Four-Quadrant Force, Clamp, Measure V/I, 16 bits up to  $\pm 50$  V,  $\pm 2$  A
- VI-305** Four-Quadrant, Floating, Programmable Pulsed, High Current up to  $\pm 50$  A, at up to  $\pm 80$  V
- VI-310** Four-Quadrant, Floating, Programmable Pulsed, High Current up to  $\pm 100$  A, at up to  $\pm 20$  V
- VI-1500** High-Voltage Programmable Four-Quadrant V/I, up to  $\pm 1500$  V, up to  $\pm 200$  mA
- RM-201** Cross-Point Relay Matrix, 12 Input by 8 Output Channels; Each Channel Has Force, Sense and Driven Guard, 1000 V/2 A Rated
- WG-400** Dual-Source Arbitrary Waveform Generator
- IEEE-488** HP-IB Interface and Software for Additional Instruments

### Optional Time-Measurement Instrumentation

- TMU-100** Time Measurement Unit,  $\pm 1.0$  ns accuracy
- WD-200** Waveform Digitizer, real-time viewing, storage and analysis of wide-bandwidth complex signals

### Optional Test-Head-Resident Instrumentation

- TMM** 16-Channel Time Measurement Unit Signal Conditioner
- HVPA** High-Voltage, Low-Current V/I Source ( $\pm 110$  V,  $\pm 1.0$  nA,  $\pm 10$  mA)
- THR-200/400/800** Low Leakage Relay Matrix (up to 2000 V/50 A)
- OPA** High-performance Op-Amp Loop Card
- FTP** Floating Time Measurement Probe with  $\pm 1000$  Float Range and 50 V Pulse Generator
- FVI**  $\pm 36$  V /  $\pm 500$  mA Floating VI with  $\pm 1000$  Float Range
- RMS** RMS Voltmeter
- PPG** 100 MHz Pulse Pattern Generator
- OPE** 8-Channel Octal Pin Electronic Drivers, with  $\pm 600$  V Input Protection
- DT-300** High-Performance 20 MHz Digital, Expandable in Groups of 16 to 64 I/O plus 4 Clocks
- HIVPE** High-Voltage ( $-5$  to  $+20$  V) Pin Electronics, 10 MHz Digital, Expandable in Groups of 16 to 64 I/O, Protected up to  $\pm 600$  V



HP 9470 Test System

- 1000V / 2A relay matrix
- 1500V VI measurement instrument
- 100A VI measurement instrument
- Power switching time capability
- Radiometric measurement unit (optical power)
- Photometric measurement unit (intensity and wavelength)

#### HP 9470 Test System

The HP 9470 test system uses a linear test system architecture and is driven by an 80386 controller with a math coprocessor running MS-DOS, 1 Mbyte RAM, a line printer, a hard disk, a floppy disk, a serial port, and a parallel port. It also includes a real-time test operating system with menu-driven program-generation. Using the concept of a program library, a new program can be generated in less than an hour. The HP 9470, with its capacity for expansion, is easily configured for today's applications in the low-cost electronic test marketplace.

#### Device Types Tested

Bipolar transistors • Diodes and arrays • Displays • LED and arrays • MOSFETs • Opto-couplers • Photo logic • Photo-interrupters • Rectifiers and bridges • SCRs, triacs and diacs • Sense FETS • Solid-state relays • Switch-mode controllers • Voltage regulators

#### HP 9470 Basic Components

One or two test heads • Single bay cabinet • 4 to 16 analog channels (force, sense and driven guard) • Low leakage 1000V / 2A cross-point matrix • Voltages up to 2000 V • Currents up to  $\pm 100$  A • 16 static digital drivers/detectors and 16 relay drivers per test head • Differential voltmeter (16-bit, 1000-volt range) • NIST traceable autocalibration • Powerful binning and branching capability • Handler/prober interface • Instrument-level diagnostics • Report generation • Menu-driven software • Turn-key device libraries • Installation and training • Optional HP-IB • Optional networking

#### Optional Mainframe Resources

**VI-20x** Series Four-Quadrant Force, Clamp, Measure V/I, 12 or 16 bits up to  $\pm 50$  V, up to  $\pm 2$  A

**VI-310** Four-Quadrant, Floating, Programmable Pulsed, High Current Force, Clamp, Measure V/I, up to  $\pm 100$  A, up to  $\pm 20$  V

**VI-1500** High-Voltage Programmable Four-Quadrant V/I, up to  $\pm 1500$  V, up to  $\pm 200$  mA

**RM-200** Cross-Point Relay Matrix, 12 Input by 4 Output Channels; Each Channel has Force, Sense and Driven Guard, 1000V / 2A Rated

**TMU-200** Time Measurement Unit,  $\pm 1.0$  ns Accuracy

**IEEE-488** HP-IB Interface and Software for Additional Instruments

**NET-200** Ethernet Option



HP 9460 and HP 9464



- UL isolation voltage testing with HP 9460
- VDE-0884 isolation voltage testing and partial discharge detection with HP 9464
- 0 to 7000V AC rms\* with programmable test times
- 0 to 50  $\mu$ A leakage threshold
- 0 to 50 pC or 0 to 200 pC partial discharge threshold

#### HP 9460 and HP 9464 Testers

HP 9460 and 9464 series testers are isolation-voltage and partial-discharge testers. They are designed to test the input-to-output and lead-to-case isolation voltage of opto-couplers (DIP) and isolated case power packages (isolated TO-220).

#### Complete Operator Control

Controls are provided for device leakage, partial discharge, and high-voltage low-limit thresholds. LEDs indicate PASS/FAIL and the type of failure. Safety interlocks protect the operator from contact with high test voltages.

#### Leakage and Partial Discharge Detection

The testers sense both excessive leakage current and partial discharge in the device under test (DUT). The HP 9464 is in compliance with VDE-0884 test methods for partial discharge testing.

#### Non-Destructive Testing

The HP 9460 prevents destruction of a device if leakage at a given voltage causes the discharge of stored energy. The test circuitry features negligible stored energy and a current-limiting design that prevents damage to devices that fail. Voltages are applied to the DUT at AC zero crossings and a solid-state switch controls voltage.

#### Multiple Handler Options

The manual version is ideal for incoming inspection, sampling, and laboratory analysis. For production applications, the testers can be factory-integrated with an automatic handler. Typical throughput is 2000 to 2400 units per hour with 1-second programmed test time. A dual-test-site handler allows testing with the HP 9460 and 9464 on one test site while the other test site is interfaced with either the HP 9470 or the HP 9472.

#### Specifications

##### HP 9460 and HP 9464

Voltage range:	0 to 7000 Vac RMS
Voltage accuracy:	1%
Leakage threshold:	0 to 50 $\mu$ A
Open-socket leakage:	< 1 $\mu$ A (at 7.0KV RMS)

##### HP 9464 Only

Partial discharge delay:	0.1 to 9.9 seconds
Partial discharge threshold:	0 to 50 and 0 to 200 pC

\*Note: Maximum voltage before partial discharge is contact-dependent.

#### Partial Discharge Calibrators

Range:	0 to 9, or 0 to 45 pC
Resolution:	1 pC
Accuracy:	$\pm 5\%$ of selected value

#### Ordering Information

Please call your local HP sales office for data sheets, prices, and application assistance for all products.

# SEMICONDUCTOR TEST EQUIPMENT

## Mixed Signal LSI Test System

HP 9490

### HP 9490 Series

- Tester series for engineering and production use
- Mixed signal control function
- Real-time DSP function
- High throughput via per-pin dc and dual CPU architecture
- Test Vector Generator per-pin digital test capability
- Application-oriented software

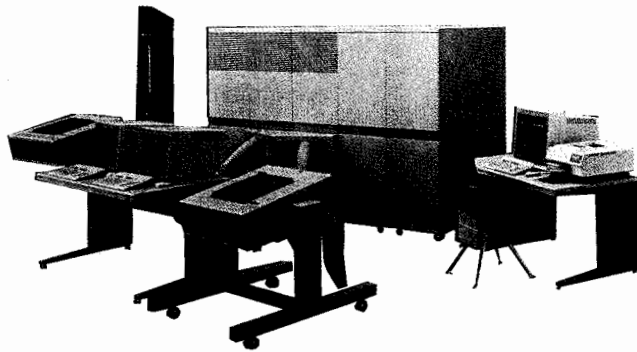

### HP 9490 Mixed Signal LSI Test System

In the semiconductor world, the mixed signal device category promises to become an important segment. Due to advances in communications and computer technologies, it is possible to realize smaller and more convenient phone systems, advance television systems, and multimedia systems, for example. In these systems, advanced mixed signal capability such as analog-to-digital conversion, analog signal measurement with high frequency/wide dynamic range, and digital signal processing is becoming commonplace.

The HP 9490 Mixed Signal Test System series provides tester capability to achieve full mixed signal test coverage with a series of systems.

In device design environments, higher digital test frequencies and more precise analog measurement capabilities are required. However, in production test areas, cost-effectiveness is a top priority. Attempting to solve all of the requirements for both applications with a single test system at first seems difficult to accomplish.

Hewlett-Packard solves this dilemma with one series of test systems. The HP 9490 series consists of two test systems, the HP 9491A Mixed Signal LSI Test System (device design oriented) and the HP 9492A Mixed Signal LSI Test System (production oriented).

### Series Concept

To develop complex test applications for mixed signal devices is usually a very time-consuming process. Once the test program has been developed for device evaluation, it may then be tailored for use in production test.

Since mixed signal devices have just recently become highly popular, in the past many IC vendors have resorted to performing final testing with larger and expensive systems. Such approaches do not provide much flexibility or opportunity to consider system cost issues because of time-to-market considerations. However, the average selling prices of these mixed signal devices typically falls after introduction, resulting in stiffer competition due to the associated relative increases in test cost.

Now the HP 9490 series solves these problems with a series tester concept. Even if you use the high-end tester for accelerating program development, you can transfer the test program for production test use without changes. The HP 9491A has a wider frequency and dynamic range than the HP 9492A, and it is a good fit for engineering design and device evaluation areas. The HP 9492A features a small footprint and lower system cost. Both systems in the HP 9490 series are compatible with respect to test programs and DUT boards because both share a common architecture.

### System Architecture

The HP 9490 Series Mixed Signal LSI Test System combines not only high performance digital and analog test functions, but also complex mixed signal control functionality such as event synchronization. The HP 9490 provides resources for device testing through fully

integrated test heads. The test heads can support a maximum 128 digital input/output channels with per-pin test vector generation. With Synchro-Pipe, which is the control line for complex mixed signal event synchronization, digital and analog modules are triggered by each other even under asynchronous timing conditions set by dual master clocks. Real-time Digital Signal Processing generates modulated or coded signals without consuming a huge amount of waveform memory. For high throughput testing, per-pin dc test functions are available. Each digital pin in the test head has a dc test unit for accelerating continuity and other parametric tests. For example, the HP 9490 can perform dc testing of all digital pins simultaneously. The dual CPU architecture also helps to preserve throughput even while test development tasks are in progress. The HP 9490 series maintains a consistent, advanced architecture from the higher performance HP 9491A to the cost-effective HP 9492A model. Even with full system functionality, the HP 9492A system cabinet footprint is only 1.21 square meters for a 64-pin system.

### Mixed Signal Test

For testing complex ICs with mixed signal capabilities, test systems must provide a variety of test functions and application technologies. The HP 9490 series offers a variety of modules for easy program development for your current and evolving test applications. The HP 9490 modules, advanced architecture, and test functions help you realize a higher quality of test in the mixed signal world.

### Digital Test Functions

For the latest mixed signal devices, pin count seems to be increasing as compared with earlier mixed signal ICs. The HP 9490 series provides system pin counts up to a maximum of 128 digital pins to test these ICs.

To simplify links with CAE systems, the HP 9490 adopts a "TG per-pin" architecture. In order to store long test patterns, each Test Vector Generator (TVG) has a maximum 1-megaword (8 bits per word) pattern memory.

For capturing high-speed digital signals, each TVG provides a maximum 1-megaword (2 bits per word) capture memory.

Each TVG has six timing edges for waveform control. The function has been designed for flexibility to allow generation of digital test patterns with various formats.

Data rates of mixed signal devices for device evaluation sometimes exceed 100 MHz, especially for high-frequency video or data communication devices. The HP 9491A's maximum 128-MHz data rate will be ideal for device design and evaluation, while the HP 9492A's maximum 32-MHz data rate is optimized to address most production applications.

The HP 9490's digital functions are sophisticated enough for digital devices, but they have been designed for mixed signal devices testing. For example, deep capture memory and real-time Digital Signal Processing functions are available as necessary functions for complex mixed signal device testing.

### Analog Test Functions

Based on high-speed transient waveform measurement experience, Hewlett-Packard has developed a sampler system for accurate sampling of HF to VHF signals and has applied this expertise to the HP 9490 series. The sampler has 12 bits of resolution and a 1-GHz bandwidth.

The 16-bit Digitizers and 16- and 18-bit Arbitrary Waveform Generators (AWGs) provide low-distortion test capability at lower frequencies. These modules are useful for testing audio, telecom, and generic low-frequency mixed signal ICs.

If the basic test system noise is higher than the best module performance, then the system and modules cannot be used to their fullest extent. With the HP 9490, system noise has been minimized by using low noise power supplies and optical data links.

To generate high-speed analog signals, the HP 9490 can provide not only LF AWG functionality with 16- or 18-bit resolution, but also HF and VHF AWGs with 12-bit resolution. Especially for complex devices in advanced TV or video systems, a 12-bit AWG with 128-MHz maximum sample rate can address the majority of applications. Each AWG and digitizer module has deep waveform memory (up to 1 megaword) to generate or capture complex, modulated signals.

For highly accurate dc characteristic testing of analog or mixed signal devices, the system features a precision dc source and measurement unit.

All analog test functions have been carefully selected to meet mixed signal device test needs now and in the future.

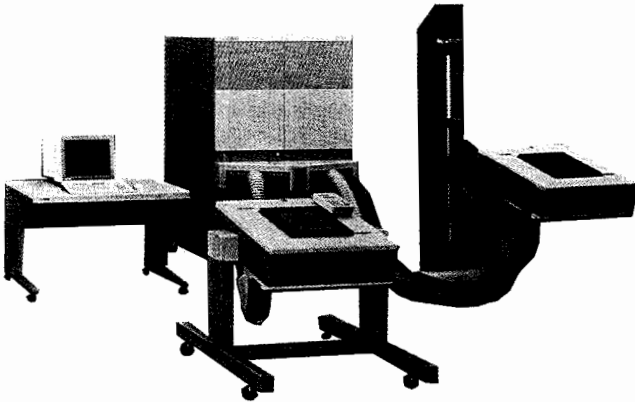

HP 9492A Mixed Signal LSI Test System

### Event Synchronization

Since mixed signal devices have become increasingly complex recently, it is difficult to test them without event synchronization technology. This technology provides important functionality that is integrally related to the bidirectional communications between the test system and the devices under test. For example, testing some telecommunication devices without event synchronization technology means that the tester cannot adequately control device signals.

The HP 9490 series solves this testing issue with Hewlett-Packard's advanced Synchro-Pipe function combined with a dual master clock architecture. In this architecture, the sequencer controls events, which consist of analog and digital input/output signals, by its own microcode test sequence. Each event is synchronized with a particular clock provided by the test system or the device. In brief, Synchro-Pipe is a trigger and flag highway that acts as a control path between modules.

Dual master clocks support synchronization of signals with two independent frequencies and timing. This architecture is also effective for accelerating dc tests. The sequencer controls dc settings and measurements with minimal time loss due to command transfer.

### Real-Time DSP Function

Additional mixed signal test challenges demand the use of advanced hardware to test devices like ISDN or MODEM ICs. Real-time Digital Signal Processing (DSP) functions on the HP 9490 help speed calculations on signal data. Real-time DSP modules are available for the AWGs, digitizers, and digital functions. Captured data need not be sent to the central array processor. For example, a digitizer with real-time DSP can analyze extremely long analog waveforms that are based on encoded data, sometimes including jitter. After converting that waveform to digital data, the real-time DSP module processes the data immediately. These steps can be performed very quickly. The real-time DSP function not only emulates the actual operating conditions of the device, but also saves waveform memory and reduces test time.

### dc Test Functions

One of the most important test areas for production environments concerns dc test. IC manufacturers carefully perform dc parametric and continuity tests for each device pin. To control yield, the number of dc test items tends to increase rapidly. Accelerating dc test throughput is a critical issue. The HP 9490's dc test function architecture provides per-pin voltage source and current measure and per-pin current source and voltage measure. These functions increase test speed via parallel dc settings and measurements. For other dc test needs, more capability is available through Parametric Measurement Unit (40V range) and Source/Monitor Unit (200V range) resources.

### Advanced Test Development and Execution Environment

Shorter test development times make a significant contribution toward reducing test costs. With the HP 9490's advanced environment for test development and execution, a total, applications-oriented environment has been constructed to minimize test costs.

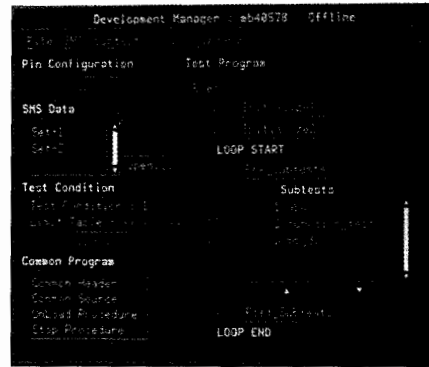

Development Manager Window

### Application Development Environment

To allow efficient development of mixed signal device test applications, software with an advanced visual user interface is necessary. The HP 9490 Application Development Environment (ADE) provides an interactive, structured, and application-oriented approach to test development. The Development Manager supervises the creation and flow of test programs in a logical, straightforward manner. Keyboard-free operation allows rapid test development for a variety of mixed signal devices. Over one dozen powerful tools including various monitors, editors, and debuggers are available. For example, the Synchro-Monitor provides a snapshot of analog and digital signal relationships. The Intrinsic Panel offers a "cut and paste" approach to create test programs with minimal typing. Even if a user isn't familiar with the operating system or programming language, these tools can shorten the program development cycle. Offline development also saves the hardware cost of a test system. Hardware and device simulation capabilities provide a virtual test system environment. Using the Waveform Editor or previously captured data are approaches to simulate actual device output for offline program debugging.

### Test Execution Environment

On the production line, the test operator oversees the test process, while the production engineer must report on current status. The HP 9490 provides a total, consistent environment for test execution. The HP 9490's series concept means the same DUT board and test program can be used on the HP 9491A and the HP 9492A. That saves engineering costs in modifying applications when they are transferred to the production line. Once the test program has been transferred, the HP 9490 Test Execution Manager helps to select and change subtests and change test limit values, data log conditions, and prober/handler settings without any changes in the main test program. Using the Snapshot Test Report, test data can be neatly summarized for the product line. For system maintenance, the HP 9490 offers diagnostic software and tools to perform system check and calibration, which can isolate faulty modules quickly.

### Network Capability

For improving productivity, the construction of a tester network is considered critical. The standard HP 9490 system has a dual CPU architecture. One CPU is a User Interface Processor (UIP), which is used for user interface activities and supervising other test systems. In addition, the UIP can be a gateway with CAE or data management systems by using basic network functions.

### System Specification Summary

#### HP 9490 Series

- Maximum 128 digital I/O channels
- 1-megaword memory (maximum) for each pin
- Synchro-Pipe (mixed signal control line)
- Per-pin dc test
- ADE, TEE software

#### HP 9491A Mixed Signal LSI Test System

- 128-MHz maximum data rate for digital test
- 12-bit/128-MHz, 18-bit/30-MHz AWGs
- 1-GHz bandwidth/12-bit samplers
- 16-bit/1-MHz, 12-bit/20-MHz digitizers

#### HP 9492A Mixed Signal LSI Test System

- 32-MHz maximum data rate for digital test
- 12-bit/30-MHz, 16-bit/500-kHz AWGs
- 128-MHz/12-bit sampler
- 16-bit/1-MHz, 12-bit/20-MHz digitizers

# SEMICONDUCTOR TEST EQUIPMENT

## Analog LSI Test System

HP 9480

- 128-MHz analog and digital synchronized testing
- 1-GHz bandwidth, 1-ps sampling resolution
- ac testing at the wafer level
- Digital Signal Processing (DSP) -based system
- High test throughput modules
- Flexible modular architecture
- Powerful debugging tools
- Distributed workstation environment

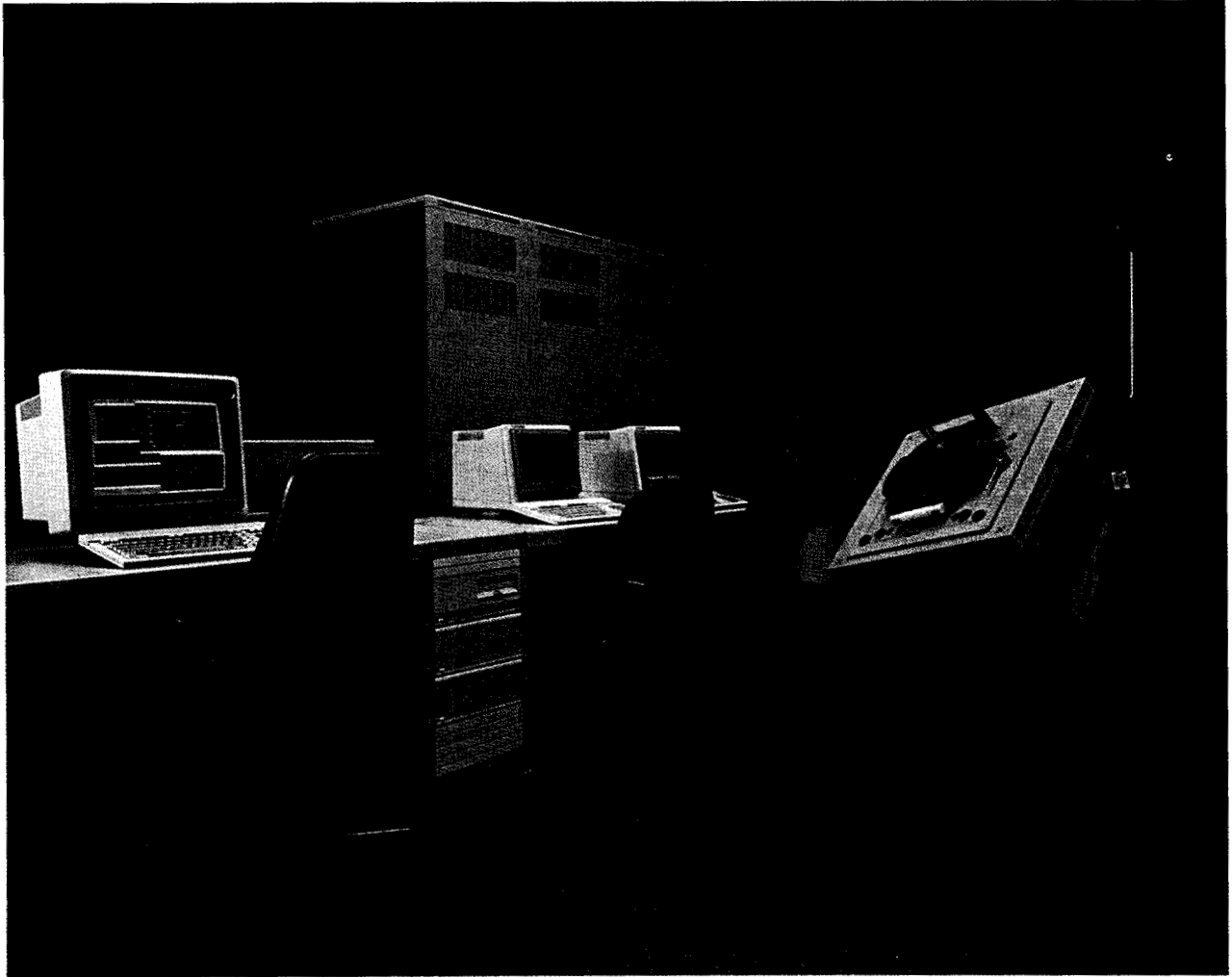

### HP 9480 Analog LSI Test System

The HP 9480 Analog LSI Test System integrates powerful test hardware and software to perform precise high-frequency signal measurements. You can use the HP 9480 to test and characterize a wide variety of devices, from mixed signal devices such as flash ADCs, video DACs, telecommunication devices, and so on, to purely analog or purely digital ICs. The HP 9480 provides full data sheet test coverage in a single insertion, thus eliminating the problem of time-consuming and costly multiple insertion testing. The HP 9480 can also perform high-frequency ac tests on wafers.

The HP 9480's modular architecture allows you to combine many state-of-the-art hardware and software features into a configuration that best suits your measurement needs. The system can generate digital stimulus patterns and analog stimulus waveforms up to 128 MHz and it can capture DUT digital response patterns up to

128 MHz. For analog DUT response, the system offers 16- and 12-bit real-time waveform digitizers and 1-GHz bandwidth samplers with 1-ps resolution. The system also offers 18-, 12-, and 10-bit arbitrary waveform generators. Digital patterns, dc voltage, and dc current can be input or output to up to 128 pins. Analog signals can be input or output using up to four channels each. Digital Signal Processing (DSP) allows complex waveform generation and high-speed signal analysis via a full floating point array processor. The HP 9480's system software is based on the HP-UX operating system. Powerful debugging tools, including an offline debugger, virtual panel, and virtual scope, significantly minimize debugging time. Furthermore, HP 9480 software is easy to operate because it incorporates menus, a user-friendly multiwindow environment, and mouse capability. These features increase test throughput and minimize time spent on program development.

## Hardware

### Device Testing Under In-Circuit Conditions

The HP 9480's analog and digital signal test capability enables you to test the dynamic parameters of devices under their true operating conditions. The HP 9480 can also perform high-frequency tests on wafers because of its coaxial cable environment and very low system noise.

For ac signal stimulus, the HP 9480 generates low-distortion sine waves (up to 128 MHz), arbitrary waveforms with 12-bit resolution (up to 128-MHz clock rate), and arbitrary waveforms with 18-bit resolution (up to 1-MHz clock rate). For recording high-frequency signals up to 1 GHz, with 12-bit resolution, the system offers four sampler channels that sample a signal with 1-ps resolution. For recording signals in real time, the system offers two choices—20-MHz/12-bit and 1-MHz/16-bit digitizers. For digital testing, the system offers up to 128 I/O pins, and features 64 kword memory for each pin. The system can generate digital stimulus patterns and clocks, and it can analyze response patterns from the test device at a data rate of 128 Mwords/s with 100-ps resolution. And because the HP 9480 can synchronize analog waveforms with digital signals and automatically execute timing adjustments, you can perform precise tests on mixed signal devices under actual operating conditions.

### Digital Signal Processing (DSP) Technology

The HP 9480 uses digital signal processing to generate and analyze analog and digital signals.

For example, you can easily and quickly modify and create waveforms in the frequency domain by using FFT commands. The HP 9480 can easily synchronize analog signals with system clocks because the waveform data is recorded into system memory. Multiple parameters such as THD, SNR, differential nonlinearity, etc., can be extracted from the recorded data without running the test again. A 32-bit full floating point array processor minimizes system controller loading by performing complex matrix computations for digital signal processing. DSP technology shortens test times by allowing multiple parameter extraction from a single test, and it minimizes hardware costs because analog and digital processing are performed by the same modules.

### Modular Architecture

The modular system architecture of the HP 9480 allows easy adaptability to your changing test needs. This means that the system's usefulness and value are maintained well into the future because system upgrades and enhancements are easy and cost-effective. Also, maintenance costs are minimized because only faulty modules need to be repaired or replaced in the event of a system malfunction.

### High Test Throughput

In addition to the high-speed testing resources, the dual test head system contributes to increased test throughput. For an ADC characteristic test, the Histogram Accelerator is available to reduce the test time by a factor of 60.

## Software

HP 9480 software is based on the HP-UX operating system and operates on HP 9000 Series 300 engineering workstations. HP-UX is fully compatible with standard UNIX systems and incorporates an advanced multiwindow system with a mouse and pop-up menus. This provides graphics-oriented test development, testing, and data analysis environments, which facilitate smooth and efficient operation.

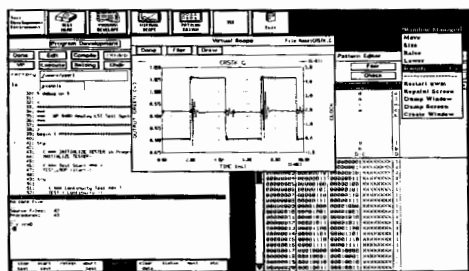

Multi-Window Environment

You can easily set up conditions and values for test execution and data analysis with the HP 9480's fill-in-the-blanks format. You simply enter the appropriate information into the mask fields displayed on the screen.

### Test Development

The HP 9480 features two debugging modes and three useful tools for you to use the test hardware effectively and reduce the amount of time spent on test program development.

The debugging modes available are offline and the standard online debugging. A hardware simulator is used with offline debugging. Therefore, offline debugging and device test execution can be performed at the same time because the test hardware is not used for offline debugging. This guarantees efficient system utilization.

Available tools are the symbolic debugger, virtual panel, and virtual scope. The symbolic debugger offers a number of features that enable the user to debug at the source code level. The symbolic debugger decreases debugging time because it allows you to modify test conditions without program recompilation. The virtual panel displays the hardware settings and output conditions in real time when debugging, thereby allowing you to confirm program measurement conditions. The multiwindow function displays hardware information on a module-by-module basis. The virtual scope displays the stimulus waveform or pattern data specified in the program and the response waveform output from the test device. These tools minimize the test development time and maximize engineering productivity.

### Testing

The HP 9480 provides easy operation in the test execution environment. The test conditions are set in a fill-in-the-blanks format displayed on the screen, and tests start by the press of a function key or the start button on the operator console. The operator console is a compact terminal to control test execution, such as test start, retest, and test stop.

For monitoring tests quickly, the virtual scope and summary logging are useful tools. The virtual scope displays waveform output from the test device. The summary logging collects data during device testing, and makes test summary, bin summary, and lot summary reports.

### Data Analysis

The HP 9480's software capabilities are complemented by a comprehensive set of data analysis functions. These functions allow you to make effective use of all test data collected during device testing. The following reports can be set up and displayed so that you can easily analyze measurement results: tabular reports, scatter diagrams, control charts, wafer maps, X-Y graphs, Shmoo plots, and bar charts.

### Tester Workstations (sold separately)

The HP 9000 Series 300 computer, the HP 9480 system controller, can connect directly to the Ethernet/IEEE802.3 local area network (LAN).

When networked, HP 9480 tasks can be distributed between workstations in the network. This increases system efficiency because tasks previously managed by one computer are now distributed between workstations. For example, you can use a test development station (TDS) as a standalone workstation for test program development, such as editing, compiling, and offline debugging, while testing, without degradation of test performance.

### Application Support for Rapid Start Up

HP Semiconductor System Centers (SSCs) offer quality application support for quick start up of your HP 9480 system. Application support packages include consultation with expert HP personnel and the tailoring of test program software and hardware to your specific test requirements.

### System Specification Summary

**128-pin I/O, 128-MHz (1 μHz resolution) clock rates**

**Analog signals analysis**

16-bit (1-MHz)/12-bit (20-MHz) real-time digitizer

1-GHz (12-bit) high-frequency sampler

**ac signal stimulus**

18-bit (1-MHz)/12-bit (128-MHz)/10-bit (128-MHz) AWG

**Digital test**

64-Kword (128-MHz) WG/WM

dc test per pin





\*V force resolution is 100  $\mu$ V, I force resolution is 50fA (high res SMU) and 5pA (other SMUs)

Ground unit (GNDU): 1 unit

$\pm 1.6$ A Accuracy:  $\pm 1$ mV

Voltage sources (VSs): 2 units  
 $\pm 1$  mV to  $\pm 40$ V Basic accuracy:  $\pm 0.1\%$

Voltage monitors (VMs): 2 units  
 $\pm 40$   $\mu$ V to  $\pm 40$ V Basic accuracy:  $\pm 0.05\%$

\*Differential voltage can be measured with 4 $\mu$ V resolution

All SMUs can function as a dc voltage source/current monitor or current source/voltage monitor. Pulse measurements can be made with SMUs and VSs.

#### Capacitance-Conductance Measurements

##### HP 4280A

Test frequency: 1 MHz,  $\pm 0.01\%$

OSC level: 30 mVrms  $\pm 10\%$ , and 10 mVrms  $\pm 10\%$

Measurement range (maximum resolution to full scale):

C: 0.001 pF to 1.2 nF Basic accuracy:  $\pm 0.5\%$

G: 0.01  $\mu$ S to 12 mS Basic accuracy:  $\pm 1.5\%$

DC bias voltage (for capacitance measurements):  $\pm 100$ V

##### HP 4284A

Test frequency: 1k, 10k, 100k, 1 MHz  $\pm 0.01\%$

OSC level: 30 mVrms  $\pm 10\%$

Measurement range:

C: 0.001 pF to 1.2 nF G: 0.01  $\mu$ S to 12 mS (at 1 MHz)

C: 0.001 pF to 10 nF G: 0.01  $\mu$ S to 100 mS (at 100 kHz)

C: 0.001 pF to 100 nF G: 0.01  $\mu$ S to 1000 mS (at 10 kHz)

C: 0.01 pF to 100 nF G: 0.1  $\mu$ S to 1000 mS (at 1 kHz)

dc bias voltage for capacitance measurements:  $\pm 40$ V (optional)

#### System controller

**Supported controller:** HP 9000 series 300 Model 330, 332, 350, 360, 370, or 375. HP 9000 series 300 Model 318M, 319C+, 340, and 345 are supported as a diskless cluster node.

**Required main memory:** 4 MB

**Recommend:** 8 MB

**Required hard disk memory:**

Test execution environment: 150 MB with 15-MB swap

Test execution and development environment: 300 MB with 20-MB swap

Required HP-HIL Device: HP 46084A ID module

#### Software

**Operating system:** HP-UX 7.0

**Programming language:** HP BASIC/UX 5.52 (optionally

C language)

**Programming utilities:** TIS (test instruction set)

PARA (parameter extraction)

PPG (probing pattern generator)

PCL (prober control library)

**Offline debugging:** TIS for offline debugging

VFP (virtual front panel)

**Data processing:** FCL (file creation library)

XYGRAPH (XY graphics)

MAP (wafer map)

Basic statistics and data management

**Interactive Measurement and Analysis (IMA) Software**

Integrated Circuit Measurement System (IC-MS) software

**Available networking:** NS, ARPA, Berkeley, NFS, SNA

#### Prober interface

Automatic wafer probers used with the HP 4062UX must be equipped with HP-IB capability. Hardware for mounting the switching matrix on the prober is also required. Contact the prober manufacturer for details concerning necessary mounting hardware. Control software for Electrogras 1034X/2001X and TSK APM6000/7000 probers is furnished.

#### Reference Data (typical)

**Command execution time**

**Connect (relays):** 4 ms

**dc source/monitor:** Force (current or voltage): 4 ms

Measure (current or voltage): 5 ms

Analog search?: 25 ms

\*When integration time is short and range is not 1 nA/10 nA. Excludes wait time set by user.

\*Analog search controls the output of one SMU to set the output of another to a given value.

#### General specifications

**Operating temperature:** 5° C to 40° C, 55% to 70% RH

**Permissible temperature change:**  $\leq 3^\circ$  C after calibration

**Air cleanliness:** Class 100,000 or higher clean room required

**Power requirements:** 100V (90V to 110V), 120V (108V to 127V), 220V (198V to 242V), 240V (216V to 252V), 48 Hz to 66 Hz, 1150 VA maximum

#### Size

Cabinet: 1600 mm H  $\times$  600 mm W  $\times$  800 mm D

48-pin matrix: 210 mm H  $\times$  406 mm W  $\times$  380 mm D

96-pin matrix: 250 mm H  $\times$  620 mm W  $\times$  600 mm D

#### Weight

Cabinet with instruments: approx. 230kg

48-pin matrix: approx. 22kg (48-pin configuration)

96-pin matrix: approx. 55kg (96-pin configuration)

**HP 4142B power limitation:** 32W

#### Ordering Information

**HP 4062UX** Semiconductor Process Control System

(consists of system cabinet, a license to use the HP 4062UX software, system documentation library, and software installations of HP-UX, HP BASIC/UX, and HP 4062UX)

**Opt 022** 1/4-inch tape media

+ \$3,940

**Opt 032** C language media

\$710

**Opt 050** 50-Hz power line frequency

\$0

**Opt 060** 60-Hz power line frequency

\$0

#### 48-pin matrix options

**Opt 310** Add HP 4085B 48-pin matrix with 12 pins (and HP 4085B/16066A/16075A/16076A)

+ \$27,300

**Opt 311** Add 1 pin (HP 16320B) to HP 4085B

+ \$660

**Opt 312** Add test fixtures for packaged devices (Add HP 16067A through HP 16070A)

+ \$3,240

**Opt 313** Add HP 16077A extension cable fixture

+ \$1,350

**Opt 314** Add HP 16071A universal fixture

+ \$405

**Opt 315** Add HP 16071B universal fixture (kelvin)

+ \$455

**Opt 316/Opt 317** Add HP 16072A personality board

+ \$220

**Opt 318/Opt 319** Add HP 16072B personality board (kelvin)

+ \$250

**Opt 340** Add Port Expander for HP 4089B

+ \$3,450

#### 96-pin matrix options

**Opt 330** Add HP 4089A 96-pin matrix with 24 pins (Add HP 4089A/16370A/16355A/16356A)

+ \$59,200

**Opt 331** Add 1 pin (HP 16320C) to HP 4089A

+ \$690

**Opt 332** Add test fixtures for packaged devices (Add HP 16371A through 16375A)

+ \$6,900

**Opt 333** Add HP 16378B extension cable fixture

+ \$4,410

**Opt 334** Add HP 16376A universal fixture

+ \$550

**Opt 335** Add HP 16376B universal fixture (kelvin)

+ \$550

**Opt 336** Add HP 16377A personality board

+ \$550

**Opt 337** Add HP 16377B personality board (kelvin)

+ \$550

#### Measuring instruments

**Opt 400** Add HP 4142B modular DC source/monitor

+ \$15,600

**Opt 405** Field installation kit for HP 4142B

+ \$4,100

**Opt 410** Add HP 41420A 200V/1A SMU

+ \$4,510

**Opt 411** Add HP 41421B 100V/100mA SMU

+ \$3,725

**Opt 414** Add HP 41424A VS/VM unit

+ \$3,390

**Opt 415** Add HP 41425A analog feedback unit

+ \$1,810

**Opt 450** Add HP IMA Software Package

\$5,590

**Opt 451** Add HP IMA License-To-Use

\$4,730

**Opt 510** Add HP 4280A 1-MHz C meter

+ \$15,200

**Opt 515** Field installation kit for HP 4280A

+ \$3,010

**Opt 520** Add HP 4274A LCR meter (100 Hz to 100 kHz)

+ \$14,200

**Opt 521** Add  $\pm 35$ V bias (Opt 001-4274A)

+ \$1,040

**Opt 522** Add  $\pm 100$ V bias (Opt 002-4274A)

+ \$950

**Opt 525** Field installation kit for HP 4274A

+ \$3,230

**Opt 530** Add HP 4284A LCR Meter

+ \$15,100

**Opt 531** Add 40V bias (Opt 001-4284A)

+ \$1,220

**Opt 535** Field installation kit for HP 4284A

+ \$4,200

# SEMICONDUCTOR TEST EQUIPMENT

## Semiconductor Parametric Test System

HP 4062C

- 25 ms  $V_{th}/hFE$  extraction (typical)
- $\pm 20$  fA to  $\pm 1$  A precise wafer measurements

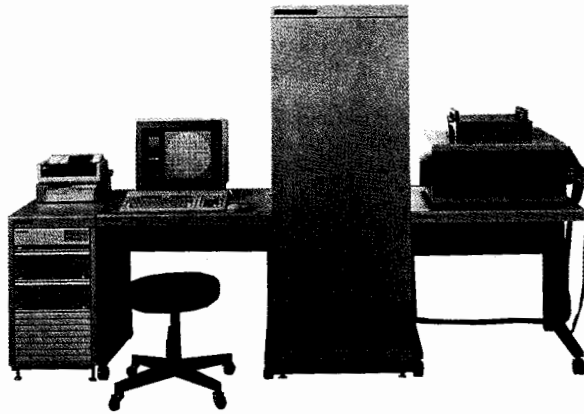

HP 4062C



(System controller, printer, and tables are sold separately.)

### HP 4062C Semiconductor Parametric Test System

The HP 4062C semiconductor parametric test system is a high-throughput, high-resolution, computer-controlled system for measuring the dc voltage and current and the 1 MHz capacitance and conductance parameters of wafer-state devices, as well as discrete and packaged devices. Based on its predecessor, the HP 4062B, this enhanced system will enable you to significantly improve IC yield and quality and increase efficiency during new-process development.

Precise 20 fA, 4  $\mu$ V, and 1 fF measurements to  $\pm 200$  V and  $\pm 1$  A are possible through the 4062C's low-noise, reliable switching matrix, which you can configure with up to 96 device-under-test (DUT) pins, and specifications are guaranteed at all DUT pins. The heart of the HP 4062C, the high-speed HP 4142B modular dc source/monitor, provides fast throughput over a wide measurement range—without sacrificing resolution—for wafer process monitoring and evaluation. Highly reliable wafer measurement results can quickly be fed back to design and process engineers to improve IC yield and quality.

The HP 4062C's language system is the simple, yet powerful, HP BASIC. Parameter measurements, such as threshold voltage and current gain, can be performed with a simple 2-line program, thanks to the HP 4062C's measurement utility subprograms. In addition, HP Interactive Measurement and Analysis (IMA) makes the measurements interactively, using the HP 4062C.

### High-Speed Measurements, Wide Measurement Range

In production environments where measurement speed is a prerequisite, the HP 4062C comes through. The HP 4062C's DC measurement subsystem provides high-speed device/process parameter extractions while maintaining measurement resolutions down to 20 fA and 4  $\mu$ V. For example, by using the dc measurement subsystem's Analog Feedback Unit (AFU), such key device parameters as threshold voltage ( $V_{th}$ ) and forward current gain ( $hFE$ ) can be obtained in as little as 25 ms: roughly 4 times faster than the HP 4062B.

The HP 4062C's switching matrix subsystem enables reliable measurement results by virtually eliminating the effects of environmental noise while minimizing leakage current and stray capacitance. The expanded measurement range of  $\pm 20$  fA to  $\pm 1$  A and  $\pm 4$   $\mu$ V to  $\pm 200$  V is guaranteed to the tip of each switching matrix DUT pin. These exacting standards ensure precise, reliable semiconductor parameter measurements through the switching matrix for each system instrument.

### Easy to Program

The HP 4062C's Test Instruction Set (TIS) software makes programming easy, and the fast execution of TIS programs ensures high-speed measurements. By using the furnished measurement library, you can quickly create and execute programs. For example, to perform a  $V_{th}$  or  $hFE$  measurement requires only 1 or 2 program lines.

### Specifications

#### Hardware

Same as HP 4062UX

#### Software

**Operating system:** HP BASIC 6.0 or later

**Programming language:** HP BASIC

#### Programming utilities:

TIS (Test Instruction Set)

PARA (Parameter Extraction)

PPG (Probing Pattern Generator)

PCL (Prober Control Library)

#### Data processing:

FCL (File Creation Library)

XYGRAPH (XY Graphics)

Basic Statistics and Data Manipulation

### HP Interactive Measurement and Analysis (IMA) Software

#### System controller

**Supported controller:** HP 9000 Series 300 Models 310, 320, 330, 332, 340, 345, 350, 360, 370, and 375

**Required main memory:** 2 Mbytes

**Required HP-HIL device:** HP 46084A ID module

**Required interface:** In addition to internal HP-IB I/O, 2 extra HP-IB I/Os (98624A) are required.

### Ordering Information

**HP 4062C** Semiconductor Parametric Test System **Price**  
\$140,400

(Consists of HP 4142B modular dc source/monitor, 48-pin matrix with 48 pins, HP 4280A 1 MHz C meter, system cabinet, system software, system library, and system software installation.)

<b>Opt 050/060</b> For 50/60 Hz line frequency	\$0
<b>Opt 100/120/220/240</b> For 100/120/220/240V Line Voltage	\$0
<b>Opt 001</b> 12-pin Configuration of 48-Pin Matrix	– \$23,760
<b>Opt 002</b> 24-pin Configuration of 48-Pin Matrix	– \$15,840
<b>Opt 003</b> 36-pin Configuration of 48-Pin Matrix	– \$7,920
<b>Opt 004</b> Add Spare Pin Board of 48-Pin Matrix	+ \$660
<b>Opt 012</b> 24-pin Configuration of 96-Pin Matrix	+ \$12,800
<b>Opt 013</b> 36-Pin Configuration of 96-Pin Matrix	+ \$21,030
<b>Opt 014</b> 48-Pin Configuration of 96-Pin Matrix	+ \$29,280
<b>Opt 015</b> 64-Pin Configuration of 96-Pin Matrix	+ \$40,300
<b>Opt 016</b> 72-Pin Configuration of 96-Pin Matrix	+ \$45,820
<b>Opt 017</b> 84-Pin Configuration of 96-Pin Matrix	+ \$54,100
<b>Opt 018</b> 96-Pin Configuration of 96-Pin Matrix	+ \$62,280
<b>Opt 019</b> Add Spare Pin Board of 96-Pin Matrix	+ \$690
<b>Opt 020</b> Replace HP 41420A with HP 41421B	– \$785
<b>Opt 021</b> Add Spare HP 41421B SMU (100 V/100 mA)	+ \$3,725
<b>Opt 022</b> Add Spare HP 41420A SMU (200 V/1A)	+ \$4,510
<b>Opt 023</b> Add Spare HP 41424A Vs/Vm	+ \$3,390
<b>Opt 024</b> Delete One HP 41421B SMU (100 V/100 mA)	– \$3,725
<b>Opt 025</b> Delete One HP 41420A SMU (200 V/1 A)	– \$4,510
<b>Opt 026</b> Delete One HP 41424A Vs/Vm	– \$3,390
<b>Opt 027</b> Delete One HP 41425A AFU	– \$1,810
<b>Opt 102</b> Delete HP 4280A	– \$12,150
<b>Opt 110</b> Delete Package Fixtures for 48-Pin Matrix	– \$4,390
<b>Opt 115</b> Delete Package Fixtures for 96-Pin Matrix	– \$7,500
<b>Opt 130</b> Delete System Rack	– \$3,900
<b>Opt 310</b> Add HP 4274A	+ \$14,200
<b>Opt 311</b> $\pm 35$ V Internal DC Bias for HP 4274A	+ \$1,040
<b>Opt 312</b> $\pm 100$ V Internal DC Bias for HP 4274A	+ \$950
<b>Opt 320</b> Add HP 4284A	+ \$15,100
<b>Opt 321</b> $\pm 40$ V Internal DC Bias for HP 4284A	+ \$1,220
<b>Opt 340</b> Add Port Expander	\$3,450
<b>Opt 405</b> HP 4062C System Software Right-To-Copy	– \$2,310
<b>Opt 450</b> Add HP IMA Software Package	+ \$4,410
<b>Opt 451</b> Add HP IMA License-To-Use	+ \$3,760
<b>Opt 910</b> Extra System Library	+ \$345

# SEMICONDUCTOR TEST EQUIPMENT

Semiconductor/Component Test System

Model 4061A

569

- Ready to use—supplied with 7 turn-key application pacs
- Reliable impedance and current measurements with one probing
- Productivity improvement through accurate and fast measurement over wide range

DESIGNED FOR  
**HP-IB**  
SYSTEMS



HP 4061A

System controller and table are sold separately

## Description

The HP 4061A semiconductor/component test system is a dedicated system for making efficient, automatic evaluations of the fundamental characteristics of semiconductor and electronic components required in research and development and production areas. This system employs reliable, accurate measurements and high-speed data processing to perform more reliable evaluations with less time and effort. The HP 4061A is supplied with 7 sophisticated applications programs. With flexible software and hardware, the system can output measurement results in nearly any required data format.

The switching subsystem, designed especially for use with the HP 4061A, allows both impedance and current measurement without changing device-under-test (DUT) connection. Using this new switching subsystem, and making impedance measurements, the HP 4061A evaluates doping profile, oxide capacitance, flat band condition, threshold voltage, surface charge, and minority carrier lifetime/surface generation velocity. The HP 4061A also measures leakage current and reverse/forward current-voltage characteristics. Surface state density evaluation, using both high- (such as 1 MHz) and low-frequency (quasi-static) C-V measurements and data processing is also possible with modifications to system software.

The system offers significant improvement in production yield and quality through fast, reliable measurements and evaluations. It is also a valuable tool for the development of new materials and devices. The HP 4061A provides the flexibility to meet the future measurement requirements of the electronics industry.

## System Configuration

pA Meter/DC Voltage Source (4140B)  
Multi-frequency LCR Meter (4275A)  
Switching Subsystem  
Rack Cabinet (29402C)

## Furnished Application Software

Semiconductor high/low frequency C-V characteristics, I-V characteristics, C-t characteristics and Zerbst analysis, impedance frequency/bias characteristics, ideal C-V curve.

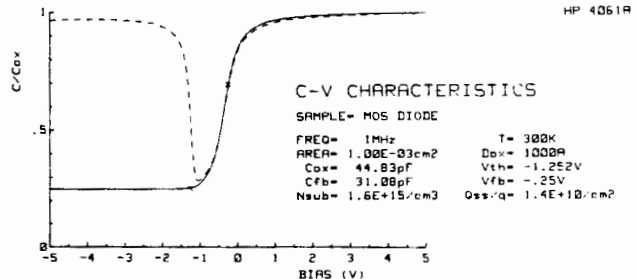

## Specifications

For detailed specifications on each of the instruments used in the HP 4061A, see the individual data sheets.

## Switching Subsystem

The switching subsystem consists of a switch control module and a switching module with interconnecting cables.

**Function:** Switches connection from DUT to either multi-frequency LCR meter, or pA meter/dc voltage source.

## System Measurement Range

(Only deviations from individual instrument specifications are listed.)

### Impedance Measurements (HP 4275A)

**Frequency range:**  $\leq 1$  MHz

**Measurement parameters:** C-G

**Capacitance:**  $\leq 2000$  pF (with  $D \leq 0.1$ )

**\*Accuracy:** (accuracy of HP 4275A)  $\times 1.5 + \Delta C$  (at  $23^\circ C \pm 5^\circ C$ )  
 $\Delta C = 1.4 \times 10^{-3} C \times f^2$  (pF) + 5 counts

**Conductance:**  $\leq 12$  mS ( $D \leq 0.1$ )

**\*Accuracy:** (accuracy of 4275A)  $\times 1.5 + \Delta G$  (at  $23^\circ C \pm 5^\circ C$ )

$\Delta G = 6 \times 10^{-3} C \times f(S) + 5$  counts

\* f: Frequency in MHz

Cx: Measured capacitance value in pF

At  $5^\circ C$  to  $40^\circ C$ ,  $\Delta C$  and  $\Delta G$  double. Example: Assuming  $C_x = 1000$  pF and  $f = 1$  MHz,  $C = (1.4 \times 10^{-3} \cdot 10^3 \cdot (1)^2) \text{pF} + 5 \text{ counts} = 1.4 \text{ pF} + 5 \text{ counts}$ .

### Current Measurements (HP 4140B)

**Accuracy:** (accuracy of HP 4140B)  $\times 1.5 + 5$  counts

After 1-hour warmup and at DUT terminal of switching module

### Impedance Measuring Section (HP 4275A)

See page 368.

### Current Measurement Section (HP 4140B)

See page 576.

## General Information

**Operating temperature:**  $5^\circ$  to  $40^\circ C$ ,  $\leq 70\%$  RH at  $40^\circ C$

**Power:** 100, 120, 220, and 240V,  $+5\%$   $-10\%$ , 48 to 66 Hz, 520 VA

**Size:** 535 mm W  $\times$  1635 mm H  $\times$  770 mm D

**Weight:** Approximately 125 kg

## System Controller

HP 9000 Series 200 Model 226A, 226S, 236A or 236S, or Series 300 Model 310 or 330.

## Ordering Information

**HP 4061A** (does not include controller)

**Price**

\$51,200

**Opt 001**  $\pm 100$  Vdc Bias for HP 4275A

\$0

**Opt 002** 1-3-5 Frequency Steps for HP 4275A

\$0

**Opt 026\*** For HP 9000 Model 226 A/S Controller

\$0

**Opt 031\*** For HP 9000 Model 310 or 330 Controller

\$0

**Opt 036\*** For HP 9000 Model 236 A/S Controller

\$0

\*Either Opt 026, 031 or 036 must be ordered.

# SEMICONDUCTOR TEST EQUIPMENT

## Semiconductor Parameter Analyzer

HP 4145B

- Fully automatic, high-speed dc characterization of semiconductor devices.
- High-resolution, wide-range sourcing and measurement I: 50 fA to 100 mA; V: 1 mV to 100 V
- Maximum 1140 measurement and display points for precise measurement and analysis
- Flexible graphic analysis functions for quick parameter extraction
- Built-in 3½-inch disk drive for storage of 240 user programs or 105 measurement results

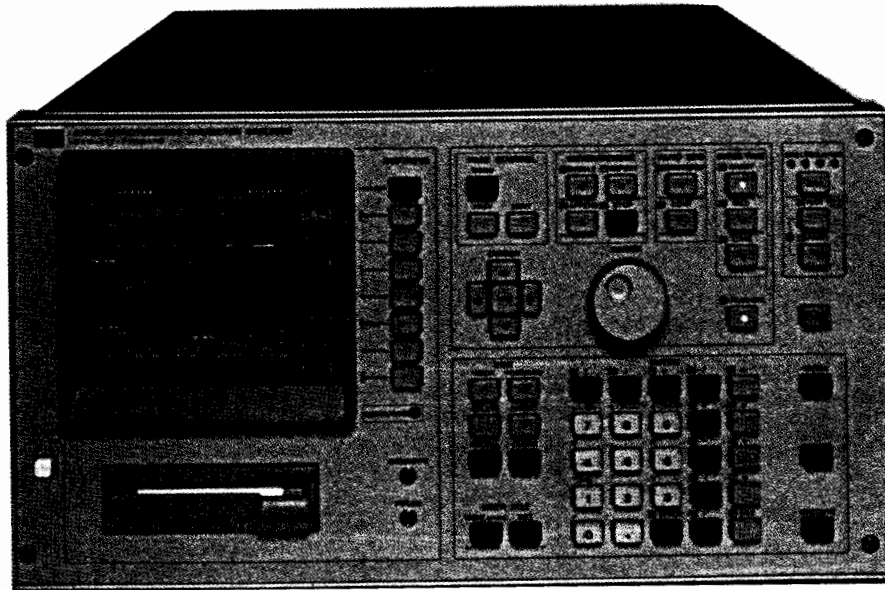

HP 4145B



### HP 4145B Semiconductor Parameter Analyzer

Designed for production-line and laboratory use, the HP 4145B is the electronics industry's first standalone instrument capable of complete dc characterization of semiconductor devices and materials. It stimulates voltage- and current-sensitive devices, measures the resulting current and voltage responses, and displays the results in a user-selectable format (graph, list, matrix, or schmo) on a built-in CRT display. An on-board programmable calculator provides real-time calculation of voltage/current-dependent parameters, such as the current gain ( $h_{FE}$ ) and transconductance ( $g_m$ ) of transistors, which can also be displayed on the CRT. A number of powerful graphic analysis tools—marker, cursor, line function, and interpolation—enhance the HP 4145B's basic capabilities and provide fast, accurate analysis of semiconductor devices, leading to increased production yields and improved device quality.

Four built-in source monitor units (SMUs) are the heart of the HP 4145B. Each SMU can be independently programmed to function as either a voltage source/current monitor or a current source/voltage monitor. Thus a bipolar transistor, for example, can be completely characterized in common-base, common-emitter, and common-collector configurations without changing connections—only changing the SMUs' operating modes is required. The HP 4145B is also equipped with 2 voltage sources and 2 voltage monitors for measurements on devices having more than 4 terminals, such as ICs.

The HP 4145B can be controlled from the front panel via the HP-IB (standard), or by measurement setups stored on diskettes.

Displayed information—measurement setups, auto-sequence programs, measurement results—can be dumped directly onto an external graphics plotter to obtain publication-quality hard copies. A built-in 3½-inch disk drive enables you to store measurement setups and measured data, which can be accessed by another compatible HP disk drive for further processing.

### Auto Sequence Programs

Measurement programs stored on a HP 4145B 3½-inch disk can be linked by an auto-sequence program, making it possible to perform a series of measurements with just one keystroke.

### Four User-Selectable Display Formats to Suit the Evaluation

Measurement results can be displayed in one of four display formats: Graphics, list, matrix, or schmo. After measurement has been made and the results displayed, the softkeys can be used to access various analysis functions for complete device evaluation. These functions include MARKER for numeric readout of measured value at any point along a plotted curve, CURSOR for numeric readout of value at any graphic point and for line positioning, STORE /RECALL for overlay comparisons, AUTO SCALE for optimum graphic scaling, and LINE FUNCTION for direct readout of line gradient and X-Y axis intercept values.



## Specifications

### Measurement

**Source/monitor unit (SMU):** Four SMUs are built into the HP 4145B. Each SMU can be programmed either to source voltage and monitor current or to source current and monitor voltage. Each SMU can also be programmed to COM mode. This sets voltage at 0 V and current compliance at 105 mA.

**Output/measurement resolution:** Voltage, 4½ digits; current, 4 digits

**Voltage measurement input resistance/current source output resistance:**  $\geq 10^{12} \Omega$

**Maximum capacitive load:** 1000 pF

### SMU voltage range, resolution, and accuracy

Voltage Range	Resolution	Accuracy <sup>1,2</sup>	Max. Current
±20 V	1 mV	±(0.1% + 10mV + 0.4 × I <sub>o</sub> )	100 mA
±40 V	2 mV	±(0.1% + 20mV + 0.4 × I <sub>o</sub> )	50 mA
±100 V	5 mV	±(0.1% + 50mV + 0.4 × I <sub>o</sub> )	20 mA

\*I<sub>o</sub> is SMU output current in amps.

### SMU Current range, resolution, and accuracy

Current Range	Resolution	Accuracy <sup>1,2</sup>	Max. Voltage
±100 mA	100 μA	±(0.3% + 100 μA + 2 μA × V <sub>o</sub> )	20 V (> 50 mA) 40 V (> 20 mA)
±10 mA	10 μA	±(0.3% + 10 μA + 200 nA × V <sub>o</sub> )	100 V (≈20 mA)
±1000 μA	1 μA	±(0.3% + 1 μA + 20nA × V <sub>o</sub> )	
±100 μA	100 nA	±(0.3% + 100 nA + 2 nA × V <sub>o</sub> )	
±10 μA	10 nA	±(0.3% + 10 nA + 200 pA × V <sub>o</sub> )	
±1000 nA	1 nA	±(0.5% + 1 nA + 20 pA × V <sub>o</sub> )	
±100 nA	100 pA	±(0.5% + 100 pA + 2 pA × V <sub>o</sub> )	
±10 nA	10 pA	±(1% + 15 pA + 200 fA × V <sub>o</sub> )	
±1000 pA	1 pA	±(1% + 6 pA + 20 fA × V <sub>o</sub> )	

V<sub>o</sub> is SMU output voltage in volts.

<sup>2</sup>50 fA resolution in current monitor mode.

<sup>1</sup> Accuracy specifications are given as ±% of reading or setting value ±% of range.

<sup>2</sup> Accuracy tolerances are specified at 25° C ± 5° C, after a 40-minute warmup time, with AUTO CAL on, and specified at the rear panel connector terminals referenced to SMU common. Tolerances are doubled for the extended temperature range of 10° to 40° C.

### SMU Voltage/Current Compliance

**Maximum voltage compliance:** 20 V, 40 V, or 100 V, depending on the output current range

**Maximum current compliance:** 20 mA, 50 mA, or 100 mA, depending on the output voltage range

**Compliance setting resolution:** Same as current and voltage output/measurement resolution. Maximum current compliance resolution, however, is 50 pA.

**Compliance accuracy:** Voltage compliance accuracy is the same as voltage output/measurement accuracy. Current compliance accuracy is current output/measurement accuracy ± (1% of range + 10 pA).

### Voltage/Current Sweep Characteristics

Output from up to 3 SMUs or voltage sources can be swept in one of three modes: VAR1, VAR2, or VAR1'.

**VAR1:** Linear or log staircase sweep

**VAR2:** Linear staircase sweep. Output from the VAR2 source is incremented after completion of each VAR1 sweep.

**VAR1':** Output from the VAR1' source is synchronized with VAR1, but at levels proportional to a user-selectable ratio or offset relative to VAR1.

**Ratio:** ±0.01 to ±10

**Offset:** Any value that will not cause VAR1' to exceed maximum allowable output.

**Hold time:** 0 to 650 s, ±(0.5% + 9 ms) with 10 ms resolution

**Delay time:** 0 to 6.5 s, ±(0.1% + 5 ms) with 1 ms resolution

**No. of measurement steps:** 1024 for a single VAR1 sweep, 1140 for a multiple sweep

### Voltage Sources (Vs) Characteristics

**Number of sources:** 2

**Output resistance:** ≤0.2 Ω

**Maximum capacitive load:** 1000 pF

### Voltage output range, resolution, and accuracy

Voltage Output Range	Resolution	Accuracy	Max. Output Current
±20 V	1 mV	±(0.5% of setting + 10 mV)	10 mA

### Voltage Monitors (Vm) Characteristics

**Number of monitors:** 2

**Input resistance:** 1 MΩ ± 1% shunted by 100 pF ± 10%

### Voltage measurement range, resolution, and accuracy

Voltage Measurement Range	Resolution	Accuracy
±2 V	100 μV	±(0.5% of reading + 10 mV)
±20 V	1 mV	±(0.2% of reading + 10 mV)

### Characteristics Common to SMUs, Voltage Sources, and Voltage Monitors

**Maximum allowable terminal voltage:** 100 V peak across SMU and V<sub>m</sub> input terminals, or SMU and V<sub>s</sub> output terminals, or between those terminals and guard; and 42 V maximum from Common to Ground.

### Display

**CRT size and screen resolution:** 152.4 mm (6 in) diagonal; 2048 × 2048 points

**Display modes:** Graphics, Schmo, List, Matrix, and Time Domain

**External CRT analog output:** X, Y, and Z outputs of 0 to 1 Vdc into 330 Ω (X and Y) and 240 Ω (Z)

### Analysis

**Calculation:** Two user functions can be input and keyboard calculations can be done using the following 11 operators: +, -, \*, /, √, EXP, LOG, LN, \*\* (power), ABS (absolute) and Δ (differential).

### Constants available on the keyboard

**q:** Electron charge (1.602189 × 10<sup>-19</sup> coulomb)

**k:** Boltzmann's Constant (1.380662 × 10<sup>-23</sup> J/K)

**ε:** Dielectric constant of vacuum (8.854185 × 10<sup>-12</sup> F/m)

**Analysis functions:** Overlay comparison with STORE/RECALL, Marker, Interpolate, Cursor, Auto scale, Zoom function (←→, →←, ↑↓, ↓↑, Line and Move Window

### General Specifications

**Operating temperature range:** +10° C to +40° C; ≤70% RH at 40° C, permissible temperature change ≤1° C/5 min

**Power:** 100/120/220 V, ± 10%; 240 V, -10% + 5%; 48 to 66 Hz; 270 VA max

**Dimensions:** 426 mm W × 235 mm H × 612 mm D (16.75 in × 9.06 in × 24.1 in)

**Weight:** 27 kg (59 lb) approximately

### Reference Data

**SMU measurement time:** Measurement time = response time + ranging time + integration time.

### SMU response time

Current Range	Setup/Settling Time	SMU Wait Time
100 nA to 100 mA 1 nA and 10 nA	2.7 ms	0.2 ms 47.5 ms

**Ranging time:** Varies from 4 ms to 74 ms

**Integration time:** Short, Med., and Long

	Short	Med.	Long
50 Hz	3.6 ms	20 ms	320 ms
60 Hz		16.7 ms	267 ms

### Accessories Furnished

**HP 16058A** Test Fixture

**HP 04145-61501** System Disc

**HP 04145-60001** Connector Plate

**HP 04145-61622** Triaxial Cable (3m), 4 ea.

**HP 04145-61630** BNC Cable (3m), 4 ea.

**HP 04145-61623** Shorting Connector

### Ordering Information

**HP 4145B** Semiconductor Parameter Analyzer

**Opt 050/060** 50Hz/60Hz Line Frequency

**Price**

\$27,500

\$0

# SEMICONDUCTOR TEST EQUIPMENT

## Modular DC Source/Monitor

HP 4142B

- Flexible, modular architecture
- Wide measurement range with high resolution  
V:  $\pm 4 \mu\text{V}$  to  $\pm 1000 \text{ V}$ , 0.05%  
I:  $\pm 20 \text{ fA}$  to  $\pm 10 \text{ A}$ , 0.2%
- Pulse measurement capabilities  
Pulse width 1 ms to 50 ms, 100  $\mu\text{s}$  resolution

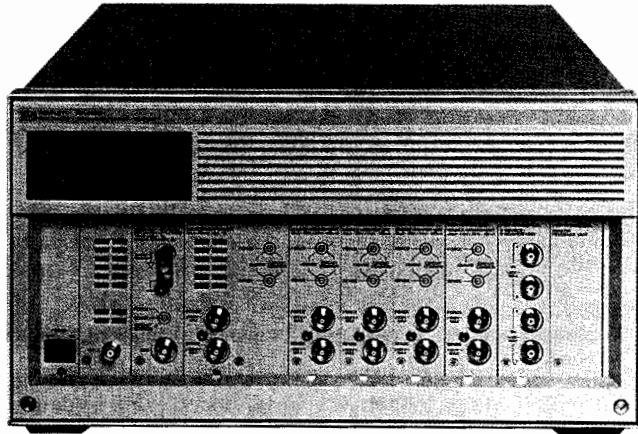

HP 4142B



### HP 4142B Modular DC Source/Monitor

Offering a wide measurement range and excellent sensitivity, the HP 4142B modular dc source/monitor is a system-use dc measurement instrument especially designed for high-throughput dc semiconductor testers. A completely user-definable system component, the HP 4142B features modular architecture that allows you to build a custom configuration to suit your measurement needs.

Eight plug-in module slots can accommodate any combination of the 5 presently available modules; as new modules become available, you can upgrade your measurement capabilities with ease. Choose from 2 types of source/monitor units (SMUs) to force or measure up to  $\pm 200 \text{ V}$  and  $\pm 1 \text{ A}$ ; a high current source/monitor unit (HCU) up to  $\pm 10 \text{ A}$ ; a high voltage source/monitor unit (HVVU) up to  $\pm 1000 \text{ V}$ , a voltage source/voltage monitor unit (VS/VMU), and an analog feedback unit (AFU). The HP 4142B's instrument command and measurement data-storage capabilities, coupled with the high-speed HP-IB interface, minimize computer loading, enhance throughput, and simplify systemization.

### Versatile SMUs and Reliable Measurement

For general-purpose dc or pulsed measurement, use the HP 41421B source monitor unit. The equivalent of 4 instruments, this precision module forces voltage up to  $\pm 100 \text{ V}$  and simultaneously measures currents down to 20 fA. It can also force currents up to  $\pm 100 \text{ mA}$  while measuring voltage down to 40  $\mu\text{V}$ .

If you test high-power components or desire a wider measurement range, use the HP 41420A source monitor unit. This versatile SMU can source  $\pm 200 \text{ V}$  or  $\pm 1$  (14 W, dc or pulsed) and still maintain a measurement resolution of 40  $\mu\text{V}$  and 20 fA. Both SMU's include a compliance feature that limits output voltage, current, or power to prevent damage to your device. Each SMU (HP 41420A or HP 41421B) acts as either a voltage source/current monitor or current source/voltage monitor. These complementary operating modes let you change the stimulus on a device without modifying the physical connections. This versatility reduces test time and eliminates instabilities caused by changing connections at the DUT.

- High-speed measurement (typical)  
Sourcing or monitoring: 4 ms  
Vth, hFE extracting: 12 ms
- Internal memory  
Program memory: > 2000 commands (typical)  
Data memory: 4004 measurement points

### Test Power Devices to 10 A and 1000 V

The HP 41422A HCU and the HP 41423A HVU expand the measurement range of the HP 4142B to 10 A and 1000 V. They dramatically expand the HP 4142B's ability to test power devices, such as power transistors, power MOSFETs, GaAs FETs, and smart ICs. Using a combination of the two units, measurements of up to 20 A and 2000 V are possible.

Using the HCU, fast pulse testing (100  $\mu\text{s}$  minimum pulse width) at high current increases test reliability by minimizing the effects of thermal drift.

Quasi-pulsed measurements by the HVU are effective for measuring breakdown voltage by minimizing the duration of the breakdown condition.

The HP 16087A module selector is a scanner that lets you remotely control the connection of the HP 41420A/41421B SMUs, the HP 41422A HCU, or the HP 41423A HVU to a test pin. It contributes to automatic testing for high-power devices with high breakdown voltage. The built-in module selector can be specified as an option of the HP 16088B test fixture.

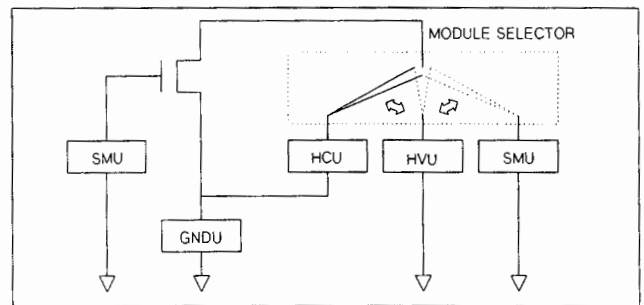

### High-Speed Parameter Extraction by Analog Feedback Technique

To find important parameters that are specified at a given voltage or current, such as  $V_t$  or hFE, connect the HP 41425A AFU to 2 SMUs. The AFU modulates the output voltage of one SMU while monitoring the current or voltage of the other. Target currents and voltage are found with great speed (12 ms). This unique analog feedback network rapidly measures  $V_t$ , hFE,  $\Delta L$ , or  $\Delta W$ ; parameters that would require excessive test time on other parametric testers.

You can also use the AFU to bias and test microwave devices. It can be integrated into the network analyzer system.

By using the AFU, you can eliminate the effect of device thermal drift and can hold the initial setting bias for ac measurement time.

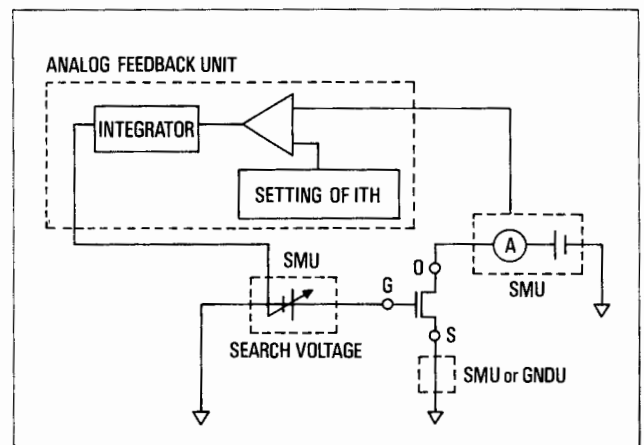

**Specifications**

**4142B Modular DC Source Monitor**

**Ground unit (GNDU):**

Use as measurement ground  
0 V, Kelvin connection

**Offset voltage:** ± 500 μV max

**Current voltage:** ± 1.6 A

**Maximum cable resistance:**

**FORCE terminal:** ≤ 1 Ω\*

**SENSE terminal:** ≤ 10 Ω\*

**Maximum capacitive load:** 10 μF max\*

**Spot measurements:** Source and monitor DC current or voltage

**Swept measurements:**

- One channel can sweep current or voltage while up to 8 channels measure current or voltage
- A second sweep channel can be slaved to the first sweep channel (dual synchronous sweep)

**Sweep modes:** Linear or logarithmic

Single or double staircase

**Sweep parameters:** Start, stop, number of steps, or steps per decade

**Maximum number of steps:** 1000

**Hold time:** 0 to 655.35 s, 10 ms resolution

**Delay time:** 0 to 65.535 s, 1 ms resolution

**Setting accuracy:** 0.5% + 1 ms\*

**Measurement Unit**

**HP 4142B Modules**

Model Number	Slots Req'd	Voltage Range	Current Range	Measurement Resolution	Accuracy	
					V	I
HP 41420A SMU <sup>1</sup>	2	±100 μV to ±200 V	±50 IA to ±1 A	40 μV/20 IA	0.05%	0.2%
HP 41421B SMU <sup>1</sup>	1	±100 μV to ±100 V	±50 IA to ±100 mA	40 μV/20 IA	0.05%	0.2%
HP 41422A HCU <sup>1</sup>	2	±200 μV to ±10 V	±500 μA to ±10 A	40 μV/20 μA	0.5%	0.5%
HP 41423A HVU	2	±10 mV to ±1000 V	±50 pA to ±10 mA	2 mV/2 pA	0.5%	1%
HP 41424A VS/VMU	1	±1 mV to ±40 V	±20 mA ±100 mA	4 μV/20 μA	0.05%	3%
HP 41425A AFU	1	Searches for a specified current or voltage on one SMU by controlling the voltage output of another SMU.				

<sup>1</sup> Provides Kelvin connections (remote sensing).

\* Differential measurement mode (40 μV resolution in normal mode).

**SMU Range, Resolution and Accuracy (at 18° to 28° C)**

Voltage Range	Set Res.	Meas. Res.	Accuracy	Max. Current
± 2 V	100 μV	40 μV	± 0.05% ± 1 mV	1 A
± 20 V	1 mV	400 μV	± 0.05% ± 10 mV	1 A (V ≤ 14 V) 0.7 A (V > 14 V)
± 40 V	2 mV	800 μV	± 0.05% ± 20 mV	350 mA
± 100 V	5 mV	2 mV	± 0.05% ± 50 mV	125 mA
± 200 V	10 mV	4 mV	± 0.05% ± 100 mV	50 mA

Current Range	Set Res.	Meas. Res.	Accuracy	Max. Voltage
± 1 nA	50 fA	20 fA	± 1% ± (0.1 + 0.2 × Vo/100)% ± 5 pA	200 V
± 10 nA	500 fA	200 fA	± 0.5% ± (0.1 × 0.2 × Vo/100)%	
± 100 nA	5 pA	2 pA		
± 1 μA	50 pA	20 pA		
± 10 μA	500 pA	200 pA	± 0.2% ± (0.1 + 0.2 × Vo/100)%	
± 100 μA	5 nA	2 nA		
± 1 mA	50 nA	20 nA		
± 10 mA	500 nA	200 nA		
± 100 mA	5 μA	2 μA		
± 1 A	50 μA	20 μA	± 0.5% ± (0.1 + 0.2 × Vo/100)%	
				100 V (I > 50 mA)
				200 V (I ≤ 50 mA)
				100 V (125 mA ≥ I > 50 mA)
				40 V (350 mA ≥ I > 125 mA)
				20 V (0.7 A ≥ I > 350 mA)
				14 V (I > 0.7 A)

\* Note: Vo is the SMU output voltage, in volts.

**Pulsed measurements (SMU)**

Force and measure pulsed current or voltage

**Ranges:** 2 V range: 10 nA to 1 A range  
20 V to 200 V range: 100 μA to 1 A range

**V pulse:** 2 V range: 1 compliance ≥ 2 nA

20 V to 200 V range: 1 compliance ≥ 20 μA

**I pulse:** 10 nA to 10 μA range: V compliance ≤ 2 V

100 μA to 1 A range: V compliance ≤ 200 V

**Pulse width:** 1 to 50 ms, 100 μs resolution

**Pulse period:** 10 to 500 ms, 100 μs resolution

**Setting accuracy:** 0.5% + 100 μs\*

**Pulsed sweeps**

- Sweep and measure pulsed current or voltage
- Sweep dc current or voltage while pulsing current or voltage. Use Pulse and Sweep specification

**Memory**

**Program memory:** Stores approximately 2000\* HP-IB commands, which can be grouped into 99 subroutines.

**Data memory:** 4004 measurement points (binary)  
1001 points (ASCII format)

**General Specifications**

**Auto calibration:** Automatically calibrates the offset errors in each measurement unit every 30 minutes\*

**Environmental information**

**Operating temperature:** 5° to 40° C

**Allowable temperature drift:** ± 3° C\*

**Operating humidity:** 5% to 80% RH

**Storage temperature:** -40° to 65° C

**Storage humidity (at 65° C):** ≤ 90% RH

**Operating inclination:** ± 20° from horizontal

**Power:** 100/120/220 V, ± 10%; 240 V 10% + 5%; 48 to 66 Hz, 750 VA max.

**Dimensions:** 426 mm W × 235 mm H × 676 mm D

**Weight**

**HP 4142B:** Approximately 23 kg

**HP 41420A/41422A/41423A:** Approximately 3 kg

**HP 4142B/41424A/41425A:** Approximately 2 kg

**Recommended computer**

HP 9000 Series 300

BASIC operating system (Version 3.0 or later)

**Software**

**Parameter measurement library:** Current Gain, Breakdown Voltage (2), Drain Current, Threshold Voltage (3), and Resistance

**Test instruction set:** Initialize, Force, Measure, Pulse, Graphics, and Data Storage

\* Reference data only.

**Ordering Information**

	<b>Price</b>
<b>HP 4142B</b> Modular DC Source/Monitor	\$11,510
<b>Opt 300</b> Install Control Unit for Module Selector	\$430
<b>Opt 302/303</b> Control Cable	\$130/110
<b>Opt 400</b> Install 41420A (needs 2 slots)	\$4,510
<b>Opt 402/403</b> Quadaxial Cable for 41420A	\$600/500
<b>Opt 410</b> Install 41421B (needs 1 slot)	\$3,725
<b>Opt 412/413</b> Quadaxial Cable for 41421B	\$600/500
<b>Opt 420</b> Install 41422 A (needs 2 slots)	\$5,000
<b>Opt 422/423</b> Dual Coaxial Cable for 41422A	\$540/490
<b>Opt 430</b> Install 41423A (needs 2 slots)	\$6,500
<b>Opt 432/433</b> Triaxial/BNC Cable for 41423A	\$580/510
<b>Opt 440</b> Install 41424A (needs 1 slot)	\$3,390
<b>Opt 442/443</b> Coaxial Cable for 41424A	\$340/320
<b>Opt 450</b> Install 41425A (needs 1 slot)	\$1,810
<b>HP 41420A</b> Source/Monitor Unit	\$4,510
<b>Opt 402/403</b> Quadaxial Cable	\$600/500
<b>HP 41421B</b> Source/Monitor Unit	\$3,725
<b>Opt 412/413</b> Quadaxial Cable	\$600/500
<b>HP 41422A</b> High-Current Source/Monitor Unit	\$5,000
<b>Opt 422/423</b> Dual Coaxial Cable	\$540/490
<b>HP 41423A</b> High-Voltage Source/Monitor Unit	\$6,500
<b>Opt 432/433</b> Triaxial/BNC Cable	\$580/510
<b>HP 41424A</b> Voltage Source/Voltage Monitor Unit	\$3,390
<b>Opt 442/443</b> Coaxial Cable	\$340/320
<b>HP 41425A</b> Analog Feedback Unit	\$1,810
<b>HP 16087A</b> Module Selector	\$1,300
<b>HP 16088B</b> Test Fixture	\$4,300
<b>Opt 010</b> Module Set for Power Devices	\$690
<b>Opt 300</b> Add Module Selector	\$650

# SEMICONDUCTOR TEST EQUIPMENT

## Softpanel Interactive Measurement and Analysis Software

HP 16276B/16277B/16278B

- Full-feature parameter analyzer
- Menu-driven softpanels

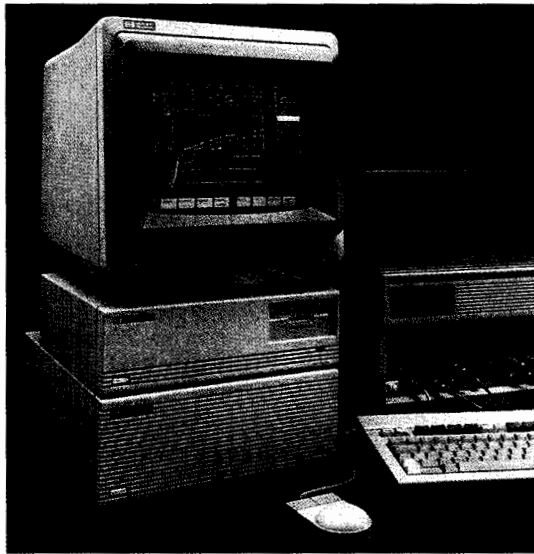

### HP Interactive Measurement and Analysis Software

HP interactive measurement and analysis (IMA) software makes semiconductor measurements interactively, using the HP 4142B DC source/monitor. The IMA software turns the HP 4142B into a fully automatic semiconductor dc parameter analyzer by providing an interactive softpanel user interface.

There are three versions of HP IMA software: IMA/WS (HP 16276B) is for HP BASIC/WS, IMA/UX (HP 16277B) for HP BASIC/UX, and IMA/PC (HP 16278B) for an HP Vectra PC with a high-performance measurement coprocessor.

Now you can use the HP 4142B like the HP 4145B semiconductor parameter analyzer, with the addition of the higher speed, wider dynamic measurement range, and more flexible module configuration of the HP 4142B, and with the enhanced capabilities of IMA software.

### Easy-to-Use Softpanels

The IMA software provides easy-to-use softpanels. You use the mouse to reduce the measurement setup to a simple fill-in-the-blanks operation. The mouse is also used to control the graphics analysis routines, output formats, and file management of the IMA.

### Automatic Measurement and Analysis

You can perform most semiconductor analysis functions using the HP IMA softpanels. For automation or customization of measurement and analysis, use the unique Analysis Instruction Set (AIS). The AIS is the subprogram library of HP BASIC and an interface with the HP BASIC program; the softpanel is the interactive user interface.

Setting up softpanels, triggering measurements, analyzing graphics, extracting data from and sending data to the graphics page, and managing files are made easy using the HP BASIC programming feature of the IMA software. By using the IMA softpanels, you can monitor and analyze program execution and manually reset parameters.

### HP 4145B Compatibility

Data-file upward compatibility with the HP 4145B is maintained for graphics and list data.

### Specifications

#### Products supported by HP IMA:

HP 4142B Modular DC Source/Monitor Unit  
 HP 41420A 200 V/1 A Source Monitor Unit (SMU)  
 HP 41421B 100 V/100 mA Source Monitor Unit (SMU)  
 HP 41422A 10 V/10 A High-Current SMU  
 HP 41423A 1000 V/10 mA High-Voltage SMU  
 HP 41424A Voltage Source/Voltage Monitor Unit

- Powerful graphics analysis for quick parameter retrieval
- Automatic measurement and analysis with HP BASIC subprogram library

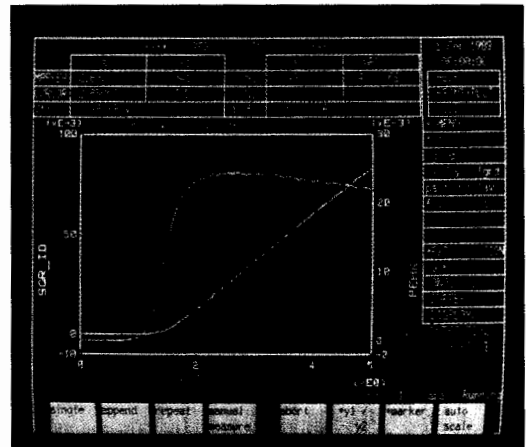

### Measurement characteristics

#### Voltage/current sweep parameters

**Var 1:** Main sweep, single or double sweep; selectable linear or logarithmic

**Var 2:** Subordinate linear staircase sweep

**Var 1':** Staircase sweep synchronized with the Var 1 sweep

**Time domain sweep:** Selectable time domain when Var 1 is not set

**Pulse:** Every source unit can be set as a pulse source

**Constant:** Every source unit can be set as a constant voltage or current source.

**Measurement modes:** Single, append, repeat, or manual

**Integration Time:** Short, medium, or long

**Display modes:** Graphics or list

#### Analysis capabilities

**User functions:** Up to 4 user functions can be defined.

**User display functions:** Up to 2 functions can be defined as numeric expressions with the marker, cursor, or line analysis data; results are displayed in real time.

**Marker function:** Interpolation, marker → min/max, or direct marker

**Cursor functions:** Cursor → marker, regression line, tangent line, line, fix line, or erase line

**Scaling functions:** Auto scale, move, zoom, init. scale, change scale, revise scale, and reset display

**Buffer function:** Four buffers are available: store, recall, recall off, and exchange.

**Display functions:** Title, grid/tick, part display, full display, and auto retrieve

### System Requirements

**Computer:** HP 9000 Model 310, 320, or 330 (HP 16276B)

Model 332, 340, 345, 350, 360, 370, or 375

(HP 16276B/16277B)

HP Vectra PC with HP 82324A High-Performance Measurement Coprocessor (HP 16278B)

**Memory:** 4 Mbytes (HP 16276B/16278B)

8 Mbytes (HP 16277B)

**Graphics I/F:** HP 98542A/98543A (16276B)

HP 98547A/98548A/98550A (16276B/16277B)

**Language system:** HP BASIC 6.0 or later (16276B)

HP BASIC/UX 5.52, HP-UX 7.0 or later (16277B)

HP BASIC 5.14 or later (16278B)

### Ordering Information

**HP 16276B** HP IMA/WS License-to-Use and Manual \$3,750

**Opt 007** Media, 3.5-in 2HD \$650

**HP 16277B** HP IMA/UX License-to-Use and Manual \$4,750

**Opt 022** Media, 1/2-in Tape \$850

**HP 16278B** HP IMA/PC License-to-Use and Manual \$3,750

**Opt 005** Media, 5.25-in 2HD \$650

**Opt 007** Media, 3.5-in 2HD \$650

### Price



# SEMICONDUCTOR TEST EQUIPMENT

Switching Matrix  
HP 4085M

575

- 48 pins with 1 pA resolution
- Easy programmable switching

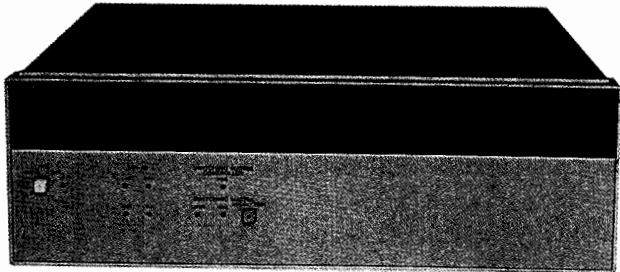

Switching Matrix Controller

HP 4085M

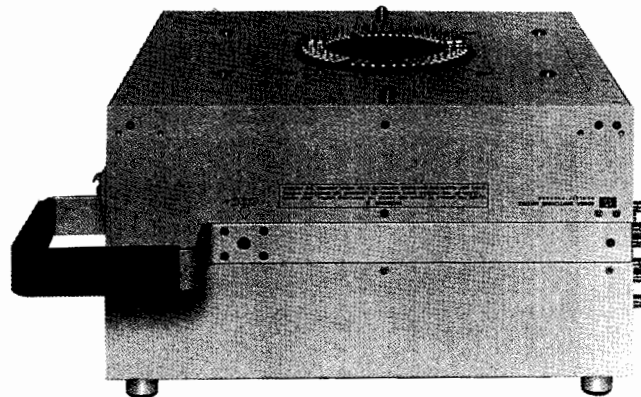

Switching Matrix

## Description

Combining the HP 4085M switching matrix with the HP 4145B semiconductor parameter analyzer produces a 1 pA, 1 mV switching system capable of 48-pin high-resolution semiconductor testing.

A design that minimizes both noise and leakage current means exceptional built-in dc measurement capabilities and the realization of 1 pA resolution measurements at any of the 48 pins.

The software included with the system makes it possible to freely switch any of the 8 instrument ports to any of the test pins from the system controller. A number of fixtures are available for wafer and various packaged device measurements. The HP 4085M retains the HP 4145B's full measurement capabilities to obtain highly reliable wide-range dc parameter measurements.

## System Configuration Example

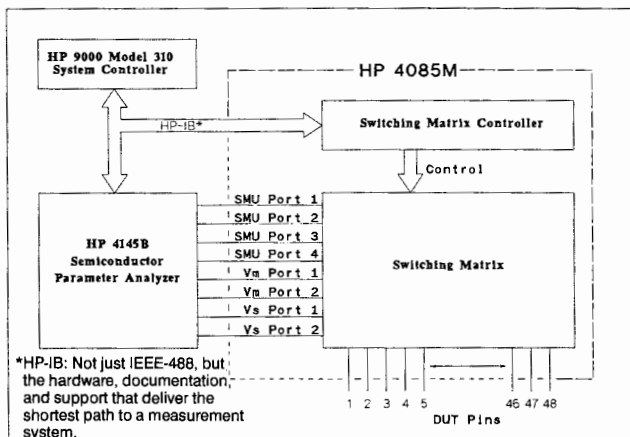

## Specifications

### Switching Matrix

**DUT pins:** From 12 to 48 pins can be installed.

**Instrument ports:**\* Eight instrument ports are included.

**Low-leakage SMU port:** 1 ea. (Port 1)

**SMU ports:** 3 ea. (Ports 2 through 4)

**Vs ports:** 2 ea. (Vs Ports 1 and 2)

**Vm ports:** 2 ea. (Vm Ports 1 and 2)

**Maximum voltage between instrument ports:**  $\pm 220$  Vdc

**Maximum current at each DUT pin:**  $\pm 500$  mA dc

\*SMU: Stimulus measurement unit

Vs: Voltage source

Vm: Voltage monitor

### General Specifications

**Operating temperature:** 10° to 40° C;  $\leq 70\%$  RH at 40° C

**Air cleanliness:** Class 100,000 or higher clean room required.

**Power requirements:** 100, 120, 220V  $\pm 10\%$ ; 240V  $+5\%$   $-10\%$ ; 48 to 66 Hz, 130 VA max

**Size:** Switching matrix, 406 mm W  $\times$  210 mm H  $\times$  380 mm D; switching matrix controller, 426 mm W  $\times$  134 mm H  $\times$  432 mm D

**Weight:** Switching matrix, approximately 25.3 kg; switching matrix controller, approximately 8 kg

### System Controller

**Required controller:** HP 9000 Series 200 Model 216S, 236A or 236S, or Series 300 Model 310, 330, 332, 350, 360 or 370

**System language:** BASIC 2.0 or later version

**Memory size:**  $\geq 320$  Kbytes

### Ordering Information

**HP 4085M Switching Matrix**  
(does not include controller)

**Opt 001** 12-Pin System

**Opt 002** 24-Pin System

**Opt 003** 36-Pin System

**Opt 004** Add One Pin

**Opt 016\*** For HP 9000 Model 216A/S Controller

**Opt 030\*** For HP 9000 Model 310 Controller

**Opt 036\*** For HP 9000 Model 236 A/S Controller

\*Opt 016, 030 or 036 must be selected according to the system controller used.

### Price

\$56,100

– \$23,700

– \$15,840

– \$7,920

+ \$660

\$0

\$0

\$0

# SEMICONDUCTOR TEST EQUIPMENT

## pA Meter/DC Voltage Source HP 4140B

- 3 basic semiconductor measurements: I, I-V, and quasi-static C-V
- Two programmable voltage sources
- Basic accuracy: 0.5%
- High resolution:  $0.001 \times 10^{-12}$  A
- HP-IB standard

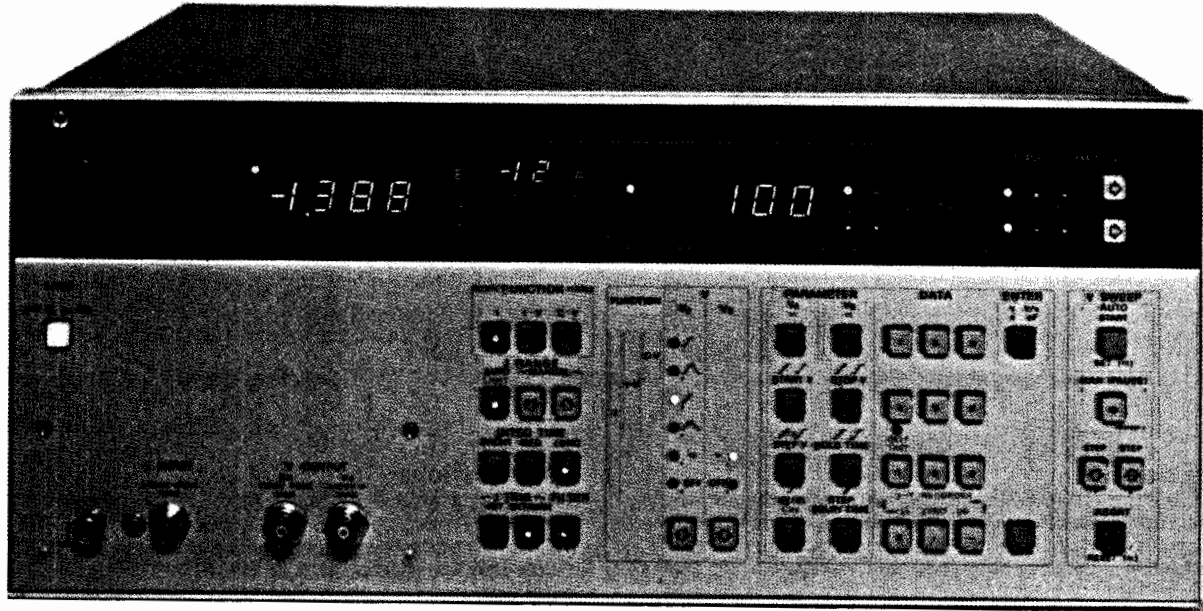

HP 4140B



### HP 4140B pA Meter/DC Voltage Source

The HP 4140B pA meter/dc voltage source is part of Hewlett-Packard's new generation of component-measurement instrumentation. It consists of an extremely stable picoampere meter and 2 programmable dc voltage sources, one of which operates as a ramp and staircase generator as well as a dc source. These features make the HP 4140B ideal for making dc-characteristic measurements such as leakage current, current-voltage characteristics, and quasi-static C-V measurements, required by the semiconductor industry for new-product development and for improving production yields. It is equally useful in measuring electronic components and materials to determine leakage currents or insulation resistances.

The HP 4140B can contribute to the development, production, and quality control of semiconductor devices and to improvements in the reliability of electronic components and equipment.

### Stable pA Measurements

Stable pA measurements can be made with the HP 4140B with a maximum resolution of  $10^{-15}$  A. This is made possible by a new measurement technique in conjunction with an offset current capability, low-noise test leads, and an electrostatic and light-shielded test fixture. These features provide both stable and fast measurements.

This measurement technique is very useful in making small leakage-current measurements and determining dc parameters of semiconductor devices, or measuring the insulation resistance and leakage current for dielectric absorption measurements necessary in the analysis of capacitors or insulation materials.

### Synchronized I-V Measurements

The HP 4140B makes automatic, synchronized current-voltage measurements that have required a large instrumentation system in the past.

The 2 voltage sources in the HP 4140B operate over a range of -100 V to +100 V with a maximum resolution of 10 mV. One operates only as a stable dc source, while the other generates a staircase voltage, a precise ramp, or a stable dc level.

Precise, programmable timing capability allows fast, accurate I-V and C-V measurements. Device stabilization times (time between the applied voltage and the subsequent current measurement) can now be programmed from the front panel of the HP 4140B or via the HP-IB bus.

### Quasi-Static C-V Measurements

Automatic quasi-static C-V measurements are easily accomplished by the ramp voltage capability of the HP 4140B. This measurement is highly significant in evaluating basic semiconductor characteristics.

The HP 4140B operates over a capacitance range of 0.1 pF to 1999 pF, with a dc voltage ramp rate of 1 mV/s to 1 V/s in 1 mV/s increments. Capacitance, which is calculated from the measured current divided by the ramp rate, can also be provided as a percentage of the capacitance of the oxide film ( $C_{ox}$ ) over a range of 0.0 to 199.9%. By providing the output voltage at each capacitance-measurement point, we have the dc (quasi-static) C-V characteristics of the device under test.

### HP-IB Capability

Interfacing the HP 4140B with an HP-IB system improves measurement efficiency and takes advantage of its high-speed (approx. 5 ms) measurement rate. Such a system minimizes measurement time for dc parameters of semiconductors and the insulation resistance and leakage current of electric components and materials. This allows rapid feedback to production for fast evaluation of a new device in the development stage.

### Specifications



**Measurement functions:** I, I-V, and C-V

**Voltage sources:** 2 separate sources ( $V_A$  and  $V_B$ )

$V_A$ :  $\pm 100$  V programmable source/function generator

$V_B$ :  $\pm 100$  V programmable dc voltage source

### Measurement function/source selection

Function	$V_A$	$V_B$
I		== (DC)
I-V		== (DC)
C-V		== (DC)

**Voltage sweep:** Auto or manual (pause)

**Current measurements**

**Displays:** Current, 3½ digits with 2-character annunciator. Voltage, 3½ digits.

**Measurement range:** ±0.001 × 10<sup>-12</sup> A to 1.000 × 10<sup>-2</sup> A full scale in 11 ranges.

**Overrange capability:** 99.9% on all ranges

**Range selection:** Auto (lowest current range is selectable) and manual

**Measurement accuracy/integration time**

Range	Accuracy* ± (% of rdg. + counts)	Integration Time**(ms)		
		Short	Medium	Long
10 <sup>-2</sup> - 10 <sup>-9</sup>	0.5 + 2	20	80	320
10 <sup>-10</sup>	2 + 2			
10 <sup>-11</sup>	5 + 3	80	320	1280
10 <sup>-12</sup>	5 + 8	160	640	2560

\* Accuracy for long integration time, 23° C ± 5° C, humidity ≤ 70%. For short and medium integration times, see reference data section.

\*\* Integration times specified at 50 Hz. For 60 Hz operation, multiply time by %.

**Zero offset:** Cancels leakage current of test leads or test fixtures.

**Offset range:** 0 to ±100 × 10<sup>-15</sup> A

**Trigger:** INT, EXT and HOLD/MAN

**Input terminal:** Triaxial

**Capacitance-voltage (C-V) measurement**

**Measurement ranges:** 0.0 pF to 100.0 pF and 200 pF to 1000 pF full scale in 2 ranges; 99.9% overrange

**Ranging:** Auto

**%C:** Capacitance change of device under test is displayed as a percent of the set value of the oxide capacitance (Cox = 100%).

**%C range:** 0.0% to 199.9%

**Cox setting ranges (2 ranges):** 0.1 pF to 199.9 pF and 200 pF to 1999 pF

**Capacitance calculation accuracy:** Accuracy is dependent on accuracy of both the current measurement and the ramp voltage.

**Zero offset:** Cancels stray capacitances of test fixtures and test leads

**Offset range:** 0 to 100 pF

**High-speed I data output:** Available with HP-IB interface only. Outputs current measurement data at 4 ms intervals (max rate).

**DC voltage sources**

**Output modes, V<sub>A</sub> and V<sub>B</sub>**

Function	V <sub>A</sub>	V <sub>B</sub>
I		(DC)
I-V		(DC)
C-V		(DC)

**Voltage ranges (V<sub>A</sub> and V<sub>B</sub>):** 0 to ±10.00 V and 0 to ±100.0 V in 2 ranges, auto range only

**Maximum current:** 10 mA, both sources

**Voltage sweep:** Auto and manual (pause), up/down step in manual (pause) mode. Sweep abort standard

**Operating parameter setting ranges**

**Start voltage and stop voltage:** 0 to ±10.00 V, 0.01 V steps; 0 to ±100.0 V, 0.1 V steps

**Step voltage:** 0 to ±10.00 V, 0.01 V steps; 0 to ±100.0 V, 0.1 V steps

**Hold time:** 0 to 199.9 seconds in 0.1 s increments; 0 to 1999 seconds in 1.0 s increments

**Step delay time:** 0 to 10.00 seconds in 0.01 s increments; 0 to 100.0 seconds in 0.1 s increments

**Ramp rate (dV/dt):** 0.001 V/s to 1.000 V/s in 0.001 V/s increments.

**Accuracy (at 23° C ± 5° C)**

**Output voltage:** ±10 V, ±(0.07% + 11 mV); ±100 V, ±(0.09% + 110 mV)

**Linearity:** Typically 0.5%, 0 to ±10 V; < 5%, > 10 V

**Current limit:** 100 μA, 1 mA and 10 mA, ±10% (V<sub>A</sub> and V<sub>B</sub>).

**Output terminals:** BNC; L-GND

**Reference Data**

**Current Measurement**

**Current measurement accuracy\***

Range	Integration Time	
	Short	Medium
10 <sup>-2</sup> to 10 <sup>-8</sup>	0.5 + 3	0.5 + 2
10 <sup>-9</sup>	0.5 + 3	0.5 + 3
10 <sup>-10</sup>	2 + 4	2 + 3
10 <sup>-11</sup>	5 + 10	5 + 4
10 <sup>-12</sup>	5 + 20	5 + 10

\* ± (% of rdg. + counts), 23° C

**Current ranging times:**\* 20 ms to 7.76 s. (Longer ranging time needed for large changes in input signal level, especially on lowest current ranges.)

\*When FILTER is on, current ranging time increases 60 ms (50 Hz power line) or 50 ms (60 Hz power line).

**Warmup time:** ≥ 1 hour

**Common mode rejection ratio:** ≥ 120 dB (≤ 2 counts)

**Analog Output I, C and V<sub>A</sub>**

**Accuracy:** ±(0.5% + 20 mV)

**Low-pass filter:** 3 position: OFF, 0.22 s ± 20% and 1s ± 20% applied to both V<sub>A</sub> and I/C data outputs

**Pen lift output:** TTL low level (≤ 0.8V) during sweep period in I-V and C-V functions

**Recorder output scaling:** Pushbutton scaling of lower left and upper right limits of X-Y recorder

**HP-IB Interface**

**Remote-controlled functions:** Measurement function, current range, integration time, I data output trigger, voltage sweep controls, current limit, V<sub>A</sub> and V<sub>B</sub> voltages, zero (offset), self-test and parameter settings (voltages, sweep/hold/delay times)

**Data Output**

Measured data (I, C and V<sub>A</sub>)

voltage setting (V<sub>A</sub> and V<sub>B</sub>)

Parameter settings

**General Information**

**Power:** 100, 120, 220 V ± 10%, 240 V + 5% - 10%; 48 to 66 Hz, 135 VA max

**Size:** 426 mm W × 177 mm H × 498 mm D (16.5 in × 7 in × 19.6 in)

**Weight:** 14.4 kg (31.7 lb)

**Accessories Furnished**

**HP 16053A test leads:** consists of 1 triaxial cable, 2 each BNC-BNC cables and 1 connection plate with mating female panel-mount connectors. Cables are 1 meter in length.

**HP 16055A test fixture:** For general device measurements. Provides electrostatic and light shielding for stable pA measurements.

**Accessories Available**

**HP 16054A connection selector:** Provides a simple method to select appropriate connection of low lead for the pA meter section.

**HP 16056A current divider (10:1):** For use only on the 10 mA range to extend the measurement capability to 100 mA.

**Ordering Information**

**HP 4140B pA Meter/DC Voltage Source**

**Price**

\$11,500

**Opt 907** Front Handle Kit (HP P/N 5061-0090)

\$76

**Opt 908** Rack Flange Kit (HP P/N 5061-0078)

\$42

**Opt 909** Rack and Handle Kit (HP P/N 5061-0084)

\$106

**Opt 910** Extra Manual

\$110

**Opt W30** Extended Repair Service (See page 671)

**Accessories**

**HP 16054A** Connection Selector

\$405

**HP 16056A** Current Divider (10:1)

\$214

☎ For off-the-shelf shipment, call 800-452-4844.

# SEMICONDUCTOR TEST EQUIPMENT

## 1 MHz C Meter/C-V Plotter HP 4280A

- Built-in sweepable dc bias source and timer for C-V (capacitance-voltage)/C-t (capacitance-time) measurements
- High-speed C-t measurements with minimum measurement interval of 10 ms (10  $\mu$ s if an external pulse generator is used)
- Basic C measurement accuracy: 0.1%
- Test lead extension up to 5 m
- 5 1/2-digit display resolution (option) for C measurement

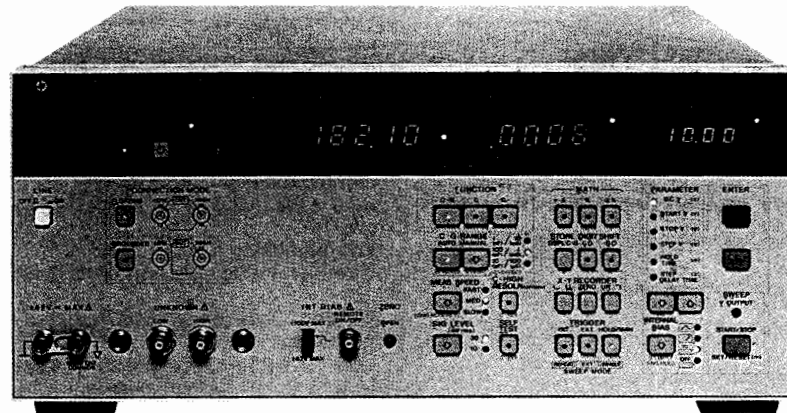

HP 4280A



### HP 4280A MHz C Meter/C-V Plotter

The HP 4280A 1 MHz C Meter/C-V Plotter measures the capacitance and conductance of semiconductor devices and materials as functions of applied voltage (C-V) or time (C-t). The HP 4280A consists of a precision 1 MHz C-G meter, a programmable dc bias source that can be swept in staircase fashion, and accurate timing control.

#### C-V and C-t Measurements

The HP 4280's internal dc bias source has a range of 0 V to  $\pm 100$  V with 1 mV resolution on the most sensitive range. Various measurement parameters for C-V and C-t measurements—hold time (bias pulse width) and delay time (measurement interval)—can be manually set from the front panel, or these parameters can be set under program control via the HP-IB. Settable range for C-t measurement interval is 10 ms to 32 s with a best-case resolution of 10  $\mu$ s. If an external pulse generator is used, however, measurement intervals as short as 10  $\mu$ s can be set. Up to 9,999 readings can be set for a C-t measurement. These capabilities make it possible for the HP 4280A to measure the C-t characteristics of virtually any device.

#### High-Speed C-t Measurement

The HP 4280A has a special sampling integration technique for measurement intervals as short as 10  $\mu$ s using an external pulse generator, such as the HP 8112A or 8160A, to provide the bias pulse. Short measurement interval makes the HP 4280A applicable to deep-level transient spectroscopy (DLTS) measurements, commonly used to analyze physical characteristics of semiconductors.

#### Precision, High-Resolution Measurements

The HP 4280A measures capacitances up to 1.900 nF, over 3 ranges, with 0.001 pF resolution on the most sensitive range. Conductance up to 12 mS can be measured with 10  $\mu$ S maximum resolution.

C and G measurements are made at 1 MHz. AC signal level is selectable between 10 mV rms or 30 mV rms, suitable for semiconductor measurements. Basic measurement accuracy is 0.1%. Maximum display resolution is 4 1/2 digits. With Option 001, however, display resolution for capacitance is 5 1/2 digits.

The accuracy and resolution of the HP 4280A satisfy the stringent requirements of laboratory and research and development measurements, which require the detection of minute changes in device characteristics.

#### Probed Measurements on Wafers

The HP 4280A has an automatic error-correction function that makes it possible to use test leads up to 5 m long (HP P/N (8120-4195).

The HP 4280A can measure either floating or grounded devices. Thus, it can be connected to a wafer prober and still provide stable, accurate C and G measurements.

#### Easy, Low-Cost Systemization

HP-IB is standard on the HP 4280A, so a process evaluation system or a lab automation system capable of evaluating the physical characteristics of semiconductor devices can easily be constructed.

The HP 4280A is equipped with analog outputs to allow users to plot device characteristics on an X-Y recorder or large-screen display.

#### Specifications (see data sheet for complete specifications)

##### Measurement functions: C, C-V and C-t

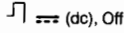
Function		Available Internal DC Bias Function
Basic Function	Selection	
C	C only, G only C-G only	Off --- (dc)
C-V	C-V G-V C & G-V	
C-t	C-t G-t C & G-t	 --- (dc), Off

#### C Measurement

##### Test signal

**Frequency:** 1 MHz  $\pm 0.01\%$ .

**OSC level:** 30 mV rms or 10 mV rms  $\pm 10\%$ .

**Measurement terminals:** 2-terminal-pair configuration (High, Low, and Guard).

**Connection mode:** Sets connection configuration between DUT (floating/grounded) and measurement circuit.

**Ranging:** Auto or manual.

##### Error compensation

**Cable length:** 0 m, 1 m or 0 to 5 m. The standard cable (HP P/N 8120-4195) up to 5 m can be internally compensated.

**Zero open:** Compensate stray capacitance and conductance at the test fixture.

**External error compensation:** Compensate errors by external computer to eliminate other error factors not listed above.

**Measurement speed:** Fast, Med, or Slow.

**Trigger:** Internal, External or Hold/Manual.

**Internal dc bias mode:** Off or --- (dc).

**Measurement Range/Resolution/Accuracy**

Range <sup>1</sup>	Resolution <sup>2</sup>	Max. Display <sup>2</sup>	Accuracy* ± (% of rdg + counts)	
			OSC: 30 mV	OSC: 10 mV
10 pF/100 μS	0.001 pF 0.01 μS	19.000 pF 120.00 μS	±(0.1% + 5) ±(0.2% + 5)	±(0.2% + 5) ±(0.3% + 5)
100 pF/1 mS	0.01 pF 0.1 μS	190.00 pF 1.2000 mS	±(0.1% + 3) ±(0.2% + 3)	±(0.2% + 3) ±(0.3% + 3)
1 nF/10 mS <sup>3</sup>	0.1 pF 0.001 mS	1.9000 nF 12.000 mS	±(0.1% + 3) ±(1.2% + 3)	±(0.2% + 3) ±(1.2% + 3)

<sup>1</sup> 100 pF/1 mS and 1 nF/10 mS ranges only in grounded measurement.  
<sup>2</sup> When measurement speed is set to Fast (10 mV/30 mV) or Med (10 mV), resolution and max. display become 1 digit less (3½-digit display).  
<sup>3</sup> Approx. 50 pF at 100 pF/1 mS range and 1.76 nF at 1 nF/10 mS range in grounded measurement. Error correction to offset residuals will reduce maximum value that can be measured.  
<sup>4</sup> Accuracy is specified at unknown terminals and at the end of HP 16082A test leads (1 m) after warm up ≥30 min., at temperature 23° C ±5° C, zero open calibration is performed, and correction is enabled. Front panel settings are C-G, floating, and 0 m or 1 m (cable length). Some errors will be added at other settings (see data sheet). C accuracy is specified when D < 0.05 and G accuracy is specified when counts of C < 1/100 of range. Error double at 0° to 55° C.  
<sup>5</sup> Add 0.1% of rdg for C and 0.2% of rdg for G when HP 16082A is used.

**C-V Measurement**

**Function:** Measures C-V, G-V, or C and G-V characteristics using internal staircase bias.  
**Measurement speed:** Fast, Med, or Slow

**C-t Measurement**

**Function:** Measures C-t, G-t or C and G-t characteristics using internal and/or external pulse bias source.  
**Internal measurement mode:** Burst or sampling mode automatically selected.

**Burst mode:** Apply 1 pulse, then make repetitive measurement with specified time interval between measurements.  
**Sampling mode:** Repeated pulse with single samples between pulses. Delay between application of measure voltage and sample can be specified.

**Measurement speed:** Fast or Med

**DC Bias Source**

**Output mode:** (dc) or Off  
**Output voltage range/resolution/accuracy**

Voltage Range	Resolution	Accuracy* ± (% of setting + volts)
± 1.999 V	1 mV	±(0.2% + 0.01 V)
± 19.99 V	10 mV	±(0.1% + 0.02 V)
± 100.0 V	100 mV	±(0.1% + 0.1 V)

\*at 23° C ±5° C, at 0° C to 55° C error doubles.

**Staircase sweep parameter settings (C-V basic function only)**  
**Start/stop voltage:** 0 V to ±100 V (max. 1 mV resolution)  
**Step voltage:** 0 v to 200 V (max. 1 mV resolution)  
**Hold/step delay time (th/td):** 3 ms to 650s (max. 1 ms resolution)  
**Pulse Bias Parameter Settings (C-t basic function only)**  
**DC/pulse/measurement voltage:** 0 V to ±100 V (max. 1 mV resolution)  
**Number of readings:** 1 to 9,999  
**Hold time (th):** Max 10 μs resolution  
**Internal bias:** 10 ms to 32 s  
**Ext bias slow:** 50 μs to 32 s  
**Ext bias fast:** 10 μs to 32 s  
**Delay time (td):** 10 μs to 32 s (max 10 μs resolution)  
**Burst mode**

Function	Meas. Speed	Block Mode	Non-Block Mode	
			Data Format	
			Binary	ASCII
C-t	Fast	10 ms to 32 s	20 ms to 32 s	150 ms to 32 s
	Med			
G-t	Fast	50 ms to 32 s	200 ms to 32 s	200 ms to 32 s
	Med			
C and G-t	Fast	100 ms to 32 s	250 ms to 32 s	250 ms to 32 s
	Med			

**Sampling Mode**  
**Ext bias slow:** 200 μs to 5 s  
**Ext bias fast:** 10 μs to 5 s

**Math functions:** Displays measured C/G values as differential values (Δ), % ratio (%), or differential % (Δ%) of the reference value.

**Other**

**HP-IB:** Not just IEEE-488, but the hardware, documentation, and support that delivers the shortest path to a measurement system.

**Data output format:** ASCII or binary  
**Block mode output:** Can make C-V/t characteristics measurement and store measured data (C-V/t or G-V/t function: 680 data; C & G-V/t function: 400 data) into the internal data buffer. Then packed data can be output.

**Recorder output**  
**Output voltage:** ±10 V for C, G, and V/t data  
**Accuracy:** ± (% of output voltage + V)  
**C or G:** ±(0.5% + 20 mV)  
**V or t:** ±(0.15% + 40 mV)

**Self-test:** Verifies normal measurement operations (not including calibration).

**Options**

**Opt 001:** High-Resolution Offset Capacitance Measurement  
**Function:** Increases C measurement resolutions by 1 digit with offset reference value.  
**C offset range:** 0 to 1023 pF (1 pF increment). C offset value can be set by measured data or numeric key.

**General Specifications**

**Operating temperature range:** 0° to 55° C; 95% RH at 40° C  
**Power:** 100/120/220 V, ±10%; 240 V, + 5% - 10%; 48 to 66 Hz, 140 VA max  
**Dimensions:** 426 mm W × 177 mm H × 498 mm D (16.5 in × 7 in × 19.5 in)  
**Weight:** 15.3 kg (33.7 lb)

**Accessories Furnished**

**HP 16080A:** Direct Coupled Test Fixture

**Reference Data**

**Measurement Time**

Meas. Speed	Measurement Function		
	C-G	C	G
Fast	30 (70)	10 (30)	10 (30)
Med	70 (110)	40 (60)	35 (55)
Slow	400 (440)	270 (290)	220 (240)

When measured values are displayed on the front panel and the recorder outputs are used, measurement times in parentheses apply.

**Residual L-R compensation:** Error compensation for residual L-R (max. 19 μH/190 Ω) is available using an external controller.

**Internal DC Characteristics of High and Low Unknown Terminals (without DC bias)**

**Maximum offset voltage:** ± 1 mV  
**Maximum allowable current:** 100 mA

**Internal DC Bias**

**Settling time (99.9% of final value):** 0.05 × voltage swing (V) + 1.7 (ms)  
**Maximum output current:** ± 6 mA  
**Hold time/step delay time/th/td:** 0.02% (basic accuracy)  
**Response time of the EXT SLOW bias circuit (99.9% of final value):** 100 μs  
**Opt 001**  
**C offset accuracy:** ±(2% of reference value + 0.5 pF) can be compensated by CORRECTION ENABLE key.

**Ordering Information**

**HP 16081A** Test Leads, 2 m, Double-Shielded, BNC  
**HP 16082A** Test Leads, 1 m, BNC  
**HP 16083A** Pulse Bias Noise Clipper

**Price**  
 \$760  
 \$260  
 \$415

**HP 4280A** 1 MHz C Meter/C-V Plotter  
**Opt 001** C High Resolution (not field-installable)  
**Opt W30** Extended Repair Service (see page 671.)

\$12,200  
 \$470

☎ For off-the-shelf shipment, call 800-452-4844.

# SEMICONDUCTOR TEST EQUIPMENT

## Circuit/Device Modeling

### IC-CAP

- Minimize design iteration cycle
- Optimize the IC performance
- Create new device models and circuit macromodels with ease

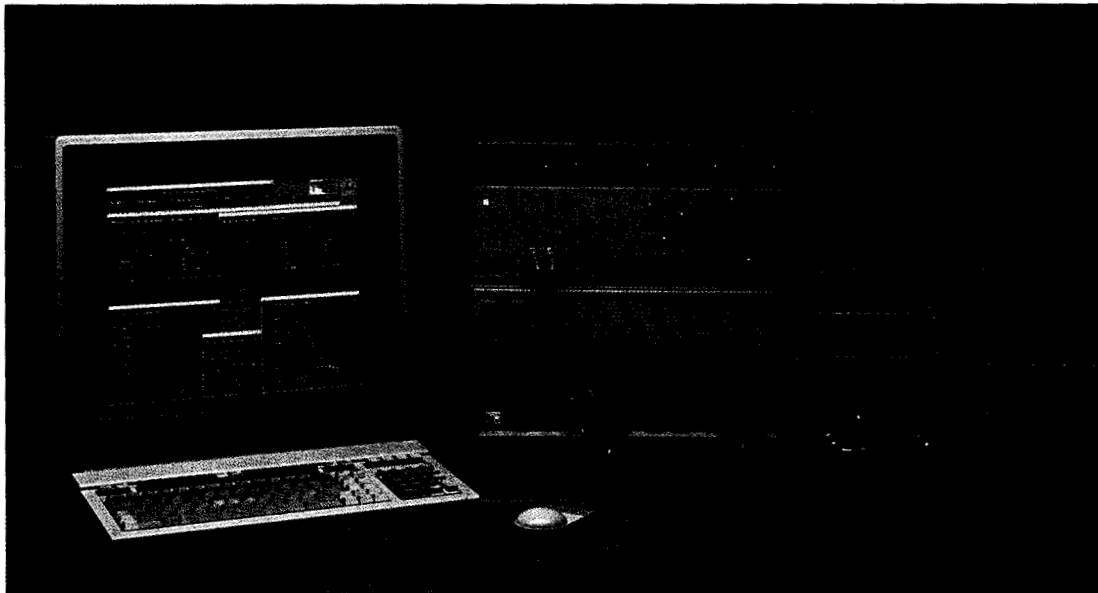

IC-CAP

## IC-CAP Circuit/Device Modeling Software

### New Approach to Modeling

Over the last decade, semiconductor technology has gone through rapid advancements resulting in dramatic improvement in the performance of ICs. State-of-the-art IC technologies use devices that require careful attention to modeling the parasitics and second-order effects. Parasitics must be included as subcircuits formed around the transistors. Analytically solving a set of device equations is inadequate for most of the semiconductor technologies.

### Subcircuit Characterization and Modeling

The success of an IC technology is rooted in its ability to achieve the desired performance while maintaining high product yield. Accurate prediction of the performance of an IC relies on the simulation models used and the capability to accurately extract device parameter as well as subcircuit component values for these models.

### Simulating a Device or Subcircuit

IC-CAP provides a direct link to SPICE circuit simulator through an open interface and uses it for analysis and optimization of device or subcircuit performance. Direct use of SPICE also eliminates any discrepancy between modeling and simulation tools.

### Extracting Parameters

IC-CAP's powerful extraction, optimization, and advanced utilities, coupled with SPICE simulator, will help you generate the most accurate device parameters or circuit element values for your designs.

### Macromodeling

Macromodels are simplified versions of complex circuits that are used for efficient simulation of circuits or systems. The user describes the topology of the macromodel in the form of a subcircuit to IC-CAP. IC-CAP performs the analysis and measurements based on the inputs and finds the optimum component or device parameter values for the best performance.

### Statistical Modeling

Through support of the HP 4062UX process control system, IC-CAP is used to collect large volume of model parameter data. Statistically significant models to cover best/worst and nominal case corners are obtained from this data. IC-CAP's batch-mode operation is designed to facilitate statistical modeling.

### Complete Characterization Solution with TECAP and IC-CAP

TECAP and IC-CAP cover a wide range of characterization needs for the semiconductor industry. All TECAP measurement and extraction files are compatible with IC-CAP. This allows a smooth migration path for present and future TECAP users as they move from single device extraction to device and subcircuit modeling.

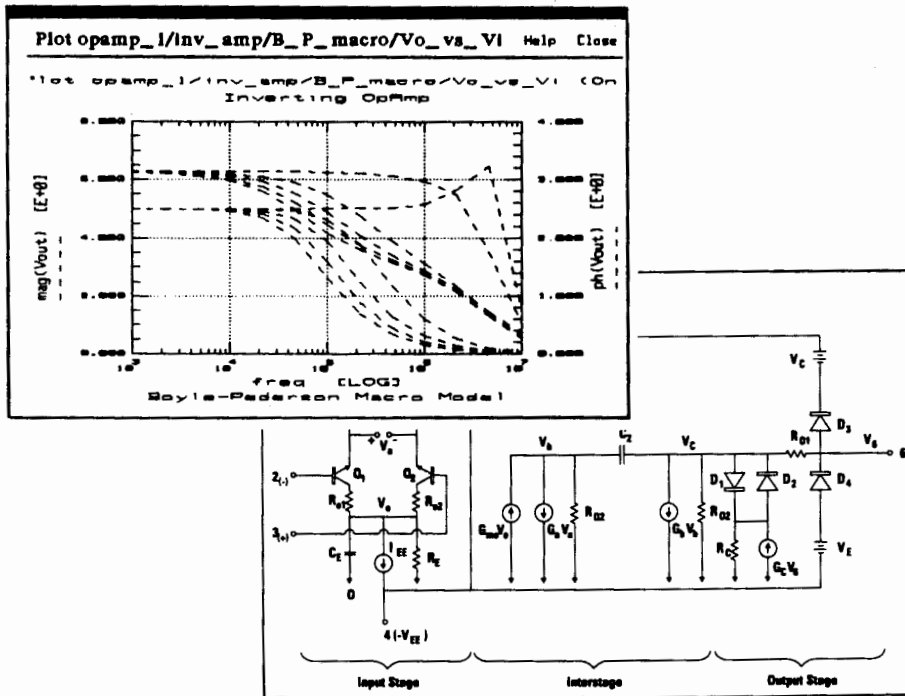

IC-CAP circuit-modeling capability is a valuable aid in macromodel development.

### IC-CAP Utilities

IC-CAP's transforms provide the user with the ability to optimize model parameters over any transformation performed on the data. Typical transforms include derivatives, algebraic and trigonometric and arithmetic operation that are contained in a powerful functions library. IC-CAP also comes with graphical analysis and calculation capabilities for real-time analysis of the measured data.

### Networking to Design Environment

Running under UNIX operating system, IC-CAP can easily be networked to your existing design environment. This enables designers to easily access model libraries. UNIX also offers the advantage of easy access to industry standard database systems and analysis packages including TekBase, Oracle, Informix, and RS/1.

### Training and Support

Hewlett-Packard offers free training for every purchase of one of the IC-CAP modeling systems. IC-CAP is covered with HP's Basic/ResponseLine support services. We recommend subscription to *Software Material Update* to stay current with the IC-CAP software.

### IC-CAP Framework

Configuring a modeling system requires the IC-CAP framework. It must be ordered with all new systems. Adding new models or measurement drivers for an existing system requires the purchase of the particular module only. For example, you can start with MOS modeling system, and later on add Bipolar models and ac measurement drivers to address the BiCMOS characterization needs.

### IC-CAP Modeling System Configuration

IC-CAP is the product of choice to perform characterization and modeling on device and subcircuit level for various technologies. IC-CAP runs on HP 9000 Series 300/400/700 running under HP-UX as well as Sun SparcStations.

Informix is a trademark of Informix Inc.

Oracle is a trademark of Oracle Corporation.

RS/1 is a trademark of BBN Corporation.

SparcStation and Sun are trademarks of Sun Microsystems Inc.

TekBase is a trademark of Leading Technology Products.

UNIX is a trademark of AT&T Bell Laboratories.

### MOS Modeling System

E3300A IC-CAP Framework

E3301A DC measurement drivers

E3302A LCRZ measurement drivers

E3304A Time Domain (TD) driver

E3305A Analysis Module

E3306A SPICE MOS model parameter extraction

E3307A SPICE BSIM model parameter extraction

Note: IC-CAP supports both BSIM and levels 2 and 3 of UCB SPICE models. You have the option to select either one or both. We also recommend the E3304A in order to characterize and validate transient performance of selected circuits.

### Bipolar Modeling System

E3300A IC-CAP Framework

E3301A DC measurement drivers

E3302A LCRZ measurement drivers

E3303A AC measurement drivers

E3304A Time Domain (TD) driver

E3305A Analysis Module

E3308A SPICE Bipolar model parameter extraction

### GaAs Modeling System

E3300A IC-CAP Framework

E3301A DC measurement drivers

E3302A LCRZ measurement drivers

E3303A AC measurement drivers

E3304A Time Domain (TD) driver

E3305A Analysis Module

E3309A GaAs model parameter extraction (includes Raytheon and Curtice models)

### Ordering Information

Please call your local HP sales office (see page 684) for a data sheet, prices, and application assistance.

# SEMICONDUCTOR TEST EQUIPMENT

## Device Modeling Software TECAP Characterization System

- Shorten IC design time
- Improve circuit designs
- Lower chip costs
- Maximize yields
- Accurate circuit simulations
- Device ac and dc measurements

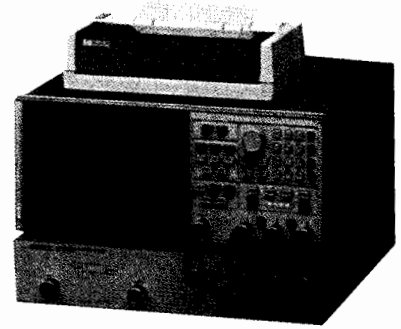
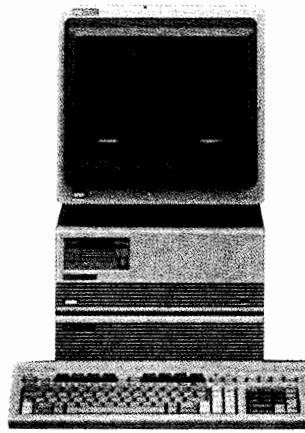
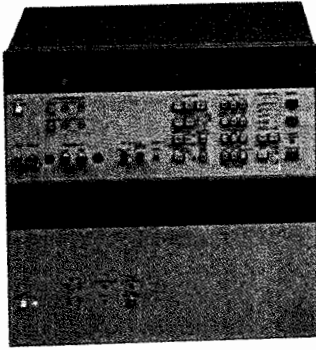

TECAP software is fully compatible with a wide range of standard HP-IB instrumentation.

### TECAP Lets You Design New ICs in Less Time — With Less Cost

The TECAP Characterization System shortens your IC design cycles and lowers design costs. TECAP—Transistor Electrical Characterization and Analysis Program—provides fast, reliable analysis of device behavior. Model parameters generated with the TECAP system will improve your circuit simulation and IC designs.

### TECAP Extracts Model Parameters in Seconds

TECAP software can automatically extract UCB MOS Level 1, 2, 3, or 4; UCB Bipolar; or GaAs model parameters in seconds. These models can simulate second-order effects, such as channel-length modulation, and offer direct compatibility with the UCB SPICE circuit simulator developed at the University of California, Berkeley.

The TECAP system can also extract parameters for your new transistor models. Newly implemented models have the same parameter extraction, optimization, and simulation capabilities as standard TECAP models. You can even add a custom extraction module to the program to fully automate parameter extraction for your model.

### Best/Worst Case Modeling

Using TECAP's statistical tools, you can accurately determine worst case performance of your process using those dominant parameters. TECAP gives you the vehicle to construct worst case models, which will allow you to increase the performance of your process with minimal process development and lower cost.

### Develop and Understand New Device Models

You can implement your own transistor models into TECAP to be completely compatible with proprietary circuit simulation programs or emerging new semiconductor technologies. You can use the versatile simulation tools to develop and test new model equations.

### TECAP Is Easy to Use

TECAP provides both ease of use for the occasional user and advanced features and capabilities for the expert user.

To measure a device, extract model parameters, or simulate device performance, you select the appropriate command. If the system needs more information from you, it will supply a diagram or table for you to edit. Every table is already furnished with default values or configurations. The table entry method allows you to have immediate access to all of your characterization routines so that you can use the design tools more productively.

### Configure System Hardware to Satisfy Your Price and Performance Requirements

The TECAP system works with a wide range of standard Hewlett-Packard computers and HP-IB instrumentation, allowing you to

choose the equipment that meets your exact needs. TECAP supports the HP 4145B and HP 8753B, as well as newer instruments such as the HP 4142B, HP 8720A, and HP 4284A. You can build an entry-level system to start with. Then, as your requirements expand, you can add the latest in high-performance measurement tools to fit your changing situation.

### TECAP Software Specifications

**Operating system:** Pascal Workstation language system, Version 3.22

**Measurement:** Voltage, current, capacitance, and 2-port ac parameters vs. bias and frequency

#### Model Parameter Generation

##### Extraction:

- Direct extraction from measured data
- Predefined routines for automatic extraction
- Interactive parameter extraction mode
- User-definable extraction routines

##### Optimization:

- Numerical fine tuning of extracted parameters using integrated SPICE-like simulator for highly accurate fits
- Compatible with user defined models
- Levenberg-Marquardt algorithm for nonlinear, least-squares fit
- Constrained optimization

**Simulation:** voltage, current, capacitance, and 2-port ac parameters vs. bias and frequency

#### Available models:

- UCB MOS Levels 1, 2, 3, and 4 (BSIM)
- UCB Bipolar (Gummel-Poon, Ebers-Moll)
- Curtice GaAs MESFET Levels 1 (quadratic) and 2 (cubic)
- UCB GaAs MESFET
- Yaeger-Dutton GaAs HEMT
- UCB JFET
- Diode
- PN Junction Capacitance
- MOS Gate Capacitance
- Classical MOS
- Up to seven user-definable models

### TECAP Data Sheets

MOS Modeling with TECAP—publication 5956-4220  
BSIM Modeling with TECAP—publication 02-5956-4217  
GaAs Modeling with TECAP—publication 02-5956-4216  
UCB Bipolar Modeling—publication 5956-4218

### Ordering Information

Please call your local HP sales office listed on page 684 for a data sheet, prices, or applications assistance.



- Substantially reduce parametric test development time
- Standardize on IC-MS for all your test development and execution needs
- Generate test plans for use in research and development and production

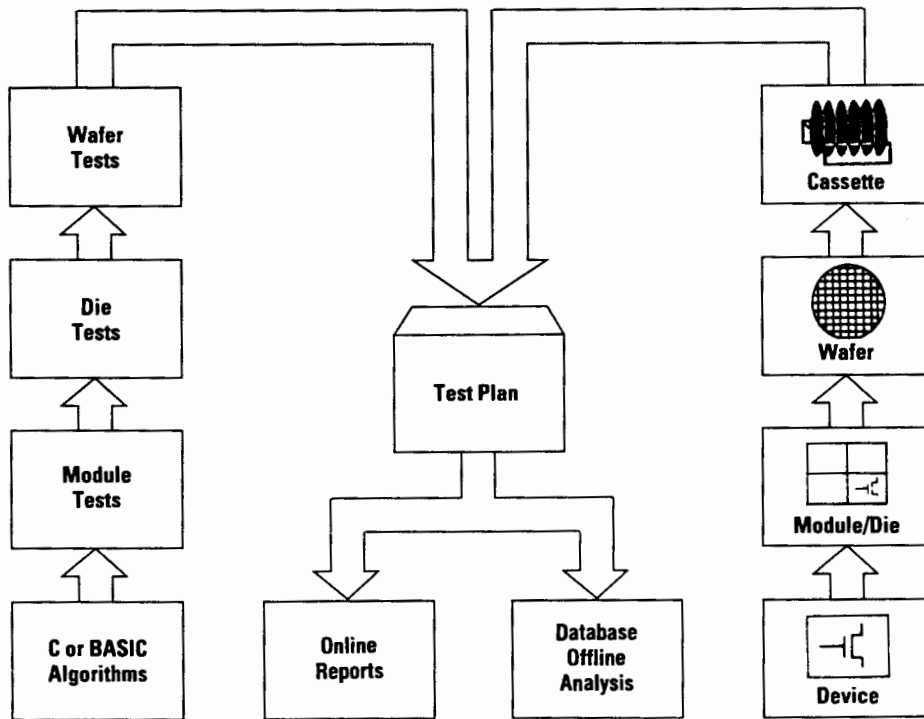

IC-MS is the ideal test manager for development and production environment.

### Impact of VLSI on Parametric Testing

Demands of a rapidly changing VLSI environment have placed great emphasis on a highly flexible and automated manufacturing process. This in turn has led to the evolution of high-speed parametric testers with intelligent instrumentation to perform thousands of measurements routinely. Different phases of VLSI development require using special test structures and corresponding test plans to provide the final evaluation of the myriad interactions between materials and processing that occur during the IC manufacturing sequence.

### A Powerful Test Shell for Process Monitoring/Development Needs

IC-MS is implemented on the HP 4062UX semiconductor process control system. It is a test shell that will help you generate and execute parametric test plans with ease and with the least amount of programming. Test plans generated by the IC-MS are used throughout the IC manufacturing process from development to production process monitoring.

### IC-MS in Development Environment

Semiconductor technology development process requires a sophisticated parametric test environment in order to gain maximum information from the experimental wafer lots. In such an environment, test plans are constantly generated and modified to meet the demands of increasingly complex tests. Designing a test plan with IC-MS involves two steps: defining the physical structures, and defining the algorithms used to test those structures. The only programming involved is creating test algorithms. Once the reference in-

formation about the physical structure of the wafer is entered, generating a test plan involves sequencing, devices, and dies and test algorithms using the X-window-based user interface. This approach offers the maximum flexibility, which is the primary requirement of testing at this stage.

### IC-MS in Production Environment

IC production environment requires a parametric test shell that is easy to operate and generates robust test plans. IC-MS takes care of all the nonapplication specific portions of the software, including the user interface. It includes many powerful features to allow for secure and error-free operation in the production mode. IC-MS is optimized for throughput and allows for maximum use of the test hardware.

### Powerful Turnkey Features

IC-MS provides many unique features to simplify the process of developing a parametric test plan. These features include on-line reporting capability for quick reports on the status of your process, open interface to allow automatic entry of the reference data, and open access to test plan data for easy integration into the popular databases. User-written algorithms are supported in both HP BASIC/UX and C.

### Ordering Information

IC-MS software product number is E3330A. It can also be ordered for a site wide installation using E3331A. IC-MS is covered by HP's Basic/ResponseLine support services. We recommend subscription to Software Material UpdateService in order to keep current with the IC-MS enhancements.

# TELECOMMUNICATIONS TEST EQUIPMENT

## General Information: Digital Communications Measurement

### Digital Communications Measurement

#### Digital Transmission

The emphasis in measuring the performance of digital transmission systems is now on monitoring the end-to-end performance in terms of percent error-free seconds and availability. Most of the digital transmission analyzers from Hewlett-Packard now incorporate analysis to G.821 for error performance, coupled with performance logging to internal memory or printer.

#### CEPT Hierarchy

The CEPT digital hierarchy has four currently defined levels for network interconnection and test: 2, 8, 34, and 140 Mb/s.

The HP 3764A digital transmission analyzer is available in a number of variants: a 2, 8, 34, and 140 Mb/s BER version for general network test and a 140 Mb/s BER and jitter version for troubleshooting and manufacturing applications. Versions with an internal synthesizer provide variable-frequency operation to 170 Mb/s and more flexible offset testing.

For field test applications at 0.7, 2, 8, 34, and 140 Mb/s, the HP 37721A digital transmission analyzer combines all the necessary measurements in a compact, portable, and rugged case, with built-in printer. The HP 37722A digital telecom analyzer provides framed measurements at 704 kb/s, 2 Mb/s, and 8 Mb/s in a lightweight, portable package.

Fast, easy measurements of error and jitter performance to 50 Mb/s are possible with the HP 3784A digital transmission analyzer. It has standard CCITT interfaces at 704 kb/s and 2, 8, and 34 Mb/s and optional data-circuit testing capability at 64 kb/s.

#### North American Hierarchy

Of the four main levels currently defined, the most important are DS1 (1.544 Mb/s) — used primarily for local distribution — and DS3 (44.736 Mb/s) which is the high-capacity building block for the long-haul toll circuits.

The HP 3789B DS3 transmission test set not only measures BER and jitter on a DS3 signal (including C-bit parity), but also extracts and measures BER and jitter on each of the component DS1 digroups, making it an ideal troubleshooting aid.

#### Digital Leased Service Measurements

In North America, digital leased services include T1 (1.544 Mb/s) and digital data systems (2.4/4.8/9.6/56 kb/s). The HP 3787B digital data test set measures both error and jitter performance on these T1 and DDS services. It has substrate drop and insert capability and can perform measurements on customer substrate primary and secondary channels. The HP 3787B is particularly suited to the manufacturing test of T1, DDS, and DCS equipment, as well as network installation and maintenance.

For T1 circuit installation and maintenance, the HP 37701A T1 tester provides a rugged, portable, and compact solution. It performs a wide range of error and signal measurements in the central office, on users' premises, and at intermediate points.

#### Jitter and Digital Networks

Jitter test sets incorporating both jitter generation and measurement capability help manufacturers design equipment to meet the recommended jitter performance specified in the standards documents. Incorporating jitter measurements into BER test sets such as the HP 3764A, HP 3784A, HP 3787B, and HP 3789B couples the analysis of timing jitter with error analysis to pinpoint fault mechanisms more efficiently.

#### SONET/SDH Transmission

Worldwide need for higher-capacity transmission and better performance has led to widespread use of optical fiber as a transmission medium. Until the introduction of SONET and SDH, all optical systems were proprietary, that is the equipment from one manufacturer could not be connected to that of another manufacturer.

SONET (Synchronous Optical Network) and SDH (Synchronous Digital Hierarchy) are new standards that specify standard optical interfaces and frame formats for transmission and equipment in synchronous optical networks. SONET is a North American standard and SDH is a CCITT International standard.

In a SONET/SDH network, equipment from one manufacturer will work with equipment from another manufacturer. Having standard optical interfaces and frame formats means that the point of interface between equipment, often called "the mid-span-meet," now must be tested rigorously.

SONET/SDH test applications are covered with the HP 75000 series 90 modular SONET/SDH analyzer and the HP 37704A SONET test set. The HP 75000 Series 90 covers both SONET and SDH standards and it is aimed at equipment manufacturers for applications such as research and development and production test. The HP 37704A is a dedicated SONET product and it is aimed at network installers and service providers for network installation and maintenance applications.

Both HP analyzers provide comprehensive test capability for their intended applications. Features include:

- Electrical and optical rates from 52 Mb/s to 622 Mb/s
- Frame alignment stress tests
- Alarm testing
- APS testing
- Payload pointer stress tests
- Payload pointer analysis
- Payload mapping and demapping tests
- BER analysis of payloads and BIPs
- DCC access

The HP 75000 Series 90 SONET/SDH analyzer is based on industry-standard VXI-bus hardware. The analyzer consists of a series of C-size VXI modules, each module addressing specific aspects of SONET/SDH testing. To cater for changes in the SONET/SDH standards, the HP 75000 Series 90 can be upgraded through customer-installable, firmware enhancements.

The HP 37704A SONET test set is rugged and portable and has been designed with plug-in interfaces to allow flexibility and future upgrading.

Also for SONET/SDH test, special options are available on the HP 3764A and HP 3784A digital transmission analyzers for jitter and BER measurements at the rates 51.84 Mb/s and 155.52 Mb/s.

#### Lightwave Transmission Systems

Lightwave transmission dominates for bit rates above 140 Mb/s and DS3. Transmission systems to transport SONET and SDH format signals operating at bit rates up to 2.488 Gb/s are under development. Parametric and functional testing of the lasers, photo-detectors, and high-speed logic devices that make up these systems requires high-performance pattern generators and error-performance analyzers.

The HP 71600 series of pattern generators and error performance analyzers covers bit rates up to 3 Gb/s. They are housed in HP's modular measurement system (MMS), allowing the user to define cost-effective configurations for manufacturing and research and development.

The new HP 71603B 3 Gb/s error performance analyzer is particularly well matched with the needs of lightwave transmission systems. It features high-quality data waveforms for component testing and user-programmable test patterns capable of simulating multiple SONET or SDH format frames at the 2.488 Gb/s transmission rate.

# TELECOMMUNICATIONS TEST EQUIPMENT

## Digital Transmission Analyzers

HP 37722A, HP 37721A

585

- Complete range of in- and out-of-service telecom installation and maintenance measurements in one tester
- Low-cost, rugged, easy to use
- Adaptable to future requirements—no need to buy new test sets
- Powerful results storage and analysis without using printer

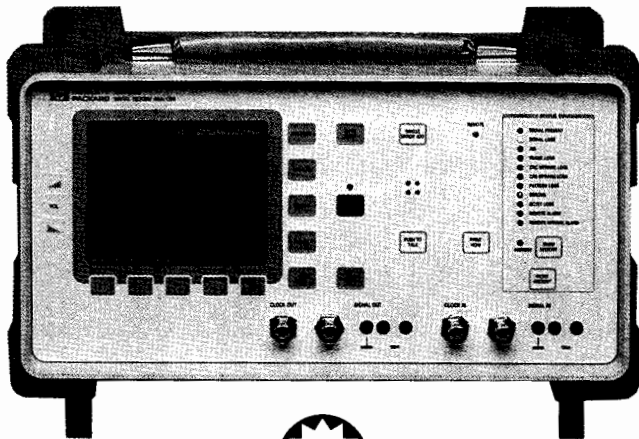

HP 37722A



### HP 37722A Digital Telecom Analyzer

The HP 37722A digital telecom analyzer is an easy-to-use, lightweight, field-portable test set for in- and out-of-service bit error and signal measurements on CEPT digital circuits and services. The HP 37722A provides framed pattern generation and measurements at 704 kb/s and 2 Mb/s. Also, it offers many other features to help increase productivity and network uptime: 80 days' results storage in text and graphic form;  $n \times 64$  kb/s testing; timeslot monitor including all signaling bits display; and timeslot access. Options provide unframed 8 Mb/s, framed/unframed 704 kb/s, 64 kb/s timeslot access and sub-rate processing (X.50 divisions 2 and 3, and X.58).

The HP 37722A is easily upgraded to the HP 37732A telecom/datum analyzer. See page 614.

#### Applications

- Installation of digital telecom circuits and services
- Long-term network monitoring
- Maintenance and troubleshooting

#### Specifications

##### Full transmit and receive capability

**Interfaces:** 64 kb/s codirectional, 704 kb/s, 2.048 Mb/s, 8448 Mb/s

**Measurements:** Bit errors, code errors, frame errors, CRC errors, REBEs (E bits), slips, round trip delay

**Error analysis:** G.821 standard, user-defined and Annex D.

**Timeslot access:** External drop and insert of one 64 kb/s timeslot to protocol analyzer via V.24/RS-232 port or to TIMS via two 600 ohm audio ports; internal talk/listen

**RS-232 remote control and printer interface**

**Universal ac power supply**

**Size:** 190 mm H  $\times$  340 mm W  $\times$  208 mm D (7.7 in  $\times$  13.4 in  $\times$  8.2 in)

**Weight:** 4.5 kg (10 lb)

#### Ordering Information

<b>HP 37722A</b> Digital Telecom Analyzer	\$6,050
<b>Opt 001</b> Timeslot Access	+\$670
<b>Opt 002</b> 8 Mb/s (unframed)	+\$340
<b>Opt 003</b> 704 kb/s (framed and unframed)	+\$560
<b>Opt 004</b> Small Siemens Connectors	\$0
<b>Opt 005</b> Sub-rate Processing	+\$1,110

#### Accessories

<b>HP 15901A Opt 001</b> Datacom Module With V.24, V.11/X.21-Leased, V.35 Interfaces	\$2,170
--	---------

- Bit and code error testing at 704 kb/s, 2, 8, 34 & 140 Mb/s
- Portable, lightweight, rugged
- Text and graphic results on large display
- Stored setups and autoseup for ease of use
- Remote control, frequency offset and measurement, multiple outputs

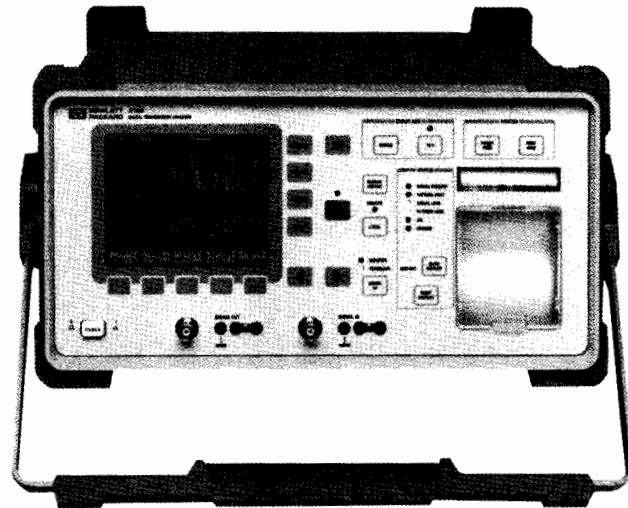

HP 37721A



### HP 37721A Digital Transmission Analyzer

The HP 37721A digital transmission analyzer is a portable, lightweight, rugged test set providing bit and code error testing at the European CEPT rates of 704 kb/s, 2, 8, 34 and 140 Mb/s. It measures error performance to CCITT Recommendation G.821, with interfaces to G.703.

A key feature of the HP 37721A is its ease of use: the autoseup facility automatically configures the test set to the incoming data; nine stored setups ensure that required test parameters are instantly available; graphic display of results shows error counts, error seconds, and alarms at a glance; and a range of logging options to an internal or external printer provides customized hard-copy proof of results.

Option 001 provides remote control via RS-232 and HP-IB interfaces and adds the ability to log results to an HP ThinkJet. Multiple outputs in Option 002 enable simultaneous loading of four channels of a multiplexer or digital radio with only one test set. With Option 003, up to 100 ppm of frequency offset is provided at all rates to evaluate clock-recovery circuits.

#### Applications

- Maintenance of digital networks (PTTs, other network operators)
- Installation of digital networks (PTTs, network operators, manufacturers)
- Long-term unattended monitoring with error performance analysis based on CCITT Recommendation G.821

#### Measurement Summary

**Error analysis:** As CCITT Recommendation G.821

**Results displayed:** Elapsed time in test period; errored seconds, percent errored seconds, error-free seconds, percent error-free seconds, severely errored seconds, percent severely errored seconds; unavailability, percent unavailability; degraded minutes, percent degraded minutes; code-error seconds; bit-error count, bit-error ratio; code-error count, code-error ratio; frequency, frequency offset; and alarms

#### Ordering Information

<b>HP 37721A</b> Digital Transmission Analyzer	\$7,670
<b>Opt 001</b> Remote Control	+\$645
<b>Opt 002</b> Multiple Outputs	+\$1,720
<b>Opt 003</b> Frequency Offset	+\$1,075

# TELECOMMUNICATIONS TEST EQUIPMENT

## Digital Transmission Analyzers

HP 3784A, 3764A

- G.821 error analysis at 704 kb/s, 2, 8 and 34 Mb/s
- Optional jitter generation and measurement at 2, 8 and 34 Mb/s
- Clock synthesizer for rates between 1 kb/s and 50 Mb/s
- Optional V.11 interfaces for testing X.21 leased circuits

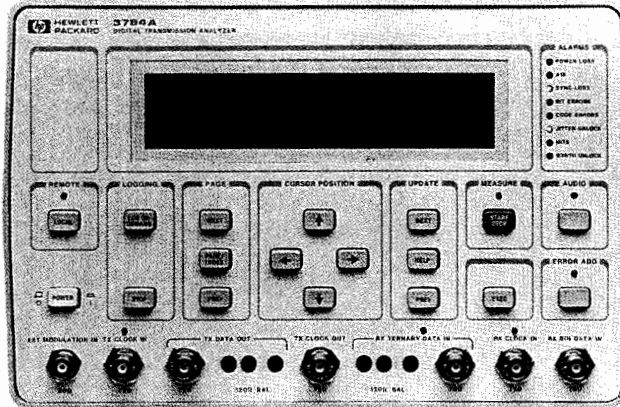

HP 3784A



### HP 3784A Digital Transmission Analyzer

The HP 3784A is a portable error performance/jitter test set, offering standard telecom interfaces at 704 kb/s, 2, 8 and 34 Mb/s, with the option of codirectional interfaces at 64 kb/s and V.11 interfaces for testing X.21 leased circuits. In addition, it has binary TTL/ECL interfaces for measurements up to 50 Mb/s, using the internal clock synthesizer.

The HP 3784A is easy to use with measurement presets, automatic receiver setup and error performance pass/fail thresholds. Automatic jitter tolerance and transfer plotting routines are provided for fast accurate testing up to and beyond CCITT limits. Through-data mode allows jitter to be added to a structured signal for jitter tolerance testing of demultiplexers.

#### Applications

- Automated production test of transmission line and terminal equipment
- Development and test of digital circuits that transport or store data
- Long-term monitoring of digital transmission equipment in the field

#### Measurement Summary

**Error Analysis:** Error count, error ratio, error and error-free intervals (seconds and deciseconds), percent unavailability, percent errored and percent severely-errored seconds, percent degraded minutes. All measurement are made simultaneously.

**Jitter Analysis:** Peak-to-peak amplitude, jitter-hit count, jitter-hit and hit-free seconds or deciseconds.

#### Ordering Information

	Price
HP 3784A digital transmission analyzer	\$11,100
Opt 002 Jitter measurements	+ \$6,300
Opt 006 64 kb/s measurement and V.11 interfaces	+ \$1,150
Opt 008 Error and jitter measurements at DS1, DS1C, DS2, and DS3	+ \$7,200

Note: Options 002 and 006 cannot be ordered together.

- Error and jitter measurements at 140 Mb/s or error measurements at 704 kb/s, 2, 8, 34 and 140 Mb/s
- Internal synthesizer for measurements from 1 kb/s to 170 Mb/s at binary interfaces
- Powerful data logging to internal or external printer
- Fast, easy measurement setup using stored presets

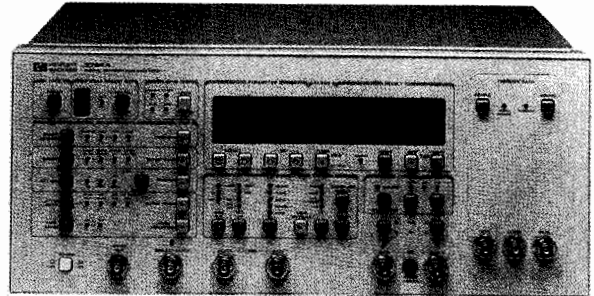

HP 3764A  
Option 007



### HP 3764A Digital Transmission Analyzer

HP 3764A digital transmission analyzer is available in a number of different versions to cover a wide range of telecom and general-purpose test applications. Each one offers pattern generation and error detection at coded and binary interfaces, and an HP-IB port for remote control operation.

A version of the HP 3764A with combined error and jitter performance measurements at 140 Mb/s is ideal for production test of telecom equipment. It can be enhanced further with a through-data mode to allow jitter to be added to any 140 Mb/s signal passing through the instrument.

Versions of the instrument with CEPT rates from 704 kb/s to 140 Mb/s offer a test solution for manufacturing and installation of digital network equipment. Other versions, including a clock synthesizer, offer data generation and error detection at binary interfaces at rates up to 170 Mb/s.

#### Applications

- Production testing of digital transmission equipment
- Installation and maintenance of digital networks
- Demultiplexer testing using through-data mode to add jitter to a structured signal
- Long-term unattended monitoring with error performance analysis based on CCITT Recommendation G.821

#### Measurement Summary

**Error analysis:** Error count, error ratio, error seconds, error-free seconds, percent unavailability, percent errored seconds, percent severely-errored seconds, percent degraded minutes. All measurements are made simultaneously and in accordance with CCITT Recommendation G.821.

**Jitter analysis:** Peak-to-peak amplitude, jitter-hit count, jitter-hit seconds, jitter-hit-free seconds. Internal filters to CCITT Recommendation 0.171 are available for performing selective jitter measurements. Where a greater degree of selectivity is required, a demodulated jitter output allows connection of external equipment such as a spectrum analyzer.

#### Ordering Information

	Price
HP 3764A digital transmission analyzer	\$12,500
Opt 002 Jitter generation and measurement at 140 Mb/s	+ \$3,400
Opt 006 Error performance at 704 kb/s, 2, 8, 34, and 140 Mb/s plus clock synthesizer	+ \$2,900
Opt 007 Jitter generation and measurement at 140 Mb/s with through-data mode plus clock synthesizer	+ \$7,600

# TELECOMMUNICATIONS TEST EQUIPMENT

T1 and Digital Data Test Sets

HP 3787B, 37701A

587

- Carry out stress and compliance tests on DDS/Dataport and T1/T1C equipment
- In manufacturing, replace whole racks of test equipment with one set
- Reduce network downtime with error monitoring, analysis, and logging

- Complete range of T1 installation and maintenance measurements in one tester
- Low cost, rugged, easy to use
- Fractional T1 BER and configuration measurements
- Powerful results storage and analysis without using a printer

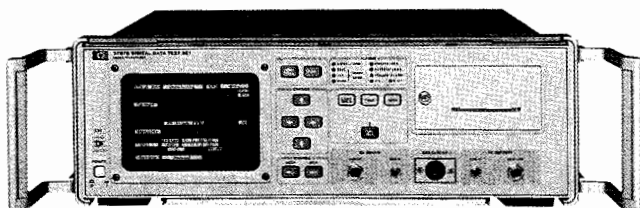

HP 3787B



## HP 3787B Digital Data Test Set

The HP 3787B combines T1/T1C and DDS testing in one, portable test set. A built-in multiplexer/demultiplexer allows test patterns, control codes, or external data to be inserted into, or extracted from, individual timeslots, subrates, and overhead channels. Measurements range from simple BER tests to full error analysis, as well as signal level and optional DS1 jitter measurement.

### Applications

- DDS/Dataport and T1 equipment manufacturing
- Network installation and maintenance
- Performance monitoring

### Specifications

Full transmit and receive capability.

**Interfaces:** DS0 A/B, DS1 (D4, ESF, T1DM, SLC-96), DS1C

**Test patterns:** 2<sup>23</sup>, 2<sup>20</sup>, 2<sup>15</sup> PRBS; QRSS, 3 in 24, 8-bit word, loop, and control codes; TA55 DDS stress patterns, 256-byte user pattern (DS0 only).

External clock input for jitter generation

Error detection, analysis and logging on all test patterns

Frame slips measurement

Built-in printer

HP-IB and RS-232 remote control interfaces

**Size:** 130 mm H × 425 mm W × 420 mm D (5.12 in × 16.73 in × 16.54 in)

**Weight:** 10.4 kg (23 lb)

### Ordering Information

<b>HP 3787B</b> Digital data test set	<b>Price</b>
<b>Opt 001</b> DS1 jitter measurement	\$9,590
<b>Opt 002</b> DC operation (48V)	+ \$935
<b>Opt 003</b> Channel VF output	+ \$620
	+ \$390

Special options are available to give 32 or 64 additional DSX-1 outputs and DS0 operation with a composite clock signal.

### Accessories

<b>HP 15513A</b> 1m WECO 310 - WECO 310 cable	\$62
<b>HP 15668A</b> Front-panel DDS clock cable	\$128
<b>HP 15669A</b> Rear-panel DDS clock cable	\$128

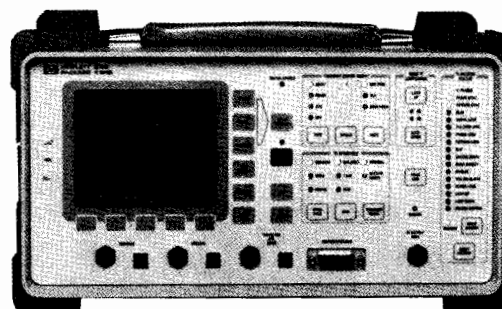

HP 37701A

## HP 37701A T1 Tester

The HP 37701A performs bit-error and signal measurements on T1 circuits in central offices, at outside locations, and on the users' premises. Built-in CSU emulation allows circuits to be proven before user equipment is connected. Autoconfigure, "trouble scan", and pre-stored setups, together with clear simple controls, make the tester easy to use. The HP 37701A T1 tester is easily upgraded to the HP 37711A T1/datacom test set (see page 621).

### Applications

- Leased T1 circuit installation and maintenance
- T1 circuit monitoring in central offices
- Acceptance testing and maintenance by T1 users
- Testing fractional T1 services

### Specifications

Full transmit and receive capability.

**Receiver range:** +6 to -36 dB DSX with equalization

**Framing:** D4, ESF, SLC-96

**Line codes:** AMI, B8ZS

**Test patterns:** 2<sup>23</sup>, 2<sup>20</sup>, 2<sup>15</sup> PRBS; QRSS, 3 in 24, 1:1, 1:7, 55 octet, 1024-bit word

**Measurements:** Error performance based on BPVs, logic, frame, and pattern errors; frequency, pattern slips, simplex current, level, round trip delay, pulse shape, clock slips, and channel mapping

Channel VF output including internal loudspeaker

RS-232 remote control and printer interface (HP-IB available)

**Size:** 190 mm H × 340 mm W × 208 mm D (7.5 in × 13.4 in × 8.2 in)

**Weight:** 4.5 kg (10 lb)

### Ordering Information

<b>HP 37701A</b> T1 tester	<b>Price</b>
<b>Opt 001</b> Pulse shape and wander/clock slips measurement	\$4,700
<b>Opt 002</b> Built-in rechargeable battery and charger	+ \$550
<b>Opt 003</b> Graphic results presentation, result storage, and G.821 performance analysis	+ \$750
<b>Opt 004</b> n × 56/n × 64 kb/s measurements	+ \$700
	+ \$1,200

### Accessories

<b>HP 15513A</b> 1m WECO 310 - WECO 310 cable	\$62
<b>HP 18182A</b> 1.5 m WECO 310 - crocodile clip cable	\$67
<b>HP 15710A</b> Soft-fabric carrying case	\$170

# TELECOMMUNICATIONS TEST EQUIPMENT

## DS3 Transmission Test Set and Digital Transmission Analyzer

HP 3789B, 3784A

HP 3789B

- Error and jitter measurement at DS3 and DS1
- Built-in DS3 to DS1 multiplexer

- C-bit parity generation and measurement
- DS3 idle signal generation and detection
- Optional built-in data logging

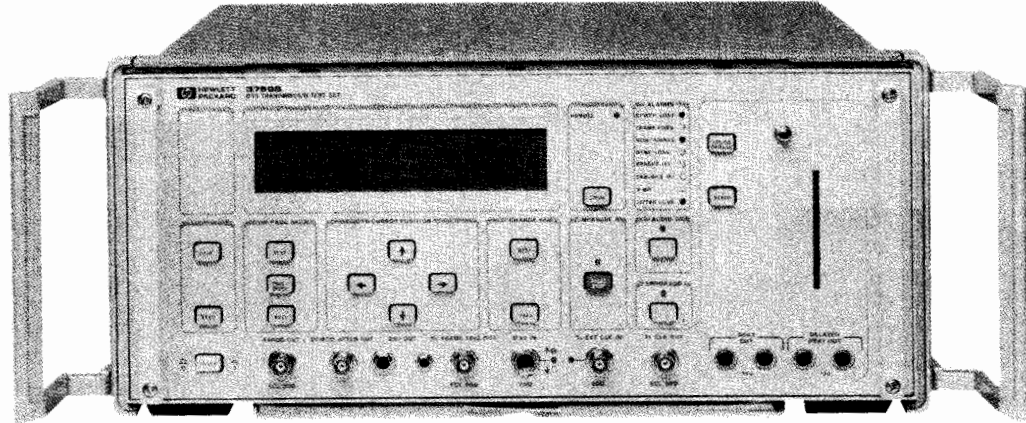

HP 3789B



### HP 3789B DS3 Transmission Test Set

The HP 3789B is a powerful test set offering outstanding monitoring and troubleshooting capabilities for DS3 digital transmission equipment. A built-in demultiplexer allows it to perform measurements on both DS3 and DS1 signals from a DS3 access point. On equipment using the new C-bit parity framing format, the HP 3789B can measure the end-to-end performance of a transmission path in both directions simultaneously from a single access point.

Jitter measurements at DS3 and DS1 are available to help diagnose timing problems quickly and easily. HP-IB and RS-232-C ports are provided for remote control operation or for logging results to an external printer. Optional enhancements include dc operation and a built-in printer or 3.5-inch disk drive.

### Applications

- System turn-up checks
- Routine testing of trunks
- Fault sectionalization
- Identifying fault mechanisms
- Preventive maintenance
- Service-quality verification
- Outage detection and isolation
- Trouble referral verification
- Equipment and route assessment
- Long-term performance monitoring

### Measurement Summary

**DS3 errors:** Bit (logic), frame, parity, and code (BPV) in the form of error count, error ratio, error seconds, and error-free seconds.

**Error bursts:** The number of bursts with > 100 errors is counted.

**Error distribution:** Error seconds, containing 1 error, 2 to 10 errors, and > 10 errors, are counted separately.

**DS3 analysis:** % availability, % unavailability, % error seconds, % degraded minutes, and consecutive severely errored seconds (CSES). These can be configured for numeric results or pass/fail results against selectable thresholds.

**DS3 jitter:** Maximum peak amplitude, jitter hit count, hit bit count, hit bit ratio, hit second count, and hit-free second count.

**DS1 errors:** Bit (logic), frame, and CRC (extended superframe format).

**DS1 jitter:** Maximum peak-peak, maximum positive peak, maximum negative peak, and jitter hit count.

**C-bit parity errors:** Cp parity errors expressed as error count, error ratio, error seconds, error-free seconds, and error seconds types A, B, and C.

**C-bit alarms:** The far-end alarm and control channel (FEAC) is monitored and decoded. The current alarm status is displayed textually and in bit format.

**FEBE bits:** The far-end block error bits are monitored and their information is displayed as error ratio, error seconds, and error seconds types A, B, and C.

### HP 3784A Digital Transmission Analyzer

#### Special Options

Special versions of the HP 3784A digital transmission analyzer offer error and jitter measurements at North American and binary interfaces, using unframed data. They provide all the features of the standard instrument (see page 586) with North American data rates, DS1 (1.544 Mb/s), DS1C (3.152 Mb/s), DS2 (6.312 Mb/s) and DS3 (44.736 Mb/s), replacing the European data rates. Another version offers STS1 (51.84 Mb/s) for testing SONET equipment.

Automatic and manual jitter measurements offer a fast, accurate means of characterizing digital transmission equipment. In addition, jitter can be added to any standard data signal passing through the instrument to allow testing of demultiplexers with a framed signal.

### Measurement Summary

**Error analysis:** Error count, error ratio, error, and error-free intervals (seconds or deciseconds), % unavailability, % errored and % severely errored seconds, and % degraded minutes. All measurements are made simultaneously.

**Jitter analysis:** Peak-to-peak amplitude, jitter hit count, jitter hit and hit-free seconds or deciseconds.

### Ordering Information

#### HP 3789B DS3 Transmission Test Set

The standard package consists of receiver; generator with 6 outputs; built-in demultiplexer to DS1, both HP-IB and RS-232-C ports, real-time clock, WECO 560A type connectors fitted to Rx and Tx (alternative connector types are available). For additional capability, select from the following options:

**Opt 002** Second Measurement Capability (including C-bit parity generation/measurement and jitter measurements at DS1) + \$555

**Opt 003** Second Measurement Capability (including C-bit parity generation/measurement and jitter measurements at both DS1 and DS3) + \$1,505

**Opt 004** Delete Option—Removes DS1 Output Capability - \$350

**Opt 005** Built-in Operation from 24V/48Vdc Supplies + \$885

**Opt 010** Built-in 24-column Printer + \$570

**Opt 011** Built-in 3.5-inch Disk Drive + \$730

**Note:** Options 010 and 011 cannot be ordered together

#### HP 3784A Digital Transmission Analyzer

**Opt 008** For Error and Jitter Measurement Capability at DS1, DS1C, DS2, and DS3 + \$7,200

**Opt 002/H09** For Error and Jitter Measurement capability at DS1, DS1C, DS3, and STS1 + \$7,800

**Opt H12** For Error Measurement Capability at DS1, DS1C, DS2, and DS3 + \$600

**Price**  
\$12,170

# TELECOMMUNICATIONS TEST EQUIPMENT

Modular SONET/SDH Analyzer

HP 75000 Series 90

589

- Supports both SONET and SDH standards
- Operates at 52, 155, and 622 Mb/s line rates

- Flexible modular architecture
- Embedded overhead and mapped payload testing

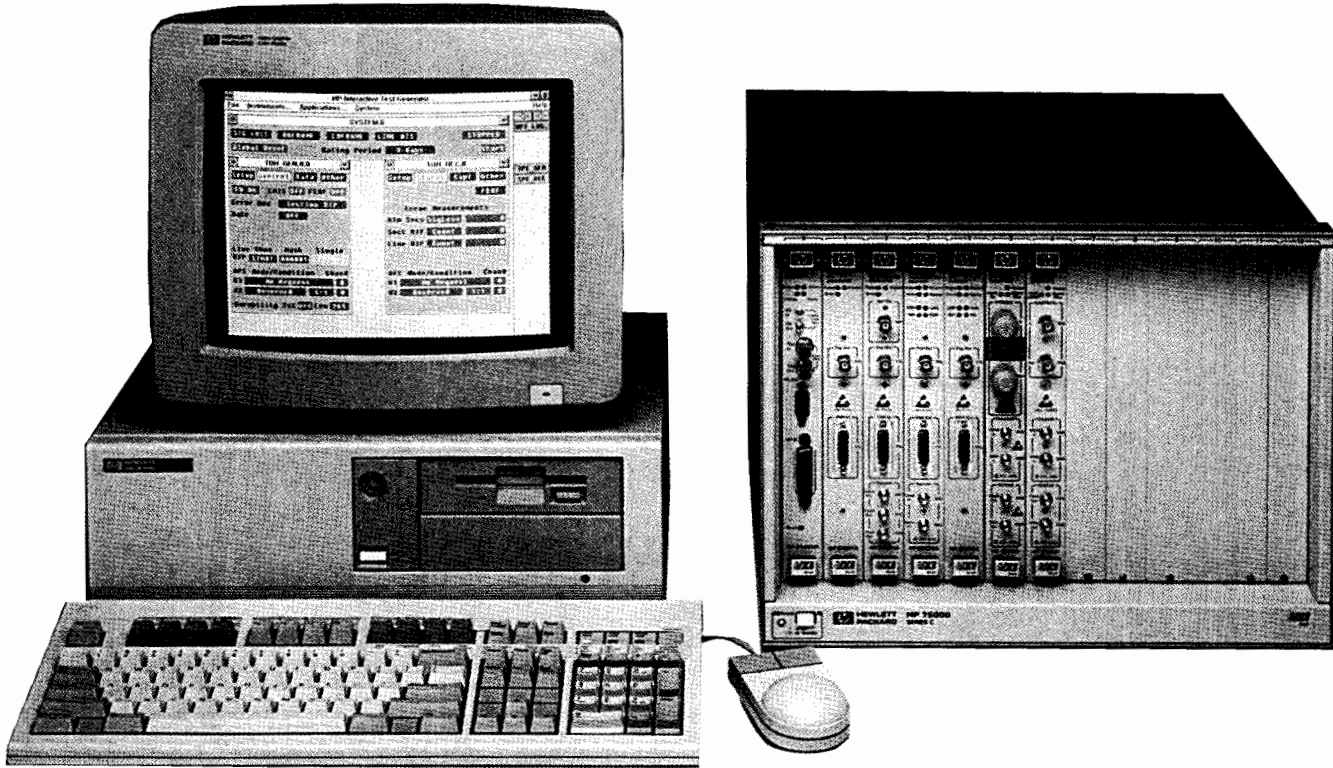

HP 75000 Series 90



## HP 75000 Series 90 SONET/SDH Analyzer

HP 75000 Series 90 modular SONET/SDH analyzer is designed to meet the varied test requirements in both development and manufacture of synchronous network equipment conforming to SONET and SDH standards. Capable of operating at 51.84, 155.52, and 622.08 Mb/s, the analyzer provides the functionality required to rigorously test a wide range of network elements—including add-drop multiplexers, line-terminal multiplexers, digital cross-connects, and regenerators.

Based on industry-standard VXI bus hardware, the HP 75000 Series 90 consists of a series of C-size VXI modules and a PC-user interface. Each module addresses a specific aspect of SONET/SDH testing. This modular architecture enables the series 90 to be tailored exactly to match the application. Example configurations include: 52/155 Mb/s analyzer, 52/155/622 Mb/s analyzer, and multiple independent transmitters.

Optical, coded electrical, and binary interfaces are provided for connection to equipment under test. Both the optical and coded electrical interfaces are supplied as optional plug-in VXI modules.

### Applications

Within telecommunications equipment manufacturers, the HP 75000 Series 90's real-time generation and analysis support in-depth testing in both development and production. Included in the comprehensive test suite are:

- Frame alignment stress tests
- Payload mapping/demapping tests
- Pointer stress tests
- Pointer analysis
- Error performance monitoring (B1, B2, B3, BIP-2, FEBE)
- Alarm testing
- Clock recovery stress tests
- Protection switching tests
- DCC access

Test applications requiring manual control of the analyzer are supported by a PC-user interface. This powerful, yet easy-to-use interface meets the needs of a wide range of applications—from in-depth research and development tests requiring byte access to any location in the synchronous frame to manual tests in production requiring fast, repeatable measurements.

The HP 75000 Series 90 is fully programmable via HP-IB, enabling it to be integrated easily into production-line ATE systems. An automatic code-generation facility simplifies the development of ATE software. Using this capability, software designed to control the analyzer's measurement hardware can be created quickly and accurately without referring to Series 90 programming manuals.

### Specifications

**Frame formats:** STS-1, STS-3, STS-3c, STS-12 to ANSI T1.105 and TA-253; STM-1, STM-4 to CCITT G.708

**Mappings:** DS1 (all VT1.5 modes) and DS-3 to ANSI T1.105 and TA-253; 2 (all TU12 modes), 34, and 140 Mb/s to CCITT G.709

### Test interfaces:

**Optical:** 52, 155, and 622 Mb/s (1310 nm)

**Coded electrical:** 52 Mb/s (B3ZS) and 155 Mb/s (CMI)

**Binary:** 52, 155, and 622 Mb/s (ECL, NRZ)

**Measurements:** EC, ER, and ES on mapped payload; B1, B2, B3, BIP-2, FEBE

**Pointer control:** Set pointer to any value (with or without NDF); pointer movement sequences as T1X1.6 and CCITT G.783

### Ordering Information

The HP 75000 Series 90 modular SONET/SDH analyzer ranges from \$35,000 to \$136,000 for a single, transmitter/receiver configuration.

Please contact your local Hewlett-Packard Sales & Support Office. See page 684.

# TELECOMMUNICATIONS TEST EQUIPMENT

## SONET Test Set HP 37704A

- Comprehensive, single-unit solution
- Field-portable and robust
- Ease of use
- Overhead and mapped payload testing

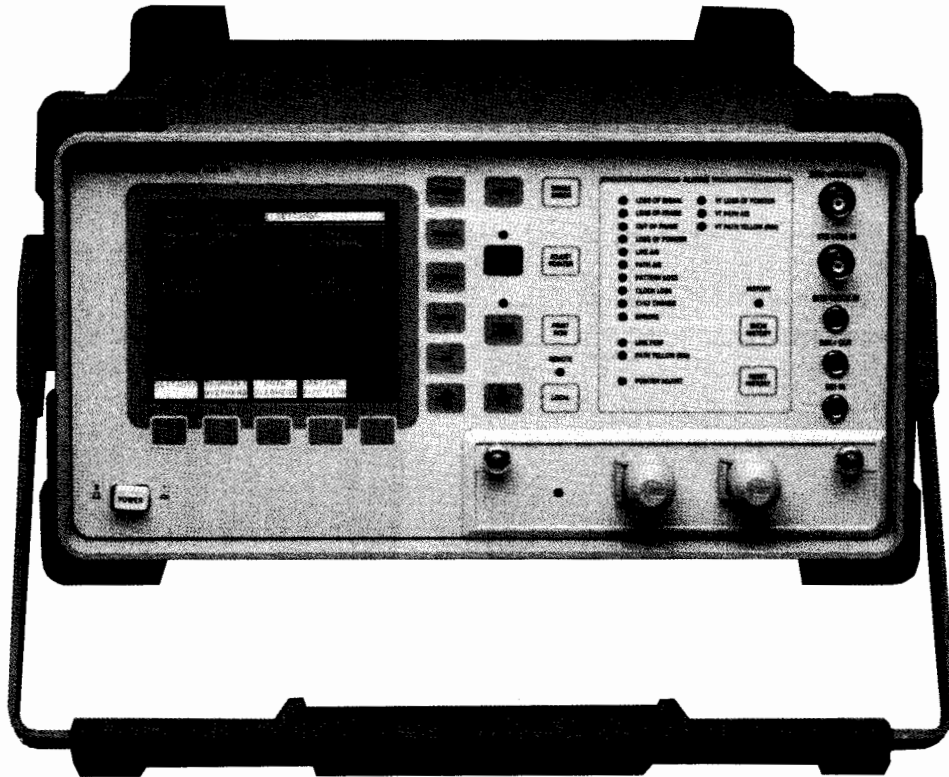

HP 37704A



### HP 37704A SONET Test Set

The HP 37704A is a comprehensive, field-portable SONET test set, for applications up to 622 Mb/s (STS-12). It provides generation and analysis of VT (DS1) and DS3-mapped SONET signals, with full control of section, line, and path overhead bytes. Plug-in modules provide connection to a range of optical and electrical interfaces. Errors, alarms, and T1X1 pointer movement sequences are generated to stress equipment up to and beyond ANSI standards.

To ensure ease of use, the test set has several important features—a large clear screen, user presets, troublescan for highlighting errors as they occur, and automatic protection switch messages in text form. Long-term measurement results can be analyzed in detail without a printer—they are read simply from the internal store and displayed graphically on the front-panel screen.

### Applications

The HP 37704A is a rugged, portable test set well-suited to installation, acceptance testing/commissioning and maintenance of SONET network equipment. In addition, its comprehensive test suite covers many applications in research and development and production.

It provides a wide range of tests for verifying SONET equipment such as line systems, add-drop multiplexers, digital cross-connects and line-terminal multiplexers:

- Payload integrity (mapping and demapping)
- Alarm and error performance monitor stimulation and response
- Desynchronizer pointer movement stressing
- Timing offset stressing
- Automatic protection switch control and stressing
- DCC channel access (for external protocol analysis)
- In-service performance monitoring

### Specifications

**Frame formats:** STS-1, STS-3 and STS-12.

**Mappings:** DS1 (all VT1.5 modes) and DS3 to ANSI T1.105 and Bellcore TA-TSY-000253 (Issue 6)

#### Test interfaces:

**Optical:** 51.84, 155.52 and 622.08 Mb/s - 1310nm

**Coded electrical:** 1.544 (B8ZS), 44.736 (B3ZS), 51.84 (B3ZS), and 155.52 (CMI) Mb/s

**Add/drop:** DS1, DS3, STS-1, and overhead DCC channels

**Overhead:** Standard and user-programmable section, line and path overhead bytes

#### Transmit and measure:

**Errors:** Bit, frame, CV (BIP), and FEBE

**Alarms:** Loss of frame, out of frame, loss of pointer, loss of signal line and path AIS, path yellow (RAI), missing NDF and line FERF, FEBE

**Payload pointer movement:** Sequences as ANSI T1X1

#### Automatic protection switch messages

**Error analysis:** ANSI T1M1.3

**Results:** Graphics, troublescan, and detailed text; internal results storage; overhead frame snapshot

**Remote control:** HP-IB and RS-232

**Modem-control port:** RS-232

**External-printer ports:** HP-IB and RS-232

**Size:** 190 mm H × 340 mm W × 420 mm D (7.8 in × 13.9 in × 17.2 in)

**Weight:** 10 kg (22 lb)

### Ordering Information

**HP 37704A** SONET Test Set

**Opt 001** Frequency Offset

**Opt 002** VT Capability

#### Accessories

**HP 37771A** STS-3 Electrical Interface

**HP 37772A** Optical Interface 52/155 Mb/s - 1310 nm

**HP 37776A** Optical Interface 622 Mb/s - 1310 nm

### Price

\$19,900

+ \$3,000

+ \$7,200

\$3,000

\$14,500

\$25,500



# TELECOMMUNICATIONS TEST EQUIPMENT

## Gigabit Error Performance Analyzers and Pattern Generators

HP 71600 Series

591

- Low-phase-noise clock source
- User-programmable patterns up to 4 Mbits with screen-based editor
- Trigger anywhere in pattern
- True complementary outputs

- Automatic setting of clock/data phase & data-decision point
- High-resolution setting of decision threshold & phase alignment
- Simultaneous detection of errored ones and errored zeros
- User-formattable results

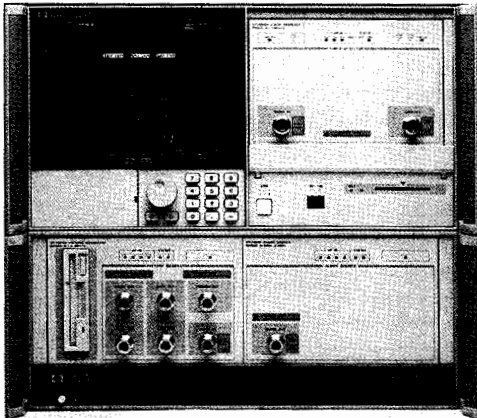

HP 71603B

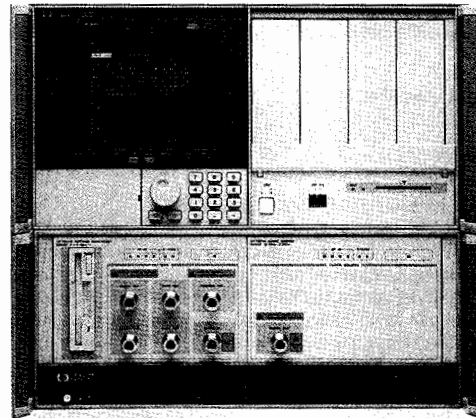

HP 71604B

### HP 71600 Series Error Performance Analyzers

The HP 71601A, HP 71603A, and HP 71603B error performance analyzers consist of pattern generator, synthesized clock source, and error detector modules configured in the HP 70000 modular measurement system (MMS). The HP 71601A covers the range 50 Mb/s to 1 Gb/s and the HP 71603A and HP 71603B from 100 Mb/s to 3 Gb/s. The HP 71600 Series features automatic clock/data alignment for rapid set-up of the error detector. The HP 71603B makes BER measurements on waveforms badly distorted by noise, jitter, and intersymbol interference through the high resolution setting of decision threshold and phase adjustment. The HP 71603B also features the simultaneous counting of errored ones and errored zeros to locate the source of pattern-dependent errors. Error distribution is analyzed by counting errored and error-free intervals between one second and one millisecond.

#### Applications

- Lightwave systems
- Submarine-cable systems
- High-speed, local area networks

#### Specifications

**Bit rate:** 50 Mb/s to 1 Gb/s (HP 71601A);  
100 Mb/s to 3 Gb/s (HP 71603A and HP 71603B)

**Patterns and data outputs:** As for pattern generators

**Data input:** 0.5 V to 2 V p-p amplitude

**Decision threshold range:** +1 to -3 V, resolution 1 mV (HP 71603B) or 10 mV (HP 71601A and HP 71603A)

**Termination voltage:** Selectable 0 V or -2 V nominal

**Clock/data delay:** ± 1 ns; resolution 1 ps (HP 71603B) or 5 ps (HP 71601A and HP 71603A)

**Errors detected:** Errored ones, zeros, and all logic errors (HP 71603B) or all logic errors (HP 71601A and HP 71603A)

**Measurements:** Error count, ratio, errored seconds, deci-seconds, centi-seconds, milliseconds and G.821 analysis

**Results logging:** Time-stamped events logged to external printer

#### Ordering Information

Model	Price
HP 71601A 50 Mb/s to 1 Gb/s error performance analyzer	\$64,300
HP 71603A 100 Mb/s to 3 Gb/s error performance analyzer	\$99,500
HP 71603B 100 Mb/s to 3 Gb/s error performance analyzer	\$110,000

Individual modules can be ordered for configuring custom-designed systems:

HP 70842A 100 Mb/s to 3 Gb/s error detector module	\$29,600
HP 70842B 100 Mb/s to 3 Gb/s error detector module	\$33,900
HP 70846A 50 Mb/s to 1 Gb/s error detector module	\$16,000
HP 15680A RF accessory kit	\$1,600

### HP 71600 Series Pattern Generators

HP 71602A, HP 71604A, and HP 71604B pattern generators consist of pattern generator and synthesized clock source modules configured in the HP 70000 modular measurement system (MMS). The HP 71602A covers the range 50 Mb/s to 1 Gb/s and the HP 71604A and HP 71604B from 100 Mb/s to 3 Gb/s. The HP 71600 Series features standard pseudo-random test patterns up to 2<sup>31</sup>-1 bits long. Users can program and run variable length test patterns from 1 bit to 8 kbits (HP 71602A and HP 71604A) or 4 Mbits long (HP 71604B). User-programmable patterns are created using the screen-based editor or, in the HP 71604B, are transferred to the pattern generator on an MS-DOS format, 3½ inch floppy disk. DC-coupled, closely-matched complementary clock and data outputs simplify connection to high-speed logic devices.

#### Applications

- Gallium-arsenide and high-speed silicon component test
- Optical component test
- SONET/SDH module parametric testing

#### Specifications

**Bit rate:** 50 Mb/s to 1 Gb/s (HP 71602A);  
100 Mb/s to 3 Gb/s (HP 71604A and HP 71604B);  
settable to 1 Hz

**Rise time (20% to 80%):** <90 ps (HP 71604A and HP 71604B);  
<180 ps (HP 71602A)

**Patterns:** 2<sup>31</sup>-1, 2<sup>15</sup>-1, 2<sup>10</sup>-1, 2<sup>7</sup>-1 (plus 2<sup>31</sup>-1 in HP 71604B); zero substitution variable mark density patterns; variable length user patterns from 1 bit to 8 kbits (HP 71602A and HP 71604A) or 4 Mbits (HP 71604B)

**Data and Data outputs:** ECL or variable 0.25 V to 2 V p-p amplitude into 50 ohms, high level +1 V to -3.75 V

**Clock/data delay:** ± 1 ns; resolution 1 ps (HP 71604B) or 5 ps (HP 71602A and HP 71604A)

#### Ordering Information

Model	Price
HP 71602A 50 Mb/s to 1 Gb/s pattern generator	\$41,600
HP 71604A 100 Mb/s to 3 Gb/s pattern generator	\$71,500
HP 71604B 100 Mb/s to 3 Gb/s pattern generator	\$76,000

Individual modules can be ordered for configuring custom-designed systems:

HP 70311A 3 GHz signal generator module	\$24,500
HP 70312A 1.5 GHz signal generator module	\$17,500
HP 70841A 100 Mb/s to 3 Gb/s pattern generator module	\$29,900
HP 70841B 100 Mb/s to 3 Gb/s pattern generator module	\$36,900
HP 70845A 50 Mb/s to 1 Gb/s pattern generator module	\$19,500

# TELECOMMUNICATIONS TEST EQUIPMENT

## Selective Level Meter and Synthesizer

HP 3586A/B, 3336A/B

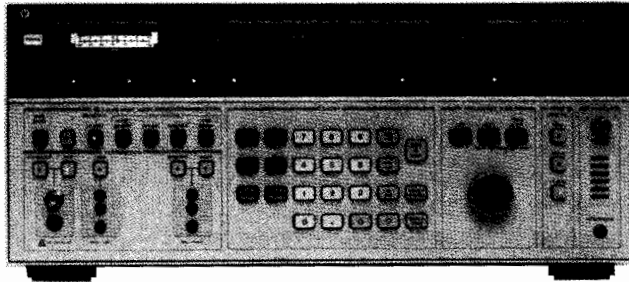

HP 3586A Selective Level Meter (CCITT)



### Selective Level Meter and Synthesizer

The HP 3586A/B Selective Level Meter and HP 3336A/B Tracking Synthesizer offer the high performance necessary to meet demanding requirements in the design, manufacture, commissioning, and maintenance of frequency division multiplex (FDM) systems. Features of the HP 3586A/B selective level meter include wideband power measurements and telephone impairment measurement of impulse noise, phase jitter, noise with tone, and signal-to-noise with tone ratios. The wide frequency coverage to 32.5 MHz allows measurements at both voice channel and carrier frequencies.

The HP 3336A/B Synthesizer/Level Generator is an excellent precision tracking signal source for the HP 3586A/B. When the selective level meter (SLM) and synthesizer are in the tracking mode, the frequency of the synthesizer is automatically set to the frequency of the SLM. The HP 3586A and HP 3336A models meet CCITT requirements, and the HP 3586B and HP 3336B models meet North American (Bell) standards.

### HP 3586A/B Specifications

(See data sheet or manual for complete specifications.)

#### Frequency

##### Frequency range:

Signal Input	HP 3586A	HP 3586B
75 $\Omega$ Unbalanced	50 Hz to 32.5 MHz	
124 $\Omega$ Balanced		4 kHz to 10 MHz
135 $\Omega$ Balanced		4 kHz to 1 MHz
150 $\Omega$ Balanced	4 kHz to 1 MHz	
600 $\Omega$ Balanced	100 Hz to 108 kHz	

**Center frequency accuracy:**  $\pm 10$  ppm/year

**Frequency counter accuracy:** Center frequency accuracy +1.0 Hz

#### Selectivity

**3 dB Bandwidth:** 20, 400, 3100 Hz  $\pm 10\%$

**Noise weighting:** Psophometric (3586A) C-message (3586B)

#### Amplitude accuracy: (75 $\Omega$ input)

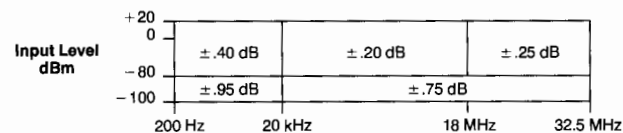

#### Dynamic range

**Noise floor** (Full scale setting -35 to -120 dBm)

Frequency	Bandwidth	Noise Level
100 kHz to 32.5 MHz	3100, 1740, 2000 Hz	-116 dBm
	20 Hz, 400 Hz	-120 dBm
10 kHz to 100 kHz	All	-105 dBm

**Harmonic distortion:** 70 dB below full scale > 4 kHz on 75  $\Omega$  and 600  $\Omega$  inputs, low distortion mode

**Intermodulation distortion:** Two-tone second and third order, separation 7 kHz to 1 MHz, 75 dB below full scale. Either tone  $\geq 10$  MHz, -70 dB.

**Non-harmonic spurious signals:** > 1600 Hz offset, -80 dBc

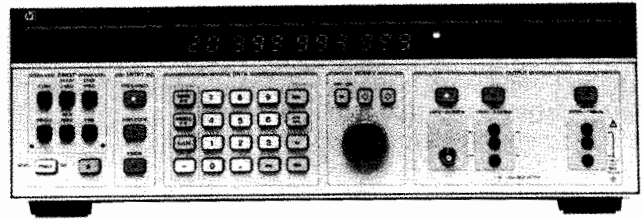

HP 3336A Synthesizer/Level Generator (CCITT)

#### General

**Power:** 100/120/220/240 V, +5%, -10% 48 to 66 Hz, 150 VA.

**Weight:** Net, 23kg (50lb); shipping, 30kg (65lb)

**Size:** 177 mm H  $\times$  425.5 mm W  $\times$  466.7 mm D (7 in  $\times$  16.75 in  $\times$  18.38 in)

### HP 3336A/B Specifications

#### Frequency Range

Signal Output	HP 3336A	HP 3336B
75 $\Omega$ Unbalanced	10 Hz to 20.999 999 999 MHz	
124 $\Omega$ Balanced		10 kHz to 10.999 999 999 MHz
135 $\Omega$ Balanced		10 kHz to 2.099 999 999 MHz
150 $\Omega$ Balanced	10 kHz to 2.099 999 999 MHz	
600 $\Omega$ Balanced	200 Hz to 109.999 999 kHz	

#### Amplitude

**Range:** 75 and 600  $\Omega$  outputs: -72.99 to +7.00 dBm; 124, 135 and 150  $\Omega$  outputs: -78.23 to +1.76 dBm

**Accuracy:** 75  $\Omega$  output, 10 Hz - 20.9 MHz (-3 to +7 dBm)  $\pm 0.15$  dB  
Opt. 005  $\pm 0.12$  dB

#### Spectral purity

**Phase noise:** < -72 dB for a 3 kHz band, 2 kHz either side of a 20 MHz carrier.

**Harmonic level:** -35 dB, 10 Hz to 30 Hz; -50 dB, 30 Hz to 50 Hz; -60 dB, 50 Hz to 1 MHz; -55 dB, 1 MHz to 5 MHz; -50 dB, 5 MHz to 20 MHz.

**Spurious:** All non-harmonically related signals will be more than 70 dB below the fundamental or -100 dBm (-115 dBm with option 005 except 150 to 600  $\Omega$ ), whichever is greater.

**Phase offset:**  $\pm 719.9^\circ$  with respect to arbitrary starting phase or assigned zero phase.

**Frequency sweep:** Linear, logarithmic

**Flatness:**  $\pm 0.15$  dB, 10 kHz - 20 MHz

**Modulation:** External AM or PM

#### General

**Power requirements:** 100/120/220/240 V, +5%, -10%, 48 to 66 Hz, 60 VA, (100 VA with all options), 10 VA standby

**Size:** 132.6 mm H  $\times$  425.5 mm W  $\times$  498 mm D (5 1/4 in  $\times$  16 3/4 in  $\times$  19 1/2 in)

**Weight:** Net, 10 kg (22 lb); shipping, 15.5 kg (34 lb)

### Ordering Information

Item	Price
<b>HP 3586A</b> Selective Level Meter (CCITT)	\$12,700
<b>Opt 001</b> 1.6/5.6 mm 75 $\Omega$ Connector	+ \$103
<b>Opt 004</b> High Stability Frequency Reference	+ \$775
<b>HP 3586B</b> Selective Level Meter (North American)	\$12,700
<b>Opt 001</b> 75 $\Omega$ connector mates with WECO 358A and 124 $\Omega$ connector mates with WECO 372A	+ \$103
<b>Opt 004</b> High Stability Frequency Reference	+ \$775
<b>HP 3336A</b> Synthesizer/Level Generator (CCITT)	\$5,920
<b>Opt 001</b> 1.6/5.6 mm 75 $\Omega$ Connector	+ \$105
<b>Opt 004</b> High Stability Frequency Reference	+ \$685
<b>Opt 005</b> High Precision Attenuator	+ \$685
<b>HP 3336B</b> Synthesizer/Level Generator (North American)	\$5,920
<b>Opt 001</b> 75 $\Omega$ WECO 358A, 124 $\Omega$ WECO 372A	+ \$105
<b>Opt 004</b> High Stability Frequency Reference	+ \$685
<b>Opt 005</b> High Precision Attenuator	+ \$685

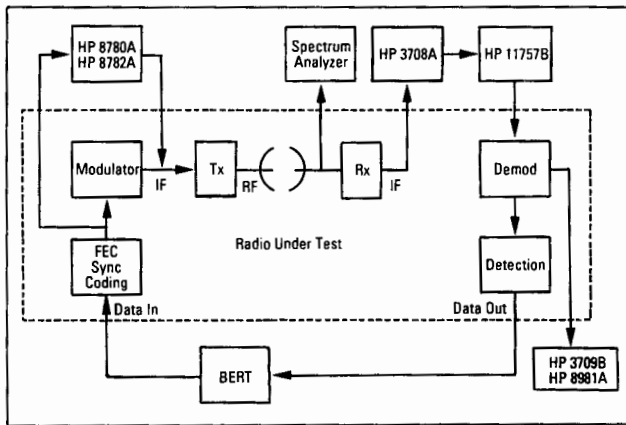

Digital microwave radio is becoming increasingly complex and hand in hand with that increasing complexity is a growing need to be able to fully characterize every facet of radio performance. You may be a research and development engineer designing components to increase the performance of radios, a production engineer manufacturing quality radios as quickly as possible, or a service provider commissioning radios in the quickest and most cost-effective manner and maintaining those radios over time to provide quality service to your customers. No matter what area of the digital microwave radio industry you work in, you will need to characterize, verify, and troubleshoot your product and Hewlett-Packard has the right test equipment to meet your needs.

## Channel Simulation

Digital microwave radio performance depends heavily on the radio's ability to correct for atmospheric conditions between antennas and to reject adjacent and co-channel interferers. Certain conditions can cause attenuation of the received signal either in the form of non-frequency selective (flat) fading or frequency selective (multipath) fading. This results in poor bit error ratio (BER) performance, and therefore, the radio's protective systems must be tested and characterized under these conditions. The HP 3708A Noise and Interference Test set provides an accurate method of assessing performance of microwave radio systems by providing the Carrier to Noise (C/N) and Carrier to Interference (C/I) conditions necessary to make C/N and C/I versus BER measurements. The HP 11757B Multipath Fading Simulator/Signature test set simulates the effects of both static and dynamic multipath fades by introducing a precisely controlled notch in and around the radio's transmission bandwidth. The built-in signature capability of the HP 11757B is useful for comparing different radios or characterizing individual radio performance over time. Not only are these instruments right for the design lab and the production floor, but their size and portability also make them ideal for field use.

## Constellation Analysis and In-Service Monitoring

A BER test is often used to determine the effects of noise, intersymbol interference (ISI), and timing problems. However, it is a go/no-go test that measures the amount of degradation that exists, but does not identify the source. Constellation analysis is an alternative that uses a vector display of I versus Q that can be used to measure amplitude, phase, closure, lock- and quad-angle errors, and nonlinear distortion such as am-am and am-pm conversion without interrupting radio operation. The HP 8981B Vector Modulation Analyzer and the HP 3709B Constellation analyzer provide the troubleshooting power that system designers, manufacturers, and service providers need to isolate IF, RF, and baseband error sources. In addition to constellation analysis, the HP 8981B has the ability to measure signal phase and magnitude dynamically, compensate for modulator and demodulator errors, and capture data for offline signal processing; the HP 8981B also has built-in demodulator capabilities. The portability of the HP 3709B makes it perfect for field troubleshooting applications and in-service monitoring.

## Receiver and Demodulator testing

Digital microwave radios have been pushing the limits of information transfer by moving toward higher order modulation schemes such as 64 and 256QAM. With these complex schemes, the accuracy and repeatability of a laboratory modulation source are especially important. The HP 8780A and the HP 8782B vector signal generators give the designer of digital radios off-the-shelf instruments to generate calibrated digital modulation formats, and to simulate impairments such as I or Q signal imbalances for testing receivers and demodulators. In addition, both instruments combine calibrated performance and programmability to best serve the needs of the manufacturing environment. By integrating a vector signal generator as the calibrated transmitter for aligning demodulators and testing receivers, performance can be verified against a known standard. This eliminates variations in receiver performance due to different "golden standards" in production.

## Service and Maintenance

A digital microwave radio can suffer from a number of impairments. Many tests are made on the radio during installation, maintenance, and repair to measure and correct for these impairments. Some measurements like spectral occupancy, frequency, and power level are measured routinely on every radio. Other measurements are done at the time of installation as part of an extensive alignment and setup procedure. The HP 11758U Digital Radio Test System combines a spectrum analyzer, multipath fading simulator, power meter, multitone IF source, and an RF source into one convenient, portable package to provide a complete radio maintenance solution. The measurements made by the HP 11758U include spectral occupancy, power, frequency, multipath, flatness, return loss, and intermodulation. The 11758U can also control the HP 3708A and a BERT to perform and display C/N versus BER measurements.

## Tutorial

The topic of digital microwave radio can be somewhat overwhelming to the newcomer. Therefore, Hewlett-Packard has developed the perfect tool for every new member of your technical team. The HP 11736B I/Q Tutor is a tutorial program that runs on HP vectra and most IBM PC-compatible computers (PC/XT/AT). It was written to train engineers, technicians, and engineering managers new to digital communications. It covers all of the major blocks of a complete digital communications system, from the analog input through modulation, transmission, demodulation, and conversion back into analog. It also explores such topics as modulation techniques, multipath fading, and theory of I/Q modulation and demodulation.

For more information on these products consult the following pages and contact your Hewlett-Packard representative.

	HP 11757B	HP 11758U	HP 3708A	HP 3709B	HP 8981B	HP 8780A	HP 8782B
Noise testing			*				
C/N versus BER		*	*				
Residual BER			*				
Multipath testing	*	*					
Go/No-Go testing	*	*					
Signatures	*	*					
In-Service diagnostics			*	*			
Nonlinearities			*	*			
Mod/Demod impairments			*	*			
Noise/Interference			*	*			
Jitter			*	*			
Service and maintenance		*					
Spectral occupancy		*					
Power		*					
Frequency		*					
Multipath	*	*					
Flatness		*					
Return loss		*					
Intermodulation		*					
Receiver testing					*	*	
Demod calibration					*	*	
BER versus quad. err.					*	*	
LO variation					*	*	
Flat fade sim.	*	*	*				*



# DIGITAL MICROWAVE RADIO TEST EQUIPMENT

## Multipath Fading Simulator/Signature Test Set, Digital Radio Test System

HP 11757B, 11758U

### HP 11757B

- Characterize adaptive equalizer performance in the lab, manufacturing, and in the field
- Measure and print static M-curves, Dynamic M-curves, Hysteresis M-curves, Dynamic S-curves, recovery time
- Fixed or moving notches
- Arbitrary fade event simulation
- Continuous simulation of variable delay from 2 to 25 nsec
- High performance, lightweight, rugged, easy to use

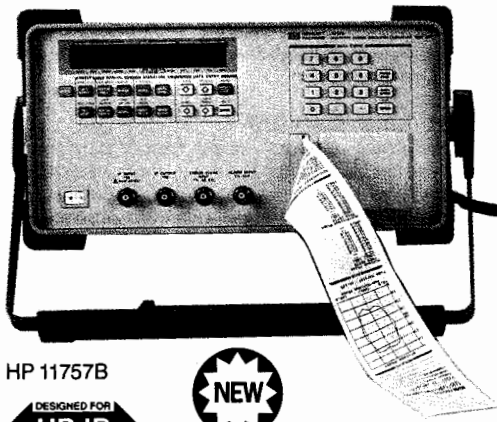

HP 11757B



### HP 11757B Multipath Fading Simulator/Signature Test Set

The 11757B Multipath Fading Simulator/Signature Test Set characterizes the equalizers in modern digital microwave radios by introducing a precisely controlled notch in and around the radio's transmission bandwidth. This allows precise measurements of the equalizer's ability to compensate for multipath fading.

The 11757B makes a variety of static and dynamic signature measurements for characterizing your radio. These are important bottom line tests of a radio's multipath fading protective system. Signatures show the range of acceptable radio performance by stressing the radio's equalizers with controlled amounts of multipath fade while monitoring the radio's bit error rate. The HP 11757B automatically records the radio's signature on a built-in printer.

The high performance of the 11757B makes it ideal for research and development and production and its portability allows you to bring the same performance to field installation and maintenance applications.

#### Specifications

##### Notch Frequency

**Range:** Standard: 40 MHz to 100 MHz  
Opt 140: 110 MHz to 170 MHz (90 MHz to 190 MHz avail. TBD)

**Resolution:** 100 kHz

**Accuracy:**  $\pm 150$  kHz

##### Depth

**Range:** 0 to 40 dB

**Resolution:** 0.1 dB

**Accuracy:** 1 to 20 dB  $\pm 0.75$  dB

21 to 30 dB  $\pm 1.50$  dB

31 to 40 dB  $\pm 3.00$  dB

##### Sweep

**Sweep time:** 10 ms to 99.9 s

**Max. slew rates:** Freq: 6000 MHz/s, depth: 4500 dB/s

**Weight:** 9 kg (20 lbs)

#### Ordering Information

	<b>Price</b>
<b>HP 11757B</b> Multipath Fading Simulator/Signature Test Set (70 MHz band)	\$19,000
<b>Opt 001</b> Delete signature capability	- \$4,000
<b>Opt 140</b> 140 MHz band	\$0
<b>Opt 147</b> Both 70 MHz and 140 MHz bands	+ \$1,000
<b>HP 11757A</b> Multipath Fading Simulator	
<b>Opt K04</b> B Retrofit Kit	Contact Hewlett-Packard

### HP 11758U

- Performs 8 different measurements
- Easy to use
- Portable

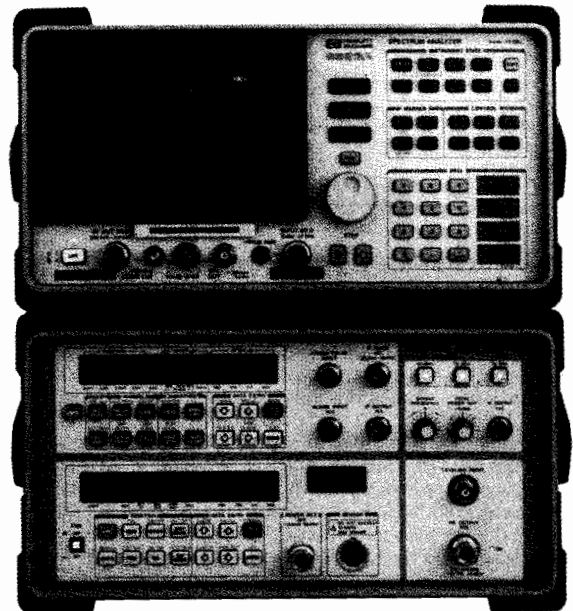

HP 11758U



### HP 11758U Digital Radio Test System

The HP 11758U Digital Radio Test System performs the functions that are most commonly used in testing radios in production, installation, and maintenance. The result is a portable, general-purpose radio testing system that performs all of the following measurements:

- Spectral occupancy and purity
- Nonlinear distortion and intermodulation
- Power measurements
- Frequency
- IF-IF, IF-RF, RF-RF, and RF-IF amplitude flatness
- Multipath fading signature testing
- Antenna return loss
- Signal monitoring and logging
- C/N vs. BER with the HP 3708A and a BERT

#### Test Functions

**Spectrum analysis:** 50 kHz to 22 GHz

**Frequency counter:** 10 MHz to 22 GHz,

**IF tracking generator:** 300 kHz to 3 GHz

**Event/interval counters:** dc to 1.6 MHz

**Power meter and sensor:** 10 MHz to 12 GHz

**Multipath fading simulator/signature test set:** 40 MHz and 140 MHz bands available

**Three tone IF source:** both 70 and 140 MHz bands available

**RF source:** 3.5 to 6.5 GHz, 10.7 to 11.7 GHz available

Special RF source options available up to 23 GHz

#### Ordering Information

**HP 11758U** Digital Radio Test System

#### Price

\$65,000

Contact your HP sales representative for more information about the wide range of options available.

# DIGITAL MICROWAVE RADIO TEST EQUIPMENT

Microwave Radio Noise and Interference Test Set, Constellation Analyzer

HP 3708A, 3709B

595

## HP 3708A

- Carrier tracking maintains accurate & repeatable C/N & C/I conditions
- Fast, alternative residual BER measurement
- Accurate simulation of radio system interference

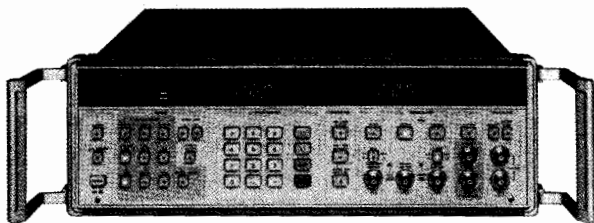

HP 3708A



## HP 3708A Noise and Interference Test Set

The HP 3708A provides an accurate method of assessing performance of microwave radio and satellite modem systems by providing the Carrier to Noise (C/N) and Carrier to Interference (C/I) conditions necessary to make C/N & C/I vs Bit Error Ratio (BER) measurements. Accurate and repeatable C/N and C/I ratios can be maintained even in the presence of severe signal variations.

The HP 3708A is equally at home in manufacturing, commissioning, or maintenance. Its measurement accuracy allows small changes in performance to be identified with confidence. The instrument is designed for easy access to the IF section of the radio system. The carrier level is monitored and calibrated levels of interference and Gaussian noise are added to stress the system in a controlled way.

The HP 3708A has the flexibility to accommodate a wide variety of radio designs, a selection of calibrated internal filters giving accurately specified Carrier to Noise ratios in any noise bandwidth. The interference facility allows the addition of a wide variety of interference signals to accurately simulate the effects of radio interference on system performance. Connectors are 75  $\Omega$  unbalanced, and standard 70 MHz and 140 MHz reference tones are provided.

### Options

**Std:** 75  $\Omega$  unbalanced connector. Reference tone oscillator frequency is 70/140 MHz.

**001:** 50  $\Omega$  unbalanced connector.

**Special options:** Reference tone oscillator frequencies, specifically for portable application of the HP 3708A in determining residual BER, are available on a special order basis.

### Ordering Information

**HP 3708A** Noise and Interference Test Set

**Opt 001** 50  $\Omega$  Unbalanced Connectors

### Price

\$19,600

+ \$210

## HP 3709B

- For troubleshooting, fine-tuning and preventive maintenance
- Identifies digital radio impairments
- Analyzes magnitude of distortions

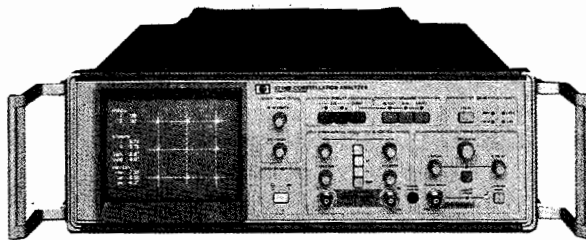

HP 3709B

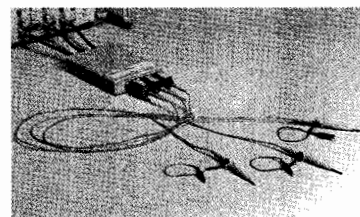

HP 15709A

## HP 3709B Constellation Analyzer

The HP 3709B is used to characterize the performance and condition of digital radios both in-service and out-of-service by analysis of constellation patterns. In addition to displaying constellation patterns, the HP 3709B measures the linear and nonlinear distortions revealed by the patterns, and can provide a formatted report containing the pattern and measurement results on a ThinkJet printer.

### Measurements

**Constellation:** Amplitude, closure, lock- and quad-angle errors, non-linear distortion (rms, am-am, am-pm)

**Modulation schemes:** QPSK, 16QAM, 64QAM, 256QAM, 9QPR, 25QPR, 49QPR, 81QPR

### Monitor Points

**I and Q signals:** Any of the above schemes with signal levels in the range 30 to 400 mV p-p across the constellation. (dc offset must be no more than  $0.5 \times$  signal amplitude).

**Clock:** 1 MHz to 80 MHz (100 mV to 1 V p-p)

**Impedance level:** All HP 3709B inputs are 75  $\Omega$  terminated.

### Options

**001:** 50  $\Omega$  unbalanced input connectors

**003:** Siemens series 1.6/5.6 mm input connectors

**130:** High Impedance Interface Kit. Contains 1 x HP 15709A High Impedance Interface and 3 x HP 10435A 1 metre 10:1 probes

**Special Options:** A low bit rate version (0.1–8 MHz) is available to special order.

## HP 15709A High Impedance Interface

This specially designed accessory provides three high impedance, filtered inputs which allow the HP 3709B to be connected to radios without protected 75 or 50  $\Omega$  monitor points, using standard oscilloscope passive probes (e.g., HP 10435A 10:1, 1 metre probe).

**Gain:**  $\times 5$  (= overall  $\times 0.5$  gain when used with 10:1 probes)

**Impedance:** 1 M $\Omega$

### Ordering Information

**HP 3709B** Constellation Display

### Price

\$14,100

# TELECOMMUNICATIONS TEST EQUIPMENT

## Digital Radio Constellation Analyzer, Vector Signal Generator

HP 8780A, 8981A, 8782B

### HP 8780A

- 10 MHz to 3 GHz synthesizer
- BPSK, QPSK, 8PSK, 16QAM, Optional 64QAM
- Burst digital modulation

### HP 8981B

- Analyzes coherent phase and amplitude modulation
- 350 MHz I vs. Q bandwidth
- Markers for measuring phase, amplitude, and time
- Displays magnitude and phase at time marker or magnitude and phase versus time
- 12-bit digitizing for HP-IB measurements
- 50 MHz to 200 MHz I/Q demodulator
- <math>0.5^\circ</math> quadrature error and <math>0.1</math> dB amplitude imbalance

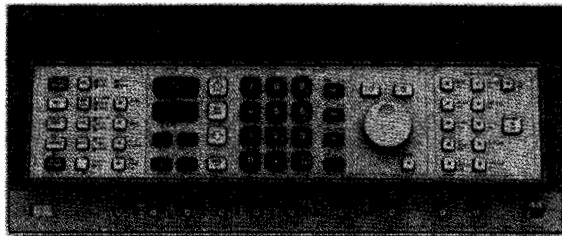

HP 8780A

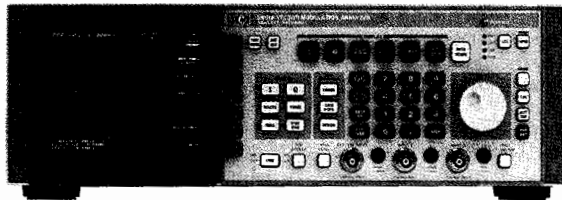

HP 8981B



### HP 8780A Vector Signal Generator

The HP 8780A Vector Signal Generator is a synthesized source with exceptional modulation for modern digital microwave radio and satellite communications testing. The Vector Signal Generator offers a wide variety of modulation using both digital and analog inputs. It generates standard formats from BPSK to 64QAM and traditional modulation like FM, AM, and pulse, as well as sophisticated complex modulation.

### HP 8981B Vector Modulation Analyzer

The HP 8981B Vector Modulation Analyzer is a two-channel X-Y sampling oscilloscope designed to analyze the in-phase (I) and quadrature phase (Q) components of modern digital microwave radio signals such as QPSK, 16QAM, and 256QAM. The HP 8981B has a 50 MHz to 200 MHz demodulator. Other demodulator frequencies available as special options.

### Applications

The vector signal generator and vector modulation analyzer are well suited to testing modern terrestrial and satellite receivers and transmitters.

The HP 8780A standard modulation patterns—BPSK, QPSK, 8PSK, 16QAM, and 64QAM (with Option 064)—are easily generated using standard data generators. Asynchronous TDMA modulation can be simulated using the Burst feature along with one of the PSK modulations. A coherent carrier output simplifies quadrature and gain alignment of vector (I/Q) demodulators.

### HP 8782B

- BPSK, QPSK, 8PSK, 16QAM, 256QAM, digital modulation and burst
- Internal pseudo random binary sequence (PRBS) generator
- AM/SCALAR modulation to simulate flat fading
- Coherent carrier output
- 100 MHz calibrated baseband analog I&Q inputs
- Optional 1 GHz unmodulated 10 output for upconversion to 0.750 to 1.25 GHz

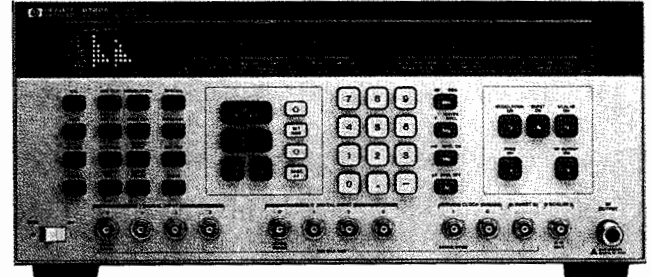

HP 8782B



### HP 8782B Low-Cost Vector Generator

The HP 8782B low-cost vector signal generator offers a wide range of built-in digital modulation from BPSK to 256QAM for microwave terrestrial and satellite communication applications. The 1 MHz to 250 MHz range covers most of the IF frequencies in commercial receivers. An internal pseudo-random bit sequence (PRBS) generator allows digital modulation without external digital data. The HP 8782B provides economical IF signal generation for research and development and manufacturing. The cost is substantially lower than the cost of the HP 8780A Vector Signal Generator.

### Applications

Use the HP 8782B to align digital radios in manufacturing. The HP 8782B can be used to provide calibrated digital modulations with extremely low quadrature error and amplitude imbalance. It can be used to simulate transmitter impairments, and to test receiver performance margins.

*For more information about the HP 8780A, HP 8782B, and the HP 8981B, refer to the Signal Generator and Signal Analyzer section of this catalog.*

### HP 11736B I/Q Tutor

The HP 11736B I/Q Tutor was written to train engineers, technicians, and engineering managers. I/Q Tutor consists of interactive training software and a user manual. It covers all the major blocks of a complete digital communications system, from the analog input through modulation, transmission, demodulation, and conversion, back into analog.

I/Q Tutor's presentation of fundamental principles followed by simulations and examples is a powerful learning tool. The user manual teaches fundamentals of phase and magnitude and employs laboratory exercises to help you explore the effects of real-world interactions of C/N ratios, data errors, multipath fades, filter factors, modulation types, and so forth.

Subjects covered include phase and magnitude, practical digital modulation techniques, BPSK, QPSK, 16QAM, Offset QPSK, and Offset 16QAM, multipath fading, high power amplifier nonlinearities, theory of I/Q modulation and demodulation, Nyquist filters, and some aspects of regulation.

### Ordering Information

**HP 11736B** Runs on HP Vectra and most IBM PC-compatible computers (PC/XT/AT) with a monochrome or color graphics card.

### Price

\$125

To order phone 1-800-227-8164.

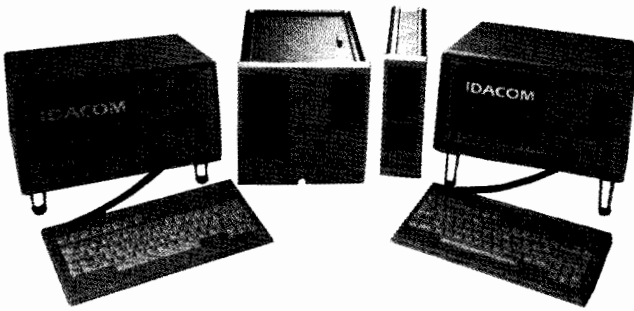

### WAN and ISDN Test Solutions

Hewlett-Packard offers a comprehensive family of protocol analyzers for testing WAN and ISDN networks.

#### HP4957A and HP4957PC Protocol Analyzers

HP's 4957A and HP4957PC product line offers low-cost, field-portable troubleshooting capabilities for installing and maintaining networks.

#### HP4954A/I/AX Protocol Analyzer

HP's 4954 series provides a high-performance alternative for research and development applications. The 4954 series offers common operating setup, mass storage, capture buffer, and remote transfer characteristics with the 4957 series.

#### HP PT502 High Speed Protocol Tester

HP's PT502 is a high-speed protocol tester for LAN interconnection protocols.

#### HP PT300/500 Protocol Testers

HP's PT300 and PT500 product lines are multiport, multiprotocol testers that feature monitoring, emulation, conformance, and performance for WAN and ISDN network product development and integration.

#### HP 37900D Protocol Tester

The HP's 37900D multiport signalling test set is a rugged, portable tester that allows faster maintenance, installation, and design of SS#7 and ISDN networks.

#### HP RTA (Remote Test and Analysis)

The RTA is a multiport, multiprotocol remote test and analysis tester that allows protocol experts to troubleshoot a remote network as though they are at the remote location.

#### HP Remote Transparent Monitor (RTM)

The RTM is a remote test access system that transports data from the remote site to a central site.



### LAN Test Solutions

Hewlett-Packard also offers a wide range of solutions for managing local area networks (LANs). Solutions for IEEE 802.4/MAP are available.

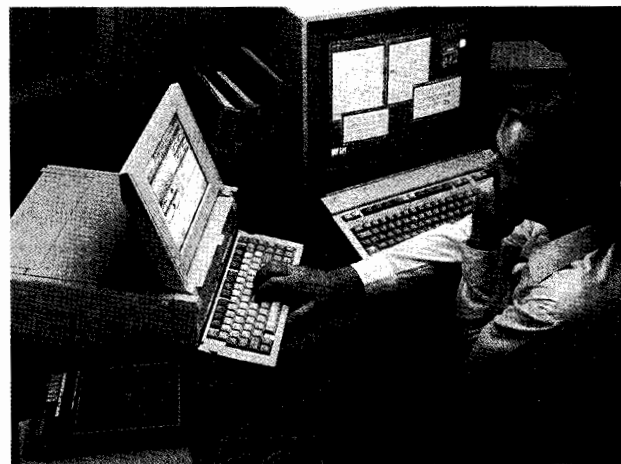

The HP network advisor complements your network management system to quickly isolate and resolve problems.

### Network Advisors

HP's new network advisor product line brings a new approach to testing either Ethernet or Token-ring networks. Utilizing expert systems technology, the network advisor guides the user to the source of a network problem. The HP 498X family also offers integrated help facilities to assist in educating the user.

#### HP 4972A Protocol Analyzer

The HP 4972A is a high-performance protocol analyzer for Ethernet networks. Its powerful facilities for traffic generation, analysis, and programmability make the HP 4972A the right tool for engineering applications.

#### HP 4990S LanProbe Distributed Analysis System

The HP 4990S LanProbe distributed analysis system offers the network manager a wide view of Ethernet LANs. The HP 4990S sets a new standard for distributed management with an easy-to-use centralized approach.

#### HP 4974S Network Analyzer

The HP 4974S analyzes IEEE 802.4/MAP networks with layer-by-layer decodes for MAP 3.0 protocols, up to and including layer 7.

# DATA COMMUNICATIONS TEST EQUIPMENT

## Protocol Analyzers

	HP 4957A/HP 4957PC	HP 4954A/I/AX	PT300/PT500	PT502
<b>Weight</b>	HP 4957A: 5.8 kg (12.8 lb) HP 4957PC: 0.2 kg (0.5 lb)	21.17 kg (46.7 lb)	PT300: 14 kg (30 lb) PT500: 20 kg (44 lb)	20 kg (44 lb)
<b>Mass storage</b>	HP 4957A: 3.5 in. diskette HP 4957PC: Utilizes PC's mass storage.	3.5 in. diskette and 20 MB hard disk	40 MB hard disk and PT300 1x PT500 2 x 800 KB 3.5 in floppy disk drives	40 MB hard disk and 2 x 800 KB 3.5-in floppy disk drives
<b>Operating speeds</b>	Monitors up to 256 kbps Simulation up to 64 kbps	Normal: Mon/Sim up to 128 kbps. ISDN: Mon/Sim (2) 64 kbps channels	Monitors at 256 kbps. Emulations: 16 kbps/64 kbps per D/B-channel — ISDN 19.2 kbps — 128 kbps per channel	Monitors and Emulates at 2.048 MB/s.
<b>Physical Interface</b>	HP 4957A: RS-232C/V.24, RS-449/422/423, V.35 interface built in, ISDN BRI S/T and U, ISDN PRI, T1, X.21.  HP4957PC: External pods available: RS-232C/V.24, V.35, RS-449/422/423, T1, ISDN BRI S/T & U, ISDN PRI, T1, X.21.	RS-232C/V.24, V.35, RS-449/422/423, X.21, ISDN BRI, ISDN PRI T1, CEPT, RS-232 for external ISDN access.	Various configurations of the following connectors: WAN RS-232C/V.24, V.35 or RS-449/V.36, V.11/X.21; ISDN Basic Rate S/T (RJ-45 or TAE8+4C), ISDN Primary Rate (RJ-45 and Bantam or DB-9), RJ-14 Voice, serial remote control DB-25, DB-15 External B-Channel access, serial & parallel printer port	T1-RJ-48 and mini bantam; EIDB-9 and adapter cables, WAN-V.35/V.11 or RS-449/422/423/V.11.
<b>Remote testing</b>	18275A remote troubleshooter, PC software with virtual-mode remote, remote data transfer, and PC data transfer; PC data analysis for SNA, X.25; other decodes available (ISDN, frame relay, X.400).	Remote data and file transfer, PC software with command-mode remote, PC data analysis for SNA, X.25; other decodes available (ISDN, frame relay, X.400).	The RTP (Remote Test Package) makes existing monitoring capabilities available remotely (Frame Relay, ISDN, X.25, X.25/Q, SDLC/SNA, Bisync, Universal: BOP, COP).	Frame Relay, X.25, SMDS
<b>Protocols</b>	Async, Bisync, SDLC/SNA, HDLC, X.25, DDCMP, IPARS, X.21, ISDN (Q.921 and Q.931), SS7, frame relay, and most character sync protocols.	Async, Bisync, SDLC/SNA, HDLC, X.25, DDCMP, IPARS, X.21, ISDN (Q.921 & Q.931), SS7.	Frame Relay, X.25, X.25/Q (QLLC/BPAD/DSP), ISDN Q.921/1.441, Q.931/1.451, LAPD/X.25 (D-Channel), SS7, SDLC/SNA, X.75, X.21, Group 4 Fax, V.110, BSC 3270, Universal (Sync: BOP, COP, Async).	Frame Relay, X.25, SMDS
<b>LAN Interconnection</b>	Frame Relay decode and statistics, X.25, SDLC/SNA	X.25, SDLC/SNA	Frame Relay, X.25, SDLC/SNA.	Frame Relay, X.25, SMDS
<b>ISDN testing</b>	BRI (S/T) and PRI (T1, CEPT): layer 1 LEDs; monitor/simulate; rate adapted monitoring; Q.921 & Q.931 decodes; layer 2 statistics; G.821 BERT; real time stamp; post-capture filtering. U interface (AMI and 2B1Q line coding) monitoring.	BRI (S/T) and PRI (T1, CEPT): dual channel testing; layer 1 LEDs; monitor/simulate/emulate; ISDN interactive tester; rate adapted monitoring; automonitor program; filtering; Q.921 & Q.931 decodes; drop and insert (PRI).	BRA D-Channel, PRA, BRA (2B+D), PRA/BRA/WAN, BRA/BRA, PRA/WAN or BRA/WAN. A wide selection of L3 message sets are supported for basic rate and primary rate. AT&T, CCITT 1988, 1TR6, NTT, ETSI, NT, VN2, TPH.	
<b>X.25 testing</b>	User-customizable X.25 decode with facilities field decode. X.25 library and link layer emulator. Link and packet layer statistics, LCN, called and calling address filtering.	X.25 decode with facilities field decode. X.25 interactive tester. Link and packet layer emulation. X.25 statistics. NET 2 certification.	Multi-link X.25 decoding, Facility field decoding, Link and Packet level emulator, Link and Packet Level Performance Analysis (statistics), X.25 test library, custom test scripts. Dual Port option.	Multi-link X.25 decoding, Facility field decoding, Link and Packet level emulator. X.25 test library, custom test scripts. Dual Port option.
<b>SDLC/SNA testing</b>	All SNA FID types decoded. User-definable data display. SNA/Bisync 3270 tester. SDLC and SNA statistics.	All FID types decoded. SNA bind decode. SNA development language with emulation, 3270 device exerciser, LU 6.2 node exerciser. SNA/Bisync statistics.	Decodes all FID types. Simultaneously emulates up to 32 stations. Includes a link level emulation of a communications or cluster controller. SDLC/SNA Network Performance Analysis (statistics).	
<b>Programming</b>	Monitor/Simulate menus. Trigger/trap datacomm events. Counters, timers, and alarms. Set leads, send strings. Subroutines, softkey triggers, display messages.	Monitor/Simulate menus. Data-CommC (full K & R programming language). SNA development language. X.21 state simulator language. Interactive testers and extensive libraries (for X.25 and ISDN).	Custom test script generation via finite state machine concept. Access to an extensive run-time library for all protocols. Customization of ISDN L3 message sets to accommodate local and vendor variants.	Custom test script generation via finite state machine concept. Access to an extensive run-time library for all protocols supported.
<b>Conformance testing</b>	Not applicable	X.25; Net 2	The PT300/PT500 is a test engine for the IDACOM conformance test system. Available test suites:  <b>X.25:</b> DDN, FIPS100, CTS-WAN, NET2, Facility, ISO8882 (U.S. GOSIP). <b>ISDN:</b> NET3, ACT23, VN2 BRA, CTS-WAN L3, ISO8882 L3, NET2 L3, CTS2 BRA, 1TR20, NET5, AT&T CPE. <b>SS7:</b> Q.781, Q.782, Bellcore MTP, NOF MTP <b>Group 4 Fax: NET31 (T.64)</b> <b>SDLC/SNA:</b> Verification	
<b>List Price (w/RS-232C/V.24) (*also Incl. RS 449/V.35)</b>	HP 4957A: \$6,990* HP 4957PC: \$2,990	\$ 18,455	Contact HP	Contact HP





### HP 4957A and HP 4957PC protocol analyzers

The 4957A is a portable and rugged protocol analyzer in a compact package. The HP 4957PC PC card transforms a PC into a powerful diagnostic tool. No matter which package you choose, you get the same powerful capability and 64 Kb/s performance for quickly isolating problems during the installation, maintenance, and design of data communication networks and equipment.

### HP 4957A and HP 4957PC Features and Benefits

- Compatible with remote troubleshooter software for unattended remote testing.
- High-speed performance package (Option 001) tests host-host and other high data rate links up to 256 Kb/s.
- Built-in RS-232C, RS-449, and V.35 interfaces (HP 4957A only) make the HP 4957A lightweight and easy to carry.
- 768 KB extended capture buffer provides the space needed for solving intermittent problems or analyzing lengthy transactions.
- LCN and called/calling address filter efficiently locates problems in X.25 networks.

### Additional Features and Benefits

- Autoconfigure automatically determines line parameters and monitors data with the press of a key.
- Bit error rate testing (BERT) quickly determines the quality of your line.
- 3½-in microfloppy disk stores 613 KB of data, timing, lead status, programs, and configurations.
- Softkey driven menus make setup and programming fast and easy with no cryptic commands to remember.
- Printouts to all RS.232C/V.24 ASCII printers provide hardcopy for records and reports.
- 128 KB nonvolatile RAM disk makes applications instantly accessible.
- Cursor timing allows timing measurements to be made quickly, without the need to write a program.
- Enhanced programming features provide run-time user comments, softkey triggering, and subroutines.
- Run-time buffer data filtering maximizes capture buffer efficiency.
- Selective store to disk (HP 4957A) captures only events of interest, making analysis more efficient.
- Copy disk utility quickly duplicates disks (HP 4957A).
- 80-column VT100 terminal emulation provides convenient terminal for applications such as configuring network equipment.

### Datacomm testing solutions

#### HP 18258A Frame relay data and performance analysis

This package provides statistics for evaluating traffic congestion and network performance. In-depth frame relay protocol decodes allow you to isolate problems quickly.

#### HP 18280A thru HP 18285A ISDN solutions

Miniature ISDN pods and software allow you to monitor and simulate at the basic rate S, T, and U reference points. Rate adapted displays permit monitoring on either side of terminal adapters. Switch and country specific decodes give accurate data displays for a variety of vendors and locations. Primary rate interfaces support both 1.544 Mb/s and 2.048 Mb/s.

#### HP 18282T T1 solution

A T1 interface pod allows you to test any DS0 channel out of a T1 data stream. You can monitor the facility data link channel when analyzing ESF data using the T1.403 decode package.

#### HP 18259A X.25 and SNA L2 and L3 performance analysis

Link and packet layer statistics, such as link utilization and packet type distribution, allow you to observe trends before serious problems occur.

#### HP 18261A SNA analysis package

This package provides powerful decoding of layer 2 and layer 3 protocols for all FID types for quick and easy problem isolation.

#### HP 18263A 3270 installation and maintenance software

Installation and maintenance software packages provide easy, automatic, offline testing of multiple 3270 clusters by emulating many of the functions of a host computer.

#### HP 18266A and HP 18267A X.25 troubleshooting

This package decodes all fields of each packet including facilities, calling/called addresses, cause and diagnostic codes, registration and call user data. An X.25 test library and emulator provide a layer 2 emulator and a library of X.25 tests.

#### HP 18273A SS#7 testing

This software decodes layer 2, 3, and 4 message fields into an easy-to-read format to make analysis quick and efficient. Users can customize hex codes and mnemonics of user parts and message types to support national variations of SS#7.

#### HP 18269A G.821 BERT testing

This interactive tester analyzes link quality according to the G.821 error performance specification for ISDN and other protocols recommended by the CCITT.

#### HP 18294A (Opt 104) X.21 interface pod and software

The solution provides Block Error Rate (BLERT) and call error rate testing, data transfer state analysis, state decoding, and test scripts for DTE and DCE simulation.

#### Data communications test library

A library of prewritten tests comes standard with the HP 4957A and HP 4957PC. The library's 58 general-purpose programs help you diagnose common datacomm problems.

#### Physical Specifications

**Size:** 160 mm H × 279 mm W × 343 mm D (6.3 in × 11.0 in × 13.5 in)

**Weight:** With all V-series y-cables: net 5.8 kg (12.8 lb); shipping 10.3 kg (22.7 lb)

#### Ordering Information

(Prices reflect typical configurations)

	Price
HP 4957A Protocol Analyzer	\$6,990 ☎
HP 4957PC Protocol Analyzer (fits most full or ½ size card slots)	\$3,600
Applications Software Package	\$500
ISDN Basic Rate Interface Pod and Software	\$2,000
ISDN PRI or T1 Interface Pod and Software	\$2,500

Contact your local Hewlett-Packard sales office for information on the availability of different options, related products, and detailed configuration and ordering information (see page 684).

☎ For off-the-shelf shipment, call 800-452-4844.

# DATA COMMUNICATIONS TEST EQUIPMENT

## Protocol Analyzers

HP 18275A and HP 4954A/I/AX

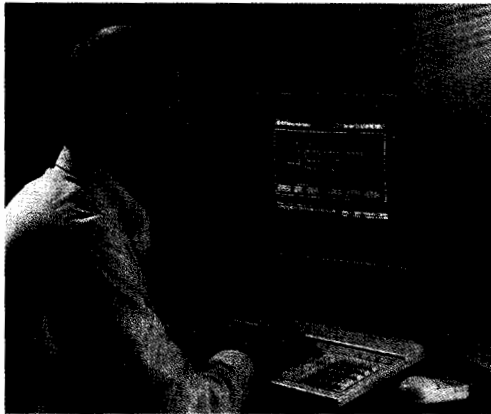

HP 18275A

### HP 18275A Remote Troubleshooter Software

The HP 18275A remote troubleshooter software transforms a PC into a powerful central-site troubleshooting tool for installing and maintaining communications equipment. Central site specialists can save time and money by solving problems more easily without traveling to the problem site.

#### Virtual Mode Remote

With the HP 18275A controlling an HP 4957A/PC in virtual mode, the screen and keyboard of the PC become those of a remote analyzer. A specialist at a central site can see what a remote technician sees, as if he or she were looking "over the shoulder" of the technician. With the HP 18275A, the HP 4957A/PC becomes the best solution for isolating network problems on the first visit.

#### Command Mode Remote

The HP 18275A also supports traditional command mode remote control of any HP 4957A/PC, HP 4954A, HP 4952A, or HP 4951C. Data can be transferred between any of these analyzers and the PC for in-depth analysis and quick problem resolution by the central site specialist. Menus and applications can also be transferred, and the PC can be used to remotely start tests on the protocol analyzer.

#### Data Analysis

With the HP 18275A decodes, a PC can be used to analyze data captured by and uploaded from any HP 4957A/PC, HP 4954A, HP 4952A, or HP 4951C. The HP 18275A comes standard with decodes for X.25, SNA, BOPS (HDLC, SDLC, LAPB, and LAP), and COPS (character async and sync).

**Statistical displays** expose problems at a high level and provide information on utilization, throughput, and bad FCS's to help detect network problems.

**Search and filter functions** allow users to focus on relevant data to pinpoint problems more quickly.

**Printing of decoded data** to ASCII files simplifies inclusion of protocol information in printed reports.

### Solutions for a Wide Range of Protocols

Additional analysis packages (requiring the HP 18275A) are available to troubleshoot problems for a wide range of protocols.

The HP 18276A X.400 (CCITT) Remote troubleshooter software decodes the most important fields of LAPB, X.25, X.224 (transport), X.225 (session), and X.400.

The HP 18277A ISDN Remote troubleshooter software decodes ISDN according to many different standards and implementations.

The HP 18278A Frame relay remote troubleshooter software reports congestion statistics and protocol errors.

The HP 18279A DPNSS/DASS Remote troubleshooter software supports DPNSS/DASS2 protocol implementations.

#### Ordering Information

<b>HP 18275A</b> Remote troubleshooter software	\$990
<b>HP 18276A</b> X.400 (CCITT) Remote troubleshooter	\$500
<b>HP 18277A</b> ISDN Remote troubleshooter software	\$500
<b>HP 18278A</b> Frame relay remote troubleshooter	\$500
<b>HP 18279A</b> DPNSS/DASS2 Remote troubleshooter	\$500



HP 4954A

### HP 4954A Protocol Analyzer

The HP 4954A is a high-performance protocol analyzer for designing data communications products, solving complex networking problems, and analyzing network performance.

**DataCommC programming language** gives you testing power and flexibility in a datacomm-enhanced version of the standard Kernighan and Ritchie "C" language.

### HP 4954I ISDN Protocol Analyzer

The HP 4954I is optimized for both research and development testing of ISDN equipment and solving complex networking problems encountered in ISDN installation and maintenance. ISDN basic rate and T1 (1.544 Mb/s) and CEPT (2.048 Mb/s) primary rate interfaces are supported.

- The ISDN interactive tester speeds functional testing.
- Layer 1 LEDs show layer 1 problems at a glance.
- Rate adaption analysis supports terminal adapter testing.
- Device emulation simplifies protocol testing.
- The ISDN Automonitor program focuses testing on active channels.

### HP 4954AX X.25 Protocol Analyzer

The HP 4954AX, a powerful testing tool for X.25 equipment developers, comes standard with the HP 18321A X.25 test environment. The HP 18322A X.25 certification test suite and the HP 18370A X.25 network performance analyzer are optional.

- The HP 18321A X.25 test environment provides emulation and interactive testing to speed functional testing.
- The HP 18322A X.25 certification test suite greatly simplifies verification of an X.25 implementation according to NET-2 (Normes Europeennes de Telecommunications) specifications.
- The HP 18370A X.25 network performance analyzer gives statistical summaries of network activity to help network managers detect problems early.

### SNA and X.21 Testing

The HP 18360A SNA emulation language, HP 18361A SNA 3270 device exerciser, and HP 18362A LU6.2 node exerciser speed testing for implementors of IBM's Systems Network Architecture (SNA).

The HP 18371A SNA/bisync network performance analyzer gives statistical summaries of network activity to help network managers detect problems early.

The HP 18352A X.21 state simulator aids X.21 DTE and DCE developers with its X.21 language, decode, and DTE protocol conformance tests.

### Physical Specifications

**Size:** 19.6 cm H × 42.5 cm W × 56.5 D cm (7.7 in × 16.7 in × 22.2 in)  
rack mountable

**Weight:** 21.17 kg (46.7 lb)

#### Ordering Information

(Prices reflect typical configurations)	
<b>HP 4954A</b> with HP 18135A RS-232C interface	\$18,455
<b>HP 4954AX</b> with HP 18135A RS-232C interface	\$23,155
<b>HP 4954I</b> with HP 18356A ISDN BRI	\$24,790
<b>HP 4954I</b> with HP 18358A or 18366A ISDN PRI + BRI	\$29,990

# DATA COMMUNICATIONS TEST EQUIPMENT

Protocol Tester

601

Model PT502: T1/E1, Fractional T1/E1 and Testing at 2 Mbps

The PT502 is a high-speed version of the PT500 protocol tester. The PT502 features data capture and analysis at rates up to 2.048 megabits per second, allowing it to test full bandwidth and fractional DS1/T1 or CEPT/E1 data traffic. The PT502 features software for Frame Relay Monitoring and Emulation. Support for other bit-oriented protocols such as X.25 and SMDS will be available in 1992.

The PT502 offers unprecedented ability to examine and generate digital traffic on T1/E1 circuits from a dedicated protocol tester. Users of high-speed wide-area data links can now test their traffic live rather than recording data to disk and examining it later. The PT502 provides a simple method of troubleshooting high-speed traffic, with filters and triggers that work in real time on full bandwidth 2.048 Mbps traffic. Test scripts designed to simulate network devices and provide load generation can now work at high data rates, letting you stress test devices effectively.

The PT502 is designed specifically for network equipment designers and troubleshooters, and can be a useful tool in your arsenal of solutions for today's high-speed networking needs. With this tester, you can finally get the complete picture of what's happening on your T1/E1 data lines at full speed.

## Features

**Data Capture:** The PT502 can capture, analyze, and send data at rates up to full T1/E1 circuit capacity.

**Flexible Platform:** The PT502 will be a base for future protocol monitoring, simulation/emulation, and statistics software in a variety of high-speed digital protocols at rates up to 2.048 Mbps. Check with your HP field engineer for the latest capabilities.

**Full Monitor/Emulation Capability:** Full data capture, filtering, and a triggering capability are provided. Using the sophisticated Frame Relay Simulation software, the tester can monitor its own simulation output in addition to monitoring the incoming traffic.

**Dynamic On-line Control:** A menu-driven interface with softkeys speeds up protocol testing. You can change communications parameters, port assignments, DCE or DTE configuration, test parameters and a variety of features from menus on the fly while applications are running, no rebooting or reloading is required.

**Programmability:** A full programming environment, including extensive protocol-specific run-time libraries, are provided at no extra cost. Sophisticated and complicated testing scenarios, or customized software, are easy to generate using the Interactive Test Language (ITL). ITL is a state-based stack-oriented language specifically designed for protocol work, which lets you create custom test scripts or device simulations you desire — quickly and efficiently.

**Upward Compatibility:** The PT502 shares the same user interface as the PT300 and PT500. ITL scripts written for software running on the PT300 or PT500 will work with the corresponding software packages on the PT502.

**Remote Access:** Facilities for remote full-screen access from another PT502 are provided.

## Product Literature

PT502 Brochure 5091-2010E  
Frame Relay Data Sheet 5091-1468E

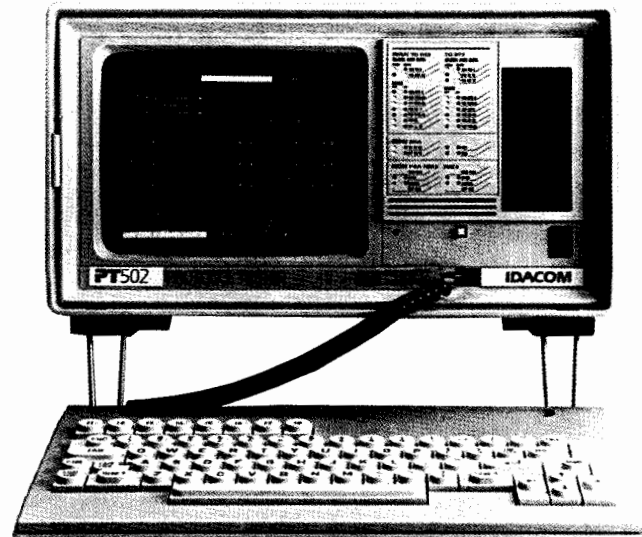

**Display Options:** Multilevel decoded character, Complete, Short, or Split Screen

## Data Transfer Rate

**Monitor** 50bps to 2.048Mbps  
**Emulation** 50bps to 2.048Mbps

## Physical Interface

**T1, CEPT**

V.35, RJ-48 and Bantam (T1) 3 pin European, BNC

## Display modes

**Character sets**  
**Display**  
**Dimensions**

Complete, Short, Split, Trace, Character  
ASCII, EBCDIC, Hex, JIS8, Teletex  
High resolution 9-inch color monitor  
22.0 cm × 38.0 cm × 47.5 cm (8.66 in ×  
14.96 in × 18.7 in)

## Weight

**Data to disk**  
**Mass storage**

20 kg (44 lb)  
64 to 30 Mbytes configurable  
40 Mbyte hard disk, 2 × 3.5-inch floppy  
drives

## Autoconfigurable

**Configurations**

Yes  
**PT502\***

## Software Applications for the PT502

You can use HP IDACOM's Frame Relay Monitor package to verify the operation of Frame Relay interfaces or switching equipment. The software can watch and record traffic over a Frame Relay link. While monitoring, the PT502 will be connected passively to a line so that it will not actually interfere with communications.

The PT502 automatically decodes Frame Relay traffic into a readable English format. While this isn't a complicated task with the straightforward Frame Relay frames, the automatic decoding becomes invaluable when decoding the Q.922 ISDN-style Switched Virtual Circuit(SVC) Management and the Permanent Virtual Circuit (PVC) Local Management Interface (LMI) messages.

**Frame Relay Monitor:** Provides flexible monitoring capabilities for frame relay traffic. Filters, triggers, flexible data recording, and extensive programmability let you find out what's really happening on your T1/E1 or Fractional T1/E1 frame relay links.

**Frame Relay Emulation:** Incorporates all the functionality of the frame relay monitor. The Emulation software package adds menu-driven message building, storage, and transmission capabilities. Under script control, dynamic and responsive test simulations or scenarios can be written to provide statistics, load generation, or device simulation.

\*: T1/V.35, CEPT/V.35  
: V.35  
: V.35/V.35

# DATA COMMUNICATIONS TEST EQUIPMENT

## Protocol/Conformance Testers

Models: PT300, PT500, and RTA

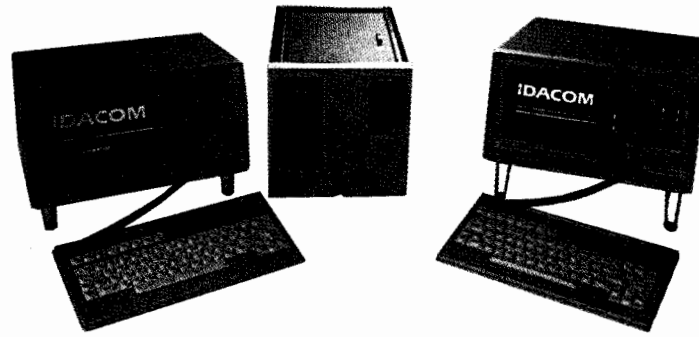

HP's vision of an integrated network testing solution is based on the premise that protocol performance and conformance testing should be applied to the complete life cycle of computer and network products. The PT series of protocol testers provides synchronized, multiport, multiprotocol analysis, monitoring, simulation/emulation, and conformance testing of a variety of digital protocols and physical interfaces. PT testers are used throughout network product development, quality assurance, installation and commissioning, acceptance testing, maintenance, and troubleshooting. The PT500 test engine is used by conformance test centers worldwide as a Conformance Test System.

### PT300, PT500, and RTA Features

**Multiport testing:** PT testers can be configured with true multiports. Each port can operate independently, allowing simultaneous monitoring and/or simulation/emulation of different protocols for different applications. Each port is capable of emulating while monitoring its own emulation. All ports operate on one synchronized timebase, thus providing common time-stamping and merged data-recording. This capability allows accurate measurements of propagation delay, response times, switch simulation, and so forth.

**Dynamic on-line control:** A menu-driven interface with softkeys speeds up protocol testing. You can change communications parameters, port assignments, DTE or DCE configuration, test parameters, and a variety of features from menus on the fly while applications are running; no rebooting, reloading, or reconfiguring will be required.

**Programming:** In addition to the fully automated high-level emulation and conformance testing software, the PT testers provide for flexibility in test script generation. Each software package comes with extensive protocol run-time libraries. You can easily generate simple and sophisticated test scripts without extensive programming effort.

**Filters, Triggers, Data Recording:** Multiple sets of data filters and recordings (to any simultaneous combination of memory, disk, or screen) save you from having to scroll through pages and pages of data. Sophisticated data-recording triggers are useful for unattended or remote monitoring applications.

**Flexible software based system:** The PT is a flexible protocol computer with application software that can be loaded on the internal hard disk. As protocols change and new protocols are designed, software upgrades will enable you to keep up with the rapidly changing communication field. A wide variety of protocols and software packages are currently supported, and the list is constantly growing.

### RTA (Remote Test and Analysis)

The RTA is a flexible and programmable test engine for remote test and analysis, which is mountable in a 19-inch rack. It has similar capabilities to the PT500, including multichannel support, but without built-in display. Test experts at a central site can control RTAs located at remote sites to perform testing and analysis of remote equipment or circuits. Multiple applications running at the remote site can be viewed from the central tester. Custom test suites can be generated at the central site and downloaded to the remote site for testing. The RTA, PT300, and PT500 share the same user interface.

### Product Literature

PT300 Brochure	4131-2131
PT500 Brochure	5091-0927E
RTA Brochure	4131-2157
Conform By Design Product Data Brochure	5091-2190E
Product Ordering Guide	5091-1559E

## Applications

### Network Testing

Synchronized time-stamps allow end-to-end transit delay measurement over multiple protocols and networks. Performance and statistics-gathering software allow fine-tuning of a network. When working with protocol converters, PADs, ISDN TAs, and other multiprotocol devices, the PT testers can monitor several protocol domains simultaneously and provide precisely filtered time-stamped reports that can help to quickly detect protocol problems. Simulation and load-generation capabilities let you exercise network devices and links. Remote capabilities let you look at geographically remote problems without actually going there.

### Evaluation and Acceptance Testing

The complicated nature of networks and communications tools, and our reliance on them for day-to-day operations, have mandated that acceptance testing be done before new equipment is connected. Testing devices in the evaluation phase is easier than locating and correcting a problem after the equipment is distributed in the network. The PT testers are supported by an extensive library of automated protocol-conformance test suites for acceptance testing.

### Conformance and Development Testing

HP provides conformance test packages specified by recognized testing authorities, and an environment for the development of test cases. Common Control Software offers a consistent user interface among executable test suites. The test suites can be used at each phase of the product life cycle. During the development phase, you can use individual test cases to check each feature as it is implemented. A variety of report formats are provided, including the option to produce detailed verdict descriptions and data recordings of protocol data exchange during test execution. Tests can be interrupted and resumed on demand. Multiple test suites for protocol conformance and verification are available for ISDN, X.25, SS#7, and SDLC/SNA protocols. This software can be used for permission-to-connect testing, verifying software and hardware upgrades, and ensuring that devices from multiple vendors conform to standards.

### ISDN Primary Rate, Basic Rate, and WAN Testing

The PT500 PRA/BRA/WAN supports independent and simultaneous monitoring and/or simulation/emulation at the PRA (primary rate), BRA (basic rate), and R interfaces. An application example is PBX development, in which all network and user functions can be tested simultaneously by simulating or monitoring all voice and data calls throughout the network.

### ISDN Basic Rate and WAN Testing

BRA/WAN versions of the PT provide independent and simultaneous monitoring and/or simulation/emulation at the ISDN BRA (basic rate) and R interfaces. For example, the complex testing of ISDN TAs is simplified through logical testing at the R and the S interface points simultaneously.

### ISDN Basic Rate Testing

The BRA/BRA configuration supports simultaneous monitoring or emulation of two completely separate S/T buses. The PT500 can simulate the ISDN network, including up to 16 links (8 per S-bus) and 4 B-Channel services.

### Voice Support (ISDN configuration)

Telephone access to B-Channel is provided via codec. An internal call progress tone generator provides realistic network emulation.

### WAN Testing

The PT family provides extensive monitoring, emulation, and analysis packages for WAN protocols. The WAN/WAN configuration provides two independent WAN ports.

**Display Options:** Multilevel decoded character, Complete, Short, or Split Screen.

### Data Transfer Rate

<b>Monitor/Emulation:</b>	2.048Mbps (See PT502 tester on page 601)
<b>Monitor:</b>	256 kbps
<b>Emulation: D-Channel</b>	64 kbps (PRA), 16 kbps (BRA)
<b>B-Channels</b>	64 kbps per channel
<b>WAN</b>	Up to 128 kbps

### Interface Ports

<b>ISDN PRA</b>	Dual RJ-48 and Bantam (T1) or DB-9 (CEPT), with external clock sync and B-Channel access
<b>ISDN BRA</b>	Dual RJ-45 (CCITT) or TAE8+4C (German PTT) connectors and B-Channel access to each BRA port
<b>WAN</b>	RS-232-C, V.35 or V.36 (RS-449) and V.11/X.21 per port

**Display Modes** Complete, Short, Split, Trace, Character

**Character Sets:** ASCII, EBCDIC, Hex, JIS8, Teletex

<b>Display</b>	<b>PT500</b>	High resolution 9-inch color monitor
	<b>PT300</b>	9-inch monochrome (ext color display)

<b>Dimensions</b>	<b>PT500</b>	22.0 cm × 38.0 cm × 47.5 cm (8.66 in × 14.96 in × 18.7 in)
	<b>PT300</b>	22.0 cm × 38.0 cm × 36.0 cm (8.66 in × 14.96 in × 14.17 in)

<b>Weight</b>	<b>PT500</b>	20 kg (44 lb)
	<b>PT300</b>	14 kg (30 lb)

**Data to disk** 64 to 30 Mbytes configurable

<b>Mass Storage</b>	<b>PT500</b>	40 Mbyte hard disk, 2 × 3.5-inch floppy drives
	<b>PT300</b>	40 Mbyte hard disk, 1 × 3.5-inch floppy drive

### Configurations

PT300 BRA D-Channel	PT500 BRA D-Channel
PT300 WAN	PT500 WAN
PT300 BRA (2B + D)	PT500 BRA (2B + D)
PT300 PRA	PT500 PRA
PT300 WAN/WAN	PT500 WAN/WAN
PT300 BRA/WAN	PT500 BRA/WAN
	PT500 PRA/WAN
	PT500 BRA/BRA
	PT500 PRA/BRA/WAN
RTA BRA D-Channel	
RTA WAN	
RTA BRA (2B + D)	
RTA WAN/WAN	
RTA BRA/WAN	

### Software Applications for the PT300, PT500, and RTA

#### New

New Relay Monitor, Frame Relay Simulation  
GSM 4.XX Monitor  
X.25 MLP Monitor, X.25 MLP Emulation

#### X.25

X.25 Monitor, X.25 Emulation  
X.25/Q Monitor (QLLC/BPAD/DSP)  
X.25 Load Generator  
X.25 Network Performance Analysis

#### X.25 Conformance Testing

Common Control Software  
DDN Test Suite  
FIPS100 Test Suite  
CTS-WAN Test Suite  
NET2 Test Suite (including Annex F and G)  
ISO8882 (U.S. GOSIP)  
Facilities Test Suite  
Switch Test Script

#### ISDN

ISDN D-Channel Monitor (PRA, BRA with PLP, and WAN)  
ISDN D-Channel Emulation (PRA, BRA with PLP, and WAN)  
ISDN Message Set (CCITT 1988) included with either package (various other Layer3 Message sets are also available)

#### ISDN Conformance Testing

Common Control Software  
NET3 L2/L3 Test Suite  
ACT23 L2 Test Suite  
VN2 BRA Test Suite  
CTS2 BRA Test Suite  
1TR20 Test Suite  
CTS-WAN L3 Test Suite (on D-Channel)  
ISO8882 L3 Test Suite (on D-Channel)  
NET2 L3 Test Suite (on D-Channel)  
AT&T CPE Test Suite  
NET5 Test Suite

#### SS#7

SS#7 Monitor, SS#7 Simulation  
CCITT Protocol Set  
ANSI Protocol Set  
Telecom Canada Protocol Set  
Hong Kong Telecom Protocol Set

#### SS#7 Conformance Testing

Common Control Software  
CCITT Q.781 Test Suite  
CCITT Q.782 Test Suite

#### SNA/BSC

SNA/SDLC Monitor, SDLC Emulation  
SDLC/SNA Network Performance Analysis  
SDLC/SNA Verification  
BSC 3270 Monitor, BSC 3270 Emulation

#### Others

Remote Test Package (RTP)  
X.21 Monitor, X.21 Emulation  
X.75 Monitor, X.75 Emulation  
Group 4 Fax Monitor, Group 4 Fax Emulation  
R-FILEX\*

# DATA COMMUNICATIONS TEST EQUIPMENT

## Remote Network Testers

### Model RTM

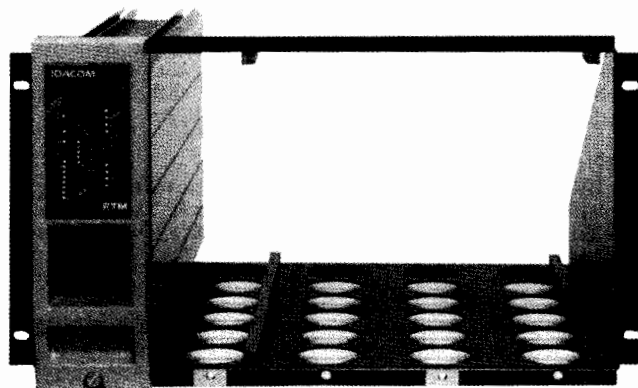

### Remote Transparent Monitor (RTM)

HP's RTM is a remote test access system that transports live data, clocks, and control lead information from a remote test site back to a Network Control Center (NCC). At the NCC, the circuit being tested is regenerated in real-time with full data integrity and with the same time correlation between events as occurred originally. When a network user has a problem, experts at a NCC can now use local equipment to analyze a network problem without locating to a remote site.

RTM equipment operates in pairs. Monitor equipment at the remote site and regeneration equipment at the local site are connected via a dedicated or a switched circuit. The RTM units are interchangeable between remote and local sites. With the flip of a switch they can be reconfigured to operate as a monitor or a regeneration unit.

#### Features

**Protocol independent:** The circuit being tested and monitored by the RTM can be any protocol from 19.2 KB/s asynchronous to 64 KB/s synchronous in selected speed increments. Since the RTM is protocol independent, circuits using modified or emerging protocols can be analyzed also.

**Maintains time correlation:** The data, clocks, and control leads are regenerated at a NCC in the same sequence as they occur on the circuit being tested.

**Link error detection:** The RTM is a smart pipeline—a revolutionary data transport system with built-in error detection. It accommodates to normal noise that may occur over the link, making the regenerated data an accurate and link-error-free reproduction of the circuit being tested. The regeneration RTM signals the operator at a NCC if major link disturbances occur.

**Lead states and transitions:** The RTM transmits lead transitions of up to 8 leads with 100 transitions per second, maintaining time correlation between the lead transition and data.

**Automatic clock adjustments:** The RTM automatically adjusts to synchronous clock rates. It also recognizes asynchronous circuits and provides its own internal clock to sample the data at a suitable rate.

**Voice channel:** Direct phone communications over the link is provided between the remote and central sites.

**Test and analysis channel:** This port acts as a transparent asynchronous communication link between the remote and central test sites.

**Command channel:** Using the command port, the operator can run diagnostics, obtain reports on link statistics, and reset link error counters.

#### Product Literature

RTM Brochure  
Centralized Network Testing

4131-2156  
4131-2155

<b>Size</b> (HWD-cm) (HWD-in)	26.5 x 8.6 x 45.7 cm 10.5 x 3.4 x 18 in
<b>Weight</b>	4.1 kg (9 lb)
<b>Modes of operation</b>	Monitor or regenerator Maintains data integrity, ensuring time correlation
<b>Protocols</b>	Protocol independent, any sync or async
<b>Circuit under test</b>	
<b>Output to test equipment</b>	
Sync (with clock):	2.4, 4.8, 9.6, 19.2, 56.0, 64.0 KB/s
Async:	0.3, 1.2, 2.4, 4.8, 9.6, 19.2 KB/s
Leads:	Up to 8 leads, 100 lead transition/sec
Monitor:	DB-25 (female) RS-422 or DB-25 (male) RS-232-C
Regeneration:	DB-25 (female) RS-422
<b>Link</b>	
Sync (network clock):	Up to 256 KB/s
Protocol:	HDLC (requires passive link)
Physical interface:	34-pin Winchester V.35
<b>Command channel</b>	
Async:	9.6 KB/s
Modes of operation:	Communication to local RTM Communication to remote RTM Transparent between local and remote sites
Physical interface:	DB-25 (female) RS-232-C
<b>Test and analysis channel</b>	
Async:	9.6 KB/s
Mode of operation	Transparent between local and remote sites
Physical interface:	DB-25 (male) RS-232-C
<b>Voice channel</b>	
Mode of operation:	Phone (front panel) PBX (rear panel) Off hook detect Ring detect Transparent connection
Physical interface:	2-wire RJ-14

# DATA COMMUNICATIONS TEST EQUIPMENT

Signaling Test Set  
HP 37900D

605

- Multilink tester for network signaling (No. 7 and ISDN)
- Message sequence tracing
- Text decoding of levels 3 and 4 data
- Optional programmable emulation to network devices



HP 37900D



## HP 37900D Signaling Test Set

This high-performance network signaling tester can be used to test common-channel Signaling System No. 7 and ISDN protocols simultaneously. It provides slots for four 2.048 Mb/s, 1.544 Mb/s, or V.35/DS-0/DS-0A signaling interface cards (or for two RS-232-C/RS-449[422]) signaling and interface card pairs. Each signaling interface card supports single-link monitoring or dual-link emulation.

The base HP 37900D signaling test set provides No. 7 monitor-only capabilities on up to two signaling interfaces. Options allow up to four signaling interfaces to be controlled and ISDN and emulation capabilities to be added.

### Features

The HP 37900D is a portable test set capable of monitoring up to four bidirectional links simultaneously or emulating up to eight links.

#### Monitoring

The monitoring capabilities allow signaling events to be followed as they happen or signaling data to be recorded for later in-depth analysis.

#### Real time:

- Activity, message decode and statistics display
- Triggers, filters, or trace-facilities control-data collection

#### Post logging:

- Data management facilities (searches, selective views, statistics, and message sequence traces)
- Text decoding of levels 2, 3, and 4 data for No. 7 or LAPD

#### Emulation

Optional emulation capabilities allow the HP 37900D signaling test set to test the response of signaling equipment to specified messages or message sequences. Following user-written test scripts, the HP 37900D can generate and receive/match No. 7 and/or ISDN messages. Users can define up to 300 specific messages or define real-time message modifications. All signaling events (including unexpected events) during a test are time-stamped and recorded in a test log. Additionally, a test sequencer allows unattended testing.

## Assessing Network Signaling Performance

The HP 37900D is a versatile tool for use in design verification, troubleshooting, and maintenance of network signaling equipment and software. It simplifies signaling conformance, compatibility, regression, or cross-switch testing.

### Specifications

**Size:** 190 mm H × 370 mm W × 480 mm D (7.5 in × 14.5 in × 18.9 in)

**Weight:** Net, 13 kg (27 lb); shipping, 22 kg (46 lb)

### Basic Characteristics

RAM buffer for logging: 2.5 MB (expandable to 6.5 MB)

Built-in hard disk: 52 MB

Flexidisk drive: 3.5 in (1.44 MB)

Level 1 status: Front-panel LEDs (plus alarm analysis in software)

**Monitor Capture performance:** 100% MSUs per link (each direction)

Time-stamp for logged data: 1 millisecond accuracy

Triggers, filters, traces: include triggering on levels 2, 3, or 4

data and erroneous SUs and filtering of specified SUs or events

Text decodes (No. 7): CCITT Red book and Blue book, No. 7

national variants and applications, GSM, NTM900

Text decodes (ISDN): Q.921 and Q.931 (Blue book), Abis

**Emulate Message generation performance:** 100% MSUs

Real-time message manipulation: Yes

Time-stamped test log: Yes

Text decode of test log: Yes

### Ordering Information

Please contact your local Hewlett-Packard Sales and Support Office. See page 684.

# DATA COMMUNICATIONS TEST EQUIPMENT

## Protocol Analyzers/Media Scanners

HP 4972A and HP J2177A, J2181A, J2187A, J2201A, J2196A

### HP 4972A LAN Protocol Analyzer

The HP 4972A is a protocol analyzer for Ethernet, IEEE 802.3, and StarLAN local area networks. The analyzer captures and displays frames integral to communication between networked systems and devices. Statistical measurements provide information on fundamental parameters that instantly characterize network performance. Messages can also be transmitted in order to test system responses or simulate heavily loaded network conditions.

#### Features:

- Trends and statistics
- Network performance analysis
- Protocol interpreters
- Background traffic generation
- Programmable messages, tests
- Simultaneous transmit, receive



Trends and statistics of media-access layer parameters are easily monitored by the HP 4972A. Key measurements include utilization, errors and collisions, and station activity. The background traffic generator is user-configurable for stress testing of networked systems and devices.

Network performance analysis applications measure network and transport layer parameters for TCP/IP and DECnet networks. System activity by IP or DECnet address, and a distribution of frames by port or message type, are tabulated. Graphs of throughput, retransmissions, response time, and packet length analyze conversations at the transport layer.

Protocol interpreter applications present protocol header information in an easily understood manner and highlight common error conditions. Interpreters are available for TCP/IP, DECnet, Novell's NetWare, Sun Microsystem's NFS, XNS, and ISO protocols.

#### Physical Specifications

**Size:** 270 mm H × 430 mm W × 570 mm D (11 in × 17 in × 22 in)

**Weight:** net 21 kg (46 lb); shipping 27 kg (60 lb)

#### Ordering Information

<b>HP 4972A</b> LAN protocol analyzer	<b>Price</b> \$19,190
<b>Opt 001</b> RGB color output	\$1,500
<b>Opt 002</b> RS-232/V.24 remote interface	\$600
<b>Opt 005</b> StarLAN interface	\$500
<b>HP 18221A</b> TCP/IP protocol interpreter	\$960
<b>HP 18222A</b> TCP/IP network performance analysis	\$960
<b>HP 18223A</b> XNS protocol interpreter	\$960
<b>HP 18224A</b> DECnet protocol interpreter	\$960
<b>HP 18225A</b> DECnet network performance analysis	\$960
<b>HP 18226A</b> ISO protocol interpreter	\$960
<b>HP 18227A</b> NetWare protocol interpreter	\$960
<b>HP 18228A</b> NFS protocol interpreter	\$960

### LAN Media Scanners



Hewlett-Packard offers 5 hand-held, battery-powered local area network (LAN) media scanners for quickly isolating wiring problems on LANs. For token-ring shielded or unshielded twisted-pair, 10Base-T, Ethernet thick- or thin-LAN, Arcnet, or almost any LAN, these easy-to-use products are designed to find the most common wiring faults.

#### J2187A Quick Scanner

The J2187A Quick Scanner uses TDR (time domain reflectometer) technology to detect and locate discontinuities in all kinds of twisted-pair and coaxial LAN cabling systems. Results are reported in plain English; for example, "Short at 53 ft."

#### J2181A Cable Scanner

The J2181A Cable Scanner provides the same TDR functionality as the J2187A, but adds the ability to measure electrical noise and dc resistance, and to print or store measurement results.

#### J2177A Pair Scanner

The more powerful J2177A Pair Scanner offers all of the capability of the J2181A along with measurement of signal loss, 10Base-T hub activation, and remote alarm generation.

#### J2201A NEXT Scanner

The J2201A NEXT Scanner combines all of the features of the above-listed 3 products and more. Designed to help installers and network managers certify new or existing wiring systems, the NEXT Scanner's autotest capability will automatically select and execute the appropriate tests for the chosen network type, including measurement of near-end crosstalk (NEXT) and signal attenuation measurements from 1 to 20 MHz. The optional cable management software package provides up-to-date records of the physical parameters of every part of your LAN.

#### J2196A Ring Scanner

The J2196A Ring Scanner was specifically designed to troubleshoot problems on token-ring LANs. At a fraction of the cost of more complex token-ring testing products, the HP Ring Scanner will quickly detect cabling problems, isolate defective MSAUs, and verify proper installation and operation of both 4 and 16 Mbps token-ring networks.

Each HP scanner is backed by a full 3-year hardware warranty (parts and labor), and is serviced and supported by Hewlett-Packard worldwide.

#### Physical specifications

**Size:** 19 cm H × 10 cm W × 2.5 cm D (7.5 in × 4.0 in × 1.0 in)

**Weight:** 0.5 to 0.9 kg (1 to 2 lb)

#### Ordering Information:

<b>HP J2187A</b> Quick Scanner	<b>Price</b> \$995
<b>HP J2181A</b> Cable Scanner	\$1,495
<b>HP J2177A</b> Pair Scanner	\$2,495
<b>HP J2201A</b> NEXT Scanner	\$3,495
<b>HP J2196A</b> Ring Scanner	\$1,295

Contact your local Hewlett-Packard sales office for information on the availability of different options, including test kits for specific network types and ac battery chargers for various destination countries.



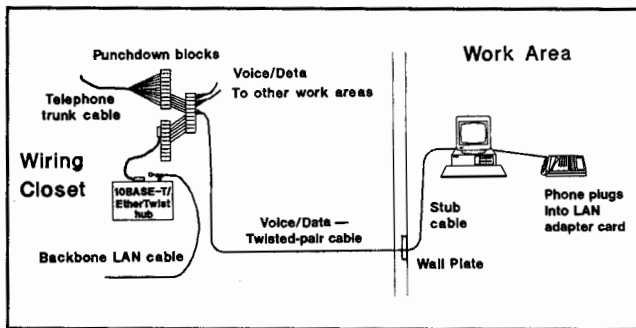

Twisted-pair cable installation

### Twisted-Pair for LANs

Twisted-pair phone cable is emerging as the most popular Ethernet LAN media. This new use of twisted-pair cable for data communications is driven by its many benefits: low cost, may already be installed, single media for both voice and data communications, support of a structured wiring system, as well as simple installation and administration. These benefits, combined with the finalization of the IEEE 802.3 10BASE-T standard, establish twisted-pair as the preferred alternative to networking with coaxial cable.

However, all twisted-pair cable is not suitable for support of 10-Mb/s data traffic. Developed and installed for voice use only, some twisted-pair cable is of poor quality, may be installed improperly, or may exist in a noisy environment. Because all of these factors affect signal quality and transmission, cabling should be evaluated prior to supporting a 10BASE-T network. The 10BASE-T standard has defined parameters for twisted-pair cable in the areas of signal attenuation, burst noise, impedance, and crosstalk attenuation.

### Testing Twisted-Pair LAN Cable

For optimum network utilization, twisted-pair cable should be tested when it is newly installed, when it is part of an existing cabling system, and as part of a troubleshooting procedure when isolating faults in a network. And because installation procedures (e.g., number of cross-connects in cable path) affect signal quality, cable should be tested after installation.

### IEEE 802.3 10BASE-T Standard

The IEEE 802.3 10BASE-T standard defines transmission of Ethernet/802.3 data over twisted-pair cable. Following are the key parameters specified:

#### Crosstalk attenuation

Crosstalk in twisted-pair cable is caused by electrical interference from adjacent twisted-pairs. Crosstalk attenuation can be measured two ways: near-end crosstalk attenuation (pair-to-pair) and multiple-disturber crosstalk attenuation (bundled). Near-end crosstalk is measured between one transmit pair and one receive pair within a cable. Multiple-disturber crosstalk is measured between one receive pair and multiple transmit pairs in bundled (25-pair) cables.

#### Attenuation

Attenuation is a measure of how much the signal amplitude decreases during transmission from one point to another. Cable quality, untwisted cable, too many cross-connect blocks, cable length, and temperature of cable's path can all affect the cable's attenuation.

#### Burst noise

Burst noise is electrical noise picked up by the cabling from an outside source (e.g., electrical equipment). If this noise is sufficiently powerful, data traffic will be corrupted.

#### IEEE 802.3 10BASE-T Specifications

	Frequency	Specification	
Attenuation*	5 MHz	≤ 11.5 dB	
	10 MHz	≤ 11.5 dB	
Crosstalk attenuation	Near-end (4-pair)	5 MHz	≥ 30.5 dB
		10 MHz	≥ 26 dB
	Multiple-disturber (25-pair)	5 MHz	≥ 27.5 dB
		10 MHz	≥ 23.0 dB
Burst noise	—	≤ 264 mV	

\* For twisted-pair cable that is not installed, the specification is 10 dB. This allows 1.5-dB attenuation for various connectors used when the cable is installed.

In addition to testing for IEEE 802.3 10BASE-T specifications, the HP 28687A wire test instrument also tests for opens, shorts, or miswiring of data pair-wires.

For information on HP's solution for testing twisted-pair LAN cabling, see the following page on the HP 28687A wire test instrument. For information on HP's complete family of 10BASE-T products pictured below (HP EtherTwist), contact your local HP sales office (see page 684) or your HP LAN dealer.



# DATA COMMUNICATIONS TEST EQUIPMENT

## Wire Test Instrument

HP 28687A

- Troubleshooting and verification of type 10BASE-T cable
- Easy to use

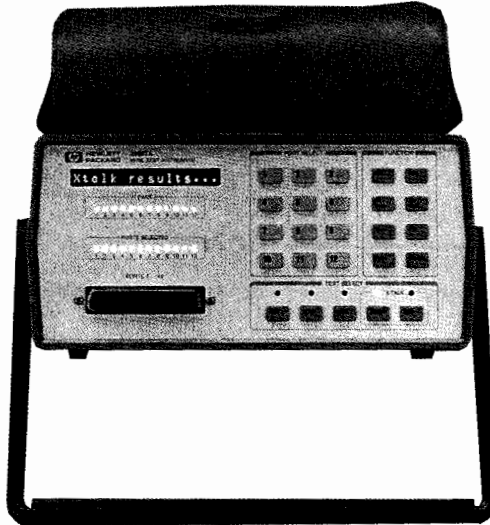

HP 28687A

### HP 28687A Wire Test Instrument

The portable HP 28687A wire test instrument verifies and troubleshoots twisted-pair LAN cabling for Type 10BASE-T networks. It lets the user quickly and easily perform the necessary tests to evaluate the key parameters specified by the IEEE 802.3 10BASE-T standard.

#### Complete Testing of Type 10BASE-T Cable

Twisted-pair LAN cable, unlike coaxial cable, allows for variations in physical characteristics and has dynamic performance requirements such as crosstalk, signal attenuation, and installation-dependent specifications. Tools developed for the telephone industry are not specialized to test for these specification requirements. The HP 28687A wire test instrument can quickly identify problems in these areas. Designed specifically to test for compliance to the IEEE 802.3 10BASE-T standard, the HP 28687A lets you easily verify and troubleshoot twisted-pair LAN cabling.

#### Easy to Use

This lightweight, portable unit saves time by simplifying the complex task of testing twisted-pair cabling. Individual tests or combinations of tests can be run, and up to 24 pairs (12 10BASE-T connections) can be tested simultaneously. The alphanumeric display steps you through the test procedures and gives you complete diagnostic information when you want it. An RS-232 printer port also allows you to quickly get a copy of the results. Twelve green LEDs indicate whether the pairs have passed or failed the test(s). Intermittent cabling problems can be identified by pushing the monitor button, which performs the selected tests and compiles statistical parameters for up to 24 hours.

#### Troubleshooting

Network downtime is expensive. While the costs of a downed network cannot always be quantified, daily business depends on a functional network. With the HP 28687A, cable problems can be easily and quickly identified.

#### Verification

To avoid intermittent problems and performance degradation, both new and in-place twisted-pair cabling should be evaluated prior to usage as a LAN medium. The HP 28687A wire test instrument verifies the suitability of in-place twisted-pair cable for your 10BASE-T network prior to usage as a local area network cabling system.

### HP 28687A Features

- The HP 28687A wire test instrument tests key parameters for Type 10BASE-T networks: crosstalk attenuation, signal attenuation over frequency, burst noise, and continuity. (Crosstalk attenuation and signal attenuation are measured using 5-MHz sine waves, 10-MHz sine waves, and 10-Mb/s pseudo-random Manchester-encoded data.)
- For added flexibility, the HP 28687A evaluates both bundled 25-pair and individual 4-pair twisted-pair cabling.
- Weighing less than 10 pounds, this unit is easily portable to any wiring closet or cable run.
- A built-in RS-232 printer port makes it easy to get hard-copy results at any time.
- Monitor function allows user-selected tests to be performed over a 24-hour period.
- To ensure reliability, the HP 28687A runs a self-test at power-on and recalibrates periodically during use.
- Easy-to-read LEDs indicate which ports have been selected for testing, which tests have been selected, and which ports have passed or failed.
- To make wiring connections quickly, the HP wire test instrument includes a built-in 50-pin Telco connector as well as a 12-port modular adapter for 8-pin jacks.

### Physical Specifications

**Size:** 27.9 cm H × 34.3 cm W × 15.9 cm D (11.0 in × 13.5 in × 6.3 in)

**Weight:** 4.1 kg (9.0 lb)

### Measurement Specifications

	Measurement Range	Accuracy	Resolution
Signal attenuation	0 to 15 dB	± 0.5 dB	0.1 dB
Crosstalk attenuation	0 to 36 dB	± 1.0 dB	0.1 dB

**Burst noise:** 232 mV minimum ± 32 mV

Measurement made through a 3-pole Butterworth low-pass filter with a 3-dB cut off at 15 MHz

#### Source characteristics

**Frequency range:** 5-MHz sine wave, 10-MHz sine wave, 10-Mb/s pseudo-random Manchester-encoded data

**Output level range:** 1.25 volts peak ± 250 mV

**Impedance:** 100 Ω ± 10 Ω

**Output connector:** 50-pin Telco connector

#### Receiver characteristics

**Frequency range:** 5 MHz to 15 MHz

**Input level range:** 20 mV peak to 1.5 V peak

**Impedance:** 100 Ω ± 10 Ω

**Input connector:** 50-pin Teleco connector

### Ordering Information

HP 28687A Wire test instrument

**Price**

\$6.500

# DATA COMMUNICATIONS TEST EQUIPMENT

Network Advisors

HP 4980A, HP 4981A, and HP 4982A

609

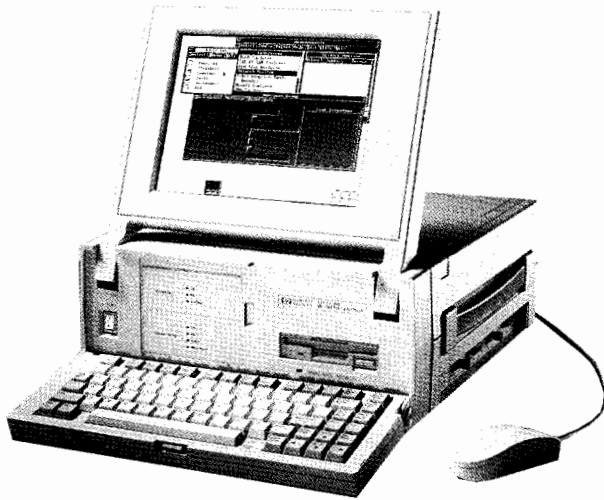

## HP Network Advisor

Have the full-time help of Ethernet and Token-Ring experts to quickly solve networking problems. The Fault Finder expert system within the HP network advisor combines the practical experience of troubleshooting experts and computer automation to identify and solve common networking problems. In addition, the HP network advisor offers a comprehensive set of network statistics and protocol decodes to speed problem resolution.

### Features

- Expert system technology quickly solves networking problems
- Statistics show network performance at a glance
- Understands network protocols
- Token-Ring and Ethernet network interfaces
- Industry standard MS-DOS operating system
- Lightweight, integral package

### Automated troubleshooting

The Fault Finder's rule-based expert system takes user-furnished symptoms, then iteratively develops hypotheses and performs measurements until a conclusion is reached. Not only are problems discovered, but Fault Finder's reasoning and potential solutions are detailed on-screen. In case a problem is not conclusively found, the HP network advisor will list the possible problems and leave a detailed record containing what has been learned about your network.

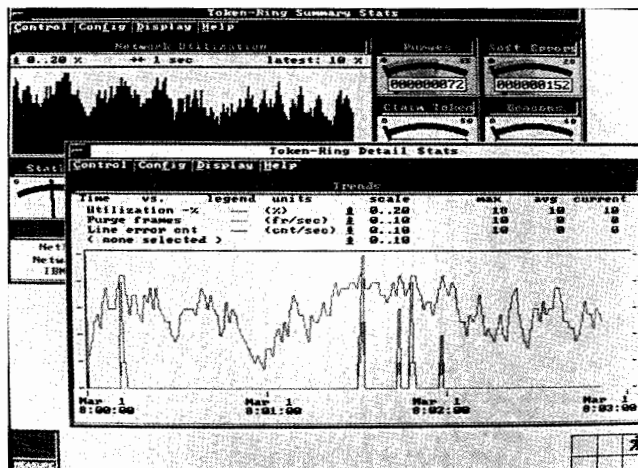

### Network performance at a glance

The HP network advisor also presents you with a comprehensive set of network and node statistics, consolidating information to give you a feel for the overall status of your network.

Critical Ethernet measurements such as utilization, collisions, errors, and protocol distribution are distilled onto a single screen. For Token-Ring networks, the HP network advisor takes advantage of the MAC layer network management functions to tell you even more about your network. Beacons, claim tokens, and a complete breakdown of report soft error contents, along with utilization, are plotted simultaneously.

When key indicators of network performance exceed network norms, you are automatically alerted and notified of the condition. The event log will also contain a notation detailing the potential problem.

### Understands network protocols

When it becomes necessary to examine the contents of frames, the HP network advisor provides a complete set of decodes. Decodes for all the major protocols (TCP/IP, DECnet, Novell, NETBIOS, 3COM, SNA, IBM PC, etc.) come standard with the HP network advisor. The HP network advisor's built-in protocol knowledge extends beyond just decoding packets. Protocol violations such as checksum, length field, and sequence number errors are brought to your attention.

### Convenient system platform

The HP network advisor is contained in a lightweight and portable package, making it easy to dispatch to a problem site. The display and keyboard are hinged to facilitate rackmount and floor standing as well as desktop operation. An optional state-of-the-art VGA resolution flat-panel color display greatly enhances the user interface of the instrument. The system runs on a 20-MHz 386SX personal computer and can be used to run standard MS-DOS applications when not used for network troubleshooting.

### Physical Specifications

**Size:** 150 mm H × 363 mm W × 427 mm D (5.9 in × 14.3 in × 16.8 in)

**Weight:** 11.4 kg (25 lb)

### Ordering information

	Price
<b>HP 4980A</b> Combination Ethernet and Token-Ring network advisor	\$25,500
<b>HP 4981A</b> Ethernet network advisor	\$19,500
<b>HP 4982A</b> Token-Ring network advisor	\$19,500
<b>Opt 002</b> 16-MB extended capture buffer	+ \$1,000
<b>Opt 1CF</b> Carrying Case	+ \$200
<b>Opt AMJ</b> Replace 52-MB hard disk with 105-MB hard disk	+ \$500
<b>Opt ADW</b> Replace monochrome display with color display	+ \$3,500
<b>Opt 100</b> Ethernet parallel port adapter	+ \$595
<b>Opt 101</b> Token-Ring parallel port adapter	+ \$845

# DATA COMMUNICATIONS TEST EQUIPMENT

## Distributed LAN Analysis System

HP 4991A and 4990A

- Enables a network manager to monitor all critical aspects of a remote or local network from a central console
- A distributed system — completely independent of network equipment and protocols
- Tracks many problems on an Ethernet LAN — cable information, communications software, traffic load, equipment malfunctions, user errors
- Installed in minutes

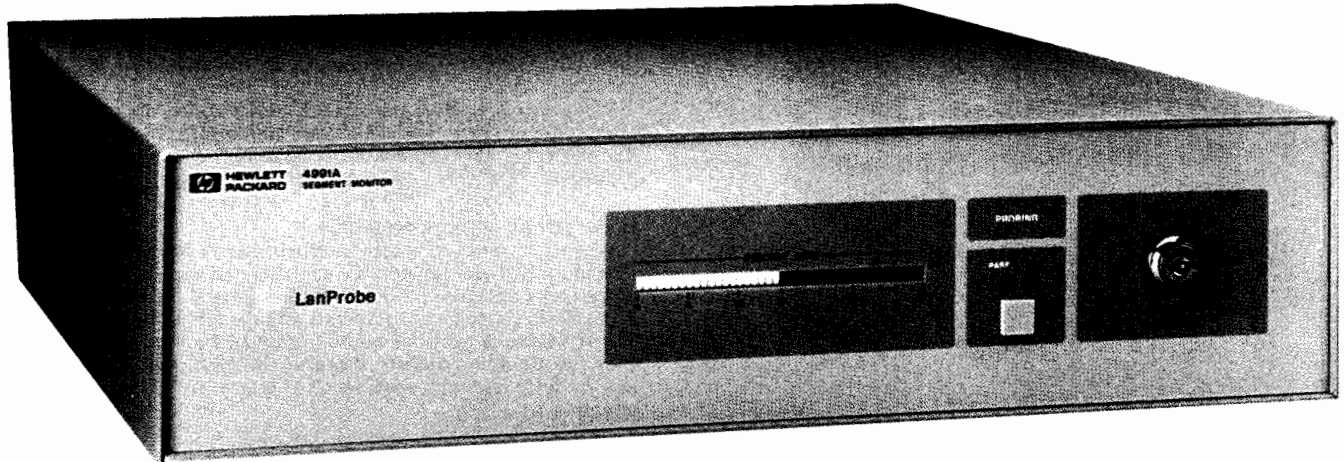

HP 4991A

The LanProbe system consists of one or more LanProbes attached to Ethernet network segments, and one ProbeView software application running on a central PC.

### HP 4991A LanProbe Segment Monitor

The LanProbe monitors all traffic on the Ethernet and collects information on node traffic on the segment. It attaches to the end of an Ethernet segment. Attachment can be direct to a thin- or thick-coaxial cable, or via an external transceiver to fiber optic or twisted-pair cabling. It collects information on: total packets, utilization, broadcasts, multicasts, and various types of errors. This information is transmitted to ProbeView software where data is displayed in graphical form. The optional NodeLocator (for coaxial cable) allows automatic mapping of nodes to within 10 feet of the actual distance. The LanProbe also performs cable tests on its segment and marks the map where the cable disconnect has occurred. Remote out-of-band access is provided through an integral 2400 baud modem or an external Hayes-compatible modem.

### HP 4990A ProbeView Software

HP ProbeView software requires an HP Vectra, IBM PC/AT, PS/2, or compatible Intel386-class workstation and runs under Microsoft® Windows 3.0. ProbeView displays a segment map with all of the nodes discovered by the LanProbe. Data collected by the LanProbe on network activity is displayed in graphical form for quick overview of network activity. An alert manager, set from within ProbeView, operates independently to allow the user to be notified if a defined threshold is exceeded in any one of the following areas: utilization, packets, bytes, broadcasts, errors, collisions. A log also records these and other significant network events. A trace facility uses existing or user-defined filters to capture and display packets. An optional protocol analysis feature (Option 200) allows the decoding of the following protocols: 802.2 or 802.3, TCP/IP, ARPA, XNS, DECnet, Novell, OSI, Banyan, and Appletalk. The map, trends, node traffic, and log information can be exported manually into CSV (comma separated variable) files or automatically through the AutoPolling and autoexport feature.

Connection to the Ethernet requires HP ARPA Services 2.1 (or later) software. RS-232C connections require no additional support.

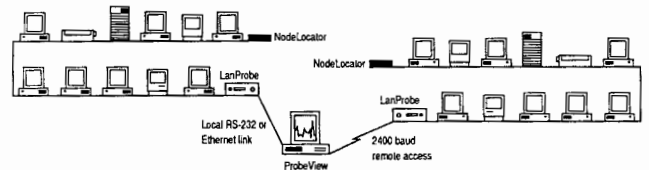

The network is managed locally or remotely.

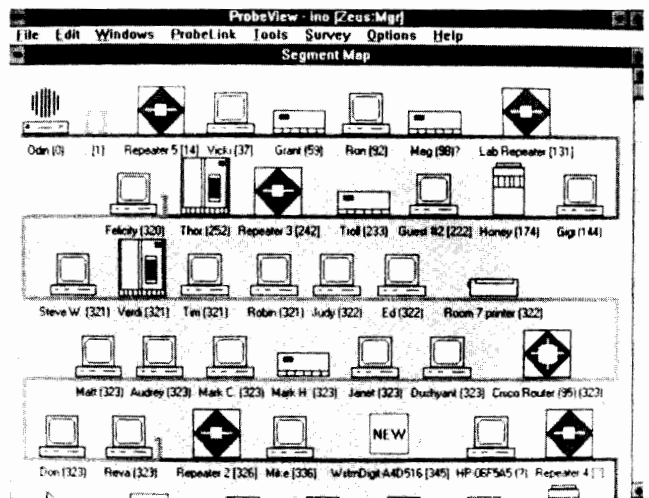

The segment map drawn by ProbeView software identifies and displays devices that are active on the monitored segment.

# DATA COMMUNICATIONS TEST EQUIPMENT

Distributed LAN Analysis System

HP4990S

611

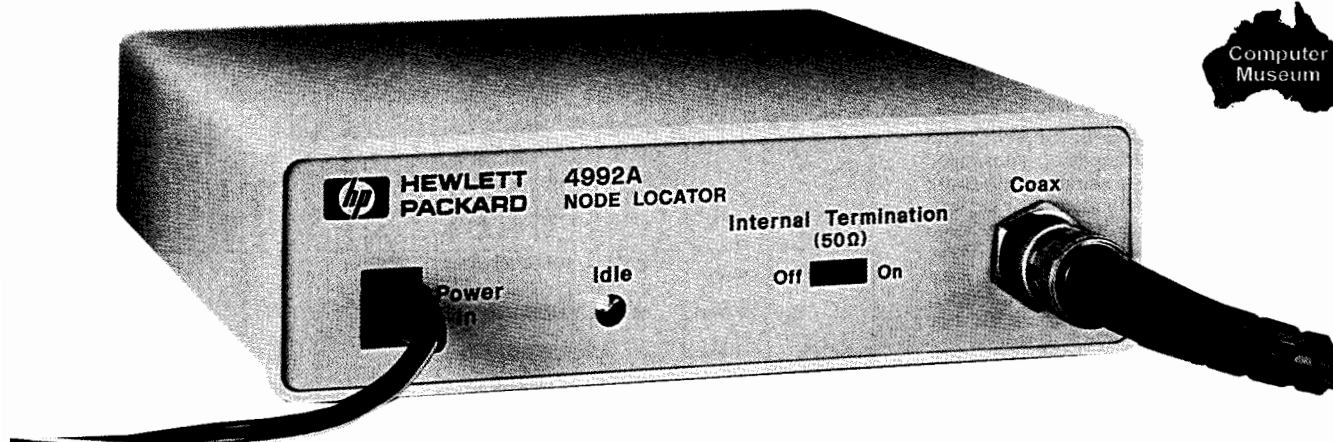

HP 4992A

The HP 4992A NodeLocator option attaches to the opposite end of the cable from the HP 4991A LanProbe segment monitor. It automatically locates the position of nodes on Ethernet networks using coaxial cabling schemes.

Installed in minutes, the LanProbe system quickly and automatically identifies all active nodes on a segment and displays them, with their adapter card vendor name and Ethernet address, on a map. You can enter additional information about the nodes, such as equipment types and physical location, into the database by clicking on an icon and typing it in.

When the NodeLocator option is used, data on the actual location of the nodes is automatically entered, and the map becomes an accurate representation of the physical layout of the segment. Thereafter, when a new node is installed and becomes active, or when a node is moved or becomes inactive, the change is detected and shown on the map in real time. The system also provides the network manager with precise cable fault information. When a fault is detected the manager workstation is alerted and the precise location of the fault is specified on the map.

The system's interactive capabilities ensure easy LAN management. The LanProbe system continuously monitors vital parameters of the LAN segment. Traffic statistics are gathered and displayed and can be exported in (comma separated variable) CSV format for further analysis. In addition, a library of predefined filters and network tests run concurrently, collecting valuable diagnostic information.

The LanProbe system provides an unmatched tool for documenting and monitoring your network.

## Features

- Network and segment maps identify nodes, addresses, and position.
- Real-time update of the maps via NodeLocator.
- Cable test option detects and reports breaks, shorts, and faulty termination.
- Statistics chart LAN utilization and performance in real time and over a period of time.
- Traces all packets or specific packets.
- Alerts based on user-definable thresholds and entry into a log.
- Remote access with built-in 2400 baud modem.
- Continuous monitoring of the LAN.
- Concurrent and interactive operation of all tools.

## Specifications

### HP 4991A LanProbe segment monitor

**Network Compatibility:** Ethernet version 2.0, IEEE 802.3

**Size:** 10.5 cm H × 41.4 cm W × 44.5 cm D (4.15 in × 16.3 in × 17.5 in)

**Weight:** 7.26 kg (16 lb)

### HP 4992A NodeLocator

**Network Compatibility:** Ethernet version 2.0, IEEE 802.3

**Size:** 41.7 cm H × 14.15 cm W × 18.29 cm D (1.64 in × 5.57 in × 7.20 in)

**Weight:** 0.55 kg (1.2 lb)

### HP 4993A ProbeView Console

Includes: Vectra 386/25 Personal Computer, 84 Mbyte half-height disk drive with embedded controller, 4 Mbyte memory, 3.5 in floppy drive, VGA color display, MS Windows-compatible HP mouse, HP 27250A ThinLAN card, MS-DOS\* USA, Microsoft\* Windows USA, HP 4990A ProbeView Manager Software, HP ARPA Services D1812B.

## Ordering Information

	Price
<b>HP 4990S</b> LanProbe distributed LAN analysis system	
<b>HP 4991A</b> LanProbe segment monitor	\$4,995
<b>Opt 001</b> LanProbe, deletes cable test, BNC connector, and NodeLocator capability	-\$300
<b>Opt 002</b> LanProbe, deletes internal modem	-\$225
<b>Opt 003</b> LanProbe, deletes cable test, BNC connector, internal modem, and NodeLocator capability	-\$525
<b>HP 4992A</b> NodeLocator	\$975
<b>HP 4993A</b> ProbeView Console	\$10,730
<b>Opt 003</b> Adds an additional 2 Mbyte of memory	\$599
<b>Opt 004</b> Adds an additional 4 Mbyte of memory	\$1,198
<b>Opt 005</b> Deletes ProbeView Manager Software, adds ProbeView Observer Software	-\$4,050
<b>Opt 006</b> Adds 5.25 in floppy disk drive	\$275
<b>Opt 007</b> Deletes ThinLAN card, adds EtherTwist card	-\$55
<b>Opt 008</b> Adds protocol analysis capability	\$2,000
Localization option must be selected. Please contact your local HP sales office for information.	
<b>HP 4990A</b> ProbeView Manager Software	\$5,000
<b>Opt 100</b> Adds ProbeView Observer Software with ProbeView Manager Software	\$950
<b>Opt 200</b> Adds protocol analysis capability to ProbeView Manager Software	\$2,000
<b>HP 18490A</b> ProbeView Observer Software only	\$950
<b>HP 18491A</b> Protocol Analysis capability only	\$2,000

Intel386 is a U.S. trademark of Intel Corp.  
Microsoft is a U.S. registered trademark of Microsoft Corporation.  
MS-DOS is a U.S. registered trademark of Microsoft Corporation.

# DATA COMMUNICATIONS TEST EQUIPMENT

## General Information: Voice and Data Testing

### Data Network Testing

There is a wide variety of tests that can be made on a data communications system. Depending on the point in the system at which the tests are made, quite different philosophies and techniques apply.

Protocol analysis is usually concerned with overall network performance, determined through monitoring or simulating network software (protocol and/or data). Digital testing involves measuring overall transmission efficiency in terms such as Bit Error Ratio (BER) and Block Error Ratio (BLER). Analog testing measures the tariffed and other key parameters of the transmission line itself.

### Digital Measurements

Bit error rate testers are used to test the quality of both the customer premises equipment and the transmission facility. They mainly test the data communications equipment (DCE) and transmission line, but also can test the data terminal equipment (DTE).

The overall quality of the link is indicated by its BER. A good link will have a bit error ratio of better than  $1 \times 10^{-5}$ . For analog datacom, this measurement will include the effect of both transmission line impairments and the modem's ability to overcome them.

Since data communications systems transmit data and control information in blocks, bit error rate testers also measure BLER and Percent Error Free Seconds (%EFS). BER, BLER, and %EFS can be used together to examine the statistics of the error mechanism.

If the BER and BLER are both high, and %EFS low, the impairment is random and probably due to noise. If the BER and %EFS are high but the BLER is low, the impairment is more bursty. This happens when lines are switched, synchronization is temporarily lost, or impulse noise is too high.

Error rates are quantitative checks of the data communications system that can be made in a few minutes. If the system is bad, diagnostic measurements are provided to help isolate the problem.

### Voice and Data Testing

Control-circuit timing analysis allows accurate pinpointing at datacom interfaces. By showing the exact timing relationships between interface control signals, it quickly finds faults such as incorrect or delayed handshaking. RS-232/V.24 breakout facilities built into testers allow experimenting with cable configurations and hardwiring circuits on or off. Graphic results presentation shows a histogram of errors and alarms against time, allowing correlation of error bursts against external causes. Knowing exactly when errors have occurred helps establish their cause.

Analog Datacom Testing

	Instrument	In-Service Testing		Basic Testing						Conditioned Circuit Testing			Additional Testing for Complete Troubleshooting						
		Bell	CCITT	Loss Continuity	Noise, Loss vs Frequency	Signal/Noise Ratio	Impulse Noise	Wideband Impulse Noise	P/AR	Envelope or Group Delay	Attenuation Distortion	NLD or Intermodulation Distortion	Phase Jitter	Amplitude Jitter	Hit Dropouts	Return Loss	Loop Holding	HP-IB	Auto End-to-End Testing
	HP 4934A		*																
	HP 4935A																		
	HP 4936A																		
	HP 4947A																		
	HP 4948A																		

\* Options J01 (820 Hz hold tone) and J02 (1020 Hz hold tone)

Digital Datacom Testing

	Instrument	Access/Rate (b/s)				Capability						
		RS-232V.24	V.35	RS-449V.11/X.21 Luased	G.703 Coctrifactional	Telecom	G.821 Analysis	Round Trip Delay	Circuit Timing Analysis	RS-232V.24 Breakout	Remote Control	Printer Output
	HP 3784A			2M	64k	1k to 50M						
	HP 3787B					DDS/DS1/DS1C						
	HP 3788A				64k	704k/2M						
	HP 4925B	72k	72k									
	HP 37701A					T1						
	HP 37711A	64k	1.5M	1.5M		T1						
	HP 37722A				64k	2M						
	HP 37732A	64k	2M	2M	64k	2M						

### Analog Impairments Affect Performance

For analog datacom, impairments on the telephone line can significantly affect the efficiency of data communications. What the user notices is a slow down in throughput (because of frequent retransmission of blocks of data), garbled data, or no data at all. These effects are a result of the line impairments distorting the modem signal so that the receiving modem cannot make correct decisions. Data bits and blocks are received in error.

The various modem types are susceptible to each impairment in differing degrees. Low speed modems generally use simple modulation schemes and are mostly affected by problems of continuity, loss, signal-to-noise ratio, and impulse noise.

As modem speeds increase, the modulation schemes become more complex and so they are more susceptible to impairments. To significantly reduce the impairing effects and improve error performance, specially selected and conditioned leased telephone lines are used.

So there is a need for testing: by the circuit supplier, when he installs or repairs a conditioned circuit, to check if impairment levels are within the agreed limits; by the circuit user, to ensure he is getting the quality of circuit he is paying for.

# DATA COMMUNICATIONS TEST EQUIPMENT

## Transmission Impairment Measuring Sets (TIMS)

HP 4934A, 4935A, 4935S, 4936A, 4947A, 4948A

613

- Complete analog testing to North American and CCITT standards
- Testing of voice-grade data circuits, program circuits, metallic digital circuits



HP 4934A

### HP 4934A TIMS

The HP 4934A transmission impairment measuring set (TIMS) increases installation and maintenance productivity for telephone companies and service providers through its ease of use, portability, and ruggedness. Hewlett-Packard offers versions of the HP 4934A that perform measurements to either IEEE 743 or CCITT specifications, including:

- Level/frequency up to 110 kHz
- Noise and noise-to-ground
- Noise-with-tone and signal-to-noise ratio
- 3-level impulse noise
- P/AR (North American version only)

Battery power is available as an option.

### HP 4947A TIMS

The HP 4947A is a full featured transmission impairment measuring set with HP-IB remote control for use in installation, maintenance, and manufacturing. The HP 4947A provides measurements to IEEE 743 (North American) standards, supplemented by a special option for a psychometric noise filter, and level/frequency to 5 kHz.

### HP 4935A/4936A TIMS

The HP 4935A/4936A transmission impairment measuring sets are rugged, portable test sets that provide the basic analog tests to isolate faults and to qualify circuits for voice, data, and broadcast services. The HP 4935A performs measurements compatible with the Bell (BSTR 41009) and IEEE (IEEE 743-1984) standards. The HP 4936A is compatible with CCITT recommendations. The HP 4935S data transmission test system consists of the HP 4935A TIMS plus the HP 4925B bit error-rate test set.

The HP 4935A/4936A measure: Level, frequency, circuit noise, noise-with-tone, signal-to-noise ratio, 3-level impulse noise (quiet) (HP 4936A), 3-level impulse noise (quiet or tone) (HP 4935A), noise-to-ground (HP 4935A), and P/AR (HP 4935A option).

- Wide choice ranging from rugged portables to systems instruments, including unique in-service TIMS

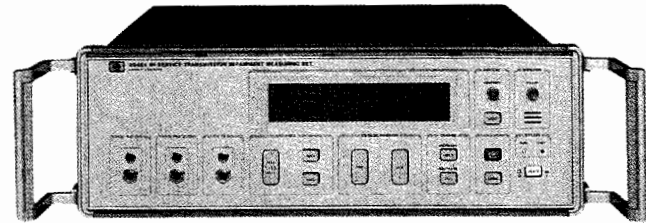

HP 4948A

### HP 4948A In-Service TIMS

The HP 4948A transmission impairment measuring set provides unique in-service measurements (North American and CCITT) on voice-grade modem circuits using the live traffic signal. It is ideal for preventive maintenance and use in network monitoring systems. The HP 4948A measures:

- Level/frequency
- Signal-to-noise ratio
- Phase and amplitude jitter
- Dropouts, gain hits, phase hits
- Impulse noise
- Attenuation and delay distortion

### Ordering Information

	Price
<b>HP 4934A TIMS</b> , including front-panel cover, power cord, 2 HP 15513A test cords (with WECO 310 jack plugs)	\$2,790
<b>Opt 001</b> Battery Pack with Built-In Charger	+ \$300
<b>Opt 010</b> Delete Test Cords	- \$100
<b>Opt J01</b> Replaces North American Features and Connectors with CCITT; 820 Hz Hold Tone; Deletes Test Cords	+ \$700
<b>Opt J02</b> same as J01, Except 1020 Hz Hold Tone	+ \$700
<b>HP 4947A TIMS</b>	\$11,800
<b>Opt 908</b> 19-in. Rackmount Kit	+ \$41
<b>HP 4935A TIMS (North American)</b>	\$3,830
<b>Opt 001</b> Rechargeable Batteries	+ \$380
<b>Opt 002</b> Add P/AR Measurement, Delete Noise-to-Ground	+ \$155
<b>Opt 003</b> Add Options 001 and 002	+ \$465
<b>HP 4936A TIMS (CCITT)</b>	\$4,880
<b>Opt 001</b> Include 820 Hz Tone, Add Rechargeable Batteries	+ \$535
<b>Opt 002</b> 1020 Hz Tone Replaces 820 Hz	\$0
<b>Opt 003</b> Add Options 001 and 002	+ \$535
<b>HP 4935S data transmission test system</b>	+ \$5,405
<b>Opt 001, 002, 003</b> Same as HP 4935A	
<b>Opt 101</b> RS-232/V.24 on HP 4925B	+ \$420
<b>Opt 102</b> V.35 Interface and 115 V Power Module (HP 18185A) on HP 4925B	+ \$620
<b>Opt 104</b> V.35 Interface and 220 V Power Module (HP 18194) on HP 4925B	+ \$660
<b>HP 4948A In-Service TIMS</b>	\$13,690
<b>Opt 006</b> 14.4 kb/s V.33 Capability	+ \$1,010
<b>Opt 908</b> 19-in. Rack Mount Kit	+ \$35
<b>Accessories</b>	
<b>HP 15513A</b> 1 m Cable, WECO 310 Jack Plug Each End	\$62
<b>HP 18134A</b> Vinyl Carrying Case for HP 4934A, HP 4935A	\$144
<b>HP 18182A</b> 1.5 m Cable, WECO 310 Jack Plug to Alligator Clips	\$67

# DATA COMMUNICATIONS TEST EQUIPMENT

## Telecom/Datacom Test Sets

HP 37732A, 37711A

- Combined telecom and datacom testing in one analyzer; no need for separate test sets or plug-ins
- Eight interfaces in one analyzer
- Powerful results storage without using printer
- Rugged, portable, easy to use

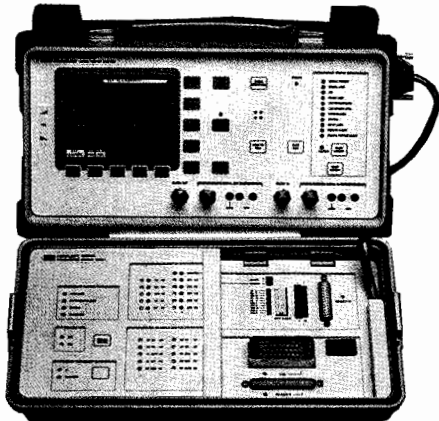

HP 37732A

### HP 37732A Telecom/Datacom Analyzer

The HP 37732A is a lightweight, field-portable, and rugged test set that combines the full telecom testing capability of the HP 37722A digital telecom analyzer (see page 585) with datacom testing. The HP 37732A telecom/datacom analyzer consists of the HP 37722A and the HP 15901A Option 001 datacom module.

The HP 37732A provides testing at V.24, V.35, V.11/X.21-leased interfaces at rates up to 2 Mb/s. It also provides a full range of BER/BLER measurements; control-circuit timing analysis with transition diagrams on the screen; a built-in V.24 breakout box; and an internal synthesizer. It offers 80 days' results storage in text and graphic form.

The HP 37732A reduces test time and speeds problem resolution by simplifying test setup. It presents results in easy-to-read and easy-to-record ways that make it easy to pinpoint the cause of a problem.

#### Applications

- Installation of digital telecom circuits and services
- Long-term network monitoring
- Maintenance and troubleshooting

#### Specifications

Telecom testing, remote control, power supply, and size specifications as HP 37722A (see page 585).

**Datacom interfaces:** V.24, V.35, V.11/X.21-leased

**Data rates:** 50 b/s to 2.048 Mb/s (synchronous: built-in synthesizer); 50 b/s to 19.2 kb/s (asynchronous)

**V.24 breakout:** Patch points, monitors, voltage sources, and switches

**V.11/V.35:** Activity indicators on data, clock, and control circuits

**Test patterns:** 63-bit, 511-bit, 2047-bit,  $2^{15}-1$ ,  $2^{20}-1$ , all 1s, all 0s, 3 to 16-bit user-definable word, FOX word

**Measurements:** Errors, BER, blocks, block-errors, BLER, error seconds, % EFS, Tx and Rx frequency, alarm seconds, clock slips, alarms, G.821 analysis

**Control-circuit timing:** Measures times between selectable start/stop events; timing range 100 ms, 1s, 10s

**Transition diagrams:** For RTS, CTS, DTR, DSR and DCD

**Weight:** 5.9 kg (12.5 lb)

#### Ordering Information

	Price
<b>HP 37732A Telecom/Datacom Analyzer</b>	\$8,280
<b>Opt 001 Time Slot Access</b>	+\$670
<b>Opt 002 8 Mb/s (unframed)</b>	+\$340
<b>Opt 003 704 kb/s (framed and unframed)</b>	+\$560
<b>Opt 004 Small Siemens Connectors</b>	\$0
<b>Opt 005 Sub-Rate Processing</b>	+\$1,110

- Combined T1 & datacom testing up to 1.5 Mb/s; no need for separate testers or plug-ins
- Four datacom interfaces in one test set
- Powerful results storage and analysis without using printer
- Rugged, portable, easy-to-use

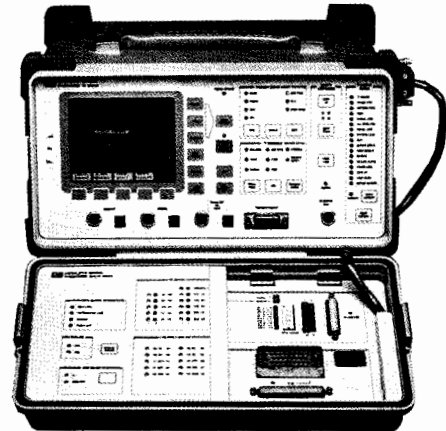

HP 37711A

### HP 37711A T1/Datacom Test Set

The HP 37711A tests at T1 (DSX and line), RS-232, RS-449 (balanced), and V.35 interfaces. The instrument consists of the HP 37701A T1 tester (see page 587) plus the HP 15901A datacom module (available separately for existing HP 37701A users). In addition to a full range of BER tests, the HP 37711A performs timing analysis on interface control leads, with transition diagrams on the screen, and it has results storage and histogram alarm/results presentation on the screen.

#### Applications

- T1 and datacom installation
- Long-term network monitoring
- Troubleshooting and service restoration

#### Specifications

T1 remote control, power supply, and size specifications as HP 37701A (see page 587).

**Datacom interfaces:** RS-232, RS-449, V.35, DTE, or DCE

**Data rates:** 600 b/s to 1.544 Mb/s (synchronous: built-in synthesizer); 50 b/s to 19.2 kb/s (asynchronous)

**RS-232 breakout:** Patch point, monitors, voltage sources, and switches

**RS-449/V.35:** Activity indicators on data, clock, and control circuits

**Test patterns:** 63, 511, 2047,  $2^{15}-1$  PRBS, QRSS, (all invertible); all 1s, 1010 ..., 24-bit word, FOX message

**Measurements:** Errors, BER, blocks, block errors, BLER, error seconds, % EFS, clock slips, alarms, Tx and Rx frequency, G.821 analysis

**Control-circuit timing:** Measures times between selectable start/stop events; timing range 1s, resolution 0.1 ms

**Transition diagrams:** For MON, RTS, CTS, DTR, DSR and DCD

**Weight:** 6 kg (13 lb)

#### Ordering Information

	Price
<b>HP 37711A T1/Datacom Test Set</b>	\$7,500
<b>Opt 001 Pulse Shape and Wander/Clock Slips Measurements</b>	+\$550
<b>Opt 002 Built-in Battery Operation</b>	+\$750
<b>Opt 004 n x 56/n x 64 kb/s T1 Measurements</b>	+\$1,200





# HEWLETT-PACKARD INTERFACE BUS

## Versatile Interconnect System for Instruments and Controllers

HP 59401A, 10833A/B/C/D, 10834A

615

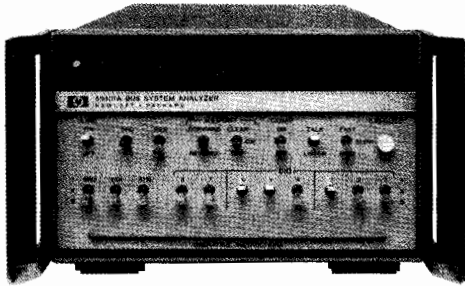

HP 59401A



HP 10833A/B/C/D

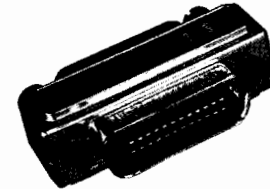

HP 10834A

### HP 59401A Bus System Analyzer

HP-IB (IEEE-488) has greatly simplified the burdensome task of instrument interfacing. Even so, software errors can occur if the system designer does not understand the bus system or the capabilities of the devices interfaced. Hardware problems can occur if the devices are not functioning properly, or if they are not compatible with the bus standard.

The HP 59401A Bus System Analyzer is especially good for design and service work. It simplifies the diagnosis of software and hardware problems by allowing the user to see the status of all bus lines, including the actual characters on the bus data lines. Because the HP 59401A can also drive all bus lines, it can completely exercise another Talker, Listener, or Controller—which is especially useful in verifying the compatibility of new or user-designed products with HP-IB.

There are several choices of analyzer operating speed. It may be operated one character at a time (for software debugging), 2 characters per second, or at regular bus speed. It may also be operated at a variable rate as determined by the external clock input.

The analyzer's 32-character memory can be used to store bus characters in Listen mode, or to output characters to the bus in Talk mode. In Compare mode, a stream of bus traffic may be stopped on a preselected character; at that time a trigger pulse is available, which is useful when analyzing transient or timing problems related to the bus.

### HP 59401A Specifications

**Display:** Monitors all bus lines. Represents data lines, any memory location, DIO front panel switch settings: in octal code and ASCII character.

**Listen mode:** Stores up to 32 characters of bus traffic in memory for real-time and repetitive testing. In Compare mode, halts bus traffic when a selected character is present. User can display any one of previous 31 characters stored in memory.

**Timing:** Accept < 750 ns; ready < 750 ns.

**Talk mode:** Bus lines can be driven directly from front panel switches. Memory can be loaded from front panel switches for driving bus with a 32-character sequence.

**Timing:** (1) data changed > 500 ns before DAV pulled low; (2) ATN driven low > 1 μs before DAV pulled low; (3) DAV driven high < 700 ns after NDAC is false; (4) DAV driven low < 700 ns after NRFD is false, if conditions 1 and 2 are met.

**Operating speeds:** One character at a time, 2 characters per second, regular bus speed, or variable rate determined by external clock input; in either Listen or Talk mode.

**External clock input:** One standard power TTL gate input; ≤ 10 MHz repetition rate.

**Compare output:** Provides one standard power TTL gate output (LOW TRUE) sync pulse when bus character is same as front panel switches.

**HP-IB load:** One bus load (capable of driving 14 other bus devices).

### General

**Temperature ranges:** operating, 0 to 50° C; storage, -40 to +75° C

**Humidity:** 95% relative, 0 to 40° C

**Power requirements:** 100, 120, 220, or 240 V +5%, -10%; 48 to 66 Hz; ≤ 42 VA

**Size:** 145.5 mm H × 205.1 mm W × 495.3 mm D (5.730 in × 8.075 in × 19.500 in)

**Weight:** Net, 5.64 kg (12.41 lb)

### Accessories

**HP 59401A** Bus System Analyzer

**HP 5061-9689** (metric) front handle kit

**HP 10833B** 2-m (6.6-ft) bus cable, furnished

### Price

\$4,170

\$55



### HP-IB Interconnection Cables

Cables for interconnecting HP-IB devices are available in four lengths. The connector block at both ends of the cable has a plug on one side and a matching receptacle on the other so that several cables may be conveniently "stacked" in parallel, thus simplifying system interconnection. Lock screws securely mount each connector block to an HP-IB instrument or to another connector block.

*NOTE: Cables are not always included with HP-IB devices, particularly those that connect directly to an HP controller. (The HP-IB interface for HP controllers provides the necessary cable and connector.) Product listings in this catalog should be checked to see if HP-IB cables are furnished.*

HP 10833 cables feature an improved shielding design to help reduce RFI levels in systems. This series of cables has significantly lower radiated emissions than previous HP-IB cables.

The HP 10834A is a shielded HP-IB to HP-IB adapter. It provides additional clearance (approximately 2.3 cm) between the HP-IB cable and the rear panel of the instrument. This allows easier access to switches, cables, and other connectors in close proximity to the connector.

### Ordering Information

**HP 10833A** HP-IB Cable, 1 m (3.3 ft)

**HP 10833B** HP-IB Cable, 2 m (6.6 ft)

**HP 10833C** HP-IB Cable, 4 m (13.2 ft)

**HP 10833D** HP-IB Cable, 0.5 m (1.6 ft)

**HP 10834A** Adapter

### Price

\$80

\$90

\$100

\$80

\$31



☎ For off-the-shelf shipment, call 800-452-4844.

# HEWLETT-PACKARD INTERFACE BUS

## Interconnect Systems

HP 59306A, 59307A, 59401A, 59501B

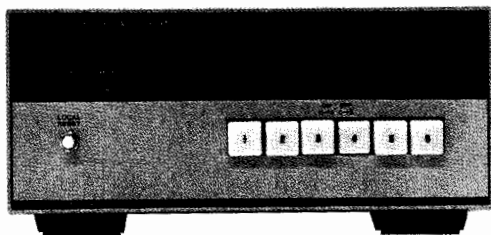

HP 59306A

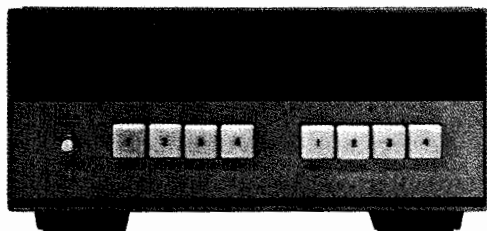

HP 59307A



HP 59501B



### HP-IB Accessory Modules

Modules in the HP 59300, 59400 and 59500 Series are ideal building blocks to extend the measurement capabilities of instruments. Modules can be interconnected via the HP-IB to HP measuring instruments, signal sources, and recording devices capable of operating directly on the HP-IB. In addition, these modules frequently serve to interconnect with devices which are not themselves capable of direct HP-IB operation.

#### HP 59306A Relay Actuator

Six Form-C relays provide control of external devices either manually from front panel pushbuttons or remotely from the HP-IB. Relay contacts are specified to switch 28 V dc or 115 V ac at 0.5 A. Each relay can be programmed independently or multiple relays can be switched together. Front panel pushbuttons light to indicate the state of each relay.

The HP 59306A is ideal for providing control of microwave coaxial switches (HP 8761A/B) as well as control of microwave programmable step attenuators (HP 8494 through 8496G/H) using external dc power supplies.

#### HP 59307A Dual VHF Switch

This module provides two single-pole 4-throw switches controlled from front panel pushbuttons or remotely from the HP-IB. The HP 59307A is a dc to 500-MHz 50 Ω switch designed to maintain fast pulse transition times. The switches are independent and bidirectional for optimum use in multiplexing 50 Ω signal lines into measuring instruments. The HP 59307A is ideal to switch a standard delay, frequency, or voltage into a measurement loop for purposes of system calibration.

#### HP 59501B Power Supply Programmer (isolated DAC)

This single-channel digital-to-analog converter can control a wide range of power supplies (output voltage, or current), as well as other analog programmable devices. It may also be used as a low level signal source, depending on the speed of the controller. It has two output ranges: 0-1 and 0-10 V dc in unipolar mode; -1 to +1 and -10 to +10 V dc in bipolar mode. Photo-isolators electrically separate HP-IB control and data lines from power supply circuitry by up to 600 V dc. (For additional details see page 535).

HP Model	Description	Dimensions — max. height × width × depth mm (inches)	Net Weight kg (lb)	Shipping Weight kg (lb)	Price
HP 59306A	Relay Actuator	101.6 × 212.9 × 294.6 (4 × 8.38 × 11.6)	2.64 (5.87)	3.23 (7.18)	\$2,400
HP 59307A	VHF Switch	101.6 × 212.9 × 294.6 (4 × 8.38 × 11.6)	2.64 (5.87)	3.23 (7.18)	\$2,000
HP 59401A	Bus System Analyzer	145.5 × 205.1 × 495.3 (5.73 × 8.08 × 19.5)	5.64 (12.44)	9.1 (20)	\$5,700
HP 59501B	Power Supply Programmer	101.6 × 212.9 × 294.6 (4 × 8.38 × 11.6)	2.61 (5.80)	3.17 (7.04)	\$1,100

# HEWLETT-PACKARD INTERFACE BUS

## Versatile Interconnect System for Instruments and Controllers

HP 37204A/B

617

- HP-IB extension up to 1,250 meters (up to 3,000 meters with fiber-optic cable)
- Data transfer rate up to 60 KB
- Cost-effective multi-drop capability; up to 30 remote sites
- Installation usually needs no software changes
- 100 percent error-free operation
- Industry-standard ST, FC and SMA fiber-optic connectors; fiber sizes from 50/125 to 100/140  $\mu\text{m}$

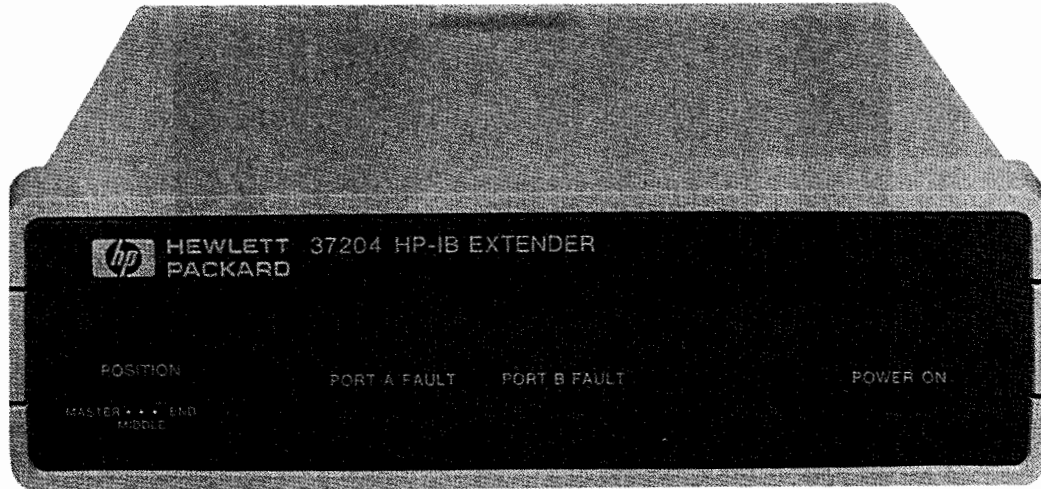

HP 37204A/B



### HP 37204A Multi-Point HP-IB Extender

The HP 37204A extends the distance between HP interface bus (IB) devices beyond the 2-meter limit. Users can link up to 31 HP 37204As (one per site) to achieve a multi-point system. Each link can be up to 1,250 meters long (3,000 meters with fiber-optic cable) and mixing of coaxial and fiber-optic links is allowable. Once installed, extenders operate automatically and transparently. Usually, programs can remain unchanged. Error correction ensures 100 percent data integrity. Partial HP-IB operation can continue after link failure by invoking truncation.

The HP 37204A supports all IEEE-488 functions, but might slow the response to a parallel poll beyond the 2  $\mu\text{s}$  limit. Extenders are listen-always devices that handshake data from a talker to all sites; if there is no addressed listener, the extender handshakes with itself. Because extenders limit the speed of all bus traffic to 60 kbyte/s maximum, extenders should be located on a separate HP-IB from disk/tape drives.

The table below shows examples of maximum speed against the number of extenders in a system. Note: If any coaxial link exceeds 250 meters, the speed of all links in the system is  $\frac{1}{10}$  normal.

Average Inter-Extender Cable Length	Number of Extenders per Chain		
	2	3	5
100 meters: coaxial cable	54 kbyte/s	26 kbyte/s	14 kbyte/s
optical fiber	52 kbyte/s	25 kbyte/s	13 kbyte/s
500 meters: coaxial cable	5.9 kbyte/s	2.8 kbyte/s	1.4 kbyte/s
optical fiber	36 kbyte/s	17 kbyte/s	9 kbyte/s

### HP 37204B Multi-Point HP-IB Extender

The HP 37204B is only for supported configurations of HP 256X/268X printers and HP 3000 computers.

#### Specifications

**Maximum distance:** 1,250 meters per link (coaxial cable); 3,000 meters per link (fiber-optic cable)

**Maximum speed:** 60 KB

**Power requirements:** 100, 120, 220, 240 V ac  $\pm 5\%$ –10%, 48 to 66 Hz, 10 VA max

**Size:** 71 mm H  $\times$  212 mm W  $\times$  254 mm D (2.8 in  $\times$  8.3 in  $\times$  10 in)

**Weight:** 1.72 kg (3.8 lb)

**Temperature:** 0° to 50° C (operating);  $-40^\circ$  to  $+70^\circ$  C (storage)

**Humidity:** 5% to 95% noncondensing

**Altitude:** Up to 4,600 meters (15,000 feet)

**Compliance:** UL 478 and 114 listed

CSA 22.2 No 220-1986 certified

Complies with IEC 435 and 380

Verified to FCC part 15 level B

Complies with FTZ 1046-84

#### Ordering Information

**HP 37204A** Equipped with dual coaxial ports.

**Opt 003** Fiber-optic interface, SMA type 905 connectors. For end extenders.

**Opt 004** Fiber-optic interface, SMA type 905 connectors. For middle extenders in a multi-point system.

**Opt 013** Fiber-optic interface, ST connectors. For end extenders.

**Opt 014** Fiber-optic interface, ST connectors. For middle extenders in a multi-point system.

**Opt 023** Fiber-optic interfaces, FC connectors. For end extenders.

**Opt 024** Fiber-optic interface, FC connectors. For middle extenders in a multi-point system.

**HP 37204B:** Equipped with dual coaxial ports.

**Option common to HP 37204A and HP 37204B**

**Opt 305** Standard 19-inch rackmount adapter; holds one or two HP 37204A/Bs

#### Price

\$1,300

+ \$540

+ \$1,000

+ \$540

+ \$1,000

+ \$540

+ \$1,000

\$1,550

+ \$87

☎ For off-the-shelf shipment, call 800-452-4844.

# DATA ACQUISITION SYSTEMS

## General Information

- Reduce manufacturing costs
- Reduce product development time
- On-going payback
- Improve product quality
- Higher process throughput
- More process up-time

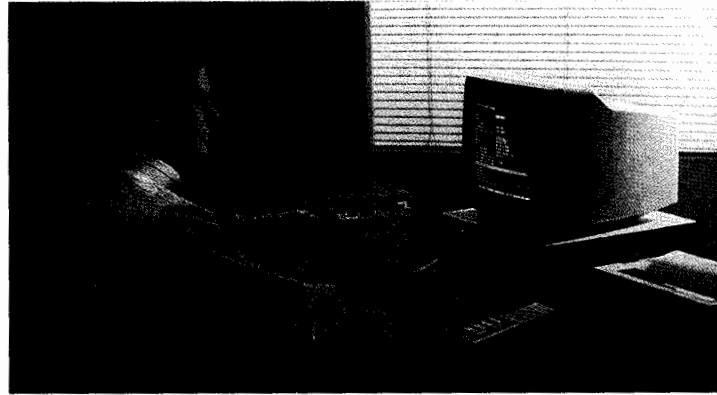

Every data acquisition system requires a combination of computers, instruments, transducers, and software. The extent to which these pieces are packaged together depends on your individual needs. Whether it is a completely integrated turnkey system, system components, plug-in board products, or a customized in-house system, Hewlett-Packard can help. Turnkey solutions can be provided by HP's own Customer Support Group or through a growing network of independent systems integrators and software suppliers. Contact your local HP sales office for more information about these programs.

Information on data acquisition plug-in board products for HP 1000 and HP 9000 computers can be found on page 627. Data acquisition software products are described on page 628. Information on instruments and computers for custom-built systems can be found under the headings for those products. The remainder of this section contains detailed information on data acquisition component systems. These systems provide solutions for a broad range of applications. Contact your local Hewlett-Packard sales office for more information on how these systems can work for you.

### Data Acquisition Family Matrix

System Description	Typical Application Areas	Max. Channels/System Differential	Max. Channels/System Single-ended	Interfaces	Typical Computers	Programming Method	Supporting Software Packages
<b>HP System 10+</b> HP 75000 Series B cardcage with measurement cards programmed by Labtech products using a PC.	<ul style="list-style-type: none"> <li>• chemical experimentation</li> <li>• pharmaceutical testing</li> <li>• material evaluation</li> <li>• energy research</li> </ul>	112	336	IEEE-488	HP Vectra PC (or IBM AT compatible)	Iconic & menu driven	Labtech® NOTEBOOK' Labtech® CONTROL'
<b>HP System 20</b> HP 75000 Series B cardcage with measurement cards programmed by built-in IBASIC controller or external computer.	<ul style="list-style-type: none"> <li>• process characterization</li> <li>• facility monitoring</li> <li>• process troubleshooting</li> <li>• remote station control</li> </ul>	112	336	IEEE-488 RS232/422 (option)	HP Vectra PC, (or IBM AT compatible), HP BASIC workstations or internal IBASIC controller	Front panel, external terminal, or external computer	HP DACQ/PC HP DACQ/300 HPITG
<b>HP 3852A</b> HP 3852 cardcage with measurement cards programmed over IEEE-488 using an external computer.	<ul style="list-style-type: none"> <li>• process control/monitoring</li> <li>• product characterization</li> <li>• process characterization</li> <li>• electromagnetic test</li> </ul>	1848	4620	IEEE-488 RS232/422 (option)	HP Vectra PC (or IBM AT compatible), HP BASIC or HPUX workstations, HP 1000 computer	Front panel or external computer	ISI Autonet® HPITG HP DACQ/PC HP DACQ/UX HP DACQ/300
<b>HP 3421A</b> HP 3421 cardcage with built-in A/D, plug-in relay multiplexer, and digital I/O, programmed by external computer.	<ul style="list-style-type: none"> <li>• small process monitoring</li> <li>• environmental monitoring</li> <li>• material evaluation</li> </ul>	30	56	HPIL IEEE-488 (option)	HP Vectra PC (or IBM AT compatible), HP BASIC workstations	External computer	HP DACQ/PC HP DACQ/300
<b>HP 3497A</b> HP 3497 cardcage with measurement cards programmed by external computer.	<ul style="list-style-type: none"> <li>• process/product characterization</li> <li>• process monitor &amp; control</li> <li>• process troubleshooting</li> </ul>	1000	8070	IEEE-488 RS232/422 (option)	HP Vectra PC (or IBM AT compatible), HP BASIC workstations	Front panel or external computer	HP DACQ/PC HP DACQ/300

'Labtech products available from Laboratory Technologies Corporation, Wilmington, MA (508) 657-5400

®ISI Autonet available from Imagination Systems Incorporated, or The Netherlands (31) 1670 64500 Virginia Beach, VA (804) 497-8200

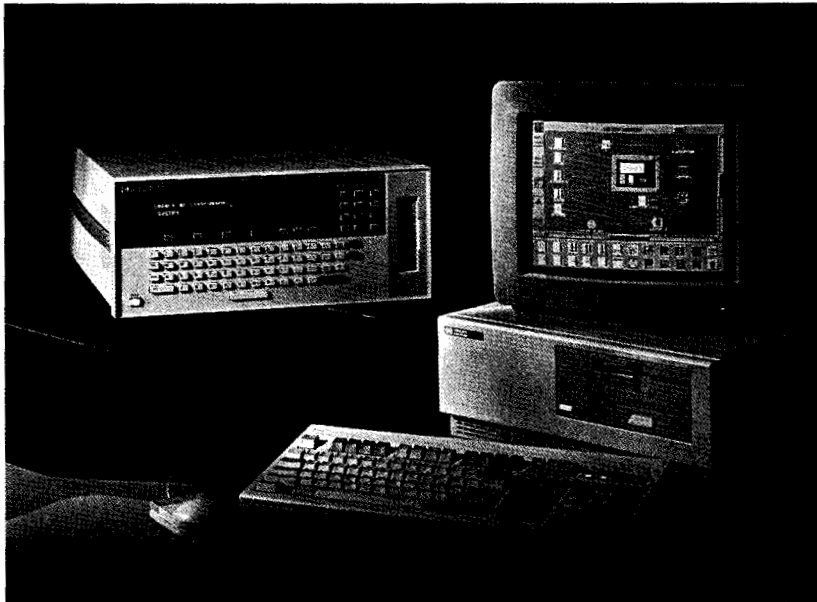

HP 75000 Series B

### Series B: Time-Saving Solutions

Whether your application is in product test/evaluation, process design/test, process monitoring/characterization, or process automation/control, you'll benefit from instrumentation that fits together quickly and has all the flexibility to adapt to your unique application.

#### When you purchase an HP 75000 system, you get:

- Menu-driven software
- A wide selection of measurement and control cards
- Built-in transducer linearizations (thermocouples, RTDs, thermistors, strain gages)
- Flexible configuration for up to 112 3-wire channels (336 single-ended) per cardage
- Accurate, repeatable measurements each time
- Reliable hardware (20+ years MTBF)
- Worldwide consulting and support services

### A Choice of Systems

Select one of the HP 75000 data acquisition systems, assembled and ready to use. Or choose from HP's wide selection of data acquisition tools and we'll build a custom application for you. As your needs change, simply expand any of these systems to match your needs.

### System 10+ : The Nonprogrammer's Solution

The HP 75000 System 10+ saves you time because you don't have to be a programmer to capture data. It is a PC-based data-gathering system for nonprogrammers. Iconic software supplied with examples will allow you to capture data almost immediately.

#### Software Suited to Your Needs

You can monitor or control your application with one of System 10+'s two easy-to-learn software packages: Labtech® Notebook or Labtech Control.

Labtech Notebook is designed for experiments and tests in which you want to gather data and analyze the results. Labtech Control is made for applications in which you want to continuously monitor and/or control a process. You can make changes to setpoints and limits as your process unfolds.

#### Nonprogramming Software

- No programming required (use only icons and menus)
- Software runs on any MS-DOS PC-AT compatible computer
- Example setups provided
- Software growth path (two compatible programs)

#### Versatile Hardware

- Complete line of data acquisition cards
- Modular design lets you add just the cards you need
- Designed to get accurate measurements, even in the presence of noise

# DATA ACQUISITION SYSTEMS

Instruments for Measurement and Control (cont'd)

HP 75000 Series B

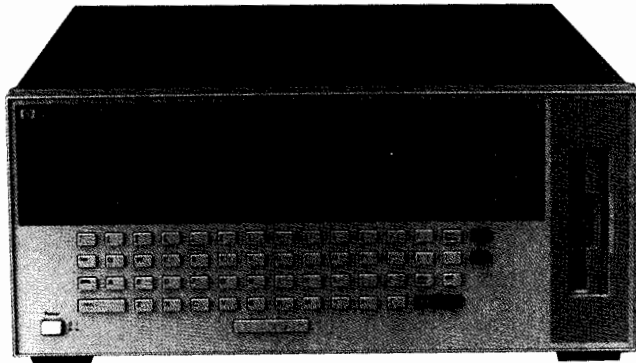

System 20

## System 20: The Intelligent System

The HP 75000 System 20 is a completely self-contained data acquisition system that is ideally suited to remote assignments. Whether your application is down the hall or across the city, System 20's built-in microprocessor lets you collect data, control your application, and send the results back to your computer.

### Instrument BASIC (IBASIC)

At the heart of System 20 is the IBASIC language, with all the functionality of an HP 9000 Series 300 BASIC workstation. Attach a terminal on the RS-232 port and you can develop programs using the built-in, full-screen IBASIC editor. You'll have the power of a stand-alone workstation right in the cardcage. You'll also have complete control of all plug-in cards as well as any external RS-232 or HP-IB equipment.

### System 20 Allows You to:

- Collect data, make decisions, and store results without a computer
- Place the instrumentation close to the transducers to reduce wiring costs and improve accuracy
- Make decisions locally for better response and to avoid tying up your computer
- Continue operating even during a power failure, using a battery backup as a UPS (uninterruptible power supply)
- Control other HP-IB or RS-232 equipment in addition to making measurements

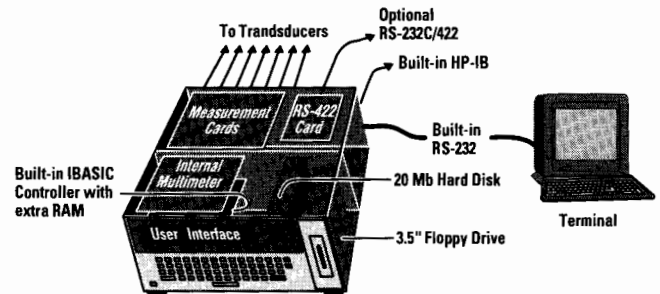

System 20

System 20 Functional Diagram

### System 20's Power and Intelligence Is Built On:

- Built-in Motorola MC 68000 microprocessor running at 8 MHz
- Up to 2 MB of RAM (all of which can be configured as nonvolatile)
- Optional built-in 3½-inch floppy drive and/or 20-MB hard disk (floppy drive reads both LIF and DOS formats)
- Autostart from hard, floppy, or nonvolatile RAM disk files
- Battery-power operation (switches automatically when ac power fails)
- Control of either RS-232 or HP-IB instruments, disks, printers, or devices

### Custom Systems: Build-Your-Own Versatility

HP 75000 Custom Systems save you time because you don't have to build your own system from scratch. We can supply you with everything you need in one system.

The Series B cardcage is a modular architecture designed to configure in minutes. Instrumentation and switch cards can be easily inserted into slots in the rear of the instrument. When the cardcage is turned on, it automatically identifies the cards and sets the menu accordingly. To save even more time, order the Installation Option and HP will install the cards for you.

### Industry Standards: Path to the Future

The Series B is a member of the HP 75000 family of industry-standard VXI products. It is programmed with easy-to-understand Standard Commands for Programmable Instruments (SCPI) over HP-IB (an IEEE-488.2 standard).

### Flexible Architecture

The HP 75000 Custom Systems are built on a flexible architecture that allows you great versatility in the way you configure your system:

- Seven external B-size VXI slots, plus two internal slots for optional multimeter
- Three external A-size VXI slots
- 112 3-wire channels (336 single-ended)
- Five high-performance instrument cards
- 18 high-quality switch cards
- Compatible with VME cards (P1 connector only)

### Optional Features

- IBASIC controller (puts the power of a workstation in the instrument)
- ½, 1-, or 2-MB nonvolatile memory for program and data storage
- Power for portable or UPS capability—automatically switches to dc power operation when ac power fails
- 3½-inch floppy disk drive (LIF and/or DOS format)
- 20-MB hard disk drive (LIF and/or DOS format)

### Series B Cards – The Right Connections

The Series B cards come with removable screw terminal connectors designed for fast and easy wiring to your system. No-solder connections and built-in strain reliefs ensure that your wires won't come loose.

### Customize Your System

An HP E1399A breadboard card makes it easy for you to develop custom instrumentation and switches. We supply you with access to the cardcage power supplies, backplane interface circuitry, and logic circuits, and we provide a comprehensive manual.

### Plug-In Cards

#### Multimeter

(two-slot card mounted internally or in rear slots)

- Programmable speed/resolution trade-off
- Balanced differential input for noise rejection
- Variety of measurements (dc volts, ac volts, ohms)
- Floats up to 120 V above ground (450 V pk terminal to chassis)
- Integration technique for noise rejection (84 dB @ 22 bits)
- 150 dB common mode noise rejection

#### Relay Multiplexers

- Break-before-make operation
- Detachable terminal block provided
- Space available for series and shunt-signal conditioning

#### FET Multiplexers

- Break-before-make operation
- Detachable terminal block provided
- Space available for series and shunt-signal conditioning

#### D/A Converter

- Output voltage or current on each channel
- Software calibration
- Four isolated channels

#### Counters

- Totalize
- Frequency
- Period
- Pulse width
- Time interval
- Gated totalize
- Up/Down count
- Ratio (range)

#### Digital I/O

- Four 8-bit bidirectional data ports
- Three handshake lines (GPIO protocols)
- TTL logic levels
- Plug-compatible with industry standard opto-isolators

#### Form C General Purpose Switch

# DATA ACQUISITION SYSTEMS

## Instruments for Measurement and Control (cont'd)

### HP 75000 Series B

#### Ordering Information

##### Cardcage

Required (Choose one)

**E1300A** Blank front panel

**E1301A** Front panel

##### Software

Required (Choose one)

**E1395C** Labtech Notebook

Optional

**E1395C Opt 001** General-purpose HP-IB programming

##### Plug-in Cards

Required

**Opt 009** Internal multimeter (E1326B)

Recommended

**E1326-80005** Banana plug adapter for multimeter

**Opt 500** Installation of cards

Optional (Choose maximum of seven)

**E1345A** 16-chl relay multiplexer

**E1347A** 16-chl thermocouple relay multiplexer

**E1346A** 48-chl single-ended relay multiplexer

**E1355A** 8-chl 120  $\Omega$  strain relay multiplexer

**E1356A** 8-chl 350  $\Omega$  strain relay multiplexer

**E1351A** 16-chl FET multiplexer

**E1353A** 16-chl thermocouple FET multiplexer

**E1352A** 32-chl single-ended FET multiplexer

**E1357A** 8-chl 120  $\Omega$  strain FET multiplexer

**E1358A** 8-chl 350  $\Omega$  strain FET multiplexer

**E1330A** Quad 8-bit digital I/O

**E1364A** 16-chl Form C switch

**E1328A** 4-chl D/A converter

**E1332A** 4-chl counter/totalizer

**E1333A** 3-chl universal counter

##### Computer

Recommended

**HP Vectra** (or IBM-AT compatible) with mouse

**MS-DOS** 3.0 or later

**Memory:** 640 KB Labtech Notebook

2 MB Labtech Control

**Disks:** 20-MB hard disk

3 $\frac{1}{2}$ -in floppy drive

**Interface:** HP 82335A (or PCIIA compatible)

**Printer:** HP QuietJet or HP LaserJet

Note: To work with the System 10+ software, your cardcage must have serial prefix (first four digits of the serial number) 3034 and above for E1300A, and 3035 and above for E1301A.

#### Price

\$2,320

\$1,900

\$1,100

\$300

\$1,340

\$660

\$760

\$810

\$925

\$925

\$875

\$975

\$1,000

\$1,125

\$1,125

\$610

\$660

\$1,110

\$910

\$910

#### Cardcage

Required (Choose one)

**E1300A** Blank front panel

**E1301A** Front panel

#### Software

Required (Choose one)

**Opt 020** IBASIC with 512 K RAM

**Opt 021** IBASIC with 1 MB RAM

**Opt 022** IBASIC with 2 MB RAM

#### Disk Drives

Recommended (Choose one)

**Opt 005** 3 $\frac{1}{2}$ " Floppy Drive

**Opt 006** 20-MB Hard Disk

**Opt 007** Floppy and Hard Disk

#### Other

**Opt 008** DC Power

**E1324A** RS-232C/422 Data Comm Card

#### Plug-in Cards

Recommended

**Opt 009** Internal multimeter (E1326B)

**E1326-80005** Banana plug adapter for multimeter

**Opt 500** Installation of cards

Optional (Choose maximum of seven)

**E1345A** 16-chl relay multiplexer

**E1347A** 16-chl thermocouple relay multiplexer

**E1346A** 48-chl single-ended relay multiplexer

**E1355A** 8-chl 120  $\Omega$  strain relay multiplexer

**E1356A** 8-chl 350  $\Omega$  strain relay multiplexer

**E1351A** 16-chl FET multiplexer

**E1353A** 16-chl thermocouple FET multiplexer

**E1352A** 32-chl single-ended FET multiplexer

**E1357A** 8-chl 120  $\Omega$  strain FET multiplexer

**E1358A** 8-chl 350  $\Omega$  strain FET multiplexer

**E1330A** Quad 8-bit digital I/O

**E1364A** 16-chl Form C switch

**E1328A** 4-chl D/A converter

**E1332A** 4-chl counter/totalizer

**E1333A** 3-chl universal counter

**E1361A** 4  $\times$  4 relay matrix

**E1366A** 50  $\Omega$  RF multiplexer

**E1367A** 75  $\Omega$  RF multiplexer

**E1368A** 18-GHz microwave switch

**E1369A** Microwave switch driver

**E1370A** Microwave switch/attenuator driver

**E1399A** Breadboard

#### Price

\$2,320

\$1,900

\$1,000

\$1,600

\$2,400

\$850

\$1,900

\$2,100

\$700

\$650

\$1,340

\$660

\$760

\$810

\$925

\$925

\$875

\$975

\$1,000

\$1,125

\$1,125

\$610

\$660

\$1,110

\$910

\$910

\$660

\$860

\$860

\$2,120

\$510

\$500

\$400



# DATA ACQUISITION SYSTEMS

Instruments for Measurement and Control

HP 3852A

623

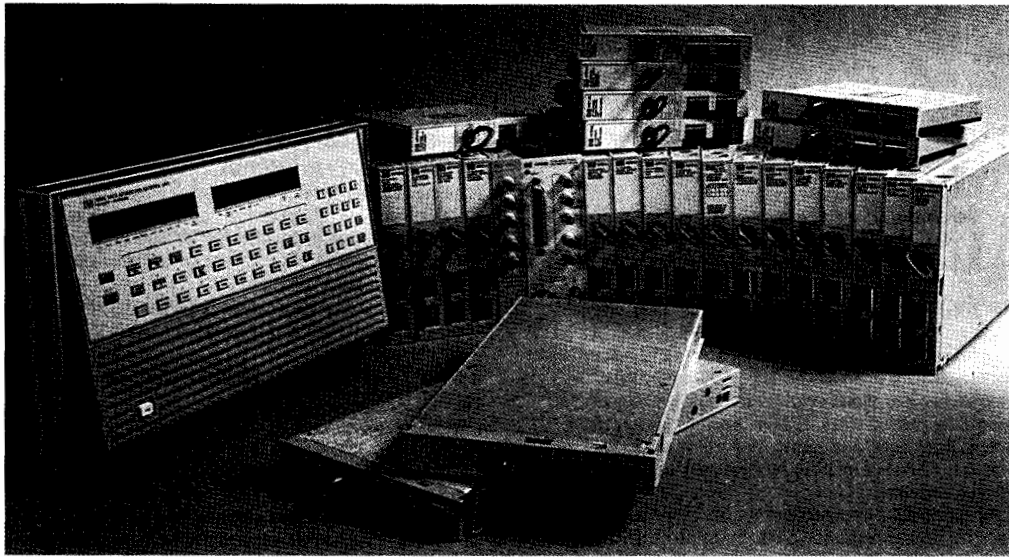

HP 3852A



## Configure the Capabilities You Need

You can easily configure an HP 3852A Data Acquisition and Control System to meet your needs for measuring physical parameters through transducers, and for providing control outputs. The HP 3852A Data Acquisition/Control Unit (mainframe) has 8 slots for plug-in function modules. If more slots are needed, up to seven extenders can be added, each with 10 additional slots. You can choose any combination of capabilities that include precision and high-speed plug-in voltmeters and a variety of analog and digital input/output functions.

A system clock and programmable pacer are built-in to drive your system. The clock—non-volatile for four years, 1 msec—resolution allows data to be time-stamped and events to be timed. The pacer—0.25  $\mu$ sec resolution—provides powerful capabilities to initiate and pace measurements, scans, or events.

## Include High-Speed and Accurate Analog Measurements in One System

Choose from three digital voltmeters to meet your measurement needs. For applications that require sensitive, accurate measurements in the presence of noise (for example, thermocouples), use the 5 $\frac{1}{2}$ -Digit Integrating Voltmeter and Relay Multiplexers. If you need speed, the 13-Bit High-Speed Voltmeter and High-Speed FET Multiplexers are the answer, providing single-channel bursts, channel-to-channel, random channel, full auto-ranging, and direct DMA transfers to a hard disk at an honest 100,000 readings/sec. High speed, high accuracy readings can be achieved with the 16-bit, 100 kHz High Speed Voltmeter. The system voltmeters can be used in the mainframe or any extender, and multiple voltmeters are allowed per cardcage.

## Add Versatility and Expandability to Your System

With the HP 3852A Data Acquisition and Control System, you'll have available a complete set of input and output plug-in modules for interfacing to measurements and for controlling and sequencing your tests. Modules are available to handle physical measurements of temperature, flow, pressure, level, and strain. The HP-IB controller module gives you the capability to autoboot subroutines stored on a disk and to store data to the disk without computer assistance.

## Take Advantage of Extensive Front-End Intelligence

The HP 3852A mainframe has considerable built-in intelligence to increase the speed of collecting measurement and control data. Control decisions can be handled faster using subroutines running within the mainframe. This intelligence can be used to *return only significant data* to the computer, thus increasing its efficiency.

Up to 5,500 readings can be stored in the standard HP 3852A mainframe. Expand this memory (used for storage of user routines as well as readings) to 256 KB, 1 MB, 2 MB, or 4 MB with an Extended Memory board. Extended memory fits inside the mainframe controller module without using an I/O slot.

The power of this front-end intelligence in combination with an HP 9000 Series 300 computer and the optional data acquisition software adapts easily to testing your complex product or characterizing your process. Of course, the mainframe can be also used with HP 1000 computers, HP Vectra PCs, other IEEE-488 controllers and instruments, and a variety of computer peripherals.

## Reduce Your Test Development Investment

Optional data acquisition software for an HP 9000 Series 300/200 computer or HP Vectra PC gets your application running quickly and easily by providing off-the-shelf solutions for:

- Data base management—store large amounts of data in files that are easy to identify and access later.
- Graphics presentations—display or plot color graphs; display a real-time strip chart; plot data with linear, log, semilog, or automatic axis scaling.
- Data analysis—this software provides high-level subroutines as tools used in a test system program running with HP BASIC.

Ease-of-use is exemplified by:

- Automatic creation of a database for storing data using only one subroutine
- Fast access to a single data item or a block of data items using only one subroutine
- Manipulation and formatting of gathered data any way you wish

Program development time is leveraged using this software, while allowing a powerful, highly customized system to be developed. Furthermore, the software can be used with any HP-IB instrument.

# DATA ACQUISITION SYSTEMS

## Instruments for Measurement and Control (cont'd)

### HP 3852A

#### Data Acquisition and Control Unit –

#### HP 3852A

##### Mainframe Supports

- 8 Function Module Slots
- Data Acquisition Operating System
- System Timer
- Measurement Pacer
- Full Alphanumeric Keyboard, Command and Result Displays

##### Benefits

- Make real-time decisions and reduce data without burdening your computer:
  - Multitasking operating system prioritizes and timeslices tasks.
  - Powerful HP 3852A command statements simplify complex measurements.
  - Execution speed of command sequences are enhanced by executing subroutines stored in the HP 3852A memory.
  - Built-in, easy-to-use transducer conversions are supported for thermocouples, thermistors, RTDs, and strain gages.
  - Post-processing and data reduction before transferring results to a computer are achievable by first storing data to the HP 3852A internal memory.
  - Limit checking of analog measurements is performed in real time or after the measurements have been stored in mainframe memory.
- Optimize measurement timing and throughput to meet your needs:
  - Real-time interrupts allow higher priority tasks and external inputs to be serviced at any time.
  - Asynchronous communication with a computer is achieved through input and output buffering.
  - Control can be timed using built-in clock and alarm capabilities (can cause an interrupt).
  - A built-in pacer simplifies measurement timing and triggering.
  - Multiple voltmeters can be used. The high-speed voltmeter can control scanning, timing, and triggering of its own high-speed FET multiplexer subsystem via ribbon cable. Several of these subsystems can run simultaneously.

#### Extender Chassis – HP 3853A

##### Extender supports:

- 10 Function Module Slots

##### Expand your system with no loss of functional capability:

- Up to seven extenders may be used with each HP 3852A mainframe.
- Any slot can be used for any function module and multiple voltmeters can be used with parallel triggering.
- All mainframe functions, including interrupts and triggering, are available through the extender control cable.

#### 5½ to 3½ Digit Integrating Voltmeter

#### HP 44701A

##### Directly measures:

- dc voltage
- ac voltage
- Resistance

##### The HP 44701A lets you:

- Accurately measure small signal changes in noisy environments
- Choose the resolution, accuracy, and noise rejection needed while maximizing measurement speed
- Optimize resistance measurements to the accuracy you need

Best dc voltage accuracy:  $\pm(0.008\% + 8\mu\text{V})$  for 3 V range

#### 13-Bit High-Speed Voltmeter

#### HP 44702A/B

##### Directly measures:

- dc voltage
- dc resistance

##### The HP 44702A/B will allow you to:

- Collect data quickly (100,000 readings/sec)
- Maximize your measurement throughput

Best dc voltage accuracy:  $\pm(0.05\% + 1.88\text{ mV})$  for 2.56 V range

#### 16-Bit High-Speed Voltmeter

#### HP 44704A

##### Directly measures:

- dc voltage
- Resistance

##### The HP 44704A will let you:

- Enjoy high accuracy at high speed
- Maximize your measurement throughput

Best dc voltage accuracy:  $\pm(0.015\% + 340\mu\text{V})$  for 2.56 V range

#### Relay Multiplexers

#### HP 44705A/44705H/44706A/44708A/

#### 44708H/44717A/44718A

##### Directly multiplexes:

- Voltage
- Resistance
- Thermocouples
- Strain gages

##### Relay Multiplexers for the HP 3852A do the following:

- Reduce the effects of real-world measurement errors in a multichannel system
- Optimize thermocouple measurement accuracy
- Measure strain accurately

#### Solid State Relay Multiplexers

#### HP 44705F/44708F

##### Directly multiplexes:

- Voltage
- 4-wire ohm resistance (44705F only)
- Thermocouples (44708F only)

##### Solid State Relay Multiplexers give you the following benefits:

- Solid state switching, free from wearout associated with electromechanical relays
- Precision measurements of real-world electrical systems
- Optimized thermocouple measurement accuracy (44708F)

#### FET Multiplexers

#### HP 44709A/44710A/44711A/44711B/44712A/

#### 44713A/44713B/44719A/44720A

##### Directly multiplexes:

- Voltage
- Resistance
- Thermocouples
- Strain gages

##### HP's FET Multiplexers allow you to:

- Maximize your measurement throughput
- Increase your system reliability

#### Anti-Noise Filter Option

#### HP 44713A/B/44713A/B Opt 003

##### Directly provides:

- Attenuation of 60 or 50 Hz noise
- Fast scanning; no need to average to get rid of unwanted noise
- One filter for each of the 24 channels

##### The anti-noise filter option allows you to:

- Scan lists quickly and accurately
- Reduce noise in a single measurement

#### 4-Channel Track/Hold with Signal Conditioning

#### HP 44730A

#### 4-Channel Dynamic Strain Gage Multiplexers

#### HP 44732A/44733A

##### Directly multiplexes:

- Transient dc voltages
- Dynamic strain gages

##### HP's 4-Channel Track/Hold and Strain Gage Multiplexers let you:

- Enhance dynamic signal measurement accuracy
- Set gains of 1, 10, or 100 on each channel
- Use the analog peak detect/hold feature

#### HP 44789A Serial Interface

##### Directly provides:

- Serial programming port for the HP 3852A
- Control port for RS-232 or RS-422 devices

##### The HP 44789A Serial Interface allows you to:

- Interface your computer to the HP 3852A using RS-232 or RS-422 devices
- Locate the HP 3852A long distances from your host computer
- Control RS-232 or RS-422 devices directly from the HP 3852A
- Program the HP 3852A from a remote terminal

##### Specifications

**Baud rates:** 300, 600, 1200, 2400, 4800, 9600, and 19200

**Interrupts:** Special character, buffer conditions, carrier detect, ring indicator, and receiver error conditions

**Handshake:** None, XON/XOFF, or hardware

**Buffer size:** User-defined up to 8 KB on both transmitter and receiver

### Arbitrary Waveform Digital-to-Analog Converter HP 44726A

Directly Outputs:

- Arbitrary waveforms
- dc voltages (2-channel, non-isolated)

The HP 44726A Arbitrary Waveform D/A Converter:

- Provides a stimulus voltage signal with a step rate of up to 800 kHz
- Gives you random-access memory (RAM) for each channel on this accessory

### Digital-to-Analog Converter HP 44727A/44727B/44727C

Directly Outputs:

- dc voltage
- dc current

Simplify your test setup by providing test or control of devices with one data acquisition control system.

#### Specifications

dc voltage:

Ranges: 0 to +10.235 V or -10.235 to +10.235 V

Resolution: 2.5 mV (12 bits plus a sign for bipolar range)

dc current:

Ranges: 0 to +20.16 mA or +4 to +20.16 mA

Resolution: 2.5  $\mu$ A (13 bits)

### 3-Channel Stepper Motor Controller HP 44714A

Directly Provides:

- Stepper motor control signals
- Limit inputs
- Built-in quadrature counters
- Pulse output

The HP 44714A 3-Channel Stepper Motor Controller lets you:

- Completely control three stepper motors with one module
- Use the module as a pulse generator

### 8-Channel LVDT Signal Conditioner/Multiplexer HP 44736A Opt H05

Directly Provides:

- Conditioning/multiplexing for up to 8 LVDTs
- Independent excitation source for each transducer
- Independent demodulation circuits for each transducer
- Fast FET multiplexer scanning of demodulator outputs
- Analog output for each demodulator at terminal block

The HP 44736A will help you:

- Simplify your data acquisition system configuration
- Reduce your cost per channel

### 5-Channel Counter/Totalizer HP 44715A

Directly Provides:

- Count measurements
- Period measurements
- Frequency measurements
- Interrupts

Reduce your costs by taking advantage of this frequency counting versatility.

### Digital Inputs with Totalize and Interrupt HP 44721A/44722A

Directly Provides:

- Logic readings
- Totalize count measurements
- Interrupts

Conveniently read a variety of digital values in your system.

### 32-Channel High-Speed Digital Sense/Control HP 44723A

Directly Provides:

- High-speed digital input and output
- Triggered input and output
- Interrupts
- Output handshaking

The HP 44723A allows you to:

- Input 16 channels or output 16 channels over 150,000 times per second
- Capture and load 16-bit patterns with external triggers
- Interrupt on any input channel on any transition or on a user-specified 16-bit pattern

### 16-Channel Digital Output HP 44724A

Directly Provides Open Drain Digital Outputs

The HP 44724A gives you convenient control of dc devices or logic levels.

Open drain outputs are used to control dc devices of up to 55 V, or drive TTL logic levels. An external power supply and external pull-up resistors are required.

### Switching

HP 44725A/44728A/44729A

Directly Switches:

- Voltage
- Current
- Power

Reliably switch the voltage, current, or power you need.

### Binary Mode Software HP 44790A

HP 44790A Binary Mode Software is a collection of subprograms used to access high-speed opcodes within the HP 3852A. It helps system programmers increase the run-time speed of data acquisition functions up to *five times* over standard high-level commands. The software is written for the professional programmer familiar with opcode programming. HP systems engineers can provide consulting services for those unfamiliar with this type of programming.

#### System Requirements

Binary Mode Software requires HP 3852A firmware Rev. 3.5 or later. It is supplied on a 3/4" single-sided disk. The subprograms are written in HP BASIC in modular form, so they can be ported to other languages.

### HP-IB Controller HP 44788A

Directly Controls:

- HP-IB disk drives (CS80/SS80)
- HP-IB printers
- HP-IB instruments

The HP-IB Controller lets you:

- Conduct remote operations without a computer
- Load subroutines at power-up into an HP 3852A from an HP-IB disk drive and start executing the subroutines
- Send data to an HP-IB disk drive without using a computer
- Print out data stored in the HP 3852A without using a computer
- Control other HP-IB instruments directly through the HP 3852A

# DATA ACQUISITION SYSTEMS

## Ordering Information

### Ordering Information

To order, specify an HP 3852A system with the appropriate software, controller, mainframe, extenders, function modules, racks, and extra terminal modules. The HP 3852A itself has no cost—each component of the system is priced individually.

#### Data Acquisition Manager

	Price
<b>HP 44458A</b> Data Acquisition and Control Software for Series 300/200 Computers on 3½" and 5¼" diskettes (BASIC 4.X, 5.X, and 6.X)	\$2,300
<b>HP 44458R</b> License to Reproduce HP 44458A or 44458B. Includes one set of software manuals.	\$1,390
<b>HP 44459A</b> Data Acquisition and Control software for HP Vectra Computers on 3½" and 5¼" diskettes (BASIC 5.3X)	\$1,700
<b>HP 44459R</b> License to reproduce HP 44459A/44459B. Includes one set of software manuals.	\$1,060
<b>HP 44460A</b> HP DACQ/UX Manual and Software, ¼" tape	\$2,050

#### Mainframe

<b>HP 3852A</b> Data Acquisition and Control Unit	\$4,350
<b>HP 44703A</b> Mainframe Extended Memory Card—256 KB*	\$830
<b>HP 44703B</b> Mainframe Extended Memory Card—1 MB*	\$1,820

Extended memory cards for 2 MB and 4 MB can be ordered from Infotek Systems, 1045 S. East Street, Anaheim, CA 92805-8508, as AM220B and AM244B, respectively. These products have been *functionally tested, but they are not warranted or supported by HP* (no RFI or environmental tests were conducted). Warranty for two years and support of individual cards are provided by Infotek.

#### Extender Chassis

<b>HP 3853A</b> Extender Chassis with 10 additional slots for function modules. A 1-meter extender control cable, and two 1-meter (3 wires each) analog signal extender cables are included. A total of seven extenders may be added to a mainframe. Extender control cables are always needed. Analog signal extender cables are needed if analog voltages must be switched to the mainframe or another extender.	\$2,880
--	---------

#### Voltmeters

<b>HP 44701A</b> 5½ to 3¼-Digit Integrating Voltmeter	\$1,830
<b>HP 44702A</b> 13-Bit High-Speed Voltmeter (100,000 readings/sec; buffer for over 8,000 readings)	\$3,110
<b>HP 44702B</b> 13-Bit High-Speed Voltmeter (100,000 readings/sec; buffer for over 64,000 readings)	\$3,750
<b>HP 44703C</b> High Speed Extended Memory Card for expanding HP 44702A Buffer to over 64,000 readings	\$720
<b>HP 44704A</b> 16-Bit High-Speed Voltmeter (100,000 readings/sec; buffer for over 64,000 readings)	\$3,900

#### Relay Multiplexers

<b>HP 44705A</b> 20-Channel Relay Multiplexer	\$960
<b>HP 44705H</b> 20-Channel High-Voltage Relay Multiplexer	\$1,200
<b>HP 44706A</b> 60-Channel Single-Ended Relay Multiplexer	\$1,200
<b>HP 44708A</b> 20-Channel Relay Multiplexer with Thermocouple Compensation	\$1,120
<b>HP 44708H</b> 20-Channel High-Voltage Relay Multiplexer with Thermocouple Compensation	\$1,390
<b>HP 44717A</b> 10-Bridge 120 Ohm Static Strain Gage Relay Multiplexer	\$1,280
<b>HP 44718A</b> 10-Bridge 350 Ohm Static Strain Gage Relay Multiplexer	\$1,280

#### FET Multiplexers

<b>HP 44709A</b> 20-Channel FET Multiplexer	\$1,100
<b>HP 44710A</b> 20-Channel FET Multiplexer with Thermocouple Compensation	\$1,210
<b>HP 44711A</b> 24-Channel High-Speed FET Multiplexer	\$1,160
<b>HP 44711B</b> 24-Channel High-Speed FET Multiplexer (use with HP 44704A)	\$1,095

\*Only one extended memory option may be added per mainframe.

<b>HP 44712A</b> 48-Channel High-Speed Single-Ended FET Multiplexer	\$1,340
<b>HP 44713A</b> 24-Channel High-Speed FET Multiplexer with Thermocouple Compensation	\$1,280
<b>HP 44713B</b> 24-Channel FET Multiplexer with Thermocouple Compensation	\$1,280
<b>HP 44714A/B</b> Opt 003 Anti-noise Filter Option	\$360
<b>HP 44719A</b> 10-Bridge 120 Ohm Static Strain Gage FET Multiplexer	\$1,390
<b>HP 44720A</b> 10-Bridge 350 Ohm Static Strain Gage FET Multiplexer	\$1,390
<b>HP 44730A</b> 4-Channel Track/Hold Multiplexer with Signal Conditioning	\$1,820
<b>HP 44732A</b> 4-Channel 120 Ohm Dynamic Strain Gage Multiplexer	\$2,040
<b>HP 44733A</b> 4-Channel 350 Ohm Dynamic Strain Gage Multiplexer	\$2,040
<b>HP 44736A</b> Opt H05 LVDT Sig Conditioner/MUX	\$480

#### Solid State Relay Multiplexer

<b>HP44705F</b> 20-Channel Solid State Multiplexer	\$1,530
<b>HP44708F</b> 20-Channel Solid State Multiplexer T/C	\$1,600

#### Analog Outputs

<b>HP 44726A</b> 2-Channel Arbitrary Waveform DAC	\$2,250
<b>HP 44727A</b> 4-Channel Voltage DAC	\$1,540
<b>HP 44727B</b> 4-Channel Current DAC	\$1,540
<b>HP 44727C</b> 2-Channel Voltage; 2-Channel Current DAC	\$1,540

#### Stepper Motor Controller

<b>HP 44714A</b> 3-Channel Stepper Motor Controller/Pulse Output	\$2,250
--	---------

#### Counter

<b>HP 44715A</b> 5-Channel Counter/Totalizer (200 kHz)	\$1,220
--	---------

#### Digital Inputs/Outputs—Switching

<b>HP 44721A</b> 16-Channel Digital Input with Totalize and Interrupt	\$870
<b>HP 44722A</b> 8-Channel AC Digital Input with Totalize and Interrupt	\$900
<b>HP 44723A</b> 32-Channel High-Speed Digital Sense/Control	\$1,180
<b>HP 44724A</b> 16-Channel Digital Output	\$860
<b>HP 44725A</b> 16-Channel General Purpose Switch	\$960
<b>HP 44728A</b> 8-Channel Relay Actuator	\$820
<b>HP 44729A</b> 8-Channel Power Controller	\$1,360

#### Interfaces

<b>HP 44788A</b> HP-IB Controller	\$750
<b>HP 44789A</b> Serial Interface	\$1,040

#### Breadboard

<b>HP 44736A</b> Breadboard	\$480
-----------------------------	-------

#### High-Speed Accessories

<b>HP 98620B</b> 2-Channel DMA Controller for HP Series 300/200 Computers	\$530
<b>HP 98622A</b> GPIO Interface for HP Series 300/200 Computers	\$390
<b>HP 98625B</b> High-Speed HP-IB Disc Interface for HP Series 300/200 controllers	\$1,000
<b>HP 44744A</b> 2-Meter GPIO Cable with Mating for HP 44702A/B and HP 98622A	\$360
<b>HP 44744B</b> 4-Meter GPIO Cable with Mating for HP 44702A/B and HP 98622A	\$400
<b>HP 44745A</b> 4-Meter GPIO Cable with Mating for HP 44702A/B and HP 12006A (GPIO interface for HP 1000 Computers)	\$400
<b>HP44790A</b> Binary Mode Software	\$1,070

#### Service and Support Products

<b>HP 44743F</b> Service Kit consists of specially designed hardware and software for operationally verifying and calibrating the HP 3852A. Fixtures for testing individual plug-in modules should be ordered separately.	\$1,920
---	---------

# DATA ACQUISITION SYSTEMS

Instruments for Measurement and Control

HP 3497A

627

- Relay multiplexer
- DVM
- FET multiplexer
- Real-time clock
- Bridge completion

- Digital inputs/outputs
- Counter
- Programmable D/As
- Optional RS-232C interface

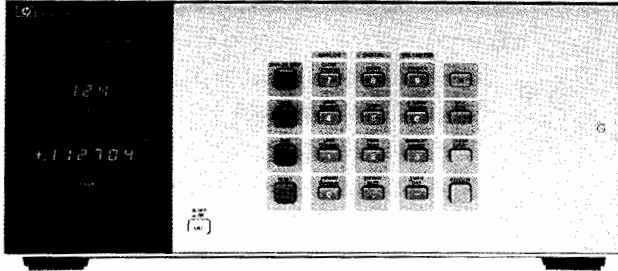

HP 3497A



## Description

The HP 3497A Data Acquisition/Control Unit combines the capabilities of several instruments and is a basic building block of an automatic data acquisition and control system. The HP 3497A is used in an HP-IB automated system and can be viewed as a precision measurement and control computer peripheral.

The HP 3497A has been designed to be a very versatile and very powerful instrument. A basic HP 3497A consists of a mainframe that includes a front panel keyboard and display, a nonvolatile real-time clock, and an HP-IB interface. Available as an option is a 5½-digit integrating digital voltmeter and current source that occupies a dedicated slot in the HP 3497A chassis. Capability is added to the HP 3497A by using any combination of plug-in assemblies. Available plug-in assemblies are:

- Relay Multiplexers with or without thermocouple compensation
- FET Multiplexer
- Digital Input/Interrupt
- Counters
- Strain gage/bridge completion
- Actuators
- Programmable voltage and current D/As
- Breadboard Assembly

Up to 5 assemblies can be added to an HP 3497A and the HP 3498A Extender chassis can hold up to 10 more plug-in assemblies.

## High Performance

The HP 3497A DVM can resolve 1-microvolt signals and is ideal for the precise measurement of the outputs of thermocouples, strain gages, and other transducers. Included on the DVM is a programmable current source that allows four-terminal resistance measurements. The multiplexer assemblies switch 3 wires (Hi, Lo, and Guard) and add less than 2 microvolts of thermal offset to the measured signal.

## Flexible Hardware Configuration

The HP 3497A card cage can hold 5 of any combination of the plug-in assemblies. This allows the multiplexing of up to 100 3-wire inputs to the DVM in a single HP 3497A, or a single HP 3497A might contain 60 multiplexer channels, 16 digital inputs, 16 actuator outputs, and a DVM. By using HP 3498A Extenders, up to 1,000 analog channels or 1,360 digital channels can be controlled, all at a single bus address.

## Ease of Use

The HP 3497A keyboard and display make the HP 3497A very easy to use and make debugging of an HP 3497A-based system easy. The calibration adjustments for the HP 3497A DVM are located behind a hinged front panel; this allows complete calibration of the DVM without removing it from the test rack. Connections to all of the HP 3497A assemblies are made with screw terminals, eliminating the need for soldering.

## Real-Time Clock

The HP 3497A mainframe includes a quartz-referenced, nonvolatile, real-time clock. In addition to providing timing data, the clock can measure elapsed time, interrupt at a preset time, and output a programmable pulse train.

## Software

HP Data Acquisition Manager is general purpose data acquisition software for computers running the HP BASIC programming language. The software reduces development time by providing a library of software "tools" (subroutines) that you can use in your programs (see page 628 for more information).

Each HP 3497A can hold one DVM assembly (Option 001) and up to 5 plug-in assemblies. Each HP 3498A (Option 298) can hold 10 additional plug-ins. To order plug-ins without a mainframe, order as 444xxx Field Installation Kits as shown below.

Clock format and power line frequency and voltage will be set at the factory based on the country from which the order was placed.

Ordering Information	Price
<b>HP 3497A</b> Data Acquisition/Control Unit	\$4,250
<b>Opt 001 or 44420A</b> 5½-Digit DVM and Current Source	\$2,200
<b>Opt 010 or 44421A</b> 20-Channel Relay Multiplexer Assembly	\$900
<b>Opt x20 or 44422x</b> Relay Multiplexer Assembly. Substitute A in place of x for software compensation. For hardware compensation, substitute the thermocouple type B, E, J, K, R, S, or T for x.	\$950
<b>Opt 030 or 44423A</b> 20-channel FET Multiplexer Assembly	\$1,040
<b>Opt 050 or 44425A</b> 16-channel Isolated Digital Input/Interrupt Assembly	\$770
<b>Opt 060 or 44426A</b> 100 kHz Reciprocal Counter	\$880
<b>Opt 070 or 44427A</b> 120 Ohm Strain Gage/Bridge Completion Assembly	\$1,260
<b>Opt 071 or 44427B</b> 350 Ohm Strain Gage/Bridge Completion Assembly	\$1,260
<b>Opt 110 or 44428A</b> 16-Channel Actuator/Digital Output Assembly	\$1,040
<b>Opt 115 or 44431A</b> 8-Channel High-Voltage Actuator Assembly	\$880
<b>Opt 120 or 44429A</b> Dual Output Voltage DAC Assembly	\$1,420
<b>Opt 130 or 44430A</b> Dual Output Current DAC Assembly	\$1,420
<b>Opt 140 or 44432A</b> Breadboard Card	\$230
<b>Opt 232</b> Delete HP-IB Interface, add RS-232C Interface	\$440
<b>HP 3498A</b> Extender and Connecting Cables	\$3,140

# DATA ACQUISITION SYSTEMS

## Software Solutions

Data Acquisition Manager - DACQ/300, DACQ/PC, DACQ/UX (HP 44458A, 44459A, 44460A)

- Reduce your software development time
- Customize your data management needs
- Optimize your software performance
- Use with the controller of your choice: either HP 9000 Series 200/300, HP Vectra PC, or HP-UX Workstation
- Use with any HP-IB instrument

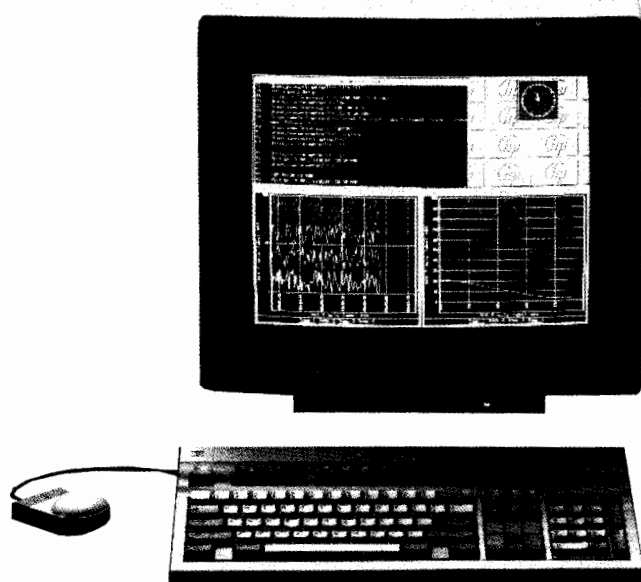

### Description

HP Data Acquisition Manager is a general-purpose subroutine library for the HP 9000 Series 200/300 controllers (HP DACQ/300), the HP-UX Workstation (DACQ/UX), or the HP Vectra Personal Computer equipped with the HP BASIC language processor (HP DACQ/PC). The software reduces your development time by providing you with software tools (subroutines written in HP BASIC and compiled Pascal) that you can add to your HP BASIC program to handle up to 90 percent of your data management functions. Customize your data management programs by adding these subroutines to match your final application needs. Optimize your software performance through HP Data Acquisition Manager's compiled subroutines and use of memory volumes (electronic disk). Eliminate the need to have several software packages because HP Data Acquisition Manager provides you with subroutines that cover a wide range of data acquisition and control tasks and works with any HP-IB instrument. Use HP Data Acquisition Manager with the controller of your choice—either the HP 9000 Series 200/300 controller, the HP Vectra Personal Computer, or the HP-UX Workstation.

### Data Management

Use HP Data Acquisition Manager to:

- Set up a database organized into archives, books, and pages
- Specify the format of books and pages
- Collect data over HP-IB, over GPIO, from the program, or from the keyboard
- Time-stamp and store the data into the database
- Document the data
- Retrieve the data from the database to display, analyze, or transmit it elsewhere

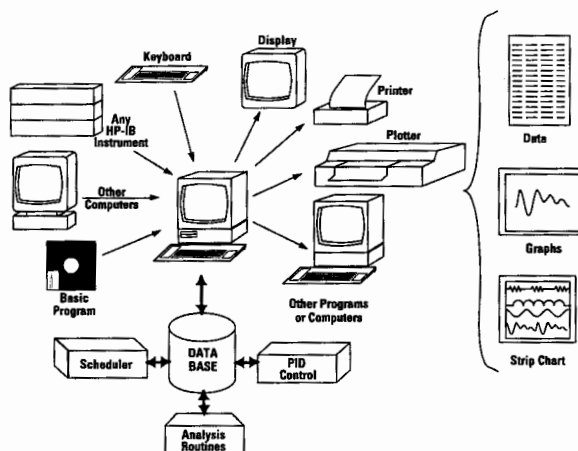

### Data Analysis

Entire arrays of data captured over HP-IB or retrieved from the database can be analyzed quickly using the data analysis subroutines. Analysis functions available are:

- Scaling ( $mx + b$ )
- Limit checking
- Statistics (high, low, mean, standard deviation)
- Math (+, -, \*, /)
- FFT and inverse FFT
- Temperature conversions (thermocouples, thermistors, RTDs)
- Strain gage conversions
- User-defined look-up tables
- Unpacking packed HP 3852 high-speed voltmeter readings

### Supported Computers

#### HP BASIC and HP-UX Workstations:

Series 300 Model 370  
 Series 300 Model 360  
 Series 300 Model 350  
 Series 300 Model 340  
 Series 300 Model 332  
 Series 300 Model 330  
 Series 300 Model 320  
 Series 300 Model 319  
 Series 300 Model 310  
 Series 200 Model 236 (monochrome only)  
 Series 200 Model 220  
 Series 200 Model 217  
 Series 200 Model 216

#### Operating System for HP DACQ/300 and HP DACQ/UX

HP BASIC 5.0 or greater for the HP BASIC workstations  
 HP BASIC/UX 5.52 with HP-UX 7.0 for the HP-UX workstations  
 Basic Language Processor for HP DACQ/PC-BASIC emulators:  
 A.xx.xx, B.xx.xx, and C.xx.xx

#### Memory

1.5 MB or greater

### Ordering Information

	Price
<b>HP 44458A</b> HP DACQ/300 software and manual, 3½-in and 5¼-in disks	\$2,300
<b>HP 44458R</b> HP DACQ/300 manual and license to copy HP DACQ/300 software (HP 44458A or HP 44458B) for use on one other computer	\$1,390
<b>HP 44459A</b> HP DACQ/PC software and manual, 3½-in and 5¼-in disks, requires HP 82300C Basic Language Processor	\$1,700
<b>HP 44459R</b> HP DACQ/PC manual and license to copy HP DACQ/PC software (HP 44459A or 44459B) for use on one other computer	\$1,060
<b>HP 44460A</b> HP DACQ/UX software and manual, ¼-in tape	\$2,050
<b>HP 44460R</b> HP DACQ/UX manual and license to copy HP DACQ/UX software (HP 44460A) for use on one other computer	\$1,250

- Up to 30 differential channels, 56 single-ended channels
- Electronic calibration for repeatable answers
- Built-in 5½ digit A/D converter with 1-microvolt sensitivity
- HP-IL (standard) and HP-IB (optional) with rear panel switch
- Optional 12-volt remote charging adapter

- "Sleep mode" for extended battery life in remote locations
- Front terminals for convenient DCV, ACV, 2- and 4-wire ohms, frequency, and temperature
- Display shows channels closed, digital states, and self-test conditions



HP 3421A

### HP 3421A Data Acquisition/Control Unit

If your measurement needs exceed the capabilities of plug-in cards but don't quite call for a top-of-the-line data acquisition unit, the HP 3421A is just what you are looking for. The HP 3421A is the instrument that beats the high cost of data logging. Use it for small data acquisition projects with the assurance that it will quickly pay its own way. The HP 3421A can be configured with several different computers into a variety of systems designed for low- to medium-size applications.

#### The Instrument

The HP 3421A scans up to 30 channels, measuring DCV, ACV, 2- and 4-wire ohms, frequency, and temperature. It also reads and writes digital information and stores up to 30 analog readings. The standard HP 3421A comes with an HP-IL interface for battery-powered flexibility or, optionally, an HP-IB for more computational power.

The HP 3421A is battery-powered with latching relays that will not change state when the ac line power is removed.

Up to three of the following assemblies may be added to the HP 3421A mainframe:

- 10-channel analog multiplexer/actuator assembly with thermocouple compensation
- 8-bit input/8-bit output digital assembly
- Breadboard assembly for custom circuitry

#### Measurement Integrity

With its 5½, 4½, 3½ digit A/D converter, the HP 3421A can resolve 1 μV out of 300 mV to monitor thermocouples and other low-level transducers. Or it can read higher-level signals by auto-ranging up to 300 volts dc.

### HP 3421A Mainframe Specifications

The HP 3421A mainframe comes with:

- A 5½, 4½, and 3½ digit integrating A/D converter
  - Built-in counter
  - Thermocouple compensation
  - Type T thermocouple linearization built in
  - HP-IL
  - 30-reading storage buffer
  - LCD 30 channel display with power and error indicators
  - Electronic calibration
  - Rechargeable battery
  - High-level command set
- All specifications apply for relative humidity less than 85 percent at 30° C

#### dc voltage

**Ranges:** 300 mV, 3 V, 30 V, 300 V, Autorange

**Basic accuracy:** ± (.009% reading + 3 counts); 5½ digits

**Reading rates:** 2 to 35 readings/second

### Ordering Information

**HP 3421A** Data Acquisition/Control Unit. \$2,550

#### Input and I/O Assembly Options

<b>Opt 020</b> 8-Channel Multiplexer/2-Channel Actuator Assembly.	+\$570
<b>Opt 021</b> 9-Channel Multiplexer/1-Channel Actuator Assembly.	+\$570
<b>Opt 022</b> 10-Channel Multiplexer Assembly.	+\$570
<b>Opt 040</b> Breadboard Assembly with connector block.	+\$130
<b>Opt 050</b> 8 bit in, 8 bit out digital I/O assembly with connector block.	+\$570
<b>Opt 201</b> Add HP-IB interface. Allows use of either HP-IB or HP-IL controller.	+\$460
<b>Opt 214</b> Add 12 volt remote charging adapter. Cannot be added if Opt 201 is specified.	+\$600

#### Field Installation Kits\*

<b>HP 44461A:</b> Add HP-IB interface. Allows use of either HP-IB or HP-IL controller (same as Opt 201).	\$460
<b>HP 44462A:</b> 8-Channel Multiplexer/2-Channel Actuator Assembly with thermocouple compensation, connector block. (Same as Opt 020. Can be reconfigured to same as Opt 021 or Opt 022.)	\$570
<b>HP 44463A:</b> Extra connector block for HP 44462A.	\$70
<b>HP 44464A:</b> Breadboard Assembly with connector block (same as Opt 040).	\$130
<b>HP 44465A:</b> 8 bit in, 8 bit out Digital I/O Assembly with connector block (same as Opt 050).	\$570
<b>HP 44466A:</b> Extra connector block for digital or breadboard assembly.	\$30
<b>HP 44469A:</b> Seven 10:1 dividers for measuring 300 Vac.	\$30

#### Accessories

<b>HP 11340A:</b> 20-meter HP-IL Cable.	\$140
<b>HP 11340B:</b> 50-meter HP-IL Cable.	\$260
<b>HP 11340C:</b> 100-meter HP-IL Cable.	\$510

\* Field installation is recommended to be performed only by service trained personnel.

# TECHNICAL COMPUTER SYSTEMS

## HP 1000 Computers for Real-Time Applications

- Computer-aided manufacturing
- Computer-aided test
- Real-time monitoring and control
- Real-time data acquisition

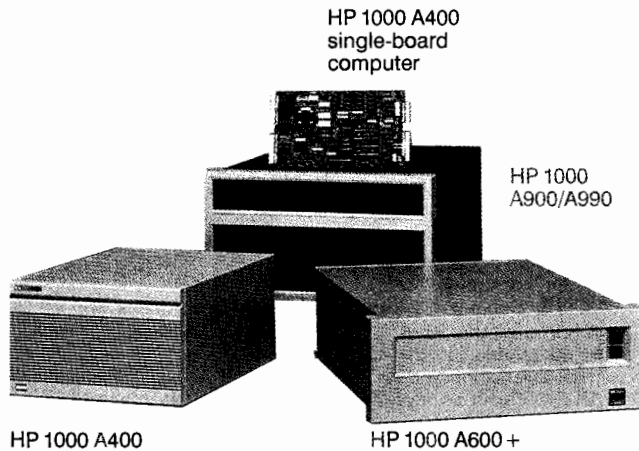

### Versatile Design for Real-Time Applications

HP 1000 open-architecture computers are modular machines designed for real-time multiprogramming and multi-user applications in manufacturing, communications, research, and other fields that require real-time response. A choice of processors and a wide variety of interfaces and software equip HP 1000 computers to solve many different applications, taking advantage of HP 1000 real-time performance features to meet the most demanding needs of OEMs, system designers, and end users.

### Fast, Efficient Handling of I/O

External sensors, measurement instruments, and other I/O devices connect to HP 1000 systems via I/O interfaces and an I/O system with multi-level, vectored hardware interrupts that expedite I/O. Each I/O channel has its own interrupt priority level, from which interrupts directly initiate service programs. Direct memory access, controlled under a distributed-intelligence I/O design, speeds data transfers to and from memory with minimal involvement of the CPU.

### Fast Processing of Data

HP 1000 systems can process data at base instruction rates up to 7 MIPS and floating point processing speeds up to 1300 KWIPS-BID. This minimizes the time needed to process input data, evaluate results, and initiate real-time action.

### Clocked Operations Timing

Clocked operations timing is provided by timebase generator interrupts that maintain a real-time clock.

### Large Main Memory Capacity

Up to 32 Mbytes of main memory can be provided to keep most critical programs resident and ready to execute quickly, avoiding the delays inherent in moving programs to and from disk.

### Powerful Real-Time Operating System

The RTE-A system supports memory-based or disk-based real-time multiprogramming operation with easy, efficient inter-process communication and priority-based scheduling of programs in response to event-interrupt, time-of-day, program, or user requests. RTE-A manages sharable memory-resident data arrays up to 2 Mbytes and virtual data arrays up to 128 Mbytes in main memory and on disk. With its VC+ extension, RTE-A supports execution of programs as large as 7.75 Mbytes.

### A Choice of Processors for Diverse Applications

Performance Level	HP 1000 Processor	Base Speed (MIPS)	Floating Point Speed (KWIPS-BID)	I/OB/W Using DMA Mbyte/s CP
1	A400	1	120	4.4
	A600 +	1	110	4.3
2	A900	3	820	3.7
3	A990	7	1300	4.0

### A400 Minicomputer

The A400 minicomputer packs a 1.0 MIPS CPU, double-precision floating point firmware, 0.5 Mbyte of memory, and a 4-port serial I/O multiplexer on a single plug-in board computer (SBC). At a price close to what you'd expect to pay for a personal computer, the A400 SBC delivers full A-Series functionality, including support under the RTE-A real-time executive operating system and complete compatibility with all other members of the A-Series family.

### A600 + Minicomputer

The A600 minicomputer offers 1.0 MIPS base execution speed and double-precision floating point firmware. Unlike the A400 minicomputer, the A600 + can support ECC memory as well as parity memory. The A600 + processor consists of a CPU card and a memory controller card.

### A900 Computer

The A900 computer is a 5-board set that incorporates a pipeline implementation and a cache memory scheme providing 3 times the base performance of the A400/A600 + computer and over 7 times the floating point performance. The A900's floating point processor and scientific and vector instruction sets are built in. ECC memory is standard for maximum system integrity.

### A990: A New Single-Board Processor

The A990 has been developed for customers who require even more performance than that provided by the A900. In addition to approximately doubled base speed and floating point speed, the A990 also provides increased I/O bandwidth and significantly improved memory cycle time. The A990 is also available in the same package configurations as the current A900.

For those applications in which speed is critical, the A990, with its standard on-board writeable control store, is also user-microprogrammable.

Customers who already have A-Series computers can field-upgrade to the new A990 processor by purchasing the 12990C upgrade package. Also, whether upgrading from an A400, A600 +, or A700 (obsolete) to an A900 or the new A990, customers will receive trade-in credits.

### Exceptional Applications Flexibility

Programs can be developed on any member of the A-Series family and executed without change on any other member, from the A400 up through the A990. Processing power, capacity, and cost can be closely matched to application requirements with the guaranteed ability to grow as and whenever necessary.

### Flexible Packaging— from Board Computers to System Processor Units

HP 1000 A-Series processors are available in a variety of packaging configurations to meet the requirements of many different applications. (See the summary below.)

Processor	A400	A600 +	A900	A990
Board Computer	12100A	2106CK/DK	Not Avail.	12990C (Upgrades only)
Micro 14/16 6-Slot Box Computer	2424A	2426G/H	Not Avail.	Not Avail.
Micro 24/26/29/99 14-Slot Box Computer	2434A 2484B	2436G/H 2486B/C	2439B 2489B	2939A 2989A
20-Slot Box Computer	2134A	2156C/D	2139B	2959A
Model 26/29/99 System Proc. Unit	Not Avail.	2196G/H	2199E	2999A



### Board Computers

Board computers make the A400 and A600+ processors available to OEMs or system designers in a space-conserving package for embedded controller applications, or for other uses in which custom integration is required either to fit within defined physical constraints or to meet cost objectives.

### Box Computers

Box computers incorporate the CPU card(s) and memory in a fully powered card cage that can be installed in a rack cabinet. Because a system console and system disk are not prerequisite to purchase, the box computer offers OEMs and system designers more configuration flexibility than the system processor unit.

### System Processor Units

System processor units (SPUs) include a box computer, interface to the system disc, the RTE-A operating system and diagnostics, site prep consultation and installation/checkout services, and 90-day on-site warranty. The higher level of SPU integration simplifies design, ordering, and implementation of systems that use a system console and a system disk. The SPU also complies with FCC and VDE EMI regulations.

### Micro 14/16 Box Computer

The Micro 14/16 box computer provides the A400 or A600+ processor in a low-cost 6-slot box for low-end systems. Exceptionally efficient cooling makes operation possible in ambient temperatures to 60° C. This and a 1.5G operating shock spec make the Micro 14/16 ideal for use in tough environmental conditions.

### Micro 24/26/29/99 Box Computer or System Processor Unit

The Micro 24/26/29/99 box computer or system processor unit provides the A400, A600+, A900, or A990 processor in the versatile 14-slot Micro/1000 package. The Micro/1000 package can be placed on a table or bench, installed in a space-saving vertical floor mount with roll-about mobility (as shown in the photo above), or rack-mounted in a larger cabinet. In addition to its compactness and convenience, the Micro/1000 package can incorporate integrated mass storage (a 20 Mbyte mini Winchester disk and a 630 kbyte diskette).

### 20-Slot Box Computer

The 20-slot box computer provides the A400, A600+, A900, or A990 processor in the largest available package for applications that need more card cage slots than the Micro/1000 package provides.

### Model 26/29/99 System Processor Unit

The Model 26/29/99 system processor unit provides either the A600+, A900, or A990 processor in the 20-slot box configuration that is intended to be rack-mounted in either a tall or a short rack cabinet (HP 29431G or HP 29429A, respectively).

### High-Density Memory

HP now offers HP 1000 memory that uses 1 Mbit DRAMs: 2, 4, and 8 Mbyte parity memory boards for the A400 and A600+ computers, and an 8 Mbyte ECC memory board for the A900 and A990 computers.

A400 and A600+ computers typically incorporate the less-expensive parity memory as the preferred memory system. For large systems in critical applications, Error Correcting Code (ECC) memory, which detects and corrects all single-bit errors and detects all double-bit errors to provide the best possible system integrity, is preferred. All A900s and A990s use ECC memory. ECC memory is optional for the A600+.

### HP 1000 Software

HP 1000 software products for program development, database management, graphics, distributed systems networking, quality decision management, programmable controller communications, and process monitoring and control are supported in all HP 1000 A-Series computers. This universality of HP 1000 software helps you to tailor comprehensive, coherent solutions to your specific application needs. Further help is available from a growing array of HP 1000 software products offered by third-party suppliers under the HP PLUS software program.

### Program Development

With a hard disk and optional software, HP 1000 systems can be used to develop programs in BASIC, FORTRAN 77, Pascal, C, and Macro/1000 assembly language. Symbolic Debug/1000, program profiling, and user microprogrammability (in the A900 and A990 processors) provide extra capability that can be used to gain extra performance.

### Computer Networking

HP's AdvanceNet software makes it easy to connect HP1000 systems across a city or a continent, sharing vital information throughout the network. LAN link is now available for fast local-area communications with other HP systems or with DEC VAX systems.

### Compatibility with HP 9000 Series 800 Systems

Applications migration consulting services are available from Hewlett-Packard to promote compatibility of the HP 1000 systems with HP 9000 Series 800 systems. Multiple HP 1000 systems used as factory floor cell controllers can thus benefit from supervision and support by HP 9000 Series 800 systems used as area managers at Level 2 in the CIM hierarchy, or in similar supporting host roles.

### Plant Automation

The HP 1000 can help improve productivity and reduce costs. Hewlett-Packard's wide range of hardware and software supports automation of instruments and machines as well as monitoring and control of real-time processes. For low point-count data acquisition, A-Series measurement and control cards provide many analog interfacing functions within the computer, without need for add-on peripheral devices.

### Automated Test Systems

HP automated test systems can be configured from HP 1000 A-Series computers and a wide range of electronic instruments to perform virtually any electronic test application.

### Prices

Prices range from \$2,600 for an HP 12100A A400 single-board computer with 0.5 Mbyte parity memory and 4-port multiplexer to approximately \$45,000 for an HP 2989 A990 Micro/1000 system with 3 Mbyte ECC memory, RTE-A/VC+ operating system, 20 Mbyte integral disk, and system console connected via an 8-port multiplexer.

### HP 12016A SCSI (Small Computer Systems Interface)

The U.S. list price of the 12016A SCSI Interface is \$1495.

The HP 12016A SCSI interface provides connection to the industry-standard SCSI I and SCSI II peripheral interfaces for fast, efficient handling of I/O. Up to 7 devices, including flexible and hard magnetic disk drives, optical disk drives, and magnetic tapes, can be connected to the HP 12016A.

In addition to those features previously mentioned, the 12016A provides:

- An interface that is compatible with all HP 1000 A-Series computers and systems.
- An interface to HP and non-HP low-cost SCSI peripherals.
- Built-in DMA capability for optimum I/O efficiency.
- DMA transfer rates up to 2.4 Mbytes/second to both HP and non-HP SCSI peripherals.
- Concurrent operation of multiple SCSI interfaces under control of the RTE-A operating system.
- Factory-supported design environment for custom device drivers.
- Supported cable lengths of 6 meters for single-ended operation and 25 meters for differential operation.
- A calculated MTBF of greater than 50,000 hours.
- A diagnostic kit for the 12016A, provided with the 12016A SCSI Interface.

# COMPUTER AIDED TEST

## Multiprogrammer: User-Adaptable Instrumentation

HP 6942A, 6944A, 6954A, and 14753A Computer Aided Test Software

- Build a test system tailored to your specific application
- Broad range of function-oriented I/O cards with a unified design
- Simultaneous and independent functions

### Introduction

Hewlett-Packard Multiprogrammer products have met the needs of automated test requirements for many years. For existing applications based on these products, the Multiprogrammer solution will continue to be available as a computer-aided test solution until October 1992. With future needs in mind, Hewlett-Packard has developed the HP 75000 family of VXI products, which are part of the HP Measurement Systems Architecture (MSA). This next generation computer-aided-test solution provides many of the features and functions of the Multiprogrammer product family, and offers a growing number of products for continued application support and flexibility. For more information on the HP 75000 family of VXI products, see page 87.

Hewlett-Packard Multiprogrammer products provide solutions for a variety of data-acquisition, control, and test applications. The application flexibility results from the architectural features of these products. The plug-in Multiprogrammer I/O cards allow card-to-card communication, isolated inputs, and external triggering, and provide a wide range of functions. The HP 6942A Multiprogrammer and the Series II I/O cards are a medium-performance, medium-speed, HP-IB solution. For applications requiring a higher level of performance and more speed, the HP 6944A or HP 6954A Multiprogrammer should be considered for use with the Series II I/O cards.

The I/O cards have many benefits. Multiple-card configurations can be established that provide instrument-like functions, such as high-speed scanning and multiple simultaneous-buffered analog-to-digital converters. Other features provide precise crystal-controlled timing or pacing of I/O operations. This allows the modular construction of instrumentation functions such as frequency measurement, time-interval measurement, and programmable pulse generation. The card-to-card communication feature allows the I/O operation of the Multiprogrammer to operate independently of the computer. The computer is then free to perform other tasks until it receives an interrupt from the Multiprogrammer. If the application requires the process to control data collection, it can be accomplished via the external trigger feature. This feature allows the process to time or pace operations independently of the computer. In addition, I/O data can be stored in the Multiprogrammer's plug-in memory system, allowing high-speed performance of other tasks by the computer.

### HP 6954A Features

- A rugged rack-mountable test system in a single unit
- Built-in HP 9000 Series 310 or Series 332 computer, and 20 Mbyte hard disk
- Includes BASIC and HP 14753A CAT programming package
- HP-IB, HP-HIL, RS-232, audio and video interfaces
- Local or remote control via HP-HIL or RS-232
- Standard HP Multiprogrammer Series II I/O cards
- HP 9000 Series 200/300 memory, accessory, and I/O cards

### HP 6942A Features

- Data transfer rate 18,000 readings/second
- HP-IB interface
- HP 14753A CAT programming package

### HP 6944A Features

- Data transfer rate of 220,000 readings/second
- HP 98633A interface to HP Series 200/300 computers
- Direct to disk at 200,000 words/second
- Requires HP 14753A CAT programming package

### HP 14753A Features

- Easy-to-use menu entry
- Faster software development
- Improved HP 6942A performance

- Isolated power supplies for analog functions
- Mainframe extenders for increased I/O capacity
- High-speed data capture and throughput

### Ordering Information

	<b>Price</b>
<b>HP 6954A</b> Multiprogrammer	\$15,270
<b>Opt 332</b> Replaces the 310 SPU and SMA card of a standard 6954A with a 332 SUP (with 2 Mbyte RAM and on-board DMA)	\$2,830
<b>Opt 001</b> Local Control Kit	\$615
<b>Opt 002</b> Delete BASIC and HP 14753A	-\$1,000
<b>Opt W30</b> 2-Year Additional Warranty (cannot be ordered with Option W03)	\$200
<b>Opt W03</b> Warranty Conversion to 90-day Onsite	\$0
<b>Opt 908</b> Rack Mount Kit	\$46
<b>Opt 910</b> Extra Installation and Service Manual	\$36
<b>HP 6942A</b> Multiprogrammer	\$7,875
<b>HP 6943A</b> Multiprogrammer Extender	\$6,200
<b>Opt 010-233</b> One-Set Documentation/Software	\$0
<b>Opt 908</b> Rack Flange Kit	\$42
<b>Opt 910</b> Extra Manual	\$32
<b>Opt W03</b> Converts 1-Year Return-to-HP Warranty to a 90-day Onsite Warranty	\$0
<b>HP 14700A</b> Extender Interface Kit	\$975
<b>HP 14701A</b> Extender Interface Kit	\$1,175
<b>HP 14702A</b> Chaining Cable	\$475
<b>HP 6944A</b> Series 200/300 Multiprogrammer	\$5,695
<b>Opt 908</b> Rack Mount Kit	\$37
<b>Opt 910</b> Extra Operating and Service Manual	\$42
<b>Opt W03</b> Converts 1-Year Return-to-HP Warranty to a 90-day Onsite Warranty	\$0
<b>HP 98633A</b> Multiprogrammer Interface Card	\$690
<b>HP 14704A</b> Multiprogrammer Interface Cable, 1 m (3.3 ft)	\$330
<b>HP 14704B</b> Multiprogrammer Interface Cable, 2 m (6.6 ft)	\$360
<b>HP 14704C</b> Multiprogrammer Interface Cable, 4 m (13.2 ft)	\$400
<b>HP 14753A</b> Computer Aided Test Programming Package	\$2,475
<b>Opt 044</b> 3/4-in. Flexible Discs	\$0
<b>Opt 042</b> 5/4-in. Flexible Discs for 9826/9836	\$0
<b>HP 14753R</b> Right to Reproduce HP 14753A CAT	\$1,325
<b>HP 14703A</b> Spare Card Connector	\$105
<b>HP 14728A</b> Buffered A/D Cable	\$495
<b>HP 69700A-69706A</b> Resistance	\$890
<b>HP 69709A</b> Power Supply Control	\$1,545
<b>HP 69720A</b> D/A Voltage Converter	\$1,035
<b>HP 69721A</b> D/A Current Converter	\$1,375
<b>HP 69730A</b> Relay Output	\$875
<b>HP 69731B</b> Digital Output	\$645
<b>HP 69734A</b> Time Base	\$1,735
<b>HP 69735A</b> Pulse Train	\$745
<b>HP 69736A</b> Timer/Pacer	\$755
<b>HP 69750A</b> Scan Control/Pacer	\$1,025
<b>HP 69751A</b> A/D Converter	\$1,395
<b>HP 69752A</b> 64-Channel FET Scanner	\$1,675
<b>HP 69753A</b> Temperature Scanner	\$1,750
<b>HP 69754A</b> 32-Channel Relay Scanner	\$1,350
<b>HP 69755A</b> 16-Channel FET Scanner	\$855
<b>HP 69759A</b> 500 kHz A/D Converter	\$3,195
<b>HP 69761A</b> Integrating DMM	\$2,575
<b>HP 69770A</b> Isolated Digital Input	\$895
<b>HP 69771A</b> Digital Input	\$850
<b>HP 69774A</b> Universal Counter	\$1,795
<b>HP 69775A</b> Counter/Totalizer	\$1,095
<b>HP 69776A</b> Interrupt	\$835
<b>HP 69790B</b> Memory	\$1,525
<b>HP 69791A</b> Memory	\$2,525
<b>HP 69792A</b> Memory Expansion	\$1,575
<b>HP 69793A</b> Breadboard	\$250



From entry-level desktop to powerful desktide servers, the HP Vectra PC Family is built for your critical business needs.

### Products for Every Need

The Hewlett-Packard PC and terminal product lines offer a broad range of excellent price/performance choices to meet a wide variety of needs, from entry-level ASCII terminals to advanced i486-based PCs.

The HP Vectra 486/25T and 486/33T PCs are high-performance products for the most critical business needs. These EISA (Extended Industry Standard Architecture) -based PCs are ideal as LAN servers supporting over 200 LAN users and 100 UNIX(R) multiuser terminals. The HP Vectra 486/25T and 486/33T PCs support up to 64 Mbytes of RAM, 2.0 Gbytes of internal mass storage capacity, and come with a 1-year, on-site limited warranty.\* These PCs perform at levels previously reserved only for minicomputers.

The HP Vectra RS/25C PC provides an excellent mid-range LAN server platform. The HP Vectra RS/25C PC offers substantial expansion capability and support up to 2.0 Gbytes of mass storage capacity with SCSI-2 hard disk drives.

The HP Vectra 386/25 and QS/20 PCs offer power of a full 32-bit 80386 microprocessor for your most demanding technical and office applications. These desktop PCs offer impressive expandability, exceptional price/performance values, and assurance you need to use them in your most critical business applications.

For entry-level to mainstream applications the HP Vectra QS/16S and 286/12 PCs are designed to meet the ongoing challenges of your technical or office environment. Designed to the same high standards as the most powerful HP Vectra PCs, the HP Vectra QS/16S and 286/12 PCs will deliver trouble-free computing as a general purpose office PC, connected node, or instrument controller.

All HP Vectra PCs are fully compatible with the PC/AT ISA (Industry Standard Architecture) and run popular operating systems such as MS-DOS®, OS/2, and SCO™ XENIX. Hewlett-Packard's commitment to industry standards ensures a smooth growth path to next-generation operating systems and applications.

If your computing environment requires terminals, Hewlett-Packard has a complete line for all your system needs within HP, DEC, and other system environments. These products are designed with state-of-the-art ergonomics, including keyboards with tactile feedback, tilt-and-swivel displays, and a choice of phosphor colors.

Hewlett-Packard graphics subsystems meet the graphics-intensive demands of CAD applications. The 16- and 20-inch high-resolution displays deliver unequalled display quality. The multiscanning display technology allows you to readily switch between CAD applications, which take advantage of high-resolution graphics cards, and office applications, which use VGA cards. This wide range of resolution support (VGA through 1280 × 1024) provides extensive flexibility and growth, and protects your display investment. For users who require only VGA resolution, the HP industry-standard solution provides display performance up to three times faster than others available.

### HP Personal Computers

Hewlett-Packard has a personal computer system to match any application need. From the entry-level 286-based PCs to the top-of-the-line i486-based systems, HP Vectra PCs excel in their class.

#### HP Vectra 286/12 PC

- 12-MHz, 286-based desktop PC
- Up to 8 Mbytes of 16-bit memory
- 4 available I/O slots (ISA)
- 3 half-height mass storage shelves

#### HP Vectra QS/16S, QS/20, and 386/25 PCs

- 16-, 20-, or 25-MHz, 386-based desktop PCs
- Up to 32 Mbytes of 32-bit memory
- 7 I/O slots
- 3 half-height mass storage shelves support up to 336 Mbytes of storage

#### HP Vectra RS/25C PC

- 25-MHz, 32-bit, 386-based with 32 Kbytes of cache memory desktide PC
- Up to 16 Mbytes of 32-bit memory
- 8 I/O slots
- 6 half-height mass storage shelves support up to 660 Mbyte of storage with ESDI and 2 Gbytes with supported SCSI drivers.

#### HP Vectra 486/25T and 486/33T PCs

- 25- or 33-MHz, 32-bit, i486-based processor with integrated coprocessor
- ESIA-based, 32-bit I/O bus
- Up to 64 Mbytes of high-speed system memory
- 8 ESIA accessory slots (ISA compatible)
- 6 half-height mass storage shelves support up to 2.0 Gbytes of internal mass storage
- 1-year, on-site limited warranty\*

\*This limited warranty is for the HP Vectra 486/25T and 486/33T PCs only. Available in the U.S. and Canada only. MS-DOS® is a U.S. registered trademark of Microsoft Corporation. SCO™ is a trademark of Santa Cruz Operation, Inc.

## PERSONAL COMPUTERS &amp; TERMINALS

## HP Vectra PC's

HP Vectra PC	Model number <sup>1</sup>	Product number	Price <sup>2</sup>	Processor	Standard memory	Package type <sup>3</sup>	Flexible Disk Size (Mbyte)	Hard Disk (Mbyte)	Video adapter
<b>286/12</b>	1	D2467A	\$ 1,699	80286	1 MB	D	3.5-in (1.44-MB)	None	Super VGA <sup>4</sup>
	1	D2460A	1,699	(12 MHz)	1 MB	D	5.25-in (1.2-MB)	None	Super VGA <sup>4</sup>
	20	D2462A	2,249		1 MB	D	3.5-in (1.44-MB)	20	Super VGA <sup>4</sup>
	20	D2461A	2,249		1 MB	D	5.25-in (1.2-MB)	20	Super VGA <sup>4</sup>
	40	D2464A	2,299		1 MB	D	3.5-in (1.44-MB)	42	Super VGA <sup>4</sup>
	40	D2463A	2,299		1 MB	D	5.25-in (1.2-MB)	42	Super VGA <sup>4</sup>
<b>QS/16S</b>	1	D1461C	\$ 2,099	80386SX	2 MB	D	3.5-in (1.44-MB)	None	None
	1	D1481C	2,099	(16 MHz)	2 MB	D	5.25-in (1.2-MB)	None	None
	40	D1462C	3,049		2 MB	D	5.25-in (1.2-MB)	42	Super VGA
	40	D1464C	3,049		2 MB	D	3.5-in (1.44-MB)	42	Super VGA
	80	D1488C	3,349		2 MB	D	5.25-in (1.2-MB)	84	Super VGA
	80	D1489C	3,349		2 MB	D	3.5-in (1.44-MB)	84	Super VGA
<b>QS/20</b>	1	D1421B	\$ 2,699	80386	1 MB	D	3.5-in (1.44-MB)	None	None
	1	D1491B	2,699	(20 MHz)	1 MB	D	5.25-in (1.2-MB)	None	None
	46	D1422B	3,649		1 MB	D	5.25-in (1.2-MB)	42	Super VGA
	47	D1424B	3,649		1 MB	D	3.5-in (1.44-MB)	42	Super VGA
	86	D1498B	3,949		1 MB	D	5.25-in (1.2-MB)	84	Super VGA
	87	D1499B	3,949		1 MB	D	3.5-in (1.44-MB)	84	Super VGA
	<b>386/25</b>	1	D2360A	\$ 3,899	80386	2 MB	D	5.25-in (1.2-MB)	None
1		D2371A	3,899	(25 MHz)	2 MB	D	3.5-in (1.44-MB)	None	None
80		D2363A	5,149		2 MB	D	5.25-in (1.2-MB)	84	Super VGA
80		D2361A	5,149		2 MB	D	3.5-in (1.44-MB)	84	Super VGA
170		D2364A	5,899		2 MB	D	5.25-in (1.2-MB)	168	Super VGA
170		D2362A	5,899		2 MB	D	3.5-in (1.44-MB)	168	Super VGA
<b>RS/25C</b>		1	D2080A*	\$ 4,799	80386	4 MB	F	3.5-in (1.44-MB)	None
	1	D2020A*	4,799	(25 MHz)	4 MB	F	5.25-in (1.2-MB)	None	None
	170	D2082A*	6,299		4 MB	F	3.5-in (1.44-MB)	168	None
	330	D2083A*	8,199		4 MB	F	3.5-in (1.44-MB)	330	None
<b>486/25T</b>	1	D2219C*	\$ 7,199	80486	4 MB	F	3.5-in (1.44-MB)	None	None
	1	D2220C*	7,199	(25 MHz)	4 MB	F	5.25-in (1.2-MB)	None	None
	170	D2221C*	8,699		4 MB	F	3.5-in (1.44-MB)	168	None
	440	D2222C*	11,699		4 MB	F	3.5-in (1.44-MB)	440	None
	670	D2223C*	12,799		4 MB	F	3.5-in (1.44-MB)	670	None
<b>486/33T</b>	1	D2236A*	\$ 8,799	80486	4 MB	F	3.5-in (1.44-MB)	None	None
	1	D2237A*	8,799	(33 MHz)	4 MB	F	5.25-in (1.2-MB)	None	None
	170	D2238A*	10,299		4 MB	F	3.5-in (1.44-MB)	168	None
	670	D2239A*	13,299		4 MB	F	3.5-in (1.44-MB)	440	None
	1000	D2240A*	15,999		4 MB	F	3.5-in (1.44-MB)	1.0 GB	None

\*NOTE: A language option must be specified when ordering an HP Vectra PC (for example, option ABA for U.S. English).

<sup>2</sup> Prices as of June 1, 1991. Check with your nearest dealer for current prices.

<sup>3</sup> D - Desktop F - Floor-standing

<sup>4</sup> Super VGA integrated on motherboard

\* New product

## HP Vectra PC Product-Specific Accessories

Option	Product #	HP Vectra 486/33T PC <sup>1</sup>	HP Vectra 486/25T PC <sup>1</sup>	HP Vectra RS/25C PC	HP Vectra 386/25 PC	HP Vectra QS/20 PC	HP Vectra QS/16S PC	HP Vectra 286/12 PC
<b>Memory</b>								
1 Mbyte Mem Expansion Kit	D1640A			X		X	X	X
2 Mbyte Mem Expansion Kit	D1354A						X	X
4 Mbyte Mem Expansion Kit	D1642A			X		X		
1 Mbyte Mem Module	D2150A	X	X					
2 Mbyte Mem Module	D2381A	X	X		X			
4 Mbyte Mem Module	D2156A	X	X					
8 Mbyte Mem Module	D2152A	X	X		X			
286/12 Expansion Card	D2401A							X
QS/20 Expansion Card	D1440A					X		
<b>Mass Storage</b>								
5¼-in 1.2 Mbyte Flexible Disk Drive	45812A	X	X	X	X	X	X	X
3½-in 1.44 Mbyte Flexible Disk Drive	D1667A	X	X	X	X	X	X	X
20 Mbyte ST-506 Disk Drive	D1296A							X <sup>2</sup>
42 Mbyte Embedded-AT Disk Drive	D1665A	X	X		X	X <sup>3</sup>	X <sup>3</sup>	X
84 Mbyte Embedded-AT Disk Drive	D1666A	X	X		X	X <sup>3</sup>	X <sup>3</sup>	X
120 Mbyte Embedded-AT Disk Drive	D1679A	X	X <sup>4</sup>		X	X <sup>4</sup>	X <sup>4</sup>	
168 Mbyte Embedded-AT Disk Drive	D1680A	X	X <sup>4</sup>		X	X <sup>4</sup>	X <sup>4</sup>	
336 Mbyte Embedded-AT Disk Drive Pair	D1688A				X <sup>5</sup>			
103 Mbyte ESDI Disk Drive	D1674A			X				
155 Mbyte ESDI Disk Drive	D1675A			X				
310 Mbyte ESDI Disk Drive	D1676A			X				
330 Mbyte ESDI Disk Drive	D1660A	X	X					
670 Mbyte ESDI Disk Drive	D1661A	X	X					
440 Mbyte SCSI-2 Disk Drive	D1685A	X	X	X				
670 Mbyte SCSI-2 Disk Drive	D1686A	X	X	X				
1 Gbyte SCSI-2 Disk Drive	D1687A	X	X	X				
ESDI Controller	D1664A	X	X					
EISA SCSI Host Bus Adapter	D1681A	X	X					
ISA SCSI Host Bus Adapter	D1682A	X	X	X				
40 Mbyte Tape Drive	D1671A	X	X	X	X	X	X	X
120 Mbyte Tape Drive	D2045A	X	X	X	X	X	X	X
Flexible Disk Expander	D1678A			X				
<b>Coprocessors</b>								
287/12 MHz	D2400A							X
387SX/16 MHz	D1453A						X	
387/20 MHz	D1670A					X		
387/25 MHz	D2070A			X	X			

<sup>1</sup>HP Vectra 486/25T and 486/33T PC memory modules must be added in pairs.

<sup>2</sup>For HP Vectra 286/12 PC Model 20 only.

<sup>3</sup>Supported on HP Vectra PCs produced as of January 1990. Reference your HP support channel for systems produced before this date.

<sup>4</sup>Supported on HP Vectra PCs produced as of October 1990. Reference your HP support channel for systems produced before this date.

<sup>5</sup>For HP Vectra 386/25 PC Model 1 only.

# PERSONAL COMPUTERS & TERMINALS

Terminals should provide a comfortable interface with the computer. Hewlett-Packard terminals are designed to work in harmony with the user, offering features like crisp, clear characters, smooth tilt/swivel positioning, and excellent tactile feedback from keyboards to add to your comfort and increase your productivity.

To select the right terminal to meet your needs (whether it's an HP, DEC, or other ASCII system), refer to the matrix below.



	HP SYSTEMS		ASCII SYSTEM	PC SYSTEMS	DEC SYSTEMS	HP SYSTEMS (GRAPHICS)	
	HP 700/92	HP 700/94	HP 700/43	HP 700/44	HP 700/32	2393A	2397A
<b>Compatibility Modes</b>	2392A DEC VT220 DEC VT100 DEC VT52	2394A DEC VT220 DEC VT100 DEC VT52	Wyse 30,50 TV905,910+,925E, 950, ADM 3A,5,31 Hazeltline 1500 ADDS VP A2 Qume 101	PC Term DEC VT220 DEC VT100 DEC VT52	DEC VT320 (VT220) DEC VT100 DEC VT52	TEK 4010/4014 ANSI x 3.64	TEK 4010/4014 ANSI x 3.64
<b>Phosphor Colors</b>	Green, Amber, Soft White	Green, Amber, Soft White	Green, Amber, Soft White	Green, Amber, Soft White	Green, Amber, Page White	Green	Color 8/64
<b>Pages of Memory</b>	8	16	4	4	4	9	9
<b>132 Column</b>	yes	yes	yes	yes	yes	Scrolled	Scrolled
<b>Printer Port</b>	yes	yes	yes	yes	yes	Opt: serial HP-IB Centronix Parallel	
<b>Keyboard Layout</b>	HP	HP	ASCII	PC AT2	DEC VT320	HP	HP
<b>Warranty</b>	1 Year	1 Year	1 Year	1 Year	1 Year	90 Day	90 Day
<b>Additional Features</b>	VPLUS Compatible Barcode reader support	VPLUS Compatible Forms Cache Local Edit checks Modified data tag Barcode reader support	58 Programmable keys Bidirectional printer port	IBM PC character set Bidirectional printer port 75 Programmable function keys in PC term mode	Full overscan, 27, 44, or 55 lines 60 Programmable Keys	I/O Device Support: Touch Screen, Graphics Tablet, Mouse, Barcode reader	
<b>Price</b>	\$875	\$1130	\$479	\$629	\$739	\$2460	\$3885

DEC VT220, DEC VT320, VT100, and VT52 are products of Digital Equipment Corporation.  
WY-30 and WY-50 are products of Wyse Technologies Systems.  
TeleVideo 905, 910+, 925E, and 950 are products of TeleVideo Systems, Inc.  
ADM3A, ADM5, and ADM 31 are products of Lear Siegler Corporation.

Hazeltline 1500 is a product of Esprit Systems, Inc.  
ADDS Viewpoint A2 is a product of Applied Digital Data Systems, Inc.  
QUME QVT-101 is a product of Qume Corporation.

# COMPUTER SUPPORT PRODUCTS

## Secondary Storage

HP Series 6300, 6400, 9144A, 9145A, 7980XC, 7980A, 7979A

637

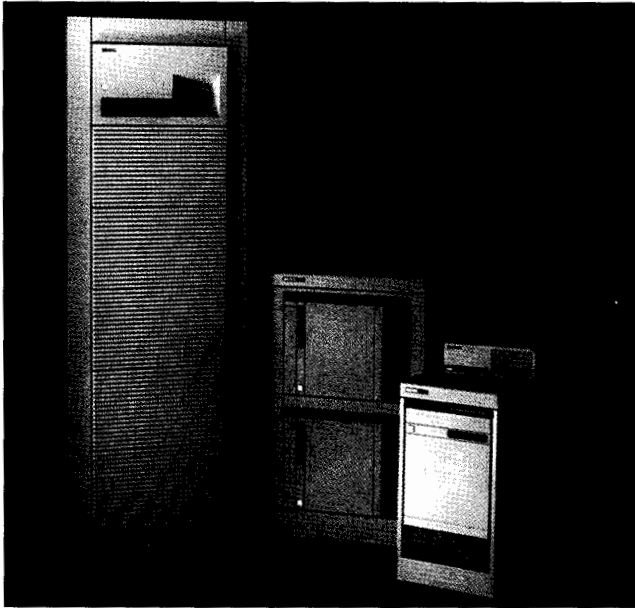

HP Series 6300

### Rewritable Optical Disk Drives and Library Systems

#### Direct Access Secondary Storage

Hewlett-Packard's family of optical products spans the 5.25-inch rewritable optical storage spectrum — from the single-disk 650 megabyte (MB) drive, to the 144-disk, 93.6 gigabyte (GB) library. Hewlett-Packard's optical products offer direct access to files that would customarily consume hard disk space or reside off line in a tape library.

#### Durable, Removable Media

Hewlett-Packard's rewritable optical storage products feature reusable disks that are compact and removable, simplifying storage and transport. Data is not susceptible to head crashes, most magnetic interference, or damage from common office mishandling. The disks accept unlimited read-write passes without disk degradation and can be stored for at least 10 years.

#### Supporting Industry Standards

Our optical family products conform to ANSI and ISO Continuous Composite recording format and use a SCSI interface.

#### Ordering Information

	Price
<b>HPC1701A Model 650/A</b> Optical disk drive with one 650-MB rewritable optical disk cartridge	\$6,395
<b>HPC1700A Model 20GB/A</b> Optical library, 32-disk capacity (20.8 GB) with two rewritable drives	\$41,000
<b>HPC1704A Model 60GB/A</b> Optical library, 88-disk capacity (57.2 GB), four rewritable drives, and optical disk cartridges	\$78,100
<b>HPC1705A Model 100GB/A</b> Optical library, 144-disk capacity (93.6 GB), four rewritable drives, and optical disk cartridges	\$106,500

#### Options

All of the above products are available with multifunction drives. Contact your HP Representative for details on other available options.

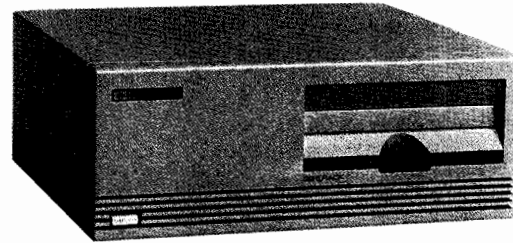

HP 9145A

#### 1/4-Inch Cartridge Tape Solution

The HP 9144A is a low-cost solution for technical systems, HP-UX Series 300, and small business systems, providing 67 MB of data storage on each 16-track cartridge tape.

The HP 9145A is a higher performance 1/4-inch cartridge tape drive for technical and small business systems. The HP 9145A has a transfer rate of 4 MB per minute (twice that of the HP 9144A) and stores 133 MB of data per cartridge tape. The HP 9145A reads and writes to 32-track cartridge tapes, and it will also read 16-track cartridge tapes.

#### Ordering Information

	Price
<b>HP 9144A</b> 1/4-inch cartridge tape drive (16-track)	\$2,600
<b>HP 9145A</b> 1/4-inch cartridge tape drive (32-track)	\$4,055

See product data sheet #5954-1959 for further information.

#### Digital Audio Tape (DAT) Backup Solution

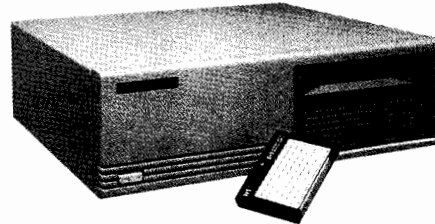

HP Series 6400 Model 1300

The HP Series 6400 Model 1300H and 1300S digital data storage (DDS) format tape drives are based on digital audio tape (DAT) technology. They provide 1.3 GB of data storage on a single cassette and have a transfer rate of 11 MB per minute. The model 1300H has an HP-IB interface and the 1300S has a SCSI interface. The tape drives provide high-capacity, unattended backup for HP's commercial and technical systems.

The HP Series 6400 Model 1300H DDS-Format Subsystem is a high-capacity, unattended backup solution for mid-range and high-end HP 3000 systems. The subsystem contains between two and four C1511A DDS drives in a single cabinet. When combined with TurboSTORE/XL II software, the subsystem is capable of 12 GB of unattended backup in less than 2 hours.

#### Ordering Information

	Price
<b>HP C1511A Series 6400 Model 1300H</b> DDS-format tape drives (HP-IB)	\$7,500
<b>HP C1590A Series 6400 Model 1300H</b> DDS-format Subsystem (HP-IB)	
4 DDS drives in subsystem	\$31,000
<b>Opt 002</b> 2 DDS drives in subsystem	\$16,000
<b>Opt 003</b> 3 DDS drives in subsystem	\$23,500
<b>HP C1512A Series 6400 Model 1300S</b> DDS-format tape drives (SCSI)	\$5,700

See product data sheets #5954-1963 and #5091-0161E for further information.

#### 1/2-Inch Tape Backup Solution

HP also offers high-performance streaming 1/2-inch tape drives, the HP 7980XC, 7980A, and 7979A. See technical data sheet #5953-6897 for details.

# COMPUTER SUPPORT PRODUCTS

## Pen Plotter – Supplies

- Designer color system
- HP SurePlot disposable drafting pens

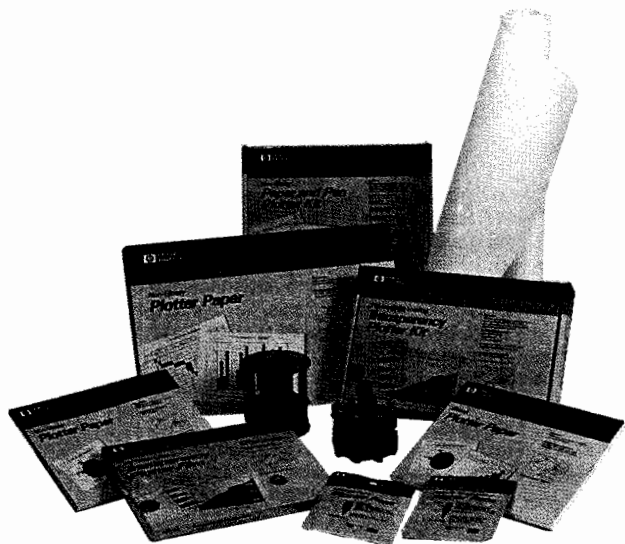

Hewlett-Packard offers a complete line of pens, drawing media, and accessories for business and technical graphics applications. All these supplies are manufactured in the HP tradition of high quality, which you'll see reflected in your work.

### Designer Color System

HP's family of compatible plotter supplies consists of fiber-tip paper pens and transparency pens, plotter paper, glossy plotter paper, and transparency plotter film. The fiber-tip pens are available in 10 matching colors so that you can create paper duplicates of your transparencies. Pen colors are black, green, aqua, blue, violet, red-violet, red, orange, yellow, and brown. Pens are available in narrow and wide line widths (0.3 mm and 0.7 mm for paper pens; 0.3 mm and 0.6 mm for transparency pens).

Paper pens can be used on all plotters. You can obtain high-quality results with HP plotter paper for graphs. Use HP glossy paper for reports and presentations. Transparency pens can be used on the HP ColorPro, DraftPro DXL and EXL, DraftMaster Series, 7475, 7550, and 7090; with HP transparency film for overhead presentations or with HP glossy paper for presentation handouts.

Quality color overheads help you make a point, sell a product or idea, enhance an image. Research proves that:

- Presentations using visual aids are 43% more effective than unaided presentations.
- Color is more persuasive than black and white for visuals.
- An average speaker using visuals can be as effective as a better speaker using no visuals.

Overall, presenters using color overheads are rated as more credible and more interesting by the audience.

### Technical Drafting Applications

Hewlett-Packard offers 3 different types of pens and 4 different types of media, so you can select the pen/media combination that's right for your application. Fiber-tip pens are available in 10 colors for use on plotter paper. Roller-ball pens come in 4 colors and are capable of plotting at 110 cm/s (43 in/s). In addition to 4 line widths for disposable drafting pens, HP offers long-body and short-body refillable drafting pens in 6 line widths.

Sheets of plotter paper, vellum, translucent bond, and polyester film are available in a range of sizes: English (A to E), metric (A4 to A0), and architectural (C to E). Polyester film, vellum, translucent bond, and plotter paper come in 914.4 mm (36 in) and 609.6 mm (24 in) rolls for use with the HP DraftMaster RX and MX roll-feed drafting plotters.

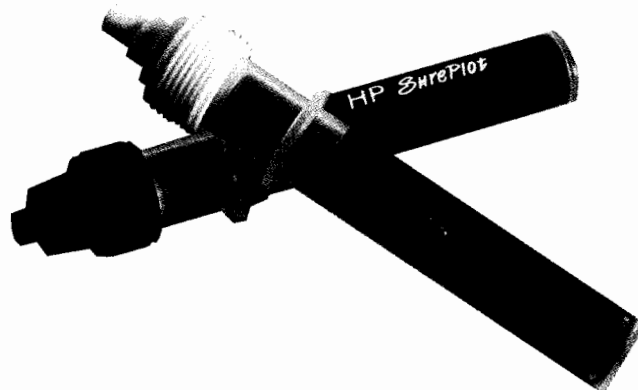

### HP SurePlot Disposable Drafting Pens

HP SurePlot disposable drafting pens provide the quality and dependability required for optimum productivity. HP SurePlot disposable drafting pens have ceramic tips for clog-free plotting. A specially designed regulator makes them leak-free. HP SurePlot pens are convenient and easy to use; no assembly or maintenance is required.

### Ordering Information

Plotter supplies may be ordered through HP's direct telephone ordering service, from any HP sales and support office, or from your local retail dealer. The HP Supplies Guide (P/N 5091-1624EUS) describes the complete range of plotter supplies and accessories.

### For Best Results

	Paper	Glossy Paper	Transparency Film	Translucent Bond	Vellum	Polyester Film
Fiber-tip pens (paper)	ColorPro 7475 7550 Plus DraftPro Series DraftMaster Series 7580 Series	ColorPro 7475 7550 DraftPro DXL DraftPro EXL DraftMaster Series				
Fiber-tip pens (transparency)		ColorPro 7475 7550 DraftPro DXL DraftPro EXL DraftMaster Series	ColorPro 7475 7550 DraftPro DXL DraftPro EXL DraftMaster Series			
Roller-ball pens	7550 Plus DraftPro Series DraftMaster Series 7580 Series			DraftPro Series DraftMaster Series 7580 Series		
Disposable drafting pens	7550 Plus DraftMaster Series 7580 Series			DraftPro Series DraftMaster Series	7550 Plus DraftPro Series DraftMaster Series 7580 Series	7550 Plus DraftPro Series DraftMaster Series 7580 Series
Refillable drafting pens					7475 7550 Plus DraftPro Series DraftMaster Series 7580 Series	7475 7550 Plus DraftPro Series DraftMaster Series 7580 Series





All Hewlett-Packard plotters are built for durability and reliability. That means less down time, higher productivity, and the ability to consistently deliver high-quality output. The high quality of HP plotters saves money through lower service costs and longer warranties. You can choose a large-format plotter from 6 pen plotters and 3 electrostatic plotters.

### HP DraftPro Series Plotters

The HP DraftPro Series plotters deliver HP reliability at a price that's within the reach of every designer. The HP DraftPro, Hewlett-Packard's lowest-priced drafting plotter, accepts media in ANSI and architectural sizes C and D. The HP DraftPro DXL accepts standard sizes from A through D; the HP DraftPro EXL accepts A through E. The HP DraftPro DXL and EXL also offer better line quality and quieter operation than the HP DraftPro, plus 1- and 2-Mbyte buffer options to help free up computer time.

### HP DraftMaster Series Plotters

HP DraftMaster Series plotters are designed to increase productivity in design and drafting workgroups. With quick acceleration and fast pen speed, HP DraftMaster plotters reduce plotting time, so they can handle higher work volumes. Built-in buffers and the efficiency of HP-GL/2 maximize productivity by freeing up computers during plotting.

The HP DraftMaster Series also features the unique HP SurePlot Drawing System to help prevent, or detect and correct, common pen plotter problems.

The HP Draftmaster SX Plus model features single-sheet feed. The HP DraftMaster RX Plus adds roll feed and an automatic media cutter for convenient media handling and long-axis drawings. The DraftMaster MX Plus includes all the features of the RX Plus, plus a 20-Mbyte spooler and four RS-232-C connectors for easy sharing in departments not using a network.

### HP 7600 Series Electrostatic Plotters

The HP 7600 Series electrostatic plotters combine fast plotting speed and high-quality output with traditional HP reliability to provide a complete, dependable plotting solution for high-volume CAD environments. The monochrome Model 250 supports 24-inch roll media; the monochrome Model 255 and color Model 355 support 36-inch roll media. All 3 models have a resolution of 406 dots per inch and come with a take-up reel and automatic cutter.

### For More Information

Your local Hewlett-Packard sales representative can provide more information about these HP plotters. Ask your representative for details and specifications today.

# COMPUTER SUPPORT PRODUCTS

Furniture  
Design Plus

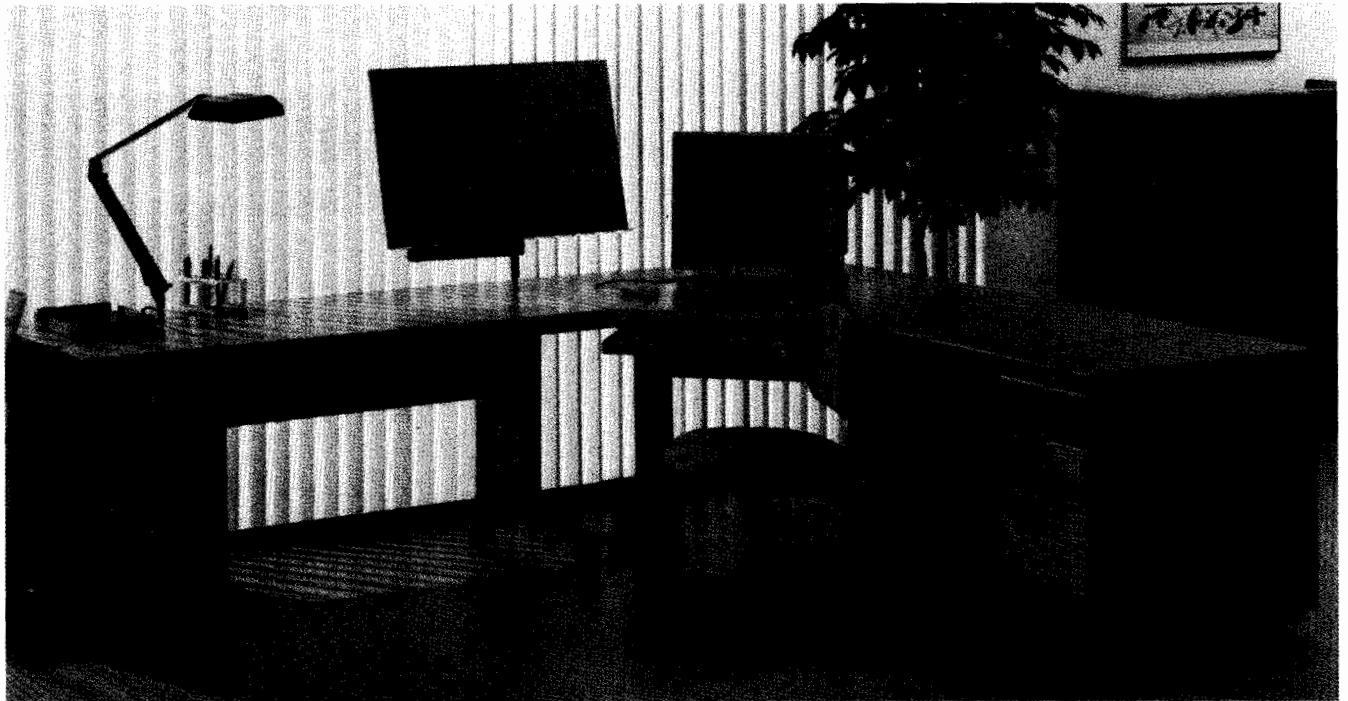

Shown above is HP's computer furniture based on logic: furniture built to match computer hardware, and with ergonomics for the user. From left to right: 92211E small drawer unit, 92214B medium table. Inserted into the table are the 92213Q task lamp and the 92213D C and D size drawing holder. Next is the 92214K CAD corner workstation, 92214A mobile support table, and 92211R mini-rack cabinet. In front is the 92208E HP ergonomic workstation chair.

## Design Plus

Design Plus furniture was developed in conformance with strict ergonomic standards for your optimal working comfort. This means no backaches from hunching, and no tired arms from using a keyboard improperly.

The furniture is constructed of the highest-quality materials. Die-cast metal legs withstand the weight of your equipment and the stress of normal office moves without danger of buckling or breaking. Matte surfaces resist scratches and stains while protecting your eyes from the glare of overhead lighting.

The CAD corner workstation has been designed to hold the deepest and heaviest of video display monitors. It has room for a keyboard on top of the work surface, as well as a keyboard drawer for ergonomics and security. Monitors are protected from accidental bumps since they don't hang out over the edge of the table. Cable management comes standard with all Design Plus workstation tables so that your equipment is organized and your environment is free from stray cables getting in the way. For more information and a template to design your optimum work area, order the *Design Plus Furniture Brochure #5954-9798*.

### HP Ergonomic executive chair with arm support:

Part No.	Color	Seat	Chair back	Quantity	Price
HP 92208M	Gray	Height 413 to 483 mm (16.25 to 19 in)	Height 457 to 514 mm (18 to 20.25 in)	(1 to 2)	\$475 each
HP 92208N	Blue	Depth 457 mm (18 in)		(3+)	\$440 each
HP 92208P	Beige	Width 483 mm (19 in)	Width 445 mm (17.5 in)		

### HP Ergonomic workstation/managerial chair:

HP 92208E	Gray	Height 413 to 527 mm (16.25 to 20.75 in)	Height 267 to 394 mm (10.50 to 15.50 in)	(1 to 2)	\$245 each
HP 92208F	Blue	Depth 457 mm (18 in)		(3+)	\$225 each
HP 92208G	Beige	Width 470 mm (18.5 in)	Width 406 mm (16 in)		
HP 92208K	Dark Brown	Arm set		(1 to 2)	\$79 each
				(3+)	\$69 each

### HP Ergonomic workbench chair

HP 92208S	Blue	Height 483 to 648 mm (19 to 25.50 in)	Height 267 to 394 mm (10.50 to 15.50 in)	(1 to 2)	\$365 each
		Depth 457 mm (18 in)		(3+)	\$340 each
		Width 470 mm (18.5 in)	Width 406 mm (16 in)		

HP 92208Q Cylinder for 92208M/N/P

HP 92208H Cylinder for 92208E/F/G

HP 92208L Dark Brown

HP 92208U Cylinder for 92208S

Caster set/5 per set

Replacement parts may be ordered from your local HP sales and service office or contact HP Support and Materials Organization at 1 (800) 227-8164.











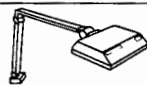

☎ For off-the-shelf shipment, call 800-452-4844.

# COMPUTER SUPPORT PRODUCTS

Furniture (cont'd)

Design Plus

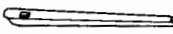
641

Part Number	Description	Height	Width	Depth	Quantity	Price
HP 92214A	<i>Design Plus</i> Mobile terminal support and transport system table. Designed to safely move terminals and small systems.	720 mm (28.4 in)	750 mm (29.5 in)	711 mm (28.0 in)	(1 to 2 tables) (3+)	\$475 each \$445 each
HP 92214B	Medium <i>Design Plus</i> System table. Comes with cable management, locking casters, and is same height as 92211R mobile rack system cabinet.	720 mm (28.4 in)	1125 mm (44.3 in)	711 mm (28.0 in)	(1 to 2 tables) (3+)	\$525 each \$495 each
HP 92214C	Large <i>Design Plus</i> System table. Comes with cable management, adjustable leveling glides, and is same height as 92211R mobile rack system cabinet.	720 mm (28.4 in)	1500 mm (59.0 in)	711 mm (28.0 in)	(1 to 2 tables) (3+)	\$585 each \$545 each
 HP 92213B	<i>Design Plus</i> CAD Mini-workstation. For use with the HP 9000 Series 300/500 computers. Comes with 362-mm (4.25-in) wide raised monitor platform, pull-out work surface that extends to 914 mm (36 in) deep, pull-out keyboard drawer and cable management. Same height as 92211R mobile mini-rack; 92211L/M fits underneath.	720 mm (28.4 in)	1125 mm (44.3 in)	711 mm (28.0 in)	(1 to 2 tables) (3+)	\$849 each \$799 each
 HP 92213F	<i>Design Plus</i> CAD workstation is designed for use with HP CAD systems. It comes with a pull-out work surface, keyboard drawer, raised monitor platform, and cable management. It attaches to other <i>Design Plus</i> Furniture.	720 mm (28.4 in)	1500 mm (59.0 in)	711 mm (28.0 in)	(1 to 2 tables) (3+)	\$899 each \$849 each
 HP 92213Q	<i>Design Plus</i> ergonomic task lamp. Specifically designed for computer workstations. Two 9-watt emitters produce the same light as 80-watts incandescent. Lamp stem fits <i>Design Plus</i> tables. UL listed and CSA approved.	N/A	N/A	N/A	(1 to 2 units) (3+)	\$280 each \$260 each
 HP 92213R	<i>Design Plus</i> clamp. Designed for the <i>Design Plus</i> lamp (92213Q). For use on non- <i>Design Plus</i> table tops. Maximum clamp opening is 127 mm (5 in). Use this clamp for HP standard tables.	N/A	N/A	N/A	(1 to 2 units) (3+)	\$28 each \$26 each
HP 92213D	"C" and "D" sized drawing holder. Mounts to workstation and system tables. Two-section arm for height and tilt position extends from 330 mm (13.0 in) to 565 mm (22.25 in).	508 mm (20.0 in)	762 mm (30.0 in)	6 mm (2.6 in)	(1 to 2 units) (3+)	\$219 each \$199 each
 HP 92214J	90-degree <i>Design Plus</i> Corner turn. Used for joining two system tables together for a larger work area. <b>NOTE:</b> Not intended to support CAD monitors.	Each side	711 mm (28.0 in)		(1 to 2 units) (3+)	\$295 each \$270 each
 HP 92214K	<i>Design Plus</i> CAD corner workstation. Perfectly fitted for use with HP CAD systems. Workstation comes with keyboard drawer and cable management. It can be joined to <i>Design Plus</i> furniture.	720 mm (28.4 in)	1125 mm (44.3 in)	1125 mm (44.3 in)	(1 to 2 tables) (3+)	\$899 each \$849 each
 HP 92211U	<i>Design Plus</i> joining bracket. For use on all <i>Design Plus</i> furniture pieces to anchor one to another. Comes with needed screws and instructions for assembly and use.	N/A	N/A	N/A	(1 to 2 units) (3+)	\$40 each \$37 each
HP 92211C	<i>Design Plus</i> Mobile sound enclosure cabinet. For use with all 293X serial 720 mm impact dot matrix printers.	720 mm (28.4 in)	750 mm (29.5 in)	500 mm (19.7 in)	(1 unit) (3+)	\$585 each \$545 each
 HP 92211L	<i>Design Plus</i> Mobile support cabinet. Rolls easily under the 92214B/C <i>Design Plus</i> system tables. Can be used as a stand-alone system cabinet for the HP 9000 Series 200/300/500; has open back. Comes with two sets of mounting rails, a cable routing kit (92199F), and two storage shelves. Internal dimensions are 325 mm (12.8 in) wide x 520 mm (20.40 in) high.	620 mm (24.4 in)	425 mm (16.7 in)	525 mm (20.7 in)	(1 to 2 units) (3 to 9) (10+)	\$310 each \$290 each \$270 each
 HP 92211M	<i>Design Plus</i> small Mobile support cabinet. Rolls easily under the 92214B/C <i>Design Plus</i> system tables. Can be used as a stand-alone system cabinet for the Series 200 Model 237 or 300. Comes with one set of mounting rails, a cable routing kit (92199F), and a pad to put under the Model 237. Internal dimensions are 325 mm (12.8 in) wide x 338 mm (13.26 in) high.	435 mm (17.1 in)	425 mm (16.7 in)	425 mm (16.7 in)	(1 to 2 units) (3 to 9) (10+)	\$250 each \$230 each \$210 each
 HP 92211N	<i>Design Plus</i> drawer unit. Rolls easily and sits next to all <i>Design Plus</i> system tables (also same height as tables). Comes with three drawers: 104 mm, 156 mm, and 312 mm (4 in, 6 in, and 12 in).	720 mm (28.4 in)	375 mm (14.8 in)	711 mm (28.0 in)	(1 to 2 units) (3 to 9) (10+)	\$745 each \$705 each \$665 each
 HP 92211R	<i>Design Plus</i> Mobile mini-rack system cabinet for HP modular peripherals and systems. Comes fully assembled with casters. Back opens for easy access. Accessories available are the 92211S mounting rail and module lock kit, 92211T filler panel kit, and 92199B power strip. Internal dimensions are 325 mm (12.8 in) wide x 572 mm (22.44 in) high.	720 mm (28.4 in)	375 mm (14.8 in)	711 mm (28.0 in)	(1 to 2 racks) (3 to 9) (10+)	\$685 each \$650 each \$615 each
HP 92211E	Small 102 mm (4 in) drawer unit for 92211R Mobile mini-rack system cabinet.	102 mm (4 in)	324 mm (12.75 in)	473 mm (18.62 in)	(1 to 2 units) (3+)	\$139 each \$129 each
HP 92211F	Medium 152 mm (6 in) drawer unit for 92211R Mobile mini-rack system cabinet.	152 mm (6 in)	324 mm (12.75 in)	473 mm (18.62 in)	(1 to 2 units) (3+)	\$149 each \$139 each
HP 92211G	Large 305 mm (12 in) drawer unit for 92211R Mobile mini-rack system cabinet.	305 mm (12 in)	324 mm (12.75 in)	473 mm (18.62 in)	(1 to 2 units) (3+)	\$159 each \$149 each
 HP 92211S	Rail kit for 92211R Mobile mini-rack cabinet. Comes with four set of rails and module locks. Used to mount up to four HP computer and peripheral equipment modules.			Rail length-638 mm (25.1 in)	(1 to 2 kits) 3 to 9 (10+)	\$50 each \$45 each \$40 each
 HP 92211T	Filler panel for 92211R mobile mini-rack cabinet. Kit contains 20 snap-in panels used to fill empty space not occupied by computer equipment modules.	23 mm (0.9 in)	325 mm (12.8 in)	23 mm (0.9 in)	(1 to 2 kits) (3 to 9) (10+)	\$40 each \$35 each \$30 each
 HP 92214P	<i>Design Plus</i> Universal support stand. For use with HP LaserJet, HP 2932/33/34, HP 2563A printers, and small HP plotters. Comes with printout catcher shelf, casters, and leveling glides. Has slot in top for bottom feeding and slot in door top for front feeding. Also has sound control pad.	720 mm (28.4 in)	600 mm (23.6 in)	450 mm (17.7 in)	(1 to 2 units) (3+)	\$295 each \$265 each
HP 92211D	<i>Design Plus</i> Mobile LaserJet Printer cabinet. Comes fully assembled with a storage shelf for paper trays and space for toner cartridges and other supplies.	720 mm (28.4 in)	508 mm (20.0 in)	711 mm (28.0 in)	(1 to 2 units) (3+)	\$385 each \$365 each

☎ For off-the-shelf shipment, call 800-452-4844.

# SOLID STATE DEVICES

## Components



Solid State Lamps

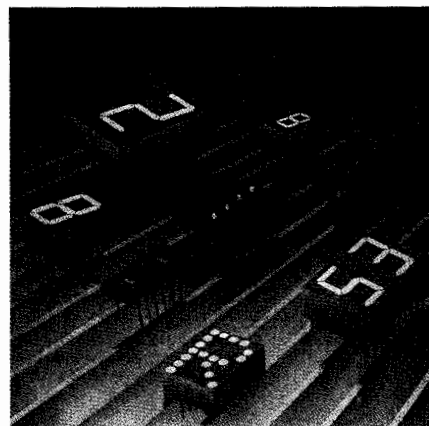

Solid State Displays



Motion Control Components

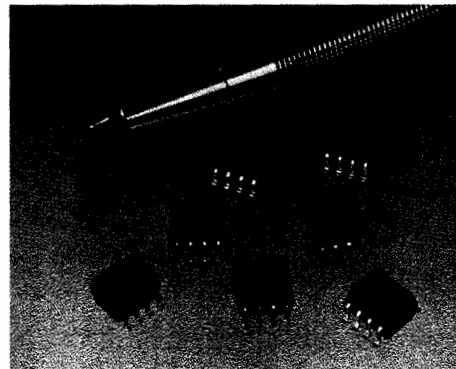

Optocouplers and Solid State Relays

### LED Solid State Lamps, Light Bars, and Arrays

Hewlett-Packard is a world leader in LED technology and offers a broad variety of LED indicator products. Products are available in high-performance green, yellow, orange, high-efficiency red, and standard red. Recent advances in fundamental semiconductor material development have allowed new areas of contribution. New AlGaAs red materials are the basis for recent low-current and very-high-brightness (15 candela at 20 mA) additions to the product line. New hermetic products include infrared-secure lamps intended for advanced military applications.

### Solid State Displays

HP offers a complete line of seven-segment displays in AlGaAs red, standard red, high-efficiency red, yellow, and high-performance green in a wide variety of package sizes. The newest members are low-current micro bright displays in red, yellow, and green.

LED alphanumeric displays in monolithic and dot matrix versions are also available. Recent developments used on-board integrated circuits (OBIC) to provide more sophisticated functions and capabilities to these displays. Some of these rugged displays are screened and tested for use in military applications and harsh environments.

The aesthetic appearance and reliable performance of LED displays make them appropriate for use in instruments, point-of-sale terminals, appliances, automobiles, telephones, moving-message panels, and other high-ambient light front-panel displays.

### Motion Control Components

HP's developments in III-IV materials, integrated circuits, lenses, and packaging allow for a natural expansion of these efforts into

development of optical incremental shaft encoders. The first HP shaft encoder was introduced in 1981. Since then, the product line has expanded to include a broad range of motion-sensing and control components.

HP's motion-sensing products include 2- and 3-channel kit encoders for commercial and industrial applications, 2- and 3-channel encoder modules for high-volume computer peripheral applications, and digital potentiometers to replace analog potentiometers for manual data entry in medical and measurement instrumentation.

HP's motion-control products include a quadrature decoder/counter integrated circuit for easy interface of an encoder to a microprocessor and a general-purpose motion control IC, which acts as a slave processor in closed-loop servo systems.

### Optocouplers

HP's family of logic-compatible, high-performance optocouplers provides solutions to problems caused by ground loops and induced common mode noise for both analog and digital applications in commercial, industrial, and military products.

Types of optocouplers available include high-speed and high-gain devices ac/dc to logic interface optocouplers, and optocouplers that interface directly with microprocessors.

### Solid State Relays

As an extension of the high-performance logic-compatible optocoupler family, HP offers miniature dual-in-line package solid-state relays for small-signal and low-power switching applications. HP's solid-state relays are replacements for low-current electro-mechanical relays in both commercial and military equipment.

### Fiber Optic Components

HP offers three families of fiber-optic components to meet a variety of communication needs.

#### 1300nm Modules

The 1300nm family includes a fully compliant FDDI transceiver and transmitter and receiver modules specified for FDDI performance of general-purpose performance from 10 to 200 MBd. The 1300nm family is suited for use in high-speed local area networks, peripheral interconnects, and general, long distance (2 km) communication links. The FDDI transceiver features the multiple sourced 2x11 pin package, interfaces directly with the FDDI MIC connector, and is specified for use with 62.5/125  $\mu\text{m}$  and 50/125  $\mu\text{m}$  fiber.

#### Low-Cost Miniature Links

The Miniature Link family offers a wide range of price performance choices for local area network, computer, industrial control, and Tempest applications. The dual-in-line small package features a unique lens design for efficient coupling of the 820nm source to a variety of fiber sizes and is offered in a variety of styles for interfacing with ST\*, SMA, and FC style fiber-optic connectors.

#### Versatile Links

The low-cost, 665nm LED-based Versatile Links are provided in a variety of transmitter and receiver combinations for applications such as industrial control and peripheral interconnects. Performance capabilities range from 5 MBd at 12 meters to 1 MBd at 24 meters over 1-mm diameter plastic fiber. HP provides plastic cable in custom lengths with a variety of connector configurations.

\* ST is a registered trademark of AT&T.



Fiber Optic Components

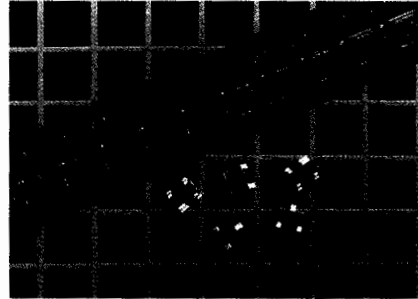

Bipolar Transistors

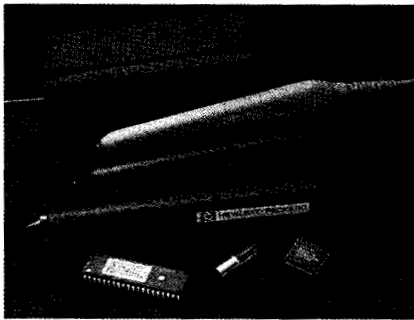

Bar Code Components



Hybrid Cascadable Amplifiers

### Silicon Bipolar Transistors

Device-to-device uniformity and superior performance are combined in the HXTR series of microwave transistors, which have been individually designed for low noise (HXTR-6000 series), high gain (HXTR-2000 series), and low-distortion linear power (HXTR-5000 series). With guaranteed RF performance specifications from 1000 to 4000 MHz, these devices are well suited for high-reliability, space, military, and industrial applications at frequencies up to 6000 MHz.

### Diodes

**Schottky Barrier Diodes:** Schottky Barrier Diodes combine extremely high rectification efficiency with picosecond switching speeds, low series resistance, and low noise characteristics. This combination makes the Schottky an excellent mixer/detector diode.

**PIN Diodes:** PIN diodes function as variable resistors at microwave frequencies. By controlling the dc bias, the RF resistance of a PIN diode can be varied from 1 Ohm to about 10 MOhms. This property of the PIN diode makes it extremely useful as a switch attenuator, modulator, phase shifter, limiter, or AGC element at all frequencies from 1 MHz to 18 GHz and above.

**Step Recovery Diodes:** The step recovery diode is most graphically described as a charge-controlled switch. That is, a forward bias stores charge and a reverse bias depletes this stored charge. When fully depleted, the SRD ceases to conduct current.

**Diodes for Hybrid Integrated Circuits:** These diodes are used to achieve circuits with lightweight, small-size operation to high

frequencies, repeatable characteristics, and lower end-product costs. Hewlett-Packard offers a wide range of PIN, Schottky, and SRD single diodes in beam lead and chip configurations, as well as Schottky silicon and GaAs beam lead pair and quad diodes.

**Integrated Products:** Hewlett-Packard manufactures a broad line of components for the control, conversion, and generation of RF and microwave signals. This line of integrated products (combinations of chip and beam lead diodes with hybrid thin film circuit technology) includes SPST switches and comb generators. Hewlett-Packard also manufactures GaAs attenuators, switches, and amplifiers, as well as silicon monolithic RF amplifiers, vector modulators, and circuits for datacom and telecom applications.

### Bar Code Products

Hewlett-Packard offers a broad line of quality bar code components. Designed to meet OEM's bar code needs, HP offers an extensive array of products ranging from optical reflective sensors, tips, and decoder ICs to slot readers, digital bar code wands, and intelligent scanners. In essence, Hewlett-Packard's family of bar code products is designed for ease of use, flexibility, integrity of design, and ruggedness.

The intelligent wand family of products represents the integration of HP's varied product offering. Hewlett-Packard's newest product, the KeyWand Bar Code Reader (HBCK-1XXX), lets you scan data directly into a personal computer via the keyboard

interface, without hardware or software modification. The need for an external decoder box or wedge is eliminated. All electronics are self-contained within a rugged compact polycarbonate wand for clutter-free operation. The SmartWand (HBCR-8XXX) is an intelligent peripheral designed to easily add bar code scanning capability to any host system that can support a +5V asynchronous interface.

Whether you need a High Performance Low Current digital wand with an extremely low power consumption, an Industrial Slot Reader, Optical Reflective Sensor, Precision Sapphire Tip, or Decode ICs, HP can meet your bar code needs.

### High Reliability Testing

Many Hewlett-Packard components are military qualified. The reliability of these devices is established by one of the finest high-reliability testing facilities in the component industry. Hewlett-Packard's High Reliability Test Groups maintain military-approved parts in stock and can recommend HP standard screening programs, patterned after MIL-S-19500, MIL-M-38510, or MIL-D-875157 for any HP component.

### Write for More Information

Specifications of HP's component products are available in individual data sheets or complete designer catalogs. These are available free of charge from your local HP sales office or authorized distributor.

# ANALYTICAL INSTRUMENTS FOR CHEMICAL ANALYSIS

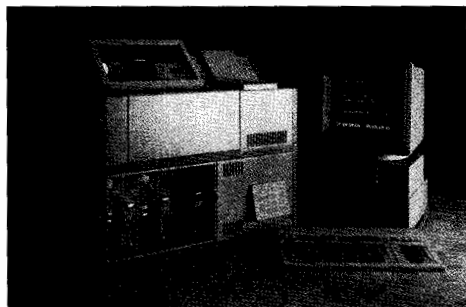

HP 1090 Series II Liquid Chromatograph

## Liquid Chromatography

The HP 1090M Series II Liquid Chromatograph is a fully integrated HPLC system with advanced data-handling capabilities. Simultaneous data acquisition and evaluation saves hours. The 1090M Series II is especially useful in methods development, purity verification, and problem-solving. The HP 1090L Series II LC provides instrument control from a single keyboard. It is ideal for routine analysis in which high throughput is paramount.

## HPLC Pumps and Autosamplers

With HP 1050 modular LC pumps, you can add capabilities one module at a time. Modules include the HP 1050 Isocratic Pump, using variable stroke design for superior flow stability; the HP 1050 Quaternary Pump, which will deliver up to 4 solvents separately; and the HP 1050 Autosampler, which is compatible with any modular HPLC system.

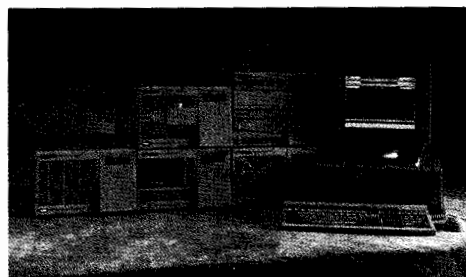

HP 1050 Series HPLC Modules

## LC Detectors

HP's standards for quality and reliability extend to our line of HPLC detectors, which include the HP 1049A Electrochemical Detector, the HP 1050 Multiple Wavelength Detector, the HP 1050 Variable Wavelength Detector, the HP 1040 Series II Diode Array Detector, the HP 1047A Refractive Index Detector, and the HP 1046A Fluorescence Detector.

## Bioanalytical Solutions

HP offers a number of turnkey bioanalytical solutions. The HP Aminoquant Series II Amino Acid Analyzer is precise, accurate, and sensitive; both the chemistry and the chromatography are ensured. It is fully automated, and most errors are eliminated. The HP Microassay System features robotic automation that provides reliability, accuracy, and high throughput on ELISA and other microtiter plate applications. In addition, the HP 1050 Series LC modules are offered in titanium to provide corrosion resistance in separations requiring aggressive mobile phases.

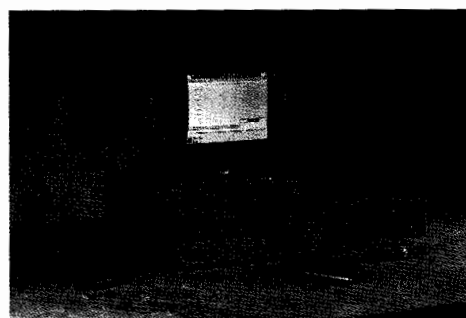

HP 3365 MS-DOS ChemStation

## UV/Visible Spectroscopy

HP Diode-Array Spectrophotometers provide more information by acquiring data at all wavelengths simultaneously. The HP 8452 UV/Vis Spectrophotometer with MS-DOS® controller provides virtually instant spectra from 190 to 820 nm and exceptional reliability. The HP 8452 UV/Vis Spectrophotometer with HP 89550A Dissolution Testing Software combines advanced analytical features with simple, secure operation.

## Data-Handling – The HP Unified Laboratory

HP offers data-handling solutions from integrators to laboratory information management systems (LIMS), plus networking capabilities that encompass the full range of HP analytical instruments. These solutions include:

- Integrators: Lowest-priced, most cost-effective on the market today.
- ChemStations: Single or multi-instrument control, data evaluation, and reporting.
- Laboratory Automation Systems: Flexible multi-user system for high-volume routine analysis.
- Laboratory Information Management Systems: Improves information and sample flow, coordinates results from multiple techniques, and links manufacturing, QA, and other corporate systems to your lab.
- ChemLAN: Connects multiple techniques on diverse computer platforms, using customized networking for your laboratory.

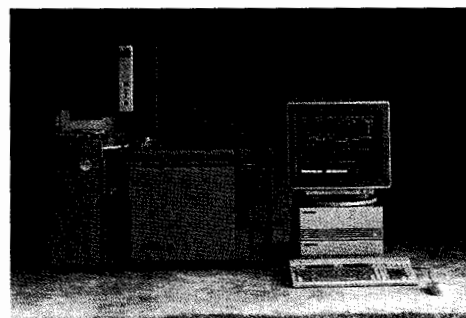

HP 5965B GC/IRD with UNIX® ChemStation

## Gas Chromatography

The industry-standard HP 5890 Series II handles even the most demanding applications with ease. Includes cool on-column inlet for faster, more precise analysis; pressure programming for low-temperature analysis and constant flow; and a high-temperature oven for analyzing higher-molecular-weight compounds.

## GC Sample Introduction/Management Systems

HP offers several proven solutions for automated sample handling. The HP 7673A Automatic Injector and Sampler offers discrimination-free injection of up to 100 different samples. Advanced robotics and the ability to add a second injector and HP 18587A Barcode Identification System make it simple and virtually trouble-free. The HP 19395A Headspace Sampler eliminates many sample-workup and extraction steps and can be used with any packed or capillary technique.

## GC Detectors

HP is a single-source supplier of reliable high-performance detection systems that provide the selectivity and sensitivity choices necessary for routine or complex chromatographic analysis. These include the following:

- Atomic Emission Detector: Detects any element (except helium).
- Flame Ionization Detector: Designed for easy operation.
- Thermal Conductivity Detector: Single-filament, single-column design.
- Electron Capture Detector: High sensitivity for electrophilic compounds.
- Nitrogen Phosphorus Detector: Optimizes selectivity and sensitivity.
- Flame Photometric Detector: Selective detection of sulfur and phosphorus.
- Infrared Detector: First FTIR specifically for use with capillary GC.
- Mass Selective Detector: Provides electron impact (EI) spectra of GC effluents.

## Mass Spectrometry

HP's line of low-cost mass-spectrometer products makes it possible for virtually every lab to afford high quality GC/MS. The HP 5971A with MS-DOS® controller provides PC-controlled MSD and makes GC/MS accessible wherever needed. High-performance features include multitasking for simultaneous data acquisition and analyzing, classical EI spectra, and Microsoft Windows® for ease of use. The HP 5970B GC/MS with MS ChemStation is a multitasking networking system using UNIX®, X-Window software to control the world's most widely used MSD, and the HP 5989A MS Engine research-grade GC/LC/MS/IR/DS offers the highest performance at the lowest cost in its class.

## HP 7680A Supercritical Fluid Extractor

The HP 7680A SFE is a graphics-driven, computer-controlled instrument designed for automated extraction of complex samples. SFE replaces time-consuming liquid-solid techniques with rapid and reproducible supercritical fluid CO<sub>2</sub> extractions.

## Columns/Supplies/Software

HP is one of the few analytical instrument makers to offer a comprehensive line of competitively priced, high-quality supplies, accessories, LC and GC columns, and consumables. In addition, HP offers dedicated software to provide turnkey solutions.

## If You Would Like to Know More

Just call your local HP sales office or distributor and ask for the analytical products representative.

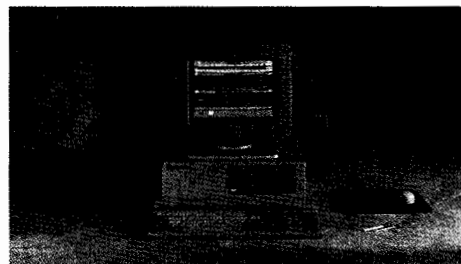

HP 5971 GC/MS with MS-DOS ChemStation

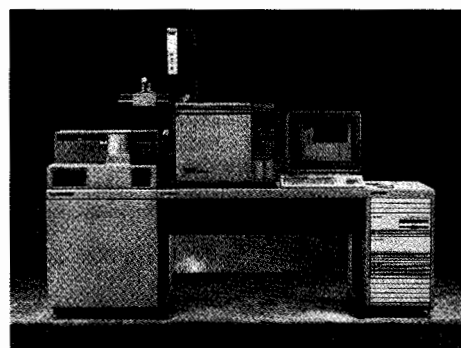

HP 5989 GC/MS with UNIX ChemStation

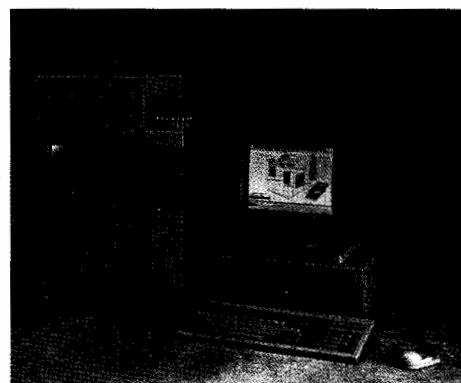

HP 7680A Supercritical Fluid Extractor

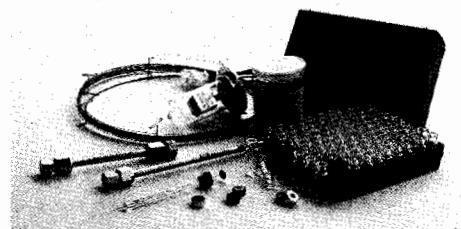

HP Columns, Software, and Supplies

# MEDICAL INSTRUMENTATION

## Diagnostic Cardiology and Echocardiography

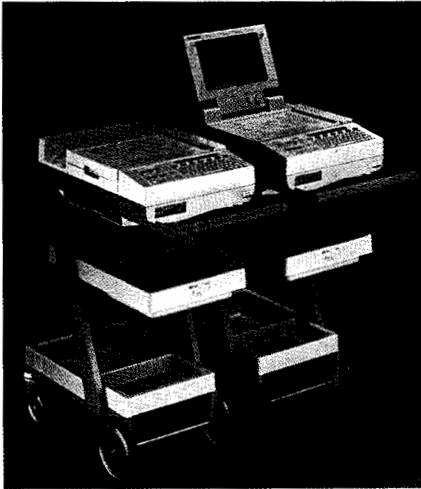

### Cardiology Instrumentation

- HP PageWriter XLi advanced cardiograph with interpretive capability and preview display
- HP PageWriter XLs standard, real-time cardiograph
- ECG Management Systems for computer-aided management of electrocardiograms
- ECG Workstations for PC-based ECG department management

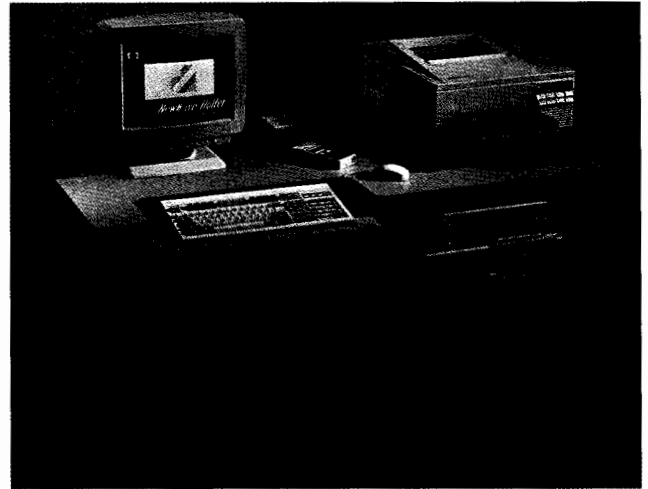

### Holter Monitoring

- HP 43420B NewWave Holter system includes HP Vectra PC, custom software, and an HP LaserJet III printer
- Optional HP 43405A Memory Module for full disclosure
- Real-time Holter analysis with advanced editing features
- Easy-to-use graphical computing environment

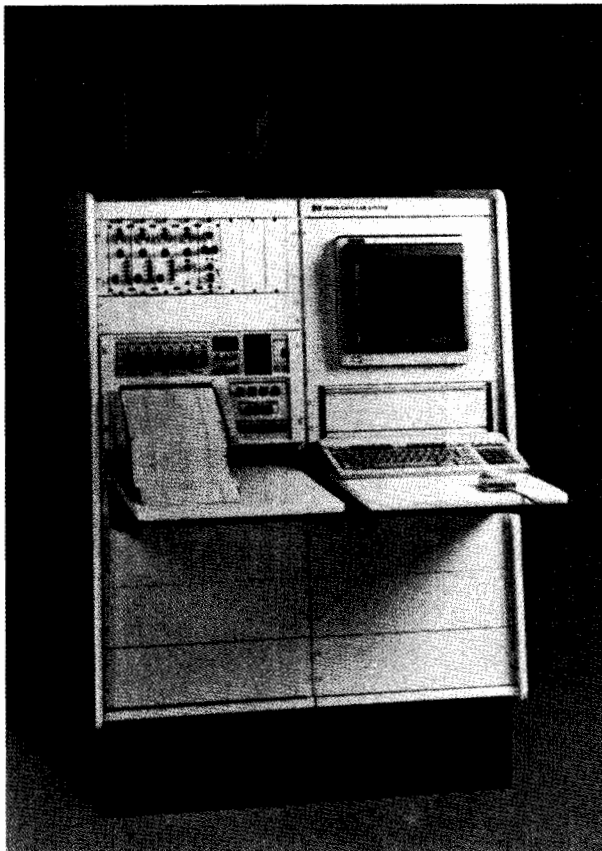

### Cardiovascular Instrumentation

- Computerized catheterization data analysis system automates on-line data collection analysis
- Comprehensive data base for generating both clinical and administrative reports
- Complete choice of plug-in signal conditioners and transducers



### HP SONOS 1000 Cardiovascular Imaging System

- The most advanced HP phased array ultrasound imaging system
- HP Precision Imaging technology and wide-aperture transducers
- Peripheral vascular imaging with 7.5 MHz linear array transducer
- Next-generation color flow imaging
- Steerable PW/CW Doppler
- Transesophageal imaging capability
- Sophisticated image review and analysis capabilities



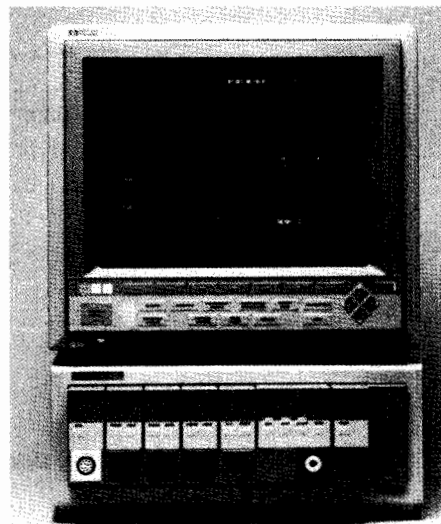
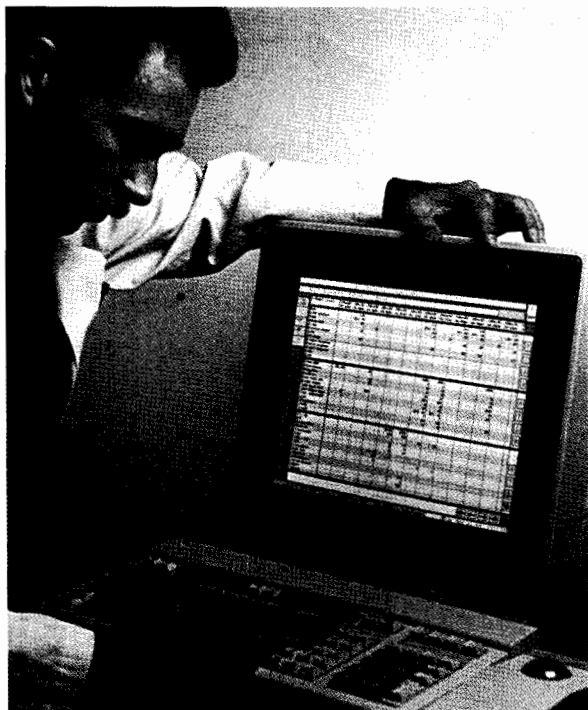

### HP CareVue 9000 Clinical Information System

- Bedside-oriented system for critical care
- Replaces paper-based charting process
- Easily adapted to each unit's specific needs
- Advanced human interface
- Collects information directly from bedside monitors and other bedside devices
- Uses local area network to incorporate information directly from ancillary departments
- Applications include flowsheet, nursing/physician notes, nursing care plans, patient acuity, severity of illness and more

### HP Component Monitoring System

- Patient monitoring system for the OR, CCU, and ICU
- Monitors up to 16 parameters simultaneously
- Choose 4, 6, or 8 waveforms, color or monochrome
- Intuitive, 2 levels of operation
- Comprehensive data management
- Interface to HP Critical Care Network

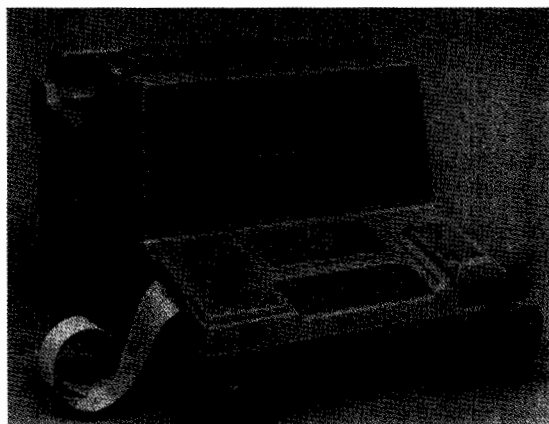

### Resuscitation

- Easy to use, 3-step operation
- Lightweight, reliable design

**For Additional Information** on HP Medical instrumentation, write to **INQUIRIES MANAGER**, Hewlett-Packard, 3000 Minuteman Road, Andover, MA 01810, and request literature in any of the following categories:

- Patient Monitoring Systems
- OR Monitoring
- Arrhythmia Central Stations
- Clinical Information Systems
- Ultrasound Imaging
- Cardiography Instrumentation/Ambulatory ECG
- Cardiovascular Instrumentation
- Obstetrical and Neonatal Instrumentation
- Resuscitation
- Healthcare Information Systems
- Supplies, Consumables, Pressure Transducers

### Obstetrical Information Management System

- Display and Alert
- Remote overview screens
- Bedside data entry
- Configurable admission/discharge forms
- 25-year guaranteed storage, retrieval and archiving
- Flexible system configurations

### Other Obstetrical products include:

- Antepartum fetal monitors
- Intrapartum fetal monitors
- Fetal ultrasound telemetry

**We invite you** to receive **ADVANCES FOR MEDICINE**, the Hewlett-Packard medical products magazine, free of charge. Simply write to: **ADVANCES FOR MEDICINE**  
Hewlett-Packard  
3000 Minuteman Road  
Andover, MA 01810

# X-RAY EQUIPMENT

## Cabinet X-Ray Systems

Models 43855A, 43855B

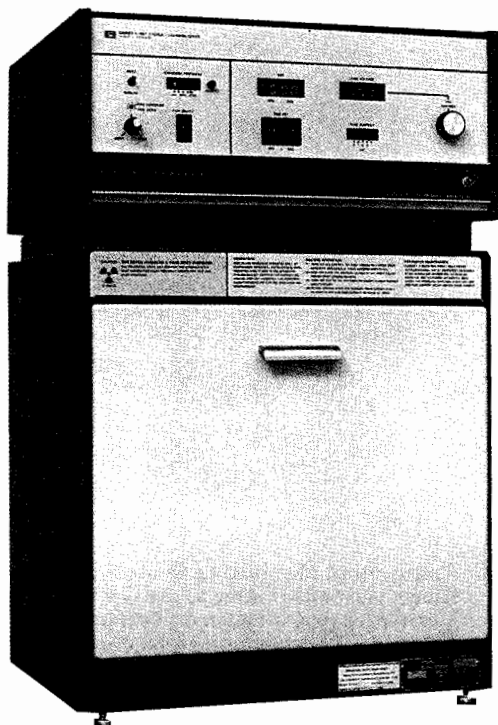

Faxitron Model 43855A  
with Option A02

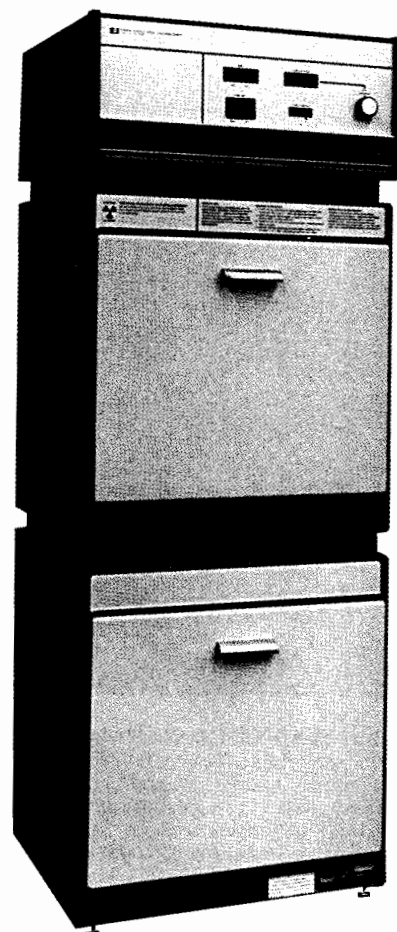

Faxitron Model 43855B

### Faxitron® Cabinet Systems

Radiography, the art and science of making pictures with X-rays, has an important place in modern technology. It is one of the major nondestructive test methods available to industry, provides an indispensable tool in scientific investigations, and is a valuable aid to law enforcement agencies.

Hewlett-Packard makes a major contribution to these activities with X-ray equipment that offers a "better way" through advanced technology and design. This equipment makes radiographs easier and safer to take.

### Scientific Applications

Oceanography, geology, marine biology, paleontology, pathology, botany, forestry, and agricultural research are a few examples of scientific disciplines that use X-rays. Applications range from the study of the interior anatomy of fossils to determining the viability of seeds.

These are among the many applications served by HP Faxitron Cabinet X-Ray Systems. They offer a unique combination of high quality radiographic capability, simplicity of operation, and convenience of use that is expanding the capabilities of scientific and industrial concerns throughout the world.

### Industrial Inspection

Industrial quality control and inspection procedures, especially in the field of electronics, benefit from nondestructive testing by radiography. The advantages of a testing method that does not harm the test objects are obvious. Radiography, therefore, offers benefits in design engineering, incoming inspection, production quality control, product reliability, and failure analysis. X-rays are used to detect misregistration or plate-thru problems in multilayer PC boards; porosity, poor substrate bonding, and wiring or lead location in transistors and integrated circuits; voids and other encapsulation problems in potted components; and solder balls or other defects in sealed relays.

Die casting is another industry that benefits from the nondestructive aspects and ability to "see inside" provided by radiography. Porosity, gas void, trapped metal inclusion, and other common defects can be detected easily and the cause determined. Expensive machining time can be avoided for castings found to be defective through X-ray inspection. The integrity of welds, alignment of connectors, inspection for proper assembly, and mechanical defects are further examples of tests that radiography performs for industry. The benefits of X-ray testing are reduced production costs, better quality assurance, and product safety. The results are increased profits.

### Medical Applications

HP Faxitron Cabinet X-Ray Systems are used by the medical profession for specimen radiography in support of diagnostic surgical procedures and in biological research. Specimen radiographs of biopsy samples are correlated with preoperative mammograms, for example, and in the evaluation of mastectomy specimens. Typical research applications include microradiography of thin bone specimens and microangiographic studies of vasculature.

# X-RAY EQUIPMENT

## Flash X-Ray Systems

HP 43703B, 43710A, 43731A, 43733A, 43734A

649

Model 43731A  
150kV

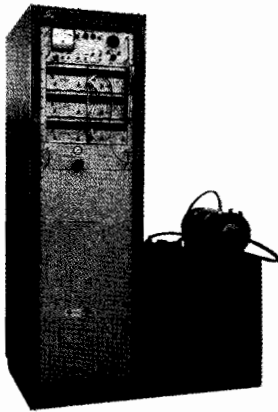

Model 43733A  
300kV

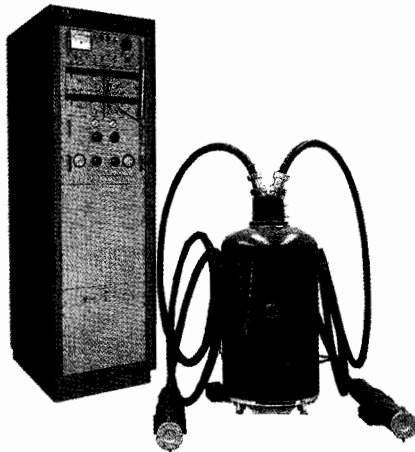

Option 035 - Dual Remote Tubehead

Model 43734A  
450kV

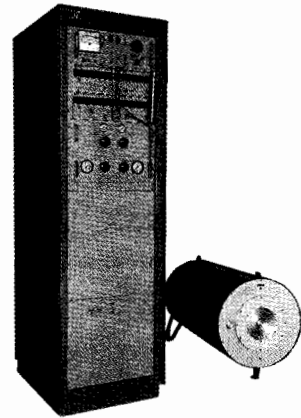

High-speed (flash) radiography is used to record and study dynamic events where interposed material, smoke, flame, debris, or pressure variations exclude the use of high-speed cameras. Typical events include ballistics, shaped charges, explosives, behind-armor studies, shock waves in solids, aerospace phenomena, and crash-injury studies.

The basic performance requirement of a flash X-ray system used for the study of transient mechanisms is to provide high-resolution radiographs with exposure times short enough to eliminate motion blur. HP series 43700 Flash X-Ray Systems produce X-ray pulses of submicrosecond duration and are designed specifically for "stop motion" radiographic applications. All HP 43700 series systems utilize the same basic components, and the same electrical theory and are modular in concept. Standard systems include 150 kV, 300 kV, 450 kV, 1 mV, and 2.3 mV models.

An HP basic single "channel" flash X-ray system, composed of a pulse generator, high-voltage power supply, cold-cathode field emission X-ray tube, and associated controls, provides a single radiograph per event. Additional pulser/X-ray tube sets (add-on channels) may be combined with the initial single-channel system to provide multiple-channel "systems." Multiple channel systems may be of identical output voltage or may use varied output voltage pulser/tube combinations.

**For specific information and consultation regarding HP X-ray systems, contact Hewlett-Packard, 1700 S. Baker Street, McMinnville, Oregon 97128; telephone (503) 472-5101.**

**ROCKVILLE (Sales)**  
No. 2 Choke Cherry Road  
Rockville, Maryland 20850  
Telephone (301) 258-2000

**ALBUQUERQUE**  
7801 Jefferson Street, N.E.  
Albuquerque, New Mexico 87109  
Telephone (505) 823-6100

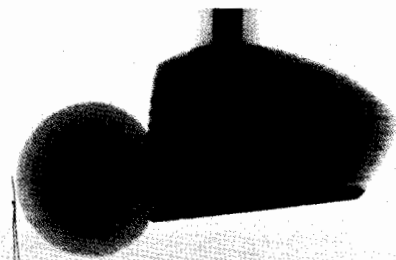
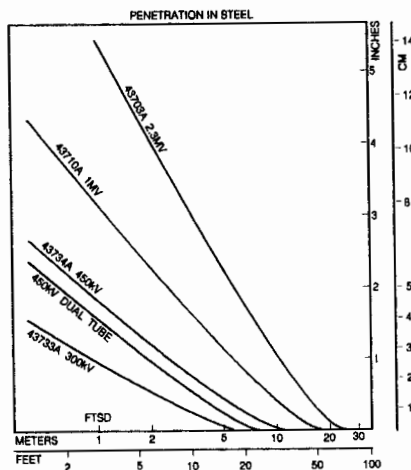
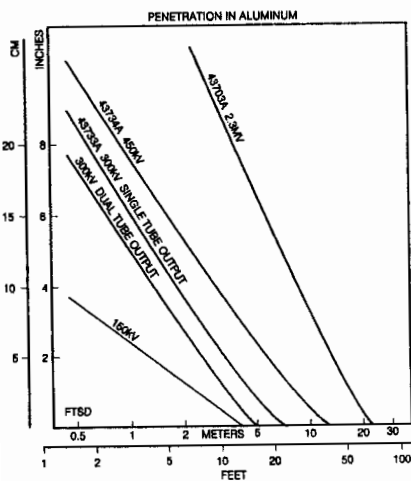

Compression of golf ball when hit with club

# CABLES & ADAPTERS

Cables, Adapters, and Typical SWR Performance

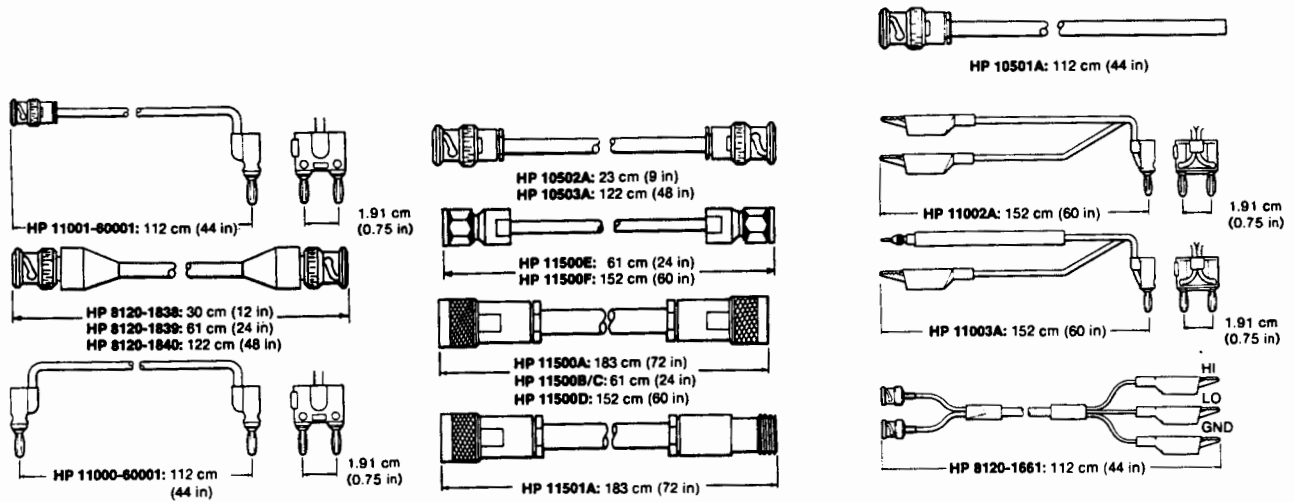

- HP 1250-0780
- HP 1250-1535
- HP 1250-1476
- HP 1250-0082
- HP 1250-1533
- HP 1250-1473
- HP 1250-0077
- HP 1250-1534
- HP 1250-1477
- HP 1250-0778
- HP 1250-1528
- HP 1250-1475
- HP 1250-0777
- HP 1250-1529
- HP 1250-1472
- HP 1250-0597
- HP 1250-0559
- HP 1250-0846
- HP 1250-0176
- HP 1250-1250
- HP 1250-1636
- HP 1250-1562
- HP 1250-1772
- HP 1250-1158
- HP 1250-1159
- HP 11524A
- HP 11525A
- HP 11533A
- HP 11902A
- HP 11534A
- HP 11902B
- HP 1250-1743
- HP 11903A
- HP 1250-1750
- HP 11903D
- HP 1250-1746
- HP 1250-1747
- HP 1250-1748
- HP 11900A
- HP 11901A
- HP 11904A
- HP 1250-1749
- HP 11900B
- HP 11901B
- HP 11904B
- HP 11900C
- HP 11901C/D
- HP 11904C/D
- HP 1250-1866
- HP 1250-0216
- HP 1250-1288
- HP 1250-0080
- HP 1250-1287
- HP 1250-0781
- HP 1250-0076
- HP 1250-1286
- HP 1250-0069
- HP 1250-0071
- HP 1250-0595
- HP 1250-1830
- HP 1250-0591
- HP 1250-0832
- HP 1250-0831
- HP 1250-1023
- HP 1250-1153
- HP 1250-1236
- HP 1250-1237
- HP 1250-1263
- HP 1251-2816
- HP 1251-2277
- HP 1250-1474
- HP 1250-1536
- HP 1250-1152
- HP 1250-1744
- HP 11903D
- HP 1250-1745
- HP 11903B

Some part numbers are not pictured.

## Coaxial Connector and Adapter Performance

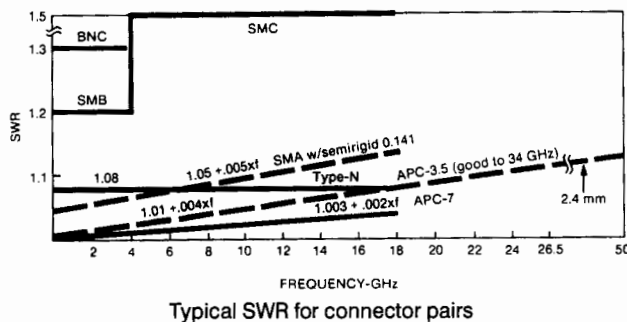

The performance curves in the graph will help you in choosing and applying HP cables, connectors, and adapters. SWR curves show design specifications for mated pairs of connectors of the type indicated. You can expect typical performance in that range.

For cross-series adapters, use the curve with the highest SWR in each case. For applications of Tee-adapters such as HP 1250-0559, 1250-0846, and 1250-0781, be sure to consider the extra shunt capacitance of the Tee.

Of course, when HP mounts various connectors onto RF and microwave products, the product specification predominates and SWR is often far superior to that shown in these utility curves. For example, the HP "precision" Type-N adapters shown on these pages are for high accuracy use dc to 1.3 GHz where SWR <1.03.

For more information on history and performance of various coax connectors, see HP's *Microwave Test Accessories Catalog*. (Lit #5952-2843(D))

#### Ordering Information

##### Cable Assemblies

HP Model	Frequency Range (GHz)	Length cm (in)	Connectors	SWR	Ins. Loss (dB)	Price
HP 10501A	dc to 12.4	183 (72)	N(m) (2)	—	—	\$110
HP 10502A	dc to 12.4	61 (24)	N(m) (2)	—	—	110
HP 10503A	dc to 18	183 (72)	N(m)-N(f)	—	—	110
HP 8120-1838	dc to 18	61 (24)	Precision N(m) (2)	1.4	1.5	625
HP 8120-1839	dc to 18	152 (60)	Precision N(m) (2)	1.4	3.0	700
HP 8120-1840	dc to 26.5	61 (24)	APC-3.5 (m) (2)	1.4	2.0	650
HP 11000-60001	dc to 26.5	152 (60)	APC-3.5 (m) (2)	1.4	4.0	750

#### Adapters, 2.4 mm

(See page 650 for technical description and performance)

HP 11900A	2.4 mm (m) to 2.4 (m)	\$450.00
HP 11900B	2.4 mm (f) to 2.4 (f)	\$450.00
HP 11900C	2.4 mm (m) to 2.4 (f)	\$450.00
HP 11901A	2.4 mm (m) to APC-3.5 (m)	\$375.00
HP 11901B	2.4 mm (f) to APC-3.5 (f)	\$375.00
HP 11901C	2.4 mm (m) to APC-3.5 (f)	\$375.00
HP 11901D	2.4 mm (f) to APC-3.5 (m)	\$375.00
HP 11902A	2.4 mm (m) to APC-7	\$425.00
HP 11902B	2.4 mm (f) to APC-7	\$425.00
HP 11903A	2.4 mm (m) to Type N (m)	\$450.00
HP 11903B	2.4 mm (f) to Type N (f)	\$450.00
HP 11903C	2.4 mm (m) to Type N (f)	\$450.00
HP 11903D	2.4 mm (f) to Type N (m)	\$450.00
HP 11904A	2.4 mm (m) to K (m) <sup>2</sup>	\$500.00
HP 11904B	2.4 mm (f) to K (f) <sup>2</sup>	\$500.00
HP 11904C	2.4 mm (m) to K (f)	\$500.00
HP 11904D	2.4 mm (f) to K (m)	\$500.00

#### Adapters Type N, Standard 50 Ω

HP 1250-0077	N(f) to BNC(m)	\$13.25
HP 1250-0082	N(m) to BNC(m)	\$14.75
HP 1250-0176	N(m) to N(f) right angle (use < 12 GHz)	\$21.00
HP 1250-0559	N tee, (m)(f)(f)	\$38.00
HP 1250-0777	N(f) to N(f)	\$13.25
HP 1250-0778	N(m) to N(m)	\$12.00
HP 1250-0780	N(m) to BNC(f)	\$14.25
HP 1250-0846	N tee (f)(f)(f)	\$20.25
HP 1250-1250	N(m) to SMA(f)	\$35.00
HP 1250-1562	N(f) to SMA(m)	\$67.50
HP 1250-1636	N(m) to SMA(m)	\$130.00
HP 1250-1772	N(f) to SMA(f)	\$72.50

#### Adapters Type N, Precision 50 Ω<sup>1</sup>

HP 1250-1472	N(f) to N(f)	\$45.00
HP 1250-1473	N(m) to BNC(m)	\$45.00
HP 1250-1474	N(f) to BNC(f)	\$30.00
HP 1250-1475	N(m) to N(m)	\$60.00
HP 1250-1476	N(m) to BNC(f)	\$41.00
HP 1250-1477	N(f) to BNC(m)	\$35.00

#### Adapters Type N, Standard 75 Ω<sup>2</sup>

HP 1250-0597	N(m) (50 Ω) to N(f) (75 Ω)	\$30.00
HP 1250-1528	N(m) to N(m)	\$60.00
HP 1250-1529	N(f) to N(f)	\$40.00
HP 1250-1533	N(m) to BNC(m)	\$41.00
HP 1250-1534	N(f) to BNC(m)	\$40.00
HP 1250-1535	N(m) to BNC(f)	\$42.00
HP 1250-1536	N(f) to BNC(f)	\$38.00

#### Price

#### Ordering Information

##### Adapters APC-3.5

HP 1250-1743	APC-3.5(m) to N(m)	\$135.00
HP 1250-1744	APC-3.5(f) to N(m)	\$165.00
HP 1250-1745	APC-3.5(f) to N(f)	\$115.00
HP 1250-1746	APC-3.5(m) to APC-7	\$150.00
HP 1250-1747	APC-3.5(f) to APC-7	\$160.00
HP 1250-1748	APC-3.5(m) to APC-3.5(m)	\$170.00
HP 1250-1749	APC-3.5(f) to APC-3.5(f)	\$185.00
HP 1250-1750	APC-3.5(m) to N(f)	\$135.00
HP 1250-1866	APC-3.5(mm) to APC-3.5(f)	\$320.00

##### Adapters SMA

HP 1250-1158	SMA(f) to SMA(f)	\$18.00
HP 1250-1159	SMA(m) to SMA(m)	\$18.50
HP 1250-1249	SMA Right angle (m) (f)	\$32.00
HP 1250-1397	SMA Right angle (m) (m)	\$40.00
HP 1250-1462	SMA(m) to SMA(f)	\$24.50
HP 1250-1698	SMA tee(m) (f) (f)	\$50.00
HP 1250-1787	SMA(m) to BNC(m)	\$35.00
HP 1250-2015	SMA(f) to BNC(m)	\$36.00

##### Adapters APC-7<sup>3</sup>

HP 11524A	APC-7 to N(f)	\$175.00
HP 11525A	APC-7 to N(m)	\$170.00
HP 11533A	APC-7 to SMA (m)	\$235.00
HP 11534A	APC-7 to SMA (f)	\$235.00

##### Adapter Banana Plug

HP 1251-2816	Dual banana plug	\$6.00
--------------	------------------	--------

##### Adapters BNC, Standard 50 Ω

HP 1250-0069	BNC(m) to UHF(f)	\$30.00
HP 1250-0071	BNC(f) to UHF(m)	\$15.00
HP 1250-0076	Right angle BNC(UG-306/D)	\$10.75
HP 1250-0080	BNC(f) to BNC(f) (UG-914/U)	\$6.50
HP 1250-0216	BNC(m) to BNC(m)	\$10.50
HP 1250-0591	BNC(f) to WECO Video (m)	\$23.50
HP 1250-0595	BNC(f) to BNC Triaxial (m)	\$20.00
HP 1250-0781	BNC tee(m)(f)(f)	\$12.00
HP 1250-1263	BNC(m) to single banana plug	\$55.00
HP 10110B	BNC(m) to dual banana plug	\$27.00
HP 1250-1830	BNC(f) to BNC Triaxial (f)	\$60.00
HP 1251-2277	BNC(f) to dual banana plug	\$15.50

##### Adapters BNC, Standard 75 Ω<sup>3</sup>

HP 1250-1286	Right angle BNC	\$20.25
HP 1250-1287	BNC(f) to BNC(f)	\$10.25
HP 1250-1288	BNC(m) to BNC(m)	\$13.25

##### Adapters SMB, SMC<sup>4</sup>

HP 1250-0670	SMC tee(m) (m) (m)	\$30.00
HP 1250-0671	SMB(m) to N(m)	\$57.50
HP 1250-0672	SMB(f) to SMB(f)	\$14.50
HP 1250-0674	SMB(m) to SMA(f)	\$37.00
HP 1250-0675	SMC(m) to SMA(f)	\$33.00
HP 1250-0813	SMB(m) to SMB(m)	\$62.50
HP 1250-0827	SMC(m) to SMC(m)	\$88.25
HP 1250-0831	SMC(m) to BNC(m)	\$26.00
HP 1250-0832	SMC(f) to BNC(f)	\$30.00
HP 1250-0837	SMC tee(m) (m) (m)	\$27.00
HP 1250-0838	SMC tee(f) (m) (m)	\$23.00
HP 1250-1023	SMC(m) to N(m)	\$37.00
HP 1250-1113	SMC(f) to SMC(f)	\$12.50
HP 1250-1152	SMC(f) to N(m)	\$55.00
HP 1250-1153	SMC(f) to N(f)	\$65.00
HP 1250-1236	SMB(f) to BNC(f)	\$32.00
HP 1250-1237	SMB(m) to BNC(f)	\$37.00
HP 1250-1391	SMB tee(f) (m) (m)	\$31.00
HP 1250-1857	SMB(f) to BNC(m)	\$57.50

<sup>1</sup>"Precision": typically ≥36 dB return loss to 1.3 GHz.

<sup>2</sup>Type N outer conductor; center pin sized for 75 Ω characteristic.

<sup>3</sup>BNC outer conductor; center pin sized for 75 Ω characteristic.

<sup>4</sup>SMB & SMC are used often inside HP instruments for intermodule RF connections.

SMB is snap-on configuration. SMC is screw-on configuration.

<sup>5</sup>The K-connector is developed and manufactured by the Wiltron Co., Morgan Hill, California.

\*APC=7 is a registered trademark of the Bunker Ramo Corporation.

☎ For off-the-shelf shipment, call 800-452-4844.

# OPERATING CASES

## Rugged Protection for Instruments



Typical Series 5000 Operating Cases with instruments and options in place.

### Operating Cases

Hewlett-Packard operating cases protect instruments and equipment from the hazards of transportation and the rigors of the environment. They offer sturdy protection when instruments are transported and used onsite. Operating cases are compression molded from a glass fiber reinforced composite material (FRP) that is lighter than aluminum and provides excellent strength and durability. Tests of this molded material show tensile and compressive strength exceeding 33,000 PSI and flexural strength exceeding 46,000 PSI.

Both standard and optional heavy-duty hardware afford excellent protection from damage and the elements. Conveniently placed, surface-mounted, spring-loaded handles fold flat when not in use, or they can be designed to reside in recesses. Front and back covers

seal with O-ring gaskets and clamping latches. All cases are rainproof under MIL-STD-108. On request, operating cases can be fabricated to meet the requirements of USA and NATO military specifications.

### Interior Configuration

Operating cases come equipped with shock-mounted aluminum frames that accept any standard 19-inch rackmounting instrument (EIA-RETMA standard) up to the height of the frames. Most full-size instruments and modular combinations of instruments can be rackmounted in any one of our operating cases. The frame arrangement and the ability to remove the front and back covers allows for convenience of operation without removing the instrument. Consequently, the instrument can be set up for operation with a minimum of delay. Both HP System I and System II cabinet styles can be mounted in operating cases (including System I and System II module combining cases).

Rackmounting offers a number of conveniences. Total systems configured of individual instruments and accessories can be combined in one or more operating cases. Patch cable, HP-IB, and HP-IL connections can be left in place within the case so that instruments are ready for use with little or no delay.

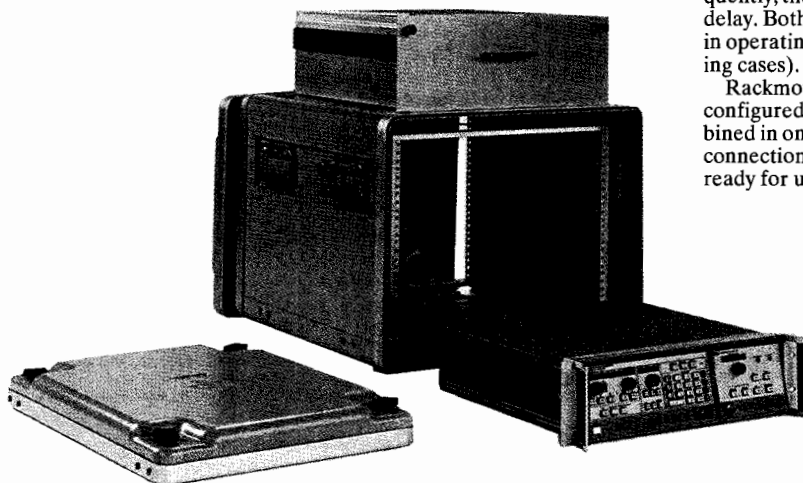

Exploded view of Series 5000 Operating Case with instrument and drawer ready for mounting

## Operating Case Series 3000

(Standard Case with Surface Mount Hardware)

HP Operating Cases are available in six standard families with rack heights from two units up.

Nominal Rack ISO	Height in	Instrument Weight				Case Height		HP Part Number	*Price		
		maximum kg	lbs	minimum kg	lbs	mm	in		1 to 4	5 to 9	10 to 24
3U	5.25	34	75	9.1	20	280.2	11.03	9211-1302	\$1,850	\$1,600	\$1,400
4U	7.00	34	75	9.1	20	348.7	13.73	9211-6472	\$2,000	\$1,750	\$1,550
5U	8.75	59	130	13.6	30	393.2	15.48	9211-1303	\$2,000	\$1,800	\$1,550
6U	10.50	59	130	13.6	30	438.9	17.28	9211-2635	\$2,050	\$1,800	\$1,600
7U	12.25	59	130	13.6	30	486.4	19.15	9211-1163	\$2,100	\$1,850	\$1,650
8U	14.00	59	130	13.6	30	527.8	20.78	9211-1241	\$2,500	\$2,250	\$2,000
9U	15.75	59	130	13.6	30	572.3	22.53	9211-1242	\$2,500	\$2,250	\$2,000
10U	17.50	59	130	13.6	30	616.7	24.28	9211-1243	\$2,500	\$2,250	\$2,050
11U	19.25	59	130	13.6	30	661.2	26.03	9211-1244	\$2,600	\$2,350	\$2,100
12U	21.00	114	250	22.7	50	718.3	28.28	9211-1245	\$2,350	\$2,050	\$1,850
13U	22.75	114	250	22.7	50	762.8	30.03	9211-2636	\$2,900	\$2,500	\$2,300
14U	24.50	114	250	22.7	50	807.2	31.78	9211-1911	\$2,900	\$2,500	\$2,300
15U	26.25	114	250	22.7	50	851.7	33.53	9211-2637	\$2,900	\$2,700	\$2,300
16U	28.00	114	250	22.7	50	896.1	35.28	9211-2638	\$2,900	\$2,700	\$2,300
17U	29.75	114	250	22.7	50	940.6	37.03	9211-2639	\$2,900	\$2,700	\$2,300
18U	31.50	114	250	22.7	50	985.0	38.78	9211-2640	\$2,900	\$2,700	\$2,300
19U	33.25	114	250	22.7	50	1029.5	40.53	9211-1713	\$2,900	\$2,700	\$2,300
20U	35.00	145	320	31.8	70	1073.9	42.28	9211-6473	\$3,100	\$2,800	\$2,500
21U	36.75	145	320	31.8	70	1109.0	43.66	9211-6474	\$3,200	\$2,900	\$2,600
22U	38.50	145	320	31.8	70	1162.8	45.78	9211-6475	\$3,400	\$3,000	\$2,600
23U	40.25	145	320	31.8	70	1207.3	47.53	9211-6476	\$3,500	\$3,100	\$2,700
24U	42.00	145	320	31.8	70	1254.8	49.40	9211-6477	\$3,500	\$3,200	\$2,800
25U	43.75	145	320	31.8	70	1296.2	51.03	9211-6478	\$3,600	\$3,300	\$2,900
26U	45.50	145	320	31.8	70	1340.6	52.78	9211-6479	\$3,900	\$3,400	\$3,000
27U	47.25	145	320	31.8	70	1371.6	54.00	9211-2641	\$4,000	\$3,500	\$3,000

Standard case width = 609.6 mm/24.00 in. Standard case depth = 723.9 mm/28.50 in. Basic case dimensions exclusive of hardware. Weight range will determine selection of shock mounts.

\*Prices shown are subject to change.

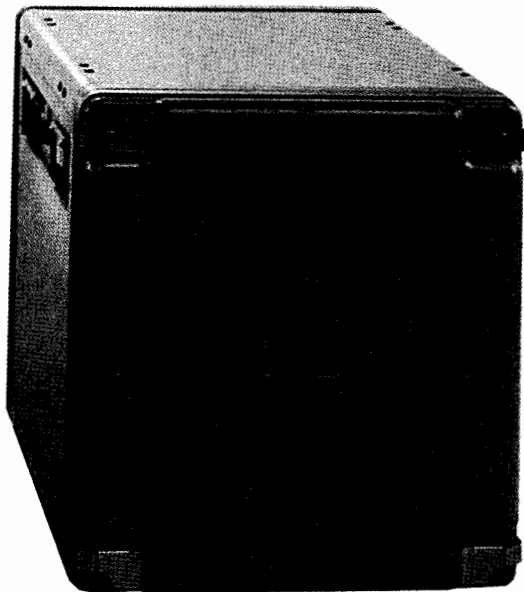

Glass Fiber Reinforced Composite (FRP) Operating Case with optional surface mount latches.

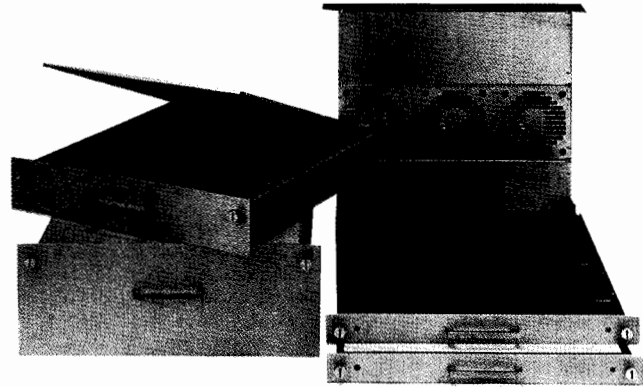

### Special Features Available

- A. Mating feet for stacking one case on top of another
- B. Mating feet (same as above) with locking mechanism
- C. 88.9 mm H (3½-inch) drawer with slides
- D. 133.4 mm H (5¼-inch) drawer with slides
- E. 177.8 mm H (7-inch) drawer with slides
- F. Slide mounted shelf
- G. Pair of instrument slides
- H. Modified inner frame depth. Standard rack depth 20 inches from front-panel mounting surface to rear surface of the rack. This option includes an appropriate change in the overall depth of the enclosure. Please specify desired inner frame depth.
- I. Increased front and/or rear cover depth. Maximum 6 inches. Please specify. (Price listed is per modification.)
- J. MIL-C 4150 certification with the exception of design and pre-production testing. Case will have increased wall thickness, hardware anodized to military specification, and will be hermetically tested using the hot water method.
- K. Latches recessed into the surface of case
- L. Handles recessed into the surface of case
- M. Addition of four permanently mounted 3½-inch diameter swivel casters
- N. Addition of four removable 3½-inch swivel casters. Also available in kit form. Ask your sales representative.
- O. Addition of two aluminum hat-section skids to the case bottom
- P. Addition of lift rings to either side of the case
- Q. Pair of T-bar instrument support brackets
- R. Pair of L-bar instrument support brackets
- S. Automatic relief valve (manual valves standard)
- T. AC power receptacle strip with four outlets. Mounted on bottom rear of rack frame. Power cord 1 meter (3 feet, 3 inches long), NEMA connectors.
- U. 1 U (1.75 inch) modular cooling device with three-fan upward venting action. 110 V.

If you require additional modifications or options that are not listed, contact your sales representative. Cases can be customized to nearly any requirement.

### How to Order

Operating Cases are ordered through your local HP Sales Office. See Custom Ordering Guidelines on page 655.

## TRANSIT CASES

### Rugged Protection for Instruments

#### Transit Cases

Hewlett-Packard transit cases are sturdy containers for use when instruments must be frequently transported or used away from laboratory or office conditions. HP cases protect your instruments from shock, vibration, moisture, impact, and contamination to provide a secure enclosure for shipping. Transit cases are a necessity whenever equipment is frequently transported from one operating location to another.

#### Product Detail

Our transit cases are compression molded from a glass fiber reinforced composite material (FRP) that is lighter than aluminum and provides excellent strength and durability. Tests of this molded material show tensile and compressive strength exceeding 33,000 PSI and flexural strength exceeding 46,000 PSI. All cases seal tightly with O-ring gaskets and clamping latches. They are rainproof under the standards of MIL-STD-108. Carrying handles are conveniently placed and are spring-loaded to fold flat when not in use.

HP cases are usually provided with foam cushions designed to cradle the instrument securely. The cushion inserts are typically molded polyurethane, or are fabricated from slabs of polyurethane or polyethylene flexible foams. Each case/cushion unit is designed as its

own shock and vibration damping system, protecting against damage from handling, dropping, or crushing.

Our standard transit cases safeguard your equipment from all but the most abusive treatment. To ensure maximum protection for instruments, transit cases are also available to meet the specified requirements of MIL-STD-108, MIL-T-21200, MIL-T-28800, MIL-T-4734, and MIL-C-4150.

Removable swivel casters are available as an option on certain cases. These are identified with an asterisk (\*) in the case tables on pages 657 and 658.

#### Instrument Cabinet System Styles

Hewlett-Packard produces two styles of cabinet systems: System I and System II. The most visible difference between the two styles is handle configuration. The handles on System I instruments are part of the instrument sideframe, projecting at 90 degrees from the instrument face. The handles on System II modules also project at 90 degrees from the instrument face but are not part of the instrument frame. These handles can be easily removed and are turned outward at the handle grip. Each cabinet style requires a different cushion insert configuration. This difference makes it important that you order your case from the proper selection table.

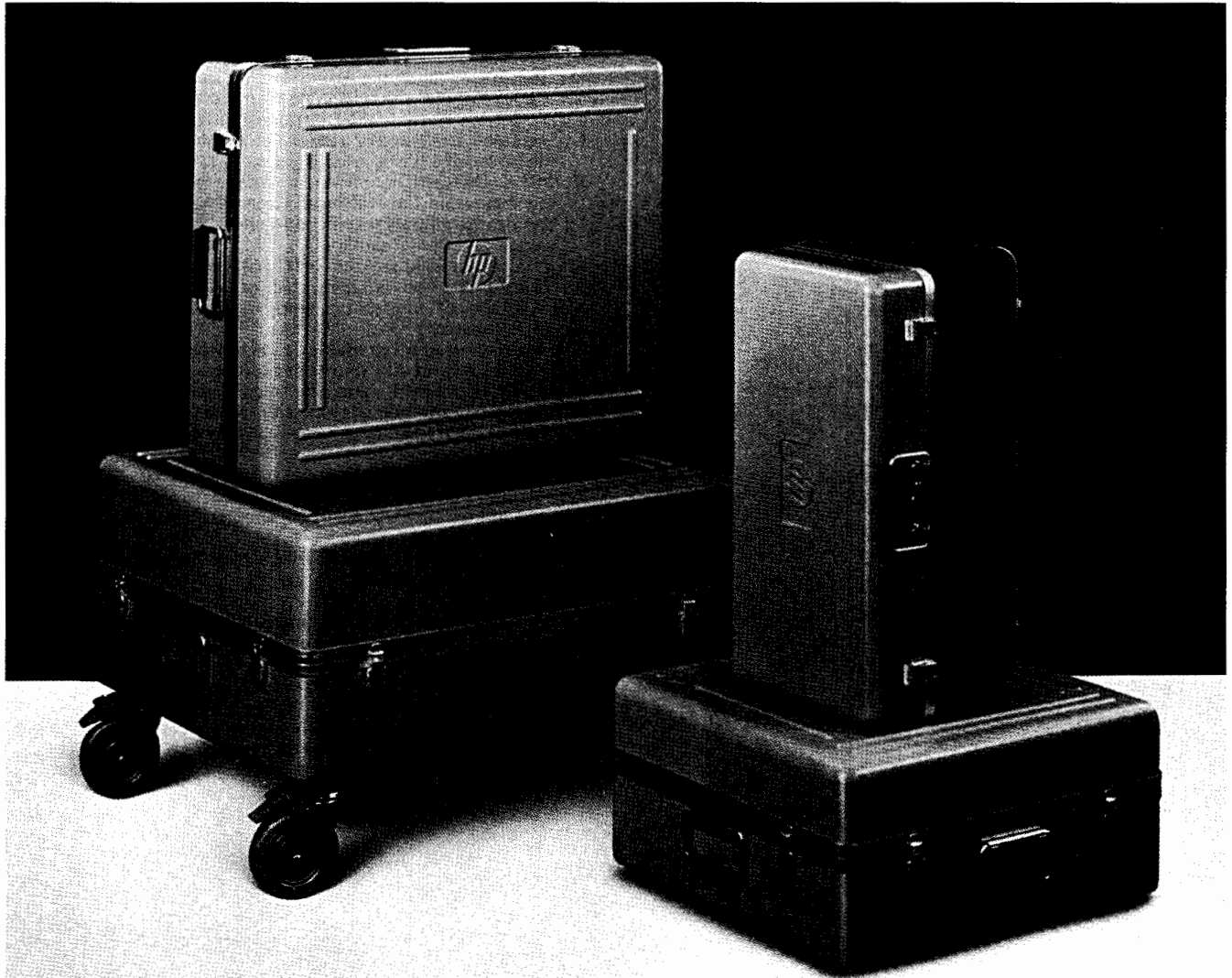



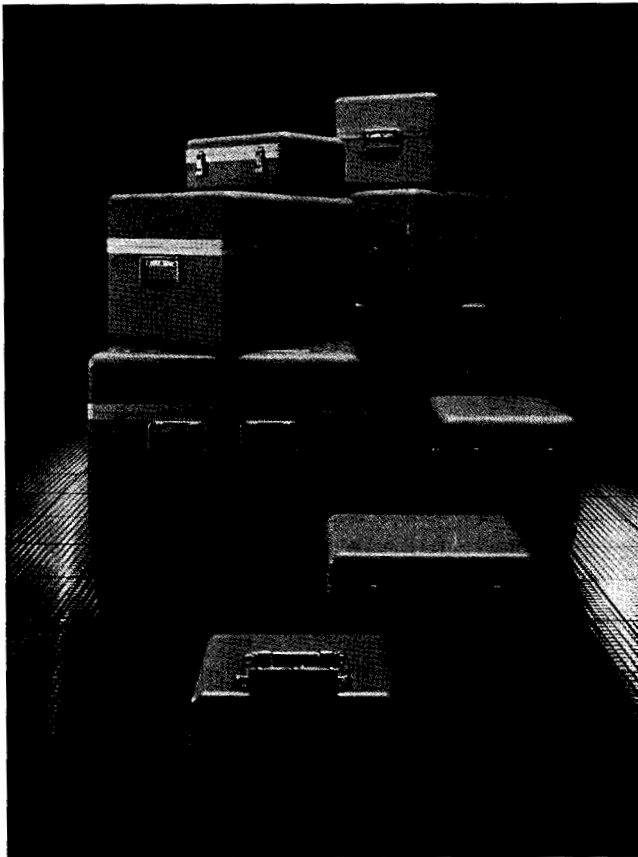

**Special or Custom Transit Cases**

Proper fit is critical in protecting your instrument, and the dimensional measurements play a key role. We recommend when ordering a custom case that you provide your HP sales office with the instrument's exact height, width, depth, the serial and model number, and any other pertinent information that may affect the design of the case or cushions (see Customer Ordering Guidelines). For example, you may wish to have additional space available for the protected storage of materials necessary for your instrument's on-site operation. Space can be provided for power/data cables, operating supplies, accessories, additional printed circuit boards, and documentation or manuals.

**Transit Case Styles**

Each transit case is coded to its style in the following tables: Transit (T), a completely removable cover with a handle at each end; Valise (V), hinged with the handle opposite the hinge; and Valise Transit (VT), a hinged transit case with a handle opposite the hinge and a handle at each end. Each case is designed and manufactured in the style that best suits the configuration of its instrument. If a style other than the standard is required for your application, a custom case can be ordered.



Typical System II Valise Transit (VT) Case

**CUSTOMER ORDERING GUIDELINES**

Hewlett-Packard offers a CUSTOMER QUESTIONNAIRE guide to help you identify specifications to meet your particular enclosure needs. To obtain information on how to order, contact your HP sales representative or call (916)785-8000, SMO Procurement.

EQUIPMENT INFORMATION	ENCLOSURE INFORMATION
<p><b>PART NUMBER:</b> Identification of the equipment or equipment system to be enclosed by part number, drawing number, etc.</p> <p><b>SIZE:</b> To assure proper fit, each instrument must be carefully measured in the following manner:</p> <p><b>WIDTH:</b> The distance across the entire body of the instrument, not including rack-mounting accessories. Instruments set up to be rackmounted require special cushion designs.</p> <p><b>DEPTH:</b> The depth of the instrument from the front-panel face to the rearmost projection from the back of the instrument. On a System II instrument, add two inches if the instrument has handles.</p> <p><b>HEIGHT:</b> The actual instrument height from the base of the cabinet to the top of the cabinet. Measure the height of feet separately.</p> <p><b>WEIGHT:</b> The weight of the equipment to be enclosed.</p> <p><b>FRAGILITY:</b> Specific fragility expressed in G forces, if that is known.</p> <p><b>USAGE REQUIREMENTS:</b> Specific information about how the equipment will be operated, stored, shipped, etc. Special requirements such as unusual heat dissipation, RFI/EMI/ESD shielding, orientation, operating environment, etc.</p>	<p><b>TYPE:</b> Transit or operating case. Style and series.</p> <p><b>SIZE:</b> The maximum size of the case or enclosure.</p> <p><b>USAGE:</b> Operating/transportation/storage requirements. Environmental exposure to moisture, humidity, salt spray, temperature, altitude changes, corrosives, solar radiation, decontaminants, rough handling, etc.</p> <p><b>OPTIONS:</b> Special latches, casters, dust boots, ventilation, drawers, shelves, writing surfaces, hold-down straps, stacking feet, cushions, internal power receptacles, etc.</p> <p><b>MISCELLANEOUS:</b> Military specifications, inspection requirements, labels and markings, color, etc.</p> <p>The case selection tables include American standard and metric measurements. The addition of any options, accessories, or standoff devices will affect the instrument's overall configuration and must be taken into consideration when ordering a transit or operating case.</p>

# TRANSIT CASES

## Rugged Protection for Instruments (cont'd)

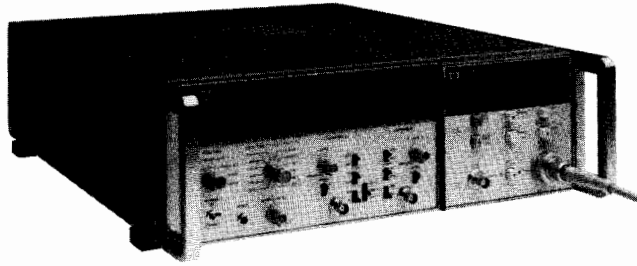

Typical full-module System I style cabinet

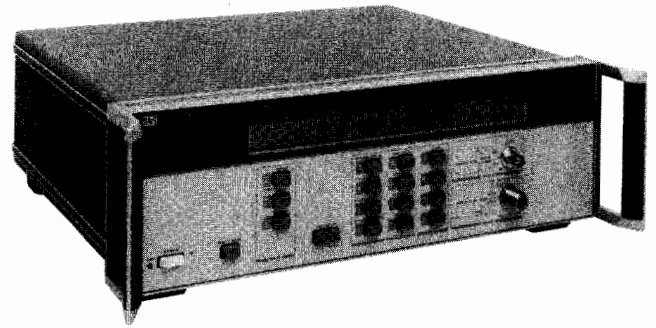

Typical full-module System II style cabinet

### System I Cabinet Style Transit Cases

Full-Module Width Instruments Instrument Width – 425.5 mm 16.75 in					
Instrument Depth – 285.8 mm 11.25 in					
Inst. Height mm	Inst. Height in	Style	HP Part Number	Price**	
				1 to 4	5 to 49
88.9	3.50	VT*	9211-1288	\$370	\$330
133.4	5.25	VT*	9211-1289	\$380	\$340
177.8	7.00	VT*	9211-1290	\$390	\$360
222.3	8.75	T*	9211-1291	\$420	\$380
Instrument Depth – 412.8 mm 16.25 in					
Inst. Height mm	Inst. Height in	Style	HP Part Number	Price**	
				1 to 4	5 to 49
88.9	3.50	VT*	9211-1292	\$400	\$370
133.4	5.25	VT*	9211-0839	\$420	\$380
177.8	7.00	VT*	9211-1293	\$430	\$390
222.3	8.75	VT*	9211-1294	\$430	\$390
266.7	10.50	T*	9211-1295	\$430	\$390
311.2	12.25	T*	9211-1313	\$450	\$410
Instrument Depth – 489.0 mm 19.25 in					
Inst. Height mm	Inst. Height in	Style	HP Part Number	Price**	
				1 to 4	5 to 49
133.4	5.25	VT*	9211-1296	\$440	\$400
177.8	7.00	VT*	9211-1735	\$450	\$410
Instrument Depth – 565.2 mm 22.25 in					
Inst. Height mm	Inst. Height in	Style	HP Part Number	Price**	
				1 to 4	5 to 49
311.2	12.25	T	9211-1297	\$480	\$430
Two-Thirds Module Width Instruments Instrument Width – 266.7 mm 10.50 in					
Instrument Depth – 270.4 mm 11.00 in					
Inst. Height mm	Inst. Height in	Style	HP Part Number	Price**	
				1 to 4	5 to 49
165.1	6.5	V	9211-1895	\$330	\$300
Half-Module Width Instruments Instrument Width – 196.9 mm 7.75 in					
Instrument Depth – 203.2 mm 8.00 in					
Inst. Height mm	Inst. Height in	Style	HP Part Number	Price**	
				1 to 4	5 to 49
165.1	6.5	V	9211-1316	\$300	\$270
Instrument Depth – 279.4 mm 11.00 in					
Inst. Height mm	Inst. Height in	Style	HP Part Number	Price**	
				1 to 4	5 to 49
165.1	6.5	V	9211-1315	\$310	\$280
Instrument Depth – 406.4 mm 16.00 in					
Inst. Height mm	Inst. Height in	Style	HP Part Number	Price**	
				1 to 4	5 to 49
165.1	6.5	V	9211-1734	\$330	\$300

\*Removable casters are an option.

\*\*Prices shown are subject to change. For quote contact SMO Procurement.

One-Third Module Width Instruments Instrument Width – 130.2 mm 5.125 in					
Instrument Depth – 203.2 mm 8.00 in					
Inst. Height mm	Inst. Height in	Style	HP Part Number	Price**	
				1 to 4	5 to 49
165.1	6.5	V	9211-1317	\$290	\$260
Instrument Depth – 279.4 mm 11.00 in					
Inst. Height mm	Inst. Height in	Style	HP Part Number	Price**	
				1 to 4	5 to 49
165.1	6.5	V	9211-1318	\$300	\$270

### System II Cabinet Style Transit Cases

Full-Module Width Instruments Instrument Width – 425.5 mm 16.75 in					
Instrument Depth – 387.4 mm 15.25 in					
Inst. Height mm	Inst. Height in	Style	HP Part Number	Price**	
				1 to 4	5 to 49
88.9	3.50	VT	9211-2642	\$430	\$390
133.4	5.25	VT	9211-2643	\$430	\$390
177.8	7.00	VT	9211-2644	\$430	\$390
222.3	8.75	VT	9211-2645	\$430	\$390
266.7	10.50	T*	9211-2646	\$430	\$390
311.2	12.25	T*	9211-2647	\$430	\$390
Instrument Depth – 463.6 mm 18.25 in					
Inst. Height mm	Inst. Height in	Style	HP Part Number	Price**	
				1 to 4	5 to 49
88.9	3.50	VT	9211-2648	\$480	\$430
133.4	5.25	VT	9211-2649	\$480	\$430
177.8	7.00	VT	9211-2650	\$480	\$430
222.3	8.75	T*	9211-2651	\$480	\$430
266.7	10.50	T*	9211-2652	\$480	\$430
311.2	12.25	T*	9211-2653	\$480	\$430
Instrument Depth – 546.1 mm 21.50 in					
Inst. Height mm	Inst. Height in	Style	HP Part Number	Price**	
				1 to 4	5 to 49
88.9	3.50	VT	9211-2654	\$520	\$470
133.4	5.25	VT	9211-2655	\$520	\$470
177.8	7.00	VT	9211-2656	\$520	\$470
222.3	8.75	T*	9211-2657	\$520	\$470
266.7	10.50	T*	9211-2658	\$520	\$470
311.2	12.25	T*	9211-2659	\$520	\$470
Instrument Depth – 622.3 mm 24.50 in					
Inst. Height mm	Inst. Height in	Style	HP Part Number	Price**	
				1 to 4	5 to 49
88.9	3.50	VT	9211-2660	\$550	\$500
133.4	5.25	VT	9211-2661	\$550	\$500
177.8	7.00	T*	9211-2662	\$550	\$500
222.3	8.75	T*	9211-2663	\$550	\$500
266.7	10.50	T*	9211-2664	\$550	\$500
311.2	12.25	T*	9211-2665	\$550	\$500

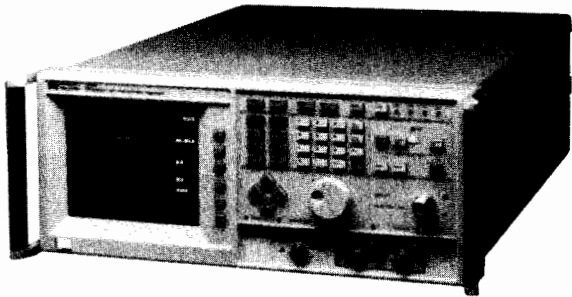

Typical System II half-module instrument

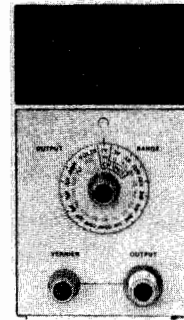

Typical System II quarter-module instrument

**System II Cabinet Style Transit Cases (Continued)**

Half-Module Width Instruments Instrument Width – 215.9 mm 8.50 in					
Instrument Depth – 247.7 mm 9.75 in					
Inst. Height mm	Inst. Height In	Style	HP Part Number	Price**	
				1 to 4	5 to 49
88.9	3.50	V	9211-2666	\$330	\$300
133.4	5.25	V	9211-2667	\$330	\$300
177.8	7.00	V	9211-2668	\$330	\$300
222.3	8.75	V	9211-2669	\$330	\$300
266.7	10.50	V*	9211-2670	\$330	\$300
Instrument Depth – 323.9 mm 12.75 in					
Inst. Height mm	Inst. Height In	Style	HP Part Number	Price**	
				1 to 4	5 to 49
88.9	3.50	V	9211-2671	\$390	\$350
133.4	5.25	V	9211-2672	\$390	\$350
177.8	7.00	V	9211-2673	\$390	\$350
222.3	8.75	V	9211-2674	\$390	\$350
266.7	10.50	V	9211-2675	\$390	\$350
Instrument Depth – 400.1 mm 15.75 in					
Inst. Height mm	Inst. Height In	Style	HP Part Number	Price**	
				1 to 4	5 to 49
88.9	3.50	V	9211-2676	\$400	\$360
133.4	5.25	V	9211-2677	\$400	\$360
177.8	7.00	V	9211-2678	\$400	\$360
222.3	8.75	V	9211-2679	\$400	\$360
266.7	10.50	V	9211-2680	\$400	\$360
Instrument Depth – 476.3 mm 18.75 in					
Inst. Height mm	Inst. Height In	Style	HP Part Number	Price**	
				1 to 4	5 to 49
88.9	3.50	V	9211-2681	\$400	\$360
133.4	5.25	V	9211-2682	\$400	\$360
177.8	7.00	V	9211-2683	\$400	\$360
222.3	8.75	V	9211-2684	\$400	\$360
266.7	10.50	V	9211-2685	\$400	\$360

Quarter-Module Width Instruments Instrument Width – 104.8 mm 4.125 in					
Instrument Depth – 247.7 mm 9.75 in					
Inst. Height mm	Inst. Height In	Style	HP Part Number	Price**	
				1 to 4	5 to 49
88.9	3.50	V	9211-2686	\$280	\$250
133.4	5.25	V	9211-2687	\$280	\$250
177.8	7.00	V	9211-2688	\$280	\$250
Instrument Depth – 323.9 mm 12.75 in					
Inst. Height mm	Inst. Height In	Style	HP Part Number	Price**	
				1 to 4	5 to 49
88.9	3.50	V	9211-2689	\$290	\$260
133.4	5.25	V	9211-2690	\$290	\$260
177.8	7.00	V	9211-2691	\$290	\$260
Instrument Depth – 400.1 mm 15.75 in					
Inst. Height mm	Inst. Height In	Style	HP Part Number	Price**	
				1 to 4	5 to 49
88.9	3.50	V	9211-2692	\$350	\$310
133.4	5.25	V	9211-2693	\$350	\$310
177.8	7.00	V	9211-2694	\$350	\$310

\*Removable casters are an option.  
 \*\*Prices shown are subject to change. For quote contact SMO Procurement.

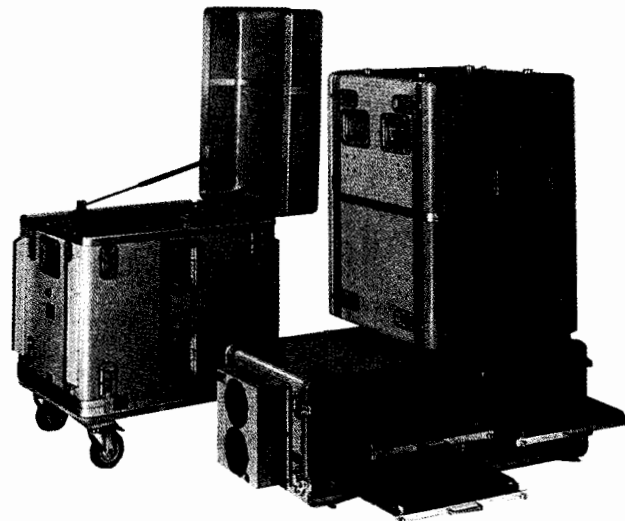

Variety of custom Operating Cases with options

# CABINETS & CABINET ACCESSORIES

## System II Plus – Handles and Rack Flanges, Bail Handle Kit

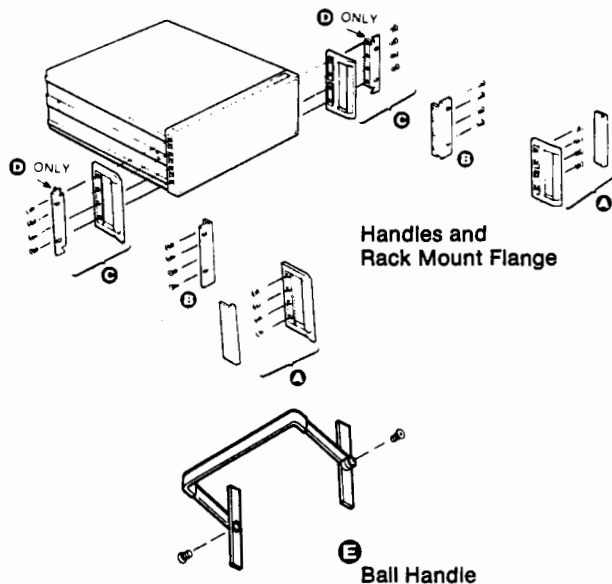
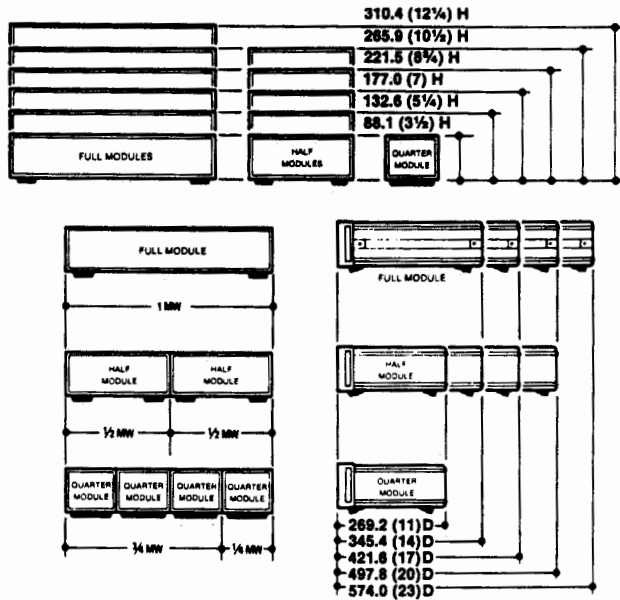

**NOTICE**—The cabinet accessory kits shown on these pages include metric fasteners to make them compatible with metric fastener-cabinets. If your instrument requires inch fasteners order HP 5062-4078 with your handle & rack flange kits. It is most important for the user to be aware of these different fasteners to avoid thread damage when attaching the accessory kits. Metric-fastener-cabinets are identified with a yellow label on the rear, which reads “Caution—metric and inch hardware” and has a “metric” embossment in the front bezel casting under the plastic trim strip and on the middle of the rear bezel casting.

### System II and System II Plus Cabinet Design

HP’s modular cabinet system offers bench-stacking and rack mounting versatility. These cabinets are designed for compatibility with EIA and IEC standards, both in width and height.

System II Plus cabinets and accessories are identical in form, fit, and function to System II but are different colors for improved visual continuity. This catalog lists System II Plus part numbers only.

### Handles and Rack Mount Flanges

Handles and rack flanges are available for all System II cabinets, although they find most use on full width modules or combinations of narrower modules locked together to form 1 MW (module width).

Certain instruments are supplied with front handles as part of the selling price. Handles and rack flanges can be supplied with most instruments by specifying the appropriate option from the following list, at the time of order. The extra cost of each option is usually specified on the instrument data sheet.

- Option 907 Front Handles
- Option 908 Rack Mount Flanges
- Option 909 Handles with Rack Flanges
- Option 913 Rack Mount Flanges (if handles already furnished) (HP 5062-4069 version)

The table below describes kits available for use after receipt of equipment. Field installation is very straightforward. A plastic trim strip is easily removed and the handle or flange attached with screws supplied in the kit. Before rack mounting, bottom feet must be removed.

### Bail Handle Kit

For 1/2 MW cabinets, you can attach this front bail handle for easy portability. Attaching hardware is furnished.

HP Part No.	Name	Price
HP 5062-4001	Bail Handle Kit for 88.1 (3 1/2) Module	\$38
HP 5062-4002	Bail Handle Kit for 132.6 (5 1/4) Module	\$35
HP 5062-4003	Bail Handle Kit for 177.0 (7) Module	\$33

### Handle and Rack Flanges

Instrument Module Height mm (In)	A Front Handle Kit		B Rack Mount Flange Kit*		C Rack Mount Flange Kits with Handles		D Rack Mount Flange Kit for Instruments with Previously Supplied Handles	
	HP Part No.	Price	HP Part No.	Price	HP Part No.	Price	HP Part No.	Price
88.1 (3 1/2)	HP 5062-3988	\$55.00	HP 5062-3974 <sup>1</sup>	\$35.00	HP 5062-3975 <sup>1</sup>	\$80.50	HP 5062-4069 <sup>2</sup>	\$35.00 <sup>2</sup>
88.1 (3 1/2)	—	—	HP 5062-3976 <sup>2</sup>	\$35.00	HP 5062-3982 <sup>2</sup>	\$80.50	HP 5062-4070 <sup>2</sup>	\$35.00 <sup>2</sup>
132.6 (5 1/4)	HP 5062-3989	\$60.00	HP 5062-3977	\$40.50	HP 5062-3983	\$90.50	HP 5062-4071	\$40.00
177.0 (7)	HP 5962-3990	\$70.00	HP 5062-3978	\$40.00	HP 5062-3984	\$100.00	HP 5062-4072	\$40.00
221.5 (8 3/4)	HP 5962-3991	\$80.00	HP 5062-3979	\$45.00	HP 5062-3985	\$115.00	HP 5062-4073	\$45.00
265.9 (10 1/2)	HP 5062-3992	\$95.00	HP 5062-3980	\$60.00	HP 5062-3986	\$130.00	HP 5062-4074	\$50.00
310.4 (12 1/4)	HP 5062-3993	\$140.00	HP 5062-3981	\$60.00	HP 5062-3987	\$170.00	HP 5062-4075	\$60.00
<b>Kit Includes</b>	2 handles + 2 trim strips + metric fasteners		2 flanges + metric fasteners + mounting screws		2 handles + 2 flanges + metric fasteners + mounting screws		2 flanges + metric fasteners + mounting screws	

<sup>1</sup>HP 5062-3974/3975/4069 Kits use standard flanges with 1.75-in hole spacing.  
<sup>2</sup>HP 5062-3976/3982/4070 Kits use special flange with 3.00-in hole spacing.

<sup>2</sup>Will not fit onto instruments with previously supplied handles.  
<sup>2</sup>Option 913 ordered on instruments supplies HP 5062-4069. For 3.00-in spacing, order HP 5062-4070 instead of Option 913.

☎ For off-the-shelf shipment, call 800-452-4844.

# CABINETS & CABINET ACCESSORIES

System II Plus – Support Shelves, Filler Panels

659

**NOTICE**—The cabinet accessory kits shown on these pages include metric fasteners to make them compatible with metric-fastener-cabinets. If your instrument requires inch fasteners order HP 5062-4078 with your rack mount adapter kits and filler panels. It is most important for the user to be aware of these different fasteners to avoid thread damage when attaching the accessory kits. Metric-fastener-cabinets are identified with a yellow label on the rear, which reads "Caution—metric and inch hardware" and has a "metric" embossment in the front bezel casting under the plastic trim strip and on the middle of the rear bezel casting.

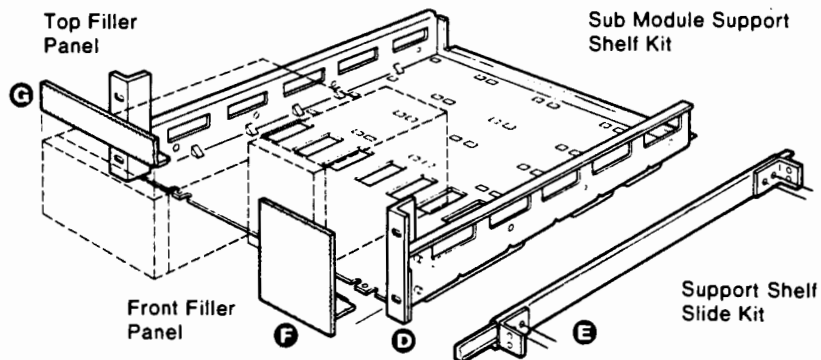
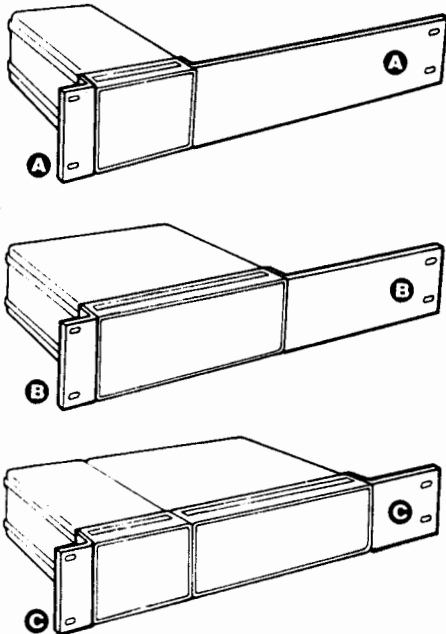

## Rack Mount Adapter Kits

Modules of less than 1 MW can be rack mounted using these kits. Individual 1/4 MW or 1/2 MW modules use the kits shown below directly. Combinations of 1/4 MW and 1/2 MW (of equal depth) are first joined side by side with the Lock Link Kit (HP 5061-9694) (following page 660), then have end flanges applied. Combinations adding to 1 MW use regular rack flange kit (previous page 658). Kits include attaching screws and front-panel rack mounting screws. Hole patterns conform to EIA and IEC standards.

## Rack Mount Adapter Kits

Module Height mm (in)	A Mounts 1/4 MW Module		B Mounts 1/2 MW or 2 each 1/4 MW <sup>1</sup> Modules		C Mounts 3/4 MW (3 ea. 1/4 MW) <sup>1</sup> or 1/2 & 1/4 MW side by side <sup>2</sup>	
	HP Part No.	Price	HP Part No.	Price	HP Part No.	Price
88.1 (3 1/4)	5062-3973	\$65.00	5062-3972	\$60.00	5062-3971	\$60.00
132.6 (5 1/4)	—	—	5062-3957	\$70.00	5062-3958	\$70.00
177.0 (7)	—	—	5062-3960	\$80.00	5062-3961	\$80.00
265.9 (10 1/2)	—	—	5062-3966	\$85.50	5062-3967	\$85.50
<b>Kit Includes</b>	1 ea. rack flange 1 ea. 1/4 MW extension adapter flange and screws		1 ea. rack flange 1 ea. 1/2 MW extension adapter flange and screws		1 ea. rack flange 1 ea. 1/4 MW extension adapter flange and screws	

<sup>1</sup> Side-by-side modules of equal depth require Lock Link Kit (HP 5062-3994).  
<sup>2</sup> 1/2 MW can be center mounted using two of these kits.

## Support Shelf, Slide, and Filler Panels

Submodules of differing heights, widths, and depths (up to 20 D) may be rack-mounted using these support shelves. Any combination of 1/4 MW and 1/2 MW will fit side by side up to 1 MW. Filler panels close up vacant spaces either on top of short modules or side by side. The slide kit provides ready access to internal shelf areas and is designed for HP racks with 24-inch depth support rails. Slide kit includes brackets and mounting screws.

## HP Part No. Name

HP Part No.	Name	Price
5062-3996	Support Shelf for 88.1 (3 1/4) H Modules	\$195
5062-3997	Support Shelf for 132.6 (5 1/4) H Modules	\$195
5062-3998	Support Shelf for 177.0 (7) H Modules	\$210
1494-0015	Slide Kit (two each slides, brackets, hardware)	\$120

## Filler Panels

Description	Size	HP Part No.	Price
E For 88.1 (3 1/4) H support shelf partially filled with instruments, and having the following front panel space to fill:	1/4 MW to fill	5062-4021	\$75
	1/2 MW to fill	5062-4022	\$80
	3/4 MW to fill	5062-4023	\$95
F For 132.6 (5 1/4) H support shelf, and having the following front panel space to fill:	1/4 MW to fill	5062-4024	\$80
	1/2 MW to fill	5062-4025	\$90
G For 177.0 (7) H support shelf, and having the following front panel space to fill:	1/4 MW to fill	5062-4066	\$75
	1/2 MW to fill	4062-4027	\$110
G For 1/4 MW and having the following vertical space to fill:	43.2 (1 1/2) H	5062-4035	\$50
	87.6 (3 1/2) H	5062-4036	\$50
G For 1/2 MW and having the following vertical space to fill:	43.2 (1 1/2) H	5062-4037	\$50
	87.6 (3 1/2) H	5062-4038	\$50

☎ For off-the-shelf shipment, call 800-452-4844.

# CABINETS & CABINET ACCESSORIES

## System II Plus – Lock Link Kits, Rack Mount Slide Kits

**NOTICE**—The cabinet accessory kits shown on these pages include metric fasteners to make them compatible with metric-fastener-cabinets. It is most important for the user to be aware of these different fasteners to avoid thread damage when attaching the accessory kits. Metric-fastener-cabinets are identified with a yellow label on the rear, which reads “Caution—metric and inch hardware” and has a “metric” embossment in the front bezel casting under the plastic trim strip and on the middle of the rear bezel casting. Due to design considerations, the slide-mount kits shown on this page are offered in both inch and metric-fastener versions.

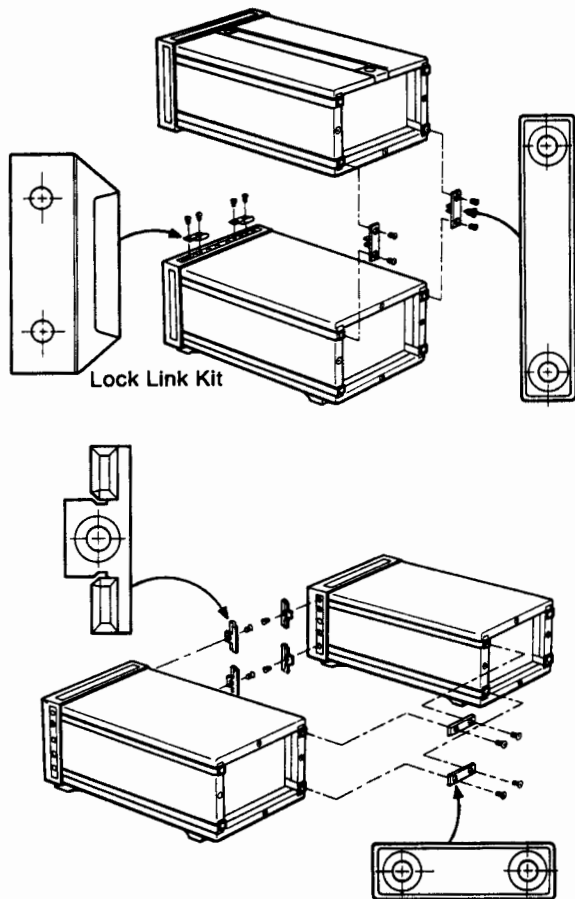

### Lock Link Kits HP 5061-9694

All submodule cabinets of *equal depths* can be linked together over/under or side by side with hardware in the lock link kit. Cabinet frames are already prethreaded to allow quick assembly. For side-by-side connections, the kit contains 12 front hooks and 6 rear links, enough for 3 side-by-side joints. For vertical connections, the kit also contains 4 front hooks and 4 rear links enough for 2 over/under joints. Kit includes metric screws (order part number 5062-4079-inch screw kit for 5061-9694). Locking cabinets together horizontally in a configuration wider than 1 MW is not recommended.

If the over/under linked combination is to include rear standoff feet (HP 5062-4009), then the over-under locking feet kit HP 5062-3999 should be used for over/under connection.

The HP 5061-9694 Lock Link Kit is not recommended for full module over/under combinations. Use Kit HP 5061-9699 Locking Feet Kit to handle those larger weights.

### Slide Kits and Rack Brackets

Rack slides are available for full-width System II cabinets to permit easy access to internal spaces. Each kit consists of two slides that mount directly to System II cabinet side-handle recess spaces (after removing side handles). The slides also mount directly to vertical support rails in HP racks. HP 1494-0060 mounts 345.4D and 421.6D depth System II cabinets; HP 1494-0059 mounts 497.8D and 574.0D.

Standard weight slides carry 38.6 kg (85 lb) maximum load. Tilting versions are available in standard duty only (HP 1494-0062 and 1494-0063).

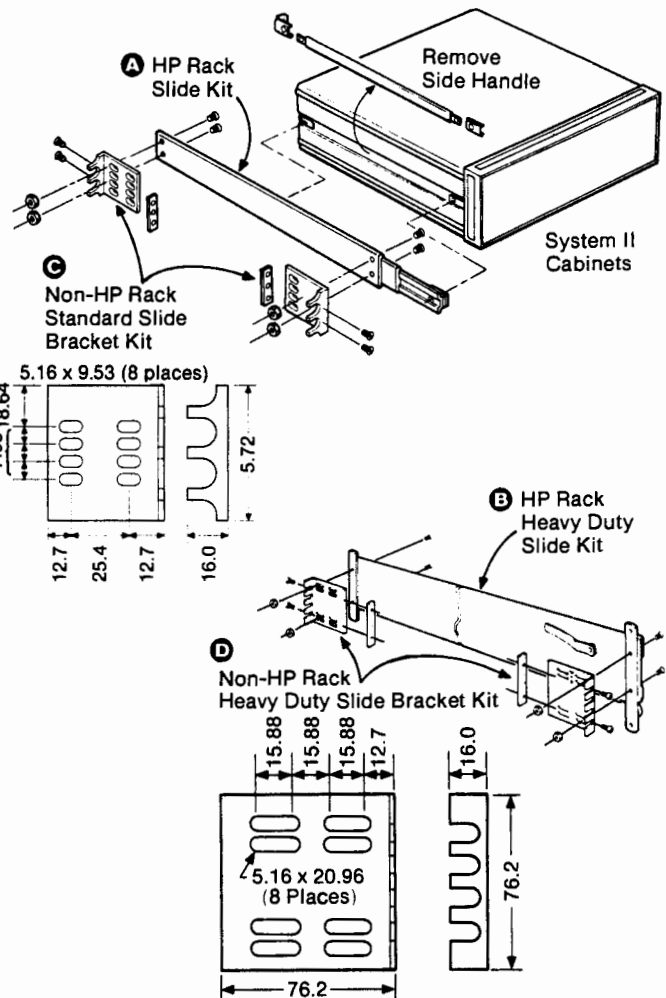

For non-HP racks, end-bracket kits are available for both standard and heavy-duty slide kits. Slotted hole arrays in the brackets provide for front-to-back rack rail spacing of 24-, 26-, and 28-inch nominal centers. They also allow choice of two vertical positions. Each kit of four brackets includes screws and four bar nuts. These general-purpose mounting brackets fit most common non-HP racks such as GE, Honeywell, etc.

### Ordering Information

Part Number	Description	Price
HP 5061-9694	Lock Link Kit	\$45 ☎
HP 1499-0060 (HP 1494-0018)	Ⓐ Non-Tilting, Std. Slide Kit, Fits 345.4D & 421.6D Cabinets	\$115 ☎
HP 1494-0059 (HP 1494-0017)	Ⓐ Non-Tilting, Std. Slide Kit, Fits 497.8D & 574.0D Cabinets	\$115 ☎
HP 1494-0062 (HP 1494-0025)	Ⓐ Tilting, Std. Slide Kit, Fits 345.4D & 421.6D Cabinets	\$200 ☎
HP 1494-0063 (HP 1494-0026)	Ⓐ Tilting, Std. Slide Kit, Fits 497.8D & 574.0D Cabinets	\$200 ☎
HP 1494-0058 (HP 1494-0016)	Ⓑ Non-Tilting, Heavy Duty Slide Kits 497.8D & 574.0D Cabinets Only	\$300 ☎
HP 1494-0061 (HP 1494-0023)	Ⓒ (4) End Brackets for Non-HP Racks, Std. Slides	\$45 ☎
HP 1494-0064 (HP 1494-0042)	Ⓒ (4) End Brackets for Non-HP Racks, Heavy Duty Slides	\$70 ☎
HP 5062-4079	Inch Screw Kit for 5061-9694	

Note: These parts can be ordered as either metric or standard.

☎ For off-the-shelf shipment, call 800-452-4844.

# CABINETS & CABINET ACCESSORIES

## System I – Rack Hardware and Accessories

661



### System I Cabinet Design

System I cabinets are still used on older HP instruments. System I can be identified by its front handles being integral with the side casting frame. These two pages describe accessories for use with System I cabinets and small modular instruments.

HP 1051A

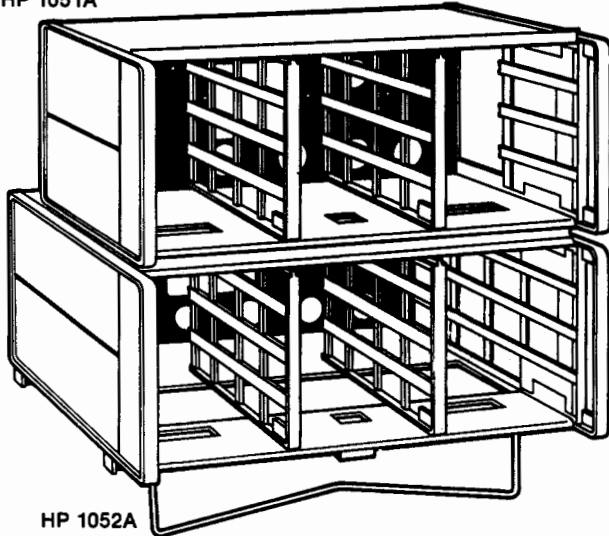

HP 1052A

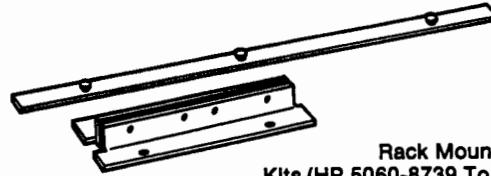

Rack Mounting Kits (HP 5060-8739 To 5060-8744)

HP 5040-6678

HP 5060-8764

HP 5060-8762

HP 5040-6680

### Combining Cases – HP 1051A, 1052A

HP 1051A and HP 1052A combining cases conveniently rack or bench mount combinations of small modular Hewlett-Packard System 1 instruments. Both cases accept  $\frac{1}{2}$  or  $\frac{1}{4}$  instrument modules, 130 mm or 198 mm wide ( $5\frac{1}{8}$  or  $7\frac{7}{8}$  in). The basic difference is that the HP 1052A is 130 mm ( $5\frac{1}{8}$  in) deeper and will accept modules up to 416 mm deep ( $16\frac{1}{2}$  in). The HP 1051A accepts instruments up to 286 mm deep ( $11\frac{1}{4}$  in). Each case is furnished with two dividers.

Accessory drawer HP 5060-8756 supplies storage space  $\frac{1}{2}$  width and 77 mm ( $3\frac{1}{2}$  in) high. Use an HP 5060-8758 filler panel above or below.

### HP 1051A, 1052A, 5060-8756 Specifications

Size	Price
<b>HP 1051A:</b> 178 mm H × 482.6 mm W × 337 mm D (7 in × 19 in × 13 $\frac{3}{4}$ in)	\$1,600
<b>HP 1052A:</b> 178 mm H × 482.6 mm W × 467 mm D (7 in × 19 in × 18 $\frac{3}{8}$ in)	\$1,600

### Weight

<b>HP 1051A:</b> Net, 4.5 kg (10 lb); shipping, 6.7 kg (15 lb)	
<b>HP 1052A:</b> Net, 5.4 kg (12 lb); shipping, 8.1 kg (18 lb)	
<b>Opt 908:</b> Rack Mount Kit	\$40
<b>Opt 910:</b> Extra Manual	\$1

### Rack Mounting Kits – HP 5060-8739 to 5060-8744

With these kits all Hewlett-Packard products in full rack-width cabinets of the integral side frame-handle style (see HP 1051A, 1052A combining cases above) can be easily prepared for rack mounting. Each kit contains two flanges, a filler strip, and mounting screws.

### Rack Mounting Kit Ordering Information

HP Part Number	Nominal Cabinet Height		Price
	Millimeters	Inches	
HP 5060-8739	88.1	3 $\frac{1}{2}$	\$50
HP 5060-8740	132.6	5 $\frac{1}{4}$	\$55
HP 5060-8741*	177	7	\$60
HP 5060-8742	221.5	8 $\frac{3}{4}$	\$70
HP 5060-8743	265.9	10 $\frac{1}{2}$	\$70
HP 5060-8744	310.4	12 $\frac{1}{4}$	\$80

\*Also used to rack mount HP 1051A & 1052A combining kits shown above.

### Rack Adapter Frames – HP 5060-8762, 5060-8764

These frames can be used to hold combinations of  $\frac{1}{2}$  and  $\frac{1}{4}$  module-width HP instruments. Each frame is furnished with mounting hardware and three dividers. Two models are available for different instrument heights. Adapter frames are for permanent or semi-permanent rack mounting. Where quick removal and reinstallation of instruments is desirable, the HP 1051A and HP 1052A should be used.

HP 5060-8762 is 178 mm (7 in) high and accepts instruments heights of  $\frac{1}{4}$ H,  $\frac{1}{2}$ H, and 1H. HP 5060-8764 is 89 mm ( $3\frac{1}{2}$  in) high and accepts instruments of  $\frac{1}{4}$ H and  $\frac{1}{2}$ H.

### Ordering Information

Part Number	Description	Price
HP 5060-8762	Rack Adapter 178 mm (7 in)	\$180
HP 5060-8764	Rack Adapter 89 mm ( $3\frac{1}{2}$ in)	\$180
HP 5040-6678	Extra Vertical Dividers for 5060-8764	\$30
HP 5040-6680	Extra Vertical Dividers for 5060-8762	\$15

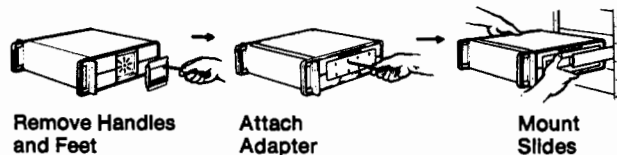

Remove Handles and Feet

Attach Adapter

Mount Slides

### Rack Mount Slide Kits and Cabinet Adapters

By removing the side handle of full-width System I cabinets, rack mount slides can be attached for easy access to internal space. Both tilting and nontilt are available, while maximum load factor is 31.7 kg (70 lb). The cabinet adapter plate attaches to the handle recess and then to the slide. Slide kits include four angle brackets that mount to rack rails with front-to-back nominal spacings of 24, 26 and 28 inches.

### Cabinet Adapters

Part Number	Description	Price
HP 1490-0722	Adapter plate for 88.9 mm H ( $3\frac{1}{2}$ in) cabinets	\$135
HP 1490-0721	Adapter plate for 133 mm H ( $5\frac{1}{4}$ in) and higher cabinets	\$260

☎ For off-the-shelf shipment, call 800-452-4844.

# CABINETS & CABINET ACCESSORIES

## System I—Slide Kits, Fans, Joining Brackets, Cases

### Rack Mount Slide Kits—HP 1490-0713 to 1490-0720

HP Part Number <sup>1</sup>	Slide Type	Cabinet Depth	Extension Length	Price
1490-0713	fixed	all sizes	482.6 (19) <sup>2</sup>	\$140
1490-0714	fixed	all sizes	635.0 (25) <sup>3</sup>	\$160

<sup>1</sup> Cabinet Adapters, below, must be added to slides.

<sup>2</sup> Slide's stationary mounting depth: 406.4 (16).

<sup>3</sup> Slide's stationary mounting depth: 558.8 (22).

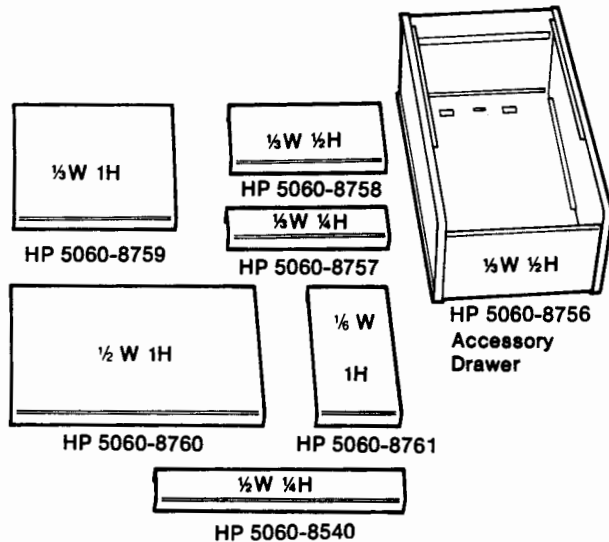

### Filler Panels—HP 5060-8540, 5060-8757 to 5060-8761

Filler panels can be used to close off any leftover space after instruments are mounted in combining cases or adapter frames (left). Panels are available in a variety of widths and heights.

HP Part No.	Module Case Height x Width	Filler Panel Dimensions		Price
		Millimeters	Inches	
5060-8540	1/4 x 1/2	38 x 198	1 1/2 x 7 <sup>25</sup> / <sub>32</sub>	\$75
5060-8757	1/4 x 1/4	38 x 130	1 1/2 x 5 1/8	\$75
5060-8758	1/2 x 1/4	77 x 130	3 1/2 x 5 1/8	\$75
5060-8759	full x 1/4	155 x 130	6 1/2 x 5 1/8	\$75
5060-8760	full x 1/2	155 x 198	6 3/2 x 7 <sup>25</sup> / <sub>32</sub>	\$75
5060-8761	full x 1/6	155 x 63	6 3/2 x 2 <sup>31</sup> / <sub>64</sub>	\$75

☎ For off-the-shelf shipment, call 800-452-4844.

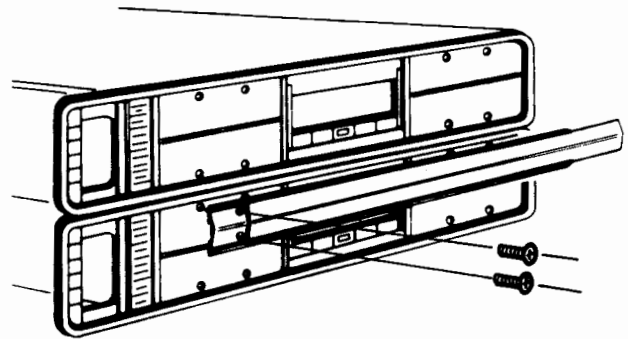

### Joining Bracket Kits—HP 5060-8541 to 5060-8545

These kits join HP System I instruments of the same width and length into easily handled single stacks. Each kit consists of two brackets, mounting hardware, and trim. They are available to fit the three most common instrument depths:

#### Ordering Information

HP 5060-8541	279 mm (11 in) EIA panel depth
HP 5060-8543	406 mm (16 in) EIA panel depth
HP 5060-8545	480 mm (19 in) EIA panel depth

#### Price

\$175
\$175
\$190

### Vectra

You can now rack mount the Vectra SPU, VGA monitor, and keyboard. A rail kit for both SPU and the monitor are required to complete the installation. For HP racks, the 12679B rail kit is needed for the SPU, and the 12679C for the VGA monitor.

#### Ordering Information

HP 35199A	Rack Mount Shelf
(1 to 9 units)	
(10 to 24)	
(25 to 49)	
(50 to 99)	

#### Price

\$79 each
\$72 each
\$68 each
\$64 each
\$70 each
\$70 each
\$360 each
\$125 each
\$50 each

#### HP 12679B Rail Kit

#### HP 12131A Keyboard Racking Kit

#### HP 35199B VGA Monitor Rack Mount

#### HP 12679C Rail Kit

☎ For off-the-shelf shipment, call 800-452-4844.



# CABINETS & CABINET ACCESSORIES

EIA Racks

HP E3660A/E3661A/E3662A Series

663

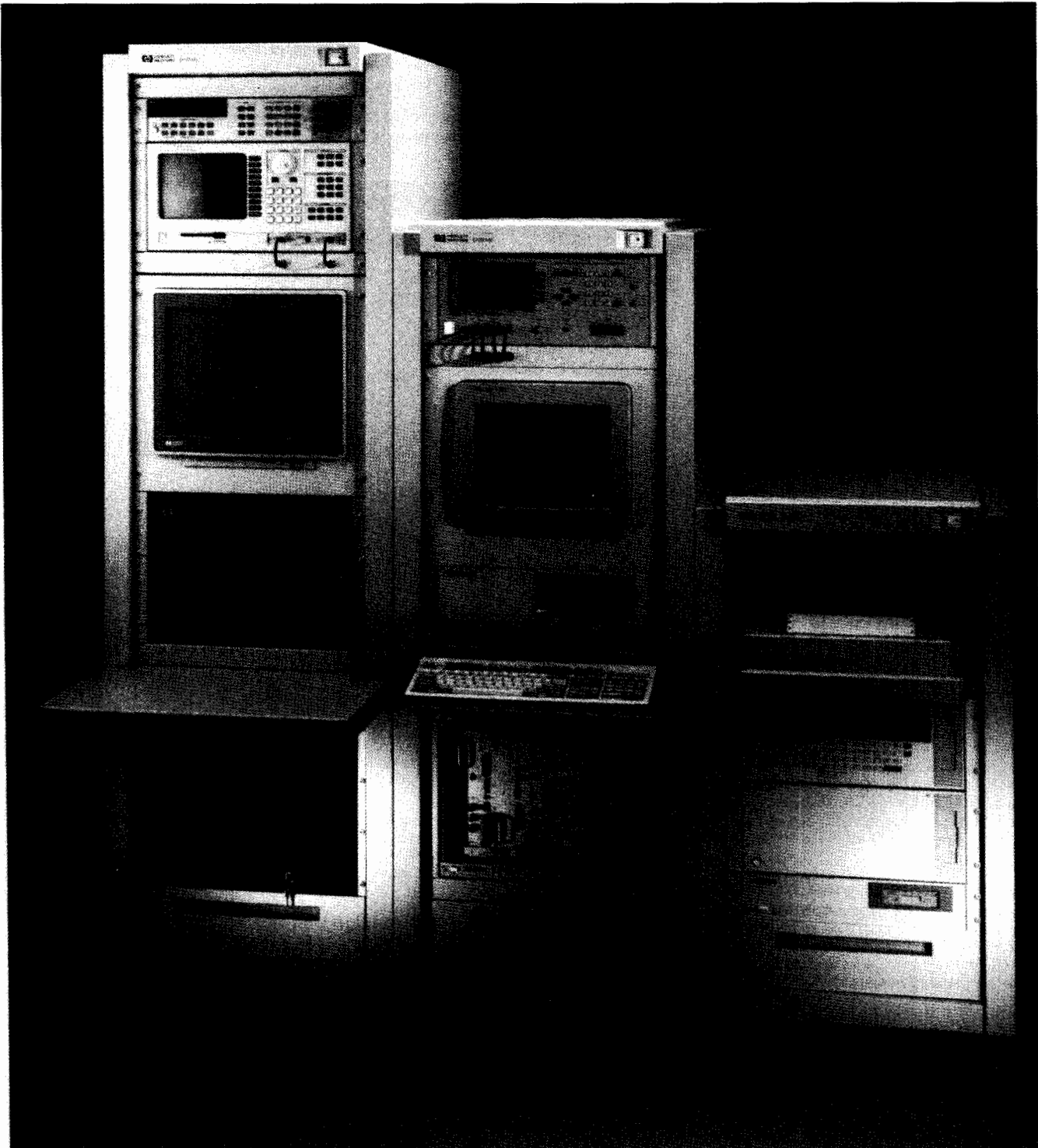

## Description

The HP 19-inch Electronic Industries Association (EIA) racks, cabinets, options, and accessories have been designed specifically to meet the needs of HP instrumentation customers. Features have been developed to make the task of rack mounting systems easier than ever before.

HP racks offer flexibility to meet the vast majority of rack mounting applications. Option and accessory selection is simplified with a product selection chart. Standard with all racks are the top, side panels, solid base, vented rear door, anti-tip foot, 3-inch heavy duty casters, and one pair of System II rails.

## The Right Height for All Systems

1100 mm, 1600 mm, and 2000 mm rack heights are available. These offer 21, 32, and 41 standard EIA units of rack mounting space (1 standard EIA rack mount increment is equal to 44.45 mm, or 1.75 in). All racks are 905 mm deep, with 851 mm of useable depth.

## Side panels

Lift up-and-off side panels allow fast and easy access to the interior of the rack from all angles without having to remove the top.

# CABINETS & CABINET ACCESSORIES

## EIA Racks

HP E3660A/E3661A/E3662A Series

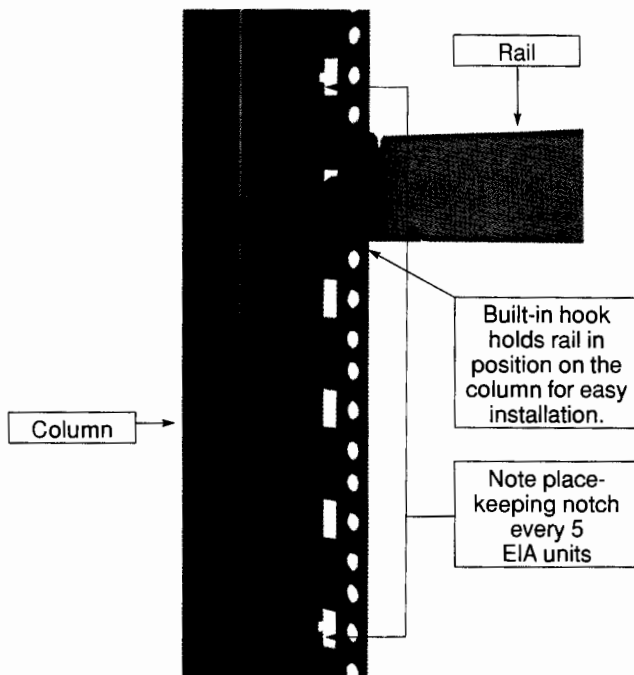

### Vertical Mounting Columns

The new vertical mounting columns have a slot feature to help position and secure the new support rails. Assembly is easy since rails do not have to be held in position when bolting them to the vertical column, ensuring that the rails can only be located in proper EIA increments.

Configuration is simplified since it is now easy to count EIA units from the base of the rack. Straight-through mounting holes are provided on vertical columns for use in conjunction with sheet metal nuts. Either standard or metric mounting hardware can be used.

### Top

The top of the new HP 19-inch rack incorporates a ventilation path through the roof on 1600 mm and 2000 mm models. This greatly enhances the ability to dissipate heat. Airflow can be passive (thermal convection) or enhanced with one of the fan options. The standard 1100 mm 19-inch rack is provided with a solid top unless an extractor fan option is ordered.

### Improved Wire Management Capabilities

The front-to-back depth of HP's new cabinets has been increased from 800 mm to 905 mm. This added 105 mm of internal space in the rear of the rack to house the new Power Distribution Unit (PDU) option, and to provide an excellent access path for bulky power and signal cables used in many current systems.

### Standard Anti-Tip Foot

A retractable anti-tip foot that easily pulls into place is standard on all racks. This provides temporary anti-tip capability for slide-mounted products when they are in their extended position. The anti-tip ballast (HP C2790A) accessory can be used when permanent anti-tip capability is desired.

### Rear Door

A vented rear door is standard. A lockable latch is provided to secure the rear door against disruption of tests, or unauthorized removal of system components. The rear door is symmetrical, so the door can be mounted to open from the left to right. This is useful for multiple bay applications.

### International Dimension Standards

These HP racks meet IEC 297-1, -2, -3 standards with regards to height, width, and depth.

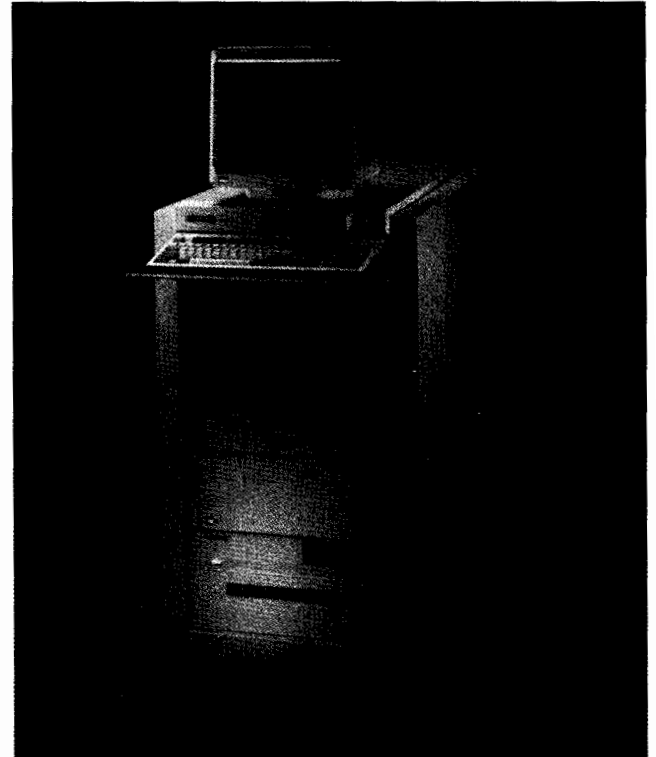

### Options

HP has included a series of optional features that provide flexibility for your configuration needs. Many of the options can be combined (for example: fan and PDU), but others are mutually exclusive. The most often requested options are shipped integrated with the basic rack.

### Power Distribution Unit 1FB

Specifying 1FB in conjunction with a localization option provides you with a 16-amp, 10-outlet vertical PDU (6 outlets in a 1100 mm rack). A front-panel master power switch is provided for rapid system shutdown in case of emergency, and for added convenience. This switch operates low power signal lines that control a relay in the PDU(s) to minimize electrical noise from current-carrying conductors. Circuit breakers are provided on both hot (live) and neutral lines. A 1930 mm (6.3 ft) 20-amp power cord is provided with each PDU. The U.S. ABA version is supplied with a 20-amp plug. International ABB versions are supplied with an unterminated power cable, allowing the user to attach a plug compatible with local power requirements. The top receptacle of all versions is intended for the extraction fan option and is configured as IEC 320.

Racks for use in the U.S. are provided with 5-15 NEMA style outlets for operation at 100/120 V (unless 200/240 V feature 0E3 is requested). International racks are provided with IEC-320 outlets for operation at 200/240 V.

**Additional Power HP Option 2 x 1FB**

Power capacity can be doubled to the maximum of 32 amps by ordering two times option 1FB, providing a second vertical PDU.

**Localization Options ABA or ABB**

These are required when ordering a Power Distribution Unit (PDU) to ensure that the HP rack meets your local power and regulatory needs. Specify ABA for a power system designed to match UL/CSA standards. Specify ABB for a power system designed to match International standards based on IEC-950 and VDE. Localization options are mutually exclusive.

**200/240 V U.S. Power HP Option 0E3**

Option 0E3 (in combination with ABA and 1FB) provides a 200/240V PDU with IEC-320 outlets that conform to UL/CSA standards.

**Top Extractor Fan 1FA**

Option 1FA provides a top-mounted extractor fan unit compatible with the PDU selection. This fan outputs 5.7 cubic meters per minute, or 200 cubic feet per minute. Option 1FA also requires a PDU and localization options. It should not be ordered in conjunction with option 1FE blower fan.

**Positive Pressure Fan HP Option 1FE**

Option 1FE provides a base-mounted blower fan unit compatible with the PDU selection. This fan inputs 12.7 cubic meters per minute, and has a replaceable/cleanable filter to avoid dust accumulation within the rack. A solid rear door is substituted for the standard vented door to create a positive pressure system with air venting only through the top of the rack. Option 1FE also requires that a PDU and localization option be specified. It should not be ordered in conjunction with option 1FA extractor fan.

**Tie-Together Kit HP Option 1FD**

This option creates multiple bay solutions, by bolting the vertical columns of adjacent racks together. The kit completes the cosmetic finish of the multi-bay solutions. When this option is ordered, no side panels are provided. At least one rack must be ordered without this option to provide left and right side panels for the completed multi-bay system. If a blower fan option is chosen for multi-bay systems, be sure to order a blower fan with each rack to ensure proper ventilation (blower fan racks have solid rear doors while standard racks have vented rear doors).

**Front Door 1FC**

This feature adds a transparent, smoke-colored Plexiglas front door that can be locked. It provides an ideal way to prevent systems from being tampered with during testing.

**HP Rack System Design Guide**

There is a complete Rack System Design Guide incorporated in the 19-in EIA Rack Cabinets, Options, and Accessories Data Sheet available from your local HP sales office. The design guide also includes rack mounting specifications for HP Instruments and controllers. To order, use literature part number 5091-0896E.

<b>Ordering Information</b>	<b>Price</b>
<b>HP E3660A</b> Rack 1100 mm	\$750
<b>HP E3661A</b> Rack, 1600 mm	\$830
<b>HP E3662A</b> Rack, 2000 mm	\$870

<b>Options</b>	<b>Price</b>
<b>Opt ABA</b> US Localization	\$0
<b>Opt ABB</b> European Localization	\$0
<b>Opt 1FB</b> 16 amp PDU	\$140
<b>Opt 0E3</b> 220/240V U.S. Power	\$0
<b>Opt 1FA</b> Extractor Fan	\$100
<b>Opt 1FE</b> Blower Fan	\$450
<b>Opt 1FC</b> Front Door	\$290
<b>Opt 1FD</b> Tie Together Kit	\$0

<b>Accessories</b>	<b>Price</b>
<b>HP E3663A</b> Support Rail (HP System II)	\$35
<b>HP E3664A</b> Support Rail (third-party products)	\$50
<b>HP E3665A</b> Support Rail (HP VXi)	\$40
<b>HP E3666A</b> Plain Shelf	\$60
<b>HP E3900A</b> Keyboard Rack Kit (fixed)	\$75
<b>HP 12131A</b> Keyboard Rack Kit (retractable)	\$360
<b>HP 46298M</b> Drawer Unit	\$235
<b>HP 46298N</b> Work Surface	\$270
<b>HP 46298R</b> Mounting Hardware	\$70
<b>HP 40101A</b> 1-EIA Unit Filler Panel	\$36
<b>HP 40102A</b> 2-EIA Unit Filler Panel	\$37
<b>HP 40103A</b> 3-EIA Unit Filler Panel	\$38
<b>HP 40104A</b> 4-EIA Unit Filler Panel	\$40
<b>HP 40105A</b> 5-EIA Unit Filler Panel	\$41
<b>HP 40106A</b> 6-EIA Unit Filler Panel	\$42
<b>HP 40107A</b> 7-EIA Unit Filler Panel	\$45
<b>HP E3668A</b> Feedthrough Panel (plain)	\$45
<b>HP E3669A</b> Feedthrough Panel (BNC)	\$100
<b>HP C2790A</b> Ballast (14kg-30lb)	\$120
<b>HP 35199A</b> Vectra SPU Rack Mount Kit (HP 12679B Rail Kit required)	\$79
<b>HP 35199B</b> D1182A VGA Monitor Rack Kit (HP 12679C Rail Kit required)	\$125
<b>HP E3901A</b> D1194/5A SVGA Monitor Kit	\$175
<b>HP E3902A</b> A1497A 16-in Monitor Kit	\$290
<b>HP E3903A</b> 98785A/98789A 16-in Monitor Kit	\$290
<b>HP 44496A</b> Peripheral Drawer (8.75 in)	\$632
<b>HP 44496B</b> Peripheral Drawer (15.75 in)	\$632

# CABINETS & CABINET ACCESSORIES

## EIA Racks

### HP E3660A/E3661A/E3662A Series Specifications

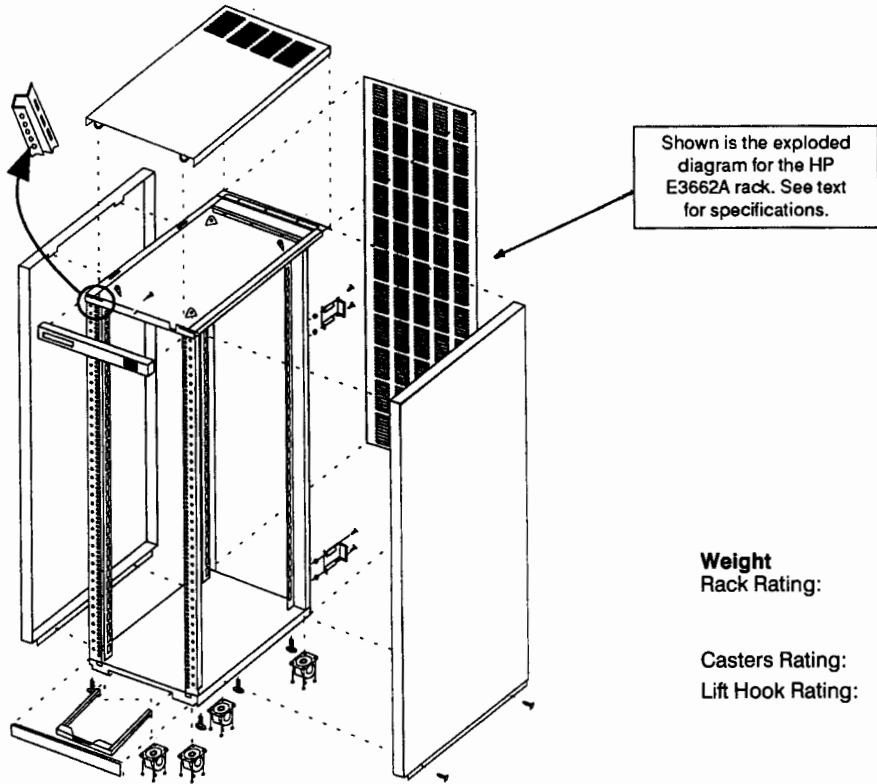

### E3660A/3661A/3662A 19-in EIA Rack Specifications

#### General

Standard rack includes: Frame, two side panels, rear door, top, lift hooks, four casters, four leveling screws, and a pair of System II support rails.

**Material:** Frame/columns: 13 Ga. cold rolled steel  
Side panels: 18 Ga. cold rolled steel

**Finish:** Sides: HP parchment white  
Top, trim strips: HP parchment white  
Front door: HP parchment white  
Frame: Umber black

#### Dimensions

		Height	Width	Depth
<b>E3660A</b>	Exterior:	1120 mm	600 mm	905 mm
	Interior:	933.45 mm	450.8 mm	851 mm
<b>E3661A</b>	Exterior:	1620 mm	600 mm	905 mm
	Interior:	1422.5 mm	450.8 mm	851 mm
<b>E3662A</b>	Exterior:	2020 mm	600 mm	905 mm
	Interior:	1822.5 mm	450.8 mm	851 mm

Front to rear column hole spacing: 610 mm (24 in)

#### Weight

**Rack Rating:** E3660A 81 kg (179 lbs) empty  
E3661A 100 kg (221 lbs) empty  
E3662A 116 kg (255 lbs) empty

**Casters Rating:** 318 kg (700 lbs) each, 818 kg (1800 lbs) total

**Lift Hook Rating:** 227 kg (500 lbs) each  
Total system and cabinet weight is a maximum 818 kg (1800 lbs), static. Lift cabinet using all four hooks.

#### Cooling

**E3660A**  
Vented rear door,  
no fan

**E3661A**  
Vented rear door/  
top, no fan

**E3662A**  
Vented rear door/  
top, no fan

Note: To calculate total BTUs of the cabinets calculate the BTU of each product installed and add them. A rule of thumb for inside cabinet temperatures is 10 to 15 degrees above ambient. Ambient is typically measured 3 ft in all directions from the cabinet.

#### Power

E3660A ABA + 1FB = 120 V 16 A 5-20 plug, U.S.  
E3660A ABB + 1FB = 200/240 V 16 A no plug, unterminated, Europe  
E3660A ABA + 1FB + 0E3 = 200/240 V 16 A L6-20 plug, U.S.

E3661A ABA + 1FB = 120 V 16 A 5-20 plug, U.S.  
E3661A ABB + 1FB = 200/240 V 16 A no plug, unterminated, Europe  
E3661A ABA + 1FB + 0E3 = 200/240 V 16 A L6-20 plug, U.S.

E3662A ABA + 1FB = 120 V 16 A 5-20 plug, U.S.  
E3662A ABB + 1FB = 200/240 V 16 A no plug, unterminated, Europe  
E3662A ABA + 1FB + 0E3 = 200/240 V 16 A L6-20 plug, U.S.

For more information on accessories, specifications, and configuration, order literature part number 5091-0896E from your local sales office.

# CABINETS & CABINET ACCESSORIES

EIA Racks

Uninterruptible Power Systems (UPS)

667

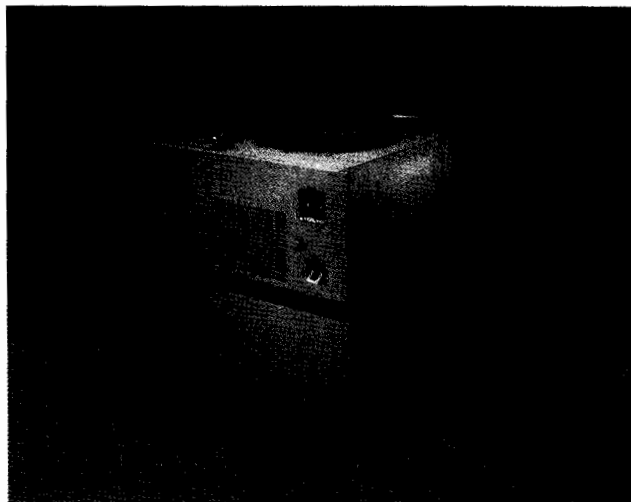

- Minimum 10 to 15 minutes backup time at full load
- Maintenance-free internal batteries
- Isolated output voltages for noise protection
- Power loss alarm contact
- Microprocessor-controlled RS-232 interface for remote monitoring/shutdown
- Low distortion (less than 3% THD)

The DELT series rack-mountable Uninterruptible Power Systems (UPSs) offer a cost-effective and reliable solution to power problems that can damage or interrupt critical test applications.

As a true, on-line UPS, the DELT series systems provide the highest level of protection — a constant flow of refined, regulated, computer-grade power — through virtually any utility line disturbance. Not only is hardware and data protected from blackouts, brownouts, surges, and spikes, but the UPS can reduce service costs as a result of running systems on clean power. The units are compact, quiet, and easy to install. A high overload capability eliminates the need for an oversized UPS to accommodate high startup currents.

The DELT series is simple to install and use. Microprocessor control offers the sophisticated user access to interface features that facilitate full automation. These include an RS-232 port for remote monitoring and shutdown, remote alarm contacts, and more.

Internal, maintenance-free batteries provide a minimum of 10 to 15 minutes of backup time for a full load. Full charging takes less than 3 hours. The battery pack is provided as a separate rack-mountable module with the same dimensions as the UPS.

These systems are manufactured for HP by Deltec Co., and are available in both 50-Hz and 60-Hz versions for worldwide use.

## General Specifications

### Input

**Voltage:** Nominal; -15% to +10%

**Current distortion:** Less than 10% (typical 5%) with full distortion, non-linear load

**Connections:** Terminal blocks

### Output

**Regulation:** 2%, steady state

**Efficiency:** 87%, no load to full load

### Voltage

**Distortion:** Less than 3%, THD

**Overload:** 150% of full load for 30 s, 300% for 10 cycles

**Crest Factor:** Greater than 3:1

**Backup time:** 10-15 min; at full load with 0.8 pF.

**Recharge time:** 3 h maximum

**Connections:** Terminal blocks

### Controls

- ac input circuit breaker
- Battery circuit breaker
- Audible alarm silence button
- Remote shutdown via RS-232 or EPO button

### Indicators

- Front-panel LEDs for: Normal mode, battery mode (ac input failure), bypass mode, low battery, and summary alarm (includes overtemp and overload)
- Audible alarms
- RS-232 communications interface
- Remote dry contact closures, form "C", for system normal and summary alarm

### Physical Characteristics: UPS

**Size:** 610 mm H × 480 mm W × 690 mm D

(8.75 in × 19 in × 27 in)

**Weight:** 59 kg (130 lb)

### Physical Characteristics: Battery Pack

**Size:** 610 mm H × 480 mm W × 690 mm D

(8.75 in × 19 in × 27 in)

**Weight:** 50 kg (110 lb)

### Ordering Information

	Price
<b>DELT-2026R2</b> 2.4k VA UPS, 60 Hz, 208 V in, 115/208 V out	\$4,275
<b>DELT-2036R2</b> 3.6k VA UPS, 60 Hz, 208 V in, 115/208 V out	\$5,775
<b>DELT-2025R1</b> 2.4k VA UPS, 50 Hz, 220 V in, 220 V out	\$4,275
<b>DELT-2025R2</b> 2.4k VA UPS, 50 Hz, 230 V in, 230 V out	\$4,275
<b>DELT-2025R3</b> 2.4k VA UPS, 50 Hz, 240 V in, 240 V out	\$4,275
<b>DELT-2035R1</b> 3.6k VA UPS, 50 Hz, 220 V in, 220 V out	\$5,775
<b>DELT-2035R2</b> 3.6k VA UPS, 50 Hz, 230 V in, 230 V out	\$5,775
<b>DELT-2035R3</b> 3.6k VA UPS, 50 Hz, 240 V in, 240 V out	\$5,775

For more information, see data sheet 5091-0896E.

# TESTMOBILE CARTS

## Testmobile Carts for Transportable Testing

### Three capacities for optimum test instrument configurations:

- Inexpensive Testmobile scope cart for tilt tray loads up to 29.5 kg (65 lb)
- General-purpose Testmobile instrument cart for tilt tray loads to 68.2 kg (150 lb)
- Heavy duty Testmobile system cart for tilt tray loads to 90.7 kg (200 lb)

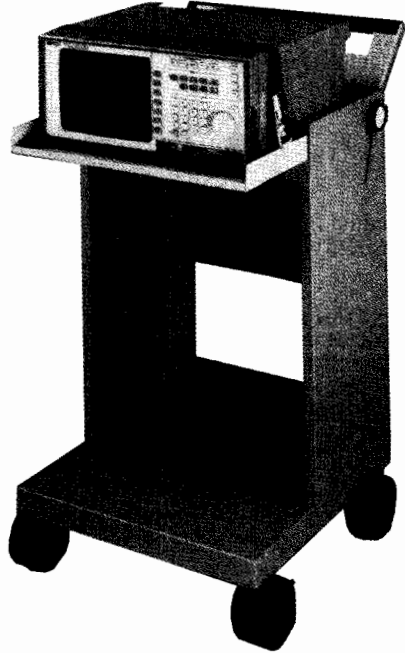

### Testmobile Scope Cart

HP's Testmobile scope cart is an inexpensive way to get away from the bench. Easy-grip handle and mar-resistant hard rubber wheels make for easy pushing. The tilt tray adjusts 30-plus degrees for viewing the scope at an angle. A nylon retaining strap and steel buckle anchor the instrument to the tray. The lower fixed tray has slots for instrument feet, and has a load capacity of 25.9 kg (65 lb). Total combined tray load capacity is 59 kg (130 lb). The tilt tray measures 464 mm W × 460 mm D (18.25 in × 18.1 in). The cart measures 720 mm H × 471 mm W × 483 mm D (28.3 in × 18.5 in × 19 in).

### Ordering Information

	Price	
<b>HP 1180A</b> Testmobile Scope Cart	\$290.00	☎
<b>HP 92199B</b> Multiple Outlet Power Strip (U.S. & Canada)	\$36.00	☎
<b>HP 92199E</b> Multiple IEC-320 Output Power Strip (for international use, requires cable assemblies below)	\$45.00	☎
<b>HP 8120-1575</b> Cable, 30 in long (for HP 92199E)	\$7.50	☎
<b>HP 8120-1860</b> Cable, 60 in long (for HP 92199E)	\$10.50	☎
<b>HP 8120-2191</b> Cable, 60 in long with 90-degree plug (for HP 92199E)	\$15.00	☎

☎ For off-the-shelf shipment, call 800-452-4844.

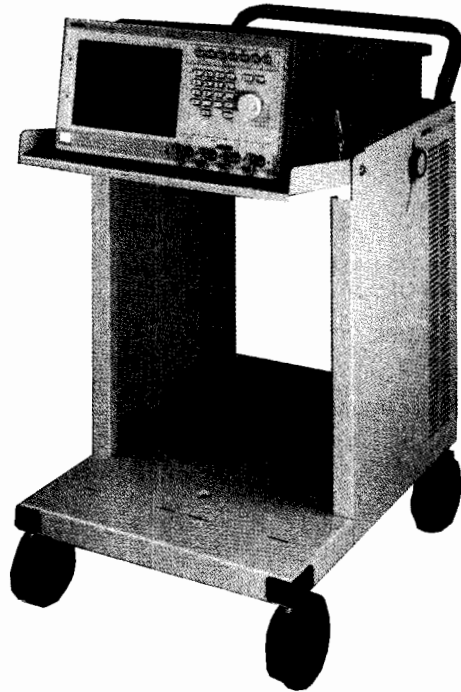

### Test Instrument Cart

The Testmobile instrument cart is a general-purpose cart with more capacity than the scope cart. It has easy-grip handle and mar-resistant hard rubber wheels. The tilt tray adjusts 30-plus degrees for viewing the scope at an angle. A nylon retaining strap and steel buckle anchor the instrument to the tray. The lower fixed tray has slots for instrument feet, and has a load capacity of 90.9 kg (200 lb). Total combined tray load capacity 159.1 kg (350 lb). The tilt tray measures 510 mm W × 607 mm D (20 in × 23 in); the cart measures 720 mm H (28.3 in).

### Ordering Information

	Price	
<b>HP 1182A</b> Testmobile Instrument Cart	\$490.00	☎
<b>HP 35182A</b> 3.5-in high drawer with support shelf	\$200.00	☎
<b>HP 92199B</b> Multiple Outlet Power Strip (U.S. & Canada)	\$36.00	☎
<b>HP 92199E</b> Multiple IEC-320 Output Power Strip (for international use, requires cable assemblies below)	\$45.00	☎
<b>HP 8120-1575</b> Cable, 30 in long (for HP 92199E)	\$7.50	☎
<b>HP 8120-1860</b> Cable, 60 in long (for HP 92199E)	\$10.50	☎
<b>HP 8120-2191</b> Cable, 60 in long with 90-degree plug (for HP 92199E)	\$15.00	☎

☎ For off-the-shelf shipment, call 800-452-4844.

# TESTMOBILE CARTS

## Testmobile Carts for Transportable Testing

669

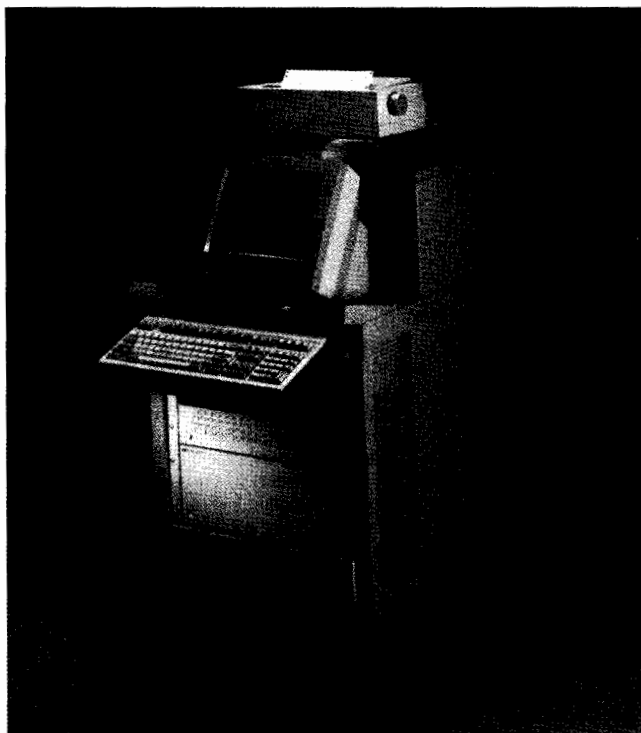

### HP 1181A Testmobile System Cart

#### Specifications

**Size:** 912 mm H × 602 mm W × 871 mm D  
(35.9 in × 23.7 in × 34.3 in)  
**Net weight:** 39 kg (86 lb)

#### Ordering Information

**HP 1181A** Testmobile System Cart

**Price**  
\$950.00

#### Accessories

**HP 35181A** Top-Mounted Printer/Plotter Stand

\$100.00

**HP 35181B** Keyboard Holder

\$100.00

**HP 35181C** 3.5-in-high Drawer

\$150.00

**HP 35181D** Work Surface

\$100.00

**HP 35181E** AntiStatic Mat Kit for HP 35181D

\$75.00

**HP 92199B** Multiple Outlet Power Strip

\$36.00

(U.S. & Canada)

**HP 92199E** Multiple IEC-320 Output Power Strip

\$45.00

(for international use, requires cable assemblies below)

**HP 8120-1575** Cable, 30 in long (for HP 92199E)

\$7.50

**HP 8120-1860** Cable, 60 in long (for HP 92199E)

\$10.50

**HP 8120-2191** Cable, 60 in long with 90-Degree Plug

\$15.00

(for HP 92199E)

☎ For off-the-shelf shipment, call 800-452-4844.

For more information, contact your local sales office and ask for Testmobile Cart family data sheet, part number 5091-2520E.

### HP 1181A Testmobile System Cart and Accessories

The HP 1181A Testmobile System Cart is the only testmobile that lets you put 200 lb of instruments on top of the tilt tray. This is HP's highest capacity testmobile cart. The top tray tilts at a 30-degree angle providing access to instruments up to 90.7 kg (200 lb). The total testmobile cart load capacity is 226.8 kg (500 lb). Any 482.6-mm-wide (19-in) EIA rack mount instrument up to 609.6-mm-deep (24-inch) can be securely mounted beneath the tilt tray in EIA columns. Heavy duty 127.0-mm-diameter (5-inch) casters make moving even a fully loaded cart easy. The usable rackmount space is 533.4 mm (21 in) high (depending on the tilt angle of the tilt tray it will be less).

A variety of handy options let you customize your testmobile cart. A top-mounted printer/plotter stand lets you easily use hardcopy output, a keyboard holder supports your keyboard, and a convenient work surface and storage drawer makes working with probes and accessories simple. In addition, multiple-output power strips for U.S. and international use are available. The HP 1181A gives you the most features and carrying capacity of any testmobile cart available from Hewlett-Packard.

# CUSTOMER SUPPORT

## General Information

### Supporting Your Success

You chose Hewlett-Packard equipment because it best meets your test, measurement, and computing needs. HP wants you to be successful and we're committed to helping you achieve the best results from your system for years to come. We don't stop serving you once the sale is complete. Our flexible support solutions—in hardware, software, customer education, and consulting services—bring you many benefits. Our support services will:

- Shorten the period between purchase and effective use of an HP product.
- Customize your hardware and software for application-specific requirements.
- Make available unique worldwide resources for maintenance and troubleshooting.
- Ensure continued measurement accuracy.

Measure the results in greater overall productivity and lower cost of ownership.

Maximizing the return from your equipment investment can be seen as a three-phase process of planning and design, implementation, and operation. Hewlett-Packard offers support services to ensure that you obtain maximum performance from your measurement system during each of these phases:

#### Performance by Design

A thorough design will ensure that your test and measurement system performs to your expectations and meets your needs. Whether you're planning a single instrument system or a complete factory, HP can offer you technical assistance through consulting services or design the system for you through project services.

### Support Life Cycle

#### Planning and Design

- Project services
- Consulting

#### Implementation

- Consulting
- Installation services
- Project services
- Educational services

#### Operation

- Hardware support
- Software support
- Educational services

### Smooth Implementation through Knowledge

A thorough understanding of your equipment's capabilities is essential to achieving maximum performance from your investment. That's why we back our products with education courses and materials to ensure that you learn the best way to apply our equipment to your environment.

We also offer site planning, site environmental surveys, and installation services to ensure that your system is installed correctly and quickly.

### Continuous Operation through Maintenance

To help you minimize equipment downtime, Hewlett-Packard maintains a worldwide customer service organization staffed with trained engineers and technicians who are backed by factory designers and a large inventory of replacement parts. We will focus the necessary resources to keep your equipment operating at peak performance.

With computers playing a larger role in today's measurement systems, software support plays an essential role in maintaining your system's performance. HP keeps you up to date on the latest software improvements to ensure that your system continues performing to its maximum potential.

### Support Life

To help you maximize your product's useful life, Hewlett-Packard will continue to offer standard support services for as long as feasible. To continue offering these services means managing our trained staff and repair parts inventories to match your needs.

In any event, HP offers support services on all of our products for at least 5 years beyond end of production.

In addition, we will make our best effort to repair or calibrate any Hewlett-Packard product, whatever its age, even if the product has passed through its support life. Charges will be made on a time and materials basis.

### Support for Your Needs

The following pages provide more details on Hewlett-Packard's wide range of support services. Ask your local HP representative to help you select the services that best meet your needs in maximizing your measurement system's performance.

### Service Selection Guide

	Services	Major Benefits	Best Fit
Hardware Support (pg. 671)	<ul style="list-style-type: none"> <li>• HP repair service</li> <li>• HP calibration service</li> <li>• 3 year on-site repair Support Options</li> <li>• 3 and 5 year customer return repair Support Options</li> <li>• 3 and 5 year customer return calibration Support Options</li> </ul>	<ul style="list-style-type: none"> <li>• Fast turnaround time</li> <li>• Cost savings</li> <li>• Dependable measurement accuracy</li> <li>• Defense standards compliance</li> </ul>	<ul style="list-style-type: none"> <li>• All instruments, especially those in critical applications or frequently used</li> </ul>
Educational Services (pg. 674)	<ul style="list-style-type: none"> <li>• Wide variety of courses covering latest HP products and technology</li> <li>• Variety of audiences and skill levels</li> <li>• Flexible delivery options</li> </ul>	<ul style="list-style-type: none"> <li>• Fast learning</li> <li>• Time and cost savings over learning independently</li> </ul>	<ul style="list-style-type: none"> <li>• Whenever new products or technology are introduced in your environment</li> <li>• New people</li> </ul>
Software Support (pg. 677)	<ul style="list-style-type: none"> <li>• HP ResponseLine software support service</li> <li>• HP BasicLine software support service</li> <li>• HP Software Update Materials service</li> </ul>	<ul style="list-style-type: none"> <li>• Software usage and problem resolution assistance</li> <li>• New software releases</li> <li>• Up-to-date software information</li> <li>• Fast, accurate support</li> </ul>	<ul style="list-style-type: none"> <li>• Test systems</li> <li>• Instruments with software</li> <li>• Instrument controllers</li> </ul>
Consulting Services (pg. 679)	<ul style="list-style-type: none"> <li>• Installation services</li> <li>• Project services</li> <li>• Productivity assistance</li> </ul>	<ul style="list-style-type: none"> <li>• Expert implementation assistance</li> <li>• Quick startup of instrument systems</li> <li>• Increased productivity</li> </ul>	<ul style="list-style-type: none"> <li>• Fast, efficient implementation of instrument system required</li> </ul>





### An Outstanding Array of Services to Protect Your Investment

Whatever your instrument support needs, HP aims to be as flexible as possible in meeting them. Therefore, we offer repair and calibration to commercial or defense requirements on a contractual or per-incident basis. With HP's conscientious repair and precise calibration services, you can measure the difference in quality, reliability, and value.

HP offers volume service discounts for both customer return and on-site services. Contact your HP representative for details.

### HP Repair Services Maximize Product Uptime Customer Return Repair

Factory-trained, expert technicians work quickly and accurately to reduce downtime so you get back to business fast. HP instruments covered by factory warranty, repair agreements, or the HP Support Options family will be repaired within 5 working days of receipt. HP office products covered by repair agreements will be repaired within 3 working days of receipt.

Each HP Customer Service Center manages its spare parts inventory so that over 85 percent of required parts are immediately available. Our global distribution network can usually deliver any other required part to us within 24 hours.

HP Customer Service Centers have the latest information about factory-designed engineering improvements or recommended modifications. These centers are equipped to install upgrades and enhance product performance and useful life.

### Repair Agreement

HP's repair agreement covers all parts and labor resulting from equipment failure. Similar to your product's warranty, it yields significant savings over per-incident repairs. Return freight is included.

### Standard Repair

Standard repair (STREP) is our single-event, fixed-price, standard repair service. Instrument problems resulting from a single failure will be repaired to HP factory workmanship standards.

Mini-STREP ensures a lower price for a simple repair. If work on your equipment requires less than 1 hour of labor and falls below a set price in parts, your cost will be the published STREP price or the mini-STREP charge, whichever is lower.

### HP SuccessLine

HP SuccessLine service provides high-quality on-site support that enables you to maximize instrument and measurement system uptime. The flexible response times and coverage periods allow you to tailor support to your service needs, while providing superior value for your money. Service includes an account-assigned customer engineer (CE), who becomes familiar with your environment and takes personal responsibility for managing your measurement systems' maintenance program.

Your CE also will perform preventive maintenance on a regular basis, scheduled in advance, to maintain your system at its optimal performance specifications.

### Priority Plus Support

This service level provides on-site repair service 24 hours a day, 7 days a week. It provides maximum coverage hours and days and HP's best possible response time. Customers within 100 miles of an HP Support Responsible Office receive an on-site visit within 4 hours.

### Priority Support

This service level provides coverage for on-site repair service from 8:00 am to 9:00 pm Monday through Friday (excluding HP holidays). This coverage allows all scheduled maintenance to be performed after normal working hours. Customers within 100 miles of an HP Support Responsible Office receive an on-site visit within 4 hours.

### Next Day Support

This repair service level provides next-day, on-site service coverage from 8:00 am to 5:00 pm Monday through Friday (excluding HP holidays) for customers within 100 miles of an HP Support Responsible Office.

### HP SuccessLine Service Selection Guide\*

	Priority Plus	Priority	Next Day
Coverage hours	24 hours a day, 7 days a week	8 am-9 pm Monday-Friday	8 am-5 pm Monday-Friday
Response time	Best response, not to exceed 4 hours	Best response, not to exceed 4 hours	Next working day
Usage environment	Highly critical; continuous user operations	Urgent; no substitute equipment	Less critical; substitute equipment available

\* Available in most locations. Check with your local HP office for detailed coverage hours.



### HP's Calibration Services Improve Measurement Accuracy

HP offers a range of calibration services to ensure that your instruments continue to provide you with the consistently high levels of measurement accuracy for which they were designed. These services can be delivered at our highly automated HP Customer Service Centers or at your site.

All measurements made in HP's calibration processes are traceable to national and international standards. In the United States, measurements are traceable to the National Institute of Standards and Technology (NIST). HP product division's Primary Standards Laboratories, directly traceable to NIST, back up HP Customer Service Centers.

### HP Calibration Service

HP engineers deliver thorough, high-quality calibrations that are among the most reliable in the industry, no matter where you are located. Your product's performance is compared to standards of known accuracy to ensure conformance with published specifications. Any adjustments necessary to bring the instrument within specification are made.

HP Calibration service also includes the following features:

- A complete data report. Upon completion of each calibration, you receive a thorough data report that states the measured product performance after adjustment.
- A calibration certificate and sticker. You receive a certificate of calibration stating environmental conditions at the time of calibration. In addition, HP affixes a sticker to your instrument indicating the next calibration due date.

### Standards Compliant Calibration Option

HP's calibration standards compliant option meets the requirements of national defense and international standards, including AQAP-6 and MIL-STD-45662. Most of our calibrations comply with version A of this standard. This option is also popular with customers who are moving toward International Standards Organization (ISO) compliance.

The standards compliant calibration option provides the same high-quality calibration as HP Calibration service plus the following features:

- An enhanced data report. If, during the calibration process, a parameter is found to be out of specification, we'll record data before any adjustment is made. Following adjustment, we'll record new data for the parameter affected by the adjustment. Both "before" and "after" data appear in your data report.
- Standards compliant documentation. HP furnishes a certificate of calibration stating compliance with the appropriate national or international standards. It also indicates environmental conditions at the time of calibration. And we affix a sticker to your instrument indicating the next calibration due date.
- Out-of-tolerance notification. If one of HP's measurement standards is found to be out of tolerance such that your calibration may be compromised, we will notify you and recalibrate your instrument free of charge.

### Calibration Agreements

Calibration agreements offer you substantial savings over one-time, fixed-price, per-incident services. Agreements also provide these significant added benefits:

- **Free recalibration after any repair performed by Hewlett-Packard**
- Free HP ExpressCal service for customer-return agreements
- Customized calibration intervals to fit your calibration management program
- Calibration-due notification

### Customer Return Calibration

Using extensively automated processes to calibrate your instruments, HP Customer Service Centers enhance the quality, repeatability, and efficiency of calibration.

### HP ExpressCal Service

You can reduce downtime with HP ExpressCal service. Simply call your HP Customer Service Center to schedule calibrations in advance. Most scheduled calibrations are completed within 24 hours. For per-incident calibrations, there is a service fee for HP ExpressCal service.

### On-Site Calibration

Hewlett-Packard offers the measurement integrity of a traceable HP calibration with the convenience of on-site service. With an on-site calibration agreement, your account-assigned HP CE, who is familiar with your instrument support needs, calibrates individual instruments and measurement systems at your site. HP also offers on-site calibrations on a per-incident basis.

### HP Volume On-Site Calibration

If you require maximum instrument uptime, an HP Customer Service Center can provide you with HP Volume On-Site Calibration service. HP engineers will come to your site to calibrate groups of HP and non-HP instruments. Contact your HP Customer Service Center for details.

## Save Time and Money

### HP Support Options

The HP Support Options family of services allows you to lock in maintenance cost savings at the time you purchase your HP instrument. Each option provides additional support beyond original product warranty, delivering HP's quality repair or calibration service for an extended period of time. These easily ordered services demonstrate HP's commitment to quality services and low cost of ownership. You can also purchase any service in the HP Support Options family during the warranty period of your HP instrument. Ask your HP sales representative for more information.

Repair services provided under the HP Support Options family include all necessary parts, labor, and materials. Calibration services include:

- calibration at HP's recommended intervals
- calibration after HP repair
- complete data reports for all measured product performance
- calibration certificate and sticker
- calibration-due notification

Customer return calibrations include free HP ExpressCal service. HP Support Option family customer return repairs and calibrations receive priority turnaround time at HP Customer Service Centers.

Standards compliant calibration options meet the requirements of national defense standards including MIL-STD-54662 and AQAP 6. They augment HP Calibration service with enhanced data reports that include "before" and "after" data. They also include out-of-tolerance notification and a certificate of calibration indicating standards compliance.

**Option W30.** This option extends the benefits of factory warranty to provide a total of 3 years of customer return repair service.

**Option W31.** This option adds to your product warranty to provide a total of 3 years of next day on-site repair service.

**Option W32.** This option provides 3 years of HP Calibration service at HP Customer Service Centers.

**Option W34.** This option provides 3 years of standards compliant calibration at HP Customer Service Centers.

**Option W50\*.** This option provides 5 total years of customer return repair service.

**Option W52\*.** This option provides 5 years of HP Calibration service at HP Customer Service Centers.

**Option 54\*.** This option provides 5 years of standards compliant calibration service at HP Customer Service Centers.

\* These 5-year options are currently offered for products that carry 3-year factory warranties.

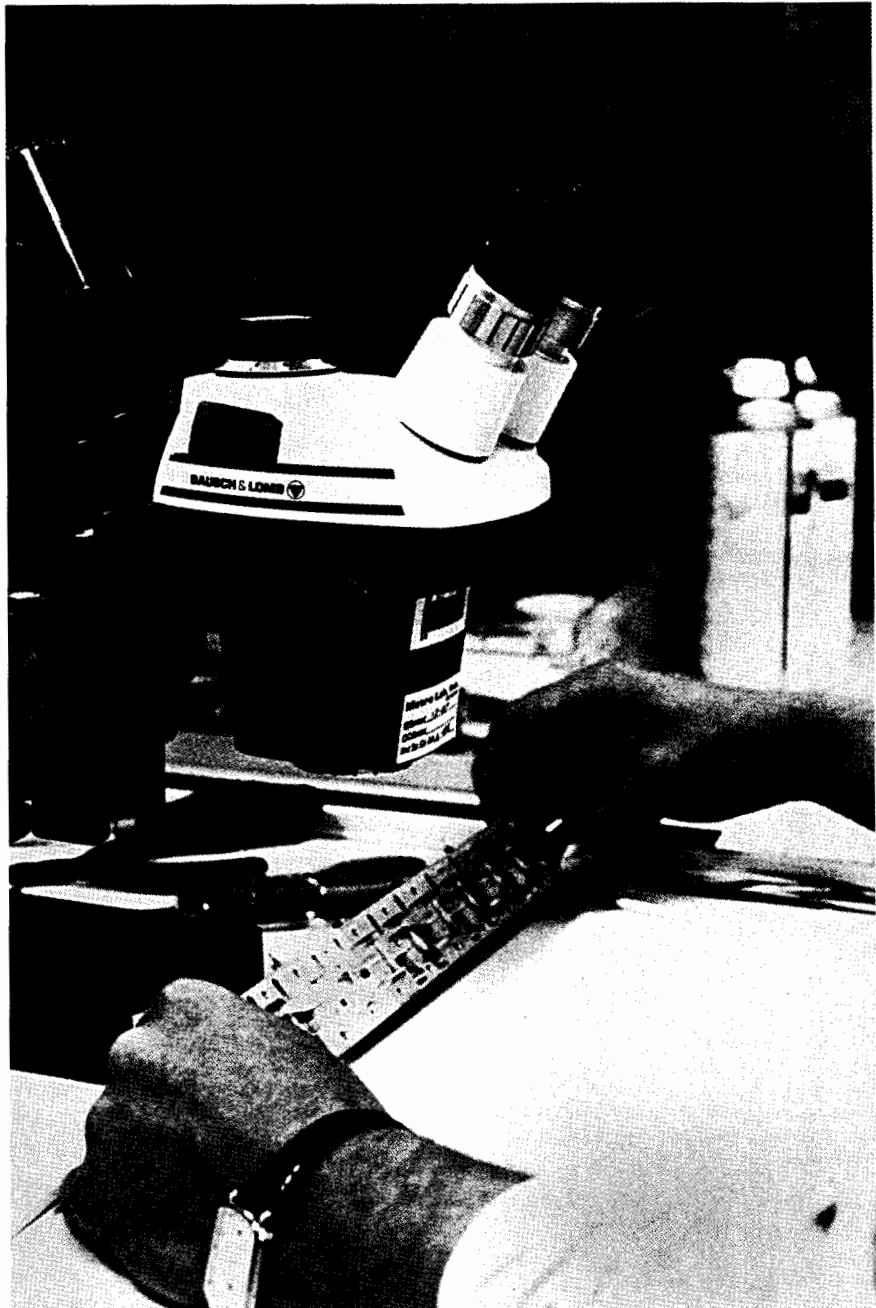

# CUSTOMER SUPPORT

## Educational Services

### HP Educational Services

We are committed to offering training that will permit you to get the best possible use of Hewlett-Packard equipment. We recognize that both initial instruction and ongoing education contribute to your success: that is why we offer courses in operation, applications, and software and hardware maintenance for HP instrument and computer products.

### Quality Training

#### Our Instructors understand your industry

They speak the language. We make sure our instructors have a deep understanding of the subject and can effectively explain—in clear, concise terms—everything you need to know, from specialized test techniques to the physics behind the measurements.

Backing them up are HP class-development teams. Product specialists, industry experts, curriculum engineers, course writers, and instructors develop training materials and design courses with the goal of maximizing your learning experience.

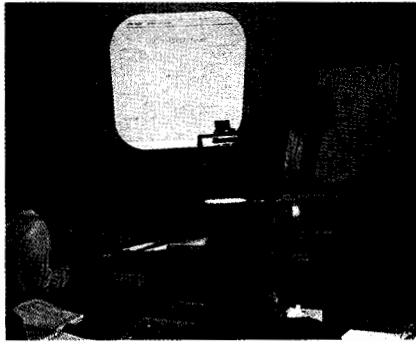

### Courses That Work for You

Our courses are consistently updated to keep pace with evolving technology and industry changes. HP designs instructional materials—including student manuals and lab and instructor materials—to serve as long-term references. A course cannot cover everything, but it can help guide your thinking on the subject matter. Our texts will help you keep in focus long after the class has ended.

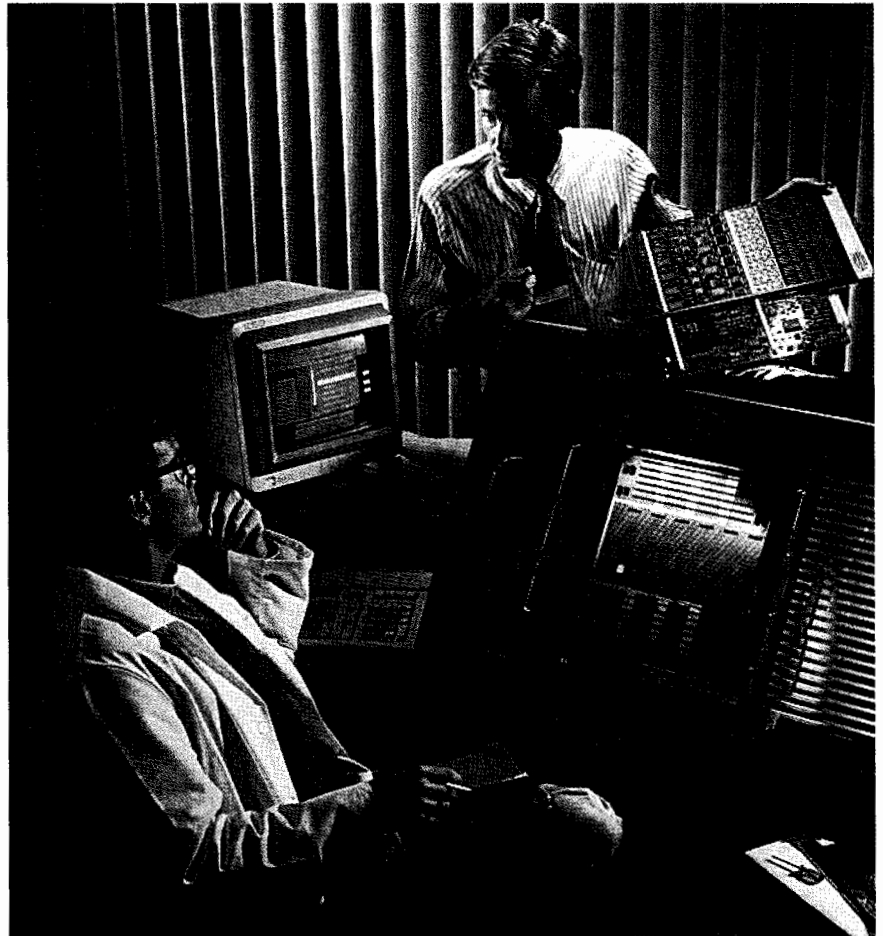

### Limited class sizes

Classes are limited to six to ten students. We believe small classes encourage closer interaction with the teacher and other students, thus permitting students to share learning experiences and applications expertise.

### It's not all books

Hands-on training is important to your success. That is why we provide lab equipment in our classes. Each course has lab time as a key training benefit.

### The payback

Our experience shows that you will learn faster with HP education courses. The benefits are twofold: the equipment can be used sooner and the time you would have spent on independent learning can be used for other opportunities.

### Worldwide Training

#### Worldwide training center network

HP has training centers throughout the world, with classes in continuous progress. Training schedules are published regularly.

#### On-site training

All HP courses can be scheduled and taught at your site. This option might prove more attractive to you, bringing the advantages of training in a familiar environment with your own equipment.

#### Off-schedule training

Additional HP classroom courses can be arranged beyond those published in the local training schedule. These classes can accommodate your emerging training needs.



### Customized classes

We can meet special training needs by developing custom training classes. These changes may include modification of class materials, development of modular training, development of special labs, integration of new sections in the course, and even the development of entirely new classes.

### Specialized training materials

HP education is typically based on classroom training, led by professional instructors with solid engineering experience. Other HP training formats include computer-based training, videotape sessions, satellite-broadcast instructions, and self-paced training modules.

### Test and Measurement

#### Curriculum

#### HP-IB Instrument Control and Data Acquisition

HP 34800A + 24D	3 days	Developing Test Plans Using FTM/300
HP 50011C	4 days	HP-IB Instrument Programming Using Series 200/300 BASIC

### Languages

HP 31112A	5 days	Introduction to Pascal
HP 31113A	5 days	HP Pascal for Advanced and System Programming
HP 31124A	5 days	Introduction to Ada/300 Development System
HP 35130B	5 days	Programming in C Language
HP 50698A	5 days	Programming in FORTRAN 77
HP 98501B	5 days	Introduction to Workstation BASIC
HP 98510D	5 days	Series 200/300 BASIC Operating and Advanced Programming
HP 98511C	5 days	Series 200/300 Pascal Operating and Advanced Programming
HP 98880A	3 days	HP BASIC/UX Programming and Operating

### General-Purpose Instrumentation

HP 18347A	1 day	HP 4951C Protocol Analyzer User Course
HP 35629A	3 days	HP 3562A Users Course
HP 3852A + 24D	4 days	HP 3852S User Training Course
HP 50015A	3 days	Data Acquisition and Control Fundamentals
HP 55280A + 24A	1 day	Basic Laser Measurement Training
HP 55283A + 24A	1 day	Advanced Laser Measurement System Training
HP 6944S + 24D	3 days	Multiprogrammer System User Course
HP 6954A + 24A	3 days	HP Series 6900 Multiprogrammer

### Microwave

HP 11776A + 24D	2 days	HP 11776A Waveform Generation Language Users Course
HP 3048A + 24A	2 days	HP 3048A Phase Noise Measurement System
HP 50740A	4 days	Microwave Fundamentals Course
HP 50740B	4 days	Microwave Fundamentals Course
HP 50740C	3 days	Microwave Fundamentals Course
HP 8510C + 24D	3 days	Basic Network Measurements Using the HP 8510B Network Analyzer
HP 85101B + 24D	2 days	Advanced Programming for the HP 8510 Network Analyzer
HP 85150B + 24D	2 days	Discovering the HP Microwave Design System
HP 85668A	4 days	HP 8566/67/68 Spectrum Analyzer Operating and Programming Course
HP 8753B + 24A	1 day	HP 8753B RF Network Analyzer Course
HP 11949A	2 days	Designing For EMC Seminar

### HP-UX

HP 50710A	5 days	Programming with HP-UX System Calls
HP 51432A	5 days	HP-UX Fundamentals for General Users
HP 51433A	5 days	HP-UX Shell Programming for General Users
HP 51434B	5 days	Fundamentals of HP-UX
HP 51435A	5 days	HP-UX Text Editing Tools
HP 51438A	2 days	SCCS and make
HP 51439A	1 day	Advanced Editing with vi
HP 51440A	3 days	Document Preparation
HP 51489B	2 days	HP-UX Basics for Application Users



HP Education . . . Engineered for Your Success

### HP-UX System Administration

HP 22861B	2 days	ARPA/Berkeley Services for the HP 9000 Series 300 and Series 800 Systems
HP 22862A	2 days	Administration of NFS and Yellow Pages
HP 35129B	3 days	HP-UX System Administration for the HP 9000 Series 500
HP 50722A	3 days	HP-UX System Administration for Application Users
HP 51436C	5 days	HP-UX System Administration for the HP 9000 Series 300
HP 51482C	5 days	HP-UX System Administration for the HP 9000 Series 800

### Board Test/Semiconductor Test

HP 4062C + 24A	3 days	HP 4062C Operating and Programming Training
HP 4062UX + 24A	3 days	Operations and Programming Training
HP 44531A	10 days	HP 3060A/61A/62A Users Course
HP 44584A + 24A	½ day	HP 3060 Enhancement Training
HP 44850A	5 days	HP 3065 Advanced Users Course
HP 44852A	10 days	HP 3065 Board Test System Users Course
HP E1031A	10 days	HP 3070 User Fundamentals
HP E1024A	5 days	HP 3070 Advanced Digital Class
HP E1287A	5 days	Introductory Training for HP 82000
HP E1289A	2 days	HP 82000 Introductory Training

### Microprocessor Development

HP 64100A + 24D	2 days	HP 64000 System Concepts and Measurements
HP 64620S + 24D	1 day	HP 64000 State/Software Analysis

### Design Systems Design capture and simulation

HP 74001A	3 days	HP EE DesignCenter System Administration
HP 74201A	2 days	HP Design Capture System Overview
HP 74202A	3 days	HP Design Verification Interface Users Course
HP 74203A	3 days	Introduction to HILO Modeling

### Printed circuit board (PCB) design

HP 74300A	3 days	Introduction to HP EGS
HP 74301A	2 days	PCB Design with HP EGS
HP 74302A	3 days	Customizing with HP EGS
HP 74495A	5 days	Introduction to HP PCD5

### Mechanical design (ME)

HP 74836T	5 days	HP ME Series 30 Users Course
-----------	--------	------------------------------

### Telecommunications

HP 37050S + 24A	5 days	HP 37050S User and System Manager Course
HP 37190A	8 days	HP 37100S Operator and Management Course
HP 37191A	3 days	HP 37100S Operator Training

### Schedules and literature

Your sales office can also provide the following training literature:

**Course data sheets.** Every HP class has a data sheet that describes the course in detail. Included are key topics, target audience, course outline, prerequisites, and ordering information.

**Education course schedule.** HP training schedules are published throughout the world and list class schedules for each area.

**Education catalog.** The catalog presents information on the entire HP course range, including curriculum flow diagrams, course objectives, outlines, and course content. It is your tool for planning the best possible education for yourself and other members of your organization.

### How to Order

To register for any HP class in the U.S., call (800) HP CLASS (800-472-5277).

Outside the U.S., contact your local HP sales office.

### HP's Software Support Services

Ongoing success with instrumentation products requires up-to-date information and software. Year after year, industry experts rate Hewlett-Packard as a leader in high-quality product service and customer support. HP offers two software support services for instrumentation products. HP BasicLine software support is an enhanced self-support product. HP ResponseLine software support provides complete software maintenance through the HP Response Center.

### HP BasicLine

HP BasicLine service for instrument products delivers current, comprehensive support information, with electronic access to information and the right to use HP software updates.

You can use the electronic databases to obtain current information on the latest HP products, support programs, and training classes. You can also use powerful search mechanisms to solve support problems for many HP instrument products. The combination of valuable support data and powerful search mechanisms adds up to increased productivity.

### Increase System Productivity through Software Updates

Hewlett-Packard continuously enhances HP software products through periodic software updates. These software updates include known defect repairs and may include additional functional and performance improvements. HP BasicLine service includes the right to use updates for all licensed software on a single system. This ensures that your software and manuals keep current and that you benefit from any fixes or enhancements that Hewlett-Packard has provided.

### Increase System Uptime through Access to HP's Worldwide Support Network

Hewlett-Packard's electronic support information has been developed through the worldwide HP Response Center network, which is also tied back to HP manufacturing divisions. This means that information developed halfway around the world, which could prevent a problem in your system, is available to you through a dial-up modem and an HP-compatible ASCII character mode terminal or HP-compatible terminal emulator.

In addition, your system and operations staff can tap into knowledge gathered from throughout the HP organization. The on-line *News Page* brings you the latest news on product announcements, support services, new programs, and training classes. This information, along with service alerts on critical problems, stays current through weekly updates by HP's worldwide support, sales, manufacturing, research and development, and marketing organizations.

### Obtain Direct Access to Valuable Problem-Solving Information

HP's software status bulletin, engineering notes, and application notes are all available electronically. The bulletin provides a complete listing of all reported software and manual defects and information for repair or workarounds. Engineering notes feature HP's recommended solutions to customers' problems, to help you solve problems quickly. Application notes present usage assistance and configuration information. Regular database updates provide you with current problem-solving and application information.

### Reduce Time Locating Essential Information

The database access software allows you to explore interactively all product and application information. Whether you are using the powerful keyword search or the menu-driven browse facility, you quickly get to the appropriate reference. And, because the databases consolidate information from multiple sources, one search brings you everything on your topic of interest.

### HP ResponseLine

HP ResponseLine service for instruments provides comprehensive software maintenance. In addition to all of the features of HP BasicLine service, you receive telephone assistance to resolve software problems and questions about product usage. You also receive fast, direct answers via access to HP's maintained electronic database. The HP Response Center network brings together the worldwide resources of HP for software maintenance.

### Obtain Rapid Response to Problems and Questions

HP ResponseLine service offers unlimited telephone assistance for normal software usage, clarification of documentation, and resolution of software problems. With timely answers to questions, you gain full advantage of your HP software's features and functions. In addition, HP ResponseLine service entitles you to the convenience of electronically submitting questions to the HP Response Center during your on-line HP SupportLine sessions.

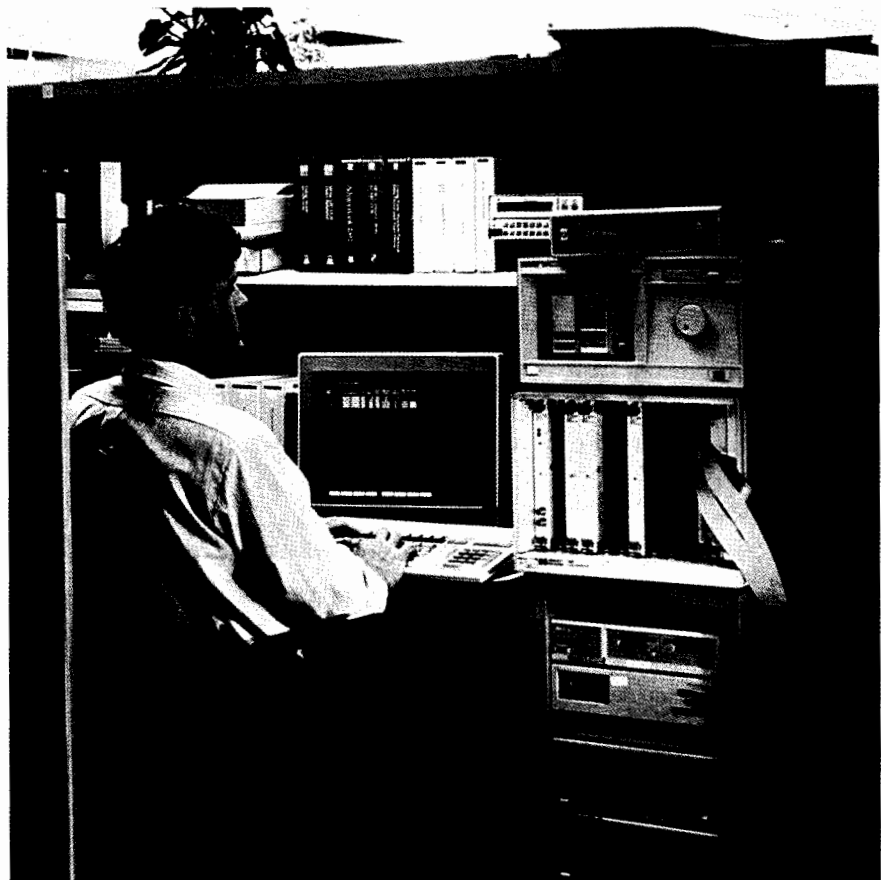

# CUSTOMER SUPPORT

## Software Support (cont'd)

### Increase System Uptime through Support Escalation Management Program

In the event that the HP Response Center cannot solve your software problem remotely, HP's well-defined escalation procedure mobilizes resources necessary to resolve the problem quickly. Using advanced-technology diagnostics and worldwide problem information databases, HP specialists isolate and analyze your software problems and then develop and implement the best solutions.

### Specific Support Services

Your local HP systems engineer can also work with you to develop HP software support services that are specific to your instrumentation and needs.

Below are a number of the test and measurement products for which HP offers software support services:

#### Microwave/Design Automation

HP 85150x Microwave design system  
 HP 85180A High-frequency structure simulator

#### Semiconductor Test

HP 4062B/C/UX Parametric test systems  
 HP 16276/7/8 Interactive measurement and analysis software  
 HP E33xx HP Integrated Circuit Characterization (IC-CAP)  
 HP 944xx HP Transistor Characterization (TECAP)  
 HP 9480/9490 Analog LSI test systems  
 HP 82000/83000 IC evaluation systems

#### Board Test

HP 307x Series of board test systems  
 HP 3065 Series of board test systems

#### Signal Analyzers

HP 35680A Instrument BASIC  
 HP 35681A Analysis Pack  
 HP 35630B HP VISTA  
 HP 35631B HP SINE  
 HP 35632B HP Modal data manager  
 HP 3566A/67A PC-based dynamic signal analyzers  
 HP 35634A PC-DSA measurement software  
 HP 35636A Order-tracking software  
 HP 35637A Swept sine software

#### Controllers/CAT

HP 3852A Data acquisition/control unit  
 HP 3235A Switch/test unit  
 HP 75000 Family of VXI products  
 HP 34806x Functional test manager software  
 HP E20xx Interactive test generator software  
 HP E21/xx HP visual engineering environment

#### Telecom/Datacom Test

HP 4990A HP ProbeView software  
 HP 18490A HP ProbeView Observer software  
 HP 37011A Telecom system software

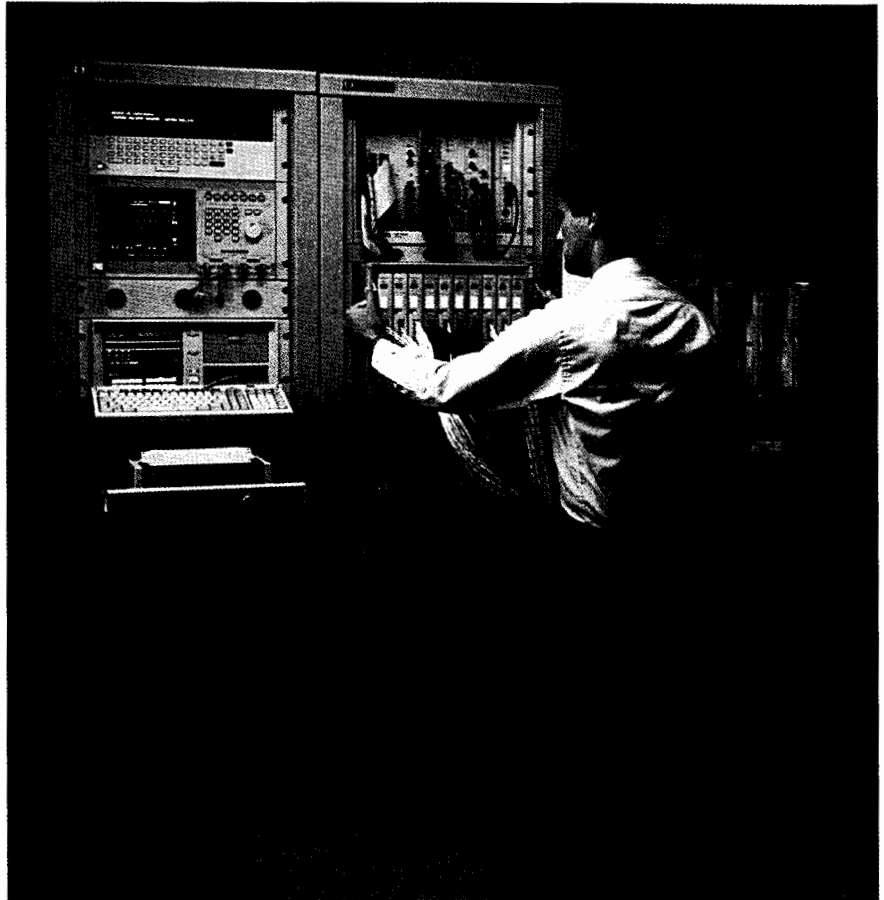



### Test and Measurement Productivity Assistance Service Productivity Assistance Services

As measurements and technology have become more complex, HP's equipment has become more sophisticated. Now that you've invested in the best instrument, let HP help you maximize your return. A wide range of productivity assistance services helps you fully take advantage of your equipment's capabilities. We help you quickly advance from installation to optimal system use. Whether you need a few hours of guidance from an experienced systems engineer or a custom plan, the Application Engineering Organization and HP Project Centers are ready to help through the following services.

#### Startup Productivity Assistance

When your measurement system arrives and your project is on a tight schedule, sometimes there is not enough time to study all of the manuals. Even though you or your people may be experts, you still might have questions about the best way to apply these new and powerful capabilities to your specific application.

HP's startup productivity assistance provides you with quick answers to your questions, letting you harness the power of your measurement system. One of HP's trained, experienced system engineers will come to your site, at your convenience, to work with you on your specific questions.

For example, startup productivity assistance service can be used to help you in the following areas:

- System setup, installation, and initialization
- Controller, instrument, and system interfacing
- Measurement techniques

Startup productivity assistance is available on a half-day and daily basis, which provides flexibility to meet your needs.

#### General Problem Solving

A few hours with an expert can often help you overcome measurement system roadblocks, or help you fine-tune your system for optimal speed and accuracy. Our trained system engineers can show you the latest tips and techniques for maximizing your HP measurement system's performance, as well as assist you in customizing and integrating the system in your environment.

#### HP Project Center Services

For larger scale, complex requirements, HP Project Centers can provide you with custom solutions. Backed by the full resources of Hewlett-Packard, HP Project Center teams deliver on-time, on-budget solutions to meet your specifications. Look to our experts to save the time, expense, and worry of devising custom solutions yourself.

HP Project Center expertise in measurement automation results from extensive experience in test-system analysis and design. HP Project Center engineers are also adept in the design of other applications, including data acquisition and control, in-circuit and functional circuit testing, semiconductor testing, and microwave/RF testing.

#### How to Order

Your HP sales representative can help you select a combination of support services to help you gain maximum use from your HP system in the minimum time possible. Ask your local HP sales representative for more details.

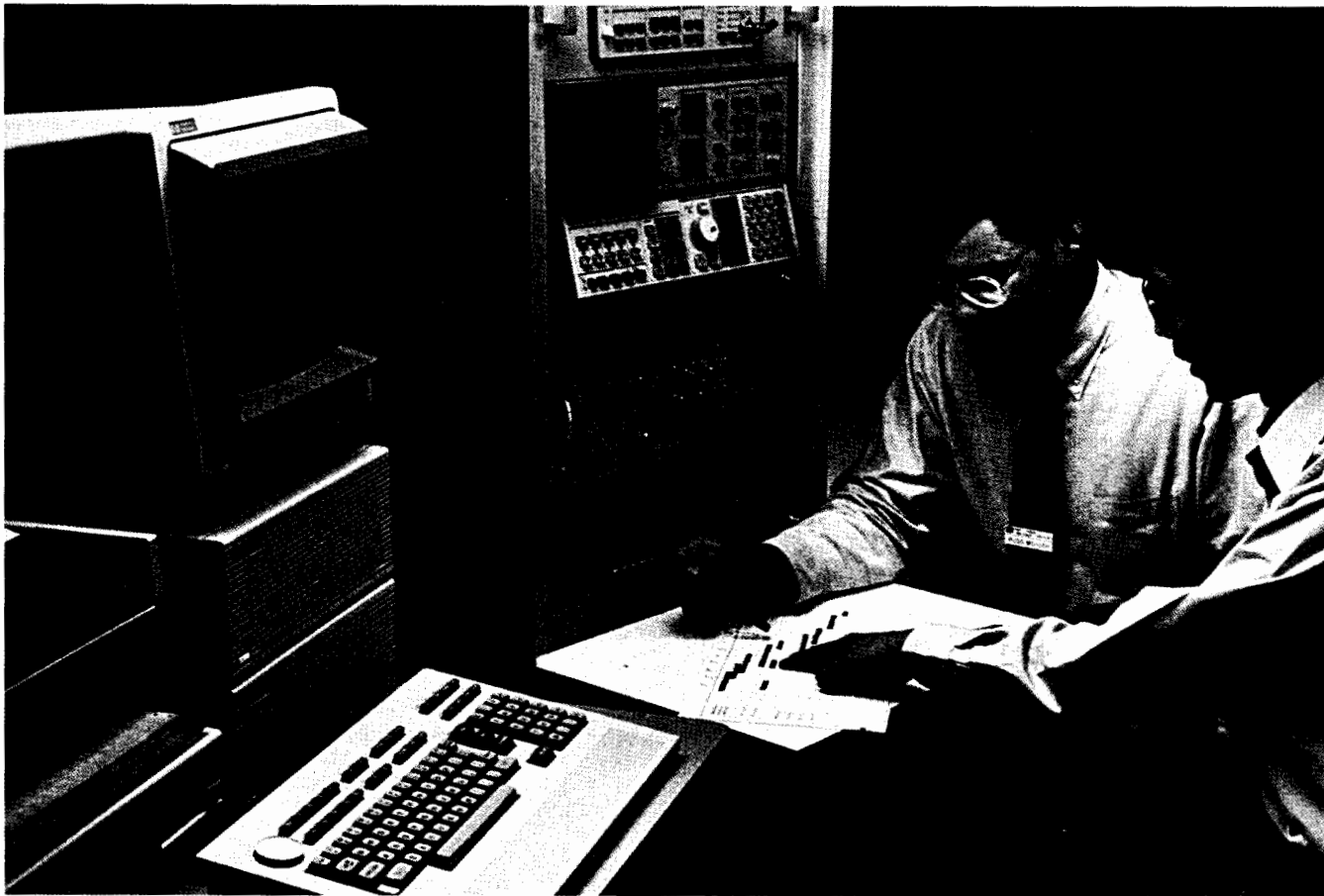

# INSTRUMENT FINANCING

## Rental, Leasing, and Gradual Purchase Plans

### Tailor Your Payments to Your Budget

Renting, leasing, or financing offers these important benefits: (1) you acquire the latest technology without a large cash outlay; (2) short-term projects can be managed economically; (3) upgrading and adding on is easy; and (4) Hewlett-Packard lets you schedule payments monthly, quarterly, even seasonally.

### Why Hewlett-Packard?

You use Hewlett-Packard's low cost of funds to finance at very competitive rates. If you need to buy the equipment, a generous equity accrual option allows you to receive credit for your previous payments. And your equipment is backed 100 percent by the company that knows it best.

### To Learn More

Contact your HP sales representative to learn how an HP financing plan can be tailored to meet your needs.

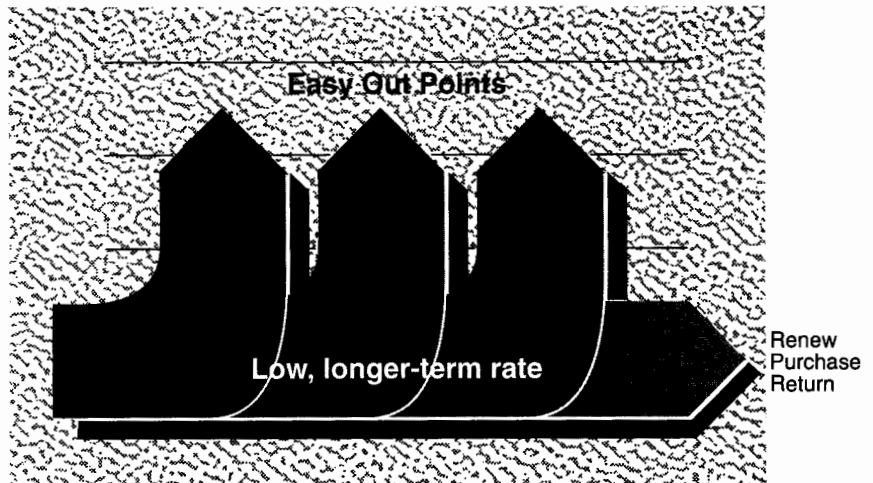

### HP EasyRent

HP EasyRent was specifically designed for instrument customers who face tight capital budget constraints. This popular rental plan combines the low rate of a longer-term plan with early exit options, called "Easy Out Points," to achieve the ease of a shorter-term plan.

HP EasyRent provides a powerful way to acquire HP instrumentation, as you need it.

### A Full Range of Choices

This chart indicates the broad range of plans available in the United States. Similar plans are available worldwide.

HEWLETT-PACKARD FINANCING PLANS				
	Key Benefit(s)	Term (Months)	Ownership	Purchase Option
<b>HP EasyRent</b>	Low cost per month Good flexibility	36 (exit options at 12 and 24 months)	HP	65% payment credit <sup>1</sup>
<b>HP Rental Plan</b>	Provides maximum flexibility/ shortest commitment	12	HP	65% payment credit <sup>1</sup>
<b>HP Operating Lease</b>	Flexibility and "off-balance sheet" financing	12 to 48	HP	65% payment credit <sup>1</sup>
<b>HP Lease with Option to Purchase</b>	Lowest monthly payment	60	HP	10% of amount financed
<b>HP Installment Plan</b>	Buy without a large cash outlay No down payment	36 to 60	HP/Customer	Full payout
<b>HP State and Local Government Plan</b>	Special financing for state and local government customers	12 to 60	HP/Customer	Full payout
<b>HP Federal Lease to Ownership</b>	Special financing for U.S. government customers	12 to 36 <sup>2</sup>	Customer	Full payout
<b>HP Federal Rental Plan</b>	Provides maximum flexibility for U.S. government customers	6 and 12 <sup>3</sup>	HP	65% payment credit <sup>1</sup>

<sup>1</sup> Sixty-five percent of each payment may be credited toward end-of-term purchase, up to a total of 80% of the amount financed.

<sup>2</sup> Twelve- to thirty-six-month terms for non-GSA customers; 36 month term for GSA customers.

<sup>3</sup> Six-month plan for HP instruments and analytical products when ordered by Federal Government-direct customers only.

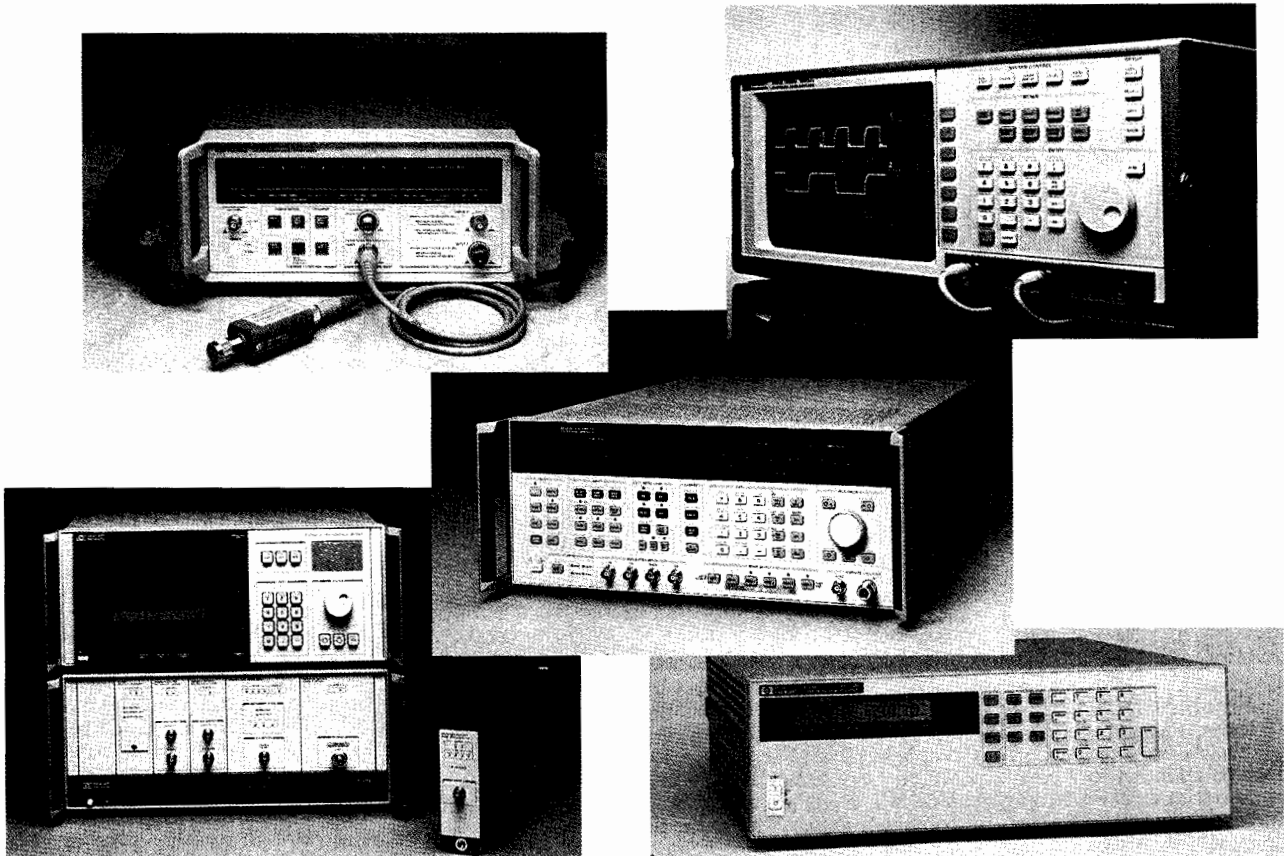

## Product Description

Hewlett-Packard offers a limited number of refurbished Test & Measurement instruments for sale. These refurbished instruments include customer return, trade show, and customer demonstration units. All instruments have been reconditioned and tested to meet electrical and mechanical specifications at time of manufacture. Refurbished instruments meet current safety requirements. These units are equipped with all standard accessories and documentation. Instruments may contain slight cosmetic defects; however, the instrument integrity is not affected. All refurbished instruments include standard warranty.

## Ordering Process

Contact your local Hewlett-Packard sales office and discuss your Test & Measurement instrument needs with a sales representative. If a refurbished instrument is the appropriate solution for your needs, the sales representative will check refurbished instrument availability. If the instrument is available, a reservation will be placed. The sales representative will then provide you with a price and availability quotation. You will then have ten (10) days to place your order.

## Affordability

Hewlett-Packard offers another affordable solution for your Test & Measurement needs. Our refurbished instruments are offered at discounted prices.

## Availability

Hewlett-Packard offers quick delivery on most refurbished Test & Measurement instruments. Most instruments are available within one week.

## Quality

Hewlett-Packard has a commitment to engineering excellence. Hewlett-Packard instruments offer proven performance and reliability. Hewlett-Packard refurbished instruments meet all original electrical and mechanical specifications.

## Reliability

Hewlett-Packard instruments are highly reliable. All refurbished instruments include full, standard warranty.

## Support

Hewlett-Packard sets the industry standard for high-quality customer support. Hewlett-Packard's support organization consists of a worldwide sales and service network staffed by highly trained engineers and technicians. Hewlett-Packard support starts before you purchase an instrument and continues long after your instrument has been delivered.

## Hewlett-Packard Sales and Service

With hundreds of sales and service offices, worldwide, Hewlett-Packard provides extensive support when and where you need it. No matter where you are, Hewlett-Packard is your local supplier.

Call your local Hewlett-Packard sales representative today.

# ORDERING INFORMATION

## Shipping, Prices, and Terms of Sale



### Communicating with HP

Hewlett-Packard is committed to providing convenient local support and the best possible attention to customer needs on a worldwide basis. There are more than 475 HP sales and support offices and distributorships in 103 countries. A listing of these offices starts on page 684.

#### Product information

Your entry point to the resources of HP is through the HP office nearest you. Our sales representatives and order support specialists are well-equipped to provide you with pre-sale assistance in product selection, as well as related business information such as current product availability and price delivered to your location. You can also call our Customer Information Centers for the same information, or for the location of your nearest Hewlett-Packard office. Locations of these centers are included in the listing of offices that starts on page 684.

#### Electronic data interchange

In addition, HP has established Electronic Data Interchange (EDI) links with many customers to allow more timely information regarding products and orders as well as provide a more efficient flow of purchase orders and invoices.

#### Sales office network

Most HP sales offices are tied into a sophisticated intra-company communications system. This not only means prompt transmission of orders to any HP product responsible division, it also speeds the flow of regular messages among HP sales offices and factories. The objective, of course, is to provide the fastest possible response to your product interests.

### Pricing and Quotations

Prices in this catalog are U.S. list prices at the time of approval for printing. HP reserves the right to change prices. The prices for an order are determined by the prices prevailing at the time the order is received. Therefore, the prices in this catalog are intended only as budgetary information.

To obtain destination prices, formal quotations, pro forma invoices, or other information you need before ordering, contact the Hewlett-Packard office, distributorship, or Customer Information Center serving your area. See page 684.

### Placing Your Order

Because many products or configurations are changed or improved during the year, we suggest that you always contact your nearest HP sales office for current product and pricing information prior to placing your order.

The HP representatives at the sales office nearest you will be pleased to provide assistance in selecting the HP equipment most appropriate to your needs, and to help you prepare your order.

The information in this catalog will, in many cases, be sufficient for you to decide to buy a particular HP product. In those instances, call the nearest HP office for information on the product's availability and price.

HP wants to be sure the product delivered to you is exactly the one you want. Therefore, when placing your order, please specify the product model, accessory, or part number, as well as the product name. Be as complete as possible in specifying exactly what you want, including standard options.

If you want special features or capabilities, such as different color or a non-standard voltage, ask your HP sales representative about availability and cost first. Then include special instructions and specification details with your order.

**Inside the USA:** Orders for end use inside the USA should be placed with your nearest U.S. sales office.

**Outside the USA:** Orders for end use outside the USA should be placed with an HP sales office or distributorship in the country of end use. More information on placing such orders is available from the HP headquarters offices listed on page 684.

### Terms of Sale

**Inside the USA:** Hewlett-Packard's standard terms for established customers in the USA are net 30 days from invoice date.

Leasing and extended financing are available. However, the financing costs are not included in any product prices in this catalog. Your nearby HP office will be pleased to discuss your requirements and work with you in setting up an appropriate program. Also see page 681.

**Outside the USA:** Please contact the nearest Hewlett-Packard sales office or an authorized HP subsidiary or distributor regarding terms for orders placed with them.

### U.S. Government Sales

For U.S. government sales, contact your nearest HP sales office. Many products in this catalog are covered on GSA federal supply schedule multi-award contracts. Contact your HP sales office for contract numbers.

### Product Changes

Although product information and illustrations in this catalog were current at the time it was approved for printing, HP, in a continuing effort to offer excellent products at a fair value, reserves the right to change specifications, designs, and models without notice.

### Shipping

**Inside the USA:** All prices include HP standard transportation and routing to any U.S. destination. If a different shipping method is needed, we will gladly ship to satisfy your requirements. Custom shipments are typically sent freight collect.

**Outside the USA:** Shipments to destinations outside the USA are made by either surface or air, as requested. Contact your HP sales office for details.



## Operating Environments

Hewlett-Packard provides solutions to customer needs through products that must operate in the expected environmental conditions. In an attempt to meet customer needs effectively, all new hardware designs are tested to internal HP standards on operating environments before they are released for sale. These internal HP standards are derived from our experience with existing environments at customer installations and from other well-known standards, such as IEC, ISO, ANSI, and MILITARY standards. These internal HP standards provide guidance to all divisions producing new hardware products and systems. The classification codes, used to identify expected environments where HP products or systems may be used, are as follows:

- A1 - Rugged Environment
- A2 - Outdoor Environment (Portable)
- B1 - Portable General Purpose Environment
- B2 - General Purpose Environment
- C1 - Controlled Office Environment
- C2 - Controlled Computer Room Environment

The classes range from the severe environments found in heavy industrial areas unsuitable for operating personnel (Class A1) to the controlled environments found in dedicated computer rooms (Class C2). Most HP hardware products are designed to meet Class B2, applying test limits commonly found in general purpose applications of light industrial and commercial facilities.

Several parameters of the operating environment are evaluated during the design process. The major ones are as follows:

- Operating temperature
- Storage temperature
- Humidity
- Altitude
- Shock
- Vibration
- Power line variation (frequency and voltage)
- Power line surge
- Power line sag and dropout
- Power line distortion susceptibility (THD)
- Electromagnetic interference (radiated and conducted)
- Magnetic interference
- Magnetic susceptibility
- Radiated susceptibility
- Electrostatic discharge
- Acoustics

Although the details of these internal HP standards are the property of HP and are treated as proprietary material, information on the classes and the test limits appropriate for each class is available for those considering the use of HP equipment at their own facility. To obtain this information contact your HP sales representative. If you are considering a specific product, ask your sales representative what environmental class it was designed to (A1, A2, B1, B2, C1, C2) and the limits it met for the environmental parameter of concern. The information you receive must not be construed as an implied warranty because the classification codes are used for guiding the design of new products and not for evaluation of production units. Only those specific parameters identified in the technical data sheet (specifications) for the model number of interest will be warranted by Hewlett-Packard according to the terms of the published warranty information.

## Support Life

Hewlett-Packard offers support services for all products for at least 5 years beyond the end of production. On most test and measurement equipment, support services are available for at least 10 years.

## Warranty

As an expression of confidence that our products will continue to meet the high standards of reliability and performance that our customers expect, Hewlett-Packard products carry the following warranty:

HP hardware products are warranted against defects in materials and workmanship. If HP receives notice of such defects during the warranty period, HP shall, at its option, either repair or replace hardware products which prove to be defective.

HP software and firmware products that are designated by HP for use with a hardware product, when properly installed on that hardware product, are warranted not to fail to execute their programming instructions due to defects in materials and workmanship. If HP receives notice of such defects during the warranty period, HP shall repair or replace software media and firmware which do not execute their programming instructions due to such defects. HP does not warrant that the operation of the software, firmware or hardware shall be uninterrupted or error free.

If HP is unable, within a reasonable time, to repair or replace any product to a condition as warranted, Buyer shall be entitled to a refund of the purchase price upon return of the product to HP.

a. **SUPPLEMENTAL STATEMENT:** Supplemental statements setting forth the duration and implementation of warranty and installation are available for most product types. These statements, if applicable to purchased products, are attached hereto and incorporated herein.

b. **DURATION AND COMMENCEMENT OF WARRANTY PERIOD:** The warranty period for each product is specified in the supplemental statement of warranty and installation attached hereto and incorporated herein. The warranty period begins either on the date of shipment or, where the purchase price includes installation by HP, on the date of installation. If Buyer schedules or delays installation more than thirty (30) days after delivery, the warranty period begins on the thirty-first (31st) day from the date of shipment.

c. **PLACE OF PERFORMANCE:** Within HP service travel areas, warranty and installation services for products installed by HP and certain other products designated by HP will be performed at Buyer's facility at no charge. Outside HP's service travel areas, warranty and installation services will be performed at Buyer's facility only upon HP's prior agreement and Buyer shall pay HP's round trip travel expenses and applicable additional expenses for such services.

On-site warranty services are provided only at the initial installation point. If products eligible for on-site warranty and installation services are moved from the initial installation point, the warranty will remain in effect only if Buyer purchases additional inspection or installation services at the new site.

Installation and on-site warranty services are available outside the country of initial purchase only if Buyer pays HP international prices. If Buyer transports a product from the country of initial purchase without having paid HP international prices, any remaining warranty covers just parts and labor and applies only if the product is returned to the country of initial purchase. Warranties requiring return to HP are limited to the country of purchase unless the product is portable (battery powered) or the customer paid HP international prices.

For product warranties requiring return to HP, products must be returned to a service facility designated by HP. Buyer shall prepay shipping charges (and shall pay all duties and taxes) for products returned to HP for warranty service. Except for products returned to Buyer from another country, HP shall pay for return of products to Buyer.

d. **LIMITATION OF WARRANTY:** The foregoing warranty shall not apply to defects resulting from:

1. Improper or inadequate maintenance by Buyer;
2. Buyer-supplied software or interfacing;
3. Unauthorized modification or misuse;
4. Operation outside of the environmental specifications of the product; or
5. Improper site preparation and maintenance.

THE WARRANTY SET FORTH ABOVE IS EXCLUSIVE AND NO OTHER WARRANTY, WHETHER WRITTEN OR ORAL, IS EXPRESSED OR IMPLIED. HP SPECIFICALLY DISCLAIMS THE IMPLIED WARRANTIES OF MERCHANTABILITY AND FITNESS FOR A PARTICULAR PURPOSE.

## EXCLUSIVE REMEDIES

The remedies provided herein are Buyer's sole and exclusive remedies. In no event shall HP be liable for direct, indirect, special, incidental or consequential damages (including loss of profits) whether based on contract, tort, or any other legal theory.

**SALES OFFICES**

Arranged Alphabetically by Country

**Headquarters Offices**

If no sales office is listed for your country or area, please contact one of these headquarters offices.

**AUSTRALIA/NEW ZEALAND**

Hewlett-Packard Australia Ltd.  
31-41 Joseph St.

**BLACKBURN**, Victoria 3130

Tel: (61/3) 272-2895

Fax: (61/3) 898-7831

Telex: AA 31024

**FAR EAST**

Hewlett-Packard Asia Pacific Ltd.  
22/F Bond Centre, West Tower  
89 Queensway, Central  
G.P.O. Box 863

**HONG KONG**

Tel: (852/5) 848-7777

Fax: (852/5) 868-4997

Telex: 76793 HPA HX

Cable: HPASIAL TD

**JAPAN**

Yokogawa-Hewlett-Packard Ltd.  
3-29-21, Takaido-Higashi  
Suginami-Ku, **TOKYO** 168

Tel: (81/3) 331-6111

Fax: (81/3) 331-1478

**UNITED KINGDOM**

Hewlett-Packard Ltd.  
Cain Road

**BRACKNELL**

Berkshire, RG12 1HN

Tel: (44/344) 36-0000

Fax: (44/344) 36-3344

**EASTERN CENTRAL EUROPE**

Hewlett-Packard GmbH  
South Eastern European Headquarters

Lieblgasse 1

P.O. Box 72

1222 **VIENNA**, Austria

Tel: (43/222) 2500-0

Fax: (43/222) 2500-444

Telex: 134 425

**NORTHERN EUROPE**

Hewlett-Packard S.A.  
Van der Hooplaan 241

P.O. Box 999

1185 LN **AMSTELVEEN**

The Netherlands

Tel: (31/20) 547 9999

Fax: (31/20) 43 1120

Telex: 18919 hpner nl

**EUROPEAN MULTICOUNTRY REGION**

Hewlett-Packard S.A.  
150, Route du Nant d'Avril  
1217 Meyrin 2

**GENEVA**, Switzerland

Tel: (41/22) 780 8111

Fax: (41/22) 780 8609

**MIDDLE EAST and AFRICA**

Hewlett-Packard S.A.  
International Sales Branch  
Middle East/Africa

7, rue du Bois-du-Lan

P.O. Box 364

1217 Meyrin 1

**GENEVA**, Switzerland

Tel: (41/22) 780 7111

Fax: (41/22) 783 7535

**CANADA**

Hewlett-Packard (Canada) Ltd.  
6877 Goreway Drive

**MISSISSAUGA**, Ontario L4V 1M8

Tel: (416) 678-9430

Fax: (416) 678-9421

**LATIN AMERICA**

Hewlett-Packard Miami  
 Multi-Country Area  
 Oficinas de Ventas y Soporte  
 5200 Blue Lagoon Drive, 9th Floor  
**MIAMI, FL 33126**  
 Tel: (305) 267-4220  
 Fax: (305) 267-4247

Hewlett-Packard Region Latino americana  
 Monte Pelvoux No. 111 - 2ndo Piso  
 Col. Lomas de Chapultepec  
 11000 **MEXICO, D.F.**  
 Tel: (525) 326-4000  
 Fax: (525) 202-7818

---

**Local Area Offices**

Arranged alphabetically by country

---

**ALGERIA**

Hewlett-Packard Trading S.A.  
 Bureau de Liaison  
 71, Lot. Benachour Abdelkader  
**CHERAGA**  
 Tel: (213) 281 0287  
 Fax: (213) 281 0287  
 Telex: 0408 63161

---

**ARGENTINA**

Hewlett-Packard Argentina  
 Montaneses 2140/50  
 1428 **BUENOS AIRES**  
 Tel: (541) 781-4061  
 (541) 781-4090

---

**AUSTRALIA****Adelaide**

Hewlett-Packard Australia Ltd.  
 191 Fullarton Road  
**DULWICH, S.A. 5065**  
 Tel: (61/8) 368-5111  
 Fax: (61/8) 332-0020

**Brisbane**

Hewlett-Packard Australia Ltd.  
 50 McDougall St.  
 P.O. Box 1406nsland 4061  
**MILTON, QLD, 4064**  
 Tel: (61/7) 858-2222

**Canberra**

Hewlett-Packard Australia Ltd.  
 Thynne Street, Fern Hill Park  
**BRUCE, A.C.T. 2617**  
 Tel: (61/6) 251-6999  
 Fax: (61/6) 251-6948  
 Telex: 62650  
 Cable: HEWPARD Canberra

**SALES OFFICES**

Arranged Alphabetically by Country (cont'd)

**AUSTRALIA (cont'd)****Melbourne**

Hewlett-Packard Australia Ltd.  
126-142 Trennery Crescent  
**ABBOTSFORD, VIC 3067**  
Tel: (61/3) 895-2895  
Fax: (61/3) 898-7831  
Cable: HEWPARD Melbourne

**Perth**

Hewlett-Packard Australia Ltd.  
Herdsman Business Park  
Hasler Rd. & Gould St.  
**OSBORNE PARK, W.A. 6017**  
Tel: (61/9) 441-8000  
Fax: (61/9) 242-1682  
Cable: HEWPARD Perth

**Sydney**

Hewlett-Packard Australia Ltd.  
17-23 Talavera Road  
P.O. Box 308  
**NORTH RYDE, N.S.W. 2113**  
Tel: (61/2) 888-4444  
Fax: (61/2) 888-9072  
Cable: HEWPARD Sydney

**AUSTRIA**

Hewlett-Packard GmbH  
Lieblgasse 1  
**1222 VIENNA**  
Tel: (43/222) 2500-0  
Fax: (43/222) 2500-444

**BAHRAIN**

Wael Pharmacy and Drugstore  
P.O. Box 648  
**MANAMA**  
Tel: (973) 25 61 23  
Fax: (973) 23 36 38  
Telex: 8550 WAEL BN

**BARBADOS**

Computers & Controls (Barbados) Ltd.  
Suite 5, 1st Floor  
Willey Shopping Plaza  
**ST. MICHAEL**  
Tel: (809) 429-4103  
Fax: (809) 429-4103

**BELGIUM**

Hewlett-Packard Belgium S.A./N.V.  
Blvd de la Woluwe, 100  
Woluwedal  
**1200 BRUSSELS**  
Tel: (32/2) 761 31 11  
Fax: (32/2) 763 06 13

**BERMUDA**

Applied Computer Technologies  
17 Reid St.  
**HAMILTON 5**  
Tel: (809) 295-1616  
Fax: (809) 292-7967  
Telex: 380 3589/ACT BA

**BOLIVIA**

SISER Ltda  
Gabriel Gonzalez 221  
Casilla 4084  
**LA PAZ**  
Tel: (591/2) 34-0962  
(591/2) 34-3245

**BRAZIL**

Edisa Informatica  
Alameda Rio Negro 750  
Alphaville 06454  
**BARUERI-SP**  
Tel: (55/11) 709-1444  
Fax: (55/11) 709-1244  
Telex: 1171351



Edisa Informatica S.A.  
Rua dos Andradas, 1001-10 andar  
**90020-PORTO ALEGRE-RS**  
Tel: (55/51) 225-7166  
Fax: (55/51) 225-4060  
Telex: 515663

Edisa Informatica S.A.  
Av. Eng. Abdias de Carvalho, 1111-5 andar  
**50751-RECIFE-PE**  
Tel: (55/81) 227-2722  
Fax: (55/81) 228-3793  
Telex: 812904

Edisa Informatica S.A.  
Praia de Botafogo, 228-4 andar  
**22250-RIO DE JANEIRO-RJ**  
Tel: (55/21) 552-0222  
Fax: (55/21) 551-1449  
Telex: 2121905

---

## BRUNEI

Komputer Wisman Sdn Bhd  
Room 1, 3rd Floor  
Jalan Tutong  
BS Begawan  
**BRUNEI DARUSSALEM**  
Tel: (673/2) 23918  
Telex: 0809 2447

---

## CANADA

**Alberta**  
Hewlett-Packard (Canada) Ltd.  
150 6th Avenue S.W.  
Petro-Canada Tower, Ste. #3600  
**CALGARY**, Alberta T2P 3Y7  
Tel: (403) 262-0777  
Fax: (403) 237-9309

Hewlett-Packard (Canada) Ltd.  
11120 178th Street  
**EDMONTON**, Alberta T5S 1P2  
Tel: (403) 486-6666  
Fax: (403) 489-8764

**British Columbia**  
Hewlett-Packard (Canada) Ltd.  
10691 Shellbridge Way  
**RICHMOND**, British Columbia V6X 2W8  
Tel: (604) 270-2277  
Fax: (604) 270-0859

**Manitoba**  
Hewlett-Packard (Canada) Ltd.  
1825 Inkster Blvd.  
**WINNIPEG**, Manitoba R2X 1R3  
Tel: (204) 694-2777  
Fax: (204) 694-3901

**New Brunswick**  
Hewlett-Packard (Canada) Ltd.  
725 Champlain St., Ste. #400  
**DIEPPE**, New Brunswick E1A 1P6  
Tel: (506) 858-9800  
Fax: (506) 859-1321

**Nova Scotia**  
Hewlett-Packard (Canada) Ltd.  
201 Brownlow Avenue  
**DARTMOUTH**, Nova Scotia B3B 1W2  
Tel: (902) 468-4725  
Fax: (902) 468-2817

**Ontario**  
Hewlett-Packard (Canada) Ltd.  
3325 North Service Road, Unit 7  
**BURLINGTON**, Ontario L7N 3G2  
Tel: (416) 336-8606  
Fax: (416) 335-3966

Hewlett-Packard (Canada) Ltd.  
252 Pall Mall Street  
Station Park, Ste. 100  
**LONDON**, Ontario  
Tel: (519) 686-2900  
Fax: (519) 432-7871

Hewlett-Packard (Canada) Ltd.  
475 Hood Rd., Unit 2  
**MARKHAM**, Ontario L3R 8H1  
Tel: (416) 678-9430  
Fax: (416) 479-3105

**SALES OFFICES**

Arranged Alphabetically by Country (cont'd)

**CANADA (cont'd)**

Hewlett-Packard (Canada) Ltd.  
6877 Goreway Drive  
**MISSISSAUGA**, Ontario L4V 1M8  
Tel: (416) 678-9430  
Fax: (416) 678-9421

Hewlett-Packard (Canada) Ltd.  
2670 Queensview Dr.  
**OTTAWA**, Ontario K2B 8K1  
Tel: (613) 820-6483  
Fax: (613) 820-0377

**Quebec**

Hewlett-Packard (Canada) Ltd.  
17500 Trans Canada Highway  
South Service Road  
**KIRKLAND**, Quebec H9J 2X8  
Tel: (514) 697-4232  
Fax: (514) 697-6941

**Saskatchewan**

Hewlett-Packard (Canada) Ltd.  
#1, 2175 Airport Rd.  
**SASKATOON**, Saskatchewan S7L 7E1  
Tel: (306) 242-3702  
Fax: (306) 664-3879

**CHILE**

ASC, S.A.  
Austria 2041  
**SANTIAGO**  
Tel: (56/2) 223-5946  
Fax: (56/2) 223-1912

**CHINA, PEOPLE'S REPUBLIC OF**

China Hewlett-Packard Co., Ltd.  
5-6/F West Wing Office  
China World Trade Center  
No. 1 Jian Guo Men Wei Avenue  
**BEIJING** 100004  
Tel: (86/1) 505-3888  
Fax: (86/1) 505-2631

China Hewlett-Packard Co., Ltd.  
Room 638, Office Building  
1376 Nan Jing Road West  
**SHANGHAI** 200040  
Tel: (86/21) 279-8668  
Fax: (86/21) 279-8677  
Telex: 086 33677 CHPSH CN

**COLOMBIA**

Instrumentacion, S.A.  
Calle 115 No. 11A10  
**BOGOTA**  
Tel: 612-1313

**COSTA RICA**

I.S. de Costa Rica  
Calle 25, Av. 6 & 8, No. 648  
**SAN JOSE**  
Tel: (50/6) 33 3722  
Fax: (50/6) 55 3528

**CSFR**

Hewlett-Packard Československo spol.s.r.o.  
Novodvorská 82  
14225 **PRAHA** 4  
Tel: 2/471 73 21  
2/471 73 22

Hewlett-Packard Československo  
spol.s.r.o.  
Polianky 5  
844 14 **BRATISLAVA**  
Tel: 7/765896  
Fax: 7/763408

**CYPRUS**

Telerexa Ltd.  
P.O. Box 1152  
Valentine House  
8 Stassandrou St.  
**NICOSIA**  
Tel: (357/2) 457 937  
Telex: 5845 tlrx cy

---

**DENMARK**

Hewlett-Packard A/S  
 Birkerød Kongevejen 25  
 3460 **BIRKERØD**  
 Tel: (45/45) 99 10 00  
 Fax: (45/42) 81 58 10

Hewlett-Packard A/S  
 Voldbjergvej 16  
 8240 **RISSKOV**, Aarhus  
 Tel: (45/45) 99 10 00  
 Fax: (45/86) 17 60 58  
 Telex: 37409 hpas dk

---

**DOMINICAN REPUBLIC**

Esacomp, S.A.  
 Av. John F. Kennedy 11  
 P.O. Box 1496  
**SANTO DOMINGO**  
 Tel: (809) 567-3241  
 Fax: (809) 566-9774  
 Telex: ITT 346 0439

---

**ECUADOR**

CYEDE Cia. Ltda.  
 Avenida Eloy Alfaro 1749  
**QUITO**  
 Tel: (593/2) 45-0975  
 Fax: (593/2) 24-4223  
 Telex: 39322548 CYEDE ED

---

**EGYPT**

ORASCOM  
 Onsi Sawiris & Co  
 P.O. Box 1191  
 160, 26th July Street  
**AGUZA/CAIRO**  
 Tel: (202) 347 33 19  
 Fax: (202) 344 02 01  
 Telex: 92768 orscm un

---

**EL SALVADOR**

IPESA de El Salvador  
 29 Avenida Norte 1223  
**SAN SALVADOR**  
 Tel: (503) 266 858  
 Telex: 301 20539 IPESA SAL

---

**FINLAND**

Hewlett-Packard Oy  
 Piispankalliontie 17  
 02200 **ESPOO (Helsinki)**  
 Tel: (358/0) 887 21  
 Fax: (358/0) 887 22 77

Hewlett-Packard Oy  
 Väinönkatu 9 C  
 40100 **JYVÄSKYLÄ**  
 Tel: (358/41) 21 85 11

Hewlett-Packard Oy  
 Valtatie 57  
 90500 **OULU**  
 Tel: (358/81) 340 144  
 Fax: (358/81) 340 145

---

**FRANCE**

**Aix-En-Provence**  
 ZI Mercure B  
 Rue Berthelot  
 13763 **LES MILLES** Cédex  
 Tel: (33) 42 24 32 43  
 Fax: (33) 42 59 48 72  
 Telex: 410 770

**Bordeaux**

Hewlett-Packard France  
 Domaine de Pélus  
 5, avenue de Pythagore  
 33700 **MERIGNAC**  
 Tel: (33) 56 34 00 84  
 Fax: (33) 56 34 80 84  
 Telex: 550 105

**SALES OFFICES**

Arranged Alphabetically by Country (cont'd)

**FRANCE (cont'd)****Brest**

Hewlett-Packard France  
ZAC Kergaradec  
8, rue Fernand Forest  
29239 **GOUESNOU**  
Tel: (33) 98 41 87 90  
Fax: (33) 98 41 74 77

**Grenoble**

Hewlett-Packard France  
57, chemin du Vieux Chêne  
ZIRST  
38240 **MEYLAN**  
Tel: (33) 76 90 38 40  
Fax: (33) 76 41 05 36

**Lille**

Hewlett-Packard France  
Parc d'activités des Prés  
1, rue Papin  
59658 **VILLENEUVE D'ASCQ**  
Tel: (33) 20 47 78 78  
Fax: (33) 20 33 36 77  
Telex: 160 124

**Lyon**

Hewlett-Packard France  
Chemin des Mouilles  
BP 162  
69131 **ECULLY** Cédex  
Tel: (33) 72 29 32 93  
Fax: (33) 78 33 49 82  
Telex: 310 617

**Nice**

Hewlett-Packard France  
Les Cardoulines-Bât.2  
Route des Dolines  
Sohpia Antipolis  
06560 **VALBONNE**  
Tel: (33) 93 65 39 40  
Fax: (33) 93 65 31 34

**Orléans**

Hewlett-Packard France  
Parc Tertiaire Héliopolis  
Route de Micy  
45380 **LA CHAPELLE ST MESMIN**  
Tel: (33) 38 43 94 56  
Fax: (33) 38 88 22 81  
Telex: 783 497

**Orsay**

Hewlett-Packard France  
Zone Industrielle de Courtaboeuf  
1, avenue du Canada  
91947 **LES ULIS** Cédex  
Tel: (33/1) 69 82 60 60  
Fax: (33/1) 69 82 60 61  
Telex: 600 048

**Rennes**

Hewlett-Packard France  
Parc d'activités de la Poterie  
Rue Louis Kerautret-Botmel  
35000 **RENNES**  
Tel: (33) 99 51 42 44  
Fax: (33) 99 32 29 19  
Telex: 740 912

**Rouen**

Hewlett-Packard France  
PAT Lavatine  
3, rue Jacques Monod  
BP 228  
76136 **MONT-ST-AIGNAN**  
Tel: (33) 35 59 19 20  
Fax: (33) 35 59 85 11  
Telex: 770 035

**Strasbourg**

Hewlett-Packard France  
4, rue de la Faisanderie  
Parc Club des Tanneries  
BP 40  
67381 **LINGOLSHEIM** Cédex  
Tel: (33) 88 76 15 00  
Fax: (33) 88 78 17 63  
Telex: 890 141

**Toulouse**

Hewlett-Packard France  
 Innoparc  
 BP 167 Voie n° 7  
 31328 LABEGE Cédex  
 Tel: (33) 61 39 11 40  
 Fax: (33) 61 39 10 97  
 Telex: 531 639

**GERMAN FEDERAL REPUBLIC****HEADQUARTERS**

Hewlett-Packard GmbH  
 Herrenberger Strasse 130  
 7030 **BÖBLINGEN**  
 Tel: (49/7031) 14-0  
 Fax: (49/7031) 14-2999

Hewlett-Packard GmbH  
 Bad Homburg  
 Hewlett-Packard Strasse  
 6380 **BAD HOMBURG**  
 Tel: (49) 6172 16-0  
 Fax: (49) 6172 16-1309  
 Telex: 410 844 hpbhg

**Berlin**

Hewlett-Packard GmbH  
 Lutzowplatz 15  
 1000 **BERLIN** 30  
 Tel: (49/30) 2500 02-0  
 Fax: (49/30) 2500 02-62  
 Telex: 018 3405 hpbm d

**Böblingen**

Hewlett-Packard GmbH  
 Schickardstrasse 2  
 7030 **BÖBLINGEN**  
 Tel: (49/7031) 14-0  
 Fax: (49/7031) 14-6429

**Bonn**

Hewlett-Packard GmbH  
 Friedrich-Ebert-Allee 26  
 5300 **BONN** 1  
 Tel: (49/228) 23400-1  
 Fax: (49/228) 235 315

**Dortmund**

Hewlett-Packard GmbH  
 Schleefstrasse 28  
 4600 **DORTMUND**-Aplerbeck  
 Tel: (49/231) 45001-0  
 Fax: (45/231) 45001-37  
 Telex: 822858 hepdoc

**Frankfurt**

Hewlett-Packard GmbH  
 Reparaturzentrum Frankfurt  
 Berner Strasse 117  
 6000 **FRANKFURT** 56  
 Tel: (49/69) 5000 60  
 Fax: (49/69) 5000 6-200  
 Telex: 412 815 hpffm

**Hamburg**

Hewlett-Packard GmbH  
 Überseering 16  
 2000 **HAMBURG** 60  
 Tel: (49/40) 63808-0  
 Fax: (49/40) 63808-327  
 Telex: 2163032

**Hannover**

Hewlett-Packard GmbH  
 Heidering 37-39  
 3000 **HANNOVER** 61  
 Tel: (49/511) 9577-0  
 Fax: (49/511) 9577-126

**Leipzig**

Hewlett-Packard GmbH  
 Nicolaistr. 25  
 O-7010 **LEIPZIG**  
 Tel: (037/41) 7133447  
 Fax: (037/41) 7133220

**Mannheim**

Hewlett-Packard GmbH  
 Rosslauer Weg 2-4  
 6800 **MANNHEIM** 31  
 Tel: (49/621) 7005-0  
 Fax: (49/621) 7005-200  
 Telex: 462105

**SALES OFFICES**

Arranged Alphabetically by Country (cont'd)

**GERMAN FEDERAL REPUBLIC  
(cont'd)****München (Munich)**

Hewlett-Packard GmbH  
Eschenstrasse 5  
8028 **TAUFKIRCHEN**  
Tel: (49/89) 61207-0  
Fax: (49/89) 61207-300  
Telex: 0524985 hpmch

**Nürnberg**

Hewlett-Packard GmbH  
Emmericher Strasse 13  
8500 **NÜRNBERG 10**  
Tel: (49/911) 9524-0  
Fax: (49/911) 9524-140  
Telex: 623860

**Ratingen**

Hewlett-Packard GmbH  
Berliner Strasse 111  
4030 **RATINGEN 1**  
Tel: (49/2102) 494-0  
Fax: (49/2102) 494-300  
Telex: 8589070

**Ulm**

Hewlett-Packard GmbH  
Messerschmittstrasse 7  
7910 **NEU ULM**  
Tel: (49/731) 7073-0  
Fax: (49/731) 7073-166  
Telex: 712816

**Waldbronn**

Hewlett-Packard GmbH  
Ermlis-Allee  
7517 **WALDBRONN 2** (Karlsruhe)  
Tel: (49/7243) 60250-0  
Fax: (49/7243) 60250-212  
Telex: 7265743

**GREAT BRITIAN**

See United Kingdom

**GREECE**

Hewlett-Packard Hellas  
32, Kiffissias Avenue  
15125 Amaroussion  
**ATHENS**  
Greece  
Tel: (30/1) 682 88 11  
Fax: (30/1) 683 29 78  
Telex: 216588 hpat gr

**GUATEMALA**

IPESA de Guatemala  
Avenida Reforma 3-48, Zona 9  
**GUATEMALA CITY**  
Tel: 316627  
Telex: 3055765 IPESA GU

**HONG KONG**

Hewlett-Packard Asia Ltd.  
22/F, Bond Centre, West Tower  
89 Queensway Central  
**HONG KONG**  
Tel: (852/5) 848-7777  
Fax: (852/5) 868-4997  
Cable: HEWPACK HONG KONG

**ICELAND**

High Performance Systems HF  
Höfdabakka 9  
110 **REYKJAVIK**  
Tel: (354/1) 67-1000  
Fax: (354/1) 67-3031

**INDIA**

Bangalore  
Hewlett-Packard India Pvt. Ltd.  
29 Cunningham Road  
**BANGALORE 560 052**  
Tel: (91/812) 261075  
Fax: (91/812) 261554

**Bombay**

Hewlett-Packard India Pvt. Ltd.  
 Unit-3, B-Wing  
 Ground Floor  
 Neelam Centre  
 Hind Cycle Road  
 Worli, **BOMBAY** 400 018  
 Tel: (91/22) 4937821  
       (91/22) 4937823  
       (91/22) 4937817  
 Fax: (91/22) 4939478  
 Telex: 11-76812 HPIB IN

**Calcutta**

Hewlett-Packard India Pvt. Ltd.  
 DBS Executive Centre  
 8 Acharya J.C. Bose Road  
**CALCUTTA** 700 017  
 Tel: (91/33) 444990  
 Fax: (91/33) 444614

**Hyderabad**

Hewlett-Packard India Pvt. Ltd.  
 9-5-13 Taramandal Complex  
 9th Floor, Saifabad  
**HYDERABAD** 500 004  
 Tel: (91/842) 231756  
       (91/842) 240289  
 Fax: (91/842) 841697 (PP)  
 Telex: 425-644 PCO IN

**Madras**

Hewlett-Packard India Pvt. Ltd.  
 DBS Executive Center  
 31-A Cathedral Garden Road  
 Near Palmgrove Hotel  
**MADRAS** 600 034  
 Tel: (91/44) 479186  
       (91/44) 475191  
 Fax: (91/44) 474382  
 Telex: 41-8132

**New Delhi**

Hewlett-Packard India Pvt. Ltd.  
 B-8 Jangpura  
 Mathura Road  
**NEW DELHI** 110 014  
 Tel: (91/11) 690329  
       (91/11) 4625521  
       (91/11) 4625416  
 Fax: (91/11) 353315

---

**INDONESIA**

BERCA Indonesia P.T.  
 Wisma Dharmala Sakti  
 10/F, J1, Jendral Sudirman Kav. 32  
 P.O. Box 2497/Jkt.  
**JAKARTA** 10220  
 Tel: (62/21) 570-3540  
 Fax: (62/21) 570-1287  
 Telex: 62065 BERCAM IA

---

**IRELAND**

Hewlett-Packard Ireland Ltd.  
 Temple House, Temple Road  
 Blackrock, Co. **DUBLIN**  
 Tel: (353/1) 883399  
 Fax: (353/1) 883742  
 Telex: 30439

---

**ISRAEL**

Computation and Measurement  
 Systems (CMS) Ltd.  
 11, Hashlosa Street  
**TEL-AVIV** 67060  
 Tel: (972) 5380-333  
 Fax: (972) 5375-055  
 Telex: 371234 HPCMS

---

**ITALY**

**Anzola Emilia-Bologna**  
 Hewlett-Packard Italiana S.p.A.  
 Via Emilia, 51/C  
 40011 **ANZOLA EMILIA-BOLOGNA**  
 Tel: (39/51) 73 10 61  
 Fax: (39/51) 73 48 30  
 Telex: 51 16 30

**SALES OFFICES**

Arranged Alphabetically by Country (cont'd)

**ITALY (cont'd)****Bari**

Hewlett-Packard Italiana S.p.A.  
Via Vitantonio di Cagno, 34  
70124 **BARI**  
Tel: (39/80) 41 07 44  
Fax: (39/80) 41 78 51

**Catania**

Hewlett-Packard Italiana S.p.A.  
Via Principe Nicola, 43 G/C  
95126 **CATANIA**  
Tel: (39/95) 37 10 87  
Fax: (39/95) 38 85 69

**Corsico**

Hewlett-Packard Italiana S.p.A.  
Via G. di Vittorio, 10  
20094 **CORSICO (MI)**  
Tel: (39/2) 440 83 51  
Fax: (39/2) 440 95 64  
Telex: 440 9564

**Firenze**

Hewlett-Packard Italiana S.p.A.  
Via Sacco e Vanzetti, 1  
50145 **FIRENZE**  
Tel: (39/55) 31 85 53  
Fax: (39/55) 37 39 65

**Genova**

Hewlett-Packard Italiana S.p.A.  
Centro Industriale di MonteSignazo  
Via Rubaldo Merello  
16141 **GENOVA**  
Tel: (39/10) 835 6633  
Fax: (39/10) 835 6631  
Telex: 28 52 38

**Limito**

Hewlett-Packard Italiana S.p.A.  
Via Nuova Rivoltana, 95  
20090 **LIMITO (MI)**  
Tel: (39/2) 757 61  
Fax: (39/2) 757 6230  
Telex: 32 31 16

**Napoli**

Hewlett-Packard Italiana S.p.A.  
Centro Direzionale di Napoli  
Via G. Porio, 4  
Isola, Fl di Viale della Costituzione  
80143 **NAPOLI**  
Tel: (39/81) 734 7082  
Fax: (39/81) 734 7098  
Telex: 71 06 98

**Padova**

Hewlett-Packard Italiana S.p.A.  
Via Pellizzo, 15  
35128 **PADOVA**  
Tel: (39/49) 807 01 66  
Fax: (39/49) 77 30 97  
Telex: 43 03 15

**Roma-Eur**

Hewlett-Packard Italiana S.p.A.  
Vial del Tintoretto, 200  
00142 **ROMA-EUR**  
Tel: (39/6) 5 48 31  
Fax: (39/6) 540 87 10  
Telex: 62 65 24

**Torino**

Hewlett-Packard Italiana S.p.A.  
C.so Svizzera, 185  
10149 **TORINO**  
Tel: (39/11) 74 40 44  
Fax: (39/11) 771 08 15  
Telex: 22 10 79

---

**JAPAN****Akita**

Yokogawa-Hewlett-Packard Ltd.  
Nihonseimei Akita Chuodori Bldg.  
4-2-7 Nakadori  
**AKITA 010**  
Tel: (81/188) 36-5021  
Fax: (81/188) 36-5099



**Atsugi**

Yokogawa-Hewlett-Packard Ltd.  
Keno Kikaku Kogyo No. 2 Bldg.  
9-32 Tamuracho

**ATSUGI 243**

Tel: (81/462) 25-0031  
Fax: (81/462) 25-0064

**Chiba**

Yokogawa-Hewlett-Packard Ltd.  
Fujimoto Daiichi Seimei Bldg.  
3-3-1 Chuo

**CHIBA 280**

Tel: (81/472) 25-7701  
Fax: (81/472) 21-0382

**Fukuoka**

Yokogawa-Hewlett-Packard Ltd.  
Daisan Hakata-Kaisei Bldg.  
1-3-6 Hakataekiminami Hakata-ku

**FUKUOKA 812**

Tel: (81/92) 472-8731  
Fax: (81/92) 473-4745

**Hachioji**

Yokogawa-Hewlett-Packard Ltd.  
9-1 Takakura-cho  
Hachioji-shi

**TOKYO 192**

Tel: (81/426) 42-1261  
Fax: (81/426) 45-2631

**Hiroshima**

Yokogawa-Hewlett-Packard Ltd.  
Nissei-Heiwakoen Bldg.  
3-25 Nakajima-cho Naka-ku

**HIROSHIMA 730**

Tel: (81/82) 241-0611  
Fax: (81/82) 241-0619

**Kawasaki**

Yokogawa-Hewlett-Packard Ltd.  
100-3 Sakado Takatsu-ku Kawasaki-shi

**KANAGAWA 221**

Tel: (81/44) 812-9707  
Fax: (81/44) 812-5242

**Kobe**

Yokogawa-Hewlett-Packard Ltd.  
Towa Building  
2-2-3 Kaigandori, Chou-ku

**KOBE 650**

Tel: (81/78) 392-4791  
Fax: (81/78) 392-4839

**Koriyama**

Yokogawa-Hewlett-Packard Ltd.  
Nihon-Dantai-seimei Bldg.  
21-10 Toramaru-machi

**KORIYAMA 963**

Tel: (81/249) 39-7111  
Fax: (81/249) 39-7234

**Kumagaya**

Yokogawa-Hewlett-Packard Ltd.  
Nissei-Kumagaya Bldg.  
2-42 Miya-machi Kumagaya-shi

**SAITAMA 360**

Tel: (81/485) 24-6563  
Fax: (81/485) 24-9050

**Kyoto**

Yokogawa-Hewlett-Packard Ltd.  
Maeda NS Bldg.  
518 Akinono-machi Nijyo-Kudaru  
Karasuma Nakakyo-ku

**KYOTO 604**

Tel: (81/75) 343-0921  
Fax: (81/75) 343-4356

**Mito**

Yokogawa-Hewlett-Packard Ltd.  
Mito Mitsui Bldg.  
1-4-73 Sannomaru

**MITO 310**

Tel: (81/292) 25-7470  
Fax: (81/292) 31-6589

**Miyazaki**

Yokogawa-Hewlett-Packard Ltd.  
Nomura Shoken Bldg.  
4-1-2 Tachibana-dori

**Miyazaki-C.****MIYAZAKI 880**

Tel: (81/985) 23-7280  
Fax: (81/985) 23-7864

**SALES OFFICES**

Arranged Alphabetically by Country (cont'd)

**JAPAN (cont'd)****Nagano**

Yokogawa-Hewlett-Packard Ltd.  
Nagano-Tokyo-kaijo Bldg.  
1081, Minamigata-machi

**NAGANO 380**

Tel: (81/262) 24-8012  
Fax: (81/262) 24-8016

**Nagaoka**

Yokogawa-Hewlett-Packard Ltd.  
Nagaoka ST Bldg.  
2-5-11 Higashi-Sakanoue-cho Nagaoka-shi

**NIGATA 940**

Tel: (81/258) 32-4005  
Fax: (81/258) 32-4006

**Nagoya**

Yokogawa-Hewlett-Packard Ltd.  
Nagoya Kokusai Center Bldg.  
1-47-1 Nakono, Nakamura-ku

**NAGOYA 450**

Tel: (81/52) 571-2262  
Fax: (81/52) 565-0896

**Nara**

Yokogawa-Hewlett-Packard Ltd.  
Nissei Nara Ekimae Bldg.  
1-1-15 Omiya-cho

**NARA 630**

Tel: (81/742) 22-8235  
Fax: (81/742) 22-8219

**Numazu**

Yokogawa-Hewlett-Packard Ltd.  
Nissei-Star Bldg.  
3-8-23 Otemachi Numazu-shi

**SHIZUOKA 410**

Tel: (81/559) 52-2711  
Fax: (81/559) 52-2722

**Omiya**

Yokogawa-Hewlett-Packard Ltd.  
Mitsui-seimei Omiya Miyamachi Bldg.  
2-96-1 Miyamachi Omiya-shi

**SAITAMA 330**

Tel: (81/48) 645-8031  
Fax: (81/48) 645-8001

**Osaka**

Yokogawa-Hewlett-Packard Ltd.  
Chuo Bldg.

5-4-20 Nishinakajima  
Yodogawa-ku

**OSAKA 532**

Tel: (81/6) 304-6021  
Fax: (81/6) 304-0216

**Sapporo**

Yokogawa-Hewlett-Packard Ltd.  
Sumitomo-seimei Sapporo Chuo Bldg.  
1-1-14 Nanjo-higashi Chuo-ku

**SAPPORO 060**

Tel: (81/11) 251-1561  
Fax: (81/11) 222-3239

**Shibuya**

Yokogawa-Hewlett-Packard Ltd.  
Tokyu Sakuragaokacho Bldg.  
31-2 Sakuragaoka Shibuya-ku

**TOKYO 150**

Tel: (81/3) 3780-5511  
Fax: (81/3) 3780-1594

**Shinagawa**

Yokogawa-Hewlett-Packard Ltd.  
Tokyo-Nissan-Minato Bldg.  
1-6-34 Konan, Minato-ku

**TOKYO, 108**

Tel: (81/3) 3458-5411  
Fax: (81/3) 3458-1998

**Suwa**

Yokogawa-Hewlett-Packard Ltd.  
Daimon Bldg.  
139-1 Yaginishi Shimosuwa-cho

**SUWA-GUN 393**

Tel: (81/266) 28-8851  
Fax: (81/266) 28-8873

**Takaido**

Yokogawa-Hewlett-Packard Ltd.  
3-29-21 Takaido-higashi  
Suginami-ku

**TOKYO 168**

Tel: (81/3) 3331-6111  
Telex: 232 2024 YHPTOK

**Takasaki**

Yokogawa-Hewlett-Packard Ltd.  
Takasaki Daiichi-seimei Bldg.  
116-1 Shin-machi Takasaki-shi  
**GUNMA 370**  
Tel: (81/273) 26-5166  
Fax: (81/273) 26-5417

**Tohoku**

Yokogawa-Hewlett-Packard Ltd.  
Yamaguchi Bldg.  
1-1-31 Ichibancho Aoba-ku  
**SENDAI 980**  
Tel: (81/22) 225-1011  
Fax: (81/22) 225-1616

**Tokyo**

Yokogawa-Hewlett-Packard Ltd.  
Shinjuku Daiichi-seimei Bldg.  
2-7-1 Nishi-shinjuku  
Shinjuku-ku  
**TOKYO 163**  
Tel: (81/3) 3348-4611  
Fax: (81/3) 3348-7969

**Toyota**

Yokogawa-Hewlett-Packard Ltd.  
Toyota-Tokyo-Kaijo Bldg.  
1-179 Miyuki-honmachi  
**TOYOTA 473**  
Tel: (81/565) 27-5611  
Fax: (81/565) 27-5400

**Tsukuba**

Yokogawa-Hewlett-Packard Ltd.  
Tsukuba-Mitsui Bldg.  
1-6-1 Takezono  
**TSUKUBA 305**  
Tel: (81/298) 51-5141  
Fax: (81/298) 51-5381

**Utsunomiya**

Yokogawa-Hewlett-Packard Ltd.  
Chiyodaseimei-Utsunomiya Bldg.  
2-3-1 Odori  
**UTSUNOMIYA 320**  
Tel: (81/286) 33-1153  
Fax: (81/286) 33-1175

**Yokohama**

Yokogawa-Hewlett-Packard Ltd.  
No. 2 Yasuda Bldg.  
2-32-12 Tsuruyacho  
Kanagawa-ku Yokohama-shi  
**KANAGAWA 221**  
Tel: (81/45) 312-1252  
Fax: (81/45) 311-0279

---

**JORDAN**

Scientific & Medical Supplies Co.  
P.O. box 1387  
**AMMAN**  
Tel: (962/6) 62 49 07  
Fax: (962/6) 62 82 58  
Telex: 21456 sabco jo

---

**KENYA**

ADCOM LIMITED INC.  
4th Floor  
Longonot Place/Kijabe Street  
P.O. Box 30070  
**NAIROBI**  
Tel: (254/2) 216 749  
Fax: (254/2) 218 924  
Telex: 22639

---

**KOREA**

Samsung Hewlett-Packard Co. Ltd.  
Samsung Building, 10-16/F  
36-1 Yeoeuido-dong  
Young deungpo-ku  
**SEOUL, 150-010**  
Tel: (82/2) 769-0114  
Fax: (82/2) 784-7084  
Telex: SAM HP K25166

Samsung Hewlett-Packard Co. Ltd.  
13/F Taegu Bank Bldg.  
118, 2-Ka  
Suseong-Dong  
Suseong-Ku  
**TAEGU**  
Tel: (82/53) 754-2666  
Fax: (82/42) 752-4696

**SALES OFFICES**

Arranged Alphabetically by Country (cont'd)

**KOREA (cont'd)**

Samsung Hewlett-Packard Co. Ltd.  
8/F, Daehan kyo Bo Bldg.  
382-1 Sun Hwa-Dong  
Chung-Gu  
**TAEJON** 301-050  
Tel: (82/42) 256-6725  
Fax: (82/42) 256-6727

**LEBANON**

Computer Information Systems S.A.L.  
Chammas Building  
P.O. Box 11-6274  
**DORA-BEIRUT**  
Tel: (961/1) 89 31 13  
Fax: (961/1) 58 18 34  
Telex: 42309 chaxis le

**LUXEMBOURG**

Hewlett-Packard Belgium S.A./N.V.  
Blvd de la Woluwe, 100  
Woluwedal  
1200 **BRUSSELS**  
Tel: (32/2) 761-3111  
Fax: (32/2) 763-0613  
Telex: 23 494 palobe b

**MALAWI**

Field Consolidated (Private) Ltd.  
System Division  
Manhattan Court  
61 Second Street  
P.O. Box 3458  
**HARARE**  
Zimbabwe  
Tel: (263/4) 73 98 81  
Fax: (263/4) 70 20 08  
Telex: 26241

**MALAYSIA**

Hewlett-Packard Sales (M) SDN BHD  
9/F, Chung Khiaw Bank Building  
Section 46, Jalan Raja Laut  
GPO Box 11119  
50736 **KUALA LUMPUR**  
Tel: (60/3) 298-6555  
Fax: (60/3) 291-5495

Hewlett-Packard Sales (M) SDN BHD  
6/F, Wisma Penang Garden  
42, Jalan Sultan Ahmad Shah  
10050 **PENANG**  
Tel: (60/4) 376-532  
Fax: (60/4) 371-027

**MEXICO**

Hewlett-Packard de Mexico  
Monte Pelvoux No. 111  
Col. Lomas de Chapultepec  
11000 **MEXICO, D.F.**  
Tel: (525) 326-4000  
Fax: (525) 540-4208

**MOROCCO**

SICOTEL  
Complexe des Habous  
Tour C, avenue des Far  
**CASABLANCA** 01  
Tel: (212) 231 22 70  
Fax: (212) 231 65 45  
Telex: 27604

**NETHERLANDS**

Hewlett-Packard Nederland B.V.  
Startbaan 16  
P.O. Box 667  
1180 NL **AMSTELVEEN**  
Tel: (31/20) 547 69 11  
Fax: (31/20) 471 825  
Telex: 13 216 HEPA NL

Hewlett-Packard Nederland B.V.  
 Boschdijk 131  
 P.O. Box 2342  
 5612 HP **EINDHOVEN**  
 Tel: (31/40) 32 69 11  
 Fax: (31/40) 44 65 46  
 Telex: 51484 hepae nl

---

## NEW ZEALAND

Hewlett-Packard (N.Z.) Ltd.  
 5 Owens Road  
 Epsom, **AUCKLAND 3**  
 Tel: (64/9) 687-159  
 Fax: (64/9) 600-507

Hewlett-Packard (N.Z.) Ltd.  
 186-190 Willis Street  
**WELLINGTON 3**  
 Tel: (64/4) 820-400  
 Fax: (64/4) 843-380

---

## NORTHERN IRELAND

See United Kingdom

---

## NORWAY

Hewlett-Packard Norge A/S  
 Oesterndalen 16-18  
 P.O. Box 34  
 1345 **OËSTERAAS**  
 Tel: (47/2) 87 97 00  
 Fax: (47/2) 24 66 96  
 (47/2) 24 30 78  
 Telex: 76621 HPNAS N

Hewlett-Packard Norge A/S  
 Boemergt. 44  
 Box 2470  
 5037 **SOLHEIMSVIK**  
 Tel: (47/5) 29 00 90  
 Fax: (47/5) 29 10 72

---

## OMAN

Intac LLC  
 P.O. Box 51196  
**MINA AL FAHAL**  
 Muscat  
 Tel: (968) 70 77 27  
 (968) 70 77 23  
 Fax: (968) 79 66 39  
 Telex: 3865

---

## PAKISTAN

Mushko Electronics (PVT) Ltd.  
 68-W Sama Plaza  
 Blue Area, F-7  
**ISLAMABAD 44000**  
 Tel: (92/51) 814 492  
 Fax: (92/51) 821 201  
 Telex: 54001 Muski Pk

Mushko Electronics (PVT) Ltd.  
 Oosman Chambers  
 Abdullah Harcoon Road  
**KARACHI 74400**  
 Tel: (92/21) 524 131  
 (92/21) 524 132  
 Fax: (92/21) 512 298  
 Telex: 2894 MUSKO PK

---

## PANAMA

Electronico Balboa, S.A.  
 Calle Samuel Lewis, Ed. Alfa  
 Apartado 4929  
**PANAMA CITY**  
 Tel: (507) 636 613  
 Fax: (507) 361 820  
 Telex: 368 3483 ELECTRON PG

---

## PERU

Cía Electro Médica, S.A.  
 Los Flamencos No. 145, Ofna. 301-302  
 San Isidro, **LIMA 1**  
 Tel: (51/14) 41-4325  
 Fax: (51/14) 42-3572  
 Telex: 39425257 PE PB SIS

**SALES OFFICES**

Arranged Alphabetically by Country (cont'd)

---

**PHILIPPINES**

The Online Advanced Systems Corp.  
 2nd Floor, Electra House  
 115-117 Esteban Street  
 Legaspi Village, Makati  
 Metro **MANILA**  
 Tel: (63/2) 816-3810  
 Fax: (63/2) 816-0590  
 Telex: 632 663 274 ONLINE PN

---

**POLAND**

Hewlett-Packard Polska sp.z o.o.  
 Ul. Newelska 6  
 01-447 **WARSZAWA**  
 Tel: 22/364711  
       22/379144  
 Fax: 22/374783  
 Telex: 813919

---

**PORTUGAL**

Hewlett-Packard Portugal S.A.  
 Torre de Santo Antonio  
 Rua Gregorio Lopes, Lote 1732B  
 Restelo  
 1400 **LISBON**  
 Tel: (351) 617 343  
 Fax: (351) 617 345  
 Telex: 43126

Hewlett-Packard Portugal S.A.  
 Edificio Tranquilidade  
 Rua D. Manuel, 296  
 4000 **PORTO**  
 Tel: (351) 493 122  
 Fax: (351) 488 721  
 Telex: 26054

---

**PUERTO RICO**

Hewlett-Packard Puerto Rico  
 P.O. Box 4048  
**AGUADILLA** 00605  
 Tel: (809) 890-60000

Hewlett-Packard Puerto Rico  
 101 Munoz Rivera Avenue  
 Esu. Calle Ochoa  
**HATO REY**, 00918  
 Tel: (809) 754-7800

---

**QATAR**

Qatar Datamation Systems  
 P.O. Box 350  
**DOHA**  
 Tel: (974) 44 19 16  
 Fax: (974) 44 12 19  
 Telex: 4833

---

**SAUDI ARABIA**

Modern Electronic Establishment  
 P.O. Box 281  
 Thouqbah  
**AL-KHOBAR** 31952  
 Tel: (966/3) 895 17 60  
       (966/3) 895 17 64  
 Fax: (966/3) 894 46 58  
 Telex: 671 106  
 Cable: ELECTA AL-KHOBAR

Modern Electronic Establishment  
 P.O. Box 1228  
 Redec Plaza, 6th Floor  
**JEDDAH** 21431  
 Tel: (966/2) 644 96 28  
 Fax: (966/2) 644 18 33  
 Telex: 402 712  
 Cable: ELECTA JEDDAH

Modern Electronic Establishment  
 P.O. Box 22015  
**RIYADH** 11495  
 Tel: (966/1) 476 30 30  
 Fax: (966/1) 476 76 49  
 Telex: 402049 MEERYD SJ

---

**SCOTLAND**

See United Kingdom

---

**SINGAPORE**

Hewlett-Packard Singapore Ltd.  
 150 Beach Road  
 #29-00 Gateway West  
 P.O. Box 2, Bras Basah Post Office  
**SINGAPORE, 9118**  
 Tel: (65) 291 9088  
 Fax: (65) 296 9023  
 Telex: 34209 HPSGSO RS

---

**SOUTH AFRICA**

Hi Performance Systems (Pty.) Ltd.  
 P.O. Box 120, Howard Place  
**CAPE TOWN 7450**  
 Tel: (27/21) 685-7922  
 Fax: (27/21) 685-3785

Hi Performance Systems (Pty.) Ltd.  
 Private Bag Wendywood  
**SANDTON 2144**  
 Tel: (27/11) 806-1000  
 Fax: (27/11) 444-1725  
 (27/11) 444-3098

---

**SPAIN****Barcelona**

Hewlett-Packard Española S.A.  
 Avda. Diagonal, 605  
 08028 **BARCELONA**  
 Tel: (34/3) 430 84 68  
 Fax: (34/3) 430 84 86  
 Telex: 52603 hpbee

**Bilbao**

Hewlett-Packard Española S.A.  
 Avda. de Zugazarte, 8  
 (Edificio El Abra 4)  
 48930 **LAS ARENAS-GUECHO**  
 Tel: (34/4) 464 32 55  
 Fax: (34/4) 464 90 83  
 Telex: 33032

**Madrid**

Hewlett-Packard Española S.A.  
 Crta. de la Coruña, km 16,500  
 28230 Las Rozas

**MADRID**

Tel: (34/1) 626 16 00  
 Fax: (34/1) 626 18 30  
 Telex: 23515 HPE

**Sevilla**

Hewlett-Packard Española S.A.  
 c/Luis de Morales, S/N  
 Edificio Forum  
 41005 **SEVILLA**  
 Tel: (34/54) 58 17 00  
 Fax: (34/54) 57 57 20  
 Telex: 72933

**Valencia**

Hewlett-Packard Española S.A.  
 Isabel La Católica, 8  
 46004 **VALENCIA**  
 Tel: (34/6) 351 59 44  
 Fax: (34/6) 351 49 06  
 Telex: 63435

---

**SURINAME**

SURTEL  
 Grote Hoftraad 3-5  
 P.O. Box 155  
**PARAMARIBO**  
 Tel: 72118  
 77880  
 Fax: 52745

---

**SWEDEN****Göteborg**

Hewlett-Packard Sverige AB  
 Topasgatan 1A  
 Box 266  
 42123 **VÄSTRA-FRÖLUNDA**  
 Tel: (46/31) 89 10 00  
 Fax: (46/31) 49 50 99

**SALES OFFICES**

Arranged Alphabetically by Country (cont'd)

**SWEDEN (cont'd)****Malmö**

Hewlett-Packard Sverige AB  
Östra Tullgatan 3  
20011 **MALMÖ**  
Box 6132  
Tel: (46/40) 702 70  
Fax: (46/40) 97 74 18

**Örebro**

Hewlett-Packard Sverige AB  
Elementvagen 16  
70227 **ÖREBRO**  
Tel: (46/19) 10 48 80  
Fax: (46/19) 27 01 87

**Stockholm**

Hewlett-Packard Sverige AB  
Skalholtsgatan 9, Kista  
P.O. Box 19  
16493 **KISTA**  
Tel: (46/8) 750 20 00  
Fax: (46/8) 752 77 81  
Telex: (854) 17886

---

**SWITZERLAND****Basel**

Hewlett-Packard (Schweiz) AG  
Clarastrasse 12  
4058 **BÄLE**  
Tel: (41/61) 681 59 20  
Fax: (41/61) 681 98 59  
Telex: 964 719

**Geneva/Meyrin**

Hewlett-Packard (Schweiz) AG  
39, rue de Veyrot  
1217 **MEYRIN 1**  
Tel: (41/22) 780 41 11  
Fax: (41/22) 782 13 68  
Telex: 27333 HPAG CH

**Widen**

Hewlett-Packard (Schweiz) AG  
Allmend 2  
8967 **WIDEN**  
Tel: (41/57) 32 11 11  
Fax: (41/57) 31 73 74  
Telex: 828 010 hpag ch

---

**TAIWAN**

Hewlett-Packard Taiwan Ltd.  
11/F, 456, Chung Haiso 1st Road  
**KAOHSIUNG**  
Tel: (886/7) 241-2418  
Fax: (886/7) 241-2323

Hewlett-Packard Taiwan Ltd.  
No. 20, Kao-Shuang Road  
**PIN CHEN 32404**  
Taoyuan Heien  
Tel: (886/3) 492-9666  
Fax: (886/3) 492-8087

Hewlett-Packard Taiwan Ltd.  
10th Fl, 540, Sec. 1  
Wen-Hsin Road  
**TAICHUNG**  
Tel: (886/4) 327-0153  
Fax: (886/4) 326-5274

Hewlett-Packard Taiwan Ltd.  
8/F, Hewlett-Packard Building  
No. 337 Fu Hsing North Road  
**TAIPEI**  
Tel: (886/2) 712-0404  
Fax: (886/2) 718-2928

---

**TANZANIA**

ADCOM LIMITED INC.  
4th Floor  
Longonot Place/Kijabe Street  
P.O. Box 30070  
**NAIROBI**  
Kenya  
Tel: (254/2) 216 749  
Fax: (254/2) 218 924  
Telex: 22639



---

**THAILAND**

Hewlett-Packard Thailand Ltd.  
 11th Floor  
 Pacific Place  
 140 Sukhumvit Road  
**BANGKOK** 10110  
 Tel: (66/2) 254-6720  
 Fax: (66/2) 254-6731  
 Telex: 086 84439 Simonco TH  
 Cable: UNIMESA Bangkok

---

**TRINIDAD & TOBAGO**

Computer and Controls Ltd.  
 80-82 Edwards Street  
 P.O. Box 51  
**PORT-OF-SPAIN**, Trinidad  
 Tel: (809) 624-2388  
 (809) 624-2389  
 Fax: (809) 625-6547

---

**TUNISIA**

Precision Electronique  
 5, rue de Chypre  
 Mutuelleville  
**1002 TUNIS BELVEDERE**  
 Tel: (216/1) 78 50 37  
 Fax: (216/1) 78 33 38  
 Telex: 0409 13238

Hewlett-Packard  
 Bilgisayar ve Olcum Sistemleri A.S.  
 Paris Cad No3 D.9  
 06670 Kavaklidere Ankara

**TURKEY**

Tel: 090 (4) 125 83 13  
 Fax: 090 (4) 125 47 45  
 Telex: 0607 46180

Hewlett-Packard  
 Bilgisayar ve Olcum Sistemleri A.S.  
 19 Mayıs Cad., Nova/Baran Plaza K. 12  
 80220 Sisli Istanbul

**TURKEY**

Tel: 090 (1) 175 29 70  
 Fax: 090 (1) 175 29 92  
 Telex: 0607 39150

---

**UGANDA**

ADCOM LIMITED INC.  
 4th Floor  
 Longonot Place/Kijabe Street  
 P.O. Box 30070  
**NAIROBI**  
 Kenya  
 Tel: (254/2) 216 749  
 Fax: (254/2) 218 924  
 Telex: 22639

---

**UNITED ARAB EMIRATES**

Emitac Ltd.  
 P.O. Box 2711  
**ABU DHABI**  
 Tel: (971/2) 77 04 19  
 Fax: (971/2) 72 30 58  
 Telex: 46306

Emitac Ltd.  
 Block "B" Arenco Bldg.  
 Zabel Road  
 P.O. Box 8391  
**DUBAI**  
 Tel: (971/4) 37 75 91  
 Fax: (971/4) 37 08 99  
 Telex: 48710

---

**UNITED KINGDOM****ENGLAND****Birmingham**

Hewlett-Packard Limited  
 Avon House  
 435 Stratford Road  
 Shirley, **SOLIHULL**  
 West Midlands B90 4BL  
 Tel: (44/21) 745-8800  
 Fax: (44/21) 733-5104  
 Telex: 339 105

**SALES OFFICES**

Arranged Alphabetically by Country (cont'd)

**ENGLAND (cont'd)****Bracknell**Hewlett-Packard Limited  
Coin Road**BRACKNELL**Berkshire RG12 1HN  
Tel: (44/344) 36 0000  
Fax: (44/344) 36 3344  
Telex: 849 555**Central London**Hewlett-Packard Limited  
Bridewell House  
9 Bridewell Place**LONDON EC4V 6BS**Tel: (44/71) 583-6565  
Fax: (44/71) 585-6565  
Ext. 57713/57803  
Telex: 298163**Gatwick**Hewlett-Packard Limited  
Churchill Court  
Gatwick Road**CRAWLEY**West Sussex RH10 2PN  
Tel: (44/293) 562955  
Fax: (44/293) 578574  
Telex: 878862**Manchester**Hewlett-Packard Limited  
Heathside Park Road  
Cheadle Heath**STOCKPORT**Cheshire SK3 0RB  
Tel: (44/61) 428-0828  
Fax: (44/61) 495-5009  
Telex: 668 068**Uxbridge**Hewlett-Packard Limited  
Harman House  
No. 1 George Street**UXBRIDGE**Middlesex UB8 1YH  
Tel: (44/895) 72020  
Fax: (44/895) 75260  
Telex: 893 135**Winnersh**Hewlett-Packard Limited  
King Street Lane**WINNERSH Wokingham**Berkshire RG 11 5AR  
Tel: (44/734) 78 4774  
Fax: (44/734) 77 7285  
Telex: 847 178**NORTHERN IRELAND**Hewlett-Packard (Ireland) Ltd.  
Carrickfergus Industrial Centre  
75 Belfast Road, **CARRICKFERGUS**  
Co. Antrim BT38 8PM  
Tel: (44/960) 367 333**SCOTLAND**Hewlett-Packard Ltd.  
1/3 Springburn Place  
College Milton North  
**EAST KILBRIDE, G74 5NU**  
Tel: (44/35) 524 92 61  
Fax: (44/35) 523 59 29  
Telex: 779615

Hewlett-Packard Ltd.

**SOUTH QUEENSFERRY**West Lothian, EH30 9TG  
Tel: (44/31) 331 11 88  
Fax: (44/31) 331

---

**UNITED STATES****Arizona**Hewlett-Packard Co. (2401)  
8080 Pointe Parkway West  
**PHOENIX, AZ 85044**  
Tel: (602) 273-8000  
Fax: (602) 273-8080

Hewlett-Packard Co. (2406)  
3400 East Britannia Dr.  
Bldg. C, Suite 124  
**TUCSON, AZ 85706**  
Tel: (602) 573-7400  
FAX: (602) 573-7429

### California

Hewlett-Packard Co. (2428)  
26701 W. Argoura Rd.  
**CALABASAS, CA 91302**  
Tel: (818) 880-3400  
Fax: (818) 880-3437

Hewlett-Packard Co. (2436)  
353 Lakeside Dr.  
**FOSTER CITY, CA 94404**  
Tel: (415) 378-8400  
Fax: (415) 378-8405

Hewlett-Packard Co. (2403)  
1421 S. Manhattan Ave.  
**FULLERTON, CA 92631**  
Tel: (714) 999-6700  
Fax: (714) 778-3033

Hewlett-Packard Co. (2438)  
7408 Hollister Ave. #A  
**GOLETA, CA 93117**  
Tel: (805) 685-6100  
Fax: (805) 685-6163

Hewlett-Packard Co. (2449)  
9800 Muirlando Ave.  
**IRVINE, CA 92718**  
Tel: (714) 472-3000  
Fax: (714) 581-3607 (Direct Dial only)

Hewlett-Packard Co. (2417)  
5651 West Manchester Ave.  
**LOS ANGELES, CA 90045**  
Tel: (213) 337-8035  
Fax: (213) 337-8338

Hewlett-Packard Co. (2407)  
351 E. Evelyn Ave.  
Bldg. 33  
**MOUNTAIN VIEW, CA 94039**  
Tel: (415) 694-2000  
Fax: (415) 694-0600

Hewlett-Packard Co. (2415)  
4244 So. Market Ct., Suite A  
**SACRAMENTO, CA 95834**  
Tel: (916) 929-7222  
Fax: (916) 927-7152

Hewlett-Packard Co. (2404)  
9606 Aero Dr.  
**SAN DIEGO, CA 92123**  
Tel: (619) 279-3200  
Fax: (619) 268-8487

### SANTA BARBARA (see GOLETA)

Hewlett-Packard Co. (2414)  
3003 Scott Blvd.  
**SANTA CLARA, CA 95054**  
Tel: (408) 988-7000  
Fax: (408) 988-7103

Hewlett-Packard Co. (2445)  
5280 Valentine Rd., Suite 205  
**VENTURA, CA 93003**  
Tel: (805) 658-6898  
Fax: (805) 650-0721

### Colorado

Hewlett-Packard Co. (2441)  
3005 Center Green Dr. #205  
Suite A  
**BOULDER, CO 80301**  
Tel: (303) 938-3065  
Fax: (303) 938-3025

Hewlett-Packard Co. (2411)  
24 Inverness Pl., East  
**ENGLEWOOD, CO 80112**  
Tel: (303) 649-5000  
Fax: (303) 649-5787

**SALES OFFICES**

Arranged Alphabetically by Country (cont'd)

**UNITED STATES (cont'd)****Connecticut**

Hewlett-Packard Co. (4457)  
3 Parkland Dr.

**DARIEN**, CT 06820

Tel: (203) 656-0040

Fax: (203) 656-5563

Hewlett-Packard Co. (4458)  
115 Glastonbury Blvd.

**GLASTONBURY**, CT 06033

Tel: (203) 633-8100

Fax: (203) 659-6087

**District of Columbia**

(see Rockville, MD)

**Florida**

Hewlett-Packard Co. (3179)  
5900 N. Andrews, Suite 100

**FORT LAUDERDALE**, FL 33309

Tel: (305) 938-9800

Fax: (305) 938-2293

Hewlett-Packard Co. (3171)  
255 East Dr., Suite B

**MELBOURNE**, FL 32901

Tel: (407) 729-0704

Fax: (407) 723-4557

Hewlett-Packard Co. (3177)  
6177 Lake Ellenor Dr.

**ORLANDO**, FL 32809

Tel: (407) 859-2900

Fax: (407) 826-9309

Hewlett-Packard Co. (3124)  
4700 Bayou Blvd.

Building 5

**PENSACOLA**, FL 32503

Tel: (904) 476-8422

Fax: (904) 476-4116

Hewlett-Packard Co. (3166)  
5550 Idlewild, #150

**TAMPA**, FL 33634

Tel: (813) 884-3282

Fax: (813) 889-4445

**Georgia**

Hewlett-Packard Co. (3108)  
2000 South Park Pl. (3112)

**ATLANTA**, GA 30339

Tel: (404) 955-7351

Fax: (404) 980-7669

**Hawaii**

Hewlett-Packard Co. (2409)  
Pacific Tower

1001 Bishop St.

Suite 2400

**HONOLULU**, HI 96813

Tel: (808) 526-1555

Fax: (808) 536-7873

**Illinois**

Hewlett-Packard Co. (2619)  
2205 E. Empire St.

**BLOOMINGTON**, IL 61704

Tel: (309) 662-9411

Fax: (309) 662-0351

Hewlett-Packard Co. (2603)  
1200 East Diehl Rd.

**NAPERVILLE**, IL 60566

Tel: (708) 505-8800

Fax: (708) 505-7876

Hewlett-Packard Co. (2601)  
5201 Tollview Dr.

**ROLLING MEADOWS**, IL 60008

Tel: (708) 255-9800

Fax: (708) 259-5878

**Indiana**

Hewlett-Packard Co. (2605)  
11911 N. Meridian St.

**CARMEL**, IN 46032

Tel: (317) 844-4100

Fax: (317) 843-1291

Hewlett-Packard Co. (2635)  
111 E. Ludwig Rd.

Suite 108

**FT. WAYNE**, IN 46825

Tel: (219) 482-4283

Fax: (219) 482-9907

**INDIANAPOLIS** (see **CARMEL**)**Iowa**

Hewlett-Packard Co. (2612)  
4050 River Center Ct.  
**CEDAR RAPIDS, IA 52402**  
Tel: (319) 393-0606  
Fax: (319) 378-1024

**Kansas**

Hewlett-Packard Co. (2622)  
North Rock Business Park  
3450 N. Rock Rd.  
Suite 300  
**WICHITA, KS 67226**  
Tel: (316) 636-4040  
Fax: (316) 636-4504

**Kentucky**

Hewlett-Packard Co. (2623)  
305 N. Hurstbourne Ln.  
Suite 100  
**LOUISVILLE, KY 40222**  
Tel: (502) 426-0100  
Fax: (502) 426-0322

**Louisiana**

Hewlett-Packard Co. (3190)  
160 James Drive East  
**ST. ROSE, LA 70087**  
Tel: (504) 467-4100  
Fax: (504) 467-4100 x291

**Maryland**

Hewlett-Packard Co. (4432)  
3701 Koppers St.  
**BALTIMORE, MD 21227**  
Tel: (301) 644-5800  
Fax: (301) 362-7650

Hewlett-Packard Co. (4400)  
2 Choke Cherry Rd.  
**ROCKVILLE, MD 20850**  
Tel: (301) 258-2000  
Fax: (301) 258-5986

**Massachusetts**

Hewlett-Packard Co. (4450)  
29 Burlington Mall Rd.  
**BURLINGTON, MA 01803-4514**  
Tel: (617) 270-7000  
Fax: (617) 221-5240

**Michigan**

Hewlett-Packard Co. (2617)  
3033 Orchard Vista S.E.  
**GRAND RAPIDS, MI 49546**  
Tel: (616) 957-1970  
Fax: (616) 956-9022

Hewlett-Packard Co. (2607)  
39550 Orchard Hill Place Dr.  
**NOVI, MI 48050**  
Tel: (313) 349-9200  
Fax: (313) 349-9240

**Minnesota**

Hewlett-Packard Co. (2606)  
2025 W. Larpenteur Ave.  
**ST. PAUL, MN 55113**  
Tel: (612) 644-1100  
Fax: (612) 641-9787

**Missouri**

Hewlett-Packard Co. (2611)  
6601 Winchester Ave.  
**KANSAS CITY, MO 64133**  
Tel: (816) 737-0071  
Fax: (816) 737-4690

Hewlett-Packard Co. (2610)  
530 Maryville Centre Dr.  
**ST. LOUIS, MO 63140**  
Tel: (314) 542-1500  
Fax: (314) 542-1586

**Nebraska**

Hewlett-Packard Co. (2616)  
11626 Nicholas St.  
**OMAHA, NE 68154**  
Tel: (402) 493-0300  
Fax: (402) 493-4334

**SALES OFFICES**

Arranged Alphabetically by Country (cont'd)

**UNITED STATES (cont'd)****New Jersey**

Hewlett-Packard Co. (4415)  
120 W. Century Rd.  
**PARAMUS, NJ 07653**  
Tel: (201) 599-5000  
Fax: (201) 599-5382

Hewlett-Packard Co. (4417)  
20 New England Ave. West  
**PISCATAWAY, NJ 08854**  
Tel: (201) 562-6100  
Fax: (201) 562-6246

**New Mexico**

Hewlett-Packard Co. (2402)  
7801 Jefferson N.E.  
**ALBUQUERQUE, NM 87109**  
Tel: (505) 823-6100  
Fax: (505) 823-1243

Hewlett-Packard Co. (2420)  
1362-C Trinity Dr.  
**LOS ALAMOS, NM 87544**  
Tel: (505) 662-6700  
Fax: (505) 662-4312

**New York**

Hewlett-Packard Co. (4444)  
5 Computer Drive South  
**ALBANY, NY 12205**  
Tel: (518) 458-1550  
Fax: (518) 458-1550 x0393

Hewlett-Packard Co. (4445)  
130 John Muir Dr.  
**AMHERST, NY 14228**  
Tel: (716) 689-3003  
Fax: (716) 636-7034

**BUFFALO (see AMHERST)**

Hewlett-Packard Co. (4442)  
200 Cross Keys Office Park  
**FAIRPORT, NY 14450**  
Tel: (716) 223-9950  
Fax: (716) 223-6331

**HUNTINGTON (see MELVILLE)**

Hewlett-Packard Co. (4440)  
7641 Henry Clay Blvd.  
**LIVERPOOL, NY 13088**  
Tel: (315) 451-1820  
Fax: (315) 451-1820 x255

Hewlett-Packard Co. (4411)  
7 Old Sod Farm Rd.  
**MELVILLE, NY 11747**  
Tel: (516) 753-0555  
Fax: (516) 753-3469

Hewlett-Packard Co. (4410)  
2975 Westchester Ave.  
**PURCHASE, NY 10577**  
Tel: (914) 935-6300  
Fax: (914) 935-6497

**ROCHESTER (see FARIPORT)****SYRACUSE (see LIVERPOOL)**

Hewlett-Packard Co. (4409)  
Executive Square Office Bldg.  
66 Middlebush Rd.  
**WAPPINGERS FALLS, NY 12590**  
Tel: (914) 298-9125  
Fax: (914) 298-9154

**North Carolina**

Hewlett-Packard Co. (3149)  
305 Gregson Dr.  
**CARY, NC 27511**  
Tel: (919) 467-6600  
Fax: (919) 460-2296  
(919) 460-2297

Hewlett-Packard Co. (3111)  
7029 Albert Pick Rd. #100  
**GREENSBORO, NC 27409**  
Tel: (919) 665-1800  
Fax: (919) 668-1797  
Mailing Address  
P.O. Box 26500  
Greensboro, NC 27426

**RALEIGH (see CARY)**

**Ohio****AKRON** (see **COPLEY**)

Hewlett-Packard Co. (2624)  
4501 Erskine Rd.

**CINCINNATI**, OH 45242

Tel: (513) 891-9870

Fax: (513) 891-0033

**COLUMBUS** (see **WESTERVILLE**)**CLEVELAND** (see **STRONGSVILLE**)

Hewlett-Packard Co. (2604)  
7887 Washington Village Dr.

**DAYTON**, OH 45459

Tel: (513) 433-2223

Fax: (513) 433-8633

Hewlett-Packard Co. (2608)  
15885 Sprague Rd.

**STRONGSVILLE**, OH 44136

Tel: (216) 243-7300

Fax: (216) 234-7230

Hewlett-Packard Co. (2614)  
675 Brooksedge Blvd.

**WESTERVILLE**, OH 43081

Tel: (614) 891-3344

Fax: (614) 891-1476

**Oklahoma**

Hewlett-Packard Co. (3182)  
3525 N.W. 56th St.

Suite C-100

**OKLAHOMA CITY**, OK 73112

Tel: (405) 946-9499

Fax: (405) 942-2127

Hewlett-Packard Co. (3183)  
6655 South Lewis

Suite 105

**TULSA**, OK 74136

Tel: (981) 481-6700

Fax: (981) 481-2250

**Oregon**

Hewlett-Packard Co. (2413)  
15115 S.W. Sequoia Pkwy.  
Suite 100

**PORTLAND**, OR 97224

Tel: (503) 598-8000

Fax: (503) 598-8155

**Pennsylvania**

Hewlett-Packard Co. (4422)  
Heatherwood Industrial Park  
50 Dorchester Rd.

P.O. Box 6080

**HARRISBURG**, PA 17112

Tel: (717) 657-5900

Fax: (717) 657-5946

Hewlett-Packard Co. (2609)  
111 Zeta Dr.

**PITTSBURGH**, PA 15238

Tel: (412) 782-0400

Fax: (412) 963-1300

Hewlett-Packard Co. (4420)  
2750 Monroe Blvd.

**VALLEY FORGE**, PA 19482

Tel: (215) 666-9000

Fax: (215) 666-2034

**South Carolina**

Hewlett-Packard Co. (3133)  
545 N. Pleasantburg Dr.

Suite 100

**GREENVILLE**, SC 29607

Tel: (803) 232-8002

Fax: (803) 232-8739

**Tennessee**

Hewlett-Packard Co. (3127)  
One Energy Center

Suite 200

Pellissippi Parkway

**KNOXVILLE**, TN 37932

Tel: (615) 966-4747

Fax: (615) 966-8147

**SALES OFFICES**

Arranged Alphabetically by Country (cont'd)

**UNITED STATES (cont'd)**

Hewlett-Packard Co. (3117)  
44 Vantage Way  
Suite 160

**NASHVILLE, TN 37228**

Tel: (615) 255-1271

Fax: (615) 726-2310

**Texas**

Hewlett-Packard Co. (3197)  
9050 Capital of Texas Hwy., North  
#290

**AUSTIN, TX 78759**

Tel: (512) 346-3855

Fax: (512) 338-7201

Mailing Address

P.O. Box 9431

Austin, TX 78766-9430

**DALLAS (see RICHARDSON)**

Hewlett-Packard Co. (2405)  
5700 Cromo Dr.

**EL PASO, TX 79912**

Tel: (915) 833-4400

Fax: (915) 581-8097

Hewlett-Packard Co. (3195)  
10535 Harwin Dr. (3187)

**HOUSTON, TX 77036**

Tel: (713) 776-6400

Fax: (713) 776-6495

Hewlett-Packard Co. (3185)  
930 E. Campbell Rd.

**RICHARDSON, TX 75081**

Tel: (214) 231-6101

Fax: (214) 699-4337

Hewlett-Packard Co. (3188)  
14100 San Pedro Ave., Suite 100

**SAN ANTONIO, TX 78232**

Tel: (512) 494-9336

Fax: (512) 491-1299

**Utah**

Hewlett-Packard Co. (2418)  
3530 W. 2100 South

**SALT LAKE CITY, UT 84119**

Tel: (801) 974-1700

Fax: (801) 974-1780

**Virginia**

Hewlett-Packard Co. (3119)  
840 Greenbrier Cir.

Suite 101

**CHESAPEAKE, VA 23320**

Tel: (804) 424-7105

Fax: (804) 424-1494

Hewlett-Packard Co. (3113)  
4401 Water Front Dr.

**GLEN ALLEN, VA 23060**

Tel: (804) 747-7750

Fax: (804) 965-9297

**NORFOLK (see CHESAPEAKE)****RICHMOND (see GLEN ALLEN)**

Hewlett-Packard Co. (3153)  
2800 Electric Rd., Suite 100

**ROANOKE, VA 24018**

Tel: (703) 774-3444

Fax: (703) 989-8049

**Washington**

Hewlett-Packard Co. (2410)  
15815 S.E. 37th St.

**BELLEVUE, WA 98006**

Tel: (206) 643-4000

Fax: (206) 643-8748

**Wisconsin**

Hewlett-Packard Co. (2615)  
275 N. Corporate Dr.

**BROOKFIELD, WI 53005**

Tel: (414) 792-8800

Fax: (414) 792-0218



---

**URUGUAY**

CONATEL, S.A.  
Ejido No. 1690  
**MONTEVIDEO**  
Tel: (5982) 93-0314

Pablo Ferrando SACI  
Avenida Italia No. 2877  
Casilla de Correo 370  
**MONTEVIDEO**  
Tel: (5982) 802 586  
Telex: 398802586

---

**USSR**

Hewlett-Packard Company  
Pokrovski Blvd. 4/17 Kv.12  
101000 **MOSCOW**  
Tel: (007/095) 923 5001  
Fax: (007/095) 230 2611

---

**VENEZUELA**

Hewlett-Packard Venezuela  
3ra. Transversal  
Los Ruices Norte  
Edificio Segre 1,2,3  
**CARACAS 1071**  
Tel: (582) 239-4133  
Fax: (582) 239-6289

---

**ZIMBABWE**

Field Consolidated (Private) Ltd.  
Systron Division  
Manhattan Court  
61 Second Street  
P.O. Box 3458  
**HARARE**  
Tel: (263/4) 73 98 81  
Fax: (263/4) 70 20 08  
Telex: 26241

---

**Please send directory corrections to:**

Test & Measurement Catalog, 54L-AF  
Hewlett-Packard Company  
5301 Stevens Creek Blvd.  
P.O. Box 58059  
Santa Clara, CA 95052-8059  
Tel: (408) 553-7271  
Fax: (408) 983-1006

# APPLICATION & PRODUCT NOTES

Free Literature to Help Solve Your Test and Measurement Problems

## Application Notes

Application Notes help you use Hewlett-Packard instruments to solve measurement problems. They are application-specific and typically include generic techniques with families of products. Product Notes describe measurement techniques that are product-specific and often show extensions of performance outside normal lab environments, including performance data and explanations of specifications.

### How to Order

To obtain a free copy of any of the Application or Product Notes listed on the following pages, just call your Hewlett-Packard Customer Information Center. Within the United States call 1 (800) 452-4844 and provide the Hewlett-Packard customer service representative with the literature number for each application note requested. Please limit your orders to 5 Application Notes per phone call. There are many Customer Information Centers outside of the United States (see page 2 for current listing). If there is not a Customer Information Center near you contact your local sales office for Application and Product Note requests. See page 684 for the current listing of HP T&M sales offices.

### A to D Converters

Interconnecting Two or More HP 5180A Waveform Recorders to Obtain Multiple Input Channels .....	5952-7670
Rotation Simulation and ADC Testing with Synthesized Signals Using the HP 3324A .....	5952-9693
Using the Direct Memory Access Capability of the HP 5180A Waveform Recorder with the HP 9826 Desktop Computer .....	5952-7710

### Air Navigation

Characterizing Barker Coded Modulation in Radar Systems /5952-8004	
Characterizing Chirp Coded Modulation in Radar Systems .....	5952-8005
Frequency & Phase Profiling Simplified .....	5952-8023
Modulation Domain Techniques for Measuring Complex Radar Signals .....	5952-8003

### Amplifiers

Accurate Mixer/Amplifier Compression Measurement Using the HP 8901A Modulation Analyzer .....	5952-8245
Amplifier Measurements Using the Scalar Network Analyzer .....	5954-1599
Complete S-Parameter and Distortion Measurement for Wide Band Video Amplifiers .....	5950-2932
Extending Dynamic Range of Scalar Transmission Measurements Using the HP 8757A, 8756A, or 8755C Scalar Network Analyzers .....	5953-8882
Noise Figure Measurement Accuracy .....	5952-3706
S-Parameter Techniques for Faster, More Accurate Network Design .....	5952-1130
Testing Magnetic Disk Read Circuits Using the HP 4195A .....	5950-2398

### Amplitude Modulation

Using the HP 5180A Waveform Recorder with a Spectrum Analyzer for New Time-Domain Measurement Capability .....	5952-7635
--	-----------

### Audio

Analyzing Phase-Locked Loop Capture & Tracking .....	5952-8007
Analyzing Phase-Locked Loop Transients in the Modulation Domain .....	5952-8001
High Speed Measurement of Semiconductor Devices from Sub-PA to 1A .....	5950-2930

The Fundamentals of Signal Analysis .....	5952-8898
---	-----------

### Automatic Test Systems

Appliance Testing .....	5954-9654
Battery Testing .....	5952-4191
Communications Cable Testing .....	5954-9638
DA&C/CAT-Environmental/Autoclave .....	5954-9637
Jet Engine Testing .....	5954-9646
Large Product Characterization .....	5954-9648
Low Phase Noise Applications of the HP 8662A and 8663A Synthesized Signal Generators .....	5953-8435
Machine Monitoring and Control .....	5954-9650
Materials Development .....	5954-9642
Microwave Switching from SPDT to Full Access Matrix .....	5953-6466
Millimeter Measurements Using the HP 3048A Phase Noise Measurement System .....	5951-6749
Missile System Testing .....	5954-9649
Non-contact Measurements with Laser Interferometer .....	5952-8022
Novel Combinations of Microwave Switches and Step Attenuators .....	5954-8892
Peak Deviation and Center Frequency Measurements for CT2 and DECT Radios .....	5091-1434E
Power Component Testing .....	5952-4192
Power Supply Testing .....	5952-4190
Practical Test System Signal Switching .....	5953-6962
Pulsed Carrier Phase Noise Measurements Using the HP 3048A Phase Noise Measurement System .....	5951-6743
Reducing Fixture-induced Test Failures .....	5952-7805
Troubleshooting Microprocessor-based Systems Using the HP 5180A Waveform Recording (Using the HP 9825 Controller) .....	5952-7634
Using the HP 3497A to Control Industrial Wastewater Treatment .....	5953-6921

### Battery Charging/Discharging/Testing

Battery Charging/Discharging .....	5952-4033
Battery Testing .....	5954-9644
Battery Testing .....	5952-4191

### Bode Plot

Analyzing Phase-Locked Loop Transients in the Modulation Domain .....	5952-8001
---	-----------

### Cable

Advanced TDR Techniques for Use with the HP 54120 Family of Digitizing Oscilloscopes .....	5952-1141
Communications Cable Testing .....	5954-9638
Direct Radio Frequency Impedance Measurements .....	5952-8853
Measuring Electrical Length Delay of Cables .....	5952-7326
Measuring the Characteristic Impedance of Balanced Cables .....	5950-2918
TDR Fundamentals for Use with HP 54120T Digitizing Oscilloscope and TDR .....	5954-2681
TDR Techniques for Differential Systems for Use with the HP 54120 Family of Digitizing Oscilloscopes .....	5952-0154

### Calibration

Applications and Operation of the 8901A Modulation Analyzer .....	5952-8208
Calibrated Signal Simulation System Utilizing I/Q Modulation Techniques .....	5952-6471

Characterization of Frequency Agile Sources with the HP 5371A Frequency and Time Interval Analyzer .....5952-7924

High Frequency Swept Measurements .....5952-9200

Jitter and Wander Analysis in Digital Communication with the HP 5371A Frequency and Time Interval Analyzer .....5952-7925

Microwave Switching from SPDT to Full Access Matrix .....5953-6466

Noise Figure Measurement Accuracy .....5952-3706

Signal Generator .....5952-2019

Signal Generator Spectral Purity .....5952-2019

Simulating Sensor Signals .....5952-9651

**Coaxial Systems**

Advanced TDR Techniques for Use with the HP 54120 Family of Digitizing Oscilloscopes .....5952-1141

Clock Rate Independent Jitter Measurements for Digital Communications Systems .....5952-7999

Configuration of a Two-tone Sweeping Generator .....5952-9316

Extending Dynamic Range of Scalar Transmission Measurements Using the HP 8757A, 8756A, or 8755C Scalar Network Analyzers .....5953-8882

High Frequency Swept Measurements .....5952-9200

Microwave Switching from SPDT to Full Access Matrix .....5953-6466

Novel Combinations of Microwave Switches and Step Attenuators for Programming Applications .....5953-8892

Principles of Microwave Connector Care .....5954-1566

Protocol Converters: Linking HP Graphics Peripherals with IBM Networks/Systems .....5953-9874

TDR Fundamentals for Use with HP 54120T Digitizing Oscilloscope and TDR .....5954-2681

**Communications**

A Guide to Microwave Upconversion .....5953-2342

Analyzing Phase-Locked Loop Capture & Tracking .....5952-8007

Analyzing Phase-Locked Loop Transients in the Modulation Domain .....5952-8001

Characterization of Frequency Agile Sources with the HP 5371A Frequency and Time Interval Analyzer .....5952-7924

Clock Rate Independent Jitter Measurements for Digital Communications Systems .....5952-7999

Communications Cable Testing .....5954-9638

Examine Channel Switching Characteristics of Cellular Radios .....5091-0394E

Examine GMSK Modulation in GSM and PCN Mobile Communications Systems .....5091-1433E

Exceptionally Complex Signal Simulation for Multi-Signal Environments in Radar EW Test .....5952-3702

Fast Characterization of Pulse Width Encoded Data .....5091-0389E

Frequency & Phase Profiling Simplified .....5952-8023

Fundamental of Time & Frequency Standards .....5952-7870

High Speed Timing Acquisition and Statistical Jitter Analysis Using the HP 5370B Universal Time Interval Counter .....5952-7908

Histograms Simplify Analysis of Random Jitter .....5091-0393

How to Measure Return Loss of Connectorized Optical Components .....5952-9661

Integrated Services Digital Network (ISDN) 23B&D Primary Access Rate (PAR) and Digital Multiplexed Interface (DMI) Testing Using the HP 3787B and Protocol Analyzer .....5959-8215

Jitter and Wander Analysis in Digital Communication with the HP 5371A Frequency and Time Interval Analyzer .....5952-7925

Large Product Characterization .....5954-9648

Low Phase Noise Applications of the HP 8662A and 8663A Synthesized Signal Generators .....5954-8435

Measurements Applications for Digital Microwave Radio .....5954-6365

Measuring Digital Microwave Radio M-Curves Signatures ...5959-7859

Microwave Switching from SPDT to Full Access Matrix .....953-6466

Millimeter Measurements Using the HP 3048A Phase Noise Measurement System .....5951-6749

Missile System Testing .....5954-9649

Peak Deviation and Center Frequency Measurements for CT2 and DECT Radios .....5091-1434E

Pulsed Carrier Phase Noise Measurements Using the HP 3048A Phase Noise Measurement System .....5951-6743

Quick Identification of Periodic Jitter Sources .....5091-0388E

Signal Generator .....952-2019

Signal Generator Spectral Purity .....5952-2019

Simple Analysis of Frequency Modulation .....5091-0390E

Standard and CRC-4 Frame Testing .....5091-2070

Testing n x64 kb/s Services .....5091-2069E

Testing Sub-rate Data Services .....5091-2072E

The Benefits of P/AR .....5952-4996D

Time Keeping and Frequency Calibration .....5952-7874

Voltage Controlled Oscillators Characterization Using the HP 5350B, 5351B, 5352B CW Microwave Frequency Counter ...5952-7852

**Component Test**

17 Fixtures, Test Sets and Accessories for the HP 8751A .....5091-1985E

3 Steps to Better Baseband, IF and RF Design with the HP 8751A .....5091-2348E

A Guideline for Designing External DC Current Bias Circuits for the HP 4192A, HP 4194A, HP 4274A, HP 4275A, HP 4276A, and HP 4277A .....5950-2912

A Test Set-Up for Characterizing High-Speed Logic Devices ...5953-6329

Accurate Mixer/Amplifier Compression Measurement Using the 8901A Modulation Analyzer .....5952-8245

Advanced Filter Evaluation and Limit Testing with the HP 4195A .....5950-2933

Amplifier Measurements Using the Scalar Network Analyzer 5954-1599

Analysis of Semiconductor Capacitance Characteristics Using the HP 4280A 1 MHz C Meter/C-V Plotter .....5953-6939

Analyzing Phase-Locked Loop Capture & Tracking .....5952-8007

Analyzing Phase-Locked Loop Transients in the Modulation Domain .....5952-8001

Automated Characterization of Microwave Voltage Controlled Oscillators Using the HP 5361A Pulse CW Microwave Counter 5952-7988

Biasing Three-Terminal Devices for Test .....5952-4193

Characteristic Impedance Measurement of PC Board Circuit Patterns Using the HP 4194A Impedance/Gain Phase Analyzer .....5950-2908

Characterization of Frequency Agile Sources with the HP 5371A Frequency and Time Interval Analyzer .....5952-7924

Complete S-Parameter and Distortion Measurement for Wide Band Video Amplifiers .....5950-2932

Constant Current Measurements Using the HP 4194A .....5950-2923

Crosstalk and Impedance Measurements of PC Board Patterns — HP 4194A Application Information .....5950-7863

Designer's Guide to RCL Measurement .....5952-4800

Dielectric Constant Measurement of Solid Materials .....5950-2390

Direct Radio Frequency Impedance Measurements .....5952-8853

Disk Drive Servo-Track Writing with Laser Interferometers ...5952-7984

# APPLICATION & PRODUCT NOTES

## Free Literature to Help Solve Your Test and Measurement Problems (cont'd)

### Application Notes

#### Component Test (cont'd)

Dynamic Component Test Using Vector Modulation Analysis	5954-6367
Efficient Evaluation of LISNs and Voltage Probes for EMI Tests Using the HP 4194A	5950-2922
Examine Channel Switching Characteristics of Cellular Radios	5091-0394E
Filter Test for Production and Incoming Inspection—HP 4194A	
Impedance Gain-Phase Analyzer	5952-7887
Fundamentals of RF and Microwave Noise Figure Measurement	5952-8255
High Accuracy and Fast RF Inductor Testing	5091-1596E
How to Measure Return Loss of Connectorized Optical Components	5952-9661
HP-IB Programming Hints for the HP 4194A	5950-2929
Impedance Characterization of High Q Devices from 1 MHz to 1000 MHz with 1 Hz Resolution	5952-8872
Impedance Characterization of Resonators Using the HP 4194A Impedance/Gain-Phase Analyzer	5950-2882
Impedance Measurement for Incoming Inspection — HP 4284A Application Information	5950-2952
Impedance Testing Using Scanner	5950-2975
Improve Electric Product Quality and Performance with HP Precision LCR Meters	5090-0233
Input/Output Impedance and Reflection Coefficient Measurements Using the HP 4194A	5950-2925
Magnetic Head Measurement Using a Constant Test Current — HP 4284A Application Information	5950-2951
Measurement of Capacitance Characteristics of Liquid Crystal Cell	5950-2994
Measuring Cable Parameters	5950-2399
Measuring the Characteristic Impedance of Balanced Cables	5950-2918
Measuring the Dielectric Constant of Solid Materials — HP 4194A Impedance/Gain-Phase Analyzer	5950-2935
Microwave Switching from SPDT to Full Access Matrix	5953-6466
Multi-frequency C-V Measurements and Doping Profile Analysis of Semiconductors Using the HP 4194A	5950-2919
Multi-frequency C-V Measurements of Semiconductors — HP 4284A Application Information	5950-2953
Negative Impedance Measurements of Crystal Oscillators Using the HP 4194A	5950-2924
Network, Spectrum, and Impedance Evaluation of IF Circuits — HP 4195A Network/Spectrum Analyzer	5950-2931
Noise Figure Measurement Accuracy	5952-3706
Parametric Analysis for Electronic Components and Circuit Evaluation Using the HP 4194A	5950-2856
Power Component Testing	5952-4192
Practical Design and Evaluation of High Frequency Circuits	5953-6910
Pre-Trigger Simplifies VCO Step Response Measurements	5952-7998
Role of DC Parametric Test in High Speed Digital and Microwave Component Manufacturing	5952-7936
Rotation Simulation and ADC Testing with Synthesized Signals Using the HP 3324A	5952-9693
Semiconductor Measurements with the HP 4140B Picoammeter/DC Voltage Source	5952-8840
Simplified Analysis of Phase-Locked Loop Capture and Tracking Range	5091-0391E
Static Head Testing for Disc Drives—HP 4194A Application Information	5952-7871
Tantalum Capacitor Measurement—HP 4284A Application Information	5950-2950

Testing Magnetic Disk Read Circuits Using the HP 4195A	5950-2398
The Fundamentals of Electronic Frequency Counters	5952-7506
Ultra Low Current Semiconductor DC Parameter Measurement System Using HP 4140B	5952-8873
Using Impedance Measurement to Evaluate Electronic Components and Materials—HP 4284A Application Information	5950-2949
VCO Step Response Analysis Made Easy	5091-0387E
Voltage Controlled Oscillators Characterization Using the HP 5350B, 5351B, 5352B CW Microwave Frequency Counter	5952-7852
Wide Range DC Current Biased Inductance Measurement	5950-2367

#### Computer Crystals

Direct Radio Frequency Impedance Measurements	5952-8853
Fundamentals of Quartz Oscillators	5952-7507
Impedance Characterization of High Q Devices from 1 MHz to 1000 MHz with 1 Hz Resolution	5952-8872
Practical Design and Evaluation of High Frequency Circuits	5953-6910
The Fundamentals of Electronic Frequency Counters	5952-7506

#### CRT Displays

Analyzing Phase-Locked Loop Capture & Tracking	5952-8007
--	-----------

#### Crystal Filters

Analyzing Phase-Locked Loop Transients in the Modulation Domain	5952-8001
Efficient Evaluation of LISNs and Voltage Probes for EMI Tests Using the HP 4194A	5950-2922
Filter Test for Production and Incoming Inspection — HP 4194A Impedance Gain-Phase Analyzer	5952-7887
Negative Impedance Measurements of Crystal Oscillators Using the HP 4194A	5950-2924

#### Crystals

Analyzing Phase-Locked Loop Capture & Tracking	5952-8007
--	-----------

#### Data Acquisition

Air Frame Testing	5954-9655
Appliance Testing	5954-9654
Battery Testing	5954-9644
Bed of Nails Test: DA Converter	5954-9659
Canning Process Characterization	5954-9640
Communications Cable Testing	5954-9638
DA&C/CAT-Environmental/Autoclave	5954-9637
Data Acquisition and Computer Aided Test Application Notes for 32 Industries in Series	5954-9631
Environment Test Electrical Sub-assembly	5954-9662
Environmental Test Auto Radio	5954-9660
Explosion Testing	5954-9641
Facility Management	5954-9647
Fan Testing	5954-9632
High Speed Timing Acquisition and Statistical Jitter Analysis Using the HP 5370B Universal Time Interval Counter	5952-7908
Internal Combustion Engine Testing	5954-9636
Jet Engine Controller Testing	5954-9646
Jet Engine Testing	5954-9646
Large Product Characterization	5954-9648
Machine Monitoring and Control	5954-9650
Materials Development	5954-9642

Microwave Switching from SPDT to Full Access Matrix .....5953-6466

Missile System Testing .....5954-9649

Non-contact Measurements with Laser Interferometer .....5952-8022

On-Road Vehicle Testing .....5954-9656

Paper Process Control .....5954-9652

Pharmaceutical Process Control .....5954-9651

Pilot Plant Monitoring .....5954-9645

Plating Line Control.....5954-9643

Practical Strain Gauge Measurements .....5952-8880

Practical Temperature Measurements .....5952-8801

Pumping Station Control .....5954-9657

Receiver Testing .....5954-9658

Residential Facility Monitoring .....5954-9639

Role of DC Parametric Test in High Speed Digital and Microwave Component Manufacturing .....5952-7936

Rolling Mill .....5954-9653

Sonar System Testing .....5954-9661

Sub-Micro Positioning with the HP 5527A Laser Position Transducer System.....5952-7942

Using the HP 3497A to Control Industrial Wastewater Treatment .....5953-6921

Vehicle Body Testing .....5954-9633

Waste Water Treatment .....5954-9634

**DC**

Ultra Low Current Semiconductor DC Parameter Measurement System Using HP 4140B .....5952-8873

**Delay Lines**

The Fundamentals of Electronic Frequency Counters .....5952-7506

**Digital Communications**

Analyzing Phase-Locked Loop Capture & Tracking .....5952-8007

Analyzing Phase-Locked Loop Transients in the Modulation Domain.....5952-8001

Characterization of Frequency Agile Sources with the HP 5371A Frequency and Time Interval Analyzer .....5952-7924

Clock Rate Independent Jitter Measurements for Digital Communications Systems .....5952-7999

Digital Radio Theory and Measurements .....5952-2857

Examine Channel Switching Characteristics of Cellular Radios .....5091-0394E

Examine GMSK Modulation in GSM and PCN Mobile Communications Systems.....5091-1433E

Fast Characterization of Pulse Width Encoded Data .....5091-0389E

Fundamental of Time & Frequency Standards .....5952-7870

High Speed Timing Acquisition and Statistical Jitter Analysis Using the HP 5370B Universal Time Interval Counter .....5952-7908

Histograms Simplify Analysis of Random Jitter .....5091-0393E

Integrated Services Digital Network (ISDN) 23B&D Primary Access Rate (PAR) and Digital Multiplexed Interface (DMI) Testing Using the HP 3787B and Protocol Analyzer .....5959-8215

Jitter and Wander Analysis in Digital Communication with the HP 5371A Frequency and Time Interval Analyzer .....5952-7925

Measurements Applications for Digital Microwave Radio .....5954-6365

Measuring Demodulator Image Rejection Using the HP 8980A Vector Analyzer .....5952-3703

Measuring Microwave Radio Antenna Return Loss Using the HP 11758T Digital Radio Test System .....5959-8749

Peak Deviation and Center Frequency Measurements for CT2 and DECT Radios .....5091-1434E

Quick Identification of Periodic Jitter Sources .....5091-0388E

Simple Analysis of Frequency Modulation .....5091-0390E

Simulating Sensor Signals .....5952-6471

Standard and CRC-4 Frame Testing .....5091-2070E

Testing n x64 kb/s Services .....5091-2069E

Testing Sub-rate Data Services .....5091-2072E

The Fundamentals of Electronic Frequency Counters .....5952-7506

Time Keeping and Frequency Calibration .....5952-7874

**Digital Data Transmission**

Analyzing Phase-Locked Loop Capture & Tracking .....5952-8007

Analyzing Phase-Locked Loop Transients in the Modulation Domain.....5952-8001

Characterizing Transient Timing Errors in Disk and Tape Drives.....5952-8000

Clock Rate Independent Jitter Measurements for Digital Communications Systems .....5952-7999

High Speed Timing Acquisition and Statistical Jitter Analysis Using the HP 5370B Universal Time Interval Counter .....5952-7908

Integrated Services Digital Network (ISDN) 23B&D Primary Access Rate (PAR) and Digital Multiplexed Interface (DMI) Testing Using the HP 3787B and Protocol Analyzer .....5959-8215

Jitter and Wander Analysis in Digital Communication with the HP 5371A Frequency and Time Interval Analyzer .....5952-7925

Measuring Digital Microwave Radio M-Curves Signatures ...5959-7859

Standard and CRC-4 Frame Testing .....5091-2070E

Testing n x64 kb/s Services .....5091-2069E

Testing Sub-rate Data Services .....5091-2072E

The Benefits of P/AR .....5952-4996D

**Digital Troubleshooting**

Advanced TDR Techniques for Use with the HP 54120 Family of Digitizing Oscilloscopes .....5952-1141

Analyzing Phase-Locked Loop Transients in the Modulation Domain.....5952-8001

Clock Rate Independent Jitter Measurements for Digital Communications Systems .....5952-7999

Determining Digital Circuit Timing Tolerance to Optimize Adjustment or Design .....5952-7488

Guidelines for Signature Analysis: Understanding the Signature Measurement .....5952-7595

Improving Time Domain Network Analysis Measurements ...5954-2682

Integrated Services Digital Network (ISDN) 23B&D Primary Access Rate (PAR) and Digital Multiplexed Interface (DMI) Testing Using the HP 3787B and Protocol Analyzer .....5959-8215

Jitter and Wander Analysis in Digital Communication with the HP 5371A Frequency and Time Interval Analyzer .....5952-7925

New Techniques of Digital Troubleshooting .....5952-7558

Reducing Fixture-induced Test Failures .....5952-7805

TDR Fundamentals for Use with HP 54120T Digitizing Oscilloscope and TDR.....5954-2681

TDR Techniques for Differential Systems for Use with the HP 54120 Family of Digitizing Oscilloscopes .....5952-0154

Testing n x64 kb/s Services .....5091-2069E

Testing Sub-rate Data Services .....5091-2072E

The Fundamentals of Electronic Frequency Counters .....5952-7506

Troubleshooting with Composite Signatures .....5952-7684

# APPLICATION & PRODUCT NOTES

## Free Literature to Help Solve Your Test and Measurement Problems (cont'd)

### Application Notes

#### Digital Troubleshooting (cont'd)

Understanding Your Test Fixture ..... 5953-6951

#### Distortion

Non-contact Measurements with Laser Interferometer ..... 5952-8022

Electrical Warfare (EW)

Single Shot Frequency Profiling of Chirped Radars

Made Easy ..... 5091-0392E

Frequency & Phase Profiling Simplified ..... 5952-8023

Analyzing Phase-Locked Loop Capture & Tracking ..... 5952-8007

#### EMI

Automatic CISPR EMI Testing for Conducted Emissions ..... 5954-2724

#### Emulation, Microprocessors

Analyzing Phase-Locked Loop Capture & Tracking ..... 5952-8007

#### Error Analysis

Direct Radio Frequency Impedance Measurements ..... 5952-8853

Fundamentals of RF and Microwave Power Measurement ..... 5952-8178

High Frequency Swept Measurements ..... 5952-9200

High Speed Timing Acquisition and Statistical Jitter Analysis  
Using the HP 5370B Universal Time Interval Counter ..... 5952-7908

Integrated Services Digital Network (ISDN) 23B&D Primary  
Access Rate (PAR) and Digital Multiplexed Interface (DMI)

Testing Using the HP 3787B and Protocol Analyzer ..... 5959-8215

Jitter and Wander Analysis in Digital Communication with the  
HP 5371A Frequency and Time Interval Analyzer ..... 5952-7925

#### Fourier Analysis

Accessing the HP 3582A Memory with HP-IB ..... 5952-8804

Analyzing Phase-Locked Loop Capture & Tracking ..... 5952-8007

Dynamic Signal Analyzer Applications ..... 5091-2777E

Fundamentals of the z-Domain and Mixed

Analog/Digital Measurements ..... 5952-7250

Monitoring of Ultrasonic Wire Bonding Machines ..... 5952-2143

Non-contact Measurements with Laser Interferometer ..... 5952-8022

The Fundamentals of Modal Testing ..... 5954-7957

The Fundamentals of Signal Analysis ..... 5952-8898

#### Frequency

Analyzing Phase-Locked Loop Transients in the  
Modulation Domain ..... 5952-8001

Applications and Operation of the 8901A Modulation Analyzer ..... 5952-8208

Characterizing Barker Coded Modulation in Radar Systems ..... 5952-8004

Characterizing Chirp Coded Modulation in Radar Systems ..... 5952-8005

Clock Rate Independent Jitter Measurements for Digital  
Communications Systems ..... 5952-7999

Examine GMSK Modulation in GSM and PCN Mobile  
Communications Systems ..... 5091-1433E

Frequency & Phase Profiling Simplified ..... 5952-8023

Frequency Profile Using an HP 5345A Time Synthesizer ..... 5952-7530

Frequency Profile Using an HP 5370A Universal Time Interval  
Counter and an HP 5359A Time Synthesizer ..... 5952-7549

Fundamentals of Microwave Frequency Counters ..... 5952-7484

Fundamentals of Quartz Oscillators ..... 5952-7507

Measuring Fractional Frequency Standard Deviation (Sigma)  
Versus Averaging Time (TAU) ..... 5952-7344

Modulation Domain Techniques for Measuring Complex  
Radar Signals ..... 5952-8003

Radar System Characterization and Testing Using the  
HP 5345A/55A 56A,B,C,D Counter ..... 5952-7892

Signal Generator ..... 5952-2019

Signal Generator Spectral Purity ..... 5952-2019

Simple Analysis of Frequency Modulation ..... 5091-0390E

Simplified Analysis of Phase-Locked Loop Capture and  
Tracking Range ..... 5091-0391E

Single Shot Frequency Profiling of Chirped Radars  
Made Easy ..... 5091-0392E

The Fundamentals of Electronic Frequency Counters ..... 5952-7506

The Fundamentals of Modal Testing ..... 5954-7957

Understanding Frequency Counter Specifications ..... 5952-7522

VCO Step Response Analysis Made Easy ..... 5091-0387E

Voltage Controlled Oscillators Characterization Using the  
HP 5350B, 5351B, 5352B CW Microwave Frequency Counter ..... 5952-7852

#### Frequency Modulation

Analyzing Phase-Locked Loop Capture & Tracking ..... 5952-8007

Analyzing Phase-Locked Loop Transients in the  
Modulation Domain ..... 5952-8001

Characterizing Barker Coded Modulation in Radar Systems ..... 5952-8004

Characterizing Chirp Coded Modulation in Radar Systems ..... 5952-8005

Clock Rate Independent Jitter Measurements for Digital  
Communications Systems ..... 5952-7999

Examine GMSK Modulation in GSM and PCN Mobile  
Communications Systems ..... 5091-1433E

Frequency & Phase Profiling Simplified ..... 5952-8023

Modulation Domain Techniques for Measuring Complex  
Radar Signals ..... 5952-8003

Peak Deviation and Center Frequency Measurements for  
CT2 and DECT Radios ..... 5091-1434E

Simple Analysis of Frequency Modulation ..... 5091-0390E

The Fundamentals of Electronic Frequency Counters ..... 5952-7506

#### Frequency Multiplication

Analyzing Phase-Locked Loop Capture & Tracking ..... 5952-8007

External Frequency Doubling of the HP 8662A Synthesized  
Signal Generator ..... 5952-8217

The Fundamentals of Electronic Frequency Counters ..... 5952-7506

#### Frequency Stability (Short-Term)

Analyzing Phase-Locked Loop Capture & Tracking ..... 5952-8007

Clock Rate Independent Jitter Measurements for Digital  
Communications Systems ..... 5952-7999

Fundamental of Time & Frequency Standards ..... 5952-7870

High Speed Timing Acquisition and Statistical Jitter Analysis  
Using the HP 5370B Universal Time Interval Counter ..... 5952-7908

Histograms Simplify Analysis of Random Jitter ..... 5091-0393E

Measuring Fractional Frequency Standard Deviation (Sigma)  
Versus Averaging Time (TAU) ..... 5952-7344

Quick Identification of Periodic Jitter Sources ..... 5091-0388E

Signal Generator ..... 5952-2019

Signal Generator Spectral Purity ..... 5952-2019

The Fundamentals of Electronic Frequency Counters ..... 5952-7506

Time Keeping and Frequency Calibration ..... 5952-7874

Voltage Controlled Oscillators Characterization Using the  
HP 5350B, 5351B, 5352B CW Microwave Frequency Counter ..... 5952-7852

**Frequency Standards**

Analyzing Phase-Locked Loop Capture & Tracking .....5952-8007  
 Analyzing Phase-Locked Loop Transients in the Modulation Domain.....5952-8001  
 Clock Rate Independent Jitter Measurements for Digital Communications Systems .....5952-7999  
 Contribution of HP Clocks to the DII I's International Atomic Time Scale .....5952-7855  
 Fundamental of Time & Frequency Standards .....5952-7870  
 Measuring Fractional Frequency Standard Deviation (Sigma) Versus Averaging Time (TAU) .....5952-7344  
 Time Keeping and Frequency Calibration .....5952-7874

**Frequency Synthesizers**

Analyzing Phase-Locked Loop Capture & Tracking .....5952-8007  
 Analyzing Phase-Locked Loop Transients in the Modulation Domain.....5952-8001  
 Examine Channel Switching Characteristics of Cellular Radios .....5091-0394E  
 External Frequency Doubling of the 8662A Synthesized Signal Generator.....5952-8217  
 Low Leakage Paper .....5952-2789  
 Low Phase Noise Applications of the HP 8662A and 8663A Synthesized Signal Generators .....5953-8435  
 Millimeter Measurements Using the HP 3048A Phase Noise Measurement System.....5951-6749  
 Pre-Trigger Simplifies VCO Step Response Measurements ...5952-7998  
 Pulsed Carrier Phase Noise Measurements Using the HP 3048A Phase Noise Measurement System .....5951-6743  
 Signal Generator.....5952-2019  
 Signal Generator Spectral Purity .....5952-2019  
 Simplified Analysis of Phase-Locked Loop Capture and Tracking Range.....5091-0391E  
 Spectral Purity of Microwave Signal Sources .....5954-8349  
 VCO Step Response Analysis Made Easy.....5091-0387E

**Graphics**

Line Quality and Accuracy—What They Are and How to Achieve Them .....5954-7132  
 Protocol Converters: Linking HP Graphics Peripherals with IBM Networks/Systems .....5953-9874  
 Using Your HP Plotter with an IBM Mainframe—For ISSCO Software Users .....5954-7174  
 Using your Plotter or Printer with Peripheral Sharing Devices, Buffers, and Spoolers .....5959-9713  
 Using Your Plotter with an IBM Mainframe—For SAS/Graph Software Users .....5954-8748

**Group Delay**

Floating Measurements and Guarding .....5952-2153  
 Frequency & Phase Profiling Simplified.....5952-8023  
 The Fundamentals of Electronic Frequency Counters .....5952-7506

**IC Testing**

A Test Set-Up for Characterizing High-Speed Logic Devices ...5953-6329  
 High Speed Timing Acquisition and Statistical Jitter Analysis Using the HP 5370B Universal Time Interval Counter .....5952-7908  
 Histograms Simplify Analysis of Random Jitter .....5091-0393E  
 Monitoring of Ultrasonic Wire Bonding Machines .....5952-2143  
 Quick Identification of Periodic Jitter Sources .....5091-0388E

Role of DC Parametric Test in High Speed Digital and Microwave Component Manufacturing .....5952-7936

**Insertion Gain/Loss**

Advanced Filter Evaluation and Limit Testing with the HP 4195A .....5950-2933  
 High Frequency Swept Measurements .....5952-9200  
 How to Measure Return Loss of Connectorized Optical Components .....5952-9661  
 Network, Spectrum, and Impedance Evaluation of IF Circuits—HP 4195A Network/Spectrum Analyzer .....5950-2931  
 Noise Figure Measurement Accuracy .....5952-3706  
 S-Parameter Design .....5952-1087

**Interface Bus (HP-IB)**

Fast Characterization of Pulse Width Encoded Data .....5091-0389E  
 Microwave Switching from SPDT to Full Access Matrix .....5953-6466

**Jitter**

Analyzing Phase-Locked Loop Capture & Tracking .....5952-8007  
 Analyzing Phase-Locked Loop Transients in the Modulation Domain.....5952-8001  
 Clock Rate Independent Jitter Measurements for Digital Communications Systems .....5952-7999  
 High Speed Timing Acquisition and Statistical Jitter Analysis Using the HP 5370B Universal Time Interval Counter .....5952-7908  
 Histograms Simplify Analysis of Random Jitter .....5091-0393E  
 Jitter and Wander Analysis in Digital Communication with the HP 5371A Frequency and Time Interval Analyzer .....5952-7925  
 Quick Identification of Periodic Jitter Sources .....5091-0388E  
 Signal Generator.....5952-2019  
 Signal Generator Spectral Purity .....5952-2019  
 The Fundamentals of Electronic Frequency Counters .....5952-7506  
 Time Domain Characterization of Magnetic Disc Drives .....5952-7928

**Logic, Logic Test**

A Test Set-Up for Characterizing High-Speed Logic Devices ...5953-6329  
 Determining Digital Circuit Timing Tolerance to Optimize Adjustment or Design .....5952-7488  
 Guidelines for Signature Analysis: Understanding the Signature Measurement.....5952-7595  
 New Techniques of Digital Troubleshooting .....5952-7558  
 Troubleshooting with Composite Signatures .....5952-7684

**Loop Gain**

Analyzing Phase-Locked Loop Capture & Tracking .....5952-8007  
 Analyzing Phase-Locked Loop Transients in the Modulation Domain.....5952-8001  
 Control System Development Using Dynamic Signal Analyzers 5953-5136  
 Fundamentals of the z-Domain and Mixed Analog/Digital Measurements .....5952-7250

**Manufacturing**

Monitoring of Ultrasonic Wire Bonding Machines .....5952-2143

**Measurement and Control**

Analyzing Phase-Locked Loop Capture & Tracking .....5952-8007  
 Control System Development Using Dynamic Signal Analyzers 5953-5136  
 Direct Characterization of Motion Control Systems .....5091-0386E

# APPLICATION & PRODUCT NOTES

## Free Literature to Help Solve Your Test and Measurement Problems (cont'd)

### Application Notes

#### Measurement and Control (cont'd)

PC Control of the HP 35665A Dynamic Signal Analyzer via HP-IB and C .....	5091-2767E
Simplified Motor Spin-up Analysis .....	5091-0385E

#### Microprocessors

Guidelines for Signature Analysis: Understanding the Signature Measurement .....	5952-7595
Histograms Simplify Analysis of Random Jitter .....	5091-0393E
Troubleshooting Microprocessor-based Systems Using the HP 5180A Waveform Recording (Using the HP 9825 Controller) .....	5952-7634
Troubleshooting with Composite Signatures .....	5952-7684

#### Microwave Component

Dynamic Component Test Using Vector Modulation Analysis .....	5954-6367
Examine Channel Switching Characteristics of Cellular Radios .....	5091-0394E
Voltage Controlled Oscillators Characterization Using the HP 5350B, 5351B, 5352B CW Microwave Frequency Counter .....	5952-7852

#### Microwave Component Measurement

Amplifier Measurements Using the Scalar Network Analyzer .....	5954-1599
--	-----------

#### Microwave Modulation

Analyzing Phase-Locked Loop Capture & Tracking .....	5952-8007
Examine GMSK Modulation in GSM and PCN Mobile Communications Systems .....	5091-1433E
Frequency & Phase Profiling Simplified .....	5952-8023
Peak Deviation and Center Frequency Measurements for CT2 and DECT Radios .....	5091-1434E

#### Microwave Signal Sources

Voltage Controlled Oscillators Characterization Using the HP 5350B, 5351B, 5352B CW Microwave Frequency Counter .....	5952-7852
---	-----------

#### Microwaves

Accurate Mixer/Amplifier Compression Measurement Using the 8901A Modulation Analyzer .....	5952-8245
Advanced TDR Techniques for Use with the HP 54120 Family of Digitizing Oscilloscopes .....	5952-1141
Applications and Operation of the 8901A Modulation Analyzer .....	5952-8208
Automated Characterization of Microwave Voltage Controlled Oscillators Using the HP 5361A Pulse CW Microwave Counter .....	5952-7988
Automatic Frequency Profiling of Chirped Radar Pulses Using the HP 5361A Pulse CW Microwave Counter .....	5952-7987
Characterization of Frequency Agile Sources with the HP 5371A Frequency and Time Interval Analyzer .....	5952-7924
Characterizing Barker Coded Modulation in Radar Systems .....	5952-8004
Characterizing Chirp Coded Modulation in Radar Systems .....	5952-8005
Configuration of a Two-tone Sweeping Generator .....	5952-9316
Digital Radio Testing with British Telecom .....	5952-1959
Direct Radio Frequency Impedance Measurements .....	5952-8853
Extending Dynamic Range of Scalar Transmission Measurements Using the HP 8757A, 8756A, or 8755C .....	
Scalar Network Analyzers .....	5953-8882
Frequency & Phase Profiling Simplified .....	5952-8023
Frequency Profiling Without a Pulse Generator .....	5952-7991
Fundamentals of Microwave Frequency Counters .....	5952-7484
Fundamentals of RF and Microwave Power Measurement .....	5952-8178
High Frequency Swept Measurements .....	5952-9200
Improving Time Domain Network Analysis Measurements .....	5954-2682

Microwave Switching from SPDT to Full Access Matrix .....	5953-6466
Modulation Domain Techniques for Measuring Complex Radar Signals .....	5952-8003
Practical Strain Gauge Measurements .....	5952-8880
Pre-Trigger Simplifies VCO Step Response Measurements .....	5952-7998
Principles of Microwave Connector Care .....	5954-1566
Quality Gains in Telecom Australia's Digital Microwave Network .....	5954-9572
Radar System Characterization and Testing Using the HP 5345A/55A 56A,B,C,D Counter .....	5952-7892
Role of DC Parametric Test in High Speed Digital and Microwave Component Manufacturing .....	5952-7936
S-Parameter Design .....	5952-1087
Single Shot Frequency Profiling of Chirped Radars Made Easy .....	5091-0392E
Spectral Purity of Microwave Signal Sources .....	5954-8349
Spectrum Analysis AM and FM .....	5954-9130
TDR Fundamentals for Use with HP 54120T Digitizing Oscilloscope and TDR .....	5954-2681
TDR Techniques for Differential Systems for Use with the HP 54120 Family of Digitizing Oscilloscopes .....	5952-0154
The Fundamentals of Electronic Frequency Counters .....	5952-7506
User's Guide to the 5355/56 Automatic Frequency Converter .....	5952-7541
Voltage Controlled Oscillators Characterization Using the HP 5350B, 5351B, 5352B CW Microwave Frequency Counter .....	5952-7852

#### Mixers

Accurate Mixer/Amplifier Compression Measurement Using the HP 8901A Modulation Analyzer .....	5952-8245
Configuration of a Two-tone Sweeping Generator .....	5952-9316
Network, Spectrum, and Impedance Evaluation of IF Circuits—HP 4195A Network/Spectrum Analyzer .....	5950-2931

#### Modulation

A Calibrated Signal Simulation System Utilizing I Q Modulation Techniques .....	5952-6471
Accurate Mixer/Amplifier Compression Measurement Using the 8901A Modulation Analyzer .....	5952-8245
Analyzing Phase-Locked Loop Capture & Tracking .....	5952-8007
Analyzing Phase-Locked Loop Transients in the Modulation Domain .....	5952-8001
Applications and Operation of the HP8901A Modulation Analyzer .....	5952-8208
Characterization of Frequency Agile Sources with the HP 5371A Frequency and Time Interval Analyzer .....	5952-7924
Characterizing Barker Coded Modulation in Radar Systems .....	5952-8004
Characterizing Chirp Coded Modulation in Radar Systems .....	5952-8005
Clock Rate Independent Jitter Measurements for Digital Communications Systems .....	5952-7999
Coherent Pulsed Tests of Radar and EW Systems .....	5954-6366
Digital Radio Testing with British Telecom .....	5952-1959
Digital Radio Theory and Measurements .....	5952-2857
Dynamic Component Test Using Vector Modulation Analysis .....	5954-6367
Examine GMSK Modulation in GSM and PCN Mobile Communications Systems .....	5091-1433E
Exceptionally Complex Signal Simulation for Multi-Signal Environments in Radar EW Test .....	5952-3702
Fast Characterization of Pulse Width Encoded Data .....	5091-0389E
Frequency & Phase Profiling Simplified .....	5952-8023



Frequency Profiling Without a Pulse Generator .....5952-7991

Jitter and Wander Analysis in Digital Communication with the HP 5371A Frequency and Time Interval Analyzer .....5952-7925

Lightwave Measurements with the HP 71400 Lightwave Signal Analyzer .....5954-9137

Measurements Applications for Digital Microwave Radio .....5954-6365

Measuring Demodulator Image Rejection Using the HP 8980A Vector Analyzer .....5952-3703

Measuring Microwave Radio Antenna Return Loss Using the HP 11758T Digital Radio Test System .....5959-8749

Modulation Domain Techniques for Measuring Complex Radar Signals .....5952-8003

Peak Deviation and Center Frequency Measurements for CT2 and DECT Radios .....5091-1434E

Practical Strain Gauge Measurements .....5952-8880

Quality Gains in Telecom Australia's Digital Microwave Network .....5954-9572

Radar System Characterization and Testing Using the HP 5345A/55A 56A,B,C,D Counter .....5952-7892

Simple Analysis of Frequency Modulation .....5091-0390E

Simulating Sensor Signals .....5952-6471

Spectrum Analysis AM and FM .....5954-9130

Voltage Controlled Oscillators Characterization Using the HP 5350B, 5351B, 5352B CW Microwave Frequency Counter ...5952-7852

**Network Analysis**

17 Fixtures, Test Sets and Accessories for the HP 8751A .....5091-1985E

3 Steps to Better Baseband, IF and RF Design with the HP 8751A .....5091-2348E

Advanced Filter Evaluation and Limit Testing with the HP 4195A .....5950-2933

Advanced TDR Techniques for Use with the HP 54120 Family of Digitizing Oscilloscopes .....5952-1141

Amplifier Measurements Using the Scalar Network Analyzer 5954-1599

Analyzing Phase-Locked Loop Capture & Tracking .....5952-8007

Complete S-Parameter and Distortion Measurement for Wide Band Video Amplifiers .....5950-2932

Conform by Design .....5091-2190E

Designing Impedance Matching Networks with the HP 8751A .....5091-1560E

Direct Radio Frequency Impedance Measurements .....5952-8853

Dynamic Component Test Using Vector Modulation Analysis 5954-6367

Frame Relay .....5091-2009E

Fundamentals of the z-Domain and Mixed Analog/Digital Measurements .....5952-7250

Improving Time Domain Network Analysis Measurements ...5954-2682

ISDN Testing .....5091-2141E

Microwave Switching from SPDT to Full Access Matrix .....5953-6466

Network, Spectrum, and Impedance Evaluation of IF Circuits—HP 4195A Network/Spectrum Analyzer .....5950-2931

PC Control of the HP 35665A Dynamic Signal Analyzer via HP-IB and C .....5091-2767E

PT500 Protocol Tester .....5091-0927E

PT502 Tester .....5091-2010E

S-Parameter Design .....5952-1087

TDR Fundamentals for Use with HP 54120T Digitizing Oscilloscope and TDR .....5954-2681

TDR Techniques for Differential Systems for Use with the HP 54120 Family of Digitizing Oscilloscopes .....5952-0154

Testing Magnetic Disk Read Circuits Using the HP 4195A .....5950-2398

Testing Switching Power Supplies Using the HP 4194A .....5950-2977

The Fundamentals of Signal Analysis .....5952-8898

**Noise**

Analyzing Phase-Locked Loop Capture & Tracking .....5952-8007

Better Noise Measurement with the HP 3588A and 3589A ...5091-2496E

Clock Rate Independent Jitter Measurements for Digital Communications Systems .....5952-7999

Digital Radio Testing with British Telecom .....5952-1959

Fast Characterization of Pulse Width Encoded Data .....5091-0389E

Histograms Simplify Analysis of Random Jitter .....5091-0393E

Noise Figure Measurement Accuracy .....5952-3706

Quality Gains in Telecom Australia's Digital Microwave Network .....5954-9572

Quick Identification of Periodic Jitter Sources .....5091-0388E

Signal Generator .....5952-2019

Signal Generator Spectral Purity .....5952-2019

Time Domain Characterization of Magnetic Disc Drives .....5952-7928

**Non-Linear Systems Measurements**

Analyzing Phase-Locked Loop Capture & Tracking .....5952-8007

Role of DC Parametric Test in High Speed Digital and Microwave Component Manufacturing .....5952-7936

**Oscillators**

Applications and Operation of the 8901A Modulation Analyzer 5952-8208

Automated Characterization of Microwave Voltage Controlled Oscillators Using the HP 5361A Pulse CW Microwave Counter 5952-7988

Better Noise Measurement with the HP 3588A and 3589A ...5091-2496E

Examine Channel Switching Characteristics of Cellular Radios .....5091-0394E

Fundamental of Time & Frequency Standards .....5952-7870

Fundamentals of Quartz Oscillators .....5952-7507

Measuring Fractional Frequency Standard Deviation (Sigma) Versus Averaging Time (TAU) .....5952-7344

Measuring Warm-Up Characteristics and Aging Rates of Oscillators .....5952-7327

Network, Spectrum, and Impedance Evaluation of IF Circuits—HP 4195A Network/Spectrum Analyzer .....5950-2931

Pre-Trigger Simplifies VCO Step Response Measurements ...5952-7998

Spectral Purity of Microwave Signal Sources .....5954-8349

The Fundamentals of Electronic Frequency Counters .....5952-7506

Time Keeping and Frequency Calibration .....5952-7874

Using the HP 5180A Waveform Recorder to Measure Microwave VCO Settling Time and Post Tuning Drift .....5952-7636

VCO Step Response Analysis Made Easy .....5091-0387E

**Oscilloscopes**

Advanced TDR Techniques for Use with the HP 54120 Family of Digitizing Oscilloscopes .....5952-1141

Bandwidth and Sampling Rate in Digitizing Oscilloscopes .....5954-2631

Extending the Frequency Range and Increasing the Effective Sample Rate of the HP 5180A Waveform Recorder .....5952-7637

Interconnecting Two or More HP 5180A Waveform Recorders to Obtain Multiple Input Channels .....5952-7670

# APPLICATION & PRODUCT NOTES

## Free Literature to Help Solve Your Test and Measurement Problems (cont'd)

### Application Notes

#### Oscilloscopes (cont'd)

TDR Fundamentals for Use with HP 54120T Digitizing Oscilloscope and TDR .....	5954-2681
TDR Techniques for Differential Systems for Use with the HP 54120 Family of Digitizing Oscilloscopes .....	5952-0154
Using the Direct Memory Access Capability of the HP 5180A Waveform Recorder with the HP 9826 Desktop Computer .....	5952-7710
Voltage and Time Resolution in Digitizing Oscilloscopes .....	5954-2652

#### Phase Linearity

Analyzing Phase-Locked Loop Capture & Tracking .....	5952-8007
Analyzing Phase-Locked Loop Transients in the Modulation Domain .....	5952-8001
Characterizing Barker Coded Modulation in Radar Systems .....	5952-8004
Characterizing Chirp Coded Modulation in Radar Systems .....	5952-8005
Complete S-Parameter and Distortion Measurement for Wide Band Video Amplifiers .....	5950-2932
Direct Radio Frequency Impedance Measurements .....	5952-8853
Frequency & Phase Profiling Simplified .....	5952-8023
The Fundamentals of Electronic Frequency Counters .....	5952-7506
Voltage Controlled Oscillators Characterization Using the HP 5350B, 5351B, 5352B CW Microwave Frequency Counter .....	5952-7852

#### Phase Modulation

Analyzing Phase-Locked Loop Capture & Tracking .....	5952-8007
Analyzing Phase-Locked Loop Transients in the Modulation Domain .....	5952-8001
Characterizing Barker Coded Modulation in Radar Systems .....	5952-8004
Characterizing Chirp Coded Modulation in Radar Systems .....	5952-8005
Clock Rate Independent Jitter Measurements for Digital Communications Systems .....	5952-7999
Digital Phase Modulation (PSK) 86601A & Wideband FM .....	5952-8143
Frequency & Phase Profiling Simplified .....	5952-8023
Single Shot BPSK Signal Characterization .....	5952-8002
The Fundamentals of Electronic Frequency Counters .....	5952-7506

#### Phase Shift

Analyzing Phase-Locked Loop Capture & Tracking .....	5952-8007
Analyzing Phase-Locked Loop Transients in the Modulation Domain .....	5952-8001
Characterizing Barker Coded Modulation in Radar Systems .....	5952-8004
Characterizing Chirp Coded Modulation in Radar Systems .....	5952-8005
Clock Rate Independent Jitter Measurements for Digital Communications Systems .....	5952-7999
Frequency & Phase Profiling Simplified .....	5952-8023
Jitter and Wander Analysis in Digital Communication with the HP 5371A Frequency and Time Interval Analyzer .....	5952-7925
The Fundamentals of Electronic Frequency Counters .....	5952-7506

#### Phase Stability

Analyzing Phase-Locked Loop Capture & Tracking .....	5952-8007
Analyzing Phase-Locked Loop Transients in the Modulation Domain .....	5952-8001
Characterizing Barker Coded Modulation in Radar Systems .....	5952-8004
Characterizing Chirp Coded Modulation in Radar Systems .....	5952-8005
Clock Rate Independent Jitter Measurements for Digital Communications Systems .....	5952-7999
Communications Cable Testing .....	5954-9638
Fundamental of Time & Frequency Standards .....	5952-7870

Histograms Simplify Analysis of Random Jitter .....	5091-0393E
Jitter and Wander Analysis in Digital Communication with the HP 5371A Frequency and Time Interval Analyzer .....	5952-7925
Quick Identification of Periodic Jitter Sources .....	5091-0388E
Time Keeping and Frequency Calibration .....	5952-7874

#### Power Measurement

Battery Testing .....	5952-4191
Biasing Three-Terminal Devices for Test .....	5952-4193
Fundamentals of RF and Microwave Power Measurement .....	5952-8178
High Frequency Swept Measurements .....	5952-9200
Power Component Testing .....	5952-4192
Power Supply Testing .....	5952-4190

#### Power Supplies

Battery Charging/Discharging .....	5952-4033
Biasing Three-Terminal Devices for Test .....	5952-4193
DC Power Supply Handbook .....	5952-4020
Power Supply Testing .....	5952-4190
Power Supply Testing with the HP 5180A Waveform Recorder .....	5952-7647

#### Process Control

Canning Process Characterization .....	5954-9640
DA&C/CAT-Environmental/Autoclave .....	5954-9637
Machine Monitoring and Control .....	5954-9650
Materials Development .....	5954-9642
Paper Process Control .....	5954-9652
Pharmaceutical Process Control .....	5954-9651
Pilot Plant Monitoring .....	5954-9645
Plating Line Control .....	5954-9643
Role of DC Parametric Test in High Speed Digital and Microwave Component Manufacturing .....	5952-7936
Rolling Mill .....	5954-9653
Using the HP 3497A to Control Industrial Wastewater Treatment .....	5953-6921
Wastewater Treatment .....	5954-9634

#### Production Test

Accessing the HP 3582A Memory with HP-IB .....	5952-8804
Appliance Testing .....	5954-9654
Battery Testing .....	5954-9644
Battery Testing .....	5952-4191
DA&C/CAT-Environmental/Autoclave .....	5954-9637
Disk Drive Servo-Track Writing with Laser Interferometers .....	5952-7984
Fan Testing .....	5954-9632
Internal Combustion Engine Testing .....	5954-9636
Jet Engine Controller Testing .....	5954-9635
Jet Engine Testing .....	5954-9646
Large Product Characterization .....	5954-9648
Missile System Testing .....	5954-9649
Monitoring of Ultrasonic Wire Bonding Machines .....	5952-2143
Parametric Analysis for Electronic Components and Circuit Evaluation Using the HP 4194A .....	5950-2856
Peak Deviation and Center Frequency Measurements for CT2 and DECT Radios .....	5091-1434E
Power Component Testing .....	5952-4192
Power Supply Testing .....	5952-4190

Practical Strain Gauge Measurements .....	5952-8880
Reducing Fixture-induced Test Failures .....	5952-7805
Role of DC Parametric Test in High Speed Digital and Microwave Component Manufacturing .....	5952-7936
The Fundamentals of Electronic Frequency Counters .....	5952-7506
Understanding Your Test Fixture .....	5953-6951

### Protocol Analysis

Conform by Design .....	5091-2190E
Frame Relay .....	5091-2009E
ISDN Application Note .....	5952-3698
ISDN Testing .....	5091-2141E
Keeping Your Big Blue Network in the Pink .....	5952-5131
LAN Application Note .....	5952-3678
PT500 Protocol Tester .....	5091-0927E
PT502 Tester .....	5091-2010E
The Care and Feeding of Your X-25 Network .....	5952-5132

### Pulse Measurements

Analyzing Phase-Locked Loop Transients in the Modulation Domain .....	5952-8001
Automatic Frequency Profiling of Chirped Radar Pulses Using the HP 5361A Pulse CW Microwave Counter .....	5952-7987
Characterization of Frequency Agile Sources with the HP 5371A Frequency and Time Interval Analyzer .....	5952-7924
Characterizing Barker Coded Modulation in Radar Systems .....	5952-8004
Characterizing Chirp Coded Modulation in Radar Systems .....	5952-8005
Characterizing Transient Timing Errors in Disk and Tape Drives .....	5952-8000
Dynamic Component Test Using Vector Modulation Analysis .....	5954-6367
Frequency & Phase Profiling Simplified .....	5952-8023
Frequency Profiling Without a Pulse Generator .....	5952-7991
Modulation Domain Techniques for Measuring Complex Radar Signals .....	5952-8003
Radar System Characterization and Testing Using the HP 5345A/55A 56A,B,C,D Counter .....	5952-7892
Recording Sonar and Other Signals Using the HP 5180A's Toggle Mode .....	5952-7641
Single Shot Frequency Profiling of Chirped Radars Made Easy .....	5091-0392E
The Fundamentals of Electronic Frequency Counters .....	5952-7506
Using the 5180A Waveform Recorder to Evaluate Floppy Disc Media and Drive Electronics .....	5952-7701

### Pulse Modulation

Analyzing Phase-Locked Loop Transients in the Modulation Domain .....	5952-8001
Characterizing Barker Coded Modulation in Radar Systems .....	5952-8004
Characterizing Chirp Coded Modulation in Radar Systems .....	5952-8005
Characterizing Transient Timing Errors in Disk and Tape Drives .....	5952-8000
Frequency & Phase Profiling Simplified .....	5952-8023
Modulation Domain Techniques for Measuring Complex Radar Signals .....	5952-8003
Recording Sonar and Other Signals Using the HP 5180A's Toggle Mode .....	5952-7641
Single Shot Frequency Profiling of Chirped Radars Made Easy .....	5091-0392E

### Radar

Amplifier Measurements Using the Scalar Network Analyzer .....	5954-1599
Analyzing Phase-Locked Loop Capture & Tracking .....	5952-8007
Analyzing Phase-Locked Loop Transients in the Modulation Domain .....	5952-8001
Automatic Frequency Profiling of Chirped Radar Pulses Using the HP 5361A Pulse CW Microwave Counter .....	5952-7987
Characterization of Frequency Agile Sources with the HP 5371A Frequency and Time Interval Analyzer .....	5952-7924
Characterizing Barker Coded Modulation in Radar Systems .....	5952-8004
Characterizing Chirp Coded Modulation in Radar Systems .....	5952-8005
Coherent Pulsed Tests of Radar and EW Systems .....	5954-6366
Dynamic Component Test Using Vector Modulation Analysis .....	5954-6367
Exceptionally Complex Signal Simulation for Multi-Signal Environments in Radar EW Test .....	5952-3702
Frequency & Phase Profiling Simplified .....	5952-8023
Frequency Profiling Without a Pulse Generator .....	5952-7991
Low Phase Noise Applications of the HP 8662A and 8663A Synthesized Signal Generators .....	5953-8435
Microwave Switching from SPDT to Full Access Matrix .....	5953-6466
Millimeter Measurements Using the HP 3048A Phase Noise Measurement System .....	5951-6749
Modulation Domain Techniques for Measuring Complex Radar Signals .....	5952-8003
Pre-Trigger Simplifies VCO Step Response Measurements .....	5952-7998
Pulsed Carrier Phase Noise Measurements Using the HP 3048A Phase Noise Measurement System .....	5951-6743
Radar System Characterization and Testing Using the HP 5345A/55A 56A,B,C,D Counter .....	5952-7892
Single Shot BPSK Signal Characterization .....	5952-8002
Single Shot Frequency Profiling of Chirped Radars Made Easy .....	5091-0392E
The Fundamentals of Electronic Frequency Counters .....	5952-7506
User's Guide to the 5355/56 Automatic Frequency Converter .....	5952-7541
Voltage Controlled Oscillators Characterization Using the HP 5350B, 5351B, 5352B CW Microwave Frequency Counter .....	5952-7852

### Receivers

Configuration of a Two-tone Sweeping Generator .....	5952-9316
Exceptionally Complex Signal Simulation for Multi-Signal Environments in Radar EW Test .....	5952-3702
Frequency & Phase Profiling Simplified .....	5952-8023
Measurements Applications for Digital Microwave Radio .....	5954-6365
Measuring Demodulator Image Rejection Using the HP 8980A Vector Analyzer .....	5952-3703
Measuring Microwave Radio Antenna Return Loss Using the HP 11758T Digital Radio Test System .....	5959-8749
Signal Generator .....	5952-2019
Signal Generator Spectral Purity .....	5952-2019

### Reflectometers

Advanced TDR Techniques for Use with the HP 54120 Family of Digitizing Oscilloscopes .....	5952-1141
High Frequency Swept Measurements .....	5952-9200
How to Measure Return Loss of Connectorized Optical Components .....	5952-9661
Improving Time Domain Network Analysis Measurements .....	5954-2682
S-Parameter Design .....	5952-1087

# APPLICATION & PRODUCT NOTES

## Free Literature to Help Solve Your Test and Measurement Problems (cont'd)

### Application Notes

#### Reflectometers (cont'd)

TDR Fundamentals for Use with HP 54120T Digitizing Oscilloscope and TDR .....	5954-2681
TDR Techniques for Differential Systems for Use with the HP 54120 Family of Digitizing Oscilloscopes .....	5952-0154

#### Remote Control

Using the HP 3497A to Control Industrial Wastewater Treatment .....	5953-6921
---	-----------

#### RFI Testing

Automatic CISPR EMI Testing for Conducted Emissions .....	5954-2724
Automatic MIL-STD EMI Testing Using the HP 85864A/B EMI Measurement Software .....	5954-2705

#### S-Parameters

Complete S-Parameter and Distortion Measurement for Wide Band Video Amplifiers .....	5950-2932
Designing Impedance Matching Networks with the HP 8751A .....	5091-1560E
S-Parameter Design .....	5952-1087
S-Parameter Techniques for Faster, More Accurate Network Design .....	5952-1130

#### Semiconductors

Analysis of Semiconductor Capacitance Characteristics Using the HP 4280A 1 MHz C Meter/C-V Plotter .....	5953-6939
Analyzing Phase-Locked Loop Capture & Tracking .....	5952-8007
Automation of Semiconductor Parameter Analysis .....	5952-7765
High Speed Measurement of Semiconductor Devices from Sub-PA to 1A .....	5950-2930
Monitoring of Ultrasonic Wire Bonding Machines .....	5952-2143
Multi-frequency C-V Measurements of Semiconductors—HP 4284A Application Information .....	5950-2953
Role of DC Parametric Test in High Speed Digital and Microwave Component Manufacturing .....	5952-7936
Semiconductor Measurements with the HP 4140B Picoammeter/DC Voltage Source .....	5952-8840
Sub-Micro Positioning with the HP 5527A Laser Position Transducer System .....	5952-7942
Techniques and Applications for High Throughput and Stable Characterization .....	5950-2954
Ultra Low Current Semiconductor DCP parameter Measurement System Using HP 4140B .....	5952-8873

#### Signal Analysis

Troubleshooting with Composite Signatures .....	5952-7684
---	-----------

#### Signal Sources

Analyzing Phase-Locked Loop Capture & Tracking .....	5952-8007
Configuration of a Two-tone Sweeping Generator .....	5952-9316
Exceptionally Complex Signal Simulation for Multi-Signal Environments in Radar EW Test .....	5952-3702
External Frequency Doubling of the 8662A Synthesized Signal Generator .....	5952-8217
Low Leakage Paper .....	5952-2789
Low Phase Noise Applications of the HP 8662A and 8663A Synthesized Signal Generators .....	5953-8435
Millimeter Measurements Using the HP 3048A Phase Noise Measurement System .....	5951-6749
Obtaining Leveled Pulse-Modulated Microwave Signals from the HP 8672A .....	5952-8251

Obtaining Millihertz Resolution from the HP 8671A and 8672A Pre-Trigger Simplifies VCO Step Response Measurements .....	5952-8184
Pulsed Carrier Phase Noise Measurements Using the HP 3048A Phase Noise Measurement System .....	5951-6743

#### Slotted Line Measurements

Frequency & Phase Profiling Simplified .....	5952-8023
--	-----------

#### Smith Chart

Designing Impedance Matching Networks with the HP 8751A .....	5091-1560E
S-Parameter Design .....	5952-1087
S-Parameter Techniques for Faster, More Accurate Network Design .....	5952-1130

#### Spectrum Analysis

Accessing the HP 3582A Memory with HP-IB .....	5952-8804
Analyzing Phase-Locked Loop Capture & Tracking .....	5952-8007
Better Noise Measurement with the HP 3588A and 3589A .....	5091-2496E
Complete S-Parameter and Distortion Measurement for Wide Band Video Amplifiers .....	5950-2932
Frequency & Phase Profiling Simplified .....	5952-8023
Network, Spectrum, and Impedance Evaluation of IF Circuits—HP 4195A Network/Spectrum Analyzer .....	5950-2931
Noise Sideband with the HP 8568 .....	5952-9350
Non-contact Measurements with Laser Interferometer .....	5952-8022
Recording Sonar and Other Signals Using the HP 5180A's Toggle Mode .....	5952-7641
Spectrum Analysis AM and FM .....	5954-9130
Spectrum Analyzer Basics .....	5952-0292
Testing Magnetic Disk Read Circuits Using the HP 4195A .....	5950-2398
The Fundamentals of Modal Testing .....	5954-7957
The Fundamentals of Signal Analysis .....	5952-8898
Using the HP 5180A Waveform Recorder with a Spectrum Analyzer for New Time-Domain Measurement Capability .....	5952-7635

#### Stripline Device Measurements

Advanced TDR Techniques for Use with the HP 54120 Family of Digitizing Oscilloscopes .....	5952-1141
TDR Fundamentals for Use with HP 54120T Digitizing Oscilloscope and TDR .....	5954-2681
TDR Techniques for Differential Systems for Use with the HP 54120 Family of Digitizing Oscilloscopes .....	5952-0154

#### Swept-Frequency Measurements

Amplifier Measurements Using the Scalar Network Analyzer .....	5954-1599
Analyzing Phase-Locked Loop Capture & Tracking .....	5952-8007
Analyzing Phase-Locked Loop Transients in the Modulation Domain .....	5952-8001
Better Noise Measurement with the HP 3588A and 3589A .....	5091-2496E
Characterizing Barker Coded Modulation in Radar Systems .....	5952-8004
Characterizing Chirp Coded Modulation in Radar Systems .....	5952-8005
Configuration of a Two-tone Sweeping Generator .....	5952-9316
Control System Development Using Dynamic Signal Analyzers .....	5953-5136
Extending Dynamic Range of Scalar Transmission Measurements Using the HP 8757A, 8756A, or 8755C Scalar Network Analyzers .....	5953-8882
Frequency & Phase Profiling Simplified .....	5952-8023
How to Measure Return Loss of Connectorized Optical Components .....	5952-9661

Low Phase Noise Applications of the HP 8662A and 8663A Synthesized Signal Generators .....5953-8435

Millimeter Measurements Using the HP 3048A Phase Noise Measurement System.....5951-6749

Modulation Domain Techniques for Measuring Complex Radar Signals .....5952-8003

Pulsed Carrier Phase Noise Measurements Using the HP 3048A Phase Noise Measurement System .....5951-6743

Single Shot Frequency Profiling of Chirped Radars Made Easy .....5091-0392E

Spectral Purity of Microwave Signal Sources .....5954-8349

Spectrum Analyzer Basics .....5952-1213

**Switching**

Analyzing Phase-Locked Loop Capture & Tracking .....5952-8007

Analyzing Phase-Locked Loop Transients in the Modulation Domain.....5952-8001

Data Acquisition and Computer Aided Test Application Notes for 32 Industries in Series .....5954-9631

Missile System Testing .....5954-9649

Novel Combinations of Microwave Switches and Step Attenuators for Programming Applications .....5953-8892

Practical Test System Signal Switching .....5953-6962

Pre-Trigger Simplifies VCO Step Response Measurements ...5952-7998

**Synthesizers**

Analyzing Phase-Locked Loop Capture & Tracking .....5952-8007

Exceptionally Complex Signal Simulation for Multi-Signal Environments in Radar EW Test .....5952-3702

Signal Generator Spectral Purity .....5952-2019

**Synthesizers/Signal Generators**

Analyzing Phase-Locked Loop Transients in the Modulation Domain.....5952-8001

External Frequency Doubling of the 8662A Synthesized Signal Generator.....5952-8217

Low Phase Noise Applications of the HP 8662A and 8663A Synthesized Signal Generators .....5953-8435

Millimeter Measurements Using the HP 3048A Phase Noise Measurement System.....5951-6749

Pulsed Carrier Phase Noise Measurements Using the HP 3048A Phase Noise Measurement System .....5951-6743

Rotation Simulation and ADC Testing with Synthesized Signals Using the HP 3324A.....5952-9693

Signal Generator.....5952-2019

Spectral Purity of Microwave Signal Sources .....5954-8349

**Tape Recording**

Characterizing Transient Timing Errors in Disk and Tape Drives.....5952-8000

Fast Characterization of Pulse Width Encoded Data .....5091-0389E

Histograms Simplify Analysis of Random Jitter .....5091-0393E

Time Domain Characterization of Magnetic Disc Drives .....5952-7928

**Telecommunications**

Amplifier Measurements Using the Scalar Network Analyzer 5954-1599

Analyzing Phase-Locked Loop Capture & Tracking .....5952-8007

Analyzing Phase-Locked Loop Transients in the Modulation Domain.....5952-8001

Clock Rate Independent Jitter Measurements for Digital Communications Systems .....5952-7999

Conform by Design .....5091-2190E

Digital Radio Testing with British Telecom .....5952-1959

Digital Radio Theory and Measurements .....5952-2857

Examine GMSK Modulation in GSM and PCN Mobile Communications Systems .....5091-1433E

Exceptionally Complex Signal Simulation for Multi-Signal Environments in Radar EW Test .....5952-3702

Frame Relay .....5091-2009E

Fundamental of Time & Frequency Standards .....5952-7870

High Speed Measurement of Semiconductor Devices from Sub-PA to 1A .....5950-2930

High Speed Timing Acquisition and Statistical Jitter Analysis Using the HP 5370B Universal Time Interval Counter .....5952-7908

How to Measure Return Loss of Connectorized Optical Components .....5952-9661

Integrated Services Digital Network (ISDN) 23B&D Primary Access Rate (PAR) and Digital Multiplexed Interface (DMI) Testing Using the HP 3787B and Protocol Analyzer .....5959-8215

ISDN Testing.....5091-2141E

Measurements Applications for Digital Microwave Radio .....5954-6365

Measuring Microwave Radio Antenna Return Loss Using the HP 11758T Digital Radio Test System .....5959-8749

Peak Deviation and Center Frequency Measurements for CT2 and DECT Radios .....5091-1434E

PT500 Protocol Tester .....5091-0927E

PT502 Tester .....5091-2010E

Quality Gains in Telecom Australia's Digital Microwave Network .....5954-9572

Simple Analysis of Frequency Modulation .....5091-0390E

Standard and CRC-4 Frame Testing .....5091-2070E

Testing n x64 kb/s Services .....5091-2069E

Testing Sub-rate Data Services .....5091-2072E

The Benefits of P/AR .....5952-4996D

The Fundamentals of Electronic Frequency Counters .....5952-7506

Time Keeping and Frequency Calibration .....5952-7874

Television Analyzing Phase-Locked Loop Capture & Tracking 5952-8007

**Temperature Measurement**

Appliance Testing .....5954-9654

Battery Testing .....5954-9644

Communications Cable Testing .....5954-9638

Explosion Testing .....5954-9641

Facility Management .....5954-9647

Internal Combustion Engine Testing .....5954-9636

Jet Engine Controller Testing .....5954-9635

Jet Engine Testing .....5954-9646

Large Product Characterization .....5954-9648

Machine Monitoring and Control .....5954-9650

Materials Development .....5954-9642

Missile System Testing .....5954-9649

Paper Process Control .....5954-9652

Pharmaceutical Process Control .....5954-9651

Pilot Plant Monitoring .....5954-9645

Practical Temperature Measurements .....5952-8801

Residential Facility Monitoring .....5954-9639

Rolling Mill .....5954-9653

Wastewater Treatment .....5954-9634

# APPLICATION & PRODUCT NOTES

## Free Literature to Help Solve Your Test and Measurement Problems (cont'd)

### Application Notes

#### Throughput Analysis

High Speed Timing Acquisition and Statistical Jitter Analysis Using the HP 5370B Universal Time Interval Counter .....	5952-7908
Machine Tool Calibration Using the HP 5528A Laser Measurement System .....	5952-7708

#### Time, Time Keeping

Analyzing Phase-Locked Loop Capture & Tracking .....	5952-8007
Fundamental of Time & Frequency Standards .....	5952-7870
Time Keeping and Frequency Calibration .....	5952-7874

#### Time-Interval

Analyzing Phase-Locked Loop Capture & Tracking .....	5952-8007
Analyzing Phase-Locked Loop Transients in the Modulation Domain .....	5952-8001
Characterizing Transient Timing Errors in Disk and Tape Drives .....	5952-8000
Clock Rate Independent Jitter Measurements for Digital Communications Systems .....	5952-7999
Determining Digital Circuit Timing Tolerance to Optimize Adjustment or Design .....	5952-7488
Fast Characterization of Pulse Width Encoded Data .....	5091-0389E
Fundamental of Time & Frequency Standards .....	5952-7870
Histograms Simplify Analysis of Random Jitter .....	5091-0393E
Modulation Domain Techniques for Measuring Complex Radar Signals .....	5952-8003
Quick Identification of Periodic Jitter Sources .....	5091-0388E
Radar System Characterization and Testing Using the HP 5345A/55A 56A,B,C,D Counter .....	5952-7892
The Fundamentals of Electronic Frequency Counters .....	5952-7506
Time Domain Characterization of Magnetic Disc Drives .....	5952-7928
Time Interval Measurement Using an Electronic Counter .....	5952-7561
Time Keeping and Frequency Calibration .....	5952-7874
Understanding Frequency Counter Specifications .....	5952-7522
Using the HP 5180A Waveform Recorder with a Spectrum Analyzer for New Time-Domain Measurement Capability .....	5952-7635

#### Timing Analysis

Analyzing Phase-Locked Loop Capture & Tracking .....	5952-8007
Analyzing Phase-Locked Loop Transients in the Modulation Domain .....	5952-8001
Characterizing Barker Coded Modulation in Radar Systems .....	5952-8004
Characterizing Chirp Coded Modulation in Radar Systems .....	5952-8005
Characterizing Transient Timing Errors in Disk and Tape Drives .....	5952-8000
Clock Rate Independent Jitter Measurements for Digital Communications Systems .....	5952-7999
Fast Characterization of Pulse Width Encoded Data .....	5091-0389E
Histograms Simplify Analysis of Random Jitter .....	5091-0393E
Modulation Domain Techniques for Measuring Complex Radar Signals .....	5952-8003
Pre-Trigger Simplifies VCO Step Response Measurements .....	5952-7998
Quick Identification of Periodic Jitter Sources .....	5091-0388E
The Fundamentals of Electronic Frequency Counters .....	5952-7506
Using the HP 5180A Waveform Recorder with a Spectrum Analyzer for New Time-Domain Measurement Capability .....	5952-7635

#### Transforms

Dynamic Signal Analyzer Applications .....	5091-2777E
--	------------

#### Fundamentals of the z-Domain and Mixed

Analog/Digital Measurements .....	5952-7250
The Fundamentals of Signal Analysis .....	5952-8898

#### Transistor Parameters

Automation of Semiconductor Parameter Analysis .....	5952-7765
Biasing Three-Terminal Devices for Test .....	5952-4193
Power Component Testing .....	5952-4192
Role of DC Parametric Test in High Speed Digital and Microwave Component Manufacturing .....	5952-7936
S-Parameter Techniques for Faster, More Accurate Network Design .....	5952-1130

#### Transmission Lines

Advanced TDR Techniques for Use with the HP 54120 Family of Digitizing Oscilloscopes .....	5952-1141
Improving Time Domain Network Analysis Measurements .....	5954-2682
Standard and CRC-4 Frame Testing .....	5091-2070E
TDR Fundamentals for Use with HP 54120T Digitizing Oscilloscope and TDR .....	5954-2681
TDR Techniques for Differential Systems for Use with the HP 54120 Family of Digitizing Oscilloscopes .....	5952-0154
Testing n x64 kb/s Services .....	5091-2069E
Testing Sub-rate Data Services .....	5091-2072E

#### Troubleshooting

Guidelines for Signature Analysis: Understanding the Signature Measurement .....	5952-7595
New Techniques of Digital Troubleshooting .....	5952-7558
Principles of Microwave Connector Care .....	5954-1566
Standard and CRC-4 Frame Testing .....	5091-2070E
Testing n x64 kb/s Services .....	5091-2069E
Testing Sub-rate Data Services .....	5091-2072E
Troubleshooting with Composite Signatures .....	5952-7684

#### Vector Measurements

Digital Radio Testing with British Telecom .....	5952-1959
Quality Gains in Telecom Australia's Digital Microwave Network .....	5954-9572
S-Parameter Design .....	5952-1087
S-Parameter Techniques for Faster, More Accurate Network Design .....	5952-1130

#### Voltage

Applications and Operation of the HP 8901A Modulation Analyzer .....	5952-8208
---	-----------

#### Voltage-Controlled Oscillators

Analyzing Phase-Locked Loop Capture & Tracking .....	5952-8007
Measuring Warm-Up Characteristics and Aging Rates of Oscillators .....	5952-7327
Pre-Trigger Simplifies VCO Step Response Measurements .....	5952-7998
Simplified Analysis of Phase-Locked Loop Capture and Tracking Range .....	5091-0391E
Using the HP 5180A Waveform Recorder to Measure Microwave VCO Settling Time and Post Tuning Drift .....	5952-7636
VCO Step Response Analysis Made Easy .....	5091-0387E

#### Wave Analysis

Bandwidth and Sampling Rate in Digitizing Oscilloscopes .....	5954-2631
Voltage and Time Resolution in Digitizing Oscilloscopes .....	5954-2652

## Product Notes

- 3065-4/5954-8670 — Fixturing for High-speed Integrity on the HP 3065 at Combinational Test System
- 3235-1/5953-7023 — Programming Guide to the HP 3235A Switch Test Unit and the HP System 1000
- 3314A-1/5953-5102 — Operator's Introduction to the HP 3314A
- 3325A-1/5953-5120 — Application Guide for the HP 3325A Synthesizer/Function Generator
- 3325B-1/5954-7987 — Remote Operation of the HP 3325B via RS232
- 3326A-1/5953-5134 — Introductory Operating Guide to the HP 3326A Two-channel Synthesizer
- 3458-1/5953-7058 — Optimizing Throughput and Reading Rate
- 3458-2/5953-7059 — High Resolution Digitizing with the HP 3458A
- 3458-3/5953-7060 — Electronic Calibration of the HP 3458A
- 34800-1/5953-7028 — Programming and Demo Guide to the HP FTM/300 Functional Test Manager Software Package
- 3488A-1/5953-6959 — Using the HP 3488A
- 3561A/5953-5186 — HP-IB Programming Commands for the HP 3561A Dynamic Signal Analyzer
- 3562A-1/5954-7973 — Operator's Introduction to the HP 3562A Dynamic Signal Analyzer
- 3562A-3/5952-0001 — Curvefitting in the HP 3562A-3
- 3562A-4/5952-8070 — Measuring Nonlinear Distortion Using the HP 3562A DSA
- 3562A/3563A-1/5952-1437 — Measuring of the Open-Loop Frequency of the Phase-Locked Loop/3562A
- 3563A-1/5952-7251 — Z-Domain Curve Fitting in the HP 3563A Analyzer
- 35651A-1/5954-7965 — Introduction to Programming the HP 35650 Series Hardware
- 35660A-4/5952-2145 — Controlling an HP-IB with the HP 35660A
- 35665A-1/5091-1678 — Controlling an HP-IB System with the HP 35665A Dynamic Signal Analyzer
- 3577A-1/5953-5119 — User's Guide to the HP 3577A Network Analyzer
- 3577B-1/5952-2141 — Measuring the Open-Loop Frequency Response of the Phase-Locked Loop
- 3588A-1/5952-2145 — Measurement Automation with HP Instrument BASIC
- 3708A-5/5954-9555 — Testing Satellite Systems
- 3785A-1/5953-5429 — Practical Jitter Measurements
- 3850A-7/5952-9344 — Noise Figure Measurement
- 3852-1/5953-7011 — Programming Guide to the HP 3852A and the HP 1000
- 3852-3/5953-7043 — Multitasking on the HP 3852A Data Acquisition Control Unit
- 44458A/5953-7022 — Using HP DACQ/300 Programming Guide
- 4935A-1/5952-4988 — Datacom Channel Testing with an HP 4935A
- 4948A-1/5954-7913 — Measurement Principles
- 4954A-1/5952-5138 — SNA Network Performance Analysis
- 4954A-2/5952-5120 — X.25 Network Performance Analysis
- 5180/9825A-1/5952-7360 — Program Note
- 5180/9826/5952-7664 — Programming Note
- 5180/HP 85A/5952-7633 — Programming Note
- 5180A-3/5952-7643 — General Purpose Subroutines for the HP 5180A Waveform Recorders
- 5182A-1/5952-7733 — Understanding the HP 5182A Waveform Recorder/Generator
- 5335A/5952-7604 — HP 5335A Universal Counter User's Introduction
- 5370B-2/5952-7834 — Better than 100 ps Accuracy in HP 5370B Time Interval Measurements
- 5370B-3/5952-7769 — High Throughput Picosecond Characterization of Pulse Parameters
- 5371A/5952-7959 — HP 5371A Frequency and Time Interval Analyzer
- 5372A-1/5091-1640E — Jitter Spectrum Analysis
- 54100/110/5954-2671 — HP's Digitizing Oscilloscope and Personal Computer Programming Series: 54100/110 and HP Vectra/IBM PC Using the National Instrument HP-IB Interface Card
- 54100/110/5954-2667 — HP's Digitizing Oscilloscope and Personal Computer Programming Series: HP 45100/54110 Digitizing Oscilloscope
- 54110 A/D/5954-2644 — Precision Time-Interval Measurements with the HP 54100/110 Digitizing Oscilloscope
- 54110D/5954-2643 — Dual Delayed Sweep Versus Random Repetitive Sampling
- 54120-1/5954-2693 — Histograms and Statistical Analysis of Signals for Use with the HP 54120T Digitizing Oscilloscope
- 54120-1/5952-2693 — Histograms and Statistical Analysis of Signals for Use with HP 54120T Digitizing Oscilloscope
- 54120-2/5952-7085 — Applying Histograms in the HP 54120 Family of Digitizing Oscilloscopes to the Analysis of Jitter
- 54120-3/5952-0164 — Extending Channel Count with the HP 54120
- 54120-3/5952-0163 — High Bandwidth Oscilloscope Sampling Architectures
- 54120-4/5952-0164D — Extending the Channel Count of High Bandwidth Oscilloscopes with Microwave Switches
- 54201A/D/5954-2642 — Solving Measurement Problems in the Communications Industry
- 54510A/5091-0636E — Hardware Troubleshooting Using the HP 54510A Digitizing Oscilloscope
- 545120-2/5952-7085 — Jitter Analysis
- 545120-3/5952-0163 — Scope Sampling Architecture
- 5527A-1/5952-7947 — Rapid Data Collection with the HP 5527A Laser Position Transducer System
- 5527A-2/5952-7973 — Achieving Maximum Accuracy and Repeatability with the HP 5527A Laser Position Transducer System

# APPLICATION & PRODUCT NOTES

## Free Literature to Help Solve Your Test and Measurement Problems (cont'd)

### Product Notes

5527A/B-3/5952-8020 — Advanced Measurement Techniques Using the HP5527A/B Laser Position Transducer System

70000-1/5954-9135 — HP 70000 System Design Overview

71400C-1/5091-2196E — Relative Intensity Noise Measurements with the HP 71400C Lightwave Signal Analyzer and Laser RIN Personality DLP

71500A-1/5952-2543 — The Microwave Transition Analyzer: A Versatile Measurement Set for Bench and Text

71500A-2/5952-2546 — The Microwave Transition Analyzer: Measure 25 ps Transitions in Switched and Pulsed Microwave Component Testing

71500A-3/5952-2545 — The Microwave Transition Analyzer: Picosecond Delta Time Accuracy

8145A/5952-9575 — Test Cost Analysis Programming Guide

8175A/5952-9604 — Wavemaker SW

8175A/5952-9606 — Coder SW

8175A/5952-9608 — Learn String Guide

8175A/5952-9622 — Link Software

83040-1/5952-1906 — Using the HP 83040 Series Modular Microcircuit Package: Assembly Instructions

83040-2/5952-1907 — Calibration and Modeling Using the HP 83040 Modular Microcircuit Package

83040-3/5091-0531E — Pre-mounted

8340-2/5954-1595 — Generating Phase-Coherent Microwave Signals with the HP 8340 and 8341 Synthesized Sweepers

8340-3/5954-8389 — Typical Performance of HP 8340 and 8341

8340-7/5954-8345 — Noise Figure Measurements with HP 8340B and 8341B

8340A-1/5953-8870 — Increasing Frequency Switching Speed of HP 8340A

8349-1/5954-1516 — Achieving Calibrated Output Power with the HP 8350 Sweep Oscillator 8349 Broadband Amplifier Combination

8350-2/5952-9330 — Improved Frequency Accuracy

8350-4/5954-1505 — Pulse Modulation Characteristics of the HP 83500 Series Sweep Oscillator RF Plug-ins

8350-6/5952-8089 — Reducing Harmonics Using Integra TMF-1800H

8350-6/5952-9345 — Reducing Harmonics Using Integra

8350-8/5954-1507 — Leveling the HP 8350B Sweep Oscillator with an HP 430 Series Power Meter

8350-9/5954-8344 — Improving Output Flatness

8360-1/5952-8089 — HP 8340/41 to HP 8360 System Conversion Guide

8360-2/5952-8090 — Obtaining Flat Test Port Power with the HP 8360 User Flatness Correction Feature

8360-3/5091-0226E — Generating Scan Modulation Patterns

8360-4/5091-0227E — Performing Two-Tone Measurements with the HP 8360

85016-1/5954-1600 — Making Measurements Using HP 85016B

8508-2/8508-90019 — Automatic Stimulus Response

8510-12/5956-4331 — Millimeter-wave Measurements Using the HP 8510B Network Analyzer

8510-13/5956-4373 — Measuring Noninsertable Devices

8510-13/5952-4373 — Measuring Noninsertable Devices

8510-14/5952-6674 — Using Multiple Test Sets with the HP 8510B

8510-15/5952-3524 — Lightwave Component Measurements

8510-16/5991-0467E — Test Port Power Flatness

8510-2/5954-1522 — Radar Cross-Section Measurements with the HP 8510 Network Analyzer

8510-3/5954-1535 — Measuring Dielectric Constant with the HP 8510 Network Analyzer

8510-5A/5956-4352 — Specifying Calibration Standards

8510-6/5954-1579 — On-Wafer Measurements Using Cascade Prober

8510-7/5954-8379 — Measuring Frequency Translation Devices

8510-8/5954-8382 — Applying TRL Cal to Non-coaxial Measurements

8642A/B-1/5953-8453 — The Benefits and Use of the HP 8642A/B

8642A/B-2/5953-8452 — Using Sweep Functions on the HP 8642A/B

8644-2/5951-6740 — VOR/ILS Testing with HP 8644A

8644A/5951-6727 — Series 200/300 HP-SL Programming Guide

8644A-1/5951-6729 — Phase Noise Measurements with the HP 8644A and 8655A Signal Generators

8645-1/5951-6711 — Agile Operation of the HP 8645A

8645-2/5951-6712 — A Catalog of HP 8645A Information

8673H-1/5952-1470 — Improved Frequency Accuracy in Scalar Analysis Using the HP 8673H with Synthesized Sweep

8720-1/5091-1942E — Amplifier Measurements with the HP 8720C

8720-2/5091-1943E — In-Fixture Measurements with the HP 8720C

8751A-1/5091-0408E — High Accuracy and High Speed Filter Measurements

8753-1/5956-4361 — Amplifier Measurements Using the HP 8753 Network Analyzer

8753-3/08753-90133 — Applications of the Test Sequence Function

8756-2/5954-1506 — Using the HP 11664C Detector Adapter to Make Millimeter-wave Scalar Measurements

8756-4/5953-8894 — How to Automate the HP 5344S Source Synchronizer, the HP 8350B Sweep Oscillator, and the HP 8756 Scalar Analyzer with an HP Series 200 Computer

8756A-1/5953-8869 — Automating the HP 8756 Scalar Network Analyzer

8757-1/5954-8386 — Using AC Detection with the HP 8756/8757 Scalar Network Analyzers to Make More Accurate Measurements

8757-2/5954-8380 — V and W Band Millimeter Scalar Measurements Using the HP 8757 Scalar Network Analyzer

8757-5/5954-1537 — Measuring Voltage-Controlled Devices

8757-6/5954-8347 — Automated Amplifier Measurements Using HP 8757A



8760-1/5959-7860 — HP 8760 Series Custom Microwave Switch Matrixes

8760A-1/5952-7860 — MW Switch

8770S-2/5954-6360 — Effective Use of the HP 8770S Signal Simulator System

8780A-1/5954-6368 — Introductory Operating Guide to the HP 8780A Vector Signal Generator

8780A-2/5952-1416 — Modulation Solutions RF & Microwave Recrs

8791-1/5953-2343 — Using Dynamic Data with HP FASS

8791-1/5953-2343 — Product Note Using Dynamic Data with 8791 10 FASS

8791-2/5953-2345 — Product Note Using WGL with FASS

8791-3/5952-1053 — Theory of Operation of the HP FASS

8791-4/5952-0507 — Secure Communications Testing with the HP FASS

8791-5/5952-1901 — Tips on External Clock Operation with the HP FASS

8791-6/5952-1903 — Jamming Signal Capability of the HP FASS

8791-7/5952-1058 — Spectral Purity of the HP FASS

8791-8/5952-2847 — Survey of Radar Test Applications Using FASS

8791-8/5952-1058 — Spectral Purity of FASS

8901A/5955-7307 — Field Reference Note

8901A-1/5952-8248 — Extending the Frequency Range of the HP 8901A Modulation Analyzer

8902A-2/5953-8436 — Accurate Signal Characterization at Millimeter-wave Frequencies

8903A-1/5952-8246 — Operating the HP 8903A Audio Analyzer Below 20 Hz

8904A/5951-6715 — A Book of Ideas for Creating Waveforms with the HP 8904A

8904A-1/5951-6748 — Using the HP 8904A Multifunction Synthesizer as a Communications Signaling Source

8904A-1/5953-8489 — Communication Signaling

8904A-2/5953-8487 — Using the HP 8904A Multifunction Synthesizer as an FM Stereo Composite Generator

8904A-3/5953-8488 — Using the HP 8904A Multifunction Synthesizer as a Modulation Source for Navigation Applications

8970B/S-2/5954-8896 — Applications and Operation of the HP 8970B Noise Figure Meter and HP 8970S MW Noise Figure Measurement System

8970B/S-3/5952-6639 — Noise Parameter Measurement Using the HP 8970B Noise Figure Meter and the ATN Model NP4 Noise Parameter Test Set

8970B/S-4/5959-8742 — Displaying HP 8970B Noise Figure Meter Measurements on the HP 8757 Scalar Network Analyzer

8980/81A-2/5952-3704 — Dynamic Range Considerations of the HP 8980A Vector Analyzer

PN3562A-2/5953-5191 — Signal Switching and Multi-channel Measurements with the HP 3562A Dynamic Signal Analyzer

# FREE PUBLICATIONS

## Free Literature to Help Solve Your Test and Measurement Problems

### Free Guides for Selecting, Using, and Maintaining HP Products

Hewlett-Packard offers a variety of free publications to help you choose the products that best fill your needs, to help you benefit from applications knowledge acquired by users inside and outside of HP, and to help you maintain your HP products. These publications range from new-product announcements, catalogs, product family brochures, and single-product technical data through application notes, product notes, and programming aids to service notes and general maintenance periodicals. The number and types of free publications vary with product family. A summary of available publications is provided here. Brief descriptions of some publications follow the summary.

### Instruments and Systems

#### Product information

*Test & Measurement News*

*Hewlett-Packard Journal*

Data sheets, brochures, and video tapes

Catalogs

HP DIRECT Instruments Now Catalog (5091-0930EUS)

HP-IB System DC Power Supplies and Electronic Loads (5091-2525EUS/EN)

RF, Microwave, & Millimeter Wave Measurement Catalog (5094-2238)

#### Application information

Application Notes (Listing begins on page 712)

Product Notes (Listing begins on page 725)

Application Briefs

Application Bulletins

Plotter Notes

Set-Up Instructions (for plotters)

Programming Notes

#### Service information

Service Notes

Bench Briefs

### Components

#### Product information

Catalogs

Coaxial Components Catalog (5959-7861)

Microwave and RF Designer's Catalog (5954-2238)

Optoelectronics Designer's Catalog (5952-2481)

Data sheets

*Hewlett-Packard Journal*

Component Update

#### Application information

Application Notes

Application Bulletins

### Periodicals

#### Test & Measurement News

Six times a year *Test & Measurement News* announces the latest HP electronic measuring instruments and accessories; computer/controller, component, and telecom products; and new product literature such as data sheets, application notes, and catalogs.

#### Hewlett-Packard Journal

The *Hewlett-Packard Journal* is published six times a year to communicate technical information from the laboratories of HP to all of the fields served by HP. It contains in-depth design descriptions of current hardware and software products, research papers, and more general information such as advances in technology.

### Application Information

#### Application Notes, Briefs and Bulletins

These aids to solving your measurement, computation, and design problems offer the benefit of the applications research and experience of both HP customers and HP engineers. Some are tutorial, others describe how-to procedures. All of the publications are oriented to multiple products. A listing of test and measurement application notes begins on page 712.

#### Product Notes

Product Notes are product-specific aids that supplement the operating and service manuals supplied with HP instruments. They cover applications of the specific instrument. They include analysis of specifications and characteristics with the goal of obtaining improved performance over limited operating conditions and narrower environmental limits.

#### Programming Notes

Programming Notes provide product-specific information on the Use and operation of instruments in HP-IB systems. Some notes address the needs of inexperienced users and cover basic operation of an HP-IB instrument Using a specific HP desktop computer. Others address the needs of experienced users.

### Service Information

#### Service Notes

Service Notes contain product-specific service information for HP electronic products. Subjects include product improvements, modifications, and procedures for troubleshooting, maintenance, and repair. Service Notes are published as appropriate throughout the life of a product. All new instrument-related Service Notes are announced in Bench Briefs.

#### Bench Briefs

Bench Briefs provides timely application information for those who repair and calibrate HP instruments. Subjects include troubleshooting tips and descriptions of new technologies, components, tools, and equipment. Also, new instrument-related Service Notes are listed in Bench Briefs as they become available.

### How to Obtain Free Publications

To obtain any of the publications described on this page, contact your nearest HP office. The listing of HP offices begins page 684. When requesting any of the catalogs listed on this page, please include the number in parentheses following the catalog's title.

# Test & Measurement

## Sales

Information on all major HP test and measurement products and services is available through your local Hewlett-Packard Test and Measurement sales office.

### Sales Offices

Worldwide listing 684

### HP DIRECT

Order basic instruments, accessories and rack mounts over the phone for quick off-the-self service.

United States 1-800 452-4844  
Hours: 9 a.m. to 5p.m.

#### Outside of the U.S

Austria	0222 2 500 350
Belgium	02 761 31 11
Canada(Toronto area)	800 387 8383
(Country wide)	800 671 3154
Denmark	80 30 16 40
France	16 1 60 77 31 08
Germany	30 33 22
Italy	02 95 301 532
Netherlands	06 0501
Spain	91 637 40 13
Sweden	08 750 24 00
Switzerland	057 31 24 90
United Kingdom	0734 441212

### Leasing/Finance

You can "pay as you go" with rental, lease, and finance plans from HP Financing.

 HPEasyRent 680

## General Information

Customers can get general information on all Hewlett-Packard sales and services throughout the world at their nearest customer information center.

### Customer Information Centers

United States 1-800-452-4844

#### Outside of the U.S

Australia	03-648-1002
Canada (Toronto)	416 678-9430
(Country wide)	800-387-3867
Europe	011-44-344-369369
United Kingdom	0734 696622
Latin American	0052 005 202 0155

## Support

HP offers support that makes it possible for the customer to get the most out of their test and measurement equipment. Contact your local HP T&M sales office for more information

### Service Agreements

Hardware	671
Software	677

### Education

(Classroom and self-paced available) 674

### Consulting services

HP Consultline	679
----------------	-----

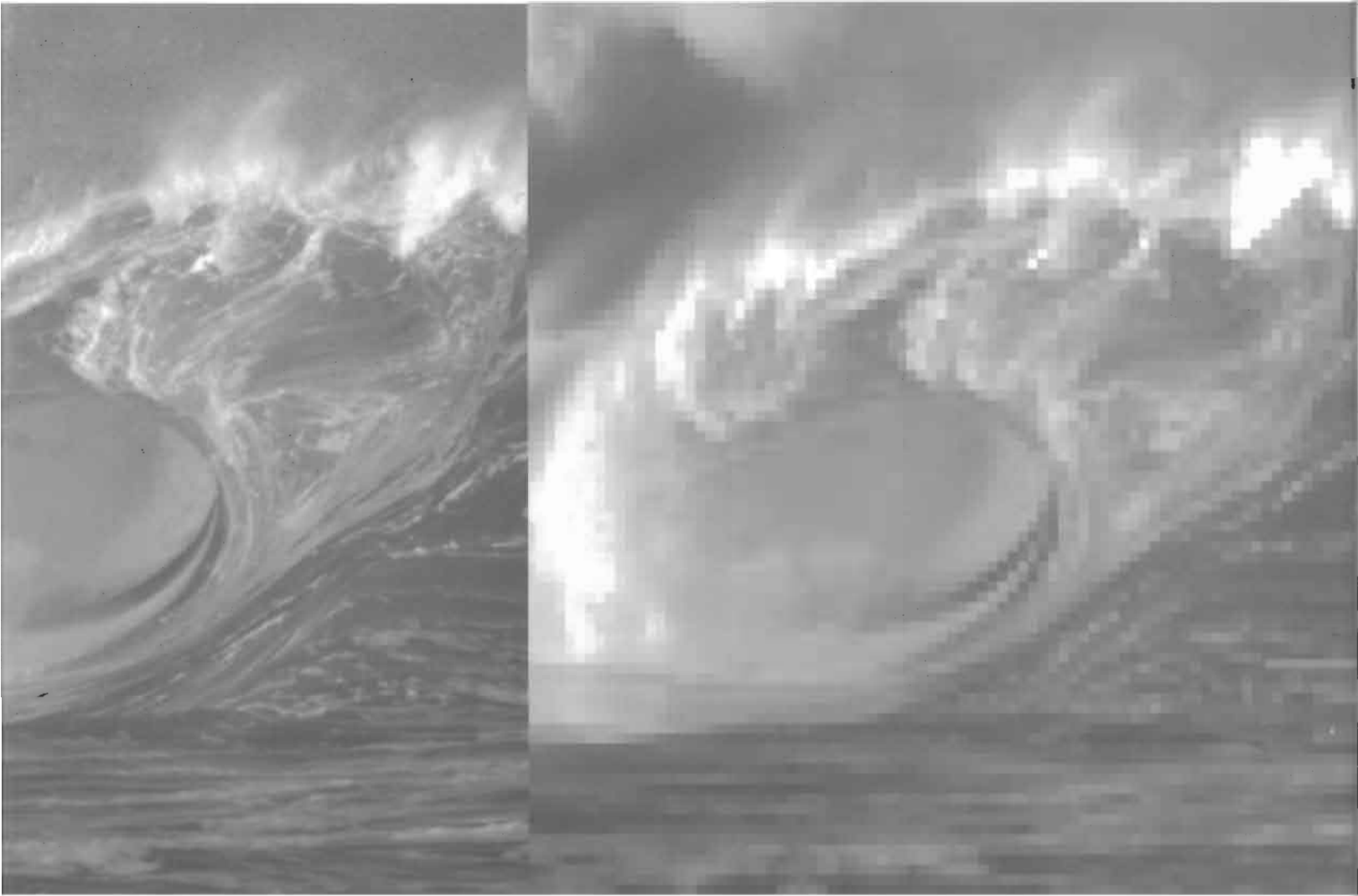

Technical information **in this document** is  
**subject to change** without notice.

Copyright © 1991  
Hewlett-Packard Company

Printed in USA 10/91