

HP Archive

This vintage Hewlett Packard document was preserved
and distributed by

[www. hparchive.com](http://www.hparchive.com)

Please visit us on the web !

On-line curator: Glenn Robb

This document is for FREE distribution only!

Wideband Modulation Analysis Using Vector Demodulation Techniques

Dana Kreitter
March 1985

RF & Microwave
Measurement
Symposium
and
Exhibition

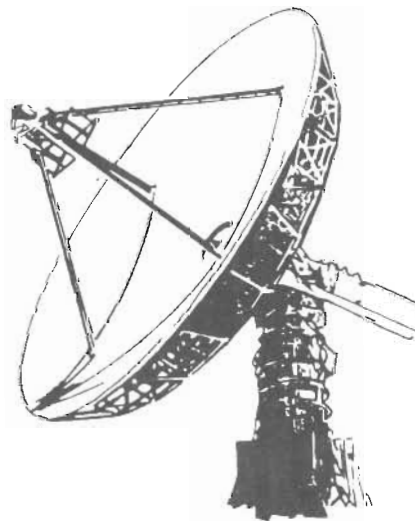

For Today's Modulation Analysis...

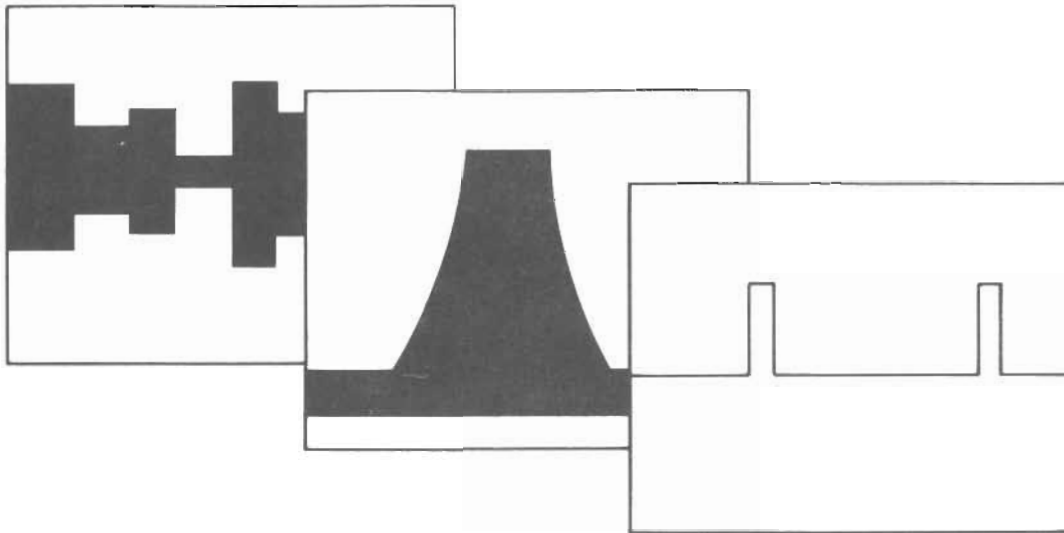

...traditional test equipment offers several significant benefits:

Over the past few years, the complexity of microwave modulation and the corresponding demands for measuring it have increased substantially. Modulation rates for data have grown steadily; but spectrum crowding necessitates packing more information into less bandwidth, leading to today's sophisticated digital modulation formats such as 16QAM and others. Radar technology is rapidly moving forward as pulse widths are narrowed, transition times are shortened, and carrier phase reveals more target information. Wideband modulation analysis of phase and amplitude has become an important measurement need in many areas.

These modulations can frequently be analyzed using one of several common test instruments:

Spectrum Analyzers

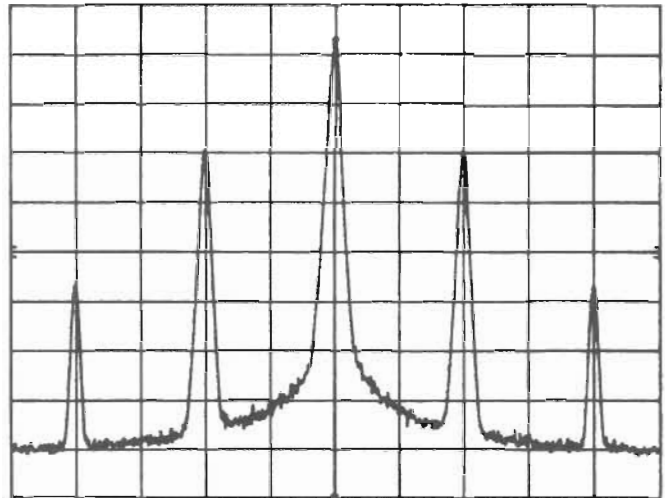

- **Broadband**
- **Frequency Domain**
- **AM/FM/PM**

Spectrum analyzers offer broadband microwave frequency coverage and provide signal analysis in the frequency domain. They can be used to analyze AM, FM or PM.

Measuring Receivers / Modulation Analyzers

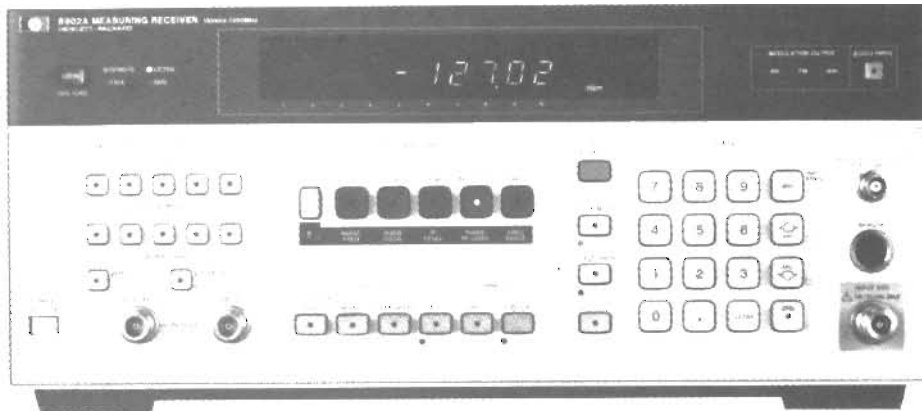

- Accuracy
- Separation of AM/FM/ØM
- One-Button Measurements
- Automatic/Programmable

Measuring receivers or modulation analyzers provide high accuracy, separation and rejection of simultaneous modulation types, one-button measurements and automated/programmable operation.

Peak Power Meters

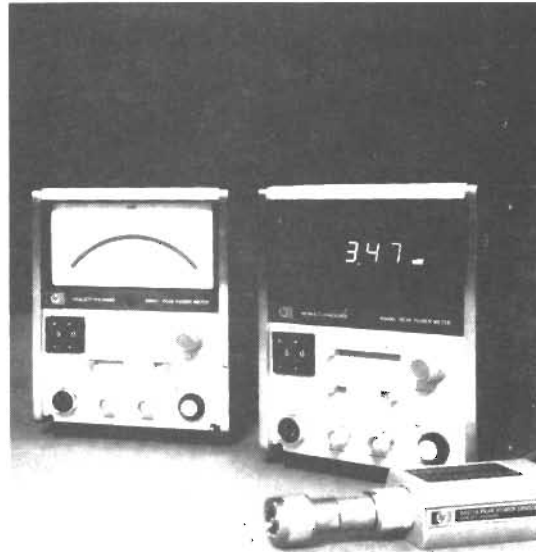

- **Direct Peak Pulse Power Measurements**
- **Easy To Use**
- **Inexpensive**

For pulse applications, peak power meters allow direct measurement of peak pulse power. They are both easy to use and inexpensive.

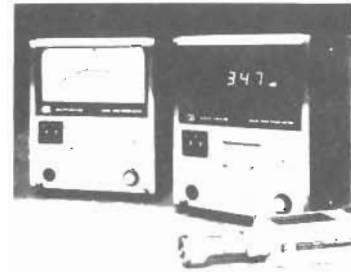

... But All Are Limited In Some Important Ways:

- Low Modulation Bandwidth
- No Magnitude & Phase Info
- No Transient Measurement Capability
- Unsuitable For Digital Modulation Analysis

However, all of these tools are limited in some important ways: Their modulation bandwidths are quite low compared to those of the data and pulse modulation signals they must measure; instantaneous phase information is unavailable; there is no transient measurement capability (e.g. during pulse switching transients); and none are suitable for digital modulation analysis.

So what alternatives exist that can produce solutions to these problems? A method is needed that combines wide modulation bandwidth with phase, amplitude and time measurements. One such method is *vector demodulation*. While the technique has been known and written about for many years, only recently has it generated wide interest.

Other Names For Vector Demodulation Are:

- **Quadrature I.F. Demodulation**
- **Coherent Detection**
- **I-Q Demodulation**

Vector demodulation goes by other names as well, such as quadrature I.F. demodulation, coherent detection, and I-Q demodulation—but they each describe what is essentially the same thing.

Vector Demodulation Will Enable Us To Examine

- **Wideband Modulation Signals**
- **Amplitude-Phase Relationships**
- **High-Speed Switching Transients**
- **Digital Modulation**

Vector demodulation fills the gaps left by other analysis methods—it allows examination of wideband modulation signals, amplitude-phase relationships, switching transients, and digital modulation.

Block Diagram Of Vector Demodulator

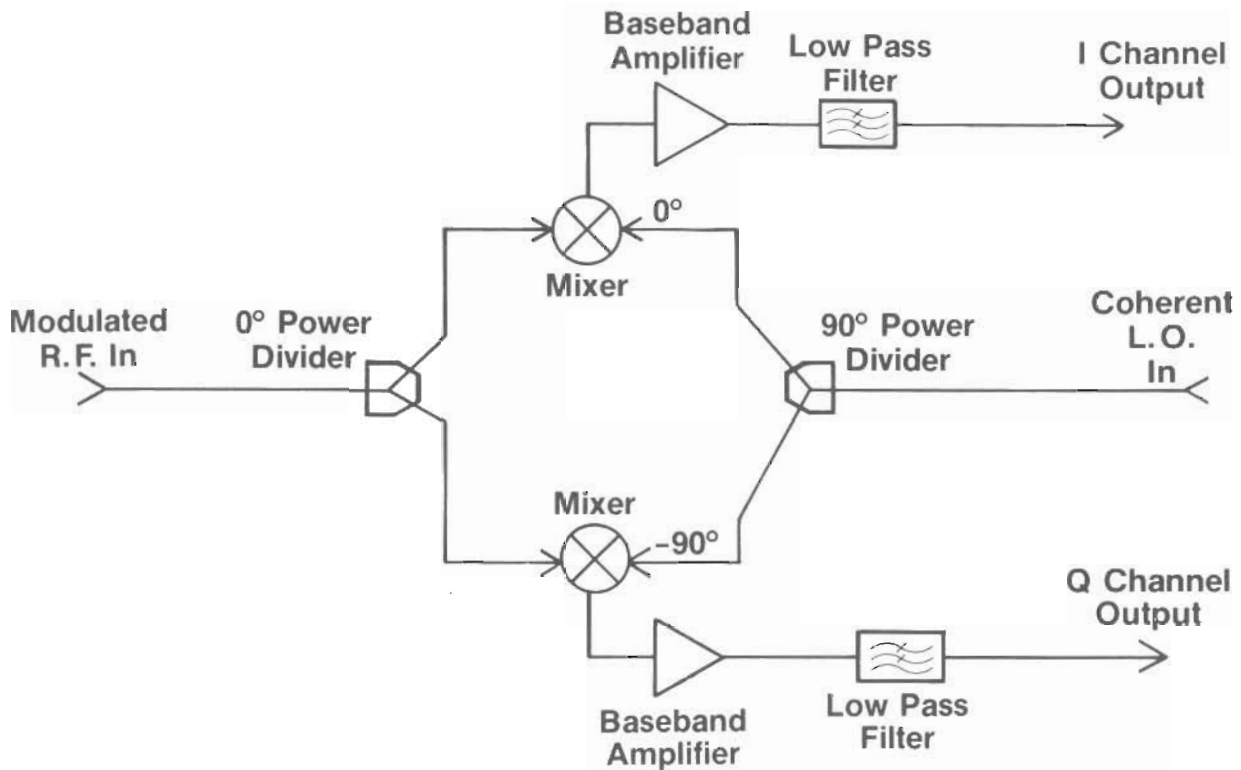

Referring to the vector demodulator block diagram, a modulated RF carrier and a *phase-coherent* LO are each divided into two signals and applied to mixers (which in this case function as demodulators) to recover the baseband modulation signal. The RF carrier is divided into signals of equal phase, while the LO is divided into quadrature-phase signals. The mixer outputs are amplified and filtered to remove unwanted mixer products. The zero-degree component is called the "I" or in-phase channel, while the 90-degree-shifted component is called the "Q" or quadrature channel. Provided that the devices employed have sufficient bandwidth, high-frequency components of the modulating signal are kept intact. Displaying these channels on a CRT reveals the phase, magnitude, and time information desired.

Several Useful Displays Are Possible Using The I, Q, and t Data

- I, Q vs. t ("Eye" Diagrams)

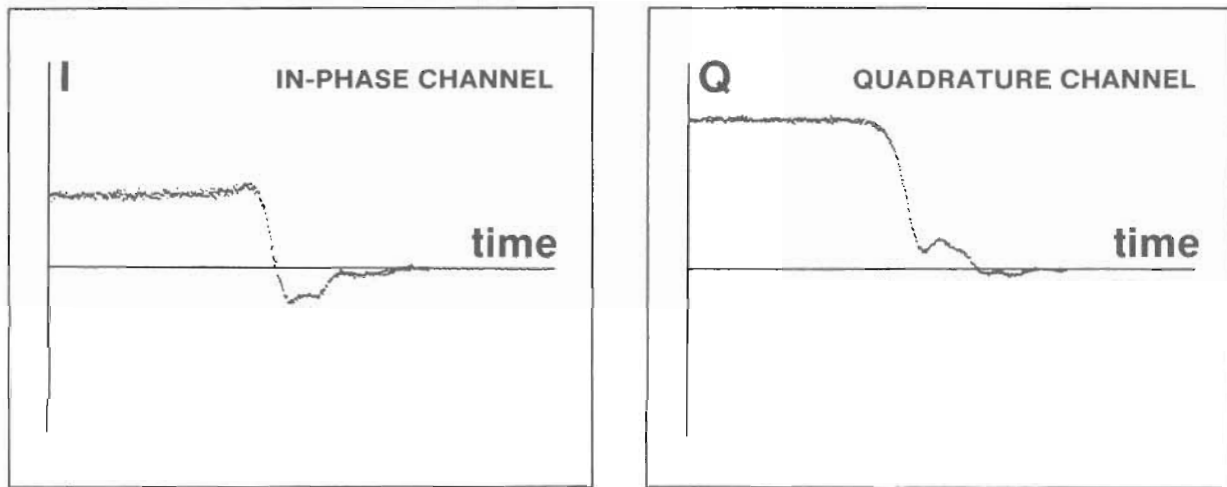

Several useful displays are possible using the I and Q data. The most familiar is to show I or Q vs. time. These plots show the trailing edge of a pulse, during which unwanted phase modulation may be occurring. In digital communications, a display of I vs. time or Q vs. time is called an "eye diagram" and each channel is modulated with its own bit stream.

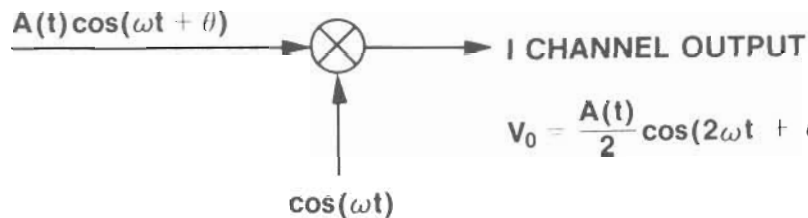

$$V_0 = \frac{A(t)}{2} \cos(2\omega t + \theta) + \frac{A(t)}{2} \cos(-\theta)$$

BASEBAND FILTERING LEAVES:

$$V_0 = \frac{A(t)}{2} \cos(-\theta) = \frac{A(t)}{2} \cos(\theta)$$

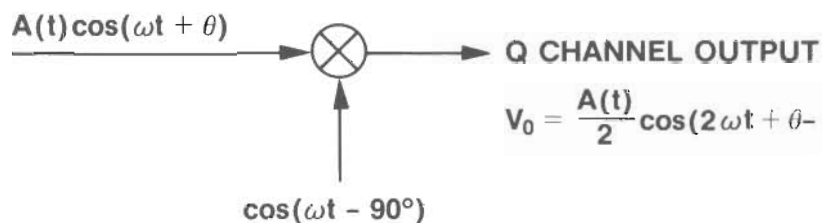

$$V_0 = \frac{A(t)}{2} \cos(2\omega t + \theta - 90^\circ) + \frac{A(t)}{2} \cos(\theta + 90^\circ)$$

AFTER BASEBAND FILTERING:

$$V_0 = \frac{A(t)}{2} \cos(\theta + 90^\circ) = -\frac{A(t)}{2} \sin \theta$$

Consider briefly the theoretical operation of the Vector demodulator: Each channel is driven with the same modulated signal of frequency ω and phase θ . The I channel input is mixed with a phase coherent cosine of the same frequency, with phase arbitrarily defined to be zero. The Q channel input is mixed with the same \cos signal except it is phase-shifted by 90 degrees.

As seen in the preceding block diagram, the baseband mixer outputs are filtered to remove the sum-frequency components, leaving the simple cosine and sine functions shown.

Since the I and Q Outputs are orthogonal...

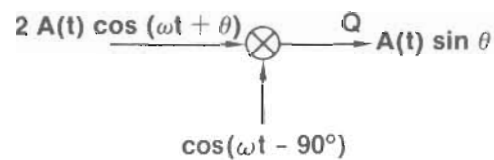
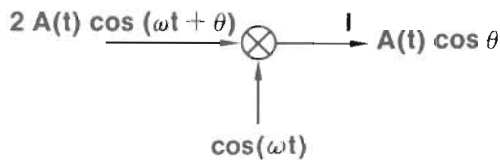

... Displaying I vs. Q results in a composite, or *VECTOR*, representation of the input signal:

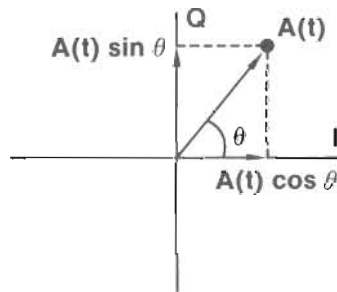

$$\text{MAGNITUDE} = \sqrt{I(t)^2 + Q(t)^2}$$

$$\text{PHASE} = \theta = \tan^{-1} \left(\frac{Q(t)}{I(t)} \right)$$

Since the two demodulator outputs are orthogonal, they lend themselves easily to display in the IQ plane. The instantaneous values of I and Q then form a vector which represents the input signal. The carrier magnitude is given by $\sqrt{I^2(t) + Q^2(t)}$ and the carrier phase by $\tan^{-1}(Q(t)/I(t))$.

• VECTOR DIAGRAMS

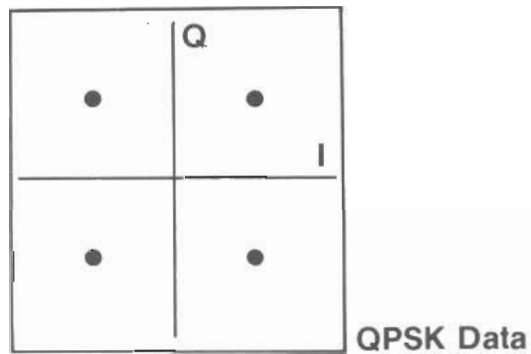
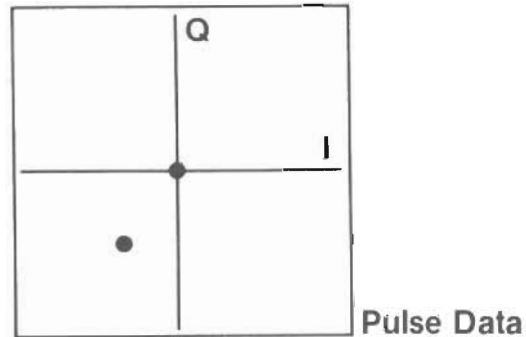

It is in this vector format that the sought-after phase information becomes evident. These two plots show the theoretical vector diagrams of a) a pulsed signal, and b) a QPSK-encoded signal. Note that the pulse representation indicates the two amplitude states of a constant-phase carrier, while the QPSK signal has constant amplitude but four discrete phase states. Any vector diagram can be rotated in phase arbitrarily—it is simply a mathematical change in the display, representing a phase offset in the carrier.

• Magnitude & Phase vs. Time

-BPSK Data

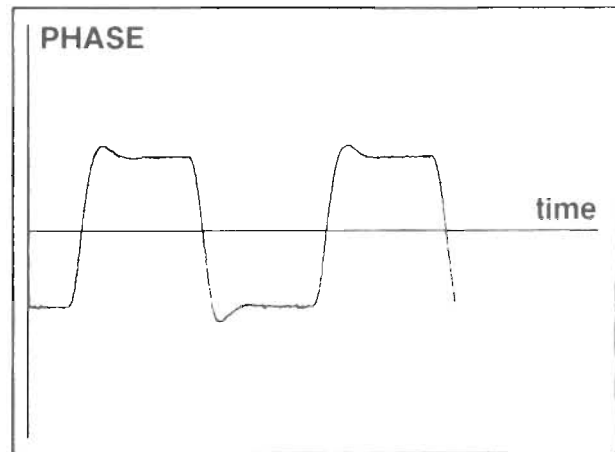
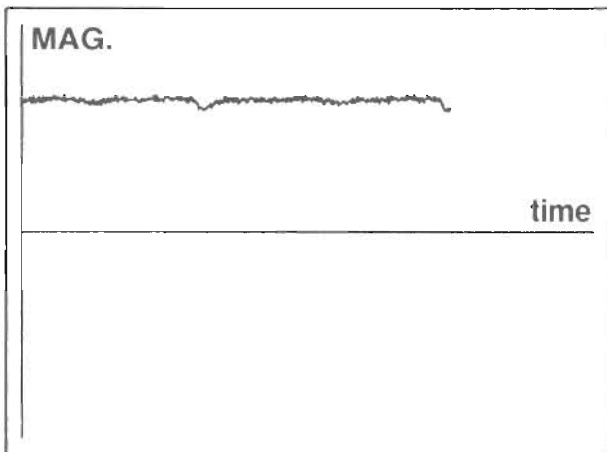

Computing and plotting the magnitude and phase of the input signal results in the last two types of data display, shown here for a BPSK signal. Note that the signal is of constant magnitude but has two distinct phase states 180 degrees apart.

Key Application Areas For Vector Demodulation

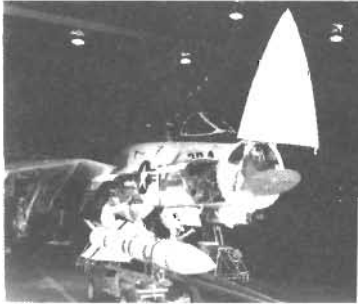

• **RADAR & EW**

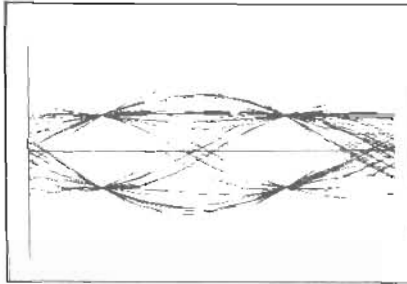

• **DYNAMIC TESTING
OF COMPONENTS**

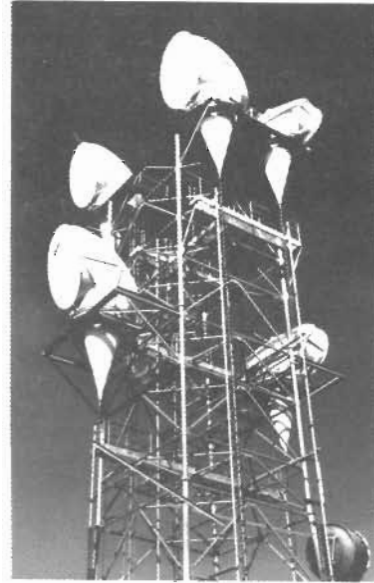

• **DIGITAL
COMMUNICATIONS**

Three key application areas for vector demodulation are 1) radar and EW, 2) digital communications, and 3) dynamic testing of components.

PULSED SYSTEMS— CONVENTIONAL ANALYSIS

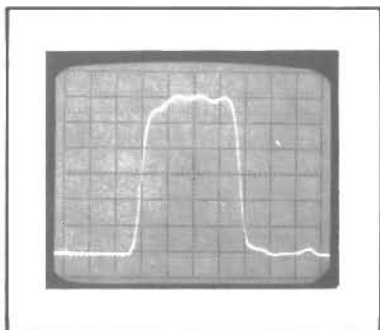

DIODE DETECTOR
-Typically low bandwidth
-No phase information
-Edge Distortion

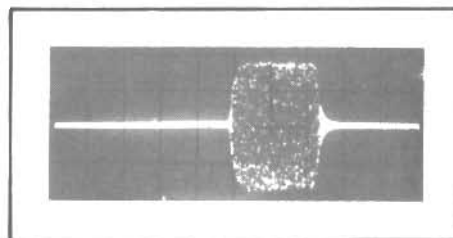

SAMPLING SCOPE
-High bandwidth
-No phase information

In radar and other pulsed systems, the measurement problems relate to the determination of various pulse parameters. Two of the more conventional methods of pulse analysis are envelope detection and sampling for scope measurement of width, rise time, time delay, etc. The detector method frequently does not have sufficient bandwidth to measure transition times, and neither it nor the sampling scope method provides any phase information about the signal.

Pulsed Systems— Vector Demodulation Analysis

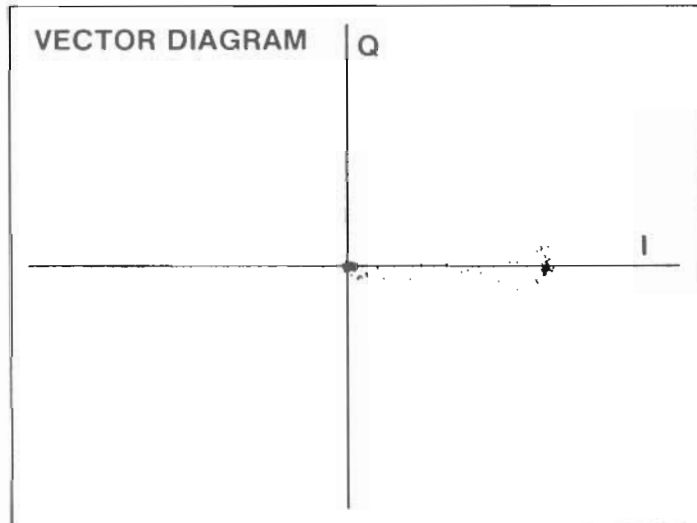
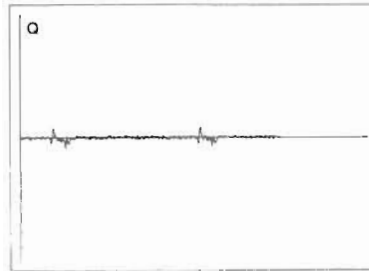
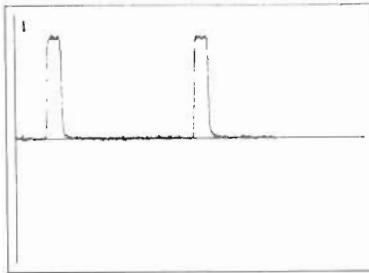

Contrast that with the information obtained by vector-demodulating the same signal. Magnitude, phase and time can now all be measured easily. This vector diagram shows the two states of the carrier amplitude, but also indicates incidental phase modulation during the transitions.

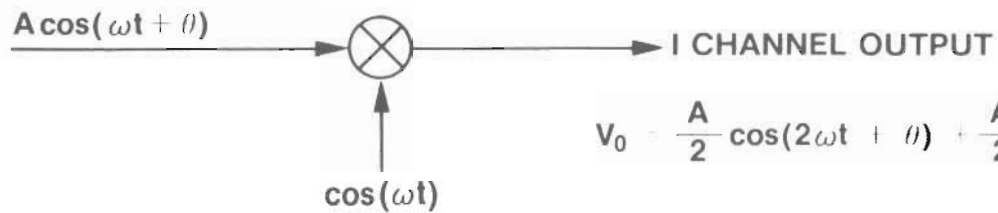

$$V_0 = \frac{A}{2} \cos(2\omega t + \theta) + \frac{A}{2} \cos(-\theta)$$

BASEBAND FILTERING LEAVES:

$$V_0 = \frac{A}{2} \cos(\theta)$$

$$\frac{dV_0}{dA} = \frac{1}{2} \cos \theta$$

$$\frac{dV_0}{d\theta} = -\frac{A}{2} \sin(\theta)$$

For $\theta \approx 0$, V_0 is relatively sensitive to input amplitude fluctuations and relatively insensitive to phase fluctuations. The I channel operates as a linear AM detector.

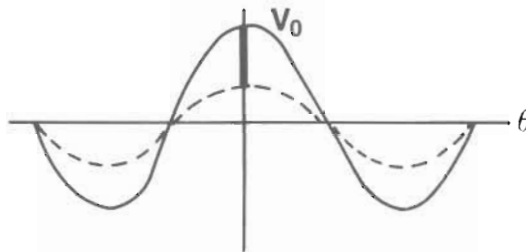

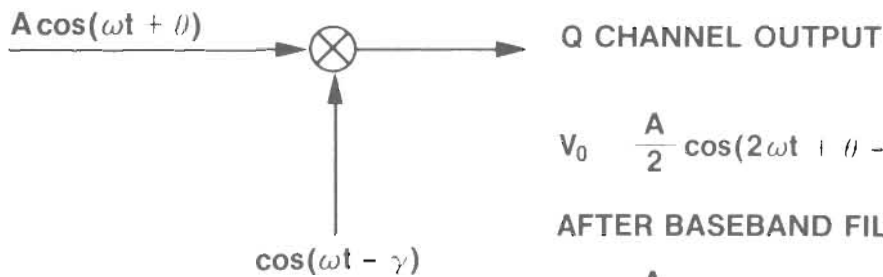

$$V_0 = \frac{A}{2} \cos(2\omega t + \theta - \gamma) + \frac{A}{2} \cos(\theta - \gamma)$$

AFTER BASEBAND FILTERING:

$$V_0 = \frac{A}{2} \cos(\theta + \gamma)$$

$$\frac{dV_0}{dA} = \frac{1}{2} \cos(\theta + \gamma)$$

$$\frac{dV_0}{d\theta} = -\frac{A}{2} \sin(\theta + \gamma)$$

If θ again equals zero and the system is in quadrature such that $\gamma = 90^\circ$, then V_0 is relatively insensitive to amplitude fluctuations and relatively sensitive to phase fluctuations. The Q channel operates as a linear phase detector.

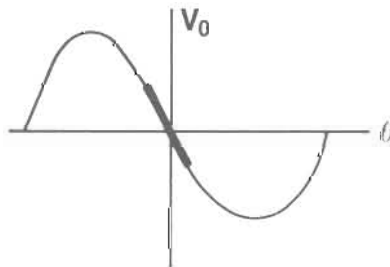

Pulsed Systems — Vector Demodulation Benefits

- **High Bandwidth — determined by mixers, power dividers, and digitizer**
- **Automated Pulse Characterization**
 - **Peak Power**
 - **Rise/Fall Time**
- **Measure Phase Drift Under Dynamic Conditions**

Vector demodulation offers several benefits when one is working with pulsed systems. First, it is relatively easy to achieve the high bandwidths necessary for short pulses. The bandwidth is determined by the choice of mixers, power dividers and the display device. Second, the method lends itself to automated measurement of rise/fall time and peak power of very fast pulses. Third, carrier phase drift can be measured under dynamic conditions (i.e., while being pulse modulated).

Pulsed Systems— Vector Demodulation Benefits, cont.

- Quantitative measurement of $\Delta\theta$
- AM-PM Conversion
— e.g., Pulse Transitions

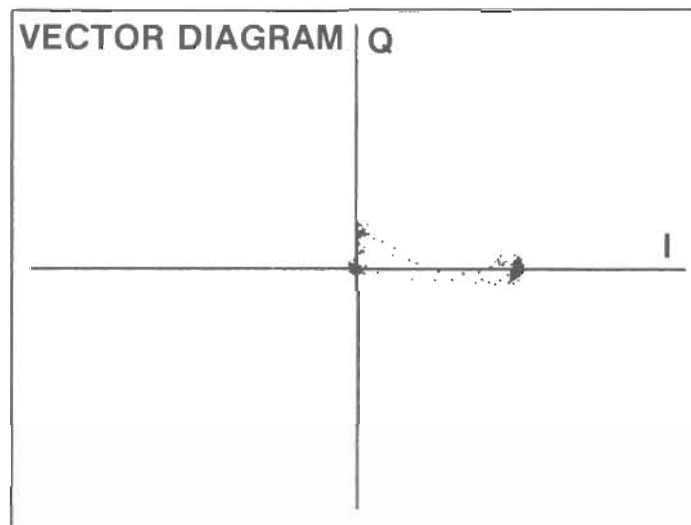

Fourth, vector demodulation allows the extraction of detailed phase information from the signal. For example, the phase characteristics of a return pulse might be compared to a transmitted-pulse reference for target profiling. Finally, measurement of AM to PM conversion is handled easily and directly with a vector demodulator.

Complex Demodulation – Chirp Radar

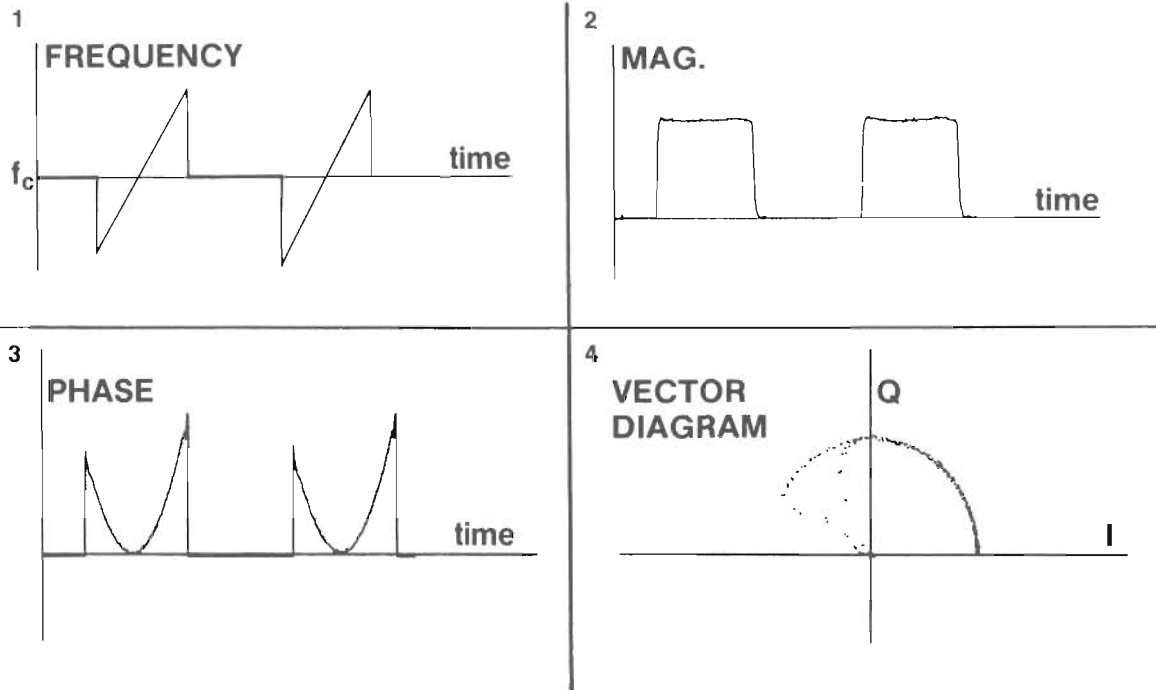

Measurement of chirp radar pulses with a vector demodulator gives insight into the operation of the chirp system as well as a means of measuring system performance such as FM linearity. In a chirp radar, the microwave carrier is ramped in frequency during the time the pulse is on. Note that while the magnitude of the signal is a simple pulse function, the phase is parabolic over time. This is because phase is the integral over time of frequency, and the frequency is changing linearly. But the vector diagram alone is extremely informative: From it, magnitude and phase are easily determined, and differentiating the phase will yield the FM characteristic to check frequency modulator linearity.

Complex Demodulation

Phase Tagging (BPSK-encoded radar)

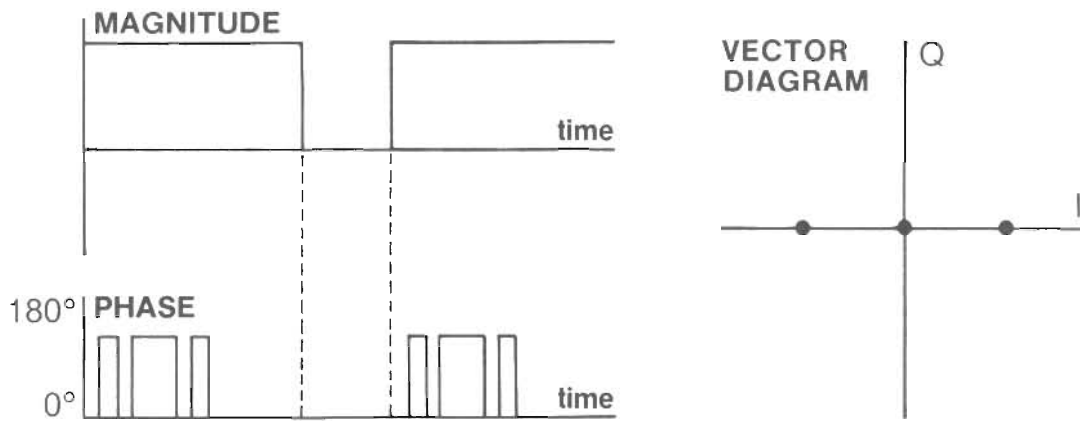

"Phase tagging" is a term that is sometimes used to describe the BPSK encoding of radar pulses to remove range ambiguity and allow significantly higher repetition rates. Vector demodulation provides a means of measuring the BPSK and pulse characteristics simultaneously.

Digital Communications Applications for Vector Demodulation

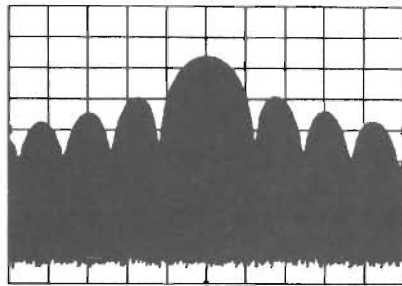

Conventional Measurement:
Observe $\frac{\sin x}{x}$ spectrum
of data

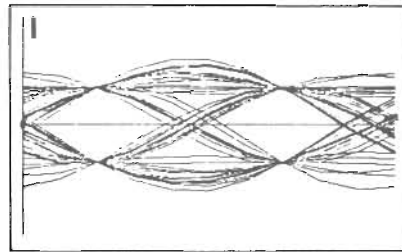

Eye Diagram:
Observe data channels vs. time;
Qualitatively assess Intersymbol
Interference (ISI).

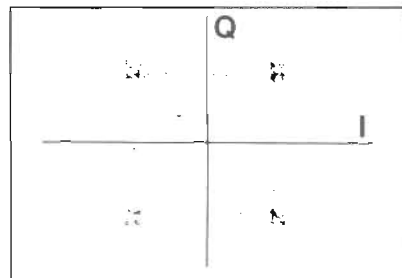

Vector Diagram:
Observe I channel vs. Q
channel; Apply statistical
methods to calculate % eye closure

In digital communications, vector demodulators are used regularly to examine the I and Q data channels. Conventional analysis would involve a spectrum analyzer and the primary measurement would be to view the $(\sin x) / x$ characteristic of the digital data. However, the usefulness of the spectrum analyzer is limited because of its inability to provide information on phase and amplitude vs. time.

This eye diagram (middle) shows random data vs. time. The amount of eye closure is an important measure of intersymbol interference (ISI) that is not obtainable from the frequency domain of the spectrum analyzer. It is, however, easily examined with a good oscilloscope.

The vector diagram, on the other hand, plots the two data channels against each other and shows the various states of the carrier and the relative ambiguity of the various data symbols. At a glance, one can assess system quadrature, amplitude offsets, phase offsets, and eye closure.

Low X-Axis Bandwidth of Oscilloscopes Prevents Direct Display of Vector Diagrams:

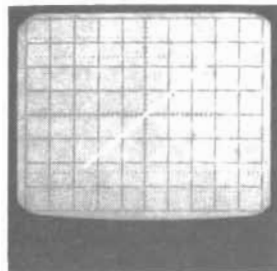

1 KHz Sinewave Inputs

HP 1740A Scope Display; X vs. Y mode

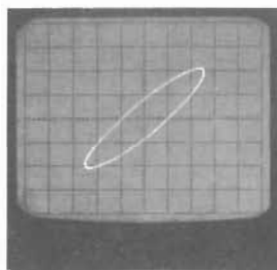

1 MHz Sinewave Inputs

However, although most scopes have an X-Y display mode, they are inadequate for vector displays because the bandwidth of their horizontal amplifiers is much too low to indicate the transitions of the data accurately. This is true even of scopes with very high time scale resolution (e.g. 1 ns/div.).

To demonstrate, consider this X-Y display of a 100 MHz scope, with a 1 MHz sine wave applied to each channel. One should observe a straight 45 degree line; but even at only 1 MHz the slow response of the horizontal amplifier is evident. For modulation bandwidths of 100 MHz, it is quite obvious that the standard X-Y display would be inadequate.

Use Digitizers and a Technical Computer to Solve Vector Display Problem:

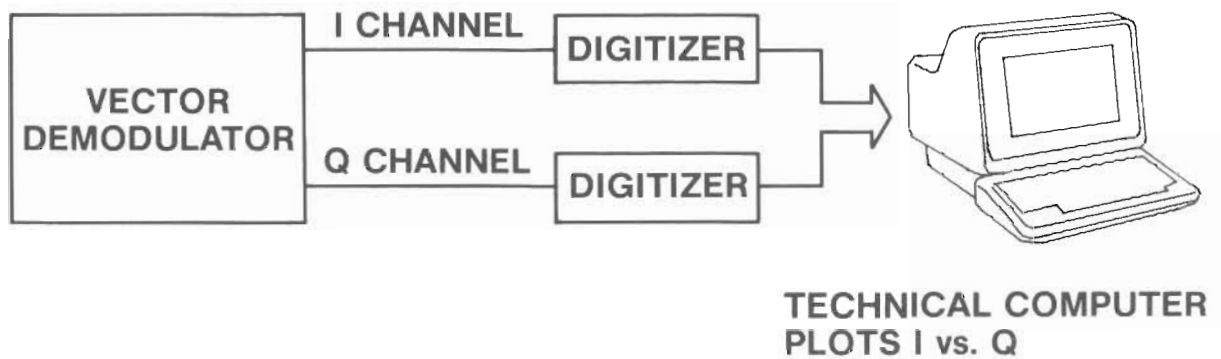

One way to effectively deal with this x-axis bandwidth problem is to digitize the I and Q components using a waveform recorder or a digital oscilloscope. The digitized data can then be processed by a computer and the necessary displays created.

Computer-Enhanced Measurement Capabilities

1. System Calibration

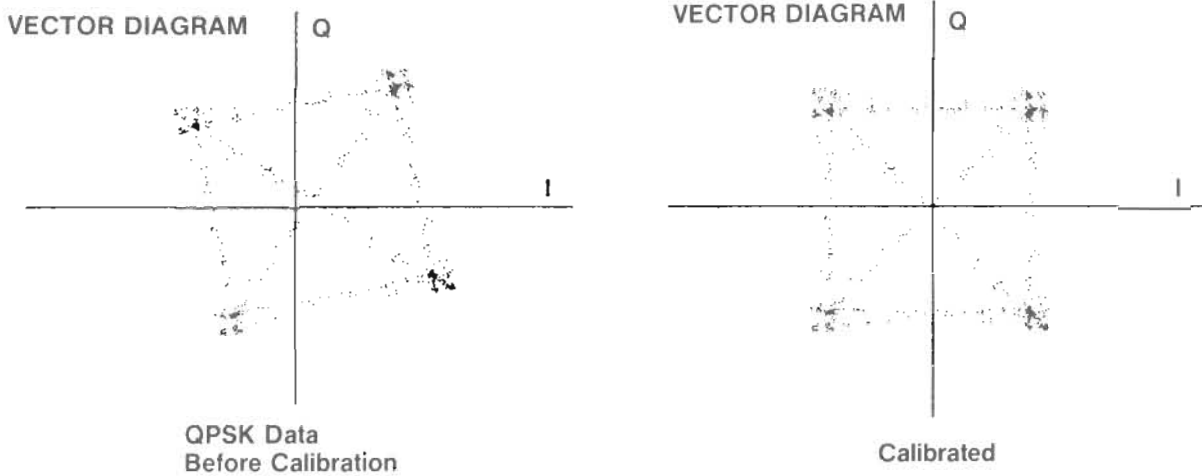

In addition to providing a means for accurate I vs. Q representation, the use of a computer significantly enhances measurement capability. For example, system calibration of phase quadrature is possible. . .

2. I, Q, t, magnitude, phase markers

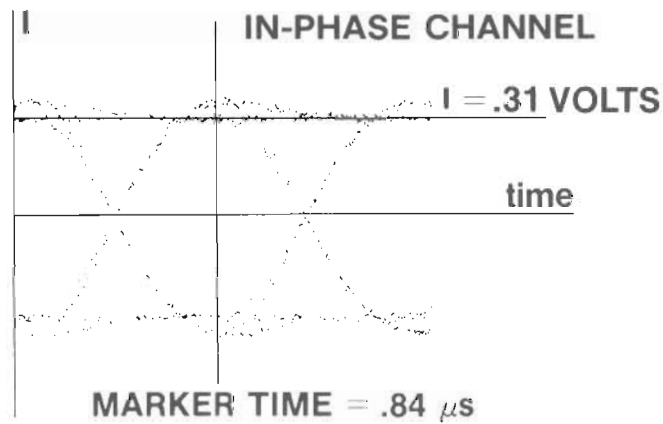
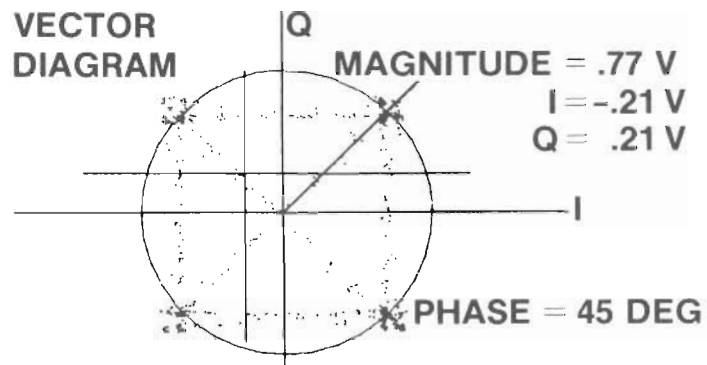

... and display markers simplify direct measurement of I, Q, t, magnitude, and phase.

3. Data Storage and Hard Copy Output

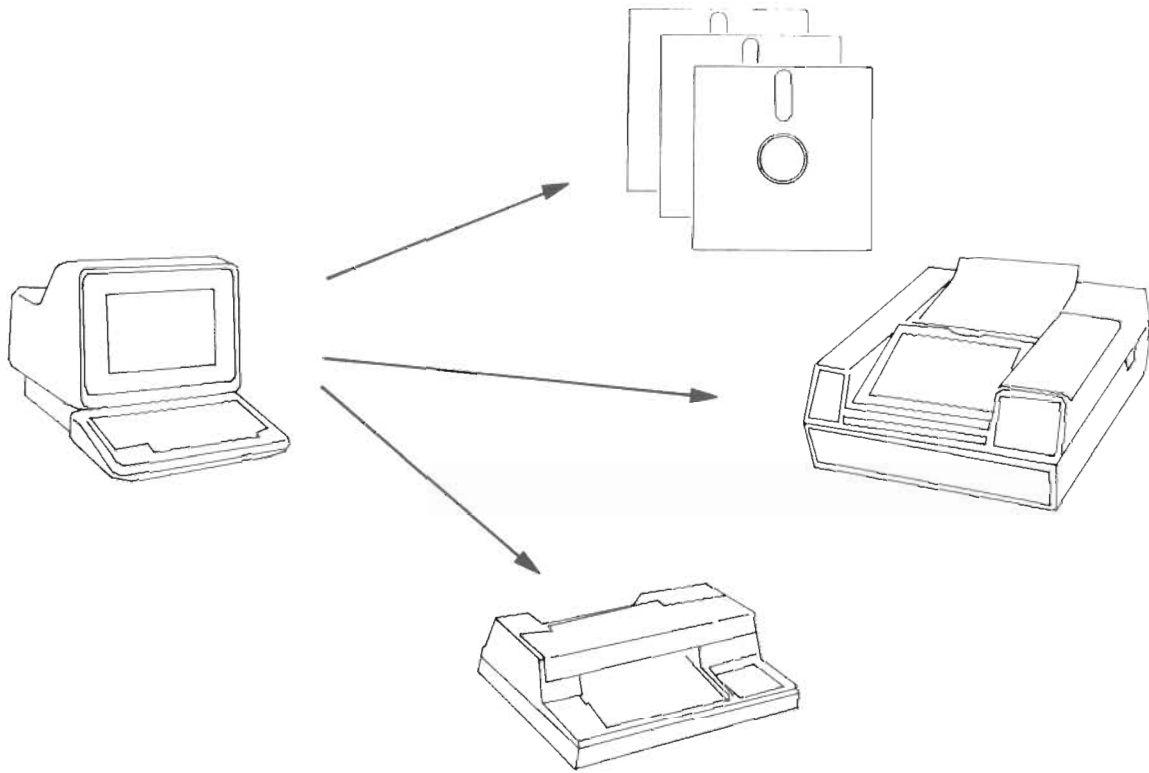

A third significant advantage is that data storage and hard copy output are possible. The combination of these features adds up to significantly improved measurement capability that benefits the design and test of digital radios.

Component Test Applications for Vector Demodulation

- **Dynamic Testing of Microwave Components**
- **Pulsed-Signal “Network Analysis”**
- **Phase and Amplitude Effects During Switching Transients**

A third application area to which vector demodulation makes a significant contribution is in the area of component test. While some component testing can be better performed using a network analyzer, it is sometimes necessary to understand the *dynamic* performance of components of pulsed microwave systems. The vector demodulator can be employed as a “pulsed signal network analyzer” to measure phase and amplitude effects during switching transients, etc.

Pulse Modulator Effects on Signal Phase

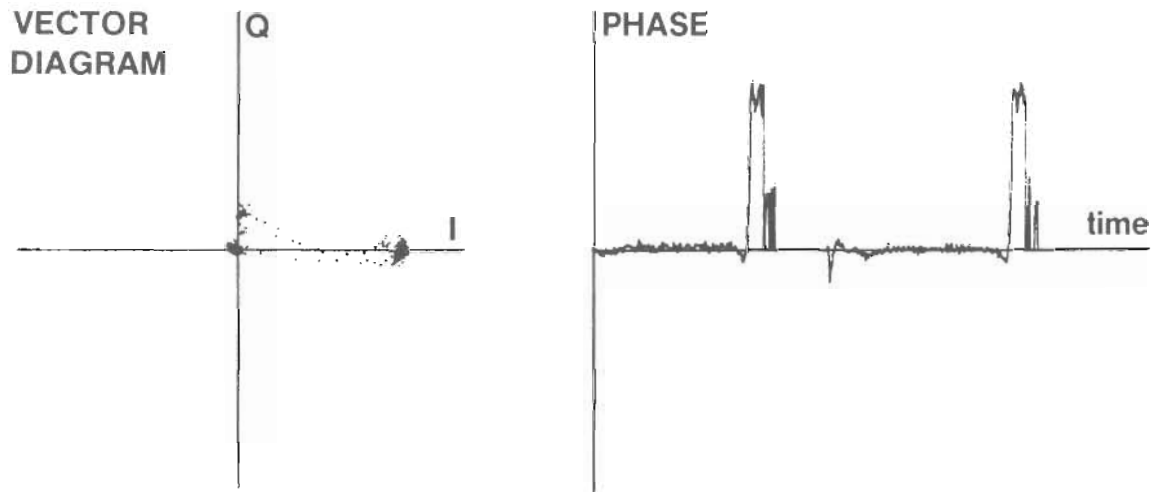

For example, the effects on signal phase of a pulse modulator are easily measured using the techniques we have been discussing. On this slide, the AM-PM conversion and phase vs. time over the duration of a pulse are plainly seen. A temporary 90 degree phase shift occurs during the first few nanoseconds of this pulse (this is not characteristic of *all* pulse modulators, however).

Phase Shifts in High-Power Amplifiers, TWTs:

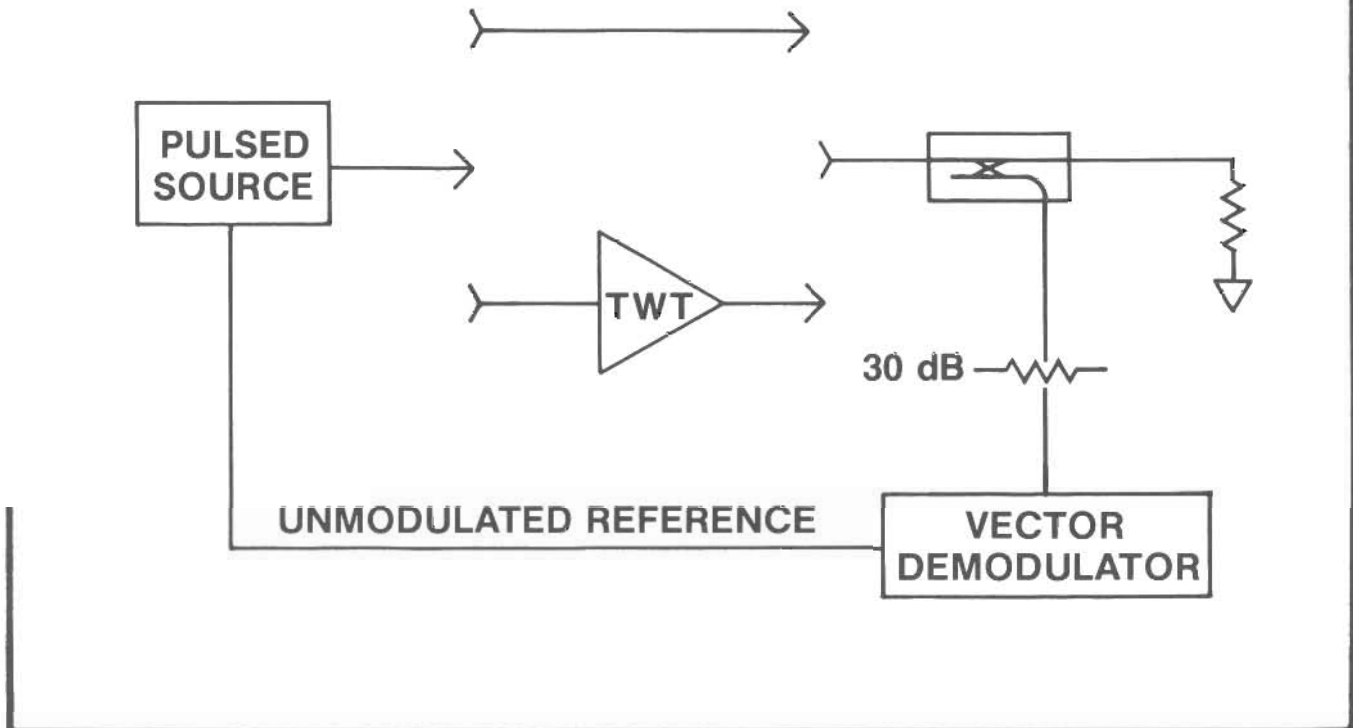

Another problem is that of measuring phase shift as a signal passes through a TWT amplifier. Measuring the transient AM-PM conversion as a radar transmitter is keyed is one item of interest; but even group delay measurements might require a vector demodulator rather than a network analyzer due to the TWT's average power limitations. The block diagram shown suggests one possible solution to these problems. The through-line is not needed for AM-PM measurements, but it is necessary to establish a reference for the group delay measurement.

Practical Realization of Vector Demodulator Using Off-the-Shelf Components

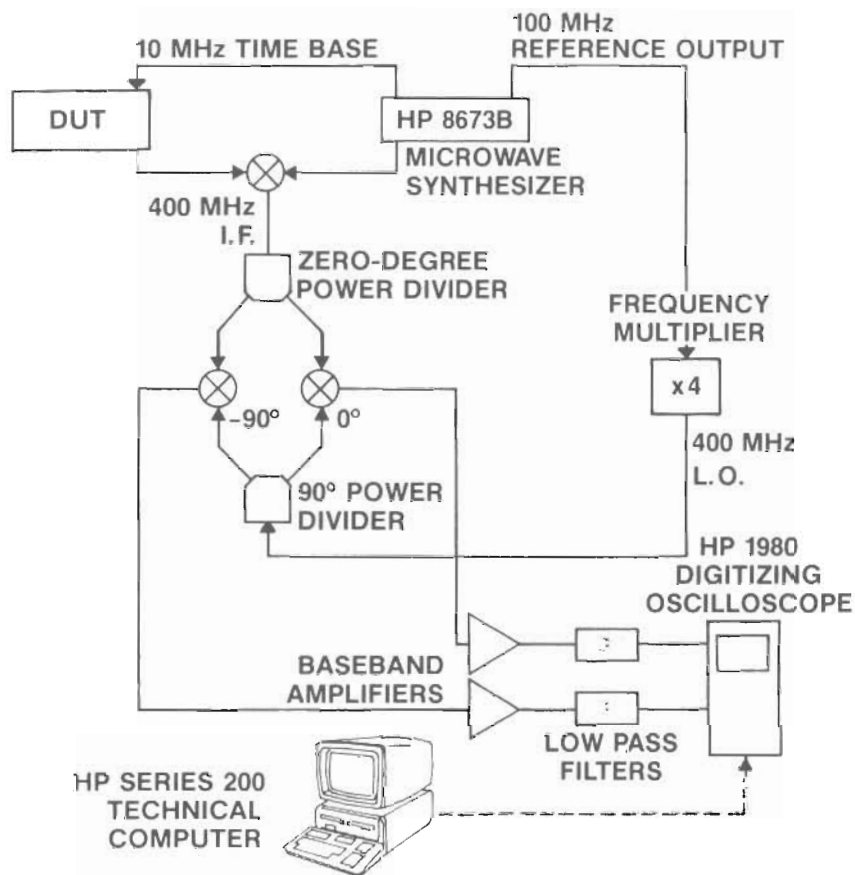

This concept-demonstration vector demodulator setup uses readily-available components and equipment. Other configurations are also possible, so long as the basic demodulator shown previously is implemented. Of course, to measure a digital radio that has I and Q outputs already available, the oscilloscope and computer analysis portion will be of most interest.

System Features

- **Broadband; uses fixed I.F.**
- **HP 8673B serves dual purpose of μ W L.O. and I.F. L.O.**
- **HP 1980 scope vs. HP 5180 waveform recorder**
- **Component cost (not incl. test equipment) less than \$1K**
- **Menu-driven software for benchtop use**
- **Programmable equipment enables automated production test**

This particular implementation accepts broadband microwave inputs, converting them immediately to a 400 MHz IF. The power dividers and baseband mixers are selected for a few-hundred MHz bandwidth centered about this IF frequency. Since the bulk of the signal processing is done at IF rather than RF, matching the components and cables is less difficult.

An HP 8673B Microwave Synthesizer serves the dual purpose of microwave LO and a coherent source from which the IF LO is generated. Recall that the LO and the RF/IF signals must be phase coherent if the system is to function properly.

The HP 1980A Oscilloscope was chosen as the digitizer, although for some applications two waveform recorders such as HP's 5180A might be preferable. The waveform recorders would allow capture of single-shot events up to 20 MHz in bandwidth, while the HP 1980A sampling scope is preferable for repetitive signals.

The HP 1980A scope features 100 MHz vertical bandwidth (3 dB), which is fast enough to measure most baseband signals. It also provides real-time display of the data channel eye diagrams, as opposed to the computer display which is limited to the stored digitized data.

An HP Series 200 technical computer was chosen for its strengths in instrument control, computing speed, and high-resolution graphics. Software can be written to display eye and vector diagrams, phase and magnitude plots, and markers for amplitude, phase, and time. The programmable test equipment also makes possible automated production testing of pulse rise time and peak power.

Tomorrow's Customary Modulation Analysis Tools

VECTOR
DEMODULATOR

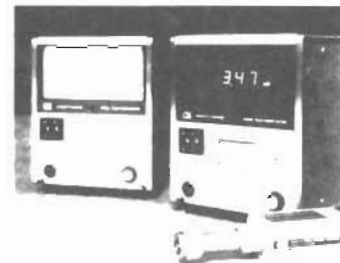
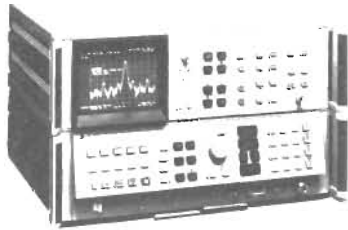

Just as we have seen in the past few years, the complexity of modulation techniques will continue to increase in the future. Customary instruments such as the spectrum analyzer and measuring receiver will continue to play an important role in modulation analysis due to their accuracy, frequency domain operation, etc. But the vector demodulator also makes several significant contributions and it is likely that it, too, will gradually become known as one of the engineer's customary pieces of measurement equipment.