

HP Archive

This vintage Hewlett Packard document was preserved
and distributed by

[www. hparchive.com](http://www.hparchive.com)

Please visit us on the web !

On-line curator: Glenn Robb

This document is for FREE distribution only!

RF MEASUREMENTS OF FIBER OPTIC COMPONENTS

Roger Wong
Network Measurements Division
1400 Fountain Grove Parkway
Santa Rosa, CA 95401

RF & Microwave
Measurement
Symposium
and
Exhibition

 HEWLETT
PACKARD

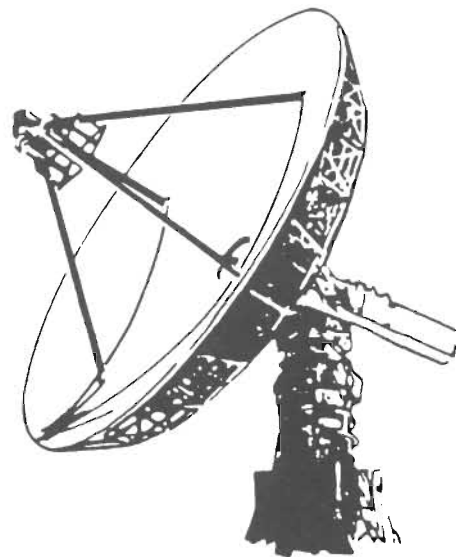

RF MEASUREMENTS OF FIBER OPTIC COMPONENTS

ABSTRACT

RF network analysis is a useful technique for measuring the baseband electrical characteristics of fiber optic components. This paper is intended as a measurements tutorial and presents a brief description of the measurement theory and measurement block diagrams, including discussion of instrumentation requirements for attenuation and bandwidth measurements of optical fiber. In addition, fault location and modal dispersion measurements achieved through conversion of frequency domain information via the inverse Fourier transform to the time domain are described.

Author: Roger Wong is an Engineering Project Manager in the economy vector network analyzer section of the Network Measurements Division of Hewlett Packard Company, located in Santa Rosa, California. He graduated from Oregon State University (BSEE) and Columbia University (MSEE). With HP since 1968, projects included development of microwave microcircuits, devices, and components for HP component products and microwave instruments.

RF MEASUREMENTS OF FIBER OPTIC COMPONENTS

4411

OBJECTIVES:

- Show How Network Analyzers Can Be Used to Characterize Components in Fiber Optic Communications Systems
- Explain Basic Theory of the Measurements
- Show Some Typical Measurement Examples

4412

CONTENTS

- Model of Typical Fiber Optic Communications Systems
- Important Parameters for:
 - Electrical/Electrical
 - Electrical/Optical
 - Optical/Electrical
 - Optical/Optical Measurements
- Frequency Domain Measurement Theory & Examples
- Time Domain & Fault Location Measurement Theory & Examples

4413

Introduction: RF characterization of fiber optic components is becoming more necessary as system modulation rates increase to microwave frequencies. RF network analyzers have been used to characterize electronic components for years and are becoming more commonplace. Additionally, network analyzers with suitable optical converters can be used to perform a wider variety of photonics measurements. Some of these measurement applications will be discussed in this presentation.

The objectives of this presentation are as follows:

- 1) To discuss how network analyzers can be used to characterize components in fiber optic communications systems.
- 2) To explain conceptually how a network analyzer works and the basic measurement theory.
- 3) To present some typical measurement examples.

In short, this presentation is intended as a measurements tutorial to explain the use of network analyzers in characterizing electronic, electro-optical, and optical components.

To accomplish the objectives, the presentation will be structured as follows: 1) show a conceptual model of a typical fiber optic communications system, 2) discuss the important parameters of interest in electronics/photonics areas, 3) discuss photonics measurements from a frequency domain approach and present some examples, and 4) discuss time domain and fault location basics and examples.

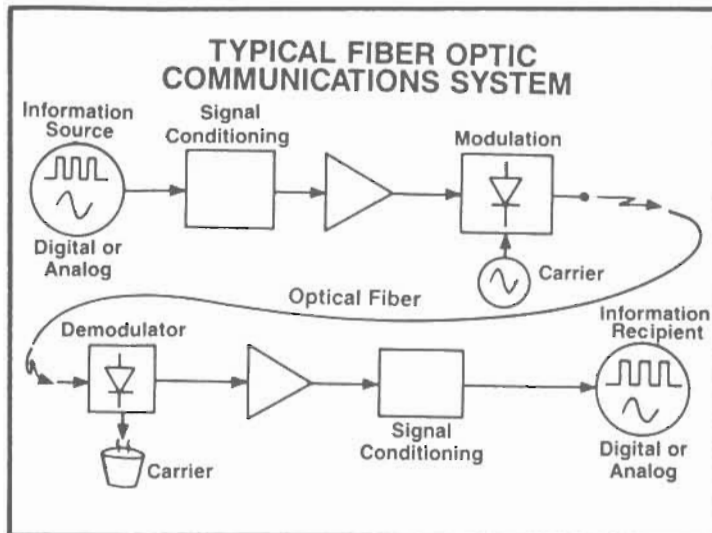

4414

A conceptual fiber optic communications system consists of several functional blocks: an information source, a signal conditioning section, linear driver amplifier, optical transmitter, optical fiber cable, optical receiver, signal conditioning section, and an information recipient. Electrical and optical measurements of components found in the linear driver amplifier, transmitter, optical fiber cable, and receiver blocks will be discussed.

- ### TRENDS:
- **Systems Use Higher and Higher Modulation Rates**
(→ GBits/Sec → Microwave Bandwidths).
 - **Component Designers Need to Characterize Electrical and Optical Devices to Microwave Frequencies.**
 - **Devices Need to be Evaluated with Modulated Signals to Characterize the Information Path.**

5005

As fiber optic communications systems use higher and higher modulation rates (i.e. 565 Mbits/sec, 1.7 Gbits/sec, etc.), more demand is created for microwave bandwidth functional blocks. This means that component designers need to characterize their electrical and optical components to microwave frequencies. And these components need to be evaluated with modulated signal to characterize the information path of the system.

PHOTONICS MEASUREMENT MATRIX

SIGNAL INPUT:	SIGNAL OUTPUT:			
	ELECTRICAL		OPTICAL	
ELECTRICAL	Equipment:	Measurements:	Equipment:	Measurements:
	Network Analyzer Test Set Example UUT=(E/G)→fiber→(G/E)	Att'n./Gain Bandwidth Distortion Elec. Length Match	Network Analyzer Photonics Source Calibrated Photonics Receiver Example UUT=laser diode	Transmitter Characteristics -sensitivity -linearity -compression
OPTICAL	Equipment:	Measurements:	Equipment:	Measurements:
	Network Analyzer Photonics Source Calibrated Photonics Receiver Example UUT=photo-diode	Receiver Charac -sensitivity -linearity -compression	Network Analyzer Photonics Source & Receiver Optical couplers Optical combiners Example UUT=Optical fiber cable	Att'n./Gain Bandwidth(opt) Dispersion Elec. length Fault location

4415

The Photonics Measurement matrix shows an overview of the four generic measurements possible when various components are excited by electrical or optical signals and when the component output signal is either electrical or optical. Network Analyzers can measure the analog quantities listed of many electronic components found in fiber optic communications systems. The network analyzer in conjunction with commercially available optical converters (electrical/optical and optical/electrical) can be used to perform measurements in the other three electro-optical areas.

ELECTRICAL/ELECTRICAL

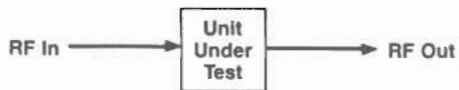

TYPICAL TEST DEVICES

- Linear Amplifiers
- Coax Cables, Passive Components, Connectors
- Repeaters (i.e. E/O + Optical Fiber + O/E)

4416

Electrical/electrical Devices: Typical examples of devices which can be characterized by network analyzers are linear amplifiers, coax cables and connectors, passive components such as electrical attenuators, filters, etc., and fiber optic repeaters (e.g. E/O converter + optical fiber cable + O/E converter).

E/E: KEY PARAMETERS

- Attenuation/Gain vs. Modulation Frequency
- Attenuation/Gain vs. Power
- Modulation Bandwidth
- Impedance (Magnitude & Phase) Levels
- Phase (Linear, Delay)
- Distortion (Group Delay, Non-Linear Phase Deviation)
- Electrical Length & Fault Location

4417

E/E Key Parameters: Important parameters which characterize most electronic components are listed. They delineate both the magnitude and phase properties of linear and quasi-linear networks in transmission and reflection modes.

ELECTRICAL/OPTICAL

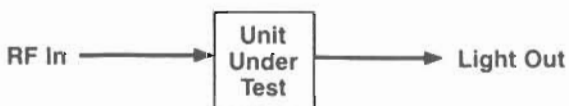

TYPICAL TEST DEVICES

- Laser Diodes & LED's
- Optical Sources
- Optical Modulators

4418

Electrical/Optical Devices: Typical test devices that are electro-optical are laser diodes, LED's, optical sources and optical modulators.

E/O: KEY PARAMETERS

- Sensitivity:
 - Optical Power Out vs RF Power (Fixed Mod. Freq.)
 - Optical Power Compression Point
 - Noise Threshold/Floor
- Transfer Characteristic vs Electrical Drive Power (Fixed Modulation Freq.)
- Transfer Characteristic vs Modulation Freq. (Fixed Electrical Drive Power)
- Linearity:
 - Δ TC vs RF Power (Fixed Mod. Freq.)
 - Δ TC vs Modulation Freq. (Fixed RF Power)

4419

E/O Key Parameters: The key parameters for electrical/optical devices are sensitivity, power compression, noise threshold, dynamic range, and linearity (or transfer characteristic flatness).

OPTICAL/ELECTRICAL

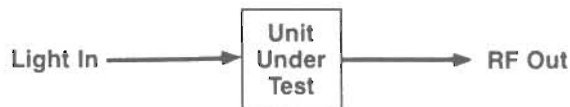

TYPICAL TEST DEVICES

- Pin Photo-Diodes
- Avalanche Photo-Diodes
- Optical Receivers

4420

Optical/Electrical Devices: These devices are the duals of the electrical/optical devices. Typical devices are PIN photo-diodes, avalanche photo-diodes, and optical receivers.

O/E: KEY PARAMETERS

- Sensitivity:
 - RF Power Out vs Optical Input Power
 - RF Power Compression Point
 - Noise Threshold/Floor
- Transfer Characteristic vs Optical Input Power (Fixed Modulation Freq.)
- Transfer Characteristic vs Modulation Freq. (Fixed Optical Input Power)
- Linearity:
 - Δ TC vs Optical Input Power (Fixed Mod. Freq.)
 - Δ TC vs Modulation Freq. (Fixed Input Optical Power)

4421

Optical/Electrical Parameters: The key parameters for the optical/electrical devices are the same as in the electrical/optical case, except that the independent and dependent variables are reversed.

OPTICAL/OPTICAL

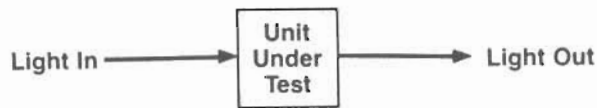

TYPICAL TEST DEVICES

- Optical Fiber Cable
- Optical Modulators
- Passive Optical Devices
- Optical Attenuators

4422

Optical/Optical Devices: Typical optical components are optical fiber cable, modulators, passive devices such as switches, splitters, combiners, etc., and attenuators to name a few.

O/O: KEY PARAMETERS

- Attenuation vs Modulation Freq.
- Optical Modulation Bandwidth
- Delay
- Pulse Dispersion (Modal)
- Electrical Length
- Fault-Location

4423

Optical/Optical Parameters: The key parameters are listed; in many instances, these parameters are of interest for electrical/electrical devices.

FREQUENCY DOMAIN MEASUREMENT THEORY & EXAMPLES

- Network Analyzer Basics
- Modulated Signals
- Frequency & Time Domain Basics
- E/E Measurement & Block Diagram
- E/O Measurement & Block Diagram
- O/E Measurement & Block Diagram
- O/O Measurement & Block Diagram

4424

The presentation will now focus on the measurement theory of the four generic measurements (i.e E/E, E/O, O/E and O/O). The slide shows the topics to be covered and their sequence. The measurements discussed (in this section) will be done from a frequency domain point of view and will be geared at a tutorial level.

Before discussing the electrical/optical measurements, a review of the basic concepts in network analyzers, modulated signals, and frequency and time domain basics would be helpful to gain further insights to the measurements.

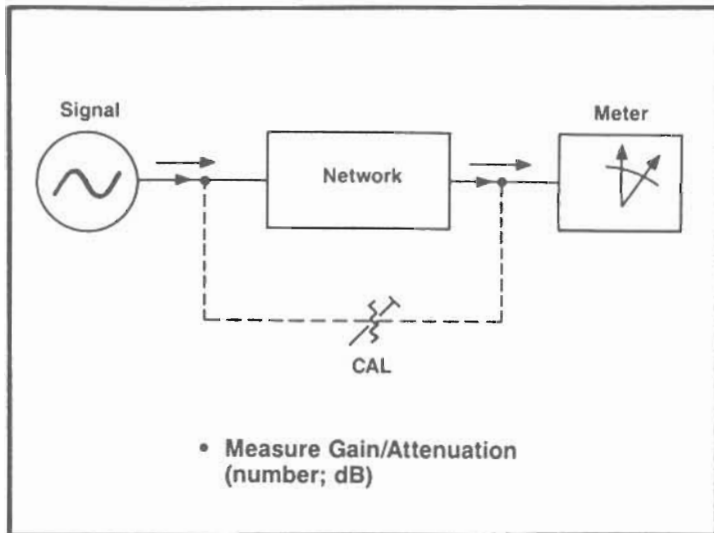

4425

Here, we have a signal source at a CW frequency, f_0 , and a receiver (e.g. power meter, diode detector, etc.). First, the system is calibrated using a variable attenuator; next, the network is inserted and either a gain or attenuation is measured. The measurement can be given as a number or in decibels (dB).

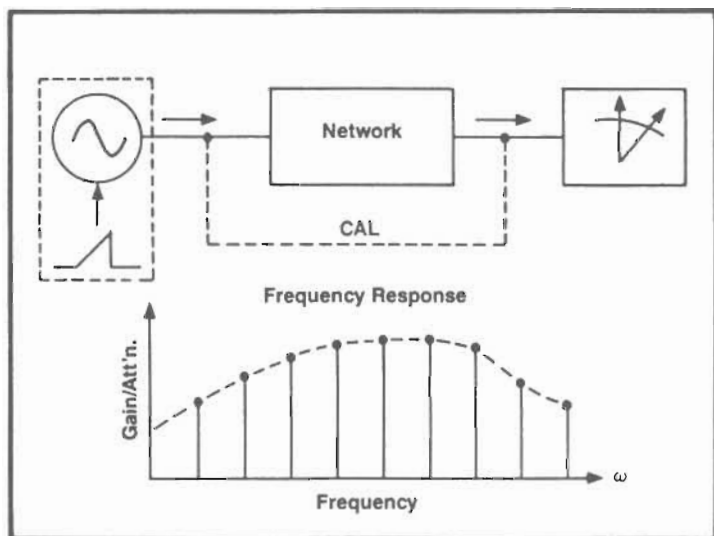

4426

In this case, the measurement can be expanded to sweep the source at a number of discrete frequencies. The single channel receiver can be calibrated over the frequency range of interest, and the network inserted between the source and receiver. The resulting measurement is the frequency response of the network.

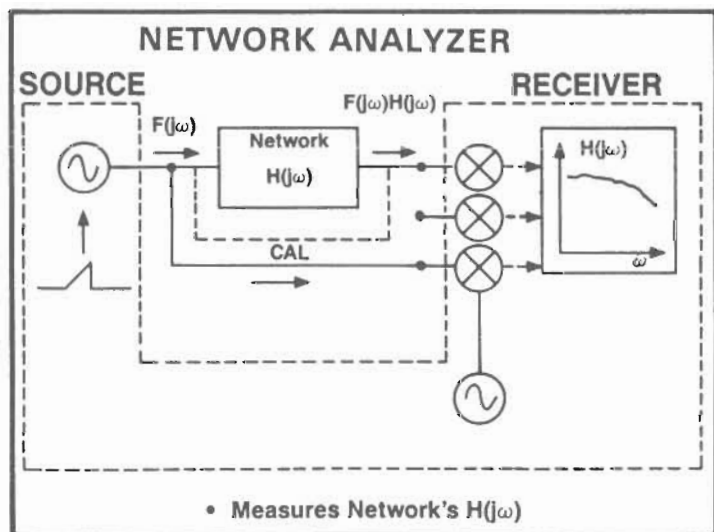

4427

The network analyzer is an extension of the single channel receiver concept. It is a multi-channel tuned receiver with a swept signal source that takes a ratio measurement. Notice that $F(j\omega)$ is incident to both the network under test and one of the network analyzer's channel simultaneously. The second channel receives the output signal $F(j\omega)H(j\omega)$. The resulting measurement is $H(j\omega)$ --both the magnitude of $H(j\omega)$ and the angle of $H(j\omega)$.

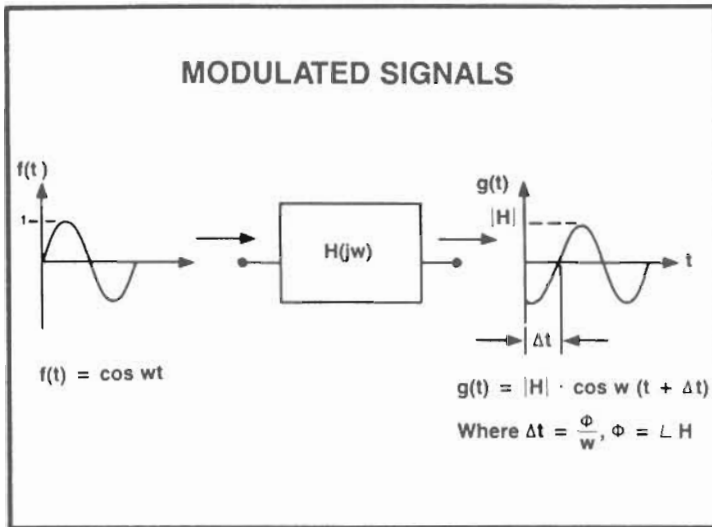

4433

Let's review some basics of modulated signals. Suppose a signal $f(t) = \cos(\omega t)$ is injected into a linear network $H(j\omega)$. The output signal $g(t)$ is operated upon by network $H(j\omega)$ as follows: 1) the magnitude of the input signal (1) is multiplied by the magnitude of $H(j\omega)$; and 2) the phase of $f(t)$ is delayed by the angle of $H(j\omega)$. Thus, the resulting $g(t)$ is given as shown.

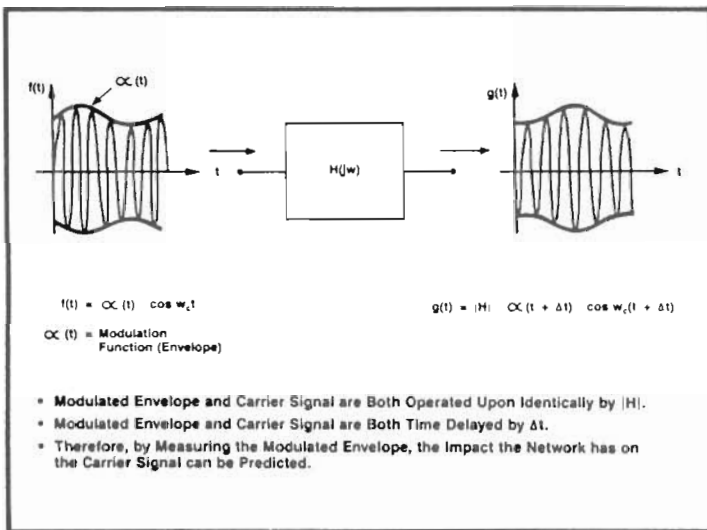

4434

Consider that we have an AM modulated input signal $f(t)$, as shown. The network $H(j\omega)$ operates upon the carrier and modulated components of the input signal $f(t)$ in an identical manner to yield the output signal $g(t)$. In other words, the modulated envelope and carrier signal are multiplied by the magnitude of $H(j\omega)$, and the modulated envelope and carrier signal are both time delayed by Δt (i.e. the phase of $H(j\omega)$). Therefore, by measuring the modulated envelope, the impact the network has on the carrier signal can be predicted.

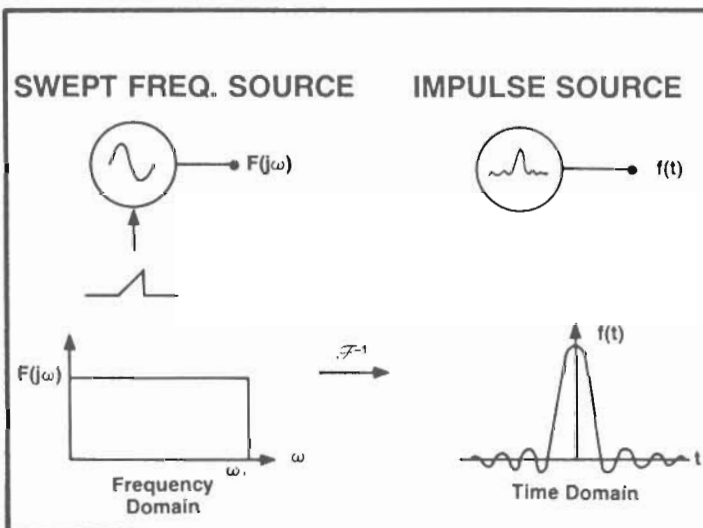

4428

Now, let's review some frequency and time domain concepts. Consider a swept frequency source whose output power over the frequency range is constant at 1 unit. In the frequency domain, it represents a constant power over the given frequency range. The inverse Fourier transform of this frequency information will give its equivalent time domain representation--a time impulse centered at $t=0$ seconds with $\text{sinc}(x)$ form. In other words, an equivalent excitation impulse can be simulated in the time domain by taking the inverse Fourier transform of the rectangular power/frequency spectrum in the frequency domain.

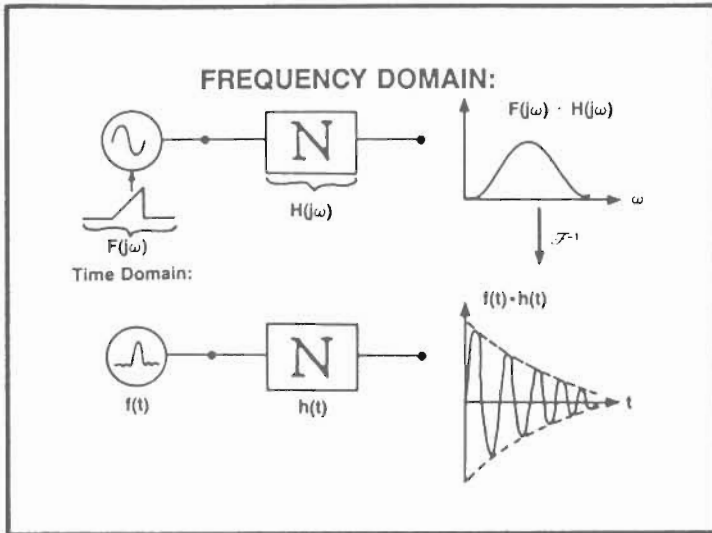

In the frequency domain, given an input signal $F(j\omega)$ and a network, $H(j\omega)$, the resulting output signal, $[G(j\omega)]$, is the product of the two functions. In the time domain, the output signal, $g(t)$, is the inverse Fourier transform of $G(j\omega)$ or given, $f(t)$ and $h(t)$, it is the convolution of the two functions $f(t)$ and $h(t)$, i.e. $g(t) = f(t) * h(t)$.

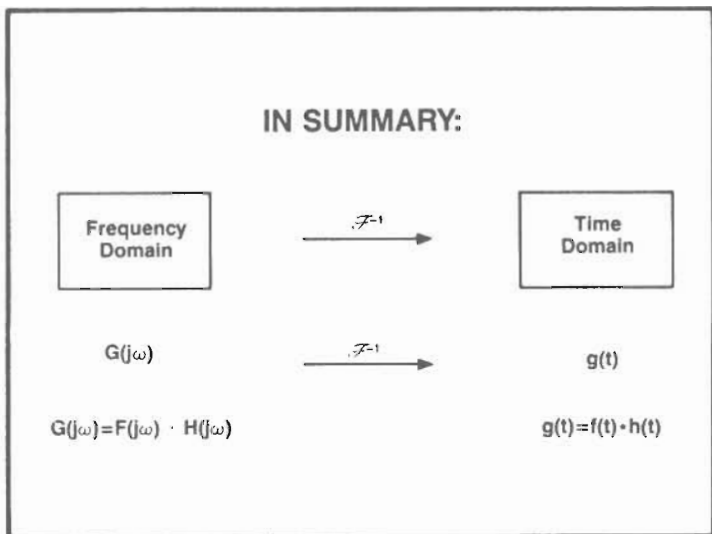

In summary, frequency domain information can be converted to the equivalent time domain information through the inverse Fourier transform. The output signal, $g(t)$, in the time domain can be derived from the frequency domain output signal, $G(j\omega)$, through the inverse Fourier transform of $G(j\omega)$.

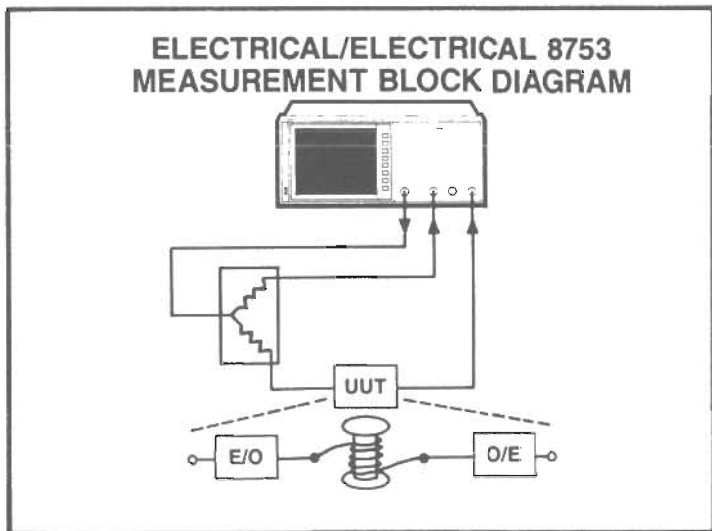

Electrical/Electrical Measurements: The measurement block diagram is shown for units under test where both the input and output signals are electrical. The specific analyzer shown in this case is the HP8753A Network Analyzer (also other HP network analyzers could be used). The unit under test selected as an example could be a repeater where the optical converters contain the analog linear circuits and no digital signal conditioning circuits.

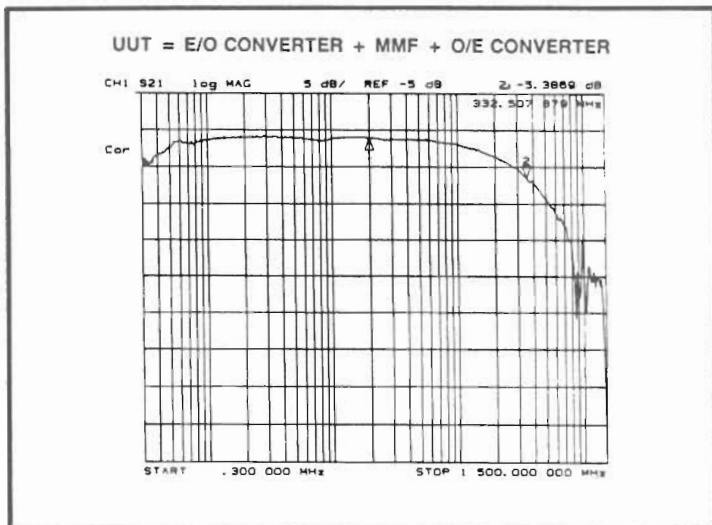

4432

The optical converters include the analog circuits connected with approximately 1.5 Km of multi-mode optical fiber. The measurement plot of the repeater shows its transmission characteristics (i.e. attenuation and frequency response flatness) and bandwidth.

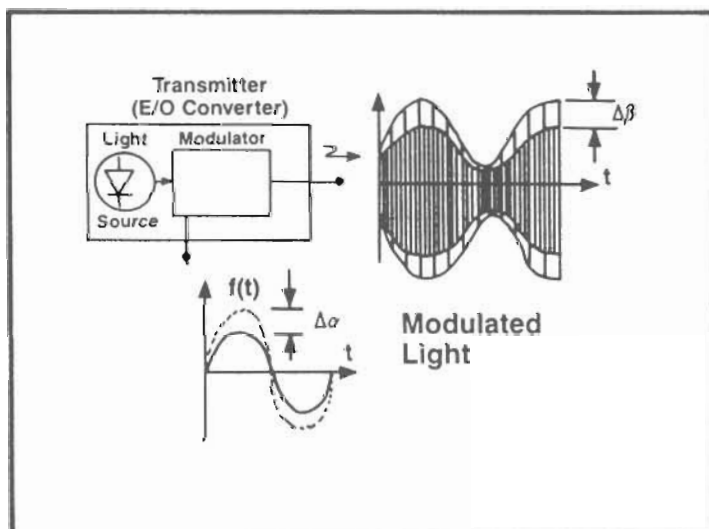

4436

Electrical/Optical Measurements:

Measurements on the test devices occur with an electrical input signal and an optical output signal. Let us use an optical transmitter as an example test device (note: the discussion applies to the other typical test devices listed earlier). The input signal modulates the optical transmitter which results in a modulated light signal at its output. If the frequency is held constant but the electrical input power is varied, then the modulated light output power will vary.

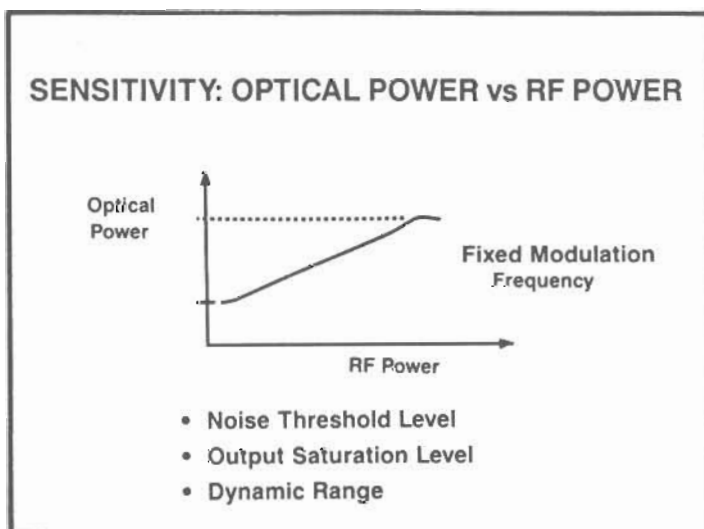

4437

Sensitivity: The modulated optical power can be plotted as a function of the input electrical drive rf power for a fixed modulation frequency. There are three significant parameters which can be obtained from this sensitivity curve: 1) noise threshold level, 2) output power saturation level and 3) dynamic range of the transmitter.

LINEARITY: TC ($\Delta P_{opt}/\Delta P_{rf}$) vs RF POWER

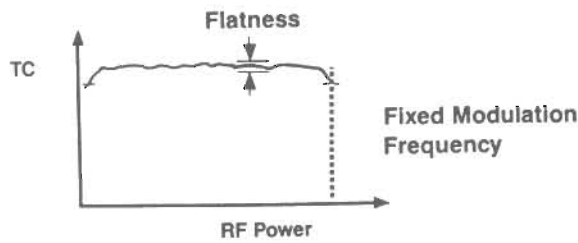

- Transfer Characteristic (TC)
- TC Flatness (Ripple)
- Power Compression Point @ 1 dB

4438

Linearity: The slope of sensitivity curve or transfer characteristic (TC) versus rf power can be plotted to show the linearity of the transmitter with greater resolution. The TC flatness or ripple and power compression characteristics also become more evident in this format.

BANDWIDTH: TC vs MODULATION FREQUENCY

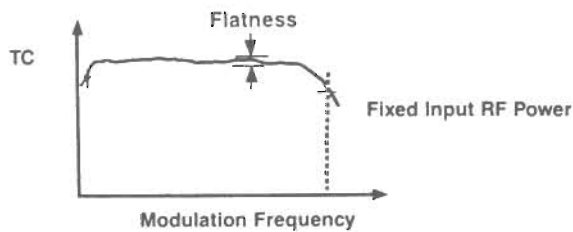

- Transfer Characteristic (TC)
- TC Flatness (Ripple)
- Bandwidth

4439

Bandwidth: If the input rf power to the transmitter were now held constant and the modulation frequency were varied, the transfer characteristic versus modulation frequency could be measured. The data plotted in this format would show the modulation bandwidth, transfer characteristic and the flatness performance of the transmitter.

MEASUREMENT BLOCK DIAGRAM (ELECTRICAL/OPTICAL)

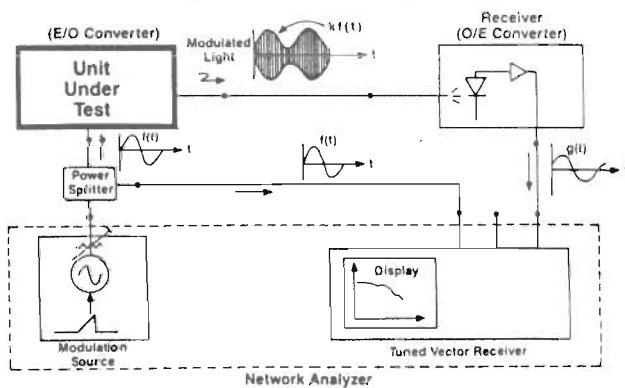

4435

E/O Measurement Block Diagram: The measurement block diagram is shown. It is necessary to know the transfer characteristics of the optical receiver to determine the transmitter's characteristics from the network analyzers measurements.

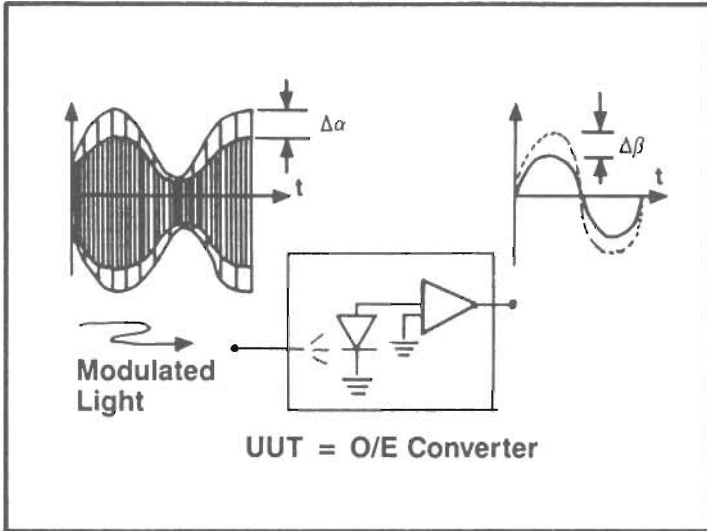

4441

Optical/Electrical Measurements: The optical/electrical measurements are the reciprocal of the electrical/ optical measurements. In this case, the input signal is modulated light and the output signal is electrical rf power.

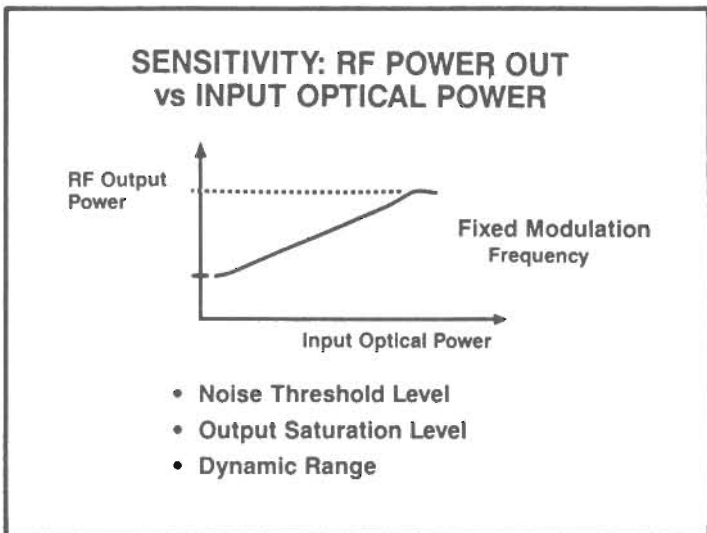

4442

Sensitivity: In a similar manner, receiver sensitivity can be measured by plotting modulated rf power versus modulated optical power. Parameters such as noise threshold level, output power saturation level, and dynamic range can be extracted for the measurement.

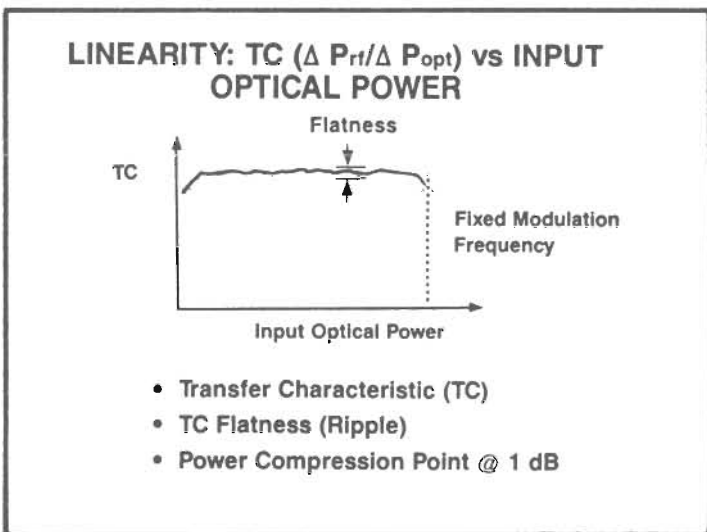

4443

Linearity: The transfer characteristic (TC), TC flatness and power compression points can be identified with greater resolution in this format.

BANDWIDTH: TC vs MODULATION FREQUENCY

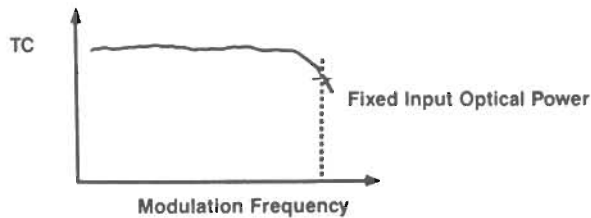

- Transfer Characteristic (TC)
- TC Flatness (Ripple)
- Bandwidth

4444

Bandwidth: By holding the modulated optical power input constant and varying the modulation frequency, modulation bandwidth, transfer characteristics and its flatness can be determined for the receiver.

MEASUREMENT BLOCK DIAGRAM (OPTICAL/ELECTRICAL)

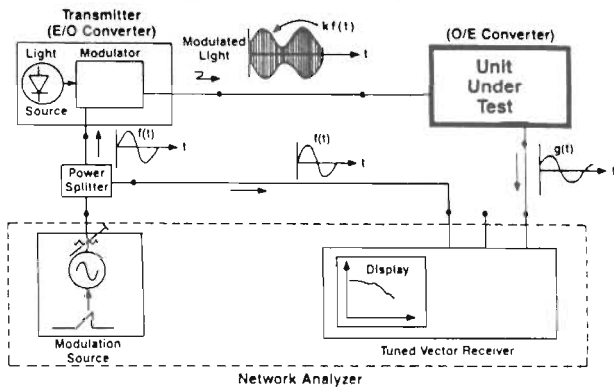

4440

O/E Measurement Block Diagram: The receiver measurement block diagram is shown. As with the E/O measurements, a calibrated or reference optical receiver whose characteristics are known is necessary to determine the unknown receiver's characteristics from the network analyzer's measurements.

MEASUREMENT BLOCK DIAGRAM (OPTICAL/OPTICAL MEASUREMENTS)

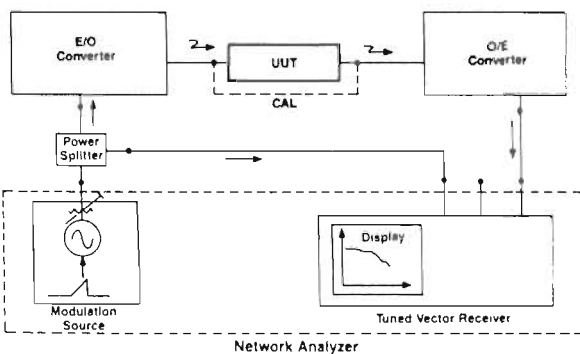

5006

Optical/Optical Measurements: For test devices where the input and output signals are light, it is adequate to use optical transmitters and receivers whose electro-optical characteristics are unknown, but the T/R set should have sufficient modulation bandwidth for the measurement application.

The measurement block diagram is shown. Remember that the input light signal to the test devices is modulated light and that the network analyzer measures the properties of the modulated envelope to determine the affect of the carrier light on the test device.

TYPICAL DEVICE: MMF

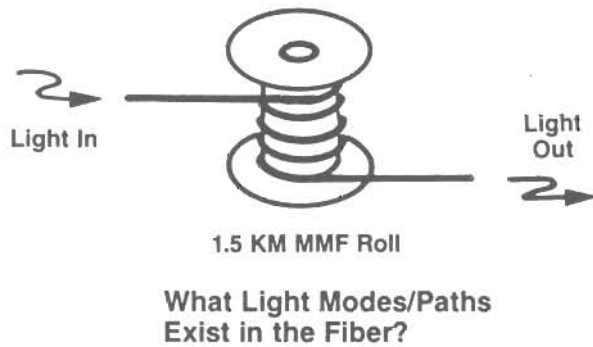

5007

Let's consider a roll of multi-mode fiber as a typical test device. As the test device name implies, there are various modes of light which travel through optical waveguide. What light modes exist and how do they interact with each other?

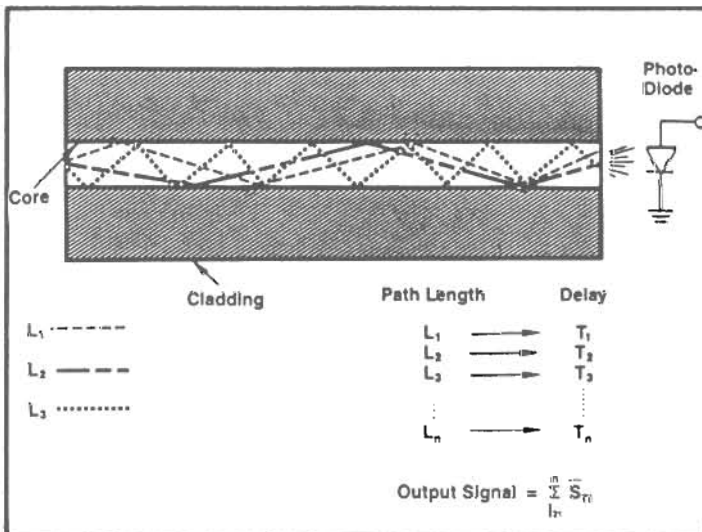

5008

As shown conceptually, various longitudinal modes of light travel down the fiber, each having a different path length and hence, different time delays. The output signal is the vectorial sum of the individual light modes, each having a different phase angle. As the modulation frequency increases, the sum of the individual vectors will tend to decrease, since the vectors of difference path lengths will tend to cancel.

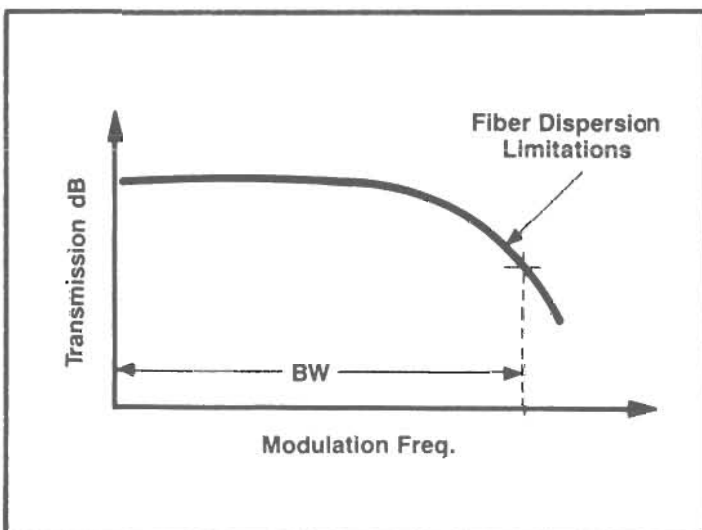

5009

Thus, we would expect that the fiber's transmission would decrease at higher modulation frequency, and the fiber would become more dispersive.

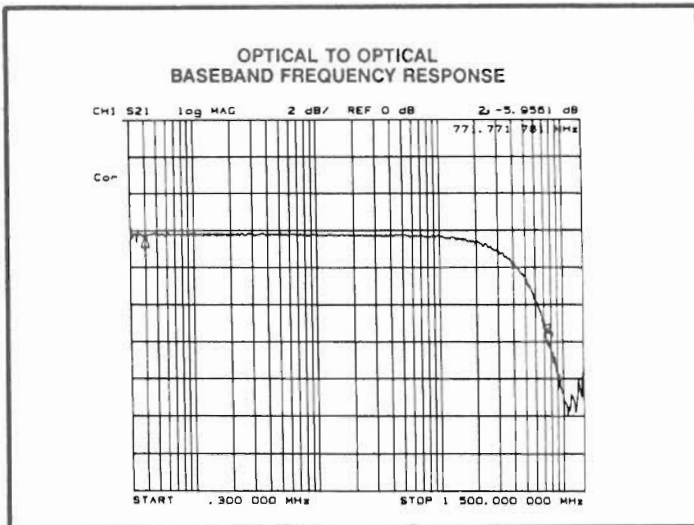

5010

The curve shown represents the transmission characteristics of a 1.5 Km length of multi-mode fiber. It's optical 3 dB bandwidth is almost 800 MHz.

TIME DOMAIN & FAULT LOCATION THEORY & EXAMPLES

- Length Measurements (Two Port/Transmission)
- Dispersion Measurements (Modal)
- Fault Location Measurements (One Port/Reflection)

5017

Thus far, the presentation has dealt with frequency domain measurements. We shall now discuss three time domain measurements: 1) two port length --transmission mode, 2) pulse dispersion (modal), and 3) one port length (reflection mode) or fault location.

TWO PORT LENGTH AND MODAL DISPERSION MEASUREMENTS

- - Calibrate w/Zero Length "Thru"
 - Measure MMF
 - Compare Calculated Input & Output Time Pulses

5011

Recall that frequency domain information can be converted to the equivalent time domain information by the inverse Fourier transform. In other words, although measurements are being taken in the frequency domain, network behavior to a time domain excitation (e.g. time impulse) can be determined. The measurement steps are outlined for two port length and modal dispersion measurements.

CALIBRATION: ZERO-LENGTH THRU

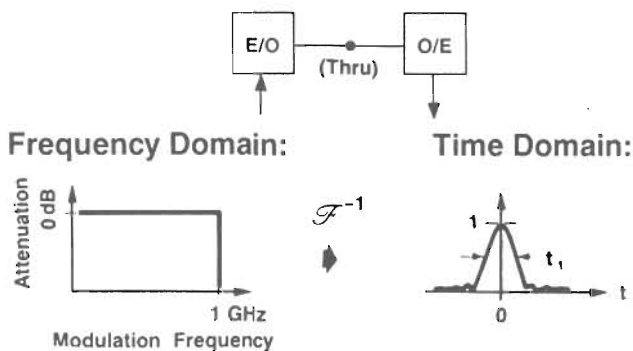

5012

Calibration: Using a reference or "zero" length patch cord (optical fiber cable), the optical system transmission response can be normalized. Over the frequency range of interest, the normalized frequency response is given as a rectangular pulse from f₁ to f₂. Its time domain equivalent is a time impulse at t=0. Note that the network analyzer allows viewing of both the frequency and time domain information conveniently.

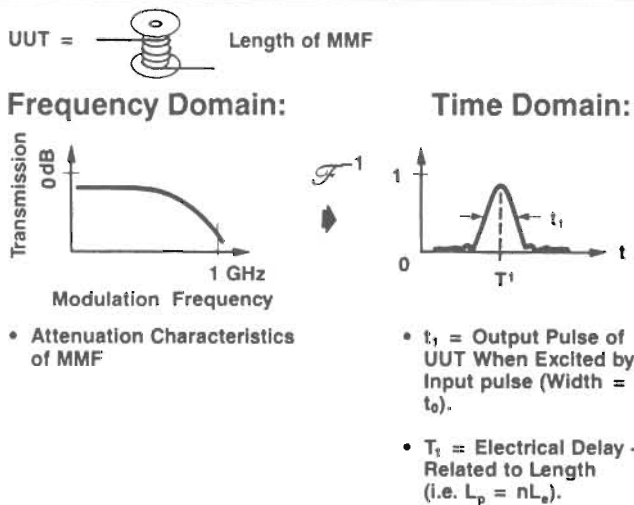

5013

Measurement of UUT: The unit under test (UUT) is inserted into the measurement system; the frequency domain response is shown. The inverse Fourier transform of the frequency domain information yields an impulse which is time delayed by T₁ and whose impulse width has widened to t₁ and been attenuated. The time delay, T₁, gives the electrical length information which can be converted to physical length, knowing the optical fiber index of refraction. Comparison of the t₁ and t₀ yields pulse dispersion information.

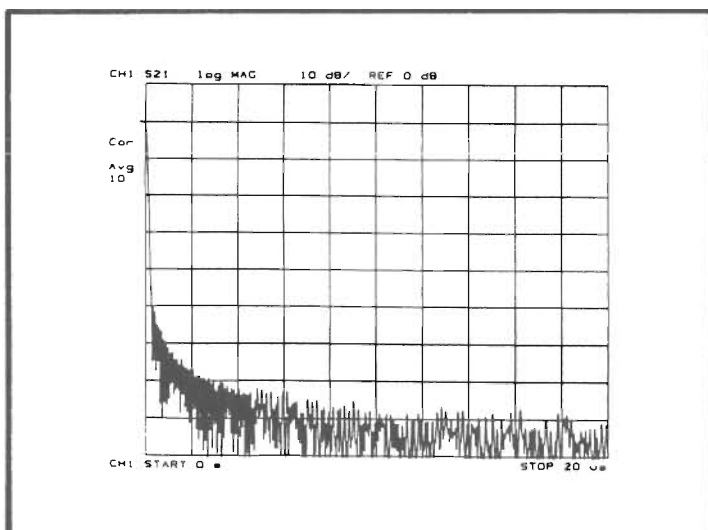

5018

The equivalent input impulse is shown, and the effective time/distance or distance range of the measurement. The twenty microseconds time window translates to a distance range of six kilometers (electrical length) or four kilometers (physical length), assuming an index of refraction of 1.5 for the optical fiber.

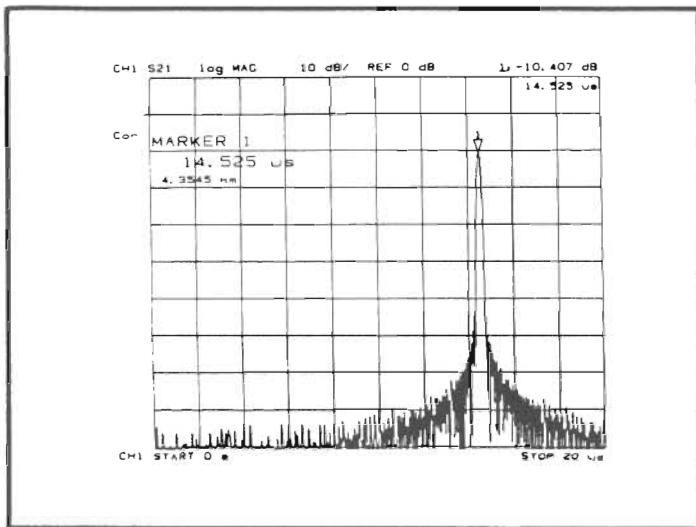

5019

The plot shows the two port length measurement of about three kilometers of multi-mode optical fiber. The time delay of 14.5 microseconds corresponds to an electrical length of 4.3545 Km; the conversion of electrical length to physical length depends upon knowing the index of refraction of the fiber very accurately. A short length of fiber was measured to determine the index of refraction of the fiber ($n=1.466$). Using the measured index of refraction and comparing the calculated length to that stated by the fiber manufacturer yields agreement better than 0.5%.

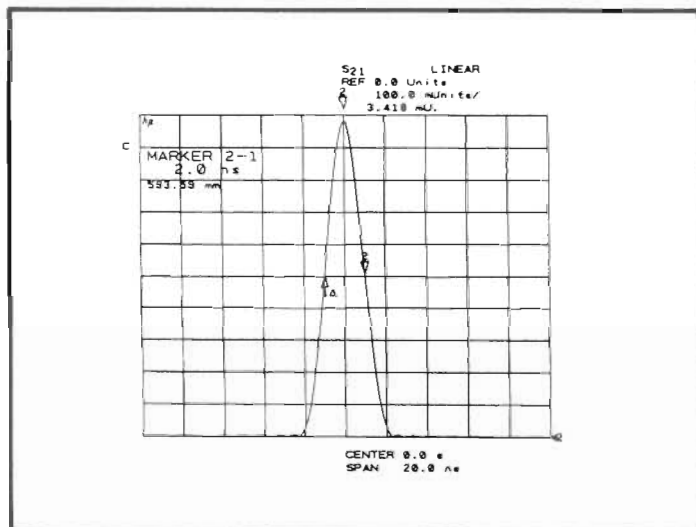

5014

Pulse Dispersion (Modal): In this measurement, the frequency range should be selected to yield a time impulse of an appropriate width. For the example, a 1 GHz frequency range yields a time impulse width under 2 nanoseconds. This time impulse is the input excitation to the network under test, in this case, a 1.5 Km length of multi-mode optical fiber cable.

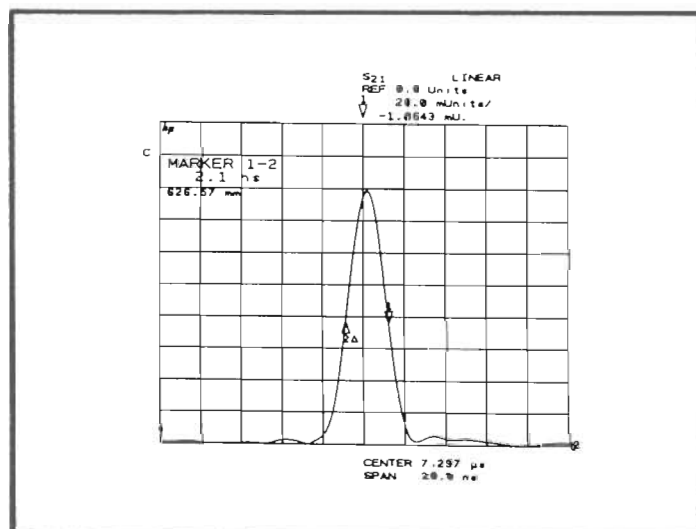

5015

Output Time Impulse: The output impulse has dispersed (spread) after traveling through the 1.5 Km multi-mode optical fiber cable, as shown.

$$t_{\text{output}} = [t_{\text{input}}^2 + t_{\text{UUT}}^2]^{1/2}$$

Where t_{xx} = the Full Width of Pulse (xx) at its Half Maximum Value.

$$t_{\text{UUT}} = [t_{\text{output}}^2 - t_{\text{input}}^2]^{1/2}$$

$$= 0.64 \text{ nsec per } 1.48 \text{ Km}$$

∴ Pulse Dispersion = 0.43 nsec per Km MMF

Reference: "Optical Fiber Communication"
by Gerd Keiser pg. 219

5016

Calculating the pulse spread via the equations shown, the pulse dispersion is 0.43 nanoseconds per Km of fiber. Note that the dispersion could also be calculated from the 3 dB bandwidth information, (i.e. $t_{\text{FWHM}} = 0.44/\text{BW}$ where t_{FWHM} is the full width of the pulse at its half-maximum value and BW is the 3dB optical bandwidth of the network under test).

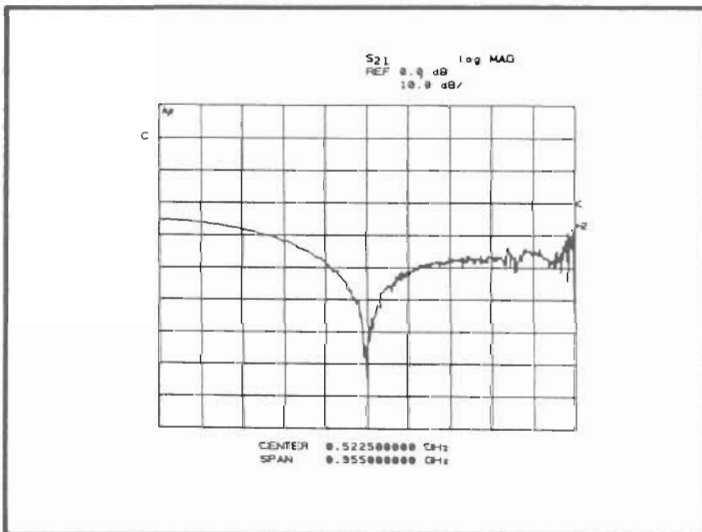

5087

The next example more graphically illustrates the value of viewing both frequency and time domain information easily. The transmission measurement shown is the attenuation characteristic of a length of multi-mode fiber whose bandwidth is approximately 350 MHz. At 500 MHz, a large attenuation is observed, which implies the cancellation of two approximately equal modes with opposite phase angles.

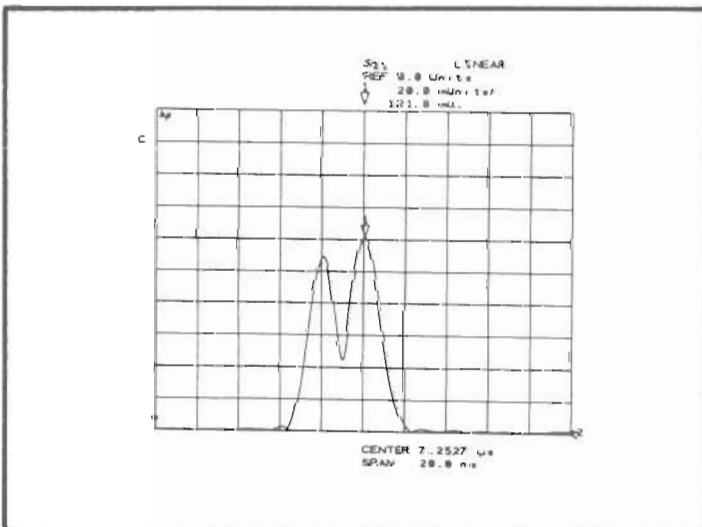

5088

The time domain information indicates the presence of two modes spaced 2 nanoseconds apart which is consistent with the frequency domain information. From a diagnostic standpoint, it is necessary to have the transmission characteristics versus modulation frequency in addition to the bandwidth and pulse dispersion parameters, in order to predict how the higher harmonics of the digital code will be affected by the transmission medium.

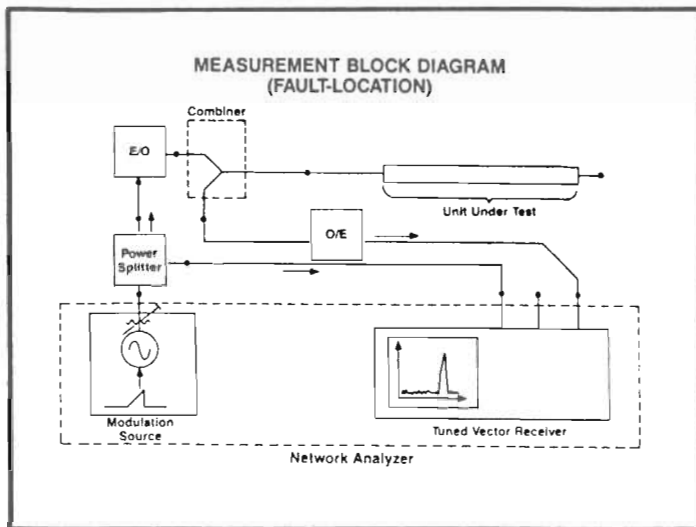

5020

Fault Location Measurements: The block diagram shows the test equipment configuration including the network analyzer, optical transmitter, combiner, receiver and unit under test (optical fiber/cable).

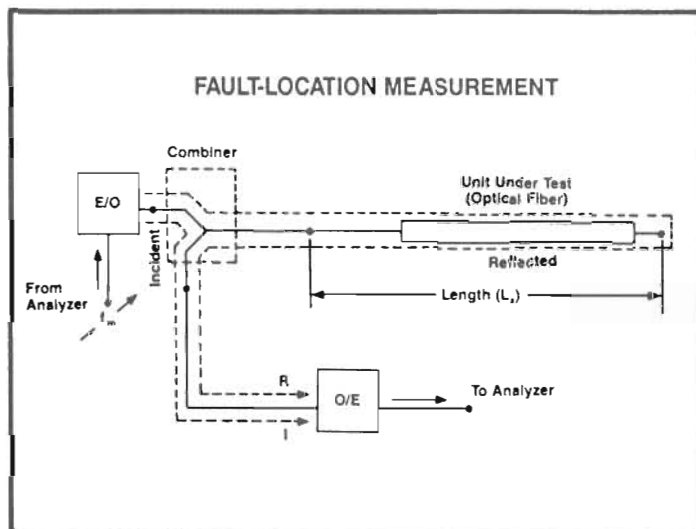

5021

Let us look at the signals present in more detail. Assume for the moment that the signal from the analyzer is a fixed frequency. Since the optical combiner does not have infinite isolation, an incident signal (I) flows to the receiver from the optical transmitter as shown. Another signal flows through the combiner to the unit under test (fiber) and is reflected off the end of the fiber; it flows back through the combiner to the receiver--the reflected signal (R).

The length of the fiber (UUT) is fixed which means that there is a constant time delay exists between the signals (I) and (R). As the modulation frequency of the analyzer is increased, the phase between the two signals change linearly. If the frequency is increased over a sufficient range, the phase will change $(n) \times (360)$; hence, a ripple pattern will be generated.

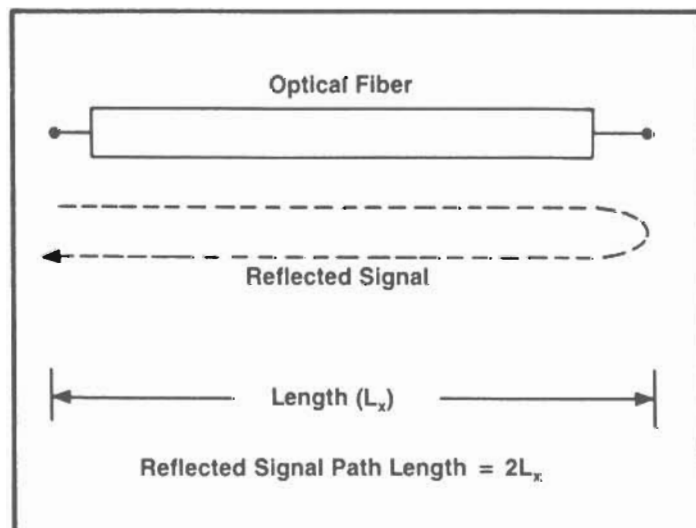

5022

The fiber is a fixed length, L_x . However, since the reflected signal is being measured, the path it travels is twice the length, $2(L_x)$.

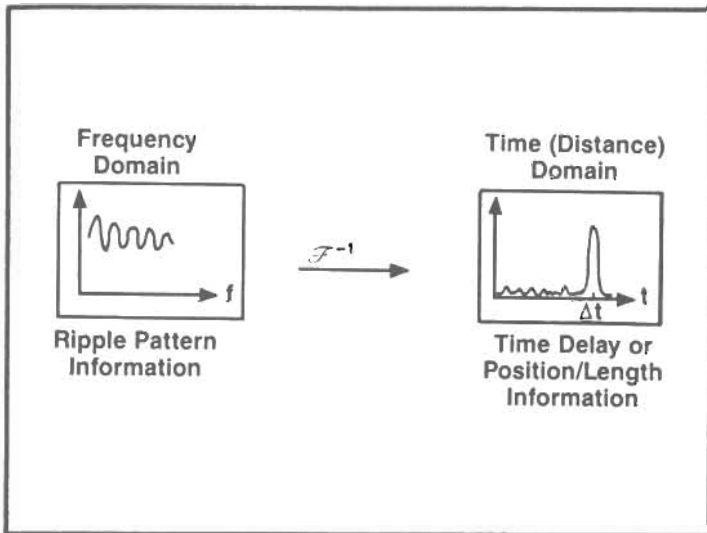

5025

The ripple pattern is measured in the frequency domain. An inverse Fourier transform operates on the frequency domain information to produce the distance (and time delay) information.

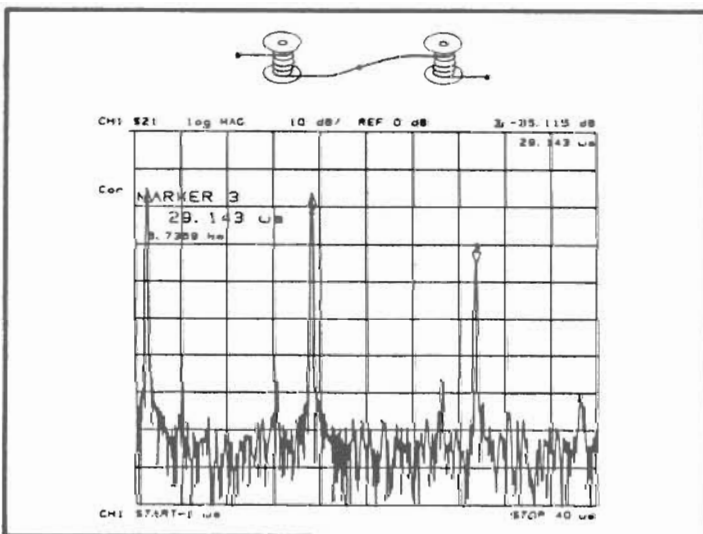

5026

The example shows two lengths of multi-mode fiber connected together, each about 1.5 Km long. Marker 3 displays the total length of the fiber; delta marker functions could be used to measure the lengths of the individual fiber lengths. Markers 1 and 2 show the beginning and end of the first length of fiber, respectively.

If more resolution were desired around a given discontinuity, the frequency range could be increased and the resulting time domain display offset by the known time delay.

SUMMARY AND CONCLUSIONS

- The Network Analyzer is a Valuable Tool for Characterizing Electrical Components in the Frequency Range of Modern High-Speed Fiber Optic Communications Systems.
- With the Addition of Optical Sources and Receivers, the Network Analyzer Capabilities are Extended to Characterizing Photonics Components.
- The Time Domain Feature of the Network Analyzer Provides Additional Measurement Capabilities of Pulse Dispersion and Fault Location of Electrical and Photonic Components.

5027

In conclusion, the network analyzer is a valuable tool for characterizing electrical components in the frequency range of modern high speed fiber optic communications systems. Both magnitude and phase information of the network can be measured.

By adding optical sources and receivers which can be modulated, network analyzer capabilities are extended to characterizing photonics components.

With the time domain feature of the network analyzer, additional measurement capabilities of pulse dispersion, two-port length and fault location of electrical and photonic components are provided.

