

A Calibrated Signal Simulation System Utilizing I/Q Modulation Techniques

Juan Grau
April 1988

RF & Microwave
Measurement
Symposium
and
Exhibition



A Calibrated Signal Simulation System Utilizing I/Q Modulation Techniques

Abstract: This paper describes the system, the performance and a technique for calibrating the system to improve SSB image rejection. Other issues addressed include the elimination of carrier leakage, amplitude ripple, and phase match between the I and Q modulating channels.

Author: Juan Grau, R&D Engineer, HP Stanford Park Division, Palo Alto, CA. A native of Mexico, Grau has a BSEE, Rice University, 1980 and MSEE from Stanford University, 1983. At HP since 1980, he worked on the HP 8902A Measuring Receiver and the HP 8981A Vector Modulation Analyzer.

Outline

1. Vector Arbitrary Waveform Synthesizer (VAWS) overview
2. The VAWS system
 - a) Baseband arbitrary waveforms
 - b) Vector signal generator
 - c) Upconversion using vector (I/Q) modulation techniques
 - d) System capabilities
3. Applications: Simulation Domains
 - a) Frequency domain: An EW jamming signal
 - b) Amplitude and phase domain: A radar chirp
 - c) I & Q domain: Digital modulation
 - d) Simulate transmission impairments by domain switching
4. Performance
 - a) System errors
 - b) Calibration
 - c) Calibrated performance
5. Summary

VAWS0020

Vector Arbitrary Waveform Synthesizer VAWS

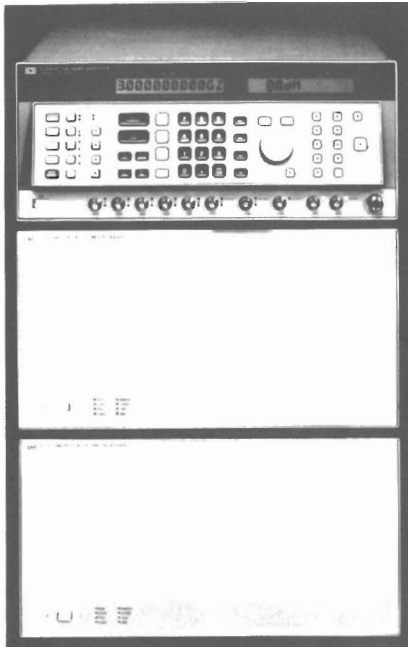

Complex signal simulation from
10 to 3000 MHz applications in . . .

RADAR

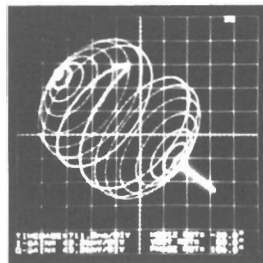

DIGITAL
COMMUNICATIONS

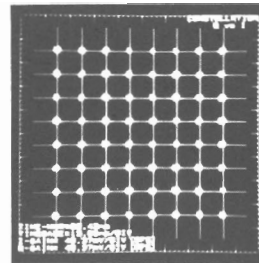

EW

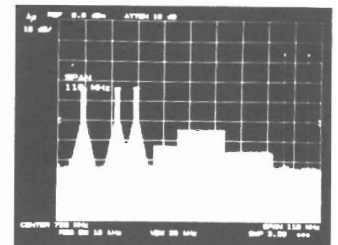

Arbitrary waveform generation is a powerful tool for signal simulation. The VAWS (Vector Arbitrary Waveform Synthesizer) system extends arbitrary waveform generation capabilities into the RF and microwave frequencies. Very complex types of modulation can thus be easily simulated. The range of possible applications for the system covers the Radar, EW and Telecommunications fields.

What is VAWS?

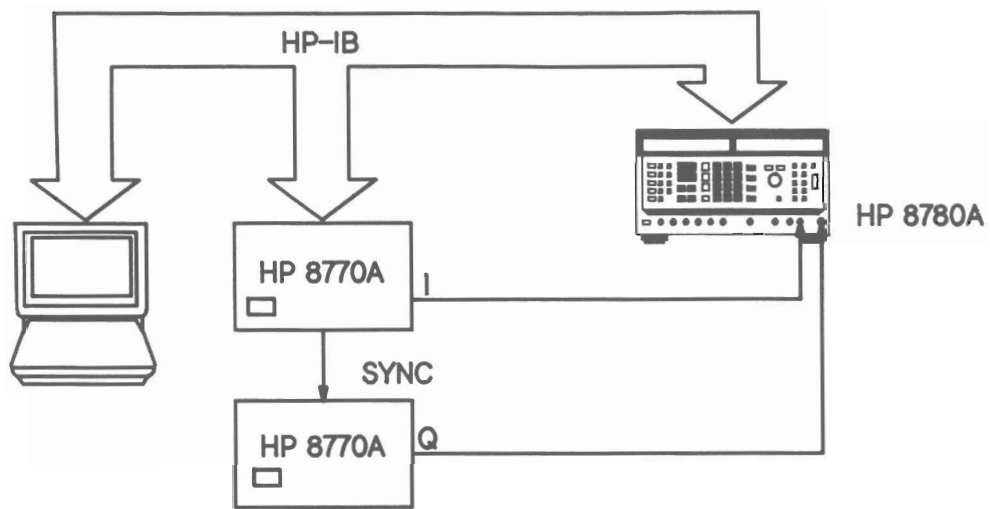

- HP Series 200/300 Computer
- 2 Arbitrary Waveform Synthesizers
- Vector Signal Generator
- HP 11775A/76A Waveform generation Software
- 50MHz baseband bandwidth
- 10Mhz to 3GHz
- I & Q modulation inputs

VAWS0030

The VAWS system is comprised of three parts:

- 1) Two Arbitrary Waveform Synthesizers to generate the baseband signals.
- 2) A Vector Signal generator to upconvert the arbitrary waveform capabilities of the AWSes to RF. It uses I/Q modulation techniques to achieve SSB type of upconversion.
- 3) A series 200/300 computer with the WAVEFORM GENERATION LANGUAGE software to tie it all together.

The VAWS System: Part 1

The Arbitrary Waveform Synthesizers

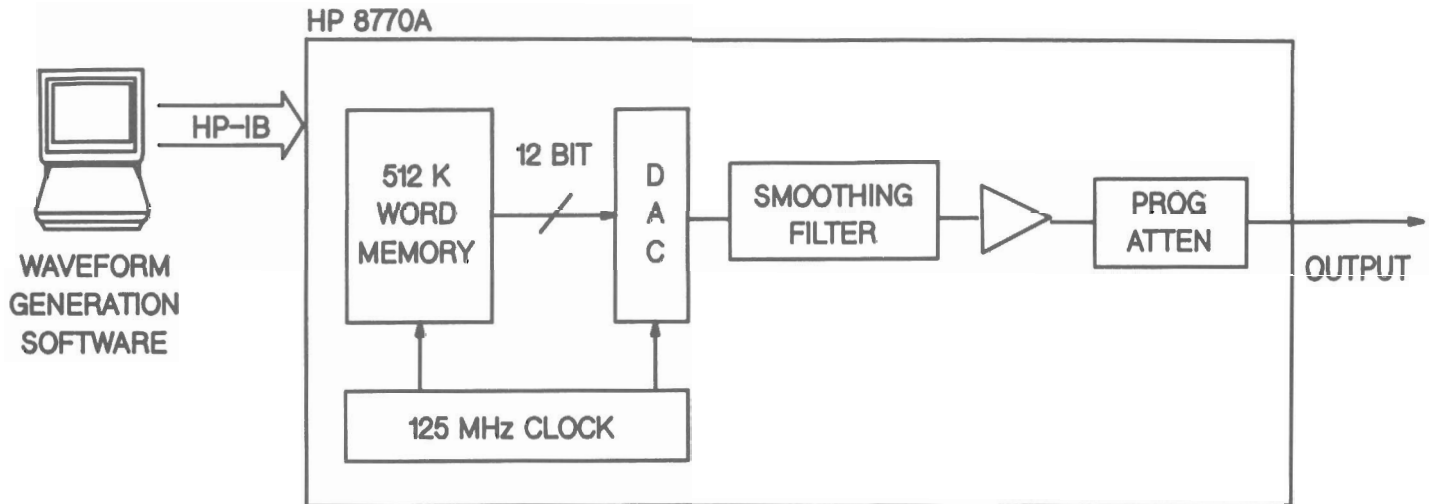

OUTPUT CHARACTERISTICS

- 50 MHz Bandwidth
- 512k Word Memory
- 12 Bit Resolution (72 dB)

VAWS0040

This is a simplified block diagram of the HP8770A Arbitrary Waveform Synthesizer. Once the waveforms have been created in the computer, they are downloaded into the AWS as a sequence of 12 bit digital information.

The HP8770A has the high-speed memory and the DAC output stage needed to generate the test signal. A sequencer provides flexible ways to scan the 512K word memory to make efficient use of it.

The DAC output stage determines the performance of the HP 8770A. It runs at a rate of 125 MHz or one new sample every 8 nsecs. Special smoothing filters remove aliasing terms from the output, and a step attenuator is present for setting low signal levels. The DAC's resolution is 12 bits which results in 72 dB of dynamic range.

The VAWS System: Part 2

The Waveform Generation Software

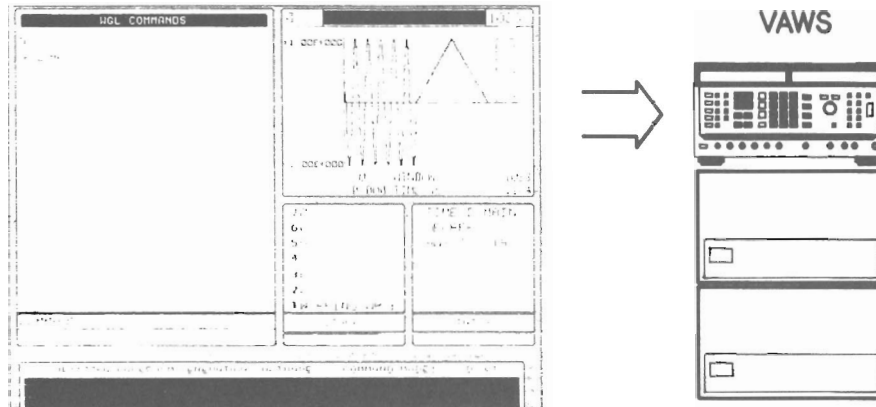

- Powerful workstation for the creation of complex waveforms
- Signals can be designed or modified in either the time or frequency domains
- Linear and non-linear distortions are easily simulated

VAWS0050

The HP 11776A Waveform Generation Software facilitates the creation of the necessary waveforms. The software manipulates waveforms in much the same way as a calculator manipulates numbers. Many of the functions normally found in calculators such as algebraic (+, -, x, /), transcendental functions etc. can be performed on waveforms. In addition, the HP 11776A allows easy conversion between the time and frequency domains opening the doors for filter simulation. In essence, the software becomes the front panel for the VAWS system.

The VAWS System: Part 3

The Vector Signal Generator

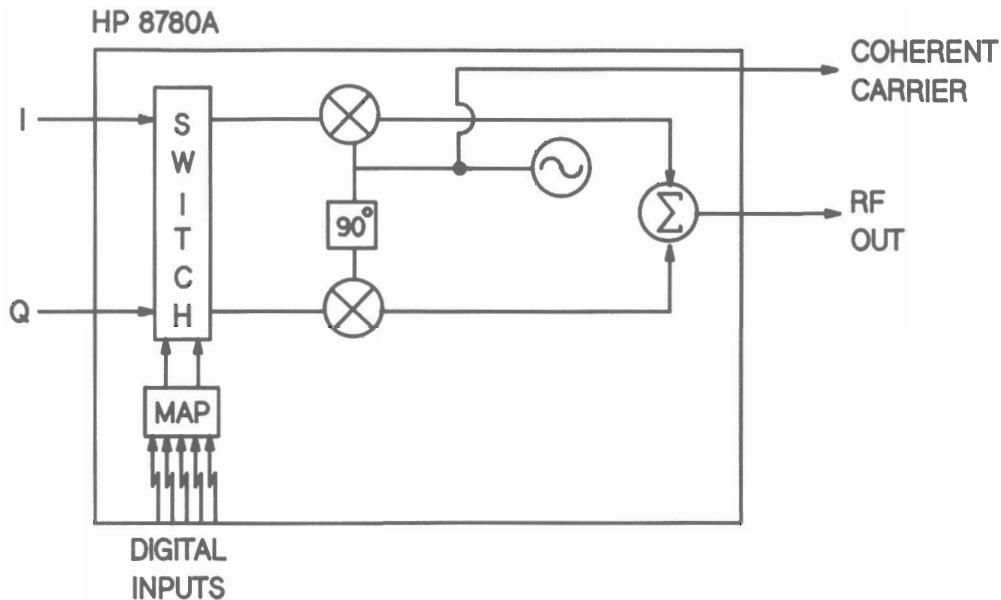

- 10 MHz to 3 GHz frequency range
- Exceptionally wideband modulation bandwidth: 700 MHz
- Vector (I/Q) modulation inputs
- Many digital modulation features
- Unmodulated coherent carrier available

VAWS0060

The Vector Signal Generator is unique in its extremely wideband modulation capability and its exceptional modulation versatility. The unmodulated coherent carrier output is useful to provide a reference to coherent detection system of any sort.

There are four types of modulation available in the HP 8780A: DIGITAL, SCALAR, FM and VECTOR modulation. In the VAWS system only the VECTOR modulation is used. In this mode, two independent modulation channels (I and Q) control the In-phase and Quadrature components of the RF signal. The baseband bandwidth of these channels is 350 MHz each, resulting in 700 MHz of available RF modulation bandwidth.

What is Vector Modulation?

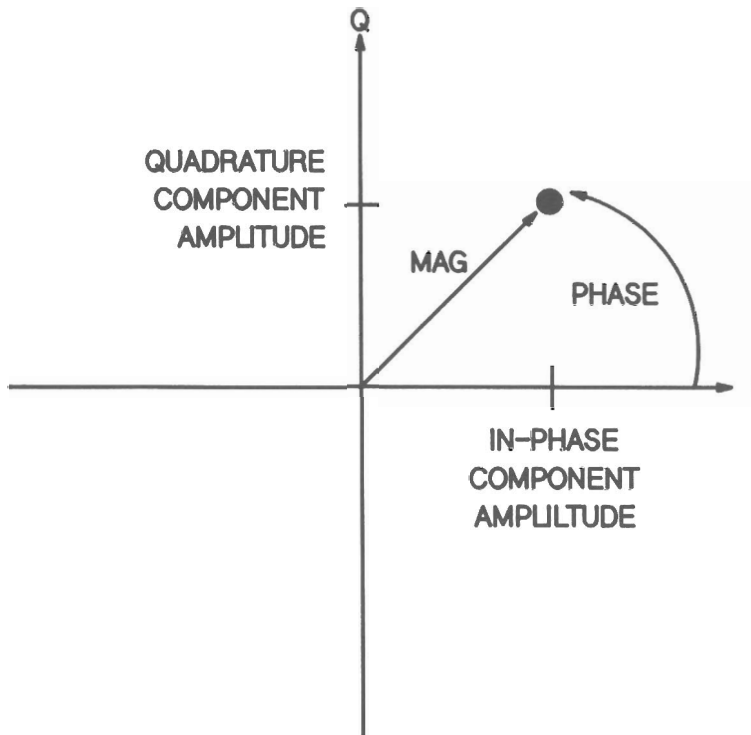

$$s(t) = I(t) \cos \omega t - Q(t) \sin \omega t$$

OR

$$A(t) [\cos \omega t + \theta(t)]$$

$$I = A(t) \cos \theta(t)$$
$$Q = A(t) \sin \theta(t)$$

$$\text{Magnitude} = A = \sqrt{I^2 + Q^2}$$

$$\text{Phase} = \theta = \tan^{-1} \left(\frac{Q}{I} \right)$$

VAWS0070

Vector Modulation means modulation in the I (in-phase) and Q (quadrature-phase) dimensions of a signal. Rather than thinking of a band-limited signal in terms of amplitude and phase, one can think of the signal in terms of its cosine wave part (I) and its sine wave part (Q). These two ways of describing an RF signal are related according to the equations shown above. Vector modulation is especially useful because of its wide bandwidth capability and flexibility for generating complex signals.

Vector modulation goes by other names as well, such as quadrature I.F. modulation, coherent detection, and I-Q or P-Q modulation -- but they each describe what is essentially the same thing.

Vector Diagrams of Various Modulation Formats

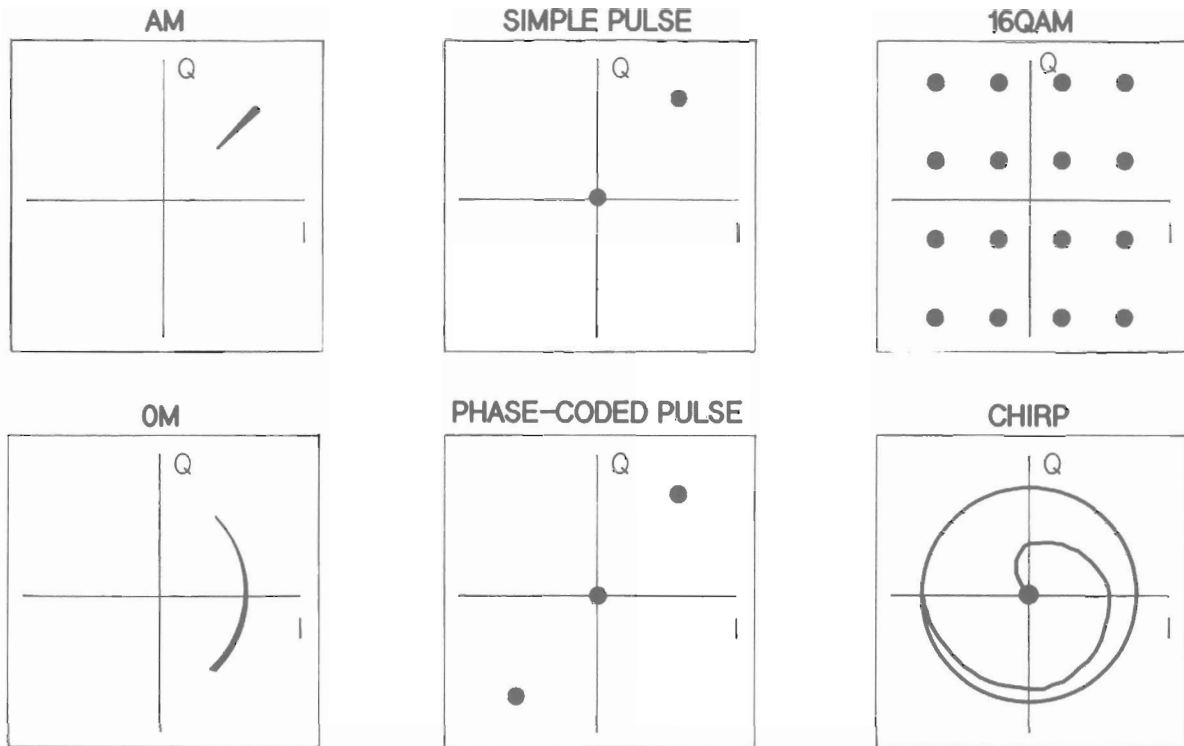

VAWS0080

Any kind of modulated signal can be described in vector modulation terms. These vector diagrams of various modulation formats give an idea of the flexibility of vector modulation analysis. Some of these modulations are obviously ideally suited to a vector analysis. Others, like the phase modulation and the chirp, are not so obvious, but may sometimes benefit from vector signal generation and analysis.

VAWS System Capabilities

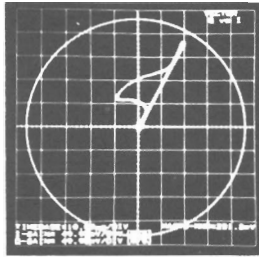
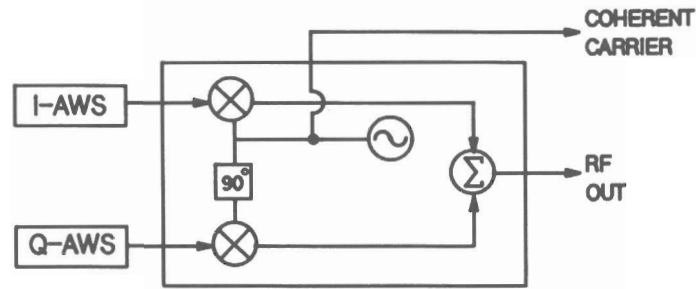

- Phase/mag transitions as fast as 8 nsec
- Frequency transitions within RF modulation bandwidth in 8 nsec
- Rf pulses with arbitrary phase/mag vs. time profiles

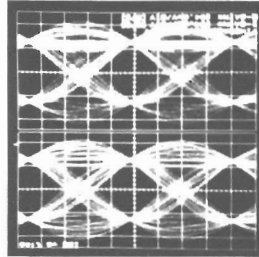

- 50 MHz of I & Q modulation B.W.

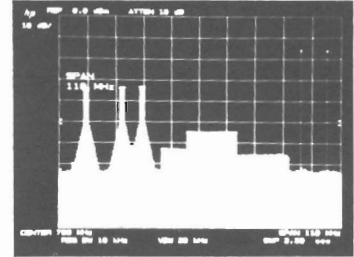

- 100 MHz of RF modulation bandwidth centered around carrier

VAWS0090

VAWS uses two separate Arbitrary Waveform Synthesizers to drive the Vector Signal Generator's I and Q modulation inputs. This allows arbitrary control over the In-phase and Quadrature components of the carrier and thus control of the carrier's amplitude and phase.

The HP8770As make 50 MHz of baseband bandwidth available per channel (I and Q). The performance made possible by such an arrangement can be summarized in one of three ways. The first and most obvious one is that arbitrary I and Q types of modulation can be simulated with bandwidths up to 50 MHz. Second, since the phase and amplitude of the carrier are related to the I and Q components, the carrier can be made to jump directly from one phase/amplitude (or frequency) state to another in as little as 8 nsecs or in a slower and arbitrary fashion. Finally, a full 100 MHz of spectrum around the carrier can be arbitrarily created by the proper choice of I and Q components. All of these options are available in the 10 to 3000 MHz output range of the HP 8780A Vector Signal Generator.

The Process of Creating RF Modulated Signals

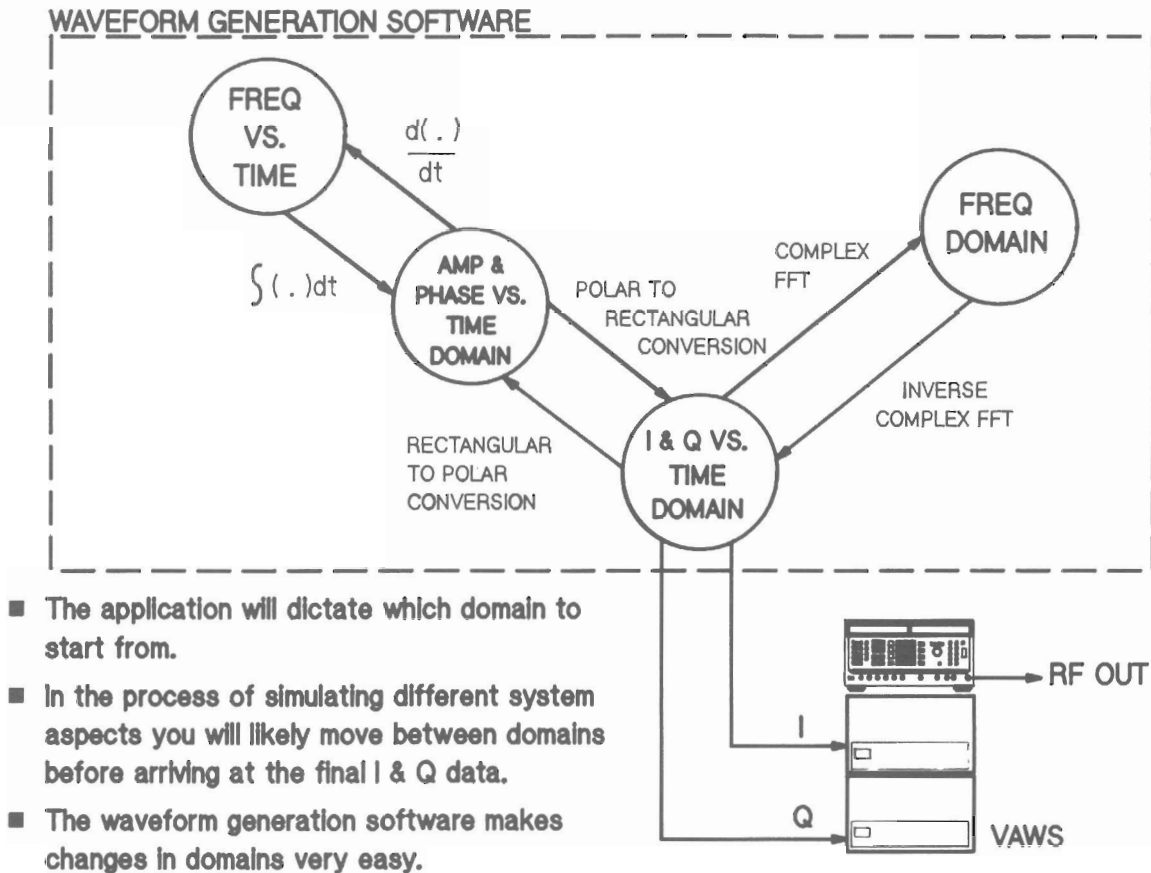

VAWS0100

This slide describes the process followed in generating RF modulated signals with the Waveform Generation Software Language. Before the signal can be downloaded to VAWS, its I and Q component have to be available. However, the signals can be created in other domains before arriving at the I and Q components. The amplitude and phase domain is related to the I and Q domain by the familiar polar to rectangular conversion equations. Moreover, the phase vs. time profile is related to its frequency vs. time profile simply by an integration.

A complex Fourier Transform of the I and Q component (where I is the real part and Q is the imaginary) yields the frequency domain representation of the same signal. If only the real part of the waveform was available, the resulting spectrum would be symmetrical about the center. Having both the real and imaginary components (I and Q) allows the generation of signals with non-symmetrical frequency spectrums.

The Waveform Generation Software has the tools that make domain switching very simple. Often times a signal is modified in a domain different from the original one. The most obvious example of this process is filtering in which a signal is created in the time domain and filtered in the frequency domain. The next few slides go into some examples that illustrate this process.

Amplitude & Phase Domain

Example 1: A Radar Chirp

1. Define the frequency vs. time profile (exponential).

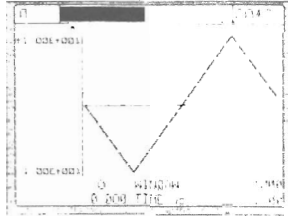

3. Define the amplitude vs. time profile (raised cosine).

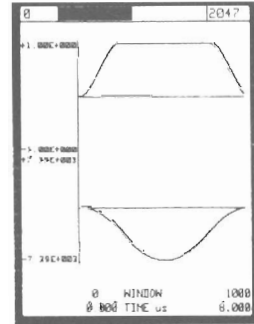

2. Convert to phase (integrate).

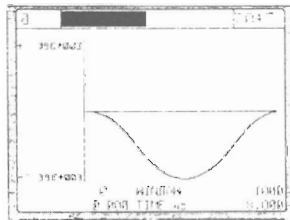

4. Convert to I & Q.

AMPLITUDE & PHASE VS. TIME

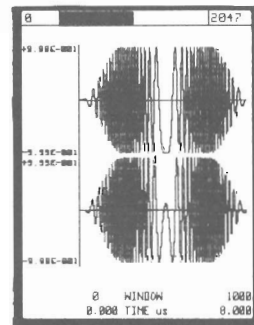

5. Download waveforms to VAWS.



VAWS0110

The first step in generating a chirp is to describe its frequency profile vs. time. Both linear or completely arbitrary profiles are allowed. This waveform is then integrated to yield the phase profile vs. time. At this time one can define the desired amplitude response which could be an ideal or shaped pulse like the one shown on step 3 above. With the amplitude and phase vs. time waveforms available a polar to rectangular conversion produce the I and Q components needed to download to the VAWS system.

Radar Actual Simulated Signals

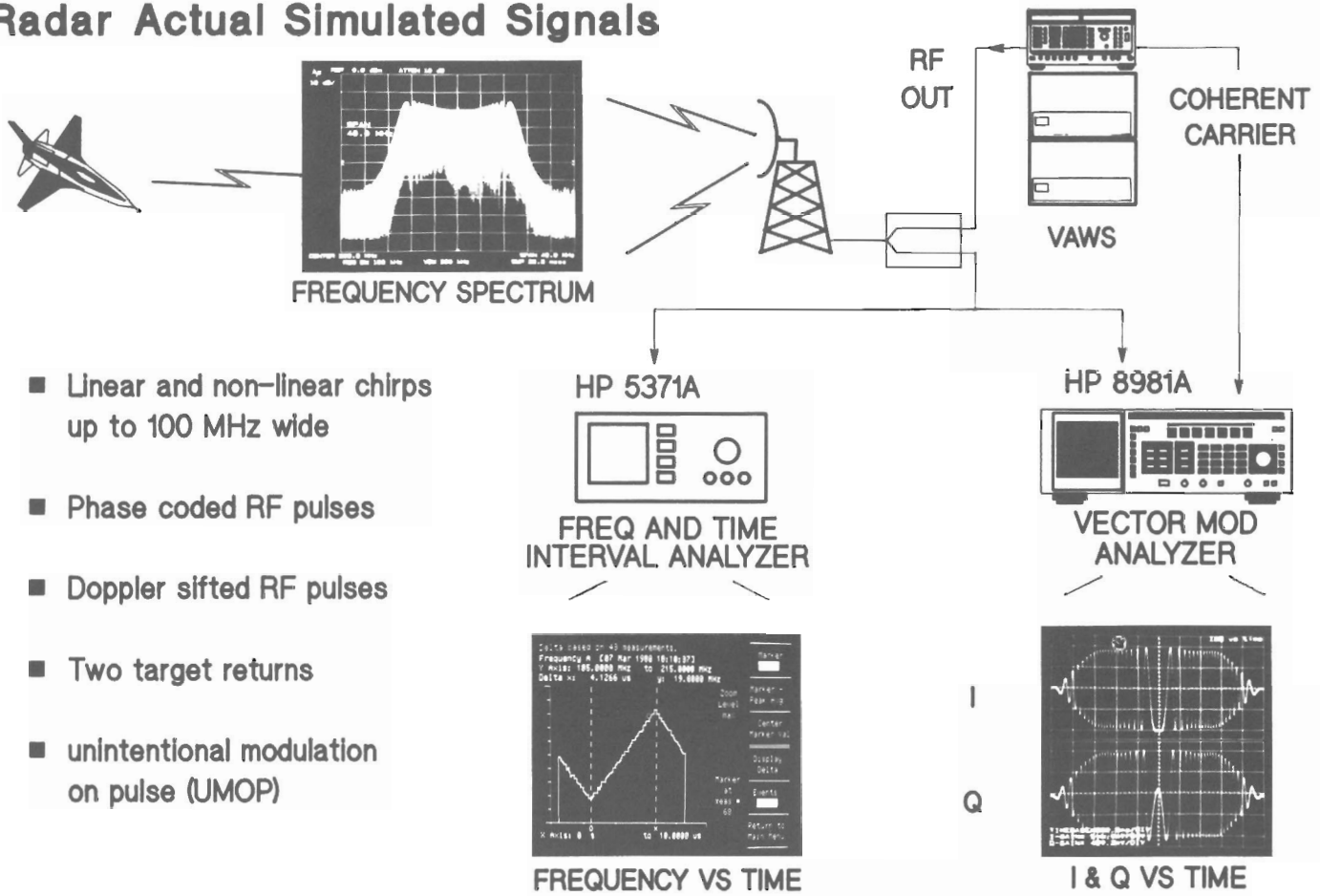

VAWS0120

This slide shows an actual chirp as seen by a spectrum analyzer, the HP 8981A Vector Modulation Analyzer and the HP 5371A Frequency and Time Interval Analyzer.

Frequency Domain

Example 2: Jamming

1. Create broadband noise as sum of individual spectral lines.



2. Zoom In on the area where the noise is to be replaced with an information channel.

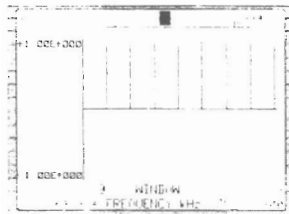

3. Replace spectrum with channel information.

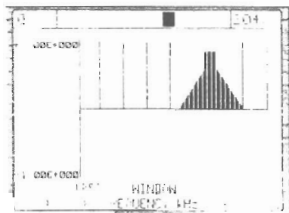

4. Do a complex inverse FFT to arrive at the I & Q time waveforms.

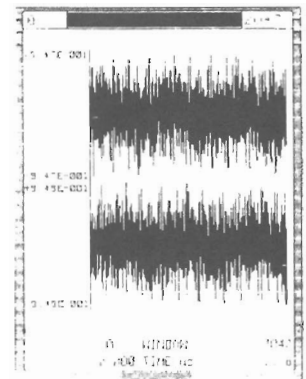

5. Download waveforms to VAWS.

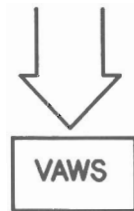

VAWS0130

This slide describes the generation of a signal with a prescribed frequency spectrum. This jamming signal used in EW applications is first defined in the frequency domain and then converted to the time domain. Once again, because the frequency domain spectrum is not symmetrical with respect to the center frequency, the resulting time domain will have a non-zero Q (imaginary) component in addition to the I (real) one.

EW Actual Simulated Signals

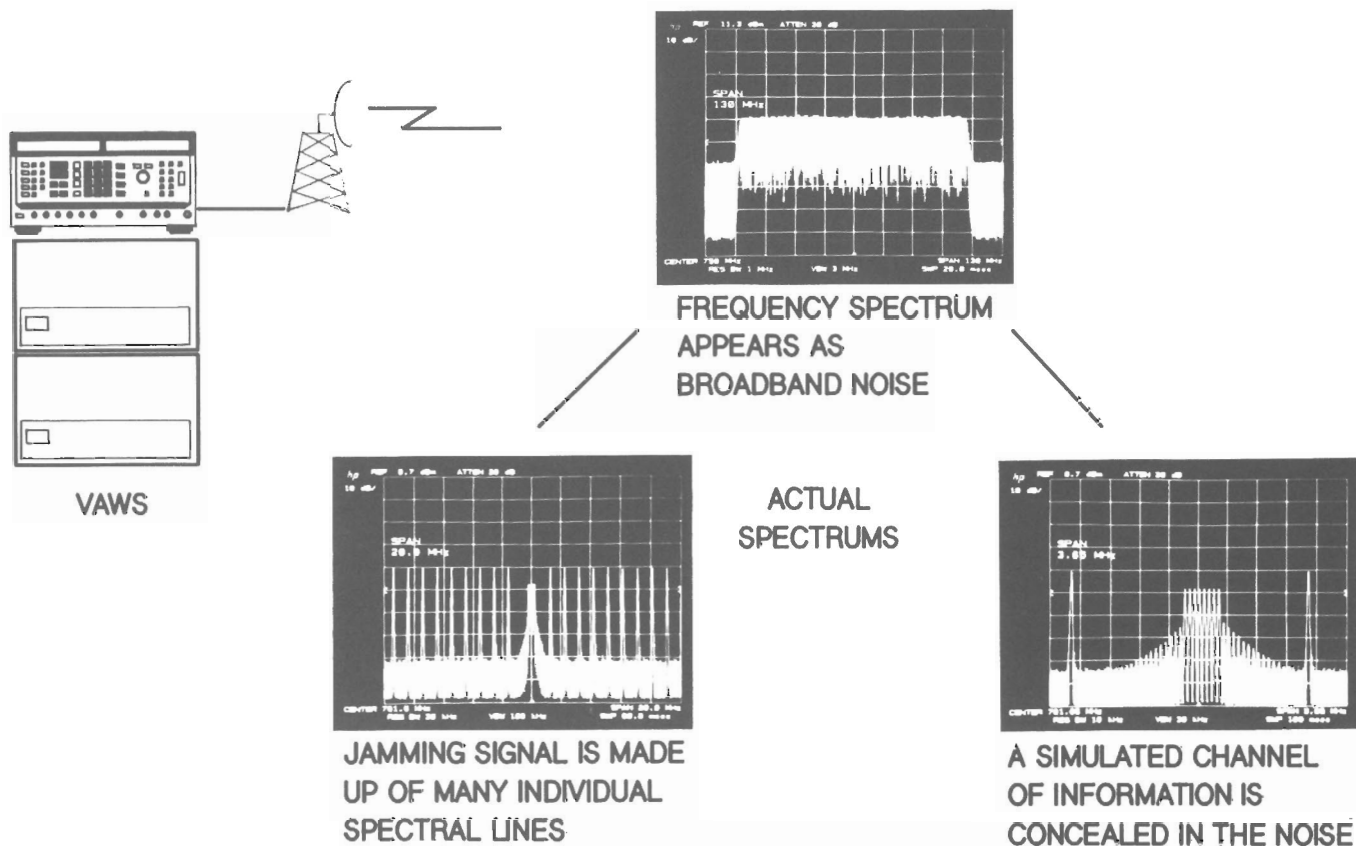

VAWS0140

The actual spectrum obtained is shown in this picture. The placement of the spectral lines was determined by the software. Zooming in on portions of the picture shows the detail in which spectrums can be generated.

I & Q Domain

Example 3: Digital Modulation

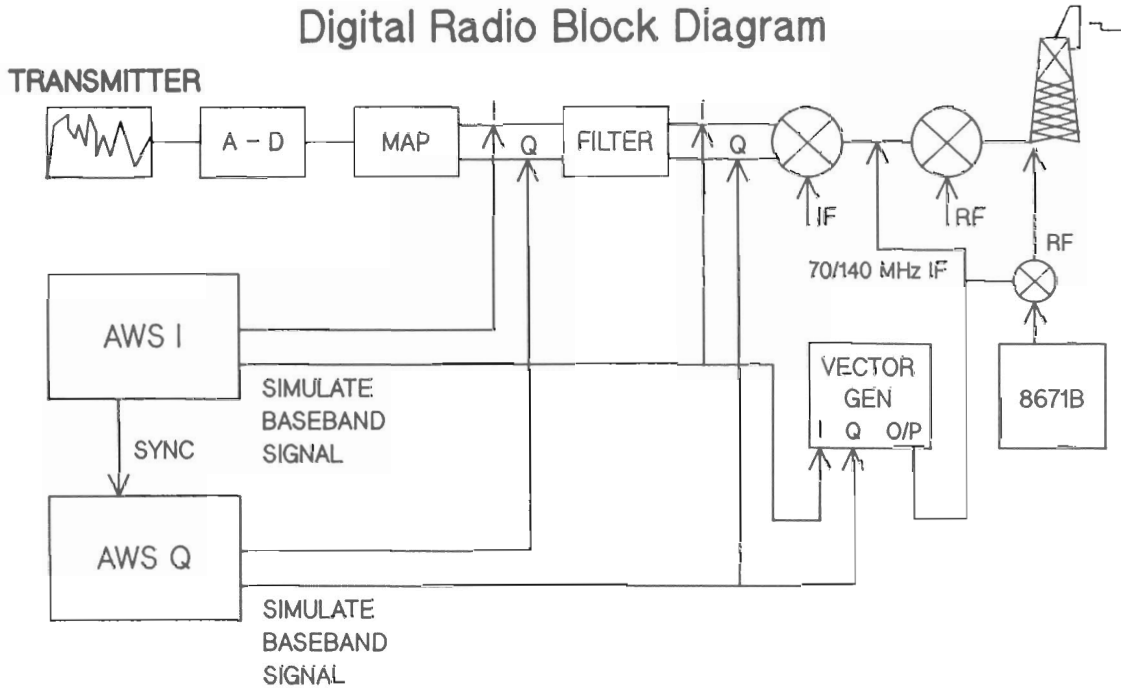

VAWS0150

The third example involves a Digital Microwave Radio (DMR) application. This slide shows a typical block diagram for a DMR and how the VAWS system fits into its testing needs. In addition to providing the IF signal, or the provision for easy upconversion (the HP 8780A 3Ghz upper frequency range makes the image filtering process required in upconversion very easy) the I and Q baseband signals are also available to test the baseband portion of the system.

Generating Digital Modulation

1. Begin with simulating pseudo-random binary data

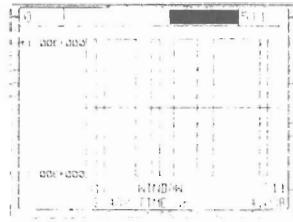

4. Multiply spectrum times Nyquist filter response $\propto = .3$ (with inverse sinc correction)

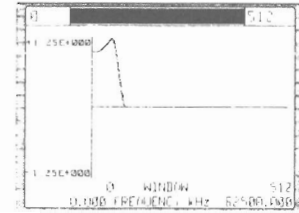

2. Map 4 bit groups into I & Q streams in a 16 QAM modulation format

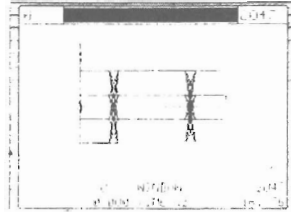

UNFILTERED EYE DIAGRAM

5. Return to the time domain

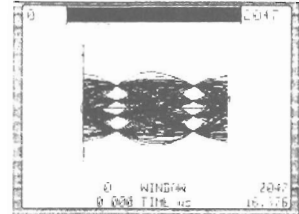

FILTERED EYE DIAGRAM

3. Transform into the frequency domain

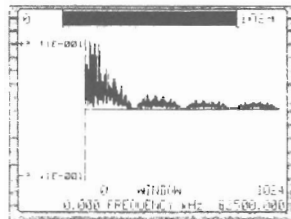

6. Download waveforms to VAWS.

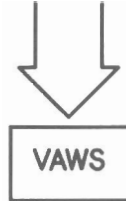

VAWS0160

This application begins by describing the waveforms in the I and Q domain. Since DMR systems require precise Nyquist filtering to minimize ISI (intersymbol interference) it is necessary to work in the frequency domain. In this domain the Nyquist filters are first mathematically described using the Nyquist equations. Then the response is multiplied by the spectrum of the original I and Q data. The result is then converted into the time domain to arrive at the filtered I and Q waveforms.

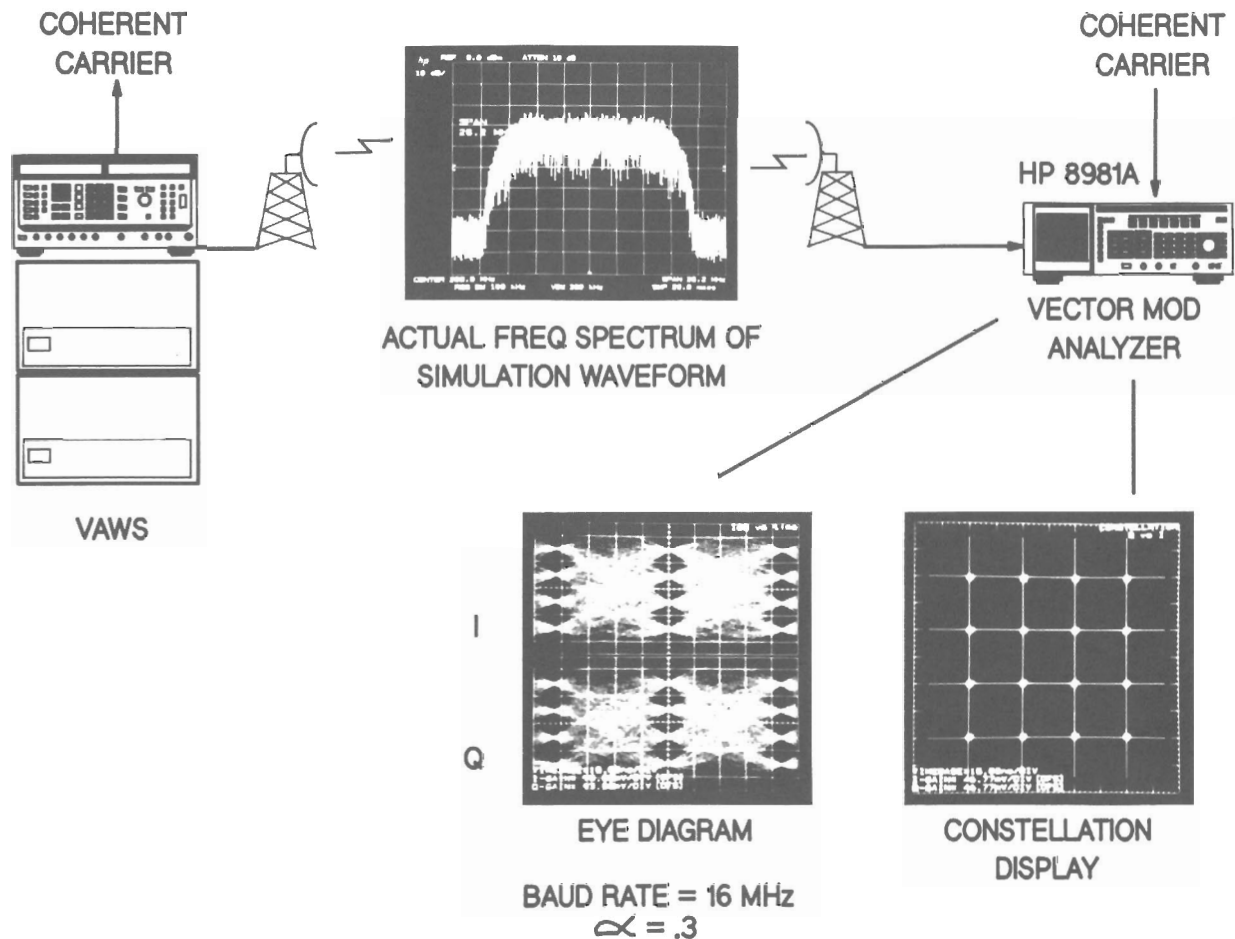

VAWS0170

This slide shows the actual output of VAWS as seen by a spectrum analyzer and a Vector Modulation Analyzer. The Nyquist filter used has an alpha of .3. This results in a frequency spectrum where the usual $\sin x/x$ sidebands expected of unfiltered data have been stripped off by filtering. The constellation display and the eye diagram are two ways of evaluating the quality of the generated signal.

Next Step: Simulating Transmission Impairments

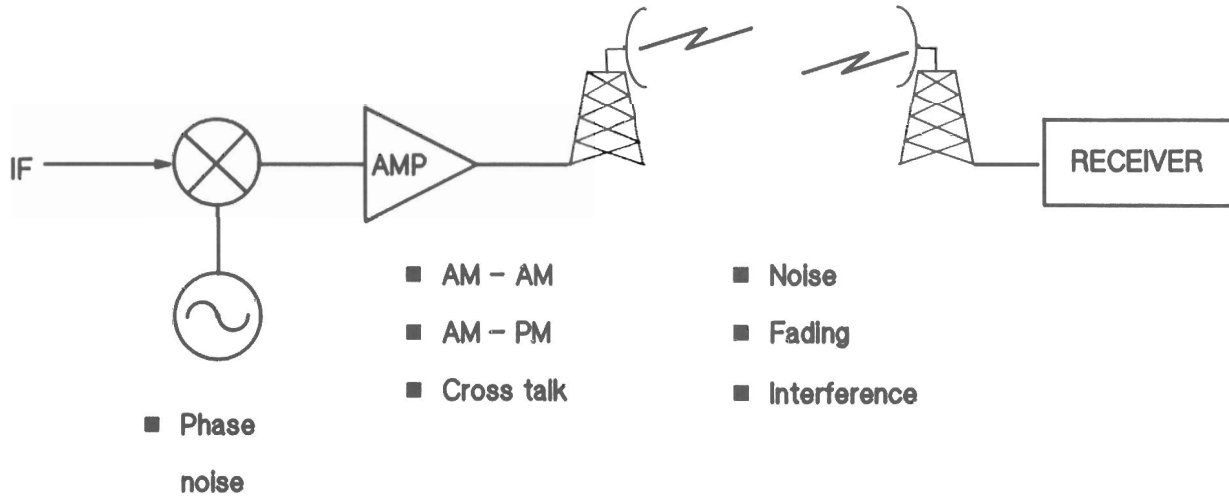

Once ideal I & Q waveforms have been created, transmission impairments can easily be simulated.

VAWS0180

Up until now we have been concentrating on the generation of ideal signals. In functional systems however, signals are corrupted in the process of getting from the transmitter to the receiver. It is sometimes useful to simulate these impairments in order to evaluate the receiver's sensitivity to them. Some of these errors are introduced in transmitter itself like phase noise compression or AM-PM conversion. Others occur in the transmission environment as is the case for noise, fading or interfering signals. The VAWS system can simulate signals exhibiting these kinds of impairments by post-processing the ideal I and Q waveforms.

Transmission Impairments Example in Digital Modulation

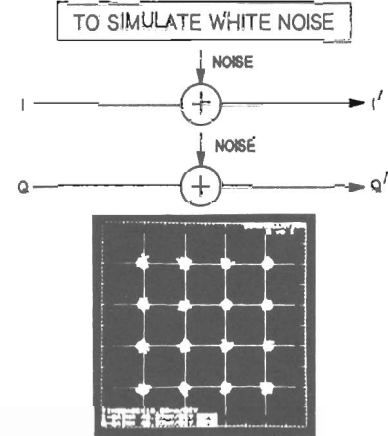
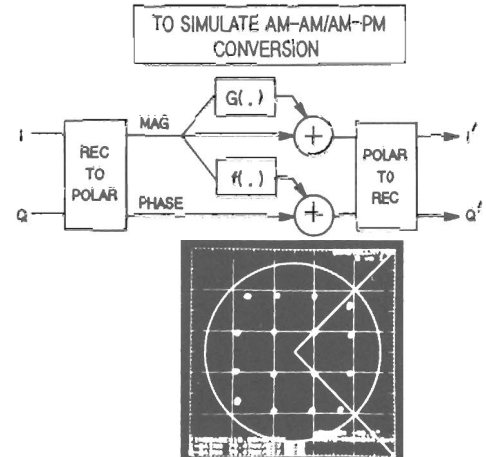
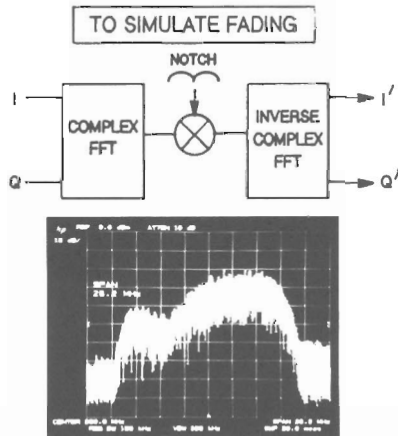
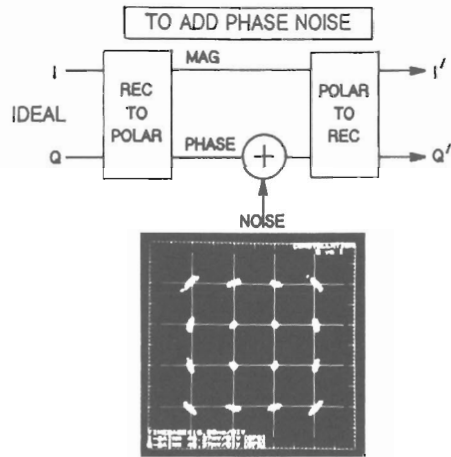

VAWS0190

This slide shows the steps followed in the simulation of signals corrupted by phase noise, AM-AM or AM-PM conversion, multipath fading or additive white gaussian noise in the transmission channel. For the sake of the example, the ideal signal used is the same filtered 16QAM signal discussed in the last example. The same techniques could be applied to any I and Q signals regardless of their origin. In fact, the operations described above could be cascaded to simulate more than one impairment at a time.

One More Application: Generating MSK Using IQ Techniques

WHAT IS MSK?

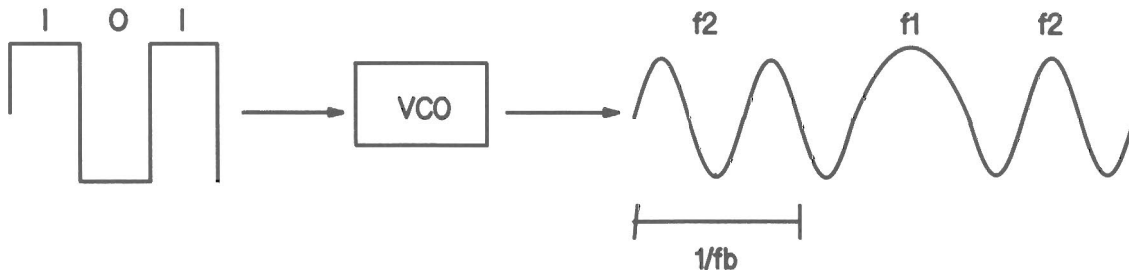

MSK = TYPE OF FSK WHERE $\frac{\Delta F}{f_b} = .5 = \text{MOD INDEX}$

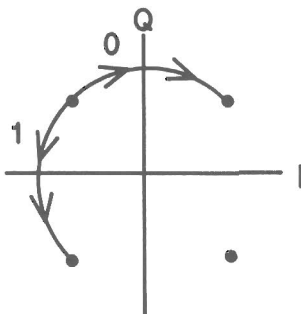

- DIGITAL MODULATION
- CONSTANT AMPLITUDE
- COHERENT DETECTION CAPABILITY

VAWS0200

Another application which the VAWS system is capable of addressing is the generation of MSK (Minimum Shift Keying) modulation. MSK is a type of FSK (frequency shift keying) in which the difference between the frequency used to represent a "1" and the frequency used to represent a "0" is equal to half of the bit rate. Some of its appeal comes from the fact that it is a digital type of frequency modulation with constant amplitude, making it very insensitive to channel non-linearities. Unlike other FSK systems, MSK lends itself to the use of coherent detection techniques.

In order for MSK to achieve a spectral efficiency comparable to other digital modulation formats data filtering is necessary. This limits frequency switching speeds thus reducing spread in the spectrum. A type of filter response often used for this purpose is a Gaussian filter and MSK filtered this way is normally referred to as GMSK.

Waveform Generation Language

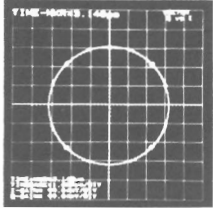
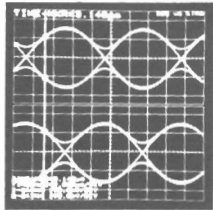
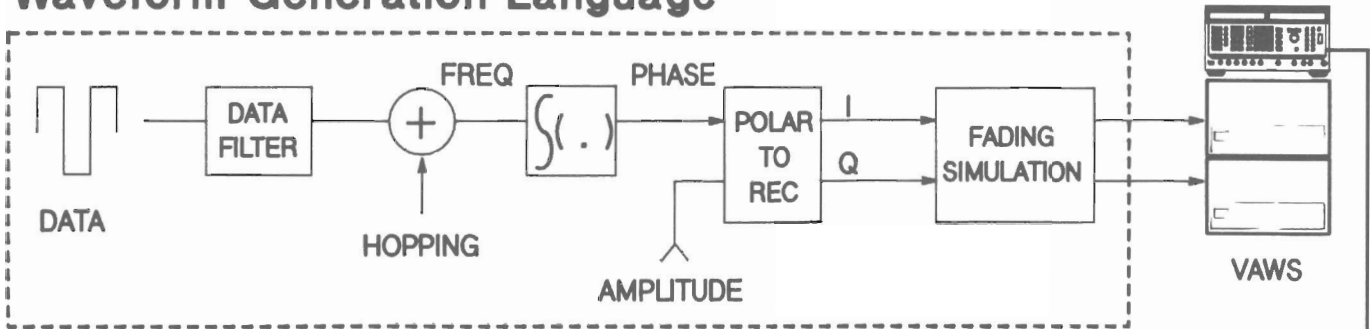

EYE & VECTOR
DIAGRAMS OF
RECEIVED SIGNAL
BT = .5



NO DATA FILTERING

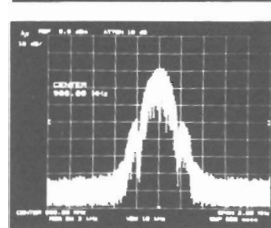
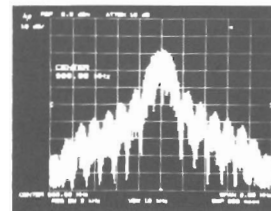

GAUSSIAN DATA
FILTERING BT = .5

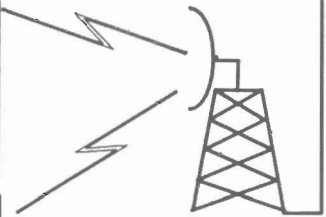

VAWS0210

Using the techniques explored previously the Waveform Generation Software can be used to create the I and Q waveforms representing MSK (or GMSK) modulation. The block diagram above describes the sequence of operations needed to generate MSK for this purpose, beginning with binary data representing the two discrete frequencies and ending with I and Q waveforms to be downloaded into VAWS. A hopping signal (consisting of a simple constant for each hopping frequency desired) can be added before converting the frequency into phase. This is important for frequency hopped MSK systems.

If the RF signal needs to be pulsed as in TDMA (Time Division Multiple Access) systems, a prescribed turn on/off response can be defined in the amplitude waveform. This controlled RF turn on/off response is another technique used to reduce the spectral splatter associated with very fast switching of the RF. Finally, transmission impairments like the ones discussed previously can also be easily simulated. Rayleigh fading and multipath fading are two commonly encountered types of impairments.

VAWS Applications

RADAR / EW

- Linear and non-linear chirps (up to 100 MHz wide)
- Phase coded RF pulses
- Arbitrary turn on/off RF pulse response
- Single, double target returns (constant velocity)
- Unintentional modulation on pulse (UMOP)
 - Phase modulation
 - Amplitude modulation
 - Frequency modulation
- 100 MHz wide comb-lines/noise
- more. . .

COMMUNICATIONS

- BPSK, QPSK, 8 PSK, 16 QAM, 64 QAM, 256 QAM (with up to 50 MHz of BW)
- Partial response filtering (QPR3, QPR7, QPR9, etc)
- Nyquist, Gaussian,*other filtering
- AM-PM, AM-AM (compression)
- Phase noise, white Gaussian noise
- Multipath fading, Rayleigh fading,*other
- Limited frequency hopping*
- MSK, GMSK,*TFM
- TDMA with controlled turn on/off response*

* Particularly useful with digital cellular radio

VAWS0220

VAWS Calibration

- Why?
- Error block diagram
- Characterizing the system with a single tone
- Image rejection, carrier leakage, frequency flatness
- The RF detector and calibration
- Correcting errors
- Performance summary

VAWS0230

VAWS can be used to generate an Arbitrary Frequency Spectrum

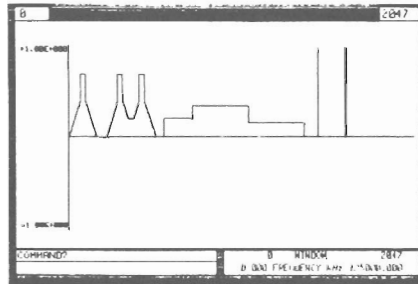

An uncalibrated system may result in a non-ideal spectrum.

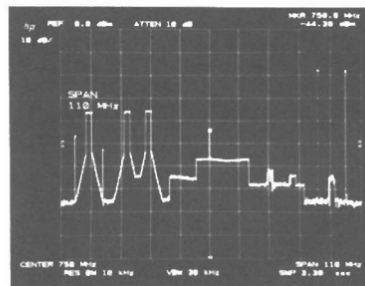

- Undesired images
- Carrier leakage
- Frequency response ripple

VAWS0240

Up until now we have discussed VAWS' versatility and capabilities in the generation and simulation of very complex RF modulated waveforms (such the arbitrary spectrum shown in the figure above). In this section we will examine the accuracy with which the system can generate these waveforms.

The level of performance achieved by simply connecting all of the system components together will be sufficient for many applications. However, to extract maximum performance, a calibration needs to be performed on the system after it has been integrated to correct for component variability.

Because the system uses a single sideband type of upconversion of the I and Q modulating signals, the I and Q channels must be extremely well matched in order to achieve maximum performance. Image rejection, carrier leakage and frequency response ripple will be discussed as measures of performance.

System Interface

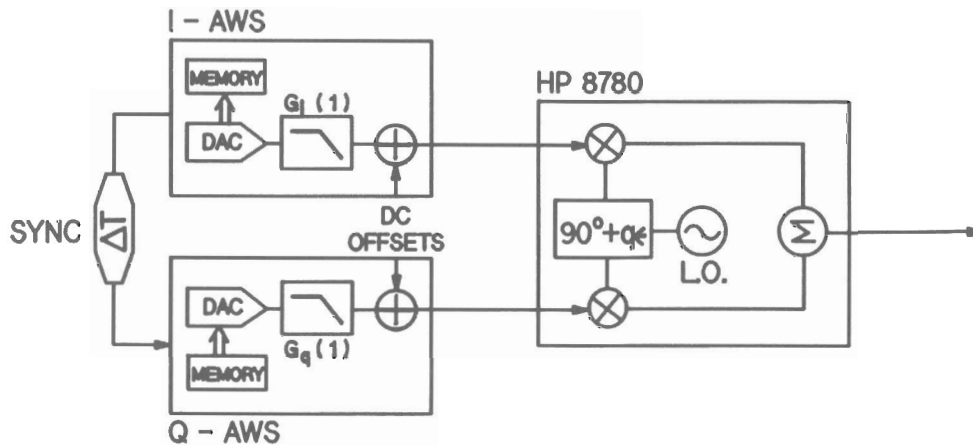

COMPONENT LIMITATIONS

- I + Q gain imbalance
- I vs. Q phase mismatch
- HP 8780 quadrature error
- AWS synchronization error
- AWS DC offsets
- AWS frequency response

SYSTEM LIMITATIONS

- Image rejection
- Carrier leakage
- Frequency response ripple

VAWS0250

System performance is limited by uncorrected, component imperfections. The Arbitrary Waveform Synthesizer's output stage (DAC and output amplifier) contributes to DC offsets and therefore carrier leakage. Differences in the smoothing filters in the AWSes give rise to gain imbalances and phase mismatch between the channels, both of which produce spurious image terms. Another source of image terms is quadrature error in the vector modulator of the HP 8780A.

The two AWSes are synchronized to ensure that events start and stop at the same time. Errors in synchronization due to different propagation delays or cable length mismatch also cause spurious image terms. Finally, frequency ripple on the AWSes smoothing filters translates to frequency non-flatness in the modulation.

Image Rejection: A Single Tone

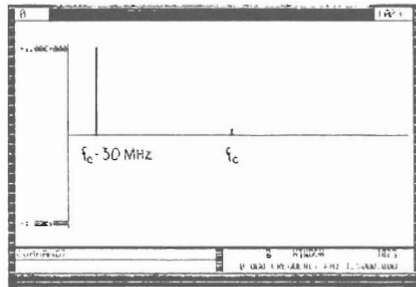

FREQUENCY DOMAIN

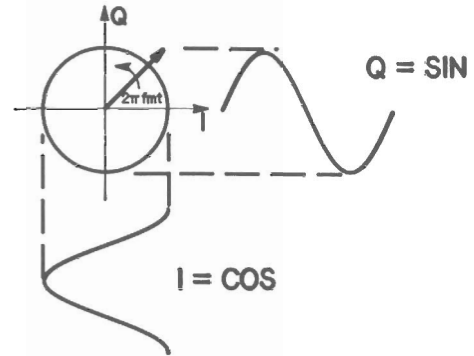

VECTOR DOMAIN

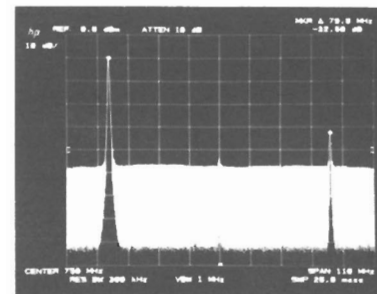
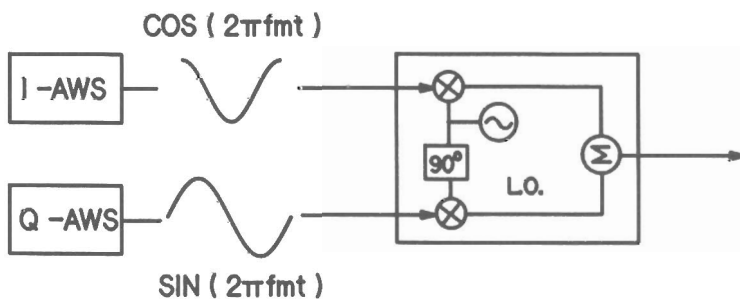

UNDESIRABLE IMAGE

VAWS0260

An arbitrary spectrum is merely a weighted sum of single tones. Knowing the response of the system to a single tone goes a long way towards characterizing the system performance of a sum of tones.

In the frequency domain a single tone is represented by a single spectral line at an offset frequency from the carrier. In the vector domain the same tone is represented by a vector with constant amplitude which rotates around a circle at a rate equal to the offset frequency. Decomposing this signal into its cartesian coordinates yields an I component equal to the cosine and a Q component equal to the sine of the offset frequency.

Programming uncalibrated VAWS I and Q channels this way creates the desired single tone plus an undesired component. This spur is called an image and is at the same offset frequency but on the other side of the carrier.

Image Cancellation Process in Vector Modulation

I - CHANNEL

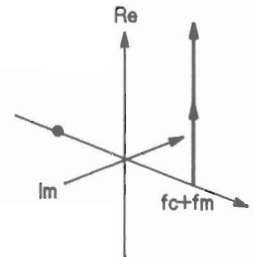
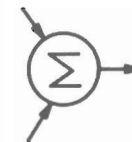
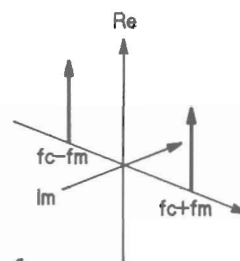
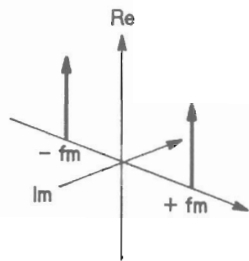
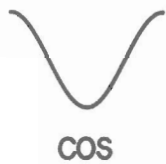

Q - CHANNEL

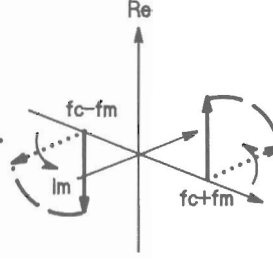
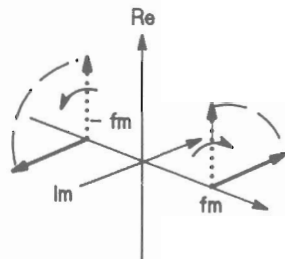
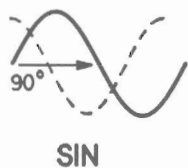

The I channel's cosine waveform has the familiar spectrum shown above. This spectrum is translated up to the carrier frequency through the mixing process. The Q channel, in contrast, goes through two separate phase shifts in the translation: a baseband phase shift and an RF one (due to the quadrature mixing). This combination results in an undesired (or image) Q component that is of equal magnitude but opposite phase from the I channel one. When added at the output, the undesired components cancel each other while the desired ones add.

VAWS0270

Some system errors result in Imperfect Cancellation

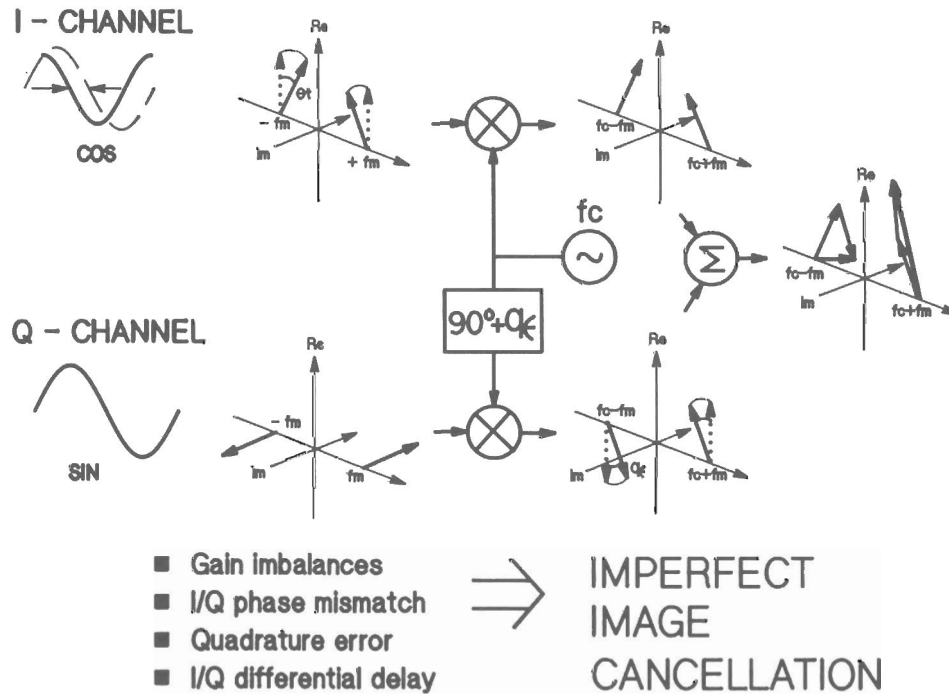

VAWS0280

Impairments such as the ones mentioned above preclude perfect cancellation of the images. If the phase response of the I channel is slightly different from that of the Q channel. The I channel's spectral components are shifted as shown above. Another anomaly illustrated above is the effect of quadrature error in the modulator. Simple geometry can be used to derive the magnitude and phase of the residual image term as a function of these two errors.

A gain imbalance gives rise to an undesired image because the magnitudes of the I and Q components do not cancel. Differential delay produces images the same way phase mismatch does. This is because at any one frequency, a delay is simply a phase shift.

Other Errors

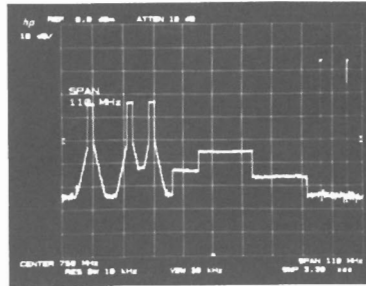

- **CARRIER LEAKAGE** results from I & Q AWS DC offsets

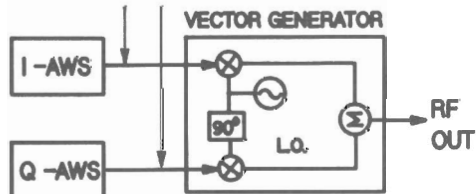

$$\text{CARRIER LEAKAGE} = A_c \cos(2\pi f_c t + \phi_c)$$

$$\text{WHERE } A_c = \sqrt{I_{\text{offs}}^2 + Q_{\text{offs}}^2}$$

$$\phi_c = \tan^{-1} \frac{Q_{\text{offs}}}{I_{\text{offs}}}$$

- **FREQUENCY RIPPLE**

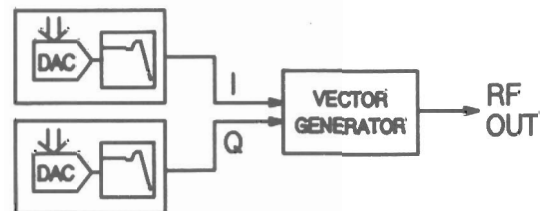

- **AWS ANTI-ALIASING FILTER** is biggest contributor

VAWS0290

System Calibration

VECTOR GENERATORS
RF detector provides a way for system to calibrate itself.

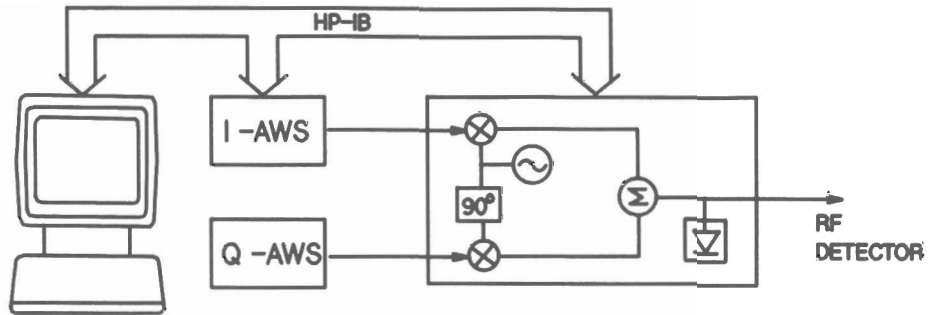

RF DETECTOR =
Peak detector for
high level signals
(>6 dBm)

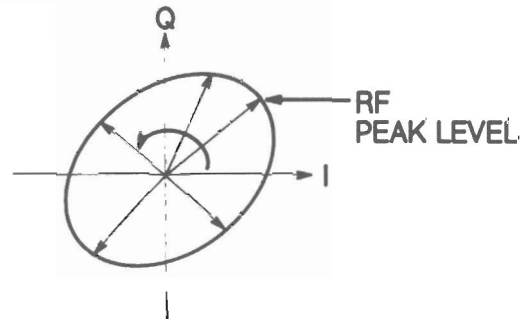

VECTOR DIAGRAM

VAWS0300

The RF detector internal to the HP8780 provides the measurement device needed for the system to calibrate itself. The detector behaves as a peak detector for signal levels greater than 6 dBm. As modulation makes the carrier vector move around the vector diagram, the detector captures and reads the value of the largest magnitude reached during excursions. With the correct choice of stimulus this peak value can be used to characterize the system.

Correcting Errors

Start by programming AWSes to a single tone at the frequency of interest.

■ DC OFFSETS

$\phi \rightarrow I, \phi \rightarrow Q$
Iterate I & Q offsets until
RF detector output
reads a minimum.

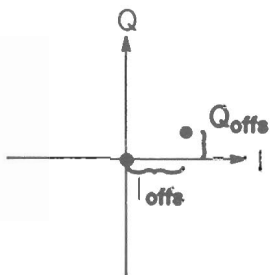

■ GAIN IMBALANCES

$\phi \rightarrow Q$
Read RF detector
 $\phi \rightarrow I$
& adjust Q level to
same detector level.

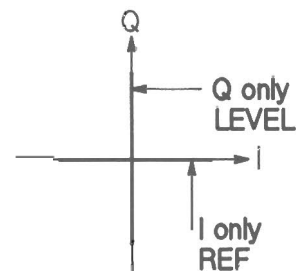

■ PHASE MISMATCH

Iterate I & Q differential
phase to a minimum RF
detector level.

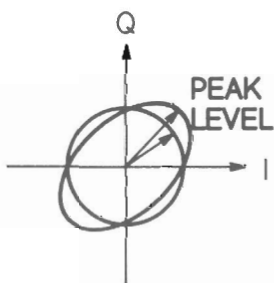

■ FREQUENCY FLATNESS

Adjust I & Q level until
RF detector reads a
REF value.

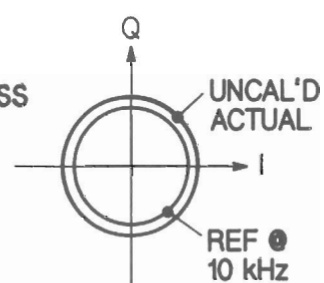

VAWS0310

-- DC offsets are calibrated by iterating the I and Q channel DC voltages until the detector reads a minimum.

-- Gain imbalances are calibrated by taking a detector reference measurement of a signal on the I channel only, and iterating the Q channel level to yield the same detector reading.

-- Phase mismatch is calibrated by programming VAWS to produce a single tone at the frequency of interest. Any phase mismatch turns the vector diagram into an ellipse. The phase of the Q channel is then iterated until the vector diagram is a circle. At this point the detector reading is a minimum and any phase mismatch has been corrected.

-- Frequency flatness is calibrated by comparing detector levels taken across the band to a reference level.

■ ΔT DIFFERENTIAL DELAY

Coarse calibration:
adjust cable lengths

Fine calibration:
handled as phase mismatch
 $\Delta\phi = \Delta T/f_m$

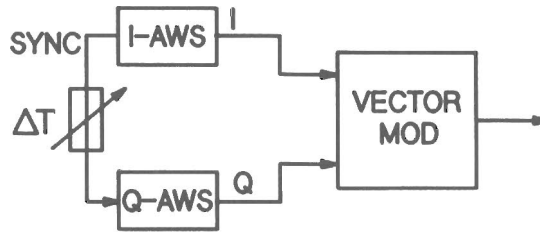

■ QUADRATURE ERROR

HP 8780 excels in this area.

No further calibration is required.

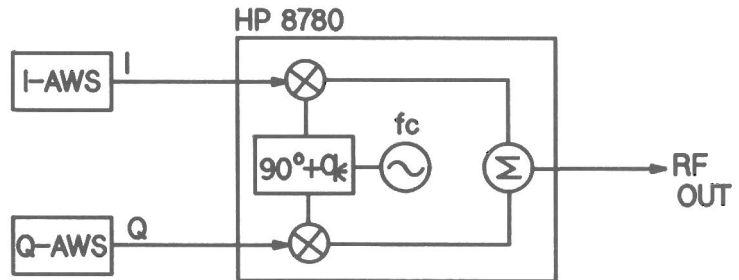

Calibration Summary

BEFORE CALIBRATION

CARRIER LEAKAGE -40 dBc

IMAGE REJECTION -25 dBc

FREQ FLATNESS ± 6.5 dB

BEFORE

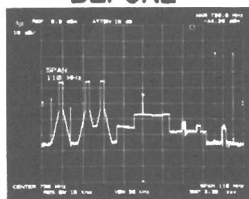

AFTER

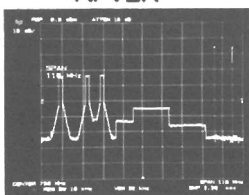

AFTER CALIBRATION

CARRIER LEAKAGE -60 dBc

IMAGE REJECTION -60 dBc

FREQ FLATNESS ± 1 dB

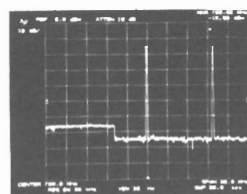
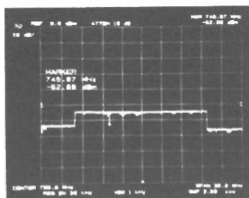
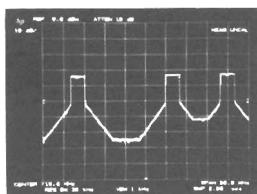

VAWS0330

The last few slides described how use of the RF detector together with careful choice of stimuli allows the VAWS system to characterize itself. The result of this characterization is a table of calibration factors for the frequency response, phase mismatch, gain imbalance and dc offsets. These factors are then used to predistort the I and Q waveforms before they are downloaded into VAWS. When predistorted I and Q waveforms are used, image rejection, carrier leakage and frequency flatness ripple performance are greatly improved. The photos above illustrate the kind of performance that can be achieved from a calibrated system.

Summary

- VAWS gives arbitrary waveform generation capability at RF (10 to 3000 MHz) using I / Q techniques
- Capable of simulating ideal and non-ideal signals
- 100 MHz of modulation bandwidth
- 50 MHz of I and Q modulation bandwidth
- 8 nsec transition time between amplitude / phase / frequency states
- Image components, carrier leakage $\angle -60$ dBc
- Frequency flatness $\angle \pm .1$ dB
- Applications in RADAR / EW and digital communications

VAWS0340

