

Innovative Signal Generation of Complex Waveforms for Improved Testing

**Dave Martinez
August 1986**

**RF & Microwave
Measurement
Symposium
and
Exhibition**

 **HEWLETT
PACKARD**

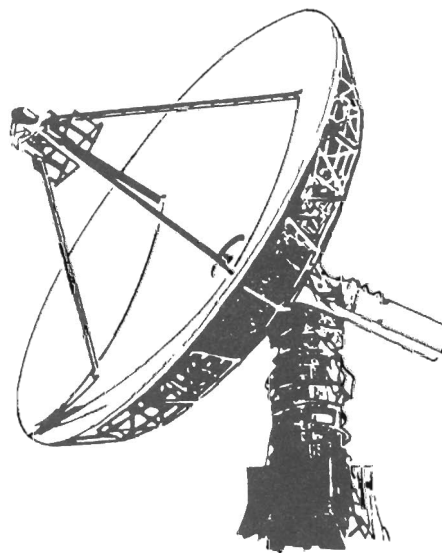

Modern electronic design often requires an accurate source of complex signals to accurately test a system's true performance. But the availability and accuracy of these signals has limited their use. This paper describes how the new, high-performance 125 Megasample/sec HP 8770S Arbitrary Waveform Synthesizer system can generate these "real- life" signals to improve testing. Theory and examples of signal simulation are presented to show the system's flexibility to generate almost any signal up to 50 MHz. Also covered are applications such as modeling a filter's response, margin testing, and a discussion of ATE considerations.

Author: Dave Martinez, Product Marketing Engineer, Stanford Park Division, Palo Alto, CA. BSEE Stanford University, 1982. With HP since 1983, working with RF & Microwave power meters and the HP 8770S Arbitrary Waveform Synthesizer system.

Innovative Signal Generation of Complex Waveforms for Improved Testing

AWSP1

Outline

1. Total performance testing and how it improves product control.
2. Digital Signal Synthesis– A new concept for generating signals.
3. Signals that this new concept can generate.
4. Integrating this new concept with existing test systems.

Ideal Radar

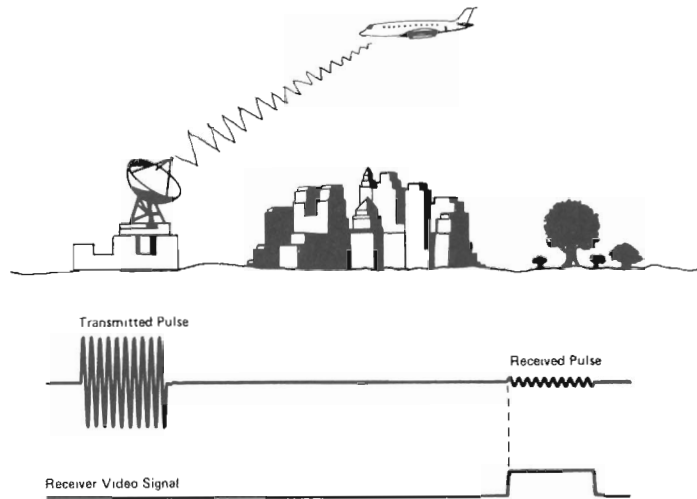

But real radars and other systems must deal with non-ideal effects.

AWSP3

Modern electronic systems have to work with non-ideal signals in non-ideal environments. For example, a radar finds a target by detecting the return pulse that is reflected off the target. Many types of distortion can make this difficult to do. Bandwidth limitations can cause ringing or overshoot on the return pulse. Or reflections from the surrounding environment can cause clutter that might hide the desired pulse. Parts of the receiver itself may introduce distortion.

Sometimes these non-ideal effects can limit the performance not just of radar systems, but of any electronic system. But testing a system's tolerance to distortion has been a difficult task because of the limited availability of precise test signals that simulate distortion. If these signals are not available, it is difficult to verify the total performance of a system.

Typical Design Question: How will my system react to different...

- Bandwidths?
- Clutter?
- Signals/Noise?
- Time-delays?
- Amplitude & Phase Non-linearities?
- Other Distortion?

AWSP4

A designer sometimes has many questions about his system's performance. The answers to these questions determine his system's total performance specifications. Finding the answers often requires test signals whose parameters can be precisely varied to test a system's response.

Without these test signals, a designer sometimes has to estimate the performance limit of his system and then add a large guard-band. Or other times, tests are not done and some system characteristics are not specified.

Generating "Real-Life" Test Signals Required Specialized Test Equipment

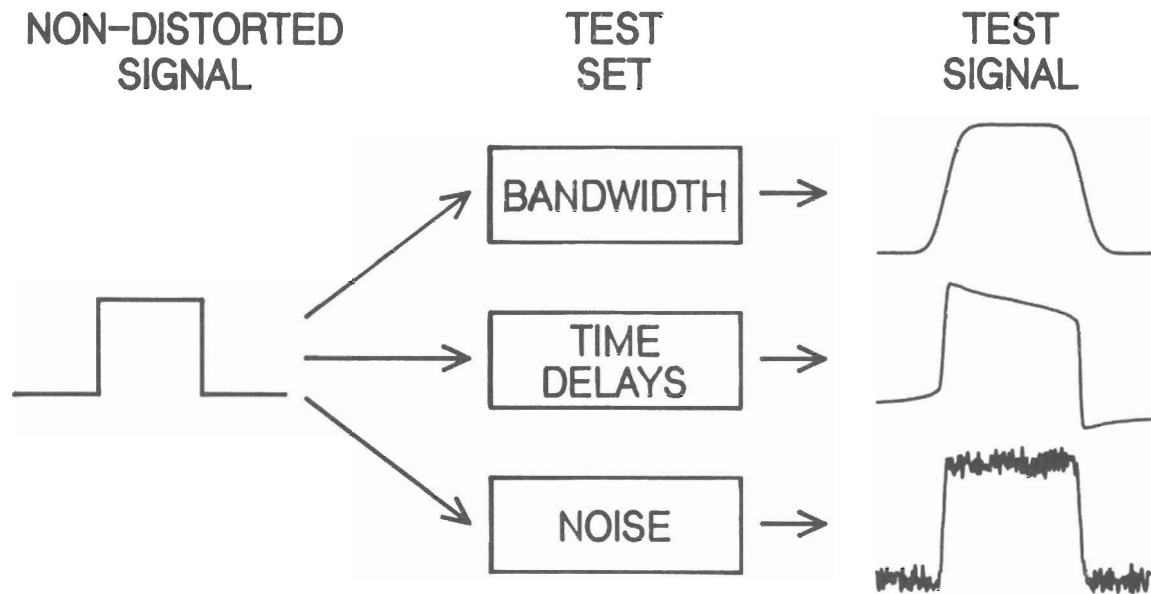

Specialized test sets have limited flexibility.

AWSP5

Many times specialized electronic test sets were designed to provide test signals representative of actual system operation, but they were limited in their flexibility. Many times these test sets couldn't provide different signals if new signals were needed for new tests. Often entire test sets had to be scrapped once their particular program had ended.

Digital Synthesis Provides Test Signal Generation Flexibility

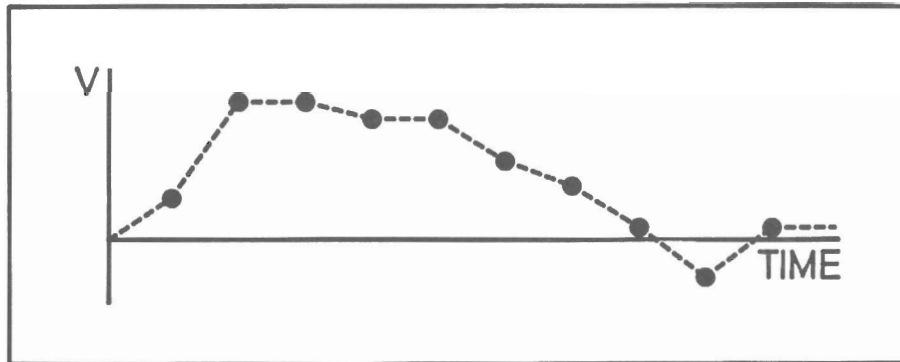

- Create or modify test signals with point-by-point flexibility.
- Generate signals with frequency components up to one-half of update rate.

AWSP6

This brings us the second part of the paper; the description of a new concept in test signal generation. This new concept is called Digital Synthesis and uses digital techniques to generate precise analog test signals with exceptional flexibility. Test signals are designed point-by-point and then reproduced by means of a Digital-to-Analog Converter (DAC).

The upper frequency limit of a signal generated by Digital Synthesis is determined by the Nyquist Sampling Theorem. This theorem says that a signal can be reproduced with frequency components up to one-half of the sampling rate. For example, in a system with an update rate of 100 MHz, Digital Synthesis can reproduce a waveform up to 50 MHz.

Digital Synthesis Lets You Generate Complex Test Signals

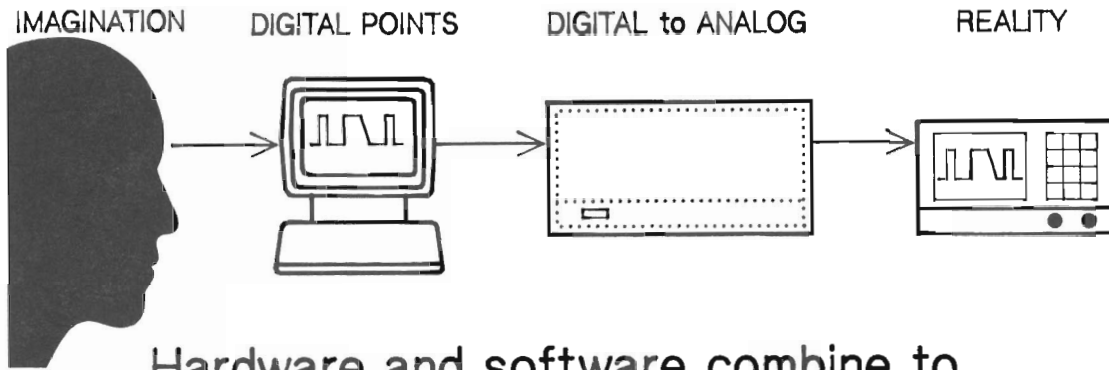

Hardware and software combine to give new capability

AWSP7

Digital Synthesis allows you to generate almost any signal that you can imagine because of its point-by-point flexibility. A signal's parameters can be easily varied, and distortion defined and added in terms of the digital representation of the test signal. It is this flexibility that allows Digital Synthesis to generate many complex test signals.

A computer and software is needed to help you create the digital data representing the desired signal. The computer also handles the transfer of the data to a high-speed memory and then to a DAC to reproduce the test signal.

In most systems of this type, the DAC sets the overall performance. The number of bits determines the amplitude resolution, and the update rate determines the upper frequency limit.

The HP 8770S Uses Digital Synthesis

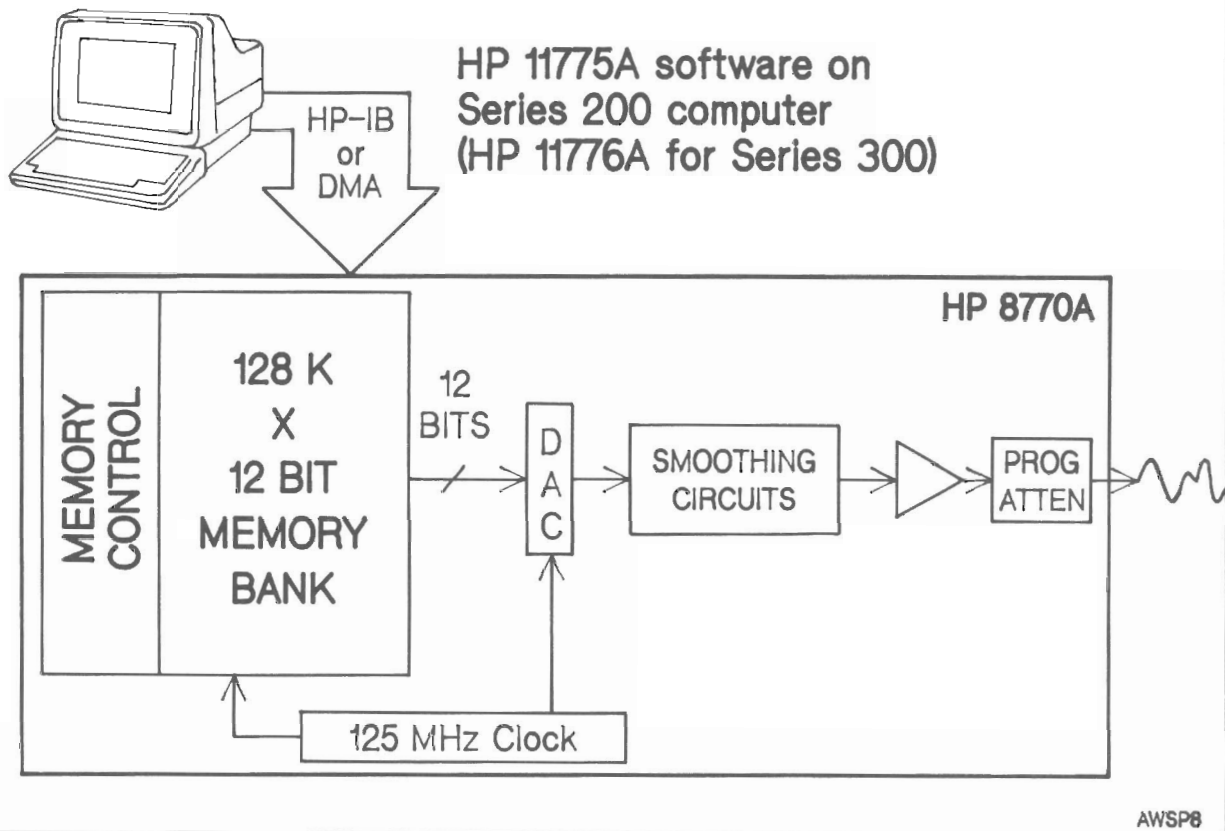

This is a block diagram of a Digital Synthesis system: the HP 8770S. It consists of a computer running the Waveform Generation Software and the HP 8770A synthesizer. A user first creates a signal on the computer and then instructs the computer to download the digital information to the HP 8770A for generation.

The HP 8770A has the high-speed memory and the DAC output stage needed to generate the test signal. The HP 8770A's memory is 128K words long with each word consisting of 12 bits. The memory also has a control capability called memory sequencing that allows memory to be conserved on long, periodic parts of signals.

The DAC output stage determines the performance of the HP 8770A. The DAC runs at a rate of 125 Megasamples/sec or one new digital output every 8 ns for an upper frequency limit of 50 MHz. The DACs resolution is 12 bits, which means that it can set its output level to 1 part in 4096 (72 dB). Special smoothing circuits remove high frequency components from the DAC, and an attenuator is present for setting low signal levels.

The HP 11775A Waveform Generation Software Makes Waveform Creation Easy

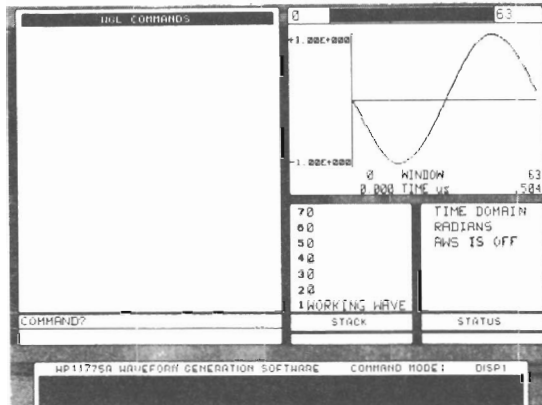

Waveform calculator with math and waveform manipulation commands.

AWSP9

Since the creation of signals is done digitally in the computer, the software becomes the "front panel" of the HP 8770S system. It was designed to be flexible and easy-to-use for creating and modifying test waveforms.

The software is an interactive "waveform calculator" with a full set of math and waveform manipulation commands. Its commands work with arrays, or rows, of numbers that digitally represent the test signal, much the same way that hand-held calculators work with single numbers.

With the software, a user can create a signal in its entirety or in sections. After a signal is created, a user can then modify or distort the signal in software before it is downloaded to the synthesizer for generation.

One Way to Make a Sine Wave from Scratch

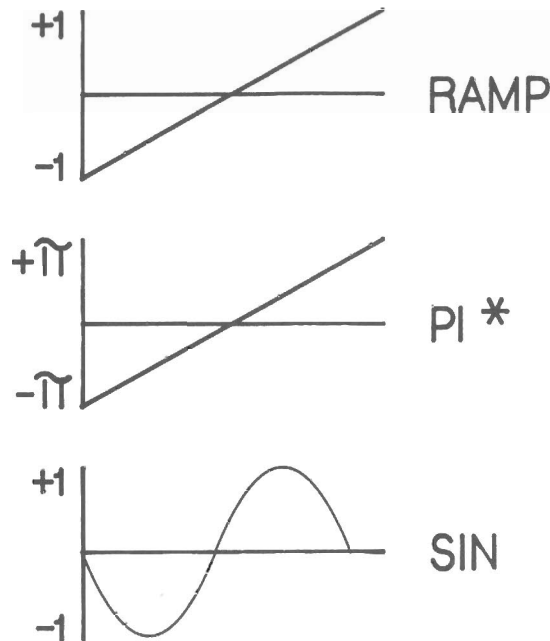

AWSP10

An example of signal creation will help to illustrate the workings of the software. This example is the creation of one cycle of a sine wave, but other waveforms such as Gaussian pulses or $\sin(x)/x$ can just as easily be created. The sine wave will be created by first creating the phase information in radians for one cycle and then taking the sin of the phase.

The left side of the slide shows the waveform at each stage of creation. The right side shows the commands needed to create the signal. The first command, RAMP, creates a waveform whose elements increase linearly from -1 to +1. Multiplying by pi causes the waveform to increase from -pi to +pi, which is the phase information for one cycle of a sine wave. Taking the sin of this waveform creates the desired signal.

Fourier Transforms Included for Working in Frequency Domain

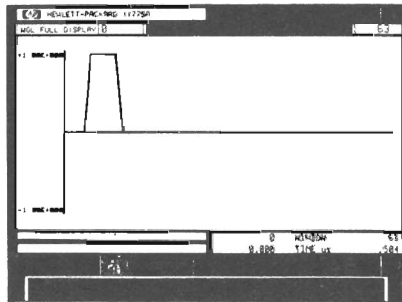

TIME
DOMAIN

FOURIER
TRANSFORM
↔

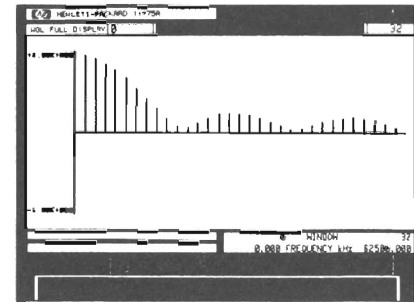

FREQUENCY
DOMAIN

Added creative power for waveform
creation and software "filtering".

AWSP11

The software also has the capability to work in the frequency domain. A Fourier transform is included that can transform the digital time domain data of a waveform into its frequency domain representation and then back to the time domain. When a waveform is in the frequency domain, both the amplitude and phase information of each frequency component are available for modification.

Create Specialized Commands for Your Particular Application

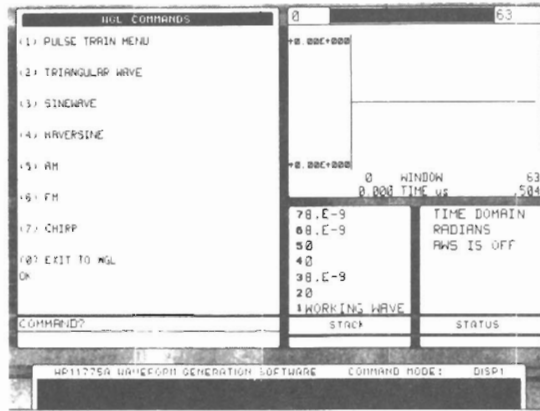

Menus and prompts make the software easier to use.

AWSP12

It is also possible to program new commands in the software to generate waveforms for specific applications. For example, here is the opening menu of a program that generates many useful receiver test waveforms. A user selects one of the options and then the program will prompt the user for the parameters of the desired signal. The program will then automatically create the signal.

There are many sample application programs already written and available with the HP 11775A software. This menu is from one of these sample programs.

What signals can this synthesizer system generate?

AWSP13

Now we move on to the third part of the paper; an overview of various signals that can be generated through Digital Synthesis. For all of the following examples, each waveform has been created and/or modified in software first. The actual generation of the signals is accomplished by downloading the digital information into the synthesizer.

Precise AM & FM Signals from One Source

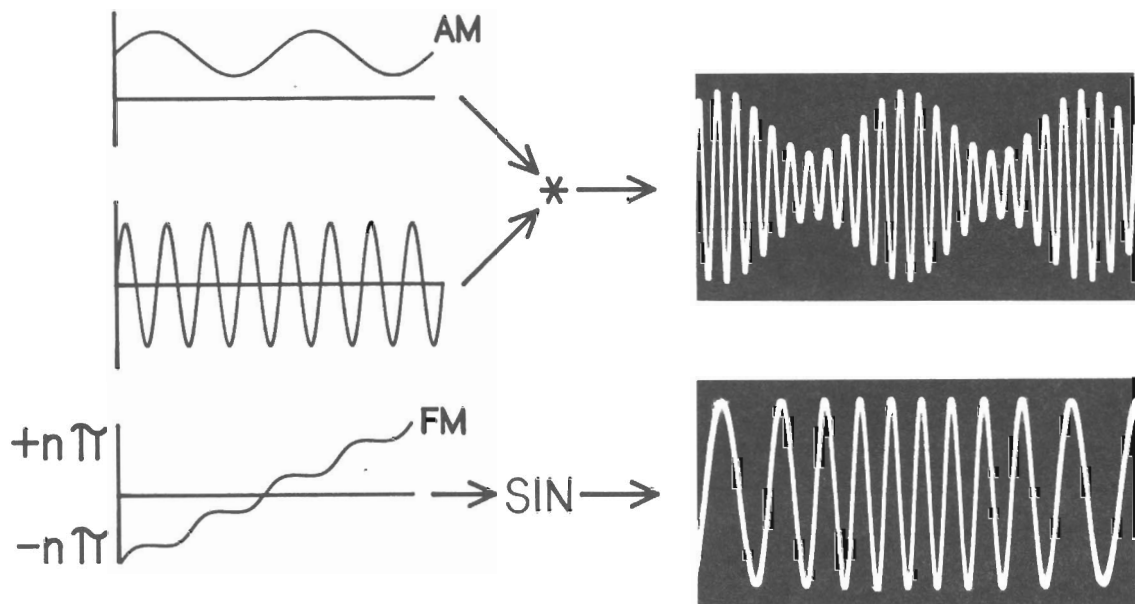

Not limited to sinusoidal modulation.

AWSPM4

Precise AM and FM signals can be generated from the synthesizer without the need for extra modulation sources. The data for each signal is first created in software. To create the AM signal, the carrier waveform and the modulation envelope are first created separately and then multiplied together. To create the FM signal, the phase information for many cycles of the carrier is first created. The modulating signal is then created and added to the carrier phase. Taking the sin of the resultant waveform gives the desired FM signal.

The quality of these signals is good because there are no analog modulation circuits to cause distortion. The AM depth can be set with 12 bit resolution. An added advantage is that since the FM signal is created in software, the deviation rate can be specified without the need of a spectrum analyzer for calibration.

Examples of Non-sinusoidal Modulation

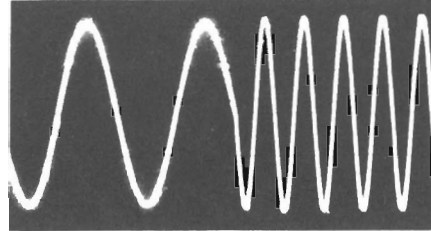
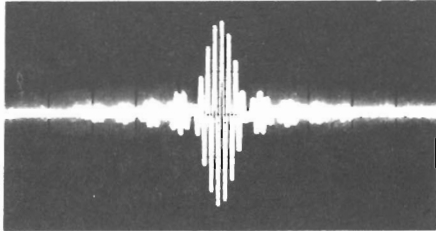

AWSP15

AM and FM signals do not have to be limited to sine wave modulation. The modulation envelope of the AM signal could have been a $\sin(x)/x$ waveform.

The FM signal could also have been a signal varied between two different frequencies. The switching between frequencies can be defined by the user to simulate a Frequency Shift Keying signal (FSK). In this application, the switch between frequencies can be made phase-continuous.

Signal Phase can be Shifted over Time

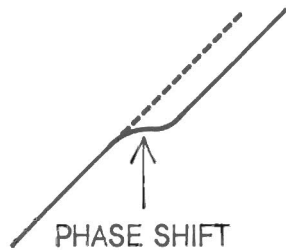

SIGNAL PHASE
vs.
TIME

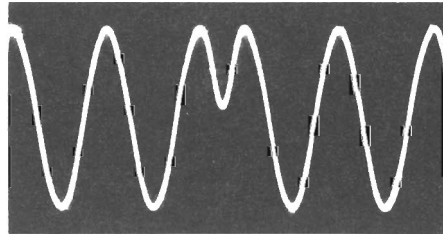

SIGNAL IN
TIME DOMAIN

Phase transitions can be varied by user.

AWSP17

Another modulation scheme in use today is phase-shift keying. This is where a carrier's phase changes over time and each phase change corresponds to a bit of information.

To generate a phase-shift signal, the software varies the phase of the carrier before taking the sin for the final signal. The advantage of this method is that the user can specify when each phase shift occurs, the path for each phase transition and also the final phase offset of the carrier after each transition.

Multi-tone Signals Made Easy with One Source

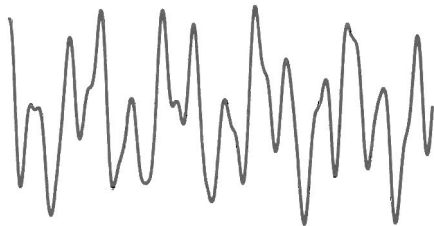

TIME
DOMAIN

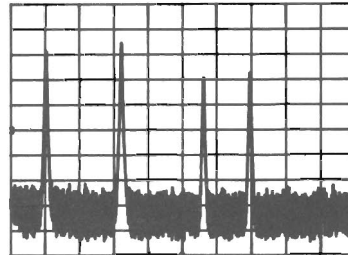

FREQUENCY
DOMAIN

System allows amplitude and
phase control of components.

AWSP16

Multi-tone signals are also easy to generate with Digital Synthesis. Multi-tone signals are useful for simulating a multiple emitter environment, for testing intermodulation distortion and the rejection of unwanted signals when the desired signal is weak.

The Fourier transform helps create multi-tone signals. A user uses the software to specify the frequencies, amplitudes and phases of each tone directly in the frequency domain. The reverse Fourier transform changes the frequency information into the desired time domain waveform.

Long Periodic Signals Made Possible with Memory Sequencing

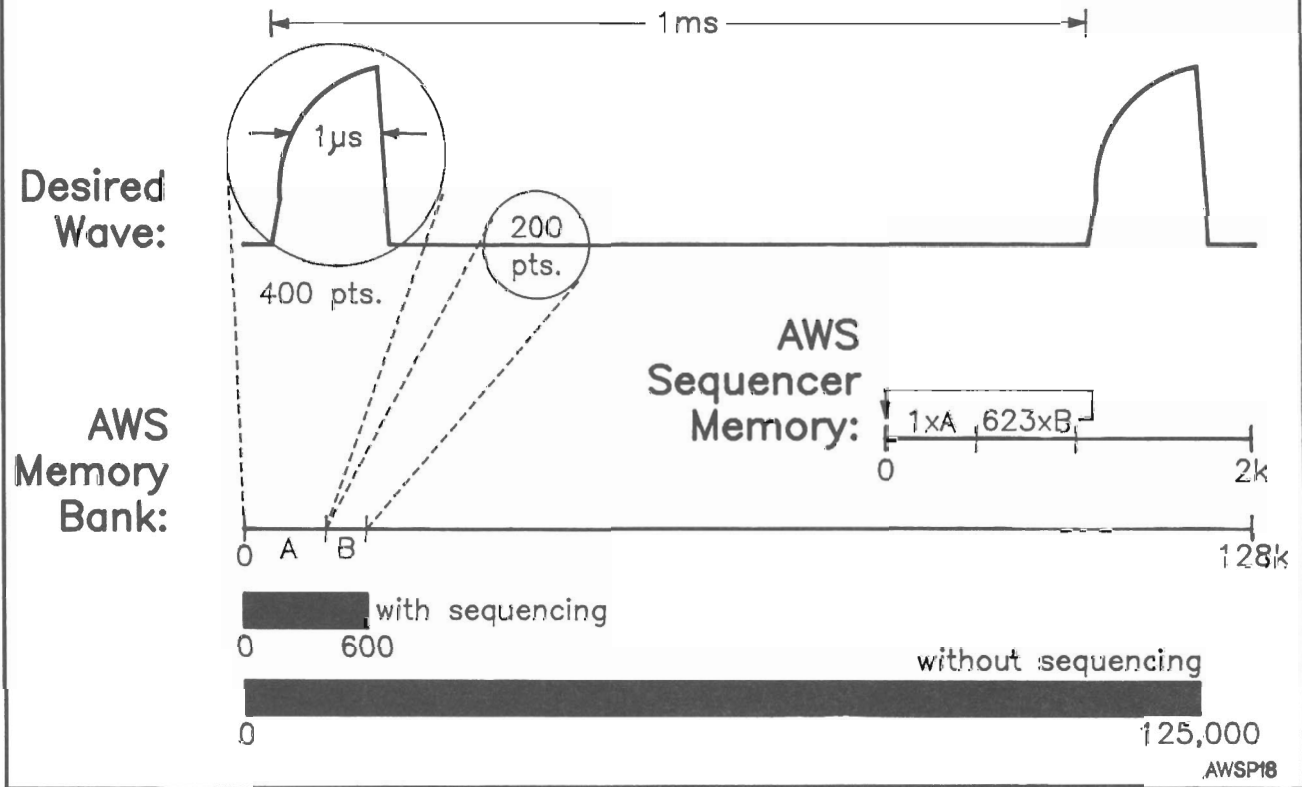

The longer the period of a signal, the more memory is usually required to contain all the digital information. Memory sequencing saves memory on these signals by taking advantage of the repeatable parts of a signal.

For example, the above pulse has a repetition interval of 1 ms. This would require about 125,000 digital words, one every 8 ns, to completely generate the signal even though most of the signal is off-time. With the memory sequencer, the amount of memory needed can be greatly reduced by defining the pulse's off-time with a section of memory repeated many times.

Not only can the memory sequencer save memory, it also makes possible other types of test signals. Examples of these signals include changing a pulse's shape and/or repetition frequency over time, and frequency hopping where a carrier must change frequencies very quickly.

Margin and Limit Testing Made Easy

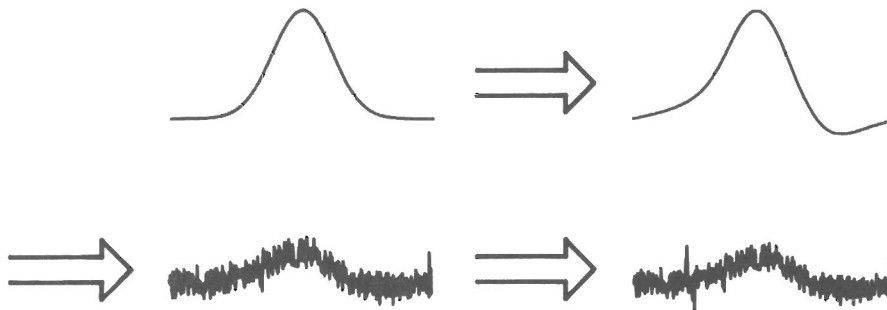

Vary signal distortion to find a systems performance margin.

AWSP19

Another application for Digital Synthesis is margin testing for finding the performance limit of systems. Margin testing is done by testing systems with signals that have gradually increasing amounts of distortion. At a certain level of distortion, the system-under-test will no longer be able to perform properly and this distortion level can then be specified without the need for large guardbands. Digital synthesis makes margin testing easy because it allows precise changes of signal parameters in software.

Create and Modify Signals in the Frequency Domain

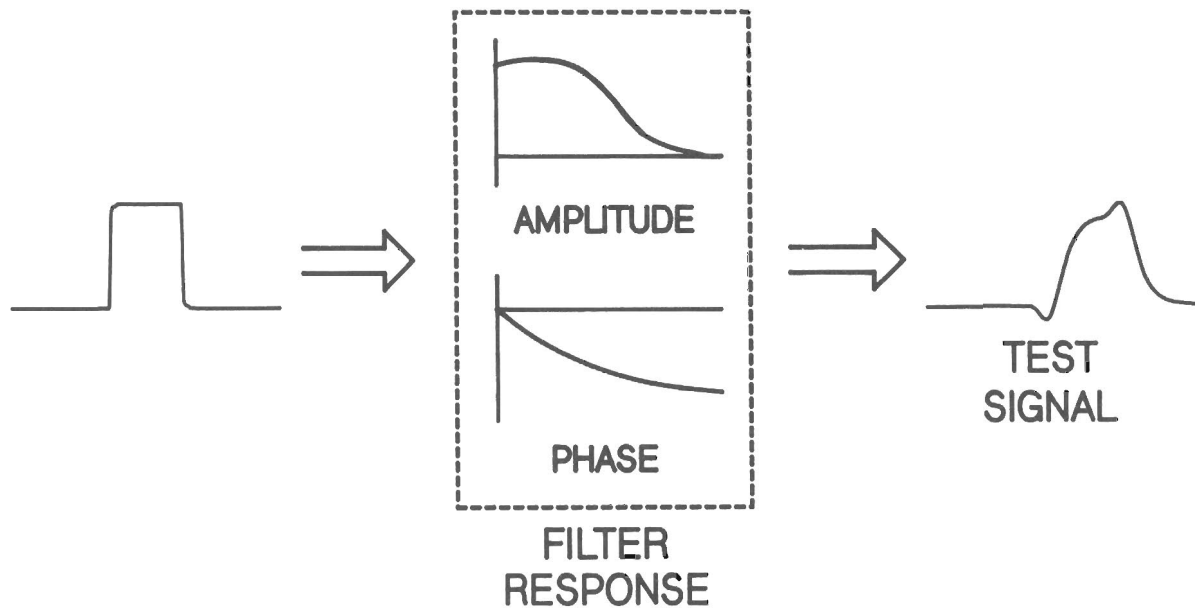

AWSP20

Changing signal parameters in terms of frequency response is enhanced with the software frequency transform. A signal can be designed in the software, transformed into the frequency domain, modified, and then transformed back into the time domain for subsequent generation. In the frequency domain, amplitude and phase components can be directly specified for modeling filters or the frequency response of components. This saves a designer the task of building many filters, for example, when testing system performance.

Isolate Frequency Bands to Find Problem Frequencies

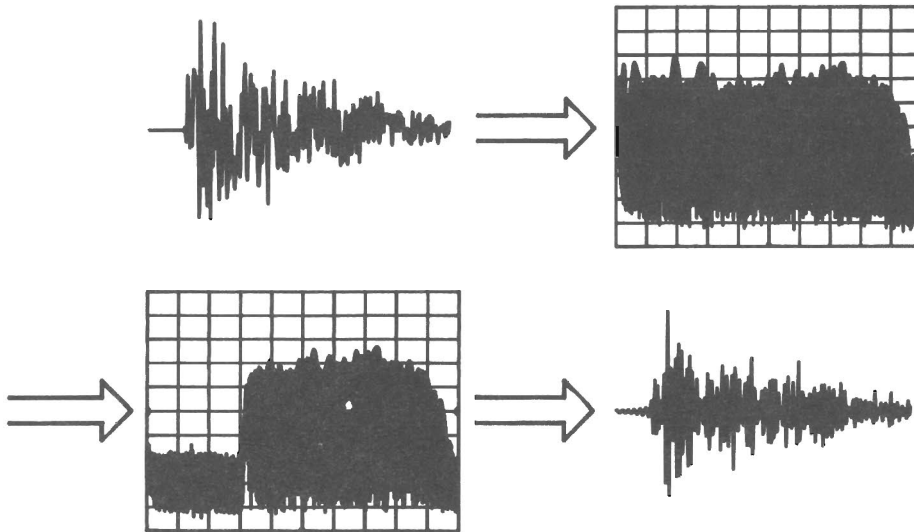

AWSP21

Here is an example of the software frequency transform in actual use. One application required the generation of a test signal with frequency components across tens of MHz for finding resonant frequencies in a device. This application also required that parts of the signal's spectrum be "notched-out" to isolate the resonant frequencies. The required test signal was first created in software, transformed into the frequency domain where the selected frequency bands could be removed, and then back into the time domain for generation by the synthesizer.

Expanding the HP 8770S to Include other Instruments

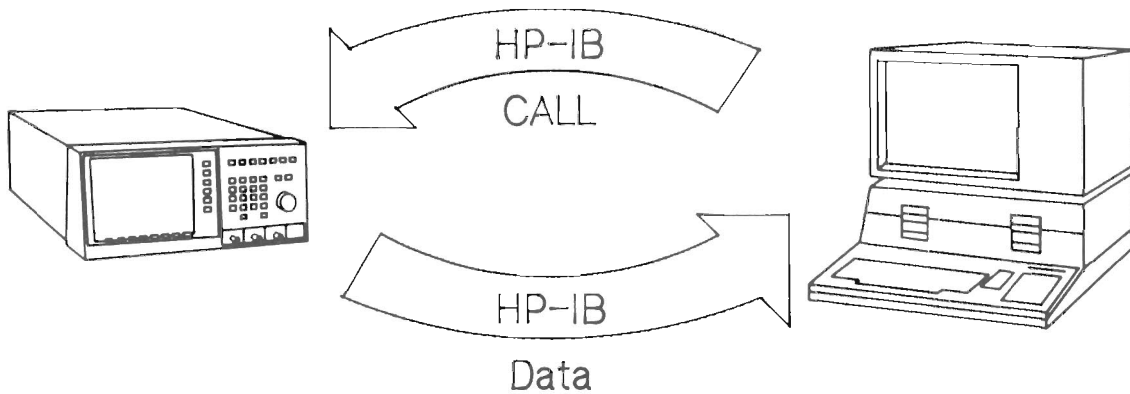

Data transfer and control done over HP-IB

AWSP22

This brings us to the fourth part of the paper; how to expand the HP 8770S to include other instruments and how to integrate the HP 8770S into a larger ATE environment.

The HP 8770S can include other instruments such as oscilloscopes through the software. The software can control other instruments through subprograms appended to the software. The software calls these subprograms whenever it needs to control an instrument or read back captured data. By using subprograms it is possible for the software to begin waveform creation by first capturing a waveform from an oscilloscope or other device.

HP 8770A with other Computers

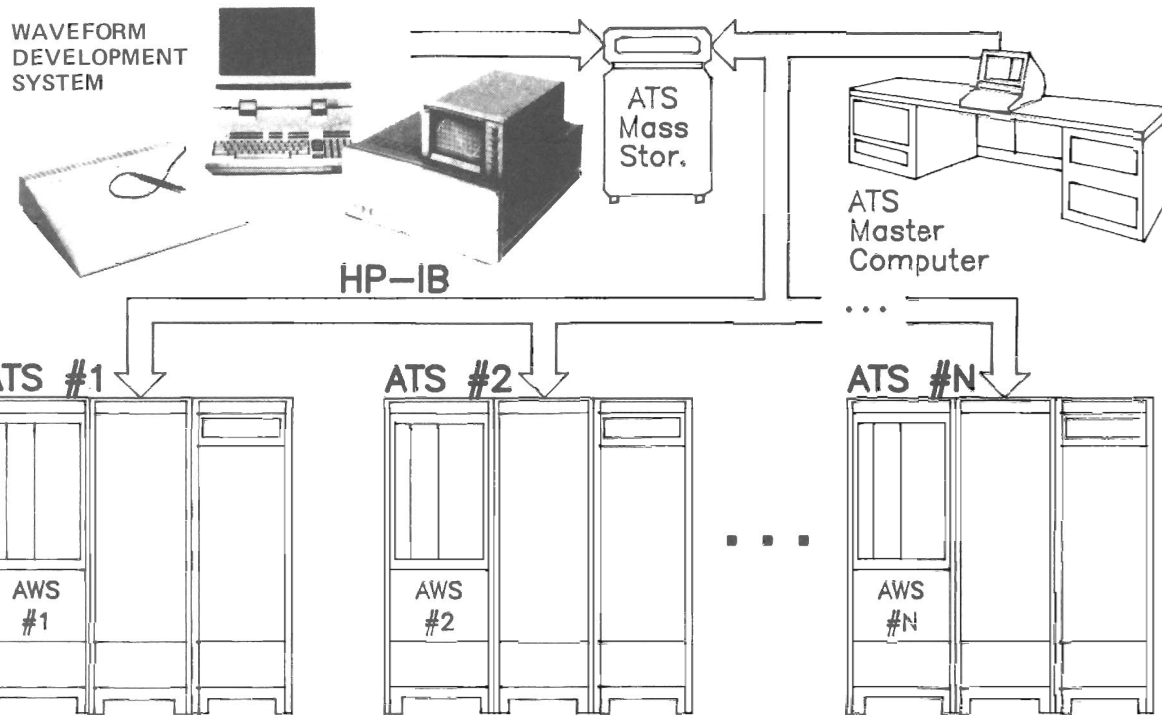

AWSP23

The HP 8770A can be included in a larger ATE environment to provide complex test signals from one source. An ATE computer can download waveform information to and also control the HP 8770A through HP-IB.

Waveform information can also be exchanged between the full HP 8770S system and an ATE computer with the translation device being the HP 8770A itself. The full HP 8770S system would first create waveform files and download them to the HP 8770A synthesizer. An ATE computer can then read back the waveform files through HP-IB from the HP 8770A and store the files in a waveform library for later use.

The HP 11775A software includes many example programs written in BASIC that handle data transfer to and from the HP 8770A synthesizer.

Summary

Digital Synthesis provides flexibility for generating complex test signals and improving electronic system testing.

AWSP24

LIST OF REFERENCES

"Receiver Testing with the HP 8770S Arbitrary Waveform Synthesizer System," Hewlett-Packard Application Note Number 314-1.

"Synthesizer Magnetic Disc Read and Servo Signals with the HP 8770S Arbitrary Waveform Synthesizer System," Hewlett-Packard Application Note Number 314-2.

"Thorough, Efficient Electromagnetic Pulse (EMP) Simulation with the HP 8770S Arbitrary Waveform Synthesizer System," Hewlett-Packard Article (HP Lit. Number 5954-6386).