

**CHOOSING A PHASE NOISE  
MEASUREMENT TECHNIQUE**  
Concepts and Implementation

**TERRY DECKER ♦ BOB TEMPLE**

**RF & Microwave  
Measurement  
Symposium  
and  
Exhibition**

 **HEWLETT  
PACKARD**

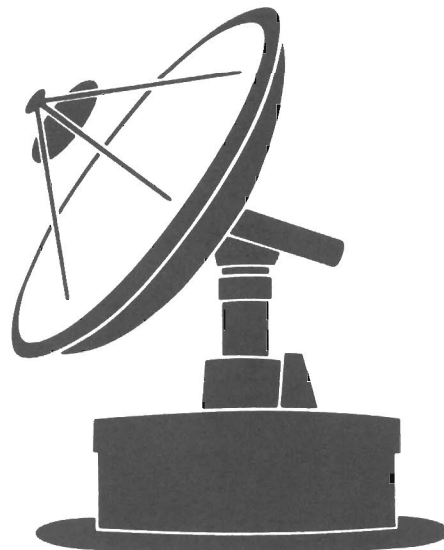

**Terry Decker**, received her BA in Physics from Carleton College in Northfield, Minnesota in 1980 and a BSEE from the University of Arizona in 1981. She worked as a microwave engineer for Hughes Aircraft Company on the Phoenix and AMRAAM programs for 4 years. She is currently a product marketing engineer responsible for phase-noise measurement systems at the Spokane Division of Hewlett-Packard Company.

**Bob Temple**, received his BA in Physics from Harvard University in 1961, and his MSEE in 1965 and PhD EE in 1971 from the University of Colorado in Boulder. Thesis topic was *The Operation and Frequency Stability Measurement of a Hydrogen Cyanide Beam Type Maser at 88.6 GHz*.

His career with Hewlett-Packard began in December 1969 at the Loveland Division designing the frequency synthesis loops for the HP 3320 and 3330 Frequency Synthesizers. He was co-project manager for the HP 3585A Spectrum Analyzer and the inventor and project manager for the HP 3047A Spectrum Analyzer System for making comprehensive phase noise and spectral purity measurements. He transferred to the Spokane Division in 1981 and supported phase noise measurements using the HP 3047A/11740A Phase Noise Measurement Systems working both within the Company and with HP customers. He is currently the Project Manager for the HP 3048A Phase Noise System.

## Agenda

- \* **Basic Phase Noise Measurement Concepts**
  - Direct Spectrum Measurement**
  - Demodulation Techniques**
  - Phase Demodulator**
  - Residual or Added Noise Measurements**
  - Single Source Measurements**
  - Phase Detector with Two Sources**
  - Reference Source**
  - Voltage Controlled Source Tuning Requirements**
  - Measurement Optimization**
  - Measurement Examples**

setdla

1486

### Slide 1

There are many techniques for measuring the phase noise from a source or added by a device. How well each of these methods works depends on both the technique and the characteristics of what is being measured. This presentation will examine the advantages and disadvantages of using several of the most prevalent methods when measuring the phase noise of typical devices. One technique using a phase detector to demodulate the phase noise from the carrier signal will be covered in detail along with a hardware implementation based on this method.

## Basic Phase Noise Measurement Concepts

$$V(t) = V_0 \left[ 1 + \frac{e(t)}{V_0} \right] \sin [2\pi\nu_0 t + \phi(t)]$$



$$\text{||} \quad A(t) \quad \nu(t) = \nu_0 + \frac{1}{2\pi} \frac{d\phi(t)}{dt}$$

Direct Spectrum

Demodulate, then analyze

$$S_V(\nu_0 \pm f)$$

$$S_A(f) \quad S_\phi(f) \quad S_\nu(f) = f^2 S_\phi(f)$$

setd1

1487

### Slide 2

There would be no need to discuss the measurement of phase noise if all sources produced perfect sinewave signals and if two-port devices were not capable of adding phase noise to a signal. The deviations from the pure sinewave signal need to be quantified as a first step to determining their effect on the end results. In this equation representing the signal voltage with respect to time,  $e(t)$  represents amplitude variations or amplitude modulation of the signal and  $\phi(t)$  represents the phase fluctuations modulating the ideal linear phase change of the signal. There are two fundamental ways to measure these perturbations of the signal: the first is to look at the signal directly on a spectrum analyzer and the second is to demodulate the fluctuations of the carrier for analysis at baseband.

On a spectrum analyzer, the sum total of all the instabilities of a signal appear as sidebands on either side of the carrier. The spectral density of these sidebands,  $S_V(\nu_0 \pm f)$ , can be read directly for a given offset. Demodulating the amplitude, phase or frequency fluctuations produces a time-domain voltage analog of these fluctuations for measurement and analysis. The analysis of this baseband signal can produce the spectral density of the amplitude fluctuations,  $S_A(f)$ , of the phase fluctuations,  $S_\phi(f)$ , or of the frequency fluctuations,  $S_\nu(f)$ . Note that the spectral densities of phase and frequency fluctuations are directly related by the square of the offset frequency.

## Direct Spectrum Analysis

$$\text{If } AM \ll P_m \quad \mathcal{L}(f) = \frac{S_v(\nu_0 \pm f)}{P_o}$$

HP 3561A/62A Dynamic Signal Analyzer

HP 3582A Spectrum Analyzer

HP 3585A Spectrum Analyzer

HP 8566A/B Spectrum Analyzer

HP 8568A/B Spectrum Analyzer

sedt2

1488

### Slide 3

The quantity that is usually measured in phase noise analysis is  $\mathcal{L}(f)$ , the single sideband phase noise of a signal. This quantity is the noise power due to the phase fluctuations of the signal in a 1 Hz bandwidth at an offset  $f$  Hz from the carrier normalized to the total signal power. If the AM noise is much less than the PM noise,  $\mathcal{L}(f)$  is read directly from the CRT of the spectrum analyzer as the relative level of the noise sidebands compared to the carrier power. Corrections are necessary to normalize the results for a 1 Hz bandwidth and to account for the logarithmic scaling of the spectrum analyzer. In addition, for a measurement of only the signal's noise, the phase noise sidebands to be measured must be greater than the spectrum analyzer's own noise sidebands by about 10 dB. The spectrum analyzers listed here are commonly used for a direct spectrum measurement of phase noise because they have synthesized local oscillators (except the HP 3582A and 3561A which perform a Fourier conversion of the signal) to prevent their own drift from affecting the result.

## Demodulate, Then Analyze

$$\text{If } \langle \phi^2(t) \rangle \ll 1 \quad \mathcal{L}(f) = \frac{S_{\phi}(f)}{2}$$

HP 5390A Frequency Stability Analyzer

HP 8901A/B Modulation Analyzer

HP 8902A Measuring Receiver

HP 3047A/11740A Spectrum Analyzer System

HP 3048A Phase Noise Measurement System

HP 11729C Carrier Noise Test Set

setd3

1489

### Slide 4

The phase noise on a carrier can be demodulated for analysis with a baseband spectrum analyzer to get the spectral density of the phase modulation  $S_{\phi}(f)$ . The single sided phase noise,  $\mathcal{L}(f)$ , can be calculated from the spectral density of the phase fluctuations,  $S_{\phi}(f)$ , (or frequency fluctuations,  $S_{\nu}(f) = f^2 \times S_{\phi}(f)$ ) if the mean square phase fluctuations  $\langle \phi^2(t) \rangle$  are small relative to one radian. Listed here are some of the instruments that are used to do this demodulation and analysis of phase noise.

## Region of Validity of $\mathcal{L}(f) \frac{S_{\phi}(f)}{2}$

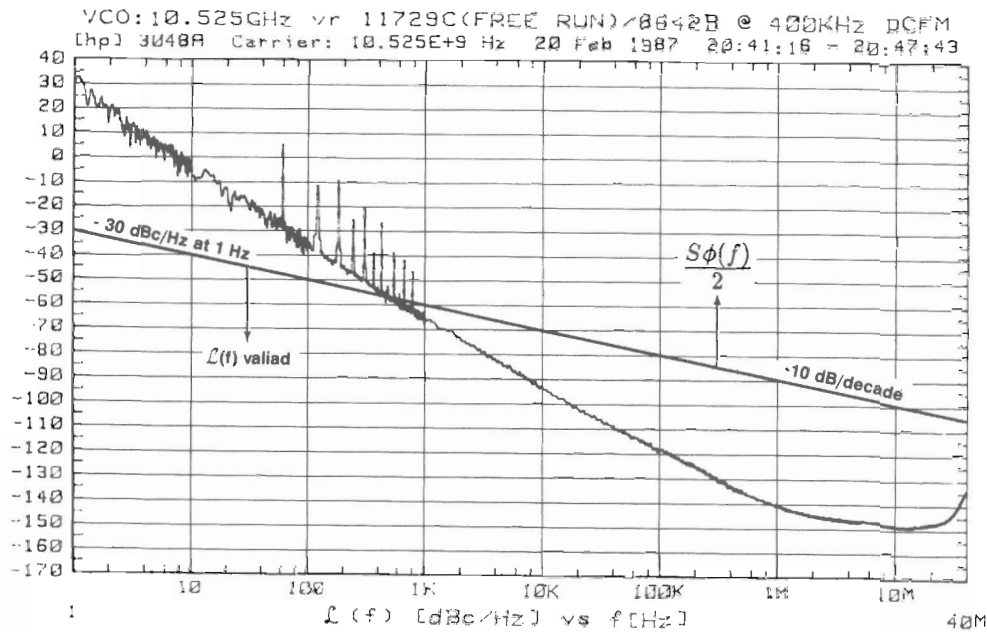

1490

### Slide 5

Caution must be exercised when  $\mathcal{L}(f)$  is calculated from the spectral density of the phase fluctuations,  $S_{\phi}(f)$ , because of the small angle criterion. This plot of  $\mathcal{L}(f)$  resulting from the phase noise of a free-running VCO illustrates the error that can occur if the instantaneous phase modulation exceeds a small angle. Approaching the carrier,  $\mathcal{L}(f)$  is obviously an invalid approximation of the actual phase noise as it reaches a relative level of +35 dBc/Hz at a 1 Hz offset (35 dB more noise power at a 1 Hz offset in a 1 Hz bandwidth than the total power in the signal).

The -10 dB/decade line is drawn on the plot for an instantaneous phase deviation of 0.2 radians integrated over any one decade of offset frequency. At approximately 0.2 radians the power in the higher order sidebands of the phase modulation is still insignificant compared to the power in the first order sideband which ensures the calculation of  $\mathcal{L}(f)$  is still valid. Below the line the plot of  $\mathcal{L}(f)$  is correct; above the line  $\mathcal{L}(f)$  is increasingly invalid and  $S_{\phi}(f)$  must be used to represent the phase noise of the signal.

## Conversion Between $S_\phi(f)$ and $S_\nu(f)$

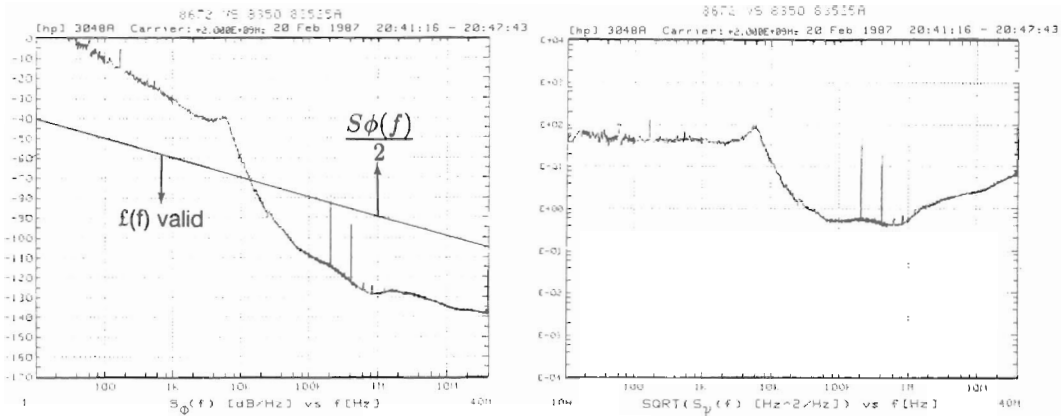

for Example 800 Hz rms SPUR at 180 Hz is 4.44 Radians rms

1491

### Slide 6

Another way to represent the instability of a signal besides  $S_\phi(f)$  or  $\mathcal{L}(f)$  is with a plot of the spectral density of frequency fluctuations,  $S_\nu(f)$ . As illustrated before,  $S_\nu(f)$  is equal to  $f^2 \times S_\phi(f)$  because  $\nu(t)$  is the derivative of  $\phi(t)$ . These two graphs are from the same data with the left one a plot of  $S_\phi(f)$  and the right one a plot of the square root of  $S_\nu(f)$ . The graph of the square root of  $S_\nu(f)$  indicates the power spectral density of the frequency modulation (FM) noise the signal has on it. A measure of the spectral density of the FM noise versus the offset from the carrier would be important in the design of an FM system for example.



## **Agenda**

**Basic Phase Noise Measurement Concepts**

**\* Direct Spectrum Measurement**

**Demodulation Techniques**

**Phase Demodulator**

**Residual or Added Noise Measurements**

**Single Source Measurements**

**Phase Detector with Two Sources**

**Reference Source**

**Voltage Controlled Source Tuning Requirements**

**Measurement Optimization**

**Measurement Examples**

1492

### **Slide 7**

Let's take a look at the direct spectrum method of measuring phase noise with a variety of spectrum analyzers.

## Direct Spectrum Measurement Choices

.001 Hz - 100 kHz	→	HP 3561A/62A
1 Hz - 25 kHz	→	HP 3582A
20 Hz - 40 MHz	→	HP 3585A
100 Hz - 1.5 GHz	→	HP 8568A/B
100 Hz - 22 GHz	→	HP 8566A/B
.01Hz - 100 kHz	→	HP 3048A using HP 3561A only

setd4

1493

### Slide 8

As listed previously there are a number of spectrum analyzers that will display the single sideband phase noise,  $\mathcal{L}(f)$ , of a signal. With the exception of the HP 3582A and 3561A which perform a Fourier conversion, the spectrum analyzers listed here have synthesized local oscillators to prevent the drift of the analyzer from affecting the measurement of the phase noise sidebands. The HP 3048A is a phase noise measurement system that consists of an interface box for frequency conversion and amplification, the HP 3561A Dynamic Signal Analyzer, a controller and software to run the measurement and produce the resulting graphs.

The HP 3048A system software provides direct spectrum measurements with the sub-Hz resolution of the HP 3561A for carrier frequencies <100 kHz. It will set up the HP 3561A, measure and plot the resulting noise voltage.

## Direct Spectrum Measurement Choices

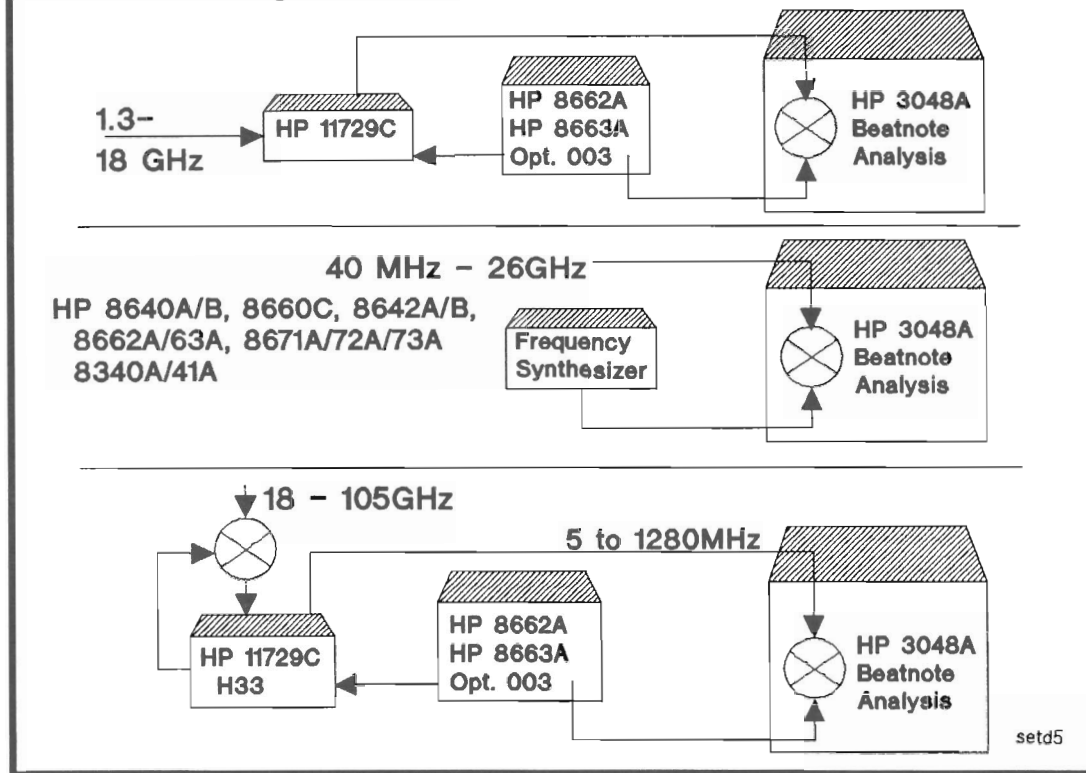

1494

### Slide 9

One important criterion for choosing a local oscillator for the downconversion of signals to baseband frequency for analysis is that the LO should not drift. The local oscillators listed here are synthesized to reduce their frequency drift to a multiple of a highly-stable crystal reference oscillator. An alternative to the single conversion to baseband using the mixer in the HP 3048A interface box is to do a preliminary downconversion using the HP 11729C Carrier Noise Test Set. As explained later, this dual conversion method can produce better sensitivity when measuring the phase noise of signals in the frequency range of 1.3 to 18 GHz. For signals above 18 GHz there is a millimeter version, Option H33 to the HP 11729C. This option allows access to a very clean mm signal to downconvert the test signal to the nominal range of the HP 11729C.

## Single Sideband Noise Floor of Several Spectrum Analyzers

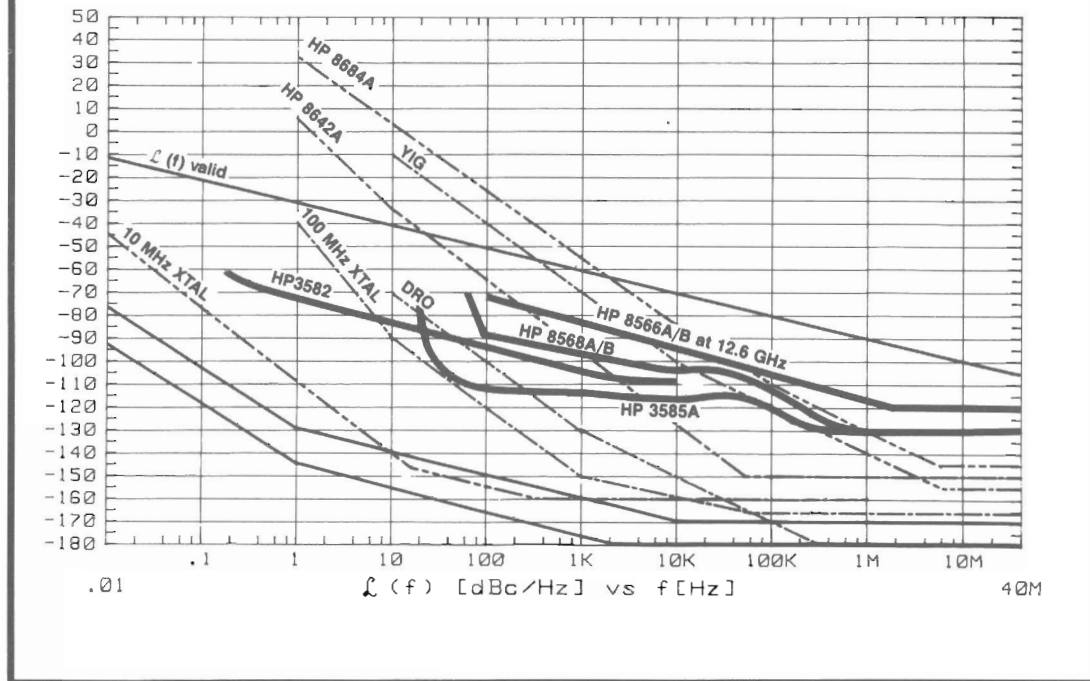

1495

### Slide 10

Throughout this presentation are a series of graphs illustrating the single sideband phase noise,  $\mathcal{L}(f)$ , of various sources on plots covering an offset frequency range of 0.01 Hz to 40 MHz and down to a relative amplitude level of  $-180$  dBc/Hz. These graphs will provide a common format for comparing measurement techniques to the typical types of sources that are measured. On the graph given here,  $\mathcal{L}(f)$  is plotted for several types of oscillators ranging from a free-running VCO (HP 8684A) to a highly-stable 10 MHz crystal oscillator used as the reference oscillator in many synthesized signal generators.  $\mathcal{L}(f)$  for the spectrum analyzers is overlaid on the graph to indicate which analyzer could be used to display the phase noise of typical sources.

Two measurement limitations for each spectrum analyzer are illustrated on this graph. The first is the analyzer's internally generated noise floor. For the superheterodyne spectrum analyzers (HP 8566A/B, 8568A/B, and 3585A), the phase noise of the analyzer's synthesized local oscillator determines its sensitivity at offsets of less than approximately 1 MHz. Beyond a 1 MHz offset the noise of the analyzers IF circuitry sets its noise floor. The resolution of the Fourier conversion and internal amplifiers determines the sensitivity of the HP 3582A. The second measurement limitation illustrated here is the minimum offset frequency specified by the analyzer. The superheterodyne spectrum analyzers are limited by their internal LO feedthrough to the IF circuitry to a minimum offset of approximately 20 to 100 Hz. The HP 3582A has measurement capability to within 0.2 Hz of the carrier due to the high resolution of its Fourier conversion process.

## HP 3561A/3048A BEAT NOTE AT 10 GHZ

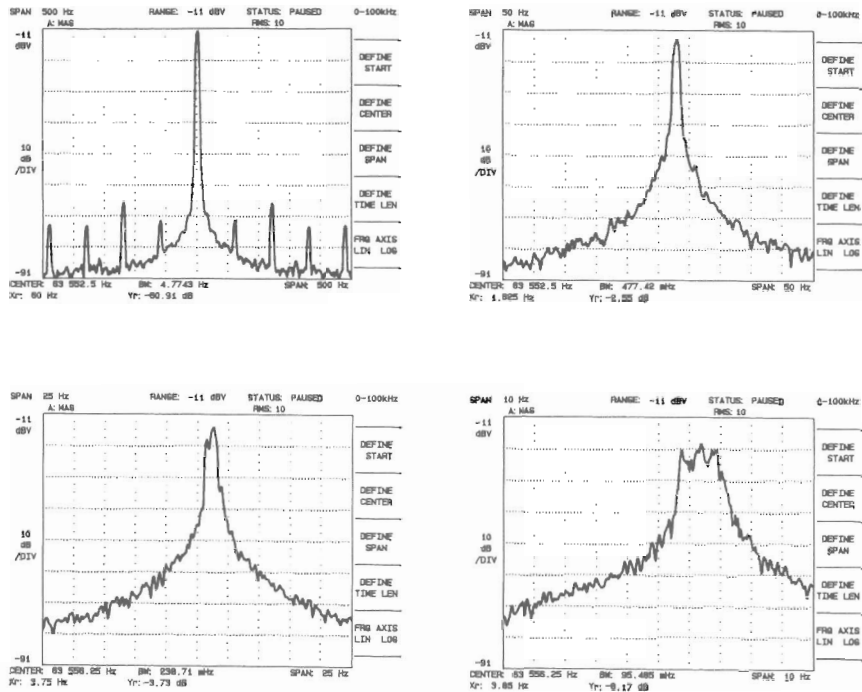

1496

### Slide 11

This is an example of the benefits of analyzing a microwave signal downconverted by the HP 11729C to an IF that is then input for measurement on the HP 3561A Dynamic Signal Analyzer within the HP 3048A System. The measurement at the upper left covers a 500 Hz span at 10.0 GHz and took approximately 1 second to complete on the HP 3561A. Sweeping the HP 8566A/B over the same range with a 10 Hz bandwidth would require 15 seconds during which any signal drift could affect the results and the resolution of low-level sidebands would be much more limited. Discrete sidebands are clearly resolved with this technique. The frequency span can be decreased for better resolution until, as in the 10 Hz span of the lower right plot, the carrier frequency is changing too much for this measure of single sideband phase noise to be valid. The carrier instability exceeds the small angle criterion that  $\mathcal{L}(f)$  depends on and a different measurement technique is required, one that determines the spectral density of the phase fluctuations rather than the power in the phase noise sidebands.

## Direct Spectrum Measurement Limitations

- Cannot separate AM and PM noise
- AM noise must be  $\ll$  PM noise
- Inadequate dynamic range for many sources
- Cannot measure close in to a drifting carrier
- Valuable for qualitative quick evaluation

1497

### Slide 12

This list summarizes the limitations of using the direct spectrum measurement technique to measure phase noise. Spectrum analyzers are valuable tools and widely used for fast, qualitative looks at the stability of a signal.

## Agenda

Basic Phase Noise Measurement Concepts

Direct Spectrum Measurement

\* Demodulation Techniques

Phase Demodulator

Residual or Added Noise Measurements

Single Source Measurements

Phase Detector with Two Sources

Reference Source

Voltage Controlled Source Tuning Requirements

Measurement Optimization

Measurement Examples

setd1a

1498

### Slide 13

Next let's take a look at several measurement techniques that demodulate the phase fluctuations of the signal for measurement and analysis.

## **Demodulation Techniques Related to Specific Instruments or Systems**

**HP 5390A Frequency Stability Analyzer**

**HP 8901A/B Modulation Analyzer**

**HP 8902A Measuring Receiver**

**HP 3048A Phase Noise Measurement System**

setd7

1499

### **Slide 14**

Listed here are several systems that demodulate the phase noise of the signal in different ways. The HP 5390A Frequency Stability Analyzer translates counter readings of the frequency of a signal over a period of time into the equivalent level of phase noise. The HP 8901A/B Modulation Analyzer and HP 8902A Measuring Receiver employ an FM discriminator to demodulate the phase noise of a signal. The HP 3048A Phase Noise Measurement System can be used in several ways to analyze phase noise, one of which is with an internal phase detector to mix the signal under test with synthesized oscillator.



# HP 5390A Frequency Stability Analyzer

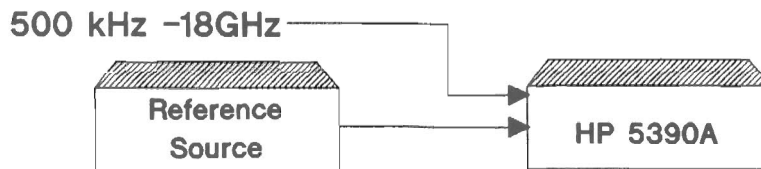

HP 8662A/63A,  
8671A/72A/73A  
8340A/41A,  
11729C/8662/63A

- Offset from source under test by  $10 \text{ Hz} \leq \nu_B \leq 67 \text{ kHz}$ .
- Source drift  $\ll \nu_B$
- Noise must fall rapidly with increasing  $f$ .

setd8

1500

## Slide 15

Although this system is now obsolete and cannot be ordered, it is instructive to examine the approach that was used to measure phase noise. The counter in the system was used to measure the difference frequency of the signal under test and a reference source. If the reference source is sufficiently more stable than the test signal and the test signal does not drift during the measurement, variations of the difference frequency represent frequency (or phase) instability of the test signal. The system software compiles a series of readings of this difference frequency and calculates the Allen or the Hadamard variance to determine the phase noise of the signal. This measurement approach can yield phase noise data very close to the carrier with very good sensitivity if a low frequency beatnote is used.

Several significant limitations are inherent with this measurement technique. One is that the two sources used must be offset to produce the beatnote to be counted. To overcome this problem an option to the system was created to add a second mixer such that the two oscillators of the same frequency to be compared were mixed with a third source at a different frequency. With this variation the difference in period of the two beatnotes is measured and translated into the corresponding phase noise. If the sources were of equal stability the result would be the combined phase noise of both sources (the instability of the third source cancels out with this method).

To produce a valid phase noise measurement this system required a nondrifting signal to measure. Also, as this is essentially a digital form of phase noise measurement with a series of discrete readings, aliasing is encountered such that data at high offset frequencies is folded down to lower offsets according to the measurement rate. This aliasing of the high offset phase noise would increase the phase noise readings at low offsets. This produced a requirement that the phase noise of the signal under test be decreasing rapidly as the offset frequency increases so that the phase noise power folded over to the lower offsets would not be significant.

# HP 5390A FREQUENCY STABILITY ANALYZER

## Theoretical Sensitivity

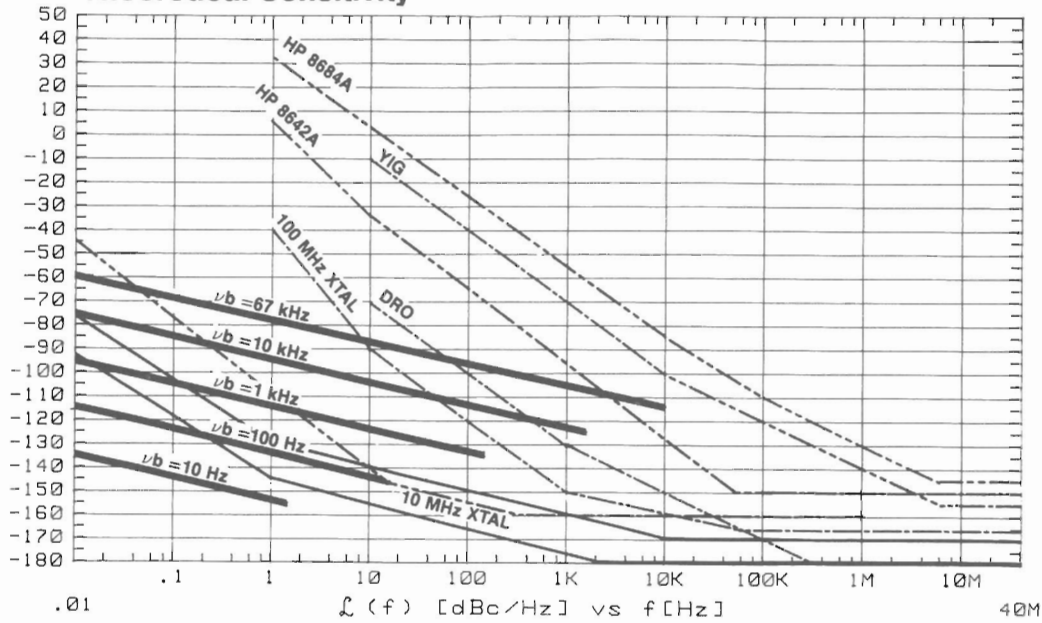

1501

### Slide 16

The sensitivity of the HP 5390A System and the offset range that could be measured were a function of the beatnote frequency that was used. Excellent sensitivity was available with a beatnote of 10 Hz but the offset range was limited to less than 1.6 Hz. This limitation is acceptable for measuring precision frequency oscillators used as time standards. With increasing beatnote frequency the HP 5390A System had a range of usefulness for measuring various sources but in general could not produce a phase noise measurement out to the noise floor of the oscillator under test.

## HP 8901A/B Modulation Analyzer HP 8902A Measuring Receiver

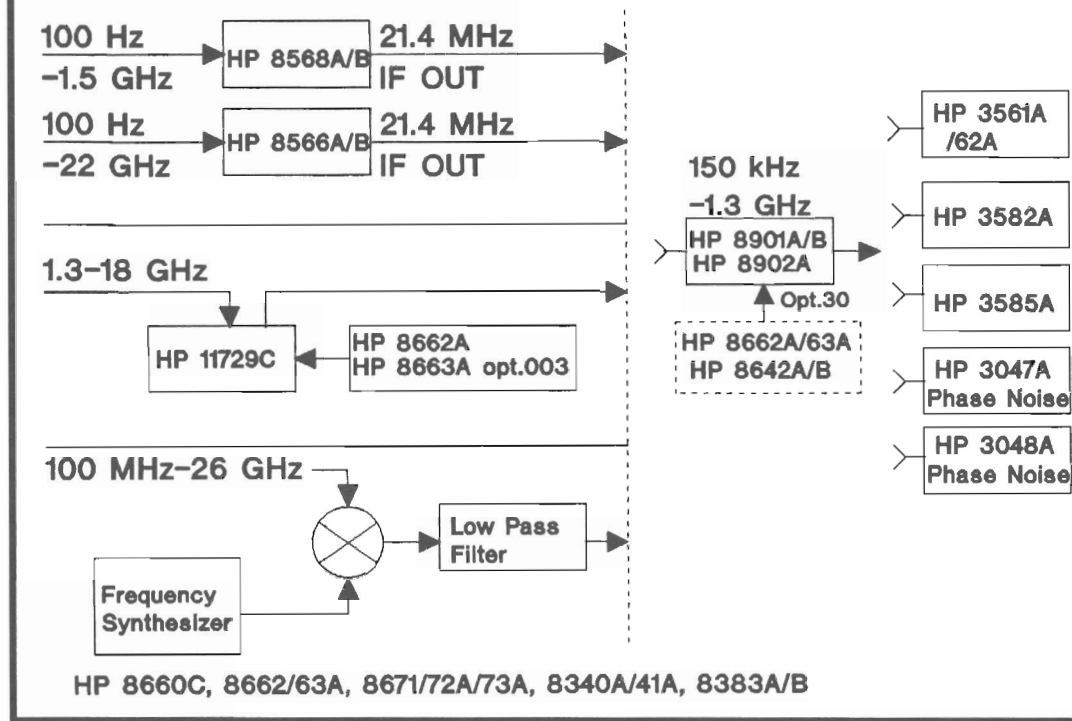

1502

### Slide 17

The HP 8901A/B Modulation Analyzer and HP 8902A Measuring Receiver convert the frequency fluctuations of a signal into voltage variations with a frequency discriminator. The discriminator output can be connected to a spectrum analyzer for a display of the spectral density of the phase noise over a range of offset frequencies or the noise can be integrated over a bandwidth. A correction is made for the calibration constant of the discriminator to achieve calibration. This calibration constant can be entered into the HP 3047A or 3048A System software for an automatically calibrated output. The phase noise of the HP 8901A/B or 8902A Internal Local Oscillator is lowest for an input frequency below 300 MHz. For signals below 300 MHz the HP 8901A/B or 8902A sensitivity is maximized as is indicated on the next slide of system sensitivity. An advantage of using a frequency discriminator approach as with the HP 8901A/B or 8902A is that a certain amount of signal drift can be tolerated in making a valid measurement of the spectral density of phase noise. Shown here are several methods for downconverting signals into the range of the HP 8901A/B or 8902A.

## HP 8902A/B Phase Noise

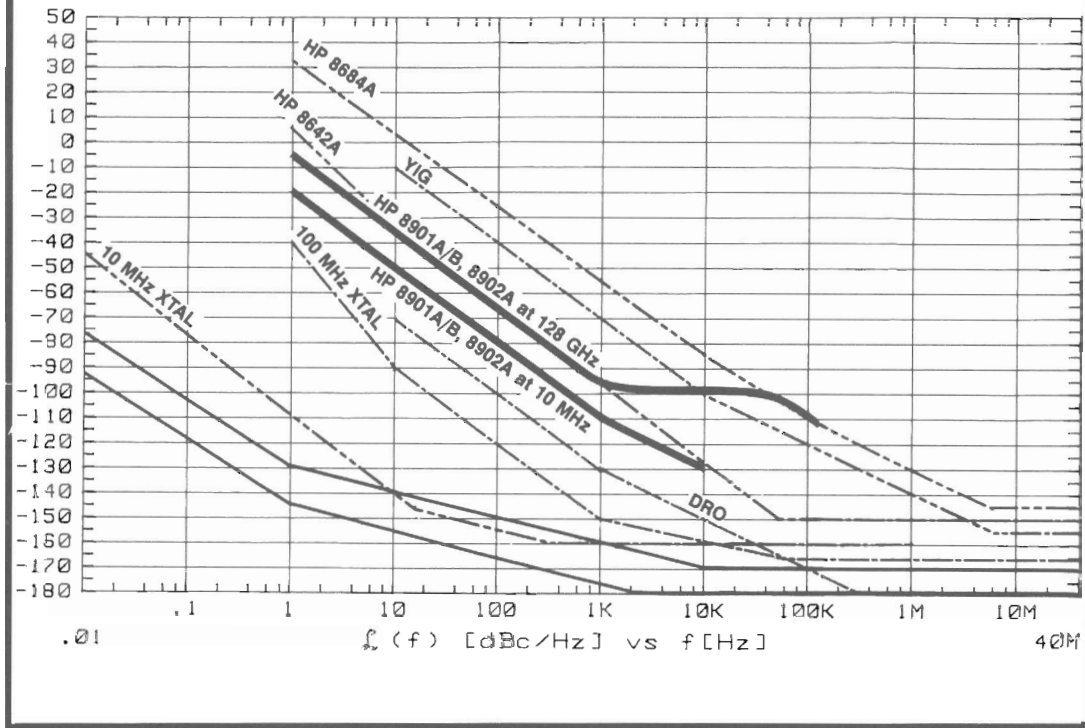

1503

### Slide 18

The curve for the HP 8901A/B or 8902A at 10 MHz on this graph is the sensitivity of the discriminator used in the analyzer and actually extends to an offset of approximately 200 kHz for input signals above 10 MHz. At 1.28 GHz the phase noise of the internal local oscillator of the HP 8901A/B or 8902A limits the sensitivity. This sensitivity is sufficient to measure the phase noise of some free-running oscillators as indicated.

## Agenda

Basic Phase Noise Measurement Concepts

Direct Spectrum Measurement

Demodulation Techniques

\* Phase Demodulator

Residual or Added Noise Measurements

Single Source Measurements

Phase Detector with Two Sources

Reference Source

Voltage Controlled Source Tuning Requirements

Measurement Optimization

Measurement Examples

1504

### Slide 19

Now we'll take a look at the phase demodulator technique used by the HP 3048A Phase Noise Measurement System. Whereas the previous phase noise measurement techniques were useful within certain limits of signal stability, offset ranges, and sensitivity levels, the phase demodulation technique used by the HP 3048A System has the broadest range of applications of any system available today.

## Doubly Balanced Mixer As Phase Detector

(Dist signal)

$$V_1 \sin [2\pi\nu_0 t + \phi(t)]$$

(Reference)

$$V_2 \sin [2\pi\nu_0 t + 90^\circ]$$

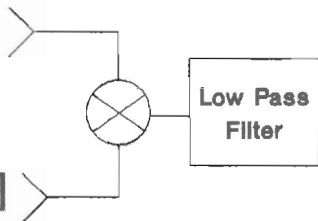

$$K_\phi \times \phi(t) = V_n(t)$$

if  $|\phi(t)| < .2 \text{ rad}$

$$S_\phi(f) = \frac{S_n(f)}{K_\phi^2}$$

单边 spectrum density

$$S_\nu(f) = f^2 S_\phi(f) = \frac{f^2 S_n(f)}{K_\phi^2}$$

$$L(f) = \frac{S_\phi(f)}{2} = \frac{S_n(f)}{2K_\phi^2} \text{ because } |\phi(t)| < .2 \text{ rad}$$

setd10

1505

### Slide 20

A doubly balanced mixer is used as a phase detector as diagramed in this slide. The two signals are input to the mixer at the same frequency but with  $90^\circ$  of phase difference. Any phase fluctuation that is not common to both signals, i.e.  $\phi(t)$ , results in a voltage fluctuation from the mixer proportional to the phase difference if the phase fluctuations are less than approximately 0.2 radian. This voltage output,  $V_n(t)$ , is equal to the difference phase fluctuation multiplied by a constant, here labeled  $K_\phi$ , that is the phase slope of the mixer in units of volts per radian. The spectral density of the phase fluctuations,  $S_\phi(f)$  is calculated by measuring the spectral density of the voltage fluctuations,  $S_n(f)$ , and dividing it by the square of the phase detector constant (squared due to the power relationship of spectral density). The spectral density of the frequency fluctuations,  $S_\nu(f)$ , and the single sideband phase noise power,  $L(f)$ , can be calculated as previously explained.

## Measurement of Phase Detector System Noise Floor

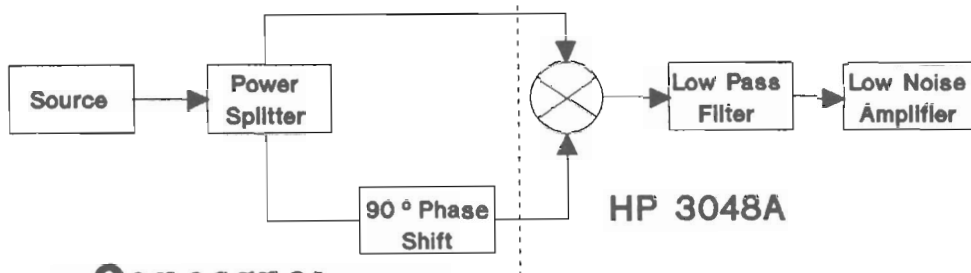

### Concerns:

- AM noise of source
- Decorrelation of source broadband PM noise floor by delay in one path
- Typical AM rejection  $\approx 30$  dB to 1.6 GHz  
 $\approx 15$  dB at higher frequencies

setd11

1506

### Slide 21

An advantage of the phase detector method of measuring phase noise is the ease of determining the system's noise floor. By dividing a test signal with a power splitter and phase shifting the signal in one path by  $90^\circ$ , the signal from each path enters the mixer in quadrature with each signal's phase fluctuations correlated to the other. The output of the mixer will remain 0 volts and the noise that is measured by the system's analyzers is the system's own internal noise. This method of determining the system's sensitivity supplies the phase detector mixer with the high level signals that are present during normal operation without adding any noise.

Several cautions must be observed when performing this system noise floor measurement. One is that the AM noise of the source may not be rejected sufficiently by the double-balanced mixer. The low frequency mixer of the HP 3048A system has approximately 30 dB of AM noise rejection. Wide frequency range microwave mixers such as the high frequency mixer of the HP 3048A are not as well balanced and the AM rejection can be much less than expected. A measurement of the AM noise of the source and comparison to the phase noise measured can verify the AM rejection of the mixer. Another caution that should be heeded is that the delay difference of the two signal paths be minimized to ensure the noise through each remains as correlated as possible. At high offset frequencies even a minimal amount of delay difference will decorrelate the source's noise and mask the system's noise floor.

## HP 3048A Phase Noise Measurement Noise Floor 5 MHz-1.6 GHz, +15 dBm Sources

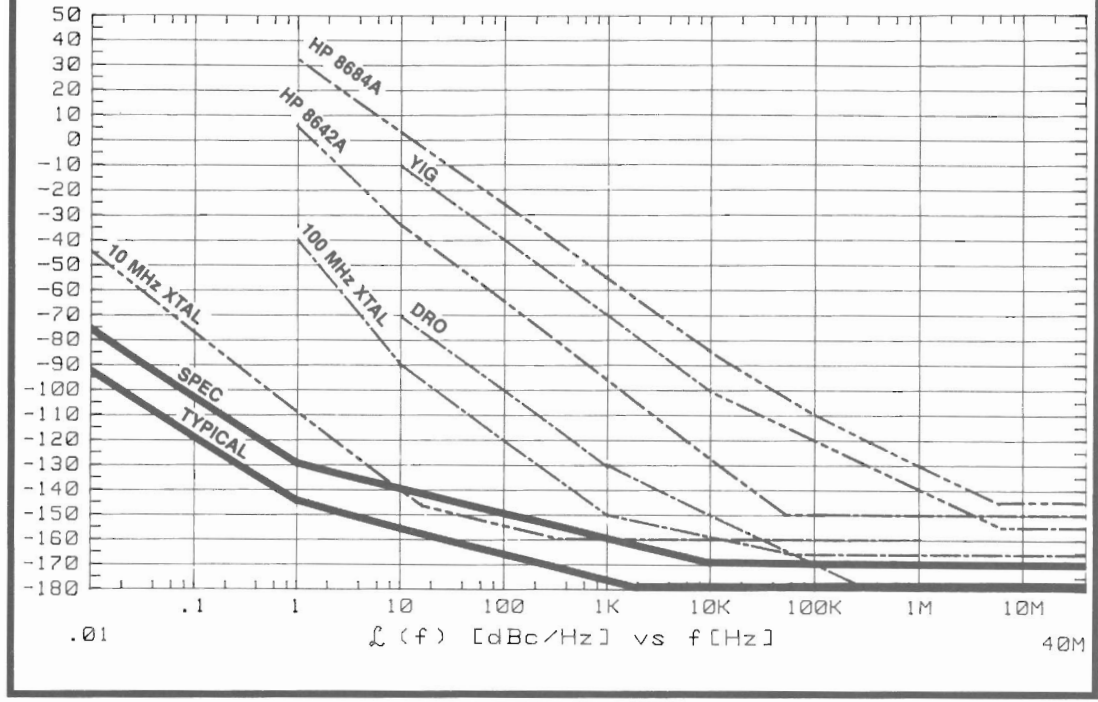

1507

### Slide 22

This graph of the resulting noise floor of the phase detector method of the HP 3048A System demonstrates why this method has the most usefulness for measuring the widest range of sources. The system's typical sensitivity allows measurement of even the cleanest of reference oscillators.



## Agenda

Basic Phase Noise Measurement Concepts

Direct Spectrum Measurement

Demodulation Techniques

Phase Demodulator

\* Residual or Added Noise Measurements

Single Source Measurements

Phase Detector with Two Sources

Reference Source

Voltage Controlled Source Tuning Requirements

Measurement Optimization

Measurement Examples

setd1a

1508

### Slide 23

One application of the phase detector method of phase noise measurement is to quantify the amount of noise added to a signal as it passes through a device. This added noise is referred to as residual noise.

## Measurement of a Single Frequency Signal Processor

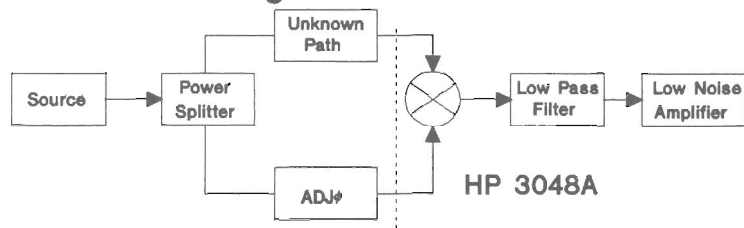

### Concerns:

- Filtering effect of unknown path
- Time delay in unknown path

setd13

1509

### Slide 24

Using almost the same technique that was used to determine the system noise floor, the noise added to a signal by a device can be measured. A single frequency signal processor (i.e. an amplifier), a surface acoustic wave (SAW) delay line, a ferrite phase shifter, etc., is inserted in one path to the phase detector and an adjustable phase shifter is placed in the other. The phase shifter is adjusted to bring the two signals into quadrature. The noise measured by the system will be the added noise of the device if it is above the system noise floor.

Care must be taken that the delay of the device under test (DUT) is not so long that the phase noise of the source in that path is decorrelated from the other path. Longer delay lines will decrease the maximum offset the phase noise can be measured to or require a quieter source. Another thing to keep in mind is that any filtering of noise by the DUT will affect the results of the measurement.

## Measurement of a Frequency Multiplier, Divider or Translator

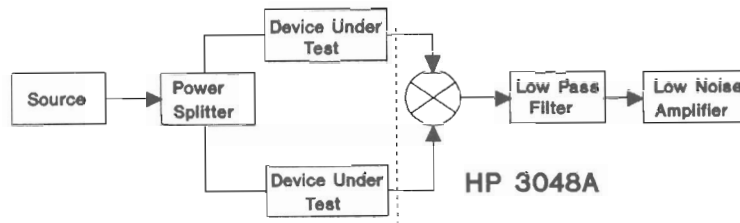

- RMS sum of noise of both devices is measured.
- Measurement sets upper limit on noise of each device.
- At each offset frequency one device is at least 3 dB better.
- Three source comparison software will sort out the noise of 3 comparable devices.

setd14

1510

### Slide 25

If the device that is measured performs a translation of the input frequency to another frequency (i.e. a mixer), multiplier or divider, etc., two of the devices must be used with one placed in each signal path. The resulting noise that is measured will be the RMS sum of the noise added by both devices. Although the noise of one device cannot be separated from that of the other device with a single measurement, important information is revealed by the measurement. The measured noise will be the maximum noise of either device and at any particular offset frequency the noise of one of the devices will be at least 3 dB lower. If three of these devices with similar noise performance are available, the three source comparison mode of the HP 3048A software will separate the noise of each device for individual analysis. If one of the devices is appreciably lower (approximately 3 to 6 dB lower) than the others, its lower noise performance will still be indicated although its added noise cannot be accurately separated from the higher noise of the other devices.

## Agenda

Basic Phase Noise Measurement Concepts

Direct Spectrum Measurement

Demodulation Techniques

Phase Demodulator

Residual or Added Noise Measurements

\* Single Source Measurements

Phase Detector with Two Sources

Reference Source

Voltage Controlled Source Tuning Requirements

Measurement Optimization

Measurement Examples

setdia

1511

### Slide 26

Another application of the phase detector method is in combination with a delay line to form a frequency discriminator. This approach permits the measurement of the noise of a source without a separate lower noise source to serve as a reference. It is also useful for measuring sources that have a high amount of drift and therefore may not be readily tracked by a phase lock loop to maintain quadrature with a reference source.

## Measurement of the Noise of a Single Source

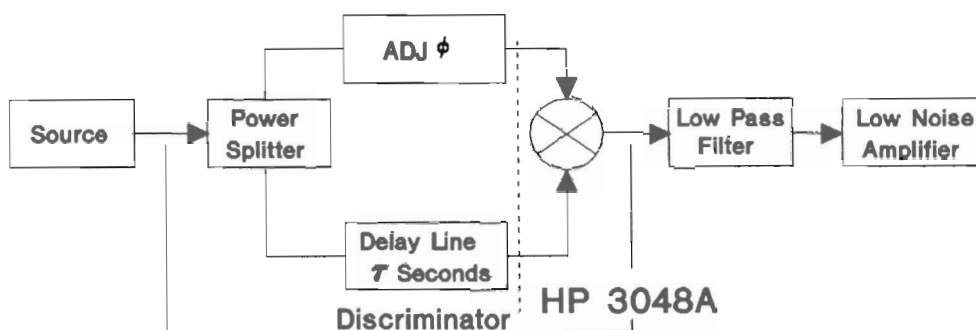

- A delay line bridge or cavity resonator may be used.
- Since delay is a linear phase shift with frequency, the phase detector output represents frequency fluctuations.

$$K_d \left[ \frac{V}{\text{Hz}} \right] = K_\phi \times 2\pi\tau \frac{\sin \pi f \tau}{\pi f \tau}$$

$$K_d \left[ \frac{V}{\text{Hz}} \right] = K_\phi \times 2\pi\tau \text{ for } f \leq \frac{1}{2\pi\tau}$$

setd16

1512

### Slide 27

In the previous example of measuring the residual noise of devices, it was important to keep the delay in both signal paths as equal as possible so the source noise would remain correlated and cancel at the phase detector. By adding a device causing a transmission delay in one path to uncorrelate the noise we can measure the phase noise of the source. The delay line converts frequency fluctuations of the source into phase fluctuations relative to the signal at the other port of the phase detector. The phase detector then converts the phase fluctuations into their voltage equivalent for measurement and analysis. The discriminator constant,  $K_d$ , of the combination of the delay line and the phase detector is calculated from the phase slope constant of the phase detector,  $K_\phi$ , and amount of delay,  $\tau$ , that was added. Note that the discriminator constant  $K_d$  is independent of offset frequency  $f$  for  $f \leq 1/2\pi\tau$ . Measurement at higher offset frequencies requires correction for the  $\sin(\pi f \tau)/\pi f \tau$  term.

## Phase Noise Calibration of a Discriminator

$$S_{\nu}(f) = \frac{S_n(f)}{K_d^2} \quad S_{\phi}(f) = \frac{S_n(f)}{f^2 K_d^2}$$

- If  $\langle \phi^2(t) \rangle$  (of source)  $\ll 1$  then  $\mathcal{L}(f) = \frac{S_n(f)}{2f^2 K_d^2}$
- Approximate sensitivity is phase detector system sensitivity at  $f = \frac{1}{2\pi\tau}$  and tipped up by 20 dB/decade for  $f < \frac{1}{2\pi\tau}$
- Calibration valid for  $f \leq \frac{1}{2\pi\tau}$  and to  $f = \frac{1}{2\tau}$  with correction for  $\frac{\sin \pi f \tau}{\pi f \tau}$
- Poor AM rejection

sedt17

1513

### Slide 28

The frequency discriminator constant,  $K_d$ , is used to calibrate the system for the spectral density of the frequency fluctuations,  $S_{\nu}(f)$ , that the measured spectral density of the voltage fluctuations  $S_n(f)$  represents. The conversion to the spectral density of the phase fluctuations,  $S_{\phi}(f)$ , and the single sideband phase noise,  $\mathcal{L}(f)$ , is straightforward and indicates the sensitivity a frequency discriminator system will have. The offset frequency squared term,  $f^2$ , in the denominator indicates the system sensitivity will increase by 20 dB per decade as the offset frequency of the measurement increases. The sensitivity gets better until it equals the sensitivity of the phase detector at an offset frequency of  $1/2\pi\tau$ . The calibration of the system from the frequency discriminator constant,  $K_d$ , is valid up to an offset frequency of one-half the inverse of the delay if the phase noise cancellation between the two paths is corrected for.

## Delay Line Discriminator Approximate Sensitivity

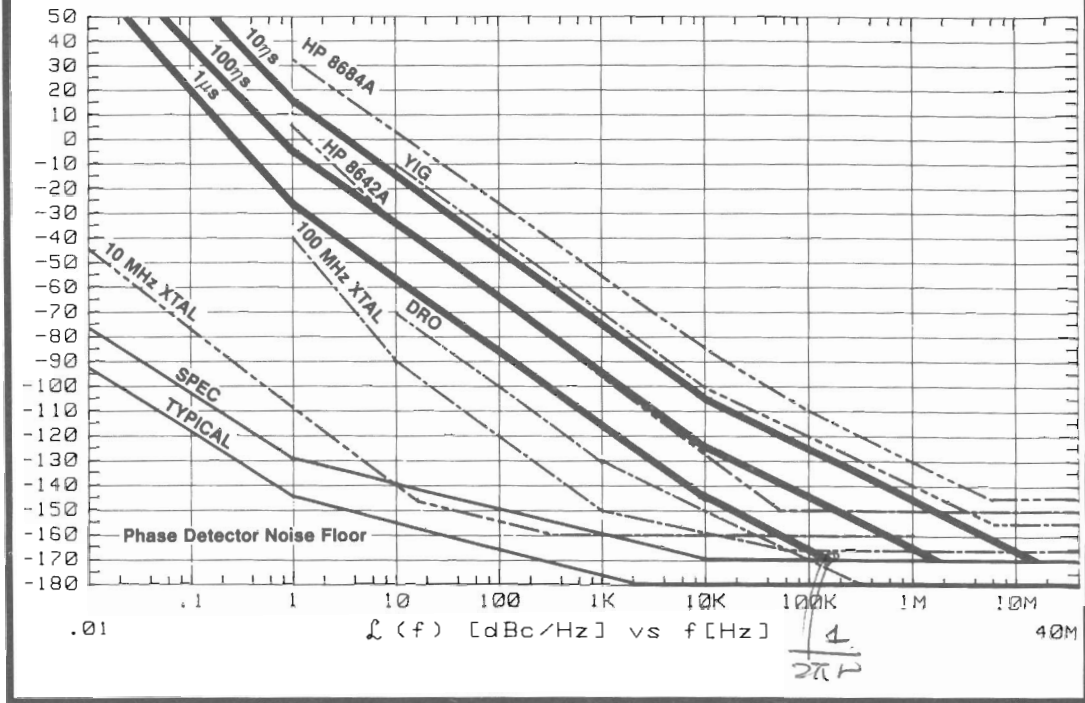

1514

### Slide 29

The dependence of a frequency discriminator's sensitivity on the offset frequency is obvious from this graph of systems with different delays. By comparing the sensitivity specified for the phase detector of the HP 3048A System to the delay line sensitivity, it is apparent the delay line sensitivity is "tipped up" by 20 dB/decade beginning at an offset of  $\frac{1}{2}\pi\tau$ . For a 10 nanosecond delay, the offset frequency where the sensitivity equals that of the phase detector is one-half the inverse of  $10 \times 10^{-9} \times \pi$  or approximately 16 MHz. At an offset of 16 kHz or three decades less, the 10 nanosecond delay line sensitivity is 60 dB (20 dB/decade) less than that of the phase detector or approximately -110 dBc/Hz.

The sensitivity graphs indicate the delay line frequency discriminator can be used to measure some types of sources with useful sensitivity. Longer delay lines will improve the sensitivity but eventually the loss in the delay line will exceed the source power available and cancel any further improvement. Also longer delay lines limit the maximum offset frequency that can be measured.

## Agenda

Basic Phase Noise Measurement Concepts

Direct Spectrum Measurement

Demodulation Techniques

Phase Demodulator

Residual or Added Noise Measurements

Single Source Measurements

\* Phase Detector with Two Sources

Reference Source

Voltage Controlled Source Tuning Requirements

Measurement Optimization

Measurement Examples

setd1a

1515

### Slide 30

To utilize the full sensitivity of the phase detector method of phase noise measurements two sources at the same frequency are needed to demodulate the phase noise for baseband analysis. This is the next technique that is examined.



## Two Source Comparison for Very Stable Sources

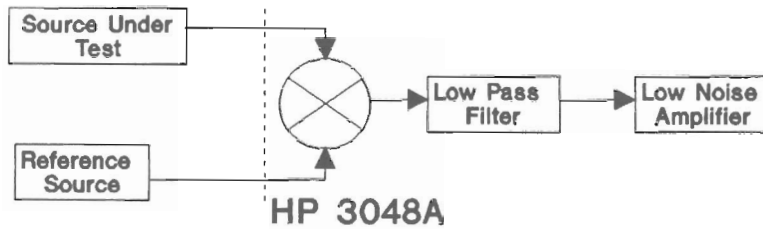

- Impractical because of required phase stability to maintain quadrature for the duration of the measurement.
- Range of  $f$  limited only by analyzer and filter.

sedt!9

1516

### Slide 31

The simplest configuration for measuring the phase noise of a signal using two sources is diagrammed on this slide. The two signals are set to the same frequency and  $90^\circ$  out of phase with respect to one another. The reference signal should have less noise than the signal under test, otherwise the sum of the noise of the two sources will be measured. The range of offset frequencies that can be measured is only limited by the low-pass filter and the analyzer that is used. The usefulness of this configuration is limited, however, as very few sources have the stability to remain in quadrature for the duration of the measurement.

## Use of a Phase-Lock-Loop to Maintain Phase Quadrature

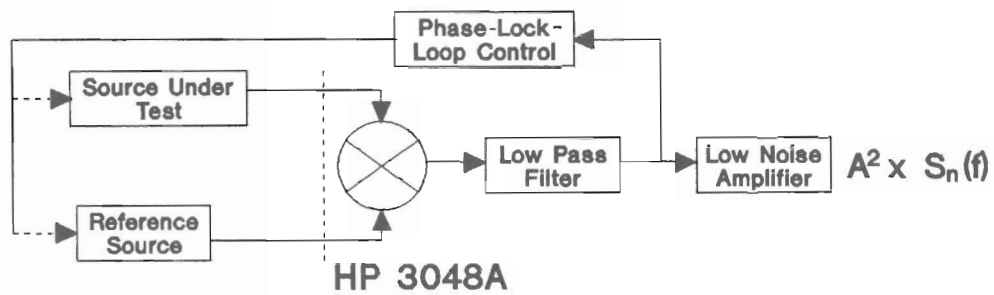

$$S_{\phi}(f) = \frac{S_n(f)}{K_{\phi}^2} \times |1 + \text{Forward gain of phase-lock-loop}|^2$$

$$S_{\phi}(f) = \frac{S_n(f)}{K_{\phi}^2} \text{ for } f \gg \text{Phase-lock-loop bandwidth}$$

sedt20

1517

### Slide 32

Adding a phase lock loop to the previous configuration provides the necessary feedback to one of the sources in order to maintain quadrature. Either source can be controlled by the loop as the effect on the measurement is the same. Since a phase-lock-loop suppresses the phase noise within the loop bandwidth, measurements are limited to offsets greater than the loop bandwidth or the results must be corrected to remove the effect of the phase-lock-loop.

## Measurement of Effect of Phase-Lock-Loop

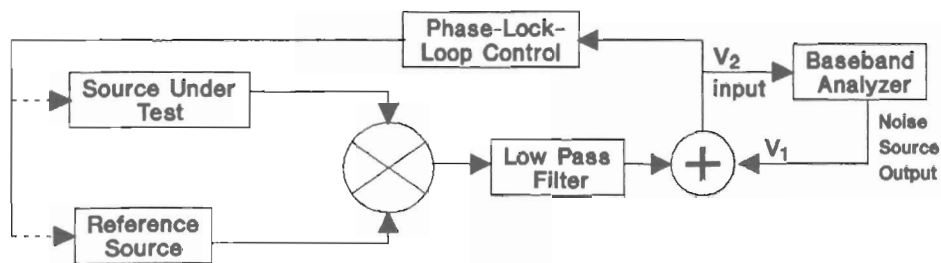

$$\left| \frac{V_2}{V_1} \right| = \frac{1}{1 + \text{Forward gain of phase-lock-loop}}$$

- This ratio is calculated from known constants and then verified by the above technique.
- Full range of  $f$  available.

sedt21

1518

### Slide 33

The HP 3048A System sets up a phase-lock-loop based on the parameters that are entered for the tuning range and sensitivity of the source that is controlled, and the sensitivity of the phase detector that is used. A theoretical response is calculated from the entered parameters and used to correct for the response of the loop bandwidth.

The dynamic response of the loop can also be verified by injecting a signal from the noise source of the HP 3561A Dynamic Signal Analyzer and measuring the control voltage from the loop as it compensates for the injected voltage. This measured data can be compared to the calculated loop response at several points. If differences between the calculated and measured response are beyond a specified limit an estimate of the accuracy spec degradation is made to advise the system operator. The operator can then decide to proceed with the calculated or corrected response, or abort the measurement and correct any problems.

With the system correcting for the response of the loop bandwidth, the range of offset frequencies that phase noise can be measured over extends from 0.01 Hz to 40 MHz. The independence of the offset range to be measured from the effects of the phase-lock-loop necessary to stabilize the source allows the system to measure a wide variety of sources with excellent accuracy.

## **Agenda**

- Basic Phase Noise Measurement Concepts**
- Direct Spectrum Measurement**
- Demodulation Techniques**
- Phase Demodulator**
- Residual or Added Noise Measurements**
- Single Source Measurements**
- Phase Detector with Two Sources**
- \* Reference Source**
- Voltage Controlled Source Tuning Requirements**
- Measurement Optimization**
- Measurement Examples**

setdla

1519

### **Slide 34**

As the reference oscillator is a key element of the two source configuration of the phase detector method, its required characteristics will be examined next. Also, several possible variations of the downconversion process to produce the demodulated voltage output from the phase detector are presented.

## Reference Source Considerations

- Ideally phase noise 10 dB below source under test for all  $f$  of interest.
- Practical Alternatives:
  - Different reference sources for different  $f$ .
  - Reference source comparable to source under test.
  - Three comparable sources and three source comparison software.
- Either source under test or reference source must be tunable with one exception, phase locked interpolation oscillator.

setd23

1520

### Slide 35

The most important (and obvious) criterion for choosing a reference source is that its phase noise be less than what is being measured. A margin of 10 dB is sufficient to ensure the measurement results are not significantly affected. If a reference source with low enough phase noise to measure the full offset range is not available, several alternatives are available. One option is to use several reference sources with sufficiently low noise at specific offset ranges. Another method would be to use a reference source comparable to the source under test so that the measurement results can be attributed to the noise from both sources. With three comparable sources, the software of the HP 3048A System will separate the phase noise from each source based on the results of three dependent measurements.

Whatever the hardware configuration, at least one of the sources must be tunable so that phase lock can be achieved and maintained. The only exception to this rule is when an interpolation oscillator is used to demodulate the phase noise of the test signal as explained next.

## Phase Locked Interpolation Oscillator

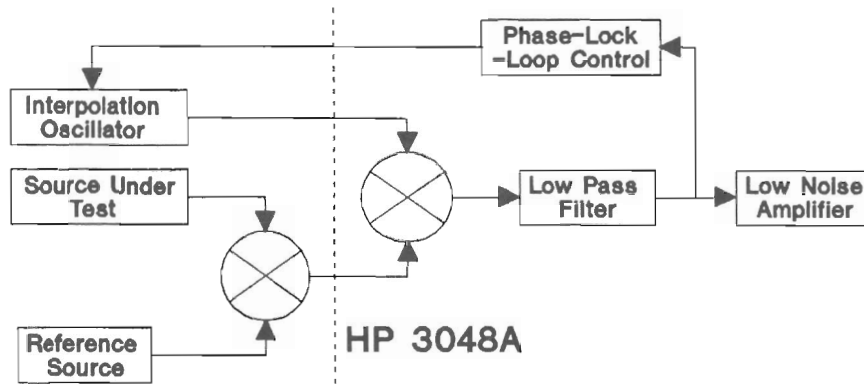

- Useful for microwave frequencies and above since only a single diode mixer is required.
- The HP 11729C is a specific implementation of this approach.

Slide 1521

### Slide 36

Using an interpolation oscillator as diagramed on this slide simplifies the measurement of low-noise microwave signals that cannot be tuned or where tuning would increase the phase noise of the signal. A reference source downconverts the signal under test to an IF. At this lower frequency an interpolation oscillator set to the IF is phase locked by the system to demodulate the phase noise on the downconverted signal. Several advantages are present with this configuration. The most important is the increased availability of appropriate sources for the downconversion and demodulation functions of the process. The reference source can be a very clean, filtered multiple of the low frequency, low-noise oscillator without any phase noise degradation due to a dc FM capability. This translates the phase noise of the signal under test to the IF without adding reference noise. Then an interpolation oscillator is chosen for a combination of sufficiently low noise and dc FM capability to track the source under test at an RF instead of a microwave frequency.

This approach using an interpolation oscillator can be used at any frequency extending into the millimeter region depending on the availability of a mixer for the downconversion. The HP 11729C was developed to specifically provide the low-noise reference signal and the downconversion for signals up to 18 GHz, HP 11729C Option H33 provides a downconversion process for signals up to 105 GHz.

## HP 11729C Carrier Noise Test Set

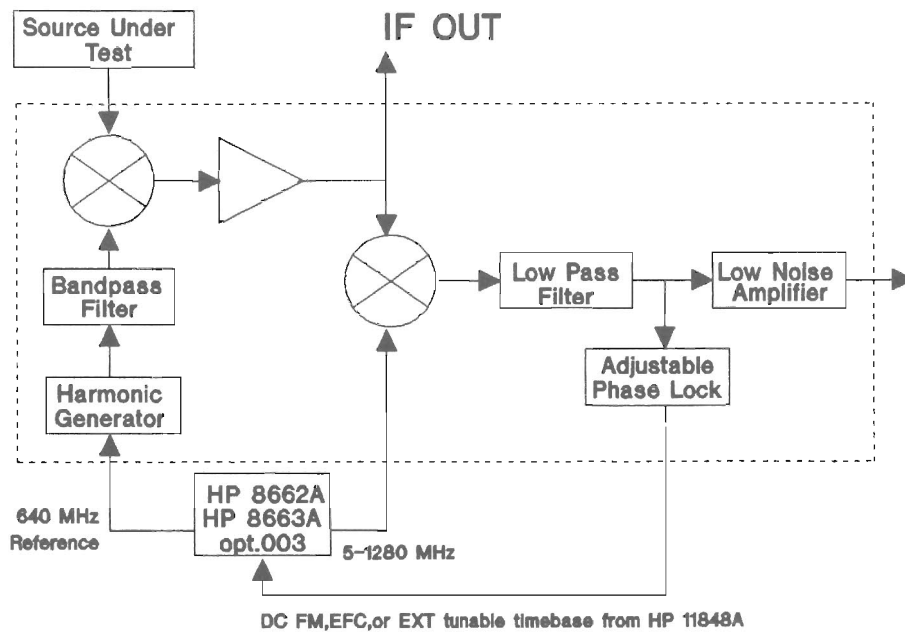

1522

### Slide 37

This is a block diagram of the HP 11729C Carrier Noise Test Set. A step recovery diode within the harmonic generator creates multiples of a very low noise 640 MHz signal available from an HP 8662A or 8663A Option 003 Signal Generator (or from its internal SAW oscillator). These multiples are further filtered before entering a 2 to 18 GHz microwave mixer for downconverting the signal under test. The resulting IF signal is mixed with the interpolation signal from the front panel output of the HP 8662A or 8663A. At this RF frequency the signal from the HP 8662A or 8663A usually has lower phase noise than the downconverted microwave signal. Quadrature can be maintained through the use of a dc FM, electronic frequency control (EFC) or an external 10 MHz timebase with wide tuning range available from the HP 3048A interface. The phase demodulation of the IF can take place in the HP 11729C for manual measurements with a spectrum analyzer. Alternately the demodulation can be done in the HP 3048A for fully automatic measurements over an offset range of 0.01 Hz to 40 MHz from the carrier.

## Phase Noise of Some Reference Sources

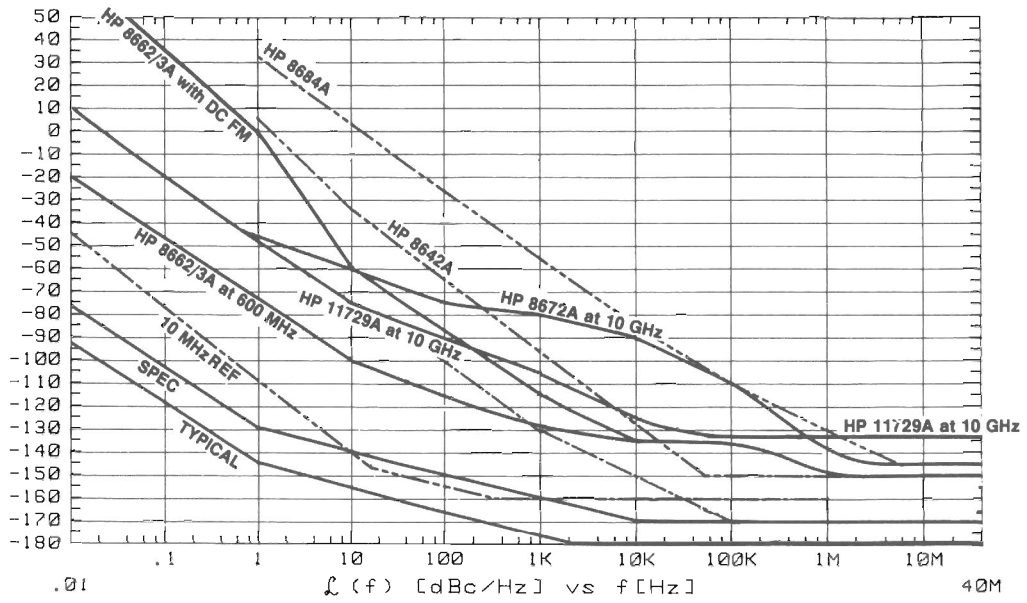

1523

### Slide 38

This graph indicates the level of phase noise that has been measured for several potential reference sources. Depending on the sensitivity that is required at the offset to be measured, a single reference source may suffice or several different references may be needed to achieve the necessary sensitivity at different offsets.



## **Agenda**

**Basic Phase Noise Measurement Concepts**

**Direct Spectrum Measurement**

**Demodulation Techniques**

**Phase Demodulator**

**Residual or Added Noise Measurements**

**Single Source Measurements**

**Phase Detector with Two Sources**

**Reference Source**

**\* Voltage Controlled Source Tuning Requirements**

**Measurement Optimization**

**Measurement Examples**

setd1a

1524

### **Slide 39**

There are several considerations that need to be made concerning phase locking of various sources. The next section covers the drift limits, phase lock loop bandwidths, and the tuning range required of the source by the HP 3048A System.

# Voltage Controlled Source Tuning Requirements

$$\text{Peak Tuning Range} = \text{PTR} \cong V_{\text{range}} \times \text{VCO}_{\text{Slope}}$$

Phase-lock-loop frequency response

tailoring available for  $.1 \text{ Hz} \leq \text{PTR} \leq 200 \text{ MHz}$

Capture Range = Initial Tuning Inaccuracy:  $\leq \text{PTR}/10$

Drift Tracking Range = Allowable Drift

During Measurement:  $\pm \text{PTR}/5$  Around Zero Beat

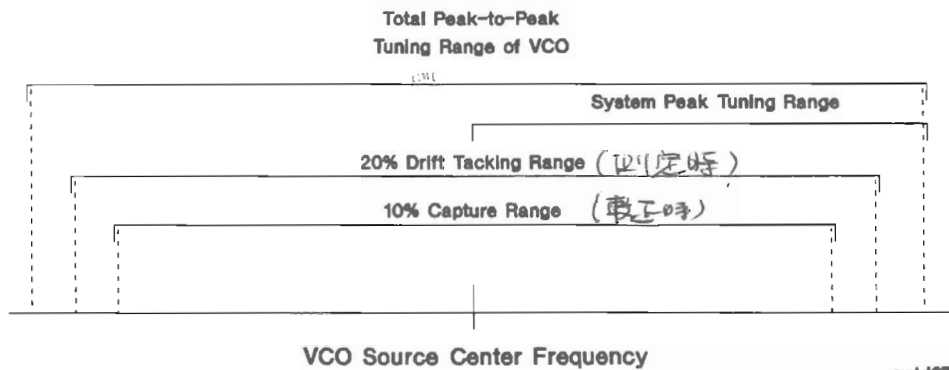

1525

## Slide 40

The maximum tuning voltage and the tuning slope of the source to be controlled by the phase-lock-loop determines the characteristics of the loop set up by the system. After the user's entry of the maximum tuning voltage, the system measures the source tuning characteristic to ensure the phase-lock-loop can be set up and maintained during the measurement. The system software also determines the correction factor needed to remove the effects of the phase-lock-loop on the amplitude of the measured noise. When the maximum tuning voltage and the tuning slope of the source are known, the peak tuning range, PTR, of the source is calculated. The system was designed to work with peak tuning ranges of 0.1 Hz to 200 MHz to accommodate sources ranging from crystal reference oscillators to free-running VCO's.

The tuning range the system actually uses to maintain quadrature is limited to a fraction of the peak tuning range to ensure the tuning slope is well behaved and the correction factor that was calibrated remains accurate. After phase lock is established, the system monitors the tuning voltage required to maintain lock during calibration and measurement. If the tuning voltage has exceeded 10% of the peak tuning range when system calibration is done and the measurement is to begin, the system stops the procedure and informs the user that the source needs to be retuned before the measurement can begin. If the tuning voltage exceeds 20% of the peak tuning range before the measurement is completed, the system again informs the user and requests the oscillator be retuned or the problem be otherwise corrected before proceeding with the measurement. These limits have been found to guarantee good results even for sources with very wide or complex tuning voltages.

## Voltage Tuning Range

$$|\text{Center Voltage}| + |\text{Voltage Tuning Range}| \leq 12 \text{ V}$$

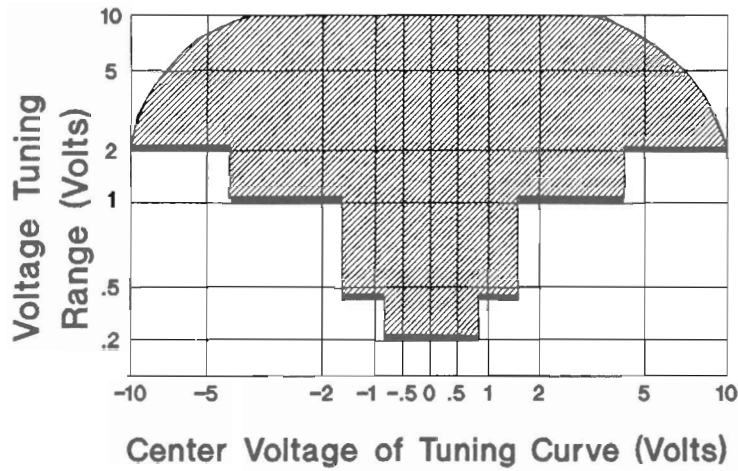

setd28

1526

### Slide 41

This graph outlines the voltage tuning range the system can provide for a given center voltage. The range of maximum tuning voltage decreases as the absolute value of the center voltage increases due to hardware limitations of the system. As an example, for a source needing a bias voltage of 2 volts the system cannot provide a maximum tuning range of less than  $\pm 1$  volt or more than  $\pm 10$  volts.

## Voltage Controlled Source Tuning Requirements (II)

- For  $.1 \text{ Hz} \leq \text{PTR} \leq 200 \text{ MHz}$   
 $.1 \text{ Hz} \leq \text{PLL BW} \leq 160 \text{ kHz}$   
where PLL BW = closed phase-lock-loop bandwidth
- For a stable phase-lock-loop:  
voltage controlled source tuning  
port bandwidth  $>$  PLL BW
- Source isolation such that  
injection locking bandwidth  $\ll$  PLL BW

setd29

1527

### Slide 42

The closed loop bandwidth of the phase-lock-loop, here labeled PLL BW, is determined from the peak tuning range, PTR, that the system has calculated. A closed loop bandwidth can be set up by the system with a 3 dB bandwidth of between 0.1 Hz and 160 kHz depending on the maximum tuning range that is available. For the phase-lock-loop to be stable, the bandwidth of the tuning port of the source must be greater than the closed phase-lock-loop bandwidth. Another criterion that must be met for a usable phase-lock-loop to be created is that there must be adequate source isolation between the two sources to prevent injection locking of one source to the other. Adding buffer amplifiers between one source and the mixer will generally provide sufficient isolation.

## Closed Phase-Lock-Loop Bandwidth (PLL BW) vs. Peak Frequency Tuning Range (PTR)

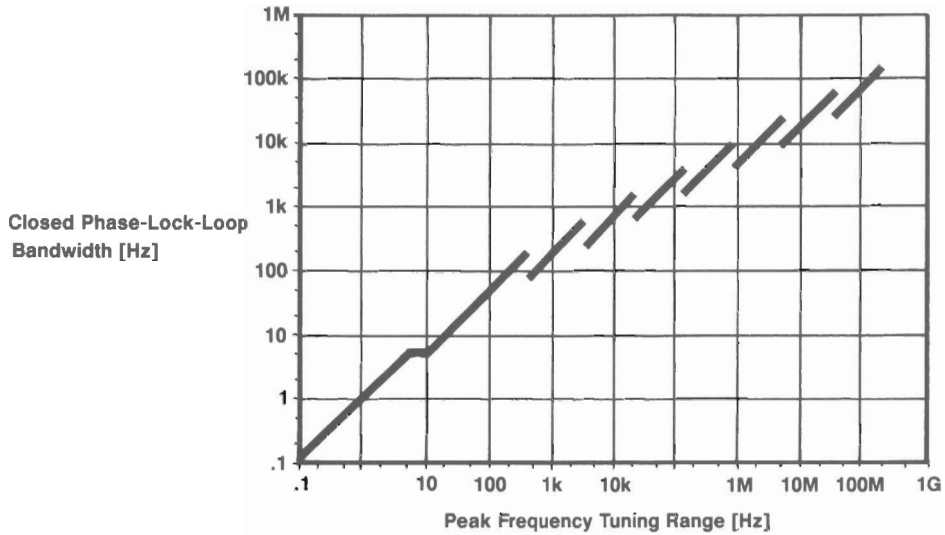

1528

### Slide 43

This graph illustrates the closed phase-lock-loop bandwidth chosen by the system as a function of the peak tuning range of the source. Knowing the approximate closed phase-lock-loop bandwidth allows the user to verify that there is sufficient bandwidth on the tuning port and whether sufficient source isolation is present to prevent injection locking.

## Voltage Controlled Source Tuning Requirements (III)

- For almost all sources without a high phase noise pedestal, satisfying the preceding requirements will result in a stable phase-lock-loop.
- The allowable phase noise pedestal is primarily a function of the peak tuning range, PTR, and therefore may set the source tuning range requirements.

setd44

1529

### Slide 44

Meeting the requirements for the tuned source that were just covered will result in a stable phase-lock-loop for measuring most sources, particularly free-running oscillators. An additional requirement is necessary when the source has a high phase-noise pedestal that may extend beyond the closed bandwidth of the phase-lock-loop. As the bandwidth of the phase-lock-loop is determined by the tuning range that is entered, this high phase-noise pedestal may determine the tuning range that is necessary to enable a stable phase lock loop.

## Tuning Characteristics of Various VCO Source Options

VCO Source	Carrier Freq.	Tuning Constant (Hz/V)	Center Voltage (V)	Voltage Tuning Range ( $\pm$ V)	Input Resistance (ohms)	Calibration Method
HP 8662/3A EFC	$\nu_o$	$5 \times 10^{-9} \times \nu_o$	0	10	1 E 6	Measure
DCFM		FM Deviation	0	10	1k/600	Use Entered
HP 8642A/B		FM Deviation	0	10	600	Use Entered
HP 8640B		FM Deviation	0	10	600	Use Entered
HP 8656B		FM Deviation	0	10	600	Use Entered
Other Signal Generator DCFM Calibrated to $\pm 1$ V		FM Deviation	0	10	$R_{in}$	Use Entered
10 MHz Source A Direct	$\nu_o$	10	0	10	1 E 6	Measure
Multiplied		$10 \times \nu_o \div 10 E 6$	0	10	1 E 6	
As a Timebase: To HP 8662/3A		$10 \times \nu_o \div 10 E 6$	0	$10^{10} \div \nu_o$	1 E 6	
To other VCO (PTR known)		$10 \times \nu_o \div 10 E 6$	0	$10^6 \times PTR \div \nu_o$	1 E 6	
10 MHz Source B Direct	$\nu_o$	100	0	10	1 E 6	Measure
Multiplied		$100 \times \nu_o \div 10 E 6$	0	10	1 E 6	
As a Timebase: To HP 8662/3A		$100 \times \nu_o \div 10 E 6$	0	$10^9 \div \nu_o \cdot 2.5$	1 E 6	
To other VCO (PTR known)		$100 \times \nu_o \div 10 E 6$		$10^5 \times PTR \div \nu_o$		
350-500 MHz Source		12 E 6	0	2	1 E 6	Measure
Other User VCO Source		Estimated within a factor of 2	-10 to +10	See Slide 41.	1 E 6	Measure

1529a

### Slide 45

This table lists the tuning parameters for several VCO source options. If a 10 MHz oscillator from the HP 3048A interface is used as an external, tunable timebase to an HP 8662A or 8663A, the tuning constant (Hz/volt) and the voltage tuning range must be calculated to account for multiplication to the front panel frequency.

## Peak Frequency Tuning Range (PTR) Required to Phase Lock

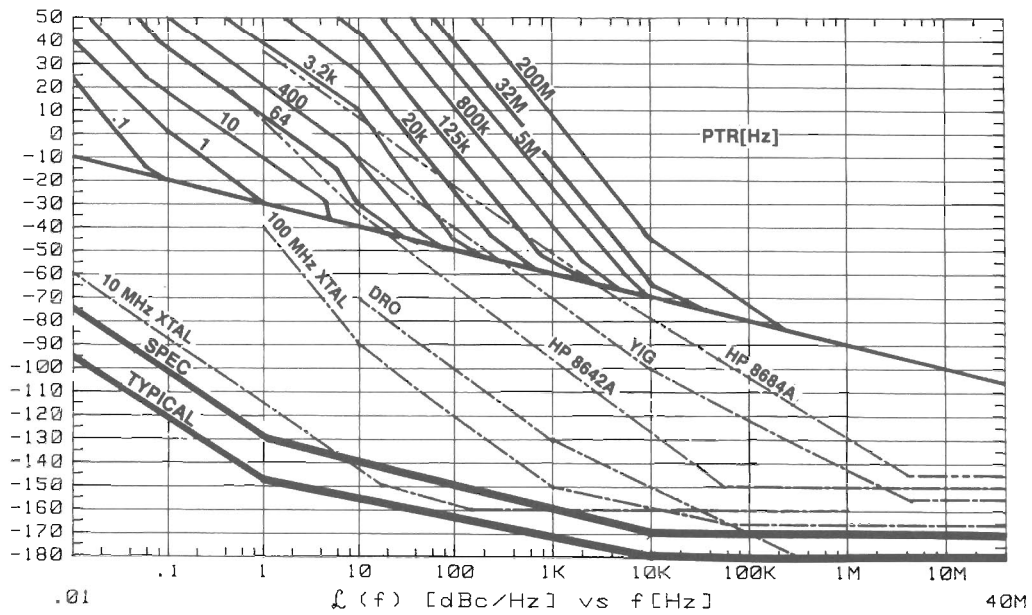

1530

### Slide 46

This graph provides a comparison between the typical phase noise expected of a variety of sources and the minimum tuning range that is necessary for the system to create a phase-lock-loop of sufficient bandwidth to make the measurement. In general, the sources with higher phase noise that require a wider tuning range are usually designed to provide the necessary tuning range due to the application for which they are intended.



## **Agenda**

**Basic Phase Noise Measurement Concepts**

**Direct Spectrum Measurement**

**Demodulation Techniques**

**Phase Demodulator**

**Residual or Added Noise Measurements**

**Single Source Measurements**

**Phase Detector with Two Sources**

**Reference Source**

**Voltage Controlled Source Tuning Requirements**

**\* Measurement Optimization**

**Measurement Examples**

setdfa

1531

### **Slide 47**

While the HP 3048A System will make measurements of the phase noise of sources with a wide variety of characteristics, there are techniques to optimize the measurements for better results as are explained next.

## Aproximate Phase Noise Floor vs. R Port Signal Level

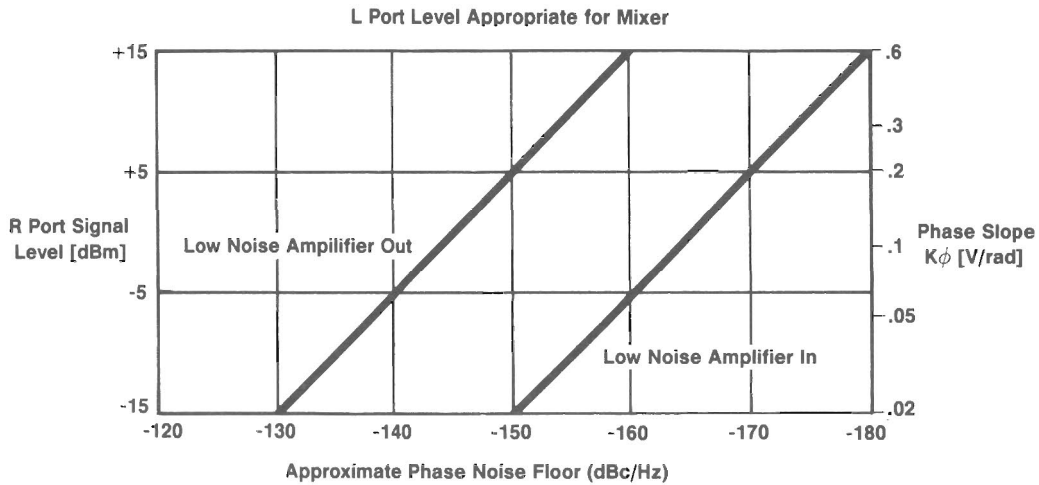

1532

### Slide 48

The sensitivity of the HP 3048A System can be improved by increasing the signal power at the R port of the phase detector. This graph illustrates the approximate noise floor of the system for a range of R port signal levels from -15 dBm to +15 dBm. The diagonal line on the left side indicates the approximate sensitivity for offsets greater than 10 kHz without the system's low noise amplifier in the signal path. The right diagonal line indicates the sensitivity with the amplifier in. These estimates of sensitivity assume the signal level at the L port is appropriate for either the microwave or the RF mixer that is used (+7 dBm or +15 dBm, respectively). The approximate calibration constant,  $K_{\phi}$ , that results from the input signal level at the R port is also given.

## Noise Floor as Set by HP 3048A VCO Control Port Noise

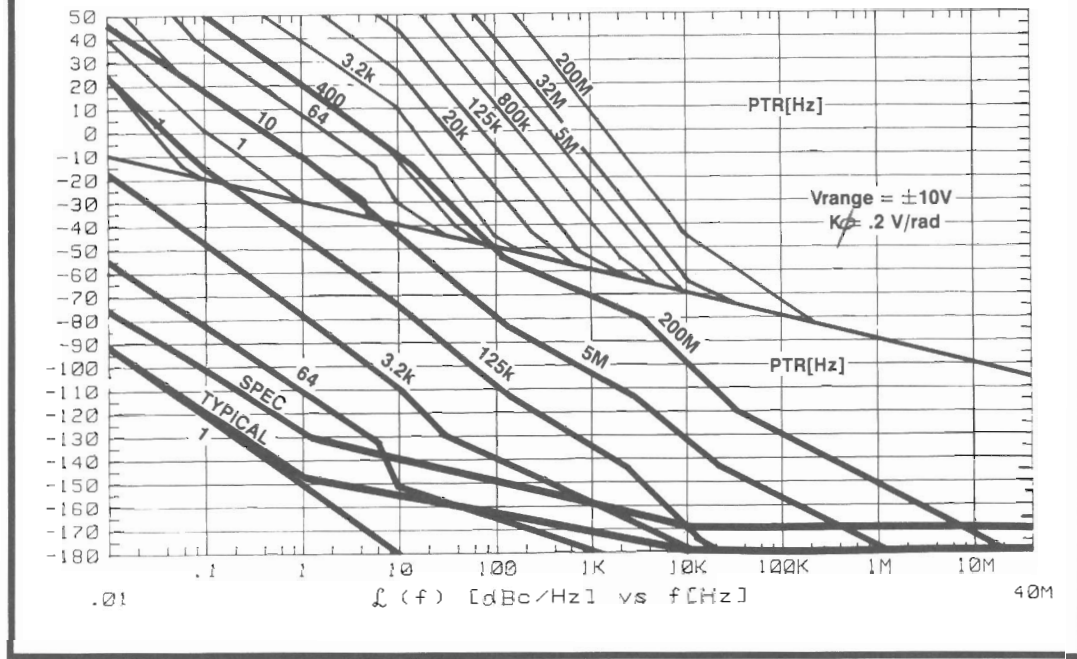

1533

### Slide 49

As the tuning port of an oscillator is a very sensitive input for adding noise to its signal, it is important to know the level of noise that could be added by the HP 3048A System from the phase-lock-loop control voltage. The dark lines of this graph are the equivalent phase noise due to the internal noise of the system at the tuning voltage control port for the maximum tuning range entered for the source. A tuning voltage of  $\pm 10$  volts and phase slope calibration constant of  $0.2\text{V/rad}$  is assumed. By comparing the noise caused by the system to the maximum noise level that the phase-lock-loop can tolerate as plotted in the upper part of the graph, a usable measurement range can be determined. As an example, should the source to be tested require a tuning range of  $125\text{ kHz}$ , the dark line labeled  $125\text{ kHz}$  is the minimum phase noise that can be measured due to the system-induced noise at the tuning port of the source.

# Delay Line Discriminator Sensitivity Compared to Noise Floor Set by VCO Control Port Noise

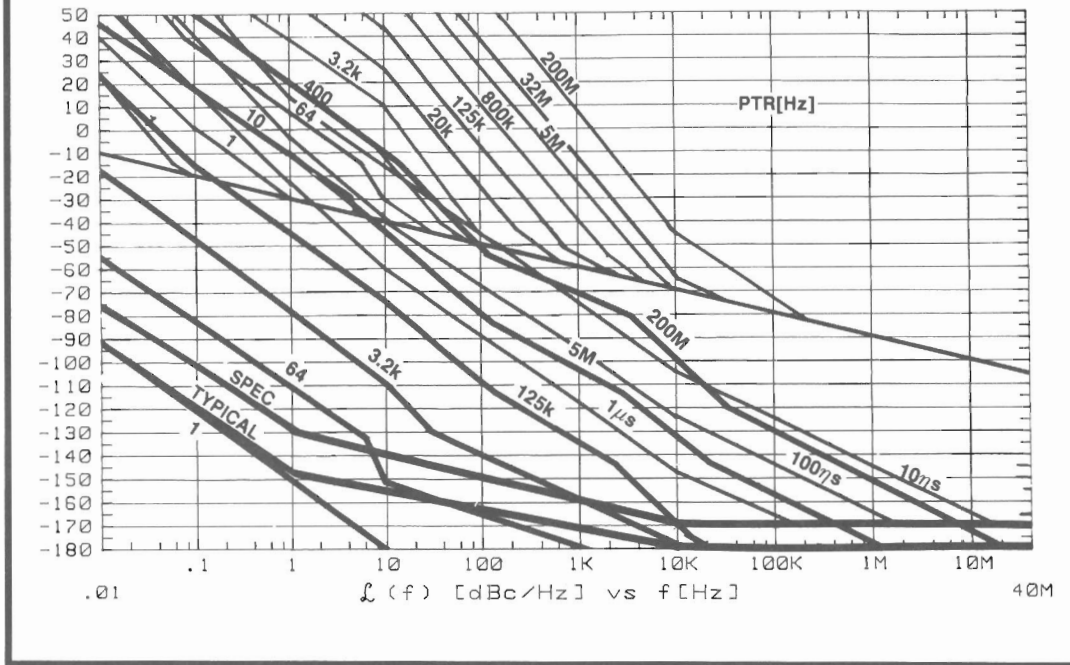

1534

## Slide 50

This graph plots the typical phase noise of various sources on the previous graph for comparison with the system's measurement limits of tuning range for the phase-lock-loop and system-added noise on the tuning line. In almost all cases, as is illustrated here, the system's added noise is significantly less than the phase noise expected of an oscillator from its maximum tuning range that is used to create a stable phase-lock-loop. Looking at the HP 8684A with a tuning range  $\pm 10$  MHz as an example, its typical phase noise at 10 kHz is approximately  $-76$  dBc/Hz. The system would set a peak tuning range, PTR, of between 5 to 10 MHz to maintain phase lock with this source. For a PTR of 5 MHz the system-added noise will be approximately  $-132$  dBc/Hz which is 56 dB less than the level to be measured.

# Phase Noise and Peak Tuning Range of of some Voltage-Controlled Sources

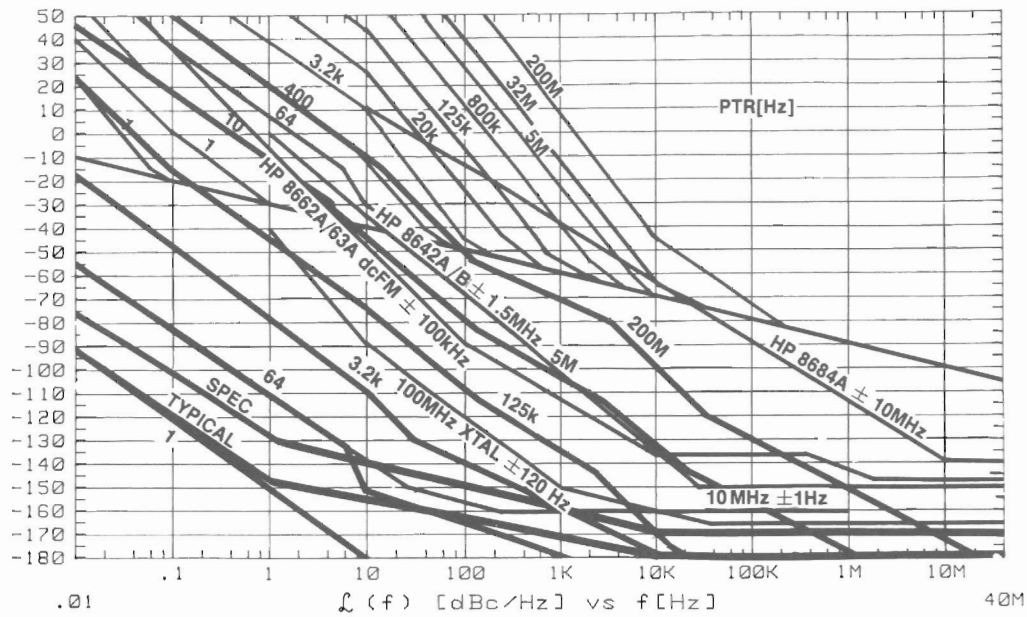

1535

## Slide 51

This graph provides a comparison of the sensitivity that can be achieved with a delay line discriminator versus the noise floor set by the system noise on the VCO control port. The sensitivity plotted for delay line lengths of 10 nanoseconds, 100 nanoseconds, and 1 microsecond assumes the use of the phase detector of the HP 3048A System with the delay line. Using the delay line avoids the addition of noise on the source tuning port but as the graph indicates the measurement sensitivity is about the same in either case.

## **Agenda**

**Basic Phase Noise Measurement Concepts**

**Direct Spectrum Measurement**

**Demodulation Techniques**

**Phase Demodulator**

**Residual or Added Noise Measurements**

**Single Source Measurements**

**Phase Detector with Two Sources**

**Reference Source**

**Voltage Controlled Source Tuning Requirements**

**Measurement Optimization**

**\* Measurement Examples**

setdla

1536

Slide 52

A few measurement examples that illustrate the various measurement techniques follow.

# Measurement of a Phase Detector System Noise Floor

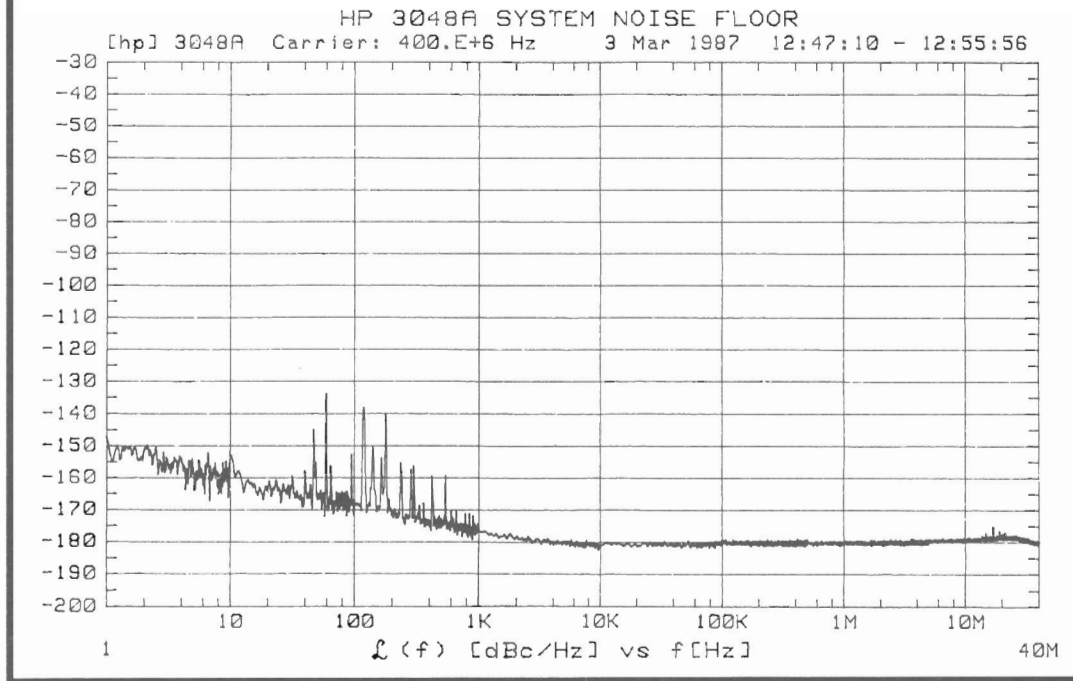

1535a

## Slide 53

This is a measurement of the HP 3048A System noise floor. Quadrature was established by adding a short piece of coax to one signal path and fine-tuning the source frequency. The calibration constant was determined from the input signal levels to the mixer.

# Measurement of a Single Frequency Signal Processor

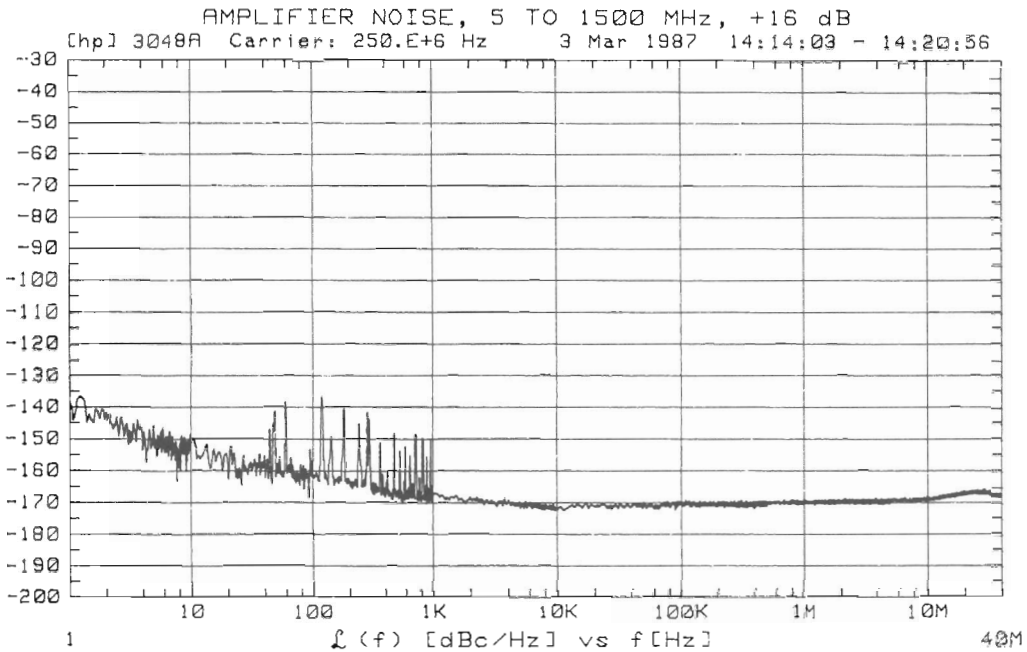

1535b

## Slide 54

This is an example of the residual or added noise of an amplifier. There are a number of ways to calibrate residual measurements; in this case a single sided spur was injected with known amplitude and offset for the system to measure and reference the measured noise to. Notice the slight decorrelation of source noise beyond 10 MHz.



# Measurement Using a Frequency Discriminator

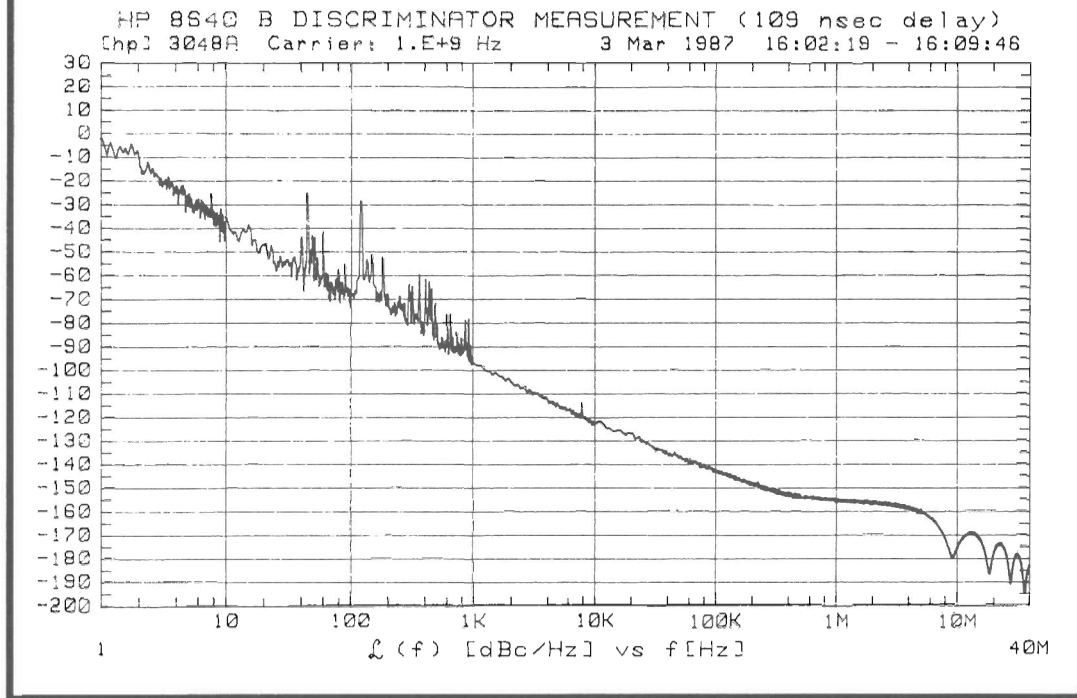

1538

## Slide 55

This is an example of frequency discriminator measurement of the phase noise of an HP 8640B Signal Generator. Three modes are available to calibrate the HP 3048A System for the delay line that is used. If the source can be modulated, the system will calibrate from the known level of modulation. Alternately, it can be derived by the system from the injection of a double-sided spur of known amplitude and offset, or the user can enter the discriminator constant,  $K_d$ , resulting from the combination of the delay line length and the phase detector constant. The maximum offset for a valid measurement without correction is  $f = 1/(2\pi\tau) = 1/(2\pi \times 109 \text{ nsec}) = 1.46 \text{ MHz}$ . At these offsets the noise on the two signals entering the two ports of the phase detector is exactly correlated and therefore cancels.

$$\frac{1}{2\pi\tau} = \frac{1}{2\pi \times 109 \times 10^{-9}}$$

# Measurement using a Phase-Lock-Loop: HP 8663A

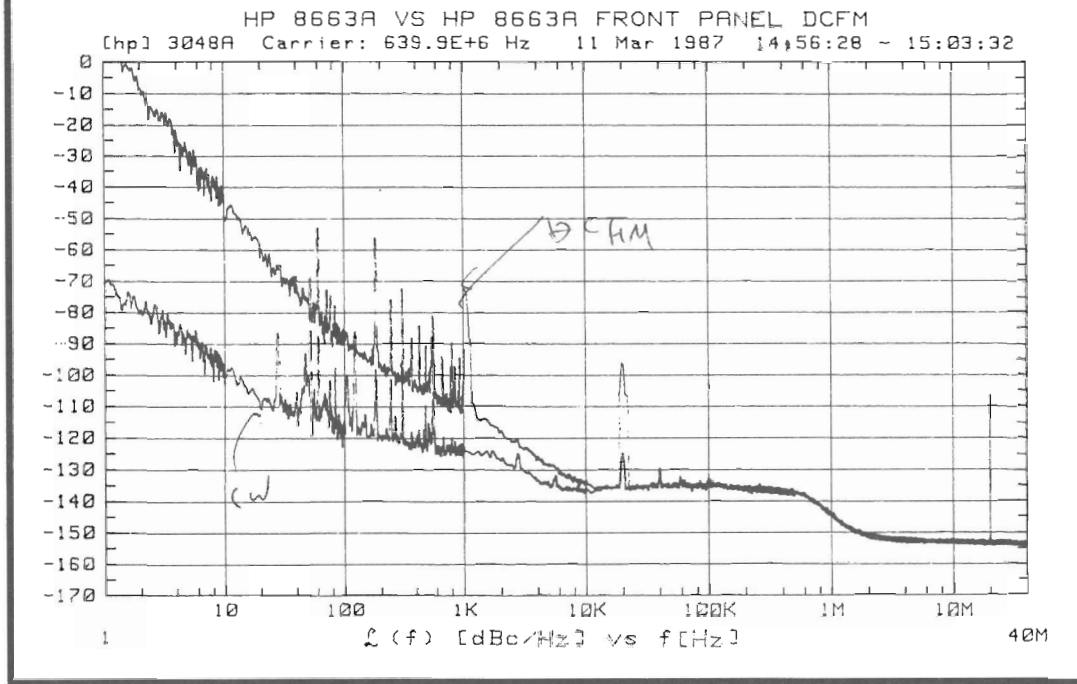

1537

## Slide 56

Two HP 8663's were measured against each other using a phase-lock-loop to maintain quadrature. The lower curve was measured using the HP 8663A EFC control as the VCO tune port, the other using the dc FM input as the VCO tune port. When dc FM is enabled, low close-in phase noise is traded for wide tuning range. The noise plotted here is the sum of the noise of two HP 8663's.

# Measurement using a Phase-Lock-Loop: HP8642A

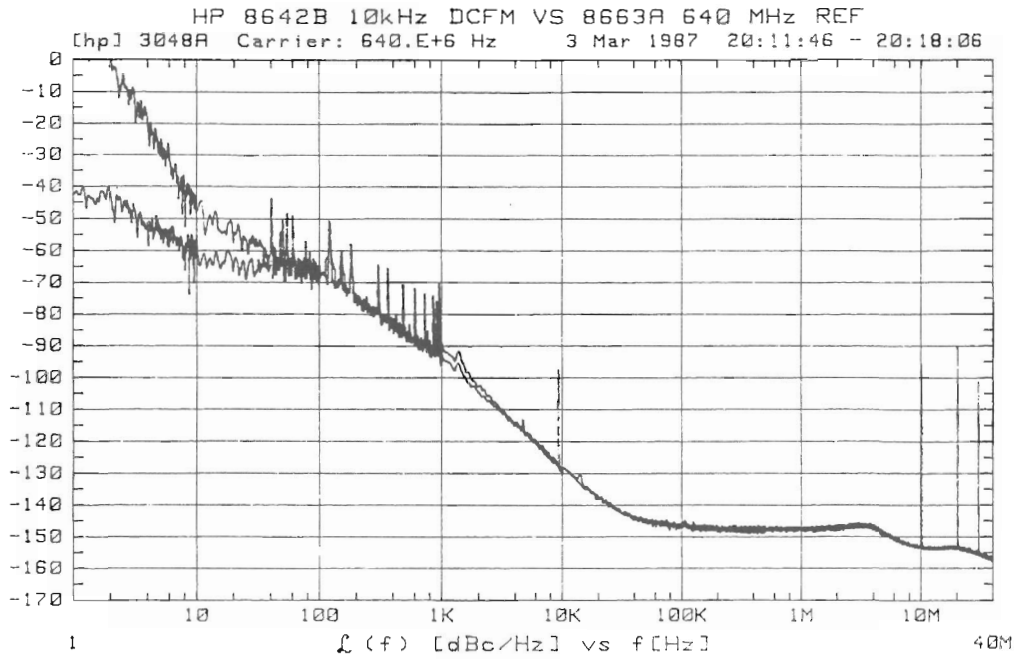

1537a

## Slide 57

In this measurement an HP 8642B was measured against the rear panel 640 MHz signal from an HP 8663A. In the lower curve the HP 8663A with the 10 MHz "A" timebase from the system interface was tuned to maintain quadrature, dc FM on the HP 8642B was used in the other. Since the 640 MHz reference of the HP 8663A is much lower in phase noise than the HP 8642B this graph is a plot of the HP 8642B only.

# Measurement using a Phase Lock Interpolation Oscillator: HP 8673B

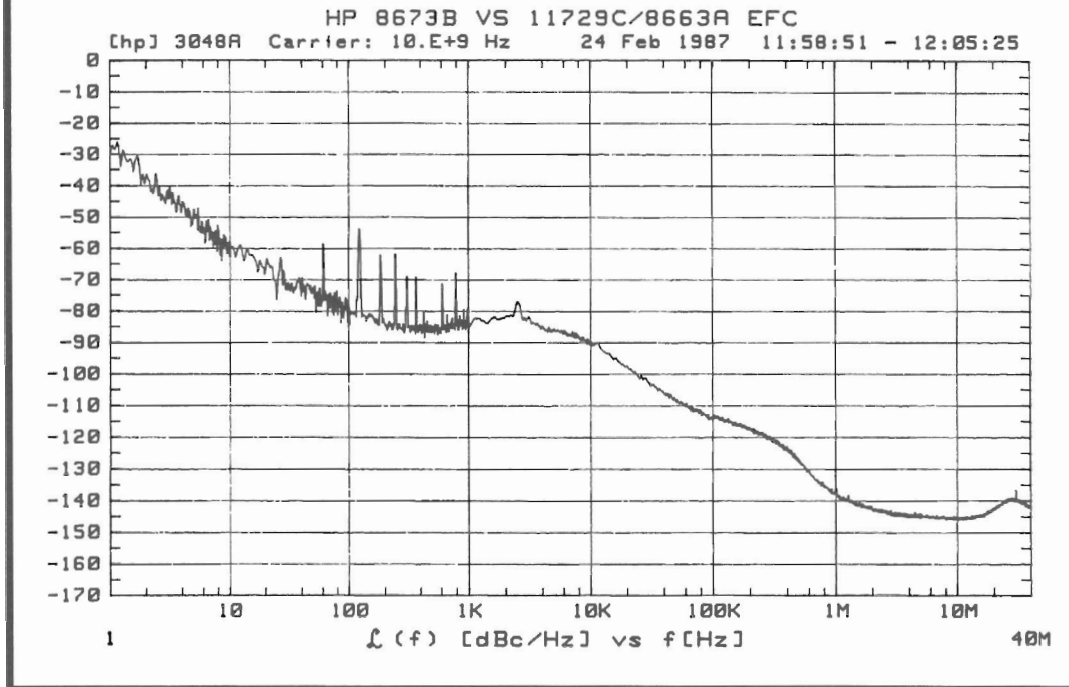

1539

## Slide 58

This measurement was made of an HP 8673B Microwave Synthesizer that was initially downconverted with the HP 11729C Carrier Noise Test Set. An HP 8663A tuned using EFC was used to track and demodulate the resulting IF.

# Measurement Using a Phase Locked Interpolation Oscillator: Gunn Diode

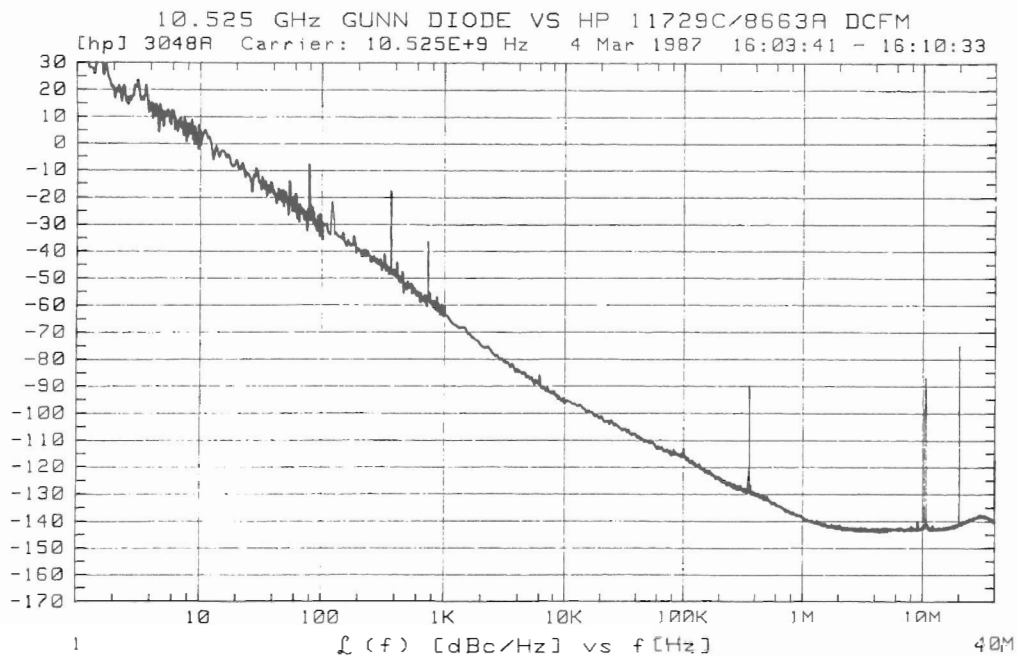

1539a

## Slide 59

This measurement was made of a free-running GUNN Diode without voltage tuning capability. The signal was initially downconverted using the HP 11729C. An HP 8663A tuned using dc FM was used to track and demodulate the resulting IF.

# AM Noise Measurement

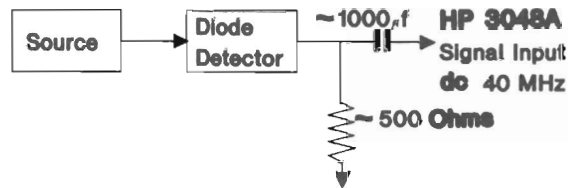
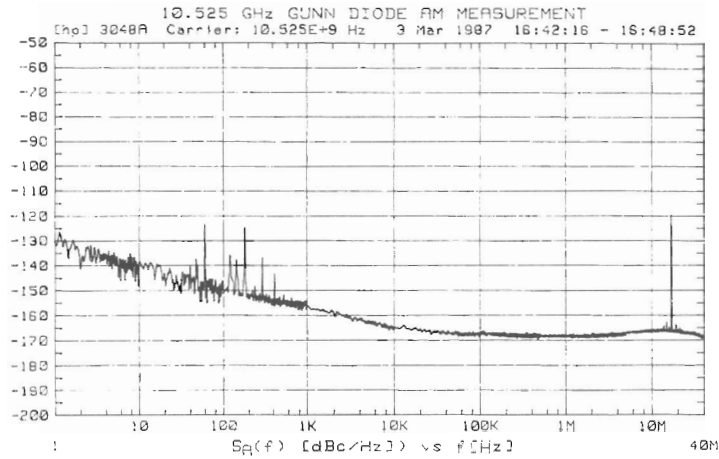

1540

## Slide 60

The HP 3048A will measure the AM noise of a signal. Calibration is accomplished by injecting a modulation sideband of a known level for the system to measure and reference the measured noise to or by entering the detector constant. An external diode detector is used to demodulate the noise from the signal for input directly to the low-noise amplifier of the system.

## REFERENCES

- 1) Ashley, R.J., et al, "The Measurement of Noise in Microwave Transmitters," *IEEE Transactions on Microwave Theory and Techniques*, Vol. MTT-25, No. 4, pp. 294-318 (April 1977)
- 2) Fischer, M., "An Overview of Modern Techniques for Measuring Spectral Purity," *Microwaves*, Vol. 18, No. 7, pp. 66-75, July 1979.
- 3) Hewlett-Packard staff, "Understanding and Measuring Phase Noise in the Frequency Domain," Application Note 207, October 1976.
- 4) Hewlett-Packard staff, "Measuring Phase Noise with the HP 3585A Spectrum Analyzer," Application Note 246-2, May 1981.
- 5) Hewlett-Packard staff, "Low Phase Noise Applications of the HP 8662A and 8663A Synthesized Signal Generators," Application Note 283-3, December 1986.
- 6) Howe, D.A., "Frequency Domain Stability Measurements: A Tutorial Introduction," NBS Technical Note 679, March 1976.
- 7) Lance, A.L., Seal, W.D., Hudson, N.W., Mendoza, F.G., and Donald Halford, "Phase Noise Measurements Using Cross-Spectrum Analysis," Conference on Precision Electromagnetic Measurements, Ottawa, Canada, June 1978.
- 8) Ondria F.G., "A Microwave System for Measurements of AM and FM Noise Spectra," *IEEE Transactions on Microwave Theory and Techniques*, Vol. MTT-16, pp. 767-781, September 1968.
- 9) Scherer, Dieter, "Design Principles and Test Methods for Low Phase Noise RF and Microwave Sources," Hewlett-Packard RF and Microwave Measurement Symposium, October 1978. (Also edited version in *Microwaves*, "Today's Lesson—Learn About Low-Noise Design," part 1, pp. 116-122, April 1979, part 2, pp. 72-77, May 1979).
- 10) Shoaf, J.H., Halford, D., Risley, A.S., "Frequency Stability Specification and Measurement: High Frequency and Microwave Signals," NBS Technical Note 632, January 1973.
- 11) Hewlett-Packard staff, "Phase Noise Characterization of Microwave Oscillators, Phase Detector Method," Product Note 11729B-1, March 1984.
- 12) Hewlett-Packard staff, "Phase Noise Characterization of Microwave Oscillators, Frequency Discriminator Method," Product Note 11729C-2, September 1985.
- 13) Kroupa, V.F., "Frequency Stability: Fundamentals and Measurement," *IEEE Press*, (Order Number: PC 01644), 1983.
- 14) Barnes, J.A., et al, "Characterization of Frequency Stability," NBS Technical Note 394, October 1970.
- 15) Lesson, D.B., Johnson, G.F., "Short-Term Stability for a Doppler Radar. Requirements, Measurements and Techniques," *Proceedings of the IEEE*, Vol. 54, No. 2, pp. 244-248, (February 1966).
- 16) Gibbs, J., Prouty B., "Using Phase Noise Measurements to Improve Performance," *Microwave Journal*, Vol. 24, No. 12, pp. 47-54, December 1981.
- 17) Barnes, J.A., Chic, A.R., Cutter, L.S., et al, "Characterization of Frequency Stability," *IEEE Transactions on Instrumentation and Measurement*, Vol. IN-20, No. 2, pp. 105-20, May 1971.
- 18) Keshner, Marvin S., "1/f Noise," *Proceedings of the IEEE*, Vol. 70, No. 3, pp. 212-218, March 1982.
- 19) Rutman, J., "Characterization of Phase and Frequency Instabilities in Precision Frequency Sources: Fifteen Years of Progress," *Proceedings of the IEEE*, Vol. 66, No. 9, pp. 1048-1075, September 1978.
- 20) McNamee, M. "Automate for Improved Phase-Noise Measurement," *Microwaves*, pp. 80-85, May 1979.
- 21) Fischer, M., "Frequency Stability Measurement Procedures," Hewlett-Packard Co., presented at the Eight Annual Precision Time and Time Interval Meeting, December 1976.
- 22) Burgoon, R., "Conversion Between Time and Frequency Domain of Intersection Points of Slopes of Various Noise Processes," *Thirty-second Annual Frequency Control Symposium*, pp. 514-519, May 1978.
- 23) Scherer, D., "The 'Art' of Phase Noise Measurements," Hewlett-Packard RF and Microwave Symposium, May 1983.
- 24) Muat, R., Upham, A., "Low Noise Oscillator Design," Hewlett-Packard RF and Microwave Symposium, March 1986.
- 25) Moulton, G., "Analysis and Prediction of Phase Noise in Resonators and Oscillators," Hewlett-Packard RF and Microwave Symposium, September 1985.