

9-1-86

FAR-FIELD ANTENNA MEASUREMENTS WITH THE HP 8510 NETWORK ANALYZER

John W. Boyles
Network Measurements Division
1400 Fountain Grove Parkway
Santa Rosa, CA 95401

RF & Microwave
Measurement
Symposium
and
Exhibition

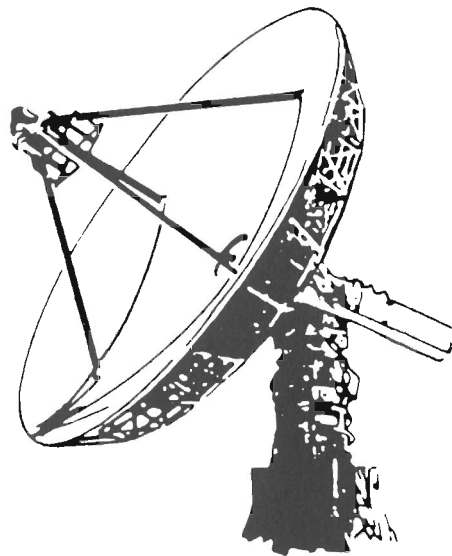

HEWLETT
PACKARD

ABSTRACT:

This paper describes the application of the HP 8510 network analyzer to far-field antenna measurements. Several hardware configurations are described, including a newly developed configuration for making antenna measurements using harmonic mixers. Short-distance, long-distance, and radar cross-section ranges are described, and measurement examples are given for each category.

In addition, the paper discusses the use of time domain gating as a means of eliminating the effects of ground path reflection, which is one of the major problem areas encountered in far-field antenna measurements. Several measurement examples are given that show the improvements that can occur using gating.

Author: John W. Boyles, Applications Engineer, Hewlett-Packard Network Measurement Division, Santa Rosa, CA. He received a BS degree from North Carolina State University in 1978 and a MS degree from the Georgia Institute of Technology in 1979, both in electrical engineering. With HP since 1979, he joined as a R&D engineer doing microwave and analog circuit design, and was one of the designers of the HP 8340A synthesized sweeper. In 1984, he became an applications engineer for the high performance network analyzers, specializing in the areas of time domain network measurements, and antenna and radar cross-section measurements.

FAR-FIELD ANTENNA MEASUREMENTS WITH THE HP 8510 NETWORK ANALYZER

4445

This paper describes the application of the HP 8510 Network Analyzer to far-field antenna measurements.

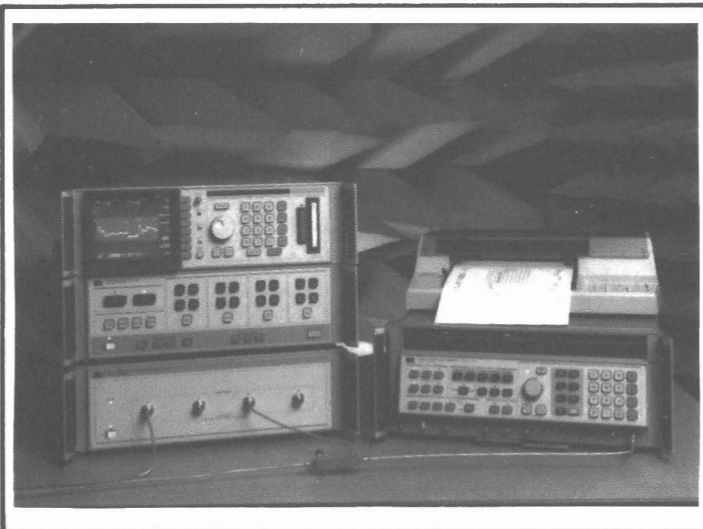

4446

The HP 8510 network analyzer is a high performance stimulus/response measurement system that consists of a microwave source, a test set, and the HP 8510A as receiver and system controller. There are several different measurement configurations available that can be customized to specific applications. Shown in this picture are the HP 8510A network analyzer, HP 8511A Frequency Converter, and HP 8340A Synthesized Sweeper.

HP 8510 CAPABILITY FOR ANTENNA TESTING

- 4-Input Phase Locked Receiver
- Magnitude and Phase Measurements
- Broadband Frequency Range (26.5 GHz)
- Millimeter Measurements (to 100 GHz)
- Wide Dynamic Range (>90 dB)
- Time Domain and Gating
- HP-IB Programmable
- Versatile Instrumentation

4447

The HP 8510 can be configured as a 4-input phase locked receiver that is capable of measuring magnitude and phase. For antenna testing, its broadband performance and wide dynamic range make it applicable for measurements from 45 MHz to 100 GHz. The built-in time domain processing features provide new ways to characterize antennas. And, in addition to antenna characterization, the instrumentation can be used in other network measurement applications.

OUTLINE OF PAPER

- I. Far-Field Requirements
- II. Antenna Parameters to Characterize
- III. Antenna Test Configurations
- IV. Antenna Measurement Techniques
- V. Measurement Examples

4448

We will begin with a brief review of the requirements of far-field antenna testing and of antenna parameters that are measured. Next, several antenna test configurations and measurement techniques will be discussed. Finally, several measurement results are shown.

I. FAR-FIELD ANTENNA TESTING

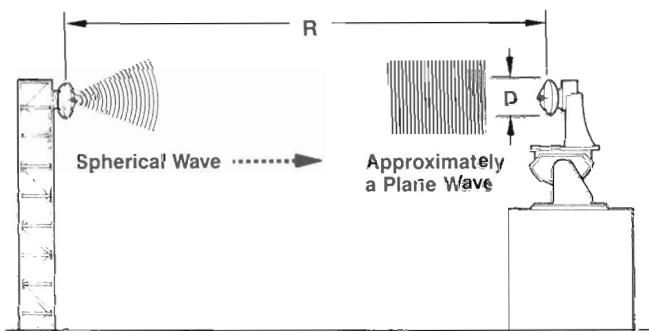

4449

A plane wave is the standard test field for an antenna, but an antenna radiates with a wavefront that is approximately spherical (the phase of the signal is constant over the contour of a sphere). However, if the test antenna is placed far enough away from the source antenna, then the field will be approximately planar over the surface of the receive antenna. This is what is meant by the "Far-Field" approximation.

THE FAR-FIELD APPROXIMATION

$$R > \frac{2 D^2}{\lambda}$$

or, since $\lambda = c/f$ Gives 22.5° Phase Taper

$$R > 6.7 D^2 f \text{ (GHz)}$$

The Required Range Size Increases with Frequency and with the Square of the Antenna Diameter

4450

A rule-of-thumb expression is used in industry to describe how far away the receive antenna must be from the source antenna to be in the "far-field." For a radiated wavefront with 22.5 degrees of phase shift across the diameter of the receiving antenna, the far-field is approximately $2D^2/\lambda$ meters from the source antenna, where D is the widest dimension of the receive antenna. An alternate form of this expression is that the far-field is approximately $6.7 \cdot D^2 \cdot f \text{ (GHz)}$. Although this formula is only an approximation, it shows how the required range size for far-field antenna testing increases with frequency and with the square of the antenna diameter.

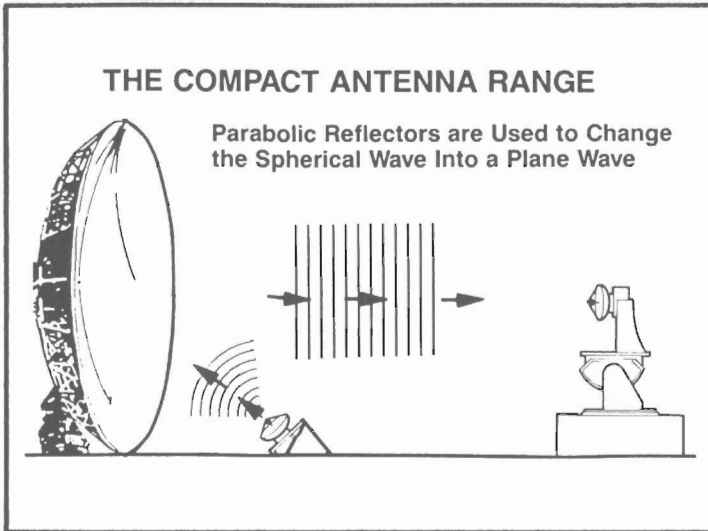

4451

Often the distances involved in conventional far-field antenna testing become restrictively large. In such cases, and in situations where it is desirable to do far-field testing indoors, a compact antenna range is often used. This technique involves using large parabolic-shaped reflectors to change the spherical wave of the antenna into a planewave, which greatly reduces the distance required to do far-field antenna testing.

II. ANTENNA PARAMETERS FOR MEASUREMENT

- A. Antenna Input Impedance
- B. Antenna Radiation Characteristics
- C. Other Parameters

Antenna parameters that are measured include reflection and transmission characteristics of the antenna, as well as other parameters.

4452

A. ANTENNA INPUT IMPEDANCE

HP 8510 CONTRIBUTIONS

- Error-Corrected Network Analysis
- Ability to Calibrate at End of a Cable
- Time Domain Helps Locate Mismatches

Antenna input impedance describes how well matched the antenna will be to the source or receiver to which it is connected. One advantage of a vector network analyzer, because it measures both magnitude *and phase*, is its ability to characterize the systematic measurement errors and then apply error-correction to remove their effects. This measurement calibration can also be performed at the end of the cable that connects to the antenna so that the antenna can be tested in its operating position. In addition, time domain network analysis can help to locate the physical position of mismatches.

4453

TIME DOMAIN MEASUREMENTS

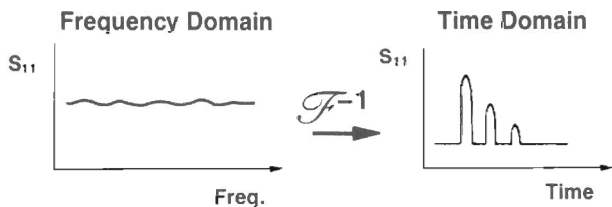

4454

As a brief review of time domain measurements, recall that the frequency domain and the time domain responses of a network are related by the inverse Fourier transform. Therefore, it is possible to characterize the response of the antenna in the frequency domain (magnitude and phase) and mathematically generate the time domain response.

TIME BAND PASS

Band Limited Time Domain Mode

- Gives Response to (Synthetic) Pulsed-RF Signal with an Impulse-Shaped Envelope

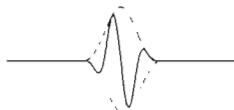

4455

The most appropriate time domain mode for antenna measurements is called Time Band Pass. This gives the response of the antenna to a pulsed-RF signal with an impulse-shaped envelope. The time domain waveform is constructed from its frequency domain components, and, for a linear system (such as an antenna), the response that is obtained is the same as if actual pulsed-RF waveforms had been used and measured.

TIME DOMAIN IMPEDANCE MEASUREMENTS

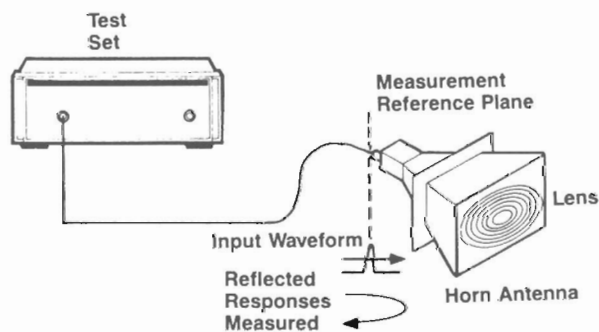

4456

For time domain impedance measurements, the time domain waveform is effectively launched into the antenna from the measurement reference plane. At each mismatch that the impulse encounters, a portion of the energy will reflect back, the amplitude being proportional to the reflection coefficient, and the location (along the time axis) being proportional to the physical location of the mismatch. These reflected responses are measured when they arrive at the calibration reference plane.

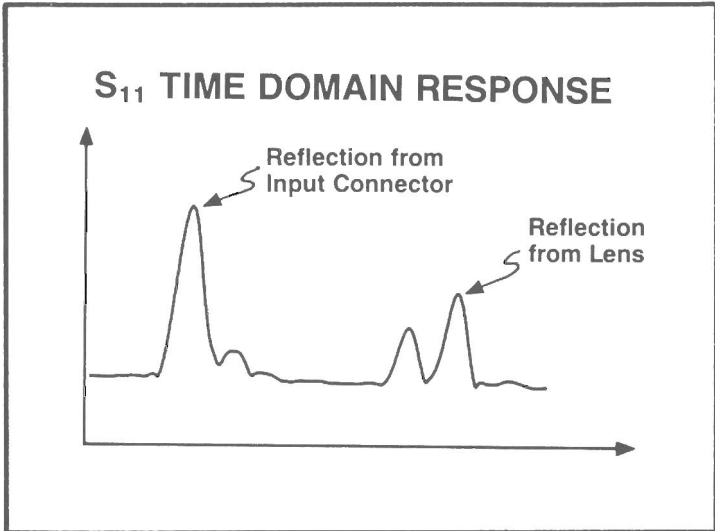

4457

The time domain response gives a display of reflection coefficient versus time. This helps to identify the actual location of the problem areas.

In this example, the time domain S₁₁ response of a broadband horn antenna loaded with a dielectric lens (illustrated in the previous slide) reveals that the largest mismatch is due to the input connector, and that two other reflections occur from the lens, one from each surface.

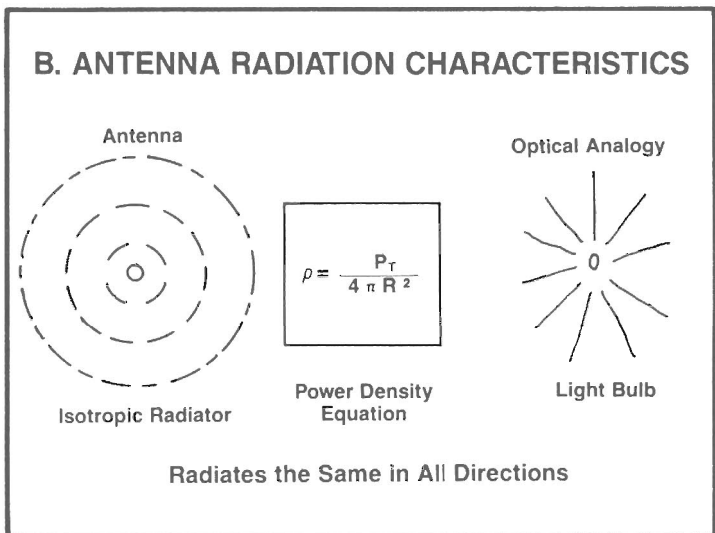

4458

Antenna radiation characteristics are by far the most common antenna parameters to be characterized. As a review, recall that an antenna which radiates equally in all directions is called an isotropic radiator. An optical analogy to this antenna is a light bulb.

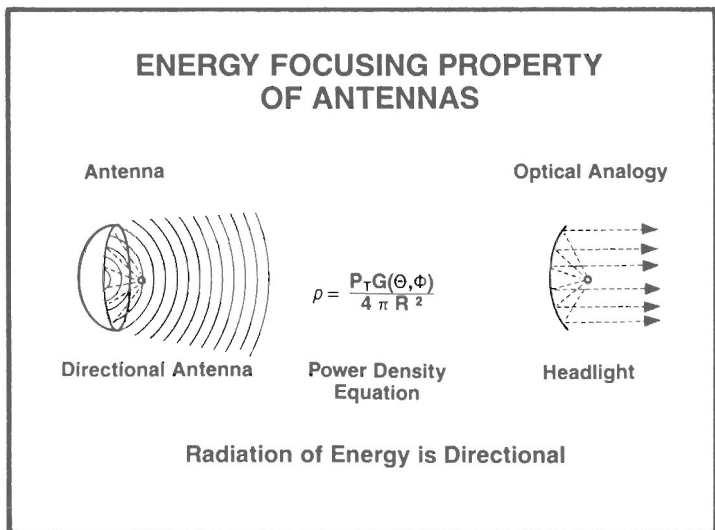

4459

However, most antennas are designed to focus energy in a particular direction. By placing a curved reflector in front of an isotropic radiator, the radiated energy that strikes the surface of the reflector is focused in one direction, similar to the way that a parabolic reflector in a headlight focuses the optical energy of the light bulb at its focal point.

RADIATION PATTERN

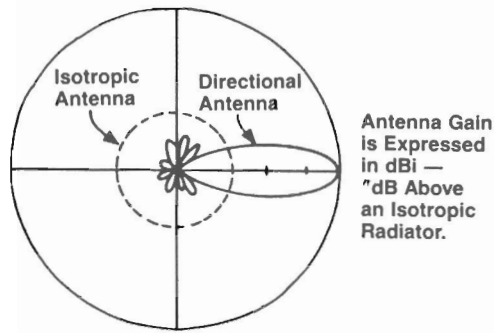

Function of Angle

4460

Therefore, an antenna has a radiation pattern that is a function of both azimuth and elevation angles, and it also is said to have "gain" in a particular direction. Unlike the gain that exists in amplifiers where the output power is greater than the input power, antenna gain is due to the focusing property of the antenna concentrating the energy in a particular direction. Antenna gain is expressed in dBi -- dB relative to an isotropic radiator.

ANTENNA GAIN

$$G = \frac{4\pi A}{\lambda^2}$$

A = Effective Antenna Aperture (Area)

- Proportional to Antenna Size
- Function of Direction Angle
- Depends on Polarization

4461

Antenna radiation pattern and gain are the most common transmission parameters to be characterized. It can be shown that antenna gain is proportional to the effective antenna aperture expressed in wavelengths, which is a measure of how electrically "large" the antenna looks to the incident field. This depends on the physical dimensions of the antenna, on how its aperture is illuminated, and on the polarization of the antenna with respect to the incident field.

C. OTHER PARAMETERS

- Antenna Bandwidth
- Polarization Properties
- Radar Cross Section

4462

Other parameters in the general category of antenna measurements include antenna bandwidth, polarization properties, and radar cross-section.

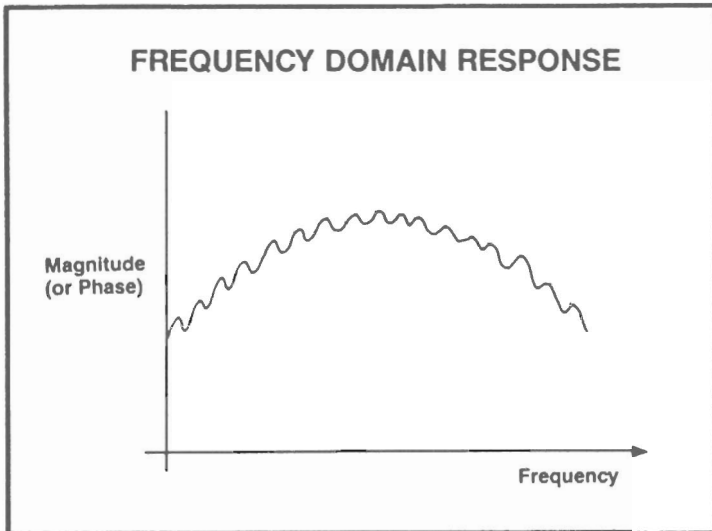

4486

Antenna bandwidth describes how the antenna performs versus frequency. Therefore, a broadband receiver is highly desirable.

A broadband measurement also makes available time domain characterization of the antenna, which will be further discussed later in the paper.

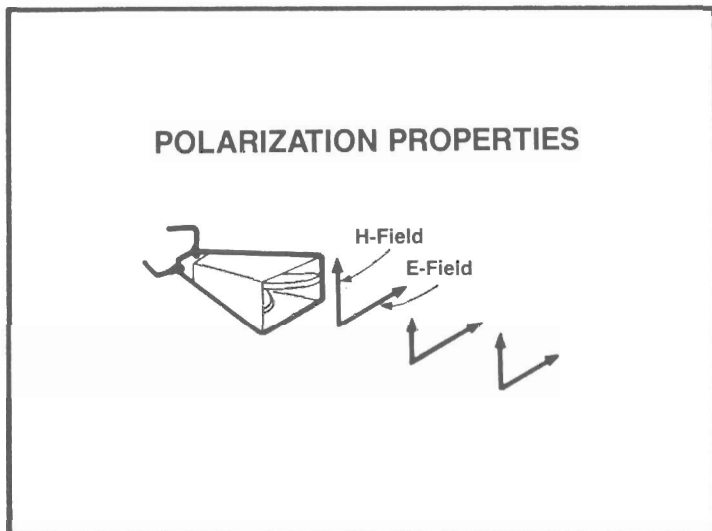

4464

The radiated fields of an antenna are polarized, and there may be more than one input to the antenna. Therefore, a receiver with multiple inputs is desirable for antenna characterization. The HP 8510 has four inputs and two measurement channels that can display any input or a ratio of two inputs. By displaying both channels simultaneously, a dual polarization measurement can be performed.

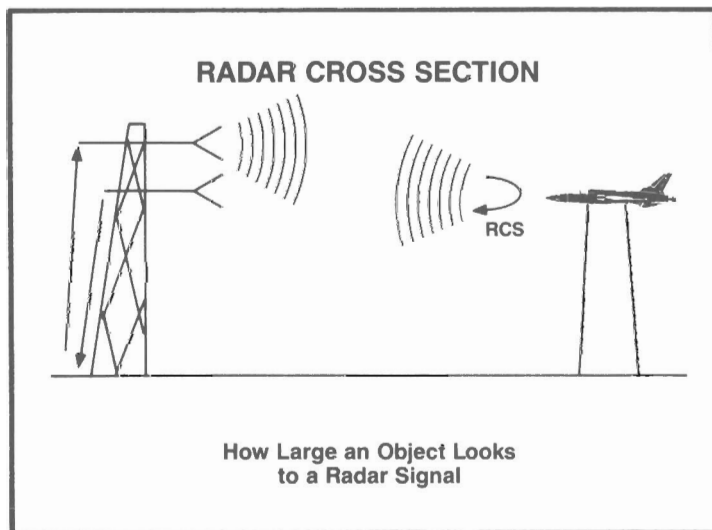

4465

Radar Cross-Section (RCS) is a measure of how large an object looks to a radar signal. Because the contribution of an antenna to the overall RCS of an aircraft (or other vehicle) can be significant, antennas often need to be individually characterized for radar cross-section. The same applies to many other objects.

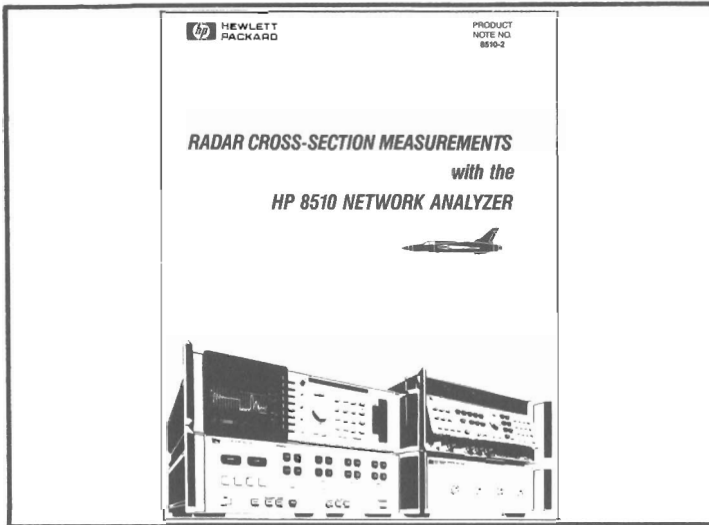

4466

Radar cross-section measurement configurations will be covered in this paper, however a more thorough treatment of RCS measurement techniques is contained in HP product note 8510-2: "Radar Cross-Section Measurements with the HP 8510 Network Analyzer," available from HP as literature number 5954-1522.

III. APPLYING THE HP 8510 TO ANTENNA MEASUREMENTS

We will now cover antenna test configurations used with the HP 8510 network analyzer.

4467

ANTENNA TEST CONFIGURATIONS

- A. Short-Distance Antenna Range
- B. RCS Measurement Range
- C. Long-Distance Antenna Range
- D. New Harmonic Mixer/ Remote Phaselock

Several antenna test configurations will be described. The first three of these configurations use standard HP 8510 instrumentation connections. The fourth, using a feature called "Remote Phaselock," is a new measurement configuration using harmonic mixers that has been developed specifically for antenna measurements.

(The distinction between a "short-distance" and a "long-distance" antenna range derives from how the phaselock reference signal is obtained.)

4468

A. SHORT-DISTANCE ANTENNA RANGE

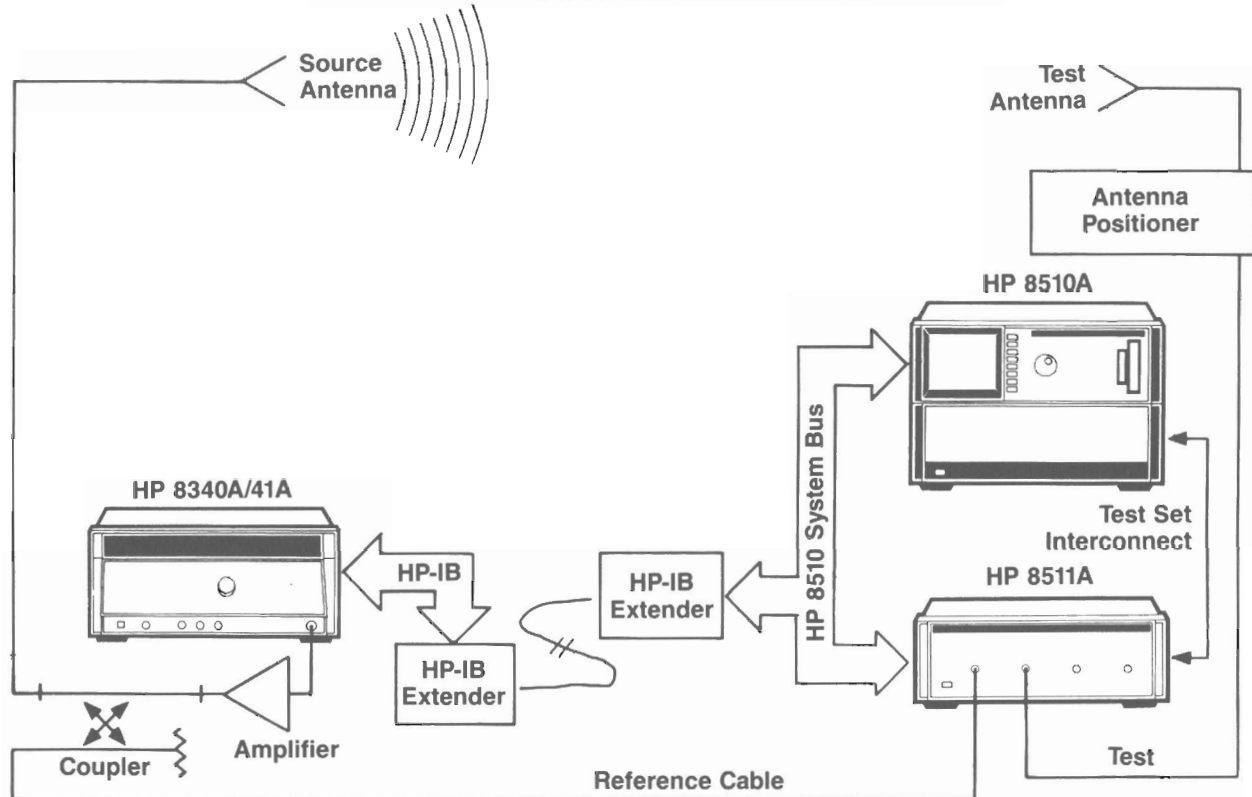

4469

The HP 8510 network analyzer consists of a microwave source (HP 8340A, 8341A), test set (HP 8511A), and the HP 8510A as the receiver. The HP 8510A controls the source and test set over a private HP-IB bus (HP 8510 system bus) with an additional IF interconnect cable to the test set. The RF source is located near the source antenna and the test set and receiver are located close to the antenna under test. If the distance between the source and the HP 8510A exceeds 20 Ft, then a pair of HP 37204A HP-IB extenders (or equivalent) are used.

In the short-distance configuration, a portion of the signal from the RF source is coupled off and sent back through a reference cable to input a_1 of the HP 8511A to provide the phaselock reference signal. The signal received by the test antenna is sent into input b_1 of the HP 8511A. The HP 8511A downconverts each signal to a 20 MHz IF that is sent to the HP 8510A. The HP 8510A measures the magnitude and phase of both signals and displays the complex ratio of test/reference.

For a test antenna with two polarizations, a second cable from the test antenna can be sent to input b_2 (or a_2) of the HP 8511A. By selecting a dual channel display, dual polarization measurements can then be made.

B. RCS MEASUREMENT RANGE

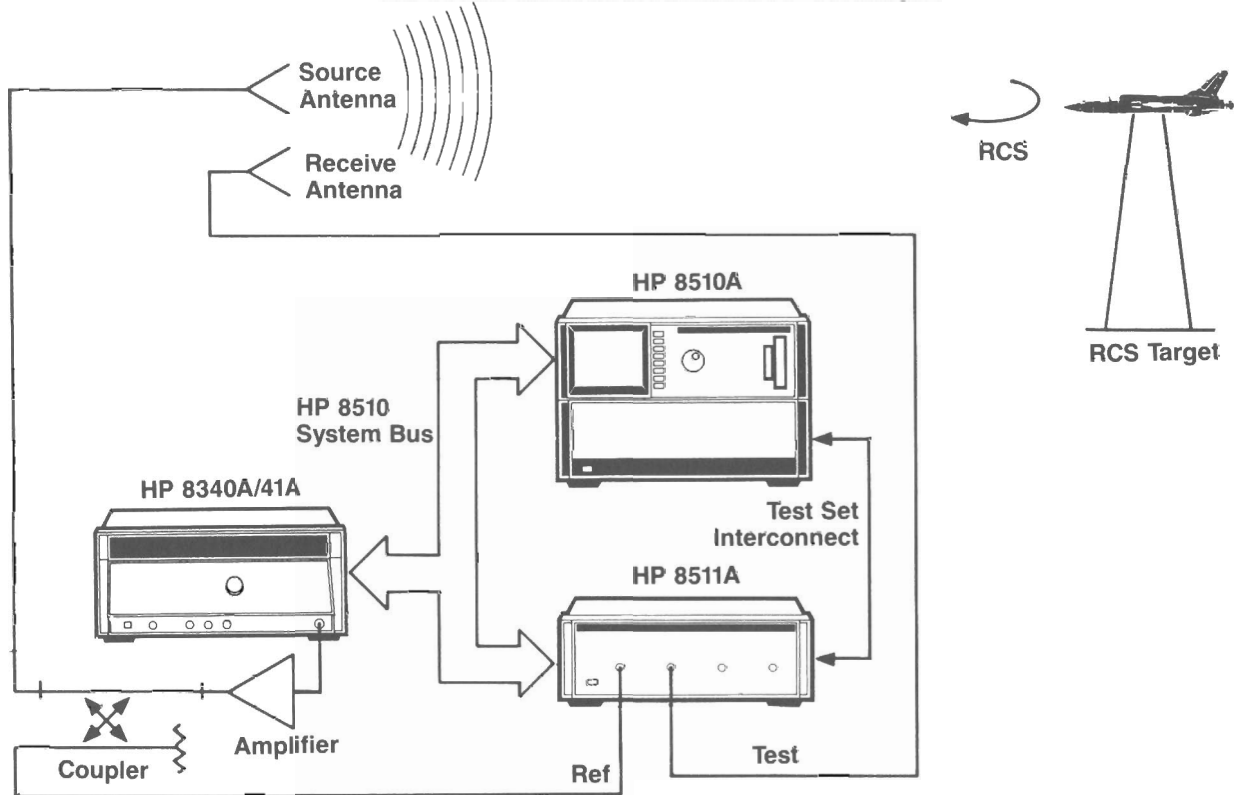

4470

The Radar Cross-Section measurement configuration is very similar to the previous block diagram, except that the two antennas are located side by side. Therefore, the source and receiver can be located closer together, which eliminates the requirement for HP-IB extenders.

As before, the phaselock reference is provided by a reference cable, which also is much shorter than with the antenna test configuration. The output of the source antenna is reflected back by the RCS target, and the signal received by the second antenna is sent into the second input of the HP 8511A. The HP 8510A displays test/reference.

C. LONG-DISTANCE ANTENNA RANGE

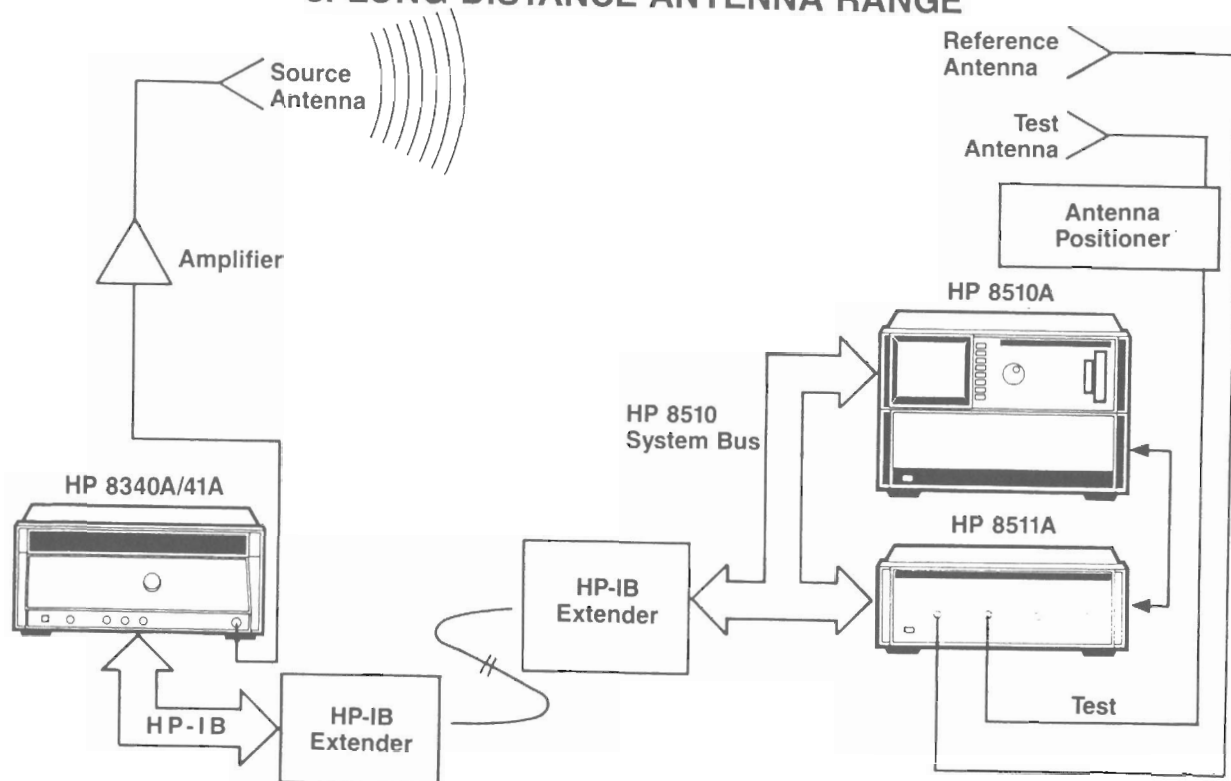

4471

The Long Distance Antenna Range configuration differs from the previous two configurations in the way that the phase-lock reference signal is obtained. At high frequencies and/or over very long distances, the use of a reference cable can become impractical. The losses in the cable can become restrictively large, or else the physical layout of the range can prohibit the use of a reference cable. Therefore, another means must be used to provide the phase-lock reference. This measurement configuration makes use of a separate reference antenna at a fixed location, pointed towards the source antenna. As discussed later, it is best if a low sidelobe antenna is used for the phaselock reference.

All RF cables used in the antenna measurement configurations given in this paper should have low loss and good phase stability characteristics. It is also important to minimize the number of adapters and connectors to reduce the effects of impedance mismatches. In addition, best measurement results are obtained when the test and reference inputs are balanced with respect to phase shift and are subjected to the same thermal environments.

CONSIDERATIONS USING THE HP 8511A

- Maximum Input Level is -10 dBm
- Damage Level is $+13$ dBm
- Phaselock Reference Signal Must Be -10 to -50 dBm
- 3 dB Pads on Inputs Recommended
- Use Good ESD Precautions

4472

USING OTHER TEST SETS IN PLACE OF THE HP 8511A

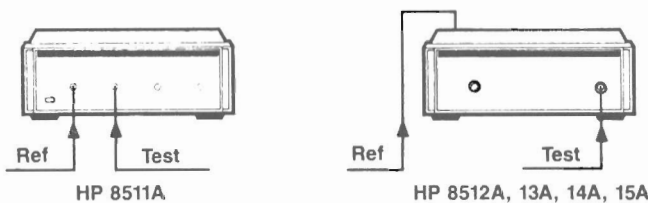

- Rear Panel Input for Reference
- Port 2 Input For Test Signal
- Less Dynamic Range Than the HP 8511A

4473

CONTROL OF SOURCE AND TEST SET

- Use HP 37204A HP-IB Extender (Or Equivalent) on HP 8510 System Bus for Control of the Source
- Test Set Location Can Be Up to 40 Ft (Maximum) from the HP 8510
 - 08510-60103 20 Ft IF Cable
 - 08510-60104 40 Ft IF Cable

4474

To obtain the best performance with the HP 8511A, the following considerations should be noted. Care must be taken not to overdrive the inputs of the frequency converter, which go into compression above -10 dBm and can be damaged at $+13$ dBm. The input used for phase-lock reference (a_1 or a_2) must have a signal level between -10 and -50 dBm. It is recommended to use 3 dB pads on the inputs to provide good port match.

Also, because of its extremely broad bandwidth, the HP 8511A has very little natural damping to fast rise time electrostatic discharges (ESD). Therefore, to prevent damage to the harmonic sampler circuitry, it is important to use good ESD precautions in handling the HP 8511A and connecting to its inputs.

It is possible to configure the other HP 8510 network analyzer test sets to make antenna measurements. This is done by removing the a_1 reference path extension cable in the back of the test set and connecting the phaselock reference signal to the a_1 input. The test signal then can go into port 2 (preferred) or into port 1. For the HP 8514A and 8515A, a fourth input can be accessed through the a_2 reference extension cable.

However, it should be noted that compared to the HP 8511A, this configuration results in less measurement sensitivity in the a_1 and port 1 input paths (but not port 2) for the HP 8512A and 8513A and in all four input paths for the HP 8514A and 8515A test sets.

Whenever the source and receiver are separated by more than 20 Ft, a pair of HP 37204A HP-IB extenders can be used to connect the source to the HP 8510A.

The IF interconnect cable to the test set can be extended a maximum of 40 Ft from the HP 8510A. [For instrument serial numbers below #2543A001199, a new pretune board, part number 85102-60204, must also be ordered with the 40 Ft cable.]

D. NEW HARMONIC MIXER/ REMOTE PHASE LOCK CONFIGURATION

4475

A new test configuration for antenna measurements, called Remote Phaselock, has recently become available that allows the HP 8510 to be configured to make measurements using harmonic mixers with a phaselocked local oscillator (LO).

ANTENNA TESTING USING HARMONIC MIXERS

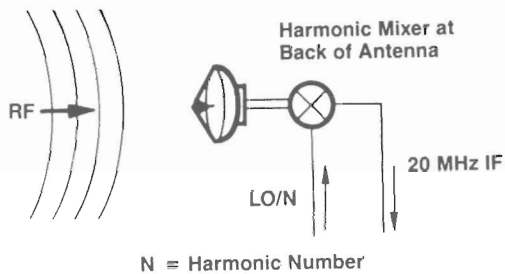

4476

The remote phaselock configuration allows the harmonic mixers to be placed on the back of the antenna under test. An LO/N signal (N=harmonic number of the mixer) is sent to the mixer where it is combined with the incoming RF signal to provide a 20 MHz IF, measured by the HP 8510A.

It is also possible to use a diplexer to allow the same cable to be used for both the LO/N and the 20 MHz IF signals.

WHY HARMONIC MIXERS?

- Eliminates RF Cable Loss Between Antenna and Test Set
- Improves Measurement Sensitivity
- Measurement Configuration is Extendable to Millimeter-Wave Frequencies

4477

The main advantages to antenna testing using harmonic mixers are the elimination of RF cable (and rotary joint) loss between the antenna and the test set, improved measurement sensitivity, and the ability to make phaselocked antenna measurements at millimeter frequencies.

HOW REMOTE PHASELOCK WORKS

Replaces HP 8511A With LO and Mixers

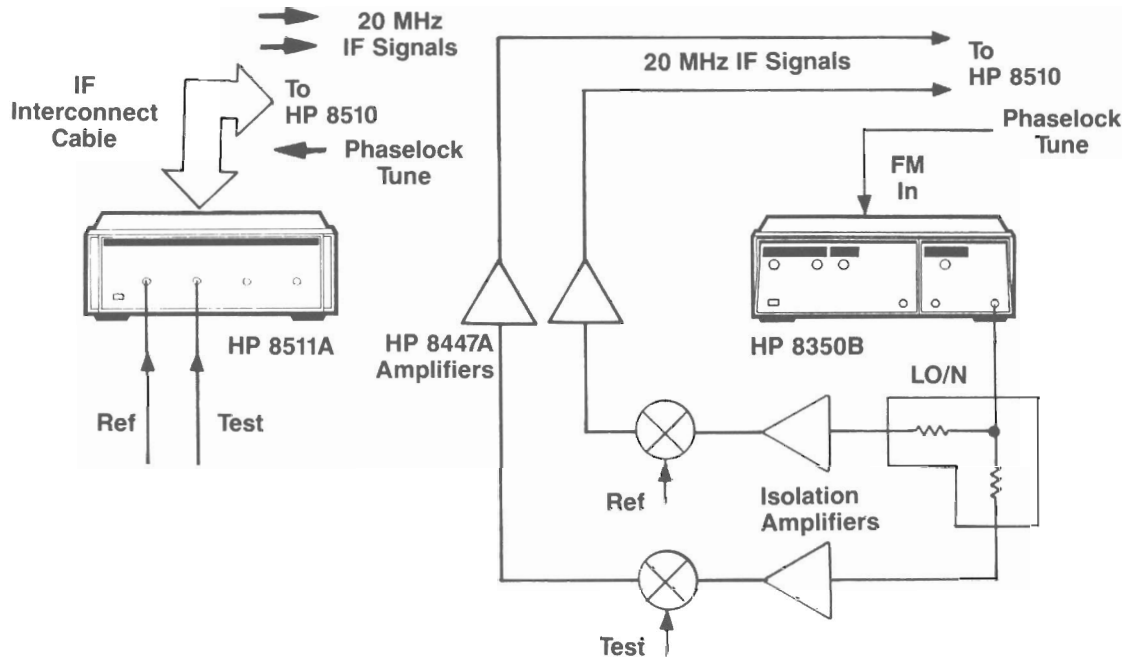

4478

The HP 8511A is a harmonic sampler with a built-in voltage controlled oscillator (VCO), a harmonic of which mixes with the Reference and Test inputs to provide 20 MHz IF signals. These 20 MHz signals are sent via the IF interconnect cable to the HP 8510A, which measures them and sends back a phaselock signal to tune the VCO in the HP 8511A.

The remote phase-lock configuration replaces the test set with external harmonic mixers and an HP 8350B sweeper as LO.

REMOTE PHASELOCK ANTENNA TEST CONFIGURATION

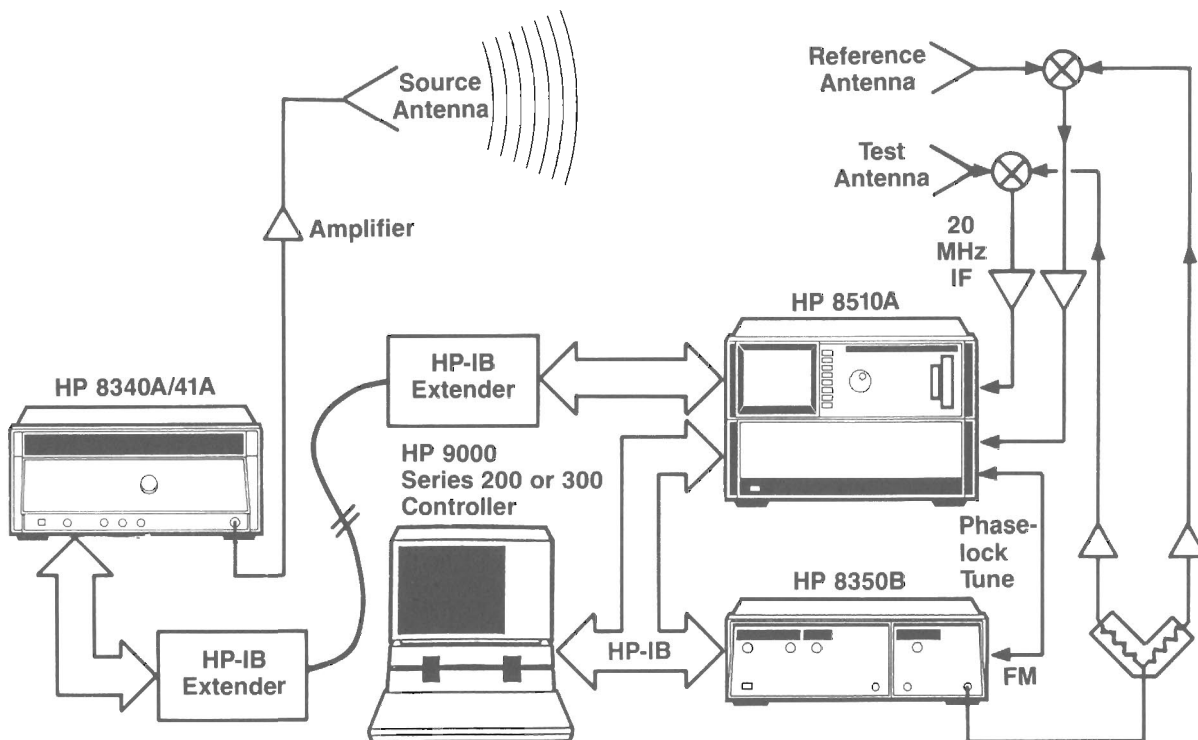

4479

This is the remote phase-lock test configuration of the HP 8510 for a long-distance antenna range. The Reference and Test signals are input into external harmonic mixers (that can be located at the back of each antenna). The HP 8350B LO output is split and applied to the mixers through two isolation amplifiers. The difference between the RF and $N \cdot LO$ signals provides the 20 MHz IF signals that are measured by the HP 8510A, which then generates an error signal that phase-locks the HP 8350B LO through its FM input. In applications where RF signal levels are low, the HP 8447A low noise preamplifier can be used to provide increased measurement sensitivity.

The remote phase-lock configuration requires external control software and both hardware and firmware modifications to the HP 8510A.

This measurement configuration can be extended to millimeter frequencies by adding the appropriate HP millimeter-wave source module and using millimeter harmonic mixers (HP 11970 Series or equivalent).

FEATURES OF REMOTE PHASELOCK

- Mixers Remotable Up to 150 Ft
- CW (Single Point) or Step Sweep Modes
- Broad LO Frequency Range Available (Any HP 8359x Plug-ins)
- Wide Variety of Mixers Can Be Used

4481

IMPROVED MEASUREMENT SENSITIVITY

- Adding HP 8447A Low Noise IF Amplifiers Provides -127 dBm IF Sensitivity (Typical)
- Averaging Reduces Noise by $10 \cdot \log_{10}(\text{Averages})$
- Example: 128 Averages Improves IF Sensitivity by 21 dB, to -148 dBm (Typical)
- RF Sensitivity Equals IF Sensitivity Plus Mixer Conversion Loss

5307

The remote phaselock configuration will allow the mixers to be removed up to 150 feet from the HP 8510. It is capable of measurements in either CW (SINGLE POINT) or STEP Sweep modes (but not RAMP). Because the HP 8510 phaselocked loop is capable of making gain adjustments to accommodate the harmonic numbers used in the mixer, and because of the broad LO frequency range available with the HP 8350B sweeper family, a wide variety of mixers can be used.

The remote phaselock measurement configuration can significantly improve HP 8510 measurement sensitivity (defined as the level where signal equals noise.) Adding the HP 8447A IF preamp (5dB noise figure, 20 dB gain) provides an IF measurement range of -30 dBm to -127 dBm (typical, no averaging). Averaging further improves measurement sensitivity by $10 \cdot \log_{10}(\text{averages})$, similar to the effect of reducing IF bandwidth. Each additional average adds approximately 200 microseconds to the measurement time per point.

To further improve measurement sensitivity, an averaging factor of 128 will lower the minimum detectable IF signal level by 21 dB to -148 dBm while increasing the measurement time by only 25 ms per point. This has the same effect as reducing the 10 kHz IF bandwidth by the averaging factor (to an effective value of 78 Hz). If a mixer with a 6 dB conversion loss is used, the resulting RF sensitivity is -142 dBm.

REMOTE PHASELOCK SHORT RANGE CONFIGURATION

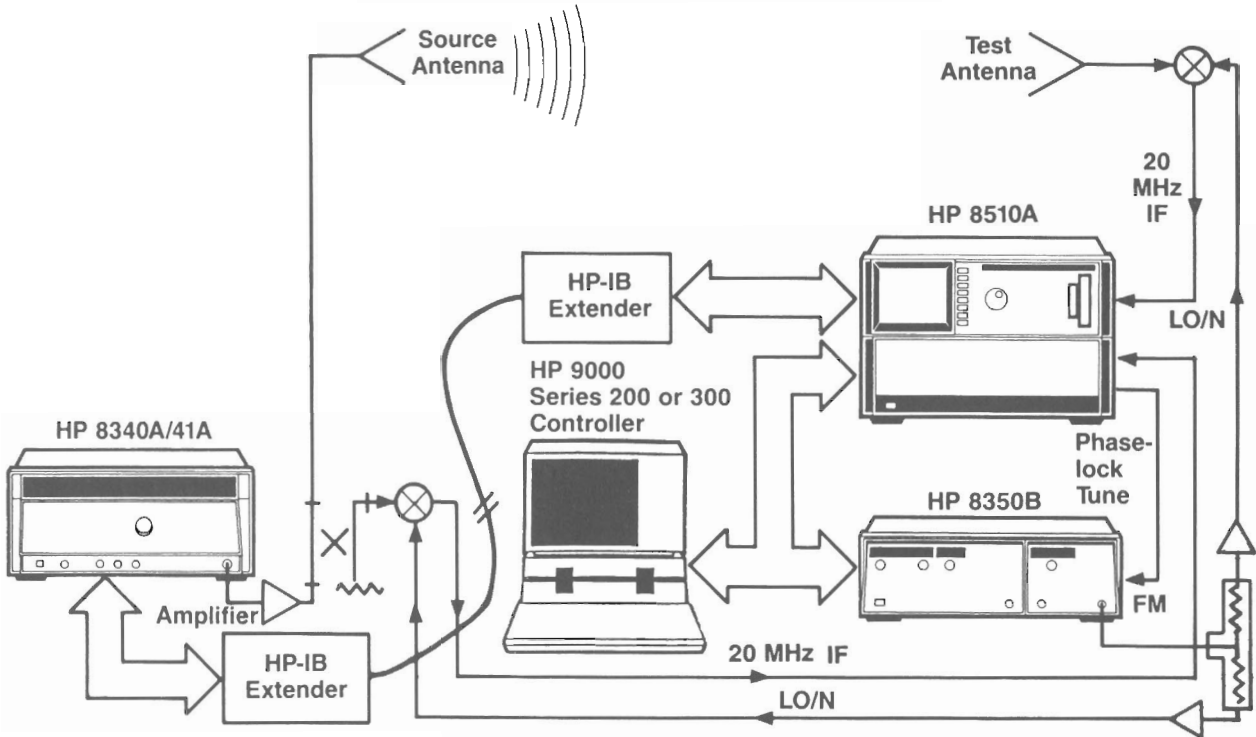

5091

The remote phase-locked configuration can also be used for short-range antenna measurements, resulting in improved measurement sensitivity over the HP 8511A configuration. In addition, because harmonic mixing allows a lower frequency LO to be used, the susceptibility to RF cable loss is reduced. This allows the short-range configuration to be used at much higher frequencies or at much longer distances than would otherwise be practical.

Although separate cables are shown for the LO and IF signals, diplexers can be added to allow a single cable to be used. It is important to note that the phase stability of the LO cable is very important. Although the LO signal is at a lower frequency, any phase instability it experiences will be multiplied by the harmonic mixing number, and the effect is the same as if the phase shift had occurred in the RF cable.

REMOTE PHASELOCK RCS TEST CONFIGURATION

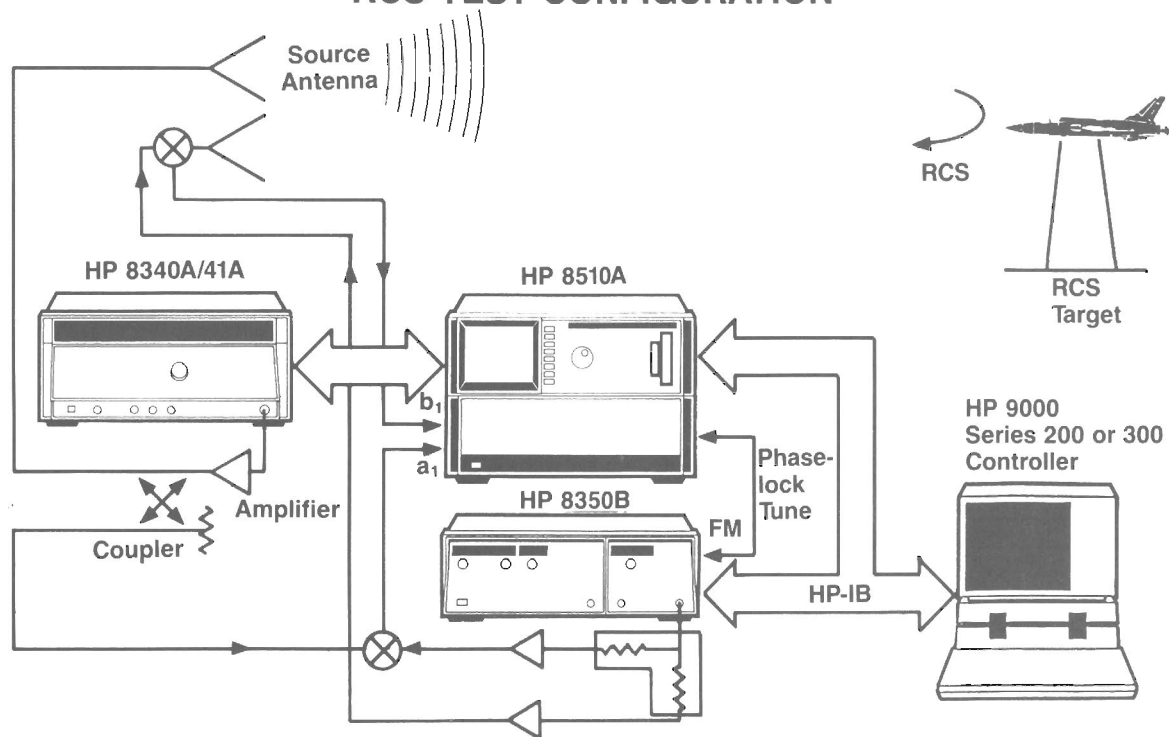

4480

The remote phaselock measurement configuration can also be used for Radar Cross Section measurements, providing improved measurement sensitivity over the HP 8511A configuration. This allows RCS testing at lower signal levels, which can be an important consideration at higher frequencies.

However, because the Ramp sweep mode is not available with remote phaselock, the HP 8511A will still be preferred for many RCS applications.

The following section describes several different measurement techniques for far-field antenna characterization.

III. FAR-FIELD ANTENNA MEASUREMENT TECHNIQUES

4482

CW ANTENNA PATTERN MEASUREMENTS

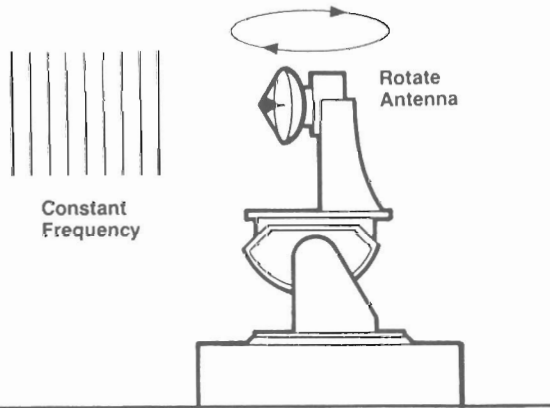

4483

The CW antenna pattern is the most common antenna measurement, done by rotating the antenna positioner while making measurements at a constant CW frequency.

CW ANTENNA PATTERN

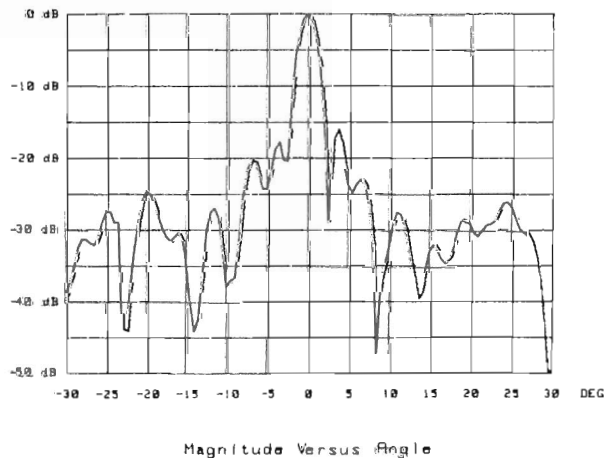

4484

The resulting CW antenna pattern is a display of magnitude (or phase) versus measurement angle. This has long been the most popular method of antenna pattern characterization. The HP 8510 provides this measurement capability using the SINGLE POINT mode. By selecting a dual channel display, a dual polarization measurement can be performed.

For manual antenna pattern measurements, a special option is available with the HP 8510A to provide a programmable analog output to interface with an antenna pattern recorder. The feature converts any parameter displayed on the HP 8510A CRT (rectangular formats only) into an analog signal output on a BNC connector that is compatible with the analog DC input of an antenna pattern recorder. Any measured parameter in a variety of formats (such as log magnitude, linear magnitude, and phase) can be selected.

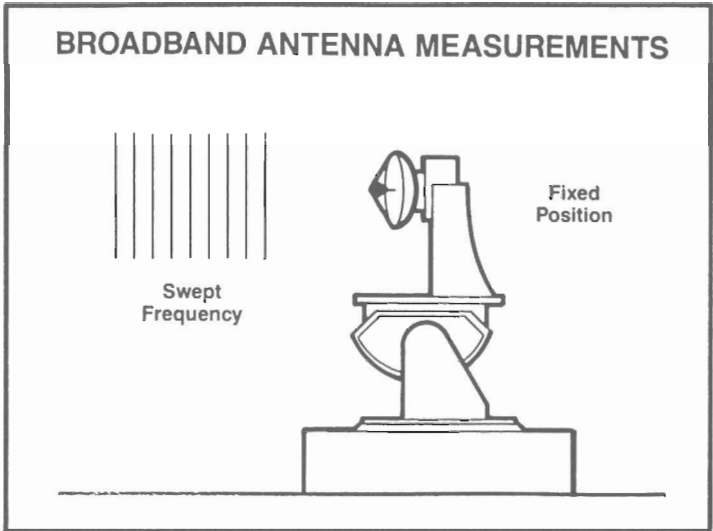

4485

Broadband antenna measurements, made possible by the swept frequency capability of the HP 8510, involve moving the antenna to a fixed position and measuring the antenna response over a frequency span.

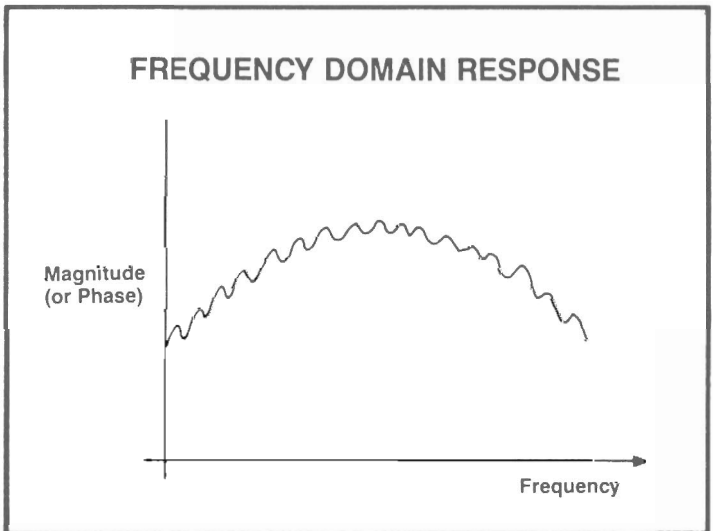

4486

The resulting response is a display of magnitude (or phase) versus frequency.

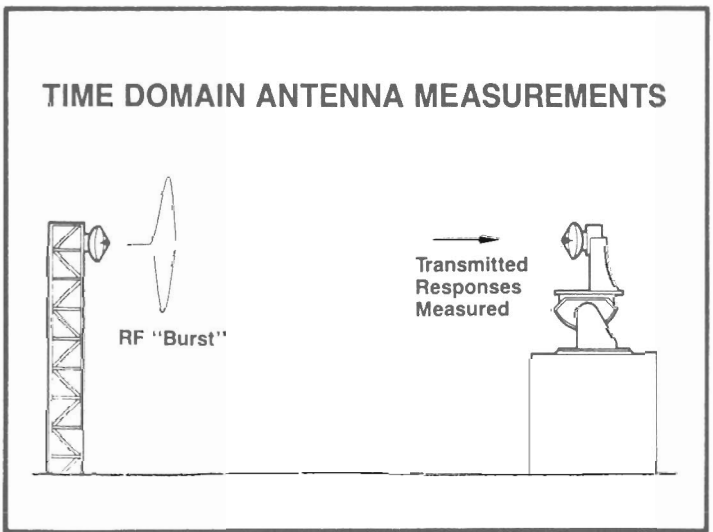

4487

As mentioned in the section on impedance measurements, the HP 8510 has the capability of calculating the antenna time domain response from the frequency domain data. Using the Time Band Pass mode, this gives the response of the antenna to a pulsed-RF signal (with an impulse shaped envelope).

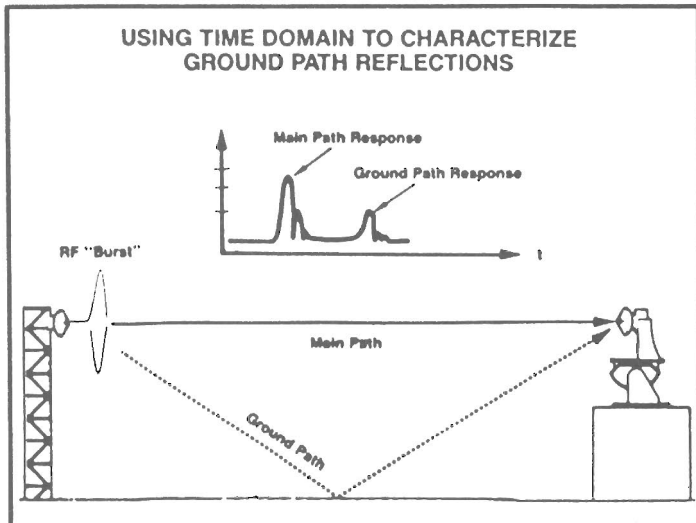

4488

The time domain response is very useful in determining the magnitude and location of ground path reflections, depending on the measurement bandwidth and the path differences involved.

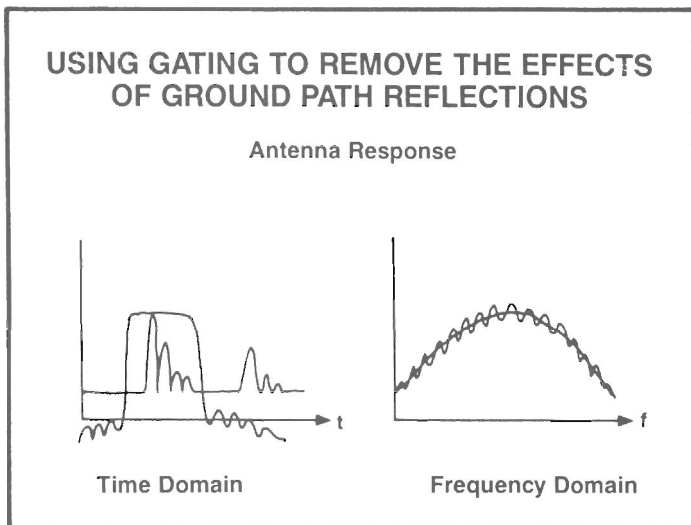

4489

Once ground path responses have been identified, the time domain gating feature can be used to remove their effects. A gate is a time filter that, when placed around the main path response, removes the effects of the responses outside the gate.

In the next section, a gating procedure is described for antenna measurements, and the limitations of applying the gating technique on an antenna range are discussed.

The gating procedure for antenna pattern measurements is to move the antenna positioner to fixed measurement positions and measure the broadband response. Gating is then applied, and the gated data are stored using an external computer. This is repeated until each antenna position is measured.

GATING PROCEDURE

1. Move Antenna to Desired Position
2. Measure Broadband (Swept) Response
3. Apply Gate and Save Gated Response
4. Move Antenna to Next Position and Repeat Measurement
5. When All Desired Positions Are Measured, Up to 401 Gated Patterns Can Be Plotted

4490

The overall measurement time for this procedure is high compared to that of a conventional CW measurement, which is a tradeoff with the reduction of ground path reflections that would otherwise distort the antenna pattern. However, the data collected during one rotation of the antenna is sufficient to plot antenna patterns at up to 401 frequencies (depending on the number of frequency points per trace that are measured). Also, gating can be done in a post-processing operation to speed up the actual data collection.

MEASUREMENT TIME

<u>Number of Points</u>	<u>Measurement Time per Sweep (STEP Sweep)</u>
51	2.8 sec
101	5.5 sec
201	11 sec
401	22 sec

Multiply the Measurement Time per Sweep by the Number of Antenna Positions to get Total Measurement Time.

4494

LIMITATIONS ON APPLYING GATING

- Reference Path Should be Free of Ground Path Reflections
- Use a Directional Antenna for Phaselock Reference

4495

EFFECTS OF GROUND PATH IN REFERENCE

- Limits the Use of Gating for the Test Path
- Test Antenna Pattern Can be as Clean as Reference Antenna at Boresight
- Example: With a -30 dB Reference Ground Path Level
Test Antenna Ground Path Level can be Reduced 30 dB Below its Main Path Level
 -30 dB Interference Signal Causes only ± 0.3 dB Uncertainty in Test Antenna Pattern

5310

This table lists the total measurement time per trace using the STEP SWEEP mode for a given number of frequency domain measurement points (exclusive of delay introduced by HP-IB extenders.) The total measurement time is obtained by adding the time per trace to the time to increment the positioner, and then multiplying the result by the total number of desired positioner settings.

The phaselock reference antenna in the long-distance configuration has an impact on the gating operation. A directional antenna (narrow beam, low sidelobes) should be chosen so that the reference signal is as free of ground path reflections as possible. The ground path signal level received by the reference antenna is determined by the amount that both source and reference antennas illuminate the ground, by the ground reflection properties, and by the additional $(1/R^2)$ loss in the ground path.

The ability to use gating to remove ground path reflections from the test path is influenced by the reflection level present in the reference path. In other words, the overall pattern of the test antenna can be made only as clean as the reference antenna pointed at boresight. However, this can still be a significant improvement.

For example, consider the case where both source and reference antennas have -15 dB sidelobes with the ground illuminated only by the sidelobes. The reference signal will therefore have a ground path level that is at least 30 dB below its main path level, which causes an error voltage of ± 0.3 dB. This indicates that gating can reduce the test antenna ground path level to be 30 dB below *its* main path signal level at each position. This can be a significant improvement, particularly when antenna sidelobes and nulls are measured. Considering only this effect of this error source, the resulting test antenna pattern overall uncertainty is only ± 0.3 dB.

BANDWIDTH LIMITATIONS

Antenna Bandwidth Determines the Time Domain Impulse Width

$$t_w = \frac{0.6}{\text{FSPAN (GHz)}} \text{ meters}$$

Wider Span Gives Narrower Pulse

4496

As illustrated in the previous discussion, the geometry of the antenna range plays an important part in the ability to use time domain to remove ground path reflections. In addition, antenna bandwidth is also an important parameter in determining whether time domain gating can be used on a particular range.

The impulse width of the time domain stimulus is determined by the measurement frequency span, with the maximum measurement span being determined by the antenna bandwidth. The wider the measurement bandwidth, the narrower will be the impulse width. This formula describes the Normal relationship between the Time Band Pass impulse width and the measurement frequency span (GHz).

REQUIRED PATH SEPARATION

- To Be Able to Use Gating, the Difference Between the Main Path and the Ground Path Must be Greater Than Several Impulse Widths
- This Establishes a Minimum Frequency Span

4491

To be able to apply gating in antenna measurements, the difference between the main path and bounce path reflections must be greater than the main path impulse response of the antenna to allow both responses to be resolved. In the limit, this means that the path difference should be at least one impulse width as given by the previous formula, but preferably the difference should be much greater.

WHY SEVERAL IMPULSE WIDTHS?

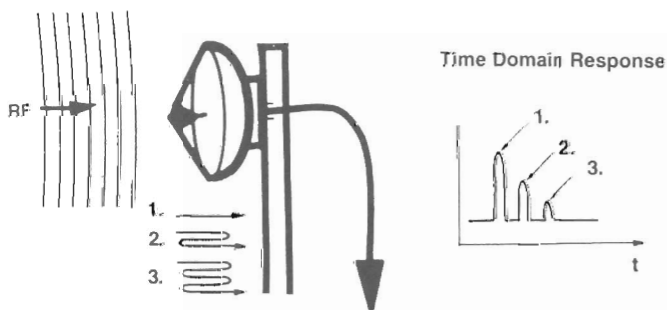

Many Antennas Have Multiple (Reflected) Paths in Their Time Domain Response

4493

The reason that a path difference of several impulse widths is desirable is that often antennas will have multiple paths in their transmission time domain responses due to internal reflections. The energy in these responses is a part of the antenna characteristic and should be retained for the measurement to be valid. Therefore, it is the duration of the antenna impulse response that determines whether gating can be used. The ground path reflections must be separated far enough in time so that no overlap occurs between the antenna impulse response to the main path signal and to the ground path signal.

PATH DIFFERENCE FORMULA

Path Difference

$$\Delta = \sqrt{R^2 + (2H)^2} - R$$

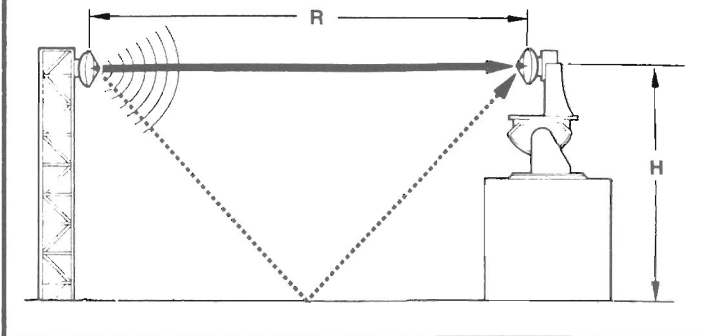

4492

The difference between the main path and ground path can be determined using this formula (for equal heights and a flat ground contour).

TIME DOMAIN RESPONSE WHERE GATING CAN BE APPLIED

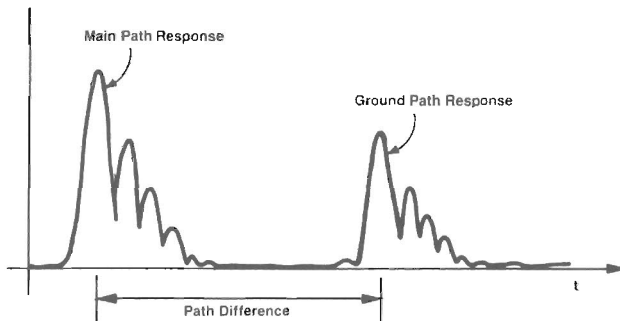

5308

This slide illustrates a situation where the difference between the antenna main path and ground path is sufficient to allow both responses to be viewed. Therefore, gating can be used to remove the ground path response.

GATING EXAMPLE

For an Outdoor Range Where

$R = 700 \text{ Ft (231 m)}$, $H = 65 \text{ Ft (21.5m)}$

Path Difference $\Delta = \sqrt{R^2 + (2H)^2} - R$

$$\Delta = 4.0\text{m}$$

Let the Impulse Width, tw , be $\frac{1}{5} \Delta$.

$$\text{FSPAN (GHz)} = 0.6/tw = 0.6/\frac{1}{5} (4)$$

$$\text{Minimum FSPAN} = 750 \text{ MHz}$$

4497

To illustrate, consider an outdoor antenna range where the antennas are at a height of 65 Ft with a separation of 700 Ft. From the path difference formula, the separation between the main path and ground path is 12 Ft (4m). Applying a criterion that this separation should be greater than 5 impulse widths to allow for multiple reflections in the antenna impulse response, the minimum frequency span can be calculated to be 750 MHz.

Therefore, antennas with a measurement bandwidth of 750 MHz and greater can be measured on this antenna range and the time domain gating technique applied to remove the effects of ground path reflections.

ANTENNA "ALIAS-FREE RANGE"

Finite Sampling in the Frequency Domain
Causes Repetitions in the Time Domain (A
Consequence of Discrete Signal Processing)

$$\text{Alias Free "Range"} = 1/\Delta F = \frac{\# \text{ Points} - 1}{\text{FSPAN}} \times 3 \times 10^8$$

Must be Greater Than the Difference
in the Main Path and the Ground Paths

This Establishes a Maximum Frequency Span

4498

ALIAS-FREE RANGE ($=1/\Delta f$)

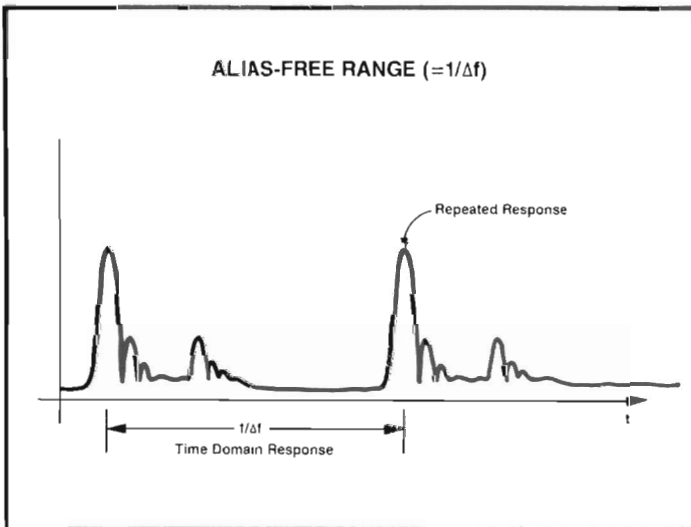

5309

ANTENNA "RANGE" EXAMPLE

In the Previous Example, $\Delta = 4.0\text{m}$;

Let # of Points = 201

Let Alias-Free Range = $5 \Delta (= 20 \text{ m})$

$$20 \text{ m} = \frac{201 - 1}{\text{FSPAN}} \times 3 \times 10^8$$

$$\boxed{\text{Maximum FSPAN} = 3.0 \text{ GHz}}$$

4499

The previous discussion showed that there is a minimum frequency span, determined by the range geometry and the antenna impulse width, over which an antenna can be measured and gating applied to remove ground path reflections. There also exists a maximum frequency span that can be used that is determined by a signal processing phenomenon called the "alias-free range."

A consequence of the HP 8510 making measurements at discrete frequencies is that repetitions of the time domain response occur that are analogous to the pulse repetition of conventional radars.

The separation between these repetitions is called the "alias-free range" and is equal to $1/\Delta f$, where Δf is the spacing between frequency domain data points. It therefore is directly proportional to the number of frequency data points and inversely proportional to the measurement span.

These response repetitions are of little consequence unless they overlap with unwanted ground path responses. When this occurs, gating cannot be used to remove the unwanted responses.

In the previous example, the path difference, Δ , was calculated to be 4m. To allow any significant ground path responses to arrive between response repetitions, a criterion is established that the alias-free range must be greater than 5Δ . Therefore, using 201 frequency domain data points, the maximum measurement span is calculated to be 3.0 GHz. Increasing the number of points to 401 increases the maximum span to 6.0 GHz.

To summarize, range geometry, antenna bandwidth and impulse response width, and the alias-free range criteria (established by the user) all determine the limits within which gating can be applied to remove the effects of ground path reflections. In this example, gating can be used on the range described for antennas measured with frequency spans between 750 MHz and 6.0 GHz.

V. MEASUREMENT EXAMPLES

This section contains several examples of antenna measurements made using the configurations described in this note.

(All antenna patterns that follow were generated using an external computer. All frequency and time domain plots were generated by the HP 8510A.)

5000

CW PATTERN OF A 3 Ft DISH ANTENNA
MEASURED AT 4 GHz USING HARMONIC MIXERS

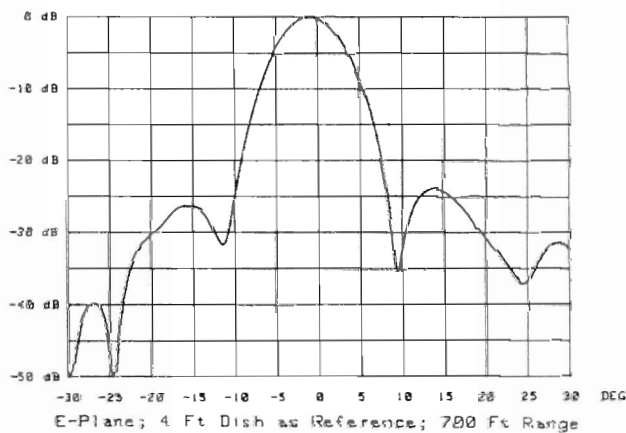

This is a conventional CW antenna pattern of a 3 Ft dish antenna at 4 GHz measured on a long-distance (700 Ft) outdoor antenna range using the remote phase-lock configuration. (The radiated reference signal was obtained using a 4 Ft dish antenna.)

5001

FREQUENCY DOMAIN RESPONSE
OF A DIPOLE ANTENNA

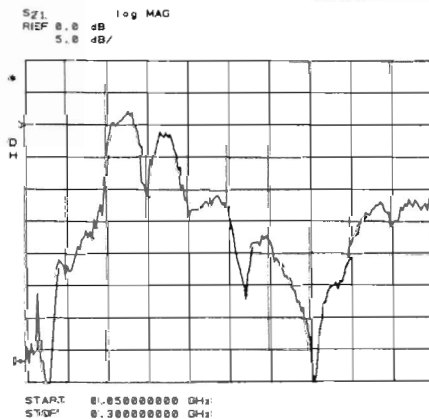

Measured Using The Short-Distance Range Configuration

As an example to illustrate the improvements that can be obtained using gating, a dipole antenna was measured¹ on a short-distance outdoor antenna range over the frequency span of 50 to 300 MHz. This shows the frequency domain log magnitude response. The large amount of ripple in the response indicates the presence of a strong ground path interference signal.

5002

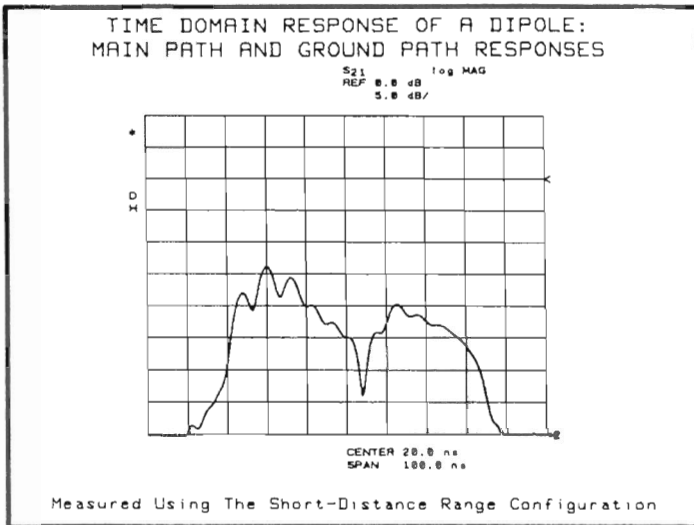

5003

The time domain response of the dipole has two signals that are similar in shape but are separated by 33 ns in time and by 6 dB in amplitude. The first response is the main path signal and the second is the ground path signal.

The distributed nature of the antenna time domain response demonstrates why a path separation of several impulse widths (as determined by the measurement span formula) is often required to obtain adequate path separation to use gating.

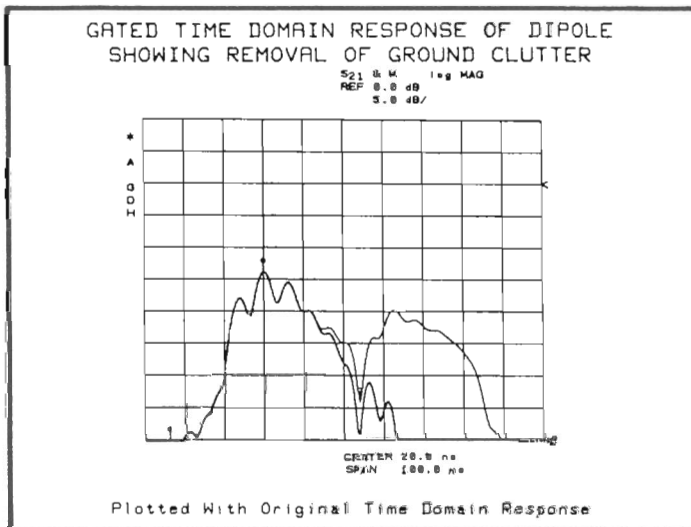

5004

Because there is adequate separation between the main path and ground path time domain responses to separate the two signals, the gating feature can be applied to remove the ground path response.

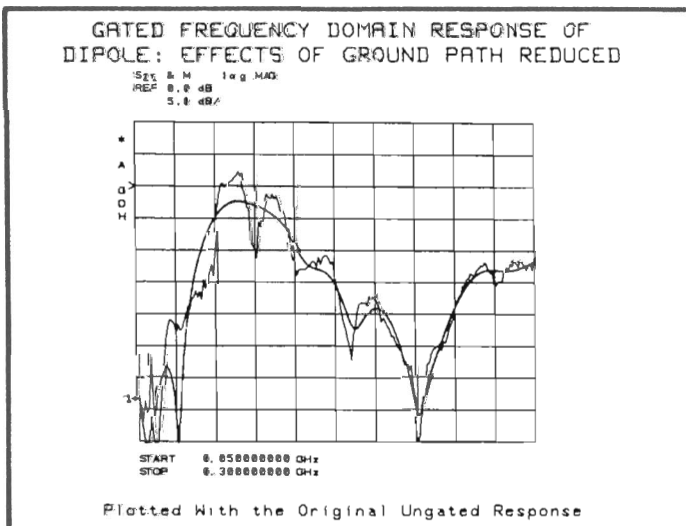

5092

The gated frequency domain response (smooth trace) shows a significant reduction in the ripple that was caused by the ground path interference signal that now has been removed.

The following series of antenna patterns show the effect of the ground path interference signal on the dipole antenna pattern and the improvements that occur using gating.

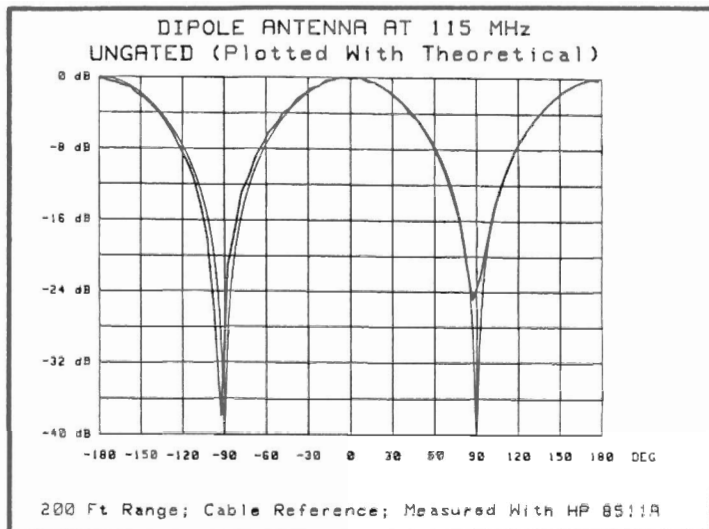

5093

This is the un gated antenna pattern at 115 MHz, plotted together with the theoretical dipole radiation pattern. At this frequency, there is fairly close agreement between the two patterns, which shows that even with a high level of ground reflection present, the geometry of the range can be such that the interference at some frequencies will be slight.

However, a noticeable lack of symmetry exists in the measured pattern that is caused by the ground path reflection.

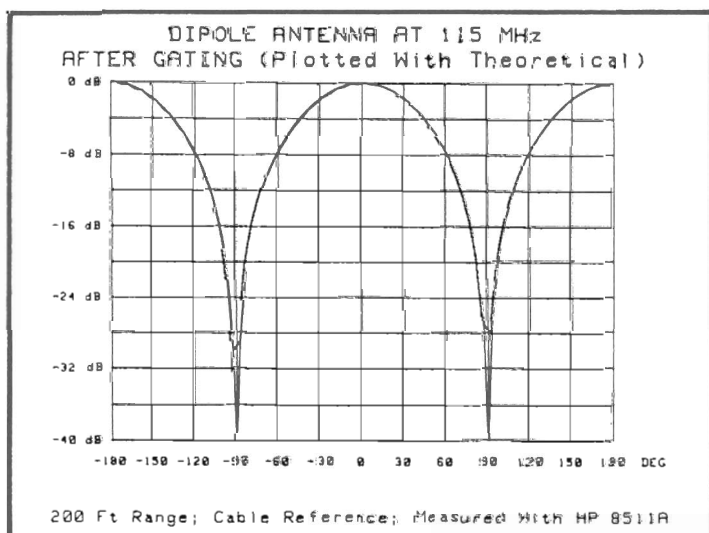

5094

After gating applied to the same measured data to remove the ground path response, the result is a very symmetrical antenna pattern that very closely matches the theoretical dipole pattern.

(Because the antenna was aligned manually and data was taken at 5 degree increments, the -90° and $+90^\circ$ angles were not actually measured, which is the reason for the disagreement at those angles.)

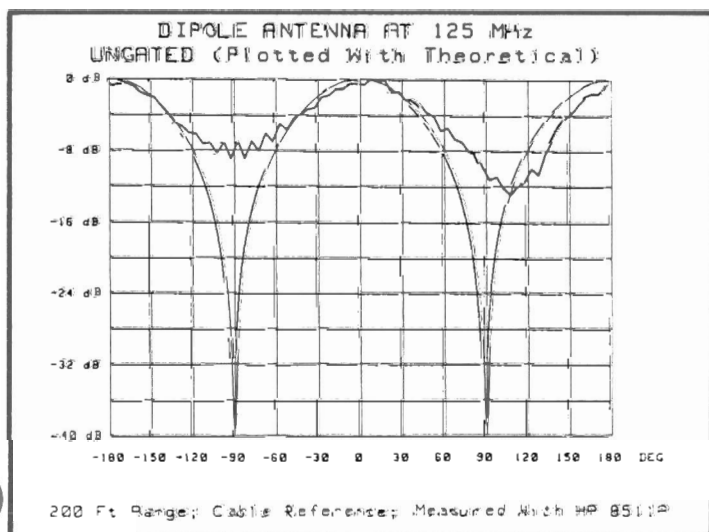

5095

As mentioned, with the gating technique, the data collected with one antenna rotation is sufficient to plot patterns over the full measurement frequency span, in this case from 50 to 300 MHz.

At 125 MHz, which is only a 10% increase in frequency, the distortion of the dipole pattern due to ground path interference is much more severe. (This demonstrates how techniques to cancel out ground path interference by modifying range geometry are inherently narrowband.) The high level of ground path reflection severely limits the ability to measure the nulls of the antenna pattern.

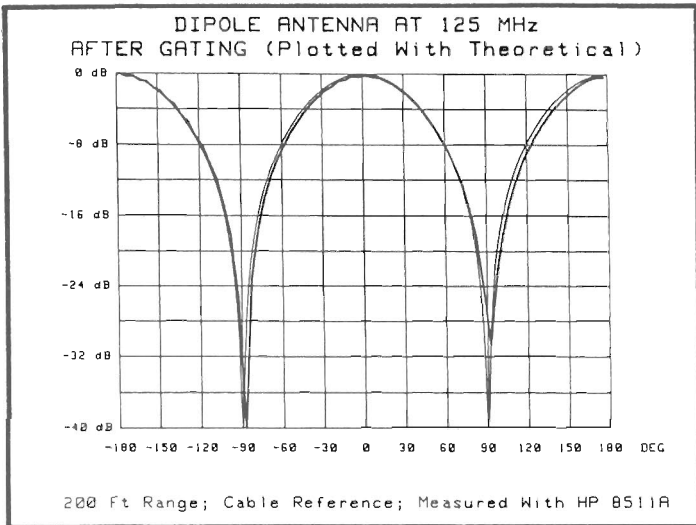

5096

After gating is applied to the same measured data, the dipole pattern is significantly improved, particularly at the antenna nulls. This is an extreme example that is used to illustrate the power of the gating technique in removing the effects of very large ground path interference signals.

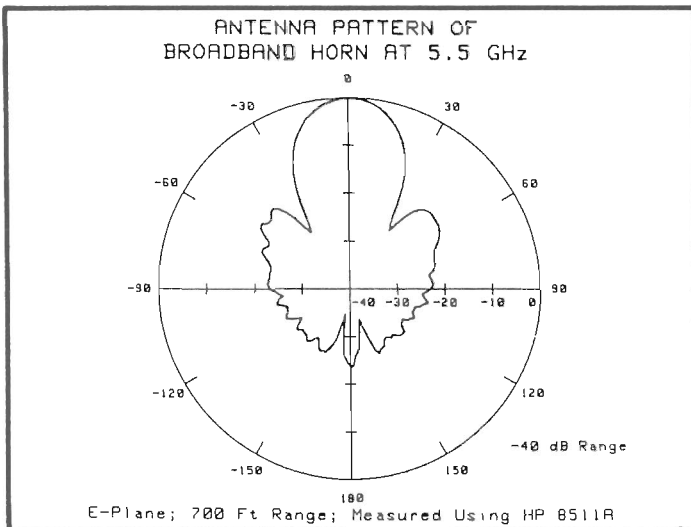

5097

As an example of the long-distance configuration using the HP 8511A, this antenna pattern of a broadband horn antenna was measured at 5.5 GHz on a 700 Ft outdoor range. A 4 Ft dish antenna was used for phase-lock reference. The lack of symmetry in the CW radiation pattern indicates a low-level ground path reflection.

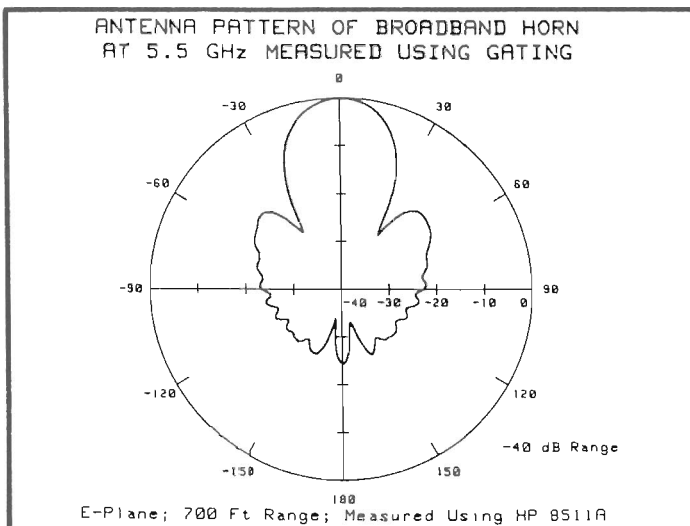

5098

After gating is applied to remove the ground path reflection, a very symmetrical antenna pattern results.

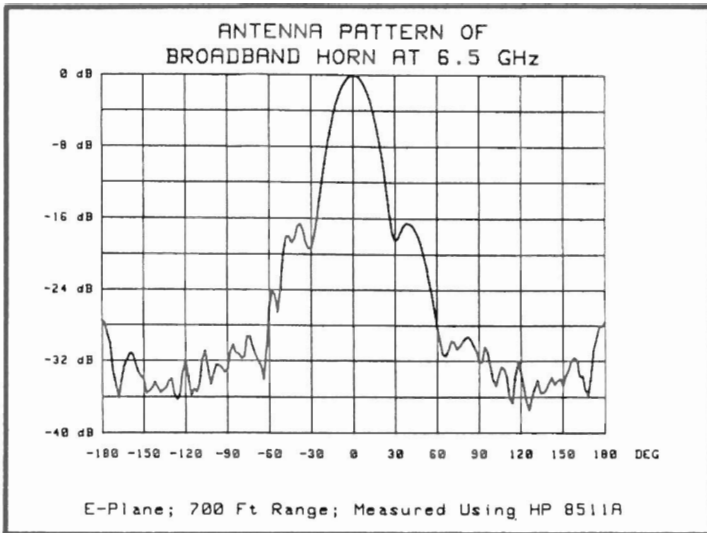

5099

A similar effect is observed in a rectangular plot of the horn antenna at 6.5 GHz. This is the same antenna and the same data, only at a different frequency. The interference of the ground path reflection is observed in the left sidelobe.

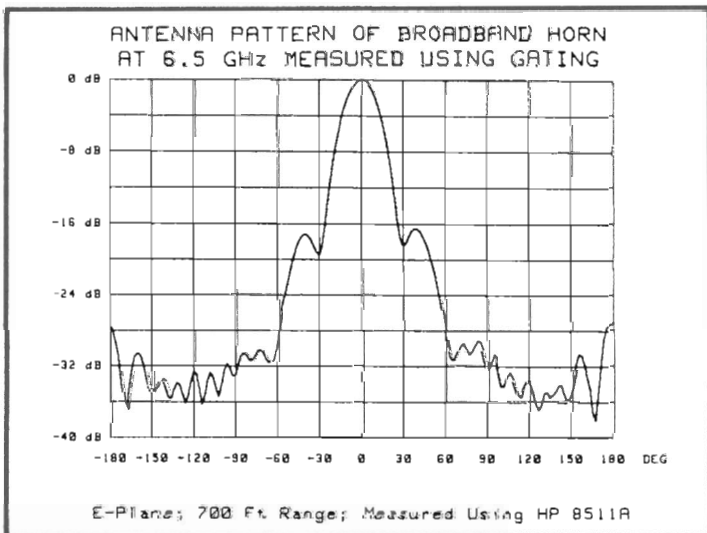

6000

After gating is applied, the interference is removed, and a very symmetrical pattern results.

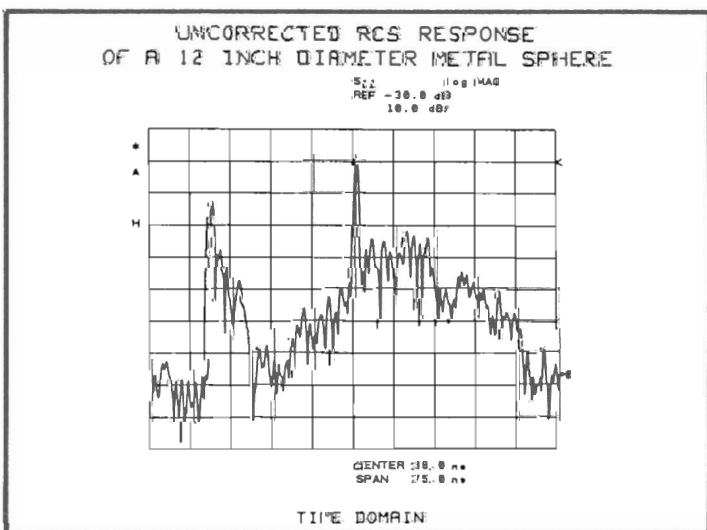

6001

As an example of radar cross-section measurements^{2,3}, consider this time domain response of a 12 inch diameter metal sphere. The large response at the center is the reflection due to the sphere. The large response at the left is due to leakage between the transmit and receive antennas. Other spurious reflected responses are present as well.

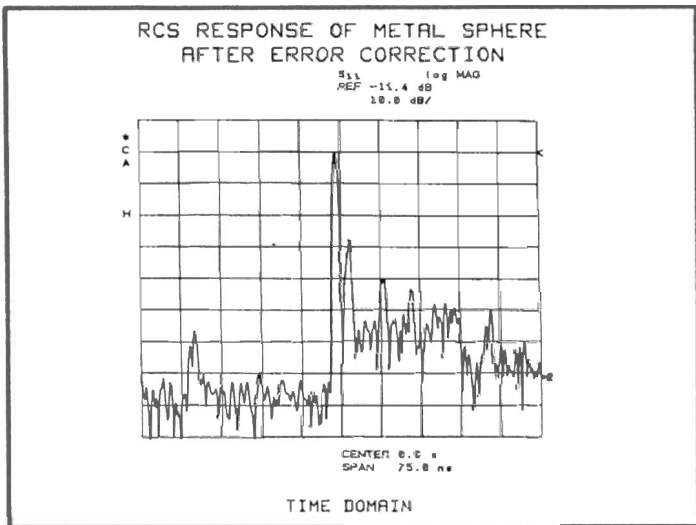

6002

Because an RCS response is a reflection measurement, it is possible to apply vector error-correction to remove the effects of systematic measurement errors. After applying error-correction procedures described in product note 8510-2, the leakage signal and other spurious responses are significantly reduced and the responses of the sphere are more clearly visible. Further improvement is possible using gating.

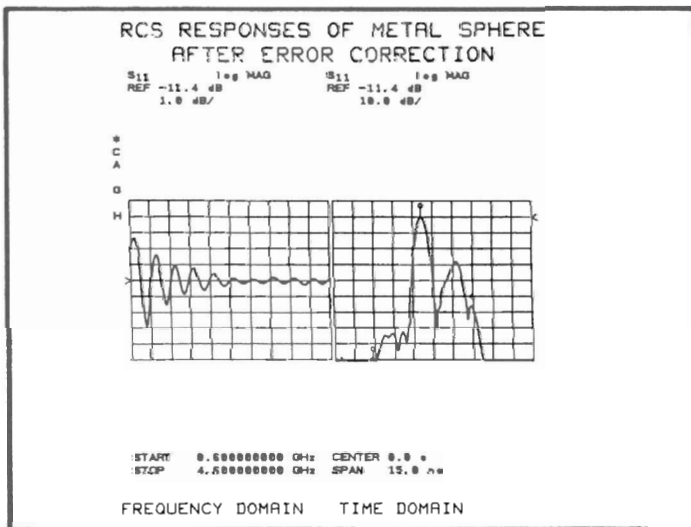

6003

These RCS responses of the sphere, that are very close to the theoretical responses, are obtained after both error correction and gating are applied.

REFERENCES:

1. J. W. Boyles, "Measuring a Dipole Antenna Radiation Pattern Using Time Domain and Gating," *RF Design*, vol. 8, no.9, September, 1985, pp. 44-52 (reprints available, HP literature number 5954-1551).
2. J. W. Boyles, "Recruit an ANA for RCS Tests," *Microwaves & RF*, vol. 24, no. 3, March 1985, pp. 87-92.
3. Hewlett-Packard Co., "Radar Cross-Section Measurements With the HP 8510 Network Analyzer," Product Note No. 8510-2, April 1985 (HP literature no. 5954-1522).

