

MEASURING COMPLEX PERMITTIVITY AND PERMEABILITY AT RF AND MICROWAVE FREQUENCIES

Bob Dildine
Yokogawa Hewlett-Packard
29-21, Takaido-Higashi 3-Chome,
Suginami-ku, Tokyo, 168 Japan

RF & Microwave
Measurement
Symposium
and
Exhibition

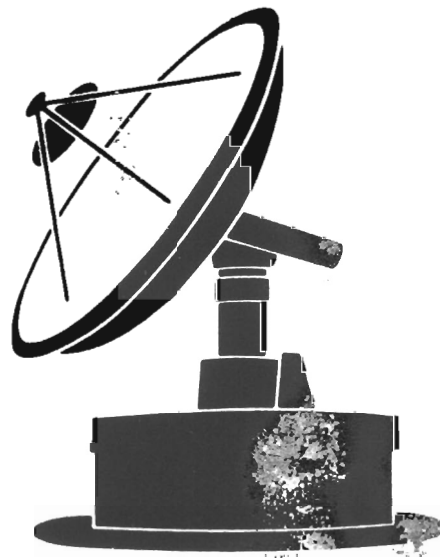

ABSTRACT

This paper concerns the measurement of complex permittivity and permeability in bulk materials at high frequencies. A survey of common measurement methods is presented, with a discussion of the strengths and weaknesses of each technique. A short discussion of measurement errors and uncertainties is included.

AUTHOR

Bob Dildine , R&D Engineer, HP Network Measurements Division, Santa Rosa, Ca. BS Electrical Engineering (1967), San Diego State College and MS Electrical Engineering and Computer Science (1973), University of California, Berkeley. The author has been with HP since 1973, and has spent most of his career as a member of the R&D team developing the HP 8510 microwave network analyzer. In 1980 he became project manager for the HP 8511-8515 test sets for the HP 8510, and was involved with the extension of the HP 8510 to millimeter-wave frequencies. He is currently on assignment at YHP's Project Center in Japan, where his research includes high-frequency techniques for measuring permittivity and permeability in bulk materials.

MEASURING COMPLEX PERMITTIVITY AND PERMEABILITY AT RF AND MICROWAVE FREQUENCIES

AUTHOR:

Bob Dildine
Yokogawa

Hewlett-Packard

29-21 Takado-Higashi 3-Chome,
Sagami-ku, Tokyo, 160 Japan

**RF & MICROWAVE
MEASUREMENT
SYMPOSIUM
AND
EXHIBITION**



8371

In this paper, common methods of measuring the complex permittivity and permeability of dielectric materials at RF and microwave frequencies will be discussed. Accuracy considerations will be discussed and an error analysis will be performed for the S-parameter method. Methods of making measurements on superconductors will not be covered.

➔ Applications
Material Properties
Measurement Methods
Sources of Error
Summary

8372

We will start off with a discussion of the reasons to measure the electrical properties of materials, and quickly review the definitions of these electrical properties. Next, we'll survey the most common methods of measuring the electrical properties of materials, including their advantages and disadvantages. We'll conclude with a brief discussion of measurement errors.

Let's begin, then, with the reasons one might want to measure the electrical properties of materials.

REASONS TO MEASURE ELECTRICAL PROPERTIES OF MATERIALS

-- Facilitate Design and Modeling

- Substrates
- Filter materials
- Magnetic cores
- Absorber materials
- RF losses
- Packaging materials
- Microwaveable food

8373

Materials are used in a wide variety of applications in electricity and electronics. Some applications include insulators, magnetic cores, substrates, absorbing materials for electromagnetic energy, and packaging materials. Most applications require that the material properties be accurately known in order to properly design the material into its intended application. Examples are knowing the permittivity of an insulator that will be used as the dielectric of a capacitor, or the permeability of a magnetic core for an inductor. Another example would be knowing the losses of a plastic that might be intended as a food packaging material for microwave cooking.

REASONS TO MEASURE ELECTRICAL PROPERTIES OF MATERIALS

-- Process Control

- Food processing
- Chemical processing

-- Material Analysis

8374

Applications

- ➔ Material Properties
- Measurement Methods
- Sources of Error
- Summary

ELECTRICAL PROPERTIES OF MATERIALS

-- Resistivity

The degree to which the material resists current flow

-- Permittivity

The degree to which the material concentrates an electric field

-- Permeability

The degree to which the material concentrates magnetic flux

8375

6

Other reasons to measure the electrical properties of materials might be to monitor manufacturing processes, such as the progress of cooking large batches of food products or determining the point at which a food is completely frozen. (A significant change in permittivity takes place as the last of the liquid water is frozen.)

The analysis of new materials also often requires the accurate measurement of their electrical properties.

Let us now review some basic definitions of the electrical properties of materials.

The major electrical properties of materials that are of interest to the electrical engineer are resistivity (or conductivity), permittivity, and permeability. The engineer may also be interested in how these quantities vary with orientation in the material, or their temperature coefficients.

The resistivity of a material is the degree to which it resists current flow. High resistivity is important for insulating materials, and low resistivity (high conductivity) is important for conductors.

Permittivity is the degree to which a material concentrates an electric field. A knowledge of permittivity is necessary in determining the appropriate materials to be used as dielectrics (as in a capacitor, for example).

Permeability is the degree to which a material concentrates a magnetic field, and is important in choosing proper core materials for inductors.

Permittivity and permeability together determine the velocity of propagation of electromagnetic energy through a material, and both are important for designing transmission lines, resonators, and understanding propagation in general.

RESISTIVITY

-- Determined by measuring the resistance of a material sample

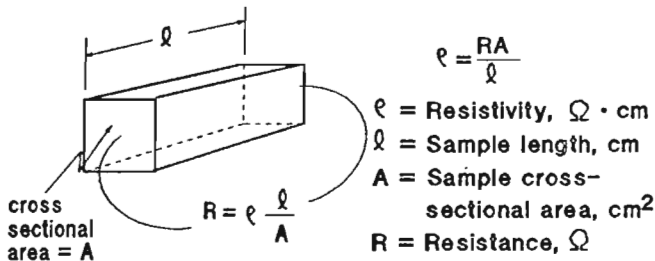

-- Usually a DC measurement

8376

Resistivity at DC can easily be determined by measuring the resistance of a sample of known cross sectional area and length. At RF and microwave frequencies the sample can be made part of a resonator and its Q measured. From these measurements, the circuit resistance is calculated and thus the resistivity of the material.

The subject of resistivity will not be discussed further in this paper.

COMPLEX PERMITTIVITY

Area of plates = A

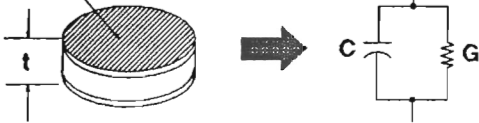

Capacitance, $C = C_0 \epsilon'$

where $C_0 = \frac{A}{t}$

ϵ' = permittivity of the dielectric material

Loss in the dielectric is represented by conductance G

8377

All practical dielectric materials have some loss associated with them, and this loss can be represented as *complex permittivity*. Consider a parallel plate capacitor as shown in the diagram. Assuming no losses in the capacitor plates, losses in the dielectric material can be represented as a conductance, G in parallel with the capacitor. Let C_0 represent the capacitance of an equivalent capacitor with no dielectric (a vacuum). The capacitance with the dielectric is $C = C_0 \epsilon'$, where ϵ' is the real part of the complex permittivity. (Von Hippel, p. 4)

COMPLEX PERMITTIVITY

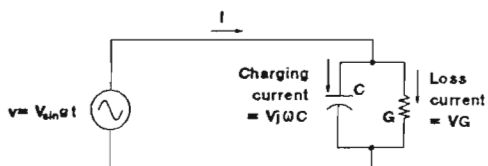

$$I = V[j\omega C + G] = V[j\omega C_0 \epsilon' + G]$$

$$\text{Let } G = \omega C_0 \epsilon''$$

$$\therefore I = V[j\omega C_0 \epsilon' + \omega C_0 \epsilon'']$$

$$= V[j\omega C_0 (\epsilon' - j\epsilon'')]$$

ϵ' accounts for charging current

ϵ'' accounts for loss current

8378

When the capacitor is placed across an AC voltage source, the current drawn is made up of two components in quadrature, the charging current, $jV\omega C$ and the loss current, VG . If the imaginary component of permittivity, ϵ'' is defined such that $G = \omega C_0 \epsilon''$, it is seen that the total current in the circuit is given by $I = V[j\omega C_0 (\epsilon' - j\epsilon'')]$. Therefore the real part of the permittivity, ϵ' accounts for the charging current and the imaginary part, ϵ'' accounts for the loss current.

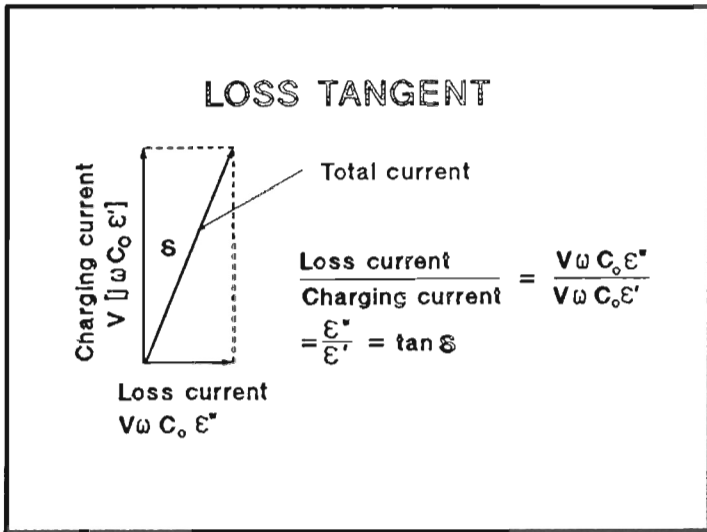

8379

Material losses are usually described in the form of the *loss tangent*, which is the ratio of the loss current to the charging current or simply the ratio ϵ''/ϵ' . This is commonly called $\tan \delta$ where δ is the complement of the power factor angle of the circuit. Note that for low loss materials, δ is very small and $\tan \delta$ is very nearly equal to δ . A convenient unit for the loss tangent of low loss materials is micro-radians. (Afsar, 1986)

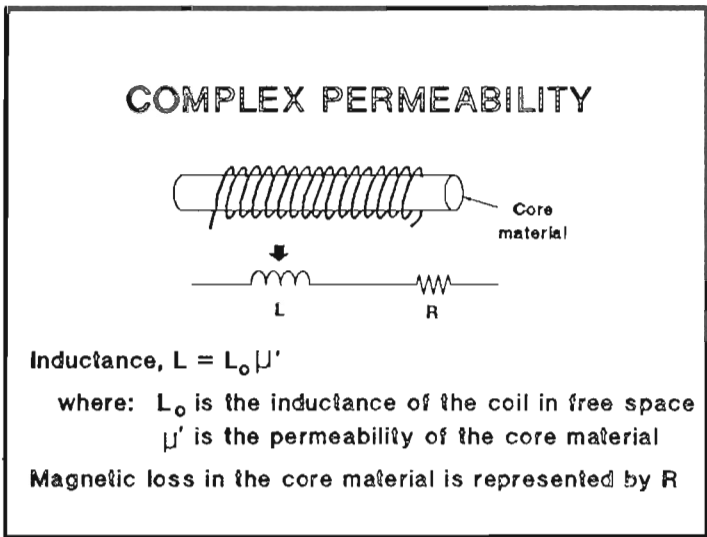

8380

A similar analysis can be performed on an inductor with core losses to represent losses in a magnetic material in the form of *complex permeability*.

Consider an inductor as shown in the diagram. Assuming no losses in the windings, the core losses can be represented by a resistance in series with the inductance. Let L_o represent the inductance of the coil with no core material (a vacuum). The inductance with the core material is $L_o \mu'$ where μ' is the real part of the core material's complex permeability.

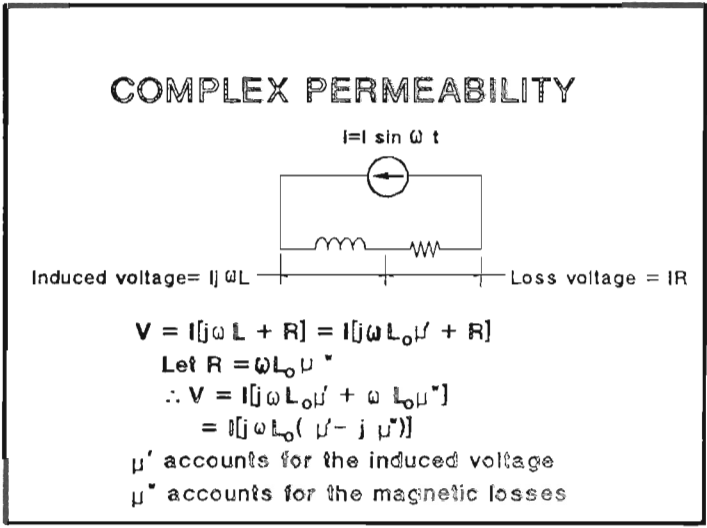

8381

When the inductor is placed in series with an AC current source, the voltage appearing across the inductor is made up of two components in quadrature, the induced voltage and the loss voltage. If the imaginary component of the permeability is defined such that $R = \omega L_o \mu''$, it is seen that the total voltage across the inductor is given by $V = I[j\omega L_o (\mu' - j \mu'')]$. Therefore the real part of the permeability, μ' accounts for the induced voltage and the imaginary part, μ'' accounts for the loss voltage. (Von Hippel, p. 5)

As in the case of permittivity, the losses in a magnetic material are usually expressed in terms of the loss tangent, $\tan \delta = \mu''/\mu'$.

RELATIVE PERMITTIVITY

$$k^* \equiv \frac{\epsilon^*}{\epsilon_0} = k' - j k''$$

$$\begin{aligned}\epsilon_0 &= \text{permittivity of free space} \\ &= \frac{1}{36\pi} \times 10^9 \text{ Farad/meter} \\ &= 8.854 \text{ pF/meter}\end{aligned}$$

8382

A useful quantity is relative permittivity, the ratio of the material's permittivity to the permittivity of free space.

The permittivity of free space is $10^{-9}/(36\pi)$ Farads per meter or about 8.854 pF per meter.

RELATIVE PERMEABILITY

$$k_m^* \equiv \frac{\mu^*}{\mu_0} = k_m' - j k_m''$$

$$\begin{aligned}\mu_0 &= \text{permeability of free space} \\ &= 4\pi \times 10^{-7} \text{ Henry/meter} \\ &= 1.257 \mu\text{H/meter}\end{aligned}$$

8383

Relative permeability, the ratio of a material's permeability to the permeability of free space, is also commonly used.

The permeability of free space, μ_0 is $(4\pi)10^{-7}$ Henries per meter or about 1.257 micro-henries per meter.

Applications

Material Properties

➔ Measurement Methods

Sources of Error

Summary

8372C

Now some of the common methods of measuring permittivity and permeability at RF and microwave frequencies will be discussed.

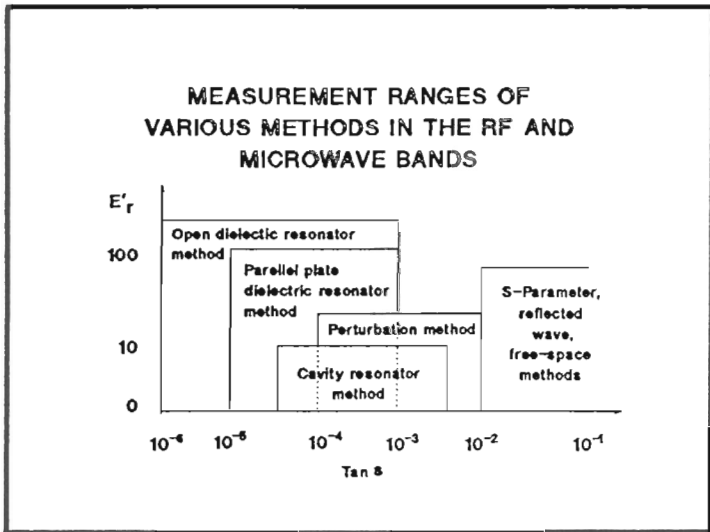

8384

There are many ways to measure the electrical properties of materials and this chart shows the methods that will be discussed in this paper and the relative ranges of permittivity and loss tangents for which each method is optimum. It should be noted that to determine complex permittivity or complex permeability, two independent quantities such as magnitude and phase must be measured. To determine both permittivity and permeability, four independent quantities must be measured.

DESTRUCTIVE

- Sample must be specific shape
- Machined to tight tolerances
- Cannot be used after measurement

8385

Some methods require that the material sample be machined or formed into a specific size or shape, and after the measurement has been made the material sample cannot be used for its original purpose. These methods are called *destructive* test methods.

NON DESTRUCTIVE

- Material can be measured in its raw form
- Can be used after it is measured

8386

Non-destructive test methods allow the material to be measured in its raw form and the sample can be used after it has been measured. These methods are particularly useful in production environments as quality control procedures or as incoming inspection procedures.

PARALLEL PLATE FIXTURE

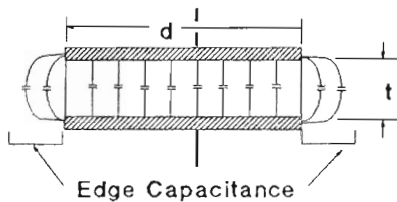

$$C_{\text{edge}} = (0.029 - 0.058 \log t) \times \pi \times (d + t)$$

C_{edge} : Edge capacitance, pF

t : Sample thickness, cm

d : Sample diameter, cm

(Electrodes are very thin compared to the dielectric)

8387

Perhaps the simplest and most straight forward way to measure a material's permittivity is to make a simple *parallel plate capacitor* from it and measure its capacitance. From the capacitance and dissipation factor, the complex permittivity is calculated. A significant source of error is due to the electric field at the edges of the capacitor that is not contained in the material sample.

The capacitance due to this edge effect can be calculated and it is recommended that this correction be applied to results obtained by this method. An alternative would be to use guarded electrodes so that the measured capacitance is not affected by the edge effect. (Von Hippel, p. 51)

CALCULATING PERMITTIVITY FROM CAPACITANCE & DISSIPATION FACTOR

$$k = \frac{\epsilon(C_p - C_{\text{edge}})}{A\epsilon_0} \quad (\text{for } D \ll 1)$$

$$k' = \frac{\epsilon(C_p - C_{\text{edge}})}{A\epsilon_0}$$

$$k'' = \frac{D\epsilon(C_p - C_{\text{edge}})}{A\epsilon_0}$$

C_p is the measured capacitance of the sample in the fixture

D is the measured dissipation factor

8388

These are the equations for calculating the complex relative permittivity from the parallel plate method.

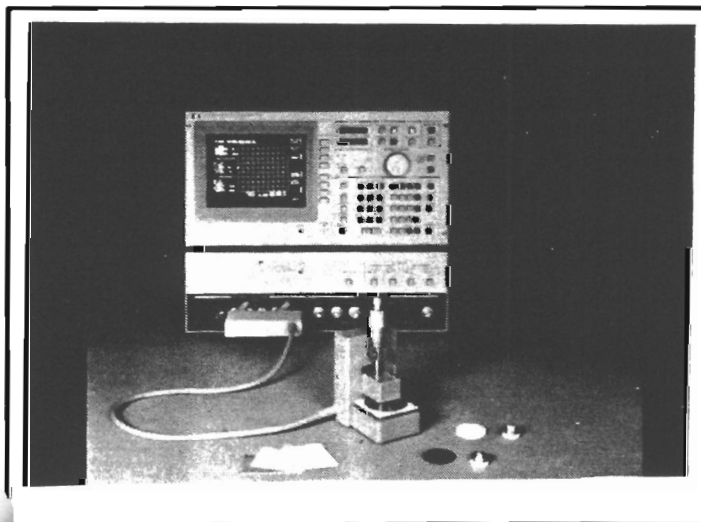

8389

The Hewlett-Packard model HP16451B test fixture combined with the HP4194A LCR meter provides a convenient method for making complex permittivity measurements from 5 Hz to 15 MHz. The HP16451B test fixture is constructed so as to eliminate the effects of fringing fields at the edges of the electrodes and has a built in micrometer to accurately measure the thickness of the material sample.

PARALLEL PLATE FIXTURE

Advantages

- Good for low frequency
(A few Hertz up to about 15 MHz)
- Simple math
- Readily available instrumentation
(HP 4194A/HP 16451B)

8390

PARALLEL PLATE FIXTURE

Disadvantages

- Not useful for high frequencies
(Above about 15 MHz)
- Measures permittivity only
- May be destructive

8391

The parallel plate fixture offers a convenient commercially available method for making permittivity measurements from a few hertz up to 15 MHz. Although commercial solutions are not readily available above 15 MHz, by combining a parallel plate fixture with a resonator, measurements can be made up to several hundred MHz. (Von Hippel, p. 59)

The math associated with this method is relatively simple and straight forward.

The Hewlett-Packard model HP16451B test fixture and the model HP4194A LCR meter provide an excellent commercially available solution for these measurements.

However, there are some disadvantages to the parallel plate method:

- * Frequency is limited to about 15 MHz, since at higher frequencies the edge effects become difficult to deal with and equipment to make precise measurements is not commercially available.
- * This method only measures permittivity.
- * Depending upon the raw state of the material, it may have to be prepared into sheets to be measured, making this method a destructive one.

REFLECTED WAVE METHOD

S_{11} measurement of the material in an open and shorted transmission line

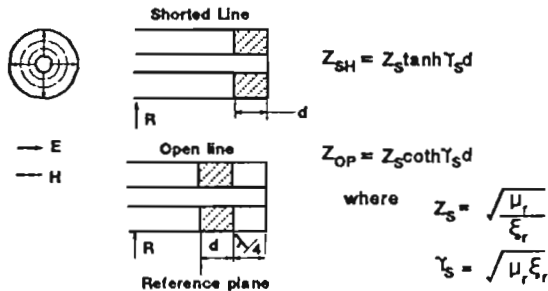

8392

The *reflected wave* method offers a means of measuring both the permittivity and permeability of a material at frequencies higher than is convenient with the parallel plate fixture. The material is put into a transmission line and the impedance of the air-to-material interface is measured. For a finite sample length, the complex reflection coefficient of the material is first measured with the sample terminated with an open circuit and then with a short circuit. From these two independent measurements, the complex permittivity and permeability is calculated. (Von Hippel, p. 67)

The sample holder can be a coaxial transmission line or waveguide. The open circuit can be replaced by a short circuit offset by one quarter wavelength. If the sample is known to have a permeability of one, only one measurement with the sample terminated in a short is necessary, thus simplifying the fixture.

REFLECTED WAVE METHOD

Advantages

- One port measurement
- Simple fixtures
 - Waveguide or coax
 - Easy fixtures for liquid
- Good for high frequencies where a long electrical length is easy to handle
- Relatively simple math for single frequency

8393

The reflected wave method only requires a one port measurement and the fixtures are relatively simple. Liquids can be accommodated by making the transmission line vertical so that the sample liquid can be poured into it.

This method is also especially good for high frequencies where a long electrical length is easy to handle.

The calculations for determining the material properties from the reflection measurements are relatively straight forward for single frequency measurements.

REFLECTED WAVE METHOD

Disadvantages

- Destructive
- Not good for low frequencies where electrical length becomes too long
- Complex math for multiple frequencies

8394

However, the reflected wave method is destructive for solid samples and the sample must fit the transmission line fixture precisely.

The length of the sample should be more than about 20° (electrical), so measurements at low frequencies require long samples for low permittivity material. For example 20° at 50 MHz for a permittivity of 2 is about 24 cm.

The method can be used over a broad frequency range with one setting of an offset short, but the math becomes more difficult. At frequencies where the short's offset is near $1/2$ wavelength the accuracy is degraded because a half wave offset short looks like a flush short and there are no longer two independent measurements.

S-PARAMETER METHOD

S_{11} and S_{21} of a sample in a transmission line are measured

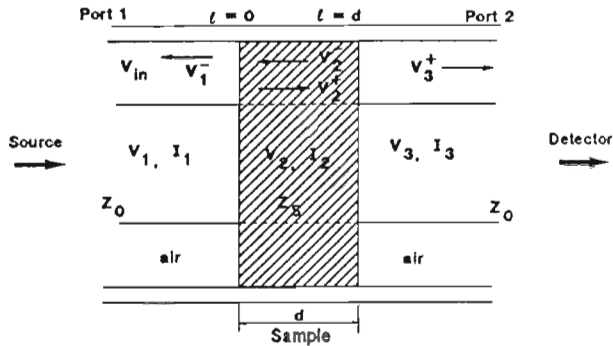

8395

The *S-parameter* method is similar to the reflection method but instead of measuring the sample's reflection coefficient with two different terminations, its reflection coefficient and transmission coefficient (S_{11} and S_{21}) are measured.

Best accuracy is obtained when the sample is $1/4$ wavelength long at the frequency of interest, but the method works well over a very broad frequency range.

S-PARAMETER METHOD

$$S_{11}(\omega) = \frac{(1 - T^2)\Gamma}{1 - T^2\Gamma^2} \quad S_{21}(\omega) = \frac{(1 - \Gamma^2)T}{1 - T^2\Gamma^2} \quad [1]$$

where Γ is the reflection coefficient between Z_0 and Z_s when the length of materials is infinite ($l = \infty$); and

$$\Gamma = \frac{Z_s - Z_0}{Z_s + Z_0} = \frac{\sqrt{\frac{\mu_r}{\epsilon_r}} - 1}{\sqrt{\frac{\mu_r}{\epsilon_r}} + 1} \quad [2]$$

The term T is the transmission coefficient in the materials (of finite length) and can be written:

$$T = \exp(-j\omega\sqrt{\mu\epsilon}d) = \exp[-j(\omega/c)\sqrt{\mu_r\epsilon_r}d] \quad [3]$$

8396

From the measured reflection coefficient of a finite sample of known length, the reflection coefficient of an infinite sample is calculated and from this plus the transmission coefficient, both the permittivity and permeability are calculated. (HP Product Note 8510-3)

S-PARAMETER METHOD

Advantages

- Broad frequency range
- Well suited to microwave measurements
- Math is straightforward
- Gives ϵ and μ
- Can use waveguide as a sample holder

8397

The S-parameter method is well suited to microwave measurements and is useful over a broad frequency range. The math is relatively straight forward although there is a possible ambiguity in taking the logarithm of a complex number if the electrical length of the sample is not known to within a half wavelength. (HP Product Note 8510-3)

This method gives both permittivity and permeability and a convenient sample holder can be nothing more than a quarter wave piece of waveguide. The TRL calibration feature of the HP8510B microwave network analyzer allows the network analyzer to be calibrated using the empty sample holder and a flat short.

S-PARAMETER METHOD

Disadvantages

- Not useful for low loss materials
- Low frequency limited by length of material
- Destructive

8398

The S-parameter method does not give accurate values of loss tangent for low loss materials ($\tan \delta < 0.1$) although it does give good results for the real part of the permittivity.

The low frequency limit is governed by the practical length of the material sample. Like the reflected wave method, the length of the sample should be about 10° to 20° (electrical).

Because the sample must fit the transmission line very precisely, sample preparation requires close tolerances and is destructive to the material.

CAVITY RESONATOR METHOD

- Material sample fills a significant portion of cavity volume
- Exact theories applied to cavities for very low loss materials

8399

Low loss tangents can be accurately measured by several methods based upon *resonant structures*. At microwave frequencies, the resonant cavity is often used where the material under test fills a significant portion of the cavity volume. Exact theories are applied to the analysis of the resonant frequency and Q of the cavity to determine the complex permittivity of the material. (Afsar, 1986)

However, because only two quantities (resonant frequency and Q) are measured there is not enough information to calculate the permeability.

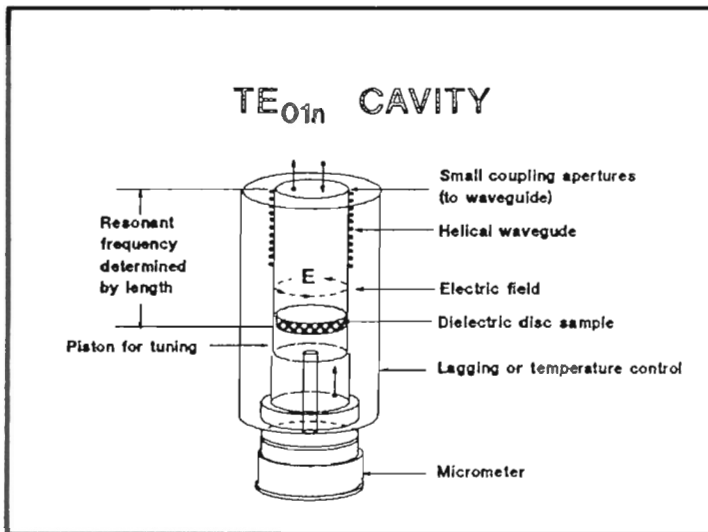

8400

Very precise permittivity measurements can be made with a well constructed cylindrical cavity operating in the TE_{01n} mode. In this case the sample is in the form of a disc with the same diameter as the cavity and ideally an integral number of 1/2 wavelengths thick. (Afsar, 1986)

These cavities are usually constructed of helical waveguide to prevent the degenerate TM₁₁ mode. The National Institute of Science and Technology (NIST) has obtained very low uncertainties with this type of cavity. (Vanzura)

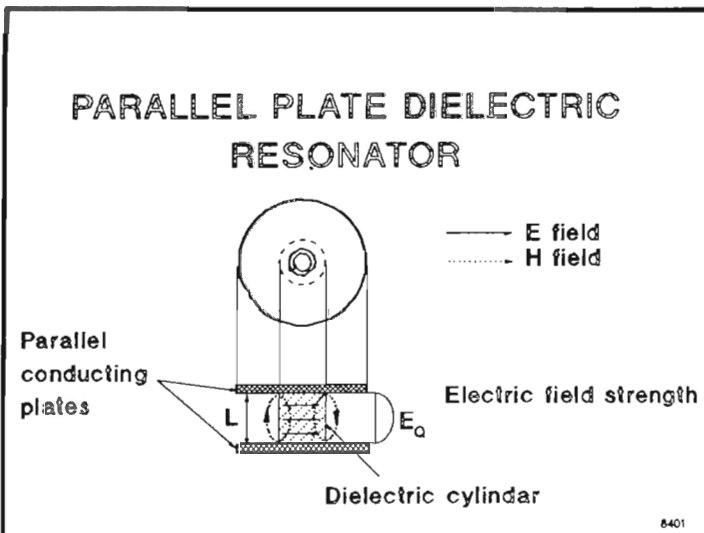

8401

The parallel plate dielectric resonator is convenient for making measurements on low loss materials. The modes of this resonator have been described by Kobayashi (Kobayashi, 1980) and the TE₀₁₁ mode is the most useful for making measurements. (Kobayashi, 1985)

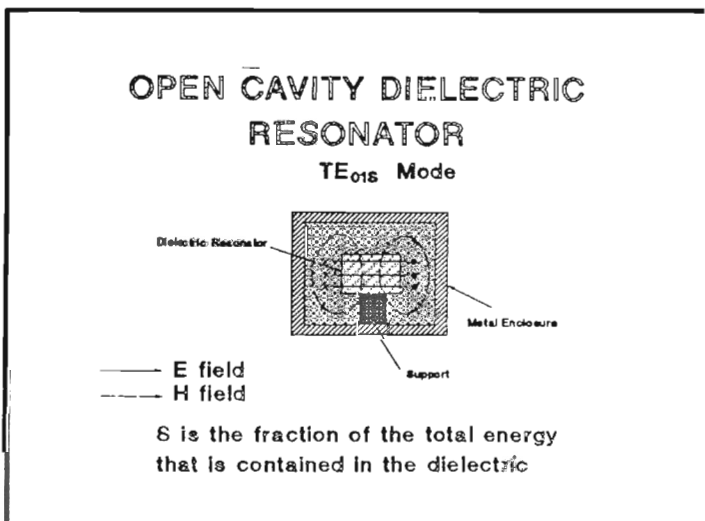

8402

The open cavity dielectric resonator operating in the TE_{01δ} mode is another method for making precise measurements of the complex permittivity of low loss materials. In this mode, δ is the fraction of the resonator's total energy that is contained within the dielectric material. (Nishikawa, 1987)

The complex permittivity is calculated from the resonant frequency and Q of the resonator with the material sample installed. The resonant frequency and Q are measured by a microwave network analyzer.

It is important to note that due to the extremely high Q's required to make accurate measurements of low loss materials, the network analyzer must have frequency resolution of a few Hertz. The HP8510B and the HP8720B are the only commercially available microwave network analyzers that meet this requirement.

OPEN CAVITY DIELECTRIC RESONATOR METHOD

- Dielectric and metal wall surface are not in contact (small error in $\tan \delta$)
- Method is suitable for a broad range of frequencies with the appropriate cavities

8403

In the open cavity dielectric resonator, the material under test does not contact the metal surface of the fixture (in this case, the resonator) and thus there are no errors due to undesired gaps or poor metalization. The method is narrow band because of the resonant cavity, but it is suited for a wide range of frequencies with the appropriate cavities.

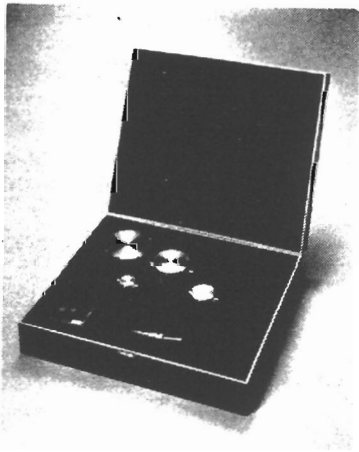

MURATA DRG
SERIES
FIXTURES

8404

A series of cavities along with software to calculate complex permittivity from their measured resonant frequency and Q is available from Murata Manufacturing Co., Ltd. These fixtures cover the frequency range of 1.5 GHz to 18 GHz and provide a convenient way to accurately measure complex permittivity at microwave frequencies. (Reference 8)

MURATA DRG 8553 MEASUREMENT FIXTURE

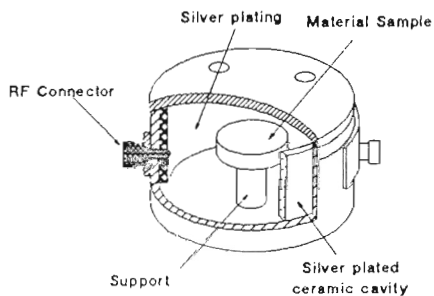

8405

The actual cavity is made from silver-plated ceramic in order to control the cavity's temperature coefficient. The material sample is machined to a specified size and shape and mounted on a dielectric support. The whole assembly is enclosed in an outer metal case for protection. (Nishikawa, 1987)

MURATA DRG SERIES FIXTURES

Frequency range: 1.5 to 18GHz
 ϵ_r range: 10 to 100
Tan δ range: 10^{-5} to 10^{-3}
Tan δ resolution: 1×10^{-6}

8406

This series of cavities is capable of measuring relative permittivities from 10 to 100 and loss tangents down to about 10 micro-radians with one micro-radian resolution.

MURATA DRESV 3 SOFTWARE

- Calculation of complex permittivity in TE_{016} mode dielectric resonator by the variational method
- Convenient way to calculate permittivity from measurements in the DRG 8553 fixture
- Written in HP Basic, it runs on a desktop computer

8407

Murata also offers software to conveniently perform the calculation of complex permittivity from the measured resonant frequency and Q of the cavity with the sample installed.

CAVITY RESONATOR METHOD

Advantages

- Good for very low loss material
- Capable of very high accuracy

8408

The cavity resonator method is good for measuring very low loss materials and is capable of very high accuracy.

CAVITY RESONATOR METHOD

Disadvantages

- Complex math
- Destructive
- Single frequency for fixed dimension cavity

8409

However it does involve rather complex math, and since the material sample must be machined to a certain size and shape it is a destructive test. Also, it is a single frequency measurement for any one sized fixture.

CAVITY PERTURBATION METHOD

- Material placed so as to disturb fields in a cavity resonator
- Measure change in resonant frequency and Q
 - Sample size small enough not to change field distribution
 - Electric field must be uniform across sample

8410

The *cavity perturbation* method for measuring complex permittivity is similar to the cavity resonator methods, but in this case a small sample of the material to be measured is placed in a resonator so as to disturb the electric field. The sample must be small enough that it doesn't change the field distribution and the field must be uniform across the sample. (Von Hippel, p.71; Afsar, 1986; Bussey)

CAVITY PERTURBATION METHOD

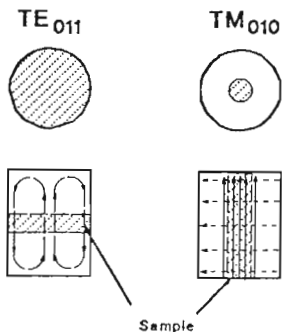

$$\epsilon' = 1 + 0.539 \left(\frac{f_1 - f_2}{f_1} \right) \frac{V}{v}$$

$$\epsilon'' = 0.269 \left(\frac{1}{Q_2} - \frac{1}{Q_1} \right) \frac{V}{v}$$

----- E field
 ————— H field

8411

The sample is usually in the form of a thin rod in a TM_{010} mode cavity. A thin tubular holder in a TM_{010} mode cavity is a convenient way to measure liquids. (Afsar, 1986)

The equations shown here are approximate for thin samples. The exact equations involve Bessel functions of the first and second kinds. (Von Hippel, p. 122)

CAVITY PERTURBATION METHOD

Advantages

- Simple, convenient, reasonably accurate
- Good for low ϵ' and moderate losses
- Simple fixture for measuring liquids

8412

The cavity perturbation method is simple, convenient, and reasonably accurate. In addition it is good for low values of permittivity and moderate losses and is a convenient way to measure liquids.

CAVITY PERTURBATION METHOD

Disadvantages

- Practical difficulties and math approximations can lead to 10% uncertainties for ϵ'
- Usually destructive
- Single frequency

8413

However, practical difficulties and math approximations can result in uncertainties of up to 10% of the measured permittivity. (Afsar, 1986)

In addition, the sample usually has to be machined to a precise size, making the measurement a destructive one. It is also a single-frequency measurement.

SUBSTRATE MEASUREMENT

- Use TE_{011} modes to probe material
- Non contact measurement preferable
- Non destructive is desirable

8414

A variation on the perturbation method has been used to measure flat sheets such as substrate material. A pair of TE_{011} mode dielectric resonators are used to probe the material. The TE_{011} mode is chosen to minimize the effects of leakage out of the fixture in the plane of the sample. Because there is no contact between the sample and the fixture in this method, errors due to undesired gaps between the two are eliminated. (Nishikawa, 1988)

SUBSTRATE FIXTURE

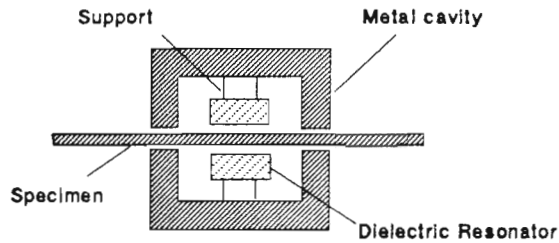

Cross Section of Measuring Instrument

8415

Two dielectric resonators, support $TE_{01\delta}$ modes. The dielectric resonators trap the electromagnetic energy in the cavity made of two separate metal pieces. The resonant frequency is perturbed by inserting the material sample between the two metal pieces which form the cavity, and the complex permittivity is calculated from the measurement of the perturbation of the resonant frequency and Q. (Nishikawa, 1988)

ELECTRIC FIELD DISTRIBUTION

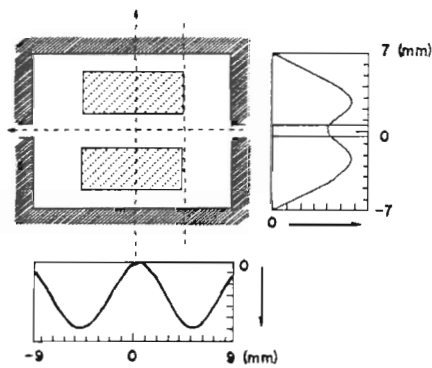

8416

The electric field distribution of the $TE_{01\delta}$ mode in the fixture is shown in the figure. The trapped energy localizes the permittivity measurement in the plane of the sample. Since the magnitude of field strength is relatively constant midway between both resonators, the amount of perturbation by the sample is not changed by changing the sample's position along the z-axis. Therefore a precise measurement independent of the sample's position along the z-axis can be made. (Nishikawa, 1988)

PERMITTIVITY

$$\epsilon_r = \frac{\Delta\omega_r}{\Delta\omega_{r0}} (\epsilon_{r0} - 1) + 1$$

- where: ϵ_r = relative permittivity of test substrate
 ϵ_{r0} = relative permittivity of reference substrate
 $\Delta\omega_r$ = change in frequency with test substrate
 $\Delta\omega_{r0}$ = change in frequency with reference substrate

8417

This method is a relative measurement, referenced to a known standard substrate. The equations to determine the relative permittivity and loss tangent are derived from the perturbational theory of small dielectric objects in a cavity. This is the equation for relative permittivity. (Nishikawa, 1988)

LOSS TANGENT

$$\tan \delta = \frac{\epsilon_{ro} - 1}{\epsilon_{ro}} \circ \frac{\omega r}{\Delta \omega r} \left(\frac{1}{Q_o} - \frac{1}{Q_{oo}} \right) + \tan \delta_o$$

where: $\tan \delta$ = loss tangent of test substrate
 $\tan \delta_o$ = loss tangent of reference substrate
 Q_o = Q of resonator with test substrate
 Q_{oo} = Q of resonator with reference substrate

8418

The loss tangent of the test substrate is found from this equation

The contribution of the substrate thickness is negligible because the test and standard substrates are of the same thickness. (Nishikawa, 1988)

MURATA DRG 8820 SERIES SUBSTRATE FIXTURES

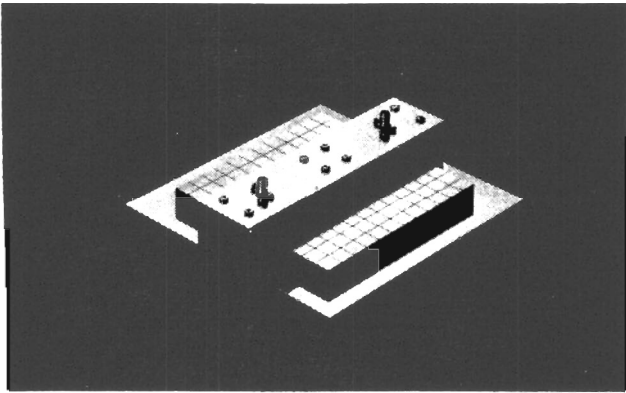

8419

A fixture for making these types of substrate measurements is available from Murata Manufacturing Company, Ltd. Fixtures are available for three different frequencies and two different substrate thicknesses. (Reference 8)

FREE SPACE METHODS

- Microwave energy is directed onto the sample with antennas
- Similar to S-Parameter method
- Can also use quasi-optical resonators

8420

Another non-destructive method that makes both permittivity and permeability measurements is the free-space method. This approach does not require a test fixture.

Quasi-optical resonators can also be used to make material measurements in free space, and are especially useful at millimeter-wave frequencies and above.

FREE SPACE METHODS

To Network Analyzer

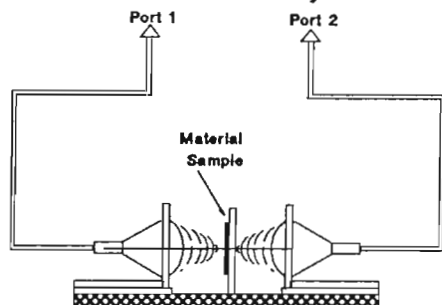

Measuring reflection and transmission of the sample

8421

In the *free-space* method, microwave energy is directed onto the material sample with narrow beam antennas. This is similar to the S-parameter method in that the waves reflected from the material and transmitted through it are measured. The same equations are used to find the surface impedance and propagation constant of the material, and to solve for permittivity and permeability. It is important to focus the microwave energy onto the center of the sample in order to avoid errors due to edge diffraction. (Ghodgaonkar)

FREE SPACE METHODS

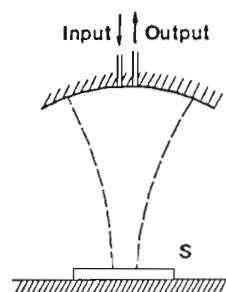

Hemispherical type of open resonator for millimeter-wave measurements.

8422

This is one example of using a *quasi-optical open resonator* of the hemispherical type. The confocal Fabry-Perot open resonator can also be used. The sample is placed in a position where the electromagnetic fields are focused, and the analysis is similar to the cavity resonator. Extremely high Q's can be obtained with these resonators, allowing measurements of loss tangents as low as micro-radians. Accuracies ranging from 0.2 to 1 percent for the real part of permittivity and 2 to 10 percent for $\tan \delta$ have been reported. (Afsar, 1984)

FREE SPACE METHODS

Advantages

- Non destructive
- Contactless
- Broadband
- Measures μ^* and ϵ^*
- No errors due to machining tolerances of sample

8423

Free-space methods are inherently non-destructive and the cross sectional shape of the sample is not important as long as it has flat parallel faces. Therefore, there are no errors due to machining tolerances of the sample.

Because the sample is not contacted by a fixture, it is a good method for making high temperature measurements. Antennas can be placed outside the temperature chamber and shined in through microwave windows. (Ghodgaonkar)

It is a broadband method and is capable of measuring both permittivity and permeability.

Free-space methods are especially good for measuring absorptive materials in the manner in which they will be used.

FREE SPACE METHODS

Disadvantages

- Requires large sample size
- Must be careful to avoid errors due edge diffraction

8424

However, the free-space methods require large sample sizes in comparison to a wavelength, and care must be taken to avoid edge diffraction.

Like the S-parameter method, the free-space method using antennas to illuminate the sample does not give accurate values of loss tangent for low loss materials.

The open resonator methods, however, do give quite good results for measuring low loss materials—but they measure only permittivity.

Applications
Material Properties
Measurement Methods
→ Sources of Error
Summary

8372D

This section discusses several sources of error in measuring the electrical properties of materials.

SOURCES OF ERROR

- Network analyzer errors
- Fixture errors
- Sample errors
- Approximations in theory

8425

The major sources of error in making material measurements are:

- * instrumentation errors due to network analyzer;
- * errors in the construction and application of the fixtures;
- * errors in preparing the sample; and
- * errors that may be due to approximations in the theory behind the measurement method used.

NETWORK ANALYZER ERRORS

- Directivity
- Port matches
- Frequency response
- Frequency accuracy

8426

There are many error sources associated with making a measurement with a modern network analyzer and they have been discussed at length elsewhere. (Rytting; Donecker; Fitzpatrick)

Directivity errors will affect the reflection coefficient measurement for samples that have low reflection coefficients (those that are lossy and have low permittivity). Samples with high reflection coefficients (those with low loss and high permittivity) will be adversely affected by port match errors. Frequency response errors affect the measurement of the reflection and transmission coefficients as they vary with frequency. And frequency accuracy is important in measuring the resonant frequency of cavity fixtures.

FIXTURE ERRORS

- Fringing capacitance
- Lead parasitics
- Finite Q
- Fixture reflections
- Improper sample placement

8427

Fixture errors can be due to fringing capacitance or lead parasitics in the parallel plate type of fixture, or finite Q in the cavity fixtures. Reflections from the fixture itself rather than the sample will also contribute to errors. Proper placement of the sample in the fixture is important to making good measurements.

SAMPLE ERRORS

- Manufacturing tolerances
- Edge diffraction
- μ not equal to 1 when required

8428

Errors in sample preparation will affect the measurements of the material's properties. Samples that are in contact with the measuring fixture must fit snugly (especially in the direction of the electromagnetic fields used to probe the sample).

Where the size of the sample enters into the calculations, it must be known as accurately as possible. Usually it is best to machine the sample to as close tolerance as possible and then precisely measure its actual dimensions.

Edge diffraction in the free-space methods yields significant errors and can make the measurement useless if not addressed.

A sample with a relative permeability not equal to 1.00 will yield errors in methods that are meant to only measure permittivity.

THEORY APPROXIMATIONS

- Approximate solutions of cavity equations
- Ambiguities in phase for S-parameter solution
- Use of inappropriate method for the material

8429

Applications
Material Properties
Measurement Methods
Sources of Error

→ Summary

8372E

Some of the methods described in the last section (such as the perturbation and cavity methods) have practical solutions that are based on approximations. The more exact the theoretical solution is, the more accurate the measurement results will be.

Methods based on measuring the propagation constant through the material (the S-parameter and free-space methods, for example) are susceptible to ambiguities in phase. If the measured phase is off by an integral multiple of 360° (electrical), the calculated permittivity and permeability give results that are physically impossible.

Finally, it is important to use the appropriate method for the material being measured. For example, the S-parameter method would not be used to measure the loss tangent of a low loss material.

There are many different ways to measure the electrical properties of materials and only a few of the most common ones have been discussed here. Other methods exist for making measurements at sub-hertz frequencies (Von Hippel, p. 52) and at millimeter-wave and optical frequencies (Afsar, 1984). In addition there are methods that are optimized for permeability measurements (Von Hippel, p. 125) and measurements on superconductors (Fiedziuszko; Fathy).

Reference

1. A. R. Von Hippel, *Dielectric Materials and Applications*. New York: MIT Technology Press and Wiley, 1954. (Note: This is probably the single most useful reference in material measurements and is considered by many to be the bible of the field.)
2. M. N. Afsar, "The measurement of the properties of materials," *Proceedings of the IEEE*, vol. 74, no. 1, pp. 183-199, Jan. 1986. (Extensive references)
3. Hewlett-Packard Company, "Measuring dielectric constant with the HP8510 network analyzer," Product note 8510-3, August 1985.
4. E. J. Vanzura, "Advances in NIST dielectric measurement capability using a mode-filtered cylindrical cavity," 1989 IEEE MTT-S International Microwave Symposium Digest, pp. 901-904, June 1989.
5. Y. Kobayashi and S. Tanaka, "Resonant modes of a dielectric rod resonator short-circuited at both ends by parallel conducting plates," *IEEE Trans. Microwave Theory and Tech.*, vol. MTT-28, no. 10, pp. 1077-1085, Oct. 1980.
6. Y. Kobayashi and M. Katoh, "Microwave measurement of dielectric properties of low-loss materials by the dielectric rod resonator method," *IEEE Trans. Microwave Theory and Tech.*, vol. MTT-33, no. 7, pp. 586-592, Jul. 1985.
7. T. Nishikawa, et. al., "Precise measurement method for temperature coefficient of dielectric resonator material," 1987 IEEE MTT-S International Microwave Symposium Digest, pp. 277-280, June 1987.
8. Murata Manufacturing Company, Ltd. International Division, 3-26-11 Nishi-rokugo, Ohta-ku, Tokyo 144, Japan.
9. H. E. Bussey, "Measurements of RF properties of materials— a survey," *Proceedings of the IEEE*, vol. 55, no. 6, pp. 1046-1053, June 1967. (Extensive references)
10. T. Nishikawa, et. al., "Precise measurement method for complex permittivity of microwave dielectric substrate," *Conference of Precise Electromagnetic Measurements*, Tsukuba, Japan, June, 1988.
11. Deepak K. Ghodgaonkar, V. V. Varadan, and V. K. Varadan, "A free-space method for measurement of dielectric constants and loss tangents at microwave frequencies," *IEEE Transactions on Instrumentation and Measurement*, vol. 37, no. 3, pp. 789-793, June 1989.
12. M. N. Afsar, "Dielectric measurements of millimeter-wave materials," *IEEE Trans. Microwave Theory and Tech.*, vol. MTT-32, no. 12, pp. 1598-1609, Dec. 1984. (Extensive references)
13. D. Rytting, "Advances in microwave error correction techniques," presented at the Hewlett-Packard RF and MW Symp. 1987.
14. S. Donecker, "Determining the measurement accuracy of the HP8510 microwave network analyzer," presented at the Hewlett-Packard RF and MW Symp. 1985.
15. J. Fitzpatrick, "Error models for systems measurement," *Microwave Journal*, May 1978.
16. S. J. Fiedziuzko and P. D. Heidmann, "Dielectric resonator used as a probe for high Tc superconductor measurements," 1989 IEEE MTT-S International Microwave Symposium Digest, pp. 555-558, June 1989.
17. A. Fathy, D. Kalokitis, E. Belohoubek, "Microwave characteristics and characterization of high Tc superconductors," *Microwave Journal*, October 1988, pp. 75-94.



**HEWLETT
PACKARD**

Copyright © Hewlett Packard Co. September, 1989

