

MEASUREMENT OF COMPLEX IMPEDANCE 1-1000 MHz

1 APR 67

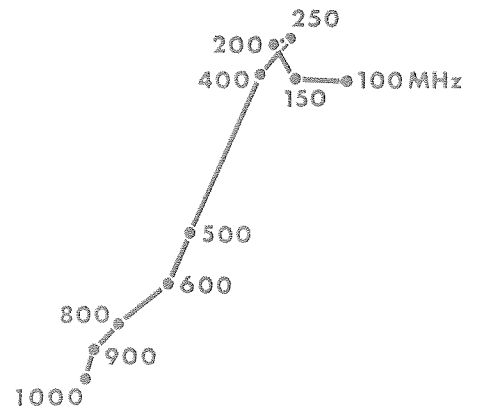

$$\frac{Z}{Z_0} = \frac{1 + \bar{\rho}}{1 - \bar{\rho}}$$

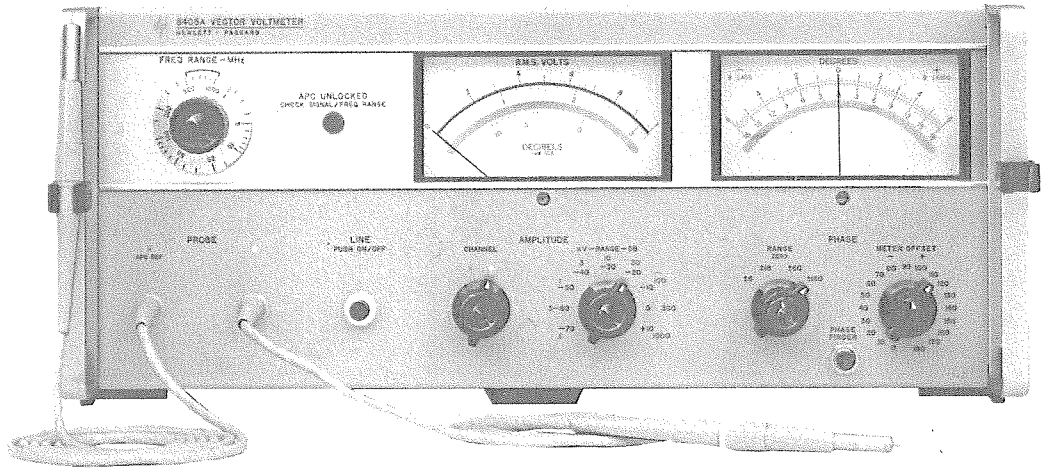
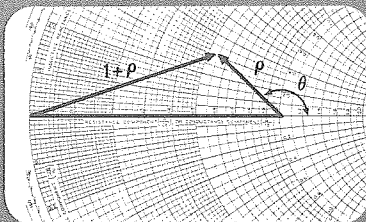
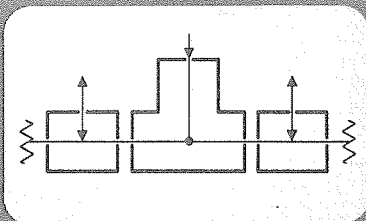
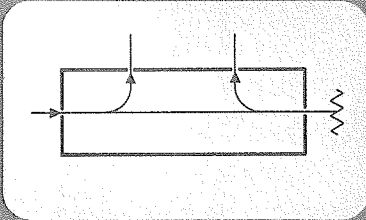
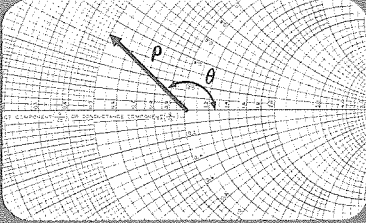
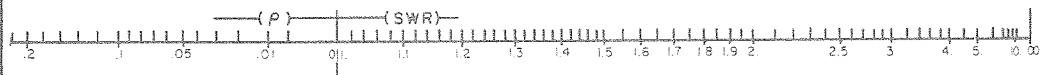



For more information, call your local HP Sales Office or East (201) 265-5000 • Midwest (312) 677-0400 • South (404) 436-6181 • West (213) 877-1282. Or, write: Hewlett-Packard, 1501 Page Mill Road, Palo Alto, California 94304. In Europe, Post Office Box 85, CH-1217 Meyrin 2, Geneva, Switzerland. In Japan, Yokogawa-Hewlett-Packard, 1-59-1, Yoyogi, Shibuya-Ku, Tokyo, 151.

INTRODUCTION

This application note considers some new techniques for measuring impedance over the frequency range of 1 to 1000 MHz. These new methods are an improvement over conventional impedance bridge and slotted line methods because they can be made rapidly over very broad frequency ranges. These techniques eliminate balancing adjustments and tuning for nulls required by interacting controls for the determination of the real and imaginary parts of impedance. Only a simple calibration is required over wide frequency ranges with these techniques. The measurements are straightforward and offer considerable time savings in the measurement of complex impedance over the 1 to 1000 MHz frequency range. Two Hewlett-Packard instruments provide the capability described: the 4815A RF Vector Impedance Meter and the 8405A Vector Voltmeter.

4815A RF VECTOR IMPEDANCE METER 0.5 to 108 MHz

The HP 4815A¹, shown in Figure 1, reads $|Z|$ and θ , \tan^{-1} of X/R, respectively on two meters from 1 to 100 k ohms over the range of 500 kHz to 108 MHz. The instrument, which includes a test oscillator, has a probe which senses the voltage at the test device when a constant current from the 4815A is applied to the unknown. Both the magnitude and phase angle of the impedance are obtained by taking the vector ratio of this voltage and current. The accuracy of the 4815A is specified for both magnitude and phase. For $|Z|$, accuracy is: $\pm 4\%$ of full-scale $\pm (f/30 \text{ MHz} + Z/25 \text{ k}\Omega)\%$ of reading; for θ : $\pm (3^\circ + f/30 \text{ MHz} + Z/50 \text{ k}\Omega)$ degrees.

¹Alonzo, Blackwell, Marantz, "Direct Reading, Fully-Automatic Vector Impedance Meters." HP Journal, Jan 1967, p. 12.

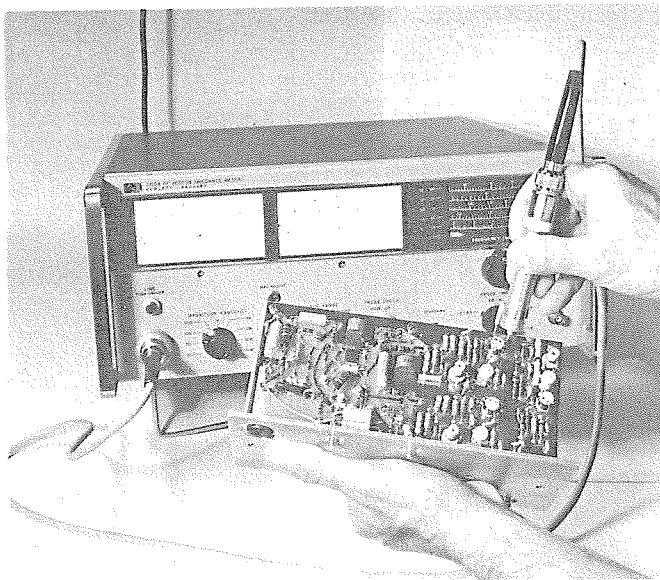

Figure 1. Probe and Read Z/θ Directly on the HP 4815A RF Vector Impedance Meter

The 4815A offers the user a convenient, direct reading, impedance meter useful for laboratory, receiving inspection and production line applications. A signal source of 0.5 to 108 MHz is included although external sources can be used which can be swept at rates of up to 1 MHz/sec. Analog outputs allow permanent data recording.

8405A VECTOR VOLTMETER 1 to 1000 MHz

For impedance measurements beyond the 100 MHz range of the 4815A, a complementary instrument is the Hewlett-Packard 8405A Vector Voltmeter. It can be easily adapted to measure impedance rapidly. The 8405A is a dual-channel millivolt/phasermeter which operates over a three decade range from 1 to 1000 MHz. It measures both voltage and phase difference between its two input channels.² This general purpose instrument is called a "Vector Voltmeter" since it also provides the phase angle between any two voltage vectors, a missing piece of information usually desired in many voltage ratio measurements. With appropriate accessories to sample the incident and reflected waves on a transmission line, which is terminated in the unknown impedance, data can be read from the 8405A voltage and phase meters directly into the Smith Chart. The impedance range is nominally from a few ohms to about 1 k Ω . It can be used outside this range, although with reduced accuracy.

Although not a completely self-contained instrument like the 4815A Impedance Meter, the Vector Voltmeter offers the user many other features arising from its general voltage/phase capabilities. In addition to its broad frequency range of 1 to 1000 MHz, it is quite useful in such applications as measuring (1) gain and phase margins of feedback devices, (2) resonances and spurious responses of high Q filters, (3) electrical length of cables, (4) complete analysis of network parameters, (5) phase linearity and group delay, (6) percent amplitude modulation of RF signals, etc.³ Furthermore, since full-scale sensitivity is 100 μV (10 μV noise level) and bandwidth is only 1 kHz, attenuations of 85 dB or more can be measured easily and accurately over this range.

The impedance measuring technique with the 8405A Vector Voltmeter measures both the forward (incident) and reverse (reflected) traveling waves on a transmission line. This data then provides the real and imaginary parts of the unknown impedance referenced to 50 ohms. This technique is a more direct approach than that of using the conventional slotted line. The slotted line requires a measurement of the standing wave ratio and then the shift of a voltage minimum when the unknown is replaced with a short. Also, at low frequencies the slotted line is not practical since its

²Fritz Weinert, "The RF Vector Voltmeter - An Important New Instrument for Amplitude and Phase Measurements from 1 MHz to 1000 MHz." HP Journal, Volume 17, No. 9, May 1966.

³Ibid.

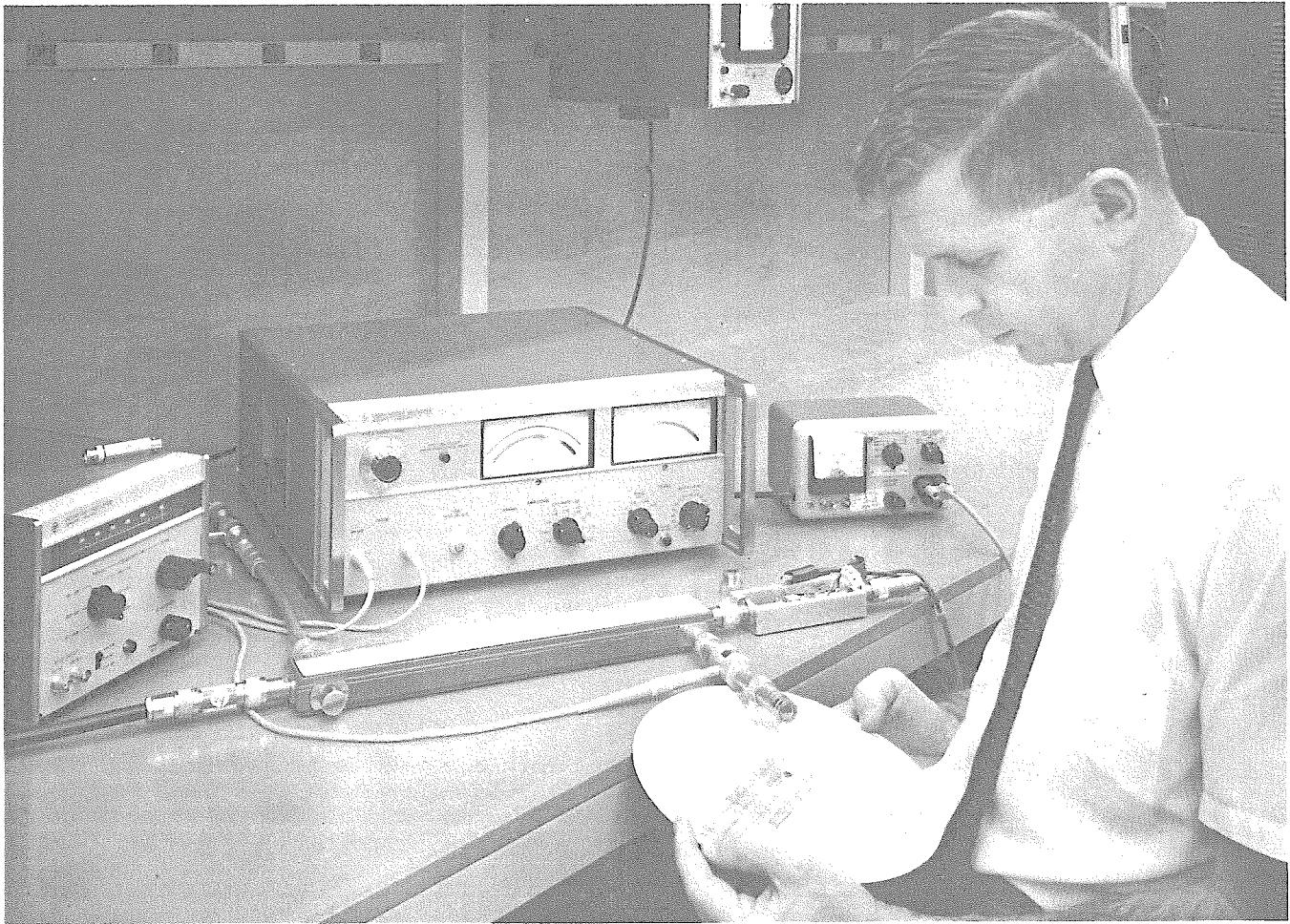

Figure 2. Measurement of Complex Input Impedance over 100 to 1000 MHz Range. Vector Voltmeter Amplitude and Phase Meter Readings Entered Directly on Smith Chart for Impedance Determination. (Smith Chart Transmission Line Calculator can be ordered from the Emeloid Company, 1239 Central Avenue, Hillside, N. J., 07205.)

physical size would have to be very long since it must be at least one-half wavelength long to measure both the maximum and minimum of the standing-wave pattern on the line. No adjustments at each frequency are needed with the Vector Voltmeter technique: simply read two meters, enter the vector on the Smith Chart, and read the complex impedance.

THEORY

A standing-wave pattern will be distributed along a transmission line when there is a load connected to it that is not equal to the line's characteristic impedance. The standing-wave pattern is composed of the sum of the voltage wave incident on the load, E_i , and the voltage wave reflected from this load, E_r .

At the load, the ratio of E_r to E_i and the phase angle between them are uniquely determined by the load impedance. Anywhere along a lossless line the magnitude of this ratio remains the same. The phase angle between E_r and E_i , however, will vary along the line as

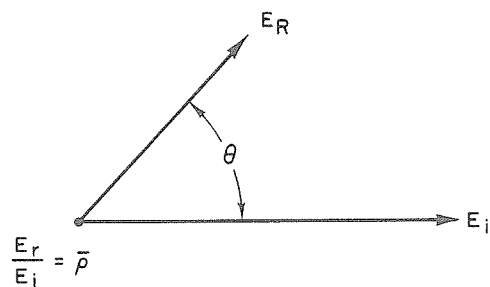

Figure 3. Angle θ and magnitude $|E_r/E_i|$ of incident and reflected waves at load uniquely determined by load impedance.

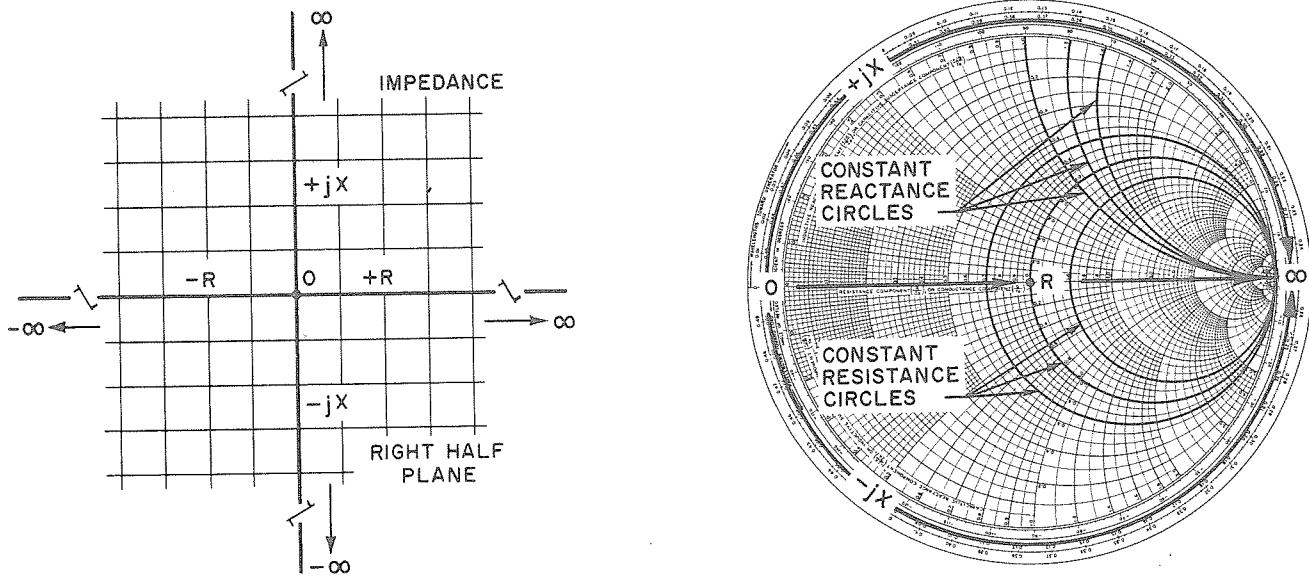

Figure 4. (a) Rectangular Impedance Chart. Right-Half Plane is Transformed into Smith Chart. (b) Smith Impedance Chart.

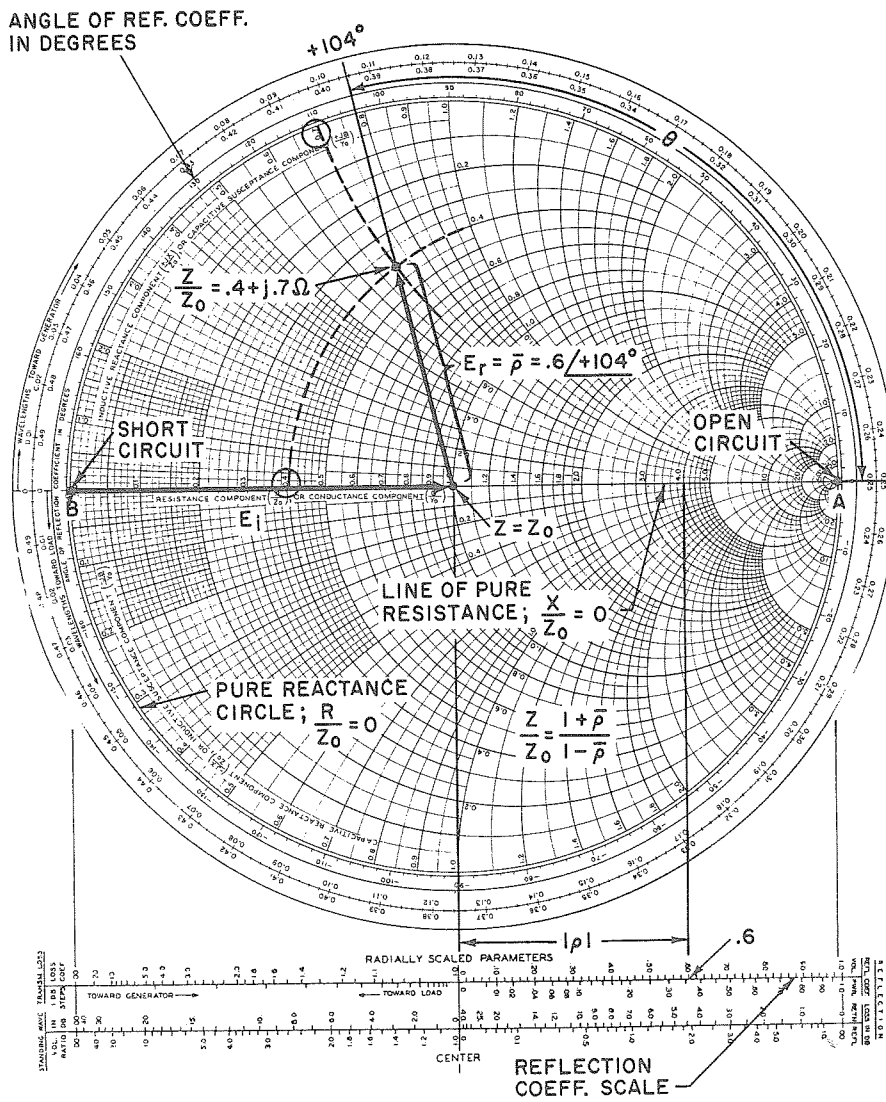

Figure 5. Impedance & Reflection Coefficient Relationships on Smith Chart

a function of distance from the load. However, the phase angle of E_r/E_i at the load can be measured remotely from the impedance plane, regardless of phase shift. This is accomplished by offsetting the phase on the 8405A with a front panel control. The appropriate offset angle is determined by an impedance that provides a known phase angle between the incident and reflected voltage waves. A short provides a standard calibration of 180° since in this case the reflected signal is always equal in magnitude to and 180° out of phase with, the incident voltage, in order for the load voltage ($E_L = E_i + E_r$) to equal zero volts.

REFLECTION COEFFICIENT AND IMPEDANCE

The ratio of reflected to incident voltage is called the reflection coefficient, $\bar{\rho}$. It is a vector quantity. That is, it has both magnitude and phase components. It is related to the impedance connected to the line by the equation:

$$Z/Z_0 = \frac{1 + \bar{\rho}}{1 - \bar{\rho}} \quad E_r/E_i = \bar{\rho} = \rho/\theta_\rho \quad (1)$$

Normally, reflectometer systems measure only the magnitude of the reflection coefficient. From this information only the VSWR of the device can be determined. But by measuring the phase angle between the incident and reflected waves impedance is now easily obtained.

USING THE SMITH CHART

Equation (1) can be solved algebraically to determine the value of Z/Z_0 once $\bar{\rho}$ has been measured with the 8405A. However, an impedance chart, called the Smith Chart, easily solves this equation graphically. The Smith Chart, shown in Figure 4, transforms the right-half plane, or positive real part, of the rectangular grid impedance chart into a circle.⁴ Although the rectangular form is much easier to read, it extends to infinity. The Smith Chart makes the infinite impedance plane finite. Lines of constant resistance are now transformed into circles from $R/Z_0 = 0$ to ∞ and lines of constant reactance are also shown from $\pm jX/Z_0 = 0$ to ∞ . Positive reactance lines are in the upper half and negative reactance lines are in the lower half of the Smith Chart.

$\bar{\rho}$ can be plotted directly on the Smith Chart as a vector originating from its center. This can be more easily visualized by drawing E_i and E_r as vectors on the Smith Chart as shown in Figure 5. E_r represents a vector that adds to the incident voltage E_i in the manner shown. E_r can have any phase angle from 0 to $\pm 180^\circ$. The angle is read along the circumference; CCW for positive angles; CW for negative angles. Its magnitude varies from 0 to E_i linearly from the center to the perimeter of the chart. Consequently, by letting $E_i = 1$ (by measuring the ratio E_r/E_i) to normalize the scale, $\bar{\rho} = E_r/E_i = E_r$. Thus, the E_r vector represents $\bar{\rho}$.

Since this chart portrays only the positive real part of an impedance from equation (1), $|\rho|$ is always ≤ 1 . The reflection coefficient scale is shown along the bottom of the Smith Chart.

By measuring the ratio E_r/E_i both in magnitude and phase, the impedance is uniquely determined. For example, in Figure 5, $\bar{\rho} = .6 \angle +104^\circ$ is therefore $(.4 + j.7)50$ or $20 + j35$ ohms.

When $\bar{\rho} = 1/0^\circ$ Z is an open circuit and is located at point A on Figure 5. A $\bar{\rho} = 1/180^\circ$ is located at B and represents a short circuit. $\bar{\rho} = 0$ is always at the center of the Smith Chart and represents $Z = Z_0$. When $|\rho|$ equals one, regardless of the phase angle, Z is either a short, open, or pure reactance since the vector falls on the perimeter of the chart. Whenever the phase angle is either 0° or 180° the unknown is a pure resistance. A phase angle falling in the upper half of the chart, $\theta = 0$ to 180° , is an inductive reactance while negative phase angles of 0 to -180° are capacitive reactances. A $Z - \theta$ Smith Chart shown in Figure 6 can be used in exactly the same way to find the magnitude of Z and its phase angle. For $\bar{\rho} = .6 \angle +104^\circ$, $Z/Z_0 = 50 \times .8 \angle +60^\circ = 40 \angle +60^\circ \Omega$.

For measurements of VSWR or Return Loss only, the relationships are

$$SWR = \frac{1 + |\rho|}{1 - |\rho|} \quad \text{Return Loss} = -20 \log |\rho| \text{ (dB)}$$

Both parameters can be read off radial scales provided on the Smith Chart for a given value of $|\rho|$. Only the absolute value of $\bar{\rho}$ is required since both SWR and return loss do not include phase information. The large dynamic range of the Vector Voltmeter allows small values of VSWR to be measured easily. Accuracy is limited primarily by the directivity of the directional coupler used.

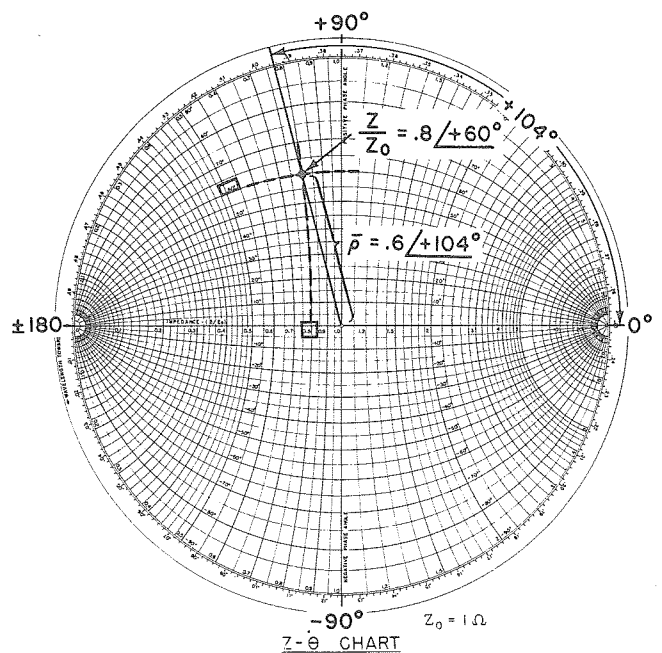
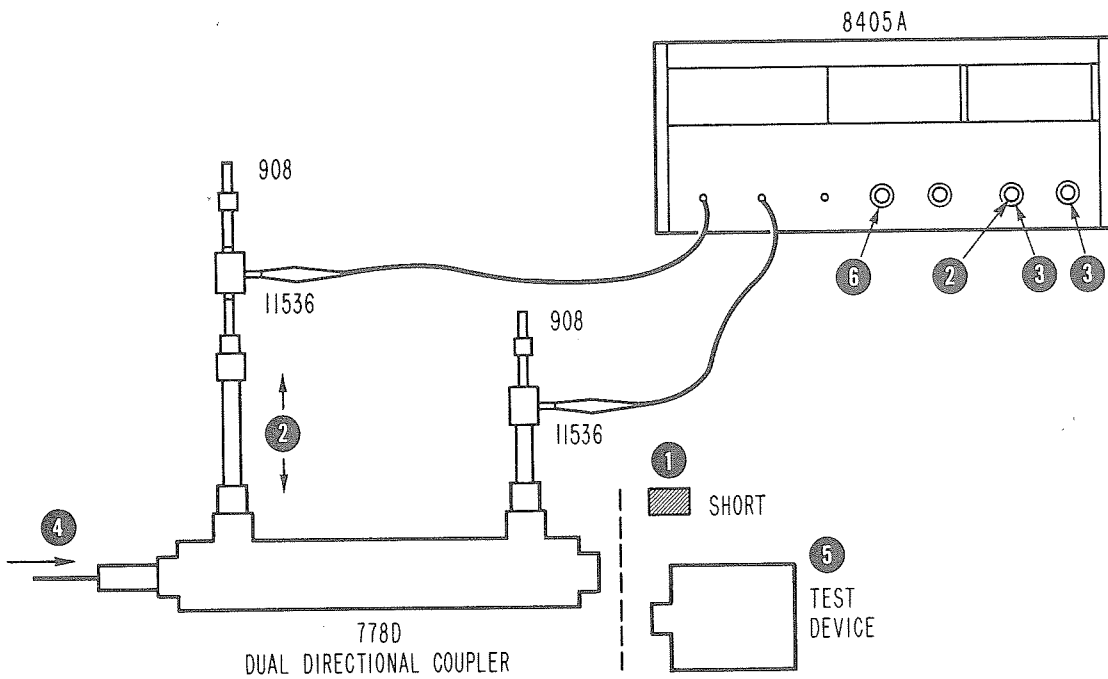

Figure 6. Z - θ Chart

⁴See "Introduction to the Smith Chart," Microwave Theory and Measurements by Engineering Staff of the Hewlett-Packard Microwave Division, Prentice Hall, Inc., 1962, p. 93.



1. Connect short to output of 778D Coupler at desired input frequency.
2. Set phase meter by adjusting line length and PHASE ZERO control for 180° reading.
3. For fine adjust set PHASE OFFSET to + or -180° and PHASE RANGE to $\pm 6^\circ$. Readjust line stretcher and PHASE ZERO for 0° meter reading.
4. Change input frequency and note any change in phase reading. Readjust line stretcher until signal paths to A & B channels are equal as determined by minimum phase shift as frequency is varied. Read B/A vs. frequency as desired.
5. Replace short by test device.
6. Measure $\rho = B_2/A_2$ magnitude and phase angle.

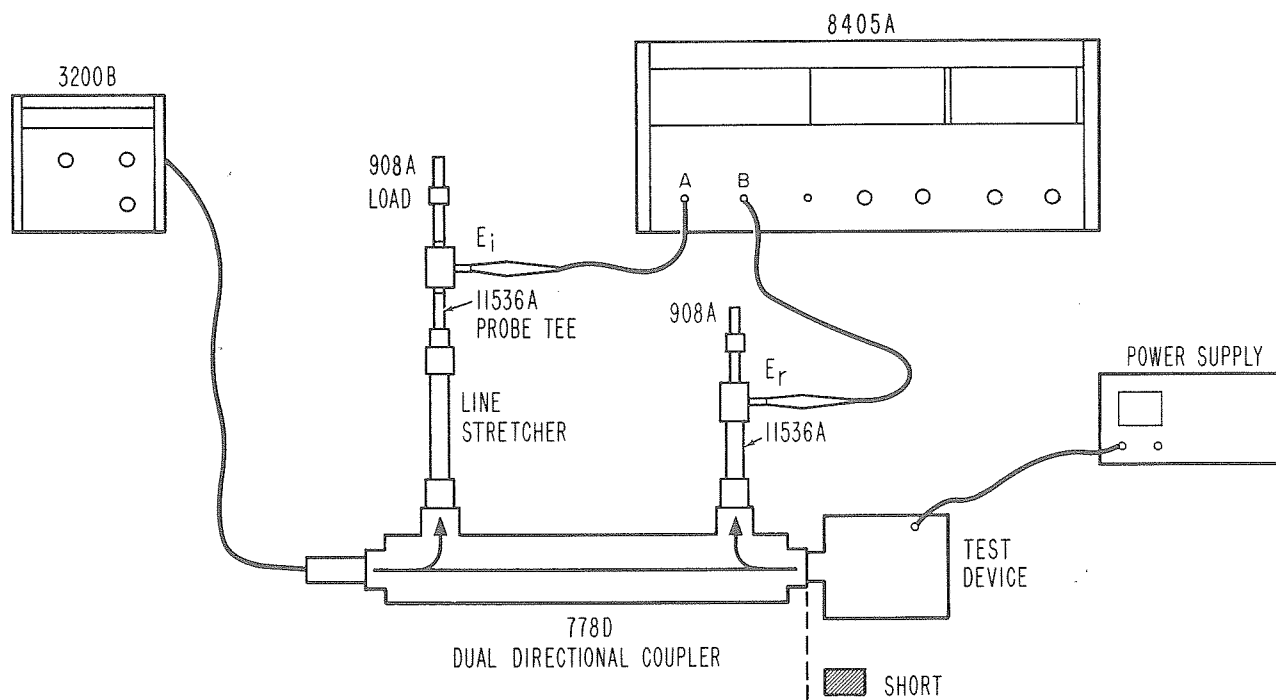

Figure 7. Measurement of Impedance with 8405A and 778D from 100 to 1000 MHz

**MEASURING ρ
100 to 1000 MHz**

From 100 MHz to 1 GHz impedance can be conveniently measured in one setup with the use of a broadband dual directional coupler. The Hewlett-Packard Model 778D covers the frequency range from 100 to 2000 MHz with 40 dB directivity up to 1000 MHz. The equipment connections are shown in Figure 7 and shown in the photograph of Figure 2.

To calibrate, a short ($\rho = 1/180^\circ$) is placed on the end of the coupler, and a phase reference of 180° is set on the vector voltmeter. This adjustment is made with a line stretcher or cable, which has been adjusted for a length which equalizes the signal path from the signal source to both A and B probes of the voltmeter. With this adjustment, the reference phase angle of 180° read on the voltmeter will then remain almost constant as the frequency of the signal source is varied. Any variation is due to coupler tracking. This tracking is the ratio B_1/A_1 . It can be measured over the desired frequency range by noting its variance from 1.00 and 180° , if any. This variation is typically negligible but can be calibrated out, if required, for greater accuracy. If measurements are required at only a few frequencies, it is possible to set the phase with the 8405A phase vernier to exactly 180° at each frequency.

With the unknown in place of the short, the magnitude and phase angle of B_2/A_2 are measured. This quantity represents the ρ of the unknown since E_i is read on channel A and E_r on channel B. Actually, the measured quantities are reduced by the coupling factors of the dual coupler. However, the coupling factors of both auxiliary arms with respect to frequency are very closely equal as indicated above and are

cancelled out in the ratio. For precise measurements, B_1/A_1 is a correction factor that can be applied for any small variation in the coupling factors and vector voltmeter probe tracking. $|\rho|$ then equals B_2A_1/A_2B_1 .

For example, assume that at 375 MHz B_1/A_1 is measured to be $0.985 \angle +179.5^\circ$ with a short. With the unknown in place of the short B_2/A_2 is measured to be $0.6 \angle +104^\circ$. ρ is actually $.6/.985 = 0.609$ at an angle of $+104.5^\circ$. 0.5° is added since the reference phase angle required a $+0.5^\circ$ correction in order to read its true value of 180° .

NEGATIVE IMPEDANCE

The vector voltmeter can also measure negative impedance with the same setup shown in Figure 7. From equation (1) it can be seen that the real part of Z/Z_0 is negative when $|\rho| > 1$.⁵ When B/A , as read on the instrument is > 1 , the impedance is negative and no longer lies within the Smith Chart. This chart, as mentioned previously, is a transformation of the positive real part of the impedance plane only.

However, it is still possible to use the conventional Smith Chart for negative resistance.⁶ The negative Smith Chart looks exactly the same as Figure 4b or 5 but the resistance scale is now negative ($-R/Z_0$). The reactance scales and reflection coefficient angles remain exactly the same. The only major change is in the magnitude of the reflection coefficient. It is now the reciprocal of that value which exists at the same radial distance on the positive real-component Smith

⁵See Appendix A.

⁶P.H. Smith, "A New Negative Resistance Smith Chart." The Microwave Journal, June 1965.

Chart. In other words, if the measured $\bar{\rho} = 2.2/+153^\circ$ this is located on a positive real Smith Chart at the angle of $+153^\circ$ but at a distance from the center of the chart of $1/2.2$ or 0.45 . Now by reading the impedance coordinates and mentally changing the resistance to a negative polarity, $Z/Z_0 = 50 (-0.4 + j.2)$ or $-20 + j10\Omega$. It is convenient when plotting real impedances which are both positive and negative to use the same chart but plot the negative part in dotted lines. An example is shown in Figure 8.

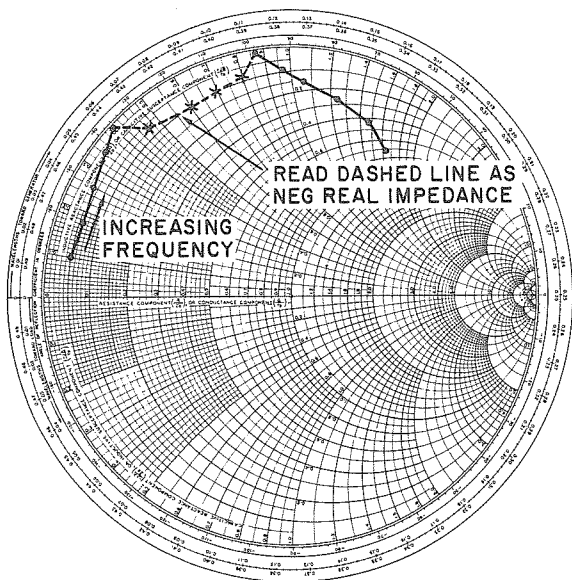

Figure 8. Smith Chart Used for Both Positive and Negative Impedances

ACCURACY

$$\text{error in } |\rho| \leq \pm(.03 + .03 |\rho|^2) \text{ for } 0 \leq \rho \leq 1.0$$

$$\text{error in } \theta_\rho \leq \pm(2^\circ + \sin^{-1} \frac{.01}{|\rho|} + \sin^{-1} .03 |\rho|^2)$$

$$\text{for } .01 \leq |\rho| \leq 1.0$$

Accuracy of the impedance measurement is more easily considered in terms of the measured accuracy of $|\rho|$ and the angle of $\bar{\rho}$. Impedance uncertainty is then related to the accuracy of $\bar{\rho}$ by equation (1).

If tracking error of the coupler is calibrated out, overall error is composed of the instrument error, mismatch error, and coupler directivity error. The error in magnitude is conservatively estimated to be $\pm(.03 + .03 |\rho|^2)$ since it assumes that the vector terms in this equation all add in phase to produce the worst case error. In practice it is found that accuracies are typically twice as good as the worst case. The error of .03 is composed of the instrument tracking error of 2% of full scale and a worst case error from the directivity of the coupler of 1%. Only the 8405A's single range tracking error is applicable since the measurement of reflection coefficient is a ratio and, therefore, the absolute measured accuracy of the incident and reflected voltages is not relevant. For smaller values

of $|\rho|$, however, where downranging on the instrument is possible an additional $\pm 1\%$ of range carryover error for each range step should be included.

The directivity error is due to the coupler's inability to ideally separate forward and reverse signals into their respective output arms. The amount of incident signal that is coupled into the reflected arm of the coupler is always more than 40 dB below the reflected signal for the 778D up to 1GHz. Therefore, the voltage error contributed by directivity (in the worst case since this directivity error is a vector that can add in any phase with the desired reflected signal) is:

$$V_1/V_2 = \text{antilog}_{10} -(40/20) = .01$$

The last term is due to mismatch uncertainty between the unknown and the 778D Coupler.⁷ This term is a function of $|\rho|^2$ as shown. The term is a conservative error since it is a vector and the maximum error occurs only randomly. The constant .03 also decreases with frequency. Furthermore, the term becomes less significant for small values of $|\rho|$.

Phase accuracy is composed of the three terms: $\pm[2^\circ + \sin^{-1} (.01/|\rho|) + \sin^{-1} .03 |\rho|^2]$. The first term is a residual of $\pm 2^\circ$ from the instrument accuracy at any one frequency plus the error in setting the phase reference due to the directivity error of the coupler. The major error is from the second term and results from the coupler directivity. At $|\rho| = .01$ this error approaches 90° . It is undefined for values of $|\rho| < .01$.

For small values of $|\rho|$, the error in the phase angle becomes very large. However, the $\sin^{-1} (.01/|\rho|)$ term decreases very rapidly with increasing $|\rho|$. From $\rho = .01/0^\circ$ to $.04/0^\circ$ ($R = 51$ to 54Ω respectively) the phase angle ambiguity due to directivity decreases from $\pm 90^\circ$ to $\pm 14.5^\circ$. At small values of $|\rho|$ it is desirable to measure the directivity term and apply it as a correction to the measured value. This can be accomplished with a 50Ω load whose real and reactive components or reflection coefficient have been previously calibrated by a standards laboratory. Using this as the unknown the measured $\bar{\rho} = \bar{\rho}_L + \bar{\rho}_D$ at a particular frequency. Since ρ_L is known, $\bar{\rho}_D = \bar{\rho} - \bar{\rho}_L$. This term can be used to correct measurements of $\bar{\rho}$ both in magnitude and phase angle. For example, in Figure 9, $\bar{\rho}_D$ at a particular frequency is measured to be $.01 \angle -50^\circ$. The unknown is measured to be $\rho_m = .073 \angle +46^\circ$. Subtracting out the directivity term, the true reflection coefficient, $\bar{\rho}_t = \bar{\rho}_m - \bar{\rho}_D$, is solved graphically to result in $\bar{\rho}_t = .073 \angle +54^\circ$.

The last term in the phase error equation is again the mismatch phase ambiguity due to the reflection between the unknown and the coupler output port.

An additional $\pm 2^\circ$ of phase error is possible with smaller ρ due to the phase error with signal amplitude of the 8405A. This error varies from one instrument to another and is best determined by an actual calibration of phase error versus signal amplitude of the

⁷See Application Note 56, "Microwave Mismatch Error Analysis."

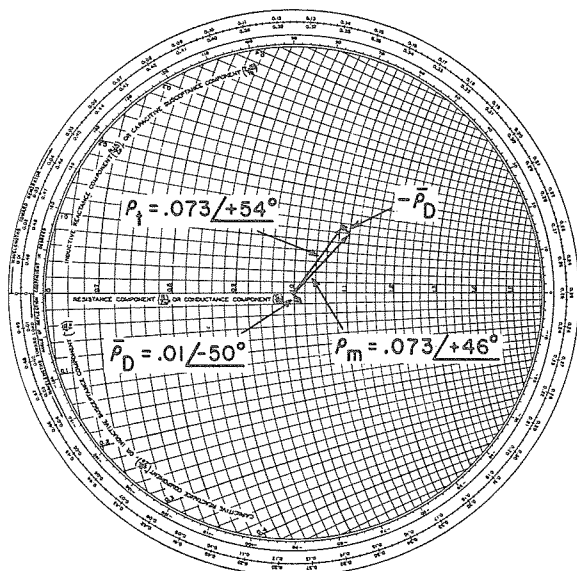

Figure 9. Subtracting Out Directivity of Coupler at Specific Frequency Improves Accuracy for Small Values of $|\rho|$.

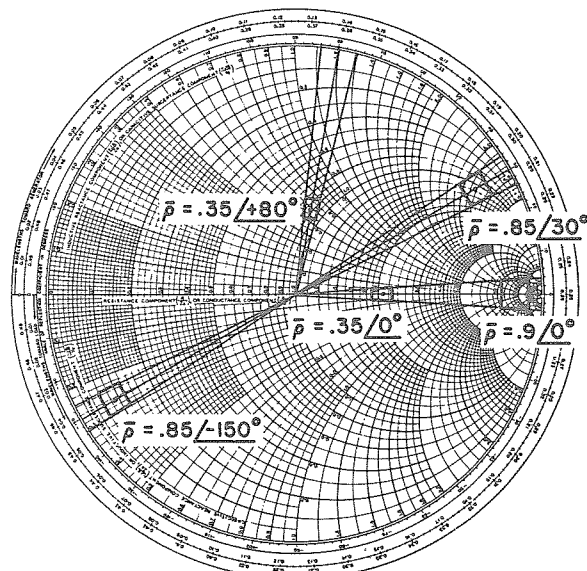

Figure 10. Smith Chart Plot of Impedance Accuracy over 100 to 1000 MHz

particular instrument being used. However, this error is usually not significant since, as ρ becomes smaller, the error caused by coupler directivity becomes the overriding factor.

Using the above accuracies, the accuracy of the impedance transferred to the Smith Chart can now be determined. One method is to substitute into equation (1) with the maximum and minimum values of ρ and calculate the range of Z/Z_0 . However, it is easier to simply plot the ambiguity directly on the Smith Chart. This is shown for several values of $\bar{\rho}$ in Figure 10. Note that the error increases rapidly with large values of $|\rho|$. With values approaching .9, Z/Z_0 can be in error as much as 100%. For example, at $\bar{\rho} = .9/0^\circ$ the real part of Z can measure between 650 to 2000 ohms when the true value is 1000 ohms. The error in the reactive part of the impedance can be similarly taken from the Smith Chart. For $\bar{\rho} = .9/180^\circ$, a 2 ohm resistor, measured values will vary from 1.25 to 3.8 ohms. The reason for these large errors for $|\rho|$ close to 1 is evident from equation (1). The denominator of this equation is the factor $1 - \bar{\rho}$. Subtracting two nearly equal numbers always results in a larger error in the difference than from the error in ρ itself.

Large errors from large and small values of impedance are a result of the low characteristic impedance of the transmission line. Since 50Ω is the most common value this limits this technique to impedance where Z falls within the range of a few ohms to a kilohm. Most transmission line components being measured for impedance, however, are close to 50Ω since this impedance provides for best match for maximum power transfer in 50Ω lines.

USEFUL BELOW 100 MHz

The setup of Figure 7 can also be used well below 100 MHz. The coupling factors of the 778D still track closely together and directivity remains greater than 40 dB. The coupling factor of nominally 0.1 (20 dB) will decrease, however, and may call for a higher amount of incident signal into the device under test if the reflected signal level falls into the noise level of the instrument. This is usually not a serious limitation except perhaps with some active devices which require very low level input signals to prevent saturation. Even then the high sensitivity and low noise level of the 8405A enables many transistors and other similar devices to be tested below 100 MHz with this method.

**MEASURING ρ
1 to 100 MHz**

Another method can be used to measure impedance referenced to 50Ω with the 8405A from 1 to 100 MHz. This setup is shown in Figure 11. Additional components required are the HP 11549A Power Splitter and two HP 8491A Pads for isolation. Two HP 11536A probe tees and one 908A Load are also required. These are used in the previous setup for measurements with the 778D.

In this method the power splitter divides the test signal into a reference and test channel. Reference channel A measures only the incident signal E_i since this arm is terminated in 50Ω. The unknown impedance is placed on the end of the 8405A probe tee on the test arm. At this point, channel B of the 8405A will measure the vector sum of the signal incident on the unknown and the signal reflected from it. Since the 11549A is a

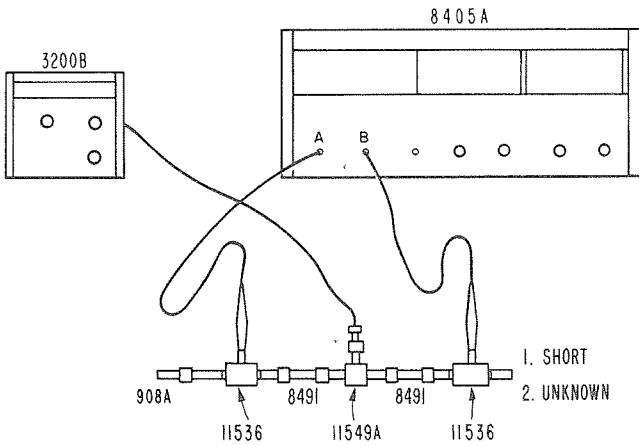

Figure 11. Measurement of Impedance with 8405A from 1 to 100 MHz

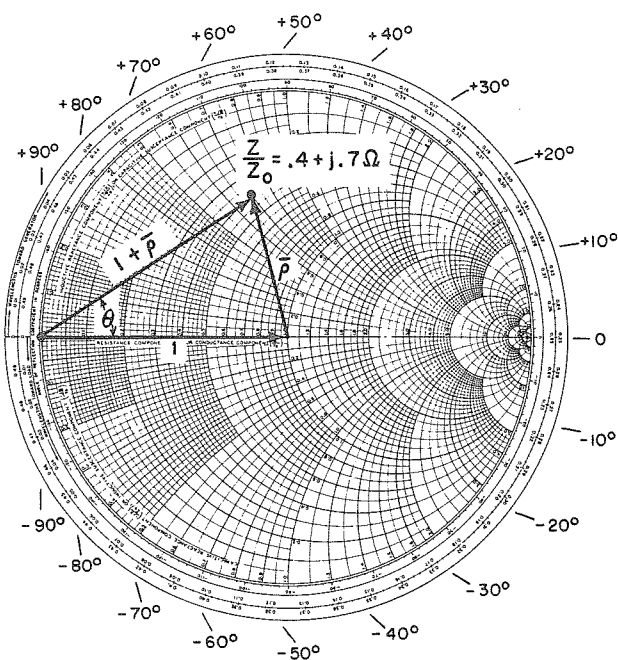

Figure 12. Determination of Impedance from 1 to 100 MHz. Relationship of Z/Z_0 to $1 + \bar{\rho}$ Vector.

symmetrical power splitter, the ratio of B to A is then:

$$B/A = \frac{E_i + E_r}{E_i} = 1 + \bar{\rho} = |1 + \rho| \angle \theta_{1 + \rho}$$

This measured ratio is a vector quantity that can also be plotted directly on the Smith Chart to measure impedances referenced to 50Ω . The magnitude of this ratio is the vector sum of $1 + \bar{\rho}$ shown in Figure 12. The measured phase angle then determines the reactive components of the impedance. Angles from 0 to $+90^\circ$ are measured CCW and 0 to -90° CW as shown in Figure 12.⁸ The measured impedance is then read at the point of the $1 + \rho$ vector. If the measured impedance

⁸Angles $> |90^\circ|$ will result from some impedances with negative real parts. Positive real impedance will always result in $\theta_{1 + \rho} \leq 90^\circ$. See Appendix B.

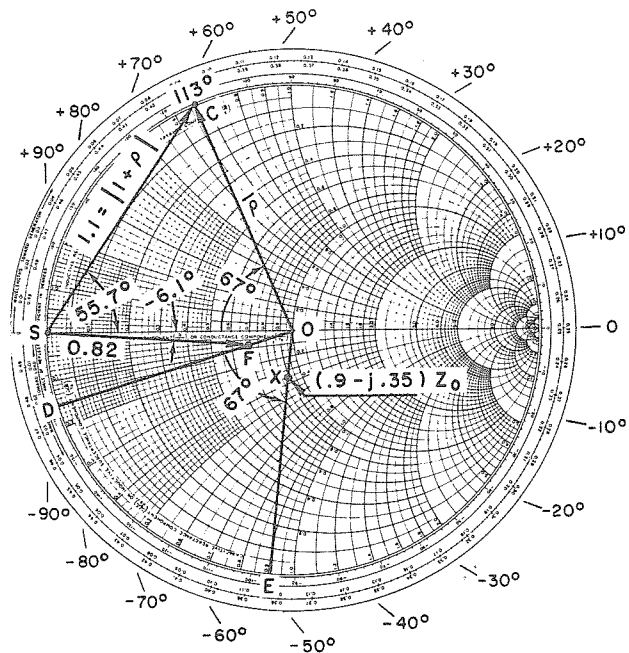

Figure 13. Example of Impedance Method from 1 to 100 MHz Using Equipment in Figure 11

is off the Smith Chart, this indicates a negative real part. Magnitude and angle of $\bar{\rho}$ can still be measured, however, and treated in the same method as in the previous section on Negative Impedance.

A short circuit is used for initial calibration to set a 180° phase reference. However, because of differences in signal path lengths for the incident signal and reflected signal to channel B, the phase reference for the short does not fall on the $1/180^\circ$ point on the Smith Chart. The following example shows the procedure to be used for measuring impedance with this technique.

EXAMPLE

At a particular frequency, with the short in place, B/A is measured to be $1.1 \angle +55.7^\circ$ as shown in Figure 13. Note that the tip of this vector is located on the outside circumference of the Smith Chart at a reflection coefficient angle of $+113^\circ$. This calibration reference point should lie on the circumference since the vector from the center of the chart to this point is $\bar{\rho}$ and its magnitude must equal one for a short. The phase angle of $\bar{\rho}$ is offset, however, by $180^\circ - 113^\circ$ or 67° in a CW direction from its true phase angle of 180° . The phase angle of the impedance to be measured therefore, will have to be offset by 67° in the opposite, or CCW direction, in order to correct for this initial phase offset.

After replacing the short with the unknown, B/A or $1 + \rho$ is now measured to be $0.82 \angle -6.1^\circ$. The point F must then be rotated 67° CCW. This angle can be conveniently plotted by striking off from point D the distance SC with a pair of dividers to where it intersects the circumference of the chart at E. The magnitude of ρ of the unknown, OF, is then measured off from O along OE. This point X equals $50 (.9 - j.35)$, or $45 - j17.5$ ohms, and is the impedance of the unknown.

ACCURACY

$$\text{error in } |1 + \rho| = \pm(.02 + .09 \rho_L^2)$$

$$\text{error in } \theta_{1 + \rho} = \pm(1.5^\circ + \sin^{-1} .09 \rho_L^2)$$

Within the 1 to 100 MHz range, accuracy is basically limited by two factors: instrument and mismatch errors. Above a few hundred MHz low 8405A probe impedance decreases accuracy and usefulness of this technique. The magnitude error has a residual of 2% due to the instrument tracking accuracy on any one range. Again, for any range switching on the 8405A a carry over of 1% per range step should be added to $|1 + \rho|$.

The second term is the mismatch ambiguity between the reflection between the probe tee and the unknown load. This term assumes the worst case, a reflection

coefficient of .09 from the probe tee at the highest frequency of 1 GHz. This constant will decrease with frequency. The actual mismatch error will rarely approach this value since it assumes that this term is always phased for a maximum error.

The first error term in the phase angle is the instrument error and the second term is from the mismatch ambiguity between the unknown and the probe tee. The same conditions for worst possible error are again assumed for the second term. This error also decreases with frequency and reflection coefficient. Impedance uncertainty can now be determined by plotting the limits of error of $1 + \bar{\rho}$ directly on the Smith Chart. This method will give a more accurate determination of impedances near 50Ω than using the coupler method since the directivity error term does not occur here.

APPENDIX A

Prove that the real part of $Z/Z_0 < 0$ for $|\rho| > 1$

$$(1) Z/Z_0 = \frac{1 + \rho e^{j\theta}}{1 - \rho e^{j\theta}} = \frac{(1 + \rho \cos\theta) + j\rho \sin\theta}{(1 - \rho \cos\theta) - j\rho \sin\theta}$$

multiplying numerator and denominator by $(1 - \rho \cos\theta + j\rho \sin\theta)$

$$(2) Z/Z_0 = \frac{1 - \rho^2 + j2\rho \sin\theta}{\rho^2 + 1 - 2\rho \cos\theta}$$

Prove that $\text{Re}[Z/Z_0] = \frac{1 - \rho^2}{\rho^2 + 1 - 2\rho \cos\theta} < 0$ for $\rho > 1$

Since $1 - \rho^2$ is always < 0 for $\rho > 1$

Prove that $\rho^2 + 1 - 2\rho \cos\theta > 0$ for $\text{Re}[Z/Z_0]$ to be < 0

for $\cos\theta = +1, \rho^2 + 1 - 2\rho > 0$

factoring: $(\rho - 1)^2 > 0$ which is always true for $\rho > 1$

for $\cos\theta = -1, \rho^2 + 1 + 2\rho > 0$

factoring: $(\rho + 1)^2 > 0$ which is always true for $\rho > 1$

APPENDIX B

Prove that positive real impedances measured by method of Figure 11 will always result in phase angles, $\alpha \leq 90^\circ$

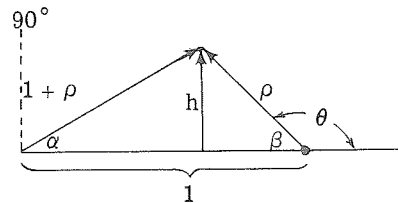

By definition $\left. \begin{array}{l} |\rho| \leq 1 \\ -180^\circ < \theta < +180^\circ \end{array} \right\}$ for positive real impedances

(1) $h = \rho \sin\beta = \rho \sin(180^\circ - \theta) = \rho \sin\theta$

(2) & $|h| \leq |\rho| \therefore |h| \leq 1$

(3) $\alpha = \sin^{-1} \frac{|h|}{|1 + \rho|}$

(4) $|1 + \rho| \geq 1$ by definition of $|\rho|$

(5) $\therefore \frac{|h|}{|1 + \rho|} \leq 1$

(6) $\therefore \alpha = \sin^{-1} \frac{|h|}{|1 + \rho|} \leq 90^\circ$