

Instruments and Equipment for Microwave Measurements

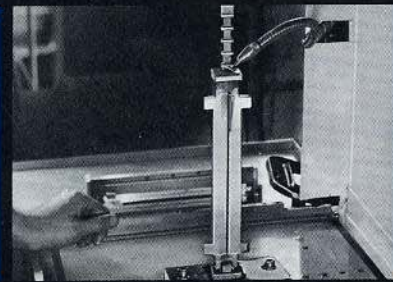

MICROWAVE CATALOG

The Philosophy of Equipment

Each instrument is designed for broadband coverage, high stability, wide applicability, convenient size and simplest possible operation. Highest quality components and materials are used in construction; utmost care is taken in manufacture. Instruments are thoroughly tested by *swept frequency* or other advanced techniques before shipment, and are warranted to meet or exceed specifications.

HEWLETT-PACKARD COMPANY

1501 Page Mill Road
Palo Alto, California, U. S. A.



Microwave Equipment for Waveguide and Coaxial Systems

Hewlett-Packard microwave test equipment is designed to provide a complete set of high-quality, low-cost instruments for measurement of microwave parameters including power, impedance, noise figure, attenuation, frequency. The equipment includes complete instrumentation for both coaxial and waveguide fields, and it has been designed for broad-band coverage, high stability, broadest application, convenient size and simplest possible operation. High-quality materials are used in careful manufacture, and all units are thoroughly tested before leaving the factory . . . and are warranted to conform with, or exceed, specifications.

Letter Designations

Model numbers of Φ waveguide components are normally preceded by a prefix letter, which designates the waveguide size and frequency band of the instrument. Following is a chart of standard waveguide specifications for these bands:

DESIGNATIONS	DIMENSIONS			TE ₁₀ OPERATING RANGE			FREESPACE WAVELENGTH (cm)	THEORETICAL ATTENUATION db/100 ft. Low to High Freq.	THEORETICAL Pk POWER RATING megawatts Low to High Freq.
				Frequency (GHz)	Wavelength (cm)	Cut-off Freq. (GHz)			
S	WR 284	RG-48/U	2.840 x 1.340	2.60 - 3.95	19.18 - 8.92	2.078	11.53 - 7.59	1.478 - 1.008	2.2 - 3.2
G	WR 187	RG-49/U	1.872 x 0.872	3.95 - 5.85	12.59 - 6.08	3.152	7.59 - 5.12	2.79 - 1.93	0.94 - 1.32
C	WR 159	—	1.590 x 0.795	4.90 - 7.05	9.37 - 5.01	3.711	6.12 - 4.25	2.89 - 2.24	0.79 - 1.0
J	WR 137	RG-50/U	1.372 x 0.622	5.30 - 8.20	9.68 - 4.29	4.301	5.66 - 3.66	4.61 - 3.08	0.56 - 0.71
H	WR 112	RG-51/U	1.122 x 0.497	7.05 - 10.0	6.39 - 3.52	5.259	4.25 - 3.00	5.51 - 4.31	0.35 - 0.46
X	WR 90	RG-52/U	0.900 x 0.400	8.20 - 12.4	6.09 - 2.85	6.557	3.66 - 2.42	8.64 - 6.02	0.20 - 0.29
M	WR 75	—	0.750 x 0.375	10.0 - 15.0	4.86 - 2.35	7.868	3.00 - 2.00	10.07 - 7.03	0.17 - 0.23
P	WR 62	RG-91/U	0.622 x 0.311	12.4 - 18.0	3.75 - 1.96	9.487	2.42 - 1.67	12.76 - 11.15	0.12 - 0.16
N	WR 51	—	0.510 x 0.255	15.0 - 22.0	3.11 - 1.60	11.571	2.00 - 1.36	17.3 - 12.6	0.08 - 0.107
K	WR 42	RG-66/U	0.420 x 0.170	18.0 - 26.5	2.66 - 1.33	14.050	1.67 - 1.13	13.3 - 9.5	0.043 - 0.058
R	WR 28	RG-96/U	0.280 x 0.140	26.5 - 40.0	1.87 - 0.88	21.075	1.13 - 0.749	21.9 - 15.0	0.022 - 0.031

Many Φ instruments also have suffix letters in the complete model number. Normally an "A" suffix identifies the original instrument, while "B," "C" and other suffixes indicate a revised, modified or special version of the basic model. However, in the case of certain Φ microwave elements, the suffix letter indicates specific attenuation or coupling, as follows:

A	3 db	D	20 db
B	6 db	E	30 db
C	10 db	F	40 db

Thus, the 20 db coupling version of Φ 750 Cross-Guide Coupler will be designated as Φ 750D. The model of the 750 built for 1" x 1/2" waveguide will, of course, have the prefix "X," so that the complete model number of a 750 series Coupler with 20 db coupling for use with 1" x 1/2" waveguide is Φ X750D Cross-Guide Coupler.

Flanges

All Φ waveguide instruments are equipped with precision cover flanges. When it is desired to connect between Φ instruments and a choke flange system under actual operating conditions Φ 290A Cover-to-Choke Flange Adapters may be used. K band and R band waveguide

equipment is normally supplied with rectangular flanges. However, when specified, circular flanges may be obtained on most K and R band instruments at no extra charge.

How to Use This Catalog

Contents of this Φ microwave instrumentation catalog have been conveniently arranged to insure maximum usefulness, and indexed on the right edge of page 3. To locate information on a given frequency range or measurement subject, just thumb through the catalog at the spot marked by the index tab . . . until you see a matching tab.

In addition to a discussion on fixed and swept-frequency measuring techniques, which prefaces the listing of instrumentation, the catalog includes a complete listing of Hewlett-Packard microwave equipment, organized primarily by frequency band designation. Thus, the catalog contains listings by the bands listed above, plus sections on 1 to 4 GC coaxial measurement, useful signal generators, SWR and impedance measurement equipment, power measuring instruments, noise figure equipment, frequency measurement and power supplies, all applicable to microwave work.

Φ Application Notes relevant to microwave measurement and available without charge, are listed on the inside back cover of the catalog.

Suggestions for Ordering

Φ instruments should be ordered by catalog model number—for example, Model X810B Waveguide Slotted Section. To speed delivery, include significant specifications and specific instructions in your order whenever you desire special options or features such as non-standard color, power line voltage, etc.

Many Φ instruments are available in cabinets for bench use or with 19" panels for rack mounting. The letter "R" after the model number indicates a rack mounting instrument.

Your order should be made out to the Hewlett-Packard Company and sent to Palo Alto, California, through your local Φ representative (see back cover) or directly, if you prefer. Outside the United States, your order often can be placed directly on your local Φ distributor or representative (see back cover). Alternatively, your order can be made out to Hewlett-Packard Company (Hewlett-Packard S. A. if you are in Western Europe) and sent to the appropriate Φ office, either directly or through your local Φ authorized sales office.

Repair parts are ordered in the same way as instruments and should be designated by the Φ stock number shown in the instruction manual and, if possible, by the schematic diagram circuit reference number. Model number and serial number of the instrument, and original purchase date should also be given, if known.

Instrument service and repair are provided both at the factory and at many field service centers (see back cover). Field servicing of instruments is normally faster; however, if you wish to return an instrument to the factory for repairs, recalibration or for any other reason, please contact Customer Service, Hewlett-Packard Company, 395 Page Mill Road, Palo Alto, California, phone: DAvenport 6-1755, for shipping instructions. Please give model number, name, serial number and as much other information as possible concerning the reason for return.



More than 50 engineers at Hewlett-Packard devote their full time to the development of new microwave products. This research and development effort, the most extensive of its kind in the industry, results in a continuing flow of new microwave equipment.

MICROWAVE MEASURING TECHNIQUES

Swept Frequency

In using microwave test equipment, an engineer relies heavily on the manufacturer's specifications to assure performance of his test system. He cannot afford tedious and complex pre-testing before using the microwave equipment.

Hewlett-Packard has always been keenly aware of its responsibility to the ultimate user of its microwave test equipment. ϕ operating philosophy calls for the best design consistent with state-of-the-art microwave concepts, plus production processes to provide the finest quality microwave test equipment at nominal expense. Even more important than design and production is the test method used to assure that the equipment performs equal to or better than published specifications. In the test process used at ϕ , known as full-range testing, each item is tested at all points within its frequency band, usually with a sweep oscillator. To provide full-range testing on a production basis Hewlett-Packard pioneered the reflectometer concept of swept frequency reflection testing. Not only have these techniques led to more comprehensive testing of Hewlett-Packard's own instruments, but they also have offered speed and accuracy to microwave measuring applications throughout the world. Full-range testing techniques are now widely known and widely accepted.

As new equipment has been developed, Hewlett-Packard engineers have refined and improved the techniques of full-range testing and applied them to even more measurement problems. To a unique degree ϕ has been able to do this in its own waveguide test department. The speed of testing and the comprehensive results obtained more than offset the slight increase in cost of a given test setup.

Systems for Full-Range Testing

Early reflectometers were subject to a variety of calibration errors. Initial calibration is generally performed with a 100 per cent reflection, such as a sliding short. Subsequent tests on a low-reflection unknown may cause error by placing the reverse detector in a much lower power region. Other scalar errors must also be considered.

An improved reflectometer system which materially reduces calibration errors has been developed at Hewlett-Packard. This arrangement (see Figure 1) enables continuous calibration over the entire frequency range by means of a broadband rotary vane attenuator in the secondary arm of the reverse coupler.

The attenuator, in effect, pre-inserts the return losses anticipated for actual tests. With the attenuator in the system, a frequency sweep of the reference short yields calibration traces that include most system errors. A series of such traces can then be compared with the performance trace of the instrument being tested on a go/no-go basis.

Scalar errors caused by nonmatch of the coupling factors, variation of detectors with frequency and power, and errors in the ratiometer and X-Y recorder can be disregarded because of their inclusion in the calibration curves. Overall accuracy of the system is still limited by the reverse coupler directivity vector—a short-coming of any high-directivity reflectometer system.

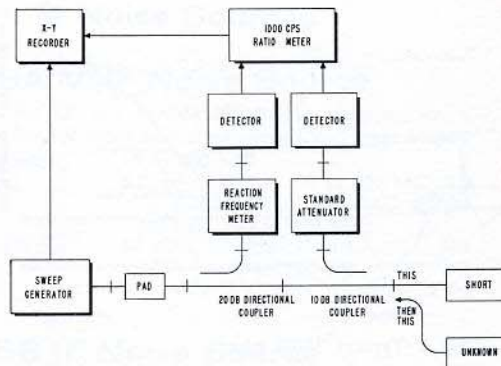
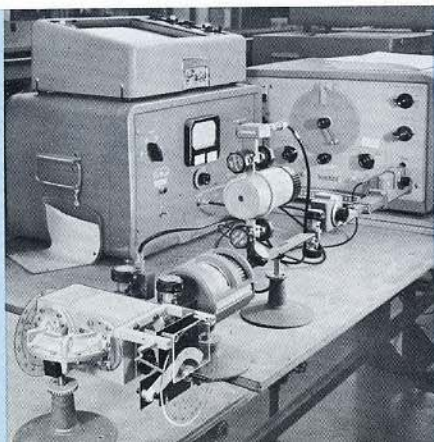

Fig. 1 Improved setup for sweep frequency SWR measurements.

This improved technique can be modified for a wide variety of basic measurements and has been adopted for production test of most Hewlett-Packard microwave instruments. SWR, directivity, attenuation, crystal matching, and TWT noise figure measurements are easily performed.

Step-by-Step Procedure for Measuring SWR

- ▶ Connect the 100 per cent calibrating short to the reverse coupler, see Figure 1.
- ▶ Set the expected value of return loss into the standard rotary vane attenuator. For instance, if the expected SWR is 1.2, the standard attenuator should be set to 20.8 db. (Return loss = $20 \text{ Log } \rho = 20 \text{ Log } [\text{SWR} - 1/\text{SWR} + 1]$.)
- ▶ Set the ratiometer range and the X-Y recorder sensitivity to keep the pen on scale.
- ▶ Sweep the frequency generator over the required range to obtain a calibration plot of frequency vs. SWR.
- ▶ Reset the attenuator to simulate other SWR values and plot additional calibration lines. A series of typical calibration lines is shown in Figure 2. Two calibration lines give enough information for go/no-go tests.
- ▶ Replace the calibrating short with the unknown load.
- ▶ Return the standard attenuator to zero db and trigger the final measurement sweep. The colored trace in Figure 2 shows an instrument SWR characteristic between 8.2 and 12.4 GC.
- ▶ Where repeated tests of identical instruments are to be performed, the calibrating traces can be inscribed on transparent paper to compare with measurement traces.



A self-imposed requirement of full-range testing of ϕ microwave equipment has led to the development and refinement of swept-frequency techniques shown here. Equipment is production tested, not just at random points, but over its entire range, to assure that it meets its rigid specifications.

S	Band	2.00 to 0.50 GC
G	Band	3.95 to 5.85 GC
J	Band	5.3 to 8.2 GC
H	Band	7.05 to 10.0 GC
X	Band	8.2 to 12.4 GC
P	Band ²	12.4 to 18.0 GC
K	Band	18.0 to 26.5 GC
R	Band	26.5 to 40.0 GC
M	Band	10 to 15 GC
TWT's, miscellaneous equipment		
1 to 4 GC Coaxial Measurements		
SWR, Impedance Measurements Signal Generators		
Power Measurements		
Noise Figure Measurements		
Frequency Measurements Power Supplies		

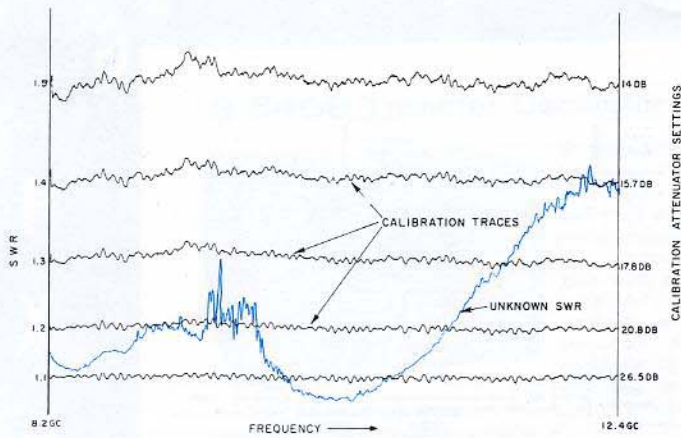

Fig. 2 Typical SWR plot.

A setup for swept frequency attenuation measurements is illustrated in Figure 3. Here, the reflected channel of the ratiometer becomes the transmission channel because the coupler-detector is placed in the forward direction. The transmission detector should be isolated by a coupler or pad to provide good matching over the entire test band.

Calibration traces are plotted with the precision attenuator set on and around the expected values of attenuation. The unknown is inserted in the line, and the standard attenuator returned to zero db. The final test sweep is then run with the unknown attenuator. Characteristics of a flap attenuator set to 15 db are shown in Figure 4.

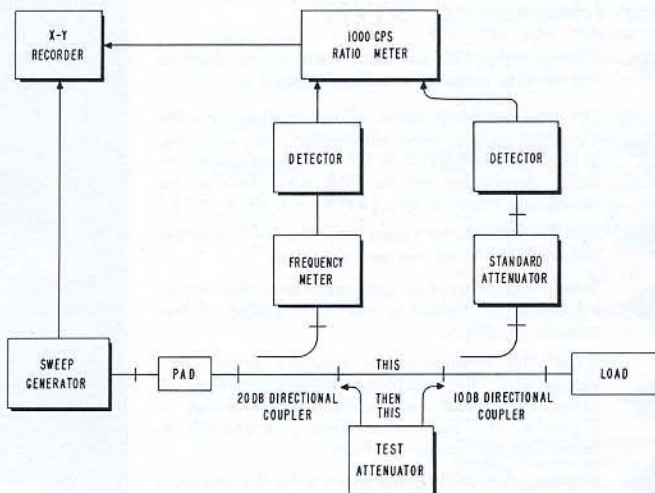

Fig. 3 Setup for accurate sweep frequency attenuation measurements.

The measurements described here can also be made with coaxial systems. Broadband coaxial pads of various values provide the standard rf attenuation when calibrating the equipment.

Measurements in coaxial systems would, however, be less accurate than those in waveguides because random directivity errors are somewhat larger in coaxial couplers.

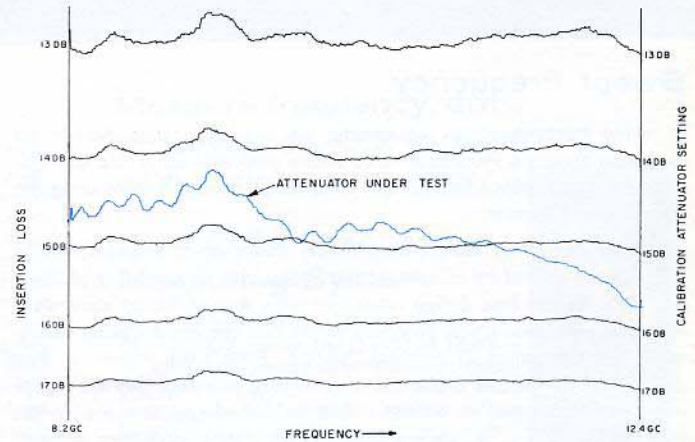

Fig. 4 Attenuation characteristics of a flap attenuator.

Measurement Errors

The errors inherent in broadband measuring procedures are divided into vector errors and scalar errors. Vector errors are primarily due to imperfect directivity of the reverse couplers. Typical multi-hole precision couplers with directivities greater than 40 db give reflection coefficient errors of 0.01 in the final reading.

A second vector error is due to variation in the matching of the standard attenuator in the calibration and measurement steps of the test procedure. This causes slight variations of transmitted power in going from the "Calibrate" to "Measure" condition. If the attenuator has an SWR of 1.15, the ambiguous mismatch error is less than 0.4 db (equivalent to a 5 per cent error of the reflection coefficient value).

Inaccuracy of the standard attenuator is the major contribution to scalar error. Rotary vane attenuators have specified accuracies of 2 per cent of the reading. For a return loss measurement of -20 db, such attenuator inaccuracies would result in a 5 per cent error of reflection coefficient value. Such errors can be minimized through point-by-point calibration of the standard attenuator. All other scalar variations are calibrated out by the test procedure.

Fixed Frequency

Although swept frequency techniques have been refined to a high degree of accuracy, fixed frequency methods of microwave measurement are also used. They offer the highest precision attainable for individual measurements because the small inherent mismatch ambiguities, which must be tolerated on a broad frequency sweep basis, may be individually tuned out.

Microwave Standards Laboratory

One of today's best examples of fixed frequency measuring precision is found in the continuing work of the Hewlett-Packard Microwave Standards Laboratory, which devotes full time to advancing the art of standards measurements. The techniques used are painstaking and tedious, but the results are completely worthwhile. Continuing correlation of the Hewlett-Packard microwave house standards with the available certification services of the National Bureau of Standards assures that high accuracy is built into all microwave equipment. Traceability to the National Standard, wherever the certification service is available, can be supplied for the applicable microwave instruments.

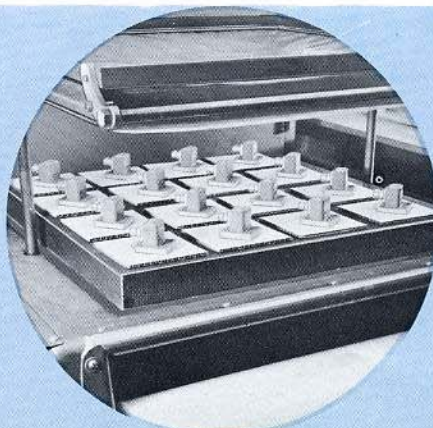

Hewlett-Packard prepares many instruments for shipment with the newest skin-pack technique. Parts are firmly affixed to heavy sheets of card stock with an overall plastic coating, which forms a rigid and protective film. These and other packing methods assure safe delivery of instruments to the user.

Frequency Measurement

Hewlett-Packard frequency measuring systems are classed according to the measurement precision desired. For general use a series of cavity frequency meters is available. These depend for their accuracy on the precise control and calibration of a high Q resonant cavity coupled into a transmission system. At the resonant frequency a slight reaction is observed on the transmission of the microwave energy which shows up as a slight dip in the output power. Cavity frequency meters are a general purpose test tool for laboratory and production use and are available in coaxial and waveguide ranges from 1 to 40 GC.

For extremely precise frequency measurements, heterodyne counter techniques are used for measurements extending from the very lowest of the microwave frequencies up through 40 GC. Counter accuracy is achieved by zero-beating harmonics of the Φ 540B Transfer Oscillator against the unknown microwave frequency, and reading the 540B fundamental frequency to high accuracy on an Φ digital counter. Broadband mixers are available for the entire frequency range. The heterodyne system is highly flexible and can perform measurements on pulsed and FM signals as well as on CW systems. Heterodyne measuring techniques are described in Application Note 2.

Impedance Measurement

The primary microwave standard of impedance measurement is the slotted line which Φ provides in coax and waveguide systems from 500 MC through 40 GC. Slotted line sections are designed for lowest residual SWR consistent with their intended broadband operation.

Below 500 MC slotted lines become somewhat unwieldy because of their large physical size, so an impedance bridge technique is used for direct measurement of impedance in both magnitude and phase, see photograph on page 25. The Φ 803A Impedance Bridge operates from 52 to 500 MC with direct readout. The bridge is balanced by means of a sensitive super-regenerative receiver, Φ Model 417A.

Attenuation Measurement

Precise attenuation measurements throughout the entire coaxial and waveguide frequency range to 40 GC are possible with Φ microwave equipment. Primary measurement techniques include the power ratio method as well as rf or IF substitution methods. Common to most of the measurements are signal generating sources and detection equipment as well as substitution attenuators required in the various frequency bands.

In the power ratio method, the signal source is connected to a detector mount through a length of lossless transmission system for which the unknown attenuator may be substituted. A reading is obtained on the output indicator after which the lossless length is replaced by the attenuator being measured. The power change at the output indicator is then a measure of the attenuation. A detector mount employing a barretter is commonly used because it permits a wider range of attenuation measurement. The attenuation in decibels may be read directly from the Φ Model 415.

RF substitution depends on substituting an attenuator of known characteristic for an unknown attenuator. For instance, the output attenuator of any Φ signal generator may be used as the standard attenuator. As the unknown attenuator is inserted in the system the standard rf attenuator is cut out until the previous reference reading is re-obtained.

The difference between the reference attenuator settings is then the attenuation of the unknown attenuator in db. Since the detector is always operated at the same level, the knowledge of the detection characteristics is not necessary.

Power Measurement

In the microwave region, power measurements are considered to be more basic than current or voltage measurements, since power is invariant with position of measurement on a lossless transmission line. In the power range up to 10 mw, measurements are customarily made by use of temperature-sensitive elements such as bolometers. Bolometers are tiny elements which convert rf power to heat and, in turn, vary their resistance in proportion to the temperature change of the element. They are normally used in a bridge configuration which allows the change of resistance in the bolometer to be determined by external audio or dc techniques. Automatic balancing bridges, such as the Φ 430C and 431A provide automatic substitution techniques which read out directly in rf power. A complete line of coaxial and waveguide bolometer mounts is available for the frequency range 10 MC through 40 GC.

For the intermediate power range up to 10 w Φ offers the unique 434A Calorimetric Power Meter, which makes direct, convenient and accurate measurements much faster than conventional calorimeter response. The instrument depends for fast action on an oil flow system which moves heat quickly from the rf dissipating element to the temperature-sensing bridge elements. The Φ 434A offers overall accuracy of 5 per cent for power measurements from dc to 12.4 GC.

Noise Figure Measurement

Φ automatic noise measuring equipment is specifically designed to speed the measurement and optimization of amplifier and receiver noise figures. The continuous presentation of noise figure aids even semi-skilled operators in tuning adjustments which increase performance from microwave receivers.

Hewlett-Packard automatic noise figure measurements depend upon the periodic insertion of a known excess noise power at the input of the device under test. Subsequent detection of noise power results in a pulse train of two power levels. The power ratio of these two levels contains the desired noise figure information. Hewlett-Packard noise figure meters automatically measure and present this ratio directly in db of noise figure.

Φ 344A Transistorized Noise Figure Meter has been specifically designed for radar system applications where time-shared noise figure measurements are extremely important to assure that radar sets are operating at peak performance.

Φ noise sources are available in all frequencies between 10 MC and 18 GC to allow measurements on all rf devices in this range.

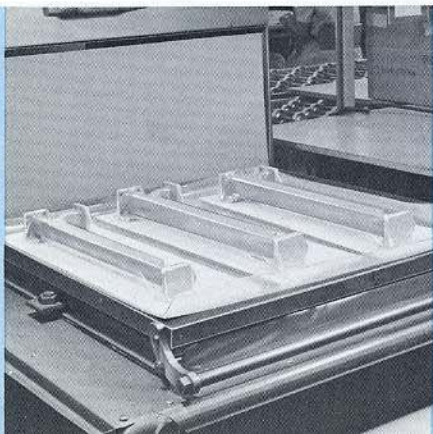

Instrument	Frequency Range	Characteristics	Price
616B Signal Generator	1800 to 4200 MC	Output 0.1 μ v to 0.233 v into 50 ohm load. Pulse, CW or FM modulation. Direct calibration	
683C Sweep Oscillator	2 - 4 GC	Electronically swept; variable sweep rate, width. Output 10 mw, SWR 3 or less. Pulse, square wave, FM, AM modulation. Leveled output	
490B Microwave Amplifier	2 - 4 GC	30 db gain; AM, helix input; 10 mw output	
491C Microwave Amplifier	2 - 4 GC	30 db gain; AM input; 1 w output	

Model	Description	Accuracy	Range	SWR (Max.)	Power (watts)	Length (inches)	Shipping Weight (lbs.)	Price
S281A	Adapter, waveguide to coax			1.25		3	1	
S290A	Adapter, cover-to-choke flange					3	7	
S347A	Noise Source, waveguide	± 0.5 db	15.2 db	1.2		22 $\frac{1}{2}$	17	
S370	Attenuators, fixed	$\pm 20\%$	3, 6, 10, 20 db	1.15		12	12	
S372	Attenuators, precision fixed	± 0.5 db	10, 20 db	1.05	2	46	37	
S375A	Attenuator, flap	± 1 db at < 10 db ± 2 db at > 10 db	0-20 db	1.15	2	14 $\frac{1}{8}$	14	
S380A	Attenuator, waveguide	± 0.3 db at 3 GC	0-10 db		1		13	
S485D	Detector Mount	Response: ± 1 db Sq. law: $< \pm 0.5$ db	Sensitivity 0.2 v/mw	1.5	1	4 $\frac{1}{2}$	5	
S485A	Detector Mount			1.35		4-11/16	5	
S486A	Thermistor Mount, compensated		0.001-10 mw	1.35		3	2	
S487B	Thermistor Mount, broadband		0.01-10 mw	1.35		2 $\frac{3}{8}$	3	
S750	Directional Couplers, cross-guide	± 1.7 db	20, 30 db			9 x 9	16	
S752	Directional Couplers, multi-hole	Mean: ± 0.4 db Variation: ± 0.5 db	3, 10, 20 db	1.1, 1.05, 1.05		50 $\frac{1}{4}$, 48, 48	40	
S810A (444A)	Slotted section, and carriage Waveguide (Detector Probe for S810A)			1.01		12 $\frac{3}{4}$	15 (1)	
S870A	Tuner, slide screw	Insertion loss: < 2 db at 20:1 SWR	Corrects SWR of 20			11	13	
S910A	Termination, low power			1.04		10 $\frac{1}{4}$	10	
S912A	Termination, high power			1.1	100	15 $\frac{1}{4}$	18	
S914A	Moving Load	Load Reflection $< 0.5\%$	$> \frac{1}{2}$ wavelength			25 $\frac{3}{4}$	19	
S920A	Adjustable Short		$> \frac{1}{2}$ wavelength			10-7/16	10	
S25	Waveguide Clamp							
24	Waveguide Stand							

Data subject to change without notice. Prices f.o.b. factory.



An automatic test set including a special bench setup and counter and printer provides a careful and effective drift check for ϕ 606/608 Signal Generators, each of which is operated, under test, for 60 minutes after a 30-minute warmup, with a complete check of drift made every 10 minutes. This and similar other tests assure that ϕ instruments will meet specs.

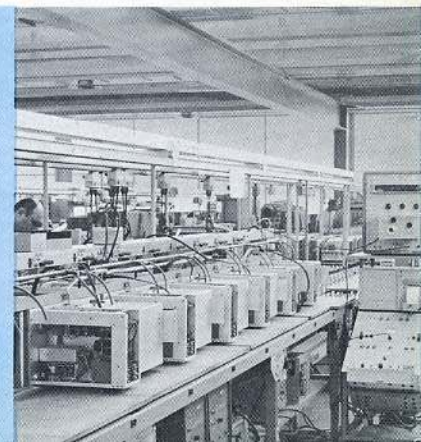

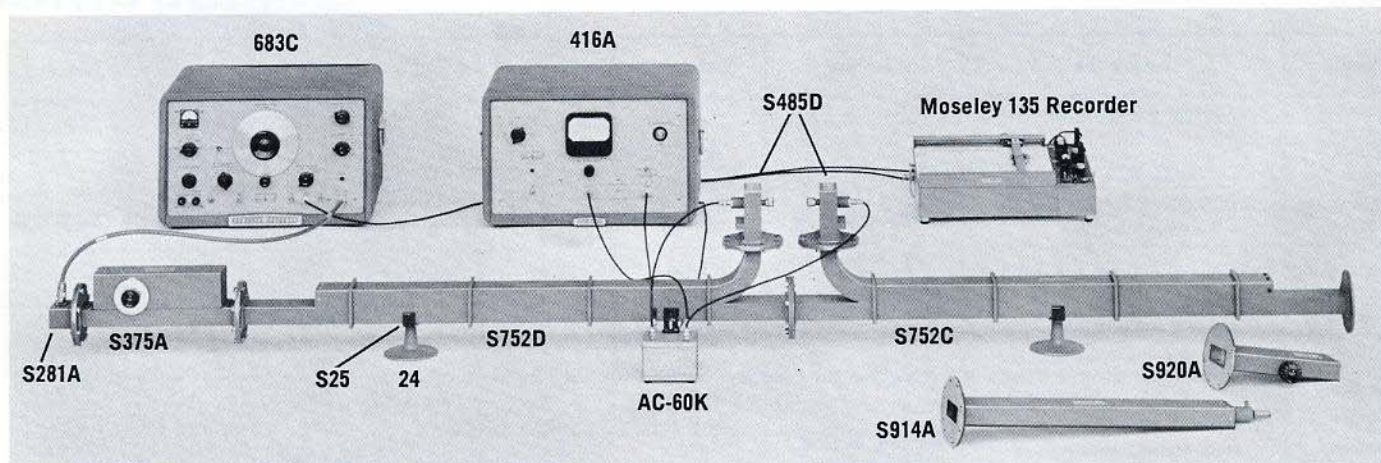

This simple measurement setup demonstrates sweep frequency techniques possible with Φ S Band instrumentation

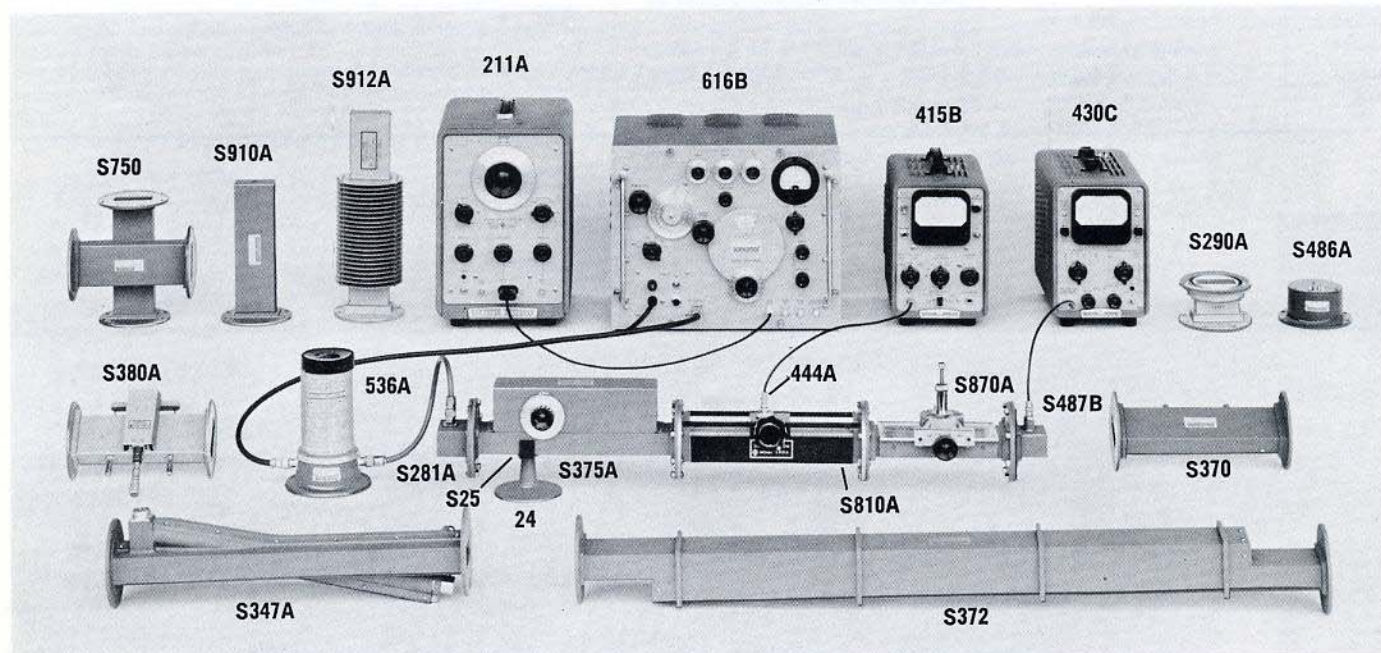

Typical Φ S Band fixed frequency measurement setup is shown with other related Φ S Band instrumentation



The Φ "Product-Centered" concept of production results in single production lines that begin with the raw materials and end with the finished product, the same workers completing each production "run" of a given instrument. This technique results in familiarity with the product, critical self-inspection and a desire to excel. For the customer, it means better products, even in mass production.

Instruments

Model	Description	Accuracy	Range	SWR (Max.)	Power (watts)	Length (inches)	Shipping Weight (lbs.)	Price
G281A	Adapter, waveguide to coax			1.25		2	2	
G290A	Adapter, cover-to-choke flange					2	3	
G347A	Noise Source, waveguide	±0.5 db	15.2 db	1.2		19	13	
G370	Attenuators, fixed	±20%	3, 6, 10, 20 db	1.15	1	10 1/8	5	
G372	Attenuators, precision fixed	±0.5 db	10, 20 db	1.05	2	30	16	
G375A	Attenuator, flap	±1 db at <10 db ±2 db at >10 db	0-20 db	1.15	2	13	9	
G382A	Attenuator, calibrated, precision	±2% of reading, or 0.1 db which- ever is greater	0-50 db	1.15	15	31 1/8	33	
G485D	Detector Mount	Response: ±1 db Sq. law: <±0.5 db	Sensitivity: 0.2 v/mw	1.50		3 1/8	3	
G485B	Detector Mount			with barretter 1.25		9-5/16	5	
G486A	Thermistor Mount, compensated		0.001-10 mw	1.50		4	3	
G487B	Thermistor Mount, broadband		0.01-10 mw	1.50		2 1/8	3	
G532A	Freq. Meter, direct reading	±0.033% at 23°C. ±0.065% overall				6 1/4 x 9 1/2 x 5	11	
G750	Directional Couplers, cross-guide	±1.7 db	20, 30 db			6 x 6	7	
G752	Directional Couplers, multi-hole	Mean: ±0.4 db Variation: ±0.5 db	3, 10, 20 db	1.10, 1.05, 1.05	2	34 3/8, 33, 33	19	
G810B (809B) (444A)	Slotted Section, waveguide (carriage for 810B) (Detector Probe for 809B)			1.01		10 1/4	5 (8) (1)	
G870A	Tuner, slide screw	Insertion loss: <2 db at 20:1 SWR	Corrects SWR of 20			8 1/4	7	
G910A	Termination, low power			1.04	2	6 5/8	4	
G914A	Moving Load	Load reflection: <0.5%	>1/2 wavelength		2	17	10	
G920A	Adjustable Short		>1/2 wavelength			7-13/16	4	
G25	Waveguide Clamp							
24	Waveguide Stand							

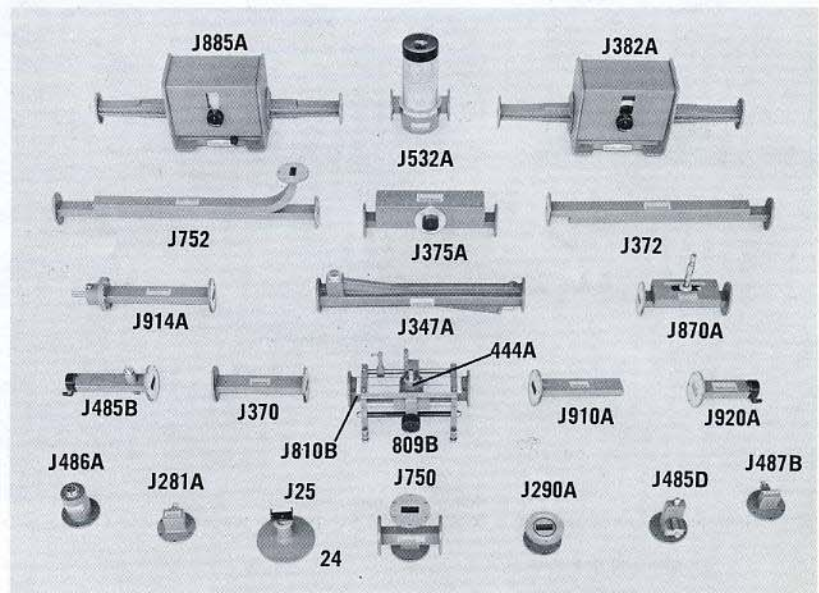

Ⓟ J Band Microwave Equipment permits a wide variety of measurements. The J Band instruments are pictured here



5.3 to 8.2 GC J-BAND

G-J 3.95 GC
to
8.20 GC

and equipment

Instrument	Frequency Range	Characteristics	Price
618B Signal Generator	3800 - 7600 MC	Output 0.1 μ v to 0.223 v into 50 ohm load. Pulse, CW, FM or square wave modulation. Direct calibration	
620A Signal Generator	7000 - 11,000 MC	Same as 618B	
684C Sweep Oscillator	4 - 8 GC	Electronically swept; variable sweep rate and width. Output 10 mw, SWR 3 or less. Pulse, square wave, FM, AM modulation. Leveled output	
492A Microwave Amplifier		30 db gain; AM, helix input; 10 mw output	
493A Microwave Amplifier	4 - 8 GC	30 db gain; AM input; 1 w output	

Model	Description	Accuracy	Range	SWR (Max.)	Power (watts)	Length (inches)	Shipping Weight (lbs.)	Price
J281A	Adapter, waveguide to coax			1.25 (1.30 from 5.3-5.5 GC)		1 $\frac{3}{4}$	2	
J290A	Adapter, cover-to-choke flange					1 $\frac{3}{4}$	2	
J347A	Noise Source, waveguide	± 0.5 db	15.2 db	1.2		19	12	
J370	Attenuators, fixed	$\pm 20\%$	3, 6, 10, 20 db	1.15	1	8 $\frac{1}{8}$	5	
J372	Attenuators, precision fixed	± 0.5 db	10, 20 db	1.05	2	22 $\frac{3}{4}$	12	
J375A	Attenuator, flap	± 1 db at < 10 db ± 2 db at < 20 db	0-20 db	1.15	2	13	9	
J382A	Attenuator, calibrated, precision	$\pm 2\%$ of reading or 0.1 db whichever is greater	0-50 db	1.15	10	25	24	
J485D	Detector Mount	Response: ± 1 db Sq. law: $< \pm 0.5$ db	Sensitivity: 0.2 v/mw	1.5		4 $\frac{1}{4}$	3	
J485B	Detector Mount			with barretter 1.25		7 $\frac{3}{8}$	4	
J486A	Thermistor Mount, compensated		0.001-10 mw	1.5		3 $\frac{3}{8}$	3	
J487B	Thermistor Mount, broadband		0.01-10 mw	1.50		1 $\frac{3}{4}$		
J532A	Frequency Meter, direct reading	$\pm 0.033\%$ at 23°C., $\pm 0.065\%$, overall				6 $\frac{1}{4}$ x 9 $\frac{1}{8}$ x 4 $\frac{1}{2}$	11	
J750	Directional Couplers, cross-guide	± 1.7 db	20, 30 db			6 x 6	4	
J752	Directional Couplers, multi-hole	Mean: ± 0.4 db Variation: ± 0.5 db	3, 10, 20 db	1.10, 1.05, 1.05	1	26 $\frac{1}{2}$, 25-9/16, 25-9/16	14	
J810B (809B) (444A)	Slotted Section, waveguide (Carriage for 810B) (Detector Probe for 809B)			1.01		10 $\frac{1}{4}$	4	
J870A	Tuner, slide screw	Insertion loss: < 2 db at 20:1 SWR	Corrects SWR of 20			7 $\frac{5}{8}$	5	
J885A	Waveguide Phase Shifter	Lesser of 3° or 10%	-360° to +360°	1.35	10	25	25	
J910A	Termination, low power			1.02	1	8-3/16	4	
J914A	Moving Load	Load Reflection $< 0.5\%$	$> \frac{1}{2}$ wavelength		2	13 $\frac{1}{2}$	9	
J920A	Adjustable Short		$> \frac{1}{2}$ wavelength			6 $\frac{1}{4}$	3	
J25	Waveguide Clamp							
24	Waveguide Stand							

Data subject to change without notice. Prices f.o.b. factory.

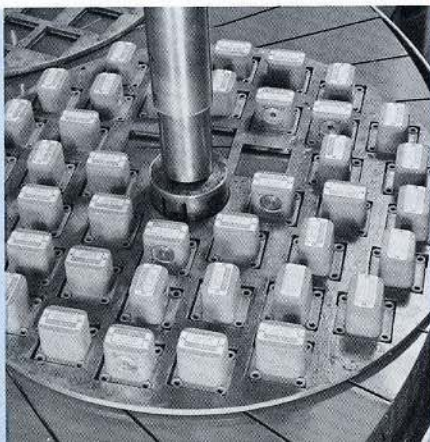



All flanges on all Hewlett-Packard microwave equipment are precision machined on modern lapping machines, a thorough process which produces surfaces with controlled convexity (15 to 30 μ in./in.), 10 μ in. rms surface finish, and produces superior performance specs with minimum rf leakage and discontinuity at equipment joints. After lapping, flanges are inspected optically, as well.

Instrument	Frequency Range	Characteristics	Price
620A Signal Generator	7000 - 11,000 MC	Output 0.1 μ v to 0.223 v into 50 ohm load. Pulse, FM or square wave modulation. Direct calibration	
HOI 686C Sweep Oscillator	7 - 11 GC	Electronically swept; variable sweep rate and width. Output 10 mw, SWR 3:1 or less. Pulse, square wave, FM, AM modulation. Levelled output	
494A Microwave Amplifier	7.0 - 12.4 GC	30 db gain; AM, helix input; 20 mw output	
495A Microwave Amplifier	8.2 - 12.4 GC	30 db gain; AM input; 1 watt output	

Model	Description	Accuracy	Range	SWR (Max.)	Power (watts)	Length (inches)	Shipping Weight (lbs.)	Price
H281A	Adapter, waveguide to coax			1.25		1 1/2	1	
H290A	Adapter, cover-to-choke flange					1 1/2	1	
H347A	Noise Source, waveguide	± 0.5 db	15.2 db, 7.05-10.0 GC	1.2		16	6	
H370	Attenuators, fixed	$\pm 20\%$	3, 6, 10, 20 db	1.15	1	6 3/8	3	
H372	Attenuators, precision fixed	± 0.5 db	10, 20 db	1.05	1	20 7/8	6	
H375A	Attenuator, flap	± 1 db at ≤ 10 db ± 2 db at > 10 db	0-20 db	1.15	2	8 1/4	5	
H382A	Attenuator, calibrated, precision	$\pm 2\%$ of reading, or 0.1 db, whichever is greater	0-50 db	1.15	10	19-15/16	23	
H421A	Detector Mount	Freq. Resp.: ± 2 db; Sens.: approx. 0.05 v/mw	-40 to 0 dbm	1.5			2	
H485B	Detector Mount			with barretter 1.25		6 3/8	3	
H486A	Thermistor Mount, compensated		0.001-10 mw	1.5		3 3/8		
H487B	Thermistor Mount, broadband		0.01-10 mw	1.5		1-5/16	2	
H532A	Frequency Meter, direct reading	$\pm 0.040\%$ at 23°C, $\pm 0.075\%$ overall				6 1/4 x 8 x 4 3/8	11	
H750	Directional Couplers, cross-guide	± 1.7 db	20, 30 db			4 x 4	3	
H752	Directional Couplers, multi-hole	Mean: ± 0.4 db Variation: ± 0.5 db	3, 10, 20 db	1.1, 1.05, 1.05	1	18 5/8, 17 1/2, 17 1/2	5	
H810B (809B) (444A)	Slotted Sections, waveguide (Carriage for 810B) (Detector Probe for 809B)			1.01		10 1/4	4	
H870A	Tuner, slide screw	Insertion loss: < 2 db at 20:1 SWR	Corrects SWR of 20			6	4	
H910A	Termination, low power			1.02	1	5 5/8	2	
H914A	Moving Load	Load Reflection: $< 0.5\%$	$> 1/2$ wavelength		1	11 1/4	4	
H920A	Adjustable Short		$> 1/2$ wavelength			4 7/8	2	
H25	Waveguide Clamp							
24	Waveguide Stand							

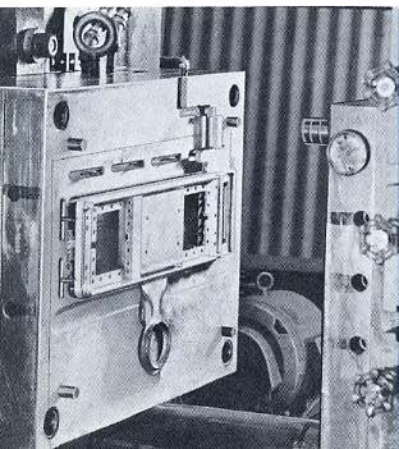
Data subject to change without notice. Prices f.o.b. factory.



Uniformity of products and economy to the buyer are assured with Hewlett-Packard's extensive die casting capability. Modern techniques and complete facilities in the  plant assure close control to produce equipment of uniformly high precision quality at prices which offer real savings to the user.



Instruments and equipment

H 7.05 GC
to
10.0 GC

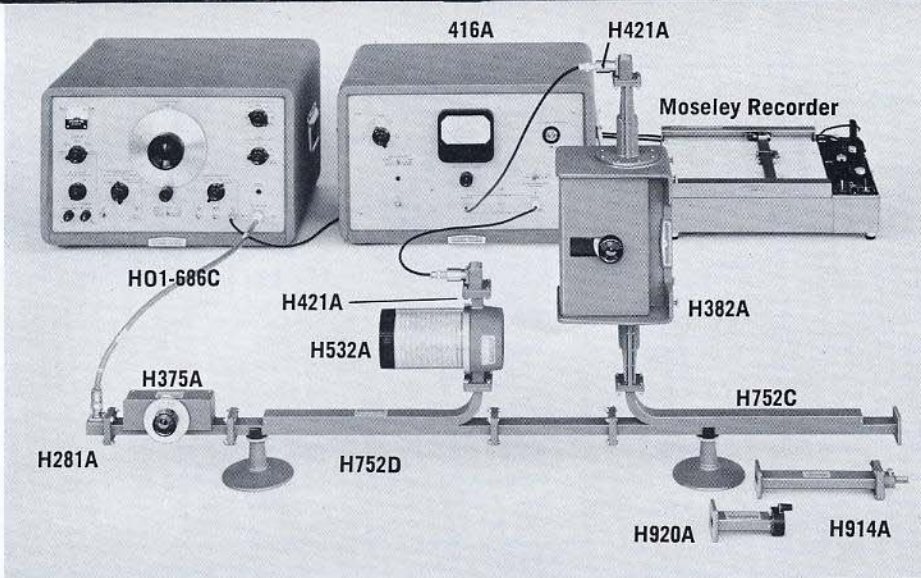

This typical \oplus H Band sweep frequency measuring system for SWR is easy to set up and calibrate

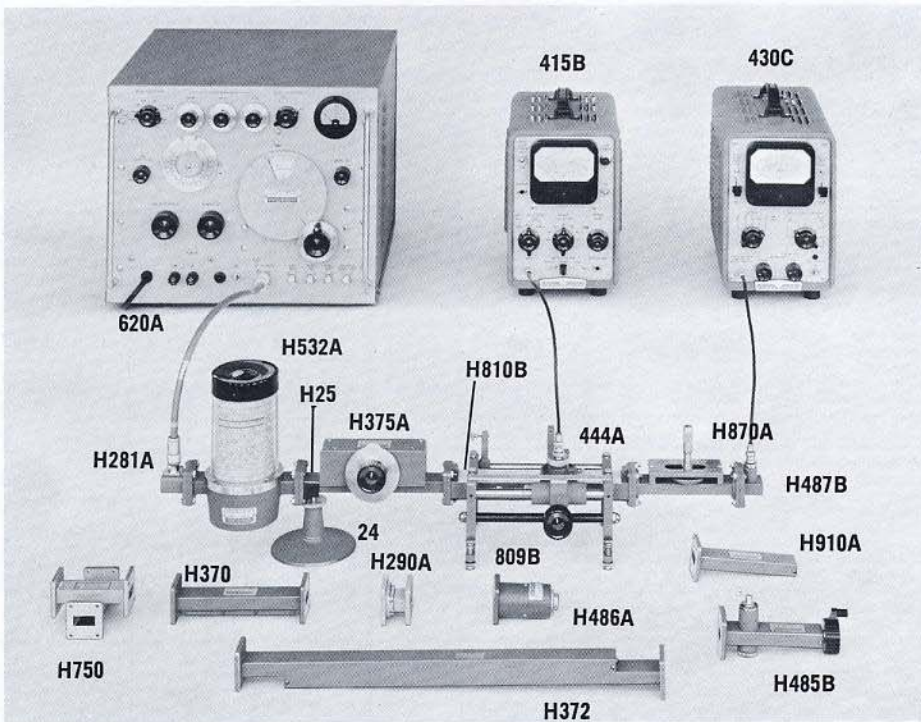

Miscellaneous \oplus H Band equipment is shown with a typical H Band fixed frequency measuring system. Calibration depends on the standard attenuator

Every microwave instrument manufactured by \oplus is given a final pre-packing check in Quality Assurance, where tests range from visual to elaborate electronic checking. The instruments go directly from this final check line into the packing department and to inventory or the shipping dock.

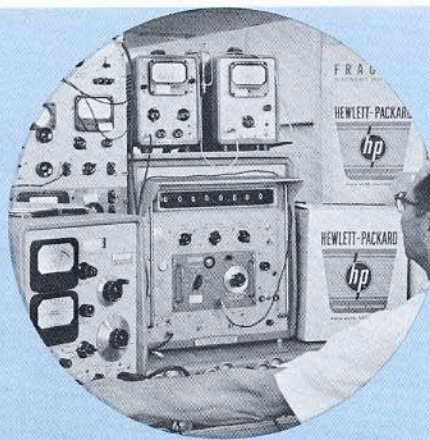

Model	Description	Accuracy	Range	SWR (Max.)	Power (watts)	Length (inches)	Shipping Weight (lbs.)	Price
X281A	Adapter, waveguide to coax			1.25		1/2	1	
X290A	Adapter, cover-to-choke flange					1/2	1/2	
X347A	Noise Source, waveguide	±0.5 db	15.2 db	1.2		14 3/4	4	
X362A	Low Pass Filter	Insertion loss, Passband: <1 db Stopband: >40 db	Passband: 8.2-12.4 GC Stopband: 16.0-37.5 GC	Passband 1.5		5-11/32	1	
X370A	Attenuators, fixed	±20%	3, 6, 10, 20 db	1.15	1	5 1/4	2	
X372	Attenuators, precision fixed	±0.5 db	10, 20 db	1.05	1	19 1/8	5	
X375A	Attenuator, flap	±1 db at <10 db ±2 db at >10 db	0-20 db	1.15	2	7-3/16	5	
X382A	Attenuator, calibrated, precision	±2% of reading or 0.1 db, whichever is greater	0-50 db	1.15	10	15 5/8	13	
X421A	Detector Mount	Freq. Resp.: ±2 db Sens.: 0.05 v/mw	-40 to 0 dbm	1.5			1	
X485B	Detector Mount			with barretter 1.25		6	2	
X486A	Thermistor Mount, compensated		0.001-10 mw	1.5		2 1/8	2	
X487B	Thermistor Mount, broadband		0.01-10 mw	1.5		1-3/16	1	
X532B	Frequency Meter, direct reading	±0.050% at 23°C. ±0.080% overall	8.2-12.4 GC			4 1/2 x 6 1/4 x 2 3/4	6	
X750	Directional Couplers, cross-guide	±1.7 db	20, 30 db			3 x 3	2	
X752	Directional Couplers, multi-hole	Mean: ±0.4 db Variation: ±0.5 db	3, 10, 20 db	1.1, 1.05, 1.05	1	16-11/16, 15-11/16, 15-11/16	4	
X810B (809B) (444A)	Slotted Section, waveguide (Carriage for 810B) (Detector Probe for 809B)	Slope: <1.01 SWR		1.01		10 1/4	4	
X870A	Tuner, slide screw	Insertion loss: <2 db at 20:1 SWR	Corrects SWR of 20			5 1/2	3	
X880A	E-H Tuner	Insertion loss: 3 db at 20:1	Corrects SWR of 20			3 1/2	3	
X885A	Waveguide Phase Shifter	<2° at 8.2-10.0 GC or 10% <3° at 10.0-12.4 GC or 10%	-360° to +360°	1.35		15 1/2	15	
X910B	Termination, low power			1.02	1	6 7/8	2	
X912A	Termination, waveguide			1.1	50	8 1/4	3	
X914B	Moving Load	Load Reflection: <0.5%	>1/2 wavelength		1	10	3	
X916C	Standard Reflection	Coefficient: ±0.0035	Nom. Reflect. Coeff.: 0.10			8 3/8	4	
X916D	Standard Reflection	Coefficient: ±0.0045	Nom. Reflect. Coeff.: 0.15			8 3/8	4	
X916E	Standard Reflection	Coefficient: ±0.007	Nom. Reflect. Coeff.: 0.20			8 3/8	4	
X920A	Adjustable Short		>1/2 wavelength			4 7/8	2	
X930A	Waveguide Shorting Switch	Insertion loss "open": <0.05 db		Open: 1.02 "Shorted": >125		3-11/16	2	
X25	Waveguide Clamp							
24	Waveguide Stand							

Data subject to change without notice. Prices f.o.b. factory.



Hewlett-Packard's in-plant manufacture of many of its own components permits close control on quality and maximum flexibility in the design of instrumentation. Electrical specifications of instruments likewise can be improved with such  manufacturing as precision wire-wound resistors used in microwave instrument ranging.



Instruments and equipment

Instrument	Frequency Range	Characteristics	Price
620A Signal Generator	7000 - 11,000 MC	Output 0.1 μ v to 0.223 v into 50 ohm load. CW, Pulse, FM or square wave modulation. Direct calibration	
626A Signal Generator	10.0 to 15.5 GC	Output \pm 10 dbm to -90 dbm. CW, Pulse, FM or square wave modulation. Direct calibration	
686C Sweep Oscillator	8.2 - 12.4 GC	Electronically swept; variable sweep rate and width. Output 10 mw, SWR 3.1 or less. Pulse, square wave, FM, AM modulation. Leveled output	
494A Microwave Amplifier	7.0 - 12.4 GC	30 db gain; AM, helix input; 20 mw output	
495A Microwave Amplifier	8.2 - 12.4 GC	30 db gain; AM input; 1 watt output	

X 8.2 GC
to
12.4 GC

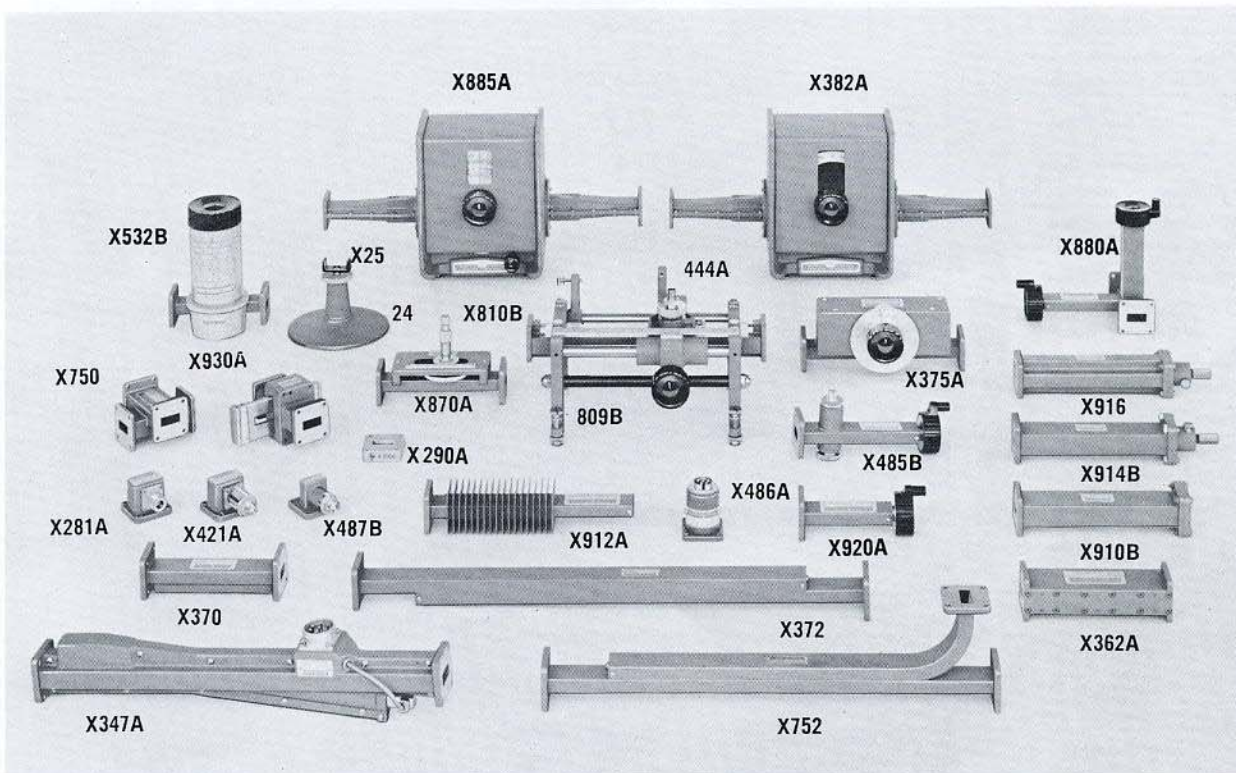

This broad array of Hewlett-Packard equipment is available for measurement in the microwave X-Band

Hewlett-Packard instruction manuals are written and printed for the convenience of the user. They serve as a guide to simple customer maintenance and adjustment, providing complete schematics, replacement parts lists and even theory of circuitry. Direct, easy to use, these instruction manuals are produced by a trained staff of technical writers and illustrators, working with sales and R&D engineers to provide maximum usefulness.

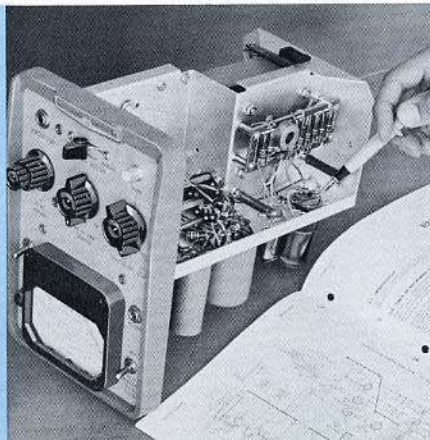

Instrument	Frequency Range	Characteristics	Price
626A Signal Generator	10.0 to 15.5 GC	Output +10 dbm to -90 dbm. Pulse, FM or square wave modulation. Direct calibration	
628A Signal Generator	15 to 21 GC	Same as 626A	
687C Sweep Oscillator	12.4 to 18.0 GC	Electronically swept; variable sweep range and rate. Leveled output ± 2 db. 10 mw output	
716A Klystron Power Supply		Beam voltage, 250 to 800 v dc @ 100 ma; repeller voltage, 0 to 800 v. Clamped modulator, regulated dc filament supply	

Model	Description	Accuracy	Range	SWR (Max.)	Power (watts)	Length (inches)	Shipping Weight (lbs.)	Price
P290A	Adapter, cover-to-choke flange					1 $\frac{1}{8}$	1	
NP292A	Adapter, waveguide-to-waveguide		15 - 18 GC	1.05		2 $\frac{3}{8}$	1	
P347A	Noise Source, waveguide	± 0.5 db	15.2 db, 12.4-18.0 GC			14 $\frac{3}{4}$	4	
P362A	Low Pass Filter	Insertion loss, Pass-band: <1 db Stopband: >40 db	Pass: 12.4-18.0 GC Stop: 23-54 GC	Passband 1.5		3-11/16	1	
P370	Attenuators, fixed	$\pm 20\%$	3, 6, 10, 20 db	1.15	1	4 $\frac{1}{8}$	1	
P372	Attenuators, precision fixed	± 0.5 db	10, 20 db	1.05	1			
P375A	Attenuator, flap	± 1 db at <10 db ± 2 db at >10 db	0-20 db	1.15	1	7 $\frac{1}{4}$	5	
P382A	Attenuator, calibrated, precision	$\pm 2\%$ of reading or 0.1 db whichever is greater	0-50 db	1.15	5	12 $\frac{1}{2}$	13	
P421A	Detector Mount	Freq. Resp.: ± 2 db Sens.: 0.05 v/mw	-40 to 0 dbm	1.5			1	
P486A	Thermistor Mount, compensated		0.001-10 mw	1.5		2 $\frac{1}{2}$	2	
P487B	Thermistor Mount, broadband		0.01-10 mw	1.5		13/16	1	
P532A	Frequency Meter, direct reading	$\pm 0.068\%$ at 23°C. $\pm 0.1\%$ overall				4 $\frac{1}{2}$ x 6 $\frac{1}{4}$ x 2 $\frac{3}{4}$	5	
P752	Directional Couplers, multi-hole	Mean: ± 0.4 db Variation: ± 0.5 db	3, 10, 20 db	1.1 1.05 1.05	1	13 $\frac{3}{4}$ 12 $\frac{1}{4}$ 12 $\frac{1}{4}$	3	
P810B (809B) (442B)	Slotted Section, waveguide (Carriage for 810B) (Detector Probe for 809B)			1.01		10 $\frac{1}{4}$	3	
P870A	Tuner, slide screw	Insertion loss: <2 db at 20:1 SWR	Corrects SWR of 20	1-20:1		5	3	
P880B	E-H Tuner	Insertion loss: 3 db at 20:1 SWR	Corrects SWR of 20			2 $\frac{1}{4}$	3	
P885A	Waveguide Phase Shifter	Lesser of 4° or 10%	-360° to +360°	1.35	5	12 $\frac{1}{8}$	13	
P910A	Termination, low power			1.02	1	4 $\frac{1}{4}$	1	
P914A	Moving Load	Load Reflection: <0.5%	> $\frac{1}{2}$ wavelength		0.5	9 $\frac{3}{4}$	1	
P920B	Adjustable Short		> $\frac{1}{2}$ wavelength			5 $\frac{3}{4}$	2	
P932A	Harmonic Mixer							
P25	Waveguide Clamp							
24	Waveguide Stand							

Data subject to change without notice. Prices f.o.b. factory.



Machine brazing, rather than conventional hand brazing, increases the quality of many ϕ microwave instruments. RF heating prevents distortion, and the special operation of these machines assures that all flux is removed from the silver solder. These brazing techniques also increase the efficiency of production and reduce costs.

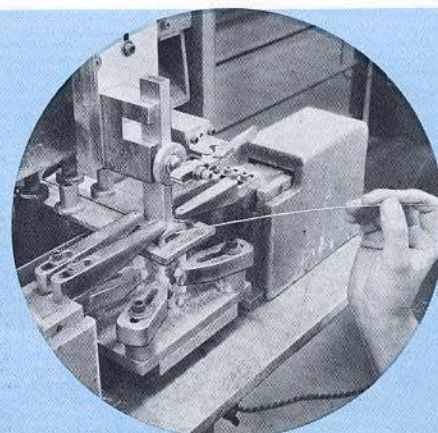

Instruments and equipment

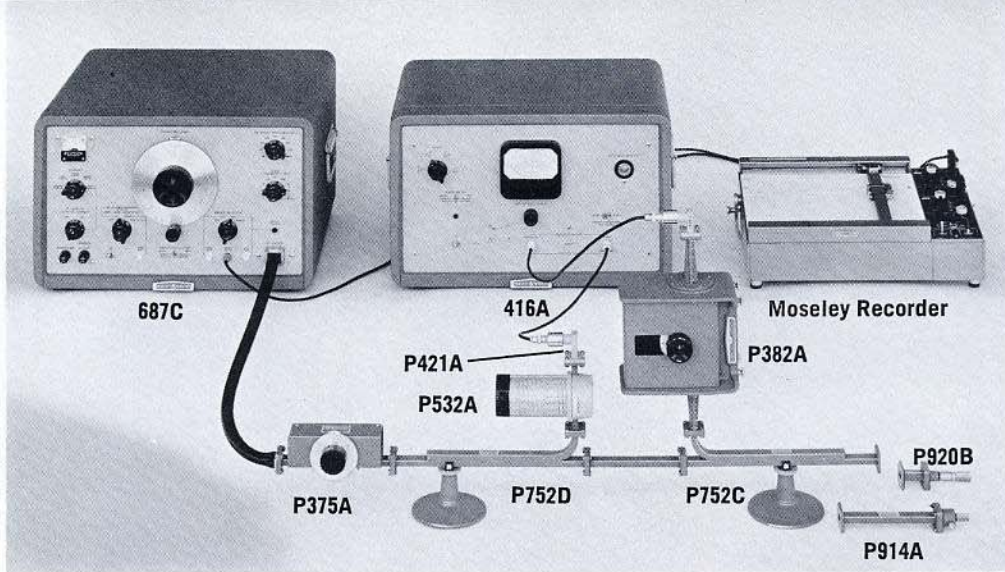

P 12.4 GC
to
18.0 GC

This P Band SWR calibration setup assures that no sharp resonance reflections escape detection

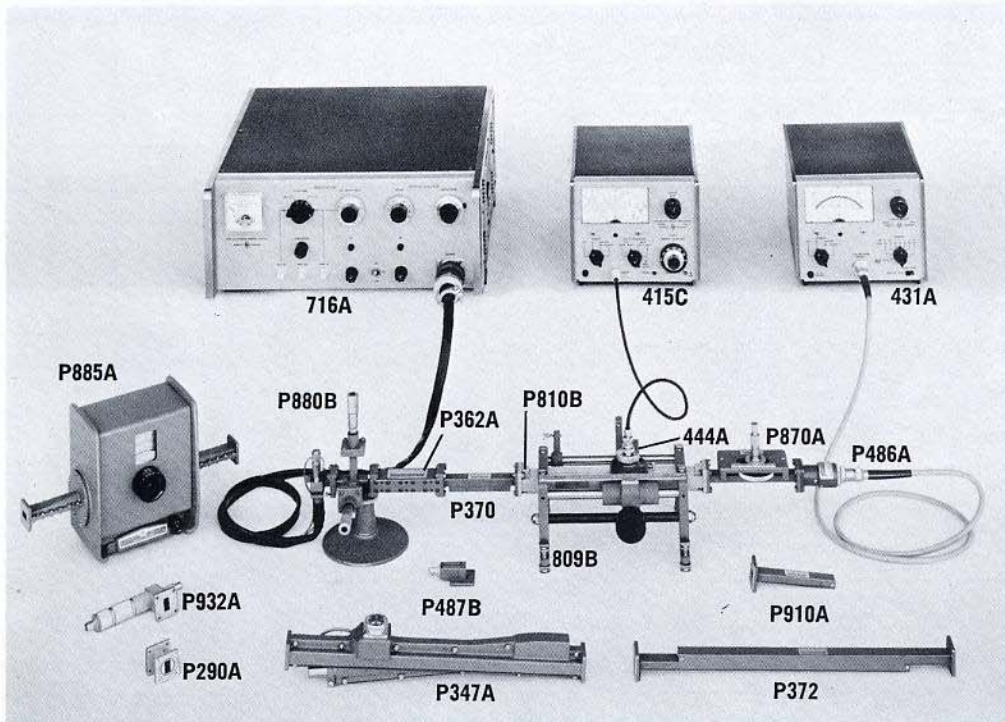

Miscellaneous P Band equipment is pictured with a typical P Band fixed frequency setup

Each Hewlett-Packard instrument is thoroughly tested, using sweep frequency and other advanced techniques to give you complete confidence in your measurements. Full-range testing of **hp** microwave instruments gives you complete confidence in every specification—in every instrument. At Hewlett-Packard, performance testing continues right up to the point of packaging for shipment.

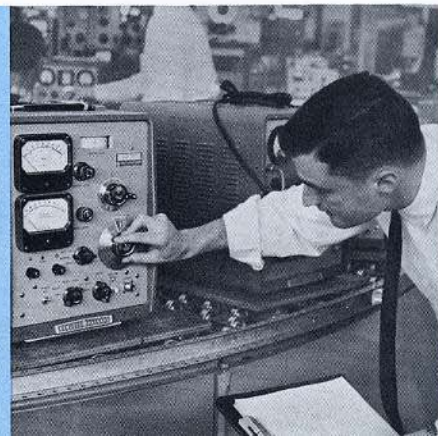

Instrument	Frequency Range	Characteristics	Price
626A Signal Generator and 938A Harmonic Generator	20.0 to 26.5 GC	Power monitor, 100 db attenuator. Pulse, FM or square wave modulation. (Requires MX292A Adapter \$40.00, AC-122X \$35.00)	626A: 938A:
686C Sweep Oscillator and 938A Harmonic Generator	18.0 to 24.8 GC	Sweep all or part of range, pulse square wave, FM and AM. (Requires MX292A \$40.00, AC-122X \$35.00)	686C: 938A:
687C Sweep Oscillator and 938A Harmonic Generator	24.8 to 26.5 GC	Sweep all or part of range, pulse, square wave, FM and AM. (Requires MP292A \$40.00, and AC-122P \$48.00)	687C: 938A:

Model*	Description	Accuracy	Range	SWR (Max.)	Power (watts)	Length (inches)	Shipping Weight (lbs.)	Price
K362A	Low Pass Filter	Insertion loss, Passband: <1 db Stopband: >40 db	Pass: 18.0-26.5 GC Stop: 31-80 GC	Passband 1.5		2 1/8	1	
K370	Attenuators, fixed	±20%	3, 6, 10, 20 db	1.15	0.5	3 1/4	1	
K372	Attenuators, precision fixed	±0.5 db	10, 20 db	1.05	0.5	1 1/2		
K375A	Attenuator, flap	±1 db at <10 db ±2 db at >10 db	0-20 db	1.15	0.5	4 1/4	3	
K382A	Attenuator, calibrated, precision	±2% or 0.1 db	0-50 db	1.15	2	7 7/8	9	
K422A	Detector Mount	Freq. Resp.: ±2 db Sens.: 0.05 v/mw	-40 to -3 dbm	2.5	0.1		1	
K486A	Thermistor Mount, compensated		0.001-10 mw	2.0		2 7/8	2	
K487C	Thermistor Mount, broadband		0.01-10 mw	2.0		1 5/8	1	
K532A	Frequency Meter, direct reading	±0.077% at 23°C. ±0.11%, overall				4 1/2 x 5 1/2 x 2 3/4	5	
K752	Directional Couplers, multi-hole	Mean: ±0.7 db Variation: ±0.5 db	3, 10, 20 db	1.1 1.05 1.05	0.5	10 3/8 9-15/16 9-15/16	3	
K815B (814B) (446B)	Slotted Section, waveguide (Carriage for 815B) (Detector Probe for 814B)			1.01		7-9/16	3	
K870A	Tuner, slide screw	Insertion loss: <2 db at 20:1 SWR	Corrects SWR of 20			4 1/4	3	
K914B	Moving Load	Load Reflection: <1.0%	>1/2 wavelength		0.5	8 1/4	1	
K920B	Adjustable Short		>1/2 wavelength		0.5	4 1/2	1	
K25	Waveguide Clamp							
24	Waveguide Stand							

*Circular flanges (UG - 425/U) are available for K Band. Specify by adding second suffix "C" to model number; e.g. K815BC.

Data subject to change without notice. Prices f.o.b. factory.



Instruments and equipment

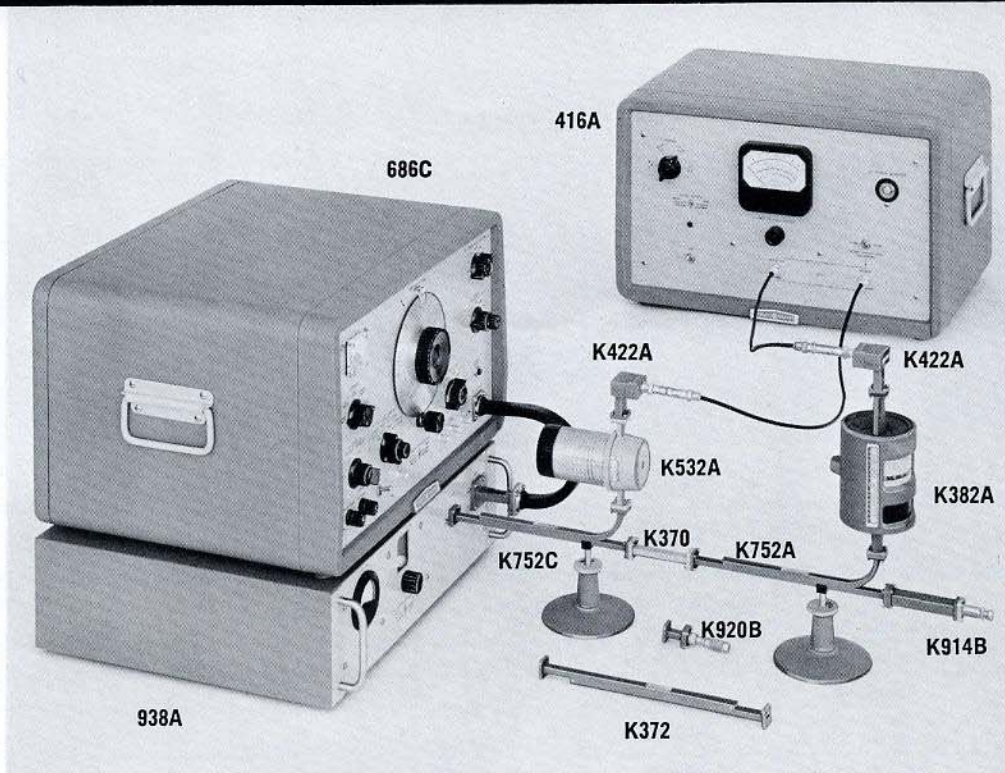

K 18.0 GC
to
26.5 GC

Attenuation measurement in the K Band is demonstrated with this sweep frequency calibration system

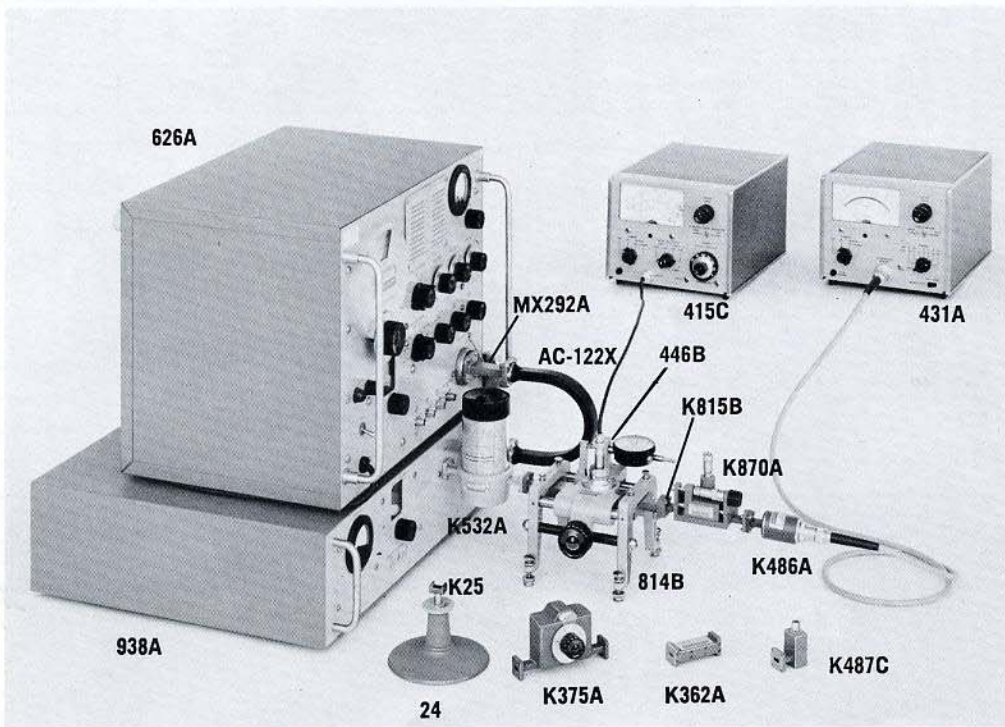

Fixed frequency measurement techniques in the K Band are ideal for matching thermistor mounts to transmission lines. Miscellaneous K Band equipment is shown in the foreground

Good engineering practices ensure that Hewlett-Packard instruments are a genuine contribution to the measurement art, of broad usefulness, durable and easily serviced. These practices begin with the "breadboard" stage and continue through the actual production and testing procedures. Careful design assures incorporation of optimum components for dependability, circuitry for performance and packaging for usefulness, serviceability, customer economy.

Instrument	Frequency Range	Characteristics	Price
626A Signal Generator and 940A Harmonic Generator	26 to 31 GC	Power monitor, 100 db attenuator. Pulse FM or square wave modulation. (Requires NP292A Adapter \$40.00, AC-122P \$48.00.)	626A: 940A:
628A Signal Generator and 940A Harmonic Generator	30 to 40 GC	Same as above except requires NP292A Adapter, \$40.00	628A: 940A:
687C Sweep Oscillator and 940A Harmonic Generator	24.8 to 36.0 GC	Sweep all or part of range, pulse square wave, FM and AM. (Requires NP292A \$40.00, AC-122P \$48.00.)	687C: 940A:

Model*	Description	Accuracy	Range	SWR (Max.)	Power (watts)	Length (inches)	Shipping Weight (lbs.)	Price
R362A	Low Pass Filter	Insertion loss, Passband: <1 db. Stopband Rej.: >40 db	Pass: 26.5 - 40.0 GC Stop: 47 - 120 GC	Passband 1.5		1-21/32	1	
R370	Attenuators, fixed	±20%	3, 6, 10, 20 db	1.15	0.5	3	1	
R372	Attenuators, precision fixed	±0.5 db	10, 20 db	1.05	0.5	10	3	
R375A	Attenuator, flap	±1 db at <10 db ±2 db at >10 db	0-20 db	1.15	0.5	4 3/8	3	
R382A	Attenuator, calibrated, precision	±2% or 0.1 db	0-50 db	1.15	1	7 1/2	9	
R422A	Detector Mount	Freq. Resp.: ±2 db Sens.: 0.05 v/mw	-40 to -3 dbm	2.5	0.1		1	
R486A	Thermistor Mount, compensated		0.001-10 mw	2.0		3	2	
R487B	Thermistor Mount, broadband		0.01-10 mw	2.0		1 3/8	1	
R532A	Frequency Meter, direct reading	±0.083% at 23°C. ±0.12%, overall	26.5 - 40.0 GC			4 1/2 x 5 1/2 x 2 3/4	4	
R752	Directional Couplers, multi-hole	Mean: ±0.7 db Variation: ±0.5 db	3, 10, 20 db	1.1 1.05 1.05	0.5	11 5/8 8 3/8 7 5/8	3	
R815B (814B) (446B)	Slotted Section, waveguide (Carriage for 815B) (Detector Probe for 814B)	Slope: <1.01 SWR		1.01		7-9/16	3	
R870A	Tuner, slide screw	Insertion loss: <2 db at 20:1 SWR	Corrects SWR of 20			4 3/8	3	
R914B	Moving Load	Load Reflec.: <1.0%	>1/2 wavelength		0.5	7	1	
R920B	Adjustable Short		>1/2 wavelength			4 1/2	1	
R25	Waveguide Clamp							
24	Waveguide Stand							

*Circular Flanges (UG-381/U) are available for R Band. Specify by adding second suffix "C" to model number; e.g. R815BC.

Data subject to change without notice. Prices f.o.b. factory.

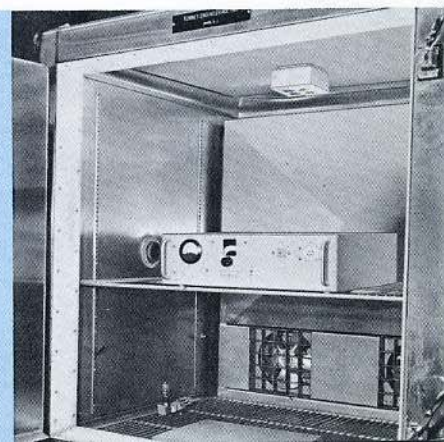

Instruments and equipment

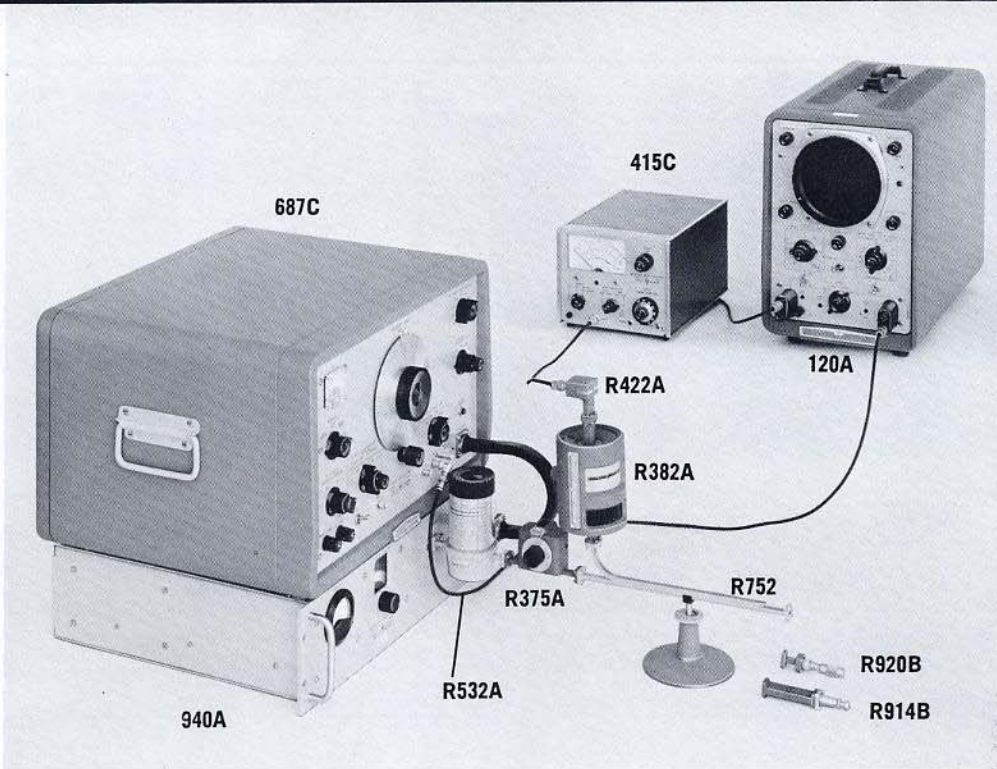

R 26.5 GC
to
40.0 GC

Typical R Band sweep frequency setup is convenient for rapid sweep of SWR

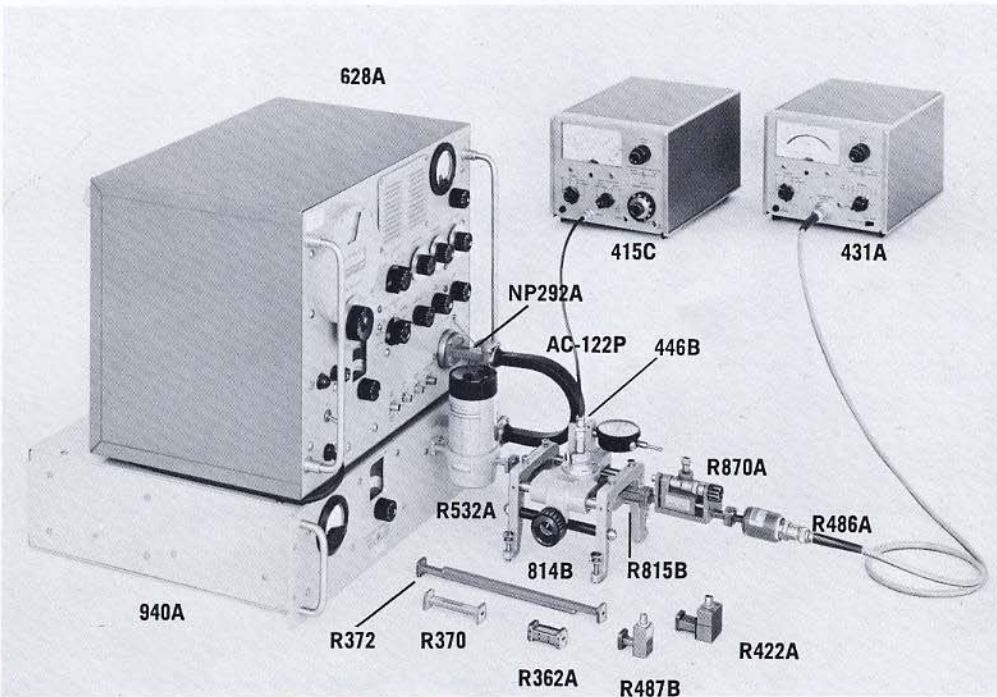

This setup for R Band fixed frequency measurement is useful for matching thermistor mounts to transmission lines. Also pictured is miscellaneous R Band equipment

Complete environmental testing facilities at  are responsible for many superior and more complete microwave instrumentation specs. Such devices as shake table, temperature boxes and humidity chambers prove that instruments will operate in extreme environments, under adverse conditions . . . or for years in your laboratory.



Model	Description	Accuracy	Range	SWR (Max.)	Power (watts)	Length (inches)	Shipping Weight (lbs.)	Price
M362A	Low Pass Filter	Insertion loss Passband: <1 db; Stopband: >40 db	Pass: 10.0 - 15.5 GC Stop: 19.47 GC	Passband 1.5		4-15/32	1	
M375A	Attenuator, flap	± 1 db at <10 db ± 2 db at <10 db	0-20 db	1.15	0.5	7/4	5	
M382A	Attenuator, calibrated, precision	$\pm 2\%$ or 0.1 db which ever is greater	0-50 db	1.15	10	15	13	
M421A	Detector Mount	Freq. Resp.: ± 2 db Sens.: 0.05 v/mw	-40 to 0 dbm	1.5			1	
M486A	Thermistor Mount, compensated		0.001-10 mw	1.5		3		
M487B	Thermistor Mount, broadband		0.01-10 mw	1.5		15/16	1	
M532A	Frequency Meter, direct reading	$\pm 0.053\%$ at 23°C. $\pm 0.085\%$ overall				4 1/2 x 6 1/4 x 2 3/4	6	
M752	Directional Couplers, multi-hole	± 0.4 , ± 0.5 db	3, 10, 20 db	1.1, 1.05, 1.05	1	16-5/16, 15-11/16, 15-11/16	4	
M810B (809B) (444A)	Slotted Section, waveguide (Carriage for 810B) (Detector Probe for 809B)		10 cm	1.01		10 1/4	4	
M870A	Tuner, slide screw	Insertion loss: <2 db at 20:1 SWR	Corrects SWR of 20			5 7/8	3	
M914A	Moving Load	Load Reflection: <0.5%	>1/2 wavelength	<1.025	1	8-1/16	3	
M920A	Adjustable Short		>1/2 wavelength			4-13/16	2	
M25	Waveguide Clamp							
24	Waveguide Stand							
Instrument		Frequency Range		Characteristics				Price
626A Signal Generator		10.0 - 15.5 GC		Output +10 dbm to -90 dbm. Pulse, FM or square wave modulation. Direct calibration.				

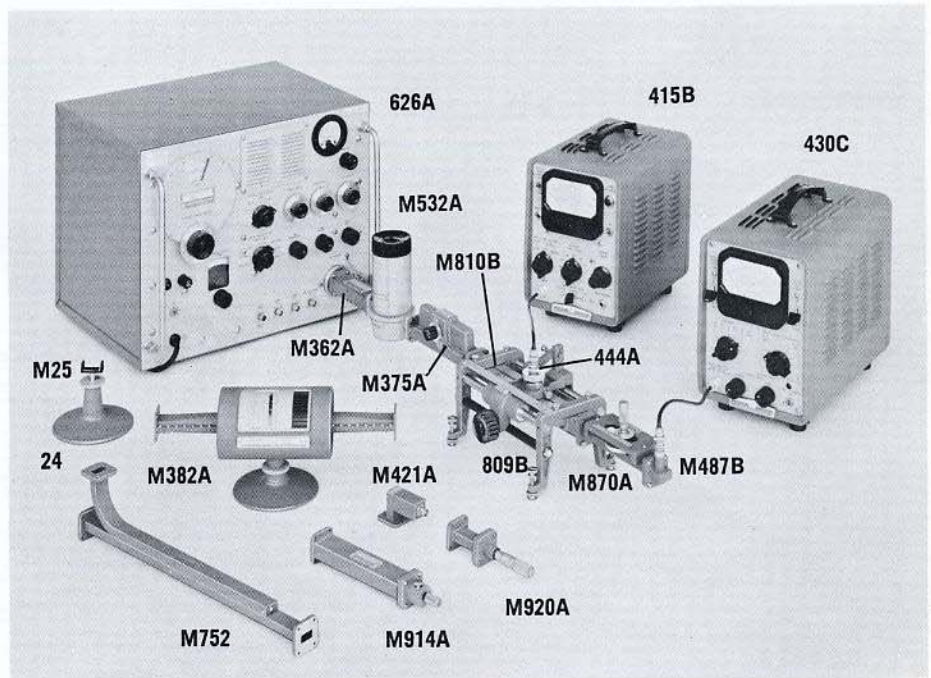

These equipment components include a typical M Band fixed frequency setup, plus miscellaneous M Band instruments

Data subject to change without notice. Prices f.o.b. factory.

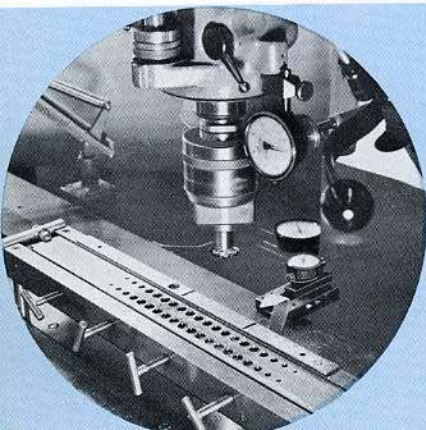

Advance production planning and modern production tooling assure utmost precision and uniformity in ϕ microwave instrumentation... and help permit fast delivery from stock. Complete tooling for the ϕ 752 series of Waveguide Directional Couplers, for example, provides uniformity and quality from run to run, reduces setup time to speed delivery, reduces rejects and lowers unit cost.



TWT Amplifiers, Miscellaneous Equipment

Microwave Amplification



Ⓢ 495A



Ⓢ 492A

These Hewlett-Packard broadband, high gain instruments give you high power amplification over the frequency range of 1.0 to 12.4 GC.

Ⓢ 489A, 491C, 493A and 495A medium power TWT Amplifiers provide at least one watt output for one milliwatt input over their complete frequency range, 1.0 to 12.4 GC collectively. These instruments, which use periodic permanent magnet TWT's, are lightweight, compact, have low power consumption. They may be easily converted from cabinet to rack mount merely by removing the feet and attaching brackets and a furnished strip. Amplitude modulation circuitry has been specially designed for wide bandwidth (down to dc) and with internal amplification so that small modulation signals cause a large output power change. Not only does the modulation circuitry permit amplitude modulation with small input signals, but power leveling may be achieved with external elements.

The 490B, 491A, 492A and 494A are electromagnetically focused, and the low power models may be phase or amplitude modulated. Very fast pulsing is possible because modulation signals are coupled directly to the grid of the TWT.

Specifications

Model	Frequency (GC)	Price
489A	1 to 2	
491C	2 to 4	
493A	4 to 8	
495A	7 to 12.4	

For all models:

Output: 1 watt
 Gain: 30 db
 AM Bandwidth: 100 KC
 Power: 115 or 230 v ± 10%, 50 to 60 cps
 Size: 16 3/4" wide, 5 1/2" high, 18 3/8" deep; 41 lbs.

Model	Frequency (GC)	Output	AM Rise Time	Phase Modulation Sensitivity	Weight (lbs.)	Price
490B	2 to 4	10 mw	15 ns	30 v p-p/360°	76	
491A	2 to 4	1 w		no modulation	92	
492A	4 to 8	20 mw	15 ns	40 v p-p/360°	85	
494A	7.0 to 12.4	20 mw	15 ns	50 v p-p/360°	84	

More Versatility With This Ⓢ Equipment

Ⓢ 292 Waveguide to Waveguide Adapters connect a given size of waveguide to the next size larger or smaller. Each operates over the portion of the waveguide frequency ranges common to both bands. See chart for specifications.

Model	SWR	Length (in.)	Frequency Range (GC)	Price
HX292B	1.05	1 1/2	8.2 - 10.0	
MX292A	1.05	2 3/8	10.0 - 12.4	
MP292A	1.05	2 3/8	12.4 - 15.0	
NP292A	1.05	2 3/8	15.0 - 18.0	
NK292A	1.05	2 3/8	18.0 - 22.0	

Ⓢ 360 Low Pass Filters eliminate harmonics, permit transmission of energy at a single known frequency, 700 to 4,100 MC. No spurious responses up to 3 times cut-off frequency. Type N fittings.

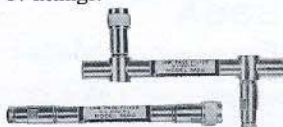

Specifications

Cut-Off Frequency: Model 360A, 700 MC; 360B, 1,200 MC; 360C, 2,200 MC; 360D, 4,100 MC.

Physical Dimensions:

Model No.	360A	360B	360C	360D
Length Overall	10 7/8"	7 - 7/32"	10 - 25/32"	7 3/8"
Outer Diameter	5/8"	5/8"	5/8"	5/8"
Center Line to Male End	2 - 5/16"	2 - 5/16"		
Center Line to Female End	2 1/4"	2 1/4"		

M 10 to 15 GC Band TWT's, miscellaneous equipment

Ⓢ 806B Coaxial Slotted Section (for 809B Universal Probe Carriage), provides continuous coverage 3 to 12 GC. Impedance 50 ohms. Special fittings mating with Type N connectors to assure minimum SWR.



Ⓢ 760D/767D Dual Directional Couplers, because of their flat coupling, are ideal for power monitoring, mixing and power sampling. Their high directivity makes them excellent for coaxial reflectometer systems. Models 760D/761D cover 250 MC to 4 GC, while 764D/767D are single octave instruments covering 216 MC to 4 GC.

Specifications

Model	Frequency Range	Mean Coupling	Coupling Variation	Directivity (minimum)	Primary SWR (max.)	Secondary SWR (max.)	Price
760D	250 - 1,000 MC	20 ± 1/2 db	± 1/2 db	35 db	1.20	1.25	
761D	1 - 4 GC	20 ± 1/2 db	± 1/2 db	30 db	1.25	1.30	
764D	216 - 450 MC	20 ± 1/2 db	± 1 db	30 db	1.10	1.20	
765D	450 - 945 MC	20 ± 1/2 db	± 1 db	30 db	1.15	1.20	
766D	940 - 1,975 MC	20 ± 1/2 db	± 1 db	26 db	1.20	1.30	
767D	1.9 - 4.0 GC	20 ± 1/2 db	± 1 db	26 db	1.25	1.50	

Power handling capacity: all couplers 50 watts CW, 10 KW peak. Type N connectors throughout. All couplers include -hp- 803A-76G Shorting Plug for reflectometer calibration.



One of the most complete standards labs in the industry guides design, production and testing of Ⓢ microwave instrumentation. For measurements where the service is available, Ⓢ calibration is traceable to the National Bureau of Standards, giving extra meaning to equipment and instrument specifications.

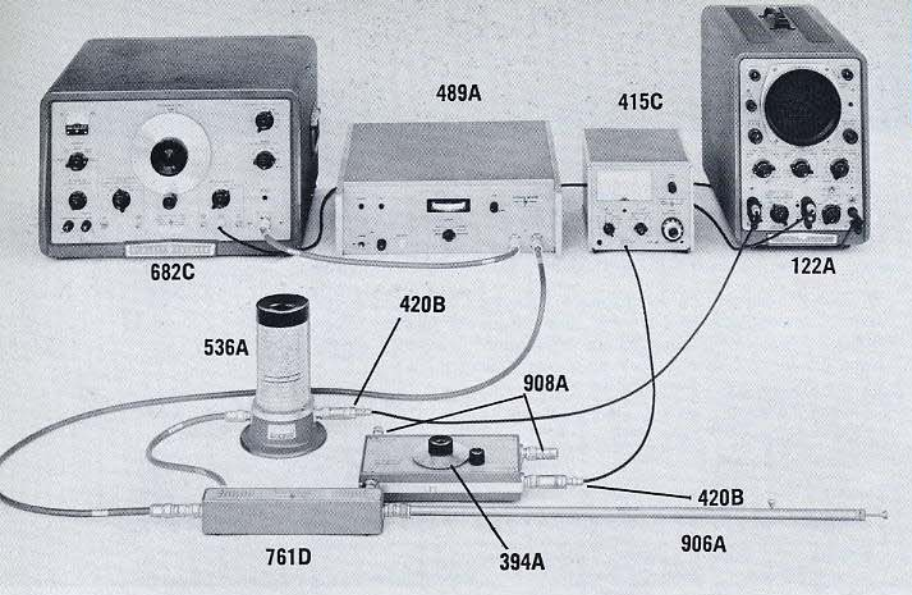

hp equipment is available for coaxial work in the 1-4 GC region. Shown here is a setup for measuring directivity of the hp 761D Dual Directional Coupler

Convenience and versatility are provided for your coaxial work in the important 1 to 4 GC frequency range with this array of dependable hp instrumentation. Seven completely new instruments are included on these pages, along with other popular hp equipment useful for these special coaxial applications.



New hp 536A Coaxial Frequency Meter

For lab or production use, 1 to 4 GC, this general-purpose frequency meter is a high-resolution, broadband, direct reading instrument. Frequency is read directly in GC with high accuracy over a wide range of environmental conditions. Readability is increased by a long spiral scale calibrated in one megacycle increments. The tuning plunger is spring-loaded to eliminate backlash. Smooth tuning and long life result from use of a non-contacting plunger.

Specifications

Frequency Range:	1 to 4 GC
Accuracy:	0.10% at 23° C 0.14% overall
Max. Temp. Coefficient/°C:	0.0016%
Connectors:	Type N
Dimensions:	9 1/8" high x 6" long x 6" deep 13 pounds

New hp 393A/394A Variable Attenuators

You get accurate attenuation in high-power coaxial systems with these direct-reading, multi-purpose instruments, the hp 393A, 0.5 to 1.0 GC, and hp 394A, 1 to 2 GC. They are variable attenuators, variable directional couplers and local oscillator mixers. The direct-reading feature eliminates the

need for calibration curves, and the attenuators handle up to 200 watts average, depending on line terminations. Two hp 908A low-power coaxial loads (furnished) permit the instruments to attenuate at levels up to 0.5 watt average power.

Specifications

Frequency Range:	hp 393A, 0.5 to 1 GC hp 394A, 1 to 2 GC
Attenuation or Coupling:	hp 393A, 5 to 120 db hp 394A, 6 to 120 db, both continuously variable
Absolute Accuracy: (with matched generator and load)	393A: ± 1 db or 1% of dial setting. 394A: ± 1.25 db or 2% of dial setting, whichever is greater
Nominal Impedance:	50 ohms
SWR:	hp 393A: <2.5, 5-10 db attenuation; <1.5, 10-30 db; <1.2, 30-120 db. hp 394A: <2.5, 6-10 db; <1.4 10-30 db; <1.4, 30-120 db
Directivity:	hp 393A: >15 db, 20-40 db; >10 db, 10-20 db hp 394A: >10 db, 10-40 db
Maximum Voltage:	500 v peak
Connectors:	Type N
Dimensions:	5 1/2" x 12" x 2 3/4"



New hp 872A Coaxial Slide Screw Tuner

Useful for correcting discontinuities or for matching coaxial systems, the hp 872A Coaxial Slide Screw Tuner features extremely low insertion loss and is easy to use. Magnitude and phase are independently adjustable, making the 872A



Coaxial Instrumentation

much more convenient than double-stub tuners. With the 872A, insertion of the precision probe into a specially developed slab line is quickly and easily varied with a micrometer drive, and position along the line may be read directly on a recessed scale. Probe travel is at least $\frac{1}{2}$ wavelength at 0.5 GC so that any phase reflection may be compensated. Logging penetration and position of the probe makes repetition of settings simple, and the probe can be withdrawn so that no correction is applied. With its negligible insertion loss when correcting an SWR of 1.5, the Φ 872A minimizes mismatch loss of Φ 434A Calorimetric Power Meter.

Specifications

Frequency Range:	0.5 to 4.0 GC
Correctable SWR:	10
Insertion Loss at Max. Correctable SWR:	1 db or less when correcting an SWR of 10. Typically 0.1 db or less when correcting an SWR of 1.5
Characteristic Impedance:	50 ohms
Connectors:	Type N
Dimensions:	27" x 6" x 5"



Φ 906A
Sliding Coaxial Termination

Model 906A is designed to measure residual SWR of slotted lines and directivity of directional couplers. This sliding coaxial termination is a movable, low-reflection load for terminating 50 ohm systems. Sliding center conductor design and headless support minimizes discontinuity at the connector junction. The Φ 906A can be used with Type N male or female fittings, with both standard or "improved" Type N connectors.

Specifications

Frequency Range:	1.0 to 12.4 GC
Load SWR:	Less than 1.05
Power Rating:	1 watt
Travel:	$>\frac{1}{2}$ wavelength at 1 GC
Dimensions:	31" long, 2 lbs.

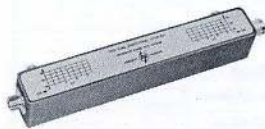

New Φ
760D/761D
Dual Directional
Couplers

These two-octave VHF-UHF instruments are especially useful for power monitoring, mixing and power sampling with

tightly controlled coupling. High directivity and flat frequency response make them ideal for swept-frequency systems. Power capacity is 50 watts CW and 10 KW peak.

Specifications

	MODEL 760D	MODEL 761D
Frequency Range:	250 - 1000 MC	1 - 4 GC
Mean Coupling:	$20 \pm \frac{1}{2}$ db	$20 \pm \frac{1}{2}$ db
Coupling Variation:	$\pm \frac{1}{2}$ db	$\pm \frac{1}{2}$ db
Directivity (min.):	35 db	30 db
Primary SWR (max.):	1.20	1.25
Secondary SWR (max.):	1.25	1.30
Connectors:	Type N	Type N



Φ 908A
Coaxial Termination

Here is the best 50 ohm termination available today. Each individual Φ 908A is factory-adjusted internally for the lowest possible SWR, making the instrument the ideal low-reflection load for terminating 50 ohm systems. SWR is less than 1.05, dc to 4 GC. Power rating is $\frac{1}{2}$ watt average. Maximum input is 1 KW peak. Type N male connector, 2" long, 3 ounces.



Φ 420A
Crystal Detector

Couples a Type N coaxial line to a modified 1N26 silicon diode for the detection of rf signals 10.0 MC to 12.5 GC. Maximum SWR 3; sensitivity, approximately 0.1 v/mw; frequency response ± 3 db. Type N male input connector, BNC female output connector. $\frac{3}{4}$ " diam., 3" long, 1 lb.

Φ 420B Coaxial Reflectometer Crystal Mount

Similar to 420A but designed specifically for applications calling for good square-law characteristics. Includes video load resistor for optimum square-law response, available in matched pairs for reflectometer applications. Frequency response of single unit same as 420A, matched pairs within ± 1 db from 1 to 4 GC. Square-law characteristic, ± 1 db max. variation from square-law over 1 to 4 GC and 0 to -40 dbm. With matched pair, difference in frequency response and square-law characteristics combined (but excluding basic sensitivity) does not exceed ± 2 db.

Data subject to change without notice. Prices f.o.b. factory.

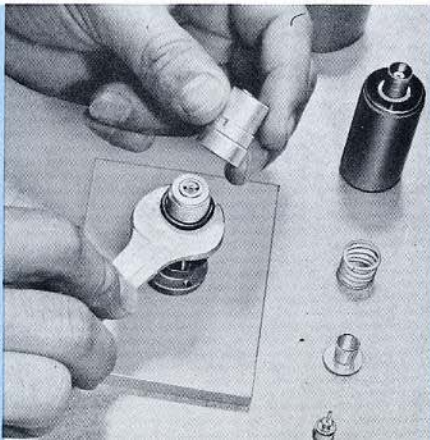

Factory and field service departments make repair and maintenance of your Hewlett-Packard microwave instrumentation fast and efficient. Complete facilities in the Φ plant and in service centers around the world are staffed by factory-trained engineers and technicians to speed service of all Φ instruments.

1 to 4 GC Coaxial
Measurements

hp Signal Generators and Doublers—50 KC to 40 GC

hp Frequency Doublers to 40 GC



Operating on harmonic generation principles, new hp 938A and 940A Frequency Doubler Sets provide output from 18.0 to 26.5 GC and 26.5 to 40.0 GC respectively. The Doublers can be driven by hp 626A or 628A Signal Generators, hp 686C and 687C Sweep Oscillators or by klystrons. The input signal may be CW, pulsed or swept; thus Doublers retain flexibility of driving instrument. Output approximately 0.5 to 1 mw with hp Signal Generators; input power 100 mw max. Output monitor accuracy ± 2 db. 100 db attenuator accurate within $\pm 2\%$ of reading or 0.2 db.

hp 606A Standard Signal Generator



50 KC to 65 MC. Output 3 v full range, continuous attenuation to 0.1 μ v. MOPA circuit with full feedback loop provides constant output over entire range.

Low distortion, broad modulating capabilities. Excellent amplitude and frequency stability. Typical speed, ease of operation.

hp 608D VHF Signal Generator



10 to 420 MC. Highest stability. Low incidental FM or frequency drift. Calibrated output 0.1 μ v to 0.5 v throughout range. Built-in crystal calibrator provides frequency check accurate within 0.01% each 1 and 5 MC. Master-oscillator, intermediate and output amplifier circuit design. Premium quality performance, direct calibration, ideal for aircraft communications equipment testing.

hp 608C VHF Signal Generator. High power (1 v max.) stable, accurate generator for lab or field use. 10 to 480 MC. Ideal for testing receivers, amplifiers, driving bridges, slotted lines, antennas.



hp 626A/628A SHF Signal Generators

Instruments bringing high power, wide range, convenience and accuracy 10 to 21 GC range. Frequencies, output voltage directly set and read. Output 10 to 20 db better than previous spot-frequency sets; SWR better than 1.2 at 0 dbm and lower. Internal pulse, FM or square wave modulation; also external pulsing or FM'ing. hp 626A, 10.0 to 15.5 GC, hp 628A, 15 to 21 GC,

hp Electronic Swept-Frequency Oscillators



Specifically designed for fast, comprehensive, full range testing techniques. Simple to operate, direct reading frequency, sweep width and rate. Open loop leveler compensates for major output power variations.

Instrument	Frequency Range	Characteristics	Price
-hp- 606A	50 KC to 65 MC	Output 0.1 μ v to 3 v. Modulation bandwidth dc to 20 KC, low drift and noise, low incidental FM, low distortion	
-hp- 608C	10 to 480 MC	Output 0.1 μ v to 1 v into 50 ohm load. AM, pulse modulation. Direct calibration	
-hp- 608D	10 to 420 MC	Output 0.1 μ v to 0.5 v. Incidental FM less than 0.001%	
-hp- 612A	450 to 1,230 MC	Output 0.1 μ v to 0.5 v into 50 ohm load. AM, pulse or square wave modulation. Direct calibration	
-hp- 614A	800 to 2,100 MC	Output 0.1 μ v to at least 0.163 v into 50 ohm load. Pulse or FM modulation. Direct calibration	
-hp- 616B	1,800 to 4,200 MC	Output 0.1 μ v to 0.223 v into 50 ohm load. Pulse or FM modulation. Direct calibration	
-hp- 618B	3,800 to 7,600 MC	Output 0.1 μ v to 0.223 v into 50 ohm load. Pulse FM or square wave modulation. Direct calibration	
-hp- 620A	7,000 to 11,000 MC	Output 0.1 μ v to 0.223 v into 50 ohm load. Pulse, FM or square wave modulation. Direct calibration	
-hp- 626A	10.0 to 15.5 GC	Output +10 dbm to -90 dbm. Pulse, FM, or square wave modulation. Direct calibration	
-hp- 628A	15 to 21 GC	Output +10 dbm to -90 dbm. Pulse, FM, or square wave modulation. Direct calibration	
-hp- 938A	18.0 to 26.5 GC	Driven by 9.0 to 13.25 GC source, such as -hp- 626A, 686C or klystrons	
-hp- 940A	26 to 40 GC	Driven by 13.25 to 20.0 GC source, such as -hp- 628A or 687C or klystrons	

Instrument	Frequency Range	Characteristics	Price
-hp- 682C	1 to 2 GC	Electronically swept; variable sweep rate, width. Output 10 mw, SWR 3:1 or less Pulse, square wave, FM, AM modulation All models offer leveled output	
-hp- 683C	2 to 4 GC		
-hp- 684C	4.0 to 8.1 GC		
-hp- 686C	8.2 to 12.4 GC		
H01 686C	7 to 11 GC		
-hp- 687C	12.4 to 18.0 GC		

Hewlett-Packard's manufacturing plant contains a complete, modern plating facility which provides high quality finishes on production units of microwave equipment. For example, rhodium flash plating over silver, used in many hp components, provides high conductivity while preventing tarnish.

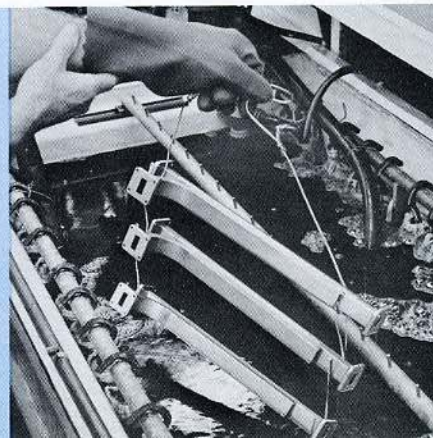

hp Microwave Impedance Measuring Instrumentation

hp 415C SWR Meter



The new Φ 415C SWR Meter is a high gain low noise amplifier and voltmeter calibrated for square-law detectors. A versatile expand arrangement allows you to expand to full scale each 2.5 db portion of the range for making measurements, such as attenuation, which require high resolution. This expansion gives you 28 calibrated full scale ranges of 2.5 db. The amplifier is tunable over a 50 cps range, and variable bandwidth permits both high sensitivity testing and swept frequency work. An ac output allows you to use the 415C as a high gain tuned amplifier, and a grounded dc recorder output is provided. High stability makes the 415C ideal for long-term monitoring. The two values of bolometer bias current are adjustable over a $\pm 10\%$ range and may be read on the front panel meter. The currents are peak-limited to protect bolometers from burnout. An optional rechargeable battery pack makes the modular instrument completely portable.

Specifications

Frequency:	1000 cps variable 5%, other frequencies between 400 and 1500 cps available.
Sensitivity:	0.1 μ v rms at 30 cps bandwidth. (Lower sensitivity at 0°C.)
Noise:	5 db below full scale with 0.1 μ v rms sensitivity and minimum bandwidth.
Range:	70 db in 10 and 2.5 db steps.
Accuracy:	± 0.1 db/10 db step, maximum cumulative ± 0.2 db; ± 0.1 db switching from any 10 db step (NORM) to any 2.5 db step (EXPAND) except ± 0.05 db switching to 0.0 (EXPAND). ± 0.02 db linearity on EXPAND scales.
Input:	Bolo - 200 ohms, bias 8.7 or 4.3 ma; Crystal - 200 ohms, 200 K.
Output: (one side grounded)	DC: 1 ma into 1500 ohms maximum. AC: 1 v rms in EXPAND, 0.5 v rms in NORM (across 10 K minimum).
Dimensions:	7 1/2" wide x 6 1/2" high x 12 1/2" deep; 8 lbs., 11 lbs. with battery.
Accessories Furnished:	8120-0078 7' detachable power cord.
Power:	115 or 230 v $\pm 10\%$, 50 to 1,000 cps, 2 watts.
Options:	1. Rechargeable battery pack, installed 2. Rear input connector in parallel,

Hewlett-Packard instrumentation described on these pages lets you make accurate SWR measurements for determining impedance in microwave circuits. Φ equipment is available for both conventional slotted line measurements and for reflectometer techniques.

Φ 415B Standing Wave Indicator. (See photo page 20.) Usable with all waveguide and coaxial slotted sections for measuring SWR or as a null detector for bridge measurements. Single frequency operation, 1,000 cps $\pm 2\%$. Readings in SWR or db. Inputs same as for the 415C.

Φ 803A VHF Bridge. The Φ 803A measures impedance in the vhf range by sampling the electric and magnetic fields in a transmission line. It is direct reading for impedances 2 to 2,000 ohms, phase angle -90° to $+90^\circ$. The easy-to-use instrument covers 52 to 500 MC, makes measurements down to 5 MC and up to 1,000 MC.

Φ 417A VHF Detector. Designed for use with the Φ 803A Bridge, Model 417A is a super-regenerative (AM) receiver covering all frequencies between 10 and 500 MC in 5 bands. Single, convenient frequency control is calibrated directly in megacycles. High sensitivity of approximately 5 μ v over the entire frequency band.

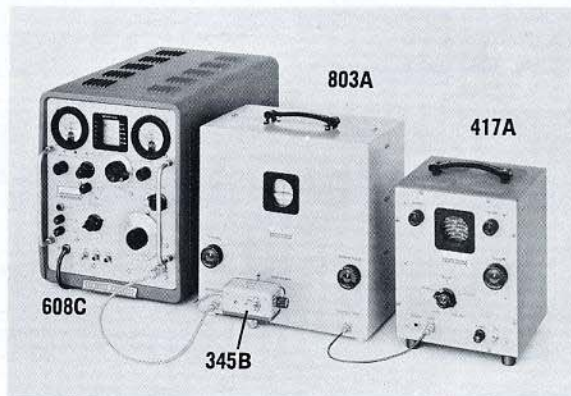

The simple Φ equipment setup shown here will measure the source impedance of the Φ 345B IF Noise Source

Data subject to change without notice. Prices f.o.b. factory.

SWR, Impedance
Measurements
Signal Generators



New hp 431A Power Meter



Extremely low drift
One zero setting for all ranges
 $\pm 3\%$ accuracy on all ranges
Grounded recorder output
Optional battery operation

Now you can measure power, $1 \mu\text{w}$ to 10 mw , with the most stable microwave power meter ever produced. The hp 431A makes continual zero-setting a thing of the past, and it is not necessary to re-zero the meter each time the range is changed.

Model 431A uses two self-balancing bridges to overcome the ambient temperature dependence of ordinary thermistor bridges. One bridge senses and measures the rf power; the other bridge senses and corrects for ambient temperature changes.

A dc output (one side grounded) also permits permanent recording of microwave power, and an optional rechargeable battery pack provides up to 24 hours of completely portable operation. New hp modular cabinet makes the 431A equally suitable for bench use or for rack mounting.

Convenient input terminals are provided for applying an accurately known dc power to the rf bridge. Not only can you apply dc to verify the calibration of the 431A easily, but you also can make dc substitution measurements where an unknown rf power can be compared to accurately known dc power. Such techniques reduce bridge inaccuracy to less than 1% and make the 431A suitable for standards laboratories.

Brief Specifications

- Power Range:** $10 \mu\text{w}$ to 10 mw full scale in 7 ranges. Also calibrated from -30 to $+10 \text{ dbm}$
- Instrument Accuracy:** $\pm 3\%$ of full scale, all ranges
- Operating Impedance:** 100 or 200 ohms, negative, for operation with thermistor mounts
- Recorder/Voltmeter Output:** Phone jack on rear with 1 ma into 2,000 ohms or less
- Calibration Input:** Binding posts on rear for calibration of bridge with precise dc standards
- Power:** $1\frac{1}{2}$ watts, 115/230 v $\pm 10\%$, 50 to 1,000 cps
- Dimensions:** $7\frac{1}{2}$ " wide x $6\frac{1}{2}$ " high x $12\frac{1}{2}$ " deep. Weight 10 lbs.
- Options:** 1. Rechargeable battery pack, installed,
2. Rear input connector in parallel,

New hp Thermistor Mounts Assure hp 431A Thermal Stability



hp 478A Thermistor Mount, 10 MC to 10 GC

No tuning is required with this wide-range, temperature-compensated coaxial mount engineered for use with the hp 431A Power Meter. Closely matched thermal environments for the two thermistor pairs assure excellent tracking, even under thermal shock.

Specifications

- Frequency Range:** 10 MC to 10 GC
- SWR:** Less than 1.5 (less than 1.3, 50 MC to 7 GC)
- Power Range:** $1 \mu\text{w}$ to 10 mw (with hp 431A)
- Elements:** Four 100 ohm, negative temperature coefficient thermistors permanently installed

hp 486A Waveguide Thermistor Mounts, 2.6 to 40.0 GC



These waveguide mounts provide close temperature tracking with the hp 431A, even in the presence of thermal shocks. Each covers its full waveguide range. These mounts make the measurement of power as low as $1 \mu\text{w}$ practical.

Specifications

	S	G	J	H	X	M	P	K	R
Frequency Range (GC):	2.6—3.95	3.95—5.85	5.3—8.2	7.05—10.0	8.2—12.4	10.0—15.0	12.4—18.0	18.0—26.5	26.5—40.0
Maximum SWR:	1.35	1.5	1.5	1.5	1.5	1.5	1.5	2.0	2.0
Weight:	24 oz.	12 oz.	8 oz.	6 oz.	6 oz.	6 oz.	5 oz.	5 oz.	4 oz.

FOR ALL BANDS:

- Power Range:** $1 \mu\text{w}$ to 10 mw with hp 431A
- Elements:** Permanently installed thermistors



Versatile, Easy to Use, Dependable

hp 434A Calorimetric Power Meter



Just connect and read power 10 mw to 10 watts
Covers dc to 12.4 GC
No barretter or thermistor needed
No external terminations or plumbing

Here's the fastest, easiest means yet devised to measure power accurately from 10 mw to 10 watts between dc and 12.4 GC. With the hp 434A, measurement is literally as simple as connecting to the 50 ohm Type N front panel terminal and reading power directly. With only two simple front panel controls, a zero-set and a range switch, the instrument is ideal for use by non-technical personnel.

The hp 434A fills the range between bolometer-type microwave power meters (such as the hp 430C and hp 431A) and conventional calorimeters for powers above 10 watts. But unlike cumbersome and slow-responding dry calorimeters, the 434A is compact, completely self-contained, moderately priced, and needs no detectors or external plumbing.

Brief Specifications

Input Power Range:	7 ranges; full scale readings 0.01 to 10 watts
Frequency Range:	DC to 12.4 GC
DC Input Impedance:	50 ohms \pm 5 ohms at Type N input jack
Input SWR:	Less than 1.3, dc to 5 GC; less than 1.5, 5 to 12.4 GC
Meter Response (full scale):	Less than 5 seconds
Controls:	Zero Set, Meter Range
Accuracy: (includes rf efficiency and substitution error)	Within \pm 5% of full scale. Better accuracies possible using appropriate techniques

hp 430C Microwave Power Meter



Use the economical hp 430C Microwave Power Meter for applications where thermal drift is less important. You get direct, automatic pulsed or CW power readings, 10 MC to 40 GC with appropriate bolometer mounts, barretters and thermistors. No calculations or tedious adjustments are required. The 430C reads direct in milliwatts, 0.01 to 10 mw, or in dbm from -20 to +10, using either a negative or positive temperature coefficient bolometer at 100 or 200 ohm levels. Higher powers may be measured by adding attenuators or directional couplers to the system.

Brief Specifications

Power Ranges:	5 ranges, 0.1 to 10 mw full scale; continuous readings from -20 to +10 dbm
External Bolometer:	Frequency range depends on bolometer mount; bolometers can operate at 100 or 200 ohms, can have positive or negative temperature coefficients
Accuracy:	\pm 5% of full scale

hp Bolometer, Thermistor Mounts for use with hp 430C

hp 477B Thermistor Mount, 10 MC to 10 GC, no tuning, 0.01 to 10 mw, SWR less than 1.5,



hp 477B

hp 476A



hp 476A Universal Bolometer Mount, 10 to 1,000 MC, no tuning, 0.01 to 10 mw,

hp 487 Waveguide Thermistor Mounts

Designed for use with hp 430C or other instruments responsive to negative temperature coefficient bolometers operating at 100 or 200 ohms, hp 487 series Mounts cover 2.6 to 40.0 GC. No tuning required. Mounts available for the following frequency bands (see respective frequency band pages for specifications): S Band, G, J, H, X, M, P, K, R,

Data subject to change without notice. Prices f.o.b. factory.

Power Measurements

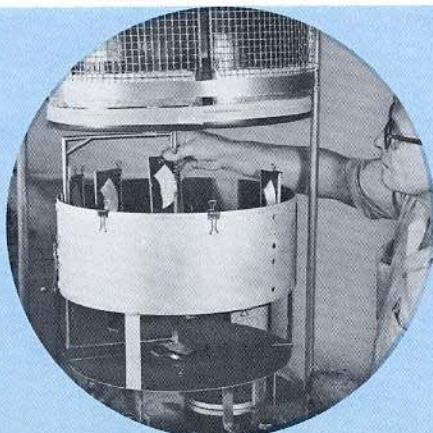

Advanced techniques of metalizing, such as vacuum deposition illustrated here, increase the ability of hp to meet superior specifications on such instruments as microwave attenuators, i.e., the hp 382A, and other devices using resistive cards.

Broad Range Microwave Instrumentation

Here are convenient, accurate instruments for making critical noise figure measurements in microwave receivers.  equipment includes both noise figure meters and noise sources covering IF through waveguide ranges.

344A Noise Figure Meter





make it valuable for use with all radars, including pulsed and CW types. Sampling techniques permit its use with high prf radar sets at rates up to 3,000 pps. Various meter options, i. e., 0-15 db, 6-20 db, handle wide range of radar noise figures. Also, an optional meter calibrated in system temperature (e.g. 50° K to 5,000° K) is useful for low noise receivers such as masers or parametric devices. Compact Model 344A is militarized for reliability. Alarms indicate noise figure above pre-set level or failure in noise source current.

344-78D Modulator





HO1-349A UHF Noise Source



Simple and convenient noise figure measurement on *operating* radars is possible with the  344A Noise Figure Meter, usable with radar receivers in any rf range for which noise sources are available. Continuous display of noise figure permits optimizing this noise figure during the operation of the radar, and high sensitivity of the 344's permits decoupling the noise source up to 20 db from the main transmitter line to minimize degradation of the system. Model 344A is used with a remote source modulator (such as the  344A-78D Modulator) and noise source so that high voltage on slip-rings is unnecessary. Designed for pulse radars with repetition rates of 90 to 500 pps, its high sensitivity and compact design

Brief Specifications

Input Frequency:	12 to 70 MC
Bandwidth:	1 MC nominal
Input Sensitivity:	Requires 40 db conversion gain between main line and 344A input
Input Impedance:	75 ohms nominal during radar scan
Accuracy:	For 0 to 15 db scale: ± 0.5 db, 0-5 db; ± 1 db, 5-10 db; ± 2 db, 10-15 db
Repetition Rate:	90 to 500 pps as specified
Total Duty Factor:	$0.075 + (100 \mu\text{sec}) \times (\text{prf})$
Input Trigger:	3 v pos. peak, 3 μsec duration
Output:	100 μamp into 2,000 to 3,000 ohms
Temperature Range:	0 to 52° C
Humidity:	95%
Dimensions:	19" x 5 1/4" x 10 7/8" (rack mount) 4 5/8" x 3 5/8" x 4 1/2" (modular)
Price:	 344AE (modular) or 344AR (rack mount) approximately including one  344A-78D Modulator (depends on options and modifications).  344A-78D Modulator, each (Not available in Western Europe.)

Data subject to change without notice. Prices f.o.b. factory.

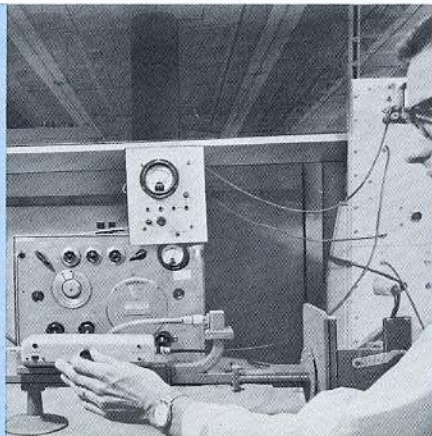

Hewlett-Packard applications engineers are ready to help solve your every microwave measuring problem, and a steady flow of Application Notes and other technical information is produced to keep engineers alert to the most advanced measurement techniques.

for Measurement of Noise Figure

hp 340B/342A Noise Figure Meters



With the hp 340B and 342A Noise Figure Meters, receiver and component alignment jobs that formerly took an hour can now be cut to 5 minutes' work — even for semi-skilled personnel. Models 340B and 342A are primarily intended for laboratory and test applications where rapid, accurate direct-reading noise figure measurements are required. Model 340B, when used with an hp noise source, automatically measures and continuously displays the noise figure of IF or rf amplifiers tuned to 30 and 60 MC. Model 342A is similar to the 340B, except that it operates on five frequencies between 30 and 200 MC. Four of these frequencies are 60, 70, 105 and 200 MC; the fifth is the basic 342A tuned amplifier frequency of 30 MC. These meters automatically compare receiver output with a noise source on and with the noise source off — and display the noise figure on a front panel meter.

Specifications

Frequency Range:	Depends on noise source used
Noise Figure Range:	3 to 30 db, indication to infinity with gas tube noise source. 0 to 15 db, indication to infinity with diode noise source or gas tube with 10 db rf pad
Zero Offset:	Permits low values to be read on sensitive external meter
Accuracy (excluding noise source):	± 0.5 db, 10 to 25 db; ± 1 db, 3 to 10 db; 25 to 30 db with waveguide noise source. ± 0.5 db, 0 to 15 db with IF noise source
Input Requirements:	—60 dbm to —10 dbm (noise source on)
IF Input Frequency:	hp 340B, 30 and 60 MC; other frequencies 10 to 70 MC available on special order. hp 342A, 30, 60, 70, 105 and 200 MC, frequency selector switch. Other frequencies optional
Bandwidth:	1 MC minimum
Input Impedance:	50 ohms nominal
Output:	AGC, nominally 0 to —6 v; Recorder, max. 1 ma into max. 2,000 ohms; power output to operate hp noise source
Dimensions:	Cabinet: 20¾" wide, 12¾" high, 14½" deep, 40 lbs.; rack mount, 19" x 10½" x 13¾", 34 lbs.
Price:	(Not available in Western Europe.)

hp Noise Sources

hp 343A VHF Noise Source

Specifically for IF and rf amplifier noise measurement, a temperature-limited diode source with broadband noise output.

Frequency Range:	10 to 600 MC
Excess Noise:	5.2 db ± 0.1 db, 10 to 200 MC; 5.2 ± 0.25 db, 200 to 400 MC; 5.2 ± 0.35 db, 400 to 600 MC
Source Impedance:	50 ohms, SWR less than 1.1, 10 to 400 MC; less than 1.3, 400 to 600 MC
Dimensions:	2¾" wide, 2½" high, 5" deep. ¾ lb.

hp 345B IF Noise Source

Operates at either 30 or 60 MC, switch selected. A selector permits matching 50, 100, 200 and 400 ohm impedances.

Spectrum Center:	30 or 60 MC. Other frequencies between 10 and 70 MC available on special order
Excess Noise:	Nominally 5.2 db into conjugate load
Source Impedance:	50, 100, 200 and 400 ± 4% ohms. Less than 1 pf shunt capacitance
Dimensions:	Same as hp 343A

hp 347A Waveguide Noise Sources

Argon gas discharge tubes mounted in waveguide sections, for all frequencies 2.6 through 18.0 GC.

Model	Range (GC)	Excess Noise (db)	Approx. Length	Price
S347A	2.6 - 3.95	15.2 ± 0.5	22½"	
G347A	3.95 - 5.85	15.2 ± 0.5	19"	
J347A	5.3 - 8.2	15.2 ± 0.5	19"	
H347A	7.05 - 10	15.2 ± 0.5	16"	
X347A	8.2 - 12.4	15.2 ± 0.5	14¾"	
P347A	12.4 - 18	15.2 ± 0.5	14¾"	

SWR all models, fired or unfired, 1.2 max., <1.1 average.

hp 349A UHF Noise Sources

Argon discharge tubes providing 15.2 db excess noise for automatic noise figure readings on scatter communications receivers, L-band radars, parametric amplifiers or other devices 400 to 4,000 MC (use with 340B and 342A). Also available with 18.2 db excess noise (hp H01-349A) for use with 344A.

Frequency Range:	400 to 4,000 MC; wider with correction
Excess Noise:	15.2 db ± 0.5 db
SWR:	Up to 2,600 MC: less than 1.35 fired; less than 1.5 unfired 2,600 to 3,000 MC: less than 1.5 fired; less than 1.5 unfired 3,000 to 4,000 MC: less than 2.0 fired; less than 3.0 unfired (Source terminated in coaxial load with less than 1.05 SWR)
Dimensions:	3" wide, 2" high, 15" deep. ¾ lbs.

Noise Figure Measurements

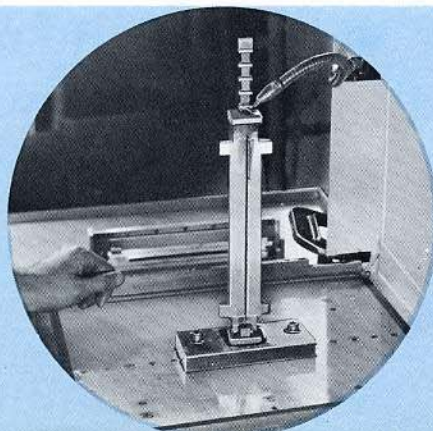

Careful precision broaching is another regular part of the hp manufacturing process. Broaching, along with casting techniques, for example, maintains dimensional tolerances on hp precision waveguide in excess of military specifications. Typical are hp X-band components such as the X914B Moving Load and X810B Slotted Section, held to ± 0.001 in. (MIL spec for RG 52/U is ± 0.003 in.)



Measure Frequency to 18 GC with Counter Accuracy

hp 540B Transfer Oscillator



hp 540B Transfer Oscillator used with hp counters, frequency converters and fixed tuned mixers permits measurement far into the microwave region with accuracy and simplicity otherwise available only at lower frequency. An internal oscillator in the 540B generates harmonics to

at least 12.4 GC for comparison by means of a broadband, untuned, diode mixer system, amplifier and oscilloscope, all built in. The oscillator also provides signals for driving external amplifiers and mixers for measurements above 12.4 GC. Use of the new P932A Harmonic Mixer extends the range of the 540B to 18 GC. In use, with the approximate signal frequency known, the hp 540B is tuned until one of its harmonics beats with the unknown, and the multiplying factor is noted. The transfer oscillator frequency is then measured directly on the hp 524 Electronic Counter, and the multiplying factor times the 524 reading gives the unknown frequency. Each of the 540B circuit elements may be used separately by shifting front panel patch cords. hp Application Note No. 2 discusses equipment set-ups for frequency measurement to 40 GC and above.

Specifications

Frequency Range:	10 MC to 12,400 MC, to 18 GC with hp P932A Harmonic Mixer
Input Signal:	CW, FM, AM. (Measure rf pulses with triggered oscilloscope.)
Input Signal Level:	Varies with frequency and individual crystals
Accuracy:	CW: Approx. 1/10,000,000 or better with 524C or 524D
Oscillator:	100 MC to 220 MC, harmonic range above 12.4 GC. Stability better than 0.002% change per minute after 30 minute warmup. Dial, 6" diam., calibrated in 1 MC increments, accuracy $\pm 0.5\%$; output approx. 2 v into 500 ohms
Amplifier:	Adjustable gain, max. 40 db or more; variable bandwidth; output, 1 v rms max. into 1000 ohms.
Oscilloscope:	Self-contained; frequency range, 100 cps to 200 KC; vertical deflection sensitivity, 5 mv rms per inch at mixer output; horizontal sweep, internal, power supply frequency with phase control or external with 1 v per inch, 20 cps to 5 KC
Dimensions:	Cabinet, 20 $\frac{3}{4}$ " wide, 12 $\frac{1}{2}$ " high, 15 $\frac{1}{4}$ " deep; rack mount, 19" x 10 $\frac{1}{2}$ " x 14 $\frac{1}{4}$ ". 42 lbs. (cabinet), 35 lbs. (rack mount).
Auxiliary Equipment:	hp 524 Electronic Counter with hp 525B Frequency Converter plug-in unit hp P932A Harmonic Mixer

Measure frequency, drift, fm deviation, 0.2 to 12.4 GC, with counter accuracy

DY-5854 Frequency Measuring System

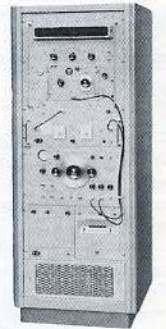

With the hp 540B Transfer Oscillator and hp 524C/D Counter, the DY-5796 Transfer Oscillator Synchronizer combines into a system that gives you measurement accuracy equal to that of the counter time base (3 parts in 10⁸ short term for hp 524C/D Counters). The DY-5854 Frequency Measuring System combines these instruments, plus a digital recorder with analog output, in 52 $\frac{1}{2}$ " of rack space, permits high-accuracy automatic frequency measurements, even on varying signals, all the way to 12.4 GC.

In the system, the hp 524C and 525B Frequency Converter cover 100 to 220 MC, and the hp 540B extends the measuring range to 12.4 GC. The DY-5796 Synchronizer provides positive locking of the transfer oscillator to the signal frequency.

By keeping the transfer oscillator and the signal frequency in permanent synchronization, the DY-5796 also permits long term measurements of low drift rates at microwave frequencies

Specifications

Frequency Range:	200 MC to 12.4 GC
Lock-on Range:	0.2% of signal frequency, max.
Accuracy:	1 count \pm time base accuracy
Stability:	3/10 ⁸ short term, 5/10 ⁸ per week with 524C/D internal time base. May be used with external frequency standard, e. g., hp 103AR, for greater accuracy
Registration:	9 places: first 2 on converter dial, next 7 on counter
Printout:	Full readout of counter printed on paper tape
Analog Output:	For potentiometer recorder: 0-100 mv. Min. load resistance 0.5 M. Calibrate control. For galvanometer recorder: 0-1 ma into 5,000 ohms or less. Zero and calibrate controls.
FM Measurement:	Deviations up to 0.2% of signal frequency at rates to 1 KC. Above 1 KC, max. deviation limit reduced at 20 db/decade to max. of 0.001% at 200 KC

Order complete DY-5854 system or separate instruments, H06-540B (hp 540B modified for the DY-5796), kit 9200-0028 to modify your own 540B, and DY-5796 Transfer Oscillator Synchronizer direct from Dymec, 395 Page Mill Road, Palo Alto, California.

Data subject to change without notice. Prices f.o.b. factory.

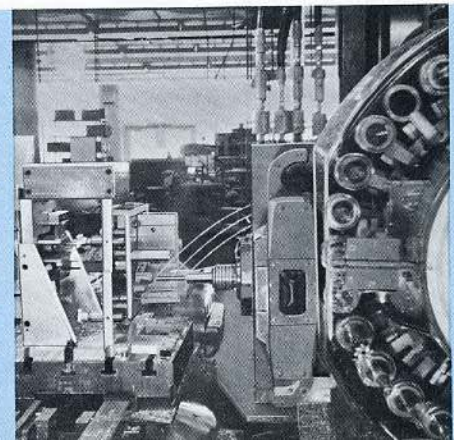

A major source of economy in hp microwave instrumentation is this automatic milling machine, which performs hours of human labor in minutes. Programmed from punched tape, the machine not only saves man-hours and production cost, but also adds to the precision of parts, thereby improving instrument specs.



Klystron Power Supplies for Convenient Microwave Work

New 716A Klystron Power Supply





This new instrument provides regulated beam voltage up to 800 v at 100 ma, 0 to 800 v regulated reflector voltage negative with respect to beam voltage and an excellently regulated dc filament voltage of 6.3 v at 0 to 2.0 amps. The instrument includes internal square wave and sawtooth modulation, square wave for amplitude modulation and sawtooth for frequency modulation.  716A also includes provisions for external modulation, plus X-axis scope output with same waveform as the modulation voltage. Both reflector and beam voltages are continuously variable, and the instrument offers low ripple, high accuracy, simple operation and compact design. It is housed in the new  universal module, suitable for bench or rack operation. Dimensions, 16 $\frac{3}{4}$ " x 6 $\frac{3}{4}$ " x 18 $\frac{3}{8}$ " (overall depth), 45 lbs.

715A Klystron Power Supply



Many different types of low-power klystrons can be operated with this compact, portable bench supply, which offers a regulated 250 to 400 v beam voltage and a 0 to 900 v regulated reflector supply (both continuously variable), plus a 6.3 v ac filament supply. Internal square wave modulation and external modulation capabilities are incorporated in this moderately priced instrument. Dimensions, 7 $\frac{3}{8}$ " x 11 $\frac{1}{2}$ " x 13 $\frac{3}{4}$ " overall depth, 24 lbs.

Application Notes Provide Valuable, Complete Information on Microwave Measurements

Hewlett-Packard Application Notes, covering a wide variety of subjects, offer valuable microwave data, including theoretical and "how to do it" information. They are composed of information derived from the experience of  engineers both in general microwave areas and in solving specific microwave measurement problems.  Application Notes are available without charge. The following is a list of titles currently available on microwave measurement; they may be requested by the "AN" number and title:

AN 1	Measuring Frequency Modulated Signals
AN 2	Frequency Measurement to 18 GC and Above
AN 3	Measurement of RF Pulse Carrier Frequency
AN 6	Homodyne Generator and Detection System
AN 7	Power Meter Accuracy
AN 9	Doppler Frequency Shift Simulation at Microwave Frequencies
AN 10	Microwave Spectrum Synthesis
AN 11	Domesticating the Traveling-Wave Tube
AN 12	How a Helix Backward-Wave Tube Works
AN 14	Traveling-Wave Tube Amplifiers
AN 16	Waves on Transmission Lines
AN 20	Hewlett-Packard Signal Generator Output Attenuators
AN 21	Microwave Standards Prospectus
AN 27	Basic Microwave Measurements
AN 28	Drift Measurements of High Stability Signals
AN 30	Measurement of Cable Characteristics
AN 38	Microwave Measurements for Calibration Laboratories
AN 39	Standards Calibration Procedures
AN 43	Continuous Monitoring of Radar Noise Figures
AN 51	Modified 485B as Mixer for X- and H-Band Receivers
AN 53	Transmission Line Testing Using the Sampling Oscilloscope
AN 54	Improved Sweep Frequency Techniques

Detailed data sheets are available, on request, for all equipment and instruments listed in this catalog.

Frequency
Measurements
Power Supplies



hp Sales and Service Representatives in North America

+ Indicates Instrument Repair Stations

EASTERN SEABOARD

Asbury Park, New Jersey
The I. E. Robinson Company
1317 Railroad Avenue
KELlog 1-3150

Baltimore 15, Maryland
Horman Associates, Inc.
3006 West Cold Spring Lane
MOhawk 4-4400

+ **Boston Area**
Burlington, Massachusetts
Yewell Associates, Inc.
Middlesex Turnpike
BRowing 2-9000

Bridgeport 8, Connecticut
Yewell Associates, Inc.
1101 East Main Street
FOREst 6-3456

Camp Hill, Pennsylvania
The I. E. Robinson Company
Park Place Office Bldg.
REgent 7-6791

Englewood, New Jersey
R. M. C. Associates
391 Grand Avenue
LOWell 7-3933

+ **New York 21, New York**
R. M. C. Associates
236 East 75th Street
TRafalgar 9-2023

+ **Philadelphia Area**
West Conshohocken, Pennsylvania
The I. E. Robinson Company
144 Elizabeth Street
CHEstnut Hill 8-1600
TAYlor 8-6200

+ **Pittsburgh 27, Pennsylvania**
S. Sterling Company
4322 Brownsville Rd.
TUxedo 4-5515

Poughkeepsie, N. Y.
Yewell Associates, Inc.
806 Main Street
GROver 1-3456

+ **Rochester 25, New York**
Edward A. Ossmann & Associates
830 Linden Avenue
LUDlow 6-4940

Syracuse, New York
Edward A. Ossmann & Associates
101 Picard Drive, P. O. Box 128
GL 4-2461

Vestal, New York
Edward A. Ossmann & Associates
149 Front St.
STillwell 5-0296

+ **Washington, D. C. Area**
Rockville, Maryland
Horman Associates, Inc.
941 Rollins Avenue
HAZelwood 7-7560

SOUTHEASTERN STATES

+ **Atlanta 5, Georgia**
Bivins & Caldwell, Inc.
3110 Maple Drive, N. E.
233-1141, Area Code 404

+ **High Point, North Carolina**
Bivins & Caldwell, Inc.
1923 N. Main Street
882-6873

Huntsville, Alabama
Bivins & Caldwell, Inc.
534-5733
(Direct line to Atlanta)

+ **Orlando, Florida**
Stiles Associates, Inc.
1226 E. Colonial Dr.
GARden 5-5541

Richmond 30, Virginia
Bivins & Caldwell, Inc.
1219 High Point Ave.
ELgin 5-7931

St. Petersburg 8, Florida
Stiles Associates, Inc.
410-150th Ave., Madeira Beach
391-0211

CENTRAL, SOUTH CENTRAL STATES

+ **Chicago 45, Illinois**
Crossley Associates, Inc.
2501 West Peterson Ave.
BRoadway 5-1600

+ **Cleveland 24, Ohio**
S. Sterling Company
5827 Mayfield Road
HILLcrest 2-8080

+ **Dallas 9, Texas**
Earl Lipscomb Associates
P. O. Box 7084
FLEetwood 7-1881 and
EDison 2-6667

+ **Dayton 19, Ohio**
Crossley Associates, Inc.
2801 Far Hills Avenue
AXminster 9-3594

+ **Detroit 35, Michigan**
S. Sterling Company
15310 West McNichols Rd.
BRoadway 3-2900

+ **Houston 5, Texas**
Earl Lipscomb Associates
P. O. Box 6646
MOhawk 7-2407

+ **Indianapolis 20, Indiana**
Crossley Associates, Inc.
5420 No. College Avenue
CLifford 1-9255

Kansas City 30, Missouri
Harris-Hanson Company
7916 Paseo Blvd.
HILLand 4-9494

+ **St. Louis 17, Missouri**
Harris-Hanson Company
2814 South Brentwood Blvd.
MISSION 7-4350

+ **St. Paul 14, Minnesota**
Crossley Associates, Inc.
842 Raymond Avenue
MIDway 6-7881

WESTERN STATES

+ **Albuquerque, New Mexico**
Neely Enterprises
6501 Lomas Blvd., N. E.
255-5586

+ **Denver 10, Colorado**
Lahana & Company
1886 South Broadway
PEARl 3-3791

Las Cruces, New Mexico
Neely Enterprises
114 S. Water Street
526-2486

+ **Los Angeles, California**
Neely Enterprises
3939 Lankershim Blvd.
North Hollywood, Calif.
TRiangle 7-1282 and
POplar 6-3811

+ **Phoenix, Arizona**
Neely Enterprises
641 East Missouri
CREstwood 4-5431

Portland 9, Oregon
ARVA
1238 N. W. Glisan
CApitol 2-7337

+ **Sacramento 14, California**
Neely Enterprises
1317 - 15th Street
GILbert 2-8901

+ **Salt Lake City 15, Utah**
Lahana & Co.
1482 Major St.
HUNter 6-8166

+ **San Diego 6, California**
Neely Enterprises
1055 Shafter Street
ACademy 3-8106

+ **San Francisco Area**
San Carlos, California
Neely Enterprises
501 Laurel Street
LYtell 1-2626

Seattle 9, Washington
ARVA
1320 Prospect Street
MAIn 2-0177

Tucson, Arizona
Neely Enterprises
232 So. Tucson Blvd.
MAIn 3-2564

CANADA

+ **Montreal, Quebec**
Hewlett-Packard (Canada) Ltd.
8270 Mayrand Street
Telephone: 735-2273

Ottawa, Ontario
Hewlett-Packard (Canada) Ltd.
1762 Carling Avenue
PARkway 2-8162

Toronto, Ontario
Hewlett-Packard (Canada) Ltd.
1415 Lawrence Avenue W.
Telephone: 249-9196

hp Sales and Service Representatives Overseas

+ Indicates Instrument Repair Stations

Argentina

Mauricio A. Suarez
Telecomunicaciones
Carlos Calvo 224, Buenos Aires
Tel. 30-6312-34-9087

+ Australia

Sample Electronics
(N.S.W.) Pty. Ltd.
48 Chippen Street, Sydney
Tel: 69-4112 and 69-6338

Sample Electronics (Vic.) Pty. Ltd.
9-11 Cremorne Street,
Richmond, E. 1, Victoria
Phones: 42-4757 (3 lines)

Austria

Austronik G. m. b. H.
54 Mollardgasse, Vienna VI
Tel: 57.06.38

+ Belgium

Electronica Marketing Co., S.A.
20-24 rue de l'Hopital, Brussels
Tel: 11.22.20

+ Denmark

Tagé Olsen A/S
Centrumgården, Room 133
6D, Vesterbrogade, Copenhagen V.
Tel: Palae 1369 and Palae 1343

Finland

INTO O/Y
11 Meritullinkatu, Helsinki
Tel: 62 14 25 and 35 125

+ France

Radio Equipements
65 rue de Richelieu, Paris 2ème
Tel: RIChelieu 49-88, 50-78
95-41

+ Germany

Hewlett-Packard
Vertriebsgesellschaft m. b. H.
Frankfurt am Main
Sophienstrasse 8
Telefon 77-31-75 and 77-94-25

Greece

K. Karayannis
Karitsi Square, Athens
Tel: 23-213 (15 Lines)

India

The Scientific Instrument
Company, Ltd.
6, Tej Bahadur Sapru Road
Allahabad 1

The Scientific Instrument
Company, Ltd.
240, Dr. Dadabhai Naoroji Road
Bombay 1

The Scientific Instrument
Company, Ltd.
11, Esplanade East, Calcutta 1

India (Continued)

The Scientific Instrument
Company, Ltd.
30, Mount Road, Madras 2

The Scientific Instrument
Company, Ltd.
B-7, Ajmeri Gate Extn.
New Delhi 1

Israel

Electronics & Engineering Ltd.
6 Feierberg St., Tel-Aviv
Phone 64288

+ Italy

Dott. Ing. Mario Vianello
Via. L. Anelli 13, Milano
Telef. 553-081 and 553-811

Dott. Ing. Mario Vianello
Via S Croce in Gerusalemme 97,
Rome
Telef. 767-250 and 767-941

+ Japan

Seki & Company, Ltd.
Daini Taihei Building
No. 1 Kanda Higashi, Fukudacho
Chiyoda-Ku, Tokyo
Tokyo (866) 3136-9

Korea

American Trading Company, Inc.
178 1st Ka., Euijoo-Ro
Sudaimoon-Ku, Seoul
Telephone: 3-4838, 3-7049, 3-7613

+ Netherlands

Electronic Marketing Co., N.V.
23, Burg. Roelstraat
Amsterdam W.
Tel: 15.28.98

New Zealand

Geo. H. Sample & Son (N.Z.) Ltd.
431 Mount Albert Road
Mount Roskill, Auckland, 53
Tel: 898-439

+ Norway

Morgenstjerne & Co.
Colletts Gate 10, Oslo
Tel. 60 17 90

Portugal

Senatejo Industrial, Lda.
Rua do Alecrim, 46-S/Loja
Lisbonne 2
Tel: 3 44 46 - Bureau
36 86 43 - Direction

Union of South Africa

F. H. Flanter & Co., (Pty.), Ltd.
Rosella House
Buitencingle Street, Cape Town
Tel. 3-3817

Spain

ATAIO, Ingenieros
A. Aguilera, No. 8
Madrid 15
Tel: 223-27-42
254-53-80

+ Sweden

Erik Ferner, AB
Snörmakarvägen 35
Bromma 1
Tel: 252870

+ Switzerland

Max Paul Frey
Hangweg 27
Köniz - Bern
Tel: (031) 63 36 44

Taiwan (Formosa)

Hwa Sheng Electronic Co., Ltd.
21 Nanking West Road, Taipei
Telephone: 4-6076

+ United Kingdom

Livingston Laboratories Ltd.
31 Camden Road
London N.W.
Tel: GULliver 8501

Yugoslavia

Belram Electronics
83 Av. Des Mimosas
Brussels 15, Belgium
Tel: 35 . 29 . 58



HEWLETT-PACKARD COMPANY

1501 PAGE MILL ROAD, PALO ALTO, CALIFORNIA, U.S.A.
CABLE "HEWPACK" DAVenport 6-7000 - Area Code 415

HEWLETT-PACKARD S. A.

RUE DU VUEX BILLARD NO. 1, GENEVA, SWITZERLAND
CABLE: "HEWPACKSA" TEL. NO. (022) 26. 43. 36

MANUFACTURING PLANTS: Bedford, England; Böblingen, Germany

