

## Errata

**Title & Document Type:** 3589A Programmers Reference Manual

**Manual Part Number:** 03589-90026

**Revision Date:** March 1995

---

### HP References in this Manual

This manual may contain references to HP or Hewlett-Packard. Please note that Hewlett-Packard's former test and measurement, semiconductor products and chemical analysis businesses are now part of Agilent Technologies. We have made no changes to this manual copy. The HP XXXX referred to in this document is now the Agilent XXXX. For example, model number HP8648A is now model number Agilent 8648A.

### About this Manual

We've added this manual to the Agilent website in an effort to help you support your product. This manual provides the best information we could find. It may be incomplete or contain dated information, and the scan quality may not be ideal. If we find a better copy in the future, we will add it to the Agilent website.

### Support for Your Product

Agilent no longer sells or supports this product. You will find any other available product information on the Agilent Test & Measurement website:

[www.tm.agilent.com](http://www.tm.agilent.com)

Search for the model number of this product, and the resulting product page will guide you to any available information. Our service centers may be able to perform calibration if no repair parts are needed, but no other support from Agilent is available.

# HP 3589A HP-IB Programmer's Reference

**(Includes HP 35689A/B)**



HP Part Number: 03589-90026  
Microfiche Part Number: 03589-90226  
Printed in U.S.A.

Print Date: March 1995

©Hewlett-Packard Company, 1991, 1995. All rights reserved.  
8600 Soper Hill Road Everett, Washington 98205-1298 U.S.A.



## **NOTICE**

The information contained in this document is subject to change without notice.

HEWLETT-PACKARD MAKES NO WARRANTY OF ANY KIND WITH REGARD TO THIS MANUAL, INCLUDING, BUT NOT LIMITED TO, THE IMPLIED WARRANTIES OF MERCHANTABILITY AND FITNESS FOR A PARTICULAR PURPOSE. Hewlett-Packard shall not be liable for errors contained herein or direct, indirect, special, incidental or consequential damages in connection with the furnishing, performance, or use of this material.

## **WARRANTY**

*A copy of the specific warranty terms applicable to your Hewlett-Packard product and replacement parts can be obtained from your local Sales and Service Office.*

This document contains proprietary information which is protected by copyright. All rights are reserved. No part of this document may be photocopied, reproduced or translated to another language without the prior written consent of Hewlett-Packard Company. This information contained in this document is subject to change without notice.

Use of this manual and flexible disc(s) or tape cartridge(s) supplied for this pack is restricted to this product only. Additional copies of the programs can be made for security and back-up purposes only.

- © Copyright 1983, 1984, 1985, 1986, 1987, 1988, 1990, 1991 Hewlett-Packard Company.
- © Copyright 1979 The Regents of the University of Colorado, a body corporate.
- © Copyright 1979, 1980, 1983 The Regents of the University of California.
- © Copyright 1980, 1984 AT&T Technologies. All Rights Reserved.
- © Copyright 1986, 1987 Sun Microsystems, Inc.
- © Copyright 1984, 1985 Productivity Products Intl.

## **RESTRICTED RIGHTS LEGEND**

Use, duplication, or disclosure by the government is subject to restrictions as set forth in subdivision (c) (1) (ii) of the Rights in Technical Data and Computer Software clause at 52.227-7013.

**HEWLETT-PACKARD COMPANY**

**3000 Hanover St.**

**Palo Alto, CA 94303**

# Table of Contents

---

## Chapter 1: Introduction to HP-IB

Notice to Experienced HP-IB Programmers . . . . .	1-1
Manual Overview . . . . .	1-2
Programming Fundamentals . . . . .	1-2
Programming Examples . . . . .	1-2
Command Reference . . . . .	1-2
Appendix . . . . .	1-2
Index . . . . .	1-2
HP-IB Overview . . . . .	1-3
What is HP-IB? . . . . .	1-3
Sending Commands Over the HP-IB . . . . .	1-3
SCPI Overview . . . . .	1-5
What is SCPI? . . . . .	1-5
Related Standards . . . . .	1-5
HP-IB Setup . . . . .	1-7
Configuring the HP-IB System . . . . .	1-7
Quick Verification . . . . .	1-10
Verification Program . . . . .	1-12

## Chapter 2: Behavior in an HP-IB System

HP-IB Interface Capabilities . . . . .	2-1
Controller Capabilities . . . . .	2-2
Bus Management Commands vs. Device Commands . . . . .	2-2
Response to Bus Management Commands . . . . .	2-3
Device Clear (DCL) . . . . .	2-3
Go To Local (GTL) . . . . .	2-3
Group Execute Trigger (GET) . . . . .	2-3
Interface Clear (IFC) . . . . .	2-3
Local Lockout (LLO) . . . . .	2-4
Parallel Poll . . . . .	2-4
Remote Enable (REN) . . . . .	2-4
Selected Device Clear (SDC) . . . . .	2-4
Serial Poll . . . . .	2-5
Take Control Talker (TCT) . . . . .	2-5
Message Exchange . . . . .	2-6
HP-IB Queues . . . . .	2-7
Command Parser . . . . .	2-8
Query Response Generation . . . . .	2-8



## Table of Contents (Continued)

Synchronization . . . . .	2-9
Sequential and Overlapped Commands . . . . .	2-9
Synchronization Methods . . . . .	2-9
Passing Control . . . . .	2-12
<b>Chapter 3: Programming with SCPI Commands</b>	
Introduction . . . . .	3-1
The Command Tree . . . . .	3-2
Sending Multiple Commands . . . . .	3-3
Command Abbreviation . . . . .	3-4
Implied Mnemonics . . . . .	3-5
Message Syntax . . . . .	3-6
Conventions . . . . .	3-6
Common Definitions . . . . .	3-6
Special Syntactic Elements . . . . .	3-7
Program Message Syntax . . . . .	3-8
Response Message Syntax . . . . .	3-11
<b>Chapter 4: Transferring Data</b>	
Introduction . . . . .	4-1
Data Types . . . . .	4-2
Conventions . . . . .	4-2
Common Definitions . . . . .	4-2
Decimal Numeric Data . . . . .	4-2
Character Data . . . . .	4-4
String Data . . . . .	4-4
Expression Data . . . . .	4-5
Block Data . . . . .	4-5
Data Encoding for Block Data . . . . .	4-7
ASCII Encoding . . . . .	4-7
Binary Encoding . . . . .	4-8
<b>Chapter 5: Using Status Registers</b>	
Introduction . . . . .	5-1
General Status Register Model . . . . .	5-2
Overview . . . . .	5-2
Condition Register . . . . .	5-2
Transition Registers . . . . .	5-2
Event Register . . . . .	5-3
Enable Register . . . . .	5-3
The Service Request Process . . . . .	5-4
Two Ways to Use Registers . . . . .	5-4
Generating a Service Request . . . . .	5-5
The HP 3589A's Register Sets . . . . .	5-7
Register Summary . . . . .	5-7
Status Byte Register Set . . . . .	5-9
Device State Register Set . . . . .	5-11
Limit Fail Register Set . . . . .	5-12

Questionable Data Register Set . . . . .	5-13
Questionable Frequency Register Set . . . . .	5-14
Questionable Power Register Set . . . . .	5-15
Standard Event Register Set . . . . .	5-16
Standard Operation Register Set . . . . .	5-18
User Defined Register Set . . . . .	5-20
 <b>Chapter 6: Programming Examples</b>	
PASSCNTL . . . . .	6-2
WAI_SYNC . . . . .	6-3
OPC_SYNC . . . . .	6-4
OPCQ_SYNC . . . . .	6-5
TRIGGERING . . . . .	6-6
RANGE_SRQ . . . . .	6-7
AVER_SRQ . . . . .	6-8
USER_SRQ . . . . .	6-10
MOVE_STATE . . . . .	6-12
TRC_LOAD . . . . .	6-14
LOG_XAXIS . . . . .	6-16
SHAPE . . . . .	6-20
THD . . . . .	6-23
NETWORK_CAL . . . . .	6-25
PLOT_CTRL . . . . .	6-27
 <b>Chapter 7: Introduction to the Command Reference</b>	
Finding the Right Command . . . . .	7-2
Conventions . . . . .	7-3
 <b>Chapter 8: Common Commands</b>	
Common Commands . . . . .	8-1
 <b>Chapter 9: ABORt Subsystem</b>	
ABORt Subsystem . . . . .	9-1
 <b>Chapter 10: ARM Subsystem</b>	
ARM Subsystem . . . . .	10-1
 <b>Chapter 11: CALCulate Subsystem</b>	
CALCulate Subsystem . . . . .	11-1
 <b>Chapter 12: CALibration Subsystem</b>	
CALibration Subsystem . . . . .	12-1
 <b>Chapter 13: DIAGnostics Subsystem</b>	
DIAGnostics Subsystem . . . . .	13-1

Table of Contents (Continued)

<b>Chapter 14: DISPlay Subsystem</b>	
DISPlay Subsystem . . . . .	14-1
<b>Chapter 15: FORMat Subsystem</b>	
FORMat Subsystem . . . . .	15-1
<b>Chapter 16: INITiate Subsystem</b>	
INITiate Subsystem . . . . .	16-1
<b>Chapter 17: INPut Subsystem</b>	
INPut Subsystem . . . . .	17-1
<b>Chapter 18: INSTRument Subsystem</b>	
INSTRument Subsystem . . . . .	18-1
<b>Chapter 19: MARKer Subsystem</b>	
MARKer Subsystem . . . . .	19-1
<b>Chapter 20: MMEMory Subsystem</b>	
MMEMory Subsystem . . . . .	20-1
<b>Chapter 21: PLOT Subsystem</b>	
PLOT Subsystem . . . . .	21-1
<b>Chapter 22: PRINt Subsystem</b>	
PRINt Subsystem . . . . .	22-1
<b>Chapter 23: PROGRam Subsystem</b>	
PROGRam Subsystem . . . . .	23-1
<b>Chapter 24: ROUTe Subsystem</b>	
ROUTe Subsystem . . . . .	24-1
<b>Chapter 25: SCReen Subsystem</b>	
SCReen Subsystem . . . . .	25-1
<b>Chapter 26: [SENSE] Subsystem</b>	
[SENSE] Subsystem . . . . .	26-1
<b>Chapter 27: SOURce Subsystem</b>	
SOURce Subsystem . . . . .	27-1
<b>Chapter 28: STATus Subsystem</b>	
STATus Subsystem . . . . .	28-1
<b>Chapter 29: SYSTem Subsystem</b>	
SYSTem Subsystem . . . . .	29-1

**Chapter 30: TEST Subsystem**

TEST Subsystem . . . . . 30-1

**Chapter 31: TRACe Subsystem**

TRACe Subsystem . . . . . 31-1

**Chapter 32: TRIGger Subsystem**

TRIGger Subsystem . . . . . 32-1

**Appendix A: HP 3589A Command Summary**

Introduction . . . . . A-1

Command List . . . . . A-2

**Appendix B: HP 3589A Error Messages**

Introduction . . . . . B-1

Error List . . . . . B-2

**Index**



# Introduction to HP-IB

---

## Notice to Experienced HP-IB Programmers

The HP 3589A's HP-IB command set is derived from the SCPI standard (described later in this chapter). SCPI command sets differ from more traditional HP-IB command sets in the following ways:

- A traditional HP-IB command typically consists of a single mnemonic. A SCPI command typically consists of a series of mnemonics separated by colons. The mnemonics are selected from a command hierarchy, which organizes commands into related groups. These multi-mnemonic commands are less cryptic than single-mnemonic commands and help to make your programs more self-documenting. Chapter 3 tells you how to use the SCPI command hierarchy.
- A traditional HP-IB command set contains mnemonics that correspond directly to an instrument's front-panel keys. The HP 3589A's SCPI command set does give you HP-IB access to all front-panel functions, but there is not a one-to-one correspondence between commands and keys. (This results from the fact that the SCPI command hierarchy is organized differently than the front-panel key hierarchy.) A special feature allows the HP 3589A to echo equivalent SCPI command mnemonics when you press a series of front-panel keys. You can enable this feature under the [ **Local/HP-IB** ] hardkey.

## Manual Overview

This manual is organized into five major parts:

- Programming Fundamentals.
- Programming Examples.
- Command Reference.
- Appendix.
- Index.

### Programming Fundamentals

This part of the manual contains five chapters, each of which discusses some aspect of programming the HP 3589A via the HP-IB:

- Chapter 1 introduces you to HP-IB and SCPI concepts. It also tells you how to configure the HP 3589A in an HP-IB system.
- Chapter 2 tells you how the analyzer interacts with the controller and other devices on the HP-IB.
- Chapter 3 describes the SCPI command hierarchy.
- Chapter 4 tells you how data is transferred between the analyzer and a controller.
- Chapter 5 describes the analyzer's register structure and tells you how the analyzer uses registers to generate service requests.

### Programming Examples

This part of the manual contains commented programming examples. It may be a good place to start if you are an experienced HP-IB programmer and are already familiar with SCPI concepts.

### Command Reference

This part of the manual contains a detailed description of each HP-IB command. The command descriptions are organized alphabetically.

### Appendix

Appendix A provides a quick reference to the HP 3589A's HP-IB command set.

### Index

This part of the manual references the page numbers where different subjects are discussed. It can be especially useful for determining which command you should use to access a particular analyzer function.

## HP-IB Overview

### What is HP-IB?

HP-IB—the Hewlett-Packard Interface Bus—is a high-performance bus that allows you to build integrated test systems from individual instruments and computers. The bus and its associated interface operations are defined by the IEEE 488.1 standard (described later in this chapter).

HP-IB cables provide the physical link between devices on the bus. There are eight data lines on each cable that are used to send data from one device to another. Devices that can be addressed to send data over these lines are called “talkers,” and those that can be addressed to receive data are called “listeners.” There are also five control lines on each cable that are used to manage traffic on the data lines and to control other interface operations. Devices that can use these control lines to specify the talker and listener in a data exchange are called “controllers.”

When an HP-IB system contains more than one device with controller capabilities, only one of the devices is allowed to control data exchanges at any given time. The device currently controlling data exchanges is called the “active controller.” Also, only one of the controller-capable devices can be designated as the “system controller.” The system controller is the one device that can take control of the bus even if it is not the active controller. The HP 3589A can act as a talker, listener, active controller, or system controller at different times.

HP-IB addresses provide a way to identify devices on the bus. For example, the active controller uses HP-IB addresses to specify which device talks and which device listens during a data exchange. This means that each device’s address must be unique. You set a device’s address on the device itself, usually using a rear-panel switch or a front-panel key sequence.

### Sending Commands Over the HP-IB

Commands are sent over the HP-IB via a controller’s language system, such as BASIC or Pascal. As a result, you will need to determine which keywords your controller’s language system uses to send HP-IB commands. When looking for keywords, keep in mind that there are actually two different kinds of HP-IB commands:

- *Bus management commands*, which control the HP-IB interface.
- *Device commands*, which control analyzer functions.

Language systems usually deal differently with these two kinds of HP-IB commands. For example, HP BASIC uses a unique keyword to send each bus management command, but always uses the keyword OUTPUT to send device commands. For more information on the differences between bus management commands and device commands, see chapter 2, “Behavior in an HP-IB System.”



The following example shows how to send a typical device command:

```
OUTPUT 719; "AVERAGE:COUNT 5"
```

This sends the command within the quotes (AVERAGE:COUNT 5) to the HP-IB device at address 719. If the device is an HP 3589A, the command instructs the analyzer to set the number of averages to 5.

---

**Note**



All examples in this manual are written for HP BASIC running on an HP Series 200 computer.

---

## SCPI Overview

### What is SCPI?

SCPI—the Standard Commands for Programmable Instruments—is a programming language designed specifically for electronic test and measurement instruments. It defines how you communicate with these instruments from an external controller (computer).

### Related Standards

Computer-controlled test instruments that were introduced in the 1960s used a wide variety of non-standard interfaces and communication protocols. During this time, Hewlett-Packard began developing the HP-IB as an internal standard. HP-IB defined a standard electrical and mechanical interface for connectors and cables. It also defined handshaking, addressing, and general protocol for transmitting individual bytes of data between instruments and computers.

#### IEEE 488.1

In 1975, the Institute of Electrical and Electronic Engineers (IEEE) approved IEEE 488-1975, which was based on Hewlett-Packard's internal HP-IB standard. This standard has been updated and is now IEEE 488.1-1987. Today, Hewlett-Packard uses the HP-IB name to indicate that a particular instrument or controller has capabilities that conform to the IEEE 488.1 standard.

Although it solved the problem of how to send bytes of data between instruments and computers, IEEE 488 did not specify the data bytes' meanings. Instrument manufacturers freely invented new commands as they developed new instruments. The format of data returned from instruments varied as well. By the early 1980s, work began on additional standards that specified how to interpret data sent via the 488 bus.

#### IEEE 488.2

In 1987, the IEEE approved IEEE 488.2-1987. This standard defined the roles of instruments and controllers in a measurement system connected by the 488 bus (HP-IB). In particular, IEEE 488.2 described how to send commands to instruments and how to send responses to controllers. Although it explicitly defined some frequently used commands, it still left the naming of most commands to instrument manufacturers. This made it possible for two similar instruments to conform to 488.2, yet have entirely different command sets.

### SCPI

SCPI goes beyond 488.2 by defining a standard set of programming commands. For a given measurement function (such as frequency), SCPI defines the specific commands used to access that function via the 488 bus. If two analyzers both conform to the SCPI standard, for example, you would use the same command to set each analyzer's center frequency.

Standard commands provide two advantages:

- If you know how to control functions on one SCPI instrument, you know how to control the same functions on any SCPI instrument.
- Programs written for a particular SCPI instrument are easily adapted to work with a similar SCPI instrument.

Figure 1-1 shows you how SCPI builds on the 488 standards.

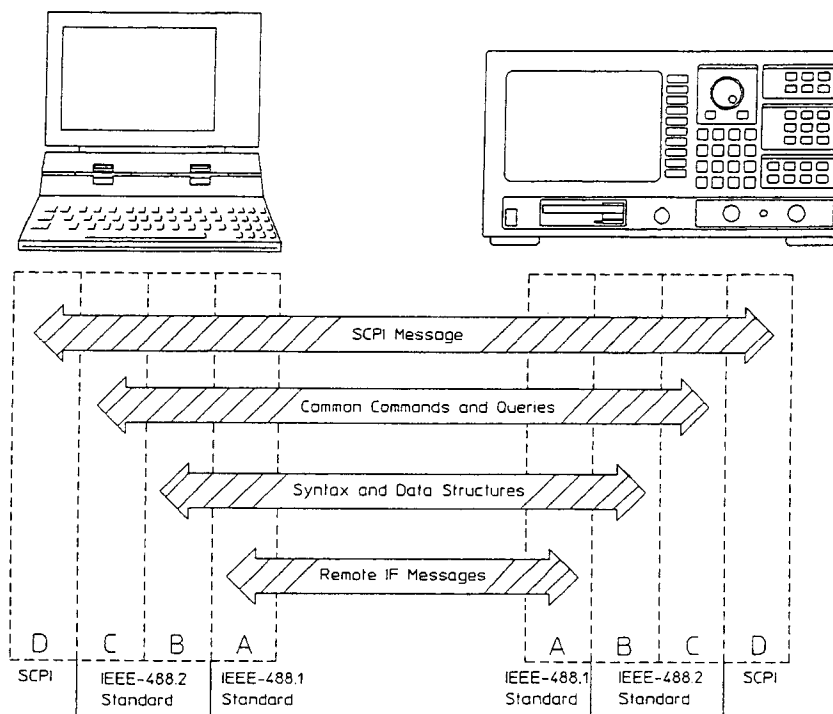

**Figure 1-1. SCPI and Related Standards**

The standards are layered to define different aspects of communication between devices:

- Layer A (IEEE 488.1) defines the physical and electrical connection between devices. It also defines how a byte of data is transmitted and how devices are instructed to talk and listen.
- Layer B (IEEE 488.2) defines the syntax and data formats used to send data between devices. It also defines the structure of status registers.
- Layer C (IEEE 488.2) defines the commands used for common tasks (such as resetting the device and reading the Status Byte).
- Layer D (SCPI) defines the commands used to control device-specific functions (such as setting frequency and amplitude). It also defines the parameters accepted by these functions and the values they return.

## HP-IB Setup

This section contains a procedure for configuring the HP 3589A and an external controller in a simple HP-IB system. Although an HP 9836 computer is the controller used in the system, other computers that support an HP-IB interface can also be used. If you are using one of those other computers, the configuration procedure can only be used as a general guide. You should consult your computer's documentation for more complete information.

This section also contains a procedure for verifying that commands can be sent over the HP-IB. HP BASIC is used for the verification procedure's test program. If your computer uses some other language, the keywords and syntax for the test program may be different. You will need to write a similar program using your language's keywords and syntax.

### Configuring the HP-IB System

#### Equipment and Software

- HP 3589A Spectrum Analyzer
- HP 9836 computer
- HP 10833A, B, C, or D HP-IB Cable
- HP BASIC

#### Procedure

1. Turn off the HP 3589A and the HP 9836, then connect them with the HP-IB cable as shown in figure 1-2.

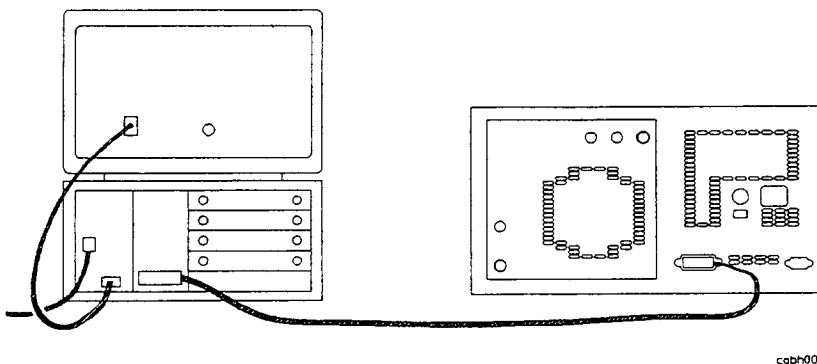
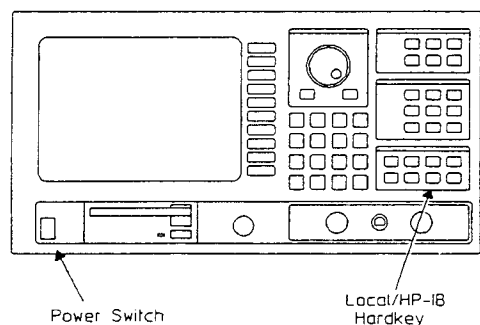

Figure 1-2. HP-IB Connections

2. Turn on the HP 9836. If necessary, load HP BASIC following the instructions in the computer's operating manual. Note that the following language extensions must be installed for the verification program to work:
  - CRTA.
  - HPIB.
  - IO.
  - EDIT.

Programs that are more complex than the verification program will probably require more language extensions.

3. Turn on the HP 3589A. When the softkey labels appear, press the [ **Local/HP-IB** ] hardkey. (see figure 1-3)



**Figure 1-3. HP 3589A Front Panel**

4. Verify that the analyzer's address is set to 19. The current address setting is displayed when you press the [ ANALYZER ADDRESS ] softkey (see figure 1-4). You can change the address by pressing [ ANALYZER ADDRESS ], then using the numeric keypad and the [ ENTER ] softkey to enter a new value. However, the instructions in the verification procedure assume that the analyzer address is set to 19.

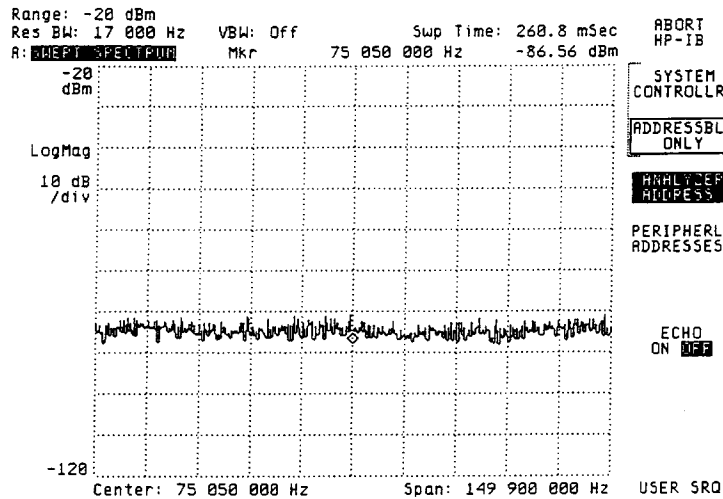

**Figure 1-4. HP 3589A Screen After Pressing Local/HP-IB**

5. Verify that the analyzer is set to the addressable-only mode. The softkey labels that appear when you press the [ Local/HP-IB ] hardkey include [ SYSTEM CONTROLLR ] and [ ADDRESSBL ONLY ]. Only one of these two softkeys can be selected at a time, and the one that is selected will have a box around it. If [ ADDRESSBL ONLY ] is not selected, then press that softkey.

---

**Note**



In any HP-IB system there can be more than one device with controller capabilities. But at any given time, only one device on the bus can be designated as the system controller.

---

## Quick Verification

Having just completed all the steps in the preceding section, you are ready to verify that commands can be sent over the HP-IB. In this quick verification, you are going to enter an HP BASIC keyword that should place the HP 3589A under remote control.

### Procedure

1. Type the following on the computer:

```
REMOTE 719
```

then press the computer's ENTER key. The RMT indicator should appear at the bottom of the HP 3589A's screen (see figure 1-5). This tells you that the analyzer is under remote control of the computer.

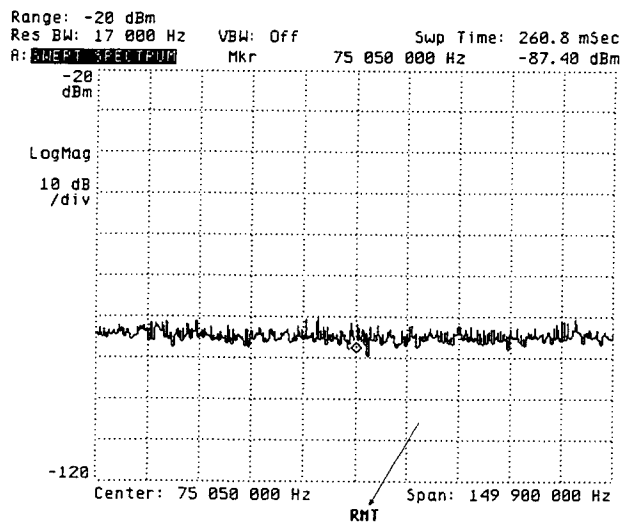

Figure 1-5. RMT Indicator

2. Now type the following on the computer:

```
LOCAL 719
```

then press the computer's ENTER key. The RMT indicator should disappear from the bottom of the screen. This tells you that the analyzer has been returned to front-panel control.

## Troubleshooting

If the RMT indicator doesn't perform as expected, check the following things:

- Be sure that your HP-IB cable connections are secure and that the cable is free of defects.
- Verify that the analyzer is in addressable-only mode and that its address is set to 19.
- Be sure you are using the required equipment and software.
- Be sure you have loaded all the required language extensions into the computer. (For a list of loaded extensions, enter the following into the computer: LIST BIN)

If everything seems to be in order, but the RMT indicator still doesn't perform as expected, contact your local HP Sales/Service office.



## Verification Program

The quick verification procedure confirmed that the computer could talk to the analyzer. However, you must write a short program to confirm that the analyzer can talk to the computer. If you enter the program correctly, the computer displays the following statement when you run the program:

FREQUENCY SPAN IS: 1.5E+8 HZ

---

### Note



The following procedure assumes that you have completed all the steps in "Configuring the HP-IB System" using all the required equipment and software.

---

### Procedure

1. Enter the following program:

```
10    PRINTER IS 1
20    ASSIGN @Hp3589a TO 719
30    ABORT 7
40    CLEAR @Hp3589a
50    OUTPUT @Hp3589a; "*RST"
60    OUTPUT @Hp3589a; "SENS:FREQ:SPAN:FULL"
70    OUTPUT @Hp3589a; "SENS:FREQ:SPAN?"
80    ENTER @Hp3589a;A
90    PRINT "FREQUENCY SPAN IS: ";A; "HZ"
100   END
```

2. See your computer and software documentation if you need help entering the program.
3. Press the computer's RUN key. The program tells the analyzer to preset. It then tells the analyzer to select its widest frequency span. Finally, the program asks the analyzer to return the value of the widest span and has the computer display the returned value as follows:

FREQUENCY SPAN IS: 1.5E+8 HZ

### Troubleshooting

If the program doesn't run correctly, be sure you have entered the program exactly as listed. Then go back to "Quick Verification" for additional troubleshooting hints.

## Behavior in an HP-IB System

---

### HP-IB Interface Capabilities

The HP 3589A has the following interface capabilities, as defined by the IEEE 488.1 standard:

SH1	complete Source handshake capability
AH1	complete Acceptor handshake capability
T6	basic Talker, Serial Poll, no Talk Only, unaddress if MLA
TE0	no Extended Talker capability
L4	basic Listener, no Listen Only, unaddress if MTA
LE0	no Extended Listener capability
SR1	complete Service Request capability
RL1	complete Remote/Local capability
PP0	no Parallel Poll capability
DC1	complete Device Clear capability
DT1	complete Device Trigger capability
C1	System Controller capability
C2	send IFC and take charge Controller capability
C3	send REN Controller capability
C12	send IF messages, receive control, pass control
E2	three-state drivers

## Controller Capabilities

The HP 3589A can either be configured as an HP-IB system controller or as an addressable-only HP-IB device. This is done by selecting either the [ SYSTEM CONTROLLR ] or [ ADDRESSBL ONLY ] softkey on the analyzer's front panel. (These keys are displayed when you press the [ Local/HP-IB ] hardkey.)

Normally, the HP 3589A is not configured as the system controller unless it is the only controller on the bus. Such a setup would be likely if you just wanted to control printers or plotters with the analyzer. It might also be the case if you were using HP Instrument BASIC to control other test equipment.

When the analyzer is being used with another controller on the bus, it is normally configured as an addressable-only HP-IB device. In this configuration, the analyzer can function as the active controller (when it is passed control), or as a talker or listener.

---

## Bus Management Commands vs. Device Commands

The HP-IB contains an attention (ATN) line that determines whether the interface is in command mode or data mode. When the interface is in command mode (ATN TRUE), a controller can send bus management commands over the bus. Bus management commands do the following things:

- Specify which devices on the interface can talk (send data) and which can listen (receive data).
- Instruct devices on the bus, either individually or collectively, to perform a particular interface operation.

The analyzer's responses to bus management commands are described in the next section.

When the interface is in data mode, device commands and data can be sent over the bus. Device commands are sent by the controller, but data can be sent either by the controller or a talker. The HP 3589A responds to two different kinds of device commands:

- *Common commands* access device functions required by the IEEE 488.2 standard.
- *Subsystem commands* access the bulk of the analyzer's functions.

The analyzer's responses to device commands are described in the Command Reference chapters.

## Response to Bus Management Commands

This section tells you how the HP 3589A responds to the HP-IB bus management commands. The commands themselves are defined by the IEEE 488.1 standard. Refer to the documentation for your controller's language system to determine how to send these commands.

### Device Clear (DCL)

The analyzer does the following things when it receives this command:

- Clears its input and output queues.
- Resets its command parser (so it is ready to receive a new program message).
- Cancels any pending \*OPC command or query.

The command does not affect the following things:

- Front-panel operation.
- Any analyzer operations in progress (other than those already mentioned).
- Any analyzer settings or registers (although clearing the output queue may indirectly affect the Status Byte's MAV bit).

### Go To Local (GTL)

This command returns the analyzer to local (front-panel) control. All keys on the analyzer's front-panel are enabled.

### Group Execute Trigger (GET)

This command triggers the analyzer (causes it to start collecting measurement data) if the following two things are true:

- The trigger source is the HP-IB (TRIG:SOUR BUS).
- The analyzer is ready to trigger. (Bit 5 of the Standard Operation condition register is set.)

GET has the same effect as the \*TRG and TRIG:IMM program messages with one important exception: \*TRG and TRIG:IMM are sent to the input queue and processed in the order received, but GET is processed immediately, even if the input queue contains other commands.

### Interface Clear (IFC)

This command causes the analyzer to halt all bus activity. It discontinues any input or output, although the input and output queues are not cleared. If the analyzer is designated as the active controller when this command is received, it relinquishes control of the bus to the system controller. If the analyzer is enabled to respond to a Serial Poll it becomes Serial Poll disabled.

## **Local Lockout (LLO)**

This command causes the analyzer to enter the local lockout mode, regardless of whether it is in the local or remote mode. The analyzer only leaves the local lockout mode when the HP-IB's Remote Enable (REN) line is set FALSE.

Local lockout ensures that the analyzer's [ **Local/HP-IB** ] hardkey is disabled when the analyzer is in the remote mode. When the key is enabled, it allows a front-panel operator to return the analyzer to local mode, thus enabling all other front-panel keys. However, when the key is disabled, it does not allow the front-panel operator to return the analyzer to local mode.

## **Parallel Poll**

The HP 3589A ignores all of the following parallel poll commands:

- Parallel Poll Configure (PPC).
- Parallel Poll Unconfigure (PPU).
- Parallel Poll Enable (PPE).
- Parallel Poll Disable (PPD).

## **Remote Enable (REN)**

REN is a single line on the HP-IB. When it is set TRUE, the analyzer will enter the remote mode when addressed to listen. It will remain in remote mode until it receives the Go to Local (GTL) command or until the REN line is set FALSE.

When the analyzer is in remote mode and local lockout mode, all front-panel keys are disabled. When the analyzer is in remote mode but not in local lockout mode, all front-panel keys are disabled except for the [ **Local/HP-IB** ] hardkey. See Local Lockout for more information.

## **Selected Device Clear (SDC)**

The analyzer responds to this command in the same way that it responds to the Device Clear command. See the latter for details.

## **Serial Poll**

The analyzer responds to both of the serial poll commands. The Serial Poll Enable (SPE) command causes the analyzer to enter the serial poll mode. While the analyzer is in this mode, it sends the contents of its Status Byte register to the controller when addressed to talk.

When the Status Byte is returned in response to a serial poll, bit 6 acts as the Request Service (RQS) bit. If the bit is set, it will be cleared after the Status Byte is returned.

The Serial Poll Disable (SPD) command causes the analyzer to leave the serial poll mode.

## **Take Control Talker (TCT)**

If the analyzer is addressed to talk, this command causes it to take control of the HP-IB. It becomes the active controller on the bus. The analyzer automatically passes control back when it completes the operation that required it to take control. Control is passed back to the address specified by the \*PCB command (which should be sent prior to passing control).

If the analyzer does not require control when this command is received, it immediately passes control back.

## Message Exchange

The analyzer communicates with the controller and other devices on the HP-IB via program messages and response messages. Program messages are used to send commands, queries, and data to the analyzer. Response messages are used to return data from the analyzer. The syntax for both kinds of messages is discussed in chapter 23.

There are two important things to remember about the message exchanges between the analyzer and other devices on the bus:

- The analyzer only talks after it receives a terminated query. (Query termination is discussed in “Query Response Generation,” later in this chapter.)
- Once it receives a terminated query, the analyzer expects to talk before it is told to do something else.

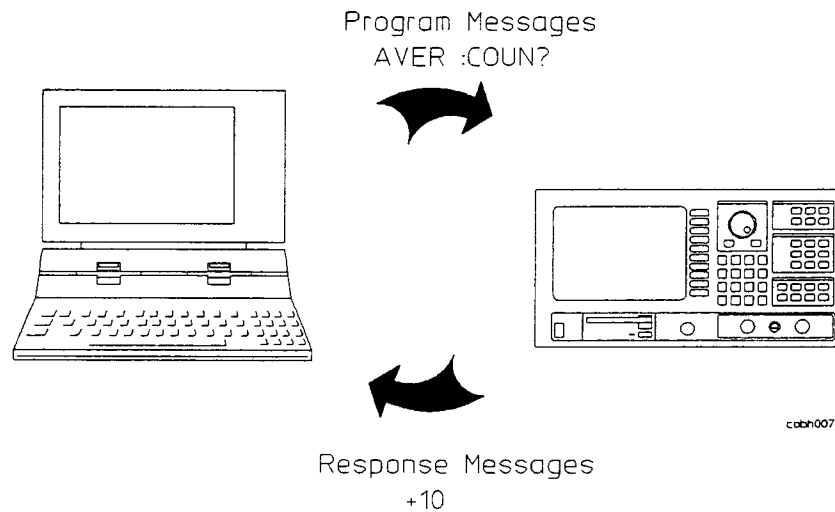

**Figure 2-6. TMSL Message Exchange**

## HP-IB Queues

Queues enhance the exchange of messages between the HP 3589A and other devices on the bus. The analyzer contains:

- An input queue.
- An error queue.
- An output queue.

### Input Queue

The input queue temporarily stores the following until they are read by the analyzer's command parser:

- Device commands and queries.
- The HP-IB END message (EOI asserted while the last data byte is on the bus).

The input queue makes it possible for a controller to send multiple program messages to the analyzer without regard to the amount of time required to parse and execute those messages. The queue holds up to 128 bytes. It is cleared when you do one of the following things:

- Turn on the analyzer.
- Send Device Clear (DCL) or Selected Device Clear (SDC).

### Error Queue

The error queue temporarily stores up to 20 error messages. Each time the analyzer detects an error, it places a message in the queue. When you send the SYST:ERR query, one message is moved from the error queue to the output queue so it can be read by the controller. Error messages are delivered to the output queue in the order they were received. The error queue is cleared when you do one of the following things:

- Turn on the analyzer.
- Send the \*CLS command.

### Output Queue

The output queue temporarily stores a single response message until it is read by a controller. It is cleared when you do one of the following things:

- Turn on the analyzer.
- Send Device Clear (DCL) or Selected Device Clear (SDC).



## Command Parser

The command parser reads program messages from the input queue in the order they were received from the bus. It analyzes the syntactic elements of the messages to determine what actions the analyzer should take.

One of the parser's most important functions is to determine the position of a program message in the analyzer's command tree. (For more information on the command tree, see chapter 3.) When the command parser is reset, the next syntactic element it receives is expected to arise from the base of the analyzer's command tree. The parser is reset when you do one of the following things:

- Turn on the analyzer.
- Send Device Clear (DCL) or Selected Device Clear (SDC).
- Follow a semicolon with a colon in a program message. (For more information, see "Sending Multiple Commands" in chapter 3.)

## Query Response Generation

When the HP 3589A parses a query, the response to that query is placed in the analyzer's output queue. You should read a query response immediately after sending the query. This ensures that the response will not be cleared before it is read. The response will be cleared before you read it if either of the following message exchange conditions occur:

- **Unterminated condition** — This condition results when you neglect to properly terminate the query (with an ASCII line feed character or the HP-IB END message) before you read the response.
- **Interrupted condition** — This condition results when you send a second program message before reading the response to the first.

---

## Synchronization

This section describes methods that synchronize the analyzer and a controller. Proper use of these tools ensures that the analyzer will be in a known state when you send a particular command or query.

### Sequential and Overlapped Commands

The analyzer is capable of processing multiple commands simultaneously. Most device commands are executed and processed as fast as they are received. They are *always* executed in the order received. Device commands can be divided into two classes:

- Sequential commands.
- Overlapped commands.

*Sequential commands* always finish execution before the next command is executed. “Finish” means all operations initiated by the command have completed. *Overlapped commands* allow execution of subsequent commands while operations initiated by the overlapped command are still in progress.

---

#### Note



Most commands are overlapped (as defined by IEEE488.2) but are handled such that synchronization is not required. Example situations where you may need to force synchronization are listed in “When to Synchronize” later this chapter.

---

### Synchronization Methods

The analyzer uses a No Pending Operation (NPO) flag to keep track of overlapped commands that are pending (not completed). The NPO flag is set to 0 when an overlapped command is pending. It is set to 1 when no overlapped commands are pending. You cannot read the NPO flag directly, but the following common commands take some action based on the setting of the flag:

- \*WAI — Holds off the processing of subsequent commands until the NPO flag is set to 1. Use this command to ensure that all current command execution is complete before executing the next command. For example, don’t execute a marker command until a measurement finishes.
- \*OPC? — Places a 1 in the analyzer’s output queue when the NPO flag is set to 1. Use this query to synchronize your controller to the completion of all overlapped commands.
- \*OPC — Sets bit 0 of the Standard Event event register to 1 when the NPO flag is set to 1. Use this when you need to synchronize the controller to the completion of all overlapped commands, but also want to leave the controller free to perform other tasks while the command is executing.

**\*WAI**

This command holds off the processing of subsequent device commands until all overlapped commands are completed (the NPO flag is set to 1). Some overlapped commands take a considerable time to finish execution. For example, the ABORt command restarts a measurement. Measurements with narrow spans or with video averaging enabled can take a long time to complete. The ABORt command is not considered to have been completely processed until the measurement is complete. The following example demonstrates the effect of the \*WAI command.

Suppose you want to determine which frequency component of a signal contains the greatest amount of energy. You might send the following series of commands:

OUTPUT 719; "ABOR"	!Abort (restart) the measurement.
OUTPUT 719; "MARK:MAX:GLOB"	!Search for max energy.
OUTPUT 719; "MARK:X?"	!Which frequency?

The following timeline shows how the processing times of the three commands relate to each other.

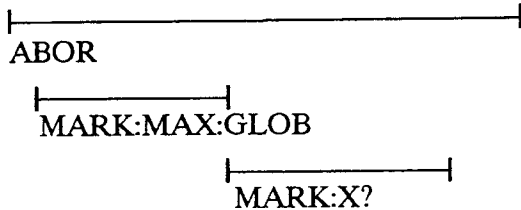

As you can see, ABOR is an overlapped command because it does not hold off the processing of MARK:MAX:GLOB. You may also recall that ABOR is not considered complete until the measurement is complete. So in this example, the marker searches for maximum energy before the measurement is complete. This may result in the MARK:X query returning an incorrect value. To solve the problem, you can insert a \*WAI command.

OUTPUT 719; "ABOR"	!Abort (restart) the measurement.
OUTPUT 719; "*WAI"	!Wait until complete.
OUTPUT 719; "MARK:MAX:GLOB"	!Search for max energy.
OUTPUT 719; "MARK:X?"	!Which frequency?

The timeline now looks like this.

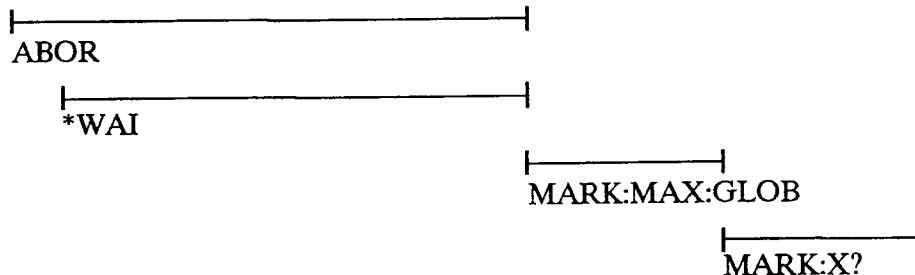

The \*WAI command keeps the search from taking place until the measurement is completed. The MARK:X query will return the correct value.

### **\*OPC? and \*OPC**

If you send \*OPC?, a 1 is placed in the analyzer's output queue when the NPO flag is set to 1. This allows you to effectively pause the controller until all pending overlapped commands are completed. Just design your program so that it must read the queue before it continues.

If you send \*OPC, bit 0 of the Standard Event register is set to 1 when the NPO flag is set to 1. This allows you to use the analyzer's register structure to generate a service request when all pending overlapped commands are completed. However, your program must also have enabled bit 0 of the Standard Event register and bit 5 of the Status Byte register. When you synchronize the analyzer and controller in this manner, the controller is free to perform some other task until the service request is generated.

\*OPC does *not* hold off the processing of subsequent commands; it only informs you when the NPO flag is set to 1. As a result, you should not send any commands to the analyzer between the time you send \*OPC and the time you receive a service request.

### **When to Synchronize**

- When you need to know that valid measurement results are available.  
Example: If you want to extract data with the marker, you should be sure the measurement is complete before issuing the marker command.

Normally, completion of a measurement is *not* a "pending operation" with respect to HP-IB synchronization. To synchronize on measurement completion, use ABOR or SENS:REST. These are overlapped commands which force data collection to start over under the new configuration and do not complete until a measurement completes. The correct sequence is:

- i. Measurement setup
- ii. Measurement restart (ABOR or SENS:REST)
- iii. Synchronize (\*WAI, \*OPC?, or \*OPC)
- iv. Desired operations on measurement data

Programming examples WAI\_SYNC, OPC\_SYNC, and OPCQ\_SYNC demonstrate this. For examples using manual arm and HP-IB trigger, see examples THD and TRIGGERING.

- When you need to know that commands affecting the hardware have finished.  
Example: If you change the source level, you may want to be sure that the signal output level is at the new setting before connecting it to the device under test.
- When you want to know that a "long" operation has finished.  
Example: When you plot or print.
- When preparing to pass control.  
Example: The HP 3589A requires control of the bus to print or plot. For this procedure to work properly, no overlapped commands should be pending except the command that requires control of the bus. See "Passing Control" later in this chapter.

Programming examples demonstrating synchronization are in chapter 6.

## Passing Control

The HP 3589A requires temporary control of the HP-IB to complete some commands. (In the description of each command, a field called “Pass control required” indicates whether or not the command requires control of the bus.) After sending such a command, the active controller must pass control to the analyzer. When the analyzer completes the command, it automatically passes control of the bus back to the controller. For control to be passed back and forth smoothly, you must take steps to ensure that the following conditions are met:

- The analyzer must have the controller’s address so it can pass control back.
- The controller must be signaled when the analyzer passes control back.

Here is a procedure for passing control:

1. Send the controller’s HP-IB address with the \*PCB command.
2. Clear the analyzer’s status registers with the \*CLS command.
3. Enable the analyzer’s status registers to generate a service request when the Operation Complete bit is set. (Send \*ESE with a value of 1 and \*SRE with a value of 32.)
4. Enable the controller to respond to the service request.
5. Send the command that requires control of the bus followed by the \*OPC command.
6. Pass control to the analyzer and wait for the service request. The service request indicates that the command has been completed and control has been passed back to the controller.

---

### Note



For this procedure to work properly, no overlapped commands should be pending except the command that requires control of the bus. For more information on overlapped commands, see “Synchronization” in this chapter.

---

Chapter 6, “Programming Examples,” contains an example program that passes control to the analyzer. In the example, control is passed so the analyzer can print the contents of its screen.

# Programming with SCPI Commands

---

## Introduction

This chapter will help you create more efficient programs with SCPI commands. It describes the general structure of the SCPI command tree and the syntax rules for SCPI program and response messages. It also explains how to do all of the following things:

- Send multiple commands.
- Shorten commands by abbreviating mnemonics.
- Shorten commands by omitting implied mnemonics.

## The Command Tree

The SCPI standard organizes related instrument functions by grouping them together on a common branch of a command tree. Each branch is assigned a mnemonic to indicate the nature of the related functions. For example, the HP 3589A's marker functions are grouped together on the **MARKER** branch of the command tree. The **FREQUENCY** branch is one of several SCPI branches—called subsystems—used by the HP 3589A.

When many functions are grouped together on a particular branch, additional branching is used to organize these functions into groups that are even more closely related. The branching process continues until each analyzer function is assigned to its own branch. For example, the function that sets the analyzer's frequency span is **SPAN**. The command looks like this:

```
[SENSe:]FREQuency:SPAN 5.0e+4HZ
```

Notice that branching points on the command tree are indicated with colons. Also notice that the parameter you assign to the function (50 kHz) is separated from the rest of the command by a space.

## Sending Multiple Commands

You can send multiple commands within a single program message by separating the commands with semicolons. For example, the following program message—sent within an HP BASIC OUTPUT statement—would turn on the offset marker and move the main marker to the highest peak on the trace:

```
OUTPUT 719;"MARKER:OFFSET ON;:MARKER:MAXIMUM:GLOBAL"
```

The analyzer's command parser allows you to simplify the previous program message. This is because one of the parser's main functions is to keep track of a program message's position in the command tree. If you take advantage of this parser function, you can create the equivalent, but simpler, program message:

```
OUTPUT 719;"MARKER:OFFSET ON;MAXIMUM:GLOBAL"
```

In the first version of the program message, the semicolon that separates the two commands is followed by a colon. Whenever this occurs, the command parser is reset to the base of the command tree. As a result, the next command is only valid if it includes the entire mnemonic path from the base of the tree.

In the second version of the program message, the semicolon that separates the two commands is not followed by a colon. Whenever this occurs, the command parser assumes that the mnemonics of the second command arise from the same branch of the tree as the final mnemonic of the preceding command. `OFFSET`, the final mnemonic of the preceding command, arises from the `MARKER` branch. So `MAXIMUM`, the first mnemonic of the second command, is also assumed to arise from the `MARKER` branch.

Here is a longer series of commands—again, sent within HP BASIC OUTPUT statements—that can be combined into a single program message:

```
OUTPUT 719;"MARKER:STATE ON"  
OUTPUT 719;"MARKER:MAXIMUM:GLOBAL"  
OUTPUT 719;"MARKER:OFFSET ON"  
OUTPUT 719;"MARKER:MAXIMUM:RIGHT"
```

The single program message would be:

```
OUTPUT 719;"MARKER:STATE ON;OFFSET ON;MAXIMUM:GLOBAL;RIGHT"
```



## Command Abbreviation

Each command mnemonic has a long form and a short form. The short forms of the mnemonics allow you to send abbreviated commands. The mnemonics' short forms are created according to the following rules:

- If the long form of the mnemonic has less than four characters, the short form is the same as the long form. For example, ARM remains ARM.
- If the long form of the mnemonic has exactly four characters, the short form is the same as the long form. For example, USER remains USER.
- If the long form of mnemonic has more than four characters and the fourth character is a consonant, the short form consists of the first four characters of the long form. For example, AVERAGE becomes AVER.
- If the long form of mnemonic has more than four characters and the fourth character is a vowel, the short form consists of the first three characters of the long form. For example, LIMIT becomes LIM.

---

### Note



The syntax descriptions in the Command Reference chapters use upper-case characters to identify the short form of a particular mnemonic.

---

If the rules listed in this section are applied to the last program message in the preceding section, the statement:

```
OUTPUT 719;"MARKER:STATE ON;OFFSET ON;MAXIMUM:GLOBAL;RIGHT"
```

becomes

```
OUTPUT 719;"MARK:STAT ON;OFFS ON;MAX:GLOB;RIGH"
```

## Implied Mnemonics

You can omit some mnemonics from SCPI commands without changing effect of the command. These special mnemonics are called *implied mnemonics*, and they are used in many subsystems.

The MARKER subsystem contains the implied mnemonic STATE at its first branching point. As a result, you can send either of the following commands to the analyzer (using HP BASIC) to turn on the main markers:

```
OUTPUT 719;"MARKER:STATE ON"
```

```
OUTPUT 719;"MARKER ON"
```

The first mnemonic in the SENSE subsystem is also an implied mnemonic, so you can omit it from any SENSE command. These two commands are equivalent:

```
OUTPUT 719;"SENSE:FREQUENCY:SPAN:FULL"
```

```
OUTPUT 719;"FREQUENCY:SPAN:FULL"
```

and so are these:

```
OUTPUT 719;"SENSE:SWEEP:MODE AUTO"
```

```
OUTPUT 719;"SWEEP:MODE AUTO"
```

## Message Syntax

As mentioned in chapter 2, the analyzer uses program messages and response messages to communicate with other devices on the HP-IB. This section uses syntax diagrams to describe the general syntax rules for both kinds of messages.

### Conventions

The flow of syntax diagrams is generally from left to right. However, elements that repeat require a return path that goes from right to left. Any message that can be generated by following a diagram from its entry point to its exit point, in the direction indicated by the arrows, is valid.

Angle brackets < > enclose the names of syntactic items that need further definition. The definition is included either in the text accompanying the diagram, in a subsequent diagram, or in the next section, “Common Definitions.”

The symbol ::= means “is defined as.” When two items are separated by this symbol, the second item can replace the first in any statement that contains the first item.

### Common Definitions

The syntax diagrams have the following definitions in common:

- <LF> is the line feed character (ASCII decimal 10).
- <^END> is assertion of the HP-IB END message while the last byte of data is on the bus.
- <SP> is the space character (ASCII decimal 32).
- <WSP> is one or more white space characters (ASCII decimal 0-9 and 11-32).
- <digit> is one character in the range 0-9 (ASCII decimal 48-57).
- <alpha> is one character of the alphabet. The character can be either upper-case (ASCII decimal 65-90) or lower-case (ASCII decimal 97-122) unless otherwise noted.

## Special Syntactic Elements

Several syntactic elements have special meanings:

- colon (:) — When a command or query contains a series of mnemonics, the mnemonics are separated by colons. A colon immediately following a mnemonic tells the command parser that the program message is proceeding to the next level of the command tree. A colon immediately following a semicolon tells the command parser that the program message is returning to the base of the command tree. For more information, see “The Command Tree” and “Sending Multiple Commands” at the beginning of this chapter.
- semicolon (;) — When a program message contains more than one command or query, a semicolon is used to separate them from each other. For example, if you want to autorange the analyzer’s inputs and then start a measurement using one program message, the message would be:

```
SENSE:POWER:RANGE:AUTO ONCE;:ABORT;:INITIATE:IMMEDIATE
```

- comma (,) — A comma separates the data sent with a command or returned with a response. For example, the SYSTEM:TIME command requires three values to set the analyzer’s clock: one for hours, one for minutes, and one for seconds. A message to set the clock to 8:45 AM would be:

```
SYSTEM:TIME 8,45,0
```

- <WSP> — One or more white space characters are optional in many parts of a program message. However, at least one is required to separate a program header (the command or query) from its program data (the parameters). The previous example contains a space between the program header (SYSTEM:TIME) and its program data (8,45,0).
- <message terminator> — A message terminator is required at the end of a program message or a response message. Program message terminators are described in “Program Message Syntax.” Response terminators are described in “Response Message Syntax.”

## Program Message Syntax

The syntax for a terminated program message is:

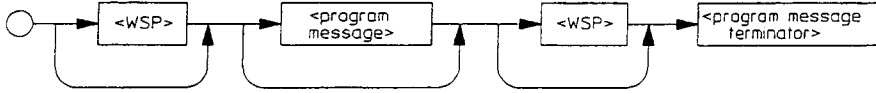

cobh024

<program message terminator> ::=

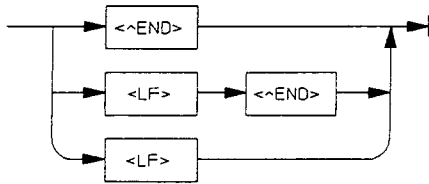

cobh023

<program message> ::=

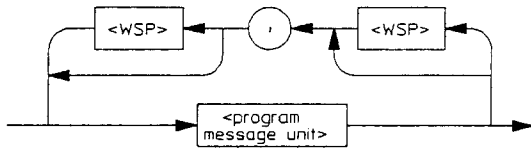

cobh022

<program message unit> ::=

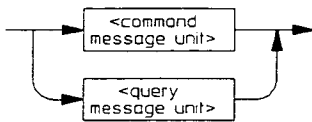

cobh021

<command message unit> ::=

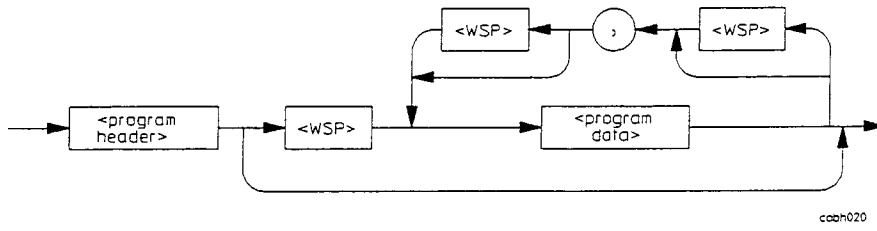

<query message unit> ::=

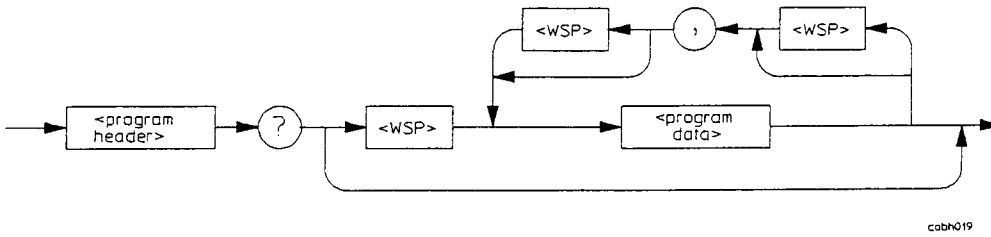

<program header> ::=

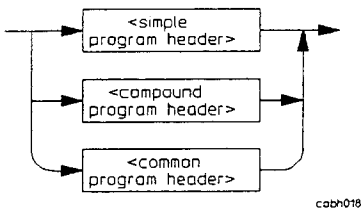

<simple program header> ::=

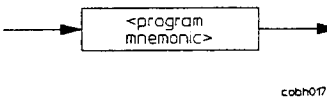

<compound program header> ::=

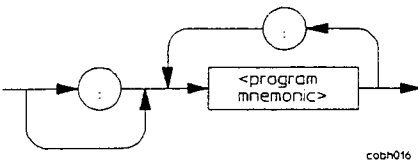

Programming with SCPI Commands  
Message Syntax

<common program header> ::=

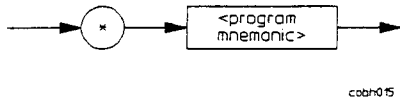

<program mnemonic> ::=

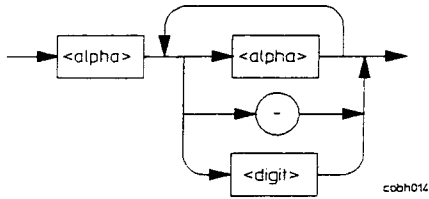

<program data> ::=

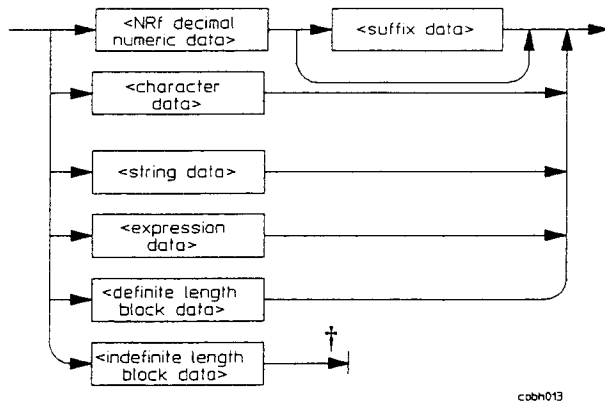

† The definition of indefinite length block data includes termination with <LF><^END>. This serves the dual function of terminating the data and terminating the program message.

Program data and response data are described in chapter 4, "Transferring Data." <suffix data> is dependent on the command sent.

## Response Message Syntax

The syntax for a terminated response message is:

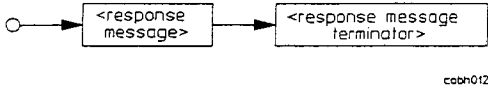

$\langle \text{response message terminator} \rangle ::=$

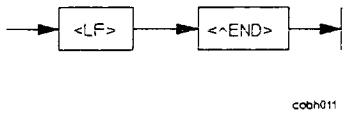

$\langle \text{response message} \rangle ::=$

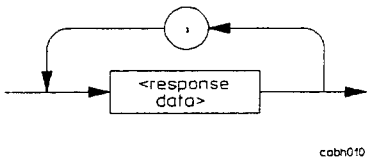



Programming with SCPI Commands  
Message Syntax

<response data> ::=

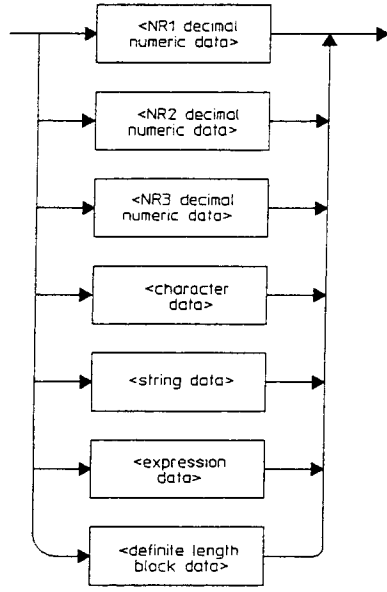

Response data and program data are described in chapter 4, "Transferring Data."

# Transferring Data

---

## Introduction

Data can be transferred between the HP 3589A and a controller via the HP-IB data lines, DIO1 through DIO8. Such transfers occur in a byte-serial (one byte at a time), bit-parallel (8 bits at a time) fashion. This chapter discusses the following aspects of data transfer:

- The different data types used during data transfers.
- Data encoding used during transfers of numeric block data.

## Data Types

The HP 3589A uses a number of different data types during data transfers. They are described in this section using syntax diagrams.

### Conventions

The flow of syntax diagrams is generally from left to right. However, elements that repeat require a return path that goes from right to left. Any data you can generate by following a diagram from its entry point to its exit point, in the direction indicated by the arrows, is valid.

Angle brackets < > enclose the names of syntactic items that need further definition. The definition is included either in the text accompanying the diagram, or in the next section, “Common Definitions.”

### Common Definitions

The syntax diagrams have the following definitions in common:

- <LF> is the line feed character (ASCII decimal 10).
- <^END> is assertion of the HP-IB END message while the last byte of data is on the bus.
- <SP> is the space character (ASCII decimal 32).
- <WSP> is one or more white space characters (ASCII decimal 0-9 and 11-32).
- <digit> is one character in the range 0-9 (ASCII decimal 48-57).
- <non-zero digit> is one character in the range 1-9 (ASCII decimal 49-57).
- <alpha> is one character of the alphabet. The character can be either upper-case (ASCII decimal 65-90) or lower-case (ASCII decimal 97-122) unless otherwise noted.

### Decimal Numeric Data

The analyzer returns three types of decimal numeric data in response to queries:

- Integers—returned as *NR1 data*.
- Fixed-point numbers—returned as *NR2 data*.
- Floating-point numbers—returned as *NR3 data*.

You can use the more flexible syntax of *NRf data* when sending any of the three decimal numeric data types to the analyzer. The NRx data syntax is described in the following four syntax diagrams.

**NR1 data:**

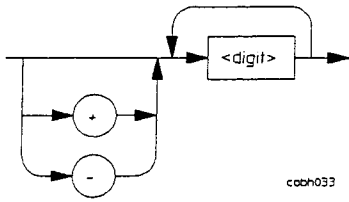

**NR2 data:**

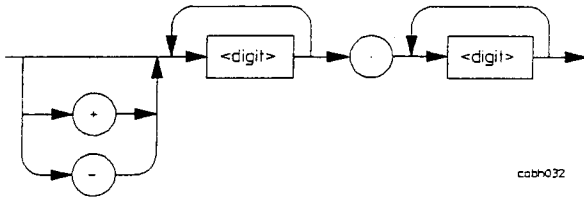

**NR3 data:**

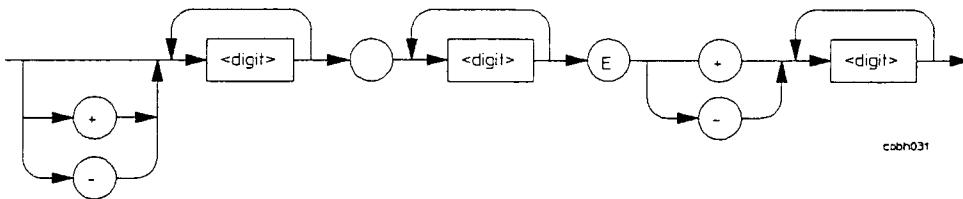

**NRf data:**

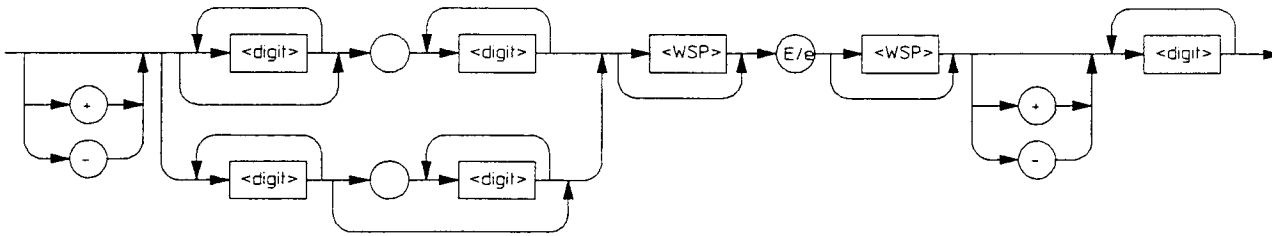

## Character Data

The format you use to send character data is:

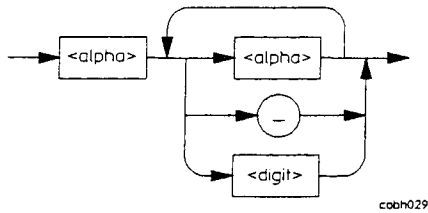

The “\_” in the circle is the underscore character (ASCII decimal 95).

The format used when the analyzer returns character data is the same as the format used to send character data, with one exception—the analyzer never returns lower-case alpha characters.

## String Data

The format you use to send string data is:

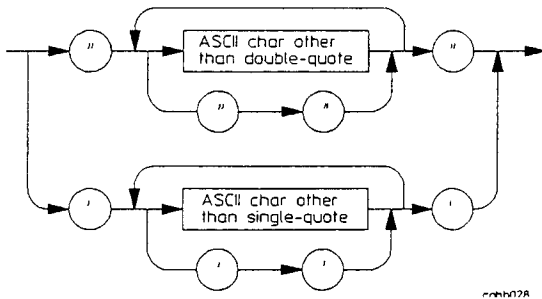

Note that you must use two double-quote characters (""") to represent one (") in a string that is delimited by double-quote characters. You must use two single-quote characters (''') to represent one (') in a string that is delimited by single-quote characters.

The format used when the analyzer returns string data is the same as the format used to send string data, with one exception: the analyzer never returns string data using the single-quote path.

## Expression Data

The format you use to send expression data is:

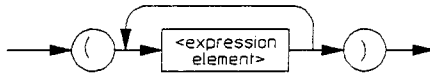

cbh027

The the only command that uses expression data is CALC:MATH:EXPR. The syntax description for that command contains a list of acceptable expression elements.

The analyzer returns expression data surrounded by double-quotes: "<expression data>".

## Block Data

The analyzer returns one type of block data in response to queries: *definite length block data*. However, when you send block data to the analyzer, you can send it either as definite length or *indefinite length block data*.

---

### Note



The analyzer always accepts block data, regardless of the setting of FORM:DATA. However, if FORM:DATA is set to ASC, values in the block must be encoded as 64-bit binary floating-point numbers. (For more information, see the next section of this chapter, "Data Encoding for Block Data.")

---

## Transferring Data Data Types

### Definite Length Block Data

The format you use to send definite length block data is:

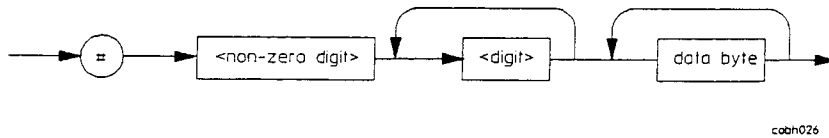

The elements #, <non-zero digit>, and <digit> make up a header for the block data. <non-zero digit> indicates how many times <digit> is repeated. The <digits> are interpreted as a single decimal number, which indicates how many bytes of data follow in the block. Here is an example:

Block Header				Block Data			
byte 1	byte 2	byte 3	byte 4	byte 5	byte 6	...	byte 19
#	2	1	5	<data_byte_1>	<data_byte_2>	...	<data_byte_15>

<non-zero digit> is 2, which means that the following two bytes should be taken together as a single decimal number. In this case, the number is 15. The following 15 bytes are the 5<sup>th</sup> through 19<sup>th</sup> bytes of the data transfer, but they are the 1<sup>st</sup> through 15<sup>th</sup> bytes of the data block.

### Indefinite Length Block Data

The format you use to send indefinite length block data is:

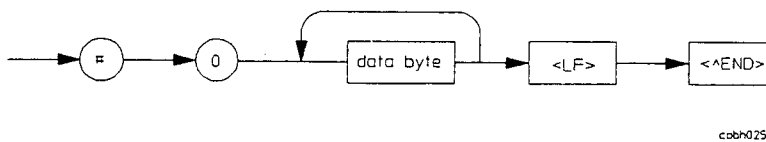

The first two bytes of the data transfer, # and 0, make up a header for the block data. The data itself does not begin until the third byte of the data transfer.

## Data Encoding for Block Data

The FORM:DATA command selects the data type and data encoding that will be used to transfer large blocks of numeric data between the analyzer and an external controller:

- REAL selects the block data type (either the definite or indefinite length syntax). The block is transferred as a series of binary-encoded floating-point numbers.
- ASCII selects the decimal numeric data type (either the NR1, NR2, NR3, NRf syntax). The block is transferred as a series of ASCII-encoded NRx numbers separated by commas.

Blocks that contain mixed data—both numbers and ASCII characters—ignore the setting of FORM:DATA. They are always transferred as either definite or indefinite length block data. The following commands transfer blocks of mixed data:

- CALC:MATH:DATA
- DISP:LIM:LOW:DATA
- DISP:LIM:UPP:DATA
- PROG:SEL:DEF
- SYST:SET

## ASCII Encoding

The ASCII 7-bit code is defined by the ANSI X3.4-1977 standard. When an ASCII-encoded byte is sent over the HP-IB, bits 0 through 6 of the byte (bit 0 being the least significant bit) correspond to the HP-IB data lines DIO1 through DIO7. DIO8 is ignored.

When you use ASCII encoding for block data, you can specify the number of significant digits to be returned for each number in the block. For example, if you send the command FORM:DATA ASC,7 then all numbers will be returned as NR3 data with 7 significant digits.



## Binary Encoding

When you use binary encoding for block data, all numbers in the block are transferred as 32-bit or 64-bit binary floating-point numbers. The binary floating-point formats are defined in the IEEE 754-1985 standard. Send FORM:DATA REAL,32 to select the 32-bit format. Send FORM:DATA REAL,64 to select the 64-bit format.

Many controllers, and the languages that run on them, use the binary floating-point formats. Both formats have three fields in common, but the length of the fields are different for each. The fields and their bit lengths appear in the following table:

**Table 4-1. Fields in Binary Floating-point Numbers**

Field	Width of Field	
	32-bit format	64-bit format
sign (s)	1 bit	1 bit
exponent (e)	8	11
fraction (f)	23	52

When the 32-bit format is used, the decimal value of the exponent field ranges from  $-126$  to  $+127$ , with a bias of  $+127$ . When the 64-bit format is used, the decimal value of the exponent field ranges from  $-1022$  to  $+1023$ , with a bias of  $+1023$ .

You can use the following formulas to determine the value (x) of a 32-bit binary floating-point number. (s, e, and f must be converted from binary to decimal before using the formulas.)

If $e = 255$ and $f \neq 0$	then x is not a number
If $e = 255$ and $f = 0$	then $x = -1^s(\infty)$
If $0 < e < 255$	then $x = -1^s(2^{e-127})(1 + f)$
If $e = 0$ and $f \neq 0$	then $x = -1^s(2^{e-126})(0 + f)$
If $e = 0$ and $f = 0$	then $x = -1^s(0)$

32-bit binary floating-point numbers are sent over the bus as follows:

	DIO	8	7	6	5	4	3	2	1
byte 1	s	e	e	e	e	e	e	e	e
byte 2	e	f	f	f	f	f	f	f	f
bytes 3 and 4	f	f	f	f	f	f	f	f	f

You can use the following formulas to determine the value (x) of a 64-bit binary floating-point number. (Again, s, e, and f must be converted from binary to decimal before using the formulas.)

if e = 2047 and f ≠ 0	then x is not a number
if e = 2047 and f = 0	then x = -1 <sup>s</sup> (∞)
if 0 < e < 2047	then x = -1 <sup>s</sup> (2 <sup>e-1023</sup> )(1 + f)
if e = 0 and f ≠ 0	then x = -1 <sup>s</sup> (2 <sup>e-1022</sup> )(0 + f)
if e = 0 and f = 0	then x = -1 <sup>s</sup> (0)

64-bit binary floating-point numbers are sent over the bus as follows:

DIO	8	7	6	5	4	3	2	1
byte 1	s	e	e	e	e	e	e	e
byte 2	e	e	e	e	f	f	f	f
bytes 3 through 8	f	f	f	f	f	f	f	f

Here is an example of a number encoded in the 32-bit binary floating-point format:

byte 1	byte 2	byte 3	byte 4
01000001	10010000	00000000	00000000
seeeeeee	effffffff	fffffffff	fffffffff

Where:

	binary	decimal
s =	0	= 0
e =	10000011	= 131
f =	.001	= .125

Therefore:

$$\begin{aligned}
 x &= (-1)^0 (2^{(131-127)}) (1.125) \\
 &= (2^4) (1.125) \\
 &= 18
 \end{aligned}$$



## Using Status Registers

---

### Introduction

The HP 3589A's status registers contain information about various analyzer conditions. This chapter describes the registers and tells you how to use them in your HP-IB programs. The registers are explained in the following sections:

- General Status Register Model
- The Service Request Process
- The HP 3589A's Register Sets

## General Status Register Model

### Overview

The general status register model, shown in figure 5-1, is the building block of the HP 3589A's status system. Most register sets in the analyzer include all of the registers shown in the general model (although commands are not always available for reading or writing a particular register). The information flow within a register set starts at the condition register and ends at the register summary bit. You control the flow by altering bits in the transition and enable registers.

Two register sets—Status Byte and Standard Event—are 8 bits wide. All others are 16 bits wide, but the most significant bit (bit 15) in the larger registers is always set to 0.

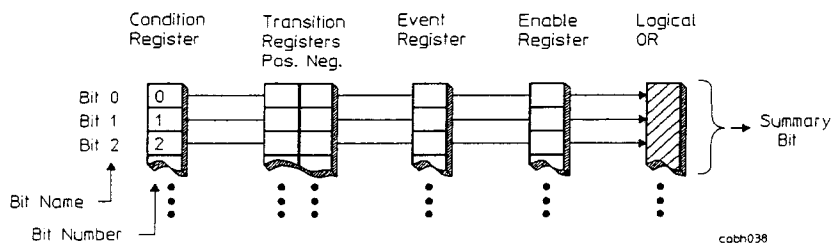

Figure 5-1. General Status Register Model

### Condition Register

Condition registers continuously monitor hardware and firmware status. Bits in a condition register are not latched or buffered, they are updated in real time. When the condition monitored by a particular bit becomes true, the bit is set to 1. When the condition becomes false, the bit is reset to 0. Condition registers are read-only.

### Transition Registers

Transition registers control the reporting of condition changes to the event registers. Positive changes in the state of a condition bit (0 to 1) are only reported to the event register if the corresponding positive transition bit is set to 1. Negative changes in the state of a condition bit (1 to 0) are only reported to the event register if the corresponding negative transition bit is set to 1. (If you set both transition bits to 1, positive *and* negative changes are reported to the corresponding event bit.) You can read and write most transition registers.

## **Event Register**

Event registers latch any reported condition changes. When a transition bit allows a condition change to be reported, the corresponding event bit is set to 1. Once set, an event bit is no longer affected by condition changes. It remains set until the event register is cleared— either when you read the register or when you send the \*CLS (clear status) command. Event registers are read-only.

An event register is cleared when you read it. All event registers are cleared when you send the \*CLS command.

## **Enable Register**

Enable registers control the reporting of events (latched conditions) to the register summary bit. If an enable bit is set to one, the corresponding event bit is included in the logical ORing process that determines the state of the summary bit. (The summary bit is only set to 1 if one or more enabled event bits are set to 1.) You can read and write all enable registers.

## The Service Request Process

### Two Ways to Use Registers

There are two methods you can use to access the information in status registers:

- The direct-read method.
- The service request (SRQ) method.

In the direct-read method, the analyzer has a passive role. It only tells the controller that conditions have changed when the controller asks the right question. In the SRQ method, the analyzer takes a more active role. It tells the controller when there has been a condition change without the controller asking. Either method allows you to monitor one or more conditions.

When you monitor a condition with the direct-read method, you must do the following things:

1. Determine which register contains the bit that monitors the condition.
2. Send the unique HP-IB query that reads that register.
3. Examine the bit to see if the condition has changed.

The direct-read method works well if you do not need to know about changes the moment they occur. It does not work well when you must know about condition changes immediately. Your program would need to continuously read the registers at very short intervals. Since this would make the program relatively inefficient, it would be better to use the SRQ method.

When you monitor a condition with the SRQ method, you must do the following things:

1. Determine which bit monitors the condition.
2. Determine how that bit reports to the request service (RQS) bit of the Status Byte.
3. Send HP-IB commands to enable the bit that monitors the condition and to enable the summary bits that report the condition to the RQS bit.
4. Enable the controller to respond to service requests.

When the condition changes, the analyzer sets its RQS bit and the HP-IB's SRQ line. Your program determines how the controller responds to the SRQ, but the important point is this: the controller is informed of the change as soon as it occurs. The time the controller would otherwise have used to monitor the condition can now be used to perform other tasks.

## Generating a Service Request

To use the SRQ method, you must understand how service requests are generated. As shown in figure 5-2, other register sets in the HP 3589A report to the Status Byte. (Most of them report directly, but three report indirectly—via the Questionable Data register set.)

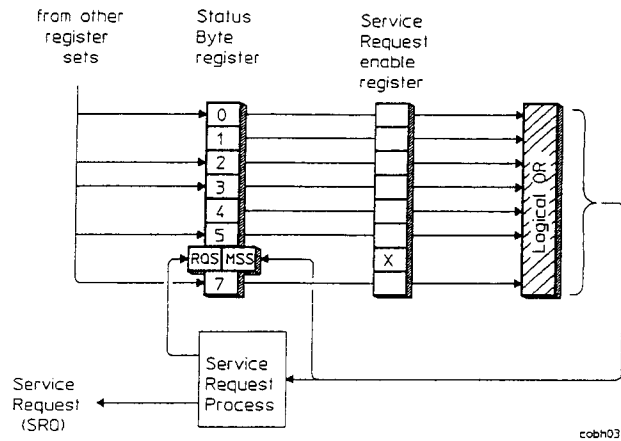

Figure 5-2. Generating a Service Request

When a register set causes its summary bit in the Status Byte to change from 0 to 1, the analyzer may initiate the service request (SRQ) process. However, the process is only initiated if both of the following conditions are true:

- The corresponding bit of the Service Request enable register is also set to 1.
- The analyzer does not have a service request pending. (A service request is considered to be pending between the time the analyzer's SRQ process is initiated and the time the controller reads the Status Byte register with a serial poll.)

The SRQ process sets the HP-IB's SRQ line true and also sets the Status Byte's request service (RQS) bit to 1. Both actions are necessary to inform the controller the HP 3589A requires service. Setting the SRQ line only informs the controller that *some* device on the bus requires service. Setting the RQS bit allows the controller to determine that the HP 3589A, in particular, requires service.



## Using Status Registers The Service Request Process

If your program enables the controller to detect and respond to service requests, it should instruct the controller to perform a serial poll when the HP-IB's SRQ line is set true. Each device on the bus returns the contents of its Status Byte register in response to this poll. The device whose RQS bit is set to 1 is the device that requested service.

---

### Note



When you read the analyzer's Status Byte with a serial poll, the RQS bit is reset to 0. Other bits in the register are not affected.

---

As implied in figure 5-2, bit 6 of the Status Byte register serves two functions. Two different methods for reading the register allow you to access the two functions. Reading the register with a serial poll allows you to access the bit's RQS function. Reading the register with \*STB allows you to access the bit's MSS function.

## The HP 3589A's Register Sets

### Register Summary

The HP 3589A uses nine register sets to keep track of instrument status:

- Status Byte.
- Device State.
- Limit Fail.
- Questionable Data.
- Questionable Frequency.
- Questionable Power.
- Standard Event.
- Standard Operation.
- User Defined.

Their reporting structure is summarized in figure 5-3. They are described in greater detail in the following sections.

Using Status Registers  
 The HP 3589A's Register Sets

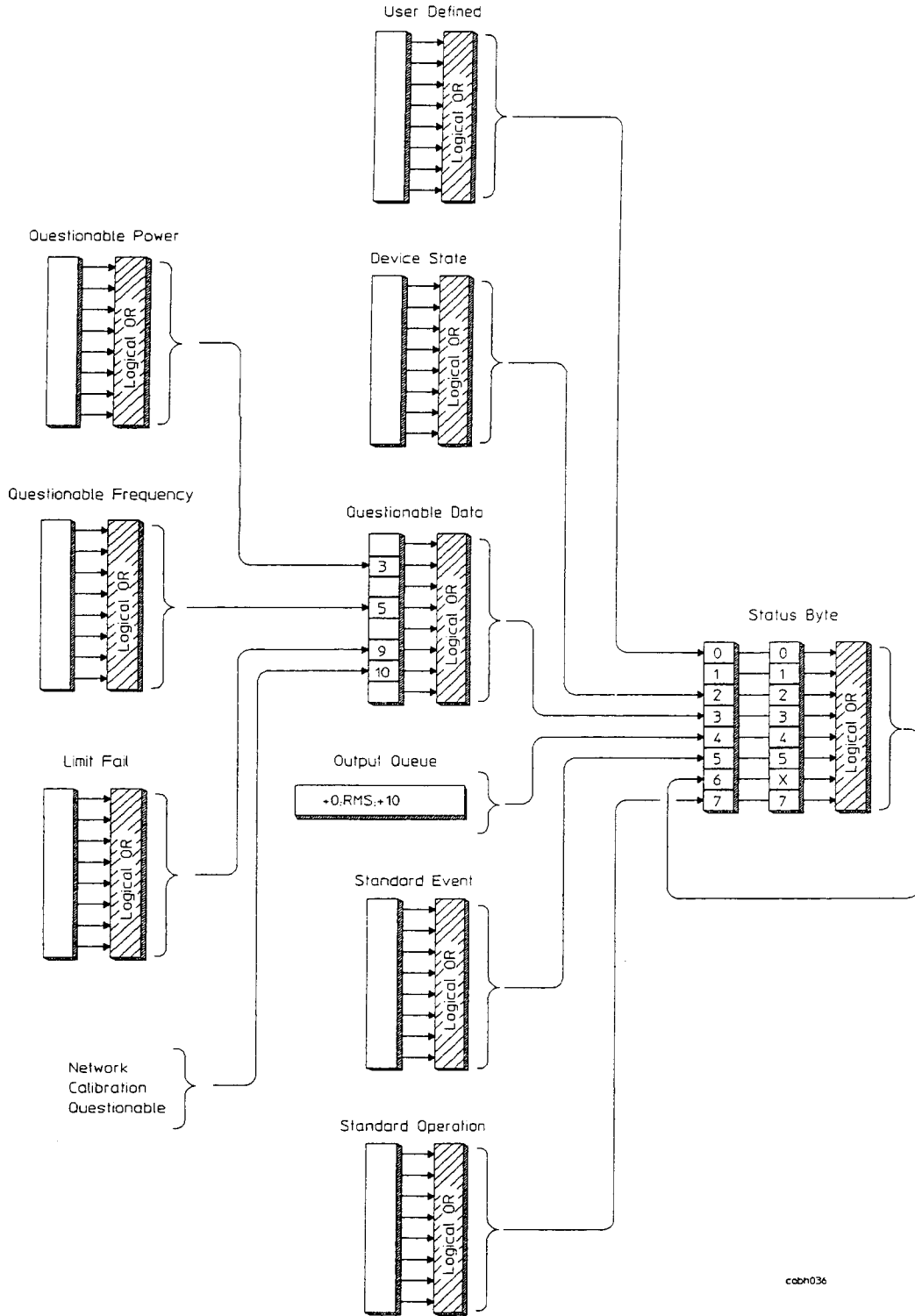

cabn036

Figure 5-3. HP 3589A Register Summary

## Status Byte Register Set

The Status Byte register set summarizes the states of the other register sets and monitors the analyzer's output queue. It is also responsible for generating service requests (see "Generating Service Requests" in this chapter).

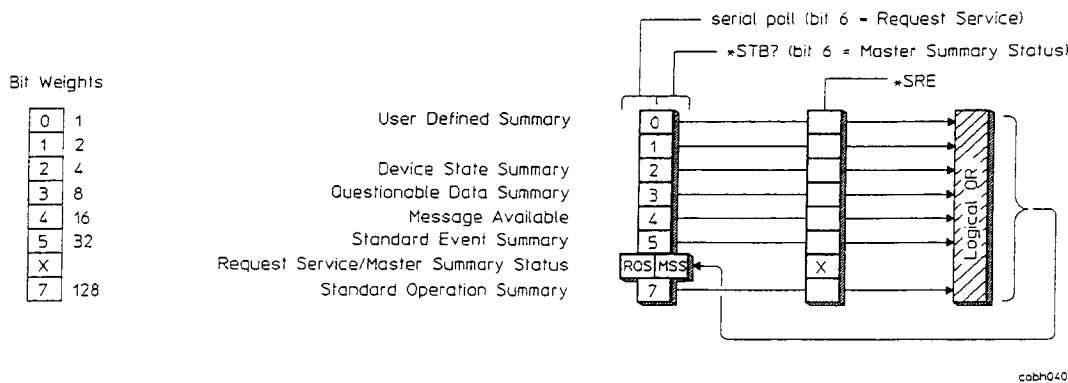

Figure 5-4. Status Byte Register Set

The Status Byte register set does not conform to the general status register model described at the beginning of this chapter. It contains only two registers: the Status Byte register and the Service Request enable register. The Status Byte register behaves like a condition register for all bits except bit 6. The Service Request enable register behaves like a standard enable register except that bit 6 is always set to 0.

Bits in the Status Byte register are set to 1 under the following conditions:

- User Defined Summary (bit 0) is set to 1 when one or more enabled bits in the User Defined event register are set to 1.
- Device State Summary (bit 2) is set to 1 when one or more enabled bits in the Device State event register are set to 1.
- Questionable Data Summary (bit 3) is set to 1 when one or more enabled bits in the Questionable Data event register are set to 1.
- Message Available (bit 4) is set to 1 when the output queue contains a response message.
- Standard Event Summary (bit 5) is set to 1 when one or more enabled bits in the Standard Event event register are set to 1.

## Using Status Registers

### The HP 3589A's Register Sets

- Master Summary Status (bit 6, when read by \*STB) is set to 1 when one or more enabled bits in the Status Byte register are set to 1.
- Request Service (bit 6, when read by serial poll) is set to 1 by the service request process (see “Generating a Service Request” in this chapter).
- Standard Operation Summary (bit 7) is set to 1 when one or more enabled bits in the Standard Operation event register are set to 1.

Additional information is available under the commands you use to read and write the Status Byte registers. The commands are shown in figure 5-4; they are described in chapter 8.

## Device State Register Set

The Device State register set monitors the states of three device specific parameters.

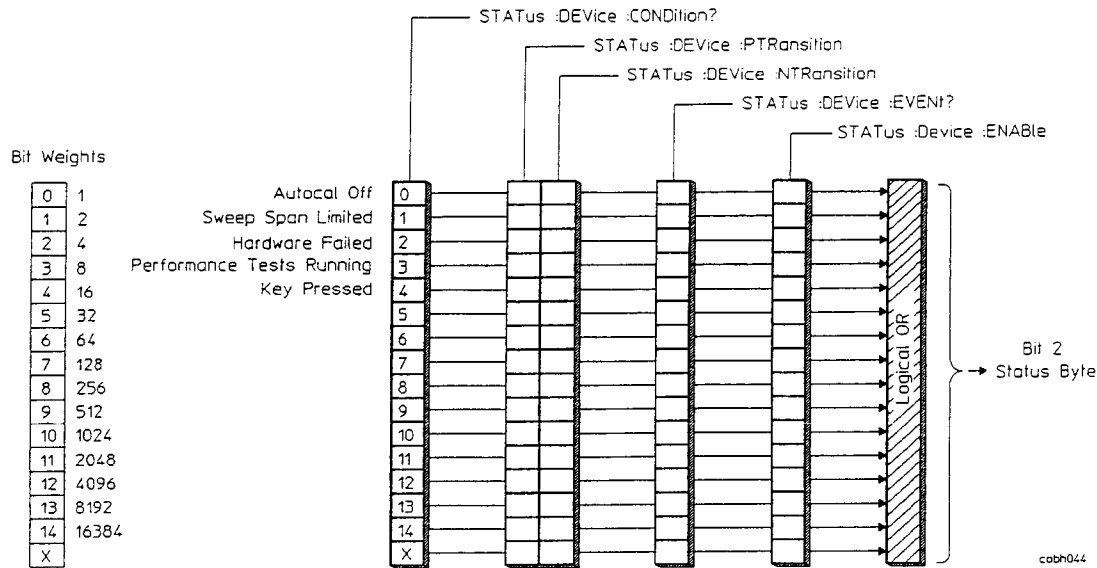

Figure 5-5. Device State Register Set

Bits in the Device State condition register are set to 1 under the following conditions:

- Autocal Off (bit 0) is set to 1 when the analyzer's autocalibration function is disabled (CAL:AUTO OFF).
- Sweep Span Limited (bit 1) is set to 1 when the current combination of span and center frequencies do not allow the measurement to fill an entire trace. (Trace values outside the range of 0 to 150 MHz are not allowed.)
- Hardware Failed (bit 2) is set to 1 when analyzer detects a failure in its own hardware.
- Performance Test Running (bit 3) is set to 1 when performance tests are running.
- Key Pressed (bit 4) is set to 1 when either a front-panel key or external keyboard key is pressed.

Additional information is available under the commands you use to read and write the Device State registers. The commands are shown in figure 5-5; they are described in chapter 28.

## Limit Fail Register Set

The Limit Fail register set monitors limit test results for both traces.

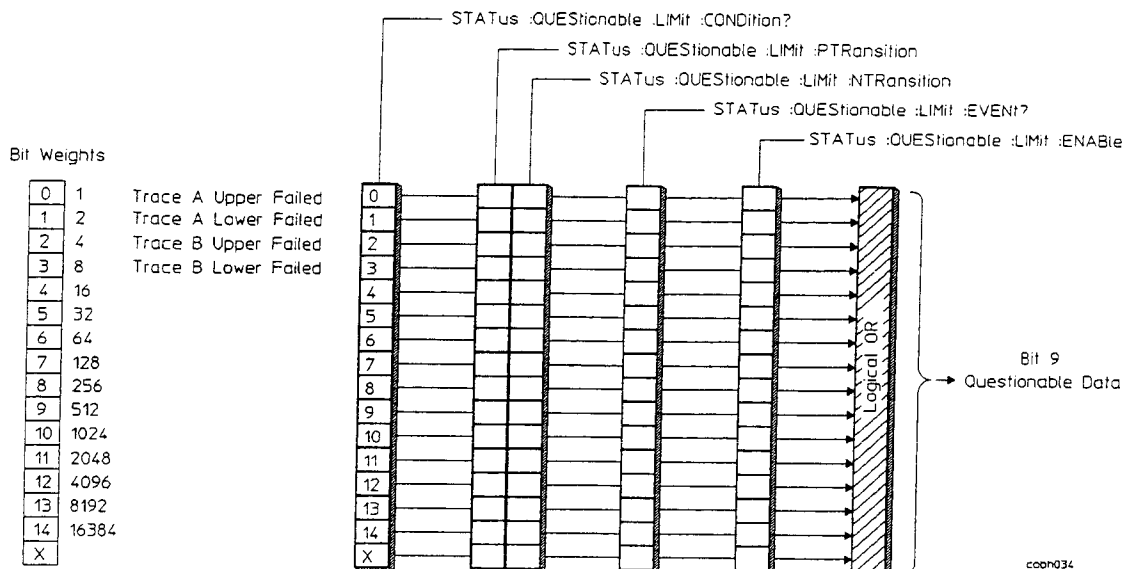

Figure 5-6. Limit Fail Register Set

Bits in the Limit Fail condition register are set to 1 under the following conditions:

- Trace A Upper Failed (bit 0) is set to 1 when any point on trace A exceeds its upper limit.
- Trace A Lower Failed (bit 1) is set to 1 when any point on trace A falls below its lower limit.
- Trace B Upper Failed (bit 2) is set to 1 when any point on trace B exceeds its upper limit.
- Trace B Lower Failed (bit 3) is set to 1 when any point on trace B falls below its lower limit.

Additional information is available under the commands you use to read and write the Limit Fail registers. The commands are shown in figure 5-6; they are described in chapter 28.

## Questionable Data Register Set

The Questionable Data register set monitors conditions that affect the quality of measurement data.

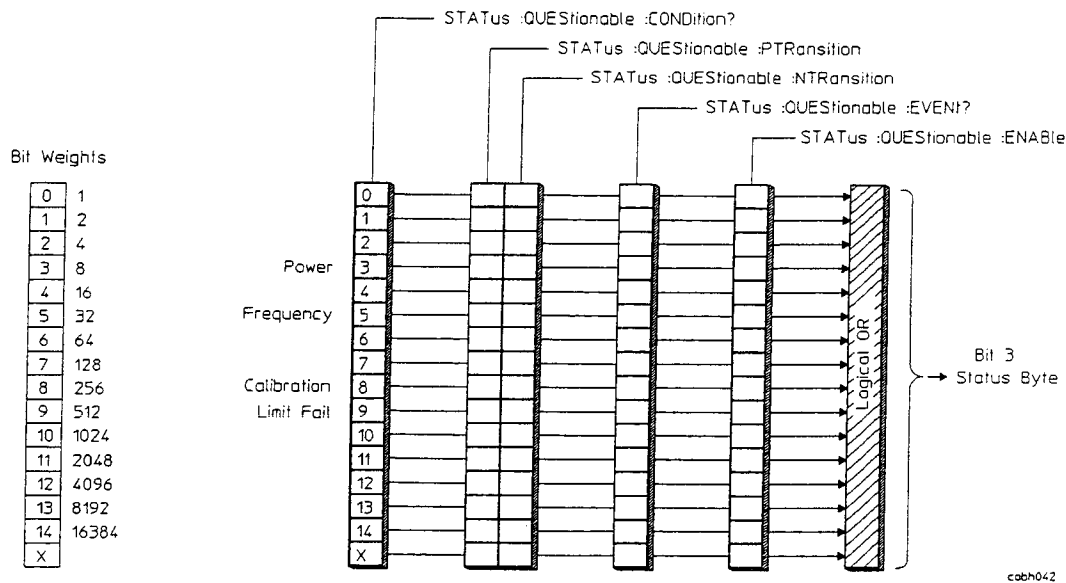

Figure 5-7. Questionable Data Register Set

Bits in the Questionable Data condition register are set to 1 under the following conditions:

- Power (bit 3) is set to 1 when one or more enabled bits in the Questionable Power event register are set to 1.
- Frequency (bit 5) is set to 1 when one or more enabled bits in the Questionable Frequency event register are set to 1.
- Calibration (bit 8) is set to 1 when the last self-calibration attempted by the analyzer failed.
- Limit Fail (bit 9) is set to 1 when one or more enabled bits in the Limit Fail event register are set to 1.
- Network Calibration (bit 10) is set to 1 when the front panel COR? LED is on and is 0 when the front panel COR LED is on. When no network calibration is applicable, (neither COR nor COR? is displayed) the bit is 0.

Additional information is available under the commands you use to read and write the Questionable Data registers. The commands are shown in figure 5-7; they are described in chapter 28.



## Questionable Frequency Register Set

The Questionable Frequency register set monitors conditions that affect the frequency accuracy of measurement data.

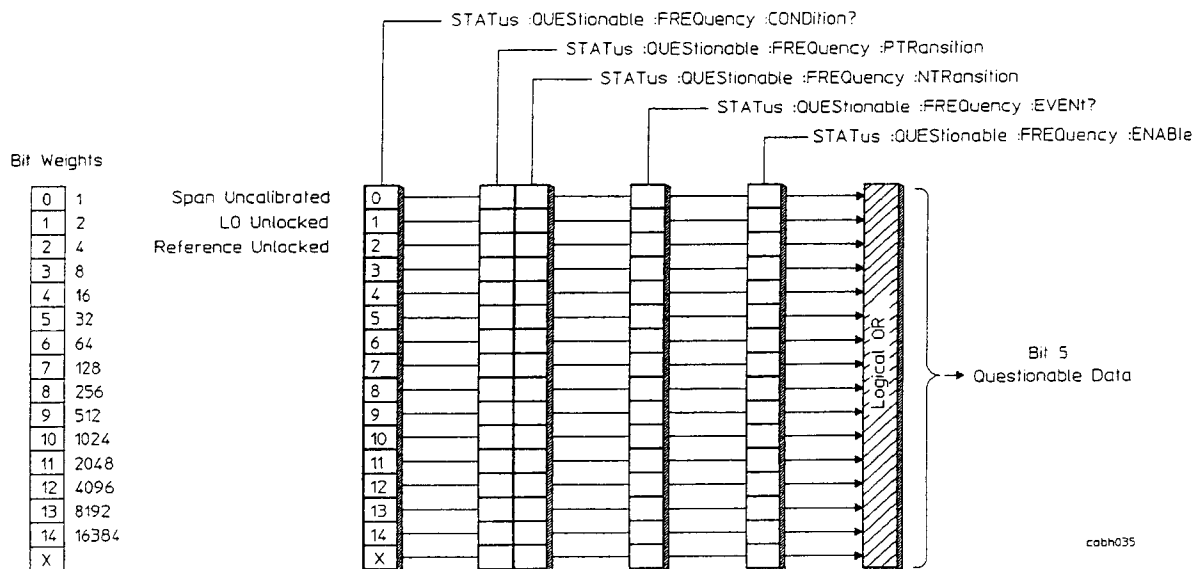

**Figure 5-8. Questionable Frequency Register Set**

Bits in the Questionable Frequency condition register are set to 1 under the following conditions:

- Span Uncalibrated (bit 0) is set to 1 when you request a span and sweep time that cannot be realized.
- LO Unlocked (bit 1) is set to 1 when the analyzer's local oscillator is not locked to its internal reference signal(s).
- Reference Unlocked (bit 2) is set to 1 when the analyzer's internal reference signal is not locked to the external reference signal being applied to the analyzer's rear panel.

Additional information is available under the commands you use to read and write the Questionable Frequency registers. The commands are shown in figure 5-8; they are described in chapter 28.

## Questionable Power Register Set

The Questionable Power register set monitors conditions that affect the amplitude accuracy of measurement data.

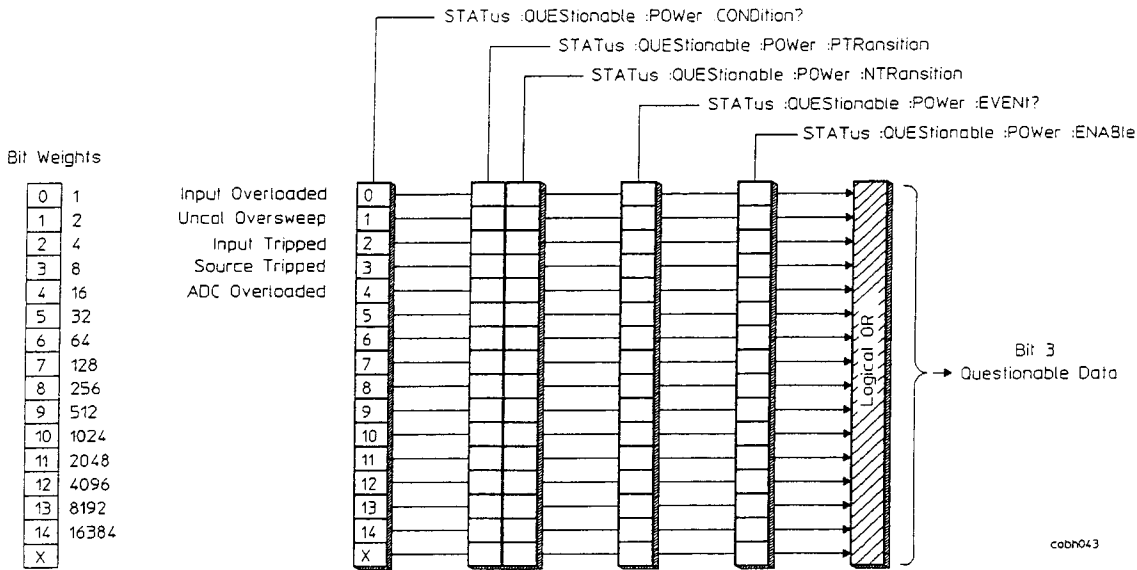

Figure 5-9. Questionable Power Register Set

Bits in the Questionable Power condition register are set to 1 under the following conditions:

- Input Overloaded (bit 0) is set to 1 when any signal between 0 and 150 MHz exceeds the current input range.
- Uncal Oversweep (bit 1) is set to 1 when the analyzer is sweeping too fast to provide accurate measurement results.
- Input Tripped (bit 2) is set to 1 when the analyzer's input-protection relay has been tripped (opened).
- Source Tripped (bit 3) is set to 1 when the analyzer's source-protection relay has been tripped (opened).
- ADC Overloaded (bit 4) is set to 1 when the analyzer's analog-to-digital converter is being overloaded.

Additional information is available under the commands you use to read and write the Questionable Power registers. The commands are shown in figure 5-9; they are described in chapter 28.

## Standard Event Register Set

The Standard Event register set monitors SCPI errors and synchronization conditions.

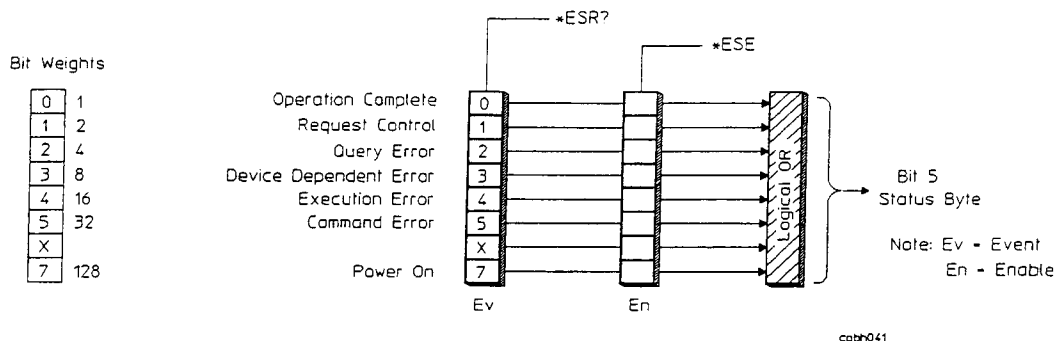

**Figure 5-10. Standard Event Register Set**

The Standard Event register set does not conform to the general status register model described at the beginning of this chapter. It contains only two registers: the Standard Event event register and the Standard Event enable register. The Standard Event event register is similar to other event registers, but it acts like conditions are always reported through a positive transition register that has all bits set to 1. The Standard Event enable register is the same as other enable registers.

Bits in the Standard Event event register are set to 1 under the following conditions:

- Operation Complete (bit 0) is set to one when the following two events occur (in the order listed):
  - You send the \*OPC command to the analyzer.
  - The analyzer completes all pending overlapped commands (see “Synchronization” in chapter 2).
- Request Control (bit 1) is set to 1 when both of the following conditions are true:
  - The analyzer is configured as an addressable-only HP-IB device (see “Controller Capabilities” in chapter 2).
  - The analyzer is instructed to do something (such as plotting or printing) that requires it to take control of the bus.

- Query Error (bit 2) is set to 1 when the SCPI command parser detects a query error.
- Device Dependent Error (bit 3) is set to 1 when the SCPI command parser detects a device-dependent error.
- Execution Error (bit 4) is set to 1 when the SCPI command parser detects an execution error.
- Command Error (bit 5) is set to 1 when the SCPI command parser detects a command error.
- Power On (bit 7) is set to 1 when you turn the analyzer on.

Additional information is available under the commands you use to read and write the Standard Event registers. The commands are shown in figure 5-10; they are described in chapter 8.

## Standard Operation Register Set

The Standard Operation register set monitors conditions in the analyzer's measurement process. It also monitors the state of the current HP Instrument BASIC program.

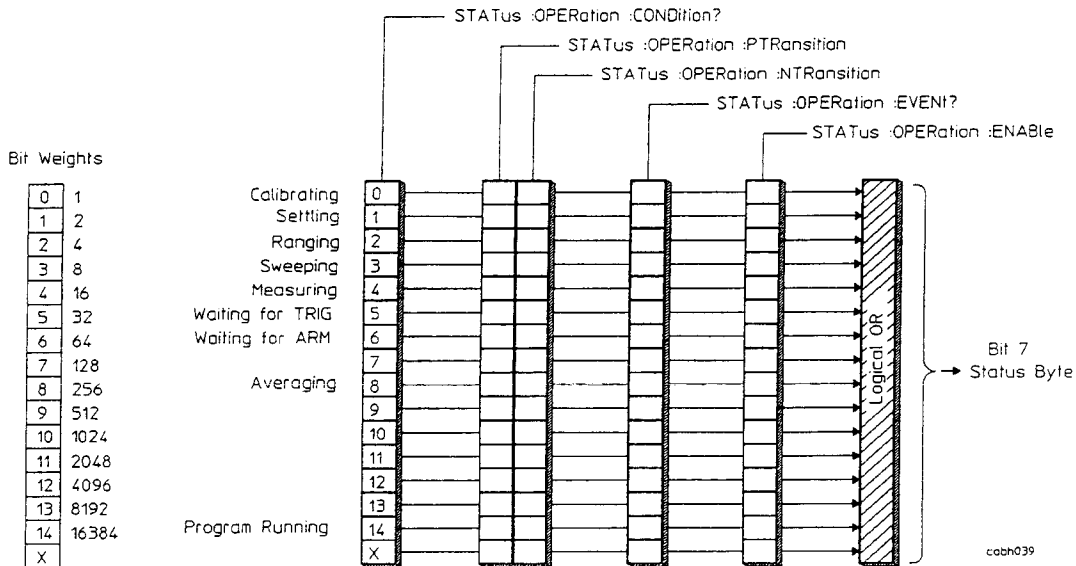

Figure 5-11. Standard Operation Register Set

Bits in the Standard Operation condition register are set to 1 under the following conditions:

- Calibrating (bit 0) is set to 1 while the self-calibration routine is running.
- Settling (bit 1) is set to 1 while the measurement hardware is settling.
- Ranging (bit 2) is set to 1 while the input range is changing.
- Sweeping (bit 3) is set to 1 during the data collecting portion of any swept spectrum or network measurement (including manual sweep and zero span). For a gated sweep measurement, this bit is 1 when the measurement is started; it is not an indicator of gating activity.
- Measuring (bit 4) is set to 1 during the data collecting portion of any swept spectrum, network, or narrow band zoom measurement. For a gated sweep measurement, this bit is 1 when the measurement is started; it is not an indicator of gating activity.
- Waiting for TRIG (bit 5) is set to 1 when the analyzer is ready to accept a trigger signal from one of the trigger sources. (If a trigger signal is sent before this bit is set, the signal is ignored.)

- Waiting for ARM (bit 6) is set to 1 when both of the following conditions are true:
  - Manual arming is selected.
  - The analyzer is ready to be armed.

(If you send the ARM:IMM command before this bit is set, the command is ignored.)

- Averaging (bit 8) is set to 1 when rms or vector averaging is enabled (AVER:TYPE RMS|VECT *and* AVER:STAT ON).
- Program Running (bit 14) is set to 1 when the current HP Instrument BASIC program is running.

Additional information is available under the commands you use to read and write the Standard Operation registers. The commands are shown in figure 5-11; they are described in chapter 28.

## User Defined Register Set

The User Defined register set detects STAT:USER:PULS commands and key-presses of the analyzer's [USER SRQ x] softkeys.

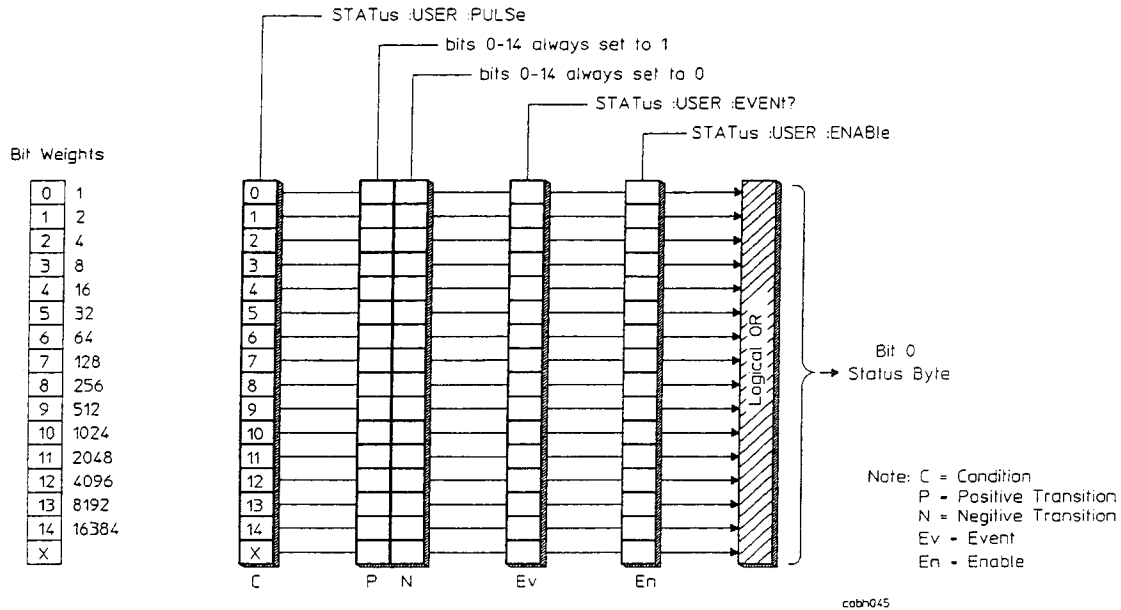

Figure 5-12. User Defined Register Set

The User Defined register set conforms to the general status register model (described at the beginning of this chapter) with the following exceptions:

- You can write (but not read) the condition register.
- You cannot write *or* read the transition registers.
- Bits in the positive transition register are always set to 1.
- Bits in the negative transition register are always set to 0.

Bits in the User Defined condition register are normally set to 0, but are set to 1 (briefly) when you press a [USER SRQ x] softkey or send a STAT:USER:PULS command. If you press [USER SRQ 5], bit 5 of the condition register is pulsed high. If you send STAT:USER:PULS 32, bit 5 of the condition register is pulsed high ( $2^5 = 32$ ).

## Programming Examples

---

This chapter contains listings of example programs written for the HP 3589A. All of the programs were written in HP BASIC for use on an HP Series 200/300 computer, although most are easily adaptable to other languages or programs. Most programs have been written to demonstrate one specific application and thus have been kept short and concise. The programs are grouped according to function as follows:

- Passing control
  - PASSCNTL
  
- Measurement synchronization
  - WAI\_SYNC
  - OPC\_SYNC
  - OPCQ\_SYNC
  - TRIGGERING
  
- Generating SRQ's
  - RANGE\_SRQ
  - AVER\_SRQ
  - USER\_SRQ
  
- Transferring data
  - MOVE\_STATE
  - TRC\_LOAD
  - LOG\_XAXIS
  
- Measurement applications
  - SHAPE
  - THD
  - NETWORK\_CAL
  
- Plotter applications
  - PLOT\_CTRL



## PASSCNTL

```
10      ! HP BASIC Program: PASSCNTL - Passing control to HP3589A
20      ! -----
30      ! This program instructs the HP 3589A perform a screen dump to a
40      ! printer and generate a service request when done. Control is
50      ! passed to the HP 3589A when the print command is issued and
60      ! automatically passed back when the instrument no longer needs it.
70      !
80      Scode=7                      !Interface select code
90      Address=19                   !Address for HP3589A
100     Hp3589a=Scode*100+Address
110     OUTPUT Hp3589a;"*CLS"        !Clear the STATUS BYTE register
120     !
130     ! Program the instrument to generate SRQ on OPERATION_COMPLETE. This
140     ! requires programming the STATUS BYTE and EVENT STATUS enable regs.
150     OUTPUT Hp3589a;"*ESE 1"     !Bit 1 = OPERATION_COMPLETE
160     OUTPUT Hp3589a;"*SRE 32"   !Bit 5 = EVENT_STATUS
170     OUTPUT Hp3589a;"*PCB 21"   !Set up Pass control back address
180     !
190     ON INTR Scode GOTO Srq_handler !Set up interrupt branching
200     ENABLE INTR Scode;2        !Enable interrupt on SRQ
210     OUTPUT Hp3589a;"*WAI"      !Ensure all pending operations done
220     DISP "HP3589A Printing screen..."
230     OUTPUT Hp3589a;"PRIN:DUMP:ALL" !Instruct analyzer to print the screen
240     OUTPUT Hp3589a;"*OPC"      !Set OPC bit when everything's complete
250     PASS CONTROL Hp3589a       !Give control of the bus to the 3589A
260     !
270     Wait_here:WAIT .5          !Wait for OPC to generate an interrupt
280     GOTO Wait_here
290     !
300     Srq_handler:              !If there's an interrupt; then
310     !Control was passed back
320     IF BINAND(SPOLL(Hp3589a),64) THEN !HP3589A is requesting service
330         BEEP
340         DISP "HP3589A Done Printing"
350     ELSE                        !It wasn't the HP3589A
360         DISP "UNKNOWN SRQ"
370     END IF
380     END
```

## WAI\_SYNC

```

10      ! HP BASIC program: WAI_SYNC - Measurement synchronization
20      ! -----
30      ! This program demonstrates how to use the *WAI command to
40      ! hold off execution of an HP-IB command until all previous
50      ! commands have finished. In this example, the trace display
60      ! will not change to the UPPER/LOWER FORMAT until after the
70      ! measurement has finished.
80      !
90      ! The *WAI command does not prevent the program from going on to the
100     ! next statement. The HP 3589A will continue to accept commands until
110     ! its input buffer fills (128 bytes). If this happens, program
112     ! execution will not continue until the *WAI command completes and the
114     ! HP 3589A's parser begins removing commands from the input queue. In
116     ! this example, the program will run to completion because the input
118     ! buffer does not become full.
120     ! -----
130     Scode=7                                !Interface select code
140     Address=19
150     Hp3589a=Scode*100+Address
160     !
161     DISP "Sending HP-IB commands..."
170     OUTPUT Hp3589a;"SCR:CONT TRACE;FORM SING" !Set format to single
180     OUTPUT Hp3589a;"SWE:TIME 8 S"           !Set record length to 8 seconds
190     OUTPUT Hp3589a;"ABORT; INIT:CONT ON"     !Restart the measurement
200     OUTPUT Hp3589a;"*WAI"                   !Tell analyzer to wait until
210                                           !the measurement has finished
220     OUTPUT Hp3589a;"SCR:CONT TRACE;FORM ULOW" !Go to upper/lower
230     BEEP
240     DISP "Finished. Display will go to UPPER/LOWER when meas. done"
250     END

```

## OPC\_SYNC

```
10      ! HP BASIC program: OPC_SYNC - Measurement synchronization
20      ! -----
30      ! This program demonstrates the how to use the *OPC command to
40      ! allow an SRQ to interrupt program execution. *OPC will set
50      ! the OPERATION_COMPLETE bit in the EVENT STATUS register
60      ! when all pending HP-IB commands have finished. With the proper
70      ! register masks, this will generate a service request.
90      !
100     Scode=7                                ! Interface select code
110     Address=19
120     Hp3589a=Scode*100+Address
130     !
140     OUTPUT Hp3589a;"SWE:TIME 8"           ! Set sweep time to 8 seconds
150     OUTPUT Hp3589a;"*CLS"                 ! Clear the STATUS BYTE register
160     OUTPUT Hp3589a;"*ESE 1"              !Program the EVENT STATUS ENABLE reg.
170     OUTPUT Hp3589a;"*SRE 32"            !Program the STATUS BYTE ENABLE reg.
180     !
190     ON INTR Scode,2 GOTO Srq_handler      !Set up interrupt branching
200     ENABLE INTR Scode;2                  !Allow SRQ to generate an interrupt
210     !
220     OUTPUT Hp3589a;"REST"                !Restart the measurement
230     OUTPUT Hp3589a;"*OPC"                !Generate SRQ when all commands have
240     !finished.
250     Start_time=TIMEDATE
260     LOOP                                  !Report elapsed time while waiting
270     DISP USING "14A, 2D.D";"Elapsed time :",TIMEDATE-Start_time
280     WAIT .1
290     END LOOP
300     !
310 Srq_handler: !Got an SRQ
320     Stb=SPOLL(Hp3589a)                    !Read STATUS BYTE and clear SRQ
330     BEEP
340     OUTPUT Hp3589a;"*ESR?"              !Read and clear EVENT STATUS reg.
350     ENTER Hp3589a;Esr
360     DISP "Got the SRQ! SPOLL returns:";Stb;" ESR returns:";Esr
370     END
```

## OPCQ\_SYNC

```

10  ! HP BASIC program: OPCQ_SYNC - Measurement synchronization
20  ! -----
30  ! This program demonstrates how to use the *OPC? HP-IB command
40  ! to suspend the bus, the controller, and the program until all
50  ! pending operations have completed. When all pending operations have
60  ! completed, the HP 3589A will return a '1' in response to *OPC?
65  ! and the program continues execution.
70  !
80  Scode=7
90  Hp3589a=Scode*100+19
100 !
110 OUTPUT Hp3589a;"*RST"           !Preset the HP3589A
120 OUTPUT Hp3589a;"*OPC?"         !Pause on ENTER statement until
130 ENTER Hp3589a;Opc             !'*RST' command has finished
140 !
150 OUTPUT Hp3589a;"SWE:TIME 8"    !Set sweep time to 8 seconds
160 DISP "Measurement started ..."
170 OUTPUT Hp3589a;"ABOR; INIT:CONT ON" !Restart the measurement
180 OUTPUT Hp3589a;"*OPC?"         !Pause until all pending operations
190 ENTER Hp3589a;Opc             !have completed.
200 BEEP
210 DISP "Measurement done"
220 END

```

## TRIGGERING

```
10 ! HP BASIC Program:  TRIGGERING
20 !
30 ! There are two ways to trigger:  1) The *TRG or TRIG:IMM commands,
40 ! or 2) Group Execute Trigger (TRIGGER 7).  For the trigger commands,
50 ! the user can use *wai if the command sequence is: "REStart; *TRG;
60 ! *WAI" (or "REStart; TRIG:IMM; *WAI").  In the HP3589A, Group Execute
70 ! Trigger (GET) bypasses the HP-IB parser.  This means that the user can
80 ! send the trigger after the *wai and the program/measurement will work.
90 !
100 ! Demonstrate the use of GET:
110 !
120 ASSIGN @Dut to 719
130 OUTPUT @Dut;"*RST"                ! Preset
140 OUTPUT @Dut;"TRIG:SOUR BUS"      ! HP-IB trigger
150 OUTPUT @Dut;"*OPC?"              ! Wait for the setup to finish
160 ENTER @Dut;Opc_response          !
170 OUTPUT @Dut;"RESt; *WAI"         ! Start up a new measurement
180 WAIT 3                           ! Wait some length of time
190 TRIGGER 7                         ! Trigger the measurement
200                                  ! (Using GET)
210 OUTPUT @Dut;"DISP:Y:RLEV (MARK:Y?)" ! Marker to ref level
220 PAUSE
230 !
240 ! Comments:
260 ! You can see that indeed the reference level is changed to the marker y
270 ! value, indicating that the measurement successfully completed.
290 !
300 ! There are some timing sensitivities that do require some waiting
310 ! between issuing the rest; *wai and the GET.  This brief interval is
320 ! the time it takes for the rest; *wai to be parsed and processed
330 ! and the instrument to get into a state where it is waiting for a bus
340 ! trigger.  If the user neglects to sync up the controller after doing
350 ! the measurement setup, the wait will have to be longer -- the interval
360 ! it takes for the setup to complete, start up the next measurement
370 ! and get ready to receive the trigger.
390 !
400 ! Demonstrate the use of *TRG (TRIG:IMM can be used as well):
410 !
420 OUTPUT @Dut;"*RST"                ! Preset
430 OUTPUT @Dut;"TRIG:SOUR BUS"      ! HP-IB trigger
440 OUTPUT @Dut;"*OPC?"              ! Wait for the setup to finish
450 ENTER @Dut;Opc_response          !
460 OUTPUT @Dut;"RESt; *TRG; *WAI"   ! Start up a new measurement
470 OUTPUT @Dut;"DISP:Y:RLEV (MARK:Y?)" ! Marker to ref level
480 STOP
490 END
500 !
510 ! Again, you see that indeed the reference level is changed to the marker
520 ! y value, indicating that the measurement successfully completed.
530 !
```

## RANGE\_SRQ

```

10 ! HP BASIC program: RANGE_SRQ
20 ! -----
30 ! This program demonstrates using the instrument's status registers
40 ! to enable SRQs for event initiated program interrupts.
50 !
60 ! -----
70 !
80 Sc=7
90 Addr=19
100 Device=(Sc*100)+Addr
110 ASSIGN @Hp3589a TO Device
120 CLEAR SCREEN
130 !
140 ! Setup registers to detect range changes.
150 !
160 OUTPUT @Hp3589a;"*CLS" ! CLEAR REGISTERS
170 OUTPUT @Hp3589a;"*SRE 128" ! ENABLE OPERATIONAL STATUS SUMMARY
180 OUTPUT @Hp3589a;"STAT:OPER:ENAB 4" ! ENABLE RANGE BIT
190 OUTPUT @Hp3589a;"STAT:OPER:PTR 4" ! ENABLE POS TRANSITIONS
200 OUTPUT @Hp3589a;"STAT:OPER:NTR 0" ! DISBALE NEG TRANSITIONS
210 !
220 ON INTR Sc GOSUB Check_srq ! Set up interrupt handling
230 ENABLE INTR Sc;2 ! Enable interrupts
240 LOCAL 7
250 DISP " Press [Range/Input] hardkey then [SINGLE AUTORANGE] softkey"
260 ! Wait for SRQ
270 !
280 Hang_out: GOTO Hang_out
290 !
300 Check_srq: !
310 DISABLE INTR 7
320 PRINT "SRQ Received -- Instrument ranging"
330 Sb=SPOLL(Device)
340 PRINT "SPOLL(";Device;) = ";Sb
350 Send_query(@Hp3589a,"STAT:OPER:EVEN?")
360 PRINT
370 ENABLE INTR Sc
380 LOCAL 7
390 DISP " Press [Range/Input] hardkey then [SINGLE AUTORANGE] softkey"
400 RETURN
410 !
420 END
430 !*****
440 ! Send a query command and print the return value.
450 !*****
460 SUB Send_query(@Device,Cmd$)
470 OUTPUT @Device;Cmd$
480 ENTER @Device;Resp
490 PRINT Cmd$;" ";Resp
500 SUBEND

```

## AVER\_SRQ

```
10      ! HP BASIC program: AVER_SRQ
20      ! -----
30      ! This program demonstrates using the instrument's status registers and
40      ! SRQs for sensing sweep completions while making a multi-sweep
50      ! averaged measurement.
70      ! -----
80      !
90      Sc=7
100     Addr=19
110     Device=(Sc*100)+Addr
120     ASSIGN @Hp3589a TO Device
130     !
140     ! Setup registers to detect measurement complete.
150     !
160     OUTPUT @Hp3589a;"*CLS"           ! CLEAR REGISTERS
170     OUTPUT @Hp3589a;"*SRE 128"      ! ENABLE OPERATIONAL STATUS SUMMARY
180     OUTPUT @Hp3589a;"STAT:OPER:ENAB 16" ! ENABLE MEAS BIT
190     OUTPUT @Hp3589a;"STAT:OPER:PTR 0" ! DISABLE POS TRANSITIONS
200     OUTPUT @Hp3589a;"STAT:OPER:NTR 16" ! ENABLE NEG TRANSITIONS
210     !
220     ON INTR Sc GOSUB Check_srq
230     !
240     ! Setup the instrument to take a 10 sweep average, each
250     ! sweep individually armed.
270     !
280     OUTPUT @Hp3589a;"AVER:COUNT 10"
290     OUTPUT @Hp3589a;"AVER ON"
300     OUTPUT @Hp3589a;"ARM:SOUR MAN"
310     OUTPUT @Hp3589a;"ABORT;INIT:CONT ON"
320     FOR I=1 TO 10
330         OUTPUT @Hp3589a;"ARM:IMM"
340         IF I<10 THEN
350             GOSUB Swp_wait
360             DISP "Hit CONTINUE to take next sweep..."
370             PAUSE
380         END IF
390     NEXT I
400     OUTPUT @Hp3589a;"*OPC?"
410     ENTER @Hp3589a;X
420     DISP "ALL DONE!"
430     STOP
440     !
450 Swp_wait:      !
460     DISP "Sweeping..."
470     ENABLE INTR Sc;2
480     !
490     ! Wait for SRQ
500     !
510 Hang_out:      !
520     IF NOT Sweep_done THEN
```

```
530         GOTO Hang_out
540     END IF
550         Sweep_done=0
560     RETURN
570     !
580 Check_srq:    !
590     !
600         Sb=SPOLL(Device)
610         Send_query(@Hp3589a,"STAT:OPER:EVEN?")
620         Sweep_done=1
630         RETURN
640     !
650     END
660     !*****
670     ! Send a query command and print the return value.
680     !*****
690     SUB Send_query(@Device,Cmd$)
700         OUTPUT @Device;Cmd$
710         ENTER @Device;Resp
720     SUBEND
```



## USER\_SRQ

```
10      ! HP BASIC Program: USER_SRQ - Responding to USER SRQ's
20      ! -----
22      ! The HP 3589A provides softkeys that generate an SRQ to interrupt
24      ! an external controller from the front panel.  This program
26      ! demonstrates how to set up, enable, and handle user SRQs.
28      ! -----
30      ! Responding to User SRQ's
40      Hp3589a=719                                !Address of HP 3589A
50      INTEGER User_status_reg
60      !
70      OUTPUT Hp3589a;"*CLS"                      !Clear all of the Status Registers
80      !
90      !Set USER STATUS REGISTER MASK to all 1's.
100     OUTPUT Hp3589a;"STAT:USER:ENAB 32767"
110     !
120     !Set STATUS BYTE Mask to generate SRQ on USER_EVENT_STATUS only
130     OUTPUT Hp3589a;"*SRE 1"
140     LOCAL Hp3589a                              !Put the instrument in LOCAL mode
150     !
160     ! Instrument is set up; Enable interupts to detect an SRQ
170     ON INTR 7 GOSUB Srq_handler                !Set up interrupt branching
180     ENABLE INTR 7;2                            !Enable interupt on SRQ
190     !
200     CLEAR SCREEN                              !Clear the alpha screen
210     Wait:DISP "On the HP 3589A, Press [Local/HP-IB] [USER SRQ] [SRQx]"
220     GOTO Wait                                  !Wait for SRQ to occur
230     !
240     Srq_handler:  !
250     IF BINAND(SPOLL(Hp3589a),64) THEN          !Bit 6 set, 3589 requires service
260         OUTPUT Hp3589a;"STAT:USER:EVEN?"      !Read USER STATUS REGISTER
270         ENTER Hp3589a;User_status_reg
280         !
290         ! Check all 16 bits in the User_status_reg
300         ! Note: Bits 10-15 can only be set via HP-IB
310         FOR Usrq_number=0 TO 15
320             IF BIT(User_status_reg,Usrq_number) THEN
330                 SELECT Usrq_number
340                 CASE 0
350                     GOSUB Service_usrq0      !Gosub service routine for USER SRQ 0
360                 CASE 1
370                     GOSUB Service_usrq1      !Gosub service routine for USER SRQ 1
380                 CASE 2 TO 15
390                     GOSUB Service_usrqx      !Goto service routine for other USER SRQ's
400                 END SELECT
410             END IF
420         NEXT Usrq_number
430         ENABLE INTR 7                        !re-enable interupts
440         LOCAL 7                              !put the instrument in local mode
450     ELSE
460         BEEP
```

```
470     DISP "UNKNOWN INTERRUPT"           !Don't know how to handle other
480     STOP                               !interrupts.
490     END IF
500     RETURN
510 Service_usrq0:      !Service routine to handle USER SRQ 0
520     PRINT "USER PRESSED SRQ 0"
530     RETURN
540 Service_usrq1:      !Service routine to handle USER SRQ 1
550     PRINT "USER PRESSED SRQ 1"
560     RETURN
570 Service_usrqx:      !Service routine to handle other USER SRQ's
580     PRINT "USER SRQ was between 2 and 15"
590     RETURN
600     END
```

## MOVE\_STATE

```
10  ! HP BASIC program: MOVE_STATE
20  ! -----
30  ! Program that demonstrates how to download and upload state files
40  ! on the HP3589A.  Downloading is demonstrated for both definite and
42  ! indefinite block data.
50  !-----
60  !
70  INTEGER Dig_cnt,State(1:2000)
80  DIM Resp$(200)
90  ASSIGN @Hp3589a TO 719;FORMAT ON
100 !
110 CLEAR SCREEN
120 CLEAR @Hp3589a
130 OUTPUT @Hp3589a;"FORM:DATA REAL"           !Select REAL 64 as data
140 ! Upload state data via HP-IB             !format for the data block
150 !
160 OUTPUT @Hp3589a;"SYST:SET?"
170 !
180 ENTER @Hp3589a USING "%,A,D";Resp$,Dig_cnt !Enter the first 2 bytes
190                                           !of the block header
200 IF (Resp$<>"#") OR (Dig_cnt<=0) THEN      !Expect a "#" and a
210   PRINT "Not correct block mode"         !non-zero digit
220   BEEP
230   CLEAR @Hp3589a
240   STOP
250 END IF
260 !
262                                           !Enter the remainder of the
264                                           !block header; Dig_cnt digits
266                                           !determine the number of bytes
268                                           !in the block
270 DISP "Uploading state"
280 ENTER @Hp3589a USING "%,&VAL$(Dig_cnt)&"D";Num_bytes
290 PRINT "Number of bytes to upload ";Num_bytes
300 ASSIGN @Hp3589a;FORMAT OFF !read items in computer's internal format
!
305 REDIM State(1:Num_bytes/2) !2 bytes per integer value
310 ENTER @Hp3589a;State(*)
320 ASSIGN @Hp3589a;FORMAT ON
330 ENTER @Hp3589a;Resp$ ! READ TERMINATING LF
340 !
350 Reply$="Y"
360 INPUT "Download state to instrument?",Reply$
370 IF ( UPC$(Reply$[1,1]) = "Y" ) THEN GOTO Download
380 !
390 ! Save state into file compatible with SAVE/RECALL STATE
400 !
410 DISP "Creating state file"
420 MASS STORAGE IS ":INTERNAL,4,0"
430 ON ERROR GOTO Create_file
```

```

440 PURGE "STATE"
450 !
460 Create_file: OFF ERROR
470 CREATE BDAT "STATE",1,Num_bytes
480 ASSIGN @F TO "STATE"
490 DISP "Writing file"
500 OUTPUT @F;State(*)
510 ASSIGN @F TO *
520 DISP "File transfer complete."
530 STOP
540 !
550 ! Download state via HP-IB
560 !
570 Download: !
580 Reply$="Y"
590 INPUT "Do definite block transfer?",Reply$
600 IF ( UPC$(Reply$[1,1]) = "Y" ) THEN
610     DISP "Definite block transfer ";
620     OUTPUT @Hp3589a USING "#,K,D,"&VAL$(Dig_cnt)&"D";"SYST:SET
#" ,Dig_cnt,Num_bytes
630 ELSE
640     DISP "Indefinite block transfer ";
650     OUTPUT @Hp3589a USING "K,#";"SYST:SET #0";
660 END IF
670 !
680 ! Upload state data via HP-IB
690 !
700 ASSIGN @Hp3589a;FORMAT OFF
710 OUTPUT @Hp3589a;State(*)
720 ASSIGN @Hp3589a;FORMAT ON
730 OUTPUT @Hp3589a;CHR$(10) END
740 DISP "complete."
750 !
760 END

```

## TRC\_LOAD

```

10  ! HP BASIC program: TRC_LOAD
20  ! -----
30  ! Program to demonstrate dumping and uploading a trace on the HP 3589
40  ! with HP BASIC. A trace is downloaded, the points reversed, then
50  ! uploaded. To see the reversal more clearly, connect a signal that is
55  ! not symmetric about the center frequency.
60  ! -----
70  !
80  DIM Dump_data(1:401),Load_data(1:401)
90  INTEGER Num_pts
100 !
110 ASSIGN @Hp3589a TO 719                !Put analyzer in manual arm mode to
120                                         !freeze the display
130 OUTPUT @Hp3589a;"ARM:SOUR MAN"
140 CLEAR SCREEN
150 DISP "Dumping trace..."
160 Dump_trace(@Hp3589a,Dump_data(*),Num_pts,"TRAC:DATA?")
180 !
190 ! Flip-flop data points before uploading
200 !
210 DISP "Reversing data points..."
220 FOR I=1 TO Num_pts
230   Load_data(Num_pts-I+1)=Dump_data(I)
240 NEXT I
250 !
260 DISP "Uploading trace..."
270 Upload_trace(@Hp3589a,Load_data(*),"TRAC:DATA")
280 DISP
290 OUTPUT @Hp3589a;"ARM:SOUR IMM"        !Return to automatic arm
300 !
310 END
320 !#####
330 !
340 SUB Dump_trace(@Hp3589a,REAL Trace_data(*),INTEGER Num_pts,Command$)
350 !-----
360 ! MODULE DESCRIPTION:
370 !   This module dumps a trace of data from the instrument.
380 !
390 ! INPUTS:   @Hp3589a   : Device to dump data from.
400 !           Command$   : HP-IB mnemonic used to prompt the instrument
410 !                       for the trace of data.
420 ! OUTPUTS:  Trace_data : Array of data received from instrument.
430 !           Num_pts    : Number of points dumped into Trace_data.
440 !
450 !-----
460 DIM A$(10)
470 INTEGER Dig_cnt
480 OUTPUT @Hp3589a;"FORM:DATA REAL"
490 OUTPUT @Hp3589a;Command$
510 Dig_cnt=-1

```

```

520 ENTER @Hp3589a USING "%,A,D";A$,Dig_cnt
530 IF (A$<"#") OR (Dig_cnt<=0) THEN
540     PRINT "NOT CORRECT BLOCK MODE"
550     CLEAR @Hp3589a
560 ELSE
570     ENTER @Hp3589a USING "%,&VAL$(Dig_cnt)&"D";Num_pts
580     IF (Num_pts MOD 8=0) THEN
590         Num_pts=Num_pts DIV 8
600         ASSIGN @Hp3589a;FORMAT OFF
610         ENTER @Hp3589a;Trace_data(*)
620         ASSIGN @Hp3589a;FORMAT ON
630         ENTER @Hp3589a;A$             ! Read CR/LF
640     ELSE
650         PRINT Data_read;" not float size (divisible by 8)"
660         CLEAR @Hp3589a
670     END IF
680 END IF
690 SUBEND
700 !#####
710 !
720 SUB Upload_trace(@Hp3589a,REAL Trace_data(*),Command$)
730 !-----
740 ! MODULE DESCRIPTION:
750 !   This module uploads a trace of data.
760 !
770 ! INPUTS:   @Hp3589a   : Device to dump data to.
780 !           Command$   : HP-IB mnemonic used to load the trace of
790 !                       data into the instrument
800 ! OUTPUTS:  Trace_data : Array of data to load into instrument.
810 !
820 !-----
840 OUTPUT @Hp3589a;"FORM:DATA REAL"
850 OUTPUT @Hp3589a USING "K,#";Command$;" #0";
860 ASSIGN @Hp3589a;FORMAT OFF
870 OUTPUT @Hp3589a;Trace_data(*),END
880 ASSIGN @Hp3589a;FORMAT ON
890 SUBEND

```

## LOG\_XAXIS

```
1  ! HP BASIC program: LOG_XAXIS
2  ! -----
3  ! Program to demonstrate dumping, re-scaling and plotting a trace of
4  ! transform-coordinated data on the computer display.
5  !
6  ! -----
7  !
8  COM REAL X_axis(1:401),Start_freq,Stop_freq
9  DIM Dump_data(1:401)
10 INTEGER Num_pts
11 !
12 ASSIGN @Hp3589a TO 719
13 GRAPHICS ON
14 GCLEAR
15 CLEAR SCREEN
16 !
17 LOOP
18   DISP "Dumping trace..."
19   Dump_trace(@Hp3589a,Dump_data(*),Num_pts,"CALC:DATA?")
20   DISP Num_pts;" points dumped."
21   !
22   Log_xaxis(@Hp3589a,Num_pts)   ! Compute log x-axis
23   !
24   OUTPUT @Hp3589a;"ARM:SOUR MAN"
25   DISP "Plotting trace..."
26   Plot_trace(Dump_data(*),X_axis(*),Num_pts)
27   OUTPUT @Hp3589a;"ARM:SOUR IMM"
28   !
29   DISP "Press CONTINUE for next trace"
30   PAUSE
31 END LOOP
32 !
33 END
34 !#####
35 !
36 SUB Dump_trace(@Hp3589a,REAL Trace_data(*),INTEGER Num_pts,Command$)
37 !-----
38 ! MODULE DESCRIPTION:
39 !   This module dumps a trace of data from the instrument.
40 !
41 ! INPUTS:   @Hp3589a   : Device selector of instrument.
42 !           Command$   : HP-IB mnemonic used to prompt the instrument
43 !                       for the trace of data.
44 ! OUTPUTS:  Trace_data : Array of data received from instrument.
45 !           Num_pts     : Number of points dumped into Trace_data.
46 !
47 !-----
48 DIM A$(10)
49 INTEGER Dig_cnt
50 !
```

```

51 OUTPUT @Hp3589a;"FORM:DATA REAL,64"
52 OUTPUT @Hp3589a;Command$
53 ASSIGN @Hp3589a;FORMAT ON
54 Dig_cnt=-1
55 ENTER @Hp3589a USING "%,A,D";A$,Dig_cnt
56 IF (A$<"#") OR (Dig_cnt<=0) THEN
57     PRINT "NOT CORRECT BLOCK MODE"
58     CLEAR @Hp3589a
59 ELSE
60     ENTER @Hp3589a USING "%,&VAL$(Dig_cnt)&"D";Num_pts
61     IF (Num_pts MOD 8=0) THEN
62         Num_pts=Num_pts DIV 8
63         ASSIGN @Hp3589a;FORMAT OFF
64         ENTER @Hp3589a;Trace_data(*)
65         ASSIGN @Hp3589a;FORMAT ON
66         ENTER @Hp3589a;A$           ! Read CR/LF
67     ELSE
68         PRINT Data_read;" not float size (divisible by 8)"
69         CLEAR @Hp3589a
70     END IF
71 END IF
72 SUBEND
73 !#####
74 !
75 SUB Plot_trace(REAL Trace_data(*),Xarray(*),INTEGER Num_pts)
76 !-----
77 ! MODULE DESCRIPTION:
78 !   This module plots a trace of data.
79 !
80 ! INPUTS:  Trace_data: Array of data to plot.
81 !          Xarray      : Array of x-axis values (corresponds to Trace_data)
82 !          Num_pts      : Number of points in Trace_data to plot.
83 !-----
84 REAL Y_scaler           ! 1/(Delta per vertical pixel)
85 REAL Max_val,Min_val    ! Maximum and minimum values in data trace
86 REAL Height            ! Display height
87 INTEGER Orig_x,Orig_y  ! Origin (in pixels)
88 !
89 Height=60
90 Orig_x=10
91 Orig_y=20
92 !
93 GCLEAR
94 Max_val=MAX(Trace_data(*))
95 Min_val=MIN(Trace_data(*))
96 !
97 ! Perform display auto-scale on data
98 !
99 Y_scaler=Height/(ABS(Max_val-Min_val))
100 X_scaler=.25           ! HP9836 Display
101 Top_pixel=(Height+Orig_y)
102 MOVE Orig_x,Top_pixel-(ABS(Max_val-Trace_data(1))*Y_scaler)

```



Programming Examples  
LOG\_X\_AXIS

```

103   FOR X=1 TO Num_pts
104   Scaled_x = Orig_x+(Xarray(X)-1)*X_scaler
105   Scaled_y = Top_pixel-(ABS(Max_val-Trace_data(X))*Y_scaler)
106   DRAW Scaled_x, Scaled_y
107   NEXT X
108   SUBEND
109   !
110   !#####
111   !
112   SUB Log_xaxis(@Hp3589a,INTEGER Num_pts)
113   !-----
114   ! MODULE DESCRIPTION:
115   !   This module computes a logarithmic x-axis for a linearly spaced
116   !   array of data.
117   !
118   ! INPUTS:   @Hp3589a   : Device selector of instrument.
119   !           Num_pts    : Number of points in X_axis to calculate.
120   ! OUTPUTS:  X_axis     : Array of x-axis values calculated.
121   !
122   !-----
123   COM REAL X_axis(1:401),Start_freq,Stop_freq
124   INTEGER I
125   REAL X,K,C,Inc,Temp_start,Temp_stop
126   !
127   Displaywidth=401
128   !
129   OUTPUT @Hp3589a;"FREQ:STAR?"
130   ENTER @Hp3589a;Temp_start
131   OUTPUT @Hp3589a;"FREQ:STOP?"
132   ENTER @Hp3589a;Temp_stop
133   !
134   ! Check for changes in frequency coverage
135   !
136   IF (Temp_start<>Start_freq) OR (Temp_stop<>Stop_freq) THEN
137     Start_freq=Temp_start
138     Stop_freq=Temp_stop
139   ELSE
140     GOTO Bail
141   END IF
142   OUTPUT @Hp3589a;"ARM:SOUR MAN"
143   !
144   ! Need to check for ~0 start frequency -> log crash
145   !
146   DISP "Recalculating x-axis scaling"
147   !
148   IF (Start_freq<.000000000001) THEN
149     Start_freq=10.0
150   END IF
151   Inc=(Stop_freq-Start_freq)/(Num_pts-1)
152   K=Displaywidth/(LGT(Stop_freq)-LGT(Start_freq))
153   C=LGT(Start_freq)*(-K)
154   I=1
155   X=Start_freq

```

```
156     LOOP
157         EXIT IF ((X>Stop_freq) OR (I>Num_pts))
158         X_axis(I)=C+K*LGT(X)
159         I=I+1
160         X=X+Inc
161     END LOOP
162     !
163     OUTPUT @Hp3589a;"ARM:SOUR IMM"
164     Bail:SUBEND
```

## SHAPE

```
1  ! HP BASIC program: SHAPE
2  ! -----
3  ! Shape factor calculation test
4  ! -----
5  !
6  REAL Meas_span,Peak_freq,Search_freq,Freq_per_bin
7  REAL Target_ampl,Left_freq,Right_freq
8  REAL Sixty_db_bw
9  INTEGER Slope_up
10 !
11 Shape_image: IMAGE "Shape factor = ",D.DD
12 !
13 ASSIGN @Hp3589a TO 719
14 !
15 ! Recall "3dB" State
16 !
17 OUTPUT @Hp3589a;"SYST:PRES"
18 !
19 Pass=1
20 LOOP
21   EXIT IF Pass>2
22   IF Pass=1 THEN
23     GOSUB Setup_3db
24   ELSE
25     GOSUB Setup_60db
26   END IF
27   DISP CHR$(129)&"Setting up filter measurement"&CHR$(128)
28   OUTPUT @Hp3589a;"REST; *WAI"      ! Take averaged measurement
29   OUTPUT @Hp3589a;"ARM:SOUR MAN"    ! Stop measurement
30   !
31   OUTPUT @Hp3589a;"DISPl:Y:SCAL:AUTO ONCE"
32   OUTPUT @Hp3589a;"FREQ:SPAN?"
33   ENTER @Hp3589a;Meas_span
34   Freq_per_bin=Meas_span/400.
35   OUTPUT @Hp3589a;"MARK:MAX:GLOB"
36   OUTPUT @Hp3589a;"MARK:FREQ?"
37   ENTER @Hp3589a;Peak_freq
38   !
39   OUTPUT @Hp3589a;"MARK:AMPL?"
40   ENTER @Hp3589a;Target_ampl
41   !
42   IF Pass=1 THEN
43     Target_ampl=Target_ampl-3.    ! (peak - 3 dB)
44     DISP CHR$(129)&"Calculating -3.0 dB Bandwidth"&CHR$(128)
45   ELSE
46     Target_ampl=Target_ampl-60.  ! (peak - 60 dB)
47     DISP CHR$(129)&"Calculating -60.0 dB Bandwidth"&CHR$(128)
48   END IF
49   !
50   ! Search for left target point
```

```

51  !
52  Right_freq=Peak_freq
53  Left_freq=Right_freq-(Meas_span/2.)
54  Slope_up=1
55  GOSUB Bin_search
56  OUTPUT @Hp3589a;"MARK:OFFS ON; OFFS:DELT:X 0; Y 0"
57  !
58  ! Search for right target point
59  !
60  Target_ampl=0. ! Relative to OFFSET MARKER
61  Right_freq=Peak_freq+(Meas_span/2.)
62  Left_freq=Peak_freq
63  Slope_up=0
64  GOSUB Bin_search
65  !
66  OUTPUT @Hp3589a;"MARK:OFFS:DELT:X?"
67  IF Pass=1 THEN
68      ENTER @Hp3589a;Three_db_bw
69  ELSE
70      ENTER @Hp3589a;Sixty_db_bw
71  END IF
72  !
73  Pass=Pass+1
74  OUTPUT @Hp3589a;"MARK:OFFS OFF"
75  END LOOP
76  !
77  BEEP
78  DISP USING Shape_image;Sixty_db_bw/Three_db_bw
79  !
80  OUTPUT @Hp3589a;"ARM:SOUR IMM" ! Re-start measurement
81  STOP
82  !
83  Bin_search: !
84  !
85  ! Look for Target_ampl +- 0.01 dB
86  !
87  ! Left_freq and Right_freq bound area of search
88  !
89  Search_freq=Left_freq+(Meas_span/4.)
90  !
91  LOOP
92  OUTPUT @Hp3589a;"MARK:X ";Search_freq
93  IF Slope_up=0 THEN
94      OUTPUT @Hp3589a;"MARK:OFFS:DELT:Y?" ! Searching for right target
95  ELSE
96      OUTPUT @Hp3589a;"MARK:Y?"
97  END IF
98  ENTER @Hp3589a;Search_ampl
99  EXIT IF (ABS(Target_ampl-Search_ampl)<=.01) OR
(ABS(Left_freq-Right_freq)<=Freq_per_bin)
100 !
101 IF Slope_up THEN
102     IF (Search_ampl>Target_ampl) THEN

```

Programming Examples  
SHAPE

```
103     Right_freq=Search_freq
104     ELSE
105     Left_freq=Search_freq
106     END IF
107 ELSE
108     IF (Search_ampl>Target_ampl) THEN
109     Left_freq=Search_freq
110     ELSE
111     Right_freq=Search_freq
112     END IF
113 END IF
114 !
115 Search_freq=Left_freq+(Right_freq-Left_freq)/2.
116 END LOOP
117 RETURN
118 !
119 ! Setup for 3 dB measurement
120 Setup_3db: !
121     OUTPUT @Hp3589a;"TEST:INP:CONF CAL"
122     OUTPUT @Hp3589a;"FREQ:CENT 10 MHz"
123     OUTPUT @Hp3589a;"BAND:AUTO OFF"
124     OUTPUT @Hp3589a;"FREQ:SPAN 2 kHz"
125     OUTPUT @Hp3589a;"BAND:RES 580 Hz"
126 RETURN
127 !
128 ! Setup for 60 dB measurement
129 Setup_60db: !
130     OUTPUT @Hp3589a;"ARM:SOUR IMM" ! Re-start measurement
131     OUTPUT @Hp3589a;"FREQ:SPAN 5 kHz"
132 RETURN
133 END
```

## THD

```

10      ! HP BASIC program: THD
20      ! -----
30      ! Total Harmonic Distortion (THD) test.
40      !
50      ! Also demonstrates the use of manual arming over HP-IB and
52      ! how OPC synchronization works with manual arm.
54      !
56      ! Note: The proper order of action is 1) measurement restart, 2) manual
58      !       arm, THEN 3) synch.  If you try to synch before sending the arm
60      !       the MEASUREMENT WILL NEVER COMPLETE.
62      ! -----
64      !
66      COM /Dut/ @Hp3589a
70      DIM Prompt${60}
80      !
90      Fund_image:  IMAGE "      Fundamental : ",K," Hz, ", 3D.2D, " dBm"
100     Thd_image:  IMAGE "      THD           : ", 2D.3D,"% (", 3D.2D, " dB )"
110     !
120     ASSIGN @Hp3589a TO 719
130     !
140     Prompt$="Move marker past last harmonic, then press MEASURE THD."
150     !
160     Start:      !
170     !
180     OUTPUT @Hp3589a;"SYST:PRES"
190     !
200     CLEAR SCREEN
210     GCLEAR
220     !OUTPUT @Hp3589a;"TEST:INP:CONF CAL" ! THD of square wave cal signal
230     OUTPUT @Hp3589a;"SYST:RPGLOCK OFF"
240     DISP Prompt$
250     !
260     ON KEY 0 LABEL "MEASURE      THD" GOSUB Measure
270     FOR I = 1 TO 9
280         ON KEY I LABEL "" GOSUB Do_nothing
290     NEXT I
300     Hang_out:  GOTO Hang_out
310     !
320     Do_nothing: RETURN
340     Measure:      !
350     CLEAR SCREEN
360     !
370     ! MEASURE LAST HARMONIC FREQUENCY LIMIT
380     !
390     OUTPUT @Hp3589a;"MARK:X?"
400     ENTER @Hp3589a;Last_x
410     !
420     ! MEASURE FUNDAMENTAL FREQUENCY
430     !
440     DISP "Frequency counting fundamental."

```

## Programming Examples

### THD

```

450  !
460  OUTPUT @Hp3589a;"ARM:SOUR IMM"
470  OUTPUT @Hp3589a;"MARK:MAX:GLOB"
480  OUTPUT @Hp3589a;"MARK:FUNC:FCO ON"
490  OUTPUT @Hp3589a;"REST; :ARM; *WAI"
500  OUTPUT @Hp3589a;"MARK:OFFS ON; OFFS:DELT:X 0; Y 0"
510  OUTPUT @Hp3589a;"MARK:X:FCO?"
520  ENTER @Hp3589a;Fund_x
530  OUTPUT @Hp3589a;"MARK:Y?"
540  ENTER @Hp3589a;Fund_y
550  OUTPUT @Hp3589a;"MARK:FUNC:FCO OFF"
560  PRINT
570  PRINT
580  PRINT USING Fund_image;Fund_x,Fund_y
590  !
600  DISP "Manually sweeping harmonics."
610  !
620  OUTPUT @Hp3589a;"SWE:MODE MAN"
630  !
640  Thd=0
650  Harm_x=2*Fund_x
660  !
670  LOOP
680      EXIT IF Harm_x>Last_x
690      OUTPUT @Hp3589a;"FREQ:MAN";Harm_x;"HZ"
700      OUTPUT @Hp3589a;"REST; :ARM; *WAI"
710      OUTPUT @Hp3589a;"MARK:X";Harm_x;"Hz"
720      OUTPUT @Hp3589a;"*WAI"
730      OUTPUT @Hp3589a;"MARK:OFFS:DELT:Y?"
740      ENTER @Hp3589a;Y
750      Thd=Thd+10.^(Y/10.)
760      Harm_x=Harm_x+Fund_x
770  END LOOP
780  !
790  Db=10.*LGT(Thd)
800  Per=100.*10.^(Db/20.)
810  PRINT
820  PRINT USING Thd_image;Per,Db
830  !
840  OUTPUT @Hp3589a;"SWE:MODE AUTO"
850  OUTPUT @Hp3589a;"ARM:SOUR IMM"
860  OUTPUT @Hp3589a;"MARK:OFFS OFF"
870  DISP Prompt$
880  RETURN
890  END

```

## NETWORK\_CAL

```

10 ! HP_BASIC program: NETWORK_CAL -- Network calibration
20 !
30 ! This program demonstrates how to automate a network calibration from the
40 ! bus, in this case S11. Note that the operator must manually connect
50 ! the standards for each calibration measurement. The program assumes
60 ! the presence of an HP35689A 50-ohm test set.
70 !
80 !
90 Scode=8
100 Address=0
110 Hp3589a=Scode*100+Address
130 !
140 OUTPUT Hp3589a;"SYST:PRES"
150 OUTPUT Hp3589a;"INST NETW"
160 OUTPUT Hp3589a;"CORR:COLL:METH S11" ! Select S11 network measurement
170 OUTPUT Hp3589a;"*OPC?"
180 ENTER Hp3589a;Ready
190 !
200 ON KEY 3 LABEL "Continue" GOTO Cal_1
210 DISP "Connect the OPEN termination to PORT 1 and press Continue"
220 BEEP
230 LOOP
240 WAIT .1
250 END LOOP
260 Cal_1: !
270 DISP ""
280 OFF KEY
290 OUTPUT Hp3589a;"CORR:COLL:STAN OPEN; *OPC?"
300 ENTER Hp3589a;Meas_done
310 !
320 ON KEY 3 LABEL "Continue" GOTO Cal_2
330 DISP "Connect the SHORT termination to PORT 1 and press Continue"
340 BEEP
350 LOOP
360 WAIT .1
370 END LOOP
380 Cal_2: !
390 DISP ""
400 OFF KEY
410 OUTPUT Hp3589a;"CORR:COLL:STAN SHOR; *OPC?"
420 ENTER Hp3589a;Meas_done
430 !
440 ON KEY 3 LABEL "Continue" GOTO Cal_3
450 DISP "Connect the 50 ohm TERM to PORT 1 and press Continue"
460 BEEP
470 LOOP
480 WAIT .1
490 END LOOP
500 Cal_3: !
510 DISP ""

```



Programming Examples  
NETWORK\_CAL

```
520 OFF KEY
530 OUTPUT Hp3589a;"CORR:COLL:STAN TERM; *OPC?"
540 ENTER Hp3589a;Meas_done
550 !
560 ON KEY 3 LABEL "Continue" GOTO Cal_4
570 DISP "Connect your NETWORK and press Continue"
580 LOOP
590   WAIT .1
600 END LOOP
610 Cal_4: !
620 DISP ""
630 OFF KEY
640 OUTPUT Hp3589a;"CORR:COLL:STAN REF; *OPC?"           ! Do the reference meas
650 ENTER Hp3589a;Meas_done
660 !
670 OUTPUT Hp3589a;"CORR:COLL:SAVE"                       ! S11 cal finished
680 !
690 OUTPUT Hp3589a;"REST; *OPC?"                           ! Measure S11
700 ENTER Hp3589a;Meas_done
710 DISP "S11 measurement is now on display"
720 !
730 END
```

## PLOT\_CTRL

```

10      ! HP BASIC program: PLOT_CTRL
20      !
30      !
40      ! Plot controller
50      !
60      ! Controls setting of rotation, P1 and P2 on HP-GL plotters for report
70      ! formatting.
80      !
90      ! For HP-GL plotters (at least 7475A) :
100     !
110     !   No rotation gives landscape format.
120     !   P1 specifies the lower left corner of the plot in (X,Y) coords
130     !   P2 specifies the upper right corner of the plot in (X,Y) coords
140     !
150     ! For 7475A :
160     !
170     !   1. 4 per page landscape :
180     !
190     !       * Rotation = 0 degrees
200     !       * Upper left quadrant  P1(1000,4500) P2(4700,7600)
210     !       * Upper right quadrant P1(6000,4500) P2(9700,7600)
220     !       * Lower left quadrant  P1(1000,500)  P2(4700,3600)
230     !       * Lower right quadrant P1(6000,500)  P2(9700,3600)
240     !
250     !   2. 2 per page portrait (side by side) :
260     !
270     !       * Rotation = 90 degrees
280     !       * Upper left  P1(100,7000) P2(4000,10000)
290     !       * Upper right P1(4500,7000) P2(8400,10000)
300     !
310     !
320     !
330     INTEGER Rotate,P1_x,P1_y,P2_x,P2_y
340     ASSIGN @Hp3589a TO 719
350     CALL Setup_pass(@Hp3589a)    ! Setup instrument for pass control
360     !
370     LOOP
380     DISP "Setup next screen to plot, then press CONTINUE."
390     PAUSE
400     !
410     ! Prompt user for rotation of plot.
420     !
430     INPUT "Enter rotation (degrees) : ",Rotate
440     OUTPUT 705;"RO ";Rotate;" " ! Send rotation to plotter
450     !
460     ! Prompt user for P1 and P2 for plot.
470     !
480     INPUT "Enter P1X, P1Y, P2X, P2Y : ",P1_x,P1_y,P2_x,P2_y
490     OUTPUT 705;"IP ";P1_x,P1_y,P2_x,P2_y;" "
500     !

```

## Programming Examples

### PLOT\_CTRL

```

501     DISP "Plotting"
510     OUTPUT @Hp3589a;"PLOT:DUMP:ALL" ! Plot screen
520     CALL Passcntrl(@Hp3589a)
530     END LOOP
540     !
550     END
560     !
570     ! #####
580     !
590     SUB Setup_pass(@Hp3589a)
600     !
610     ! Setup the instrument for pass control.
620     ! Program the instrument to generate SRQ on OPERATION_COMPLETE. This
630     ! requires programming the STATUS BYTE and EVENT STATUS enable regs.
640     !
650     OUTPUT @Hp3589a;"*CLS"           !Clear the registers
660     OUTPUT @Hp3589a;"*ESE 1"       !Bit 1 = OPERATION_COMPLETE
670     OUTPUT @Hp3589a;"*SRE 32"     !Bit 5 = EVENT_STATUS
680     OUTPUT @Hp3589a;"*PCB 21"     !Set up Pass control back address
690     SUBEND
700     !
710     ! #####
720     !
730     SUB Passcntrl(@Hp3589a)
740     !
750     ! Passes control to the analyzer and waits
760     ! for control to be passed back
770     !
780     ! The instrument is to be setup by SUB Setup_pass.
790     !
800     Scode=7
810     ON INTR Scode GOTO Srq_handler !Set up interrupt branching
820     ENABLE INTR Scode;2           !Enable interrupt on SRQ
830     !
840     OUTPUT @Hp3589a;"*OPC"       !Set OPC bit when everything complete
850     PASS CONTROL @Hp3589a       !Give control of the bus to the 3589A
860     !
870     Wait_here:WAIT .5             !Wait for OPC to generate an interrupt
880     GOTO Wait_here
890     !
900     Srq_handler:                 !If there's an interrupt, then
910     !Control was passed back
920     Status_byte=SPOLL(@Hp3589a)
930     IF BINAND(Status_byte,64) THEN !HP3589A is requesting service
940     OUTPUT @Hp3589a;"*CLS"       !Clear all event registers
950     ELSE                           !It wasn't the HP3589A
960     DISP "UNKNOWN SRQ. Press CONTINUE to continue program."
970     BEEP
980     PAUSE
990     DISP " "
1000    END IF
1010    SUBEND
1020    !

```

## Introduction to the Command Reference

---

The command reference chapters describe all of the HP 3589A's SCPI commands. The command descriptions have the following things in common:

- A brief description of the command. This one- or two-line description appears just below the heading.
- A syntax description. This consists of one or two fields, depending on whether the command has just a command form, just a query form, or both. It shows you the syntax expected by the analyzer's SCPI command parser.
- Example statements. This field appears at the end of the first syntax description. It contains two HP BASIC output statements that use the command.
- A returned format description. This field is only used if the command has a query form. It tells you how data is returned in response to the query.
- An attribute summary. This field defines the command's preset state. It also defines attributes that affect command synchronization. (See "Synchronization" in chapter 2 for more information.)
- A detailed description. This field contains information that will help you use the command more efficiently.

## Finding the Right Command

If you are looking for a command you've seen in a program, remember that commands can omit implied mnemonics. For example, the command `SENSe:FREQUency:CENTer 10 MHZ` contains the implied mnemonic `SENSe`. But `SENSe` can be omitted to create the equivalent command `FREQUency:CENTer 10 MHZ`. (See "Implied Mnemonics" in chapter 2.)

You will not find an entry for `FREQUency:CENTer`—or any other command that omits an implied mnemonic—in the command reference. If you don't find a command where you expect it, try scanning the command list in appendix A for the equivalent command that contains the implied mnemonic. After you locate the equivalent command, you can find its description in one of the command reference chapters.

If you are looking for a command that accesses a particular function, use the index. For example, if you want to find the command that changes the analyzer's center frequency, look for "center frequency" in the index. It sends you to the page that describes the `SENSe:FREQUency:CENTer` command.

## Conventions

Syntax and returned format descriptions use the following conventions:

- `< >` Angle brackets enclose the names of syntactic items that need further definition. The definition will be included in accompanying text.
- `::=` “is defined as” When two items are separated by this symbol, the second item can replace the first in any statement that contains the first item. For example, `A::=B` indicates that B can replace A in any statement that contains A.
- `|` “or” When items in a list are separated by this symbol, one and only one of the items can be chosen from the list. For example, `A|B` indicates that A or B can be chosen, but not both.
- `...` An ellipsis (trailing dots) is used to indicate that the preceding element may be repeated one or more times.
- `[ ]` Square brackets indicate that the enclosed items are optional.
- `{ }` Braces are used to group items into a single syntactic element. They are most often used to enclose lists and to enclose elements that are followed by an ellipsis.

In addition, the case of letters in the command mnemonics is significant. Mnemonics that are longer than four characters can have a short form or a long form. The analyzer accepts either form. Upper-case letters show the short form of a command mnemonic. For more information, see “Command Abbreviation” in chapter 3.



## Common Commands

---

This chapter contains all of the IEEE 488.2 common commands that are implemented in the HP 3589A. An important property of all common commands is that you can send them without regard to a program message's position in the command tree. For more information on the analyzer's command tree, see chapter 3.



**\*CAL?**

**query**

Calibrates the analyzer and returns the result.

**Query Syntax:**            \*CAL?

**Example Statements:**      Output 719; "\*CAL?"

                                 Output 719; "\*cal?"

**Return Format:**            +{0|1}

**Attribute Summary:**      Preset state: not applicable  
                                 Overlapped: no  
                                 Pass control required: no  
                                 SCPI Compliance: confirmed (1991.0)

**Description:**

The analyzer performs a full calibration when you send this query. If the calibration completes without error, the analyzer returns 0. If the calibration fails, the analyzer returns 1.

This query is the same as the CAL:ALL? query.

---

**\*CLS****command**

Clears the Status Byte by emptying the error queue and clearing all event registers.

**Command Syntax:** \*CLS

**Example Statements:** Output 719;"\*Cls"  
Output 719;"\*CLS"

**Attribute Summary:** Preset state: not applicable  
Overlapped: no  
Pass control required: no  
SCPI Compliance: instrument-specific

**Description:**

This command clears the Status Byte register. It does so by emptying the error queue and clearing (setting to 0) all bits in the event registers of the following register sets:

- User Event.
- Device State.
- Questionable Power.
- Questionable Frequency.
- Limit Fail.
- Questionable Data.
- Event Status.
- Standard Operation.

In addition, \*CLS cancels any preceding \*OPC command or query. This ensures that bit 0 of the Standard Event register will not be set to 1 and that no response will be placed in the analyzer's output queue when pending overlapped commands are completed.

\*CLS does not change the current state of enable registers or transition filters.

---

**Note**

To guarantee that the Status Byte's Message Available and Master Summary Status bits will be cleared, send \*CLS immediately following a Program Message Terminator.

---

See chapter 5 for more information on the Status Byte register.

**\*ESE**

command/query

Sets bits in the Standard Event enable register.

**Command Syntax:**        \*ESE (<number>|<bound>)

<number> ::= an integer (NRf data)  
          limits: 0:255

<bound> ::= MAX|MIN

Example Statements:        Output 719;"\*ese 1"  
                              Output 719;"\*Ese 64"

**Query Syntax:**         \*ESE?

**Return Format:**        <number>

<number> ::= an integer (NRl data)

**Attribute Summary:**    Preset state: not affected by Preset  
                              Overlapped: no  
                              Pass control required: no  
                              SCPI Compliance: confirmed (1991.0)

**Description:**

This command allows you to set bits in the Standard Event enable register. Assign a decimal weight to each bit you want set (to 1) according to the following formula:

$$2^{(\text{bit\_number})}$$

with acceptable values for bit\_number being 0 through 7. Then add the weights and send the sum with this command.

When an enable register bit is set to 1, the corresponding bit of the Standard Event event register is enabled. All enabled bits are logically ORed to create the Standard Event summary, which reports to bit 5 of the Status Byte. Bit 5 is only set to 1 if both of the following are true:

- One or more bits in the Standard Event event register are set to 1.
- At least one set bit is enabled by a corresponding bit in the Standard Event enable register.

The setting last specified with \*ESE is saved in nonvolatile memory. It can be recalled at power-up, depending on the setting of the Power-on Status Clear flag (set with \*PSC). When the flag is 0 at power-up, all bits in the Standard Event enable register are set according to the saved \*ESE value. When the flag is 1 at power-up, all bits in the Standard Event enable register are initialized to 0.

The query returns the current state of the Standard Event enable register. The state is returned as a sum of the decimal weights of all set bits.

For more information on the Standard Event register set, see chapter 5.

**\*ESR?****query**

Reads and clears the Standard Event event register.

**Query Syntax:**           \*ESR?

**Example Statements:**     Output 719; "\*ESR?"  
                              Output 719; "\*esr?"

**Return Format:**           <number>

<number> ::= an integer (NR1 data)  
                  limits: 0:255

**Attribute Summary:**     Preset state: undefined value  
                              Overlapped: no  
                              Pass control required: no  
                              SCPI Compliance: confirmed (1991.0)

**Description:**

This query returns the current state of the Standard Event event register. The state is returned as a sum of the decimal weights of all set bits. The decimal weight for each bit is assigned according to the following formula:

$$2^{(\text{bit\_number})}$$

with acceptable values for bit\_number being 0 through 7.

The register is cleared after being read by this query.

A bit in this register is set to 1 when the condition it monitors becomes true. A set bit remains set, regardless of further changes in the condition it monitors, until one of the following occurs:

- You read the register with this query.
- You clear all event registers with the \*CLS command.

For more information on the Standard Event register set, see chapter 5.

**\*IDN?**

**query**

Returns a string that uniquely identifies the analyzer.

**Query Syntax:**            \*IDN?

**Example Statements:**       Output 719; "\*Idn?"  
                              Output 719; "\*IDN?"

**Return Format:**            <company>, <model>, <serial\_num>, 0"

    <company> ::= HEWLETT-PACKARD  
    <model>   ::= 3589A  
    <serial\_num> ::= 10 ASCII characters

**Attribute Summary:**       Preset state: instrument-dependent  
                              Overlapped: no  
                              Pass control required: no  
                              SCPI Compliance: confirmed (1991.0)

**Description:**

The response to this query uniquely identifies your analyzer.

**\*OPC****command/query**

Tells you when all pending overlapped commands have been completed.

**Command Syntax:** \*OPC

**Example Statements:** Output 719; "\*opc"  
Output 719; "\*Opc?"

**Query Syntax:** \*OPC?

**Return Format:** +1

**Attribute Summary:** Preset state: not applicable  
Overlapped: no  
Pass control required: no  
SCPI Compliance: confirmed (1991.0)

**Description:**

Some commands are processed sequentially by the analyzer. A sequential command holds off the processing of subsequent commands until it has been completely processed. However, most commands do not hold off the processing of subsequent commands; they are referred to as overlapped commands.

The analyzer uses the No Pending Operation (NPO) flag to keep track of overlapped commands that are still pending (that is, not completed). The NPO flag is reset to 0 when an overlapped command is pending. It is set to 1 when no overlapped commands are pending. You cannot read the NPO flag directly, but you can use \*OPC and \*OPC? to tell when the flag is set to 1.

If you use \*OPC, bit 0 of the Event Status event register is set to 1 when the NPO flag is set to 1. This allows the analyzer to generate a service request when all pending overlapped commands are completed (assuming you have enabled bit 0 of the Event Status register and bit 5 of the Status Byte register).

If you use \*OPC?, 1 is placed in the output queue when the NPO flag is set to 1. This allows you to effectively pause the controller until all pending overlapped commands are completed. It must wait until the response is placed in the queue before it can continue.

**Note**

The \*CLS and \*RST commands cancel any preceding \*OPC command or query. Pending overlapped commands are still completed, but you can no longer determine when. Two HP-IB bus management commands—Device Clear (DCL) and Selected Device Clear (SDC)—also cancel any preceding \*OPC command or query.

**\*PCB****command**

Sets the pass-control-back address.

**Command Syntax:**       \*PCB <number\_1>[,<number\_2>]

<number\_1> ::= MAX|MIN|an integer (NRf data)  
              limits: 0:30

<number\_2> ::= MAX|MIN|an integer (NRf data)  
              limits: 0:30

**Example Statements:**       Output 719; "\*PCB 21"  
                              Output 719; "\*pcb 17"

**Attribute Summary:**       Preset state: not affected by Preset  
                              Overlapped: no  
                              Pass control required: no  
                              SCPI Compliance: confirmed (1991.0)

**Description:**

Use this command to specify the address of your controller before you pass control of the HP-IB to the analyzer. When the analyzer completes the operation that required it to have control of the bus, it automatically passes control back to the controller at the specified address.

The optional second number is only used for controllers that support extended addressing. It is interpreted as the secondary address of the controller.

The address last specified with this command is saved in nonvolatile memory, so it is unaffected when you turn the analyzer off and on. It is also unaffected by the \*RST command.





**\*RST**

**command**

Executes a device reset.

**Command Syntax:**        \*RST

**Example Statements:**      Output 719;"\*rst"  
                              Output 719;"\*Rst"

**Attribute Summary:**      Preset state: not applicable  
                              Overlapped: yes  
                              Pass control required: no  
                              SCPI Compliance: instrument-specific

**Description:**

This command returns the analyzer to its preset state. In addition, it cancels any pending \*OPC command or query.

---

**Note**



The preset state of each parameter is listed under the Attribute Summary of the associated command.

---

The following are not affected by this command:

- The state of the Power-on Status Clear flag.
- The state of all enable and transition registers.
- The HP-IB input and output queues.
- The time and date (SYST:TIME and SYST:DATE).
- The HP-IB address settings (SYST:COMM:GPIB:ADDR, PLOT:ADDR, and PRIN:ADDR).
- The HP-IB controller capability setting.
- The default disk selection (MMEM:MSI).
- Contents of limit, data, function, and constant registers.
- Contents of the RAM disks.
- Calibration constants.

**\*SRE****command/query**

Sets bits in the Service Request enable register.

**Command Syntax:**        \*SRE {<number>|<bound>}

<number> ::= an integer (NRf data)  
                  limits: 0:255

<bound> ::= MAX|MIN

**Example Statements:**        Output 719;"\*SRE 12"  
                                  Output 719;"\*sre 4"

**Query Syntax:**            \*SRE?

**Return Format:**            <number>

<number> ::= an integer (NR1 data)

**Attribute Summary:**        Preset state: not affected by Preset  
                                  Overlapped: no  
                                  Pass control required: no  
                                  SCPI Compliance: confirmed (1991.0)

**Description:**

This command allows you to set bits in the Service Request enable register. Assign a decimal weight to each bit you want set (to 1) according to the following formula:

$$2^{(\text{bit\_number})}$$

with acceptable values for bit\_number being 0 through 7. Then add the weights and send the sum with this command.

**Note**

The analyzer ignores the setting you specify for bit 6 of the Service Request enable register. This is because the corresponding bit of the Status Byte register is always enabled.

## Common Commands

The analyzer requests service from the active controller when one of the following occurs:

- A bit in the Status Byte register changes from 0 to 1 while the corresponding bit of the Service Request enable register is set to 1.
- A bit in the Service Request enable register changes from 0 to 1 while the corresponding bit of the Status Byte register is set to 1.

The setting last specified with \*SRE is saved in nonvolatile memory. It can be recalled at power-up, depending on the setting of the Power-on Status Clear flag (set with \*PSC). When the flag is 0 at power-up, all bits in the Service Request enable register are set according to the saved \*SRE value. When the flag is 1 at power-up, all bits in the Service Request enable register are initialized to 0.

The query returns the current state of the Service Request enable register. The state is returned as a sum of the decimal weights of all set bits.

**\*STB?****query**

Reads the Status Byte register.

**Query Syntax:**           \*STB?

**Example Statements:**      Output 719; "\*Stb?"  
                              Output 719; "\*STB?"

**Return Format:**           <number>

<number> ::= an integer (NR1 data)  
                  limits: 0:255

**Attribute Summary:**      Preset state: undefined value  
                              Overlapped: no  
                              Pass control required: no  
                              SCPI Compliance: confirmed (1991.0)

**Description:**

This query returns the current state of the Status Byte register. The state is returned as a sum of the decimal weights of all set bits. The decimal weight for each bit is assigned according to the following formula:

$$2^{(\text{bit\_number})}$$

with acceptable values for bit\_number being 0 through 7.

The register is not cleared by this query. To clear the Status Byte register, you must send the \*CLS command.

Bits in the Status Byte register are defined as follows:

- Bit 0 summarizes all enabled bits of the User Status event register.
- Bit 1 is reserved.
- Bit 2 summarizes all enabled bits of the Device State event register.
- Bit 3 summarizes all enabled bits of the Questionable Data event register.
- Bit 4 is the Message Available (MAV) bit. It is set whenever there is something in the analyzer's output queue.
- Bit 5 summarizes all enabled bits of the Event Status event register.
- Bit 6, when read with this query (\*STB?), acts as the Master Summary Status (MSS) bit. It summarizes all enabled bits of the Status Byte register. (Bit 6 acts as the Request Service (RQS) bit when it is read by a serial poll.)
- Bit 7 summarizes all enabled bits of the Standard Operation event register.

For more information on the Status Byte register, see chapter 5.

**\*TRG**

**command**

Triggers the analyzer if TRIG:SOUR is BUS.

**Command Syntax:**       \*TRG

**Example Statements:**     Output 719;"\*trg"  
                              Output 719;"\*Trg"

**Attribute Summary:**     Preset state: not applicable  
                              Overlapped: no  
                              Pass control required: no  
                              SCPI Compliance: confirmed (1991.0)

**Description:**

This command triggers the analyzer if the following two conditions are met:

- The HP-IB is designated as the trigger source. (Send the TRIG:SOUR BUS command.)
- The analyzer is waiting to trigger. (Bit 5 of the Standard Operation condition register must be set.)

The \*TRG command has the same effect as TRIG:IMM. It also has the same effect as the HP-IB bus management command Group Execute Trigger (GET) with the following exception: \*TRG is sent to the input queue and processed in the order received, but GET is processed immediately, even if the input queue contains other commands.

See the programming example TRIGGERING for correct useage of trigger with synchronization.

---

**\*TST?****query**

Tests the analyzer hardware and returns the result.

**Query Syntax:**            \*TST?

**Example Statements:**    Output 719; "\*TST?"  
                              Output 719; "\*tst?"

**Return Format:**            +(0|1)

**Attribute Summary:**    Preset state: not applicable  
                              Overlapped: no  
                              Pass control required: no  
                              SCPI Compliance: confirmed (1991.0)

**Description:**

The analyzer's self-test performs a full calibration and then compares the resulting trace to specified limits. If the trace is within the limits, the analyzer returns 0. If the trace exceeds the limits, the analyzer returns 1.

**\*WAI**

**command**

Holds off processing of subsequent commands until all preceding commands have been processed.

**Command Syntax:**        \*WAI

**Example Statements:**     Output 719; "\*WAI"  
                              Output 719; "\*wai"

**Attribute Summary:**     Preset state:  not applicable  
                              Overlapped:   no  
                              Pass control required:  no  
                              SCPI Compliance:  confirmed (1991.0)

**Description:**

Some commands are processed sequentially by the analyzer. A sequential command holds off the processing of any subsequent commands until it has been completely processed. However, most commands do not hold off the processing of subsequent commands; they are referred to as overlapped commands. \*WAI ensures that overlapped commands will be completely processed before subsequent commands (those sent after \*WAI) are processed.

## **ABORt Subsystem**

---

This subsystem contains a single command—ABORt—which is used to immediately stop the current measurement.



---

**ABORt****command**

Immediately stops the measurement in progress and starts a new one.

**Command Syntax:** ABORt

Example Statements:      Output 719;"Abort"  
                              Output 719;"ABOR"

**Attribute Summary:**    Preset state: not applicable  
                              Overlapped: yes  
                              Pass control required: no  
                              SCPI Compliance: confirmed (1991.0)

**Description:**

This command aborts any measurement in progress. It does not affect the value of INIT:CONT. As a result, ABOR has the same effect as SENS:REST—it aborts the current measurement *and* starts a new one.

Both ABOR and SENS:REST serve a special synchronizing function. When you send either of these program messages to restart a measurement, the analyzer's No Pending Operation (NPO) flag is not set to 1 until the measurement is complete. The three methods that test the state of this flag—\*WAI, \*OPC, and \*OPC?—allow you to hold off subsequent actions until the measurement is complete. See "Synchronization" in chapter 2 for more information on the NPO flag.

---

**Note**

When video averaging is enabled (AVER:TYPE RMS and AVER:STAT ON), the NPO flag is not set to 1 until *n* measurements have been combined into one trace. You specify the value of *n* with the AVER:COUN command.

---

## ARM Subsystem

---

The ARM subsystem contains two commands that control the analyzer's trigger arming functions. One command selects the type of arming (automatic or manual). The other command arms the trigger (when manual arming is selected). See the TRIGger subsystem for commands that control other trigger functions.

**ARM[:IMMEDIATE]**

**command**

Arms the trigger if ARM:SOUR is MAN.

**Command Syntax:** ARM[:IMMEDIATE]

**Example Statements:** Output 719;"arm"  
Output 719;"Arm:Imm"

**Attribute Summary:** Preset state: not applicable  
Overlapped: yes  
Pass control required: no  
SCPI Compliance: confirmed (1991.0)

**Description:**

Two conditions must be met before this command can arm the trigger:

- Manual arming must be selected (ARM:SOUR is MAN).
- Bit 1 (Settling) *or* bit 6 (Waiting for ARM) of the Standard Operation condition register must be set to 1.

ARM:IMM is ignored at all other times.

See the programming example THD for correct usage of manual arming with synchronization.

---

**ARM:SOURce****command/query**

Specifies whether arming is automatic or manual.

**Command Syntax:** ARM:SOURce {IMMEDIATE|MANual}

**Example Statements:** Output 719;"ARM:SOURCE IMMEDIATE"  
Output 719;"arm:sour man"

**Query Syntax:** ARM:SOURce?

**Return Format:** IMM|MAN

**Attribute Summary:** Preset state: IMM  
Overlapped: yes  
Pass control required: no  
SCPI Compliance: confirmed (1991.0)

**Description:**

Send IMM to select automatic arming. Send MAN to select manual arming.

When automatic arming is selected, the analyzer waits for the hardware to settle, and then waits for a trigger signal (specified by TRIG:SOUR) before starting a measurement. When manual arming is selected, the analyzer waits for the hardware to settle, waits for ARM:IMM, and then waits for a trigger signal before starting a measurement.

---

**Note**

If you send ARM:SOUR MAN and TRIG:SOUR IMM, then you can use ARM:IMM to trigger a single sweep.

---

See the programming example TRIGGERING for correct useage of trigger with synchronization.



## CALCulate Subsystem

---

The CALCulate subsystem contains commands that control the processing of measurement data. The commands let you select a coordinate system for display of the measurement data, define trace math functions and constants, and dump coordinate transformed data to your controller. The following block diagram shows you how measurement data is processed:

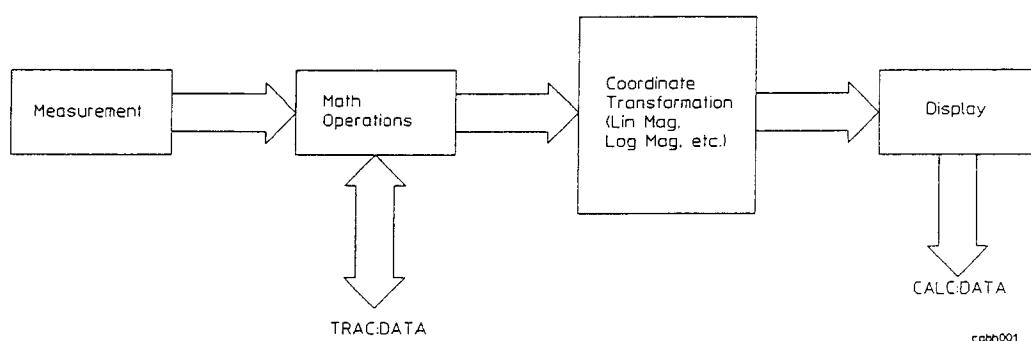

**Figure 11-13. Flow of Measurement Data**

After measurement data is collected, any specified math operations are performed. Data is then transformed into the specified coordinate system and sent to the display. TRAC:DATA gives you access to the raw measurement data after math operations have been performed. CALC:DATA gives you access to the display data—after the coordinate transformation.

---

### Note



You can take measurement data out of the analyzer with either TRAC:DATA or CALC:DATA, but you can only put it back into the analyzer with TRAC:DATA.

---

The CALCulate mnemonic contains an optional trace specifier: [1|2]. To direct a command to trace A, omit the specifier or use 1. To direct a command to trace B, use 2. Commands that are not trace-specific—like CALC:MATH:EXPR (define a math expression)—ignore the specifier.

**CALCulate[1|2]:DATA?****query**

Returns trace data that is transformed to the current coordinate system (CALC:FORM).

**Query Syntax:** CALCulate[1|2]:DATA?

**Example Statements:** Output 719;"calc2:data?"  
Output 719;"Calculatel:Data?"

**Return Format:** <block>

When data is ASCII-encoded, (FORM ASC) <block> takes the following form:

```
<block> ::= <point>{,<point>}...
<point> ::= y-axis value for 1 of the 401 points that make up a
           trace OR a <RE,IM> pair for 1 of the 401 points that
           make up a polar or Smith Chart trace
           limits: -9.9E37:9.9E37
```

When data is binary-encoded, (FORM REAL) <block> takes the following form:

```
<block> ::= #<byte><length_bytes>{<point>}...
<byte>  ::= one ASCII-encoded byte specifying the number of length
           bytes to follow
<length_bytes> ::= ASCII-encoded bytes specifying the number of data
           bytes to follow
<point> ::= y-axis value for 1 of the 401 points that make up a
           trace OR a <RE,IM> pair for 1 of the 401 points that
           make up a polar or Smith Chart trace
           limits: -9.9E37:9.9E37
```

**Attribute Summary:** Preset state: not applicable  
Overlapped: no  
Pass control required: no  
SCPI Compliance: confirmed (1991.0)

**Description:**

This query returns a block of coordinate-transformed trace data.

For all trace types except polar and Smith Chart, the block is returned as a series of 401 amplitude values. The unit for these values is the same as the reference level unit (returned with DISP:Y:RLEV? UNIT).

For polar and Smith Chart traces, 802 values are returned; 401 pairs of real and imaginary numbers in the order: real,imaginary,real, ...

You cannot return trace data to the display with CALC:DATA, because it has no command form. Use TRAC:DATA if you want to read and write trace data. (See the introduction to this chapter for more information.)

**CALCulate[1|2]:DCONvert:AOFFSET****command/query**

Specifies a constant amplitude adjustment for down-converted signals.

**Command Syntax:** CALCulate[1|2]:DCONvert:AOFFSET <param>

<param> ::= {<number>[<unit>]}|<step>|<bound>  
 <number> ::= a real number (NRf data)  
           limits: -300.0:300.0  
 <unit> ::= DB  
 <step> ::= UP|DOWN  
 <bound> ::= MAX|MIN

**Example Statements:** Output 719;"CALC:DCON:AOFFSET -3"  
 Output 719;"calc:dconvert:aoff 19 db"

**Query Syntax:** CALCulate[1|2]:DCONvert:AOFFSET?[UNIT]

**Return Format:** <number>|("<unit>")

<number> ::= a real number (NR2 data)  
 <unit> ::= unit that applies to the returned number

**Attribute Summary:** Preset state: +0.00E+0DB  
 Overlapped: yes  
 Pass control required: no  
 SCPI Compliance: instrument-specific

**Description:**

The value sent is used to adjust the amplitude of the displayed trace data. The adjustment is not applied when the analyzer is in the swept network mode, i.e., INST:SEL is NETW.



---

**CALCulate[1|2]:DCONvert:AXIS****command/query**

Selects between normal and reversed (mirrored) y-axis annotation for down-converted signals.

**Command Syntax:** CALCulate[1|2]:DCONvert:AXIS (MIRRor|NORMal)

**Example Statements:** Output 719;"Calc:Dconvert:Axis Mirror"  
Output 719;"CALCULATE2:DCON:AXIS NORM"

**Query Syntax:** CALCulate[1|2]:DCONvert:AXIS?

**Return Format:** MIRR|NORM

**Attribute Summary:** Preset state: NORM  
Overlapped: yes  
Pass control required: no  
SCPI Compliance: instrument-specific

**Description:**

If a trace is saved or transferred to a controller when MIRR is selected, the order of points in the trace will be reversed. MIRR has no effect when the analyzer is in swept network mode, i.e. INST:SEL is NETW.

**CALCulate[1|2]:DCONvert:FREQUENCY:CENTer****command/query**

Specifies a down-converted signal's center frequency.

**Command Syntax:** CALCulate[1|2]:DCONvert:FREQUENCY:CENTer <param>

```

<param> ::= (<number>[<unit>])|<step>|<bound>
<number> ::= a real number (NRf data)
             limits: 0:9.9E37
<unit> ::= HZ
<step> ::= UP|DOWN
<bound> ::= MAX|MIN

```

**Example Statements:** Output 719;"calculate2:dcon:frequency:cent 1.2 ghz"  
Output 719;"Calc:Dconvert:Freq:Center 0"

**Query Syntax:** CALCulate[1|2]:DCONvert:FREQUENCY:CENTer?

**Return Format:** NR3

**Attribute Summary:** Preset state: +1.00E+9 Hz  
Overlapped: yes  
Pass control required: no  
SCPI Compliance: instrument-specific

**Description:**

The value sent is used to adjust the display's y-axis annotation when y-axis annotation adjustments for down-converted signals is enabled (CALC:DCON:FREQ:STAT is USER) and the analyzer is in swept spectrum or narrowband zoom mode (INST:SEL is SPEC or FFT). The frequency adjustment only affects display annotation; it doesn't affect the frequency values of a trace that is saved or transferred to a controller.

**CALCulate[1|2]:DCONvert:FREQUENCY:STATE****command/query**

Enables and disables y-axis annotation adjustments for down-converted signals.

**Command Syntax:** CALCulate[1|2]:DCONvert:FREQUENCY:STATE {USER|NORMal}

**Example Statements:** Output 719;"CALC:DCON:FREQUENCY:STAT USER"  
Output 719;"calculate:dcon:freq:state normal"

**Query Syntax:** CALCulate[1|2]:DCONvert:FREQUENCY:STATE?

**Return Format:** USER|NORM

**Attribute Summary:** Preset state: NORM  
Overlapped: yes  
Pass control required: no  
SCPI Compliance: instrument-specific

**Description:**

When you send CALC:DCON:FREQ:STAT:USER, the analyzer adjusts y-axis annotation by an amount equal to

$$\text{user} - \text{actual}$$

Where user is the value of the user-specified, down-converted signal's center frequency (CALC:DCON:FREQ:CENT) and actual is the value of the analyzer's center frequency (SENS:FREQ:CENT).

The setting of this parameter is ignored if INST:SEL is NETW.



**CALCulate[1|2]:FORMat:PHASe:PREFereNce****command/query**

Sets the upper phase limit of a wrapped-phase trace.

**Command Syntax:**      CALCulate[1|2]:FORMat:PHASe:PREFereNce  
                           (<value>|<step>|<bound>)

<value> ::= <number>[<unit>]  
 <number> ::= a real number (NRf data)  
                   limits: -360.0:360.0  
 <unit> ::= DEG|RAD  
 <step> ::= UP|DOWN  
 <bound> ::= MAX|MIN

**Example Statements:**      Output 719;"calculate:format:phase:preference -360"  
                                   Output 719;"Calc2:Form:Phas:Pref -360"

**Query Syntax:**            CALCulate[1|2]:FORMat:PHASe:PREFereNce? [UNIT]

**Return Format:**            <number>|{"<unit>"}

<number> ::= a real number (NR2 or NR3 data)  
 <unit> ::= unit that applies to returned number

**Attribute Summary:**      Preset state: +1.80E+2 DEG  
                                   Overlapped: yes  
                                   Pass control required: no  
                                   SCPI Compliance: instrument-specific

**Description:**

The value sent with this command is used only if the trace coordinate system is phase (CALC:FORM is PHAS). If the trace coordinate system type is unwrapped phase (CALC:FORM is UPH), the phase value is ignored.

**CALCulate[1|2]:FORMat:PHASe:SLOPe****command/query**

Adjusts the slope of a phase trace.

**Command Syntax:** CALCulate[1|2]:FORMat:PHASe:SLOPe {<value>|<step>|<bound>}

<value> ::= <number>[<unit>]  
 <number> ::= a real number (NRf data)  
           limits: -72000.0:72000.0  
 <unit> ::= DEG|RAD  
 <step> ::= UP|DOWN  
 <bound> ::= MAX|MIN

**Example Statements:**      Output 719;"CALC:FORM:PHAS:SLOP -72000"  
                               Output 719;"calculate:format:phase:slope -72000"

**Query Syntax:** CALCulate[1|2]:FORMat:PHASe:SLOPe? [UNIT]**Return Format:** <number>|{"<unit>"}

<number> ::= a real number (NR2 or NR3 data)  
 <unit> ::= unit that applies to returned number

**Attribute Summary:**    Preset state: +0.00E+0 DEG  
                           Overlapped: yes  
                           Pass control required: no  
                           SCPI Compliance: instrument-specific

**Description:**

The phase of each trace point is adjusted according to the following formula:

$$\text{phase}(n) = n/400 \times \text{slope}$$

where:            phase(n) is the phase added to point n  
                   n is the point number  
                   slope is the value of CALC:FORM:PHAS:SLOP

The value sent with this command is used only if the trace coordinate system type is either phase or unwrapped phase (CALC:FORM is PHAS or UPH) and the phase slope is turned on (CALC:FORM:PHAS:SLOP:STAT is ON).

**CALCulate[1|2]:FORMat:PHASe:SLOPe:STATe**

**command/query**

Turns phase slope adjustments on and off.

**Command Syntax:**        CALCulate[1|2]:FORMat:PHASe:SLOPe:STATe {OFF|0|ON|1}

**Example Statements:**    Output 719;"Calculate:Format:Phase:Slope:State Off"  
                              Output 719;"CALC2:FORM:PHAS:SLOP:STATE 1"

**Query Syntax:**         CALCulate[1|2]:FORMat:PHASe:SLOPe:STATe?

**Return Format:**         +{0|1}

**Attribute Summary:**    Preset state:    +0  
                              Overlapped:    yes  
                              Pass control required: no  
                              SCPI Compliance: instrument-specific

**Description:**

The analyzer uses the value of CALC:FORM:PHAS:SLOP to adjust the slope of a phase trace only if the phase slope is on (CALC:FORM:PHAS:SLOP:STAT is ON).

---

**CALCulate[1|2]:FORMat:PHASe:WRAP****command/query**

Turns phase wrap adjustments on and off.

**Command Syntax:** CALCulate[1|2]:FORMat:PHASe:WRAP {OFF|0|ON|1}

**Example Statements:** Output 719;"calc:form:phas:wrap 0"  
Output 719;"Calculate:Format:Phase:Wrap On"

**Query Syntax:** CALCulate[1|2]:FORMat:PHASe:WRAP?

**Return Format:** +(0|1)

**Attribute Summary:** Preset state: +0  
Overlapped: yes  
Pass control required: no  
SCPI Compliance: instrument-specific

**Description:**

The analyzer uses the value of CALC:FORM:PHAS:PREF to adjust the upper limit of a phase trace only if the phase wrap is on (CALC:FORM:PHAS:WRAP is ON).

This command provides the same control as the PHASE WRAP ON/OFF softkey.  
The SCPI-compliant method uses CALC:FORM PHASE to turn phase wrap ON and CALC:FORM UPH to turn phase wrap OFF.



**CALCulate[1|2]:GDAPerture:APERture****command/query**

Selects an aperture for a group delay trace.

**Command Syntax:**      CALCulate[1|2]:GDAPerture:APERture  
                           {<value>|<step>|<bound>}

    <value> ::= <number>[PCT]  
     <number> ::= a real number (NRf data)  
                   limits: 0.5:16  
                   discrete values: 0.5, 1, 2, 4, 8, 16  
     <step> ::= UP|DOWN  
     <bound> ::= MAX|MIN

**Example Statements:**      Output 719;"CALCULATE2:GDAPERTURE:APERATURE 8"  
                               Output 719;"calc:gdap:aper 0.5 pct"

**Query Syntax:**            CALCulate[1|2]:GDAPerture:APERture? [UNIT]

**Return Format:**            <number>|{"PCT"}

    <number> ::= a real number (NR2 or NR3 data)

**Attribute Summary:**      Preset state: +5.00E-1 PCT  
                               Overlapped: yes  
                               Pass control required: no  
                               SCPI Compliance: confirmed (1991.0)

**Description:**

The value sent with this command is used only if trace type is group delay (CALC:FORM is GDEL).

**CALCulate[1|2]:MATH:CONStant:MPHase****command/query**

Loads a complex number into one of the constant registers as a magnitude/phase pair.

**Command Syntax:**        CALCulate[1|2]:MATH:CONStant:MPHase  
                          <const>,<mag>[,<phase>]

<const> ::= K1|K2|K3|K4|K5  
 <mag> ::= <number>|<bound>  
 <phase> ::= {<number>[DEG|RAD]}|<bound>  
 <number> ::= a real number (NRf data)  
                   limits: -9.9E37:9.9E37 (mag)  
                           -72000.0:72000.0 (phase)  
 <bound> ::= MAX|MIN

**Example Statements:**        Output 719;"Calculate2:Math:Constant:Mphase K1, 2, 45 Deg"  
                                   Output 719;"CALC:MATH:CONS:MPH K4, 5, -1.57 RAD"

**Query Syntax:**            CALCulate[1|2]:MATH:CONStant:MPHase? <const>

**Return Format:**            <number>,<number>

<number> ::= a real number (NR2 or NR3 data)

**Attribute Summary:**        Preset state: not affected by Preset  
                                   Overlapped: yes  
                                   Pass control required: no  
                                   SCPI Compliance: instrument-specific

**Description:**

To use a constant in a trace math function, you must first load it into one of the analyzer's five constant registers: K1 through K5. You can load it as a magnitude/phase pair with this command or as a real/imaginary command with the CALC:MATH:CONS:RIM command. You can then include the constant register's name at the appropriate place in your function definition. (Functions are defined with the CALC:MATH:EXPR command.)

When the analyzer is queried, magnitude is returned first, phase is second. The phase value returned is always in degrees.

**CALCulate[1|2]:MATH:CONSTant[:RIMaginary]****command/query**

Loads a complex number into one of the constant registers as a real/imaginary pair.

**Command Syntax:**        CALCulate[1|2]:MATH:CONSTant[:RIMaginary]  
                           <const>,<real>[,<imag>]

<const> ::= K1|K2|K3|K4|K5  
 <real> ::= <number>|<bound>  
 <imag> ::= <number>|<bound>  
 <number> ::= a real number (NRf data)  
                   limits: -9.9E37:9.9E37  
 <bound> ::= MAX|MIN

**Example Statements:**        Output 719;"Calc:Math:Cons:Rim K1,1.5,.2"  
                                   Output 719;"CALCULATE1:MATH:CONSTANT K5,1.414"

**Query Syntax:**            CALCulate[1|2]:MATH:CONSTant[:RIMaginary]? <const>

**Return Format:**            <number>,<number>

<number> ::= a real number (NR2 or NR3 data)

**Attribute Summary:**        Preset state: not affected by Preset  
                                   Overlapped: yes  
                                   Pass control required: no  
                                   SCPI Compliance: instrument-specific

**Description:**

To use a constant in a trace math function, you must first load it into one of the analyzer's five constant registers: K1 through K5. You can load it as a real/imaginary pair with this command or as a magnitude/phase command with the CALC:MATH:CONS:MPH command. You can then include the constant register's name at the appropriate place in your function definition. (Functions are defined with the CALC:MATH:EXPR command.)

When the analyzer is queried, the real number is returned first, imaginary is second.

**CALCulate[1|2]:MATH:DATA****command/query**

Loads a complete set of math definitions.

**Command Syntax:**        CALCulate[1|2]:MATH:DATA <block>

```

<block> ::= #<byte>[<length_bytes>]<data_bytes>
  <byte> ::= one ASCII-encoded byte specifying the number of length
             bytes to follow
<length_bytes> ::= ASCII-encoded bytes specifying the number of data
                  bytes to follow
  <data_bytes> ::= the bytes that make up a complete set of math
                  definitions

```

**Example Statements:**    Output 719;"calculate2:math:data?"  
                               Output 719;"Calc:Math:Data?"

**Query Syntax:**         CALCulate[1|2]:MATH:DATA?

**Return Format:**        <block>

**Attribute Summary:**    Preset state: not applicable  
                               Overlapped: yes  
                               Pass control required: no  
                               SCPI Compliance: instrument-specific

**Description:**

This command allows you to transfer a complete set of math definitions—the same information contained in a math file—between the analyzer and your controller. This allows you to store a set of math definitions on your controller's file system. The definitions cannot be altered.

When you transfer a set of math definitions to the analyzer, you can use either the definite or the indefinite length block syntax. When the analyzer returns the set to a controller, it always uses the definite length block syntax. See "Block Data" in chapter 4 for more information.

**CALCulate[1|2]:MATH[:EXPRession]****command/query**

Loads an expression into one of the constant registers.

**Command Syntax:** CALCulate[1|2]:MATH[:EXPRession] <func>,<expr>

```

<func> ::= F1|F2|F3|F4|F5
<expr> ::= ([<expr_element>]...)
<expr_element> ::= SPEC|<network>|(D1:D8)|<network_reg>|(K1:K5)|(F1:F5)|
                Sqrt(NBW)|JW|Sqrt|CONJ|( )|+|-|*|/
<network> ::= XMSN|REFL|VSWR|IMP|S11|S21|S12|S11
<network_reg> ::= D_NORM|D_1_REF|D_2_REF|D_S21_CAL|D_S12_CAL|D_S11_OC|
                D_S11_SC|D_S11_T|D_S22_OC|D_22_SC|D_22_T

```

**Example Statements:**

```

Output 719;"CALC:MATH F3,(Sqrt(SPEC*(CONJ(SPEC))))"
Output 719;"calculatel:math:expression f2,(refl*k2)"

```

**Query Syntax:** CALCulate[1|2]:MATH[:EXPRession]? <func>**Return Format:** "<expr>"

**Attribute Summary:**

```

Preset state: not affected by Preset
Overlapped: yes
Pass control required: no
SCPI Compliance: confirmed (1991.0)

```

**Description:**

Before you can obtain the results of a trace math function, you must load the function into one of the analyzer's five function registers: F1 through F5. Once you have loaded the function register with CALC:MATH:EXPR, select that function for trace data using DISP:RES. You can then take a measurement and obtain the results with either TRAC:DATA? (pre-coordinate transform) or CALC:DATA? (post-coordinate transform).

You define trace math functions using operands (SPEC, <network>, D1:D8, <network reg>, K1:K5, F1:F5, Sqrt(NBW)) and operators (+, -, \*, /, JW, Sqrt, CONJ). You combine these elements according to the rules of standard algebraic notation. Use parentheses to control the order of operations.

Refer to the help text for more information on trace math functions.

## CALibration Subsystem

---

The CALibration subsystem contains the commands that control the analyzer's self-calibration functions. You can initiate a single calibration or enable the autocalibration function. After calibration, you can display the calibration data for the active trace.

The data derived from the analyzer's self-calibration routine is used only to correct spectrum traces (INST:SEL is SWEP or FFT). You must complete the appropriate network calibrations (under SENS:CORR) to correct network traces.

This subsystem also contains a command that allows you to enable and disable the analyzer's oversweeping function.

---

**CALibration[:ALL]?****query**

Calibrates the analyzer and returns the result.

**Query Syntax:** CALibration[:ALL]?

**Example Statements:** Output 719;"Calibration:All?"  
Output 719;"CAL?"

**Return Format:** +{0|1}

**Attribute Summary:** Preset state: not applicable  
Overlapped: no  
Pass control required: no  
SCPI Compliance: confirmed (1991.0)

**Description:**

The analyzer performs a full calibration when you send this query. If the calibration completes without error, the analyzer returns 0. If the calibration fails, the analyzer returns 1.

This query is the same as the \*CAL? query.

---

**CALibration:AUTO****command/query**

Calibrates the analyzer or sets the state of the autocalibration function.

**Command Syntax:** CALibration:AUTO {OFF|0|ON|1|ONCE}

**Example Statements:** Output 719;"cal:auto 0"  
Output 719;"Calibration:Auto Off"

**Query Syntax:** CALibration:AUTO?

**Return Format:** +(0|1)

**Attribute Summary:** Preset state: +1  
Overlapped: yes  
Pass control required: no  
SCPI Compliance: confirmed (1991.0)

**Description:**

Send ON to enable the analyzer's autocalibration function, OFF to disable it. This function calibrates the analyzer several times during the first hour of operation and once per hour thereafter.

Send ONCE to initiate a single calibration.



**CALibration:CORRection:SRATe**

**command/query**

Turns oversweeping on and off.

**Command Syntax:** CALibration:CORRection:SRATe (OFF|0|ON|1)

**Example Statements:** Output 719;"CALIBRATION:CORRECTION:SRATE ON"  
Output 719;"cal:corr:srat 0"

**Query Syntax:** CALibration:CORRection:SRATe?

**Return Format:** +{0|1}

**Attribute Summary:** Preset state: +1  
Overlapped: yes  
Pass control required: no  
SCPI Compliance: instrument-specific

**Description:**

The analyzer provides calibrated measurement results for sweep rates at or below the following limits (given in Hz/s):

- Oversweep on:  $RBW^2 \times 2$
- Oversweep off:  $RBW^2 \div 2$

where RBW is the resolution bandwidth (setting of SENS:BAND:RES) in Hz.

---

**DIAGnostics:SOURce:PADA:TWENTy****command/query**

Switches the source's first 20 dB attenuator in and out.

**Command Syntax:**       DIAGnostics:SOURce:PADA:TWENTy {IN|OUT}

**Example Statements:**     Output 719;"DIAG:SOUR:PADA:TWEN OUT"  
                          Output 719;"diagnostics:source:pada:twenty in"

**Query Syntax:**         DIAGnostics:SOURce:PADA:TWENTy?

**Return Format:**         IN|OUT

**Attribute Summary:**    Preset state:   OUT  
                          Overlapped:   yes  
                          Pass control required: no  
                          SCPI Compliance: instrument-specific

**Description:**

Use this command only as directed in the *HP 3589A Performance Test Guide*.

---

**DIAGnostics:SOURce:PADB:TWENTy****command/query**

Switches the source's second 20 dB attenuator in and out.

**Command Syntax:**           DIAGnostics:SOURce:PADB:TWENTy {IN|OUT}

**Example Statements:**       Output 719;"Diagnostics:Source:Padb:Twenty In"  
                              Output 719;"DIAG:SOUR:PADB:TWEN OUT"

**Query Syntax:**             DIAGnostics:SOURce:PADB:TWENTy?

**Return Format:**            IN|OUT

**Attribute Summary:**       Preset state:   OUT  
                              Overlapped:   yes  
                              Pass control required: no  
                              SCPI Compliance: instrument-specific

**Description:**

Use this command only as directed in the *HP 3589A Performance Test Guide*.

## DISPlay Subsystem

---

DISPlay is one of two subsystems that control the analyzer's presentation of data on its front-panel display—the other is SCReen. DISPlay also allows you to define trace limits and control limit testing.

The DISPlay mnemonic contains an optional trace specifier: [1|2]. To direct a command to trace A, omit the specifier or use 1. To direct a command to trace B, use 2.

---

**DISPlay[1|2]:GRATicule****command/query**

Turns the trace graticules on and off.

**Command Syntax:** DISPlay[1|2]:GRATicule {OFF|0|ON|1}

**Example Statements:** Output 719;"disp2:grat OFF"  
Output 719;"Display:Graticule 0"

**Query Syntax:** DISPlay[1|2]:GRATicule?

**Return Format:** +(0|1)

**Attribute Summary:** Preset state: +1  
Overlapped: yes  
Pass control required: no  
SCPI Compliance: instrument-specific

**Description:**

When the graticules are turned off, they are not displayed on the analyzer's screen and they are not plotted or printed.

---

**DISPlay[1|2]:GRATICule:TYPE****command/query**

Selects the graticule type for polar displays.

**Command Syntax:** DISPlay[1|2]:GRATICule:TYPE {POLar|SCHart}

**Example Statements:** Output 719;"DISPLAY:GRATICULE:TYPE POLAR"  
Output 719;"disp2:grat:type sch"

**Query Syntax:** DISPlay[1|2]:GRATICule:TYPE?

**Return Format:** POL|SCH

**Attribute Summary:** Preset state: POL  
Overlapped: yes  
Pass control required: no  
SCPI Compliance: instrument-specific

**Description:**

POL selects the standard graticule for polar displays, SCH selects the Smith chart graticule.

The selection made with this command is used only if CALC:FORM is POL.

---

**DISPlay[1|2]:LABel****command/query**

Loads a title for the specified trace.

**Command Syntax:** DISPlay[1|2]:LABel <STRING>

**Example Statements:** Output 719;"Disp:Lab 'TP4, rev A.02'"  
Output 719;"DISPLAY:LABEL ''"

**Query Syntax:** DISPlay[1|2]:LABel?

**Return Format:** STRING

**Attribute Summary:** Option: not applicable  
Overlapped: yes  
Preset State: not applicable  
SCPI Compliance: instrument-specific

**Description:**

Trace titles appear above the upper-left corner of traces and can be up to 15 characters long. They replace the default trace titles supplied by the analyzer. You can delete a user-defined trace title by sending the null string ("") with this command; this causes the analyzer to display the default trace title.

---

**Note**

If you send \*RST or SYST:PRES, user-defined titles are automatically deleted, restoring the default titles for both traces.

---

---

**DISPlay[1|2]:LIMit:BEEP****command/query**

Turns the limit-fail beeper on and off.

**Command Syntax:** DISPlay[1|2]:LIMit:BEEP {OFF|0|ON|1}

**Example Statements:** Output 719;"disp:lim:beep 1"  
Output 719;"Display2:Limit:Beep Off"

**Query Syntax:** DISPlay[1|2]:LIMit:BEEP?

**Return Format:** +{0|1}

**Attribute Summary:** Preset state: +0 (both displays)  
Overlapped: yes  
Pass control required: no  
SCPI Compliance: instrument-specific

**Description:**

The limit-fail beeper emits an audible tone when all of the following conditions are met:

- analyzer's beeper is on (SYST:BEEP:STAT is ON).
- limit beeper is on (DISP:LIM:BEEP is ON).
- limit testing is on (DISP:LIM:STAT is ON).
- The trace falls outside its current limits.

You can use DISP:LIM:LOW:SEGM and DISP:LIM:UPP:SEGM to define a trace's current limits via the HP-IB.



---

**DISPlay[1|2]:LIMit:LINE****command/query**

Turns limit lines on and off for the specified trace.

**Command Syntax:** DISPlay[1|2]:LIMit:LINE {OFF|0|ON|1}

**Example Statements:** Output 719;"Displ:Lim:Line Off"  
Output 719;"DISPLAY:LIMIT:LINE 1"

**Query Syntax:** DISPlay[1|2]:LIMit:LINE?

**Return Format:** +{0|1}

**Attribute Summary:** Preset state: +0 (both displays)  
Overlapped: yes  
Pass control required: no  
SCPI Compliance: instrument-specific

**Description:**

Sending DISP:LIM:LINE ON only enables the display of limit lines in the specified trace. To test the trace against those limits, you must turn on limit testing by sending DISP:LIM:STAT ON.

---

**Note**

A trace can be evaluated against limits even when limit lines are not displayed.



---

You can use DISP:LIM:LOW:SEGM and DISP:LIM:UPP:SEGM to define limit lines via the HP-IB.

**DISPlay[1|2]:LIMit:LOWer:DATA****command/query**

Loads a complete lower limit line for the specified trace.

**Command Syntax:** DISPlay[1|2]:LIMit:LOWer:DATA <block>

<block> ::= #<byte>[<length\_bytes>]<data\_bytes>

<byte> ::= one ASCII-encoded byte specifying the number of length bytes to follow

<length\_bytes> ::= ASCII-encoded bytes specifying the number of data bytes to follow

<data\_bytes> ::= the bytes that make up a complete lower limit line

**Example Statements:** Output 719;"display2:limit:lower:data?"  
Output 719;"Disp:Lim:Low:Data?"

**Query Syntax:** DISPlay[1|2]:LIMit:LOWer:DATA?

**Return Format:** <block>

**Attribute Summary:** Preset state: not applicable  
Overlapped: yes  
Pass control required: no  
SCPI Compliance: instrument-specific

**Description:**

This command transfers a complete lower limit line—the same information contained in a lower limit file—between the analyzer and your controller. This allows you to store a complete lower limit on your controller's file system. The limit cannot be altered.

When you transfer a complete lower limit to the analyzer, you can use either the definite or the indefinite length block syntax. When the analyzer returns the limit to a controller, it always uses the definite length block syntax. See "Block Data" in chapter 4 for more information.

**DISPlay[1|2]:LIMit:LOWer:DELeTe**

**command**

Deletes the lower limit line from the specified trace.

**Command Syntax:** DISPlay[1|2]:LIMit:LOWer:DELeTe

**Example Statements:** Output 719;"DISPLAY1:LIMIT:LOWER:DELETE"  
Output 719;"disp2:lim:low:del"

**Attribute Summary:** Preset state: not applicable  
Overlapped: yes  
Pass control required: no  
SCPI Compliance: instrument-specific

**Description:**

To delete a lower limit, send DISP:LIM:LOW:DEL. To delete an upper limit, send DISP:LIM:UPP:DEL.

**DISPlay[1|2]:LIMit:LOWer:MOVE****command/query**

Moves the lower limit line up or down for the specified trace.

**Command Syntax:** DISPlay[1|2]:LIMit:LOWer:MOVE (<number>|<step>|<bound>)

<number> ::= a real number (NRf data)  
limits: -1.0E6:1.0E6

<step> ::= UP|DOWN

<bound> ::= MAX|MIN

**Example Statements:** Output 719;"DISPLAY1:LIMIT:LOWER:MOVE 3"  
Output 719;"disp:lim:low:move -12"

**Query Syntax:** DISPlay[1|2]:LIMit:LOWer:MOVE?

**Return Format:** <number>

<number> ::= a real number (NR2 or NR3 data)

**Attribute Summary:** Preset state: not affected by Preset  
Overlapped: yes  
Pass control required: no  
SCPI Compliance: instrument-specific

**Description:**

DISP:LIM:LOW:MOVE specifies a vertical offset for every segment in a lower limit. The offset is referenced to the limit's original y-axis position. The offset is unitless, so it assumes the current vertical/division unit (returned with DISP:Y:PDIV? UNIT).

**DISPlay[1|2]:LIMit:LOWer:REPort?****query**

Returns the frequency, amplitude, and failure value for all points failing the lower limit test.

**Query Syntax:** DISPlay[1|2]:LIMit:LOWer:REPort?

**Example Statements:** Output 719;"DISP2:LIM:LOW:REP?"  
Output 719;"display:limit:lower:report?"

**Return Format:** <block>

When data is ASCII-encoded, (FORM ASC) <block> takes the following form:

```
<block> ::= [<point>[,<point>]...]
<point> ::= <x-axis_value>,<y-axis_value>,<y-axis_offset>
```

When data is binary-encoded, (FORM REAL) <block> takes the following form:

```
<block> ::= #<byte><length_bytes>[<point>]...
<byte> ::= one ASCII-encoded byte specifying the number of length
           bytes to follow
<length_bytes> ::= ASCII-encoded bytes specifying the number of data
                  bytes to follow
<point> ::= <x-axis_value><y-axis_value><y-axis_offset>
```

The following definitions apply to both ASCII- and binary-encoded data.

```
<x-axis_value> ::= x-axis value of the failed point
                 limits: 0.0:150.0E6 (Hz)
<y-axis_value> ::= y-axis value(s) of the failed point (2 if complex)
                 limits: -9.9E37:9.9E37
<y-axis_offset> ::= y-axis offset from limit value(s) (2 if complex)
                 limits: -9.9E37:9.9E37
```

**Attribute Summary:** Preset state: not applicable  
Overlapped: no  
Pass control required: no  
SCPI Compliance: instrument-specific

**Description:**

The unit for returned y values is the same as the current reference level unit (returned with DISP:Y:RLEV UNIT). Y-axis values are complex numbers (1 real value and 1 imaginary value per point) for network data and real for all other. The unit for returned failure values is the same as the current vertical/division unit (returned with DISP:Y:PDIV? UNIT).

No data is returned if limit testing is disabled (DISP:LIM:STAT OFF) or if all trace points are above the specified lower limit.

**DISPlay[1|2]:LIMit:LOWer:SEGment****command/query**

Loads one or more segments of a lower limit line for the specified trace.

**Command Syntax:** DISPlay[1|2]:LIMit:LOWer:SEGment <block>

When data is ASCII-encoded, (FORM ASC) <block> takes the following form:

```
<block> ::= <segment>[,<segment>]...
<segment> ::= <start_freq>,<start_y_value>,<stop_freq>,<stop_y_value>
```

When data is binary-encoded, (FORM REAL) <block> takes the following form:

```
<block> ::= #<byte>[<length_bytes>]<segment>[<segment>]...
<byte> ::= one ASCII-encoded byte specifying the number of length
           bytes to follow
<length_bytes> ::= ASCII-encoded bytes specifying the number of data
                  bytes to follow
<segment> ::= <start_freq><start_y_value><stop_freq><stop_y_value>
```

The following definitions apply to both ASCII- and binary-encoded data.

```
<start_freq> ::= a real number
                limits: 0.0:150.0E6 (Hz)
<start_y_value> ::= a complex number for network, else real
                   limits: -9.9E37:9.9E37
<stop_freq> ::= a real number
                limits: 0.0:150.0E6 (Hz)
<stop_y_value> ::= a complex number for network, else real
                  limits: -9.9E37:9.9E37
```

**Example Statements:** Output 719;"Display1:Limit:Lower:Segment 7e6,0,10e6,5"  
 Output 719;"DISP:LIM:LOW:SEGM  
 10E6,5,13E6,0,13E6,0,16e6,-5"

**Query Syntax:** DISPlay[1|2]:LIMit:LOWer:SEGment?

**Return Format:** <block>

**Attribute Summary:** Preset state: not affected by Preset  
 Overlapped: yes  
 Pass control required: no  
 SCPI Compliance: instrument-specific

**Description:**

The amplitude values you send with each segment are unitless, so they assume the current reference level unit (returned with DISP:Y:RLEV UNIT). The analyzer doesn't clear the previous lower limit definition when you send new segments—it only overwrites those portions of the limit redefined by the new segments. Send DISP:LIM:LOW:DEL if you want to clear the previous limit.

**DISPlay[1|2]:LIMit:MODE****command/query**

Specifies how limit lines should respond to changes in the reference level setting.

**Command Syntax:** DISPlay[1|2]:LIMit:MODE {ABSolute|RELative}

**Example Statements:** Output 719;"disp2:lim:mode rel"  
Output 719;"Display:Limit:Mode Absolute"

**Query Syntax:** DISPlay[1|2]:LIMit:MODE?

**Return Format:** ABS|REL

**Attribute Summary:** Preset state: ABS (both displays)  
Overlapped: yes  
Pass control required: no  
SCPI Compliance: instrument-specific

**Description:**

When you select **ABS**, the absolute y-axis values of limit lines are held constant when the reference level changes. When you select **REL**, the y-axis offsets between limit lines and the reference level are held constant when the reference level changes. (You change the reference level with the **DISP:Y:RLEV** command.)

---

**DISPlay[1|2]:LIMit:RESult?****query**

Returns the result of the last limit test (passed or failed).

**Query Syntax:** DISPlay[1|2]:LIMit:RESult?

**Example Statements:** Output 719;"Disp2:Lim:Res?"  
Output 719;"DISPLAY:LIMIT:RESULT?"

**Return Format:** OFF|UND|PASS|FAIL

**Attribute Summary:** Preset state: not applicable  
Overlapped: no  
Pass control required: no  
SCPI Compliance: instrument-specific

**Description:**

This query only returns PASS or FAIL if the limit testing is turned on (DISP:LIM:STAT ON) and a limit is defined for the specified trace. If limit testing is turned off, this query returns OFF. If no limit is defined, this query returns UND (undefined).

You can use DISP:LIM:LOW:SEGM and DISP:LIM:UPP:SEGM to define limits via the HP-IB.



---

**DISPlay[1|2]:LIMit:STATE****command/query**

Turns limit testing on and off.

**Command Syntax:** DISPlay[1|2]:LIMit:STATe {OFF|0|ON|1}Example Statements: Output 719;"display2:limit:state on"  
Output 719;"Disp:Lim:Stat 1"**Query Syntax:** DISPlay[1|2]:LIMit:STATE?**Return Format:** +(0|1)**Attribute Summary:** Preset state: +0 (both displays)  
Overlapped: yes  
Pass control required: no  
SCPI Compliance: instrument-specific**Description:**

When limit testing is on, the current trace is evaluated against the limits defined in its upper and lower limit registers. You can load these registers via the HP-IB using the DISP:LIM:LOW:SEGM and DISP:LIM:UPP:SEGM commands.

To determine whether or not a trace is within the specified limits, you can send the DISP:LIM:RES query or monitor bits in the Limit Fail condition register. To return failed points, you can send the DISP:LIM:LOW:REP and DISP:LIM:UPP:REP queries.

---

**Note**

Limit lines are not automatically displayed when limit testing is enabled. To display limit lines, you must send DISP:LIM:LINE ON.

---

**DISPlay[1|2]:LIMit:UPPer:DATA****command/query**

Loads a complete upper limit line for the specified trace.

**Command Syntax:** DISPlay[1|2]:LIMit:UPPer:DATA <block>

<block> ::= #<byte>[<length\_bytes>]<data\_bytes>  
 <byte> ::= one ASCII-encoded byte specifying the number of length bytes to follow  
 <length\_bytes> ::= ASCII-encoded bytes specifying the number of data bytes to follow  
 <data\_bytes> ::= the bytes that make up a complete upper limit line

**Example Statements:** Output 719;"DISP1:LIM:UPP:DATA?"  
 Output 719;"display2:limit:upper:data?"

**Query Syntax:** DISPlay[1|2]:LIMit:UPPer:DATA?

**Return Format:** <block>

**Attribute Summary:** Preset state: not applicable  
 Overlapped: yes  
 Pass control required: no  
 SCPI Compliance: instrument-specific

**Description:**

This command just transfers a complete upper limit line—the same information contained in a upper limit file—between the analyzer and your controller. This allows you to store a complete upper limit on your controller's file system. The limit cannot be altered.

When you transfer a complete upper limit to the analyzer, you can use either the definite or the indefinite length block syntax. When the analyzer returns the limit to a controller, it always uses the definite length block syntax. See "Block Data" in chapter 4 for more information.

**DISPlay[1|2]:LIMit:UPPer:DELeTe**

**command**

Deletes the upper limit line from the specified trace.

**Command Syntax:** DISPlay[1|2]:LIMit:UPPer:DELeTe

**Example Statements:** Output 719;"DISPLAY1:LIMIT:UPPER:DELETE"  
Output 719;"disp2:lim:upp:del"

**Attribute Summary:** Preset state: not applicable  
Overlapped: yes  
Pass control required: no  
SCPI Compliance: instrument-specific

**Description:**

To delete an upper limit, send DISP:LIM:UPP:DEL. To delete a lower limit, send DISP:LIM:LOW:DEL.

**DISPlay[1|2]:LIMit:UPPer:MOVE****command/query**

Moves the upper limit line up or down for the specified trace.

**Command Syntax:** DISPlay[1|2]:LIMit:UPPer:MOVE (<number>|<step>|<bound>)

<number> ::= a real number (NRf data)  
limits: -1.0E6:1.0E6

<step> ::= UP|DOWN

<bound> ::= MAX|MIN

**Example Statements:** Output 719;"DISPLAY1:LIMIT:UPPER:MOVE 3"  
Output 719;"disp:lim:upp:move -12"

**Query Syntax:** DISPlay[1|2]:LIMit:UPPer:MOVE?

**Return Format:** <number>

<number> ::= a real number (NR2 or NR3 data)

**Attribute Summary:** Preset state: not affected by Preset  
Overlapped: yes  
Pass control required: no  
SCPI Compliance: instrument-specific

**Description:**

DISP:LIM:UPP:MOVE specifies a vertical offset for every segment in an upper limit. The offset is referenced to the limit's original y-axis position. The offset is unitless, so it assumes the current vertical/division unit (returned with DISP:Y:PDIV? UNIT).

**DISPlay[1|2]:LIMit:UPPer:REPort?****query**

Returns the frequency, amplitude, and failure value for all points failing the upper limit test.

**Query Syntax:** DISPlay[1|2]:LIMit:UPPer:REPort?

**Example Statements:** Output 719;"Display2:Limit:Upper:Report?"  
Output 719;"DISP:LIM:UPP:REP?"

**Return Format:** <block>

When data is ASCII-encoded, (FORM ASC) <block> takes the following form:

```
<block> ::= [<point>[,<point>]...]
<point> ::= <frequency>,<y-axis_value>,<y-axis_offset>
```

When data is binary-encoded, (FORM REAL) <block> takes the following form:

```
<block> ::= #<byte><length_bytes>[<point>]...
<byte> ::= one ASCII-encoded byte specifying the number of length
           bytes to follow
<length_bytes> ::= ASCII-encoded bytes specifying the number of data
                  bytes to follow
<point> ::= <frequency><y-axis_value><y-axis_offset>
```

The following definitions apply to both ASCII- and binary-encoded data.

```
<frequency> ::= a real number (frequency of the failed point)
               limits: 0.0:150.0E6 (Hz)
<y-axis_value> ::= y-axis value(s) of the failed point (2 if complex)
                 limits: -9.9E37:9.9E37
<y-axis_offset> ::= y-axis offset-from-limit value(s) (2 if complex)
                  limits: -9.9E37:9.9E37
```

**Attribute Summary:** Preset state: not applicable  
Overlapped: no  
Pass control required: no  
SCPI Compliance: instrument-specific

**Description:**

The unit for returned amplitude values is the same as the current reference level unit (returned with DISP:Y:RLEV UNIT). The unit for returned failure values is the same as the current vertical/division unit (returned with DISP:Y:PDIV? UNIT).

No data is returned if limit testing is disabled (DISP:LIM:STAT OFF) or if all trace points are below the specified upper limit.

**DISPlay[1|2]:LIMit:UPPer:SEGMENT****command/query**

Loads one or more segments of an upper limit line for the specified trace.

**Command Syntax:** DISPlay[1|2]:LIMit:UPPer:SEGMENT <block>

When data is ASCII-encoded, (FORM ASC) <block> takes the following form:

```
<block> ::= <segment>[,<segment>]...
<segment> ::= <start_freq>,<start_ampl>,<stop_freq>,<stop_ampl>
```

When data is binary-encoded, (FORM REAL) <block> takes the following form:

```
<block> ::= #<byte><length_bytes><segment>[<segment>]...
<byte> ::= one ASCII-encoded byte specifying the number of length
           bytes to follow
<length_bytes> ::= ASCII-encoded bytes specifying the number of data
                  bytes to follow
<segment> ::= <start_freq><start_ampl><stop_freq><stop_ampl>
```

The following definitions apply to both ASCII- and binary-encoded data.

```
<start_freq> ::= a real number
                limits: 0.0:150.0E6 (Hz)
<start_y_value> ::= a complex number for network, else real
                  limits: -9.9E37:9.9E37
<stop_freq> ::= a real number
               limits: 0.0:150.0E6 (Hz)
<stop_y_value> ::= a complex number for network, else real
                 limits: -9.9E37:9.9E37
```

**Example Statements:** Output 719;"DISP:LIM:UPP:SEGM  
10E6,5,13E6,0,13E6,0,16E6,-5"  
Output 719;"Display2:Limit:Upper:Segment 7e6,0,10e6,5"

**Query Syntax:** DISPlay[1|2]:LIMit:UPPer:SEGMENT?

**Return Format:** <block>

**Attribute Summary:** Preset state: not affected by Preset  
Overlapped: yes  
Pass control required: no  
SCPI Compliance: instrument-specific

**Description:**

The amplitude values you send with each segment are unitless, so they assume the current reference level unit (returned with DISP:Y:RLEV UNIT). The analyzer doesn't clear the previous upper limit definition when you send new segments—it only overwrites those portions of the limit redefined by the new segments. Send DISP:LIM:UPP:DEL if you want to clear the previous limit.

**DISPlay[1|2]:PARTition**

**command/query**

Select the portion of the analyzer's screen to be used for HP Instrument BASIC program output.

**Command Syntax:** DISPlay[1|2]:PARTition {OFF|0|FULL|UPPer|LOWer}

**Example Statements:** Output 719;"DISPLAY:PARTITION FULL"  
Output 719;"disp:part 0"

**Query Syntax:** DISPlay[1|2]:PARTition?

**Return Format:** OFF|FULL|UPP|LOW

**Attribute Summary:** Preset state: OFF  
Overlapped: yes  
Pass control required: no  
SCPI Compliance: instrument-specific

**Description:**

OFF allocates no display area for program output. FULL allocates the entire trace display area. UPP allocates that portion of the trace display area normally used by the *upper* trace (when SCR:FORM is ULOW). LOW allocates that portion of the trace display area normally used by the *lower* trace.

This command is only valid if HP Instrument BASIC is installed.

---

**DISPlay[1|2]:PARTition:CLEar** **command**

Clear the portion of the analyzer's screen allocated to HP Instrument BASIC program output.

**Command Syntax:**       DISPlay[1|2]:PARTition:CLEar

**Example Statements:**     Output 719;"Disp:Part:Cle"  
                          Output 719;"DISPLAY2:PARTITION:CLEAR"

**Attribute Summary:**    Preset state: not applicable  
                          Overlapped: yes  
                          Pass control required: no  
                          SCPI Compliance: instrument-specific

**Description:**

You allocate the portion of the screen cleared by this command with the DISP:PART command.

This command is only valid if HP Instrument BASIC is installed.

The trace specifier is not applicable to this command because the command is not trace-specific. Its value is ignored.



**DISPlay[1|2]:RESults****command/query**

Select the data to be displayed in the specified trace.

**Command Syntax:** DISPlay[1|2]:RESults <param>

```

<param> ::= INPut|<network>|{F1:F5}|{K1:K5}|{D1:D8}|<network_reg>|
          SPECtrum|NORMalize
<network> ::= TRANsmission|XMSN|REFLectioN|VSWR|IMPedance|
             S11|S21|S12|S22
<network_reg> ::= DNORm|D1Ref|D2Ref|D21Cal|D12Cal|D11oc|D11Sc|D11T|D22oc|
                D22Sc|D22T

```

**Example Statements:** Output 719;"display1:results spectrum"  
 Output 719;"Disp:Res Norm"

**Query Syntax:** DISPlay[1|2]:RESults?**Return Format:** <param>

```

<param> ::= INPut|<network>|{F1:F5}|{K1:K5}|{D1:D8}|<network_reg>|
          SPEC|NORM
<network> ::= TRAN|XMSN|REFL|VSWR|IMP|S11|S21|S12|S22
<network_reg> ::= DNOR|D1R|D2R|D21C|D12C|D11|D11S|D11T|D22|D22S|D22T

```

**Attribute Summary:** Preset state: SPEC (both displays)  
 Overlapped: yes  
 Pass control required: no  
 SCPI Compliance: instrument-specific

**Description:**

SPEC displays the results of the current measurement.  
 NORM displays a normalized spectrum (SPEC/D8).  
 F1 through F5 display the results of the corresponding trace math function.  
 K1 through K5 display the contents of the corresponding constants.  
 Registers D1 through D8 display the contents of the corresponding data registers.

INP displays the receiver input.  
 TRAN displays normalized transmission.  
 REFL displays normalized reflection.  
 VSWR displays normalized VSWR.  
 IMP displays normalized impedance.  
 S11, S12, S21, and S22 displayed the corresponding S-parameter results.  
 DNOR through D22T display the contents of the corresponding network register.  
 SPEC is the same as INP; it is included for HP 3588A compatibility.  
 NORM is the same as TRAN; it is included for HP 3588A compatibility.  
 XMSN is the same as TRAN; it is included to match the trace title of the math expression.

---

**DISPlay[1|2]:Y[:SCALe]:AUTO****command/query**

Rescales and repositions the trace vertically to provide the best display of trace data.

**Command Syntax:** DISPlay[1|2]:Y[:SCALe]:AUTO {ONCE|OFF|0}

**Example Statements:** Output 719;"DISP2:Y:SCAL:AUTO ONCE"  
Output 719;"display2:y:auto 0"

**Query Syntax:** DISPlay[1|2]:Y[:SCALe]:AUTO?

**Return Format:** +0

**Attribute Summary:** Preset state: +0 (both displays)  
Overlapped: yes  
Pass control required: no  
SCPI Compliance: confirmed (1991.0)

**Description:**

Send DISP:Y:SCAL:AUTO ONCE to initiate vertical autoscaling of the specified trace. The analyzer's autoscaling algorithm changes the values of DISP:Y:RLEV and DISP:Y:SCAL:PDIV to provide the best display of your data.

OFF has no effect on the analyzer. ON is not a valid option, because the analyzer does not support a continuous autoscaling mode.

**DISPlay[1|2]:Y[:SCALe]:MAXimum****command/query**

Sets the reference level in the specified display.

**Command Syntax:** DISPlay[1|2]:Y[:SCALe]:MAXimum (<value>|<step>|<bound>)

```

<value> ::= <number>[<unit>]
<number> ::= a real number (NRf data)
             limits: -72000.0:72000.0
<unit> ::= DBM|DBV|DBVRMS|DBUV|DBUVRMS|V|VRMS|DEG|RAD|S|DB
<step> ::= UP|DOWN
<bound> ::= MAX|MIN

```

**Example Statements:** Output 719;"Display1:Y:Scale:Maximum -15dBm"  
Output 719;"DISP:Y:SCAL:MAX 10"

**Query Syntax:** DISPlay[1|2]:Y[:SCALe]:MAXimum? [UNIT]**Return Format:** <number>|{"<unit>"}

```

<number> ::= a real number (NR2 or NR3 data)
<unit> ::= unit that applies to returned number

```

**Attribute Summary:** Preset state: undefined value (dependent on autorange)  
Overlapped: yes  
Pass control required: no  
SCPI Compliance: instrument-specific

**Description:**

The reference level determines the upper limit of the specified trace display area. The trace moves up or down in the display area when you change the reference level.

You can link the reference level of magnitude traces (CALC:FORM MLOG or MLIN) to the current input range with the DISP:Y:SCAL:RLEV:AUTO command.

Reference level determines the value of the reference line for both rectangular and polar trace types. To change the position of the reference line, use the DISP:Y:SCAL:RPOS command.

---

**DISPlay[1|2]:Y[:SCALe]:MAXimum:AUTO****command/query**

Turns reference level tracking on and off.

**Command Syntax:** DISPlay[1|2]:Y[:SCALe]:MAXimum:AUTO {OFF|0|ON|1}

**Example Statements:** Output 719;"disp:y:max:auto 1"  
Output 719;"Display1:Y:Scale:Maximum:Auto On"

**Query Syntax:** DISPlay[1|2]:Y[:SCALe]:MAXimum:AUTO?

**Return Format:** +(0|1)

**Attribute Summary:** Preset state: +1 (both displays)  
Overlapped: yes  
Pass control required: no  
SCPI Compliance: instrument-specific

**Description:**

If reference level tracking is enabled, the analyzer maintains the current offset between reference level (DISP:Y:SCAL:RLEV) and input range (SENS:POW:RANG) whenever the range changes.

---

**Note**

Reference level tracking only affects magnitude traces (CALC:FORM MLOG or MLIN). Even then, it never tracks input range changes while constants or data registers are displayed (DISP:RES Kx or DISP:RES Dx).

---

**DISPlay[1|2]:Y[:SCALE]:PDIVision****command/query**

Set the vertical units per division for the specified trace.

**Command Syntax:** DISPlay[1|2]:Y[:SCALE]:PDIVision {<value>|<step>|<bound>}

<value> ::= <number>[<unit>]  
 <number> ::= a real number (NRf data)  
           limits: 1.0E-12:7200.0  
 <unit> ::= DB|V|VRMS|DEG|RAD|S  
 <step> ::= UP|DOWN  
 <bound> ::= MAX|MIN

**Example Statements:**      Output 719;"DISPLAY2:Y:SCALE:PDIVISION 2.5"  
                               Output 719;"displ:y:pdiv 40 mvrms"

**Query Syntax:** DISPlay[1|2]:Y[:SCALE]:PDIVision? [UNIT]**Return Format:** <number>|{"<unit>"}

<number> ::= a real number (NR2 or NR3 data)  
 <unit> ::= unit that applies to returned number

**Attribute Summary:**      Preset state: +1.00E+1 dBm (both displays)  
                               Overlapped: yes  
                               Pass control required: no  
                               SCPI Compliance: confirmed (1991.0)

**Description:**

This command defines the value of each division on the specified trace. When the trace display format is single (SCR:FORM SING) or front/back (SCR:FORM FBAC), the number of vertical divisions is 10. When the format is upper/lower (SCR:FORM ULOW), the number of vertical divisions is 5.

There are 4 divisions for polar. Per div entry is not allowed for Smith chart because the graticule has no "divisions."

**DISPlay[1|2]:Y[:SCALe]:RLEVel****command/query**

Sets the reference level in the specified display.

**Command Syntax:** DISPlay[1|2]:Y[:SCALe]:RLEVel {<value>|<step>|<bound>}

<value> ::= <number>[<unit>]  
 <number> ::= a real number (NRf data)  
           limits: -72000.0:72000.0  
 <unit> ::= DBM|DBV|DBVRMS|DBUV|DBUVRMS|V|VRMS|DEG|RAD|S|DB  
 <step> ::= UP|DOWN  
 <bound> ::= MAX|MIN

**Example Statements:**     Output 719;"Display1:Y:Rlevel -15dBm"  
                           Output 719;"DISP:Y:SCAL:RLEV 10"

**Query Syntax:** DISPlay[1|2]:Y[:SCALe]:RLEVel? [UNIT]**Return Format:** <number>|{"<unit>"}

<number> ::= a real number (NR2 or NR3 data)  
 <unit> ::= unit that applies to returned number

**Attribute Summary:**   Preset state: undefined value (dependent on autorange)  
                           Overlapped: yes  
                           Pass control required: no  
                           SCPI Compliance: confirmed (1991.0)

**Description:**

The reference level determines the upper limit of the specified trace display area. The trace moves up or down in the display area when you change the reference level.

You can link the reference level of magnitude traces (CALC:FORM MLOG or MLIN) to the current input range with the DISP:Y:SCAL:RLEV:AUTO command.

Reference level determines the value of the reference line for both rectangular and polar trace types. To change the position of the reference line, use the DISP:Y:SCAL:RPOS command.

---

**DISPlay[1|2]:Y[:SCALe]:RLEVel:AUTO****command/query****Command Syntax:** DISPlay[1|2]:Y[:SCALe]:RLEVel:AUTO {OFF|0|ON|1}**Example Statements:**  
Output 719;"Display:Y:Rlevel:Auto On"  
Output 719;"DISP:Y:SCAL:RLEV:AUTO OFF"**Query Syntax:** DISPlay[1|2]:Y[:SCALe]:RLEVel:AUTO?**Return Format:** +{0|1}**Attribute Summary:**  
Option: +1 (both displays)  
Overlapped: yes  
Preset State: not applicable  
SCPI Compliance: confirmed (1991.0)**Description:**

If reference level tracking is enabled, the analyzer maintains the current offset between reference level (DISP:Y:SCAL:RLEV) and input range (SENS:POW:RANG) whenever the range changes.

---

**Note**

Reference level tracking only affects magnitude traces (CALC:FORM MLOG or MLIN). Even then, it never tracks input range changes while constants or data registers are displayed (DISP:RES Kx or DISP:RES Dx).

---

**DISPlay[1|2]:Y[:SCALe]:RLINE****command/query**

Turns the reference line on and off.

**Command Syntax:** DISPlay[1|2]:Y[:SCALe]:RLINe {OFF|0|ON|1}

**Example Statements:** Output 719;"display:y:scale:rline 1"  
Output 719;"Disp:Y:Rlin Off"

**Query Syntax:** DISPlay[1|2]:Y[:SCALe]:RLINe?

**Return Format:** +{0|1}

**Attribute Summary:** Option: +0  
Overlapped: yes  
Preset State: not applicable  
SCPI Compliance: instrument-specific

**Description:**

The analyzer displays a reference line for rectangular trace types, only. Trace types are selected with the CALC:FORM command. The position of the reference line is set with DISP:Y:SCAL:RPOS.



**DISPlay[1|2]:Y[:SCALe]:RPOsition****command/query**

Sets the position of the reference line.

**Command Syntax:** DISPlay[1|2]:Y[:SCALe]:RPOsition ({<number>[PCT]}|<step>|<bound>)<number> ::= an integer (NRf data)  
limits: 0:100

&lt;step&gt; ::= UP|DOWN

&lt;bound&gt; ::= MAX|MIN

**Example Statements:** Output 719;"DISP2:Y:RPOS 100 PCT"  
Output 719;"display:y:scale:rposition 50"**Query Syntax:** DISPlay[1|2]:Y[:SCALe]:RPOsition?**Return Format:** NR1**Attribute Summary:** Option: +1.00E+2 PCT  
Overlapped: yes  
Preset State: not applicable  
SCPI Compliance: confirmed (1991.0)**Description:**

The reference line's position is set as a percentage of the distance to the top of the trace area: 100% places the line at the top of the trace area, 50% places it at the middle, and 0% places it at the bottom. The value sent with the command is not used when the trace type is polar or Smith chart (CALC:FORM is POL).

## FORMat Subsystem

---

The FORMat subsystem contains a single command—FORM:DATA. The command determines which data type and data encoding will be used when large blocks of numeric data are transferred between the HP 3589A and a controller.

**FORMat[:DATA]****command/query**

Specifies the data type and data encoding to be used during transfers of some block data.

**Command Syntax:** FORMat[:DATA] {ASCi|REAL}[,{<number>|<bound>}]

<number> ::= an integer (NRf data)

limits: 3:64

<bound> ::= MAX|MIN

Example Statements:      Output 719;"Form Asc,10"  
                          Output 719;"FORMAT:DATA REAL"

**Query Syntax:**       FORMat[:DATA]?

**Return Format:**       {ASC|REAL},{<number>}

<number> ::= an integer (NRl data)

limits: 3:64

**Attribute Summary:**   Preset state: ASC,3  
                          Overlapped: no  
                          Pass control required: no  
                          SCPI Compliance: instrument-specific

**Description:**

FORM:DATA only affects data transfers initiated by the following commands:

- CALC:DATA?
- DISP:LIM:LOW:REP?
- DISP:LIM:LOW:SEGM
- DISP:LIM:UPP:REP?
- DISP:LIM:UPP:SEGM
- PROG:SEL:NUMB
- TRAC:DATA

FORM:DATA ASC selects NRf data for transfers *to* the analyzer and NR3 data for transfers *from* the analyzer. Data encoding is ASCII. You control the number of significant digits in the returned numbers with the second parameter, which has a range of 3 through 12 when the first parameter is ASC.

FORM:DATA REAL selects definite or indefinite length block data for transfers *to* the analyzer but only definite length block data for transfers *from* the analyzer. Data encoding is binary (the binary floating-point format defined in the IEEE 754-1985 standard). The only allowed values for the second parameter are 32 and 64; it determines how many bits will be used for each number.

See "Data Encoding for Block Data" in chapter 4 for more information.

## INITiate Subsystem

---

The INITiate subsystem contains two commands used to control initiation of the trigger system in SCPI instruments. However, neither of these commands affects the HP 3589A's trigger system because it is implemented with no trigger system IDLE state. The commands are included so you can write programs that work with the HP 3589A and with other SCPI instruments.

---

**INITiate:CONTInuous****command/query**

Sets the trigger system to a continuously initiated state.

**Command Syntax:**       INITiate:CONTInuous {ON|1}

**Example Statements:**     Output 719;"initiate:continuous on"  
                              Output 719;"Init:Cont 1"

**Query Syntax:**         INITiate:CONTInuous?

**Return Format:**         +1

**Attribute Summary:**     Preset state: +1  
                              Overlapped: no  
                              Pass control required: no  
                              SCPI Compliance: confirmed (1991.0)

**Description:**

The HP 3589A's trigger system is always continuously initiated. As a result, this command has no effect on the analyzer state. It is included so you can write programs that work with this analyzer and with other SCPI instruments.

---

**INITiate[:IMMediate]****command**

Forces the triggering system to exit the idle state.

**Command Syntax:**       INITiate[:IMMediate]

**Example Statements:**     Output 719;"INIT"  
                          Output 719;"initiate:immediate"

**Attribute Summary:**     Preset state: not applicable  
                          Overlapped: no  
                          Pass control required: no  
                          SCPI Compliance: confirmed (1991.0)

**Description:**

The HP 3589A's trigger system never enters the idle state. As a result, this command has no effect on the analyzer state. It is included so you can write programs that work with this analyzer and with other SCPI instruments.

---

**Note**

The program message ABOR; INIT:IMM or ABOR; INIT:CONT ON is equivalent to the message SENS:REST. All three restart a measurement. However, SENS:REST is not supported by the SCPI standard.

---



## **INPut Subsystem**

---

INPut is one of two subsystems that control the characteristics of the analyzer's input circuitry—the other is SENSE (under its POWER mnemonic). The commands in the INPut subsystem control input impedance and the input-protection relay.



**INPut:IMPedance****command/query**

Selects the impedance of the analyzer's input circuitry.

**Command Syntax:** INPut:IMPedance {<value>|<bound>}

```

<value> ::= <number>[<unit>]
<number> ::= a real number (NRf data)
             limits: 50.0:1.0E6
             discrete values: 50, 75, 1E6
<unit> ::= OHM
<bound> ::= MAX|MIN

```

**Example Statements:** Output 719;"Input:Impedance 50 Ohm"  
Output 719;"INP:IMP 1E6"

**Query Syntax:** INPut:IMPedance? [UNIT]

**Return Format:** <number>{"<unit>"}

```

<number> ::= a real number (NR2 or NR3 data)
<unit> ::= unit that applies to returned number

```

**Attribute Summary:** Preset state: +5.00E+1 ohm  
Overlapped: yes  
Pass control required: no  
SCPI Compliance: confirmed (1991.0)

**Description:**

When you select an input impedance of 1 megohm, dBm calculations use the reference impedance value you specify with the INP:IMP:REF command.

**Note**

When you select an input impedance of 75 ohms, you *must* use the 25 ohm adapter barrel (supplied with the instrument) or a 50-75Ω minimum loss pad for accurate results. Insert the adapter between your test signal and the input connector.

**INPut:IMPedance:REference****command/query**

Selects the reference impedance to be used for dBm calculations when the input impedance is 1 megohm.

**Command Syntax:** INPut:IMPedance:REference {<value>|<step>|<bound>}

```

<value> ::= <number>[<unit>]
<number> ::= a real number (NRf data)
             limits: 1.0:1.0E8
<unit> ::= OHM
<step> ::= UP|DOWN
<bound> ::= MAX|MIN

```

**Example Statements:** Output 719;"inp:imp:ref 600 ohm"  
Output 719;"Input:Impedance:Reference 50"

**Query Syntax:** INPut:IMPedance:REference? [UNIT]

**Return Format:** <number>|{"<unit>"}

```

<number> ::= a real number (NR2 or NR3 data)
<unit> ::= unit that applies to returned number

```

**Attribute Summary:** Preset state: +5.00E+1 ohm  
Overlapped: yes  
Pass control required: no  
SCPI Compliance: instrument-specific

**Description:**

The value entered with this command is only used for dBm calculations when you select the 1 megohm input impedance (INP:IMP 1 MOHM). The dBm calculations determine trace amplitude values when the logarithmic magnitude coordinate system is selected (CALC:FORM MLOG).

---

**INPut:TRIP:CLEAr****command**

Resets the analyzer's input-protection relay.

**Command Syntax:** INPut:TRIP:CLEAr

**Example Statements:** Output 719;"INPUT:TRIP:CLEAR"  
Output 719;"inp:trip:cle"

**Attribute Summary:** Preset state: not applicable  
Overlapped: yes  
Pass control required: no  
SCPI Compliance: instrument-specific

**Description:**

The input-protection relay is tripped (opened) when the signal level at the input connector is significantly above the maximum input range. Bit 2 (Input Tripped) of the Questionable Power condition register tells you if the input-protection relay has been tripped.

## INSTrument Subsystem

---

The INSTrument subsystem contains a single command—INST:SEL. The command selects or activates one of the measurement types.

---

**INSTRument[:SElect]****command/query**

Selects or activates one of the measurement types.

**Command Syntax:** INSTRument[:SElect ](SWEpt|FFT|NETWork)

**Example Statements:** Output 719;"Instrument:Sel Netw"  
Output 719;"INST:FFT"

**Query Syntax:** INSTRument:SElect?

**Return Format:** CHAR

**Attribute Summary:** Option: not applicable  
Overlapped: yes  
Preset State: not applicable  
SCPI Compliance: confirmed (1991.0)

**Description:**

Same as SENS:FINC command.

When you switch between swept spectrum (INST:SWEP), narrow band zoom (INST:FFT), and network (INST:NETW) measurements, the state of many other parameters can change. As a result, you should select the measurement type near the beginning of any program sequence that defines the instrument state.

See the help text or your *HP 3589A Operating Manual* for information on the analyzer's measurement types.

## MARKer Subsystem

---

The MARKer subsystem lets you control most of the analyzer's marker functions and read marker values. One marker function not controlled by this subsystem is limit testing. Commands that control limit testing and limit data are found in the DISPlay subsystem (under its LIMit mnemonic).

The MARKer mnemonic contains an optional trace specifier: [1|2]. To direct a command to trace A, omit the specifier or use 1. To direct a command to trace B, use 2. Commands that are not trace-specific – like marker on/off (MARKer:STAT) or move marker to point (MARKer:POINT) – ignore the specifier. All marker commands that use the trace specifier appear in the following table.

Command Name	Comments
MARKer[1 2]:MAX[:GLOBal]	Trace number used to indicate which trace contains the max/min you wish to move to; both markers are moved to that frequency.
MARKer[1 2]:MAX:LEFT	
MARKer[1 2]:MAX:NEXT	
MARKer[1 2]:MAX:RIGHT	
MARKer[1 2]:MIN[:GLOBal]	
MARKer[1 2]:OFFSet	Trace specifier used to set marker values independently for each trace.
MARKer[1 2]:OFFSet:DELTA:X	
MARKer[1 2]:OFFSet:DELTA:Y	
MARKer[1 2]:OFFSet:DELTA:Y:COMPLex	
MARKer[1 2]:OFFSet:X	
MARKer[1 2]:OFFSet:Y	
MARKer[1 2]:OFFSet:Y:COMPLex	
MARKer[1 2]:[STATe]	
MARKer[1 2]:TARGet	
MARKer[1 2]:Y?	Trace specifier used query or set marker information by trace and coordinate.
MARKer[1 2]:Y:COMPLex?	
MARKer[1 2]:Y:NOISe?	
MARKer[1 2]:Y:READout	

---

**MARKer[1|2]:FUNCTION:FCOunt****command/query**

Turns the frequency counter on and off.

**Command Syntax:** MARKer[1|2]:FUNCTION:FCOunt {OFF|0|ON|1}**Example Statements:**  
Output 719;"Mark:Func:Fco 0"  
Output 719;"MARKER:FUNCTION:FCOUNT ON"**Query Syntax:** MARKer[1|2]:FUNCTION:FCOunt?**Return Format:** +{0|1}**Attribute Summary:**  
Preset state: +0  
Overlapped: yes  
Pass control required: no  
SCPI Compliance: instrument-specific**Description:**

The frequency counter determines the frequency of the largest signal at the main marker position. You can move the main marker with MARK:X, MARK:POIN, MARK:MIN, or one of the MARK:MAX commands. You can read the counted frequency with the MARK:X:FCO query.

**MARKer[1|2]:FUNCTION:NOISe****command/query**

Turns the noise level function on and off.

**Command Syntax:** MARKer[1|2]:FUNCTION:NOISe {OFF|0|ON|1}

**Example Statements:** Output 719;"marker:function:noise on"  
 Output 719;"Mark:Func:Nois Off"

**Query Syntax:** MARKer[1|2]:FUNCTION:NOISe?**Return Format:** +{0|1}

**Attribute Summary:** Preset state: +0  
 Overlapped: yes  
 Pass control required: no  
 SCPI Compliance: instrument-specific

**Description:**

The noise level marker determines the noise spectral density (normalized to a 1 Hz bandwidth) at the main marker position. You can move the main marker with MARK:X, MARK:POIN, MARK:MIN, or one of the MARK:MAX commands. You can read the noise spectral density with the MARK:Y:NOIS query.

**Note**

The noise level marker is not available for narrow band zoom measurements (INST:SEL:FFT).



---

**MARKer[1|2]:MAXimum[:GLOBal]****command**

Moves the main marker to the highest peak on the specified trace.

**Command Syntax:** MARKer[1|2]:MAXimum[:GLOBal]

**Example Statements:** Output 719;"MARK2:MAX:GLOB"  
Output 719;"marker:maximum"

**Attribute Summary:** Preset state: not applicable  
Overlapped: no  
Pass control required: no  
SCPI Compliance: instrument-specific

**Description:**

This command moves the marker to the highest peak one time. The command MARK:MAX:TRAC controls a marker function that automatically moves the marker to the highest peak *each time the trace is updated*.

---

**MARKer[1|2]:MAXimum:LEFT****command**

Moves the main marker one peak to the left of its current location on the specified trace.

**Command Syntax:** MARKer[1|2]:MAXimum:LEFT

**Example Statements:** Output 719;"Marker1:Maximum:Left"  
Output 719;"MARK2:MAX:LEFT"

**Attribute Summary:** Preset state: not applicable  
Overlapped: no  
Pass control required: no  
SCPI Compliance: instrument-specific

**Description:**

A peak is a local maximum on a trace. The slope of a trace is positive to the left of a peak and negative to the right.

This command moves the marker to peaks that are at least one point to the left of the current marker location. If the peak search algorithm doesn't find a peak, the marker doesn't move. You can increase the number of peaks found by decreasing the value of DISP:Y:SCAL:PDIV.

When swept spectrum or narrow band zoom is active (INST:SEL SWEP or INST:SEL FFT), the marker-search functions find peaks that are at least one-half division high (or one-quarter division, if the display format is upper/lower). The slope on either side of a peak must not change sign for at least one-half vertical division.

When swept network is active (INST:SEL NETW), the marker-search functions find peaks that are at least one-quarter division high (or one-eighth division high if the display format is upper/lower). The slope on either side of a peak must not change sign for at least one-quarter vertical division.

---

**Note** Peaks are found only in rectangular trace types.



---

**MARKer[1|2]:MAXimum:NEXT****command**

Move the active marker to the next local maximum on the active trace.

**Command Syntax:** MARKer[1|2]:MAXimum:NEXT

**Example Statements:** Output 719; "MARK2:MAXIMUM:NEXT"  
Output 719; "marker2:max:next"

**Attribute Summary:** Preset state: not applicable  
Overlapped: no  
Pass control required: no  
SCPI Compliance: instrument-specific

**Description:**

Move the active marker to the next local maximum on the active trace. For polar and Smith Chart displays of network measurement results, this feature is not available.

When swept spectrum or narrow band zoom is active (INST:SEL SWEP or INST:SEL FFT), the marker-search functions find peaks that are at least one-half division high (or one-quarter division, if the display format is upper/lower). The slope on either side of a peak must not change sign for at least one-half vertical division.

When swept network is active (INST:SEL NETW), the marker-search functions find peaks that are at least one-quarter division high (or one-eighth division high if the display format is upper/lower). The slope on either side of a peak must not change sign for at least one-quarter vertical division.

---

**Note** Peaks are found only in rectangular trace types.



---

**MARKer[1|2]:MAXimum:RIGHT****command**

Moves the main marker one peak to the right of its current location on the specified trace.

**Command Syntax:** MARKer[1|2]:MAXimum:RIGHT

**Example Statements:** Output 719;"mark:max:riht"  
Output 719;"Marker2:Maximum:Right"

**Attribute Summary:** Preset state: not applicable  
Overlapped: no  
Pass control required: no  
SCPI Compliance: instrument-specific

**Description:**

A peak is a local maximum on a trace. The slope of a trace is positive to the left of a peak and negative to the right.

This command only finds peaks that are at least one point to the right of the current marker location. If the peak search algorithm doesn't find a peak, the marker doesn't move. You can increase the number of peaks found by decreasing the value of DISP:Y:SCAL:PDIV.

When swept spectrum or narrow band zoom is active (INST:SEL SWEP or INST:SEL FFT), the marker-search functions find peaks that are at least one-half division high (or one-quarter division, if the display format is upper/lower). The slope on either side of a peak must not change sign for at least one-half vertical division.

When swept network is active (INST:SEL NETW), the marker-search functions find peaks that are at least one-quarter division high (or one-eighth division high if the display format is upper/lower). The slope on either side of a peak must not change sign for at least one-quarter vertical division.

---

**Note** Peaks are found only in rectangular trace types.



---

**MARKer[1|2]:MAXimum:TRACk****command/query**

Turns the peak tracking function on and off.

**Command Syntax:** MARKer[1|2]:MAXimum:TRACk {OFF|0|ON|1}

**Example Statements:** Output 719;"MARKER:MAXIMUM:TRACK ON"  
Output 719;"mark:max:trac 0"

**Query Syntax:** MARKer[1|2]:MAXimum:TRACk?

**Return Format:** +(0|1)

**Attribute Summary:** Preset state: +0  
Overlapped: no  
Pass control required: no  
SCPI Compliance: instrument-specific

**Description:**

When peak tracking is enabled, the analyzer automatically positions the main marker on the largest peak of the active trace (SCR:ACT) each time the trace is updated. If you just want to move the marker to the highest peak *one time*, use the MARK:MAX:GLOB command.

---

**MARKer[1|2]:MINimum[:GLOBal]****command**

Moves the main marker to the lowest point on the specified trace.

**Command Syntax:** MARKer[1|2]:MINimum[:GLOBal]

**Example Statements:** Output 719;"Mark1:Min"  
Output 719;"MARKER2:MINIMUM:GLOBAL"

**Attribute Summary:** Preset state: not applicable  
Overlapped: no  
Pass control required: no  
SCPI Compliance: instrument-specific

**Description:**

This command moves the marker to the lowest peak one time. To move the marker to the *highest* peak one time, use the MARK:MAX:GLOB command.

---

**MARKer[1|2]:OFFSet****command/query**

Turns the display of the offset marker on and off in the specified trace.

**Command Syntax:** MARKer[1|2]:OFFSet {OFF|0|ON|1}

**Example Statements:** Output 719;"marker2:offset on"  
Output 719;"Mark:Offs 1"

**Query Syntax:** MARKer[1|2]:OFFSet?

**Return Format:** +{0|1}

**Attribute Summary:** Preset state: +0 (both traces)  
Overlapped: no  
Pass control required: no  
SCPI Compliance: instrument-specific

**Description:**

This command just controls the *display* of offset markers. You can always set and query an offset marker's position, even when it is not being displayed. Use MARK:OFFS:X, MARK:OFFS:Y, MARK:OFFS:DELT:X, and MARK:OFFS:DELT:Y to set and query an offset marker's position.

You can't use MARK:TO:SPAN when offset marker is off.

**MARKer[1|2]:OFFSet:DELTA:X****command/query**

Specifies the offset marker's x-axis position as an offset from the main marker's position.

**Command Syntax:** MARKer[1|2]:OFFSet:DELTA:X (<value>|<bound>)

```

<value> ::= <number>[<unit>]
<number> ::= a real number (NRf data)
           limits: -150.0E6:150.0E6
<unit> ::= HZ|S
<bound> ::= MAX|MIN

```

**Example Statements:** Output 719;"MARK2:OFFS:DELT:X 10KHZ"  
Output 719;"marker1:offset:delta:x 5e6"

**Query Syntax:** MARKer[1|2]:OFFSet:DELTA:X? [UNIT]

**Return Format:** <number>|{"<unit>"}

```

<number> ::= a real number (NR2 or NR3 data)
<unit> ::= unit that applies to returned number

```

**Attribute Summary:** Preset state: +0.00E+0 Hz (both traces)  
Overlapped: no  
Pass control required: no  
SCPI Compliance: instrument-specific

**Description:**

This command specifies the offset marker's x-axis position as an offset from the main marker's position. To specify the offset marker's absolute x-axis position, use the MARK:OFFS:X command.



**MARKer[1|2]:OFFSet:DELTA:Y****command/query**

Specifies the offset marker's y-axis position as an offset from the main marker's position.

**Command Syntax:** MARKer[1|2]:OFFSet:DELTA:Y (<value>|<bound>)

```

<value> ::= <number>[<unit>]
<number> ::= a real number (NRf data)
             limits: -1.0e+10:1.0e+10
<unit> ::= DB|V|VRMS|DEG|RAD|S
<bound> ::= MAX|MIN

```

**Example Statements:** Output 719;"Marker1:Offset:Delta:Y 3dB"  
Output 719;"MARK:OFFS:DELT:Y 7"

**Query Syntax:** MARKer[1|2]:OFFSet:DELTA:Y?

**Return Format:** <number>|("<unit>")

```

<number> ::= a real number (NR2 or NR3 data)
<unit> ::= unit that applies to returned number

```

**Attribute Summary:** Preset state: undefined value  
Overlapped: no  
Pass control required: no  
SCPI Compliance: instrument-specific

**Description:**

This command specifies the offset marker's y-axis position as an offset from the main marker's position. To specify the offset marker's absolute y-axis position, use the MARK:OFFS:Y command.

**MARKer[1|2]:OFFSet:DELTA:Y:COMPLex****command/query**

Specifies the offset marker's y-axis position as an offset from the main marker's position for polar and Smith chart trace types.

**Command Syntax:** MARKer[1|2]:OFFSet:DELTA:Y:COMPLex <param>,<param>

```

<param> ::= (<value>|<bound>)
<value> ::= <number>[<unit>]
<number> ::= a real number (NRf data)
             limits: -1.0e+10:1.0e+10
<unit> ::= DB|V|VRMS|DEG|RAD|S
<bound> ::= MAX|MIN

```

**Example Statements:** Output 719;"Marker1:Offset:Delta:Y:Comp 3dB,40Deg"  
Output 719;"MARK:OFFS:DELT:Y:COMP 7,90"

**Query Syntax:** MARKer[1|2]:OFFSet:DELTA:Y:COMPLex?

**Return Format:** <number>,<number>

```

<number> ::= a real number (NR2 or NR3 data)

```

**Attribute Summary:**

```

Preset state:  undefined value
Overlapped:    no
Pass control required: no
SCPI Compliance: instrument-specific

```

**Description:**

This command specifies the offset marker's "y-axis" position as an offset from the main marker's position for polar and Smith chart trace types, only.

The selected marker readout units determine how the values are interpreted (M,P or R,I).

To specify the offset marker's absolute y-axis position, use the MARK:OFFS:Y:COMP command.

**MARKer[1|2]:OFFSet:X****command/query**

Specifies the offset marker's x-axis position.

**Command Syntax:** MARKer[1|2]:OFFSet:X {<value>|<step>|<bound>}

```

<value> ::= <number>[<unit>]
<number> ::= a real number (NRf data)
           limits: 0.0:150.0E6
<unit> ::= HZ|S
<step> ::= UP|DOWN
<bound> ::= MAX|MIN

```

**Example Statements:**      Output 719;"mark2:offs:x 50e6"  
                               Output 719;"Marker2:Offset:X 400kHz"

**Query Syntax:** MARKer[1|2]:OFFSet:X? [UNIT]**Return Format:** <number>|("<unit>")

```

<number> ::= a real number (NR2 or NR3 data)
<unit> ::= unit that applies to returned number

```

**Attribute Summary:**      Preset state: +7.51E+7 Hz (both traces)  
                               Overlapped: no  
                               Pass control required: no  
                               SCPI Compliance: instrument-specific

**Description:**

This command specifies the offset marker's absolute x-axis position. To specify the offset marker's x-axis position as an offset from the main marker's position, use the MARK:OFFS:DELT:X command.

**MARKer[1|2]:OFFSet:Y****command/query**

Specifies the offset marker's y-axis position.

**Command Syntax:** MARKer[1|2]:OFFSet:Y {<value>|<bound>}

```

<value> ::= <number>[<unit>]
<number> ::= a real number (NRf data)
             limits: -72000.0:72000.0
<unit> ::= DBM|DBV|DBVRMS|DBUV|DBUVRMS|V|VRMS|DEG|RAD|S|DB
<bound> ::= MAX|MIN

```

**Example Statements:** Output 719;"MARKER1:OFFSET:Y 0.2 VRMS"  
Output 719;"mark2:offs:y -10dbm"

**Query Syntax:** MARKer[1|2]:OFFSet:Y? [UNIT]

**Return Format:** <number>|{"<unit>"}

```

<number> ::= a real number (NR2 or NR3 data)
<unit> ::= unit that applies to returned number

```

**Attribute Summary:** Preset state: +0.00E+0 dBm (both traces)  
Overlapped: no  
Pass control required: no  
SCPI Compliance: instrument-specific

**Description:**

This command specifies the offset marker's absolute y-axis position. To specify the offset marker's y-axis position as an offset from the main marker's position, use the MARK:OFFS:DELT:Y command.

**MARKER [1|2]:OFFSet:Y:COMPLex****command/query**

Specifies the offset marker's y-axis position for polar and Smith chart trace types.

**Command Syntax:** MARKer[1|2]:OFFSet:Y:COMPLex <param>,<param>

```

<param> ::= <value>|<bound>
<value> ::= <number>[<unit>]
<number> ::= a real number (NRf data)
             limits: -72000.0:72000.0
<unit> ::= DBM|DBV|DBVRMS|DBUV|DBUVRMS|V|VRMS|DEG|RAD|S|DB
<bound> ::= MAX|MIN

```

**Example Statements:** Output 719;"MARKER1:OFFSet:Y:COMPLEx 0.2 VRMS,0.2 VRMS"  
Output 719;"mark2:offs:y:comp -10dbm,30 DEG"

**Query Syntax:** MARKer[1|2]:OFFSet:Y:COMPLex?

**Return Format:** <number>,<number>

```

<number> ::= a real number (NR2 or NR3 data)

```

**Attribute Summary:** Preset state: 0,0 (both traces)  
Overlapped: no  
Pass control required: no  
SCPI Compliance: instrument-specific

**Description:**

This command specifies the offset marker's absolute "y-axis" position for polar and Smith chart trace types, only.

The selected marker readout units determine how the values are interpreted (M,P or R,I).

To specify the offset marker's y-axis position as an offset from the main marker's position for polar and Smith chart trace types, use the MARK:OFFS:DELT:Y:COMP command.

**MARKer[1|2]:POINT****command/query**

Moves the main marker to a particular display point.

**Command Syntax:** MARKer[1|2]:POINT {<number>|<step>|<bound>}

```
<number> ::= an integer (NRf data)
           limits: 0:400
<step>   ::= UP|DOWN
<bound>  ::= MAX|MIN
```

**Example Statements:** Output 719;"Mark:Poin 0"  
Output 719;"MARKER2:POINT 200"

**Query Syntax:** MARKer[1|2]:POINT?

**Return Format:** <number>

```
<number> ::= an integer (NR1 data)
```

**Attribute Summary:** Preset state: +200 (both traces)  
Overlapped: no  
Pass control required: no  
SCPI Compliance: instrument-specific

**Description:**

A trace is divided into 401 points along its x-axis. This command specifies the main marker's x-axis position by point number. To specify its x-axis position by frequency (or time), use the MARK:X command.

---

**MARKer[1|2][:STATe]****command/query**

Enables the main markers or disables all markers and marker functions at once.

**Command Syntax:** MARKer[1|2][:STATe] {OFF|0|ON|1}

**Example Statements:** Output 719;"marker:state off"  
Output 719;"Mark 1"

**Query Syntax:** MARKer[1|2][:STATe]?

**Return Format:** +{0|1}

**Attribute Summary:** Preset state: +1  
Overlapped: no  
Pass control required: no  
SCPI Compliance: instrument-specific

**Description:**

ON enables the display of the main markers.

OFF disables the display of main and offset markers for both traces, even if you append a trace specifier to the MARKer mnemonic. In addition, it disables the frequency counter (MARK:FUNC:FCO), the noise-level marker (MARK:FUNC:NOIS), and the peak tracking function (MARK:MAX:TRACK).

**MARKer[1|2]:TARGet****command/query**

Specifies a marker target level.

**Command Syntax:** MARKer[1|2]:TARGet {(<number>[<unit>])|<step>|<bound>}

<number> ::= a real number (NRf data)  
 limits: -9.9E37:9.9E37

<unit> ::= DBM|DBV|DBVRMS|DBUV|DBUVRMS|V|VRMS|DEG|RAD|S|DB

<step> ::= UP|DOWN

<bound> ::= MAX|MIN

**Example Statements:** Output 719;"mark2:target -9.9e+37"  
 Output 719;"Mark:Targ -9.9e+37"

**Query Syntax:** MARKer[1|2]:TARGet?**Return Format:** NR3

**Attribute Summary:** Preset state: 0 dBm  
 Overlapped: no  
 Pass control required: no  
 SCPI Compliance: instrument-specific

**Description:**

Specifies a marker target level to be used by the marker target search commands (MARK:TARG:LEFT|RIGHT). A separate target value is maintained for each trace type: phase, log mag, delay, etc. If offset marker is off, this is an absolute target. If offset marker is on, this is a relative target.



---

**MARKer[1|2]:TARGet:LEFT****command**

Move the active marker to the nearest target value to the left of the present marker position on the active trace.

**Command Syntax:** MARKer[1|2]:TARGet:LEFT

**Example Statements:** Output 719;"MARKER2:TARG:LEFT"  
Output 719;"mark:targ:left"

**Attribute Summary:** Preset state: not applicable  
Overlapped: no  
Pass control required: no  
SCPI Compliance: instrument-specific

**Description:**

Move the active marker to the nearest target value to the left of the present marker position on the active trace. The target value is defined with the marker target level (MARK:TARG) command.

Trace slope at the target value affects the search result. If the slope is positive, the analyzer moves the marker to the first display point whose value is less than or equal to the target value. If the slope is negative, the analyzer moves the marker to the first display point whose value is greater than or equal to the target value.

---

**MARKer[1|2]:TARGet:RIGHT****command**

Move the active marker to the nearest target value to the right of the current position on the active trace.

**Command Syntax:** MARKer[1|2]:TARGet:RIGHT

**Example Statements:** Output 719;"Mark:Target:Righ"  
Output 719;"MARK:TARGET:RIGH"

**Attribute Summary:** Preset state: not applicable  
Overlapped: no  
Pass control required: no  
SCPI Compliance: instrument-specific

**Description:**

Move the active marker to the nearest target value to the right of the current position on the active trace. Target value is specified by the marker target level (MARK:TARG) command.

Trace slope at the target value affects the search result. If the slope is positive, the analyzer moves the marker to the first display point whose value is greater than or equal to the target value. If the slope is negative, the analyzer moves the marker to the first display point whose value is less than or equal to the target value.

---

**MARKer[1|2]:TO:SPAN****command**

Resets the span to the frequency difference between the main and offset markers.

**Command Syntax:** MARKer[1|2]:TO:SPAN

**Example Statements:** Output 719;"MARK2:TO:SPAN"  
Output 719;"marker1:to:span"

**Attribute Summary:** Preset state: not applicable  
Overlapped: no  
Pass control required: no  
SCPI Compliance: instrument-specific

**Description:**

When swept spectrum measurements are selected (INST:SEL SWEP), this command resets the start frequency (SENS:FREQ:STAR) to the smaller of the two marker's frequencies. It resets the stop frequency (SENS:FREQ:STOP) to the larger of the two frequencies.

When narrow band zoom measurements are selected (INST:SEL FFT), this command resets the center frequency (SENS:FREQ:CENT) to one-half the sum of the main and offset marker frequencies. It resets the span (SENS:FREQ:SPAN) to the difference between these two frequencies. If the difference doesn't exactly match one of the spans available for narrow band zoom measurements, the analyzer selects the next larger span. Offset marker and main marker must be on.

**MARKer[1|2]:X****command/query**

Specifies the main marker's x-axis position.

**Command Syntax:** MARKer[1|2]:X {<value>|<step>|<bound>}

```

<value> ::= <number>[<unit>]
<number> ::= a real number (NRf data)
           limits: 0.0:150.0E6
<unit> ::= HZ|S
<step> ::= UP|DOWN
<bound> ::= MAX|MIN

```

**Example Statements:** Output 719;"mark:x 98.1 mahz"  
Output 719;"Marker:X 150ms"

**Query Syntax:** MARKer[1|2]:X? [UNIT]

**Return Format:** <number>|("<unit>")

```

<number> ::= a real number (NR2 or NR3 data)
<unit> ::= unit that applies to returned number

```

**Attribute Summary:** Preset state: +7.51E+7 Hz (both traces)  
Overlapped: no  
Pass control required: no  
SCPI Compliance: instrument-specific

**Description:**

This command specifies the main marker's x-axis position by frequency (or time). To specify its x-axis position by display point number, use the MARK:POIN command.

When the swept spectrum or swept network measurement is selected (INST:SEL SWEP or INST:SEL NETW), the marker is moved to the first display point that is less than or equal to the value sent. When the narrowband zoom measurement is selected (INST:SEL FFT), the marker is moved to the display point closest to the value sent.

---

**MARKer[1|2]:X:FCOunt?****query**

Returns the last frequency measured by the frequency counter.

**Query Syntax:** MARKer[1|2]:X:FCOunt? [UNIT]

**Example Statements:** Output 719;"MARKER:X:FCOUNT?"  
Output 719;"mark:x:fco?"

**Return Format:** <number>|{"<unit>"}

<number> ::= a real number (NR2 or NR3 data)

<unit> ::= unit that applies to returned number

**Attribute Summary:** Preset state: undefined value  
Overlapped: no  
Pass control required: no  
SCPI Compliance: instrument-specific

**Description:**

The frequency counter must be turned on before you can read a value with this query. Send MARK:FUNC:FCO ON to turn the frequency counter on. To assure that a frequency count measurement is complete, do a SENS:REST; \*WAI.

---

**MARKer[1|2]:Y?****query**

Returns the main marker's y-axis position.

**Query Syntax:** MARKer[1|2]:Y?

**Example Statements:** Output 719;"Mark:Y?"  
Output 719;"MARKER1:Y?"

**Return Format:** <number>

<number> ::= a real number (NR2 or NR3 data)

**Attribute Summary:** Preset state: undefined value  
Overlapped: no  
Pass control required: no  
SCPI Compliance: instrument-specific

**Description:**

This query always returns the y-axis position of the main marker, even if the marker is not currently displayed on the analyzer's screen. The value returned tells you the amplitude of the specified trace at the marker's x-axis position (specified with MARK:X or MARK:POIN). The marker units are the same as for the reference level for the specified trace.

---

**MARKer[1|2]:Y:COMPLex?****query**

Returns the main marker's complex value.

**Query Syntax:** MARKer[1|2]:Y:COMPLex?

**Example Statements:** Output 719;"Mark:Y:Comp?"  
Output 719;"MARKER1:Y:COMPLEX?"

**Return Format:** <number>,<number>

<number> ::= a real number (NR2 or NR3 data)

**Attribute Summary:** Preset state: undefined value  
Overlapped: no  
Pass control required: no  
SCPI Compliance: instrument-specific

**Description:**

For use with the Smith Chart and polar trace types. This query returns the complex marker values for the specified trace in magnitude and phase if MARK:Y:READ is MPH and real-imaginary if MARK:Y:READ is RIM. All units match the units currently displayed for the polar or Smith Chart trace types. For magnitude, real, and imaginary values, the unit is the same as the unit for the reference level. For phase values, the unit is the same as the unit last used to set the reference level for the phase trace type.

---

**MARKer[1|2]:Y:NOISe?****query**

Returns the value last measured by the noise level marker.

**Query Syntax:** MARKer[1|2]:Y:NOISe? [UNIT]

**Example Statements:** Output 719;"marker:y:noise?"  
Output 719;"Mark:Y:Nois?"

**Return Format:** <number>|("<unit>")

<number> ::= a real number (NR2 or NR3 data)

<unit> ::= unit that applies to returned number

**Attribute Summary:** Preset state: undefined value  
Overlapped: no  
Pass control required: no  
SCPI Compliance: instrument-specific

**Description:**

The noise level marker must be turned on before you can read a value with this query. Send MARK:FUNC:NOIS ON to turn on the noise-level marker. To assure that a noise marker measurement has completed, do a SENS:REST; \*WAI.



---

**MARKer[1|2]:Y:READout****command/query**

Select marker readout of real and imaginary or magnitude and phase.

**Command Syntax:** MARKer[1|2]:Y:READout {MPHase|RIMaginary}

Example Statements: Output 719;"MARKER:Y:READ MPHase"  
Output 719;"marker2:y:readout MPHase"

**Query Syntax:** MARKer[1|2]:Y:READout?

**Return Format:** CHAR

**Attribute Summary:** Preset state: MPH  
Overlapped: no  
Pass control required: no  
SCPI Compliance: instrument-specific

**Description:**

The marker readout command is used with polar and Smith Chart displays. When MPH is active, the analyzer displays frequency, magnitude, and phase values. When RIM is active, the analyzer displays frequency, real, and imaginary values.

This command also determines whether magnitude and phase values or real and imaginary values are returned for MARK:Y:COMP?.

## MMEMory Subsystem

---

The MMEMory subsystem contains commands that control the analyzer's mass storage (disk) functions. Two of the mass storage devices are RAM-based disks—one using non-volatile RAM and the other using volatile RAM. The other mass storage device is an internal disk drive that uses 3.5-inch flexible disks. (The internal drive may be deleted on some instruments.)

Most MMEMory commands are directed to one of the disks with the following disk specifiers:

- NVRAM:—This specifies the non-volatile RAM disk.
- RAM:—This specifies the volatile RAM disk.
- INT:—This specifies the internal disk.

If you omit disk specifiers from MMEMory commands, the commands are automatically directed to the default disk. You select the default disk with the MMEM:MSI command.

---

**MMEMory:COPY****command**

Copies the contents of one disk to another or one file to another.

**Command Syntax:**       MMEMory:COPY '<pathname>', '<pathname>'

<pathname> ::= [<disk>][<filename>]

<disk> ::= NVRAM:|RAM:|INT:

<filename> ::= 1 through 10 ASCII characters (use A:Z, a:z, 0:9, and underscore)

**Example Statements:**       Output 719;"MMEM:COPY 'RAM:', 'INT:'"  
                              Output 719;"mmemory:copy 'STATE1', 'RAM:STATE1'"

**Attribute Summary:**       Preset state: not applicable  
                              Overlapped: no  
                              Pass control required: no  
                              SCPI Compliance: instrument-specific

**Description:**

To copy a disk, just use a disk specifier for each <pathname>. To copy a file, use disk specifiers and filenames. If you just want to rename a file, use the MMEM:REN command.

---

**MMEMory:DELeTe****command**

Deletes one file or the contents of an entire disk.

**Command Syntax:**       MMEMory:DELeTe '[<disk>][<filename>]'

      <disk> ::= NVRAM:|RAM:|INT:

      <filename> ::= 1 through 10 ASCII characters (use A:Z, a:z, 0:9, and  
                  underscore)

**Example Statements:**       Output 719;"Mmemory:Delete 'RAM:'"  
                              Output 719;"MMEM:DEL 'NVRAM:TRACE2' "

**Attribute Summary:**       Preset state: not applicable  
                              Overlapped: no  
                              Pass control required: no  
                              SCPI Compliance: instrument-specific

**Description:**

If you send the command with a disk specifier only, the contents of the entire disk are deleted.

---

**MMEMory:GET:PROG****command**

Loads an HP Instrument BASIC program into the analyzer from the specified disk.

**Command Syntax:** MMEMory:GET:PROG ' [<disk>]<filename>'

<disk> ::= NVRAM:|RAM:|INT:

<filename> ::= 1 through 10 ASCII characters (use A:Z, a:z, 0:9, and underscore); file must contain a program

**Example Statements:** Output 719;"mmem:get:prog 'MEAS\_SEQ5'"  
Output 719;"Mmemory:Get:Program 'RAM:ZERO\_SPAN'"

**Attribute Summary:** Preset state: not applicable  
Overlapped: no  
Pass control required: no  
SCPI Compliance: instrument-specific

**Description:**

You can load an HP Instrument BASIC program from disk either with this command or with the MMEM:LOAD:PROG command. You can load a program from your controller with the PROG:SEL:DEF command.

This command is only valid if the HP Instrument BASIC option is installed.

**MMEMory:INITialize****command**

Formats the specified disk.

**Command Syntax:** MMEMory:INITialize '<disk>' [, (<number>|<bound>)]

<disk> ::= NVRAM: | RAM: | INT:  
 <number> ::= an integer (NRf data)  
                   limits: 0:8  
 <bound> ::= MAX | MIN

Example Statements:       Output 719;"MMEMORY:INITIALIZE 'RAM:',5"  
                           Output 719;"mmem:init 'INT:',1"

**Attribute Summary:**   Preset state: +0  
                           Overlapped: no  
                           Pass control required: no  
                           SCPI Compliance: instrument-specific

**Description:**

The parameter you enter after the disk specifier is actually an encoded value that determines the disk's formatted capacity (in kilobytes):

Number	RAM Disk	NVRAM Disk	Internal Disk
0	64	63	640
1	640	"	640
2	710	"	710
3	788	"	788
4	270	"	—
5	640	"	64
6	1000	—	—
7	1500	—	—
8	2000	—	—

The interleave factor for the internal disk is always 1.

**MMEMemory:LOAD:LIMit:LOWer** **command**

Loads a lower limit into the analyzer from the specified disk.

**Command Syntax:** MMEMemory:LOAD:LIMit:LOWer {A|B},' [<disk>]<filename>'

<disk> ::= NVRAM: |RAM: |INT:

<filename> ::= 1 through 10 ASCII characters (use A:Z, a:z, 0:9, and underscore); file must contain a limit or a trace

**Example Statements:** Output 719;"Mmem:Load:Lim:Low A, 'INT:L\_LIM2'"  
Output 719;"MMEMORY:LOAD:LIMIT:LOWER B, 'oldLim'"

**Attribute Summary:** Preset state: not applicable  
Overlapped: no  
Pass control required: no  
SCPI Compliance: instrument-specific

**Description:**

This command loads the contents of a file into the lower limit register of the specified trace. The file must have been saved either by storing upper or lower limits or trace data with the MMEM:STOR:LIM:UPP, MMEM:STOR:LIM:LOW, or MMEM:STOR:TRAC command. Additional limit commands are available under DISP:LIM.

**MMEMory:LOAD:LIMit:UPPer****command**

Loads an upper limit into the analyzer from the specified disk.

**Command Syntax:** MMEMory:LOAD:LIMit:UPPer (A|B), '[<disk>]<filename>'

<disk> ::= NVRAM:|RAM:|INT:

<filename> ::= 1 through 10 ASCII characters (use A:Z, a:z, 0:9, and underscore); file must contain a limit or a trace

**Example Statements:** Output 719;"mmemory:load:limit:upper b,'oldLim'"  
Output 719;"Mmem:Load:Lim:Upp B,'INT:U\_LIM2'"

**Attribute Summary:** Preset state: not applicable  
Overlapped: no  
Pass control required: no  
SCPI Compliance: instrument-specific

**Description:**

This command loads the contents of a file into the upper limit register of the specified trace. The file must have been saved either by storing upper or lower limits or trace data with the MMEM:STOR:LIM:UPP, MMEM:STOR:LIM:LOW, or MMEM:STOR:TRAC command. Additional limit commands are available under DISP:LIM.



---

**MMEMory:LOAD:MATH****command**

Loads a complete set of math definitions into the analyzer from the specified disk.

**Command Syntax:**       MMEMory:LOAD:MATH '[<disk>]<filename>'

      <disk> ::= NVRAM:|RAM:|INT:  
      <filename> ::= 1 through 10 ASCII characters (use A:Z, a:z, 0:9, and  
                          underscore); file must contain a set of math  
                          definitions

Example Statements:       Output 719;"MMEM:LOAD:MATH 'NVRAM:myMath' "  
                          Output 719;"mmemory:load:math 'MATH1' "

**Attribute Summary:**   Preset state: not applicable  
                          Overlapped: no  
                          Pass control required: no  
                          SCPI Compliance: instrument-specific

**Description:**

This command uses the contents of a file to load all of the analyzer's function registers (F1 through F5) and constant registers (K1 through K5). The file must have been saved by storing math data with the MMEM:STOR:MATH command.

---

**MMEMory:LOAD:PROGram****command**

Loads an HP Instrument BASIC program into the analyzer from the specified disk.

**Command Syntax:**       MMEMory:LOAD:PROGram ' [<disk>]<filename>'

<disk> ::= NVRAM:|RAM:|INT:

<filename> ::= 1 through 10 ASCII characters (use A:Z, a:z, 0:9, and underscore); file must contain a program

**Example Statements:**       Output 719;"Mmemory:Load:Program 'PROG2'"  
                              Output 719;"MMEM:LOAD:PROG 'INT:MYPROG'"

**Attribute Summary:**       Preset state: not applicable  
                              Overlapped: no  
                              Pass control required: no  
                              SCPI Compliance: instrument-specific

**Description:**

You can load an HP Instrument BASIC program from disk either with this command or with the MMEM:GET:PROG command. You can load a program from your controller with the PROG:SEL:DEF command.

This command is only valid if the HP Instrument BASIC option is installed.

**MMEemory:LOAD:STATE****command**

Loads an instrument state into the analyzer from the specified disk.

**Command Syntax:** MMEemory:LOAD:STATE {1|MAX|MIN},' [<disk>]<filename>'

<disk> ::= NVRAM:|RAM:|INT:

<filename> ::= 1 through 10 ASCII characters (use A:Z, a:z, 0:9, and underscore); file must contain an instrument state

**Example Statements:** Output 719;"mmem:load:stat 1,'statel'"  
Output 719;"Mmemory:Load:State 1,'STATE\_2'"

**Attribute Summary:** Preset state: not applicable  
Overlapped: no  
Pass control required: no  
SCPI Compliance: instrument-specific

**Description:**

This command uses the contents of a file to redefine the instrument state. The file must have been saved by storing instrument state with the MMEM:STOR:STAT command.

---

**MMEMory:LOAD:TRACe****command**

Loads a trace into the analyzer from the specified disk.

**Command Syntax:** MMEMory:LOAD:TRACe <data\_reg>,' [<disk>]<filename>'

<data\_reg> ::= {D1|D2|D3|D4|D5|D6|D7|D8}

<disk> ::= NVRAM:|RAM:|INT:

<filename> ::= 1 through 10 ASCII characters (use A:Z, a:z, 0:9, and underscore); file must contain a trace

**Example Statements:** Output 719;"MMEMORY:LOAD:TRACe D6,'SPEC'"  
Output 719;"mmem:load:trac d2,'INT:trace4'"

**Attribute Summary:** Preset state: not applicable  
Overlapped: no  
Pass control required: no  
SCPI Compliance: instrument-specific

**Description:**

This command loads the contents of a file into one of the analyzer's eight data registers (D1 through D8). The file must have been saved by storing trace data with the MMEM:STOR:TRAC command. After loading the data register, you can display its contents with the trace data (DISP:RES) command.

---

**MMEMemory:MSI****command/query**

Selects a default disk for file and disk operations.

**Command Syntax:** MMEMemory:MSI '<disk>'

&lt;disk&gt; ::= NVRAM: | RAM: | INT:

**Example Statements:**  
Output 719;"Mmem:Msi 'INT:'"  
Output 719;"MMEMORY:MSI 'NVRAM:'"**Query Syntax:** MMEMemory:MSI?**Return Format:** "<disk>"**Attribute Summary:**  
Preset state: not affected by Preset  
Overlapped: no  
Pass control required: no  
SCPI Compliance: instrument-specific**Description:**

If you omit disk specifiers from MMEMemory commands, the commands are automatically directed to the default disk. This command uses the following mnemonics to select the default disk:

- NVRAM:—This selects the non-volatile RAM disk.
- RAM:—This selects the volatile RAM disk.
- INT:—This selects the internal disk.

---

**MMEMory:PACK****command**

Increases the amount of usable space on the specified disk.

**Command Syntax:**       MMEMory:PACK [ '<disk>' ]

<disk> ::= NVRAM: | RAM: | INT:

**Example Statements:**     Output 719;"mmemory:pack 'INT:'"  
                          Output 719;"Mmem:Pack"

**Attribute Summary:**     Preset state: not applicable  
                          Overlapped: no  
                          Pass control required: no  
                          SCPI Compliance: confirmed (1991.0)

**Description:**

When you delete files from a LIF-formatted disk, you sometimes leave spaces that are too small to be used for new files. This command recovers these unusable spaces.

---

**MMEMory:REName****command**

Renames a file.

**Command Syntax:** MMEMory:REName '<pathname>', '<filename>'

&lt;pathname&gt; ::= [&lt;disk&gt;]&lt;filename&gt;

&lt;disk&gt; ::= NVRAM:|RAM:|INT:

&lt;filename&gt; ::= 1 through 10 ASCII characters (use A:Z, a:z, 0:9, and underscore)

Example Statements:      Output 719;"MMEM:REN 'INT:LIMIT','OLDLIMIT'"  
                          Output 719;"mmemory:rename 'myprog','yourProg'"

**Attribute Summary:**    Preset state: not applicable  
                          Overlapped: no  
                          Pass control required: no  
                          SCPI Compliance: instrument-specific

**Description:**

Renaming only allows you to change a file's name on the current disk. It does not allow you to *move* a file by changing the file's name and disk specifier. To move a file, first copy it to another disk with the MMEM:COPY command, then delete it from the original disk with the MMEM:DEL command.

---

**MMEMory:RESave:PROG****command**

Saves a program that has already been saved once.

**Command Syntax:** MMEMory:RESave:PROG ' [<disk>]<filename>'

<disk> ::= NVRAM:|RAM:|INT:

<filename> ::= 1 through 10 ASCII characters (use A:Z, a:z, 0:9, and underscore)

**Example Statements:** Output 719;"Mmemory:Resave:Program 'meas\_seq5'"  
Output 719;"MMEM:RES:PROG 'NVRAM:Program2'"

**Attribute Summary:** Preset state: not applicable  
Overlapped: no  
Pass control required: no  
SCPI Compliance: instrument-specific

**Description:**

This command saves the current HP Instrument BASIC program to the specified disk. If the filename you specify matches the name of another file on the disk, the old file is overwritten. (Use MMEM:SAVE:PROG or MMEM:STOR:PROG if you want to ensure that the old file is not overwritten.)

This command is only valid when the HP Instrument BASIC option is installed.



---

**MMEMory:SAVE:PROG****command**

Saves a program for the first time.

**Command Syntax:** MMEMory:SAVE:PROG ' [<disk>]<filename>'

&lt;disk&gt; ::= NVRAM:|RAM:|INT:

&lt;filename&gt; ::= 1 through 10 ASCII characters (use A:Z, a:z, 0:9, and underscore)

Example Statements:      Output 719;"mmem:save:prog 'PROGRAM\_1'"  
                          Output 719;"Mmemory:Save:Program 'RAM:yourProg'"

**Attribute Summary:**   Preset state: not applicable  
                          Overlapped: no  
                          Pass control required: no  
                          SCPI Compliance: instrument-specific

**Description:**

You can use this command or the MMEM:STOR:PROG command to save the current HP Instrument BASIC program to the specified disk. If the filename you specify matches the name of another file on the disk, the save is aborted to preserve the old file. (Use MMEM:RES:PROG if you want to overwrite the old file.)

This command is only valid when the HP Instrument BASIC option is installed.

**MMEMemory:STORE:LIMit:LOWer****command**

Saves the specified lower limit to a disk.

**Command Syntax:** MMEMemory:STORE:LIMit:LOWer {A|B},' [<disk>]<filename>'

<disk> ::= NVRAM:|RAM:|INT:

<filename> ::= 1 through 10 ASCII characters (use A:Z, a:z, 0:9, and underscore)

**Example Statements:** Output 719;"MMEMORY:STORE:LIMIT:LOWER B,'oldLim'"  
Output 719;"MME:STORE:LIM:LOW A,'INT:L\_LIM2'"

**Attribute Summary:** Preset state: not applicable  
Overlapped: no  
Pass control required: no  
SCPI Compliance: instrument-specific

**Description:**

The first parameter specifies which lower limit you are saving—the one from trace A or the one from trace B. If the filename you specify matches the name of another file on the disk, the old file is overwritten.

---

**MMEMemory:STORe:LIMit:UPPer****command**

Saves the specified upper limit to a disk.

**Command Syntax:** MMEMemory:STORe:LIMit:UPPer {A|B},' [<disk>]<filename>'

<disk> ::= NVRAM:|RAM:|INT:

<filename> ::= 1 through 10 ASCII characters (use A:Z, a:z, 0:9, and underscore)

**Example Statements:** Output 719;"Mmem:Stor:Lim:Upp A,'RAM:uLim2'"  
Output 719;"MMEMORY:STORE:LIMIT:UPPER A,'LIMIT'"

**Attribute Summary:** Preset state: not applicable  
Overlapped: no  
Pass control required: no  
SCPI Compliance: instrument-specific

**Description:**

The first parameter specifies which upper limit you are saving—the one from trace A or the one from trace B. If the filename you specify matches the name of another file on the disk, the old file is overwritten.

**MMEMory:STORe:MATH****command**

Saves a complete set of math definitions to the specified disk.

**Command Syntax:**       MMEMory:STORe:MATH '[<disk>]<filename>'

      <disk> ::= NVRAM:|RAM:|INT:  
      <filename> ::= 1 through 10 ASCII characters (use A:Z, a:z, 0:9, and  
                  underscore)

**Example Statements:**       Output 719;"mmemory:store:math 'MATH1'"  
                              Output 719;"Mmem:Stor:Math 'NVRAM:myMath'"

**Attribute Summary:**       Preset state: not applicable  
                              Overlapped: no  
                              Pass control required: no  
                              SCPI Compliance: instrument-specific

**Description:**

A complete set of math definitions includes the current values in all of the function registers (F1 through F5) and all of the constant registers (K1 through K5). If the filename you specify with this command matches the name of another file on the disk, the old file is overwritten.

**MMEMory:STORe:PROG**

**command**

Saves a program for the first time.

**Command Syntax:** MMEMory:STORe:PROG '[<disk>]<filename>'

<disk> ::= NVRAM:|RAM:|INT:  
 <filename> ::= 1 through 10 ASCII characters (use A:Z, a:z, 0:9, and underscore)

**Example Statements:** Output 719;"MMEM:STOR:PROG 'PROG2' "  
 Output 719;"mmemory:store:program 'INT:myProg' "

**Attribute Summary:** Preset state: not applicable  
 Overlapped: no  
 Pass control required: no  
 SCPI Compliance: instrument-specific

**Description:**

You can use this command or MMEM:SAVE:PROG to save the current HP Instrument BASIC program to the specified disk. If the filename you specify matches the name of another file on the disk, the save is aborted to preserve the old file. (Use MMEM:RES:PROG if you want to overwrite the old file.)

This command is only valid when the HP Instrument BASIC option is installed.

---

**MMEMory:STORe:STATe****command**

Saves the instrument state to the specified disk.

**Command Syntax:**       MMEMory:STORe:STATe (1|MAX|MIN), '[<disk>]<filename>'

    <disk> ::= NVRAM:|RAM:|INT:

    <filename> ::= 1 through 10 ASCII characters (use A:Z, a:z, 0:9, and underscore)

**Example Statements:**       Output 719;"Mmemory:Store:State 1,'STATE\_2'"  
                              Output 719;"MMEM:STOR:STAT 1,'statel'"

**Attribute Summary:**       Preset state: not applicable  
                              Overlapped: no  
                              Pass control required: no  
                              SCPI Compliance: instrument-specific

**Description:**

If the filename you specify with this command matches the name of another file on the disk, the old file is overwritten.

---

**MMEMemory:STORe:TRACe****command**

Saves the specified trace to a disk.

**Command Syntax:** MMEMemory:STORe:TRACe {A|B},' [<disk>]<filename>'

&lt;disk&gt; ::= NVRAM: | RAM: | INT:

&lt;filename&gt; ::= 1 through 10 ASCII characters (use A:Z, a:z, 0:9, and underscore)

Example Statements:      Output 719;"mmem:stor:trac a,'INT:trace4'"  
                          Output 719;"Mmemory:Store:Trace B,'SPEC'"

**Attribute Summary:**    Preset state: not applicable  
                          Overlapped: no  
                          Pass control required: no  
                          SCPI Compliance: instrument-specific

**Description:**

The first parameter specifies which trace you are saving—trace A or trace B. If the filename you specify matches the name of another file on the disk, the old file is overwritten.

## **PLOT Subsystem**

---

The PLOT subsystem contains commands that control plotting parameters. It also contains commands that allow you to plot different portions of the analyzer's screen.



**PLOT:ADDRESS****command/query**

Tells the analyzer which HP-IB address is assigned to your plotter.

**Command Syntax:** PLOT:ADDRESS {<number>|<step>|<bound>}

<number> ::= an integer (NRf data)  
          limits: 0:30  
<step> ::= UP|DOWN  
<bound> ::= MAX|MIN

**Example Statements:** Output 719;"PLOT:ADDRESS 0"  
                          Output 719;"plot:addr 3"

**Query Syntax:** PLOT:ADDRESS?

**Return Format:** <number>

<number> ::= an integer (NR1 data)

**Attribute Summary:** Preset state: not affected by Preset  
                          Overlapped: no  
                          Pass control required: no  
                          SCPI Compliance: instrument-specific

**Description:**

When you initiate a plot with one of the PLOT:DUMP commands, the analyzer expects to find a plotter at the HP-IB address specified with PLOT:ADDR. If there isn't a plotter at the specified address, the plot is automatically aborted.

---

**PLOT:DUMP:ALL****command**

Plots everything currently displayed on the analyzer's screen.

**Command Syntax:** PLOT:DUMP:ALL

**Example Statements:** Output 719;"Plot:Dump:All"  
Output 719;"PLOT:DUMP:ALL"

**Attribute Summary:** Preset state: not applicable  
Overlapped: yes  
Pass control required: yes  
SCPI Compliance: instrument-specific

**Description:**

This command allows you to plot anything you can display with the SCR:CONT command. Everything on the screen is plotted *except* the softkey labels.

If you don't know how to pass control, see "Passing Control" in chapter 2.

**PLOT:DUMP:GRATICule**

**command**

Plots all displayed graticules.

**Command Syntax:** PLOT:DUMP:GRATICule

**Example Statements:** Output 719;"plot:dump:graticule"  
Output 719;"Plot:Dump:Grat"

**Attribute Summary:** Preset state: not applicable  
Overlapped: yes  
Pass control required: yes  
SCPI Compliance: instrument-specific

**Description:**

Graticules are always plotted with solid lines, regardless of their appearance on the analyzer's screen.

If you don't know how to pass control, see "Passing Control" in chapter 2.

---

**PLOT:DUMP:MARKer****command**

Plots all displayed main markers and their coordinates.

**Command Syntax:** PLOT:DUMP:MARKer

**Example Statements:** Output 719;"PLOT:DUMP:MARK"  
Output 719;"plot:dump:marker"

**Attribute Summary:** Preset state: not applicable  
Overlapped: yes  
Pass control required: yes  
SCPI Compliance: instrument-specific

**Description:**

Markers must be displayed (MARK:STAT ON) before they can be plotted. Markers are annotated with their x-axis and y-axis coordinates when you plot them with PLOT:DUMP:MARK.

If you don't know how to pass control, see "Passing Control" in chapter 2.

---

**PLOT:DUMP:OFFSet:MARKer****command**

Plots all displayed offset markers and their coordinates.

**Command Syntax:** PLOT:DUMP:OFFSet:MARKer

**Example Statements:** Output 719;"Plot:Dump:Offset:Marker"  
Output 719;"PLOT:DUMP:OFFS:MARK"

**Attribute Summary:** Preset state: not applicable  
Overlapped: yes  
Pass control required: yes  
SCPI Compliance: instrument-specific

**Description:**

Offset markers must be displayed (MARK:OFFS ON) before they can be plotted. Offset markers are annotated with their x-axis and y-axis coordinates when you plot them with PLOT:DUMP:OFFS:MARK.

If you don't know how to pass control, see "Passing Control" in chapter 2.

---

**PLOT:DUMP:TRACe****command**

Plots all displayed traces.

**Command Syntax:** PLOT:DUMP:TRACe

**Example Statements:** Output 719;"plot:dump:trac"  
Output 719;"Plot:Dump:Trace"

**Attribute Summary:** Preset state: not applicable  
Overlapped: yes  
Pass control required: yes  
SCPI Compliance: instrument-specific

**Description:**

When you use this command, displayed traces are plotted without graticules, annotation, or markers.

If you don't know how to pass control, see "Passing Control" in chapter 2.

**PLOT:EJECT**

**command/query**

Turns the page-eject feature on and off for plotters that support such a feature.

**Command Syntax:** PLOT:EJECT {OFF|0|ON|1}

**Example Statements:** Output 719;"PLOT:EJECT ON"  
Output 719;"plot:ejec 0"

**Query Syntax:** PLOT:EJECT?

**Return Format:** +(0|1)

**Attribute Summary:** Preset state: +1  
Overlapped: no  
Pass control required: no  
SCPI Compliance: instrument-specific

**Description:**

Check your plotter's documentation to be sure that it supports the requested page-eject state.

**PLOT:LTYPe:TRACe[1|2]****command/query**

Selects the line type for the specified trace.

**Command Syntax:** PLOT:LTYPe:TRACe[1|2] {<number>|<bound>}

<number> ::= an integer (NRf data)  
limits: -4096:4096

<bound> ::= MAX|MIN

**Example Statements:** Output 719;"Plot:Ltyp:Tracl -4096"  
Output 719;"PLOT:LTYPE:TRACE2 1"

**Query Syntax:** PLOT:LTYPe:TRACe[1|2]?

**Return Format:** <number>

<number> ::= an integer (NR1 data)

**Attribute Summary:** Preset state: -4096 (both traces)  
Overlapped: no  
Pass control required: no  
SCPI Compliance: instrument-specific

**Description:**

The trace specifier determines whether you are selecting the line type for trace A or trace B. Omit the specifier or send 1 for trace A; send 2 for trace B. The <number> parameter is actually an encoded value. Encoded values for the most commonly used line types follow:

- Solid: -4096
- Dotted: 1
- Dashed: 2

Check your plotter's documentation to see if it supports additional line types.



**PLOT:PEN:ALPHA****command/query**

Selects the pen to be used for plotting alpha characters.

**Command Syntax:** PLOT:PEN:ALPHA {<number>|<step>|<bound>}

<number> ::= an integer (NRf data)  
          limits: 1:16  
<step> ::= UP|DOWN  
<bound> ::= MAX|MIN

**Example Statements:** Output 719;"plot:pen:alpha 6"  
                          Output 719;"Plot:Pen:Alph 1"

**Query Syntax:** PLOT:PEN:ALPHA?

**Return Format:** <number>

<number> ::= an integer (NR1 data)

**Attribute Summary:** Preset state: +4  
                          Overlapped: no  
                          Pass control required: no  
                          SCPI Compliance: instrument-specific

**Description:**

The alpha pen is used to plot the instrument state and the disk catalog. (You can display these with the SCR:CONT command.)

**PLOT:PEN:GRATICule****command/query**

Selects the pen to be used for plotting graticules.

**Command Syntax:** PLOT:PEN:GRATICule {<number>|<step>|<bound>}

<number> ::= an integer (NRf data)  
          limits: 1:16

<step> ::= UP|DOWN

<bound> ::= MAX|MIN

**Example Statements:** Output 719;"PLOT:PEN:GRAT 1"  
                          Output 719;"plot:pen:graticule 2"

**Query Syntax:** PLOT:PEN:GRATICule?

**Return Format:** <number>

<number> ::= an integer (NR1 data)

**Attribute Summary:** Preset state: +1  
                          Overlapped: no  
                          Pass control required: no  
                          SCPI Compliance: instrument-specific

**Description:**

The graticule pen is used to plot trace graticules, the border around the instrument state, and the border around the disk catalog.

## **PLOT:PEN:INITialize**

**command**

Returns plotter pen assignments to their default values.

**Command Syntax:** PLOT:PEN:INITialize

**Example Statements:** Output 719;"Plot:Pen:Initialize"  
Output 719;"PLOT:PEN:INIT"

**Attribute Summary:** Preset state: not applicable  
Overlapped: no  
Pass control required: no  
SCPI Compliance: instrument-specific

### **Description:**

Here are the default pen values:

- PLOT:PEN:ALPH = 4
- PLOT:PEN:GRAT = 1
- PLOT:PEN:MARK1 = 5
- PLOT:PEN:MARK2 = 6
- PLOT:PEN:TRAC1 = 2
- PLOT:PEN:TRAC2 = 3

**PLOT:PEN:MARKer[1|2]****command/query**

Selects the pen used to plot markers for the specified trace.

**Command Syntax:** PLOT:PEN:MARKer[1|2] {<number>|<step>|<bound>}

<number> ::= an integer (NRf data)  
limits: 1:16

<step> ::= UP|DOWN

<bound> ::= MAX|MIN

**Example Statements:** Output 719;"plot:pen:mark1 3"  
Output 719;"Plot:Pen:Marker1 2"

**Query Syntax:** PLOT:PEN:MARKer[1|2]?

**Return Format:** <number>

<number> ::= an integer (NR1 data)

**Attribute Summary:** Preset state: +5 (MARK1), +6 (MARK2)  
Overlapped: no  
Pass control required: no  
SCPI Compliance: instrument-specific

**Description:**

The marker pen is used to plot markers and limit lines. The trace specifier you send with this command determines whether you are selecting the pen number for trace A markers or trace B markers. Omit the specifier or send 1 for trace A; send 2 for trace B.

**PLOT:PEN:TRACe[1|2]****command/query**

Selects the pen used to plot the specified trace.

**Command Syntax:** PLOT:PEN:TRACe[1|2] {<number>|<step>|<bound>}<number> ::= an integer (NRf data)  
limits: 1:16

&lt;step&gt; ::= UP|DOWN

&lt;bound&gt; ::= MAX|MIN

**Example Statements:** Output 719;"plot:pen:trace2 10"  
Output 719;"Plot:Pen:Trac2 1"**Query Syntax:** PLOT:PEN:TRACe[1|2]?**Return Format:** <number>

&lt;number&gt; ::= an integer (NR1 data)

**Attribute Summary:** Preset state: +2 (TRAC1), +3 (TRAC2)  
Overlapped: no  
Pass control required: no  
SCPI Compliance: instrument-specific**Description:**

The trace pen is used to plot traces and all of the following trace-specific annotation:

- Trace title.
- Marker readout.
- X-axis annotation.
- Y-axis annotation.
- Limit test results.

The trace specifier you send with this command determines whether you are selecting the pen number for trace A or trace B. Omit the specifier or send 1 for trace A; send 2 for trace B.

**PLOT:SPEed****command/query**

Specifies the plotting speed that will be requested by the analyzer.

**Command Syntax:** PLOT:SPEed {<number>|<step>|<bound>}

<number> ::= an integer (NRf data)  
limits: 1:100

<step> ::= UP|DOWN

<bound> ::= MAX|MIN

**Example Statements:** Output 719;"PLOT:SPE 50"  
Output 719;"plot:speed 10"

**Query Syntax:** PLOT:SPEed?

**Return Format:** <number>

<number> ::= an integer (NR1 data)

**Attribute Summary:** Preset state: +50  
Overlapped: no  
Pass control required: no  
SCPI Compliance: instrument-specific

**Description:**

You request a plot speed in units of cm/s. Check your plotter's documentation to be sure that it supports the requested plotting speed.



## PRINT Subsystem

---

The PRINT subsystem contains two commands. One command tells the analyzer where to send print data; the other prints the contents of the analyzer's screen.



**PRINT:ADDRESS****command/query**

Tells the analyzer which HP-IB address is assigned to your printer.

**Command Syntax:** PRINT:ADDRESS (<number>|<step>|<bound>)

<number> ::= an integer (NRf data)  
          limits: 0:30  
<step> ::= UP|DOWN  
<bound> ::= MAX|MIN

**Example Statements:** Output 719;"Print:Address 1"  
                          Output 719;"PRIN:ADDR 14"

**Query Syntax:** PRINT:ADDRESS?

**Return Format:** <number>

<number> ::= an integer (NR1 data)

**Attribute Summary:** Preset state: not affected by Preset  
                          Overlapped: no  
                          Pass control required: no  
                          SCPI Compliance: instrument-specific

**Description:**

When you initiate a print operation with the PRIN:DUMP:ALL command, the analyzer expects to find a printer at the HP-IB address specified with PRIN:ADDR. If there isn't a printer at the specified address, the print operation is automatically aborted.

---

**PRINT:DUMP:ALL****command**

Prints everything currently displayed on the analyzer's screen.

**Command Syntax:** PRINT:DUMP:ALL

**Example Statements:** Output 719;"prin:dump:all"  
Output 719;"Print:Dump:All"

**Attribute Summary:** Preset state: not applicable  
Overlapped: yes  
Pass control required: yes  
SCPI Compliance: instrument-specific

**Description:**

This command allows you to print anything you can display with the SCR:CONT command. Everything on the screen is printed *except* the softkey labels.

---

**Note**

Print information is sent as a bit-mapped graphic, so your printer must accept raster dumps.

---



## PROGram Subsystem

---

The commands in the PROGram subsystem are only available when the HP Instrument BASIC option is installed. They allow you to interact with the program currently loaded in the analyzer.

All of the commands in this subsystem are grouped under the mnemonic *SElected*. Since *SElected* is an implied mnemonic, you can omit it from all PROGram commands. See “Implied Mnemonics” in chapter 3 for more information.

**PROGram[:SElected]:DEFine**

**command/query**

Loads an HP Instrument BASIC program into the analyzer from an external controller. (Use the query form to save.)

**Command Syntax:**        PROGram[:SElected]:DEFine <block>

    <block> ::= #<byte>[<length\_bytes>]<data\_bytes>

    <byte> ::= one ASCII-encoded byte specifying the number of length bytes to follow

    <length\_bytes> ::= ASCII-encoded bytes specifying the number of data bytes to follow

    <data\_bytes> ::= the bytes that define a program

**Example Statements:**        Output 719;"PROGRAM:SELECTED:DEFINE?"  
                                  Output 719;"prog:def?"

**Query Syntax:**             PROGram[:SElected]:DEFine?

**Return Format:**            <block>

**Attribute Summary:**        Preset state: not applicable  
                                  Overlapped: no  
                                  Pass control required: no  
                                  SCPI Compliance: confirmed (1991.0)

**Description:**

This command transfers a program between the analyzer and your controller. This allows you to develop a program on your controller and then load it into the analyzer when it's done.

When you transfer a program to the analyzer, you can use either the definite or the indefinite length block syntax. When the analyzer returns the program to your controller, it always uses the definite length block syntax. See "Block Data" in chapter 4 for more information.

---

**PROGram[:SElected]:DElete[:SElected]****command**

Deletes the current HP Instrument BASIC program.

**Command Syntax:**        PROGram[:SElected]:DElete[:SElected]

**Example Statements:**     Output 719;"program:selected:delete:selected"  
                              Output 719;"Prog:Del"

**Attribute Summary:**     Preset state: not applicable  
                              Overlapped: no  
                              Pass control required: no  
                              SCPI Compliance: confirmed (1991.0)

**Description:**

In addition to deleting the current program, this command deletes all of the programs variables—both those in COM and those not in COM.

---

**PROGram[:SElected]:MALLOCate**

**command/query**

Allocates stack space for HP Instrument BASIC programs.

**Command Syntax:**        PROGram[:SElected]:MALLOCate {<number>|<bound>|DEFault}

    <number> ::= an integer (NRf data)  
                  limits: 1200 bytes:3 megabytes

    <bound> ::= MAX|MIN

**Example Statements:**        Output 719;"PROG:SEL:MALL DEF"  
                              Output 719;"program:selected:mallocate 8192"

**Query Syntax:**            PROGram[:SElected]:MALLOCate?

**Return Format:**            <number>

    <number> ::= an integer (NRl data)

**Attribute Summary:**        Preset state: not affected by Preset  
                              Overlapped: no  
                              Pass control required: no  
                              SCPI Compliance: confirmed (1991.0)

**Description:**

Stack space is the portion of memory used for temporary storage of program variables (excluding those variables stored in COM). It provides the programs "working space."

---

**Note**



If you encounter the message "ERROR 2 Memory overflow." while your program is running, you need to allocate more stack space.

---

**PROGram[:SElected]:NUMBER****command/query**

Loads a new value for the specified numeric variable.

**Command Syntax:**      PROGram[:SElected]:NUMBER '<variable>',<block>

<variable> ::= name of a numeric variable

When data is ASCII-encoded, (FORM ASC) <block> takes the following form:

<block> ::= <number>[,<number>]...

<number> ::= a real number (NRf data)  
limits: -9.9E37:9.9E37

When data is binary-encoded, (FORM REAL) <block> takes the following form:

<block> ::= #<byte>[<length\_bytes>]<number>[<number>]...

<byte> ::= one ASCII-encoded byte specifying the number of length bytes to follow

<length\_bytes> ::= ASCII-encoded bytes specifying the number of data bytes to follow

<number> ::= a real number (32- or 64-bit binary floating point)  
limits: -9.9E37:9.9E37

**Example Statements:**      Output 719;"Program:NUMBER 'Address',19"  
                              Output 719;"PROG:NUMB 'Scode',7"

**Query Syntax:**            PROGram[:SElected]:NUMBER? '<variable>'

**Return Format:**            <block>

**Attribute Summary:**      Preset state: not applicable  
                              Overlapped: no  
                              Pass control required: no  
                              SCPI Compliance: confirmed (1991.0) (FORM ASC)

**Description:**

When you load an array with this command, values in the <block> parameter are loaded into the 1<sup>st</sup> through n<sup>th</sup> elements of the array (where *n* is the number of values in the block).



**PROGram[:SElected]:STATe**

**command/query**

Selects the state of the current HP Instrument BASIC program.

**Command Syntax:**        PROGram[:SElected]:STATe <param>

      <param> ::= {STOP|PAUSe|RUN|CONTInue}

**Example Statements:**        Output 719;"prog:sel:stat paus"  
                                   Output 719;"Program:State Continue"

**Query Syntax:**            PROGram[:SElected]:STATe?

**Return Format:**            STOP|PAUS|RUN

**Attribute Summary:**        Preset state: STOP  
                                   Overlapped: no  
                                   Pass control required: no  
                                   SCPI Compliance: confirmed (1991.0)

**Description:**

The analyzer generates an error message if you send RUN or CONT while a program is running. It also generates an error if you send CONT while a program is stopped.





## **ROUTE Subsystem**

---

The ROUTE subsystem commands control the selection of an external S parameter test set.

---

**ROUTe:CLOSe****command/query**

Selects test set IN with command shown in the syntax field.

**Command Syntax:** ROUTe:CLOSe TSET

**Example Statements:** Output 719;"Route:Close Tset"  
Output 719;"ROUT:CLOS TSET"

**Query Syntax:** ROUTe:CLOSe?

**Return Format:** NR1

**Attribute Summary:** Preset state: 1  
Overlapped: yes  
Pass control required: no  
SCPI Compliance: instrument-specific

**Description:**

Selects test set IN with command shown in the syntax field. To select test set OUT, send ROUT:OPEN TSET. When queried, a "1" is returned if the test set is IN, a "0" if it is OUT.

---

**ROUTe:OPEN****command/query**

Selects test set OUT with command shown in the syntax field.

**Command Syntax:**       ROUTe:OPEN TSET

**Example Statements:**    OUTPUT 711;"rout:open tset"  
                          OUTPUT 711;"Route:Open Tset"

**Query Syntax:**         ROUTe:OPEN?

**Return Format:**        NR1

**Attribute Summary:**    Preset state: 0  
                          Overlapped: yes  
                          Pass control required: no  
                          SCPI Compliance: instrument-specific

**Description:**

Selects test set OUT with command shown in the syntax field. To select test set IN, send ROUT:CLOS TSET. When queried, a "0" is returned if the test set is IN, a "1" if it is OUT.



## SCReen Subsystem

---

SCReen is one of two subsystems that control the analyzer's presentation of data on its front-panel display. The other subsystem is DISPlay (excluding the commands grouped under its LIMit mnemonic).



**SCReen:ACTive**

**command/query**

Selects the active trace.

**Command Syntax:** SCReen:ACTive {A|B}

**Example Statements:** Output 719;"Scr:Act A"  
Output 719;"SCREEN:ACTIVE B"

**Query Syntax:** SCReen:ACTive?

**Return Format:** A|B

**Attribute Summary:** Preset state: A  
Overlapped: yes  
Pass control required: no  
SCPI Compliance: instrument-specific

**Description:**

Only the active trace is displayed on the analyzer's screen when SCR:FORM is SING.

---

**SCReen:ANNotation****command/query**

Enables and disables the display of frequency information on the analyzer's screen.

**Command Syntax:** SCReen:ANNotation {OFF|0|ON|1}

**Example Statements:** Output 719;"screen:annotation off"  
Output 719;"Scr:Ann 0"

**Query Syntax:** SCReen:ANNotation?

**Return Format:** +{0|1}

**Attribute Summary:** Preset state: +1  
Overlapped: yes  
Pass control required: no  
SCPI Compliance: instrument-specific

**Description:**

When SCR:ANN is OFF, frequency information is not displayed on the analyzer's screen and it is not printed or plotted. However, all frequency information is still available via HP-IB.

---

**SCReen:CONTents****command/query**

Specifies what will be displayed on the analyzer's screen.

**Command Syntax:** SCReen:CONTents {TRACe|STATe|MMEMory}

**Example Statements:** Output 719;"SCR:CONT STAT"  
Output 719;"screen:contents trace"

**Query Syntax:** SCReen:CONTents?

**Return Format:** TRAC|STAT|MMEM

**Attribute Summary:** Preset state: TRAC  
Overlapped: yes  
Pass control required: no  
SCPI Compliance: instrument-specific

**Description:**

Send TRAC to display any trace data. (You can then choose the trace data you want to display with the DISP:RES command.) Send STAT to display the current state of the most important measurement setup parameters. Send MMEM to display the contents of the analyzer's default disk. (You select the default disk with the MMEM:MSI command.)

---

**SCReen:FORMat****command/query**

Selects a format for displaying trace data.

**Command Syntax:** SCReen:FORMat {SINGle|ULOWer|FBACk}

**Example Statements:** Output 719;"Screen:Format Single"  
Output 719;"SCR:FORM ULOW"

**Query Syntax:** SCReen:FORMat?

**Return Format:** SING|ULOW|FBAC

**Attribute Summary:** Preset state: SING  
Overlapped: yes  
Pass control required: no  
SCPI Compliance: instrument-specific

**Description:**

When you select SING, the analyzer uses the entire trace display area for the active trace (SCR:ACT). When you select ULOW, the analyzer uses the upper half of the trace display area for trace A and the lower half for trace B. When you select FBAC, the analyzer uses the entire trace display area, but overlays the two traces in that area.

---

**SCReen:GRATicule****command/query**

Turns the trace graticules on and off.

**Command Syntax:** SCReen:GRATicule {OFF|0|ON|1}

**Example Statements:** Output 719;"scr:grat on"  
Output 719;"Screen:Graticule Off"

**Query Syntax:** SCReen:GRATicule?

**Return Format:** +(0|1)

**Attribute Summary:** Preset state: +1  
Overlapped: yes  
Pass control required: no  
SCPI Compliance: instrument-specific

**Description:**

When the graticules are turned off they are not displayed on the analyzer's screen and they are not plotted or printed.

---

**SCReen[:STATe]****command/query**

Turns the analyzer's screen on and off.

**Command Syntax:** SCReen[:STATe] {OFF|0|ON|1}

**Example Statements:** Output 719;"SCREEN:STATE OFF"  
Output 719;"scr 1"

**Query Syntax:** SCReen[:STATe]?

**Return Format:** +{0|1}

**Attribute Summary:** Preset state: +1  
Overlapped: yes  
Pass control required: no  
SCPI Compliance: instrument-specific

**Description:**

When the screen is turned off, the message "DISPLAY BLANKING ON" replaces all other information. Only this message is plotted or printed.



## **[SENSe] Subsystem**

---

Commands in the SENSe subsystem determine how measurement data will be acquired. Because SENSe is an implied mnemonic, you can omit from all SENSe commands. See “Implied Mnemonics” in chapter 3 for more information.



**[SENSe:]AVERage:CLEar**

**command**

Clears the current peak hold.

**Command Syntax:**        [SENSe:]AVERage:CLEar

**Example Statements:**      Output 719;"AVERAGE:CLE"  
                              Output 719;"sense:aver:cle"

**Attribute Summary:**      Preset state: not applicable  
                              Overlapped: yes  
                              Pass control required: no  
                              SCPI Compliance: instrument-specific

**Description:**

Clears the current peak hold. It does not clear any other type of averaged measurement.

**[SENSe:]AVERage:COUNT****command/query**

Specifies a count and a weighting factor for averaged measurement data.

**Command Syntax:** [SENSe:]AVERage:COUNT (<number>|<step>|<bound>)

<number> ::= an integer (NRf data)  
                   limits: 1:1024  
 <step> ::= UP|DOWN  
 <bound> ::= MAX|MIN

**Example Statements:**     Output 719;"Sens:Aver:Coun 10"  
                               Output 719;"AVERAGE:COUNT 5"

**Query Syntax:**           [SENSe:]AVERage:COUNT?

**Return Format:**           <number>

<number> ::= an integer (NR1 data)

**Attribute Summary:**     Preset state: +10  
                               Overlapped: yes  
                               Pass control required: no  
                               SCPI Compliance: approved (1992.0)

**Description:**

The value in AVER:COUN is only used when the following conditions are met:

- AVER:STAT is ON (1).
- AVER:TYPE is not peak hold (MAX).

In its role as a counter, AVER:COUN determines how many measurement results will be combined in one trace before the No Pending Operation (NPO) flag is set to 1 for SENS:REST. This lets you use \*OPC to determine when the specified number of measurement results have been combined. (See "Synchronization" in chapter 2 for more information on the NPO flag.)

In its role as a weighting factor, AVER:COUN (*N*) determines how the results of the current measurement (*new* data) will be combined with the averaged trace (*old* data). Data is combined, point by point, in a method referred to as "exponential averaging," according to the formula:

$$\left(\frac{1}{N} \times \text{new}\right) + \left(\frac{N-1}{N} \times \text{old}\right)$$

**Note**

Averaging does not stop after the count is reached.



**[SENSe:]AVERage[:STATe]****command/query**

Turns averaging on and off.

**Command Syntax:** [SENSe:]AVERage[:STATe] {OFF|0|ON|1}

Example Statements:      Output 719;"sense:average:state off"  
                               Output 719;"Aver 1"

**Query Syntax:** [SENSe:]AVERage[:STATe]?**Return Format:** +(0|1)

**Attribute Summary:**   Preset state: +0  
                               Overlapped: yes  
                               Pass control required: no  
                               SCPI Compliance: approved (1992.0)

**Description:**

When you select OFF, each trace represents the results of a single measurement. When you select ON, each trace represents the combined results of several measurements, and the averaging function specified in AVER:TYPE determines how results are combined.

When averaging is on and AVER:TYPE is RMS or VECT (power or vector averaging), SENS:REST does not set the No Pending Operation (NPO) flag to 1 until the specified number (AVER:COUN) of measurement results have been combined. When averaging is on and AVER:TYPE is MAX (peak hold) (or when averaging is off), SENS:REST sets the NPO flag to 1 each time a measurement is completed. See "Synchronization" in chapter 2 for more information on the NPO flag.

Average Type	NPO flag set to 1 when:
RMS (vector & video)	measurement count number complete
MAX (peak hold)	each time measurement complete

**Note**

Trigger conditions must be met for each measurement—even when averaging is turned on.

---

**[SENSe:]AVERage:TCONtrol****command/query**

Specifies the analyzer's behavior after the count (AVER:COUN) is reached.

**Command Syntax:** [SENSe:]AVERage:TCONtrol (EXPonential)

**Example Statements:** Output 719;"AVER:TCON EXP"  
Output 719;"sense:average:tcontrol exponential"

**Query Syntax:** [SENSe:]AVERage:TCONtrol?

**Return Format:** EXP

**Attribute Summary:** Preset state: EXP  
Overlapped: yes  
Pass control required: no  
SCPI Compliance: approved (1992.0)

**Description:**

EXP is the only valid option for the HP 3589A. It indicates that averaging doesn't stop when the count (AVER:COUN) is reached. This command is only included for SCPI compatibility.

**[SENSe:]AVERage:TYPE****command/query**

Selects a method for combining the results of several measurements.

**Command Syntax:** [SENSe:]AVERage:TYPE {RMS|MAX|VECTor|VIDeo|PEAK}

**Example Statements:** Output 719;"Average:Type Max"  
Output 719;"SENS:AVER:TYPE VID"

**Query Syntax:** [SENSe:]AVERage:TYPE?

**Return Format:** RMS|MAX|VECT

**Attribute Summary:** Preset state: RMS  
Overlapped: yes  
Pass control required: no  
SCPI Compliance: approved (1992.0)

**Description:**

Sets the average type. Averaging must be turned on (SENS:AVER:STAT ON) for measurement results to be averaged. The HP 3589A provides three types of averaging: RMS (power) averaging, vector averaging, and peak hold, which is actually a display function.

## RMS Averaging

RMS (power) averaging is performed whenever the average type is set to RMS, VECT, or VID and the analyzer is in a scalar measurement mode - i.e. either swept spectrum or narrowband zoom. This kind of averaging reduces the variance of each point's magnitude and smooths out the noise floor. When the average type is queried, the analyzer returns "RMS." Exponential weighting is applied to RMS averaging.

## Vector Averaging

Vector averaging is performed whenever the average type is set to RMS, VECT, or VID and the analyzer is in a vector measurement mode - i.e., swept network. This kind of averaging reduces the variance of each point's real and imaginary parts and smooths out the noise floor. When the average type is queried, the analyzer returns "VECT." Exponential weighting is applied to vector averaging.

## Peak Hold

The peak hold function is performed whenever the average type is set to MAX or PEAK (peak hold is not available for swept network). Peak hold maintains the peak value of each display point over the course of several measurements. If the average type is queried, the analyzer returns "MAX." The average count (SENS:AVER:COUN) has no meaning while peak hold is active.

**Note**

Peak hold is a display function. The maximum value of each point is not reset when you change the analyzer's measurement parameters. To reset the trace data, send SENS:AVER:CLE.

---

**[SENSe:]BANDwidth:NOISe?****query**

Returns the noise equivalent bandwidth for the current measurement.

**Query Syntax:** [SENSe:]BANDwidth:NOISe? [UNIT]

**Example Statements:** Output 719;"SENSe:BANDwidth:NOISe?"  
Output 719;"band:noise?"

**Return Format:** <number>|{ Hz }

<number> ::= a real number (NR2 or NR3 data)

**Attribute Summary:** Preset state: +1.81E+4 Hz  
Overlapped: no  
Pass control required: no  
SCPI Compliance: instrument-specific

**Description:**

With user math you can divide each point of a linear magnitude spectrum by the square root of the noise equivalent bandwidth to create a power spectral density trace (DISP:RES SPEC, CALC:FORM MLIN, and CALC:MATH:EXPR F1,(SPEC/SQRT(NBW))).

Then, you can transfer the result to your controller with CALC:DATA?.

**[SENSe:]BANDwidth:NOISe:CORRection?**

**query**

Returns the noise correction factor for the current measurement.

**Query Syntax:** [SENSe:]BANDwidth:NOISe:CORRection? [UNIT]

**Example Statements:** Output 719;"SENSE:BANDWIDTH:NOISE:CORRECTION?"  
Output 719;"band:noise:corr?"

**Return Format:** <number>|{ dB }

<number> ::= a real number (NR2 or NR3 data)

**Attribute Summary:** Preset state: +4.26E+1 dB  
Overlapped: no  
Pass control required: no  
SCPI Compliance: instrument-specific

**Description:**

With user math you can divide each point of a linear magnitude spectrum by the square root of the noise equivalent bandwidth to create a power spectral density trace (DISP:RES SPEC, CALC:FORM MLIN, and CALC:MATH:EXPR F1,(SPEC/SQRT(NBW))).

Then, you can transfer the result to your controller with CALC:DATA?.

**[SENSe:]BANDwidth[:RESolution]****command/query**

Selects a value for the resolution bandwidth filter.

**Command Syntax:** [SENSe:]BANDwidth[:RESolution] (<value>|<step>|<bound>)

<value> ::= <number>[<unit>]  
 <number> ::= a real number (NRf data)  
           limits: 1.1:17000.0  
           discrete values: 1.1, 2.3, 4.5, 9.1, 18, 36, 73,  
                           150, 290, 580, 1200, 2300, 4600, 9100, 17000  
 <unit> ::= HZ  
 <step> ::= UP|DOWN  
 <bound> ::= MAX|MIN

**Example Statements:**      Output 719;"Band Down"  
                               Output 719;"SENSE:BANDWIDTH:RESOLUTION 4.6KHZ"

**Query Syntax:** [SENSe:]BANDwidth[:RESolution]? [UNIT]**Return Format:** <number>|{ <unit> }

<number> ::= a real number (NR2 or NR3 data)  
 <unit> ::= unit that applies to returned number

**Attribute Summary:**   Preset state: +1.7E+4 Hz  
                           Overlapped: yes  
                           Pass control required: no  
                           SCPI Compliance: confirmed (1991.0)

**Description:**

The resolution bandwidth filter determines the frequency resolution of swept measurements (INST:SEL SWEP or NETW).

**Note**

When bandwidth coupling is on (SENS:BAND:RES:AUTO ON), changes in frequency span (SENS:FREQ:SPAN) can force automatic changes in the resolution bandwidth setting.



**[SENSe:]BANDwidth[:RESolution]:AUTO****command/query**

Turns bandwidth coupling on and off.

**Command Syntax:** [SENSe:]BANDwidth[:RESolution]:AUTO {OFF|0|ON|1|ONCE}

Example Statements:      Output 719;"bandwidth:resolution:auto once"  
                               Output 719;"Sens:Band:Auto 1"

**Query Syntax:** [SENSe:]BANDwidth[:RESolution]:AUTO?**Return Format:** +{0|1}

**Attribute Summary:**    Preset state: +1  
                               Overlapped: yes  
                               Pass control required: no  
                               SCPI Compliance: confirmed (1991.0)

**Description:**

Bandwidth coupling applies to swept spectrum measurements, only. When bandwidth coupling is on, the analyzer couples (creates dependencies among) the following parameters:

- Frequency span, set with SENS:FREQ:SPAN.
- Resolution bandwidth (RBW), set with SENS:BAND:RES.
- Video bandwidth (VBW), set with SENS:BAND:VID.
- Sweep time, set with SENS:SWE:TIME.

Here is the order of dependency among coupled parameters (from least dependent to most):

Span → RBW → VBW → Sweep time

If you change a particular parameter when bandwidth coupling is on, the analyzer changes the more dependent parameters automatically. For example, if you change RBW, the analyzer changes VIDEO BANDWIDTH and sweep time. Be sure to set the least dependent parameters first when bandwidth coupling is on. See the help text or your *HP 3589A Operating Manual* for more information on bandwidth coupling.

When you send SENS:BAND:RES:AUTO ONCE, you restore the optimum relationships between the coupled parameters. This provides the best compromise between frequency resolution and speed for most measurements.

---

**[SENSe:]BANDwidth[:RESolution]:FFT?****query**

Returns the measurement resolution value for the current narrow band zoom measurement.

**Query Syntax:** [SENSe:]BANDwidth[:RESolution]:FFT? [UNIT]

**Example Statements:** Output 719;"SENSE:BANDWIDTH:RESOLUTION:FFT?"  
Output 719;"band:fft?"

**Return Format:** <number>|{ Hz }

<number> ::= a real number (NR2 or NR3 data)

**Attribute Summary:** Preset state: +3.59E+2 Hz  
Overlapped: no  
Pass control required: no  
SCPI Compliance: confirmed (1991.0)

**Description:**

The measurement resolution value is dependent on span (SENS:FREQ:SPAN) and zoom type (SENS:WIND:TYPE). It is only valid for narrow band zoom measurements (INST:SEL FFT). It is analogous to the resolution bandwidth value (SENS:BAND:RES) used for swept measurements.

**[SENSe:]BANDwidth[:RESolution]:TRACk****command/query**

Enables[/disables] dynamic adjustment of resolution bandwidth during logarithmic sweep.

**Command Syntax:** [SENSe:]BANDwidth[:RESolution]:TRACk {OFF|0|ON|1}

**Example Statements:** OUTPUT 719;"Bandwidth:Trac 1"  
OUTPUT 719;"SENS:BANDWIDTH:RES:TRACk OFF"

**Query Syntax:** [SENSe:]BANDwidth[:RESolution]:TRACk?

**Return Format:** NR1

**Attribute Summary:** Preset state: 1  
Overlapped: yes  
Pass control required: no  
SCPI Compliance: confirmed (1991.0)

**Description:**

Use TRACK OFF for a fixed RBW value – the value specified for RES BW – for an entire sweep. Use TRACK ON to balance two conflicting measurement requirements: preventing LO feedthrough at low frequencies, which requires a narrow RBW, and minimizing measurement time, which requires a wide RBW.

When TRACK ON is active, the RBW setting is linked to the sweep frequency. You specify the RBW's upper limit with the BAND command, but until that limit is reached, the analyzer selects an RBW from the following table:

Sweep Freq (Hz)	RBW (Hz)
≤ 50	4.5
≤ 500	18
≤ 5,000	290
≤ 50,000	1,200
> 50,000	17,000

**Note**

The analyzer's measurement hardware must settle each time the RBW changes during the sweep.

**[SENSe:]BANDwidth:VIDeo****command/query**

Selects a value for the video bandwidth filter.

**Command Syntax:** [SENSe:]BANDwidth:VIDeo {<value>|<step>|<bound>}

```

<value> ::= <number>[<unit>]
<number> ::= a real number (NRf data)
             limits: 0.019:26248.0
<unit> ::= HZ
<step> ::= UP|DOWN
<bound> ::= MAX|MIN

```

**Example Statements:**      Output 719;"BAND:VID UP"  
                                  Output 719;"bandwidth:video 2000"

**Query Syntax:**            [SENSe:]BANDwidth:VIDeo? [UNIT]

**Return Format:**            <number>|{ <unit> }

```

<number> ::= a real number (NR2 or NR3 data)
<unit> ::= unit that applies to returned number

```

**Attribute Summary:**      Preset state: +2.62E+4 Hz  
                                  Overlapped: yes  
                                  Pass control required: no  
                                  SCPI Compliance: confirmed (1991.0)

**Description:**

The video filter has a trace smoothing function for swept spectrum measurements (SENS:FUNC 'POW:SWEP'). You increase the amount of smoothing by decreasing the bandwidth of the filter.

**Note**

When bandwidth coupling is on (SENS:BAND:RES:AUTO ON), changes in frequency span (SENS:FREQ:SPAN) or resolution bandwidth (SENS:BAND:RES) can force automatic changes in the video bandwidth setting.

Use the SENS:BAND:VID:STAT command to turn the video filter on and off.

---

**[SENSe:]BANDwidth:VIDeo:STATe**

**command/query**

Turns video filtering on and off.

**Command Syntax:** [SENSe:]BANDwidth:VIDeo:STATe {OFF|0|ON|1}

**Example Statements:** Output 719;"Sense:Bandwidth:Video:State Off"  
Output 719;"BAND:VID:STAT 1"

**Query Syntax:** [SENSe:]BANDwidth:VIDeo:STATe?

**Return Format:** +{0|1}

**Attribute Summary:** Preset state: +0  
Overlapped: yes  
Pass control required: no  
SCPI Compliance: instrument-specific

**Description:**

This command turns the video filter on and off. To set the filter's bandwidth, use the SENS:BAND:VID command.

---

**[SENSe:]CORRection:COLLect[:ACQuire]:STANdard** **command**

Invokes a network calibration measurement.

**Command Syntax:** [SENSe:]CORRection:COLLect[:ACQuire]:STANdard  
{QUICK|SHORT|OPEN|TERMination|THRU|REFerence}

**Example Statements:** OUTPUT 719;"correction:coll:stan thru"  
OUTPUT 719;"Sense:Corr:Collect:Acq:Stan Ref"

**Attribute Summary:** Preset state: not applicable  
Overlapped: yes  
Pass control required: no  
SCPI Compliance: confirmed (1991.0)

**Description:**

Invokes measurement of reference data for the standard specified as a parameter. The type of network calibration to be performed must first be specified with SENS:CORR:COLL:METH.

See the NETWORK\_CAL programming example in chapter 6.

**[SENSe:]CORRection:COLLect[:ACQuire]:STANdard:AUTO**      **command/query**

Selects whether measuring incident power for S parameters occurs automatically or manually.

**Command Syntax:**      [SENSe:]CORRection:COLLect[:ACQuire]:STANdard:AUTO  
                                  {OFF|0|ON|1}

**Example Statements:**      OUTPUT 719;"SENSE:CORR:COLLECT:ACQ:STAN:AUTO OFF"  
                                  OUTPUT 719;"corr:collect:stan:auto on"

**Query Syntax:**      [SENSe:]CORRection:COLLect[:ACQuire]:STANdard:AUTO?

**Return Format:**      NR1

**Attribute Summary:**      Preset state: OFF  
                                  Overlapped: yes  
                                  Pass control required: no  
                                  SCPI Compliance: instrument-specific

**Description:**

When AUTO is active, the analyzer initiates reference measurements. It alternates between the incident signal and the transmitted (or reflected) signal on successive sweeps. Measurements stop after ten cycles to minimize wear on test set relays.

When AUTO is ON, the reference measurement is performed each time and OPC for measurements is not generated until both the incident power measurement *and* the S parameter measurement are complete.

Results of a reference measurement are stored in one of two data registers, depending on which S-parameter is selected. When either S11 or S21 is selected, the reference data is stored in D\_1\_REF. When either S12 or S22 is selected, the reference data is stored in D\_2\_REF.

---

**[SENSe:]CORRection:COLLect:METhod****command/query**

Specifies network function for measurement calibration.

**Command Syntax:** [SENSe:]CORRection:COLLect:METhod  
{TRANsmission|REFLection|S11|S21|S12|S22}

**Example Statements:** OUTPUT 719;"Correction:Coll:Method Transmission"  
OUTPUT 719;"SENS:CORR:COLLECT:METH S11"

**Query Syntax:** [SENSe:]CORRection:COLLect:METhod?

**Return Format:** CHAR

**Attribute Summary:** Preset state: TRAN  
Overlapped: yes  
Pass control required: no  
SCPI Compliance: instrument-specific

**Description:**

Trace data for the active trace is set to match the network function selected by this command.



**[SENSe:]CORRection:COLLect:SAVE**

**command**

Causes the correction data (error coefficients) for the current METHOD to be calculated.

**Command Syntax:** [SENSe:]CORRection:COLLect:SAVE

**Example Statements:** OUTPUT 719;"sense:corr:coll:save"  
OUTPUT 719;"Corr:Collect:Save"

**Attribute Summary:** Preset state: not applicable  
Overlapped: yes  
Pass control required: no  
SCPI Compliance: confirmed (1991.0)

**Description:**

Sending this command before the requisite standards have been acquired causes an error to be reported.

See the NETWORK\_CAL programming example in chapter 6.

---

**[SENSe:]CORRection:DEFault****command**

Resets all registers used in normalizations and calibrations (including reference traces) to their ideal, preset values, and recomputes all network calibration constants based on the ideal traces.

**Command Syntax:** [SENSe:]CORRection:DEFault

**Example Statements:** OUTPUT 719;"CORR:DEFAULT"  
OUTPUT 719;"sens:correction:def"

**Attribute Summary:** Preset state: not applicable  
Overlapped: yes  
Pass control required: no  
SCPI Compliance: instrument-specific

**Description:**

This gives you a method that removes all prior calibrations which may be inconsistent with a new measurement.

---

**[SENSe:]CORRection:EDELay:DISTance**

**command/query**

Enters an electrical delay in units of length.

**Command Syntax:** [SENSe:]CORRection:EDELay:DISTance <param>

<param> ::= {(<number>[<unit>])|<bound>}

<number> ::= a real number (NRf data)  
limits: -3.0E8:3.0E8

<unit> ::= M|CM

<bound> ::= MAX|MIN

Example Statements: OUTPUT 719;"Sens:Correction:Edel:Distance -3 M"  
OUTPUT 719;"CORR:EDEL:DISTANCE 0"

**Query Syntax:** [SENSe:]CORRection:EDELay:DISTance?

**Return Format:** NR3

**Attribute Summary:** Preset state: 0  
Overlapped: yes  
Pass control required: no  
SCPI Compliance: confirmed (1991.0)

**Description:**

Enters an electrical delay in units of length.

---

**[SENSe:]CORRection:EDELay:STATe****command/query**

Sets the state of the electrical delay feature (on/off).

**Command Syntax:** [SENSe:]CORRection:EDELay:STATe {OFF|0|ON|1}

**Example Statements:** OUTPUT 719;"corr:edelay:stat 0"  
OUTPUT 719;"Sens:Correction:Edel:State On"

**Query Syntax:** [SENSe:]CORRection:EDELay:STATe?

**Return Format:** NR1

**Attribute Summary:** Preset state: 0 (off)  
Overlapped: yes  
Pass control required: no  
SCPI Compliance: confirmed (1991.0)

**Description:**

Sets the state of the electrical delay feature (on/off).

---

**[SENSe:]CORRection:EDELay[:TIME]**

**command/query**

Enters an electrical delay in units of time.

**Command Syntax:** [SENSe:]CORRection:EDELay[:TIME] <param>

<param> ::= {{<number><unit>}}|<bound>  
<number> ::= a real number (NRf data)  
          limits: -1.0:1.0  
<unit> ::= S  
<bound> ::= MAX|MIN

**Example Statements:**       OUTPUT 719;"SENS:CORR:EDELAY:TIME 62 ns"  
                              OUTPUT 719;"correction:edel 0"

**Query Syntax:**           [SENSe:]CORRection:EDELay[:TIME]?

**Return Format:**         NR3

**Attribute Summary:**     Preset state: 0  
                          Overlapped: yes  
                          Pass control required: no  
                          SCPI Compliance: confirmed (1991.0)

**Description:**

Enters an electrical delay in units of time.

---

**[SENSe:]DETECTOR[:FUNCTION]****command/query**

Turns the peak detector on and off.

**Command Syntax:** [SENSe:]DETECTOR[:FUNCTION] (POSitive|SAMPle)**Example Statements:** Output 719;"det pos"  
Output 719;"Sense:Detector:Function Positive"**Query Syntax:** [SENSe:]DETECTOR[:FUNCTION]?**Return Format:** POS|SAMP**Attribute Summary:** Preset state: POS  
Overlapped: yes  
Pass control required: no  
SCPI Compliance: confirmed (1991.0)**Description:**POSitive turns the peak detector on. SAMPle turns the peak detector off. See the help text or your *HP 3589A Operating Manual* for more information about the peak detector.

---

**Note**

The peak detector should be on for all swept spectrum measurements. It should be off for scalar network measurements (made with the analyzer's source).

**[SENSe:]DETECTOR:STIME****command/query**

Specifies the sampling time for manually swept measurements.

**Command Syntax:** [SENSe:]DETECTOR:STIME (<value>|<step>|<bound>)

&lt;value&gt; ::= &lt;number&gt;[S]

<number> ::= a real number (NRf data)  
limits: 4.0E-6:4295.0

&lt;step&gt; ::= UP|DOWN

&lt;bound&gt; ::= MAX|MIN

Example Statements:      Output 719;"DETECTOR:STIME 4.0E-6 S"  
                          Output 719;"det:stim up"**Query Syntax:** [SENSe:]DETECTOR:STIME? [UNIT]**Return Format:** <number>|{ s }

&lt;number&gt; ::= a real number (NR2 or NR3 data)

**Attribute Summary:**   Preset state: +4.00E-6 s  
                          Overlapped: yes  
                          Pass control required: no  
                          SCPI Compliance: instrument-specific**Description:**Sample time specifies how long the analyzer should measure at a single frequency during manual sweeps (SENS:SWE:MODE MAN). It does not specify the time *between* measurements, which can be significantly longer than the sample time.

**[SENSe:]FREQUENCY:CENTer****command/query**

Specifies the center frequency for the current measurement.

**Command Syntax:** [SENSe:]FREQUENCY:CENTer {<value>|<step>|<bound>}

```

<value> ::= <number>[<unit>]
<number> ::= a real number (NRf data)
             limits: 0.0:150.0E6
<unit> ::= HZ
<step> ::= UP|DOWN
<bound> ::= MAX|MIN

```

**Example Statements:**      Output 719;"Sens:Freq:Cent 20e6 Hz"  
                               Output 719;"SENSE:FREQUENCY:CENTER 98.1 MAHZ"

**Query Syntax:** [SENSe:]FREQUENCY:CENTer? [UNIT]**Return Format:** <number>|{ <unit> }

```

<number> ::= a real number (NR2 or NR3 data)
<unit> ::= unit that applies to returned number

```

**Attribute Summary:**      Preset state: +7.505E+7 Hz  
                               Overlapped: yes  
                               Pass control required: no  
                               SCPI Compliance: confirmed (1991.0)

**Description:**

Center frequency (SENS:FREQ:CENT) and frequency span (SENS:FREQ:SPAN) work together to define the band of frequencies you want to analyze. The current value of one parameter is held constant when you change the value of the other.

**Note**

When SENS:FREQ:SPAN is set to 0, the analyzer acts as a fixed-tuned receiver and SENS:FREQ:CENT tunes the receiver to the desired frequency. This measurement set up is “zero span” and the magnitude of the signal is displayed versus time.



**[SENSe:]FREQUency:CENTer:TRACk**

**command/query**

Turns the signal tracking function on and off.

**Command Syntax:** [SENSe:]FREQUency:CENTer:TRACk (OFF|0|ON|1)

**Example Statements:** Output 719;"frequency:center:track off"  
Output 719;"Sens:Freq:Cent:Trac 0"

**Query Syntax:** [SENSe:]FREQUency:CENTer:TRACk?

**Return Format:** +{0|1}

**Attribute Summary:** Preset state: +0  
Overlapped: yes  
Pass control required: no  
SCPI Compliance: instrument-specific

**Description:**

When signal tracking is turned on, the analyzer automatically tracks a drifting signal. It works by adjusting the value of the center frequency (SENS:FREQ:CENT) to keep the largest signal centered in the current frequency span (SENS:FREQ:SPAN).

**[SENSe:]FREQuency:MANual****command/query**

Specifies the measurement frequency during manually swept measurements.

**Command Syntax:** [SENSe:]FREQuency:MANual {<value>|<step>|<bound>}

```

<value> ::= <number>[<unit>]
<number> ::= a real number (NRf data)
             limits: 0.0:150.0E6
<unit> ::= HZ
<step> ::= UP|DOWN
<bound> ::= MAX|MIN

```

**Example Statements:** Output 719;"FREQ:MAN 114980000"  
Output 719;"frequency:manual 490khz"

**Query Syntax:** [SENSe:]FREQuency:MANual? [UNIT]

**Return Format:** <number>|{ <unit> }

```

<number> ::= a real number (NR2 or NR3 data)
<unit> ::= unit that applies to returned number

```

**Attribute Summary:** Preset state: +7.505E+7 Hz  
Overlapped: yes  
Pass control required: no  
SCPI Compliance: confirmed (1991.0)

**Description:**

The manual frequency value is only used if manually sweeping is enabled (SENS:SWE:MODE MAN). The range of values you can specify for manual frequency is limited by the current values of the start frequency (SENS:FREQ:STAR) and the stop frequency (SENS:FREQ:STOP).

**[SENSe:]FREQuency:SPAN****command/query**

Specifies the frequency span for the current measurement.

**Command Syntax:** [SENSe:]FREQuency:SPAN (<value>|<step>|<bound>)

<value> ::= <number>[<unit>]  
 <number> ::= a real number (NRf data)  
                   limits: 0.0:150.0E6  
 <unit> ::= HZ  
 <step> ::= UP|DOWN  
 <bound> ::= MAX|MIN

**Example Statements:**      Output 719;"Sense:Frequency:Span 40 kHz"  
                                   Output 719;"FREQ:SPAN DOWN"

**Query Syntax:** [SENSe:]FREQuency:SPAN? [UNIT]**Return Format:** <number>|{ <unit> }

<number> ::= a real number (NR2 or NR3 data)  
 <unit> ::= unit that applies to returned number

**Attribute Summary:**      Preset state: +1.499E+8 Hz  
                                   Overlapped: yes  
                                   Pass control required: no  
                                   SCPI Compliance: confirmed (1991.0)

**Description:**

SENS:FREQ:SPAN and SENS:FREQ:CENT work together to define the band of frequencies you want to analyze. The current value of one parameter is held constant when you change the value of the other.

**Note**

When SENS:FREQ:SPAN is set to 0, the analyzer acts as a fixed-tuned receiver and SENS:FREQ:CENT tunes the receiver to the desired frequency. This measurement setup is called *zero span* and the magnitude of the signal is displayed versus time.

During swept measurements (INST:SEL SWEP or NETW), the frequency span can be 0 Hz or it can be within the range of 10 Hz to 150 MHz. During narrow band zoom measurements (INST:SEL FFT), the frequency span is limited to 16 discrete values ranging from 1.22 Hz to 40 kHz. The values are derived from the following formula:

$$40,000 / 2^n$$

where  $n$  has integer values ranging from 0 to 15.

When bandwidth coupling is on (SENS:BAND:RES:AUTO ON) changes in span can force automatic changes in the following parameters:

- Resolution bandwidth, set with SENS:BAND:RES
- Video bandwidth, set with SENS:BAND:VID
- Sweep time, set with SENS:SWE:TIME

Bandwidth coupling applies only to swept spectrum measurements.

**[SENSe:]FREQuency:SPAN:FULL**

**command**

Sets the analyzer to the widest frequency span available for the current measurement type.

**Command Syntax:** [SENSe:]FREQuency:SPAN:FULL

**Example Statements:** Output 719;"freq:span:full"  
Output 719;"Sense:Frequency:Span:Full"

**Attribute Summary:** Preset state: not applicable  
Overlapped: yes  
Pass control required: no  
SCPI Compliance: confirmed (1991.0)

**Description:**

During swept spectrum measurements (INST:SEL SWEP or NETW), this command sets span (SENS:FREQ:SPAN) to 150 MHz and center frequency (SENS:FREQ:CENT) to 75 MHz. During narrow band zoom measurements (INST:SEL FFT), this command sets span (SENS:FREQ:SPAN) to 40 kHz and leaves center frequency (SENS:FREQ:CENT) unchanged.

**[SENSe:]FREQUency:STARt****command/query**

Specifies the start frequency for the current measurement.

**Command Syntax:** [SENSe:]FREQUency:STARt {<value>|<step>|<bound>}

```

<value> ::= <number>[<unit>]
<number> ::= a real number (NRf data)
             limits: 0.0:150.0E6
<unit> ::= HZ
<step> ::= UP|DOWN
<bound> ::= MAX|MIN

```

**Example Statements:**      Output 719;"FREQUENCY:START 10"  
                                  Output 719;"sens:freq:star 100khz"

**Query Syntax:** [SENSe:]FREQUency:STARt? [UNIT]

**Return Format:** <number>|{ <unit> }

```

<number> ::= a real number (NR2 or NR3 data)
<unit> ::= unit that applies to returned number

```

**Attribute Summary:**      Preset state: +1.00E+5 Hz  
                                  Overlapped: yes  
                                  Pass control required: no  
                                  SCPI Compliance: confirmed (1991.0)

**Description:**

Start frequency (SENS:FREQ:STAR) and stop frequency (SENS:FREQ:STOP) work together to define the band of frequencies you want to analyze. SENS:FREQ:STAR defines the band's lower limit, SENS:FREQ:STOP defines its upper limit. Here's how they work together for each of the two measurement types:

- Swept spectrum or network (INST:SEL SWEP or NETW)—The current value of one parameter is held constant when you change the value of the other.
- Narrow band zoom (INST:SEL FFT)—The offset between the two parameters is held constant when you change the value of either.

**Note**

During swept spectrum measurements, the span changes when you change the start frequency. This can cause changes in other parameters if bandwidth coupling is on. See SENS:BAND:RES:AUTO for more information.

**[SENSe:]FREQUENCY:STEP****command/query**

Specifies the step size to be used for changing frequency parameters.

**Command Syntax:** [SENSe:]FREQUENCY:STEP {<value>|<step>|<bound>}

```

<value> ::= <number>[<unit>]
<number> ::= a real number (NRf data)
             limits: -150.0E6:150.0E6
<unit> ::= HZ
<step> ::= UP|DOWN
<bound> ::= MAX|MIN

```

**Example Statements:** Output 719;"Freq:Step 60 Hz"  
Output 719;"SENSe:FREQUENCY:STEP 1E6"

**Query Syntax:** [SENSe:]FREQUENCY:STEP? [UNIT]

**Return Format:** <number>|{ <unit> }

```

<number> ::= a real number (NR2 or NR3 data)
<unit> ::= unit that applies to returned number

```

**Attribute Summary:** Preset state: +1.00E+3 Hz  
Overlapped: yes  
Pass control required: no  
SCPI Compliance: instrument-specific

**Description:**

Step size determines the frequency change that results when you send UP or DOWN with any of the following commands:

- SENS:FREQ:CENT
- SENS:FREQ:STAR
- SENS:FREQ:STOP
- SENS:FREQ:MAN

The step size you specify with SENS:FREQ:STEP is only used for the listed commands when SENS:FREQ:STEP:STAT is MAN.

**[SENSe:]FREQUENCY:STEP:STATE****command/query**

Specifies whether the step size for frequency parameters is determined by the analyzer or by the value of SENS:FREQ:STEP.

**Command Syntax:** [SENSe:]FREQUENCY:STEP:STATE {AUTO|MANual}

**Example Statements:** Output 719;"sense:frequency:step:state auto"  
Output 719;"Freq:Step:Stat Man"

**Query Syntax:** [SENSe:]FREQUENCY:STEP:STATE?

**Return Format:** AUTO|MAN

**Attribute Summary:** Preset state: AUTO  
Overlapped: yes  
Pass control required: no  
SCPI Compliance: instrument-specific

**Description:**

SENS:FREQ:STEP:STAT allows you to enable either the analyzer-determined (AUTO) or the user-determined (MAN) step size for the following frequency commands:

- SENS:FREQ:CENT
- SENS:FREQ:STAR
- SENS:FREQ:STOP
- SENS:FREQ:MAN

Step size determines the change that results when you send UP or DOWN with a command. Use SENS:FREQ:STEP to define the user-determined step size for the listed commands.



**[SENSe:]FREQuency:STOP****command/query**

Specifies the stop frequency for the current measurement.

**Command Syntax:** [SENSe:]FREQuency:STOP {<value>|<step>|<bound>}

```

<value> ::= <number>[<unit>]
<number> ::= a real number (NRf data)
             limits: 0.0:150.0E6
<unit> ::= HZ
<step> ::= UP|DOWN
<bound> ::= MAX|MIN

```

**Example Statements:**      Output 719;"FREQ:STOP 150E+6 HZ"  
                                  Output 719;"frequency:stop 480khz"

**Query Syntax:** [SENSe:]FREQuency:STOP? [UNIT]**Return Format:** <number>|{ <unit> }

```

<number> ::= a real number (NR2 or NR3 data)
<unit> ::= unit that applies to returned number

```

**Attribute Summary:**      Preset state: +1.5E+8 Hz  
                                  Overlapped: yes  
                                  Pass control required: no  
                                  SCPI Compliance: confirmed (1991.0)

**Description:**

Stop frequency (SENS:FREQ:STOP) and start frequency (SENS:FREQ:STAR) work together to define the band of frequencies you want to analyze. SENS:FREQ:STOP defines the band's upper limit, SENS:FREQ:STAR defines its lower limit. Here's how they work together for each of the two measurement types:

- Swept spectrum or network (INST:SEL SWEP or NETW)—The current value of one parameter is held constant when you change the value of the other.
- Narrow band zoom (INST:SEL FFT)—The offset between the two parameters is held constant when you change the value of either.

**Note**

During swept spectrum measurements, the span changes when you change the stop frequency. This can cause changes in other parameters if bandwidth coupling is on. See SENS:BAND:RES:AUTO for more information.

**[SENSe:]FUNCTION****command/query**

Selects one of the analyzer's measurement types.

**Command Syntax:** [SENSe:]FUNCTION '(POWER:FFT|POWER:SWEPT|POWER:NETWork)'

**Example Statements:**  
Output 719;"Function 'Power:Fft'"  
Output 719;"SENS:FUNC 'POW:SWEP'"

**Query Syntax:** [SENSe:]FUNCTION?

**Return Format:** {POWER:FFT|POWER:SWEPT|POWER:NETWORK}

**Attribute Summary:**  
Preset state: POWER:SWEPT  
Overlapped: yes  
Pass control required: no  
SCPI Compliance: instrument-specific

**Description:**

Performs the same function as INSTRUMENT:SELECT. This command exists to maintain program compatibility with the HP 3588A. Each of the three selections are further explained in the following.

When you switch between swept spectrum (SENS:FUNC 'POW:SWEP'), narrow band zoom (SENS:FUNC 'POW:FFT'), and network (SENS:FUNC 'POW:NET') measurements, the state of many other parameters can change. As a result, you should select the measurement type near the beginning of any program sequence that defines the instrument state.

See the help text or your *HP 3589A Operating Manual* for information on the analyzer's measurement types.

**[SENSe:]FUNCTION:POWer:FFT**

**command**

Selects the narrow band zoom measurement as the current measurement type.

**Command Syntax:** [SENSe:]FUNCTION:POWer:FFT

**Example Statements:** Output 719;"func:pow:fft"  
Output 719;"Sense:Function:Power:Fft"

**Attribute Summary:** Preset state: not applicable  
Overlapped: yes  
Pass control required: no  
SCPI Compliance: instrument-specific

**Description:**

When you switch between narrow band zoom (SENS:FUNC:POW:FFT), swept spectrum (SENS:FUNC:POW:SWEP) measurements and network (SENS:FUNC:POW:NETW), the state of many other parameters can change. As a result, you should select the measurement type near the beginning of any program sequence that defines the instrument state.

---

**Note**



Since this command has no query form, you must use the SENS:FUNC query to determine which measurement type is currently selected. The query returns 'POW:FFT' when narrow band zoom is selected.

---

See the help text or your *HP 3589A Operating Manual* for information on the analyzer's three measurement types.

---

**[SENSe:]FUNCTION:POWer:NETWork****command**

Selects a network measurement type.

**Command Syntax:** [SENSe:]FUNCTION:POWer:NETWork

**Example Statements:** OUTPUT 719;"sens:function:pow:network"  
OUTPUT 719;"Func:Pow:Network"

**Attribute Summary:** Preset state:  
Overlapped:  
Pass control required: no  
SCPI Compliance: instrument-specific

**Description:**

Has the same function as the command INST:SEL NETW. This command exists to maintain program compatibility with the HP 3588A.

When you switch between narrow band zoom (SENS:FUNC:POW:FFT), swept spectrum (SENS:FUNC:POW:SWEP) measurements and network (SENS:FUNC:POW:NETW), the state of many other parameters can change. As a result, you should select the measurement type near the beginning of any program sequence that defines the instrument state.

---

**Note**

Since this command has no query form, you must use the SENS:FUNC query to determine which measurement type is currently selected. The query returns 'POW:NETW' when network is selected.

---

See the help text or your *HP 3589A Operating Manual* for information on the analyzer's three measurement types.

---

**[SENSe:]FUNCTION:POWER:SWEPT**

**command**

Selects the swept spectrum measurement as the current measurement type.

**Command Syntax:** [SENSe:]FUNCTION:POWER:SWEPT

**Example Statements:** Output 719;"FUNCTION:POWER:SWEPT"  
Output 719;"func:pow:swep"

**Attribute Summary:** Preset state: not applicable  
Overlapped: yes  
Pass control required: no  
SCPI Compliance: instrument-specific

**Description:**

When you switch between swept spectrum (SENS:FUNC:POW:SWEP), narrow band zoom (SENS:FUNC:POW:FFT), and network (SENS:FUNC:POW:NETW) measurements, the state of many other parameters can change. As a result, you should select the measurement type near the beginning of any program sequence that defines the instrument state.

---

**Note**



Since this command has no query form, you must use the SENS:FUNC query to determine which measurement type is currently selected. The query returns 'POW:SWEP' when swept spectrum is selected.

---

See the help text or your *HP 3589A Operating Manual* for information on the analyzer's two measurement types.

**[SENSe:]IMPedance:TYPE****command/query**

Specifies whether a 25Ω adapter or a minimum loss pad is used for 75Ω measurements without a test set.

**Command Syntax:** [SENSe:]IMPedance:TYPE {MLP|ADAPter}

**Example Statements:** OUTPUT 719;"Sense:Impedance:Type Adapter"  
OUTPUT 719;"IMP:TYPE MLP"

**Query Syntax:** [SENSe:]IMPedance:TYPE?

**Return Format:** CHAR

**Attribute Summary:** Preset state: not affected by preset  
Overlapped: yes  
Pass control required: no  
SCPI Compliance: instrument-specific

**Description:**

ADAPTER specifies the 25Ω in-line adapter. The 25Ω adapters are supplied with the instrument.

MLP specifies a 50Ω to 75Ω minimum loss pad used for 75Ω measurements without a test set. Minimum loss pads provide the highest quality 75Ω measurement short of using a test set.

**[SENSe:]POWer:RANGe**

**command/query**

Selects the sensitivity of the analyzer's input circuitry.

**Command Syntax:** [SENSe:]POWer:RANGe {<value>|<step>|<bound>}

```

<value> ::= <number>[<unit>]
<number> ::= a real number (NRf data)
              limits: -20.00:21.76
<unit> ::= DBM|DBV|DBVRMS|V|VRMS
<step> ::= UP|DOWN
<bound> ::= MAX|MIN
    
```

**Example Statements:** Output 719;"Pow:Rang Up"  
 Output 719;"SENSe:POWer:RANGe 0 DBM"

**Query Syntax:** [SENSe:]POWer:RANGe? [UNIT]

**Return Format:** <number>|{ <unit> }

```

<number> ::= a real number (NR2 or NR3 data)
<unit> ::= unit that applies to returned number
    
```

**Attribute Summary:** Preset state: undefined value (dependent on autorange)  
 Overlapped: yes  
 Pass control required: no  
 SCPI Compliance: confirmed (1991.0)

**Description:**

The range setting determines the maximum ac signal level that can be applied to the analyzer's input connector without overdriving the input circuitry. The following table shows the range settings available for each of the analyzer's three input impedances (INP:IMP).

50Ω	75Ω	1 MΩ
20 dBm (2.24 Vrms)	21.76 dBm (3.35 Vrms)	20 dBm*(+7 dBV) (2.24 Vrms)
10 dBm (707 mVrms)	11.76 dBm (1.06 Vrms)	10 dBm*(-3 dBV) (707 mVrms)
0 dBm (223 mVrms)	1.76 dBm (335 mVrms)	0 dBm*(-13 dBV) (223 mVrms)
-10 dBm (70.7 mVrms)	-8.23 dBm (106 mVrms)	-10 dBm*(-23 dBV) (70.7 mVrms)
-20 dBm (22.4 mVrms)	-18.23 dBm (33.5 mVrms)	-20 dBm*(-33 dBV) (22.4 mVrms)

\* Referenced to 50Ω

You can set the range manually with SENS:POW:RANG, or you can let the analyzer select the range automatically with SENS:POW:RANG:AUTO (there is no autorange for network measurements). If you set the range manually, two bits in the Questionable Power condition register help you decide when to change the range setting:

- Bit 0 (Input Overloaded) is set to 1 when *any signal between 0 and 150 MHz* exceeds the current input range.
- Bit 4 (ADC Overloaded) is set to 1 when *any signal in the current span* is overloading the analyzer's analog-to-digital converter.

---

**Note**

If reference level tracking is on (DISP:Y:SCAL:RLEV:AUTO ON), the reference level setting (DISP:Y:SCAL:RLEV) changes automatically when the range changes.

---



---

**[SENSe:]POWer:RANGe:AUTO****command/query**

Automatically selects the best range for the current input signal.

**Command Syntax:** [SENSe:]POWer:RANGe:AUTO {OFF|0|ON|1|ONCE}

Example Statements: Output 719;"sense:power:range:auto on"

Output 719;"Pow:Rang:Auto Once"

**Query Syntax:** [SENSe:]POWer:RANGe:AUTO?

**Return Format:** +{0|1}

**Attribute Summary:** Preset state: +1  
Overlapped: yes  
Pass control required: no  
SCPI Compliance: confirmed (1991.0)

**Description:**

Send single autorange (SENS:POW:RANG:AUTO ONCE) to execute the analyzer's autoranging algorithm *one time* for the current input signal.

Send enable autorange (SENS:POW:RANG:AUTO ON) to enable the algorithm to *continuously* monitor the input signal and adjust the range.

The autoranging algorithm selects the best input range for the current input signal. The algorithm selects a less sensitive range if the signal level is large enough to overdrive the input circuitry. It selects a more sensitive range if the signal level is small enough to compromise dynamic range. (See SENS:POW:RANG for more information on the available ranges.)

**[SENSe:]POWer:RANGe:LDISortion****command/query**

Enables and disables the analyzer's low distortion mode.

**Command Syntax:** [SENSe:]POWer:RANGe:LDISortion {OFF|0|ON|1}

**Example Statements:** Output 719;"SENS:POW:RANG:LDIS 0"  
Output 719;"power:range:ldistortion 1"

**Query Syntax:** [SENSe:]POWer:RANGe:LDISortion?

**Return Format:** +(0|1)

**Attribute Summary:** Preset state: +0  
Overlapped: yes  
Pass control required: no  
SCPI Compliance: instrument-specific

**Description:**

Low-distortion mode reduces the distortion contribution of the HP 3589A's analog input circuitry. If you are measuring signal components that are within 10 dB of the analyzer's published distortion specification, this mode may improve your measurement results.

Refer to the help text or the *HP 3589A Operating Manual* for more information on low-distortion mode.

## [SENSe:]REStart

command

Immediately stops the current measurement and starts a new one.

**Command Syntax:** [SENSe:]REStart

**Example Statements:** Output 719;"Sense:Restart"  
Output 719;"REST"

**Attribute Summary:** Preset state: not applicable  
Overlapped: yes  
Pass control required: no  
SCPI Compliance: instrument-specific

### Description:

Although SENS:REST allows you to abort the current measurement and start a new one it is not supported by the SCPI standard. The program message ABOR;INIT:CONT ON aborts the current measurement and starts a new one for *any* SCPI instrument.

- Both SENS:REST and ABOR;INIT:CONT ON serve a special synchronizing function. When you send either of these commands to restart a measurement, the analyzer's No Pending Operation (NPO) flag is not set to 1 until the measurement is complete. The three methods that test the state of this flag—\*WAI, \*OPC, and \*OPC?—allow you to hold off subsequent actions until the measurement is complete. See "Synchronization" in chapter 2 for more information on the NPO flag.

---

### Note



When vector or RMS averaging is enabled (AVER:TYPE RMS or VECT and AVER:STAT ON), the NPO flag is not set to 1 until  $n$  measurements have been combined into one trace. You specify the value of  $n$  with the AVER:COUN command.

---

---

**[SENSe:]SWEep:GATE****command/query**

Turns the gated sweep feature on or off.

**Command Syntax:** [SENSe:]SWEep:GATE {OFF|0|ON|1}

**Example Statements:** OUTPUT 719;"SWEEP:GATE OFF"  
OUTPUT 719;"sense:swe:gate 0"

**Query Syntax:** [SENSe:]SWEep:GATE?

**Return Format:** CHAR

**Attribute Summary:** Preset state: 0 (off)  
Overlapped: ues  
Pass control required: no  
SCPI Compliance: instrument-specific

**Description:**

When gated sweep is ON and "SWEEP:GATE OFF" is received, the result is a linear sweep.

**[SENSe:]SWEep:GATE:DELay:MODE**

**command/query**

Selects whether delay time is set manually or determined automatically from the RBW setting.

**Command Syntax:** [SENSe:]SWEep:GATE:DELay:MODE {AUTO|MANual}

**Example Statements:**  
OUTPUT 719;"Sense:Swe:Gate:Del:Mode Manual"  
OUTPUT 719;"SWE:GATE:DEL:MODE AUTO"

**Query Syntax:** [SENSe:]SWEep:GATE:DELay:MODE?

**Return Format:** CHAR

**Attribute Summary:**  
Preset state: AUTO  
Overlapped: yes  
Pass control required: no  
SCPI Compliance: instrument-specific

**Description:**

Delay time is the time between receiving a user gate trigger and when data gating begins.

When AUTO is selected, the gate delay is equal to the IF filter settling time. The automatic gated sweep delay time value may be queried with the SWE:GATE:DEL:TIME:AUTO? command.

Manual delay time is available for both edge and level gate types.

---

**[SENSe:]SWEep:GATE:DELay:TIME:AUTO?****query**

Causes the analyzer to respond with the auto gate delay value in seconds.

**Query Syntax:** [SENSe:]SWEep:GATE:DELay:TIME:AUTO?

**Example Statements:** OUTPUT 719;"sweep:gate:delay:time:auto?"  
OUTPUT 719;"Sens:Swe:Gate:Del:Time:Auto?"

**Return Format:** NR3

**Attribute Summary:** Preset state: +1.3e-4 S (.00013s)  
Overlapped: no  
Pass control required: no  
SCPI Compliance: instrument-specific

**Description:**

This is the gate delay used when delay time is selected by the analyzer (SWEep:GATE:DELay:MODE is AUTO).

---

**[SENSe:]SWEep:GATE:DELay:TIME[:MANual]**

**command/query**

Specifies the gated sweep delay time when the gated sweep delay mode is manual.

**Command Syntax:** [SENSe:]SWEep:GATE:DELay:TIME <param>  
<param> ::= {(<number>[<unit>])|<step>|<bound>}  
<number> ::= a real number (NRf data)  
          limits: 0:2000.0  
<unit> ::= S  
<step> ::= UP|DOWN  
<bound> ::= MAX|MIN

**Example Statements:** OUTPUT 719;"sweep:gate:del:time 500 ms"  
OUTPUT 719;"Sens:Sweep:Gate:Del:Time:Man 130 us"

**Query Syntax:** [SENSe:]SWEep:GATE:DELay:TIME?

**Return Format:** NR3

**Attribute Summary:** Preset state: .00013s  
Overlapped: yes  
Pass control required: no  
SCPI Compliance: instrument-specific

**Description:**

Specifies the gated sweep delay time when the gated sweep delay mode is manual (SWE:GATE:DEL:MODE in MAN).

**[SENSe:]SWEep:GATE:POLarity****command/query**

Specifies the active sense of the user's gate signal.

**Command Syntax:** [SENSe:]SWEep:GATE:POLarity {POSitive|NEGative}

**Example Statements:**  
OUTPUT 719;"SENS:SWEeP:GATE:POL NEG"  
OUTPUT 719;"sweep:gate:polarity positive"

**Query Syntax:** [SENSe:]SWEep:GATE:POLarity?

**Return Format:** CHAR

**Attribute Summary:**  
Preset state: NEG  
Overlapped: yes  
Pass control required: no  
SCPI Compliance: instrument-specific

**Description:**

In edge mode, POS means to start gating data on the rising edge. In level mode, POS means start data collection when the user's gate control signal is high.

The trigger mode is specified with the SWEep:GATE:TYPE command.



**[SENSe:]SWEep:GATE:TIME****command/query**

Specifies the length of time the gate is open after it is triggered.

**Command Syntax:** [SENSe:]SWEep:GATE:TIME <param>

<param> ::= ((<number>[<unit>])|<step>|<bound>)

<number> ::= a real number (NRf data)  
limits: 20.0E-6:2000.0

<unit> ::= S

<step> ::= UP|DOWN

<bound> ::= MAX|MIN

**Example Statements:** OUTPUT 719;"Swe:Gate:Time 30 ms"  
OUTPUT 719;"SENS:SWEEP:GATE:TIME .001 s"

**Query Syntax:** [SENSe:]SWEep:GATE:TIME?

**Return Format:** NR3

**Attribute Summary:** Preset state: 1 ms  
Overlapped: yes  
Pass control required: no  
SCPI Compliance: instrument-specific

**Description:**

This is programmable for edge triggering, only.

---

**[SENSe:]SWEep:GATE:TYPE****command/query**

Specifies whether the gate is edge triggered or level triggered by the gate signal.

**Command Syntax:** [SENSe:]SWEep:GATE:TYPE {EDGE|LEVEL}

**Example Statements:** OUTPUT 719;"sense:sweep:gate:type edge"  
OUTPUT 719;"Swe:Gate:Type Lev"

**Query Syntax:** [SENSe:]SWEep:GATE:TYPE?

**Return Format:** CHAR

**Attribute Summary:** Preset state: EDGE  
Overlapped: yes  
Pass control required: no  
SCPI Compliance: instrument-specific

**Description:**

In edge mode, the gate is triggered (opened) by the user's gate signal and the gate stays "open" for a period of time specified by SWEep:GATE:TIME.

In level mode, the gated is "opened" and "closed" by the external gate signal.

For more information, refer to the on-line help under the SWEEP hardkey.

**[SENSe:]SWEep:MODE****command/query**

Specifies whether sweeping is done automatically or manually.

**Command Syntax:** [SENSe:]SWEep:MODE {AUTO|MANual}

**Example Statements:**  
Output 719;"swe:mode man"  
Output 719;"Sense:Sweep:Mode Auto"

**Query Syntax:** [SENSe:]SWEep:MODE?

**Return Format:** AUTO|MAN

**Attribute Summary:**  
Preset state: AUTO  
Overlapped: yes  
Pass control required: no  
SCPI Compliance: confirmed (1991.0)

**Description:**

When you select automatic sweeping (AUTO), the analyzer sweeps from start frequency (SENS:FREQ:STAR) to stop frequency (SENS:FREQ:STOP) at a speed determined by sweep time (SENS:SWE:TIME). When you select manual sweeping (MAN), the analyzer measures at a single frequency—the manual frequency (SENS:FREQ:MAN). The analyzer samples the manual frequency for an amount of time determined by sample time (SENS:DET:STIM).

The setting of SENS:SWE:MODE is ignored for narrow band zoom measurements (INST:SEL FFT).

---

**[SENSe:]SWEep:SPACing****command/query**

Specifies either a linear or logarithmic spacing for the sweep.

**Command Syntax:** [SENSe:]SWEep:SPACing {LINear|LOGarithmic}

**Example Statements:** OUTPUT 719;"Sense:Swe:Spac Log"  
OUTPUT 719;"SWEEP:SPAC LINEAR"

**Query Syntax:** [SENSe:]SWEep:SPACing?

**Return Format:** CHAR

**Attribute Summary:** Preset state: LIN  
Overlapped: yes  
Pass control required: no  
SCPI Compliance: confirmed (1991.0)

**Description:**

Logarithmic sweeping is only available for network measurements.

**[SENSe:]SWEep:TIME****command/query**

Specifies the sweep time for automatically swept measurements.

**Command Syntax:** [SENSe:]SWEep:TIME {<value>|<step>|<bound>}

<value> ::= <number>[S]  
 <number> ::= a real number (NRf data)  
           limits: 1.0E-3:1.718E6  
 <step> ::= UP|DOWN  
 <bound> ::= MAX|MIN

**Example Statements:** Output 719;"SWEEP:TIME DOWN"  
 Output 719;"swe:time 400 ms"

**Query Syntax:** [SENSe:]SWEep:TIME? [UNIT]

**Return Format:** <number>|{ s }

::= a real number (NR2 or NR3 data)

**Attribute Summary:** Preset state: +2.608E-1 s  
 Overlapped: yes  
 Pass control required: no  
 SCPI Compliance: confirmed (1991.0)

**Description:**

This command specifies how long the analyzer takes to sweep from start (SENS:FREQ:STAR) to stop (SENS:FREQ:STOP). If you select a sweep time that is too short to provide calibrated measurement results, bit 1 (Uncal Oversweep) of the Questionable Power condition register is set to 1.

When bandwidth coupling is on (SENS:BAND:RES:AUTO ON), changes in any of the following parameters can force automatic changes in the sweep time setting:

- Frequency span, set with SENS:FREQ:SPAN.
- Resolution bandwidth, set with SENS:BAND:RES.
- Video bandwidth, set with SENS:BAND:VID.

---

**[SENSe:]SWEep:TIME:FFT?****query**

Causes the analyzer to respond with the measurement time for the current record length of the narrow-band zoom measurement.

**Query Syntax:** [SENSe:]SWEep:TIME:FFT?

**Example Statements:** OUTPUT 719;"sweep:time:fft?"  
OUTPUT 719;"Sens:Sweep:Time:FFT?"

**Return Format:** NR3

**Attribute Summary:** Preset state: 10 ms  
Overlapped: no  
Pass control required: no  
SCPI Compliance: instrument-specific

**Description:**

Preset state for this query is defined to be the FFT measurement time immediately after preset (if you changed to a narrow-band zoom measurement immediately after preset).

---

**[SENSe:]WINDow[:TYPE]****command/query**

Determines the frequency resolution of narrow band zoom measurements.

**Command Syntax:** [SENSe:]WINDow[:TYPE] (HANNing|FLATtop)

**Example Statements:** Output 719;"Wind Flat"  
Output 719;"SENSe:WINDow:TYPE HANNING"

**Query Syntax:** [SENSe:]WINDow[:TYPE]?

**Return Format:** HANN|FLAT

**Attribute Summary:** Preset state: FLAT  
Overlapped: yes  
Pass control required: no  
SCPI Compliance: instrument-specific

**Description:**

HANN selects the Hanning window, which provides better frequency resolution for narrow band zoom measurements (INST:SEL FFT). FLAT selects the Flat Top window, which provides better amplitude accuracy. Sending HANN is equivalent to pressing the [HI RES ZOOM] softkey on the analyzer's front panel. Sending FLAT is equivalent to pressing the [HI ACCRCY ZOOM] softkey.

## **SOURce Subsystem**

---

Commands in the SOURce subsystem control the analyzer's source (tracking generator).



**SOURce:OUTPut:IMPedance****command/query**

Selects the impedance of the analyzer's source.

**Command Syntax:** SOURce:OUTPut:IMPedance {<value>|<bound>}

```

<value> ::= <number>[<unit>]
<number> ::= an integer (NRf data)
             limits: 50:75
             discrete values: 50, 75
<unit> ::= OHM
<bound> ::= MAX|MIN

```

**Example Statements:**      Output 719;"source:output:impedance 50"  
                               Output 719;"Sour:Outp:Imp 75 Ohm"

**Query Syntax:** SOURce:OUTPut:IMPedance? [UNIT]**Return Format:** <number>|{ <unit> }

```

<number> ::= an integer (NR1 data)
<unit> ::= unit that applies to returned number

```

**Attribute Summary:**      Preset state: +50 ohm  
                               Overlapped: yes  
                               Pass control required: no  
                               SCPI Compliance: instrument-specific

**Description:**

You can select the source's output impedance explicitly with this command, or you can couple it to the input impedance with the SOUR:OUTP:IMP:MODE command.

**Note**

When you select an output impedance of 75 ohms, you *must use* the 25Ω adapter barrel (supplied with the instrument) or a 50-75Ω minimum loss pad for accurate results (see IMP:TYPE). Insert the adapter between the analyzer's source connector and your test device.

---

**SOURce:OUTPut:IMPedance:MODE****command/query**

Turns impedance coupling on and off.

**Command Syntax:** SOURce:OUTPut:IMPedance:MODE {OFF|0|ON|1}

**Example Statements:** Output 719;"SOUR:OUTP:IMP:MODE 1"  
Output 719;"source:output:impedance:mode on"

**Query Syntax:** SOURce:OUTPut:IMPedance:MODE?

**Return Format:** +(0|1)

**Attribute Summary:** Preset state: +1  
Overlapped: yes  
Pass control required: no  
SCPI Compliance: instrument-specific

**Description:**

When impedance coupling is turned on, the output impedance (SOUR:OUTP:IMP) tracks changes in the input impedance (INP:IMP) with one exception: If you switch from a 50 or 75 ohm input impedance to a 1 megohm input impedance, the output impedance retains its current setting.

---

**Note**

If you set the output impedance explicitly with the SOUR:OUTP:IMP command, impedance coupling is automatically turned off.

---

---

**SOURce:OUTPut:PROTection:CLEar****command**

Resets the analyzer's source-protection relay.

**Command Syntax:**        SOURce:OUTPut:PROTection:CLEar

**Example Statements:**        Output 719;"Source:Output:Protection:Clear"  
                              Output 719;"SOUR:OUTP:PROT:CLE"

**Attribute Summary:**        Preset state:    not applicable  
                              Overlapped:    yes  
                              Pass control required:    no  
                              SCPI Compliance:    instrument-specific

**Description:**

The source-protection relay is tripped (opened) when the signal level at the analyzer's source connector is significantly above the maximum source amplitude or when excessive dc voltage is present. Bit 3 (Source Tripped) of the Questionable Power condition register tells you if the source-protection relay has been tripped.

---

**SOURce:OUTPut[:STATe]****command/query**

Turns the analyzer's source on and off.

**Command Syntax:** SOURce:OUTPut[:STATe] {OFF|0|ON|1}

**Example Statements:** Output 719;"sour:outp 0"  
Output 719;"Source:Output:State On"

**Query Syntax:** SOURce:OUTPut[:STATe]?

**Return Format:** +{0|1}

**Attribute Summary:** Preset state: +0  
Overlapped: yes  
Pass control required: no  
SCPI Compliance: instrument-specific

**Description:**

When the source is off, the output amplitude is approximately – 100 dBm.

**SOURce:POWer[:LEVel][:IMMediate][:AMPLitude]** **command/query**

Specifies the output amplitude of the analyzer's source.

**Command Syntax:** SOURce:POWer[:LEVel][:IMMediate][:AMPLitude] <param>

```

<param> ::= {<number>[<unit>]}|<step>|<bound>
<number> ::= a real number (NRf data)
             limits: -56.7:15.0
<unit> ::= DBM|DBV|DBVRMS|V|VRMS
<step> ::= UP|DOWN
<bound> ::= MAX|MIN

```

**Example Statements:** Output 719;"SOUR:POW:LEV:IMM:AMPL 0 DBM"  
Output 719;"source:power .2 vrms"

**Query Syntax:** SOURce:POWer[:LEVel][:IMMediate][:AMPLitude]? [UNIT]

**Return Format:** <number>|{ <unit> }

```

<number> ::= a real number (NR2 or NR3 data)
<unit> ::= unit that applies to returned number

```

**Attribute Summary:** Preset state: -1.00E+1 dBm  
Overlapped: yes  
Pass control required: no  
SCPI Compliance: confirmed (1991.0)

**Description:**

The smallest possible increment between source amplitude values is 0.1 dBm. You can select the increment with the SOUR:POW:LEV:IMM:AMPL:STEP command.

**SOURce:POWer[:LEVel][:IMMediate][:AMPLitude]:STEP** **command/query**

Specifies the step size to be used for changing the source amplitude.

**Command Syntax:** SOURce:POWer[:LEVel][:IMMediate][:AMPLitude]:STEP <param>

```

<param> ::= (<number>[<unit>])|<step>|<bound>
<number> ::= a real number (NRf data)
           limits: 0.1:69.9
<unit> ::= DB
<step> ::= UP|DOWN
<bound> ::= MAX|MIN

```

**Example Statements:** Output 719;"Sour:Pow:Lev:Imm:Ampl:Step 0.1"  
Output 719;"SOURCE:POWER:IMMEDIATE:STEP 400MVRMS"

**Query Syntax:** SOURce:POWer[:LEVel][:IMMediate][:AMPLitude]:STEP? [UNIT]

**Return Format:** <number>|{ <unit> }

```

<number> ::= a real number (NR2 or NR3 data)
<unit> ::= unit that applies to returned number

```

**Attribute Summary:** Preset state: +1.00E-1 dB  
Overlapped: yes  
Pass control required: no  
SCPI Compliance: instrument-specific

**Description:**

Step size determines the amplitude change that results when you send UP or DOWN with the SOUR:POW:LEV:IMM:AMPL command.



## STATus Subsystem

---

The STATus subsystem provide access to most of the HP 3589A's status reporting structures (register sets). Some of the common commands (described in chapter 8) provide access to the other register sets.

Most of the commands in this subsystem are used to set bits in registers; most of the queries are used to read registers. Decimal weights are assigned to bits according to the following formula:

$$\text{weight} = 2^n$$

where  $n$  is the bit number (with acceptable values of 0 through 14).

To set a single register bit to 1, send the decimal weight of that bit with the command that writes the register. To set more than one bit to 1, send the *sum* of the decimal weights of all the bits. Queries that read registers always return the sum of the decimal weights of all bits that are currently set to 1.

See chapter 5 for more information about the analyzer's register sets.



**STATus:DEVIce:CONDition?**

**query**

Reads the Device State condition register.

**Query Syntax:**                 STATus:DEVIce:CONDition?

**Example Statements:**         Output 719;"status:device:condition?"  
                                   Output 719;"Stat:Dev:Cond?"

**Return Format:**                <number>

    <number> ::= an integer (NR1 data)

**Attribute Summary:**         Preset state: not applicable  
                                   Overlapped: no  
                                   Pass control required: no  
                                   SCPI Compliance: instrument-specific

**Description:**

This query returns the sum of the decimal weights of all bits currently set to 1 in the Device State condition register. (The decimal weight of a bit is  $2^n$ , where  $n$  is the bit number.)

See "Device State Register Set" in chapter 5 for a definition of bits in the register set. See "General Status Register Model" in chapter 5 for information about the role of condition registers in register sets.

**STATus:DEvice:ENABle****command/query**

Sets bits in the Device State enable register.

**Command Syntax:** STATus:DEvice:ENABle {<number>|<bound>}

<number> ::= an integer (NRf data)  
 limits: 0:32767

<bound> ::= MAX|MIN

Example Statements:     Output 719;"STAT:DEV:ENAB 0"  
                           Output 719;"status:device:enable 4"

**Query Syntax:** STATus:DEvice:ENABle?**Return Format:** <number>

<number> ::= an integer (NR1 data)

**Attribute Summary:**   Preset state: not affected by Preset  
                           Overlapped: no  
                           Pass control required: no  
                           SCPI Compliance: instrument-specific

**Description:**

To set a single bit in the Device State enable register to 1, send the bit's decimal weight with this command. To set more than one bit to 1, send the *sum* of the decimal weights of all the bits. (The decimal weight of a bit is  $2^n$ , where  $n$  is the bit number.)

See "Device State Register Set" in chapter 5 for a definition of bits in the register set. See "General Status Register Model" in chapter 5 for information about the role of enable registers in register sets.

---

**STATus:DEVIce[:EVENT]?**

**query**

Reads and clears the Device State event register.

**Query Syntax:**           STATus:DEVIce[:EVENT]?

**Example Statements:**       Output 719;"Status:Device:Event?"  
                                   Output 719;"STAT:DEV?"

**Return Format:**           <number>

                  <number> ::= an integer (NR1 data)

**Attribute Summary:**       Preset state: not applicable  
                                   Overlapped: no  
                                   Pass control required: no  
                                   SCPI Compliance: instrument-specific

**Description:**

This query returns the sum of the decimal weights of all bits currently set to 1 in the Device State event register. (The decimal weight of a bit is  $2^n$ , where  $n$  is the bit number.)

---

**Note**                    The Device State event register is automatically cleared after it is read by this query.



---

See “Device State Register Set” in chapter 5 for a definition of bits in the register set. See “General Status Register Model” in chapter 5 for information about the role of event registers in register sets.

**STATus:DEVIce:NTRansition****command/query**

Sets bits in the Device State negative transition register.

**Command Syntax:**        STATus:DEVIce:NTRansition {<number>|<bound>}

<number> ::= an integer (NRf data)  
                  limits: 0:32767

<bound> ::= MAX|MIN

**Example Statements:**        Output 719;"stat:dev:ntr 2"  
                                  Output 719;"Status:Device:Ntransition 7"

**Query Syntax:**            STATus:DEVIce:NTRansition?

**Return Format:**            <number>

<number> ::= an integer (NR1 data)

**Attribute Summary:**        Preset state: not affected by Preset  
                                  Overlapped: no  
                                  Pass control required: no  
                                  SCPI Compliance: instrument-specific

**Description:**

To set a single bit in the Device State negative transition register to 1, send the bit's decimal weight with this command. To set more than one bit to 1, send the *sum* of the decimal weights of all the bits. (The decimal weight of a bit is  $2^n$ , where  $n$  is the bit number.)

See "Device State Register Set" in chapter 5 for a definition of bits in the register set. See "General Status Register Model" in chapter 5 for information about the role of negative transition registers in register sets.

**STATus:DEVIce:PTRansition**

**command/query**

Sets bits in the Device State positive transition register.

**Command Syntax:**        STATus:DEVIce:PTRansition {<number>|<bound>}

<number> ::= an integer (NRf data)  
          limits: 0:32767

<bound> ::= MAX|MIN

Example Statements:        Output 719;"STATUS:DEVICE:PTRANSITION 4"  
                              Output 719;"stat:dev:ptr 6"

**Query Syntax:**         STATus:DEVIce:PTRansition?

**Return Format:**        <number>

<number> ::= an integer (NR1 data)

**Attribute Summary:**    Preset state: not affected by Preset  
                              Overlapped: no  
                              Pass control required: no  
                              SCPI Compliance: instrument-specific

**Description:**

To set a single bit in the Device State positive transition register to 1, send the bit's decimal weight with this command. To set more than one bit to 1, send the *sum* of the decimal weights of all the bits. (The decimal weight of a bit is  $2^n$ , where  $n$  is the bit number.)

See "Device State Register Set" in chapter 5 for a definition of bits in the register set. See "General Status Register Model" in chapter 5 for information about the role of positive transition registers in register sets.

---

**STATus:OPERation:CONDition?****query**

Reads the Standard Operation condition register.

**Query Syntax:** STATus:OPERation:CONDition?

**Example Statements:** Output 719;"Stat:Oper:Cond?"  
Output 719;"STATUS:OPERATION:CONDITION?"

**Return Format:** <number>

<number> ::= an integer (NR1 data)

**Attribute Summary:** Preset state: not applicable  
Overlapped: no  
Pass control required: no  
SCPI Compliance: confirmed (1991.0)

**Description:**

This query returns the sum of the decimal weights of all bits currently set to 1 in the Standard Operation condition register. (The decimal weight of a bit is  $2^n$ , where  $n$  is the bit number.)

See "Standard Operation Register Set" in chapter 5 for a definition of bits in the register set. See "General Status Register Model" in chapter 5 for information about the role of condition registers in register sets.

---

**STATus:OPERation:ENABLE**

**command/query**

Sets bits in the Standard Operation enable register.

**Command Syntax:**        STATus:OPERation:ENABle {<number>|<bound>}

    <number> ::= an integer (NRf data)  
                  limits: 0:32767

    <bound> ::= MAX|MIN

**Example Statements:**        Output 719;"status:operation:enable 16384"  
                                  Output 719;"Stat:Oper:Enab 64"

**Query Syntax:**            STATus:OPERation:ENABLE?

**Return Format:**            <number>

    <number> ::= an integer (NR1 data)

**Attribute Summary:**        Preset state: not affected by Preset  
                                  Overlapped: no  
                                  Pass control required: no  
                                  SCPI Compliance: confirmed (1991.0)

**Description:**

To set a single bit in the Standard Operation enable register to 1, send the bit's decimal weight with this command. To set more than one bit to 1, send the *sum* of the decimal weights of all the bits. (The decimal weight of a bit is  $2^n$ , where  $n$  is the bit number.)

See "Standard Operation Register Set" in chapter 5 for a definition of bits in the register set. See "General Status Register Model" in chapter 5 for information about the role of enable registers in register sets.

**STATus:OPERation[:EVENT]?****query**

Reads and clears the Standard Operation event register.

**Query Syntax:** STATus:OPERation[:EVENT]?

**Example Statements:** Output 719;"STAT:OPER?"  
Output 719;"status:operation:event?"

**Return Format:** <number>

<number> ::= an integer (NR1 data)

**Attribute Summary:** Preset state: not applicable  
Overlapped: no  
Pass control required: no  
SCPI Compliance: confirmed (1991.0)

**Description:**

This query returns the sum of the decimal weights of all bits currently set to 1 in the Standard Operation event register. (The decimal weight of a bit is  $2^n$ , where  $n$  is the bit number.)

**Note**

The Standard Operation event register is automatically cleared after it is read by this query.

See "Standard Operation Register Set" in chapter 5 for a definition of bits in the register set. See "General Status Register Model" in chapter 5 for information about the role of event registers in register sets.



**STATus:OPERation:NTRansition**

**command/query**

Sets bits in the Standard Operation negative transition register.

**Command Syntax:** STATus:OPERation:NTRansition {<number>|<bound>}

<number> ::= an integer (NRf data)  
                   limits: 0:32767

<bound> ::= MAX|MIN

**Example Statements:**      Output 719;"Status:Operation:Ntransition 1"  
                                   Output 719;"STAT:OPER:NTR 65535"

**Query Syntax:**             STATus:OPERation:NTRansition?

**Return Format:**            <number>

<number> ::= an integer (NR1 data)

**Attribute Summary:**      Preset state: not affected by Preset  
                                   Overlapped: no  
                                   Pass control required: no  
                                   SCPI Compliance: confirmed (1991.0)

**Description:**

To set a single bit in the Standard Operation negative transition register to 1, send the bit's decimal weight with this command. To set more than one bit to 1, send the *sum* of the decimal weights of all the bits. (The decimal weight of a bit is  $2^n$ , where  $n$  is the bit number.)

See "Standard Operation Register Set" in chapter 5 for a definition of bits in the register set. See "General Status Register Model" in chapter 5 for information about the role of negative transition registers in register sets.

**STATUS:OPERation:PTRansition**

**command/query**

Sets bits in the Standard Operation positive transition register.

**Command Syntax:**        STATUS:OPERation:PTRansition {<number>|<bound>}

    <number> ::= an integer (NRf data)  
                  limits: 0:32767

    <bound> ::= MAX|MIN

Example Statements:        Output 719;"stat:oper:ptr 16"  
                            Output 719;"Status:Operation:Ptransition 0"

**Query Syntax:**         STATUS:OPERation:PTRansition?

**Return Format:**        <number>

    <number> ::= an integer (NR1 data)

**Attribute Summary:**    Preset state: not affected by Preset  
                          Overlapped: no  
                          Pass control required: no  
                          SCPI Compliance: confirmed (1991.0)

**Description:**

To set a single bit in the Standard Operation positive transition register to 1, send the bit's decimal weight with this command. To set more than one bit to 1, send the *sum* of the decimal weights of all the bits. (The decimal weight of a bit is  $2^n$ , where  $n$  is the bit number.)

See "Standard Operation Register Set" in chapter 5 for a definition of bits in the register set. See "General Status Register Model" in chapter 5 for information about the role of positive transition registers in register sets.

---

**STATus:PRESet**

**command**

Sets bits in most enable and transition registers to their default state.

**Command Syntax:**           STATus:PRESet

Example Statements:           Output 719;"Stat:Pres"  
                                   Output 719;"STATUS:PRESET"

**Attribute Summary:**       Preset state: not applicable  
                                   Overlapped: no  
                                   Pass control required: no  
                                   SCPI Compliance: confirmed (1991.0)

**Description:**

STAT:PRES has the following effect on the Limit Fail, Questionable Frequency, and Questionable Power register sets:

- Sets all enable register bits to 1.
- Sets all positive transition register bits to 1.
- Sets all negative transition register bits to 0.

It has the following effect on the Device State, Questionable Data, and Standard Operation register sets:

- Sets all enable register bits to 0.
- Sets all positive transition register bits to 1.
- Sets all negative transition register bits to 0.

STAT:PRES also sets all bits in the User Defined enable register to 0. It has no effect on any other register.

---

**STATus:QUEStionable:CONDition?****query**

Reads the Questionable Data condition register.

**Query Syntax:** STATus:QUEStionable:CONDition?

**Example Statements:** Output 719;"status:questionable:condition?"  
Output 719;"Stat:Ques:Cond?"

**Return Format:** <number>

<number> ::= an integer (NR1 data)

**Attribute Summary:** Preset state: not applicable  
Overlapped: no  
Pass control required: no  
SCPI Compliance: confirmed (1991.0)

**Description:**

This query returns the sum of the decimal weights of all bits currently set to 1 in the Questionable Data condition register. (The decimal weight of a bit is  $2^n$ , where  $n$  is the bit number.)

See "Questionable Data Register Set" in chapter 5 for a definition of bits in the register set. See "General Status Register Model" in chapter 5 for information about the role of condition registers in register sets.

---

**STATus:QUEStionable:ENABle**

**command/query**

Sets bits in the Questionable Data enable register.

**Command Syntax:** STATus:QUEStionable:ENABle {<number>|<bound>}

<number> ::= an integer (NRf data)  
limits: 0:32767

<bound> ::= MAX|MIN

**Example Statements:** Output 719;"STAT:QUES:ENAB 40"  
Output 719;"status:questionable:enable 0"

**Query Syntax:** STATus:QUEStionable:ENABle?

**Return Format:** <number>

<number> ::= an integer (NR1 data)

**Attribute Summary:** Preset state: not affected by Preset  
Overlapped: no  
Pass control required: no  
SCPI Compliance: confirmed (1991.0)

**Description:**

To set a single bit in the Questionable Data enable register to 1, send the bit's decimal weight with this command. To set more than one bit to 1, send the *sum* of the decimal weights of all the bits. (The decimal weight of a bit is  $2^n$ , where  $n$  is the bit number.)

See "Questionable Data Register Set" in chapter 5 for a definition of bits in the register set. See "General Status Register Model" in chapter 5 for information about the role of enable registers in register sets.

---

**STATus:QUESTionable[:EVENT]?****query**

Reads and clears the Questionable Data event register.

**Query Syntax:** STATus:QUESTionable[:EVENT]?**Example Statements:**  
Output 719;"Status:Questionable?"  
Output 719;"STAT:QUES:EVENT?"**Return Format:** <number>

&lt;number&gt; ::= an integer (NR1 data)

**Attribute Summary:**  
Preset state: not applicable  
Overlapped: no  
Pass control required: no  
SCPI Compliance: confirmed (1991.0)**Description:**This query returns the sum of the decimal weights of all bits currently set to 1 in the Questionable Data event register. (The decimal weight of a bit is  $2^n$ , where  $n$  is the bit number.)

---

**Note** The Questionable Data event register is automatically cleared after it is read by this query.

---

See "Questionable Data Register Set" in chapter 5 for a definition of bits in the register set. See "General Status Register Model" in chapter 5 for information about the role of event registers in register sets.

**STATus:QUEStionable:FREQuency:CONDition?**

**query**

Reads the Questionable Frequency condition register.

**Query Syntax:** STATus:QUEStionable:FREQuency:CONDition?

**Example Statements:** Output 719;"stat:ques:freq:cond?"  
Output 719;"Status:Questionable:Frequency:Condition?"

**Return Format:** <number>

<number> ::= an integer (NR1 data)

**Attribute Summary:** Preset state: not applicable  
Overlapped: no  
Pass control required: no  
SCPI Compliance: confirmed (1991.0)

**Description:**

This query returns the sum of the decimal weights of all bits currently set to 1 in the Questionable Frequency condition register. (The decimal weight of a bit is  $2^n$ , where  $n$  is the bit number.)

See "Questionable Frequency Register Set" in chapter 5 for a definition of bits in the register set. See "General Status Register Model" in chapter 5 for information about the role of condition registers in register sets.

**STATus:QUESTIONable:FREQUENCY:ENABLE**

**command/query**

Sets bits in the Questionable Frequency enable register.

**Command Syntax:** STATus:QUESTIONable:FREQUENCY:ENABLE {<number>|<bound>}

<number> ::= an integer (NRf data)  
limits: 0:32767

<bound> ::= MAX|MIN

**Example Statements:** Output 719;"STATUS:QUESTIONABLE:FREQUENCY:ENABLE 4"  
Output 719;"stat:ques:freq:enab 5"

**Query Syntax:** STATus:QUESTIONable:FREQUENCY:ENABLE?

**Return Format:** <number>

<number> ::= an integer (NR1 data)

**Attribute Summary:** Preset state: not affected by Preset  
Overlapped: no  
Pass control required: no  
SCPI Compliance: confirmed (1991.0)

**Description:**

To set a single bit in the Questionable Frequency enable register to 1, send the bit's decimal weight with this command. To set more than one bit to 1, send the *sum* of the decimal weights of all the bits. (The decimal weight of a bit is  $2^n$ , where  $n$  is the bit number.)

See "Questionable Frequency Register Set" in chapter 5 for a definition of bits in the register set. See "General Status Register Model" in chapter 5 for information about the role of enable registers in register sets.



---

**STATUS:QUESTIONABLE:FREQUENCY[:EVENT]?**

**query**

Reads and clears the Questionable Frequency event register.

**Query Syntax:**                   STATUS:QUESTIONABLE:FREQUENCY[:EVENT]?

**Example Statements:**           Output 719;"Stat:Ques:Freq:Even?"  
                                       Output 719;"STATUS:QUESTIONABLE:FREQUENCY?"

**Return Format:**                   <number>

<number> ::= an integer (NR1 data)

**Attribute Summary:**           Preset state: not applicable  
                                       Overlapped: no  
                                       Pass control required: no  
                                       SCPI Compliance: confirmed (1991.0)

**Description:**

This query returns the sum of the decimal weights of all bits currently set to 1 in the Questionable Frequency event register. (The decimal weight of a bit is  $2^n$ , where  $n$  is the bit number.)

---

**Note**



The Questionable Frequency event register is automatically cleared after it is read by this query.

---

See "Questionable Frequency Register Set" in chapter 5 for a definition of bits in the register set. See "General Status Register Model" in chapter 5 for information about the role of event registers in register sets.

**STATUS:QUESTIONABLE:FREQUENCY:NTRANSITION**

**command/query**

Sets bits in the Questionable Frequency negative transition register.

**Command Syntax:** STATUS:QUESTIONABLE:FREQUENCY:NTRANSITION <param>

```
<param> ::= <number>|<bound>
<number> ::= an integer (NRf data)
             limits: 0:32767
<bound> ::= MAX|MIN
```

**Example Statements:** Output 719;"status:questionable:frequency:ntransition 0"  
Output 719;"Stat:Ques:Freq:Ntr 7"

**Query Syntax:** STATUS:QUESTIONABLE:FREQUENCY:NTRANSITION?

**Return Format:** <number>

```
<number> ::= an integer (NR1 data)
```

**Attribute Summary:** Preset state: not affected by Preset  
Overlapped: no  
Pass control required: no  
SCPI Compliance: confirmed (1991.0)

**Description:**

To set a single bit in the Questionable Frequency negative transition register to 1, send the bit's decimal weight with this command. To set more than one bit to 1, send the *sum* of the decimal weights of all the bits. (The decimal weight of a bit is  $2^n$ , where  $n$  is the bit number.)

See "Questionable Frequency Register Set" in chapter 5 for a definition of bits in the register set. See "General Status Register Model" in chapter 5 for information about the role of negative transition registers in register sets.

**STATus:QUEStionable:FREQuency:PTRansition**

**command/query**

Sets bits in the Questionable Frequency positive transition register.

**Command Syntax:**        STATus:QUEStionable:FREQuency:PTRansition <param>

    <param> ::= <number>|<bound>  
 <number> ::= an integer (NRf data)  
           limits: 0:32767  
 <bound> ::= MAX|MIN

**Example Statements:**        Output 719;"STAT:QUES:FREQ:PTR 2"  
                               Output 719;"status:questionable:frequency:ptransition 3"

**Query Syntax:**            STATus:QUEStionable:FREQuency:PTRansition?

**Return Format:**            <number>

    <number> ::= an integer (NR1 data)

**Attribute Summary:**        Preset state: not affected by Preset  
                               Overlapped: no  
                               Pass control required: no  
                               SCPI Compliance: confirmed (1991.0)

**Description:**

To set a single bit in the Questionable Frequency positive transition register to 1, send the bit's decimal weight with this command. To set more than one bit to 1, send the *sum* of the decimal weights of all the bits. (The decimal weight of a bit is  $2^n$ , where  $n$  is the bit number.)

See "Questionable Frequency Register Set" in chapter 5 for a definition of bits in the register set. See "General Status Register Model" in chapter 5 for information about the role of positive transition registers in register sets.

---

**STATus:QUEStionable:LIMit:CONDition?****query**

Reads the Limit Fail condition register.

**Query Syntax:** STATus:QUEStionable:LIMit:CONDition?

**Example Statements:** Output 719;"stat:ques:lim:cond?"  
Output 719;"Status:Questionable:Limit:Condition?"

**Return Format:** <number>

<number> ::= an integer (NR1 data)

**Attribute Summary:** Preset state: not applicable  
Overlapped: no  
Pass control required: no  
SCPI Compliance: instrument-specific

**Description:**

This query returns the sum of the decimal weights of all bits currently set to 1 in the Limit Fail condition register. (The decimal weight of a bit is  $2^n$ , where  $n$  is the bit number.)

See "Limit Fail Register Set" in chapter 5 for a definition of bits in the register set. See "General Status Register Model" in chapter 5 for information about the role of condition registers in register sets.

---

**STATus:QUEStionable:LIMit:ENABle**

**command/query**

Sets bits in the Limit Fail enable register.

**Command Syntax:**        STATus:QUEStionable:LIMit:ENABle {<number>|<bound>}

    <number> ::= an integer (NRf data)  
                  limits: 0:32767

    <bound> ::= MAX|MIN

**Example Statements:**        Output 719;"STATUS:QUESTIONABLE:LIMIT:ENABLE 4"  
                                  Output 719;"stat:ques:lim:enab 12"

**Query Syntax:**            STATus:QUEStionable:LIMit:ENABle?

**Return Format:**            <number>

    <number> ::= an integer (NR1 data)

**Attribute Summary:**        Preset state: not affected by Preset  
                                  Overlapped: no  
                                  Pass control required: no  
                                  SCPI Compliance: instrument-specific

**Description:**

To set a single bit in the Limit Fail enable register to 1, send the bit's decimal weight with this command. To set more than one bit to 1, send the *sum* of the decimal weights of all the bits. (The decimal weight of a bit is  $2^n$ , where  $n$  is the bit number.)

See "Limit Fail Register Set" in chapter 5 for a definition of bits in the register set. See "General Status Register Model" in chapter 5 for information about the role of enable registers in register sets.

**STATus:QUEStionable:LIMit[:EVENT]?****query**

Reads and clears the Limit Fail event register.

**Query Syntax:** STATus:QUEStionable:LIMit[:EVENT]?

**Example Statements:** Output 719;"Stat:Ques:Lim:Even?"  
Output 719;"STATUS:QUESTIONABLE:LIMIT?"

**Return Format:** <number>

<number> ::= an integer (NR1 data)

**Attribute Summary:** Preset state: not applicable  
Overlapped: no  
Pass control required: no  
SCPI Compliance: instrument-specific

**Description:**

This query returns the sum of the decimal weights of all bits currently set to 1 in the Limit Fail event register. (The decimal weight of a bit is  $2^n$ , where  $n$  is the bit number.)

**Note**

The Limit Fail event register is automatically cleared after it is read by this query.



See "Limit Fail Register Set" in chapter 5 for a definition of bits in the register set. See "General Status Register Model" in chapter 5 for information about the role of event registers in register sets.

---

**STATus:QUEStionable:LIMit:NTRansition**

**command/query**

Sets bits in the Limit Fail negative transition register.

**Command Syntax:**        STATus:QUEStionable:LIMit:NTRansition <param>

    <param> ::= <number>|<bound>  
    <number> ::= an integer (NRf data)  
              limits: 0:32767  
    <bound> ::= MAX|MIN

**Example Statements:**        Output 719;"status:questionable:limit:ntransition 0"  
                                  Output 719;"Stat:Ques:Lim:Ntr 15"

**Query Syntax:**             STATus:QUEStionable:LIMit:NTRansition?

**Return Format:**            <number>

    <number> ::= an integer (NR1 data)

**Attribute Summary:**        Preset state: not affected by Preset  
                                  Overlapped: no  
                                  Pass control required: no  
                                  SCPI Compliance: instrument-specific

**Description:**

To set a single bit in the Limit Fail negative transition register to 1, send the bit's decimal weight with this command. To set more than one bit to 1, send the *sum* of the decimal weights of all the bits. (The decimal weight of a bit is  $2^n$ , where  $n$  is the bit number.)

See "Limit Fail Register Set" in chapter 5 for a definition of bits in the register set. See "General Status Register Model" in chapter 5 for information about the role of negative transition registers in register sets.

**STATus:QUESTionable:LIMit:PTRansition**

**command/query**

Sets bits in the Limit Fail positive transition register.

**Command Syntax:** STATus:QUESTionable:LIMit:PTRansition <param>

<param> ::= <number>|<bound>  
 <number> ::= an integer (NRf data)  
           limits: 0:32767  
 <bound> ::= MAX|MIN

**Example Statements:** Output 719;"STAT:QUES:LIM:PTR 2"  
 Output 719;"status:questionable:limit:ptransition 3"

**Query Syntax:** STATus:QUESTionable:LIMit:PTRansition?

**Return Format:** <number>

<number> ::= an integer (NRl data)

**Attribute Summary:** Preset state: not affected by Preset  
 Overlapped: no  
 Pass control required: no  
 SCPI Compliance: instrument-specific

**Description:**

To set a single bit in the Limit Fail positive transition register to 1, send the bit's decimal weight with this command. To set more than one bit to 1, send the *sum* of the decimal weights of all the bits. (The decimal weight of a bit is  $2^n$ , where  $n$  is the bit number.)

See "Limit Fail Register Set" in chapter 5 for a definition of bits in the register set. See "General Status Register Model" in chapter 5 for information about the role of positive transition registers in register sets.



**STATus:QUEStionable:NTRansition**

**command/query**

Sets bits in the Questionable Data negative transition register.

**Command Syntax:** STATus:QUEStionable:NTRansition {<number>|<bound>}

<number> ::= an integer (NRf data)  
 limits: 0:32767

<bound> ::= MAX|MIN

**Example Statements:** Output 719;"Status:Questionable:Ntransition 8"  
 Output 719;"STAT:QUES:NTR 65535"

**Query Syntax:** STATus:QUEStionable:NTRansition?

**Return Format:** <number>

<number> ::= an integer (NRl data)

**Attribute Summary:** Preset state: not affected by Preset  
 Overlapped: no  
 Pass control required: no  
 SCPI Compliance: confirmed (1991.0)

**Description:**

To set a single bit in the Questionable Data negative transition register to 1, send the bit's decimal weight with this command. To set more than one bit to 1, send the *sum* of the decimal weights of all the bits. (The decimal weight of a bit is  $2^n$ , where  $n$  is the bit number.)

See "Questionable Data Register Set" in chapter 5 for a definition of bits in the register set. See "General Status Register Model" in chapter 5 for information about the role of negative transition registers in register sets.

---

**STATus:QUESTIONable:POWer:CONDition?****query**

Reads the Questionable Power condition register.

**Query Syntax:** STATus:QUESTIONable:POWer:CONDition?

**Example Statements:** Output 719;"stat:ques:pow:cond?"  
Output 719;"Status:Questionable:Power:Condition?"

**Return Format:** <number>

<number> ::= an integer (NR1 data)

**Attribute Summary:** Preset state: not applicable  
Overlapped: no  
Pass control required: no  
SCPI Compliance: confirmed (1991.0)

**Description:**

This query returns the sum of the decimal weights of all bits currently set to 1 in the Questionable Power condition register. (The decimal weight of a bit is  $2^n$ , where  $n$  is the bit number.)

See "Questionable Power Register Set" in chapter 5 for a definition of bits in the register set. See "General Status Register Model" in chapter 5 for information about the role of condition registers in register sets.



**STATUS:QUESTIONABLE:POWER[:EVENT]?**

**query**

Reads and clears the Questionable Power event register.

**Query Syntax:** STATUS:QUESTIONABLE:POWER[:EVENT]?

**Example Statements:** Output 719;"Stat:Ques:Pow?"  
 Output 719;"STATUS:QUESTIONABLE:POWER:EVENT?"

**Return Format:** <number>

<number> ::= an integer (NR1 data)

**Attribute Summary:** Preset state: not applicable  
 Overlapped: no  
 Pass control required: no  
 SCPI Compliance: confirmed (1991.0)

**Description:**

This query returns the sum of the decimal weights of all bits currently set to 1 in the Questionable Power event register. (The decimal weight of a bit is  $2^n$ , where  $n$  is the bit number.)

**Note**



The Questionable Power event register is automatically cleared after it is read by this query.

See "Questionable Power Register Set" in chapter 5 for a definition of bits in the register set. See "General Status Register Model" in chapter 5 for information about the role of event registers in register sets.

---

**STATus:QUESTionable:POWer:NTRansition**

**command/query**

Sets bits in the Questionable Power negative transition register.

**Command Syntax:**        STATus:QUESTionable:POWer:NTRansition {<number>|<bound>}

    <number> ::= an integer (NRf data)  
                  limits: 0:32767

    <bound> ::= MAX|MIN

**Example Statements:**        Output 719;"status:questionable:power:ntransition 0"  
                                  Output 719;"Stat:Ques:Pow:Ntr 12"

**Query Syntax:**            STATus:QUESTionable:POWer:NTRansition?

**Return Format:**            <number>

    <number> ::= an integer (NR1 data)

**Attribute Summary:**        Preset state: not affected by Preset  
                                  Overlapped: no  
                                  Pass control required: no  
                                  SCPI Compliance: confirmed (1991.0)

**Description:**

To set a single bit in the Questionable Power negative transition register to 1, send the bit's decimal weight with this command. To set more than one bit to 1, send the *sum* of the decimal weights of all the bits. (The decimal weight of a bit is  $2^n$ , where  $n$  is the bit number.)

See "Questionable Power Register Set" in chapter 5 for a definition of bits in the register set. See "General Status Register Model" in chapter 5 for information about the role of negative transition registers in register sets.

**STATus:QUEStionable:POWer:PTRansition****command/query**

Sets bits in the Questionable Power positive transition register.

**Command Syntax:** STATus:QUEStionable:POWer:PTRansition {<number>|<bound>}<number> ::= an integer (NRf data)  
limits: 0:32767

&lt;bound&gt; ::= MAX|MIN

Example Statements: Output 719;"STAT:QUES:POW:PTR 65535"  
Output 719;"status:questionable:power:ptransition 2"**Query Syntax:** STATus:QUEStionable:POWer:PTRansition?**Return Format:** <number>

&lt;number&gt; ::= an integer (NR1 data)

**Attribute Summary:** Preset state: not affected by Preset  
Overlapped: no  
Pass control required: no  
SCPI Compliance: confirmed (1991.0)**Description:**To set a single bit in the Questionable Power positive transition register to 1, send the bit's decimal weight with this command. To set more than one bit to 1, send the *sum* of the decimal weights of all the bits. (The decimal weight of a bit is  $2^n$ , where  $n$  is the bit number.)

See "Questionable Power Register Set" in chapter 5 for a definition of bits in the register set. See "General Status Register Model" in chapter 5 for information about the role of positive transition registers in register sets.

---

**STATUS:QUESTIONABLE:PTRANSITION**

**command/query**

Sets bits in the Questionable Data positive transition register.

**Command Syntax:**       STATUS:QUESTIONABLE:PTRANSITION {<number>|<bound>}

<number> ::= an integer (NRf data)  
                  limits: 0:32767

<bound> ::= MAX|MIN

**Example Statements:**       Output 719;"Status:Questionable:Ptransition 21"  
                              Output 719;"STAT:QUES:PTR 31"

**Query Syntax:**           STATUS:QUESTIONABLE:PTRANSITION?

**Return Format:**           <number>

<number> ::= an integer (NR1 data)

**Attribute Summary:**       Preset state: not affected by Preset  
                              Overlapped: no  
                              Pass control required: no  
                              SCPI Compliance: confirmed (1991.0)

**Description:**

To set a single bit in the Questionable Data positive transition register to 1, send the bit's decimal weight with this command. To set more than one bit to 1, send the *sum* of the decimal weights of all the bits. (The decimal weight of a bit is  $2^n$ , where  $n$  is the bit number.)

See "Questionable Data Register Set" in chapter 5 for a definition of bits in the register set. See "General Status Register Model" in chapter 5 for information about the role of positive transition registers in register sets.

**STATus:USER:ENABLE****command/query**

Sets bits in the User Defined enable register.

**Command Syntax:** STATus:USER:ENABLE (<number>|<bound>)<number> ::= an integer (NRf data)  
limits: 0:32767

&lt;bound&gt; ::= MAX|MIN

Example Statements: Output 719;"stat:user:enab 65535"  
Output 719;"Status:User:Enable 1023"**Query Syntax:** STATus:USER:ENABLE?**Return Format:** <number>

&lt;number&gt; ::= an integer (NR1 data)

**Attribute Summary:** Preset state: not affected by Preset  
Overlapped: no  
Pass control required: no  
SCPI Compliance: instrument-specific**Description:**

To set a single bit in the User Defined enable register to 1, send the bit's decimal weight with this command. To set more than one bit to 1, send the *sum* of the decimal weights of all the bits. (The decimal weight of a bit is  $2^n$ , where  $n$  is the bit number.)

See "User Defined Register Set" in chapter 5 for a definition of bits in the register set. See "General Status Register Model" in chapter 5 for information about the role of enable registers in register sets.



---

**STATus:USER[:EVENT]?**

**query**

Reads and clears the User Defined event register.

**Query Syntax:** STATus:USER[:EVENT]?

**Example Statements:** Output 719;"STATUS:USER:EVENT?"  
Output 719;"STATUS:USER?"

**Return Format:** <number>

<number> ::= an integer (NR1 data)

**Attribute Summary:** Preset state: not applicable  
Overlapped: no  
Pass control required: no  
SCPI Compliance: instrument-specific

**Description:**

This query returns the sum of the decimal weights of all bits currently set to 1 in the User Defined event register. (The decimal weight of a bit is  $2^n$ , where  $n$  is the bit number.)

---

**Note**

The User Defined event register is automatically cleared after it is read by this query.



---

See “User Defined Register Set” in chapter 5 for a definition of bits in the register set. See “General Status Register Model” in chapter 5 for information about the role of event registers in register sets.

**STATus:USER:PULSe****command**

Pulse bits in the User Defined condition register.

**Command Syntax:**        STATus:USER:PULSe {<number>|<bound>}

<number> ::= an integer (NRf data)  
          limits: 0:32767

<bound> ::= MAX|MIN

**Example Statements:**        Output 719;"Stat:User:Puls 0"  
                              Output 719;"STATUS:USER:PULSE 512"

**Attribute Summary:**        Preset state: not applicable  
                              Overlapped: no  
                              Pass control required: no  
                              SCPI Compliance: instrument-specific

**Description:**

Each bit in the User Defined condition register is normally set to 0, but is set to 1 (briefly) when you send the bit's decimal weight with the STAT:USER:PULS command. (The decimal weight of a bit is  $2^n$ , where  $n$  is the bit number.)

See "User Defined Register Set" in chapter 5 for more information.



## **SYSTEM Subsystem**

---

The SYSTEM subsystem collects commands that are not related to analyzer performance. Instead, these commands control global functions, such as instrument preset, time, and date.

**SYSTEM:BEEPer:STATe**

**command/query**

Toggles the analyzer's beeper on and off.

**Command Syntax:**        SYSTEM:BEEPer:STATe {OFF|0|ON|1}

**Example Statements:**        Output 719;"system:beeper:state on"  
                                   Output 719;"Syst:Beep:Stat 1"

**Query Syntax:**             SYSTEM:BEEPer:STATe?

**Return Format:**            +{0|1}

**Attribute Summary:**        Preset state: +1  
                                   Overlapped: no  
                                   Pass control required: no  
                                   SCPI Compliance: confirmed (1991.0)

**Description:**

When the beeper is enabled, it emits an audible tone when some messages are either displayed or placed in the error queue. It also emits an audible tone when a trace falls outside its specified limits if limit testing *and* the limit-fail beeper are enabled (DISP:LIM:STAT ON and DISP:LIM:BEEP ON).

---

**SYSTEM:COMMunicate:GPIB:ADDRESS**

**command/query**

Sets the analyzer's HP-IB address.

**Command Syntax:**       SYSTEM:COMMunicate:GPIB:ADDRESS {<number>|<step>|<bound>}

<number> ::= an integer (NRf data)  
                   limits: 0:30  
 <step> ::= UP|DOWN  
 <bound> ::= MAX|MIN

**Example Statements:**       Output 719;"SYST:COMM:GPIB:ADDR 19"  
                               Output 719;"system:communicate:gpiib:address 11"

**Query Syntax:**           SYSTEM:COMMunicate:GPIB:ADDRESS?

**Return Format:**           <number>

<number> ::= an integer (NR1 data)

**Attribute Summary:**       Preset state: not affected by Preset  
                               Overlapped: no  
                               Pass control required: no  
                               SCPI Compliance: confirmed (1991.0)

**Description:**

The analyzer's address is saved in non-volatile memory, so it is retained when you turn the analyzer off and on.

---

**Note**



When you use this command, wait at least 5 seconds before sending another command to the new address.

---

**SYSTem:COMMunicate:GPIB:ECHO**

**command/query**

Enables and disables the echoing of SCPI command mnemonics to the analyzer's screen.

**Command Syntax:** SYSTem:COMMunicate:GPIB:ECHO {OFF|0|ON|1}

**Example Statements:** Output 719;"System:Communicate:Gpib:Echo Off"  
 Output 719;"SYST:COMM:GPIB:ECHO 1"

**Query Syntax:** SYSTem:COMMunicate:GPIB:ECHO?

**Return Format:** +{0|1}

**Attribute Summary:** Preset state: +0  
 Overlapped: no  
 Pass control required: no  
 SCPI Compliance: instrument-specific

**Description:**

When echoing is enabled, you can operate the analyzer from the front panel and it will display the SCPI commands you must send over the HP-IB to achieve the same results. Mnemonics are displayed in the lower-left corner of the screen and do not include the optional nodes.

**SYSTem:DATE****command/query**

Sets the date in the analyzer's battery-backed clock.

**Command Syntax:** SYSTem:DATE <year>,<month>,<day>

<year> ::= MAX|MIN|an integer (NRf data)  
limits: 0:9999

<month> ::= MAX|MIN|an integer (NRf data)  
limits: 1:12

<day> ::= MAX|MIN|an integer (NRf data)  
limits: 1:31

**Example Statements:** Output 719;"syst:date 1990,2,20"  
Output 719;"System:Date 1991,11,4"

**Query Syntax:** SYSTem:DATE?

**Return Format:** <year>,<month>,<day>

<year> ::= an integer (NR1 data)

<month> ::= an integer (NR1 data)

<day> ::= an integer (NR1 data)

**Attribute Summary:** Preset state: not affected by Preset  
Overlapped: no  
Pass control required: no  
SCPI Compliance: confirmed (1991.0)

**Description:**

You must enter the year as a four-digit number, including century and millennium information (1990, not 90).



---

**SYSTEM:ERRor?**

**query**

Returns one error message from the analyzer's error queue.

**Query Syntax:**                SYSTem: ERRor?

**Example Statements:**        Output 719;"SYSTEM:ERROR?"  
                                   Output 719;"syst:err?"

**Return Format:**                <err\_num>,"<gen\_info>;<details>"

    <err\_num> ::= an integer (NR1 data)  
     <gen\_info> ::= general description of error  
     <details> ::= additional details (if any)

**Attribute Summary:**        Preset state: not applicable  
                                   Overlapped: no  
                                   Pass control required: no  
                                   SCPI Compliance: confirmed (1991.0)

**Description:**

The error queue temporarily stores up to 20 error messages. When you send the SYST:ERR query, one message is moved from the error queue to the output queue so your controller can read the message. The error queue delivers messages to the output queue in the order received.

---

**Note**



The error queue is cleared when you turn on the analyzer and when you send the \*CLS command.

---

Appendix B lists the HP 3589A's error messages.

**SYSTem:PRESet****command**

Returns most of the analyzer's parameters to their preset states.

**Command Syntax:** SYSTem:PRESet

**Example Statements:** Output 719;"Syst:Pres"  
Output 719;"SYSTEM:PRESET"

**Attribute Summary:** Preset state: not applicable  
Overlapped: yes  
Pass control required: no  
SCPI Compliance: instrument-specific

**Description:**

In addition to returning parameters to their preset states, this command does all of the following things:

- Cancels any pending \*OPC command or query.
- Clears the error queue.
- Clears all event registers (sets all bits to 0).

**Note**

The preset state of each parameter is listed under the Attribute Summary of the associated command.



SYST:PRES does not affect the following parameters:

- The state of the Power-on Status Clear flag.
- The state of all enable and transition registers.
- The HP-IB input and output queues.
- The time and date. (SYST:TIME and SYST:DATE).
- The HP-IB address settings. (SYST:COMM:GPIB:ADDR, PLOT:ADDR, and PRIN:ADDR)
- The HP-IB controller capability setting.
- The default disk selection. (MMEM:MSI)
- Contents of limit, data, function, and constant registers.
- Contents of the RAM disks.
- Calibration constants.

**SYSTEM:RPGLock**

**command/query**

Enables and disables the knob on the analyzer's front panel.

**Command Syntax:**       SYSTEM:RPGLock {OFF|0|ON|1}

**Example Statements:**       Output 719;"System:Rpglock Off"  
                              Output 719;"SYST:RPGL 1"

**Query Syntax:**           SYSTEM:RPGLock?

**Return Format:**          +{0|1}

**Attribute Summary:**       Preset state: +1  
                              Overlapped: no  
                              Pass control required: no  
                              SCPI Compliance: instrument-specific

**Description:**

When the knob is enabled, front-panel operators can position the marker or scroll through the disk catalog while the analyzer is being controlled via HP-IB.

**SYSTem:SET****command/query**

Transfers an instrument state between the analyzer and an external controller.

**Command Syntax:** SYSTem:SET <block>

<block> ::= #<byte>[<length\_bytes>]<data\_bytes>

<byte> ::= one ASCII-encoded byte specifying the number of length bytes to follow

<length\_bytes> ::= ASCII-encoded bytes specifying the number of data bytes to follow

<data\_bytes> ::= the bytes that define an instrument state

**Example Statements:** Output 719;"system:set?"  
Output 719;"Syst:Set?"

**Query Syntax:** SYSTem:SET?

**Return Format:** <block>

**Attribute Summary:** Preset state: undefined value \*  
Overlapped: yes  
Pass control required: no  
SCPI Compliance: confirmed (1991.0)

**Description:**

This command transfers a complete instrument state—the same information contained in a state file—between the analyzer and your controller. This allows you to store an instrument state on your controller's file system. The state cannot be altered.

When you transfer an instrument state to the analyzer, you can use either the definite or the indefinite length block syntax. When the analyzer returns the state to a controller, it always uses the definite length block syntax. See "Block Data" in chapter 4 for more information.

\* depends on range and reference level which depend on input signal

**SYSTem:SNUMber?**

**query**

Returns the analyzer's serial number.

**Query Syntax:** SYSTem:SNUMber?

**Example Statements:** Output 719;"SYST:SNUM?"  
Output 719;"system:snumber?"

**Return Format:** <ser\_num>

<ser\_num> ::= 10 ASCII characters

**Attribute Summary:** Preset state: not applicable  
Overlapped: no  
Pass control required: no  
SCPI Compliance: confirmed (1991.0)

**Description:**

This query returns the analyzer's serial number.

**SYSTem:TIME****command/query**

Sets the time in the analyzer's battery-backed clock.

**Command Syntax:** SYSTem:TIME <hour>,<minute>,<second>

```

    <hour> ::= MAX|MIN|an integer (NRf data)
              limits: 0:23
    <minute> ::= MAX|MIN|an integer (NRf data)
              limits: 0:59
    <second> ::= MAX|MIN|an integer (NRf data)
              limits: 0:60
  
```

**Example Statements:**      Output 719;"System:Time 14,5,00"  
                               Output 719;"SYSTem:TIME 8,58,00"

**Query Syntax:** SYSTem:TIME?

**Return Format:** <hour>,<minute>,<second>

```

    <hour> ::= an integer (NR1 data)
    <minute> ::= an integer (NR1 data)
    <second> ::= an integer (NR1 data)
  
```

**Attribute Summary:**      Preset state: not affected by Preset  
                               Overlapped: no  
                               Pass control required: no  
                               SCPI Compliance: instrument-specific

**Description:**

Set the time using a 24-hour format. For example, 3:05 pm becomes 15:05 and is sent as SYST:TIME 15,5,0.

**SYSTEM:VERSion**

**command**

Displays the version number of the analyzer operating system software.

**Command Syntax:**       SYSTEM:VERSion

Example Statements:       Output 719;"System:Version"  
                              Output 719;"SYSTEM:VERS"

**Attribute Summary:**     Preset state: not affected by Preset  
                              Overlapped: no  
                              Pass control required: no  
                              SCPI Compliance: instrument-specific

**Description:**

Displays the version number of the analyzer operating system software.

## TEST Subsystem

---

Commands in the TEST subsystem access functions that should only be used as described in the *HP 3588A Performance Test Guide*. Refer to that manual for more information on these functions.



---

**TEST:INPut:CONFig****command/query**

Connects: the input circuitry either to the input BNC or the calibrator signal.

**Command Syntax:** TEST:INPut:CONFig {FPANel|CALibrator}

**Example Statements:** Output 719;"test:inp:conf cal"  
Output 719;"Test:Input:Config Fpanel"

**Query Syntax:** TEST:INPut:CONFigure?

**Return Format:** FPAN|CAL

**Attribute Summary:** Preset state: FPAN  
Overlapped: no  
Pass control required: no  
SCPI Compliance: instrument-specific

**Description:**

Use this command only as described in the *HP 3588A Performance Test Guide*.

**TEST:SOURce:DAC:ATTenuation****command/query**

Sets the source's attenuation DAC.

**Command Syntax:** TEST:SOURce:DAC:ATTenuation {<value>|<step>|<bound>}

&lt;value&gt; ::= &lt;number&gt;[DB]

<number> ::= a real number (NRf data)  
limits: 0.0:39.9

&lt;step&gt; ::= UP|DOWN

&lt;bound&gt; ::= MAX|MIN

**Example Statements:** Output 719;"TEST:SOURCE:DAC:ATTENUATION 0"  
Output 719;"test:sour:dac:att 20"**Query Syntax:** TEST:SOURce:DAC:ATTenuation? [UNIT]**Return Format:** <number>|("dB")

&lt;number&gt; ::= a real number (NR2 or NR3 data)

**Attribute Summary:** Preset state: +0.00E+0 dB  
Overlapped: no  
Pass control required: no  
SCPI Compliance: instrument-specific**Description:**Use this command only as described in the *HP 3589A Performance Test Guide*.



## TRACe Subsystem

---

The TRACe subsystem contains commands that are used to define and manipulate trace data. One of these commands—TRAC:DATA—allows you to transfer measurement data between the analyzer and an external controller. The following block diagram shows you the position of TRAC:DATA in the data flow:

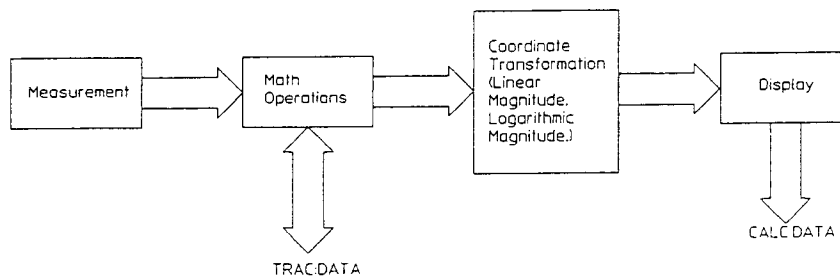

cobn006

**Figure 31-14. Flow of Measurement Data**

After measurement data is collected, any specified math operations are performed. Data is then transformed into the specified coordinate system and sent to the display. TRAC:DATA gives you access to the raw measurement data after math operations have been performed. CALC:DATA gives you access to the display data—after the coordinate transformation.

### Note



You can take measurement data out of the analyzer with either TRACE:DATA or CALC:DATA, but you can only put it back into the analyzer with TRAC:DATA.

The TRACe mnemonic contains an optional trace specifier: [1|2]. To direct a command to trace A, omit the specifier or use 1. To direct a command to trace B, use 2.

---

**TRACe[1|2]:COPY****command**

Copies the specified trace into a data register.

**Command Syntax:** TRACe[1|2]:COPY {D1|D2|D3|D4|D5|D6|D7|D8}

**Example Statements:** Output 719;"Trac:Copy D2"  
Output 719;"TRACE1:COPY D5"

**Attribute Summary:** Preset state: not applicable  
Overlapped: no  
Pass control required: no  
SCPI Compliance: confirmed (1991.0)

**Description:**

The trace in a data register can either be displayed directly (using DISP:RES) or included in a math function (using CALC:MATH:EXPR).

---

**Note**

To save the contents of a data register to disk, you must display the contents in trace A or trace B (with DISP:RES) and then save trace A or trace B (with MMEM:STOR:TRAC).

---

**TRACe[1|2]:DATA****command/query**

Transfers a trace between the analyzer and an external controller.

**Command Syntax:** TRACe[1|2]:DATA <block>

When data is ASCII-encoded, (FORM ASC) <block> takes the following form:

```
<block> ::= [<point>[,<point>]...]
<point> ::= y-axis value for 1 of 401 spectrum trace points or
           real & imag values for 1 of 401 network trace points
           limits: -9.9E37:9.9E37
```

When data is binary-encoded, (FORM REAL) <block> takes the following form:

```
<block> ::= #<byte>[<length_bytes>][<point>]...
<byte>  ::= one ASCII-encoded byte specifying the number of length
           bytes to follow
<length_bytes> ::= ASCII-encoded bytes specifying the number of data
           bytes to follow
<point> ::= y-axis value for 1 of 401 spectrum trace points or
           real & imag values for 1 of 401 network trace points
           limits: -9.9E37:9.9E37
```

**Example Statements:**      Output 719;"trace:data 1,1,1,1,1"  
                              Output 719;"Trac2:Data?"

**Query Syntax:** TRACe[1|2]:DATA?

**Return Format:** <block>

**Attribute Summary:**      Preset state: not applicable  
                              Overlapped: yes  
                              Pass control required: no  
                              SCPI Compliance: confirmed (1991.0)

**Description:**

This command transfers a block of corrected measurement data (after math operations have been performed) between the analyzer and your controller. The block is transferred as 401 amplitude values. The unit for these values is Vrms. (See TRC\_LOAD example in chapter 6.)

**Note**

If you send fewer than 401 values for spectrum data (swept spectrum and narrow-band zoom) or 802 values for network data, the analyzer replaces points 0 through  $(n - 1)$  of the specified trace with the values you send (where  $n$  is the number of values you send). The remaining points are unchanged.

---

**TRACe[1|2]:TITLe****command/query**

Loads a title for the specified trace.

**Command Syntax:** TRACe[1|2]:TITLe '<title>'

<title> ::= 0 through 15 ASCII characters

**Example Statements:** Output 719;"TRAC2:TITL 'Filter Shape'"  
Output 719;"tracel:title ''"

**Query Syntax:** TRACe[1|2]:TITLe?

**Return Format:** <title>

**Attribute Summary:** Preset state: (both traces)  
Overlapped: no  
Pass control required: no  
SCPI Compliance: instrument-specific

**Description:**

Trace titles appear above the upper-left corner of traces and can be up to 15 characters long. They replace the default trace titles supplied by the analyzer. You can delete a user-defined trace title by sending the null string ("") with this command; this causes the analyzer to display the default trace title.

---

**Note**

If you send \*RST or SYST:PRES, user-defined titles are automatically deleted, restoring the default titles for both traces.

---

## TRIGger Subsystem

---

The TRIGger subsystem contains commands that control two of the analyzer's trigger functions. One command selects the source of the trigger signal. The other command triggers the analyzer if the trigger source is BUS. See the ARM subsystem for commands that control the trigger arming functions.



**TRIGger:DElay****command/query**

Specifies trigger delay time.

**Command Syntax:** TRIGger:DElay ({<number>[<unit>]}|<step>|<bound>}

&lt;number&gt; ::= a real number (NRf data)

limits: 0.0:2000.0

&lt;unit&gt; ::= S

&lt;step&gt; ::= UP|DOWN

&lt;bound&gt; ::= MAX|MIN

**Example Statements:** OUTPUT 711;"TRIG:DELAY 44 ms"  
OUTPUT 711;"trig:del 0"**Query Syntax:** TRIGger:DElay?**Return Format:** NR3**Attribute Summary:** Preset state: 0  
Overlapped: yes  
Pass control required: no  
SCPI Compliance: confirmed (1991.0)**Description:**

Trigger delay is the amount of time elapsed between the receipt of a trigger and the start of a measurement. Trigger delay is a function of resolution bandwidth for swept spectrum and network measurements (it is a function of the number of decimations being performed at the start of a measurement).

For narrowband zoom, trigger delay is a function of frequency span.

In a log sweep with LOG RBW AUTO active, the RBW automatically chosen for the first segment of the log sweep determines the available values of trigger delay.

---

**TRIGger[:IMMEDIATE]****command**

Triggers the analyzer if TRIG:SOUR is BUS.

**Command Syntax:** TRIGger[:IMMEDIATE]

**Example Statements:** Output 719;"Trigger:Immediate"  
Output 719;"TRIG"

**Attribute Summary:** Preset state: not applicable  
Overlapped: yes  
Pass control required: no  
SCPI Compliance: confirmed (1991.0)

**Description:**

This command triggers the analyzer if the following two conditions are met:

- The HP-IB is designated as the trigger source. (Send the TRIG:SOUR BUS command.)
- The analyzer is waiting to trigger. (Bit 5 of the Standard Operation condition register is set.)

It is ignored at all other times.

TRIG:IMM has the same effect as \*TRG. It also has the same effect as the HP-IB bus management command Group Execute Trigger (GET) with the following exception: TRIG:IMM is sent to the input queue and processed in the order received, but GET is processed immediately, even if the input queue contains other commands.

See the programming example TRIGGERING for correct useage of trigger with synchronization.

---

**TRIGger:SLOPe****command/query**

Selects positive or negative edge trigger for external trigger.

**Command Syntax:** TRIGger:SLOPe {POSitive|NEGative}

**Example Statements:** OUTPUT 711;":trig:slop neg"  
OUTPUT 711;"Trigger:Slop Positive"

**Query Syntax:** TRIGger:SLOPe?

**Return Format:** CHAR

**Attribute Summary:** Preset state: NEG  
Overlapped: yes  
Pass control required: no  
SCPI Compliance: confirmed (1991.0)

**Description:**

Selects positive or negative edge trigger for external trigger.

---

**TRIGger:SOURce****command/query**

Selects the source of a trigger event.

**Command Syntax:** TRIGger:SOURce {IMMediate|EXTernal|BUS}Example Statements: Output 719;"trig:sour ext"  
Output 719;"Trigger:Source Immediate"**Query Syntax:** TRIGger:SOURce?**Return Format:** IMM|EXT|BUS**Attribute Summary:** Preset state: IMM  
Overlapped: yes  
Pass control required: no  
SCPI Compliance: confirmed (1991.0)**Description:**

Send IMM to select free run triggering, which automatically triggers the analyzer as soon as it is armed.

Send EXT to select the analyzer's EXT TRIG connector (on the rear panel) as the trigger source. If EXT is selected, the analyzer is triggered by a high-to-low transition of the TTL signal applied to this connector.

Send BUS to select the analyzer's HP-IB connector (also on the rear panel) as the trigger source. If BUS is selected, the analyzer is triggered when you send any of the following HP-IB commands:

- \*TRG
- TRIG:IMM
- Group Execute Trigger (GET)

GET is a *bus management* command. See "Response to Bus Management Commands" in chapter 2 for more information.

---

**Note**

The analyzer must be waiting to trigger when it receives an external trigger signal or bus trigger command, otherwise the signal or command is ignored. Bit 5 of the Standard Operation condition register is set to 1 when the analyzer is waiting to trigger.

---

See the programming example TRIGGERING for correct useage of trigger with synchronization.



# HP 3589A Command Summary

---

## Introduction

This appendix contains a listing of all the SCPI commands recognized by the HP 3589A. It begins with the *common commands* and then lists the *subsystem commands* in alphabetical order. The appendix uses the following conventions:

- Syntax is taken from the command descriptions in the Command Reference chapters. Refer to those descriptions for more information on a particular command.
- Indentation is used to show a subsystem command's relative position in the SCPI command tree. See chapter 3 for more information on the command tree.
- An italic font is used for commands that fill a position in the command tree but do not affect the analyzer state. For example, *DISPlay[1|2]:LIMit:UPPer* gives you access to the command *DISPlay[1|2]:LIMit:UPPer:DELeTe*, but it does not affect the analyzer state. (In fact, it is not even recognized by the command parser.)

## Command List

### Common Commands

\*CAL?  
\*CLS  
\*ESE <number>  
\*ESR?  
\*IDN?  
\*OPC  
\*PCB <number\_1>[,<number\_2>]  
\*PSC <number>  
\*RST  
\*SRE <number>  
\*STB?  
\*TRG  
\*TST?  
\*WAI

### ABORT

### ARM

ARM[:IMMEdiate]  
ARM:SOURce {IMMEdiate|MANual}

### CALCulate[1|2]

CALCulate[1|2]:DATA?  
*CALCulate[1|2]:DCONvert*  
CALCulate[1|2]:DCONvert:AOFFset {<number>[<unit>]} | <step> | <bound>  
CALCulate[1|2]:DCONvert:AXIS {MIRROr|NORMAl}  
*CALCulate[1|2]:DCONvert:FREQuency*  
CALCulate[1|2]:DCONvert:FREQuency:CENTer <param>  
CALCulate[1|2]:DCONvert:FREQuency:STATe {USER|NORMAl}  
CALCulate[1|2]:FORMat <param>  
*CALCulate[1|2]:FORMat:PHASe*  
CALCulate[1|2]:FORMat:PHASe:PREFereNce <number>[unit]  
CALCulate[1|2]:FORMat:PHASe:SLOPe <number>[unit]  
CALCulate[1|2]:FORMat:PHASe:SLOPe:STATe {OFF|0|ON|1}  
CALCulate[1|2]:FORMat:PHASe:WRAP {OFF|0|ON|1}  
*CALCulate[1|2]:GDAPerture*  
CALCulate[1|2]:GDAPerture:APERture <number>[unit]  
*CALCulate[1|2]:MATH*  
*CALCulate[1|2]:MATH:CONStant*  
CALCulate[1|2]:MATH:CONStant:MPHase <param>  
CALCulate[1|2]:MATH:CONStant[:RIMag] <param>  
CALCulate[1|2]:MATH:DATA <MATH>  
CALCulate[1|2]:MATH[:EXPRession] {F1|F2|F3|F4|F5},<EXPR>

## CALibration

CALibration[:ALL]?  
 CALibration:AUTO {OFF|0|ON|1|ONCE}  
*CALibration:CORRection*  
 CALibration:CORRection:SRATe {OFF|0|ON|1}

## DIAGnostics

*DIAGnostics:SOURce*  
*DIAGnostics:SOURce:PAD*  
 DIAGnostics:SOURce:PAD:TEN {IN|OUT}  
*DIAGnostics:SOURce:PADA*  
 DIAGnostics:SOURce:PADA:TWENTy {IN|OUT}  
*DIAGnostics:SOURce:PADB*  
 DIAGnostics:SOURce:PADB:TWENTy {IN|OUT}

## DISPlay[1|2]

DISPlay[1|2]:GRATicule {OFF|0|ON|1}  
 DISPlay[1|2]:GRATicule:TYPE {POLar|SCHart}  
 DISPlay[1|2]:LABel <STRING>  
*DISPlay[1|2]:LIMit*  
 DISPlay[1|2]:LIMit:BEEP {OFF|0|ON|1}  
 DISPlay[1|2]:LIMit:LINE {OFF|0|ON|1}  
*DISPlay[1|2]:LIMit:LOWer*  
 DISPlay[1|2]:LIMit:LOWer:DATA <LIMIT>  
 DISPlay[1|2]:LIMit:LOWer:DELeTe  
 DISPlay[1|2]:LIMit:LOWer:MOVE <number>  
 DISPlay[1|2]:LIMit:LOWer:REPort?  
 DISPlay[1|2]:LIMit:LOWer:SEGMENT <BLOCK>  
 DISPlay[1|2]:LIMit:MODE {ABSolute|RELative}  
 DISPlay[1|2]:LIMit:RESult?  
 DISPlay[1|2]:LIMit:STATe {OFF|0|ON|1}  
*DISPlay[1|2]:LIMit:UPPer*  
 DISPlay[1|2]:LIMit:UPPer:DATA <LIMIT>  
 DISPlay[1|2]:LIMit:UPPer:DELeTe  
 DISPlay[1|2]:LIMit:UPPer:MOVE <number>  
 DISPlay[1|2]:LIMit:UPPer:REPort?  
 DISPlay[1|2]:LIMit:UPPer:SEGMENT <BLOCK>  
 DISPlay[1|2]:PARTition {OFF|0|FULL|UPPer|LOWer}  
 DISPlay[1|2]:PARTition:CLEar  
 DISPlay[1|2]:RESults <param>  
*DISPlay[1|2]:Y*  
*DISPlay[1|2]:Y[:SCALE]*  
 DISPlay[1|2]:Y[:SCALE]:AUTO {ONCE|OFF|0}  
 DISPlay[1|2]:Y[:SCALE]:MAXimum <number>[unit]  
 DISPlay[1|2]:Y[:SCALE]:MAXimum:AUTO {OFF|0|ON|1}  
 DISPlay[1|2]:Y[:SCALE]:PDIVision <number>[unit]



DISPlay[1|2]:Y[:SCALE]:RLEVel <number>[unit]  
DISPlay[1|2]:Y[:SCALE]:RLEVel:AUTO {OFF|0|ON|1}  
DISPlay[1|2]:Y[:SCALE]:RLINe {OFF|0|ON|1}  
DISPlay[1|2]:Y[:SCALE]:RPOSition <number>[unit]

#### FORMat

FORMat[:DATA] {ASCIi|REAL}[,<number>]

#### INITiate

INITiate:CONTInuous {ON|1}  
INITiate[:IMMEdiate]

#### INPut

INPut:IMPedance <number>[unit]  
INPut:IMPedance:REFerence <number>[unit]  
*INPut:TRIP*  
INPut:TRIP:CLEar

#### INSTrument

INSTrument:SELEct {SWEPT|FFT|NETWork}

#### MARKer[1|2]

##### *MARKer[1|2]:FUNctIon*

MARKer[1|2]:FUNctIon:FCOunt {OFF|0|ON|1}  
MARKer[1|2]:FUNctIon:NOISe {OFF|0|ON|1}

##### *MARKer[1|2]:MAXimum*

MARKer[1|2]:MAXimum[:GLOBal]  
MARKer[1|2]:MAXimum:LEFT  
MARKer[1|2]:MAXimum:NEXT  
MARKer[1|2]:MAXimum:RIGHT  
MARKer[1|2]:MAXimum:TRACk {OFF|0|ON|1}

##### *MARKer[1|2]:MINimum*

MARKer[1|2]:MINimum[:GLOBal]  
MARKer[1|2]:OFFSet {OFF|0|ON|1}

##### *MARKer[1|2]:OFFSet:DELTA*

MARKer[1|2]:OFFSet:DELTA:X <number>[unit]  
MARKer[1|2]:OFFSet:DELTA:Y <number>[unit]  
MARKer[1|2]:OFFSet:X <number>[unit]  
MARKer[1|2]:OFFSet:Y <number>[unit]

MARKer[1|2]:POINt <number>

MARKer[1|2][:STATe] {OFF|0|ON|1}

MARKer[1|2]:TARGet <number>[unit]

MARKer[1|2]:TARGet:LEFT  
MARKer[1|2]:TARGet:RIGHT

*MARKer[1|2]:TO*  
    *MARKer[1|2]:TO:SPAN*  
*MARKer[1|2]:X <number>[unit]*  
    *MARKer[1|2]:X:FCOunt?*  
*MARKer[1|2]:Y?*  
    *MARKer[1|2]:Y:IMAGinary?*  
    *MARKer[1|2]:Y:MAGNitude?*  
    *MARKer[1|2]:Y:NOISe?*  
    *MARKer[1|2]:Y:PHASe?*  
    *MARKer[1|2]:Y:READout*  
    *MARKer[1|2]:Y:REAL?*

## **MMEMory**

*MMEMory:COpy <MMEMNAME>,<MMEMNAME>*  
*MMEMory:DELeTe <MMEMNAME>*  
*MMEMory:GET*  
    *MMEMory:GET:PROGram <FILENAME>*  
*MMEMory:INITialize [<MSINAME>][,<number>]*  
*MMEMory:LOAD*  
    *MMEMory:LOAD:LIMit*  
        *MMEMory:LOAD:LIMit:LOWer {A|B},<FILENAME>*  
        *MMEMory:LOAD:LIMit:UPPer {A|B},<FILENAME>*  
    *MMEMory:LOAD:MATH <FILENAME>*  
    *MMEMory:LOAD:PROGram <FILENAME>*  
    *MMEMory:LOAD:STATe <number>,<FILENAME>*  
    *MMEMory:LOAD:TRACe {D1|D2|D3|D4|D5|D6|D7|D8},<FILENAME>*  
*MMEMory:MSI <MSINAME>*  
*MMEMory:PACK [<MSINAME>]*  
*MMEMory:REName <FILENAME>,<FILE>*  
*MMEMory:RESave*  
    *MMEMory:RESave:PROGram <FILENAME>*  
*MMEMory:SAVE*  
    *MMEMory:SAVE:PROGram <FILENAME>*  
*MMEMory:STORE*  
    *MMEMory:STORE:LIMit*  
        *MMEMory:STORE:LIMit:LOWer {A|B},<FILENAME>*  
        *MMEMory:STORE:LIMit:UPPer {A|B},<FILENAME>*  
    *MMEMory:STORE:MATH <FILENAME>*  
    *MMEMory:STORE:PROGram <FILENAME>*  
    *MMEMory:STORE:STATe <number>,<FILENAME>*  
    *MMEMory:STORE:TRACe {A|B},<FILENAME>*

## PLOT

PLOT:ADDRESS <number>  
*PLOT:DUMP*  
PLOT:DUMP:ALL  
PLOT:DUMP:GRATICule  
PLOT:DUMP:MARKer  
*PLOT:DUMP:OFFSet*  
PLOT:DUMP:OFFSet:MARKer  
PLOT:DUMP:TRACe  
PLOT:EJECT {OFF|0|ON|1}  
*PLOT:LTYPe*  
PLOT:LTYPe:TRACe[1|2] <number>  
*PLOT:PEN*  
PLOT:PEN:ALPHa <number>  
PLOT:PEN:GRATICule <number>  
PLOT:PEN:INITialize  
PLOT:PEN:MARKer[1|2] <number>  
PLOT:PEN:TRACe[1|2] <number>  
PLOT:SPEEd <number>

## PRINT

PRINT:ADDRESS <number>  
*PRINT:DUMP*  
PRINT:DUMP:ALL

## PROGrama

*PROGrama[:SElected]*  
PROGrama[:SElected]:DEFine <PROGRAM>  
*PROGrama[:SElected]:DElete*  
PROGrama[:SElected]:DElete[:SElected]  
PROGrama[:SElected]:MALLocate <number>  
PROGrama[:SElected]:NUMBer <NVARNAME>, <BLOCK>  
PROGrama[:SElected]:STATe {STOP|PAUSE|RUN|CONTInue}  
PROGrama[:SElected]:STRing <SVARNAME>, <STRING>

## ROUTE

ROUTE:CLOSe {TSET}  
ROUTE:OPEN {TSET}

## SCReen

SCReen:ACTive {A|B}  
 SCReen:ANNOtation {OFF|0|ON|1}  
 SCReen:CONTeNts {TRACe|STATe|MMEMory|FTABle|TTABle}  
 SCReen:FORMat {SINGle|ULOWer|FBACk}  
 SCReen:GRATicule {OFF|0|ON|1}  
 SCReen[:STATe] {OFF|0|ON|1}

## [SENSe:]

### [SENSe:]AVERage

[SENSe:]AVERage:CLEar  
 [SENSe:]AVERage:COUNt <number>  
 [SENSe:]AVERage[:STATe] {OFF|0|ON|1}  
 [SENSe:]AVERage:TCONtrol {EXPOntial}  
 [SENSe:]AVERage:TYPE {RMS|MAX|VIDeo|PEAK}

### [SENSe:]BANDwidth

[SENSe:]BANDwidth:NOISe?  
 [SENSe:]BANDwidth:NOISe:CORRection?  
 [SENSe:]BANDwidth[:RESolution] <number>[unit]  
 [SENSe:]BANDwidth[:RESolution]:AUTO {OFF|0|ON|1|ONCE}  
 [SENSe:]BANDwidth[:RESolution]:FFT?  
 [SENSe:]BANDwidth[:RESolution]:TRACk {OFF|0|ON|1}  
 [SENSe:]BANDwidth:VIDeo <number>[unit]  
 [SENSe:]BANDwidth:VIDeo:STATe {OFF|0|ON|1}

### [SENSe:]CORRection

[SENSe:]CORRection:COLLect  
 [SENSe:]CORRection:COLLect[:ACQuire]  
 [SENSe:]CORRection:COLLect[:ACQuire]:STANdard <param>  
 [SENSe:]CORRection:COLLect[:ACQuire]:STANdard:AUTO <param>  
 [SENSe:]CORRection:COLLect:METhod <param>  
 [SENSe:]CORRection:COLLect:SAVE  
 [SENSe:]CORRection:DEFault  
 [SENSe:]CORRection:EDELay  
 [SENSe:]CORRection:EDELay:DISTance <number>[unit]  
 [SENSe:]CORRection:EDELay:STATe {OFF|0|ON|1}  
 [SENSe:]CORRection:EDELay[:TIME] <number>[unit]

### [SENSe:]DETEctor

[SENSe:]DETEctor[:FUNCTion] {POSitive|SAMPle}  
 [SENSe:]DETEctor:STIME <number>[unit]

### [SENSe:]FREQuency

[SENSe:]FREQuency:CENTer <number>[unit]  
 [SENSe:]FREQuency:CENTer:TRACk {OFF|0|ON|1}  
 [SENSe:]FREQuency:MANual <number>[unit]  
 [SENSe:]FREQuency:SPAN <number>[unit]  
 [SENSe:]FREQuency:SPAN:FULL  
 [SENSe:]FREQuency:STARt <number>[unit]

```
[SENSe:]FREQuency:STEP <number>[unit]
    [SENSe:]FREQuency:STEP:STATe {AUTO|MANual}
[SENSe:]FREQuency:STOP <number>[unit]
[SENSe:]FUNctIon <STRING>
    [SENSe:]FUNctIon:POWer
        [SENSe:]FUNctIon:POWer:FFT
        [SENSe:]FUNctIon:POWer:NETWork
        [SENSe:]FUNctIon:POWer:SWEPt
    [SENSe:]IMPedance
        [SENSe:]IMPedance:TYPE {MLP|ADAPter}
[SENSe:]POWer
    [SENSe:]POWer:RANGe <number>[unit]
        [SENSe:]POWer:RANGe:AUTO {OFF|0|ON|1|ONCE}
        [SENSe:]POWer:RANGe:LDISortion {OFF|0|ON|1}
[SENSe:]REStArt
[SENSe:]SWEep
    [SENSe:]SWEep:GATE {OFF|0|ON|1}
        [SENSe:]SWEep:GATE:DELay
            [SENSe:]SWEep:GATE:DELay:MODE {AUTO|MANual}
            [SENSe:]SWEep:GATE:DELay:TIME:AUTO?
            [SENSe:]SWEep:GATE:DELay:TIME[:MANual]<param>
        [SENSe:]SWEep:GATE:POLarity {POSitive|NEGative}
        [SENSe:]SWEep:GATE:TIME <number>[unit]
        [SENSe:]SWEep:GATE:TYPE {EDGE|LEVel}
    [SENSe:]SWEep:MODE {AUTO|MANual}
    [SENSe:]SWEep:SPACing {LINear|LOGarithmic}
    [SENSe:]SWEep:TIME <number>[unit]
        [SENSe:]SWEep:TIME:FFT?
[SENSe:]WINDow
    [SENSe:]WINDow[:TYPE] {HANNing|FLATtop}
```

## SOURCE

```
SOURCE:OUTPut
    SOURCE:OUTPut:IMPedance <number>[unit]
        SOURCE:OUTPut:IMPedance:MODE {OFF|0|ON|1}
SOURCE:OUTPut:PROTection
    SOURCE:OUTPut:PROTection:CLEar
    SOURCE:OUTPut[:STATe] {OFF|0|ON|1}
SOURCE:POWer
    SOURCE:POWer[:LEVel]
        SOURCE:POWer[:LEVel][:IMMediate]
            SOURCE:POWer[:LEVel][:IMMediate][:AMPLitude] <param>
            SOURCE:POWer[:LEVel][:IMMediate][:AMPLitude]:STEP <param>
```

## STATus

### *STATus:DEvice*

STATus:DEvice:CONDition?  
STATus:DEvice:ENABle <number>  
STATus:DEvice[:EVENT]?  
STATus:DEvice:NTRansition <number>  
STATus:DEvice:PTRansition <number>

### *STATus:OPERation*

STATus:OPERation:CONDition?  
STATus:OPERation:ENABle <number>  
STATus:OPERation[:EVENT]?  
STATus:OPERation:NTRansition <number>  
STATus:OPERation:PTRansition <number>

### STATus:PRESet

### *STATus:QUEStionable*

STATus:QUEStionable:CONDition?  
STATus:QUEStionable:ENABle <number>  
STATus:QUEStionable[:EVENT]?  
*STATus:QUEStionable:FREQuency*  
STATus:QUEStionable:FREQuency:CONDition?  
STATus:QUEStionable:FREQuency:ENABle <number>  
STATus:QUEStionable:FREQuency[:EVENT]?  
STATus:QUEStionable:FREQuency:NTRansition <number>  
STATus:QUEStionable:FREQuency:PTRansition <number>

### *STATus:QUEStionable:LIMit*

STATus:QUEStionable:LIMit:CONDition?  
STATus:QUEStionable:LIMit:ENABle <number>  
STATus:QUEStionable:LIMit[:EVENT]?  
STATus:QUEStionable:LIMit:NTRansition <number>  
STATus:QUEStionable:LIMit:PTRansition <number>  
STATus:QUEStionable:NTRansition <number>

### *STATus:QUEStionable:POWer*

STATus:QUEStionable:POWer:CONDition?  
STATus:QUEStionable:POWer:ENABle <number>  
STATus:QUEStionable:POWer[:EVENT]?  
STATus:QUEStionable:POWer:NTRansition <number>  
STATus:QUEStionable:POWer:PTRansition <number>  
STATus:QUEStionable:PTRansition <number>

### *STATus:USER*

STATus:USER:ENABle <number>  
STATus:USER[:EVENT]?  
STATus:USER:PULSe <number>

## SYSTem

*SYSTem:BEEPer*

SYSTem:BEEPer:STATe {OFF|0|ON|1}

*SYSTem:COMMunicate*

*SYSTem:COMMunicate:GPIB*

SYSTem:COMMunicate:GPIB:ADDRess <number>

SYSTem:COMMunicate:GPIB:ECHO {OFF|0|ON|1}

SYSTem:DATE <number>,<number>,<number>

SYSTem:ERRor?

SYSTem:PRESet

SYSTem:RPGLock {OFF|0|ON|1}

SYSTem:SET <STATE>

SYSTem:SNUMber?

SYSTem:TIME <number>,<number>,<number>

SYSTem:VERSion

## TEST

*TEST:INPut*

TEST:INPut:CONFig {FPANel|CALibrator}

*TEST:SOURce*

*TEST:SOURce:DAC*

TEST:SOURce:DAC:ATTenuation <number>[unit]

## TRACe[1|2]

TRACe[1|2]:COPY {D1|D2|D3|D4|D5|D6|D7|D8}

TRACe[1|2]:DATA <BLOCK>

TRACe[1|2]:TITLe <STRING>

## TRIGger

TRIGger:DELay<number>[unit]

TRIGger[:IMMediate]

TRIGger:SLOPe {POSitive|NEGative}

TRIGger:SOURce {IMMediate|EXTernal|BUS}

# **Error Messages**

---

## **Introduction**

This appendix contains a listing of all the error messages that can be generated by the HP 3589A in response to TMSL commands. Each message consists of an error number (always negative) followed by a string. The string contains a general description of the error followed by additional information about the cause of the error. In many cases, the additional information is just a listing of the command that caused the error.

In this appendix, error numbers and their general descriptions are shown using a bold font. Phrases that complete the descriptions with additional information are grouped under the associated error number.

Up to 20 error messages are temporarily stored in the analyzer's error queue. They are returned to the controller, one message at a time, when you send the SYST:ERR query.



## Command Errors

- 100,"Command error;
- 101,"Invalid character;
- 102,"Syntax error;
- 103,"Invalid separator;
- 104,"Data type error;
- 105,"GET not allowed;
- 108,"Parameter not allowed;  
Too many parameters.
- 109,"Missing parameter;  
Missing Parameter  
Extra Parameter(s)
- 110,"Command header error;
- 111,"Header separator error;
- 112,"Program mnemonic too long;
- 113,"Undefined header;
- 114,"Header suffix out of range;
- 120,"Numeric data error;
- 121,"Invalid character in number;
- 123,"Exponent too large;
- 124,"Too many digits;
- 128,"Numeric data not allowed;
- 130,"Suffix error;
- 131,"Invalid suffix;  
Invalid Suffix

- 138,"Suffix not allowed;
- 140,"Character data error;
- 141,"Invalid character data;
- 148,"Character data not allowed;
- 150,"String data error;
- 151,"Invalid string data;
- 158,"String data not allowed;
- 160,"Block data error;
- 161,"Invalid block data;
- 168,"Block data not allowed;
- 170,"Expression error;
- 171,"Invalid expression;
- 178,"Expression data not allowed;

## Execution Errors

**-200,"Execution error;**

Recording mode canceled because: %s  
Instrument BASIC not installed.  
SAVE/RECALL PROGRAM Not Allowed while RECORDING ENABLED.  
Marker Value is not valid.  
Received HP-IB control without requesting it.  
HP-IB control not received.  
Instrument State Controller Missing  
Invalid Function Code  
Invalid Instrument State Request  
Invalid Instrument State Value  
Invalid Instrument State  
Plot/Print Already In Progress  
Serial number must be 10 characters.  
Not a valid serial number.  
F%d definition is not valid for execution.

**-201,"Invalid while in local;**

**-210,"Trigger error;**

**-211,"Trigger ignored;**

**-212,"Arm ignored;**

**-220,"Parameter error;**

Invalid Instrument State Parameter

**-221,"Settings conflict;**

Invalid program state change requested.  
Marker is not ON.  
Offset Marker is not ON.  
Invalid during NARROW BAND ZOOM.

**-222,"Data out of range;**

Out of range.

**-223,"Too much data;**

**-224,"Illegal parameter value;**

**-231,"Data questionable;**

**-240,"Hardware error;**

Hardware failure: %s  
INPUT PROTECTION TRIPPED Clear trip in Range menu.  
SOURCE PROTECTION TRIPPED Clear trip in Source menu.  
Local Oscillator Unlocked  
Hardware Failure

**-241,"Hardware missing;**

**-250,"Mass storage error;**

Improper mass storage unit specifier.  
Improper file name  
Disk operation aborted.  
Mass storage units must be same when renaming.  
Improper file type.  
File does not contain a STATE.  
File does not contain a TRACE.  
File does not contain MATH definitions.  
File does not contain LIMIT definitions.  
Source and destination units are same.  
Operation not allowed while file(s) open.  
Illegal format parameter(s).  
Bad disk.

**-251,"Missing mass storage;**

Mass storage unit not present.

**-252,"Missing media;**

Disk not in drive.

**-253,"Corrupt media;**

Not a valid directory.

**-254,"Media full;**

Insufficient disk space.

**-255,"Directory full;**

Full directory.

**-256,"File name not found;**

File name is undefined.

**-257,"File name error;**

Duplicate file name.

Error Messages  
Execution Errors

- 258,"Media protected;**  
Write protected disk.
  
- 260,"Expression error;**
  
- 280,"Program error;**  
%s
  
- 283,"Illegal variable name;**  
Illegal variable name.
  
- 284,"Program currently running;**  
Program currently running.
  
- 285,"Program syntax error;**  
ERROR 949 Syntax error at cursor  
Downloaded program line must have a line number.
  
- 286,"Program runtime error;**

## Device-Specific Errors

-300,"Device-specific error;

-310,"System error;

Calibration Failure

Calibration DMA Timeout

Calibration Overloads

Serial number already set.

-311,"Memory error;

-314,"Save/recall memory lost;

-350,"Too many errors;

---

## Query Errors

-400,"Query error;

-410,"Query INTERRUPTED;

-420,"Query UNTERMINATED;

-430,"Query DEADLOCKED;

-450,"Query not allowed;



# Index

---

## A

aborting a measurement 9-2, 26-44  
absolute limit lines 14-12  
active controller 1-3, 2-2 - 2-3, 2-5  
active trace 25-2  
address  
    controller 2-12  
    general 1-3  
    HP 3589A 1-8, 29-3  
    plotter 21-2  
    printer 22-2  
addressable-only 1-9, 2-2  
alpha 3-6  
amplitude  
    source output 27-6  
    step size 27-7  
analyzer identification 8-6  
aperture, group delay 11-12  
arm  
    automatic 10-3  
    manual 10-2 - 10-3  
    *See also* trigger  
ASCII  
    data transfer format 15-2  
    encoding 4-7  
autoranging 26-42  
autoscaling, vertical 14-23  
averaging  
    count 26-3  
    enabling 26-4  
    max 26-6  
    peak hold 26-6  
    rms 26-6  
    video 26-6  
    weighting 26-3, 26-5

## B

bandwidth  
    coupling 26-10  
    resolution 26-9  
    video 26-13 - 26-14  
BASIC  
    *See* HP Instrument BASIC  
beeper  
    limit test 14-5  
    main 29-2  
binary encoding 4-8

blanking  
    entire screen 25-7  
    frequency annotation 25-3  
block data 4-5, 4-7 - 4-9  
bus management command 1-3, 2-2  
bus trigger 8-14, 32-5

## C

calculate data  
    format 11-7  
    *See also* trace data  
    transferring via HP-IB 11-2  
calibration  
    automatic 12-3  
    calculation 26-18  
    clear correction data 26-19  
    network function selection 26-17  
    single 12-3  
    test 8-2, 12-2  
catalog 25-4  
center frequency 26-25  
character data 4-4  
clearing status 8-3  
    on power-up 8-9  
clock  
    setting date 29-5  
    setting time 29-11  
command  
    abbreviation 3-4  
    message unit 3-9  
    mode 2-2  
    parser 2-8, 3-3  
    tree 3-2  
common command 2-2  
common program header 3-10  
complex marker query 19-26  
compound program header 3-9  
condition register  
    Device State 28-2  
    Limit Fail 28-21  
    Questionable Data 28-13  
    Questionable Frequency 28-16  
    Questionable Power 28-27  
    Standard Operation 28-7  
configuring the HP-IB system 1-7



## Index (Continued)

- constant
  - defining 11-13 - 11-14
  - defining magnitude and phase 11-13
  - defining real and imaginary parts 11-14
  - displaying 14-22
- continuing a program 23-6
- continuous trigger
  - See* free run trigger
- controller 1-3
  - See also* active controller
  - See also* system controller
- Controller Capabilities 2-2
- coordinates
  - linear magnitude 11-7
  - logarithmic magnitude 11-7
- copy
  - disk 20-2
  - file 20-2
- counter
  - enabling 19-2
  - value 19-24
- D**
- D\_XX registers, displaying 14-22
- data encoding 4-7 - 4-9
- data formats 4-2 - 4-6
- data mode 2-2
- data register
  - displaying 14-22
  - loading 31-2
- data registers, displaying 14-22
- data transfer format
  - ASCII 15-2
  - real 15-2
- data type 4-2
  - block data 4-5
  - character data 4-4
  - decimal numeric data 4-2
  - expression data 4-5
  - fixed-point number 4-2
  - floating-point number 4-2
  - NR1 data 4-3
  - NR2 data 4-3
  - NR3 data 4-3
  - NRf data 4-3
  - string data 4-4
- date 29-5
- decimal numeric data 4-2
- default disk 20-12
- definite length block data 4-6
- delay
  - distance units 26-20
  - time units 26-22
- trigger 32-2
- delete
  - disk 20-3
  - file 20-3
  - lower limit lines 14-8
  - program 23-3
  - upper limit lines 14-16
- Device Clear (DCL) 2-3
- device command 1-3, 2-2
- Device State register set 5-11
  - condition register 28-2
  - enable register 28-3
  - event register 28-4
  - negative transition register 28-5
  - positive transition register 28-6
- digit 3-6
- disk
  - copying 20-2
  - default 20-12
  - deleting 20-3
  - displaying catalog 25-4
  - formatting 20-5
  - initializing 20-5
  - packing 20-13
  - specifiers 20-1
- display
  - See* screen
- display data
  - See* calculate data
  - See also* trace data
- display label 14-4
  - See also* trace data, creating a title for
- display scaling
  - See* scaling
- down converter
  - amplitude adjustment 11-3
  - frequency adjustment 11-5 - 11-6
  - mirror frequency axis 11-4
- E**
- echoing mnemonics 29-4
- electrical delay (time) 26-22
- electrical length/delay 26-20
- enable register
  - Device State 28-3
  - Limit Fail 28-22
  - Questionable Data 28-14
  - Questionable Frequency 28-17
  - Questionable Power 28-28
  - Standard Operation 28-8
  - User Defined 28-33
- ^END 3-6
- error messages, reading 29-6

error queue 2-7  
 event register  
   Device State 28-4  
   Limit Fail 28-23  
   Questionable Data 28-15  
   Questionable Frequency 28-18  
   Questionable Power 28-29  
   Standard Operation 28-9  
   User Defined (reading) 28-34  
   User Defined (setting) 28-35  
 expression data 4-5  
 external trigger 32-5

## F

files  
   copying 20-2  
   deleting 20-3  
   *See also* loading  
   packing 20-13  
   renaming 20-14  
   *See also* storing  
 fixed-point number 4-2  
 floating-point number 4-2  
 format  
   data transfer 15-2  
   trace display 25-5  
 formatting disks 20-5  
 free run trigger 32-5  
 frequency  
   annotation blanking 25-3  
   center 26-25  
   counter 19-2  
   counter value 19-24  
   full span 26-30  
   manual 26-27  
   resolution 26-9, 26-56  
   span 26-28  
   start 26-31  
   step size (enabling) 26-33  
   step size (setting) 26-32  
   stop 26-34  
   zero span 26-28  
 full span 26-30  
 function  
   defining 11-16  
   displaying 14-22

## G

gated sweep 26-45  
   delay time 26-48  
   delay, auto/manual 26-46  
   gate length 26-50

  signal polarity 26-49  
   trigger mode 26-51  
 generating a Service Request 5-5  
 getting  
   *See also* loading  
   programs 20-4  
 Go To Local (GTL) 2-3  
 go, no-go testing  
   *See* limit test  
 graticule  
   assigning plotter pen 21-11  
   displaying 25-6  
   enabling and disabling 14-2  
   plotting 21-4  
   selecting polar or Smith chart 14-3  
 group delay  
   displaying 11-7  
   selecting aperture 11-12  
 Group Execute Trigger (GET) 2-3

## H

high-accuracy zoom 26-56  
 high-resolution zoom 26-56  
 HP Instrument BASIC  
   allocating stack space 23-4  
   clearing screen output 14-21  
   continuing a program 23-6  
   deleting program 23-3  
   loading programs from disk 20-4, 20-9  
   partitioning screen for 14-20  
   pausing a program 23-6  
   reading and writing numeric variables 23-5  
   reading and writing string variables 23-7  
   resaving programs 20-15  
   running a program 23-6  
   saving programs 20-16  
   stopping a program 23-6  
   storing programs 20-20  
   transferring programs via HP-IB 23-2  
 HP-IB interface capabilities 2-1  
 HP-IB overview 1-3 - 1-4  
 HP-IB setup 1-7 - 1-12  
 HP-IB trigger  
   *See* bus trigger

## I

identifying the analyzer 8-6  
 IEEE 488.1 standard 1-5  
 IEEE 488.2 standard 1-5  
 imaginary part  
   displaying 11-7  
 imaginary part of a constant 11-14

- impedance
    - coupling source and input 27-3
    - input 17-2
    - reference 17-3
    - selection 26-39
    - source 27-2
  - implied mnemonics 3-5
  - incident power, auto/man 26-16
  - indefinite length block data 4-6
  - input
    - autoranging 26-42
    - impedance 17-2
    - reference impedance 17-3
    - resetting the protection relay 17-4
    - setting range manually 26-40
  - input queue 2-7
  - instrument state
    - displaying 25-4
    - loading from disk 20-10
    - storing to disk 20-21
    - transferring via HP-IB 29-9
  - instrument type, selecting 18-2
  - integer 4-2
  - interface capabilities 2-1
  - Interface Clear (IFC) 2-3
- L**
- LF 3-6
  - Limit Fail register set 5-12
    - condition register 28-21
    - enable register 28-22
    - event register 28-23
    - negative transition register 28-24
    - positive transition register 28-25
  - limit lines
    - absolute 14-12
    - defining lower segments 14-11
    - defining upper segments 14-19
    - deleting lower lines 14-8
    - deleting upper lines 14-16
    - displaying 14-6
    - See also* limit test
    - loading lower lines from disk 20-6
    - loading upper lines from disk 20-7
    - moving lower lines 14-9
    - moving upper lines 14-17
    - relative 14-12
    - storing lower lines to disk 20-17
    - storing upper lines to disk 20-18
    - transferring lower lines via HP-IB 14-7
    - transferring upper lines via HP-IB 14-15
  - limit test
    - beeper 14-5
    - displaying limits 14-6
    - enabling 14-14
    - See also* limit lines
    - reporting failed points 14-10, 14-18
    - result 14-13
  - line types
    - defining 21-9
    - See also* plotter
  - linear magnitude 11-7
  - listener 1-3
  - loading
    - instrument state (from disk) 20-10
    - instrument state (via HP-IB) 29-9
    - lower limit lines (from disk) 20-6
    - lower limit lines (via HP-IB) 14-7
    - math definitions (from disk) 20-8
    - math definitions (via HP-IB) 11-15
    - programs (from disk) 20-4, 20-9
    - programs (via HP-IB) 23-2
    - traces files 20-11
    - upper limit lines (from disk) 20-7
    - upper limit lines (via HP-IB) 14-15
  - Local Lockout (LLO) 2-4
  - logarithmic
    - magnitude 11-7
    - sweep 26-53
  - long form 3-4
  - low distortion mode 26-43
- M**
- magnitude of a constant 11-13
  - manual overview 1-2
  - manual sweep
    - enabling 26-52
    - sample time 26-24
    - selecting frequency 26-27
  - marker
    - assigning plotter pen 21-13
    - disabling all 19-18
    - enabling main marker 19-18
    - frequency counter enabling 19-2
    - frequency counter value 19-24
    - main marker x-axis position 19-23
    - main marker y-axis position 19-25
    - noise level enabling 19-3
    - noise level value 19-27
    - See also* offset marker
    - peak search left 19-5
    - peak search next 19-6
    - peak search right 19-7
    - peak tracking 19-8
    - plotting main marker 21-5
    - plotting offset marker 21-6

position by display point 19-17  
 readout 19-28  
 target 19-19  
 to highest peak 19-4  
 to lowest point 19-9  
 units 19-26  
 units, setting 19-28  
 mass memory  
   *See* disk  
 mass storage  
   *See* disk  
 math  
   defining constants 11-13 - 11-14  
   defining functions 11-16  
   displaying constants 14-22  
   displaying functions 14-22  
   loading definitions from disk 20-8  
   storing definitions to disk 20-19  
   transferring definitions via HP-IB 11-15  
 max averaging 26-6  
 measurement data  
   *See* trace data  
 measurement mode  
   *See* measurement type  
 measurement time query 26-55  
 measurement type  
   narrow band zoom 26-35 - 26-36  
   network 26-37  
   swept spectrum 26-35, 26-38  
 Message Exchange 2-6 - 2-8  
 Message Syntax 3-6 - 3-12  
 mnemonic  
   echoing 29-4  
   implied 3-5  
**N**  
 narrow band zoom measurement  
   selecting 26-35 - 26-36  
   setting frequency resolution 26-56  
 negative transition register  
   Device State 28-5  
   Limit Fail 28-24  
   Questionable Data 28-26  
   Questionable Frequency 28-19  
   Questionable Power 28-30  
   Standard Operation 28-10  
 network measurements, displaying 14-22  
 network registers  
   displaying 14-22  
 No Pending Operation flag 2-9, 8-7  
 noise level marker  
   enabling 19-3  
   value 19-27

non-zero digit 4-2  
 normalization  
   displaying normalized spectrum 14-22  
 NPO flag 2-9  
 NR1 data 4-3  
 NR2 data 4-3  
 NR3 data 4-3  
 NRf data 4-3

**O**

offset marker  
   absolute position 19-14 - 19-15  
   enabling 19-10  
   *See also* marker  
   position relative to main marker 19-11 - 19-12  
   to span 19-22  
 offset marker, complex  
   absolute position 19-16  
 offset marker, polar  
   position relative to main marker 19-13  
 \*OPC 2-11  
 \*OPC? 2-11  
 output queue 2-7  
 overlapped command 2-9, 8-7, 8-16  
 oversweep  
   enabling 12-4

**P**

packing files 20-13  
 page eject  
   enabling 21-8  
   *See also* plotter  
 Parallel Poll 2-4  
 passing control 2-12, 8-8  
 pausing a program 23-6  
 peak detector 26-23  
 peak hold  
   averaging 26-6  
   clear 26-2  
 peak search  
   continuous 19-8  
   next 19-6  
   single 19-4  
   to left 19-5  
   to right 19-7  
 peak tracking 19-8  
   *See also* signal tracking  
 pen assignments  
   *See* plotter  
 phase  
   displaying wrapped 11-11  
   displaying wrapped or unwrapped 11-7

## Index (Continued)

- phase of a constant 11-13
  - phase slope
    - adjusting 11-9
    - enabling 11-10
  - phase wrap
    - enabling 11-11
    - reference 11-8
  - plotter
    - address 21-2
    - assigning alpha pen 21-10
    - assigning graticule pen 21-11
    - assigning marker pens 21-13
    - assigning trace pens 21-14
    - defining line types 21-9
    - initializing pen assignments 21-12
    - page eject enabling 21-8
    - speed setting 21-15
  - plotting
    - entire screen 21-3
    - graticule 21-4
    - main marker 21-5
    - offset marker 21-6
    - trace only 21-7
  - polar display
    - enabling 11-7
    - selecting graticule type 14-3
  - polar offset marker 19-13, 19-16
  - polarity of gated sweep 26-49
  - positive transition register
    - Device State 28-6
    - Limit Fail 28-25
    - Questionable Data 28-32
    - Questionable Frequency 28-20
    - Questionable Power 28-31
    - Standard Operation 28-11
  - preset
    - device 8-10, 29-7
    - status 28-12
  - preset states
    - See the individual commands*
  - printer address 22-2
  - printing screen contents 22-3
  - program
    - data 3-10
    - header 3-9
    - See HP Instrument BASIC*
    - message 2-6, 3-6, 3-8
    - message syntax 3-8
    - message terminator 3-8
    - message unit 3-8
    - mnemonic 3-10
  - protection relay
    - input 17-4
    - source 27-4
- ## Q
- query message unit 3-9
  - Query Response Generation 2-8
  - Questionable Data register set 5-13
    - condition register 28-13
    - enable register 28-14
    - event register 28-15
    - negative transition register 28-26
    - positive transition register 28-32
  - Questionable Frequency register set 5-14
    - condition register 28-16
    - enable register 28-17
    - event register 28-18
    - negative transition register 28-19
    - positive transition register 28-20
  - Questionable Power register set 5-15
    - condition register 28-27
    - enable register 28-28
    - event register 28-29
    - negative transition register 28-30
    - positive transition register 28-31
  - queues 2-7
  - Quick Verification 1-10
- ## R
- range
    - autoranging 26-42
    - manual selection 26-40
  - real data transfer format 15-2
  - real part
    - displaying 11-7
    - of a constant 11-14
  - recalling
    - See loading*
  - reference data, collecting 26-15
  - reference impedance 17-3
  - reference level
    - See also scaling*
    - setting 14-24, 14-27
    - tracking input range 14-25
  - reference limit, setting value 14-24
  - reference line
    - enabling 14-29
    - setting position 14-30
  - reference tracking 14-25

- register set
    - Device State 5-11
    - Limit Fail 5-12
    - Questionable Data 5-13
    - Questionable Frequency 5-14
    - Questionable Power 5-15
    - Standard Event 5-16
    - Standard Operation 5-18
    - Status Byte 5-9
    - User Defined 5-20
  - register summary 5-8
  - relative limit lines 14-12
  - Remote Enable (REN) 2-4
  - renaming files 20-14
  - resaving programs 20-15
    - See also* storing
  - reset device 8-10, 29-7
  - resolution
    - for narrow band zoom measurements 26-56
    - for swept spectrum measurements 26-9
  - resolution bandwidth 26-9
    - tracking during log sweep 26-12
  - response data 3-12
  - response message 2-6, 3-6, 3-11
  - Response Message Syntax 3-11
  - response message terminator 3-11
  - Response to Bus Management Commands 2-3 - 2-5
  - restarting a measurement 9-2, 26-44
  - rms averaging 26-6
  - running a program 23-6
- S**
- sample time 26-24
  - saving programs 20-16
    - See also* storing
  - scaling
    - increment per vertical division 14-26
    - reference level 14-24, 14-27
    - vertical autoscaling 14-23
  - SCPI background 1-5
  - screen
    - blanking entire screen 25-7
    - blanking frequency annotation 25-3
    - clearing HP Instrument BASIC area 14-21
    - displaying graticules 25-6
    - partitioning for HP Instrument BASIC 14-20
    - plotting 21-3
    - printing 22-3
    - selecting contents 14-22, 25-4
    - selecting the active trace 25-2
    - trace display format 25-5
  - select instrument type 18-2
  - Selected Device Clear (SDC) 2-4
  - selecting the test set 24-2
  - self-test 8-15
  - Sending Commands Over the HP-IB 1-3
  - sending multiple commands 3-3
  - sensitivity
    - See* range
  - sequential command 2-9
  - serial number 29-10
  - Serial Poll 2-5, 5-6
  - service request 5-4 - 5-5
    - enabling 8-11
    - on power-up 8-9
  - Service Request enable register 5-5
  - short form 3-4
  - signal tracking 26-26
    - See also* peak tracking
  - simple program header 3-9
  - Smith chart display 14-3
  - source
    - amplitude step 27-7
    - coupling impedance to input 27-3
    - enabling 27-5
    - impedance 27-2
    - resetting the protection relay 27-4
    - setting amplitude 27-6
  - SP 3-6
  - span
    - frequency 26-28
    - full 26-30
    - zero 26-28
  - Special Syntactic Elements 3-7
  - spectrum, displaying 14-22
  - SRQ
    - See* service request
  - stack space
    - allocating for programs 23-4
    - See also* HP Instrument BASIC
  - Standard Event register set 5-16
    - command descriptions 8-4 - 8-5
  - Standard Operation register set 5-18
    - condition register 28-7
    - enable register 28-8
    - event register 28-9
    - negative transition register 28-10
    - positive transition register 28-11
  - start frequency 26-31
  - starting a measurement
    - See* restarting a measurement
  - state
    - See* instrument state
  - Status Byte register 5-5
    - reading 8-13
  - Status Byte register set 5-9

- status clearing 8-3
    - on power-up 8-9
  - status group
    - See* register set
  - status preset 28-12
  - step size
    - frequency (enabling) 26-33
    - frequency (setting) 26-32
    - source amplitude 27-7
  - stop frequency 26-34
  - stopping a program 23-6
  - storing
    - instrument state (to disk) 20-21
    - instrument state (via HP-IB) 29-9
    - lower limit lines (to disk) 20-17
    - lower limit lines (via HP-IB) 14-7
    - math definitions (to disk) 20-19
    - math definitions (via HP-IB) 11-15
    - programs (to disk) 20-15 - 20-16, 20-20
    - programs (via HP-IB) 23-2
    - trace files 20-22
    - upper limit lines (to disk) 20-18
    - upper limit lines (via HP-IB) 14-15
  - string data 4-4
  - subsystem 3-2
  - subsystem command 2-2
  - sweep
    - gate polarity 26-49
    - gated 26-45
    - manual 26-52
    - oversweep 12-4
    - spacing (lin/log) 26-53
    - See also* swept spectrum measurement
    - time 26-54
  - swept spectrum measurement
    - selecting 26-35, 26-38
    - setting frequency resolution 26-9
    - sweep time 26-54
  - synchronization 2-9 - 2-11
  - syntax conventions
    - program and response messages 3-6
  - system controller 1-3, 1-9, 2-2
- T**
- Take Control Talker (TCT) 2-5
  - talker 1-3
  - terminator
    - program message 3-8
    - response message 3-11
  - test
    - See* limit test
    - See* self-test
  - test set in/out 24-2
  - time 29-11
  - trace data
    - assigning plotter pens 21-14
    - See also* calculate data
    - copying to data register 31-2
    - creating a title for 14-4, 31-4
    - display format 25-5
    - displaying 14-22, 25-4
    - loading from disk 20-11
    - plotting 21-7
    - storing to disk 20-22
    - transferring via HP-IB 31-3
  - trace type
    - See* coordinates
  - tracking
    - peak 19-8
    - resolution bandwidth 26-12
    - signal 26-26
  - tracking generator
    - See* source
  - trigger
    - See also* arm
    - automatic 32-5
    - bus 8-14, 32-5
    - delay 32-2
    - exiting the idle state 16-3
    - external 32-5
    - free run 32-5
    - initiating 16-2
    - manual 32-3
    - slope 32-4
- U**
- units
    - complex marker 19-26
    - marker query 19-28
  - User Defined register set 5-20
    - enable register 28-33
    - event register, reading 28-34
    - event register, setting 28-35
- V**
- variable
    - See also* HP Instrument BASIC
    - reading and writing 23-5, 23-7
  - Verification Program 1-12
  - version, analyzer operating system 29-12
  - vertical scaling
    - See* scaling
  - video averaging 26-6

video bandwidth filter  
  enabling 26-14  
  selecting 26-13

**W**

\*WAI 2-10  
window 26-56  
WSP 3-6

**Z**

zero span 26-28  
zoom type 26-56





*About this edition*

March 1995: Appendix B, *Error Messages*, which was left out of the previous edition, was added to this edition.

July 1991: Previous edition.

