

Errata

Title & Document Type: 8756A Operation Manual

Manual Part Number: 08756-90013

Revision Date: August 1983

HP References in this Manual

This manual may contain references to HP or Hewlett-Packard. Please note that Hewlett-Packard's former test and measurement, semiconductor products and chemical analysis businesses are now part of Agilent Technologies. We have made no changes to this manual copy. The HP XXXX referred to in this document is now the Agilent XXXX. For example, model number HP8648A is now model number Agilent 8648A.

About this Manual

We've added this manual to the Agilent website in an effort to help you support your product. This manual provides the best information we could find. It may be incomplete or contain dated information, and the scan quality may not be ideal. If we find a better copy in the future, we will add it to the Agilent website.

Support for Your Product

Agilent no longer sells or supports this product. You will find any other available product information on the Agilent Test & Measurement website:

www.tm.agilent.com

Search for the model number of this product, and the resulting product page will guide you to any available information. Our service centers may be able to perform calibration if no repair parts are needed, but no other support from Agilent is available.

8756A SCALAR NETWORK ANALYZER

SERIAL NUMBERS

This manual applies directly to HP Model 8756A Scalar Network Analyzer having serial number prefix 2317A.

For additional information about serial numbers, refer to INSTRUMENTS COVERED BY MANUAL in Section I.

© Copyright HEWLETT-PACKARD COMPANY 1983
1400 FOUNTAIN GROVE PARKWAY, SANTA ROSA, CA 95404 U.S.A.



INTRODUCTION

This Operation Manual is supplied with the 8756A Operating and Service Manual as a reference document for the Instrument Operator. It contains a description of the instrument, specifications, and preparation for use, as well as information on using the 8756A in both manual and automatic test applications, and should be kept with the 8756A.

The convenience and accuracy of the 8756A Scalar Network Analyzer make it well suited for a variety of bench top and automatic (HP-IB) test equipment applications, which may be tailored to your individual needs.

In OPERATING INFORMATION you will find the information needed to operate the 8756A in either the local or remote mode. A thorough understanding of this section will help to eliminate a multitude of operator errors, and should be the first stop for the operator who is not already highly skilled in the operation of the 8756A.

Following the OPERATING INFORMATION, you will find Operating Note(s) and Programming Notes. An Operating Note illustrates a specific application (Basic Network Measurements Using 8756A Scalar Network Analyzer and 8350B Sweep Oscillator) of locally operating the 8756A. A Programming Note, on the other hand, applies to remote operation (using an external controller).

Under Programming Notes, the Introductory Operating Guide focuses on teaching you how to remotely program your instrument with a specific controller. It is meant to be an introduction to the 8756A's remote capabilities, HP-IB, and use of the controller illustrated. The Quick Reference Guide is controller independent. It is a condensed description of the 8756A's HP-IB operating characteristics. Once you are familiar with programming the 8756A, the Quick Reference Guide will provide a summary of all of the HP-IB operating information without explanations.

CONTENTS

INTRODUCTION

GENERAL INFORMATION	1-1
Introduction	1-1
Specifications	1-1
Safety Considerations	1-2
Instruments Covered by Manual	1-2
Description	1-2
Options	1-3
Accessories Supplied	1-4
Equipment Required but not supplied	1-4
Equipment Available	1-4
Hewlett-Packard Interface Bus (HP-IB)	1-6
8756 System Interface	1-6
INSTALLATION	2-1
Introduction	2-1
Initial Inspection	2-1
Preparation for Use	2-1
Storage and Shipment	2-8
OPERATION	3-i
OPERATING INFORMATION	3-1
Introduction	3-1
Operating Characteristics	3-1
Operating Instructions	3-2
Operator's Checks	3-2
Error Messages	3-2
Front Panel Operating Features	3-3
Soft Key Operating Features	3-14
Rear Panel Operating Features	3-24
HP-IB Operating Features	3-26
CRT Graphics	3-44
HP 8756A Modified ASCII Character Set	3-45
HP 8756A Status Byte Descriptions	3-46
Front Panel Key Codes	3-46
Operator's Check	3-46
Soft Key Menu Map	3-53

OPERATING NOTES

PROGRAMMING NOTES

SECTION II INSTALLATION

2-1. INTRODUCTION

2-2. This section provides installation instructions for the Model 8756A Scalar Network Analyzer and its accessories. This section also includes information about initial inspection, damage claims, preparation for using the instrument, packaging, storage, and shipment.

2-3. INITIAL INSPECTION

2-4. Inspect the shipping container for damage. If the shipping container or cushioning material is damaged it should be kept until the contents of the shipment have been checked for completeness and the instrument has been checked mechanically and electrically. The contents of the shipment should be as shown in Figure 1-1. Procedures for checking electrical performance are given in Section IV. If the instrument does not pass the electrical performance tests, refer to the adjustments in Section V of this manual. If a circuit malfunction is suspected, refer to troubleshooting information in Section VIII. If the instrument does not pass the above electrical tests, or if the shipment contents are incomplete, or if there is mechanical damage or defect, notify the nearest Hewlett-Packard office. If the shipping container is damaged, or the cushioning material shows signs of stress, notify the carrier as well as the Hewlett-Packard office. Keep the shipping materials for carrier's inspection. The HP office will arrange for repair or replacement without waiting for claim settlement.

2-5. PREPARATION FOR USE

2-6 Power Requirements

2-7 The Model 8756A Scalar Network Analyzer requires a power source of 100, 120, 220, or 240 Vac, +5% to -10%, 50 to 60 Hz, single-phase. Power consumption is approximately 100 volt-amps.

2-8. Line Voltage and Fuse Selection

2-9. Figure 2-1 illustrates the line voltage selection card and fuse location in the Power Line Module on the rear panel of the 8756A. Select the line voltage and fuse as follows:

- a. Measure the ac line voltage.
- b. Refer to Figure 2-1. At the instrument rear panel power line module, select the line voltage (100, 120, 220, or 240 volts) closest to the voltage you measured in step a. Note the available line voltage must be within +5% or -10% of the line voltage selection as shown in Table 2-1. If it is not, you must use an autotransformer between the power source and the 8756A.

Table 2-1. Line Voltage/Fuse Selection

Measured ac Line Voltage	PC Selector Board Position	Fuse/HP Part Number
90 to 105 volts	100	2.0A 2110-0002
108 to 126 volts	120	2.0A 2110-0002
198 to 231 volts	220	1.5A 2110-0043
216 to 252 volts	240	1.5A 2110-0043

- c. Make sure the correct fuse is installed in the fuse holder. The required fuse rating for each line voltage is indicated in Table 2-1 and below the power line module on the rear panel of the 8756A.

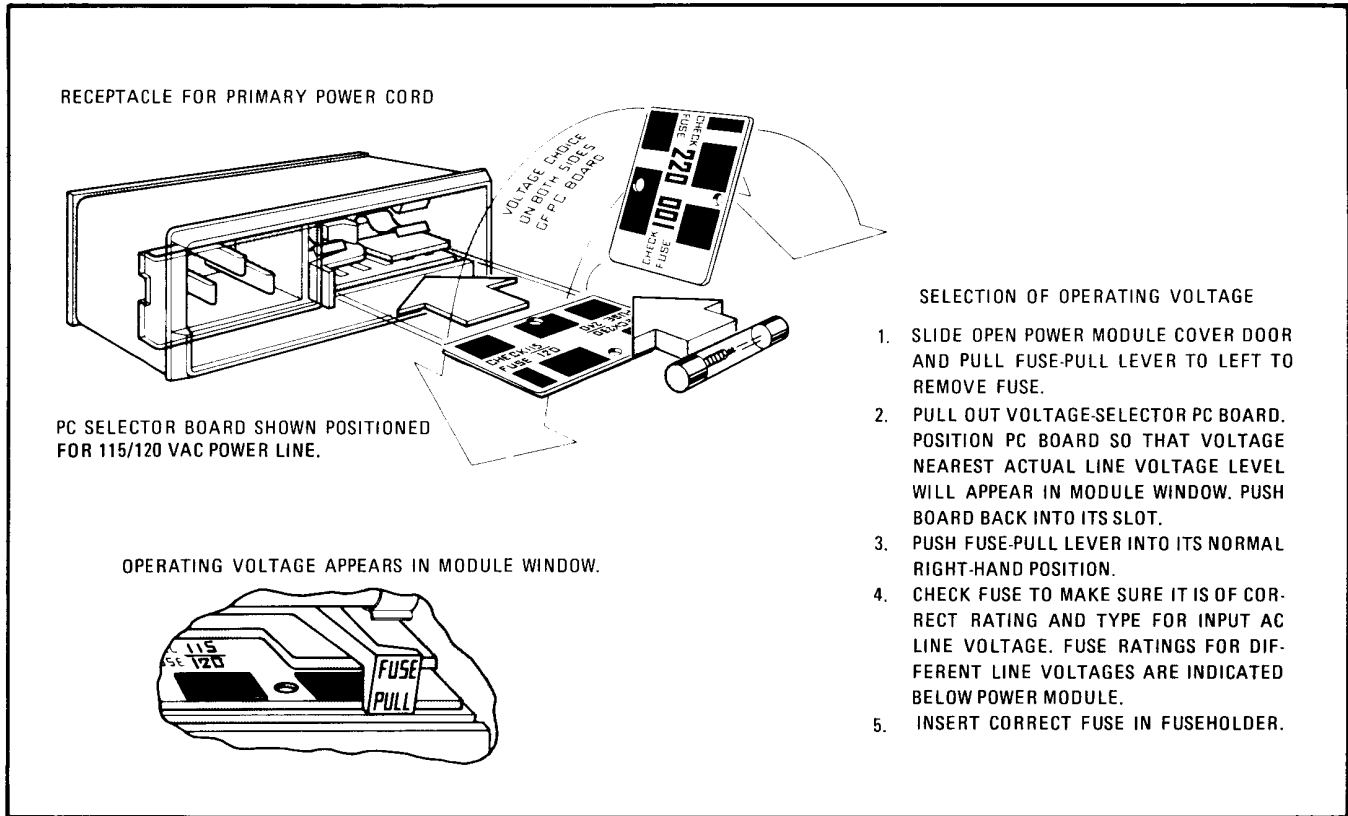

Figure 2-1. Power Line Module

CAUTION

To prevent damage to the instrument, make the correct line voltage and fuse selection before connecting line power to the instrument.

NOTE

The 8756A contains internal factory installed fuses which are not operator serviceable or replaceable.

2-10. POWER CABLE

2-11. In accordance with international safety standards, this instrument is equipped with a three-wire power cable. When connected to an appropriate power line outlet, this cable grounds the instrument cabinet. Table 2-2 shows the styles of plugs available on power cables supplied with HP instruments. The HP Part Numbers for the plugs are part numbers for the

complete power cables. The type of power cable/plug shipped with the instrument depends upon the country of destination.

WARNING

Before switching on this instrument, be sure that only the specified power cable is used. The instrument is provided with a three-wire power cord which grounds the instrument cabinet. This power cord should only be inserted in a socket outlet provided with a protective earth contact. This protective action should not be negated by the use of an extension cord (power cable) without a protective conductor (ground). Grounding one conductor of a two-conductor outlet is not sufficient protection.

Table 2-2. AC Power Cables Available

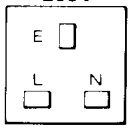
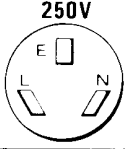
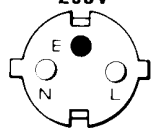
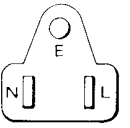
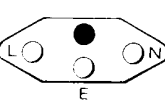
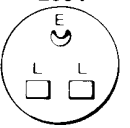
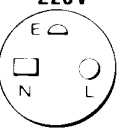
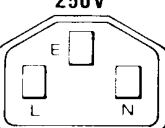
Plug Type ¹	Cable HP Part Number ²	CD ³	Plug Description ²	Cable Length (inches)	Cable Color	For Use in Country
	8120-1351 8120-1703	0 6	Straight BS1363A 90°	90 90	Mint Gray Mint Gray	United Kingdom, Cyprus, Nigeria, Zimbabwe, Singapore
	8120-1369 8120-0696	0 4	Straight NZSS198/ASC112 90°	79 87	Gray Gray	Australia, New Zealand
	8120-1689 8120-1692	7 2	Straight CEE7-VII 90°	79 79	Mint Gray Mint Gray	East and West Europe, Saudi Arabia, Egypt, Republic of So. Africa, India (unpolarized in many nations)
	8120-1348 8120-1398 8120-1754 8120-1378 8120-1521 8120-1676	5 5 7 1 6 2	Straight NEMA5-15P 90° Straight NEMA5-15P 90° Straight NEMA5-15P 90° Straight NEMA5-15P	80 80 36 80 80 36	Black Black Black Jade Gray Jade Gray Jade Gray	United States, Canada, Japan (100V or 200V), Mexico, Philippines, Taiwan
	8120-2104	3	Straight SEV1011.1959 24507, Type 12	79	Gray	Switzerland
	8120-0698	6	Straight NEMA6-15P			United States, Canada
	8120-1957 8120-2956	2 3	Straight DHCK 107 90°	79 79	Gray Gray	Denmark
	8120-1860	6	Straight CEE22-VI (System Cabinet Use)			

1. E = Earth Ground; L = Line; N = Neutral
 2. Part number shown for plug is industry identifier for plug only. Number shown for cable is HP Part Number for complete cable including plug.
 3. The Check Digit (CD) is a coded digit that represents the specific combination of numbers used in the HP Part Number. It should be supplied with the HP Part Number when ordering any of the power assemblies listed above, to expedite speedy delivery.

2-12. The offset pin of the three-prong connector is the grounding pin. When operating the 8756A from a two-contact outlet, the protective grounding feature may be preserved by using a three-prong to two-prong adapter (USA connectors only, HP Part Number 1251-0048) and connecting the green wire of the adapter to ground.

2-13. HP-IB Address Selection

2-14. When the 8756A is used under remote control with the HP-IB, the controller on the bus refers to the 8756A by an HP-IB "address". The 8756A is preset in firmware to address 16, and is differentiated from any other instrument on the bus by this address. The HP-IB address may be modified by a front panel SHIFT function.

2-15. Twenty-nine different address codes are available (1 to 29). The 8756A is shipped from the factory preset to address 16. In all standard 8756A instruments, the HP-IB address will be read by the processor from firmware upon initial power on only. This HP-IB address will remain in effect until the address is changed by resetting through the front panel [SHIFT] [LOCAL] function. The HP-IB address may be read directly from the front panel by pressing [SHIFT] [LOCAL]. The current HP-IB address is then displayed on the CRT. If the HP-IB address must be changed from that which is displayed, enter the new address and press [ENT] to terminate the entry. The display should now show the new HP-IB address. This address is not affected by turning the LINE switch off, or by a PRESET command.

2-16. HP-IB address labels are available by ordering HP Part Number 7120-6853 (each). (See Figure 2-2). These labels allow easy reference to the HP-IB address of each system component.

2-17. Mating Connectors

2-18. All of the externally mounted connectors of the 8756A are listed in Table 2-3. Opposite each 8756A connector is an industry identification, the part number of a mating connector, and the part number of an alternate source for the mating connector. For HP part numbers of the externally mounted connectors themselves, refer to Section VI, Replacable Parts.

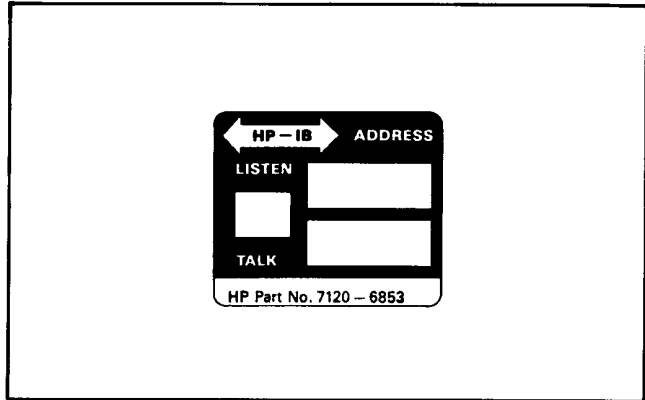

Figure 2-2. HP-IB Address Label

2-19. HP Interface Bus and 8756 System Interface Connectors and Cables

2-20. The HP Interface Bus Interface Connector is located on the rear panel of the 8756A. A10J2 allows the 8756A to be connected to a controller via HP-IB, with or without additional instruments. An illustration of pin configuration and signals on the HP Interface Bus connector is given in Figure 2-3.

2-21. The 8756 System Interface Connector is located on the rear panel of the 8756A. A10J1 allows the 8756A to be connected to the 8350B or 8340A swept microwave sources, and/or the 7470A or 9872C digital plotters. The 8756A itself controls the 8756 System Interface, and there must be no other controllers attached to this connector (see Figure 2-3).

2-22. All instruments on the HP Interface Bus or the 8756 System Interface Bus are interconnected by HP-IB Interface Cables. A list of the available HP-IB Cables and their part numbers is given in Figure 2-4. As many as 15 instruments may be connected in parallel on the HP Interface Bus or the 8756 System Interface. To achieve design performance on the bus, proper voltage levels and timing relationships must be maintained. If the system cable is too long or if the accumulated cable length between instruments is too long, the data and control lines cannot be driven properly and the system may fail to perform. Therefore, the following restrictions must be observed:

- a. With two instruments in a system, the cable length must not exceed 4 metres (12 feet).

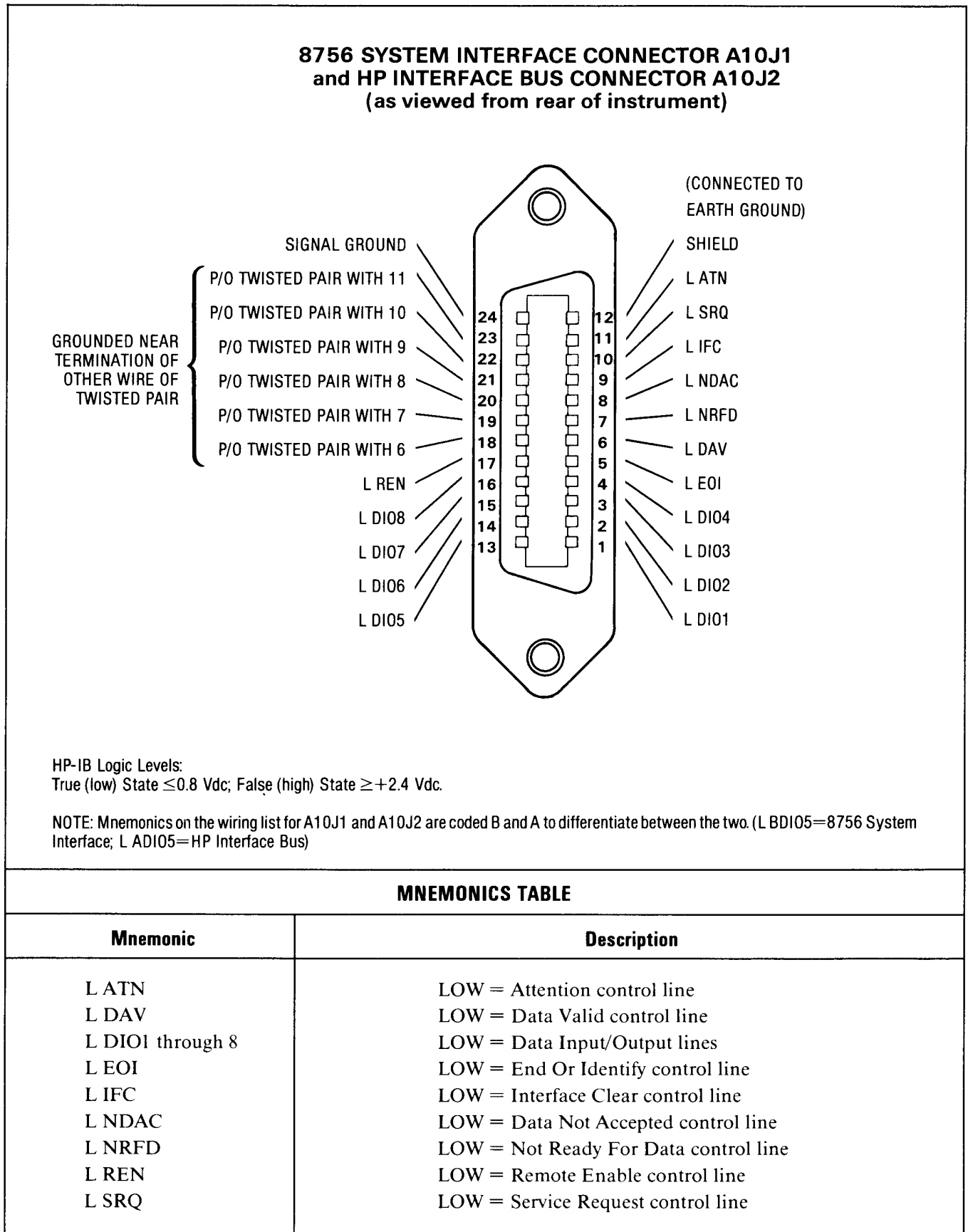

Figure 2-3. 8756A System Interface Connector and HP-IB Connector Signal/Pin Configuration

Table 2-3. Model 8756A Mating Connectors

8756A Connector		Mating Connector	
Connector Name	Industry Identification	HP Part Number	Alternate Source
J1 A (Front Panel)	Audio 5-Pin Connector	1251-1865	Switchcraft 12 CL5M
J2 B (Front Panel)	Audio 5-Pin Connector	1251-1865	Switchcraft 12 CL5M
J3 R (Front Panel)	Audio 5-Pin Connector	1251-1865	Switchcraft 12 CL5M
*A10J1 8756 System Interface (Rear Panel)	24-Pin Micro Ribbon	1251-0293	Amphenol 57-30240
*A10J2 HP Interface Bus (Rear Panel)	24-Pin Micro Ribbon	1251-0293	Amphenol 57-30240
A10J3 Pos Z Blank (Rear Panel)	BNC	1250-0256	Specialty Connector 25-P118-1
A10J4 Sweep In (Rear Panel)	BNC	1250-0256	Specialty Connector 25-P118-1
A10J5 Stop Sweep (Rear Panel)	BNC	1250-0256	Specialty Connector 25-P118-1
J4 Modulator Drive 1 (Rear Panel)	BNC	1250-0256	Specialty Connector 25-P118-1
J5 Modulator Drive 2 (Rear Panel)	BNC	1250-0256	Specialty Connector 25-P118-1
J6 Modulator Drive 3 (Rear Panel)	BNC	1250-0256	Specialty Connector 25-P118-1
J7 Display Output X (Rear Panel)	BNC	1250-0256	Specialty Connector 25-P118-1
J8 Display Output Y (Rear Panel)	BNC	1250-0256	Specialty Connector 25-P118-1
J9 Display Output Z (Rear Panel)	BNC	1250-0256	Specialty Connector 25-P118-1

*Refer to Figure 2-4 for HP-IB Interface Cable information. HP-IB Interface connector A10J2 signals and pin configuration are given in Figure 2-3. 8756 System Interface Connector A10J1 signals and pin configuration are given in Figure 2-3.

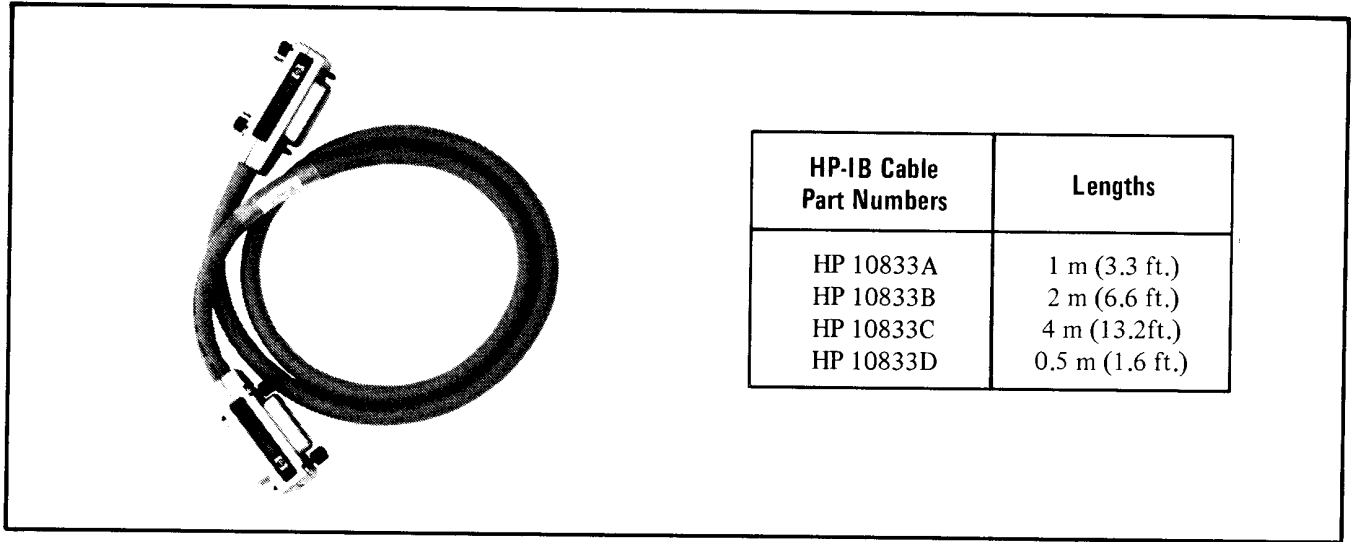

Figure 2-4. HP-IB Interface Cables Available

- b. When more than two instruments are connected on the bus, the cable length to each instrument must not exceed 2 metres (6 feet).
- c. The total cable length between all units must not exceed 20 metres (65 feet).

2-24. Operating Environment

2-25. Temperature. The instrument may be operated in temperatures from 0°C to +55°C.

2-26. Humidity. The instrument may be operated in environments with humidity from 5% to 80% relative at +25°C to +40°C. However, the 8756A should be protected from temperature extremes which cause condensation within the instrument.

2-27. Altitude. The instrument may be operated at altitudes up to 4572 metres (approximately 15,000 feet).

2-28. Cooling. Clearances for ventilation should be at least 10 cm (4 inches) at the rear of the cabinet and 7.6 cm (3 inches) at the sides. The clearances provided by the plastic feet in bench stacking and the filler strips in rack mounting are adequate for the top and bottom cabinet surfaces. The fan mounted on the rear of the 8756A pulls air into the instrument and out through the sides. Insure that the air intake and exhaust venting holes are not obstructed within the limits given above.

2-29. Front Handles (Option 907)

CAUTION

When installing front handles and rack mount kits, insure that the correct screws, specified in the installation figures in this section of the manual, are used. Use of a screw which is longer than the specified length may result in damage to internal components located behind the screw mounting holes in the instrument.

2-30. Instruments with Option 907 contain a Front Handle Kit. This kit supplies the necessary hardware and installation instructions for mounting two front handles on the instrument. Installation instructions are also given in Figure 2-5. Additional Option 907 Kits may be ordered as HP Part Number 5061-0090.

2-31. Rack Mounting (Option 908)

2-32. Instruments with Option 908 contain a Rack Mount Kit. This kit supplies the necessary hardware and installation instructions for preparing the instrument to mount on an equipment rack with 482.6 mm (19 in.) support spacing. Installation instructions are also given in Figure 2-6. Additional Option 908 Kits may be ordered as HP Part Number 5061-0078.

2-33. Rack Mounting with Front Handles (Option 909)

2-34. Instruments with Option 909 contain a Rack Mount Kit with Front Handles, a combination of the Option 907 Kit and the Option 908 Kit. This kit supplies the necessary hardware and installation instructions for preparing the instrument to mount on equipment rack with 482.6 mm (19 in.) support spacing, with the addition of front handles. Installation instructions are also given in Figure 2-7. Additional Option 909 Kits may be ordered as HP Part Number 5061-0084.

2-35. STORAGE AND SHIPMENT

2-36. Environment

2-37. The instrument may be stored or shipped in environments within the following limits:

Temperature -40°C to $+75^{\circ}\text{C}$
 Humidity 5% to 95% relative at 0°
 to $+40^{\circ}\text{C}$
 Altitude Up to 15240 metres
 (Approximately 50,000 feet)

2-38. The instrument should be protected from temperature extremes which may cause condensation in the instrument.

2-39. Packaging

2-40. Original Packaging. Containers and materials identical to those used in factory packaging are available through Hewlett-Packard

offices. A complete diagram and listing of packaging materials used for the 8756A is shown in Figure 2-9. If the instrument is being returned to Hewlett-Packard for servicing, attach a tag indicating the type of service required, return address, model number, and full serial number (located on rear panel serial plate). Mark the container FRAGILE to assure careful handling. In any correspondence, refer to the instrument by model number and full serial number.

2-41. Other Packaging. The following general instructions should be used for repackaging with commercially available packaging materials:

- a. Wrap the instrument in heavy paper or plastic. If shipping to a Hewlett-Packard Office or Service Center, attach a tag indicating the type of service required, return address, model number, and full serial number.
- b. Use a strong shipping container.
- c. Use enough shock-absorbing material around all sides of the instrument to provide a firm cushion and to prevent movement inside the container. Protect the control panel with cardboard.
- d. Seal the shipping container securely.
- e. Mark the shipping container FRAGILE to assure careful handling.
- f. In any correspondence, refer to the instrument by model number and full serial number.

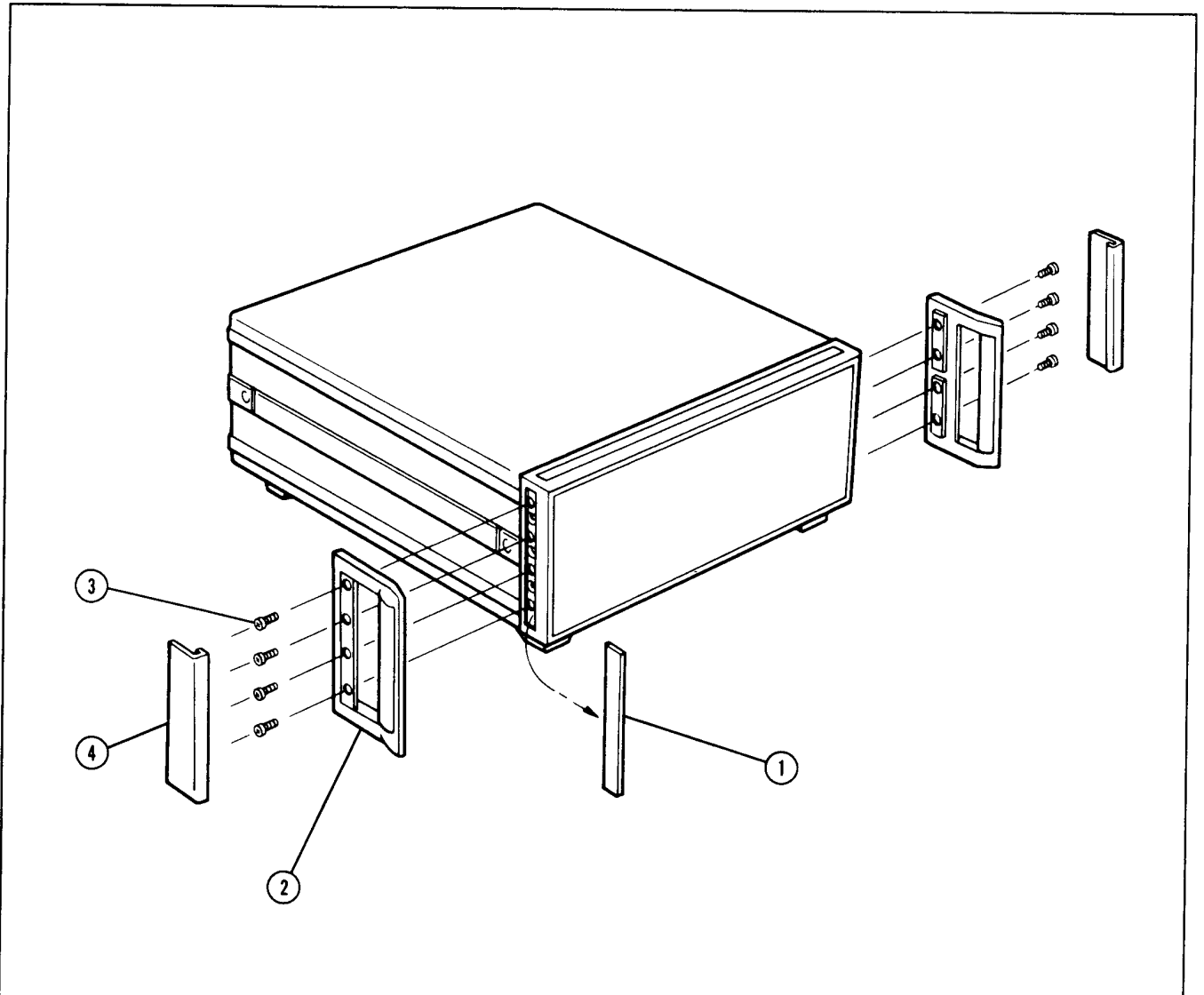

INSTALLATION INSTRUCTIONS

1. REMOVE SIDE TRIM STRIPS 1.
2. ATTACH FRONT HANDLE ASSEMBLY 2 WITH FOUR 8-32 x 3/8 SCREWS 3 PER SIDE.
3. PRESS FRONT HANDLE TRIM 4 IN PLACE.

OPTION 907 (HP Part No. 5061-0090) CONTENTS

Item	Qty.	HP Part No.	C D	Description
2	2	5060-9900	0	Front Handle Assembly
3	6	2510-0195	6	#8-32 x 3/8 Screw
4	2	5020-8897	8	Front Handle Trim

Figure 2-5. Option 907 Front Handles Kit

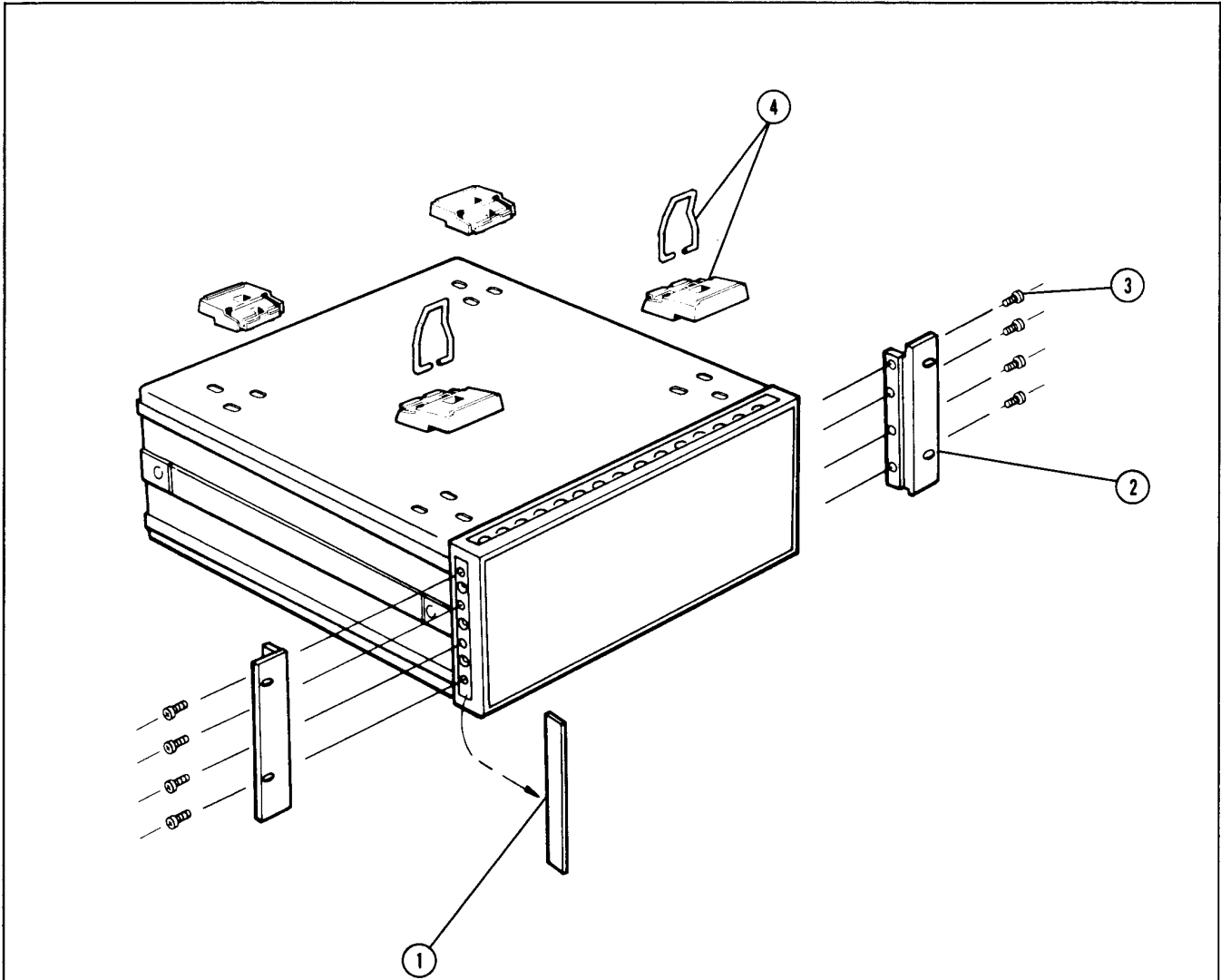

INSTALLATION INSTRUCTIONS

1. REMOVE SIDE TRIM STRIPS 1.
2. ATTACH RACK MOUNT FLANGE 2 WITH 8-32 x 3/8 SCREWS 3.
3. REMOVE FEET AND TILT STANDS 4 BEFORE RACK MOUNTING.

OPTION 908 (HP Part No. 5061-0078) CONTENTS

Item	Qty.	HP Part No.	C D	Description
2	2	5020-8863	8	Rack Mount Flange
3	6	2510-0193	7	#8-32 x 3/8 Screw

Figure 2-6. Option 908 Rack Mount Kit

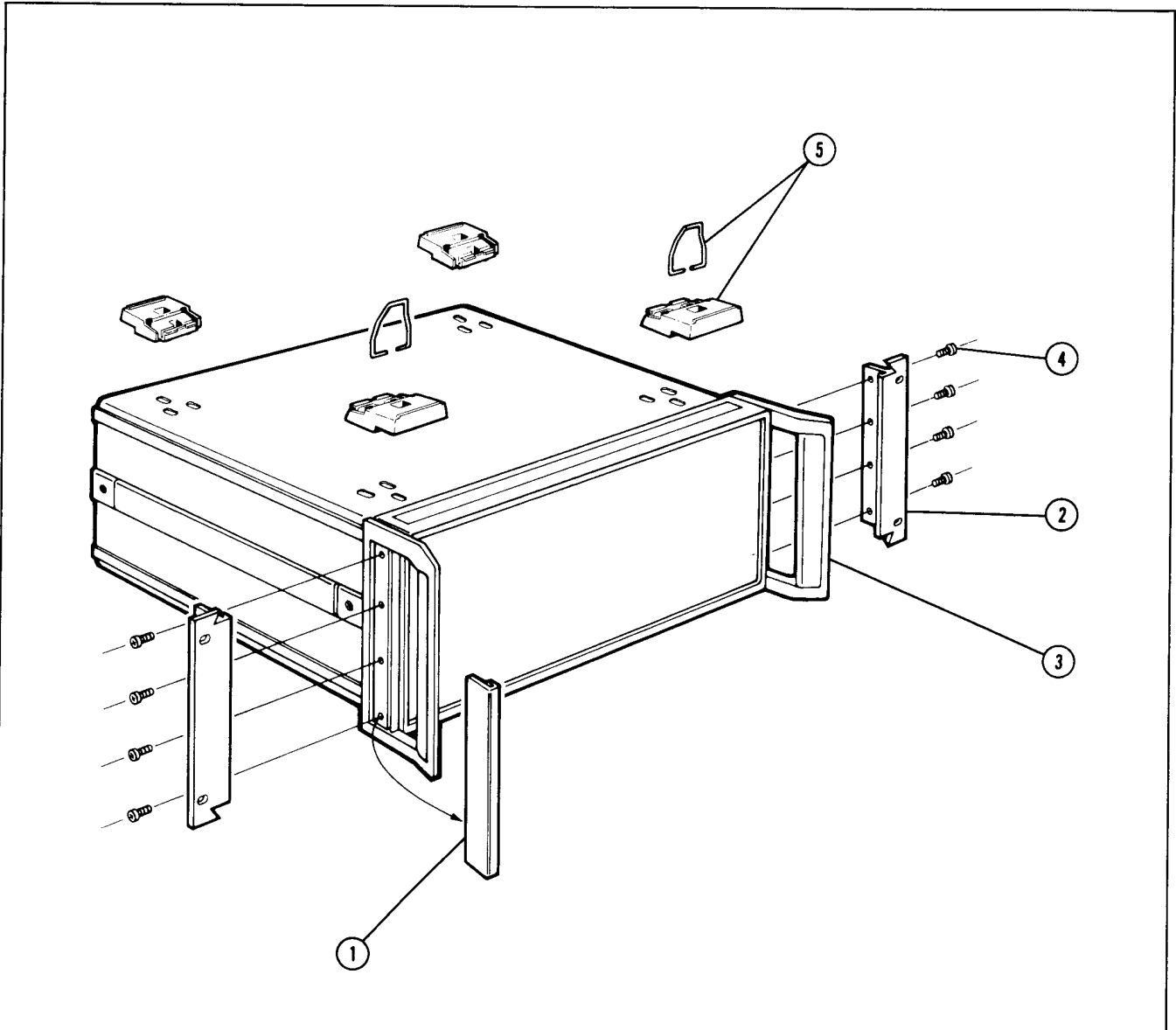

INSTALLATION INSTRUCTIONS

1. REMOVE SIDE TRIM STRIPS **1**.
2. ATTACH RACK MOUNT FLANGE **2** AND FRONT HANDLE ASSEMBLY **3** WITH FOUR 8-32 x 5/8 SCREWS **4** PER SIDE.
3. REMOVE FEET AND TILT STANDS **5** BEFORE RACK MOUNTING.

OPTION 909 (HP Part No. 5061-0084) CONTENTS

Item	Qty.	HP Part No.	C D	Description
2	2	5020-8875	2	Rack Mount Flange
3	2	5060-9900	0	Front Handle Assembly
4	6	2510-0194	8	#8-32 x 5/8 Screw

Figure 2-7. Option 909 Rack Mount Kit with Handles

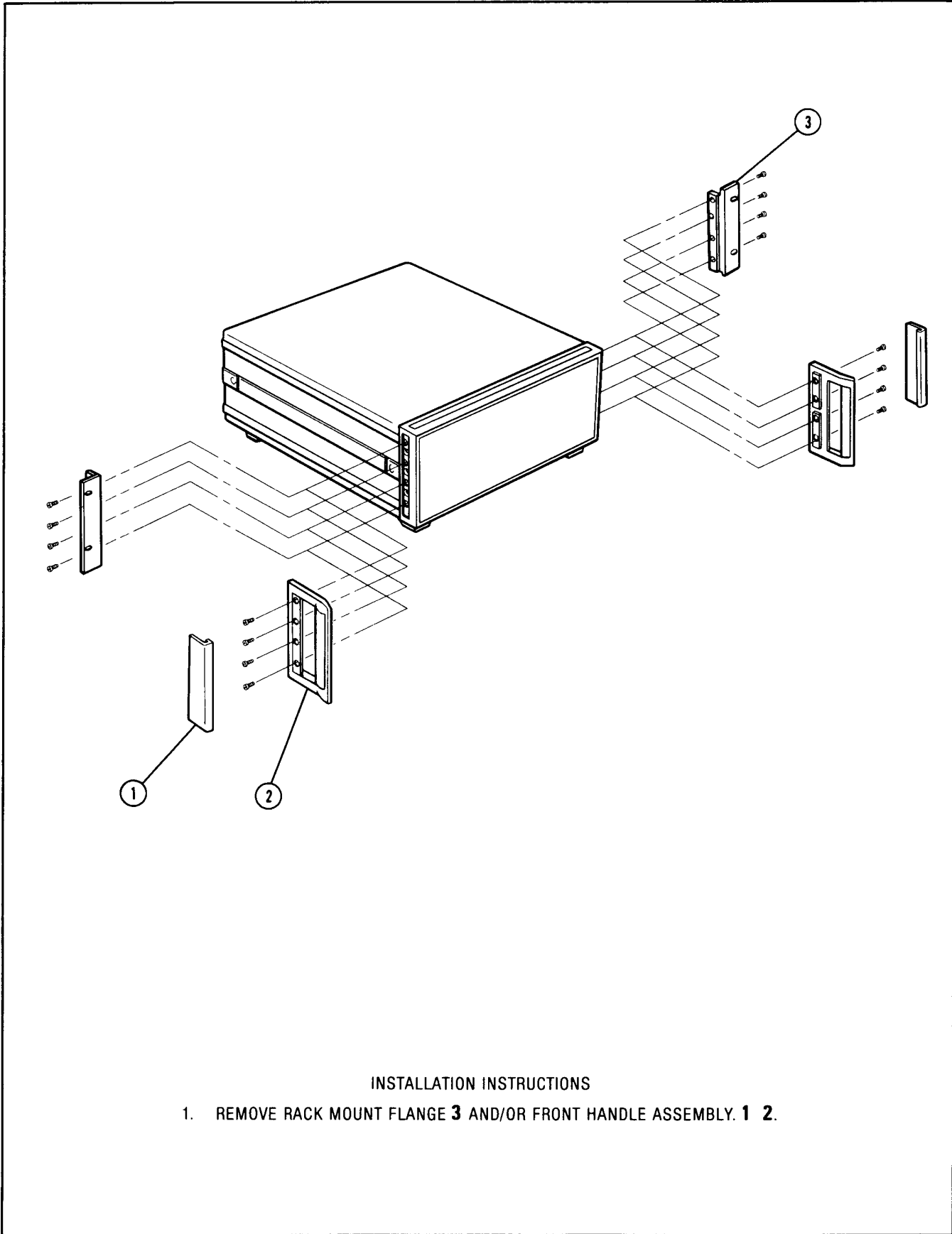
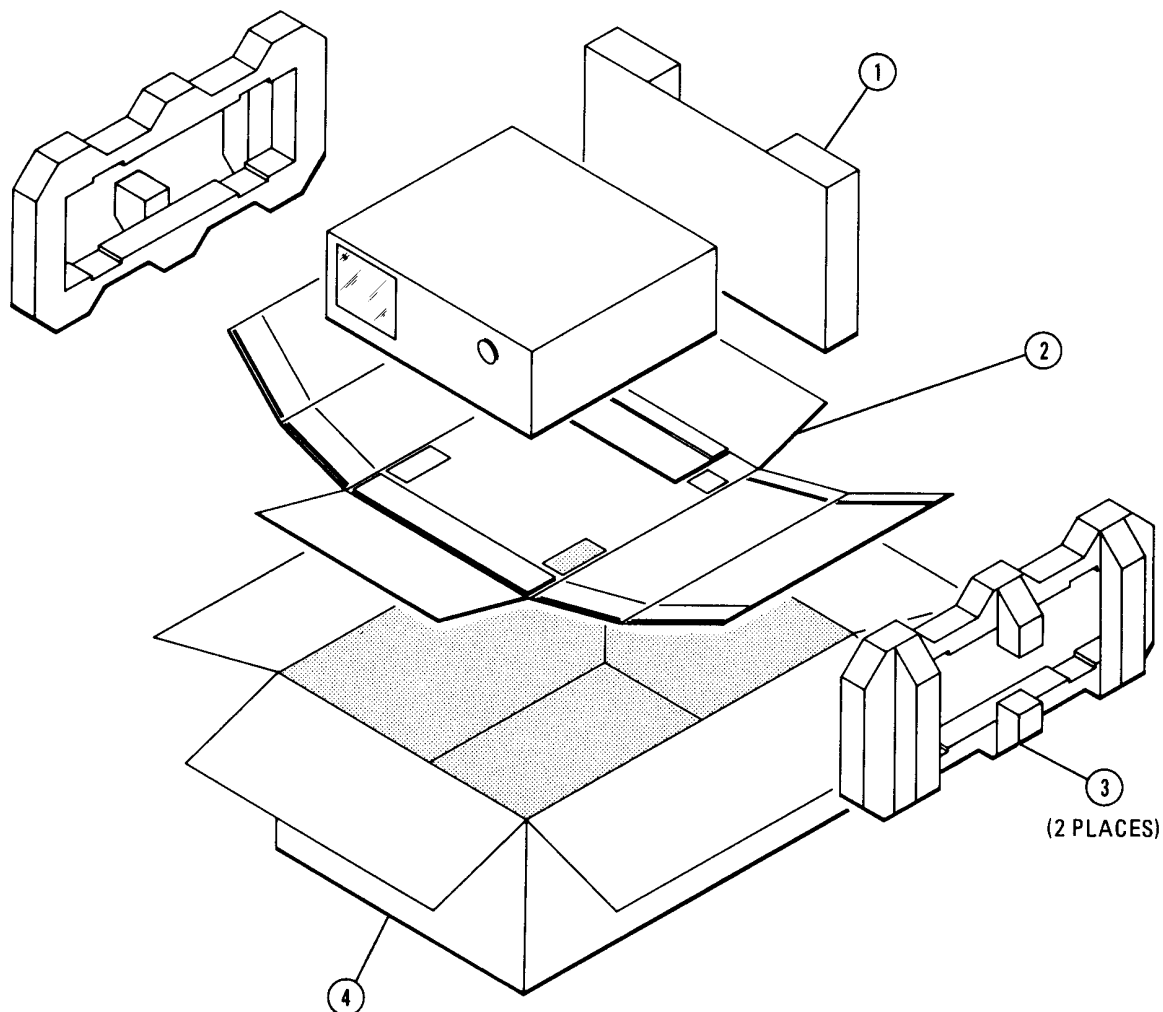

Figure 2-8. Preparation of Instrument for Shipment



Ref. Desig.	HP Part Number	CD	Description
1	08756-80011	6	Rear Spaces - Corrugated
2	08756-80009	2	Carton - Inner
3	08756-80010	5	Side Rail
4	9211-4499	7	Carton - Outer
5	9222-0069	2	Poly Bag - To Cover Instrument (Not Shown)

Figure 2-9. Packaging for Shipment Using Factory Packaging Materials

SAFETY CONSIDERATIONS

GENERAL

This product and related documentation must be reviewed for familiarization with safety markings and instructions before operation. This product has been designed and tested in accordance with international standards.

SAFETY SYMBOLS



Instruction manual symbol: the product will be marked with this symbol when it is necessary for the user to refer to the instruction manual (refer to Table of Contents).



Indicates hazardous voltages.



Indicates earth (ground) terminal.

WARNING

The **WARNING** sign denotes a hazard. It calls attention to a procedure, practice, or the like, which, if not correctly performed could result in personal injury. Do not proceed beyond a **WARNING** sign until the indicated conditions are fully understood and met.

CAUTION

The **CAUTION** sign denotes a hazard. It calls attention to an operating procedure, practice, or the like, which, if not correctly performed or adhered to, could result in damage to or destruction of part or all of the product. Do not proceed beyond a **CAUTION** sign until the indicated conditions are fully understood and met.

SERVICING

WARNING

Any servicing, adjustment, maintenance, or repair of this product must be performed only by qualified personnel.

Adjustments described in this manual may be performed with power supplied to the product while protective covers are removed. Energy available at many points may, if contacted, result in personal injury.

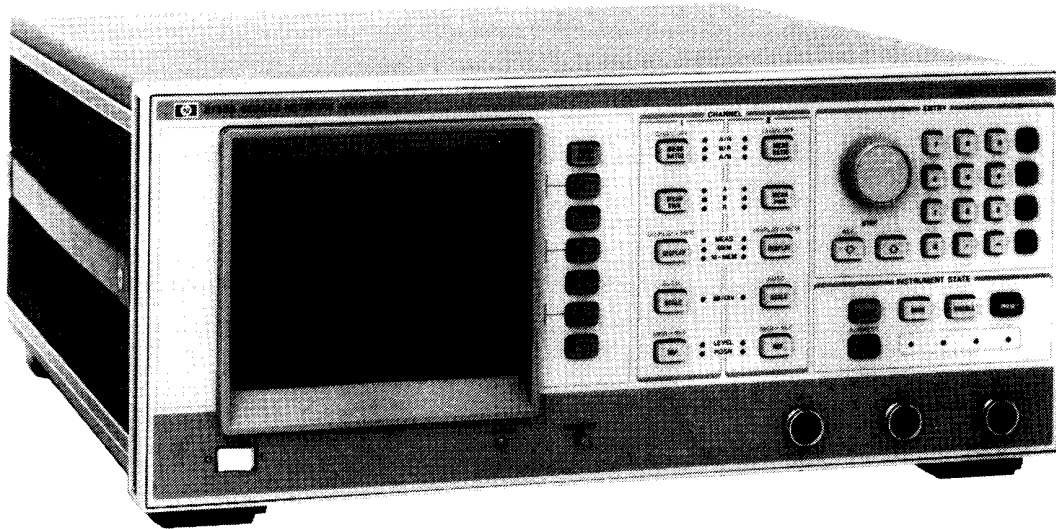

8756A SCALAR NETWORK ANALYZER

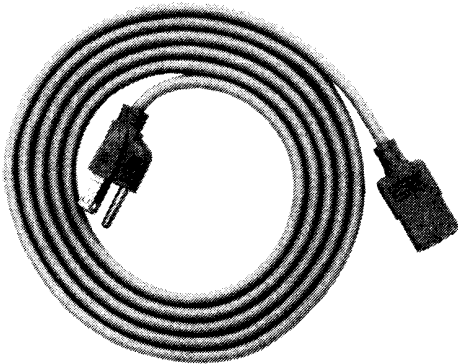

POWER CABLE*

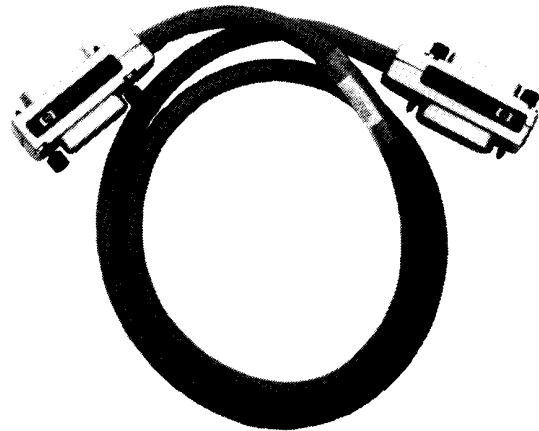

HP-IB INTERFACE CABLE

*POWER CABLE/PLUG SUPPLIED DEPENDS ON COUNTRY OF DESTINATION. REFER TO SECTION II FOR PART NUMBER INFORMATION.

Figure 1-1. Model 8756A Scalar Network Analyzer and Accessories Supplied

SECTION I GENERAL INFORMATION

1-1. INTRODUCTION

1-2. This Operating and Service manual contains information required to install, operate, test, adjust, and service the Hewlett-Packard Model 8756A Scalar Network Analyzer. Figure 1-1 shows the instrument and accessories supplied. This section covers instrument identification, description, options, accessories, specifications, and other basic information.

1-3. This manual is divided into eight sections which provide information as follows:

- a. SECTION I, GENERAL INFORMATION, includes a brief description of the instrument, safety considerations, specifications, supplemental characteristics, instrument identification, options available, accessories available, and a list of recommended test equipment.
- b. SECTION II, INSTALLATION, provides information for initial inspection, preparation for use, rack mounting, mating connectors, storage and shipment.
- c. SECTION III, OPERATION, consists of three subsections which contain general operating information, local operation information (not-HP-IB), and remote operation information (Programming Notes which provide information on HP-IB use of the 8756A).
- d. SECTION IV, PERFORMANCE TESTS, contains information required to verify that instrument performance is in accordance with published specifications.
- e. SECTION V, ADJUSTMENTS, contains information required to properly adjust and align the instrument after repair.
- f. SECTION VI, REPLACEABLE PARTS, contains information required to order all parts and assemblies.
- g. SECTION VII, MANUAL BACKDATING CHANGES, contains backdating information to make this manual compatible with earlier equipment configurations.
- h. SECTION VIII, SERVICE, provides an overall instrument block diagram with troubleshooting and repair procedures. Each assembly within the instrument is covered on a separate Service Sheet which contains a circuit description, schematic diagram, component location diagram, and troubleshooting information to aid in the proper maintenance of the instrument.

1-4. Supplied with this manual is an Operating Information Supplement. The Supplement is a copy of the first three sections of this manual, and should be kept with the instrument for use by the operator. Additional copies of the Operating Information Supplement can be ordered through your nearest Hewlett-Packard office. The part number is listed on the title page.

1-5. Also listed on the title page of this manual is a Microfiche part number. This number can be used to order 4x6-inch microfilm transparencies of the manual. Each microfiche contains up to 60 photo-duplicates of the manual pages. The microfiche package also includes the latest Manual Changes supplement as well as all pertinent Service Notes.

1-6. SPECIFICATIONS

1-7. Instrument specifications are listed in Table 1-1. These specifications are the performance standards or limits against which the instrument is tested. Table 1-2 lists supplementen-

tal characteristics. Supplemental characteristics are not specifications but are typical characteristics included as additional information for the user.

1-8. SAFETY CONSIDERATIONS

1-9. This product has been manufactured and tested in accordance with international safety standards. Before operation, this product and related documentation must be reviewed for familiarization with safety markings and instructions. A complete listing of Safety Considerations precedes Section I of this manual.

1-10. INSTRUMENTS COVERED BY MANUAL

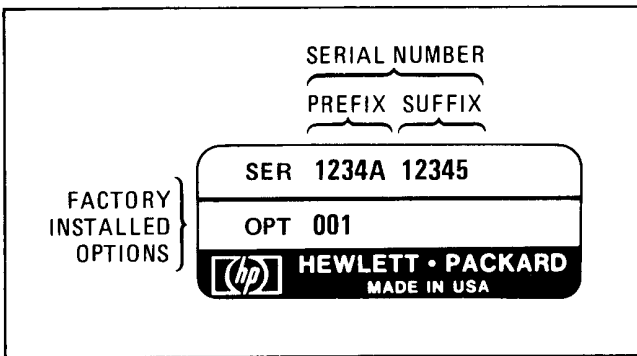

Figure 1-2. Typical Serial Number Plate

1-11. Attached to the rear panel of the instrument is a serial number plate (Figure 1-2). The serial number is in two parts. The first four digits and letter are the serial number prefix; the last five digits are the suffix. The prefix is the same for all identical instruments; it changes only when a change is made to the instrument. The suffix, however, is assigned sequentially and is different for each instrument. The contents of this manual apply to instruments with the serial number prefix(es) listed under SERIAL NUMBERS on the title page.

1-12. An instrument manufactured after the printing of this manual may have a serial number prefix that is not listed on the title page. This unlisted serial number prefix indicates the instrument is different from those described in this manual. The manual for this newer instrument is accompanied by a yellow Manual Changes supplement. This supplement contains

'change information' that explains how to adapt the manual to the newer instrument.

1-13. In addition to change information, the supplement may contain information for correcting errors in the manual. To keep this manual as current and accurate as possible, Hewlett-Packard recommends that you periodically request the latest Manual Changes supplement. The supplement for this manual is identified with this manual's print date and part number, both of which appear on the manual's title page. Complimentary copies of the supplement are available from Hewlett-Packard.

1-14. For information concerning a serial number prefix that is not listed on the title page or in the Manual Changes supplement, contact your nearest Hewlett-Packard office.

1-15. DESCRIPTION

1-16. The Model 8756A Scalar Network Analyzer is a microprocessor based receiver. It is capable of making scalar (magnitude only) reflection and transmission measurements at RF (radio frequency) and microwave frequencies. The 8756A is completely programmable over the Hewlett-Packard Interface Bus (HP-IB), and can control a plotter (HP 7470A or 9872C) or sweep oscillator (HP 8350B or 8340A) through the 8756 System Interface. A complete manual measurement with the 8756A requires the connection of detector(s) and/or bridge(s) to the A, B, or R detector inputs on the front panel, and the use of a compatible source.

1-17. The CHANNEL area on the front panel controls the operation of two independent, but **identical** channels, and three detector inputs. The Entry area allows data entry using the knob, step keys, or keypad. The Display shows the measurement data, channel information, and Soft Key menus. The Instrument State area allows storage and recall of the instrument state, provides for a **PRESET** of the 8756A, and shows the status of the instrument under remote operation.

1-18. Upon initial power on, or after [**PRESET**] is pressed, the 8756A automatically performs an internal hardware check to verify proper operation, and initializes certain functions. If errors or failures occur during this test, they are indicated on the CRT Display.

1-19. Five Key Channel Operation

1-20. Five front panel keys for each channel select **[MEAS RATIO]** (A/R, B/R, A/B), **[MEAS POWER]** (A, B, R), **[DISPLAY]** (Measurement, Memory, or Measurement minus Memory), **[SCALE]** (20, 10, 5, 2, 1, .5, .2, or .1 dB per division), and **[REF]** (LEVEL or POSition). Use of the **[SHIFT]** key enables **[CHAN OFF]**, **[DISPLAY→MEM]**, **[MKR→REF]**, and **[AUTO]** (which scales the data and changes the Reference Level so that the data fits on the CRT Display).

1-21. Data Entry

1-22. Data for the various functions may be entered using one of the Entry area functions (knob, step keys, or keypad).

1-23. Digital Display

1-24. Data for both channels is shown on the CRT Display. The Channel Annotation area, above the graticule, annotates the Measurement, Scale per Division, Reference Level value, and Cursor value. The Reference Position for each channel activated is shown on the left side of the graticule. Soft Keys may be enabled using the keys to the immediate right of the display. These functions include: **[CURSOR]** (reads the value of the cursor for both channels), **[AVERAGE]** (Averaging Factor, Averaging ON/OFF), **[CAL]** (Short/Open calibration and Detector Offset), **[PLOT]** (outputs the current display to an HP 7470A or 9872C Plotter), **[DISPLAY]** (Labels ON/OFF, Hold, Menu OFF), and **[MORE]** (Modulation ON/OFF, Service).

1-25. Instrument State and SAVE/RECALL

1-26. The Instrument State for remote operation is identified by 4 LED's (Light Emitting Diodes). Local operation may be restored by pressing **[LOCAL]**. **[PRESET]** is used to perform a hardware self-test and restores the instrument to a predefined state. **[SAVE]** and **[RECALL]** are used to save/recall up to nine front panel states.

1-27. AC Modulation

1-28. The 8756A uses the AC detection technique in conjunction with its detector inputs. This technique has the advantage of providing nearly

drift-free operation. An RF or microwave signal is square-wave modulated at 27.8 kHz, and provides the source for the 8756A. Absolute power, reflection, or transmission signals are then detected and the modulation envelope is carried to an 8756A detector input. After filtering and shaping, the data is digitized and displayed.

1-29. The modulation drive needed for the 27.8 kHz modulation is available from any one of the three Modulator Drives BNC outputs on the rear panel of the 8756A. They may be used to drive the external AM or PULSE INPUT (8340A) of the RF or microwave source, or to drive an external modulator as required for a source without internal modulation capability.

1-30. OPTIONS

1-31. Option 907, Front Handles Kit

1-32. Option 907 (HP Part Number 5061-0090) contains a pair of front handles and the necessary hardware for mounting the handles to the 8756A. Refer to Section II of this Operating and Service Manual for a detailed description of this kit and instructions for installation.

1-33. Option 908, Rack Mount Kit

1-34. Option 908 (HP Part Number 5061-0078) contains a pair of flanges and the necessary hardware to mount the 8756A in an equipment rack with 482.6 mm (19 inches) horizontal spacing. Refer to Section II of this Operating and Service Manual for a detailed description of this kit and instructions for installation.

1-35. Option 909, Rack Mount/Front Handles Kit

1-24. Option 909 (HP Part Number 5061-0084) contains one Option 907 Front Handles Kit and one Option 908 Rack Mount Kit (see descriptions in preceding paragraphs). Refer to Section II of this Operating and Service Manual for a detailed description of this kit and instructions for installation.

1-36. Option 910, Extra Operating and Service Manual

1-37. The standard instrument is supplied with one Operating and Service Manual (including an Operating Information supplement). Each

Option 910 provides one additional Operating and Service Manual (and supplement). To obtain additional Operating and Service Manuals after initial shipment, order by manual part number, listed on the title page and rear cover of this manual.

1-38. ACCESSORIES SUPPLIED

1-39. Figure 1-1 shows the 8756A Scalar Network Analyzer HP-IB cable and power cable. The power cable supplied depends upon the country of destination. Refer to Section II of this manual for HP Part Number information.

1-40. EQUIPMENT REQUIRED BUT NOT SUPPLIED

1-41. A swept microwave source with 27.8 kHz modulation capability, (internal or through the use of an external modulator) and from one to three detectors and/or directional bridges are required to make microwave measurements with the 8756A. Refer to EQUIPMENT AVAILABLE for specific examples.

EQUIPMENT AVAILABLE

1-42. 11664A/B Detectors

1-43. Up to three Model 11664A/B Detectors may be used with the 8756A. The 11664A/B detects the envelope of the 27.8 kHz modulated RF signal. Each detector uses a biased Schottky diode to achieve -50 dBm sensitivity. The frequency range of the 11664A Detector is 10 MHz to 18 GHz. The extended frequency range of the 11664B Detector is 10 MHz to 26.5 GHz.

1-44. 85020A/B or 85021A/B/C Directional Bridges

1-45. The 85020A/B and 85021A/B/C are Directional Bridges designed for the 8756A and 8755C Scalar Network Analyzers. Within each bridge, one zero-bias Schottky diode detector measures the return loss of the test device. Ratio measurements may be made by adding a power splitter (HP 11667A) and detector (HP 11664A/B). The 85020A has a frequency range of 0.01 to 4.3 GHz, with a nominal impedance of 50 ohms. The 85020B has a frequency range of 0.01 to 2.4 GHz with a nominal impedance of 75 ohms. The 85021A/B provides an extended frequency range, with the 85021A (APC-7 test port connec-

tor) and the 85021C (Precision Type N test port connector) covering 0.01 to 18 GHz, and the 85021B (APC-3.5 test port connector) covering 0.01 to 26.5 GHz. 85021A/B/C nominal impedance is 50 ohms.

1-46. 11665B Modulator

1-47. The 11665B Modulator is required if the RF signal source used does not have the capability of modulating the RF output at a 27.8 kHz rate. The 11665B Modulator modulates test signals from 15 MHz to 18 GHz with the 27.8 kHz from the 8756A. Refer to the Section III Operation portion of this manual for further information on test setup and measurements regarding the use of the 11665B Modulator.

1-48. 11666A Reflectometer Bridge

1-49. Reflection measurements from 40 MHz to 18 GHz may be made with one coupling device using the 11666A Reflectometer Bridge. With the addition of an external 11664A/B Detector, two simultaneous ratio measurements of insertion and return loss may be made. Refer to the Section III Operation portion of this manual for further information on test setup and measurements regarding the use of the 11666A Reflectometer Bridge.

1-50. 11667A Power Splitter

1-51. The 11667A Power Splitter is recommended when making low loss wideband transmission measurements with the 8756A. This two-resistor type splitter provides excellent output SWR at the auxiliary arm when used for source leveling or ratio measurement applications. The 0.25 dB tracking between output arms over a frequency range of dc to 18 GHz allows wideband measurements to be made with a minimum of uncertainty.

1-52. 11678A Low Pass Filter Kit

1-53. The 11678A Low Pass Filter Kit contains five low pass filters with the following cutoff frequencies: 11688A, 2.8 GHz; 11689A, 4.4 GHz; 11684A, 6.8 GHz; 11685A, 9.56 GHz; and 11686A, 13.0 GHz. The use of low pass filters is recommended to reduce undesirable harmonics generated by the RF source when making precise broadband measurements.

1-54. 11668A High Pass Filter

1-55. The 11668A High Pass Filter accessory is recommended when making measurements on active devices which have gain below 50 MHz. Use of the 11668A High Pass Filter, placed after the 11665B Modulator, reduces the modulator drive feedthrough from 8mV to 1mV and prevents possible amplifier saturation.

1-56. 11679A/B Extension Cables

1-57. The 11679A 7.6 m (25 foot) Extension Cable and the 11679B 61 m (200 foot) Extension Cable fit directly between the 11664A/B Detector or 11666A Reflectometer Bridge and 8756A Scalar Network Analyzer. Remote detector operation is thus permitted without performance degradation.

1-58. 11664C Detector Adaptor

1-59. The 11664C Detector Adaptor allows the use of standard diode detectors with the 8756A. After initial detector calibration with the specific diode detector used, the 11664C is interchangeable with the 11664A/B detectors. Frequency range of the 11664C is limited on the upper end by the diode detector used, thus extending the operating range of the 8756A.

1-60. Sweep Oscillators

1-61. The 8340A Synthesized Sweep Oscillator, the 8620C, and 8350A/B Sweep Oscillator families may be used as swept or CW signal sources for the 8756A. With either the 8350B or the 8340A, the 8756A is able to: Interrogate start/stop/marker frequencies and annotate the CRT display; Save and recall front-panel states of the sweeper simultaneously with the 8756A; Preset the sweeper simultaneously with the 8756A; Enable modulation; Set the proper sweep time; Sweep two different frequency or power ranges and display both simultaneously (Alternate Sweep). The 8620C Sweep Oscillator and the 8340A Synthesized Sweep Oscillator modulate the RF output signal with the 8756A Modulator Drive output. With the 8620C, the Modulator Drive is connected to the Sweep Oscillator rear panel EXT AM input. With the 8340A, the Modulator Drive is connected to the Synthesized Sweep Oscillator front panel PULSE MODULATION INPUT. The 8350A/B Sweep

Oscillator is capable of internally modulating the RF source at 27.8 kHz.

1-62. Plotters

1-63. Hard copy plots are automatically produced by the 8756A when used with an HP 7470A or 9872C digital plotter. Plots may be segmented into: Graticule lines only; Labeling and annotation; Channel 1 trace; Channel 2 trace; Plot all.

1-64. Service Accessories

1-65. A Service Accessory Kit (HP Part Number 08756-60020) is available for servicing the 8756A. The accessory kit includes:

- One 15-pin printed circuit board extender (HP Part Number 5060-0049). This board is provided for use in troubleshooting the Log Amplifier Assemblies (A7, A8, A9).
- One special purpose printed circuit board extender (HP Part Number 08756-60015). This board is provided to aid in troubleshooting the A3 through A6 Assemblies. Two +5V test points and two digital ground test points are provided for powering digital troubleshooting devices (logic probe, logic pulser, current tracer).
- One 16-pin I.C. Test Clip (HP Part Number 1400-0734) and one 20-pin I.C. Test Clip (HP Part Number 1400-0979) are provided as an aid for probing Integrated Circuits when troubleshooting.
- One Log Amplifier Assembly Extractor (HP Part Number 03950-4001). Provided for ease in removing Log Amplifier Assemblies, which do not have board-mounted extractors.

1-66. RECOMMENDED TEST EQUIPMENT

1-67. Equipment required to maintain the 8756A is listed in Table 1-3. Other equipment may be substituted if it meets or exceeds the critical specification listed in the table.

1-68. HEWLETT-PACKARD INTERFACE BUS. (HP-IB)

1-69. The 8756A is factory equipped with a remote programming interface using the Hewlett-Packard Interface Bus (HP-IB). This provides a remote operator with the same control of the instrument (except the line switch and internal tests) available to the manual (local) operator. Remote control is maintained by a system controller (desktop computer, computer, etc.) that sends commands or instructions to and receives data from the 8756A using the HP-IB. Several output modes are available for outputting data. Through a subset of HP-GL (Hewlett-

Packard Graphics Language), user graphics may be plotted on the 8756A CRT. The HP-IB is Hewlett-Packard's implementation of the IEEE Standard 488-1978. A complete general description of the HP-IB is provided in the manual entitled "Condensed Description to the Hewlett-Packard Interface Bus" (HP Part Number 59401-90030).

1-70. 8756 System Interface

1-71. The 8756A also has an 8756 System Interface. This is a port used exclusively by the 8756A to control and extract information from a compatible digital plotter and/or sweep oscillator.

Table 1-1. Model 8756A Specifications and General Requirements

**8756A
SCALAR NETWORK ANALYZER**

SPECIFICATIONS

Dynamic Range: +10 dBm to -50 dBm in all three inputs (A, B, and R).

Dynamic Accuracy: Dynamic accuracy of a single channel measurement using 11664A/B Detector. Measurement taken over +10 to -50 dBm at 25°C ±5°C, at a CW frequency.

±(0.1 dB +0.01 dB/dB) from +10 to -40 dB.
±(0.2 dB +0.02 dB/dB) from -40 to -50 dBm.

Modulator Drive: 3 separate modulator drive outputs on rear panel, each capable of driving one HP 11665B Modulator. Modulation drive may be turned on and off via the front panel or HP-IB. In the "OFF" state, the modulator drive signal turns the 11665B fully on (minimum insertion loss).

Frequency 27.8 kHz ±100 Hz.
Symmetry 50% ±2%.

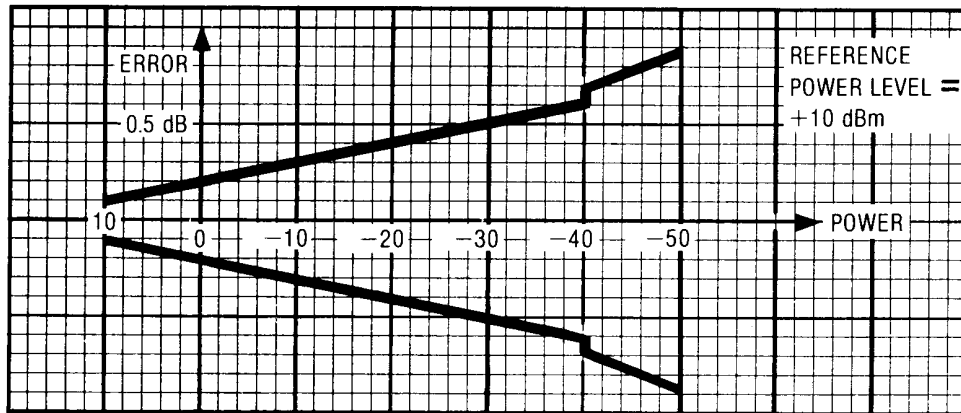

Dynamic Accuracy

GENERAL REQUIREMENTS

Sweep Voltage: Horizontal sweep voltage provided by the Sweep Oscillator through the Sweep Input on the back panel of the HP 8756A.

Voltage level: 0 to +10V.

Voltage Levels	
Blanked	+5V typical
Unblanked	0V typical
Marker	-4V typical
Active Marker	-8V typical

Modulation Requirements: Square-wave amplitude modulation.

Frequency 27.8 kHz.
≥30 dB on/off ratio.
45% to 55% symmetry.

Marker and Blanking Requirements: Blanking and marker signals are provided by the Sweep Oscillator through the Pos Z Blank input on the back panel of the HP 8756A.

Sweep Time: Minimum sweep time ≥150 ms.

Table 1-2. Supplemental Characteristics for 8756A

SUPPLEMENTAL CHARACTERISTICS	
<p>NOTE: Values in this table are not specifications but are typical characteristics included for user information.</p>	
<p>Scale Resolution: 0.1, 0.2, 0.5, 1, 2, 5, 10, or 20 dB per division. Independently controlled for each measurement channel.</p> <p>Reference Offset: Offset level adjustable in 0.01 dB increments from -70.00 to +20.00 dBm (absolute) or -90.00 to +90.00 dB (ratio).</p>	<p>Measurements: Two independent display channels selectable for: A, B, R, A/R, B/R, or A/B inputs.</p>
DISPLAY CHARACTERISTICS	
<p>Resolution: Vertical: 0.006 dB for display. 0.01 dB for "Display Cursor". Horizontal: 401 points.</p> <p>Graticule: 8 vertical, 10 horizontal divisions. 1 division approximately 0.9 cm.</p>	<p>Averaging: Averaging Factors of 2, 4, 8, 16, 32, 64, 128, or 256 may be selected for each channel.</p> <p>Normalization: Traces are stored and normalized to 0.006 dB resolution, independent of scale/division or offset. The horizontal resolution is 401 points.</p>
HP-IB CHARACTERISTICS	
<p>Interface: HP-IB interface operates according to IEEE 488-1978 standard.</p> <p>Speed: ASCII format, trace: 800 ms typical. ASCII format, point: 10 ms typical. Binary format, trace: 35 ms typical.</p> <p>User-accessible Graphics: Number of vectors: typically 750 two-inch vectors with 60 Hz refresh rate. Writing speed: typically 10 μs per vector.</p> <p>Transfer Formats: Data may be transferred as either ASCII strings (nominally 6 characters per reading) or as 16 bit integers. Readings may be taken at a single point or as an entire 401 point measurement trace.</p>	<p>Programmable Functions: Input selection (A, B, R, A/R, B/R, A/B) Scale/division Reference Level Normalization Averaging Open/short calibration Instrument preset Save/recall registers Trace and calibration memory Autoscale Plot Modulation on/off</p> <p>Interrupts: HP-IB Service Requests are generated for the following conditions: Front-Panel key pressed Sweeper out of range Illegal command Instrument self-test error</p>
SYSTEM INTERFACE	
<p>Description: The 8756 System Interface is a port used exclusively by the 8756A to control and</p>	<p>extract information from compatible digital plotters and sweep oscillators.</p>
GENERAL	
<p>Operating Temperature Range: 0°C to +55°C.</p> <p>Power: 100, 120, 220, or 240 +5% -10%. 50 to 60 Hz. Approximately 100 volt-amps.</p>	<p>Dimensions: 188H X 425.5W X 451 mm D (7.4 X 16.75 X 17.75 in).</p> <p>Weight: Net, 15 kg (33 lb). Shipping, 20 kg (44 lb).</p>

Table 1-3. Recommended Test Equipment (1 of 2)

Instrument	Critical Specifications	Recommended Model	Use*
Sweep Oscillator	0 – 10V SWEEP OUT Ramp Positive Z-Axis Blanking HP-IB Programmable	HP 8350B (HP 8350A)	P, A, T
RF Plug-in	Compatible with Sweep Oscillator Internal 70 dB Step Attenuator Frequency Range: Includes 50 MHz Leveled Power Output: ≥13 dBm at 50 MHz	HP 83525A Opt 002	P, A, T
Detector	No Substitute	HP 11664A (HP 11664B)	P, A, T
12 dB Step Attenuator	1 dB Steps Type N (f) Connectors Calibration Data at 50 MHz to 0.01 dB Resolution	HP 355C Opt 001 Opt J14	P, A, T
120 dB Step Attenuator	10 dB Steps Type N (f) Connectors Calibration Data at 50 MHz to 0.01 dB Resolution	HP 355D Opt 001 Opt H88	P, A, T
Oscilloscope	Dual Channel Bandwidth: ≥100 MHz	HP 1740A	P, T
Oscilloscope Probes	10:1 Divider (3 required)	10 10041A	T
Universal Counter	Frequency Range: ≥30 kHz Frequency Resolution: ≤1 Hz Time Internal Resolution: ≤100 ms	HP 5316A	P, T
Digital Voltmeter	Accuracy: ≤0.03% Resolution: ≤5 mV Input Impedance (DC): ≥10 MΩ	HP 3456A (HP 3455A)	A, T
Power Meter	HP-IB Programmable	HP 436A	A, T
Power Sensor	Frequency Range: Includes 50 MHz Sensitivity: ≤-55 dBm (HP 11708A 50 MHz Reference Attenuator Included) Compatible with Power Meter	HP 8484A	P, A, T
Signature Multimeter	Signature Analyzer Clock Frequency: ≥10 MHz	HP 5005A/B	T
Logic Probe	TTL Compatible Data Rate: ≥16 MHz Compatible with Logic Pulser	HP 545A (HP 10525T)	T

Table 1-3. Recommended Test Equipment (2 of 2)

Instrument	Critical Specifications	Recommended Model	Use*
Logic Pulser	TTL Compatible	HP 546A (HP 10526T)	T
Current Tracer	TTL Compatible Compatible with Logic Pulser	HP 547A	T
Service Kit	No Substitute	HP P/N 08756-60020	T
(Equipment below required for Calibration Constants Adjustment Procedure only)			
Modulator	On/Off Ratio: ≥ 30 dB at 50 MHz Modulation Rate: 27.778 kHz	HP 11665B	A, T
Controller	Personal Computer (No Substitute)	HP 85F	A, T
Printer/Plotter ROM	Compatible with Controller	HP P/N 00085-15002	A, T
Advanced Programming ROM	Compatible with Controller	HP P/N 00085-15005	A, T
16K Memory Module	Compatible with Controller	HP 82903A	A, T
"CAL56A" Program Tape	No Substitute	HP P/N 08756-10001	A, T
Adapter	N(f) to N(F)	HP P/N 1250-1472	A, T
Adapter	N(m) to N(m)	HP P/N 1250-1475	A, T
Band Pass Filter	CF = 50 MHz, BW = 10 MHz Rejection >20 dB at 20 MHz >20 dB at 100 MHz SWR ≤ 1.2	Telonic P/N 50-10-2-EF	A, T

SECTION III OPERATION

The Operation section of this manual consists of the following subsections:

1. **OPERATING INFORMATION:** A complete (Local and Remote) reference on operating the Model 8756A.
2. **OPERATING NOTES:** Provide tutorial information on Locally operating the Model 8756A with other instruments.
3. **PROGRAMMING NOTES:** Provide tutorial information on Remotely operating the Model 8756A with other instruments and controllers.

8756A SCALAR NETWORK ANALYZER

© Copyright HEWLETT-PACKARD COMPANY 1983
1400 FOUNTAIN GROVE PARKWAY, SANTA ROSA, CA 95404 U.S.A.

Printed: APRIL 1983



**HEWLETT
PACKARD**

SECTION III

OPERATING INFORMATION

3-1. INTRODUCTION

3-2. This subsection provides complete information necessary for the correct set-up and operation of the Model 8756A Scalar Network Analyzer. For specific information on operating the 8756A with the Model 8350B Sweep Oscillator, please refer to the Operating Note BASIC NETWORK MEASUREMENTS USING 8756A SCALAR NETWORK ANALYZER AND 8350B SWEEP OSCILLATOR, #8756A/8350B/0000-99, which follows this manual. For additional information on using the 8756A over the Hewlett-Packard Interface Bus (HP-IB), please refer to the 8756A Programming Notes, also included in this section.

3-3. OPERATING CHARACTERISTICS

3-4. The Model 8756A Scalar Network Analyzer is a microprocessor based receiver. It is capable of making scalar (magnitude only) reflection and transmission measurements at RF (radio frequency) and microwave frequencies. The Model 8756A is programmable over the Hewlett-Packard Interface Bus (HP-IB). Whether or not the Model 8756A is being controlled over HP-IB, it can control a specific plotter and/or sweep oscillator through the 8756 SYSTEM INTERFACE. A measurement with the instrument requires the connection of detector(s) and/or directional bridge(s) to the A, B, or R detector inputs on the front panel, and the use of a compatible RF/microwave source.

3-5. The 8756A uses the AC detection technique in conjunction with its detectors. This technique provides very stable measurements even with temperature variations and RF interference. An RF or microwave signal is amplitude modulated with a 27.8 kHz square wave, providing the stimulus to the test device. When a signal is then detected by a compatible detector, the 8756A filters, shapes, digitizes, and displays the response. The 8756A provides the necessary 27.8 kHz modulation drive from any one of three rear panel Modulator Drive BNC outputs. They may be used to drive the external AM input of the RF or microwave source or an external modulator for a source without internal amplitude modulation capability.

3-6. The 8350B Sweep Oscillator provides the 27.8 kHz with its internal square wave modulation. All 83500 series plug-ins and most 86200 series plug-ins with the 11869A Adapter are compatible with this internal modulation. (The Models 86220A, 86230B, 86241A, 86242A, 86250A, 86250B, 86260A, 86260B, 86260C plug-ins require an external modulator for compatibility with the 8756A.)

3-7. OPERATING INSTRUCTIONS

3-8. The following describe the operation of the 8756A:

- * FRONT PANEL: Fig. 3-1.
- * SOFT KEYS: Fig. 3-2 and Appendix A.
- * REAR PANEL: Fig. 3-3.
- * HP-IB: Fig. 3-4.
- * CRT GRAPHICS: Fig. 3-5.

3-9. OPERATOR'S CHECKS

3-10. The Operator's Checks (see Fig. 3-6) verify that the 8756A is functioning correctly. It does not thoroughly check all specifications to their limits, but is an appropriate test for daily instrument verification, incoming inspection, or verification after repair or replacement of **digital** circuits.

3-11. ERROR MESSAGES

3-12. Error Messages are shown in the ACTIVE ENTRY AREA of the CRT display when conditions indicate a problem with the 8756A. For more information on these messages, refer to Section VIII Service.

FRONT PANEL OPERATING FEATURES

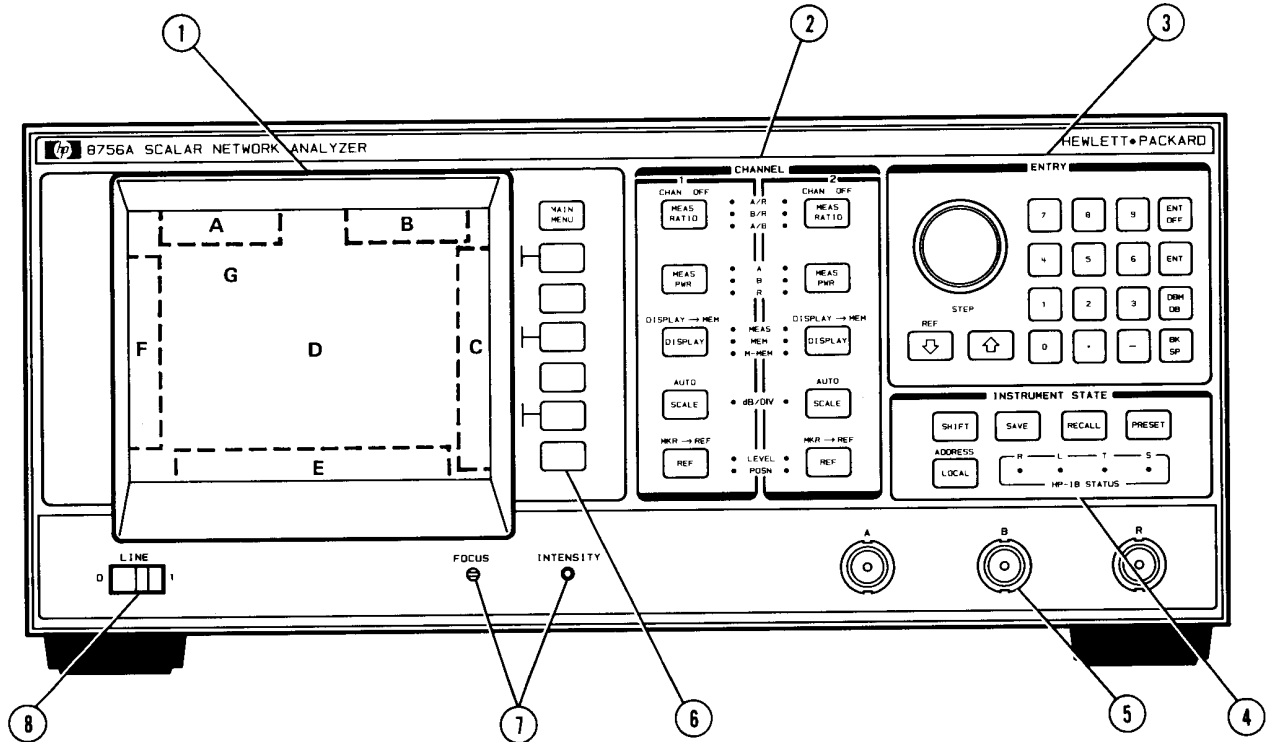

1. **CRT Display** of measurement annotation, soft key labels, data traces, and other information.
2. **CHANNEL** determines the measurement, display, scale, and reference line functions.
3. **ENTRY** provides Data Entry for the SCALE, REF, and soft keys by means of the Knob, the STEP keys, or the Keypad.
4. **INSTRUMENT STATE** provides information on the instrument and allows inputs to alter the state.
5. **DETECTOR INPUTS** allow connection of 8756A compatible detectors and/or bridges.
6. **SOFT KEYS** provide additional functions for the 8756A.
7. **CRT DISPLAY CONTROLS**.
8. **LINE** controls AC power to the 8756A. 1 = ON, 0 = OFF.

Figure 3-1. Front Panel Operating Features (1 of 11)

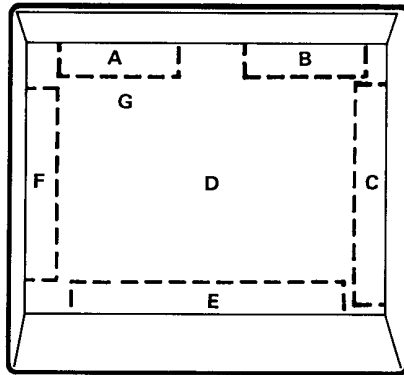

1. CRT Display. The display for the 8756A is divided into several information sections, described below.

A and B **MODE LABELS.** The ratio or power measurement, the CURSOR (or Model 8350B/8340A Active Marker) amplitude, the scale per division, and the reference level value are displayed. The Channel 1 LABEL is shown in area A; Channel 2 in area B. The Active Channel is shown with higher display intensity.

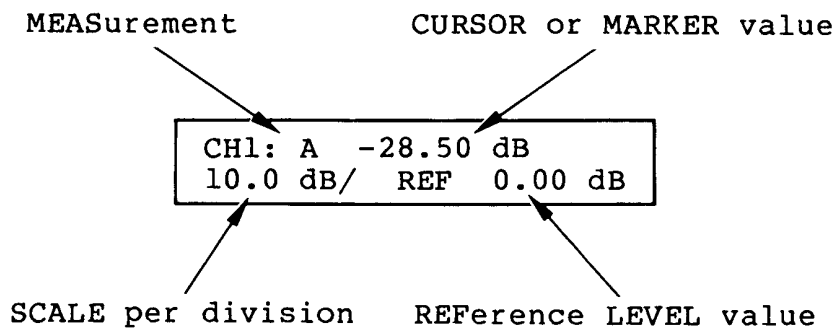

C **SOFT KEY LABELS.** The menu of available soft key selections are annotated. A particular menu or function is chosen by pressing the soft key to the right of the soft key label.

D **DATA DISPLAY AREA.** The data trace(s) are displayed depending on the soft key or CHANNEL functions selected.

Figure 3-1. Front Panel Operating Features (2 of 11)

- E** **FREQUENCY LABELS.** The Start, CURSOR or Active Marker (CURSOR takes precedent), Stop Frequencies, and the Alternate Sweep frequencies (if that function is selected) are annotated when the Model 8350B Sweep Oscillator or 8340A Synthesized Sweeper HP-IB is connected to the 8756 SYSTEM INTERFACE on the Rear Panel. The 8350B or 8340A must have their HP-IB address set to 19 decimal.
- F** Reference Line Positions for channel 1 and 2 are denoted on the left margin of the graticule grid. The Reference Line lies on major graticule lines only.
- G** **ACTIVE ENTRY AREA.** The last entry or HP-IB command function selected is denoted here. Exceptions are PRESET, MEAS RATIO, and MEAS PWR.

Figure 3-1. Front Panel Operating Features (3 of 11)

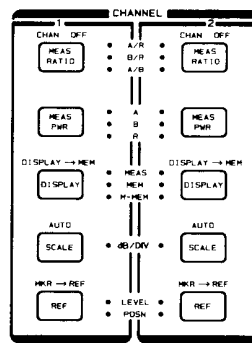

2. CHANNEL. This area selects the measurement, display, scale, and reference line functions of the 8756A. Each channel has identical column of independent keys. The function selection for each key is denoted by the corresponding lamp (LED), located in the center of the CHANNEL area, and is selected by repeated pressing of that key. Selection of a function (except CHAN OFF) designates that channel the Active Channel and is indicated by a higher intensity MODE LABEL. Trace data is displayed for that channel. Labels are also displayed, unless the soft key function LABELS ON/OFF has selected labels OFF.

CHAN OFF

MEAS RATIO

- A/R
- B/R
- A/B

Selects MEASUREMENT of detector signal RATIOS A/R, B/R, or A/B. When A/R is selected, the displayed data is the measured value of A in dBm (decibel power ratio compared to one milliwatt) minus the measured value of R in dBm. Since the values are in dBm, a logarithmic subtraction equals the linear division A/R. The displayed units for the measurement are dB (decibels). Similar operation occurs for B/R and A/B.

The shift function of this key shuts off labels and data for the channel selected. The channel is turned back on by selecting any other function referring to that channel.

MEAS PWR

- A
- B
- R

Selects MEASUREMENT of detector power A, B, or R in dBm.

Figure 3-1. Front Panel Operating Features (4 of 11)

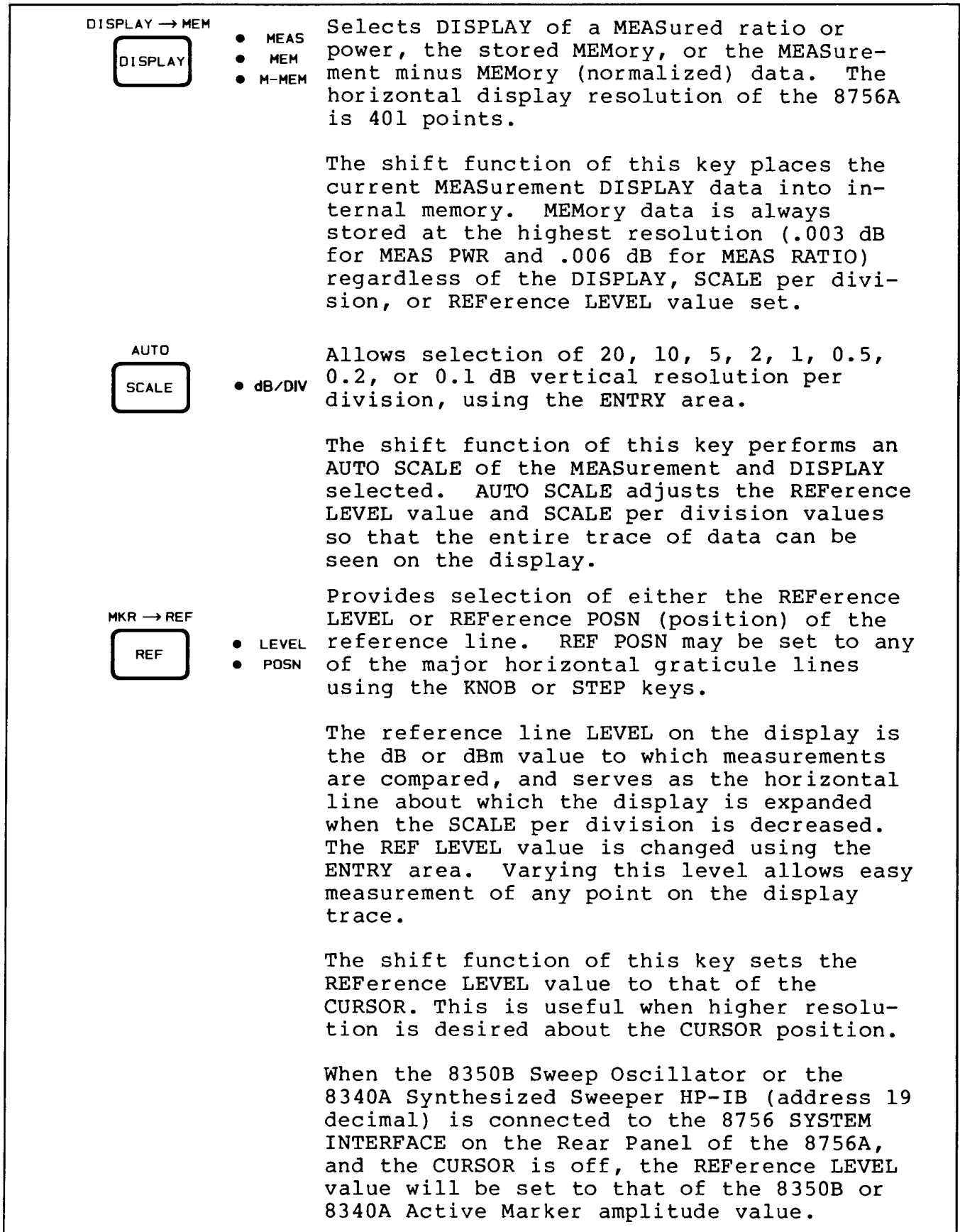
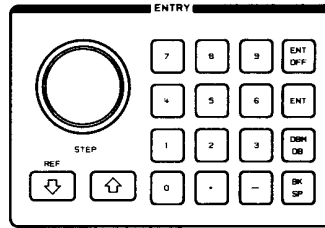

Figure 3-1. Front Panel Operating Features (5 of 11)



3. ENTRY. Data Entry for the SCALE, REF, and soft keys is provided by means of the Knob, the STEP keys, or the Keypad.



Clears the ACTIVE ENTRY AREA.



Terminates the AVG FACTOR (under AVERAGE menu) and ADDRESS (in the INSTRUMENT STATE area) Keypad entries.



Used to terminate keypad entries for SCALE, REF LEVEL, STEP REF, and DET OFFSET (under CAL menu) functions.



Allows backspace to delete of the last digit(s) entered.

Figure 3-1. Front Panel Operating Features (6 of 11)

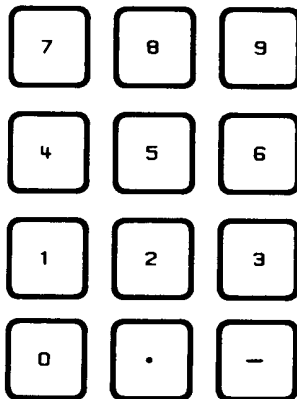

Keypad allows selection of digits, sign, and decimal point for numerical value functions (except CURSOR functions). A terminator (ENT or dBm/dB) is required, except for SAVE and RECALL.

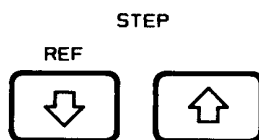

Increments or decrements the numerical value of a function (except CURSOR functions) to the next allowed value.

The shift function of the STEP DOWN key provides for setting the REFERENCE LEVEL step size when using the STEP keys with REF LEVEL. After selecting this function, enter the value desired, and terminate with the dBm/dB key.

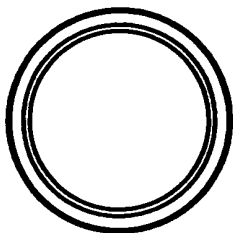

Allows easy entry of CURSOR, SCALE, REF LEVEL, REF POSN, AVG FACTOR, or DET OFFSET (under CAL menu) functions.

Figure 3-1. Front Panel Operating Features (7 of 11)

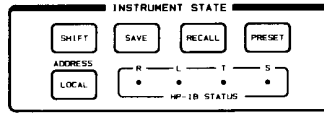

4. INSTRUMENT STATE. This area provides information on the instrument and allows inputs to alter the state.



Enables the shift (blue) functions of the front panel keys.



Allows retention of the current front panel settings. Up to 9 settings may be stored by pressing this key followed by a single digit (1 through 9) on the Keypad. No terminating key is needed. The stored DISPLAY MEMORY for each channel is not saved along with the Instrument State.



Allows recovery of up to 9 front panel settings which have been previously retained in storage registers using the SAVE key. The front panel setting desired is selected by depressing this key followed by a single digit (1 through 9). No terminating key is needed.

NOTE

When the Model 8350B Sweep Oscillator or the Model 8340A Synthesized Sweeper HP-IB (address 19 decimal) is connected to the 8756 SYSTEM INTERFACE, SAVE and RECALL are performed on both the sweep oscillator and the 8756A. Additionally, the Alternate Sweep feature of these sweep oscillators may be enabled by selecting Alternate N, where N is the register for the alternate sweep and front panel settings desired. N must be selected on the sweep oscillator keypad.

Figure 3-1. Front Panel Operating Features (8 of 11)

PRESET

Presets conditions on the 8756A and the 8756 SYSTEM INTERFACE. A self test of the 8756A is first performed, indicated by the lighting of all LED's on the front panel and clearing of the CRT display. Then the following actions take place:

1. Both Channels turned ON:
 - a. MEAS PWR A on Channel 1.
 - b. MEAS PWR B on Channel 2.
 - c. DISPLAY MEAS.
 - d. SCALE 20 dB/div.
 - e. REF LEVEL 0 dB for all DISPLAY's (MEAS, MEM, M-MEM).
 - f. AVERAGING OFF
 - g. AVERAGING FACTOR = 8.
 - h. CURSOR OFF.
 - i. LABELS ON.
 - j. MAIN MENU soft keys.
 - k. Channel 1 set as ACTIVE channel.
 - m. Modulation drive ON.

2. When the 8350B Sweep Oscillator or 8340A Synthesized Sweeper HP-IB (address 19) is connected to the 8756 SYSTEM INTERFACE, the following actions are performed on that source:
 - a. Instrument Preset.
 - b. Sweep time set to 200 ms.
 - c. 8350B Square wave modulation ON; RF Output ON/OFF depending on plug-in internal switch setting.
 - d. 8340A PULSE Modulation Input ON; RF Output ON.

3. If a 9872C or 7470A Plotter (HP-IB address set to 05 decimal) is connected to the 8756 SYSTEM INTERFACE, the following actions are performed on the plotter:
 - a. Abort plot if in progress.
 - b. Return pen to holder.
 - c. The position of P1 and P2 are left unchanged.
 - d. Default conditions for other features.

Figure 3-1. Front Panel Operating Features (9 of 11)

The following are not changed during a PRESET or on receipt of the "IP" command over HP-IB:

REF POSN, MEMOrY, RECALL registers, instrument HP-IB addresses.

ADDRESS



Returns the 8756A to LOCAL operation from the remote operation state unless a Local Lockout command has been received over HP-IB.

The shift function of this key causes the HP-IB address for the 8756A to be displayed in the ACTIVE ENTRY AREA. The address may be changed, if desired, using the keypad and terminated with the ENT key. Allowable values are 1 through 29 decimal; 0, 30, and 31 decimal are not accessible.



This area displays the current HP-IB status of the 8756A, where:

- R = Remote operation
- L = Listen mode
- T = Talk mode
- S = Service request (SRQ) asserted

Figure 3-1. Front Panel Operating Features (10 of 11)

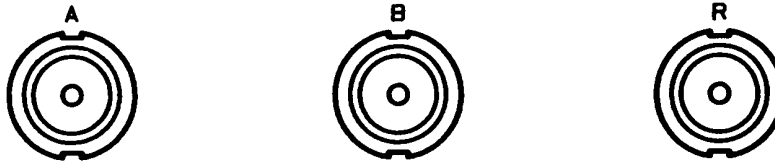

5. DETECTOR INPUTS. Each input has identical characteristics and allows connection of 8756A compatible detectors and/or bridges. A is typically used for the connection of a reflectometer bridge for reflection measurements. B is typically used for the connection of a detector for transmission measurements. R is typically used for the reference detector input when making ratio measurements.

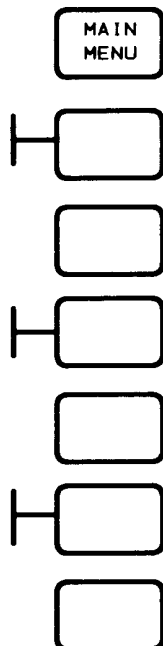

6. SOFT KEYS. These keys provide for additional functions of the 8756A beyond that of the Front Panel keys discussed above. Related functions are grouped into a soft key menu. A particular function on the menu displayed in the SOFT KEY LABEL area is selected by pressing the key to the immediate right of the label. The MAIN MENU key displays and restores the MAIN MENU to the SOFT KEY LABEL area. More details on the soft key menus and functions are discussed in the Fig. 3-2, SOFT KEY OPERATING FEATURES.

7. CRT DISPLAY CONTROLS.

INTENSITY



Allows for adjustment of the CRT display brightness.

FOCUS



Allows for screwdriver adjustment of the focus of the CRT display.

Figure 3-1. Front Panel Operating Features (11 of 11)

SOFT KEY OPERATING FEATURES

MAIN MENU

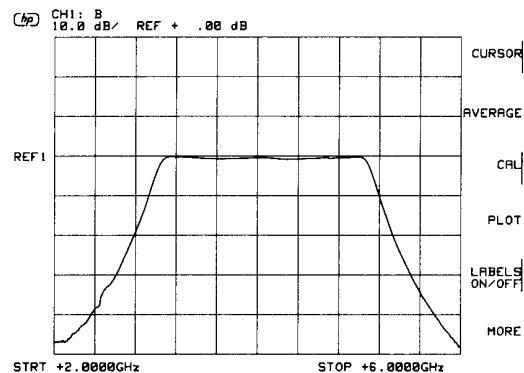

The MAIN MENU is the primary means of selecting all of the Soft Key functions and menus. When the MAIN MENU or PRESET key is pressed, the MAIN MENU of Soft Keys is always displayed. A particular soft key menu or function is selected by then pressing the key to the immediate right of the label on the CRT display. Selection of MAIN MENU does not alter any previously selected function parameter, either from the Front Panel or Soft Key. The following pages describe each Soft Key menu or function listed in the MAIN MENU.

Figure 3-2. Soft Key Operating Features (1 of 10)

CURSOR Menu

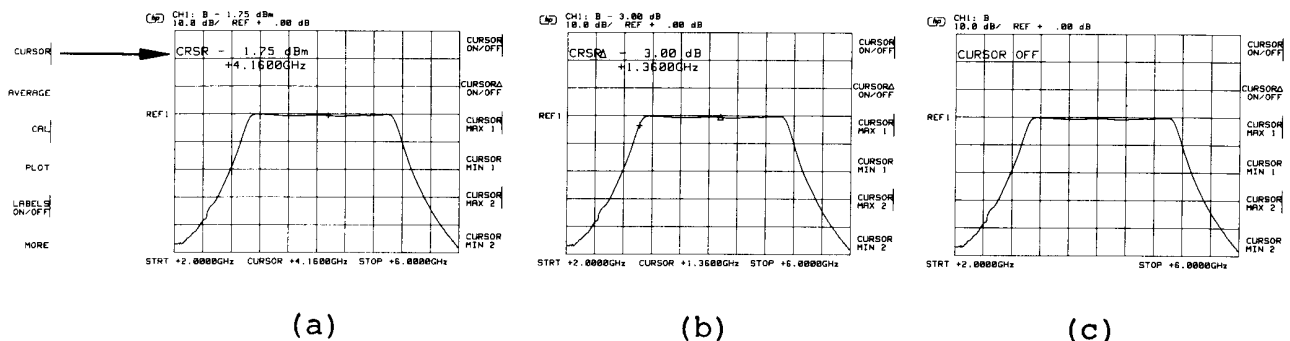

When CURSOR is selected on the MAIN MENU, the CRT will appear as shown in (a), with the CURSOR (+ symbol) turned ON.

CURSOR ON/OFF alternately turns the CURSOR ON, as shown in (a), and OFF, as shown in (c). When ON, the CURSOR appears on any of the active data traces. The Knob is used to move the CURSOR to any point on the data traces. The amplitude of the measurement for a selected channel appears in the upper right corner of the MODE LABEL, and also appears in the ACTIVE ENTRY AREA for the Active Channel. This amplitude is always the selected MEASUREMENT and DISPLAY reading, resolved to 0.01 dB, regardless of the SCALE per division or REFERENCE LEVEL value.

If either the 8350B Sweep Oscillator or the 8340A Synthesized Sweeper HP-IB is connected to the 8756 SYSTEM INTERFACE, the CURSOR frequency value appears in the FREQUENCY LABELS and also in the ACTIVE ENTRY AREA for the Active Channel. When Alternate Sweep is selected, both CURSOR frequencies will appear for each sweep in the FREQUENCY LABELS.

Figure 3-2. Soft Key Operating Features (2 of 10)

CURSOR Δ ON/OFF alternately turns the CURSOR Δ ON, as shown in (b), and OFF, as shown in (a). When ON, the last set position of the CURSOR (regardless of whether the CURSOR was ON or OFF) is marked by the Δ symbol.

Rotating the Knob moves the CURSOR (+ symbol), and the amplitude readings in the MODE LABELS and ACTIVE ENTRY AREA are now relative to the Δ symbol position.

If either the 8350B Sweep Oscillator or the 8340A Synthesized Sweeper HP-IB is connected to the 8756 SYSTEM INTERFACE, the absolute value frequency difference between the Δ symbol position and the + symbol position are annotated in the FREQUENCY LABELS and also in the ACTIVE ENTRY AREA. When Alternate Sweep is selected, both CURSOR Δ frequencies will appear for each sweep in the FREQUENCY LABELS.

CURSOR MAX 1 positions the CURSOR (+ symbol) to the maximum value point on the Channel 1 trace.

CURSOR MIN 1 positions the CURSOR (+ symbol) to the minimum value point on the Channel 1 trace.

CURSOR MAX 2 positions the CURSOR (+ symbol) to the maximum value point on the Channel 2 trace.

CURSOR MIN 2 positions the CURSOR (+ symbol) to the minimum value point on the Channel 2 trace.

Both the MAX and MIN functions may be used with either CURSOR or CURSOR Δ selected.

Figure 3-2. Soft Key Operating Features (3 of 10)

AVERAGE Menu

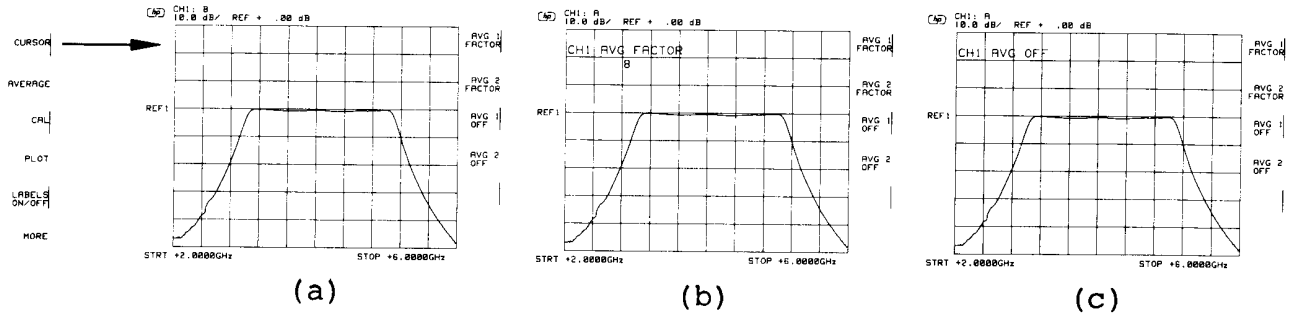

When AVERAGE is selected on the MAIN MENU, the AVERAGE Menu appears, as shown in (a).

AVG 1 FACTOR turns averaging ON for Channel 1. The Averaging Factor last set is displayed in the ACTIVE ENTRY AREA, as shown in (b). (The PRESET value is 8.) This factor may be changed at this time using the ENTRY area.

AVG 2 FACTOR turns averaging ON for Channel 2. The Averaging Factor last set is displayed in the ACTIVE ENTRY AREA, as shown in (b), except that Channel 2 is the Active Channel. (The PRESET value is 8.) This factor may be changed at this time using the ENTRY area.

The Averaging Factors allowed are 1 (no averaging), 2, 4, 8, 16, 32, 64, 128, and 256.

The averaging technique used is exponential averaging, with data displayed using the following formula:

$$\begin{matrix} \text{CURRENT} \\ \text{DISPLAYED} \\ \text{DATA} \end{matrix} = \frac{(\text{AF}-1)}{\text{AF}} * \begin{matrix} \text{LAST} \\ \text{DISPLAYED} \\ \text{DATA} \end{matrix} + \frac{1}{\text{AF}} * \begin{matrix} \text{CURRENT} \\ \text{MEASURED} \\ \text{DATA} \end{matrix}$$

where AF=Averaging Factor.

AVG 1 OFF turns averaging OFF for Channel 1; this condition is indicated as shown in (c).

AVG 2 OFF turns averaging OFF for Channel 2; this condition is indicated as shown in (c), except that Channel 2 is the Active Channel.

Figure 3-2. Soft Key Operating Features (4 of 10)

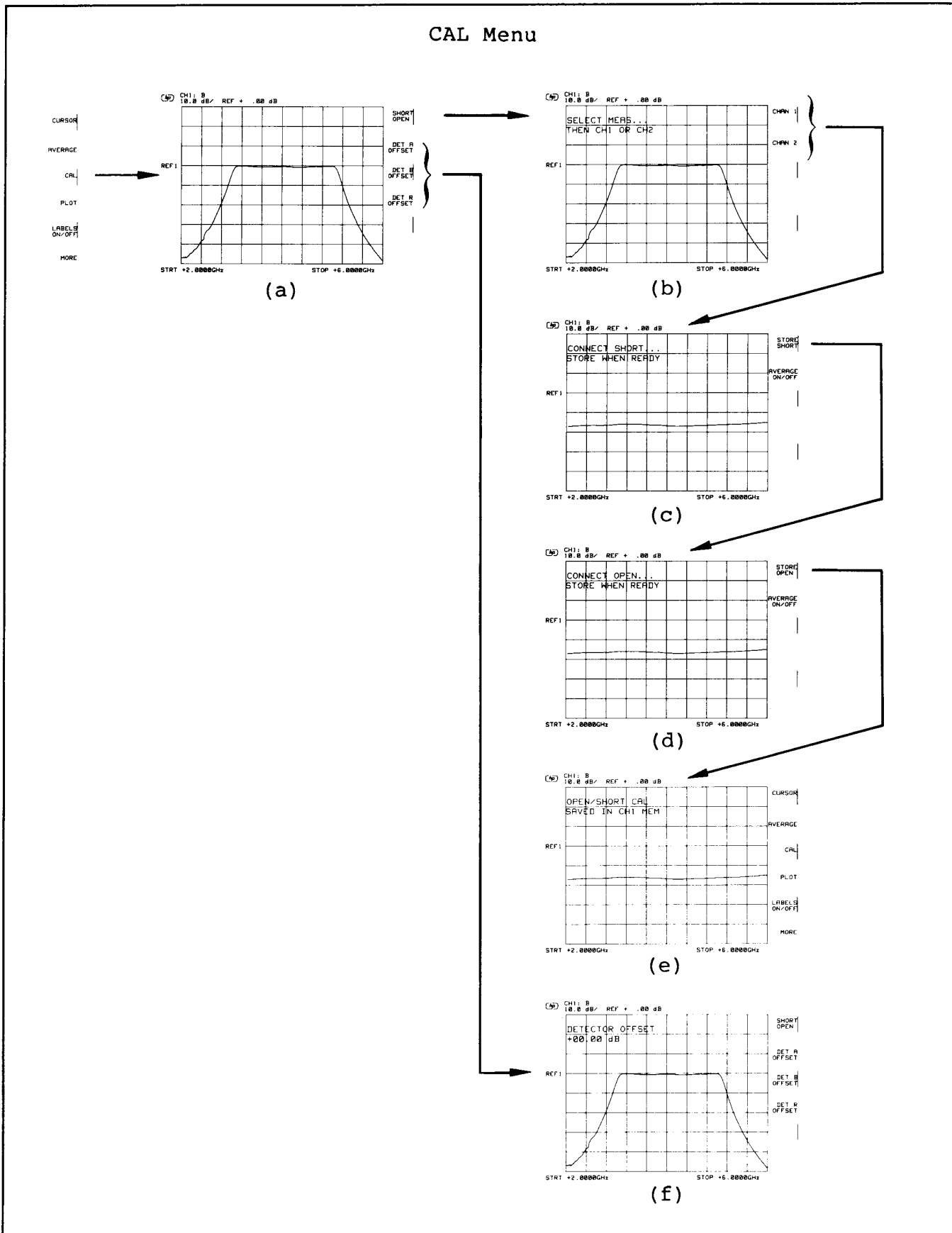

Figure 3-2. Soft Key Operating Features (5 of 10)

When CAL is selected on the MAIN MENU, the CAL Menu appears, as shown in (a).

SHORT OPEN begins the Open/Short Calibration, useful for making accurate reflection measurements. Through a series of prompts, the user performs an open & short circuit average, which in turn, is stored into MEMORY for calibration of the Channel desired.

The user is first prompted, as shown in the ACTIVE ENTRY AREA of (b), to SELECT MEAS...THEN CH1 or CH2. At this point, the user selects MEAS RATIO or MEAS PWR on Channel desired.

When ready, the soft key CHAN1 or CHAN2 is pressed, depending on which Channel was selected for making the reflection measurement. This action displays the next prompt CONNECT SHORT...STORE WHEN READY, as shown in the ACTIVE ENTRY AREA of (c). At this point, a short circuit should be connected to the test port of the directional bridge/coupler. If desired, averaging may be turned ON/OFF with the AVERAGE ON/OFF soft key to reduce noise on the trace. (The Averaging Factor is whatever value last set.)

When the short circuit trace data is displayed as desired, STORE SHORT is depressed. This action displays the next prompt CONNECT OPEN...STORE WHEN READY, as shown in the ACTIVE ENTRY AREA of (d). At this point, an open circuit (a shielded open is recommended) to the test port. As with the short circuit, averaging may be turned ON/OFF with the AVERAGE ON/OFF soft key to reduce noise on the trace.

When the open circuit trace data is displayed as desired, STORE OPEN is depressed. The ACTIVE ENTRY AREA now indicates the action taken: OPEN/SHORT CAL SAVED IN CH1 (or 2) MEM, as shown in (e). This acknowledges that the open/short calibration is now stored in MEMORY for the Channel selected. Selection of DISPLAY M-MEM for that Channel shows the trace data relative to the calibration.

DET A OFFSET displays the current value of offset entered for the A detector input, as shown in (f).

DET B OFFSET displays the current value of offset entered for the B detector input.

DET R OFFSET displays the current value of offset entered for the R detector input.

The value of OFFSET may be changed using the ENTRY area. The OFFSET is useful for entering the difference between the reading on the 8756A with a specific detector and the reading with a power meter; this provides better accuracy. The OFFSET is also useful for entering the value of attenuation used when an attenuator is connected in front of a detector (padding).

Figure 3-2. Soft Key Operating Features (6 of 10)

PLOT Menu

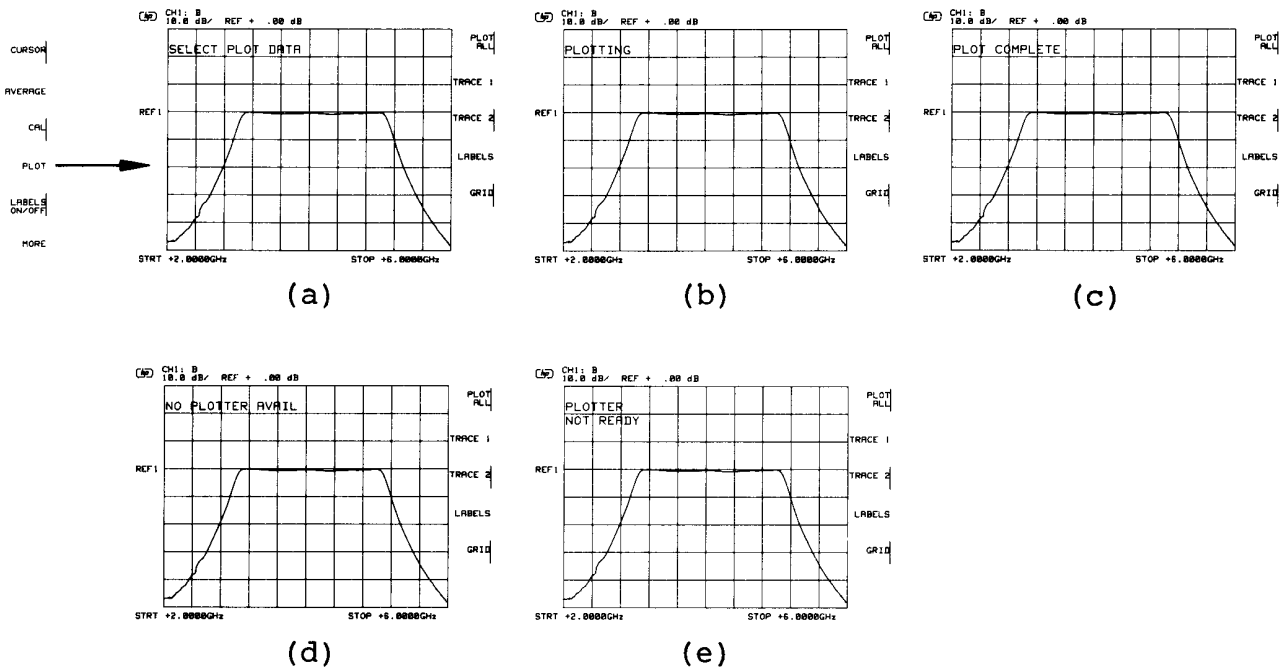

When PLOT is selected on the MAIN MENU, the PLOT menu appears, as shown in (a). The prompt SELECT PLOT DATA is shown in the ACTIVE ENTRY AREA. This menu allows for plots to be made onto the HP-IB Plotter (either the 7470A or 9872C) connected to the 8756 SYSTEM INTERFACE. The Plotter address switches must be set to 00101 binary or 05 decimal for proper operation. The P1 and P2 positions (bottom left limit and upper right limit, respectively) will be the Plotter's default values, but may be changed by the user at any time after powering on the Plotter. Refer to the Plotter Operating Manual for the procedure on changing P1 and P2.

Figure 3-2. Soft Key Operating Features (7 of 10)

PLOT ALL draws the grid, labels, trace data, CURSOR, and markers on the HP-IB plotter. Graphics written to the CRT over the HP-IB of the 8756A will not be drawn on this plot; however, the user may access the plotter by means of passing through commands (see HP-IB Operating Features, Fig. 3-4).

TRACE 1 draws the trace data, CURSOR, and markers for Channel 1.

CURSOR is denoted as \diamond , the CURSOR \triangle AS \triangle , and the markers as \diamond .

TRACE 2 draws the trace data, CURSOR, and markers for Channel 2.

CURSOR is denoted as \diamond , the CURSOR \triangle AS \triangle , and the markers as \diamond .

LABELS draws the MODE LABELS, reference line position labels, and the FREQUENCY LABELS.

GRID draws the grid (or graticule) lines.

If the HP-IB Plotter has its address switches set to 05 decimal, and its HP-IB is properly connected to the 8756 SYSTEM INTERFACE, the CRT Display is frozen, the plotter begins plotting, and the ACTIVE ENTRY AREA appears as shown in (b) when any of the PLOT Menu soft keys are pressed. When the plot is finished, the CRT display appears as shown in (c).

If the HP-IB Plotter is improperly connected (or not connected at all) to the 8756 SYSTEM INTERFACE, the CRT display appears as shown in (d).

If the HP-IB Plotter is not ready (paper not loaded, error message, etc.), but is properly connected to the 8756 SYSTEM INTERFACE, the CRT display appears as shown in (e).

When the 8350B Sweep Oscillator or 8340A Synthesized Sweeper HP-IB is also connected to the 8756 SYSTEM INTERFACE, annotation of Start, Stop, and CURSOR (if ON) frequencies will also appear on the bottom of the plots when PLOT ALL or LABELS is pressed. If the CURSOR is off and a marker or markers are on, the Active Marker will appear in the frequency annotation and will be shown on the trace data as a \diamond .

Figure 3-2. Soft Key Operating Features (8 of 10)

LABELS ON/OFF

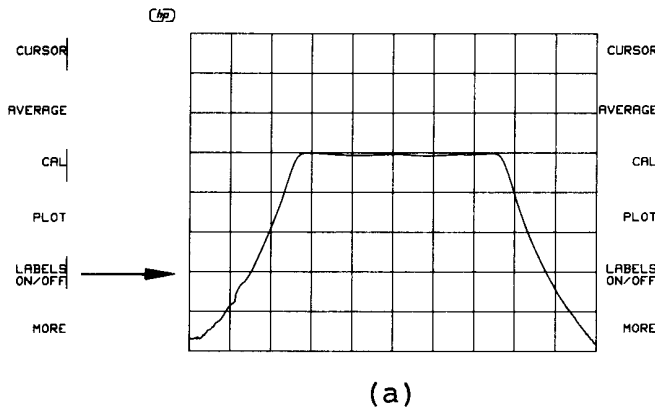

When LABELS ON/OFF is selected on the MAIN MENU, the MODE LABELS, and Reference Line Position labels are alternately turned OFF, as shown in (a), and ON.

When the 8350B Sweep Oscillator or the 8340A Synthesized Sweeper HP-IB is connected to the 8756 SYSTEM INTERFACE, the FREQUENCY LABELS will be alternately turned OFF and ON also.

Figure 3-2. Soft Key Operating Features (9 of 10)

MORE Menu

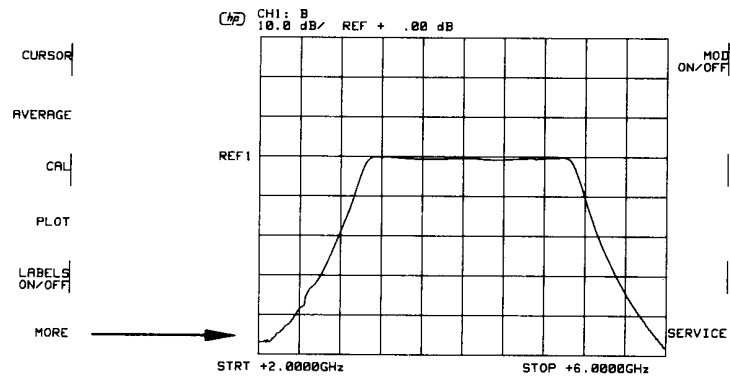

(a)

When MORE is selected on the MAIN MENU, the MORE menu appears, as shown in (a).

MOD ON/OFF turns the 27.8 kHz square wave output from the MODULATOR DRIVES, located on the rear panel of the 8756A, ON and OFF. When OFF, the MODULATOR DRIVES provide the power necessary to hold an external modulator in the minimum insertion loss mode.

SERVICE provides for enabling the built-in serviceability routines (see Section VIII Service).

REAR PANEL OPERATING FEATURES

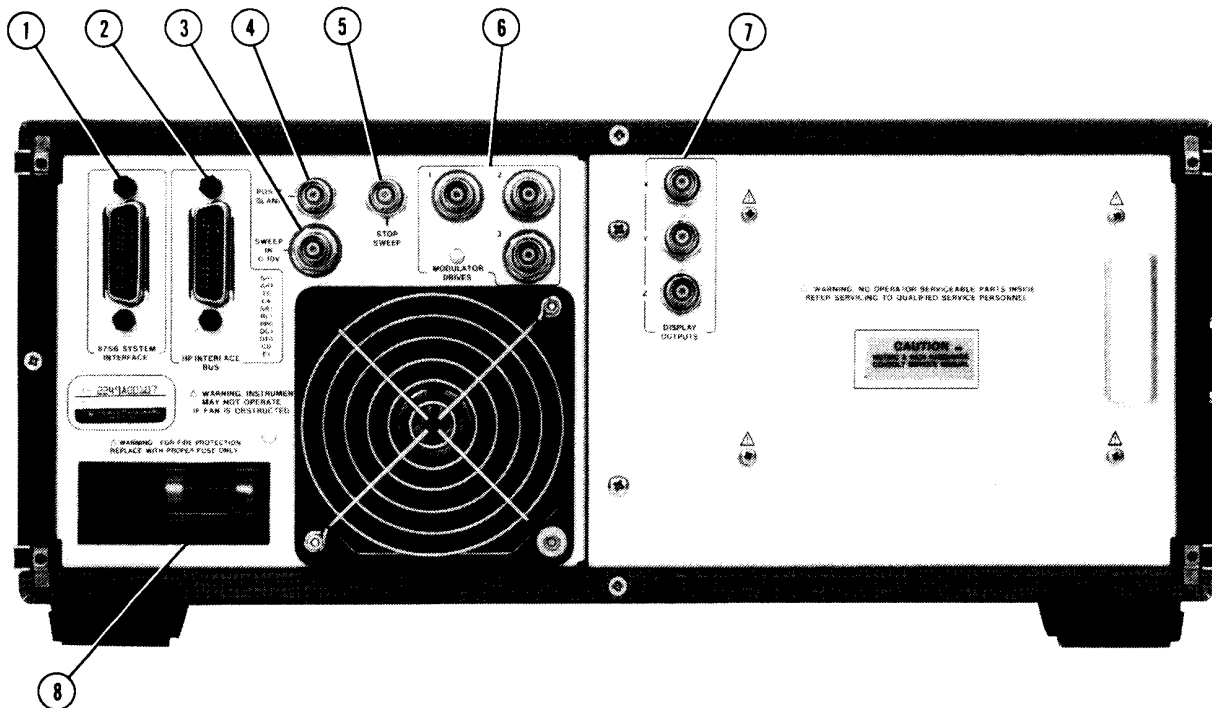

1. 8756 SYSTEM INTERFACE

Input/Output connector provides control of the HP 8350B Sweep Oscillator or the HP 8340A Synthesized Sweeper and the HP-IB Plotters, Model 7470A or 9872C, through their respective HP-IB connectors. This control is accomplished without the use of an external HP-IB controller. The 8350B or the 8340A address must be set to 19 decimal; the 7470A or 9872C address must be set to 05 decimal.

The 8756 SYSTEM INTERFACE control of the 8350B or the 8340A provides frequency annotation shown in the FREQUENCY LABELS of the CRT display, SAVE, RECALL, and PRESET (pressed on either instrument) of both instruments, and Alternate Sweep capability.

The 8756 SYSTEM INTERFACE control of the 7470A or the 9872C provides for hard copy plots, using the PLOT Menu of the Soft Keys, and PRESET to default values for the plotter.

2. HP INTERFACE BUS

Input/Output connector allows interfacing to HP-IB controllers. The HP-IB address is set at the factory to 16 decimal, which may be changed using the ADDRESS function (SHIFT LOCAL). Other instruments may be connected to the HP-IB, but must be set to a different address value.

Figure 3-3. Rear Panel Operating Features (1 of 2)

3. **SWEEP IN 0-10V**
Input BNC connector accepts the 0 to +10 volt sweep ramp signal from the sweep oscillator.
4. **POS Z BLANK**
Input BNC connector accepts retrace and bandswitch blanking and accepts negative Intensity Marker (Z-axis modulation) signals. The signal levels sensed on this input are +5 volts for blanking, 0 volts for display, -4 volts for markers, and -8 volts for the Active Marker.
5. **STOP SWEEP**
Output BNC connector provides the interface signal to stop the sweep on the 8350B Sweep Oscillator or the 8340A Synthesized Sweeper, used only when these are controlled by the 8756 SYSTEM INTERFACE.

NOTE

Connection of the SWEEP IN 0-10V and the POS Z BLANK from a sweeper or source are the minimum requirements needed for proper operation of the 8756A. When the 8350B Sweep Oscillator or the 8340A Synthesized Sweeper is connected to the 8756 SYSTEM INTERFACE, connection of STOP SWEEP is mandatory.

6. **MODULATOR DRIVES**
Output connectors, each providing 27.8 kHz square wave signals (nominally +/- 6 volts, unloaded), for driving external HP 11665B modulators or the external Amplitude Modulation of a sweep oscillator. When using the 8340A Synthesized Sweeper, this modulator drive should be connected to the PULSE MODULATION INPUT.
7. **DISPLAY OUTPUTS**
Output connectors providing X, Y, and Z outputs for driving another peripheral such as a large screen display (for example, Model 1310B). The added peripheral should have a bandwidth of 5 MHz or greater. The open circuit amplitude of the X and Y axis outputs range from 0 to 1 volt from a source impedance of about 340 ohms. The Z axis output has the same voltage range, but a source impedance of about 250 ohms. A 0 volt Z axis output corresponds to display mode, 1 volt output corresponds to blanking mode. These output circuits are designed for use with Hewlett-Packard large screen displays with 10 K ohms impedances, and cannot drive impedances less than 600 ohms. Cable lengths to this display should not exceed 6 feet (1.83 meters).
8. **POWER LINE MODULE**
Input connector accepts line voltage. Line voltage selection of 100, 120, 220, or 240 volts is chosen by correctly inserting the printed circuit selector board. Refer to Fig. 2-1 in Section II Installation for instructions.

Figure 3-3. Rear Panel Operating Features (2 of 2)

HP-IB OPERATING FEATURES

Remote operation of the HP 8756A Scalar Network Analyzer is accomplished using the Hewlett-Packard Interface Bus, HP-IB, which is the Hewlett-Packard implementation of IEEE standard 488 dated 1978 and IEC 625-1. For more information on the HP-IB, refer to the Tutorial Description of the Hewlett-Packard Interface Bus, Literature No. 5959-0156, and Condensed Description of the Hewlett-Packard Interface Bus, Part No. 59401-90030.

NOTE

Remote operation of the HP 8756A applies to operations with the HP INTERFACE BUS (HP-IB) connector on the rear panel of the HP 8756A. Do not connect an HP-IB controller to the 8756 SYSTEM INTERFACE connector; HP-IB control of the instruments connected to this port is described in the 8756 SYSTEM INTERFACE section below.

PROGRAMMING COMMANDS

The HP 8756A accepts specific programming commands (LISTEN mode) for selecting front panel key functions, soft key functions, and special HP-IB only functions. It outputs data from a designated channel measurement trace or memory trace in one of two formats specified by the user, as well as other TALK functions. Also, the HP 8756A can pass through HP-IB commands to either the HP 8350B Sweep Oscillator or the HP 8340A Synthesized Sweeper and the HP 7470A or 9872C plotter connected to the 8756 SYSTEM INTERFACE.

All of these codes are described in these tables.

Table 3-1. Function Select Commands.

Table 3-2. Output Mode Commands and Formats.

Table 3-3. Cross Reference of Tables 1 and 2.

For more information on the front panel key functions, see Figure 3-1; on the soft key functions, see Figure 3-2. These perform the same function whether under remote or local.

INPUT COMMAND SYNTAX

The 8756A commands may be sent as upper and/or lower case ASCII characters. Variable length commands (two characters followed by two or more digits) and all commands beginning with the letter "O" must be terminated with a semicolon ";", a carriage return, line feed "[cr][lf]", a "[lf]", a "DB;", a "db;", a "DB[cr][lf]", or a "db[cr][lf]". The latter four are useful for improving legibility of programs.

NOTE

Commands and characters enclosed in quotation marks " " refer to the standard ASCII Character Set.

Figure 3-4. HP-IB Operating Features (1 of 7)

FORMATS OF NUMERICAL INPUTS

Throughout Tables 3-1 and 3-3, numerical inputs are appended to some commands. These are:

Format/Values

- m 0 = Function Off.
 1 = Function On.

- d Variable length parameter, including sign and decimal point, if desired. These parameters require the terminators ";", "[cr][lf]", "[lf]", "DB;", "db;", "DB[cr][lf]", or "db[cr][lf]". **When the value of d does not correspond to the function's resolution or range, d will be rounded and assigned the closest allowable value.**

- n Decimal integers 1 through 9.

- q Values unique to the particular function and explained under COMMAND DESCRIPTION or NOTES.

HP-IB ONLY FUNCTIONS

HP-IB only functions are shown in Table 3-1.

The Blank CRT Display Features commands provide for blanking the entire CRT display or restoring the display to its normal, power on condition.

The Clear Status command clears (sets to zero) both Status Bytes.

The Format Data commands are useful for outputting data, as shown in Table 3-2. The Format Data ASCII, "FD0" command, will output data in the format of ASCII signed digits, as shown in the table. The Format Data Binary, "FD1" command, will output data in the form of two bytes, the most significant byte sent first, when using the Output Cursor, Output Data, or Output Value commands. If these are read as a 16 bit word, and converted to a decimal value, the following formulas may be used to scale the data:

MEAS RATIO or M-MEM:

$$\text{dB value} = (\text{decimal value}) * 180 / 32767 - 90$$

MEAS PWR

$$\text{dBm value} = (\text{decimal value}) * 90 / 32767 - 70$$

The Pass Through command is discussed under the 8756 SYSTEM INTERFACE. Request Mask is explained under SERVICE REQUEST & STATUS BYTES.

Figure 3-4. HP-IB Operating Features (2 of 7)

The Set Cursor Position command is useful for setting the CURSOR on a data trace at a specific frequency. Given the Start and Stop frequencies, the CURSOR may be set to a Frequency using the formula:

$$\text{Set Cursor Position value} = (\text{Frequency} - \text{Start}) * 400 / (\text{Stop} - \text{Start})$$

Non Swept Mode stops the update of data traces with the 0 to 10 volt sweep ramp, and is used to hold data for taking the measurement and outputting the data. Swept Mode causes the data traces to update with the sweep ramp, and should be received by the 8756A to restore normal swept frequency displays.

Take Sweep is used to take a specific number of sweeps, then hold data on the display. This is useful for controlling the 8756A in normalization (M-MEM) and averaging applications.

Write Key is used to put user defined labels on the Soft Keys. The "WK" command is followed by the soft key number in ASCII, range 1 through 6. Then, this is followed by "[ASCII label]" for a single line label or "[ASCII label][term],[ASCII label][term]" for a two line label. The ASCII label must be seven characters or less and terminated as shown by [term] = [cr][lf] or semicolon ; .

Write Memory is used to write to a particular channel memory with 401 points of data. After receiving the "WM" command, the 8756A expects 401 values in the format ("FD1" or "FD0") previously selected. These values, in turn, are written to the Channel Memory previously designated ("C1" or "C2").

HP-IB OUTPUT COMMANDS

Data is output from the 8756A by first sending one of the "O" commands listed in Table 3-2. Output Cursor, Output Data, and Output Value are used to obtain measurement data, in either ASCII format ("FD0") or Binary format ("FD1"), where the most significant byte is sent first.

Refer to Table 3-2 for Output Identity and Output Keycode. The Output Status command is explained under SERVICE REQUEST & STATUS BYTES.

HP-IB ERROR MESSAGES

Any alphanumeric sequence which is not a recognized 8756A command will be noted on the CRT in the ACTIVE ENTRY Area as "UNKNOWN CMD-" followed by the last one or two characters received by the 8756A over HP-IB. The 8756A will not lock out further HP-IB traffic, and will execute any subsequent valid command. Further, a syntax error service request (SRQ) will be sent if that SRQ bit has been enabled in the Request Mask (see SERVICE REQUEST & STATUS BYTES below). If there are many errors in the alphanumeric sequence, only the last error is displayed in the ACTIVE ENTRY AREA.

Figure 3-4. HP-IB Operating Features (3 of 7)

CAPABILITY IDENTIFICATION CODE

The 8756A has the following capability code, in conformance with IEEE 488-1978:

SH1: Source handshake
 AH1: Acceptor handshake
 T6: Basic talker; Serial Poll; Unaddress to talk if addressed to listen
 L4: Basic listener; Unaddressed to listen if addressed to talk
 SR1: Service Request
 RL1: Remote; Local
 PP0: No Parallel Poll
 DC1: Device Clear
 DT0: No Device Trigger
 C0: No Controller (Take or Pass Control)
 E1: Open collector bus drivers

DEFAULT ADDRESS

The HP-IB address for the HP 8756A is set at the factory to decimal 16. The current address value may be easily determined by depressing the ADDRESS (SHIFT LOCAL) key on the front panel and observing the ACTIVE ENTRY AREA on the CRT display. It may be changed, if desired, by keying in the digits, using the Keypad in the ENTRY area, range 01 to 29 decimal, followed by pressing the ENT key. (Remember that most HP-IB controllers use address 21 decimal; thus, use of address 21 decimal should be avoided. Further, see 8756 SYSTEM INTERFACE below.) This address will become the address and remain unchanged even if power is turned off, or "IP" is received.

8756 SYSTEM INTERFACE

The 8756 Rear Panel has another control port called the 8756 SYSTEM INTERFACE. This connector is physically the same as that defined for the Hewlett-Packard Interface Bus, but is specifically used to control an HP-IB Sweep Oscillator (HP 8350B or 8340A) or an HP-IB plotter (HP 7470A or 9872C) through their respective HP-IB. Sweep Oscillator or Plotter HP-IB commands are **passed through** the HP 8756A's HP-IB to the 8756 SYSTEM INTERFACE.

The transfer of commands and data is performed by first sending a Pass Through "PTd" command to the HP 8756A, where d is 19 decimal for passing through to the HP-IB Sweep Oscillator or 05 decimal for passing through to the HP-IB Plotter.

Subsequent addressing of the 8756 SYSTEM INTERFACE address will pass through commands to the instrument selected. The "PTd" command may be sent at any time.

The address of the 8756 SYSTEM INTERFACE is determined by complementing the least significant bit of the current HP 8756A

address. For example, since the HP 8756A default address is 16 decimal = 10000 binary, the default 8756 SYSTEM INTERFACE address is 17 decimal = 10001 binary. As another example, if the HP 8756A address is 7 decimal = 111 binary, then the SYSTEM INTERFACE address becomes 6 decimal = 110 binary.

An example of pass through commands to the HP-IB Sweep Oscillator with address 19 decimal using the default HP 8756A address is:

1. Address device 16 (the HP-IB of the HP 8756A); send the characters "PT19;" or "PT19[cr][lf]".
2. Address device 17 (the 8756 SYSTEM INTERFACE); send sweeper HP-IB commands.
3. Address device 16. This returns the HP 8756A to its normal HP-IB operation.
4. Subsequent addressing of device 17 will send commands to the HP-IB Sweep Oscillator.

An example of pass through commands to the HP-IB Plotter with address 05 decimal using the default HP 8756A address is:

1. Address device 16 (the HP-IB of the HP 8756A); send the characters "PT05;" or "PT05[cr][lf]".
2. Address device 17 (the 8756 SYSTEM INTERFACE); send HP-GL commands to the Plotter.
3. Address device 16. This returns the HP 8756A to its normal HP-IB operation.
4. Subsequent addressing of device 17 will send commands to the HP-IB plotter.

RESPONSE TO UNIVERSAL COMMANDS

ABORT

The HP 8756A responds to the ABORT message (IFC, Interface Clear line set to TRUE) by stopping all Listener or Talker functions.

CLEAR

The DCL (Device Clear) and SDC (Selective Device Clear) messages clear all status bytes, the Request Mask, the HP-IB of the HP 8756A and the 8756 SYSTEM INTERFACE. The current front panel settings are unchanged.

Figure 3-4. HP-IB Operating Features (5 of 7)

PASS CONTROL

The HP 8756A does not respond to the TCT (Take Control) message; thus it cannot take or pass control of the HP-IB.

REMOTE/LOCAL/LOCAL LOCKOUT

The HP 8756A is in remote mode when the REN (Remote Enable) line on the interface goes low (TRUE) and it receives its Listen Address. This condition is indicated when the "R" (Remote) and "L" (Listen) LED's are lit in the INSTRUMENT STATE area of the front panel. When the HP 8756A receives its Talk Address, the "T" (Talk) LED is lit and the "L" LED goes out. Under remote, only the LINE switch and the LOCAL key are enabled. On receipt of the LLO (Local Lockout) message, the LOCAL key is disabled.

The state of the REN line is also sensed by the 8756 SYSTEM INTERFACE; an instrument on this interface, designated as the pass through instrument on the 8756 SYSTEM INTERFACE with the PT command, is placed in remote or local depending on the state of this line. When the 8756A is placed in Local Lockout, the HP-IB Sweep Oscillator is also placed in Local Lockout.

The HP 8756A will return to local mode when it receives the GTL (Go To Local) message or when the REN line goes high (FALSE). It will also return to local when the LOCAL key is pressed unless the LLO message was previously received. On power on, the HP 8756A is in local mode.

When the 8756A is first placed in Remote, the instrument state front panel settings are unchanged. Those functions not specifically programmed are also not changed, unless the "IP" command is received.

PARALLEL POLL & STATUS BIT

The HP 8756A does not respond to the PPC (Parallel Poll Configure) or PPU (Parallel Poll Unconfigure) messages.

TRIGGER

The HP 8756A does not respond to the GET (Group Execute Trigger) message.

SERVICE REQUEST & STATUS BYTES

The HP 8756A can initiate a Service Request (SRQ) message when one of the following conditions exists:

1. A Service Request (SRQ) has been initiated by the instrument designed as the pass through instrument.
2. HP-IB Command Syntax Error.
3. End of Operation (sweep or plot completed).

Figure 3-4. HP-IB Operating Features (6 of 7)

4. Self Test failed.
5. Any front panel key pressed.
6. Numeric Entry completed (HP-IB or front panel).
7. Soft key only pressed.
8. Battery voltage low (for nonvolatile memory).

The actual condition may be determined by executing a Serial Poll and then reading the Status Byte. A Serial Poll operation consists of sending the HP 8756A its Talk address, sending the SPE (Serial Poll Enable) message, reading the Status Byte on the bus, and sending the SPD (Serial Poll Disable) message.

Both the Status Byte and Extended Status Byte are obtained by sending the Output Status "OS" command and by immediately reading the two byte values, respectively. The Status Bytes of the HP 8756A are described in Table 3-6. The SRQ is cleared only by executing a Serial Poll, Device Clear (DCL), Selective Device Clear (SDC), PRESET, or sending the CS or OS commands.

The Request Mask function "RM" can be used to select a particular set of condition(s) for initiating a Service Request (SRQ). The mask value is determined by summing the decimal values of each selected condition that needs to be determined. The default Request Mask is zero (no SRQ's are initiated), which is reset to this value at power on.

PRESET

A self test is first performed when the "IP" command is received by the HP 8756A, followed by presetting conditions as described under INSTRUMENT STATE, PRESET in Figure 3-1.

Figure 3-4. HP-IB Operating Features (7 of 7)

CRT GRAPHICS

INTRODUCTION

The HP 8756A CRT Graphics are also controlled by the 8756 SYSTEM INTERFACE. The Graphics commands are mostly a subset of the Hewlett-Packard Graphics Language (HP-GL), shown in Table 3-4. This HP-GL subset allows the HP 8756A to understand most HP desktop computer plotter output commands. The HP 8756A CRT Graphics characters used for labeling are shown in Table 3-5, HP 8756A Modified ASCII Code Conversion Table. These modified ASCII characters are available only when using the "LB" command explicitly; most desktop computer plotter commands use the Standard ASCII Code character set.

The address of the CRT Graphics is the HP 8756A address minus 1; since the default address of the HP 8756A is 16 decimal, the default address of the CRT is 15 decimal. An example of addressing the CRT Graphics using the default addresses is:

1. Address device 16 (the HP-IB of the HP 8756A); send the characters "PT15;" or "PT15[cr][lf]".
2. Address device 17 (the 8756 SYSTEM INTERFACE); send Table 4 commands.
3. Address device 16. This returns the HP 8756A to its normal HP-IB operation.
4. Subsequent addressing of device 17 will send commands to the CRT Graphics.

NOTE

All CRT Graphics Commands must be terminated with a semicolon ";" or a "[lf]"; the character "[cr]" is ignored. For the syntax examples shown below, [term] = either of these terminators.

PLOTTING

The plotting area defined on the CRT display is divided into graphics display units (GDU's) where one GDU is approximately 0.05 mm. The plotting area and the location of the graticule are shown below:

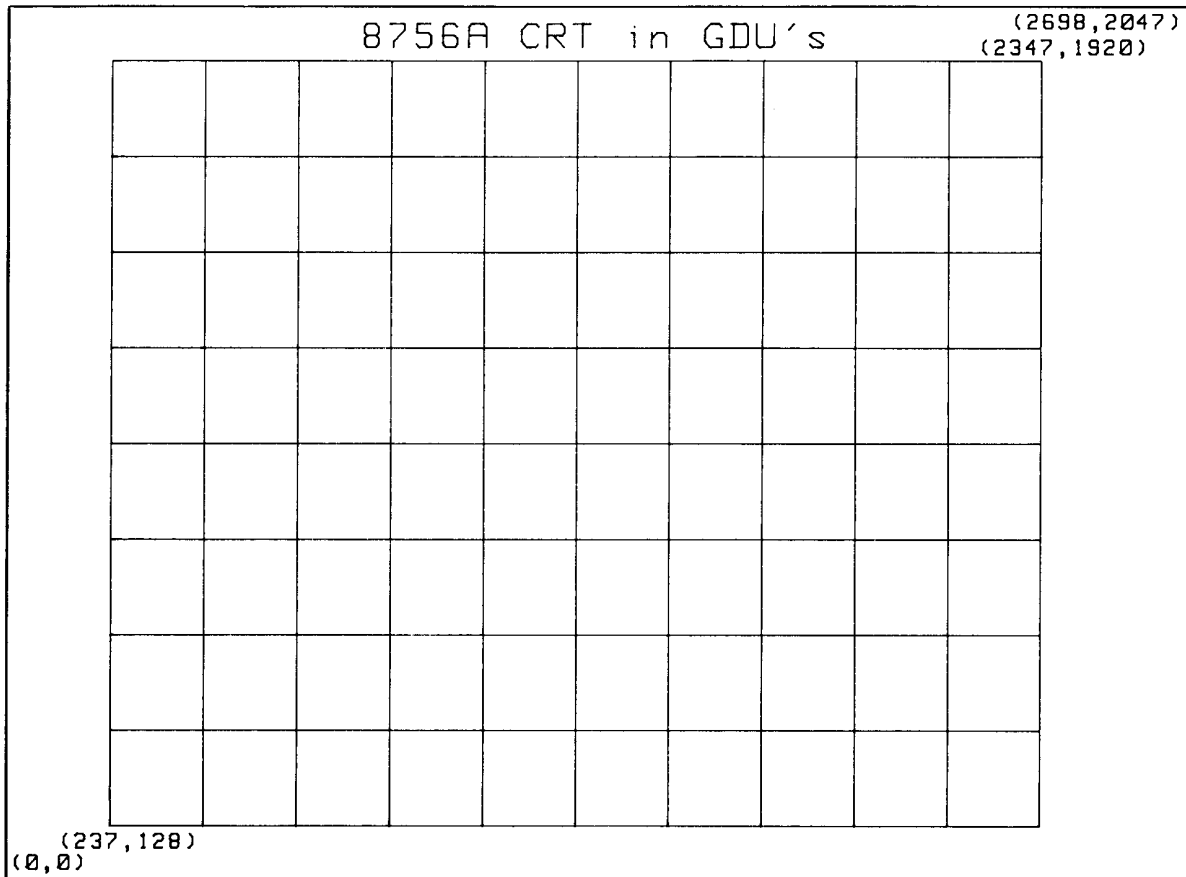

The scaling points for bottom left and for top right are set at $P1 = (0,0)$ and $P2 = (2698,2047)$, respectively.

ERASE PAGE COMMAND EP

The Erase Page Command EPn erases graphics memory page n.

Syntax:

EP n [term]
or
EP [term]

where n = 1 to 5. EP with no parameters erases all five pages.

Figure 3-5. CRT Graphics (2 of 6)

SELECT GRAPHICS PAGE COMMAND GP

The Select Graphics Page Command GP turns a graphics memory page on or off.

Syntax:

GP n,m [term]
 or
 GP [term]

where n = 1 to 5 and m = 1 = On and m = 0 = Off. Each page is 500 16 bit words. GP without parameters selects and turns on page 1. To begin writing to a particular Graphics Page, the GP command is used. If over 500 words are written to that page, the overflow will be written into the next Graphics Page.

NOTE

Care should be exercised when writing to Graphics Page 5 so to avoid exceeding the 500 word limit. Overflow will change the normal display on the CRT. If this happens, normal conditions may be restored by sending the "IP" command or returning to Local and pressing PRESET.

PLOT ABSOLUTE COMMAND PA

The Plot Absolute Command PA allows for movement of the beam to the point specified in plotter units by the X and Y coordinate parameters that complete the command.

Syntax:

PA X₁ coordinate, Y₁ coordinate (,X₂ coordinate, Y₂ coordinate, ... , ... , X_n coordinate, Y_n coordinate) [term]

A PA command requires that both the X and Y coordinates (a coordinate pair) be specified. The X coordinate parameter specifies the absolute X location in GDU's where the beam is to move. The Y coordinate parameter specifies the absolute Y location in GDU's where the beam is to move.

Any number of coordinate pairs may be listed after the PA instruction, separated by commas, but the maximum user graphics memory is 2500 16 bit words. The beam will move to each point in the order given.

If the point specified by a PA command lies off the plotting area, a line is drawn to the plotting area limit, and the beam is turned off. The beam remains off until a point on the plotting area is specified.

Figure 3-5. CRT Graphics (3 of 6)

SELECT GRAPHICS PAGE COMMAND GP

The Select Graphics Page Command GP turns a graphics memory page on or off.

Syntax:

GP n,m [term]
or
GP [term]

where n = 1 to 5 and m = 1 = On and m = 0 = Off. Each page is 500 16 bit words. GP without parameters selects and turns on page 1. To begin writing to a particular Graphics Page, the GP command is used. If over 500 words are written to that page, the overflow will be written into the next Graphics Page.

NOTE

Care should be exercised when writing to Graphics Page 5 so to avoid exceeding the 500 word limit. Overflow will change the normal display on the CRT. If this happens, normal conditions may be restored by sending the "IP" command or returning to Local and pressing PRESET.

PLOT ABSOLUTE COMMAND PA

The Plot Absolute Command PA allows for movement of the beam to the point specified in plotter units by the X and Y coordinate parameters that complete the command.

Syntax:

PA X₁ coordinate, Y₁ coordinate (,X₂ coordinate, Y₂ coordinate, ... , ... , X_n coordinate, Y_n coordinate) [term]

A PA command requires that both the X and Y coordinates (a coordinate pair) be specified. The X coordinate parameter specifies the absolute X location in GDU's where the beam is to move. The Y coordinate parameter specifies the absolute Y location in GDU's where the beam is to move.

Any number of coordinate pairs may be listed after the PA instruction, separated by commas, but the maximum user graphics memory is 2500 16 bit words. The beam will move to each point in the order given.

If the point specified by a PA command lies off the plotting area, a line is draw to the plotting area limit, and the beam is turned off. The beam remains off until a point on the lotting area is specified.

Figure 3-5. CRT Graphics (3 of 6)

PEN COMMANDS PD AND PU

The Pen Down Command PD turns the CRT beam ON; the Pen Up Command PU command turns the CRT beam OFF. Both do not move the beam to a new location.

Syntax:

PU [term]
PD [term]

Neither command requires nor permits any parameters; both require the terminator [term]. The beam will always retain the beam state (on or off) of the last received Pen Command.

LETTERING

LABEL COMMAND LB

The Label Command LB allows lettering of text, expressions, or string variables on the CRT display.

Syntax:

LB character string [ETX]

The Label mode can be terminated only by sending the ASCII character ETX (the byte value = 0000 0011 or decimal 3) at the end of the character string.

Before using the Label Command, the beam should be moved to the location where labeling is to begin by using the PU command followed by the PA command. This point will be the lower left corner of the first character. After lettering a character, the beam stops at the lower left corner of the next character space.

ABSOLUTE DIRECTION COMMAND DI

The Absolute Direction Command DI specifies the direction in which characters are lettered.

Syntax:

DI run, rise [term]

run, rise allowable values are:

1, 0 for 0 degrees
0, 1 for 90 degrees
-1, 0 for 180 degrees
0, -1 for 270 degrees

Figure 3-5. CRT Graphics (4 of 6)

or
DI [term]

Run and rise values are in decimal and specify the direction according to the relationship:

$$\text{angle} = \arctan \frac{\text{rise}}{\text{run}}$$

where rise is the vertical value, run is the horizontal value, and angle is the value relative to the positive horizontal axis in the cartesian (x-y) coordinate system.

A DI command with no parameters selects the DI 1,0 values (horizontal, 0 degrees).

ABSOLUTE CHARACTER SIZE COMMAND SI

The Absolute Character Size Command SI specifies the size of characters in centimeters.

Syntax:

SI width, height [term]

width, height values allowed are
 0.14 , 0.17 Smallest size (MODE LABELS & SOFT KEY LABELS)
 0.21 , 0.25 . (ACTIVE ENTRY AREA)
 0.28 , 0.34 .
 0.35 , 0.42 Largest size

or

SI [term]

An SI command with no parameters selects the smallest size.

GRAPH ENHANCEMENT

SELECT PEN COMMAND SP

The Select Pen Command SP allows selection of beam intensity.

Syntax:

SP n [term]

n values allowed are:

0 Beam off
 1 Brightest Intensity
 2 .
 3 .
 4 Lowest Intensity

The value of n must be an integer in the range of 0 through 4. When the SP command is received, the beam remains at the last set position. Subsequent PA commands will be executed with the new intensity.

Figure 3-5. CRT Graphics (5 of 6)

LINE TYPE COMMAND LT

The Line Type Command LT specifies the type of line that will be used with the PA command.

Syntax:

LT y, z [term]

where the z value (pattern length) is ignored.
and where the y values allowed are:

0 solid line
1 solid line
2 short dashes
3 long dashes

After receiving the LT command, all subsequent PA commands with the beam on (PD command) will draw the specified pattern. An LT command with no parameters will draw a solid line.

SCALING

OUTPUT P1 AND P2 COMMAND OP

The Output P1 and P2 Command OP outputs the current coordinates of the scaling points P1 and P2 in GDU's.

Syntax:

OP [term]

The format of the output is the following:

$P1_x$, $P1_y$, $P2_x$, $P2_y$ [cr] [lf]

where $P1_x$ = lower left P1 x value
 $P1_y$ = lower left P1 y value
 $P2_x$ = upper right P2 x value
 $P2_y$ = upper right P2 y value, all in GDU's.

ADDITIONAL GRAPHICS CONTROL

DEFAULT COMMAND DF

The Default Command DF sets certain graphics functions to a predefined state.

Syntax:

DF [term]

The following conditions are set when DF is received:

DI 1,0	Lettering orientation 0 degrees--horizontal
LT 1	Solid line
SI 0.14,0.17	Smallest size

Figure 3-5. CRT Graphics (6 of 6)

Table 3-1. Function Select Commands (1 of 3)











FRONT PANEL KEYS		
	HP-IB COMMAND	COMMAND DESCRIPTION
Channel Selection	C1 C2	Channel 1 selected; all subsequent commands will apply to Chan. 1 until Chan. 2 is selected. Channel 2 selected; all subsequent commands will apply to Chan. 2 until Chan. 1 is selected.
CHAN OFF  <ul style="list-style-type: none"> • A/R • B/R • A/B 	C0 (Zero) AR BR AB	Turn off channel. A detector/R detector Ratio Measurement B detector/R detector Ratio Measurement A detector/R detector Ratio Measurement
 <ul style="list-style-type: none"> • A • B • R 	IA IB IR	A detector Absolute Power Measurement B detector Absolute Power Measurement R detector Absolute Power Measurement
DISPLAY->MEM  <ul style="list-style-type: none"> • MEAS • MEM • M-MEM 	SM ME MY M-	Store Measured Data in Memory Display Measured Data Display Memory Data Display Measured - Memory Data
AUTO  <ul style="list-style-type: none"> • dB/DIV 	AS SDd	Autoscale Data on CRT Set Scale per Division; d set to 20, 10, 5, 2, 1, .5, .2, or .1.
MKR->REF  <ul style="list-style-type: none"> • LEVEL • POSN 	MR RLd RPq	Moves the Cursor (or Active Marker if no Cursor) and trace to the reference line. Reference Level value in dB or dBm; value d must be in the range of MEAS RATIO or M-MEM: +90 to -90 dB. MEAS PWR: +20 to -70 dBm. Reference Position setting on CRT, where q has values from 0 to 8 corresponding to the major horizontal graticule lines: 0 = bottom graticule line 4 = center graticule line 8 = top graticule line

Table 3-1. Function Select Commands (2 of 3)

FRONT PANEL KEYS		
	HP-IB COMMAND	COMMAND DESCRIPTION
<p>STEP</p> <p>REF</p>  	<p>UP</p> <p>DN</p>	<p>Increment Active Parameter.</p> <p>Decrement Active Parameter.</p>
	SVn	Save Front Panel key settings.
	RCn	Recall Front Panel key settings.
	IP	Presets the 8756A and the 8756 System Interface.
	MM	Restore Main Menu soft key labels and functions.
SOFT KEYS		
	HP-IB COMMAND	COMMAND DESCRIPTION
CURSOR ON/OFF	CUm	Turns Cursor On/Off.
CURSOR MAX	CX	Moves Cursor to maximum for active channel.
CURSOR MIN	CN	Moves Cursor to minimum for active channel.
CURSOR Δ ON/OFF	CDm	Turns Cursor Δ On/Off.
AVERAGING OFF	A0 (zero)	Turns averaging off.
AVERAGING FACTOR	AFd	Sets the averaging factor; d is set to 2,4,8,16,32, 64, 128, or 256.*
PLOT ALL	PA	Plot entire display (except user graphics) on external plotter.
PLOT LABELS	PC	Plot only characters/labels on external plotter.
PLOT GRID	PG	Plot only grid on external plotter.
PLOT TRACE 1	P1	Plot only trace 1 data on external plotter.
PLOT TRACE 2	P2	Plot only trace 2 data on external plotter.
MOD ON/OFF	MDm	Square wave modulation from rear panel outputs On/Off.

* Averaging is turned on when AFd is received. AF; or AF0; turns averaging on with previously set factor.

Table 3-1. Function Select Commands (3 of 3)

HP-IB only FUNCTIONS		
	HP-IB COMMAND	COMMAND DESCRIPTION
Blank CRT Display Features (CRT graphics not affected)	BL0 (zero) BL5	Restore display to normal. Blank All.
Clear Status	CS	Clear both Status Bytes.
Format Data ASCII	FD0 (zero)	ASCII Format for data with the WM, OD, OC, and OV commands; units are dBm or dB, and output in [+DD.DD] format, where D = ASCII digit.
Format Data Binary	FD1	Binary Format for data with the WM, OD, OC, and OV commands; two bytes are output in the following scale: Two Byte MEAS RATIO value or (decimal) M-MEM MEAS PWR 32767 +90 dB +20 dBm 0 -90 dB -70 dBm
Pass Through	PTd	Designates the pass through address for the 8756 System Interface.
Request Mask	RMd	Mask selected bits of the Status Byte; d is a decimal integer from 0 to 255.
Set Cursor Position	SCd	Places Cursor at horizontal position d. Range: 0 to 400 decimal.
Non Swept Mode	SW0 (zero)	Stop tracking sweep ramp; freeze data on display.
Swept Mode	SW1	Continuously track sweep ramp voltage and update display.
Take Sweep	TSD	Take d sweeps of data, then hold display.
Write Key	WKq	Write soft key label for a particular soft key; q is an ASCII string; the first character is the soft key number, range 1 to 6. This is followed by "[ASCII label][term]" or "[ASCII label][term],[ASCII label][term]" where the [ASCII label] <= 7 characters and [term] = [cr][lf] or ; .
Write Memory	WM	Write Memory trace data; the # of data points is 401; the format must be previously set by the FDM command.

Table 3-2. Output Commands

	HP-IB COMMAND	COMMAND DESCRIPTION	FORMAT	
			FD0	FD1
Output Cursor	OC	Output Cursor or Cursor/ Δ amplitude and horizontal position; format set by FDM command.	[+DD.DDD][,] [DDD][lf]	[BB] [DDD] [EOI]
Output Data Output Memory	OD OM	Output MEAS Data or MEM data; # of data points is 401; format set by FDM command.	400 [+DD.DDD,] [+DD.DDD][lf]	401 [BB] [EOI]
Output Value	OV	Output current measurement value; usually for CW measurements. Nonswept mode SW0 and format FDM must be previously set.*	[+DD.DDD][lf]	[BB] [EOI]
Output Identity	OI	Output the 8756A identity.	The character string output is "8756A[cr] [lf]".	
Output Keycode	OK	Output keycode for last key pressed. Refer to Table 7.	[DD] [lf]	
Output Status	OS	Output Status Bytes; the status byte is sent first followed by the extended status byte. Then both bytes will be cleared.	[BB] [EOI]	
NOTES				
D = ASCII digit B = 8 bit byte , = comma EOI = End or Identify HP-IB line TRUE cr = carriage return lf = line feed				

* If Averaging ON, measured data is averaged over a period of (Averaging Factor) * 10 milliseconds; this averaged value is then outputted.

Table 3-3. Cross Reference of Tables 3-1 and 3-2

A0	Averaging Off
AB	A/B Ratio Measurement
AFd	Averaging On and Factor d
AR	A/R Ratio Measurement
AS	Autoscale
BL0	Restore CRT to normal mode
BL5	Blank All (except user CRT graphics)
BR	B/R Ratio Measurement
C0	Channel Off
C1	Select Channel 1 On
C2	Select Channel 2 On
CDm	Cursor Delta On/Off
CN	Cursor to Minimum
CS	Clear Status Bytes
CUm	Cursor On/Off
CX	Cursor to Maximum
DN	Step Down/Decrement
FDO	Format Data Binary
FDl	Format Data ASCII
IA	Absolute Power A Measurement
IB	Absolute Power B Measurement
IP	Preset
IR	Absolute Power R Measurement
MDm	Modulation On/Off
ME	Display Measurement
MM	Restore Main Soft Key Menu
MR	Cursor (or Marker) to Reference Line
MY	Display Memory
M-	Display Measurement - Memory
OC	Output Cursor Value and Position
OD	Output Trace Data
OI	Output Identity
OK	Output Keycode of last key pressed
OM	Output Memory
OS	Output Status Bytes
OV	Output Current Measurement Value
P1	Plot trace 1 on external plotter
P2	Plot trace 2 on external plotter
PA	Plot all on external plotter (except user CRT graphics)
PC	Plot labels on external plotter
PG	Plot grid on external plotter
PTd	Pass Through to address d
RCn	Recall Register n
RLd	Reference Level set to d
RMD	Service Request Mask
RPq	Reference Position on vertical division q = 0 to 8
SCd	Set Cursor to horizontal position d
SDd	Scale per Division set to d
SM	Store Measurement into Memory
SVn	Save Register n
SWm	Sweep update display On/Off
TSd	Take d sweeps, then hold display
UP	Step up/increment
WKq	Write Soft Key label
WM	Write to Memory trace data

NOTE

For the WKq command, q is an ASCII string; the first character is the soft key number, range 1 through 6. This is followed by [ASCII label][term][,][ASCII label][term] or [ASCII label][term], where the [ASCII label] is no more than 7 characters and [term] = [carriage return][line feed] or ; .

Table 3-4. CRT Graphics Commands (1 of 2)

HP-GL subset.	
HP-IB COMMAND	COMMAND DESCRIPTION
DF	Default; sets default values.
DI run,rise	Absolute Character Direction; run,rise allowable values are: 1, 0 = 0 degrees 0, 1 = 90 degrees -1, 0 = 180 degrees 0,-1 = 270 degrees
LB[text][ETX]	Label text. Character set is shown in Table 5, 8756A Modified ASCII Character Set.
LTy,z	Line Type; the y = pattern number 1 to 4; z = pattern length which is ignored. For y = 0 or 1 = solid line 2 = short dashes 3 = long dashes
OP	Output P1 and P2 positions.
PA x1, y1 (,x2, y2, ..., ..., xN, yN)	Plot Absolute; x and y are integers and are in Graphics Display Units (GDU's).
PD	Pen Down.
PU	Pen Up.
SI w, h	Absolute Character Size; w = width; h = height. Values allowed are: 0.14, 0.17 Smallest size 0.21, 0.25 0.28, 0.34 0.35, 0.42 Largest size
SP n	Select pen; n = 0 to 4; 0 Pen up 1 Brightest Intensity 2 3 4 Lowest Intensity
<p>The following HP-GL commands will be accepted but their functions are not implemented and no error will be noted: IM (Input SRQ Mask), IP (Input P1 and P2), IW (Input Window), OC (Output Current Position), OE (Output Error), and PG (Output Page), SL (Character Slant), SR (Size Relative for characters).</p>	

Table 3-4. CRT Graphics Commands (2 of 2)

NON HP-GL COMMANDS		
	HP-IB COMMAND	COMMAND DESCRIPTION
Erase Page	EPn	Erase Page n, where n = 1 to 5; if no n value is given, all pages are erased.
Select Graphics Page On/Off	GPn,m	Turn graphics page n (1 to 5) On/Off (m = 1 or 0). Each page may use up to 500 16 bit words. GP without parameters selects and turns on page 1.
NOTE		
All Graphics Commands must be terminated with a semicolon ";" or a "[linefeed]" (the character [carriage return] is ignored).		

Table 3-5. HP 8756A Modified ASCII Character Set

8756A MODIFIED ASCII CODE CONVERSION TABLE									
		MOST SIGNIFICANT CHARACTER							
		Ø	1	2	3	4	5	6	7
LEAST SIGNIFICANT CHARACTER	Ø		centered *	SP	Ø	@	P	`	p
	1	HP logo	centered o	!	1	A	Q	a	q
	2	β	↑	"	2	B	R	b	r
	3		←	#	3	C	S	c	s
	4	upper-half tic	↓	\$	4	D	T	d	t
	5	lower-half tic	→	%	5	E	U	e	u
	6	left-half tic	√	&	6	F	V	f	v
	7	right-half tic	π	'	7	G	W	g	w
	8	back space	Δ	(8	H	X	h	x
	9	1/2 shift down	μ)	9	I	Y	i	y
	A	line feed	° (degree)	*	:	J	Z	j	z
	B	inv. line feed	Ω	+	:	K		k	
	C	1/2 shift up	ρ	.	<	L	\	l	
	D	carriage return	Γ	-	=	M		m	
	E	horizontal tic	θ	.	>	N	^	n	□
	F	vertical tic	λ	/	?	O	—	o	▶

EXAMPLES:

HP logo	=	Ø1
A	=	41
i	=	69
√	=	16
▶	=	7F
line feed	=	Ø9

(Note: These characters are output only when the LB command is used directly)

Table 3-6. HP 8756A Status Byte Descriptions

STATUS BYTE (#1)								
Bit #	7	6	5	4	3	2	1	0
Decimal Value	128	64	32	16	8	4	2	1
Function	SRQ on 8756 System Interface SRQ	Request Service (SRQ)	SRQ on HP-IB Syntax Error	SRQ on Operation Complete (Sweep or Plot)	SRQ on Soft Key Only Pressed	SRQ on Change in Extended Status Byte	SRQ on Numeric Entry Completed (HP-IB or Front Panel)	SRQ on Any Front Panel Key Pressed
EXTENDED STATUS BYTE (#2)								
Bit #	7	6	5	4	3	2	1	0
Decimal Value	128	64	32	16	8	4	2	1
Function							SRQ on Low Battery Voltage	SRQ on Self Test Failure

Table 3-7. Front Panel Keycodes

<p>MAIN MENU = 24 Soft Key 1 = 32 Soft Key 2 = 8 Soft Key 3 = 0 Soft Key 4 = 16 Soft Key 5 = 14 Soft Key 6 = 38</p> <p>CHANNEL 1: MEAS RATIO = 10 MEAS PWR = 2 DISPLAY = 37 SCALE = 18 REF = 13</p> <p>CHANNEL 2: MEAS RATIO = 27 MEAS PWR = 30 DISPLAY = 34 SCALE = 21 REF = 5</p>	<p>ENTRY: STEP DOWN = 22 STEP UP = 6 0 KEY = 20 1 KEY = 4 2 KEY = 3 3 KEY = 7 4 KEY = 12 5 KEY = 11 6 KEY = 15 7 KEY = 36 8 KEY = 35 9 KEY = 39 . KEY = 19 - KEY = 23 ENT OFF = 9 ENT = 1 DBM DB = 33 BK SP = 17</p> <p>INSTRUMENT STATE: SHIFT = 25 SAVE = 28 RECALL = 26 LOCAL = 29</p>
<p>(Values are in decimal)</p>	

OPERATOR'S CHECKS

The Operator's Checks verify that the 8756A is functioning correctly. It does not thoroughly check all specifications to their limits, but is an appropriate test for daily instrument verification, incoming inspection, or verification after repair or replacement of digital circuits.

EQUIPMENT

Scalar Network Analyzer	HP 8756A
HP-IB Cable	HP 10833A/B/C/D*
Sweep Oscillator.
Detector.	HP 11664A/B*
Microwave Test Device	20 dB Attenuator (HP 8491)*

*NOTE

These three components are necessary to perform the A, B, and R Detector Input Checks. The Sweep Oscillator is any RF or microwave source capable of outputting at any frequency within the frequency range of the 11664A Detector (10 MHz to 18 GHz) or the 11664B Detector (10 MHz to 26.5 GHz), and also capable of outputting a 0 to 10 volt sweep ramp and positive z blanking. The Sweep Oscillator also must be able to accept an external 27.8 kHz AM modulation input. If an external AM input is not available, an external modulator, such as the HP 11665B Modulator, should be connected to the RF output of the Sweep Oscillator. Modulator Drive is available from any of 3 BNC output connectors on the Rear Panel of the 8756A. (The HP 8350A/B Sweep Oscillator has internal 27.8 kHz square wave modulation of the RF output.) The Microwave Test Device used should be kept exclusively for these Operator's Checks, so that future comparisons will be valid.

Figure 3-6. Operator's Check (1 of 5)

PROCEDURE

The following Procedure assumes a working familiarity with the 8756A front panel controls. Refer to Fig. 3-1 for more information on operating the 8756A Front Panel, if necessary. Refer also to the Sweep Oscillator Operating & Service Manual for its operation.

Self-Test, HP INTERFACE BUS, and 8756 SYSTEM INTERFACE Checks

1. Set up the equipment as shown below.

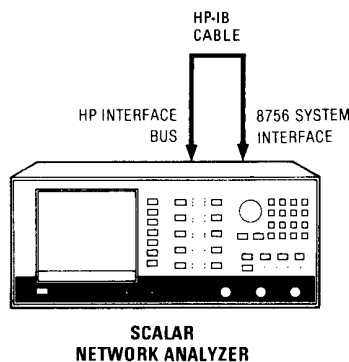

Operator's Setup for Self-Test, HP-IB, and 8756 SYSTEM INTERFACE Checks

2. Turn on the 8756A. Press **[PRESET]** to start the built-in Self-Test routine. If the Self-Test passes, the graticule, MODE LABELS, and MAIN MENU will appear on the display. If the Self-Test fails, an error message will be displayed in the ACTIVE ENTRY AREA.
3. On the 8756A, press the Soft Keys **[MORE]** **[SERVICE]** **[A6 HPIB]**. Press the Soft Key **[HPIB LSTN]** to begin the first HP-IB test. If this test passes, the message "HPIB LSTN PASS" will appear in the ACTIVE ENTRY AREA. If this test fails, a FAIL message will appear. Press **[MAIN MENU]** to end this test.
4. Press the Soft Key **[A6 HPIB]** again to run the second HP-IB test, then press the Soft Key **[HPIB TALK]**. If this test passes, the message "HP TALK PASS" will appear in the ACTIVE ENTRY AREA. If this test fails, a FAIL message will be displayed. Press **[PRESET]** to end this test, and remove HP-IB cable.

Figure 3-6. Operator's Check (2 of 5)

A, B, and R Input Checks

5. Set up the equipment as shown below.

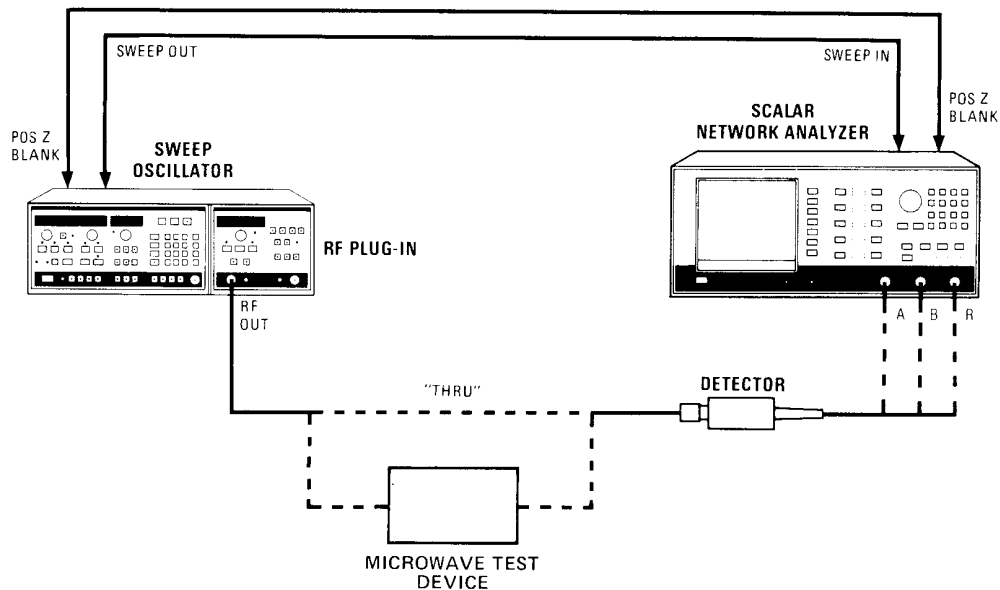

Operator's Check Setup for A, B, and R Input Checks

Turn on the Sweep Oscillator. Set Sweep time to approximately 500 milliseconds. Adjust the Start and Stop frequencies to include the frequency range of the Microwave Test Device or the full range of the Sweep Oscillator. Turn RF on. Record the Start and Stop frequencies for future reference. Connect the Detector output to the A Detector Input of the 8756A. On the 8756A, press **[PRESET]**. Press Channel 1 **[SHIFT] [MEAS RATIO]** (CHAN OFF) to turn Channel 2 off.

6. Connect Detector input to the RF output of the Sweep Oscillator for a "thru" (0 dB insertion loss) connection. On the 8756A, press Channel 1 **[SHIFT] [SCALE]** (AUTOSCALE) to put the trace on the display, then press **[MAIN MENU]**, the Soft Key **[CURSOR]** to turn CURSOR on, and finally Soft Key **[CURSOR MAX 1]** to find the trace maximum. Note the CURSOR value displayed in the ACTIVE ENTRY AREA. If the CURSOR value is less than +10.00 dBm, increase the RF power level on the Sweep Oscillator until the CURSOR value reads +10.00 dBm. This value is the upper limit of the dynamic range of the 8756A. On Channel 1 of the 8756A, press **[SHIFT] [DISPLAY]** (DISPLAY-->MEM) to store the trace in memory.

Figure 3-6. Operator's Check (3 of 5)

NOTE

If the Sweep Oscillator is operating properly, but the CURSOR value is not reading the correct absolute power value, check to see that the 27.8 kHz modulation has been correctly applied. If +10.00 dBm cannot be achieved, the upper level of dynamic range will not be tested.

7. Disconnect the Detector from the RF output of the Sweep Oscillator. Then, on the 8756A, press Channel 1 **[SHIFT] [SCALE]** (AUTOSCALE) to put the trace on the display. Press the Soft Key **[AVERAGE]** then **[AVG 1 FACTOR]** to turn averaging on with a factor of 8. Wait about 20 seconds to allow averaging to settle. Then press **[MAIN MENU]** followed by **[CURSOR]** and **[CURSOR MAX 1]**. The Cursor value should display -50.00 dBm or lower. This is the noise floor power level. Note this information for future reference. It is normal for this value to change ± 1 dB; however, the noise floor should always be -50.00 dBm or lower.
8. Insert the Microwave Test Device between the RF output of the Sweep Oscillator and the Detector. On the 8756A, press Channel 1 **[DISPLAY M-MEM]** and then **[SHIFT SCALE]** (AUTOSCALE). Wait about 20 seconds to allow averaging to settle. Press **[CURSOR MAX 1]** to find the trace maximum. The CURSOR value in the ACTIVE ENTRY AREA now displays the insertion loss of the Microwave Test Device. Note this value for future reference. If a HP 7470A or 9872C HP-IB plotter is available, make a hardcopy plot of the display for future reference. (Refer to Fig. 3-2 for more information on outputting to the plotter.) If a compatible plotter is not available, sketch the display, noting Start and Stop frequencies, noise floor, and insertion loss. This plot or sketch will be used for comparison during future Operator's Checks of the A Detector Input. The characteristics of the Microwave Test Device should not vary significantly from one comparison to the next.

Figure 3-6. Operator's Check (4 of 5)

9. Connect the Detector input to the B input of the 8756A. On the 8756A, press **[PRESET]**, Channel 1 **[SHIFT] [MEAS RATIO]** (CHAN OFF) to turn Channel 2 off, and select Channel 1 **[MEAS PWR]** to B. Repeat Steps 6 through 8 for the B Detector Input.
10. Connect the Detector input to the R input of the 8756A. On the 8756A, press **[PRESET]**, Channel 1 **[SHIFT] [MEAS RATIO]** (CHAN OFF) to turn Channel 2 off, and select Channel 1 **[MEAS PWR]** to R. Repeat Steps 6 through 8 for the R Detector Input.
11. If any test fails, or Microwave Test Device measurements do not reasonably match previous measurements, refer to the Performance Tests in Section IV.
12. When finished with the Operator's Checks, reconnect the 8756A with the cabling configuration necessary for correct operation with your Sweep Oscillator (the HP 8340A and 8350B require additional connections).

Figure 3-6. Operator's Check (5 of 5)

M A N U A L C H A N G E S

MANUAL IDENTIFICATION

Model Number: 8756A

Date Printed: August 1983

Part Number: 08756-90013

This supplement contains important information for correcting manual errors and for adapting the manual to instruments containing improvements made after the printing of the manual.

To use this supplement, make all ERRATA corrections and all appropriate serial number related changes indicated in the tables below.

SERIAL PREFIX OR NUMBER	MAKE MANUAL CHANGES
2404A	1

SERIAL PREFIX OR NUMBER	MAKE MANUAL CHANGES

► NEW ITEM

NOTE

Manual change supplements are revised as often as necessary to keep manuals as current and accurate as possible. Hewlett-Packard recommends that you periodically request the latest edition of this supplement. Free copies are available from all HP offices. When requesting copies, quote the manual identification information from your supplement, or the model number and print date from the title page of the manual.



ERRATA

Page 1-0, Figure 1-1:

To note at bottom of Figure add: For HP-IB Interface Cable lengths available, refer to Section II.

► Page 1-3, Paragraph 1-30:

Add:

SOFTWARE OPTION

85015A system software may be purchased as an HP 8756A option. Order as follows:

OPTION 201

3½ in discs for use with an HP 9816S computer with an HP 9121 disc drive

OPTION 202

5¼ in discs for use with an HP 9816S computer with an HP 82901M disc drive

OPTION 203

5¼ in discs for use with either an HP 9826S or 9836S computer

Page 1-3, Paragraph 1-31:

Delete Option 907.

Page 1-3, Paragraph 1-35:

Delete Option 909.

Add:

Option 913, Rack Mount Kit

Option 913 (HP Part No. 5061-2072) contains a pair of flanges and the necessary hardware to mount an HP 8756A that **HAS** handles, in an equipment rack. Horizontal spacing is 482.6 mm (19 in). Refer to Section II for details.

► Page 1-9, Table 1-3:

Add: *P = Performance Test; A = Adjustment; T = Troubleshooting

► Page 1-10, Table 1-3:

Add: *P = Performance Test; A = Adjustment; T Troubleshooting

Page 2-9, Figure 2-5:

Delete Option 907 (front handles are standard on the HP 8756A).

Page 2-11, Figure 2-7:

Delete Item 3.

► Change Option 909 to option 913, 5061-2072.

Page 3-i:

► Add: The recommended cleaner for use on the inside of the CRT cover is HP Part Number 8500-2163.

Insert after page 3-1, the "8756A PROGRAMMING INFORMATION CLARIFICATION," and the "EXAMPLES OF SELECTED 8756A COMMANDS USING HP SERIES 200 COMPUTERS" of this change sheet.

OPERATING INFORMATION

Page 3-7, REF:

Add:

NOTE

The 8756A has three independent reference levels; one for each display mode (MEAS, MEM, and M-MEAS). The reference level for the MEM mode is set to the current reference level of the MEAS mode whenever DISPLAT—> MEM IS pressed.

ERRATA (Cont'd)

Page 3-9, Figure 3-1:

Add the following to paragraph 2:

After Power On or PRESET, the REFERENCE LEVEL step size is set to the current SCALE per division value. After a specific step size is set, this constant value will remain, regardless of the SCALE value.

Page 3-10, Figure 3-1:

Add to NOTE:

When using the 8340A, Alternate Sweep must be between registers 1 and 2.

STEP keys on both the 8756A and the 8350B or 8340A cannot be used to step through RECALL registers of both front panel states. The STEP keys on the 8350B or 8340A may be used to step through their **own** RECALL front panel registers.

Page 3-11, Figure 3-1:

Add the following to paragraph 1:

n. Reference Level STEP=SCALE per division value.

Page 3-25, Figure 3-3:

Add to NOTE:

Since this SWEEP IN 0–10V input is required, stopping the sweep, such as placing the sweep oscillator in CW mode, will place the 8756A in a waiting for sweep state. CW mode is usable as long as the sweep ramp is provided. (On the 8350B Sweep Oscillator, the sweep ramp is provided when [SHIFT] [CW] is pressed. On the 8340A Synthesized Sweeper, the [CF] [ΔF] mode must be used, with ΔF set to 100 Hz).

Page 3-27, Figure 3-4:

Delete "or M-MEM"

Page 3-37, SP n [term]:

Under COMMAND DESCRIPTION for HP-IB COMMAND SP n, delete 4 and change 3 to "Lowest Intensity."

Change the first sentence in the description to read:

The value of n must be an integer in the range of 0 through 3.

Page 3-42, Table 3-2:

Add [EOI] to terminate all data formats.

Under Output Cursor, Change FD1 to [BB] [BB] [EOI].

Page 3-43, Table 3-3:

Change "FD0" to "FD1"

Change "FD1" to "FD0"

Page 3-44, SP n:

Under COMMAND DESCRIPTION for HP-IB COMMAND SP n, delete 4 and change 3 to "Lowest Intensity"

►Page 3-45, Table 3-5:

Add:

Note: character set is Hexadecimal.

ERRATA (Cont'd)**OPERATING NOTES****8756A/8350B/0000-99**

Page 3, Figure 3:

Change the REFLECTED arm loss of the DIRECTIONAL BRIDGE to -6 dB

Page 4, Figure 4:

Change 11664B to 11664A

PROGRAMMING NOTES**Quick Reference Guide**

Page 7, Take Sweep:

To Command Description add: Nonswept mode, SW0, must be previously set.

Page 8, Output Cursor:

Under FORMAT, change FD1 to [BB] [BB] [EOI].

Page 10 SP n:

Under COMMAND DESCRIPTION for HP-IB COMMAND SP n, delete 4 and change 3 to "Lowest Intensity".

CHANGE 1

This change implements Revision 2.0 Firmware.

OPERATING INFORMATION

Page 3-4, Figure 3-1:

To D, add: The active channel is shown with a higher display intensity.

Page 3-23, Figure 3-2:

Above **SERVICE**, add the soft key **FREQ LBL ON/OFF**.

Add: **FREQ LBL ON/OFF** turns ON and OFF the CRT display of frequency information.

Page 3-40, Table 3-1:

Add **FREQ LBL OFF, BL1**, Turns CRT frequency information OFF (**BL0** turns information back on).

Page 3-43, Table 3-3:

Add **BL1**, Frequency labels OFF (**BL0** turns frequency back on).

Page 3-53/3-54, Appendix A:

To the MORE MENU, above **SERVICE**, add the soft key **FREQ LBL ON/OFF**.

Back Cover, SUBJECT INDEX:

Add **FREQ LBL ON/OFF** 23, 40, 53.

CHANGE 1 (Cont'd)**OPERATING NOTE**

Page 7, Fifth paragraph:

To the first sentence, add: (when more than one channel is displayed, active channel information is shown with a higher display intensity).

Page 8, Figure 8:

To the MORE MENU, above SERVICE, add the soft key **FREQ LBL ON/OFF**.

Page 18:

Add: **FREQ LBL ON/OFF**. **FREQ LBL ON/OFF** turns ON and OFF CRT display of frequency information.

Page 22, first column:

Change **SHIFT CW** to **CW**.

Page 27, Figure 22:

To the bottom left menu, above the soft key SERVICE, add the soft key **FREQ LBL ON/OFF**.

PROGRAMMING NOTES**Quick Reference Guide**

Page 6, Table 1:

Add **FREQ LBL OFF**, **BL1**. Turns CRT frequency information OFF (**BL0** turns frequency information back on).

Page 9, Table 3:

Add **BL1**. Frequency labels OFF (**BL0**) turns frequency information back on).

Introductory Operating Guide

8756/Series 200 Programming Note

Page 20, Table 3:

Add **BL1**, Frequency labels OFF (**BL0** turns frequency information back on).

Introductory Operating Guide

HP 8756A/HP 85 Programming Note

Page 19, Table 3:

Add **BL1**, Frequency labels OFF (**BL0** turns frequency back on).

8756A PROGRAMMING INFORMATION CLARIFICATION

The following paragraphs clarify and augment the programming information in Section III (Operation) of this manual.

Input Selection

Select the desired input (IA, AR, etc.) **ONLY** while in the Swept mode (SW1). When using the Take Sweep command (TSn), prior to performing a Trace Transfer (OD), select the input **BEFORE** placing the HP 8756A in the Non Swept mode (SW0). If already in the Non Swept mode, the HP 8756A **MUST** be returned to the Swept mode **BEFORE** selecting the input (eg. OUTPUT 716; "SW1 AR SW0").

External Modulation

When using External Modulation, note that the HP 8756A MODULATION ON/OFF state is **NOT** stored in the SAVE/RECALL registers, and must be set manually.

Alternate Sweep

When programming the Alternate sweep mode, the following method is recommended:

OUTPUT 716: "RC3" This recalls register 3 from the HP 8756A.
 OUTPUT 717: "AL14" This alternates register 4 from the source.
 OUTPUT 716 This exits Pass-Through.

Using Pass-Through Mode

Ensure that instruments are not set to the HP 8756A Pass-Through address.

General Programming Information

When using a TIMEOUT interrupt, set the time parameter to a minimum of 5 seconds (without a plotter) and 9 seconds (with an HP 9872C or 7475A). The instruments require this time to complete their Instrument Preset functions.

The powerful Alternate Sweep function of the 8756A and source combination is fully programmable. While in Alternate Sweep, the source may be programmed via the "Pass Through" mode of the 8756A. At least one of the following codes must be included when programming the source in Alternate Sweep:

FA, FB, CF, DF, ST, M1, M2, M3, M4, M5, or PL

When the 8756A receives a command to output a value, that value must be read before another command may be sent. If all values are not read, the 8756A will ignore further commands from the computer until the values are read, or until it is Preset or Cleared.