

## Errata

**Title & Document Type:** 1340A X-Y Display Operating and Service Manual

**Manual Part Number:** 01340-90915

**Revision Date:** July 1982

### About this Manual

We've added this manual to the Agilent website in an effort to help you support your product. This manual provides the best information we could find. It may be incomplete or contain dated information, and the scan quality may not be ideal. If we find a better copy in the future, we will add it to the Agilent website.

### HP References in this Manual

This manual may contain references to HP or Hewlett-Packard. Please note that Hewlett-Packard's former test and measurement, life sciences, and chemical analysis businesses are now part of Agilent Technologies. The HP XXXX referred to in this document is now the Agilent XXXX. For example, model number HP8648A is now model number Agilent 8648A. We have made no changes to this manual copy.

### Support for Your Product

Agilent no longer sells or supports this product. You will find any other available product information on the Agilent Test & Measurement website:

[www.agilent.com](http://www.agilent.com)

Search for the model number of this product, and the resulting product page will guide you to any available information. Our service centers may be able to perform calibration if no repair parts are needed, but no other support from Agilent is available.



**Agilent Technologies**



## OPERATING AND SERVICE MANUAL

# MODEL 1340A X-Y DISPLAY

(Including Options 001, 002, 004, 039, 110, 216,  
300, 301, 302, 303, 304, 315, 316, 317, 324, 330,  
331, 561, 604, 607, 631, and 639.)

### SERIAL NUMBERS

This manual applies directly to instruments with serial numbers prefixed 2038A.

With changes described in Section VII this manual will apply to 1748A.

For additional important information about serial numbers, see INSTRUMENTS COVERED BY MANUAL in SECTION I.

COPYRIGHT HEWLETT-PACKARD COMPANY/COLORADO SPRINGS DIVISION 1977  
1900 GARDEN OF THE GODS ROAD, COLORADO SPRINGS, COLORADO, U.S.A.

ALL RIGHTS RESERVED

Manual Part Number 01340-90915  
Microfiche Part Number 01340-90815  
Operating Note Part No. 01340-90902

PRINTED JULY 1982

## **SAFETY**

*This product has been designed and tested according to International Safety Requirements. To ensure safe operation and to keep the product safe, the information, cautions, and warnings in this manual must be heeded. Refer to Section I and the Safety Summary for general safety considerations applicable to this product.*

## **CERTIFICATION**

*Hewlett-Packard Company certifies that this product met its published specifications at the time of shipment from the factory. Hewlett-Packard further certifies that its calibration measurements are traceable to the United States National Bureau of Standards, to the extent allowed by the Bureau's calibration facility, and to the calibration facilities of other International Standards Organization members.*

## **WARRANTY**

This Hewlett-Packard product is warranted against defects in material and workmanship for a period of one year from date of shipment. During the warranty period, Hewlett-Packard Company will, at its option, either repair or replace products which prove to be defective.

The cathode-ray tube (CRT) in the instrument and any replacement CRT purchased from HP are also warranted against electrical failure for a period of one year from the date of shipment from Colorado Springs. **BROKEN TUBES AND TUBES WITH PHOSPHOR OR MESH BURNS, HOWEVER, ARE NOT INCLUDED UNDER THIS WARRANTY.**

For warranty service or repair, this product must be returned to a service facility designated by HP. However, warranty service for products installed by HP and certain other products designated by HP will be performed at Buyer's facility at no charge within the HP service travel area. Outside HP service travel areas, warranty service will be performed at Buyer's facility only upon HP's prior agreement and Buyer shall pay HP's round trip travel expenses.

For products returned to HP for warranty service, Buyer shall prepay shipping charges to HP and HP shall pay shipping charges to return the product to Buyer. However, Buyer shall pay all shipping charges, duties, and taxes for products returned to HP from another country.

### **LIMITATION OF WARRANTY**

The foregoing warranty shall not apply to defects resulting from improper or inadequate maintenance by Buyer, Buyer-supplied software or interfacing, unauthorized modification or misuse, operation outside of the environmental specifications for the product, or improper site preparation or maintenance.

**NO OTHER WARRANTY IS EXPRESSED OR IMPLIED. HP SPECIFICALLY DISCLAIMS THE IMPLIED WARRANTIES OF MERCHANTABILITY AND FITNESS FOR A PARTICULAR PURPOSE.**

### **EXCLUSIVE REMEDIES**

**THE REMEDIES PROVIDED HEREIN ARE BUYER'S SOLE AND EXCLUSIVE REMEDIES. HP SHALL NOT BE LIABLE FOR ANY DIRECT, INDIRECT, SPECIAL, INCIDENTAL, OR CONSEQUENTIAL DAMAGES, WHETHER BASED ON CONTRACT, TORT, OR ANY OTHER LEGAL THEORY.**

## **ASSISTANCE**

*Product maintenance agreements and other customer assistance agreements are available for Hewlett-Packard products.*

*For any assistance, contact your nearest Hewlett-Packard Sales and Service Office. Addresses are provided at the back of this manual.*

## TABLE OF CONTENTS

Section	Page	Section	Page
<b>I GENERAL INFORMATION</b> .....	1-1	<b>V ADJUSTMENTS</b> .....	5-1
1-1. Introduction .....	1-1	5-1. Introduction .....	5-1
1-5. Specifications .....	1-1	5-3. Safety Requirements .....	5-1
1-7. Description .....	1-1	5-5. Equipment Required .....	5-1
1-9. Options .....	1-1	5-7. Adjustments .....	5-1
1-11. Accessories Supplied .....	1-1	5-11. Adjustment Procedures.....	5-1
1-13. Recommended Test Equipment ....	1-6	5-12. Low-voltage Power Supply Adjustment .....	5-2
1-15. Instruments Covered by Manual ..	1-6	5-13. High-voltage Power Supply Adjustment .....	5-3
<b>II INSTALLATION</b> .....	2-1	5-14. Focus Limit Adjustment .....	5-4
2-1. Introduction .....	2-1	5-15. Intensity Limit Adjustment .....	5-4
2-3. Initial Inspection .....	2-1	5-16. Pattern Adjustment .....	5-5
2-5. Preparation for Use .....	2-1	5-17. X- and Y-amplifier Balance Adjustments .....	5-5
2-6. Power Requirements .....	2-1	5-18. X- and Y-amplifier Gain Set .....	5-6
2-7. Line Voltage Selection .....	2-1	5-19. Z-amplifier Balance Adjustment ..	5-6
2-8. Power Cables .....	2-1	5-20. Z-amplifier Gain and High Frequency Adjustments .....	5-7
2-9. Repacking for Shipment .....	2-1	5-21. Input Attenuator Compens- ation .....	5-8
<b>III OPERATION</b> .....	3-1	<b>VI REPLACEABLE PARTS</b> .....	6-1
3-1. Introduction .....	3-1	6-1. Introduction .....	6-1
3-3. Panel Features .....	3-1	6-3. Abbreviations .....	6-1
3-5. Preoperational Procedure.....	3-1	6-5. Replaceable Parts List .....	6-1
3-6. General .....	3-1	6-7. Ordering Information .....	6-1
3-7. Bandwidth Reduction .....	3-2	6-10. Direct Mail Order System .....	6-1
3-8. Input Polarity Selection .....	3-2	<b>VII MANUAL CHANGES</b> .....	7-1
3-9. Application Considerations .....	3-3	7-1. Introduction .....	7-1
3-10. General .....	3-3	7-3. Manual Changes .....	7-1
3-11. Interfacing Considerations .....	3-3	7-6. Manual Change Instructions.....	7-1
3-12. General .....	3-3	<b>VIII SERVICE</b> .....	8-1
3-16. Display Adjustments .....	3-3	8-1. Introduction .....	8-1
3-17. Focus .....	3-3	8-4. Theory of Operation .....	8-1
3-20. Performance Specifications.....	3-3	8-6. Troubleshooting .....	8-1
<b>IV PERFORMANCE TESTS</b> .....	4-1	8-7. Initial Troubleshooting Procedure .....	8-1
4-1. Introduction .....	4-1	8-8. DC Voltages and Waveforms .....	8-1
4-3. Equipment Required .....	4-1	8-9. Recommended Test Equipment .....	8-1
4-5. Test Record .....	4-1	8-11. Repair .....	8-1
4-7. Calibration Cycle .....	4-1	8-12. Assembly Removal .....	8-1
4-11. Performance Test Procedures.....	4-1	8-13. CRT Removal .....	8-3
4-12. Dynamic Range Test (X and Y Amplifiers) .....	4-1	8-14. Preventive Maintenance .....	8-1
4-13. X-, Y-Amplifier Bandwidth and Rise Time .....	4-3	8-16. Circuit Boards .....	8-4
4-14. Phase Shift .....	4-4		
4-15. Diagonal Settling Time .....	4-5		
4-16. Repeatability .....	4-6		
4-17. TTL Blanking (Option 216 Only) .....	4-7		

**LIST OF ILLUSTRATIONS**

Figure	Title	Page	Figure	Title	Page
1-1.	Model 1340A X-Y Display .....	1-0	5-1.	Pattern Adjustment Test Setup .....	5-5
2-1.	Power Receptacles .....	2-1	5-2.	Gain Set Adjustment Test Setup .....	5-6
3-1.	Input Attenuation and Bandwidth Selection Switches .....	3-2	5-3.	Z-amplifier Gain and High Frequency Test Setup .....	5-7
3-2.	Input Termination Impedance of Display Connected in Parallel .....	3-3	5-4.	Input Attenuator Adjustment Test Setup .....	5-8
3-3.	Brightness vs Cross section of Typical CRT Spot .....	3-4	8-1.	Service Sheet 1, Model 1340A Overall Block Diagram .....	8-5
3-4.	Settling Time .....	3-4	8-2.	Component Identification, Control Assembly, A1 .....	8-6
3-5.	Linearity of Beam Position Showing Ideal Positioning and Possible Error .....	3-4	8-3.	Component Identification, X-Y-Z Assembly, A1 .....	8-6
3-6.	Geometric Distortion Caused by CRT (Exaggerated) .....	3-5	8-4.	Service Sheet 2, X-Y Amplifiers .....	8-7
3-7.	Controls and Connectors .....	3-5	8-5.	Component Identification, HVPS Assembly, A3 .....	8-8
4-1.	Dynamic Range Test Setup .....	4-2	8-6.	Service Sheet 3, HVPS and Z-axis Amplifier .....	8-9
4-2.	Bandwidth and Rise Time Test Setup ..	4-3	8-7.	Component Identification, LVPS Assembly, A2 .....	8-10
4-3.	Phase-shift Test Setup .....	4-4	8-8.	Service Sheet 4, LV Power Supply .....	8-11
4-4.	Phase-shift Measurement .....	4-4	8-9.	Component Identification, DC Power Supply Assembly, A5 (Option 002) .....	8-12
4-5.	Diagonal Settling Time Test Setup .....	4-5	8-10.	Service Sheet 5, DC Power Supply (Option 002) .....	8-13
4-6.	Repeatability Test Setup .....	4-6	8-11.	Service Sheet 6, Adjustment Locations .....	8-15
4-7.	Option 216 Test Setup .....	4-7			

**LIST OF TABLES**

Table	Title	Page	Table	Title	Page
1-1.	Specifications .....	1-1	6-1.	Reference Designators and Abbreviations .....	6-2
1-2.	Supplemental Characteristics .....	1-2	6-2.	Replaceable Parts .....	6-3
1-3.	Available Options .....	1-4	6-3.	List of Manufacturers' Codes .....	6-10
1-4.	Recommended Test Equipment .....	1-6			
3-1.	X, Y, and Z Input Switch Coding .....	3-2	8-1.	Schematic Notes .....	8-2
3-2.	Input Signal Polarity Selection .....	3-2	8-2.	Assembly Index .....	8-4
5-1.	Adjustable Components .....	5-1	8-3.	X, Y, and Z Input Switch Coding .....	8-6
5-2.	LVPS Tolerances .....	5-2			

## **SAFETY SUMMARY**

*The following general safety precautions must be observed during all phases of operation, service, and repair of this instrument. Failure to comply with these precautions or with specific warnings elsewhere in this manual violates safety standards of design, manufacture, and intended use of the instrument. Hewlett-Packard Company assumes no liability for the customer's failure to comply with these requirements.*

### **GROUND THE INSTRUMENT.**

To minimize shock hazard, the instrument chassis and cabinet must be connected to an electrical ground. The instrument is equipped with a three-conductor ac power cable. The power cable must either be plugged into an approved three-contact electrical outlet or used with a three-contact to two-contact adapter with the grounding wire (green) firmly connected to an electrical ground (safety ground) at the power outlet. The power jack and mating plug of the power cable meet International Electrotechnical Commission (IEC) safety standards.

### **DO NOT OPERATE IN AN EXPLOSIVE ATMOSPHERE.**

Do not operate the instrument in the presence of flammable gases or fumes. Operation of any electrical instrument in such an environment constitutes a definite safety hazard.

### **KEEP AWAY FROM LIVE CIRCUITS.**

Operating personnel must not remove instrument covers. Component replacement and internal adjustments must be made by qualified maintenance personnel. Do not replace components with power cable connected. Under certain conditions, dangerous voltages may exist even with the power cable removed. To avoid injuries, always disconnect power and discharge circuits before touching them.

### **DO NOT SERVICE OR ADJUST ALONE.**

Do not attempt internal service or adjustment unless another person, capable of rendering first aid and resuscitation, is present.

### **USE CAUTION WHEN EXPOSING OR HANDLING THE CRT.**

Breakage of the Cathode-ray Tube (CRT) causes a high-velocity scattering of glass fragments (implosion). To prevent CRT implosion, avoid rough handling or jarring of the instrument. Handling of the CRT shall be done only by qualified maintenance personnel using approved safety mask and gloves.

### **DO NOT SUBSTITUTE PARTS OR MODIFY INSTRUMENT.**

Because of the danger of introducing additional hazards, do not install substitute parts or perform any unauthorized modification of the instrument. Return the instrument to a Hewlett-Packard Sales and Service Office for service and repair to ensure that safety features are maintained.

### **DANGEROUS PROCEDURE WARNINGS.**

Warnings, such as the example below, precede potentially dangerous procedures throughout this manual. Instructions contained in the warnings must be followed.

**WARNING**

**Dangerous voltages, capable of causing death, are present in this instrument.  
Use extreme caution when handling, testing, and adjusting.**

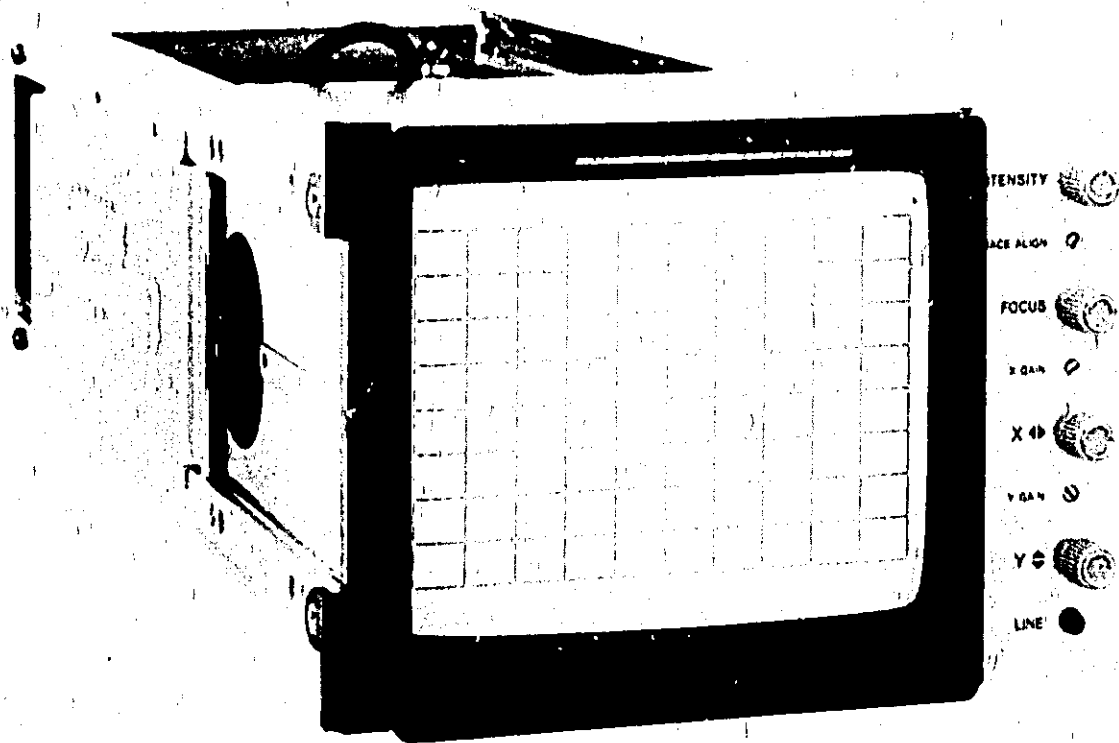

*Figure 1-1. Model 1340A X-Y Display*

## SECTION I

### GENERAL INFORMATION

#### 1-1. INTRODUCTION.

1-1. This manual contains information required to install, operate, test, adjust, and service the Hewlett-Packard Model 1340A.

1-3. Supplied with this manual is an Operating Note that should be kept with the instrument for use by the operator. The part number is listed on the title page.

1-4. Also listed on the title page of this manual is a Microfiche part number. This number can be used to order 4 x 6-inch microfilm transparencies of the manual. Each microfiche contains up to 96 photo-duplicates of the manual pages. The microfiche package also includes the latest Manual Changes supplement.

#### 1-5. SPECIFICATIONS.

1-6. Instrument specifications are listed in table 1-1. These specifications are the performance standards or limits against which the instrument is tested. Table 1-2 lists supplemental characteristics. Supplemental characteristics are not specifications but are typical characteristics included as additional information for the user.

#### 1-7. DESCRIPTION.

1-8. The Hewlett-Packard Model 1340A is an X-Y display recommended for OEM system use in electronic test equipment, chemical or physical analytical systems, medical electronic equipment or any application where a high-quality image is required. The display uses a post-accelerator CRT with 6.6 kV accelerating potential and aluminized P31 phosphor.

#### 1-9. OPTIONS.

1-10. Standard options are modifications installed on HP instruments and are available on request. Table 1-3 lists available options for the 1340A.

#### 1-11. ACCESSORIES SUPPLIED.

1-12. The following accessories are supplied with the 1340A:

- One blue contrast filter
- One ac line cord

*Table 1-1. Specifications*

#### **VERTICAL AND HORIZONTAL AMPLIFIERS**

##### **RESPONSE**

**Rise Time:**  $\leq 120$  ns (10% to 90% points) for full-screen deflection or less.

**Phase Shift:**  $< 3^\circ$  to 1 MHz for full-screen input signals.

**DEFLECTION CHARACTERISTICS:** front panel adjustable from 800 mV to 2 volts for full-scale deflection of X or Y amplifiers.

**LINEAR WRITING SPEED:**  $\geq 25$  cm/ $\mu$ s (9.8 in./ $\mu$ s).

**SETTLING TIME:** signal settles to within one spot diameter of final value in  $\leq 300$  ns for any on-screen final location. Off-screen deflection (if any) must not exceed specified dynamic range.

**REPEATABILITY:**  $\leq 0.4$  mm (0.015 in.) error (full-screen) for re-addressing a point from any on- or off-screen location within specific dynamic range.

**LINEARITY:** 5% of full scale along major axes.

**MAXIMUM INPUT:**  $\pm 40$  V (dc + peak ac) for high impedance input termination;  $\pm 3.5$  V (dc + peak ac) for 50  $\Omega$  input termination.

**DYNAMIC RANGE:** beam may be deflected offscreen up to 1/2 screen diameter in any direction provided

that the zero input position is onscreen without degradation of specifications.

**CROSSTALK:**  $< 0.25$  mm (0.01 in.) with one input terminated in 50  $\Omega$  and the other axis excited by a 1-V, 500 kHz signal;  $< 0.5$  mm (0.02 in.) at 3 MHz when driven from a terminated 50  $\Omega$  source.

#### **Z-AXIS AMPLIFIER**

**RISE TIME:**  $< 70$  ns.

**ANALOG BLANKING RANGE:** a 1 V change in Z-input voltage causes a full scale change in brightness.

**MAXIMUM INPUT:**  $\pm 40$  V (dc + peak ac) for high impedance input termination;  $\pm 3.5$  V (dc + peak ac) for 50  $\Omega$  input termination.

#### **CATHODE-RAY TUBE**

**VIEWING AREA:** 114 cm<sup>2</sup> (17.73 in.<sup>2</sup>); 9.6 cm (3.78 in.) vertically by 11.9 cm (4.69 in.) horizontally.

**SPOT SIZE:**  $< 0.46$  mm (0.018 in.) at center of screen at normal viewing brightness; measured using shrinking raster method.



Table 1-1. Specifications (Cont'd)

**SAFETY PROTECTION**

When ordered with Option 315 the instrument is listed by Underwriters Laboratories for use in Electronic Data Processing Equipment (UL 478). When ordered with Option 330, Model 1340A is listed by UL as a component for use in Medical and Dental Electronic Equipment (UL 544).

**WARNING**

These displays are designed and manufactured primarily for OEM system applications. Therefore, without Option 315 or Option 330, the top and bottom protective covers are not provided and internal wiring connections of **HAZARDOUS VOLTAGES ARE EXPOSED**. Operator protection must be provided by the purchaser

and/or user of the instrument. If in doubt, order either Option 315 or Option 330 which provides the covers.

**GENERAL OPERATING ENVIRONMENT**

**Temperature:** 0°C to +55°C; nonoperating, -40°C to +70°C.

**Humidity:** to 95% relative humidity at +40°C.

**Altitude:** to 4600 m (15 000 ft); nonoperating, 15 300 m (50 000 ft).

**Vibration:** vibrated in three planes for 15 minutes each with 0.38 mm (0.015 in.) excursion, 5 Hz to 55 Hz, 1 minute per octave, 10 minutes each resonance.

**Shock:** 30 g level shock, 11 ms duration and 1/2 sine wave shape.

Table 1-2. Supplemental Characteristics

**VERTICAL AND HORIZONTAL AMPLIFIERS**

**INPUTS:** BNC connectors with shield grounded.

**Input RC:** approx 1 M $\Omega$  shunted by  $\approx$  50 pF, 50 $\Omega$  (nominal) input termination selectable internally.

**Bandwidth:** dc to >3 MHz (3 dB down) for 5 cm or less deflection.

**Input Deflection:** Independently switch-selectable 5:1 attenuators extend range from approximately 4 V to 10 V for full-screen deflection of X or Y amplifiers.

**Polarity:** a positive input signal moves beam up or to the right. Negative polarity selectable by internal switches.

**POSITION:** front-panel controls allow undeflected spot to be set off screen from any where within the viewing area. Spot position, with both inputs grounded and position controls electrically centered, is approximately at the geometric center of the viewing area.

**DRIFT**

**Position:** typically < 0.5 mm/hr (0.02 in./hr) and typically < 1 mm (0.04 in.) in 24 hours (with covers installed and after a 15-minute warmup period).

**Gain:** typically < 1% under all conditions of specified line voltage with covers installed, with a temperature range between +20°C and +55°C (+68°F and +131°F), and after a 15-minute warmup period.

**Z-AXIS AMPLIFIER**

**ANALOG BLANKING:** cutoff level can be set from +0.2 Vdc to -1 Vdc with intensity control. Brightness is limited to a safe level for any Z-axis input voltage with intensity control set fully counterclockwise.

**BLANKING POLARITY:** positive going input signal, applied to the Z-axis input, increases brightness. Negative polarity is selectable internally.

**INPUT:** BNC connector with shield grounded.

**Input RC:** approx 1 M $\Omega$  shunted by  $\approx$  40 pF, 50 $\Omega$  (nominal) input termination selectable internally.

**GAIN:** internally adjustable over 2:1 attenuation range.

**CATHODE-RAY TUBE**

**TYPE:** post deflection accelerator, approximately 6.6 kV accelerating potential. Aluminized P31 phosphor, electrostatic focus and deflection.

**GRATICULE:** internal graticule, 8 x 10 divisions, 1 div =  $\approx$  1.2 cm (Refer to table 1-3 for CRT's without graticules).

**RESOLUTION:** Line resolution at center screen is approximately 25 lines/cm at the specified line brightness.

**SAFETY PROTECTION**

**X-RAY EMISSION:**  $\approx$  0.5 mr/hr measured with Victoreen Model 440 RF/C.

**GENERAL****FRONT PANEL CONTROLS**

**Knob Adjustments:** Intensity, Focus, Position  $\blacktriangleleft$   $\blacktriangleright$  (X), Position  $\blacktriangleup$   $\blacktriangledown$  (Y).

**Screw-driver Adjustments:** Trace Align, X Gain, Y Gain.

**LINE POWER:** Selectable 100, 120, 220, or 240 Vac, +5% to -10%, 48 Hz to 66 Hz (see note); average power dissipation at 60 Hz and 120 Vac is approximately 35 watts.

**NOTE**

Unit meets all electrical specifications from 48 - 440 Hz, but does not meet line leakage requirements for medical and dental listings at line frequencies above 66 Hz.

**DIMENSIONS:** see outline drawing.

Table 1-2 Supplemental Characteristics (Cont'd)

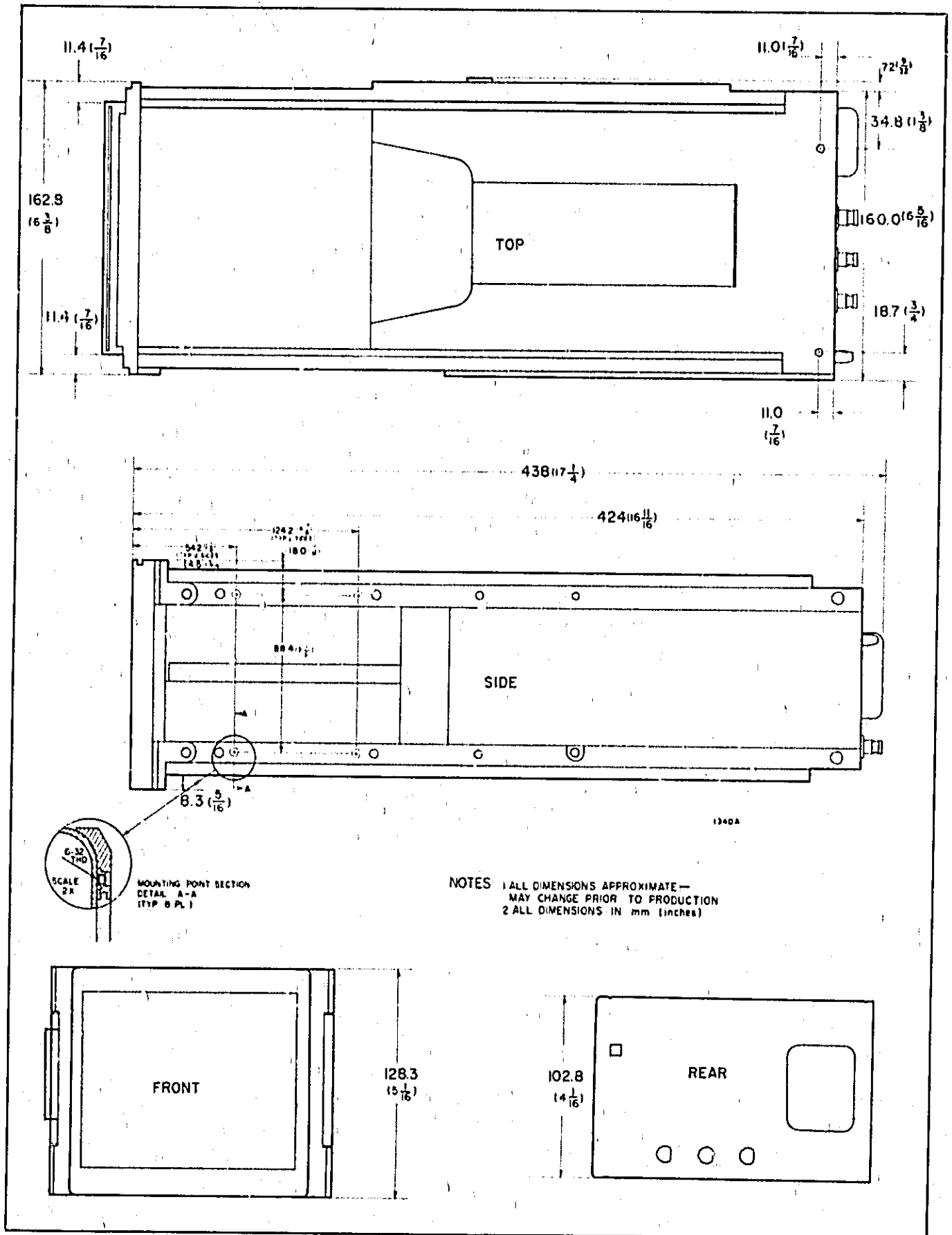

Table 1-3 Available Options

Options	Description	Kit Part Number
	<b>MODULES</b>	
001	Basic module without control panel.	See Table 6-2, Section VI
002	Basic module with dc supply voltages	
003	Basic module with dc power supply	
	<b>CABINET CONFIGURATIONS</b>	
005	Front panel line switch for system II cabinets.	
315	Basic module with System II 5-1/4 in. high, half rack width cabinet, 15-in. long struts with control panel. (Model 1340A is supplied without cabinet and with control panel.)	
316	Basic module with all necessary hardware assembled for mounting in 10380A or 10386A with 18-inch side struts. Front casting, two 18-inch struts, no covers, rear cover panel.	
317	Basic module with System II 5.25-in. high, full-rack width cabinet with 15-in. long struts (17-1/8 in. overall length). Painted blank front panel and filter panel included.	
580	Meets measurement equipment requirements for Canadian Standards Association safety certification, consists of option 315 with CSA labeling. See table 6-2 for option 315 replaceable parts.	
	<b>Z AMPLIFIER</b>	
216	TTL blanking level added to Z axis amplifier. High state (+2.5 V to +5 V) blanks any analog Z-input signal. Low state (0.0 V to +0.8 V) returns blanking to analog Z-axis input. Input through rear-panel BNC connector.	
	<b>CRT</b>	
004	Standard CRT replaced with CRT having P4 aluminized phosphor, 8-by-10-div internal graticule.	
007	Standard CRT P7 ALIG and amber filter.	
039	Standard CRT replaced with CRT having P9 aluminized phosphor, 8-by-10-div internal graticule.	
604	Standard CRT replaced with CRT having P1 aluminized phosphor, no internal graticule.	
607	Standard CRT replaced with CRT having P7 aluminized phosphor, no internal graticule.	
631	Standard CRT replaced with CRT having P3 aluminized phosphor, no internal graticule.	
639	Standard CRT replaced with CRT having P3 aluminized phosphor, no internal graticule.	
	<b>SIGNAL INPUTS</b>	
324	Remote program connector added to rear panel. X-, Y-, and Z-signal inputs wired in parallel with BNC inputs. (NOTE: input capacitance increases to approximately 120 pF.)	

Table 1-3 Available Options (Cont'd)

Options	Description	Kit Part Number
<b>POWER CORDS</b>		
300	Power cord for use in Great Britain and Singapore, 2.3 m (7.5 ft), removable, 240 V max, 3 conductor 90° IEC.	
301	Power cord for use in Australia and New Zealand, 2.3 m (7.5 ft), removable, 240 V max, 3 conductor IEC.	
302	Power cord for use in East and West Europe, 2.3 m (7.5 ft), removable, 240 V max, 3 conductor 90° IEC.	
303	Power cord for use in USA, Canada, Japan, and Mexico, 2.3 m (7.5 ft), removable, 240 V max, 3 conductor IEC to NEMA 5-15P.	
304	Power cord used in USA, Canada, Japan, and Mexico, 77.2 cm (30 in.) coiled, extends to 1.8 m (6 ft), removable, 120 V max, 3 conductor IEC to NEMA 5-15P. (NOTE: not available with Option 315 or 330.)	
306	Power cord, for use in Switzerland, 2.3 m (7.5 ft), removable, 240 V max, 3 conductor 90° IEC.	
307	Power cord, for use in USA only, hospital-grade AC line cord.	
<b>SAFETY</b>		
330	Listed by Underwriter Laboratories for medical and dental electronic equipment (UL 544). Includes special hospital-grade AC line cord, special AC line transformer, special marking on top cover and rear panel, and clear CRT impact-protection shield in lieu of standard blue contrast filter.	
332	Listed by underwriter laboratories for medical and dental electronic equipment (UL 544) includes special hospital-grade AC line cord and transformer, special marking on top cover, feet, rear panel, and tilt stands; and a blue impact protection CRT filter.	
333	Listed by underwriter laboratories for medical and dental electronic equipment (UL 544) includes special hospital-grade AC line cord and transformer special marking on top cover, feet, rear panel, and tilt stands; and a neutral gray impact protection CRT filter.	
335	Underwriter Laboratories recognized components for use in medical and dental equipment (UL 544) display module without cabinet.	
336	Includes special hospital-grade AC line cord, special AC line transformer, and clear CRT implosion shield in lieu of standard blue contrast filter.	
337	Listed by Underwriter Laboratories for medical and dental electronic equipment (UL 544). Consists of a basic display module with special hospital-grade AC line cord and transformer; and a blue impact-protection CRT filter.	
500	Listed by Underwriter Laboratories for medical and dental electronic equipment (UL 544). Consists of basic display module with special hospital-grade AC line cord and transformer; and neutral gray impact-protection CRT filter.	
910	No Manual: But gets Option Note 01340-90902	
912	Extra manual	
912	X Ray label and special power cord.	

**1-13. RECOMMENDED TEST EQUIPMENT.**

1-14. Equipment required to maintain the 1340A is listed in table 1-4. Other equipment may be substituted if it meets or exceeds the critical specifications listed in the table.

**1-15. INSTRUMENTS COVERED BY MANUAL.**

1-16. Attached to the instrument is a serial number plate. The serial number is in the form: 0000A00000. It is in two parts; the first four digits and the letter are the serial prefix and the last five digits are the suffix. The prefix is the same for all identical instruments; it changes only when a change is made to the instrument. The suffix however, is assigned sequentially and is different for each instrument. The contents of this manual apply to instruments with the serial number prefix(es) listed under SERIAL NUMBERS on the title page.

1-17. An instrument manufactured after the printing of this manual may have a serial number prefix that is

not listed on the title page. This unlisted serial number prefix indicates the instrument is different from those described in this manual. The manual for this newer instrument is accompanied by a yellow Manual Changes supplement. This supplement contains "change information" that explains how to adapt the manual to the newer instrument.

1-18. In addition to change information, the supplement may contain information for correcting errors in the manual. To keep this manual as current and accurate as possible, Hewlett-Packard recommends that you periodically request the latest Manual Changes supplement. The supplement for this manual is identified with the manual print date and part number, both of which appear on the manual title page. Complimentary copies of the supplement are available from Hewlett-Packard.

1-19. For information concerning a serial number prefix that is not listed on the title page or in the Manual Changes supplement, contact your nearest Hewlett-Packard office.

Table 1-4. Recommended Test Equipment

Instrument	Critical Specification	Recommended Model	Use
Function Generator	Output 1: Sine, Square Wave Amplitude: $0 \pm 10$ Volts into High Z load Amplitude: $0 \pm 2$ Volt into $50 \Omega$ load Offset: $\pm 1$ Volt Frequency: 10 MHz Output Z: $50 \Omega$ Output 2: Sine Amplitude: 1 V into $50 \Omega$ Frequency: 10 kHz	HP 3312A	P,A,T
Pulse Generator (2 Required)	 Period: $0.1 \mu s$ to 1 ms Width: square wave Amplitude: 1 Volt Transition Time: $< 5$ ns Output Z: $50 \Omega$	HP 8013B	P,A,T
Digital Multimeter	Volts: $\pm 300$ VDC Inputs Z: $10 M \Omega$	HP 3476A	A,T
High Voltage Probe	40 kV for use with above DMM	HP 34111A	A,T
Oscilloscope	Bandwidth: 100 MHz Input Z: $50 \Omega$ and $1 M \Omega$ $\approx 20$ pF Vertical Sensitivity: 5 mV	HP 1740A	A,T
Oscilloscope Probe (2 each)	Division Ratio: 10:1 Impedance: $10 M \Omega$ , $\approx 10$ pF	HP 10004D	A,T
P = Performance Checks    A = Adjustments    T = Troubleshooting			

## SECTION II INSTALLATION

### 2-1. INTRODUCTION.

2-2. This section provides installation instructions for the Model 1340A. This section also includes information about initial inspection, damage claims, and packaging instructions.

### 2-3. INITIAL INSPECTION.

2-4. Inspect the shipping container for damage. If the shipping container or cushioning material is damaged, it should be kept until the contents of the shipment have been checked mechanically and electrically.

### 2-5. PREPARATION FOR USE.

**WARNING**

This instrument is designed and manufactured primarily for OEM systems. Without Option 315 or Option 317, protective covers are not provided and internal, hazardous voltages are exposed when ac power is connected. Operator protection from these hazardous voltages must be provided by the system in which the instrument is used.

2-6. **POWER REQUIREMENTS.** The 1340A operates from any power source supplying 100, 120, 220, or 240 Vac (+5% -10%), single phase, 48 Hz to 66 Hz that can deliver at least 35 watts. (See **LINE POWER** note in table 1-2.)

2-7. **LINE VOLTAGE SELECTION.** The instrument is normally shipped from the factory set to operate at 120 Vac. To operate from any of the other sources, proceed as follows:

**WARNING**

Component replacement, (including ac fuse) and all adjustments should be performed only by service trained personnel who are aware of the hazards involved (for example, fire and electrical shock).

- a. Remove power cable (if attached).
- b. Remove top cover of 1340A (if installed).
- c. Install line select jumper connector (E1 or E2) as indicated on LVPS schematic at rear of this manual.

### NOTE

AC input requirement selected by E1 or E2 jumper connector will be displayed as a color code through rear-panel openings indicating selection of either 100, 120, 220, or 240volts.

d. Replace internal input line fuse with 300 mA/T fuse (HP Part No. 2110-0044) for 220/240 Vac operation.

e. Replace top cover of 1340A (if required).

f. Connect input ac power cable.

2-8. **POWER CABLES.** This instrument is equipped with a three-wire power cable. When connected to an appropriate ac power receptacle, this cable grounds the instrument cabinet. The type of power cable plug shipped with each instrument depends on the country of destination. See figure 2-1 for part numbers of the power cables with plug configurations available.







HP POWER CABLE PART NUMBERS			
8170-1692	8170-0698	8170-0696	8170-1992
			
OPTION 302	OPTION 303	OPTION 301	OPTION 307
8170-1703	8170-2296	8170-2061	
			
OPTION 300	OPTION 306	OPTION 304	
INPUT POWER RECEPTACLE TYPES			

Figure 2-1. Power Receptacles

### 2-9. REPACKING FOR SHIPMENT.

2-10. If the instrument is to be shipped to a Hewlett-Packard Sales/Service Office for service or repair, attach a tag showing owner (with address), complete instrument serial number, and a description of the service required.

2-11. Use the original shipping carton and packing material. If the original packing material is not available, the Hewlett-Packard Sales/Service Office will provide information and recommendations on materials to be used.

## SECTION III

### OPERATION

#### 3-1. INTRODUCTION.

3-2. This section contains operating instructions, applications and interfacing considerations for the HP Model 1340A.

#### WARNING

Without Option 315 or Option 317, protective covers are not provided and internal, hazardous voltages are exposed when ac power is connected. Operator protection from these hazardous voltages must be provided by the system in which the instrument is used.

#### 3-3. PANEL FEATURES.

3-4. The Model 1340A is an X, Y, Z display with analog voltage inputs for X-, Y-, and Z-axis controls. All signals must be externally supplied through rear-panel connectors. The instrument is intended for use as a general-purpose graphic display. Intensity, trace align, focus, position  $\blacktriangleleft\blacktriangleright$  (X), position  $\blacktriangle$  (Y), X-gain, and Y-gain controls are accessible on the front panel. Trace align, X-gain, and Y-gain controls are screwdriver adjustments. Controls and connectors are illustrated and briefly described in figure 3-7.

#### WARNING

Component replacement (including ac fuse) and internal adjustments must be made by qualified maintenance personnel.

#### 3-5. PREOPERATIONAL PROCEDURE.

#### CAUTION

The INTENSITY control will adjust display brightness from completely off (ccw) to maximum brightness (cw). To avoid damage to CRT phosphor, increase intensity slowly until display brightness is at a comfortable viewing level.

3-6. GENERAL. Prepare the 1340A for operation as follows (instruments with options may require modification of input levels):

#### NOTE

The instrument is normally shipped with the input attenuator switches set for the 1-volt full scale, high-input impedance configurations. For other input configurations refer to table 3-1 and figure 3-1.

- a. Set INTENSITY fully counterclockwise.
- b. Set horizontal and vertical POSITION controls to midrange.
- c. Set line switch (rear panel) to ON. LINE indicator lamp (front panel) should light.

#### CAUTION

A high-intensity display over an extended period will burn the CRT phosphor.

- d. Adjust INTENSITY control. Display spot brightness should vary from completely extinguished (full ccw position) to acceptable viewing brightness as control is turned cw. Adjust for comfortable viewing brightness of display spot.
- e. Adjust position  $\blacktriangle$  (Y) through its full range. Display spot will move vertically on CRT, disappearing from viewing area at either extreme of control.
- f. Adjust position  $\blacktriangleleft\blacktriangleright$  (X) through its full range. Display spot will move horizontally on CRT, disappearing from viewing area at either extreme of control.
- g. Set  $\blacktriangleleft\blacktriangleright$  and  $\blacktriangle$  position controls to center display spot on CRT.
- h. Set FOCUS control for smallest, sharpest display spot.
- i. Apply 1-kHz, 1-volt p-p sine-wave signal to X amplifier input connector on rear panel of instrument.
- j. Adjust TRACE ALIGN to align trace horizontally.
- k. Set X GAIN for trace length of 119 mm (4.7 in.), or as required by application.
- l. Connect 1-kHz, 1-volt p-p sine-wave signal to Y amplifier input connector on rear panel of instrument.
- m. Adjust Y GAIN for trace length of 95.2 mm (3.75 in.), or as required by application.

Table 3-1. X, Y, and Z Input Switch Coding

ATTEN	IMP	X					Y					Z
		S1-1	S1-2	S1-3	S1-4	S1-5	S2-4	S2-5	S2-6	S2-7	S2-8	S2-1
1	50 ohm	ON	ON	OFF	ON	OFF	ON	ON	OFF	ON	OFF	ON
1	1 M	OFF	ON	OFF	ON	OFF	OFF	ON	OFF	ON	OFF	OFF
5	1 M	OFF	OFF	ON	OFF	ON	OFF	OFF	ON	OFF	ON	N/A
5	50 ohm	ON	OFF	ON	OFF	ON	ON	OFF	ON	OFF	ON	N/A

**3-7. BANDWIDTH REDUCTION.** In certain cases, the full 3-MHz bandwidth of the deflection amplifiers is not required. In fact, in some applications it may be desirable to reduce the bandwidth to eliminate system noise problems. The X- and Y-amplifier bandwidth can be limited by disengaging the following input attenuation and bandwidth selection switches (see figure 3-1 for switch location):

Amplifier	Disengage Switch
X	A1S3-8
Y	A1S3-7

Engaging the bandwidth limit switches reduces the bandwidth of the amplifiers to approximately 165 kHz.

**3-8. INPUT POLARITY SELECTION.** The X-, Y-, and Z-amplifiers can be conditioned by the input attenuation and bandwidth selection switches for input signals with different polarities. To condition the equipment for different polarity signals, set applicable switches as indicated in table 3-2. (See figure 3-1 for switch location.)

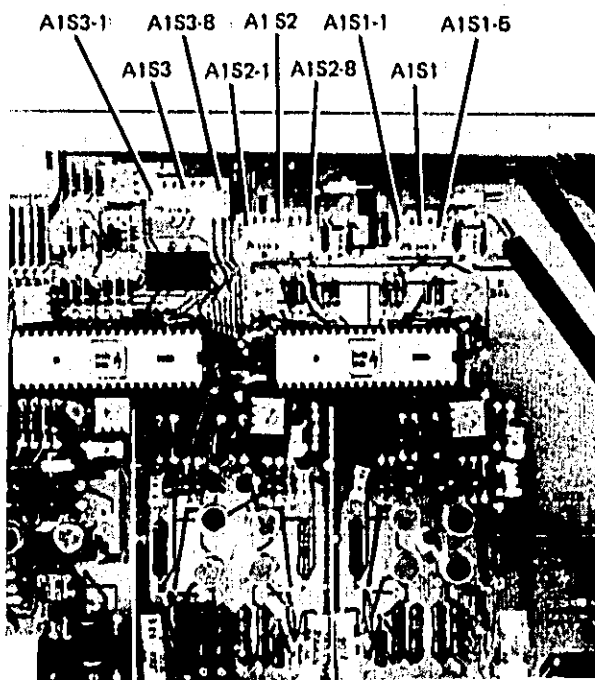

Figure 3-1. Input Attenuation and Bandwidth Selection Switches

Table 3-2. Input Signal Polarity Selection

INPUT POLARITY	X AMPLIFIER INPUT		Y AMPLIFIER INPUT		Z AMPLIFIER INPUT	
	Switch A1, S3-5	Switch A1, S3-6	Switch S3-3	Switch S3-4	Switch S3-1	Switch S3-2
Positive	CLOSED	OPEN	CLOSED	OPEN	CLOSED	OPEN
Negative	OPEN	CLOSED	OPEN	CLOSED	OPEN	CLOSED



### 3-9. APPLICATION CONSIDERATIONS.

**3-10. GENERAL.** This section contains interfacing considerations, display adjustments, definitions for specification terminology, and optional features.

### 3-11. INTERFACING CONSIDERATIONS.

**3-12. GENERAL.** Front-panel gain controls allow adjustment from 800 mV to 2 V to give full-screen deflection in both the X and Y axes of display. One graticule division is equal to 1.2 cm (0.47 in.). Switch-selectable attenuation is available to provide full-screen deflection within the range of 4 V to 10 V. This attenuation range plus the gain adjustments allow the 1340A to interface with most systems.

**3-13. Crosstalk and Ringing.** The importance of 50-ohm input terminations as related to display quality and reduction of crosstalk cannot be overemphasized. The undesirable effects of crosstalk and ringing will increase as pipe length or system bandwidth are increased. However, the use of the 50 $\Omega$  terminations will usually reduce crosstalk and reflections to a negligible level.

#### NOTE

Crosstalk can also be produced by input driving circuits and ground loops.

**3-14.** Ringing is one possible undesirable side effect of improperly terminated inputs. For instance, an abrupt transition from blanked to unblanked in an improperly terminated Z-axis input line may cause ringing which would appear as intensity fluctuations in the display. For minimum induced crosstalk and ringing, displays connected in parallel should be connected in a "daisy-chain" configuration with only the last display in the chain terminated in 50 ohms (figure 3-2).

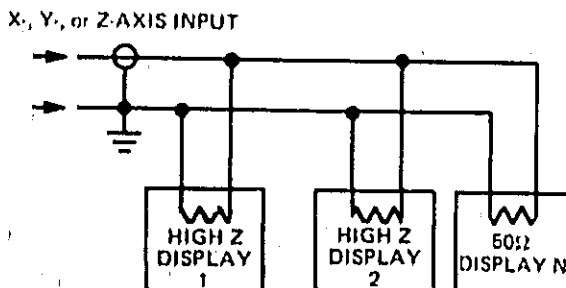

Figure 3-2. Input Termination Impedance of Displays Connected in Parallel

**3-15.** Setting the intensity control fully ccw prevents the beam from being turned full-on, regardless of the voltage applied to the Z-axis input. This condition is provided to protect the CRT from damage when a system failure causes loss of control over the Z-axis input voltage or loss of deflection voltages. Therefore, the system operator only has to turn the intensity control fully ccw in the event of a system failure.

**3-16. DISPLAY ADJUSTMENTS.** In order to obtain best performance and flexibility of the 1340A, it is essential that front-panel controls be set properly.

**3-17. FOCUS.** To focus a display, position the beam approximately 2/3 the diagonal distance from center screen towards any corner of the screen and adjust the focus control for optimum spot size. Position the beam to the remaining three quadrants and check for optimum focus at each location. Often, one quadrant of the screen will not focus as precisely as the other three and this quadrant should be adjusted for the best focus.

**3-18. Astigmatism Adjustment.** This control (internal adjustment A3R24) is used to match voltage on the forward-most element of the focus lens to voltage on the deflection plates to prevent the deflection plates from acting as part of the focus lens. Without this balanced voltage condition, the focal length of the electron gun is changed at the sides of the beam with respect to the top and bottom of the beam, or vice versa, which distorts the beam shape.

**3-19.** To check the astigmatism adjustment, rotate the focus control back and forth through the point of optimum focus. If the dots elongate vertically and then horizontally, it indicates improper astigmatism adjustment.

#### NOTE

Astigmatism is properly adjusted if the dots in the corners slant approximately 45° from upper left to lower right and vice versa as the focus control passes through the point of optimum focus.

**3-20. PERFORMANCE SPECIFICATIONS.** Major performance specifications, what they mean, how they are determined, and how they affect system performance are explained in the following paragraphs.

**3-21. Spot Size and Resolution.** If you scan a CRT spot with a microscope photometer and plot brightness versus distance (spot width), the result approximates a Gaussian curve (figure 3-3). The spot size is the width of the Gaussian curve at its 50% point (see section I, table 1-2).

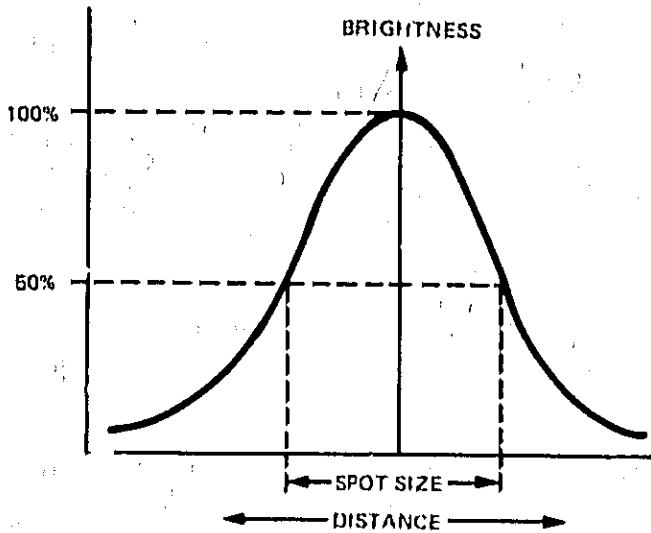

Figure 3-3. Brightness vs Cross Section of Typical CRT Spot

3-22. In practice, the 50% point can be determined by using the shrinking raster measurement method. The shrinking raster measurement is obtained by displaying a raster of lines (or dots) on the CRT and then adjusting the vertical and horizontal gain until the individual lines (or dots) are no longer individually identifiable. The size of the raster is then divided by the number of lines in the raster to determine the spot size. The point where the raster (or dots) merge is approximately the theoretical 50% point on the Gaussian curve.

3-23. The shrinking raster method should be used if a scanning microscope photometer is not available, because observing an individual line (or dot) with an optical comparator can be very misleading. On a single dot, the eye can see to about the 3% point on the Gaussian curve. Here the dot appears to be approximately twice the width it is across the 50% points.

3-24. **Settling Time.** Settling time is defined as the elapsed time between an input step command and the time for the beam to settle within a specified tolerance to its final position (see figure 3-4). Settling time must be taken into account when moving the beam from one location to another. Otherwise, there may be tails on dots, or line distortions at the starting point of vectors.

3-25. **Linearity.** Linearity can be defined as either a scaling error in locating a point on the CRT with given input voltages relative to known full scale input voltages or an error in locating a point within any calibrated increment on the CRT other than full-screen. In other words, if known X and Y input voltages correspond to a certain CRT screen position and other known voltages correspond to another position, then any intermediate voltages between these two sets of voltages correspond to points located proportionately

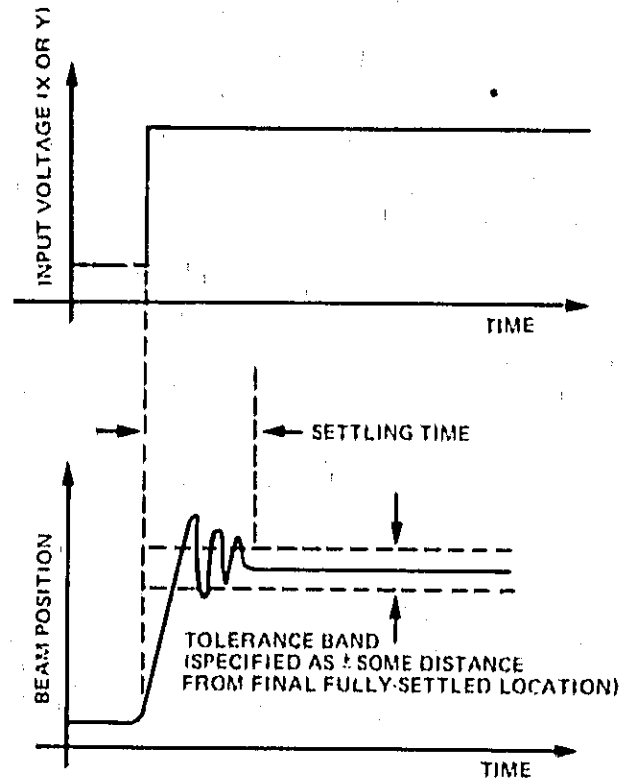

Figure 3-4. Settling Time

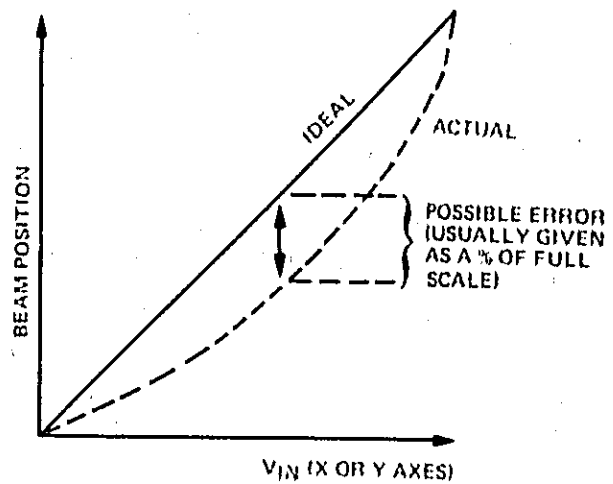

Figure 3-5. Linearity of Beam Position Showing Ideal Positioning and Possible Error

between the two predetermined points with a possible error of  $\pm 3\%$  of the distance between the two known points. The increment of position shown in figure 3-5 may be either full screen or any portion of the screen.

3-26. Linearity is specified only along the major CRT screen axes. For CRT line distortion other than along the major axes, refer to the CRT geometry specifications listed in table 1-1 and see figure 3-6.

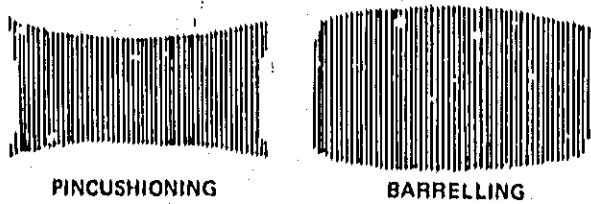
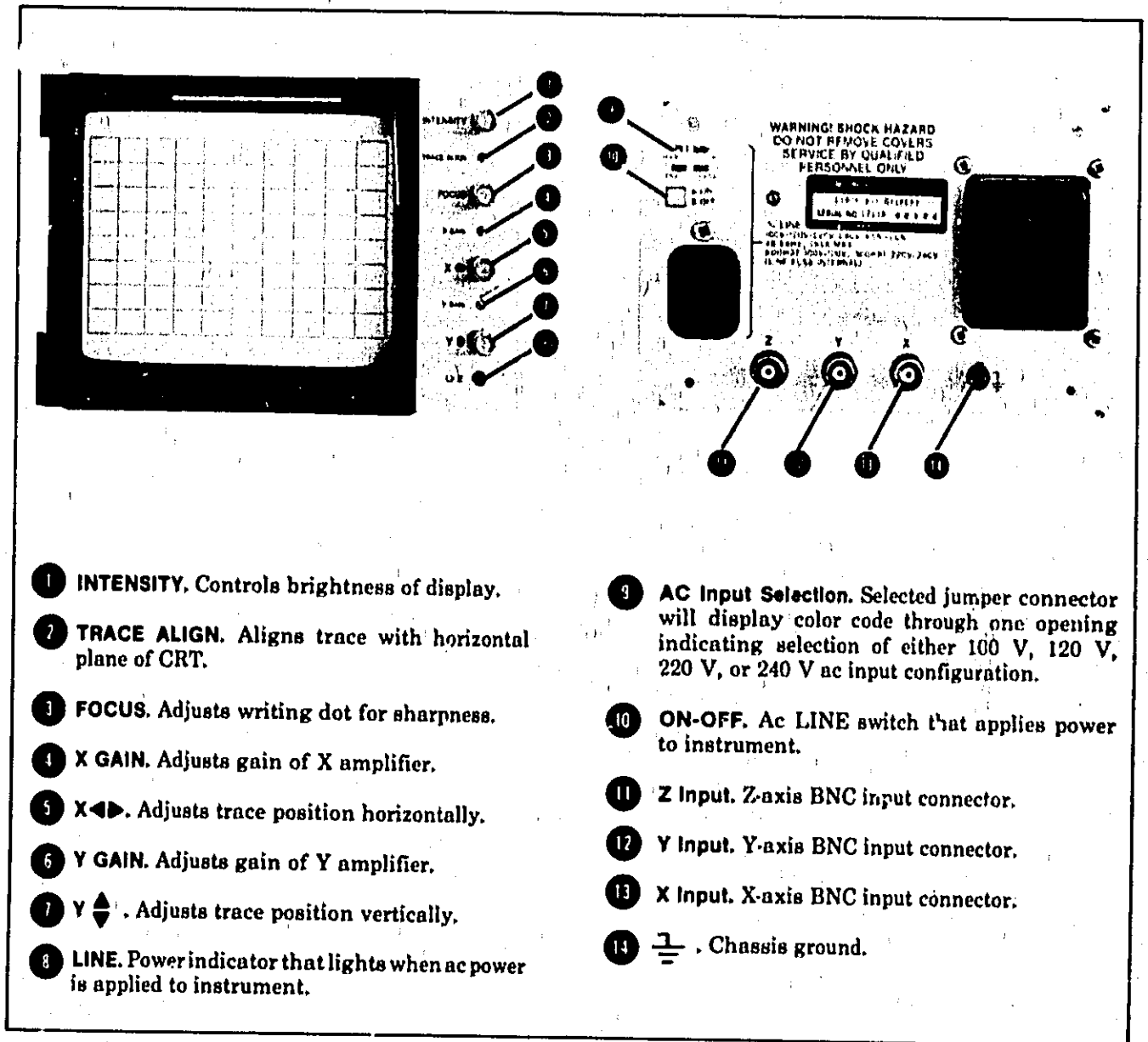

Figure 3-6. Geometric Distortion Caused by CRT (exaggerated)

3-27. From the specifications, it is difficult to relate the actual position of a point on the CRT to the input voltages applied to the X and Y axes, except on the major axes. This is because a CRT is an open-loop device (unlike an X-Y plotter) with no method of applying feedback to the amplifier circuits to make corrections to beam positioning. Therefore, a point along a line from the CRT screen center to a point in the CRT corner is subject to a location error caused by nonlinearity along the major axes and an additional geometric distortion error component which increases in significance as the beam moves out from the CRT center.



- 1 INTENSITY. Controls brightness of display.
- 2 TRACE ALIGN. Aligns trace with horizontal plane of CRT.
- 3 FOCUS. Adjusts writing dot for sharpness.
- 4 X GAIN. Adjusts gain of X amplifier.
- 5 X◀▶. Adjusts trace position horizontally.
- 6 Y GAIN. Adjusts gain of Y amplifier.
- 7 Y▲▼. Adjusts trace position vertically.
- 8 LINE. Power indicator that lights when ac power is applied to instrument.
- 9 AC Input Selection. Selected jumper connector will display color code through one opening indicating selection of either 100 V, 120 V, 220 V, or 240 V ac input configuration.
- 10 ON-OFF. Ac LINE switch that applies power to instrument.
- 11 Z Input. Z-axis BNC input connector.
- 12 Y Input. Y-axis BNC input connector.
- 13 X Input. X-axis BNC input connector.
- 14  $\perp$ . Chassis ground.

Figure 3-7. Controls and Connectors

## SECTION IV

### PERFORMANCE TESTS

#### 4-1. INTRODUCTION.

4-2. The procedures in this section test the instrument's electrical performance using the specifications of table 1-1 as the performance standards. All tests can be performed without access to the interior of the instrument.

#### 4-3. EQUIPMENT REQUIRED.

4-4. Equipment required for the performance tests is listed in Section I, table 1-4. Any equipment that satisfies the critical specifications given in the table may be substituted for the recommended models.

#### 4-5. TEST RECORD.

4-6. Results of the performance tests may be tabulated on the Test Record at the end of this section. The Test Record lists the tested specifications and their acceptable limits. The results recorded at incoming inspection can be used for comparison in periodic maintenance and troubleshooting and after repairs or adjustments.

#### 4-7. CALIBRATION CYCLE.

4-8. Periodic calibration is not normally required for this instrument. Performance tests, however, should be

made after service work has been performed or if improper operation is suspected.

4-9. Further performance checks are included in the adjustments section that require access to the inside of the instrument. These checks are not considered normal requirements for a standard performance test.

**WARNING**

The instrument is designed and manufactured primarily for OEM systems. Without Option 315 or Option 317, protective covers are not provided and internal, hazardous voltages are exposed when ac power is connected. Component replacement, including ac fuse, and internal adjustments must be made by qualified maintenance personnel.

4-10. The X (horizontal) and Y (vertical) amplifiers are identical, therefore, only one test has been written and should be applied to both amplifiers before proceeding to the next test.

#### 4-11. PERFORMANCE TEST PROCEDURES.

---

#### 4-12. DYNAMIC RANGE TEST (X AND Y AMPLIFIERS).

##### SPECIFICATIONS:

The dynamic range shall extend offscreen to at least 1/2 screen diameter in any direction provided the zero input position is on screen.

##### DESCRIPTION:

A square-wave signal and a ramp signal are used in an oscilloscope-type presentation. Amplitude of the waveforms is 1.5 times the screen diameter and the display is then checked for distortion.

##### NOTE

Care must be taken to correctly identify changes in output of the pulse generator. Otherwise, these changes can be misinterpreted as dynamic range irregularities.

**PERFORMANCE TESTS**

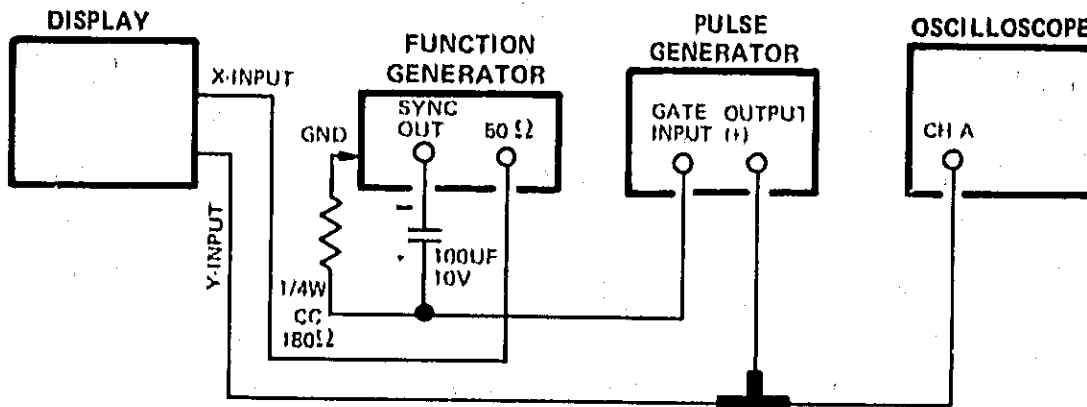

Figure 4-1. Dynamic Range Test Setup

**EQUIPMENT:**

Function Generator .....	HP 3312A
Oscilloscope .....	HP 1740A
Pulse Generator .....	HP 8013A

**PROCEDURE:**

- a. Connect equipment as shown in figure 4-1.

**NOTE**

Sync output from the recommended function generator (table 1-4) must be shifted to gate the pulse generator. The R-C network shown in figure 4-1 shift the output level from the function generator to assure stable gating of the pulse generator.

- b. Set pulse generator as follows:

PULSE PERIOD .....	10 $\mu$ s
PULSE WIDTH .....	Square Wave
AMPLITUDE (V) .....	(see Note below)

**NOTE**

The output amplitude of the pulse generator is set for a full screen display of 96 mm when driving the Y (vertical) amplifier and 119 mm when driving the X (horizontal) amplifier.

- c. Set function generator as follows:

FREQUENCY .....	20 kHz
FUNCTION .....	(Sawtooth)
OFFSET .....	OFF
AMPLITUDE .....	full-screen deflection

- d. On oscilloscope, note amplitude of pulse generator output required to produce 96 mm (119 mm) display on 1340A CRT.
- e. Increase output amplitude from pulse generator by 1.5 times that noted in step d.
- f. Displayed waveform on 1340A should extend offscreen in one direction (depending on which axis is driven by pulse generator).

**NOTE**

If trouble is experienced while performing this procedure, check the power supplies, their decoupling networks, and the X-, Y-amplifier outputs, particularly the plate average of +85 volts.

**PERFORMANCE TESTS**

**4-13. X-, Y-AMPLIFIER BANDWIDTH AND RISE TIME.**

**SPECIFICATION:**

Rise time is  $\leq 120$  ns (10% to 90% points) for full-screen deflection (or less). Bandwidth is dc to greater than 3 MHz (3 dB down) for 5 cm or less deflection.

**DESCRIPTION:**

This test measures bandwidth of the amplifiers; bandwidth is then used to compute rise time.

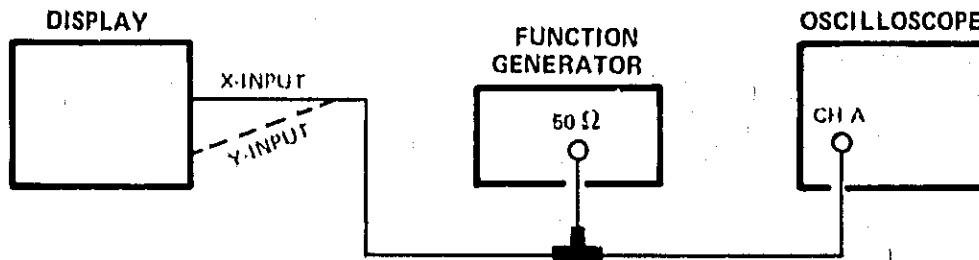

Figure 4-2. Bandwidth and Rise Time Test Setup

**EQUIPMENT:**

- Function Generator ..... HP 3312A
- Oscilloscope..... HP 1740A

**PROCEDURE:**

- a. Connect equipment as shown in figure 4-2.
- b. Set function generator as follows:
  - FREQUENCY ..... 10 kHz
  - FUNCTION..... (Sine Wave)
- c. Connect output of function generator to one input on 1340A.
- d. Adjust function generator output for 5 cm trace deflection on 1340A CRT.
- e. Using oscilloscope, note p-p amplitude from function generator.
- f. Maintaining same amplitude noted in step e, increase function generator frequency until trace deflection on 1340A CRT decreases to 3.5 cm.
- g. Final frequency setting of function generator is 3 dB bandwidth of amplifier under test.
- h. Using the following formula, compute rise time:

$$r^1(\text{ns}) = \frac{.350}{\text{BW (MHz)}}$$

- i. Repeat above procedure for other amplifier and complete following:

X AMPL BANDWIDTH.....MHz

X AMPL RISE TIME .....ns

Y AMPL BANDWIDTH.....MHz

Y AMPL RISE TIME .....ns

**PERFORMANCE TESTS**

**4-14. PHASE SHIFT.**

**SPECIFICATION:**

3° to 1 MHz for input signals causing full-screen deflection.

**DESCRIPTION:**

This test verifies the phase shift difference between the X and Y amplifiers. Phase shift must remain the same (within 3°) to at least 1 MHz.

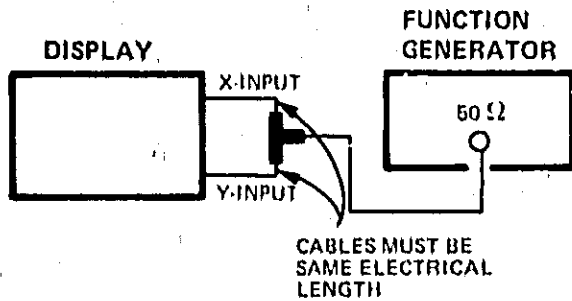

Figure 4-3. Phase-shift Test Setup

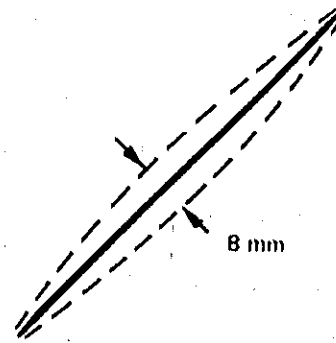

Figure 4-4. Phase-shift Measurement

**Equipment:**

Function Generator ..... HP 3312A

**PROCEDURE:**

**NOTE**

This test cannot be performed properly if the internal input attenuators are not set for the same range.

- a. Connect equipment as shown in figure 4-3.
- b. Set function generator as follows:

FREQUENCY ..... 50 kHz  
 FUNCTION ..... (Sine Wave)

- c. Adjust output amplitude of function generator for full-screen, diagonal trace on 1340A CRT. (Front-panel gain control may need readjusting for corner-to-corner presentation.)
- d. While watching diagonal trace on 1340A CRT, increase frequency until trace separation is 8 mm (see figure 4-4).

Frequency causing 8 mm trace separation is: \_\_\_\_\_.

**PERFORMANCE TESTS**

**4-15. DIAGONAL SETTLING TIME.**

**SPECIFICATION:**

Signal settles to within one spot diameter of final value in  $\leq 300$  ns for any on-screen movement. Off-screen deflection must not exceed specified dynamic range.

**DESCRIPTION:**

The intensity (Z-axis) is turned on a short time after the X- or Y-axis transition. Blanking time must be  $\leq 300$  ns before a significant tail (1 spot diameter) is seen on the spot indicating the beam position is just reaching its settling point.

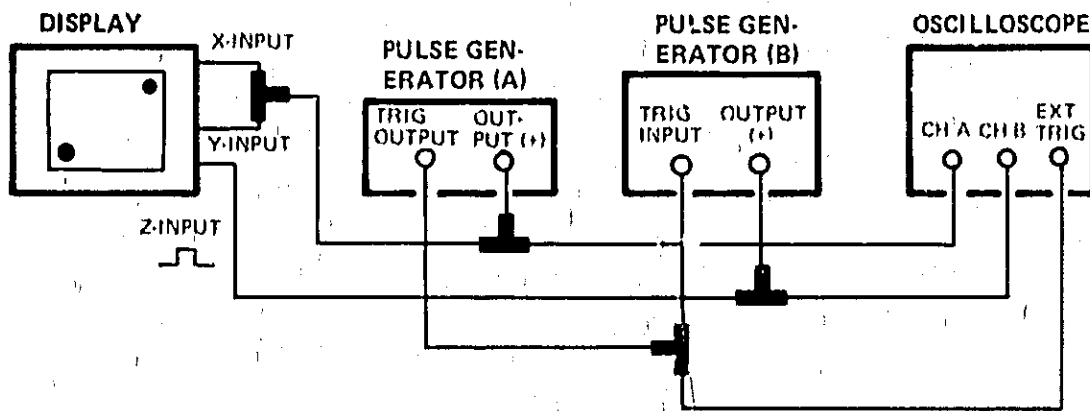

Figure 4-5. Diagonal Settling Time Test Setup

**EQUIPMENT:**

- Pulse Generators (2) ..... HP 8013B
- Oscilloscope ..... HP 1740A

**PROCEDURE:**

- a. Connect equipment as shown in figure 4-5.
- b. Set pulse generator (A) as follows:
  - PULSE PERIOD ..... 10  $\mu$ s
  - PULSE DELAY ..... minimum
  - PULSE WIDTH ..... Square Wave
- c. Adjust pulse generator (A) AMPLITUDE to position two spots on diagonal corners of 1340A CRT. Position and Gain controls of 1340A may require adjustments for proper positioning of the spots.
- d. Set pulse generator (B) as follows:
  - PULSE PERIOD ..... (+) EXT
  - PULSE DELAY ..... 400 ns
  - PULSE WIDTH ..... 1  $\mu$ s
  - AMPLITUDE ..... 1V
- e. Reduce pulse generator (B) PULSE DELAY time until tail of one spot diameter in length is visible at one or both diagonal spots.
- f. Measure delay time on oscilloscope. Test limit is 300 ns maximum. Diagonal Settling Time is: \_\_\_\_\_ ns.



**PERFORMANCE TESTS**

**4-16. REPEATABILITY.**

**SPECIFICATION:**

0.4 mm error (full-screen) for re-addressing a point from any on- or off-screen location within the specified dynamic range.

**DESCRIPTION:**

This test verifies the amplifier performance stability with a varying input signal.

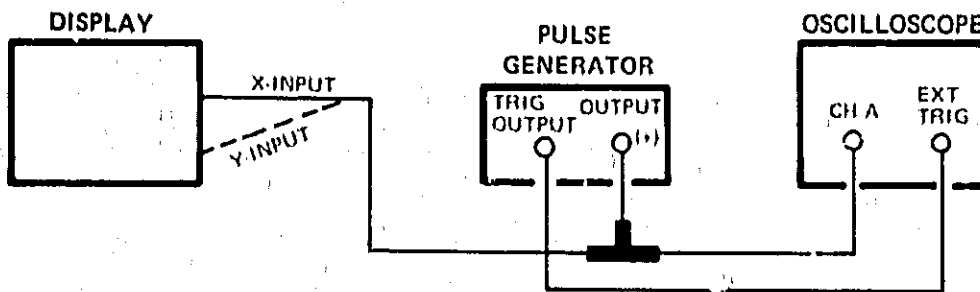

Figure 4-6. Repeatability Test Setup

**EQUIPMENT:**

Pulse Generator .....	HP 8013B
Oscilloscope .....	HP 1740A

**NOTE**

This test requires a pulse generator with a very stable baseline during changes in pulse period, pulse width, and amplitude. If a pulse generator other than that recommended is used, the baseline shift should be carefully measured. The baseline shift should not exceed 0.05% of the amplitude change.

**PROCEDURE:**

- a. Connect equipment as shown in figure 4-6.
- b. Set pulse generator as follows:

PULSE PERIOD .....	0.1 ms
PULSE WIDTH .....	50 μs

- c. Using 1340A controls, position baseline spot at center of CRT.

**NOTE**

Use oscilloscope as a monitor when accomplishing step d. Do not exceed specified dynamic range of the 1340A.

- d. Vary pulse generator amplitude, pulse period, and pulse width verniers and notice any position change in spot. Spot movement should be 0.4 mm or less.

**PERFORMANCE TESTS**

**4-17. TTL BLANKING (OPTION 216 ONLY).**

**SPECIFICATION:**

Option 216 - high state (+2.5 V to +5.0 V) blanks any analog Z-axis input signal. Low state (0 V to +0.8 V) returns blanking function to Z-axis input.

**DESCRIPTION:**

This test verifies the upper and lower TTL blanking and unblanking limits.

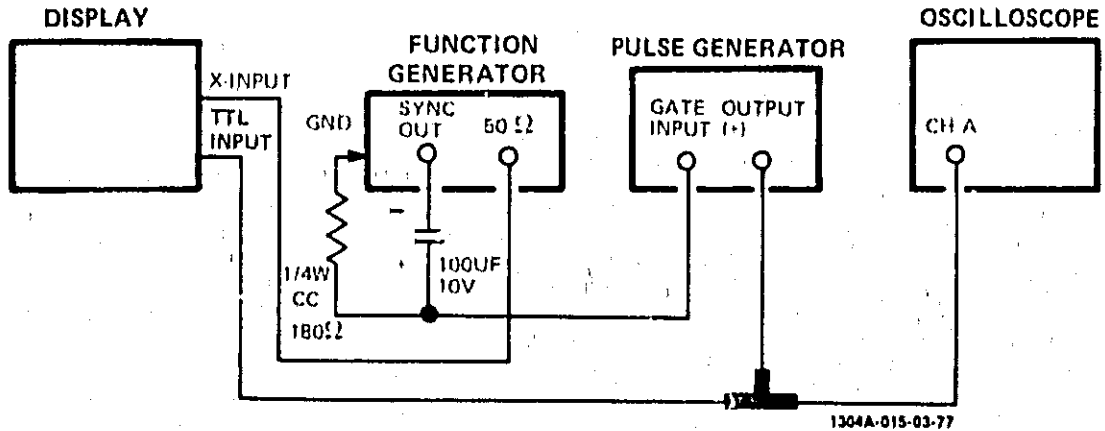

Figure 4-7. Option 216 Test Setup

**EQUIPMENT:**

Function Generator .....	HP 3312A
Pulse Generator .....	HP 8013B
Oscilloscope .....	HP 1740A

**PROCEDURE:**

- a. Connect equipment as shown in figure 4-7.

**NOTE**

Sync output from the recommended function generator (table 1-4) must be shifted to gate the pulse generator. The R-C network shown in figure 4-7 shifts the output level from the function generator so that stable gating of the pulse generator is assured.

- b. Set function generator as follows:

FREQUENCY .....	10 kHz
FUNCTION .....	(Sawtooth)
AMPLITUDE .....	full screen deflection

- c. Set pulse generator as follows:

PULSE PERIOD .....	10 μSEC
PULSE WIDTH .....	Square Wave
AMPLITUDE/OFFSET .....	+2.5 V +0.8 V

- d. Increase 1340A INTENSITY control until segmented line is displayed on CRT indicating blanking and unblanking is occurring.
- e. Disconnect pulse generator from 1340A Z-axis input connector.

**PERFORMANCE TEST RECORD**

**HEWLETT-PACKARD**  
**MODEL 1340A**  
**X-Y DISPLAY**

Serial No. \_\_\_\_\_

Tested By \_\_\_\_\_  
 Date \_\_\_\_\_

Paragraph Number	Test	Min	Results Actual	Max
4-12	Dynamic Range Test Y-amplifier X-amplifier	off-screen off-screen		
4-13	X, Y-amplifier Bandwidth and Rise Time X-amplifier Bandwidth X-amplifier Rise Time Y-amplifier Bandwidth Y-amplifier Rise Time	3 MHz 3 MHz		130 ns 130 ns
4-14	Phase Shift	1 MHz		
4-15	Diagonal Settling Time			300 ns
4-16	Repeatability			0.4 mm
4-17	TTL Blanking (Opt 216 only)	+0.8 V (unblank) +2.5 V (blank)		

## SECTION V

### ADJUSTMENTS

#### 5-1. INTRODUCTION.

5-2. This section describes adjustments and checks required to return the instrument to peak operating capabilities when repairs have been made. Included in this section are equipment setups and adjustment procedures.

#### 5-3. SAFETY REQUIREMENTS.

5-4. Although this instrument has been designed in accordance with international safety standards, general safety precautions must be observed during all phases of operation, service, and repair of the instrument. Failure to comply with the precautions listed in the Safety Summary at the front of this manual or with specific warnings given throughout the manual could result in serious injury or death. Service and adjustments should be performed only by qualified service personnel.

#### 5-5. EQUIPMENT REQUIRED.

5-6. A complete list of required test equipment is given in Section I, table 1-4. Test equipment equivalent to that recommended may be substituted, provided it meets the required characteristics. For best results, use recently calibrated test equipment.

#### 5-7. ADJUSTMENTS.

5-8. The adjustments given in this section are not interrelated. Refer to table 5-1 for a list of adjustable components and their functions.

5-9. After repair, the applicable adjustments should be made, but a complete readjustment of the instrument is unnecessary. Prior to any adjustments, however, the power supply outputs should be checked for proper voltage levels.

5-10. For best results, allow the instrument to warm up for 15 minutes before making adjustments. Adjustment locations are shown on Service Sheet 6 at the back of this manual. Service sheet 6 folds out to enable use while performing procedures.

#### 5-11. ADJUSTMENT PROCEDURES.

**WARNING**

Adjustment procedures described are performed with power supplied to the instrument and should be performed only by trained service personnel who are aware of the hazards involved (for example, fire and electrical shock).

*Table 5-1. Adjustable Components*

Reference Designator	Adjustment Name	Adjustment Paragraph	Service Sheet	Description
A2R15	+165 V Adj	5-12	4, 6	+165 V LVPS Adjustment.
A3R2	HV Adj	5-13	3, 6	Adjust for proper CRT filament voltage.
A3R22 A3R24	Focus Adj AST	5-14	3, 6	Centers FOCUS control and adjusts astigmatism of CRT.
A1R74	INT LIMIT	5-15	3, 6	Sets maximum intensity limit for CRT.
A3R25	PATTERN	5-16	3, 6	Adjusts CRT deflection for minimum distortion.
A1R7 A1R19	X BAL Y BAL	5-17	2, 6	Balance X and Y amplifiers for minimum spot movement while GAIN controls are varied.

## ADJUSTMENTS

Table 5-1. Adjustable Components (Cont'd)

Reference Designator	Adjustment Name	Adjustment Paragraph	Service Sheet	Description
A1R13 A1R25	Y GAIN SET X GAIN SET	5-18	2, 6	Establishes range of front-panel X and Y GAIN controls.
A1R67	Z BAL.	5-19	2, 6	Balances the Z-axis amplifier.
A1R70 A1R75 A1C31	Z GAIN HF Adj No. 1 HF Adj No. 2	5-20	2, 6	Z-axis amplifier response adjustment.
A1C1 A1C10	X-Input Comp Y-Input Comp	5-21	2, 6	AC compensation for 5:1/Hi impedance range.

## 5-12. LOW-VOLTAGE POWER SUPPLY ADJUSTMENT.

## REFERENCE:

Service Sheet 4.

## DESCRIPTION:

The +165 Vdc Power Supply is adjusted for an output of +165 V  $\pm$  1 V. The low-voltage supplies are then checked for proper output.

## EQUIPMENT:

DMM (Digital Multimeter)..... HP 3476A

## PROCEDURE:

Adjust +165 V low-voltage power supply as follows:

- Connect DMM between pin 10 (+165 V) and pin 3 (ground) of ribbon cable A2W1.
- Adjust +165 V Adj A2R15 for +165 V  $\pm$  1 V indication on DMM.
- Check other dc voltages as indicated in table 5-2.

Table 5-2. LVPS Tolerances

Power Supply	Test Point (A2W1 Pin No.)	Tolerance	Range
+15 V	Pin 5	$\pm$ 5%	+14.25 to +15.75 V
-15 V	Pin 1	$\pm$ 5%	-14.25 to -15.75 V
-7.5 V	Pin 4	$\pm$ 10%	-6.75 to -8.25 V
+3.5 V	Pin 2	$\pm$ 10%	+3.15 to +3.85 V

## ADJUSTMENTS

### 5-13. HIGH-VOLTAGE POWER SUPPLY ADJUSTMENT.

**REFERENCE:**

Service Sheet 3.

**DESCRIPTION:**

The HVPS is adjusted to the voltage specified on the high-voltage transformer ( $\pm 3\%$ ) to assure proper filament voltage for the CRT.

**EQUIPMENT:**

DMM (Digital Multimeter).....	HP 3476A
High-voltage Probe (1000:1) .....	HP 34111A

#### NOTE

Digital Multimeter must have a 10-megohm input termination and a 10-V range to be compatible with the 1000:1 probe.

**PROCEDURE:**

- a. Set 1340A front-panel INTENSITY control fully ccw.
- b. Set rear-panel LINE switch to OFF position.

**WARNING**

Voltages capable of causing injury or death are present in the high-voltage power supply. Use an insulated adjustment tool and proceed carefully.

- c. Note voltage marked on high-voltage transformer.
- d. Set rear-panel LINE switch to ON.
- e. Connect DMM to +165 V (pin 5 of ribbon connector A3W1) and note voltage indication.
- f. Connect DMM to +165 V through high-voltage probe (1000:1) and note voltage indication.
- g. Compute percentage of error introduced by high-voltage probe (difference between indications noted in step e and step f).
- h. Set LINE switch to OFF.
- i. Connect DMM through high-voltage probe to cathode output at assembly A3 (square pin to which (4) wire is connected).
- j. Set LINE switch to ON.
- k. While monitoring voltage at cathode output, adjust A3R2, HV ADJ, on assembly A3 for DMM indication equal to that listed on high-voltage transformer (step c).

#### NOTE

Final indication on DMM should include percentage of error noted in step g.

- l. Set LINE switch to OFF.
- m. Disconnect high-voltage probe from cathode output square pin.

## ADJUSTMENTS

---

### 5-14. FOCUS LIMIT ADJUSTMENT.

**REFERENCE:**

Service Sheet 3.

**DESCRIPTION:**

Focus Adj A3R22 centers the range of the front-panel FOCUS control.

**EQUIPMENT:**

None

**PROCEDURE:**

- a. Set INTENSITY and vertical/horizontal POSITION controls for spot of normal intensity at center of CRT.
  - b. Set front-panel FOCUS control to midrange.
  - c. Adjust Focus Adj A3R22 and AST control A1R24 for sharpest focus of round spot.
- 

### 5-15. INTENSITY LIMIT ADJUSTMENT.

**REFERENCE:**

Service Sheet 3.

**DESCRIPTION:**

Intensity limit adjustment A1R74 sets maximum intensity of the CRT by limiting the grid-to-cathode voltage to 40 volts above cutoff.

**EQUIPMENT:**

DMM (Digital Multimeter)..... HP 3476A

**PROCEDURE:**

- a. Connect DMM to pin 1 of ribbon cable A3W1 at A1 assembly.
- b. Slowly adjust front-panel INTENSITY control until CRT displayed spot just extinguishes. Note DMM indication.

**CAUTION**

The INTENSITY control will adjust display brightness from completely off (ccw) to maximum brightness (cw). To avoid damage to the CRT be certain to accomplish step c before proceeding with this adjustment.

- c. Using Y POSITION control move spot from CRT viewing area.
  - d. Set front-panel INTENSITY control fully clockwise (maximum brightness).
  - e. With DMM connected as directed in step a, adjust INT LIMIT A1R74 for 40 V indication on DMM above that voltage noted in step b.
  - f. Set front-panel INTENSITY control fully counterclockwise.
  - g. Disconnect DMM.
-

**ADJUSTMENTS**

**5-16. PATTERN ADJUSTMENT.**

**REFERENCE:**  
Service Sheet 3.

**DESCRIPTION:**  
The function generator outputs provide a raster display which is adjusted for the squrest shape.

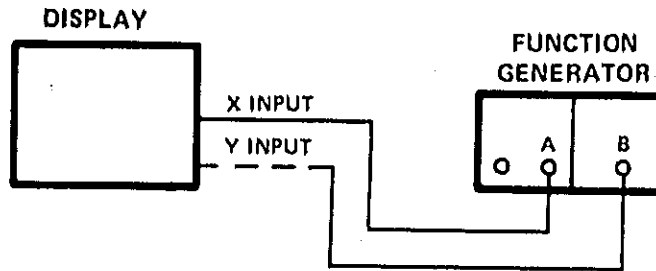

*Figure 5-1. Pattern Adjustment Test Setup*

**EQUIPMENT:**  
Function Generator ..... HP 3312A

- PROCEDURE:**
- a. Connect equipment as shown in figure 5-1.
  - b. Set function generator outputs as follows:
 

FREQUENCY A .....	15 kHz
FREQUENCY B .....	10 kHz
FUNCTION A and B .....	~ Sine Wave
AMPLITUDE A and B .....	Near full screen deflection square pattern
  - c. Adjust pattern control A3R25 for squrest pattern, i.e., straight sides, no barreling or pincushioning.

**5-17. X- AND Y-AMPLIFIER BALANCE ADJUSTMENTS.**

**REFERENCE:**  
Service Sheet 2.

**DESCRIPTION:**  
X- and Y-amplifier balances are adjusted so that there is minimum spot movement as the front-panel GAIN controls are rotated through their range.

**EQUIPMENT:**  
None

- PROCEDURE:**
- a. Using vertical and horizontal POSITION controls, center spot on CRT.
  - b. While rotating front-panel X GAIN control through its range, adjust A1R7 for minimum spot shift.
  - c. While rotating front-panel Y GAIN control through its range, adjust A1R19 for minimum spot shift.



## ADJUSTMENTS

### 5-18. X- AND Y-AMPLIFIER GAIN SET.

**REFERENCE:**

Service Sheet 2.

**DESCRIPTION:**

X- and Y-amplifier gains are adjusted so that front-panel gain controls have a range of 0.8 V to 2 V.

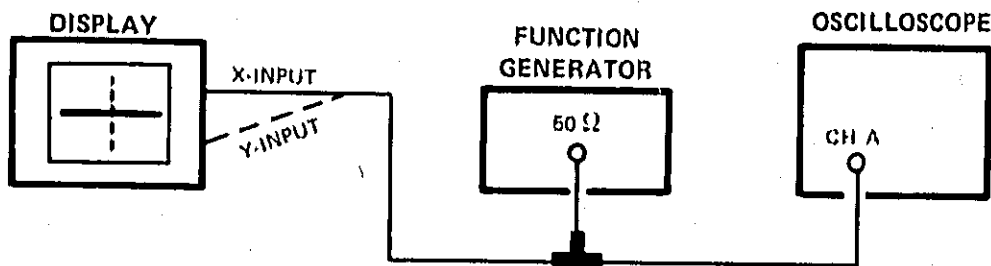

Figure 5-2. Gain Set Adjustment Test Setup

**EQUIPMENT:**

Function Generator .....	HP 3312A
Oscilloscope.....	HP 1740A

**PROCEDURE:**

- a. Connect equipment as shown in figure 5-2.
- b. Set X- and Y-input attenuators for 50 $\Omega$  range (see Service Sheet 2).
- c. Set front-panel X- and Y-GAIN controls fully clockwise.
- d. Set function generator output as follows:
 

FREQUENCY .....	1 kHz
FUNCTION .....	Square Wave
AMPLITUDE .....	0.4 V p-p
- e. Adjust X-amplifier GAIN SET control (A1R25) for 5 div (60 mm), and Y-amplifier GAIN SET control (A1R13) for 4 div (48 mm).
- f. Increase output of function generator to 2 V p-p.
- g. Verify that front-panel X- or Y-GAIN control can decrease spot separation to less than 5 div (60 mm).

### 5-19. Z-AMPLIFIER BALANCE ADJUSTMENT.

**REFERENCE:**

Service Sheet 3.

**DESCRIPTION:**

Z-amplifier balance control is adjusted so that there is minimum change in intensity as the Z GAIN control is rotated through its range.

**EQUIPMENT:**

None

**PROCEDURE:**

- a. Using vertical and horizontal POSITION controls, center spot on CRT.
- b. While rotating Z-GAIN control, A1R70, through its range, adjust A1R67 for minimum change in intensity.

**ADJUSTMENTS**

**5-20. Z-AMPLIFIER GAIN AND HIGH FREQUENCY ADJUSTMENTS.**

**REFERENCE:**  
Service Sheet 3.

**DESCRIPTION:**  
Z-axis GAIN control A1R70 is normally operated at full gain (fully clockwise). Amplifier response is adjusted for the fastest transition consistent with minimum overshoot.

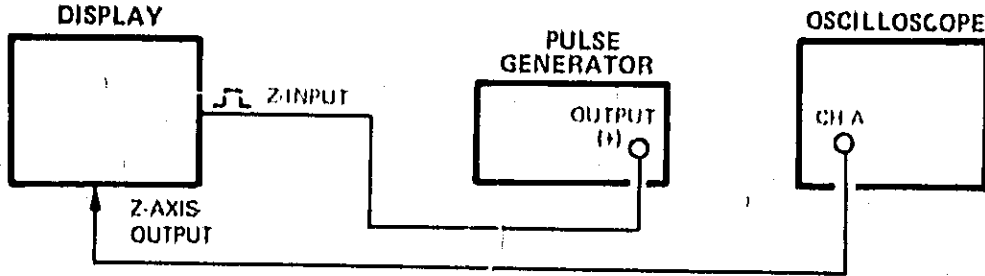

Figure 5-3. Z-amplifier Gain and High Frequency Adjustment Test Setup

**EQUIPMENT:**

Pulse Generator.....	HP 8013B
Oscilloscope.....	HP 1740A
10:1 Divider Probe.....	HP 10004D

**PROCEDURE:**

- a. Using front-panel FOCUS control, defocus spot on CRT.
- b. Set Z-amplifier input attenuator for 50Ω range. (A1S2-1, closed)
- c. Set Z-axis gain control A1R70 fully clockwise.
- d. Connect equipment as shown in figure 5-3.
- e. Using 10:1 divider probe, connect oscilloscope to leg of A1R82 closest to A1Q15 (Z-axis output, refer to page 8-15).
- f. Set pulse generator as follows:
 

PULSE PERIOD .....	0.1 ms (10 KHz)
PULSE WIDTH .....	Sqr are Wave
AMPLITUDE .....	0.5 V p-p
- g. Adjust front-panel INTENSITY control so waveform observed at A1R82 does not limit at top or bottom.
- h. Adjust HF ADJ No. 1 (A1R75) and HF ADJ No. 2 (A1C31) to achieve fast-rise response as observed on oscilloscope (<70 ns) consistent with sharp corners and minimum overshoot.

## ADJUSTMENTS

## 5-21. INPUT ATTENUATOR COMPENSATION.

## REFERENCE:

Service Sheet 2.

## DESCRIPTION:

This procedure adjusts input attenuators for the X- and Y-axis amplifiers. No adjustments are required for the 1:1/50 and the 1:1/Hi impedance ranges. The 5:1/Hi impedance range requires ac compensation. Service Sheet 2 shows switch settings for the 5:1/Hi impedance input.

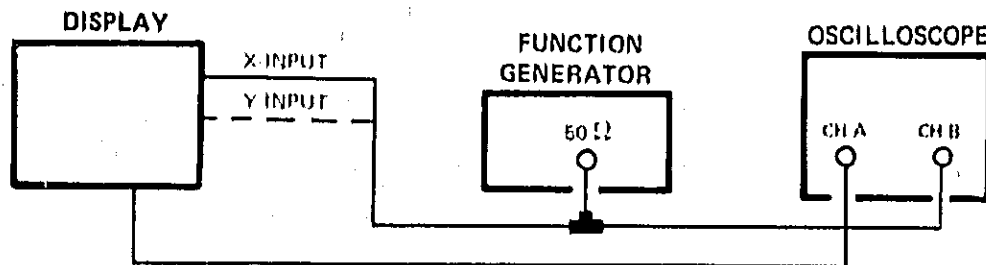

Figure 5-4. Input Attenuator Adjustment Test Setup

## EQUIPMENT:

Function Generator .....	HP 3312A
Oscilloscope .....	HP 1740A
10:1 Divider Probe .....	HP 10004D

## PROCEDURE:

## NOTE

Ensure 10:1 Divider Probe is compensated.

Connect the function generator output to only one input at a time. Using 10:1 divider probe, connect oscilloscope to appropriate amplifier output.

- Set both X- and Y-input attenuator switches for 5:1/Hi impedance input.  
S1-1, 2, and 4, S2-4, 5, and 7: OPEN      S1-3 and 5, S2-6 and 8: CLOSED
- Connect equipment as shown in figure 5-4.
- Set function generator output as follows:

FREQUENCY .....	10 kHz
FUNCTION .....	Square Wave
AMPLITUDE .....	5 V p-p

- Adjust appropriate attenuator compensation capacitor (A1C1 for X INPUT; A1C10 for Y INPUT) for sharp square-wave response on oscilloscope.

## NOTE

Since the input waveform may not be square, use ALT and overlap the output waveform with the input waveform and compensate with the compensation capacitor. Vary the appropriate X or Y position control on the 1340A to achieve the best overlap prior to adjusting the compensation.

## SECTION VI

### REPLACEABLE PARTS

#### 6-1. INTRODUCTION.

6-2. This section contains information for ordering parts. Table 6-1 lists abbreviations used in the parts list, table 6-2 lists all replaceable parts in reference designator order, and table 6-3 contains the names and addresses that correspond to the manufacturers' code numbers.

#### 6-3. ABBREVIATIONS.

6-4. Table 6-1 lists abbreviations used in the parts list, the schematics, and throughout the manual. In some cases, two forms of the abbreviation are used, one all in capital letters, and one partial or no capitals. This occurs because the abbreviations in the parts list are always all capitals. However, in other parts of the manual other abbreviation forms are used with both lower and uppercase letters.

#### 6-5. REPLACEABLE PARTS LIST.

6-6. Table 6-2 is the list of replaceable parts and is organized as follows:

- a. Electrical assemblies in alphanumerical order by reference designation.
- b. Chassis-mounted parts in alphanumerical order by reference designation.
- c. Electrical assemblies and their components in alphanumerical order by reference designation.

The information given for each part consists of the following:

- a. Complete reference designation.
- b. Hewlett-Packard part number.
- c. Total quantity (Qty) in instrument.
- d. Description of part.

e. Typical manufacturer of part in identifying five-digit code.

f. Manufacturer's number for part.

The total quantity for each part is given only once—at the first appearance of the part number in the list.

#### 6-7. ORDERING INFORMATION.

6-8. To order a part listed in the replaceable parts table, quote the Hewlett-Packard part number, indicate the quantity required, and address the order to the nearest Hewlett-Packard office.

6-9. To order a part that is not listed in the replaceable parts table, include the instrument model number, instrument serial number, the description and function of the part, and the number of parts required. Address the order to the nearest Hewlett-Packard office.

#### 6-10. DIRECT MAIL ORDER SYSTEM.

6-11. Within the USA, Hewlett-Packard can supply parts through a direct mail order system. Advantages of using the system are as follows:

a. Direct ordering and shipment from HP Parts Center in Mountain View, California.

b. No maximum or minimum on any mail order (there is minimum order amount for parts ordered through local HP offices when orders require billing and invoicing).

c. Prepaid transportation (there is small handling charge for each order).

d. No invoices—to provide these advantages, check or money order must accompany each order.

6-12. Mail order forms and specific ordering information is available through your local HP office.

Table 6-1. Reference Designators and Abbreviations

REFERENCE DESIGNATORS

<b>A</b> = assembly	<b>F</b> = fuse	<b>MP</b> = mechanical part	<b>U</b> = integrated circuit
<b>B</b> = motor	<b>FL</b> = filter	<b>P</b> = plug	<b>V</b> = vacuum tube, neon bulb, photocell, etc
<b>BT</b> = battery	<b>IC</b> = integrated circuit	<b>O</b> = transistor	<b>VR</b> = voltage regulator
<b>C</b> = capacitor	<b>J</b> = jack	<b>R</b> = resistor	<b>W</b> = cable
<b>CP</b> = coupler	<b>K</b> = relay	<b>RT</b> = thermistor	<b>X</b> = socket
<b>CR</b> = diode	<b>L</b> = inductor	<b>S</b> = switch	<b>Y</b> = crystal
<b>DL</b> = delay line	<b>LS</b> = loud speaker	<b>T</b> = transformer	<b>Z</b> = tuned cavity network
<b>DS</b> = device signaling stamp	<b>M</b> = meter	<b>TB</b> = terminal board	
<b>E</b> = misc electronic part	<b>MK</b> = microphone	<b>TP</b> = test point	

ABBREVIATIONS

<b>A</b> = amperes	<b>H</b> = henries	<b>N/O</b> = normally open	<b>RMO</b> = rack mount only
<b>AFC</b> = automatic frequency control	<b>HDW</b> = hardware	<b>NOM</b> = nominal	<b>RMS</b> = root-mean square
<b>AMPL</b> = amplifier	<b>HEX</b> = hexagonal	<b>NPO</b> = negative positive zero (zero temperature coefficient)	<b>RWV</b> = reverse working voltage
<b>BFO</b> = beat frequency oscillator	<b>HG</b> = mercury	<b>NPN</b> = negative-positive-negative	<b>S-B</b> = slow-blow
<b>BE CU</b> = beryllium copper	<b>HR</b> = hour(s)	<b>NRFR</b> = not recommended for field replacement	<b>SCR</b> = screw
<b>BH</b> = binder head	<b>HZ</b> = hertz	<b>NSR</b> = not separately replaceable	<b>SE</b> = selenium
<b>BP</b> = bandpass	<b>IF</b> = intermediate freq	<b>ORD</b> = order by description	<b>SECT</b> = section(s)
<b>BRS</b> = brass	<b>IMPG</b> = impregnated	<b>OH</b> = oval head	<b>SEMICON</b> = semiconductor
<b>BWO</b> = backward wave oscillator	<b>INCD</b> = incandescent	<b>OX</b> = oxide	<b>SI</b> = silicon
<b>CCW</b> = counter-clockwise	<b>INCL</b> = included	<b>P</b> = peak	<b>SIL</b> = silver
<b>CER</b> = ceramic	<b>INS</b> = insulation(ed)	<b>PC</b> = printed circuit	<b>SL</b> = slide
<b>CMO</b> = cabinet mount only	<b>INT</b> = internal	<b>PF</b> = picofarads = 10 <sup>-12</sup> farads	<b>SPG</b> = spring
<b>COEF</b> = coefficient	<b>K</b> = kilo = 1000	<b>PH BRZ</b> = phosphor bronze	<b>SPL</b> = special
<b>COM</b> = common	<b>LH</b> = left hand	<b>PHL</b> = phillips	<b>SST</b> = stainless steel
<b>COMP</b> = composition	<b>LIN</b> = linear taper	<b>PIV</b> = peak inverse voltage	<b>SR</b> = splitting
<b>COMPL</b> = complete	<b>LK WASH</b> = lock washer	<b>PNP</b> = positive-negative-positive	<b>STL</b> = steel
<b>CONN</b> = connector	<b>LOG</b> = logarithmic taper	<b>P/O</b> = part of	<b>TA</b> = tantalum
<b>CP</b> = cadmium plate	<b>LPF</b> = low pass filter	<b>POLY</b> = polystyrene	<b>TD</b> = time delay
<b>CRT</b> = cathode-ray tube	<b>M</b> = milli = 10 <sup>-3</sup>	<b>PORC</b> = porcelain	<b>TGL</b> = toggle
<b>CW</b> = clockwise	<b>MEG</b> = meg = 10 <sup>6</sup>	<b>POS</b> = position(s)	<b>THD</b> = thread
<b>DEPC</b> = deposited carbon	<b>MET FLM</b> = metal film	<b>POT</b> = potentiometer	<b>TI</b> = titanium
<b>DR</b> = drive	<b>MET OX</b> = metallic oxide	<b>PP</b> = peak-to-peak	<b>TOL</b> = tolerance
<b>ELECT</b> = electrolytic	<b>MFR</b> = manufacturer	<b>PT</b> = point	<b>TRIM</b> = trimmer
<b>ENCAP</b> = encapsulated	<b>MHZ</b> = mega hertz	<b>PWV</b> = peak working voltage	<b>TWT</b> = traveling wave tube
<b>EXT</b> = external	<b>MINAT</b> = miniature	<b>RECT</b> = rectifier	<b>U</b> = micro = 10 <sup>-6</sup>
<b>F</b> = farads	<b>MOM</b> = momentary	<b>RF</b> = radio frequency	<b>VAR</b> = variable
<b>FH</b> = flat head	<b>MOS</b> = metal oxide substrate	<b>RH</b> = round head or right hand	<b>VDCW</b> = dc working volts
<b>FIL H</b> = filament head	<b>MTG</b> = mounting		<b>W/</b> = with
<b>FXD</b> = fixed	<b>MY</b> = "mylar"		<b>W</b> = watts
<b>G</b> = giga (10 <sup>9</sup> )	<b>N</b> = nano (10 <sup>-9</sup> )		<b>WIV</b> = working inverse voltage
<b>GE</b> = germanium	<b>N/C</b> = normally closed		<b>WW</b> = wirewound
<b>GL</b> = glass	<b>NE</b> = neon		<b>W/O</b> = without
<b>GRO</b> = grounded	<b>NI PL</b> = nickel plate		

Table 6-2. Replaceable Parts

Reference Designator	HP Part Number	C D	Qty	Description	Mfr Code	Mfr Part Number
A1	01340 66516		1	BOARD ASSEMBLY X, Y, Z AMPLIFIER	28480	01340 66516
A2	01340 66602		1	BOARD ASSEMBLY LOW VOLTAGE POWER SUPPLY	28480	01340 66602
A3	01340 66603		1	BOARD ASSEMBLY HIGH VOLTAGE POWER SUPPLY	28480	01340 66603
A4	01340 66604		1	BOARD ASSEMBLY CONTROL	28480	01340 66604
A5	01340 66606		1	BOARD ASSEMBLY DC POWER OPTION 002 ONLY	28480	01340 66606
E1	01340 67601		1	LINE SELECT ASSY 100V 120V NOT SUPPLIED WITH OPTION 002 OR 003	28480	01340 67601
E2	01340 67602		1	LINE SELECT ASSY 220V 240V NOT SUPPLIED WITH OPTION 002 OR 003	28480	01340 67602
E3	1610 0038		1	POST BINDING	28480	1610 0038
E4	0340 0664		2	INSULATOR 1STR	28480	0340 0664
E5	0340 0665		1	INSULATOR 15TR	28480	0340 0665
H1	0340 0867		4	INSULATOR BUSHING	28480	0340 0867
H2	0360 1C72		3	LUG SOLDER	28480	0360 1C72
H3	0400 0002		1	GROMMET RUBBER	82099	761 J B
H4	0400 0000		1	GROMMET VINYL	82099	3002
H6	0670 0164		2	SCREW RETAINING FILTER 2 56 25 IN LG	28480	0670 0164
H6	0674 0289		3	SCREW TAPPING 2 28 312 IN LG PAN HD	28480	0674 0289
H7	1200 0081		6	INSULATOR BUSHING NYLON	28480	1200 0081
H8	1400 0017		1	CLAMP CABLE 312 DIA 376 WD NYL	06693	374 E
H9	2190 0008		2	WASHER LK EXT T NO 6 141 IN ID OPT 002 ONLY	04604	1341
H10	2190 0064		1	WASHER LK INTL 265 ID 408 OD 02 T	28480	2190 0084
H11	2190 0045		3	WASHER LK INCL NO 2 068 IN ID	28480	1601 009
H12	2200 0107		1	SCREW MTL 0 375 LG	28480	2200 0107
H13	2200 0129		1	SCREW MTL 2 00 LG	28480	2200 0129
H14	2190 0019		2	WHL 116 IN 226 OD 03T	28480	2190 0019
H15	2200 0179		1	SCREW MTL 0 125 LG	28480	2200 0179
H16	2200 0180		1	SCREW MTL 1 375 LG	28480	2200 0180
H17	2200 0528		3	SCREW MTL 1 875 LG	28480	2200 0528
H18	2200 0575		3	SCREW MACHINE	28480	2200 0575
H19	2260 0001		1	NUT HEX DBL CHAM 4 40 THD 094 IN THK	28480	2260 0001
H20	2260 0003		1	NUT HEX PLST CLKG 4 40 THD 141 IN THK	72062	976M40
H21	2360 0115		2	SCREW MTL 0 312 LG 6 32	28480	2360 0115
H22	2360 0102		4	SCREW MTL 0 260 LG 6 32	28480	2360 0102
H23	2360 0117		4	MS 6 32 438 LG	28480	2360 0117
H24	2360 0201		1	MS 6 32 600 LG	28480	2360 0201
H25	2060 0001		3	NUT H 6 32 003	28480	2060 0001
H26	2060 0072		1	NUT H 4 32 062	28480	2060 0072
H27	3060 0010		1	WFL 147 ID 312 OD 03 T	28480	3060 0010
H28	3060 0098		3	WFL 099 ID 260 OD 032 T	28480	3060 0098
H29	3060 0106		1	WFL 126 ID 281 OD 03 T	28480	3060 0106
H30	3060 0236		4	WFL 117 ID 260 OD 03 T	28480	3060 0236
H31	2260 0009		3	NUT HEX DBL CHAM 4 40 THD 003 IN THK	28480	2260 0009
H32	2200 0146		1	MS 4 40 438 LG	28480	2200 0146
J1	1260 0083		4	CONNECTOR BNC FEMALE	02600	31 222 1021
J2	1260 0083		4	CONNECTOR BNC FEMALE	02600	31 222 1021
J3	1260 0083		4	CONNECTOR BNC FEMALE	02600	31 222 1021
J4	1260 0083		4	CONNECTOR BNC FEMALE OPT 215 ONLY	02600	31 222 1021
L1	01340 66001		1	COIL TRACE ALIGN	28480	01340 66001
MP1	0370 0604		1	PUSHBUTTON MINT GRAY SQ	28480	0370 0604
MP2	0370 2612		4	KNOB RND	28480	0370 2612
MP3	7100 0389		1	COVER XIMR	28480	7100 0389
MP4	01340 00201		1	PANEL REAR STANDARD MODEL	28480	01340 00201
MP6	01340 00601		1	SHIELD HV OUTER	28480	01340 00601
MP6	01340 00602		1	SHIELD HV INNER	28480	01340 00602
MP7	01340 02706		1	FILTER BLUE	28480	01340 02702
MP7	01340 02701		1	FILTER CLEAR OPTION 330	28480	01340 02701
MP7	01340 02703		1	FILTER AMBER OPTION 607	28480	01340 02703
MP7	01340 02705		1	FILTER GRAY OPTIONS 333 337	28480	01340 02705
MP8	01340 04101		1	RETAINER FILTER	28480	01340 04101
MP9	01340 60602		1	SUBASSY SHIELD SUPPORT	28480	01340 60602
MP10	01340 04103		1	PLATE COVER REAR	28480	01340 04103
MP10	01340 04104		1	PLATE COVER REAR OPTIONS 330 337 AND 333	28480	01340 04104
MP11	4040 1311		1	COVER LOW VOLTAGE	28480	4040 1311
MP12	6040 7648		1	PLATE COVER CRT	28480	6040 7648
MP13	6040 8381		1	PANEL FRONT	28480	6040 8381
MP14	6060 0977		1	COVER TOP OPTION 316 AND 680	28480	6060 0977
MP15	01337 00204		1	PANEL REAR OPTION 316 ONLY	28480	01337 00204
MP15	01340 00213		1	PANEL REAR OPTION 003	28480	01340 00213
MP16	01340 00207		1	PANEL FRONT BLANK OPTION 317 ONLY	28480	01340 00207
MP17	01340 00208		1	PANEL COVER REAR BLANK OPTION 317 ONLY	28480	01340 00208
MP18	01340 00209		1	PANEL SUB FRONT OPTION 317 ONLY	28480	01340 00209
MP19	01340 01201		1	BRACKET MOUNTING OPTION 316 ONLY	28480	01340 01201
MP20	1460 1346		1	STAND TILT OPTIONS 316 317 330 332 333 AND 680	28480	1460 1346
MP21	6060 0844		1	COVER TOP OPTION 317 ONLY	28480	6060 0844
MP22	6060 0846		1	COVER BOTTOM OPTION 317 ONLY	28480	6060 0846
MP23	6060 0973		1	COVER BOTTOM OPTION 316 ONLY	28480	6060 0973

See introduction to this section for ordering information

Table 6-2. Replaceable Parts (Cont'd)

Reference Designation	HP Part Number	Qty	Description	Mfr Code	Mfr Part Number
MP24	6001 0430	2	TRIM FRONT SIDE OPTIONS 316 316 317 330 332 333 AND 680	28480	6001 0430
MP25	6020 6803	1	CASTING FRONT OPTION 316 317 330 332 333 AND 680	28480	6020 6803
MP26	6020 6804	1	CASTING REAR OPTION 316 317 330 332 333 AND 680	28480	6020 6804
MP27	6020 6816	1	CASTING FRONT FRAME OPTIONS 316 316 317 330 332 333 AND 680	28480	6020 6816
MP28	6020 6816	1	CASTING REAR FRAME OPTIONS 316 316 317 330 332 333 AND 680	28480	6020 6816
MP29	6020 6836	4	STRUT CORNER OPTIONS 316 AND 317 ONLY	28480	6020 6836
MP30	6020 6837	1	CASTING CORNER OPTION 316 ONLY	28480	6020 6837
MP31	6040 7201	4	FOOT OPTIONS 316 AND 317 ONLY	28480	6040 7201
MP32	6040 7202	1	TRIM STRIP, TOP (OPTION 317 ONLY)	28480	6040 7202
MP33	6040 7203	1	TRIM TOP FRONT (OPTION 316 ONLY)	28480	6040 7203
MP34	6040 6382	1	FRONT PNL INSERT RIGHT (OPTIONS 316 AND 316 ONLY)	28480	6040 6382
MP35	6040 6383	1	FRONT PNL INSERT LEFT (OPTIONS 316, 316, AND 317 ONLY)	28480	6040 6383
MP36	6060 0911	1	SIDE PERF (OPTION 317 ONLY)	28480	6060 0911
MP37	7120 6806	1	LABEL CONTROL PANEL	28480	7120 6806
MP38			NOT ASSIGNED		
MP39	6040 7649	1	PN SOCKET CRT	28480	6040 7649
MP40	6060 0911	1	PERF SIDE OPTION 317 ONLY	28480	6060 0911
Q1	1854 0433	3	TRANSISTOR NPN 61 PD-90W FT-2 MHZ	28480	1854 0433
Q2	1854 0330	1	TRANSISTOR NPN 61 PD-21W FT-10 MHZ (NOT SUPPLIED WITH OPTION 002)	28480	1854 0330
Q3	1854 0433		TRANSISTOR NPN 61 PD-90W FT-2 MHZ (OPTION 002 ONLY)	28480	1854 0433
Q4	1854 0433		TRANSISTOR NPN 61 PD-90W FT-2 MHZ (OPTION 002 ONLY)	28480	1854 0433
T1	01340 66002	1	TRANSFORMER INPUT PWR (NOT SUPPLIED WITH OPTION 002)	28480	01340 66002
U1	1826 0106	2	IC 7816 V RGLTR (NOT SUPPLIED WITH OPTION 002)	28480	1826 0106
U2	1826 0214	1	IC V RGLTR (NOT SUPPLIED WITH OPTION 002)	28480	1826 0214
U3	1826 0106	1	IC 7816 V RGLTR (OPTION 002 ONLY)	28480	1826 0106
V1	6083 6112	1	CRT P31 AL NG (OPTION 631 ONLY)	28480	6083 6112
V1	6083 6162	1	CRT P31 AL IG	28480	6083 6162
V1	6083 6161	1	CRT P4 AL NG (OPTION 004 ONLY)	28480	6083 6161
V1	6083 6170	1	CRT P30 AL IG (OPTION 030 ONLY)	28480	6083 6170
V1	6083 6171	1	CRT P30 AL NG (OPTION 630 ONLY)	28480	6083 6171
V1	6083 6131	1	CRT P7 AL NG (OPTION 607)	28480	6083 6131
V1	6083 6174	1	CRT P7 AL IG (OPTION 007)	28480	6083 6174
V1	6083 6162	1	CRT P4 AL IG (OPTION 004)	28480	6083 6162
W1	8120 1992	1	CABLE PWR FORD HOSPITAL GRADE (OPTIONS 307 330 332 333 336 336 337)	28480	8120 1992
W1	8120 2956	1	CABLE 3 COND (OPTION 812 ONLY)	28480	8120 2956
	01340 90916		SERVICE MANUAL	28480	01340 90916
W1	8120 1521	1	CABLE UNSHLD 3 COND 18AWG	28480	8120 1521
W1	8120 1703	1	CABLE, 3 COND (OPTION 300 ONLY)	28480	8120 1703
W1	8120 0606	1	CABLE, 3 COND (OPTION 301 ONLY)	28480	8120 0606
W1	8120 1602	1	CABLE, 3 COND (OPTION 302 ONLY)	28480	8120 1602
W1	8120 0608	1	CABLE, 3 COND (OPTION 303 ONLY)	28480	8120 0608
W1	8120 2061	1	CABLE, 3 COND (OPTION 304 ONLY)	28480	8120 2061
W1	8120 2296	1	CABLE, 3 COND (OPTION 306 ONLY)	28480	8120 2296
XV1	6040 7640	1	SOCKET CRT BASE	28480	6040 7640

See introduction to this section for ordering information

Table 6-2. Replaceable Parts (Cont'd)

Reference Designator	HP Part Number	C D	Qty	Description	Mfr Code	Mfr Part Number
A1	01340 66516		1	BOARD ASSEMBLY X Y Z AMPLIFIER (LESS A1A1 AND A1A2)	28480	01340 66516
A1A1	1KA2 5006		2	IC: X Y PREAMPLIFIER (NOT SUPPLIED WITH A1 ORDER SEPARATELY)	28480	1KA2 5006
A1A2	1KA2 5006			IC: Z PREAMPLIFIER (NOT SUPPLIED WITH A1 ORDER SEPARATELY)	28480	1KA2 5006
A1C1	0121 0606		3	CAPACITOR V TRMR 1.5 PF 250V	28480	0121 0606
A1C2	0160 2257		2	CAPACITOR FXD 10 PF +-5% 500VDC CER 0+-60	28480	0160 2257
A1C3	0160 2066		4	CAPACITOR FXD .01 UF +80-20% 100VDC CER	28480	0160 2066
A1C4	0160 3447		2	CAPACITOR FXD 470 PF +-10% 1KVDC CER	66280	C016B102F221K526 CDH
A1C5	0160 2265		2	CAPACITOR FXD 22 PF +-5% 500VDC CER 0+-30	28480	0160 2265
A1C6	0160 3447			CAPACITOR FXD 470 PF +-10% 1KVDC CER	66280	C016B102F221K526 CDH
A1C7	0160 3443		4	CAPACITOR FXD .1 UF +80-20% 50WVDC CER	28480	0160 3443
A1C8	0160 3443			CAPACITOR FXD .1 UF +80-20% 50WVDC CER	28480	0160 3443
A1C9	0160 3443			CAPACITOR FXD .1 UF +80-20% 50WVDC CER	28480	0160 3443
A1C10	0121 0606			CAPACITOR V TRMR 1.5 PF 250V	28480	0121 0606
A1C11	0160 2257			CAPACITOR FXD 10 PF +-5% 500VDC CER 0+-60	28480	0160 2257
A1C12	0160 2066			CAPACITOR FXD .01 UF +80-20% 100VDC CER	28480	0160 2066
A1C13	0160 2265			CAPACITOR FXD 22 PF +-5% 500VDC CER 0+-30	28480	0160 2265
A1C14	0160 3443			CAPACITOR FXD .1 UF +80-20% 50WVDC CER	28480	0160 3443
A1C15	0140 0102		2	CAPACITOR FXD 68 PF +-5% 300VDC	72136	DM16E 660J0300WV1CR
A1C16	0160 3666		7	CAPACITOR FXD .01 UF +80-20% 500VDC CER	28480	0160 3666
A1C17	0160 2236		4	CAPACITOR FXD 1 PF +-1 PF 500VDC	28480	0160 2236
A1C18	0160 2236			CAPACITOR FXD 1 PF +-1 PF 500VDC	28480	0160 2236
A1C19	0160 3666			CAPACITOR FXD .01 UF +80-20% 500VDC CER	28480	0160 3666
A1C20	0160 0166		6	CAPACITOR FXD .068 UF +-10% 200VDC	06001	AE22C683KT
A1C21	0160 0166			CAPACITOR FXD .068 UF +-10% 200VDC	06001	AE22C683KT
A1C22	0140 0192			CAPACITOR FXD 68 PF +-5% 300VDC	72136	DM16E 660J0300WV1CR
A1C23	0160 3666			CAPACITOR FXD .01 UF +80-20% 500VDC CER	28480	0160 3666
A1C24	0160 2236			CAPACITOR FXD 1 PF +-1 PF 500VDC	28480	0160 2236
A1C25	0160 2236			CAPACITOR FXD 1 PF +-1 PF 500VDC	28480	0160 2236
A1C26	0160 3666			CAPACITOR FXD .01 UF +80-20% 500VDC CER	28480	0160 3666
A1C27	0160 0166			CAPACITOR FXD .068 UF +-10% 200VDC	06001	AE22C683KT
A1C28	0160 0166			CAPACITOR FXD .068 UF +-10% 200VDC	06001	AE22C683KT
A1C29	0160 2066			CAPACITOR FXD .01 UF +80-20% 100VDC CER	28480	0160 2066
A1C30	0150 0116		1	CAPACITOR FXD 47 PF +-10% 500VDC	28480	0150 0116
A1C31	0121 0606			CAPACITOR V TRMR 1.5 PF 250V	28480	0121 0606
A1C32	0160 2066			CAPACITOR FXD .01 UF +80-20% 100VDC CER	28480	0160 2066
A1C33	0160 3638			CAPACITOR FXD .22 UF +80-20% 200VAC	16546	C24082242
A1C34	0160 0166		1	CAPACITOR FXD .068 UF +-10% 200VDC	06001	AE22C683KT
A1CR1	1901 0028		14	DIODE PWR RECT 400V 750MA DO 29	28480	1901 0028
A1CR2	1901 0028			DIODE PWR RECT 400V 750MA DO 29	28480	1901 0028
A1CR3	1901 0096		6	DIODE SWITCHING 120V 50MA 100NS	28480	1901 0096
A1CR4	1901 0040		1	DIODE SWITCHING 30V 50MA 2NS DO 35	28480	1901 0040
A1CR5	1901 0028			DIODE PWR RECT 400V 750MA DO 29	28480	1901 0028
A1CR6	1901 0096			DIODE SWITCHING 120V 50MA 100NS	28480	1901 0096
A1CR7	1901 0646		4	DIODE PWR RECT 200V 1A 150NS	14099	52F
A1CR8	1901 0028			DIODE PWR RECT 400V 750MA DO 29	28480	1901 0028
A1CR9	1901 0096			DIODE SWITCHING 120V 50MA 100NS	28480	1901 0096
A1CR10	1901 0646			DIODE PWR RECT 200V 1A 150NS	14099	52F
A1CR11	1901 0028			DIODE SWITCHING RECT 400V 750MA DO 29	28480	1901 0028
A1CR12	1901 0096			DIODE SWITCHING 120V 50MA 100NS	28480	1901 0096
A1CR13	1901 0646			DIODE PWR RECT 200V 1A 150NS	14099	52F
A1CR14	1901 0028			DIODE SWITCHING RECT 400V 750MA DO 29	28480	1901 0028
A1CR15	1901 0096			DIODE SWITCHING 120V 50MA 100NS	28480	1901 0096
A1CR16	1901 0646			DIODE PWR RECT 200V 1A 150NS	14099	52F
A1J1	1200 0474		1	SOCKET IC 14 PIN DIP	28480	1200 0474
A1MP1	1600 0441		2	SHIELD, AMPLIFIER	28480	1600 0441
A1Q1	1853 0036		4	TRANSISTOR PNP SI PD-310MW FT-250MHZ	28480	1853 0036
A1Q2	1853 0036			TRANSISTOR PNP SI PD-310MW FT-250MHZ	28480	1853 0036
A1Q3	1853 0038		6	TRANSISTOR PNP SI TO 39 PD-1W FT-100MHZ	28480	1853 0038
A1Q4	1854 0623		4	TRANSISTOR NPN SI TO 39 PD-1W FT-150MHZ	28480	1854 0623
A1Q5	1854 0623			TRANSISTOR NPN SI TO 39 PD-1W FT-150MHZ	28480	1854 0623
A1Q6	1853 0038			TRANSISTOR PNP SI TO 39 PD-1W FT-100MHZ	28480	1853 0038
A1Q7	1853 0036			TRANSISTOR PNP SI PD-310MW FT-250MHZ	28480	1853 0036
A1Q8	1853 0036			TRANSISTOR PNP SI PD-310MW FT-250MHZ	28480	1853 0036
A1Q9	1853 0038			TRANSISTOR PNP SI TO 39 PD-1W FT-100MHZ	28480	1853 0038
A1Q10	1854 0623			TRANSISTOR NPN SI TO 39 PD-1W FT-150MHZ	28480	1854 0623
A1Q11	1854 0623			TRANSISTOR NPN SI TO 39 PD-1W FT-150MHZ	28480	1854 0623
A1Q12	1853 0038			TRANSISTOR PNP SI TO 39 PD-1W FT-100MHZ	28480	1853 0038
A1Q13	1854 0019		1	TRANSISTION NPN SI TO 18 PD-360MW	07933	R F 2849
A1Q14	1853 0038			TRANSISTOR PNP SI TO 39 PD-1W FT-100MHZ	28480	1853 0038
A1Q15	1854 0410		1	TRANSISTOR NPN SI TO 39 PD-1W FT-200MHZ	28480	1854 0410
A1Q16	1854 0216		1	TRANSISTOR NPN SI PD-350MW FT-300MHZ	28480	1854 0216
A1R1	0684 3331		6	RESISTOR 33K 1% .25W FC TC=-400/+800	28480	0684 3331
A1R2	0684 3331			RESISTOR 33K 1% .25W FC TC=-400/+800	28480	0684 3331
A1R3	0757 0706		3	RESISTOR 61.1 1% .25W F TC=0+-100	28480	0757 0706
A1R4	0757 0487		2	RESISTOR 825K 1% .125W F TUBULAR	28480	0757 0487
A1R5	0757 0472		2	RESISTOR 200K 1% .125W F TC=0+-100	28480	0757 0472

See introduction to this section for ordering information



Table 6-2. Replaceable Parts (Cont'd)

Reference Designator	HP Part Number	C D	Qty	Description	Mfr Code	Mfr Part Number
A1R6	0684 2211		3	RESISTOR 220 10% 25W FC TC--400+800	01121	CB2211
A1R7	2100 0654		1	RESISTOR TRMR 500 10% C TOP ADJ 1 TRN	32997	3386P Y46 501
A1R8	0683 1825		3	RESISTOR 1.8K 5% 25W FC TC--400+700	28480	0683 1825
A1R9	0684 2241		3	RESISTOR 220K 10% 25W FC TC--800+800	28480	0684 2241
A1R10	0757 0420		3	RESISTOR 750 1% 125W F TC-0--100	16701	CA 1.8 TO 751 F
A1R11	0684 8211		3	RESISTOR 820 10% 25W FC TC--400+800	01121	CB8211
A1R12	0757 0465		4	RESISTOR 100K 1% 125W F TC-0--100	16701	CA 1.8 TO 1003 F
A1R13	2100 3211		6	RESISTOR TRMR 1K 10% C TOP ADJ 1 TRN	32997	3386P Y46 102
A1R14	0684 3331			RESISTOR 33K 10% 25W FC TC--100+800	28480	0684 3331
A1R15	0684 3331			RESISTOR 33K 10% 25W FC TC--100+800	28480	0684 3331
A1R16	0757 0706			RESISTOR 51.1 1% 25W F TC-0--100	28480	0757 0706
A1R17	0757 0487			RESISTOR 826K 1% 125W F TUBULAR	28480	0757 0487
A1R18	0684 2241			RESISTOR 220 10% 25W FC TC--400+800	01121	CB2211
A1R19	2100 0654			RESISTOR TRMR 500 10% C TOP ADJ 1 TRN	32997	3386P Y46 501
A1R20	0683 1825			RESISTOR 1.8K 5% 25W FC TC--400+700	28480	0683 1825
A1R21	0757 0472			RESISTOR 200K 1% 125W F TC-0--100	28480	0757 0472
A1R22	0684 2241			RESISTOR 220K 10% 25W FC TC--600+900	28480	0684 2241
A1R23	0757 0420			RESISTOR 750 1% 125W F TC-0--100	16701	CA 1.8 TO 751 F
A1R24	0684 8211			RESISTOR 820 10% 25W FC TC--400+800	01121	CB8211
A1R25	2100 3211			RESISTOR TRMR 1K 10% C TOP ADJ 1 TRN	32997	3386P Y46 102
A1R26	0757 0465			RESISTOR 100K 1% 125W F TC-0--100	16701	CA 1.8 TO 1003 F
A1R27	0684 1831	2		RESISTOR 18K 10% 25W FC TC--400+800	28480	0684 1831
A1R28	0698 0085	2		RESISTOR 2.61K 1% 120W F TC-0--100	28480	0698 0085
A1R29	0757 0405		1	RESISTOR 182 1% 125W F TC-0--100	16701	CA 1.8 TO 182R F
A1R30	0698 0085			RESISTOR 2.61K 1% 125W F TC-0--100	28480	0698 0085
A1R31	0684 1831			RESISTOR 18K 10% 25W FC TC--400+800	28480	0684 1831
A1R32	0698 3438		2	RESISTOR 147 1% 125W F TC-0--100	28480	0698 3438
A1R33	0684 5631	4		RESISTOR 56K 10% 25W FC TC--400+800	01121	CB5631
A1R34	0684 5631			RESISTOR 56K 10% 25W FC TC--400+800	01121	CB5631
A1R35	0684 6811	8		RESISTOR 680 10% 25W FC TC--400+800	28480	0684 6811
A1R36	0684 6811			RESISTOR 680 10% 25W FC TC--400+800	28480	0684 6811
A1R37	0698 3175	4		RESISTOR 147K 1% 5W F TC-0--100	28480	0698 3175
A1R38	0757 0847	9		RESISTOR 27.4K 1% 5W F TC-0--100	28480	0757 0847
A1R39	0757 0847			RESISTOR 27.4K 1% 5W F TC-0--100	28480	0757 0847
A1R40	0698 3175			RESISTOR 147K 1% 5W F TC-0--100	28480	0698 3175
A1R41	0757 0290	4		RESISTOR 6.19K 1% 125W F TC-0--100	16701	CA 1.8 TO 6191 F
A1R42	0757 0338	6		RESISTOR 1K 1% 25W F TC-0--100	16701	CA 1.8 TO 1001 F
A1R43	0757 0847			RESISTOR 27.4K 1% 5W F TC-0--100	28480	0757 0847
A1R44	0757 0290			RESISTOR 6.19K 1% 125W F TC-0--100	16701	CA 1.8 TO 6191 F
A1R45	0757 0338			RESISTOR 1K 1% 25W F TC-0--100	16701	CA 1.8 TO 1001 F
A1R46	0757 0847			RESISTOR 27.4K 1% 5W F TC-0--100	28480	0757 0847
A1R47	0698 3438			RESISTOR 147 1% 125W F TC-0--100	28480	0698 3438
A1R48	0684 5631			RESISTOR 56K 10% 25W FC TC--400+800	01121	CB5631
A1R49	0684 5631			RESISTOR 56K 10% 25W FC TC--400+800	01121	CB5631
A1R50	0684 6811			RESISTOR 680 10% 25W FC TC--400+800	28480	0684 6811
A1R51	0684 6811			RESISTOR 680 10% 25W FC TC--400+800	28480	0684 6811
A1R52	0698 3175			RESISTOR 147K 1% 5W F TC-0--100	28480	0698 3175
A1R53	0757 0847			RESISTOR 27.4K 1% 5W F TC-0--100	28480	0757 0847
A1R54	0757 0847			RESISTOR 27.4K 1% 5W F TC-0--100	28480	0757 0847
A1R55	0698 3175			RESISTOR 147K 1% 5W F TC-0--100	28480	0698 3175
A1R56	0757 0290			RESISTOR 6.19K 1% 125W F TC-0--100	16701	CA 1.8 TO 6191 F
A1R57	0757 0338			RESISTOR 1K 1% 25W F TC-0--100	13701	CA 1.8 TO 1003 F
A1R58	0757 0847			RESISTOR 27.4K 1% 5W F TC-0--100	28480	0757 0847
A1R59	0757 0290			RESISTOR 6.19K 1% 125W F TC-0--100	16701	CA 1.8 TO 6191 F
A1R60	0757 0338			RESISTOR 1K 1% 25W F TC-0--100	16701	CA 1.8 TO 1001 F
A1R61	0757 0847			RESISTOR 1K 1% 25W F TC-0--100	28480	0757 0847
A1R62	0684 1231			RESISTOR 12K 10% 25W FC TC--400+800	28480	0684 1231
A1R63	0757 0706			RESISTOR 51.1 1% 25W F TC-0--100	28480	0757 0706
A1R64	0684 2241			RESISTOR 220K 10% 25W FC TC--800+800	28480	0684 2241
A1R65	0684 2211		1	RESISTOR 220 10% 25W FC TC--400+800	01121	CB2211
A1R66	0684 1061	1		RESISTOR 1M 10% 25W FC TC--800+900	01121	CB1061
A1R67	2100 0654			RESISTOR TRMR 500 10% C TOP ADJ 1 TRN	32997	3386P Y46 501
A1R68	0683 1825			RESISTOR 1.8K 5% 25W FC TC--400+700	28480	0683 1825
A1R69	0684 3331			RESISTOR 33K 10% 25W FC TC--400+800	28480	0684 3331
A1R70	2100 3211			RESISTOR TRMR 1K 10% C TOP ADJ 1 TRN	32997	3386P Y46 102
A1R71	0684 3331			RESISTOR 33K 10% 25W FC TC--400+800	28480	0684 3331
A1R72	0757 0419		2	RESISTOR 681 1% 125W F TC-0--100	16701	CA 1.8 TO 681R F
A1R73	0757 0419			RESISTOR 681 1% 125W F TC-0--100	16701	CA 1.8 TO 681R F
A1R74	2100 3211			RESISTOR TRMR 1K 10% C TOP ADJ 1 TRN	32997	3386P Y46 102
A1R75	2100 3211			RESISTOR TRMR 1K 10% C TOP ADJ 1 TRN	32997	3386P Y46 102
A1R76	0684 1011	1		RESISTOR 100 10% 25W FC TC--400+800	01121	CB1011
A1R77	0684 3311		4	RESISTOR 330 10% 25W FC TC--400+800	01121	CB3311
A1R78	0757 0190	2		RESISTOR 20K 1% 5W F TC-0--100	28480	0757 0190
A1R79	0757 0761	1		RESISTOR 22.1K 1% 25W F TC-0--100	16701	CS 1.4 TO 2212 F
A1R80	0757 0847			RESISTOR 27.4K 1% 5W F TC-0--100	28480	0757 0847
A1R81	0761 0070	1		RESISTOR 8.2K 6% 1W A D TC-0--200	28480	0761 0070
A1R82	0757 0190			RESISTOR 20K 1% 5W F TC-0--100	28480	0757 0190
A1R83	0757 0433	2		RESISTOR 3.32K 1% 125W F TC-0--100	24546	CA 1.8 TO 3321 F
A1R84	0684 3311			RESISTOR 330 10% 25W FC TC--400+800	01121	CB3311
A1R85	0757 0420			RESISTOR 750 1% 125W F TC-0--100	16701	CA 1.8 TO 751 F
A1R86	0684 3331			RESISTOR 33K 1% 125W F TC-0--100	24546	CA 1.8 TO 3302 F

See introduction to this section for ordering information

Table 6-2. Replaceable Parts (Cont'd)

Reference Designator	HP Part Number	C D	Qty	Description	Mfr Code	Mfr Part Number
A1S1	3101 2150		1	SWITCH ASSY 6 POS	28480	3101 2150
A1S2	3101 2268		2	SWITCH ASSY 8 POS	28480	3101 2268
A1S3	3101 2268			SWITCH ASSY 8 POS	28480	3101 2268
A1VR1	1902 0026		1	DIODE ZNR 10V 5% DO 7 PD- 4W TC-+ 06%	04713	5210939 162
A1VR2	1902 3139		3	DIODE ZNR 8 25V 5% DO 7 PD- 0.4W TC-+ 063%	04713	5210939 168
A1VR4						
A1VR5	1902 0074		1	DIODE ZNR 7 15V 5% DO 7 PD- 0.4W TC-+ 047%	04713	5210939 140
A1XA1	1201 0654		2	IC SOCKET 40 PIN DIP	28480	1201 0654
A1XA2	1201 0654			IC SOCKET 40 PIN DIP	28480	1201 0654
A2	01340 65502			BOARD ASSEMBLY LOW VOLTAGE POWER SUPPLY (NOT SUPPLIED WITH OPTION 002)	28480	01340 65502
A2C1	0160 2643		1	CAPACITOR FXD 70 UF 300VDC	28480	0160 2643
A2C2	0160 0168		1	CAPACITOR FXD 1 UF +-10% 200VDC POLYE	06001	AE22C104KT
A2C3	0160 2351		2	CAPACITOR FXD 2000 UF +75-10% 50VDC AL	66289	39D243 058
A2C4	0160 0291		1	CAPACITOR FXD 1 UF +-10% 35VDC TA	28480	0160 0291
A2C5	0160 2351				66289	39D243 058
A2C6	0140 0195		1	CAPACITOR FXD 2000 UF +75-20% 50VDC AL	28480	0140 0195
A2C7	0160 0195		2	CAPACITOR FXD 150 PF +-5% 300VDC MICA Q-70	28480	0160 0195
A2C8	0160 0195			CAPACITOR FXD 33 UF +-20% 35VDC TA	28480	0160 0195
A2CR1	1906 0006		3	DIODE FW BRDG 400V 1A	28480	1906 0006
A2CR2	1901 0028			DIODE PWR RECT 400V 750MA DO 29	0271C	MP403
A2CR3	1901 0028			DIODE PWR RECT 400V 750MA DO 29	0271C	MP403
A2CR4	1906 0006			DIODE FW BRDG 400V 1A	28480	1906 0006
A2CR6	1906 0006			DIODE FW BRDG 400V 1A	28480	1906 0006
A2CR6	1901 0028			DIODE PWR RECT 400V 750MA DO 29	0271C	MP403
A2CR7	1901 0028			DIODE PWR RECT 400V 750MA DO 29	0271C	MP403
A2CR8	1901 0040		1	DIODE SWITCHING 30V 50MA 2N5 DO 35	28480	1901 0040
A2F1	2110 0016		2	FUSE 6A 250V SLO BLO 1 25 X 25 UL	EF 364	MDL 6/10
A2F1	2110 0044		1	FUSE 3A 250V SLO BLO 1220V/740V OPERATION ONLY	EF 364	MDL 6/10
A2F2	2110 0016			FUSE 6A 250V SLO BLO 1 25 X 25 UL	EF 364	MDL 6/10
A2F3	2110 0011		1	FUSE 062A 250V NORM BLO 1 25 X 25 UL	EF 364	AGC 1-16
A2J1	1200 0690		3	SOCKET T5TR	28480	1200 0690
A2J2	1200 0690			SOCKET T5TR	28480	1200 0690
A2J3	1200 0690			SOCKET T5TR	28480	1200 0690
A2MP1	2110 0260		6	CLIP FUSE	28480	2110 0260
A2P1	1261 4743		1	CONNECTOR AC POWER	28480	1261 4743
A2P2	1261 6090		2	CONNECTOR 8 PIN M	28480	1261 6090
A2P3	1261 6090		1	CONNECTOR 13 PIN M	28480	1261 6090
A2Q1	1L34 0071		1	TRANSISTOR NPN SI PD-300MW FT-200MHZ NOT ASSIGNED	01205	5KA1124
A2Q2						
A2Q3	1853 0336		1	TRANSISTOR NPN SI PD-625MW FT-50MHZ	28480	1853 0336
A2Q4	1854 0675		1	TRANSISTOR NPN SI PD-625MW FT-50MHZ	28480	1854 0675
A2Q5	1854 0063		2	TRANSISTOR NPN 2N2218 SI TO 6 PD-800MW	28480	1854 0063
A2Q6	1854 0063			TRANSISTOR NPN 2N2218 SI TO 6 PD-800MW	28480	1854 0063
A2R1	0680 1841		1	RESISTOR 180K 10% 1W CC TC-0-882	01121	GB1841
A2R2	0683 1005		1	RESISTOR 105K 5% 25W FC TC--400+500	01121	CB1005
A2R3	0684 8211		1	RESISTOR 20 10% 25W FC TC--400+600	01121	CB8211
A2R4	0757 0777		1	RESISTOR 121K 1% 25W F TC-0-100	16701	CS 1-4 TO 1213 F
A2R5	0757 0441		1	RESISTOR 11K 1% 125W F TC-0-100	16701	C4 1-8 TO 1102 F
A2R6	0684 3941		1	RESISTOR 390K 10% 25W FC TC--400+600	01121	CB3941
A2R7	0683 8225		2	RESISTOR 8.2K 5% 25W FC TC--400+700	01121	CB8225
A2R8	0608 3618		1	RESISTOR E2 5% 2W MO TC-0-200	28480	0608 3618
A2R9	0687 6611		2	RESISTOR 560 10% 5W CC TC-0-520	01121	EB5611
A2R10	0684 2701		1	RESISTOR 27 10% 25W FC TC--400+500	1121	CB2701
A2R11	0683 8225		1	RESISTOR 8.2K 5% 25W FC TC--400+700	01121	CB8225
A2R12	0687 5611		1	RESISTOR 560 10% 5W CC TC-0-520	01121	EB5611
A2R13	0764 0013		1	RESISTOR E6 5% 2W MO TC-0-200	28480	0764 0013
A2R14	0687 1021		1	RESISTOR 1K 10% 5W CC TC-0-647	01121	FB1021
A2R15	2100 3273		1	RESISTOR TRMR 2K 10% C SIDE ADJ 1 TRN	92607	3356X Y46 202
A2R16	0757 0801		1	RESISTOR 160 1% 5W F TC-0-100	28480	0757 0801
A1R17	0757 1001		1	RESISTOR E6.2 1% 5W F TC-0-100	28480	0757 1001
A2R18	0683 0275		1	RESISTOR 2.75K 5% 25W FC TC--400+500	01121	CB2755
A2S1	3101 2262		1	SWITCH PB	28480	3101 2262
A2VR1	1902 0188		1	DIODE ZNR 4.12V 5% DO 7 PD- 4W TC-- 0.41%	04713	5210939 71
A2VR2	1902 0041		1	DIODE ZNR 5.11V 5% DO 7 PD- 4W TC-- 0.00%	04713	5210939 98
A2VR3	1902 0049		1	DIODE ZNR 6.19V 5% PD- 4W	28480	1902 0049
A2VR4	1902 0568		2	DIODE ZNR 200V 5% DO 15 PD- 1W TC-- 0.88%	04713	5211213 449
A2V1	8120 2602		2	CABLE FLEXIBLE	28480	8120 2602

See Introduction to this section for ordering information

Table 6-2. Replaceable Parts (Cont'd)

Reference Designator	HP Part Number	C D	Qty	Description	Mfr Code	Mfr Part Number
A3	013406603		1	BOARD ASSEMBLY HIGH VOLTAGE POWER SUPPLY	28480	013406603
A3A1	0134061101		1	TRANSFORMER HIGH VOLTAGE BOARD & TRANS	28480	0134061101
A3A1C1	01602264		1	CAPACITOR FXD 20 PF +-B' 500VDC CER 0+-30	28480	01602264
A3A1CR1	19010633		1	DIODE HV RECT 10KV 5MA 269MA	28480	19010633
A3A2	00600490		1	MULTIPLIER HIGH VOLTAGE	28480	00600490
A3C1	01600162		1	CAPACITOR FXD .022 UF +-10% 200VDC POLYE	06001	AE17C223KT
A3C2	01603658		1	CAPACITOR FXD .1 UF +-20% 50VDC CER	28480	01603658
A3C3	01604051		4	CAPACITOR FXD .01 UF +-20% 4KVDC	66289	430P103040
A3C4	01604051		1	CAPACITOR FXD .01 UF +-20% 4KVDC	66289	430P103040
A3C5	01603453		1	CAPACITOR FXD .05 UF +-20% 100VDC CER	66289	C023B101H203MS26 CDH
A3C6	01600684		2	CAPACITOR FXD 1000 PF +-20% 4KVDC	66289	430P102040
A3C7	01600684		1	CAPACITOR FXD 1000 PF +-20% 4KVDC	66289	430P102040
A3C8	01604051		1	CAPACITOR FXD .01 UF +-20% 4KVDC	66289	430P103040
A3C9	01603656		1	CAPACITOR FXD .01 UF +-80-20% 500VDC CER	28480	01603656
A3C10	01800269		1	CAPACITOR FXD 1 UF +-75-10% 150VDC AL	66289	30D106G150RAZ DSM
A3C11	01604051		1	CAPACITOR FXD .01 UF +-20% 4KVDC	66289	430P103040
A3C12	01603656		1	CAPACITOR FXD .01 UF +-80-20% 500VDC CER	28480	01603656
A3C13	01603656		1	CAPACITOR FXD .01 UF +-80-20% 500VDC CER	28480	01603656
A3C14	01800141		1	CAPACITOR FXD 50 UF +-75-10% 80VDC AL	66289	30D50G0600D2 DSM
A3CR1	19010028		7	DIODE PWR RECT 400V 750MA DO 29	28480	19010028
A3CR2	19010028		1	DIODE PWR RECT 400V 750MA DO 29	28480	19010028
A3CR3	19010040		1	DIODE SWITCHING 30V 50MA 2NS DO 35	28480	19010040
A3CR4	19010040		1	DIODE SWITCHING 30V 50MA 2NS DO 35	28480	19010040
A3CR5				DELETED		
A3CR6	19010028		1	DIODE PWR RECT 400V 750MA DO 29	28480	19010028
A3CR7	19010028		1	DIODE PWR RECT 400V 750MA DO 29	28480	19010028
A3CR8	19010028		1	DIODE PWR RECT 400V 750MA DO 29	28480	19010028
A3CR9	19010028		1	DIODE PWR RECT 400V 750MA DO 29	28480	19010028
A3DS1	21400018		2	LAMP GLOW A9A C80 EB VDC 700UA T 2 BULB	74276	C7A (NE 20)
A3DS2	21400018		1	LAMP GLOW A9A C80 EB VDC 700UA T 2 BULB	74276	C7A (NE 20)
A3J1	12615112		1	CONNECTOR 3 PIN F	28480	12615112
A3L1	01400116		1	COIL MLD 22 UH 10% Q=60 .215 DX .56 LG	09800	153736
A3L2	01400120		1	COIL MLD 220 UH 5% Q=65 .165 DX .375 LG	09800	153782
A3P1	12614316		1	CONNECTOR 7 CONT M	28480	12614316
A3R1	07670194		1	RESISTOR 1.33M 1% .5W FC TC=0+-100	28480	07670194
A3R2	21003357		3	RESISTOR TRMR 500K 10% C SIDE ADJ 1 TRN	32007	3386X Y46 504
A3R3	07670465		1	RESISTOR 100K 1% .125W FC TC=0+-100	16701	C4 1.8 TO 1003 F
A3R4	06832266		1	RESISTOR 22M 5% .25W FC TC=-400+-1200	01121	CB2266
A3R5	06841011		1	RESISTOR 100 10% .25W FC TC=-400+-500	01121	CB1011
A3R6	06873011		1	RESISTOR 100 10% .25W FC TC=0+-520	01121	CB3011
A3R7	07670465		1	RESISTOR 100K 1% .125W FC TC=0+-100	16701	C4 1.8 TO 1003 F
A3R8	06844731		1	RESISTOR 47K 10% .25W FC TC=-400+-800	01121	CB4731
A3R9	06842221		1	RESISTOR 2.2K 10% .25W FC TC=-400+-700	01121	CB2221
A3R10	06846621		1	RESISTOR 5.6K 10% .25W FC TC=-400+-700	01121	CB5621
A3R11	06873041		1	RESISTOR 300K 10% .5W CC TC=0+-802	01121	EB3041
A3R12	06841001		1	RESISTOR 10 10% .25W FC TC=-400+-500	01121	CB1001
A3R13	06890167		1	RESISTOR 20M 5% .1W CF TC=0+-250	28480	06890167
A3R14	06846811		1	RESISTOR 680 10% .25W FC TC=-400+-800	28480	06846811
A3R15	06841061		1	RESISTOR 10M 10% .25W FC TC=-400+-1100	01121	CB1061
A3R16	06846811		1	RESISTOR 680 10% .25W FC TC=-400+-800	28480	06846811
A3R17	06846811		1	RESISTOR 680 10% .25W FC TC=-400+-800	28480	06846811
A3R18	06846811		1	RESISTOR 680 10% .25W FC TC=-400+-800	28480	06846811
A3R19	07670452		1	RESISTOR 27.4K 1% .125W FC TC=0+-100	16701	C4 1.8 TO 2742 F
A3R20	07670446		1	RESISTOR 15K 1% .125W FC TC=0+-100	16701	C4 1.8 TO 1502 F
A3R21	06890172		1	RESISTOR 3M 5% .1W CF TC=0+-250	28480	06890172
A3R22	21003358		1	RESISTOR TRMR 1M 20% C SIDE ADJ 1 TRN	73138	72 154 0
A3R23	06890171		1	RESISTOR 6.5M 5% .1W CF TC=0+-250	28480	06890171
A3R24	21003357		1	RESISTOR TRMR 500K 10% C SIDE ADJ 1 TRN	32007	3386X Y46 504
A3R25	21003357		1	RESISTOR TRMR 500K 10% C SIDE ADJ 1 TRN	32007	3386X Y46 504
A3R26	06841021		1	RESISTOR 1K 10% .25W FC TC=-400+-800	01121	CB1021
A3U1	18260167		1	IC OP AMP	28480	18260167
A3VR1	19020175		1	DIODE ZNR 100V 5% DO 16 PD-1W TC=0+-083%	04713	5211213 403
A3VR2	19020668		1	DIODE ZNR 200V 5% DO 16 PD-1W TC=0+-088%	04713	5211213 449
A3VR3	19023402		1	DIODE ZNR 806V 2% DO 7 PD-4W TC=0+-081%	04713	5210030 444
A3W1	81202602		1	CABLE FLEXIBLE	28480	81202602

See Introduction to this section for ordering information

Table 6-2. Replaceable Parts (Cont'd)

Reference Designator	HP Part Number	C D	Qty	Description	Mfr Code	Mfr Part Number
A4	01340 66604		1	BOARD ASSEMBLY CONTROL (NOT SUPPLIED WITH OPTION 001)	28480	01340 66604
A4D51	1890 0621		1	DIODE, LIGHT-EMITTING GRN	28480	1890 0621
A4R1	2100 3692		3	RESISTOR VAR 6K (INTENSIFY)	28480	2100 3692
A4R2	2100 3690		1	RESISTOR VAR 6K (TRACE ALIGN)	28480	2100 3690
A4R3	2100 3691		1	RESISTOR VAR 1M (FOCUS)	28480	2100 3691
A4R4	2100 3689		2	RESISTOR VAR 1K (X GAIN)	28480	2100 3689
A4R5	2100 3692			RESISTOR VAR 6K (X POSITION)	28480	2100 3692
A4R6	2100 3689			RESISTOR VAR 1K (Y GAIN)	28480	2100 3689
A4R7	2100 3692			RESISTOR VAR 6K (Y POSITION)	28480	2100 3692
A4R8	0684 1021		1	RESISTOR 100 10% 1% 25W	28480	0684 1021
A4R9	0684 2711		1	RESISTOR 270 10% 25W FC TC--400+800	01121	0684 1021 CB2711
A4H10	0684 2711			RESISTOR 270 10% 25W FC TC--400+800	01121	CB2711
A4W1	8120 0622		1	CABLE ASSY RIBBON	28480	8120 0622
<b>OPTION 002</b>						
A5	01340 66606		1	BOARD ASSEMBLY DC POWER (OPTION 002 ONLY)	28480	01340 66606
A5C1	0160 3443		1	CAPACITOR FXD 1UF 180-20% 50WVDC CER	28480	0160 3443
A5C2	0160 0207		1	CAPACITOR FXD .01UF +-5% 200VDC POLYE	05001	AE 13C10311
A5C3	0160 3690		1	CAPACITOR FXD CE 018UF 60V	28480	0160 3690
A5C4	0180 1819		1	CAPACITOR FXD 100UF +75-10% 50VDC AL	66289	300107G0600117 D5M
A5C5	0180 2843		1	CAPACITOR FXD 70UF 300VDC	28480	0180 2843
A5C6	0180 0196		1	CAPACITOR FXD .33UF +-20% 35VDC TA	28480	0180 0196
A5C7	0180 0291		2	CAPACITOR FXD 1UF +-10% 35VDC TA	28480	0180 0291
A5C8	0180 0291			CAPACITOR FXD 1UF +-10% 35VDC TA	28480	0180 0291
A5CR1	1901 0669		2	DIODE PWR RECT 400V 1A 150NS	28480	1901 0669
A5CR2	1901 0669			DIODE PWR RECT 400V 1A 150NS	28480	1901 0669
A5CR3	1901 0028		1	DIODE PWR RECT 400V 750MA D0 29	28480	1901 0028
A5CR4	1901 0040		1	DIODE SWITCHING 30V 60MA 2NS D0 35	01296	PG512
A5F1	2110 0080		1	FUSE .75AT 250V SLO-BLO 1 25 X 26 UL IEC	6F364	MDL 3 4
A5F2	2110 0020		1	FUSE BAT 250V SLO-BLO 1 25 X 26 UL	6F364	MDL B-10
A5F3	2110 0012		1	FUSE 600A 250V FAST-BLO 1 25 X 26 UL	28480	2110 0012
A5J1	1261 6112		2	SOCKET-TSTR	27264	09 62 3031
A5J2	1261 6112			SOCKET-TSTR	27264	09 62 3031
A5J3	1200 0690		1	SOCKET-TSTR	28480	1200 0690
A5L1	9100 3139		1	COIL 75UH 15% 6D X 876 LG	28480	9100 3139
A5L2	0140 0137		1	COIL MLD 1MH 5% 0-60	28480	0140 0137
A5P1	1261 3106		1	CONNECTOR 4 PIN M POST TYPE	27264	09 60 1041
A5Q1	1854 0433		2	TRANSISTOR NPN 51 SPEC	28480	1854-0433
A5Q2	1854-0433			TRANSISTOR NPN 51 SPEC	28480	1854-0433
A5Q3	1854-0063		2	TRANSISTOR NPN 2N2218 51 TO 5 PD-800MW	28480	1854-0063
A5Q4	1854-0063			TRANSISTOR NPN 2N2218 51 TO 5 PD-800MW	28480	1854-0063
A5R1	0767-0780		1	RESISTOR 162K 1% 25W FC TC-0--100	28480	0767-0780
A5R2	2100 3351		1	RESISTOR-TRMR 600 10% C SIDE ADJ 1-TRN	28480	2100 3351
A5R3	0767 0430		1	RESISTOR FXD 12MF 2 21K 1% 125W	28480	0767 0430
A5R4	0767 0438		2	RESISTOR 5 11K 1% 125W F TC-0--100	24546	CA 1.8 TO 6111F
A5R5	0767 0438			RESISTOR 5 11K 1% 125W F TC-0--100	24546	CA 1.8 TO 6111F
A5R6	0698 3161		1	RESISTOR 2 87K 1% 125W F TC-0--100	24546	CA 1.8 TO 2871F
A5R7	0760 0014		1	RESISTOR 1K 2% 1W MO TC-0--200	28480	0760 0014
A5R8	0767 0449		1	RESISTOR 20K 1% 125W F TC-0--100	24546	CA 1.8 TO 2002F
A5R9	0767 0280		2	RESISTOR 1K 1% 125W F TC-0--100	24546	CA 1.8 TO 1001F
A5R10	0767 0290			RESISTOR 1K 1% 125W F TC-0--100	24546	CA 1.8 TO 1001F
A5R11	0687 6611		2	RESISTOR 660 10% 5W CC TC-0--100	01121	EB6611
A5R12	0698 3618		1	RESISTOR 82 5% 2W MO TC-0--200	28480	0698 3618
A5R13	0767 0801		1	RESISTOR 150 1% 5W F TC-0--100	28480	0767 0801
A5R14	0684 2701		1	RESISTOR 27 10% 25W FC TC--400+800	28480	0684 2701
A5R15	0687 6611		1	RESISTOR 660 10% 5W CC TC-0--100	01121	EB6611
A5R16	0764 0013		1	RESISTOR 66 5% 2W MO TC-0--200	28480	0764 0013
A5R17	0767 1001		1	RESISTOR 66 2 1% 5W F TC-0--100	28480	0767 1001
A5T1	01340 61103		1	TRANSFORMER, AC	28480	1340 61103
A5U1	1826 0428		1	IC GENERIC	28480	1826 0428
A5U2	1826 0106		1	IC VOLT. REGULATOR	28480	1826 0106
A5VR1	1902 0188		1	DIODE ZNR 4 12V 5% D0 7 PD-4W TC-0 041%	28480	1902 0188
A5VR2	1902 0041		1	DIODE ZNR 6 11V 5% D0 7 PD-4W TC-0 009%	28480	1902 0041
A5VR3	1902 0049		1	DIODE ZNR 6 19V 5% 4W	28480	1902 0049
A5W1	8120 2602		1	CABLE, RIBBON	16912	F5N22A 10
<b>OPTION 324</b>						
MP15	01340 00211		1	REAR PANEL	28480	01340 00211
H33	1261 0218		3	CONN RP LOCK POST	28480	1261 0218
H34	1261 0064		3	CONN RP 26 F REC P	28480	1261 0064
J1	01340 61608		1	CABLE ASSY INPUT Z	28480	01340 61608
J2	01340 61607		1	CABLE ASSY INPUT Y	28480	01340 61607
J3	01340 61606		1	CABLE ASSY INPUT X	28480	01340 61606

See Introduction to this section for ordering information

Table 6-3. List of Manufacturers' Codes

Mfr Code	Manufacturer Name	Address	Zip Code
01121	ALLEN BRADLEY CO	MILWAUKEE WI	63204
01538	SMALL PARTS INC	COSTA MESA CA	92626
02660	BUNKEN HANO CORP AMPHENOL CONNECTOR DIV	BROAD VIEW IL	60163
03888	PYROFILM CORP	WHIPPANY NJ	07081
04604	EAGLE CHEMICAL CO INC	CHICAGO IL	60612
04713	MOTOROLA INC SEMICONDUCTOR PRODUCT DIV	PHOENIX AZ	85008
05683	MEG PRODUCT DIV OF MANDREL INDUSTRIES INC	SEATTLE WA	98126
06001	GENERAL ELECTRIC CO CAPACITOR AND BATTERY PRODUCTS DEPT	IRMO SC	29073
07033	RAYTHEON CO SEMICONDUCTOR DIV HQ	MOUNTAIN VIEW CA	94040
16546	US CAPACITOR CORP	HURBANK CA	91604
16701	RAPIDAG NEEDLE CO	LAKE WORTH FL	33460
20480	HEWLETT-PACKARD CO CORPORATE HQ	FALO ALTO CA	04304
37997	HOURS INC TRIMPOY PROD DIV	RIVERSIDE CA	92507
56289	SPRAGUE ELECTRIC CO	NORTH ADAMS MA	01247
6F364	BUSSMAN MFG DIV OF MCGRAW EDISON CO	ST LOUIS MO	63017
72136	ELECTRO MOTIVE MFG CO INC	WILLMANTIC CT	06226
72967	ELASTIC STOPNUT DIVISION OF AMERACE ESHA CORP	UNION NJ	07003
73138	BECKMAN INSTRUMENTS INC HELIPOT DIV	FULLERTON CA	07634
74276	SIGNALITE INC	NEPTUNE NJ	07763
76854	OAK MFG CO DIV OF OAK ELECTRO NETICS CORP	CRYSTAL LAKE IL	60014
78180	ILLINOIS TOOL WORKS INC SHAKETPROOF DIV	ELGIN IL	60120
79063	ZIERICK MFG CO	MT KISCO NY	10849
82009	GOODYEAR SUPPLIES AND MECHANICAL CO INC	NEW YORK NY	10013
90800	AMERICAN PRECISION INDUSTRIES INC DELEVAN DIV	EAST AURORA NY	14052

See Introduction to this section for ordering information

**SECTION VII  
MANUAL CHANGES**

**7-1. INTRODUCTION.**

7-2. This section contains information for adapting this manual to instruments for which the content does not apply directly.

**7-3. MANUAL CHANGES.**

7-4. To adapt this manual to your instrument, refer to table 7-1 and make all of the manual changes listed opposite your instrument serial number. Perform these changes in the sequence listed.

7-5. If your instrument serial number is not listed on the title page of this manual or in table 7-1 below, it may be documented in a yellow MANUAL CHANGES supplement. For additional information about serial number coverage refer to INSTRUMENTS COVERED BY MANUAL in Section I.

*Table 7-1. Manual Changes*

Serial Prefix	Make Changes
1748A	1

**7-6. MANUAL CHANGE INSTRUCTIONS.**

**CHANGE 1**

Change the following pages:

- Replace page 6-3/4 with 7-3/4
- Replace page 6-5/6 with 7-5/6
- Replace page 8-5/6 with 7-11/12
- Replace page 8-7/8 with 7-7/8
- Replace page 8-9/10 with 7-9/10
- Replace page 8-15 with 7-15

Table 7-2. Replaceable Parts

Reference Designator	HP Part Number	C D	Qty	Description	Mfr Code	Mfr Part Number
A1	01340 66601		1	BOARD ASSEMBLY X Y Z AMPLIFIER	28480	01340 66601
A2	01340 66602		1	BOARD ASSEMBLY LOW VOLTAGE POWER SUPPLY	28480	01340 66602
A3	01340 66603		1	BOARD ASSEMBLY HIGH VOLTAGE POWER SUPPLY	28480	01340 66603
A4	01340 66604		1	BOARD ASSEMBLY CONTROL	28480	01340 66604
A5	01340 66606		1	BOARD ASSEMBLY DC POWER OPTION 002 ONLY	28480	01340 66606
E1	01340 67601		1	LINE SELECT ASSY 100V 120V NOT SUPPLIED WITH OPTION 002 OR 003	28480	01340 67601
E2	01340 67602		1	LINE SELECT ASSY 220V 240V NOT SUPPLIED WITH OPTION 002 OR 003	28480	01340 67602
E3	1610 0038		1	POST BINDING	28480	1610 0038
E4	0340 0664		2	INSULATOR TSTR	28480	0340 0664
E5	0340 0666		1	INSULATOR TSTR	28480	0340 0666
H1	0340 0857		4	INSULATOR BUSHING	28480	0340 0857
H2	0360 1632		3	LUG SOLDER	70963	761 J/B
H3	0400 0002		1	GROMMET RUBBER	82009	3002
H4	0400 0009		1	GROMMET VINYL	01638	6760
H5	0620 0164		2	SCREW RETAINING FILTER 2 56 25 IN LG	28480	0620 0144
H6	0624 0289		3	SCREW TAPPING 2 28 312 IN LG PAN HD	28480	0624 0289
H7	1200 0081		6	INSULATOR BUSHING NYLON	28480	1200 0081
H8	1400 0017		1	CLAMP CABLE 312 DIA 375 WD NYL	06683	374 6
H9	2190 0008		2	WASHER LK EXT T NO 6 141 IN ID OPT 002 ONLY	04604	1341
H10	2190 0084		1	WASHER LK INTL 266 ID 408 OD 02-T	28480	2190 0084
H11	2190 0045		3	WASHER LK HCLL NO 2 088 IN ID	76854	1601 009
H12	2200 0107		1	SCREW MTL 0 376 LG	28480	2200 0107
H13	2200 0129		1	SCREW MTL 2 00 LG	28480	2200 0129
H14	2190 0019		2	WHL 115 IN 2260 OD 03T	28480	2190 0019
H15	2200 0179		1	SCREW MTL 0 125 L	28480	2200 0179
H16	2200 0180		1	SCREW MTL 1 376 LG	28480	2200 0180
H17	2200 0628		3	SCREW MTL 1 875 LG	28480	2200 0628
H18	2200 0676		3	SCREW MACHINE	28480	2200 0676
H19	2260 0001		1	NUT HEX DBL CHAM 4 40 THD 094 IN THK	28480	2260 0001
H20	2260 0003		1	NUT HEX PLST CLKG 4 40 THD 141 IN THK	72962	876NMO
H21	2360 0116		2	SCREW MTL 0 312 LG 6 32	28480	2360 0116
H22	2360 0192		4	SCREW MTL 0 260 LG 6 32	28480	2360 0192
H23	2360 0117		4	MS 6 32 438 LG	28480	2360 0117
H24	2360 0201		1	MS 6 32 500 LG	28480	2360 0201
H25	2960 0001		3	NUTH J 8 32 093	28480	2960 0001
H26	2960 0072		1	NUTH 1-4 32 062	28480	2960 0072
H27	3060 0010		1	WFL 147 ID 312 OD 03 T	28480	3060 0010
H28	3060 0098		3	WFL 089 ID 250 OD 032 T	28480	3060 0098
H29	3060 0106		1	WFL 126 ID 281 OD 03 T	28480	3060 0106
H30	3060 0236		4	WFL 117 ID 260 OD 03 T	28480	3060 0236
H31	2260 0009		3	NUT HEX DBL CHAM 4 40 THD 093 IN THK	28480	2260 0009
H32	2200 0146		1	MS 4 40 438 LG	28480	2200 0146
J1	1260 0083		4	CONNECTOR BNC FEMALE	02660	31 222 1021
J2	1260 0083		4	CONNECTOR BNC FEMALE	02660	31 222 1021
J3	1260 0083		4	CONNECTOR BNC FEMALE	02660	31 222 1021
J4	1260 0083		4	CONNECTOR BNC FEMALE OPT 216 ONLY	02660	31 222 1021
L1	01340 66001		1	COIL TRACE ALIGH	28480	01340 66001
MP1	0370 0604		1	PUSHBUTTON MINT GRAY 50	28480	0370 0603
MP2	0370 2612		4	KNOB HND	28480	0370 2612
MP3	7100 0389		1	COVER XFAIR	28480	7100 0389
MP4	01340 00201		1	PANEL REAR STANDARD MODEL	28480	01340 00201
MP5	01340 00601		1	SHIELD HV OUTER	28480	01340 00601
MP6	01340 00602		1	SHIELD HV INNER	28480	01340 00602
MP7	01340 02706		1	FILTER BLUE	28480	01340 02702
MP7	01340 02701		1	FILTER CLEAR OPTION 330	28480	01340 02701
MP7	01340 02703		1	FILTER AMBER OPTION 607	28480	01340 02703
MP7	01340 02706		1	FILTER GRAY OPTIONS 333 337	28480	01340 02706
MP8	01340 04101		1	RETAINER FILTER	28480	01340 04101
MP9	01340 60602		1	SUBASSY SHIELD SUPPORT	28480	01340 60602
MP10	01340 04103		1	PLATE COVER REAR	28480	01340 04103
MP10	01340 04104		1	PLATE COVER REAR OPTIONS 330 332 AND 333	28480	01340 04104
MP11	4040 1311		1	COVER LOW VOLTAGE	28480	4040 1311
MP12	6040 7648		1	PLATE COVER CRT	28480	6040 7648
MP13	6040 8381		1	PANEL FRONT	28480	6040 8381
MP14	6060 9977		1	COVER TOP OPTION 316 AND 580	28480	6060 9977
MP15	01332 00204		1	PANEL REAR OPTION 316 ONLY	28480	01332 00204
MP15	01340 00213		1	PANEL REAR OPTION 003	28480	01340 00213
MP16	01340 00207		1	PANEL FRONT BLANK OPTION 317 ONLY	28480	01340 00207
MP17	01340 00208		1	PANEL COVER REAR BLANK OPTION 317 ONLY	28480	01340 00208
MP18	01340 00209		1	PANEL SUB FRONT OPTION 317 ONLY	28480	01340 00209
MP19	01340 01201		1	BRACKET MOUNTING OPTION 316 ONLY	28480	01340 01201
MP20	1460 1346		1	STAND TILT OPTIONS 316 317 330 332 333 AND 580	28480	1460 1346
MP21	6060 9834		1	COVER TOP OPTION 317 ONLY	28480	6060 9834
MP22	6060 9846		1	COVER BOTTOM OPTION 317 ONLY	28480	6060 9846
MP23	6060 9973		1	COVER BOTTOM OPTION 316 ONLY	28480	6060 9973

See introduction to this section for ordering information

Table 7-2. Replaceable Parts (Cont'd)

Reference Designation	HP Part Number	Qty	Description	Mfr Code	Mfr Part Number
MP24	6001 0430	2	TRIM FRONT SIDE (OPTIONS 316 316 317, 330 332, 333 AND 680)	28480	6001 0430
MP25	6020 8803	1	CASTING FRONT (OPTION 316, 317, 330 332, 333, AND 680)	28480	6020 8803
MP26	6020 8804	1	CASTING REAR (OPTION 316 317, 330, 332, 333, AND 680)	28480	6020 8804
MP27	6020 8816	1	CASTING FRONT FRAME (OPTIONS 316 316, 317, 330, 332, 333 and 680)	28480	6020 8816
MP28	6020 8816	1	CASTING REAR FRAME (OPTIONS 316 316 317, 330 332, 333 and 680)	28480	6020 8816
MP29	6020 8836	4	STRUT CORNER (OPTIONS 316 AND 317 ONLY)	28480	6020 8836
MP30	6020 8837	1	CASTING CORNER (OPTION 316 ONLY)	28480	6020 8837
MP31	6040 7201	4	FOOT (OPTIONS 316 AND 317 ONLY)	28480	6040 7201
MP32	6040 7202	1	TRIM STRIP, TOP (OPTION 317 ONLY)	28480	6040 7202
MP33	6040 7203	1	TRIM TOP FRONT (OPTION 316 ONLY)	28480	6040 7203
MP34	6040 8382	1	FRONT PNL INSERT, RIGHT (OPTIONS 316 AND 316 ONLY)	28480	6040 8382
MP35	6040 8383	1	FRONT PNL INSERT, LEFT (OPTIONS 316, 316, AND 317 ONLY)	28480	6040 8383
MP36	6060 0911	1	SIDE PERF (OPTION 317 ONLY)	28480	6060 0911
MP37	7120 6806	1	LABEL CONTROL PANEL	28480	7120 6806
MP38			NOT ASSIGNED		
MP39	6040 7649	1	PN SOCKET CRT	28480	6040 7649
MP40	6060 0911	1	PERF SIDE (OPTION 317 ONLY)	28480	6060 0911
Q1	1854 0433	3	TRANSISTOR NPN SI PD-90W FT-2 MHZ	28480	1854 0433
Q2	1854 0330	1	TRANSISTOR NPN SI PD-21W FT-10MHZ (NOT SUPPLIED WITH OPTION 002)	28480	1854 0330
Q3	1854 0433	1	TRANSISTOR NPN SI PD-90W FT-2 MHZ (OPTION 002 ONLY)	28480	1854 0433
Q4	1854 0433	1	TRANSISTOR NPN SI PD-90W FT-2 MHZ (OPTION 002 ONLY)	28480	1854 0433
T1	01340 66002	1	TRANSFORMER INPUT PWR (NOT SUPPLIED WITH OPTION 002)	28480	01340 66002
U1	1826 0106	2	IC 7815 V RGLTR (NOT SUPPLIED WITH OPTION 002)	28480	1826 0106
U2	1826 0214	1	IC V RGLTR (NOT SUPPLIED WITH OPTION 002)	28480	1826 0214
U3	1826 0106	1	IC 7815 V RGLTR (OPTION 002 ONLY)	28480	1826 0106
V1	6083 6112	1	CRT P31 AL NG (OPTION 631 ONLY)	28480	6083 6112
V1	6083 6162	1	CRT P31 AL IG	28480	6083 6162
V1	6083 6161	1	CRT P4 AL NG (OPTION 004 ONLY)	28480	6083 6161
V1	6083 6170	1	CRT P39 AL IG (OPTION 039 ONLY)	28480	6083 6170
V1	6083 6171	1	CRT P39 AL NG (OPTION 639 ONLY)	28480	6083 6171
V1	6083 6131	1	CRT, P7 AL NG (OPTION 007)	28480	6083 6131
V1	6083 6174	1	CRT, P7 AL IG (OPTION 007)	28480	6083 6174
V1	6083 6162	1	CRT, P4 AL IG (OPTION 004)	28480	6083 6162
W1	8120 1992	1	CABLE PAR CORD HOSPITAL GRADE (OPTIONS 307, 330, 332, 333 336, 336 337)	28480	8120 1992
W1	8120 2866	1	CABLE, 3 COND (OPTION 812 ONLY)	28480	8120 2866
	01340 00015		SERVICE MANUAL	28480	01340 00015
W1	8120 1621	1	CABLE UNSHLD 3 COND 18AWG	28480	8120 1621
W1	8120 1703	1	CABLE, 3 COND (OPTION 300 ONLY)	28480	8120 1703
W1	8120 0606	1	CABLE, 3 COND (OPTION 301 ONLY)	28480	8120 0606
W1	8120 1607	1	CABLE, 3 COND (OPTION 302 ONLY)	28480	8120 1607
W1	8120 0608	1	CABLE, 3 COND (OPTION 303 ONLY)	28480	8120 0608
W1	8120 2061	1	CABLE, 3 COND (OPTION 304 ONLY)	28480	8120 2061
W1	8120 2296	1	CABLE, 3 COND (OPTION 305 ONLY)	28480	8120 2296
XV1	6040 7649	1	SOCKET CRT BASE	28480	6040 7649

See Introduction to this section for ordering information



Table 7-2. Replaceable Parts (Cont'd)

Reference Designator	HP Part Number	C D	Qty	Description	Mlr Code	Mlr Part Number
A1	01340 66501		1	BOARD ASSEMBLY X Y Z AMPLIFIER (LESS A1A1 AND A1A2)	2P480	01340 66501
A1A1	1KA2 5006		2	IC X Y PREAMPLIFIER (NOT SUPPLIED WITH A1 ORDER SEPARATELY)	2B480	1KA2 5006
A1A2	1KA2 5006			IC Z PREAMPLIFIER (NOT SUPPLIED WITH A1 ORDER SEPARATELY)	2B480	1KA2 5006
A1C1	0121 0606			CAPACITOR V TRMR 1.5 PF 250V	2B480	0121 0606
A1C2	0160 2267			CAPACITOR FXD 10 PF +-5% 500VDC CER 0+-60	2B480	0160 2267
A1C3	0160 2066			CAPACITOR FXD 01 UF +-80-20% 100VDC CER	2B480	0160 2066
A1C4	0160 3447			CAPACITOR FXD 470 PF +-10% 1KVDC CER	65289	C0168102F221K525 CDH
A1C5	0160 2266		2	CAPACITOR FXD 22 PF +-5% 500VDC CER 0+-30	2B480	0160 2266
A1C6	0160 3447			CAPACITOR FXD 470 PF +-10% 1KVDC CER	65289	C0168102F221K525 CDH
A1C7	0160 3443		4	CAPACITOR FXD .1 UF +-80-20% 50WVDC CER	2B480	0160 3443
A1C8	0160 3443			CAPACITOR FXD .1 UF +-80-20% 50WVDC CER	2B480	0160 3443
A1C9	0160 3443			CAPACITOR FXD .1 UF +-80-20% 50WVDC CER	2B480	0160 3443
A1C10	0121 0606			CAPACITOR V TRMR 1.5 PF 250V	2B480	0121 0606
A1C11	0160 2267			CAPACITOR FXD 10 PF +-5% 500VDC CER 0+-60	2B480	0160 2267
A1C12	0160 2066			CAPACITOR FXD 01 UF +-80-20% 100VDC CER	2B480	0160 2066
A1C13	0160 2266			CAPACITOR FXD 22 PF +-5% 500VDC CER 0+-30	2B480	0160 2266
A1C14	0160 3443			CAPACITOR FXD .1 UF +-80-20% 50WVDC CER	2B480	0160 3443
A1C15	0140 0102		2	CAPACITOR FXD 68 PF +-5% 300VDC	72136	DM15E 66QJ0300WV1CR
A1C16	0160 3666		2	CAPACITOR FXD 01 UF +-80-20% 500VDC CER	2B480	0160 3666
A1C17	0160 2236		4	CAPACITOR FXD 1 PF +-1 PF 500VDC	2B480	0160 2236
A1C18	0160 2236			CAPACITOR FXD 1 PF +-1 PF 500VDC	2B480	0160 2236
A1C19	0160 3666			CAPACITOR FXD 01 UF +-80-20% 500VDC CER	2B480	0160 3666
A1C20	0140 0166		6	CAPACITOR FXD .068 UF +-10% 200VDC	06001	AE 22C683KT
A1C21	0160 0166			CAPACITOR FXD .068 UF +-10% 200VDC	06001	AE 22C683KT
A1C22	0140 0102			CAPACITOR FXD 68 PF +-5% 300VDC	72136	DM15E 66QJ0300WV1CR
A1C23	0160 3666			CAPACITOR FXD 01 UF +-80-20% 500VDC CER	2B480	0160 3666
A1C24	0160 2236			CAPACITOR FXD 1 PF +-1 PF 500VDC	2B480	0160 2236
A1C25	0160 2236			CAPACITOR FXD 1 PF +-1 PF 500VDC	2B480	0160 2236
A1C26	0160 3666			CAPACITOR FXD 01 UF +-80-20% 500VDC CER	2B480	0160 3666
A1C27	0160 0166			CAPACITOR FXD .068 UF +-10% 200VDC	06001	AE 22C683KT
A1C28	0160 0166			CAPACITOR FXD .068 UF +-10% 200VDC	06001	AE 22C683KT
A1C29	0160 2066			CAPACITOR FXD 01 UF +-80-20% 100VDC CER	2B480	0160 2066
A1C30	0160 0116		1	CAPACITOR FXD 47 PF +-10% 500VDC	2B480	0160 0116
A1C31	0121 0606			CAPACITOR V TRMR 1.5 PF 250V	2B480	0121 0606
A1C32	0160 2066			CAPACITOR FXD 01 UF +-80-20% 100VDC CER	2B480	0160 2066
A1C33	0160 3638			CAPACITOR FXD .22 UF +-80-20% 200VAC	16546	C24082242
A1C34	0160 0166		1	CAPACITOR FXD .068 UF +-10% 200VDC	06001	AE 22C683KT
A1CR1	1901 0028		14	DIODE PWR RECT 400V 750MA DO 29	2B480	1901 0028
A1CR2	1901 0028			DIODE PWR RECT 400V 750MA DO 29	2B480	1901 0028
A1CR3	1901 0006		6	DIODE SWITCHING 120V 50MA 100NS	2B480	1901 0006
A1CR4	1901 0040		1	DIODE SWITCHING 30V 50MA 2NS DO 35	2B480	1901 0040
A1.1	1200 0474		1	SOCKET IC 14 PIN DIP	2B480	1200 0474
A1MP1	1600 0441		2	SHIELD, AMPLIFIER	2B480	1600 0441
A1Q1	1853 0036		4	TRANSISTOR PNP SI PD-310MW FT-250MHZ	2B480	1853 0036
A1Q2	1853 0036			TRANSISTOR PNP SI PD-310MW FT-250MHZ	2B480	1853 0036
A1Q3	1853 0038		6	TRANSISTOR PNP SI TO 39 PD-1W FT-100MHZ	2B480	1853 0038
A1Q4	1854 0223		4	TRANSISTOR NPN SI TO 39 PD-1W FT-150MHZ	2B480	1854 0223
A1Q5	1854 0523			TRANSISTOR NPN SI TO 39 PD-1W FT-150MHZ	2B480	1854 0523
A1Q6	1853 0038			TRANSISTOR PNP SI TO 39 PD-1W FT-100MHZ	2B480	1853 0038
A1Q7	1853 0036			TRANSISTOR PNP SI PD-310MW FT-250MHZ	2B480	1853 0036
A1Q8	1853 0036			TRANSISTOR PNP SI PD-310MW FT-250MHZ	2B480	1853 0036
A1Q9	1853 0038			TRANSISTOR PNP SI TO 39 PD-1W FT-100MHZ	2B480	1853 0038
A1Q10	1854 0523			TRANSISTOR NPN SI TO 39 PL-1W FT-150MHZ	2B480	1854 0523
A1Q11	1854 0523			TRANSISTOR NPN SI TO 39 PD-1W FT-150MHZ	2B480	1854 0523
A1Q12	1853 0038			TRANSISTOR PNP SI TO 39 PD-1W FT-100MHZ	2B480	1853 0038
A1Q13	1854 0019		1	TRANSITION NPN SI TO 18 PD-300VW	07033	RT 2840
A1Q14	1853 0038			TRANSISTOR PNP SI TO 39 PD-1W FT-100MHZ	2B480	1853 0038
A1Q15	1854 0419		1	TRANSISTOR NPN SI TO 39 PD-1W FT-200MHZ	2B480	1854 0419
A1Q16	1854 0216		1	TRANSISTOR NPN SI PD-350W FT-300MHZ	2B480	1854 0216
A1R1	0684 3331		6	RESISTOR 33K 10% .25W FC TC--400/+800	2B480	0684 3331
A1R2	0684 3331			RESISTOR 33K 10% .25W FC TC--400/+800	2B480	0684 3331
A1R3	0757 0706		3	RESISTOR 51.1 1% .25W F TC 0+-100	2B480	0757 0706
A1R4	0757 0487		2	RESISTOR 825K 1% .125W F TUBULAR	2B480	0757 0487
A1R5	0757 0472		2	RESISTOR 200K 1% .125W F TC 0+-100	2B480	0757 0472

See introduction to this section for ordering information

Table 7-2. Replaceable Parts (Cont'd)

Reference Designator	HP Part Number	C D	Qty	Description	Mfr Code	Mfr Part Number
A1R6	0684 2211		3	RESISTOR 220 10% .25W FC TC--400+800	01121	CB2211
A1R7	2100 0684		3	RESISTOR TRMR 800 10% C TOP ADJ 1 TRN	32997	3386P-Y46 E01
A1R8	0683 1826		3	RESISTOR 1 BK 5% .25W FC TC--400+700	28480	0683 1826
A1R9	0684 2241		3	RESISTOR 220K 10% .25W FC TC--800+900	28480	0684 2241
A1R10	0757 0420		3	RESISTOR 750 1% .125W F TC-0-100	16701	C4 1/8 TO 751 F
A1R11	0684 8211		3	RESISTOR 820 10% .25W FC TC--400+600	01121	CB8211
A1R12	0757 0466		4	RESISTOR 100K 1% .125W F TC-0-100	16701	C4 1/8 TO 1003 F
A1R13	2100 3211		3	RESISTOR TRMR 1K 10% C TOP ADJ 1 TRN	32997	3386P-Y46 102
A1R14	0684 3331		6	RESISTOR 33K 10% .25W FC TC--100+600	28480	0684 3331
A1R15	0684 3331		6	RESISTOR 33K 10% .25W FC TC--100+800	28480	0684 3331
A1R16	0757 0706			RESISTOR 611 1% .25W F TC-0-100	28480	0757 0706
A1R17	0757 0487			RESISTOR 825K 1% .125W F TUBULAR	28480	0757 0487
A1R18	0684 2211			RESISTOR 220 10% .25W FC TC--400+800	01121	CB2211
A1R19	2100 0684			RESISTOR TRMR 800 10% C TOP ADJ 1 TRN	32997	3386P-Y46 501
A1R20	0683 1826			RESISTOR 1 BK 5% .25W FC TC--400+700	28480	0683 1826
A1R21	0757 0472			RESISTOR 200K 1% .125W F TC-0-100	28480	0757 0472
A1R22	0684 2241			RESISTOR 220K 10% .25W FC TC--800+900	28480	0684 2241
A1R23	0757 0 20			RESISTOR 750 1% .125W F TC-0-100	16701	C4 1/8 TO 751 F
A1R24	0684 8211			RESISTOR 820 10% .25W FC TC--400+600	01121	CB8211
A1R25	2100 3211			RESISTOR TRMR 1K 10% C TOP ADJ 1 TRN	32997	3386P-Y46 102
A1R26	0757 0466			RESISTOR 100K 1% .125W F TC-0-100	16701	C4 1/8 TO 1003 F
A1R27	0684-1831		2	RESISTOR 18K 10% .25W FC TC--400+600	28480	0684 1831
A1R28	0698 0085		2	RESISTOR 2 61K 1% .125W F TC-0-100	28480	0698 0085
A1R29	0757 0406		1	RESISTOR 182 1% .125W F TC-0-100	16701	C4 1/8 TO 182 F
A1R30	0698 0085		1	RESISTOR 2 61K 1% .125W F TC-0-100	28480	0698 0085
A1R31	0684 1831			RESISTOR 18K 10% .25W FC TC--400+800	28480	0684-1831
A1R32	0698 3438		2	RESISTOR 147 1% .125W F TC-0-100	28480	0698 3438
A1R33	0684 6631		4	RESISTOR 56K 10% .25W FC TC--400+800	01121	CB5631
A1R34	0684 6631		4	RESISTOR 56K 10% .25W FC TC--400+800	01121	CB5631
A1R35	0684 6811		8	RESISTOR 680 10% .25W FC TC--400+800	28480	0684 6811
A1R36	0684 6811			RESISTOR 680 10% .25W FC TC--400+800	28480	0684 6811
A1R37	0698 3175		4	RESISTOR 147K 1% .5W F TC-0-100	28480	0698 3175
A1R38	0757 0847		0	RESISTOR 27.4K 1% .5W F TC-0-100	28480	0757 0847
A1R39	0757 0847			RESISTOR 27.4K 1% .5W F TC-0-100	28480	0757 0847
A1R40	0698 3175			RESISTOR 147K 1% .5W F TC-0-100	28480	0698 3175
A1R41	0757 0290		4	RESISTOR 6 19K 1% .125W F TC-0-100	16701	C4 1/8 TO 6191 F
A1R42	0757 0338		5	RESISTOR 1K 1% .25W F TC-0-100	16701	C4 1/8 TO 1001 F
A1R43	0757 0847			RESISTOR 27.4K 1% .5W F TC-0-100	28480	0757 0847
A1R44	0757 0290			RESISTOR 6 19K 1% .125W F TC-0-100	16701	C4 1/8 TO 6191 F
A1R45	0757 0338			RESISTOR 1K 1% .25W F TC-0-100	16701	C4 1/8 TO 1001 F
A1R46	0757 0847			RESISTOR 27.4K 1% .5W F TC-0-100	28480	0757 0847
A1R47	0698 3438			RESISTOR 147 1% .125W F TC-0-100	28480	0698 3438
A1R48	0684 6631			RESISTOR 56K 10% .25W FC TC--400+800	01121	CB5631
A1R49	0684 6631			RESISTOR 56K 10% .25W FC TC--400+800	01121	CB5631
A1R50	0684 6811			RESISTOR 680 10% .25W FC TC--400+800	28480	0684 6811
A1R51	0684 6811			RESISTOR 680 10% .25W FC TC--400+800	28480	0684 6811
A1R52	0698 3175			RESISTOR 147K 1% .5W F TC-0-100	28480	0698 3175
A1R53	0757 0847			RESISTOR 27.4K 1% .5W F TC-0-100	28480	0757 0847
A1R54	0757 0847			RESISTOR 27.4K 1% .5W F TC-0-100	28480	0757 0847
A1R55	0698 3175			RESISTOR 147K 1% .5W F TC-0-100	28480	0698 3175
A1R56	0757 0290			RESISTOR 6 19K 1% .125W F TC-0-100	16701	C4 1/8 TO 6191 F
A1R57	0757 0338			RESISTOR 1K 1% .25W F TC-0-100	16701	C4 1/8 TO 1001 F
A1R58	0757 0847			RESISTOR 27.4K 1% .5W F TC-0-100	28480	0757 0847
A1R59	0757 0290			RESISTOR 6 19K 1% .125W F TC-0-100	16701	C4 1/8 TO 6191 F
A1R60	0757 0338			RESISTOR 1K 1% .25W F TC-0-100	16701	C4 1/8 TO 1001 F
A1R61	0757 0847			RESISTOR 1K 1% .25W F TC-0-100	28480	0757 0847
A1R62	0684 1231			RESISTOR 12K 10% .25W FC TC--400+800	28480	0684 1231
A1R63	0757 0706			RESISTOR 51 5 1% .25W F TC-0-100	28480	0757 0706
A1R64	0684 2241			RESISTOR 220K 10% .25W FC TC--800+900	28480	0684 2241
A1R65	0684 2211		1	RESISTOR 220 10% .25W FC TC--400+800	01121	CB2211
A1R66	0684 1061		1	RESISTOR 1M 10% .25W FC TC--800+900	01121	CB1061
A1R67	2100 0684			RESISTOR TRMR 800 10% C TOP ADJ 1 TRN	32997	3386P-Y46 501
A1R68	0683 1826			RESISTOR 1 BK 5% .25W FC TC--400+700	28480	0683 1826
A1R69	0684 3331			RESISTOR 33K 10% .25W FC TC--400+800	28480	0684 3331
A1R70	2100 3211			RESISTOR TRMR 1K 10% C TOP ADJ 1 TRN	32997	3386P-Y46 102
A1R71	0684 3331			RESISTOR 33K 10% .25W FC TC--400+800	28480	0684 3331
A1R72	0757 0419		2	RESISTOR 681 1% .125W F TC-0-100	16701	C4 1/8 TO 681 F
A1R73	0757 0419		2	RESISTOR 681 1% .125W F TC-0-100	16701	C4 1/8 TO 681 F
A1R74	2100 3211			RESISTOR TRMR 1K 10% C TOP ADJ 1 TRN	32997	3386P-Y46 102
A1R75	2100 3211			RESISTOR TRMR 1K 10% C TOP ADJ 1 TRN	32997	3386P-Y46 102
A1R76	0684 1011		1	RESISTOR 100 10% .25W FC TC--400+800	01121	CB1011
A1R77	0684 3331		4	RESISTOR 330 10% .25W FC TC--400+800	01121	CB3311
A1R78	0757 0190		2	RESISTOR 20K 1% .5W F TC-0-100	28480	0757 0190
A1R79	0757 0761		1	RESISTOR 22.1K 1% .25W F TC-0-100	16701	C5 1/4 TO 2212 F
A1R80	0757 0847			RESISTOR 27.4K 1% .5W F TC-0-100	28480	0757 0847
A1R81	0761 0070		1	RESISTOR 8 2 K 5% 1W MO TC-0-200	28480	0761 0070
A1R82	0757 0190			RESISTOR 20K 1% .5W F TC-0-100	28480	0757 0190
A1R83	0757 0433		2	RESISTOR 332K 1% .125W F TC-0-100	24546	C4 1/8 TO 3321 F
A1R84	0684 3311			RESISTOR 330 10% .25W FC TC--400+800	01121	CB3311
A1R85	0757 0420			RESISTOR 750 1% .125W F TC-0-100	16701	C4 1/8 TO 751 F
A1R86	0684 3331			RESISTOR 33K 1% .125W F TC-0-100	24546	C4 1/8 TO 3302 F

See introduction to this section for ordering information

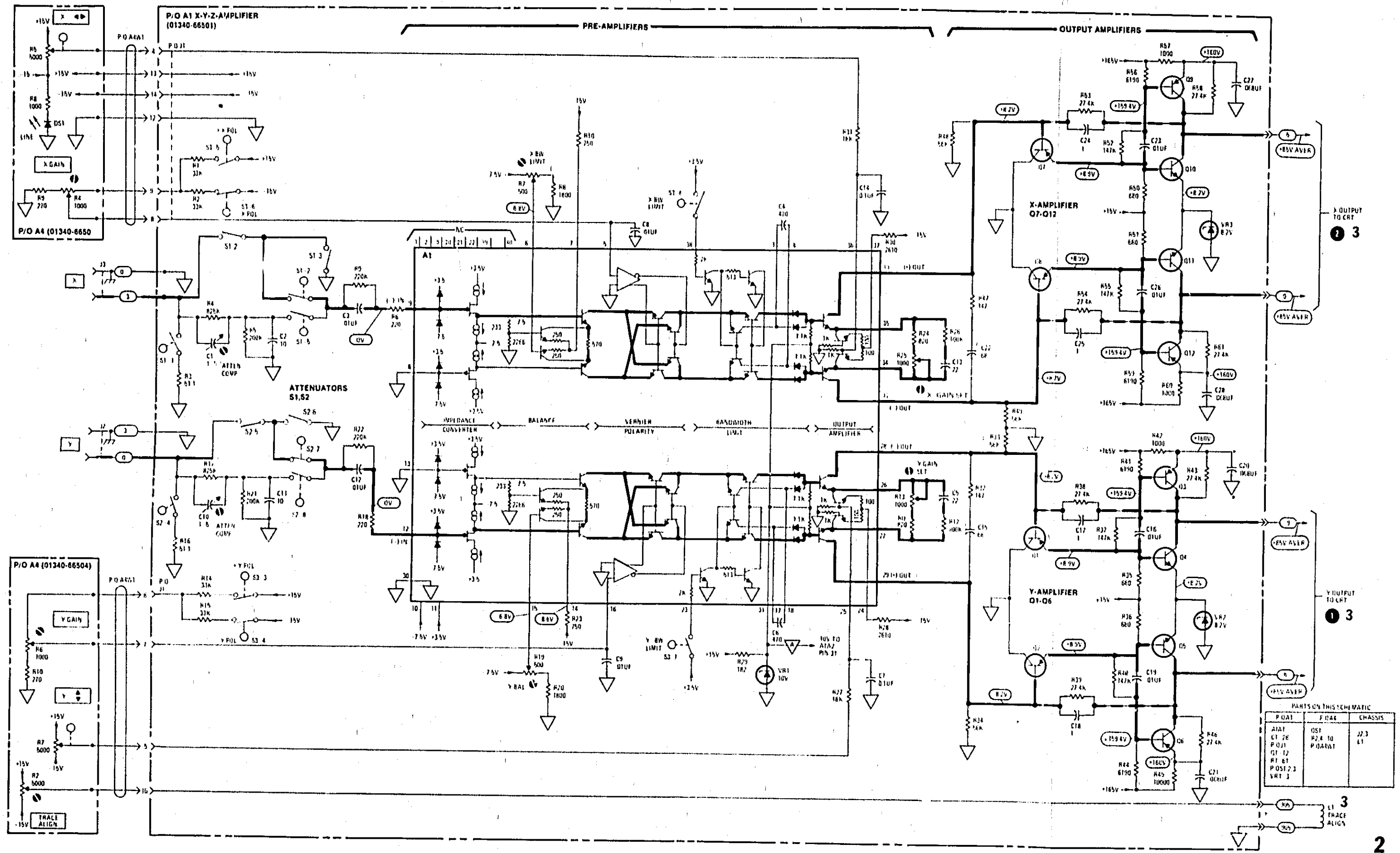

PARTS ON THIS SCHEMATIC

P/O A4	F OAR	CHASSIS
A1A1	Q51	J2,3
C1 2E	R2,4 10	L1
P/O A1	P/O A1A1	
Q1 12		
R1 6T		
P/O S1 2,3		
VRT 1		

Figure 7-1  
Service Sheet 2, X-Y Amplifiers  
7-7

**SERVICE SHEET 3**

**THEORY OF OPERATION**

**Z-AXIS AMPLIFIER**

**Input Attenuator and Impedance Converter (P/O A1A2).** A high or low input impedance termination may be selected by switch A1S2-1. Output from the attenuator section is applied to one section of preamplifier IC A1A2. The IC input is an impedance converter with an active current source in both the source and the drain.

**IC Preamplifier-Bandwidth Limit.** The preamplifier consists of a bipolar paraphase amplifier and a cross-connected, common-base amplifier. The paraphase amplifier converts the single-ended input to a differential signal with a special input from the Z BAL control for offset adjustment. The cross-connected, common-base amplifier is used for GAIN vernier control.

**IC Output Amplifier.** The output amplifier of the IC consists of a differential amplifier and a differential current source which also serves as an intensity control circuit. The differential amplifier converts the single-ended intensity voltage to a differential current. Magnitude of the current is controlled by external current sink A1R87 (INT LIMIT). External blanking can be used to control the CRT display. A TTL logic level (\*) applied through J4 to the base of A1Q16 causes it to conduct heavily, acting as a drain to current supply A1R87. This blanks the CRT.

**Z-AMPLIFIER OUTPUT.** The output from A1A2 is applied to emitter-follower A1Q13. The output of A1Q13 is applied to amplifier A1Q14/A1Q15 where the signal voltage is raised to the required level to drive the control grid of the CRT. The gain of the amplifiers is stabilized by negative feedback from the collectors of A1Q14/A1Q15 to the base of A1Q13. HF Adj. No. 2 (A1C31) provides adjustment for the fast corner of the signal. Slower compensation is provided by lag-compensation network A1C30/A1R75. Diode A1CR3 is a high-speed diode, and A1CR1 and A1CR2 are high-current diodes. Together they provide protection for the output amplifiers against arcs and transients. The output of the Z-axis amplifier is applied to a level translator on High-voltage Assembly A3 where it establishes the potential difference between the grid and cathode of the CRT.

**HIGH-VOLTAGE POWER SUPPLY**

**HV Generator and Level Translator.** Transistor Q1 and transformer A3A1T1 form an oscillator circuit with the main source of power coming from the +24 V UNREG low-voltage power supply. The primary windings of A3A1T1 are connected to provide positive feedback to the base of Q1 to sustain oscillations. Two windings are provided in the secondary of A3A1T1: one winding supplies high voltage, and the other supplies heater power to the cathode-ray tube.

**WARNING**

Heater winding of the high-voltage transformer is connected to -2140 V cathode potential and is dangerous to life. Use extreme caution when handling, testing, and adjusting.

The HV winding of A3A1T1 is tapped and provides a sine wave for the level translator. The winding is also tapped at another point and is applied to High-voltage Multiplier Assembly A3A2 where the voltage is doubled, rectified, filtered, and then applied to the post accelerator of the CRT. The full output of the secondary of A3A1T1 is rectified and provides the negative high voltage for the CRT cathode.

Diode rectifier A3A1CR1 and filter network A3C3, A3C4, and A3R10 provide the -2140 V potential for the cathode, grid reference level, and focus reference level. The focus reference level is divided by A3R21, A3R22, A3R23, and front-panel FOCUS control, A4R3. Feedback for high-voltage regulator A3U1 is through A3C6 and A3R13.

The sine-wave signal from the secondary top on high-voltage transformer A3A1T1 is applied through A3A1C1/A3R11 to the Z-axis level translator. The top and bottom of the sine wave are clipped by the following action: The top of the sine wave is clipped by the action of A3CR9. The clipping level is established by a fixed voltage divider network consisting of A3R19, A3R20, and A3VR3. The bottom of the sine wave is clipped by the action of A3CR8. The lower clipping level is established by the Z-axis signal from the Z-axis amplifier.

With front-panel INTENSITY control A4R1 set for maximum intensity the Z-axis amplifier output is at its highest level. This output causes maximum clipping action on the bottom section of the sine wave from A3A1T1. This results in the smallest peak-to-peak swing of the sine wave, since the upper clipping level is held constant by the fixed voltage divider network. As INTENSITY control A4R1 is turned toward minimum intensity, clipping action on the bottom of the sine wave becomes less, resulting in a greater peak-to-peak swing. The clipped sine wave is ac coupled through A3C7 to a rectifier circuit consisting of A3CR6 and A3CR7. The rectifier circuit provides a dc level equal to the peak-to-peak amplitude of the clipped sine wave. The dc level is referenced to the cathode potential. Diodes A3CR6 and A3CR7 are connected so that the dc level established is negative with respect to the cathode and is applied to the CRT grid. Capacitor A3C8 is not returned directly to the -2140-volt cathode but is connected to the Z-axis amplifier output for coupling fast Z-axis transitions to the grid.

**High-voltage Regulator.** Operational amplifier A3U1 compares the voltage at the junction of A3R2 and A3R13 (with respect to ground, 0 V) and drives HV oscillator Q2 to correct for any differences. Since the input of A3U1 (pin 3) is a very high resistance, it will

draw negligible current. Therefore, current flow between the +165 V regulated supply and the -2140 V cathode voltage is established by resistor string A3R1, A3R2, and A3R13, with the junction of A3R2 and A3R13 being held at 0 V by the action of A3U1. For example, if the high voltage goes more negative, the input to A3U1 (pin 3) will start to go negative and its output (pin 6) will follow. This applies a more negative average voltage to the feedback winding on HV transformer A3A1T1. Since HV oscillator Q1 is an NPN device (conducts only on positive peaks of the base waveform), the more negative average voltage applied to A3A1T1 causes the oscillator to conduct less, and for a shorter period of time. With Q1 conducting less, less power is available in the transformer and the hv output will go positive, returning the high voltage to its previously adjusted level.

**Cathode-ray Tube.** In addition to the cathode, control grid, focus grid, X- and Y-deflection plates discussed previously, the CRT contains other elements vital to its operation. The heater is powered by a separate winding on the HV transformer, A3A1T1, and is raised to the cathode potential by a direct connection.

**CAUTION**

The heater voltage is 5.9 Vac, however, use extreme care when measuring because the ac voltmeter must be floated at -2140 volts. The common input of most ac powered voltmeters are not rated for this use; there-

fore, a battery operated unit is normally used. Do not contact the case of the ac voltmeter or its leads when measuring this high potential. Isolate voltmeter case from the 1340A chassis.

The required voltage for the accelerator electrode of the CRT is supplied from zener diode regulator A3VR3. Astigmatism (A3R24) and the Pattern (A3R25) are screw-driver adjustments located on the high-voltage power supply assembly.

The post accelerator is a conductive coating around the inner part of the CRT glass. It provides a high-accelerating field for the electron beam and collect electrons produced by secondary emission when the beam strikes the screen.

**WARNING**

Use extreme care when measuring the post accelerator voltage. The potential is approximately 4500 V with respect to ground and is dangerous to life.

**A1 AND A3 REMOVAL PROCEDURES.**

Refer to paragraph 8-12 for A1 and A3 Assemblies removal.

**NOTE**

Refer to Service Sheet 2 for Assembly A1 and Assembly A4 Component Identification Locations.

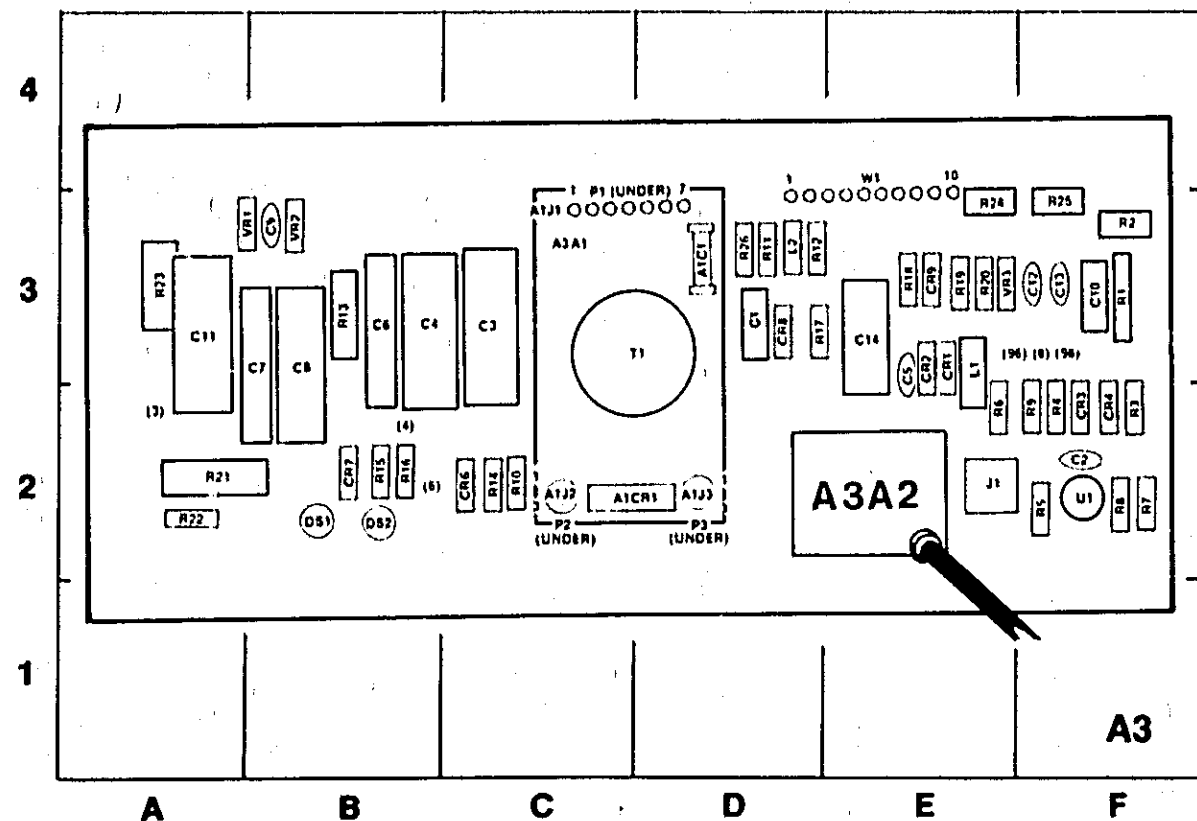

Figure 7-5. Component Identification, HVPS Assembly, A3

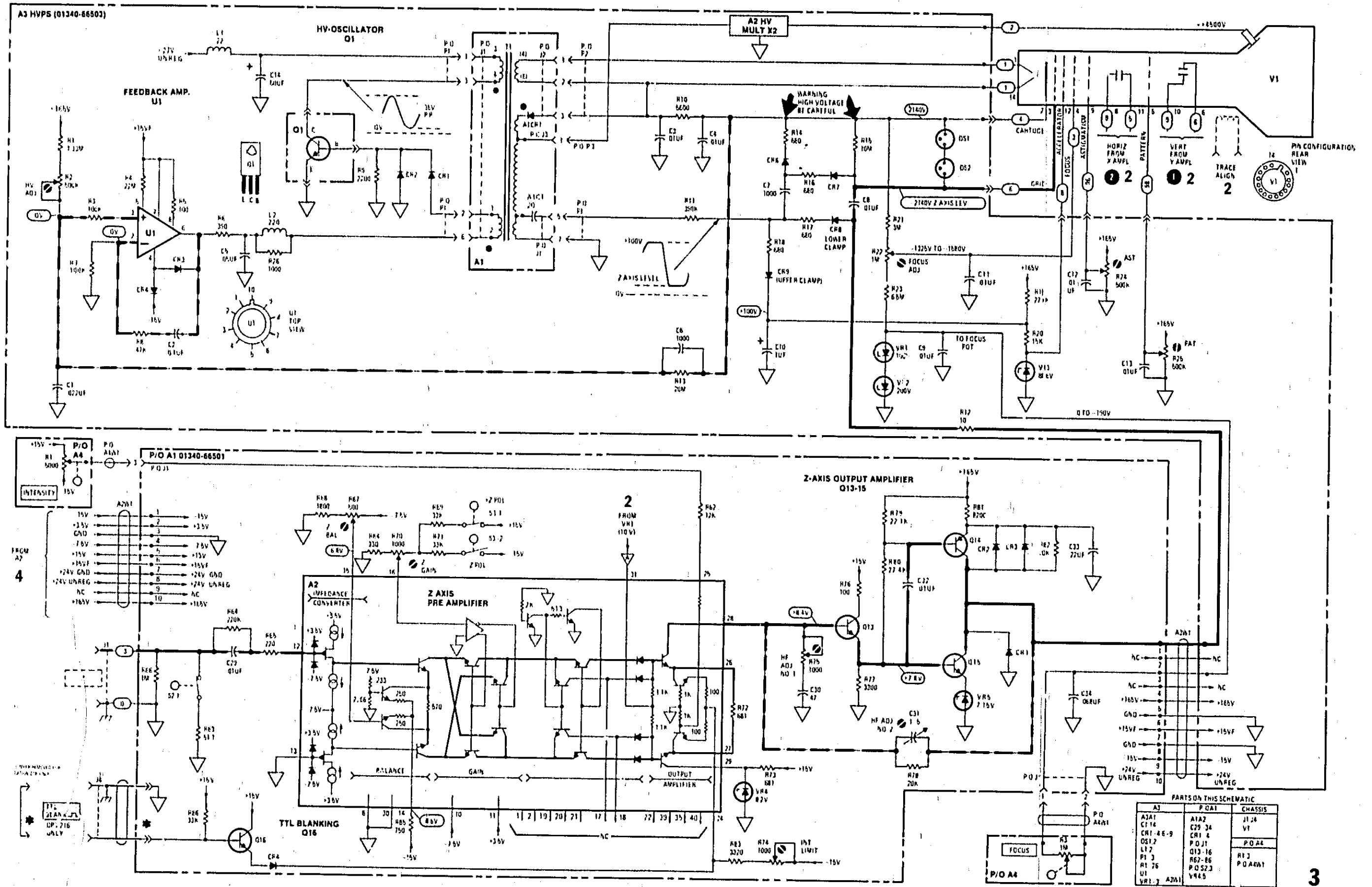

Figure 7-6  
Service Sheet 3, HVPS and Z-Axis Amplifier  
7-9

**SERVICE SHEET 4**

**THEORY OF OPERATION**

**General.** The low-voltage power supply converts the ac input line voltage to several dc levels required to power individual circuits in the instrument. All supplies except the +24-volt UNREG line to the HV oscillator are regulated. The +24-volt UNREG line is fused with a 0.6 A overload protection fuse.

The +15-volt and -15-volt supplies have a three-terminal IC regulator with a nominal output being 15 volts. The actual voltage depends on the IC regulator and is acceptable within  $\pm 5\%$  of nominal (14.25 volts to 15.75 volts). The lower voltages (+3.5 volts and -7.5 volts) required to operate A1A1 and A1A2 are developed within these supplies.

**+165-volt Regulator.** The ac input voltage from power transformer T1 is applied to bridge rectifier A2CR1. The dc output from A2CR1 is filtered by A2C1. A +15 V reference is applied through A2CR2 to the emitter of A2Q3. The base of A2Q3 is connected to a voltage divider across the output circuit with A2R15 being used as the adjustable reference. If the output of the supply decreases, the base of A2Q3 becomes less positive causing it to conduct more heavily. With A2Q3 conducting heavily, the conduction through Darlington pair Q2 and A2Q4 increases. This results in an increase in output voltage. When the output voltage again reaches +165 volts, conduction through A2Q3 decreases, allowing the output voltage to stabilize.

Transistor A2Q1 and resistor A2R2 form a current limiting circuit. As current requirements increase toward the limit of the supply, the voltage drop across A2R2 is applied to the base of A2Q1 which conducts, limiting the current drain from the Darlington pair.

**REMOVAL PROCEDURE**

Refer to paragraph 8-12 for A2 Assembly removal.

**TROUBLESHOOTING**

**General.** If trouble is suspected, visually inspect the instrument. Look for loose or burned components that might suggest a source of trouble. Verify that all circuit board connections are making good contact.

**Component Identification.** Components on the assembly associated with this service sheet are shown adjacent to the schematic.

**Troubleshooting Hints.** Before any extensive troubleshooting, check the external power source for proper input. When troubleshooting the low-voltage power supply, check voltages indicated on the schematic.

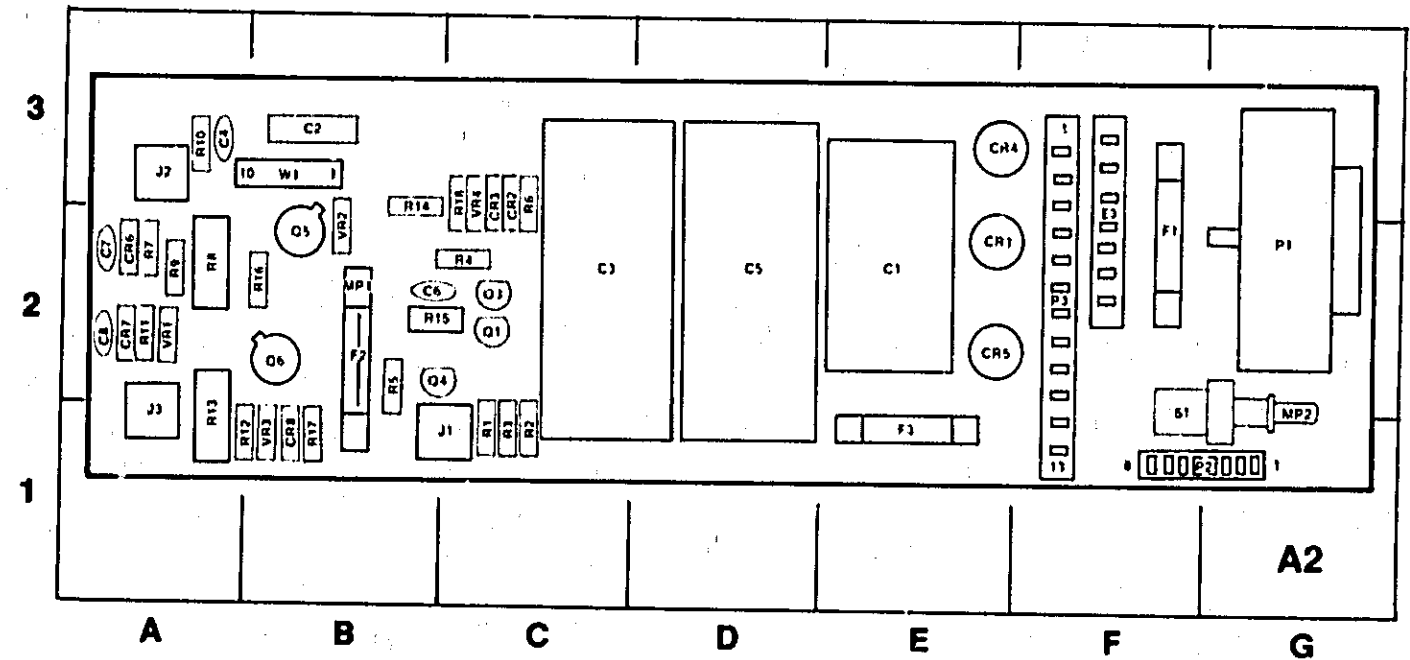

REF DESIG	GRID LOC	REF DESIG	GRID LOC	REF DESIG	GRID LOC	REF DESIG	GRID LOC	REF DESIG	GRID LOC	REF DESIG	GRID LOC	REF DESIG	GRID LOC
C1	E-2	CR1	E-2	E3	F-2	MP2	G-2	Q5	B-2	R7	A-2	R16	B-2
C2	B-3	CR2	C-3	F1	F-2	P1	G-2	Q6	B-2	R8	A-2	R17	B-1
C3	C-2	CR3	C-3	F2	B-2	P2	F-1	R1	C-1	R9	A-2	R18	C-3
C4	A-3	CR4	E-3	F3	E-1	P3	F-2	R2	C-1	R10	A-3	S1	F-2
C5	D-2	CR5	E-2	J1	B-1	Q1	C-2	R3	C-1	R11	A-2	VR1	A-2
C6	B-2	CR6	A-2	J2	A-3	Q2	C-2	R4	C-2	R12	B-1	VR2	B-3
C7	A-2	CR7	A-2	J3	A-1	Q3	C-2	R5	B-2	R13	A-1	VR3	B-1
C8	A-2	CR8	B-1	MP1	B-2	Q4	B-2	R6	C-3	R14	B-3	VR4	C-3
										R15	B-2	W1	B-3

Figure 7-7. Component Identification, LVPS Assembly, A2

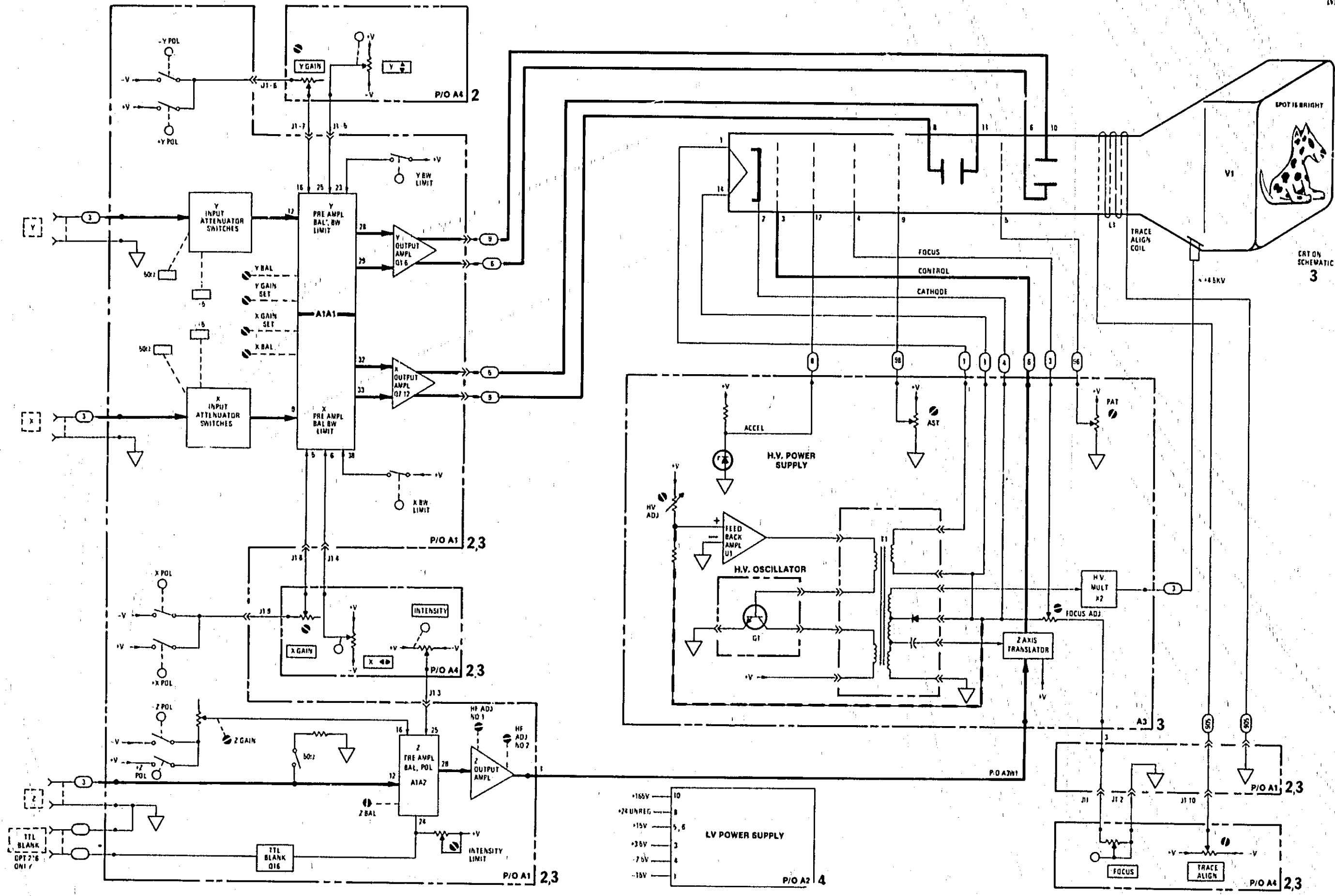

Figure 7-8.  
Service Sheet 4, LV Power Supply  
7-11

**SERVICE SHEET 2**

**THEORY OF OPERATION**

**General.** The X- and Y-amplifier attenuators, preamplifiers, and output amplifiers are identical; therefore, only the X-amplifier circuit will be discussed.

**Input Attenuator and Impedance Converter (P/O A1A1).** By properly positioning switch segments of A1S1, the X-input voltage/impedance ranges may be selected. (Refer to table 8-3 for proper switch selection for all amplifiers.) Output from the attenuator section is applied to one section of the preamplifier IC A1A1. The IC input is an impedance converter with an active current source in both the source and drain.

**IC Preamplifier-Bandwidth Limit.** The preamplifier consists of a bipolar paraphase amplifier and a cross-connected, common-base amplifier. The paraphase amplifier converts the single-ended input to a differential signal with a special input from the X BAL control for offset adjustment. The cross-connected, common-base amplifier is used for GAIN vernier control. The bandwidth amplifier consists of two amplifiers: one with a capacitor connected across its collectors, and one without a capacitor. The bandwidth limit switch selects the proper amplifier for the desired bandwidth characteristics.

**IC Output Amplifier.** The output amplifier of the IC consists of a differential amplifier and a differential current source which also serves as a position control circuit. The differential amplifier converts the single-ended position voltage to a differential current. Magnitude of the current is controlled by external current sink A1R30.

**X-amplifier Output.** The differential output from A1A1 is applied to two identical amplifiers A1Q7/A1Q9/A1Q10 and A1Q8/A1Q11/A1Q12 where the signal voltage is

raised to the required level to drive the CRT horizontal plates. The gain of the amplifiers is stabilized by negative feedback from the collectors of A1Q9/A1Q10 to the base of A1Q7 and from the collectors of A1Q11/A1Q12 to the base of A1Q8.

**A1 REMOVAL PROCEDURE**

Refer to paragraph 8-12 for A1 Assembly removal.

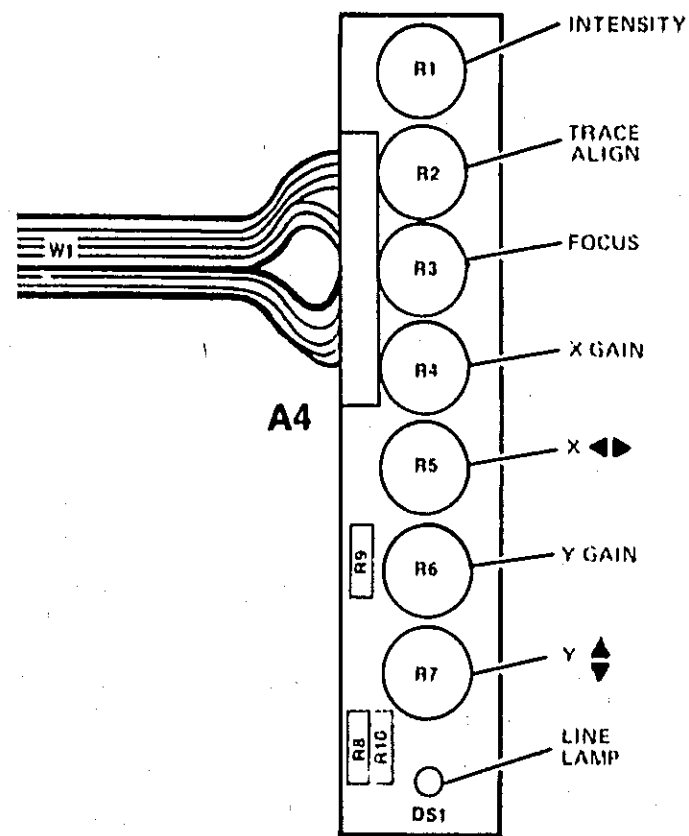

Figure 8-2. Component Identification, Control Assembly, A1

Table 8-3. X, Y, and Z Input Switch Coding

ATTEN	IMP	X					Y					Z
		S1-1	S1-2	S1-3	S1-4	S1-5	S2-4	S2-5	S2-6	S2-7	S2-8	
1	50 ohm	ON	ON	OFF	ON	OFF	ON	ON	OFF	ON	OFF	ON
1	1 M	OFF	ON	OFF	ON	OFF	OFF	ON	OFF	OFF	OFF	OFF
5	1 M	OFF	OFF	ON	OFF	ON	OFF	OFF	ON	OFF	ON	N/A
5	50 ohm	ON	OFF	ON	OFF	ON	ON	OFF	ON	OFF	ON	N/A

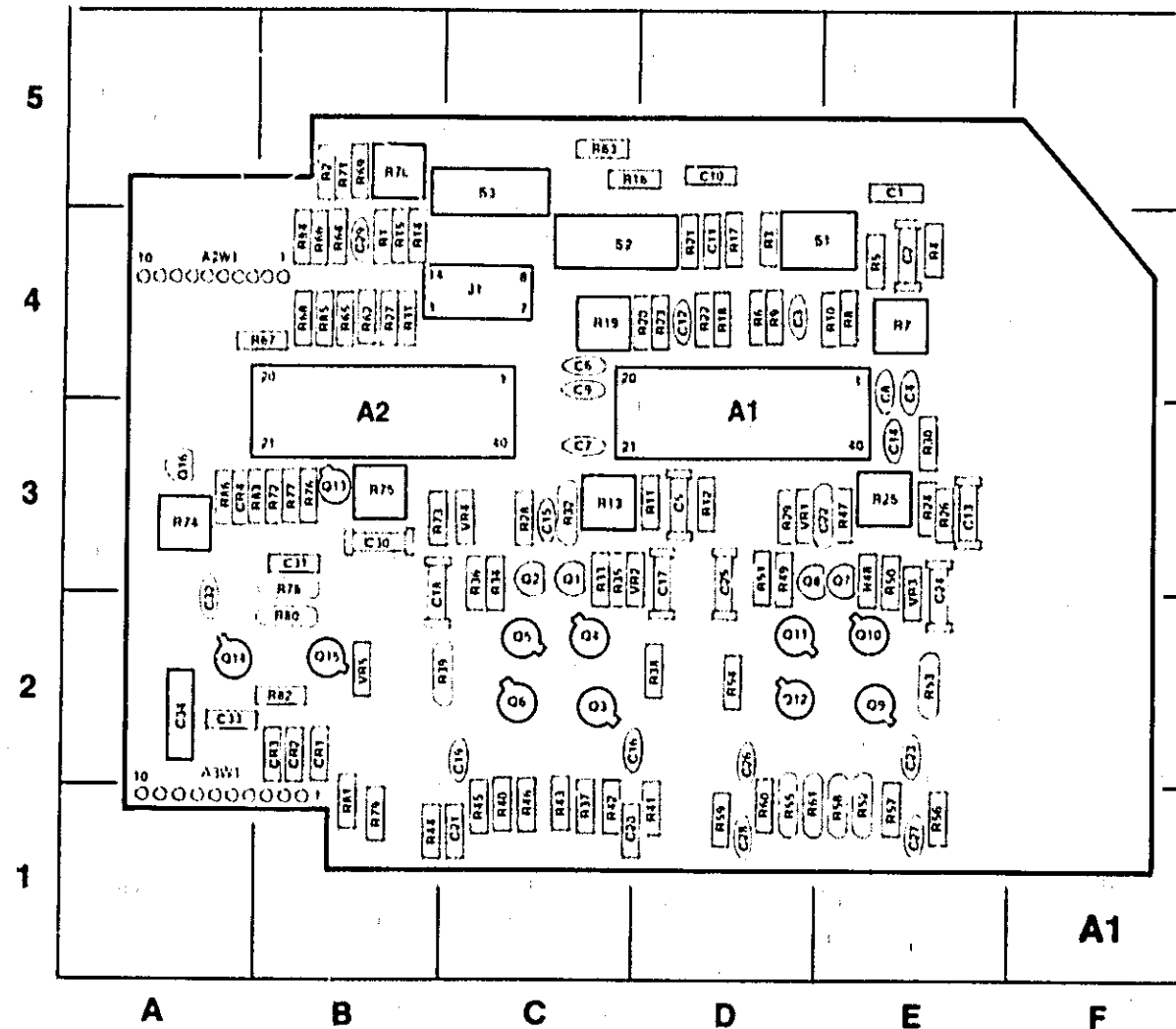

Figure 7-3. Component Identification, X-Y-Z Assembly, A1

REF DESIG	GRID LOC	REF DESIG	GRID LOC	REF DESIG	GRID LOC	REF DESIG	GRID LOC	REF DESIG	GRID LOC	REF DESIG	GRID LOC	REF DESIG	GRID LOC
A1A1	D-3	C21	C-1	Q4	C-2	R10	E-4	R32	C-3	R53	E-2	R74	A-3
A1A2	B-3	C22	E-4	O5	C-2	R11	D-3	R33	C-3	R54	D-2	R75	B-3
C1	E-5	C23	E-2	O6	C-2	R12	D-3	R34	C-3	R55	D-1	R76	B-3
C2	E-4	C24	E-3	O7	E-3	R13	C-3	R35	C-3	R56	E-1	R77	B-3
C3	D-4	C25	D-3	O8	D-3	R14	B-4	R36	C-3	R57	E-1	R78	A-3
C4	E-4	C26	D-2	O9	E-2	R15	B-4	R37	B-1	R58	E-1	R79	B-1
C5	D-3	C27	E-1	O10	E-2	R16	C-5	R38	D-2	R59	D-1	R80	B-2
C6	C-4	C28	D-1	O11	O-2	R17	D-4	R39	B-2	R60	D-1	R81	B-1
C7	C-3	C29	B-4	O12	O-2	R18	D-4	R40	B-1	R61	D-1	R82	B-2
C8	E-4	C30	B-3	O13	B-3	R19	C-4	R41	C-1	R62	B-4	R83	B-3
C9	C-4	C31	B-3	O14	A-2	R20	D-4	R42	B-1	R63	C-5	R84	B-4
C10	D-5	C32	A-2	O15	B-2	R21	D-4	R43	B-1	R64	B-4	R85	B-4
C11	D-4	C33	A-2	O16	A-3	R22	D-4	R44	B-1	R65	B-4	R86	A-3
C12	D-4	C34	A-2	R1	B-4	R23	D-4	R45	B-1	R66	B-4	P/OS1	D-4
C13	E-3	CR1	B-2	R2	B-5	R24	E-3	R46	B-1	R67	B-4	P/OS2	C-4
C14	E-4	CR2	B-2	R3	D-4	R25	E-4	R47	E-3	R68	B-4	P/OS3	C-5
C15	C-3	CR3	B-2	R4	E-4	R26	E-3	R48	E-3	R69	B-5	VR1	D-3
C16	C-2	CR4	A-3	R5	E-4	R27	B-4	R49	D-3	R70	B-5	VR2	D-3
C17	D-3	P/OJ1	C-4	R6	D-4	R28	C-3	R50	E-3	R71	B-5	VR3	E-3
C18	B-2	O1	C-3	R7	E-4	R29	D-3	R51	D-3	R72	B-3	VR4	C-3
C19	C-2	O2	C-3	R8	E-4	R30	E-3	R52	E-1	R73	B-3	VR5	B-2
C20	B-1	O3	C-2	R9	D-4	R31	B-4						



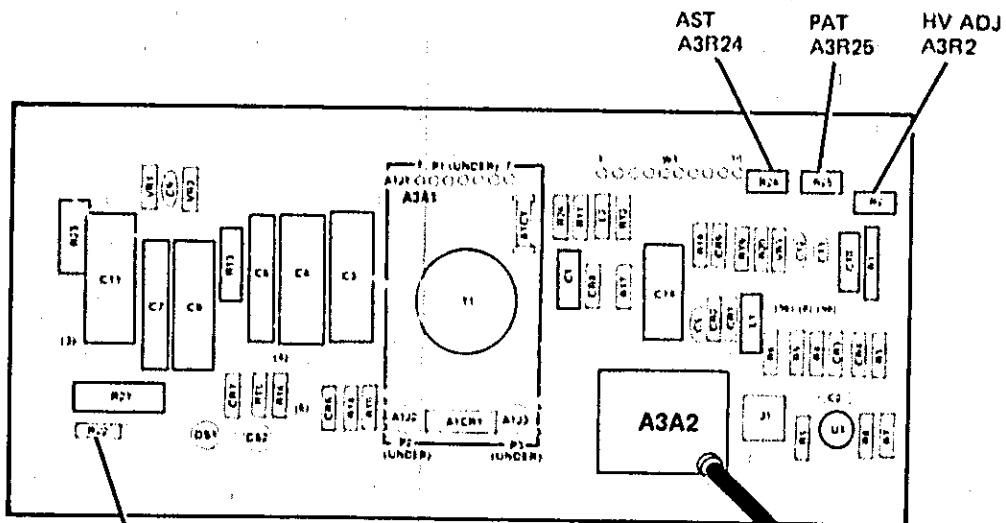
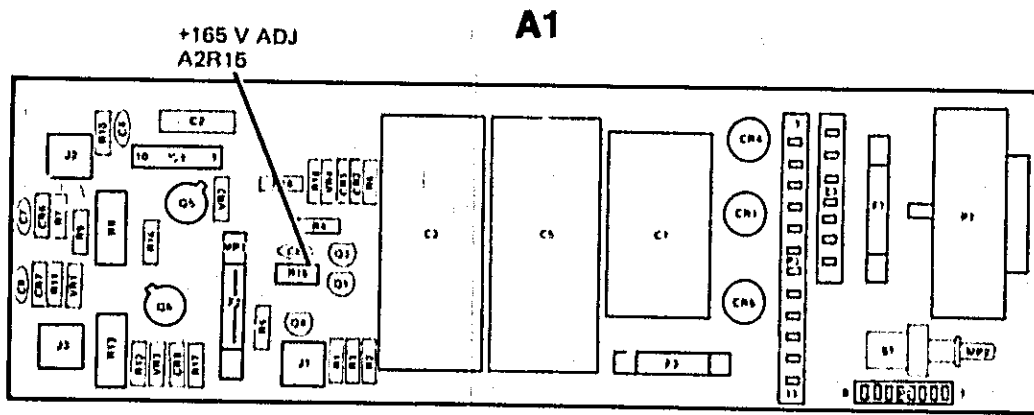
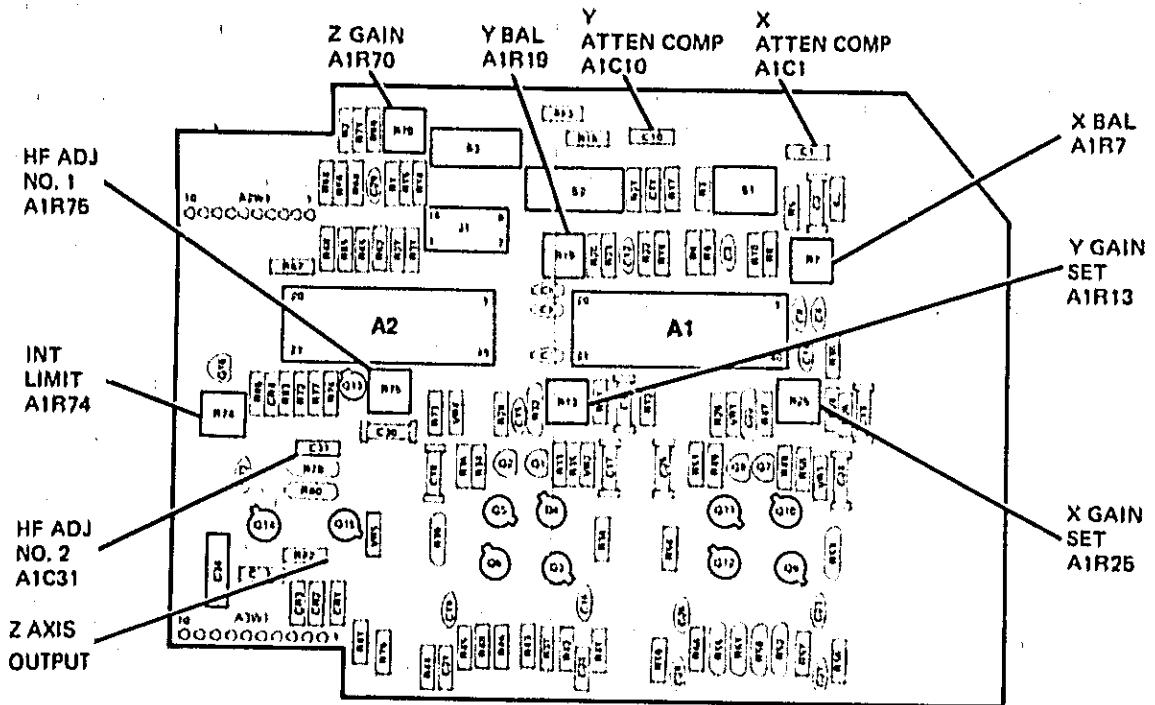

Figure 8-11.  
Service Sheet 6, Adjustment Locations

## SECTION VIII

## SERVICE

**8-1. INTRODUCTION.**

8-2. This section provides instructions for troubleshooting and repairing the Model 1340A X-Y Display.

8-3. Detailed theory of operation and troubleshooting information are located opposite the schematics on fold-out Service Sheets.

**8-4. THEORY OF OPERATION.**

8-5. Overall theory of operation is on the foldout page opposite the block diagram (Service Sheet 1). Each section of the diagram refers to service sheets where detailed theory, schematics, and troubleshooting information are presented. Table 8-1 explains any unusual symbols that appear on the schematics.

**8-6. TROUBLESHOOTING.****WARNING**

Maintenance described herein is performed with power supplied to the instrument. Such maintenance should be performed only by trained service personnel who are aware of the hazards involved (for example, fire and electrical shock). Where maintenance can be performed without power applied, the power should be removed.

Before any repair is completed, ensure that all safety features are intact and functioning, and the all necessary parts are connected to their protective grounding means.

8-7. **INITIAL TROUBLESHOOTING PROCEDURE.** Before troubleshooting the 1340A in detail, try to perform the adjustment procedures listed in Section V of this manual. Some apparent malfunctions may be corrected by these adjustments, or failure to obtain a correct adjustment will often reveal the source of trouble.

8-8. **DC VOLTAGES AND WAVEFORMS.** DC voltages, waveforms, and conditions for making these measurements are given on, or adjacent to, the schematics on the service sheets. Since conditions for making these measurements may differ from one circuit to another, always check the specific conditions listed for each schematic.

**8-9. RECOMMENDED TEST EQUIPMENT.**

8-10. Test equipment required to maintain the 1340A is listed in Section I, table 1-4. Equipment other than that listed may be used if it meets the listed critical specifications.

**8-11. REPAIR.**

8-12. **ASSEMBLY REMOVAL.** Instruction for removing major board assemblies are given in the following procedure. The removal procedure includes instructions for System II instruments. To remove assemblies, proceed as follows (refer to table 8-2 for the list of assemblies indexed to Service Sheets):

**NOTE**

Disregard steps a through g for basic instruments. When removing assemblies from the basic instrument, start with step h.

Table 8-1. Schematic Notes

REFER TO ANSI Y 32.2 AND Y32.14 FOR SCHEMATIC SYMBOLS NOT LISTED IN THIS TABLE.

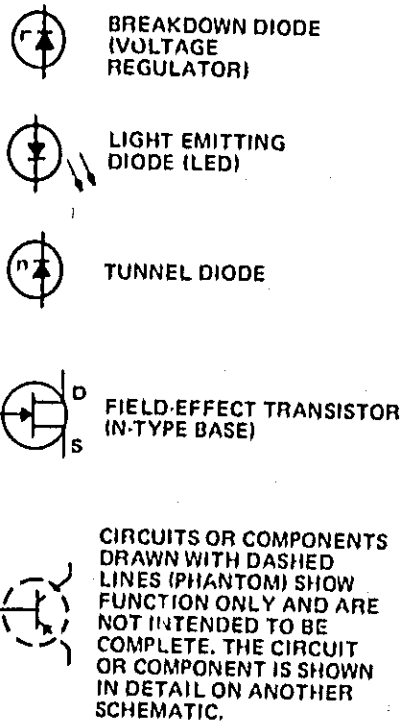
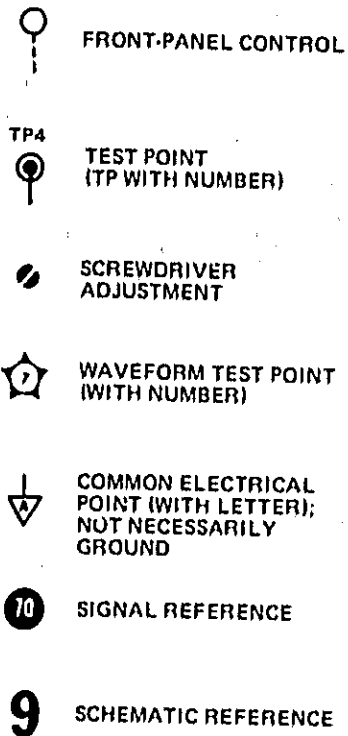
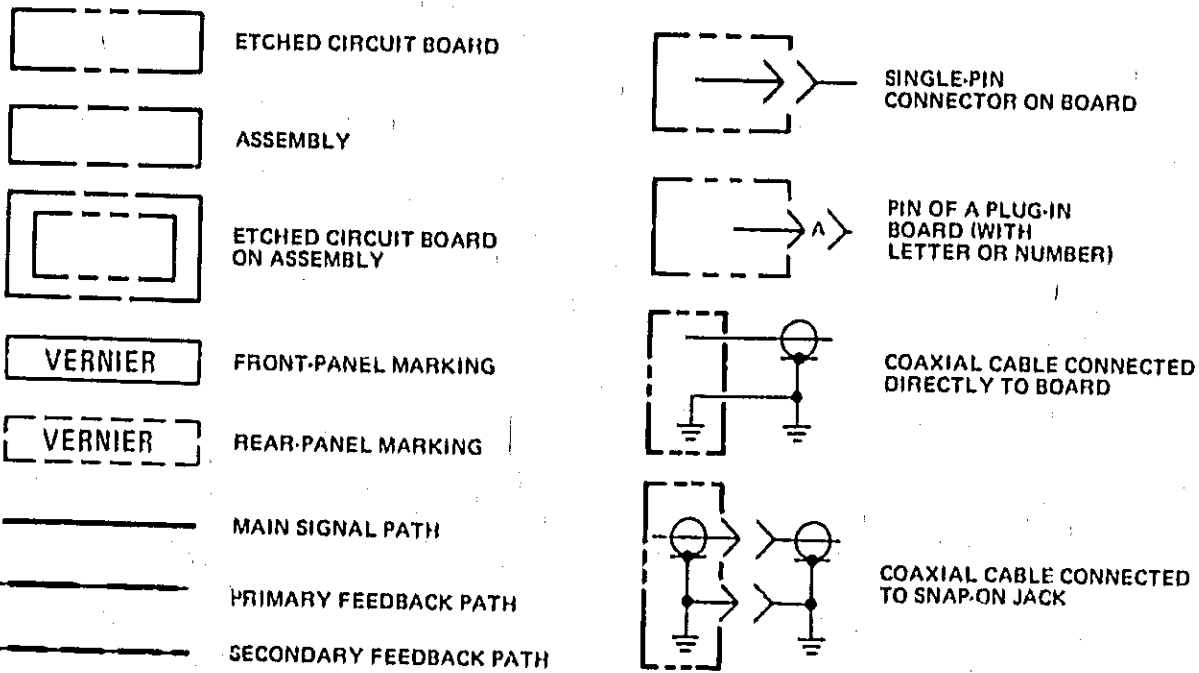

(925) WIRE COLORS ARE GIVEN BY NUMBERS IN PARENTHESIS USING THE RESISTOR COLOR CODE

(925) IS WHI-RED-GRN

0 - BLACK	5 - GREEN
1 - BROWN	6 - BLUE
2 - RED	7 - VIOLET
3 - ORANGE	8 - GRAY
4 - YELLOW	9 - WHITE

• OPTIMUM VALUE SELECTED AT FACTORY, TYPICAL VALUE SHOWN; PART MAY HAVE BEEN OMITTED.

UNLESS OTHERWISE INDICATED: RESISTANCE IN OHMS, CAPACITANCE IN PICO FARADS AND INDUCTANCE IN MICROHENRIES

CW CLOCKWISE END OF VARIABLE RESISTOR  
 NC NO CONNECTION  
 P/O PART OF

VF (A) V - VOLTAGE  
 F - FILTERED  
 (A) - FILTER SOURCE

- a. Remove top and bottom covers (System II instruments).
- b. Remove trim strips from top and sides of front frame (System II instruments).
- c. Remove Control Assembly A4 from front frame by removing four retaining screws (top frame (1), bottom frame (1), side frame (2)).
- d. Disconnect A4W1 ribbon cable connector from A1 Assembly. Remove Control Assembly A4 from instrument.
- e. Remove front, left filler panel from front frame by removing two retaining screws at side of front frame.
- f. Remove rear-panel filler by removing four retaining screws.
- g. Remove basic instrument module from System II frame by removing two retaining screws.
- h. Remove plastic shield covering LVPS Assembly A2 by pulling shield from basic frame.
- i. Remove retaining screw holding HVPS Assembly A3 shield to basic frame.
- j. Remove HVPS shield by pushing toward rear of instrument until tabs are clear, then rotate upwards and remove.
- k. Remove screws holding LVPS regulators U1, U2, and Q2 to basic frame.
- l. Remove screw holding HVPS oscillator Q1 to basic frame.

**WARNING**

Failure to discharge high voltage ( $\approx +4500$  V) can result in severe electrical shock to personnel and damage to the instrument.

**CAUTION**

In the following step, be careful not to damage the CRT glass.

- m. Using water-pump pliers, disconnect post accelerator lead from CRT at CRT connection by squeezing pronged connector leads together. Immediately discharge lead to ground.
- n. Unsolder six wires (three (3) and three (0)) connected to A1 Assembly. These wires are from X, Y, and Z BNC input connectors.
- o. Disconnect input ac transformer cable connector from LVPS Assembly, A2.

- p. Remove one screw holding input ac power connector to rear panel.
- q. Disconnect input ac power connector ground lead (544) from rear panel.
- r. Remove four screws (one per side rail) holding rear panel in place. Remove rear panel.

**NOTE**

The following steps outline the procedure for removing all board assemblies from the instrument. For the removal of individual assemblies only, modify the following steps as required.

- s. Remove two ribbon cables at A1 Assembly. One cable is from A2 Assembly and one is from A3 Assembly.
- t. Unsolder CRT filament leads (two (1) wires) from rear of HVPS Assembly A3.
- u. Unsolder focus wire (3) from rear of HVPS Assembly A3.
- v. Disconnect five square-pin leads (98), (8), (96), (4), and (6) from HVPS Assembly A3. Remove HVPS Assembly A3 by sliding to rear of instrument.
- w. Disconnect six square-pin leads, (5) (9) - X output, (6) (9) - Y output, and two (905) to trace align coil from A1 Assembly.
- x. Remove Assembly A1 by sliding it to rear of instrument.
- y. Remove Assembly A2 by sliding it to rear of instrument.
- z. To reinstall assemblies, reverse removal procedure.

**WARNING**

To prevent personal injury wear a face mask or goggles and protective gloves and handle the CRT carefully. Do not lift the CRT or support its weight by the neck.

**8-13. CRT REMOVAL.** To remove the CRT from the instrument proceed as follows:

- a. Accomplish steps a through y in paragraph 8-12 for System II instruments. Accomplish steps h through y in paragraph 8-12 for standard instruments.
- b. Disconnect socket and cable from CRT base.
- c. Remove four screws retaining front bezel to four side rails. Remove bezel.

- d. Remove CRT through front of CRT shield.
- e. To reinstall CRT, reverse removal procedure.

Table 8-2. Assembly Index

Assembly	Name	Service Sheet(s)
A1	X-Y-Z AMPLIFIERS	2, 3
A2	LVPS	4
A3	HVPS	3
A4	CONTROL ASSY	2, 3

**8-14. PREVENTIVE MAINTENANCE.** Painted surfaces can be cleaned with a commercial, spray-type window cleaner or with a mild soap and water solution.

**CAUTION**

Do not use chemical cleaning agents that might damage the plastics used in this instrument. Recommended cleaning agents are isopropyl alcohol, a kelite solution (1 part kelite to 20 parts water), or a solution of 1% mild detergent and 99% water.

**8-15.** Corroded spots are best removed with soap and water. Stubborn residues can be removed with a fine abrasive. Protect such areas from further corrosion with an application of silicone resin such as GE DRIFILM 88.

**8-16. CIRCUIT BOARDS.**

**8-17. Board Connections.** Square-pin connectors are identified on circuit boards by color code of connecting wire or by the signal name. Connector pins on plugs and jacks are identified by either a number or a letter (letters G, I, O, and Q are omitted). Coaxial wires are identified by different shrink tubing colors.

**8-18. Servicing Etched Circuit Boards.** All the etched circuit boards have plated-through component holes. This allows components to be removed or replaced from either side of the board. When unsoldering large components such as potentiometers, rotate the soldering iron tip from lead to lead while applying pressure to the part to lift it from the board. HP Service Note M-20E contains additional information for repair of circuit boards.

## SERVICE SHEET 1

### BASIC PRINCIPLES OF OPERATION

**General.** The following paragraphs contain functional descriptions keyed to a simplified block diagram located on the opposite page. The block diagram is drawn for function and does not show circuit details. Schematics, along with detailed theory descriptions of each circuit are located on subsequent service sheets. Refer to table 8-2 for service sheet identification.

**Low-voltage Power Supply.** The low-voltage power supply converts the ac line input to three regulated dc voltages, +15 V, -15 V, and +165 V. From the regulated +15 V and -15 V supplies, +3.5 V and -7.5 V are developed for use as bias supplies for IC's on the X-Y-Z Amplifier assembly. +24 V UNREG is tapped off before the +15 V regulator for use in the high-voltage oscillator circuit.

**High-voltage Power Supply.** The high-voltage power supply provides voltages to operate the CRT; -2140 V for the cathode voltage, a grid voltage referenced to the cathode, CRT heater voltage, and a post-accelerator voltage of ~+4500 V. A Z-axis amplifier is used to control intensity of the CRT beam.

**X- and Y-amplifier Circuits.** The X- and Y-amplifier circuits are identical. They amplify the input signals to drive the CRT horizontal and vertical deflection plates. Each amplifier is design for (+), (-), or differential inputs (special option). Input voltage/impedance characteristics are switch-selectable.

### TROUBLESHOOTING

Use this block diagram and Section V of this manual to isolate the trouble to a specific section of the instrument. Next turn to the service sheets which cover that section and isolate the trouble to a specific circuit or component.

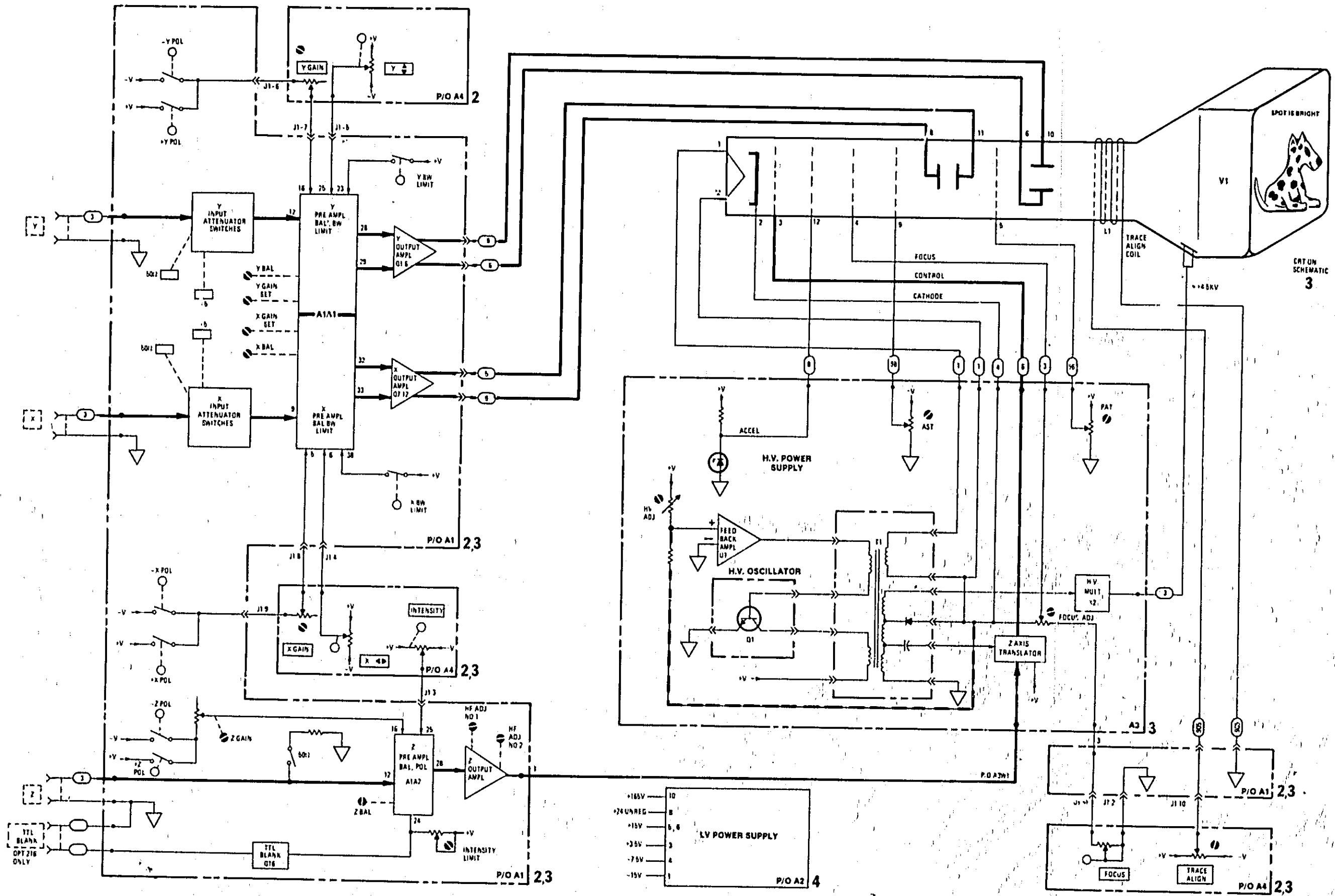

Figure 8-1. Service Sheet 1, Model 1340A Overall Bloch Diagram 8-5

**SERVICE SHEET 2**

**THEORY OF OPERATION**

**General.** The X- and Y-amplifier attenuators, preamplifiers, and output amplifiers are identical; therefore, only the X-amplifier circuit will be discussed.

**Input Attenuator and Impedance Converter (P/O A1A1).** By properly positioning switch segments of A1S1, the X-input voltage/impedance ranges may be selected. (Refer to table 8-3 for proper switch selection for all amplifiers.) Output from the attenuator section is applied to one section of the preamplifier IC A1A1. The IC input is an impedance converter with an active current source in both the source and drain.

**IC Preamplifier-Bandwidth Limit.** The preamplifier consists of a bipolar paraphase amplifier and a cross-connected, common-base amplifier. The paraphase amplifier converts the single-ended input to a differential signal with a special input from the X BAI control for offset adjustment. The cross-connected, common-base amplifier is used for GAIN vernier control. The bandwidth amplifier consists of two amplifiers: one with a capacitor connected across its collectors, and one without a capacitor. The bandwidth limit switch selects the proper amplifier for the desired bandwidth characteristics.

**IC Output Amplifier.** The output amplifier of the IC consists of a differential amplifier and a differential current source which also serves as a position control circuit. The differential amplifier converts the single-ended position voltage to a differential current. Magnitude of the current is controlled by external current sink A1R30.

**X-amplifier Output.** The differential output from A1A1 is applied to two identical amplifiers A1Q7-A1Q9-A1Q10 and A1Q8/A1Q11-A1Q12 where the signal voltage is

raised to the required level to drive the CRT horizontal plates. The gain of the amplifiers is stabilized by negative feedback from the collectors of A1Q9/A1Q10 to the base of A1Q7 and from the collectors of A1Q11/A1Q12 to the base of A1Q8.

**A1 REMOVAL PROCEDURE**

Refer to paragraph 8-12 for A1 Assembly removal.

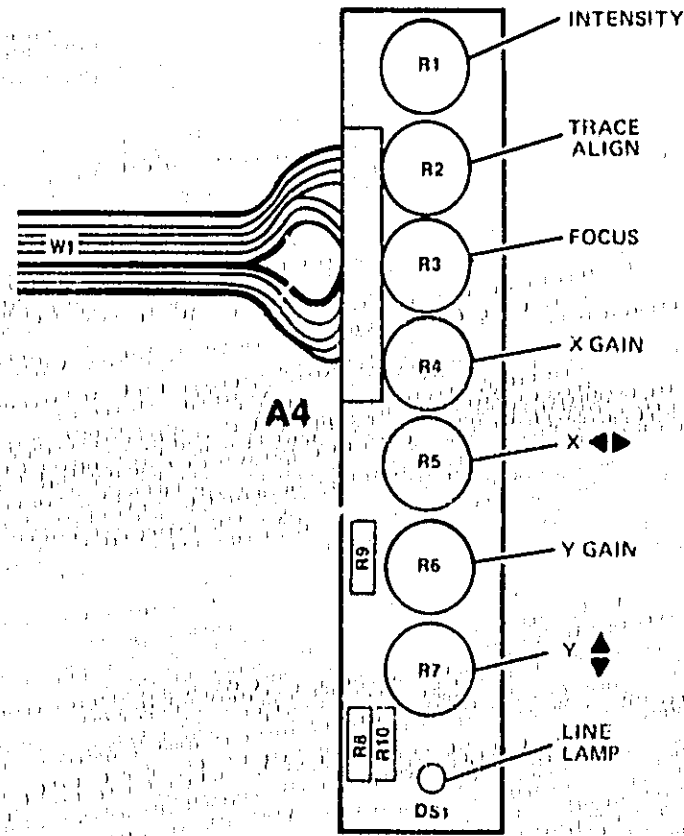

Figure 8-2. Component Identification, Control Assembly, A1.

Table 8-3. X, Y, and Z Input Switch Coding

ATTEN	IMP	X					Y					Z
		S1-1	S1-2	S1-3	S1-4	S1-5	S2-4	S2-5	S2-6	S2-7	S2-8	
1	50 ohm	ON	ON	OFF	ON	OFF	ON	ON	OFF	ON	OFF	ON
1	1 M	OFF	ON	OFF	ON	OFF	OFF	ON	OFF	ON	OFF	OFF
5	1 M	OFF	OFF	ON	OFF	ON	OFF	OFF	ON	OFF	ON	N/A
5	50 ohm	ON	OFF	ON	OFF	ON	ON	OFF	ON	OFF	ON	N/A

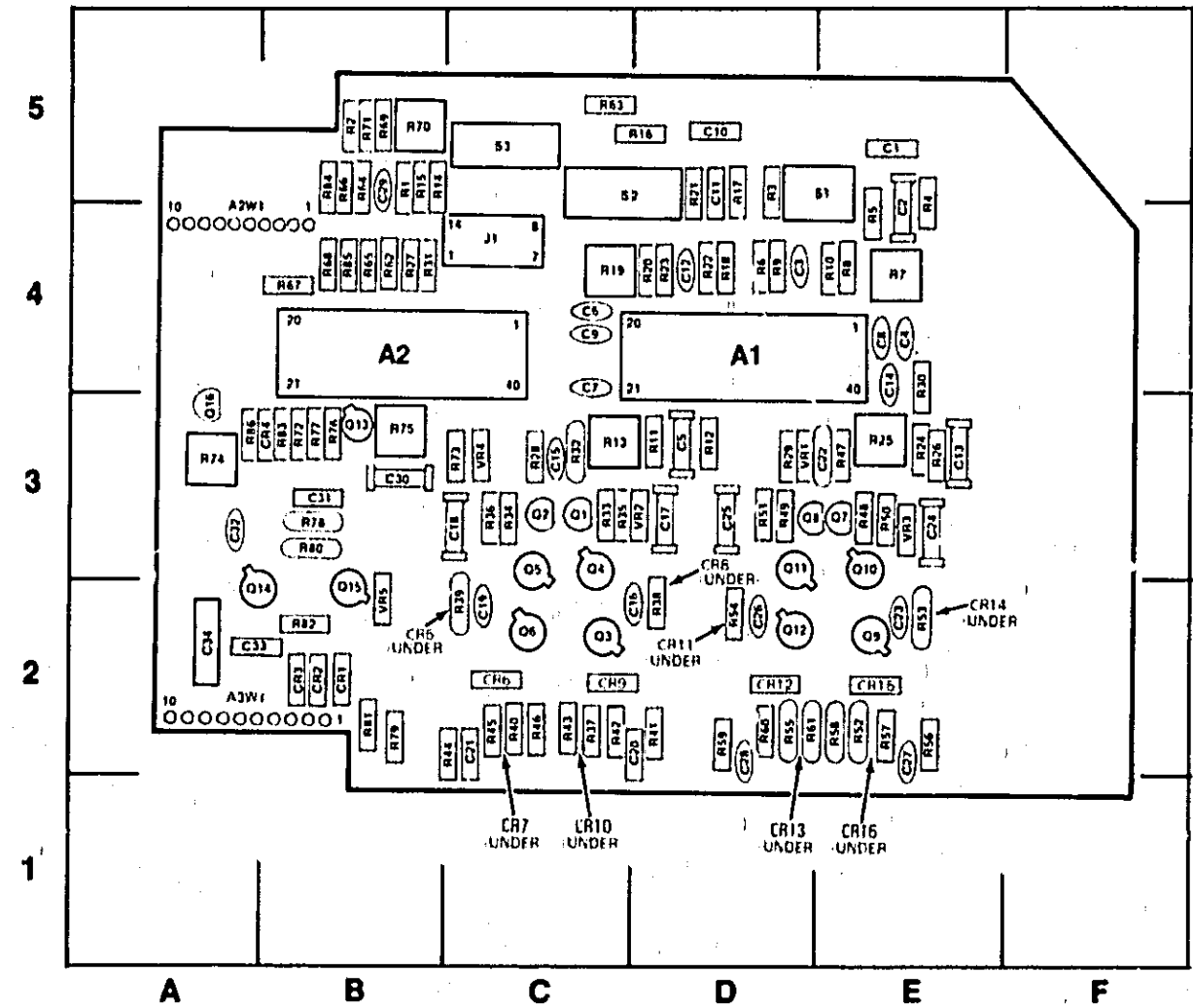
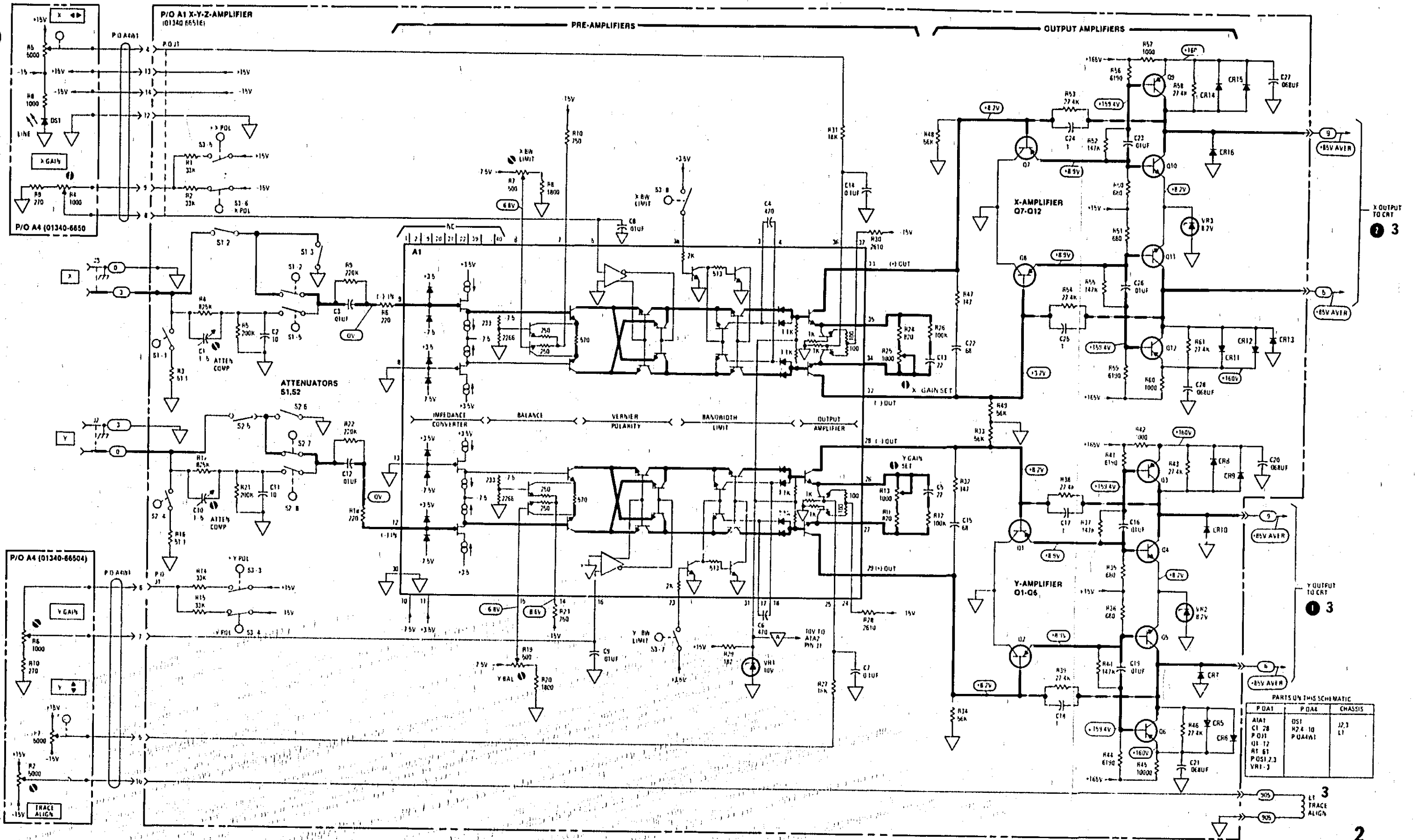

Figure 8-3. Component Identification, X-Y-Z Assembly, A1



PARTS IN THIS SCHEMATIC

P/O A1	P/O A4	CHASSIS
A1A1	DS1	J2,3
C1, 28	R2, 4, 10	LT
P/O A1	P/O A4A1	
Q1, 12		
R1, 61		
P/DS1, 2, 3		
VR1-3		

2

Figure 8-1  
Service Sheet 2, X-Y Amplifiers  
8-7



## SERVICE SHEET 3

### THEORY OF OPERATION

#### Z-AXIS AMPLIFIER

**Input Attenuator and Impedance Converter (P/O A1A2).** A high or low input impedance termination may be selected by switch A1S2-1. Output from the attenuator section is applied to one section of preamplifier IC A1A2. The IC input is an impedance converter with an active current source in both the source and the drain.

**IC Preamplifier-Bandwidth Limit.** The preamplifier consists of a bipolar paraphase amplifier and a cross-connected, common-base amplifier. The paraphase amplifier converts the single-ended input to a differential signal with a special input from the ZBAL control for offset adjustment. The cross-connected, common-base amplifier is used for GAIN vernier control.

**IC Output Amplifier.** The output amplifier of the IC consists of a differential amplifier and a differential current source which also serves as an intensity control circuit. The differential amplifier converts the single-ended intensity voltage to a differential current. Magnitude of the current is controlled by external current sink A1R87 (INT LIMIT). External blanking can be used to control the CRT display. A TTL logic level (+) applied through J4 to the base of A1Q16 causes it to conduct heavily, acting as a drain to current supply A1R87. This blanks the CRT.

**Z-AMPLIFIER OUTPUT.** The output from A1A2 is applied to emitter-follower A1Q13. The output of A1Q13 is applied to amplifier A1Q14/A1Q15 where the signal voltage is raised to the required level to drive the control grid of the CRT. The gain of the amplifiers is stabilized by negative feedback from the collectors of A1Q14/A1Q15 to the base of A1Q13. HF Adj. No. 2 (A1C31) provides adjustment for the fast corner of the signal. Slower compensation is provided by lag-compensation network A1C30/A1R75. Diode A1CR3 is a high-speed diode, and A1CR1 and A1CR2 are high-current diodes. Together they provide protection for the output amplifiers against arcs and transients. The output of the Z-axis amplifier is applied to a level translator on High-voltage Assembly A3 where it establishes the potential difference between the grid and cathode of the CRT.

#### HIGH-VOLTAGE POWER SUPPLY

**HV Generator and Level Translator.** Transistor Q1 and transformer A3A1T1 form an oscillator circuit with the main source of power coming from the +24 V UNREG low-voltage power supply. The primary windings of A3A1T1 are connected to provide positive feedback to the base of Q1 to sustain oscillations. Two windings are provided in the secondary of A3A1T1: one winding supplies high voltage, and the other supplies heater power to the cathode-ray tube.

### WARNING

Heater winding of the high-voltage transformer is connected to -2140 V cathode potential and is dangerous to life. Use extreme caution when handling, testing, and adjusting.

The HV winding of A3A1T1 is tapped and provides a sine wave for the level translator. The winding is also tapped at another point and is applied to High-voltage Multiplier Assembly A3A2 where the voltage is doubled, rectified, filtered, and then applied to the post accelerator of the CRT. The full output of the secondary of A3A1T1 is rectified and provides the negative high voltage for the CRT cathode.

Diode rectifier A3A1CR1 and filter network A3C3, A3C4, and A3R10 provide the -2140 V potential for the cathode, grid reference level, and focus reference level. The focus reference level is divided by A3R21, A3R22, A3R23, and front-panel FOCUS control, A4R3. Feedback for high-voltage regulator A3U1 is through A3C6 and A3R13.

The sine-wave signal from the secondary top on high-voltage transformer A3A1T1 is applied through A3A1C1/A3R11 to the Z-axis level translator. The top and bottom of the sine wave are clipped by the following action: The top of the sine wave is clipped by the action of A3CR9. The clipping level is established by a fixed voltage divider network consisting of A3R19, A3R20, and A3VR3. The bottom of the sine wave is clipped by the action of A3CR8. The lower clipping level is established by the Z-axis signal from the Z-axis amplifier.

With front-panel INTENSITY control A4R1 set for maximum intensity the Z-axis amplifier output is at its highest level. This output causes maximum clipping action on the bottom section of the sine wave from A3A1T1. This results in the smallest peak-to-peak swing of the sine wave, since the upper clipping level is held constant by the fixed voltage divider network. As INTENSITY control A4R1 is turned toward minimum intensity, clipping action on the bottom of the sine wave becomes less, resulting in a greater peak-to-peak swing. The clipped sine wave is ac coupled through A3C7 to a rectifier circuit consisting of A3CR6 and A3CR7. The rectifier circuit provides a dc level equal to the peak-to-peak amplitude of the clipped sine wave. The dc level is referenced to the cathode potential. Diodes A3CR6 and A3CR7 are connected so that the dc level established is negative with respect to the cathode and is applied to the CRT grid. Capacitor A3C8 is not referenced directly to the -2140-volt cathode but is connected to the Z-axis amplifier output for coupling fast Z-axis transitions to the grid.

**High-voltage Regulator.** Operational amplifier A3U1 compares the voltage at the junction of A3R2 and A3R13 (with respect to ground, 0 V) and drives HV oscillator Q2 to correct for any differences. Since the input of A3U1 (pin 3) is a very high resistance, it will

draw negligible current. Therefore, current flow between the +165 V regulated supply and the -2140 V cathode voltage is established by resistor string A3R1, A3R2, and A3R13, with the junction of A3R2 and A3R13 being held at 0 V by the action of A3U1. For example, if the high voltage goes more negative, the input to A3U1 (pin 3) will start to go negative and its output (pin 6) will follow. This applies a more negative average voltage to the feedback winding on HV transformer A3A1T1. Since HV oscillator Q1 is an NPN device (conducts only on positive peaks of the base waveform), the more negative average voltage applied to A3A1T1 causes the oscillator to conduct less, and for a shorter period of time. With Q1 conducting less, less power is available in the transformer and the hv output will go positive, returning the high voltage to its previously adjusted level.

**Cathode-ray Tube.** In addition to the cathode, control grid, focus grid, X- and Y-deflection plates discussed previously, the CRT contains other elements vital to its operation. The heater is powered by a separate winding on the HV transformer, A3A1T1, and is raised to the cathode potential by a direct connection.

### CAUTION

The heater voltage is 5.9 Vac, however, use extreme care when measuring because the ac voltmeter must be floated at -2140 volts. The common input of most ac powered voltmeters are not rated for this use; there-

fore, a battery operated unit is normally used. Do not contact the case of the ac voltmeter or its leads when measuring this high potential. Isolate voltmeter case from the 1340A chassis.

The required voltage for the accelerator electrode of the CRT is supplied from zener diode regulator A3VR3. Astigmatism (A3R24) and the Pattern (A3R25) are screw-driver adjustments located on the high-voltage power supply assembly.

The post accelerator is a conductive coating around the inner part of the CRT glass. It provides a high-accelerating field for the electron beam and collect electrons produced by secondary emission when the beam strikes the screen.

### WARNING

Use extreme care when measuring the post accelerator voltage. The potential is approximately 4500 V with respect to ground and is dangerous to life.

#### A1 AND A3 REMOVAL PROCEDURES.

Refer to paragraph 8-12 for A1 and A3 Assemblies removal.

#### NOTE

Refer to Service Sheet 2 for Assembly A1 and Assembly A3 Component Identification Locations.

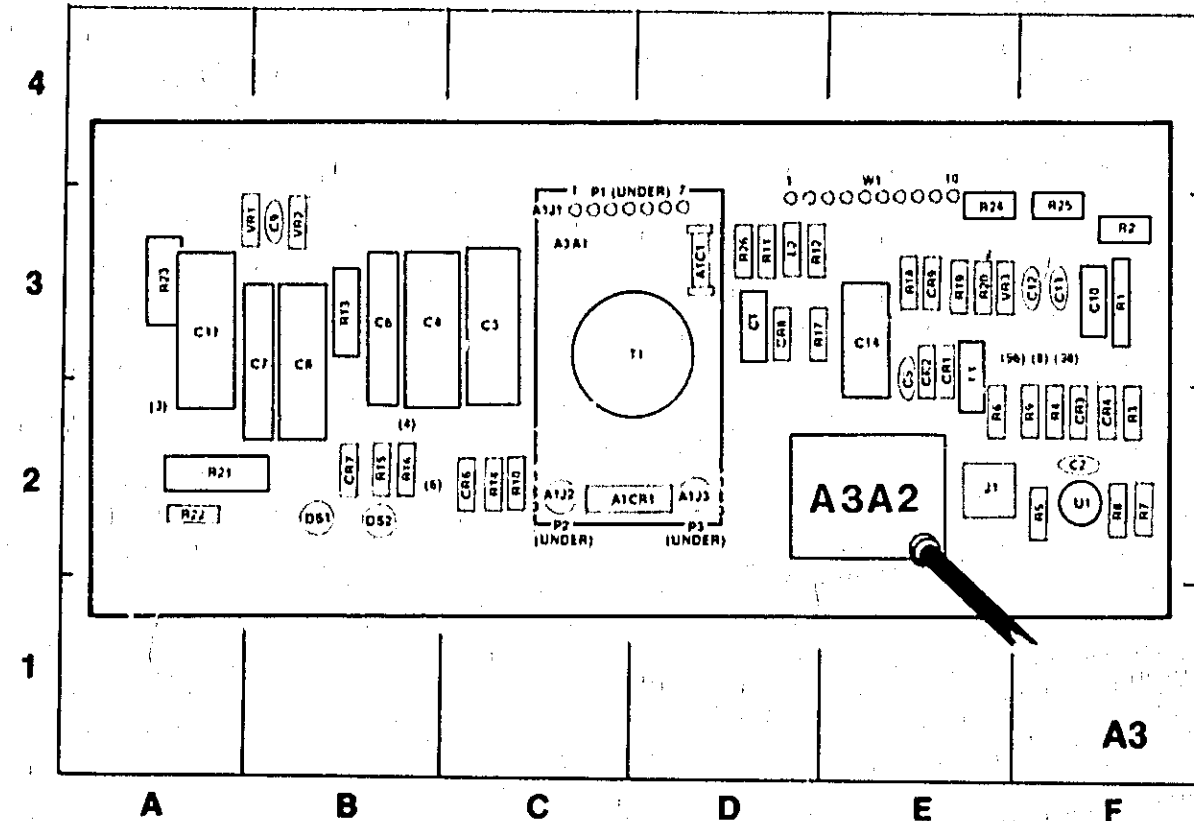

Figure 8-5. Component Identification, HVPS Assembly, A3

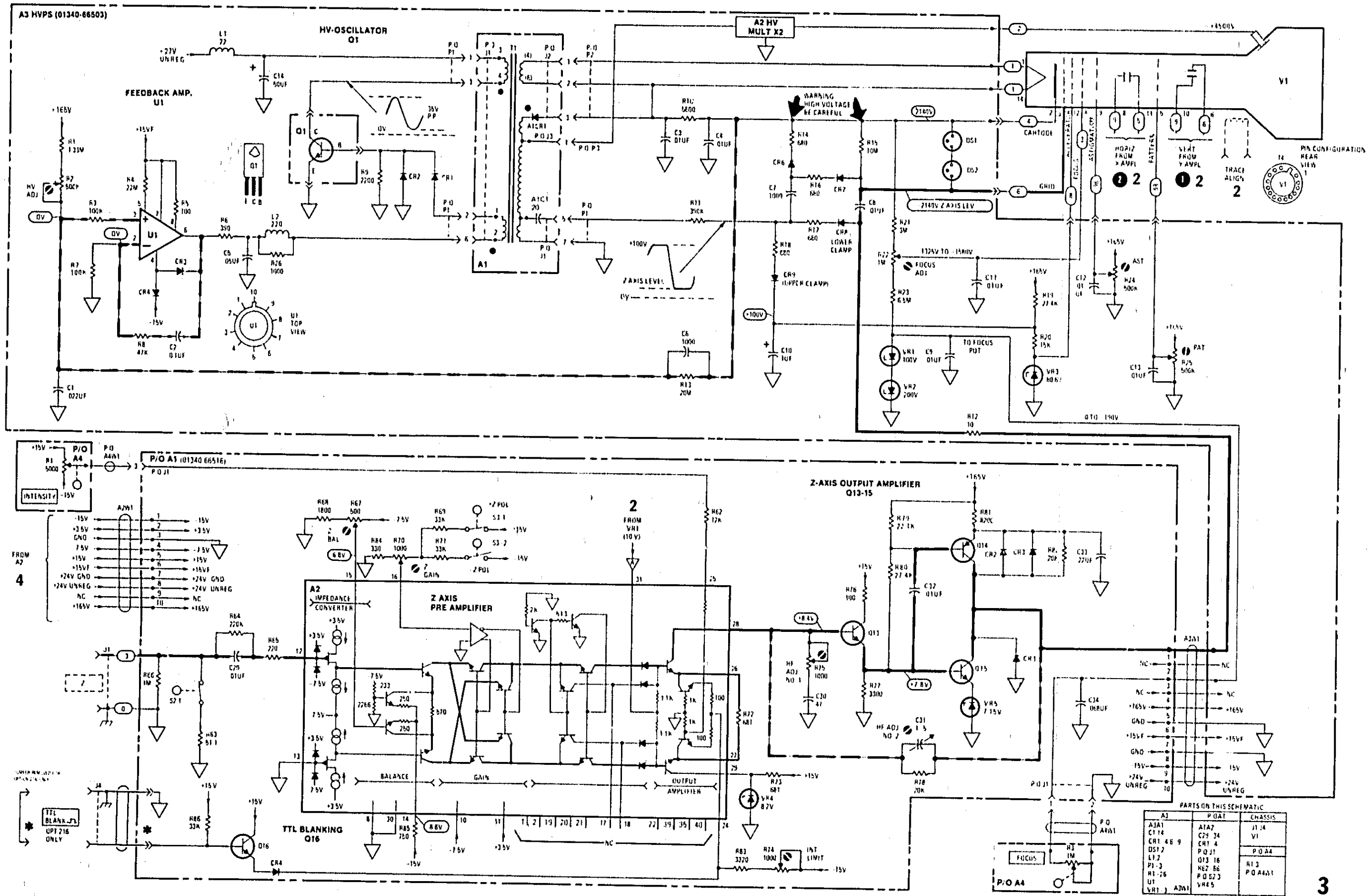

Figure 8-6  
Service Sheet 3, HVPS and Z-Axis Amplifier  
8-9

**SERVICE SHEET 4**

**THEORY OF OPERATION**

**General.** The low-voltage power supply converts the ac input line voltage to several dc levels required to power individual circuits in the instrument. All supplies except the +24-volt UNREG line to the HV oscillator are regulated. The +24-volt UNREG line is fused with a 0.6 A overload protection fuse.

The +15-volt and -15-volt supplies have a three-terminal IC regulator with a nominal output being 15 volts. The actual voltage depends on the IC regulator and is acceptable within  $\pm 5\%$  of nominal (14.25 volts to 15.75 volts). The lower voltages (+3.5 volts and -7.5 volts) required to operate A1A1 and A1A2 are developed within these supplies.

**+165-volt Regulator.** The ac input voltage from power transformer T1 is applied to bridge rectifier A2CR1. The dc output from A2CR1 is filtered by A2C1. A +15 V reference is applied through A2CR2 to the emitter of A2Q3. The base of A2Q3 is connected to a voltage divider across the output circuit with A2R15 being used as the adjustable reference. If the output of the supply decreases, the base of A2Q3 becomes less positive causing it to conduct more heavily. With A2Q3 conducting heavily, the conduction through Darlington pair Q2 and A2Q4 increases. This results in an increase in output voltage. When the output voltage again reaches +165 volts, conduction through A2Q3 decreases, allowing the output voltage to stabilize. Transistor A2Q1 and resistor A2R2 form a current limiting circuit. As current requirements increase toward the limit of the supply, the voltage drop across A2R2 is applied to the base of A2Q1 which conducts, limiting the current drain from the Darlington pair.

**REMOVAL PROCEDURE**

Refer to paragraph 8-12 for A2 Assembly removal.

**TROUBLESHOOTING**

**General.** If trouble is suspected, visually inspect the instrument. Look for loose or burned components that might suggest a source of trouble. Verify that all circuit board connections are making good contact.

**Component Identification.** Components on the assembly associated with this service sheet are shown adjacent to the schematic.

**Troubleshooting Hints.** Before any extensive troubleshooting, check the external power source for proper input. When troubleshooting the low-voltage power supply, check voltages indicated on the schematic.

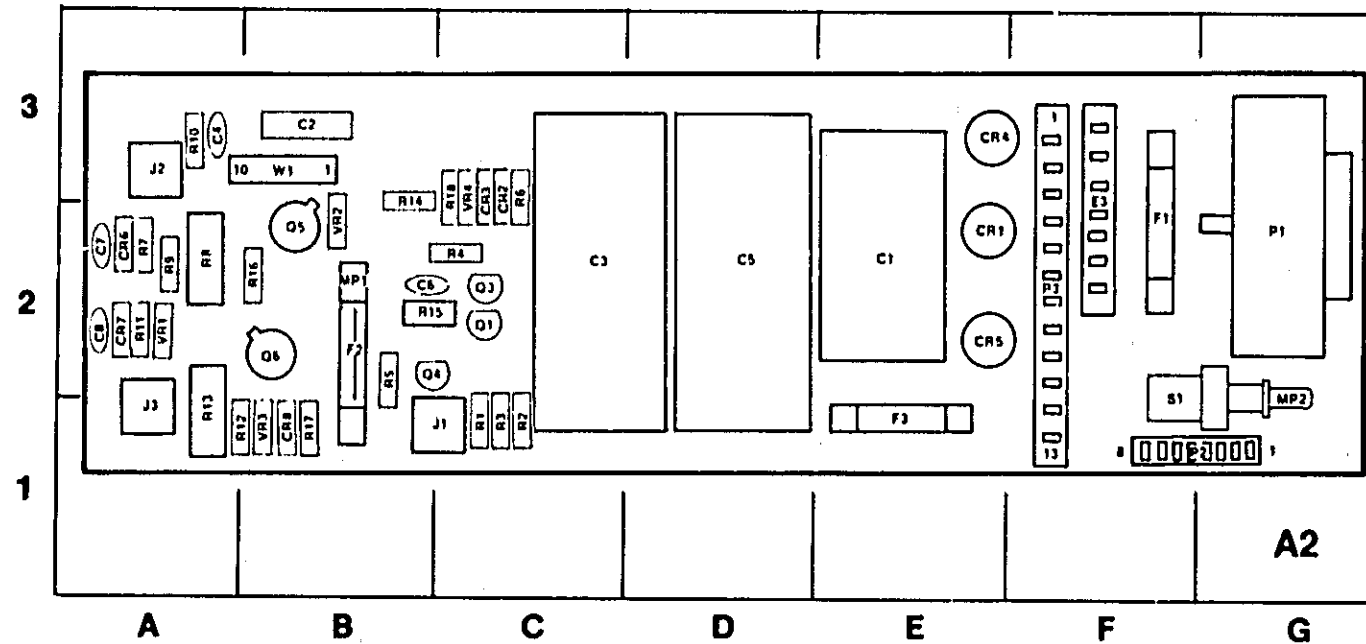

REF DESIG	GRID LOC	REF DESIG	GRID LOC	REF DESIG	GRID LOC	REF DESIG	GRID LOC	REF DESIG	GRID LOC	REF DESIG	GRID LOC	REF DESIG	GRID LOC
C1	E-2	CR1	E-2	E3	F-2	MP2	G-2	Q5	B-2	R7	A-2	R16	B-2
C2	B-3	CR2	C-3	F1	F-2	P1	G-2	Q6	B-2	R8	A-2	R17	B-1
C3	C-2	CR3	C-3	F2	B-2	P2	F-1	R1	C-1	R9	A-2	R18	C-3
C4	A-3	CR4	E-3	F3	E-1	P3	F-2	R2	C-1	R10	A-3	S1	F-2
C6	D-2	CR6	E-2	J1	B-1	Q1	C-2	R3	C-1	R11	A-2	VR1	A-2
C6	B-2	CR6	A-2	J2	A-3	Q2	C-2	R4	C-2	R12	B-1	VR2	B-3
C7	A-2	CR7	A-2	J3	A-1	Q3	C-2	R5	B-2	R13	A-1	VR3	B-1
C8	A-2	CR8	B-1	MP1	B-2	Q4	B-2	R6	C-3	R14	B-3	VR4	C-3
										R15	B-2	W1	B-3

Figure 8-7. Component Identification, LVPS Assembly, A2

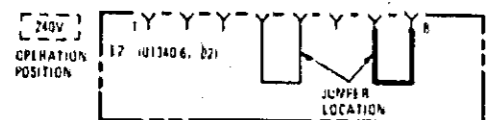
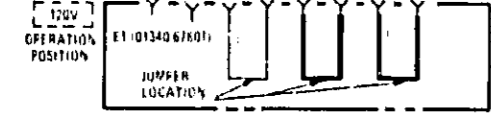
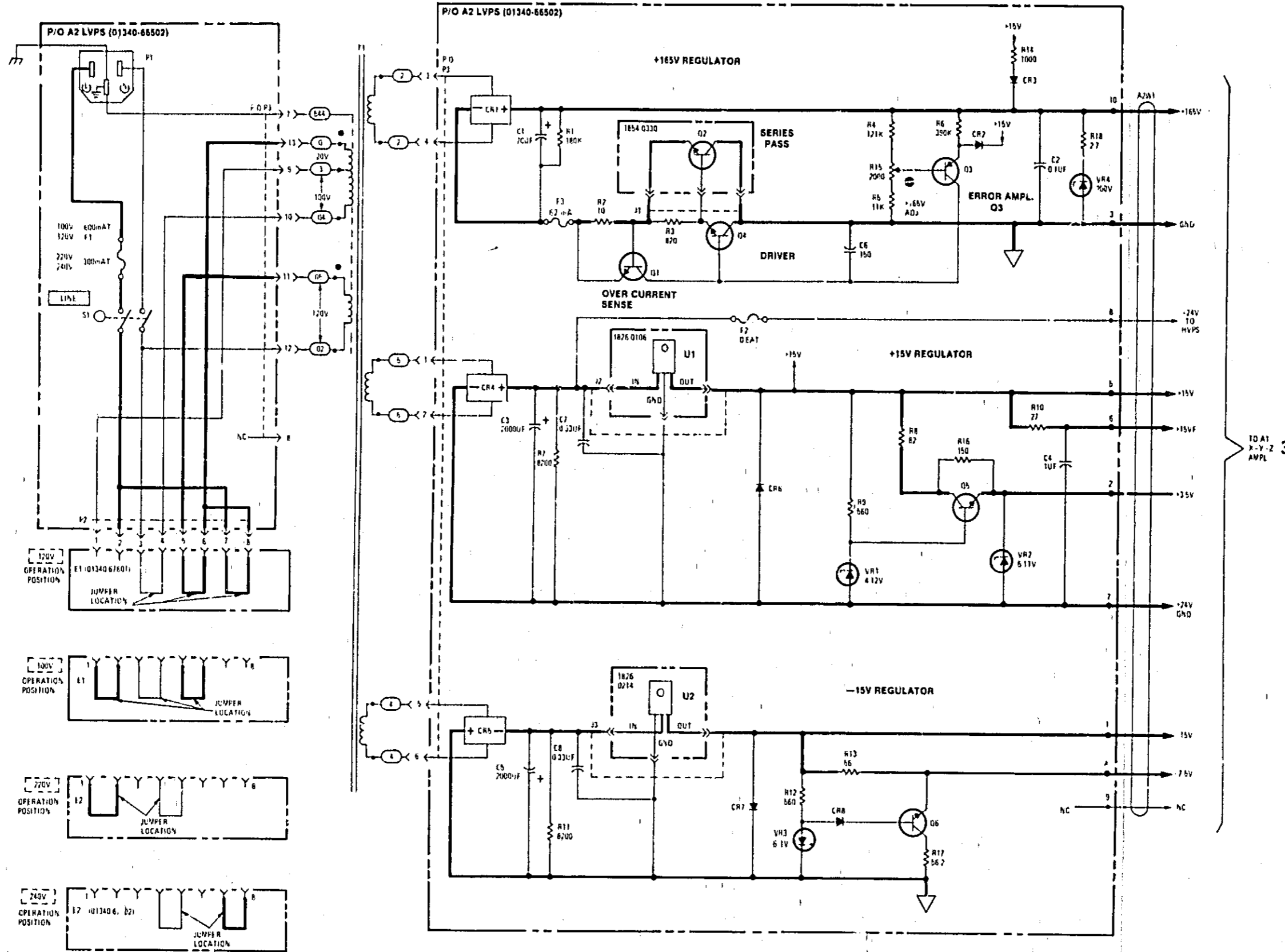

PARTS ON THIS SCHEMATIC

A2	CHASSIS
C1 6	E1 2
CR1 8	Q2
F1 3	T1
J1 3	U1 2
P1 3	
Q1 3 6	
R1 18	
S1	
VR1 4	
WT	

Figure 8-8  
Service Sheet 4, LV Power Supply  
8-11

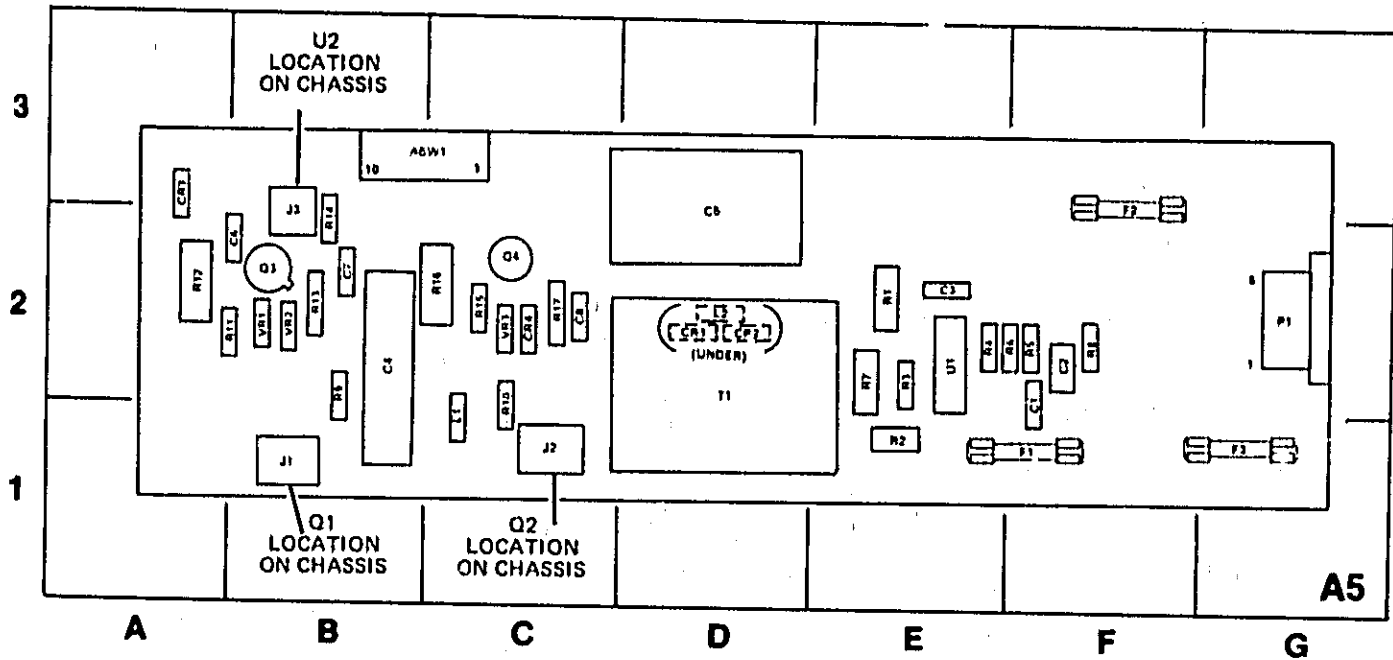

REF DESIG	GRID LOC	REF DESIG	GRID LOC	REF DESIG	GRID LOC	REF DESIG	GRID LOC
C1	F-2	F1	F-1	Q4	C-2	R12	A-2
C2	F-2	F2	F-3	R1	F-2	R13	B-2
C3	E-2	F3	G-1	R2	E-2	R14	B-2
C4	B-2	J1	C-1	R3	E-2	R15	C-2
C5	D-3	J2	B-1	R4	E-2	R16	C-2
C6	B-2	J3	B-2	R5	F-2	R17	C-2
C7	B-2	L1	C-1	R6	F-2	T1	D-2
C8	D-2	L2	D-2	R7	F-2	U1	E-2
CR1	D-2	P1	G-2	R8	F-2	U2	CHASSIS
CR2	D-2	Q1	CHASSIS	R9	B-2	VR1	B-2
CR3	A-3	Q2	CHASSIS	R10	C-2	VR2	B-2
CR4	C-2	Q3	B-2	R11	B-1	VR3	C-2
						W1	B-3

Figure 8-9. Component Identification, DC Power Supply Assembly, A5 (Option 002)

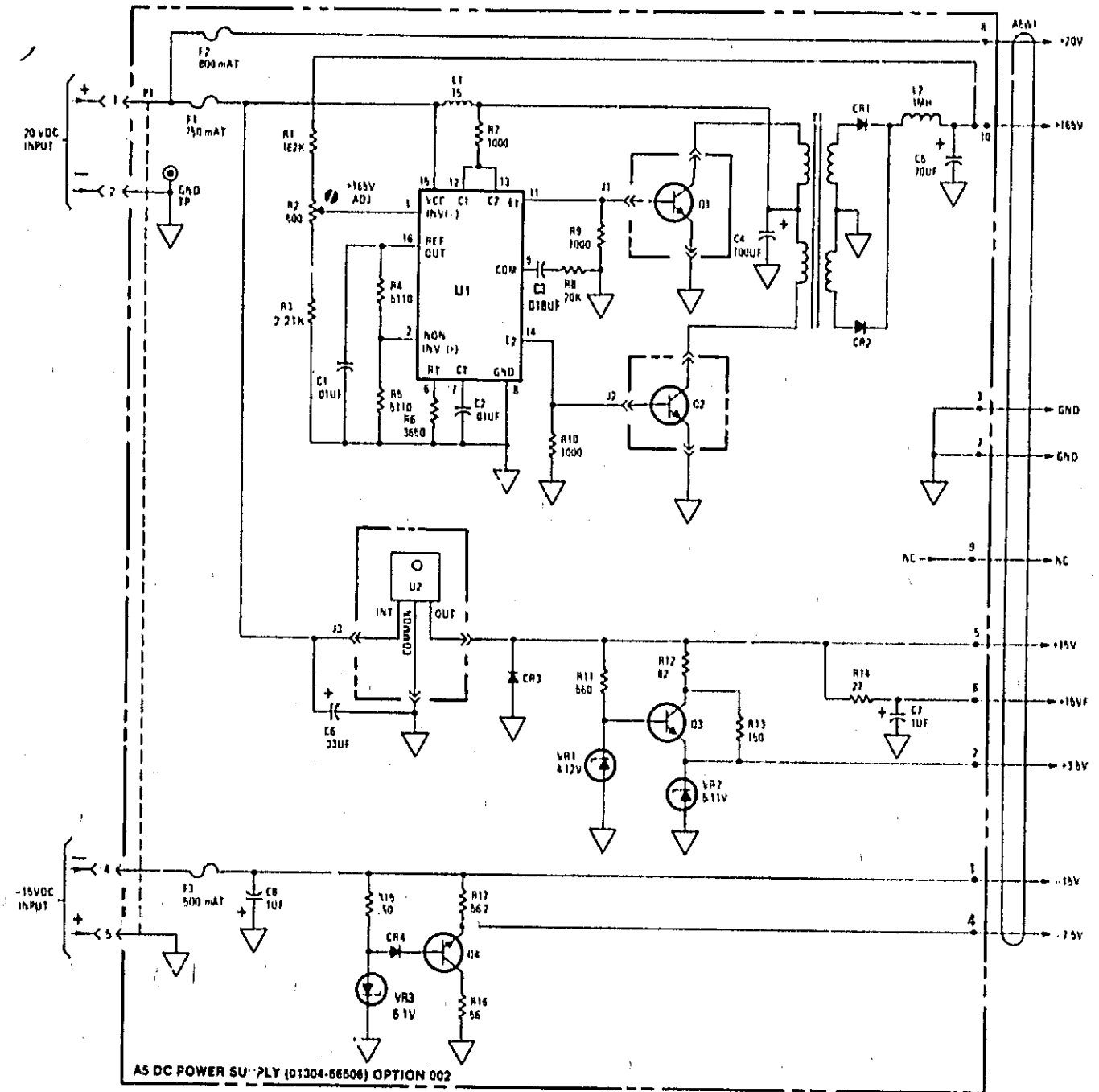

PARTS ON THIS SCHEMATIC

AS	
C1-8	
CR1-8	
F1-3	
J1-3	
L1-2	
P1	
Q1-4	
R1-17	
T1	
U1-2	
VR1-3	
WT	

Figure 8-10.  
Service Sheet 5, DC Power Supply (Option 002)  
8-13/(8-14 blank)

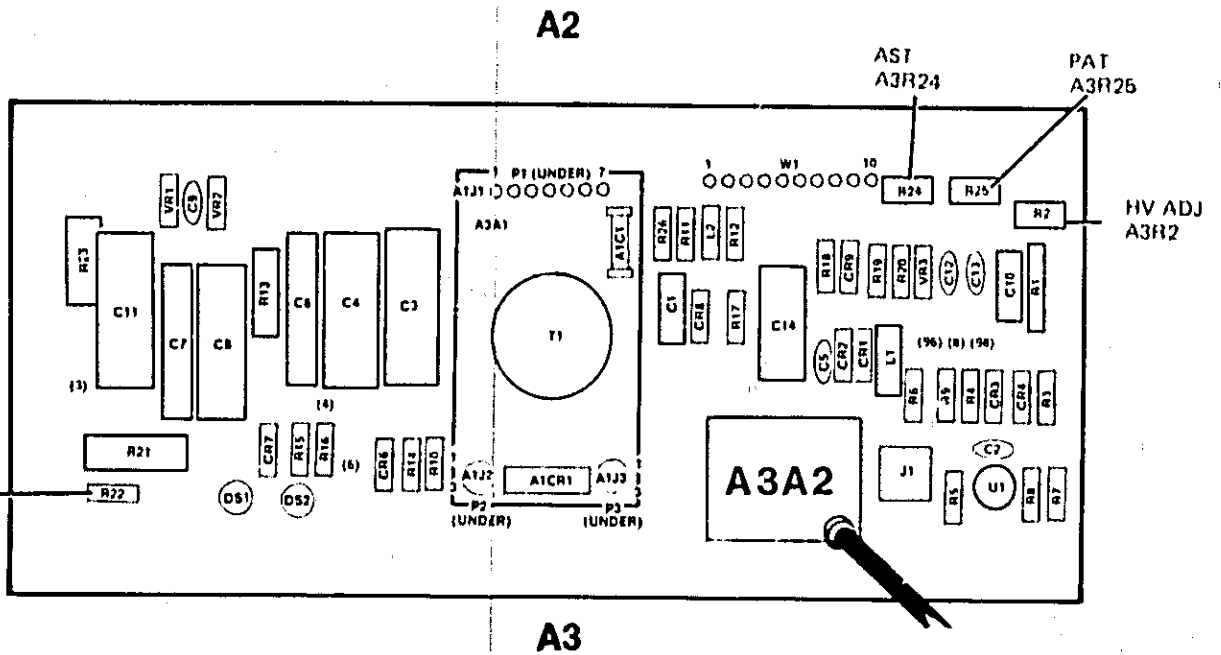
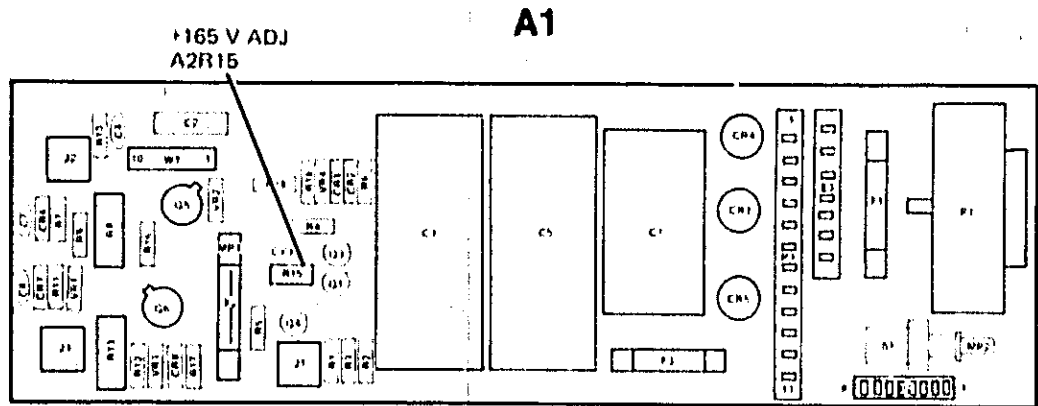
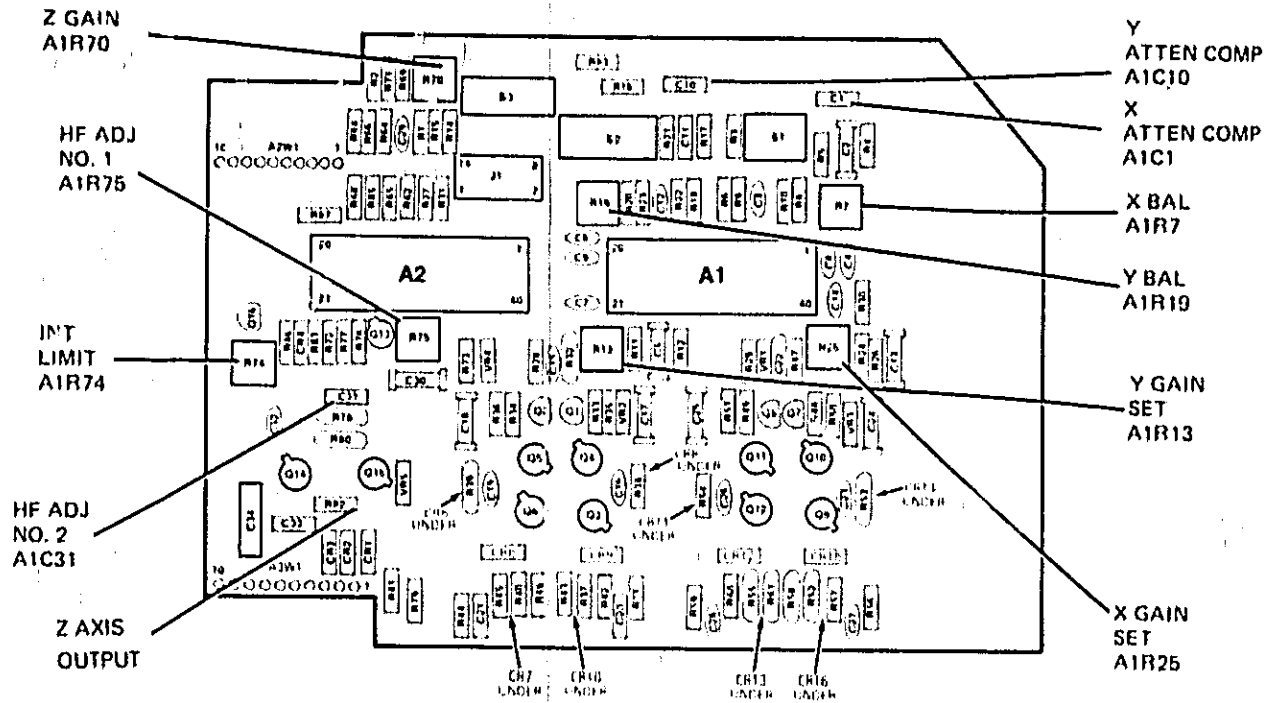

Figure 8-11.  
Service Sheet 6, Adjustment Locations  
8-15

# MANUAL CHANGES

## MANUAL IDENTIFICATION

Model Number: 1340A  
 Date Printed: July 1982  
 Part Number: 01340-90915

This supplement contains important information for correcting manual errors and for adapting the manual to instruments containing improvements made after the printing of the manual.

To use this supplement:  
 Make all ERRATA corrections.  
 Make all appropriate serial number related changes indicated in the tables.

Serial Prefix or Number	Make Manual Changes	Serial Prefix or Number	Make Manual Changes
2415A	1	2642A	1,2,3,4,5,6,7
2514A	1,2		
2516A	1,2,3		
2605A	1,2,3,4		
2615A	1,2,3,4,5		
2620A	1,2,3,4,5,6		

► NEW ITEM

► ERRATA

### SECTION VI. REPLACEABLE PARTS

Table 6-2. Replaceable Parts,

- Delete: A1C7 and A1C14.
- Change: A1C16, HP Part No and Mfr Part No to 01345-80701.
- Change: A1C19, HP Part No and Mfr Part No to 01345-80701.
- Change: A1C23, HP Part No and Mfr Part No to 01345-80701.
- Change: A1C26, HP Part No and Mfr Part No to 01345-80701.
- Change: A1CR7, HP Part No 1901-0028, DIODE-PWR RECT 400V 750MA, Mfr Code 28480, Mfr Part No 1901-0028.

### NOTE

Manual change supplements are revised as often as necessary to keep manuals as current and accurate as possible. Hewlett-Packard recommends that you periodically request the latest edition of this supplement. Free copies are available from all HP offices. When requesting copies quote the manual identification information from your supplement, or the model number and print date from the title page of the manual.

27 OCTOBER 1986

Page 1 of 8





Change: A1CR10, HP Part No 1901-0028, DIODE-PWR RECT 400V 750MA, Mfr Code 28480, Mfr Part No 1901-0028.

Change: A1CR13, HP Part No 1901-0028, DIODE-PWR RECT 400V 750MA, Mfr Code 28480, Mfr Part No 1901-0028.

Change: A1CR16, HP Part No 1901-0028, DIODE-PWR RECT 400V 750MA, Mfr Code 28480, Mfr Part No 1901-0028.

Change: A1R12, HP Part No 0757-0469, RESISTOR 150K 1% .125W, Mfr Code 28480, Mfr Part No 0757-0469.

Change: A1R26, HP Part No 0757-0469, RESISTOR 150K 1% .125W, Mfr Code 28480, Mfr Part No 0757-0469.

Change: A1R27, HP Part No 0757-0283, RESISTOR 2K 1% .125W, Mfr Code 28480, Mfr Part No 0757-0283.

Change: A1R31, HP Part No 0757-0283, RESISTOR 2K 1% .125W, Mfr Code 28480, Mfr Part No 0757-0283.

Change: A1R33 and A1R34, HP Part No 0684-5631, RESISTOR 56K 10% .25W TC= 0-400, Mfr Code 28480, Mfr Part No 0684-5631.

Change: A1R48 and A1R49, HP Part No 0757-0459, RESISTOR 56.2K 1% .125W TC= +-100, Mfr Code 24546, Mfr Part No CT4-1/8-TO-5622-F.

Add: A1R87, HP Part No 0757-0401, RESISTOR 100 1% F TC 0+-100, Mfr Code 28480, Mfr Part No 0757-0401.

Add: A1R88, HP Part No 0757-0401, RESISTOR 100 1% F TC 0+-100, Mfr Code 28480, Mfr Part No 0757-0401.

Change: MP7, HP Part No 01340-02701, FILTER-CLEAR (OPTIONS 330 AND 335).

## SECTION VIII. SERVICE

Service Sheet 2, X-Y Amplifier,

Replace A1C7 and A1C14 with 100 ohm resistors, A1R87 and A1R88.

Change values of A1R12 and A1R26 to 150K.

Change values of A1R27 and A1R31 to 2K.

## CHANGE 1

### SECTION VI. REPLACEABLE PARTS

Table 6-2. Replaceable Parts,

Change: A3, BOARD ASSY-HIGH VOLTAGE POWER SUPPLY, HP Part No and Mfr Part No to 01340-66517.

Delete: E4.

Delete: H7.

Delete: H18.

Delete: H21.

Delete: MP6.

Delete: Q1.

Delete: T1.

Change: V1, CRT P31 NG OPTION 631 ONLY, HP Part No and Mfr Part No to 5083-5451.

Change: V1, CRT P4 IG OPTION 004 ONLY, HP Part No and Mfr Part No to 5083-6462.

Change: V1, CRT P4 NG OPTION 604 ONLY, HP Part No and Mfr Part No to 5083-6461.  
 Change: V1, CRT P39 IG OPTION 039 ONLY, HP Part No and Mfr Part No to 5083-6470.  
 Change: V1, CRT P39 NG OPTION 639 ONLY, HP Part No and Mfr Part No to 5083-6471.  
 Change: V1, CRT P7 IG OPTION 007 ONLY, HP Part No and Mfr Part No to 5083-6474.  
 Change: V1, CRT P7 NG OPTION 607 ONLY, HP Part No and Mfr Part No to 5083-6431.

Change: A3A1C1, Reference Designator to A3C16.  
 Change: A3A1CR1, Reference Designator to A3CR10.  
 Change: A3A2, HIGH VOLTAGE MULTIPLIER, HP Part No and Mfr Part No to 0960-0629.  
 Change: A3C14, CAPACITOR 27UF 100VDC, HP Part No and Mfr Part No to 0180-4613.  
 Add: A3C15, CAPACITOR 27UF 100VDC, HP Part No and Mfr Part No 0180-4613.

Add: A3H1, MACH SCREW - PAN HEAD, HP Part No and Mfr Part No 0515-0055.  
 Add: A3MP1, HEAT SINK TO-220, HP Part No and Mfr Part No 1205-0373.  
 Add: A3MP2, HIGH VOLTAGE COVER, HP Part No and Mfr Part No 01345-04103.  
 Add: A3Q1, TRANSISTOR NPN PD=90W FT=2MHZ, HP Part No and Mfr Part No 1854-0433.  
 Add: A3T1, HIGH VOLTAGE TRANSFORMER, HP Part No and Mfr Part No 01340-61104.

### SECTION VIII. SERVICE

Service Sheet 3, Figure 8-5. Component Identification, HVPS Assembly, A3:  
 Replace with figure 1 of this change sheet.

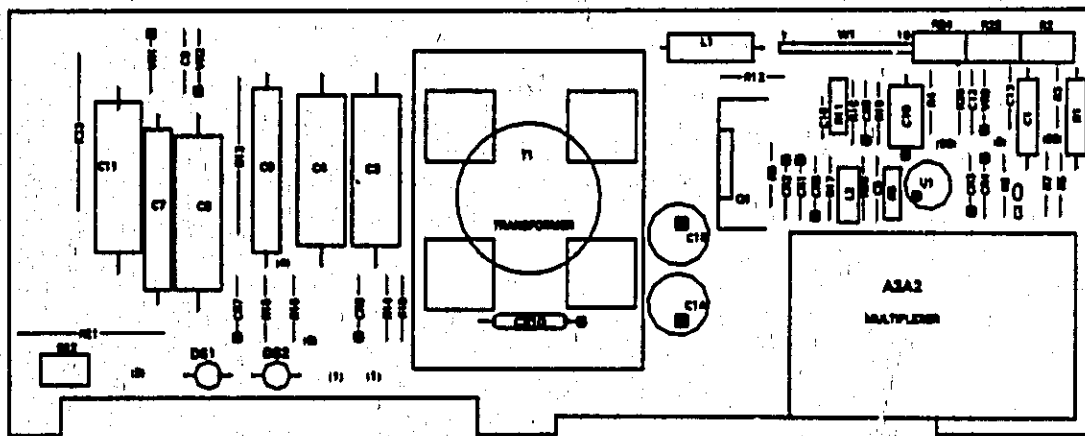

Figure 1. Component Identification, HVPS Assembly A3

Service Sheet 3, High Voltage Power Supply and Z-Axis Amplifier:  
 Change the value of A3C14 to 27UF.  
 Add A3C15 at the +27V UREG Power Supply Input to ground.  
 Change Reference Designators of A3A1C1 and A3A1CR1 to A3C16 and A3CR10 respectively.  
 Delete all references to A3A1. All A3A1 parts are now mounted on A3, High Voltage Power Supply Assembly.

Service Sheet 6, Figure 8-11. Adjustment Locations:  
Replace with figure 2 of this change sheet.

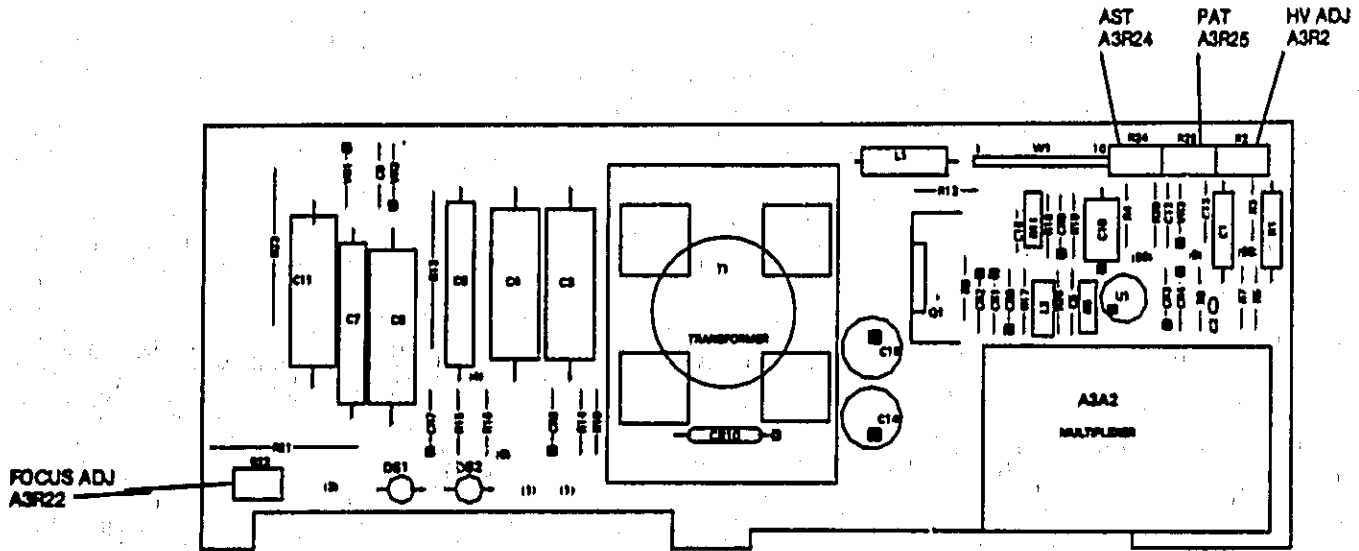

Figure 2. Adjustment Locations for HVPS, Assembly A3

Change connections on A3T1 as in figure 3.

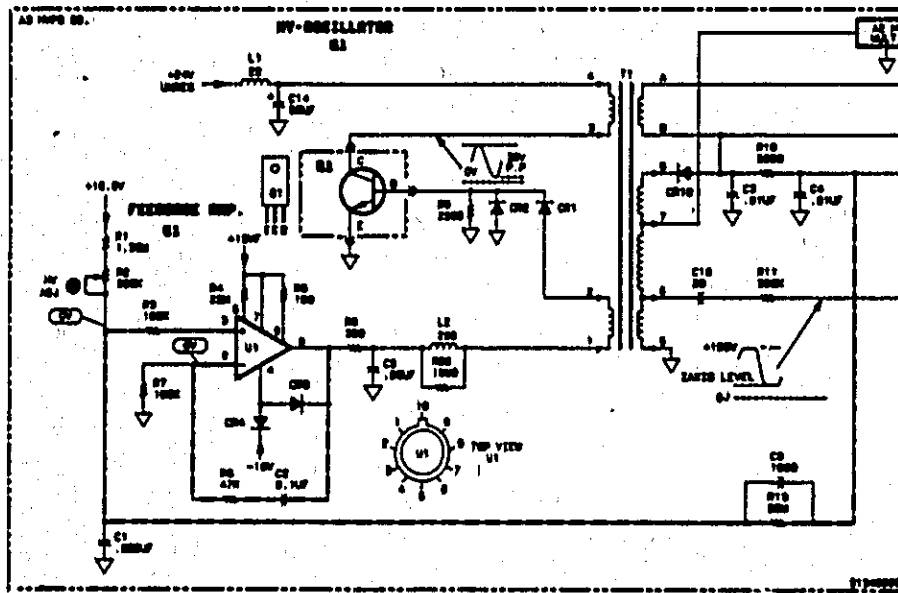

Figure 3. Pin Connections for A3T1

**CHANGE 2**

**SECTION VI. REPLACEABLE PARTS**

Table 6-2. Replaceable Parts,

- Change: A1, HP Part No and Mfr Part No to 01340-66520 (2 places).
- Change: A3, HP Part No and Mfr Part No to 01340-66519 (2 places).
- Change: A1C1, HP Part No 0121-0060, 2, CAPACITOR-VAR TRMR-CER 2-8UF 350VDC PC MTG, Mfr Code 28480, Mfr Part No 0121-0060.
- Change: A1C2, HP Part No 0160-2264, CAPACITOR-FXD 20PF ±5% 500VDC CER 0±30, Mfr Code 28480, Mfr Part No 0160-2264.
- Change: A1C10, HP Part No 0121-0060, CAPACITOR-VAR TRMR-CER 2-8UF 350VDC PC MTG, Mfr Code 28480, Mfr Part No 0121-0060.
  
- Change: A1C11, HP Part No 0160-2264, CAPACITOR-FXD 20PF ±5% 500VDC CER 0±30, Mfr Code 28480, Mfr Part No 0160-2264.
- Change: A3C2, HP Part No 0160-5332, CAPACITOR-FXD .1UF ±20% 250VAC, Mfr Code 56289, Mfr Part No 923CX7R68M050B.

**SECTION VIII. SERVICE**

Service Sheet 2, Figure 8-4. X-Y Amplifiers:

- Change the value of C1 and C10 to 2-8.
- Change the value of C2 and C11 to 20.

Service Sheet 3, Figure 8-5. Component Identification, HVPS Assembly, A3:

Replace with figure 4 of this change sheet.

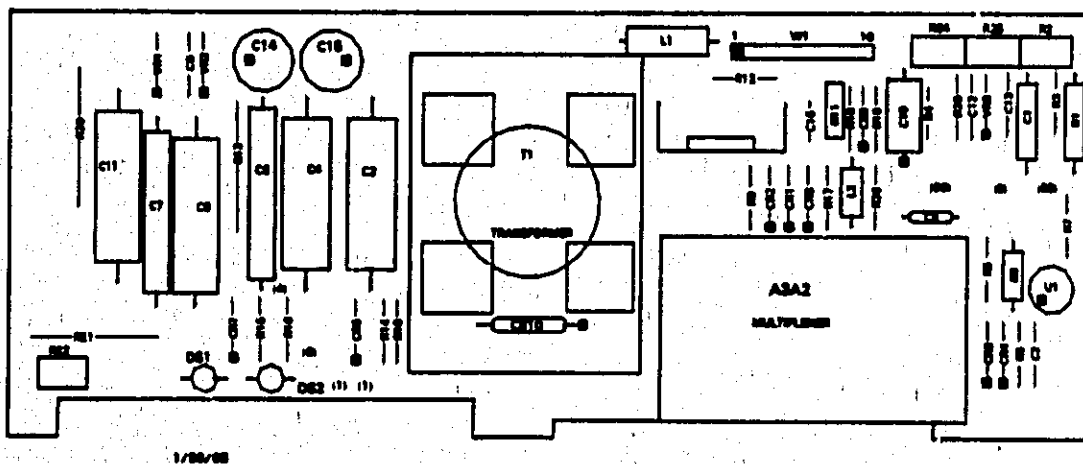

Figure 4. Component Identification for HVPS A3

Service Sheet 6. Figure 8-11. Adjustment Locations,  
 Replace with figure 5 of this change sheet.

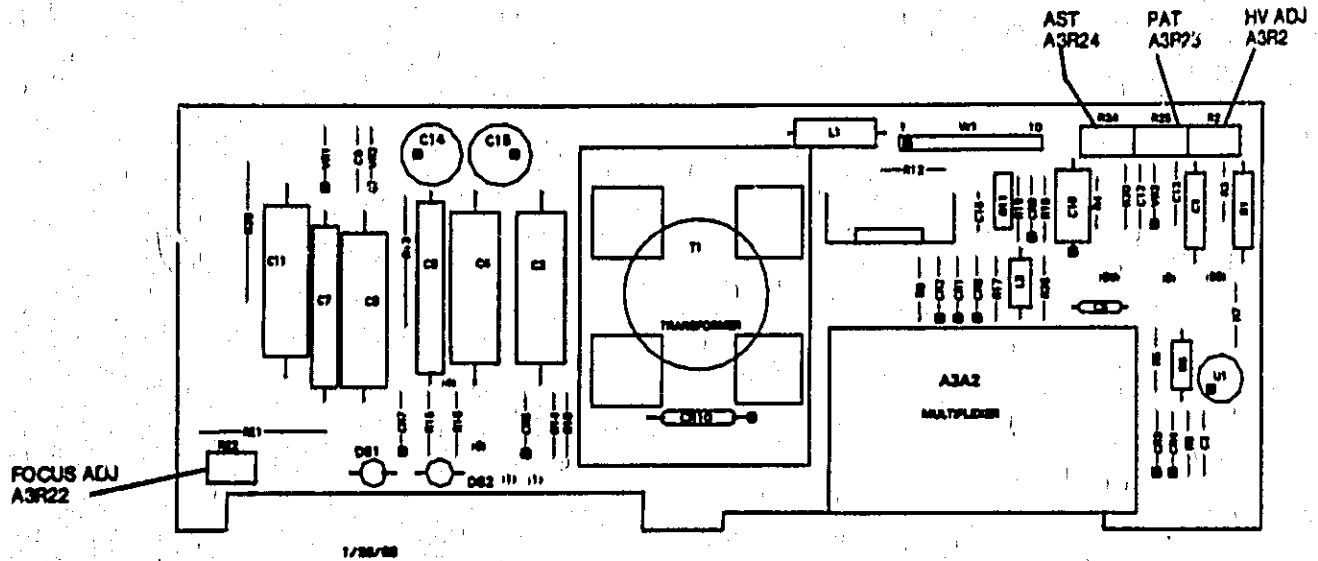

Figure 5. Adjustment Locations for HVPS Assembly A3

**CHANGE 3**

**SECTION VI. REPLACEABLE PARTS**

Table 6-2. Replaceable Parts,

- Add: H33, HP Part No 0515-1403, TORX M4X0.7X6 FH 90 DEGREES SPECIAL, Mfr Code 28460, Mfr Part No 0150-1403.
- Change: MP14, HP Part No and Mfr Part No to 5061-9557.
- Add: MP14, HP Part No 01340-04107, 1, COVER-TOP (OPTIONS 330, 332, AND 333), Mfr Code 28480, Mfr Part No 01340-04107.
- Change: MP21, HP Part No and Mfr Part No to 5061-9434.
- Change: MP22, HP Part No and Mfr Part No to 5061-9446.
  
- Change: MP23, HP Part No 5061-9573, COVER-BOTTOM (OPTIONS 315, 330, 332, 333, AND 580), Mfr Code 28480, Mfr Part No 5061-9573.
- Change: MP25, HP Part No and Mfr Part No to 5021-5803.
- Change: MP26, HP Part No and Mfr Part No to 5021-5804.
- Change: MP27, HP Part No and Mfr Part No to 5021-5815.
- Change: MP28, HP Part No and Mfr Part No to 5021-5816.
  
- Change: MP29, HP Part No and Mfr Part No to 5021-5836.
- Change: MP30, HP Part No and Mfr Part No to 5021-5837.
- Change: MP36, HP Part No and Mfr Part No to 5061-9511.

**CHANGE 4**

**SECTION VI. REPLACEABLE PARTS**

Table 6-2. Replaceable Parts,

Change: A3, HP Part No and Mfr Part No to 01340-66521.  
Change: A3T1, HP Part No and Mfr Part No to 01340-61105.

**CHANGE 5**

**SECTION VI. REPLACEABLE PARTS**

Table 6-2. Replaceable Parts,

Change: MP9, HP Part No and Mfr Part No to 01340-60603.  
Add: MP106, HP Part No 0134F 00602, Qty 1, Mfr Code 28480, Mfr Part No 01345 -00602.  
Add: MP107, HP Part No 0403-0490, Qty 4, BUMPER, Mfr Code 28480, Mfr Part No 0403-0490.  
Add: MP108, HP Part No 1400-0026, Qty 2, CLAMP-HOSE, Mfr Code 28480, Mfr Part No 1400-0026.

**CHANGE 6**

**SECTION VI. REPLACEABLE PARTS**

Table 6-2. Replaceable Parts,

Change: A3, HP Part No and Mfr Part No to 01340-66525.  
Change: A32, HP Part No 0960-0734, MULTIPLIER-HIGH VOLTAGE 4X, Mfr Code 28480, Mfr Part No 0960-0734.

**▶CHANGE 7**

**SECTION VI. REPLACEABLE PARTS**

Table 6-2. Replaceable Parts,

Change: A2, HP Part No and Mfr Part No 01340-66526.  
Add: A2C9, HP Part No 0180-0161, CAPACITOR-FXD 3.3UF 35 VDC TA, Mfr Code 28480, Mfr Part No 0180-0161.  
Add: A2C10, HP Part No 0180-0161, CAPACITOR-FXD 3.3UF 35 VDC TA, Mfr Code 28480, Mfr Part No 0180-0161.  
Add: A2CR9, HP Part No 1901-0731, DIODE-PWR RECT 400 V 1MA, Mfr Code 28480, Mfr Part No 1901-0731.  
Add: A2CR10, HP Part No 1901-0731, DIODE-PWR RECT 400 V 1MA, Mfr Code 28480, Mfr Part No 1901-0731.

**SECTION VIII. SERVICE**

Service Sheet 4,

Add: C10 and CR10 to +15V REGULATOR and C9 and CR9 to -15V REGULATOR as in figure 6 of this change sheet.

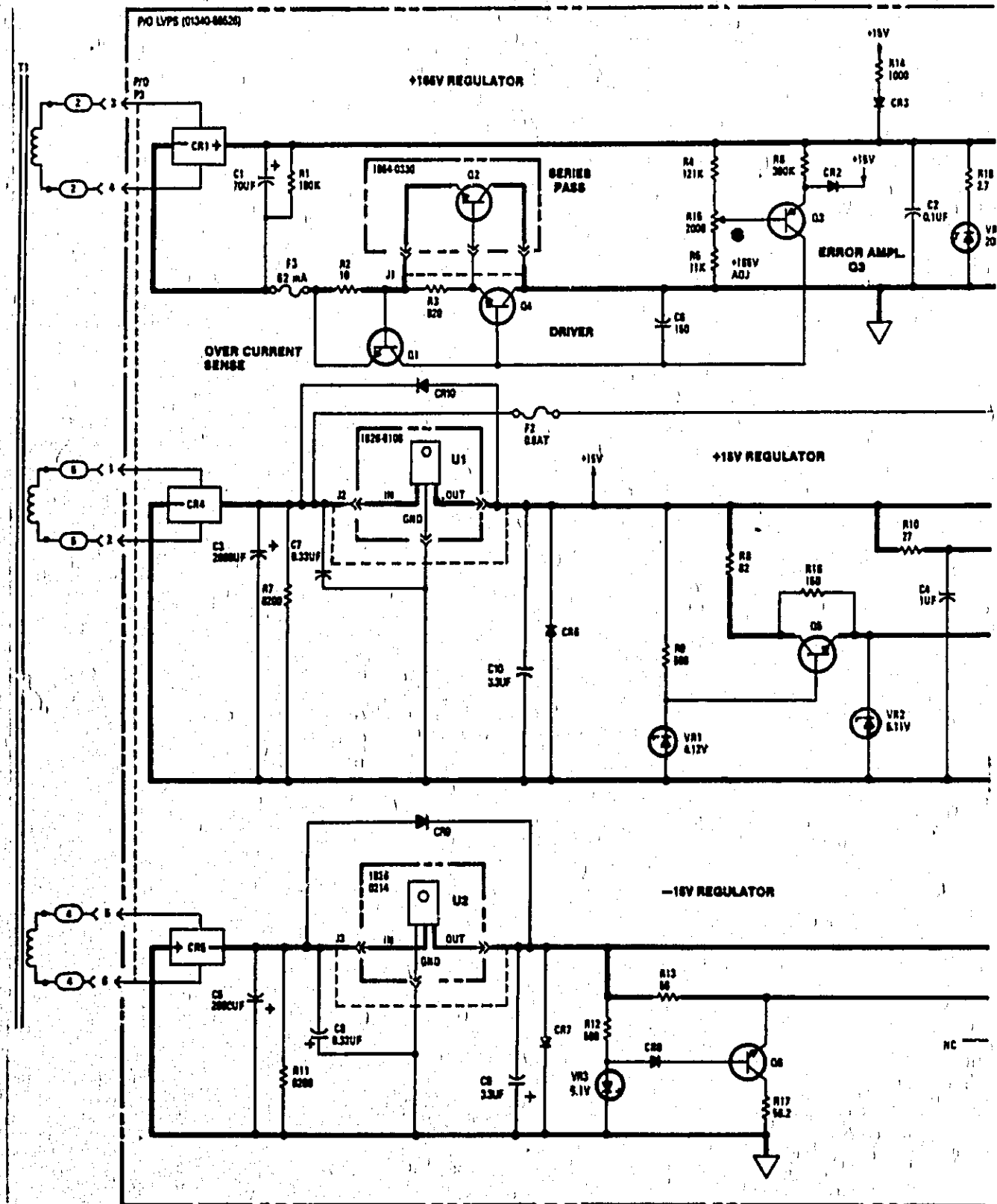

Figure 6. Component Additions to LVPS Assembly, A2.