



MODEL 3314A FUNCTION GENERATOR

Serial Numbers: 2141A00101 and Greater

**Manual Part No. 03314-90020
Microfiche Part No. 03314-90070**

**©Copyright by Hewlett-Packard Company 1982
P.O. Box 69, Marysville, Washington, U.S.A., 98270**

Notice

Hewlett-Packard to Agilent Technologies Transition

This manual may contain references to HP or Hewlett-Packard. Please note that Hewlett-Packard's former test and measurement, semiconductor products and chemical analysis businesses are now part of Agilent Technologies. To reduce potential confusion, the only change to product numbers and names has been in the company name prefix: where a product name/number was HP XXXX the current name/number is now Agilent XXXX. For example, model number HP8648 is now model number Agilent 8648.

Contacting Agilent Sales and Service Offices

The sales and service contact information in this manual may be out of date. The latest service and contact information for your location can be found on the Web at:

<http://www.agilent.com/find/assist>

If you do not have access to the Internet, contact your field engineer or the nearest sales and service office listed below. In any correspondence or telephone conversation, refer to your instrument by its model number and full serial number.

United States

(tel) 1 800 452 4844
(fax) 1 800 829 4433

Canada

(tel) +1 877 894 4414
(fax) +1 888 900 8921

Europe

(tel) (31 20) 547 2323
(fax) (31 20) 547 2390

Latin America

(tel) (305) 269 7500
(fax) (305) 269 7599

Japan

(tel) (81) 426 56 7832
(fax) (81) 426 56 7840

Australia

(tel) 1 800 629 485
(fax) (61 3) 9210 5947

New Zealand

(tel) 0 800 738 378
(fax) 64 4 495 8950

Asia Pacific

(tel) (852) 3197 7777
(fax) (852) 2506 9284



Agilent Technologies

CERTIFICATION

Hewlett-Packard Company certifies that this product met its published specifications at the time of shipment from the factory. Hewlett-Packard further certifies that its calibration measurements are traceable to the United States National Bureau of Standards, to the extent allowed by the Bureau's calibration facility, and to the calibration facilities of other International Standards Organization members.

WARRANTY

This Hewlett-Packard product is warranted against defects in material and workmanship for a period of one year from date of shipment. During the warranty period, Hewlett-Packard Company will, at its option, either repair or replace products which prove to be defective.

For warranty service or repair, this product must be returned to a service facility designated by -hp-. Buyer shall prepay shipping charges to -hp- and -hp- shall pay shipping charges to return the product to Buyer. However, Buyer shall pay all shipping charges, duties, and taxes for products returned to -hp- from another country.

HP software and firmware products which are designated by HP for use with a hardware product, when properly installed on that hardware product, are warranted not to fail to execute their programming instructions due to defects in materials and workmanship. If HP receives notice of such defects during their warranty period, HP shall repair or replace software media and firmware which do not execute their programming instructions due to such defects. HP does not warrant that the operation of the software, firmware or hardware shall be uninterrupted or error free.

LIMITATION OF WARRANTY

The foregoing warranty shall not apply to defects resulting from improper or inadequate maintenance by Buyer, Buyer-supplied software or interfacing, unauthorized modification or misuse, operation outside of the environmental specifications for the product, or improper site preparation or maintenance.

NO OTHER WARRANTY IS EXPRESSED OR IMPLIED. HEWLETT-PACKARD SPECIFICALLY DISCLAIMS THE IMPLIED WARRANTIES OF MERCHANTABILITY AND FITNESS FOR A PARTICULAR PURPOSE.

EXCLUSIVE REMEDIES

THE REMEDIES PROVIDED HEREIN ARE BUYER'S SOLE AND EXCLUSIVE REMEDIES. HEWLETT-PACKARD SHALL NOT BE LIABLE FOR ANY DIRECT, INDIRECT, SPECIAL, INCIDENTAL, OR CONSEQUENTIAL DAMAGES, WHETHER BASED ON CONTRACT, TORT, OR ANY OTHER LEGAL THEORY.

ASSISTANCE

Product maintenance agreements and other customer assistance agreements are available for Hewlett-Packard products.

For any assistance, contact your nearest Hewlett-Packard Sales and Service Office. Addresses are provided at the back of this manual.

SAFETY SUMMARY

The following general safety precautions must be observed during all phases of operation, service, and repair of this instrument. Failure to comply with these precautions or with specific warnings elsewhere in this manual violates safety standards of design, manufacture, and intended use of the instrument. Hewlett-Packard Company assumes no liability for the customer's failure to comply with these requirements. This is a Safety Class 1 instrument.

GROUND THE INSTRUMENT

To minimize shock hazard, the instrument chassis and cabinet must be connected to an electrical ground. The instrument is equipped with a three-conductor ac power cable. The power cable must either be plugged into an approved three-contact electrical outlet or used with a three-contact to two-contact adapter with the grounding wire (green) firmly connected to an electrical ground (safety ground) at the power outlet. The power jack and mating plug of the power cable meet International Electrotechnical Commission (IEC) safety standards.

DO NOT OPERATE IN AN EXPLOSIVE ATMOSPHERE

Do not operate the instrument in the presence of flammable gases or fumes. Operation of any electrical instrument in such an environment constitutes a definite safety hazard.

KEEP AWAY FROM LIVE CIRCUITS

Operating personnel must not remove instrument covers. Component replacement and internal adjustments must be made by qualified maintenance personnel. Do not replace components with power cable connected. Under certain conditions, dangerous voltages may exist even with the power cable removed. To avoid injuries, always disconnect power and discharge circuits before touching them.

DO NOT SERVICE OR ADJUST ALONE

Do not attempt internal service or adjustment unless another person, capable of rendering first aid and resuscitation, is present.

DO NOT SUBSTITUTE PARTS OR MODIFY INSTRUMENT

Because of the danger of introducing additional hazards, do not install substitute parts or perform any unauthorized modification to the instrument. Return the instrument to a Hewlett-Packard Sales and Service Office for service and repair to ensure that safety features are maintained.

DANGEROUS PROCEDURE WARNINGS

Warnings, such as the example below, precede potentially dangerous procedures throughout this manual. Instructions contained in the warnings must be followed.

WARNING

Dangerous voltages, capable of causing death, are present in this instrument. Use extreme caution when handling, testing, and adjusting.

SAFETY SYMBOLS

General Definitions of Safety Symbols Used On Equipment or In Manuals.



Instruction manual symbol: the product will be marked with this symbol when it is necessary for the user to refer to the instruction manual in order to protect against damage to the instrument.



Indicates dangerous voltage (terminals fed from the interior by voltage exceeding 1000 volts must be so marked).

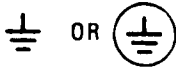

Protective conductor terminal. For protection against electrical shock in case of a fault. Used with field wiring terminals to indicate the terminal which must be connected to ground before operating equipment.



Low-noise or noiseless, clean ground (earth) terminal. Used for a signal common, as well as providing protection against electrical shock in case of a fault. A terminal marked with this symbol must be connected to ground in the manner described in the installation (operating) manual, and before operating the equipment.

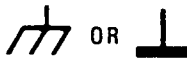

Frame or chassis terminal. A connection to the frame (chassis) of the equipment which normally includes all exposed metal structures.



Alternating current (power line).



Direct current (power line).



Alternating or direct current (power line).

WARNING

The **WARNING** sign denotes a hazard. It calls attention to a procedure, practice, condition or the like, which, if not correctly performed or adhered to, could result in injury or death to personnel.

CAUTION

The **CAUTION** sign denotes a hazard. It calls attention to an operating procedure, practice, condition or the like, which, if not correctly performed or adhered to, could result in damage to or destruction of part or all of the product.

NOTE :

The **NOTE** sign denotes important information. It calls attention to procedure, practice, condition or the like, which is essential to highlight.

SECTION 1

GENERAL INFORMATION

1-1. INTRODUCTION

This Service Manual contains information for Service-Trained personnel to install, test, adjust and service the Hewlett-Packard Model 3314A Function Generator. A front panel overview and the HP-IB Summary are also included, however, the Operating and Programming Manual should be used for detailed operating information.

1-2. MANUAL AND INSTRUMENT IDENTIFICATION

The -hp- part number for this manual and for a microfiche of this manual are located on the title page. Each 4 x 6 inch microfiche contains up to 96 photoduplicates of the Service Manual pages. The latest Manual Changes Supplement as well as Service Notes are also included in the microfiche.

Attached to the 3314A's rear panel is a serial number plate.

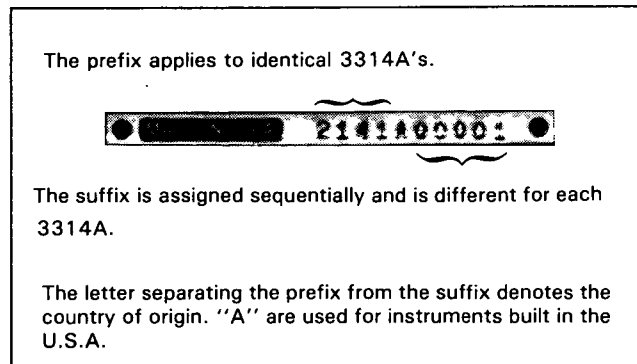

Figure 1-1. Serial Number Plate

This manual applies to 3314As within the serial number range on the title page. Instruments outside this range are covered by a Manual Change Supplement or by the Backdating Section of this manual. In addition to change information, the Manual Change Supplement also contains information correcting errors in the manual.

1-3. DESCRIPTION

The 3314A Function Generator is a multi-mode, programmable function generator. The 3314A features Sine, Triangle and Squarewave functions from 1mHz to

19.99MHz. In addition, the 3314A can be redefined as an ARbitrary Waveform Generator. ARB waveforms are made up of a series of voltage ramps called vectors. The operator has control over the number of vectors, the height and length of each vector. The operating modes include:

| Free Run | Gate | N Cycle |
|---------------|---------------|-----------|
| CW | CW | 1/2 Cycle |
| linear sweeps | linear sweeps | Fin X N |
| log sweeps | ARB | Fin ÷ N |
| ARB | | |

In addition, the 3314A has a programmable time interval for internal triggering. A trigger (either internal or external) is an important part of every operating mode except Free Run when not sweeping.

1-4. OPTIONS

The 3314A may be equipped with one or more of the following options:

- Option 001, Simultaneous X3 Output
- Option 907, Front Handle Kit
- Option 908, Rack Mount Adapters
- Option 910, Extra Manual Set

1-5. SUPPLIED ACCESSORIES

Every 3314A is supplied with the following accessories:

- A Operating and Programming Manual
- A Service Manual
- A Power Cord
- A 50Ω Feedthrough Termination

The power cord included with your 3314A was selected at the factory based upon the country of destination. If your power cord is incompatible with your AC mains outlet, contact your local -hp- Sales Office.

1-6. SPECIFICATIONS

The 3314A's specifications are listed in Table 1-1. Specifications. These specifications are the performance standards or limits against which every 3314A is tested. Some of the 3314A's operating characteristics are listed in Table 1-2, Supplemental Characteristics. The Operating and Programming Manual contains detailed discussions of the remaining operating characteristics.

Table 1-1. Specifications

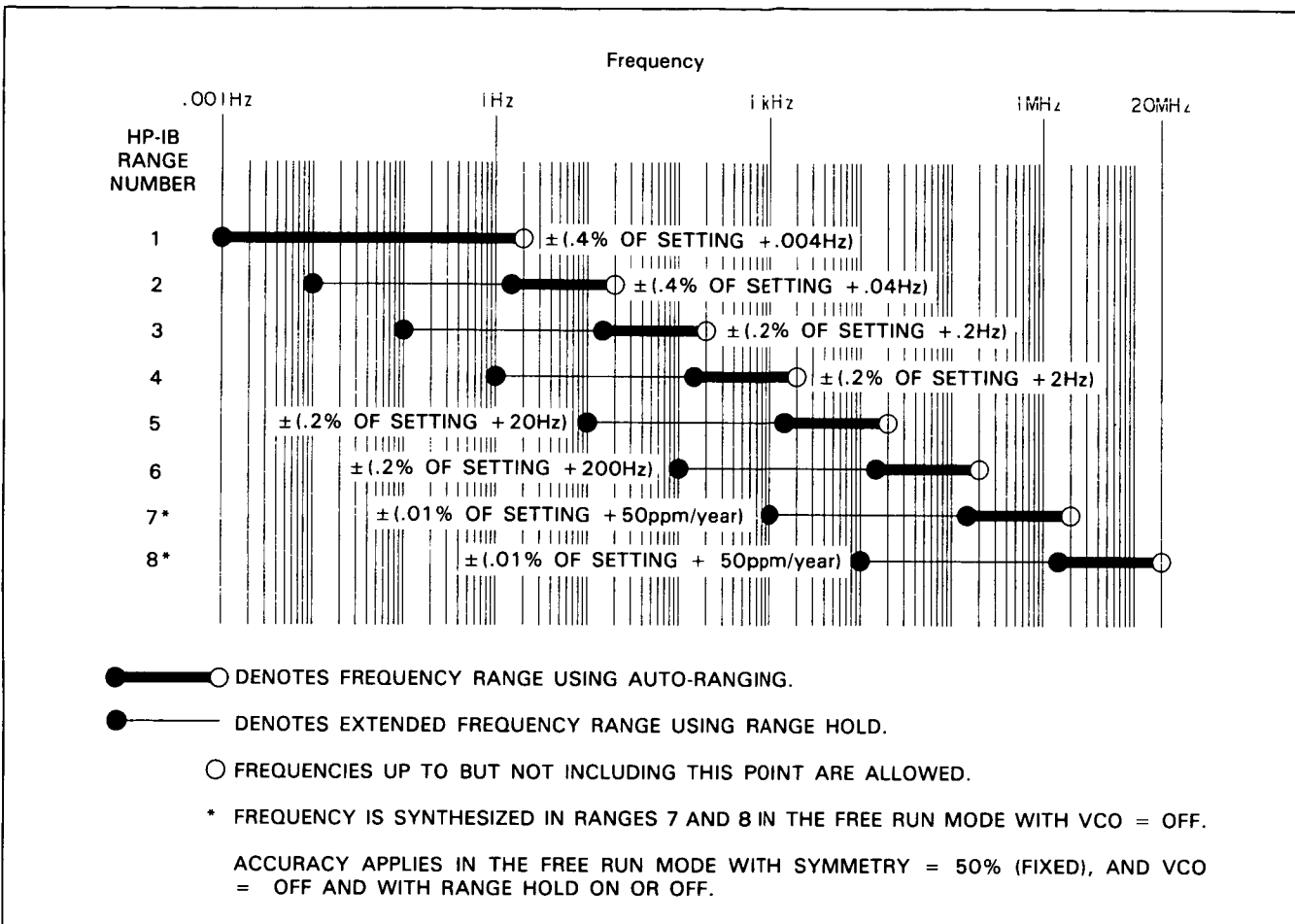

Amplitude

Absolute Amplitude Accuracy:

±(1% of display + .035Vp-p), sine wave and square wave
 ±(1% of display + .06Vp-p), triangle

Amplitudes: 1.00Vp-p to 10.00Vp-p (Range 4)
 Frequency: 10kHz
 Auto-Range: ON

Flatness--sine wave:

Combines sine power flatness and vernier attenuator flatness
 Relative to 10kHz, 1.00 V to 10.00Vp-p (Range 4)

| | | | |
|-------|-------|-------|----------|
| 20Hz | 50kHz | 1MHz | 19.99MHz |
| .07dB | .33dB | 1.5dB | |

Step Attenuator Accuracy:

| | | | |
|------|--------|-------|----------|
| | .001Hz | 50kHz | 19.99MHz |
| 20dB | .05dB | | .3dB |
| 40dB | | | .5dB |
| 60dB | | | |

DC Offset

Offset Accuracy:

±(3% of display + 10 mVDC + 0.5% of AC Amplitude Range)

Frequency: < 100kHz
 Auto-Range: ON

Residual DC Offset:

< 0.5% of AC Amplitude Range

Setting: OVDC
 Frequency: ≤ 100kHz

Symmetry

Symmetry Accuracy (Fixed):

50% ±0.2%

Fixed Symmetry: 50% (SYM light OFF)
 Frequency: 1Hz to 100kHz
 Function: square wave

Table 1-1. Specifications (Cont'd)

| | | | | | | | | | |
|--|--------|---------|----------|----------|---------|--------|--------|--|---|
| <p>Symmetry Accuracy (Variable)</p> <p>±0.5% of period:</p> <p>Frequency: 1Hz to 100kHz Function: square wave</p> <p>Phase</p> <p>Phase Offset--Phase lock Modes</p> <p>Accuracy: ±2° (50Hz to 25kHz)</p> <p>Phase Offset is referenced to the signal output for Fin + N or the trigger input for Fin X N.</p> <p>Start/Stop Phase--Burst Modes:</p> <p>Accuracy: ±3° (applies from .001Hz to 1kHz)</p> <p>Function Characteristics</p> <p>Sine Harmonic Distortion:</p> <p>Individual harmonics will be below these levels, relative to carrier level. Offset = 0V. Function Invert = OFF. *Add 4dB for ambient temperature 0 to 5°C or 45 to 55°C.</p> <table border="1" style="margin-left: auto; margin-right: auto;"> <tr> <td style="text-align: center;">20Hz</td> <td style="text-align: center;">50kHz</td> <td style="text-align: center;">1999kHz</td> <td style="text-align: center;">19.99MHz</td> </tr> <tr> <td style="text-align: center;">- 55dB*</td> <td style="text-align: center;">- 40dB</td> <td colspan="2" style="text-align: center;">- 25dB</td> </tr> </table> <p>Square Wave Rise/Fall Time:</p> <p>≤9ns, 10% to 90% of a 10 Vp-p output</p> <p>Square Wave Aberrations:</p> <p><5% at 10 Vp-p output</p> <p>Triangle Linearity:</p> <p>±0.2% of the p-p voltage</p> <p>Frequency: .01Hz to 1kHz, Amplitude = 10 Vp-p Deviation is from a best fit straight line, from 10% to 90% of each ramp.</p> | 20Hz | 50kHz | 1999kHz | 19.99MHz | - 55dB* | - 40dB | - 25dB | | <p>Internal Trigger Interval</p> <p>Period Accuracy: ±(0.01% + 50 ppm/year) of displayed interval (excluding sweep intervals)</p> <p>Frequency Sweep</p> <p>Sweep Frequency Accuracy--Manual Sweep:</p> <p>±(0.2% of Stop Freq + 0.1% of Stop Freq Range), Stop Freq Range ≤ 200kHz ±1% of Stop Freq, Stop Freq in 2MHz Range ±3% of Stop Freq, Stop Freq in 20MHz Range</p> <p>Modulation</p> <p>Amplitude Modulation Envelope Distortion:</p> <p>≤ -40dB</p> <p>Carrier: = 1MHz, 10Vp-p, sine wave Modulating Input: 1kHz, sine wave Index of Modulation: 95%</p> <p>VCO Linearity:</p> <p>±0.15% of p-p frequency, .1Hz through 200kHz Range ±1% of p-p frequency, 2MHz Range ±3% of p-p frequency, 20MHz Range</p> <p>-8Vdc to +1 Vdc input (-80% to +10%) Deviation is from a best fit straight line.</p> <p>Option 001--Simultaneous X 3 Output</p> <p>Specifications for Option 001 were not available for this printing.</p> |
| 20Hz | 50kHz | 1999kHz | 19.99MHz | | | | | | |
| - 55dB* | - 40dB | - 25dB | | | | | | | |

1-7. SAFETY CONSIDERATIONS

The 3314A is a Safety Class 1 instrument (provided with a protective earth terminal). The instrument and manuals should be reviewed for safety markings and instructions before operation.

1-8. GROUNDING

The outer conductor of all BNC type connectors, the shield and pins 12 and 18 through 24 of the HP-IB connector, the frame, chassis, covers, and all exposed metal surfaces are connected to the protective earth terminal.

WARNING

Do NOT interrupt the protective earth ground or "float" the 3314A. This action could expose operators to potentially hazardous voltages!

1-9. RECOMMENDED TEST EQUIPMENT

Equipment required to maintain the 3314A is listed in Table 1-3. Recommended Test Equipment. Other equipment may be substituted if it meets or exceeds the performance of the listed equipment. When substitutions are made, the user may have to change the test procedures to accommodate different operating characteristics.

Table 1-2. Supplemental Characteristics

| | |
|--|---|
| <p>General</p> <p>Specifications apply when:</p> <p>Main signal output is terminated into 50 ± 0.1 ohms Warm-up is ≥ 30 minutes Within ± 5°C, and 24 hours of last internal calibration Temperature 0° to 55°C Relative Humidity ≤ 95% at 40°C Altitude ≤ 15,000 ft.</p> <p>Storage Limits:</p> <p>Temperature – 40° to + 75°C Altitude ≤ 15,000 ft.</p> <p>Power:</p> <p>100/120/220/240 V, + 5% – 10%, 48 to 66 Hz 95 VA maximum</p> | <p>Weight:</p> <p>7.3 kg (16 lbs) net 10.5 kg (23 lbs) shipping</p> <p>Dimensions:</p> <p>132.6 mm (5.22 in) high 212.3 mm (8.36 in) wide 419.0 mm (16.50 in) deep</p> <p>Accessories Included:</p> <p>11048C 50 ohm feed through</p> <p>Accessories:</p> <p>Transit case for one 3314A; -hp- #9211-2677</p> |
|--|---|

1-10. OPERATOR MAINTENANCE

Operator Maintenance is limited to replacing the line fuse. There are no operator controls inside the 3314A. The Z-Axis polarity switch is located inside the 3314A, however, only Service Trained personnel using the instructions located in Section 2 of this manual are to set this switch.

WARNING

Under no circumstances should an operator remove any covers, screws, shields or in any other way enter the 3314A. There are no operator controls inside the 3314A.

Table 1-3. Recommended Test Equipment

| Instrument | Critical Specs | Recommended Model |
|---|---|--|
| Electronic Counter | Freq Measurement to 20MHz. Accuracy ± 2 counts, Resolution 8 Digits | -hp-5328A PA (-hp- 5345A) |
| High Speed Digital Voltmeter | DC Voltage 0v-10v Sample/Hold Measurement, External Trigger: Low True TTL Edge Trigger, Trigger Delay: Selectable, 10us to 140us. | -hp- 3437A P |
| Synthesizer/Function Generator | Sine Output: 1kHz Amplitude: 1Vrms into 10kohm | -hp-3325A PA (-hp- 3335A) |
| VHF Attenuator (see Note 1) | Atten: 100dB in 10dB steps, Freq Range 50Hz to 20MHz, Impedance 50 Ohms | -hp- 355D P |
| Spectrum Analyzer | Freq Range 40MHz to 120MHz, Amplitude Accuracy: $\pm .5$ dB | -hp- 8557A P (-hp- 8558B) (-hp-141T,8552B) |
| Spectrum Analyzer (see Note 2) | Freq Range 20 Hz to 40MHz, Amplitude Accuracy: $\pm .2$ dB | -hp- 3585A PA |
| Thermal Converter | Input Impedance 50 Ohms, Input Voltage .5Vrms, Freq: 2kHz to 20MHz, Frequency Response: $\pm .05$ dB | -hp- 11051A P |
| AC/DC Digital Voltmeter | DC Function, Acc. $\pm .05\%$, AC Function: True RMS, Acc. $\pm .2\%$ Resolution 6 Digits | -hp- 3455A PA (-hp- 3456A) |
| Resistor | 1M Ω $\pm 5\%$ | P |
| Capacitor | 1uf $\pm 20\%$ | P |
| Oscilloscope | Vertical BW DC to 275MHz, Deflection .01v to 10v/Div Horizontal Sweep: .05us to 1s/Div X10 Mag, Delayed Sweep | -hp- 1725A PA (-hp- 1745A) |
| Power Supply | Volts: - 8v to +2V DC Amps: 10mA | -hp- 6235A P |
| BNC Tee/ Adaptor | Male Female Female/ BNC to Dual Banana Plug | -hp- 1250-0781 PA -hp- 1250-2277 |
| BNC to Triax Adaptor | Female BNC to Male | -hp- 1250-0595 P |
| 50 Ohm Load | Accuracy $\pm .2\%$ Power Rating: 1W | -hp- 11048C PA |
| <p>Note 1: Variable attenuator must be characterized. Note 2: The 3585A is required because of its $\pm .2$dB Amplitude Accuracy.</p> <p>P=Performance Test A=Adjustments ()=Alternative Instruments</p> | | |

SECTION II

INSTALLATION

2-1. INTRODUCTION

This section provides installation instructions for the 3314A Function Generator. This section also provides information about initial inspection and damage claims, preparation for using the 3314A and what to do in-case of difficulty. In addition, installation instruction sheets for several -hp- accessories (rack, handle and foot kits) are located at the end of this section.

2-2. INITIAL INSPECTION

Inspect the shipping container for damage. If the shipping container or cushioning material is damaged, it should be kept until the contents of the shipment have been checked for completeness and the instrument has been checked mechanically and electrically. The contents of the shipment should be:

- An Operating and Programming Manual
- A Service Manual
- A Power Cord
- A 50 Ω Feedthrough Termination

If the contents are incomplete, if there is mechanical damage or defect or if the 3314A does not pass the Performance Tests, notify the nearest Hewlett-Packard office. If the shipping container or the cushioning material is damaged, notify the carrier as well. Keep the shipping material for the carrier's inspection. The -hp- office will arrange for repair or replacement at -hp- option without waiting for a claim settlement.

WARNING

The integrity of the protective earth ground may be interrupted if the 3314A has been mechanically damaged. Under no circumstances should a 3314A be connected to power if it is damaged.

2-3. MATING CONNECTORS

The 3314A uses 50 Ω BNC(f) type connectors for all signal I/O. The outer shield is connected to protective earth ground.

The HP-IB connector is an Amphenol or Cinch type 57 connector. See Figure 2-1 for pin assignments.

2-4. LINE VOLTAGE SELECTION

Figure 2-2 provides instructions for line voltage and fuse selection. The line voltage switch positions and line fuse are selected at the factory based upon the country of destination. Always check the line voltage switch and line fuse before connecting the 3314A to power.



Connecting the 3314A to a power source when the line voltage switches are improperly set will destroy the line fuse.

Using the wrong line fuse value or type will not protect the circuitry inside the 3314A and may result in damage to your 3314A.

2-5. Z-AXIS POLARITY SELECTION

The polarity of the Z-Axis output can be inverted by setting S501 on the A2 PC board. This switch is set at the factory to output positive ($> +5V$) blanking pulses, negative ($< -5V$) intensifying pulses and 0V baseline.

To gain access to this switch:

1. Disconnect the 3314A from its power source.
2. Remove the top handle and then the top cover.
3. Remove the three screws that secure the A3 PC Assembly shield to the main deck. See Figure 2-3.
4. Raise the A3 PC Assembly on its hinges to expose the A2 PC Assembly.
5. S501 is located at the left edge of the A2 PC Assembly.
6. Set S501 as required. "BLK-" is for negative blanking pulses. "BLK+" is for positive blanking pulses.
7. Re-assemble the 3314A.

2-6. HP-IB ADDRESS SELECTION

The HP-IB address is set from the front panel and stored in non-volatile memory.

To view the address:

1. Press the blue shift key and then the LCL key. The current address will be displayed for about 1/2 second.

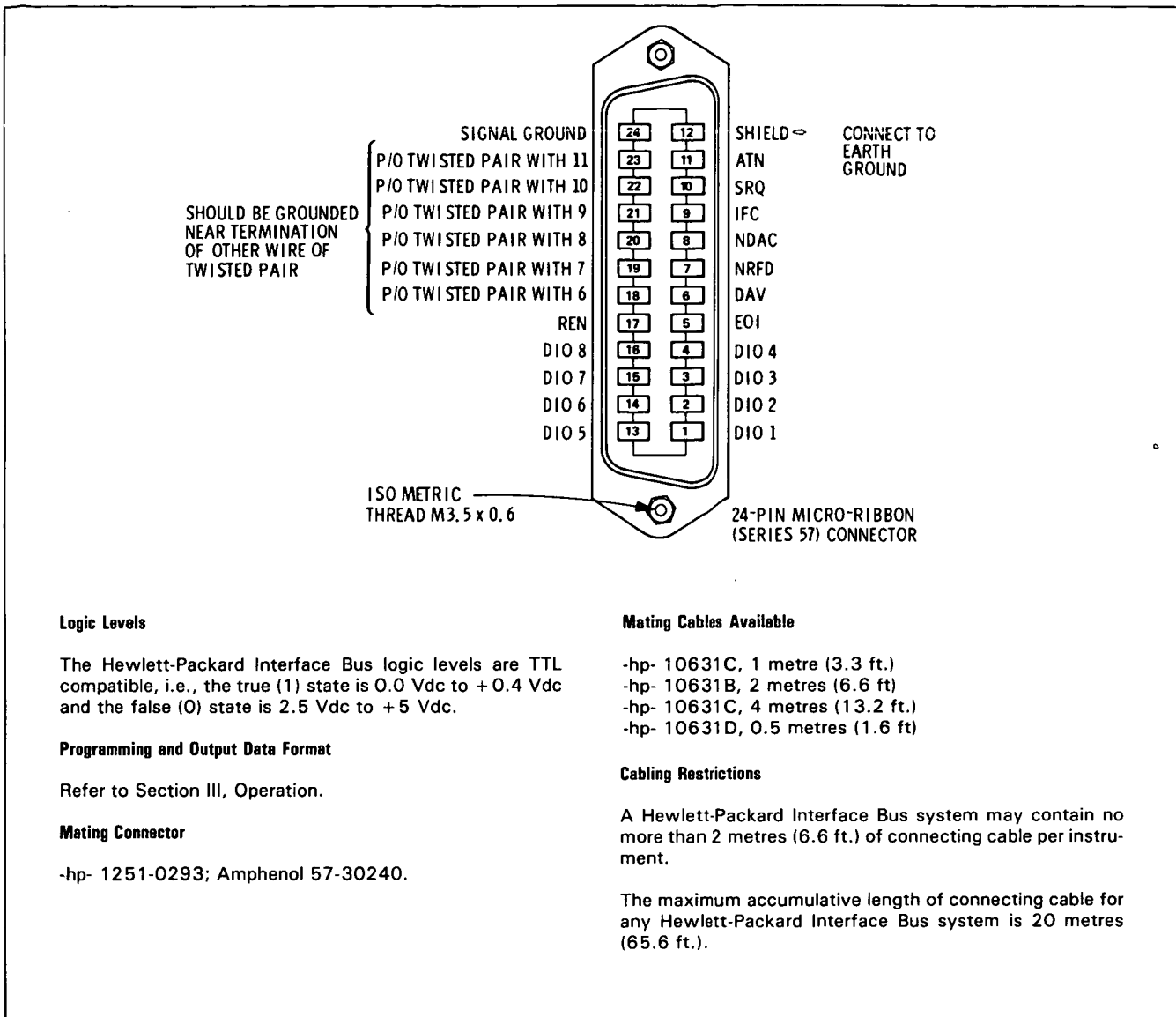

Logic Levels

The Hewlett-Packard Interface Bus logic levels are TTL compatible, i.e., the true (1) state is 0.0 Vdc to +0.4 Vdc and the false (0) state is 2.5 Vdc to +5 Vdc.

Programming and Output Data Format

Refer to Section III, Operation.

Mating Connector

-hp- 1251-0293; Amphenol 57-30240.

Mating Cables Available

- hp- 10631C, 1 metre (3.3 ft.)
- hp- 10631B, 2 metres (6.6 ft)
- hp- 10631C, 4 metres (13.2 ft.)
- hp- 10631D, 0.5 metres (1.6 ft)

Cabling Restrictions

A Hewlett-Packard Interface Bus system may contain no more than 2 metres (6.6 ft.) of connecting cable per instrument.

The maximum accumulative length of connecting cable for any Hewlett-Packard Interface Bus system is 20 metres (65.6 ft.).

Figure 2-1. HP-IB Connector Detail

To change the address:

1. Press the RECALL key and then the LCL key. The current address will be displayed indefinitely.
2. Set the 3314A's address from 0 to 30 inclusive with the Modify knob. Address 31 is not allowed. Incrementing the past 30 sets the address to Listen Only. When the 3314A is set to Listen Only, the displayed address will be "L-O".
3. Press the STORE key and then the LCL key to execute the entry.

The HP-IB address is set at the factory to 7. 7 is also the default address if the non-volatile memory is lost.

If you are using a controller in the "command" mode or are using an older type that requires the Talk and Listen addresses, use Table 2-1 to determine the proper addresses.

2-7. POWER ON AND OPERATOR'S CHECKS

Connect the 3314A to its power source using the power cord provided. If the power cord included with your 3314A is not compatible with the outlet, contact your nearest -hp- office for a replacement.

Table 2-1. HP-IB Address

| Device | Talk | Listen |
|-------------|------|--------|
| 0 | @ | SP |
| 1 | A | ! |
| 2 | B | " |
| 3 | C | # |
| 4 | D | \$ |
| 5 | E | % |
| 6 | F | & |
| 7 | G | ' |
| 8 | H | (|
| 9 | I |) |
| 10 | J | * |
| 11 | K | + |
| 12 | L | , |
| 13 | M | - |
| 14 | N | . |
| 15 | O | / |
| 16 | P | 0 |
| 17 | Q | 1 |
| 18 | R | 2 |
| 19 | S | 3 |
| 20 | T | 4 |
| 21 | U | 5 |
| 22 | V | 6 |
| 23 | W | 7 |
| 24 | X | 8 |
| 25 | Y | 9 |
| 26 | Z | : |
| 27 | [| ; |
| 28 | \ | < |
| 29 |] | = |
| 30 | ^ | > |
| Listen Only | | |

3314A factory setting

usually the controller

Set the LINE switch, located at the upper left corner of the front panel, to the ON position. At this time the 3314A will

initiate a 2 second count down to allow electrical stabilization.

do a CALibrate ALL to generate a full complement of calibration constants. Every frequency range and all three functions are checked by a CAL ALL.

display the appropriate calibration errors if the CAL ALL failed. The 3314A will attempt to calibrate itself for another 20 seconds or until a calibration is successful.

This checks ~80% of the all the 3314A's circuitry. A special memory test has been built into the 3314A to test every ROM and RAM IC. To perform this test, hold the "ARB" key in while power is turned ON. While the 3314A is checking the memory, the front panel will be completely blank (about 30 seconds). After the test is finished, all the front panel LEDs will be lit if the test was successful. If the test was not successful, one or more of these LEDs will be off.

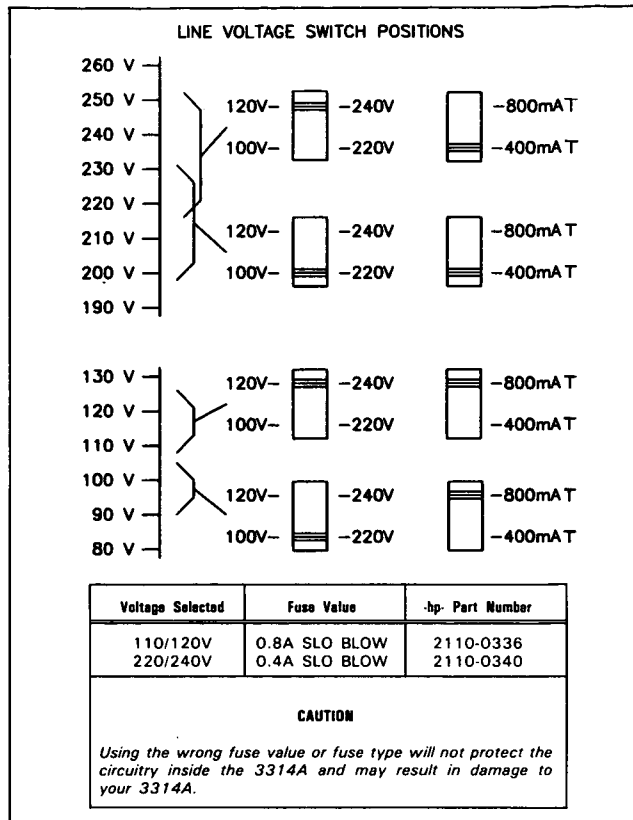

Figure 2-2. Line Voltage/Line Fuse Selection

| ROM IC# | LED | RAM IC# | LED |
|---------|--------|---------|-------------|
| 1 | FREQ | 1 | SW/TR INTVL |
| 2 | AMPTD | 2 | START FREQ |
| 3 | OFFSET | 3 | STOP FREQ |
| 4 | SYM | 4 | MKR FREQ |
| 5 | PHASE | | |
| 6 | N | | |

In addition, you can now check every front panel key. When a key is pressed, a corresponding LED should go OFF. The Modify knob and arrow keys cause elements of the 7 segment display to go OFF.

2-8. WHAT TO DO IN CASE OF DIFFICULTY

There are several operator actions that should be performed before an 3314A is diagnosed as defective.

1. Clear the 3314A's memory completely by holding the PRESET key in while setting power ON. The 3314A will display "E09" after the normal start up to indicate the the non-volatile memory has been cleared.

2. Check the Line Voltage and the Line Voltage Select Switches. These must be compatible.

3. Check the Line Fuse for the proper value and type. Normal blow type fuses are not allowed.
4. Clean the air filter.
5. Perform the Operators Checks. See Paragraph 2-7.
6. Check the system cabling and the loading of each output.
7. Check the performance of the 3314A against the specifications with the instructions in Section 4 of this manual.

Hewlett-Packard has a world-wide service organization in case your 3314A requires service. Page ii of this manual contains explicit warranty information and should be thoroughly understood before an instrument is shipped to a repair facility. When a 3314A is shipped to a repair facility, use one of the Service Repair Tags to insure timely action. If you need more Service Repair Tags, order part number 9320-3896 from your nearest sales and service office.

2-9. RE-PACKAGING A 3314A

The best material to re-pack a 3314A is the original material used by the factory. If this material has not been retained, the following steps should be performed:

1. Wrap the 3314A in heavy paper or plastic. If you are shipping the 3314A to a -hp- office, attach one of the Service Repair Tags. The front panel should also be protected with an additional piece of cardboard.
2. Use a strong shipping container. A double wall carton made of 350 pound test material is adequate.

3. Use a layer of shock-absorbing material 70 to 100 mm (3 to 4 inches) thick around all sides of the instrument to provide firm cushioning. Do not use loose filler such as styrofoam chips.
4. Seal the shipping container.
5. Mark the shipping container FRAGILE to ensure careful handling.
6. In any correspondence, refer to the 3314A by its full serial number.

2-10. INSTALLING ACCESSORIES

-hp- manufactures several kits to adapt your 3314A with handles, feet and rack mounts. These kits are available from -hp-.

| | | |
|---|-----------|------------|
| 5 1/4 H Front Handle Kit | 5061-0089 | Option 907 |
| 5 1/4 H Rack Adapter Kit (Half Module) | 5061-0057 | Option 908 |
| 5 1/4 H Support Shelf Kit | 5061-0097 | |
| Slide Kit (For Support Shelf) | 1494-0041 | |
| Lock Link Kit (Vertical and Horizontal) | 5061-0094 | |
| 5 1/4 H Bail Handle Kit (Half Module) | 5061-2002 | |
| Feet-Rear Panel Stand-Off | 5061-2009 | |
| Feet-Rear and Cord Wrap | 5061-0095 | |

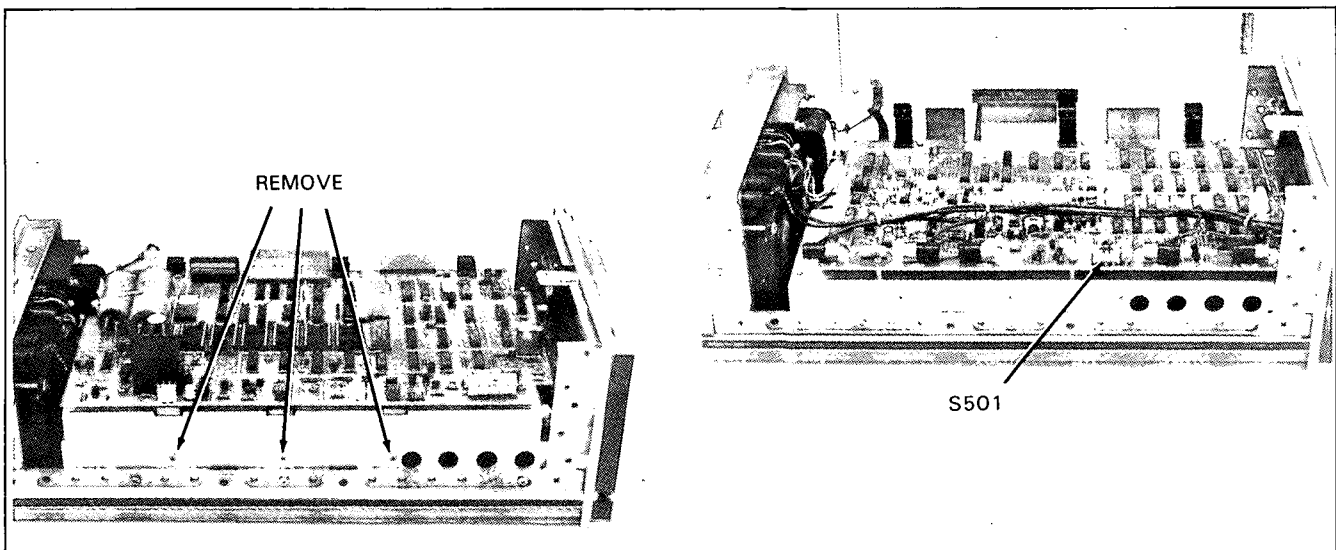

Figure 2-3. Z-AXIS Polarity Selection

5¹/₄H FRONT HANDLE KIT

[PRODUCT HT. 132.6mm / 5.219 in.]

HP PART NUMBER 5061-0089 (OPTION 907)

CONTENTS

| QTY. | | PART NO. |
|-------------|------------------------------|-----------|
| 2 | FRONT HANDLE ASS'Y | 5060-9899 |
| 2 | FRONT HANDLE TRIM | 5020-8896 |
| 6 | #8-32 x 3/8 SCREW | 2510-0195 |

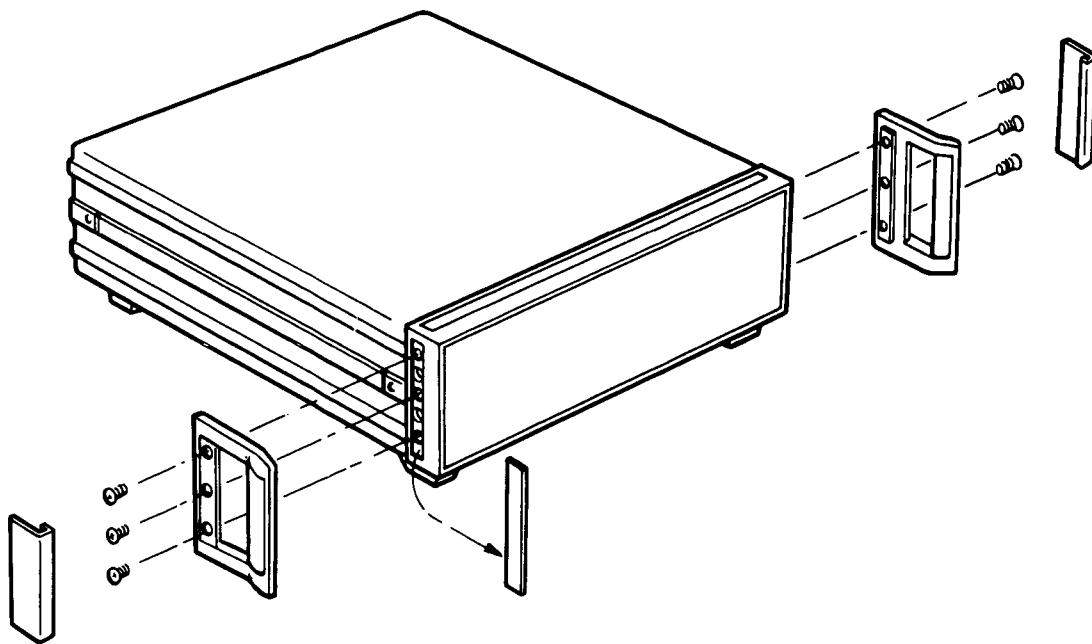

INSTRUCTIONS

1. REMOVE SIDE TRIM STRIPS.
2. ATTACH FRONT HANDLE ASS'Y WITH 3 SCREWS PER SIDE.
3. PRESS FRONT HANDLE TRIM IN PLACE.

LABEL NO. 5955-0414

5 1/4H RACK ADAPTER KIT HALF MODULE

[PRODUCT HT. 132.6mm/5.219 in.]

HP PART NUMBER 5061-0057

CONTENTS

| QTY. | | PART NO. |
|-------------|----------------------------|-----------|
| 1 | ADAPTER ASS'Y | 5061-0006 |
| 1 | RACK FLANGE | 5020-8862 |
| 6 | 8-32 x 3/8 SCREW | 2510-0193 |

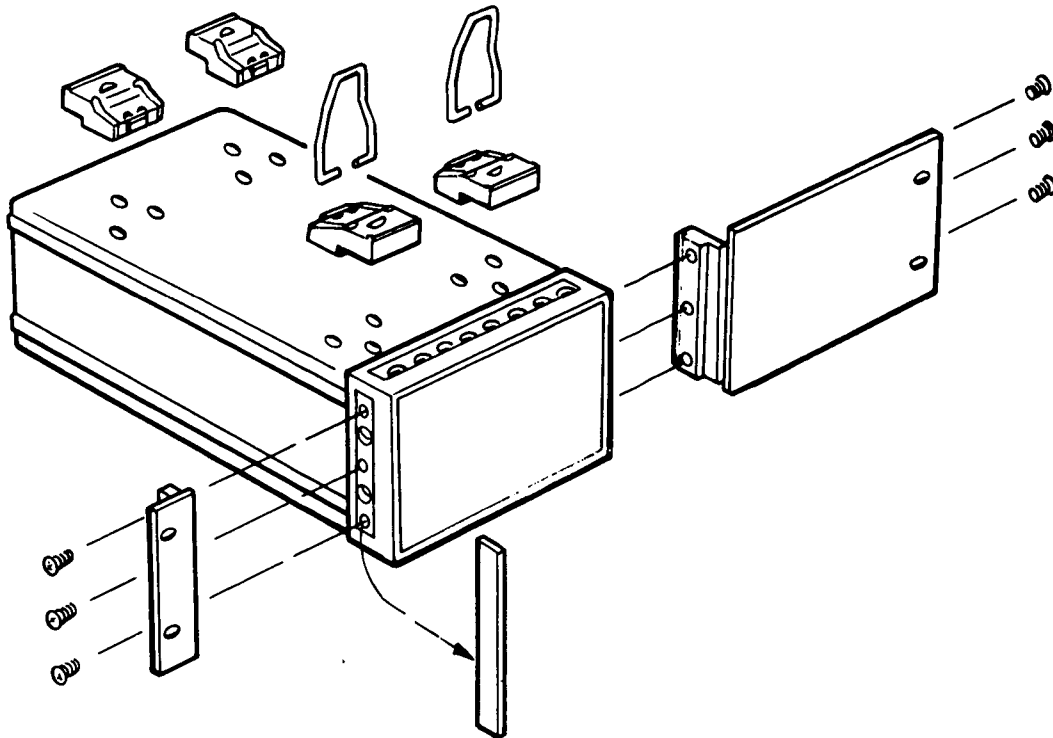

INSTRUCTIONS

1. REMOVE SIDE TRIM STRIPS.
2. ATTACH ADAPTER ASS'Y TO LEFT OR RIGHT SIDE WITH 3 SCREWS.
3. ATTACH RACK FLANGE TO OPPOSITE SIDE WITH 3 SCREWS.

LABEL NO. 5955-0423

5¹/₄H SUPPORT SHELF KIT SUB MODULES

[PRODUCT WTS. to 22.7kg/50 lbs.]

HP PART NUMBER 5061-0097

CONTENTS

| QTY. | | PART NO. |
|-------------|--------------------------------|-----------|
| 1 | SUPPORT SHELF ASS'Y | 5061-0097 |
| 8 | TIE DOWN CLIPS | 1600-0517 |
| 8 | #6-32 x 3/16 SCREW* | 2360-0330 |
| 8 | #6-32 x 7/16 SCREW** | 2360-0199 |
| 8 | #6 WASHER | 3050-0227 |

* STANDARD CABINETS ** PLASTIC CABINETS

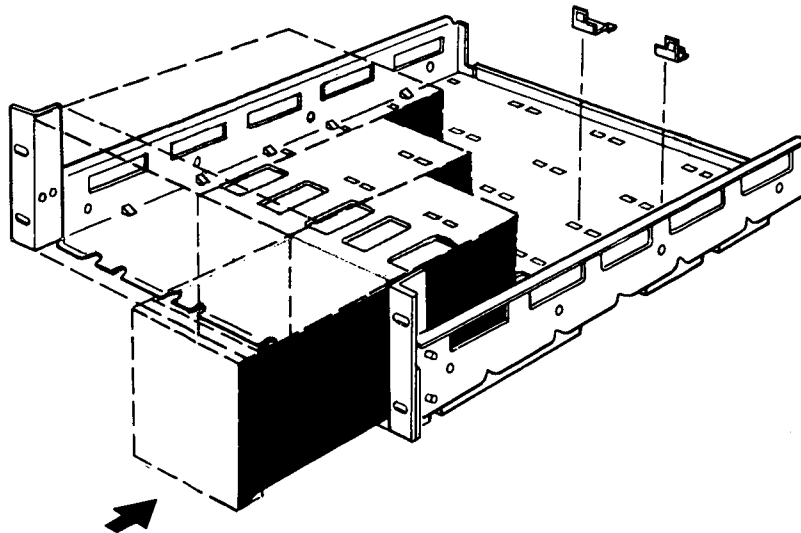

INSTRUCTIONS

1. REMOVE FEET FROM SUB MODULE INSTRUMENT.
2. SET MODULE ON FLOOR OF TRAY AND SLIDE BACK UNTIL TRAY TAB IS INSERTED IN FRONT FRAME.
3. INSERT 2 TIE DOWN CLIPS IN APPROPRIATE TRAY SLOTS, PRESS CLIPS OVER REAR CASTING BOSSES AND LOCK DOWN WITH APPROPRIATE #6-32 SCREWS & WASHERS.
4. MOUNT SUPPORT SHELF IN ANY STD. 19" RACK ENCLOSURE.

LABEL NO. 5955-0484

SLIDE KIT SUB-MODULE SUPPORT SHELF SYSTEM II

HP PART NUMBER 1494-0041

CONTENTS

| QTY. | | PART NO. |
|-------------|--|-----------|
| 1 PR. | SLIDE ASSEMBLY | 1494-0041 |
| 8 | #8-32 x ¼ PAN HEAD SCREW | |
| 8 | #8-32 NUT W/LOCKWASHER | 2580-0006 |
| 8 | #10-32 x 7/16 PAN HEAD SCREW | |
| 8 | #10-32 UNISTRUT NUT | 0590-0678 |

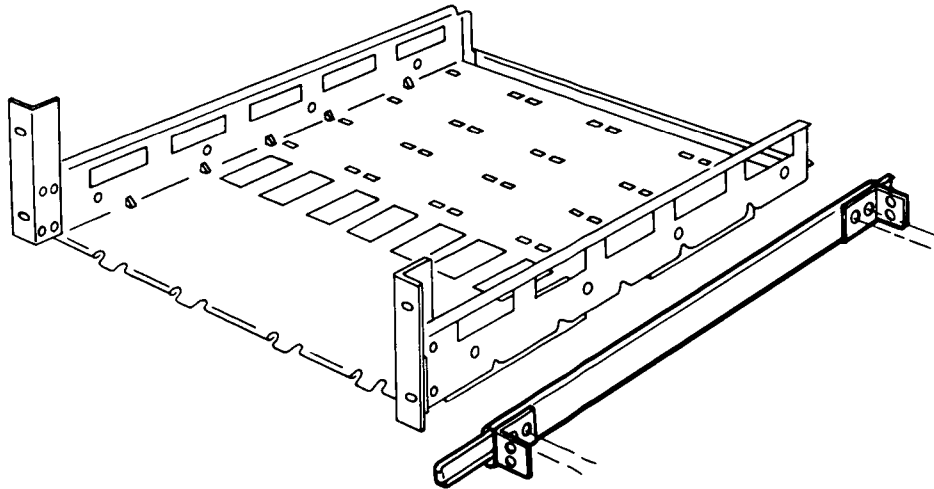

INSTRUCTIONS

1. ATTACH SLIDE (INNER MEMBER) TO EACH SIDE OF SUPPORT SHELF USING 4 # 8-32 x ¼ P.H. SCREWS AND NUTS PER SIDE.
2. INSERT 2 UNISTRUT NUTS IN THE REAR OF EACH OF THE 4 VERTICAL COLUMNS OF THE H.P. SYSTEMS ENCLOSURE.
3. ATTACH SLIDE (OUTER MEMBER) TO EACH SIDE OF SYSTEMS ENCLOSURE USING 4 #10-32 x 7/16 P.H. SCREWS PER SIDE.

LABEL NO.5955-3358



LOCK LINK KIT VERTICAL AND HORIZONTAL

HP PART NUMBER 5061-0094

THE VERTICAL AND HORIZONTAL LOCK LINK HARDWARE IS USED FOR LOCKING TOGETHER VARIOUS BENCH AND RACK MOUNTABLE COMBINATIONS OF FULL AND SUB MODULE CABINETS OF EQUAL DEPTHS. SUFFICIENT HORIZONTAL LINKS (12 FRONT, 6 REAR), TO FORM THREE SIDE BY SIDE JOINTS (UP TO 4 SUB MODULE INSTRUMENTS), AND SUFFICIENT VERTICAL LINKS (4 FRONT, 4 REAR) TO FORM TWO SETS OF OVER-UNDER JOININGS.*

CONTENTS

| QTY | | PART NO. |
|----------|--|-----------|
| 4 . . . | VERTICAL LOCK LINK, FRONT | 1600-0367 |
| 8 . . . | #6-32 x 3/16 PAN HEAD | 2360-0330 |
| 4 . . . | VERTICAL LOCK LINK, REAR | 0050-0517 |
| 8 . . . | #6-32 x 7/16 FLAT HEAD (100) PLASTIC MOD. | 2360-0360 |
| 8 . . . | #6-32 x 5/16 FLAT HEAD (100) METAL MOD. | 2360-0334 |
| 12 . . . | HORIZONTAL LOCK LINK, FRONT | 0050-0515 |
| 12 . . . | #8-32 x 1/4 FLAT HEAD (100) | 2510-0192 |
| 6 . . . | HORIZONTAL LOCK LINK, REAR | 0050-0516 |
| 12 . . . | #6-32 x 7/16 FLAT HEAD (100) PLASTIC MOD. | 2360-0360 |
| 12 . . . | #6-32 x 5/16 FLAT HEAD (100) METAL MOD. | 2360-0334 |

INSTRUCTIONS

Vertical Locking

1. REMOVE TOP TRIM STRIP FROM BOTTOM FRONT FRAME.
2. ATTACH FRONT VERTICAL LOCK LINKS TO BOTTOM FRONT FRAME USING 2 #6-32 PAN HD. SCREWS PER LINK.
3. SLIDE TOP CABINET BACK TO LOCK FRONT FRAMES TOGETHER.
4. ATTACH REAR VERTICAL LOCK LINKS OVER APPROPRIATE REAR BOSSES USING 2 #6-32 F.H.M. SCREWS PER LINK.

Horizontal Locking

1. REMOVE APPROPRIATE SIDE TRIM STRIPS.
2. ATTACH FRONT HORIZONTAL LOCK LINKS TO FRONT FRAMES USING 1 #8-32 F.H.M. SCREW PER LINK. OPPOSING LINKS MUST BE INSTALLED TO INTERLOCK.
3. PRESS CABINETS TOGETHER, SLIDE LEFT CABINET BACK TO LOCK FRONT FRAMES.
4. ATTACH REAR HORIZONTAL LOCK LINKS OVER APPROPRIATE REAR BOSSES, USING 2 #6-32 F.H.M. SCREWS PER LINK.

*LOCKING CABINET TOGETHER HORIZONTALLY IN A CONFIGURATION WIDER THAN 1 FULL MODULE WIDTH OR LOCKING MORE THAN TWO SUB MODULES VERTICALLY IS NOT RECOMMENDED.

LABEL NO. 5955-0438

FRONT LOCK LINKS 

REAR LOCK LINKS 

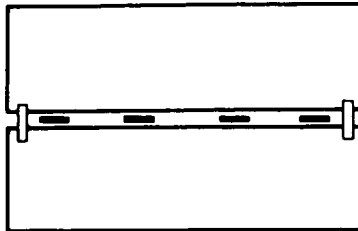

- VERTICAL LOCK LINKS FRONT
- VERTICAL LOCK LINKS REAR

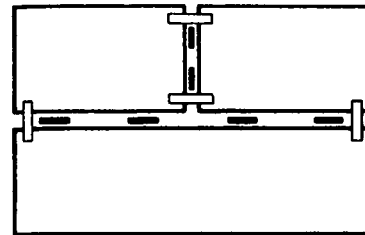

- 4 - VERTICAL LOCK LINKS FRONT
- 2 - VERTICAL LOCK LINKS REAR
- 4 - HORIZONTAL LOCK LINKS FRONT
- HORIZONTAL LOCK LINKS REAR

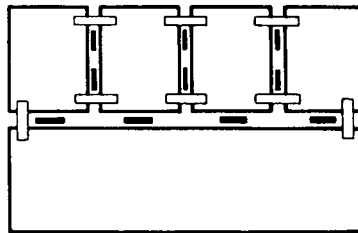

- 4 - VERTICAL LOCK LINKS FRONT
- 2 - VERTICAL LOCK LINKS REAR
- 12 - HORIZONTAL LOCK LINKS FRONT
- 6 - HORIZONTAL LOCK LINKS REAR

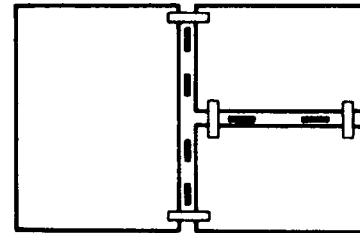

- 2 - VERTICAL LOCK LINKS FRONT
- 2 - VERTICAL LOCK LINKS REAR
- 8 - HORIZONTAL LOCK LINKS FRONT
- 2 - HORIZONTAL LOCK LINKS REAR

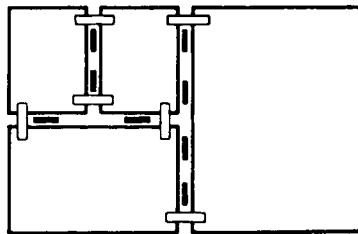

- 2 - VERTICAL LOCK LINKS FRONT
- 2 - VERTICAL LOCK LINKS REAR
- 12 - HORIZONTAL LOCK LINKS FRONT
- 4 - HORIZONTAL LOCK LINKS REAR

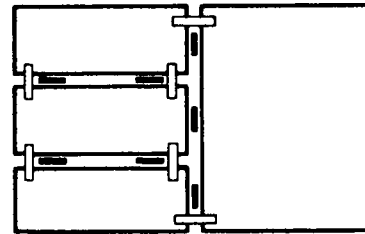

- 4 - VERTICAL LOCK LINKS FRONT
- 4 - VERTICAL LOCK LINKS REAR
- 6 - HORIZONTAL LOCK LINKS FRONT
- 2 - HORIZONTAL LOCK LINKS REAR

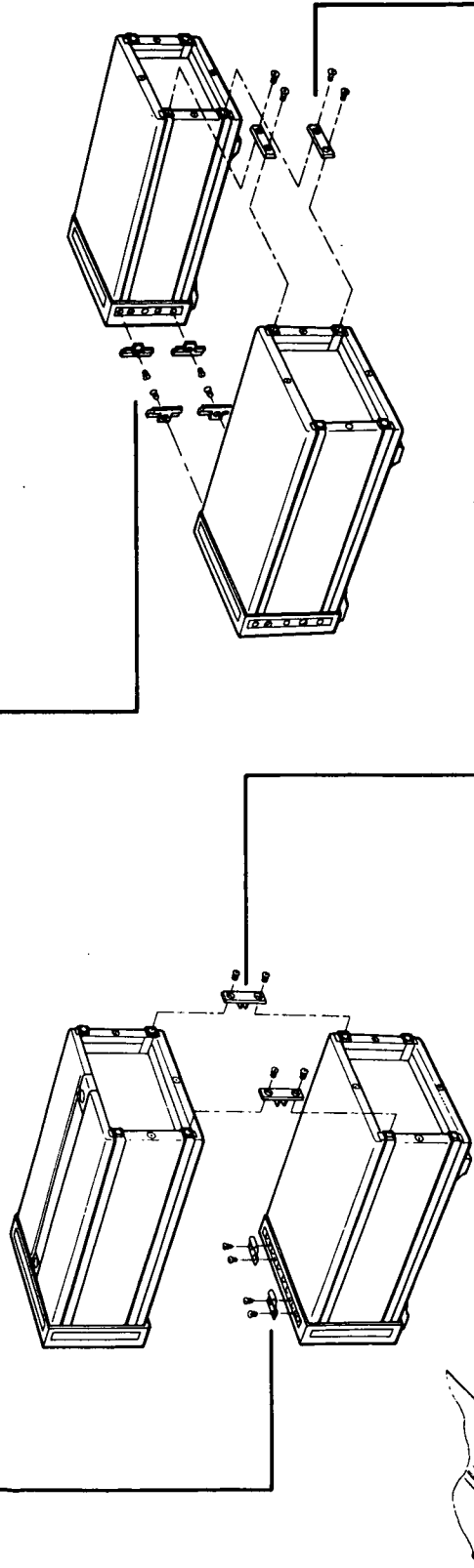
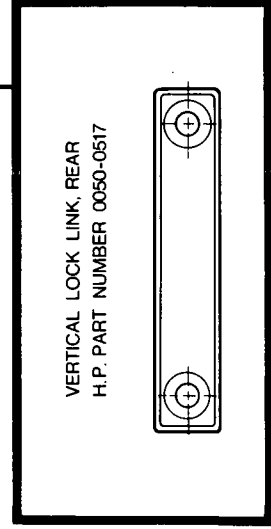
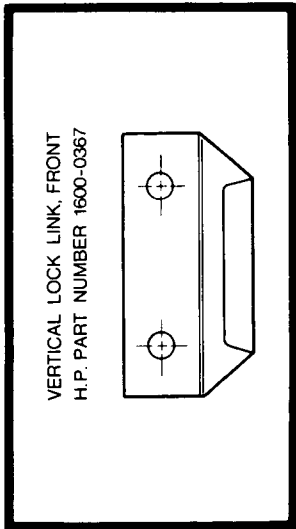
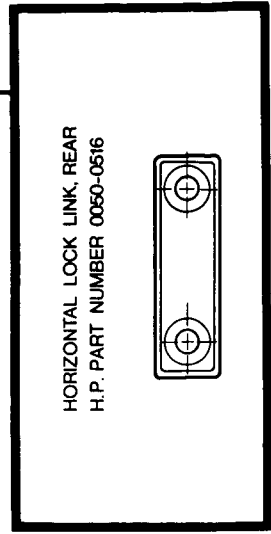
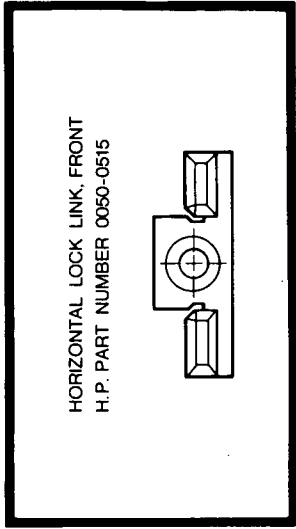

5¹/₄H BAIL HANDLE KIT HALF MODULE

[PRODUCT HT. 132.6mm / 5.219 in.]

HP PART NUMBER 5061-2002

CONTENTS

| QTY. | | PART NO. |
|-------------|--------------------------------|-----------|
| 1 | BAIL HANDLE ASS'Y | 5061-0036 |
| 2 | BAIL HANDLE ADAPTER | 5040-7217 |
| 2 | BAIL HANDLE RETAINER | 5040-7216 |
| 2 | #8-32 x 5/8 SCREW | 2510-0194 |
| 2 | SPACER | 0380-0004 |

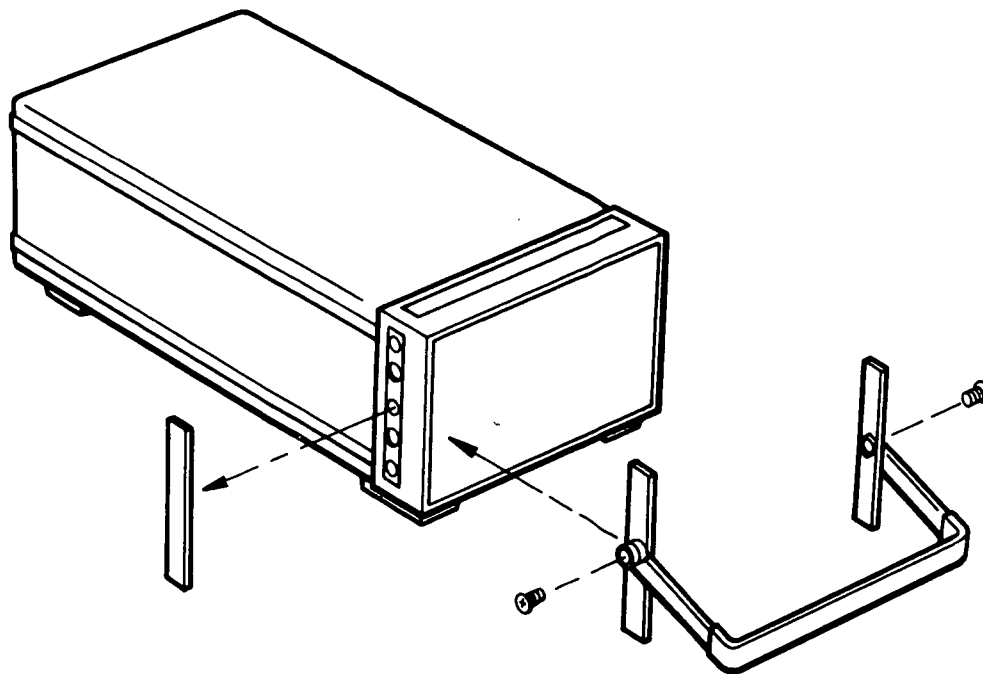

INSTRUCTIONS

1. REMOVE SIDE TRIM STRIPS.
2. ATTACH HANDLE ASSEMBLY WITH 1 SCREW PER SIDE.

LABEL NO. 5955-0442

FEET-REAR PANEL STAND-OFF FULL & SUB MODULES

HP PART NUMBER 5061-2009

CONTENTS

| QTY. | | PART NO. |
|-------------|----------------------------------|-----------|
| 4 | FOOT-REAR PANEL STAND-OFF . . . | 5040-7221 |
| 4 | #6-32 x 5/16 PAN HD. SCREW . . . | 2360-0195 |

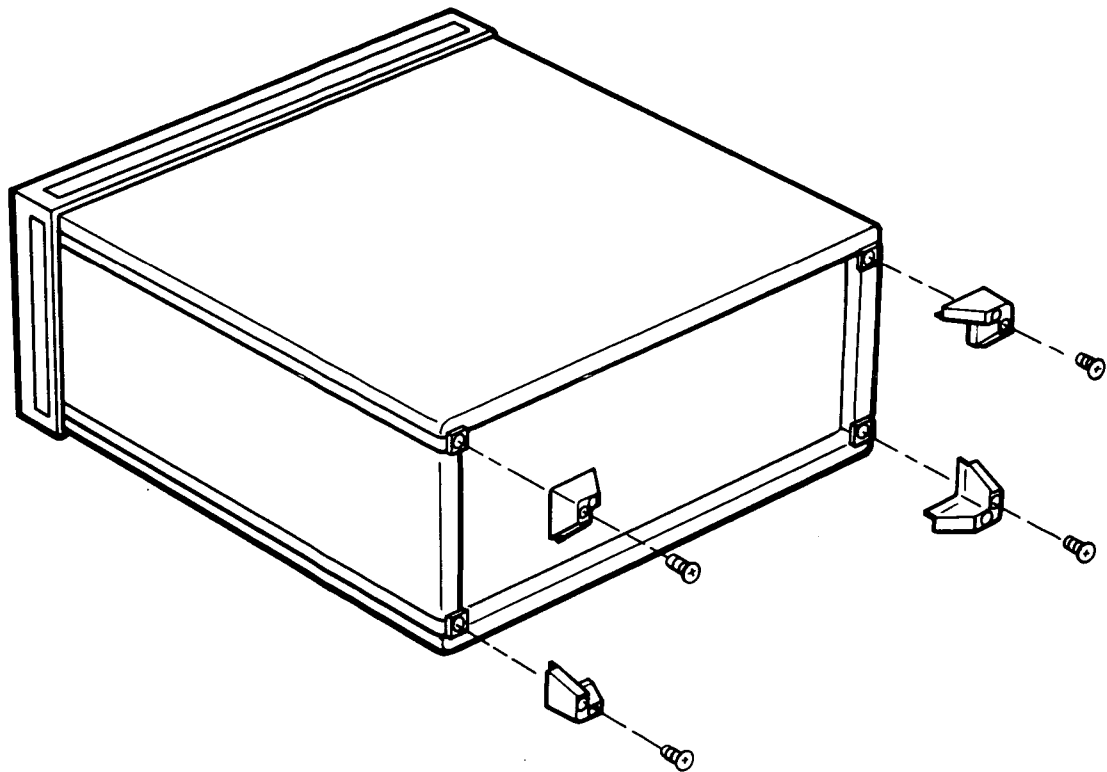

INSTRUCTIONS

1. PLACE ONE FOOT OVER EACH CORNER BOSS ON REAR CASTING AND SECURE WITH 1 SCREW.

LABEL NO. 5955-0440

FEET-REAR & CORD WRAP SUB MODULES

HP PART NUMBER 5061-0095

CONTENTS

| QTY. | | PART NO. |
|-------------|-----------------------------------|-----------|
| 4 | FOOT—REAR & CORD WRAP | 5040-7213 |
| 4 | #6-32 x 1 PAN HD. SCREW | 2360-0209 |

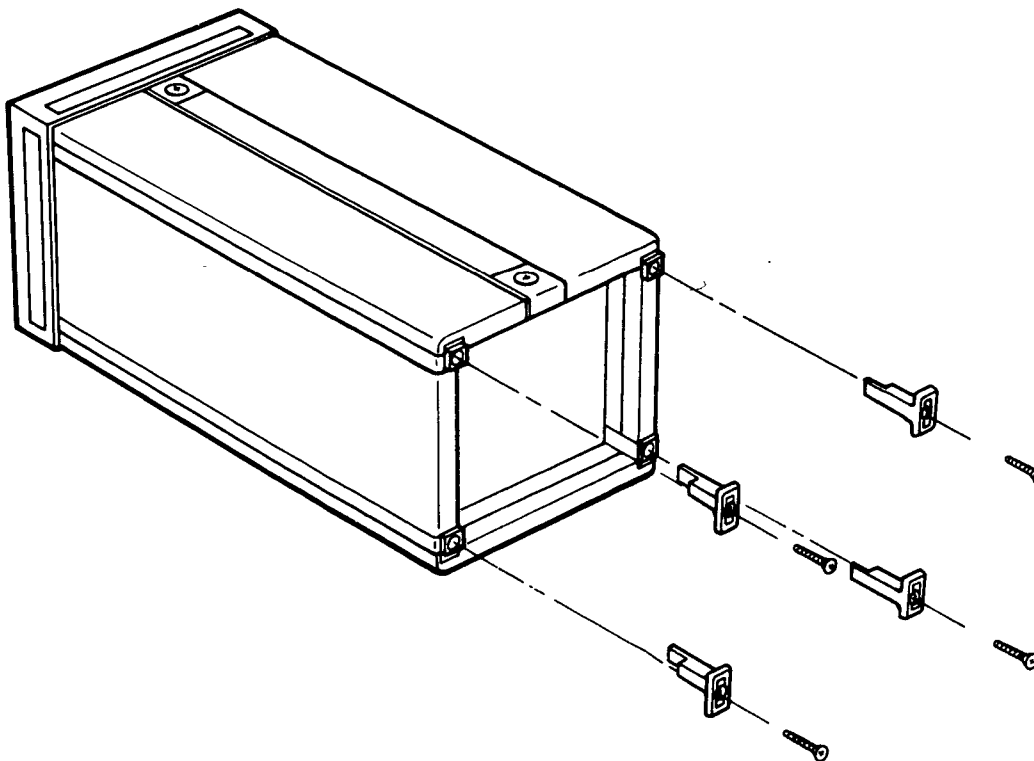

INSTRUCTIONS

1. PLACE ONE FOOT OVER EACH CORNER BOSS ON REAR CASTING AND SECURE WITH 1 SCREW.

LABEL NO. 5955-0446

SECTION III OPERATION

3-1. INTRODUCTION

This section contains a front and rear panel overview, error code listing and an HP-IB Summary. The Operating and Programming Manual should be used for detailed operating information.

Table 3-1. Error Codes With Status Byte Bit #

| Error # | Definition | Status Byte bit # |
|---------|--|----------------------|
| 00 | No Error (used via HP-IB, only) | |
| | --- OPERATOR ERRORS (non-ARB) --- | |
| 01 | Frequency/Symmetry conflict | 0 |
| 02 | Bus address entry error | 0 |
| 03 | Front panel failure/Invalid keycode | 0 |
| 04 | Calibration measurement not performed | 1 |
| 05 | Allowed in sweep, only | 0 |
| 06 | Not allowed in sweep | 0 |
| 07 | Not allowed in log sweep | 0 |
| 08 | Store 0 not allowed | 0 |
| 09 | Non-volatile memory lost;battery down | 0 |
| | --- OPERATOR ERRORS (ARB) --- | |
| 10 | Vector insert not allowed | 0 |
| 11 | Vector delete not allowed | 0 |
| 18 | Allowed in ARB, only | 0 |
| 19 | Not allowed in ARB | 0 |
| | --- PLL ERRORS --- | |
| 20 | Unstable input frequency | 1 |
| 21 | Input frequency outside of acquisition range | 1 |
| 22 | 3314A output frequency would be out of range | 1 |
| 23 | SW/TR INTVL > 20ms | 1 |
| 24 | Internal phase locked loop, unlocked | 0 |
| | --- FREQUENCY CALIBRATION ERRORS --- | |
| 30 | No frequency detected | 0 |
| 31 | Frequency error exceeds correction capability | 0 |
| 32 | Frequency unstable during calibration | 0 |
| | --- AMPLITUDE CALIBRATION ERRORS --- | |
| 34 | Signal amplitude outside measurement range | 0 |
| 35 | Signal amplitude gain too high | 0 |
| 36 | Signal amplitude gain too low | 0 |
| 37 | Signal amplitude gain exceeds correction capability | 0 |
| 38 | Signal amplitude gain offset exceeds correction capability | 0 |
| | --- HP-IB ERRORS --- | |
| 41 | Mnemonic invalid | 0 |
| 42 | Definition number invalid | 0 |
| 43 | Data invalid | 0 |
| 44 | Units invalid | 0 |
| 45 | Range Hold not allowed | 0 |
| 46 | ARB/SWEEP parameter conflict | 0 |
| 47 | Not allowed in MAN Sweep | 0 |
| | --- OVERLOAD --- | |
| 50 | AM or FM/VCO input voltage exceeds normal operating limits | 1 |
| 51 | Output voltage exceeds safe operating limits; | 3 |

HP-IB PROGRAMMING SUMMARY

HP-IB Address

The 3314A's HP-IB address is set at the factory to 7. To view the current HP-IB address, press the BLUE shift key and then the LOCAL key. To change the HP-IB address, press the RECALL and then the LOCAL keys, rotate the TUNING KNOB until the desired address is displayed and then press the STORE and LOCAL keys. Listen Only is set by incrementing the address past 30.

3314A Programming Codes

| 3314A Function | HP-IB Codes | | Format Of Returned Data | 3314A Function | HP-IB Codes | | Format of Returned Data |
|---|----------------------------------|-------|---|--|---------------------------------------|-------|--|
| | Program | Query | | | Program | Query | |
| Amplitude milli-Volt p-p Volt p-p | AP MV VO | QAP | AP 00000ddd.ddVO or AP 000000d.dddVO or AP 000000.dddVO or AP 00000.0dddVO | Preset | PR | | |
| Ampl Modulation OFF ON | AM 0 1 | QAM | AMd | Range Down | RD | | |
| ARB OFF ON ON/Clear Wave | AR 0 1 2 | QAR | ARd | Range Hold OFF DC Offset Amplitude Frequency | RH 0 1 to 2 1 to 4 1 to 8 | | |
| Calibrate All | CA | | | Range Up | RU | | |
| Calibrate Disable | CD | | | Recall (non-ARB) Register | RC 0 to 5 | | |
| Calibrate Enable | CE | | | Recall Wave (ARB) ARB ON and recall Wave | RW 0 to 5 | QRW | RWd |
| Calibrate Freq | CF | | | SRQ Mask, bits 0-3 Mask | ML @ to 0 | | |
| Data Transfer Mode Unbuffered 96 Byte Buffer | DM 1 2 | | | SRQ Mask, bits 4-7 Mask | MH @ to 0 | | |
| Delete Vector | DV | | | Start Frequency Hertz kilo-Hertz Mega-Hertz | ST HZ KZ MZ | QST | ST 00000000.HZ or ST 00000000.dHZ or ST 00000000.ddHZ or ST 0000000.dddHZ |
| Δ t milli-Seconds Seconds | DT MS SN | QDT | DT 00000.00000SN or DT 0000.00000SN | Stop Frequency Hertz kilo-Hertz Mega-Hertz | SP HZ KZ MZ | QSP | SP 00000000.HZ or SP 00000000.dHZ or SP 00000000.ddHZ or SP 0000000.dddHZ |
| Display Errors OFF ON | DE 0 1 | | | Store (non-ARB) Register | SO 1 to 5 | | |
| Error Codes | | QER | ERdd | Sweep OFF Linear Log | SW 0 1 2 | QSW | SWd |
| Frequency Hertz kilo-Hertz Mega-Hertz | FR HZ KZ MZ | QFR | FR 00000000.HZ or FR 00000000.dHZ or FR 00000000.ddHZ or FR 0000000.dddHZ | Sweep Status Mask (bit 5 of Status Byte) Masked = 1 at Start = 1 at Stop = 1 either | SM 0 1 2 3 | | |
| Freq Modulation OFF ON | FM 0 1 | QFM | FMd | Symmetry Percent | SY PC | QSY | SY 00000000.PC |
| Function Invert OFF ON | FI 0 1 | QFI | FI d | Sweep/Trig Interval milli-Seconds Seconds | TI MS SN | QTI | TI 00000000.SN or TI 00000000.dSN or TI 00000000.ddSN or TI 0000000.dddSN or TI 000000.dddSN or TI 00000.0dddSN or TI 0000.00dddSN |
| Function OFF Sine Square Triangle Insert Vector | FU 0 1 2 3 IV | QFU | FU d | Trigger Level 1V Threshold 0V Threshold | LV 1 2 | QLV | LVd |
| Manual Sweep OFF ON | MA 0 1 | QMA | MA d | Trigger Slope Positive Negative | SL 1 2 | QSL | SLd |
| Manual Trigger | MN | | | Trigger Source Internal External | SR 1 2 | QSR | SRd |
| Marker Frequency Hertz kilo-Hertz Mega-Hertz | MK HZ KZ MZ | QMK | MK 00000000.HZ or MK 00000000.dHZ or MK 00000000.ddHZ or MK 0000000.dddHZ | VCO OFF ON | VC 0 1 | QVC | VCd |
| Mode Free Run Gate N Cycle 1/2 Cycle Fin X N Fin + N | MO 1 2 3 4 5 6 | QMO | MO d | Vector Height Enter | VH EN | QVH | VHs000000000.HZ |
| N Enter | NM EN | QNM | NM 0000000000.EN | Vector Length Enter | VL EN | QVL | VL 0000000000.HZ |
| Offset Volts DC | OF VO | QOF | OFs0000000000.ddVO or OFs00000000.dddVO | Vector Marker Enter | VM EN | QVM | VM 0000000000.HZ |
| Phase degree | PH DG | QPH | PHs0000000000.dDG PHASE | | | | |
| PLL Status Mask (bit 5 of Status Byte) Masked = 1 at Lock = 1 at Unlock = 1 either | PM 0 1 2 3 | | | | | | |

d = ASCII digits 0 to 9.
s = sign bit, ASCII space or -
All other characters are exactly as shown.
All returned data is followed by an ASCII carriage return and line feed with HP-IB EOI true, concurrent with the line feed.

HP-IB PROGRAMMING SUMMARY (cont)

Status Byte

Bits of the Status Byte are set (1) only after unmasking that bit and the condition is met. All bits are reset immediately after the Status Byte is sent.

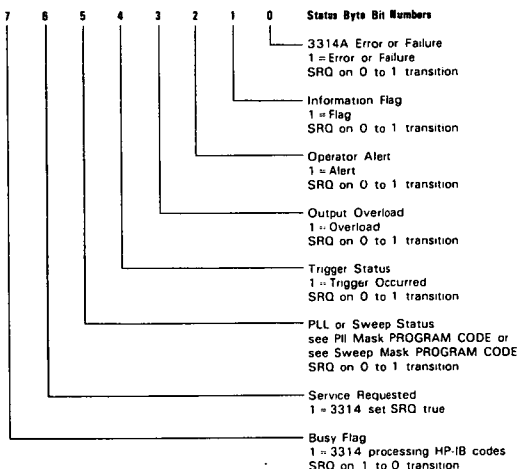

Unmasking The Status Byte

The 3314A will Request Service (SRQ line true) when a bit of the Status Byte is unmasked and the operating condition to set that bit exists. Masking is not affected by PRESET or CLEAR 7. All bits except bit 7 will set SRQ at the 0 to 1 logic transition. Bit 7 will set SRQ at the 1 to 0 logic transition and is useful when using Data Transfer Mode 2, indicating when the 3314A is ready to be programmed again.

| ML | 3 | 2 | 1 | 0 | Bit Number | MH | 7 | 6 | 5 | 4 | Bit Number |
|----|----------|----------|----------|----------|------------|----|----------|---|----------|----------|------------|
| @ | MASKED | MASKED | MASKED | MASKED | | @ | MASKED | | MASKED | MASKED | |
| A | MASKED | MASKED | MASKED | UNMASKED | | A | MASKED | | MASKED | UNMASKED | |
| B | MASKED | MASKED | UNMASKED | MASKED | | B | MASKED | | UNMASKED | MASKED | |
| C | MASKED | MASKED | UNMASKED | UNMASKED | | C | MASKED | | UNMASKED | UNMASKED | |
| D | MASKED | UNMASKED | MASKED | MASKED | | D | MASKED | | MASKED | MASKED | |
| E | MASKED | UNMASKED | MASKED | UNMASKED | | E | MASKED | | MASKED | UNMASKED | |
| F | MASKED | UNMASKED | UNMASKED | MASKED | | F | MASKED | | UNMASKED | MASKED | |
| G | MASKED | UNMASKED | UNMASKED | UNMASKED | | G | MASKED | | UNMASKED | UNMASKED | |
| H | UNMASKED | MASKED | MASKED | MASKED | | H | UNMASKED | | MASKED | MASKED | |
| I | UNMASKED | MASKED | MASKED | UNMASKED | | I | UNMASKED | | MASKED | UNMASKED | |
| J | UNMASKED | MASKED | UNMASKED | MASKED | | J | UNMASKED | | UNMASKED | MASKED | |
| K | UNMASKED | MASKED | UNMASKED | UNMASKED | | K | UNMASKED | | UNMASKED | UNMASKED | |
| L | UNMASKED | UNMASKED | MASKED | MASKED | | L | UNMASKED | | UNMASKED | MASKED | |
| M | UNMASKED | UNMASKED | MASKED | UNMASKED | | M | UNMASKED | | MASKED | UNMASKED | |
| N | UNMASKED | UNMASKED | UNMASKED | MASKED | | N | UNMASKED | | UNMASKED | MASKED | |
| O | UNMASKED | UNMASKED | UNMASKED | UNMASKED | | O | UNMASKED | | UNMASKED | UNMASKED | |

Error Codes

| ER # | Definition | Status Byte Bit # | ER # | Definition | Status Byte Bit # |
|------|---|-------------------|------|--|-------------------|
| 00 | No errors since errors were last queried (HP-IB function, only) | | | --- FREQUENCY CALIBRATION ERRORS --- | |
| | --- OPERATOR ERRORS (non-ARB) --- | | 30 | No frequency detected | 0 |
| G1 | Frequency/Symmetry conflict | 0 | 31 | Frequency error exceeds correction capability | 0 |
| O2 | Bus address entry error | 0 | 32 | Frequency unstable during calibration | 0 |
| O3 | Front panel key failure | 0 | | --- AMPLITUDE CALIBRATION ERRORS --- | |
| O4 | Calibration measurements not performed | 1 | 34 | Signal amplitude outside measurement range | 0 |
| O5 | Allowed in sweep, only | 0 | 35 | Signal amplitude gain too high | 0 |
| O6 | Not allowed in sweep | 0 | 36 | Signal amplitude gain too low | 0 |
| O7 | Not allowed in log sweep | 0 | 37 | Signal amplitude gain out of limit | 0 |
| O8 | Store 0 not allowed | 0 | 38 | Signal amplitude gain offset out of limit | 0 |
| O9 | Non-volatile memory lost; battery down | 0 | | --- HP-IB ERRORS --- | |
| | --- OPERATOR ERRORS (ARB) --- | | 41 | Mnemonic invalid | 0 |
| 10 | Vector insert not allowed | 0 | 42 | Definition number invalid | 0 |
| 11 | Vector delete not allowed | 0 | 43 | Data invalid | 0 |
| 18 | Allowed in ARB, only | 0 | 44 | Units invalid | 0 |
| 19 | Not allowed in ARB | 0 | 45 | Range Hold not allowed | 0 |
| | --- PLL ERRORS --- | | 46 | ARB/SWEEP parameter conflict | 0 |
| 20 | Unstable input frequency | 1 | 47 | Not allowed in Manual Sweep | 0 |
| 21 | Input frequency outside of capture range | 1 | | --- OVERLOAD --- | |
| 23 | Internal interval > 20ms | 1 | 50 | AM or FM/VCO input voltage exceeds normal operating limits (HP-IB) function only | 1 |
| 24 | Internal synthesis unlocked | 0 | 51 | Output voltage exceeds safe operating limits, 3314A has disconnected itself | 3 |

SECTION IV

PERFORMANCE TESTS

4-1. INTRODUCTION

The following tests are designed to compare various 3314A parameters to their given specifications, in order to determine the functional accuracy of the instrument. Test data can be entered on the Performance Test Record located at the end of this section. The test record which contains the tested specifications and acceptable limits, may be copied without written permission from the Hewlett-Packard Co.

The following Performance tests include:

- Frequency Accuracy.....4-2
- Time Axis and Variable Symmetry.....4-3
- Internal Trigger Accuracy.....4-4
- Triangle Linearity.....4-5
- Start/Stop Phase Accuracy.....4-6
- Residual DC and DC Offset Accuracy.....4-7
- Square Wave Rise Time and Overshoot.....4-8
- Sine Wave Harmonics.....4-9
- AM Harmonics.....4-10
- VCO Linearity.....4-11
- Phase Locked Loop Phase Accuracy.....4-12
- Amplitude Accuracy.....4-13
- Sine Wave Power Flatness.....4-14
- Manual Sweep Accuracy.....4-15
- Step Attenuator Accuracy.....4-16
- Vernier Attenuator Flatness.....4-17

When "PRESET" is pressed on the 3314A, the instrument defaults to the following conditions:

- MODE -- Free Run
- FREQ -- 1kHz
- AMPTD -- 100mVp-p
- OFFSET -- 0VDC
- SYM -- 50%
- TRIGGER SLOPE -- Positive
- TRIGGER LEVEL -- 1Vp-p
- TRIGGER SOURCE -- Internal
- PHASE -- 0°
- N -- 1
- SW/TR INTVL -- 10ms
- START FREQ -- 1kHz
- STOP FREQ -- 10kHz
- MKR -- 5kHz

NOTE

The following tests were developed using the listed equipment. Similar equipment with equal or better performance may be used, however, the operator will be responsible for determining whether or not his or her results are accurate.

4-2. FREQUENCY ACCURACY TEST

This is a test to verify the accuracy of the 3314A output signal frequency.

Specification:

- Range 1,2: $\pm(0.4\%$ of setting + 0.2% of range)
- Range 3,4,5,6,: $\pm(0.2\%$ of setting + 0.1% of range)
- Range 7,8: $\pm(0.01\%$ of setting + 50ppm/year)

Equipment Required:

- hp- 5328A Universal Counter
- hp- 11048C 50 Ohm Feedthrough Termination

Procedures:

- A. Preset the 3314A.
- B. Set the 3314A as follows:

- Amplitude 1Vp-p
- Frequency 19.99MHz
- Frequency Range Hold On

C. Set the Counter as follows:

- Function Freq A
- Resolution 1Hz
- Input Attenuation x1
- Coupling DC
- Channel Input Sep

D. Connect the output of the 3314A to the Counter input (see Figure 4-1).

E. Record the Counter frequency to 4 significant digits in the test record. Compare this value to the limits given in part A of Table 4-2 for the frequency setting of 19.99MHz.

F. Using the Range Down function, decrement the frequency of the 3314A to the settings listed in part A of Table 4-2, recording the measured value in the test record.

NOTE

In order to measure the 199.9Hz frequency setting, set the resolution of the counter to 0.1Hz.

G. Using the Modify Knob only, set the frequency of the 3314A to 00.1Hz.

H. Set the Counter to "Per A" and the resolution to 1kHz.

I. Measure the period of the 00.1Hz signal. Take the reciprocal of that value and compare the result to the limits shown in part B of Table 4-2 for the 00.1Hz setting.

J. Set the Counter function to "Freq A" and the resolution to 0.1Hz.

Table 4-1. Recommended Equipment List

| Instrument | Critical Specs | Recommended Model |
|------------------------------------|---|----------------------------------|
| Electronic Counter | Freq Measurement to 20MHz. Accuracy ± 2 counts. Resolution 8 Digits. | -hp- 5328A |
| High Speed Digital Voltmeter | DC Voltage 0V-10V Sample/Hold Measurement. External Trigger: Low True TTL Edge Trigger, Trigger Delay: Selectable, 10us to 140us. | -hp- 3437A |
| Synthesizer/ Function Generator | Sine Output: 1kHz. Amplitude: 1VRMS into 10k Ω . | -hp- 3325A |
| VHF Attenuator (see note 1) | Atten: 100dB in 10dB steps, Freq Range 50Hz to 20MHz, Impedance 50 Ω . | -hp- 355D |
| Spectrum Analyzer | Freq Range 40MHz to 120MHz. Amplitude Accuracy: ± 0.5 dB. | -hp- 8557A |
| Spectrum Analyzer | Freq Range 20Hz to 40MHz. Amplitude Accuracy: ± 0.5 dB. | -hp- 3585A |
| Thermal Converter | Input Impedance 50 Ohms, Input Voltage 0.5VRMS. Freq: 2kHz to 20MHz. Freq Response: ± 0.05 dB. | -hp- 11049A |
| AC/DC Digital Voltmeter | DC Function: Acc. $\pm 0.05\%$, AC Function: True RMS, Acc. $\pm 0.2\%$. Resolution 6 Digits. | -hp- 3455A |
| Resistor | 1Mohm $\pm 5\%$. | |
| Capacitor | 1uf | |
| Oscilloscope | Vertical BW DC to 100MHz, Deflection 0.01V to 10V/Div. Horizontal Sweep: 0.05us to 1s/Div. x10 Mag Delayed Sweep. | -hp- 1725A |
| Power Supply | Volts: -8VDC to +2VDC. Amps: 10mA. | -hp- 6235A |
| BNC Tee Adaptor | Male Female Female/ BNC to Dual Banana Plug. | -hp- 1250-0781 -hp- 1250-2277 |
| BNC to Triax Adaptor | Female BNC to Male | -hp- 1250-0595 |
| 50 Ohm Load | Accuracy $\pm 0.2\%$. Power Rating: 1w. | -hp- 11048C |
| | Note 1: Variable Attenuator must be characterized. | |

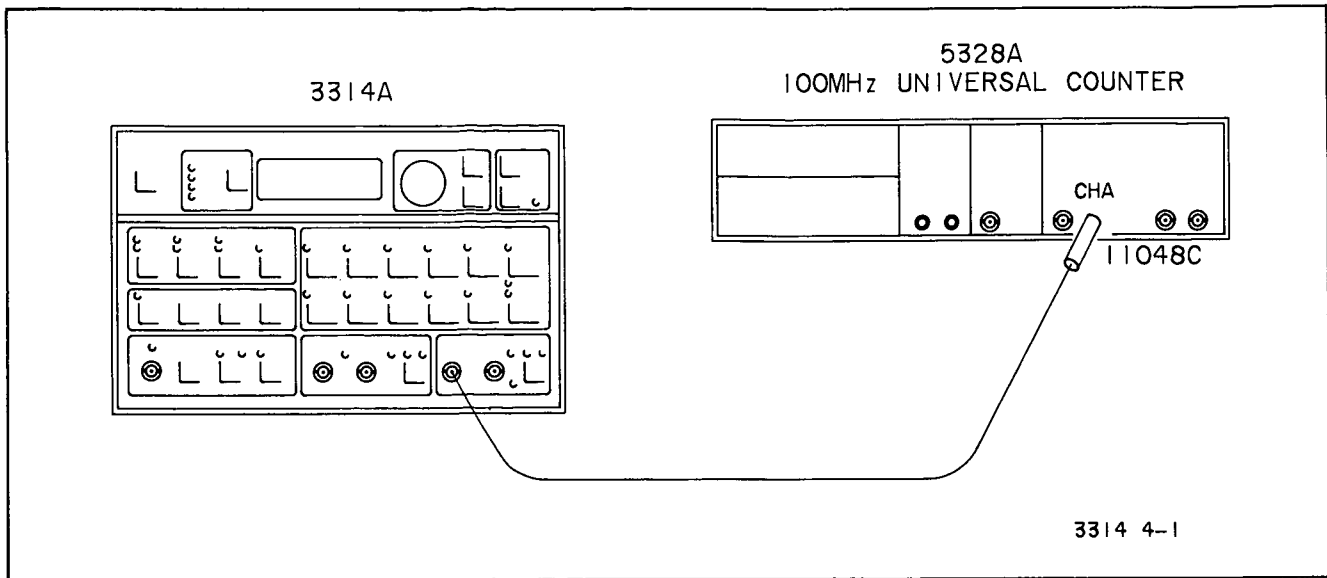

Figure 4-1. Frequency Accuracy Test

K. Using the Range Up function, increment the value of frequency displayed on the 3314A to the values listed in part B of Table 4-2, recording the measured value in the test record.

NOTE

Allow the Counter at least 15 seconds to stabilize and display the correct frequency measurement.

Table 4-2. Frequency Accuracy Measurement Parameters With Specified Limits

| 3314A Frequency Setting (A) | Upper Limit | Lower Limit |
|-----------------------------|-------------|-------------|
| 19.99MHz | 19.992MHz | 19.988MHz |
| 1999kHz | 1999.2kHz | 1998.8kHz |
| 199.9kHz | 200.5kHz | 199.3kHz |
| 19.99kHz | 20.05kHz | 19.93kHz |
| 1999.Hz | 2005Hz | 1993Hz |
| 199.9Hz | 200.5Hz | 199.3Hz |

| 3314A Frequency Setting (B) | Upper Limit | Lower Limit |
|-----------------------------|-------------|-------------|
| 00.1Hz | 0.3Hz | 0.0Hz |
| 001H | 3Hz | 0.0Hz |
| 0.01kHz | 30Hz | 00Hz |
| 00.1kHz | 300Hz | 0Hz |
| 001kHz | 1000.1Hz | 999.9Hz |
| 0.01MHz | 10.001kHz | 9.999kHz |

4-3. TIME AXIS AND VARIABLE SYMMETRY

This is a test to check the Symmetry function of the 3314A.

Specification:

| %Symmetry | Specification |
|-----------|----------------------|
| 50% | 50% ± 0.2% of period |
| 5% | 5% ± 0.5% of period |
| 95% | 95% ± 0.5% of period |

Equipment Required:

- hp- 5328A Universal Counter
- hp- 11048C 50 Ohm Feedthrough Termination

Procedures:

- A. Preset the 3314A.
- B. Set the 3314A as follows:

Function Square
 Frequency 100kHz
 Amplitude 10Vp-p
 Symmetry 50%

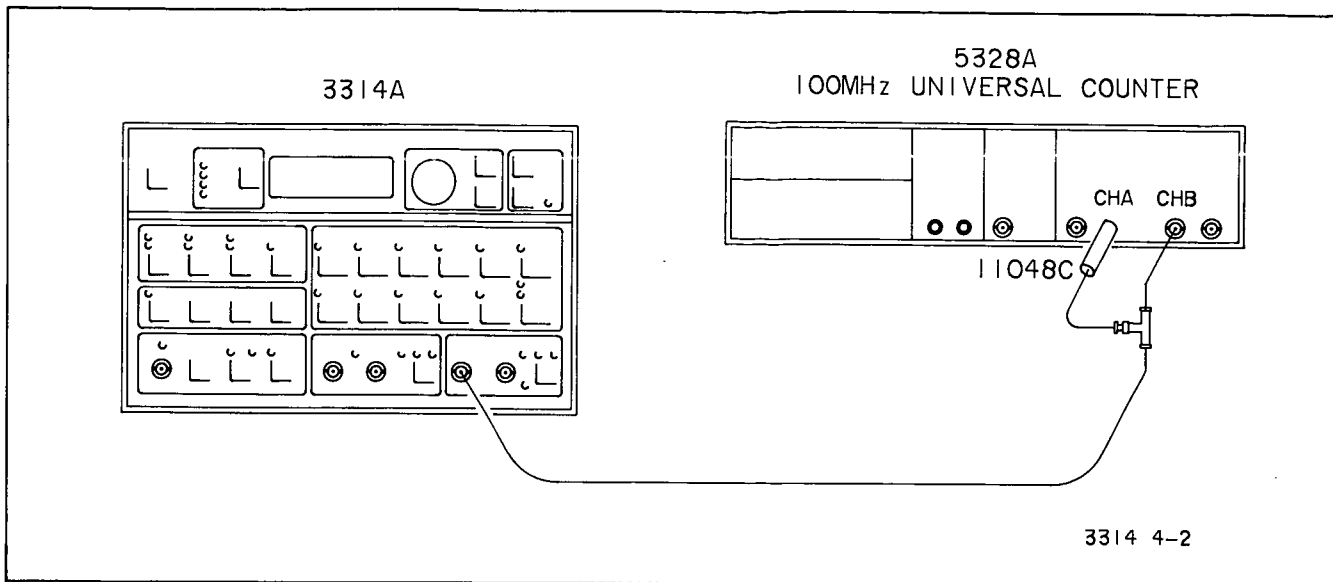

Figure 4-2. Time Axis and Variable Symmetry

C. Set the Counter as follows:

| | |
|-----------------------|-----------|
| Function | Per Avg A |
| Resolution | 0.1kHz |
| Attenuation | x10 |
| Channel A Slope | + |
| Channel B Slope | - |
| Coupling | DC |
| (Both Channels) | |
| Channel Input | Com |

D. Connect the 3314A to the Counter as shown in Figure 4-2.

E. Record the period of the 3314A Square Wave signal (t) displayed on the Counter.

F. Change the Counter function to "TI Avg A-B".

G. Record reading (t_1).

H. Calculate the percent of symmetry using the following equation and record in the test record:

$$\%Symmetry = (t_1/t)100\%$$

I. Adjust the symmetry on the 3314A to 5%, set the Counter function back to Period Avg A, and repeat steps E through H.

J. Adjust the symmetry on the 3314A to 95%, set the Counter function back to Period Avg A, and repeat steps E through H.

4-4. INTERNAL TRIGGER ACCURACY

This test measures the accuracy of the 3314A Internal Trigger Period.

Specification:

$$\pm 0.01\% \text{ of setting} + 50\text{ppm/year}$$

Equipment Required:

-hp- 5328A Universal Counter

Procedures:

A. Preset the 3314A.

B. Set the Counter as follows:

| | |
|---------------------|-----------|
| Function | Per Avg A |
| Resolution | 1MHz |
| Attenuation | x1 |
| Coupling | AC |
| Channel Input | Sep |

C. Connect the 3314A to the Counter as shown in Figure 4-3.

D. Record the measured value of the 3314A trigger period in the test record. The reading should be 10ms ± 0.001 ms.

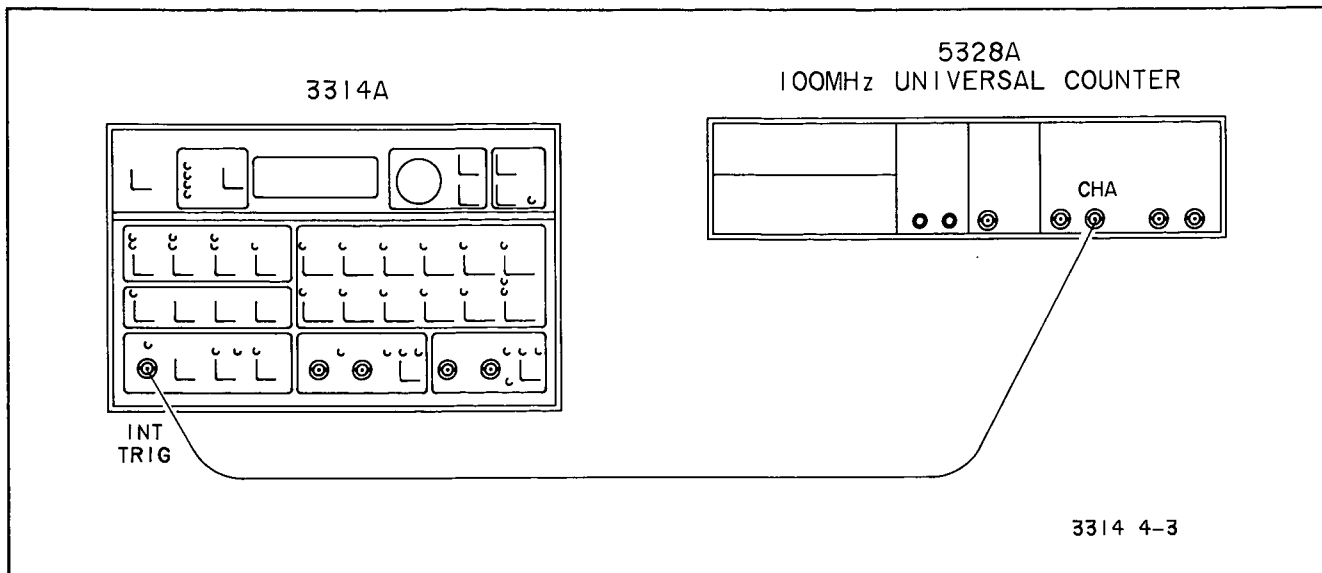

Figure 4-3. Internal Trigger Accuracy

4-5. TRIANGLE LINEARITY

This procedure determines the linearity of the 3314A Triangle wave at frequencies between 1Hz and 1kHz.

Specification:

±0.2%

Equipment Required:

- hp- 3437A High Speed Digital Voltmeter
- hp- 11048C 50 Ohm Feedthrough Termination
- hp- 1250-0595 Triax to BNC Connector

Procedures:

- A. Preset the 3314A.
- B. Set the 3314A as follows:

 Function Triangle
 Amplitude 10Vp-p
- C. Set the Digital Voltmeter as follows:

 Range 10V
 Trigger Ext
 Readings 1
 Delay 0.00055s

D. Connect the 3314A to the Voltmeter as shown in Figure 4-4.

E. Note the Digital Voltmeter reading. Record this value on the Performance Test Record under "Positive Slope Measurement". This is the 10% point on the positive slope of the Triangle (see Figure 4-5).

F. Increment the delay on the Digital Voltmeter to the values listed below. At each increment note and record the corresponding voltage under "Positive Slope Measurement" in the Performance Test Record. (Each increment represents a 10% segment of the positive slope.)

| Delay | Percent of Slope |
|---------|------------------|
| 0.00060 | 20 |
| 0.00065 | 30 |
| 0.00070 | 40 |
| 0.00075 | 50 |
| 0.00080 | 60 |
| 0.00085 | 70 |
| 0.00090 | 80 |
| 0.00095 | 90 |

G. Measurements for the negative slope of the Triangle wave are made by incrementing the delay on the voltmeter to the values listed below. Note and record the corresponding voltages under "Negative Slope Measurement" in the Performance Test Record.

| Delay | Percent of Slope |
|---------|------------------|
| 0.00105 | 90 |
| 0.0011 | 80 |
| 0.00115 | 70 |
| 0.0012 | 60 |
| 0.00125 | 50 |
| 0.0013 | 40 |
| 0.00135 | 30 |
| 0.0014 | 20 |
| 0.00145 | 10 |

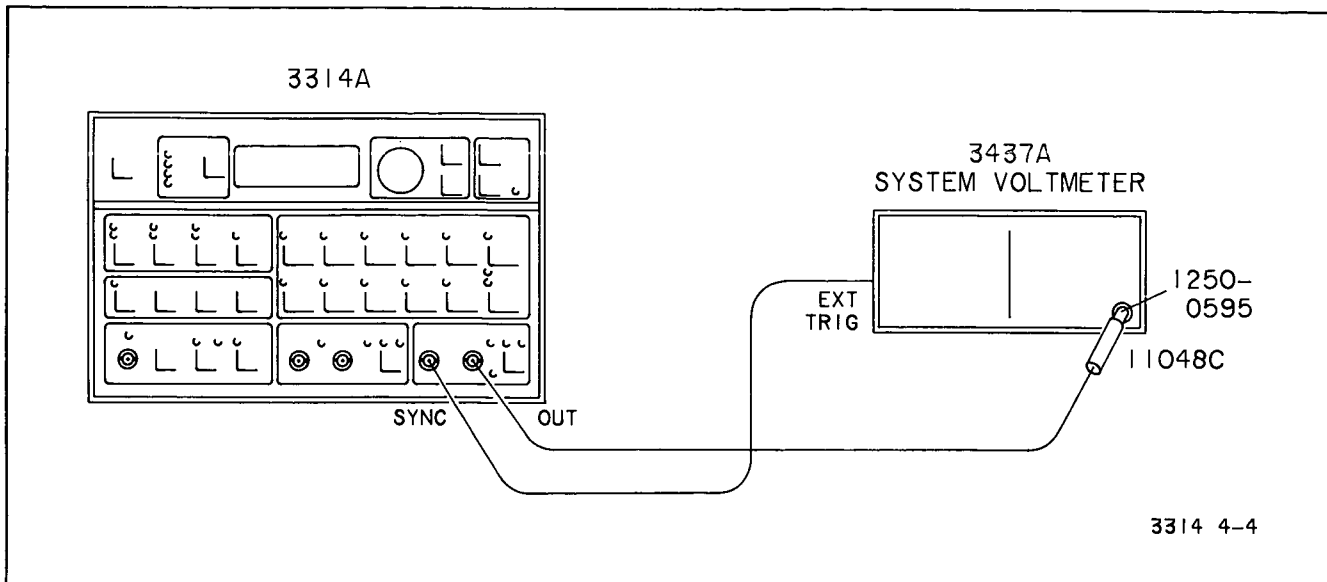

Figure 4-4. Triangle Linearity

H. Algebraically add the voltages recorded in the "Positive Slope Measurement" column and enter the total in the "Σy" space.

I. Multiply Σy by 45 (which is Σx) and enter the result in the ΣxΣy space.

J. Multiply each y value by the corresponding x value and enter the result in the "x Times y" column. Total these values and enter the result in the "Σxy" space.

K. The equation for determining the "best fit straight line" specification for each y value is:

$$y = mx + b$$

where m and b are constants to be calculated from data previously taken.

NOTE

Calculate the values of m and b to at least 5 decimal places.

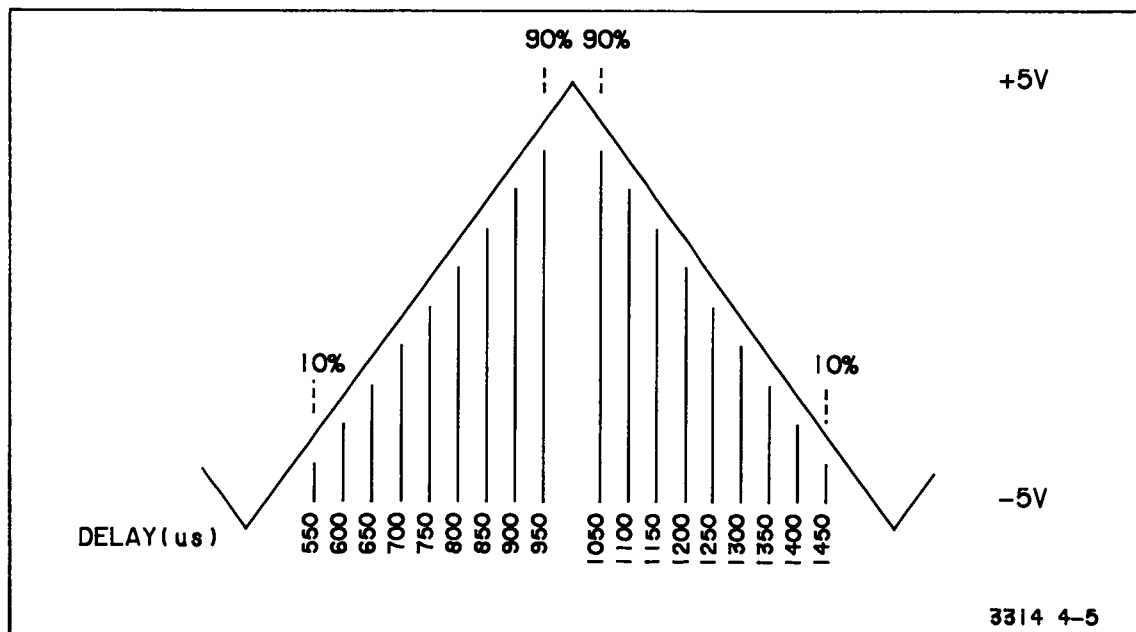

Figure 4-5. Triangle Linearity

L. Determine the value of m using the following equation:

$$m = \frac{\Sigma xy - \Sigma x \Sigma y / n}{\Sigma x^2 - (\Sigma x)^2 / n}$$

where Σx , Σy , Σxy , $\Sigma x \Sigma y$, Σx^2 , and $(\Sigma x)^2$ are the previously calculated values entered on the performance test record, and $n = 9$ (the number of points to be calculated).

M. Determine the value of b using the equation:

$$b = \Sigma y / n - m \Sigma x / n$$

N. Calculate the "best fit straight line" value for y_0 through y_9 using the equation:

$$y = mx + b$$

Enter each result on the Performance Test Record in the "Best Fit Straight Line" column.

O. Algebraically add the voltages recorded in the "Negative Slope Measurement" column and enter the total in the " Σy " space.

P. Repeat steps I through N to determine the "best fit straight line" values for the negative slope.

4-6. Start/Stop PHASE ACCURACY

This test determines the Start/Stop phase accuracy of the N Cycle mode on the 3314A.

Specification:

$$\pm 3^\circ$$

Equipment Required:

- hp- 3437A High Speed Digital Voltmeter
- hp- 11048C 50 Ohm Feedthrough Termination
- hp- 1250-0595 Triax to BNC Connector

Procedures:

A. Preset the 3314A.

B. Set the 3314A as follows:

Function Triangle
 Amplitude 10Vp-p
 Mode N Cycle
 Trigger Negative Edge

C. Set the Digital Voltmeter as follows:

Range 10V
 Trigger Ext
 Readings 1
 Delay 0.00025s

D. Connect the 3314A to the Digital Voltmeter as shown in Figure 4-6.

E. Record the voltage reading displayed on the Digital Voltmeter.

F. Set the delay on the Voltmeter to 0.00075s, and record the voltage reading.

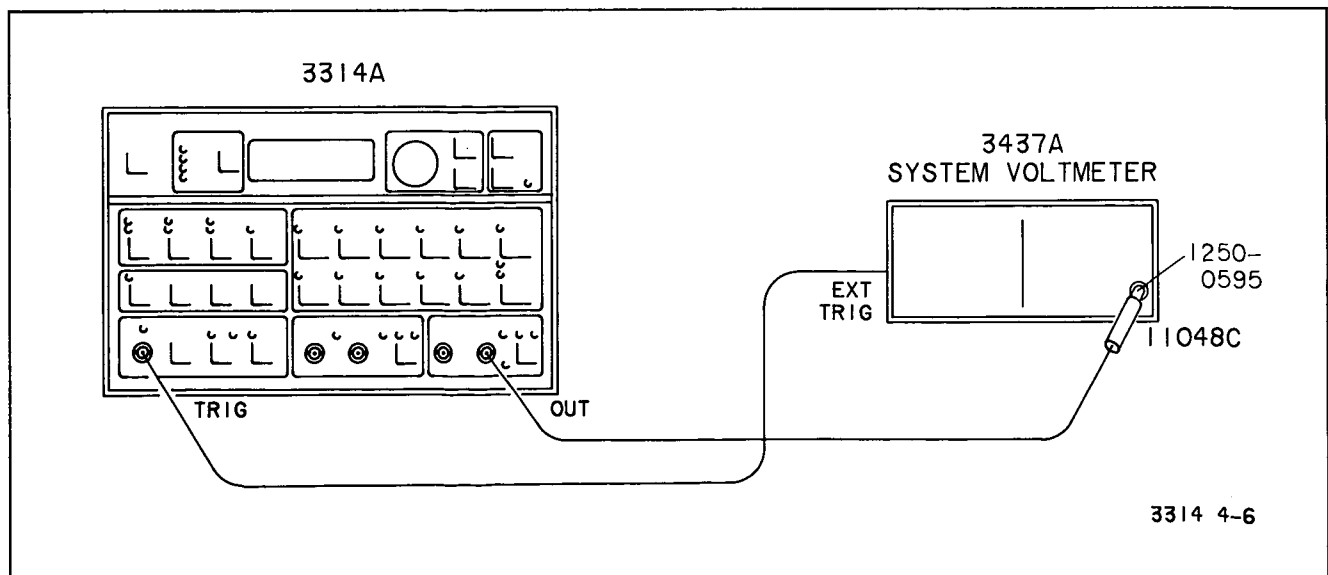

Figure 4-6. Start/Stop Phase Accuracy

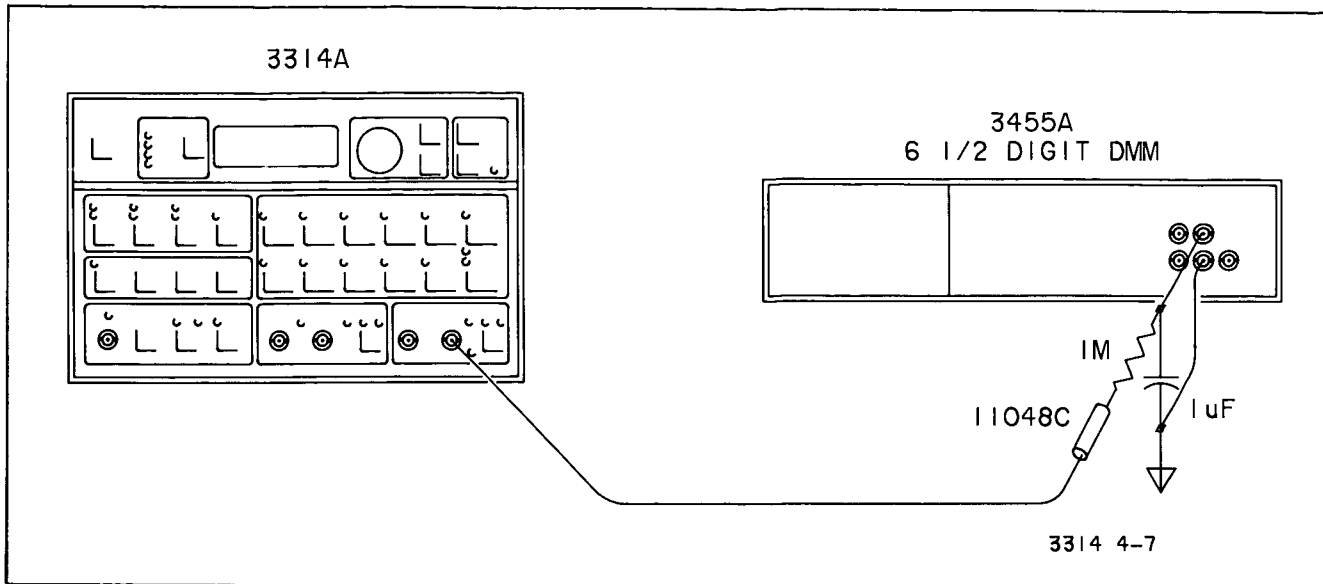

Figure 4-7. Residual and Variable DC Offset Accuracy

G. Average the readings taken in steps E and F and record in the Performance Test Record under "AVG"

H. Set the delay on the Voltmeter to 0.010s, and record the corresponding voltage.

I. This test passes if the average of the readings taken in steps E & F is within $\pm 0.167V$ of the reading taken in step H. (0.167V corresponds to 3° of phase difference.)

4-7. RESIDUAL DC AND DC OFFSET ACCURACY

This is a test to determine the accuracy of the Residual DC Offset (0V DC offset) and the Variable DC Offset function of the 3314A.

Specification:

- Residual: $\pm 0.5\%$ of AC Amplitude Range
- Variable: $\pm (3\%$ of setting, $+10mV$, $+0.5\%$ of AC Amplitude Range)

Equipment Required:

- hp- 3455A Digital Voltmeter
- 1 MΩ/1 μF Low Pass Filter
- hp- 11048C 50 Ohm Feedthrough Termination

Procedures: (Residual)

- A. Preset the 3314A.
- B. Set the 3314A as follows:

Frequency 100kHz
 Amplitude 10Vp-p

C. Set the Digital Voltmeter as follows:

Function DC
 Trigger Internal
 Range Auto

D. Connect the 3314A to the Digital Voltmeter as shown in Figure 4-7.

E. Record and compare the Residual DC Offset measured on the Digital Voltmeter to the limits corresponding to the 10.00V 3314A setting given in Table 4-3.

NOTE

Tables 4-3 and 4-4 are provided for convenience in spot checking the measured parameters. The values obtained in this test may be permanently recorded in the corresponding section of the Performance Test Record.

F. Using the Range Down function, decrement the amplitude displayed on the 3314A to the values listed in Table 4-3. Record and compare the measured Residual Offset at each decrement to its corresponding limits.

(Variable Offset)

G. Set the amplitude of the 3314A to 10V and adjust the DC Offset to 5V.

H. Record and compare the DC Offset measured on the Digital Voltmeter to the limits shown in Table 4-4 for the 10V setting with 5V DC offset.

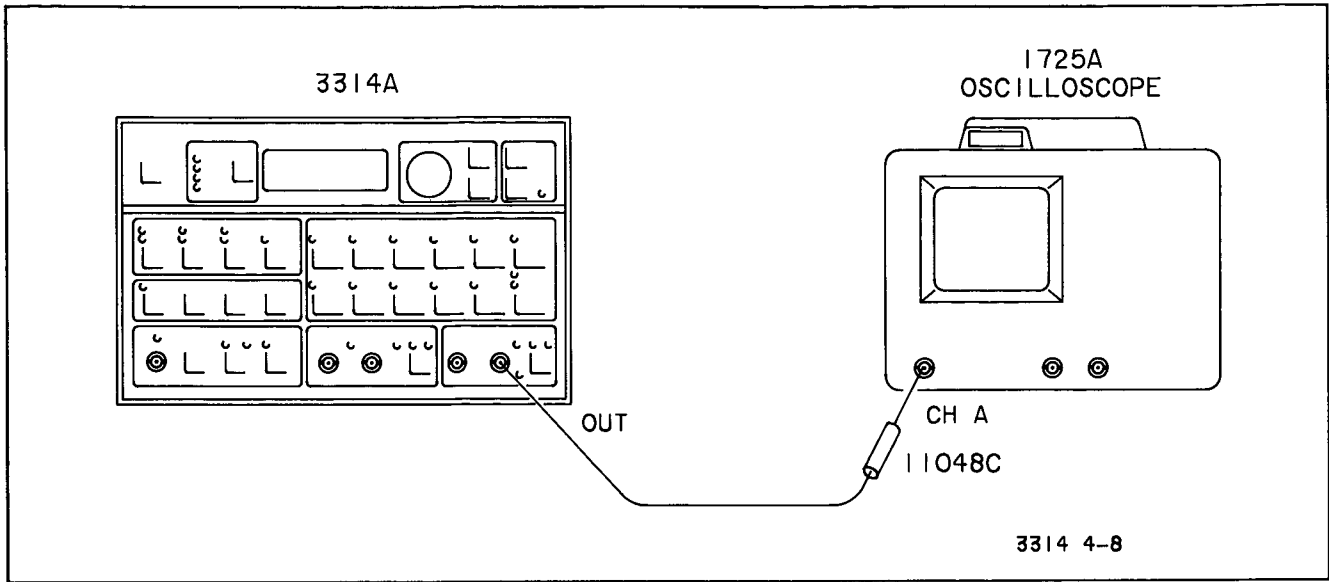

Figure 4-8. Square Wave Rise Time and Overshoot

I. Using the Range Down function, decrement the amplitude of the 3314A to the values shown in Table 4-4, each time recording and comparing the measured Offset to its corresponding limits.

J. Set the amplitude on the 3314A to 10V and adjust the DC offset to 0.887V.

K. Record and compare the DC Offset measured on the Digital Voltmeter to the limits given in the appropriate section of Table 4-4.

L. Repeat step I for the offset of 0.887V.

M. Set the amplitude of the 3314A to 10V and adjust the DC offset to -0.887V.

N. Record and compare the DC Offset measured on the Digital Voltmeter to the corresponding limits shown in Table 4-4.

O. Repeat step I for the offset of -0.887V.

P. Set the amplitude of the 3314A to 10V and adjust the DC offset to -5V.

Q. Record and compare the DC Offset measured on the Digital Voltmeter to the corresponding limits shown in Table 4-4.

R. Repeat step I for the Offset of -5V.

Table 4-3. Residual DC Offset Limits

| 3314A Voltage Setting | Residual Offset | |
|-----------------------|-----------------|-------------|
| | Upper Limit | Lower Limit |
| 10.00V | 50mV | -50mV |
| 1.000V | 5mV | -5mV |
| 100.0mV | 0.5mV | -0.5mV |
| 10.00mV | 0.1mV | -0.1mV |

Table 4-4. Variable DC Offset Limits

| Voltage Setting | DC Offset | Upper Limit | Lower Limit |
|-----------------|-----------|-------------|-------------|
| 10.00V | 5V | 5.21V | 4.79V |
| 1.000V | 5V | 5.16V | 4.84V |
| 100.0mV | 5V | 5.16V | 4.84V |
| 10.00mV | 5V | 5.16V | 4.84V |
| 10.00V | 0.887V | 0.974V | 0.8V |
| 1.000V | 0.887V | 0.924V | 0.85V |
| 100.0mV | 0.887V | 0.924V | 0.85V |
| 10.00mV | 0.887V | 0.924V | 0.85V |
| 10.00V | -0.887V | -0.8V | -0.974V |
| 1.000V | -0.887V | -0.85V | -0.924V |
| 100.0mV | -0.887V | -0.85V | -0.924V |
| 10.00mV | -0.887V | -0.85V | -0.924V |
| 10.00V | -5V | -4.79V | -5.21V |
| 1.000V | -5V | -4.84V | -5.16V |
| 100.0mV | -5V | -4.84V | -5.16V |
| 10.00mV | -5V | -4.84V | -5.16V |

4-8. SQUARE WAVE RISE TIME AND OVERSHOOT

This test examines the Rise/Fall time and Peak Overshoot of the 3314A Square Wave signal.

Specification:

- Square Wave Rise/Fall Time (10% to 90%) 9ns
- Square Wave Overshoot <5% at 10Vp-p

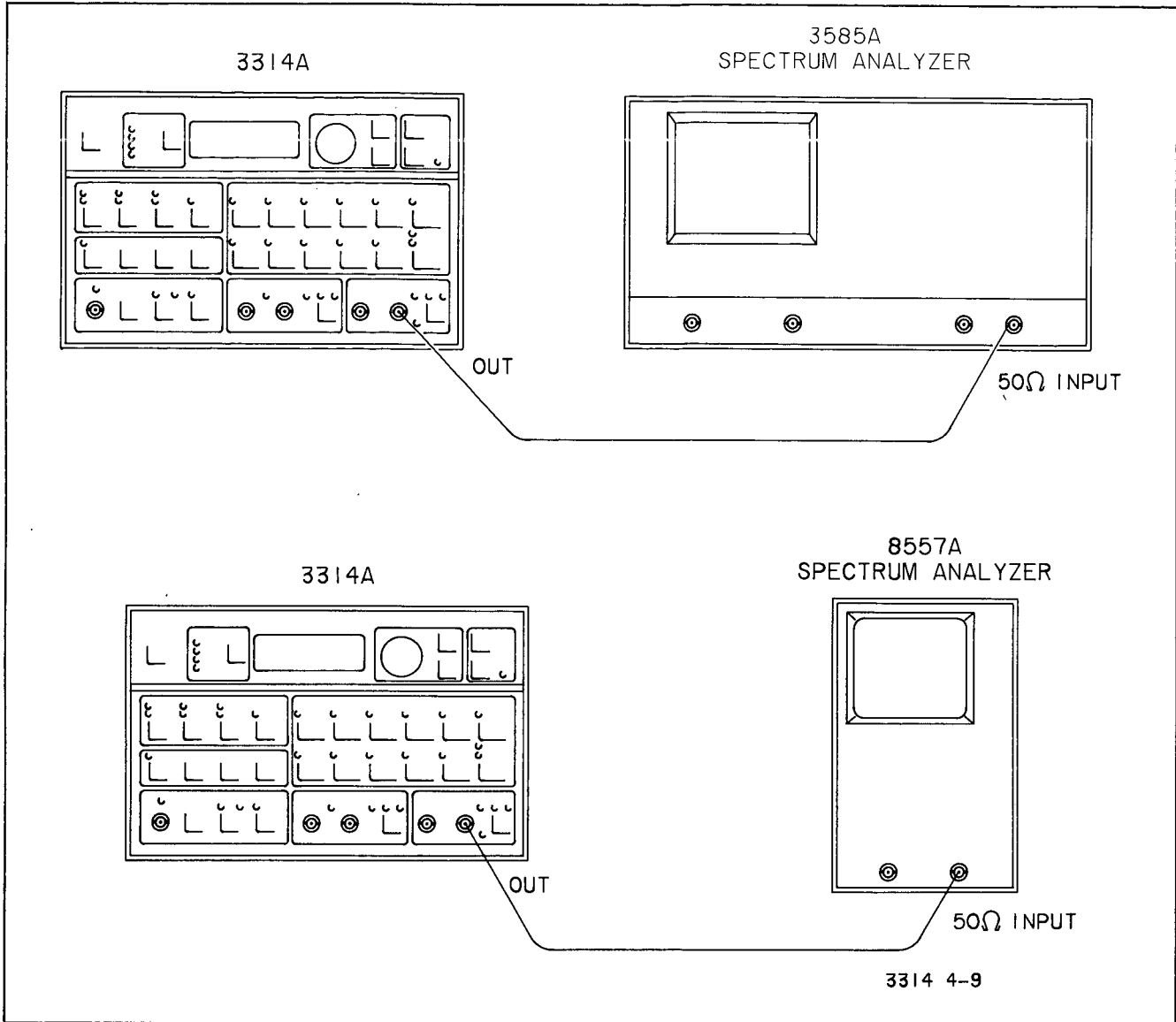

Figure 4-9. Sine Wave Harmonics

Equipment Required:

- hp- 1725A Oscilloscope*
- hp- 11048C 50 Ohm Feedthrough Termination

*An Oscilloscope other than the 1725A may be used provided it has at least a 275MHz bandwidth. This is necessary because the 3314A's fast rise time in some instances, can cause an Oscilloscope with a bandwidth <275MHz to ring, and in turn, mask the 3314A's actual response.

Procedures:

A. Preset the 3314A.

B. Set the 3314A as follows:

- Function Square
- Frequency 19.99MHz
- Amplitude 10Vp-p

C. Set the Oscilloscope as follows:

- Volts/Div 2V
- Time/div 0.01us/cm
- Coupling DC
- Horizontal Display Main
- Main Triggering Positive

D. Connect the 3314A to the Oscilloscope as shown in Figure 4-8.

E. While observing the waveform on the Oscilloscope, use the Horizontal Position knob to ad-

just the waveform until the bottom of the Square wave's rising edge is on top of the Y-axis graticule. Note the distance between the 10% and 90% points on the rising edge. If the distance between the points is less than or equal to -9cm (note scope setting), the specification is met.

F. Set the Main Triggering function of the Oscilloscope to negative.

G. Observe the trailing edge of the waveform. Note the distance between the 90% and 10% points. If the distance is less than or equal to 1cm, the test passes.

H. Set the Time/div setting on the Oscilloscope to 1us/cm.

I. Rotate the Oscilloscope's "Cal" knob (located on the VOLTS/DIV knob) counterclockwise until the waveform is four divisions tall. The "intensified" portion on the top of the wave should be <0.5V (1 minor division).

4-9. SINE WAVE HARMONICS

This is a test to check the amplitude levels of the Sine Wave Harmonics.

Specification:

| | |
|----------------------------|--------|
| 20Hz to 50kHz | - 55dB |
| 50kHz to 1.999MHz | - 40dB |
| 1.999MHz to 19.99MHz | - 25dB |

Equipment Required:

- hp- 3585A Spectrum Analyzer
- hp- 8557A Spectrum Analyzer

Procedures:

- A. Preset the 3314A.
- B. Set the 3314A as follows:
 - Frequency 20.0Hz (Range 3)
 - Amplitude 10Vp-p
 - Function Sine
 - Range Hold On
- C. Connect the 3314A to the 3585A as shown in Figure 4-9.

NOTE

To get to the frequencies listed in the following ranges (see Tables 4-5, 4-6, 4-7), set the 3314A to the middle value in the range (i.e. range 3, 100.0Hz), activate Range Hold, then use the Modify knob to select the frequencies. Be sure that the frequency on the 3314A is set exactly as shown in the table.

D. To verify that the Sine wave harmonics are within specification, set the Spectrum Analyzer as follows:

- 1. Press "INSTR PRESET".
- 2. Press "DSPL LINE" and adjust the Control knob for a -55 dB level.
- 3. Press "STOP FREQ" and set it to 8 times the 3314A frequency setting.
- 4. Press "MARKER" and using the Control knob, place it over the fundamental.
- 5. Press "MKR-REF LVL" and wait for the sweep to update the screen display.

E. Observe the harmonics displayed on the Spectrum Analyzer and verify that they are below the -55dB level.

F. Repeat steps D (parts 3-5) and E for the 3314A frequency settings listed in Tables 4-5 and 4-6 whose harmonic level specification is -55dB.

G. Press "INSTR PRESET" on the Spectrum Analyzer.

H. Press "DSPL LINE" and adjust the Control knob for a -40dB level.

I. Repeat step D, parts 3-5 for the 3314A frequency settings listed in Table 4-6 whose harmonic level specification is -40dB. Verify that these levels are within the specification.

J. Disconnect the 3314A from the 3585A Spectrum Analyzer.

K. To measure the harmonics of the frequencies listed in Table 4-7, connect the 3314A to the 8557A Spectrum Analyzer as shown in Figure 4-9.

L. Set the frequency of the 3314A to 1.00MHz.

M. Set the 8557A as follows:
 Input Range + 30dBm
 Time/div Auto
 Start Frequency 1MHz

N. Measure 2nd through 7th harmonics.

O. Set the frequency on the 3314A to 10.00MHz, and adjust the start frequency on the 8557A to 10MHz.

P. Measure 2nd through 7th harmonics.

Q. Set the frequency on the 3314A to 19.99MHz, and adjust the start frequency on the 8557A to 19.99MHz.

R. Measure the 2nd through 7th harmonics.

SINE WAVE HARMONICS

**Table 4-5. Sine Wave Harmonic Test Frequencies
3Hz Resolution Bandwidth**

| 3314A Frequency | Range | 2nd | 3rd | Harmonics dB | | | |
|-----------------|-------|-----|-----|--------------|-----|-----|-----|
| | | | | 4th | 5th | 6th | 7th |
| 20.0Hz | 3 | | | | | | |
| 100.0Hz | 3 | | | | | | |
| 199.9Hz | 3 | | | | | | |
| 100.Hz | 4 | | | -55dB | | | |
| 1000.Hz | 4 | | | | | | |
| 1999.Hz | 4 | | | | | | |

**Table 4-6. Sine Wave Harmonic Test Frequencies
300Hz Resolution Bandwidth**

| 3314A Frequency | Range | 2nd | 3rd | Harmonics dB | | | |
|-----------------|-------|-----|-----|--------------|-----|-----|-----|
| | | | | 4th | 5th | 6th | 7th |
| 1.00kHz | 5 | | | | | | |
| 10.0kHz | 5 | | | | | | |
| 19.99kHz | 5 | | | | | | |
| 10.0kHz | 6 | | | -55dB | | | |
| 100.0kHz | 6 | | | | | | |
| 199.9kHz | 6 | | | | | | |
| 100.kHz | 7 | | | -40dB | | | |
| 1000.kHz | 7 | | | | | | |
| 1999.kHz | 7 | | | | | | |

**Table 4-7. Sine Wave Harmonic Test Frequencies
(8557A Spectrum Analyzer)**

| 3314A Frequency | Range | 2nd | 3rd | Harmonics dB | | | |
|-----------------|-------|-----|-----|--------------|-----|-----|-----|
| | | | | 4th | 5th | 6th | 7th |
| 1.00MHz | 8 | | | | | | |
| 10.00MHz | 8 | | | -25dB | | | |
| 19.99MHz | 8 | | | | | | |

4-10. AM HARMONICS

This test measures the AM envelope distortion.

Specification:

Sideband harmonics 40dB below sideband level

Equipment Required:

- hp- 3325A Synthesizer/Function Generator
- hp- 3585A Spectrum Analyzer
- hp- 11048C 50 Ohm Feedthrough Termination

Procedures:

- A. Preset the 3314A.
- B. Set the 3314A as follows:

 Frequency 1MHz
 Amplitude 10Vp-p
 External Modulation AM
- C. Set the 3325A as follows:

 Function Sine
 Frequency 1kHz
 Amplitude 1Vp-p
- D. Press "INSTR PRESET" on the Spectrum Analyzer and set it as follows:

 Center Frequency 1MHz
 Frequency Span 10kHz
- E. Connect the 3314A to the Synthesizer and Spectrum Analyzer as shown in Figure 4-10.
- F. Press "DSPL LINE" on the Spectrum Analyzer and adjust the Control knob for a -46dB level.
- G. Press "MARKER" and place it over the carrier peak.
- H. Press "MKR → REFLVL".
- I. Note the levels of the AM sideband harmonics (located at 1kHz intervals from sideband) relative to "DSPL LINE". The levels should not exceed this reference.

4-11. VCO LINEARITY

This is a test to determine the linearity of the Voltage Controlled Oscillator.

Specification:

± 3% of setting

Equipment Required:

- hp- 6235A Triple Output Power Supply
- hp- 5328A Universal Counter
- hp- 3455A Digital Voltmeter
- hp- 11048C 50 Ohm Feedthrough Termination

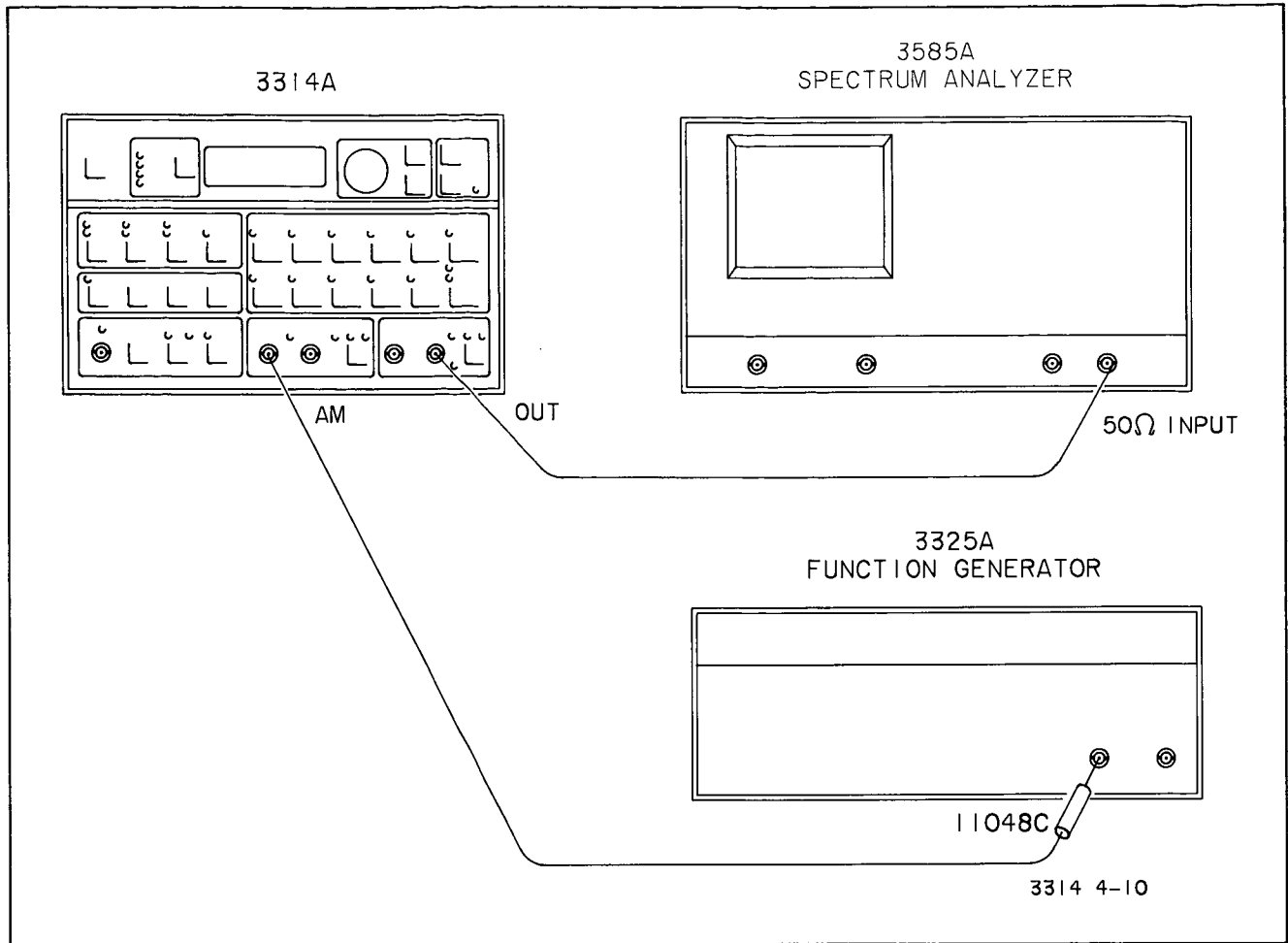

Figure 4-10. AM Harmonics

Procedures:

A. Preset the the 3314A.

B. Set the 3314A as follows:

Frequency 10MHz
 Amplitude 10Vp-p
 VCO On

C. Set the Counter as follows:

Function Frequency A
 Resolution 0.1kHz
 Channel Input Sep

D. Set the Voltmeter as follows:

Range Auto
 Function DC
 Trigger Internal

E. Connect the Counter, Voltmeter, and Power Sup-
 ply to the 3314A as shown in Figure 4-11.

F. Set the power supply voltage to $-8V \pm 10mV$ and record the frequency reading on the Counter. Frequency should be $2MHz \pm 300kHz$.

G. Set the power supply voltage to $-4.5V \pm 10mV$ and record the frequency reading on the Counter. Frequency should be $5.5MHz \pm 300kHz$.

H. Set the power supply voltage to $+1V \pm 10mV$ and record the frequency reading on the Counter. Frequency should be $11MHz \pm 300kHz$.

4-12. PHASE LOCKED LOOP PHASE ACCURACY

This is a test to determine the Phase Accuracy of the 3314A Phase Locked Loop.

Specification:

± 2 degrees of setting

Equipment Required:

- hp- 3325A Synthesizer/Function Generator
- hp- 5328A Universal Counter
- hp- 11048C 50 Ohm Feedthrough Termination

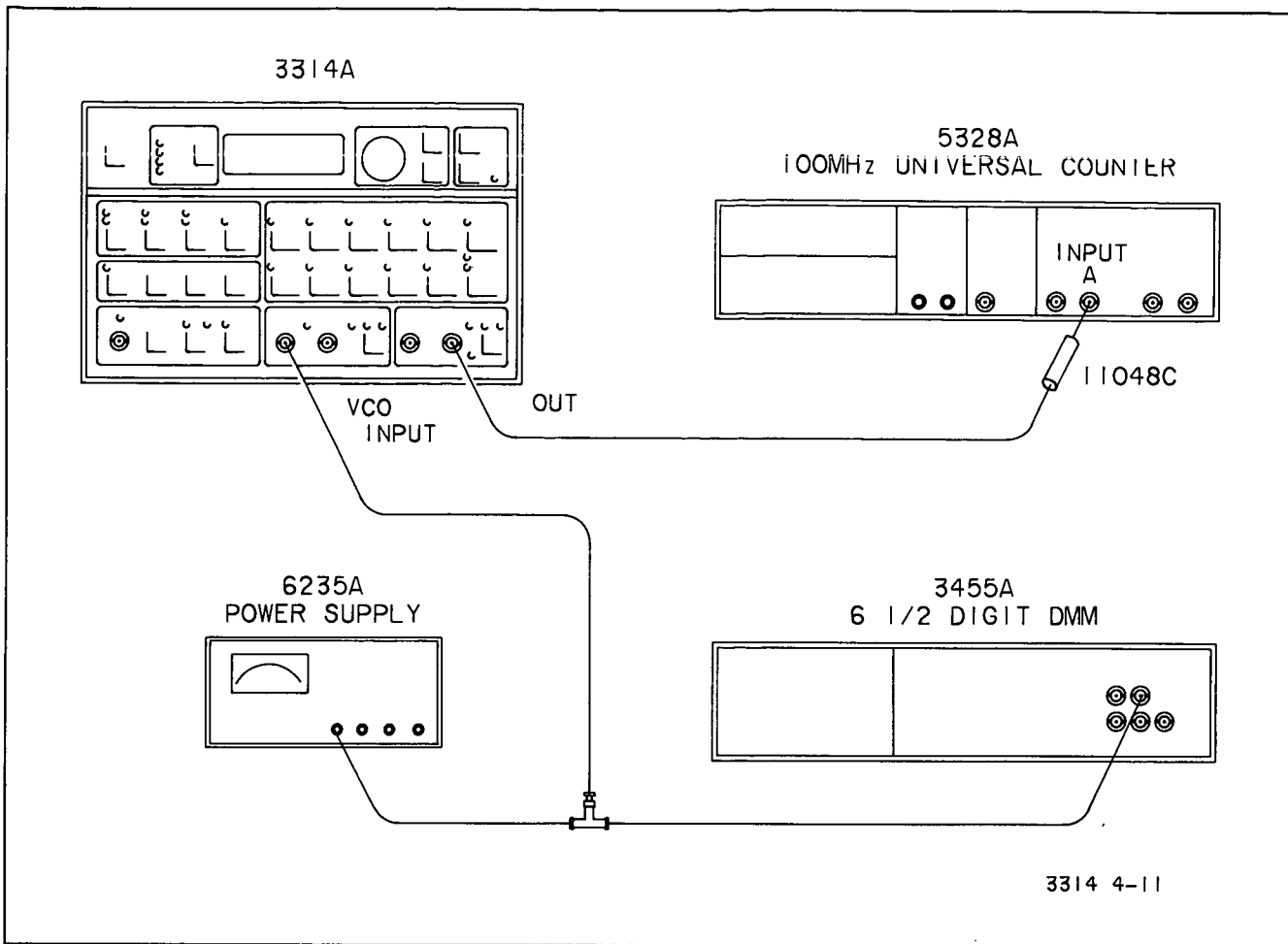

Figure 4-11. VCO Linearity

Procedures:

A. Preset the 3314A.

B. Set the 3314A as follows:

Function Square
 Amplitude 1Vp-p
 Trigger Source Ext
 Mode Fin x N
 Trigger Threshold 0V
 Phase -199.9 degrees

C. Set the Synthesizer/Function Generator as follows:

Function Square
 Amplitude 1Vp-p
 Frequency 50Hz

D. Set the Universal Counter as follows:

Coupling DC
 Attenuation x1
 Slope Setting Cha. +, Chb. +
 Function Period Avg A
 Periods Averaged 10²
 Channel Input Com

E. Connect the Synthesizer/Function Generator and the Universal Counter to the 3314A as shown in Figure 4-12.

F. Note and record the period (t) of the 50Hz signal now being measured on the Universal Counter.

G. Change the function of the Universal Counter to "TI Avg A-B" and record the corresponding period (t₁).

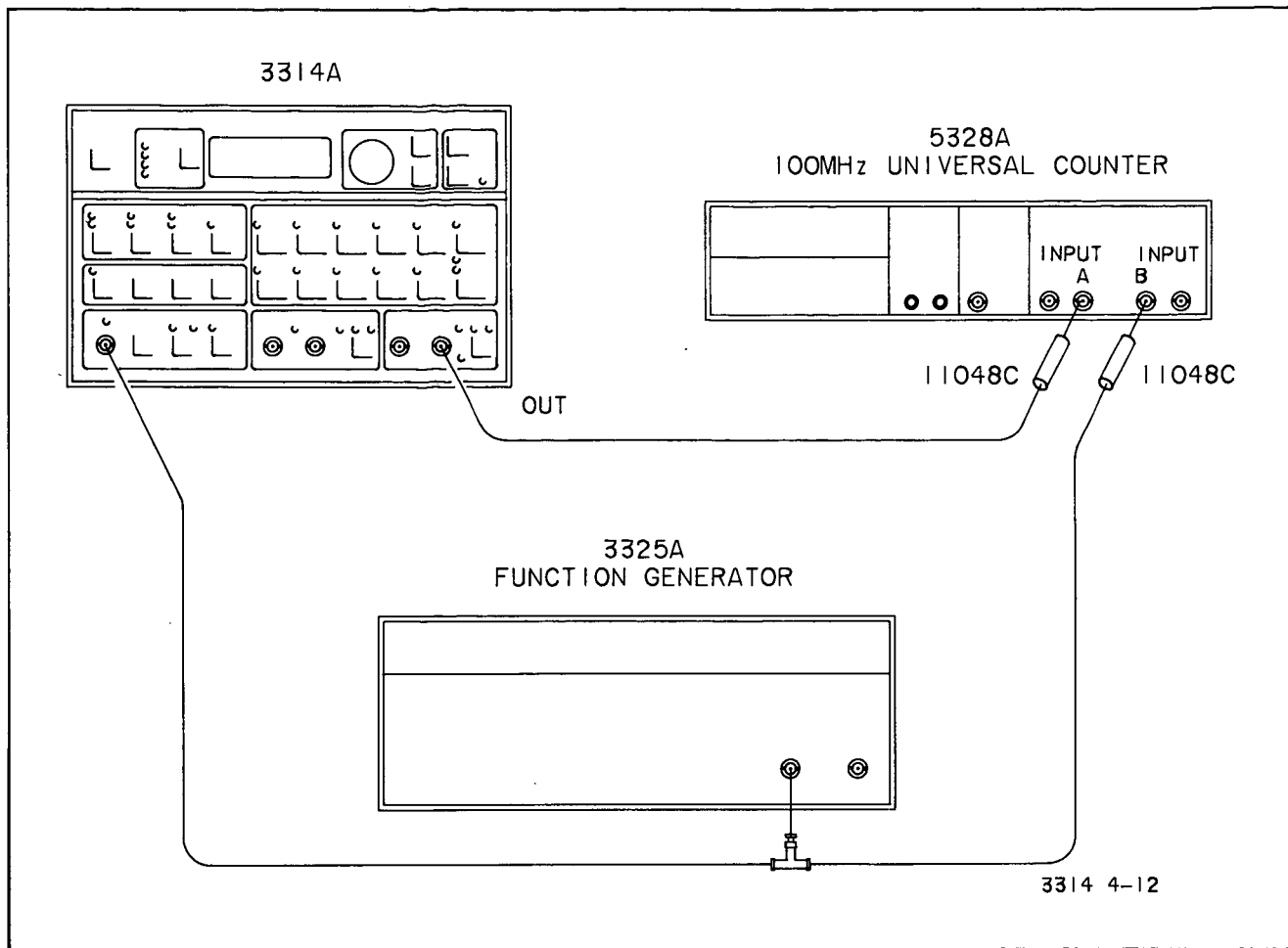

Figure 4-12. Phase Locked Loop Phase Accuracy

H. The accuracy of the phase setting displayed on the 3314A can be determined by the following equation:

$$\phi = (t_1/t)360^\circ$$

where t is the period of the 50Hz Synthesizer/Function Generator signal (constant throughout the test), and t₁ is the change in time between the trailing edges of the phase locked signals (varies with phase setting).

I. Repeat step H for phase settings on the 3314A of -90°, 0°, +90°, and +199.9° noting that each phase setting will have a corresponding value of t₁ to be entered into the above equation.

NOTE

The data taken above can be entered into the Performance Test Record for permanent reference and comparison.

4-13. AMPLITUDE ACCURACY

This test determines the amplitude accuracy of the 3314A's Sine, Square, and Triangle wave signals.

Specifications:

| | |
|-------------|------------------------|
| Sine/Square | ± 1% of setting ± 35mV |
| Triangle | ± 1% of setting ± 60mV |

Equipment Required:

- hp- 3455A Digital Voltmeter
- hp- 11048C 50 Ohm Feedthrough Termination

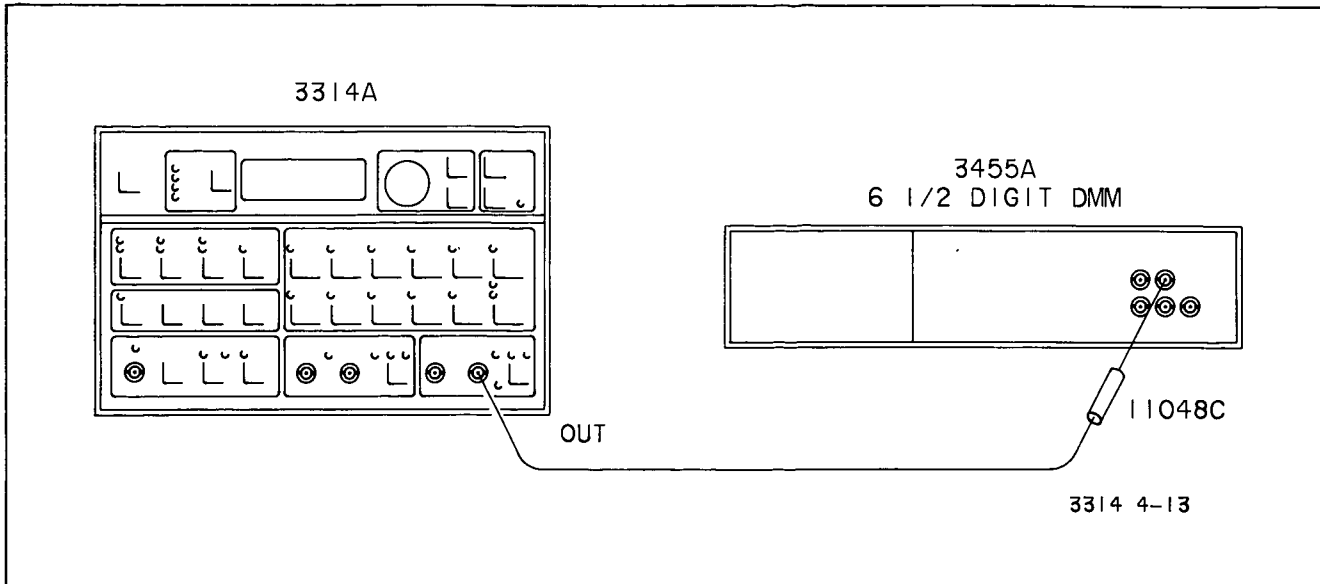

Figure 4-13. Amplitude Accuracy

Procedures:

A. Preset the 3314A.

B. Set the 3314A as follows:

Frequency 10kHz
 Amplitude 10Vp-p

C. Set the Digital Voltmeter as follows:

Range Auto
 Function AC
 Trigger Internal

D. Connect the 3314A to the Digital Voltmeter as shown in Figure 4-13.

NOTE

Cable length between the 3314A and the Digital Voltmeter should be as short as possible.

E. Calibrate the 3314A by pressing the Blue Shift Key followed by the "RCL" Key.

F. Note and record the voltage measured on the Digital Voltmeter. Reading should be 3.535V ±0.0477V.

G. Repeat step E.

H. Change the function on the 3314A to a Square wave.

I. Note and record the voltage measured on the Digital Voltmeter. Reading should be 5.0V ±0.0477V.

J. Repeat step E.

K. Change the function on the 3314A to a Triangle wave.

L. Note and record the voltage measured on the Digital Voltmeter. Reading should be 2.8867V ±0.0477V.

4-14. SINE WAVE POWER FLATNESS

This is a test to check the amplitude flatness of the 3314A Sine wave signal.

Specification:

| | |
|------------------|----------|
| 20Hz to 50kHz | ± 0.04dB |
| 50kHz to 1MHz | ± 0.17dB |
| 1MHz to 19.99MHz | ± 0.8dB |

Equipment Required:

- hp- 3455A Digital Voltmeter
- hp- 11049A Thermal Converter

NOTE

For accurate test results, allow the 3314A and the Thermal Converter time to settle and adjust to surrounding temperatures. Avoid sudden temperature changes around the Thermal Converter.

Procedures:

A. Preset the 3314A.

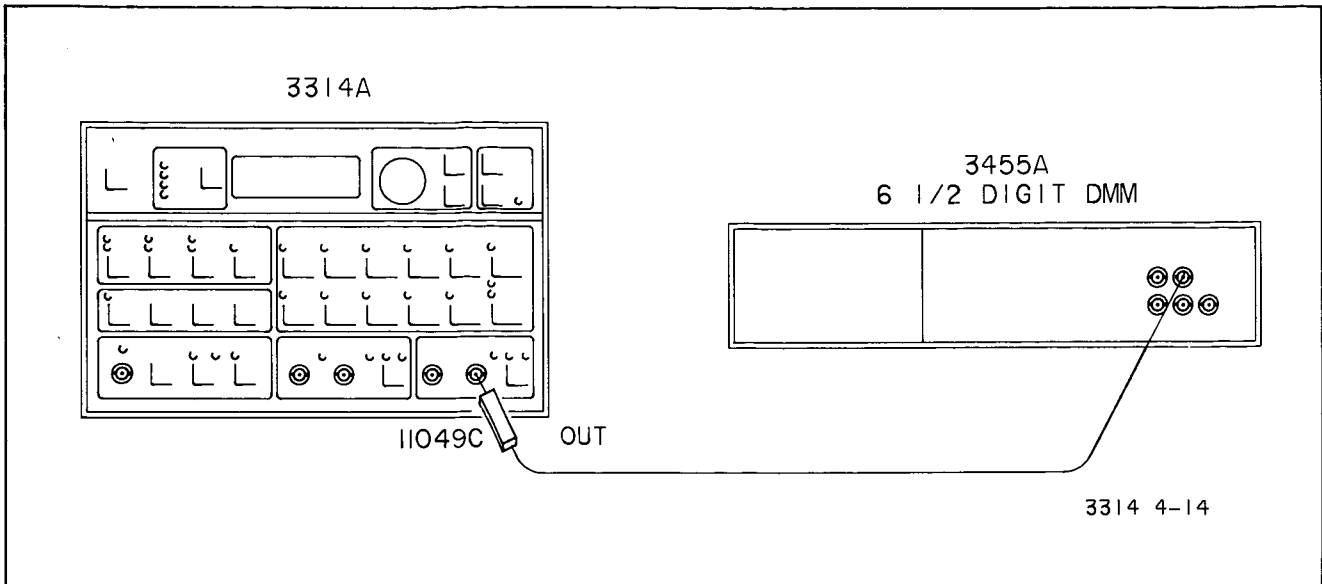

Figure 4-14. Sine Wave Power Flatness

B. Set the 3314A as follows:

Amplitude 7.5Vp-p
 Frequency 10kHz

C. Set the 3455A as follows:

Range 1
 Function DC
 Trigger Internal

I. Repeat steps G & H for the 3314A frequency settings given below:

- 50kHz
- 800kHz
- 1MHz
- 5MHz
- 19.99MHz

J. Set the amplitude of the 3314A to 7.5Vp-p and the frequency to 10kHz.

K. Note and record the voltage reading on the Digital Voltmeter.

L. Using the data taken in steps E & K, calculate the reference drift of the 3314A using the equation given below:

$$\text{Drift(dB)} = 20 \text{ Log (Step E Reference/Step K Reference)}$$

M. If Drift(dB) is < 0.025dB, the data taken in steps F,G,H, and I is acceptable. Proceed to step O.

N. If Drift(dB) is > 0.025dB, the data taken in steps F,G,H, and I is unacceptable. Repeat steps A through L. If the test fails again, perform the Amplitude Accuracy Test for amplitude verification and repeat Flatness test.

O. Disconnect the Thermal Converter from the 3314A.

CAUTION

Double check the 3314A Signal Amplitude. The input signal to the Thermal Converter must not exceed 3V RMS (8Vp-p).

D. Connect the 3314A to the Thermal Converter and the Digital Voltmeter as shown in Figure 4-14.

E. Record the voltage measured on the Digital Voltmeter. This is the reference voltage for the 7.5Vp-p 3314A setting.

F. Set the frequency on the 3314A to 100Hz.

G. Carefully adjust the amplitude on the 3314A until the voltage measured on the Digital Voltmeter is equal to the reference voltage recorded in step E.

H. Record the 3314A's displayed amplitude (in Vp-p) in the appropriate section of Table 4-8 in the Performance Test Record.

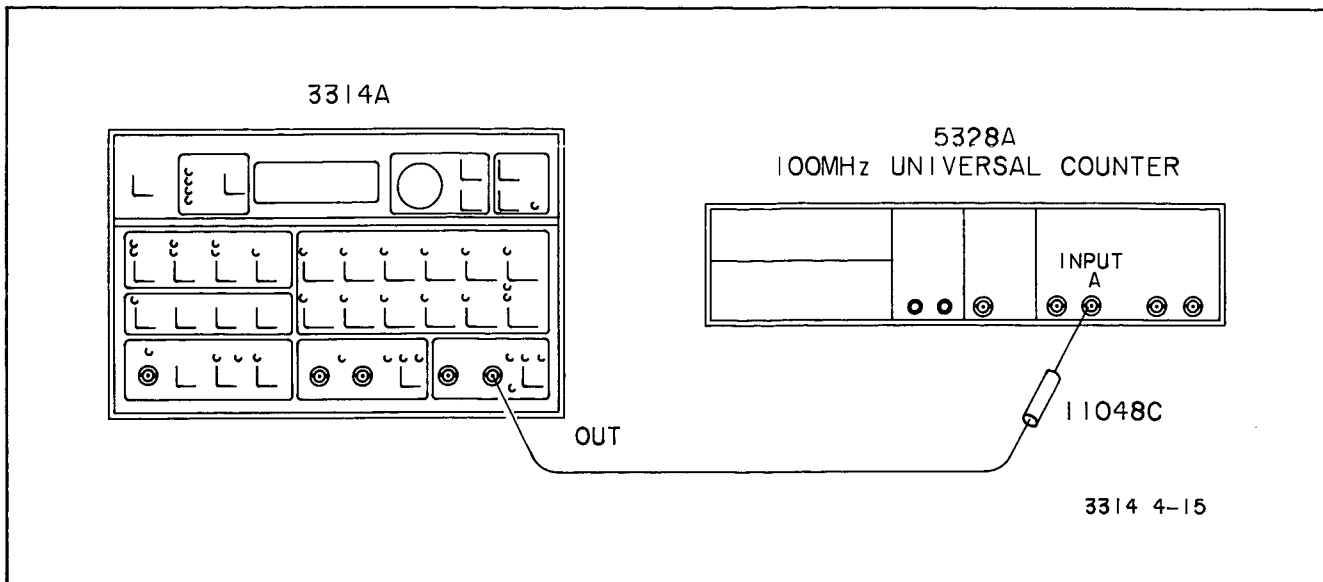

Figure 4-15. Manual Sweep Accuracy

P. Using the equation: Flatness Error (dB) = 20 Log (7.50V/Displayed Amplitude), calculate the Flatness Error in dB for each amplitude entered in the Performance Test Record. Compare the result of each calculation to the specification given in the table.

4-15. MANUAL SWEEP ACCURACY

This test checks the accuracy of the 3314A Manual Linear Sweep.

Specification:

- Manual Linear Sweep Accuracy:
- Stop Range = 20MHz ± 3% of Stop Frequency
 - Stop Range = 2MHz ± 1% of Stop Frequency
 - Stop Range ≤ 200kHz ± 0.2% of Stop Frequency
0.1% of Range

Equipment Required:

- hp- 5328A Universal Counter
- hp- 11048C 50 Ohm Feedthrough Termination

Procedures:

A. Preset the 3314A.

B. Set the 3314A as follows:

- Amplitude 10Vp-p
- Start Frequency 1MHz
- Stop Frequency 10MHz
- Sweep Linear

C. Set the Counter as follows:

- Function Frequency A
- Resolution 10Hz
- Channel Input Sep

D. Connect the 3314A to the Counter as shown in Figure 4-15.

E. Press the "MAN SWEEP" key on the 3314A.

F. Press "START FREQ".

G. Record the frequency reading on the Universal Counter. Reading should be 1MHz ± 100kHz.

H. Set "STOP FREQ" on the 3314A to 1MHz and "START FREQ" to 100kHz.

I. Record the frequency reading on the Universal Counter. The reading should be 100kHz ± 1kHz.

J. Set "STOP FREQ" on the 3314A to 100kHz and "START FREQ" to 10kHz.

K. Record the frequency reading on the Universal Counter. The reading should be 10kHz ± 400Hz.

4-16. STEP ATTENUATOR ACCURACY

This test compares the accuracy of the 3314A Step Attenuator against an attenuator of known precision.

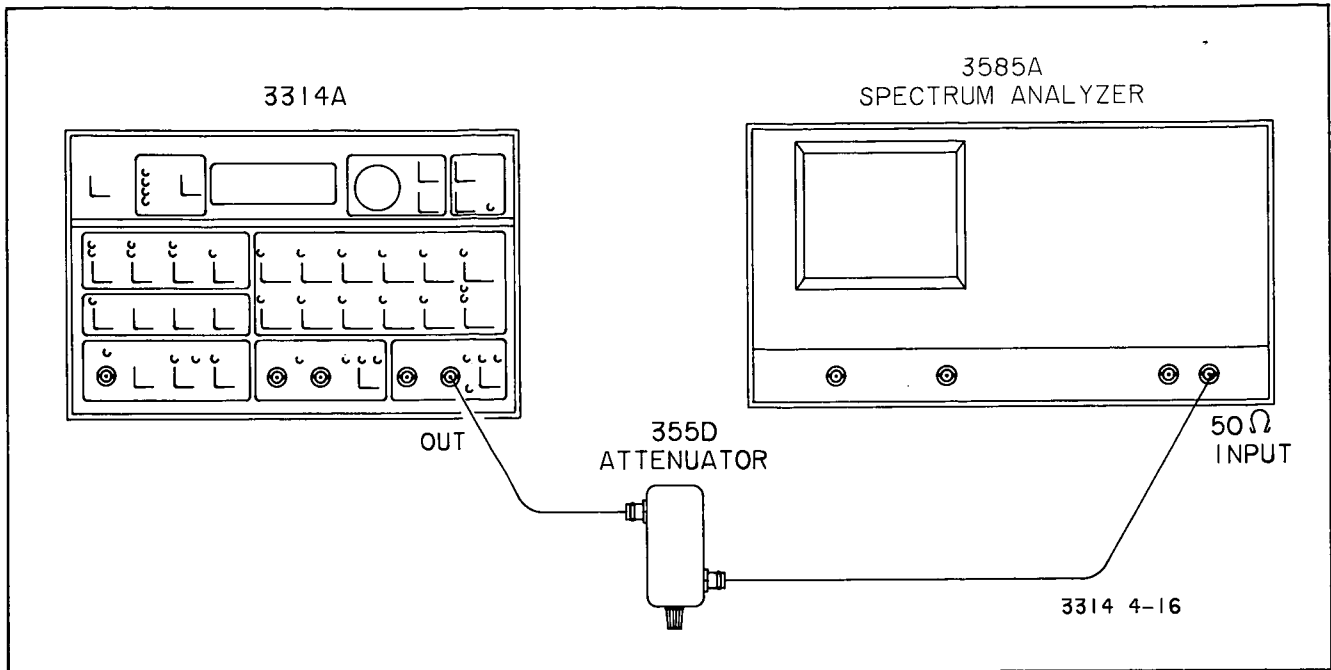

Figure 4-16. Step Attenuator Accuracy

Specification:

- 0.001Hz to 50kHz ±0.05dB
- 50kHz to 19.99MHz (20dB,40dB Attenuation) ±0.3dB
- 50kHz to 19.99MHz (60dB attenuation only) ±0.5dB

Equipment Required:

- hp- 3585A Spectrum Analyzer
- hp- 355D VHF Attenuator*

***NOTE**

This attenuator must have current certification data at frequencies of 50kHz, 1MHz, 20MHz, and attenuations of 20dB, 40dB, and 60dB.

Procedures:

- A. Preset the 3314A.
- B. Set the 3314A as follows:

| | |
|-----------------|--------|
| Frequency | 50kHz |
| Amplitude | 10Vp-p |
- C. Set the 355D to 20dB attenuation.
- D. Connect the 3314A to the Attenuator and Spectrum Analyzer as shown in Figure 4-16.

E. Set the 3585A as follows:

1. Press "INSTR PRESET".
2. Enter Center Frequency (3314A Frequency Setting).
3. Set Frequency Span to 2x Center Frequency.
4. Enable "COUNTER".
5. Press "MKR → CF".
6. Disable COUNTER
7. Press "MANUAL".
8. Press "CLEAR A".
9. Press "MKR → REF LVL".
10. Set "dB/DIV" to 1dB.
11. Press "REF LVL" and adjust to approximately 1dB below full scale.
12. Set Video Bandwidth to 10Hz.
13. Press "OFFSET".
14. Press "ENTER OFFSET".
15. Press "SAVE (off)", "4 (cal)".

F. Using the Range Down function, set the amplitude of the 3314A to 1.000Vp-p.

G. Set the attenuation on the 355D to 0dB.

H. Record the Marker Amplitude displayed on the CRT in the appropriate section of Table 4-9 located in the Performance Test Record.

I. From the reading taken in step H, subtract the Insertion Loss Error of the 355D. Add that quantity to the 355D attenuation setting and enter the result under "Actual Attenuation" in Table 4-9. (See Performance Test Record for an example.)

J. Set the attenuation of the 355D to 40dB.

K. Set the amplitude of the 3314A to 10.00Vp-p.

L. Repeat step E.

M. Using the Range Down function, set the amplitude of the 3314A to 100mVp-p.

N. Set the attenuation of the 355D to 0dB.

O. Repeat steps H&I.

P. Set the attenuation of the 355D to 60dB.

Q. Set the amplitude of the 3314A to 10.00Vp-p.

R. Repeat step E.

S. Using the Range Down function, set the amplitude of the 3314A to 10.0mVp-p.

T. Set the attenuation of the 355D to 0dB.

U. Repeat steps H & I.

V. Set the 3314A to the remaining frequencies shown in Table 4-9. Repeat steps E through U for each setting.

4-17. VERNIER ATTENUATOR FLATNESS

This test checks the flatness of the 3314A Vernier Attenuator.

Specification:

| | |
|---------------|----------|
| 20Hz to 50kHz | ± 0.03dB |
| 50kHz to 1MHz | ± 0.16dB |
| 1MHz to 20MHz | ± 0.7dB |

Equipment Required:

- hp- 3585A Spectrum Analyzer
- hp- 355D VHF Attenuator*

***NOTE**

This attenuator must have current certification data at frequencies of 10kHz, 50kHz, 1MHz, 20MHz, and attenuations of 10dB and 20dB.

Procedures:

A. Preset the 3314A.

B. Set the 3314A as follows:

Frequency 10kHz
 Amplitude 10Vp-p
 Range Hold On

C. Set the 355D to 10dB attenuation.

D. Connect the 3314A to the Attenuator and Spectrum Analyzer as shown in Figure 4-17.

E. Set the 3585A as follows:

1. Press "INSTR PRESET".
2. Enter Center Frequency (3314A Frequency Setting).
3. Set the Frequency Span to 2x Center Frequency.
4. Enable "COUNTER".
5. Press "MKR → CF".
6. Disable COUNTER.
7. Press "MANUAL".
8. Press "CLEAR A".
9. Press "MKR → REF LVL".
10. Set "dB/DIV" to 1dB.
11. Press "REF LVL" and adjust to approximately 1dB below full scale.
12. Set Video Bandwidth to 10Hz.
13. Press "OFFSET".
14. Press "ENTER OFFSET".
15. Press "SAVE (off)", "4 (cal)".

F. Using the Modify knob, set the amplitude of the 3314A to 3.16Vp-p.

G. Set the attenuation of the 355D to 0dB.

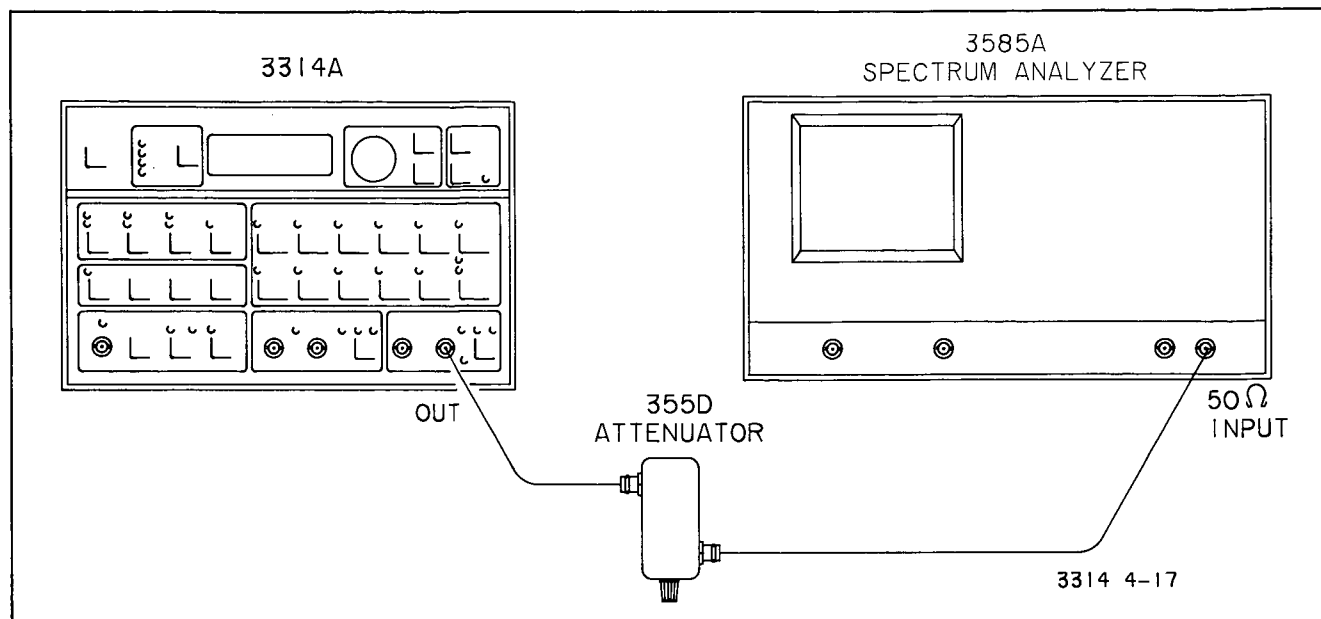

Figure 4-17. Vernier Attenuator Flatness

H. Record the Marker Amplitude displayed on the CRT in the appropriate section of Table 4-10 located in the Performance Test Record.

I. From the reading taken in step H, subtract the Insertion Loss Error of the 355D. Add that quantity to the 355D attenuator setting and enter the result under "Actual Attenuation" in Table 4-10. (See Performance Test Record for example.)

NOTE

The "Actual Attenuation" calculated for settings of 10dB & 20dB at 10kHz is the reference attenuation to which "Actual Attenuation" at 50kHz, 1MHz, and 20MHz will be compared. (See Table 4-10.)

J. Set the attenuation of the 355D to 10dB.

K. Set the amplitude of the 3314A to 10.0Vp-p and the frequency to 50kHz.

L. Repeat steps E through I.

M. Set the attenuation of the 355D to 10dB.

N. Set the amplitude of the 3314A to 10.0Vp-p and the frequency to 1MHz.

O. Repeat steps E through I.

P. Set the attenuation of the 355D to 10dB.

Q. Set the amplitude of the 3314A to 10.0Vp-p and the frequency to 19.99MHz.

R. Repeat steps E through I.

S. Set the attenuation of the 355D to 20dB.

T. Set the amplitude of the 3314A to 10.0Vp-p and the frequency to 10kHz.

U. Repeat step E.

V. Set the amplitude of the 3314A to 1.00Vp-p.

W. Set the attenuation of the 355D to 0dB.

X. Repeat steps H & I.

Y. Set the attenuation of the 355D to 20dB.

Z. Set the amplitude of the 3314A to 10.0Vp-p and the frequency to 50kHz.

A.A. Repeat steps E, V-X.

B.B. Set the attenuation of the 355D to 20dB.

C.C. Set the amplitude of the 3314A to 10.0Vp-p and the frequency to 1MHz.

D.D. Repeat steps E, V-X.

E.E. Set the attenuation of the 355D to 20dB.

F.F. Set the amplitude of the 3314A to 10.0Vp-p and the frequency to 19.99MHz.

G.G. Repeat steps E, V-X.

PERFORMANCE TEST RECORD

HEWLETT-PACKARD MODEL 3314A

Tests Performed By _____

FUNCTION GENERATOR

Date _____

SERIAL NO. _____

FREQUENCY ACCURACY TEST:

| 3314A Frequency (A) | Specification | Counter Reading |
|---------------------|---------------|-----------------|
| 19.99 MHz | ± 2000 Hz | _____ |
| 1999 kHz | ± 200 Hz | _____ |
| 199.9 kHz | ± 600 Hz | _____ |
| 19.99 kHz | ± 60 Hz | _____ |
| 1999. Hz | ± 6 Hz | _____ |
| 199.9 Hz | ± 6 Hz | _____ |
| <hr/> | | |
| 3314A Frequency (B) | | |
| 00.1 Hz | ± 0.2 Hz | _____ |
| 001 Hz | ± 2 Hz | _____ |
| 0.01 kHz | ± 20 Hz | _____ |
| 00.1 kHz | ± 200 Hz | _____ |
| 001 kHz | ± 0.1 Hz | _____ |
| 0.01MHz | ± 1Hz | _____ |

TIME AXIS AND VARIABLE SYMMETRY:

| %Symmetry | Specification | Calculated% |
|-----------|---------------|-------------|
| 50% | ± 0.2% | _____ |
| 5% | ± 0.5% | _____ |
| 95% | ± 0.5% | _____ |

INTERNAL TRIGGER ACCURACY:

| Period | Specification | Counter Reading |
|--------|---------------|-----------------|
| 10.0ms | ± 0.001 ms | _____ |

PERFORMANCE TEST RECORD (Cont'd)

TRIANGLE LINEARITY

| x Values | Positive Slope Measurement | x Times y | Calculated Best Fit Straight Line | Tolerance* |
|-----------|----------------------------|-----------|-----------------------------------|-------------|
| $x_1 = 1$ | 10% _____ | _____ | (y_1) _____ | $\pm 0.02V$ |
| $x_2 = 2$ | 20% _____ | _____ | (y_2) _____ | $\pm 0.02V$ |
| $x_3 = 3$ | 30% _____ | _____ | (y_3) _____ | $\pm 0.02V$ |
| $x_4 = 4$ | 40% _____ | _____ | (y_4) _____ | $\pm 0.02V$ |
| $x_5 = 5$ | 50% _____ | _____ | (y_5) _____ | $\pm 0.02V$ |
| $x_6 = 6$ | 60% _____ | _____ | (y_6) _____ | $\pm 0.02V$ |
| $x_7 = 7$ | 70% _____ | _____ | (y_7) _____ | $\pm 0.02V$ |
| $x_8 = 8$ | 80% _____ | _____ | (y_8) _____ | $\pm 0.02V$ |
| $x_9 = 9$ | 90% _____ | _____ | (y_9) _____ | $\pm 0.02V$ |

$$\begin{aligned} \Sigma x &= 45 & \Sigma y & \text{_____} & \Sigma xy & \text{_____} \\ (\Sigma x)^2 &= 2025 & \Sigma x \Sigma y & \text{_____} & m &= \text{_____} \\ \Sigma x^2 &= 285 & & & b &= \text{_____} \end{aligned}$$

*Tolerance is the maximum allowable difference between the "Positive Slope Measurement" (or "Negative Slope Measurement") and the "Calculated Best Fit Straight Line" value.

Tolerance is calculated by:

$$\text{Tolerance} = (\text{Triangle Amplitude})(\text{Specification})$$

$$= (10Vp-p)(0.2\%)$$

$$= 0.02V$$

| x Values | Negative Slope Measurement | x Times y | Calculated Best Fit Straight Line | Tolerance* |
|-----------|----------------------------|-----------|-----------------------------------|-------------|
| $x_9 = 9$ | 90% _____ | _____ | (y_9) _____ | $\pm 0.02V$ |
| $x_8 = 8$ | 80% _____ | _____ | (y_8) _____ | $\pm 0.02V$ |
| $x_7 = 7$ | 70% _____ | _____ | (y_7) _____ | $\pm 0.02V$ |
| $x_6 = 6$ | 60% _____ | _____ | (y_6) _____ | $\pm 0.02V$ |
| $x_5 = 5$ | 50% _____ | _____ | (y_5) _____ | $\pm 0.02V$ |
| $x_4 = 4$ | 40% _____ | _____ | (y_4) _____ | $\pm 0.02V$ |
| $x_3 = 3$ | 30% _____ | _____ | (y_3) _____ | $\pm 0.02V$ |
| $x_2 = 2$ | 20% _____ | _____ | (y_2) _____ | $\pm 0.02V$ |
| $x_1 = 1$ | 10% _____ | _____ | (y_1) _____ | $\pm 0.02V$ |

$$\begin{aligned} \Sigma x &= 45 & \Sigma y & \text{_____} & \Sigma xy & \text{_____} \\ (\Sigma x)^2 &= 2025 & \Sigma x \Sigma y & \text{_____} & m &= \text{_____} \\ \Sigma x^2 &= 285 & & & b &= \text{_____} \end{aligned}$$

PERFORMANCE TEST RECORD (Cont'd)

N CYCLE PHASE ACCURACY:

| Step E Reading | Step F Reading | AVG | Specification | Step H Reading |
|----------------|----------------|-----|---------------|----------------|
| | | | ± 0.167V | |

RESIDUAL DC AND DC OFFSET ACCURACY:

(Residual)

| 3314A Voltage | Offset | Specification | Voltmeter Reading |
|---------------|--------|---------------|-------------------|
| 10.00V | 0V | ± 0.05V | _____ |
| 1.000V | 0V | ± 0.005V | _____ |
| 100.0mV | 0V | ± 0.0005V | _____ |
| 10.00mV | 0V | ± 0.00005V | _____ |

(Variable)

| 3314A Voltage | Offset | Specification | Voltmeter Reading |
|---------------|--------|---------------|-------------------|
| 10.00V | 5V | ± 0.21V | _____ |
| 1.000V | 5V | ± 0.16V | _____ |
| 100.0mV | 5V | ± 0.16V | _____ |
| 10.00mV | 5V | ± 0.16V | _____ |
| 10.00V | 0.887V | ± 0.087V | _____ |
| 1.000V | 0.887V | ± 0.037V | _____ |
| 100.0mV | 0.887V | ± 0.037V | _____ |
| 10.00mV | 0.887V | ± 0.037V | _____ |

DC OFFSET ACCURACY (cont):

| 3314A Voltage | Offset | Specification | Voltmeter Reading |
|---------------|----------|---------------|-------------------|
| 10.00V | - 0.887V | ± 0.087V | _____ |
| 1.000V | - 0.887V | ± 0.037V | _____ |
| 100.0mV | - 0.887V | ± 0.037V | _____ |
| 10.00mV | - 0.887V | ± 0.037V | _____ |
| 10.00V | - 5V | ± 0.21V | _____ |
| 1.000V | - 5V | ± 0.16V | _____ |
| 100.0mV | - 5V | ± 0.16V | _____ |
| 10.00mV | - 5V | ± 0.16V | _____ |

PERFORMANCE TEST RECORD (Cont'd)

SQUARE WAVE RISE TIME AND OVERTHOOT:

| Rise Time | | Fall Time | |
|---------------|----------------------|---------------|----------------------|
| Specification | Oscilloscope Reading | Specification | Oscilloscope Reading |
| ≤ 1 cm | _____ | ≤ 1 cm | _____ |

Overshoot

| | |
|---------------|----------------------|
| Specification | Oscilloscope Reading |
| ± 0.5V | _____ |

SINE WAVE HARMONICS:

| 3314A Frequency | Range | Specification | Pass | Fail |
|-----------------|-------|--------------------|-------|-------|
| 20.0Hz | 3 | HARMONICS < - 55dB | _____ | _____ |
| 100.0Hz | 3 | HARMONICS < - 55dB | _____ | _____ |
| 199.9Hz | 3 | HARMONICS < - 55dB | _____ | _____ |
| 100. Hz | 4 | HARMONICS < - 55dB | _____ | _____ |
| 1000. Hz | 4 | HARMONICS < - 55dB | _____ | _____ |
| 1999. Hz | 4 | HARMONICS < - 55dB | _____ | _____ |
| 1.00kHz | 5 | HARMONICS < - 55dB | _____ | _____ |
| 10.00kHz | 5 | HARMONICS < - 55dB | _____ | _____ |
| 19.99kHz | 5 | HARMONICS < - 55dB | _____ | _____ |
| 10.0kHz | 6 | HARMONICS < - 55dB | _____ | _____ |
| 100.0kHz | 6 | HARMONICS < - 40dB | _____ | _____ |
| 199.9kHz | 6 | HARMONICS < - 40dB | _____ | _____ |
| 100. kHz | 7 | HARMONICS < - 40dB | _____ | _____ |
| 1000. kHz | 7 | HARMONICS < - 40dB | _____ | _____ |
| 1999. kHz | 7 | HARMONICS < - 40dB | _____ | _____ |

Measured Levels

| | | | 2nd | 3rd | 4th | 5th | 6th | 7th |
|----------|---|--------|-------|-------|-------|-------|-------|-------|
| 1.00MHz | 8 | - 25dB | _____ | _____ | _____ | _____ | _____ | _____ |
| 10.00MHz | 8 | - 25dB | _____ | _____ | _____ | _____ | _____ | _____ |
| 19.99MHz | 8 | - 25dB | _____ | _____ | _____ | _____ | _____ | _____ |

PERFORMANCE TEST RECORD (Cont'd)

AM HARMONICS:

| Specification | Pass | Fail |
|---|-------|-------|
| Harmonic Levels Below "DSPL Line" Reference | _____ | _____ |

VCO LINEARITY:

| Power Supply Voltage | Specification | Counter Reading |
|----------------------|-----------------|-----------------|
| - 8V ± 10mV | 2MHz ± 300kHz | _____ |
| - 4.5V ± 10mV | 5.5MHz ± 300kHz | _____ |
| 1V ± 10mV | 11MHz ± 300kHz | _____ |

PHASE LOCKED LOOP PHASE ACCURACY:

| 3314A Phase Setting | Specification | (t) | (t ₁) | Calculated Phase |
|---------------------|---------------|-------|-------------------|------------------|
| - 199.9° | SETTING ± 2° | _____ | _____ | _____ |
| - 90° | SETTING ± 2° | _____ | _____ | _____ |
| 0° | SETTING ± 2° | _____ | _____ | _____ |
| 90° | SETTING ± 2° | _____ | _____ | _____ |
| 199.9° | SETTING ± 2° | _____ | _____ | _____ |

AMPLITUDE ACCURACY:

| Function | Specification | Voltmeter Reading |
|----------|-------------------|-------------------|
| Sine | 3.535V ± 0.0477V | _____ |
| Square | 5.0V ± 0.0477V | _____ |
| Triangle | 2.8867V ± 0.0477V | _____ |

SINE WAVE POWER FLATNESS:

$$\text{Drift(dB)} = 20 \text{ Log } \frac{\text{Step E Reference}}{\text{Step K Reference}} < 0.025\text{dB}$$

$$\text{Flatness Error(dB)} = 20 \text{ Log } \left(\frac{7.5\text{V}}{\text{Displayed Amplitude}} \right)$$

Step E Reference _____

Drift(dB) _____

Step K Reference _____

PERFORMANCE TEST RECORD (Cont'd)

Table 4-8. Sine Wave Power Flatness

| 3314A Frequency | 3314A Displayed Amplitude | VREF | Specification | Calculated Flatness Error |
|-----------------|---------------------------|-------|---------------|---------------------------|
| 100 Hz | _____ | _____ | ± 0.04dB | _____ |
| 50 kHz | _____ | _____ | ± 0.04dB | _____ |
| 800kHz | _____ | _____ | ± 0.17dB | _____ |
| 1MHz | _____ | _____ | ± 0.17dB | _____ |
| 5MHz | _____ | _____ | ± 0.8dB | _____ |
| 19.99MHz | _____ | _____ | ± 0.8dB | _____ |

MANUAL SWEEP ACCURACY:

| "Start Freq" | "Stop Freq" | Specification | Counter Reading |
|--------------|-------------|-----------------|-----------------|
| 1 MHz | 10 MHz | 1 MHz ± 100 kHz | _____ |
| 100 kHz | 1 MHz | 100 kHz ± 1 kHz | _____ |
| 10 kHz | 100 kHz | 10 kHz ± 400 Hz | _____ |

Table 4-9. Step Attenuator Accuracy

| 3314A Frequency | 355D Attenuation | 3585A Marker Amplitude | 355D Insertion Loss | Actual Attenuation | Upper Limit | Lower Limit |
|-----------------|------------------|------------------------|---------------------|--------------------|-------------|-------------|
| 50 kHz | 20 dB | _____ | _____ | _____ | 20.05 dB | 19.95 dB |
| | 40 dB | _____ | _____ | _____ | 40.05 dB | 39.95 dB |
| | 60 dB | _____ | _____ | _____ | 60.05 dB | 59.95 dB |
| 1 MHz | 20 dB | _____ | _____ | _____ | 20.3 dB | 19.7 dB |
| | 40 dB | _____ | _____ | _____ | 40.3 dB | 39.7 dB |
| | 60 dB | _____ | _____ | _____ | 60.5 dB | 59.5 dB |
| 19.99 MHz | 20 dB | _____ | _____ | _____ | 20.3 dB | 19.7 dB |
| | 40 dB | _____ | _____ | _____ | 40.3 dB | 39.7 dB |
| | 60 dB | _____ | _____ | _____ | 60.5 dB | 59.5 dB |

Example: Actual Attenuation = 355D Attenuation Setting + (Marker Reading - Insertion Loss)

$$= 20 \text{ dB} + (0.01 \text{ dB} - (-0.013 \text{ dB}))$$

$$= 20.023 \text{ dB}$$

PERFORMANCE TEST RECORD (Cont'd)

Table 4-10. Vernier Attenuator Flatness

| 3314A Frequency | 355D Attenuation | 3585A Marker Amplitude | 355D Insertion Loss | Actual Attenuation | Upper Limit | Lower Limit |
|-----------------|------------------|------------------------|---------------------|--------------------|--------------|--------------|
| 10 kHz | 10 dB | _____ | _____ | *Ref | _____ | _____ |
| | 20 dB | _____ | _____ | *Ref | _____ | _____ |
| 50 kHz | 10 dB | _____ | _____ | _____ | Ref +0.03 dB | Ref -0.03 dB |
| | 20 dB | _____ | _____ | _____ | Ref +0.03 dB | Ref -0.03 dB |
| 1 MHz | 10 dB | _____ | _____ | _____ | Ref +0.16 dB | Ref -0.16 dB |
| | 20 dB | _____ | _____ | _____ | Ref +0.16 dB | Ref -0.16 dB |
| 19.99 MHz | 10 dB | _____ | _____ | _____ | Ref +0.7 dB | Ref -0.7 dB |
| | 20 dB | _____ | _____ | _____ | Ref +0.7 dB | Ref -0.7 dB |

Example: Actual Attenuation = 355D Attenuation Setting + (Marker Reading - Insertion Loss)

$$= 20 \text{ dB} + (0.01 \text{ dB} - (-0.013 \text{ dB}))$$

$$= 20.023 \text{ dB}$$

*Reference for attenuation flatness.

SECTION V

ADJUSTMENTS

5-1. INTRODUCTION

The adjustment and measurement procedures contained in this section are intended to restore the 3314A to its optimum operating condition. Adjustment of the instrument will be necessary following repair, replacement of components, or if desired, after the instrument has failed a Performance Test. These procedures should also be followed for periodic maintenance of the instrument*. The individual adjustments and measurements should be completed in the order in which they are presented. They include:

| | |
|--|------|
| Battery Voltage and | |
| Current Drain Check | 5-2 |
| Power Supply Adjustment | 5-3 |
| 5V Switching Supply | |
| Frequency Check | 5-4 |
| Crystal Oscillator | |
| Frequency Check | 5-5 |
| RAM/ROM Test | 5-6 |
| Amplitude Calibration | |
| Reference Voltage Check | 5-7 |
| Multiplex DAC Offset | |
| Adjustment | 5-8 |
| Frequency Accuracy | |
| Calibration Adjustment | 5-9 |
| Z-Axis Polarity | |
| Observation | 5-10 |
| Log Sweep Start Frequency | |
| Adjustment | 5-11 |
| Linear Sweep Start. | |
| Frequency Adjustment | 5-12 |
| DC Offset Adjustment | 5-13 |
| Phase Lock Phase Adjustment | 5-14 |
| Symmetry Adjustment | 5-15 |
| Hold Phase Zero Adjustment | 5-16 |
| DC/AC Balance Adjustment | 5-17 |
| Low Frequency Harmonic | |
| Distortion Adjustment | 5-18 |
| Amplitude Calibration | |
| Pad Selection | 5-19 |
| High Frequency Harmonic | |
| Distortion Adjustment | 5-20 |
| Attenuator High Frequency | |
| Compensation Adjustment | 5-21 |
| x3 (Option 001) Functional Check | 5-22 |

* It is recommended that a routine adjustment of the 3314A be performed at least once a year.

The adjustment and measurement locations for the procedures described in this section are found on page 5-21/22.

WARNING

Maintenance described herein is performed with power supplied to the instrument and protective covers removed. Such maintenance should be performed by service-trained personnel who are aware of the hazards involved (for example, fire and electrical shock). Where maintenance can be performed without power applied, the power cord should be removed.

NOTE

Allow the 3314A a "warm-up" period of 30 minutes prior to making adjustments.

5-2. BATTERY VOLTAGE AND CURRENT DRAIN CHECK

This procedure checks for excessive current drawn by RAM and measures the voltage across Battery A3B1 and at pin 18 of A3U211 (CMOS RAM Memory).

Equipment Required:

-hp- 3455A Digital Voltmeter

Procedures:

A. Turn the 3314A off.

B. Set the digital voltmeter as follows:

| | |
|-------------------|----------|
| Function | DC |
| Range | Auto |
| Trigger | Internal |
| Math | Off |
| Sample Rate | Maximum |

C. Using the voltmeter, measure the voltage across A3R13. This voltage has a typical value of 1.35mV and a maximum value of 18.5mV. A voltage > 18.5mV across A3R13 indicates excessive current drain which may result in the discharge of A3B1.

Table 5-1. Recommended Equipment List

| Equipment | Critical Specifications | Recommended Model |
|------------------------------------|---|-------------------|
| Digital Voltmeter | DC Function, Acc. $\pm 0.05\%$. Resolution 6 Digits. | -hp- 3455A |
| Universal Counter | Freq. Measurement to 20MHz. Acc: ± 2 counts. Resolution 8 Digits. | -hp- 5328A |
| Oscilloscope | Vertical BW DC to 275MHz. Deflection 0.01V to 10V/Div. Horizontal Sweep 0.05 μ s. | -hp- 1725A |
| Spectrum Analyzer | Freq. Range 20MHz to 40MHz. Amplitude Accuracy: ± 0.2 dB. | -hp- 3585A |
| Synthesizer/ Function Generator | Sine Output: 1kHz. Amplitude: 1VRMS into 10k Ω . | -hp- 3325A |
| 50 Ω Load | Accuracy: $\pm 0.2\%$. Power Rating: 1w. | -hp- 11048C |
| Spectrum Analyzer | Freq. Range 40MHz to 120MHz. Amplitude Acc: ± 0.5 dB. | -hp- 8558B |
| BNC/TEE Adaptor | Male Female Female BNC. | -hp- 1250-0781 |
| 10:1 Probe | 1M Ω , 20-26pf input capacitance. | -hp- 10041A |

NOTE

If the voltage measured across A3R13 indicates a large current drain, suspect bad RAMs.



Servicing personnel should wear a static control wristband to avoid Electrostatic Discharge ("Static Zap") of the components within the 3314A. Potentials as low as 500V though not noticed by touching the instrument, can damage sensitive components within the instrument.

D. Simultaneously short the (+) terminal of A3B1 to ground while measuring the DC voltage across the battery. Maintain the short and measurement for approximately five seconds. Monitor the voltmeter display and verify that the voltage remains $> 2.20V$. (**REMOVE SHORT IMMEDIATELY AFTER MAKING THIS MEASUREMENT.**)

NOTE

If the battery voltage failed to remain $> 2.20V$, suspect not only bad RAMs, but also the possibility that A3CR2 may have been destroyed while probing. This would result in current loading by the power supplies.

E. Measure the voltage at pin 18 of A3U211 with respect to ground. The voltage should be $\geq 2.5VDC$ but $< 3.5VDC$.

NOTE

This step is a check to insure that the short applied in step D did not drain A3B1 below its required operating potential.

5.3. POWER SUPPLY ADJUSTMENT

This adjustment enables the 3314A to generate accurate voltage levels (through Amplitude Calibration) and calibrate its frequency over the proper range by setting the $-15VDC$ and $+15VDC$ supply levels and measuring the $+5VDC$ supply.

Equipment Required:

-hp- 3455A Digital Voltmeter

Procedures:

A. Preset the 3314A.

B. Set the digital voltmeter as follows:

Function DC
 Range Auto
 Trigger Internal
 Math Off
 Sample Rate Maximum

C. Using the voltmeter, measure the -15VDC supply with respect to ground on A1J5 pin 17.

D. If necessary, adjust A3R113 until -15VDC ± 5mV is measured on the voltmeter.

E. Measure the +15VDC supply with respect to ground on A1J5 pin 20.

F. If necessary, adjust A3R114 until +15VDC ± 5mV is measured on the voltmeter.

G. Measure the +5VDC supply with respect to ground at A3TP3. The level should be 5.1VDC ± 100mV.

NOTE

If the voltage measured in step G is below the specified level, disconnect cables A3J1 through A3J3 while continuing to monitor the +5V supply at A3TP3. This will determine which PC assembly is causing the failure. If after J1 through J3 have been disconnected the voltage remains below the required level, suspect problems with either the controller hardware or power supplies.

5-4. 5V SWITCHING SUPPLY FREQUENCY CHECK

This procedure measures the Switching Frequency of the +5VDC supply.

Equipment Required:

- hp- 5328A Universal Counter
- hp- 10041A 10:1 Probe

Procedures:

- A. Preset the 3314A.
- B. Set the counter as follows:

Function Freq A
 Resolution 1Hz
 Level A Preset
 Slope +
 Coupling AC
 Attenuation x10
 Input Termination 1 MΩ
 Sample Rate Adjust CCW
 as necessary

C. Using the probe, measure the Switching frequency at the collector of A3Q108. The frequency should be 33kHz ± 3.3kHz.

NOTE

Note that this is the "average" value and that instantaneous deviations greater than the 10% spread may occur. If the measured frequency remains outside the 33kHz ± 3.3kHz range, suspect hardware problems or a possible short of the +5V supply.

5-5. CRYSTAL OSCILLATOR FREQUENCY CHECK

This procedure measures the Crystal Oscillator frequency.

Equipment Required:

- hp- 5328A Universal Counter

Procedures:

- A. Preset the 3314A.
- B. Set the counter as follows:

Function Freq A
 Resolution 1Hz
 Level A Preset
 Slope +
 Coupling AC
 Attenuation x10
 Input Termination 1 MΩ
 Sample Rate Adjust CCW
 as necessary

C. Using the counter, measure the Crystal Oscillator frequency at A3TP5 (MPU CLK 1) and A3TP4 (MPU CLK 2). The frequency should be 1.0MHz ± 50Hz.

NOTE

If the frequency measured in step C is outside the given range by 10% or more, the crystal may have to be replaced.

5-6. RAM/ROM TEST

This procedure checks for RAM or ROM failures within the 3314A and tests the functioning of the front panel keys.

Equipment Required:

NONE

Procedures:

- A. Turn the 3314A OFF, then ON, while simultaneously pressing the "ARB" key.

Table 5-2. RAM/ROM Location and Reference LED's

| ROM Test | | | | | | |
|----------------------|-------------|-------------|-------------|-------------|-----------|-----------|
| LED | FREQ | AMPTD | OFFSET | SYM | PHASE | N |
| Reference Designator | U238 | U236 | U210 | U209 | U208 | U207 |
| ROM Address Block | 4000-5FFF | 6000-7FFF | 8000-9FFF | A000-B000 | C000-D000 | E000-FFFF |
| RAM Test | | | | | | |
| LED | SW/TR INTVL | START FREQ | STOP FREQ | MKR | | |
| Reference Designator | U234 | U233 | U211 | U212 | | |
| RAM Location | UPPER4 NMOS | LOWER4 NMOS | UPPER4 CMOS | LOWER4 CMOS | | |

B. After power has been restored to the 3314A, release the "ARB" key.

C. The 3314A front panel will be blank for approximately 30 seconds while the RAM/ROM Test is in Progress. At the end of this period, all front panel LED'S and display segments should illuminate.

D. RAM or ROM failures are indicated by the non-illumination of the LED corresponding to the selected front panel parameter listed in Table 5-2. For example, if the ROM with reference designator U236 failed, the "AMPTD" LED on the 3314A front panel would not illuminate.

NOTE

Should a LED assigned to the RAM/ROM locations fail to illuminate, press its corresponding key. If the LED illuminates when the key is pressed, then the RAM or ROM is probably bad. If the LED does not illuminate when the key is pressed, then the LED is most likely defective.

E. After replacing any failed RAM or ROMs, repeat test beginning with step A. This is necessary because of the serial manner in which the RAMs are checked. (The RAM test stops after the first bad RAM is found.) Repeat this test until all RAM (and ROM) LEDs illuminate then proceed to step F.

F. After determining RAM/ROM quality, press each front panel key and verify that its corresponding LED toggles. This assures that each key functions properly.

G. Observe the rightmost seven segment display while pressing the "Range Up" key. Segment "B" of the display (see Figure 5-1), should toggle.

H. Press the "Range Down" key to verify that it toggles segment "C" (see Figure 5-1), of the seven segment display.

I. Press Modify keys "←" and "→" to verify that they toggle segments "F" and "E" respectively.

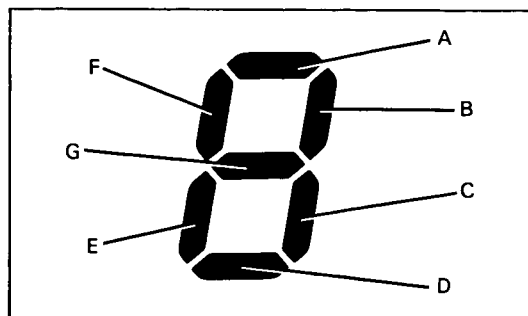

Figure 5-1. Seven Segment Display

J. Observe the "1" on the left side of the 3314A display. Rotate the Modify Knob clockwise to confirm that the upper segment toggles. Rotate the Modify Knob counterclockwise to confirm that the bottom segment toggles.

K. Recycle the power on the 3314A to exit the RAM/ROM test. "E09" will appear in the display due to the memory in RAM that was lost while the test was being performed. This is the normal instrument response.

5-7. AMPLITUDE CALIBRATION REFERENCE VOLTAGE CHECK

This procedure verifies the Reference Voltage levels for Amplitude Calibration.

Equipment Required:

- hp- 3455A Digital Voltmeter

Procedures:

A. Preset the 3314A.

B. Set the digital voltmeter as follows:

- Function DC
- Range Auto
- Trigger Internal
- Math Off
- Sample Rate Maximum

C. Using the voltmeter, measure the voltage between A1U805 pin 3 and ground. The level should be +5.515VDC ±0.005V.

D. Measure the voltage between A1U805 pin 6 and ground. The level should be -5.515VDC ±0.005V.

NOTE

If the voltages measured in steps C and D are outside their given tolerances, check the levels of the +15VDC and -15VDC supplies. Adjust the supplies if necessary and repeat steps C and D of this test. If the voltages still do not meet the specification, check the values of A1R804 through A1R807 against those given on the schematic. A1U805 may also need to be replaced.

5-8. MULTIPLEX DAC OFFSET ADJUSTMENT

This adjustment cancels the offset voltage of A2U207, thus assuring the proper functioning of the Multiplex DAC.

Equipment Required:

-hp- 3455A Digital Voltmeter

Procedures:

- A. Preset the 3314A.
- B. Set the digital voltmeter as follows:

Function DC
 Range Auto
 Trigger Internal
 Math Off
 Sample Rate Maximum

NOTE

Due to the precision required for this adjustment, connect the 3455A ground to A2J8 pin 4 of the 3314A.

- C. Using the voltmeter, measure the DC voltage between A2U213 pin 1 and ground. The level should be 0.0VDC \pm 0.1mV.
- D. If necessary, adjust A2R212 (DAC Offset) until 0.0VDC \pm 0.1mV is measured.

NOTE

Sweep and Amplitude accuracy are affected by this adjustment.

5-9. FREQUENCY ACCURACY CALIBRATION ADJUSTMENT

This adjustment sets the Frequency Calibration potentiometer to the center of the calibration range, thus insuring the 3314A's ability to calibrate frequency over its entire operating temperature range.

Equipment Required:

NONE

Procedures:

- A. Preset the 3314A.
- B. Set A3S1(4) and A3S1(5) to the "closed" position.
- C. Turn the 3314A OFF, then ON.
- D. Return A3S1(4) and A3S1(5) to the "open" position. (The 3314A is now in Test Mode 01.)
- E. Adjust A2R429 (Freq Cal) until 000 \pm 002 is shown in the 3314A display.
- F. Press the "Range Down" key to return the 3314A to normal operation. Verify that the instrument passes the calibration without "E31" appearing in the display*.

NOTE

If "E31" continues to be displayed, press the "Range Up" key four times to set the frequency to 10MHz. If "E31" was displayed as the frequency changed to 10MHz, adjust A1C218 (10MHz Adjust) in either direction and perform a calibration ("Blue", "RCL"). Repeat adjustment and calibration until "E31" no longer appears when the calibration is performed. (If E31 continued to appear after adjusting A1C218, check the power supplies for proper amplitude, adjust if necessary, and repeat Frequency Accuracy Calibration adjustment.)

5-10. Z-AXIS POLARITY OBSERVATION

This procedure measures the amplitude of the Z-Axis Marker pulse and verifies its change in polarity when the Z-Axis switch is toggled.

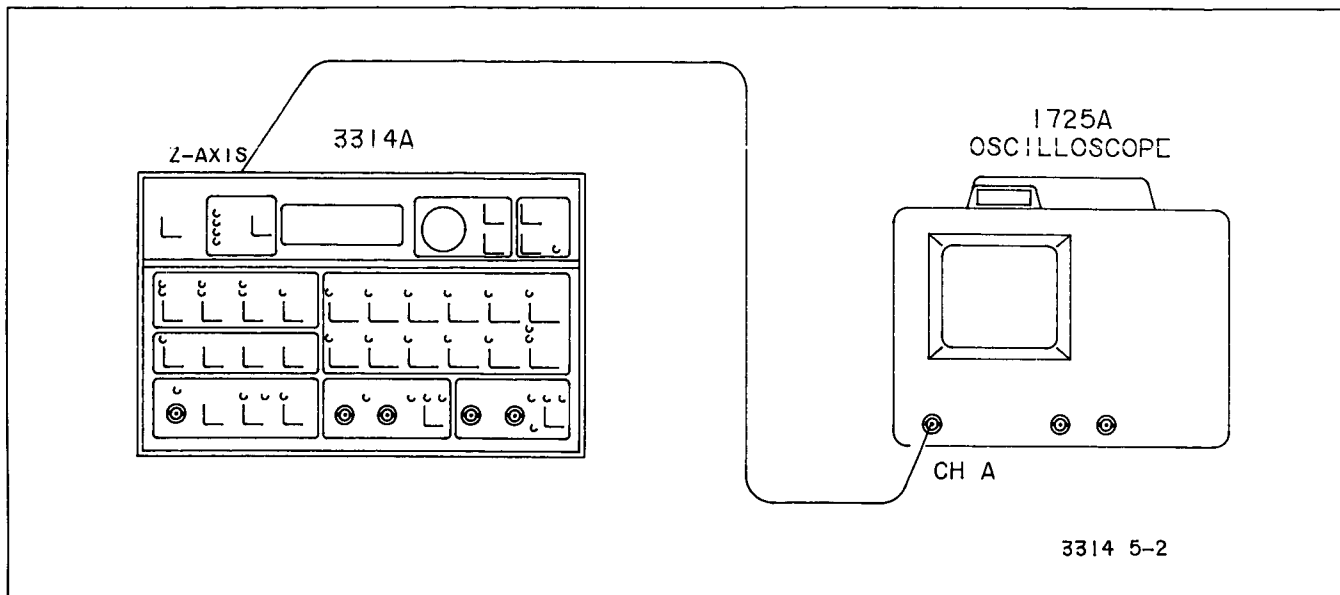

Figure 5-2. Z-Axis Polarity Observation

Equipment Required:

-hp- 1725A Oscilloscope

Procedures:

A. Preset the 3314A.

B. Set the oscilloscope as follows:

Volts/Div 5V
 Coupling DC
 Vert Display A
 Internal Trig A
 Time/Div 2ms
 Horiz Display Main

C. Connect the 3314A's "Z-Axis" output to the oscilloscope's channel A input.

D. Enable the 3314A Linear Sweep.

E. Observe the waveform on the oscilloscope. The waveform should have the amplitude and polarity as shown in Figure 5-3 if A2S501 is in the "BLK +" position. If A2S501 is in the "BLK -" position, the waveform should appear as shown in Figure 5-4.

NOTE

Note the position that the Z-Axis switch is currently in. It should be returned to that position as soon as this test is completed.

F. Switch A2S501 from its previous state and observe the waveform's change in polarity. This assures that the Z-Axis switch is functioning properly.

G. Return A2S501 to the position it was in when the instrument was received.

5-11. LOG SWEEP START FREQUENCY ADJUSTMENT

This adjustment provides accurate Log Sweep Start frequencies by setting the Frequency Control Voltage (FCV) to the correct level.

Equipment Required:

-hp- 5328A Universal Counter

Procedures:

A. Preset the 3314A.

B. Set the counter as follows:

Function Per Avg A
 Periods Averaged 10
 Level A Preset
 Slope +
 Coupling AC
 Attenuation x1
 Sample Rate Adjust CCW
 as necessary

C. Connect the 3314A to the counter.

D. Enable the 3314A "Log Sweep".

E. Perform a calibration of the Sweep Stop frequency by pressing "Blue", "RCL".

F. Press "Man Sweep".

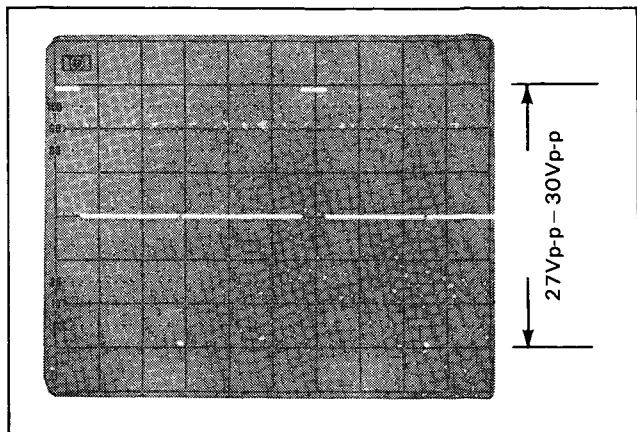

Figure 5-3. Z-Axis Polarity Observation "BLK+"

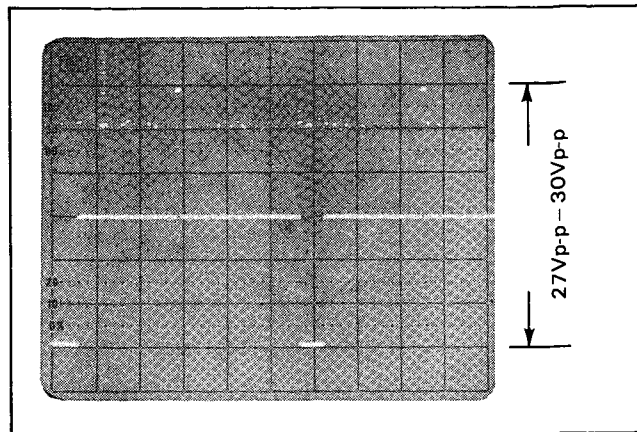

Figure 5-4. Z-Axis Polarity Observation "BLK-"

G. Press "Stop Freq" and record the period measured on the counter. (This period should be between 97.8 μ s and 102.2 μ s.)

H. Press "Start Freq". 1000Hz should now be displayed on the 3314A.

I. While monitoring the counter's display, adjust A2R427 (Log Sweep) until a reading 10x the period recorded in step G ($\pm 1\mu$ s) is measured on the counter.

NOTE

If this adjustment fails to provide accurate Log Sweep Start frequencies, suspect problems with either the frequency generator on the A1 board, the Freq/Sym DAC, or the FCV line.

5-12. LINEAR SWEEP START FREQUENCY ADJUSTMENT

This adjustment insures accurate Linear Sweep Start frequencies by providing the proper reference to the Multiplex DAC.

Equipment Required:

- hp- 5328A Universal Counter

Procedures:

A. Preset the 3314A.

B. Set the counter as follows:

| | |
|-------------------|--------|
| Function | Freq A |
| Resolution | 1Hz |
| Level A | Preset |
| Slope | + |
| Coupling | AC |
| Attenuation | x1 |

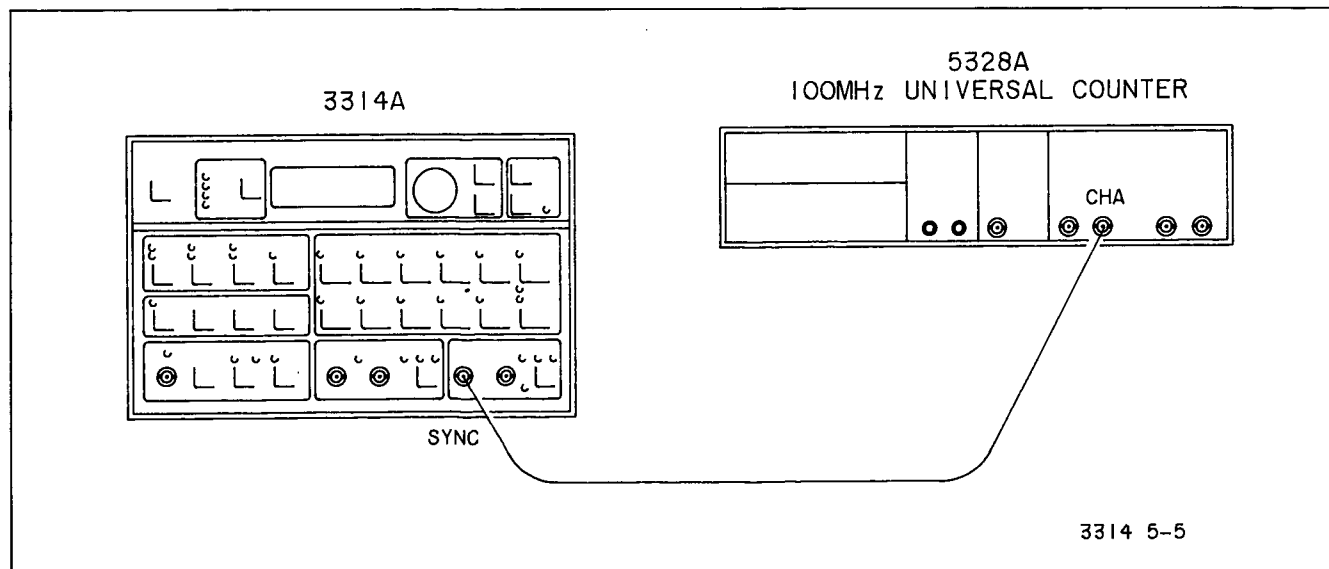

Figure 5-5. Log Sweep Start Frequency Adjustment

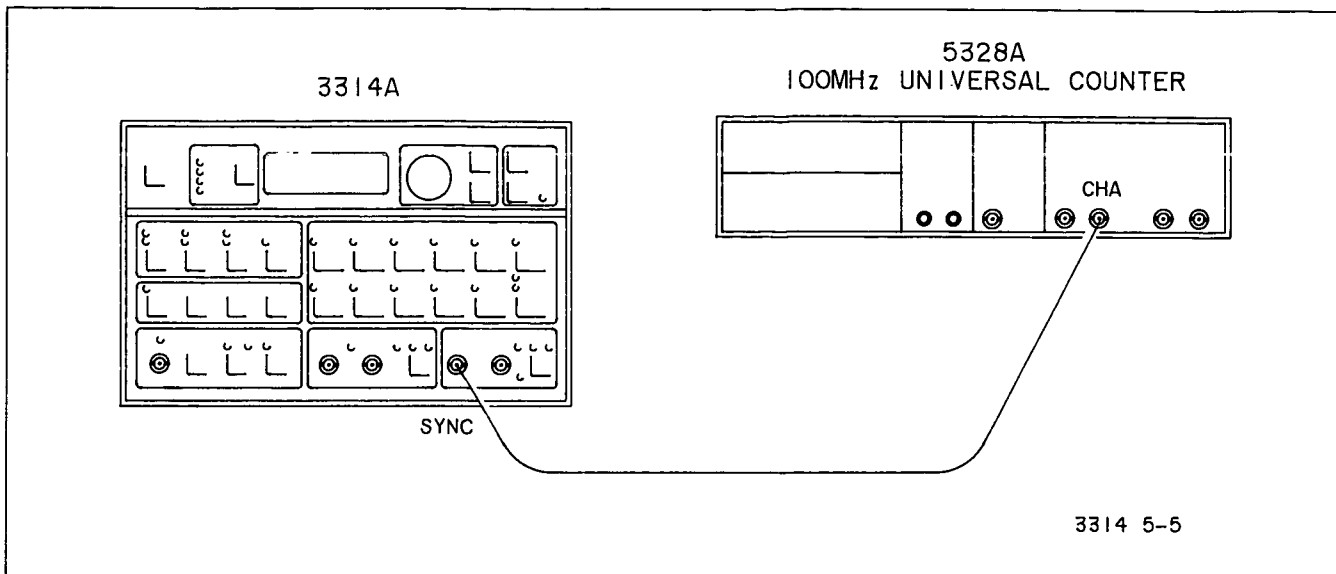

Figure 5-6. Linear Sweep Start Frequency Adjustment

- C. Connect the 3314A to the counter.
- D. Enable the 3314A "Linear Sweep".
- E. Perform a calibration of the Sweep Stop frequency by pressing "Blue", "RCL".
- F. Press "Man Sweep".
- G. Press "Stop Freq" and record the period measured on the counter. (This period should be between $99.7\mu\text{s}$ and $100.3\mu\text{s}$.)
- H. Press "Start Freq". 1000Hz should now be displayed on the 3314A.
- I. While monitoring the counter's display, adjust A2R205 (Lin Sweep) until a reading 10x the period recorded in step G ($\pm 1\mu\text{s}$) is measured on the counter.

NOTE

If this adjustment fails to produce the desired results, consider possible problems with A2U201 or the A2U212 analog switch.

5-13. DC OFFSET ADJUSTMENT

This adjustment assures accurate DC Offset levels.

Equipment Required:

-hp- 3455A Digital Voltmeter

Procedures:

- A. Preset the 3314A.

- B. Set the 3314A as follows:

| | |
|-----------------|--------|
| Function | Off |
| DC Offset | 0.002V |

- C. Set the voltmeter as follows:

| | |
|-------------------|----------|
| Function | DC |
| Range | Auto |
| Trigger | Internal |
| Math | Off |
| Sample Rate | Maximum |

- D. Connect the 3314A to the digital voltmeter.

- E. Note the DC Offset measured on the voltmeter. If necessary, adjust A2R267 (DC Zero) until an Offset of $0.002\text{VDC} \pm 5\text{mV}$ is indicated by the voltmeter.

NOTE

If small errors between the actual and displayed offset continue to exist after adjusting A2R267, check the values of A2R233, A2R234, A2R264, A2R265, and A2R266 against those given on the schematic. If large errors result, look for problems on the output amplifier board.

5-14. PHASE LOCK PHASE ADJUSTMENT

This adjustment insures the Phase accuracy between the 3314A and the reference to which it is locked, by regulating bias currents which control the phase difference and stabilize the phase locked loop.

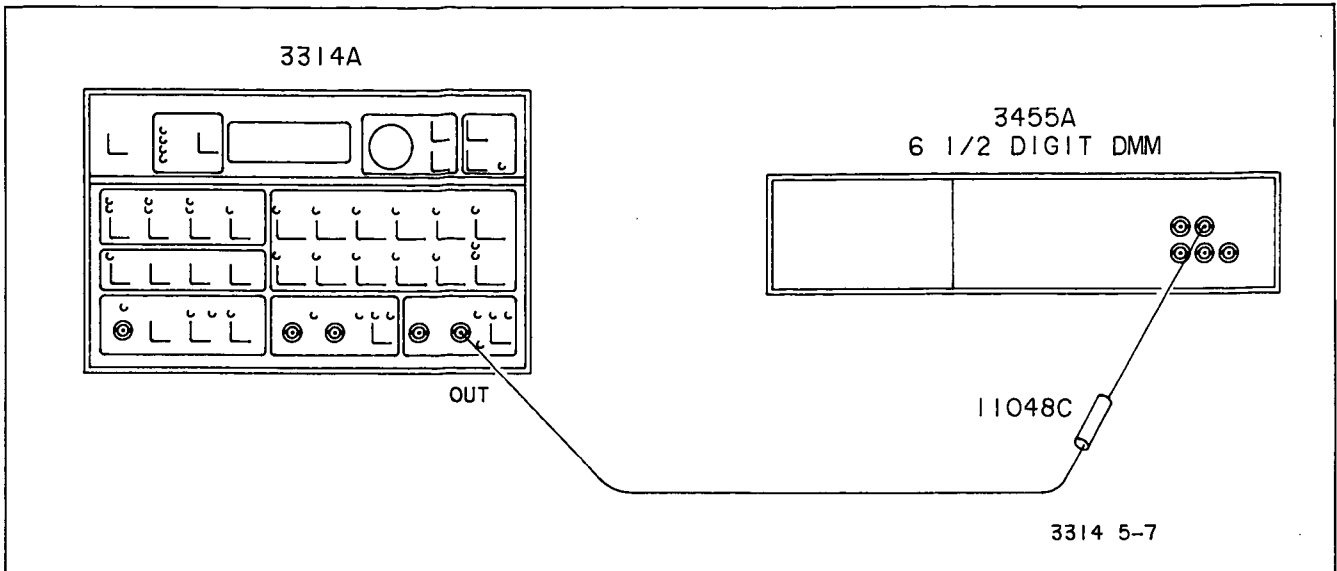

Figure 5-7. DC Offset Adjustment

Equipment Required:

-hp- 1725A Oscilloscope

Procedures:

A. Preset the 3314A.

B. Set the 3314A as follows:

Mode Fin x N
 Trig Intvl 0.1ms

C. Set the oscilloscope as follows:

| | Chan. A | Chan. B |
|---------------------|-------------|---------|
| Coupling | DC | DC |
| Volts/Div | 0.5V | 0.5V |
| Vert Display | Alt | |
| Int Trig | B | |
| Time/Div | 0.02ms | |
| DLY Time Int | Delta T Off | |
| Horiz Display | Main | |

D. Connect the "Sync" and "Trigger" outputs of the 3314A to oscilloscope channels A and B respectively.

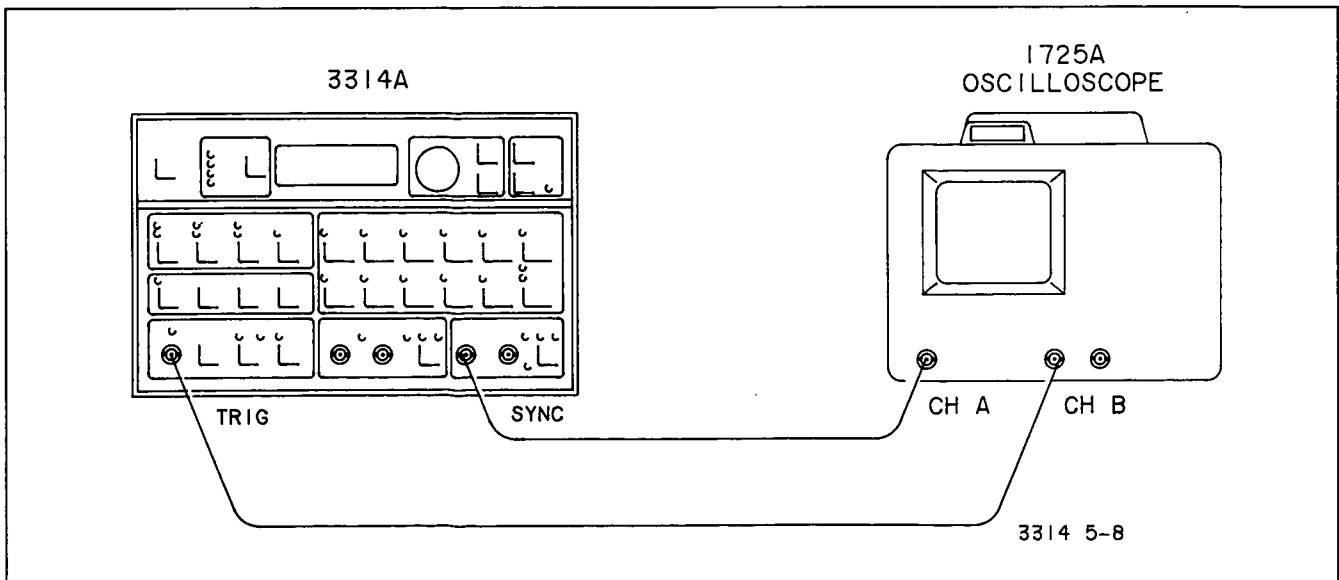

Figure 5-8. Phase Lock Phase Adjustment

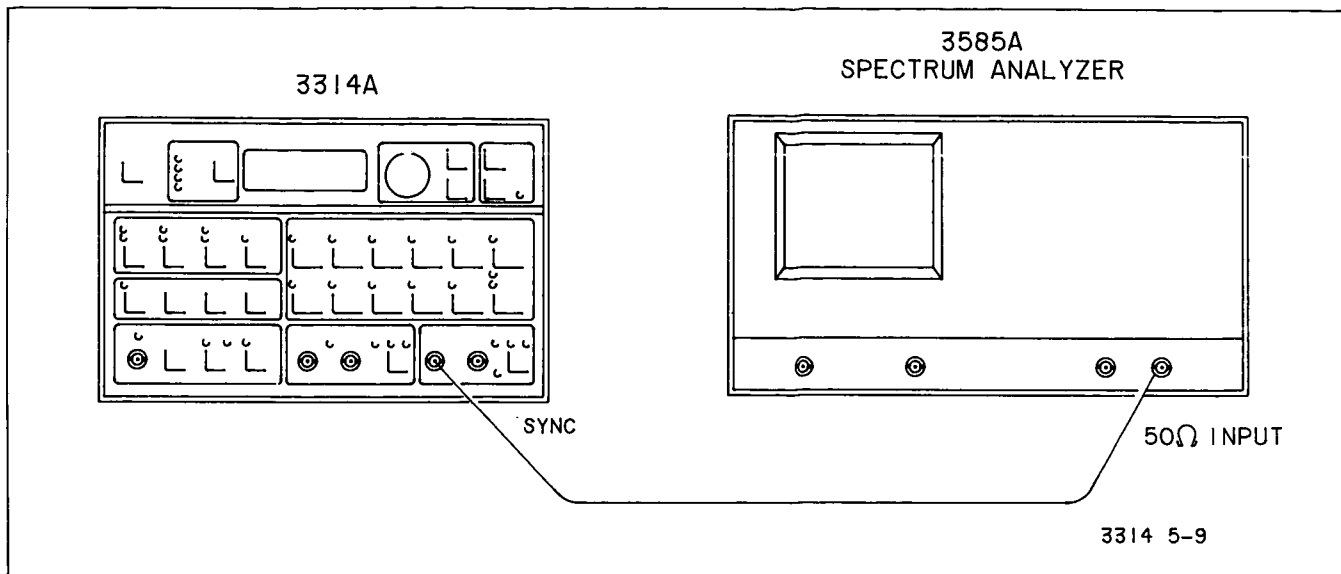

Figure 5-9. Symmetry Adjustment

E. Activate "Range Hold" on the 10kHz range by pressing the "Freq" key followed by the "Blue"/"Range Down" keys.

F. Observe the waveforms displayed on the oscilloscope. Both square waves should be in phase. Center both waveforms around the oscilloscope's x-axis graticule.

G. Set the phase on the 3314A to +180°.

H. Set the "Delayed Time/Division" knob on the oscilloscope to 0.5 μ s.

I. Adjust the Time Interval Stop Control until the Marker overlaps the rising edge of the 3314A Trigger square wave (chan. B).

J. Change the oscilloscope's "Horiz Display" to "DLY'D" and increase the beam intensity.

K. Using the "Time Interval Stop Control", set the rising edge of the Trigger signal so that it is centered on the oscilloscope's y-axis graticule.

L. Adjust A2R113 (Phase +180) so that the falling edge of the 3314A "Sync" square wave coincides with the "Trigger" rising edge on the y-axis graticule*. The edges should not be more than 166ns apart.

Note

Expect at least 1 μ s of phase jitter on the "Sync" falling edge. Adjust the edge so that the y-axis graticule appears in the "center" of the jitter.

M. Set the phase on the 3314A to -180°. The "Sync" waveform will shift a full period in relation to the "Trigger" waveform.

N. Adjust A2R108 (Phase -180) so that the falling edge of the 3314A "Sync" square wave coincides with the "Trigger" rising edge on the y-axis graticule*. The edges should not be more than 166ns apart.

Note

Expect at least 1 μ s of phase jitter on the "Sync" falling edge. Adjust the edge so that the y-axis graticule appears in the "center" of the jitter.

O. Set the 3314A phase back to +180° and verify that "Phase +180" is within its specification. If necessary, adjust A2R113 until the specification is met (<166ns).

P. Set the 3314A phase to -180° and verify that "Phase -180" is within its specification (<166ns). Adjust A2R108 if necessary.

Q. Repeat steps O and P until both phase adjustments remain within specification.

R. Set the 3314A phase to 0°. Verify that both the "Sync" and "Trigger" waveforms are in phase.

5-15. SYMMETRY ADJUSTMENT

This adjustment minimizes the second harmonic of the differential triangle wave thus producing a symmetrical waveform. This assures that the functions derived from the triangle wave (sine, square), will also be symmetrical.

Equipment Required:

-hp- 3585A Spectrum Analyzer

Procedures:

A. Preset the 3314A.

B. Set the 3314A as follows:

Amplitude 3Vp-p
Function triangle

C. Press "Instr Preset" on the spectrum analyzer.

D. Set the spectrum analyzer as follows:

Stop Freq 10kHz
Counter On

E. Connect the 3314A to the spectrum analyzer by first removing phono cable A1J8 from the instrument. Second, move the "Sync" cable from A1J1 to A1J2 and connect the 3314A to the analyzer's 50Ω input via the 3314A's "Sync" output. (See Figure 5-9.)

F. Press "Manual" on the spectrum analyzer and enter 1kHz. This places the spectrum analyzer marker over the 3314A fundamental.

G. After the counter reading on the spectrum analyzer screen has stabilized, press the following key sequence:

"MKR - OFS → STEP"
"Counter" (Off)
"Offset"
"Enter Offset"
"Manual" (Enter 0Hz)
"Manual"
"Up Arrow"
"Up Arrow"

The marker on the spectrum analyzer screen is now over the second harmonic of the 1kHz triangle wave signal.

H. Note the amplitude of the second harmonic (see screen upper right). This level should be ≤ -75dB. If necessary, adjust A1R110 (Symmetry) on the 3314A until this level is brought into specification.

I. Press "Cont" on the spectrum analyzer. Observe that the 1kHz spectrum up to the 9th harmonic is displayed on the screen.

J. Check the level of the EVEN harmonics (4th-8th) to verify that they are ≤ -75dB.

K. Place phono cable A1J8 back in the instrument and move the "Sync" cable back to A1J1.

NOTE

If this adjustment fails to yield satisfactory results, check for possible problems with either the Freq/Sym DAC or the A1U103 biasing circuit.

5-16. HOLD PHASE ZERO ADJUSTMENT

This procedure sets the zero point of the servo loop by adjusting the offset of the input to the Hold Phase Servo Amplifier.

Equipment Required:

-hp- 1725A Oscilloscope

Procedures:

A. Preset the 3314A.

B. Set the 3314A as follows:

Mode Gate
Frequency 10kHz
Amplitude 10Vp-p
Function triangle
Trig Intvl 1ms

C. Set the oscilloscope as follows:

Volts/Div 2V
Time/Div 0.2ms
Coupling 50Ω
Vert Display A
Int Trig A
Horiz Display Main

D. Connect the 3314A to the oscilloscope.

E. Using the Vertical Position knob on the oscilloscope, adjust the display until the triangle wave is centered around the x-axis graticule.

F. Observe the horizontal segment of the waveform between the triangle bursts. If necessary, adjust A1R269 (Hold Phase Zero) until the segment is centered on the x-axis graticule.

NOTE

Gate, N Cycle, 1/2 Cycle, and ARB modes are affected by this adjustment.

5-17. DC/AC BALANCE ADJUSTMENT

These adjustments minimize residual signals at 0V amplitudes and insure amplitude accuracy while "Amplitude Range Hold" is activated.

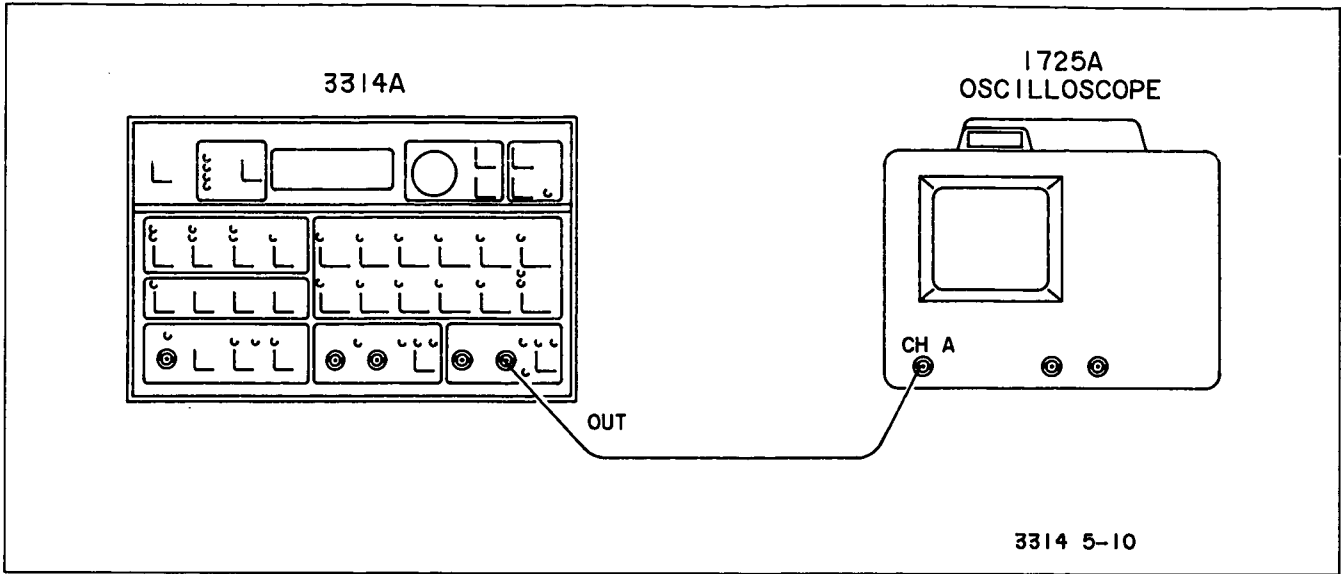

Figure 5-10. Hold Phase Zero Adjustment

Equipment Required:

-hp- 1725A Oscilloscope

Procedures:

- A. Set A3S1(4) and A3S1(5) to the "closed" position.
- B. Turn the 3314A OFF, then ON.
- C. Return A3S1(4) and A3S1(5) to the "open" position.
- D. Press "Range Up". (The 3314A is now in Test Mode 02.)

E. Set the oscilloscope as follows:

- Volts/Div 0.01V
- Time/Div 0.1ms
- Vert Display A
- Int Trig A
- Horiz Display Main
- Coupling 50Ω
- BW Limit 20MHz
- Main Triggering Ext

F. Set the Coupling Select lever on the oscilloscope to ground and center the trace on the x-axis graticule.

G. Set the coupling on the oscilloscope back to DC and connect the 3314A's "Sync" and "Function" out-

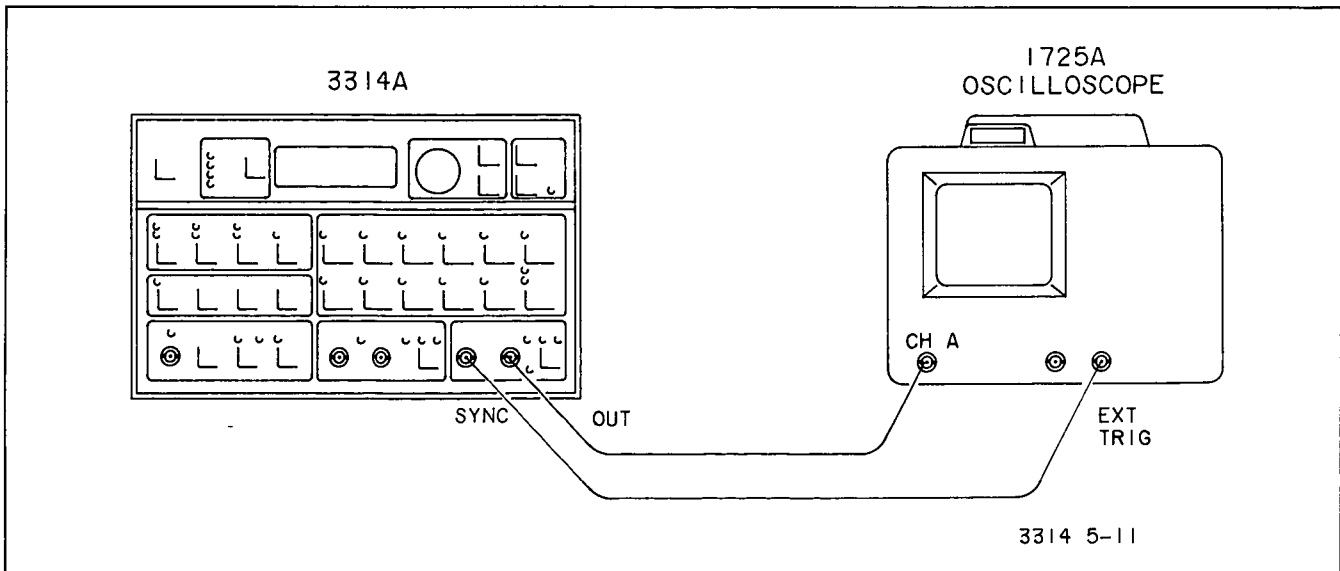

Figure 5-11. DC/AC Balance Adjustment

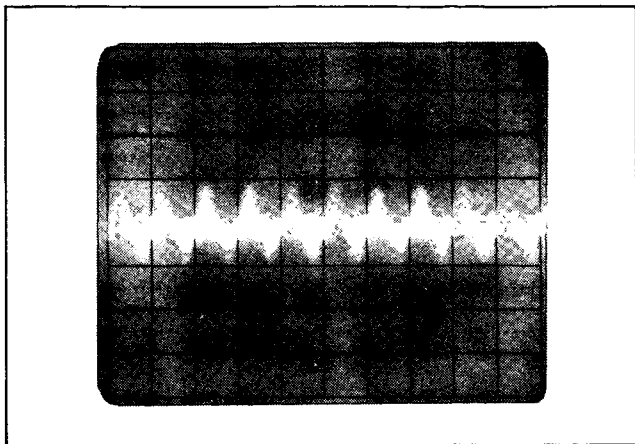

Figure 5-12A. DC/AC Balance Sine Adjustment

puts to the oscilloscope's "Ext Trig" and channel A inputs respectively.

H. Observe the "pulsating" beam on the oscilloscope. Adjust A1R559 (Sine AC Bal) to make the beam as narrow as possible.

I. While continuing to observe the beam on the oscilloscope, adjust A1R542 (DC Bal) until the beam (which will continue to pulsate) remains centered around the x-axis graticule. (See Figure 5-12A.)*

NOTE

The beam may shift 1 or 2 divisions with respect to the x-axis graticule which is acceptable.

J. Press "Range Up" on the 3314A to invoke Test Mode 03.

K. Adjust A1R511 (Triangle AC Bal) to make the beam as narrow as possible. (See Figure 5-12B.)

L. Press "Range Up" two times to exit the test modes and return the 3314A to normal operation.

NOTE

This adjustment may affect the symmetry of the instrument. It is therefore recommended that the symmetry (paragraph 5-15), be checked and adjusted (if necessary) before proceeding.

5-18. LOW FREQUENCY HARMONIC DISTORTION ADJUSTMENT

These adjustments minimize the harmonic distortion on the lower frequencies generated by the 3314A.

Equipment Required:

-hp- 3585A Spectrum Analyzer

Procedures:

A. Preset the 3314A.

B. Set the amplitude of the 3314A to 3.0Vp-p.

C. Press "Instr Preset" on the spectrum analyzer and set the Stop frequency at 10kHz.

D. Connect the 3314A to the spectrum analyzer.

E. Determine the exact frequency of the signal by pressing the following spectrum analyzer keys:

"Manual" (enter 1kHz)
 "Counter" (on)

F. After the counter reading on the spectrum analyzer has stabilized, press the following key sequence (this accurately locates each harmonic):

"MKR - OFS - STEP"
 "Counter" (Off)
 "Manual" (enter 0Hz)
 "Manual"
 "Up Arrow"
 "MKR - REFLVL"
 "Offset" (on)
 "Enter Offset"
 "Manual"
 "Up Arrow"

The spectrum analyzer marker is now over the second harmonic.

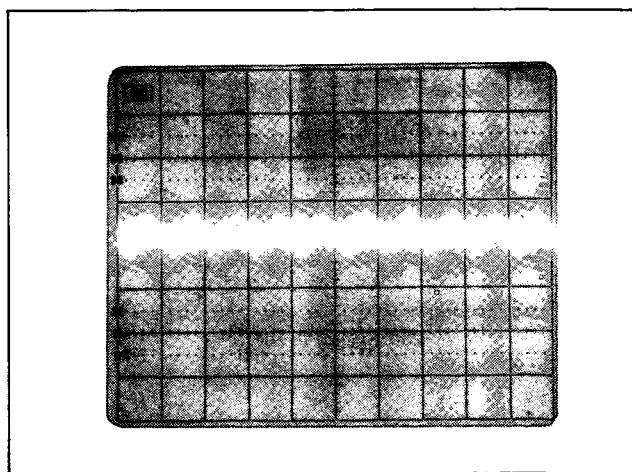

Figure 5-12B. DC/AC Balance Triangle Adjustment

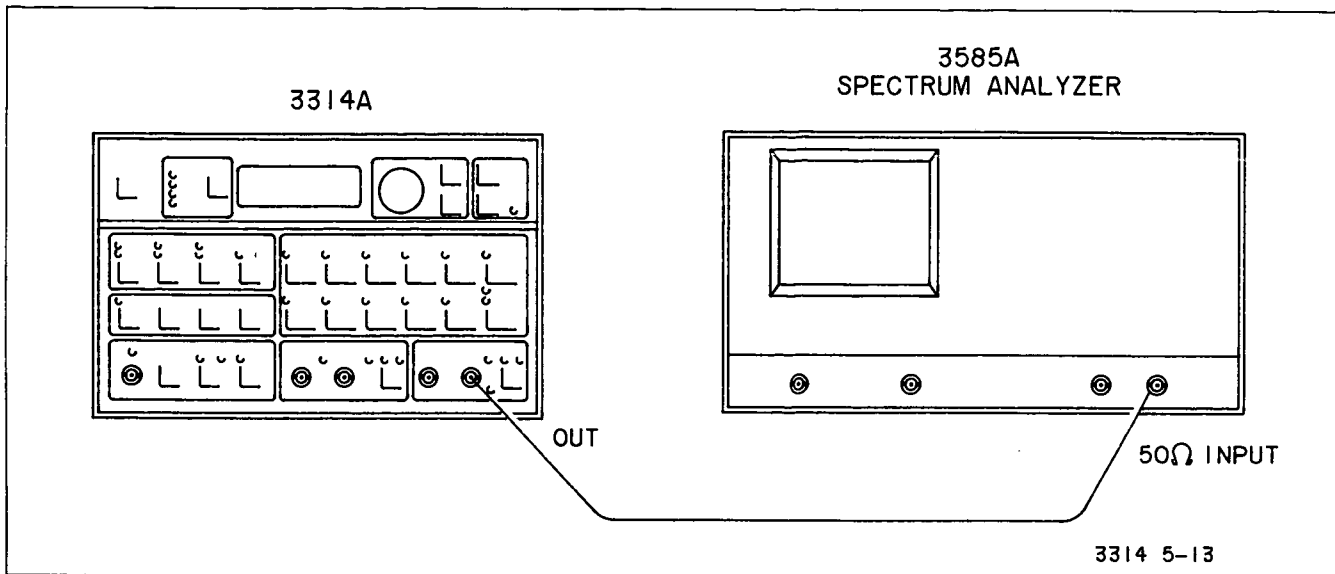

Figure 5-13. Low Frequency Harmonic Distortion Adjustment

G. Adjust A1R334 (Even Harmonics) until the second harmonic is at its minimum level. This level should not exceed -60dB .

H. Press "Up Arrow" three times on the spectrum analyzer to place the marker over the 5th harmonic.

I. Adjust A1R550 until the 5th harmonic level is at a minimum.

J. Press "Down Arrow" two times to place the marker over the 3rd harmonic.

K. Adjust A1R551 until the 3rd harmonic is at a minimum level.

L. A1R550 and A1R551 interact. Therefore, repeated adjustments of the 3rd and 5th harmonic levels will have to be made to insure that they remain at a minimum. (Third harmonic $\leq -60\text{dB}$, Fifth harmonic $\leq -60\text{dB}$.)

M. Press "Instr Preset" on the spectrum analyzer and set the Stop frequency to 110kHz . Verify that harmonic levels out to the tenth harmonic are less than or equal to -60dB .

5-19. AMPLITUDE CALIBRATION PAD SELECTION

This procedure is a method for selecting three resistors which in turn minimize the amplitude difference between the sine, square, and triangle functions. This enables Amplitude Calibration to correct for accurate voltage levels.

NOTE

DC/AC Balance and Low Frequency Harmonic distortion must be completed before proceeding.

NOTE

Due to the length and involvement of this procedure, it is recommended that the "Sine Shaper Replacement Kit" (P/N 03314-86501) which contains a Sine Shaper IC and three factory selected resistors, be ordered from the nearest -hp- Sales and Service Office. This procedure should be followed if the Kit is unavailable or if the situation requires immediate action.

Equipment Required:

- hp- 3455A Digital Voltmeter
- hp- 11048C 50Ω load

Procedures:

- A. Preset the 3314A and set the amplitude to 10Vp-p .
- B. Set the digital voltmeter as follows:

| | |
|-------------------|----------|
| Function | AC |
| Range | Auto |
| Trigger | Internal |
| Math | Off |
| Sample Rate | Maximum |

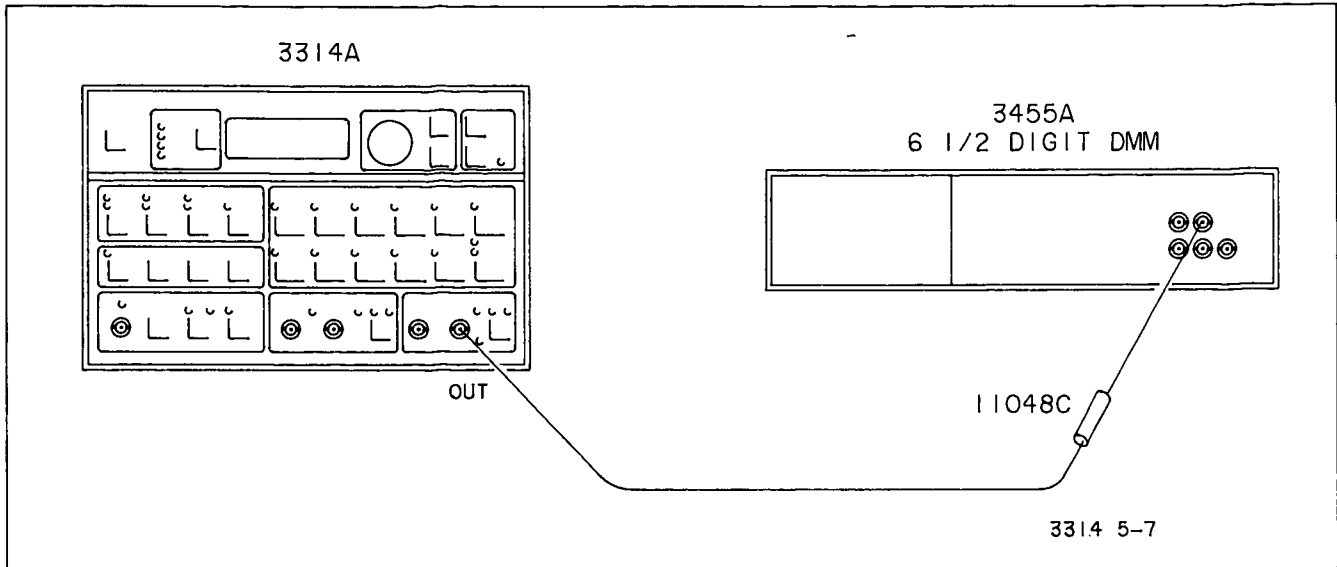

Figure 5-14. Amplitude Calibration Pad Selection.

C. Remove the phono cable from A8J1 and perform a calibration on the 3314A by pressing “Blue” “RCL”. (E34 will appear in the display.)

D. Set the 3314A CAL OFF by pressing “Blue”/“STO” and replace the phono cable.

E. Measure the voltage across pins 24 and 27 of A1U502. If this voltage is > 0.404V, the following selection procedure is invalid. Increase the value of A1R522 until the voltage is ≤ 0.404V and repeat adjustment procedure beginning with step C. If the voltage across pins 24 and 27 was ≤ 0.404V, proceed to step F.

F. Connect the 3314A to the voltmeter via the 3314A’s “Function” output. (See Figure 5-14.)

G. Record the reading on the voltmeter. This is the RMS value of the 3314A sine wave signal. Convert this value to Vp-p using the equation:

$$V_{p-p} = 2.828 * \text{RMS Reading}$$

H. Change the function on the 3314A to square wave.

I. Record the reading on the voltmeter. This is the RMS value of the 3314A square wave signal. Convert this value to Vp-p using the equation:

$$V_{p-p} = 2 * \text{RMS Reading}$$

J. Change the function on the 3314A to triangle.

K. Record the reading on the voltmeter. This is the RMS value of the triangle signal. Convert this value to Vp-p using the equation:

$$V_{p-p} = 3.464 * \text{RMS Reading}$$

L. Calculate the percent error between the sine wave and square wave Vp-p amplitudes determined in steps G and I using the equation:

$$\%Error = [(square V_{p-p} - sine V_{p-p}) / sine V_{p-p}] * 100\%$$

If %Error is inside the -12% to +12% range, the sine and square wave amplitude difference is acceptable, proceed to step Q.

If %Error is outside the -12% to +12% range, A1R522 may be the wrong value. However, gain errors in the amplifier stages, or a decrease in amplitude of the triangle signals at the inputs of A1U502 are possible reasons for %Error failing to meet the specification. If after investigation the above parameters prove acceptable, proceed to step M.

M. From %Error calculated in step L and the value of R522 currently in the board, determine the “padded” value of R522 using Table 5-3*.

NOTE

If $|\%Error|$ is >30% (see Table 5-3), R522 can be determined using the equation:

$$R522 = 2 / (\%Error / 122 * (1 / 259.6 + 2 / R522 \text{ in Bd}) + 2 / R522 \text{ in Board})$$

Table 5-3. R522 Selection Chart

| % Error = (Square Vp-p - Sine Vp-p)/Sine Vp-p X100 | | | | | | | | |
|--|--------------------|--------------------|--------------------|--------------------|------------------|------------------|------------------|------------------|
| R522 In Board | -30% To -24% | -24% To -20% | -20% To -16% | -16% To -12% | 12% To 16% | 16% To 20% | 20% To 24% | 24% To 30% |
| 320 | 505 | 466 | 421.7 | 383 | | | | |
| 350 | 540.9 | 505 | 466 | 421.7 | 320 | | | |
| 383 | 588.1 | 540.9 | 505 | 466 | 320 | 320 | | |
| 421.7 | 660 | 588.1 | 588.1 | 540.9 | 350 | 320 | 320 | |
| 466 | 738.5 | 738.5 | 660 | 588.1 | 383 | 383 | 350 | 320 |
| 505 | 845 | 845 | 738.5 | 738.5 | 660 | 421.7 | 383 | 350 |
| 540.9 | 979.3 | 845 | 738.5 | 738.5 | 421.7 | 421.7 | 383 | 350 |
| 588.1 | 1153 | 979.3 | 845 | 738.5 | 466 | 466 | 421.7 | 383 |
| 660 | 1364 | 1153 | 979.3 | 845 | 540.9 | 505 | 466 | 421.7 |
| 738.5 | 1.65k | 1364 | 1153 | 979.3 | 588.1 | 540.9 | 505 | 466 |
| 845 | 2.1k | 1.65k | 1364 | 1153 | 660 | 588.1 | 588.1 | 540.9 |
| 979.3 | 2.8k | 2.1k | 1.65k | 1364 | 738.5 | 660 | 660 | 588.1 |
| 1153 | 14.12k | 2.8k | 2.1k | 1.65k | 845 | 738.5 | 738.5 | 660 |
| 1364 | 6.65k | 4.12k | 2.8k | 2.1k | 979.3 | 845 | 845 | 738.5 |
| 1.65k | 14k | 6.65k | 4.12k | 2.8k | 1153 | 979.3 | 979.3 | 845 |
| 2.1k | | 14k | 6.65k | 4.12k | 1364 | 1153 | 1153 | 979.3 |
| 2.8k | | 14k | 14k | 14k | 1.65k | 1364 | 1364 | 1153 |
| 4.12k | | | | 14k | 2.1k | 1.65k | 1.65k | 1364 |
| 6.65k | | | | | 2.8k | 2.1k | 1.65k | 1.65k |
| 14k | | | | | 2.8k | 2.8k | 2.1k | 1.65k |

N. Insert the "padded" value of R522 and repeat the Low Frequency Harmonic distortion adjustment followed by the DC/AC Balance adjustment.

O. Repeat steps C through L. If %Error still does not meet the specification, then the adjustment fails. If %Error does meet the specification, proceed to step P.

P. Measure the voltage across pins 24 and 27 of A1U502. If the new %Error meets the specification but the voltage is > 0.361V, the adjustment fails. If the voltage is < 0.361V, proceed to step Q.

Q. Calculate and record the average of the sine and square wave Vp-p amplitudes determined in steps G and I.

R. Using the average calculated in step Q, calculate the "padded" value of A1R506 (Sine/Square Amplitude Adjust) given the equation:

$$R506(\text{New}) = (\text{Avg}/10V_{p-p}) * R506 (\text{Currently in Board})$$

Choose the closest 1% resistor.

S. Calculate the "padded" value of A1R528 (Triangle Amplitude Adjust) using the equation:

$$R528\text{New} = [(R506\text{new}/R506\text{old})(10V_{p-p})/\text{triangle } V_{p-p}] * R528 \text{ in Board}$$

where: "R506new" is the value chosen in step R, and "triangle Vp-p" is the value determined in step K.

Choose the closest 1% resistor.

5-20. HIGH FREQUENCY HARMONIC DISTORTION ADJUSTMENT

This adjustment insures accurate high frequencies and minimizes high frequency harmonic distortion.

Equipment Required:

- hp- 1725A Oscilloscope
- hp- 8558B Spectrum Analyzer
- hp- 10041A 10:1 Probe

Procedures:

A. Set A3S1(4) and A3S1(5) on the 3314A to the "closed" position.

B. Turn the 3314A OFF, then ON.

C. Set A3S1(4) and A3S1(5) back to the "open" position.

D. Press "Range Up" three times to invoke test mode 04.

E. Set the oscilloscope as follows:

| | | |
|---------------------|---------|---------|
| | Chan. A | Chan. B |
| Volts/Div | 0.02V | 1V |
| Coupling | DC | DC |
| Vert Display | A | |
| Int Trigger | B | |
| Horiz Display | X-Y | |

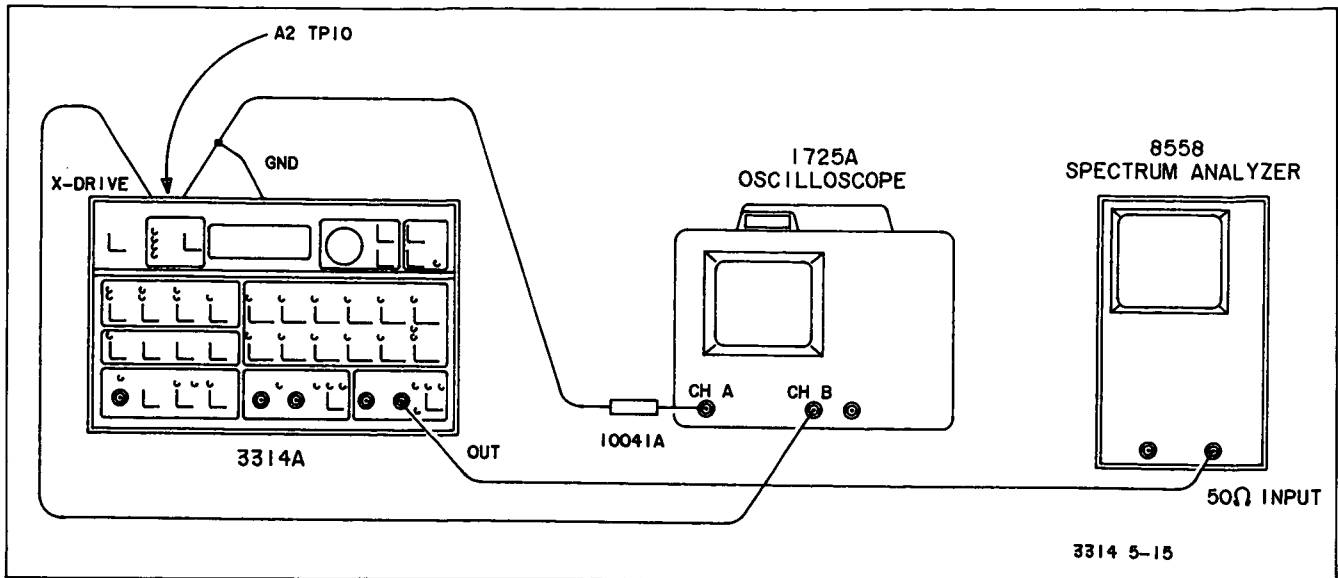

Figure 5.15. High Frequency Harmonic Distortion Adjustment

F. Set the spectrum analyzer as follows:

- Input Attenuation 70dB
- Freq Span/Div 10MHz
- Resolution BW Coupled at optimum
- Freq Start 0Hz
- Sweep Time/Div Auto
- Trigger Line
- dB/Div 10dB
- Reference Level 60dBm
- Ref Level Fine 0dBm

G. Connect the 3314A to the oscilloscope and spectrum analyzer. (See Figure 5-15.)

NOTE

Center oscilloscope trace with both inputs grounded.

H. Adjust "Input Atten" on the spectrum analyzer until the fundamental is within 10dB of full scale. Adjust "Ref Level Fine" until the fundamental is referenced to the top graticule on the analyzer screen.

I. Using a non-ferrous screwdriver, adjust A1C218 until the X-Y plot is centered (average of positive and negative deviations is 0V) around the oscilloscope's x-axis graticule (see Figure 5-16).

J. Adjust A1C307 and A1C308 until the X-Y plot is as flat as possible. (Note: Adjusting A1C307 flattens the response while A1C308 minimizes harmonic distortion levels. (See Figure 5-16.)

K. Repeat steps I and J until the trace on the oscilloscope remains within 0.6Vp-p with a second har-

monic level < -35dB. (All other harmonics should remain below -30dB.)

L. Press "Range Up" on the 3314A to exit test mode 04 and return the 3314A to normal operation.

5-21. ATTENUATOR HIGH FREQUENCY COMPENSATION ADJUSTMENT

This adjustment compensates for stray capacitances on the Output Amplifier board which result in a limited amplifier bandwidth.

Equipment Required:

- hp- 1725A Oscilloscope*

* An oscilloscope other than the 1725A may be used provided it has at least a 275MHz bandwidth. This is necessary because the 3314A's fast rise time can cause

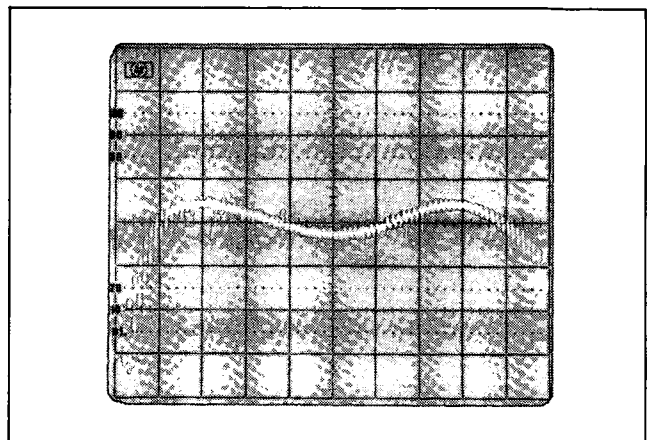

Figure 5-16. High Frequency Harmonic Distortion Adjustment

an oscilloscope with a bandwidth less than 275MHz to “ring”, and in turn, mask the 3314A’s actual response.

Procedures:

A. Preset the 3314A.

B. Set the 3314A as follows:

Frequency 1MHz
 Amplitude 10mVp-p
 Function square

C. Set the oscilloscope as follows:

Volts/Div 0.01V
 Coupling DC
 Vert Display A
 Int Trigger A
 Time/Div 0.1µs
 Horiz Display Main

D. Connect the 3314A to the oscilloscope.

E. While monitoring the square wave on the oscilloscope, adjust A8C29 until the overshoot of the waveform is at a minimum. (Avoid rounding the waveform.)

5-22. X3 (OPTION 001) FUNCTIONAL CHECK

This procedure provides a functional check of Option 001 by verifying the amplitude level at the x3 output and testing the 3314A Overload Protection feature.

NOTE

This procedure applies only to those instruments which have had Option 001 installed.

Equipment Required:

- hp- 1725A Oscilloscope
- hp- 11048C 50Ω load
- hp- 1250-0781 BNC/TEE Adaptor

Procedures:

A. Preset the 3314A.

B. Set the amplitude of the 3314A to 10Vp-p.

C. Set the oscilloscope as follows:

Volts/Div 5V
 Coupling DC
 Vert Display A
 Int Trigger A
 Time/Div 0.2ms
 Horiz Display Main

D. Set up and connect the instruments as shown in Figure 5-18A.

E. Observe the x3 output on the oscilloscope. Verify that its amplitude is 30Vp-p.

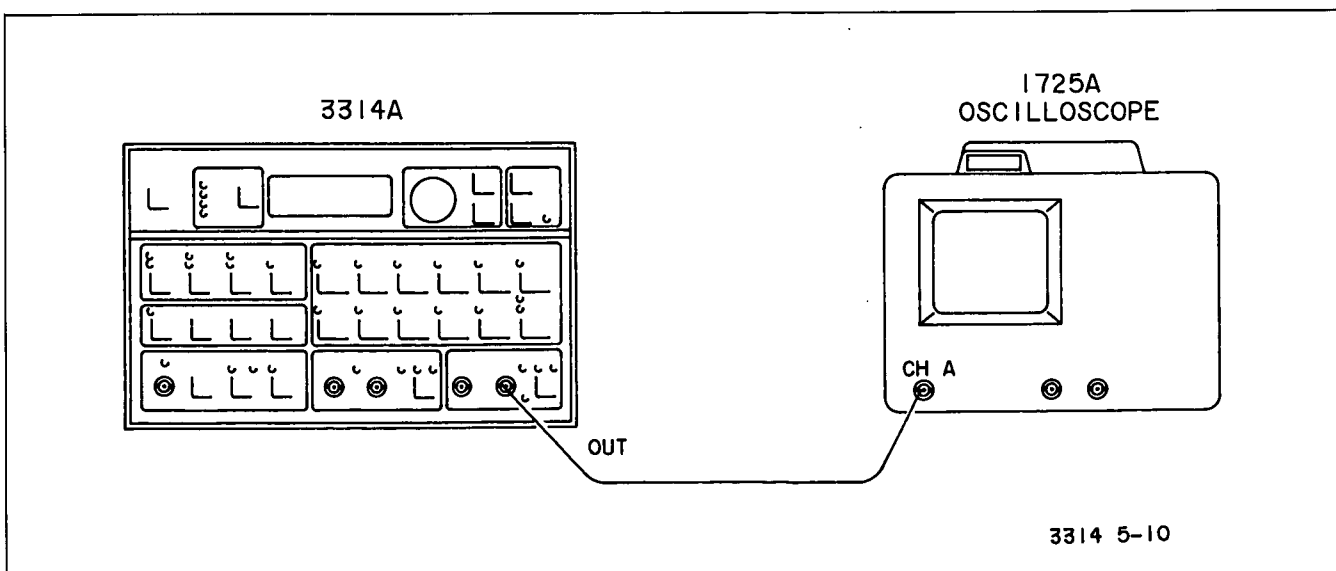

Figure 5-17. Attenuator High Frequency Compensation Adjustment

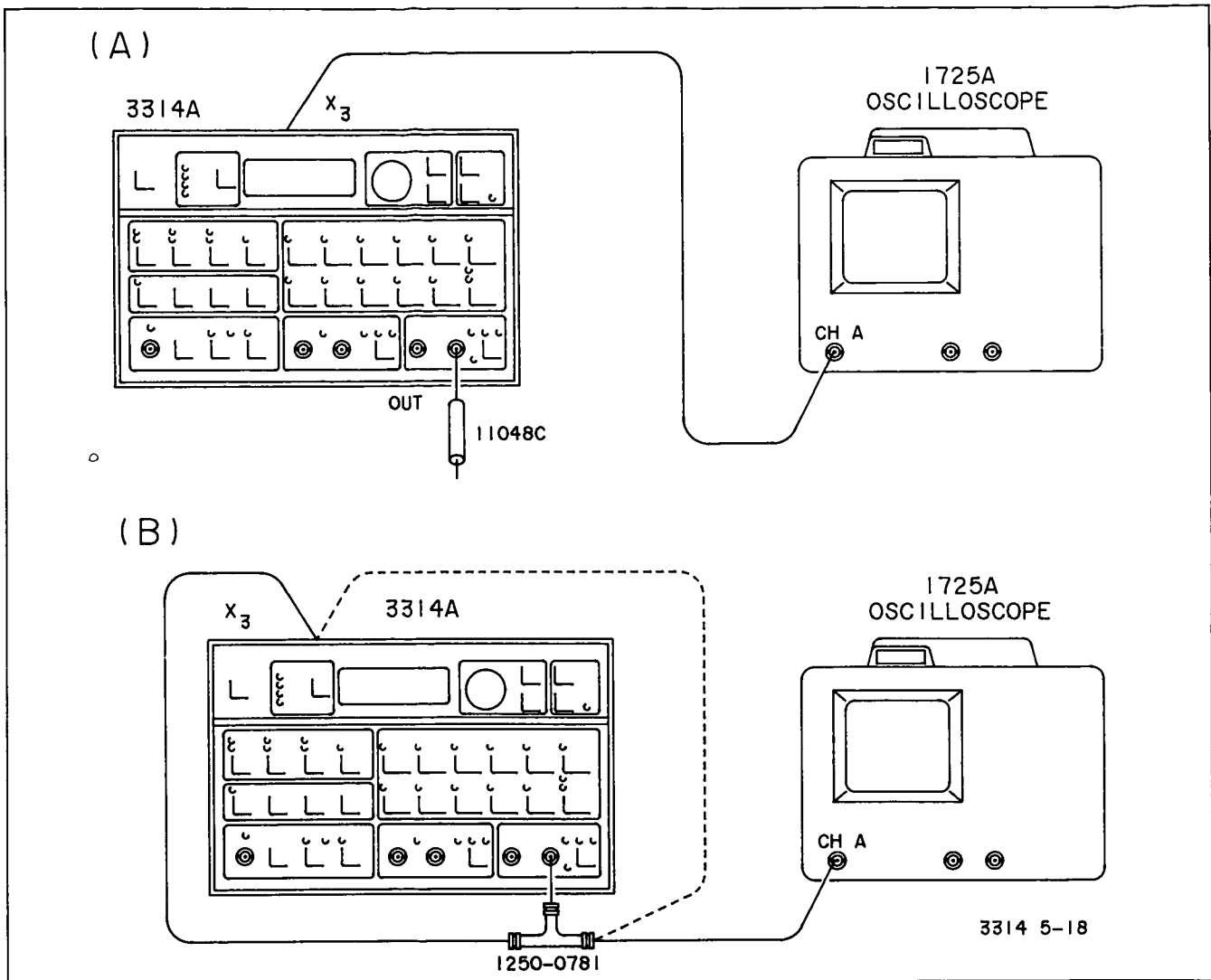

Figure 5-18. X3 (Option 001) Functional Check

F. Replace the 50Ω load on the front of the 3314A with the BNC/TEE connector.

G. Move the cable from the x3 output to one end of the TEE.

H. Observe the oscilloscope and verify that a signal is present at the output of the 3314A.

I. Using another cable, connect the x3 output to the other end of the TEE. (See part B of Figure 5-18.)

J. Satisfactory operation of the Overload Protection feature is indicated by a flashing "E51" in the 3314A display. The flashing "E51" signifies that all attenuator relays on the A8 board have opened in order to protect the 3314A from the excessive voltage present at the Function output. The open relays can also be detected by observing the oscilloscope and noting the shift of the signal to either a +20V or -20VDC level.