

For New Design Applications Contact Elantec Sales Office

Features

- Low offset voltage—0.5 mV typ., 2 mV max
- Low supply current—13 mA typ., 17 mA max
- High slew rate—
EL2039—600 V/ μ s
EL2040—400 V/ μ s
- Large open loop gain—15 kV/V (83 dB)
- Wide gain-bandwidth—
EL2039—600 MHz
EL2040—400 MHz
- High power bandwidth—
EL2039—9.5 MHz
EL2040—6.3 MHz
- Output voltage swing— \pm 11V
- MIL-STD-883 Rev. C compliant
- Improved replacements for HA2539 and HA2540

Applications

- Pulse and video amplifiers
- Wideband amplifiers
- High speed sample-hold circuits
- Local area networks

Ordering Information

Part No.	Temp. Range	Package	Outline #
EL2039CN	0°C to +75°C	14-Pin P-DIP	MDP0031
EL2040CN	0°C to +75°C	14-Pin P-DIP	MDP0031

General Description

The EL2039 and EL2040 monolithic operational amplifiers are pin compatible with the HA2539 and HA2540, but have patented circuitry for improved dynamic performance and DC accuracy, and a typical power reduction of 35%. Additionally, these Elantec amplifiers are stable when driving capacitive loads and are well behaved when the output is overdriven. Both devices are compensated for closed loop gains \geq 10. The EL2039 is the fastest of the series with a 600 V/ μ s slew rate and 600 MHz gain-bandwidth product. The EL2040 has a 400 V/ μ s slew rate and 400 MHz gain-bandwidth product. The EL2039 and EL2040 are fabricated with Elantec's Complementary Bipolar process and are zener zap trimmed for low offset voltage.

Elantec's high speed amplifiers are widely used in military, video and medical applications. They are especially suited for high speed video amplifiers, pulse detectors, and wide bandwidth filters.

Elantec's EL2039C and EL2040C comply with MIL-I-45208A and other applicable quality specifications. For information on Elantec's processing, see the Elantec document, QRA-1: *Elantec's Processing—Monolithic Products.*

Connection Diagrams

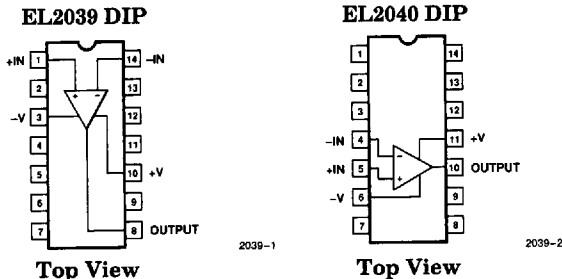

Note: Non-designated pins are no connects and are not electrically connected internally.

Manufactured under U.S. Patent No. 4,837,523

EL2039C/EL2040C

Very High Slew Rate Wideband Operational Amplifier

EL2039C/EL2040C

Absolute Maximum Ratings ($T_A = 25^\circ\text{C}$)

V_S	Voltage between $V+$ and $V-$	35V	T_J	Operating Junction Temperature	150°C
V_{DIFF}	Differential Input Voltage	6V	T_{ST}	Storage Temperature	-65°C to +150°C
I_{OP}	Output Current, Peak	50 mA	T_{LT}	Lead Temperature	
I_{OC}	Output Current, Continuous	25 mA		(Soldering, 5 seconds)	300°C
P_D	Internal Power Dissipation	See Curves			
T_A	Operating Temperature Range	0°C to +75°C			

Important Note:

All parameters having Min/Max specifications are guaranteed. The Test Level column indicates the specific device testing actually performed during production and Quality inspection. Elantec performs most electrical tests using modern high-speed automatic test equipment, specifically the LTX77 Series system. Unless otherwise noted, all tests are pulsed tests, therefore $T_J = T_C = T_A$.

Test Level	Test Procedure
I	100% production tested and QA sample tested per QA test plan QCX0002.
II	100% production tested at $T_A = 25^\circ\text{C}$ and QA sample tested at $T_A = 25^\circ\text{C}$, T_{MAX} and T_{MIN} per QA test plan QCX0002.
III	QA sample tested per QA test plan QCX0002.
IV	Parameter is guaranteed (but not tested) by Design and Characterization Data.
V	Parameter is typical value at $T_A = 25^\circ\text{C}$ for information purposes only.

DC Electrical Characteristics $V_S = \pm 15\text{V}$; $R_L = 1\text{ k}\Omega$, unless otherwise specified

Parameter	Description	Temp	Min	Typ	Max	Test Level	Units
V_{OS}	Input Offset Voltage	25°C		0.5	2	I	mV
		Full			6	III	mV
TCV_{OS}	Average Offset Voltage Drift	Full		20		V	$\mu\text{V}/^\circ\text{C}$
I_B	Bias Current	25°C		5	15	I	μA
		Full			20	III	μA
I_{OS}	Offset Current	25°C		1	4	I	μA
		Full			6	III	μA
R_{IN}	Input Resistance	25°C		10		V	k Ω
C_{IN}	Input Capacitance	25°C		1		V	pF
V_{CM}	Common Mode Range	Full	± 11	± 12		II	V
e_{IN}	Input Noise Voltage ($f = 1\text{ kHz}$, $R_G = 0\Omega$)	25°C		6		V	$\text{nV}/\sqrt{\text{Hz}}$
A_{VOL}	Large Signal Voltage Gain (Note 1)	25°C	10k	15k		I	V/V
		Full	5k			III	V/V
$CMRR$	Common-Mode Rejection Ratio (Note 2)	Full	60	90		II	dB
V_O	Output Voltage Swing	Full	± 11	± 12		II	V
I_O	Output Current (Note 11)	Full	± 25	± 50		II	mA
R_O	Output Resistance	25°C		30		V	Ω
I_S	Supply Current	Full		13	17	II	mA
$PSRR$	Power-Supply Rejection Ratio (Note 7)	Full	60	85		II	dB

EL2039C/EL2040C**Very High Slew Rate Wideband Operational Amplifier****AC Electrical Characteristics—EL2039**

Parameter	Description	Temp	Min	Typ	Max	Test Level	Units
GBW	Gain-Bandwidth Product (Notes 3, 4)	25°C		600		V	MHz
FPBW	Full-Power Bandwidth (Notes 1, 5, 8)	25°C	8.7	9.5		I	MHz
t_r	Rise Time (Note 6)	25°C		4		V	ns
OS	Overshoot (Note 6)	25°C		35		V	%
SR	Slew Rate (Note 6)	25°C	550	600		I	V/ μ s
t_s	Settling Time (Note 6) 10V Step to 0.1%	25°C		100		V	ns

AC Electrical Characteristics—EL2040

Parameter	Description	Temp	Min	Typ	Max	Test Level	Units
GBW	Gain-Bandwidth Product (Notes 3, 4)	25°C		400		V	MHz
FPBW	Full-Power Bandwidth (Notes 1, 5, 8)	25°C	5.5	6		I	MHz
t_r	Rise Time (Note 6)	25°C		5		V	ns
OS	Overshoot (Note 6)	25°C		15		V	%
SR	Slew Rate (Note 6)	25°C	350	400		I	V/ μ s
t_s	Settling Time (Notes 9, 10) 10V Step to 0.1%	25°C		70		V	ns

Note 1: $V_O = \pm 10V$.

Note 2: Two tests are performed, $V_{CM} = 0V$ to $+10V$ and $V_{CM} = 0V$ to $-10V$.

Note 3: $V_O = 90$ mV.

Note 4: $A_V = 10$.

Note 5: Full Power Bandwidth guaranteed based on slew rate measurement using: $FPBW = \frac{\text{Slew Rate}}{2\pi V_{\text{peak}}}$.

Note 6: Refer to Test Circuits section of data sheet.

Note 7: Two tests are performed. $V_+ = +15V$, and V_- is changed from $-5V$ to $-15V$. $V_- = -15V$, and V_+ is changed from $+5V$ to $+15V$.

Note 8: $R_L = 1$ k Ω .

Note 9: Settling time measurements are made with techniques in the following reference: "Take The Guesswork Out of Settling-Time Measurements," EDN, September 19, 1985.

Note 10: $A_V = -10$, $R_L = 1k$.

Note 11: $R_L = 200\Omega$.

EL2039C/EL2040C

Very High Slew Rate Wideband Operational Amplifier

EL2039C/EL2040C

EL2039/EL2040 Typical DC Performance Curves

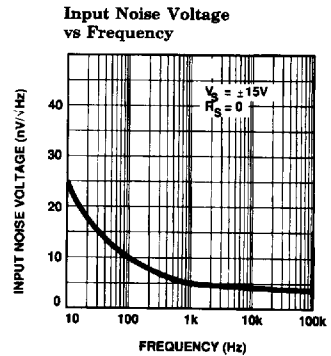
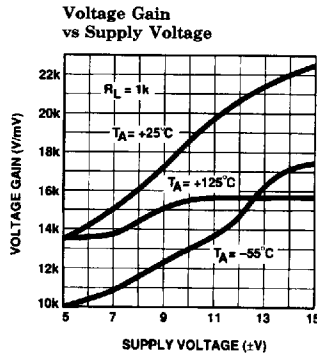
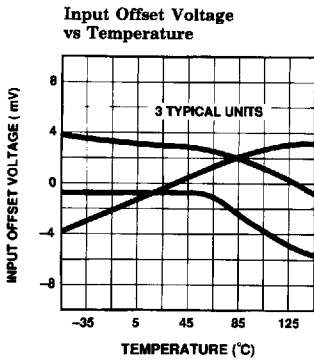
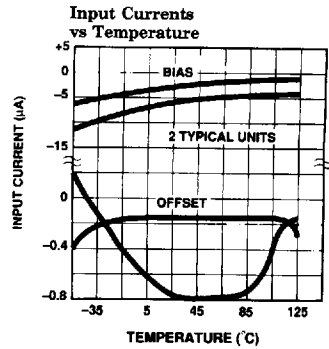
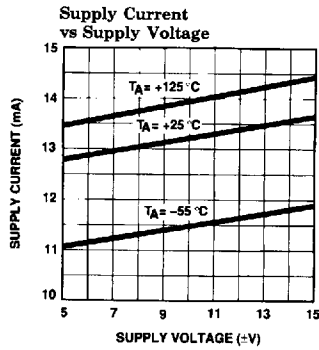
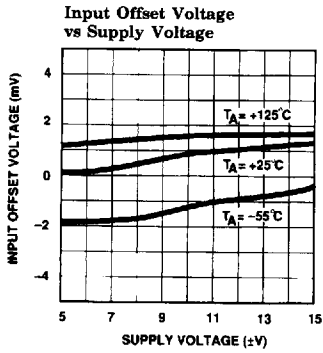

**14-Lead Plastic DIP
Maximum Power Dissipation
vs Ambient Temperature**

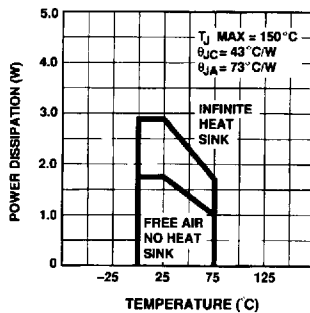

2039-5

EL2039C/EL2040C

Very High Slew Rate Wideband Operational Amplifier

EL2039 Typical AC Performance Curves

Slew Rate vs Supply Voltage

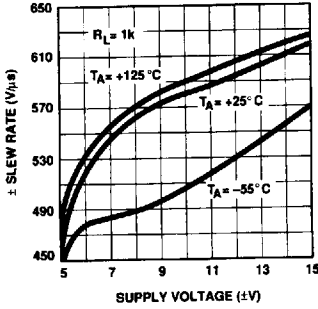

Output Voltage Swing vs Frequency

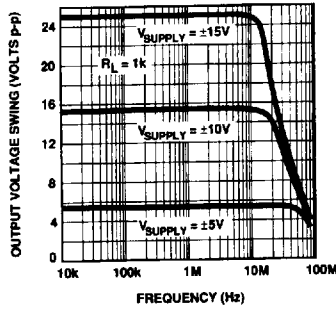

Open Loop Voltage Gain vs Frequency

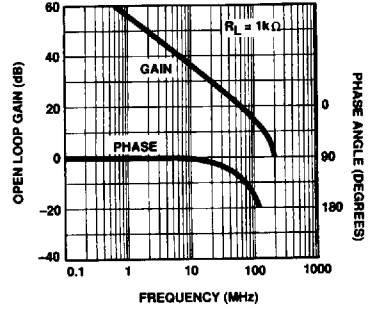

Gain Bandwidth Product at 10 MHz vs Supply Voltage

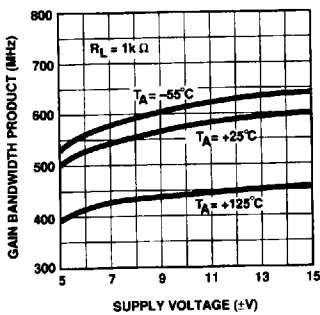

Input Referred Power Supply Rejection Ratio vs Frequency

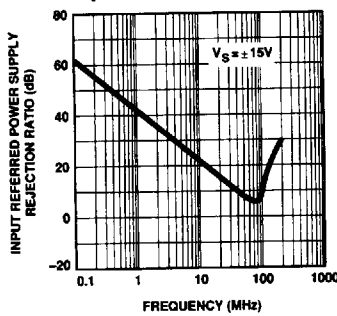

Input Referred Common Mode Rejection Ratio vs Frequency

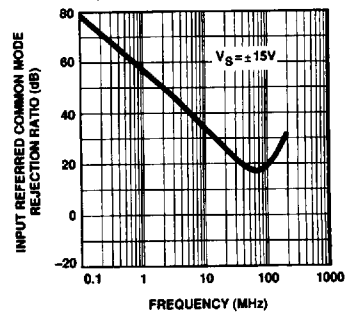

Settling Time

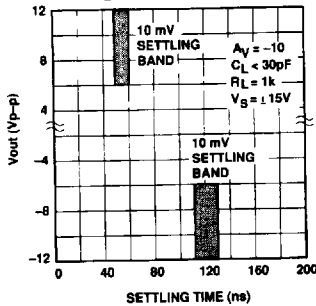

Large Signal Response

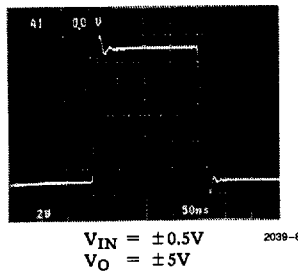

Small Signal Response

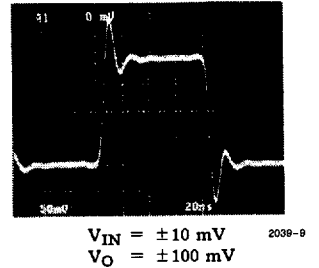

2039-6

2039-6

2039-6

2039-7

EL2039C/EL2040C

Very High Slew Rate Wideband Operational Amplifier

EL2039C/EL2040C

EL2039 Typical AC Performance Curves — Contd.

HA2539 at Onset of Clipping

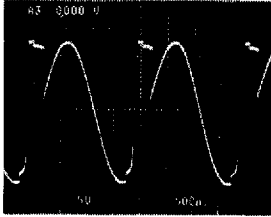

2039-10

EL2039 at Onset of Clipping

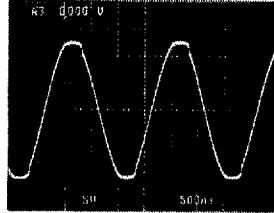

2039-11

EL2040 Typical AC Performance Curves

1

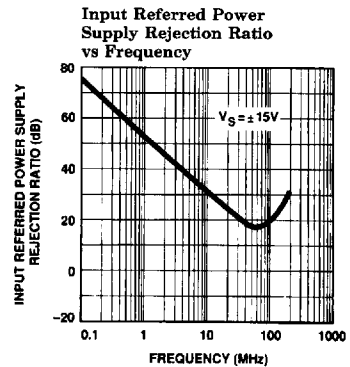
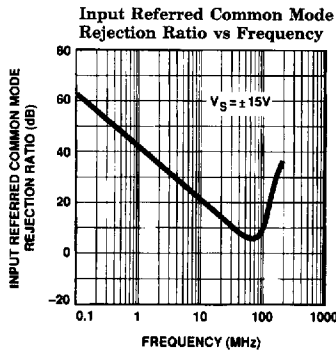
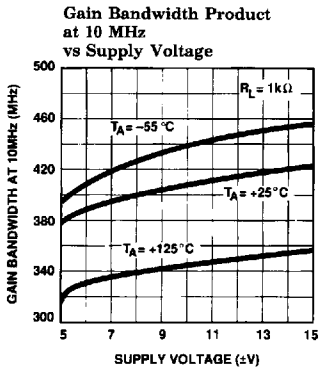
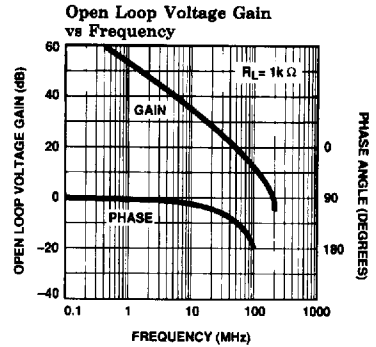
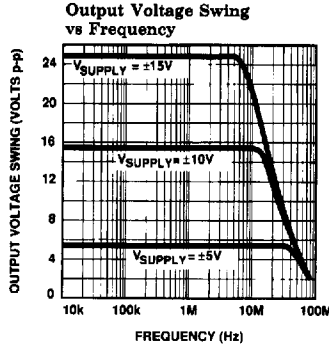
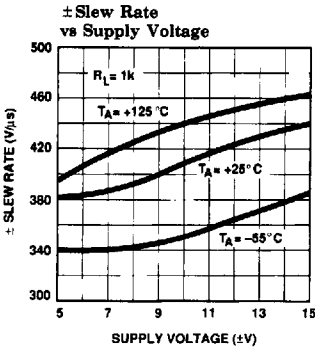

2039-12

EL2039C/EL2040C

Very High Slew Rate Wideband Operational Amplifier

EL2040 Typical AC Performance Curves — Contd.

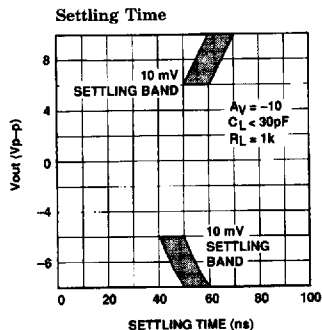

2039-13

Large Signal Response

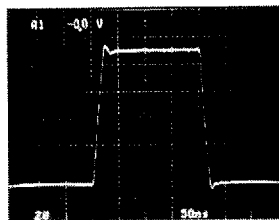

$V_{IN} = \pm 0.5\text{V}$
 $V_O = +5\text{V}$

2039-14

Small Signal Response

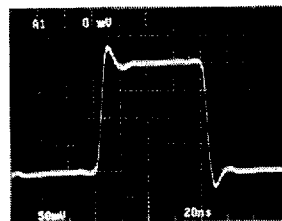

$V_{IN} = \pm 10\text{ mV}$
 $V_O = \pm 100\text{ mV}$

2039-15

Test Circuit

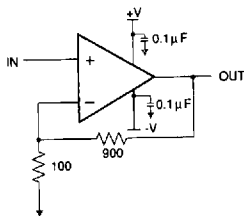

2039-16

$A_v = 10$
 $C_L = 10\text{ pF}$ Scope Probe

Burn-In Circuit

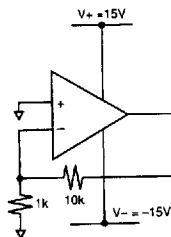

2039-17

EL2039C/EL2040C

Very High Slew Rate Wideband Operational Amplifier

EL2039C/EL2040C

Schematic

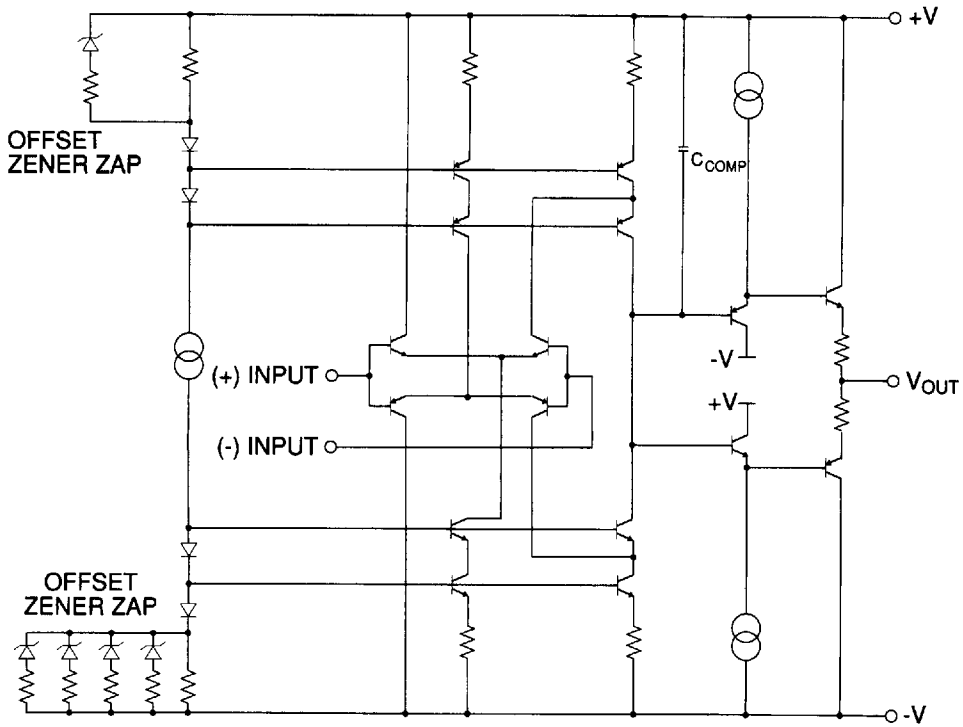

2039-16

1

EL2039C/EL2040C

Very High Slew Rate Wideband Operational Amplifier

EL2039 Macromodel

```

* Connections:
*
*
*
*
*
*
+ input
|
- input
|
+ Vsupply
|
- Vsupply
|
output
|
.subckt M2039 1 14 10 3 8

```

* Input Stage

```

ie 37 3 1.7mA
r6 36 37 60
r7 38 37 60
rc1 10 30 75
rc2 10 39 75
q1 30 1 36 qn
q2 39 14 38 qna
ediff 33 0 39 30 7.25
rdiff 33 0 1Meg

```

* Compensation Section

```

ga 0 34 33 0 5.2m
rh 34 0 .525Meg
ch 34 0 1.5pF
rc 34 40 600
cc 40 0 7pF

```

* Poles

```

ep 41 0 40 0 1
rpa 41 42 75
cpa 42 0 7pF
rpb 42 43 50
cpb 43 0 3pF

```

* Output Stage

```

ios1 10 50 1.25mA
ios2 51 3 1.25mA
q3 3 43 50 qp
q4 10 43 51 qn
q5 10 50 52 qn
q6 3 51 53 qp
ros1 52 8 25
ros2 8 53 25

```

* Power Supply Current

```

ips 10 3 9.5mA

```

* Models

```

.model qn npn(is = 800.0E-18 bf = 170 tf = 0.2nS)
.model qna npn(is = 864E-18 bf = 200 tf = 0.2nS)
.model qp pnp(is = 800E-18 bf = 60 tf = 0.2nS)
.ends

```

EL2039C/EL2040C

Very High Slew Rate Wideband Operational Amplifier

EL2040 Macromodel

```

* Connections:  + input
*              |
*              | - input
*              |
*              | + Vsupply
*              | - Vsupply
*              |
*              | output
*              |
.subckt M2040  5  4  11  6  10
* Input Stage
ie 37 6 1.3mA
r6 36 37 60
r7 38 37 60
rc1 11 30 75
rc2 11 39 75
q1 30 5 36 qn
q2 39 4 38 qna
ediff 33 0 39 30 7.25
rdiff 33 0 1Meg
* Compensation Section
ga 0 34 33 0 5.2m
rh 34 0 .525Meg
ch 34 0 1.5pF
rc 34 40 600
cc 40 0 7pF
* Poles
ep 41 0 40 0 1
rpa 41 42 75
cpa 42 0 7pF
rpb 42 43 50
cpb 43 0 3pF
* Output Stage
ios1 11 50 1.25mA
ios2 51 6 1.25mA
q3 6 43 50 qp
q4 11 43 51 qn
q5 11 50 52 qn
q6 6 51 53 qp
ros1 52 10 25
ros2 10 53 25
* Power Supply Current
ips 11 6 9.5mA
* Models
.model qn npn(is=800.0E-18 bf=130 tf=0.2nS)
.model qna npn(is=864E-18 bf=150 tf=0.2nS)
.model qp pnp(is=800E-18 bf=60 tf=0.2nS)
.ends

```

EL2039C/EL2040C

Very High Slew Rate Wideband Operational Amplifier

EL2039C/EL2040C

EL2040 Macromodel — Contd.

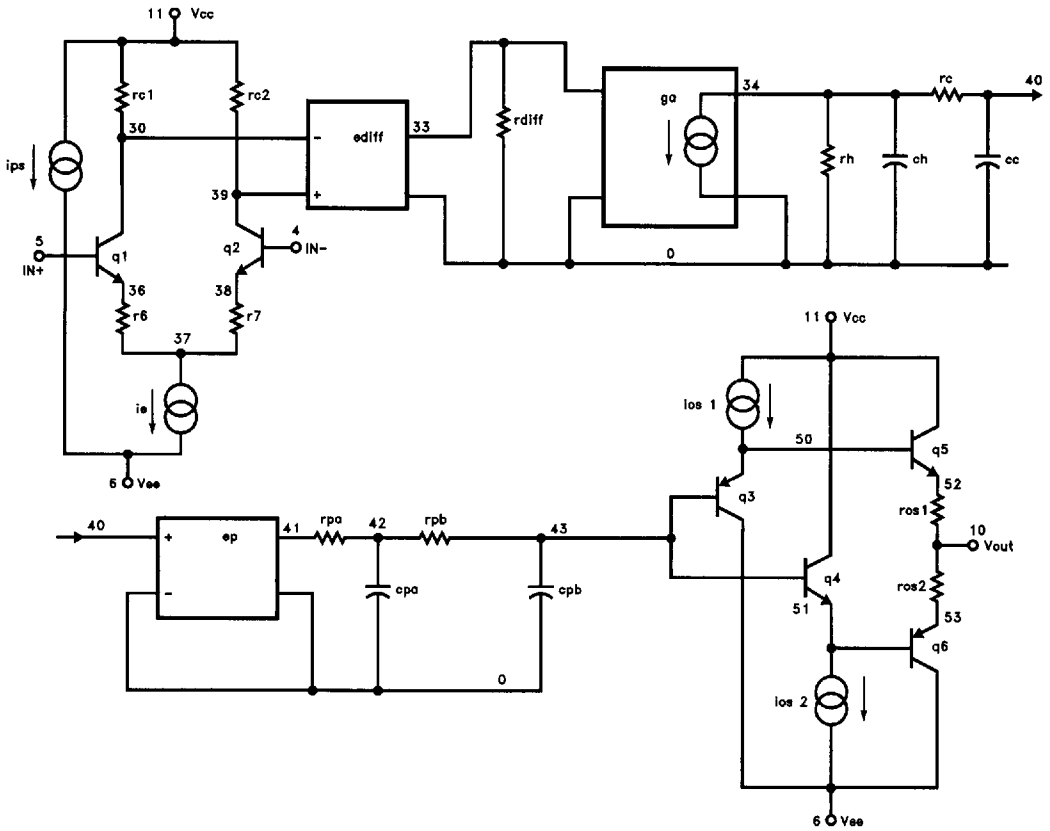

2039-20

1