

HP 3588A Performance Test Guide



HP Part Number: 03588-90018

Printed in U.S.A.

Print Date: March 1996

©Hewlett-Packard Company, 1990-96. All rights reserved.
8600 Soper Hill Road, Everett, WA 98205-1298



SAFETY SUMMARY

The following general safety precautions must be observed during all phases of operation, service, and repair of this instrument. Failure to comply with these precautions or with specific warnings elsewhere in this manual violates safety standards of design, manufacture, and intended use of the instrument.

Hewlett-Packard Company assumes no liability for the customer's failure to comply with these requirements. This is a Safety Class 1 instrument.

GROUND THE INSTRUMENT

To minimize shock hazard, the instrument chassis and cabinet must be connected to an electrical ground. The instrument is equipped with a three-conductor ac power cable. The power cable must either be plugged into an approved three-contact electrical outlet or used with a three-contact to two-contact adapter with the grounding wire (green) firmly connected to an electrical ground (safety ground) at the power outlet. The power jack and mating plug of the power cable meet International Electrotechnical Commission (IEC) safety standards.

DO NOT OPERATE IN AN EXPLOSIVE ATMOSPHERE

Do not operate the instrument in the presence of flammable gases or fumes. Operation of any electrical instrument in such an environment constitutes a definite safety hazard.

KEEP AWAY FROM LIVE CIRCUITS

Operating personnel must not remove instrument covers. Component replacement and internal adjustments must be made by qualified maintenance personnel. Do not replace components with power cable connected. Under certain conditions, dangerous voltages may exist even with the power cable removed. To avoid injuries, always disconnect power and discharge circuits before touching them.

DO NOT SERVICE OR ADJUST ALONE

Do not attempt internal service or adjustment unless another person, capable of rendering first aid and resuscitation, is present.

DO NOT SUBSTITUTE PARTS OR MODIFY INSTRUMENT

Because of the danger of introducing additional hazards, do not install substitute parts or perform any unauthorized modification to the instrument. Return the instrument to a Hewlett-Packard Sales and Service Office for service and repair to ensure the safety features are maintained.











DANGEROUS PROCEDURE WARNINGS

Warnings, such as the example below, precede potentially dangerous procedures throughout this manual. Instructions contained in the warnings must be followed.

Warning	Dangerous voltages, capable of causing death, are present in this instrument. Use extreme caution when handling, testing, and adjusting.
----------------	-------------------------------------------------------------------------------------------------------------------------------------------------

SAFETY SYMBOLS

General Definitions of Safety Symbols Used On Equipment or In Manuals.

	Instruction manual symbol: the product will be marked with this symbol when it is necessary for the user to refer to the instruction manual in order to protect against damage to the instrument.
	Indicates dangerous voltage (terminals fed from the interior by voltage exceeding 1000 volts must be so marked.)
 OR 	Protective conductor terminal. For protection against electrical shock in case of a fault. Used with field wiring terminals to indicate the terminal which must be connected to ground before operating equipment.
	Low-noise or noiseless, clean ground (earth) terminal. Used for a signal common, as well as providing protection against electrical shock in case of a fault. A terminal marked with this symbol must be connected to ground in the manner described in the installation (operating) manual, and before operating the equipment.
 OR 	Frame or chassis terminal. A connection to the frame (chassis) of the equipment which normally includes all exposed metal structures.
	Alternating current (power line.)
	Direct current (power line.)
	Alternating or direct current (power line.)

Warning The **WARNING** sign denotes a hazard. It calls attention to a procedure, practice, condition or the like, which if not correctly performed or adhered to, could result in injury or death to personnel.

Caution The **CAUTION** sign denotes a hazard. It calls attention to an operating procedure, practice, condition or the like, which, if not correctly performed or adhered to, could result in damage to or destruction of part or all of the product.

Note The **NOTE** sign denotes important information. It calls attention to procedure, practice, condition or the like, which is essential to highlight.

Table of Contents

Chapter 1: General Information

Introduction	1-1
Safety Considerations	1-1
Instrument Description	1-1
Serial Numbers	1-2
Options	1-2
Accessories	1-3
Recommended Test Equipment	1-3
Specifications	1-7

Chapter 2: Installation

Introduction	2-1
Incoming Inspection	2-1
Incoming Tests	2-1
Power Requirements	2-2
Power Cable and Grounding Requirements	2-3
Operating Environment	2-5
Analyzer Cooling	2-5
HP-IB System Interface Connections	2-6
Screen (CRT) Cleaning	2-6
Installation	2-7
Turning on the HP 3588A	2-7
Storage and Shipment	2-7
Storage	2-7
Shipment	2-7

Chapter 3: Operation Verification and Performance Tests

Introduction	3-1
Safety Considerations	3-1
Test Duration	3-2
Calibration Cycle	3-2
Equipment Required	3-2
Measurement Uncertainty	3-2
Operation Verification and Performance Test List	3-3
Specifications and Performance Tests	3-4
How to Do an Operation Verification or Performance Test	3-5

Table of Contents (Continued)

1 Local Oscillator Feedthrough	3-6
2 Phase Noise	3-7
3 Residual Responses	3-8
4 Noise Level	3-10
5 Frequency Accuracy	3-13
6 Spurious Responses	3-15
7 Image Responses	3-17
8 Input Harmonic Distortion	3-19
9 Intermodulation Distortion	3-22
10 Source Amplitude Accuracy and Frequency Response	3-27
11a. Input Amplitude Accuracy Flatness	3-31
11b. Alternate Input Amplitude Accuracy Flatness	3-46
12 Reference Level Accuracy	3-53
13 Log Scale Accuracy	3-56
14 Source Dynamic Accuracy	3-60
15 Input Return Loss	3-63
16 Source Return Loss	3-65
17 Source Harmonic Distortion	3-68
18 Source Spurious Responses	3-71
19 Source Noise	3-73
Performance Test Record	1 thru 20
Operation Verification Test Record	1 thru 8

Index

Sales and Service Offices



Chapter 1

General Information

General Information

Introduction

This guide contains the operation verification and performance tests, along with general information, specifications, and installation information. It is, therefore, part of the documentation supplied with every HP 3588A Spectrum Analyzer with an additional copy supplied with the Service Package, option 915.

Safety Considerations

The HP 3588A Spectrum Analyzer is a Safety Class 1 instrument (provided with a protective earth terminal). Although this instrument has been designed in accordance with international safety standards, this manual contains information, cautions and warnings that must be followed to ensure safe operation and retain the HP 3588A Spectrum Analyzer in safe operating condition. Service must be performed by trained service personnel who are aware of the hazards involved (such as fire and electrical shock).

Instrument Description

The HP 3588A Spectrum Analyzer is a high performance, 10 Hz to 150 MHz, synthesized spectrum analyzer offering swept spectrum and narrow band zoom measurements. Swept spectrum mode uses digital IF filters that allow increased measurement speed (up to four times faster than conventional swept-tuned analyzers for comparable measurements) with no additional amplitude error or resolution loss. Narrow band zoom uses an implementation of the Fast Fourier Transform to provide even faster measurements (up to 350 times faster than conventional swept-tuned analyzers for comparable measurements) with even greater resolving power. Narrow band zoom mode can be used for spans of 40 kHz and less. The HP 3588A Spectrum Analyzer has a built-in source with programmable amplitude that allows scalar network measurements. Measurements can be saved using the internal non-volatile memory or the optional internal 3.5-inch flexible disk drive. Plots and prints of the measurements can be made directly to HP-IB printers and plotters. The HP 3588A Spectrum Analyzer also supports the HP Instrument BASIC programming language (IBASIC).

Serial Numbers

Hewlett-Packard makes frequent improvements to its products to enhance their performance, usability, or reliability, and to control costs. HP service personnel have access to complete records for each instrument model, based on the equipment's serial number. Whenever you contact HP about our analyzer, have the complete serial number available to ensure obtaining the most complete and accurate information possible.

A serial number label is attached to the rear of the analyzer. The serial number has two parts – the prefix (the first four numbers and a letter) and the suffix (the last five numbers).

Options

The following options are available for the HP 3588A Spectrum Analyzer:

- 001 Precision Frequency Reference
- 003 Additional 2 Mbyte RAM
- 004 Delete Disk Drive
- 006 Semiautomated Performance Test Kit
- 1C2 HP Instrument BASIC
- 908 Rack Mount Kit
- 915 Service Package
- 916 Extra Operation Manual
- 920 Extra HP-IB Manual
- W30 Adds an additional 2 years to standard warranty
(for a total of 3-years warranty)

Accessories

The following accessories are available for the HP 3588A Spectrum Analyzer.

Table 1-1. Accessories

Accessory	Part Number
Active probe	HP 41800A
Rack Mount kit	HP 35660-86010
Box of ten 3.5-inch double-sided, double-density disks	HP 92192A
Coax BNC (m)-to-coax BNC(m) connector for option 001	HP 1250-1499
25 Ω BNC feedthrough series resistor	HP 1250-2275
Nylon mounting clip for BNC feedthrough series resistor	HP 1400-1356
Operating Manual	HP 03588-90000
Includes Getting Started Guide	HP 03588-90005
HP-IB Programming Reference	HP 03588-90025
Using HP Instrument BASIC with the HP 3588A	HP 03588-90040
Service Package	
Includes	
Service kit	HP 03588-84401
Service Manual	HP 03588-90017
Performance Test Guide	HP 03588-90051
Semiautomated Performance Test Kit †	HP 03588-84402
Includes	
Semiautomated Performance Test Guide	HP 03588-90006
Semiautomated Performance Test Disk	HP 03588-19405

† HP 3588A Spectrum Analyzers without disk drives (option 004), require HP BASIC on a series 200 or 300 computer

Recommended Test Equipment

Table 1-2 lists the recommended equipment needed to test the performance of the HP 3588A Spectrum Analyzer. Table 1-3 lists additional equipment needed to adjust and troubleshoot the analyzer. Other equipment may be substituted for the recommended model if it meets or exceeds the listed critical specifications. When substitutions are made, you may have to modify the procedures to accommodate the different operating characteristics.

Table 1-2. Recommended Test Equipment

Instrument	Critical Specifications	Recommended Model
Digital Multimeter	Frequency Range 10 Hz to 300 kHz AC Range 2 mV to 20V Amplitude Accuracy $\pm 0.1\%$ dBm Math Mode	HP 3458A
Frequency Standard	Frequency Accuracy ± 0.0025 ppm	HP 5061B
Milliwatt Power Meter	Power Range ± 0.2 dBm 10 Hz to 100 Hz ± 0.4 dB 100 Hz to 30 kHz ± 0.27 dB 300 kHz ± 0.035 dB 30 kHz to 150 MHz ± 0.13 dB Input Impedance 50Ω 0 dBm Control Voltage Output	W & G EPM-1 † Wandel & Goltermann, Inc 1800 Wyatt Drive, Suite 2 Santa Clara, CA 95054 (408) 988-7622
Power Meter	Frequency Range 100 kHz to 150 MHz Input Range 100 kHz to 150 MHz Amplitude Accuracy (with power sensor) ± 0.27 dB	HP 438A Alternate HP 436A
Power Sensor	SWR: ≤ 1.20 Impedance 50Ω	HP 8482A
Power Splitter	SWR ≤ 1.10 Input Impedance 50Ω Two Outputs	HP 11667A
Spectrum Analyzer	Frequency Range 100 Hz to 150 MHz Amplitude Range -100 to 20 dBm Dynamic Range ≤ -52 dBc Phase Noise: < -86 dBm/Hz at 500 Hz offset Marker Noise Function	HP 85688B10
Synthesized Signal Generator	Dynamic Range < -92 dBc Frequency Range 1 MHz to 150 MHz Impedance: 50Ω Resolution: 0.1 Hz External Reference Input	HP 8663A Alternate HP 8662A
Step Attenuator (with calibration data at 100 kHz and 300 kHz)	0 to 20 dB: ± 0.02 dB	HP 355D
Synthesizer/Level Generator	Frequency Range 10 MHz to 25 MHz Harmonic Distortion: ≤ -32 dBc	HP 3335A
Synthesizer	Frequency Range 10 Hz to 10 MHz Impedance: 50Ω	HP 3326A Alternate HP 3325A HP 3325B
21 MHz Low Pass Filter	Filter Rejection: ≤ -60 dB Impedance 50Ω	TTE # J87-21M-50-613B TTE, Inc 2214 S. Benny Avenue Los Angeles, CA 90064
50 MHz Low Pass Filter	Filter Rejection: ≤ -60 dB Impedance 50Ω	TTE # J87-50M-50-613B

† This equipment is only used in test 11a. An alternate test is included in this manual, which does not require this equipment.

Table 1-2. Recommended Test Equipment (continued)

Instrument	Critical Specifications	Recommended Model
10 dB Amplifier	Frequency Range: 10 kHz to 150 MHz	QB-210 Q-Bit Corp. PO Box 2208 Melbourne, Florida 32901 (407) 727-1838
50Ω Directional Bridge	Directivity > 40 dB Impedance 50Ω Frequency Range 50 to 150 MHz	HP 35677-63502
Power Supply	Volts +20 Vdc Amps 0.5	HP 6236B
Attenuator	(2) 10 dB 20 to 30 MHz	HP 8491A opt 010
50Ω Feedthrough Termination	±0.2%	HP 11048C
100 kΩ Feedthrough Termination	±0.2%	see figure 1-1
Adapters	(4) N(m)-to-BNC(f) (4) SMA(m)-to-BNC(f) BNC(f)-to-Dual Banana Plug (2) N(f)-to-BNC(m) N(f)-to-BNC(f) N(m)-to-BNC(m) (2) SMA (m) to BNC (m) BNC Tee BNC(f) to dual banana plug (m) (2) BNC(f) to alligator clip	HP 1250-0780 HP 1250-1200 HP 1251-2277 HP 1250-0077 HP 1250-1536 † HP 1250-0082 HP 1250-1787 HP 1250-0781 HP 1251-2277 Pomona model 2630 ITT Pomona Electronics 1500 East Ninth street Pomona, CA 91769 (714) 623-3463
Cables	(7) BNC-to-BNC 122 cm Error Correction Cable	HP 8120-1840 HP 03588-61630 †

† This equipment is only used in test 11a. An alternate test is included in this manual, which does not require this equipment.

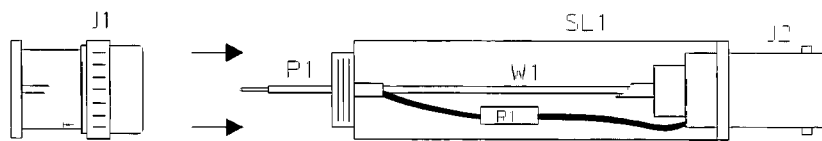

MATERIALS

Item	Qty	Description	HP Part Number
J1	1	Connector BNC male	1250-0052
J2	1	Connector BNC female	1250-0083
P1	1	Pin	1250-0089
SL1	1	Sleeve	1531-0246
R1	1	Resistor 100 kΩ	0757-0465
W1	2cm	Wire 24 AWG	8150-0295

Figure 1-1. 100 kΩ Feedthrough Termination

Table 1-3. Additional Recommended Test Equipment †

Instrument	Critical Specifications	Recommended Model
Frequency Counter	Frequency Range 10 to 500 MHz Resolution < 1 Hz at 10 MHz Frequency Accuracy: $\pm 25 \times 10^3$ Hz Sensitivity -28 dBm Impedance 1 M Ω	HP 5334B Opt 030 Alternate HP 5343A
Logic Probe	TTL/CMOS Maximum Clock > 25 MHz	HP 545A Alternative HP 5006A HP 5005A/B
Oscilloscope	Bandwidth ≥ 150 MHz Vertical Sensitivity 10 mV/div Input Coupling AC, DC, 50W Waveform Math: A-B Trigger Ext, Int, Chop	HP 54111D
Oscilloscope Probe	Impedance ≥ 1 M Ω Division Ratio 10:1	HP 10431A
Resistive Divider Probe Kit	Impedance 50 Ω Division Accuracy $\pm 3\%$ Input Capacitance < 0.7 pF Division Ratio 1:1, 5:1, 10:1, 20:1, 50:1, 100:1	HP 10020A
Ball Driver Hex Tool	Size 3/32	Bondhus
Spectrum Analyzer	Impedance 1 M Ω Frequency Range 20 Hz to 200 kHz Amplitude Accuracy: ± 1 dB	HP 3585B
HP 3588A Service Kit	Includes: Power Supply Test Board SMB Extender Cables (7) Extender Board, 12 pin Extender Board, 48 pin Fast Bus Extender Cable BNC-to-SMB Cable (2) Capacitive Load SMB-to-SMB Adapter (2) Flat -Edge Adjustment Tool Small Adjustment Tool	HP 03588-84401 Includes: HP 35672-66590 HP 03585-61610 HP 03588-66595 HP 03588-66596 HP 35660-61621 HP 03585-61616 HP 35660-64401 HP 1250-0669 HP 8710-1928 HP 8710-1514

† Not required for performance tests — only required for adjustment and troubleshooting procedures

Specifications

Note: All receiver specifications are with the source turned off and low-distortion mode off, unless otherwise noted. Specifications apply from 10 Hz to 150 MHz unless otherwise noted.

Amplitude Measurement Range

Maximum Safe Input Power

	50Ω	75Ω	1 MΩ
Average Continuous Power (10 Hz to 150 MHz)	+26 dBm	+28 dBm	—
DC Voltage	± 4 volts	± 4 volts	—
Combined AC/DC	± 4 Vpk	± 4 Vpk	± 25 Vpk

Input Range Settings

(characteristic only)

50Ω input (in 10 dB steps)	+20 dBm to -20 dBm
75Ω input (in 10 dB steps)	+22 dBm to -18 dBm with included adapter and automatic corrections
1 MΩ input	0 dBm (for reference impedance = 50Ω)
Allowable dc on input without degrading performance	
50 and 75Ω inputs	± 3 Vdc
1 MΩ input	± 25 Vdc

Amplitude Display Range

Reference Level Range

(characteristic only)	-600 to +600 dBm
	-600 to +600 dB

Dynamic Range

A/D Overload Level

A/D overload occurs for signals > 2 dB relative to the selected range.

Noise Level

Noise is specified in dBm/Hz using the marker noise key.

Specification is for swept spectrum mode with low-distortion mode off and 50Ω input impedance. Add 10 dB to specification if low-distortion mode is on. For 75Ω input, add 2 dB to the specification.

50Ω input noise (-20 dBm range)

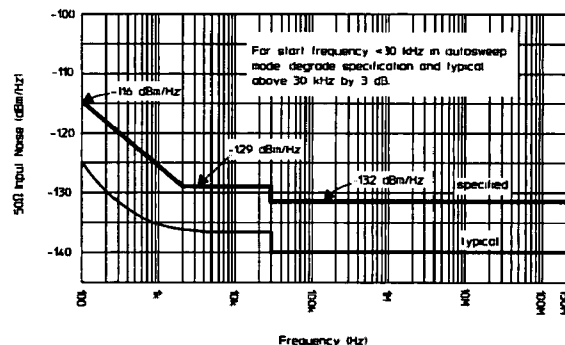

1 MΩ input noise (terminated in 100 fΩ)

< -110 dBm/Hz below 40 MHz. Degrade 10 dB/decade below 1/f corner at 100 fHz.

Narrowband zoom mode

Input noise is the same as in autosweep mode, except degrade by 4 dB for spans > 10 fHz.

Spurious Responses

General Spurious

Unless specifically mentioned in other spurious specifications, spurious responses are < -70 dBc for signal levels = range (< -80 dBc typical).

Harmonic Distortion †

Low-distortion mode, 50 and 75Ω inputs

Harmonic distortion products are < -80 dBc (< -90 dBc typical) for spectrally pure input signals with total input power level = range. Degrade specification by 10 dB when low-distortion mode is off.

1 MΩ input < -65 dBc (< -75 dBc typical)

Intermodulation Distortion †

Low-distortion mode, 50 and 75Ω inputs

Intermodulation distortion products are < -80 dBc (< -90 dBc typical) with respect to 2 tones 6 dB below range. Degrade specification by 10 dB when low-distortion mode is off.

1 MΩ input < -65 dBc (< -75 dBc typical)

† Degrade 10 dB (5 dB for 1 MΩ input) when input frequency < 30 kHz

Residual Responses

Residual responses are ≤ -110 dBm on the -20 dBm range. Degrade specification by 10 dB when low-distortion mode is on. Degrade 10 dB for 40 kHz spans in narrowband zoom mode.

Image, Multiple and Out of Band Responses

< -70 dBc (< -80 dBc typical) where applied carrier level = range

Local Oscillator Feedthrough

Local oscillator feedthrough (appears as signal at dc) is > 20 dB below range
Degrade specification by 10 dB when low-distortion mode is on.

Spectral Purity

Phase noise is ≤ -105 dBc when measured at a 1 kHz offset and normalized to a 1 Hz noise power bandwidth

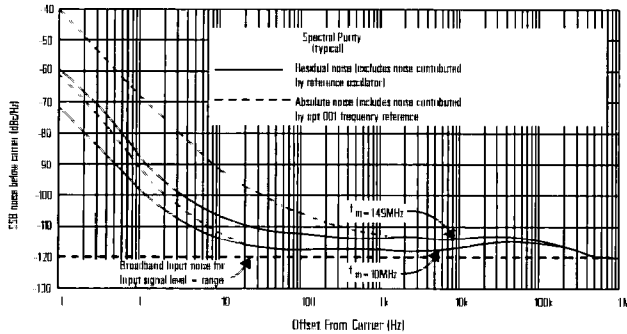

Note: The HP 3588A noise bandwidth is < 1 Hz for narrowband zoom mode spans < 150 Hz, causing measurement phase noise in dBc to be REDUCED by $10 \times \log [1/\text{noise bandwidth}]$ relative to the above graph. Thus, good dynamic range is maintained even for extremely small offset frequencies in very narrow spans

Amplitude Accuracy

Amplitude accuracy is the sum of full scale absolute accuracy and scale fidelity (linearity). Recalibration due to change in instrument state is not required for the accuracy shown.

Full Scale Absolute Accuracy (applies over the entire 0 to 55°C temperature range) (see table below)

For swept mode, these accuracies apply for sweep times ≥ 4 times the default auto-coupled sweep time. Add ± 0.1 dB for default auto-coupled sweep times

Add the following frequency response errors for narrowband zoom mode (These errors are called "window flatness" and result from windowing during the FFT operation done in narrowband zoom mode. Window flatness errors are incurred within each display bin.)

- High-accuracy zoom (Flattop window) ± 0.005 dB
- High-resolution zoom (Hanning window) +0, -1.5 dB

Scale Fidelity (Linearity)

Log Scale Accuracy

Level †	Incremental ‡	Typical
0 to -30 dB	< 0.05 dB	0.02 dB
-30 to -40 dB	< 0.1 dB	0.03 dB
-40 to -50 dB	< 0.3 dB	0.05 dB
-50 to -60 dB	< 0.5 dB	0.10 dB
-60 to -70 dB	< 0.7 dB	0.10 dB
-70 to -80 dB	-	0.25 dB
-80 to -90 dB	-	0.25 dB
-90 to -100 dB	-	0.40 dB
-100 to -110 dB	-	0.70 dB
-110 to -120 dB	-	4.0 dB

Specified for frequencies ≥ 100 kHz

† relative to the specified range

‡ incremental deviation must be added to other reference level accuracy specifications to obtain the total cumulative error

Input Port Return Loss

> 20 dB for 50 and 75Ω input and all operating ranges.

Frequency

Range

Specifications apply over the range of 10 Hz to 150 MHz (10 Hz to 40 MHz for 1 MΩ input)

Frequency Accuracy

Frequency accuracy is measured using the frequency counter marker function, and is the sum of initial accuracy + aging + frequency counter resolution. Aging is referenced to the most recent reference calibration at 23°C

Initial Accuracy

	Without Opt 001	With Opt 001 †
(20 to 30æC)	± 0.5 ppm	± 0.01 ppm
(0 to 55æC.)	± 3.0 ppm	± 0.07 ppm

† add ± 0.1 ppm if instrument is on < 48 hours

Aging ± 0.25 ppm/month ± 0.125 ppm/month

Frequency Counter Resolution 0.1 Hz

Full Scale Absolute Accuracy

	10 Hz	100 Hz	30 kHz	300 kHz	40 MHz	150 MHz
50Ω Input	± 2.5 dB	± 1.0 dB	± 0.5 dB	± 0.4 dB	± 0.5 dB	
	(± 1.0 dB typ.)	(± 0.5 dB typ.)		(± 0.2 dB typ.)		
75Ω Input	± 2.5 dB	± 1.0 dB		± 0.8 dB		
1 MΩ Input	± 2.5 dB	± 1.0 dB		± 0.6 dB		

Note: The calibrated reference level accuracy at 300 kHz where reference level - range is $< \pm 0.3$ dB (0.1 dB typical)

Frequency Span Range

(characteristic only)

Swept spans:

Range	10 Hz to 150 MHz, and zero span
Resolution	0.1 Hz
Accuracy	Greater of 0.1 Hz or 0.125% of span
Start/stop frequency	0 Hz to 150 MHz

Narrowband zoom mode spans:

Range	1.23 Hz to 40 kHz in $\times 2$ steps
Accuracy	$\pm 0.001\%$ of span

Resolution Bandwidth

Resolution Bandwidth Sizes

Swept spectrum mode filter bandwidth	1.1 Hz - 17 kHz $\pm 10\%$
Narrowband zoom mode	
High-accuracy zoom	0.90% of span (11 mHz-360 Hz)
High-resolution zoom	0.37% of span (4.5 mHz-148 Hz)

Bandwidth Selectivity (shape factor)

(ratio of -60 dB to -3 dB bandwidths)

Swept spectrum mode (see figure below)

Manual sweep	< 4.0:1
Auto-coupled sweep	4.3:1 (typical)
Auto-coupled oversweep	5.1:1 (typical)

Narrowband zoom mode

High-accuracy zoom	2.6:1
High-resolution zoom	9.1:1

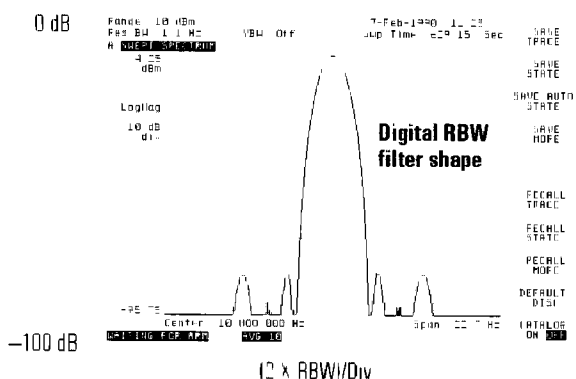

Narrowband Zoom Mode FFT Equivalent Noise Bandwidth

High-accuracy zoom	0.955% of span
High-resolution zoom	0.375% of span

Video Bandwidth

Coupled to resolution bandwidth from (1.54 \times RBW) to (0.012 \times RBW) in 7 steps, and OFF

Sweep Rate

(characteristic only, with coupling on)

Oversweep mode on	2 X RBW ² Hz/second (max)
Oversweep mode off	RBW ² 2 Hz/second (max)

Narrowband Zoom Mode Measurement Speed

(characteristic only)
> 7 measurements per second for spans ≥ 10 kHz

Narrowband Zoom Mode Time Record Length

(characteristic only)
400/span seconds

HP-IB Binary Trace Transfer Rate

(characteristic only) < 120 ms/trace

Trigger

(characteristic only)

Trigger Input

Triggers on negative TTL transition or contact closure to ground

Trigger Output

Trigger is a negative TTL transition. Fanout is 3 TTL LS loads

Source

Amplitude Range -59.9 dBm to +10 dBm, and OFF.

Amplitude Resolution 0.1 dB

Absolute Amplitude Accuracy ± 1 dB
(at 300 kHz and +10 dBm output level)

Dynamic Accuracy

Add 0.02 dB/dB below 10 dBm output level to the absolute accuracy specification

Frequency Response

Output level variation is $< \pm 1$ dB over the specified frequency range relative to the level at 300 kHz

Frequency Range 10 Hz to 150 MHz

(characteristic only)

Spurious Products

Harmonic Products < -30 dBc

Non-Harmonic Products < -40 dBc

Noise

< -80 dB relative to the carrier in a 1 Hz bandwidth for offsets > 500 Hz from the carrier

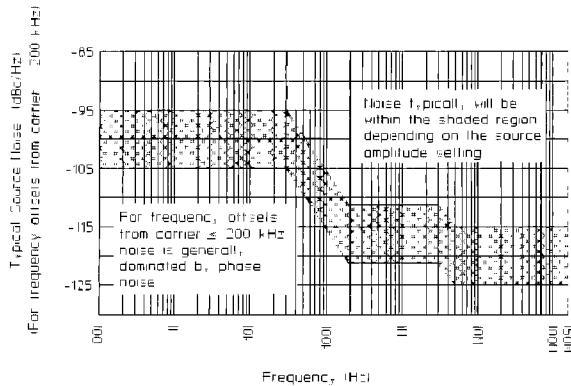

Output Port Return Loss > 20 dB

General

Environmental

Temperature

Standard instrument	
Operating	5° to 50°C
Storage (no disk in drive)	-20° to 60°C
Delete disk option	
Operating	0° to 55°C
Storage	-40° to 70°C

Humidity (non-condensing)

Standard instrument	
Operating	8% to 80% at 30°C
Storage (no disk in drive)	5% to 95%
Delete disk option	
Operating	5% to 95% at 40°C
Storage	5% to 95% at 40°C

Altitude

Standard instrument	
Operating	2 150m (7,000 ft)
Storage (no disk in drive)	4 570m (15,000 ft)
Delete disk option	
Operating †	4 570m (15,000 ft)
Storage	4 570m (15,000 ft)

† above 2 285 meters (7,500 feet), derate operating temperature by -3.6°C/1 000m (-1.1°C/1,000 ft)

Calibration Interval 1 year

Warmup Time 30 minutes

Power Requirements

115 VAC operation	90 - 132 Vrms, 47 - 440 Hz
230 VAC operation	198 - 264 Vrms, 47 - 66 Hz

Maximum Power Dissipation 450 VA

Weight

Net	28 kg (61 lbs)
Shipping	38 kg (81 lbs)

Dimensions

Height	222 mm (8.75 in)
Width	425.5 mm (16.75 in)
Depth	630 mm (24.8 in)

HP-IB

Implementation of IEEE Std 488.1 & 488.2
SH1, AH1, T6, TE0, L4, LE0, SR1, RL1, PP0, DC1, DT1, C1, C2, C3, C12, E2

Peripherals Supported

HP-IB graphics printers
(raster dumps only)
HP-IB plotters using HP GL

Standard Internal Memory 1 Mbyte RAM
(fully partitionable)

Memory Option 003 2 Mbyte RAM
Additional available



Chapter 2

Installation

Installation

Introduction

This chapter contains power requirements and operating environment information needed to install the HP 3588A Spectrum Analyzer. Also included in this chapter are instructions for cleaning the screen and information on storage and shipment.

Incoming Inspection

The HP 3588A Spectrum Analyzer was carefully inspected both mechanically and electrically before shipment. It should be free of marks or scratches and, it should meet its published specifications upon receipt. Shipped with the analyzer is the power cord and the plastic transportation disk, part number HP 5061-2819 (unless disk drive is deleted, option 004).

Inspect the analyzer for physical damage incurred in transit. If the analyzer was damaged in transit, save all packing materials, file a claim with the carrier, and call your Hewlett-Packard sales and service office.

Warning **If the analyzer is mechanically damaged, the integrity of the protective earth ground may be interrupted. Do not connect the analyzer to power if it is damaged.**

Incoming Tests

Finish incoming inspection by testing the electrical performance of the analyzer using the operation verification or performance tests in chapter 3, or using the semiautomated operation verification or performance tests in the Semiautomated Performance Test Kit, option 006. The operation verification tests verify the basic operating integrity of the analyzer; the tests in this guide take about 2 hours to complete and the semiautomated tests take about 1 hour to complete. The performance tests verify that the analyzer meets all the performance specifications; the tests in this guide take about 7 hours to complete and the semiautomated tests take about 3 hours to complete.

Power Requirements

The analyzer can operate from a single-phase ac power source supplying voltages as shown in table 2-1. With all options installed, power consumption is less than 450 VA.

The line-voltage selector switch is set at the factory to match the most commonly used line voltage of the country of destination; the appropriate fuse is also installed. To check or change either the line-voltage selector switch or the fuse, see figure 2-1, table 2-1, and the following procedures.

Warning Only a qualified service person, aware of the hazards involved, should measure the line voltage.

Caution Before applying ac line power to the analyzer, ensure the line-voltage selector switch (on the rear panel) is set for the proper line voltage and the correct line fuse is installed in the fuse holder.

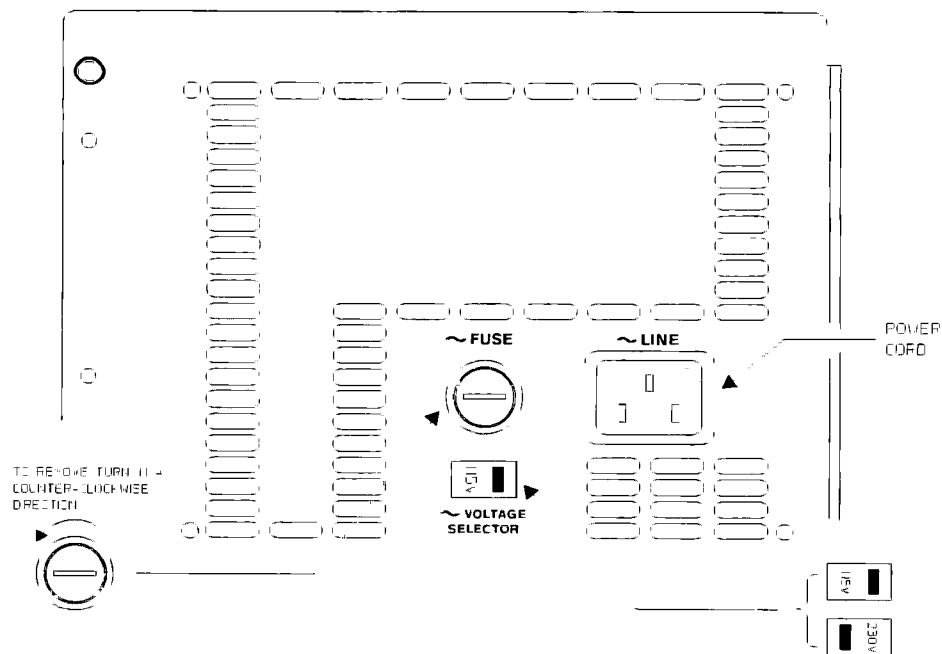

Figure 2-1. Voltage Selection and Fuse Replacement

Caution Refer to product's rear panel for fuse rating and type.

Table 2 1. Line Voltage and Fuse Selection

AC Line Voltage		Selector Switch	Fuse	
Range	Frequency		HP Part Number	Type
90-132 Vrms	47-440	120	2110-0342	8A 250V Normal Blo
198-264 Vrms	47-66	240	2110-0055	4A 250V Fast Acting
90-132 Vrms	47-440	115	2110-0056	6A 250V Fast Acting
198-264 Vrms	47-66	230	2110 0003	3A 250V Fast Acting

To change the line voltage selector switch:

1. Unplug the power cord from the analyzer.
2. Slide the line voltage selector switch (see figure 2-1) to the proper voltage (see table 2-1).

To change the fuse:

1. Unplug the power cord from the analyzer.
2. Using a small screw driver, turn the fuse holder cap counter-clockwise and remove when the fuse cap is free from the housing (see figure 2-1).
3. Pull the fuse from the fuse holder cap.
4. To reinstall, select the proper fuse (see table 2-1) and place in the fuse holder cap. Place the fuse holder cap in the housing and turn clockwise while pressing in.

Power Cable and Grounding Requirements

On the HP-IB connector, pin 12 and pins 18 through 24 are tied to protective earth ground and the HP-IB cable shield. The instrument frame, chassis, covers, all exposed metal surfaces including the BNC connectors' outer shell are connected to protective earth ground.

Warning **DO NOT interrupt the protective earth ground or "float" the HP 3588A Spectrum Analyzer. This action could expose the operator to potentially hazardous voltages.**

The analyzer is equipped with a three-conductor power cord that grounds the analyzer when plugged into an appropriate receptacle. The type of power cable plug shipped with each analyzer depends on the country of destination. See figure 2-2 for the available power cables and plug configurations.

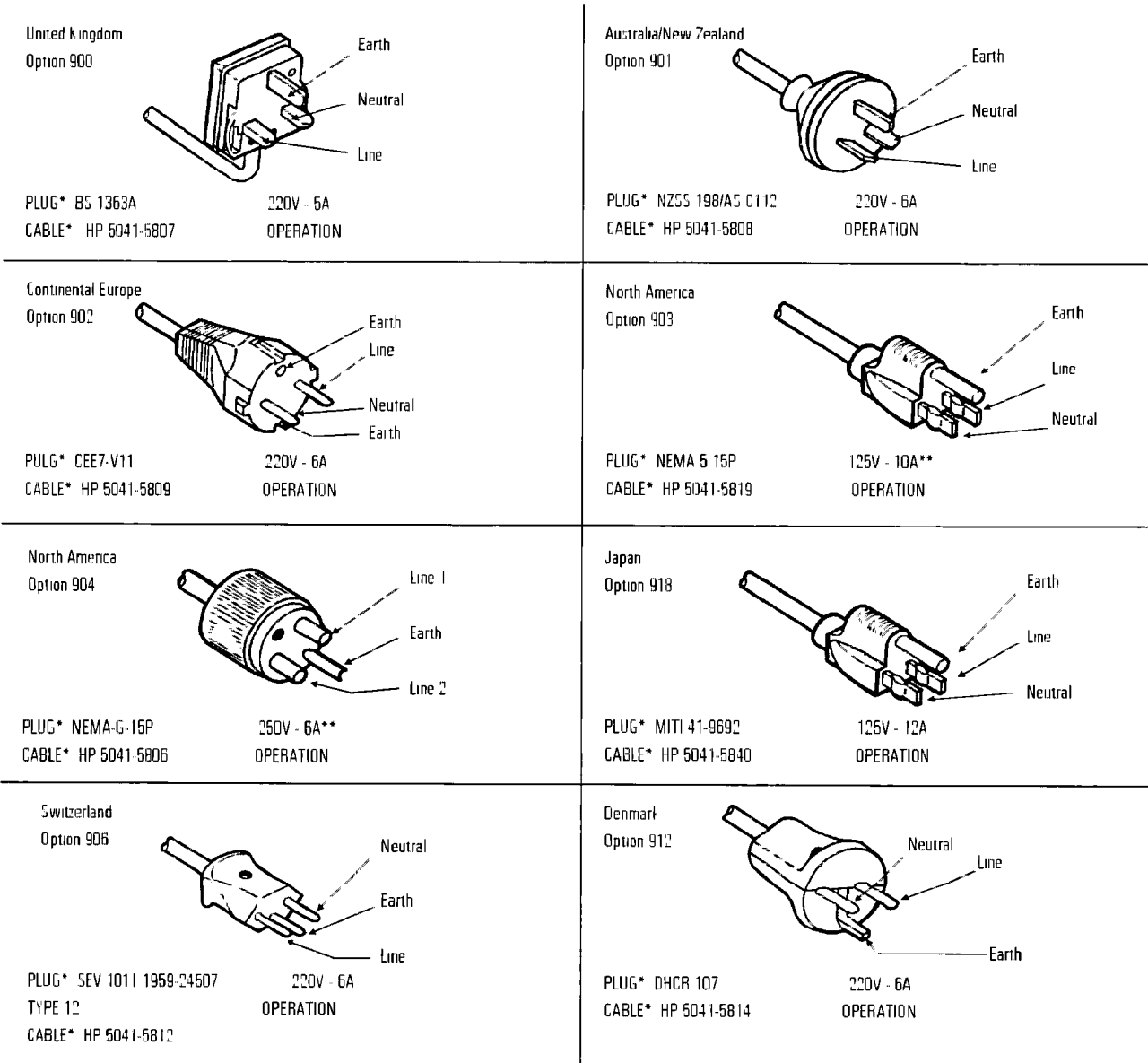

Figure 2-2. Power Cables

*The number shown for the plug is the industry identifier for the plug only, the number shown for the cable is an HP part number for a complete cable including the plug

**UL listed for use in the United States of America

Warning

The power cable plug must be inserted into an outlet provided with a protective earth terminal. Defeating the protection of the grounded analyzer cabinet can subject the operator to lethal voltages.

Operating Environment

The operating and storage environment specifications for the analyzer, with and without the disk drive, are listed in chapter 1, "General Information."

Warning **To prevent potential fire or shock hazard, do not expose the analyzer to rain or other excessive moisture.**

Protect the analyzer from moisture and temperatures or temperature changes that cause condensation within the analyzer.

Caution **The disk drive is designed for operation in a typical office environment. Use of the equipment in an environment containing dirt, dust, or corrosive substances will drastically reduce the life of the disk drive and the flexible disks. The disks should be stored in a dry, static-free environment.**

Analyzer Cooling

Cooling air enters the analyzer through both sides and exhausts through the rear panel. Install the analyzer to allow free circulation of cooling air.

HP-IB System Interface Connections

The analyzer is compatible with the Hewlett-Packard Interface Bus (HP-IB). The HP-IB is Hewlett-Packard's implementation of IEEE Standard 488.2. The analyzer is connected to the HP-IB by connecting an HP-IB interface cable to the connector located on the rear panel. Total allowable transmission path length is 2 meters times the number of devices or 20 meters, whichever is less. Operating distances can be extended using an HP-IB Extender.

For additional HP-IB programming information, see the *HP 3588A HP-IB Programming Reference*.

Caution

The analyzer contains metric threaded HP-IB cable mounting studs as opposed to English threads. Use only metric threaded HP-IB cable lockscrews to secure the cable to the analyzer. Metric threaded fasteners are black, while English threaded fasteners are silver.

Screen (CRT) Cleaning

The analyzer screen is covered with a plastic diffuser screen (this is not removable by the operator). Under normal operating conditions, the only cleaning required will be an occasional dusting. However, if a foreign material adheres itself to the screen, set the power switch to STANDBY

(0

1), remove the power cord, dampen a soft, lint-free cloth, with a mild detergent mixed in water, and carefully wipe the screen.

Warning

Do not apply any water mixture directly to the screen or allow moisture to go behind the front panel. Moisture behind the front panel will severely damage the instrument. To prevent damage to the screen, do not use cleaning solutions other than the above.

Installation

The analyzer is shipped with plastic feet in place, ready for use as a portable bench analyzer. The plastic feet are shaped to make full-width modular instruments self-align when they are stacked.

To install the analyzer in an equipment cabinet, follow the instructions shipped with the Rack Mount Kit, option 908.

Turning on the HP 3588A

First, apply proper line power to the analyzer, then press the rocker-switch in the lower left-hand corner of the analyzer to ON (I). The analyzer requires about 35 seconds to test memory and self-calibrate.

For measurement specific information or other operating information, see the *HP 3588A Getting Started Guide* or other appropriate manual.

Storage and Shipment

Storage

Store the analyzer in a clean, dry, and static free environment. For other requirements, see environmental specifications in chapter 1.

Shipment

Caution

When transporting the analyzer (with disk drive), insert the plastic disk protector, part number HP 5061-2819, into the disk drive to prevent damage.

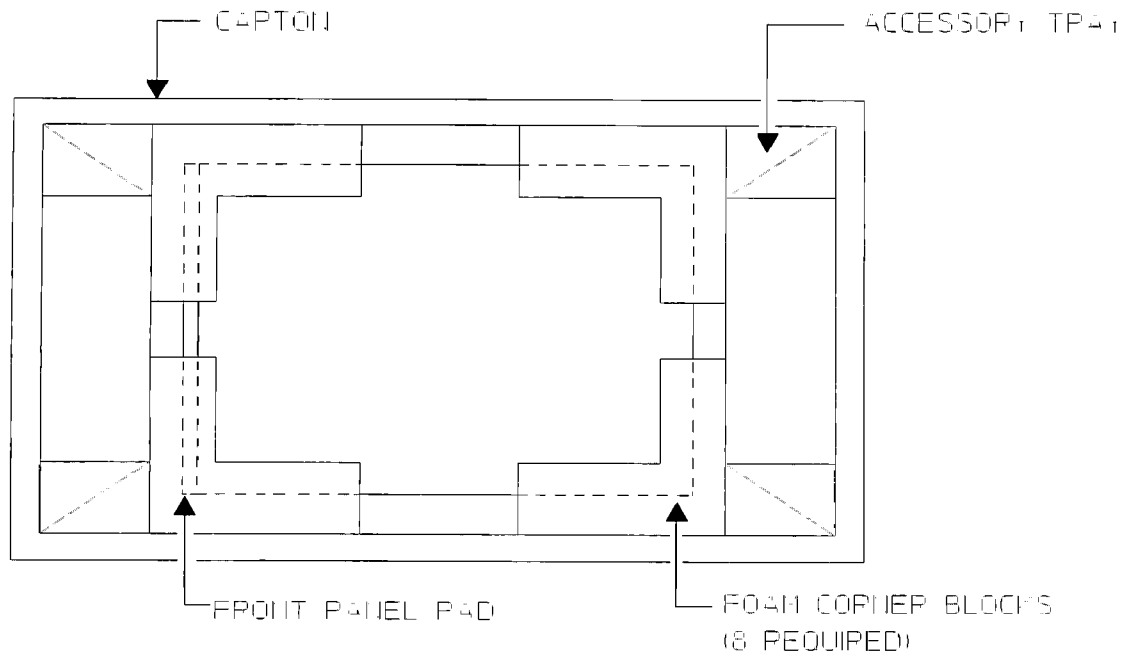

Figure 2-3. Repacking for Shipment

- Containers and materials identical to those used in factory packaging are available through Hewlett-Packard offices, see figure 2-3. If the analyzer is being returned to Hewlett-Packard for service, attach a tag describing the type of service required, the return address, model number, and full serial number. Also, mark the container FRAGILE to ensure careful handling. In any correspondence, refer to the analyzer by model number and full serial number.
- If it is necessary to package the analyzer in a container other than original packaging, observe the following (use of other packaging is not recommended):
 - Protect the front panel with cardboard and wrap the analyzer in heavy paper or anti-static plastic.
 - Use a double-wall carton made of at least 350-pound test material and cushion the analyzer to prevent damage.
 - Identify the shipment as above and mark FRAGILE.

Caution

Do not use styrene pellets in any shape as packing material for the analyzer. The pellets do not adequately cushion the analyzer and do not prevent the analyzer from shifting in the carton. In addition, the pellets create static electricity that can damage electronic components.



Chapter 3

Operation Verification and Performance Tests

Operation Verification and Performance Tests

Introduction

This section contains the operation verification tests and the performance tests. The operation verification tests give a high confidence level (>90%) that the HP 3588A Spectrum Analyzer is operating properly and within specifications. The operation verification tests are a subset of the performance tests. Operation verification should be used for incoming and after-repair inspections.

The performance tests provide the highest level of confidence (>98%) and are used to verify that the HP 3588A Spectrum Analyzer conforms to its published specifications. Some repairs require a performance test to be done after the repair (see the HP 3588A Service Manual for this information).

Safety Considerations

Although the HP 3588A Spectrum Analyzer is designed in accordance with international safety standards, this manual contains information, cautions, and warnings that must be followed to ensure safe operation and to keep the unit in safe condition. The operation verification and performance test procedures must be performed by trained service personnel who are aware of the hazards involved (such as fire and electrical shock).

Warning

Any interruption of the protective (grounding) conductor inside or outside the unit, or disconnection of the protective earth terminal can expose operators to potentially dangerous voltages.

Under no circumstances should an operator remove any covers, screws, shields or in any other way access the interior of the HP 3588A Spectrum Analyzer. There are no operator controls inside the analyzer.

Test Duration

Operation verification require approximately 2 hours to complete. The performance tests require approximately 7 hours to complete.

Caution

Before applying line power to the analyzer or testing its electrical performance, see chapter 2, "Installation."

Calibration Cycle

To verify the HP 3588A Spectrum Analyzer is meeting its published specifications, do the performance tests every 12 months.

Equipment Required

The equipment needed for operation verification and performance tests is listed in table 1-2. Other equipment may be substituted for the recommended model if it meets or exceeds the listed critical specifications

Measurement Uncertainty

The Performance Test Record contains a table listing the measurement uncertainty and ratio for each performance test using the recommended test equipment. The table also provides a place to record the measurement uncertainty and ratio for each performance test using equipment other than the recommended test equipment.

Operation Verification and Performance Test List

The following table lists the operation verification and performance tests.

Table 3-1. Operation Verification and Performance Test List

Operation Verification Tests	Performance Tests
1 Local Oscillator Feedthrough	1 Local Oscillator Feedthrough
2 Phase Noise	2 Phase Noise
3 Residual Responses	3 Residual Responses
4 Noise Level	4 Noise Level
5 Frequency Accuracy	5 Frequency Accuracy
6 Spurious Responses	6 Spurious Responses
7 Image Responses	7 Image Responses
8 Input Harmonic Distortion	8 Input Harmonic Distortion
10 Source Amplitude Accuracy and Frequency Response	9 Intermodulation Distortion
11a Input Amplitude Accuracy and Flatness	10 Source Amplitude Accuracy and Frequency Response
11b Alternate Input Amplitude Accuracy and Flatness	11a Input Amplitude Accuracy and Flatness
12 Reference Level Accuracy	11b Alternate Input Amplitude Accuracy and Flatness
14 Source Dynamic Accuracy	12 Reference Level Accuracy
17 Source Harmonic Distortion	13 Log Scale Accuracy
18 Source Spurious Responses	14 Source Dynamic Accuracy
19 Source Noise	15 Input Return Loss
	16 Source Return Loss
	17 Source Harmonic Distortion
	18 Source Spurious Responses
	19 Source Noise

Specifications and Performance Tests

The following table lists specifications and the performance test or tests that verify each specification

Table 3-2. Specification and Performance Tests

Specification	Performance Test
Dynamic Range Noise Level Spurious Responses Spectral Purity	4. Noise Level 1. Local Oscillator Feedthrough 3. Residual Responses 6. Spurious Responses 7. Image Responses 8. Input Harmonic Distortion 9. Intermodulation Distortion 2. Phase Noise
Amplitude Accuracy Full Scale Absolute Accuracy Scale Fidelity Input Port Return Loss	11a. or 11b. Input Amplitude Accuracy and Flatness 12. Reference Level Accuracy 13. Log Scale Accuracy 15. Input Return Loss
Frequency Accuracy	5. Frequency Accuracy
Source Absolute Amplitude Accuracy Dynamic Accuracy Frequency Response Spurious Products Noise Output Port Return Loss	10. Source Amplitude Accuracy and Frequency Response 14. Source Dynamic Accuracy 10. Source Amplitude Accuracy and Frequency Response 17. Source Harmonic Distortion 18. Source Spurious Responses 19. Source Noise 16. Source Return Loss

How to Do an Operation Verification or Performance Test

The operation verification tests are a subset of the performance tests. A shaded box at the beginning of each test tells if the test is an operation verification test in addition to a performance test. The shaded box also specifies if the entire test or only part of the test should be performed for operation verification.

There are two types of keys on the HP 3588A Spectrum Analyzer — hardkeys and softkeys.

- Hardkeys are front-panel buttons whose functions are always the same. Hardkeys have a label printed directly on the key itself. Throughout this guide, they are printed like this: [**Hardkey**]
- Softkeys are keys whose functions change with the analyzer's current menu selection. A softkey's function is indicated by a video label to the left of the key (on the edge of the analyzer's screen). Throughout this guide, softkeys are printed like this: [SOFTKEY]
- Some softkeys toggle through different settings. Toggle softkeys have a highlighted word in their label that changes with each press of the softkey. Throughout this guide, toggle softkeys are depicted as they appear after you press the softkey. For example, [FREQ CNTR **ON** OFF] means to press [FREQ CNTR ON OFF] until the word ON is highlighted.

Record the results of each test in the "Operation Verification Test Record" or the "Performance Test Record." These test records may be reproduced without written permission of Hewlett-Packard.

If a test fails, contact your local Hewlett-Packard sales and service office or have a qualified service technician see the "Service" section of the HP 3588A Service Manual.

Note

To minimize the time required to change instrument configurations between tests, do the tests in the order given.

1. Local Oscillator Feedthrough

Operation Verification – Yes

For Operation Verification, the procedure is the same as the Performance Test procedure.

This test verifies that the HP 3588A Spectrum Analyzer meets its dynamic range specification for local oscillator (LO) feedthrough. In this test, the analyzer measures the LO feedthrough, which appears as a signal at 0 Hz.

Equipment Required None

1. Press the following keys:

- [**Preset**]
- [**Spcl Fctn**]
 - [SINGLE CAL]
 - [AUTO CAL ON OFF]
- [**Range/Input**]
 - [RANGE]
 - 20**
 - [dBm]
- [**Freq**]
 - [CENTER]
 - 0**
 - [Hz]
 - [SPAN]
 - 1**
 - [kHz]
- [**Sweep**]
 - [SWEEP AUTO **MAN**]
- [**Res BW**]
 - [RES BW]
 - 4.5**
 - [Hz]
- [**Avg/Pk Hld**]
 - [VIDEO AVERAGE]

2. Enter the **Man** readout in the test record.

2. Phase Noise

Operation Verification – Yes

For Operation Verification, the procedure is the same as the Performance Test procedure.

This test verifies that the HP 3588A Spectrum Analyzer meets its dynamic range specification for spectral purity. In this test, the analyzer uses its internal 10 MHz calibration signal as a clean signal source for measuring phase noise.

Equipment Required None

1. Press the following keys:

```

[ Preset ]
[ Spcl Fctn ]
  [ SINGLE CAL ]
  [ AUTO CAL ON OFF ]
  [ PRFM TESTS ] ( NOTE: Ignore source uncalibrated message )
  [ CALIBRATR TO INPUT ]
[ Sweep ]
  [ OVERSWEEP ON OFF ]
[ Freq ]
  [ CENTER ]
  10
  [ MHz ]
  [ SPAN ]
  5
  [ kHz ]
[ Marker ]
  [ ZERO OFFSET ]
  [ MARKER X ENTRY ]
  10.001
  [ MHz ]
[ Marker Fctn ]
  [ NOISE LEVEL ON OFF ]

```

2. Enter the Δ Mkr readout in the test record.

3. Residual Responses

Operation Verification – Yes

For Operation Verification, the procedure is the same as the Performance Test procedure.

This test verifies that the HP 3588A Spectrum Analyzer meets its dynamic range specification for residual responses. In this test, the analyzer measures the residual responses of the power line frequency and its harmonics, the power supply switching frequency, the reference frequencies, and the oscillator harmonics.

Equipment Required: 50Ω Feedthrough Termination

1. Connect the 50Ω feedthrough termination to the INPUT connector.

2. Press the following keys:

[Preset]

[Spcl Fctn]

[SINGLE CAL]

[AUTO CAL ON OFF]

[Range/Input]

[RANGE]

-20

[dBm]

[Meas Type]

[NARROW BAND ZOOM]

[Avg/Pk Hld]

[VIDEO AVERAGE]

[Freq]

[SPAN]

36.0625

[Hz]

3. For each of the following frequencies, perform steps a and b:

Frequency
50 Hz† or 60 Hz‡
100 Hz† or 120 Hz‡
150 Hz† or 180 Hz ‡
12.5 kHz
24.7623 kHz
35.7134 kHz
100 kHz
187.5 kHz
250 kHz
10 MHz

† If local line frequency is 50 Hz, check this frequency

‡ If local line frequency is 60 Hz, check this frequency

a. Press the following keys:

[CENTER] (to frequency in table)

b. After the averaging is complete (10 averages) enter the **Mkr** readout in the test record.

4. Noise Level

Operation Verification – Yes

For Operation Verification, check only the frequencies listed in the shaded boxes.

This test verifies that the HP 3588A Spectrum Analyzer meets its dynamic range specification for noise level. In this test, the analyzer's noise level marker function measures the noise level. The noise level is measured using the receiver's 50Ω input path, with low distortion mode on and off, and using the $1\text{ M}\Omega$ input path.

Equipment Required: 50Ω Feedthrough Termination
 $100\text{ k}\Omega$ Feedthrough Termination

1. Connect the 50Ω feedthrough termination to the INPUT connector.

2. Press the following keys:

[Preset]

[Spcl Fctn]

[SINGLE CAL]

[AUTO CAL ON OFF]

[Range/Input]

[RANGE]

-20

[dBm]

[Freq]

[ZERO SPAN]

[Marker Fctn]

[NOISE LVL ON OFF]

[Meas Type]

[LOW DIST ON OFF]

3. For each of the following frequencies, perform steps a and b

For Performance Tests

Resolution Bandwidth	Frequency
17 kHz	150 MHz
	140 MHz
	120 MHz
	71 MHz
	19 MHz
	5.3 MHz
53 kHz	
290 Hz	5.3 kHz
73 Hz	530 Hz

For Operation Verification

Resolution Bandwidth	Frequency
17 kHz	150 MHz
	120 MHz
	19 MHz
73 Hz	530 Hz

- a. Press the following keys:
 [Res BW]
 [RES BW] (to resolution bandwidth in table)
 [Freq]
 [CENTER] (to frequency in table)
- b. Enter the **Mkr** readout in the test record.
4. Press the following keys:
 [Meas Type]
 [LOW DIST ON OFF]
5. Repeat step 3.
6. Disconnect the 50Ω feedthrough termination, and connect the 100 kΩ feedthrough termination to the INPUT connector.
7. Press the following keys:
 [Range/Input]
 [1 MEGOHM]

8. For each of the following frequencies, perform steps a and b

For Performance Tests

Resolution Bandwidth	Frequency
17 kHz	40 MHz
	10.1 MHz
	10.1 kHz
290 Hz	10.1 kHz
73 Hz	1.1 kHz
9.1 Hz	110 Hz

For Operation Verification

Resolution Bandwidth	Frequency
17 kHz	40 MHz
290 Hz	10.1 kHz
9.1 Hz	110 Hz

a. Press the following keys.

[**Res BW**]

[RES BW] (to resolution bandwidth in table)

[**Freq**]

[CENTER] (to frequency in table)

b. Enter the **Mkr** readout in the test record.

5. Frequency Accuracy

Operation Verification – Yes

For Operation Verification, the procedure is the same as the Performance Test procedure.

This test verifies that the HP 3588A Spectrum Analyzer meets its frequency accuracy specification. In this test, the analyzer's counter function measures an accurate 100 MHz signal. The frequency limits are then calculated using the number of days since the last frequency reference adjustment.

Note The HP 3588A Spectrum Analyzer must be on for 48 hours before performing this test.

Equipment Required	Synthesized Signal Generator Frequency Standard N(m)-to-BNC(f) Adapter BNC Cables (2)
--------------------	------------------------------------------------------------------------------------------------

1. Connect the test equipment as shown in figure 3-1.

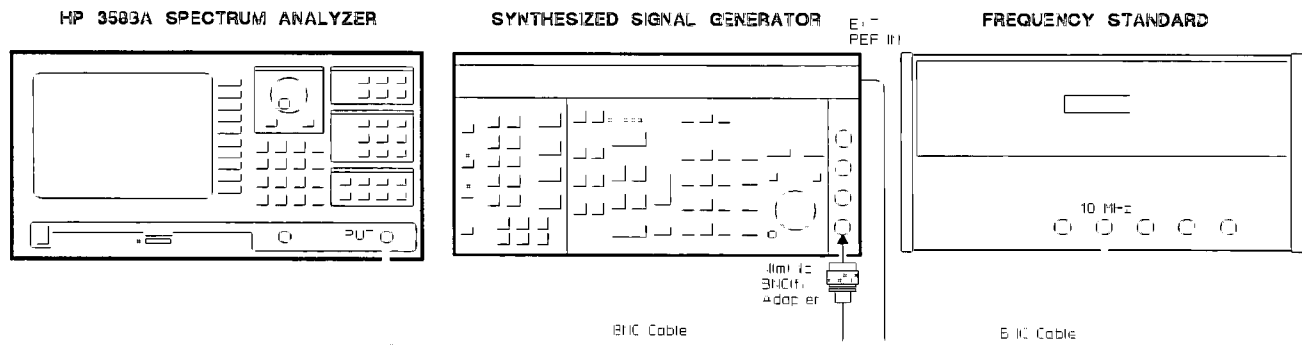

Figure 3-1. Frequency Accuracy Setup

2. Set the signal generator as follows:

Frequency 100 MHz
Amplitude 0 dBm

3. Press the following keys:

[Preset]
[Spcl Fctn]
[SINGLE CAL]
[AUTO CAL ON **OFF**]

4. Wait for a complete sweep, then press the following keys:

[Marker]
[MKR -> PEAK]
[Marker Fctn]
[FREQ CNTR **ON OFF**]

5. Enter the **Cntr** readout in the test record.

6. Calculate the lower frequency limit specification using one of the following formulas, and enter the result in the test record's Calculated Lower Limit column.

Without option 001 = $100 \times 1E6 - (25 \times N) - 50 - 0.1$
(N = number of months since the 80 MHz reference VCXO was adjusted)

With option 001 = $100 \times 1E6 - (12.5 \times N) - 1 - 0.1$
(N = number of months since the oven frequency was adjusted)

7. Calculate the upper frequency limit specification using one of the following formulas, and enter the result in the test record's Calculated Upper Limit column.

Without option 001 = $100 \times 1E6 + (25 \times N) + 50 + 0.1$
(N = number of months since the 80 MHz reference VCXO was adjusted)

With option 001 = $100 \times 1E6 + (12.5 \times N) + 1 + 0.1$
(N = number of months since the oven frequency was adjusted.)

6. Spurious Responses

Operation Verification – Yes

For Operation Verification, the procedure is the same as the Performance Test procedure

This test verifies that the HP 3588A Spectrum Analyzer meets its dynamic range specification for spurious responses. In this test, the analyzer measures spurious responses such as, API spurs, step loop spurs, sum loop spurs, and LO sideband spurs. The analyzer first measures a signal from the signal generator, establishing a reference level. Then using its offset marker, the analyzer measures the spur.

Equipment Required:

- Synthesized Signal Generator
- N(m)-to-BNC(f) Adapter
- BNC Cables (2)

1. Connect the test equipment as shown in figure 3-2.

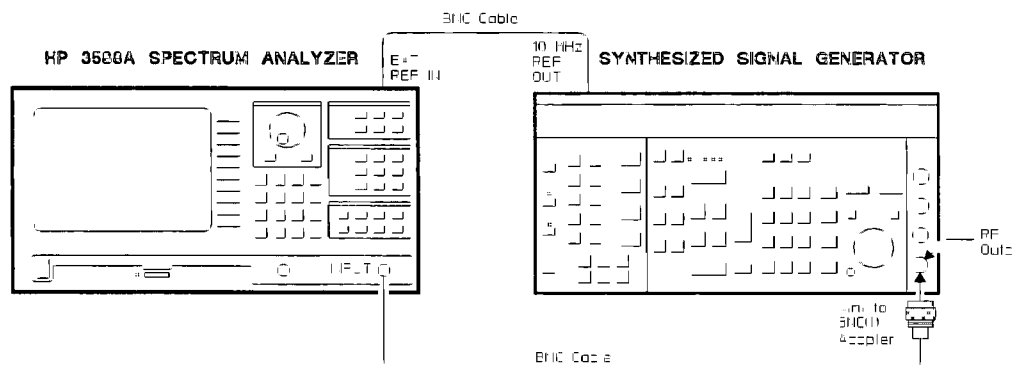

Figure 3-2. Spurious Responses Setup

2. Set the signal generator's amplitude to -21 dBm.

3 Press the following keys:

- [**Preset**]
- [**Spcl Fctn**]
 - [SINGLE CAL]
 - [AUTO CAL ON **OFF**]
- [**Range/Input**]
 - [RANGE]
 - 20**
 - [dBm]
- [**Res BW**]
 - [RES BW]
 - 4.5**
 - [Hz]
- [**Avg/Pk Hld**]
 - [VIDEO AVERAGE]
- [**Sweep**]
 - [SWEEP AUTO **MAN**]

4. For each of the following source frequencies, perform steps a through c:

Source Frequency (MHz)	Spur Frequency (MHz)
7.8125	10.8428
9.8125	9.8248
149.8125	149.8248
95.81274	95.81254
95.8149	95.8129
100.79274	100.79254
100.7949	100.7929
100.79454	100.79254
100.794504	100.792504
100.7945004	100.7925004
1.8125	4.81373
7.81496	4.81373
144.8125	144.822623
144.832746	144.822623
89.9125	89.8125

- a. Set the signal generator's frequency to the source frequency in the table.
- b. Press the following keys:
 - [MANUAL FREQ] (to source frequency in table)
 - [**Marker**]
 - [ZERO OFFSET]
 - [**Sweep**]
 - [MANUAL FREQ] (to spur frequency in table)
- c. Enter the **D Man** readout in test record.

7. Image Responses

Operation Verification – Yes

For Operation Verification, the procedure is the same as the Performance Test procedure.

This test verifies that the HP 3588A Spectrum Analyzer meets its dynamic range specification for image responses. In this test, the analyzer measures the IF image spurs. The analyzer first measures a signal from the signal generator, establishing a reference level. Then, using its offset marker, the analyzer measures the image spurs.

Equipment Required:

- Synthesized Signal Generator
- N(m)-to-BNC(f) Adapter
- BNC Cables (2)

1. Connect the test equipment as shown in figure 3-3.

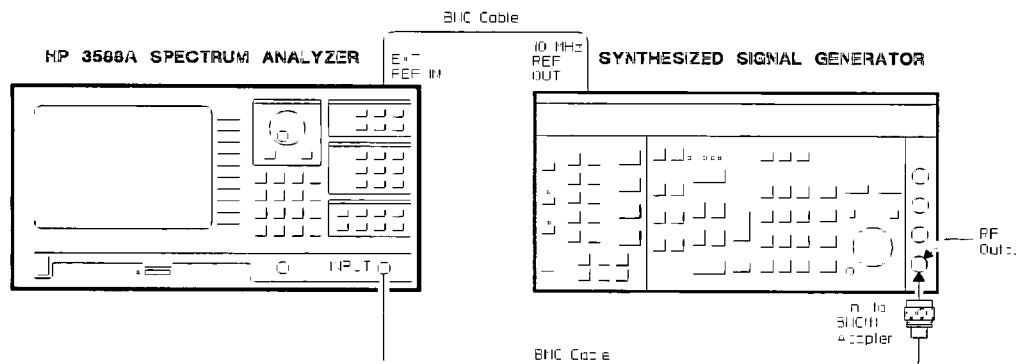

Figure 3-3. Image Responses Setup

2. Set the signal generator as follows:

Amplitude +10 dBm
Frequency 61.23456 MHz

3. Press the following keys:

- [**Preset**]
- [**Spcl Fctn**]
 - [SINGLE CAL]
 - [AUTO CAL ON **OFF**]
- [**Range/Input**]
 - [RANGE]
 - 10**
 - [dBm]
- [**Res BW**]
 - [RES BW]
 - 4.5**
 - [Hz]
- [**Sweep**]
 - [SWEEP AUTO **MAN**]
 - [MANUAL FREQ]
 - 61 23456**
 - [MHz]
- [**Marker**]
 - [ZERO OFFSET]
- [**Avg/Pk Hld**]
 - [VIDEO AVERAGE]

4. For each of the following frequencies, perform steps a and b:

Frequency (MHz)
40 85956
60 85956
61 35956

a. Press the following keys:

- [**Sweep**]
 - [MANUAL FREQ] (to frequency in table)

b. Enter the Δ **Man** readout in the test record.

8. Input Harmonic Distortion

Operation Verification – Yes

For Operation Verification, only perform steps 1 through 4.

This test verifies that the HP 3588A Spectrum Analyzer meets its dynamic range specification for input harmonic distortion. In this test, a low pass filter attenuates the harmonics of a signal from the synthesizer/level generator. The analyzer then measures the signal, establishing a reference level. Then, using its offset marker, the analyzer measures the second and third harmonics. Harmonic distortion is measured using the receiver's 50Ω input path, with low distortion mode on and off, and using the $1\text{ M}\Omega$ input path.

Equipment Required:

- Synthesizer/Level Generator
- 21 MHz Low Pass Filter
- 50Ω Feedthrough Termination
- BNC Cables (3)

1. Connect the test equipment as shown in figure 3-4.

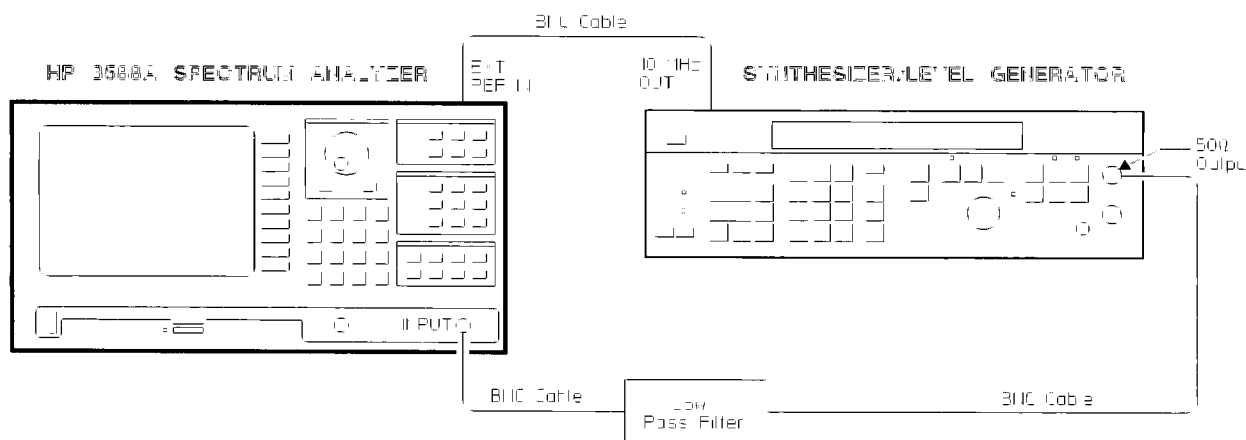

Figure 3-4. Input Harmonic Distortion Setup

2. Set the synthesizer/level generator's amplitude to -2 dBm .

3. Press the following keys:

- [**Preset**]
- [**Spcl Fctn**]
 - [SINGLE CAL]
 - [AUTO CAL ON **OFF**]
- [**Range/Input**]
 - [RANGE]
 - 0**
 - [dBm]
- [**Res BW**]
 - [RES BW]
 - 4.5**
 - [Hz]
- [**Sweep**]
 - [SWEEP AUTO **MAN**]
- [**Avg/Pk Hld**]
 - [VIDEO AVERAGE]
- [**Meas Type**]
 - [LOW DIST **ON OFF**]

4 For each of the following fundamental frequencies, using the filter listed perform steps a through e:

Low Pass Filter	Fundamental Frequency (MHz)	Second Harmonic (MHz)	Third Harmonic (MHz)
50 MHz	47.265018	94.530036	141.795054
21 MHz	18.816541	37.633082	56.449623

a. Set the synthesizer/level generator's frequency to the fundamental frequency in the table.

b. Press the following keys:

- [**Sweep**]
 - [MANUAL FREQ] (to fundamental frequency in table)
- [**Marker**]
 - [ZERO OFFSET]
- [**Sweep**]
 - [MANUAL FREQ] (to second harmonic in table)

c. Enter the Δ **Man** readout in the test record.

d. Press the following keys:

- [MANUAL FREQ] (to third harmonic in table)

e. Enter the Δ **Man** readout in the test record.

5. Press the following keys:

[**Meas Type**]
 [LOW DIST ON **OFF**]

6. Repeat step 4.

7. Disconnect the cable connected to the INPUT connector. Connect the 50Ω feedthrough termination to the INPUT connector, and connect the cable to the 50Ω feedthrough termination.

8. Press the following keys.

[**Range/Input**]
 [1 MEGOHM]

9. For each of the following fundamental frequencies, using the filter listed perform steps a through e

Low Pass Filter	Fundamental Frequency (MHz)	Second Harmonic (MHz)
21 MHz	18 816541	37 633082

a. Set the synthesizer/level generator's frequency to the fundamental frequency in the table.

b. Press the following keys:

[**Sweep**]
 [MANUAL FREQ] (to fundamental frequency in table)

[**Marker**]
 [ZERO OFFSET]

[**Sweep**]
 [MANUAL FREQ] (to second harmonic in table)

c. Enter the Δ Man readout in the test record.

d. Press the following keys:

[MANUAL FREQ] (to third harmonic in table)

e. Enter the Δ Man readout in the test record.

9. Intermodulation Distortion

Operation Verification – No

Do not perform this test for Operation Verification.

This test verifies that the HP 3588A Spectrum Analyzer meets its dynamic range specification for intermodulation distortion. In this test, a 50Ω directional bridge mixes two signals. The resulting modulated signal is measured by the analyzer establishing a reference level. Then, using its offset marker, the analyzer measures the second and third order intermodulation products (the sum and difference frequencies). Intermodulation distortion is measured using the receiver's 50Ω input path, with low distortion mode on and off and using the $1\text{ M}\Omega$ input path.

Equipment Required:

- Synthesized Signal Generator
- Synthesizer/Level Generator
- 50Ω Directional Bridge
- 50Ω Feedthrough Termination
- N(m)-to-BNC(f) Adapters (4)
- SMA(m)-to-BNC(f) Adapters (4)
- BNC Cables (7)
- BNC to Alligator Clip (2)
- Dual Banana to BNC(f) Adapter
- BNC Tee
- SMA(m)-to-BNC(m) Adapters(2)
- N(f)-to-BNC(m) Adapters (2)
- 10 dB Amplifiers (2)
- 10 dB Attenuators (2)
- Power Supply

1. Connect the test equipment as shown in figure 3-5.

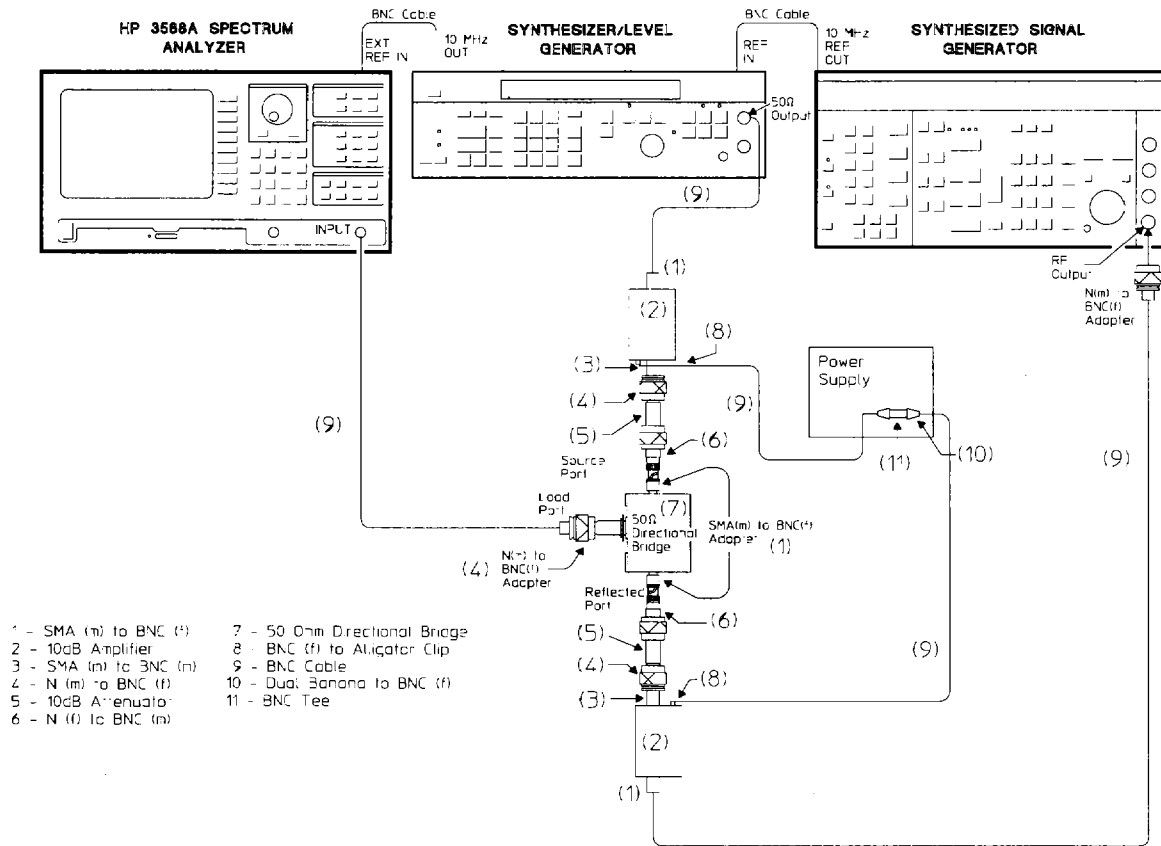

Figure 3-5. Intermodulation Distortion Setup

2. Press the following keys:

- [Preset]
- [Spcl Fctn]
 - [SINGLE CAL]
 - [AUTO CAL ON OFF]
- [Range/Input]
 - [RANGE]
 - 20
 - [dBm]
- [Freq]
 - [FULL SPAN]
- [Res BW]
 - [RES BW]
 - 1.1
 - [Hz]
- [Meas Type]
 - [LOW DIST ON OFF]

[Sweep]
 [SWEEP AUTO **MAN**]
 [MANUAL FREQ]
23.634466
 [MHz]

3. Set the signal generator's frequency to 23 634466 MHz, and adjust its amplitude for a **Man** readout of $-26.0 \text{ dBm} \pm 0.1 \text{ dB}$ (approximately -19 dBm).
- 4 For each of the following source frequencies, perform steps a through h:

Source Frequency	2nd Order Difference	2nd Order Sum	3rd Order
23 6346 MHz	134 Hz	47 269066 MHz	23 634734 MHz
23 637307 MHz	2 841 Hz	47 271773 MHz	23 640148 MHz
23 694466 MHz	60 Hz	47 328923 MHz	23 754466 MHz

- a. Press the following keys:

[Sweep]
 [MANUAL FREQ] (to source frequency in table)

- b. Set the synthesizer/level generator's frequency to the source frequency in the table, and adjust its amplitude for a **Man** readout of $-26.0 \text{ dBm} \pm 0.1 \text{ dB}$ (approximately -19 dBm).

- c. Press the following keys:

[Marker]
 [ZERO OFFSET]

[Avg/Pk Hld]
 [VIDEO AVERAGE]

[Sweep]
 [MANUAL FREQ] (to second order difference frequency in table)

- d. Enter the Δ **Man** readout in the test record.

- e. Press the following keys:

[MANUAL FREQ] (to second order sum frequency in table)

- f. Enter the Δ **Man** readout in the test record.

- g. Press the following keys:

[MANUAL FREQ] (to third order frequency in table)

- h. Enter the Δ **Man** readout in the test record.

- i. Press the following keys:

[Marker]
 [OFFSET ON **OFF**]

[Avg/Pk Hld]
 [OFF]

- 5 Press the following keys:

[Meas Type]
 [LOW DIST ON **OFF**]

[Sweep]
 [MANUAL FREQ]
23.634466
 [MHz]

6. Adjust the signal generator's amplitude for a **Man** readout of $-26.0 \text{ dBm} \pm 0.1 \text{ dB}$ (approximately -19 dBm).
7. Repeat step 4.
8. Disconnect the cable connected to the INPUT connector. Connect the 50Ω feedthrough termination to the INPUT connector, and connect the cable to the 50Ω feedthrough termination.
9. Press the following keys:

[Sweep]
 [MANUAL FREQ]
23.634466
 [MHz]
 [Range/Input]
 [1 MEGOHM]

10. Adjust the signal generator's amplitude for a **Man** readout of $-6.0 \text{ dBm} \pm 0.1 \text{ dB}$ (approximately $+1 \text{ dBm}$).
11. For each of the following source frequencies, perform steps a through g.

Source Frequency	2nd Order	3rd Order
23 6346 MHz	134 Hz	23 634734 MHz
23 637307 MHz	2 841 kHz	23 640148 MHz
23 694466 MHz	60 kHz	23 754466 MHz

- a. Press the following keys:

[Sweep]
 [MANUAL FREQ] (to source frequency in table)

- b. Set the synthesizer/level generator's frequency to the source frequency in the table, and adjust its amplitude for a **Man** readout of $-6.0 \text{ dBm} \pm 0.1 \text{ dB}$ (approximately $+1 \text{ dBm}$).

c. Press the following keys:

[**Marker**]

[ZERO OFFSET]

[**Avg/Pk Hld**]

[VIDEO AVERAGE]

[**Sweep**]

[MANUAL FREQ] (to second order frequency in table)

d. Enter the Δ **Man** readout in the test record.

e. Press the following keys:

[MANUAL FREQ] (to third order frequency in table)

f. Enter the Δ **Man** readout in the test record

g. Press the following keys:

[**Marker**]

[OFFSET ON **OFF**]

[**Avg/Pk Hld**]

[OFF]

10. Source Amplitude Accuracy and Frequency Response

Operation Verification — Yes

For Operation Verification, check only the frequencies listed in the shaded boxes.

This test verifies that the HP 3588A Spectrum Analyzer meets its source specification for absolute amplitude accuracy and frequency response. In this test, a multimeter measures the analyzer's source from 10 Hz to 100 kHz and a power meter measures the analyzer's source from 300 kHz to 150 MHz. The value measured at 300 kHz is used to calculate the lower and upper limit specifications for all frequencies except 300 kHz.

Equipment Required:	Digital Multimeter
	Power Meter
	Power Sensor
	50 Ω Feedthrough Termination
	BNC(f)-to-Dual Banana Plug Adapter
	N(f)-to-BNC(m) Adapter
	BNC Cable

1. Connect the 50 Ω feedthrough termination to the multimeter using the adapter.
2. Measure the resistance of the feedthrough termination and enter as the reference impedance for dBm operation (RES). Then set the multimeter's function to ac volts (most accurate mode), ac bandwidth to 10 Hz - 1 MHz, and math mode to dBm. For an HP 3458A Digital Multimeter, press the following keys

blue shift key	Reset
OHM	
blue shift key	S
Menu Scroll ↓	(until SMATH is shown)
10 (RES)	ENTER
ACV	
blue shift key	C
Menu Scroll ↑	(until ACBAND is shown)
10, 1000000	ENTER
blue shift key	S
Menu Scroll ↓	(until SETACV is shown)
3 (SYNC)	ENTER
blue shift key	L
Menu Scroll ↓	(until MATH is shown)
5 (dBm)	ENTER

Note If your digital multimeter does not have dBm math capability, record the resistance of the feedthrough termination (RES) for later calculations

1. Connect the test equipment as shown in figure 3-6.

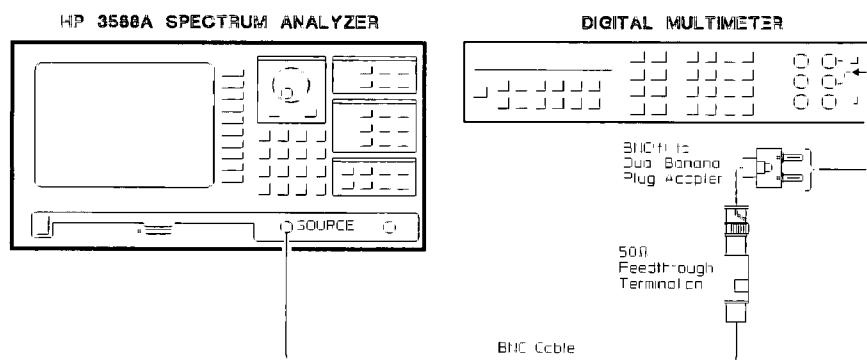

Figure 3-6. Source Responses Setup for Low Frequencies

2. Press the following keys:

[Preset]

[**Spcl Fctn**]

[SINGLE CAL]

[AUTO CAL ON **OFF**]

[**Freq**]

[FULL SPAN]

[**Source**]

[SOURCE **ON** OFF]

[SOURCE AMPLITUDE]

10

[dBm]

[**Sweep**]

[SWEEP AUTO **MAN**]

3. For each of the following frequencies, perform steps a and b:

For Performance Tests	
Frequency	
10 Hz	
100 Hz	
1 kHz	
10 kHz	
30 kHz	
100 kHz	

For Operation Verification	
Frequency	
10 Hz	
100 Hz	
10 kHz	
30 kHz	

- a. Press the following keys:
 [MANUAL FREQ] (to frequency in table)
- b. Enter the multimeter's readout in the test record.

Note

If your digital multimeter does not have dBm math capability, use the following formula to convert your measurement results to dBm.

$$10 \times \log_{10} ((\text{readout}^2/\text{RES})/1 \text{ mW}) = \text{dBm}$$

readout = multimeter's readout in volts

RES = measured resistance of the feedthrough termination

4. Connect the test equipment as shown in figure 3-7.

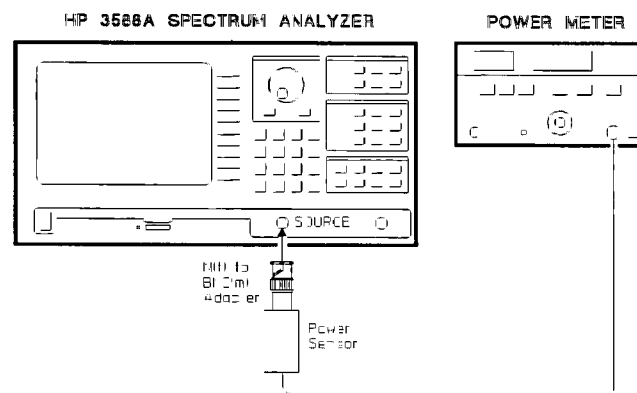

Figure 3-7. Source Response Setup for High Frequencies

5. Set the power meter's function to dBm

6. For each of the following frequencies, perform steps a through e:

For Performance Tests	
Frequency	
300 kHz	
500 kHz	
1 MHz	
2 MHz	
5 MHz	
10 MHz	
25 MHz	
40 MHz	
55 MHz	
70 MHz	
85 MHz	
100 MHz	
120 MHz	
135 MHz	
150 MHz	

For Operation Verification	
Frequency	
300 kHz	
10 MHz	
40 MHz	
100 MHz	
150 MHz	

- a. Press the following keys:
[MANUAL FREQ] (to frequency in table)
 - b. Set the power meter's calibration factor for the frequency in the table.
 - c. Enter the power meter's readout in the test record.
7. Subtract 1 dB from the measured value at 300 kHz. Enter the result in the test record as the lower limit specification for all frequencies, except 300 kHz.
8. Add 1 dB to the measured value at 300 kHz. Enter the result in the test record as the upper limit specification for all frequencies, except 300 kHz.

11a. Input Amplitude Accuracy and Flatness

Operation Verification – Yes

For Operation Verification, only perform steps 1 through 34

This test verifies that the HP 3588A Spectrum Analyzer meets its amplitude accuracy specification. In this test, the analyzer measures the power splitter and cable errors at four spans and stores the results in its internal data registers. A milliwatt power meter provides correction to the source, maintaining 0 dBm at the power sensor input. Then the analyzer measures the flatness of each frequency span. Using its internal math functions, the analyzer corrects for any errors caused by the power splitter and cables. This test checks the input flatness from 10 Hz to 150 MHz in the 50 Ω input path and from 10 Hz to 40 MHz in the 1 M Ω input path.

Note

Test 11b, "Alternate Input Amplitude Accuracy and Flatness" does not require a milliwatt power meter. Perform either this test or test 11b, "Alternate Input Amplitude Accuracy and Flatness."

Equipment Required

Milliwatt Power Meter
Power Splitter
Error Correction Cable
50 Ω Feedthrough Termination
BNC Cables (3)
N(f)-to-BNC(f) Adapter
N(m)-to-BNC(f) Adapters(3)

1. Set the power switch to STANDBY

(0
1) and remove the power cord. Remove the top cover (see figure 3-8).

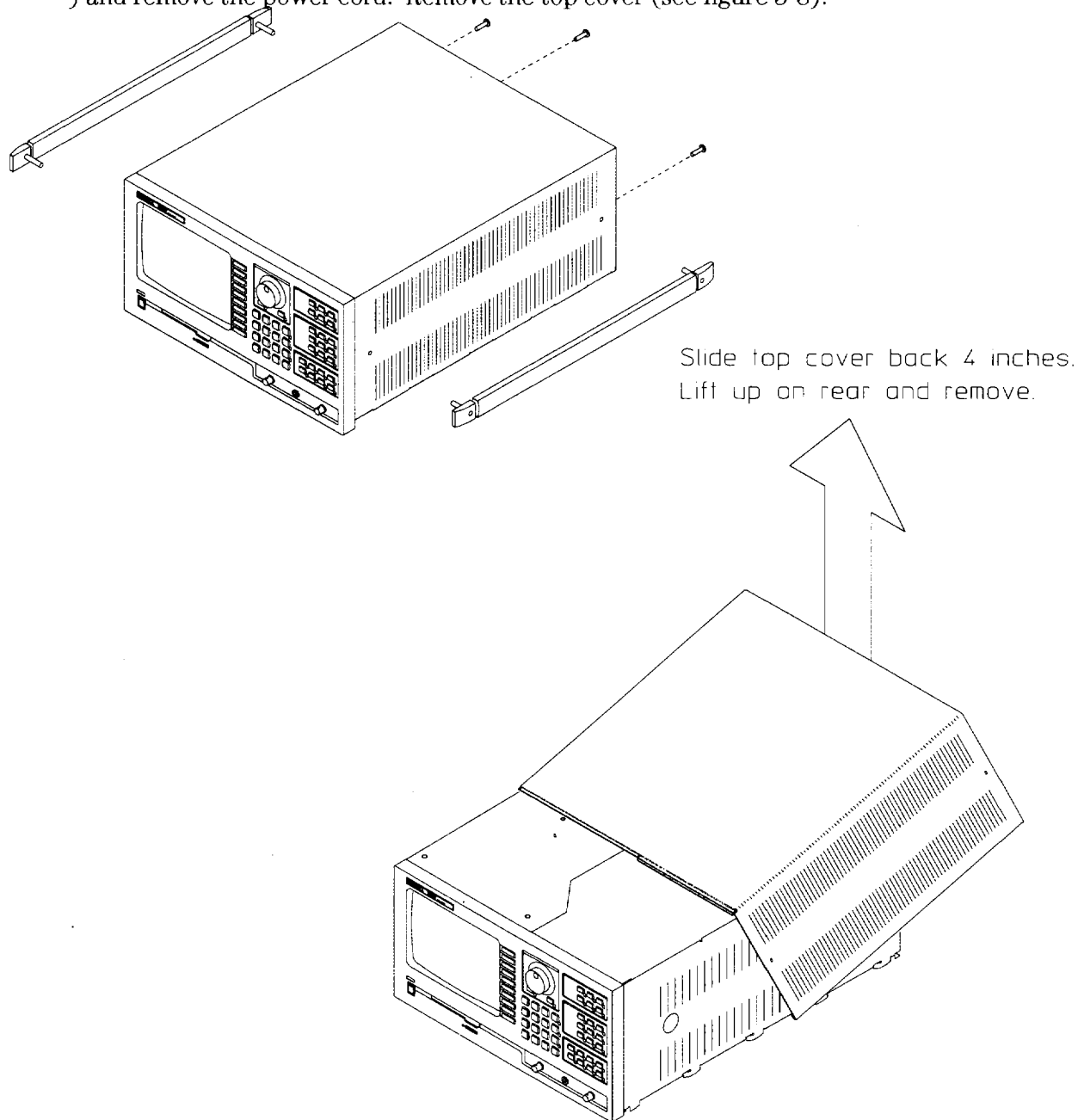

Figure 3-8. Removing Top Cover

Warning

When replacing the handle assemblies, be careful to position properly and attach firmly. If improperly attached, the handles could come off when lifting the analyzer, causing personal injury.

2. Reconnect the power cord and set the power switch to ON (I).
3. Set the milliwatt power meter as follows:

Range	0 dBm, ± 0.2 dBm (red)
Ri	50Ω, 0 dBm
Control Voltage Gain	maximum (clockwise)
Control Voltage Polarity	+ (positive)
4. Connect the milliwatt power sensor to its calibration output and adjust CAL for a 0 dBm reading
5. Connect the test equipment as shown in figure 3-9.

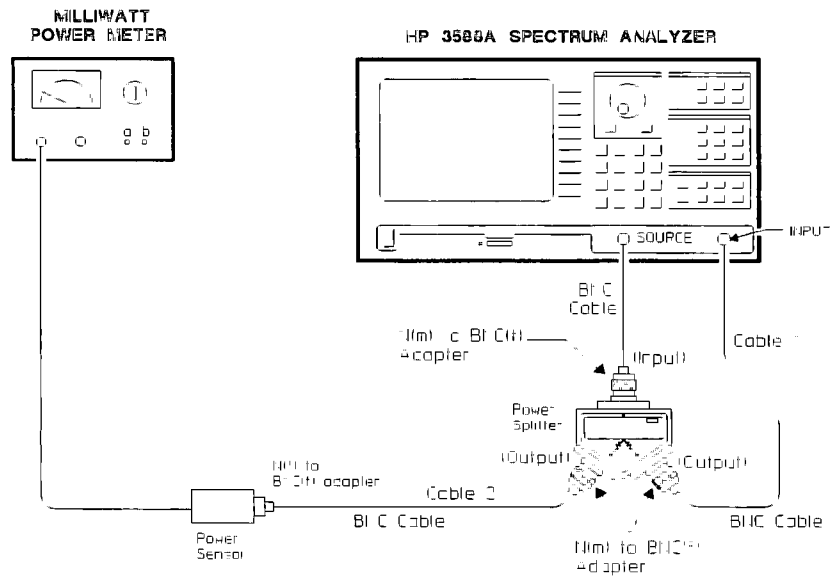

Figure 3-9. Frequency Response Setup

6. Press the following keys:

[**Preset**]
[**Spcl Fctn**]
 [SINGLE CAL]
 [AUTO CAL ON **OFF**]
[**Trigger**]
 [ARM AUTO **MAN**]
[**Source**]
 [SOURCE **ON** OFF]
 [SOURCE AMPLITUDE]
 6 (nominal loss of power splitter)
 [dBm]
[**Freq**]
 [START]
 10
 [Hz]
 [STOP]
 100
 [Hz]
[**Res BW**]
 [RES BW]
 4.5
 [Hz]
[**Range/Input**]
 [RANGE]
 10
 [dBm]
[**Sweep**]
 [SWEEP TIME]
 13
 [SEC]
[**Trigger**]
 [ARM]

7. Wait for a complete sweep, then press the following keys:

[Save/Recall]

[DEFAULT DISK]
[VOLATILE RAM DISK]
[CANCEL/RETURN]
[SAVE TRACE]
[INTO D1]
[SAVE STATE]
STATE1

Note

To type in STATE1, use the marker knob to highlight the space after STATE, then press [1]. If a character needs to be deleted, use the marker knob to highlight the character, then press [DELETE CHARACTER].

[ENTER]

[Freq]

[START]
100
[Hz]
[STOP]
30
[kHz]

[Res BW]

[RES BW]
73
[Hz]

[Sweep]

[SWEEP TIME]
12
[SEC]

[Trigger]

[ARM]

8. Wait for a complete sweep, then press the following keys:

[Save/Recall]
[SAVE TRACE]
[INTO D3]
[SAVE STATE]
STATE2
[ENTER]
[Freq]
[START]
30
[kHz]
[STOP]
40
[MHz]
[Res BW]
[RES BW]
4.6
[kHz]
[Sweep]
[SWEEP TIME]
10
[SEC]
[Trigger]
[ARM]

9. Wait for a complete sweep, then press the following keys:

[Save/Recall]
[SAVE TRACE]
[INTO D5]
[SAVE STATE]
STATE3
[ENTER]
[Freq]
[STOP]
150
[MHz]
[Res BW]
[RES BW]
4.6
[kHz]
[Sweep]
[SWEEP TIME]
15
[SEC]
[Trigger]
[ARM]

10. Wait for a complete sweep, then press the following keys:

[**Save/Recall**]
[SAVE TRACE]
[INTO D7]
[SAVE STATE]
STATE4
[ENTER]

11. Referring to figure 3-9, disconnect the cable connected to the INPUT connector (cable 1) and connect to the power sensor. Connect the cable that was connected to the power sensor (cable 2) to the INPUT connector. Do NOT disconnect the cables from the power splitter.

12. Press the following keys:

[**Trigger**]
[ARM]

13. Wait for a complete sweep, then press the following keys:

[**Save/Recall**]
[SAVE TRACE]
[INTO D8]
[RECALL STATE]
STATE3
[ENTER]
[**Trigger**]
[ARM]

14. Wait for a complete sweep, then press the following keys:

[**Save/Recall**]
[SAVE TRACE]
[INTO D6]
[RECALL STATE]
STATE2
[ENTER]
[**Trigger**]
[ARM]

15. Wait for a complete sweep, then press the following keys:

[**Save/Recall**]
[SAVE TRACE]
[INTO D4]
[RECALL STATE]
STATE1
[ENTER]
[**Trigger**]
[ARM]

16. Wait for a complete sweep, then press the following keys:

[Save/Recall]

[SAVE TRACE]

[INTO D2]

[Math]

[DEFINE F1] ($F1 = \text{SPEC}/(D2/D1)$)

[SPECTRUM]

[/]

[(]

[DATA REG (D1-D8)]

[DATA REG D2]

[/]

[DATA REG (D1-D8)]

[DATA REG D1]

[)]

[ENTER]

[DEFINE F2] ($F2 = \text{SPEC}/(D4/D3)$)

[SPECTRUM]

[/]

[(]

[DATA REG (D1-D8)]

[DATA REG D4]

[/]

[DATA REG (D1-D8)]

[DATA REG D3]

[)]

[ENTER]

[DEFINE F3] ($F3 = \text{SPEC}/(D6/D5)$)

[SPECTRUM]

[/]

[(]

[DATA REG (D1-D8)]

[DATA REG D6]

[/]

[DATA REG (D1-D8)]

[DATA REG D5]

[)]

[ENTER]

[DEFINE F4] ($F4 = \text{SPEC}/(D8/D7)$)

[SPECTRUM]

[/]

[(]

[DATA REG (D1-D8)]

[DATA REG D8]

[/]

[DATA REG (D1-D8)]

[DATA REG D7]

[)]

[ENTER]

- 17 Connect the error correction cable from the milliwatt power meter (red to A and black to B) to A42 J5 (EXT LVL). See figure 3-10.

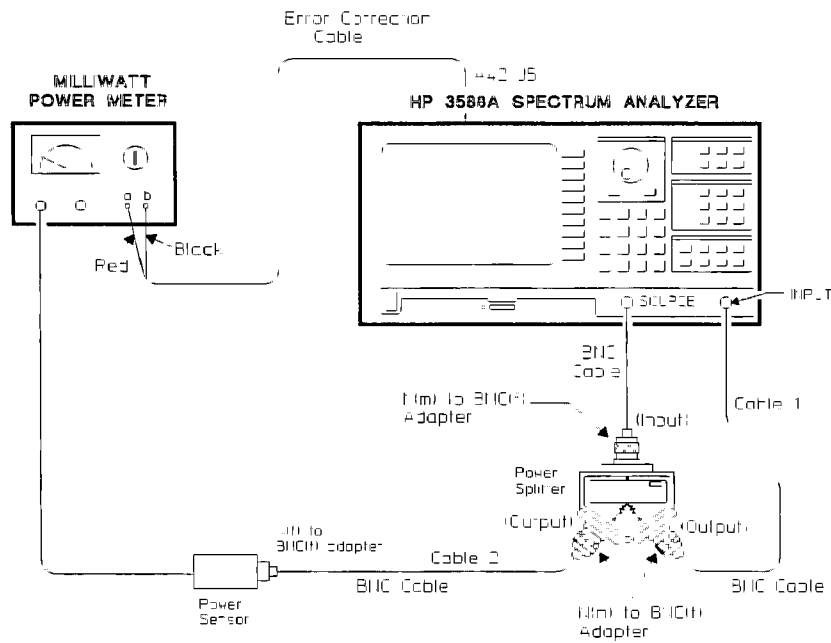

Figure 3-10. Connecting Error Correction Cable

Note

A calibration failure will occur if the HP 3588A Spectrum Analyzer does an internal calibration while the error correction cable is connected to A42 J5. Make sure to disconnect the error correction cable before pressing [**Preset**], [**SINGLE CAL**], [**AUTO CAL ON OFF**], or before cycling power.

18. Adjust the milliwatt power meter's control voltage reference to 0 dBm. If unable to adjust to 0 dBm, set the control voltage polarity to - (negative) and adjust the control voltage reference again.

19. Press the following keys:

[Save/Recall]
[RECALL STATE]
STATE4
[ENTER]
[Trace Data]
[FUNCTION (F1-F5)]
[F4]
[Res BW]
[RES BW]
9.1
[kHz]
[Sweep]
[SWEEP TIME]
200
[SEC]
[Trigger]
[ARM]

20. Wait for the sweep to reach the first graticule, then press the following keys:

[Sweep]
[SWEEP TIME]
60
[SEC]

21. After a complete sweep, press the following keys.

[Scale]

[AUTOSCALE]

[Marker]

[MKR -> PEAK]

22. Enter the **Mkr** readout in the test record as the maximum measured value for 30 kHz to 150 MHz.
23. Position the marker at the minimum point on the trace, and enter the **Mkr** readout in the test record as the minimum measured value for 30 kHz to 150 MHz.
24. Position the marker at the maximum point above 300 kHz and below 40 MHz, and enter the **Mkr** readout in the test record as the maximum measured value for 300 kHz to 40 MHz.
25. Position the marker at the minimum point above 300 kHz and below 40 MHz, and enter the **Mkr** readout in the test record as the minimum measured value for 300 kHz to 40 MHz.
26. Press the following keys:

[Save/Recall]

[RECALL STATE]

STATE2

[ENTER]

[Trace Data]

[FUNCTION (F1-F5)]

[F2]

[Res BW]

[RES BW]

73

[Hz]

[Sweep]

[SWEEP TIME]

50

[SEC]

[Trigger]

[ARM]

27. Wait for the a complete sweep, then press the following keys:

[Scale]

[AUTOSCALE]

[Marker]

[MKR -> PEAK]

28. Enter the **Mkr** readout in the test record as the maximum measured value for 100 Hz to 30 kHz.
29. Position the marker at the minimum point on the trace, and enter the **Mkr** readout in the test record as the minimum measured value for 100 Hz to 30 kHz.

30 Press the following keys:

[Save/Recall]
[SAVE STATE]
STATE2
[ENTER]
[RECALL STATE]
STATE1
[ENTER]
[Trace Data]
[FUNCTION (F1-F5)]
[F1]
[Res BW]
[RES BW]
4.5
[Hz]
[Sweep]
[SWEEP TIME]
50
[SEC]
[Trigger]
[ARM]

31. Wait for a sweep, then press the following keys.

[Scale]
[AUTOSCALE]
[Save/Recall]
[SAVE STATE]
STATE1
[ENTER]
[Marker]
[MKR -> PEAK]

32. Enter the **Mkr** readout in the test record as the maximum measured value for 10 Hz to 100 Hz

33. Position the marker at the minimum point on the trace, and enter the **Mkr** readout in the test record as the minimum measured value for 10 Hz to 100 Hz.

Note

This completes the Operation Verification procedure for Input Amplitude Accuracy and Flatness. Set the power switch to STANDBY

(0

1) and remove the power cord. Disconnect the error correction cable from A42 J5, and replace the top cover and handle assembly (see figure 3-8).

To complete the Performance Test procedure, continue following this procedure (do not disconnect the error correction cable or replace the top cover)

34. Disconnect cable 2 from the INPUT connector. Connect a 50Ω feedthrough termination to the INPUT connector and connect cable 2 to the feedthrough termination.

35. Press the following keys:

[Save/Recall]

[RECALL STATE]

STATE3

[ENTER]

[Input/Range]

[1 MEGOHM]

[Trace Data]

[FUNCTION (F1-F5)]

[F3]

[Sweep]

[SWEEP TIME]

120

[SEC]

[Trigger]

[ARM]

36. Wait for the sweep to reach the first graticule, then press the following keys:

[Sweep]
[SWEEP TIME]
30
[SEC]

37. After a complete sweep, press the following keys

[Scale]
[AUTOSCALE]
[Marker]
[MKR -> PEAK]

38. Enter the **Mkr** readout in the test record as the maximum measured value for 30 kHz to 40 MHz.

39. Position the marker at the minimum point on the trace, and enter the **Mkr** readout in the test record as the minimum measured value for 30 kHz to 40 MHz.

40. Press the following keys:

[Save/Recall]
[RECALL STATE]
STATE2
[ENTER]
[Input/Range]
[1 MEGOHM]
[Trigger]
[ARM]

41. Wait for a complete sweep, then press the following keys:

[Scale]
[AUTO SCALE]
[Marker]
[MKR -> PEAK]

42. Enter the **Mkr** readout in the test record as the maximum measured value for 100 Hz to 30 kHz.

43. Position the marker at the minimum point on the trace, and enter the **Mkr** readout in the test record as the minimum measured value for 100 Hz to 30 kHz.

44. Press the following keys:

[**Save/Recall**]

[RECALL STATE]

STATE1

[ENTER]

[**Input/Range**]

[1 MEGOHM]

[**Trigger**]

[ARM]

45. Wait for a complete sweep, then press the following keys:

[**Scale**]

[AUTOSCALE]

[**Marker**]

[MKR -> PEAK]

46. Enter the **Mkr** readout in the test record as the maximum measured value for 10 Hz to 100 Hz.

47. Position the marker at the minimum point on the trace, and enter the **Mkr** readout in the test record as the minimum measured value for 10 Hz to 100 Hz.

48. Set the power switch to STANDBY

(⁰
1) and remove the power cord. Disconnect the error correction cable from A42 J5, and replace the top cover and handle assembly (see figure 3-8)

11b. Alternate Frequency Response (Amplitude Flatness)

Operation Verification – Yes

For Operation Verification, only perform steps 1 through 6. Also, check only the frequencies listed in the shaded box.

This test verifies that the HP 3588A Spectrum Analyzer meets its amplitude accuracy specification for frequency response. In this test, the analyzer generates and measures a signal from 10 Hz to 150 MHz using the receiver's 50 Ω input path and from 10 Hz to 40 MHz using the 1 M Ω input path. The source amplitude levels measured in test 10, Source Amplitude Accuracy and Frequency Response, are subtracted from the levels measured in this test for the 50 Ω input path. Since the receiver's 1 M Ω input path requires a lower source level, this test measures the source's output (with a multimeter from 10 Hz to 100 kHz and with a power meter from 300 kHz to 40 MHz). These levels are subtracted from the levels measured for the 1 M Ω input path. Then for specified frequency ranges in both the 50 Ω and 1 M Ω input paths, the largest negative error is subtracted from the largest positive error, resulting in the frequency response error.

Equipment Required:

Power Meter
Power Sensor
Digital Multimeter
50 Ω Feedthrough Termination
N(f)-to-BNC(m) Adapter
BNC Cable
BNC(f)-to-Dual Banana Plug Adapter

Note

This test is an alternate for test 11a, "Frequency Response." Perform either this test or test 11a, "Frequency Response."

1. Connect the SOURCE connector to the INPUT connector using a BNC cable.

2 Press the following keys:

[**Preset**]

[**Spcl Fctn**]

[SINGLE CAL]

[AUTO CAL ON **OFF**]

[**Freq**]

[FULL SPAN]

[**Source**]

[SOURCE **ON** OFF]

[SOURCE AMPLITUDE]

10

[**dBm**]

[**Range/Input**]

[RANGE]

20

[**dBm**]

[**Res BW**]

[RES BW]

4.5

[**Hz**]

[**Sweep**]

[SWEEP AUTO **MAN**]

3. For each of the following frequencies, perform steps a and b.

For Performance Tests	
Frequency	
10 Hz	
100 Hz	
1 kHz	
10 kHz	
30 kHz	
100 kHz	
300 kHz	
500 kHz	
1 MHz	
2 MHz	
5 MHz	
10 MHz	
25 MHz	
40 MHz	
55 MHz	
70 MHz	
85 MHz	
100 MHz	
120 MHz	
135 MHz	
150 MHz	

For Operation Verification	
Frequency	
10 Hz	
100 Hz	
10 kHz	
30 kHz	
300 kHz	
10 MHz	
40 MHz	
100 MHz	
150 MHz	

- a. Press the following keys:
 [MANUAL FREQ] (to frequency in table)
- b. Enter the **Man** readout in the test record's Measured Value column.
4. Enter the measured values recorded for test 10, Source Amplitude Accuracy and Frequency Response, in the test record's Reference Value column (50Ω input impedance).
5. Subtract the reference value from the measured value for each frequency, and enter the result in the test record's Input Error column.
6. Disconnect the cable connected to the INPUT connector. Connect the 50Ω feedthrough termination to the INPUT connector, and connect the cable to the 50Ω feedthrough termination.

7. Press the following keys:

[Range/Input]

[1 MEGOHM]

[Source]

[SOURCE AMPLITUDE]

-5

[dBm]

[Sweep]

8. For each of the following frequencies, perform steps a and b.

Frequency
10 Hz
100 Hz
1 kHz
10 kHz
30 kHz
100 kHz
300 kHz
500 kHz
1 MHz
2 MHz
5 MHz
10 MHz
25 MHz
40 MHz

a. Press the following keys:

[MANUAL FREQ] (to frequency in table)

b. Enter the **Man** readout in the test record's Measured Value column.

9. Connect the 50Ω feedthrough termination to the multimeter using the adapter.

- Measure the resistance of the feedthrough termination and enter as the reference impedance for dBm operation (RES). Then set the multimeter's function to ac volts (most accurate mode), ac bandwidth to 10 Hz - 1 MHz, and math mode to dBm. For an HP 3458A Digital Multimeter, press the following keys:

blue shift key	Reset
OHM	
blue shift key	S
Menu Scroll ↓	(until SMATH is shown)
10 (RES)	ENTER
ACV	
blue shift key	C
Menu Scroll ↑	(until ACBAND is shown)
10, 1000000	ENTER
blue shift key	S
Menu Scroll ↓	(until SETACV is shown)
3 (SYNC)	ENTER
blue shift key	L
Menu Scroll ↓	(until MATH is shown)
5 (dBm)	ENTER

Note

If your digital multimeter does not have dBm math capability, record the resistance of the feedthrough termination (RES) for later calculations.

- Connect the test equipment as shown in figure 3-11.

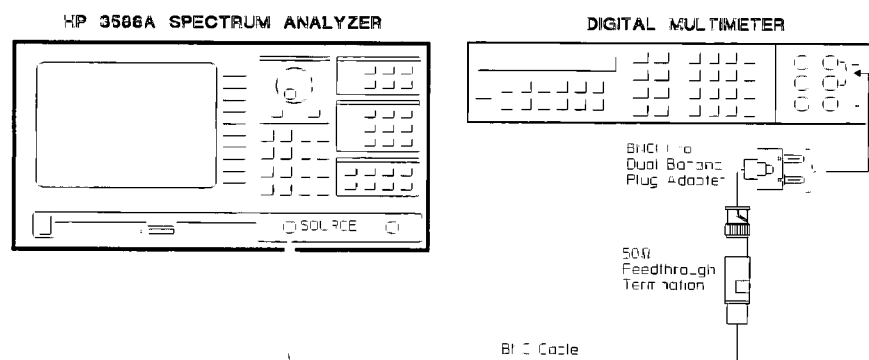

Figure 3-11 Low Frequency Response Setup

2. For each of the following frequencies, perform steps a and b.

Frequency
10 Hz
100 Hz
1 kHz
10 kHz
30 kHz
100 kHz

- a. Press the following keys:
 [MANUAL FREQ] (to frequency in table)
- b. Enter the multimeter's readout in the test record's Reference Value column.

Note

If your digital multimeter does not have dBm math capability, use the following formula to convert your measurement results to dBm.

$$10 \times \log_{10} ((\text{readout}^2 / \text{RES}) / 1 \text{ mW}) = \text{dBm}$$

readout = multimeter's readout in volts

RES = measured resistance of the feedthrough termination

3. Connect the test equipment as shown in figure 3-12.

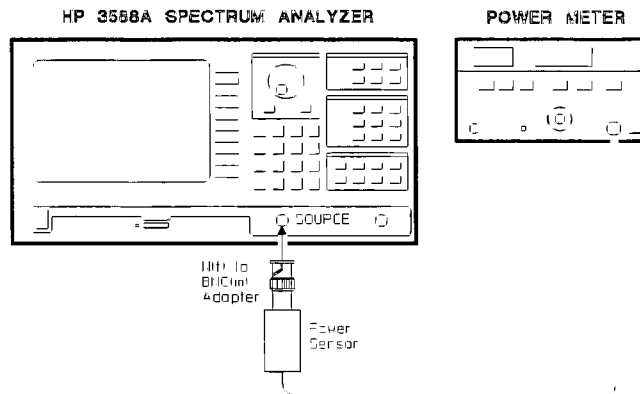

Figure 3-12. High Frequency Response Setup

4. Set the power meter's function to dBm.
5. For each of the following frequencies, perform steps a through c:

Frequency
300 kHz
500 kHz
1 MHz
2 MHz
5 MHz
10 MHz
25 MHz
40 MHz

- a. Press the following keys:
[MANUAL FREQ] (to frequency in table)
 - b. Set the power meter's calibration factor for the frequency in the table.
 - c. Enter the power meter's readout in the test record's Reference Value column.
6. Referring to the test record, subtract the reference value from the measured value (for each frequency) and enter the result in the test record's Input Error column.

12. Reference Level Accuracy

Operation Verification – Yes

For Operation Verification, the procedure is the same as the Performance Test procedure.

This test verifies that the HP 3588A Spectrum Analyzer meets its amplitude accuracy specification for calibrated level accuracy. In this test, the synthesizer is adjusted to an exact amplitude level at 300 kHz. The analyzer's range is set to the amplitude level and the signal is measured. Then the receiver's input range is subtracted from the measured value. This test checks the calibrated level accuracy at five levels from -20 to +20 dBm.

Equipment Required

Synthesizer
Digital Multimeter
50 Ω Feedthrough Termination
BNC(f)-to-Dual Banana Plug Adapter
BNC Cables (2)

1. Connect the 50 Ω feedthrough termination to the multimeter using the adapter.
2. Measure the resistance of the feedthrough termination and enter as the reference impedance for dBm operation (RES). Then set the multimeter's function to ac volts (most accurate mode) and math mode to dBm. For an HP 3458A Digital Multimeter, press the following keys:

blue shift key	Reset
OHM	
blue shift key	S
Menu Scroll ↓	(until SMATH is shown)
10 (RES)	ENTER
ACV	
blue shift key	S
Menu Scroll ↓	(until SETACV is shown)
3 (SYNC)	ENTER
blue shift key	L
Menu Scroll ↓	(until MATH is shown)
5 (dBm)	ENTER

Note

If your digital multimeter does not have dBm math capability, record the resistance of the feedthrough termination (RES) for later calculations.

1. Connect the test equipment as shown in figure 3-13.

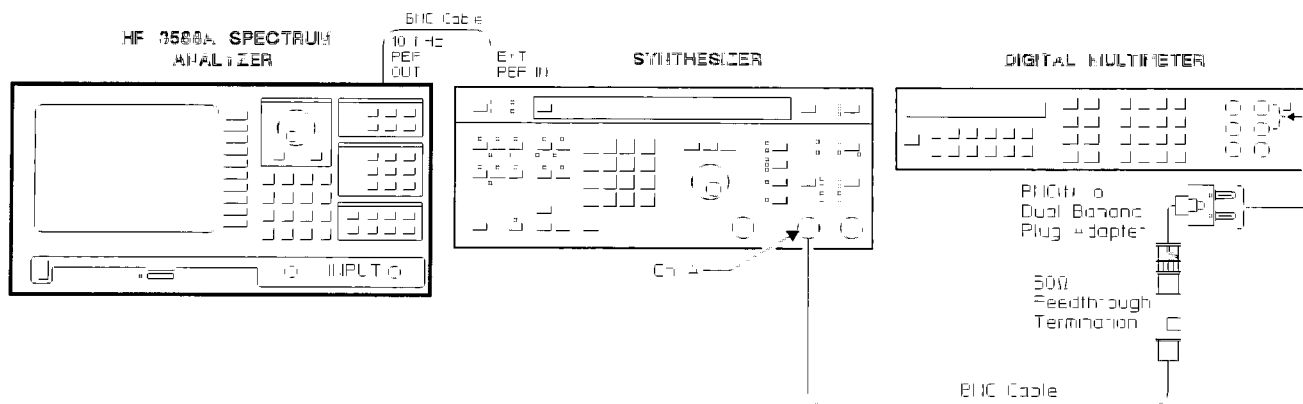

Figure 3-13. Reference Level Accuracy Setup

2. Set the synthesizer's frequency to 300 kHz.
3. Press the following keys:

[Preset]
[Spcl Fctn]
[SINGLE CAL]
[AUTO CAL ON **OFF**]
[Freq]
[CENTER]
300
[kHz]
[SPAN]
1
[kHz]
[Sweep]
[SWEEP AUTO **MAN**]

4. For each of the following amplitudes, perform steps a through f.

Range
-20 dBm ± 0.01 dB
-10 dBm ± 0.01 dB
0 dBm ± 0.01 dB
+10 dBm ± 0.01 dB
+20 dBm ± 0.01 dB

- a. Connect the synthesizer's output to the multimeter through the 50 Ω feedthrough termination and adapter.
- b. Adjust the synthesizer's amplitude to the range in the table as read by the multimeter.

Note

If your digital multimeter does not have dBm math capability, use the following formula to convert your measurement results to dBm

$$10 \times \log_{10} (\text{readout}^2 / \text{RES} / 1 \text{ mW}) = \text{dBm}$$

readout = multimeter's readout in volts

RES = measured resistance of the feedthrough termination

- c. Disconnect the cable connected to the multimeter. Using the same cable (without the 50 Ω feedthrough termination), connect the synthesizer to the INPUT connector.
- d. Press the following keys:
 [Range/Input]
 [RANGE] (to range in table)
- e. Enter the **Man** readout in the test record
- f. Subtract the range from the **Man** readout, and enter the result in the test record.

13. Log Scale Accuracy

Operation Verification – No

Do not perform this test for Operation Verification.

This test verifies that the HP 3588A Spectrum Analyzer meets its amplitude accuracy specification for log scale accuracy. In this test, a power splitter connects the synthesizer's output to the analyzer and to the multimeter. The synthesizer is adjusted to a reference level using the analyzer. From this reference level, the synthesizer's amplitude is reduced in 10 dB steps. Both the multimeter and the receiver measure the synthesizer's output. The value the analyzer measures is subtracted from the value the multimeter measures, resulting in the log scale accuracy for that amplitude. This test checks log scale accuracy at 7 amplitude levels at 100 kHz.

Equipment Required:

Digital Multimeter
Synthesizer
Step Attenuator (with calibration data at 100 kHz)
Power Splitter
50 Ω Feedthrough Termination
N(m)-to-BNC(f) Adapters (3)
BNC(f)-to-Dual Banana Plug Adapter
BNC Cables (5)

1. Connect the 50 Ω feedthrough termination to the multimeter using the adapter.
2. Measure the resistance of the feedthrough termination and enter as the reference impedance for dBm operation (RES). Then set the multimeter's function to ac volts (most accurate mode). For an HP 3458A Digital Multimeter, press the following keys:

blue shift key	Reset
OHM	
blue shift key	S
Menu Scroll ↓	(until SMATH is shown)
10 (RES)	ENTER
ACV	
blue shift key	S
Menu Scroll ↓	(until SETACV is shown)
3 (SYNC)	ENTER

Note If your digital multimeter does not have dBm math capability, record the resistance of the feedthrough termination (RES) for later calculations

1. Connect the test equipment as shown in figure 3-14.

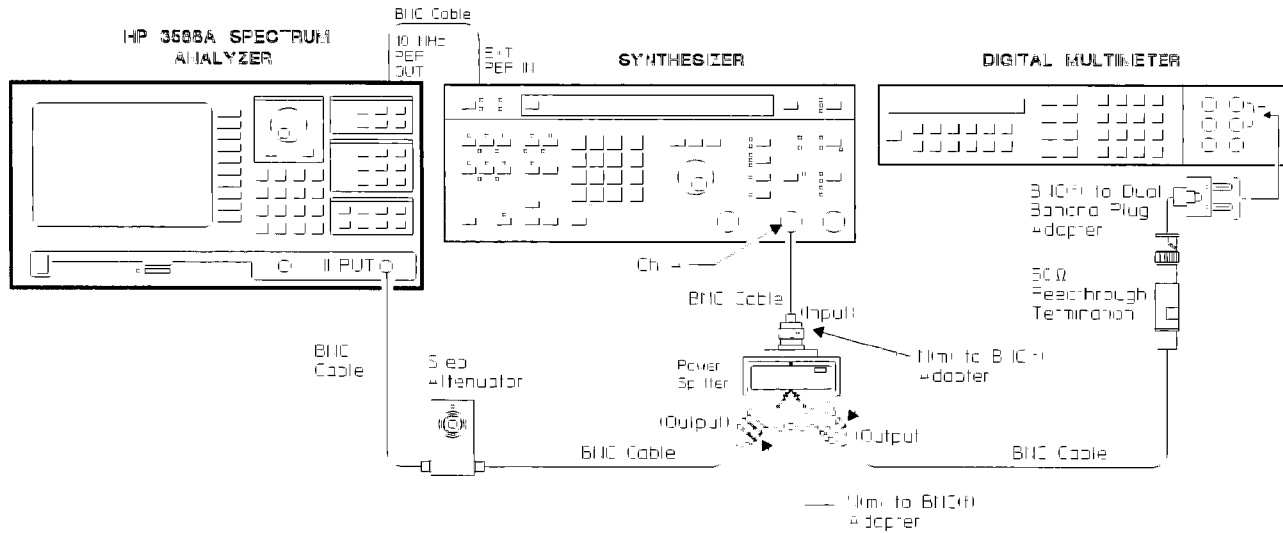

Figure 3-14. Log Scale Accuracy Setup

2. Press the following keys

- [Preset]
- [Spcl Fctn]
 - [SINGLE CAL]
 - [AUTO CAL ON OFF]
- [Freq]
 - [CENTER]
 - 100**
 - [Hz]
 - [SPAN]
 - 1**
 - [Hz]
- [Sweep]
 - [SWEEP AUTO MAN]
- [Range/Input]
 - [RANGE]
 - 10**
 - [dBm]

3. Set the step attenuator to 0 dB.
4. Set the synthesizer as follows.

Frequency	100 kHz
Amplitude	(adjust for Man readout of 10 dBm ±0.01 dB)

5. Press the following keys:

[**Marker**]
[ZERO OFFSET]
[**Avg/Pk Hld**]
[VIDEO AVERAGE]

6. Set the multimeter's math mode to dBm and null. For an HP 3458A Digital Multimeter, press the following keys:

blue shift key	L
Menu Scroll ↓	(until MATH is shown)
5, 9 (dBm, NULL)	ENTER

Note

If your digital multimeter does not have math null capability, record the multimeter readout in dBm for later calculations.

If your digital multimeter does not have dBm math capability, use the following formula to convert your measurement results to dBm

$$10 \times \log_{10} ((\text{readout}^2 / \text{RES}) / 1 \text{ mW}) = \text{dBm}$$

readout = multimeter's readout in volts

RES = measured resistance of the feedthrough termination

1. For each of the following levels, perform steps a through c.

Level (dB)
-10
-20
-30
-40
-50

- a. Adjust the synthesizer's amplitude down from the reference amplitude set in step 6 by the amount in the table.
- b. Enter the multimeter readout in the test record's Reference Value column.

Note

If your digital multimeter does not have math null capability, subtract the multimeter readout in step 8 from the current multimeter readout before entering in the test record's Reference Value column

- c. Press [**Meas Restart**], then enter the Δ **Man** readout in the test record's Measured Value column.
2. Set the step attenuator to 10 dB.
3. Enter the multimeter readout in the test record's Reference Value column.
4. Enter the step attenuator's 10 dB insertion loss error at 100 kHz (from step attenuator's calibration data sheet) in the test record's Insertion Loss Error column.
5. Press [**Meas Restart**], then enter the Δ **Man** readout in the test record's Measured Value column.
6. Set step attenuator to 20 dB.
7. Enter the multimeter readout in the test record's Reference Value column.
8. Enter the step attenuator's 20 dB insertion loss error at 100 kHz (from step attenuator's calibration data sheet) in the test record's Insertion Loss Error column.
9. Press [**Meas Restart**], then enter the Δ **Man** readout in the test record's Measured Value column.
10. For input levels of -10 through -50, subtract the measured value from the reference value and enter the result in the test record
11. For input levels of -60 and -70, subtract the attenuator setting, the insertion loss error, and the measured value from the reference value. Enter the result in the test record

14. Source Dynamic Accuracy

Operation Verification – Yes

For Operation Verification, the procedure is the same as the Performance Test procedure.

This test verifies that the HP 3588A Spectrum Analyzer meets its source specification for dynamic accuracy. In this test, a step attenuator attenuates the source output by 20 dB, establishing a reference level. Then, the source internally attenuates the output, and the step attenuator's attenuation is decreased by the same amount. Using the offset marker, the analyzer measures the source output again. This value minus the correction for the step attenuator error is the source dynamic accuracy. This test checks dynamic accuracy at 300 kHz for all of the fixed attenuation pads and two attenuation levels in the variable attenuation circuit.

Equipment Required: Step Attenuator (with calibration data at 300 kHz)
 BNC Cables (2)

1. Connect the test equipment as shown in figure 3-15.

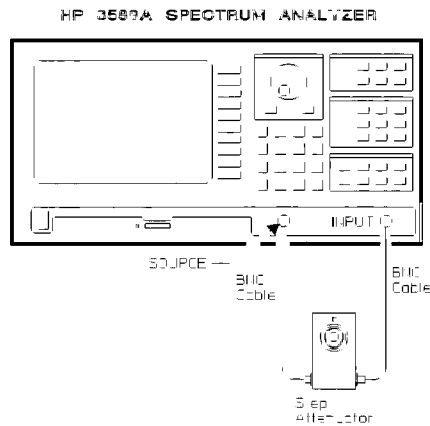

Figure 3 15 Source Dynamic Accuracy Setup

2. Set the step attenuator to 20 dB

3. Press the following keys:

```
[ Preset ]
[ Spcl Fctn ]
  [ SINGLE CAL ]
  [ AUTO CAL ON OFF ]
[ Sweep ]
  [ SWEEP AUTO MAN ]
  [ MANUAL FREQ ]
  300
  [ kHz ]
[ Res BW ]
  [ RES BW ]
  290
  [ Hz ]
[ Range/Input ]
  [ RANGE ]
  10
  [ dBm ]
[ Source ]
  [ SOURCE ON OFF ]
  [ SOURCE AMPLITUDE ]
  10
  [ dBm ]
[ Marker ]
  [ ZERO OFFSET ]
[ Spcl Fctn ]
  [ PRFM TESTS ] (NOTE: Ignore source uncalibrated message)
  [ SRCE 10 dB IN OUT ]
```

4. Set the step attenuator to 10 dB.

5. Enter the Δ **Man** readout in the test record for the measured value of the 10 dB PAD.

6. Press the following keys.

```
[ SRCE 10 dB IN OUT ]
[ SRCE DAC ATTEN ]
  10
  [ dB ]
```

7. Enter the Δ **Man** readout in the test record for the measured value of the 10 dB DAC.

8. Press the following keys

```
[ SRCE DAC ATTEN ]
  0
  [ dB ]
[ SRCE 20 dB A IN OUT ]
```

9. Set the step attenuator to 0 dB.

10. Enter the Δ **Man** readout in the test record for the measured value of the 20 dB PAD A.

11. Press the following keys:

[SRCE 20 dB A IN **OUT**]
[SRCE 20 dB B **IN** OUT]

12. Enter the Δ **Man** readout in the test record for the measured value of the 20 dB PAD B.

13. Press the following keys:

[SRCE 20 dB B IN **OUT**]
[SRCE DAC ATTEN]
20
[dB]

14. Enter the Δ **Man** readout in the test record for the measured value of the 20 dB DAC.

15. Using the step attenuator's calibration data sheets, calculate and enter the correction for the step attenuator's error.

- The correction for the source's 10 dB attenuation is the step attenuator's 20 dB insertion loss error, minus its 10 dB insertion loss error
- The correction for the source's 20 dB attenuation is the step attenuator's 20 dB insertion loss error.

16. For each attenuation, subtract the correction from the measured value, and enter the result in the test record.

15. Input Return Loss

Operation Verification – No

Do not perform this test for Operation Verification.

This test verifies that the HP 3588A Spectrum Analyzer meets its amplitude accuracy specification for input return loss. In this test, a signal generator provides a signal to the source port of the 50Ω directional bridge. A spectrum analyzer measures the change that occurs to the directional bridge's reflected port when the HP 3588A analyzer's input is connected to the directional bridge's load port. This test checks the input return loss at all attenuator settings at 100 MHz and 150 MHz.

Equipment Required

- Synthesized Signal Generator
- Spectrum Analyzer
- 50Ω Directional Bridge
- SMA(m)-to-BNC(f) Adapters (2)
- N(m)-to-BNC(f) Adapter
- N(m)-to-BNC(m) Adapter
- BNC Cables (3)

1. Connect the test equipment as shown in figure 3-16.

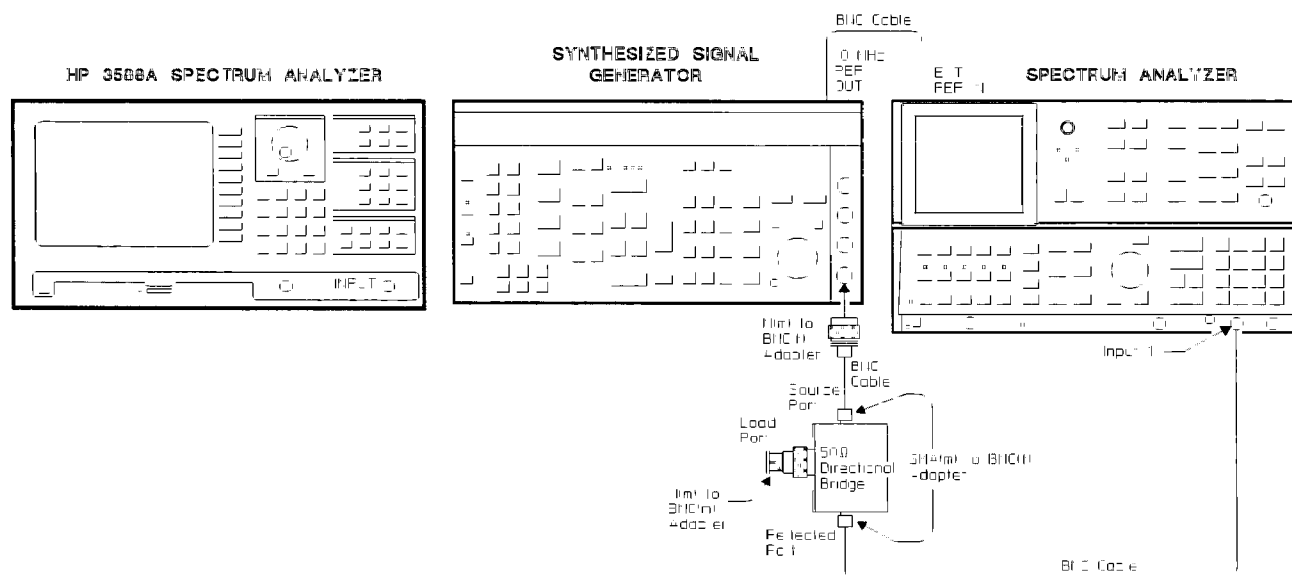

Figure 3-16. Input Return Loss Setup

1. Press the following keys:

[Preset]
[Spcl Fctn]
[SINGLE CAL]
[AUTO CAL ON OFF]

2. Set the signal generator as follows:

Amplitude -15 dBm
Frequency 100 MHz

3. Set the spectrum analyzer as follows:

Input 1
Frequency Span 0 Hz
Resolution BW 10 kHz
Center Frequency 100 MHz
Sweep Single

4. After the spectrum analyzer completes a sweep, measure and record the peak amplitude or set a relative marker value using marker functions.
5. Connect the load port of the bridge directly to the INPUT connector using adapter (do NOT use a BNC cable).
6. For each of the following ranges, perform steps a through e:

Range
+20
+10
0
-10
-20

- a. Press the following keys:
[Range/Input]
[RANGE] (to range in table)
 - b. Set the spectrum analyzer to sweep again.
 - c. After the spectrum analyzer completes the sweep, measure the peak amplitude relative to the peak amplitude when the load port was not connected (use marker functions, or subtract the peak amplitude when the load port was not connected from the peak amplitude when the load port was connected). Enter the result in the test record.
7. Disconnect the load port of the bridge from the INPUT connector.
 8. Repeat steps 3 through 7, setting the frequency in steps 3 and 4 to 150 MHz.

16. Source Return Loss

Operation Verification — No

Do not perform this test for Operation Verification.

This test verifies that the HP 3588A Spectrum Analyzer meets its source specification for return loss. In this test, a signal generator provides a signal to the source port of a 50Ω directional bridge. A spectrum analyzer measures the change that occurs to the directional bridge's reflected port when the HP 3588A analyzer's source is connected to the directional bridge's load port. This test checks the source return loss for 6 source amplitudes at 60 MHz, 120 MHz, and 150 MHz.

Equipment Required	Spectrum Analyzer
	Synthesized Signal Generator
	50Ω Directional Bridge
	SMA(m)-to-BNC(f) Adapters (2)
	N(m)-to-BNC(f) Adapter
	N(m)-to-BNC(m) Adapter
	BNC Cables (3)

1. Connect the test equipment as shown in figure 3-16.

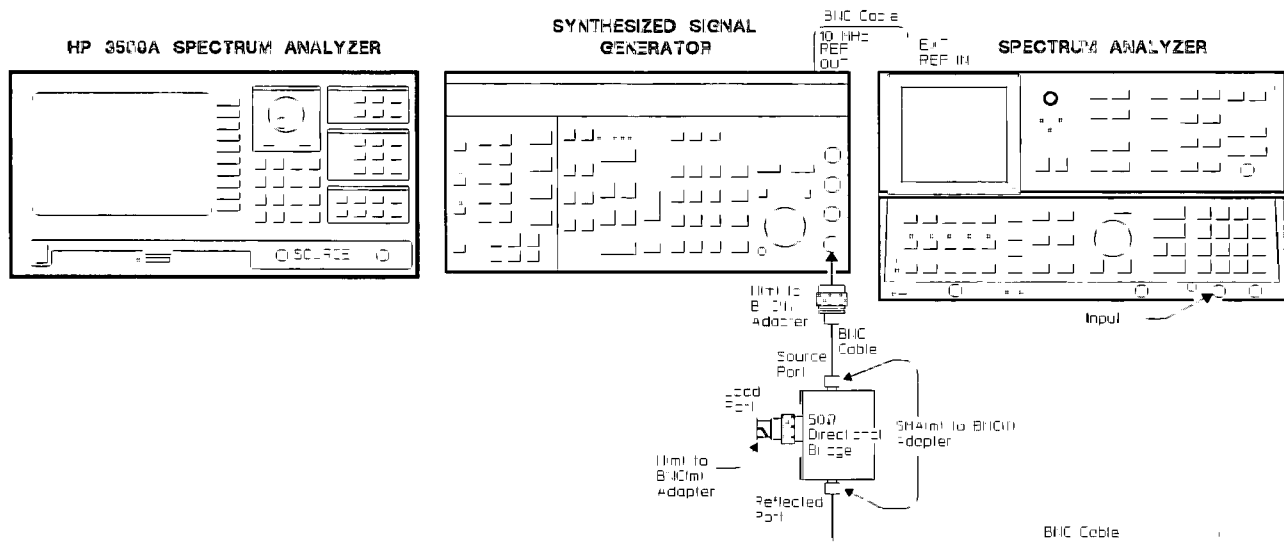

Figure 3-16 Source Return Loss Setup

2. Set the signal generator as follows:

Amplitude	-15 dBm
------------------	----------------

3. Set the spectrum analyzer as follows:

Input	1
Frequency Span	0 Hz
Resolution BW	10 kHz

4. Press the following keys:

[**Preset**]
[**Spcl Fctn**]
 [SINGLE CAL]
 [AUTO CAL ON **OFF**]
[**Freq**]
 [FULL SPAN]
[**Sweep**]
 [SWEEP AUTO **MAN**]
 [MANUAL FREQ]
 0
 [Hz]
[**Source**]
 [SOURCE **ON** OFF]

5. Set the signal generator's frequency to 60 MHz

6. Set the spectrum analyzer as follows:

Center Frequency	60 MHz
Sweep	Single

7. After the spectrum analyzer completes the sweep, measure and record the peak amplitude or set a relative marker using marker functions.
8. Connect the load port of the directional bridge directly to the SOURCE connector using adapter (do NOT use a BNC cable).

9. For each of the following source amplitudes, perform steps a through c:

Source Amplitude (dBm)
+10
0
-10
-20
-30
-40

- a. Press the following keys:
[SOURCE AMPLITUDE] (to source amplitude in table)
 - b. Set the spectrum analyzer to sweep again.
 - c. After the spectrum analyzer completes the sweep, measure the peak amplitude relative to the peak amplitude when the directional bridge was not connected to the SOURCE connector (use marker functions, or subtract the peak amplitude before the directional bridge was connected from the peak amplitude after the directional bridge was connected). Enter the result in the test record.
10. Disconnect the directional bridge's load port from the SOURCE connector
11. Repeat steps 5 through 10, setting the frequency in steps 5 and 6 to 120 MHz.
12. Repeat steps 5 through 9, setting the frequency in steps 5 and 6 to 150 MHz.

17. Source Harmonic Distortion

Operation Verification – Yes

For Operation Verification, check only the frequencies listed in the shaded box.

This test verifies that the HP 3588A Spectrum Analyzer meets its source specification for harmonic distortion. In this test, a spectrum analyzer measures the source output, establishing a reference level. The spectrum analyzer then measures the second and third harmonic relative to the reference level.

Equipment Required: Spectrum Analyzer
 BNC Cables (2)

1. Connect the test equipment as shown in figure 3-17

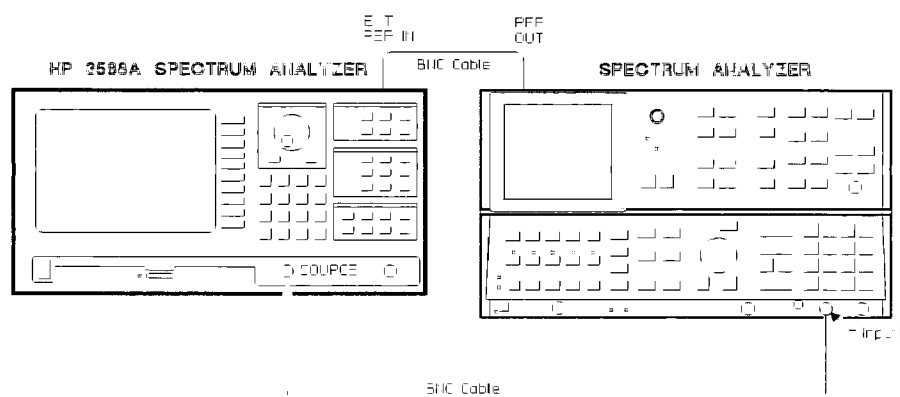

Figure 3-17. Source Harmonic Distortion Setup

2. Press the following keys:

[**Preset**]
 [**Spcl Fctn**]
 [SINGLE CAL]
 [AUTO CAL ON **OFF**]
 [**Source**]
 [SOURCE **ON** OFF]
 [SOURCE AMPLITUDE]
10
 [dBm]
 [**Sweep**]
 [SWEEP AUTO **MAN**]

3. Set the spectrum analyzer as follows:

Reference Level + 10 dBm
 Frequency Span 5 kHz
 Sweep Mode Single

4. For each of the following fundamental frequencies, perform steps a through g:

For Performance Tests

Fundamental Frequency	Second Harmonic	Third Harmonic
100 kHz	200 kHz	300 kHz
1 MHz	2 MHz	3 MHz
10 MHz	20 MHz	30 MHz
50 MHz	100 MHz	150 MHz
75 MHz	150 MHz	—

For Operation Verification

Fundamental Frequency	Second Harmonic	Third Harmonic
100 kHz	200 kHz	300 kHz
50 MHz	100 MHz	150 MHz

a. Press the following keys:

[MANUAL FREQ] (to fundamental frequency in table)

b. Set the spectrum analyzer's center frequency to the fundamental frequency in the table and start a sweep.

c. After the spectrum analyzer completes the sweep, measure and record the peak amplitude of the fundamental frequency or set a relative marker using marker functions.

- d. Change the spectrum analyzer's center frequency to the second harmonic and start a sweep.
- e. After the spectrum analyzer completes the sweep, measure the peak amplitude of the second harmonic relative to the peak amplitude of the fundamental frequency (use marker functions, or subtract the peak amplitude of the fundamental frequency from the peak amplitude of the second harmonic). Enter the result in the test record
- f. Change the spectrum analyzer's center frequency to the third harmonic and start a sweep
- g. After the spectrum analyzer completes the sweep, measure the peak amplitude of the third harmonic relative to the peak amplitude of the fundamental frequency (use marker functions, or subtract the peak amplitude of the fundamental frequency from the peak amplitude of the third harmonic). Enter the result in the test record.

18. Source Spurious Responses

Operation Verification – Yes

For Operation Verification, the procedure is the same as the Performance Test procedure

This test verifies that the HP 3588A Spectrum Analyzer meets its source specification for spurious responses. In this test, a spectrum analyzer measures the source's output, establishing a reference level. The spectrum analyzer then measures a spur relative to the reference level.

Equipment Required: Spectrum Analyzer
 BNC Cables (2)

1. Connect the test equipment as shown in figure 3-18.

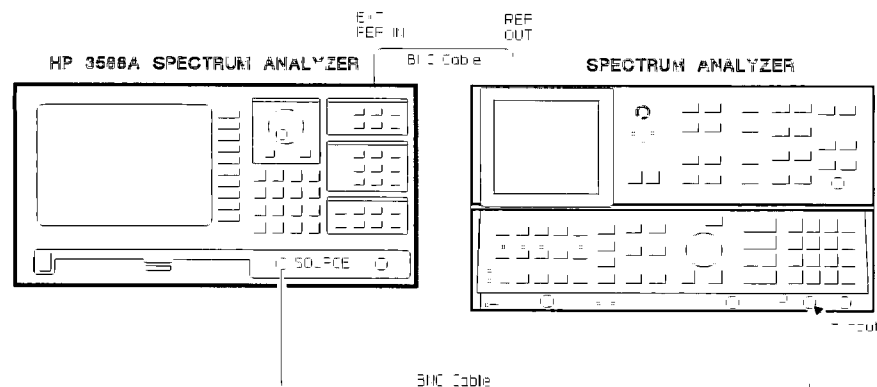

Figure 3-18. Source Spurious Responses Setup

2. Press the following keys:

- [**Preset**]
- [**Spcl Fctn**]
 - [SINGLE CAL]
 - [AUTO CAL ON **OFF**]
- [**Source**]
 - [SOURCE **ON OFF**]
 - [SOURCE AMPLITUDE]
 - 10**
 - [dBm]
- [**Sweep**]
 - [SWEEP AUTO **MAN**]

3. For each of the following spur frequencies, perform steps a through e

Reference Frequency	Spur Frequency
101 kHz	10.1875 MHz
101 MHz	101.1875 MHz
	101.375 MHz
149.9 MHz	10.3875 MHz

a. Press the following keys:

- [MANUAL FREQ] (to reference frequency in table)

b. Set the spectrum analyzer as follows:

- Center Frequency** (to reference frequency in table)
- Frequency Span** 20 kHz
- Reference Level** + 10 dBm

c. After the spectrum analyzer completes a sweep, measure and record the peak amplitude or set a relative marker using marker functions.

d. Set the spectrum analyzer as follows:

- Center Frequency** (to spur frequency in table)
- Frequency Span** 100 Hz

e. After the spectrum analyzer completes a sweep, measure the peak amplitude relative to the reference frequency's peak amplitude (use marker functions, or subtract the peak amplitude of the reference frequency from the peak amplitude of the spur frequency). Enter the result in the test record.

19. Source Noise

Operation Verification – Yes

For Operation Verification, check only the frequencies listed in the shaded box

This test verifies that the HP 3588A Spectrum Analyzer meets its source specification for noise. In this test, a spectrum analyzer measures the HP 3588A analyzer's source, establishing a reference level. Then, using its noise marker function, the spectrum analyzer measures the source at six offset frequencies. The spectrum analyzer's noise marker function normalizes the marker value to a 1 Hz bandwidth.

Equipment Required: Spectrum Analyzer
 BNC Cables (2)

1. Connect the test equipment as shown in figure 3-19.

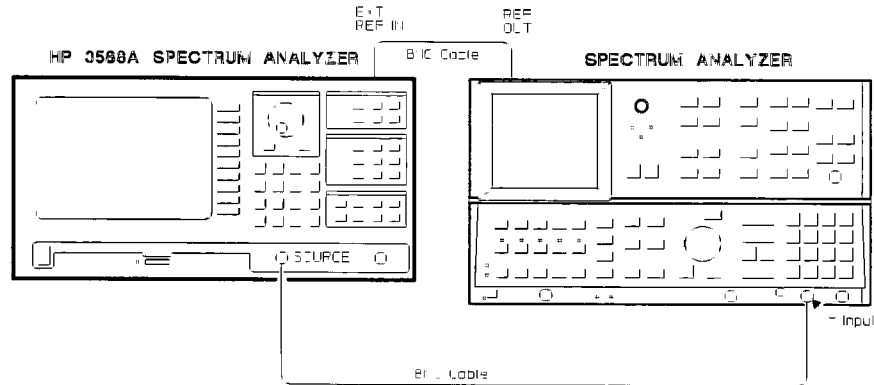

Figure 3-19. Source Noise Setup

2 Press the following keys:

- [**Preset**]
- [**Spcl Fctn**]
 - [SINGLE CAL]
 - [AUTO CAL ON **OFF**]
- [**Source**]
 - [SOURCE **ON** OFF]
 - [SOURCE AMPLITUDE]
 - 10**
 - [dBm]
- [**Sweep**]
 - [SWEEP AUTO **MAN**]

3 For each of the following reference frequencies, perform steps a through e:

For Performance Tests

Reference Frequency (MHz)	Offset Frequency (MHz)
8.0125	8.013012
	8.015060
	8.025301
	8.076506
	8.332531
	9.612656
140.0125	140.013012
	140.015060
	140.025301
	140.076506
	140.332531
	141.612656

For Operation Verification

Reference Frequency (MHz)	Offset Frequency (MHz)
8.0125	8.013012
	8.076506

a. Press the following keys:

- [**Sweep**]
- [MANUAL FREQ] (to reference frequency in table)

b. Set the spectrum analyzer as follows:

- Noise Marker Function Off
- Frequency Span 20 kHz
- Reference Level + 10 dBm
- Center Frequency (to reference frequency in table)
- Sweep Mode Single

c. After the spectrum analyzer completes the sweep, measure the peak amplitude and enter in the test record as the reference value for each offset frequency.

d. Set the spectrum analyzer as follows:

Frequency Span	100 Hz
Reference Level	-50 dBm
Noise Marker Function	On

e. For each offset frequency, perform steps i through iii.

- i. Change the spectrum analyzer's center frequency to the offset frequency in the table and start a sweep.
- ii. After the spectrum analyzer completes the sweep, measure the peak amplitude and enter the noise marker value in the test record.
- iii. Referring to the test record, subtract the reference value from the measured value and enter in the test record.

Performance Test Record

Calibration Entity and Address _____

Test Performed By _____

Report Number _____

Customer _____

Trace Number _____

Installed Options _____

Test Date _____

Temperature _____

Humidity _____

Power Line Frequency _____

Trace Number: _____ Report Number _____ Test Date: ___/___/___

Test Equipment:

Digital Multimeter

Model _____

Trace Number _____

Calibration Due Date _____

Frequency Standard

Model _____

Trace Number _____

Calibration Due Date _____

Milliwatt Power Meter

Model _____

Trace Number _____

Calibration Due Date _____

Power Meter

Model _____

Trace Number _____

Calibration Due Date _____

Power Sensor

Model _____

Trace Number _____

Calibration Due Date _____

Trace Number: _____ Report Number: _____ Test Date ____/____/____

Power Splitter

Model _____

Trace Number _____

Calibration Due Date _____

Spectrum Analyzer

Model _____

Trace Number _____

Calibration Due Date _____

Step Attenuator

Model _____

Trace Number _____

Calibration Due Date _____

Synthesized Signal Generator

Model _____

Trace Number _____

Calibration Due Date _____

Synthesizer/Level Generator

Model _____

Trace Number _____

Calibration Due Date _____

Trace Number: _____ Report Number _____ Test Date: ___/___/___

Two-Channel Synthesizer

Model _____

Trace Number _____

Calibration Due Date _____

50Ω Directional Bridge

Model _____

Trace Number _____

Calibration Due Date _____

Trace Number: _____ Report Number: _____ Test Date: ___/___/___

Measurement Uncertainty

Performance Test	Using Recommended Test Equipment		Using Other Test Equipment	
	Measurement Uncertainty	Ratio	Measurement Uncertainty	Ratio
1 Local Oscillator Feedthrough	NA ¹	NA ¹	NA ¹	NA ¹
2 Phase Noise	NA ¹	NA ¹	NA ¹	NA ¹
3 Residual Responses	NA ¹	NA ¹	NA ¹	NA ¹
4 Noise Level	NA ¹	NA ¹	NA ¹	NA ¹
5 Frequency Accuracy (following adjustment)	±0.000003 ppm	> 10:1		
6. Spurious Responses Typical scale fidelity Test signal spurious responses: < 120 MHz 120 to 150 MHz	±0.25 dB < -90 dBc < -100 dBc	NA ²		NA ²
7 Image Responses Typical scale fidelity Test signal spurious responses: < 120 MHz 120 to 150 MHz	±0.25 dB < -90 dBc < -100 dBc	NA ²		NA ²
8 Input Harmonic Distortion Typical scale fidelity Test signal harmonics	±0.25 dB < -100 dBc	NA ²		NA ²
9. Intermodulation Distortion Typical scale fidelity Typical test signals distortion	±0.25 dB < -86 dBc	NA ²		NA ²
10 Source Amplitude Accuracy and Frequency Response				
10 Hz	±0.011 dB	> 10:1		
100 Hz	±0.010 dB	> 10:1		
1 kHz	±0.010 dB	> 10:1		
10 kHz	±0.011 dB	> 10:1		
30 kHz	±0.012 dB	> 10:1		
100 kHz	±0.017 dB	> 10:1		
300 kHz	±0.109 dB ³	8:1:1		
500 kHz	±0.109 dB ³	8:1:1		
1 MHz	±0.109 dB ³	8:1:1		
2 MHz	±0.109 dB ³	8:1:1		
5 MHz	±0.109 dB ³	10:1		
10 MHz	±0.087 dB ³	9.9:1		
25 MHz	±0.089 dB ³	9.9:1		
40 MHz	±0.089 dB ³	9.6:1		
55 MHz	±0.092 dB ³	9.6:1		
70 MHz	±0.092 dB ³	9.6:1		
85 MHz	±0.092 dB ³	9.6:1		
100 MHz	±0.092 dB ³	9.1:1		
120 MHz	±0.098 dB ³	9.1:1		
135 MHz	±0.098 dB ³	9.1:1		
150 MHz	±0.098 dB ³	9.1:1		

¹ internal test

² single sided specification ³ root sum-squares calculation method

Trace Number: _____ Report Number _____ Test Date: ___/___/___

Performance Test	Using Recommended Test Equipment		Using Other Test Equipment	
	Measurement Uncertainty	Ratio	Measurement Uncertainty	Ratio
11a. Input Amplitude Accuracy and Flatness 50Ω				
10 to 100 Hz	±0.035 dB	> 10:1		
100 Hz to 30 kHz	±0.035 dB	> 10:1		
30 kHz to 40 MHz	±0.035 dB	> 10:1		
40 kHz to 50 MHz	±0.035 dB	> 10:1		
50 MHz to 100 MHz	±0.045 dB	10:1		
100 MHz to 150 MHz	±0.060 dB	> 10:1		
1 MΩ				
10 to 100 Hz	±0.035 dB	> 10:1		
100 Hz to 30 kHz	±0.035 dB	> 10:1		
30 kHz to 40 MHz	±0.035 dB	> 10:1		
11b. Alternate Input Amplitude Accuracy and Flatness				
50Ω				
10 Hz	±0.011 dB	> 10:1		
100 Hz	±0.010 dB	> 10:1		
1 kHz	±0.010 dB	> 10:1		
10 kHz	±0.011 dB	> 10:1		
30 kHz	±0.012 dB	> 10:1		
100 kHz	±0.017 dB	> 10:1		
300 kHz	±0.109 dB ³	3.5:1		
500 kHz	±0.109 dB ³	3.5:1		
1 MHz	±0.109 dB ³	3.5:1		
2 MHz	±0.109 dB ³	3.5:1		
5 MHz	±0.097 dB ³	3.9:1		
10 MHz	±0.089 dB ³	4.2:1		
25 MHz	±0.089 dB ³	4.2:1		
40 MHz	±0.092 dB ³	4.1:1		
55 MHz	±0.092 dB ³	5.1:1		
70 MHz	±0.092 dB ³	5.1:1		
85 MHz	±0.098 dB ³	5.1:1		
100 MHz	±0.098 dB ³	4.8:1		
120 MHz	±0.098 dB ³	4.8:1		
135 MHz	±0.098 dB ³	4.8:1		
150 MHz	±0.098 dB ³	4.8:1		
1 MΩ				
10 Hz	±0.011 dB	> 10:1		
100 Hz	±0.010 dB	> 10:1		
1 kHz	±0.010 dB	> 10:1		
10 kHz	±0.011 dB	> 10:1		
30 kHz	±0.012 dB	> 10:1		
100 kHz	±0.017 dB	10:1		
300 kHz	±0.109 dB ³	> 10:1		
500 kHz	±0.109 dB ³	5.1:1		

¹ internal test

² single-sided specification ³ root-sum-squares calculation method

Trace Number: _____ Report Number: _____ Test Date: ___/___/___

Performance Test	Using Recommended Test Equipment		Using Other Test Equipment	
	Measurement Uncertainty	Ratio	Measurement Uncertainty	Ratio
11b Alternate Input Amplitude Accuracy and Flatness (cont.)				
1 MHz	$\pm 0.109 \text{ dB}^3$	5:1:1		
2 MHz	$\pm 0.109 \text{ dB}^3$	5:1:1		
5 MHz	$\pm 0.097 \text{ dB}^3$	6:4:1		
10 MHz	$\pm 0.089 \text{ dB}^3$	6:2:1		
25 MHz	$\pm 0.089 \text{ dB}^3$	6:2:1		
40 MHz	$\pm 0.092 \text{ dB}^3$	6:0:1		
12 Reference Level Accuracy	$\pm 0.036 \text{ dB}$	8:1		
13 Log Scale Accuracy				
0 to 30 dB	$\pm 0.007 \text{ dB}$	7:1		
-40 dB	$\pm 0.044 \text{ dB}$	2:2:1 ⁴		
-50 dB	$\pm 0.044 \text{ dB}$	6:6:1		
-60 dB	$\pm 0.064 \text{ dB}$	7:3:1		
-70 dB	$\pm 0.064 \text{ dB}$	10:1		
14 Source Dynamic Accuracy				
10 dB pad	$\pm 0.02 \text{ dB}$	9:8:1		
20 dB pad	$\pm 0.02 \text{ dB}$	> 10:1		
15 Input Return Loss	$\pm 0.9 \text{ dB}$	NA ²		NA ²
16 Source Return Loss	$\pm 0.9 \text{ dB}$	NA ²		NA ²
17 Source Harmonic Distortion	$\pm 2.5 \text{ dB}$	NA ²		NA ²
18 Source Spurious Responses	$\pm 1.5 \text{ dB}^3$	NA ²		NA ²
19 Source Noise	$\pm 1.65 \text{ dB}^3$	NA ²		NA ²

¹ internal test

² single sided specification ³ root sum squares calculation method

⁴ Unable to meet the 4:1 ratio with current test equipment. Verify accuracy of multimeter if calculated value is within 0.05 dB of specification

Trace Number: _____ Report Number _____ Test Date: ___/___/___

1. Local Oscillator Feedthrough PASS _____ FAIL _____

Specification: >20 dB below range

Frequency	Measured Value	Specification
0 Hz	_____ dBm	< -40 dBm

2. Phase Noise PASS _____ FAIL _____

Specification

1 kHz offset normalized to 1 Hz noise power bandwidth <-105 dBc

Measured Value	Specification
_____ dB/Hz	< -105 dB/Hz

3. Residual Responses PASS _____ FAIL _____

Specification: -20 dBm range <-110 dBm

Frequency	Measured Value (dBm)	Specification (dBm)
50 Hz or 60 Hz	_____	< -110
100 Hz or 120 Hz	_____	< -110
150 Hz or 180 Hz	_____	< -110
12.5 kHz	_____	< -110
24 7623 kHz	_____	< -110
35 7134 kHz	_____	< -110
100 kHz	_____	< -110
187.5 kHz	_____	< -110
250 kHz	_____	< -110
10 MHz	_____	< -110

Trace Number: _____ Report Number: _____ Test Date ___/___/___

4. Noise Level PASS _____ FAIL _____

Specification:

50Ω input impedance <-132 dBm/Hz above 30 kHz (degrade by 3 dB for start frequency ≤30 kHz in auto-sweep mode)
 <-129 dBm/Hz between 2 kHz and 30 kHz inclusive
 100 Hz to 2 kHz is 1/f noise and is <-129 dBm/Hz at 2 kHz and <-116 dBm/Hz at 100 Hz
 add 10 dB to specification if low-distortion mode is ON

75Ω input impedance add 2 dB to 50Ω specification

1 MΩ input impedance <-110 dBm/Hz below 40 MHz with 1/f corner at 100 kHz (terminated in 100 kΩ)

Step	Low Distortion	Input Impedance	Resolution Bandwidth	Frequency	Measured Value (dBm/Hz)	Specification (dBm/Hz)
3	ON	50Ω	17 kHz	150 MHz	_____	< -122
				140 MHz	_____	< -122
				120 MHz	_____	< -122
				71 MHz	_____	< -122
				19 MHz	_____	< -122
				5.3 MHz	_____	< -122
				53 kHz	_____	< -122
				290 Hz	_____	< -119
73 Hz	_____	< -114				
5	OFF	50Ω	17 kHz	150 MHz	_____	< -132
				140 MHz	_____	< -132
				120 MHz	_____	< -132
				71 MHz	_____	< -132
				19 MHz	_____	< -132
				5.3 MHz	_____	< -132
				53 kHz	_____	< -132
				290 Hz	_____	< -129
73 Hz	_____	< -124				
8	OFF	1 MΩ	17 kHz	40 MHz	_____	< -110
				10.1 MHz	_____	< -110
				10.1 kHz	_____	< -110
				290 Hz	_____	< -100
				73 Hz	_____	< -90
				9.1 Hz	_____	< -80

Trace Number: _____ Report Number _____ Test Date: ___/___/___

5. Frequency Accuracy PASS _____ FAIL _____

Specification: initial accuracy without option 001 = ± 0.5 ppm
with option 001 = ± 0.01 ppm
add ± 0.1 ppm if instrument on <48 hours

aging without option 001 = ± 0.25 ppm/month
with option 001 = ± 0.125 ppm/month
frequency counter resolution = ± 0.1 Hz

Calculated Lower Limit (Hz) †	Measured Value (Hz)	Calculated Upper Limit (Hz) ‡
<		<

† Without Option 001 - $100 \times 10^6 - (25 \times \text{months}) - 50 - 0.1 =$ _____

† With Option 001 - $100 \times 10^6 - (12.5 \times \text{months}) - 1 - 0.1 =$ _____

‡ Without Option 001 - $100 \times 10^6 + (25 \times \text{months}) + 50 + 0.1 =$ _____

‡ With Option 001 - $100 \times 10^6 + (12.5 \times \text{months}) + 1 + 0.1 =$ _____

Months - number since last frequency adjustment

6. Spurious Responses PASS _____ FAIL _____

Specification: spurious sidebands <-70 dBc

Source Frequency (MHz)	Spur Frequency (MHz)	Measured Value (dB)	Specification (dB)
7.8125	10.8428	_____	< -70
9.8125	9.8248	_____	< -70
149.8125	149.8248	_____	< -70
95.81274	95.81254	_____	< -70
95.8149	95.8129	_____	< -70
100.79274	100.79254	_____	< -70
100.7949	100.7929	_____	< -70
100.79454	100.79254	_____	< -70
100.794504	100.792504	_____	< -70
100.7945004	100.7925004	_____	< -70
1.8125	4.81373	_____	< -70
7.81496	4.81373	_____	< -70
144.8125	144.822623	_____	< -70
144.832746	144.822623	_____	< -70
89.9125	89.8125	_____	< -70

Trace Number _____ Report Number: _____ Test Date ___/___/___

7. Image Responses PASS _____ FAIL _____

Specification: carrier level < range <-70 dBc

Frequency (MHz)	Measured Value (dB)	Specification (dB)
40 85956	_____	< -70
60 85956	_____	< -70
61 35956	_____	< -70

8. Input Harmonic Distortion PASS _____ FAIL _____

Specification: low distortion mode ON
50Ω and 75Ω input <-80 dBc

low distortion mode OFF
50Ω and 75Ω input <-70 dBc
1 MΩ input <-65 dBc

Step	Low Distortion	Input Imp.	Low Pass Filter	Fundamental (MHz)	Harmonic (MHz)	Measured Value (dB)	Specification (dB)
4	ON	50Ω	50 MHz	47 265018	94 530036 141 795054	_____	< -80 < -80
			21 MHz	18 816541	37 633082 56 449623	_____	< -80 < -80
6	OFF	50Ω	50 MHz	47 265018	94 530036 141 795054	_____	< -70 < -70
			21 MHz	18 816541	37 633082 56 449623	_____	< -70 < -70
9	OFF	1 MΩ	21 MHz	18 816541	37 633082	_____	< -65

Trace Number: _____ Report Number _____ Test Date: ___/___/___

9. Intermodulation Distortion PASS _____ FAIL _____

Specification: low distortion mode ON
 50Ω and 75Ω input <-80 dBc

low distortion mode OFF
 50Ω and 75Ω input <-70 dBc
 1 MΩ input <-65 dBc

Step	Low Distortion	Input Impedance	Source Frequency	Frequency	Measured Value (dB)†	Specification (dB)
4	ON	50Ω	23 6346 MHz	134 Hz	_____	< -80
				47 269066 MHz	_____	< -80
				23 634734 MHz	_____	< -80
			23 637307	2 841 kHz	_____	< -80
				47 271773 MHz	_____	< -80
				23 640148 MHz	_____	< -80
			23 694466	60 kHz	_____	< -80
				47 328923 MHz	_____	< -80
				23 754466 MHz	_____	< -80
7	OFF	50Ω	23 6346 MHz	134 Hz	_____	< -70
				47 269066 MHz	_____	< -70
				23 634734 MHz	_____	< -70
			23 637307	2 841 kHz	_____	< -70
				47 271773 MHz	_____	< -70
				23 640148 MHz	_____	< -70
			23 694466	60 kHz	_____	< -70
				47 328923 MHz	_____	< -70
				23 754466 MHz	_____	< -70
11	OFF	1 MΩ	23 6346 MHz	134 Hz	_____	< -65
				23 634734 MHz	_____	< -65
				23 637307	_____	< -65
			23 637307	2 841 kHz	_____	< -65
				23 640148 MHz	_____	< -65
				23 694466	_____	< -65
			23 694466	60 kHz	_____	< -65
				23 754466 MHz	_____	< -65
				23 754466 MHz	_____	< -65

Trace Number: _____ Report Number: _____ Test Date ____/____/____

10. Source Amplitude Accuracy and Frequency Response PASS _____ FAIL _____

Specification: at 300 kHz 10 dBm ±1 dB

frequency response relative to 300 kHz

300 kHz output level ±1 dB

Frequency	Lower Limit (dBm)	Measured Value (dBm)	Upper Limit (dBm)
10 Hz	_____ †	_____	_____ ‡
100 Hz	_____ †	_____	_____ ‡
1 kHz	_____ †	_____	_____ ‡
10 kHz	_____ †	_____	_____ ‡
30 kHz	_____ †	_____	_____ ‡
100 kHz	_____ †	_____	_____ ‡
300 kHz	+9.0	_____	+11.0
500 kHz	_____ †	_____	_____ ‡
1 MHz	_____ †	_____	_____ ‡
2 MHz	_____ †	_____	_____ ‡
5 MHz	_____ †	_____	_____ ‡
10 MHz	_____ †	_____	_____ ‡
25 MHz	_____ †	_____	_____ ‡
40 MHz	_____ †	_____	_____ ‡
55 MHz	_____ †	_____	_____ ‡
70 MHz	_____ †	_____	_____ ‡
85 MHz	_____ †	_____	_____ ‡
100 MHz	_____ †	_____	_____ ‡
120 MHz	_____ †	_____	_____ ‡
135 MHz	_____ †	_____	_____ ‡
150 MHz	_____ †	_____	_____ ‡

† Measured Value at 300 kHz - 1 dB

‡ Measured Value at 300 kHz + 1 dB

Trace Number _____ Report Number _____ Test Date ___/___/___

11a. Input Amplitude Accuracy and Flatness PASS _____ FAIL _____

Specification:

50Ω input 10 Hz - 100 Hz ±2.5 dB
 100 Hz - 30 kHz ±1.0 dB
 30 kHz - 150 MHz ±0.5 dB
 300 kHz - 40 MHz ±0.4 dB

75Ω input 10 Hz - 100 Hz ±2.5 dB
 100 Hz - 30 kHz ±1.0 dB
 30 kHz - 150 MHz ±0.8 dB

1 MΩ input 10 Hz - 100 Hz ±2.5 dB
 100 Hz - 30 kHz ±1.0 dB
 30 kHz - 40 MHz ±0.6 dB

Add the following frequency response errors for windows used in narrow band zoom mode operation:

high accuracy zoom ±0.005 dB
 high resolution zoom +0, -1.5 dB

Impedance	Range	Upper Limit (dBm)	Measured Value (dBm)	Lower Limit (dBm)
50Ω	30 kHz - 150 MHz	+0.5	Maximum _____	-0.5
		+0.5	Minimum _____	-0.5
	300 kHz - 40 MHz	+0.4	Maximum _____	-0.4
		+0.4	Minimum _____	-0.4
100 Hz - 30 kHz	+1.0	Maximum _____	-1.0	
	+1.0	Minimum _____	-1.0	
10 Hz - 100 Hz	+2.5	Maximum _____	-2.5	
	+2.5	Minimum _____	-2.5	
1 MΩ	30 kHz - 40 MHz	+0.6	Maximum _____	-0.6
		+0.6	Minimum _____	-0.6
	100 Hz - 30 kHz	+1.0	Maximum _____	-1.0
+1.0		Minimum _____	-1.0	
10 Hz - 100 Hz	+2.5	Maximum _____	-2.5	
	+2.5	Minimum _____	-2.5	

Trace Number: _____ Report Number: _____ Test Date: ___/___/___

11b. Alternate Input Amplitude Accuracy and Flatness PASS _____ FAIL _____

Specification: same as 11a

Input Impedance	Frequency	Measured Value (dBm)	Reference Value (dBm)	Calculated Value (dBm)	Specifications (0 dBm)
50Ω	10 Hz	_____ -	_____ =	_____	±2.5 dB
	100 Hz	_____ -	_____ =	_____	±1.0 dB
	1 kHz	_____ -	_____ =	_____	±1.0 dB
	10 kHz	_____ -	_____ =	_____	±1.0 dB
	30 kHz	_____ -	_____ =	_____	±0.5 dB
	100 kHz	_____ -	_____ =	_____	±0.5 dB
	300 kHz	_____ -	_____ =	_____	±0.4 dB
	500 kHz	_____ -	_____ =	_____	±0.4 dB
	1 MHz	_____ -	_____ =	_____	±0.4 dB
	2 MHz	_____ -	_____ =	_____	±0.4 dB
	5 MHz	_____ -	_____ =	_____	±0.4 dB
	10 MHz	_____ -	_____ =	_____	±0.4 dB
	25 MHz	_____ -	_____ =	_____	±0.4 dB
	40 MHz	_____ -	_____ =	_____	±0.4 dB
	55 MHz	_____ -	_____ =	_____	±0.5 dB
	70 MHz	_____ -	_____ =	_____	±0.5 dB
	85 MHz	_____ -	_____ =	_____	±0.5 dB
	100 MHz	_____ -	_____ =	_____	±0.5 dB
	120 MHz	_____ -	_____ =	_____	±0.5 dB
	135 MHz	_____ -	_____ =	_____	±0.5 dB
150 MHz	_____ -	_____ =	_____	±0.5 dB	

Trace Number: _____ Report Number _____ Test Date: ___/___/___

Input Impedance	Frequency	Measured Value (dBm)	Reference Value (dBm)	Calculated Value (dBm)	Specifications (0 dBm)
1 MΩ	10 Hz	_____ -	_____ =	_____	±2.5 dB
	100 Hz	_____ -	_____ =	_____	±1.0 dB
	1 kHz	_____ -	_____ =	_____	±1.0 dB
	10 kHz	_____ -	_____ =	_____	±1.0 dB
	30 kHz	_____ -	_____ =	_____	±0.6 dB
	100 kHz	_____ -	_____ =	_____	±0.6 dB
	300 kHz	_____ -	_____ =	_____	±0.6 dB
	500 kHz	_____ -	_____ =	_____	±0.6 dB
	1 MHz	_____ -	_____ =	_____	±0.6 dB
	2 MHz	_____ -	_____ =	_____	±0.6 dB
	5 MHz	_____ -	_____ =	_____	±0.6 dB
	10 MHz	_____ -	_____ =	_____	±0.6 dB
	25 MHz	_____ -	_____ =	_____	±0.6 dB
	40 MHz	_____ -	_____ =	_____	±0.6 dB

12. Reference Level Accuracy PASS _____ FAIL _____

Specification:
at 300 kHz reference level = range <±0.3 dB

Measured Value (dBm)	Range (dBm)	Calculated Value (dB)	Specification (dB)
_____ -	-20 =	_____	<±0.3
_____ -	-10 =	_____	<±0.3
_____ -	0 =	_____	<±0.3
_____ -	10 =	_____	<±0.3
_____ -	20 =	_____	<±0.3

Trace Number _____ Report Number: _____ Test Date ___/___/___

13. Log Scale Accuracy PASS _____ FAIL _____

Specification: 0 to -30 dB <0.05 dB
 -30 to -40 dB <0.1 dB
 -40 to -50 dB <0.3 dB
 -50 to -60 dB <0.5 dB
 -60 to -70 dB <0.7 dB

Level (dB)	Reference Value (dB)	Measured Value (dB)	Calculated Value (dB)	Specification (dB)
-10	_____ -	_____ =	_____	< ±0.05
-20	_____ -	_____ =	_____	< ±0.05
-30	_____ -	_____ =	_____	< ±0.05
-40	_____ -	_____ =	_____ †	< ±0.10
-50	_____ -	_____ =	_____	< ±0.30

Level (dB)	Reference Value (dB)	Attenuator Setting (dB)	Insertion Loss Error	Measured Value (dB)	Calculated Value (dB)	Specification (dB)
-60	_____ -	10 -	_____ -	_____ -	_____	< ±0.50
-70	_____ -	20 -	_____ -	_____ -	_____	< ±0.70

† The digital multimeter needs to be verified if the Calculated Value is within 0.05 dB of specification

14. Source Dynamic Accuracy PASS _____ FAIL _____

Specification: at 300 kHz ±0.02 dB/dB below 10 dBm

Attenuation	Measured Value (dB)	Correction (dB)	Dynamic Accuracy (dB)	Specification (dB)
10 dB PAD	_____ -	_____ † =	_____	±0.2
10 dB DAC	_____ -	_____ † =	_____	±0.2
20 dB PAD A	_____ -	_____ † =	_____	±0.4
20 dB PAD B	_____ -	_____ † =	_____	±0.4
20 dB DAC	_____ -	_____ † =	_____	±0.4

† 20 dB insertion loss error at 300 kHz minus 10 dB insertion loss error at 300 kHz
 ‡ 20 dB insertion loss error at 300 kHz

Trace Number: _____ Report Number: _____ Test Date: ___/___/___

15. Input Return Loss PASS FAIL

Specification: >20 dB

Frequency (MHz)	Range (dBm)	Measured Value (dB)	Specification (dB)
100	20	_____	< -20
	10	_____	< -20
	0	_____	< -20
	-10	_____	< -20
	-20	_____	< -20
150	20	_____	< -20
	10	_____	< -20
	0	_____	< -20
	-10	_____	< -20
	-20	_____	< -20

16. Source Return Loss PASS FAIL

Specification >20 dB

Reference Frequency (MHz)	Source Amplitude (dBm)	Measured Value (dB)	Specification (dB)
60	+10	_____	< -20
	0	_____	< -20
	-10	_____	< -20
	-20	_____	< -20
	-30	_____	< -20
	-40	_____	< -20
120	+10	_____	< -20
	0	_____	< -20
	-10	_____	< -20
	-20	_____	< -20
	-30	_____	< -20
	-40	_____	< -20
150	+10	_____	< -20
	0	_____	< -20
	-10	_____	< -20
	-20	_____	< -20
	-30	_____	< -20
	-40	_____	< -20

Trace Number: _____ Report Number: _____ Test Date: ___/___/___

17. Source Harmonic Distortion PASS _____ FAIL _____

Specification: <-30 dBc

Fundamental Frequency	Harmonic	Measured Value (dB)	Specification (dB)
100 kHz	200 kHz	_____	< -30
	300 kHz	_____	< -30
1 MHz	2 MHz	_____	< -30
	3 MHz	_____	< -30
10 MHz	20 MHz	_____	< -30
	30 MHz	_____	< -30
50 MHz	100 MHz	_____	< -30
	150 MHz	_____	< -30
75 MHz	150 MHz	_____	< -30

18. Source Spurious Responses PASS _____ FAIL _____

Specification: <-40 dBc

Reference Frequency	Spur Frequency (MHz)	Measured Value (dB)	Specification (dB)
101 kHz	10 1875	_____	< -40
101 MHz	101 1875	_____	< -40
	101 375	_____	< -40
149.9 MHz	10 3875	_____	< -40

Trace Number: _____ Report Number: _____ Test Date: ___/___/___

19. Source Noise PASS FAIL

Specification 1 Hz bandwidth, offsets > 500 Hz from carrier
 <-80 dB relative to the carrier

Reference Frequency (MHz)	Offset Frequency (MHz)	Measured Value (dBm)	Reference Value (dBm)	Calculated Value (dB)	Specification (dB)
8 0125	8 013012	_____ -	_____ =	_____	< -80
	8 015060	_____ -	_____ =	_____	< -80
	8 02530	_____ -	_____ =	_____	< -80
	8 076506	_____ -	_____ =	_____	< -80
	8 33253	_____ -	_____ =	_____	< -80
	9 612656	_____ -	_____ =	_____	< -80
140 0125	140 013012	_____ -	_____ =	_____	< -80
	140 015060	_____ -	_____ =	_____	< -80
	140 02530	_____ -	_____ =	_____	< -80
	140 076506	_____ -	_____ =	_____	< -80
	140 33253	_____ -	_____ =	_____	< -80
	140 612656	_____ -	_____ =	_____	< -80

Operation Verification Test Record

Calibration Entity and Address _____

Test Performed By _____

Report Number _____

Customer _____

Trace Number _____

Installed Options _____

Test Date _____

Temperature _____

Humidity _____

Power Line Frequency _____

Trace Number _____ Report Number: _____ Test Date ___/___/___

1. Local Oscillator Feedthrough

PASS _____ FAIL _____

Specification: >20 dB below range

Frequency	Measured Value	Specification
0 Hz	_____ dBm	< -40 dBm

2. Phase Noise

PASS _____ FAIL _____

Specification: 1 kHz offset normalized to
 1 Hz noise power bandwidth < -105 dBc

Measured Value	Specification
_____ dB/Hz	< -105 dB/Hz

3. Residual Responses

PASS _____ FAIL _____

Specification: -20 dBm range <-110 dBm

Frequency	Measured Value (dBm)	Specification (dBm)
50 Hz or 60 Hz	_____	< -110
100 Hz or 120 Hz	_____	< -110
150 Hz or 180 Hz	_____	< -110
12.5 kHz	_____	< -110
24.7623 kHz	_____	< -110
35.7134 kHz	_____	< -110
100 kHz	_____	< -110
187.5 kHz	_____	< -110
250 kHz	_____	< -110
10 MHz	_____	< -110

Trace Number: _____ Report Number: _____ Test Date: ___/___/___

4. Noise Level

PASS _____ FAIL _____

Specification:
 50Ω input impedance <-132 dBm/Hz above 30 kHz (degrade by 3 dB for start frequency ≤30 kHz in auto-sweep mode)
 <-129 dBm/Hz between 2 kHz and 30 kHz inclusive
 100 Hz to 2 kHz is 1/f noise and is <-129 dBm/Hz at 2 kHz and <-116 dBm/Hz at 100 Hz
 add 10 dB to specification if low-distortion mode is ON

75Ω input impedance add 2 dB to 50Ω specification

1 MΩ input impedance (terminated in 100 kΩ) <-110 dBm/Hz below 40 MHz with 1/f corner at 100 kHz

Step	Low Distortion	Input Impedance	Resolution Bandwidth	Frequency	Measured Value (dBm/Hz)	Specification (dBm/Hz)	
3	ON	50Ω	17 kHz	150 MHz	_____	< -122	
				120 MHz	_____	< -122	
				19 MHz	_____	< -122	
			73 Hz	530 Hz	_____	< -114	
5	OFF	50Ω	17 kHz	150 MHz	_____	< -132	
				120 MHz	_____	< -132	
				19 MHz	_____	< -132	
			73 Hz	530 Hz	_____	< -124	
8	OFF	1 MΩ	17 kHz	40 MHz	_____	< -110	
				290 Hz	10.1 kHz	_____	< -100
				9.1 Hz	110 Hz	_____	< -80

Trace Number: _____ Report Number: _____ Test Date: ___/___/___

5. Frequency Accuracy

PASS _____ FAIL _____

Specification initial accuracy without option 001 = ±0.5 ppm
 with option 001 = ±0.01 ppm
 add ±0.1 ppm if instrument on <48 hours

aging without option 001 = ±0.25 ppm/month
 with option 001 = ±0.125 ppm/month

frequency counter resolution = ±0.1 Hz

Calculated Lower Limit (Hz) †	Measured Value (Hz)	Calculated Upper Limit (Hz) ‡
<		<

† Without Option 001 - $100 \times 10^6 - (25 \times \text{months}) - 50 - 0.1 - \underline{\hspace{2cm}}$

† With Option 001 - $100 \times 10^6 - (12.5 \times \text{months}) - 1 - 0.1 - \underline{\hspace{2cm}}$

‡ Without Option 001 - $100 \times 10^6 + (25 \times \text{months}) + 50 + 0.1 - \underline{\hspace{2cm}}$

‡ With Option 001 - $100 \times 10^6 + (12.5 \times \text{months}) + 1 + 0.1 - \underline{\hspace{2cm}}$

Months = number since last frequency adjustment

6. Spurious Responses

PASS _____ FAIL _____

Specification: spurious sidebands <-70 dBc

Source Frequency (MHz)	Spur Frequency (MHz)	Measured Value (dB)	Specification (dB)
7 8125	10 8428	_____	< -70
9 8125	9 8248	_____	< -70
149 8125	149 8248	_____	< -70
95 81274	95 81254	_____	< -70
95 8149	95 8129	_____	< -70
100 79274	100 79254	_____	< -70
100 7949	100 7929	_____	< -70
100 79454	100 79254	_____	< -70
100 794504	100 792504	_____	< -70
100 7945004	100 7925004	_____	< -70
1 8125	4 81373	_____	< -70
7 81496	4 81373	_____	< -70
144 8125	144 822623	_____	< -70
144 832746	144 822623	_____	< -70
89 8125	89 8125	_____	< -70

Trace Number: _____ Report Number: _____ Test Date: ___/___/___

7. Image Responses

PASS _____ FAIL _____

Specification: carrier level < range <-70 dBc

Frequency (MHz)	Measured Value (dB)	Specification (dB)
40.85956	_____	< -70
60.85956	_____	< -70
61.35956	_____	< -70

8. Input Harmonic Distortion

PASS _____ FAIL _____

Specification: low distortion mode ON
50Ω and 75Ω input <-80 dBc

Step	Low Dist.	Input Imp.	Low Pass Filter	Fundamental (MHz)	Harmonic (MHz)	Measured Value (dB)	Specification (dB)
4	ON	50Ω	50 MHz	47.265018	94.530036 141.795054	_____	< -80 < -80
			21 MHz	18.816541	37.633082 56.449623	_____	< -80 < -80

10. Source Amplitude Accuracy and Frequency Response PASS _____ FAIL _____

Specification: at 300 kHz 10 dBm ±1 dB

frequency response relative to 300 kHz 300 kHz output level ±1 dB

Frequency	Lower Limit (dBm)	Measured Value (dBm)	Upper Limit (dBm)
10 Hz	_____ †	_____	_____ ‡
100 Hz	_____ †	_____	_____ ‡
10 kHz	_____ †	_____	_____ ‡
30 kHz	_____ †	_____	_____ ‡
300 kHz	+9.0	_____	+11.0
10 MHz	_____ †	_____	_____ ‡
100 MHz	_____ †	_____	_____ ‡
150 MHz	_____ †	_____	_____ ‡

† Measured Value at 300 kHz - 1 dB
‡ Measured Value at 300 kHz + 1 dB

11a. Input Amplitude Accuracy and Flatness

PASS _____ FAIL _____

Trace Number: _____ Report Number _____ Test Date: ___/___/___

Specification:

50Ω input
 10 Hz - 100 Hz ±2.5 dB
 100 Hz - 30 kHz ±1.0 dB
 30 kHz - 150 MHz ±0.5 dB
 300 kHz - 40MHz ±0.4 dB

Impedance	Range	Upper Limit (dBm)	Measured Value (dBm)	Lower Limit (dBm)
50Ω	30 kHz - 150 MHz	+ 0.5 + 0.5	Maximum _____ Minimum _____	- 0.5 - 0.5
	300 kHz - 40 MHz	+ 0.4 + 0.4	Maximum _____ Minimum _____	- 0.4 - 0.4
	100 Hz - 30 kHz	+ 1.0 + 1.0	Maximum _____ Minimum _____	- 1.0 - 1.0
	10 Hz - 100 Hz	+ 2.5 + 2.5	Maximum _____ Minimum _____	- 2.5 - 2.5

11b. Alternate Input Amplitude Accuracy and Flatness

PASS _____ FAIL _____

Specification: same as 11a

Input Impedance	Frequency	Measured Value (dBm)	Reference Value (dBm)	Input Error (dBm)	Specification (0 dBm)
50Ω	10 Hz	_____ -	_____ =	_____	±2.5 dB
	100 Hz	_____ -	_____ =	_____	±1.0 dB
	10 kHz	_____ -	_____ =	_____	±1.0 dB
	30 kHz	_____ -	_____ =	_____	±0.5 dB
	300 kHz	_____ -	_____ =	_____	±0.4 dB
	10 MHz	_____ -	_____ =	_____	±0.4 dB
	40 MHz	_____ -	_____ =	_____	±0.4 dB
100 MHz	_____ -	_____ =	_____	±0.5 dB	
150 MHz	_____ -	_____ =	_____	_____	±0.5 dB

Trace Number _____ Report Number _____ Test Date: ___/___/___

12. Reference Level Accuracy

PASS _____ FAIL _____

Specification: _____ at 300 kHz reference level = range _____ $\leq \pm 0.3$ dB

Measured Value (dBm)	Range (dBm)	Calculated Value (dB)	Specification (dB)
_____ -	-20 =	_____	$< \pm 0.3$
_____ -	-10 =	_____	$< \pm 0.3$
_____ -	0 =	_____	$< \pm 0.3$
_____ -	10 =	_____	$< \pm 0.3$
_____ -	20 =	_____	$< \pm 0.3$

14. Source Dynamic Accuracy

PASS _____ FAIL _____

Specification: _____ at 300 kHz _____ ± 0.02 dB/dB below 10 dBm

Attenuation	Measured Value (dB)	Correction (dB)	Dynamic Accuracy (dB)	Specification (dB)
10 dB PAD	_____ -	_____ † =	_____	± 0.2
10 dB DAC	_____ -	_____ † =	_____	± 0.2
20 dB PAD A	_____ -	_____ † =	_____	± 0.4
20 dB PAD B	_____ -	_____ † =	_____	± 0.4
20 dB DAC	_____ -	_____ † =	_____	± 0.4

† 20 dB insertion loss error at 300 kHz minus 10 dB insertion loss error at 300 kHz
‡ 20 dB insertion loss error at 300 kHz

17. Source Harmonic Distortion

PASS _____ FAIL _____

Specification: _____ < -30 dBc

Fundamental Frequency	Harmonic	Measured Value (dB)	Specification (dB)
100 kHz	200 kHz	_____	< -30
	300 kHz	_____	< -30
50 MHz	100 MHz	_____	< -30
	150 MHz	_____	< -30

Trace Number: _____ Report Number: _____ Test Date: ___/___/___

18. Source Spurious Responses

PASS _____ FAIL _____

Specification: <-40 dBc

Reference Frequency	Spur Frequency (MHz)	Measured Value (dB)	Specification (dB)
101.1 Hz	10.1875	_____	< -40
101 MHz	101.1875	_____	< -40
	101.375	_____	< -40
149.9 MHz	10.3875	_____	< -40

19. Source Noise

PASS _____ FAIL _____

Specification:

1 Hz bandwidth offsets > 500 Hz from carrier

<-80 dB relative to the carrier

Reference Frequency (MHz)	Offset Frequency (MHz)	Measured Value (dBm)	Reference Value (dBm)	Calculated Value (dB)	Specification (dB)
8.0125	8.013012	_____ -	_____ =	_____	< -80
	8.076506	_____ -	_____ =	_____	< -80

Index

A

accessories 1-3
amplitude accuracy
 frequency response 3-31, 3-46
 input return loss 3-63
 log scale 3-56
 reference level 3-53
 source 3-27
 source dynamic 3-60
amplitude flatness 3-31, 3-46

C

calibration cycle 3-2
cleaning screen 2-6
cooling 2-5

D

distortion
 input harmonic 3-19
 intermodulation 3-22
 source harmonic 3-68
dynamic accuracy
 source 3-60

E

equipment list 1-3

F

frequency
 accuracy 3-13
 response input 3-31, 3-46
 response source 3-27
fuse 2-2

G

grounding requirements 2-3

H

hardkeys 3-5
harmonic distortion
 input 3-19
 source 3-68
HP-IB interface 2-6

I

image response 3-17
incoming inspection 2-1
input
 frequency accuracy 3-13
 frequency response 3-31, 3-46
 harmonic distortion 3-19
 image responses 3-17
 intermodulation distortion 3-22
 local oscillator feedthrough 3-6
 log scale accuracy 3-56
 noise 3-10
 phase noise 3-7
 reference level accuracy 3-53
 residual responses 3-8
 return loss 3-63
 spurious responses 3-15
installation 2-7
intermodulation distortion 3-22

L

local oscillator feedthrough 3-6
log scale accuracy 3-56

M

measurement uncertainty 3-2

N

noise
 input 3-10
 phase 3-7
 source 3-73

O

operating environment 2-5
operation verification
 test confidence level 3-1
 test duration 2-1
 test list 3-3
options 1-2

P

performance tests
 test confidence level 3-1
 test duration 2-1
 test list 3-3
phase noise 3-7
power
 cables 2-3
 requirements 2-2

R

recommended test equipment 1-3
reference level accuracy 3-53
residual responses 3-8
return loss
 input 3-63
 source 3-65

S

safety 3-1
 See front matter
scale fidelity
 log scale accuracy 3-56
screen cleaning 2-6
shipment 2-7
source
 amplitude accuracy 3-27
 dynamic accuracy 3-60
 frequency response 3-27
 harmonic distortion 3-68
 noise 3-73
 return loss 3-65
 spurious responses 3-71
specifications 1-7
spurs
 image responses 3-17
 input harmonic distortion 3-19
 intermodulation distortion 3-22
 local oscillator feedthrough 3-6
 residual responses 3-8
 source 3-71
 source harmonic distortion 3-68
 spurious responses 3-15
storage 2-7

T

test
 duration 2-1
 equipment 1-3
transportation disk 2-1

V

voltage selector switch 2-2

