

About this Manual

We've added this manual to the Agilent website in an effort to help you support your product. This manual is the best copy we could find; it may be incomplete or contain dated information. If we find a more recent copy in the future, we will add it to the Agilent website.

Support for Your Product

Agilent no longer sells this product. Our service centers may be able to perform calibration and repair if necessary, but no other support from Agilent is available. You will find any other available product information on the Agilent Test & Measurement website, www.tm.agilent.com.

HP References in this Manual

This manual may contain references to HP or Hewlett-Packard. Please note that Hewlett-Packard's former test and measurement, semiconductor products and chemical analysis businesses are now part of Agilent Technologies. We have made no changes to this manual copy. In other documentation, to reduce potential confusion, the only change to product numbers and names has been in the company name prefix: where a product number/name was HP XXXX the current name/number is now Agilent XXXX. For example, model number HP8648A is now model number Agilent 8648A.



OPERATION AND SERVICE MANUAL

MODEL 4145A
SEMICONDUCTOR
PARAMETER ANALYZER

SERIAL NUMBERS

**This manual applies to instruments with
serial numbers prefixed 2149J- and above.**

© COPYRIGHT: YOKOGAWA-HEWLETT-PACKARD, LTD., 1982
9-1, TAKAKURA-CHO, HACHIOJI-SHI, TOKYO, JAPAN

Manual Part No. 04145-90000

Microfiche Part No. 04145-90050

Printed: AUG. 1984

TABLE OF CONTENTS

Section	Title	Page	Section	Title	Page
I GENERAL INFORMATION					
1-1.	Introduction	1-1	3-37.	Auto-Calibration	3-27
1-4.	Description	1-2	3-40.	Display Pages	3-28
1-11.	Specifications	1-3	3-42.	Page Control	3-28
1-13.	Safety Considerations	1-3	3-45.	MENU Page	3-30
1-16.	Instruments Covered by Manual	1-3	3-47.	CHANNEL DEFINITION Page .	3-30
1-21.	Options	1-4	3-49.	SOURCE SETUP Page	3-30
1-23.	Accessories Supplied	1-4	3-51.	MEAS & DISP MODE SETUP Page	3-30
1-25.	Accessories Available	1-4	3-53.	GRAPHICS PLOT Page	3-30
1-27.	Warranty Limitation for Accessories	1-4	3-55.	LIST DISPLAY Page	3-30
II INSTALLATION					
2-1.	Introduction	2-1	3-57.	MATRIX DISPLAY Page	3-30
2-3.	Initial Inspection	2-1	3-59.	SCHMOO PLOT Page	3-30
2-5.	Preparation for Use	2-1	3-61.	AUTO SEQUENCE SETUP Page.	3-31
2-6.	Power Requirements	2-1	3-63.	OUTPUT SEQUENCE SETUP Page	3-31
2-8.	Line Voltage and Fuse Selection	2-1	3-65.	USER FILE CATALOG Page ..	3-31
2-10.	Line Frequency Filter	2-1	3-67.	OPERATION GUIDE Page	3-31
2-12.	Power Cable	2-2	3-69.	DIAGNOSTICS Page	3-31
2-16.	Operating Environment	2-2	3-71.	Softkey Prompt (SKP)	3-31
2-19.	Installation Instructions.	2-2	3-73.	System Messages	3-31
2-21.	Installation of Options 907, 908 and 909	2-2	3-75.	Time Domain Measurement Setup	3-74
2-23.	Storage and Shipment	2-4	3-77.	DUT Connection	3-76
2-24.	Environment	2-4	3-79.	DUT Connection Using the 16058A	3-76
2-26.	Packaging	2-4	3-81.	DUT Connection Using the Connector Plate	3-80
III OPERATION					
3-1.	Introduction	3-1	3-83.	Floating Measurement	3-82
3-3.	Panel Features	3-2	3-85.	Guarding	3-82
3-5.	Flexible Disc Handling ...	3-10	3-87.	Applications Package	3-83
3-7.	CRT Display	3-10	3-89.	HP-IB Interface	3-86
3-10.	Self Test	3-12	3-91.	Connection to HP-IB	3-86
3-12.	Error Messages/Error Codes	3-12	3-93.	HP-IB Status Indicators .	3-86
3-14.	Initial Control Setting ..	3-18	3-95.	LOCAL Key	3-86
3-16.	User-Area Filing Operations	3-18	3-97.	HP-IB Control Switch	3-86
3-18.	Arithmetic Capabilities ..	3-19	3-99.	HP-IB Interface Capabilities	3-87
3-21.	Source and Measurement Channels	3-21	3-101.	HP-IB Control Modes	3-87
3-23.	Stimulus/Measurement Units (SMU)	3-21	3-103.	HP-GL Control of the CRT	3-87
3-25.	Voltage Sources (Vs) and Voltage Monitors (Vm) .	3-23	3-105.	Remote Program Codes and Parameter Setting	3-88
3-27.	Compliance	3-23	3-107.	HP-GL Commands	3-97
3-29.	Sweep Measurement	3-24	3-109.	Device Clear	3-100
3-33.	Time Domain Measurement ..	3-26	3-111.	Data Output	3-101
3-35.	Integration Time	3-27	3-113.	Service Request Status Byte	3-102
			3-115.	Programming Guide for 4145A	3-104
			3-117.	PLOT	3-108
			3-119.	PRINT	3-110
			3-121.	External Display	3-111
			3-123.	Disc Copy	3-112
			3-125.	Head Cleaning	3-113

TABLE OF CONTENTS

Section	Title	Page	Section	Title	Page
3-127.	Protection againt Hazardous Voltage Exceeding ±42V	3-114	5-34.	Disc Check	5-23
3-129.	PLOT/PRINT Operations Using HP-IB Controller	3-114	5-36.	Flexible-disc Drive Checks and Adjustments	5-23
3-131.	Measurement Ranges and Resolution	3-116	5-38.	Sure Flexible-disc Drive Checks and Adjustment .	5-23
3-133.	Resolution and Format for Displayed Data and Data Output	3-118	5-40.	MSU DIAGNOSTICS Mode	5-24
IV	PERFORMANCE TEST		5-43.	MSU Read Test	5-26
4-1.	Introduction	4-1	5-46.	MSU Write Test	5-28
4-3.	Equipment Required	4-1	5-49.	MSU EXERCISER	5-30
4-5.	Test Record	4-1	5-52.	Drive Belt Tension Check and Adjustment	5-32
4-7.	Calibration Cycle	4-1	5-53.	Index Timing Check and Adjustment	5-33
4-9.	Graphics Display Unit Intensity and Focus Check	4-2	5-54.	Track Alignment Check and Adjustment	5-34
4-10.	Page and Key Function Check	4-4	5-55.	Track Zero Switch Check and Adjustment	5-38
4-11.	SMU Accuracy Test	4-5	5-56.	Jitter Check and Adjustment	5-41
4-12.	VS Accuracy Test	4-19	5-57.	Index Detector Alignment Check and Adjustment ..	5-43
4-13.	VM Accuracy Test	4-22	VI	REPLACEABLE PARTS	
4-14.	External CRT X-Y-Z Output Check	4-25	6-1.	Introduction	6-1
4-15.	HP-IB Interface Test	4-27	6-3.	Abbreviations	6-1
V	ADJUSTMENT		6-5.	Replaceable Parts List ...	6-1
5-1.	Introduction	5-1	6-7.	Ordering Information	6-2
5-3.	Safety Requirement	5-1	6-10.	Direct Mail Order System .	6-2
5-7.	Equipment Required	5-1	VII	MANUAL CHANGES	
5-9.	Adjustment Relationships .	5-1	7-1.	Introduction	7-1
5-11.	Adjustment Locations	5-1	7-3.	Manual Changes	7-1
5-13.	Initial Operation Procedure	5-3	VIII	SERVICE	
5-15.	Basic Operating Checks ...	5-3	8-1.	Introduction	8-1
5-17.	Top Cover Removal	5-3	8-3.	Safety Considerations	8-1
5-19.	Bottom Cover Removal	5-3	8-5.	Recommended Test Equipment	8-1
5-21.	A3 Board Access	5-3	8-7.	Troubleshooting	8-1
5-23.	Graphics Display Unit Intensity and Focus Check and Adjustment ..	5-6	8-9.	Repair	8-1
5-24.	DC Power Supply Adjustment	5-8	8-11.	Block Diagram Discussion ..	8-2
5-25.	Sample Hold Switch AC Offset Adjustment	5-11	8-13.	Board Level Theory	8-4
5-26.	Demultiplexer Noise Rejection Adjustment ..	5-13	8-15.	Troubleshooting Guide	8-6
5-27.	D-A Converter Gain Adjustment	5-16	8-17.	Assembly Removal	8-8
5-28.	A-D Converter Gain Adjustment	5-18	8-18.	Assembly Locations	8-8
5-29.	VM Range Adjustment	5-20	8-20.	A1 through A8 Board Removal	8-9
5-30.	Mass Storage Unit Test ...	5-23	8-22.	A13 through A16 Board Removal	8-9
5-32.	Flexible-disc Drive Access	5-23	8-24.	Front Panel Removal	8-9
			8-26.	Display (1345A) Removal ..	8-10
			8-28.	Rear Assembly A Removal ..	8-11
			8-30.	A11 and A12 Board Removal.	8-11
			8-32.	Rear Assembly B Removal ..	8-12
			8-34.	FDD and A9 Board Removal .	8-13
			8-36.	A1 Graphic Display Control Board.	8-69

TABLE OF CONTENTS

Section	Title	Page	Section	Title	Page
8-38.	A2 Microprocessor Digital Control Board	8-72	8-48.	A10 Keyboard and Display Control Board	8-115
8-40.	A3 SMU Control and A-D Converter Board	8-78	8-50.	A11 Switching Power Supply Board	8-120
8-42.	A4 D-A Converter Board	8-84	8-52.	A13 SMU Power Source Board	8-129
8-44.	A5 SMU Board	8-98	8-54.	A16 Vs/Vm Board	8-138
8-46.	A9 HP-IB and MSU Control Board	8-111			

LIST OF TABLES

Number	Title	Page	Number	Title	Page
1-1.	Specifications	1-5	4-12.	HP-IB Interface Test Program ..	4-29
1-2.	Reference Data	1-13	4-13.	Controller Instructions and Operator Response for HP-IB Interface Test Program	4-33
1-3.	Accessories Supplied	1-16	4-14.	Error Messages for HP-IB Interface Test Program	4-35
3-1.	4145A Self Test	3-12	5-1.	Adjustable Components	5-2
3-2.	Error Messages	3-13	5-2.	Adjustment Requirements	5-4
3-3.	Operational Error-Codes	3-15	5-3.	Check Points and Limits	5-10
3-4.	Self Test Error-Codes	3-17	5-4.	Test Point/Trimmer Capacitor Combination	5-14
3-5.	Arithmetic Operators	3-19	5-5.	MSU DIAGNOSTICS Mode	5-24
3-6.	SMU Source Ranges	3-22	5-6.	Message on MSU EXERCISER Page .	5-30
3-7.	Application Package Setups	3-83	5-7.	MSU EXERCISER Softkey Prompts .	5-31
3-8.	HP-IB Interface Capabilities ..	3-87	6-1.	List of Reference Designators and Abbreviations	6-1
3-9.	HP-GL Commands	3-97	6-2.	Manufacturers Codes	6-2
3-10.	Recommended HP-IB Plotters	3-108	6-3.	Replaceable Parts	6-3
3-11.	Recommended HP-IB Printers	3-110	7-1.	Manual Changes by Serial Number	7-1
3-12.	Recommended External Displays .	3-111	7-2.	Parts Change Information	7-27
3-13.	Number of Output/Display Digits	3-118	8-1.	Hardware-related Error Codes ..	8-6
4-1.	Recommended Test Equipment	4-A	8-2.	SMU Status Codes	8-6
4-2.	Source Parameter Changes	4-8	8-3.	Jumper Settings	8-19
4-3.	Test Limits for Voltage Control Accuracy Test	4-8	8-4.	List of Digital Section Troubleshooting Flow Diagrams	8-22
4-4.	Source Parameter Changes	4-12	8-5.	Program Locations	8-76
4-5.	Test Limits for Voltage Measurement Accuracy Test ..	4-12	8-6.	Relationship between Current and Range Resistors	8-103
4-6.	Source Parameter Changes	4-15	8-7.	V Monitor Amplifier Ranging ...	8-104
4-7.	Test Limits for Current Measurement Accuracy Test ..	4-15			
4-8.	Source Parameter Changes	4-18			
4-9.	Test Limits for Current Control Accuracy Test	4-18			
4-10.	Test Limits for SU Accuracy Test	4-21			
4-11.	Test Limits for MU Accuracy Test	4-24			

LIST OF ILLUSTRATIONS

Number	Title	Page	Number	Title	Page
1-1.	Model 4145A and Accessories	1-1	3-38.	HP-IB Control Switch	3-86
1-2.	Serial Number Plate	1-3	3-39.	Remote Program Codes and Parameter Setting	3-88
2-1.	Voltage and Fuse Selection	2-2	3-40.	Data Output Format	3-100
2-2.	Power Cable Supplied	2-3	3-41.	Status Byte for the 4145A	3-102
2-3.	Rack Mount Kit	2-5	3-42.	Sample Program 1	3-105
3-1.	Contents of Section III	3-1	3-43.	Sample Program 2	3-107
3-2.	Front Panel Features	3-2	3-44.	Plot Function	3-108
3-3.	Rear Panel Features	3-8	3-45.	Print Function	3-110
3-4.	Disc Installation and Removal ..	3-10	3-46.	External Display	3-111
3-5.	Useable Display Area	3-11	3-47.	Disc Copy	3-112
3-6.	Operator Adjustment	3-11	3-48.	Head Cleaning	3-113
3-7.	Byte Size of Arithmetic Expressions	3-20	3-49.	Programs for HP-IB controlled PLOT Operations	3-115
3-8.	Source and Measurement Channels of the 4145A	3-21	3-50.	Measurement Ranges and Resolution	3-116
3-9.	Simplified Circuit Diagram of One of the Four SMUs	3-21	3-51.	Display/Output Format	3-119
3-10.	Specifiable Voltage/Current Output	3-22	4-1.	Test Pattern for GDU	4-2
3-11.	Simplified Circuit Diagram of V_s	3-23	4-2.	GDU Connector Location	4-3
3-12.	Simplified Circuit Diagram of V_m	3-23	4-3.	Display for Key Function Check.	4-4
3-13.	Voltage/Current Output Specified by the COMPLIANCE ..	3-23	4-4.	Voltage Control Accuracy Test Setup	4-5
3-14.	Staircase Sweep Output	3-24	4-5.	Measurement Setup	4-6
3-15.	Relationship Between VARI and VAR2	3-25	4-6.	Voltage Measurement Accuracy Test Setup	4-9
3-16.	Relationship Between VARI and VARI'	3-26	4-7.	Measurement Setup	4-10
3-17.	Time Domain Measurement	3-27	4-8.	Measurement Setup	4-13
3-18.	Page Control Keys	3-28	4-9.	Measurement Setup	4-16
3-19.	Page Flow and the Relationship ..	3-29	4-10.	SU Accuracy Test Setup	4-19
3-20.	MENU Page	3-32	4-11.	Measurement Setup	4-21
3-21.	CHANNEL DEFINITION Page	3-34	4-12.	MU Accuracy Test Setup	4-22
3-22.	SOURCE SETUP Page	3-38	4-13.	Measurement Setup	4-23
3-23.	MEAS & DISP MODE SETUP Page	3-42	4-14.	External CRT X-Y-Z Output Check Setup	4-25
3-24.	GRAPHICS PLOT Page	3-48	4-15.	Scope Displays of X-Y-Z Output (Example)	4-26
3-25.	LIST DISPLAY Page	3-54	4-16.	HP-IB Interface Test Setup	4-27
3-26.	MATRIX DISPLAY Page	3-57	4-17.	Program Listing of HP-IB Interface Test	4-30
3-27.	SCHMOO PLOT Page	3-59	5-1.	Test Pattern for GDU	5-6
3-28.	AUTO SEQUENCE SETUP Page	3-62	5-2.	INTENSITY and FOCUS Locations ..	5-6
3-29.	OUTPUT SEQUENCE SETUP Page	3-66	5-3.	Connector Location	5-7
3-30.	4145A FILE CATALOG Page	3-67	5-4.	DC Power Supply Adjustment Setup	5-8
3-31.	OPERATION GUIDE Page	3-70	5-5.	A11R17 Adjustment	5-9
3-32.	DIAGNOSTICS Page	3-71	5-6.	A5J1 Check	5-10
3-33.	Time Domain Measurement Setup ..	3-74	5-7.	Check Point Locations	5-10
3-34.	DUT Connection Using the 16058A.	3-76	5-8.	Sample Hold Switch AC Offset Adjustment Setup	5-11
3-35.	DUT Connection Using the Connector Plate	3-80	5-9.	AC Offset Adjustment	5-12
3-36.	Example of Guarding	3-82	5-10.	Check/Adjustment Point Locations	5-12
3-37.	Connection Examples for Application Package	3-85			

LIST OF ILLUSTRATIONS

Number	Title	Page	Number	Title	Page
5-14.	D-A Converter Gain Adjustment Setup	5-16	8-1.	Four Major Sections of the 4145A	8-3
5-15.	Check/Adjustment Point Locations	5-17	8-2.	Overall Block Diagram	8-5
5-16.	Results from LED Annunciators ..	5-18	8-3.	Assembly Level Trouble Isolation Flow Diagram	8-7
5-17.	Check/Adjustment Point Locations	5-19	8-4.	Assembly Locations	8-8
5-18.	Vm Range Adjustment Setup	5-20	8-5.	Front Panel Removal	8-9
5-19.	Test Point Locations	5-22	8-6.	1345A Removal	8-10
5-20.	Flexible-disc Drive Access	5-23	8-7.	Rear Assembly A Removal	8-11
5-21.	Component Locations for MSU DIAGNOSTICS Mode Setting	5-25	8-8.	A11 and A12 Board Removal	8-12
5-22.	CRT Display of MSU DIAGNOSTICS Page	5-25	8-9.	Rear Assembly B Removal	8-12
5-23.	CRT Display of MSU Read Test ...	5-26	8-10.	A19 Board Assembly	8-13
5-24.	CRT Display of MSU Write Test ..	5-28	8-11.	FDD and A9 Board Removal	8-13
5-25.	CRT Display fo MSU EXERCISER Page	5-30	8-12.	Flow Diagram Notes	8-14
5-26.	Drive Belt Tension Check and Adjustment Setup	5-32	8-13.	Signature Analysis	8-21
5-27.	Index Timing Checks and Adjustment	5-33	8-14.	A1 Board Troubleshooting Flow Diagram	8-25
5-28.	R47 Location	5-33	8-15.	A2 Board Troubleshooting Flow Diagram	8-31
5-29.	Track Alignment Check and Adjustment	5-34	8-16.	A3 Board Troubleshooting Flow Diagram	8-43
5-30.	Scope Display of Bursts	5-35	8-17.	A4 Board Troubleshooting Flow Diagram	8-53
5-31.	Check/Adjustment Point Locations	5-37	8-18.	A9 Board Troubleshooting Flow Diagram	8-59
5-32.	Track Zero Switch and Adjustment Setup	5-38	8-19.	A10 Board Troubleshooting Flow Diagram	8-65
5-33.	Scope Display of Track Zero Switch Switching	5-39	8-20.	Schematic Diagram Note	8-68
5-34.	Check/Adjustment Point Locations	5-40	8-21.	Block Diagram of A1 Board	8-69
5-35.	Jitter Check and Adjustment Setup	5-41	8-22.	A1 Graphic Display Control Board Assembly Component Locations.	8-70
5-36.	Scope Display of Jitter	5-42	8-23.	A1 Graphic Display Control Board Assembly Schematic Diagram ..	8-71
5-37.	Check/Adjustment Point Locations	5-42	8-24.	Block Diagram of the A2 Board ..	8-72
5-38.	Index Detector Alignment Check and Adjustment Setup	5-43	8-25.	A2 Microprocessor Digital Control Board Assembly Component Locations	8-74
5-39.	Index Detector Alignment Gap ...	5-44	8-26.	A2 Microprocessor Digital Control Board Assembly Schematic Diagram	8-75
5-40.	Check/Adjustment Point Locations	5-45	8-27.	Block Diagram of the A3 Board ..	8-78
6-1.	Major Mechanical Parts (Exploded View)	6-29	8-28.	A3 SMU Control and A-D Converter Board Assembly Component Locations	8-80
			8-29.	A3 SMU Control and A-D Converter Board Assembly Schematic Diagram	8-81
			8-30.	Block Diagram of A4 Board	8-84
			8-31.	I-V Converter Output	8-85
			8-32.	Analog Switch	8-85
			8-33.	A4 D-A Converter Board Assembly Component Locations	8-86
			8-34.	A4 D-A Converter Board Assembly Schematic Diagram	8-87
			8-35.	A5 Board Troubleshooting Flow Diagram	8-88

LIST OF ILLUSTRATIONS

Number	Title	Page	Number	Title	Page
8-36.	Self-Test Waveform	8-97	8-69.	A15 Floating Power Supply Board Assembly Schematic Diagram .	8-69
8-37.	SMU Board Block Diagram	8-98	8-70.	A16 Board Troubleshooting Flow Diagram	8-136
8-38.	SMU V Mode Operation	8-99	8-71.	Vs Block Diagram	8-138
8-39.	SMU I Mode Operation	8-99	8-72.	Vm Block Diagram	8-138
8-40.	Current Compliance in V Mode ..	8-100	8-73.	A16 Vs/Vm Board Assembly Component Locations	8-140
8-41.	V Error Amplifier	8-100	8-74.	A16 Vs/Vm Board Assembly Schematic Diagram	8-141
8-42.	Three Control Modes	8-101			
8-43.	Example of Diode Feedback	8-102			
8-44.	Power Amplifier Output Stage ..	8-102			
8-45.	Range Resistors	8-103			
8-46.	Range Resistor Circuit	8-104			
8-47.	A5 SMU Board Assembly Component Locations	8-106			
8-48.	A5 SMU Board Assembly Schematic Diagram	8-107			
8-49.	A9 HP-IB and MSU Control Board Assembly Component Locations	8-112			
8-50.	A9 HP-IB and MSU Control Board Assembly Schematic Diagram .	8-113			
8-51.	Block Diagram of Key Control ..	8-115			
8-52.	A10 Keyboard and Display Board Assembly Component Locations	8-116			
8-53.	A10 Keyboard and Display Board Assembly Component Locations	8-117			
8-54.	A11 Board Troubleshooting Flow Diagram	8-118			
8-55.	Rectifier Circuit	8-120			
8-56.	Switching Circuit	8-120			
8-57.	Power Loss Detection Circuit ..	8-121			
8-58.	A11 Switching Power Supply Board Assembly Component Locations	8-122			
8-59.	A11 Switching Power Supply Board Assembly Schematic Diagram	8-123			
8-60.	A12 Board Troubleshooting Flow Diagram	8-124			
8-61.	A12 DC Power Supply Board Assembly Component Locations	8-126			
8-62.	A12 DC Power Supply Board Assembly Schematic Diagram .	8-127			
8-63.	A13 Board Troubleshooting Flow Diagram	8-128			
8-64.	Voltage Change Sequence	8-129			
8-65.	A13 SMU Power Source Board Assembly Component Locations.	8-130			
8-66.	A13 SMU Power Source Board Assembly Schematic Diagram .	8-131			
8-67.	A15 Board Troubleshooting Flow Diagram	8-132			
8-68.	A15 Floating Power Supply Board Assembly Component Locations	8-68			

SECTION I GENERAL INFORMATION

1-1. INTRODUCTION

1-2. This operation and service manual contains the information required to install, operate, test, adjust, and service the Hewlett-Packard Model 4145A Semiconductor Parameter Analyzer. Figure 1-1 shows the instrument and supplied accessories. This section covers specifications, instrument identification, description, options, accessories, and other basic information.

1-3. Listed on the title page of this manual is a microfiche part number that can be used to order 4 x 6 inch microfilm transparencies of the manual. Each microfiche contains up to 60 photo-duplicates of the manual pages. The microfiche package also includes the latest manual changes supplement as well as all pertinent service notes. To order an additional manual, use the part number listed on the title page of this manual.

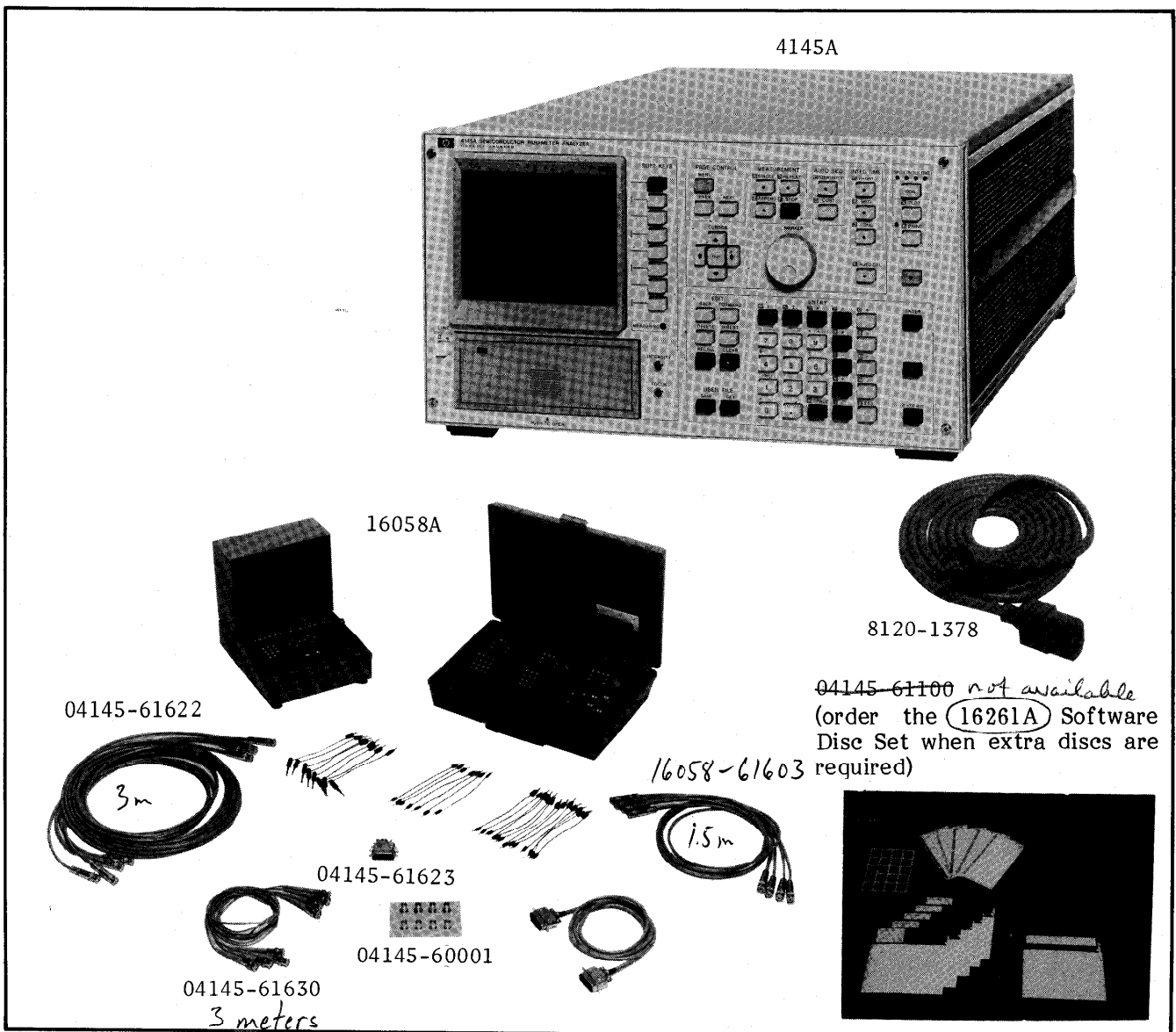

1m => 16053-61003

Figure 1-1. Model 4145A and Accessories.

1-4. DESCRIPTION

1-5. The Hewlett-Packard Model 4145A Semiconductor Parameter Analyzer is a fully automatic, high performance, programmable test instrument designed to measure, analyze, and graphically display the DC characteristics of a wide range of semiconductor devices, such as diodes, bipolar transistors, field-effect transistors, wafers, ICs, etc. Main applications include computer-aided design (CAD) of ICs, new device evaluation, materials evaluation, component selection for circuit design, incoming/outgoing inspection, semiconductor process control, quality control, and quality assurance. It is equipped with four programmable stimulus/measurement units (SMU), two programmable voltage source units (Vs), two voltage monitor units (Vm), a fully interactive graphics display, removable flexible-disc storage, softkeys, full arithmetic keyboard, and HP-IB. And it can be used on the bench or as part of a complete measurement system in the laboratory or on the production line.

1-6. For device stimulation and characteristics measurement, the 4145A has eight channels. Channels 1 through 4 are stimulus/measurement units (SMU); channels 5 and 6 are voltage source units (Vs); and channels 7 and 8 are voltage monitor units (Vm).

Each SMU channel has three modes of operation: voltage source/current monitor (V), current source/voltage monitor (I), and common (COM). Source voltage and source current can be held constant or swept linearly or logarithmically. When used as a voltage source/current monitor (V mode), each SMU can be programmed to output DC voltages from 0V to $\pm 100V$ over three ranges—0V to $\pm 19.999V$, $\pm 20V$ to $\pm 39.998V$, and $\pm 40V$ to $\pm 100V$ --with a resolution of 1mV, 2mV, and 5mV, respectively. When used as a current source/voltage monitor (I mode), each SMU can be programmed to output currents from $\pm 1pA$ to $\pm 100mA$ over nine ranges, with a resolution of 1pA max. (current measurement resolution is 50fA max.), depending on the current range. Current through the sample in V mode and voltage across the sample in I mode can be limited to prevent damage to the sample.

The two Vs channels are programmable voltage sources. Output voltage can be held constant or linearly or logarithmically swept from 0V to $\pm 20V$ with 1mV resolution. The voltage sources are used when many bias and voltage sources are required.

Of the six source channels (four SMUs, two Vs), any combination of three can be automatically swept in a linear or logarithmic staircase manner within the range of each channel. Hold times from 0 to 650 seconds and delay times from 0 to 6.5 seconds can be programmed. In a multi-channel sweep setup, one channel functions as the main sweep channel. One of the other channels can be swept synchronously with the main channel, while one other channel can be swept subordinately to the main channel. SMUs not swept can be used as constant current or constant voltage sources.

The two Vm channels are used to measure voltages up to $\pm 20V$.

1-7. Measurement results, measurement setups, operator prompts, error messages, and diagnostics are displayed on a fully interactive, microprocessor based graphics display. Measurement results can be displayed in one of four modes: graphic, list, matrix, and schmoo. Front Panel softkeys provide a wide range of automatic display control functions, such as AUTO SCALE, STORE, RECALL, CURSOR, MARKER, vertical and horizontal ZOOM, LINE (two), GRAD, 1/GRAD, X intercept, Y intercept, and INTERPOLATE. Softkeys are used in all phases of instrument operation—from measurement setup to measurement analysis—and make overall instrument operation quick and easy.

By pressing the PLOT key or PRINT key, the presently displayed screen, whether a measurement result or measurement setup, can be dumped directly onto an HP-IB compatible printer/plotter, providing clear, inexpensive hard copies. The plot area is user selectable within the limits of the printer/plotter, and if a multi-pen plotter is used, multi-color plots can be made automatically. All PLOT and PRINT operations are done automatically, without a controller. Also, the 4145A's display is equipped with X-Y-Z outputs to allow connection of a large-screen graphics display.

The 4145A is fluent in HP-GL (Hewlett-Packard Graphics Language), permitting external control of its display via the HP-IB.

Cursor and marker positioning is user controllable via the front panel, and X-Y1-Y2 coordinates are digitally displayed on the CRT.

1-8. The 4145A is equipped with a flexible-disc drive unit that accommodates a single-sided, single-density, 13.3cm (5.25 in.), 92K byte disc. One cleaning disc and five work-discs—each containing the necessary operating system software, four general purpose measurement programs, and 36.6K bytes of user area—are furnished with the 4145A. Up to 47 measurement setup programs or 11 sets of measurement data, plus auto sequence programs, can be stored (SAVE) in the user area and recalled (GET) later. Additional discs can be purchased to increase storage capability, and the entire user area of each disc can be quickly copied.

1-9. All instrument functions are handled by a high speed microprocessor, under the control of the operating system software stored on each furnished flexible disc. Measurement setup, display mode selection, graphic scaling, diagnostics, operation guide, menu, and catalog are arranged as individual display pages. Paging is controlled by the MENU, PREV, and NEXT keys. Instructions, softkey labels, and error messages and codes are displayed on each page. Also, the 4145A is remotely controllable via the HP-IB and the 4145A's display can be used as an independent display via the HP-IB.

1-10. Furnished with the 4145A is the 16058A, a specially designed shielded test fixture which connects to the 4145A's rear panel. Eight different interchangeable DUT boards are provided, allowing measurement of diodes; 3-terminal and 4-terminal transistors; 8-pin, 10-pin, and 12-pin devices; and 18-pin and 24-pin DIP ICs. The 16058A is equipped with a light-shielded lid to allow stable measurement of light-sensitive devices, such as photo diodes, photo transistors, and photo resistors. Also, to insure operator safety when potentially dangerous voltages are applied to a sample, a warning will be displayed on the 4145A if the test fixture lid is open and measurement will not be made until the lid is closed. For user-fabricated test fixtures and jigs, a special connector, four 3-meter triaxial cables, and four 3-meter coaxial cables are also furnished.

1-11. SPECIFICATIONS

1-12. Complete specifications of the Model 4145A Semiconductor Parameter Analyzer are given in Table 1-1. These specifications are the performance standards or limits against which the instrument is tested. The test procedures for the specifications are covered in Section IV, Performance Tests. Table 1-2 lists Reference Data. Reference Data are not specifications but are typical characteristics included as additional information for the operator. When the 4145A Semiconductor Parameter Analyzer is shipped from the factory, it meets the specifications listed in Table 1-1.

1-13. SAFETY CONSIDERATIONS

1-14. The Model 4145A Semiconductor Parameter Analyzer has been designed to conform to the safety requirements of an IEC (International Electromechanical Committee) Safety Class I instrument and is shipped from the factory in a safe condition.

1-15. This operation and service manual contains information, cautions, and warnings which must be followed by the user to ensure safe operation and to maintain the instrument in a safe condition.

1-16. INSTRUMENTS COVERED BY MANUAL

1-17. Hewlett-Packard uses a two-section nine character serial number which is stamped on the serial number plate (Figure 1-2) attached to the instrument's rear-panel. The first four digits and the letter are the serial prefix and the last five digits are the suffix. The letter placed between the two sections identifies the country where the instrument was manufactured. The prefix is the same for all identical instruments; it changes only when a change is made to the instrument. The suffix, however, is assigned sequentially and is different for each instrument. The contents of this manual apply to instruments with the serial number prefix(es) listed under SERIAL NUMBERS on the title page.

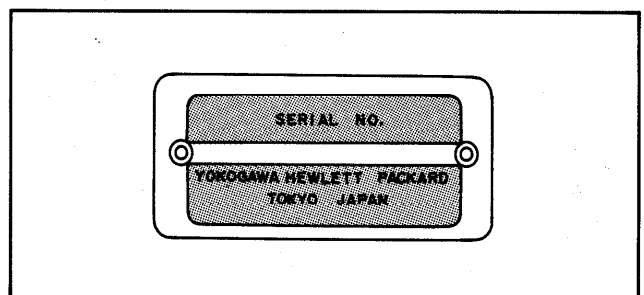

Figure 1-2. Serial Number Plate.

1-18. An instrument manufactured after the printing of this manual may have a serial number prefix that is not listed on the title page. This unlisted serial number prefix indicates the instrument is different from those described in this manual. The manual for this new instrument may be accompanied by a yellow Manual Changes supplement or have a different manual part number. This supplement contains "change information" that explains how to adapt the manual to the newer instrument.

1-19. In addition to change information, the supplement may contain information for correcting errors (called Errata) in the manual. To keep this manual as current and accurate as possible, Hewlett-Packard recommends that you periodically request the latest Manual Changes supplement. The supplement for this manual is identified with the manual print date and part number, both of which appear on the manual's title page. Complimentary copies of the supplement are available from Hewlett-Packard. If the serial prefix or number of an instrument is lower than that on the title page of this manual, see Section VII, Manual Changes.

1-20. For information concerning a serial number prefix that is not listed on the title page or in the Manual Change supplement, contact the nearest Hewlett-Packard office.

1-21. OPTIONS

1-22. Options are modifications to the standard instrument that implement the user's special requirements for minor functional changes. The 4145A has four options:

- Option 907 : Front Handle Kit.
Furnishes Carrying handles for both ends of front-panel.
- Option 908 : Rack Frange Kit.
Furnishes flanges for rack mounting for both ends of front-panel.
- Option 909 : Rack Flange and Front Handle Kit. Furnishes both front handles and rack flanges for instrument.
- Option 910 : An extra copy of the Operation and Service Manual.

Installation procedures for these options are given in Section II.

1-23. ACCESSORIES SUPPLIED

1-24. The Model 4145A Semiconductor Parameter Analyzer, along with its furnished accessories, is shown in Figure 1-1. The Additionally, a spare fuse (HP Part No. 2110-0015 or 2110-0305) and an Operation and Service Manual (HP Part No. 04145-90000) are furnished with the 4145A.

1-25. ACCESSORIES AVAILABLE

1-26. The Model 16261A Software Disc Set, containing five software discs, is available when extra discs are required.

1-27. Warranty Limitation for Accessories

1-28. The Personality Board (P/N: 16058-60003) and eight Boards (P/N: 16058-60004 through 16058-60011) furnished with the 16058A Test Fixture are warranted against defects in material and workmanship for a period of three months from the date of delivery. During the warranty period, Hewlett-Packard Company will, at its option, either repair or replace components which prove to be defective. This warranty does not apply to defects resulting from improper use or inadequate maintenance.

Table 1-1. Specifications (Sheet 1 of 8)

* Specifications listed below are for the 4145A only. For 16058A specifications, refer to the 16058A Operation Note.

GENERAL INFORMATION

Basic Functions : Measures the DC current through voltage-biased devices and the DC voltage across current-biased devices; Arithmetic calculation; Displays measurement results and calculation results on a built-in CRT display; graphics analysis capabilities; storage and recall of measurement setups, measurement data, and auto-sequence programs.

Source and Measurement Units :

Stimulus/Measurement Units (SMU) : Four SMU channels. Each SMU can be programmed to function as a variable or constant DC voltage source/current monitor or as a variable or constant DC current source/voltage monitor.

Voltage Sources (Vs) : Two Vs channels. Each Vs can be programmed to function as a variable or constant DC voltage source.

Voltage Monitors (Vm) : Two Vm channels. Each Vm can measure DC voltages up to $\pm 20V$.

SOURCE/MEASUREMENT FUNCTIONS

Measurement and output accuracies are specified at $23 \pm 5^\circ C$ after the instrument has been allowed to warm up for at least 40 minutes, with AUTO CAL set to ON, INTEG TIME set to SHORT and referenced to SMU common. Specified accuracy doubles for operation between $10^\circ C$ and $40^\circ C$.

Stimulus/Measurements Units (SMU) : Four SMU channels. Each SMU measures current when operating as a voltage source, or measures voltage when operating as a current source. Source and measurement ranges, resolution, and accuracy specifications are given in the tables below.

Accuracy specifications in the below tables are given as $\pm n\%$ of specified output or measured value, $\pm n\%$ of range value. I_o is output current (I), V_o is output voltage (V).

Voltage Range	Resolution	Accuracy	Max. Current
$\pm 20V$	1mV	0.1%+0.05%+0.4 Ω * I_o	100mA
$\pm 40V$	2mV		50mA
$\pm 100V$	5mV		20mA

Table 1-1. Specifications (Sheet 2 of 8)

Current Range	Resolution	Accuracy	Max. Voltage
±100mA	100μA	0.3%+(0.1+0.2*Vo/100)%	20V (>50mA)
			40V (>20mA)
±10mA	10μA		100V (≤20mA)
±1000μA	1μA		
±100μA	100nA		
±10μA	10nA		
±1000nA	1nA		
±100nA	100pA		0.5%+(0.1+0.2*Vo/100)%
±10nA	10pA		1%+(0.1+0.2*Vo/100)%+5pA
±1000pA	1pA		

Setting Resolution : Voltage, 4·1/2 digits (1mV max.);
Current, 4 digits (1pA max.).

Measurement Resolution : Voltage, 4·1/2 digits (1mV max.);
Current, 4 digits (50fA max.).

Ranging : Automatic.

Current/Voltage Limiting (Compliance) : Current output from an SMU operating as a voltage source and voltage output from an SMU operating as a current source can be limited.

Compliance Range : Current, 50pA to maximum allowable output current of each voltage range; Voltage, 0V to maximum allowable output voltage of each current range.

Accuracy: Current compliance, accuracy of current source+1% of range +10pA;
Voltage compliance, accuracy of voltage source.

Residual Resistance (Voltage Source/Current Measurement Mode) : 0.4Ω.

Input Resistance (Current Source/Voltage Measurement Mode) : ≥10¹²Ω.

Capacitive Load : ≤1000pF.

Table 1-1. Specifications (Sheet 3 of 8)

Voltage Sources (Vs) : Two Vs channels. Each Vs can be programmed to function as a variable or constant DC voltage source. Output ranges, resolution, and accuracy specifications are given in the table below.

Output Voltage Range	Resolution	Accuracy	Max. Output Current
±20V	1mV	0.5% of setting +10mV	10mA

Output Impedance : Less than 0.2Ω

Capacitive Load : $\leq 1000\text{pF}$

Voltage Monitors (Vm) : Two Vm channels. Output ranges, resolution, and accuracy specifications are given in the table below.

Measurement Voltage Range	Resolution	Accuracy
±2V	100 μ V	0.5% of reading + 10mV
±20V	1mV	0.2% of reading + 10mV

Input Impedance : $1\text{M}\Omega \pm 1\%$

Capacitance in Parallel with Output : $150\text{pF} \pm 10\%$

Table 1-1. Specifications (Sheet 4 of 8)

SPECIFICATIONS COMMON TO ALL CHANNELS

Maximum Withstand Voltage : 100V (SMU, guard terminal, Vs, and Vm)

Maximum Voltage Between Common and GND : Less than $\pm 42V$.

Source Modes (SMUs Only) : V (voltage source/current monitor),
I (current source/voltage monitor), and COM*.

Source Functions (SMUs Only) : VAR1, staircase sweep;
VAR1', synchronous (VAR1) staircase sweep;
VAR2, subordinate (VAR1) staircase sweep;
CONST, constant source (voltage or current).

* : In COM mode, output voltage is 0V and compliance is 105mA.

Voltage/Current Sweep : Output from each SMU (voltage or current) and each Vs (voltage) can be swept by assigning source function VAR1, VAR1', or VAR2.

Max. Number of Steps : 512 in single-sweep measurements, up to 575 in multi-sweep measurements.

VAR1 : Main sweep. Linear or logarithmic sweep is selectable.

Linear Sweep : Staircase sweep in accordance with the user specified START, STOP, and STEP values.

Log Sweep : Staircase sweep in accordance with the user specified START and STOP values and selected LOG step (10, 25, or 50 points per decade).

VAR2 : Subordinate linear staircase sweep in accordance with the user specified START, STEP, and NO. OF STEPS values. VAR2 source channel output is incremented one STEP each time the VAR1 source channel completes one sweep.

VAR1' : Staircase sweep synchronized with the VAR1 sweep. Sweep is made with a user specified, fixed ratio or offset value. VAR1' output is calculated as :

$$\begin{aligned} \text{VAR1}' &= a \times \text{VAR1} \text{ (fixed ratio)} \\ \text{VAR1}' &= b + \text{VAR1} \text{ (fixed offset)} \end{aligned}$$

where "a" is the user-specified ratio (from ± 0.01 to ± 10) and "b" is the user-specified offset value. Ratio and offset must be such that the VAR1' source channel does not exceed its maximum output limit.

HOLD TIME : 0 to 650 seconds, 10ms resolution (max.). Accuracy is $\pm 0.5\% + 9\text{ms}$.

DELAY TIME : 0 to 6.5 seconds, 1ms resolution. Accuracy is $\pm 0.1\% + 5xN$ for GRAPHICS and SCHMOO plots and $\pm 0.1\% + 10xN$ for LIST and MATRIX displays. Where N is the number of measurement channels used in the measurement.

Output Sequence : The order in which the source channels begin output is fully programmable.

Measurement Modes : SINGLE, REPEAT, APPEND

Integration Time (at each measurement point) : SHORT, 3.6ms; MED, 20ms at 50Hz line frequency, 16.7ms at 60Hz line frequency; LONG, 16 times MED.

Table 1-1. Specifications (Sheet 5 of 8)

DISPLAY FUNCTIONS

Display : CRT. Electrostatic focus and deflection, post accelerated. Aluminized P-31 phosphor.

Screen Size : 16cm (6.25in) diagonal.

Screen Resolution : 2048 x 2048 points.

Display Characters and Symbols : Upper-case alphabetic characters, numerics, comma, (,), @, Ω, ° (deg), ", %, #, q, k, e, m, μ, n, p, +, -, *, /, √, Δ. All are entered from the front panel.

Display Modes : GRAPHICS, LIST, MATRIX, SCHMOO, and TIME DOMAIN.

GRAPHICS Display : Two-axes (X-Y) or three-axes (Y-Y₁-Y₂) plot of measured parameters and USER FUNCTION calculations.

LIST Display : Used in conjunction with VAR1 sweep. Up to six measurement parameters and USER FUNCTION results can be displayed for each step of the VAR1 source channel.

MATRIX Display : Used in conjunction with VAR1 and VAR2 sweeps. Up to six columns of sweep-dependent measurement results or USER FUNCTION results can be displayed.

SCHMOO Display : Used in conjunction with VAR1 and VAR2 sweeps. Sweep-dependent measurement results or calculation results are displayed on an X-Y-Z graph.

TIME DOMAIN Display : Measurement and calculation results are displayed on a two-axes (X-Y) or three-axes (X-Y₁-Y₂) graph as a function of time. VAR1 sweep is replaced by time.

Parameters : Initial Wait Time, 0 to 100 seconds (10ms resolution); Measurement Interval, 10ms to 10 seconds (10ms resolution); Number of Readings, 512.

Table 1-1. Specifications (Sheet 6 of 8)

ARITHMETIC AND ANALYSIS FUNCTIONS

Arithmetic Functions : Arithmetic expressions can be entered and executed directly from the front panel. Results are displayed on the CRT.

Arithmetic Operators : +, -, *, /, $\sqrt{\quad}$, EXP (Napierian constant), LOG (common log), LN (natural log), ** (exponentiation), ABS (absolute), EEX (scientific notation), and Δ (differential calculation).

Keyboard Operation : Arithmetic expressions are executed by pressing the EXECUTE key. Results are displayed on the CRT.

USER FUNCTION : Up to two USER FUNCTION can be defined as arithmetic expressions. USER FUNCTIONS are executed during measurement and the results are displayed with measurement results.

Physical Constants : Three commonly used physical constants are permanently stored in memory. The stored value of each constant has seven-digit accuracy but only the five most significant digits are displayed.

q : Electron Charge, 1.602189×10^{-19} C

k : Boltzmann's Constant, 1.380662×10^{-23} J/°K

e : Dielectric Constant of vacuum, 8.854185×10^{-12} F/m.

Engineering Units : m (10^{-3}), μ (10^{-6}), n (10^{-9}), p (10^{-12})

Analysis Functions :

Overlay Graph Comparison : A GRAPHIC plot can be stored and later recalled to obtain an overlay comparison of two measurements. A SCHMOO plot can also be stored, but when the RECALL key is pressed, only the stored plot is displayed. Pressing RECALL a second time redisplay the previous plot. Only one set of data can be stored and scaling information is not included.

Auto Retrieve Function : Measurement data obtained in any display mode is automatically redisplayed whenever the display mode is changed. However, when the value of a measurement setup parameter is changed, all measurement data is cleared.

MARKER : On a GRAPHICS plot, the MARKER can be moved along a plotted curve or line. The X, Y_1 , and Y_2 coordinates at the MARKER location are digitally displayed on the CRT.

INTERPOLATE : Allows positioning of the MARKER between two measurement points. The X, Y_1 , and Y_2 coordinates at the MARKER location are estimated and digitally displayed on the CRT.

CURSOR : On a GRAPHICS plot, the CURSOR is two intersecting and perpendicular lines which can be positioned at any point on the graph. There are two GRAPHICS cursors : LONG and SHORT. The X, Y_1 , and Y_2 coordinates at the CURSOR location are digitally displayed on the CRT.

On a SCHMOO plot the CURSOR highlights the symbol at a measurement point and only the Z-axis value is digitally displayed on the CRT.

On LIST and MATRIX displays the CURSOR is a moveable pointer (\blacktriangleright).

Table 1-1. Specifications (Sheet 7 of 8)

AUTO SCALE : GRAPHIC plots can be automatically rescaled after measurement, providing optimum display of measurement results.

ZOOM Function (\leftrightarrow , \rightarrow , \updownarrow , \updownarrow) : Used in conjunction with the CURSOR on GRAPHIC plots. Expands (\leftrightarrow , \updownarrow) or contracts (\rightarrow , \updownarrow) the graph in the indicated direction and in reference to the CURSOR location.

MOVE WINDOW : Repositions the LONG or SHORT CURSOR to the exact center of the plot area and moves displayed plots in reference to the CURSOR.

LINE : Draws a straight line between two moveable cursors. X and Y axes intercepts are digitally displayed, as are the line gradient (GRAD) and gradient reciprocal (1/GRAD) values.

MASUREMENT/DISPLAY SETUP AND STORAGE FUNCTIONS

Measurement/Display Setup : Interactive fill-in-the-blank programming of channel definitions, source outputs, and measurement/display modes.

Measurement Setup Storage : The existing measurement setup can be stored in the user-area on the flexible disc and recalled later by using the SAVE and GET keys, respectively.

Measurement Data Storage : The existing measurement results can be stored in the user-area on the flexible disc and recalled later by using the SAVE and GET key, respectively.

Auto-Sequence Program : A series of different measurements can be programmed for automatic execution. The maximum number of program steps is 24, and useable commands are GET, SINGLE, SAVE D, PLOT, PRINT, PAUSE, WAIT, and PAGE.

Storage Medium : 5.25 in. single-sided, single-density, soft-sectored mini flexible disc.

User-Area : 92K bytes.

Number of User Records : 131

Record Allocation : Measurement setup (file type P), 3 records;
Measurement data (file type D), 12 records;
Auto-sequence program (file type S), 1 record.

Table 1-1. Specifications (Sheet 8 of 8)

GENERAL SPECIFICATIONS

Data Input/Output :

External CRT Analog Output : From 0 to +1 Vdc, X and Y outputs (in series with approx. 330 Ω) Z output (in series with approx. 240 Ω), via rear panel BNC connectors. Frequency Bandwidth, DC - 2MHz.

External Plotter/Printer Output : Measurement data and all data appearing on the CRT may be output via the HP-IB to an HP plotter/printer operated in the LISTEN ONLY Mode. Output is initiated using the PLOT or PRINT key.

HP-GL Control : The CRT of the 4145A may be program controlled in the Graphics Display Mode via an HP-IB compatible Controller.

HP-IB and Remote-Control Functions : The 4145A may be interfaced to any HP controller or other instrument having HP-IB interface capability. (HP-IB is Hewlett-Packard's implementation of IEEE-488 and ANSI-MC.1.1 standards.)

Self-Test Function : At power ON, the 4145A automatically verifies its own operational status. HP-IB and DIAGNOSTICS page allow Self-Test to be performed at any time.

Operating Temperature Range: 10 °C to +40 °C; \leq 70% RH (40 °C)
Permissible Temperature Change: \leq 1 °C/5 min.;
Maximum Wet-bulb temperature : 29 °C

Power Requirements : 100/120/220V \pm 10% : 240V -10% + 5%;
48 - 66Hz; Max. 270VA

Dimensions : 426W x 235H x 612D (mm) (approx.)

Weight : Approx. 27kg
Approx. 33kg (including accessories)

Table 1-2. Reference Data (Sheet 1 of 3)

REFERENCE DATA

(The following information is reference data only. It is not guaranteed specifications, nor does it include Test Fixture specifications.)

Measurement Time : (Response time + ranging time + integration time)/1 point measurement

Response Time : The following calculation is applicable where current range does not change (settling and set-up time + SMU wait time).

Current Range	Settling and Set-Up Time	SMU Wait Time
100nA - 100mA	2.7ms	0.2ms
1nA - 10nA		47.5ms

Ranging Time : 4ms - 74ms (depending on range)

Measurement Time : (Ranging time must be added.)

Settling and Set-Up Time	Delay Time	SMU Wait Time	Ranging Time	Integration Time
← 2.7ms →	Setting Value	0.2ms or 47.5ms	4ms ? 74ms	3.6ms ? 320ms

Example : Minimum measurement time = 2.7ms + 0.2ms + 3.6ms = 6.5ms. In the Graphics Display Mode, write time (≥5.6ms) must be added.

	60Hz	50Hz
Long	267	320
Med	16.7	20
short	3.6	
	(ms)	(ms)

Table 1-2. Reference Data (Sheet 2 of 3)

STIMULUS/MEASUREMENT UNIT (SMU)

Offset Current when operated as a Voltmeter : $6\text{pA} + 2\text{pA} \times V_o/100$

Offset Voltage when operated as a Current Meter : $10\text{mV} + 0.4\Omega \times I_o$

Noise Characteristics : (all values typical)

Voltage Source Noise : 0.01% of range (RMS)

Current Source Noise : 0.1% of range + $3\text{pA} + 0.01\text{pA} \times C_g$ (RMS)

(C_g : Guard capacitance in pF)

Voltage Monitor : 0.02% of range (peak-to-peak)

Current Monitor : 0.3% of range + 10pA

(peak-to-peak)

Output Overshoot : (all values typical)

Voltage Source Overshoot : 5mV

Current Source Overshoot : 1% or less

Current Range Switching Transient Noise : (All values typical)

Range Increment : 0.01% of voltage range + 10mV

Range Decrement : When switching into 10nA or 1nA range, $10\text{mV} + 100/(10 + C_x)\text{mV}$ where C_x = load capacitance (pF); when switching into all other ranges, 10mV.

Guard Capacitance : $\leq 700\text{pF}$

Guard Potential Offset : 1mV (typical)

Guard Current Induced Potential Error : $100\Omega \times I_g$ (I_g = guard current)

Voltage Sources (V_s)

Output Noise : 6 mVrms (typical)

Voltage Monitors (V_m)

Noise Level : 0.3mVp-p at 2V-range (when Integration time is set to MED or LONG), 3mVp-p at 20V range.

REFERENCE DATA COMMON TO ALL UNITS

Noise Rejection : (Integration time set to MED or LONG.)

Normal Mode Rejection : $\geq 60\text{dB}$ (typical)

Common Mode Rejection : (all values typical)

Current Source/Measurement : $\leq 1\text{pA}/1\text{V}$

Table 1-2. Reference Data (Sheet 3 of 3)

ACCESSORIES FURNISHED WITH 4145A

16058A Test Fixture (includes the following subcomponents)

- 16058-60003 Personality Board
- 16058-60004 PTFE Blank Board
- 16058-60005 Socket Board (Transistor)
- 16058-60006 Socket Board (24-pin DIP)
- 16058-60007 Socket Board (18-pin DIP)
- 16058-60008 Socket Board (Diode)
- 16058-60009 Socket Board (8-pin package)
- 16058-60010 Socket Board (10-pin package)
- 16058-60011 Socket Board (12-pin package)
- 16058-61600 Connection Cable (large-to-small), 12 ea.
- 16058-61601 Connection Cable (small-to-small), 8 ea.
- 16058-61602 Miniature Clip Lead, 8 ea.
- 16058-61603 Triaxial Cable (1.5m), 4 ea.
- 16058-61604 Fixture System Cable
- 16058-60100 Accessory Case

22 pin Socket Board

16147-60001

INS/Judy
Nov 1984

28 pin Socket Board

16147-60002

- 04145-60001 Connector Plate
- 04145-61622 Triaxial Cable (3m), 4 ea.
- 04145-61630 BNC Cable (3m), 4 ea.
- 04145-61623 Shorting Connector
- 04145-61100 Software Discs (5 per box)
(including P/N 9164-0168 Head Cleaning Disc)

OPTIONS

- Option 907 : Front Handle Kit (HP P/N 5061-0091)
- Option 908 : Rack Flange Kit (HP P/N 5061-0079)
- Option 909 : Rack and Handle Kit (HPP/N 5061-0085)
- Option 910 : Extra Manual (HP P/N 04145-90000)

TRIAx TO BNC CABLE

85014-60002

@45

Table 1-3. Accessories Supplied (Sheet 1 of 5)

Configuration	Description	
	<p>16058A Test Fixture</p> <p>Shielded Test Fixture for measurement of discrete components. Equipped with safety lid.</p> <p>Following subcomponents are furnished with the 16058A.</p> <p>16058-60003 Personality Board 16058-61603 Triaxial Cables, 1.5m, 4 ea. 16058-61604 System Cable Socket Board/Connection Cable Set* (Contents are shown below.)</p>	
<p>* Socket Board/Connection Cable Set (included in the 16058A)</p> 		
No.	Dimension of Socket (Unit in mm)	HP P/N and Description
①		Blank PTFE board for measurement of high resistance devices.
②		Socket Board with two sockets. For measurement of four-pin devices, such as transistors.

Table 1-3. Accessories Supplied (Sheet 2 of 5)

No.	Dimension of Socket (Unit in mm)	HP P/N and Description
③		<p>16058-60006 : Socket Board for 24 pin DIP ICs.</p>
④		<p>16058-60007 : Socket Board for 18 pin DIP ICs.</p>
⑤		<p>16058-60008 : Socket Board with two pairs of sockets for measurement of axial lead devices such as diodes.</p>
⑥		<p>16058-60009 : Socket Board with an 8-pin socket.</p>
⑦		<p>16058-60010 : Socket Board with a 10-pin socket.</p>
⑧		<p>16058-60011 : Socket Board with a 12-pin socket.</p>

Table 1-3. Accessories Supplied (Sheet 3 of 5)

No.	Dimension of Socket (Unit in mm)	HP P/N and Description
9	Cable length : Approx. 115	16058-61600 : Connection Cable (large-to-Small) used for interconnecting the Personality Board to the Socket Board. Twelve cables are furnished.
10	Cable length : Approx. 115	16058-61601 : Connection Cable (small-to-small) used for interconnecting the Connection Switch to the Socket Board. Eight cables are furnished.
11	Cable length : Approx. 115	16058-61602 : Miniature Clip Lead used for direct connection to DUT. Eight leads are furnished.
12		16058-60100 : Carrying-case for all 16058A accessories.
Configuration		Description
		<p>Connector Plate (04145-60001) :</p> <p>Connector Plate for measurements made without the 16058A. For example, direct connection for a wafer probe. Dimensions are given below.</p> 

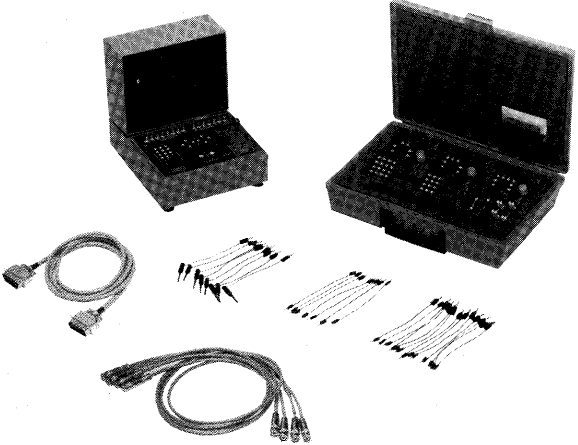
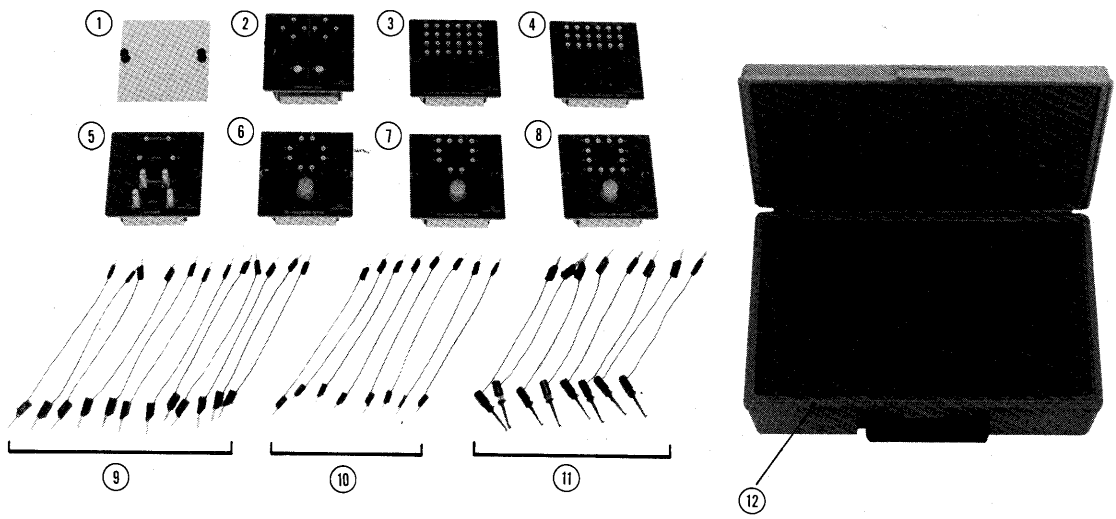
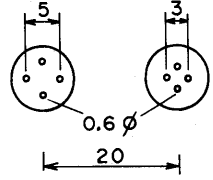
Table 1-3. Accessories Supplied (Sheet 4 of 5)

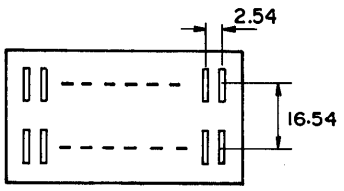
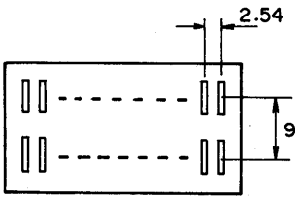
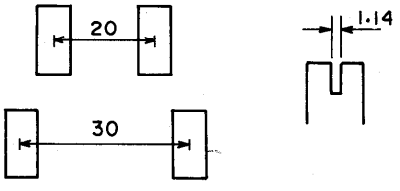
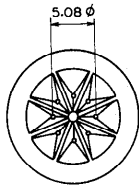
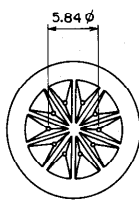
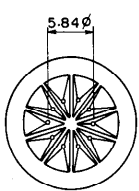

Configuration	Description
	<p>Three-meter triaxial (m) Cable (04145-61622):</p> <p>Triaxial (m) cable for connection between the 4145A's SMU terminals and the Connector Plate. Cable length is 3m. Four cables are furnished. Refer to Figure 3-35 for the usage.</p>
	<p>Three-meter BNC (m) Cable (04145-61630):</p> <p>BNC (m) cable for connection between the 4145A's Vs or Vm terminals and the Connector Plate. Cable length is 3m. Four cables are furnished. Refer to Figure 3-35 for the usage.</p>
	<p>Shorting Connector (04145-61623):</p> <p>Allows SMU output voltage to exceed $\pm 42V$ when the 16058A Test Fixture is not used. With the Shorting Connector connected to the System Cable connector on the rear panel, the instrument's fixture-lid-open detector is disabled, and the instrument assumes a fixture-lid-closed condition.</p> <p style="text-align: center;">WARNING</p> <p style="text-align: center;">A POTENTIAL SHOCK HAZARD EXISTS WHEN THE SHORTING CONNECTOR IS CONNECTED TO THE 4145A. DO NOT TOUCH THE OUTPUT TERMINAL OR INNER CONDUCTOR OF SMU DURING MEASUREMENT.</p>

Table 1-3. Accessories Supplied (Sheet 5 of 5)

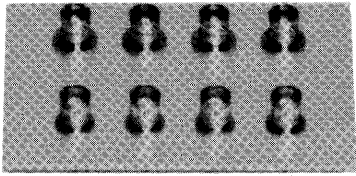
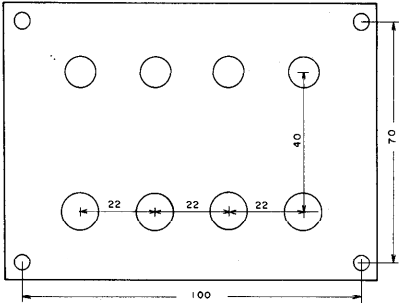
Configuration	Description
	<p style="text-align: right;"><i>16261A only available</i></p> <p>Software Discs (04145-61100):</p> <p>Disc set includes 5 Software Discs, Cleaning Disc (P/N: 9164-0168), labels, and write-protect tabs. If extra discs are required, order the 16261A Software Disc Set. It contains 5 software Discs.</p> <p style="text-align: center;">Note</p> <p>Software discs cannot be purchased individually.</p>

SECTION II INSTALLATION

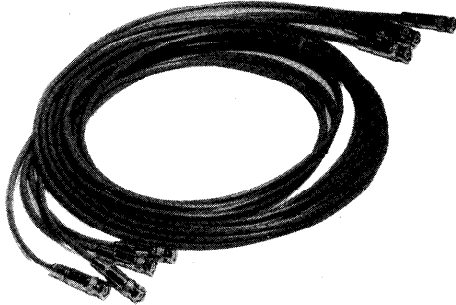
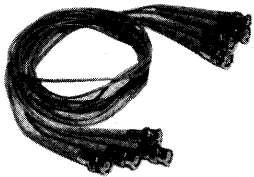
2-1. INTRODUCTION

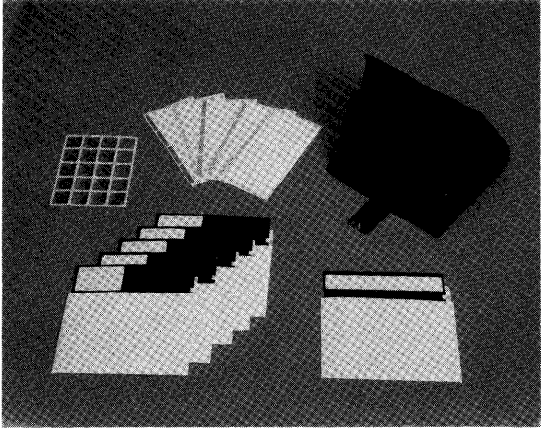
2-2. This section provides installation instructions for the Model 4145A Semiconductor Parameter Analyzer. This section also includes information on initial inspection and damage claims, preparation for using the 4145A, and packaging, storage, and shipment.

2-3. INITIAL INSPECTION

2-4. The 4145A Semiconductor Parameter Analyzer, as shipped from the factory, meets all the specifications listed in Table 1-1. Upon receipt, inspect the shipping container for damage. If the shipping container or cushioning material is damaged, it should be kept until the contents of the shipment have been checked for completeness and the instrument has been checked mechanically and electrically. The contents of the shipment should be as shown in Figure 1-1. The procedures for checking the general electrical operation are given in Section III (Paragraph 3-10 SELF TEST) and the procedures for checking the 4145A Semiconductor Parameter Analyzer against its specifications are given in Section IV. First, do the self test. If the 4145A is electrically questionable, then do the Performance Tests to determine whether the 4145A has failed or not.

If the contents are incomplete, if there is mechanical damage or defects (scratches, dents, broken switches, etc.), or if the performance does not meet the self test or performance tests, notify the nearest Hewlett-Packard office (see list at back of this manual). The HP office will arrange for repair or replacement without waiting for claim settlement.

2-5. PREPARATION FOR USE

2-6. POWER REQUIREMENTS

2-7. The 4145A requires a power source of 100, 120, 220 Volts ac $\pm 10\%$, or 240 Volts ac $+5\%-10\%$, 48 to 66Hz single phase; power consumption is 270VA maximum.

WARNING

IF THE INSTRUMENT IS TO BE ENERGIZED VIA AN EXTERNAL AUTOTRANSFORMER UNIT FOR VOLTAGE REDUCTION, BE SURE THAT THE COMMON TERMINAL IS CONNECTED TO THE NEUTRAL POLE OF THE POWER SUPPLY.

2-8. Line Voltage and Fuse Selection

CAUTION

BEFORE TURNING THE 4145A LINE SWITCH TO ON, VERIFY THAT THE INSTRUMENT IS SET TO THE VOLTAGE OF THE POWER TO BE SUPPLIED.

2-9. Figure 2-1 provides instructions for line voltage and fuse selection. The line voltage selection switch and the proper fuse are factory installed for 100 or 120 volts ac operation.

CAUTION

USE PROPER FUSE FOR LINE VOLTAGE SELECTED.

CAUTION

MAKE SURE THAT ONLY FUSES FOR THE REQUIRED RATED CURRENT AND OF THE SPECIFIED TYPE ARE USED FOR REPLACEMENT. THE USE OF MENDED FUSES AND THE SHORT-CIRCUITING OF FUSE-HOLDERS MUST BE AVOIDED.

2-10. LINE FREQUENCY FILTER

2-11. To reject the effects of line-frequency noise, set the FILTER switch on the rear panel to the frequency of the ac power source.

2-12. POWER CABLE

2-13. To protect operating personnel, the National Electrical Manufacturer's Association (NEMA) recommends that the instrument panel and cabinet be grounded. The Model 4145A is equipped with a three-conductor power cable which, when plugged into an appropriate receptacle, grounds the instrument. The offset pin on the power cable is the ground wire.

2-14. To preserve the protection feature when operating the instrument from a two contact outlet, use a three prong to two prong adapter (HP Part No. 1251-8196) and connect the grounding tab on the adapter to power line ground.

CAUTION

THE MAINS PLUG MUST ONLY BE INSERTED IN A SOCKET OUTLET PROVIDED WITH A PROTECTIVE EARTH CONTACT. THE PROTECTIVE ACTION MUST NOT BE NEGATED BY THE USE OF AN EXTENSION CORD (POWER CABLE) WITHOUT PROTECTIVE CONDUCTOR (GROUNDING).

2-15. Figure 2-2 shows the available power cords, which may be used in various countries including the standard power cord furnished with the instrument. HP Part number, applicable standards for power plug, power cord color, electrical characteristics and countries using each power cord are listed in the figure. If

assistance is needed for selecting the correct power cable, contact the nearest Hewlett-Packard office.

2-16. OPERATING ENVIRONMENT

2-17. Temperature. The instrument may be operated in temperatures from +10°C to +40°C.

2-18. Humidity. The instrument may be operated in environments with relative humidities to 70% at 40°C. However, the instrument should be protected from temperature extremes which cause condensation within the instrument.

2-19. INSTALLATION INSTRUCTIONS

2-20. The HP Model 4145A can be operated on the bench or in a rack mount. The 4145A is ready for bench operation as shipped from the factory. For bench operation a two-leg instrument stand is used. For use, the instrument stands are designed to be pulled towards the front of instrument.

2-21. Installation of Options 907, 908 and 909.

2-22. The 4145A can be installed in a rack and be operated as a component of a measurement system. Rack mounting information for the 4145A is presented in Figure 2-3.

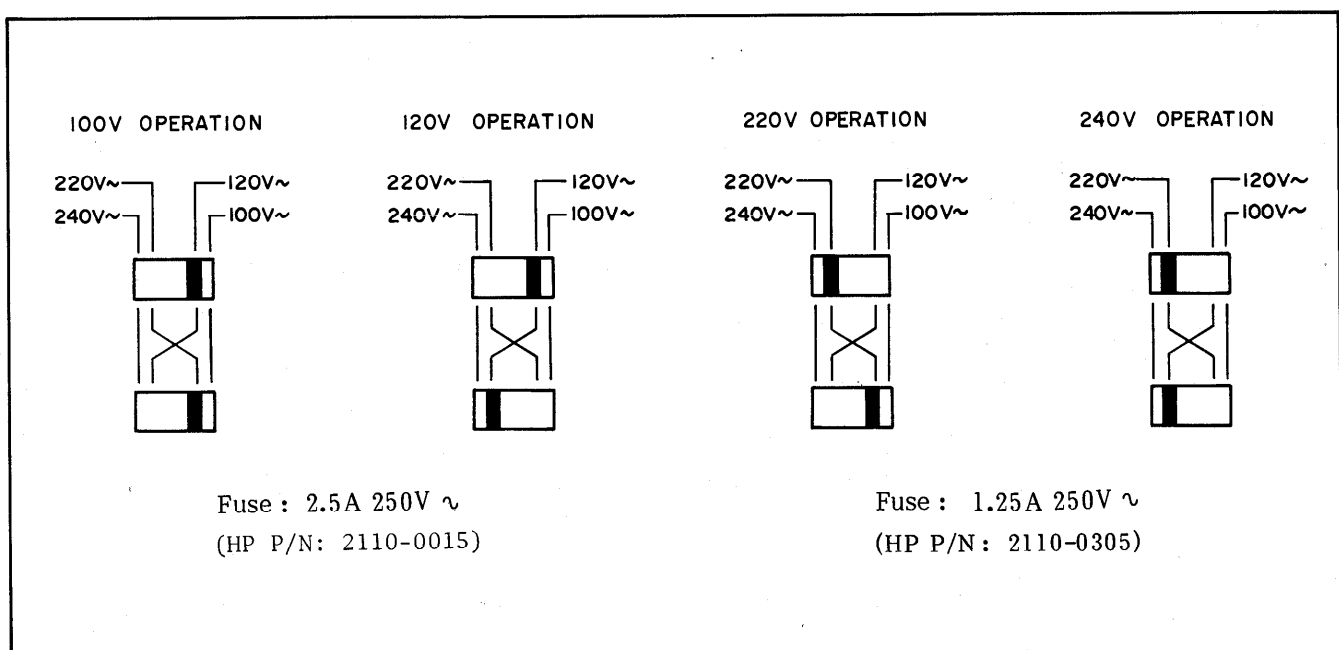

Figure 2-1. Voltage and Fuse Selection.

<p>OPTION 900 United Kingdom</p>  <p>Plug : BS 1363A, 250V Cable : HP 8120-1351</p>	<p>OPTION 901 Australia/New Zealand</p>  <p>Plug : NZSS 198/AS C112, 250V Cable : HP 8120-1369</p>
<p>OPTION 902 European Continent</p>  <p>Plug : CEE-VII, 250V Cable : HP 8120-1689</p>	<p>OPTION 903 U.S./Canada</p>  <p>Plug : NEMA 5-15P, 125V, 15A Cable : HP 8120-1378</p>
<p>OPTION 905* Any country</p>  <p>Plug : CEE 22-VI, 250V Cable : HP 8120-1396</p>	<p>OPTION 906 Switzerland</p>  <p>Plug : SEV 1011.1959-24507 Type 12, 250V Cable : HP 8120-2104</p>
<p>OPTION 912 Denmark</p>  <p>Plug : DHCR 107, 220V Cable : HP 8120-2956</p>	<p>* Plug option 905 is frequently used for interconnecting system components and peripherals.</p> <p>NOTE: Each option number includes a 'family' of cords and connectors of various materials and plug body configurations (straight, 90° etc.)</p>

Figure 2-2. Power Cables Supplied

2-23. STORAGE AND SHIPMENT

2-24. ENVIRONMENT

2-25. The instrument may be stored or shipped in environments within the following limits:

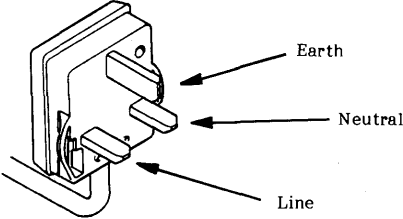
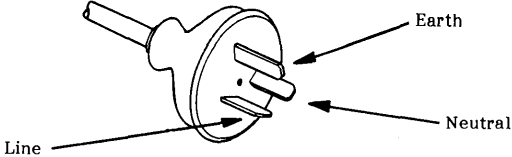
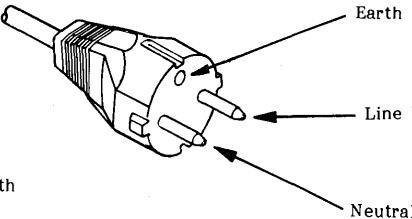
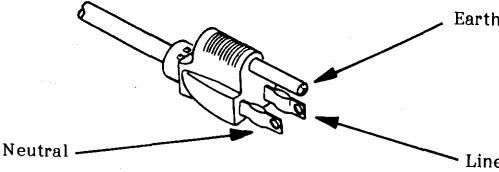
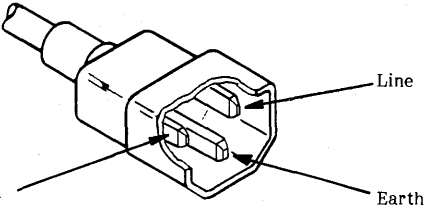
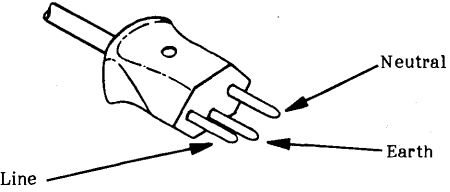
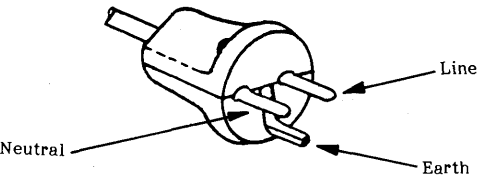
Storage:

Temperature -22 °C to +55 °C
(+4 °C to +50 °C with discs)

Humidity 8% to 80% (RH)

Shipment :

Temperature -40 °C to +62 °C
(-40 °C to +50 °C with discs)

Humidity 8% to 80% (RH)

The instrument should be protected from temperature extremes which cause condensation inside the instrument.

2-26. PACKAGING

2-27. Original Packaging. Containers and materials identical to those used in factory packaging are available from Hewlett-Packard. If the instrument is being returned to Hewlett-Packard for servicing, attach a tag indicating the type of service required, return address, model number, and full serial number. Also mark the container FRAGILE to assure careful handling. In any correspondence, refer to the instrument by model number and full serial number.

2-28. Other Packaging. The following general instructions should be used for re-packing with commercially available materials:

- a. Wrap instrument in heavy paper or plastic. If shipping to Hewlett-Packard office or service center, attach tag indicating type of service required, return address, model number, and full serial number.
- b. Use strong shipping container. A double-wall carton made of 350 pound test material is adequate.
- c. Use enough shock absorbing material (3 to 4 inch layer) around all sides of instrument to provide firm cushion and prevent movement inside container. Protect control panel with cardboard.

- d. Seal shipping container securely.
- e. Mark shipping container FRAGILE to ensure careful handling.
- f. In any correspondence, refer to instrument by model number and full serial number.

Option	Kit Part Number	Parts Included	Part Number	Q'ty	Remarks
907	Handle Kit 5061-0091	Front Handle Trim Strip X8-32 x 3/8 Screw	③ 5060-9901 ④ 5020-8898 2510-0195	2 2 6	9.525mm
908	Rack Flange Kit 5061-0079	Rack Mount Flange X8-32 x 3/8 Screw	② 5020-8864 2510-0193	2 6	9.525mm
909	Rack Flange & Handle Kit 5061-0085	Front handle Rack Mount Flange X8-32 x 3/8 Screw	③ 5060-9901 ⑤ 5020-8876 2510-0194	2 2 6	15.875mm

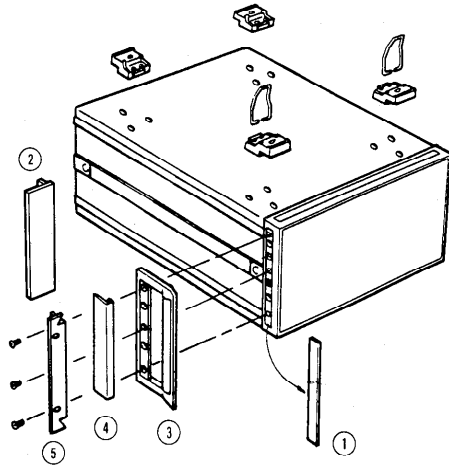

1. Remove adhesive-backed trim strips ① from side at right and left front of instrument.
2. HANDLE INSTALLATION : Attach front handle ③ to sides at right and left front of instrument with screws provided and attach trim ④ to handle.
3. RACK MOUNTING : Attach rack mount flange ② to sides at right and left front of instrument with screws provided.
4. HANDLE AND RACK MOUNTING : Attach front handle ③ and rack mount flange ⑤ together to sides at right and left front of instrument with screws provided.
5. When rack mounting (3 and 4 above), remove all four feet (lift bar at inner side of foot, and slide foot toward the bar).

Figure 2-3. Rack Mount Kit.

SECTION III OPERATION

3-1. INTRODUCTION

3-2. This section provides all the information necessary to operate the Model 4145A Semiconductor Parameter Analyzer. Included are descriptions of the front and rear panels, graphics display, lamps, and connectors; discussions on operating procedures and measuring techniques for typical applications; and instructions on the instruments self-test function and HP-IB capabilities. A breakdown of the contents of this section is given in Figure 3-1. Warnings and cautions are given throughout; they must be observed to insure operator safety and continued instrument serviceability.

TO A PROTECTIVE EARTH-GROUNDED SOCKET. ANY INTERRUPTION OF THE PROTECTIVE EARTH GROUNDING WILL CAUSE A POTENTIAL SHOCK HAZARD THAT COULD RESULT IN SERIOUS PERSONAL INJURY.

ONLY FUSES OF THE REQUIRED RATED CURRENT AND OF THE SPECIFIED TYPE SHOULD BE USED. DO NOT USE REPAIRED FUSES OR SHORTED FUSEHOLDERS. TO DO SO CAN CAUSE A SHOCK OR FIRE HAZARD.

WARNING

BEFORE THE INSTRUMENT IS TURNED ON, ALL PROTECTIVE EARTH TERMINALS, EXTENSION CORDS, AUTO-TRANSFORMERS AND DEVICES CONNECTED TO THE INSTRUMENT MUST BE CONNECTED

CAUTION

BEFORE THE INSTRUMENT IS TURNED ON, IT MUST BE SET TO THE VOLTAGE OF THE POWER SOURCE (MAINS), OR DAMAGE TO THE INSTRUMENT MAY RESULT.

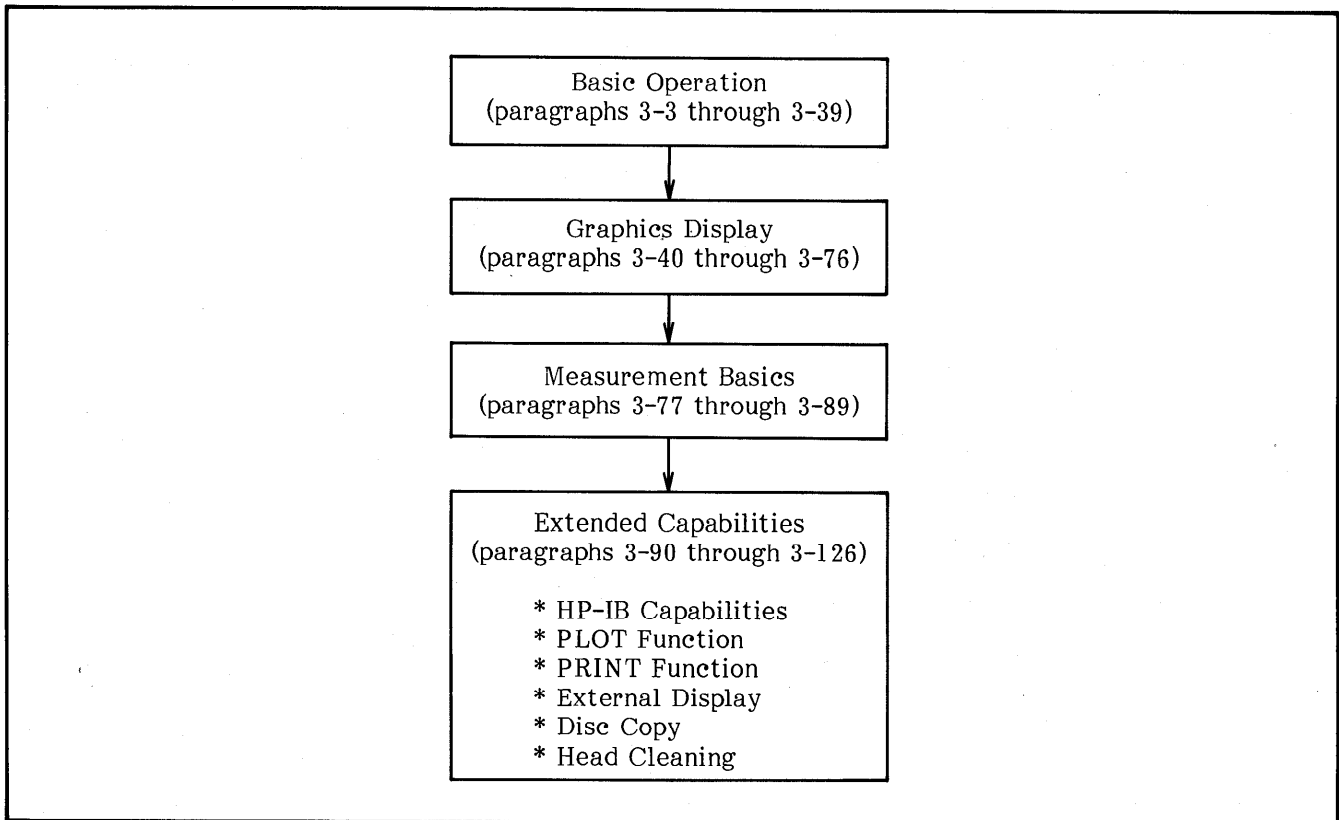
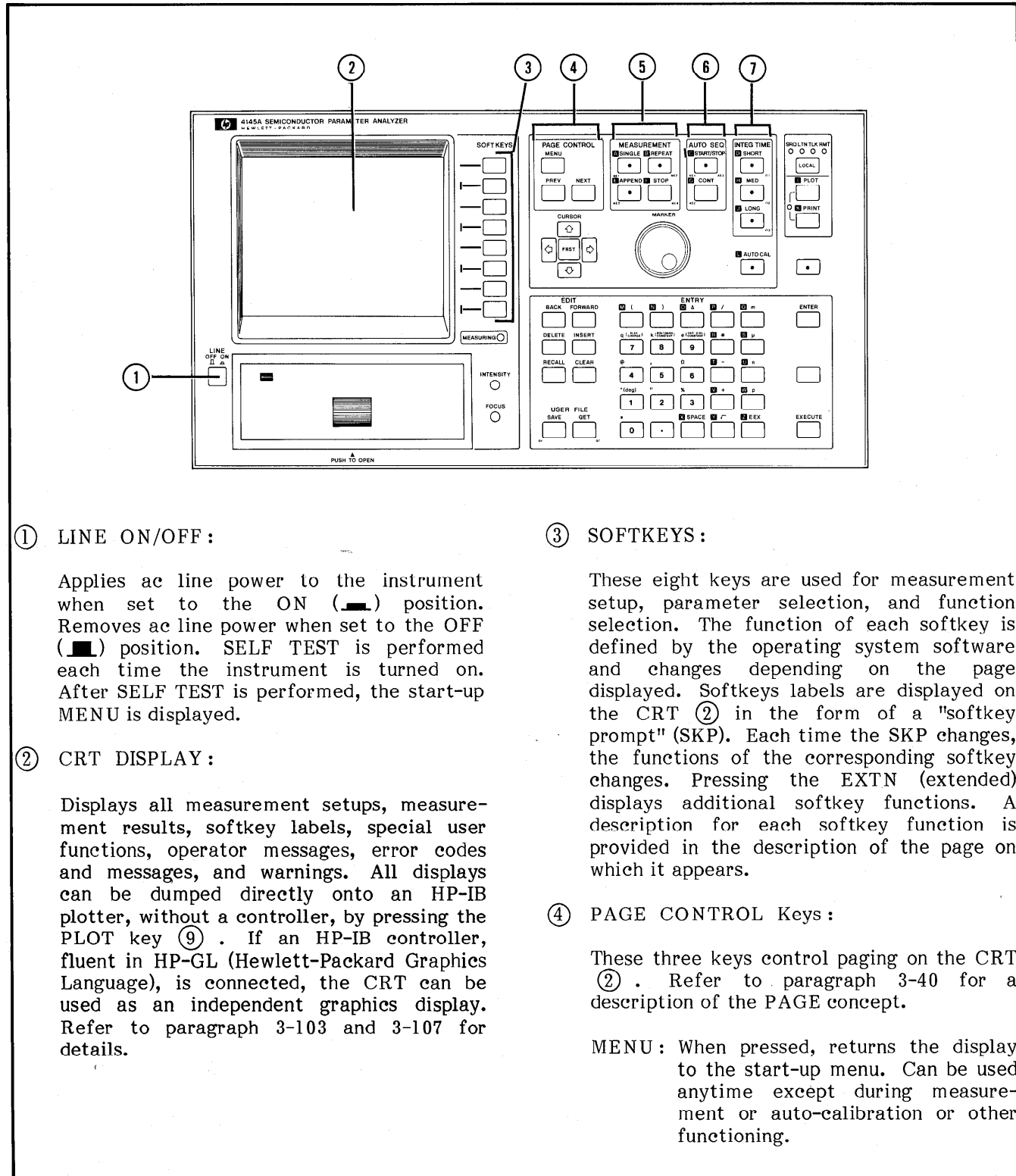

Figure 3-1. Contents of Section III.

3-3. PANEL FEATURES

3-4. The front and rear panels of the 4145A are briefly described in Figures 3-2 and 3-3, respectively. Detailed information is given starting in paragraph 3-5.



① LINE ON/OFF :

Applies ac line power to the instrument when set to the ON (■) position. Removes ac line power when set to the OFF (□) position. SELF TEST is performed each time the instrument is turned on. After SELF TEST is performed, the start-up MENU is displayed.

② CRT DISPLAY :

Displays all measurement setups, measurement results, softkey labels, special user functions, operator messages, error codes and messages, and warnings. All displays can be dumped directly onto an HP-IB plotter, without a controller, by pressing the PLOT key (9). If an HP-IB controller, fluent in HP-GL (Hewlett-Packard Graphics Language), is connected, the CRT can be used as an independent graphics display. Refer to paragraph 3-103 and 3-107 for details.

③ SOFTKEYS :

These eight keys are used for measurement setup, parameter selection, and function selection. The function of each softkey is defined by the operating system software and changes depending on the page displayed. Softkeys labels are displayed on the CRT (2) in the form of a "softkey prompt" (SKP). Each time the SKP changes, the functions of the corresponding softkey changes. Pressing the EXTN (extended) displays additional softkey functions. A description for each softkey function is provided in the description of the page on which it appears.

④ PAGE CONTROL Keys :

These three keys control paging on the CRT (2). Refer to paragraph 3-40 for a description of the PAGE concept.

MENU: When pressed, returns the display to the start-up menu. Can be used anytime except during measurement or auto-calibration or other functioning.

Figure 3-2. Front Panel Features (Sheet 1 of 6).

NEXT: Advances the display to the next page. Each time this key is pressed, the instrument checks the presently displayed page for any illegal settings, and if it detects any errors, it displays the corresponding error message and does not advance to the next page, or automatically changes the settings.

PREV: Returns the display to the previous page. Each time this key is pressed, the instrument checks the presently displayed page for any illegal settings.

⑤ MEASUREMENT Keys :

These keys start and stop the measurement. After all measurement conditions have been set and the GRAPHICS PLOT page, LIST DISPLAY page, MATRIX DISPLAY page, or SCHMOO PLOT page is displayed, measurement is started by pressing SINGLE, REPEAT, or APPEND. Measurement can be stopped by pressing STOP. Measurement is a sequential operation consisting of voltage or current sweep, measurement, and storage of the measurement result.

SINGLE: When this key is pressed, results of the previous measurement are erased from memory, the new measurement is made, and the results are stored in memory.

REPEAT: When this key is pressed, measurement is repeatedly made until STOP is pressed. Results of the previous measurement are updated during each new measurement.

APPEND: Functions similarly to the SINGLE key except that results of the previous measurement are not erased from memory of the CRT. Results of a measurement made using this key are stored in the remaining unused portion of memory and are displayed over (overlay plot) the previous plot. Measurement can be made using this key until "Buffer full" is displayed.

STOP: Immediately stops the measurements.

⑥ AUTO SEQ Key :

These keys start and stop the ASP (Auto Sequence Program) listed on the SETUP AUTO SEQUENCE page. Refer to paragraph 3-61 for details on Auto Sequence Programs.

START/STOP: Starts the ASP from line 1. If pressed during the ASP, the ASP stops immediately. Once stopped, the ASP cannot be continued from the stop point.

CONT: If the ASP contains a PAUSE statement, this key continues the program from the line immediately following the PAUSE statement.

⑦ INTEG TIME Keys :

These keys are used to select the digital integration time. When MED or LONG integration is selected, the integration time is an integral number of the line frequency period, eliminating line frequency noise. SHORT is the initial control setting. The integration time can be changed at any time, even during measurement.

SHORT: Measurement data is stored directly into memory without integration.

MED: Integration time is set to one line frequency period. Sixteen samples are taken at each measurement point.

LONG: Integration time is set to sixteen line frequency periods. A total of 256 samples are taken at each measurement point.

Figure 3-2. Front Panel Features (Sheet 2 of 6).

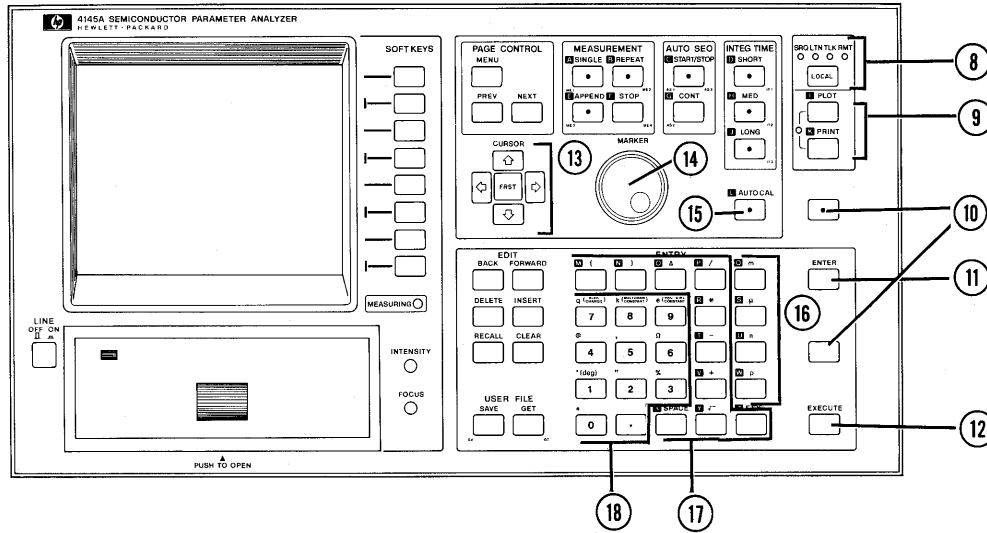

⑧ HP-IB Status Indicators and LOCAL Key :

These four LED lamps—SRQ, LISTEN, TALK, and REMOTE—indicate the status of the 4145A when interfaced with a controller via the HP-IB, or connected directly to a printer/plotter. The LOCAL key, when pressed, releases the 4145A from remote (HP-IB) control and enables control from the front panel. The LOCAL key does not function when the instrument is set to local lockout by the controller or in the GL mode.

⑨ PLOT and PRINT Keys

The PLOT key is used to dump whatever is displayed on the CRT directly onto an HP-IB plotter (e.g., HP9872C), without a controller. Plot area can be set from the 4145A's front panel. Plotting starts when EXECUTE is pressed. Pressing PLOT a second time stops the plot immediately. Refer to paragraph 3-117 for more information on the PLOT function. The PRINT key functions similarly to the PLOT key except that a printer is used instead of a plotter and only alphanumeric data is output. If the PRINT key is used to output the results of a graphic plot, for example, only the numeric value of each measurement point is printed. Refer to paragraph 3-119 for more information on the PRINT function.

⑩ BLUE Key and GREEN Key :

These keys are used to access additional key functions. Additional key functions are labeled in blue and green.

BLUE Key: This key is used when entering comments, variables, and program names. Once this key is pressed (key indicator lamp on), it remains on until pressed again. When the CHANNEL DEFINITION page is displayed or when a SAVE/GET operation, COMMENT operation or PURGE operation is being performed, the BLUE key is automatically set to ON (key indicator lamp on).

GREEN Key: This key is used when entering physical constants and certain special symbols. It is valid for one key-in operation only; that is, it must be pressed each time a green-labeled key function is desired.

Figure 3-2. Front Panel Features (Sheet 3 of 6).

⑪ ENTER Key :

This key is used to enter parameter values, alphanumeric characters, special characters, and unit indicators displayed on the Keyboard Input Line (see Figure 3-5) into the internal display buffer. When this key is pressed, data displayed on the Keyboard Input Line is moved to the display field indicated by the field pointer (►) and stored in the display buffer. Data stored in the display buffer by the ENTER key can be recalled (re-displayed on the Keyboard Input Line) by pressing the RECALL Key ⑲. Up to 60 characters can be entered into the buffer, but only 27 characters can be displayed at one time. To display the rest of the buffer contents, use the BACK key or FORWARD key.

⑫ EXECUTE Key :

This key executes GET, SAVE, PRINT, PLOT, PURGE, and REPACK commands, and arithmetic expressions displayed on the Keyboard Input Line.

Note: The PURGE and REPACK commands are available only when the USER FILE CATALOG is displayed.

⑬ CURSOR Control Keys :

These keys control the positioning of the field pointer (►) and the long and short cursors. (They do not control the cursor on the Keyboard Input Line.)

Field Pointer Control :

Pressing the \uparrow , \downarrow , \leftarrow , or \rightarrow key moves the field pointer (►) in the indicated direction. The FAST key cannot be used for field pointer control.

Long/Short Cursor Control :

Pressing the \uparrow , \downarrow , \leftarrow , or \rightarrow key moves the cursor in the indicated direction. Movement continues until the key is released. Two direction-keys can be pressed simultaneously to move the cursor diagonally. Pressing the FAST key in conjunction with one or two of the direction keys, causes the cursor to move more rapidly.

⑭ MARKER Control Dial :

This dial controls the marker (◎ or *) on the GRAPHICS PLOT page. Rotating the dial clockwise moves the marker from the sweep start point to the sweep stop point.

⑮ AUTO CAL KEY :

This key enables continuous auto-calibration of the 4145A. The AUTO CAL function is set to ON (key indicator lamp on) when the instrument is turned on. Refer to paragraph 3-37 for details.

⑯, ⑰, ⑱ DATA ENTRY Keys :

These keys are used to enter numeric values, arithmetic operators, and engineering units. Data entered with these keys is displayed on the CRT's Keyboard Input Line and entered into the display buffer by pressing the ENTER key ⑪. An arithmetic expression entered with these keys is executed by pressing the EXECUTE key.

⑰ Engineering Unit Keys :

Four engineering units are available—m (milli, 10^{-3}), μ (micro, 10^{-6}), n (nano, 10^{-9}), and p (pico, 10^{-12})—for use with the numeric keys ⑱.

⑰ Arithmetic Operator and Function Keys :

Nine arithmetic operators and functions are available—+, -, *, /, $\sqrt{\quad}$, Δ , (,), EEX (scientific notation)—for use in arithmetic calculations. Five additional operator and functions are available with the alphabetic (blue) keys : ** (exponentiation), LOG, LN (natural log), EXP (natural base), and ABS (absolute). The SPACE key is also included in this key group.

⑱ Numeric Keys :

These keys—0 through 9 and decimal point—are used for entering measurement parameter values and for making quick arithmetic calculations.

Figure 3-2. Front Panel Features (Sheet 4 of 6).

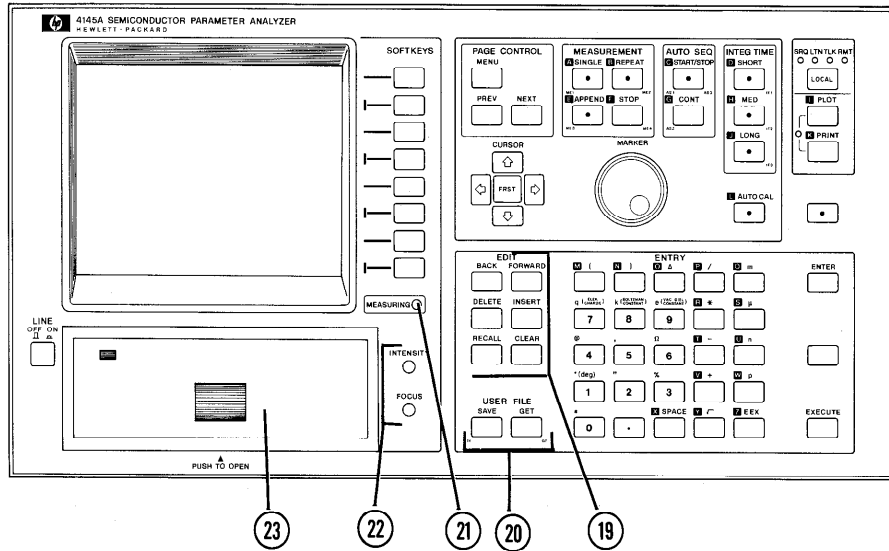

19 EDIT Keys :

These keys are used to edit data displayed on the Keyboard Input Line.

BACK : Moves the Keyboard Input Line cursor (—) left one position. If this key is pressed while the cursor is at the left-most position, the displayed text will move to the right.

FORWARD : Moves the Keyboard Input Line cursor (—) right one position. If this key is pressed while the cursor is at the right-most position, the displayed text will move to the left.

DELETE : Causes the character at the position of the cursor to be deleted. The cursor remains at the same position and all text to the right of the deleted character moves one position to the left as each character is deleted.

INSERT :

Causes the character at the position of the cursor and all text to the right of the cursor to move right one position, leaving a space at the position of the cursor and allowing insertion of additional characters. To exit from this mode, press INSERT a second time.

RECALL :

Causes previous entries or executions to be re-displayed on the Keyboard Input Line.

CLEAR :

Clears all text from the Keyboard Input Line and returns the cursor to the home (left-most) position.

Figure 3-2. Front Panel Features (Sheet 5 of 6).

⑳ USER FILE Keys :

These keys are used to store program or data files onto the disc or to recall them.

SAVE : Used to store the existing measurement setup, measurement result, or auto-sequence program onto the flexible disc. Press **SAVE**, enter the file type (P for a measurement setup, D for a measurement result, S for an auto-sequence program), file name, and comment (if necessary), and then press **EXECUTE** ⑫.

GET : Used to recall a measurement setup, measurement result, or auto-sequence program from the flexible disc. Press **GET**, enter the file type (P for a measurement setup, D for a measurement result, S for an auto-sequence program), and file name, and then press **EXECUTE** ⑫.

㉑ MEASURING Lamp :

This lamp comes on when the 4145A is measuring. When measurement is completed or when the **STOP** key is pressed, this lamp goes off immediately.

㉒ CRT Adjustment :

INTENSITY determines the brightness of traces displayed on the CRT. **FOCUS** adjusts the writing beam for sharp, well-defined traces.

㉓ FLEXIBLE DISC DRIVE :

Accommodates a 92K byte, single-sided, single-density, 5-1/4 inch flexible disc, and functions as the 4145A's mass storage unit (MSU). The lamp, located in the upper left-hand corner of the drive unit door, comes on when the 4145A is reading data from the disc. To open the door, press firmly on the center of the door until an audible click is heard, then release the door. Refer to paragraph 3-5 for information on proper handling of the flexible disc.

Figure 3-2. Front Panel Features (Sheet 6 of 6).

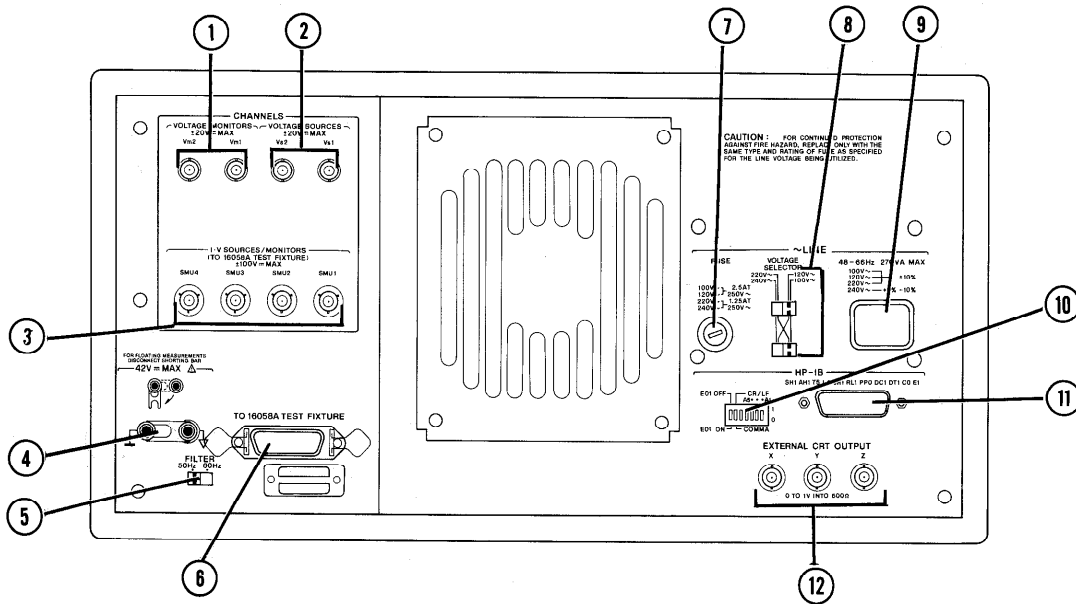

① Voltage Monitor (Vm) Input Connectors :

Two female BNC connectors for input to Vm1 and Vm2. Used in applications in which a user-fabricated test fixture is used. These connectors cannot be connected to the 16058A Test Fixture. Maximum allowable input voltage is $\pm 20V$ dc.

② Voltage Source (Vs) Output Connectors :

Two female BNC connectors for Vs1 and Vs2. Used in applications in which a user-fabricated test fixture is used. These connectors cannot be connected to the 16058A Test Fixture. Maximum output voltage is $\pm 20V$ dc.

③ SMU Output Connectors :

Four triaxial connectors for SMU1 through 4. Can be connected to the 16058A Test Fixture or to a user-fabricated test fixture. Each connector outputs or measures up to $\pm 100V$ or $\pm 100mA$.

④ COM (COMMON)-GROUND Terminals :

Common (∇) and Ground (\perp) for floating and grounded measurements. The common terminal is tied directly to the outer-conductor of the Vm ①, Vs ②, and SMU ③ connectors; the ground terminal is tied directly to the instrument chassis. For grounded measurements, these terminals must be interconnected using the shorting-bar. For floating measurements, disconnect the shorting-bar.

WARNING

A POTENTIAL SHOCK HAZARD MAY EXIST WHEN COMMON IS NOT CONNECTED TO GROUND (SHORTING-BAR DISCONNECTED). DO NOT, REGARDLESS OF THE OUTPUT VOLTAGE, TOUCH THE COMMON TERMINAL OR OUTER CONDUCTOR OF THE SMU, Vs, OR Vm CONNECTORS DURING A FLOATING MEASUREMENT (SHORTING-BAR DISCONNECTED).

Figure 3-3. Rear Panel Features (Sheet 1 of 2).

⑤ FILTER Switch :

This switch determines the measurement integration time, to reduce the effects of line-frequency noise. Set this switch to the frequency of the ac power source.

⑥ System Cable Connector :

Twenty-four pin connector for inter-connection between the 16058A Test Fixture and the 4145A. Vs1, Vs2, Vm1, Vm2, and the fixture-lid-open detector are connected to this connector. When the 16058A is not used, this connector should be terminated with the furnished shorting-termination if voltages exceeding $\pm 42V$ are to be output.

WARNING

WHEN THE SHORTING-TERMINATION IS CONNECTED TO THE SYSTEM CABLE CONNECTOR, THE 4145A'S PROTECTIVE CIRCUIT IS DISABLED. VOLTAGES AT THE SMU AND Vs OUTPUTS CAN REACH $\pm 100V$ AND $\pm 20V$, RESPECTIVELY. DO NOT TOUCH THE POINT OR POINTS AT WHICH THE SMU'S OR VOLTAGE SOURCES ARE CONNECTED.

⑦ LINE FUSE Holder :

The 4145A's power-line fuse is installed in this holder.

100V/120V operation :
2.5AT, 250V (HP P/N : 2110-0015)

200V/240V operation :
1.25AT, 250V (HP P/N : 2110-0305)

⑧ LINE VOLTAGE SELECTOR Switches

These switches select the appropriate ac operating voltage. Selectable voltages are 100V/120V $\pm 10\%$ and 220V $\pm 10\%$ / 240V $\pm 5\%$ -10% (48 - 66Hz). Refer to paragraph 2-5.

⑨ LINE Input Receptacle :

AC power cable is connected to this receptacle. Refer to paragraph 2-5.

⑩ HP-IB Control Switch :

This switch sets the 4145A's HP-IB address (0 - 30), data output format (COMMA or CR/LF), and interface capability (EOI ON or OFF). Specific information on this switch is given in paragraph 3-97.

⑪ HP-IB Connector :

Twenty-four pin connector; connects the 4145A to the HP-IB for remote operations. Also used to connect a printer/plotter.

⑫ External CRT Output Connectors :

Three BNC (f) connectors for connection to an external X-Y-Z display. Refer to paragraph 3-121.

Figure 3-3. Rear Panel Features (Sheet 2 of 2).

3-5. FLEXIBLE DISC HANDLING

3-6. Five work-discs and one head-cleaning disc are furnished with the 4145A. Each work-disc contains the required operating system software, four general purpose measurement setups, and 33.5K bytes of user area. Installation and removal procedures for the disc are shown in Figure 3-4. Precautions on handling and storing the flexible discs are given below.

1. When not in use, each disc should be placed in its own outer jacket. Exposed areas of the disc should be completely covered by the jacket.
2. Store discs in an upright position. Do not stack or pile discs.
3. Store discs in a clean, dry, fireproof cabinet. Do not expose to direct sunlight, extremes of temperature or humidity, or magnetic fields.
4. Do not touch the exposed surface of the disc.
5. Do not apply strong pressure to the protective jacket. When labelling a disc, use a felt-tip pen. Do not use a pencil or ball-point pen.
6. Do not bend the discs.

CAUTION

DO NOT INSERT ANYTHING OTHER THAN FLEXIBLE DISCS INTO THE DISC DRIVE.

Note

Use only the discs furnished with the 4145A.

3-7. CRT DISPLAY

3-8. The 4145A is equipped with the HP Model 1345A Digital Display. For complete information on the 1345A, refer to the 1345A Operation and Service Manual, included in this binder.

3-9. Useable display area on the CRT is shown in Figure 3-5. Operator adjustments are given in Figure 3-6.

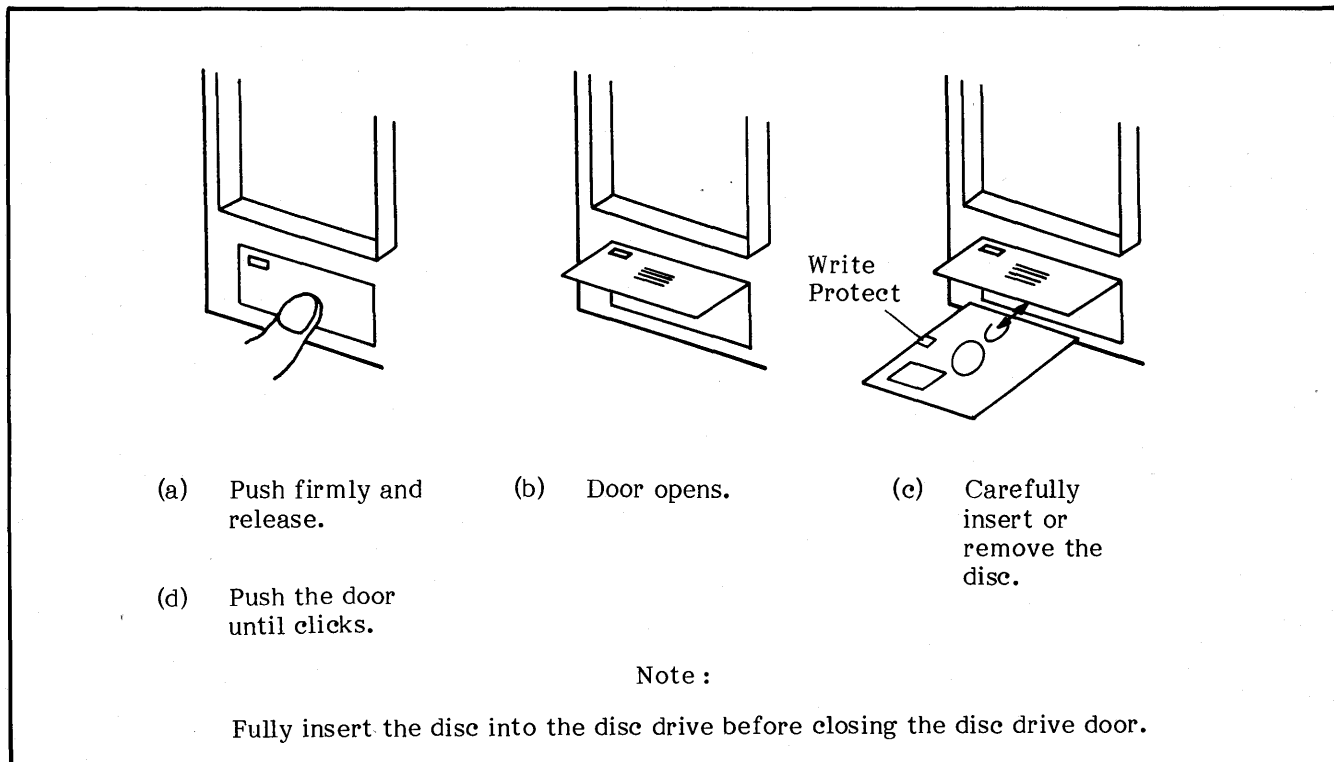
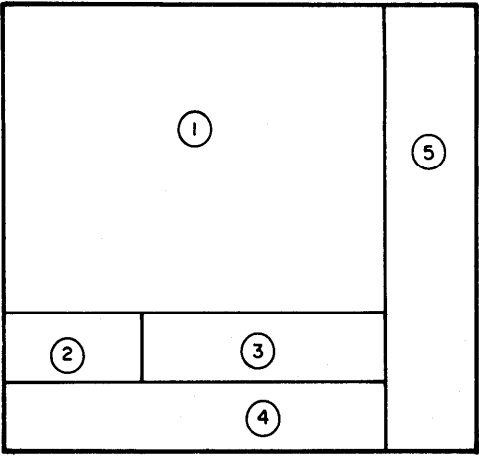

Figure 3-4. Disc Installation and Removal.



The CRT is sectioned into five areas, as shown in the figure. Description for each area is as follows :

- ① **Page Display Area :**
The instrument's various pages are displayed in this area. When the PLOT key is pressed, only this area is output to the plotter.
- ② **Command Display Area :**
The SAVE, GET, PLOT, PRINT, PURGE and REPACK commands are displayed in this area.
- ③ **Keyboard Input Line :**
All keyboard (front panel) entries are displayed in this area. Up to 60 characters can be entered but only 27 can be displayed. To edit the displayed characters, use the BACK, FORWARD, DELETE and INSERT keys. When the RECALL key is pressed, the previous entry is re-displayed.
- ④ **System Message Line :**
Displays instructions, error messages, and error codes. When the instrument is turned on, instrument status is displayed.
- ⑤ **Softkey Prompt Display Area :**
Displays Softkey Prompts (SKP).

Note

② , ③ , and ④ are erased by pressing the CLEAR key.

Figure 3-5. Useable Display Area.

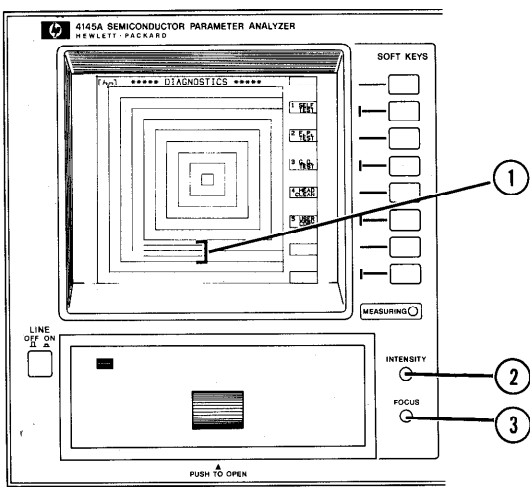

CRT intensity and focus adjustment. (Requires a small flat-tip screwdriver.)

- ① Turn on the 4145A. The MENU page will be displayed on the CRT.
- ② Press the EXTN softkey and the DIAG softkey.
- ③ Press the GDU TEST softkey. Display will be as shown in the figure.
- ④ Adjust INTENSITY ② until all three lines (each line has a different intensity) are visible. (①)
- ⑤ Adjust FOCUS ③ until the corners of the displayed trace are sharp.
- ⑥ Press the MENU key.

Figure 3-6. Operator Adjustment.

3-10. SELF TEST

3-11. The 4145A is equipped with an automatic self-diagnostic function that is initiated each time the instrument is turned on to confirm normal operation of the instrument's basic functions. The SELF TEST can also be initiated from the DIAGNOSTICS page or via the HP-IB. When SELF TEST is performed at instrument turn-on, the five tests listed in Table 3-1 are automatically performed. If the instrument is operating normally, the MENU page will be displayed when the SELF TEST is completed. If an error is detected, an error code will be displayed on the CRT. When SELF TEST is initiated from the DIAGNOSTICS page or via the HP-IB, only two tests are performed (MPU test and SMU test). If the instrument fails the SELF TEST, contact the nearest Hewlett-Packard Service Office (see list at back of this manual).

3-12. ERROR MESSAGES/ERROR CODES

3-13. Error messages and error codes are displayed on the System Message Line of the CRT whenever an illegal operation or out-of-range measurement is made, or whenever an internal circuit fails. Error messages and error codes related to operator errors (not instrument failure) are listed in Table 3-2 and 3-3, respectively. Error codes related to instrument failure are listed in Table 3-4. If the instrument displays one of the error codes listed in Table 3-4, contact the nearest Hewlett-Packard Sales/Service Office.

Note

One of the error codes listed in Table 3-4 may be displayed if the instrument is turned on after experiencing an extreme change of ambient temperature. In this case, allow the instrument to fully warm up (ignore the displayed error code), and then turn it off and on one time.

Table 3-1. 4145A SELF TEST

Test Name	Description
MPU test	Checks the basic functions of the MPU (Microprocessor Unit) by checking four ROMs (Read-Only Memory) and sixteen RAMs (Random-Access Memory).
GDU test	Checks the functions of the GDU (Graphics Display Unit).
MSU test	Checks the MSU (Mass Storage Unit : Flexible Disc Drive and Disc).
HP-IB test	Checks all HP-IB interface capabilities.
SMU test	Checks the basic functions of the four SMUs.

Table 3-2. Error Messages (Sheet 1 of 2)

Error Message	Meaning	Corrective Action
No source name	An SMU that has been assigned a source mode (COM, V, or I) has not been assigned a corresponding V or I source name.	If the source mode is COM or V, enter a source name in the V column; if the source mode is I, enter a source name in the I column.
Duplicate name	Two or more channels have the same name.	Re-assign the channel names.
Illegal function	VAR1, VAR1', or VAR2 is specified more than once.	Specify VAR1, VAR1', and VAR2 only once.
	VAR1 and VAR1' are not in the same source mode.	Set VAR1 and VAR1' to the same source mode.
Overflow	Number of steps for VAR1 exceeds 512.	Change the value of START/STOP or STEP.
	An attempt was made to input a value that is outside specified limits.	Enter a value that is within specified limits.
No name	No name is entered in the NAME field on the MEAS/DISP MODE SETUP page.	Select a name from those displayed in the softkey prompt area.
No monitor channel	No monitor channel name is entered in the NAME field on the MEAS/DISP MODE SETUP page, or the name entered in the NAME field cannot be used as a monitor channel name.	Select a monitor channel name from those displayed in the softkey prompt area.
Illegal setup	LOG Sweep: START and STOP (Display) (MIN and MAX) values have different signs.	Change one of the signs.
	Current value is too high because source mode has been changed from V to I.	Change the current (I) value setting.
	INTERVAL or NO. OF RDNGS for a time domain measurement is set to 0.	Enter correct value : Up to 10s for INTERVAL and from 1 to 512 for NO. OF RDNGS.
	Duplications on the OUTPUT SEQUENCE SETUP page.	Rearrange the output sequence.
Buffer full	Measurement data exceeds the capacity of the data buffer.	Data buffer capacity is 512 measurement points for a single sweep, or up to 575 (depends on the number of monitor channels used, VAR2 steps and the number of times APPEND is used) in other cases.

Table 3-2. Error Messages (Sheet 2 of 2)

Error Message	Meaning	Corrective Action
Syntax error	An illegal name was entered in a GET or SAVE command.	The first character of a file name must be alphabetic, and all succeeding characters must be alphanumeric.
	PLOT area is not specified, contains one or more alphabetic characters, or is missing coordinate delimiters (comma or space).	Re-enter the PLOT area correctly.
	Illegal file type.	Use P, D, or S for the file type.
Busy	Auto calibration is being performed.	Auto calibration is performed every 5 minutes.
No data	PRINT Key was pressed with no measurement data in the data buffer.	Perform a measurement.
Printer/Plotter is not connected	No printer or plotter is connected to the instrument, or the printer or plotter is not set to LISTEN.	Connect the printer or plotter.
Not compatible	The discs used in the copy operation have different system labels, or one of the discs is not a 4145A useable disc.	Copy cannot be performed.
Close the fixture lid	The fixture lid is open at the start of a measurement in which the output voltage may exceed $\pm 42V$ or lid is open during the User Mode (See Fig. 39).	Close the lid or change the setup. Make sure the system cable is properly connected.
Output disabled, close the fixture lid	The fixture lid was opened during a measurement in which the output voltage may exceed $\pm 42V$.	Close the fixture lid and make the measurement again. Do not open the fixture lid during measurement. Make sure the system cable is properly connected.
Emergency	Output was shut down to prevent SMU damage.	Make sure the setup and all connections are correct.
Recovered from power down	Indicates that there was a momentary power loss.	When a power loss occurs during measurement, output is shut down. Press MEASUREMENT key to continue the measurement.
Step overflow	NO OF STEPS for VAR1 exceeds 512.	Change START value, STOP value, or STEP value.
Disabled function	A disabled softkey was pressed.	The softkey cannot be used in the existing measurement setup.

Table 3-3. Operational Error-Codes (Sheet 1 of 2)

Display	Meaning
Error E01	Arithmetic operator (-, +, /, *) or parenthesis is required.
Error E02	EXECUTE was pressed with no executable text on the Keyboard Input Line.
Error E03	Object buffer overflow.
Error E04	Improper Δ (delta) operation.
Error E05	User function is used in the expression. (User function cannot be used in an arithmetic expression.)
Error E06	No variable or constant following an arithmetic operator.
Error E07	Arithmetic expression contains an undefined variable.
Error E08	Too many signs or parentheses.
Error E09	Constant value is too large.
Error I01	Stack Register overflow.
Error I02	Improper calculation was attempted. For example, the divisor is zero.
Error I03	Insufficient Δ data.
Error M02	Disc is not inserted or is not correctly inserted.
Error M03	The disc is write protected.
Error M04	Illegal file name or file type.
Error M05	The file name specified in the SAVE command has already been reserved for the specified file type.
Error M06	Number of total files exceeds 96.
Error M07	Number of total records exceeds 131.
Error M08	User area may be lost. Copy immediately onto another disc.
Error M19	The disc was not initialized for the 4145A.
Error Z01	The program specified by the GET command in the auto-sequence program contains an error. Press CONT to perform the next step of the auto-sequence program.
Error Z02	The SINGLE command can be executed from the GRAPHICS, MATRIX, LIST, or SCHMOO page only. Press CONT to perform the next step of the auto-sequence program.
Error Z03	PLOT or PRINT was performed by the auto-sequence program but no printer/plotter is connected to the 4145A or the printer/plotter is not set to LISTEN. Press CONT to perform the next step of the auto-sequence program.

Table 3-3. Operational Error-Codes (Sheet 2 of 2)

Display	Meaning																						
Error Z04	The test fixture lid is open during an auto-sequence program in which the output voltage may exceed $\pm 42V$. Press CONT to perform the next step of the auto-sequence program.																						
Data Errors	<p>Depending on the number of channels used in the measurement, up to six 2-digit numbers are displayed, in the format shown below, whenever the measurement cannot be performed correctly.</p> <p style="text-align: center;">Error DXX XX XX XX XX XX</p> <p>Here, XX is a 2-digit number which represents channel status. The left-to-right order in which the 2-digit error codes appear corresponds to the order in which the channels are assigned on the MEAS/DISP MODE SETUP page. Also, the number of 2-digit error codes that appear is identical to the number of channels used in the measurement. The left digit of XX is hexadecimal and must be converted into a 4-digit binary number, as described below. The right digit is decimal and requires no conversion. Also, zero means no error.</p> <p><u>XX</u></p> <ul style="list-style-type: none"> 1: Stack register overflow 2: Calculation error 3: Insufficient data for Δ measurement 7: Undefined user-function 8: INTERVAL in a time domain measurement is too short. Complete measurement data cannot be stored before the next measurement begins. <p>Convert hexadecimal number into binary.</p>  <p>Channel correspondence is shown below :</p> <p>GRAPHICS PLOT:</p> <table style="margin-left: auto; margin-right: auto;"> <tr> <td>Error</td> <td>DXX</td> <td>XX</td> <td>XX</td> </tr> <tr> <td></td> <td>X axis</td> <td>Y1 axis</td> <td>Y2 axis</td> </tr> </table> <p>LIST DISPLAY:</p> <table style="margin-left: auto; margin-right: auto;"> <tr> <td>Error</td> <td>DXX</td> <td>XX</td> <td>XX</td> <td>XX</td> <td>XX</td> <td>XX</td> </tr> <tr> <td></td> <td>1st</td> <td>2nd</td> <td>3rd</td> <td>4th</td> <td>5th</td> <td>6th</td> </tr> </table> <p>MATRIX DISPLAY, SCHMOO PLOT:</p> <p style="text-align: center;">Error DXX</p>	Error	DXX	XX	XX		X axis	Y1 axis	Y2 axis	Error	DXX	XX	XX	XX	XX	XX		1st	2nd	3rd	4th	5th	6th
Error	DXX	XX	XX																				
	X axis	Y1 axis	Y2 axis																				
Error	DXX	XX	XX	XX	XX	XX																	
	1st	2nd	3rd	4th	5th	6th																	

Table 3-4. Hardware-Related Error-Codes

Display	Meaning
Error P01 - P04	One of the four ROMs (Read Only Memory) is not functioning properly.
Error P05-P20	One of the sixteen RAMs (Random Access Memory) is not functioning properly.
Error P21	MPU's (Microprocessor Unit) peripheral circuit is not functioning properly.
Error M08-M18	MSU (Mass Storage Unit : Flexible Disc and drive) is not functioning properly. Try another disc.
Error A01	SMU controller is not functioning properly.
CHAN (!!!DOWN!!!)	
CHAN (XX,XX,XX,XX)	SMU itself is not functioning properly. (XX indicates the SMU number and error code. Refer to Fig. 3-20.)

Note

If a momentary power loss occurs, the 4145A's display may go blank. To recover, turn off the instrument, wait a few seconds, and then turn on the instrument.

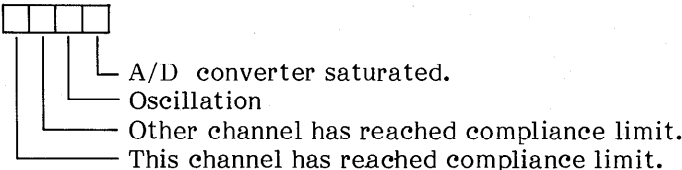
Note

The 4145A will function properly even though error M13 or M14 is displayed.

3-14. INITIAL CONTROL SETTINGS

3-15. To facilitate operation, the instrument is automatically set to the following initial control settings each time it is turned on :

Front Panel Controls :

MEASUREMENT keys OFF
 AUTO SEQ key OFF
 INTEG TIME keys SHORT
 PLOT/PRINT keys OFF
 AUTO CAL key ON
 BLUE key OFF

Internal Setup :

CRT Display MENU
 Page
 Measurement Program GENL
 (see note)
 PLOT Area Previously
 (for external plotter) specified
 values

Note

Each flexible disc contains four different application programs, of which GENL is one. Refer to paragraph 3-87 for details on the furnished applications programs.

All data stored on the disc is retained; that is, the disc is not erased when the instrument is turned off.

3-16. USER-AREA FILING OPERATIONS

3-17. The 4145A uses a 5.25 inch, single-sided, single-density flexible disc as the storage medium for its MSU (mass storage unit). Each of the five work-discs furnished with the 4145A contains the necessary operating system software, four general purpose measurement programs, and enough user area for 131 records. Up to 96 files can be stored in the user-area.

Note

A record is the minimum unit for storage on the disc. A file consists of 1, 3, or 12 records, depending on the file type.

Three types of files can be stored in the user-area :

1. Measurement program files—file type P :
 Specifying file type P in the SAVE command reserves 3 records on the disc and stores the existing measurement setup (channel assignments, parameter settings, graphic scaling, output sequence, etc.) at the reserved 3-record location.
2. Measurement data files—file type D :
 Specifying file type D in the SAVE command reserves 12 records on the disc and stores the measurement setup and measurement results (GRAPHICS, LIST, MATRIX, or SCHMOO) at the reserved 12-record location.
3. Auto-sequence program files—file type S :
 Specifying file type S in the SAVE command reserves 1 record on the disc and stores the existing auto-sequence program at the reserved 1-record location.

For more information on file types, number of records used, etc., refer to Figure 3-30, 4145A FILE CATALOG Page.

Four filing operations—SAVE, GET, PURGE, and REPACK—can be performed from the front panel. Each is described below :

SAVE :

Used to store the existing measurement setup (except INTEG TIME, AUTO CAL, and softkey functions), the existing auto-sequence program, output sequence setup, or the measurement results. SAVE cannot be used when the disc is write-protected. Before saving a measurement setup, a page check must be performed (refer to para. 3-44). To SAVE a file, press the SAVE key (SAVE will appear on the Keyboard Input Line of the CRT) and input the file type (P, D, or S) and file name. The file name can contain up to six characters, of which the first must be alphabetic and the last five must be alphanumeric.

GET :

Used to recall user-stored files from the disc. GET cannot be used to recall any of the furnished measurement programs. To GET a file from the user-area of the disc, press the GET key (GET will appear on the Keyboard Input Line of the CRT) and input the file type (P, D, or S) and file name.

PURGE:

Used to delete user-stored files from the disc. PURGE cannot be used with a write-protected disc, nor can it be used to delete any of the furnished measurement programs. It is available only when the 4145A FILE CATALOG page is displayed. To PURGE a file from the user-area of the disc, go to the MENU and select CAT softkey. When the 4145A FILE CATALOG page appears on the display, press the PURGE softkey (PURGE will appear on the Keyboard Input Line of the CRT) and input the file type (P, D, or S) and file name. DO NOT turn off the instrument during PURGE.

REPACK:

Used to repack all files stored in the user-area of the disc. REPACK cannot be used when the disc is write-protected, and is available only when the 4145A FILE CATALOG page is displayed. To REPACK the user-area, go to the MENU and select CAT softkey. When the 4145A FILE CATALOG page appears on the display, press the REPACK softkey (REPACK will appear on the Keyboard Input Line of the CRT) and then press EXECUTE.

SAVE, GET, PURGE, and REPACK cannot be input using the alphabetic keys and can be used for user-area filing operations only. No filing operations can be performed on the operating system software or the furnished applications programs.

3-18. ARITHMETIC CAPABILITIES

3-19. Arithmetic operations that can be performed on the 4145A are listed in Table 3-5. To perform an arithmetic operation, first key in the expression (it will appear on the display as you do so), then press EXECUTE. The result will be displayed on the Keyboard Input Line of the CRT in a floating decimal format (scientific notation).

Example: $\sqrt{2 + 1}$

Key strokes: $\sqrt{\quad}$ 2 $+$ 1 EXECUTE

Displayed Result: 2.4142E+00

Results of arithmetic operations are always displayed in scientific notation consisting of a 5-digit base and 2-digit exponent, regardless of the expression's complexity. Thus, if 1+2 is executed, the result is displayed as 3.0000E+00. Also, the exponent is always a multiple of three, regardless of the exponent used in the original expression. For example, if 1E+07 is executed, the result is displayed as 10.000E+06. The decimal point is always positioned so that the exponent is a multiple of three.

Results are always rounded before being displayed if they contain more than 5 digits. The first excess digit is checked, and if its value is 6 or greater, the digit to the left (the fifth digit) is incremented (rounded up) by one; if its value is 5 or less, the fifth digit is unchanged. For example, executing 1+1.00001 will result in 2.0000E+00, but executing 1+1.00006 will result in 2.0001E+00.

Table 3-5. Arithmetic Operators

Sign	Name	Example	
		Equation	Key Strokes
+	Addition	5+3	5 + 3 EXECUTE
-	Subtraction	5-3	5 - 3 EXECUTE
*	Multiplication	5*3 (5x3)	5 * 3 EXECUTE
/	Division	5/3 (5÷3)	5 / 3 EXECUTE
$\sqrt{\quad}$	Square Root	$\sqrt{5}$	$\sqrt{\quad}$ 5 EXECUTE
**	Exponentiation	5**3 (5 ³)	5 * * 3 EXECUTE
log	Common Logarithm	log 5	L O G (5) EXECUTE
ln	Natural Logarithm	ln5	L O G (5) EXECUTE
EXP	Base of Natural Log	e ⁵	E X P (5) EXECUTE
	Absolute	-5	A B S (5) EXECUTE
EEX	Scientific Notation	5x10 ³	5 E E X 3 EXECUTE

Arithmetic hierarchy is as follows :

- ** exponentiation
- *,/ multiplication and division
- +, - addition and subtraction

Parentheses can be used to change this hierarchy; when used, they take highest priority. However, parentheses cannot be used for implied multiplication. The * operator must always be used to indicate multiplication. Thus, executing 2(3+5) will result in error E01. The correct format is 2*(3+5).

A delta (Δ) function is also provided, but it is not intended for general keyboard calculations. It is used in defining user functions (see paragraph 3-20) or in certain keyboard calculations on the GRAPHICS, MATRIX, LIST, or SCHMOO page.

There are limits to the size of arithmetic expressions that can be executed. Refer to Figure 3-7.

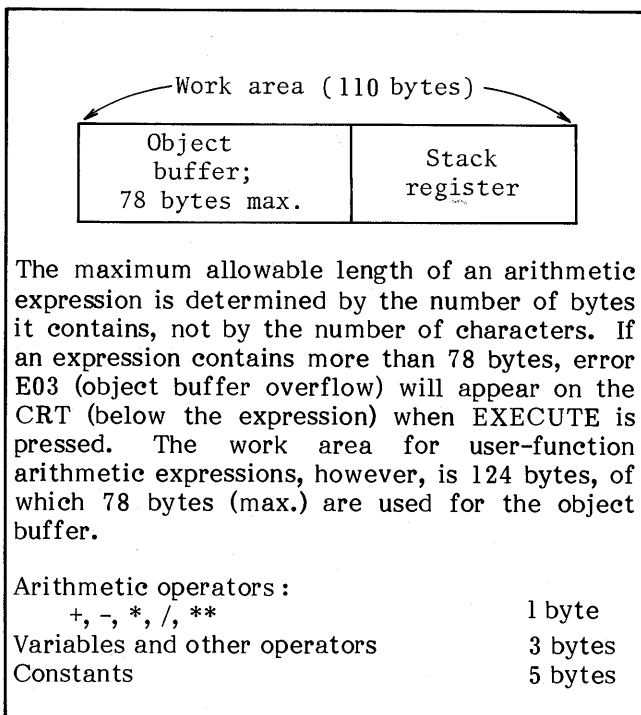

Figure 3-7. Byte Size of Arithmetic Expressions.

3-20. Up to two user functions can be defined as arithmetic expressions in the USER FCTN field on the CHANNEL DEFINITION page. This allows automatic calculation of secondary parameters, such as h_{FE} and g_m , which are functions of applied and measured voltages and currents. For example, if the static collector characteristics of a bipolar transistor are to be measured and plotted, the transistor's forward current transfer ratio, h_{FE} , can be defined as $HFE=IC/IB$ in the USER FUNCTION field on the CHANNEL DEFINITION page. HFE will appear as a softkey prompt on the MEAS&DISP MODE SETUP page and can be selected as the Y2 axis. When measurement is made on the GRAPHICS page, HFE will be plotted along with the primary characteristics—IC, IB, and VCE. Similarly, the transconductance, g_m , of a field-effect transistor can be defined as $GM=\Delta ID/\Delta VG$.

The delta (Δ) function can be used in user-function definitions or for keyboard calculations on the GRAPHICS, LIST, MATRIX, or SCHMOO page. In the latter case the value returned by executing ΔA (where A is the name of one of the source or monitor channels) depends on the location of the marker (GRAPHICS page) or cursor (MATRIX, LIST, and SCHMOO pages). Here, ΔA is calculated as half the difference between the values of A above and below the cursor (marker) location. In equation form

$$\Delta A = \frac{A_1 - A_2}{2}$$

where A_1 is the value of A at the measurement step following the cursor (marker) position and A_2 is the value of A at the measurement step preceding the cursor (marker) position.

Note

The result of the arithmetic function may include a rounding error.

3-21. SOURCE AND MEASUREMENT CHANNELS

3-22. The 4145A is equipped with eight channels for device stimulus and measurement. Channels 1 through 4 are stimulus/measurement units (SMUs), channels 5 and 6 are voltage sources (VS1 and VS2), and channels 7 and 8 are voltage monitors (Vm1 and Vm2). Refer to Figure 3-8. By correctly combining and setting up the source and measurement channels, a wide range of semiconductor devices can be measured. The SMUs are described in paragraph 3-23; the voltage sources and voltage monitors, in paragraph 3-25.

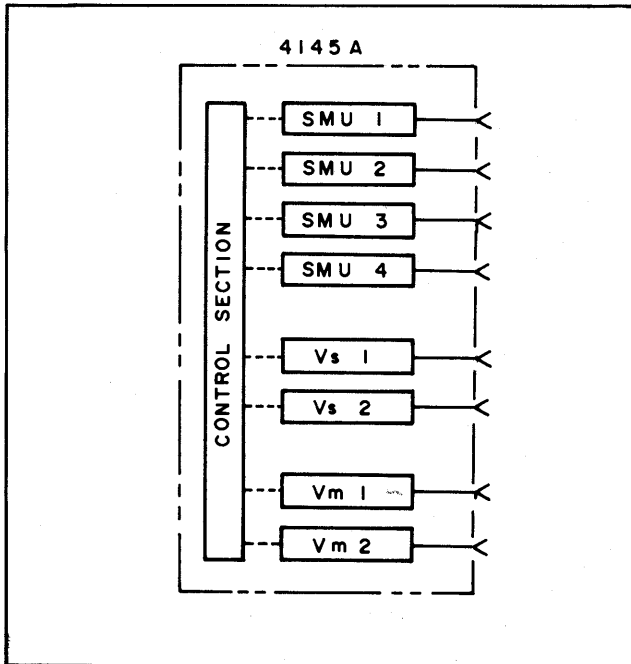

Figure 3-8. Source and Measurement Channels of the 4145A.

Note

When the current source SMU is set to 0 ampere, a slight positive current flows out.

3-23. Stimulus/Masurement Units (SMU)

3-24. A simplified circuit diagram of one of the four SMUs is illustrated in Figure 3-9. Each SMU can be set up to function as a voltage source/current monitor, current source/voltage monitor, or source common by specifying source mode V, I, or COM, respectively, in the SOURCE MODE field on the CHANNEL DEFINITION page (see Figure 3-21). Output voltage (SOURCE MODE V) and output current (SOURCE MODE I) can be held constant or can be swept (linearly or logarithmically) by specifying source function CONST or VAR1, VAR1', VAR2, respectively, in the SOURCE FCTN field on the CHANNEL DEFINITION page. When the source mode is COM, source function is automatically set to CONST. Refer to paragraph 3-29 for details on swept measurements.

Output in either SOURCE MODE is internally limited to 2 watts on each output range. Refer to Table 3-6 for range limits, range resolution, and output limits. Also, refer to paragraph 3-131 for measurement ranges and resolution. Figure 3-10 graphically illustrates the specifiable voltage/current out-put. Voltages and currents enclosed by the bold line can be specified.

Output voltage and current, sweep mode (linear or log), START, STOP, STEP, and COMPLIANCE for each SMU are specified on the SOURCE SETUP page (see Figure 3-22).

- Notes: 1) Range change is performed automatically.
- 2) If the Current Source can't output specified current, output voltage increases up to its voltage compliance.
- 3) If a voltage exceeding 100V is applied to the SMU, 199.99V may be displayed as the measurement result.

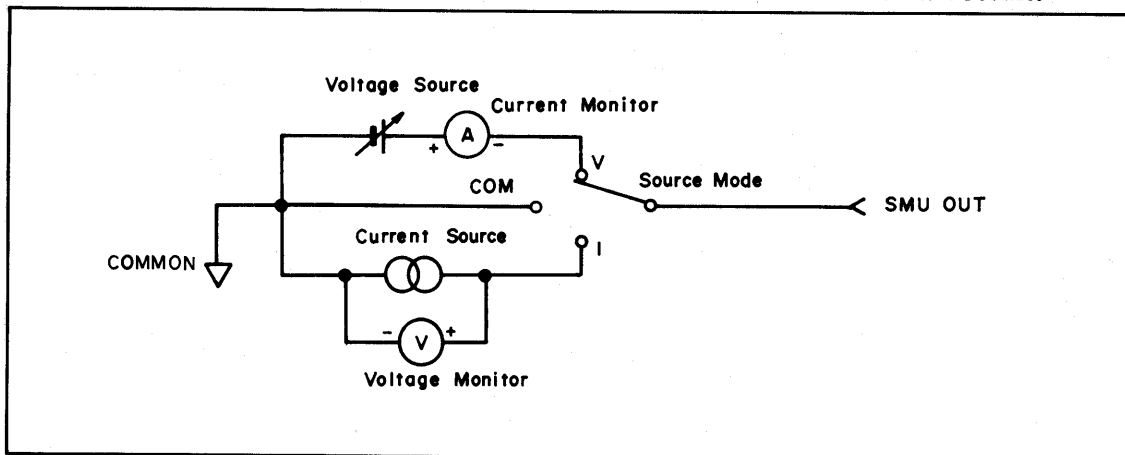

Figure 3-9. Simplified Circuit Diagram of One of the Four SMUs.

Table 3-6. SMU Source Ranges

Source Mode	Range	Resolution	Maximum Output	
V	±20V	1mV	100mA	
	±40V	2mV	50mA	
	±100V	5mV	20mA	
I	±1nA	1pA	100V	
	±10nA	10pA		
	±100nA	100pA		
	±1µA	1nA		
	±10µA	10nA		
	±100µA	100nA		
	±1mA	1µA		
	±10mA	10µA		
	±100mA*	20mA		100µA
		50mA	20V	
100mA				

*: The 100mA range consists of three subranges.

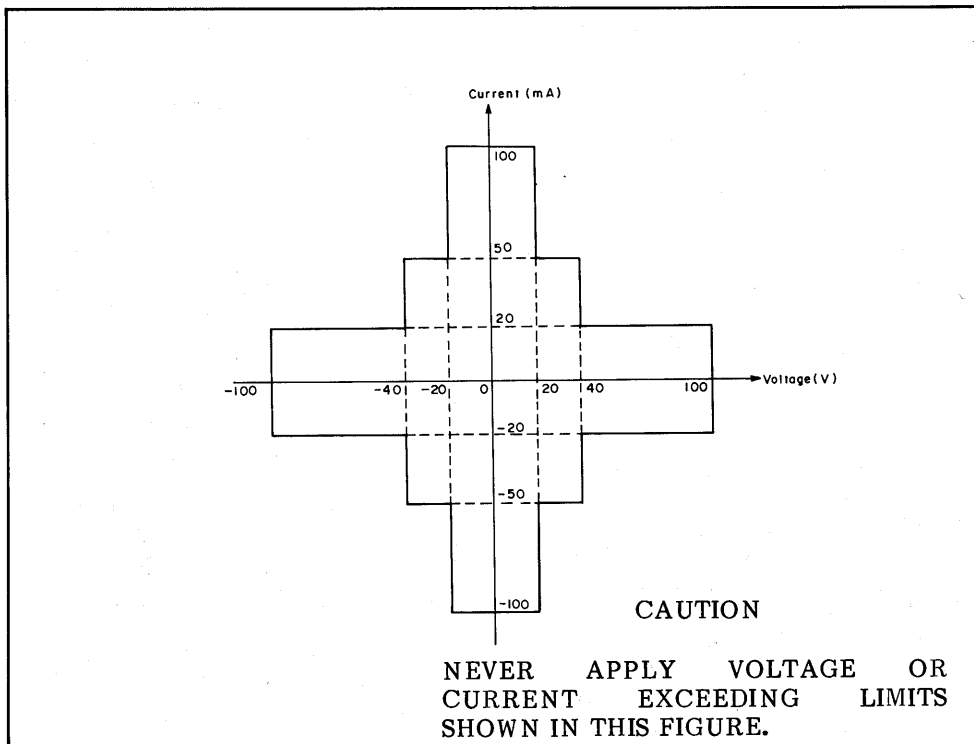

Figure 3-10. Specifiable Voltage/Current Output.

3-25. Voltage Sources (Vs) and Voltage Monitors (Vm)

3-26. Simplified circuit diagrams of the voltage sources (Vs) and the voltage monitors (Vm) are shown in Figures 3-11 and 3-12, respectively. Output voltage from each Vs can be held constant or can be swept (linearly or logarithmically) by specifying source function CONST or VAR1, VAR1', VAR2, respectively, in the SOURCE FUNCTION field on the CHANNEL DEFINITION page (see Figure 3-21). Refer to paragraph 3-29 for details on swept measurements. Maximum output voltage is $\pm 20V$ with 1mV resolution. Maximum output current is 10mA.

Up to $\pm 20V$ can be measured by the voltage monitors. There are two measurement ranges : 20V and 2V. Resolution for each range is 1mV and $100\mu V$, respectively.

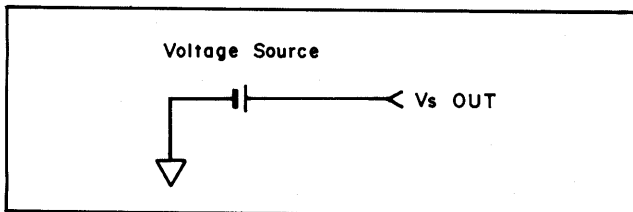

Figure 3-11. Simplified Circuit Diagram of Vs.

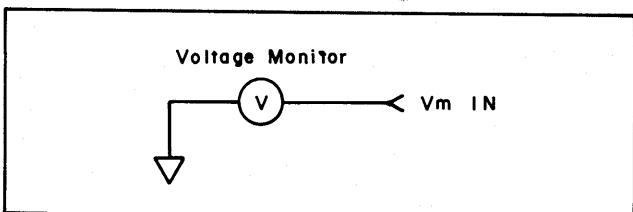

Figure 3-12. Simplified Circuit Diagram of Vm.

3-27. COMPLIANCE

3-28. To prevent over-voltage or over-current damage to the device under test, several levels of output protection, termed COMPLIANCE, have been incorporated into the 4145A. The maximum output current from an SMU operating in SOURCE MODE V (voltage source/current monitor) can be specified by entering the desired limit in the COMPLIANCE field of each source channel on the SOURCE SETUP page. Similarly, the maximum output voltage from an SMU operating in SOURCE MODE I (current source/voltage monitor) can be specified. Maximum specifiable compliance depends on the voltage or current range at which the source channel is operating. Refer to the Maximum Output column in Table 3-6. Setting resolution for current and voltage compliance is 50pA and

1mV, respectively. When an SMU is operating in SOURCE MODE COM, its current compliance is automatically set to 105mA and cannot be changed.

If a source channel reaches compliance during measurement, an error code (see Table 3-3) will appear on the CRT. Measurement data obtained prior to this point is valid, but measurement data obtained after compliance is reached may not be valid. The reason for this is that once a source channel reaches compliance, it tends to act as a constant source. Consider, for example, an SMU that is set to SOURCE MODE V (voltage source/current monitor) and SOURCE FCTN VAR1 (variable voltage source). START voltage, STOP voltage, and COMPLIANCE are 0V, +20V, and 10mA, respectively. Also, assume that the device under test has a resistance of 1000 ohms. When the measurement is started, the SMU will begin sweeping its output voltage toward +20V. But when the output voltage reaches +10V, the current through the device under test is 10mA. Compliance has been reached. The SMU will continue to try to sweep toward the +20V STOP voltage, but because the current through the device under test is now constant at 10mA, the voltage across it must be constant at +10V.

The specified compliance is valid for positive and negative values, regardless of the polarity specified in the COMPLIANCE field; that is, specifying a current compliance of, say, 40mA, as in Figure 3-13, is valid for +40mA and -40mA. Output currents greater than $\pm 40mA$ (shaded areas in Figure 3-13) are not possible.

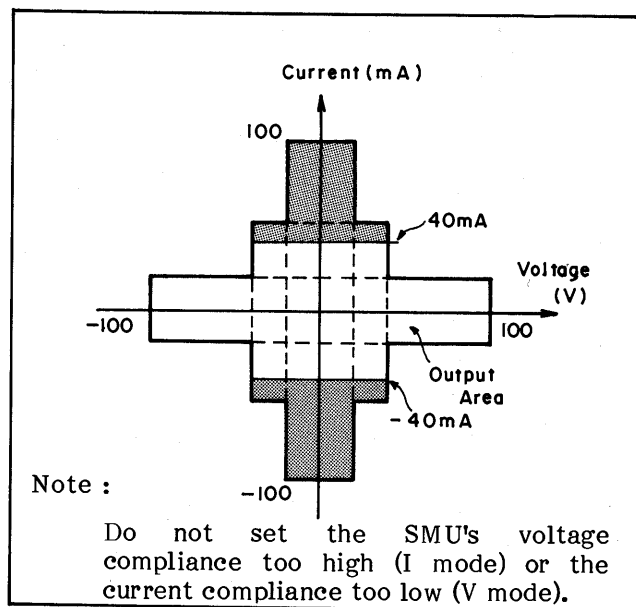

Figure 3-13. Voltage/Current Output Specified by the COMPLIANCE.

3-29. SWEEP MEASUREMENT

3-30. Output from the SMUs and voltage sources (Vs) can be swept in a staircase manner, as shown in Figure 3-14, by specifying VAR1, VAR1', or VAR2 in the SOURCE FCTN field on the CHANNEL DEFINITION page. The maximum number of source channels that can be swept is three. VAR1, VAR1', and VAR2 can be specified only once on the CHANNEL DEFINITION page and VAR1' cannot be specified without VAR1. VAR1, VAR1', and VAR2 are described in paragraph 3-31.

Sweep setup is made on the SOURCE SETUP page by selecting the SWEEP MODE and entering the desired START, STOP, STEP, DELAY, and HOLD values. Each sweep parameter is described below :

- START:** Voltage or current value at which sweep begins
- STOP:** Voltage or current value at which sweep stops
- STEP:** Sweep incremental or decremental value. Can be specified in LINEAR SWEEP MODE only.

DELAY: Wait time before measurement is made at each step (softkey function).

HOLD: Wait time before sweep begins (softkey function).

SWEEP MODE:

LINEAR or LOG. In LINEAR mode, output is swept linearly in accordance with the specified STEP value. In LOG mode, output is swept logarithmically at 10 steps, 25 steps or 50 steps (selectable with softkeys) per decade. LOG cannot be specified for VAR2. Refer to paragraph 3-32 for further details on LOG sweeps.

The above sweep parameters are for VAR1 only. Sweep parameters available for VAR2 are START, STEP, and NO. OF STEPS. Sweep parameters available for VAR1' are OFFSET (specifiable in linear sweep mode only) and RATIO, both of which are softkey functions. Also, when displaying measurement results on the GRAPHICS page, either LINEAR or LOG scaling can be specified on the MEAS/DISP MODE SETUP page, regardless of the SWEEP MODE of VAR1.

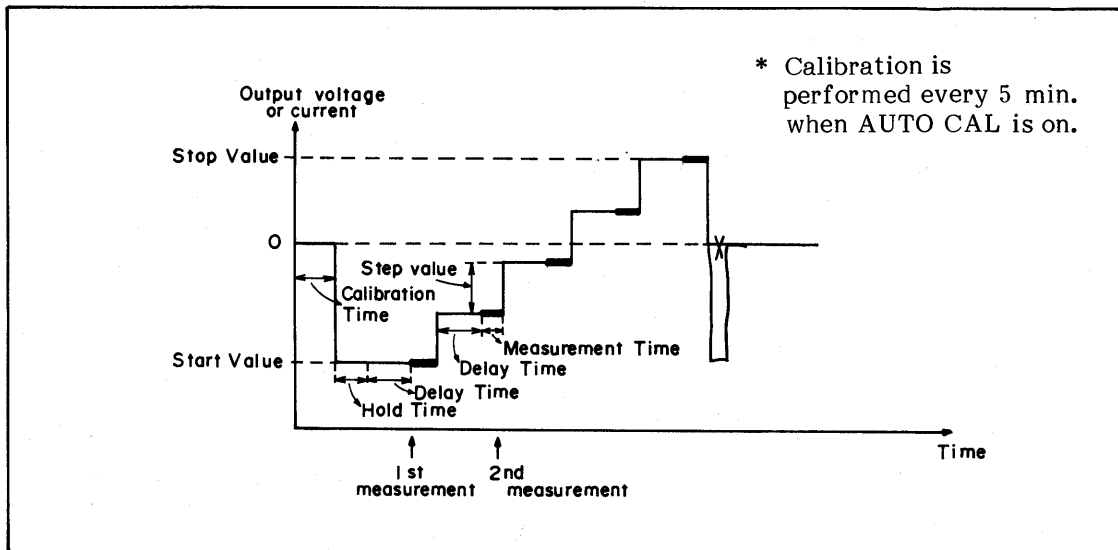

Figure 3-14. Staircase Sweep Output.

3-31. Of the six source channels (four SMUs, two voltage sources), three can be swept by specifying VAR1, VAR1', or VAR2 in the SOURCE FCTN field on the CHANNEL DEFINITION page. The remaining three source channels are either "not used" or are set to CONST source function. The VAR1 source channel is the main sweep channel and VAR2 and VAR1' are VAR1 dependent, as shown in Figures 3-15 and 3-16, respectively, and as described below :

VAR2 (subordinate sweep) :

At the completion of the VAR1 sweep, VAR2 is incremented or decremented by the specified STEP value (5 in Figure 3-15) and VAR1 is swept again. The total number of VAR1 sweeps is determined by the NO. OF STEPS (6)

in Figure 3-15) specified for VAR2. VAR2 cannot be swept logarithmically. Also, VAR1 and VAR2 can have different source functions. START, STEP, and NO. OF STEPS must be specified.

VAR1' (synchronous sweep) :

VAR1' can be used only when VAR1 is used and it must have the same source mode (V or I) as that specified for VAR1. VAR1' is swept in synchronism with VAR1 at either a constant offset value or constant ratio. VAR1' offset and ratio values are entered with the corresponding softkey. The offset value and ratio must be such that the VAR1' source channel does not exceed its maximum output limits.

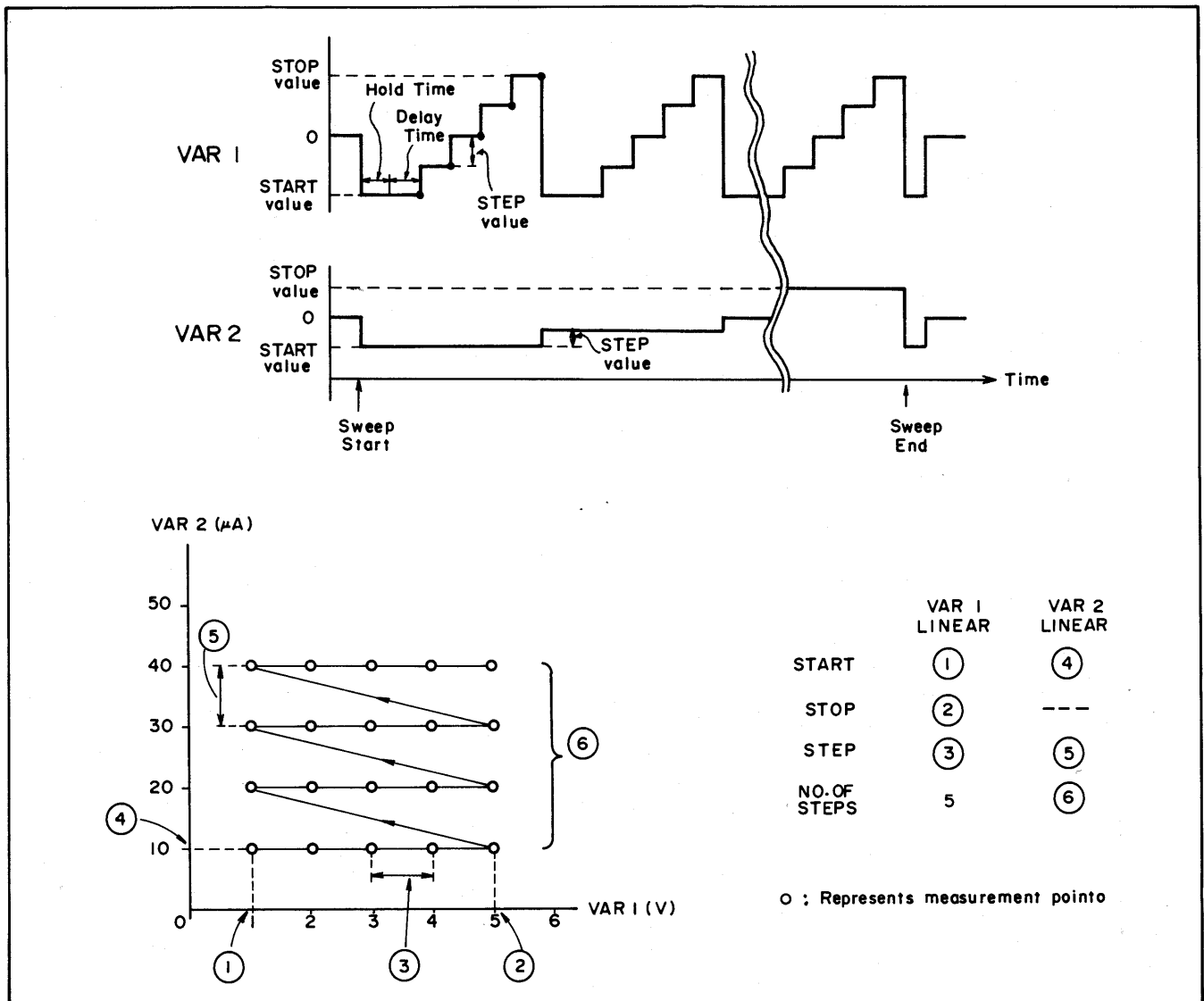

Figure 3-15. Relationship Between VAR1 and VAR2.

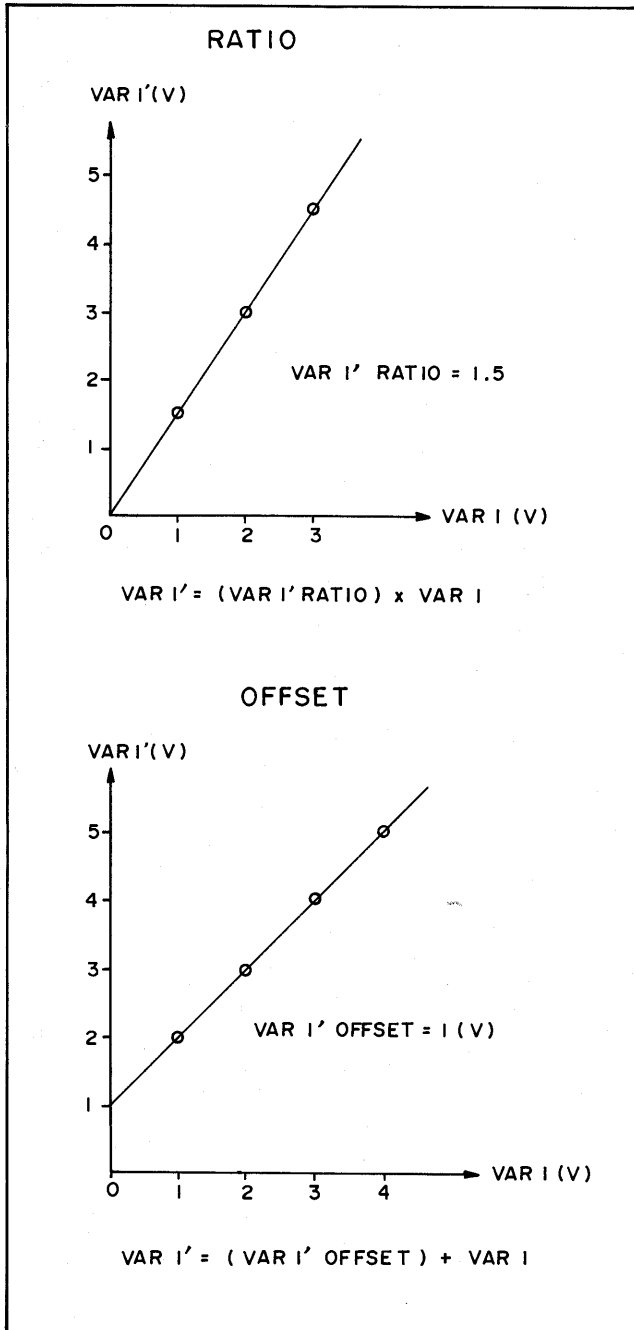

Figure 3-16. Relationship Between VAR1 and VAR1'.

3-32. The number of measurement points per decade in LOG sweep is selectable at 10, 25, or 50. The output at each point is determined by the number of measurement points per decade and the sweep START value. The output at the nth measurement point is calculated as :

$$\text{Output at nth point} = \text{START value} \times 10^{\frac{n-1}{\alpha}} \quad (3-1)$$

where α is the number of measurement points per decade (10, 25, 50).

3-33. TIME DOMAIN MEASUREMENT

3-34. A time domain measurement is one in which the voltages and/or currents applied to the device under test are held constant and the desired device parameter is measured as a function of time. Only one source channel can be swept and only with the VAR2 source function. All other channels are either "not used" or must be set to CONST source function. Selectable TIME DOMAIN parameters are WAIT TIME, INTERVAL, and NO. OF RDNGS (number of readings). Each is described below :

WAIT TIME :

Time before source channels begin outputting voltage or current. Also valid for the VAR2 source channel. Setting range is from 0 to 100 seconds and resolution is 10 milliseconds.

INTERVAL :

Time between each measurement point. Setting range is from 10 milliseconds to 10 seconds and resolution is 10 milliseconds.

NO. OF RDNGS :

Total number of measurement points. If VAR2 is used, NO. OF RDNGS per each step of VAR2. Up to 512 measurement points can be specified, depending on the number of VAR2 steps.

To make a TIME DOMAIN measurement, do not assign VAR1 to any of the source channels on the CHANNEL DEFINITION page. (Assigning VAR2 is optional.) Output values for all CONST sources must still be entered on the SOURCE SETUP page. If VAR2 is used, its START, STEP, and NO. OF STEPS must also be entered. Also, HOLD TIME and DELAY TIME are not used in a TIME DOMAIN measurement.

TIME DOMAIN parameters—WAIT TIME, INTERVAL, and NO. OF RDNGS—must be entered on the MEAS/DISP MODE SETUP page. Refer to Figure 3-33. Integration time during TIME DOMAIN measurement is automatically set to SHORT and cannot be changed.

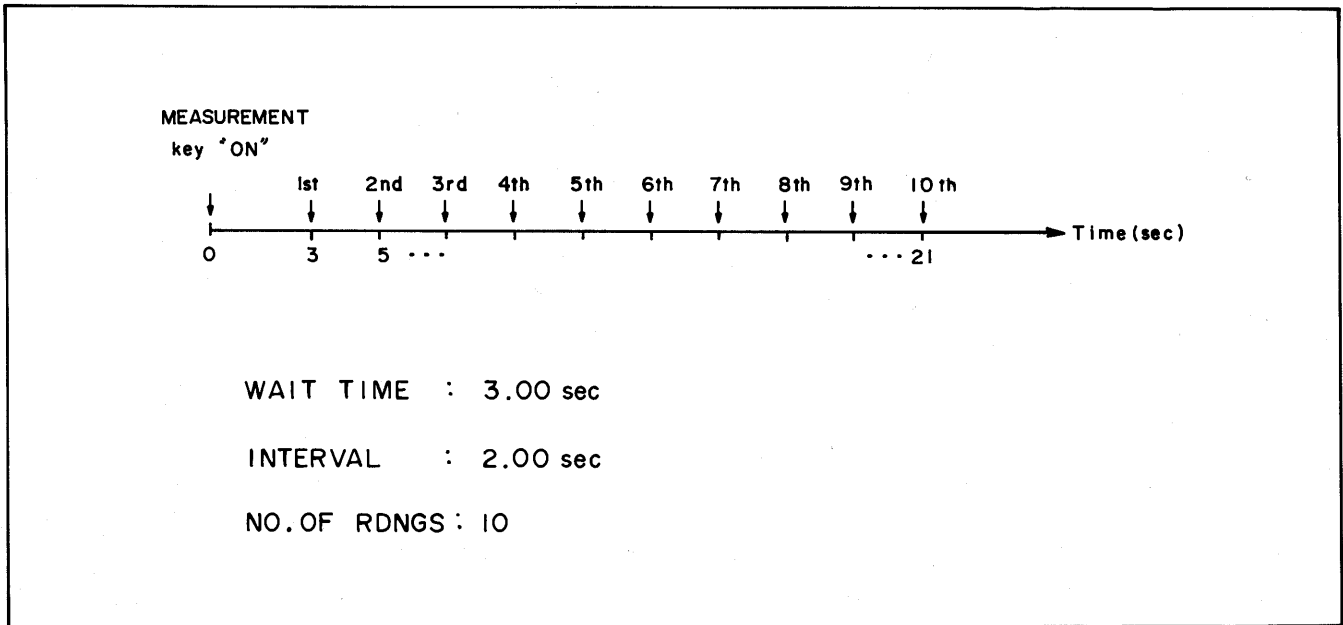

Figure 3-17. Time Domain Measurement.

3-35. INTEGRATION TIME

3-36. To prevent line frequency noise and other noise sources from affecting the accuracy of measurements, the 4145A is equipped with three digital integration times, which are selectable from the front panel. Each is described below:

SHORT: Digital integration is not performed.

MEDIUM: Measurement result is the average value of 16 samples taken during one line frequency period.

LONG: Measurement result is the average value of 256 samples taken during sixteen line frequency periods.

Integration time can be changed during measurement, but cannot be changed while the 4145A is in TALK mode (PLOT or PRINT), when the disc drive's read/write lamp first comes on, or during auto scaling. In time domain measurements only SHORT integration time is available.

3-37. AUTO-CALIBRATION

3-38. To both monitor and compensate for transient changes in output voltage and current caused by ambient temperature changes, each SMU is equipped with an auto-calibration function. This function allows each SMU to periodically monitor its own output and, if necessary, provide appropriate compensation.

3-39. The auto-calibration function of the SMUs is controlled by the AUTO CAL key on the front panel. With AUTO CAL turned on (key indicator lamp on), calibration is automatically performed every five minutes for about six seconds. If one of the MEASUREMENT keys or the AUTO CAL key is pressed during auto-calibration, "Busy" will be displayed on the CRT until auto-calibration is completed.

3-40. DISPLAY PAGES

3-41. The 4145A displays thirteen different screens. Each screen is called a page and each has a different purpose in relation to instrument operation. By changing from one page to another, different functions and capabilities, such as measurement set up, measurement, diagnostics, certain filing functions, etc., are made available. PAGE control is described in paragraph 3-42. Detailed explanations of each page are given Figures 3-20 through 3-32.

3-42. PAGE CONTROL

3-43. Display paging is controlled by the PAGE CONTROL keys—MENU, NEXT, and PREV—or the softkeys, as shown in Figure 3-18. (Softkeys for PAGE control are available only when the MENU is displayed.) Page-flow and the relationship between pages are shown in Figure 3-19. The solid lines (—) show page changes that are possible with the NEXT key or PREV key; the dashed lines (---) show page changes that are possible with the softkeys. To go to the GRAPHICS, LIST, MATRIX, or SCHMOO page from the MEAS/DISP MODE SETUP page, it is first necessary to select the desired display mode with the softkeys and then press the NEXT key.

All pages except the GRAPHICS, LIST, MATRIX, and SCHMOO pages can be displayed directly from the MENU page by pressing the appropriate softkey. For example, pressing softkey 3 while the MENU page is displayed automatically displays the MEAS/DISP MODE SETUP page. Pressing the MENU key automatically returns the display to the MENU page, regardless of the present display page. To change from the GRAPHICS page to, say, the LIST page, press the PREV key to display the MEAS/DISP MODE SETUP page, select LIST with the softkeys, and then press the NEXT key. Paging cannot be performed during measurement, printing, or plotting.

3-44. When the NEXT key or PREV key is pressed while the CHANNEL DEFINITION page, SOURCE SETUP page, MEAS/DISP MODE SETUP, or OUTPUT SEQUENCE SETUP page is displayed, the page is checked for completeness and correctness. If an illegal setup is detected, an error message will be displayed and no page change will occur. In this case you must either correct the setup or press the MENU key. Changes made on the CHANNEL DEFINITION, SOURCE SETUP, MEAS/DISP MODE SETUP and OUTPUT SEQUENCE SETUP pages are not valid for SAVE until the PREV or NEXT key is pressed.

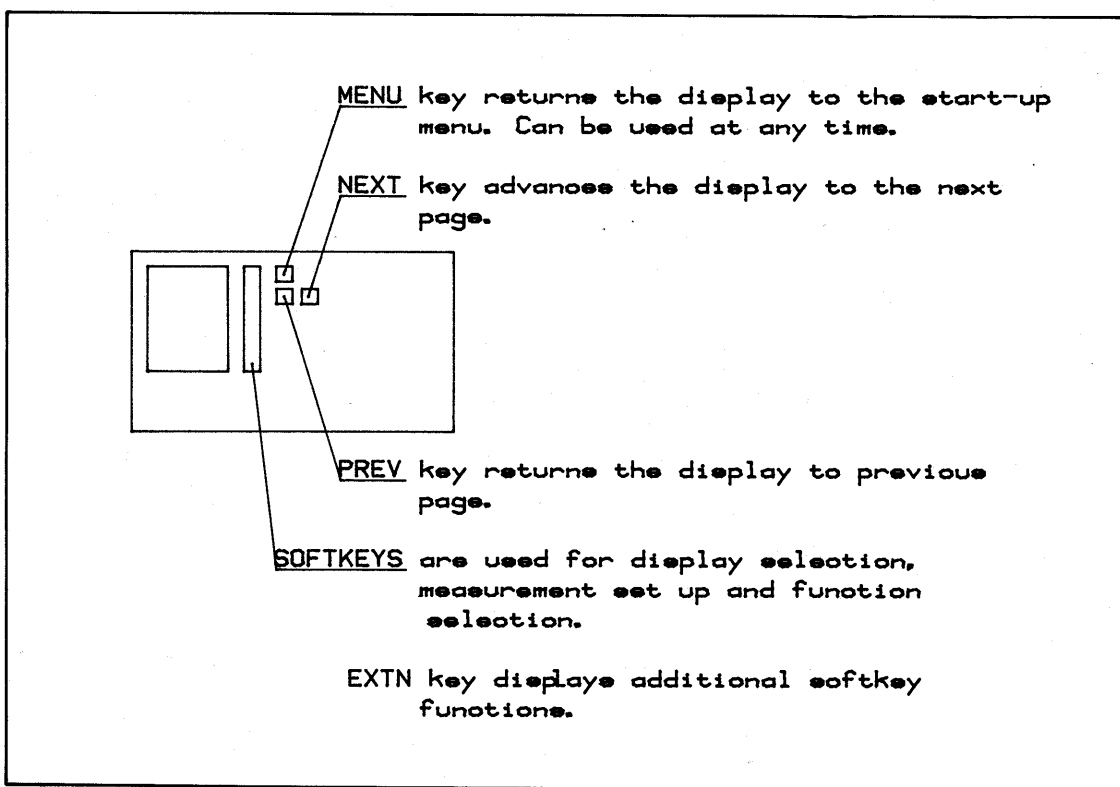
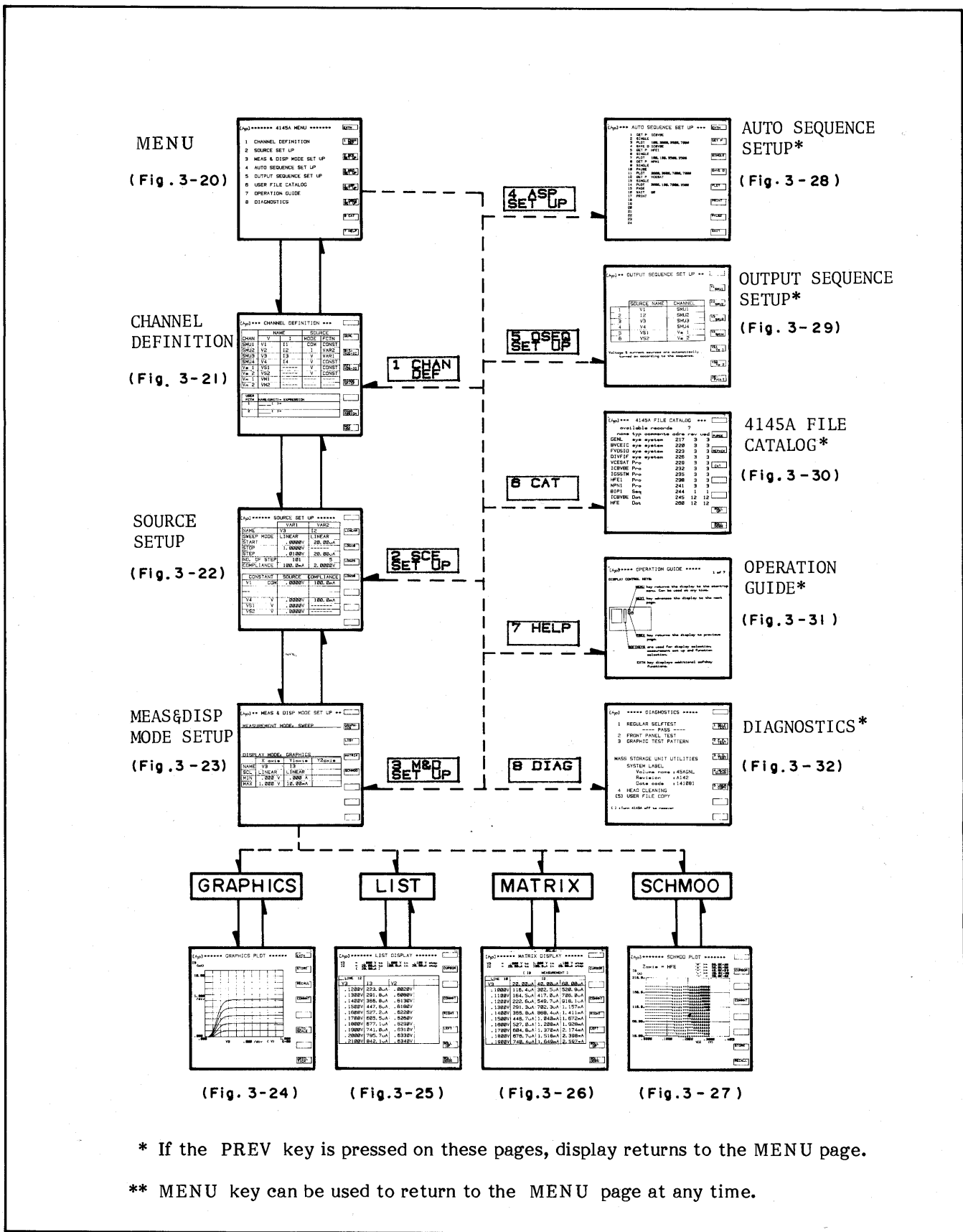

Figure 3-18. Page Control Keys.



* If the PREV key is pressed on these pages, display returns to the MENU page.

** MENU key can be used to return to the MENU page at any time.

Figure 3-19. Page Flow and the Relationship.

3-45. MENU PAGE

3-46. The start-up menu is displayed when the instrument is turned on and each time the MENU key is pressed. Displayed on the MENU page are the accessible pages, corresponding softkey prompts (SKP), the instrument's present HP-IB status, line frequency filter setting, and the status of each SMU. A detailed description of the MENU page is given in Figure 3-20.

3-47. CHANNEL DEFINITION PAGE

3-48. The CHANNEL DEFINITION page is displayed when softkey 1 or the NEXT key is pressed while the MENU page is displayed. On this page the operator must define the name, mode, and function of each channel that is to be used in the measurement. User functions are also defined on this page. A detailed description of the CHANNEL DEFINITION page is given in Figure 3-21.

3-49. SOURCE SETUP PAGE

3-50. The SOURCE SETUP page is displayed when softkey 2 is pressed on the MENU page or when the NEXT key is pressed on the CHANNEL DEFINITION page. On this page the operator must enter the output parameters (START, STOP, STEP, COMPLIANCE, etc.) for the source channels (SMUs and voltage sources) defined on the CHANNEL DEFINITION page. A detailed description of the SOURCE SETUP page is given in Figure 3-22.

3-51. MEAS/DISP MODE SETUP PAGE

3-52. The MEAS/DISP MODE SETUP page is displayed when softkey 3 is pressed on the MENU page or when the NEXT key is pressed on the SOURCE SETUP page. On this page the operator must select the desired display mode (GRAPHICS, LIST, MATRIX, SCHMOO), enter the appropriate source and monitor names, and enter the desired scaling factors. A detailed description of the MEAS/DISP MODE SETUP page is given in Figure 3-23.

3-53. GRAPHICS PLOT PAGE

3-54. The GRAPHICS PLOT page is displayed when the MEAS/DISP MODE SETUP page has been set up for GRAPHICS MODE DISPLAY and the NEXT key is pressed. On this page the operator can make the measurement by pressing the SINGLE, REPEAT, or APPEND key and can analyze the measurement results with the softkeys. A detailed description of the GRAPHICS PLOT page is given in Figure 3-24.

3-55. LIST DISPLAY PAGE

3-56. The LIST DISPLAY page is displayed when the MEAS/DISP MODE SETUP page has been set up for LIST mode display and the NEXT key is pressed. On this page the operator can make the measurement by pressing the SINGLE, REPEAT, or APPEND key and can analyze the measurement results with the softkeys. A detailed description of the LIST DISPLAY page is given in Figure 3-25.

3-57. MATRIX DISPLAY PAGE

3-58. The MATRIX DISPLAY page is displayed when the MEAS/DISP MODE SETUP page has been set up for MATRIX mode display and the NEXT key is pressed. On this page the operator can make the measurement by pressing the SINGLE, REPEAT, or APPEND key and can analyze the measurement results with the softkeys. A detailed description of the MATRIX DISPLAY page is given in Figure 3-26.

3-59. SCHMOO PLOT PAGE

3-60. The SCHMOO PLOT page is displayed when the MEAS/DISP MODE SETUP page has been set up for SCHMOO mode display and the NEXT key is pressed. On this page the operator can make the measurement by pressing the SINGLE or REPEAT key and can analyze measurement results with the softkeys. A detailed description of the SCHMOO PLOT page is given in Figure 3-27.

3-61. AUTO SEQUENCE SETUP PAGE

3-62. The AUTO SEQUENCE SETUP page is displayed when softkey 4 is pressed on the MENU page. On this page the operator can set up an auto-sequence program (ASP). A detailed description of the AUTO SEQUENCE SETUP page is given in Figure 3-28.

3-63. OUTPUT SEQUENCE SETUP PAGE

3-64. The OUTPUT SEQUENCE SETUP page is displayed when softkey 5 is pressed on the MENU page. On this page the operator can specify the order in which the SMUs and voltage sources begin output. A detailed description of the OUTPUT SEQUENCE SETUP page is given in Figure 3-29.

3-65. USER FILE CATALOG PAGE

3-66. The USER FILE CATALOG page is displayed when softkey 6 is pressed on the MENU page. On this page the operator can PURGE or REPACK files stored on the flexible disc. The number of records available, stored files, file type, comments, file addresses, number of records reserved for each file, and number of records actually used by each file are displayed. A detailed description of the USER FILE CATALOG page is given in Figure 3-30.

3-67. OPERATION GUIDE PAGE

3-68. The OPERATION GUIDE page is displayed when softkey 7 is pressed on the MENU page. This page provides brief paging information and brief descriptions of error messages and error codes. A detailed description of the OPERATION GUIDE page is given in Figure 3-31.

3-69. DIAGNOSTICS PAGE

3-70. The DIAGNOSTICS page is displayed when softkey 8 (press EXTN softkey to display softkey 8) is pressed on the MENU page. On this page the operator can perform SELF TEST, front panel test, graphics display test, disc cleaning, and disc copy (user-area only). A detailed description of the DIAGNOSTICS page is given in Figure 3-32.

3-71. SOFTKEY PROMPTS (SKP)

3-72. Softkey prompts (the function of each softkey) are displayed along the right side of the CRT display. There are eight softkeys, and the softkey prompts for the lower seven keys change depending on the page being displayed and the position of the Field Pointer (►) on the CHANNEL DEFINITION, SOURCE SETUP, and MEAS/DISP MODE SETUP pages. The softkey prompt of the top softkey is always EXTN (extended), regardless of the page being displayed or the position of the Field Pointer. EXTN is displayed only when additional softkey functions exist.

3-73. SYSTEM MESSAGES

3-74. System messages are instructions to the operator and are displayed on the System Message Line (refer to Figure 3-5), which is located at the bottom of the CRT display. System messages guide the operator through all phases of instrument operation, and make measurement setup a simple matter of filing in blanks on the CHANNEL DEFINITION, SOURCE SETUP, and MEAS/DISP MODE SETUP pages.

MENU PAGE

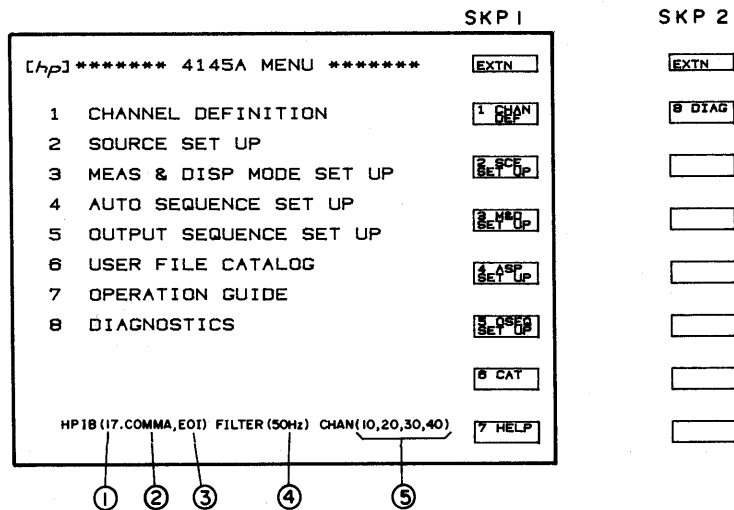

Figure A

Initial Condition :

When the 4145A is turned on, the display will be blank while SELF TEST is being performed. When SELF TEST has been completed and no fatal error have been detected, the MENU page will be displayed as shown in Figure A. The status of the instrument, as detected by the SELF TEST, is displayed at the bottom of the CRT.

- 1: HP-IB Address (0 - 30):
Shows the setting of the HP-IB Control Switch (located on the rear panel). To change the address, turn the instrument off, set the desired address, and turn the instrument on again.
- 2: Output data delimiter :
COMMA or CR/LF is displayed depending on the setting of the HP-IB Control Switch.
- 3: EOI (End or Identify) :
EOI is displayed when bit 7 of the HP-IB Control Switch is set to EOI ON.
- 4: Line Filter setting :
Indicates the setting of the Line Filter Switch on the rear panel. (50Hz) indicates that the instrument is set for operation from a 50Hz AC source. The LINE FILTER switch on the rear panel should be set to the frequency of the AC source if accurate measurements are to be obtained.

Figure 3-20. MENU Page (Sheet 1 of 2).

5: SMU Status :

Displays each SMU channel number and its status. (10, 20, 30, 40) indicates that all SMUs are functioning properly. Each 2-digit number represents the channel number and the channel status.

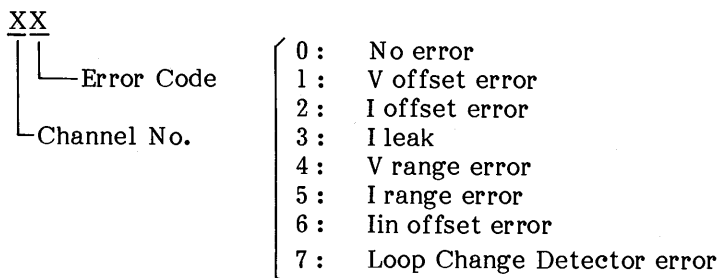

For example, (10, 20, 31, 40) indicates that SMU 3 has a V offset error and should not be used. SMUs 1, 2, and 4, however, are functioning properly and can be used for measurement. When (!!!DOWN!!!) is displayed, the SMU control circuit is not functioning properly and, thus, measurement can not be made.

Softkey Prompts (SKP) :

The MENU page has two softkey prompts (SKP1 and SKP2), as shown in Figure A. SKP1 is displayed when the MENU page first appears. To display SKP2, press the EXTN softkey; to re-display SKP1, press the EXTN softkey again.

Note

If the instrument is turned on after experiencing an extreme change of ambient temperature, one of error code may be displayed. In this case, allow the instrument to fully warm up (ignor the displayed error code), and then turn it off and on one time.

Figure 3-20. MENU Page (Sheet 2 of 2).

CHANNEL DEFINITION PAGE

SKP 3

[hp] *** CHANNEL DEFINITION ***

CHAN	NAME		SOURCE		GENL
	V	I	MODE	FCTN	
SMU1	V1	I1	COM	CONST	<input type="checkbox"/>
SMU2	V2	I2	I	VAR2	<input type="checkbox"/>
SMU3	V3	I3	V	VAR1	<input type="checkbox"/>
SMU4	V4	I4	V	CONST	<input type="checkbox"/>
V 1	VS1	-----	V	CONST	<input type="checkbox"/>
V 2	VS2	-----	V	CONST	<input type="checkbox"/>
Vm 1	VM1	-----	-----	-----	<input type="checkbox"/>
Vm 2	VM2	-----	-----	-----	<input type="checkbox"/>

USER FCTN	NAME (UNIT) = EXPRESSION	
1	< > =	<input type="checkbox"/>
2	< > =	<input type="checkbox"/>

CHAN ASSIGN
NOE

Figure A

Purpose and function of this Page :

1. To assign voltage (V) and current (I) names to each channel that will be used in the measurement.
2. To set the source mode of each SMU. (Determines whether the SMU will be used as a V source or I source.)
3. To set the source function of each SMU. (Determines whether the SMU will be used as a constant source or variable source.)
4. To define User Functions.

Initial Condition :

When the 4145A is turned on, the CHANNEL DEFINITION page is automatically setup as shown in Figure A and the field-pointer (▶) will be located in the V column of SMU1. (This setup is the GENL measurement setup stored on each disc. Refer to paragraph 3-87.)

Field-Pointer (▶) :

Changing or entering a V NAME, I NAME, SOURCE MODE, SOURCE FUNCTION, or USER FUNCTION can be accomplished only by positioning the field-pointer at the field to be changed. New information can then be entered with the appropriate front panel keys or softkeys. Positioning of the field-pointer is controlled by the CURSOR keys (FAST cannot be used on this page). When one of these keys is pressed the field-pointer will move one field in the direction of the arrow labelled on the key. Also, each time new information is entered into a field, the field-pointer will automatically move to the next field, as shown in Figure B.

Figure 3-21. CHANNEL DEFINITION Page (Sheet 1 of 4).

[hp] *** CHANNEL DEFINITION ***

CHAN	NAME		SOURCE	
	V	I	MODE	FCTN
SMU1				
SMU2				
SMU3				
SMU4			V	
V 1			V	
V 2			V	
Vm 1			---	---
Vm 2			---	---

USER FCTN	NAME (UNIT) -> EXPRESSION
1	
2	

Figure B

NAME and USER FUNCTION Entry :

- (1) Position the field-pointer at the desired field.
- (2) Key in the desired name or user-function expression (it will appear on the Keyboard Input Line on the CRT as you do so).
- (3) Press ENTER. The name or expression will be moved from the Keyboard Input Line to the field at which the field-pointer is positioned and the field-pointer will move to the next field.

Note

V NAME, I NAME, and USER FCTN NAME can be up to six characters long, of which the first character must be alphabetic and the remaining characters must be alphanumeric. A NAME can be used only once on this page. USER FCTN expressions can be up to sixty characters long and can contain channel names (V or I), numerics, and arithmetic operators.

SOURCE MODE and SOURCE FCTN Entry :

- (1) Position the field-pointer at the desired field.
- (2) Select the desired mode or function from those listed on the softkey prompts. (The softkey prompts will change depending on the location of the field-pointer.)
- (3) When the softkey is pressed, the selected mode or function will appear in the field and the field-pointer will move to the next field.

Note

SOURCE MODE and SOURCE FCTN can be entered only with the softkeys.

V NAME and I NAME :

These are unique names used to identify each channel that is to be used in the measurement. Each SMU has two names : one for its source function and one for its monitor function. Both must be entered if the SMU has been assigned a SOURCE MODE. If no V NAME is entered for a voltage source (Vs) or voltage monitor (Vm), the channel is considered as not used. The NOT USE softkey can be used to delete the NAMES, SOURCE MODE, and SOURCE FCTN of a channel and effectively turn it off. The NOT USE softkey is available only when the field-pointer is in the V NAME column.

SOURCE MODE :

Each SMU used in the measurement must be assigned a SOURCE MODE. Three SOURCE MODEs are available : V (voltage source/current monitor), I (current source/voltage monitor), and COM (common). A COM source is regarded as a voltage source whose output is 0V and compliance is 105mA. SOURCE MODE selection can be made only with the softkeys and only when the field-pointer is in the SOURCE MODE column.

SOURCE FCTN :

Each SMU and each Vs used in the measurement must be assigned a SOURCE FCTN. Four SOURCE FCTNs are available : VAR1 (main sweep), VAR1' (synchronous sweep), VAR2 (subordinate sweep), and CONST (constant source). SOURCE FCTN selection can be made only with the softkeys and only when the field-pointer is in the SOURCE FCTN column. Refer to paragraph 3-29 for details on VAR1, VAR1', and VAR2.

Note

If the SOURCE MODE of an SMU is COM, SOURCE FCTN is automatically set to CONST.

USER FCTN :

The user function is an extremely versatile, useful analysis aid. It is a user-defined arithmetic expression consisting of variables (V NAMES and I NAMES only) and constants and is executed at each measurement point during measurement. The results can be displayed (GRAPHICS PLOT, LIST, MATRIX, SCHMOO) along with measurement results. Any of the arithmetic operators listed in Table 3-5, plus Δ and parentheses, can be used in USER FCTN expressions. The only variables that can be used in a USER FCTN expression are the names listed in the V NAME and I NAME columns on the CHANNEL DEFINITION page. Two USER FCTNs can be defined and each can be up to 60 characters long.

SOFTKEY PROMPTS and SOFTKEYS FUNCTIONS :

The softkey prompts (SKP) displayed on the CRT automatically change as the field-pointer is moved to different areas of the page. The relationship between field-pointer location and the softkey prompts is shown in Figures C and D. For example, when the field-pointer is at ④ in Figure C, SKP 6 in Figure D, will be displayed on the CRT. SKP 8 and SKP 9 are displayed only after the CHAN ASSIGN softkey has been pressed on SKP3.

Figure 3-21. CHANNEL DEFINITION Page (Sheet 3 of 4).

[h/p] *** CHANNEL DEFINITION ***

CHAN	NAME		SOURCE	
	V	I	MODE	FCTN
SMU1	V ①	I1	COM	CONST
SMU2	V2	I2 ②	③	V/ ④
SMU3	V3	I3		
SMU4	V4	I4	V	CONST
V 1	V1 ⑤		V	CONST
V 2	VS2		V	CONST
Vm 1	VM1			
Vm 2	VM2			

USER FCTN	NAME (UNIT) =	EXPRESSION
1	⑥	⑦
2	⑧	⑧

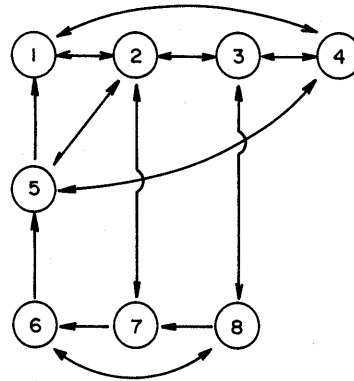

Figure C

①	⑤ ⑥	③	④	② ⑦ ⑧	SKP 8	SKP 9
SKP 3	SKP 4	SKP 5	SKP 6	SKP 7	SKP 8	SKP 9
<input type="text"/>	<input type="text"/>	<input type="text"/>	<input type="text"/>	<input type="text"/>	<input type="text"/>	<input type="text"/>
GENL		V	VAR1		SMU1	V= 1
B-I-C VCE-I-C		I	VAR2		SMU2	V= 2
FET VBS-ID		COM	CONST		SMU3	
GRADE VCE-IF			VAR1		SMU4	
<input type="text"/>	<input type="text"/>	<input type="text"/>	<input type="text"/>	<input type="text"/>	<input type="text"/>	<input type="text"/>
CHAN ASSIGN					CHAN ASSIGN	CHAN ASSIGN
DEL	DEL					

Figure D

CHAN ASSIGN (Channel Assignment):

This softkey allows you to quickly rearrange the SMU and Vs channel assignments, without having to reassign channel names (V and I), SOURCE MODEs, and SOURCE FCTNs. It is extremely helpful when DUT connections have been made or when measuring devices which require the same measurement setup but which have different pin-outs. The procedure is given below.

- (1) Move the field-pointer to area ① in Figure C. SKP 3 in Figure D, will be displayed.
- (2) Press the CHAN ASSIGN softkey. The field-pointer will automatically move to the first row in the CHAN column, rows 1 through 6 in the CHAN column will be blank, and SKP8 will be displayed.
- (3) Assign the channel numbers in the desired order. The field-pointer will move down the CHAN column as you do so. When the field-pointer reaches the fifth row, SKP9 will be displayed.
- (4) Press the CHAN ASSIGN softkey again to enter the new channel assignments. The field-pointer will move back to area ① in Figure C.

SOURCE SETUP PAGE

SKPI0

[hp]***** SOURCE SET UP *****				<input type="text"/>
	VAR1	VAR2		<input type="text"/>
NAME	V3	I2	LINEAR	<input type="text"/>
SWEEP MODE	LINEAR	LINEAR		<input type="text"/>
START	. 0000V	20. 00uA		<input type="text"/>
STOP	1. 0000V	-----	LOG10	<input type="text"/>
STEP	. 0100V	20. 00uA		<input type="text"/>
NO. OF STEP	101	5	LOG25	<input type="text"/>
COMPLIANCE	100. 0mA	2. 0000V		<input type="text"/>
				<input type="text"/>
CONSTANT	SOURCE	COMPLIANCE		<input type="text"/>
V1	COM	. 0000V	100. 0mA	<input type="text"/>
				<input type="text"/>
V4	V	. 0000V	100. 0mA	<input type="text"/>
VS1	V	. 0000V	-----	<input type="text"/>
VS2	V	. 0000V	-----	<input type="text"/>

Figure A

Purpose and function of this page :

1. Select the sweep mode (linear or log) for the VAR1 source channel.
2. Set the START, STOP, and STEP values for the VAR1 source channel.
3. Set the START and STEP values and NO. OF STEP for the VAR2 source channel.
4. Set the RATIO and OFFSET values for the VAR1' source channel.
5. Set the HOLD TIME and DELAY TIME.
6. Set the source (output) value for the CONST channels.
7. Set the COMPLIANCE value for each source channel.

Setup :

To change or enter source channel parameters on this page, move the field-pointer (▶) to the desired field and enter the parameter value with the ENTRY keys. Each time an entry is made the field-pointer will automatically move to the next field, as shown in Figure B. Except for SWEEP MODE, only numeric values and engineering units (m, μ , n, p) can be entered on this page. The source name assigned to each source channel on the CHANNEL DEFINITION page is automatically entered on this page.

Note

Entered value may be automatically changed to acceptable value when the ENTER key is pressed or the page is changed.

Figure 3-22. SOURCE SETUP Page (Sheet 1 of 4).

[hp]***** SOURCE SET UP *****

	VAR1	VAR2
NAME	V3	I2
SWEEP MODE	LINEAR	
START		
STOP		-----
STEP		
NO. OF STEP		
COMPLIANCE		

CONSTANT	SOURCE	COMPLIANCE
V1	COM	
V4	V	
VS1	V	-----
VS2	V	-----

Figure B

Parameter Entry :

When entering numeric values on this page, it is not necessary to enter the value unit. The unit for voltage values is V (volt); for current values, A (ampere); and for time values, s (seconds). For example, the key strokes required to enter a current value of 10.5mA are

[1][0][.][5][m][ENTER]

This value, 10.5m, will be displayed on the Keyboard Input Line. When the ENTER key is pressed the entered value will be moved to the field at which the field-pointer is located and the unit A will be automatically entered. Voltage and current limits for the SMUs and voltage sources (Vs) are listed below. Refer to Table 3-6 for specifiable voltage and current.

SMU	Voltage Range	0 to ±100V
	Current Range	0 to ±100mA
Vs	Voltage Range	0 to ±20V

Note

Values can be entered in fixed decimal format or floating decimal format (scientific notation).

SWEEP MODE Selection :

SWEEP MODE can be selected only with the softkeys and only when the field-pointer is in the SWEEP MODE row of the VAR1 column.

LINEAR : Linear staircase sweep at the specified STEP value

LOG 10 : }
 LOG 25 : } Logarithmic staircase sweep at 10, 25, or 50 measurements per decade
 LOG 50 : }

Figure 3-22. SOURCE SETUP Page (Sheet 2 of 4).

START, STOP, STEP Values for VAR1 :

START and STOP determine the sweep range for the VAR1 source channel. START value can be less than, equal to, or greater than the STOP value. If LOG has been selected as the SWEEP MODE, START and STOP must have the same signs. If the specified START and STOP values are identical, no sweep is performed and measurement is made at one point only. STEP determines the number of measurement points for LINEAR sweep. If LOG has been selected as the SWEEP MODE, the instrument's operating system software automatically calculates and enters the appropriate STEP value. In LINEAR SWEEP MODE, if the STEP value is greater than the START/STOP range ($STEP > |STOP - START|$), no sweep is performed and measurement is made at the START value only. NO. OF STEP (number of steps) for VAR1 is automatically calculated by the instrument as

$$\text{NO. OF STEP} = \left\lfloor \frac{STOP - START}{STEP} \right\rfloor + 1 \quad (3-2)$$

The START, STOP, and STEP values must be such that NO. OF STEP does not exceed 512. Also, both the START and STOP values for LOG sweep must be greater than zero. Even if zero is entered, it is automatically changed to 1mV or 1pA.

START, STEP, and NO. OF STEP for VAR2 :

START, STEP, and NO. OF STEP (number of steps) determine the sweep range for the VAR2 source channel. VAR2 sweeps are VAR1 dependent; that is, VAR2 is swept one STEP for each complete sweep of VAR1. The maximum NO. OF STEP for VAR2 is 32. When only one monitor channel (SMU or Vm) is used the maximum number of measurement points is

$$\text{Measurement Points} = (\text{NO. OF STEP VAR1}) \times (\text{NO. OF STEP VAR2}) \quad (3-3)$$

If the number of measurement points exceeds 570, "Buffer full" will be displayed on the CRT.

RATIO and OFFSET Values for VAR1' :

VAR1' can be swept in unison with VAR1 at a constant RATIO or OFFSET. The output from the VAR1' source channel is calculated as

$$\text{VAR1}' = (\text{RATIO}) \times \text{VAR1} \quad (3-4)$$

$$\text{VAR1}' = \text{VAR1} + (\text{OFFSET}) \quad (3-5)$$

To enter RATIO and OFFSET, move the field-pointer to area ② or ③ in Figure C, press the VAR1' RATIO or VAR1' OFFSET softkey, enter the desired value, and press EXECUTE. The entered value will be displayed on the CRT, between the two tables. Both RATIO and OFFSET can be entered, but only the one displayed on this page is valid during measurement.

Note

The specified RATIO or OFFSET values must be such that the VAR1' source channel does not exceed its maximum output (SMU, $\pm 100V$; Vs, $\pm 20V$). Also, output from VAR1' may lead or lag the VAR1 output by 1ms in V mode and from 4ms to 50ms in I mode. For log sweep measurements, only VAR1' RATIO can be specified.

Figure 3-22. SOURCE SETUP Page (Sheet 3 of 4).

HOLD TIME and DELAY TIME :

HOLD TIME is the initial wait time and the wait time after a VAR2 step change. DELAY TIME is the wait time after VAR1 step change. To enter HOLD TIME and DELAY TIME, move the field-pointer to area ② or ③ in Figure C, press the HOLD TIME or DELAY TIME softkey, enter the desired value, and press EXECUTE.

SOURCE Value for CONSTANT Channels :

The NAME and SOURCE MODE of all source channels that were assigned the CONST SOURCE FCTN on the CHANNEL DEFINITION page are listed in the CONSTANT column on this page. The order in which they are listed is identical to the order on the CHANNEL DEFINITION page. To enter the SOURCE value, move the field-pointer to the desired field, key in the value, and press ENTER. The SOURCE value for a COM source channel is set to 0V by the instrument and cannot be changed.

COMPLIANCE Value :

COMPLIANCE is a special feature for protecting samples against over-voltage or over-current damage. Refer to paragraph 3-27. It limits the current output from a voltage source or the voltage output from a current source. COMPLIANCE for a COM source is set to 105mA by the instrument. The COMPLIANCE for a CONSTANT Vs is 10mA but is not displayed on this page.

Softkey Prompts (SKP) :

Depending on the position of the field-pointer, the softkey prompts automatically change. Figure C shows the relationship between the position of field-pointer and softkey prompts.

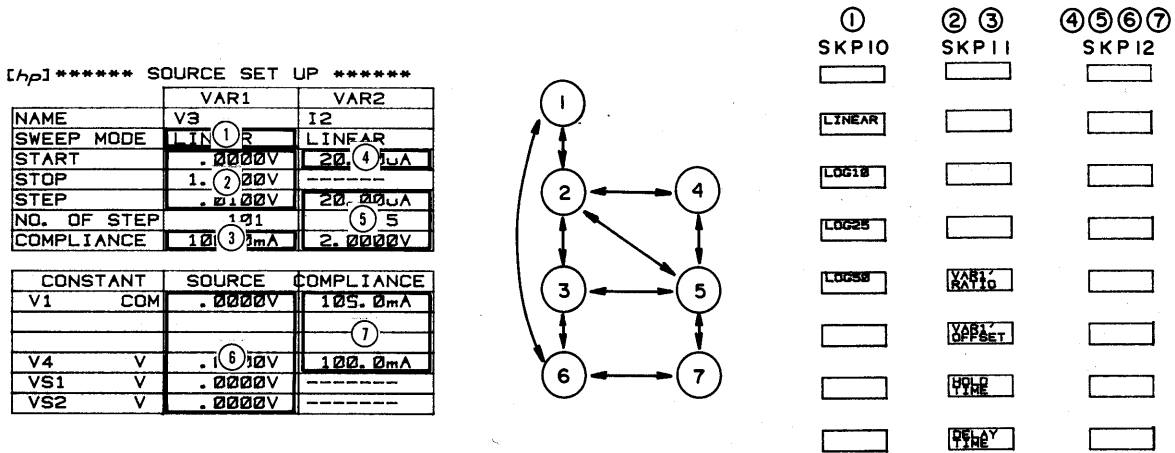

Figure C

Figure 3-22. SOURCE SETUP Page (Sheet 4 of 4).

MEAS & DISP MODE SETUP PAGE

SKP13				SKP14	SKP15	SKP16	SKP17																				
[hp]** MEAS & DISP MODE SET UP **					EXTN	EXTN																					
MEASUREMENT MODE: SWEEP				LINEAR																							
GRAPHICS				LOG	I1																						
LIST					V2																						
DISPLAY MODE: GRAPHICS					I3																						
MATRIX					I4																						
SCHMOO					VM1																						
<table border="1"> <thead> <tr> <th></th> <th>X axis</th> <th>Y1axis</th> <th>Y2axis</th> </tr> </thead> <tbody> <tr> <td>NAME</td> <td>V3</td> <td>I3</td> <td></td> </tr> <tr> <td>SCL</td> <td>LINEAR</td> <td>LINEAR</td> <td></td> </tr> <tr> <td>MIN</td> <td>.0000V</td> <td>.000 A</td> <td></td> </tr> <tr> <td>MAX</td> <td>1.0000V</td> <td>10.00mA</td> <td></td> </tr> </tbody> </table>					X axis	Y1axis	Y2axis	NAME	V3	I3		SCL	LINEAR	LINEAR		MIN	.0000V	.000 A		MAX	1.0000V	10.00mA			VM2	NOT USE	NOT USE
	X axis	Y1axis	Y2axis																								
NAME	V3	I3																									
SCL	LINEAR	LINEAR																									
MIN	.0000V	.000 A																									
MAX	1.0000V	10.00mA																									

Figure A

Purpose and function of this page :

1. Select the Display Mode for the measurement.
2. Select the monitor channels.
3. Set up the display parameters.

MEASUREMENT MODE:

The existing MEASUREMENT MODE — SWEEP or TIME DOMAIN — is displayed on this page but cannot be changed on this page. MEASUREMENT MODE depends on whether or not VAR1 is assigned to a source channel (SMU or Vs) on the CHANNEL DEFINITION page. If VAR1 is assigned, MEASUREMENT MODE is SWEEP; if not, MEASUREMENT MODE is TIME DOMAIN. Refer to paragraph 3-75 for details on TIME DOMAIN measurements.

DISPLAY MODE Selection:

When this page is initially displayed, the field-pointer (►) will be located on the DISPLAY MODE line and the display modes — GRAPHICS, LIST, MATRIX, SCHMOO — will be listed in the softkey prompt area of the CRT. The table below the DISPLAY MODE line will change depending on which display mode is selected. The field-pointer will automatically move as names are selected and values are input and the softkey prompts will change depending on the location of the field-pointer.

DISPLAY MODE can be selected only when the field-pointer is on the DISPLAY MODE line. To select the DISPLAY MODE, press the desired softkey. The field-pointer will automatically move to the NAME field of the DISPLAY MODE table.

Figure 3-23. MEAS & DISP MODE SETUP Page (Sheet 1 of 6).

GRAPHICS PLOT Setup :

Pressing the NEXT key when this page is as shown in Figure A will display the GRAPHICS PLOT page, as shown in Figure B. The name and scaling of each axis is determined by the NAME, SCL, MIN, and MAX information appearing on the MEAS/DISP MODE SETUP page.

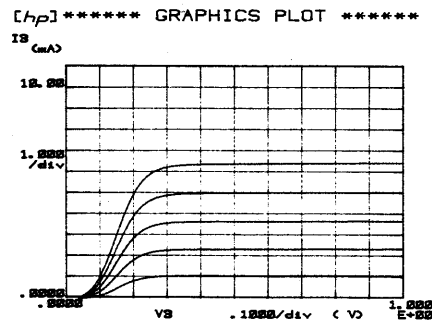

Figure B

- NAME :** Can be entered only with the softkeys. Determines the channels that will be used in the measurement. Only those channels whose names are listed in the softkey prompt area can be selected. The channel names or user-function names (press EXTN) selected on this page will be X, Y₁, and, if used, Y₂ axes on the GRAPHICS PLOT page.
- SCL (Scale) :** Determines the grid scaling on the GRAPHICS PLOT page. LINEAR or LOG can be selected with the softkeys. Not related to the SWEEP MODE selected on the SOURCE SETUP page.
- MIN/MAX :** Determines the minimum and maximum values of each axis. Value units (V or A) are automatically entered by the instrument.

Note

MIN and MAX must have the same sign for an axis that is to be displayed with LOG scaling. Also, if 0 is entered for MIN or MAX in LOG scale, 0.1mV, 0.01pA, or 1E-35 is assumed.

GRAPHICS DISPLAY Scaling :

Scaling on the GRAPHICS PLOT page depends on the selected SCL and the MIN and MAX values.

1. When LINEAR has been selected and 0 is not within the MIN/MAX range (i.e., $0 \leq \text{MIN}$ or $\text{MAX} \geq 0$), MIN and MAX will be located as shown in Figure C.

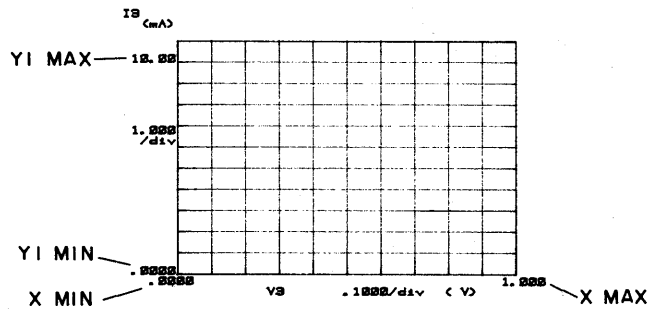

Figure C

When setup for LINEAR scaling, the X axis has 10 divisions and the Y axes, 11. The value per division is calculated as

$$\text{Value/div.} = \frac{|\text{Max-Min}|}{10} \quad (3-6)$$

2. When LINEAR has been selected and 0 is within the MIN/MAX range (i.e., $\text{MIN} < 0 < \text{MAX}$), the MIN and MAX values specified on the MEAS/DISP MODE SETUP may be different from those displayed on the GRAPHICS PLOT page. This occurs when the MIN or MAX value is not a multiple of Value/div. in equation 3-6. Division scaling is always in reference to 0. For example if the MIN and MAX values on the MEAS/DISP MODE SETUP page are -2 and 1, respectively, the MIN and MAX values displayed on the GRAPHICS PLOT page are -.12 and .96, respectively.
3. When LOG has been selected, the number of divisions depends on the number of decades between the MIN and MAX values. For example, when the MIN and MAX values are 1 and 9, respectively, only one division is displayed and the displayed MIN and MAX values are 1E00 and 1E+01; when the MIN and MAX values are 0.9 and 10, respectively, two divisions are displayed and the displayed MIN and MAX values are 1E-01 and 1E+01.

- Notes:
- 1) If Y1 and Y2 have different scale modes (SCL), the division lines displayed on the GRAPHICS PLOT page are for Y1, and Y2 will have a separate set of tick marks.
 - 2) In LOG scale, an extra decade may be displayed because of the quantum error, and also if the MIN/MAX range is very large, part of the graph will not have division lines.
 - 3) If MIN and MAX are close, their displayed value may include quantum error, and if they are so close that the difference between them is smaller than best resolution, the maximum allowable resolution is used.

1mV (voltage)
 50pA (current)
 100ms (time)
 1E-34 (user function units)

Also, 1 division can not be less than 0.1 in LOG scale :

Figure 3-23. MEAS & DISP MODE SETUP Page (Sheet 3 of 6).

LIST DISPLAY Setup :

When LIST is selected on the DISPLAY MODE line, the MEAS/DISP MODE SETUP page will be as shown below.

[hp] ** MEAS & DISP MODE SET UP **

MEASUREMENT MODE, SWEEP

DISPLAY MODE, LIST

NAMES	IC

Figure D

The field-pointer will be in the top row of the NAMES table. Up to six of the names listed in the softkey prompt area can be entered. Measurement results of each name listed here will be digitally listed on the LIST DISPLAY page. The measurement results are those obtained at each VAR1 step.

MATRIX DISPLAY Setup :

When MATRIX is selected on the DISPLAY MODE line, the MEAS/DISP MODE SETUP page will be as shown below.

[hp] ** MEAS & DISP MODE SET UP **

MEASUREMENT MODE, SWEEP

DISPLAY MODE, MATRIX

NAME	IC

Figure E

The field-pointer will be in the top row of the NAMES table. Only one of the names listed in the softkey prompt area can be entered. Measurement results of the name listed here will be digitally listed on the MATRIX DISPLAY page. The measurement results are those obtained at each VAR1 and VAR2 step.

Note

If VAR2 is not assigned on the CHANNEL DEFINITION page, only one sweep will be made and thus only one set of measurement results will be listed.

SCHMOO PLOT Setup :

When SCHMOO is selected on the DISPLAY MODE line, the MEAS/DISP MODE SETUP page will be as shown below.

[hp]** MEAS & DISP MODE SET UP **

MEASUREMENT MODE: SWEEP

DISPLAY MODE: SCHMOO		HFE
NAME	M	150. E+00
LIMIT	Δ	140. E+00
	+	130. E+00
	*	120. E+00

Figure F

A SCHMOO PLOT is a three dimensional display, where VAR1 is the X-axis, VAR2 is the Y-axis, and the channel whose name is listed in the NAME field is the Z-axis. When measurement is made, the results are distinguished by the symbols listed in the SCHMOO table. X-axis and Y-axis scaling is determined by the VAR1 and VAR2 sweep parameters. The LIMIT for each symbol is the lower limit. For example, if the LIMITs for M and Δ are .500 and .100, respectively, M represents measurement results greater than .500 and Δ represents measurement results between .100 and .500. For measurement results less than the LIMIT for :, - is used. To enter a LIMIT, move the field-pointer to the M, Δ, +, or : field, enter the value with the ENTRY keys, and press ENTER.

SCHMOO PLOT Scaling :

X and Y axes scaling is determined by the VAR1 and VAR2 sweep parameters. The X-axis can have up to 41 points and the Y axis, up to 21 points. MIN and MAX values for each axis are calculated as follows :

1. SWEEP MODE of VAR1 is LINEAR :

$$\left. \begin{array}{l} \text{X-axis (VAR1): MIN} = a, \text{ MAX} = a+40xb \\ \text{Y-axis (VAR2): MIN} = c, \text{ MAX} = c+20xd \end{array} \right\} (3-7)$$

where a = START value of VAR1
 b = STEP value of VAR1
 c = START value of VAR2
 d = STEP value of VAR2

when STEP = 0, MIN and MAX = START.

Figure 3-23. MEAS & DISP MODE SETUP Page (Sheet 5 of 6).

2. SWEEP MODE of VAR1 is LOG :

$$\left. \begin{array}{l} \text{X-axis (VAR1): MIN = a, MAX = } ax10^{\frac{40}{\alpha}} \\ \text{Y-axis (VAR2): MIN = c, MAX = c+20xd} \end{array} \right\} (3-8)$$

where

a = START value of VAR1
 α = Number of steps per decade (10, 25, 50)
 c = START value of VAR2
 d = STEP value of VAR2

Note

Equation 3-8 applies only when START \leq STOP. When START > STOP, X-axis MAX value is calculated as

$$\text{X-axis: MAX} = ax10^{-\frac{40}{\alpha}} \quad (3-9)$$

Figure 3-23. MEAS & DISP MODE SETUP Page (Sheet 6 of 6).

GRAPHICS PLOT PAGE

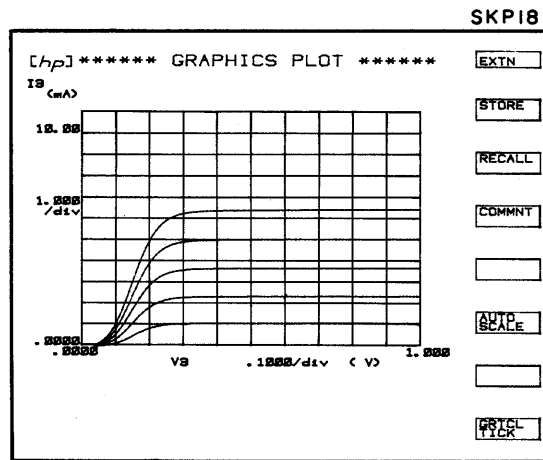

Figure A

Function of this page :

1. Graphically display measurement results.
2. Allow analysis of measurement results with the softkeys and arithmetic capabilities.

MEASUREMENT :

Each time this page is displayed, the results of the previous measurement are automatically re-displayed, regardless of the display mode used in the previous measurement. If any change is made on the CHANNEL DEFINITION page or SOURCE SETUP page or if a NAME on the MEAS/DISP MODE SETUP page is changed, the results of the previous measurement are erased from the data buffer and a new measurement must be made. To make a new measurement, press the SINGLE, REPEAT, or APPEND key. Measurement results will be displayed as the measurement progresses.

- Notes :
- 1) If the X axis value or Y axis value of a measurement point is outside the plot area, no trace will be drawn between it and the previous and succeeding measurement points.
 - 2) In LOG scale, if the measurement data has two polarities, result is not correctly displayed.
 - 3) Only 576 measurement points can be displayed.

Softkey Prompts (SKP) :

Softkey prompts displayed on the GRAPHICS PLOT page are shown in Figure B.

SKP 18 is displayed when this page is first displayed. The other SKPs (19 through 23) can be displayed by pressing the EXTN softkey. When EXTN is pressed on SKP23, SKP18 is displayed. SKP23 (blank) can be used when taking photographs of the CRT.

Figure 3-24. GRAPHICS PLOT Page (Sheet 1 of 6).

SKP 18	SKP 19	SKP 20	SKP 21	SKP 22	SKP 23
EXTN	EXTN	EXTN	EXTN	EXTN	
STORE	MARKER	LONG CURSOR	CURSOR	V _{OFF} START	
RECALL		← →	LINE ON	V _{OFF} STOP	
COMMNT	ENTER PLATE	→ ←	LINE1	V _{OFF} STEP	
		↑ ↓	LINE2	V _{OFF} START	
AUTO SCALE	MARBER	↑ ↓	GRAB	V _{OFF} STEP	
		MOVE WINDOW	GRAB VALUE	HOLD TIME	
PRCL-TRCK		SHORT CURSOR	CHANGE POINT	DELAY	

Figure B

Softkey Functions :

STORE : Stores displayed measurement results.

RECALL : Recalls (re-displays) stored measurement results.

These two softkeys provide overlay comparisons of two measurement results. To store the results of a measurement, press the STORE softkey. The frame around the STORE softkey prompt will be highlighted until the data is completely stored, after which it will return to normal intensity. Measurement results are stored in the display buffer as background data, and when recalled, will be of slightly less intensity than normal. Two important points to remember are (1) scaling information is not stored and (2) rescaling is not performed on recalled measurement results, even if the AUTO SCALE function is used. Thus, if the plot to be overlaid is scaled differently from the stored plot, any comparison between the two is meaningless. To recall a stored plot, press the RECALL softkey. The frame around the softkey prompt will be highlighted and will remain so until the softkey is pressed again.

COMMNT :

User-entered comments of up to 30 characters can be displayed on the CRT. The procedure is as follows :

1. Press the COMMNT softkey. The frame around the softkey prompt will be highlighted and the BLUE key will be set to on.
2. Key in the comment (up to 30 characters). There is no restriction on character type.
3. Press the ENTER key. The comment will be displayed directly below the page title and the frame around the COMMNT softkey prompt will be de-highlighted (normal intensity).

With the comment function set to on (COMMNT softkey prompt highlighted), anything displayed on the Keyboard Input Line will be entered and displayed as a comment if the ENTER key is pressed, even if a comment is already displayed below the page title. This allows you to change or delete an existing comment. For example, to delete a comment, press the COMMNT softkey, CLEAR the Keyboard Input Line, and press ENTER.

Figure 3-24. GRAPHICS PLOT Page (Sheet 2 of 6).

**AUTO
SCALE** :

Re-scales the plot area to provide optimum display of the existing measurement results. When auto-scaling is performed, the minimum and maximum measured values are used as the plot-area scaling factors. The MIN and MAX values specified on the MEAS/DISP MODE SETUP page, however, are not changed and the new scaling factors are cancelled when the PREV or MENU key is pressed. To re-scale the existing plot, press the AUTO SCALE softkey. The frame around the softkey prompt will be highlighted and will remain so until auto-scaling is completed, about 5 seconds.

**GRICL
TICK** :

Graticule or tick mode control. When this softkey is pressed, grid lines are replaced by tick-marks along each axis. To return to graticule mode, press this softkey again.

MARKER :

Displays a marker (⊙) which can be moved along plotted curves by rotating the MARKER dial. X, Y₁, and Y₂ coordinates of the marker location are digitally displayed above the plot area. When the Y₂ axis is used, two markers (⊙,*) are displayed. Both have the same X-axis coordinates and move in unison. The marker can be used for keyboard calculations. Instead of entering the numeric value of a measurement result, the channel name can be entered.

Note

When a log sweep is made, marker location displayed may include quantum error.

**INTER-
POLATE** :

Used for higher resolution marker positioning. Normally the marker moves from one measurement point to the next and cannot be positioned between two measurement points. With the INTERPOLATE function, however, the marker can be positioned at any point between two measurement points.

**MARKER
SKIP** :

Moves the marker or markers to the next VAR2 step. VAR1 does not change. If this softkey is pressed when the marker is at the last VAR2 step, the marker will return to the first VAR2 step. Also, INTERPOLATE is turned off when MARKER SKIP is performed.

Figure 3-24. GRAPHICS PLOT Page (Sheet 3 of 6).

**LONG
CURSOR** :

Displays the LONG CURSOR. When this softkey is pressed, the frame around the softkey prompt will be highlighted and the LONG CURSOR will be displayed at the center of the plot area. The LONG CURSOR can be moved to any point in the plot-area by pressing the appropriate CURSOR keys. Pressing the FAST CURSOR key while pressing one of the directional CURSOR keys moves the cursor faster. The X, Y₁, and Y₂ coordinates of the cursor location are digitally displayed above the plot area. The LONG CURSOR is turned off by pressing this softkey again, by turning on the SHORT CURSOR, or by pressing the PREV or MENU key.

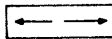

: Horizontal zoom-in (x2).

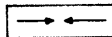

: Horizontal zoom-out (x2).



: Vertical zoom-in (x2).

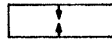

: Vertical zoom-out (x2).

These softkeys are used in conjunction with the LONG and SHORT cursors to zoom-in on or zoom-out from the cursor location. When one of these keys is pressed, the cursor will be repositioned at the center of the plot-area and the whole plot-area, including the plotted curves, will be enlarged or reduced in the indicated direction. The relative position of the cursor and plotted curves remains the same. That is, when the cursor is centered by the zoom function, the plotted curves are moved in reference to the cursor. Vertical zooming is performed on the Y₁-axis only.

**MOVE
WINDOW** :

Moves the LONG CURSOR or SHORT CURSOR to the center of the plot area, maintaining the relative position of the cursor and plotted curves.

**SHORT
CURSOR** :

Displays the SHORT CURSOR. When this softkey is pressed, the frame around the softkey prompt will be highlighted and the SHORT CURSOR will be displayed at the center of the plot-area. The CURSOR can be moved to any point in the plot-area by pressing the appropriate CURSOR keys. Pressing the FAST CURSOR key while pressing one of the directional keys moves the cursor faster. The X, Y₁, and Y₂ coordinates of the cursor location are digitally displayed above the plot area. The SHORT CURSOR is turned off by pressing this softkey again, by turning on the LONG CURSOR, or by pressing the PREV or MENU key.

Note

When the LINE is displayed and either SHORT or LONG CURSOR is on, the location of the CURSOR may change if AUTO-SCALE, ZOOM or MOVE WINDOW is performed.

CURSOR :

Moves the LONG CURSOR or SHORT CURSOR to the position of the MARKER. MARKER must be turned on.

LINE ON :

Turns on the instrument's graphics analysis functions — LINE 1, LINE 2, GRAD MODE, GRAD VALUE, and CHANGE POINT. When this softkey is pressed, LINE 1 (solid line) and two SHORT CURSORS are displayed. The GRAD, 1/GRAD, X-intercept, and Y-intercept values are also displayed, below the plot area. The graphics analysis functions are available only when this softkey is turned on (frame highlighted).

LINE1 : Displays LINE 1 (solid line)

LINE2 : Displays LINE 2 (dashed line)

Each line has two SHORT CURSORS. One cursor is moveable and the other is fixed. The gradient, or slope, of each line can be changed by moving the moveable cursor with the CURSOR keys. Both lines can be displayed at the same time, but only one (frame highlighted) can be moved. The gradient (GRAD), gradient reciprocal (1/GRAD), X-intercept, and Y-intercept values for both lines are displayed below the plot area. The moveable cursor and fixed cursor can be interchanged by pressing the CHANGE POINT softkey.

GRAD MODE :

Fixed gradient value. When this key is pressed, the fixed cursor is turned off (only the moveable cursor remains), and the line moves at a constant gradient value.

GRAD VALUE :

Line gradient entry. The desired line gradient can be entered from the front panel. When this softkey is pressed, the existing gradient value will be displayed on the Keyboard Input Line. To enter a new value, press the CLEAR key, key in the desired value, and press ENTER. The line will automatically adjust to the new gradient.

CHANGE POINT :

Interchanges the moveable and fixed cursors of the line.

Note

GRAD value and 1/GRAD value display 170E+39 and 5.88E-39 instead of overflow and zero, respectively.

Figure 3-24. GRAPHICS PLOT Page (Sheet 5 of 6).

- VAR1
START** : Changes the START value for VAR1.
- VAR1
STOP** : Changes the STOP value for VAR1.
- VAR1
STEP** : Changes the STEP value for VAR1.
- VAR2
START** : Changes the START value for VAR2.
- VAR2
STEP** : Changes the STEP value for VAR2.
- HOLD
TIME** : Changes the HOLD TIME (0 - 655.35 sec).
- DELAY
TIME** : Changes the DELAY TIME (0 - 6.500 sec).

These softkeys allow the operator to check or change the existing measurement parameters, without having to return to the SOURCE SETUP page. The new values are automatically entered on the SOURCE SETUP page. Measurement parameter values can be changed during measurement but only DELAY TIME is valid immediately; HOLD TIME is valid for the next VAR2 step; VAR1 and VAR2 parameters are valid for the next measurement.

Notes

- 1: Range and resolution are the same as those on the SOURCE SETUP page.
- 2: Error message "Step overflow" will be displayed when an attempt is made to enter a value that causes the number of steps for VAR1 to exceed 512.
- 3: VAR1 START, STOP, and STEP softkeys are disabled when VAR1 has not been assigned (e.g., Time Domain measurement), and when VAR1 is assigned VAR2 START and STEP softkeys are disabled when VAR2 has not been assigned. VAR1 STEP is disabled in log sweeps. Also, HOLD TIME and DELAY TIME are disabled in Time Domain measurements.

Figure 3-24. GRAPHICS PLOT Page (Sheet 6 of 6).

LIST DISPLAY PAGE

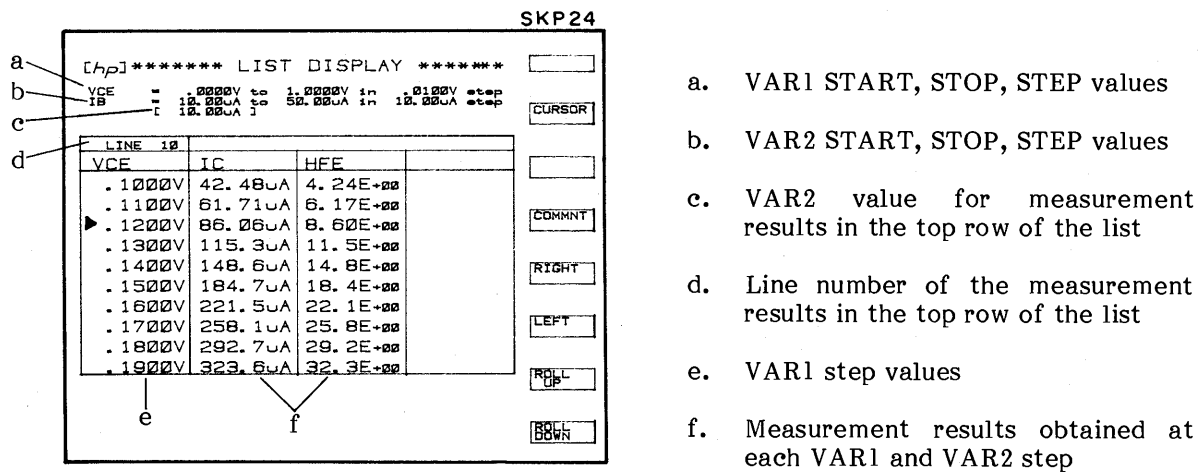

Figure A

Function of this page :

1. Display the measurement results obtained at each VAR1 and VAR2 (if used) step for all monitor channels selected on the MEAS/DISP MODE SETUP page.
2. Allow analysis of measurement results with the softkeys and arithmetic capabilities.

MEASUREMENT :

Each time this page is displayed, the results of the previous measurement are automatically re-displayed, regardless of the display mode used in the previous measurement. If any change is made on the CHANNEL DEFINITION page or SOURCE SETUP page or if a NAME on the MEAS/DISP MODE SETUP page is changed, the results of the previous measurement are erased from the data buffer and a new measurement must be made. To make a new measurement, press the SINGLE, REPEAT, or APPEND key. Measurement results of the first three monitor channels selected on the MEAS/DISP MODE SETUP page will be displayed as the measurement progresses. The list contains four columns. Each VAR1 step is listed in the left-most column. The VAR2 STEP corresponding to the top line VAR1 STEP is displayed in brackets above the list (c in Figure A). The remaining three columns list the measurement results of the first three monitor channels selected on the MEAS/DISP MODE SETUP page. If more than three monitor channels are selected on the MEAS/DISP MODE SETUP page, measurement results for the fourth, fifth, and sixth monitor channels can be displayed by pressing the LEFT softkey. Only ten lines can be displayed. To display additional lines, use the ROLL UP or ROLL DOWN softkeys.

Figure 3-25. LIST DISPLAY Page (Sheet 1 of 3).

DISPLAY :

Measurement results are displayed in a 3x10 "window", as shown in Figure B. The "field" can be moved left, right, up, or down by pressing the LEFT, RIGHT, ROLL UP, or ROLL DOWN softkey to view other measurement results.

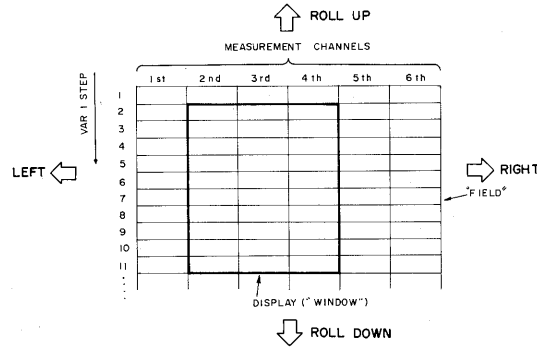

Figure B

Softkey Functions :

This page has only one softkey prompt (shown in Figure A). The function of each softkey is described below.

CURSOR :

Turns on the line cursor (▶). When this softkey is pressed, the cursor will be displayed in the VAR1 column and it can be moved up or down with the CURSOR keys. The cursor is used when making keyboard calculations. Instead of entering the numeric value of a measurement result or VAR1 or VAR2 step, the channel name can be used in arithmetic expressions. Using the values listed in Figure A, suppose you want to calculate the square roof of IC when VCE is .1200V. Simply move the cursor down the VCE column and stop at VCE = .1200V, then key in

√ I C EXECUTE

The square root of 86.06 μA will then be displayed on the Keyboard Input Line.

COMMNT :

User-entered comments of up to 30 characters can be displayed on the CRT. The procedure is as follows :

1. Press the **COMMNT** softkey. The frame around the softkey prompt will be highlighted and the **BLUE** key will be set to on.
2. Key in the comment (up to 30 characters). There is no restriction on character type.
3. Press the **ENTER** key. The comment will be displayed directly below the page title and the frame around the **COMMNT** softkey prompt will be de-highlighted (normal intensity).

With the comment function set to on (**COMMNT** softkey prompt highlighted), anything displayed on the Keyboard Input Line will be entered and displayed as a comment if the **ENTER** key is pressed, even if a comment is already displayed below the page title. This allows you to change or delete an existing comment. For example, to delete a comment, press the **COMMNT** softkey, **CLEAR** the Keyboard Input Line, and press **ENTER**.

RIGHT : Shifts the monitor channel columns to the right.

LEFT : Shifts the monitor channel columns to the left.

ROLL UP : Rolls the list up.

ROLL DOWN : Rolls the list down.

These softkeys allow the operator to view all measurement results. (Refer to Figure B.) When the **ROLL UP** or **ROLL DOWN** softkey is pressed and held, line movement is continuous.

Note

When **ROLL UP/DOWN** is performed during measurement which has more than 100 steps, displayed values may include rounding errors.

Figure 3-25. LIST DISPLAY Page (Sheet 3 of 3).

MATRIX DISPLAY PAGE

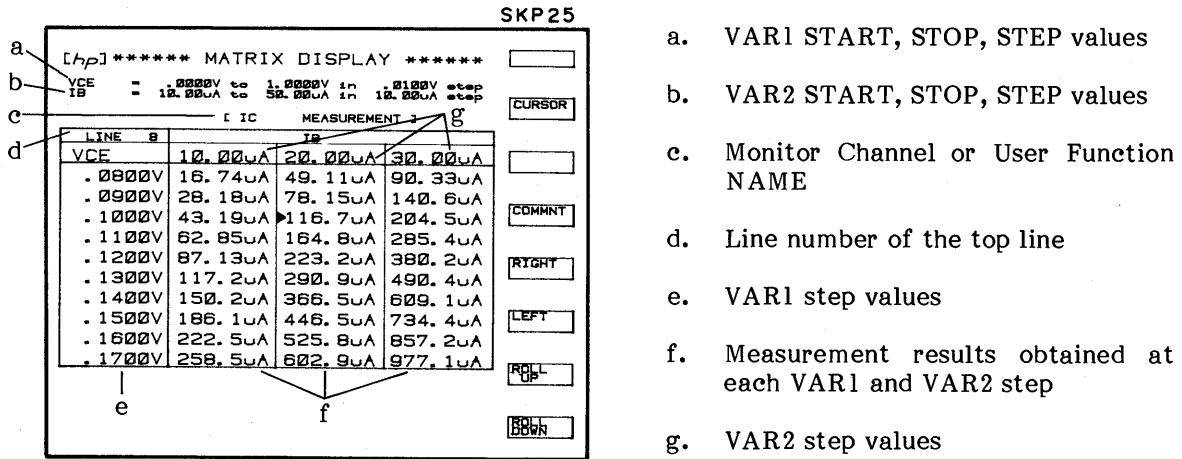

Figure A

Function of this page :

1. Display the measurement results obtained at each VAR1 and VAR2 step for the monitor channel selected on the MEAS/DISP MODE SETUP page.
2. Allow analysis of measurement results with the softkeys and arithmetic capabilities.

MEASUREMENT :

Each time this page is displayed, the results of the previous measurement are automatically re-displayed, regardless of the display mode used in the previous measurement. If any change is made on the CHANNEL DEFINITION page or SOURCE SETUP page or if NAME on the MEAS/DISP MODE SETUP page is changed, the results of the previous measurement are erased from the data buffer and a new measurement must be made. To make a new measurement, press the SINGLE, or REPEAT, key. Measurement results of the monitor channel selected on the MEAS/DISP MODE SETUP page will be displayed as the measurement progresses. Results are displayed for each VAR1 step (e in Figure A) and VAR2 step (f in Figure A). Only three VAR2 steps and ten VAR1 steps can be displayed at one time. Measurement results not displayed can be viewed by pressing the LEFT, RIGHT, ROLL UP, or ROLL DOWN softkey.

Figure 3-26. MATRIX DISPLAY Page (Sheet 1 of 2).

DISPLAY :

Measurement results are displayed in a 3 x 10 "window," as shown in Figure B. The "field" can be moved left, right, up, or down by pressing the LEFT, RIGHT, ROLL UP, or ROLL DOWN softkeys to view other measurement results.

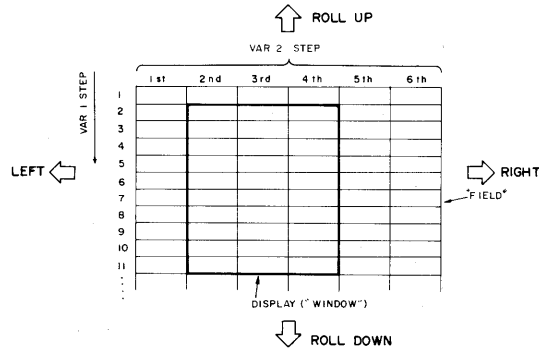
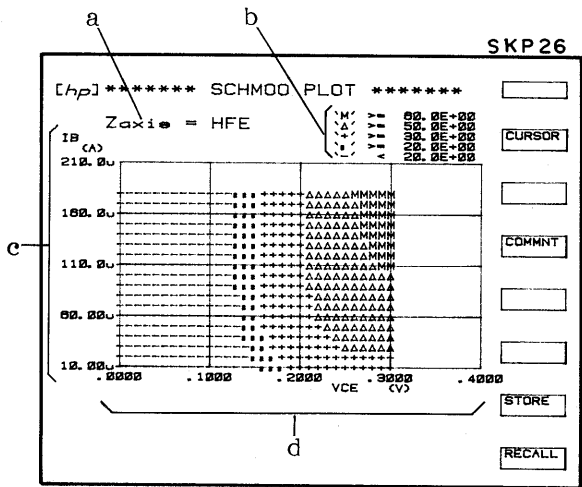

Figure B

Softkey Prompts :

This page has only one softkey prompt (shown in Figure A). Refer to the Softkey Functions description given in Figure 3-25 for the function of each softkey.

SCHMOO PLOT PAGE



- a. Monitor channel name selected on the MEAS/DISP MODE SETUP.
- b. Limits specified on the MEAS/DISP MODE SETUP page.
- c. VAR2 source name
- d. VAR1 source name

Figure A

Function of this page :

1. Plot measurement results on an X-Y-Z graph.
2. Allow analysis of measurement results with the softkeys and arithmetic capabilities.

MEASUREMENT :

To make a measurement, press the SINGLE or REPEAT key (APPEND can not be used). Measurement results will be displayed as the measurement progresses.

Figure 3-27. SCHMOO PLOT Page (Sheet 1 of 3).

X-Axis and Y-Axis Scaling :

Scaling for the X and Y axes is determined by the START and STEP values of VAR1 and VAR2 and by the VAR1 SWEEP MODE. The maximum number of measurement points along the X-axis is 41; along the Y-axis, 21. However, 41x21 measurement points cannot be displayed, because the display buffer can hold only 575 measurement points.

1. Linear VAR1 Sweep :

X-axis (VAR1): Min. = a, Max. = a + 40 x b
 Y-axis (VAR2): Min. = c, Max. = c + 20 x d

where
 a = VAR1 START value
 b = VAR1 STEP value
 c = VAR2 START value
 d = VAR2 STEP value

Note

STOP value is not used in determining axes scaling. Also, if the VAR1 STEP value or VAR2 STEP value is 0, the minimum and maximum scale values for the respective axis are set to the START value.

2. Logarithmic VAR1 Sweep :

X-axis (VAR1): Min. = a, Max. = $a \times 10^{\frac{40}{\alpha}}$
 Y-axis (VAR2): Min. = c, Max. = c + 20 x d

where
 a = VAR1 START value
 α = Number of step per decade (10, 25, or 50)
 c = VAR2 START value
 d = VAR2 STEP value

Note

If VAR1 START > STOP, the exponent in the equation for X-axis Max. becomes as follows.

$$\text{X-axis Max.} = a \times 10^{-\frac{40}{\alpha}}$$

Figure 3-27. SCHMOO PLOT Page (Sheet 2 of 3).

Softkey Functions :

This page has only one softkey prompt (shown in Figure A). The function of each softkey is described below.

CURSOR :

Similar to the CURSOR on the GRAPHICS PLOT page. The cursor highlights the symbol at a measurement point. To move the cursor, use the CURSOR keys. The cursor can be used to simplify keyboard calculations.

Note

When the cursor is moved to a part of the plot area where there are no symbols, * is displayed and no Z-axis value is displayed.

COMMNT :

Same as the COMMNT softkey on the other display pages.

STORE : Stores displayed measurement results.

RECALL : Replaces displayed measurement results with stored measurement results.

These softkeys are similar to the STORE and RECALL softkeys on the GRAPHICS PLOT page (Figure 3-24). The only difference is that recalled measurement results are not displayed over the existing measurement results; that is, only one set of measurement results is displayed. When the frame around the RECALL softkey prompt is highlighted, only stored measurement results are displayed. Conversely, when the frame is not highlighted only the results of the last measurement are displayed. STORE and RECALL operations on this page are unrelated to those on the GRAPHICS PLOT page. For example, measurement results stored on the GRAPHICS PLOT page cannot be recalled on this page.

Figure 3-27. SCHMOO PLOT Page (Sheet 3 of 3).

AUTO SEQUENCE SETUP PAGE

SKP 27		SKP 28
[hp]*** AUTO SEQUENCE SET UP ***	<input type="button" value="EXTN"/>	<input type="button" value="EXTN"/>
1 GET P ICBVBE		
2 SINGLE	<input type="button" value="GET P"/>	<input type="button" value="PAGE"/>
3 PLOT 100, 3000, 3500, 7000		
4 SAVE D ICBVBE	<input type="button" value="SINGLE"/>	<input type="button" value=""/>
5 GET P HFE1		
6 SINGLE	<input type="button" value="SAVE D"/>	<input type="button" value="ASP CLEAR"/>
7 PLOT 100, 100, 3500, 3500		
8 GET P NPN1	<input type="button" value="PLOT"/>	<input type="button" value=""/>
9 SINGLE		
10 PAUSE	<input type="button" value="PRINT"/>	<input type="button" value=""/>
11 PLOT 3000, 3000, 7000, 7000		
12 GET P VCESAT	<input type="button" value="PAUSE"/>	<input type="button" value="LINE DELETE"/>
13 SINGLE		
14 PLOT 3000, 100, 7000, 3500	<input type="button" value="WAIT"/>	<input type="button" value="LINE INSERT"/>
15 PAGE		
16 WAIT 00		
17 PRINT		
18		
19		
20		
21		
22		
23		
24		

Figure A

Function of this page :

Set up or edit an auto-sequence program.

Auto-Sequence Program :

An auto-sequence program is setup (written) by the operator and can perform a series of instrument operations, without operator assistance. An auto-sequence program can

1. call pre-stored measurement setups from the disc (GET P command),
2. perform a SINGLE measurement (SINGLE command),
3. store measurement results onto the disc (SAVE D command),
4. dump measurement results onto an HP-IB plotter (PLOT command),
5. print out measurement results onto an HP-IB printer (PRINT command),
6. half execution until CONT is pressed (PAUSE command),
7. wait a specified time (WAIT command), and
8. advance the page on an HP-IB plotter (PAGE command).

Figure 3-28. AUTO SEQUENCE SETUP Page (Sheet 1 of 4).

Programming :

Setting up the auto-sequence programs requires no special programming knowledge. When this page is first displayed, the field-pointer will be on line 1 and the auto-sequence commands will be listed in the softkey prompt area of the CRT. To enter a command, simply press the desired softkey. The selected command will be displayed on the line and if the command requires no parameters, the field-pointer will automatically move to the next line. If the command requires parameters (plot area, file name, wait time), the field-pointer will not move, indicating that the operator must enter parameters from the front panel. After the parameters have been keyed in and the ENTER key pressed, the field-pointer will move to the next line. Up to twenty-four lines can be entered. Blank lines are allowed but are ignored during auto-sequence program execution.

Program Commands :

There are eight program commands — GET P, SINGLE, SAVE D, PLOT, PRINT, PAUSE, WAIT, PAGE. They are available with the softkeys only. Each is described below.

GET P : GET P file name

This command calls the specified (file name) measurement setup from the disc and displays the display page (GRAPHICS, LIST, MATRIX, or SCHMOO) specified in the measurement setup. To enter this command, press the GET P softkey, key in the desired file name, and press ENTER.

SINGLE :

This command executes one measurement. Equivalent to pressing the SINGLE key on the front panel. If SINGLE is entered on line 1 of an auto-sequence program, the program can be executed only on the GRAPHICS PLOT, LIST, MATRIX, or SCHMOO PLOT page. Execution on any other page will result in error Z02. To enter this command, press the SINGLE softkey.

SAVE D : SAVE D file name

This command stores measurement results into the specified (file name) data file on the disc. The file name specified in this command must be unique; that is, the file name of an existing data file cannot be used. To enter this command, press the SAVE D softkey, key in the desired file name, and press ENTER.

PLOT : PLOT Xmin, Ymin, Xmax, Ymax

This command dumps the existing display (GRAPHICS PLOT, LIST, MATRIX, or SCHMOO PLOT) onto an HP-IB plotter. Scaling parameters (Xmin, Ymin, Xmax, Ymax) must be delimited by a comma or a space. To enter this command, press the PLOT softkey, key in the scaling parameters, and press ENTER.

PRINT :

This command outputs measurement results to an HP-IB printer. To enter this command press the PRINT softkey.

PAUSE :

This command halts program execution until the CONT key is pressed. While the program is halted, the operator can change paper on the plotter, change test samples, etc. To enter this command, press the PAUSE softkey.

WAIT : WAIT time

This command stops program execution for the specified time. Specifiable time is from 0 to 65535 seconds. Fractional values are rounded to the nearest whole number. To enter this command, press the WAIT softkey, key in the desired wait time, and press ENTER.

PAGE :

This command advances the plotter paper to the top of the next page. The plotter used must be equipped with automatic paper advance.

Program Edit Functions :

There are three program edit functions — ASP CLEAR, LINE DELETE, LINE INSERT. They are available with the softkeys only. Each is described below.

**ASP
CLEAR** :

Clears the entire auto-sequence program and returns the field-pointer to line 1.

**LINE
DELETE** :

Deletes the program line indicated by the field-pointer.

**LINE
INSERT** :

Inserts one blank line between the line at which the field-pointer is located and the preceding line. The field-pointer remains at the blank line and a new command can be entered. If a line is inserted into a 24-line program, the last line is deleted.

Program Execution :

To execute an auto-sequence program, press the AUTO SEQ START/STOP key. The program will begin and the AUTO SEQ START/STOP indicator lamp will come on. The line number and the command being executed are displayed on the Keyboard Input Line during program execution. The program continues execution until it comes to a PAUSE command or until all lines have been executed. When the program is halted by the PAUSE command, press the AUTO SEQ CONT key to continue the program. To stop the program, press AUTO SEQ START/STOP key again. The indicator lamp will go off and the program will stop at the present line.

Figure 3-28. AUTO SEQUENCE SETUP Page (Sheet 3 of 4).

Note

An auto-sequence program cannot be executed when the instrument is measuring, plotting, printing, or in GL1 mode (under HP-GL control). The AUTO SEQ STOP key cannot be pressed when the auto-sequence program is executing a GET P or SAVE D command.

Note

Once an auto-sequence program containing a SAVE D command is executed, it can not be executed again. If it is executed again, error M05 (file name already reserved) will be displayed on the CRT. To run the auto-sequence program again, change the file name specified in the SAVE D command.

Note

If an error-code ZXX is displayed, the auto-sequence program stops and waits as if a PAUSE command was executed. Refer to Table 3-3 for meaning of the error-code. To continue the program, press the CONT key. The program continues from the next line.

Note

If the length of PLOT command exceeds 26 characters, line number is not displayed when the ASP is executed.

OUTPUT SEQUENCE SETUP PAGE

SKP 29

[hp] ** OUTPUT SEQUENCE SET UP **

	SOURCE NAME	CHANNEL
1	V1	SMU1
2	I2	SMU2
3	V3	SMU3
4	V4	SMU4
5	VS1	V _• 1
6	VS2	V _• 2

Voltage & current sources are automatically turned on according to the sequence.

V1 SMU1

I2 SMU2

V3 SMU3

V4 SMU4

VS_• 1

VS_• 2

DE FAULT

Figure A

Function of this page :

Specify the order in which source channels begin output. When measurement begins, the source channels used in the measurement are turned on in the order specified on this page. The source channels' output sequence is important when measuring devices such as MOSFET transistors or operational amplifier ICs that have FET inputs.

Setup :

When the instrument is turned on, the output sequence setup is as shown above. To change the setup use the CURSOR keys (to move the field-pointer) and the softkeys.

Note

To include the OUTPUT SEQUENCE SETUP when storing a measurement setup onto the disc, you must return to the MENU after setting up this page. Only then will the new OUTPUT SEQUENCE SETUP be valid for a SAVE P operation.

Figure 3-29. OUTPUT SEQUENCE SETUP Page.

USER FILE CATALOG PAGE

The screenshot shows a terminal window titled "USER FILE CATALOG" with the following content:

```

[hp]*** SKP30
USER FILE CATALOG ***
available records 7
name  typ  comments  addr  rev  used
GENL  eye  system      217   3   3
BVCEIC eye  system      220   3   3
FVDSID eye  system      223   3   3
DIVFIF eye  system      226   3   3
VCESAT Pro   229   3   3
ICBVBE Pro   232   3   3
IGSSTM Pro   235   3   3
HFE1  Pro   238   3   3
NPN1  Pro   241   3   3
BIP1  Seq   244   1   1
ICBVBE Dat   245  12  12
HFE   Dat   260  12  12
    
```

Annotations a-i point to the following elements:

- a: Available records (7)
- b: File name (GENL)
- c: File type (eye)
- d: File comments (system)
- e: File address (217)
- f: Number of records reserved (3)
- g: Number of records used (3)
- h: System files (GENL, BVCEIC, FVDSID, DIVFIF)
- i: User-area files (VCESAT, ICBVBE, IGSSTM, HFE1, NPN1, BIP1, ICBVBE, HFE)

Controls visible on the right side include: PURGE, REPACK, CAT, ROLL UP, and ROLL DOWN.

Figure A

Function of this Page :

1. Display information pertaining to files stored on the disc.
2. PURGE (delete) files from the user-area and REPACK the user-area.

Each of the five work-discs furnished with the 4145A has a user-area in which up to 131 records or 96 files can be stored. The number of records per file depends on the file type, as listed below.

Program files (measurement setups)	3rcd/file
Data files (measurement results with setups)	12rcd/file
ASP files (auto-sequence program files)	1rcd/file

Information for up to 12 files can be displayed on this page. To display information on other files, press the ROLL UP or ROLL DOWN softkey. Each item — a through i — in Figure A is described below.

- a. Available records :
Shows the number of unreserved records.
- b. File name :
Lists the names of all files stored on the disc.

Figure 3-30. 4145A FILE CATALOG Page (Sheet 1 of 3).

c. File type :

Lists the file-type of each file stored on the disc.

Sys : System file

Pro : Program file (measurement setups), file type P

Dat : Data file (measurement results), file type D

Seq : ASP file (auto-sequence program), file type S

When storing or recalling a file, the file type — P, D, or S — must be specified in the SAVE or GET command. System files can be recalled only when the CHANNEL DEFINITION page is displayed and only with the softkeys.

d. File comments :

Lists any comments that were specified in the SAVE command when the file was stored. When specifying a comment in the SAVE command, it must be entered after the file name, must be preceeded by a space, and must not be more than eight characters long.

e. File address :

Shows the address of the first record of each file. The first user-area address is 229. Addresses below 229 are used for operating system software and system files.

f. Number of records reserved :

Shows the number of records reserved for each file. Normally, the number of records reserved is equal to the number of records used, but there are cases when this is not true. For example, if a program file (3 records) is stored after a data file (12 records) has been purged, the new file will have 12 records but will use only 3. The 9 unused records are wasted. They cannot be used for storage of additional files. To delete reserved but unused records, press the REPACK softkey.

g. Number of records used :

Shows the number of records used by each file. This number depends on the file type.

h. System files :

Four general purpose application programs. They can be recalled only when the CHANNEL DEFINITION page is displayed and only with the softkeys. System files cannot be purged.

Figure 3-30. 4145A FILE CATALOG Page (Sheet 2 of 3).

Softkeys :

This page has only one softkey prompt (shown in Figure A). The function of each softkey is described below.

PURGE :

This softkey is for deleting files from the disc. To purge a file, press the PURGE softkey, key in the file type and file name, and press EXECUTE. If the CLEAR key is pressed before EXECUTE, the PURGE operation is cancelled.

REPACK :

This softkey repacks all files in the user-area. Unused records resulting from a PURGE operation are closed. To repack the user-area, press the REPACK softkey and then press EXECUTE. The time required to complete the REPACK operation depends on the number of unused records, ranging from a few seconds to a few minutes.

CAUTION

DO NOT TURN OFF THE INSTRUMENT WHILE REPACK IS BEING PERFORMED. TO DO SO MAY ERASE THE USER-AREA FILES.

Note

When REPACK is performed, the file order may change.

CAT :

If the disc is changed while the FILE CATALOG page is displayed, this softkey displays the FILE CATALOG of the new disc.

ROLL UP :

This softkey rolls-up the file list. If this softkey is pressed and held, continuous roll-up is performed.

ROLL DOWN :

This softkey rolls-down the file list. If this softkey is pressed and held, continuous roll-down is performed.

OPERATION GUIDE PAGE

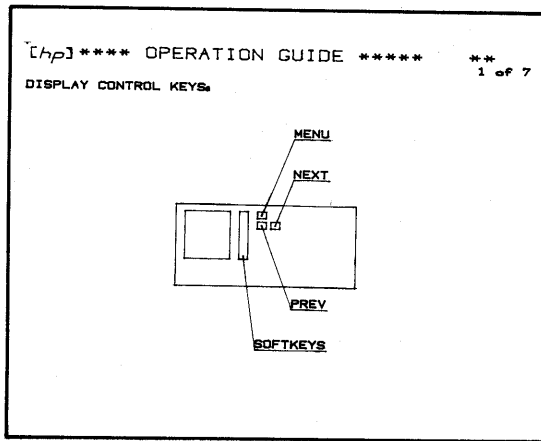

Figure A

Function of this page :

Provide basic operating instructions. Included are descriptions of the display control keys, display relationships, and a list of error messages and error codes. This page has seven screens. To view screens 2 through 7, use the NEXT or PREV key.

Construction :

Screen flow is as shown below. The MENU key can be pressed at any time.

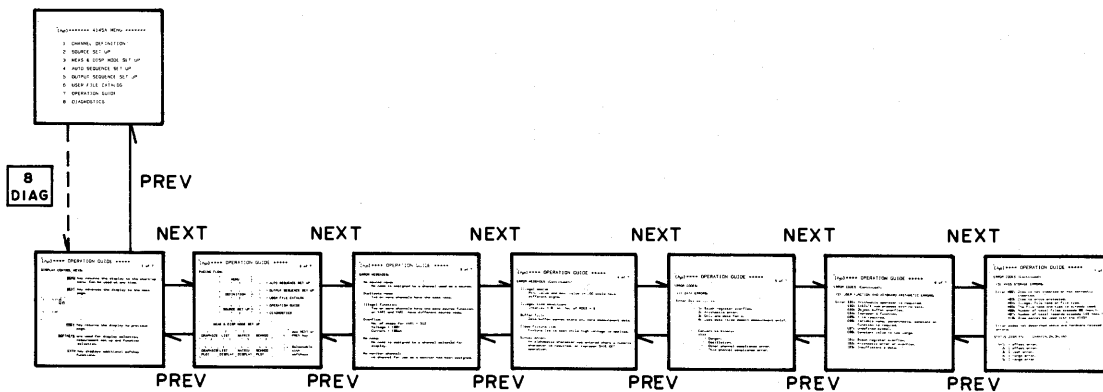

Figure B

Figure 3-31. OPERATION GUIDE Page.

DIAGNOSTICS PAGE

SKP 31

```

[hp] ***** DIAGNOSTICS *****
1  REGULAR SELFTEST          [1 SELF TEST]
   ----- PASS -----
2  FRONT PANEL TEST         [2 F.P. TEST]
3  GRAPHIC TEST PATTERN     [3 G.T. TEST]

MASS STORAGE UNIT UTILITIES [4 HEAD CLEAN]
  SYSTEM LABEL
  Volume name : 4145A  --- a
  Revision    : A3    --- b
  Date code   : 160282 --- c
4  HEAD CLEANING
5  USER FILE COPY
  [ ]
  [ ]
    
```

- a. System name
- b. Revision number
- c. Software data code

Figure A

Functions of this page :

1. Display the disc's system label.
2. Perform Disc-Drive Head cleaning.
3. Copy all files in the user-area onto another disc.

Softkey functions :

One Softkey Prompt (SKP31) is displayed on this page.

[1 SELF TEST] : Self Test

Two Self-Tests are performed when this softkey is pressed. They are as follows :

1. MPU Test : Checks the ROMs and RAMs. If an abnormality is detected, an error-code will be displayed in the center of CRT.
2. SMU Test : Checks SMUs 1 through 4 and their control circuit. If an abnormality is detected, CHAN (!!! DOWN !!!) or CHAN (10, 20, 31, 40) will be displayed. In the latter, SMU3 is down.

If the SELF TEST detects an abnormality, contact the nearest Hewlett-Packard Sales or Service Office.

Figure 3-32. DIAGNOSTICS Page (Sheet 1 of 3).

2 F.P. TEST : Front Panel Test

This softkey is used for testing the operation of the front panel controls. When this key is pressed, the display will change to that shown in Figure B and the front panel lamp test will begin. In the lamp test, all lamps on the front panel are momentarily turned on and then turned on one at that time. During the lamp test no keyboard operations can be performed. When the lamp test is completed, the rotary dial test and key test can be performed. To perform the rotary dial (MARKER) test, rotate the dial and observe the COUNT display on the CRT. Rotating the dial clockwise 360 degrees increases COUNT by 120; rotating the dial counterclockwise 360 degrees decreases COUNT by 120. COUNT can be reset to zero by pressing the CLEAR key. In the key test, NEXT KEY shows number of the key that should be pressed next; LAST KEY shows the number of the key that was just pressed. Key numbers are shown in Figure C. To perform this test, press key 1; LAST KEY should change to 1 and NEXT KEY, to 2. Continue in this manner until all the keys have been checked. When key 66 (EXECUTE) is pressed, NEXT KEY and LAST KEY will both be 66, and when key 66 is released, the display will change back to that shown in Figure A.

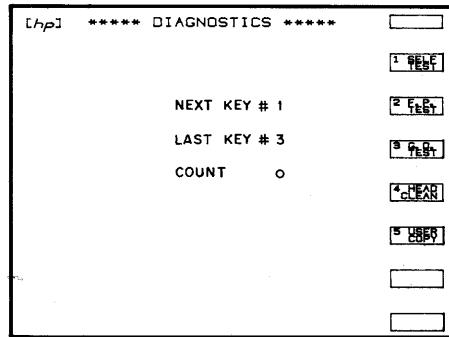

Figure B

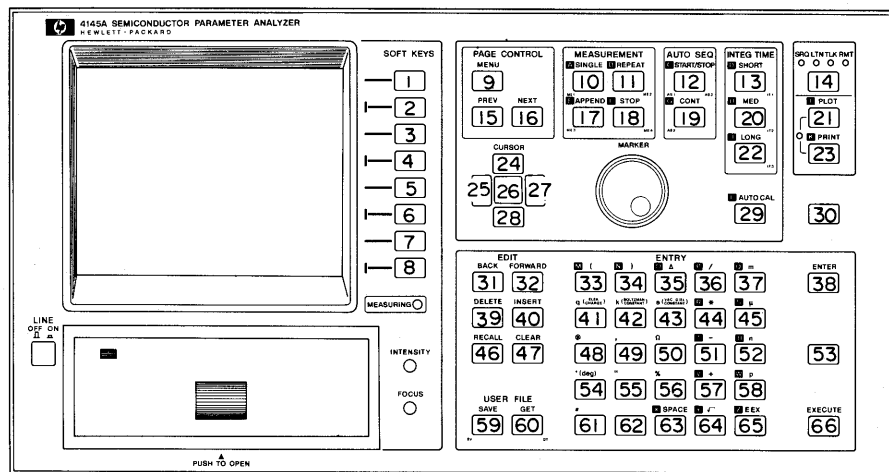

Figure C

Figure 3-32. DIAGNOSTICS Page (Sheet 2 of 3).

**3 G.D.
TEST** : Graphic Display Test

This softkey is used for INTENSITY and FOCUS adjustments. Adjustment procedure is given in Figure 3-6.

**4 HEAD
CLEAN** : Head Cleaning

This softkey provides Disc Drive Head cleaning. The procedure is given in Figure 3-48.

**5 USER
COPY** : User File Copy

This softkey is used for copying the user-area files onto another disc. The procedure is given in Figure 3-47.

3-75. TIME DOMAIN MEASUREMENT SETUP

3-76. The 4145A can measure voltage or current as a function of time. This is called a time domain measurement and is made possible by replacing the main sweep, VAR1, with time. Measurement is made at constant, user-specified time intervals and results can be displayed on the GRAPHICS PLOT, LIST DISPLAY, MATRIX DISPLAY, or SCHMOO PLOT page, just as in a normal VAR1 sweep measurement. (If results are to be displayed on a SCHMOO PLOT, VAR2 must be used.) The page-by-page setup for a typical time domain measurement, along with measurement results, is shown in Figure 3-33.

[Chp]* CHANNEL DEFINITION *****

CHAN	V	I	SOURCE	MODE	IFCTN
SMU1	V1	I1	COM	CONST	
SMU2	V2	I2	I	CONST	
SMU3	V3	I3	V	CONST	
SMU4	V4	I4	V	CONST	
Vm 1	VS1		V	CONST	
Vm 2	VS2		V	CONST	
Vm 1	VM1				
Vm 2	VM2				

[Chp]*** SOURCE SET UP *******

NAME	VAR1	VAR2
SWEEP MODE		LINEAR
START		
STOP		
STEP		
NO. OF STEP		
COMPLIANCE		

CONSTANT	SOURCE	COMPLIANCE
V1	COM	100.00V 100.0mA
I2	I	1.000mA 1.000V
V3	V	2.0000V 100.0mA
V4	V	1.0000V 100.0mA
VS1	V	5.0000V
VS2	V	-5.0000V

[Chp] MEAS & DISP MODE SET UP ** [EXTN]**

MEASUREMENT MODE: TIME DOMAIN	
WAIT TIME	1.00
INTERVAL	.50
NO. OF RDNGS	250

DISPLAY MODE: GRAPHICS		
X axis	Y1axis	Y2axis
NAME	TIME	I3
SCL	LINEAR	LINEAR
MIN	00.00	000.0A
MAX	250.00	1.0000A

- ① Do not select VAR1 as the source function for any of the source channels. VAR2, however, can be selected, if desired. VAR1' can not be used.
- ② Because VAR1 is not assigned on the CHANNEL DEFINITION page, the VAR1 column on the SOURCE SETUP page is blank.
- ③ Enter the SOURCE and COMPLIANCE values for each CONSTANT source. If VAR2 is to be used, enter the sweep parameters.
- ④ WAIT TIME : Identical to the HOLD TIME of a VAR1 sweep measurement. Settable range is 0 to 100 seconds with 10 millisecond resolution.
- ⑤ INTERVAL : The time between measurements. Settable range is .01 to 10 seconds with 10 millisecond resolution.
- ⑥ NO. OF RDNGS : The number of measurements to be made. If VAR2 is used, this is the number of measurements to be made at each VAR2 step. Settable range is 1 to 512. However, if VAR2 NO. OF STEP x NO. OF RDNGS 570, "buffer full" will be displayed when measurement is made.

Figure 3-33. Time Domain Measurement Setup (Sheet 1 of 2).

Example Measurement

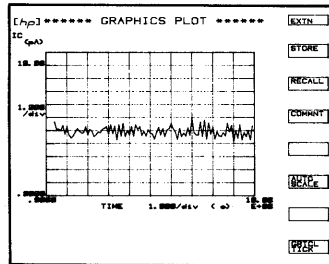

LINE #	TIME	IC
0	0.00	6.050pA
1	1.00	5.049pA
2	2.00	4.900pA
3	3.00	4.849pA
4	4.00	4.549pA
5	5.00	4.549pA
6	6.00	4.950pA
7	7.00	5.550pA
8	8.00	5.150pA
9	9.00	5.099pA

Note

If INTERVAL is too short, error-code (e.g. Error D08) will be displayed. In this case, data is meaningless because the next measurement begins before the present measurement is completed. This meaningless data is not displayed.

Figure 3-33. Time Domain Measurement Setup (Sheet 2 of 2).

3-77 DUT CONNECTION

3-78. DUTs can be connected to the 4145A through the 16058A Test Fixture or through the furnished connector plate (P/N : 04145-60001). Connection using the 16058A is described in paragraph 3-79 and connection using the furnished connector plate, in paragraph 3-81.

3-79. DUT Connection Using the 16058A

3-80. The 16058A Test Fixture is designed to connect packaged devices, such as transistors, diodes and ICs, to the SMUs, voltage sources, and voltage monitors on the 4145A. Eight different, interchangeable DUT Socket Boards are furnished with the 16058A. Connection between the 4145A and 16058A is shown in Figure 3-34. Also shown are examples using four of the furnished DUT Socket Boards.

The procedure for connecting the 16058A is as follows :

1. Turn off the 4145A. If the 24-pin Shorting Connector (P/N : 04145-61623) is connected to the System Cable connector on the rear panel, remove it.
2. Connect the 16058A to the 4145A as shown below. Use the furnished System Cable (P/N : 16058-61604) and triaxial cables (P/N : 16058-61603). The System Cable contains the Vs lines, Vm lines, and the fixture-lid-open detection line.

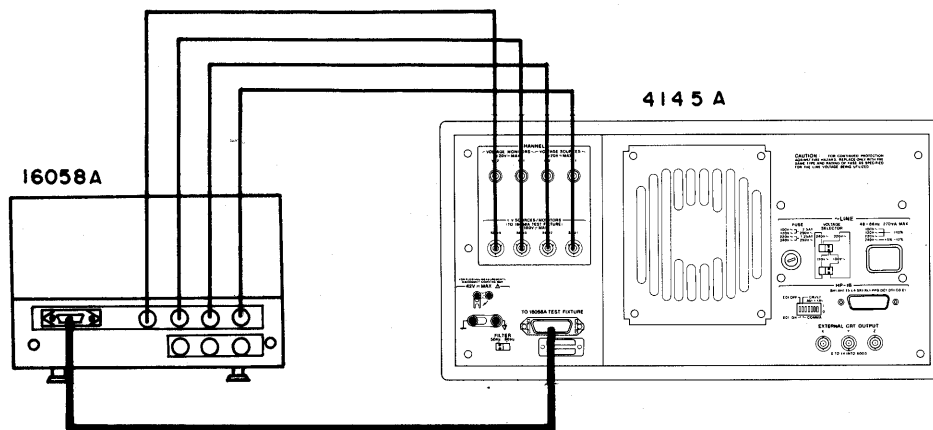

CAUTION

THE SYSTEM CABLE CONNECTOR AND THE HP-IB CONNECTOR, BOTH OF WHICH ARE LOCATED ON THE 4145A'S REAR PANEL, ARE IDENTICAL. DO NOT CONNECT THE 16058A TO THE HP-IB CONNECTOR OR THE HP-IB CABLE TO THE 4145A'S SYSTEM CABLE CONNECTOR.

3. Select a DUT Socket Board suitable for the device to be measured, and insert it into the 16058A's Personality Board. To insert the board, pull out the two black fasteners, place the socket board on the Personality Board so that it covers the opening, and press the two black fasteners.

Figure 3-34. DUT Connection Using the 16058A (Sheet 1 of 4).

- To connect the SMU, Vs, and Vm terminals on the Personality Board to the terminals on the DUT Socket Board, use the furnished connection leads (P/N's : 16058-61600, 16058-61601, and 16058-61602). Examples are given below.

Example 1 : Transistor Socket Board

Connect SMUs 1 through 4 directly to terminals 1 through 4, respectively, as shown below.

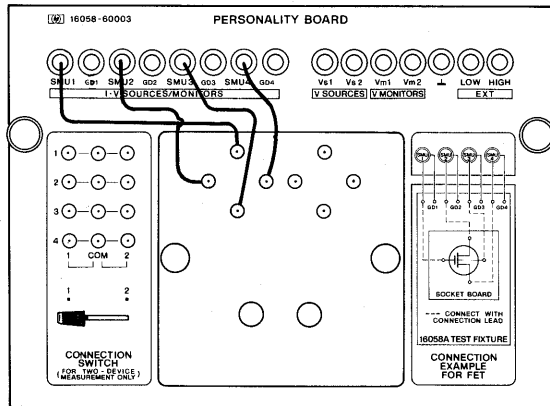

terminal 1 to SMU1
 terminal 2 to SMU2
 terminal 3 to SMU3
 terminal 4 to SMU4

Example 2 : 8-pin Socket Board

Connect SMUs 1 through 4 directly to terminals 1, 3, 5, and 7, respectively, as shown below.

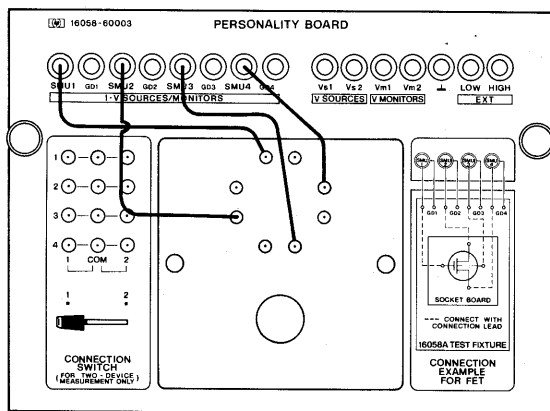

terminal 1 to SMU1
 terminal 3 to SMU2
 terminal 5 to SMU3
 terminal 7 to SMU4

Figure 3-34. DUT Connection Using the 16058A (Sheet 2 of 4).

Example 3: Using the CONNECTION SWITCH

Connect the Socket Board terminals and SMUs 1 and 2 to the CONNECTION SWITCH, as shown below. When the switch is set to position 1, the SMUs are connected to the top two terminals (NARROW) of the Socket Board and when it sets to position 2, the SMUs are connected to the lower two terminals. When the switch is set to the center position, the Socket Board is not connected to the SMUs.



The Connection Switch is as shown below:

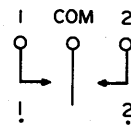

Example 4: Blank Teflon Board

This board is used when measuring high resistance components or components that can not be measured with the other Socket Boards. To connect the component, use the miniature-clip leads (P/N : 16058-61602).

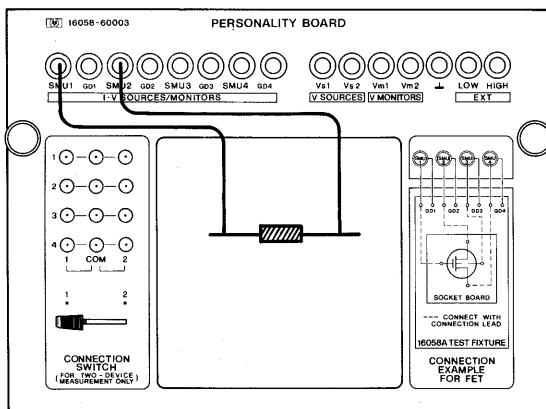

Figure 3-34. DUT Connection Using the 16058A (Sheet 3 of 4).

5. Turn on the 4145A and set up the measurement as required.
6. Close the test fixture lid and press SINGLE, REPEAT, or APPEND to start the measurement.

Note

If the output voltage from an SMU or Vs will exceed $\pm 42V$ during the measurement, the test fixture lid must be closed to start the measurement. If an attempt is made to start the measurement while the test fixture lid is open, "Close the fixture lid" will be displayed on the CRT and measurement will not begin.

Note

If the test fixture lid is opened during a measurement in which the output voltage exceeds $\pm 42V$, measurement will stop immediately and all sources will be turned off (0V) as if the STOP key had been pressed.

7. The figure below shows the connections between the 4145A and the 16058A.

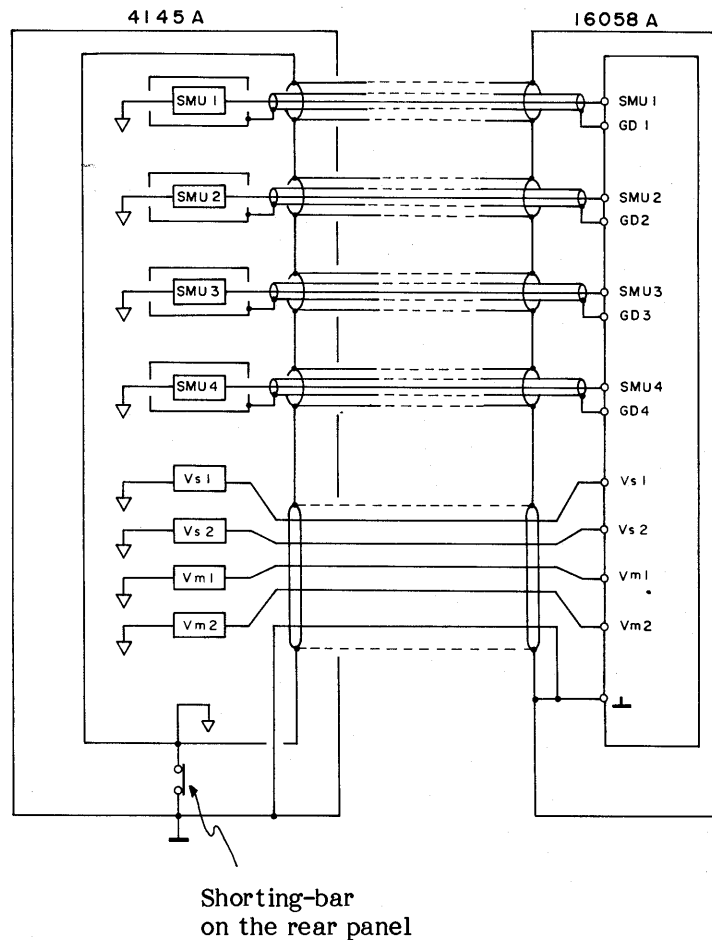

Figure 3-34. DUT Connection Using the 16058A (Sheet 4 of 4).

3-81. DUT Connection Using the Connector Plate

3-82. The furnished connector plate (P/N : 04145-60001) has four BNC connectors and four triaxial connector. It is intended for use with user-fabricated or user-furnished test fixtures. For best measurements results, the test fixture should be enclosed in a shielding-box and the connector plate should be mounted on the box, as shown in Figure 3-35. This significantly reduces the effects of RFI and EMI, and is especially important when making low-current measurements on wafers at the probe station. The procedure for connecting the connector plate, shielding-box and 4145A is given in Figure 3-35.

Mounting the Connector Plate and Connecting the 4145A :

1. Drill the holes required to mount the connector plate onto the shielding-box. Hole spacing is given in Table 1-3.
2. Mount the connector plate on the shielding-box. Make sure there is good electrical contact between the plate and the box.
3. Turn off the 4145A.
4. Connect the furnished 24-pin Shorting Connector (P/N : 04145-61623) to the System Cable connector (labelled TO 16058A TEST FIXTURE) on the rear panel.

Note

If the Shorting Connector is connected, output from the SMUs is not limited to $\pm 42V$; that is, the 4145A assumes a fixture-lid-closed condition.

5. Connect the 4145A to the connector plate with the four furnished 3-meter triaxial cables (P/N : 04145-61622) and the four furnished 3-meter BNC cables (P/N : 04145-61630), as shown below.

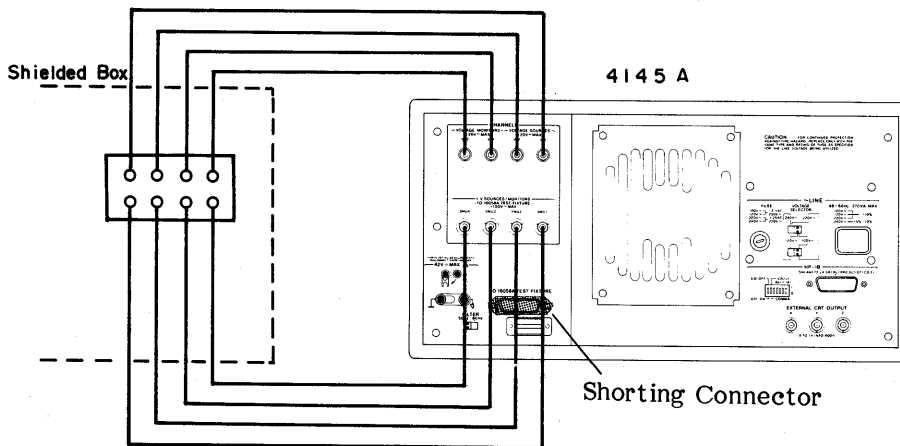
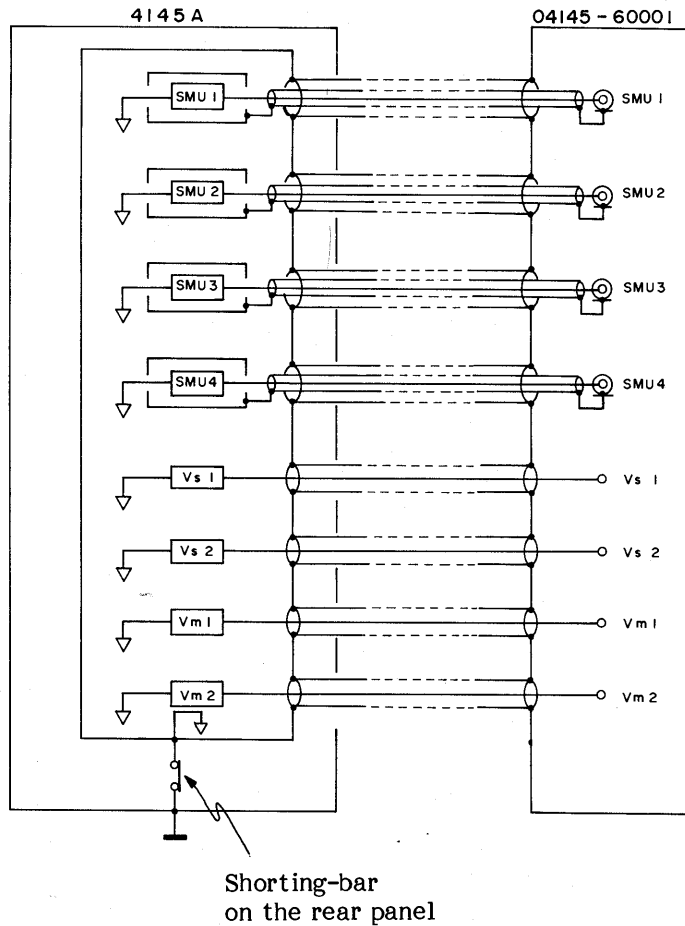

Figure 3-35. DUT Connection Using the Connector Plate (Sheet 1 of 2).

6. Turn on the 4145A and make the necessary measurement setup.
7. The figure below shows the connections between the 4145A and the connector plate.



WARNING

A POTENTIAL SHOCK HAZARD EXISTS WHEN THE SHORTING CONNECTOR IS CONNECTED TO THE 4145A. DO NOT TOUCH THE OUTPUT TERMINAL OR INNER CONDUCTOR OF SMU DURING MEASUREMENT.

Note

Do not connect the inner shield (guard) of an SMU to ground (\perp) or common (∇).

Figure 3-35. DUT Connection Using the Connector Plate (Sheet 2 of 2).

3-83. FLOATING MEASUREMENT

3-84. When the DUT is grounded or when the external voltage source or shield case for DUT is connected to ground, measurement can not be performed or measurement results may be affected by ground loops. The 4145A can be used for floating measurements by disconnecting the shorting-bar on the rear-panel. In this condition, the measurement and source circuit is floating above chassis ground, and voltages over $\pm 42V$ may be present on the COM terminal.

WARNING

A POTENTIAL SHOCK HAZARD MAY EXIST WHEN COMMON IS NOT CONNECTED TO GROUND (SHORTING-BAR DISCONNECTED). DO NOT, REGARDLESS OF THE OUTPUT VOLTAGE, TOUCH THE COMMON TERMINAL OR OUTER CONDUCTOR OF THE SMU, V_s , OR V_m CONNECTORS DURING A FLOATING MEASUREMENT (SHORTING-BAR DISCONNECTED).

CAUTION

DO NOT FLOAT THE INSTRUMENT AT VOLTAGES EXCEEDING 42V.

Note

When the 16058A Test Fixture is used, floating measurements can not be made, because source common is connected to chassis ground inside the test fixture.

3-85. GUARDING

3-86. When low-current measurements are made (SMU's set to I monitor), guarding can be used to reduce the effects of leakage current. Voltage at the guard terminal is held at the same potential as the SMU output voltage. Connect the guard terminal (GD1 through 4 terminals on the Personality Board) of the SMU used for I monitor to the outer shield of the DUT. Figure 3-36 shows an example of guarding.

WARNING

GUARD POTENTIAL IS THE SAME AS SMU OUTPUT. DO NOT TOUCH THE GUARD TERMINAL DURING MEASUREMENT.

Note

Do not connect the guard terminal to the common terminal.

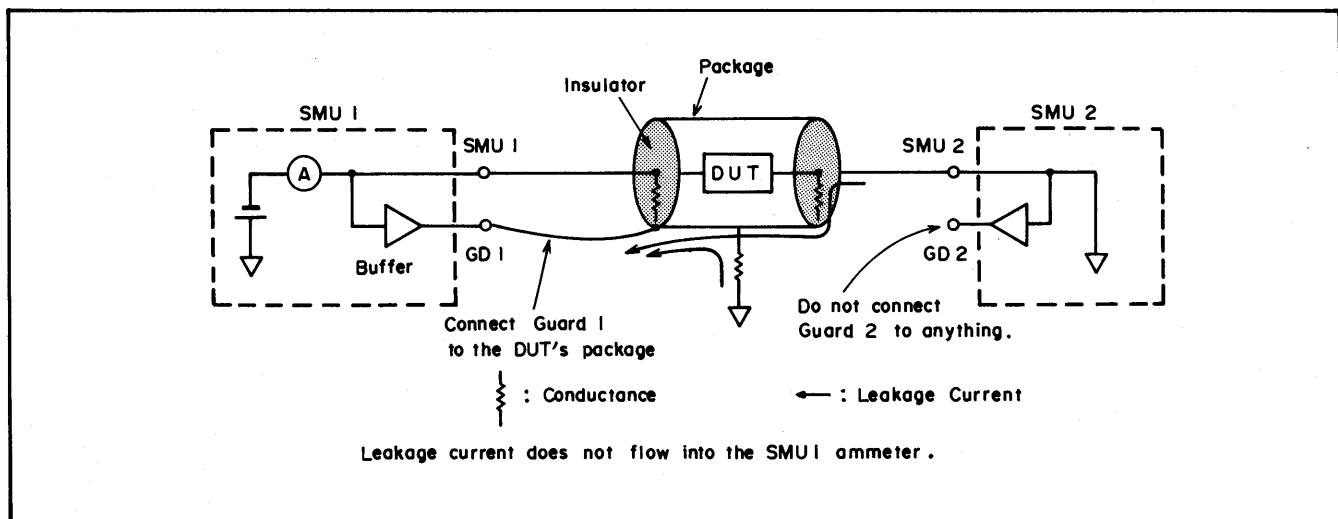

Figure 3-36. Example of Guarding.

3-87. APPLICATIONS PACKAGE

3-88. Each disc furnished with the 4145A contains the following four setups for frequently made measurements :

1. GENL
2. B-Tr VCE-IC
3. FET VDS-ID
4. DIODE VF-IF

When the 4145A is turned on, GENL is automatically loaded. The other furnished measurement setups can be loaded by pressing the appropriate softkey on the CHANNEL DEFINITION page. These furnished setups can not be loaded with the GET command, nor can they be purged from the disc. The contents (channels used, sweep parameters, etc.) of each furnished measurement setup are listed in Table 3-7. Connection examples for each setup are given in Figure 3-37.

Table 3-7. Application Package Setups (Sheet 1 of 2)

	GENL	B-Tr VCE-IC	FET VDS-ID	DIODE VF-IF
SMU1 (V NAME / I NAME) MODE / FCTN	V1 / I1 COM / CONST	VE / IE COM / CONST	VS / IS COM / CONST	VF / IF V / VAR1
SMU2 (V NAME / I NAME) MODE / FCTN	V2 / I2 I / VAR2	VB / IB I / VAR2	VDS / ID V / VAR1	—
SMU3 (V NAME / I NAME) MODE / FCTN	V3 / I3 V / VAR1	VCE / IC V / VAR1	VG / IG V / VAR2	V / I COM / CONST
SMU4 (V NAME / I NAME) MODE / FCTN	V4 / I4 V / CONST	—	—	—
Vs 1 (NAME / FCTN) Vs 2 (NAME / FCTN)	VS1 / CONST VS2 / CONST	—	—	—
Vm 1 NAME / Vm 2 NAME	VM1 / VM2	—	—	—
USER FUNCTION	—	HFE = IC / IB	—	—

Table 3-7. Application Package Setups (Sheet 2 of 2)

VAR1	SWEEP MODE	LINEAR	LINEAR	LINEAR	LINEAR
	START	.000V	.000V	-2.500V	-.5000V
	STOP	1.000V	1.000V	2.500V	2.0000V
	STEP	.010V	.010V	.0500V	.0100V
	COMPLIANCE	100.0mA	100.0mA	20.00mA	40.0mA
VAR2	START	20.00 μ A	10.00 μ A	.0000V	---
	STEP	20.00 μ A	10.00 μ A	-1.0000V	---
	NO OF STEP	5	5	5	---
	COMPLIANCE	2.0000V	2.0000V	1.000mA	---
CONST	NAME	V1	VE	VS	V
	SOURCE / COMPLI	0V/105mA	0V/105mA	0V/105mA	0V/105mA
	NAME	V4	---	---	---
	SOURCE / COMPLI	0V/100mA	---	---	---
CONST	NAME	VS1	---	---	---
	SOURCE / COMPLI	0V / ---	---	---	---
CONST	NAME	VS2	---	---	---
	SOURCE / COMPLI	0V / ---	---	---	---
DISPLAY MODE		GRAPHICS			
X axis	NAME	V3	VCE	VDS	VF
	SCALE	LINEAR	LINEAR	LINEAR	LINEAR
	MIN	.0000V	.0000V	-2.5000V	-.5000V
	MAX	1.0000V	1.0000V	2.5000V	2.0000V
Y axis	NAME	I3	IC	IG	IF
	SCALE	LINEAR	LINEAR	LINEAR	LINEAR
	MIN	.000A	.000A	.000A	-10.00mA
	MAX	10.00mA	10.00mA	1.000A	40.00mA

A. GENL:

General setup assigning all V names and I names.

B. B-Tr VCE-IC:

Setup for measurement of NPN bipolar transistors. When the transistor is connected to the 16058A test fixture, as shown below, V_{CE-IC} (collector/emitter voltage — collector current) characteristics common emitter Bipolar Transistor can be measured. Also, HFE (= IC/IB) is assigned as the User Function.

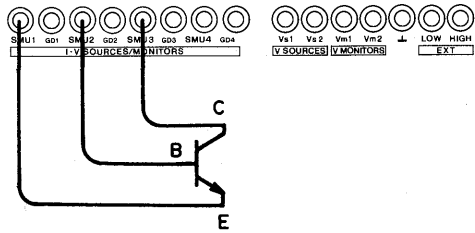

C. FET VDS-ID:

Setup for measurement of N-channel junction FETs (Field-Effect Transistor). When the FET is connected to the 16058A test fixture, as shown below, V_{DS-I_D} (drain/source voltage — drain current) characteristics of a common drain FET can be measured.

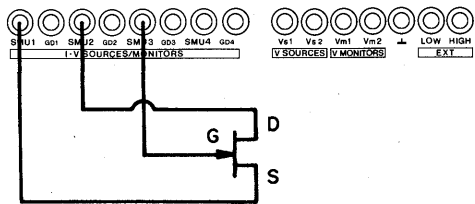

D. DIODE VF-IF:

Setup for measurement of general PN junction diodes. When the diode is connected as shown below, V_F-I_F (forward bias voltage — forward current) characteristics can be measured.

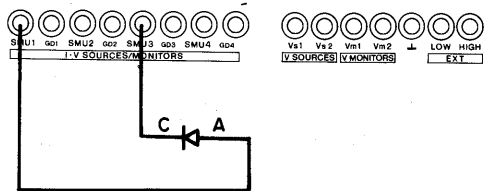

Figure 3-37. Connection Examples for Application Package.

3-89. HP-IB INTERFACE

3-90. The 4145A can be remotely controlled via the HP-IB, a carefully defined instrument interface which simplifies integration of instruments and a calculator or computer into a system.

Note

HP-IB is Hewlett-Packard's implementation of IEEE Std. 488, Standard Digital Interface for Programmable Instrumentation.

3-91. CONNECTION TO HP-IB

3-92. The 4145A can be connected into an HP-IB bus configuration with or without a controller (i.e., with or without an HP calculator). In an HP-IB system without a controller, the instrument functions as a "talk only" device (refer to paragraph 3-117 and 3-119.)

3-93. HP-IB STATUS INDICATORS

3-94. The HP-IB Status Indicators are four LED lamps located on the front panel. When lit, these lamps show the existing status of the 4145A in the HP-IB system as follows :

SRQ : SRQ signal from the 4145A to the controller is on the HP-IB line. Refer to paragraph 3-113.

LISTEN : The 4145A is set to listen.

TALK : The 4145A is set to talk.

REMOTE : The 4145A is under remote control.

3-95. LOCAL KEY

3-96. The LOCAL key releases the 4145A from HP-IB remote control and allows measurement conditions to be set from the front-panel. The REMOTE lamp will go off when this key is pressed. LOCAL control is not available when the 4145A is set to "local lockout" status by the controller.

Note

The 4145A is set to "local lockout" when the 4145A is in G11 mode.

3-97. HP-IB CONTROL SWITCH

3-98. The HP-IB Control Switch, located on the rear panel, has seven bit switches as shown in Figure 3-38. Each bit has two settings : logical 0 (down position) and logical 1 (up position). The switch has three functions as follows :

- (1) Bit switches 1 through 5 (Address Bits) are used to set the HP-IB address (in binary) of the 4145A. Any address between 0 (00000) and 30 (11110) can be set.
- (2) Bit switch 6 (Data Form Bit) determines the output data delimiter. When the bit switch is set to 0, the delimiter is a comma (,); when set to 1, the delimiter is a carriage return and line feed (CR/LF).
- (3) Bit switch 7 (EOI; End or Identify) determines whether or not the 4145A sends the EOI signal when data transfer ends.

The HP-IB Control Switch settings are displayed when the 4145A is turned on. Refer to Figure 3-20.

Note

The HP-IB Control Switch, as set at the factory, is shown in Figure 3-38.

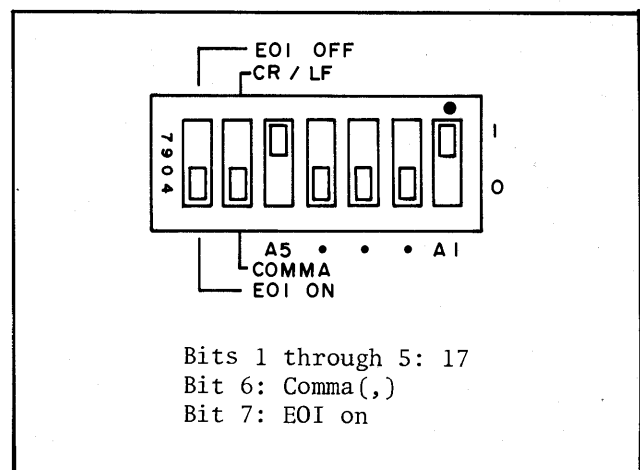

Figure 3-38. HP-IB Control Switch.

3-99. HP-IB INTERFACE CAPABILITIES

3-100. The 4145A has eight HP-IB interface functions. Refer to Table 3-8.

Table 3-8. HP-IB Interface Capabilities

Code	Interface Function* (HP-IB Capabilities)
SH1**	Source Handshake
AH1	Acceptor Handshake
T5	Talker (basic talker, serial poll, talk only mode, unaddress to talk if addressed to listen)
L4	Listener (basic listener, unaddress to listen if addressed to talk)
SR1	Service Request
RL1	Remote/local (with local lockout)
DC1	Device Clear
DT1	Device Trigger
E1	End Message Sending
<p>* Interface functions provide the means for a device to receive, process, and transmit messages over the bus.</p> <p>** The suffix number of the interface code indicates the limitation of the function capability as defined in Appendix C of IEEE Std. 488.</p>	

3-101. HP-IB CONTROL MODES

3-102. When controlled via the HP-IB, the 4145A has two modes :

(1) System Mode :

Setup and measurement is made by a controller via the HP-IB. This is much like manual setup and measurement operation.

(2) User Mode :

Direct control of the CRT and each SMU, Vs, and Vm via the HP-IB. The instrument is set to this mode when program code "US" is sent. Output from each SMU or Vs can be set, and measurement can be made by triggering the desired SMU or Vm. The CRT is blank in this mode, but can be used as a programmable graphics display by sending program code "GL2". To exit from this User Mode (return to System Mode), send a device CLEAR command or a paging command (DE, SS, SM, or MD).

3-103. HP-GL CONTROL OF THE CRT

3-104. The 4145A's CRT can be controlled via the HP-IB by using HP-GL (Hewlett-Packard Graphics Language) commands. There are two HP-GL modes : GL1, which can be used only when the 4145A is operating in System Mode; and GL2, which can be used only in User Mode. Each HP-GL mode is described below.

1. GL1 Mode (Overlay Write) :

This mode is set by sending program code "GL1." It is available only in the System Mode and only on the GRAPHICS PLOT page. In GL1 mode, additional information, such as labels, comments, lines, and curves, can be displayed on graphs plotted by the 4145A. Also, in GL1 mode the 4145A is set to "local lockout."

2. GL2 Mode (Blank) :

This mode is set by sending program code "GL2." It is available only in the User Mode (programming code "US"). In GL2 mode, the CRT is completely independent from the 4145A's CRT control circuit and can be operated as a stand-alone graphics display.

If the display RAM contains too much display data, the 1345A may not be able to complete the display process within one refresh cycle. The display will be incomplete. To exit from the GL1 mode or GL2 mode, send program code "GL0."

To exit from the GL1 mode or GL2 mode, send program code "GL0."

3-105. Remote Program Codes and Parameter Setting

3-106. Figure 3-39 shows the available remote program codes and parameter settings. Program codes are divided into three categories : (1) System Mode program codes, (2) User Mode program codes, and (3) program codes common to both modes. User functions, OUTPUT SEQUENCE, PURGE, REPACK, DISC COPY, and HEAD CLEAN can not be programmed.

Programming notes :

1. Numeric values can be entered in fixed decimal format or floating decimal format. (max. 12 char and max. 2 digits exponent.)

Example : Fixed decimal : 25.32
Floating decimal : 2.532E+01

2. Voltage (V), current (A), and time (s) units are not required when entering numeric values.
3. Terminator (; or CR or LF) is required at the end of each parameter setting on a program line. In the examples given below, (TERM) represents the terminator.
4. Channel names must be enclosed in apostrophes (' ').

SYSTEM MODE PROGRAM CODES

Following program codes are used when the 4145A is set to System Mode.

Direct Paging (to change page) :

DE : CHANNEL DEFINITION Page
SS : SOURCE SETUP Page
SM : MEAS & DISP MODE SETUP Page
MD : Display Page (page selected for DISPLAY MODE)
US : User Mode

Notes

1. When the 4145A receives a Direct Paging command, it checks the setup on the displayed page before proceeding to the specified page. If an illegal setup is detected, an error message will be displayed, the SRQ bit will be turned on, and the page will not be changed.
2. Display returns to the MENU page when the 4145A receives a Device Clear command.

Figure 3-39. Remote Program Codes and Parameter Setting (Sheet 1 of 9).

CHANNEL DEFINITION Page (program code "DE")

Setup for SMUs 1 through 4

$$\text{CH } \underset{(1)}{N}^* \text{ , } \frac{\text{'XXXXXX'\}}{(2)} \text{ , } \frac{\text{'XXXXXX'\}}{(3)} \text{ , } \frac{N}{(4)} \text{ , } \frac{N(\text{TERM})}{(5)}$$

- (1) SMU channel number (1 - 4)
- (2) V NAME (up to 6 characters)
- (3) I NAME (up to 6 characters)
- (4) SOURCE MODE (1 - 3)
 - 1: V
 - 2: I
 - 3: COM**
- (5) SOURCE FUNCTION (1 - 4)
 - 1: VAR1
 - 2: VAR2
 - 3: CONST
 - 4: VAR1'

* If nothing is specified after the channel number, the channel is turned off (NOT USE).

** When SOURCE MODE is set to 3 (COM), SOURCE FUNCTION must be set to 3 (CONST).

Setup for Vs1 and Vs2

$$\text{VS } \underset{(1)}{N}^* \text{ , } \frac{\text{'XXXXXX'\}}{(2)} \text{ , } \frac{N(\text{TERM})}{(3)}$$

- (1) Vs channel number (1 or 2)
- (2) V NAME (up to 6 characters)
- (3) SOURCE FUNCTION (1 - 4)
 - 1: VAR1
 - 2: VAR2
 - 3: CONST
 - 4: VAR1'

* If nothing is specified after the channel number, the channel is turned off (NOT USE).

Setup for Vm1 and Vm2

$$\text{VM } \underset{(1)}{N}^* \text{ , } \frac{\text{'XXXXXX'\}}{(2)} (\text{TERM})$$

- (1) Vm channel number (1 or 2)
- (2) V NAME (up to 6 characters)

* If nothing is specified after the channel number, the channel is turned off (NOT USE).

Figure 3-39. Remote Program Codes and Parameter Setting (Sheet 2 of 9).

SOURCE SETUP Page (program code "SS")

Setup for VAR1

$$\frac{XX}{(1)} \frac{N}{(2)}, \frac{\pm NN.NNN}{(3)}, \frac{\pm N.NNNN}{(4)}, \frac{N.NNNN}{(5)}, \frac{N.NNN(TERM)}{(6)}$$

- (1) SOURCE MODE of VAR1 (VR or IR)
 - VR: Voltage Source
 - IR: Current Source
- (2) SWEEP MODE (1 - 4)
 - 1: LINEAR
 - 2: LOG 10
 - 3: LOG 25
 - 4: LOG 50
- (3) START value
- (4) STOP value
- (5) STEP value*
- (6) COMPLIANCE value

* If SWEEP MODE (2) is set to 2, 3, or 4, omit STEP (5).

Setup for VAR2

$$\frac{XX}{(1)} \frac{\pm N.NNNN}{(2)}, \frac{\pm N.NNNN}{(3)}, \frac{NN}{(4)}, \frac{N.NNN(TERM)}{(5)}$$

- (1) SOURCE MODE or the VAR2 (VP or IP)
 - VP: Voltage Source
 - IP: Current Source
- (2) START value
- (3) STEP value
- (4) Number of steps
- (5) COMPLIANCE value

Setup for CONSTANT SMUs

$$\frac{XX}{(1)} \frac{N}{(2)}, \frac{\pm N.NNNN}{(3)}, \frac{N.NNNN(TERM)}{(4)}$$

- (1) SOURCE MODE of the channel (VC or IC)
 - VC: Voltage Source
 - IC: Current Source
- (2) SMU channel number (1 - 4)
- (3) Output value
- (4) COMPLIANCE value

Setup for CONSTANT Vs

$$\frac{SC}{(1)} \frac{N}{(2)}, \frac{\pm N.NNNN(TERM)}{(2)}$$

- (1) Vs channel number (1 or 2)
- (2) Output value

Figure 3-39. Remote Program Codes and Parameter Setting (Sheet 3 of 9).

HOLD TIME Setting

$$\text{HT } \frac{\text{N.NN}(\text{TERM})}{(1)}$$

(1) HOLD TIME

DELAY TIME Setting

$$\text{DT } \frac{\text{N.NN}(\text{TERM})}{(1)}$$

(1) DELAY TIME

VARI' RATIO/OFFSET Setting

$$\text{XX } \frac{\pm\text{N.NN}(\text{TERM})}{(1) \quad (2)}$$

(1) RATIO/OFFSET (RT or FS)

RT: RATIO
FS: OFFSET

(2) Value

MEAS & DISP MODE SETUP Page (program code "SM")

Time Domain Measurement Setup (only when VARI is not selected on the CHANNEL DEFINITION page)

WAIT TIME Setting

$$\text{WT } \frac{\text{N.NNN}(\text{TERM})}{(1)}$$

(1) WAIT TIME

INTERVAL Setting

$$\text{IN } \frac{\text{N.NN}(\text{TERM})}{(1)}$$

(1) INTERVAL Time

NO. OF RDNGS Setting

$$\text{NR } \frac{\text{NNN}(\text{TERM})}{(1)}$$

(1) No. of Readings

DISPLAY MODE Selection

DM1: GRAPHICS
DM2: LIST
DM3: MATRIX
DM4: SCHMOO

Figure 3-39. Remote Program Codes and Parameter Setting (Sheet 4 of 9).

Setup for GRAPHICS mode ("DM1")

$$\frac{XX}{(1)} \frac{'XXXXXX'}{(2)}, \frac{N}{(3)}, \frac{\pm N.NNN}{(4)}, \frac{\pm N.NNN}{(5)} (TERM)$$

(1) AXES

XN : X axis

YA : Y1 axis

YB : Y2 axis*

XT : X axis for time domain measurement**

(2) Monitor channel NAME for the specified axis (must be one of the monitor channel names specified on the CHANNEL DEFINITION page).

(3) SCALE 1 : LINEAR 2 : LOG

(4) MIN value

(5) MAX value

* Y2 axis is optional.

** For time domain measurements, (2) and (3) should be omitted.

Setup for LIST mode ("DM2")

$$LI \frac{'XXXXXX'}{(1)}, \frac{'XXXXXX'}{(2)}, \frac{'XXXXXX'}{(3)}, \frac{'XXXXXX'}{(4)}, \frac{'XXXXXX'}{(5)}, \frac{'XXXXXX'}{(6)} (TERM)$$

(1)~(6) Monitor channel NAMES. At least one NAME must be specified (must be the monitor channel names specified on the CHANNEL DEFINITION page).

Setup for MATRIX mode ("DM3")

$$MX \frac{'XXXXXX'}{(1)} (TERM)$$

(1) Monitor channel NAME (must be one of the monitor channel names specified on the CHANNEL DEFINITION page).

Setup for SCHMOO mode ("DM4")

$$SH \frac{'XXXXXX'}{(1)}, \frac{\pm NN.NN}{(2)}, \frac{\pm NN.NNN}{(3)}, \frac{\pm N.NNNN}{(4)}, \frac{\pm N.NNNN}{(5)} (TERM)$$

(1) Monitor channel NAME (must be one of the monitor channel names specified on the CHANNEL DEFINITION page).

(2) Minimum value for "M"

(3) Minimum value for "Δ"

(4) Minimum value for "+"

(5) Minimum value for ":"

* If no minimum value is specified for (2), (3), (4), or (5), the corresponding symbol will not be used in the SCHMOO PLOT. A comma (,) must be entered, however.

MEASUREMENT Codes (program code "MD")

ME1 : SINGLE*

ME2 : REPEAT

ME3 : APPEND

ME4 : STOP

* The GET (Group Execute Trigger) command can be used in place of the ME1 program code. An example of the GET command is the TRIGGER command on the 85A or 9845A.

Following program codes are valid on any page.

AUTO SEQ codes

AS1 : START
AS2 : CONTINUE
AS3 : STOP

SAVE Function

SV 'X XXXX XXXXXX' (TERM)
(1) (2) (3) (4) (5)

- (1) File type
 - P: Program file
 - D: Program/Data file
 - S: ASP file
- (2) Space
- (3) File name (up to 6 characters)
- (4) Space
- (5) Comment (up to 8 characters)

* (4) and (5) are optional.

GET Function

GT 'X XXXX' (TERM)
(1) (2) (3)

- (1) File type
- (2) Space
- (3) File name

Assignment of Data Output Channel

DO 'XXXXX'
(1)

- (1) Monitor channel NAME (must be one of the monitor channel names specified on the CHANNEL DEFINITION page).

PRINT Function

PR : PRINT function ON*
PF : PRINT function OFF

* Refer to paragraph 3-129 for instructions covering HP-IB controlled plot operations.

Graphics Language (GL1) Mode (only on the GRAPHICS PLOT Page)

GL1 : Graphics Display mode ON
GL0 : Graphics Display mode OFF

Figure 3-39. Remote Program Codes and Parameter Setting (Sheet 6 of 9).

USER MODE PROGRAM CODES

Following program codes are used when the 4145A is set to User Mode.

User Mode

US: User mode ON*

* To release the 4145A from this mode, send a page command ("DE", "SS", "SM", or "MD") or a device clear command.

Output command for SMUs

$$\frac{XX}{(1)} \frac{N^*}{(2)}, \frac{N}{(3)}, \frac{\pm N.NNNN}{(4)}, \frac{N.NNNN(TERM)}{(5)}$$

(1) SOURCE MODE (DV or DI)

DV: Voltage Source

DI: Current Source

(2) SMU channel number (1 - 4)

(3) Output Range

For voltage source (0 - 3)

0: AUTO

1: 20V

2: 40V

3: 100V

For current source (0 - 9)

0: AUTO

1: 1nA

2: 10nA

3: 100nA

4: 1μA

5: 10μA

6: 100μA

7: 1mA

8: 10mA

9: 100mA

(4) Output value

(5) COMPLIANCE value

* If nothing is specified after the channel number, the channel is turned off (NOT USE).

Figure 3-39. Remote Program Codes and Parameter Setting (Sheet 7 of 9).

Output command for Vs

$$DS \frac{N}{(1)}, \frac{\pm N.NNNN(TERM)}{(2)}$$

- (1) Vs channel number (1 or 2)
- (2) Output value

Triggering (Measurement)

$$\frac{XX}{(1)} \frac{N}{(2)}$$

- (1) Measurement mode of the channel to be triggered
 - TV: Voltage Monitor
 - TI: Current Monitor
- (2) Channel number
 - 1: SMU1
 - 2: SMU2
 - 3: SMU3
 - 4: SMU4
 - 5: Vm1
 - 6: Vm2

Graphics Language (GL2) Mode

GL2: Graphic Display mode ON
 GL0: Graphic Display mode OFF

Note

In User Mode, measurement cannot be performed with the fixture lid open because of the protective function. To perform the measurement without closing the fixture lid, use the Shorting Connector as shown in Figure 3-35.

Figure 3-39. Remote Program Codes and Parameter Setting (Sheet 8 of 9).

COMMON PROGRAM CODES

Following program codes are available in the System Mode or in the User Mode.

INTEGRATION TIME

IT1 : SHORT
IT2 : MEDIUM
IT3 : LONG

SELF TEST

SF

Data Ready Service Request

If "DR1" is sent (Data Ready Service Request ON), bit 1 (Data Ready) and bit 7 (RQS) of the 4145A's STATUS BYTE are set to 1 when measurement data is valid.

DR0 : OFF
DR1 : ON

HP-IB Data Buffer Clear

To clear the HP-IB data output buffer and bit 1 (Data Ready) of the Status Byte. Buffer Clear must be performed before data output from the 4145A.

BC

Auto Calibration

CA0 : OFF
CA1 : ON*

* Auto calibration in the User Mode is performed only once when "CA1" is sent. Also, if the mode is changed, Auto Calibration is set to OFF.

PLOT function

PL $\frac{NNN}{(1)}$, $\frac{NNN}{(2)}$, $\frac{NNNN}{(3)}$, $\frac{NNNN(TERM)}{(4)}$

- (1) Xmin
- (2) Ymin
- (3) Xmax
- (4) Ymax

PF : PLOT function OFF

* Refer to paragraph 3-129 for instructions covering HP-IB controlled plot operations.

Figure 3-39. Remote Program Codes and Parameter Setting (Sheet 9 of 9).

3-107. HP-GL COMMANDS

3-108. HP-GL commands that can be used when the 4145A is set to User Mode (refer to paragraph 101) are listed in Table 3-9.

For more detailed information on HP-GL, refer to the operation manual of any HP-IB compatible plotter.

Table 3-9. HP-GL Commands (Sheet 1 of 3)

Code	Name	Meaning	Coding Example *1
VECTOR Group			
PU	Pen Up	Turns off the beam.	PU
PD	Pen Down	Turns on the beam.	PD
PA	Plot Absolute	Moves the beam to the point specified by the X- and Y-coordinates.	PA X -coordinate, Y -coordinate, ... X -coordinate, Y -coordinate
PR	Plot Relative	Moves the beam the specified units.	PR X -increment, Y -increment, ... X -increment, Y -increment
CHARACTER Group			
CS	Designates Standard Character Set	Selects the character set. *2	CS Character Set#
LB	Label	Writes characters using the assigned character set.	LB(Character) [ETX] *3
DR	Relative Direction	Selects the writing direction. *4 ($-128 \leq \frac{\text{run}}{\text{rise}} \leq 127$)	DR run, rise
SR	Relative Character Size	Selects the character size. *5	SR width, height.
CP	Character Plot	Moves the beam the specified of characters. ($-128 \leq \text{number} \leq 127$)	CP horizontal, vertical
LINE TYPE Group			
LT	Line Type	Selects the line type.	LT pattern number *6
SP	Pen Select	Selects the beam intensity.	SP intensity number *7
VS	Velocity Select	Selects the beam writing speed.	VS velocity *8, beam intensity number.
AXES Group *9			
XT	X Tick	Writes an X-axis tick mark at the present beam position	XT
YT	Y Tick	Writes a Y-axis tick mark at the present beam position.	YT
SETUP Group *10			
IP	Input P1 and P2	Sets up the scaling points, P1 and P2.	IP P1x, P1y, P2x, P2y
OP	Output P1 and P2	Outputs the scaling points.	OP
IW	Input Window	Limits the plot area.	IW X _{LL} , Y _{LL} , X _{UR} , Y _{UR}

Table 3-9. HP-GL Commands (Sheet 2 of 3)

Code	Name	Meaning	Coding Example *1
CONFIGURATION and STATUS Group			
DF	Default	Returns the CRT setup to the default condition. *11	DF
IN	Initialize	Returns to the default condition and clears the display.	IN
IM	Input Mask	Selects mask value of the error number *12 which can cause an SRQ.	IM mask value
OE	Output Error	Outputs the error number *12 that caused an SRQ.	OE
OS	Output Status	Outputs the CRT's status byte. *13	OS
ORIGINAL INSTRUCTION Group *14			
MA	Memory Address	Sets the memory pointer to the specified address.	MA address number
MJ	Memory Jump	Sets the "Memory Jump" command to the address.	MJ jump address
MC	Memory Count	Outputs the memory count to which the memory pointer points.	MC
MK	Memory Clear	Clears the user memory and resets the memory pointer.	MK
PG	Page	= MK(Memory Clear)	PG
AF	Advance Full Page	= MK(Memory Clear)	AF

*1 Terminator (; or LF) is required at the end of each command.

*2 Only one Character set is available on the 4145A.

*3 Indicated Label Terminator (use ASCII CODE ETX).
 Example for LB command sent by HP85 (displays 4145A)
 OUTPUT 717; "LB 4145A" & CHR \$ (3)

*4 All run and rise values are converted into 0°, 90°, 180° or 270° as follows:

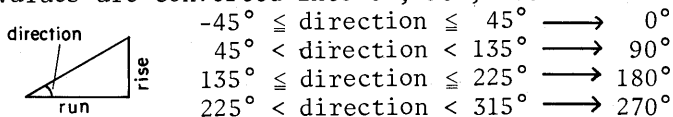

*5 Four character sizes (x1.0, x1.5, x2.0, and x2.5) are selectable according to larger value of width or height as follows:

- $0 \leq \text{larger value} < 3 \longrightarrow \text{x1.0 size}$
- $3 \leq \text{larger value} < 4 \longrightarrow \text{x1.5 size}$
- $4 \leq \text{larger value} < 5 \longrightarrow \text{x2.0 size}$
- $5 \leq \text{larger value} \leq 127 \longrightarrow \text{x2.5 size}$

*6 Four line types are selectable as follows:
 0: Line with dot at the last point
 1 or 2: Short dashed line
 3 ~ 6: Long dashed line
 7: Solid line

*7 Four beam intensities are selectable as follows:
 0: Blank
 1: Dim
 2: Half brightness
 3: Full brightness

Table 3-9. HP-GL Commands (Sheet 3 of 3)

- *8 Four beam speeds are selectable as follows:
- 5: 0.05 inch/μsec
 - 10: 0.10 inch/μsec
 - 15: 0.15 inch/μsec
 - 20: 0.20 inch/μsec
- *9 Tick length is fixed at 0.8% of $|P2x - P1x|$ or $|P2y - P1y|$.
- *10 IP, OP, and IW are fixed at $P1 = (0,0)$, $P2 = (2047, 2047)$. Also, the limits of the GRAPHICS PLOT page is $LL = (220, 493)$, $UR = (1570, 1725)$
- *11 Default condition is as follows:
- | | | | |
|----|-------------------------|---|-----------------|
| DR | Relative Direction | : | 0° |
| SR | Relative Character Size | : | X1 size |
| LT | Line Type | : | Solid line |
| SP | Pen Select | : | Full brightness |
| VS | Velocity Select | : | 0.20 inch/μsec |
| IM | Input Mask | : | 225 |
- *12 Error number that occurs first is output. Error meanings are as follows:
- 1: Instruction is not recognized (mask value=1)
 - 2: Wrong number of parameter (mask value=2)
 - 3: Bad parameter (mask value=4)
 - 4: Illegal character (mask value=8)
 - 7: All of the display memory has been used (mask value=64)
- *13 Status values output from the CRT status byte have the following meanings (more than one may exist):
- 1: Beam is ON
 - 8: Initialized
 - 32: Error
- *14 ORIGINAL INSTRUCTION Group controls the vector memory using the memory pointer. The vector memory outputs (to the CRT) the display data at the address designated by the memory pointer. The memory pointer scans the vector memory. Using "MA", "MJ", "MC", and "MK", the display can be controlled. Available memory addresses are 2453 through 4094 in GL1 mode, and 410 through 4094 in GL2 mode.

3-109. DEVICE CLEAR

3-110. The 4145A's control settings return to the initial control settings described in paragraph 3-14 when it receives a Selected Device Clear or Group Device Clear.

3-111. DATA OUTPUT

3-112. The 4145A outputs measurement and status data to external devices via the HP-IB. The data output format depends on whether the 4145A is set to System Mode or User Mode. In System Mode, all measurement and status data stored in the data buffer are output when the 4145A receives program code "DO". In user mode, measurement and status data for the triggered channel are output when the 4145A receives program code "DO". The output formats are shown in Figure 3-40.

1. Data Output Format for the System Mode

When the remote program code "DO" is sent, the 4145A outputs data in following format*¹.

$$\underbrace{X}_{(1)} \underbrace{\pm NN.NNN}_{(2)} \underbrace{E \pm NN}_{(3)} \underbrace{,}_{(4)} X \pm NN.NNNE \pm NN, \dots X \pm NN.NNNE \pm NN \underbrace{(CR)}_{(5)} \underbrace{(LF)}_{(5)}$$

- (1) Data Status*²
- (2) Measurement Data
- (3) Exponent*³
- (4) Comma (data delimiter)*⁴
- (5) Data Terminator

2. Data Output Format for the User Mode

When the remote program code "TI 'CH#'" or "TV 'CH#'" is sent, the SMU makes a measurement and the 4145A outputs data in the following format.

$$\underbrace{X}_{(1)} \underbrace{X}_{(2)} \underbrace{X}_{(3)} \underbrace{\pm NN.NNN}_{(4)} \underbrace{E \pm NN}_{(5)} \underbrace{(CR)}_{(6)} \underbrace{(LF)}_{(6)}$$

- (1) Data Status*²
- (2) Monitor Channel
 - A: SMU1
 - B: SMU2
 - C: SMU3
 - D: SMU4
 - E: Vm1
 - F: Vm2
- (3) Measurement mode (V or I)
- (4) Measurement data
- (5) Exponent*³
- (6) Data Terminator

Figure 3-40. Data Output Format (Sheet 1 of 2).

- *1 The order of data output is the same as the displayed order.
- *2 Data Status indicates the condition of the monitor channel and is output in code, as listed below.
- N : Normal
 - L : INTERVAL is too short.
 - V : A-D converter saturation
 - X : Oscillation
 - C : This channel compliance error
 - T : Other channel compliance error
- Priority is as follows :
L>V>X>C>T>N
- *3 Scientific notation is used.
- | | | |
|----------------|-------|------|
| 10^0 | | E+00 |
| $10^{-3}(m)$ | | E-03 |
| $10^{-6}(\mu)$ | | E-06 |
| $10^{-9}(n)$ | | E-09 |
| $10^{-12}(p)$ | | E-12 |
- *4 The delimiter, bit switch 6 on the HP-IB Control Switch (Figure 3-38), is set at the factory to comma (,). This causes the 4145A in the System Mode to output all data as a continuous string. When the data delimiter is set to CR/LF, a carriage return and line feed signal is output after each field. This is useful when outputting data to certain peripherals, such as a strip-printer.

Figure 3-40. Data Output Format (Sheet 2 of 2).

3-113. SERVICE REQUEST STATUS BYTE

3-114. The 4145A outputs an RQS (Request Service) signal whenever bit 1, 2, 3, 4, 6, or 8 of the Service Request Status Byte is set. The make-up of the Status Byte is shown in Figure 3-41.

Bit 8	Bit 7	Bit 6	Bit 5	Bit 4	Bit 3	Bit 2	Bit 1
Emergency	RQS	Self-Test Fail	Busy	Illegal Program	END Status 4	Syntax Error 2	Data Ready 1

Bit 7 (RQS) indicates whether or not a service request exists. Following are the service request states of the 4145A.

- Bit 1: Data Ready
This bit is set when complete measurement data is ready for output onto the HP-IB. It is reset when data transfer starts or when the 4145A receives program code "BC" (Buffer Clear).
- Bit 2: Syntax Error
This bit is set when the 4145A receives an erroneous remote program code. If this bit is set while bit 8 is set, it has another meaning. Refer to the description for bit 8.
- Bit 3: End Status
This bit is set when Self-Test, PLOT, or PRINT is completed.
- Bit 4: Illegal Program
This bit is set when the 4145A receives an invalid program. If this bit is set while bit 8 is set, it has another meaning. Refer to the description for bit 8.
- Bit 5: Busy
This bit is set when measurement or auto calibration is being performed. It is automatically reset when measurement or calibration ends. This bit does not set the RQS bit.
- Bit 6: Self-Test Fail
This bit is set when Self-Test fails. It is reset when Self-Test is performed again and the result is pass. If this bit is set while bit 8 is set, it has another meaning. Refer to the description for bit 8.

Figure 3-41. Status Byte for the 4145A (Sheet 1 of 2).

- Bit 7 : RQS (Request Service)
This bit is set whenever bit 2, 3, 4, 6, or 8 is set. Also set when bit 1 is set if program code "DR1" (Data Ready ON) has been sent.
- Bit 8 : Emergency
This bit is set when a potentially dangerous condition exists. The meaning of this bit depends on whether bit 2, bit 4 or bit 6 is set. Each is described below.
- Bit 2 : Fixture lid open
This bit and bit 8 are set when the fixture lid is opened during or at the start of a measurement in which the output voltage will exceed $\pm 42V$. In user mode, regardless the output voltage, this bit is set if the fixture lid is open or shorting connector is not connected.
- Bit 4 : SMU shut down
This bit and bit 8 are set when SMU output is shut down by the instrument to prevent damage to SMU.
- Bit 6 : Power Failure
This bit and bit 8 are set when the SMU output was reset by a momentary power loss.

Note

All bits except bit 5 are reset by a Serial Poll, and all bits except bit 1 and 5 are reset by a Device Clear.

Figure 3-41. Status Byte for the 4145A (Sheet 2 of 2).

3-115. Programming Guide for 4145A

3-116. Sample programs for the HP Model 9825B Desktop Computer and HP Model 85A Personal Computer are provided in Figures 3-42 and 3-43, respectively.

Note

1. Specific information for HP-IB programming with the 9825B or 85A is provided in the 9825B or 85A programming manual.
2. Equipment required for these sample programs includes:
 - 9825B Desktop Computer with 98210A String-Advanced Programming ROM, 98213A General I/O + Extended I/O ROM, and 98034B HP-IB Interface Card.
 - 85A Personal Computer with 00085-15003 I/O ROM, 00085-15004 Matrix ROM, and 82937A HP-IB Interface Card.
3. Before executing the sample programs, set the HP-IB control switch as follows:
 - Address: 17
 - Delimiter: comma
4. Before executing sample program 2, close the fixture lid or connect the shorting connector.

Sample Program 1

Description :

These programs are examples of remote control, data output for a Bi-polar Transistor measurement made in the System Mode. The programs have three capabilities :

- (1) Control of the 4145A via the HP-IB
- (2) Measurement via the HP-IB
- (3) Data output from the 4145A via the HP-IB

9825B Program :

```

10 : dim A$ [1100]
20 : wrt717,"IT1 CA1 DR0 BC"
30 : wrt717, "DE CH1, 'VE', 'IE', 3, 3;
    CH2,'VB','IB',2,2;CH3,'VC','IC',1,1
    CH4"
40 : wrt717, "VS1; VS2; VM1; VM2"
50 : wrt717,"SS VR1,0,1,.05,50E-3;IP
    10E-6,10±-6,4,3"
60 : wrt717,"SM DM1,XN'VC',1,0,1;YA'IC',
    1,0,10E-3"
70 : wrt717, "MD ME1"
80 : rds (717) → A
90 : if bit (0,A)=0;gto 80
100 : wrt 717,"DO 'IC' "
110 : red717,A$
120 : prtA$
130 : end

```

85A Program :

```

10 DIMA$ [1100]
20 OUTPUT717; "IT1 CA1 DR0 BC"
30 OUTPUT717; "DE CH1, 'VE', 'IE', 3,
    3;CH2,'VB','IB',2, 2; CH3, 'VC',
    'IC', 1, 1; CH4"
40 OUTPUT717; "VS1; VS2; VM1; VM2"
50 OUTPUT717;"SS VR1,0,1,.05,50E-3;
    IP 10E-6,10E-6,4,3"
60 OUTPUT717;"SM DM1 XN 'VC',1,0,
    1;YA 'IC',1,0,10E-3"
70 OUTPUT717;"MD ME1"
80 A=SPOLL(717)
90 IF BIT (A,0)=0 THEN 80
100 OUTPUT717;"DO 'IC' "
110 ENTER717;A$
120 DISP A$
130 END

```

These programs perform the following :

Line	Description
10	Define a string variable, A\$, to store measurement data.
20	Set measurement integration time (IT1), auto calibration (CA1), data ready (DR0), and data buffer clear (BC).
30/40	Setup the CHANNEL DEFINITION Page (DE).
50	Setup the SOURCE SETUP Page (SS).
60	Setup the MEAS & DISP MODE SETUP Page (SM).
70	Preceed to the GRAPHICS PLOT Page (MD) and perform one measurement (ME1).
80	Read the 4145A's Status Byte and assign the result to variable A.
90	Wait until bit 0 of variable A set to 1 (Data Ready).
100	Send a data output (DO) command to obtain the measurement data from the 'IC' monitor channel.
110	Enter the measurement data into the string variable, A\$.
120	Display (85A) or print (9825B) the string variable A\$.

Figure 3-42. Sample Program 1 (Sheet 1 of 2).

The proceeding two programs can be modified, as follows, to make overlay plots on the GRAPHICS PLOT Page.

9825B Program :

```

.
.
.
100 : dim G$ [20]
110 : wrt 717, "GL1;IN"
120 : wrt 717, "PA1570, 493;PD;
      PA220, 1725;PU"
130 : wrt 717, "PA1000, 1000;
      PD; SR 0, 3"
140 : "4145A" → G$
150 : wrt 717, "LB" & G$
      & chr (3)
160 : wrt 717, "GL0"
170 : end

```

85A Program :

```

.
.
.
100 DIM G$ [20]
110 OUTPUT717; "GL1;IN"
120 OUTPUT717; "PA1570, 493;PD;
      PA220, 1725;PU"
130 OUTPUT 717; "PA1000, 1000;
      PD; SR 0, 3"
140 G$ = "4145A"
150 OUTPUT717; "LB" & G$
      & CHR$ (3)
160 OUTPUT717; "GL0"
170 END

```

These program modifications perform the following.

Line	Description
110	Set the 4145A to GL1 mode (GL1), and initialize the CRT (IN).
120	Draw a line from lower right corner to upper left corner of the plot area.
130	Move the beam (PA), and select the character size (SR).
140	Enter the data to be displayed into the string variable G\$.
150	PLOT "4145A" (LB).
160	Release the 4145A from GL1 mode.

These program modifications make overlay plots as shown below.

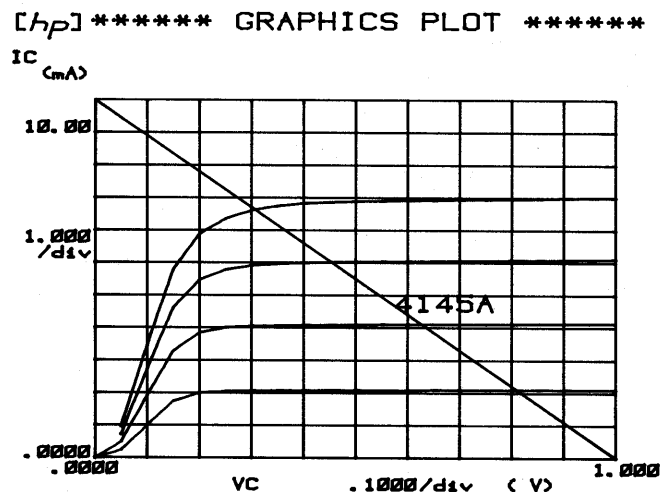

Figure 3-42. Sample Program 1 (Sheet 2 of 2).

Sample Program 2

Description

These programs are examples of remote control, data output in the User Mode. The programs have three capabilities:

- (1) Control of an SMU via the HP-IB
- (2) Trigger of the SMU via the HP-IB
- (3) Data output from the SMU via the HP-IB

Note

Before executing the program, close the fixture lid or connect the Shorting Connector to the rear panel.

9825B Program :

```

10 : dim A$ [30]
20 : wrt717, "US"
30 : wrt717, "IT1CA1 BC"
40 : 1.5→I
50 : wrt717, "DV1, 1," ,I, ",1E-3"
60 : wrt717, "DV2, 1, 0, 1E-3"
70 : wrt717, "TI1"
80 : red717, A$
90 : dsp A$
100 : wrt717, "DV1; DV2"
110 : end

```

85A Program :

```

10 DIM A$ [30]
20 OUTPUT717; "US"
30 OUTPUT717; "IT1 CA1BC"
40 I = 1.5
50 OUTPUT717; "DV1, 1," ;I; ",1E-3"
60 OUTPUT717; "DV2, 1, 0, 1E-3"
70 OUTPUT717; "TI1"
80 ENTER717; A$
90 DISP A$
100 OUTPUT717; "DV1; DV2"
110 END

```

These programs perform the following :

Line	Description
10	Define a string variable, A\$, to store measurement data.
20	Set the 4145A to User Mode (US).
30	Set measurement integration time (IT1), auto calibration (CA1), and data buffer clear (BC).
40/50	Set up SMU1 (DV1).
60	Set up SMU2 (DV2).
70	Trigger for I measurement of SMU1 (TI1).
80	Enter measurement data into the string variable, A\$.
90	Display the string variable A\$.
100	STOP the output for SMU1 and SMU2.

Also, CRT Display can be used as a Graphic Display when program code "GL2" is sent and HP-GL program codes are used, as shown in Figure 3-42.

Figure 3-43. Sample Program 2.

3-117. PLOT

3-118. The 4145A can directly dump an existing display onto an HP-IB plotter, without the aid of a controller. A list of recommended plotters is given in Table 3-10.

Note

Other plotters can be used, but they must have a LISTEN ONLY mode. Also, on some older type plotters, it may not be possible to precisely position alphabetic or numeric strings, such as labels, within a specified plot area.

Table 3-10. Recommended HP-IB Plotters

HP7225B	PLOTTER
HP7245B	PLOTTER-PRINTER
HP9872C/T	PLOTTER
HP7580A	PLOTTER

Operating instructions for the PLOT function are given in Figure 3-44.

Connection to the Plotter :

- (1) Equipment :
An HP-IB plotter (setable to LISTEN ONLY) and an HP-IB Cable (e.g., 10631B).
- (2) Interconnect the 4145A and the plotter as shown below :

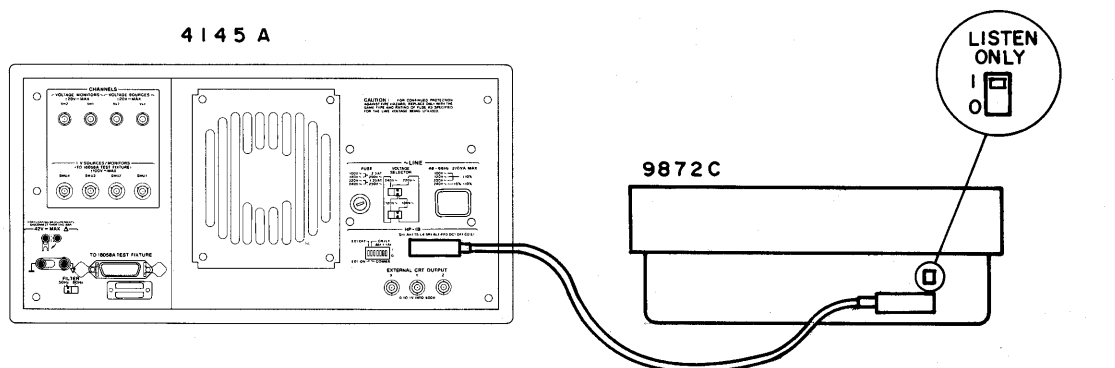

- (3) Turn off the plotter.
- (4) Set the plotter to LISTEN ONLY mode and then turn it on.

Plotting :

- (1) Select the desired page. If the GRAPHICS PLOT, LIST DISPLAY, MATRIX DISPLAY, or SCHMOO PLOT page is to be plotted, measurement can be made before the plot.
- (2) Press the PLOT key.
- (3) The following will be displayed on the Keyboard Input Line.

PLOT 200 , 200 , 7400 , 4800
 Xmin Ymin Xmax Xmax

These values represent the lower-left (Xmin and Ymin) and upper-right (Xmax and Ymax) coordinates of the plot area that was used in the last PLOT operation. (Whenever a PLOT is made, the new plot area parameters are automatically stored on the disc.)

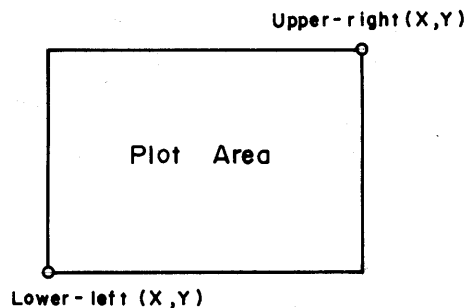

Figure 3-44. Plot Function (Sheet 1 of 2).

Note

The values displayed on the Keyboard Input Line when the PLOT key is pressed are in .025mm units. Note that the maximum value of the X coordinate and Y coordinate for the recommended plotters are different. Refer to the plotter's manual.

- (4) If necessary, change the displayed values with the EDIT Keys. ENTER key is not required.) The following limitations must be observed :
 - A. Xmin, Ymin, Xmax, and Ymax must not exceed 32767.
 - B. The specified plot area must be within the limits of the plotter.
 - C. Each value must be delimited by a comma (,) or space.
- (5) Press the EXECUTE Key to start plotting. "Plotting" will be displayed on the CRT's System Message Line. During plotting, the 4145A is in TALK ONLY mode, and the TLK lamp (HP-IB status indicators) will be lit. In this condition, only the PLOT or PRINT Key is available. Also, the Xmin, Ymin, Xmax, and Ymax values in effect when the EXECUTE key is pressed are stored on the disc, except when the disc is write-protected.
- (6) When the plot is completed, the instrument automatically returns to normal operation mode.

Note

To stop the PLOT, press the PLOT key or PRINT key. If the CLEAR key is pressed before the EXECUTE key is pressed, the PLOT operation will be cancelled. Plotting can not be temporarily stopped.

PLOT Contents :

- (1) Following are not plotted.
 - A. Softkey Prompts
 - B. Data on the Keyboard Input Area
 - C. Data on the System Message Line
- (2) Following are plotted when measurement data is in the Data Buffer and the CRT is displaying the GRAPHICS PLOT, LIST DISPLAY, MATRIX DISPLAY, or SCHMOO PLOT page.
 - A. Setup conditions for VAR1, VAR2, and CONSTANT Sources.
 - B. User Function expressions

Pen Selection :

When a multi-color plotter is used, pen # is selected as follows :

Pen #	Used for :
1	Grid Lines
2	Recalled Traces
3	Existing Traces
4	Plot Area Frame, Marker, Cursors, Lines

Note

Refer to paragraph 3-129 for instructions covering HP-IB controlled plot operations.

Figure 3-44. Plot Function (Sheet 2 of 2).

3-119. PRINT

3-120. The 4145A can directly print out measurement data on an HP-IB printer, without the aid of a controller. A list of recommended printers is given in Table 3-11.

Note

The printer must have a LISTEN ONLY mode.

Table 3-11. Recommended HP-IB Printers

HP9876A	PRINTER
HP2631B/G	PRINTER
HP2671A/G	PRINTER
HP7245B	PLOTTER PRINTER

Operating instructions for the PRINT function are given in Figure 3-45.

Connection to the Printer :

Refer to steps (1) through (4) of "Connection to the Plotter" in Figure 3-44.

Printing :

- (1) Press the PRINT key. "PRINT" will be displayed on the Keyboard Input Line.
- (2) Press the EXECUTE key to start printing. "Printing" will be displayed on the CRT's System Message Line. During printing, the 4145A is in TALK ONLY mode, and TLK lamp (HP-IB status indicators) will be lit. In this condition, only the PLOT or PRINT key is available.
- (3) All measurement data stored in the Data Buffer is printed out.

Note

If no data is in the data buffer, nothing will be printed.

- (4) When printing is completed, the instrument automatically returns to normal operation mode.

Note

To stop the PRINT, press the PRINT key or PLOT key. If the CLEAR key is pressed before the EXECUTE key is pressed, the PRINT operation is cancelled. Printing can not be temporarily stopped.

Print Contents :

1. Setup conditions for VAR1, VAR2 and CONSTANT Sources.
2. Measurement data

Note

User functions are not printed out.

Note

Refer to paragraph 3-129 for instructions covering HP-IB controlled plot operations.

Figure 3-45. Print Function.

3-121. EXTERNAL DISPLAY

3-122. The 4145A's CRT is equipped with X-Y-Z analog outputs which can be connected directly to a large screen graphics display. With the X, Y, and Z EXTERNAL CRT OUTPUTS (located on the rear panel) connected to an external display, the displays on the 4145A's CRT will be displayed on the external display also. Recommended external displays are listed in Table 3-12.

Table 3-12. Recommended External Displays

Model No.	Screen Size (HxW)
HP1304A	20cmx25cm
HP1311B	22cmx28cm
HP1317A	26cmx35cm
HP1310B	28cmx38cm
HP1321B	30cmx35cm

Note

The bandwidth of the external display must be at least 2MHz.

Figure 3-46 shows the interconnections between the 4145A and the external display. Details on the X-Y-Z analog outputs are described in the 1345A's operating and service manual.

Note

Output impedance of the EXTERNAL CRT OUTPUTS is 330Ω (X and Y) and 240Ω (Z). Thus, the input impedance of the external display must be sufficiently higher to obtain satisfactory display results.

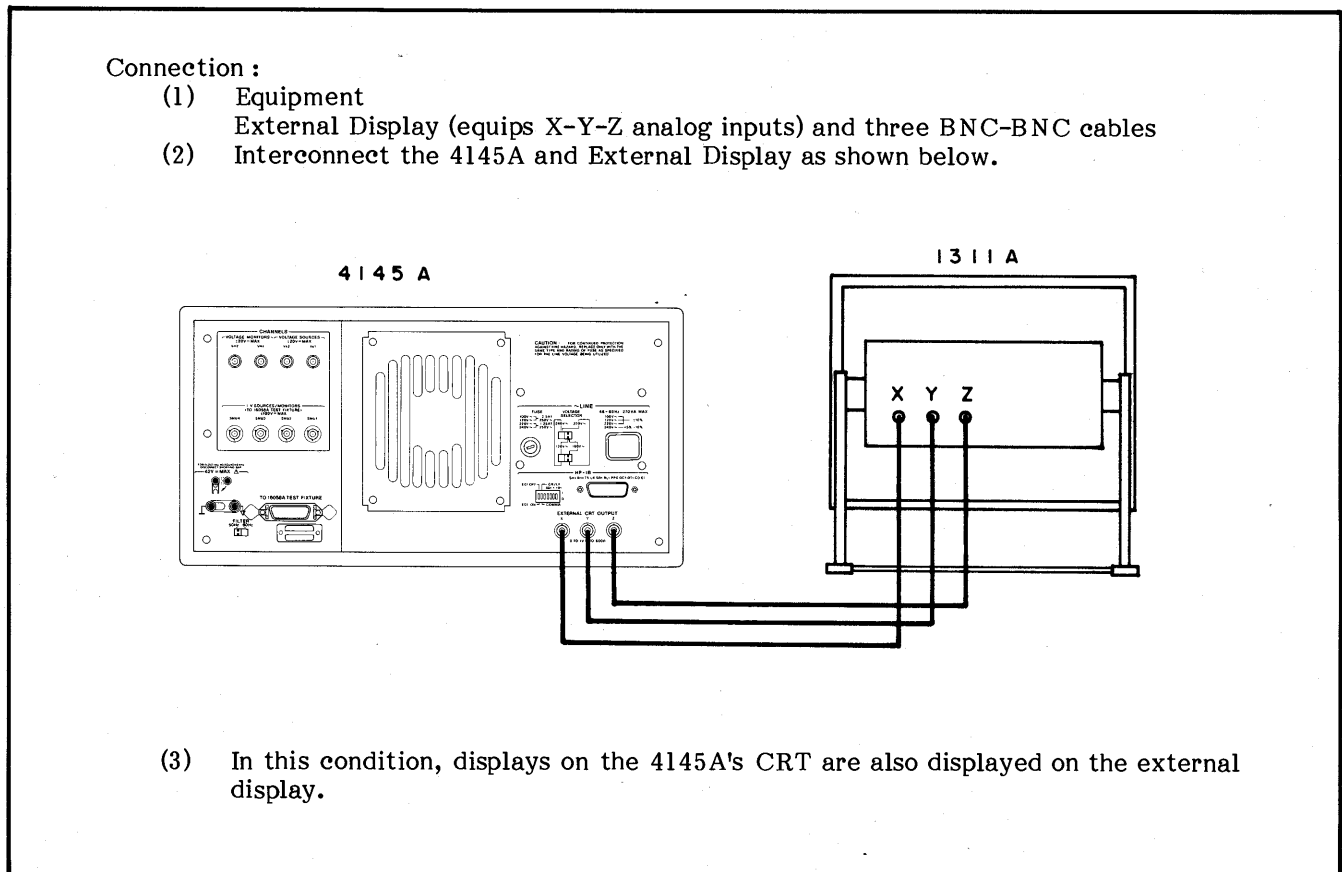

Figure 3-46. External Display.

3-123. DISC COPY

3-124. All files in the user area of a 4145A disc can be copied onto another disc, either one at time or all at once. The procedure is given in Figure 3-47. The operating system software and the system files, however, can not be copied. Also, only 4145A replacement discs (P/N : 04145-61100) can be used.

Note

The 4145A is automatically reset after a disc copy operation.

Copy One File :

- (1) Load a desired file using the GET function.
- (2) Change discs and store the file by using the SAVE function.

Full User Area Copy :

- (1) On the MENU page press the DIAGNOSTICS softkey. Display will be as shown below.

```

[hp] ***** DIAGNOSTICS *****
1 REGULAR SELFTEST          [1 SELF TEST]
   ---- PASS ----
2 FRONT PANEL TEST         [2 F.P. TEST]
3 GRAPHIC TEST PATTERN     [3 F.P. TEST]

MASS STORAGE UNIT UTILITIES
SYSTEM LABEL
Volume name : 45AGNL       [4 HEAD CLEANING]
Revision   : A142
Date code  : 141091       [5 USER FILE COPY]
4 HEAD CLEANING
5 USER FILE COPY
  
```

- (2) Press the USER COPY softkey.
- (3) Insert the Master Disc (disc to be copied) and press the CONTINUE softkey. A portion of the user area files will be loaded into the 4145A's RAM. This takes a few seconds.
- (4) Insert the Copy Disc (target disc) and press the CONTINUE softkey. The files loaded into the 4145A's RAM in step 3 will be copied onto the disc.
- (5) Repeat steps (3) and (4) if instructed to do so.
- (6) Copy is finished. To copy additional discs, repeat steps (3) and (4). To return to the initial condition, press the RESET softkey.

Figure 3-47. Disc Copy.

3-125. HEAD CLEANING

3-126. The read/write head in the flexible-disc drive unit should be cleaned every six months. If the 4145A is used in a dusty environment, head cleaning should be performed more frequently. Also, if the instrument does not properly perform the SAVE and GET operations, head cleaning should be performed immediately. The head-cleaning procedure is given in Figure 3-48.

Head Cleaning Procedure

- (1) Turn on the 4145A.
- (2) Press the DIAGNOSTICS softkey on the MENU Page. Display will be as shown below.

```

[hp] ***** DIAGNOSTICS *****
1  REGULAR SELFTEST
   ----- PASS -----
2  FRONT PANEL TEST
3  GRAPHIC TEST PATTERN

MASS STORAGE UNIT UTILITIES
SYSTEM LABEL
Volume name : 45AGNL
Revision    : A142
Date code   : 141081
4  HEAD CLEANING
5  USER FILE COPY
    
```

- (3) Press the HEAD CLEAN softkey.
- (4) Remove the disc and insert the cleaning disc.
- (5) Press the HEAD CLEAN softkey again.
- (6) Head cleaning takes only a few seconds.

Note

Do not touch the exposed surface of the cleaning disc.

Figure 3-48. Head Cleaning.

3-127. Protection Against Hazardous Voltage Exceeding $\pm 42V$

3-128. To insure operator safety, the 4145A is equipped with a high voltage detect circuit that shuts down the SMUs and voltage sources when a potentially dangerous condition exists. If the lid of the 16058A Test Fixture is not closed at the start of a measurement in which there is a possibility that the voltage output from at least one SMU will equal or exceed $\pm 42V$, or if the lid is opened during such a measurement, the measurement will be aborted as if the STOP key had been pressed.

A switch inside the 16058A Test Fixture detects whether the fixture lid is open or closed. When the lid is closed, the switch connects the OPEN/CLOSE line of the system cable to ground, allowing the output voltage from any or all of the SMUs to exceed $\pm 42V$. When the lid is open, however, the OPEN/CLOSE line is open circuited, limiting output voltage to $\pm 42V$.

When the 4145A is used for an application that does not require the 16058 Test Fixture, the Shorting Connector (PN: 04145-61623, furnished with the 4145A) should be connected to the system cable connector on the 4145A's rear panel. The Shorting Connector grounds the OPEN/CLOSE to allow maximum output from the SMUs.

Note

The $\pm 42V$ limit applies to both voltage source operation and I mode current source operation of the SMUs. For example, if the voltage compliance of an SMU operating in I mode is set at 50V, there is a possibility the output voltage will exceed 42V.

3-129. PLOT/PRINT Operations Using HP-IB Controller

3-130. When performing a PLOT or PRINT operation using an HP-IB controller, use the following procedure.

- (1) Set the plotter or printer to "addressable."
- (2) Interconnect the 4145A, HP-IB plotter or printer, and controller with HP-IB cables.
- (3) Send the PLOT or PRINT command to the 4145A.
- (4) Set the 4145A to TALKER and set plotter or printer to LISTENER.
- (5) Set the ATN (Attention) Line to "Inactive" to start the plot or print operation. (REMOTE or RESUME command sets the ATN line "Inactive".)
- (6) End of plot or print can be detected by monitoring the EOI Line or SRQ Line.

Note

If the controller attempts an HP-IB operation during a plot or print operation, an error may result or data may be incorrectly plotted or printed. Therefore, you cannot detect the end of a plot or print operation by reading the status byte of the 4145A. *Must use interrupts.*

Figure 3-49 shows programming examples of HP-IB controlled plot operations with the HP85 and HP9845 controllers.

Note

To execute the HP85 and HP9845 programs, the controller's I/O ROM and an HP-IB interface card are required.

HP85 (HP86/HP87) program

```

10 ON INTR 7 GOTO 70 ! Interrupt (PLOT END) handling Instructions
20 ENABLE INTR 7;8 ! Enables controller to respond to an SRQ
30 OUTPUT 717 ;"PL100,100,5000,3000"
40 SEND 7 ; UNT UNL TALK 17 LISTEN 5 ! Assigns TALKER and LISTENER
50 RESUME 7 ! Sets ATN line to "Inactive"
60 GOTO 60
70 A=SPOLL(717)
80 IF BIT(A,2) THEN PRINT "END"
90 STATUS 7,1 ; B ! Reads and clears the interface register
100 BEEP
110 END

```

9845 (9835)

~~HP9826 (HP9836) program~~

```

10 CONTROL MASK 7;128!Permits interrupt only for an SRQ
20 ON INT #7 GOTO 80!Interrupt(PLOT END) handling instructions
30 CARD ENABLE 7!Enables controller to respond to an interrupt
40 OUTPUT 717;"PL100,100,5000,3000"
50 CONFIGURE 7 TALK = 17 LISTEN = 5
60 REMOTE 7!Sets ATN line to "Inactive"
70 GOTO 70
80 STATUS 717;A
90 IF BIT(A,2) THEN PRINT "END"
100 BEEP
110 END

```

9826 (9836)

~~HP9845 (HP9835) Program~~

```

10 ON INTR 7 GOTO 70 !Interrupt (PLOT END) handling instructions
20 ENABLE INTR 7;2 !Enables controller to respond an SRQ
30 OUTPUT 717;"PL100,100,5000,3000" DATA
40 SEND 7;UNT UNL TALK 17 LISTEN 5 ! Assigns TALKER and LISTENER
50 REMOTE 7 !Sets ATN line to "Inactive"
60 GOTO 60
70 A=SPOLL(717) ! A=68
80 IF BIT(A,2) THEN PRINT "END"
90 BEEP
100 END

```

↑
END status (called 'Bit 3' on pg 3-102)

Bit 0

Figure 3-49. Programs for HP-IB controlled PLOT Operations.

3-131. Measurement Ranges and Resolution

3-132. The 4145A measures dc voltage and current with (1) the voltage monitor function of each SMU, (2) the current monitor function of each SMU and (3) the voltage monitors (Vm). The measurement ranges and resolution for the SMUs and voltage monitors are shown in Figure 3-50.

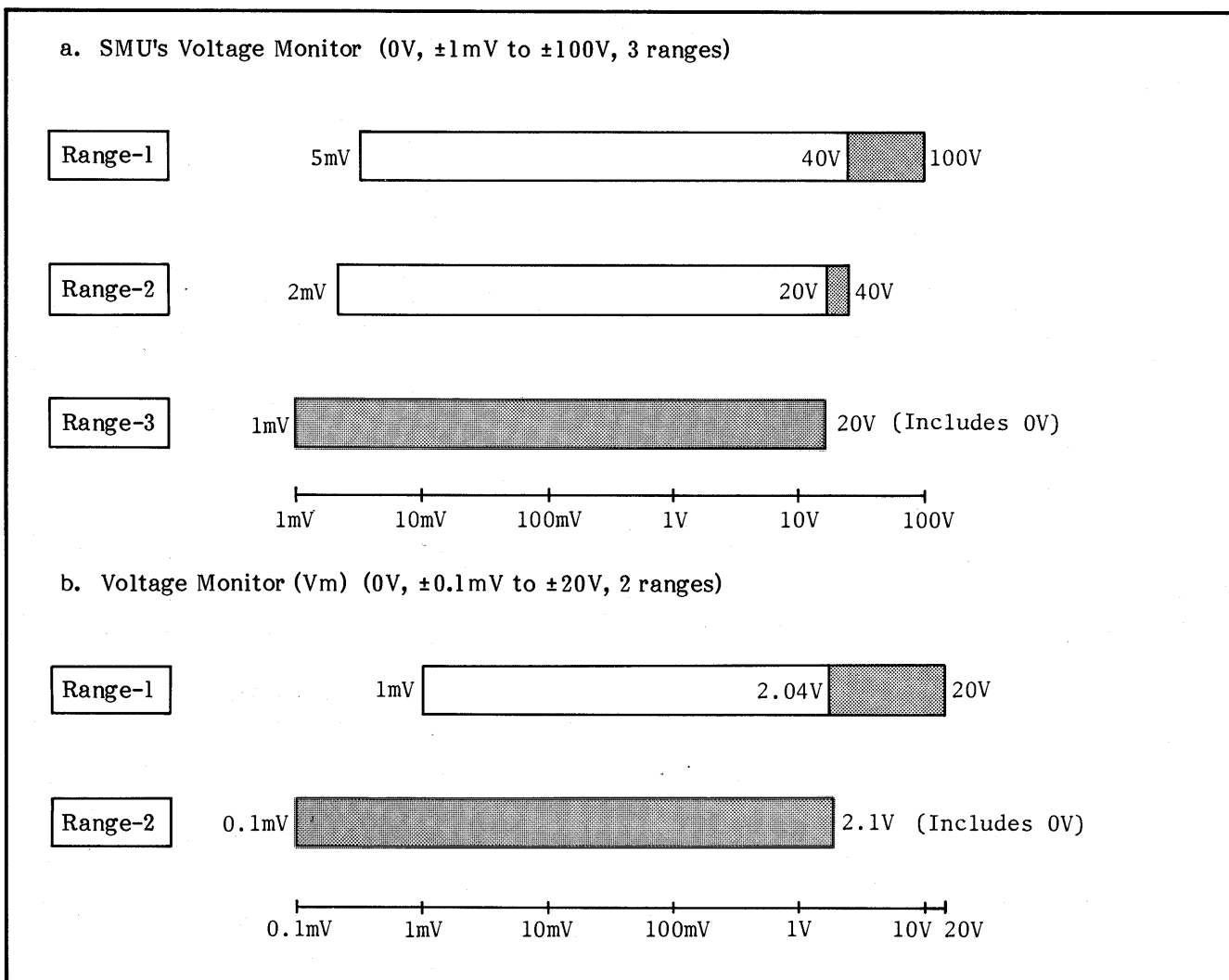
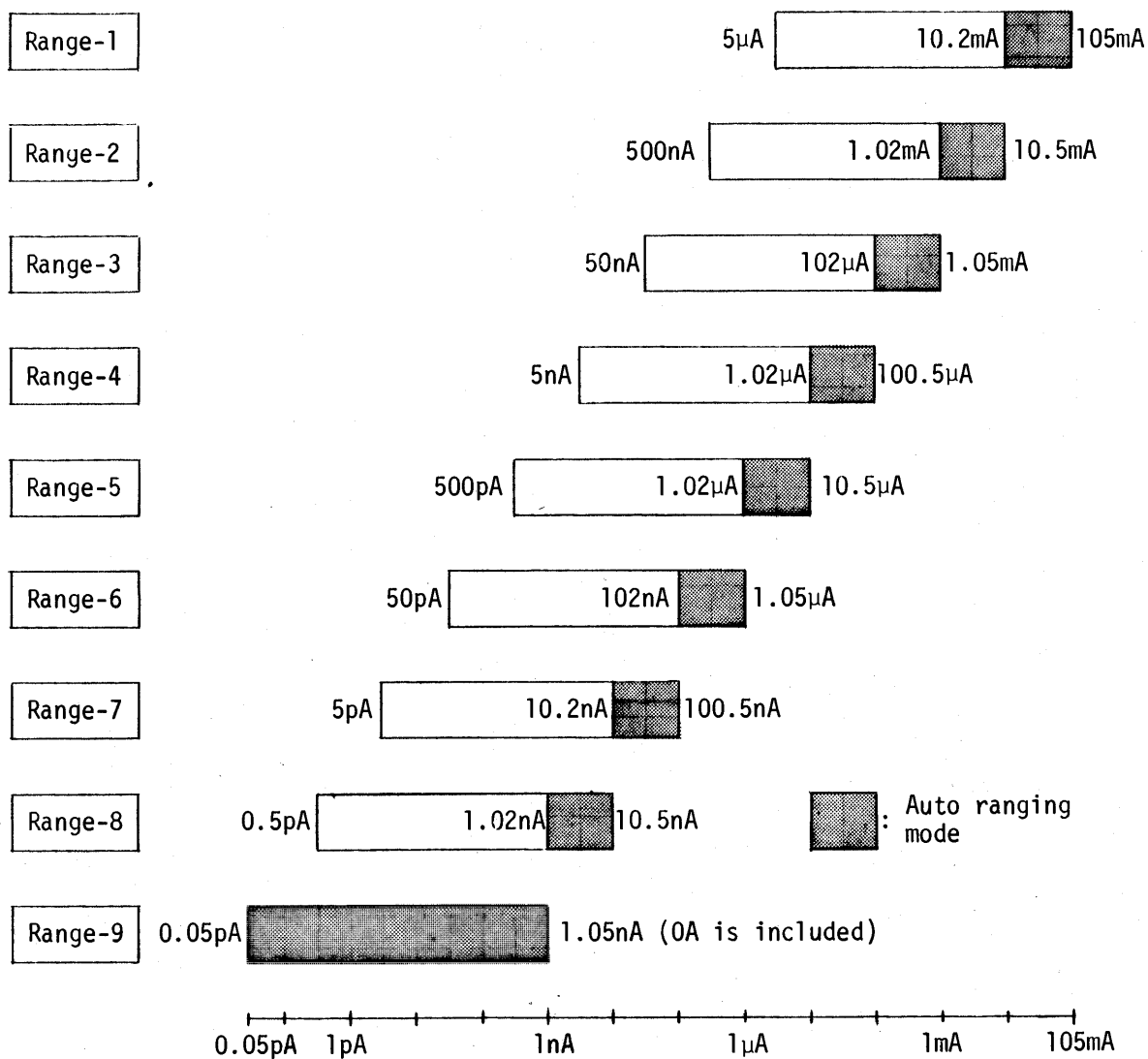

Figure 3-50. Measurement Ranges and Resolution.

c. SMU's Current Monitor (0A, $\pm 0.05\text{pA}$ to $\pm 105\text{mA}$, 9 ranges)



Note: The maximum range in auto ranging mode is determined by the compliance setting.

Figure 3-50. Measurement Ranges and Resolution.

3-133. Resolution and Format for Displayed Data and Data Output.

3-134. Measurement results are stored as raw data. The 4145A then manipulates the stored raw data with (1) the user functions (i.e., to calculate HFE or GM) or (2) the analysis functions (Marker, Cursor, and Line).

Display resolution may differ depending on the measurement resolution because of the inherent errors of the digital data manipulations. The raw data are stored using a 3-byte 2's complement format (one byte has 8 bits; the first byte is for the exponent, the second and third bytes are for the mantissa). Therefore, the display resolution may be higher than that given in the specifications because of the conversion from 2's complement to decimal. The number of output/display digits and the display format are listed in Tables 3-13 and Figure 3-51.

Table 3-13. Number of Output/Display Digits

Output/Display Functions	Display Digits and Format					
	Voltage		Current		User Function	
	Digits	Format	Digits	Format	Digits	Format
Marker/Cursor in GRAPHICS Display	5	a	4	b	3	c
LIST Display						
MATRIX Display						
Cursor in SCHMOO Display						
PRINT Function	4	d	4	d	not available	
HP-IB Data Output						
Keyboard Execution						
Line in GRAPHICS Display	3 Digits, Format: c					

a. Voltage Display Format (5 digits, Min. = 0.1mV)

$ V < 10V$	s n . n n n n V
$10V \leq V < 100V$	s n n . n n n V
$ V = 100V$	s n n n . n n V
s: Polarity (blank or "-") n: Numeric (0 to 9) .: Decimal point V: Unit (volt)	

b. Current Display Format (4 digits, Min. = 0.05pA)

All current values	s d d d d u A
s: Polarity (blank or "-") d: Numeric (0 to 9) or decimal point u: Engineering unit ("m", "μ", "n", or "p") A: Unit (Ampere)	

c. User Function Display Format (3 digits)

$1.00 \leq \text{Mantissa} < 99.9$	s d d d n E ± mm
$100 \leq \text{Mantissa} < 999$	s n n n E ± mm
s: Polarity (blank or "-") d: Numeric ("0" to "9") or decimal point n: Numeric ("0" to "9") E: Exponent ±mm: 2-digit exponent (Engineering notation, multiples of 3, from -39 to +36)	

d. Display Format for Keyboard-Executed Calculations

All variable values	s d d d d n E ± mm
Designations are the same as those of format c.	

e. HP-IB Data Output Format (5 digits)

All variable values	s n d d d n n E ± mm
Designations are the same as those of format c.	

Figure 3-51. Display/Output Format.

3-144. Disc Initializing

3-145. The purpose of disc initialization is to generate a directory onto the disc, which enables you to use the disc for the 4145B. Measurement Setups, Auto Sequence Programs, and measurement results from the 4145B can be stored on the initialized disc. Also, for archival purposes, the 4145B's operating system can be copied to the initialized disc, by using the operating system copy function (Refer to paragraph 3-146). The procedure to initialize a disc is described in Figure 3-61. The recommended disc is the HP 92192A, Micro Floppy Disc (double sided, double density).

Disc Initializing Procedure

- (1) Turn on the 4145B
- (2) Press the CATALOG softkey on the MENU Page. Display will be as shown below.

```

[hp] *** USER FILE CATALOG ***
Volume : HP4145 Rev. 1.0
available records - 2075
file name comments adrs blk
EXTN
PURGE
CAT
NEXT SCREEN
PREV SCREEN
ROLL UP
ROLL DOWN

```

- (3) Press the EXTN softkey, then softkey prompt will be SKP 31.
- (4) Remove the disc and insert the blank disc.
- (5) Press the INIT DISC softkey.
- (6) "Initialize OK ?" will be displayed in the system message area. Press the EXEC softkey. If the QUIT softkey is pressed before pressing the EXEC softkey, the FORMAT operation is cancelled.
- (7) Disc initialization takes only a few minutes.

Note

By executing the Disc Initializing, all the programs and datas that are existing on the disc are purged.

Figure 3-61. Disc Initializing Procedures

3-146. Operating System Copy

Note

3-147. For archival purposes, the 4145B can copy the Operating System Software onto discs that are initialized by the 4145B or HP series 200/300 Desktop Computers. The procedure is described in Figure 3-63.

The Operating System Copy function cannot copy the files of the user area onto the disc.

CAUTION

The Operating System Copy function erases all files of the user area on the disc.

Note

Copying the 4145B's Operating System Software for any means, except for archival purposes, without the prior written consent of Hewlett-Packard Company is prohibited. If extra system discs are required for purposes other than archival purposes, order P/N 04145-61501.

Operating System Software Copy:

- (1) Turn on the 4145B.
- (2) Same procedure as that is step (2) of Figure 3-61.
- (3) Same procedure as that is step (3) of Figure 3-61.
- (4) Press the COPY SYS softkey.
- (5) When "Copy system OK ?" is displayed, press the EXEC softkey. If the QUIT softkey is pressed before pressing the EXEC softkey, the Operating System Software Copy operation is cancelled.

Note

The System Disc must be in the 4145B's disc drive, if the QUIT softkey is pressed in the cancel procedure.

- (6) Insert the Master Disc (disc to be copied) that contains the Operating System and press the EXEC softkey.
- (7) After the disc has been accessed, "Insert the copy disc." is displayed. Remove the Master Disc and insert the initialized disc (target disc), then press the EXEC softkey.
- (8) "Copy completed" is displayed when Copy is finished. To copy additional discs, press the EXEC softkey and repeat steps (6) to (7). To return to the MENU page, press the QUIT softkey, insert the System Disc and press the EXEC or QUIT softkey.

Figure 3-62. Operating System Copy Procedures

3-148. DISC COPY

3-149. All files in the user area of a 4145B disc can be copied onto another disc. The procedure is given in Figure 3-63. The operating system software and the system files can also be copied with this function.

User Area and Operating System Copy :

- (1) Same procedures as that are steps (1) to (3) of Figure 3-61.
- (2) Press the DISC COPY softkey.
- (3) Insert the Master Disc (disc to be copied) and press the EXEC softkey. A portion of the user area files will be loaded into the 4145B's RAM. This takes a few seconds.
- (4) Insert the Copy Disc (target disc) and press the EXEC softkey. The files loaded into the 4145B's RAM in step (3) will be copied onto the target disc.

Note

Write protect the Master Disc to protect the files from operational errors.

- (5) Repeat steps (3) and (4) if instructed to do so.
- (6) Copy is finished. To copy additional discs, repeat steps (3) and (4). To return to the MENU page, press the QUIT softkey.

Note

Do not use the Disc that cannot complete the Disc Copy operation for the 4145B.

Note

If you want to copy one file, the procedure is given below.

Copy One File :

- (1) Turn on the 4145B.
- (2) Load a desired file using the GET function.
- (3) Change discs and store the file by using the SAVE function.

Figure 3-63. Disc Copy Procedures

3-150. FILE TRANSFER

3-151. The 4145B can transfer the setup programs, Auto Sequence Programs and measurement results from the HP 4145A's or another 4145B's disc without the aid of a controller. Operating instructions for the FILE TRANSFER function are given in Figure 3-64.

From the HP 4145A

Connection:

- (1) Equipment
HP 16267A File Transfer Software Disc for the 4145A and HP-IB cable.
- (2) Interconnect the 4145B and 4145A as shown below.

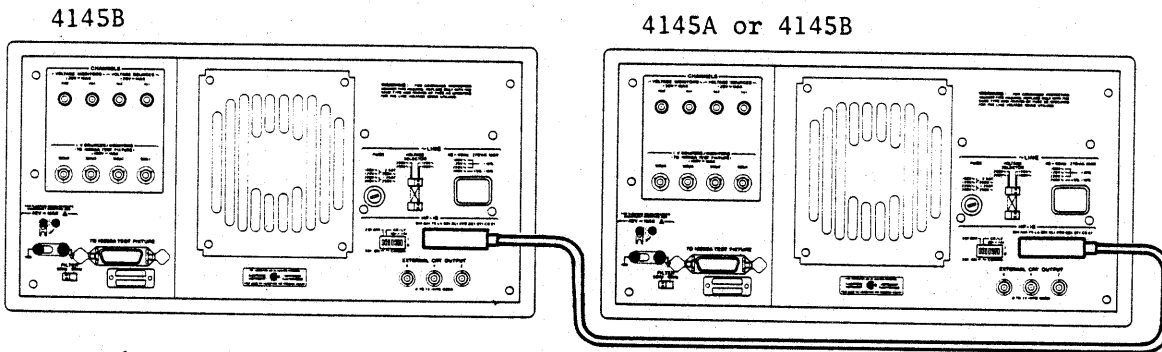

Note

Except for the 4145A and 4145B, nothing is with the HP-IB cable.

Transfer:

- (3) Insert the HP 16267A File Transfer Software Disc to the 4145A's built-in disc drive.
- (4) Turn the 4145A on.
- (5) Insert the System Disc and turn the 4145B on.
- (6) For the 4145A, press the CATALOG softkey. For the 4145B, press the CATALOG softkey on the MENU page and press the EXTN softkey.
- (7) For the 4145A, remove the File Transfer Software Disc and insert the disc containing the setup programs, Auto Sequence Programs and measurement results to be copied to the 4145B's Disc. For the 4145B, insert the copy disc (target disc).
- (8) For the 4145A, press the SEND DATA softkey and for the 4145B, press the REC DATA softkey.
- (9) The filename of the file being transferred will be displayed. If the ABORT softkey on the 4145A or 4145B is pressed before the transfer is complete, the File Transfer operation is aborted. After pressing the ABORT softkey, the catalog of the existing files on the disc is displayed.
- (10) "Transfer completed." is displayed when the File Transfer operation is finished.

Figure 3-64. File Transfer Procedures (Sheet 1 of 2)

From another 4145B:**Connection:**

- (1) **Equipment:**
Another 4145B and an HP-IB cable.
- (2) Interconnect the 4145B's with the HP-IB cable as shown in the above figure.

Transfer:

- (3) Turn both 4145B's on and press the CATALOG softkey on the MENU page. When the CATALOG page is displayed, press the EXTN softkey.
- (4) Insert the disc containing files to be copied into one 4145B and insert the copy disc (target disc) into the other 4145B.
- (5) Press the SEND DATA softkey on the 4145B from which the files will be copied, Press the REC DATA softkey on the 4145B that will be receiving the files.
- (6) The filename of the file being transferred will be displayed. If the ABORT Softkey is pressed on either 4145B before the transfer is complete, the File Transfer operation will be aborted.
- (7) "Transfer completed" is displayed when the File Transfer operation is finished.

3-152. Data File Structure

3-153. Data files stored on discs can be read on HP9000 Series 200 and 300 computers running BASIC 3.0 or 4.0. Paragraphs 3-154 through 3-162 explain the structure of data files; paragraphs 3-163 and 3-164 describe how to read measurement data from a disc. These paragraphs were written for users familiar with 4145B operation and BASIC 3.0 or 4.0 data storage and retrieval techniques. If this is not the case, however, this section and Chapter 7 (Data Storage and Retrieval) of the BASIC 3.0 or 4.0 Programming Techniques Manual will help you understand data file structure.

3-154. The 4145B's data files are divided into four main sectors, as follows.

1) BDAT System sector	256 bytes
2) File Comment sector	256 bytes
3) Setup Data sector	768 bytes
4) Measurement Data sector	4608 bytes

3-155. BDAT System Sector

3-156. This sector contains an End-of-File pointer and the number of defined records in the file. You cannot directly access the system sector. For more information, refer to Reading and Writing BDAT Files in Chapter 7 of the BASIC 3.0 or 4.0 Programming Techniques Manual.

3-157. File Comment Sector

3-158. This sector contains the file comment displayed on the catalog page. Figure 3-65 shows the structure of the File Comment Sector.

3-159. Setup Data Sector

3-160. This sector contains CHANNEL DEFINITION, SOURCE SETUP, MEAS & DISP SETUP, and OUTPUT SEQUENCE SETUP page data. Figure 3-66 shows the structure of the Setup Data sector. A brief explanation of each block in this sector is as follows.

- 1) ID TABLE [bytes 16 through 169]
This block contains symbolic name, status, function, and channel data for each SMU, VS, VM, and User Function. Data for each item is contained in an 11-byte long data group, and all groups have the same structure. Figure 3-67 shows the 4145B's CHANNEL DEFINITION page and provides more detailed information on ID TABLE data groups.

- 2) SVCBV (Source Value Control Block for Variables) [bytes 171 through 264]
The SVCBV contains setup, Hold Time, and Delay Time data for variables VAR1, VAR2, and VAR1'. Data for each variable is contained in a 26-byte long data group, and all variable data groups have the same structure. Hold and Delay Times are written using the 4145B's 4 byte floating point data format as shown and explained in Figure 3-68. Figure 3-69 shows the 4145B's SOURCE SET UP page and provides more detailed information on SVCBV data groups.

- 3) SVCBC (Source Value Control Block for Constants) [bytes 265 through 330]
The SVCBC contains setup data for each constant (SMU 1 4, VS1, and VS2). Data for each constant is contained in an 11-byte long data group, and all groups have the same structure. Figure 3-70 shows SVCBC data group structure and provides more detailed information.

- 4) DACB (Data Array Control Block) [bytes 331 through 390]
The DACB contains Data Area data for each channel (SMUs 1 4, VM1, and VM2). Data for each channel is contained in a 10-byte long data group, and all groups have the same structure. Figure 3-71 shows DACB data group structure and provides more detailed information.

- 5) DCB (Display Control Block) [bytes 401 and 402]
This block contains display mode data. Figure 3-72 shows DCB structure and provides more detailed information.

- 6) GRAPHIC PLOT DCB [bytes 403 through 463]
This block contains data on the ID TABLES to be displayed on the GRAPHIC PLOT page, and on the X, Y1, and Y2 axes. ID TABLE data and data for each axis is contained in a 20-byte long data group, and all groups have the same structure. Figure 3-73 shows GRAPHIC PLOT DCB structure and provides more detailed information. If the first byte in a data group is a space, that axis is not used.

- 7) LIST DCB [bytes 463 through 528]
The LIST DCB contains data on the ID TABLES to be displayed on the LIST page. Data for each Measurement Channel is contained in an 11-byte long data group, and all groups have the same structure as the ID TABLE structure shown in Figure 3-67. If the first byte in a data group is a space, that Measurement Channel is not used.
- 8) MATRIX DCB [bytes 529 through 539]
This block contains data on the ID TABLE to be displayed on the MATRIX page. MATRIX DCB data is contained in an 11-byte data group that has the same structure as the ID TABLE structure shown in Figure 3-67.
- 9) SCHMOO DCB [bytes 540 through 570]
This block contains data on the ID TABLE to be displayed on the SCHMOO PLOT page, and on the Z axis limits as defined on the MEAS & DISP MODE SETUP page. SCHMOO DCB data is contained in an 11-byte data group that has the same structure as the ID TABLE structure shown in Figure 3-67. Z axis limits are written using the 4145B's 4 byte floating point data format shown in Figure 3-68.
- 10) TBCB (Time Base Control Block) [bytes 571 through 582]
The TBCB contains Wait, Interval, and Number of Steps data. Each data group is written using the 4145B's 4 byte floating point data format shown in Figure 3-68. Figure 3-74 shows TBCB structure and provides more information.
- 11) MCCB (Measurement Channel Control Block) [bytes 615 through 623]
This block contains measurement mode, measure, not use, and measurement range data. Data is contained in a 9-byte data group. Figure 3-75 shows MCCB structure and provides more detailed information.
- 12) OSEQ (OUTPUT SEQUENCE) [bytes 625 through 630]
This block contains channel (SMUs 1 ~ 4, VS1, and VS2) output sequence data. Figure 3-76 shows OSEQ structure and provides more detailed information.
- 13) DATA ST (DATA STORE) [byte 760]
This byte shows whether the Measurement Data sector contains measurement data or not.
- 00H = no data
01H = data
- 3-161. Measurement Data Sector
- 3-162. This sector contains Measurement data and data header information. The measurement data portion contains SMU status and channel number data in addition to the measurement data. The data header portion contains the measurement data's measurement append number and the VAR2 step number. Figure 3-77 shows the Measurement Data Sector's structure and provides more detailed information.
- The Measurement Data Sector begins with record number 2,432 and finishes with record number 4,735. This sector is divided into equal measurement data areas, depending on the number of measurement channels used. For example, if two channels are used, the first measurement data area will cover records 2,432 through 3,583, while the second measurement data area will cover records 3,584 through 4,735.
- 3-163. Reading Data Files
- 3-164. The procedure for reading a data file is as follows.
- 1) Confirm the presence of measurement data by reading the DATA ST byte (byte 760) in the Setup Data sector.
 - 2) Confirm which measurement channels were used by reading the MCCB (bytes 615 through 623) of the Setup Data sector.
 - 3) Retrieve the number of the measurement data record by reading the DACB (bytes 331 through 390) of the Setup Data sector.
 - 4) Read the desired measurement data record (retrieved in step 3) from the Measurement Data sector. Returned measurement data includes the VAR1 and VAR2 step numbers, and the measurement append number.

Figure 3-78 shows a sample program for reading a data file from a disc in accordance with the preceding procedure, and for plotting the data on the computer's CRT. The X axis corresponds to the VARI setting (linear) and the Y axis corresponds to the Y1 axis setting on the GRAPHIC PLOT page.

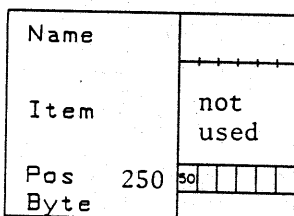
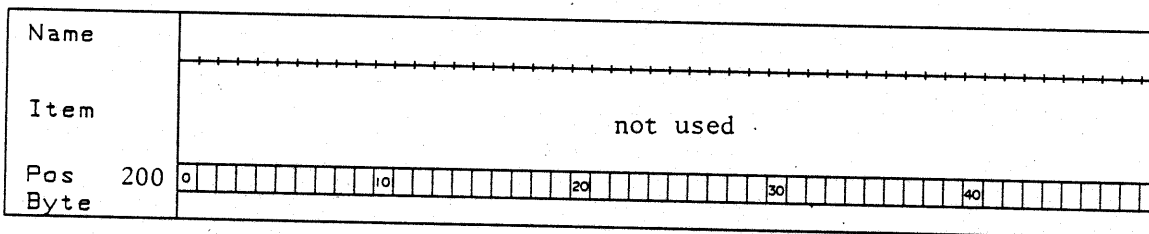
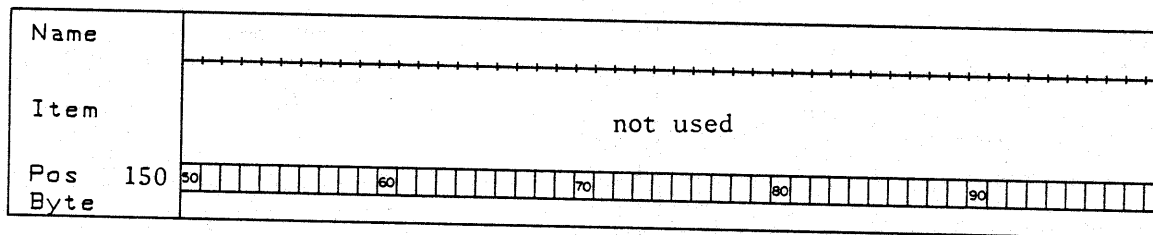
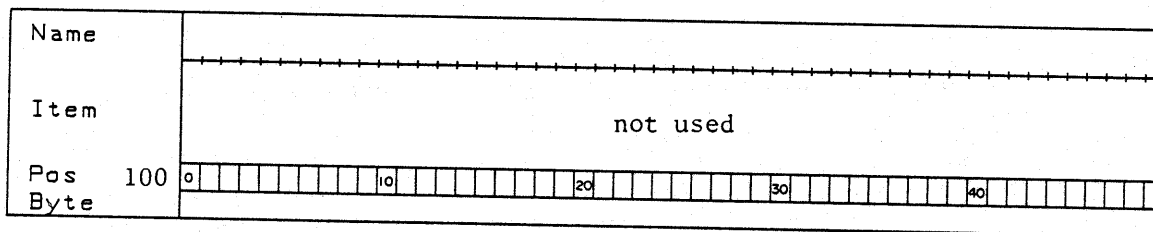
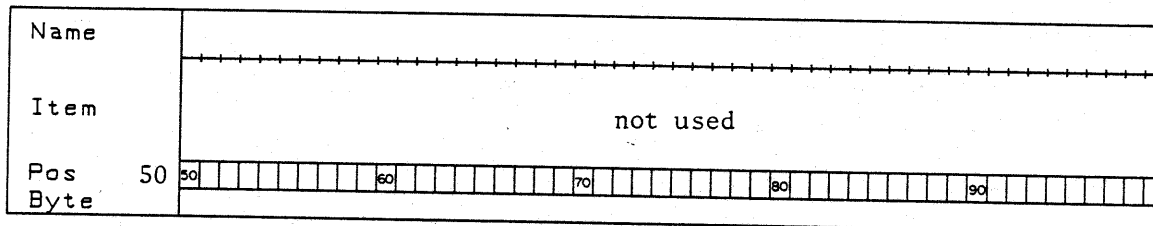
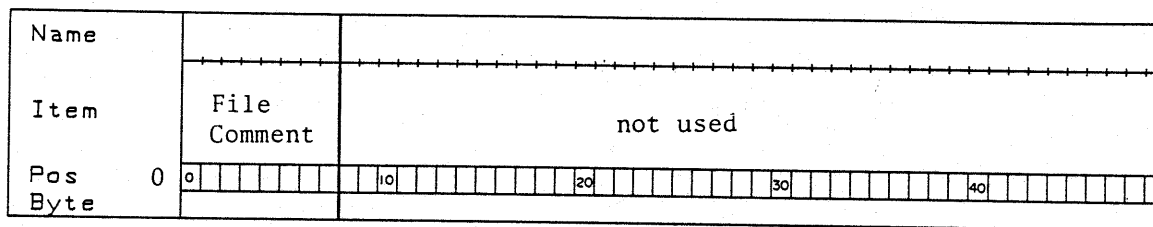

Figure 3-65. Structure of the File Comment Sector

Name	ID TABLE			
Item	not used	SMU 1 V	SMU 1 I	SMU 2 V
Pos Byte	0	20	30	40
Byte	16	11	11	11

Name	ID TABLE				
Item	SMU 2 I	SMU 3 V	SMU 3 I	SMU 4 V	SMU 4 I
Pos Byte	50	60	70	80	90
Byte	11	11	11	11	11

Name	ID TABLE				
Item	Vs 1	Vm 1	Vs 2	Vm 2	
Pos Byte	100	20	30	40	
Byte	11	11	11	11	

Name	ID TABLE		SVCBV		
Item	User Function 1	User Function 2	Var 1		
Pos Byte	150	60	70	80	90
Byte	11	11	26		

Not used

Name	SVCBV				
Item	Var 2		HOLD TIME	DELAY TIME	Not used
Pos Byte	200	20	30	40	
Byte	26		4	4	8

Name	SVCBV	SVCBC		
Item	Var 1'	SMU 1	SMU 2	SMU 3
Pos Byte	250	70	80	90
Byte	26	11	11	11

Figure 3-66. Data File Structure of the Setup Data Sector (1 of 3)

Name	SVCBC			DACB	
Item	SMU 4	Vs 1	Vs 2	SMU 1	SMU 2
Pos Byte 300	0	10	20	30	40
	11	11	11	10	10

Name	DACB				
Item	SMU 3	SMU 4	Vm 1	Vm 2	
Pos Byte 350	50	60	70	80	90
	10	10	10	10	10

		DCB			
Name		GRAPHIC PLOT DCB			
Item		X axis		Y1 axis	
Pos Byte 400	0	10	20	30	40
	11	20	20		
		DISP MODE		MEAS MODE	

Name	GRAPHIC PLOT DCB	LIST DCB			
Item	Y2 axis	1st MEAS. CHAN.	2nd MEAS. CHAN.	3rd MEAS. CHAN.	4th
Pos Byte 450	50	60	70	80	90
	20	11	11	11	11

Name	LIST DCB			MATRIX DCB	SCHMOO DCB
Item	MEAS. CHAN	5th MEAS. CHAN.	6th MEAS. CHAN.		ID
Pos Byte 500	0	10	20	30	40
		11	11	11	11

Name	SCHMOO DCB				TBCB	CMTBUF
Item	1st limit	2nd limit	3rd limit	4th limit	Time Base	Comment
Pos Byte 550	50	60	70	80	90	
	20				12	32

Figure 3-66. Data File Structure of the Setup Data Sector (2 of 3)

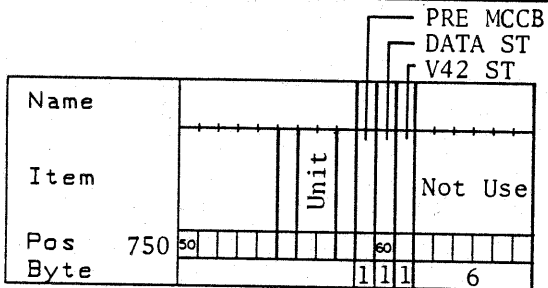
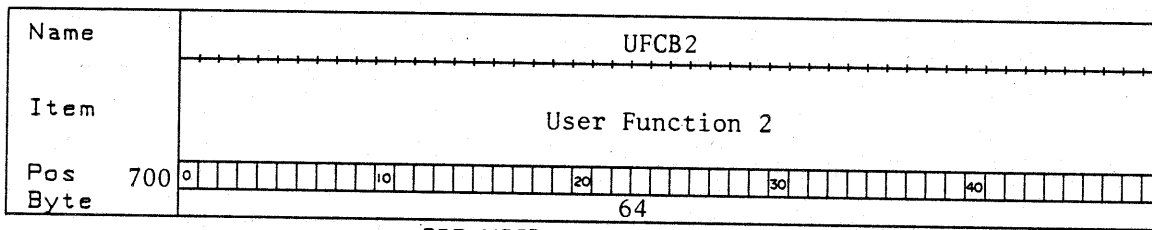
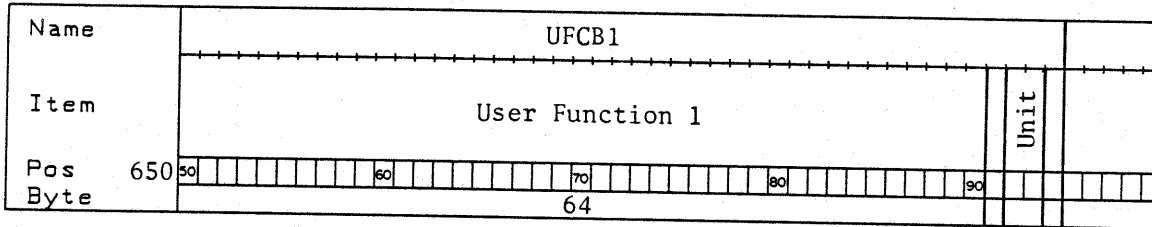
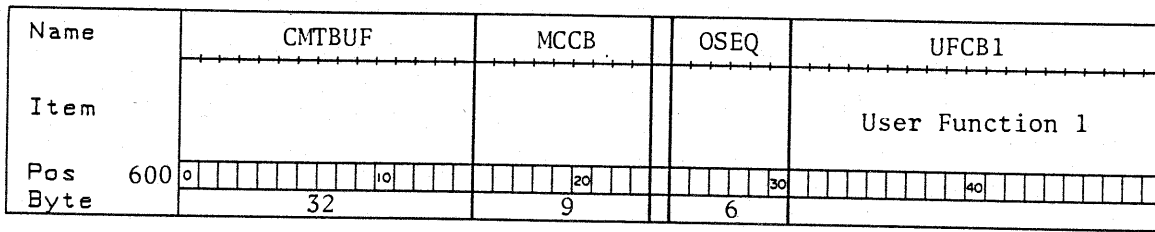
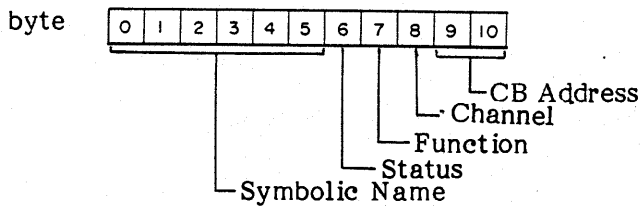

Figure 3-66. Data File Structure of the Setup Data Sector (3 of 3)



1) Symbolic Name

The Symbolic Name bytes contain the user-specified SMU, Vs, Vm, or User Function name that is assigned on the 4145B's CHANNEL DEFINITION page. This name can be up to 6 ASCII characters long.

2) Status

The Status byte containsur channel's source mode setting that is assigned on the CHANNEL DEFINITION page. Each bit is defined as follows.

bit 0	_____	0: Normal	1: Common
bit 1 ~ 4	_____	Always 0	
bit 5	_____	0: Source	1: Monitor
bit 6	_____	0: V mode	1: I mode
bit 7	_____	0: SMU, Vm, Vs	1: User Function

Example

- 00H*: V source
- 01H: Common
- 20H: V monitor, Vs or User Function not used
- 40H: I source
- 60H: I monitor
- 80H: User Function

*Hexadecimal notation.

3) Function

The Function byte contains the channels source function setting that is assigned on the CHANNEL DEFINITION page. Several examples are as follows.

- 00H: Monitor, User Function not used
- 40H: User Function 1
- 41H: User Function 2
- 80H: Constant
- 81H: Var 1
- 82H: Var 2
- 84H: Var 1'

4) Channel

The channel byte contains one of the following settings.

- 00H: SMU1, User Function
- 01H: SMU2
- 02H: SMU3
- 03H: SMU4
- 04H: Vs1, Vm1
- 05H: Vs2, Vm2

Figure 3-67. ID TABLE Structure (1 of 2)

5) CB Address

The CB Address bytes contain detailed channel address information, as follows.

If Var1, Var2 or Var1' is used, these bytes contain the SVCBV's address.

If a constant is used, these bytes contains SVCBC's address.

If a channel is set to Monitor, these bytes contains DACB's address.

If a channel is set to User Function, these bytes contain the UFCB's address.

Figure 3-67. ID TABLE Structure (2 of 2)

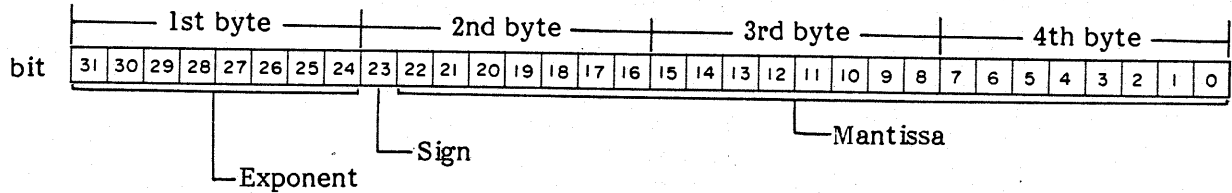

Exponent : 2's complement binary -128 Exponent 127

Sign : "1" is -, "0" is +

Mantissa : Normalized 2's complement binary
0.5 Mantissa 1

Real Value : $REAL\ Value = (1 - 2 \times Sign) \times Mantissa \times 2^{Exponent - 23}$
 *"-23" means that the decimal point of the mantissa is set at bit 23.
 2^{-129} REAL Value 2^{127}

Following is a sample program to transform 4byte Floating Point Data Format values to REAL values.

```

10   INTEGER Byte1,Byte2,Byte3,Byte4
20   REAL Mantissa,Exponent,Real1
30   !
40   Exponent=FNSigned(Byte1)-23
50   Mantissa=(FNSigned(Byte2)*256.+Byte3)*256.+Byte4
60   Real1=Mantissa*2^Exponent
70   DISP Real1
80   END
90   !
100  DEF FNSigned(INTEGER Byte)
110  !
120  IF BIT(Byte,7) THEN
130      RETURN (Byte-256)
140  ELSE
150      RETURN (Byte)
160  END IF
170  !
180  FNEND

```

Figure 3-68. HP 4145B 4byte Floating Point Data Format

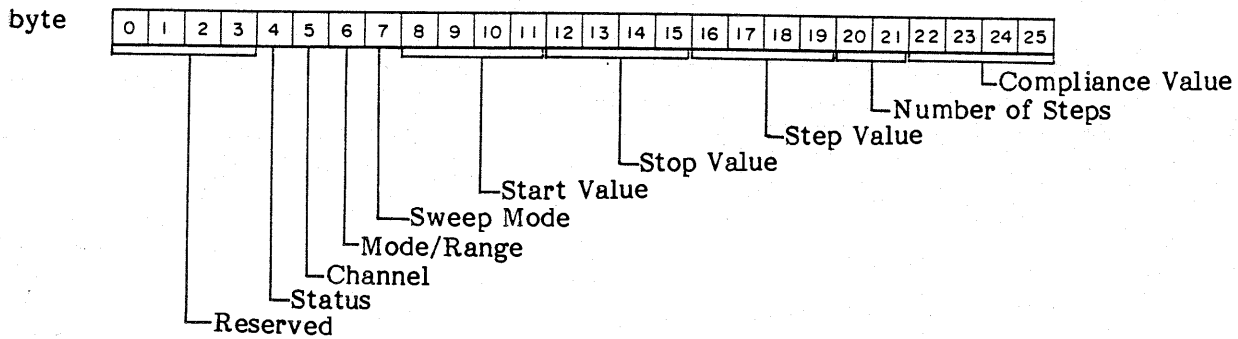

1) Status

The Status byte contains a variable's used or not used setting.

00H: Not used
80H: Used

2) Channel

The Channel byte contains the channel setting that corresponds to the variable used.

00H: SMU1
01H: SMU2
02H: SMU3
03H: SMU4
04H: Vs1
05H: Vs2

3) Mode/Range

The Mode/Range byte contains a variable's V source, I source, and source range setting.

bit 0 through 4 — transform binary to decimal number

7: 100V range	10: 100mA range
8: 40V range	11: 10mA range
9: 20V range	12: 1mA range
	13: 100 μ A range
	14: 10 μ A range
	15: 1 μ A range
	16: 100nA range
	17: 10nA range
	18: 1nA range

bit 5 and 6 — always 0
bit 7 — 0: V mode 1: I mode

Figure 3-69. VAR1, VAR2, and VAR1' Structure (1 of 2)

4) Sweep Mode

The Sweep Mode byte contains a variable's linear sweep or log sweep setting that is assigned on the SOURCE SETUP page. If a variable is set to log sweep, this byte shows the number of the steps for one decade. (Transform a 2's complement binary to a REAL value.)

00H	:	Linear Sweep
0AH	:	Log10 increasing (10 steps for one decade)
04H	:	Log25 increasing (4 steps for one decade)
02H	:	Log50 increasing (2 steps for one decade)
F6H	:	Log10 decreasing
FCH	:	Log25 decreasing
FEH	:	Log50 decreasing

Refer to Figure 3-68, sample program lines 120 through 160 to transform a 2's complement binary value to a REAL value.

5) Start Value, Stop Value, Step Value and Compliance Value

These bytes contain values that are assigned on the SOURCE SET UP page. These values are written using 4145B 4byte Floating Point Data Format. Refer to Figure 3-68.

6) No. of Steps

The No. of Steps bytes contain the number of steps that are assigned on the SOURCE SET UP page. This value is written using the 2byte Integer format.

Figure 3-69. VAR1, VAR2, and VAR1' Structure (2 of 2)

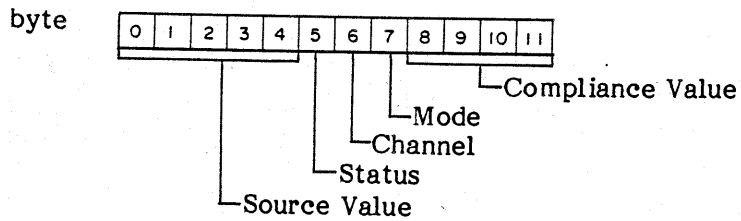

1) Source Value and Compliance Value

These bytes contain constant source values and compliance values that are assigned on the SOURCE SET UP page. The values are written using the 4145B 4byte Floating Point Data Format. Refer to Figure 3-68.

2) Status

The Status byte contains a channel's used or not used setting.

00H : Not used
80H : Used

3) Channel

The Channel byte contains the channel setting.

00H : SMU1
01H : SMU2
02H : SMU3
03H : SMU4
04H : Vs1
05H : Vs2

4) Mode

The Mode byte contains the source mode setting that is assigned on the SOURCE SET UP page.

01H : Common
80H : I mode

Figure 3-70. SVCBC Structure

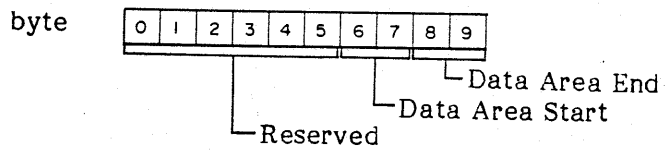

- 1) Data Area Start
The Data Area Start bytes contain the starting address of a channel's measurement data in the Measurement Data Sector.
- 2) Data Area End
The Data Area End bytes contain the last address of a channel's measurement data in the Measurement Data Sector.

Note

Data Area Addresses are 1300H through 24FFH.

Figure 3-71. DACB Structure

byte

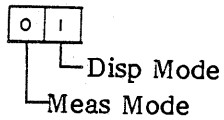

1) Meas Mode

The Meas Mode byte contains the measurement mode's sweep or time domain measurement setting.

- 00H: Sweep Measurement
- 01H: Time Domain Measurement

2) Disp Mode

The Disp Mode byte contains the display mode setting that is assigned on the MEAS & DISP MODE SET UP page.

- 01H: Graphic Plot
- 02H: List
- 04H: Matrix
- 08H: Schmoop Plot

Figure 3-72. DCB Structure

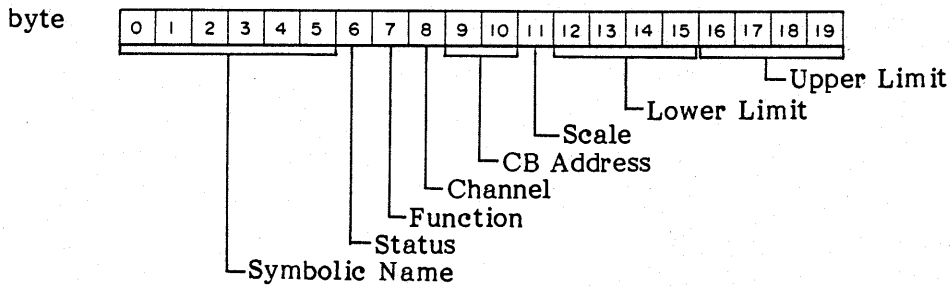

- 1) Symbolic Name, Status, Function, Channel and CB address
 These bytes contain the ID TABLE data that is to be displayed on the GRAPHIC PLOT page as X, Y₁ or Y₂ axes.

- 2) Scale
 This Scale byte contains the scale setting for The GRAPHIC PLOT page.
 - 00H : Linear
 - 01H : Log increasing
 - FFH : Log decreasing

- 3) Lower Limit, Upper Limit
 These bytes contain the Lower (Left) and Upper (Right) Limits of the X, Y₁, or Y₂ axis. These bytes are written using the 4145B 4byte Floating Point Data Format as shown Figure 3-68.

Figure 3-73. GRAPHIC PLOT DCB Structure

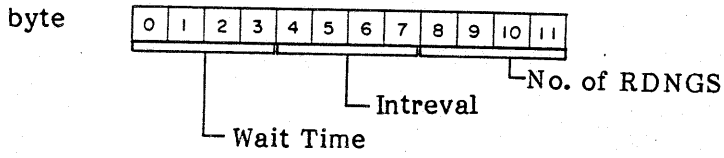

1) Wait Time, Interval, No. of RDNGS

These bytes contain wait time, interval time, and number of RDNGS data for a time domain measurement. These bytes are written using the 4145B's 4 byte floating point data format as shown Figure 3-68.

Figure 3-74. TBCB Structure

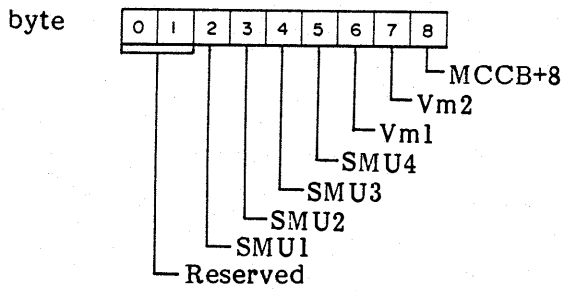

1) SMUs 1 4, Vm1, Vm2

These bytes contain channel setting data (Whether the channel is set to or not, V measurement, or I measurement). Each bit (for each byte) is as follows.

bit 0~3	Always 1 (means auto range)	
bit 4 and 5	Always 0	
bit 6	0: Not measure	1: Measure
bit 7	0: V measure	1: I measure

2) MCCB+8

This byte also contains channel setting data (whether measure or not measure is set). Each bit is defined as follows.

bit 0	SMU1	0: Not measure	1: Measure
bit 1	SMU2	0: Not measure	1: Measure
bit 2	SMU3	0: Not measure	1: Measure
bit 3	SMU4	0: Not measure	1: Measure
bit 4	Vm1	0: Not measure	1: Measure
bit 5	Vm2	0: Not measure	1: Measure
bit 6 and 7	Always 0		

Figure 3-75. MCCB Structure

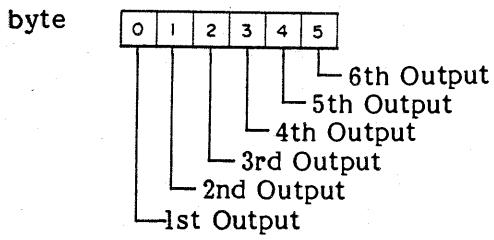

- 1) 1st through 6th Output
Each byte contains channel number setting data as follows.

00H: SMU1
01H: SMU2
02H: SMU3
03H: SMU4
04H: Vs1
05H: Vs2

Figure 3-76. OSEQ Structure

1 channel SMU Measurement Data Sector

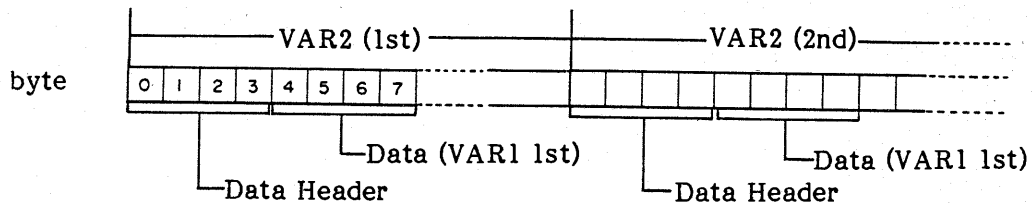

① Data Header

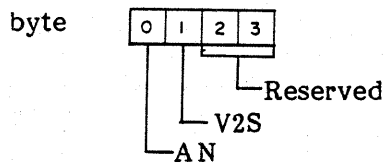

1) AN

This AN byte contains (measurement) Append Number data (bit 7 is always 1)

80H: initial measurement data
 81H: 1st append measurement data
 82H: 2nd append measurement data
 83H: 3rd append measurement data
 . . .

2) V2S

This V2S byte contains VAR2 step number data.

00H: 1st Var2 step
 01H: 2nd Var2 step
 02H: 3rd Var2 step
 03H: 4th Var2 step
 . . .

Figure 3-77 Measurement Data Sector Structure (1 of 2)

② Data

byte

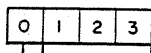

1) Status & Ch

The Status & Ch byte contains data error status and channel number data.

bit 0~2	transform binary to decimal number
	0: SMU1
	1: SMU2
	2: SMU3
	3: SMU4
	4: Vm1
	5: Vm2
	7: lost data
bit 3~6	Status
	if bit 3 is 1 : A/D converter is saturated.
	if bit 4 is 1 : Oscillation
	if bit 5 is 1 : Other channel has reached compliance
	if bit 6 is 1 : This channel has reached compliance.
bit 7	always 0

2) Measurement Data

Data contained in the measurement Data bytes written using the 4145B's 3 byte floating point data format, which is the same as the 4 byte floating point format shown in Figure 3-68, except the last byte is omitted.

3) Blank (unused) areas.

All blank measurement data bytes will return "FFH".

③ Blank (unused) Area

Blank measurement data bytes will return "FFH".

Figure 3-77 Measurement Data sector Structure (2 of 2)

Note

This sample program runs under the BASIC 3.0 or 4.0 environment, and requires loading the GRAPH binary files as well as the appropriate files from your disc drive.

```

10  INTEGER Base,Smu_no,Data_ptr,Flag,Stat,Ch
20  INTEGER Comment(0:127),Prog45(0:383),Data45(2432:4735)
30  INTEGER Meas_ch_active(5)
40  INTEGER Data_start,Data_end
50  INTEGER Prev_valid
60  REAL Sweep_start,Sweep_end,Sweep_step,Var1,Vary
70  REAL Ymin,Ymax
80  DIM Filename$(100),Workdir$(100)
90  !
100 Workdir$=SYSTEM$(“MSI”)
110 MASS STORAGE IS “:HP9122;700,0”
120 !
130 GINIT
140 GRAPHICS ON
150 GCLEAR
160 !
170 LINPUT “Please enter file name”,Filename$
180 ASSIGN @File TO Filename$
190 !
200 ENTER @File;Comment(*).Prog45(*),Data45(*)
210 !
220 IF FNGet_byte(Prog45(*),760)=0 THEN                ! DATAST
230   DISP “No valid data !!!”
240 ELSE
250   Ch_active_frag=0
260   FOR Channel=0 TO 5
270     Meas_ch_active(Channel)=BIT(FNGet_byte(Prog45(*),617+Channel),6)
280     Ch_active_frag=Ch_active_frag+Meas_ch_active(Channel)
290   NEXT Channel
300   IF Ch_active_frag<>0 THEN
310     FOR Channel=0 TO 5
320       IF BIT(FNGet_byte(Prog45(*),617+Channel),6) THEN          ! MCCB
330         Smu_no=Channel
340         Data_start=FNGet_word(Prog45(*),331+Smu_no*10+6)        ! DACB
350         Data_end=FNGet_word(Prog45(*),331+Smu_no*10+8)        ! DACB
360         Sweep_start=FNGet_real(Prog45(*),171+8)
370         Sweep_end=FNGet_real(Prog45(*),171+12)
380         Sweep_step=FNGet_real(Prog45(*),171+16)
390         Ymin=FNGet_real(Prog45(*),423+12)
400         Ymax=FNGet_real(Prog45(*),423+16)
410       !
420       VIEWPORT 10,120,10,90
430       WINDOW Sweep_start,Sweep_end,Ymin,Ymax
440       !
450       Var1=Sweep_start
460       FOR Data_ptr=Data_start TO Data_end-1 STEP 4
470         Vary=FNGet_data(Data45(*),Data_ptr,Flag,Stat,Ch)
480         SELECT Flag
490         CASE 0! Data
500           IF Prev_valid THEN
510             DRAW Var1,Vary
520           ELSE
530             MOVE Var1,Vary
540           END IF
550           Prev_valid=1
560         CASE 1
570           Var1=Sweep_start
580           Prev_valid=0
590         CASE -1

```

Figure 3-78. Sample Program for Reading a Data File (Sheet 1 of 4)

```

600         Prev_valid=0
610         END SELECT
620         Var1=Var1+Sweep_step
630     NEXT Data_ptr
640     ELSE
650     END IF
660 NEXT Channel
670 ELSE
680     DISP "Not measurement channel !!!"
690 END IF
700 END IF
710 !
720 MASS STORAGE IS Workdir$
730 !
740 END
750 !-----
760 DEF FNGet_real(INTEGER Array(*),Pointer) !-----
770 !-----
780     INTEGER Byte_1st,Byte_2nd,Byte_3rd,Byte_4th
790     REAL Real_value
800     !
810     Byte_1st=FNGet_byte(Array(*),Pointer+0)
820     Byte_2nd=FNGet_byte(Array(*),Pointer+1)
830     Byte_3rd=FNGet_byte(Array(*),Pointer+2)
840     Byte_4th=FNGet_byte(Array(*),Pointer+3)
850     Byte_to_real(Byte_1st,Byte_2nd,Byte_3rd,Byte_4th,Real_value)
860     RETURN (Real_value)
870 FNEND
880 !-----
890 DEF FNGet_data(INTEGER Array(*),Pointer,Data_flag,Smu_status,Channel) !----
900 !-----
910     INTEGER Byte_1st,Byte_2nd,Byte_3rd,Byte_4th
920     REAL Real_value
930     !
940     Byte_1st=FNGet_byte(Array(*),Pointer+0)
950     Byte_2nd=FNGet_byte(Array(*),Pointer+1)
960     Byte_3rd=FNGet_byte(Array(*),Pointer+2)
970     Byte_4th=FNGet_byte(Array(*),Pointer+3)
980     Byte_to_data(Byte_1st,Byte_2nd,Byte_3rd,Byte_4th,Real_value,Data_flag,Sm
u_status,Channel)
990     IF Data_flag=1 THEN
1000     SELECT Channel
1010     CASE 0 TO 5                ! SMU #1~4. Vm #1~2
1020     Channel=Channel+1
1030     CASE 7                    ! lost data
1040     Channel=-1
1050     CASE ELSE                ! illegal
1060     Channel=0
1070     END SELECT
1080     END IF
1090     RETURN (Real_value)
1100 FNEND
1110 !-----
1120 DEF FNGet_string$(INTEGER Array(*),Pointer,Length) !-----
1130 !-----
1140     INTEGER Char_pointer
1150     INTEGER Char_valid
1160     DIM String$(100)
1170     DIM Char$(1)
1180     !
1190     String$=""

```

Figure 3-78. Sample Program for Reading a Data File (Sheet 2 of 4)

```

1200 Char_valid=0
1210 FOR Char_pointer=MIN(Length,100) TO 1 STEP -1
1220 Char$=CHR$(FNGet_byte(Array(*),Pointer+Char_pointer-1))
1230 IF NUM(Char$)<32 THEN Char$=" " ! change control to space
1240 IF Char$<>" " THEN Char_valid=1 ! end of trailing space
1250 IF Char_valid THEN String$=Char$&String$ ! concatenate
1260 NEXT Char_pointer
1270 RETURN (String$)
1280 FNEND
1290 !-----
1300 DEF FNGet_word(INTEGER Array(*),Pointer) !-----
1310 !-----
1320 INTEGER Upper_byte,Lower_byte,Word_value
1330 !
1340 IF (Pointer MOD 2)=0 THEN
1350 RETURN (Array(Pointer DIV 2))
1360 ELSE
1370 Upper_byte=FNGet_byte(Array(*),Pointer+0)
1380 Lower_byte=FNGet_byte(Array(*),Pointer+1)
1390 Byte_to_word(Upper_byte,Lower_byte,Word_value)
1400 RETURN (Word_value)
1410 END IF
1420 FNEND
1430 !-----
1440 DEF FNGet_byte(INTEGER Array(*),Pointer) !-----
1450 !-----
1460 INTEGER Upper_byte,Lower_byte
1470 !
1480 Word_to_byte(Array(Pointer DIV 2),Upper_byte,Lower_byte)
1490 IF (Pointer MOD 2)=0 THEN
1500 RETURN (Upper_byte) ! even address
1510 ELSE
1520 RETURN (Lower_byte) ! odd address
1530 END IF
1540 FNEND
1550 !-----
1560 SUB Byte_to_real(INTEGER Byte1,Byte2,Byte3,Byte4,REAL Real1) !-----
1570 !-----
1580 REAL Flac,Expo
1590 !
1600 Flac=(FNSigned8(Byte2)*256.+Byte3)*256.+Byte4
1610 Expo=FNSigned8(Byte1)-23
1620 Real1=Flac*2^Expo
1630 SUBEND
1640 !-----
1650 SUB Byte_to_data(INTEGER Byte1,Byte2,Byte3,Byte4,REAL Real1,INTEGER Data_f
lag,Smu_status,Channel)
1660 !-----
1670 SELECT Byte1
1680 CASE 255 ! no data
1690 Data_flag=-1
1700 Smu_status=0
1710 Channel=0
1720 Real1=0
1730 CASE ELSE
1740 IF BIT(Byte1,7) THEN ! header mark
1750 Data_flag=1
1760 Smu_status=BINAND(Byte1,IVAL("01111111",2))
1770 Channel=Byte2
1780 Real1=0
1790 ELSE ! normal data

```

Figure 3-78. Sample Program for Reading a Data File (Sheet 3 of 4)

```

1800     Data_flag=0
1810     Byte_to_real(Byte2,Byte3,Byte4,0,Real1)
1820     Smu_status=SHIFT(BINAND(Byte1,IVAL("01111000",2)),3)
1830     Channel=BINAND(Byte1,IVAL("00000111",2))
1840     END IF
1850     END SELECT
1860 SUBEND
1870 !-----
1880 SUB Byte_to_word(INTEGER Byte1,Byte2,Word1) !-----
1890 !-----
1900     Word1=BINIOR(SHIFT(Byte1,-8),Byte2)           ! conjunction MSB and LSB
1910 SUBEND
1920 !-----
1930 SUB Word_to_byte(INTEGER Word1,Byte1,Byte2) !-----
1940 !-----
1950     Byte1=BINAND(SHIFT(Word1,8),IVAL("11111111",2))! MSB, right justify
1960     Byte2=BINAND(Word1,IVAL("11111111",2))       ! LSB
1970 SUBEND
1980 !-----
1990 DEF FNSigned8(INTEGER Byte1) !-----
2000 !-----
2010     IF BIT(Byte1,7) THEN
2020         RETURN (Byte1-IVAL("100",16))
2030     ELSE
2040         RETURN (Byte1)
2050     END IF
2060 FNEND
2070 !-----

```

Figure 3-78. Sample Program for Reading a Data File (Sheet 4 of 4)

SECTION IV

PERFORMANCE TESTS

4-1. INTRODUCTION

4-2. This section describes the tests and procedures used to verify the instrument specifications listed in Table 1-1. All tests can be performed without access to the interior of the instrument. A simpler, automatic operational test is presented in Section III under Self Test (paragraph 3-10). The performance tests described here can also be used to perform incoming inspection of the instrument and to verify that the instrument meets specified performance after troubleshooting and/or adjustment. If the performance tests indicate that the instrument is operating outside specified limits, check that the controls on the instruments used in the test and the test set-up itself are correct, then proceed with adjustments and/or troubleshooting.

Note

1. To ensure proper test results and instrument operation, Hewlett-Packard suggest a 40 minute warm-up and stabilization period before performing any of the performance tests.
2. Initial control settings described in paragraph 3-14 must be used for each performance test. Exceptions to these settings will be noted as they occur. After completing a performance test, return 4145A controls to the initial control settings.

4-3. EQUIPMENT REQUIRED

4-4. Equipment required for performance tests is listed in Table 4-1. Any equipment that satisfies the critical specifications given in the table may be substituted for the recommended model(s).

Note

Equipment should be calibrated by an instrument traceable to NBS or an equivalent standards; or calibrated directly by an authorized calibration organization such as NBS. The

calibration cycle should be in accordance with stability specifications of each component.

4-5. TEST RECORD

4-6. Performance test results can be recorded on the Test Record at the completion of the test. The Test Record is at the end of this section. It lists all test specifications and acceptable limits. The results recorded at incoming inspection can be used for comparison in periodic maintenance, troubleshooting, and after repairs or adjustments.

4-7. CALIBRATION CYCLE

4-8. This instrument requires periodic verification of performance. Depending on the conditions under which the instrument is used, e.g., environmental conditions or frequency of use, the instrument should be checked with the performance tests described here, at least once a year. To keep instrument down-time to a minimum and to insure optimum operation, preventive maintenance should be performed at least twice a year.

PERFORMANCE TESTS

4-9. GRAPHICS DISPLAY UNIT INTENSITY AND FOCUS CHECK

PURPOSE: This check visually verifies that the writing beam of the Graphics Display Unit (GDU) has the correct intensity and is properly focused.

PROCEDURE:

1. Turn on the 4145A, then display the DIAGNOSTICS page by pressing the DIAG softkey.
2. Display the test pattern for the GDU as shown in Figure 4-1 by pressing the G.D. TEST softkey.
3. Verify that the brightness of the writing beam for lines 1, 2, 3, and 4 is as described below:
 - line 1 : full brightness
 - line 2 : dim
 - line 3 : half brightness
 - line 4 : second brightness
4. Verify that the writing beam is properly focused for sharp, well-defined trace at points A, B, C, and D, and over the entire CRT display.

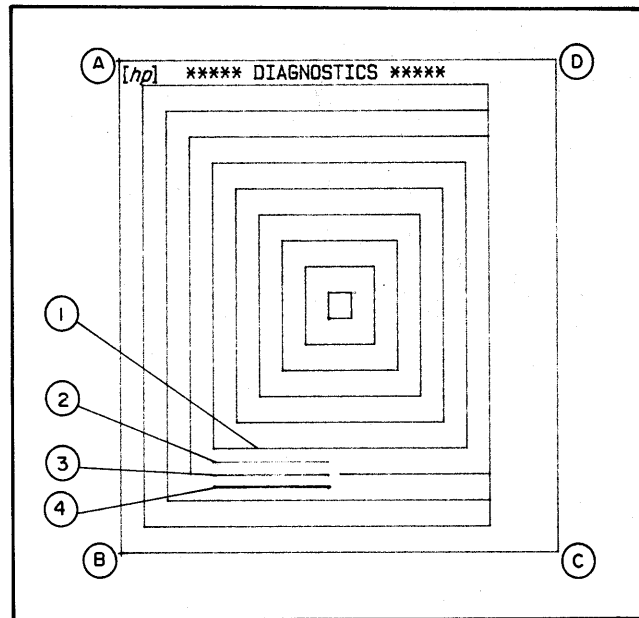

Figure 4-1. Test Pattern for GDU.

PERFORMANCE TESTS

Note

If intensity and focus of the writing beam need adjustment, perform Graphic Display Unit Intensity and Focus Adjustment in Section V of this manual. If any trace distortion is observed, perform performance tests and adjustments in Section IV and V of the 1345A's Operating and Service Manual, located at the back of this binder.

Note

When the procedures in Section IV and V of the 1345A's manual are performed, the connector on the A1 GDU Control Board must be disconnected. Refer to Figure 4-2 for its location.

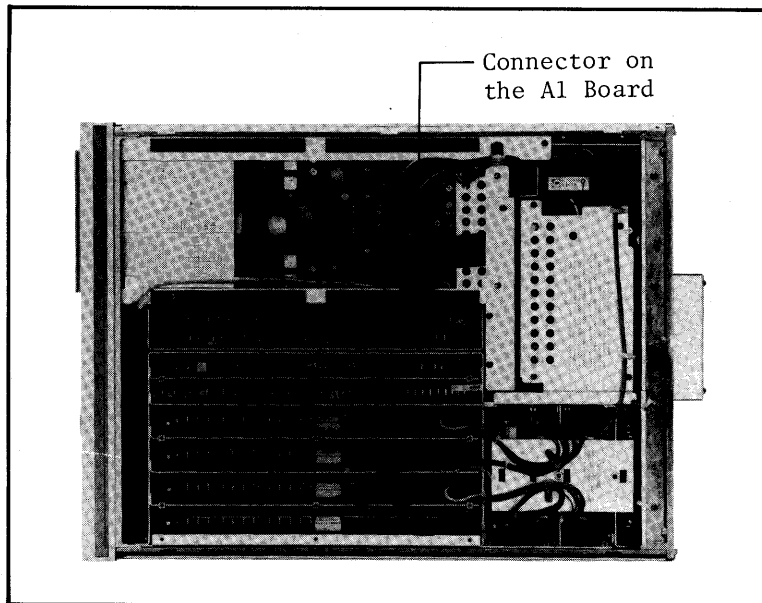

Figure 4-2. GDU Connector Location.

PERFORMANCE TESTS

4-10. PAGE AND KEY FUNCTION CHECK

PURPOSE: This check verifies that the thirteen pages, including MENU, CHANNEL DEFINITION, DIAGNOSTICS, and so on, can be displayed without error codes or error messages. Also, this check verifies that the sixty-six keys function properly.

PROCEDURE:

1. Insert one of the discs (software discs furnished with the 4145A) into the flexible-disc drive, then turn on the 4145A.
2. Verify that each of the thirteen pages is displayed without any error codes or error messages, by pressing the MENU key, PREV key, NEXT key, and softkeys. Refer to Section III of this manual for details on page control.
3. Repeat step 2 for the rest of the discs.
4. Display the MENU page, then display the DIAGNOSTICS page by pressing the DIAG softkey.
5. Obtain the display shown Figure 4-3 by pressing the F.P. TEST softkey.
6. Check that the LED indicator lamps and sixty-six keys function properly as described in Figure 3-32 in Section III of this manual.

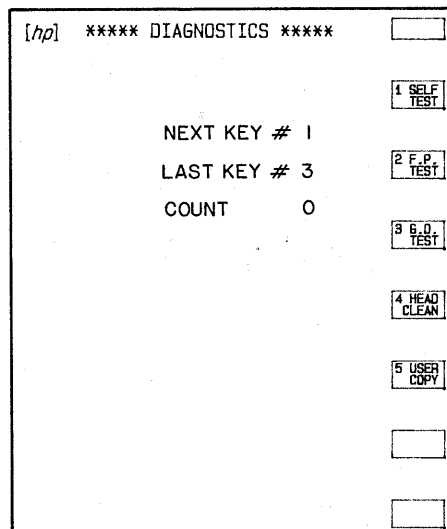

Figure 4-3. Display for Key Function Check.

PERFORMANCE TESTS

4-11. SMU ACCURACY TEST

DESCRIPTION :

The SMU Accuracy Test consists of four tests :

- (1) Voltage Control Accuracy Test
- (2) Voltage Measurement Accuracy Test
- (3) Current Measurement Accuracy Test
- (4) Current Control Accuracy Test

(1) VOLTAGE CONTROL ACCURACY TEST

PURPOSE: This test verifies that the specified output voltage is correctly output from each SMU channel.

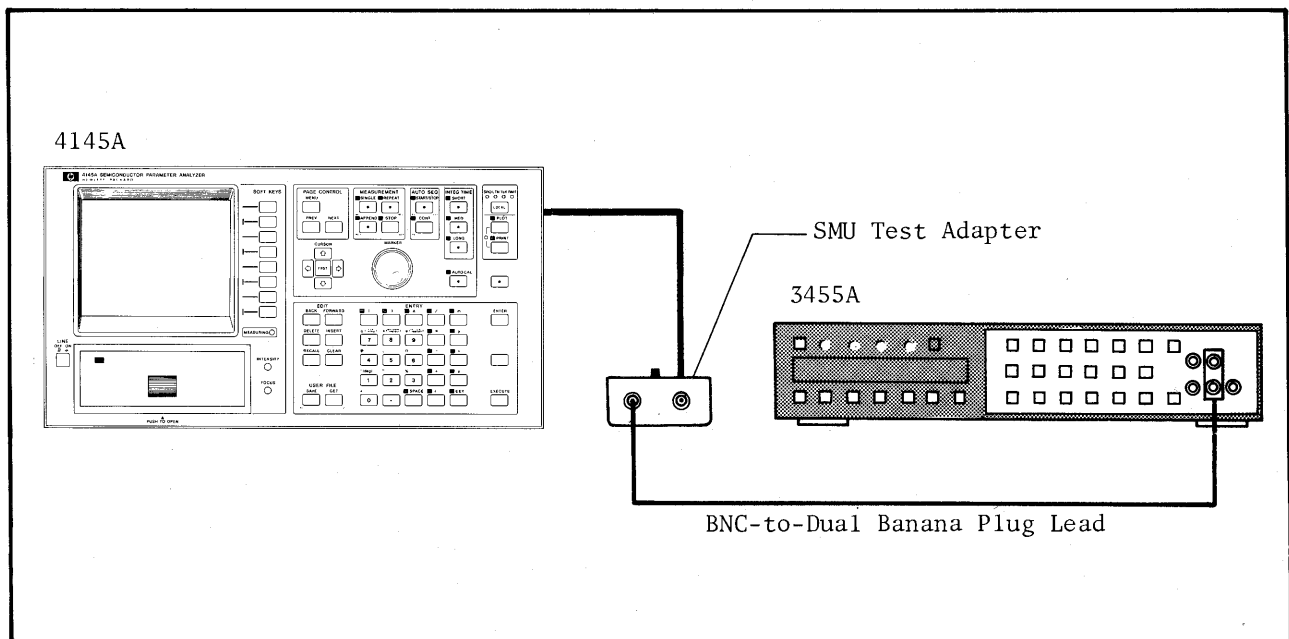

Figure 4-4. Voltage Control Accuracy Test Setup.

PERFORMANCE TESTS

EQUIPMENT :

DVM HP MODEL 3455A*
 SMU Test Adapter HP P/N 04145-65001
 BNC (Male)-to-Dual Banana Plug Test Lead HP MODEL 11001A
 Shorting Connector HP P/N 04145-61623

* The 3455A must be calibrated before testing.

PROCEDURE :

1. Connect the adapter (HP P/N : 04145-65001) to the 4145A's SMU channel 1 connector on the rear panel.
2. Connect the shorting connector to the 24 pin connector (labeled "TO 16058A TEST FIXTURE") on the rear panel.
3. Connect the 3455A to the adapter's BNC connector and set the adapter's SELECTOR switch to V_o.
4. Set the 3455A's controls* as follows :

FUNCTION ==V
 RANGE AUTO
 TRIGGER INTERNAL
 MATH OFF
 AUTO CAL OFF
 HIGH RESOLUTION ON

* This setting is the same for all SMU accuracy tests.

5. Set the 4145A's controls as follows :

[hp]*** CHANNEL DEFINITION ***

CHAN	NAME		SOURCE	
	V	I	MODE	FCTN
SMU1	V1		V	VAR1
SMU2				
SMU3				
SMU4				
Vs 1		-----	V	
Vs 2		-----	V	
Vm 1	VM	-----	----	----
Vm 2		-----	----	----

USER FCTN	NAME (UNIT) = EXPRESSION
1	V0 (V) = V1
2	_____ () =

- i) On the CHANNEL DEFINITION page :

Set up the page as shown in Figure 4-5. To define SMU1, press the NOT USE softkey to delete the line, then assign V name, SOURCE MODE, and SOURCE FCTN. VM is used as a dummy to display V1's output after measurement.

Figure 4-5. Measurement Setup.

PERFORMANCE TESTS

[hp]***** SOURCE SET UP *****

	VAR1	VAR2
NAME	V1	
SWEEP MODE	LINEAR	LINEAR
START	.0000V	
STOP	20.000V	-----
STEP	20.000V	
NO. OF STEP	2	
COMPLIANCE	100.0mA	

CONSTANT	SOURCE	COMPLIANCE

5.000 Delay Time (5s)

[hp]** MEAS & DISP MODE SET UP **

MEASUREMENT MODE: SWEEP

DISPLAY MODE: LIST

NAMES	VO
	VM

Figure 4-5. Measurement Setup (Cont'd).

ii) On the SOURCE SET UP page :

Set the source channel parameters as shown in Figure 4-5. Set HOLD TIME and DELAY TIME to 0 seconds and 5 seconds, respectively.

iii) On the MEAS & DISP MODE SET UP page :

Select LIST as the display mode for the measurement results.

iv) INTEG TIME LONG

6. Perform measurement by pressing the REPEAT key.
7. Record the readings on the 3455A for the start voltage (0 volts) and stop voltage (20 volts) when they are output, then verify that the recorded readings satisfy the test limits listed in Table 4-3.
8. Press the STOP key to end measurement.
9. Repeat steps 5 through 8 for each Source Setup listed in Table 4-2. The source parameters--START, STOP, and STEP--on the SOURCE SET UP page in step 4 must be changed as listed in the table.
10. Repeat steps 5 through 9 for SMU channels 2, 3, and 4.

PERFORMANCE TESTS

Table 4-2. Source Parameter Changes

Source Parameters	Source Setup (xxx Volts to xxx volts)				
	-20 to -20	0 to 40	-40 to -40	0 to 100	-100 to -100
START	-20.000V	.0000V	-40.000V	.0000V	-100.00V
STOP	-20.000V	40.000V	-40.000V	100.00V	-100.00V
STEP	20.000V	40.000V	40.000V	100.00V	100.00V
DELAY TIME	0 s	5 s	0 s	5 s	0 s

Table 4-3. Test Limits for Voltage Control Accuracy Test

Range of SMU Channel Tested	Voltage Sweep (xxx volts to xxx volts)	Output Voltage from SMU (Volt)	Test Limit
20 volt	0 to 20	.0000	0 volts \pm 0.01 volts
		20.000	20 volts \pm 0.03 volts
	-20 to -20	-20.000	-20 volts \pm 0.03 volts
40 volt	0 to 40	.0000	0 volts \pm 0.02 volts
		40.000	40 volts \pm 0.06 volts
	-40 to -40	-40.000	-40 volts \pm 0.06 volts
100 volt	0 to 100	.0000	0 volts \pm 0.05 volts
		100.00	100 volts \pm 0.15 volts
	-100 to -100	-100.00	-100 volts \pm 0.15 volts

PERFORMANCE TESTS

(2) VOLTAGE MEASUREMENT ACCURACY TEST

PURPOSE: This test verifies that the SMU accurately performs voltage measurements.

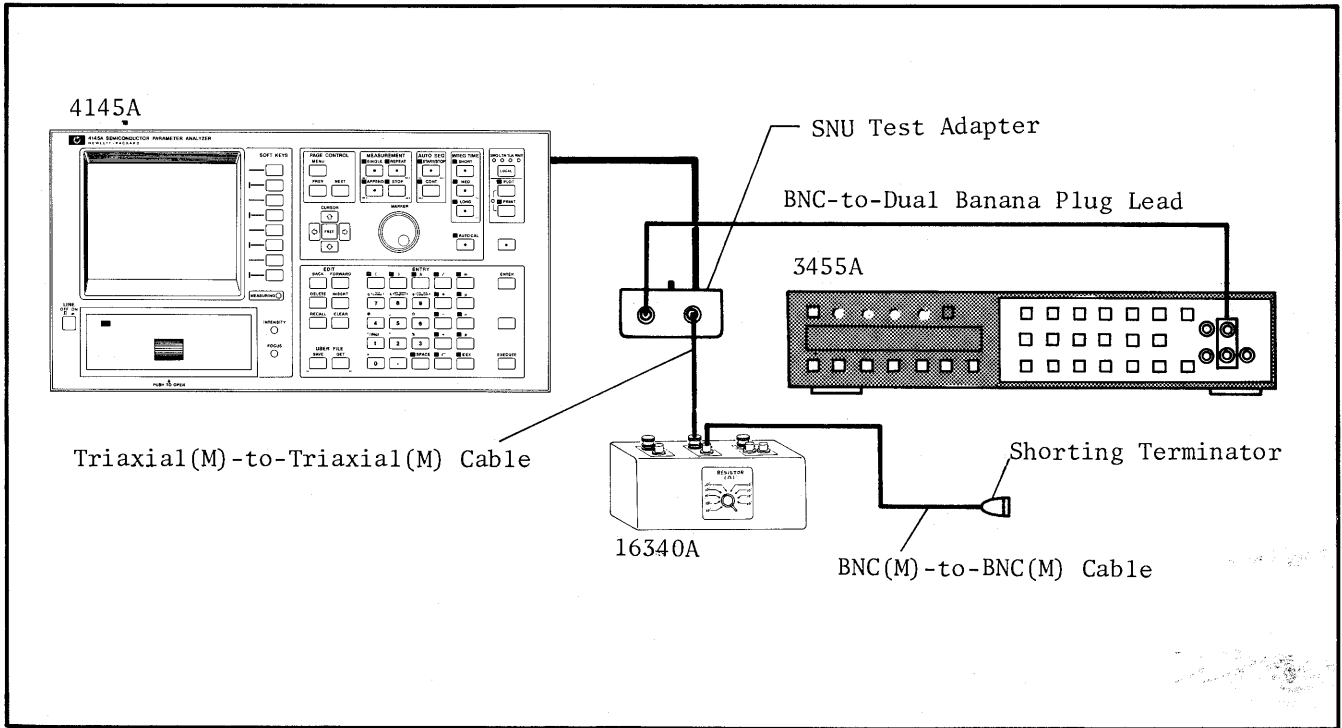

Figure 4-6. Voltage Measurement Accuracy Test Setup.*

* This setup is the same as for the Current Measurement Test and Current Control Accuracy Test.

EQUIPMENT:

DVM	HP MODEL 3455A
RC Box	HP MODEL 16340A
SMU Test Adapter	HP P/N 04145-65001
BNC (Male)-to-Dual Banana Plug Test Lead	HP MODEL 11001A
Triaxial (Male)-to-Triaxial (Male) Cable	HP P/N 16053-61002*
BNC (Male)-to-BNC (Male) Cable	HP P/N 16053-61003*
Shorting Connector	HP P/N 04145-61623
Shorting Terminator	HP P/N 04145-65002

* furnished with the 16340A

PERFORMANCE TESTS

PROCEDURE :

1. Connect the adapter (HP P/N : 04145-65001) to the 4145A's SMU channel 1 connector on the rear panel.
2. Connect the 3455A and the 16340A's female triaxial connector (for the $10^2\Omega - 10^{10}\Omega$ range) to the female BNC connector (labeled "MONITOR") and the female triaxial connector (labeled "TO 16340A") of the adapter, respectively. Use BNC (male)-to-dual banana test lead and triaxial (male)-to-triaxial (male) cable.
3. Connect the BNC-to-BNC cable (furnished with the 16340A) to the female BNC connector (for the $10^2\Omega - 10^{10}\Omega$ range), then terminate the cable with the shorting terminator.
4. Connect the shorting connector to the 24 pin connector (labeled "TO 16058A TEST FIXTURE") on the rear panel.
5. Set the adapter's SELECTOR switch to V_G , then set the 16340A's range to $10^8\Omega$.
6. Set the 3455A's controls as described in step 3 of the Voltage Control Accuracy Test.
7. Set the 4145A's controls as follows :

[hp] *** CHANNEL DEFINITION ***				
CHAN	NAME		SOURCE	
	V	I	MODE	FCTN
SMU1	V1	I1	I	VAR1
SMU2				
SMU3				
SMU4				
Vs 1		-----	V	
Vs 2		-----	V	
Vm 1		-----	-----	-----
Vm 2		-----	-----	-----

USER FCTN	NAME (UNIT) = EXPRESSION
1	_____ () =
2	_____ () =

- i) On the CHANNEL DEFINITION page :

Set up the page as shown in Figure 4-7.

- ii) On the SOURCE SET UP page :

Set up the page as shown in Figure 4-7.

- iii) On the MEAS & DISP MODE SET UP page :

Select LIST as the display mode for measurement results.

Figure 4-7. Measurement Setup.

PERFORMANCE TESTS

[hp]***** SOURCE SET UP *****			[hp]** MEAS & DISP MODE SET UP **									
	VAR1	VAR2										
NAME	I1		MEASUREMENT MODE: SWEEP									
SWEEP MODE	LINEAR	LINEAR										
START	150.0nA											
STOP	150.0nA	-----										
STEP	150.0nA											
NO. OF STEP	1		DISPLAY MODE: LIST									
COMPLIANCE	20.000V											
			<table border="1" style="width: 100%; border-collapse: collapse;"> <tr> <td rowspan="7" style="text-align: center; vertical-align: middle;">NAMES</td> <td style="text-align: center;">V1</td> </tr> <tr><td> </td></tr> <tr><td> </td></tr> <tr><td> </td></tr> <tr><td> </td></tr> <tr><td> </td></tr> <tr><td> </td></tr> </table>		NAMES	V1						
NAMES	V1											
CONSTANT	SOURCE	COMPLIANCE										

Figure 4-7. Measurement Setup (Cont'd).

8. Perform the first measurement for the SMU's 20 volt range by pressing the REPEAT key.
9. Record the readings on the 4145A for the monitored voltage value V1a and on the 3455A for Va, then end measurement by pressing the STOP key.
10. Change the source parameters--START and STOP--to -150.0nA on the SOURCE SET UP page for the second measurement.
11. Perform the second measurement by pressing the REPEAT key.
12. Record the readings on the 4145A for the monitored voltage value V1b and on the 3455A for Vb, then end measurement by pressing the STOP key.
13. Verify that the error and offset defined by the following equations satisfy the test limit listed in Table 4-5.

$$\text{error} = \frac{V1a - V1b}{Va - Vb} - 1$$

$$\text{offset} = V1a - (1 + \text{error}) * Va$$

14. Repeat steps 7 through 13 for the 40 volt range and 100 volt range. The source parameters--START, STOP, STEP, and COMPLIANCE--on the SOURCE SET UP page must be changed as listed in Table 4-4.
15. Repeat steps 7 through 14 for SMU channels 2, 3, and 4.

PERFORMANCE TESTS

Table 4-4. Source Parameter Changes

	SMU Range Tested	40 volt		100 volt	
	Measurement	1st	2nd	1st	2nd
Source Parameter	START	350.0nA	-350.0nA	900.0nA	-900.0nA
	STOP	350.0nA	-350.0nA	900.0nA	-900.0nA
	STEP	350.0nA	350.0nA	900.0nA	900.0nA
	COMPLIANCE	40.000V	40.000V	100.00V	100.00V

Table 4-5. Test Limits for Voltage Measurement Accuracy Test

SMU Range Tested	20 volt	40 volt	100 volt
Error (%)	±0.1	±0.1	±0.1
Offset	±10mV	±20mV	±50mV

PERFORMANCE TESTS

(3) CURRENT MEASUREMENT ACCURACY TEST

PURPOSE: This test verifies that the SMU accurately performs current measurements.

EQUIPMENT:

The equipment required is the same as that for the Voltage Measurement Accuracy Test.

PROCEDURE:

1. Perform steps 1 through 6 of the Voltage Measurement Accuracy Test described on pages 4-9 to 4-12.
2. Set the adapter's SELECTOR switch to V_0 , and the 16340A's range to $10^2 \Omega$.

[hp] *** CHANNEL DEFINITION ***

CHAN	NAME		SOURCE	
	V	I	MODE	FCTN
SMU1	V1	I1	V	VAR1
SMU2				
SMU3				
SMU4				
Vs 1		-----	V	
Vs 2		-----	V	
Vm 1		-----	----	----
Vm 2		-----	----	----

USER FCTN	NAME (UNIT) = EXPRESSION
1	() =
2	() =

3. Set the 3455A's controls as described in step 3 of the Voltage Control Accuracy Test.

4. Set the 4145A's controls as follows:

i) On the CHANNEL DEFINITION page:

Set up the page as shown in Figure 4-9.

ii) On the SOURCE SET UP page:

Set up the page as shown in Figure 4-9.

[hp] ***** SOURCE SET UP *****

	VAR1	VAR2
NAME	V1	
SWEEP MODE	LINEAR	LINEAR
START	9.1000V	
STOP	9.1000V	-----
STEP	9.1000V	
NO. OF STEP	1	
COMPLIANCE	100.0mA	

CONSTANT	SOURCE	COMPLIANCE

Figure 4-8. Measurement Setup.

PERFORMANCE TESTS

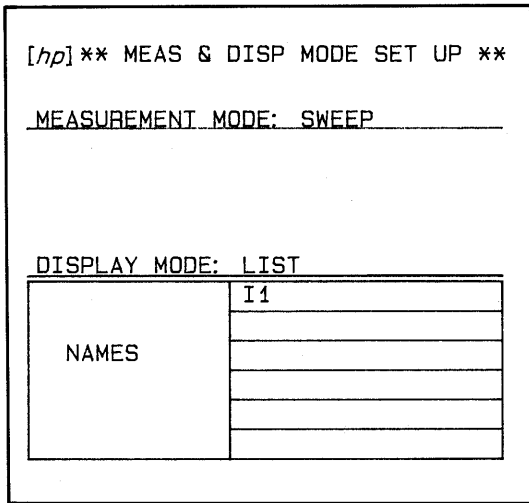

iii) On the MEAS & DISP MODE SET UP page :

Select LIST as the display mode for the measurement results.

iv) INTEG TIME LONG

Figure 4-8. Measurement Setup (Cont'd).

5. Perform measurement by pressing the REPEAT key.
6. Record the readings on the 4145A for monitored current value I1a and on the 3455A for Va.
7. End measurement by pressing the STOP key.
8. Change the source parameters—START, STOP, and STEP—on the SOURCE SET UP page to -9.1000V, then perform measurement by pressing the REPEAT key.
9. Record the readings on the 4145A for monitored current value I1b and on the 3455A for Vb, then end measurement by pressing the STOP key.
10. Verify that the error and offset defined by the following equations satisfy the test limits listed in Table 4-7.

$$\text{error} = \frac{I1a - I1b}{\frac{Va - Vb}{R}} - 1$$

R: Calibrated value of the 16340A's resistor

$$\text{offset} = I1a - (1 + \text{error}) * \frac{Va}{R}$$

11. Repeat steps 2 through 8 for ranges 10³Ω through 10⁹Ω. The required source parameter and adaptor SELECTOR switch position must be changed as listed in Table 4-6.
12. Repeat steps 2 through 9 for SMU channels 2, 3, and 4.

PERFORMANCE TESTS

Table 4-6. Source Parameter Changes

Source Parameter	16340A's Range									
	$10^3\Omega$	$10^4\Omega$	$10^5\Omega$	$10^6\Omega$	$10^7\Omega$	$10^8\Omega$	$10^9\Omega$	$10^9\Omega$		
START	—	—	—	—	—	—	—	.91	-.91	
STOP	—	—	—	—	—	—	—	.91	-.91	
STEP	—	—	—	—	—	—	—	.91	-.91	
COMPLIANCE	10.00mA	1.000mA	100.0μA	10.00μA	1.000μA	100.0nA	10.00nA	1.000nA		
Selector Switch Position	V_0				V_G					

Table 4-7. Test Limits for Current Measurement Accuracy Test

16340A's Range	$10^2\Omega$	$10^3\Omega$	$10^4\Omega$	$10^5\Omega$	$10^6\Omega$	$10^7\Omega$	$10^8\Omega$	$10^9\Omega$	$10^9\Omega$
Error (%)	±0.3	±0.3	±0.3	±0.3	±0.3	±0.5	±0.5	±1	±1
Offset	±0.12mA	±12μA	±1.2μA	±0.12μA	±12nA	±1.2nA	±0.12nA	±17pA	±6.2pA

PERFORMANCE TESTS

(4) CURRENT CONTROL ACCURACY TEST

PURPOSE: This test verifies that the specified output current is correctly output from each SMU channel.

EQUIPMENT:

Same as that for the Voltage Measurement Accuracy Test.

PROCEDURE:

1. Perform steps 1 through 4 of the Voltage Measurement Accuracy Test described on pages 4-9 to 4-12.
2. Set the adapter's SELECTOR switch to V , and the 16340A's range to $10^2\Omega$.

[hp] *** CHANNEL DEFINITION ***

CHAN	NAME		SOURCE	
	V	I	MODE	FCTN
SMU1	V1	I1	I	VAR1
SMU2				
SMU3				
SMU4				
Vs 1		-----	V	
Vs 2		-----	V	
Vm 1		-----	----	----
Vm 2		-----	----	----

USER FCTN	NAME (UNIT) - EXPRESSION
1	____ () -
2	____ () -

[hp] ***** SOURCE SET UP *****

	VAR1	VAR2
NAME	I1	
SWEEP MODE	LINEAR	LINEAR
START	91.00mA	
STOP	91.00mA	-----
STEP	91.00mA	
NO. OF STEP	1	
COMPLIANCE	10.000V	

CONSTANT	SOURCE	COMPLIANCE

3. Set the 3455A's controls as described in step 3 of the Voltage Control Accuracy Test.

4. Set the 4145A's controls as follows:

- i) On the CHANNEL DEFINITION page:

Set up the page as shown in Figure 4-9.

- ii) On the SOURCE SET UP page:

Set up the page as shown in Figure 4-9.

- ii) On the SOURCE SET UP page:

Set up the page as shown in Figure 4-9.

Figure 4-9. Measurement Setup.

PERFORMANCE TESTS

```

[hp]** MEAS & DISP MODE SET UP **

MEASUREMENT MODE: SWEEP

DISPLAY MODE: LIST

```

NAMES	V1

iii) On the MEAS & DISP MODE SET UP page :

Select LIST as the display mode for the measurement results.

iv) INTEG TIME LONG

Figure 4-9. Measurement Setup (Cont'd).

5. Perform the first measurement by pressing the REPEAT key.
6. Record the reading on the 3455A for Va.
7. End the measurement by pressing the STOP key.
8. Change the source parameters--START, STOP, and STEP--on the SOURCE SET UP page to 11mA, then perform the second measurement by pressing the REPEAT key.
9. Record the reading on the 3455A for Vb, then end measurement by pressing the STOP key.
10. Verify that the error and offset defined by the following equations satisfy the test limits listed in Table 4-9.

$$\text{error} = \frac{V_a - V_b}{I_1 - I_2} \cdot R - 1$$

$$\text{offset} = \frac{V_a}{R} - (1 + \text{error}) \cdot I_1$$

R: Calibrated value of the 16340A's resistor

I1, I2: START values set on the SOURCE SET UP page for the measurements of Va and Vb.

11. Repeat steps 2 through 8 for ranges $10^2 \Omega$ and $10^3 \Omega$. The source parameters must be changed as described in Table 4-8.
12. Repeat steps 2 through 9 for SMU channels 2, 3, and 4.

PERFORMANCE TESTS

Table 4-8. Source Parameter Changes

16340A's Range	Meas. (Measurement)	Source Parameter			
		START	STOP	STEP	COMPLIANCE
$10^2\Omega$	1st	-91.000mA		91.000mA	10.000V
	2nd	-11.000mA		11.000mA	
$10^3\Omega$	1st	9.1000mA		9.1000mA	
	2nd	1.1000mA		1.1000mA	
	1st	-9.1000mA		9.1000mA	
	2nd	-1.1000mA		1.1000mA	

Table 4-9. Test Limits for Current Control Accuracy Test

16340A's Range	$10^2\Omega$	$10^3\Omega$
Error (%)	± 0.3	± 0.3
Offset	$\pm 0.12\text{mA}$	$\pm 12\mu\text{A}$

PERFORMANCE TESTS

4-12. VS ACCURACY TEST

PURPOSE: This test verifies that the specified output voltage is correctly output from each VS (Voltage Source) channel.

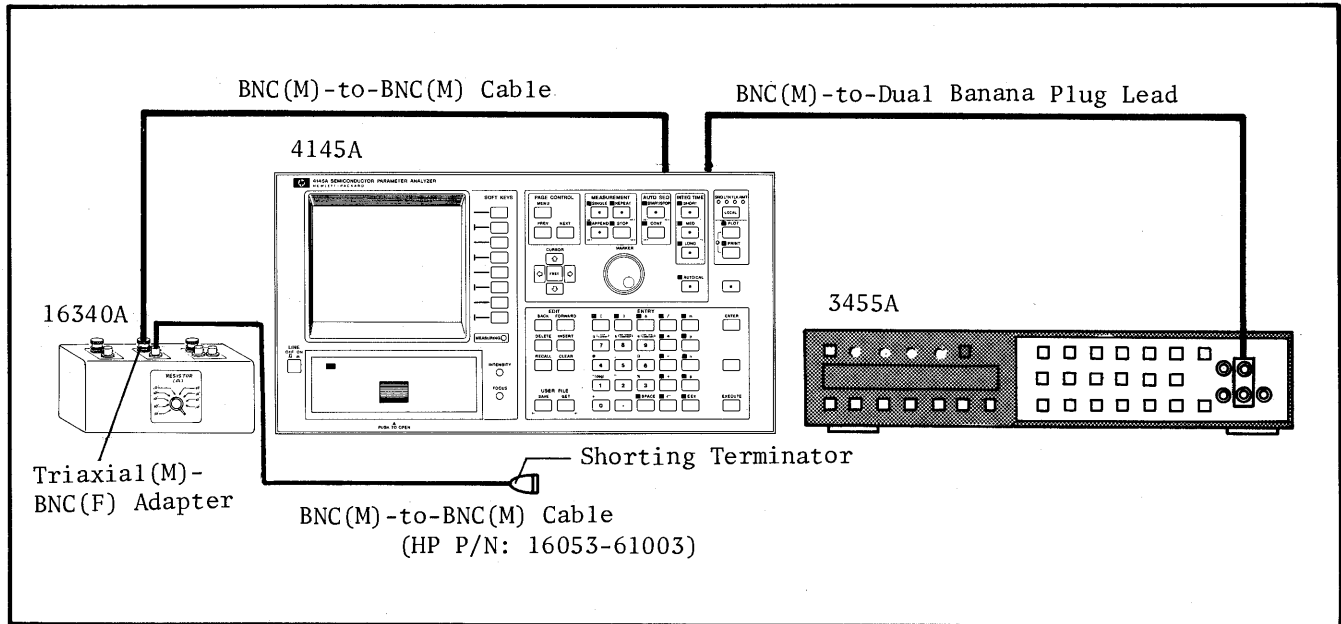

Figure 4-10. VS Accuracy Test Setup.

EQUIPMENT:

DVM	HP MODEL 3455A
RC Box	HP MODEL 16340A
BNC (Male)-to-Dual Banana Plug Test Lead	HP MODEL 11001A
BNC (Male)-to-BNC (Male) Cable	HP P/N 16053-61003*
Triaxial (Male)-BNC (Female) Adapter	HP P/N 1250-0595*
BNC T Type Adapter	HP P/N 1250-0781*
BNC (Male)-to-BNC (Male) Cable	HP P/N 11170B
Shorting Terminator	HP P/N 04145-65002

* furnished with the 16340A

PROCEDURE:

1. Connect the triaxial (male)-BNC (female) adapter and BNC (male)-to-BNC (male) cable (HP P/N: 16053-61003) to the 16340A's female triaxial connector and female BNC connector for ranges $10^2\Omega$ to $10^{10}\Omega$, respectively.
2. Terminate the BNC cable with the shorting terminator. See Figure 4-10.
3. Connect the BNC T type adapter to VS channel 1 (Vs1), then connect the 3455A and the 16340A to the VS channel 1 (Vs1) as shown in Figure 4-10.

PERFORMANCE TESTS

4. Set the 16340A's range to $10^4 \Omega$.

5. Set the 3455A's controls as follows :

FUNCTION ==V
 RANGE AUTO
 TRIGGER INTERNAL
 MATH OFF
 AUTO CAL OFF
 HIGH RESOLUTION ON

6. Set the 4145A's controls as follows :

[hp] *** CHANNEL DEFINITION ***

CHAN	NAME		SOURCE	
	V	I	MODE	FCTN
SMU1				
SMU2				
SMU3				
SMU4				
Vs 1	VS1	-----	V	CONST
Vs 2		-----	V	
Vm 1	VM1	-----	----	----
Vm 2		-----	----	----

USER FCTN	NAME (UNIT) = EXPRESSION
1	____ () =
2	____ () =

[hp] ***** SOURCE SET UP *****

	VAR1	VAR2
NAME		
SWEEP MODE		LINEAR
START		
STOP		-----
STEP		
NO. OF STEP		
COMPLIANCE		

CONSTANT	SOURCE	COMPLIANCE
VS1	V	.0000V

i) On the CHANNEL DEFINITION page:

Set up the page as shown in Figure 4-11. VM1 is used as a dummy to display Vs1's output after measurement.

ii) On the SOURCE SET UP page :

Set up the page as shown in Figure 4-11.

Figure 4-11. Measurement Setup.

PERFORMANCE TESTS

```

[hp]** MEAS & DISP MODE SET UP **

MEASUREMENT MODE: TIME DOMAIN

|              |      |
|--------------|------|
| WAIT TIME    | .00s |
| INTERVAL     | .01s |
| NO. OF RDNGS | 1    |



DISPLAY MODE: LIST

|       |     |
|-------|-----|
| NAMES | VM1 |
|       |     |
|       |     |
|       |     |
|       |     |

```

iii) On the MEAS & DISP MODE SET UP page :

Select LIST as the display mode for measurement results.

Figure 4-11. Measurement Setup (Cont'd).

7. Perform measurement by pressing the REPEAT key.
8. Record the reading on the 3455A, then verify that the reading satisfies the test limit listed in Table 4-10.
9. End the measurement by pressing the STOP key.
10. Repeat steps 6 through 9 for VS's outputs 20 volts and -20 volts.
11. Repeat steps 6 through 10 for VS channel 2.

Table 4-10. Test Limits for VS Accuracy Test

VS Output (volt)	0	20	-20
Test Limit	0V ± 0.01V	20V ± 0.11V	-20V ± 0.11V

PERFORMANCE TESTS

4-13. VM ACCURACY TEST

PURPOSE: This test verifies that each of VM (Voltage Monitor) channels (Vm1 and Vm2) accurately perform voltage monitoring.

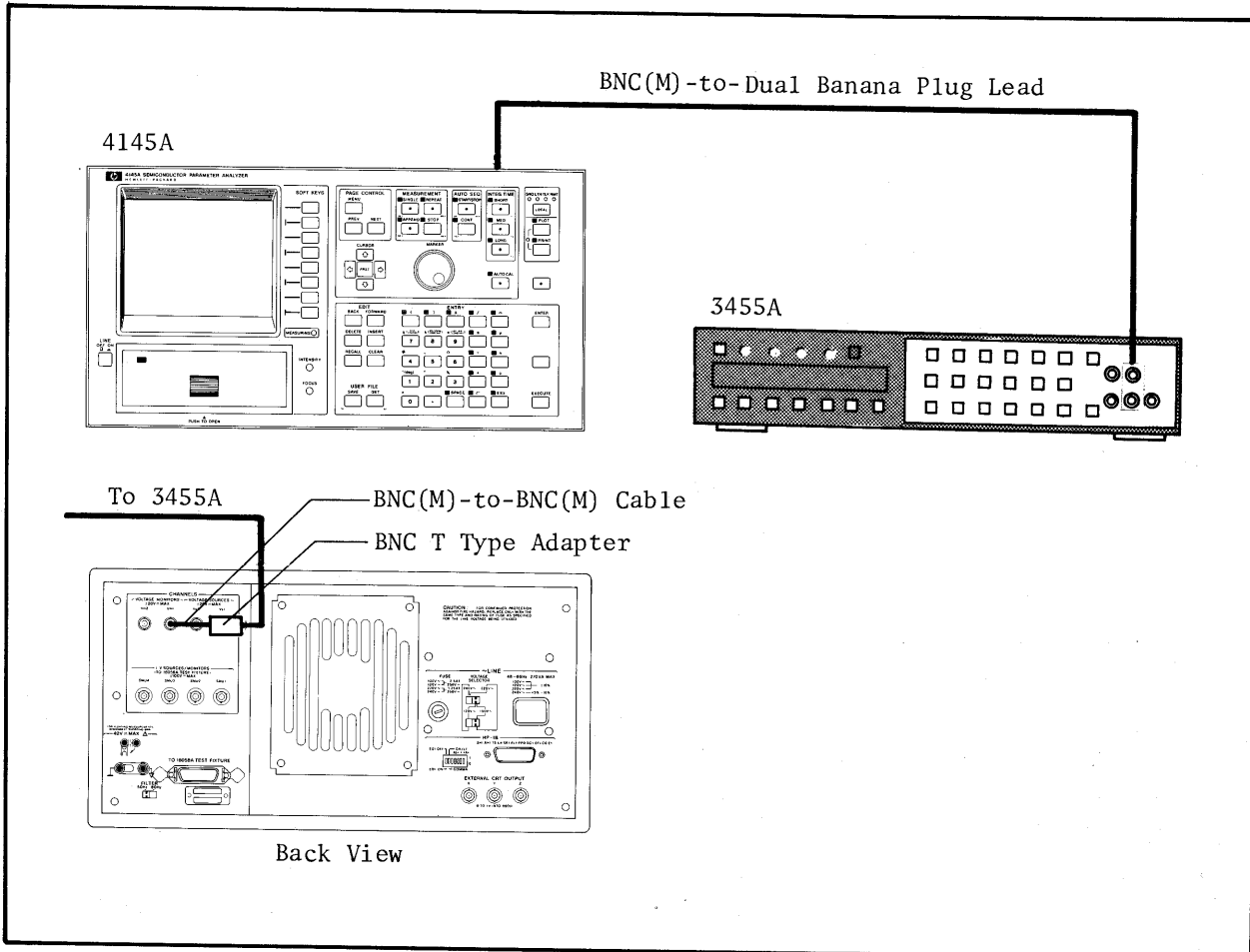

Figure 4-12. MU Accuracy Test Setup.

EQUIPMENT:

- DVM..... HP MODEL 3455A
- BNC (male)-to-Dual Banana Plug Test Lead HP MODEL 11001A
- BNC (Male)-to-BNC (Male) Cable..... HP MODEL 10502A
- BNC T Type Adapter..... HP P/N 1250-0781

PROCEDURE:

1. Connect the BNC T type adapter to the 4145A's VS channel 1 (Vs1) connector on the rear panel.
2. Connect VM channel 1 (Vm1) and the 3455A to VS channel 1 (Vs1) as shown in Figure 4-12.

PERFORMANCE TESTS

3. Set the 3455A's controls as follows :

FUNCTION ==V
 RANGE AUTO
 TRIGGER INTERNAL
 MATH OFF
 AUTO CAL OFF
 HIGH RESOLUTION ON

4. Set the 4145A's controls as follows :

i) On the CHANNEL DEFINITION page :

Set up the page as shown in Figure 4-13.

[hp] *** CHANNEL DEFINITION ***

CHAN	NAME		SOURCE	
	V	I	MODE	FCTN
SMU1				
SMU2				
SMU3				
SMU4				
Vs 1	VS1	-----	V	CONST
Vs 2		-----	V	
Vm 1	VM1	-----	----	----
Vm 2		-----	----	----

USER FCTN	NAME (UNIT) = EXPRESSION
1	____ () =
2	____ () =

[hp] ***** SOURCE SET UP *****

	VAR1	VAR2
NAME		
SWEEP MODE		LINEAR
START		
STOP		-----
STEP		
NO. OF STEP		
COMPLIANCE		

CONSTANT	SOURCE	COMPLIANCE
VS1	V 2.0000V	-----

ii) On the SOURCE SET UP page :

Set up the page as shown in Figure 4-13.

Figure 4-13. Measurement Setup.

PERFORMANCE TESTS

```

[hp]** MEAS & DISP MODE SET UP **

MEASUREMENT MODE: TIME DOMAIN

|              |      |
|--------------|------|
| WAIT TIME    | .00s |
| INTERVAL     | .01s |
| NO. OF RDNGS | 1    |



DISPLAY MODE: LIST

|       |     |
|-------|-----|
| NAMES | VM1 |
|       |     |
|       |     |
|       |     |
|       |     |

```

- iii) On the MEAS & DISP MODE SET UP page:

Select LIST as the display mode for the measurement results.

Figure 4-13. Measurement Setup (Cont'd).

- Perform measurement by pressing the REPEAT key.
- Record the readings on the 4145A for monitored voltage value VM1a and on the 3455A for Va, then end measurement by pressing the STOP key.
- Repeat steps 4 through 6 for VS output -2 volts, then record the readings on the 4145A for monitored voltage value VM1b and on the 3455A for Vb.
- Verify that the error and offset defined by the following equations satisfy the test limits listed in Table 4-11.

$$\text{error} = \frac{VM1a - VM1b}{Va - Vb} - 1$$

$$\text{offset} = VM1a - (1 + \text{error}) * Va$$

- Repeat steps 4 through 7 for VS outputs 20 volts and -20 volts.

Table 4-11. Test Limits for VM Accuracy Test

VM Range Tested	2 volt		20 volt	
VS Output (volt)	2	-2	20	-20
Error (%)	±0.5		±0.2	
Offset	±10mV		±10mV	

PERFORMANCE TESTS

4-14. EXTERNAL CRT X-Y-Z OUTPUT CHECK

PURPOSE: This check verifies that the external CRT X-Y-Z-signal is properly output.

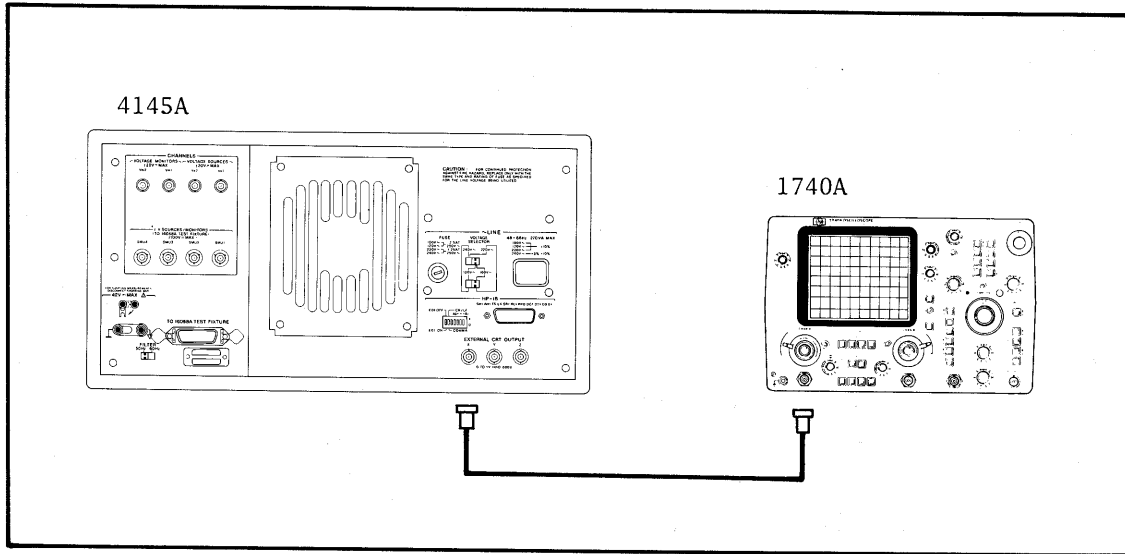

Figure 4-14. External CRT X-Y-Z Output Check Setup.

EQUIPMENT:

- Oscilloscope HP MODEL 1740A
- BNC (Male)-BNC (Male) Cable HP MODEL 11170B

PROCEDURE:

1. Turn off the 4145A.
2. Connect channel A (or channel B) input to the EXTERNAL CRT X-output as shown in Figure 4-14.
3. Set the 1740A's controls as follows :
 - VOLT/DIV 0.2
 - COUPLING DC
 - TIME/DIV 0.5msec
 - TRIGGER INT channel A
4. Insert one of the discs (software discs furnished with the 4145A) into the flexible-disc drive, then turn on the 4145A and the oscilloscope. The MENU page will be displayed on the CRT display.

PERFORMANCE TESTS

5. Verify that 0V-1V signal is observed as shown in Figure 4-15.
6. Perform steps 1 through 5 for EXTERNAL CRT Y-output and Z-output. Verify that the scope displays are observed as shown in Figure 4-15.

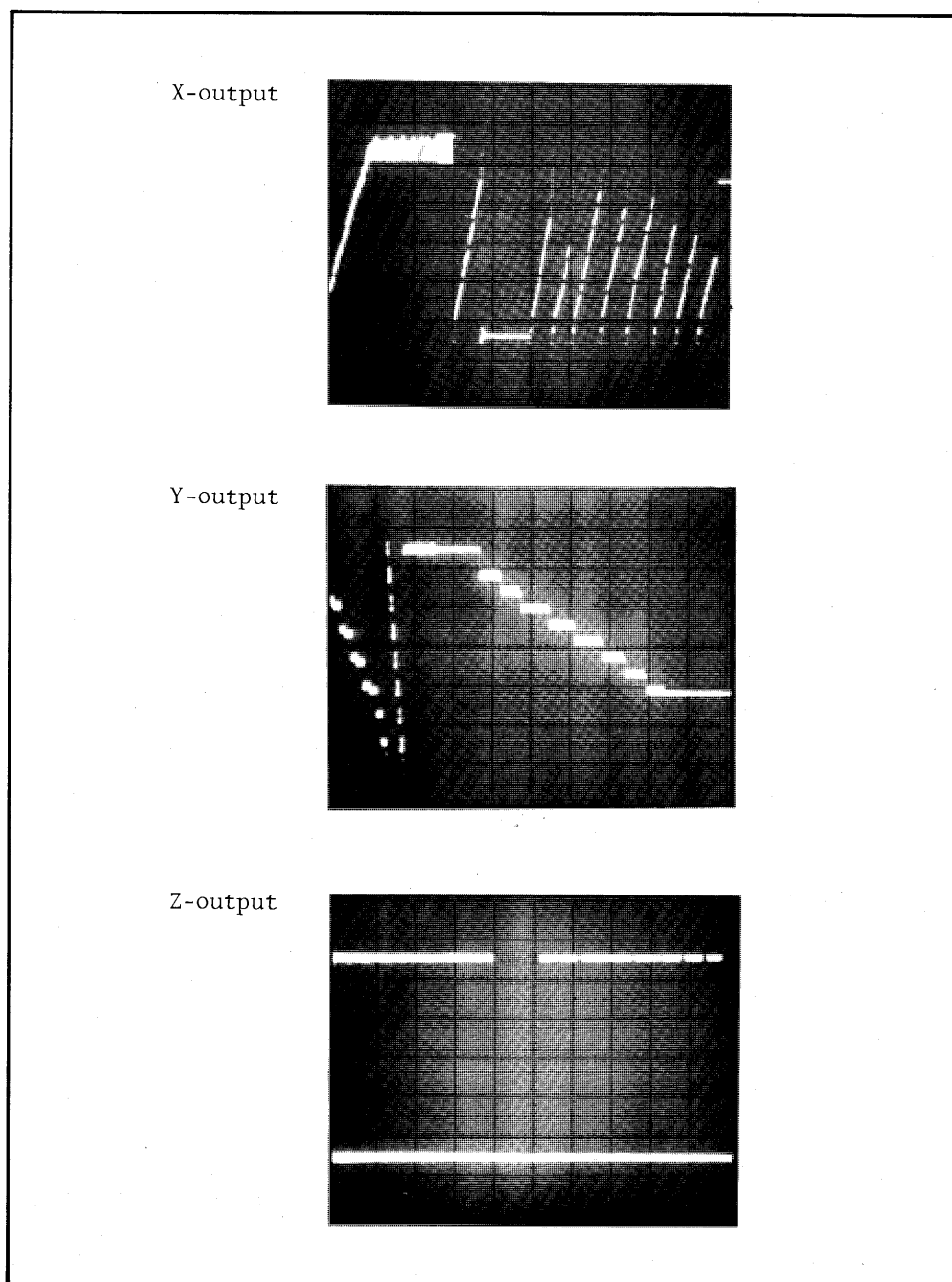

Figure 4-15. Scope Displays of X-Y-Z Output (Example).

PERFORMANCE TESTS

4-15. HP-IB INTERFACE TEST

PURPOSE: This test verifies the instrument's HP-IB capabilities (see Table 3-8).

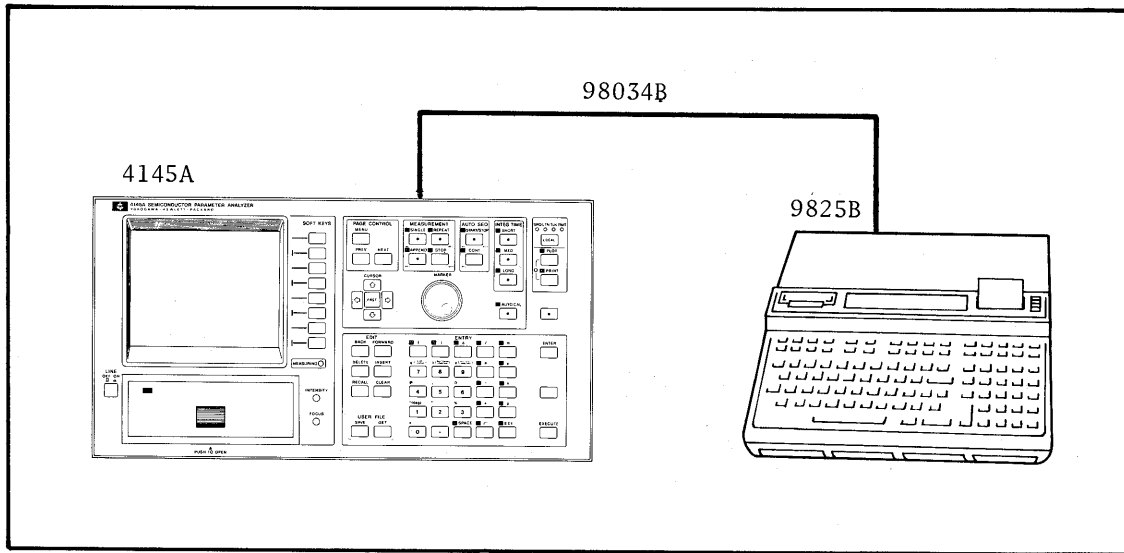

Figure 4-16. HP-IB Interface Test Setup.

EQUIPMENT:

- Desktop Computer HP MODEL 9825B
- Interface Card with Cable HP MODEL 98034B
- I/O ROM's HP MODEL 98210A and 98213A

PROCEDURE:

1. Turn off both the 4145A and the 9825B.
2. Connect the 98034B between the 4145A and the 9825B as shown in Figure 4-16, and the I/O ROM's in the ROM slots.
3. Set the HP-IB control switch, located on the rear panel, as follows :

bits 1 - 5 : 10101 (21₁₀)
 bit 6 : 0
 bit 7 : 1

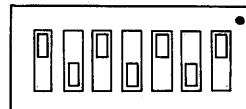

4. Turn on the 4145A.
5. After the MENU page has been displayed, verify that the HP-IB status message on the system message line is as follows :

HP-IB (21 , COMMA ,)

PERFORMANCE TESTS

6. Turn off the 4145A, then reset the HP-IB control switch as follows :

bits 1 - 5 : 01010 (10₁₀)
 bit 6 : 1
 bit 7 : 0

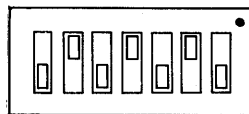

7. Turn on the 4145A, then verify that the HP-IB status message on the system message line is as follows :

HP-IB (10, CR/LF, EOI)

8. Turn off the 4145A, then reset the HP-IB control switch as follows :

bits 1 - 5 : 10001 (17₁₀)
 bit 6 : 0
 bit 7 : 0

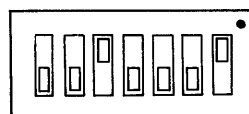

9. Turn on the 9825B and the 4145A.
10. Load the HP-IB Interface Test Program into the desktop computer (controller). The test program, listed in Figure 4-17, includes eight tests, listed in Table 4-12.
11. Execute the program and follow the prompts and instructions output by the controller. Details on controller instructions and appropriate operator responses are given in Table 4-13. An error message is printed out if any step of the test fails, then the test is discontinued. See Table 4-14 for explanations of error messages.

Note

The 16058A Test Fixture or shorting connector (P/N 04145-61623) must be connected to the 4145A and the fixture lid must be closed during the HP-IB interface Test.

Table 4-12. HP-IB Interface Test Program

HP-IB INTERFACE TEST PROGRAMS		
DESCRIPTION:		
<p>The HP-IB Interface Test Program tests the 4145A's HP-IB interface capabilities. With the test program, The tests listed below are performed in the order listed.</p>		
TEST NO.	Test	(HP-IB) Capabilities Tested
1	PLOT & Data Transfer TEST	<ol style="list-style-type: none"> 1. PLOT Function of the 4145A 2. Data Transfer via the HP-IB 3. Talk Only
2	Listener and Remote/Local Test	<ol style="list-style-type: none"> 1. Listener 2. Remote/Local
3	Local Lockout Test	Local Lockout
4	Talker Test*	<ol style="list-style-type: none"> 1. Talker 2. EOI (End or Identify) Output
5	IFC Test	Response of the 4145A to Interface Clear Command from the Controller
6	Device Clear Test	Device Clear
7	Trigger Test	Response of the 4145A to Group Execute Trigger
8	SRQ Line Test*	<ol style="list-style-type: none"> 1. Service Request 2. Serial Poll
<p>* The test for EOI output and the SRQ Line Test are performed automatically without operator response.</p>		

```

0:  **** 4145A HP-IB PERFORMANCE TEST PROGRAM **** 12/25/1981 *:
1:  dim A#[500],B#[500],D#[32],E#[32]
2:  lcl 7
3:  0}U}V}E;cmpU}U
4:  time 30000;on err "ERR"
5:  "4145A HP-IB PERFORMANCE TEST"}E$;gsb "SLOWDSP"
6:  "PLOT & Data Transfer TEST"}E$;gsb "SLOWDSP"
7:  dsp "Press PLOT then CONTINUE";beep;stp
8:  dsp "Press EXECUTE(4145A)";beep
9:  lcl 7
10: cmd 7,"U5"
11: 0}E
12: rds(7,J,J,R)}J
13: if bit(7,R);gsb "E0IF3"
14: if E;stp ;gto 6
15: for I=1 to 50
16: gsb "GETDIO"
17: next I
18: gsb "TRNS"
19: if D#[1,15]="H X X X X X X X";gto "PASS"
20: gsb "PRTDIO"
21: stp ;gto 3
22: "PASS":dsp "      *** PASS 1 ***";wait 2000
23: dsp "Press PLOT again,then CONTINUE ";beep;stp ;gto "L3"
24: "GETDIO":rdb(731)}R
25: band(R,U)}U;ior(R,V)}V;ret
26: "ERR":prt E$,"TIMEOUT ERROR"
27: fxd 0;prt " on line",erl
28: prt " ";prt " ";stp ;end
29: "PRTDIO":
30: prt "*** STUCK BUS ***"
31: prt "*** DIO LINES ***"
32: prt "8-7-6-5-4-3-2-1"
33: prt D#[1,15]
34: prt " ";prt "DIO8 must be H";prt " ";prt " ";ret
35: "TRNS":
36: eor(U,V)}U
37: "X X X X X X X X"}D#[1,15]
38: for I=0 to 7
39: 15-2*I}K
40: if bit(I,U)=1;gto 43
41: "H"}D#[K,K]
42: if bit(I,R);"L"}D#[K,K]
43: next I
44: ret
45: end
46: "L3":
47: 0}U}V;cmpU}U
48: 17}Y;beep;ent "HP-IB Address ? (default=17)",Y;700+Y}Y
49: "LISTENER REMOTE/LOCAL TEST"}E$;gsb "SLOWDSP"
50: dsp "LTN & RMT on ? (CONT)";rem Y;beep;stp
51: dsp "Press LOCAL,RMT } off ? (CONT)";rem Y;beep;stp
52: "LOCAL LOCKOUT TEST"}E$;gsb "SLOWDSP"

```

Figure 4-17. Program Listing of HP-IB Interface Test (Sheet 1 of 3).

```

53: dsp "Press LOCAL,RMT still on ?(CONT)";rem Y;llc 7;beep;stp
54: lcl 7
55: gto 58
56: 0)E;rds(7,K,L,M)N;if bit(7,M)=1;gsb "EOIF3"
57: if E=1;gto 49
58: "TALKER TEST"}E$;gsb "SLOWDSP"
59: rem 7
60: dsp "TLK on & RMT off ? (CONT)";cmd 7,"?5"&char(Y-700+64);beep;stp
61: wrt Y,"USBCTV1";wait 100
62: red Y,A$;wait 100
63: wrt Y,"TV1";gsb "EOICLK"
64: "IFC TEST"}E$;gsb "SLOWDSP";cli 7
65: dsp "TLK off & RMT on ? (CONT)";beep;stp
66: gsb "DCLCHK"
67: gsb "TRGCHK"
68: gto "L2"
69: "EOICLK":
70: "EOI TEST (AUTO)"}E$;gsb "SLOWDSP"
71: 0)E
72: if rdb(Y)#13;jmp 0
73: if bit(0,rds(7,M,M,M)}P)=1;gsb "EOIF1"
74: if E=1;stp ;gto 70
75: if rdb(Y)#10;jmp 0
76: if bit(0,rds(7,M,M,M)}Q)=0;gsb "EOIF2"
77: if E=1;stp ;gto 70
78: dsp "*** PASS 2 ***";wait 2000;ret
79: "L2":
80: clr Y
81: "SRQ LINE TEST (AUTO)"}E$;gsb "SLOWDSP"
82: 0)E
83: gsb "GETBUS"
84: if bit(5,R)=1;gsb "SRQF1"
85: if E=1;stp ;gto 81
86: wrt Y,"Q"
87: gsb "GETBUS"
88: if bit(5,R)=0;gsb "SRQF2"
89: if E=1;stp ;gto 81
90: rds(Y)}S
91: if S#66;prt "SERIAL POLL ERROR";prt "STATUS BYTE is ",dtoS,"(octal)";stp
92: dsp "*** PASS 5 ***";wait 2000
93: dsp "* 4145A HP-IB TEST COMPLETED *";beep;stp
94: gto 3
95: "DCLCHK":
96: "DEVICE CLEAR TEST (AUTO)"}E$;gsb "SLOWDSP"
97: clr 7
98: gsb "MENCHK"
99: if E=1;prt "DEVICE CLEAR (DCL) FAIL";stp ;gto 97
100: wrt Y,"SS"
101: clr Y
102: gsb "MENCHK"
103: if E=1;prt "SELECTED DEVICE CLEAR (SDC) FAIL";stp ;gto 101
104: dsp "*** PASS 3 ***";wait 2000
105: ret
106: "MENCHK":

```

Figure 4-17. Program Listing of HP-IB Interface Test (Sheet 2 of 3).

```
107: wrt Y,"PL"
108: red Y,A$
109: wrt Y,"PF"
110: 1}E
111: for I=1 to 497
112: if A$[I,I+3]="MENU";0}E;gto 114
113: next I
114: ret
115: "TRGCHK":
116: "TRIGGER TEST (AUTO)"E$;gsb "SLOWDSP"
117: wrt Y,"DECH2;CH3;SMIN.5;DM2LI'I1';MD"
118: trg Y
119: wait 1000
120: wrt Y,"BCDO'I1'"
121: red Y,A$
122: "LVXCTN"}B$[1,6]
123: 1}E
124: for I=1 to 6
125: if A$[I,1]=B$[I,1];0}E;gto 126
126: next I
127: if E=1;prt "TRIGGER TEST FAIL";prt "OUTPUT DATA";prt A$;stp ;gto 116
128: dsp " *** PASS 4 ***";wait 300
129: ret
130: "EOIF1":prt "FAIL:EOI LOW FOR [CR]";1}E;ret
131: "EOIF2":prt "FAIL:EOI HIGH FOR [LF]";1}E;ret
132: "EOIF3":prt "FAIL:EOI LINE LOW";1}E;ret
133: "SRQF1":prt "FAIL:SRQ LINE LOW";1}E;ret
134: "SRQF2":prt "FAIL:SRQ LINE HIGH";1}E;ret
135: "SLOWDSP": ""D$;len(E$)W;for W=1 to len(E$);E$[W,W]}D$[W,W];dsp D$
136: wait 30;next W;wait 600;ret
137: "GETBUS":rds(7,P,Q,R)}S
138: band(R,U)}U;ior(R,V)}V;ret
139: "#trk1-24":end
```

Figure 4-17. Program Listing of HP-IB Interface Test (Sheet 3 of 3).

Table 4-13. Controller Instructions and Operator Responses for HP-IB Interface Test Program

Controller Instructions Displayed	Operator Response/Description
4145A HP-IB PERFORMANCE TEST	
PLOT & Data Transfer TEST	
Press PLOT then CONTINUE.	Press the PLOT key of the 4145A, then press <input type="button" value="CONTINUE"/> .
Press EXECUTE (4145A).	Press the EXECUTE key of the 4145A within thirty seconds, then verify that the TLK and PLOT lamps of the 4145A are lit.
*** PASS 1 ***	If all steps of the PLOT & Data Transfer Test are correct, this message is displayed.
Press PLOT again, then CONTINUE.	Press the PLOT key of the 4145A, then press <input type="button" value="CONTINUE"/> .
HP-IB Address? (default = 17)	Input the 4145A's HP-IB address (17), then press <input type="button" value="CONTINUE"/> .
LISTENER REMOTE/LOCAL TEST	
LTN & RMT on? (CONT)	Verify that the LTN and RMT lamps of the 4145A are lit, then press <input type="button" value="CONTINUE"/> . If either of the lamps is not lit, end the test.
Press LOCAL, REMOTE → off?	Press the LOCAL key of the 4145A and verify that RMT lamp goes off. Then press <input type="button" value="CONTINUE"/> . If the RMT lamp does not go off, end the test.
EOI TEST (AUTO)	The EOI Test is performed automatically.
*** PASS 2 ***	If all steps of the EOI Test are correct, this message is displayed.
IFC TEST	
TLK off & RMT on?	Verify that the TLK and RMT lamps of the 4145A are off and on, respectively, then press <input type="button" value="CONTINUE"/> . If the lamps are not in the correct status, end the test.
DEVICE CLEAR TEST (AUTO)	The Device Clear Test is performed automatically.
*** PASS 3 ***	If all steps of the Device Clear Test are correct, this message is displayed.
TRIGGER TEST (AUTO)	The Trigger Test is performed automatically.
*** PASS 4 ***	If all steps of the Trigger Test are correct, this message is displayed.

Table 4-13. Controller Instructions and Operator Responses for HP-IB Interface Test Program (Cont'd)

Controller Instructions Displayed	Operator Response/Description
SRQ LINE TEST (AUTO)	The SRQ Line Test is performed automatically.
*** PASS 5 ***	If all steps of the SRQ Line Test are correct, this message is displayed.
4145A HP-IB TEST COMPLETED	The test has been passed.

Table 4-14. Error Messages for HP-IB Interface Test Program

(1) TIMEOUT ERROR

This error message is displayed if the HP-IB Handshake is not properly performed within thirty seconds*. Examples of the TIMEOUT ERROR message are described below:

```

PLOT & Data Tran
sfer TEST
TIMEOUT ERROR
on line      27
    
```

The ATN line is connected to GND (ground).

```

PLOT & Data Tran
sfer TEST
TIMEOUT ERROR
on line      10
    
```

One of lines NRFD, DAV, or NDAC for three-wire-handshake is connected to GND (ground).

* If the EXECUTE key of the 4145A is not pressed within thirty seconds after "Press EXECUTE (4145A)" has been displayed during the PLOT & Data Transfer Test.

Note

This error message may be displayed when the error is detected in other tests.

(2) STUCK BUS ERROR

This error message is displayed if any of the DIO lines (DIO 1 - 8) are shorted or disconnected. An example of the STUCK BUS ERROR message is described below.

```

** STUCK BUS **
** DIO LINES **
8-7-6-5-4-3-2-1
H X X X X L X X
DIO8 must be H
    
```

The DIO3 line is stuck at low level, but the DIO8 line is at high level.

Note

This message is displayed only in the PLOT & Data Transfer Test.

Table 4-14. Error Messages for HP-IB Interface Test Program (Cont'd)

(3) SRQ LINE ERROR

This error message is displayed if the SRQ line is disconnected or shorted. There are two kinds of SRQ Line Error messages as described below.

```

  FAIL:SRQ LINE LO
  W
  
```

The SRQ line stays LOW.

```

  FAIL:SRQ LINE HI
  GH
  
```

The SRQ line stays HIGH.

(4) EOI LINE ERROR

This message is displayed if the EOI line is disconnected or shorted. Examples of the EOI LINE ERROR message are described below:

```

  FAIL:EOI LINE LO
  W
  
```

The EOI line stays LOW.

```

  FAIL:EOI HIGH FO
  R [LF]
  
```

The EOI line is at HIGH level when the LF (line feed) signal is output.

Note

When the HP-IB control switch for the EOI is turned off, this message is displayed.

(5) SERIAL POLL ERROR

After the Service Request function of the 4145A has been verified, this message is displayed along with status byte information of the 4145A if Serial Poll is not performed properly. In the test program, the Serial Poll test has been passed when the status byte from the 4145A is 102 (octal). An example of the SERIAL POLL ERROR message described below:

```

  SERIAL POLL ERRO
  R
  STATUS BYTE is
  0.00
  (octal)
  
```

Table 4-14. Error Messages for HP-IB Interface Test Program (Cont'd)

<p>(6) DEVICE CLEAR (DCL) FAIL</p> <p>This message is displayed if the 4145A does not respond to universal command DCL.</p>
<p>(7) SELECTED DEVICE CLEAR (SDL) FAIL</p> <p>This message is displayed if the 4145A does not respond to addressed command SDC.</p>
<p>(8) TRIGGER TEST ERROR</p> <p>This message is displayed if the 4145A does not respond properly to addressed command GET (Group Execute Trigger).</p>

PERFORMANCE TEST RECORD

Hewlett-Packard
 Model 4145A
 SEMICONDUCTOR PARAMETER ANALYZER

Tested by _____

Serial Number _____

Date _____

Paragraph	Test and Result						
4-9	Graphic Display Unit Intensity and Focus Check						Pass . Fail *
4-10	Page and Key Function Check						Pass . Fail *
4-11	SMU Accuracy Test						
4-11-(1)	Voltage Control Accuracy Test						
	SMU Range Tested	Output from SMU	Test Limit	Actual Result			
				SMU1	SMU2	SMU3	SMU4
	20V	0V	0V±0.01V	_____	_____	_____	_____
		20V	20V±0.03V	_____	_____	_____	_____
		-20V	-20V±0.03V	_____	_____	_____	_____
40V	0V	0V±0.02V	_____	_____	_____	_____	
	40V	40V±0.06V	_____	_____	_____	_____	
	-40V	-40V±0.06V	_____	_____	_____	_____	
100V	0V	0V±0.05V	_____	_____	_____	_____	
	100V	100V±0.15V	_____	_____	_____	_____	
	-100V	-100V±0.15V	_____	_____	_____	_____	
4-11-(2)	Voltage Measurement Accuracy Test						
	SMU Range Tested	Error/Offset	Test Limit	Actual Result			
				SMU1	SMU2	SMU3	SMU4
	20V	Error	±0.1%	_____%	_____%	_____%	_____%
		Offset	±10mV	_____	_____	_____	_____
	40V	Error	±0.1%	_____%	_____%	_____%	_____%
Offset		±20mV	_____	_____	_____	_____	
100V	Error	±0.1%	_____%	_____%	_____%	_____%	
	Offset	±50mV	_____	_____	_____	_____	

* check (✓) either Pass or Fail.

PERFORMANCE TEST RECORD

Paragraph	Test and Result						
4-11-(3)	Current Measurement Accuracy Test						
	16340A Range	Error/Offset	Test Limit	Actual Result			
				SMU1	SMU2	SMU3	SMU4
	10 ² Ω	Error Offset	±0.3% ±0.12mA	_____% _____	_____% _____	_____% _____	_____% _____
	10 ³ Ω	Error Offset	±0.3% ±12μA	_____% _____	_____% _____	_____% _____	_____% _____
	10 ⁴ Ω	Error Offset	±0.3% ±1.2μA	_____% _____	_____% _____	_____% _____	_____% _____
	10 ⁵ Ω	Error Offset	±0.3% ±0.12μA	_____% _____	_____% _____	_____% _____	_____% _____
	10 ⁶ Ω	Error Offset	±0.3% ±12nA	_____% _____	_____% _____	_____% _____	_____% _____
	10 ⁷ Ω	Error Offset	±0.5% ±1.2nA	_____% _____	_____% _____	_____% _____	_____% _____
	10 ⁸ Ω	Error Offset	±0.5% ±0.12nA	_____% _____	_____% _____	_____% _____	_____% _____
	10 ⁹ Ω	Error Offset	±1% ±17pA	_____% _____	_____% _____	_____% _____	_____% _____
	10 ⁹ Ω	Error Offset	±1% ±6.2pA	_____% _____	_____% _____	_____% _____	_____% _____
4-11-(4)	Current Control Accuracy Test						
	16340A Range	Error/Offset	Test Limit	Actual Result			
				SMU1	SMU2	SMU3	SMU4
	10 ² Ω	Error Offset	±0.3% ±0.12mA	_____% _____	_____% _____	_____% _____	_____% _____
10 ³ Ω	Error Offset	±0.3% ±12μA	_____% _____	_____% _____	_____% _____	_____% _____	
4-12	VS Accuracy Test						
	Output From VS	Test Limit	Actual Result				
			VS1	VS2			
	0V	0V±0.01V					
	20V	20V±0.11V					
-20V	-20V±0.11V						

PERFORMANCE TEST RECORD

Paragraph	Test and Result					
4-13	VM Accuracy Test					
	VM Range Tested	Output from VS	Error/Offset	Test Limit	Actual Result	
					VM1	VM2
	2V	2V	Error Offset	±0.5% ±10mV	_____% _____	_____% _____
		-2V	Error Offset	±0.5% ±10mV	_____% _____	_____% _____
	20V	20V	Error Offset	±0.2% ±10mV	_____% _____	_____% _____
-20V		Error Offset	±0.2% ±10mV	_____% _____	_____% _____	
4-14	External CRT X-Y-Z Output Check			Output	Result*	
				X-output	Pass · Fail	
				Y-output	Pass · Fail	
				Z-output	Pass · Fail	
4-15	HP-IB Interface Test				Result*	
	(1) HP-IB Control Switch Function "HP-IB (21, COMMA,)" and "HP-IB (21, CR/LF, EOI)" are displayed on the CRT.				Pass · Fail	
	(2) PLOT & Data Transfer Test "***PASS 1***" is displayed on the 9825B.				Pass · Fail	
	(3) Listener and Remote/Local Test, Local Lockout Test, and Talker Test, EOI Test "***PASS 2***" is displayed on the 9825B.				Pass · Fail	
	(4) IFC Test and Device Clear Test "***PASS 3***" is displayed on the 9825B.				Pass · Fail	
	(5) Trigger Test "***PASS 4***" is displayed on the 9825B.				Pass · Fail	
	(6) SRQ Line Test "***PASS 5***" is displayed on the 9825B.				Pass · Fail	

* check (✓) either Pass or Fail.

Table 4-1. Recommended Test Equipment

Equipment	Critical Specifications	Recommended Model	Use* ¹
Digital DC Voltmeter	Voltage range : 100mV to 200V f.s. Sensitivity : 100 μ V Accuracy : 0.002% Input impedance: > 10M Ω	HP 3455A	P, A, T
Oscilloscope	Band width : > 10MHz Vertical Sensitivity: 0.001 Volt/DIV Channel : dual	HP 1740A* ²	P, A, T
RC Box	Range : 10 ² Ω - 10 ¹¹ Ω Accuracy: 0.1% - 1% Furnished accessories: (1) Triaxial (Male)-to-Triaxial (Male) Cable (HP P/N: 16053-61002) (2) BNC (Male)-to-BNC (Male) Cable (HP P/N: 16053-61003) (3) Triaxial (Male)-BNC (Female) Adapter (HP P/N: 1250-0595) (4) BNC T Type Adapter (HP P/N: 1250-0781)	HP 16340A	P
Desktop Computer	For HP-IB controller	HP 9825B	P
HP-IB Interface Card with cable		HP 98034B	P
I/O ROMs		HP 98210A HP 98213A	P
Test Fixture with Furnished Accessories		HP 16058A	P, A
Cables	Alligator Clips-to-Dual Banana Plug Test Lead	HP 11002A	P, A, T
	Probe and Alligator Clip-to-Dual Banana Test Lead	HP 11003A	
	BNC (Male)-to-BNC (Male), 61cm	HP 11170B	
	BNC (Male)-to-Dual Banana Plug Test Lead	HP 11001A	
	BNC (Male)-to-BNC (Male), 23cm	HP 10502A	
* ¹ : P = Performance Test, A = Adjustment, T = Troubleshooting			
* ² : The waveforms shown in Section V were obtained with the 1741A.			

Table 4-1. Recommended Test Equipment (Cont'd)

Equipment	Critical Specifications	Recommended Model	Use* ¹
Probes	10:1 Divider Probe Input impedance: 10M Ω	HP 10004A	A, T
	1:1 Probe	HP 10007B	
4145A Product Support Package	Tools included: (1) CE Disc (HP P/N: 04145-65101) (2) Blank Disc (HP P/N: 04145-65102) (3) Eccentric Rod (HP P/N: 04145-65103) (4) Tension Gauge (HP P/N: 04145-65104) (5) SMU Test Adapter (HP P/N: 04145-65001) (6) Shorting Terminator (HP P/N: 04145-65002) (7) Extender Board (24-pin Single) (HP P/N: 04145-66520) (8) Extender Board (24-pin Dual) (HP P/N: 04145-66521) (9) Cleaning Disc (HP P/N: 9164-0168) (10) Disc Case (HP P/N: 1540-0773)	HP P/N 04145-65100	P, A, T
Shorting Connector		HP P/N 04145-61623	P
Signature Analyzer		HP 5004A	T

SECTION V ADJUSTMENT

5-1. INTRODUCTION

5-2. This section provides the information needed to adjust the 4145A to the specifications listed in Table 1-1. The prime purpose of adjustment is to return the instrument to its peak operating capabilities after repairs have been made. The instrument should be tested and adjusted whenever a part or component has been replaced. If the instrument falls out of adjustment, readjustment alone often returns the instrument to normal operating conditions without repairs. Adjustment procedures should also be performed periodically to maintain top operating performance. The recommended adjustment schedule for the 4145A is every six months. All adjustable components referred to in individual tests are listed in Table 5-1. If proper performance cannot be achieved after adjustment procedures have been performed, refer to the troubleshooting procedures described in Section VIII.

Note

To ensure proper adjustment and instrument operation, allow 40 minute warm-up time to stabilize operating conditions before performing any of the adjustment procedures described herein.

5-3. SAFETY REQUIREMENTS

5-4. Although the instrument has been designed in accordance with international safety standards, this manual contains supplementary information, cautions, and warnings which must be followed to ensure safe operating conditions (see Section II and III). Adjustments described in this section should be performed only by qualified service personnel.

WARNING

ANY DISTURBANCE OF THE PROTECTIVE (GROUNDED) CONDUCTOR INSIDE OR OUTSIDE THE INSTRUMENT, OR DISCONNECTION OF THE PROTECTIVE GROUND TERMINAL CAN MAKE THE INSTRUMENT UNSAFE. INTENTIONAL INTERRUPTION FOR ANY REASON IS PROHIBITED.

5-5. Opening covers in order to remove parts, except those which can be accessed by hand, exposes live components and terminals. Use appropriate caution.

5-6. Capacitors in the instrument may still be charged after the instrument has been disconnected from the power source.

WARNING

ADJUSTMENTS DESCRIBED IN THIS SECTION ARE PERFORMED WITH POWER SUPPLIED TO THE INSTRUMENT AND WITH PROTECTIVE COVERS REMOVED. ELECTRICAL CURRENT EXISTING AT MANY POINTS MAY, IF CONTACTED, RESULT IN SERIOUS PERSONAL INJURY.

5-7. EQUIPMENT REQUIRED

5-8. Equipment needed to adjust the 4145A is listed in Table 4-1. Each piece of equipment listed in Table 4-1 must be calibrated to satisfy its own specifications and required characteristics. If the recommended model is not available, any instrument whose specifications equal to or surpass the required specifications may be substituted.

5-9. ADJUSTMENT RELATIONSHIPS

5-10. The adjustment procedures described in this section, beginning with paragraph 5-24, should be performed in the order described because each step is interactive. Neglecting or changing the order of the procedures may make it impossible to obtain optimum instrument performance. Table 5-2 lists necessary adjustment procedures after the instrument has been repaired.

5-11. ADJUSTMENT LOCATIONS

5-12. To help locate the appropriate adjustment points, brief descriptions of their locations are given in each adjustment section. Refer to Section VIII for overall component locations. The locations, connectors, and other components related to the adjustment are shown in the individual board assembly component illustrations (fold-out service sheets).

Table 5-1. Adjustable Components

Paragraph	Reference Designator	Name of Control	Description
5-23	INTENSITY FOCUS	INTENSITY FOCUS	Adjusts the writing beam intensity and focus.
5-24	A11R17	V ADJ	Adjusts the power supply voltage by adjusting switching duty cycle.
5-25	A3R30	C ADJ	Eliminates AC offset generated in the sample hold switch.
5-26	A4C1 A4C2 A4C3 A4C4 A4C5 A4C6 A4C7 A4C8 A4C9 A4C10	I1 V1 I2 V2 I3 V3 I4 V4 E1 E2	Eliminates AC offset generated in the demultiplexer.
5-27	A4R11	GAIN	Adjusts the gain of the D-A converter for analog output.
5-28	A3R1	AD GAIN	Adjusts the gain of the A-D converter.
5-29	A16R4 A16R104	G ADJ G ADJ	Adjusts the gain of Voltage Monitor 1 (Vm 1) and Voltage Monitor (Vm 2).
5-52	DRIVE MOTOR		Adjusts the drive belt tension for optimum read/write capability of the flexible-disc drive.
5-53	R47		Adjusts the index timing for correct sector selection.
5-54	STEPPER MOTOR		Adjusts the track alignment for accessing a specified track.
5-55	TRACK ZERO SWITCH		Adjusts the switching timing of the track zero switch.
5-56	R69		Minimizes jitter in read data for proper read data sampling.
5-57	INDEX DETECTOR		Adjusts the index detector alignment for correct sector selection.

5-13. INITIAL OPERATING PROCEDURES

5-14. Before making the adjustments described starting in paragraph 5-23, perform the procedures described in paragraph 5-15 through 5-22 to locate and to gain access to adjustment controls. These procedures provide access to the various adjustment points and facilitate thoroughgoing adjustment. The Initial Control Settings described in paragraph 3-14 must be used for each adjustment, and COM (COMMON)-GROUND terminals, located on the rear panel, must be shorted using the shorting bar.

5-15. BASIC OPERATING CHECKS

5-16. Check that the instrument's line voltage selector switches, located on the rear panel, are set for the local line voltage. This should be performed before making any adjustments.

After the recommended 40 minute warm-up period, the instrument should pass the SELF TEST (no error messages appear), and the initial control settings should be automatically set in preparation for measurement. If the instrument displays an error message or does not have the correct initial control settings, refer to the troubleshooting procedures given in Section VIII.

5-17. TOP COVER REMOVAL

5-18. Remove the top cover in order to gain access to the adjustment controls as follows :

- (1) Fully loosen the retaining screw at the rear of the top cover.
- (2) Slide the top cover towards the rear and lift off.

5-19. BOTTOM COVER REMOVAL

5-20. Remove the bottom cover in order to gain access to the adjustment controls as follows:

- (1) Fully loosen the retaining screw at the rear of the bottom cover.
- (2) Slide the bottom cover towards the rear and lift off.

WARNING

WHEN TOP COVER OR BOTTOM COVER IS REMOVED, LIVE COMPONENTS ARE EXPOSED.

5-21. A3 BOARD ACCESS

5-22. The following adjustments procedure and A3SI switch settings are facilitated by extending the A3 SMU Control and A-D Converter Board with an extender board (HP P/N : 04145-66521). The seven bits of A3SI are initially set to all zeros (0000000) and changed as necessary to set the 4145A in test mode. Refer to each adjustment procedure for the required setting.

- (1) Sample Hold Switch AC Offset Adjustment
- (2) Demultiplexer Noise Rejection Adjustment
- (3) D-A Converter Gain Adjustment
- (4) A-D Converter Gain Adjustment

Note

For the above adjustments, the following messages are displayed on the system message line in the order given after the 4145A has been turned on.

- (1) Busy
- (2) Error A01
———about 30 second interval———
- (3)* HP-IB (XX, COMMA, EOI)
FILTER (XX HZ)
CHAN (!!!!DOWN!!!!)

* This message is displayed on the MENU page.

These messages are shown only because the 4145A is in the test mode, and indicate that the 4145A is functioning properly.

WARNING

TO GUARD AGAINST ELECTRICAL SHOCK, USE INSULATED TOOLS FOR ALL ADJUSTMENTS.

Table 5-2. Adjustment Requirements

Assembly Repaired or Replaced	Required Checks/Adjustments
A1 Graphics Display Control Board (P/N: 04145-66501)	None
A2 Microprocessor Digital Control Board (P/N: 04145-66502)	None
A3 SMU Control and A-D Converter Board (P/N: 04145-66503)	Para. 5-25 and -28
A4 D-A Converter Board (P/N: 04145-66504)	Para. 5-26 and -27
A5 SMU Board (P/N: 04145-66505)	None
A9 HP-IB and MSU Control Board (P/N: 04145-66509)	None
A10 Keyboard and Display Control Board (P/N: 04145-66510)	None
A11 Switching Power Supply Board (P/N: 04145-66511)	Para. 5-24
A12 DC Power Supply Board (P/N: 04145-66512)	None
A13 SMU Power Source Board (P/N: 04145-66513)	None
A15 Floating Power Supply Board (P/N: 04145-66515)	None
A16 Vs/Vm Board (P/N: 04145-66516)	Para. 5-29

Table 5-2. Adjustment Requirements (Cont'd)

Assembly Repaired or Replaced	Required Checks/Adjustments
Graphics Display Unit (HP 1345A)	Refer to the 1345A's manual.
Flexible-disc Drive (P/N: 0950-0863) <ul style="list-style-type: none"> <li data-bbox="233 453 829 510">(1) PC Board Assembly (P/N: 04145-65110) Replacement <li data-bbox="233 527 727 583">(2) Drive Belt (P/N: 04145-65114) Replacement <li data-bbox="233 600 899 657">(3) Head Carriage Assembly (P/N: 04145-65112) Replacement <li data-bbox="233 674 899 730">(4) Front Cabinet Assembly (P/N: 04145-65113) Replacement <li data-bbox="233 747 870 804">(5) Drive Motor Assembly (P/N: 04145-65111) Replacement <li data-bbox="233 821 786 877">(6) LED (P/N: 04145-65115) for write- protection <li data-bbox="233 894 902 921">(7) LED (P/N: 04145-65115) for Index Detector <li data-bbox="233 938 862 995">(8) Phototransistor (P/N: 04145-65116) for write-protection <li data-bbox="233 1012 862 1068">(9) Phototransistor (P/N: 04145-65116) for index detection 	Para. 5-43 and -46 Para. 5-53, -56, and -57 Para. 5-52 and -53 Para. 5-54, -55, and -56 Para. 5-53, -56, and -57 Para. 5-52 and -53 Verify that the write-protect function works properly. Para. 5-57 Verify that the write-protect function works properly. Para. 5-57

ADJUSTMENTS

5-23. GRAPHICS DISPLAY UNIT INTENSITY AND FOCUS CHECK AND ADJUSTMENT

PURPOSE: This check and adjustment sets intensity and focus of the 4145A Graphic Display Unit (GDU) for clear display.

PROCEDURE:

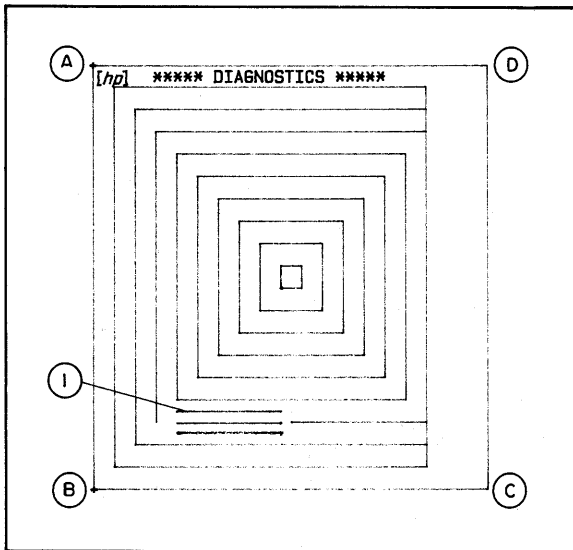

Figure 5-1. Test Pattern for GDU.

1. Obtain the DIAGNOSTICS page by pressing the EXTN softkey and the DIAG softkey while viewing the MENU page.
2. Display the test pattern (Figure 5-1) by pressing the G.D. TEST softkey.
3. Adjust INTENSITY with an insulated screwdriver until line 1 (see Figure 5-1) is just barely visible. Refer to Figure 5-2 for the INTENSITY adjustment location.
4. Adjust FOCUS for sharp, well-defined trace at points A, B, C, and D first, then over the entire CRT. Refer to Figure 5-2 for the FOCUS adjustment location.

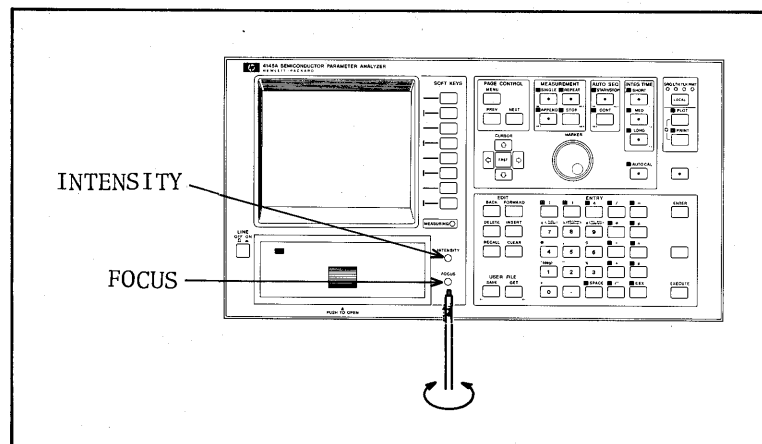

Figure 5-2. INTENSITY and FOCUS Locations.

ADJUSTMENTS

Note 1

If the writing beam intensity and focus cannot be properly adjusted or if any distortion of trace is observed, refer to Section IV and V of the 1345A's Operating and Service Manual, located at the back of this binder.

Note 2

When the procedures in Section IV and V of the 1345A's Operating and Service manual are performed, the connector on the 4145A's A1 GDU Control Board must be disconnected. See Figure 5-3 for the connector location.

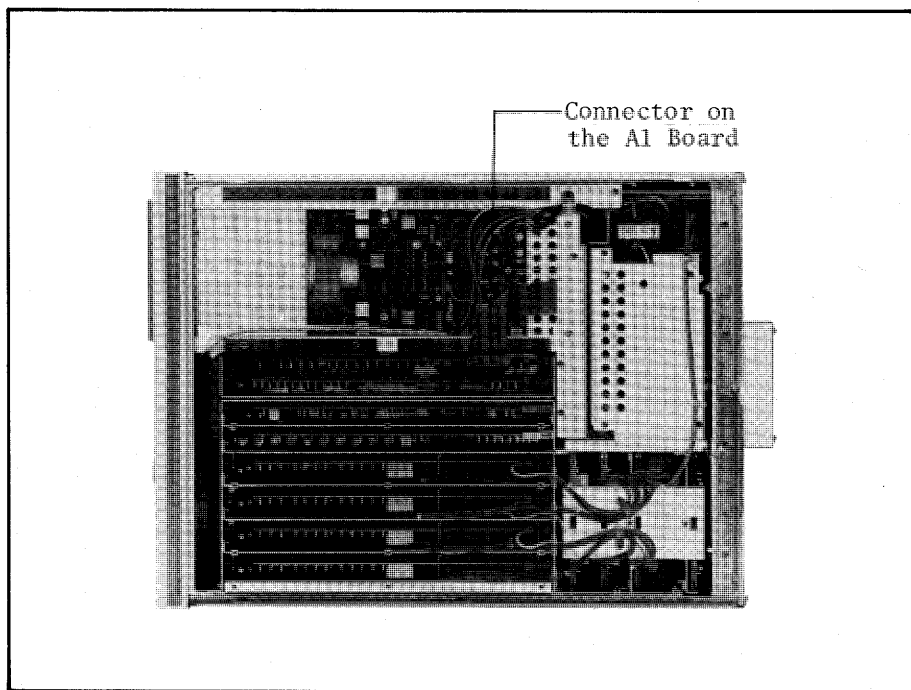

Figure 5-3. Connector Location.

ADJUSTMENTS

5-24. DC POWER SUPPLY ADJUSTMENT

PURPOSE: This adjustment accurately sets the regulated power supply output voltage for all sections of the 4145A.

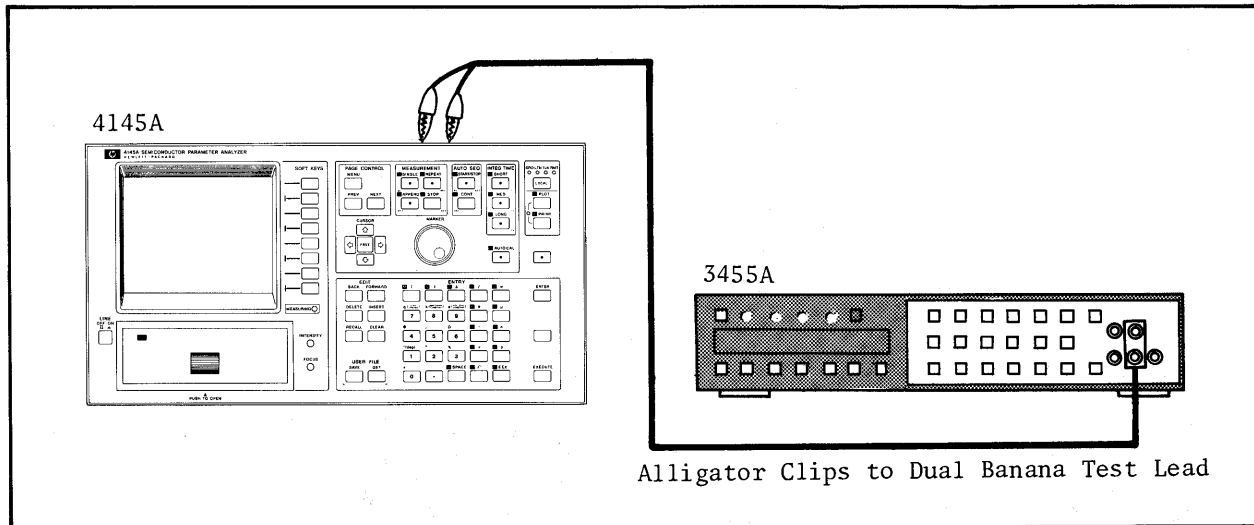

Figure 5-4. DC Power Supply Adjustment Setup.

EQUIPMENT:

DVM*	HP MODEL 3455A
Test Lead (alligator clips to dual banana plug)	HP MODEL 11002A
Test Lead (probe and alligator clip to dual banana plug)	HP MODEL 11003A

*DVM must have at least 3 1/2 digit display capability.

PROCEDURE:

1. Connect the DVM HI input to A2TP16 (+5V) (see Figure 5-7 for the location), and the LOW input to the chassis using an alligator clip-to-dual banana plug test lead.

2. Set the 3455A's controls as follows:

FUNCTION	==V
RANGE	AUTO
TRIGGER	INTERNAL

3. Disconnect the test fixture and cables from the 4145A, then turn on the 4145A and the 3455A.

Note

Perform adjustment and checks while viewing the MENU page.

ADJUSTMENTS

4. Adjust A11R17 (see Figure 5-6 for location) until the reading on the DVM is between 5.040V and 5.065V when 100 volt power line voltage is used. Use an insulated screwdriver.

Note

When 115 or 220 volt power line voltage is used, the limit is between 5.050V and 5.075V.

WARNING

A11R17 IS LOCATED BENEATH THE SHIELD ON THE A11 BOARD. DO NOT REMOVE THE SHIELD FOR THIS ADJUSTMENT. DC VOLTAGES EXCEEDING 100V ARE PRESENT ON THE A11 BOARD.

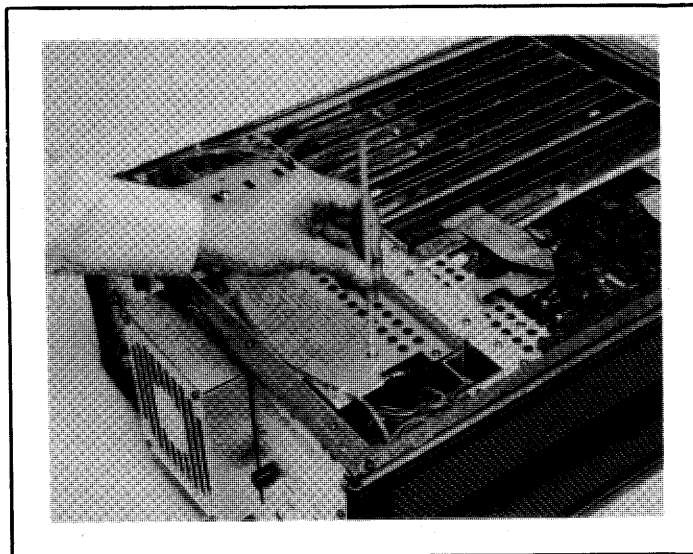

Figure 5-5. A11R17 Adjustment.

5. Connect the DVM to the points listed in Table 5-3, and verify that the DVM readout at each point is within the limits given in the table. Refer to Figure 5-7 for the locations of the points listed in Table 5-3.

WARNING

WHEN A5J1 PIN 1 AND A5J1 PIN10 ARE CHECKED, THE 11003A TEST LEAD (PROBE AND ALLIGATOR CLIP TO DUAL BANANA) SHOULD BE USED FOR THE CHECK. IF THE TEST LEAD IS NOT AVAILABLE, USE THE 11002A TEST LEAD WITH A SHORT WIRE AS SHOWN IN FIGURE 5-6, BUT BE CAREFUL. DC VOLTAGE EXCEEDING 100V IS PRESENT AT THE CHECK POINT.

ADJUSTMENTS

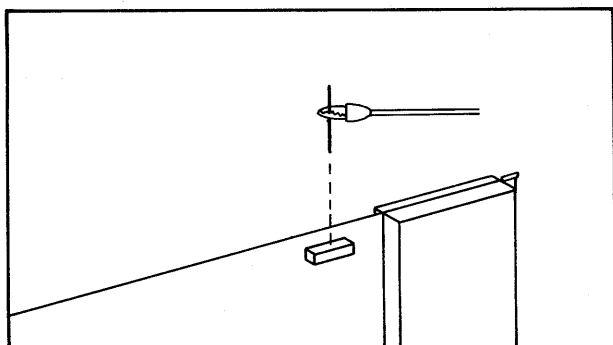

Figure 5-6. A5J1 Check.

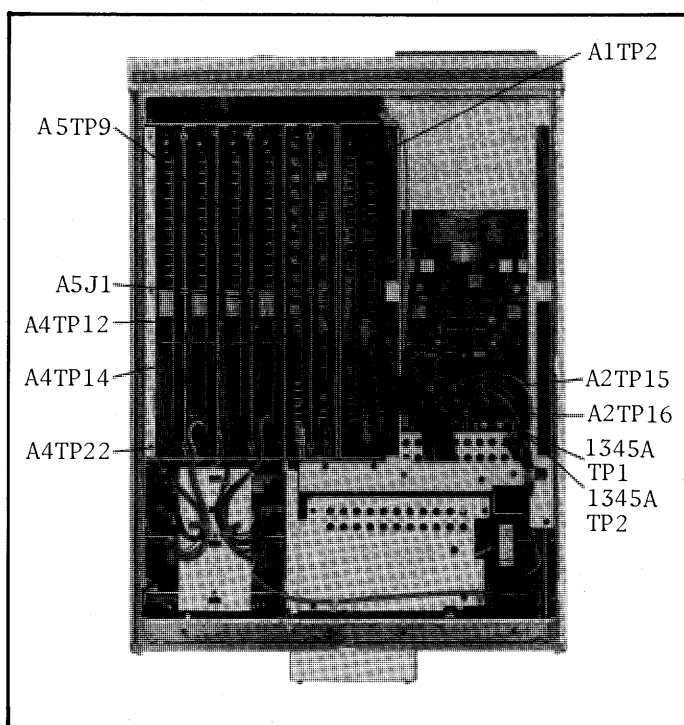

Figure 5-7. Check Point Locations.

Table 5-3. Check Points and Limits

Grounded Section			Floated Section		
Test Lead Connection		Limit	Test Lead Connection		Limit
HI input	LOW input		HI input	LOW input	
A2TP14	GND (CHASSIS)	$-5V \pm 0.25V$	A4TP12	A5TP9 (CM*)	$15V \pm 0.5V$
A2TP15	GND (CHASSIS)	$12V \pm 1.2V$	A4TP14	A5TP9 (CM*)	$-15V \pm 0.5V$
1345A TP1	GND (CHASSIS)	$-15V \pm 0.75V$	A4TP22	A5TP9 (CM*)	$5V \pm 0.25V$
1345A TP2	GND (CHASSIS)	$15V \pm 0.75V$	A5J1 pin 1	A5TP9 (CM*)	$130V - 13V + 26V$
			A5J1 pin10	A5TP9 (CM*)	$-130V + 13V - 26V$

* CM: COMMON

ADJUSTMENTS

5-25. SAMPLE HOLD SWITCH AC OFFSET ADJUSTMENT

PURPOSE: This adjustment eliminates AC offset generated by A3U24 (Sample Hold Switch).

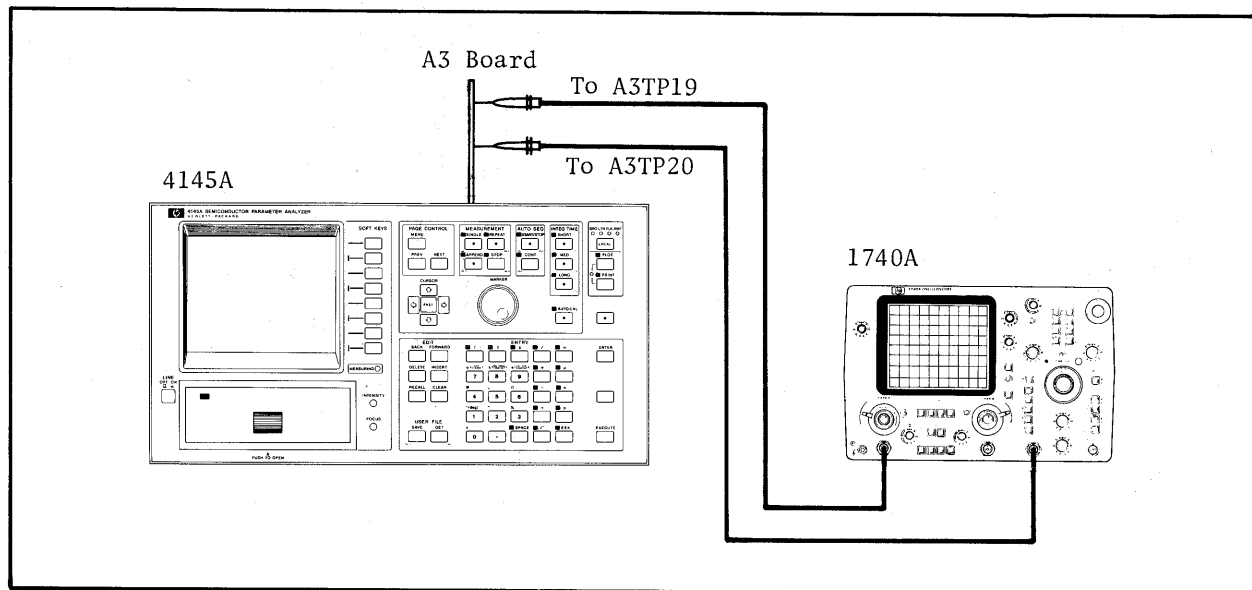

Figure 5-8. Sample Hold Switch AC Offset Adjustment Setup.

EQUIPMENT:

- Oscilloscope HP MODEL 1740A
- 1 : 1 Probe (2 ea) HP MODEL 10007B
- Extender Board HP P/N 04145-66521

PROCEDURE:

1. Extend the A3 SMU Control and A-D Converter Board with the extender board (HP P/N : 04145-26521).
2. Set A3S1 (SW1) to 1001011. See Figure 5-10 for the location of A3S1.
3. Verify that A3W2 through A3W6 are set to N (Normal Mode).
4. Connect the channel A or B input to A3TP19 and the EXT TRIGGER input to A3TP20 (see Figure 5-10 for the locations). Obtain channel A or B input GND (ground) from A3TP3.

CAUTION

BE CAREFUL NOT TO TOUCH THE GND CLIP TO A3TP2 and A3TP4. ±15 VOLTS IS PRESENT AT THE TEST POINTS.

5. Set the 1740A's controls as follows :

- VOLT/DIV 0.005
- COUPLING AC
- TIME/DIV 0.1msec
- TRIGGER EXT
- SWEEP MODE NORM
- MAGx5 ON

ADJUSTMENTS

6. Disconnect the test fixture and cables from the 4145A, then turn on the 4145A and the 1740A.
7. Adjust A3R30 (see Figure 5-10 for the location) until the height of the pulse at A3TP19 is minimized (less than 0.5mV) as shown in Figure 5-9.

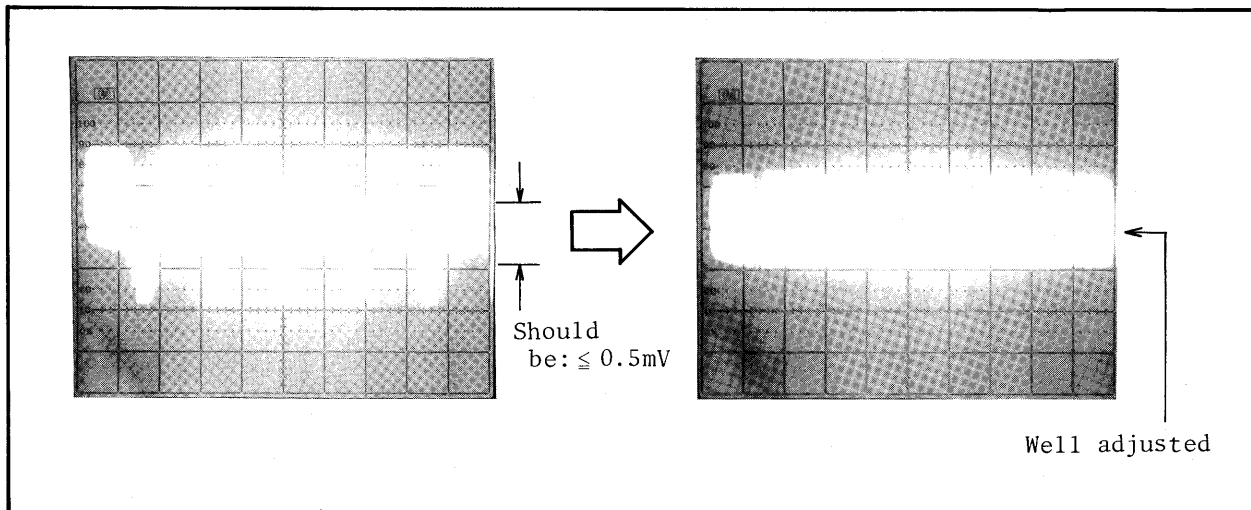

Figure 5-9. AC Offset Adjustment.

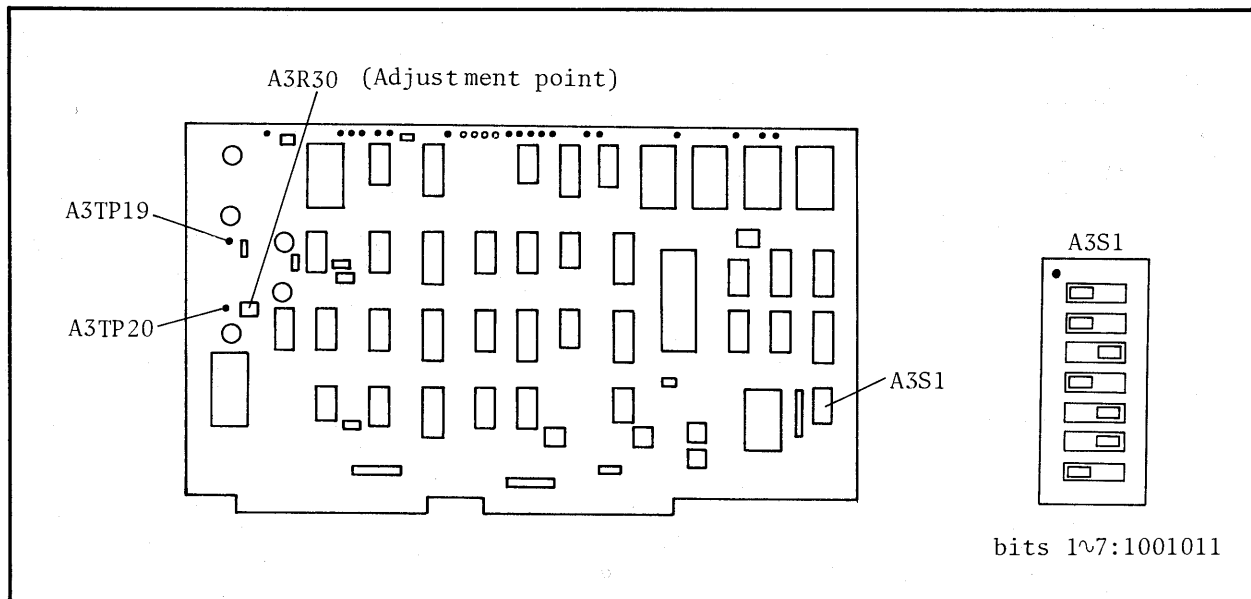

Figure 5-10. Check/Adjustment Point Locations.

ADJUSTMENTS

5-26. DEMULTIPLEXER NOISE REJECTION ADJUSTMENT

PURPOSE: This adjustment eliminates AC offset generated by the demultiplexer (Sample Hold Switch) on the A4 board.

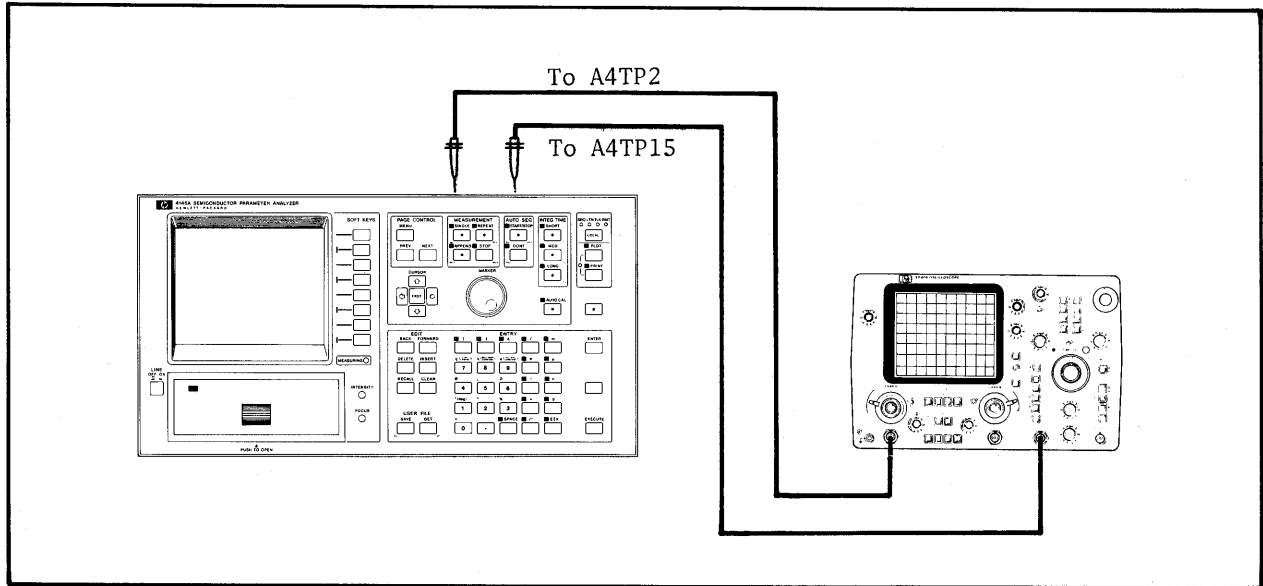

Figure 5-11. Demultiplexer Noise Rejection Adjustment Setup.

EQUIPMENT:

- Oscilloscope HP MODEL 1740A
- 1 : 1 Probe (2ea) HP MODEL 10007B

PROCEDURE:

1. Remove the A3 SMU Control and A-D Converter Board and the A4 D-A Converter Board, and set A3S1 (SW1) to 1001011. See Figure 5-13 for the location of A3S1.
2. Verify that jumpers A3W2 through A3W6 and A4W1 (see Figure 5-13) are set to N (Normal Mode).
3. Reinstall the A3 and A4 boards.
4. Connect the channel A or B input to A4TP2 and the EXT TRIGGER input to A4TP15 (see Figure 5-13 for the locations). Obtain channel A or B input GND (ground) from A4TP13.

CAUTION

BE CAREFUL WHEN CONNECTING THE GND CLIP. ±15 VOLTS IS PRESENT AT A4TP12 AND A4TP14.

ADJUSTMENTS

5. Set the 1740A's controls as follows :

VOLT/DIV 0.005
 COUPLING AC
 TIME/DIV 0.2msec
 TRIGGER EXT
 SWEEP MODE NORM
 MAGx5 ON

6. Disconnect the test fixture and cables from the 4145Aa, then turn on the 4145A and 1740A.
7. Adjust A4C1 until the height of the pulse at A4TP2 is minimized (less than 0.5mV) as shown in Figure 5-14.
8. Perform step 7 for each test point/trimmer capacitor combination listed in Table 5-4.

Table 5-4. Test Point/Trimmer Capacitor Combinations

Test Point/Trimmer Capacitor Combinations	
Test Point	Trimmer Adjusted
A4TP3	A4C2
A4TP4	A4C3
A4TP5	A4C4
A4TP6	A4C5
A4TP7	A4C6
A4TP8	A4C7
A4TP9	A4C8
A4TP10	A4C9
A4TP11	A4C10

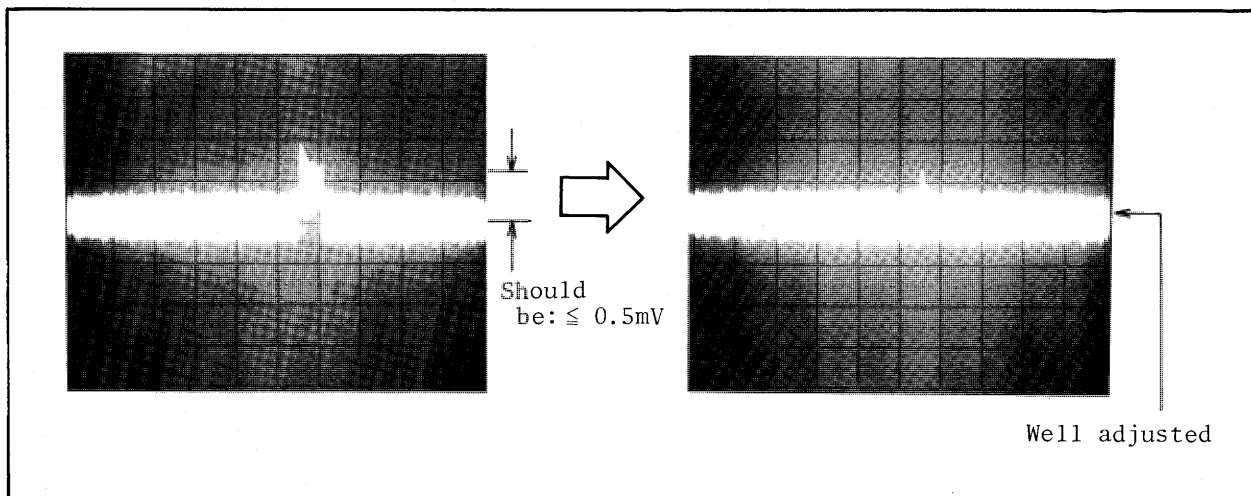

Figure 5-12. Scope Display for Adjustment.

ADJUSTMENTS

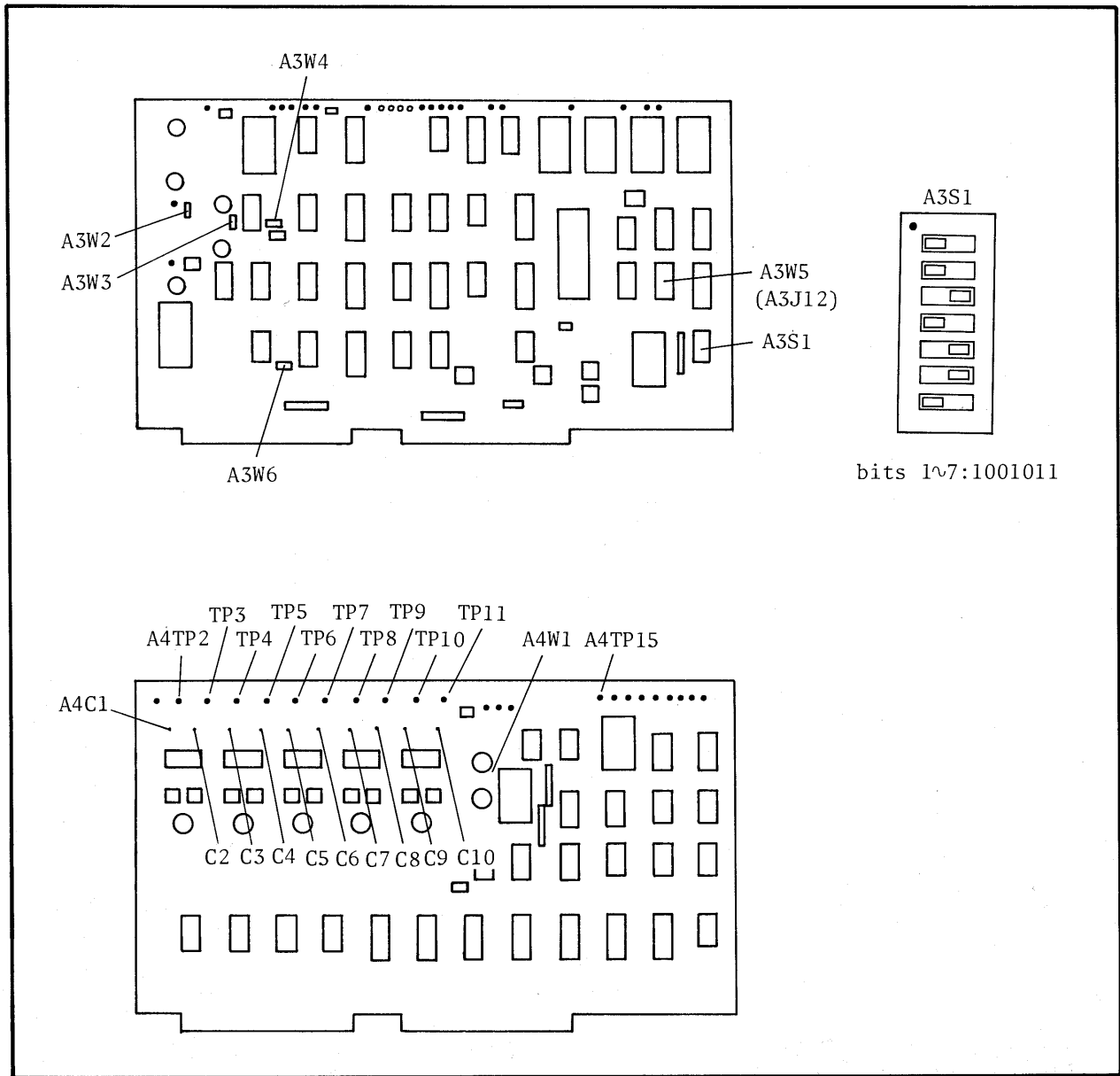

Figure 5-13. Test Point Locations.

ADJUSTMENTS

5-27. D-A CONVERTER GAIN ADJUSTMENT

PURPOSE: This adjustment accurately sets the gain of the D-A Converter for analog output.

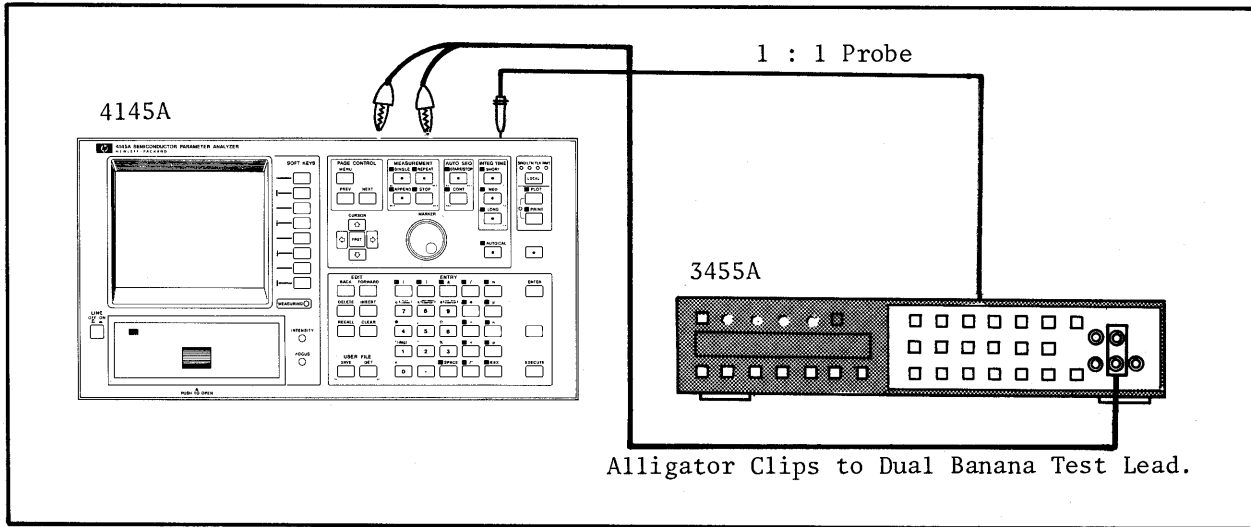

Figure 5-14. D-A Converter Gain Adjustment Setup.

EQUIPMENT:

- DVM HP MODEL 3455A*
- Test Lead (alligator clips to dual banana plug) HP MODEL 11002A
- 1 : 1 Probe HP MODEL 10007B

* The 3455A must be calibrated before this adjustment.

PROCEDURE:

1. Remove the A3 SMU Control and A-D Converter Board and A4 D-A Converter Board, and set A3S1 (SW1) to 1001100. See Figure 5-15 for the location of A3S1.
2. Verify that jumpers A3W2 through A3W6 and A4W1 (see Figure 5-15 for the locations) are set to N (Normal Mode).
3. Reinstall the A3 and A4 boards.
4. Connect DVM HI input to A4TP2 (-10V), LOW input to A4TP13 (AGND : analog ground), and EXT TRIGGER input to A4TP15 (see Figure 5-11 for the locations).

CAUTION

BE CAREFUL WHEN THE LOW INPUT IS CONNECTED TO A4TP13. ±15V IS PRESENT AT A4TP12 AND A4TP14.

ADJUSTMENTS

- Set the 3455A's controls as follows :

FUNCTION = V
 RANGE AUTO
 TRIGGER EXT

- Disconnect the test fixture and cables from the 4145A, then turn on the 4145A and the 3455A.
- Adjust A4R11 (see Figure 5-11 for location) until the reading on the DVM is $-10.000V \pm 0.5mV$. The voltage at A4TP2 is a staircase signal. Adjust A4R11 only at the -10V step.

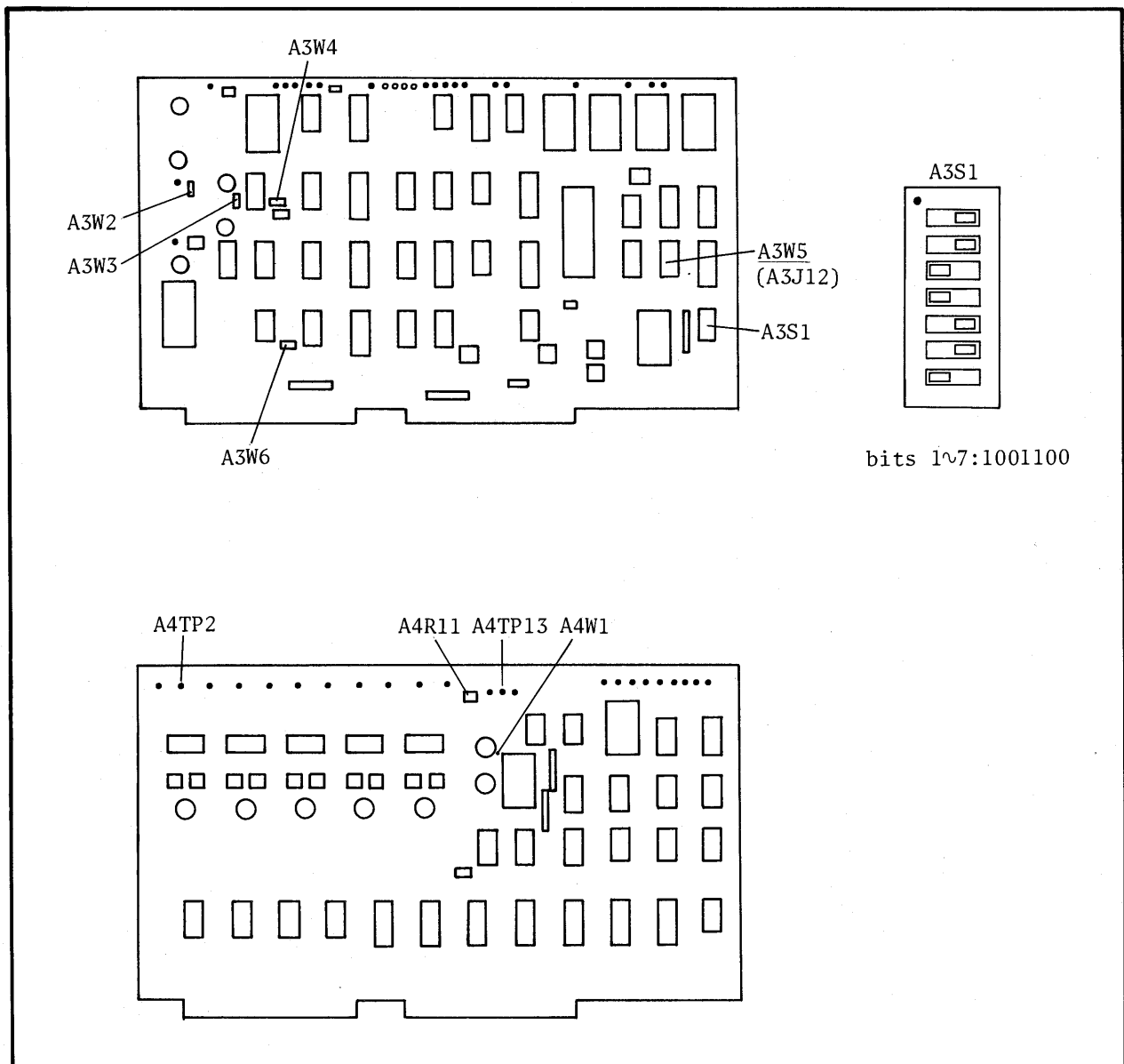

Figure 5-15. Check/Adjustment Point Locations.

ADJUSTMENTS

5-28. A-D CONVERTER GAIN ADJUSTMENT

PURPOSE: This adjustment accurately sets the gain of the A-D converter.

1. Remove the A3 SMU Control and A-D Converter Board and the A4 D-A Converter Board, and set A3S1 (SW1) to 1001101. See Figure 5-17 for the location of A3S1.
2. Verify that jumpers A3W2 through A3W6 and A4W1 (see Figure 5-16 for the locations) are set to N (Normal Mode).
3. Reinstall the A3 and A4 boards.
4. Disconnect the test fixture and cables from the 4145A, then turn on the 4145A.
5. Adjust A3R1 (see Figure 5-17 for the location) until the LED annunciator pattern indicates "pass" as shown in Figure 5-16.

RESULT	Annunciators				Description
	DS1	DS2	DS3	DS4	
Pass	○	○	○	○	Adjustment is accurately set.
Fail	●	●	○	○	Gain is under-adjusted. Adjust A3R1 clockwise.ckwise.
Fail	○	○	●	●	Gain is over-adjusted. Adjust A3R1 counterclockwise.

○ : ON (blinking), ● : OFF

Figure 5-16. Results from LED Annunciators.

ADJUSTMENTS

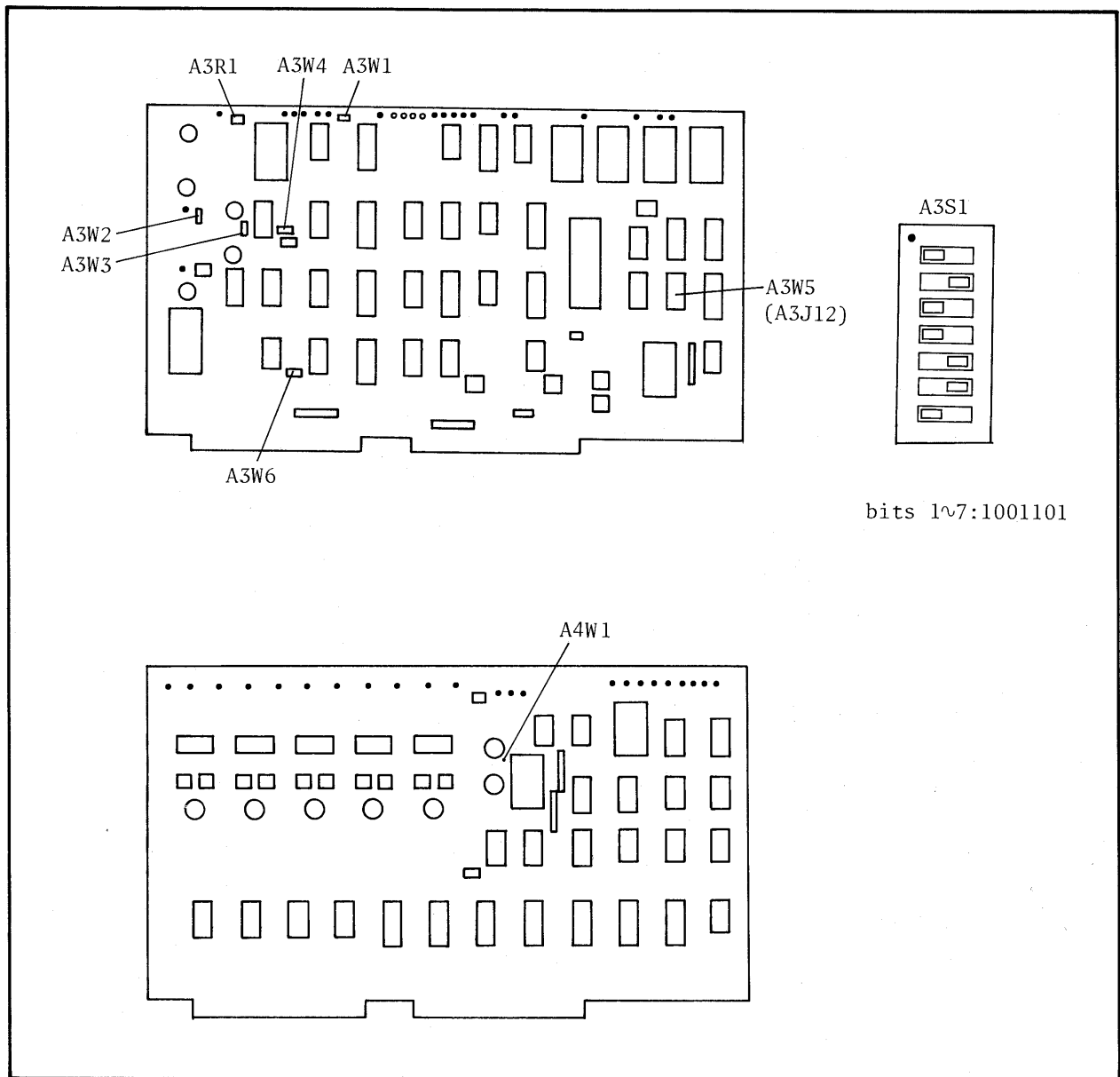

Figure 5-17. Check/Adjustment Point Locations.

ADJUSTMENTS

5-29. VM RANGE ADJUSTMENT

PURPOSE : This adjustment accurately sets the gain of the Voltage Monitor 1 (Vm1) and Voltage Monitor 2 (Vm2).

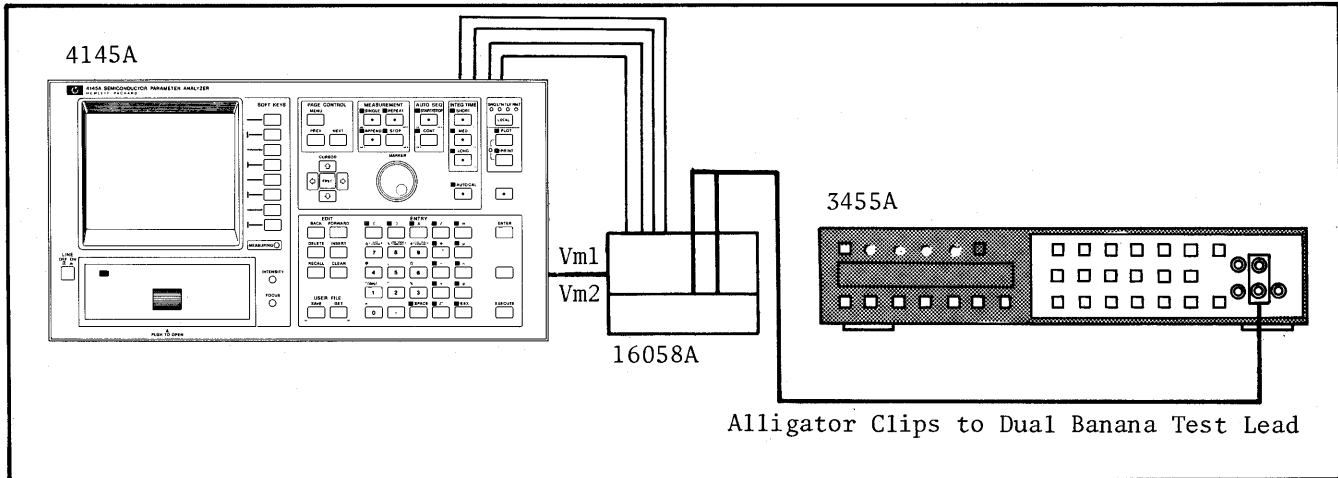

Figure 5-18. VM Range Adjustment Setup.

EQUIPMENT :

- DVM HP MODEL 3455A
- Test Fixture (with cables) HP MODEL 16058A
- TEST Lead (alligator clips to dual banana plug) HP MODEL 10007B

PROCEDURE :

1. Connect the 16058A and the 4145A with the triaxial cables and the system cable (furnished with the 16058A).
2. Set the 4145A's controls as follows :
 - i) On the CHANNEL DEFINITION page :

Set up the page as shown in the figure.

[hp] *** CHANNEL DEFINITION ***

CHAN	NAME		SOURCE	
	V	I	MODE	FCTN
SMU1	V1	I1	V	CONST
SMU2	V2	I2	V	CONST
SMU3	V3	I3	V	VAR1
SMU4				
Vs 1		-----	V	
Vs 2		-----	V	
Vm 1	VM1	-----	----	----
Vm 2	VM2	-----	----	----

USER	FCTN	NAME (UNIT) = EXPRESSION
1		() =
2		() =

ADJUSTMENTS

- ii) On the SOURCE SET UP page and MEAS & DISP MODE SET UP page :

Set up the pages as shown in the figure below :

[hp] ***** SOURCE SET UP *****

	VAR1	VAR2
NAME	V3	
SWEEP MODE	LINEAR	LINEAR
START	.0000V	
STOP	1.0000V	-----
STEP	1.0000V	
NO. OF STEP	2	
COMPLIANCE	100.0mA	

CONSTANT	SOURCE	COMPLIANCE
V1	V	20.000V 100.0mA
V2	V	20.000V 100.0mA

[hp] ** MEAS & DISP MODE SET UP **

MEASUREMENT MODE: SWEEP _____

DISPLAY MODE: LIST

NAMES	VM1
	VM2

- iii) INTEG TIME LONG

- 3. Connect the cables between the Personality Board and socket board as shown below. Use any of the socket boards and miniature banana-pin plug cables* (furnished with the 16058A).

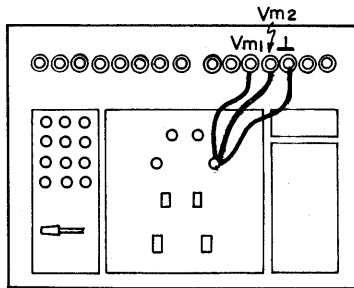

- 4. Set the 3455A's controls as follows :

FUNCTION == V
 RANGE AUTO
 TRIGGER INTERNAL

- 5. Perform measurement by pressing the REPEAT key.

ADJUSTMENTS

6. Record the readings on the 4145A for offset value $VM1_0$ (for $Vm1$) and $VM2_0$ (for $Vm2$).
7. End measurement by pressing the STOP key.
8. Change the cable connection to monitor the voltage value between point A and the ground terminal with the 3455A as shown below. Then press the REPEAT key.

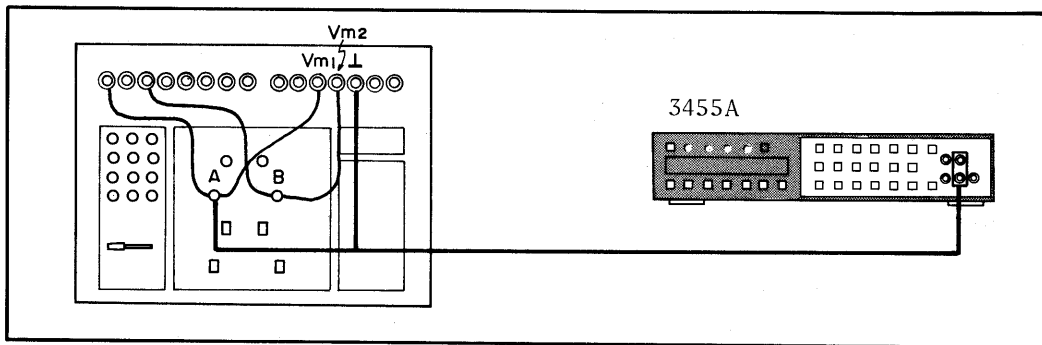

9. Adjust A16R4 (see Figure 5-19 for the location) for $Vm1$ gain until $VM1$ (value displayed on the 4145A) and $Vdvm1$ (reading on the 3455A) satisfy the following inequality. Then press the STOP key.

$$VM1 - 5/2VM1_0 - 10 \text{ counts} \leq Vdvm1 \leq VM1 - 5/2VM1_0 + 10 \text{ counts}$$

10. Change the 3455A's connection to point B, then press the REPEAT key.
11. Adjust A16R104 (see Figure 5-19 for the location) for $Vm2$ gain until $VM2$ (value displayed on the 4145A) and $Vdvm2$ (reading on the 3455A) satisfy the following inequality. Then press the STOP key.

$$VM2 - 5/2VM2_0 - 10 \text{ counts} \leq Vdvm2 \leq VM2 - 5/2VM2_0 + 10 \text{ counts}$$

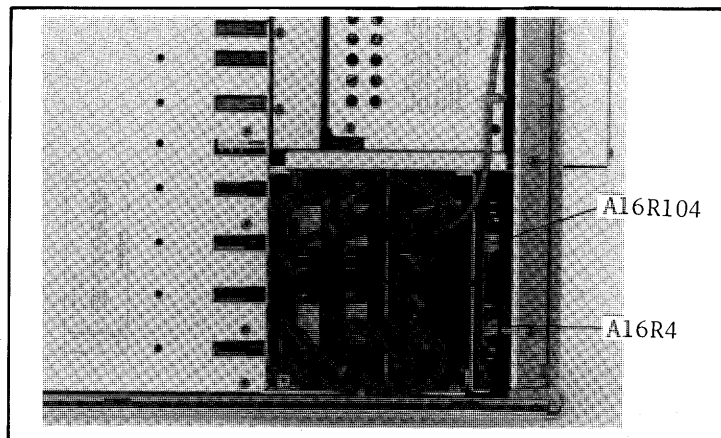

Figure 5-19. Adjustment Point Locations.

5-30. MASS STORAGE UNIT TEST

5-31. The Mass Storage Unit (MSU) consists of flexible-disc drive (FDD) and a disc (software disc). The MSU Test includes disc check and flexible-disc drive checks and adjustments described starting in paragraph 5-43.

5-32. FLEXIBLE-DISC DRIVE ACCESS

5-33. To facilitate throughgoing adjustment of the flexible-disc drive, the drive unit must be pulled out (removed but not electrically disconnected) from the 4145A.

1. Stand the 4145A on its side, and remove the bottom cover.
2. Loosen and remove the four retaining screws from the flexible-disc drive.
3. Carefully remove the drive unit from the 4145A through the front panel. Leave all cables connected to the drive unit.
4. Place the drive unit on a clean work surface as shown in Figure 5-20.

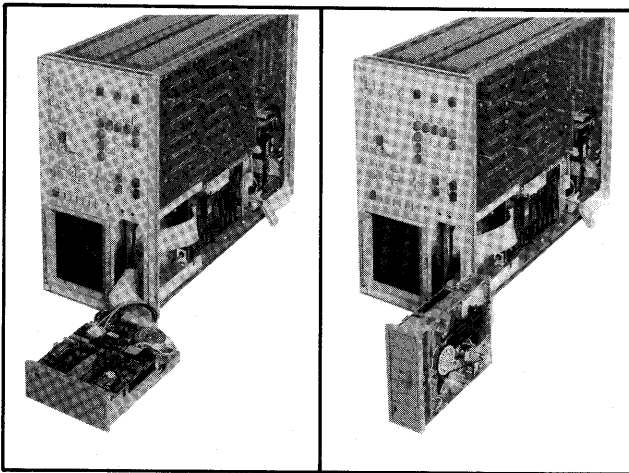

Figure 5-20. Flexible-disc Drive Access.

5-34. DISC CHECK

5-35. A visual check of the disc should be made periodically. When contamination, wear, bends, or creases are observed, and the 4145A is experiencing an MSU trouble, try the MSU operation again using a new disc. If the anomaly persists, perform the SMU tests described

starting in paragraph 5-43. A good rule of thumbs is to use a new disc instead of the suspicious disc even if the disc is visually perfect. For troubleshooting the MSU, see to Section VIII in this manual and contact the nearest Hewlett-Packard Sales Office.

5-36. FLEXIBLE-DISC DRIVE CHECKS AND ADJUSTMENTS

5-37. There are eight flexible-disc drive checks and adjustments:

- (1) MSU Read Test (paragraph 5-43)
- (2) MSU Write Test (paragraph 5-46)
- (3) Drive Belt Tension Check and Adjustment (paragraph 5-52)
- (4) Index Timing Check and Adjustment (paragraph 5-53)
- (5) Track Alignment Check and Adjustment (paragraph 5-54)
- (6) Track Zero Switch Check and Adjustment (paragraph 5-55)
- (7) Jitter Check and Adjustment (paragraph 5-56)
- (8) Index Detector Alignment Check and Adjustment (paragraph 5-57)

To perform checks and adjustments 1 through 8, except 3, the 4145A must be set to MSU DIAGNOSTICS Mode. See paragraph 5-40 for details.

5-38. SURE FLEXIBLE-DISC DRIVE CHECKS AND ADJUSTMENTS

5-39. Be aware of the following cautions for your own protection and to avoid damage to the flexible-disc drive.

WARNING

MOST OF THE FLEXIBLE-DISC DRIVE CHECKS AND ADJUSTMENTS DESCRIBED HEREIN ARE PERFORMED WITH POWER SUPPLIED TO THE INSTRUMENT. SUCH ADJUSTMENTS MUST BE PERFORMED ONLY BY QUALIFIED SERVICE PERSONNEL.

5-40. MSU DIAGNOSTICS MODE

5-41. When checks and adjustments of the flexible-disc drive (FDD) are performed, the 4145A must be set to MSU (Mass Storage Unit) DIAGNOSTICS Mode. The mode is provided to perform checks and adjustments of the FDD without using special electronic tools. When the 4145A is in MSU DIAGNOSTICS mode, the drive motor of the FDD goes on automatically. MSU DIAGNOSTICS Mode is used for the MSU Read Test, the MSU Write Test, and the MSU EXERCISER listed in Table 5-5.

5-42. Set the 4145A to the MSU DIAGNOSTICS mode is as follows :

1. Turn off the 4145A, and remove the top cover.
2. Remove A2U14 and install the MSU Test ROM (A1U8; HP P/N 04145-85018) in its place. The MSU Test ROM is provided on the A1 Graphic Display Control Board. See Figure 5-21 for A2U14 and MSU Test ROM locations.
3. Set A2S1 to 1010011. See Figure 5-21 for the A2S1 setting and its location. The seven bits of A2S1 are initially set to all ones (1111111). After checks and adjustments of the FDD have been performed, A2S1 must be set to the initial setting.

Table 5-5. MSU DIAGNOSTICS Mode

Mode	Description	Related Paragraph
MSU READ TEST	The MSU Read Test can be performed when the READ TEST softkey is pressed.	5-43
MSU WRITE TEST	The MSU Write Test can be performed when the WRITE TEST softkey is pressed.	5-46
MSU EXERCISER	The following checks and adjustments of the FDD can be performed: <ol style="list-style-type: none"> 1. Index Timing Check And Adjustment 2. Track Alignment Check And Adjustment 3. Track Zero Switch Check And Adjustment 4. Jitter Check And Adjustment 5. Index Detector Alignment Check And Adjustment 	5-49 5-53 5-54 5-55 5-56 5-57

4. Put the 4145A on its side, and remove the bottom cover.
5. Set A9W3 (see Figure 5-21 for location) from T/N (test/normal position) to E (EXERCISER).
6. Remove the HP-IB cable connector connected to the A9 HP-IB and MSU Control Board from the A9 board.
7. Disconnect the test fixture from the 4145A, then turn on the 4145A. The 4145A will go into MSU DIAGNOSTICS mode and display the MSU DIAGNOSTICS page shown in Figure 5-22.

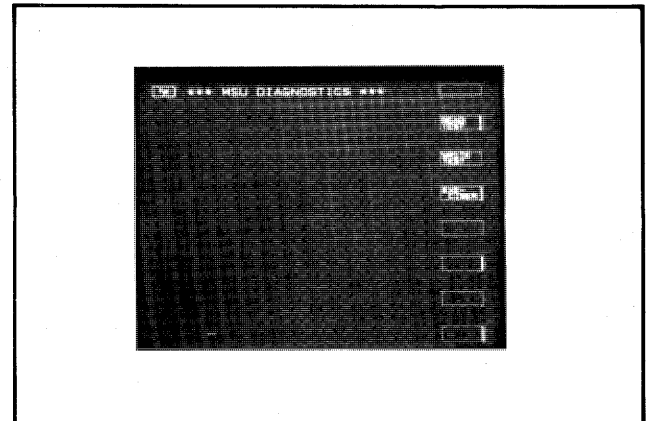
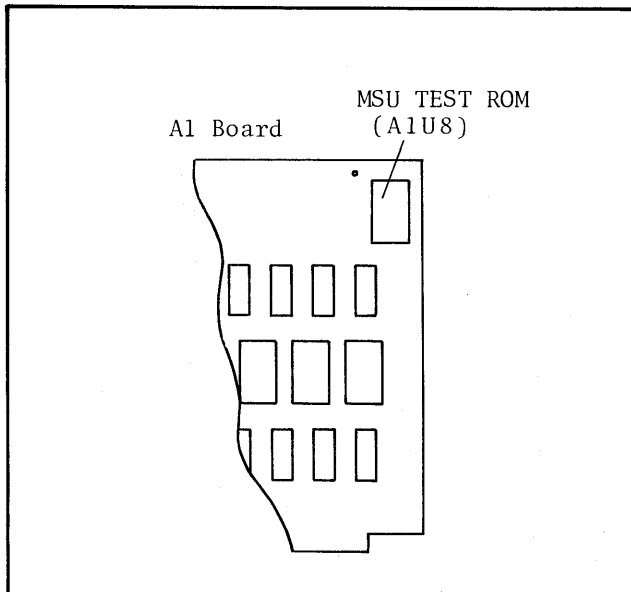

Figure 5-22. CRT Display of MSU DIAGNOSTICS Page.

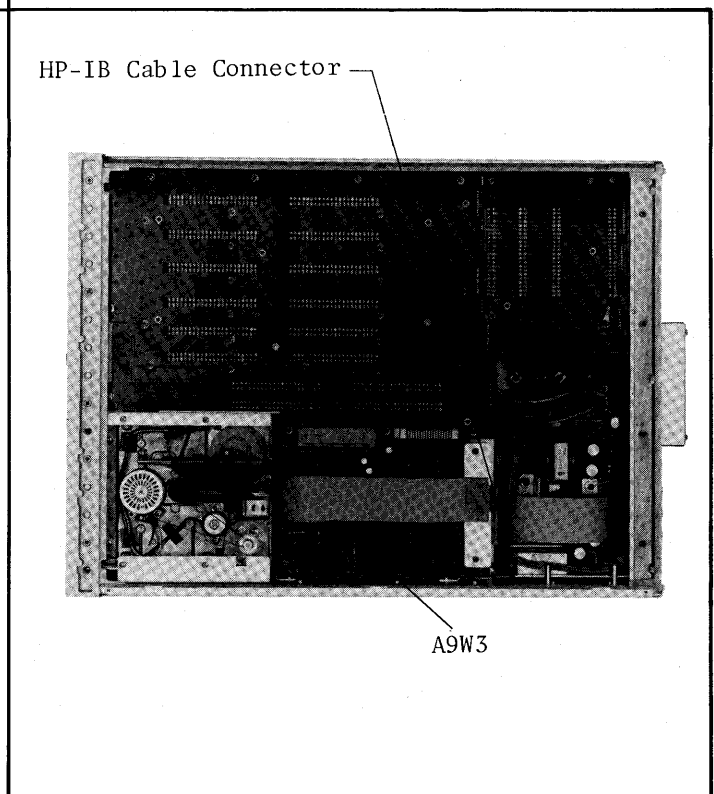
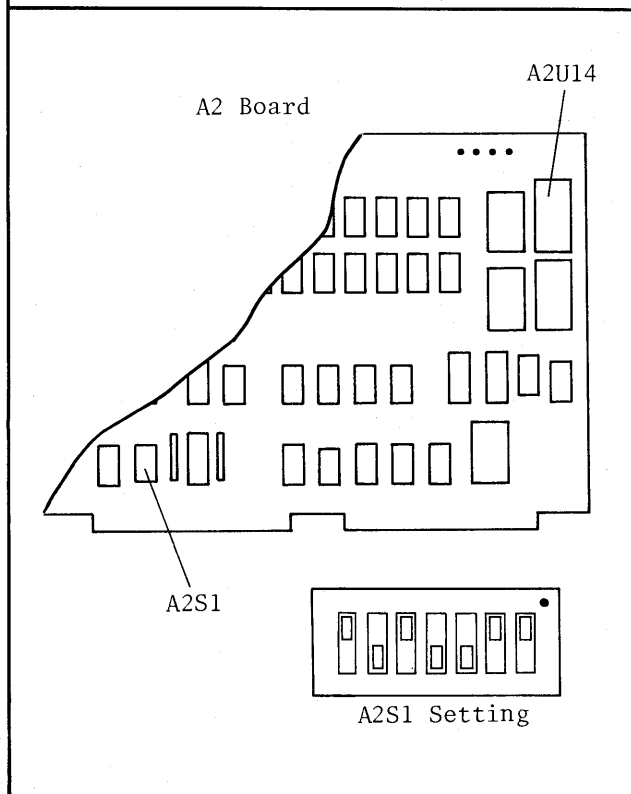

Figure 5-21. Component Locations for MSU DIAGNOSTICS Mode setting.

CHECKS AND ADJUSTMENTS

5-43. MSU READ TEST

5-44. The MSU Read Test is provided for the flexible-disc drive (FDD) read capability check. After the READ TEST softkey has been pressed while viewing the MSU DIAGNOSTICS page, the 4145A displays the screen shown in Figure 5-23-1, and the read test is performed automatically.

5-45. The disc surface is divided into forty tracks, and each track is divided into nine sectors (one sector equals 256 bytes) or 360 sectors total on a single disc. In the MSU Read Test all forty tracks are checked by track and by sector. The test results are displayed on the CRT as shown in Figure 5-23. For the read test, the software disc supplied with 4145A can be used.

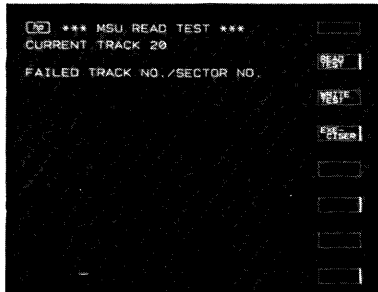

- (1) When the READ TEST softkey is pressed, this display is shown. The display shows the track number where the read test is being performed. When an error is detected, the failed track number and the failed sector number are displayed.

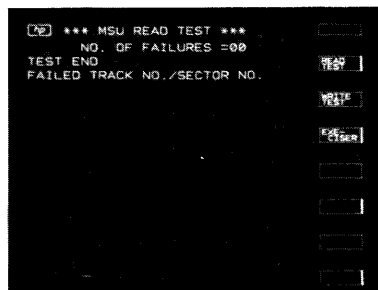

- (2) When no error is detected, this display is shown, and the read test ends automatically.

Figure 5-23. CRT Display of MSU Read Test.

CHECKS AND ADJUSTMENTS

<pre> (1) *** MSU READ TEST *** NO. OF FAILURES =02 TEST END FAILED TRACK NO./SECTOR NO. 20/01 20/02 </pre>	<p>(3) In this case, two errors were detected on sectors 01 and 02 of track 20. If only a few errors are detected, perform the read test again with another disc. If no errors are detected in the second test, the disc used in the first test is probably defective.</p>
<pre> (2) *** MSU READ TEST *** NO. OF FAILURES >65 TEST END FAILED TRACK NO./SECTOR NO. 00/01 00/02 00/03 00/04 00/05 00/06 00/07 00/08 00/09 01/01 01/02 01/03 01/04 01/05 01/06 01/07 01/08 01/09 02/01 02/02 02/03 02/04 02/05 02/06 02/07 02/08 02/09 03/01 03/02 03/03 03/04 03/05 03/06 03/07 03/08 03/09 04/01 04/02 04/03 04/04 04/05 04/06 04/07 04/08 04/09 05/01 05/02 05/03 05/04 05/05 05/06 05/07 05/08 05/09 06/01 06/02 06/03 06/04 06/05 06/06 06/07 06/08 06/09 07/01 07/02 </pre>	<p>(4) If more than sixty-five errors are detected, the read test ends automatically even if not completed. After the display at left has been shown, perform the read test again with another disc. If the results are still the same, the flexible-disc drive is probably defective.</p>

Figure 5-23. CRT Display of MSU Read Test (Cont'd).

Note

If the results of the MSU Read Test are as shown in Figure 5-23-(4) with every disc, the flexible-disc drive is probably at fault. The flexible-disc drive checks and adjustments must be performed, and the troubleshooting procedures described in Section VIII may also be necessary.

CHECKS AND ADJUSTMENTS

5-46. MSU WRITE TEST

5-47. The MSU Write Test is provided for the flexible-disc drive (FDD) write capability check. After the WRITE TEST softkey has been pressed while viewing the MSU DIAGNOSTICS page, the 4145A goes into test status, and the MSU Write Test is performed automatically.

5-48. In the MSU Write Test the following procedure is performed automatically in the order below :

1. Re-format the entire disc surface.
2. Write pattern "1A_H" on all 360 sectors.
3. Read the data "1A_H" and verify that the data has been correctly written. If any errors are detected, display the error message shown in Figure 5-24-(3).
4. Write pattern "E5_H" on all 360 sectors.
5. Read and verify the data "E5_H". If any errors are detected, display the error message shown in Figure 5-24-(3).

The software discs furnished with the 4145A must not be used for the MSU Write Test, because the 4145A's operation software and other important programs and data are lost after the test has been completed. The blank disc, included in FDD Service Kit (HP P/N : 04145-65100), is recommended for use.

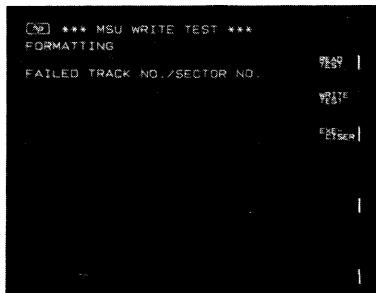

- (1) When the WRITE TEST softkey is pressed, this display is shown. The write test is performed in the order described in paragraph 5-48.

Figure 5-24. CRT Display of MSU Write Test.

CHECKS AND ADJUSTMENTS

<pre> *** MSU WRITE TEST *** NO. OF FAILURES =00 TEST END FAILED TRACK NO./SECTOR NO. </pre>	<p>(2) If the write test ends without failures, this display is shown.</p>
<pre> *** MSU WRITE TEST *** NO. OF FAILURES =26 TEST END FAILED TRACK NO./SECTOR NO. 14/04 15/04 16/04 17/04 18/04 19/04 20/04 21/04 22/04 23/04 24/04 25/04 26/04 14/04 15/04 16/04 17/04 18/04 19/04 20/04 21/04 22/04 23/04 24/04 25/04 26/04 </pre>	<p>(3) In this case, thirteen errors were detected for each of patterns "1A_H" and "E5_H". Perform the write test again with another disc. If no errors are detected in the second test, the disc used in the first test is probably defective.</p>

Figure 5-24. CRT Display of MSU Write Test (Cont'd).

Note

The MSU Write Test ends automatically if more than sixty-five failures are detected. Perform the write test again using another disc. If the same results are obtained, the flexible-disc drive checks and adjustments must be performed, and the troubleshooting procedures described in Section VIII may also be necessary.

CHECKS AND ADJUSTMENTS

5-49. MSU EXERCISER

5-50. The 4145A goes into the MSU EXERCISER when the EXER- CISER softkey is pressed while viewing the MSU DIAGNOSTICS page, and the MSU EXERCISER page is displayed as shown in Figure 5-25. The flexible-disc drive (FDD) is in the head load status during the MSU EXERCISER if a disc has been inserted into the FDD. The MSU EXERCISER is provided for the checks and adjustments listed in Table 5-5.

5-51. Explanations of the three messages shown on the CRT and the seven softkey prompts (TRACK 00 , STEP IN , STEP OUT , ALT 0-6 , WRITE 1f , WRITE 2f , and INDEX TIMING) are given in Tables 5-6 and 5-7.

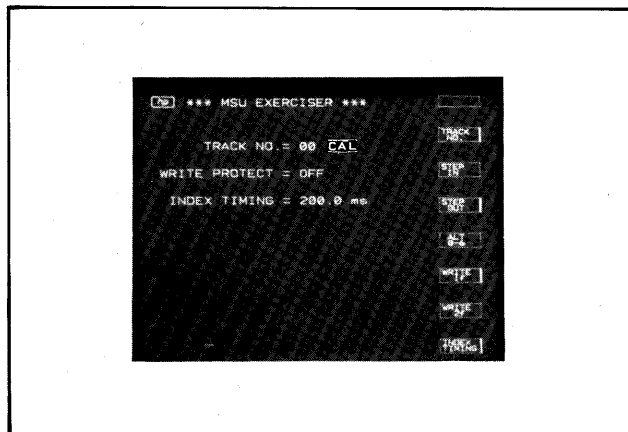

Figure 5-25. CRT Display of MSU EXERCISER Page.

Table 5-6. Messages on MSU EXERCISER Page

MESSAGE	DESCRIPTION
TRACK NO. = nn CAL*	Shows the track number in decimal where the Read/Write head is currently located. When "TRACK NO. = -- UNCAL*" is displayed, the head must be stepped to track 00 using the TRACK 00 softkey because it is either outside track 00 or inside track 39.
WRITE PROTECT = xx	Shows whether a disc is write-protected or -unprotected. If the disc is write-protected, "WRITE PROTECT = ON" will be shown. "WRITE PROTECT = OFF" will be shown otherwise.
INDEX TIMING = nnn.n ms	Shows the index timing (disc speed) in milliseconds when the INDEX TIMING softkey is pressed.
<p>* Either "CAL" or "UNCAL" is always displayed along with the track number on the TRACK NO. message line. CAL means that the Read/Write head location is in calibrated status, while UNCAL means that the head is in uncalibrated status. UNCAL is displayed when the head steps out of track 00 or inside track 39. In the calibrated status the displayed track number is the same as the track number where the head is actually located. In uncalibrated status, there is no guarantee of the truth of the displayed track number. To recover from the uncalibrated status, press the TRACK 00 softkey described in Table 5-7.</p>	

CHECKS AND ADJUSTMENTS

Table 5-7. MSU EXERCISER Softkey Prompts

SOFT KEY	DESCRIPTION
<div style="border: 1px solid black; padding: 2px; display: inline-block;">TRACK 00</div>	Moves the Read/Write head to track 00. When "UNCAL" is displayed on the TRACK NO. message line, press this key to recover from uncalibrated status. The 4145A then automatically detects the index timing on track 00 to display the detected value on the CRT.
<div style="border: 1px solid black; padding: 2px; display: inline-block;">STEP IN</div>	Steps the Read/Write head towards track 39 (inward on the disc). The head moves one track every time the key is pressed.
<div style="border: 1px solid black; padding: 2px; display: inline-block;">STEP OUT</div>	Steps the Read/Write head towards the lower track (outwards on the disc). The head moves one track every time the key is pressed.
<div style="border: 1px solid black; padding: 2px; display: inline-block;">ALT 0 -6</div>	Sets the FDD into Alternate Movement. In Alternate Movement, the Read/Write head alternately moves between track 00 and track 06. To escape from Alternate Movement, press the key again.
<div style="border: 1px solid black; padding: 2px; display: inline-block;">WRITE 1f</div>	Data "1f" is written once on the whole track specified when this key is pressed. On the 4145A, data "1f" means data "00H".
<div style="border: 1px solid black; padding: 2px; display: inline-block;">WRITE 2f</div>	Data "2f" is written once on the whole track specified when this key is pressed. On the 4145A, data "2f" means data "FFH".
<div style="border: 1px solid black; padding: 2px; display: inline-block;">INDEX TIMING</div>	Displays the index timing of the FDD with 100 μ sec resolution when this key is pressed. To stop detecting the speed, press the key again.

CHECKS AND ADJUSTMENTS

5-52. DRIVE BELT TENSION CHECK AND ADJUSTMENT

PURPOSE: This check and adjustment accurately sets the drive belt tension of the flexible-disc drive (FDD) for the optimum read/write capability.

EQUIPMENT:

Tension Gauge* HP P/N 04145-65104

* included in the 4145A Product Support Package (HP P/N : 04145-65100)

PROCEDURE:

1. Remove the FDD from the 4145A, and disconnect the two connectors, DC power supply cable connector, and flat cable connector from the FDD.
2. Carefully put the FDD on its top side, and set the tension gauge as shown in Figure 5-26.
3. Verify that the reading on the gauge is within the limit (76 grams to 82 grams) when the dial gauge is pushed to the gauge stopper. If out of the limit, perform steps 4 through 6.
4. Slightly loosen the two drive motor retaining screws.
5. Adjust the belt tension until the reading on the gauge is within 80 grams to 82 grams while moving the drive motor position.
6. Tighten the drive motor retaining screws and apply a small amount of glue.

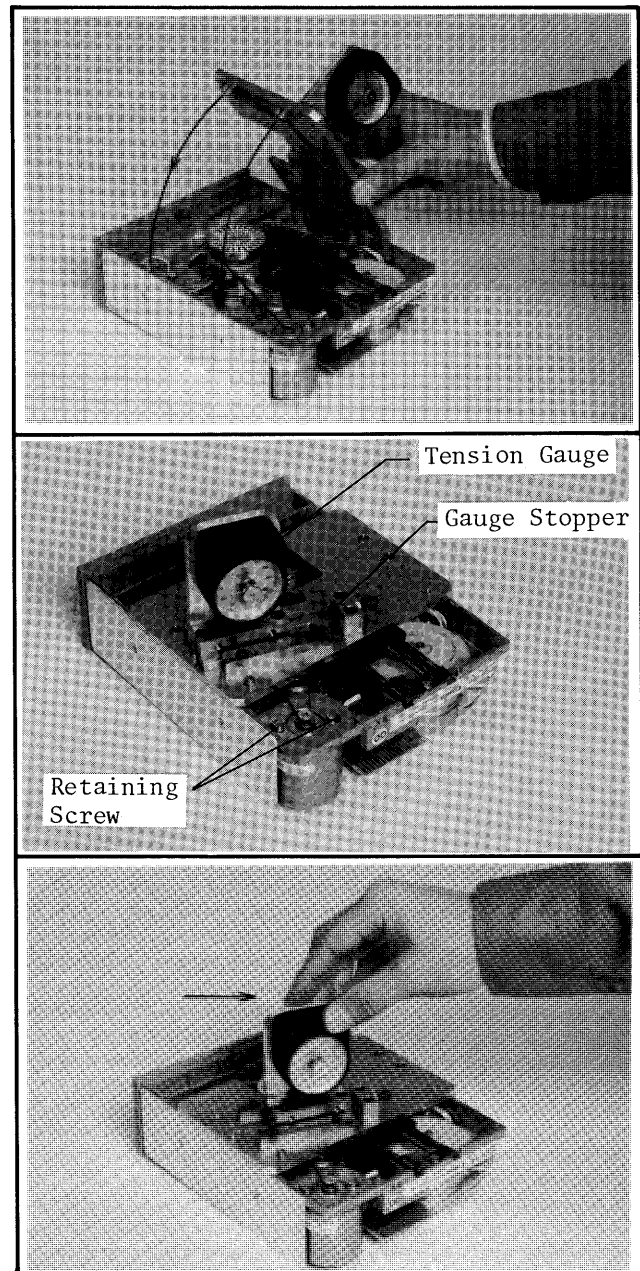

Figure 5-26. Drive Belt Tension Check and Adjustment Setup.

CHECKS AND ADJUSTMENTS

5-53. INDEX TIMING CHECK AND ADJUSTMENT

PURPOSE: This check and adjustment correctly sets the index timing (drive motor rotational speed) of the flexible-disc drive (FDD) for correct sector selection.

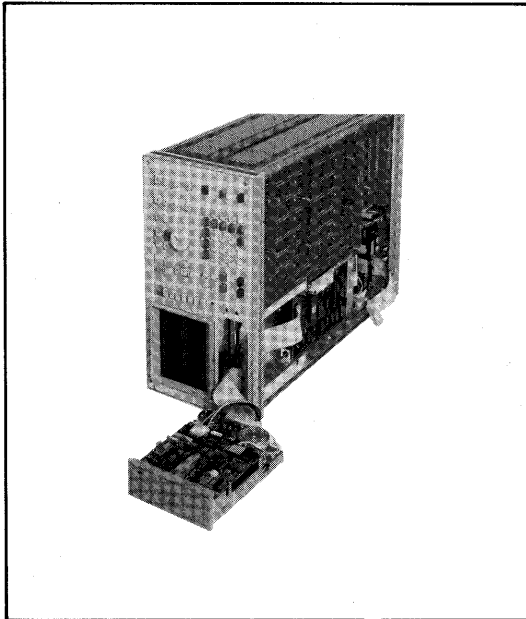

Figure 5-27. Index Timing Checks and Adjustment.

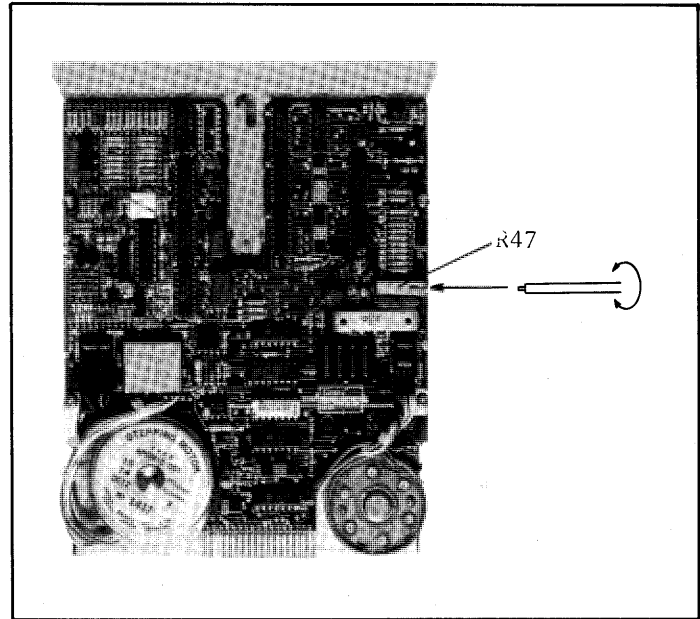

Figure 5-28. R47 Location.

EQUIPMENT:

FDD Service Kit HP P/N 04145-65100

PROCEDURE:

1. Turn off the 4145A, and set it to MSU DIAGNOSTICS Mode.
2. Insert a blank disc (included in the 4145A Product Support Package) into the FDD, and turn on the 4145A to display the MSU DIAGNOSTICS page.
3. Press the EXER- CISER softkey so that the 4145A goes into the MSU EXERCISER.
4. Step the Read/Write head to track 16 by pressing the STEP IN softkey.
5. Press the INDEX TIMING softkey to monitor the index timing of the FDD. Perform step 6 if the index timing is not within 200 ± 5 msec.
6. Adjust R47 (see Figure 5-28 for the location) until the index timing is within 200 ± 1 msec, monitoring the timing on the CRT. Use an insulated screwdriver.

CHECKS AND ADJUSTMENTS

5-54. TRACK ALIGNMENT CHECK AND ADJUSTMENT

PURPOSE: This check and adjustment verifies and correctly sets track alignment in order to eliminate errors when accessing a specified track.

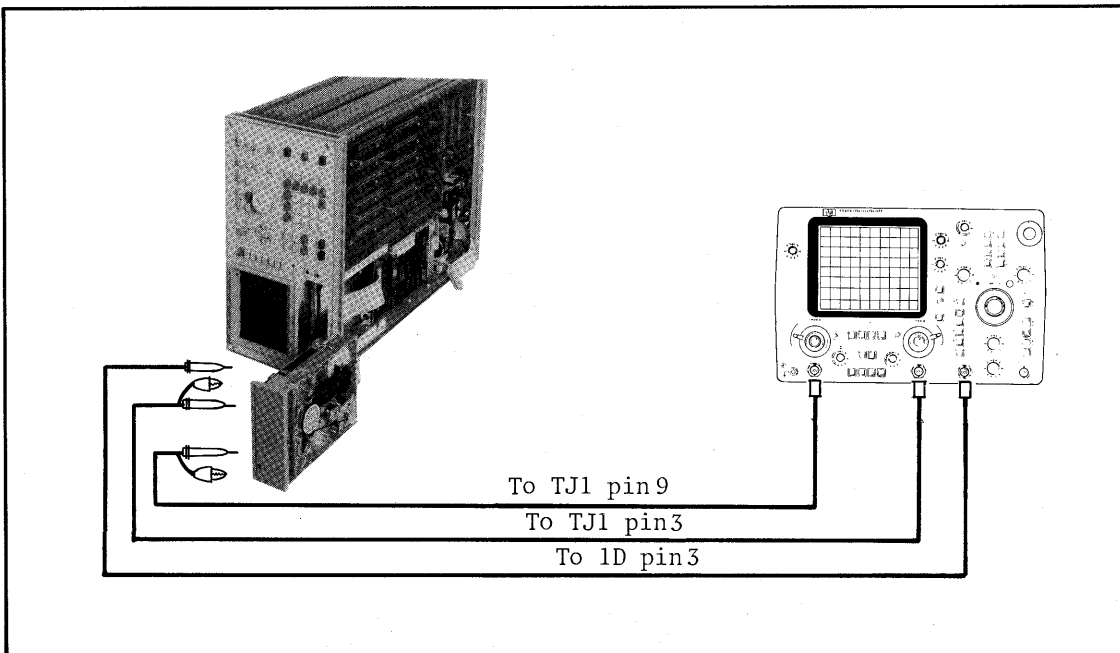

Figure 5-29. Track Alignment Check and Adjustment.

EQUIPMENT:

Oscilloscope	HP MODEL 1740A
10 : 1 Divider Probe (2ea)	HP MODEL 10040A
1 : 1 Probe	HP MODEL 10007B
4145A Product Support Package	HP P/N 04145-65100

PROCEDURE:

1. Connect channel A input to TJ1 pin 9 and channel B input to TJ1 pin 7 (see Figure 5-31 for the locations) on the flexible-disc drive (FDD) PC board using 10 : 1 divider probes.
2. Obtain the external trigger from 1D pin 3 (see Figure 5-31 for location) using a 1 : 1 probe.
3. Set the 4145A to the MSU DIAGNOSTICS Mode, but do not turn on the 4145A.

CHECKS AND ADJUSTMENTS

- Set the 1740A's controls as follows :

VOLT/DIV	{ channel A 0.02	(uncalibrated)
	{ channel B 0.02	(uncalibrated)
COUPLING	{ channel A AC	
	{ channel B AC	(inverted)
DISPLAY	A+B	
TIME/DIV	10msec	
TRIGGER	EXT	
POS/NEG.	NEG.	
SWEEP MODE	NORM	
SWEEP VERNIER	ON	

- Insert the CE disc (included in the 4145A Product Support Package) into the FDD, then turn on the 4145A and the 1740A.
- Press the EXER- CISER softkey to set the 4145A to the MSU EXERCISER.
- Step the Read/Write head to track 16, using the STEP IN softkey.
- Adjust the MAIN TIME/DIV knob and SWEEP VERNIER (of the 1740A) till at least four sets of bursts are displayed as shown in Figure 5-30-(1).
- Adjust the amplitude of the first orientation burst to six scale divisions with CAL VERNIER as shown in Figure 5-30-(2).

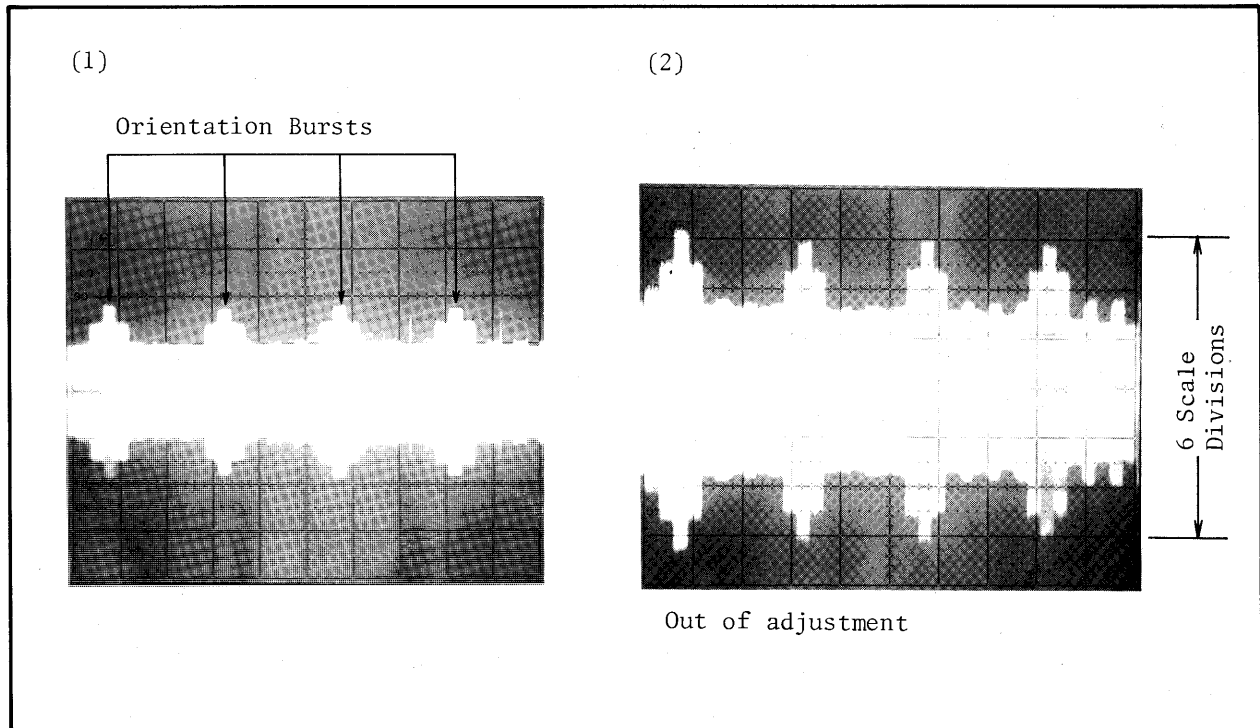

Figure 5-30. Scope Display of Bursts.

CHECKS AND ADJUSTMENTS

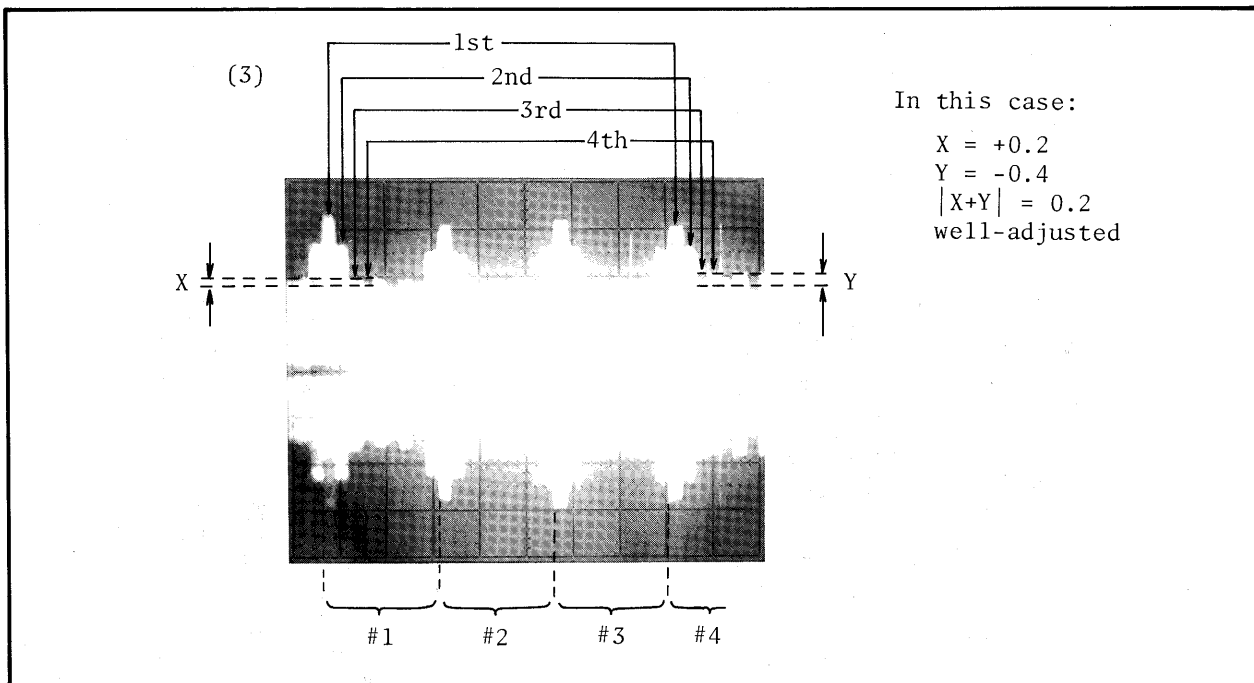

Figure 5-30. Scope Display of Bursts (Cont'd).

10. Read values of X and Y, and check whether they satisfy the following inequality:

$$|X+Y| \leq 1.5 \text{ (scale divisions) 5.1}$$

If the inequality is satisfied, steps 11 through 13 are not necessary.

Note

Values X and Y are the difference between the third burst and the fourth burst. The polarity of X and Y is positive if the third burst is higher than the fourth one. Otherwise, it is negative. See Figure 5-30-(3) for a pictorial explanation of X and Y.

11. Loosen the two retaining screws of the stepper motor (see Figure 5-31 for the location) and rotate it gradually until the orientation bursts reach their maximum amplitude. Then perform step 9.
12. Carefully rotate the stepper motor until X and Y satisfy the following inequality, or till both are zero.

$$|X+Y| \leq 0.3 \text{ (scale divisions) 5.2}$$

See Figure 5-30-(3) for details.

13. Tighten the retaining screws and apply a small amount of glue.

CHECKS AND ADJUSTMENTS

Note

After Track Alignment Adjustment, Track Zero Switch Check and Adjustment must be performed.

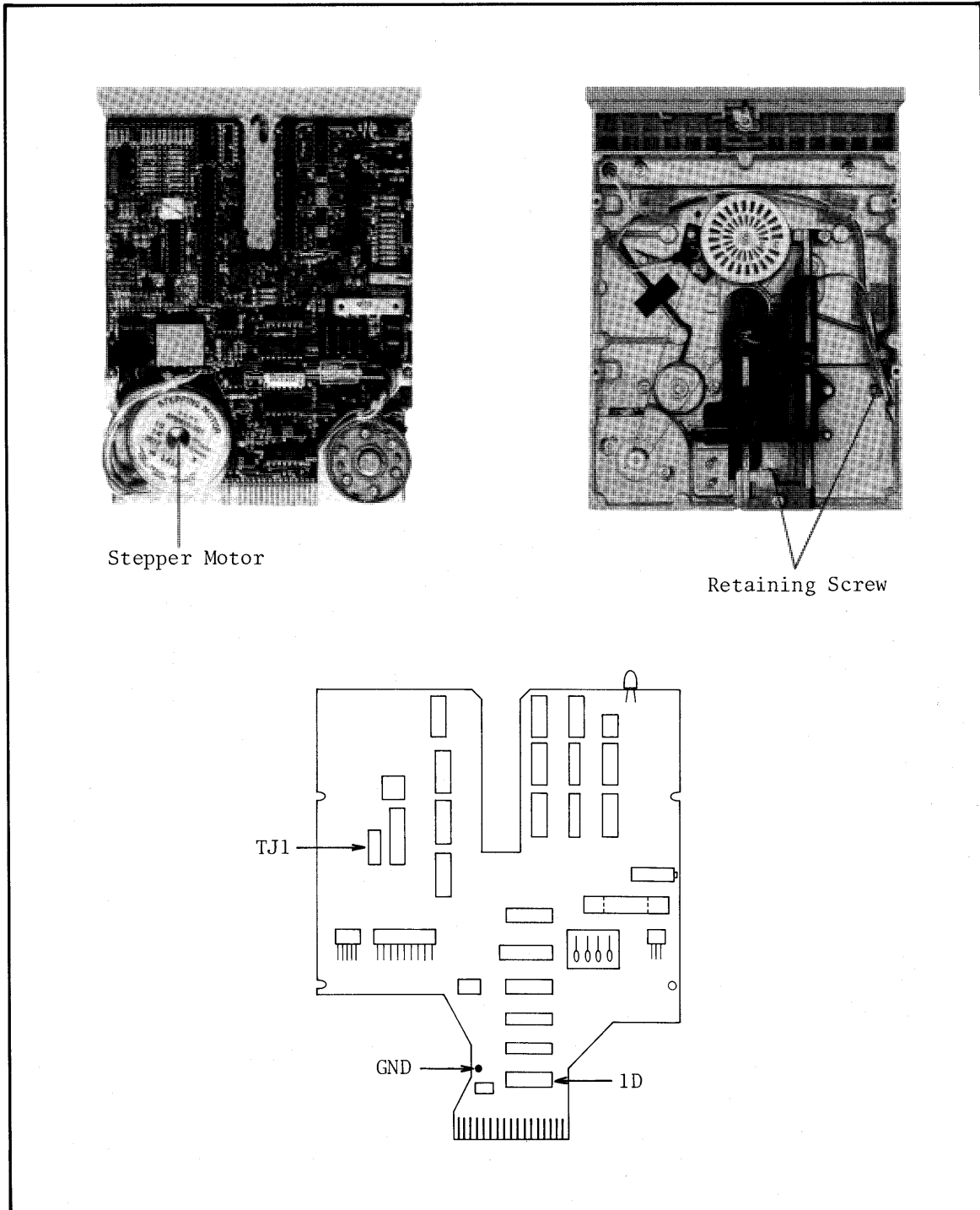

Figure 5-31. Check/Adjustment Point Locations.

CHECKS AND ADJUSTMENTS

5-55. TRACK ZERO SWITCH CHECK AND ADJUSTMENT

PURPOSE: This check and adjustment verifies that the track zero switch works properly and correctly sets the switching timing.

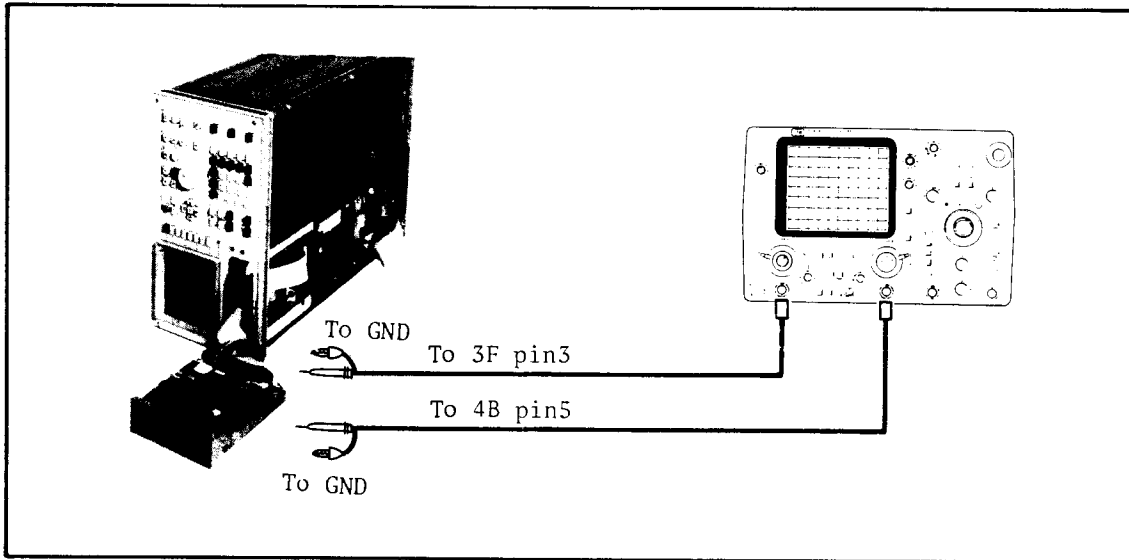

Figure 5-32. Track Zero Switch Check and Adjustment Setup.

EQUIPMENT:

- Oscilloscope HP MODEL 1740A
- 10 : 1 Divider Probe (2ea) HP MODEL 10040A
- 4145A Product Support Package HP P/N 04145-65100

PROCEDURE:

1. Manually set the space between the head carriage and outer stop on the spiral wheel to between 2mm and 3mm, as shown in the figure.
2. Connect channel A input to 3F pin 3, and channel B input to 4B pin 5 (see Figure 5-34 for the locations).
3. Set the 4145A to MSU DIAGNOSTICS Mode, but do not turn on the 4145A.

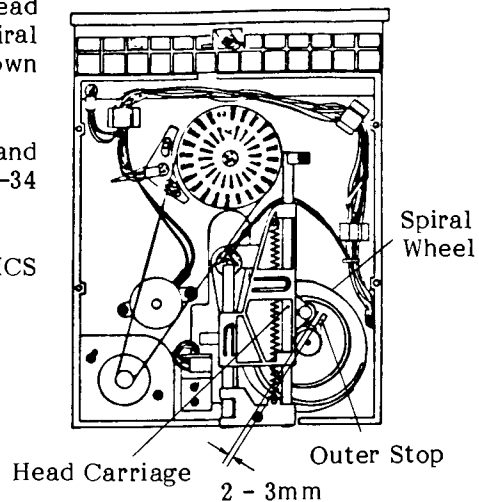

CHECKS AND ADJUSTMENTS

4. Set the 1740A's controls as follows :

VOLT/DIV	{	channel A 0.2
	}	channel B 0.2
COUPLING	{	channel A DC
	}	channel B DC (inverted)
DISPLAY		A+B
TIME/DIV		20msec
TRIGGER		INT channel B
POS/NEG.		NEG.
SWEEP VERNIER		ON (if necessary)
5. Insert a blank disc (included in the FDD Service Kit) into the FDD.
6. Turn on the 4145A and the 1740A, then press the EXER- CIZER softkey to set the 4145A to MSU EXERCISER.
7. Press the ALT 0-6 softkey to set the FDD to EXERCISER Alternate Movement. The Read/Write head then moves between track 00 and track 06 alternately.
8. Observe and verify that the track zero switch operates between track 02 and track 03 when the Read/Write head moves towards track 39, and between track 03 and track 01 when the Read/Write head moves towards track 00 (see Figure 5-33). If the track zero switch is working properly, step 8 is not necessary.
9. Loosen the retaining screws of the track zero switch (see Figure 5-34 for the location), and adjust the track zero switch manually until it switches between track 02 and track 03 when the Read/Write Head moves towards track 39, and between track 03 and 01 when the Read/Write head moves towards track 00.
10. Tighten the track zero switch retaining screws and apply a small amount of glue.
11. Verify that the head carriage touches the outer stop when the Read/Write Head is moved two tracks from track 00 using the STEP OUT soft key.

CHECKS AND ADJUSTMENTS

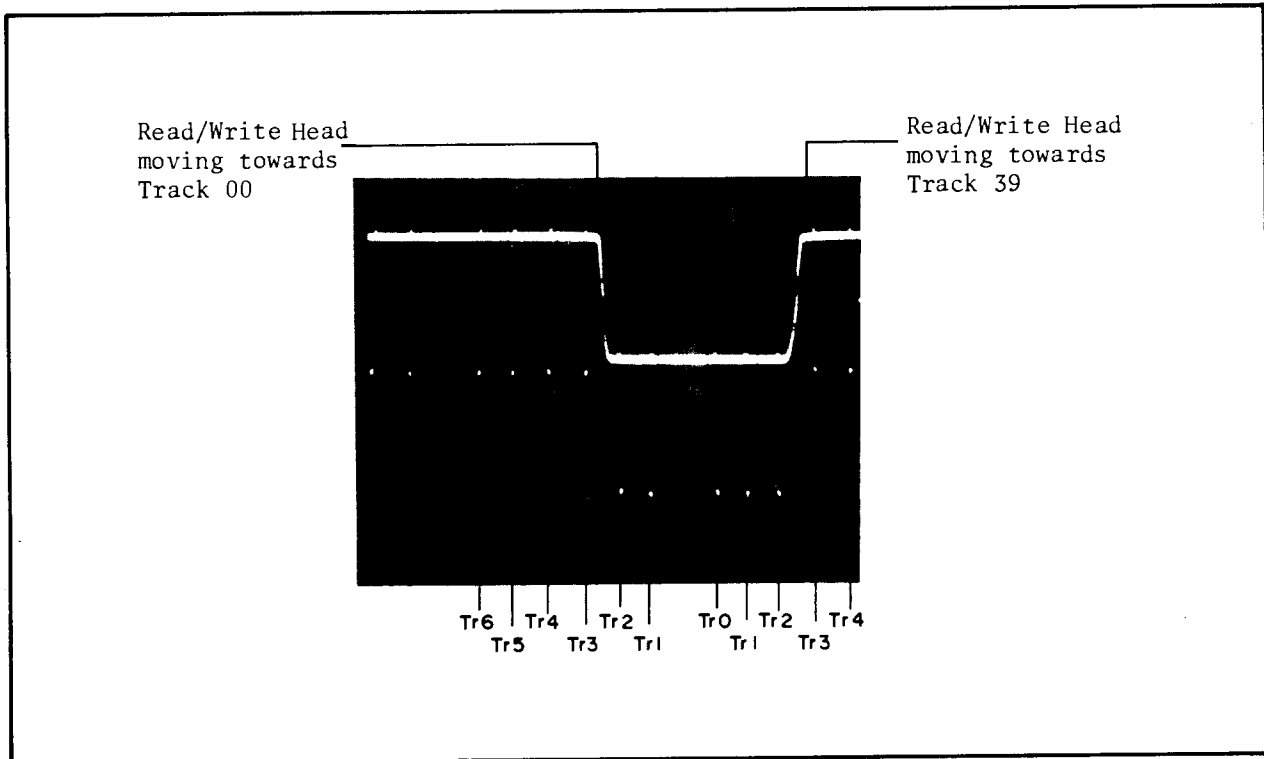

Figure 5-33. Scope Display of Track Zero Switch Switching.

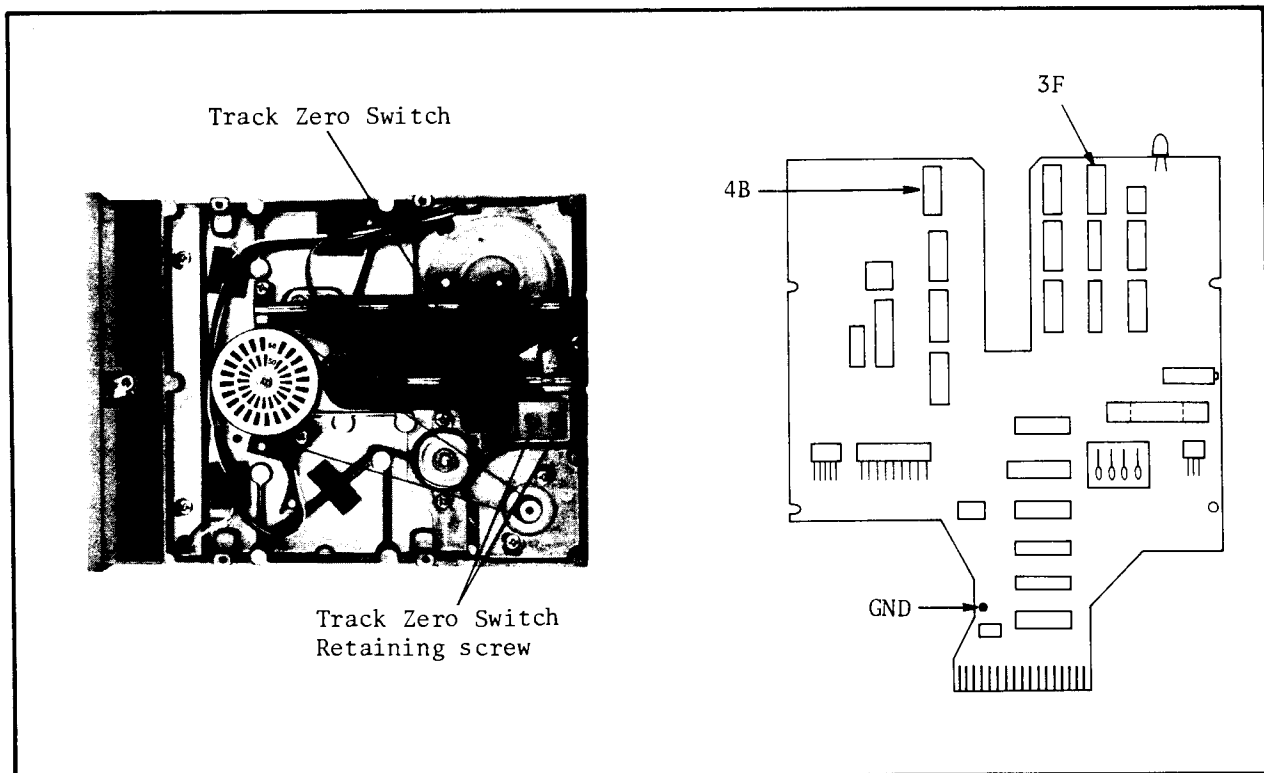

Figure 5-34. Check/Adjustment Point Locations.

CHECKS AND ADJUSTMENTS

4. Insert a blank disc (included in the 4145A Product Support Package) into the FDD.
5. Turn on the 4145A and the 1740A, then press the EXERCISER softkey to set the 4145A to MSU EXERCISER.
6. Step the Read/Write head of the FDD to track 39 by pressing the STEP IN softkey.
7. Write all "ones" once on all of track 39 by pressing the WRITE 2f softkey.
8. Adjust the trigger level of the 1740A so that the signal from TJI pin 7 appears as a "cat's-eye" as shown in Figure 5-36.
9. If jitter is less than 300nsec, steps 10 through 12 are unnecessary.
10. Adjust R69 (see Figure 5-37 for the location) until jitter is less than 300 ns.
11. Step the Read/Write head to track 00 by pressing the TRACK 00 softkey, then write all "ones" on all of track 00 by pressing the WRITE 2f softkey.
12. Verify that the jitter is less than 300 ns. If it exceeds 500 ns, replace the PC Board with new one.

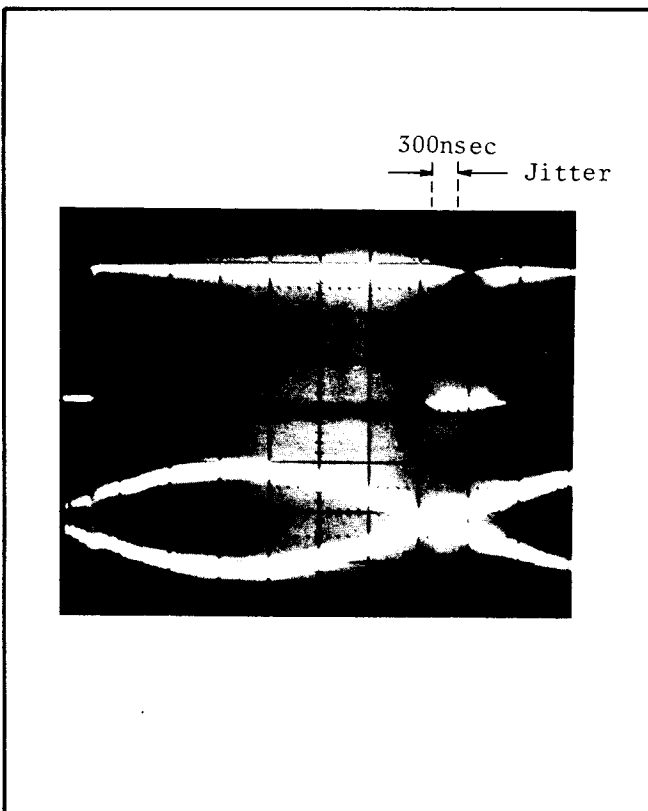

Figure 5-36. Scope Display of Jitter.

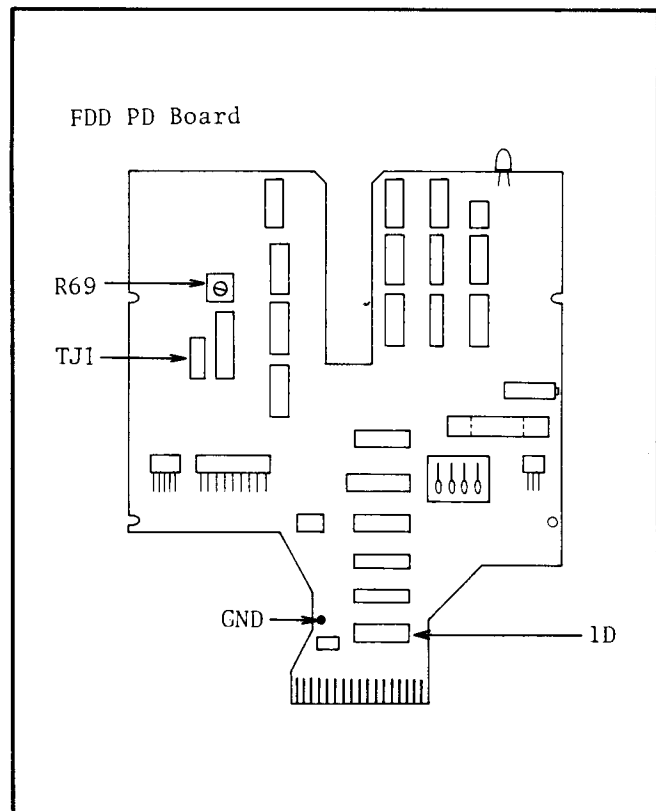

Figure 5-37. Check/Adjustment Point Locations.

CHECKS AND ADJUSTMENTS

5-57. INDEX DETECTOR ALIGNMENT CHECK AND ADJUSTMENT

PURPOSE: This check and adjustment checks and correctly sets the index detector alignment for a correct sector selection.

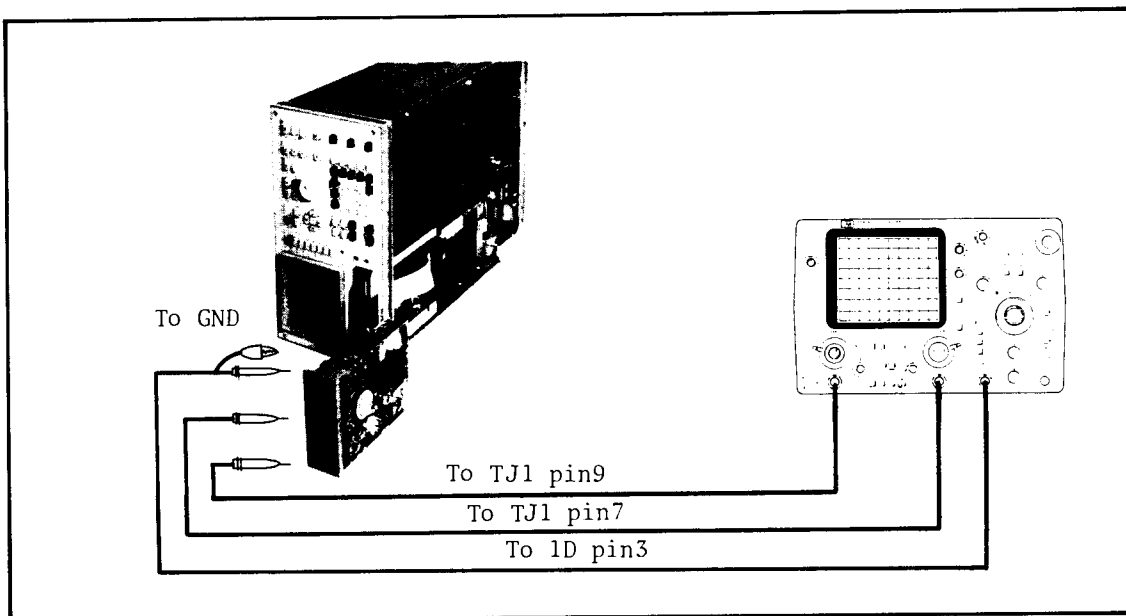

Figure 5-38. Index Detector Alignment Check and Adjustment Setup.

EQUIPMENT:

Oscilloscope	HP MODEL 1740A
10 : 1 Divider Probe (2ea)	HP MODEL 10040A
1 : 1 Probe	HP MODEL 10007B
4145A Product Support Package	HP P/N 04145-65100

PROCEDURE:

1. Connect oscilloscope channel A input to TJ1 pin 9 and channel B input to TJ1 pin 7 (see Figure 5-40 for locations) on the flexible-disc Drive (FDD) PC Board using 10 : 1 Divider Probes. Also, connect EXT TRIGGER input to 1D pin 3 (see Figure 5-41 for location) for the external trigger.

CHECKS AND ADJUSTMENTS

2. Set the 4145A to MSU DIAGNOSTICS Mode, but do not turn on the 4145A.
3. Set the 1740A's controls as follows :

VOLT/DIV	{	channel A 0.05	
	}	channel B 0.05	
COUPLING	{	channel A AC	
	}	channel B AC	(Inverted)
DISPLAY		A+B	
TIME/DIV		100 μ sec	
TRIGGER		EXT	
POS/NEG.		NEG.	
SWEEP MODE		NORM	
4. Insert the CE disc (included in the FDD Service Kit) into the FDD, and turn on the 4145A and the 1740A.
5. Press the EXER- CISER softkey to set the 4145A to MSU EXERCISER.
6. Check whether the index alignment gap is within the $450 \pm 200 \mu$ s limit. Refer to Figure 5-39 for a pictorial explanation of the gap. If the gap is out of the limit, perform steps 7 through 9.
7. Loosen the retaining screw of the index detector (photo transistor) holder (see Figure 5-40 for the location).
8. Adjust the holder position using the eccentric rod (included in FDD Service Kit) until the time delay from the trigger point to the start point of a data burst is within $450 \pm 20 \mu$ s (see Figure 5-39).
9. Tighten the retaining screw and apply a small amount of glue.

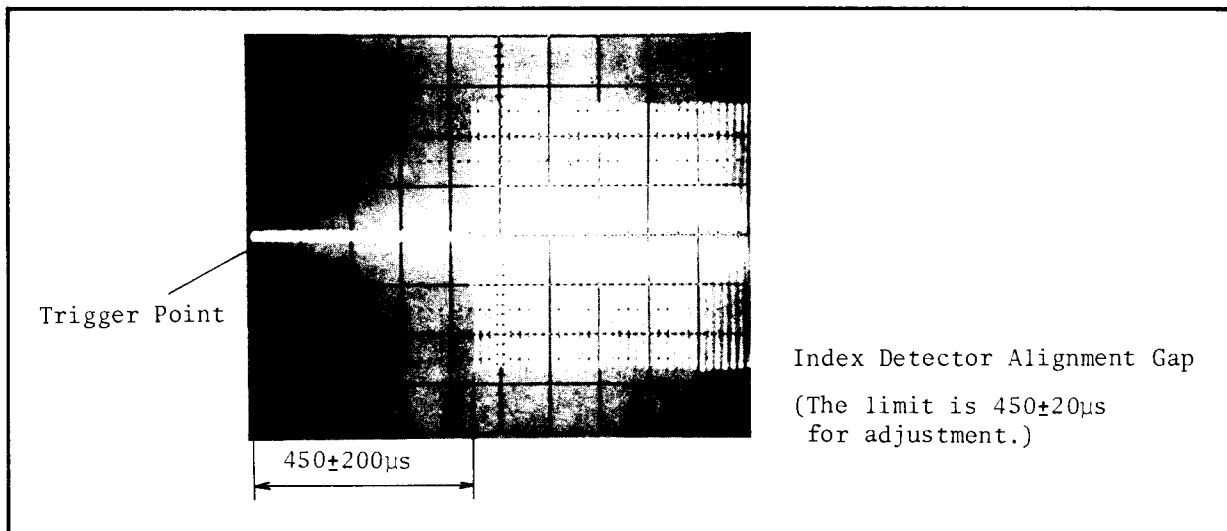

Figure 5-39. Index Detector Alignment Gap.

CHECKS AND ADJUSTMENTS

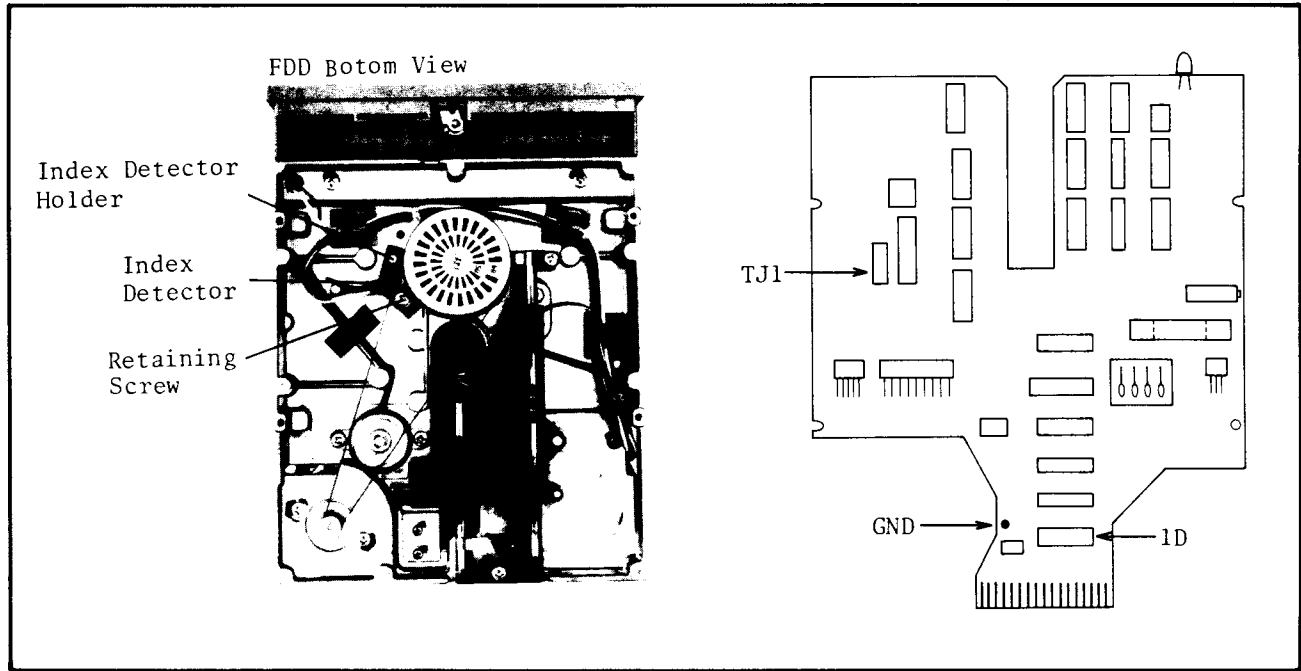

Figure 5-40. Check/Adjustment Point Locations.