

sheet 11 of 11
page 1 upper

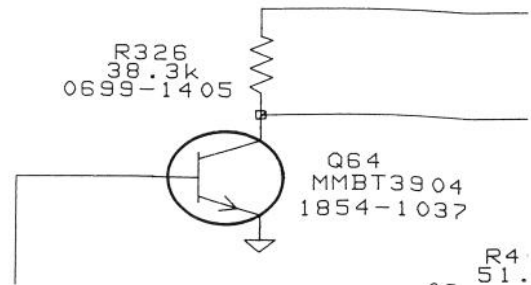

sheet 11 of 11
page 2 upper

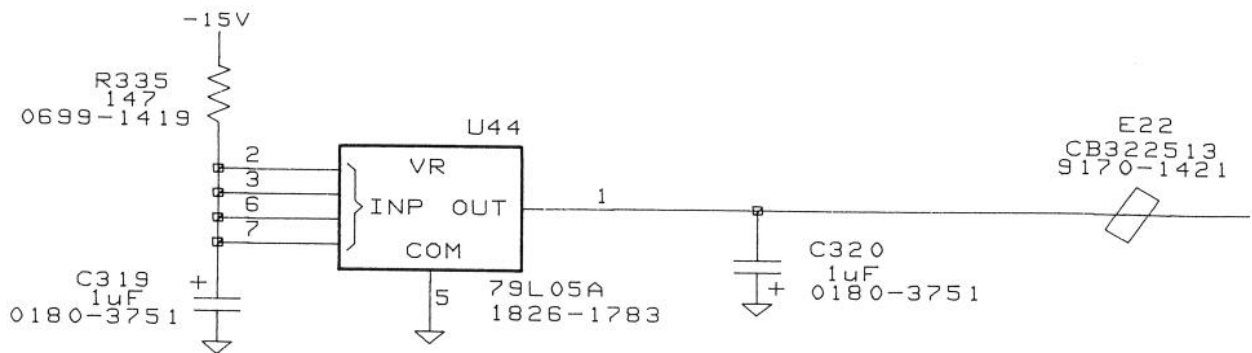
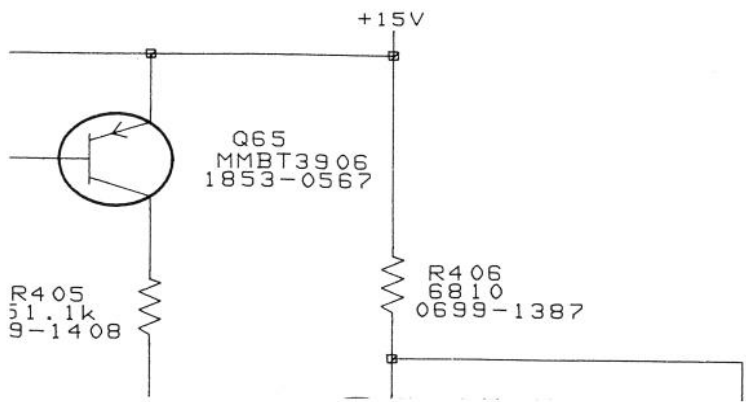
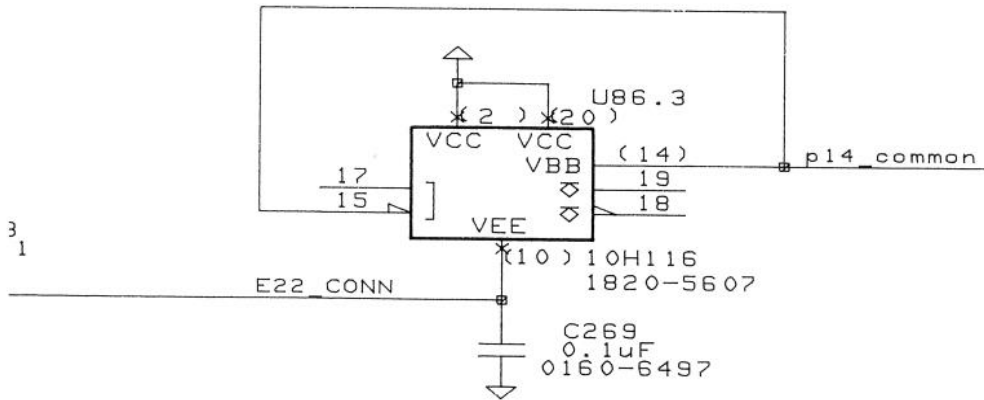

0	1	2	3	4	
16	17		19		21
45	48	81	83	D2	

sheet 11 of 4
page 3 upper

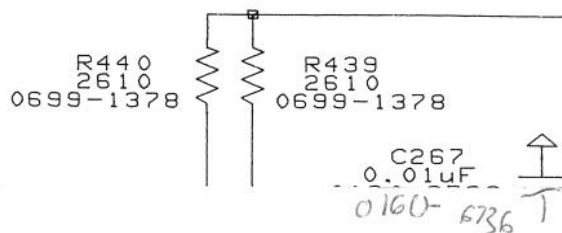
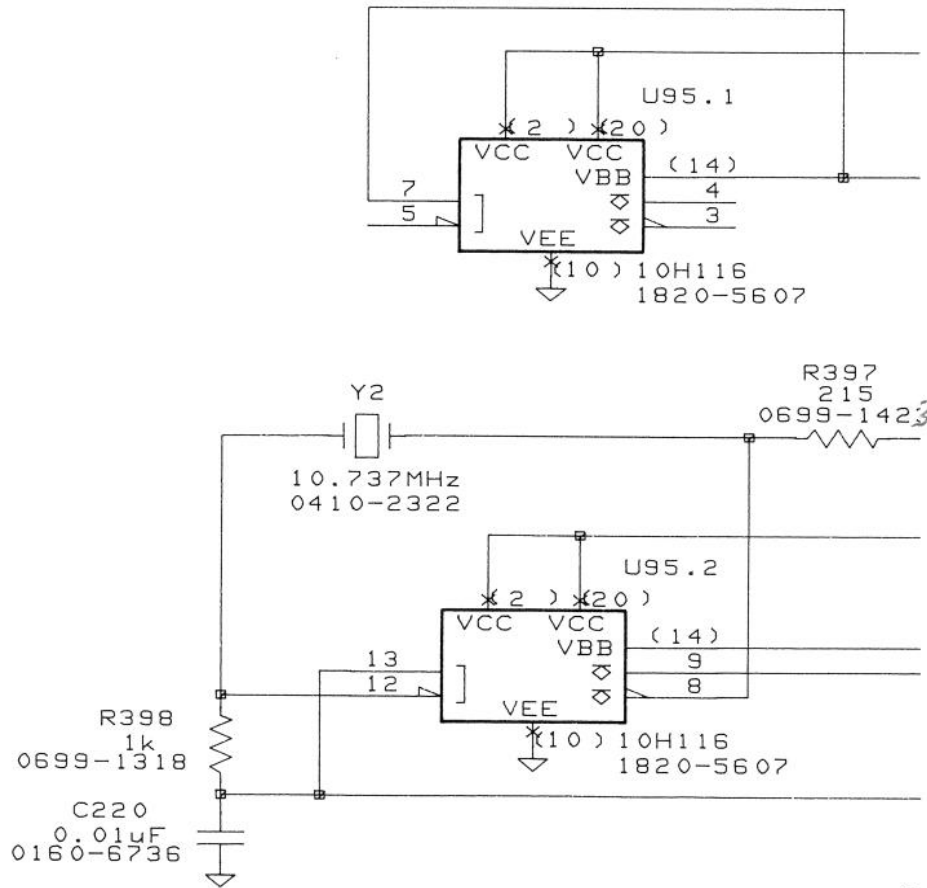

R4
21
0699-1

08	9		11	12	14	15				D-54600-66501-3		
22	29	30	32	33	38	43	SYM	REVISIONS			APPROVED	DATE
							A	AS ISSUED			JS	

sheet 11 of 11
page 4 upper

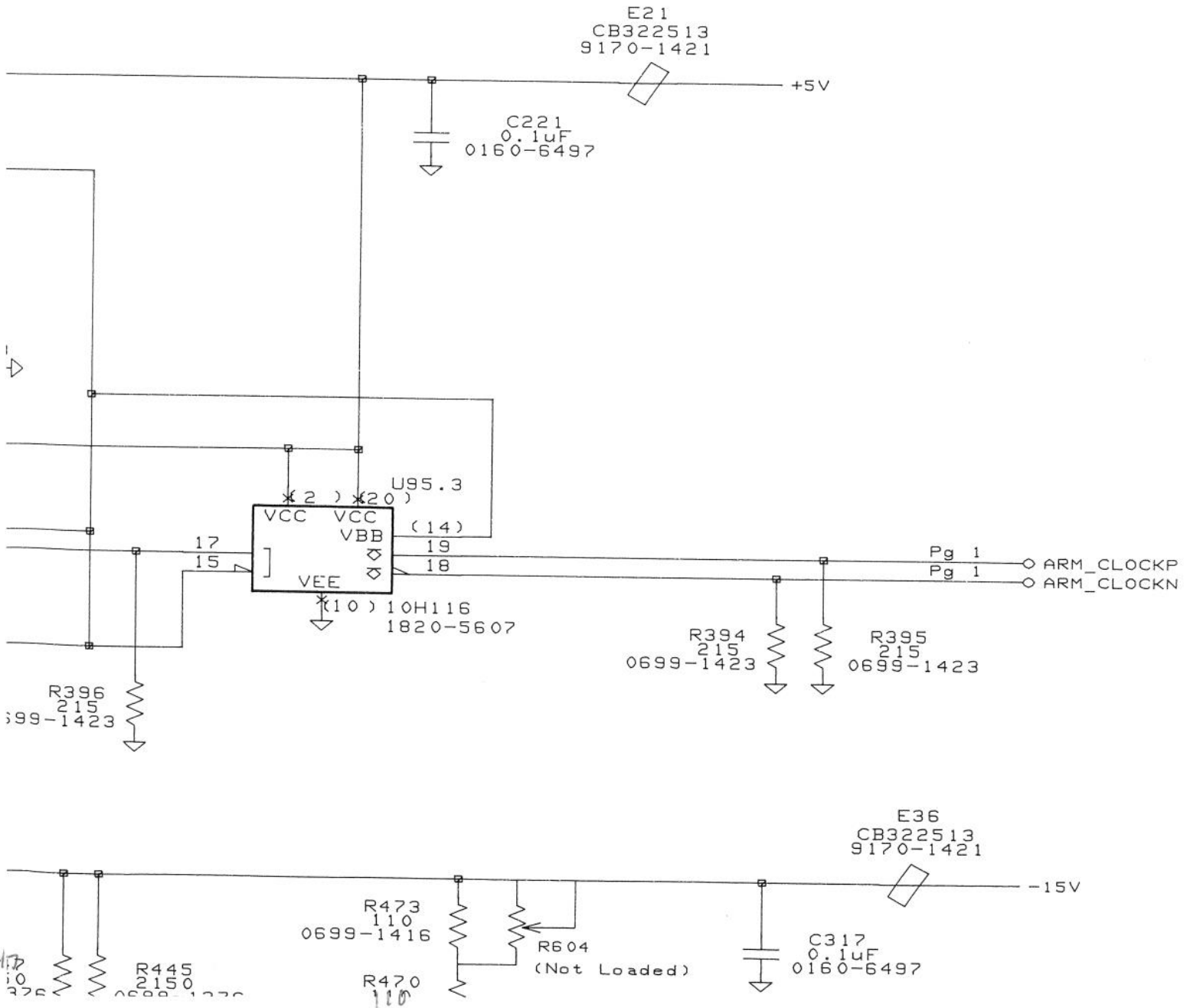

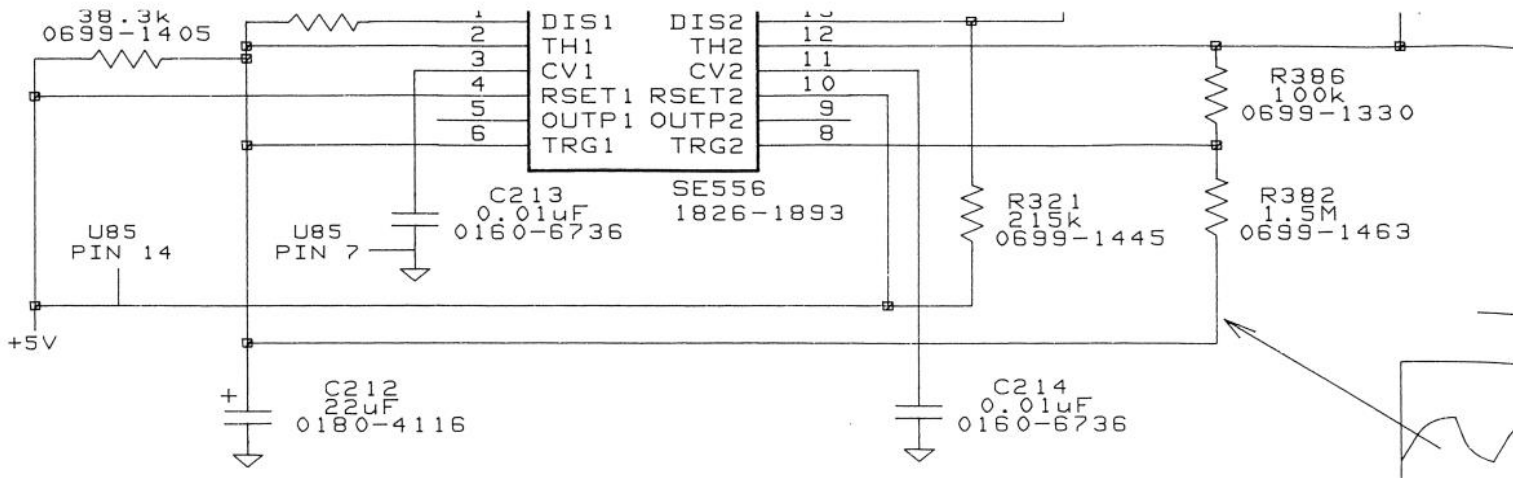

- Parts on this schematic:
- C195, 212-214, 220, 221, 262-267, 269, 317-320
 - CR41
 - E21, 22, 36, 37
 - L6, 7
 - Q38, 39, 64-66
 - R321, 326, 335, 378, 382-384, 386, 387, 394-398, 404-406, 436-441, 444-447, 469-473, 604
 - U44, 85, 86, 95
 - Y1, 2

sheet 11 of 11
page 1 lower

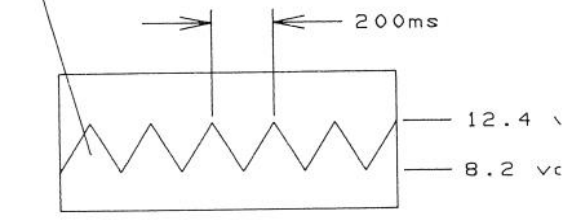
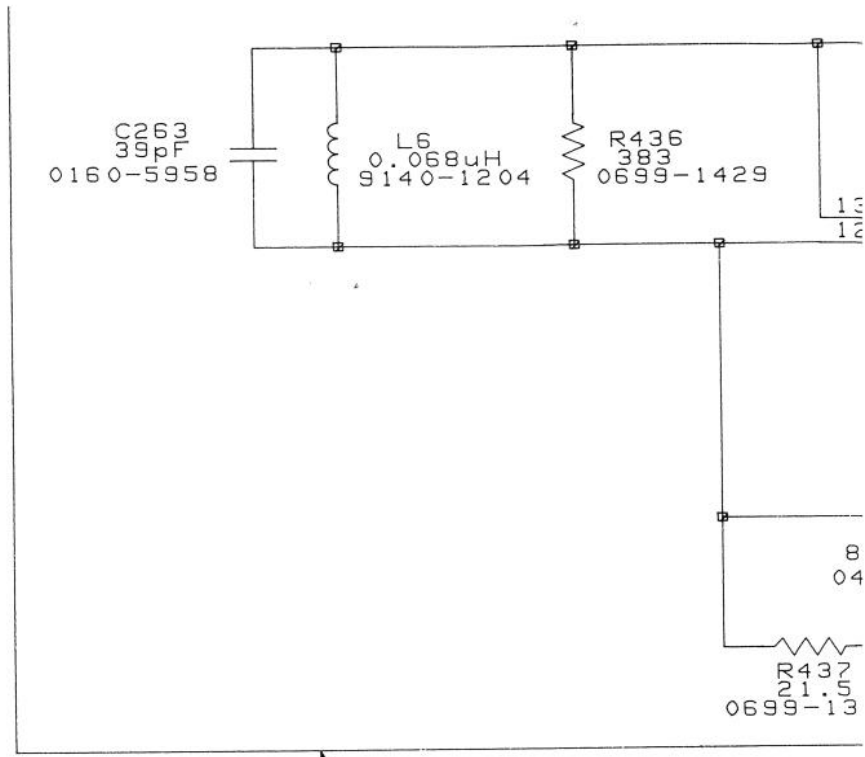
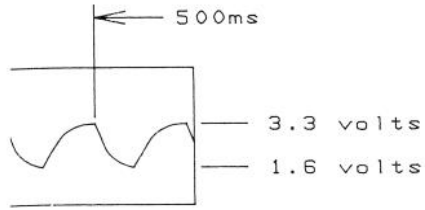
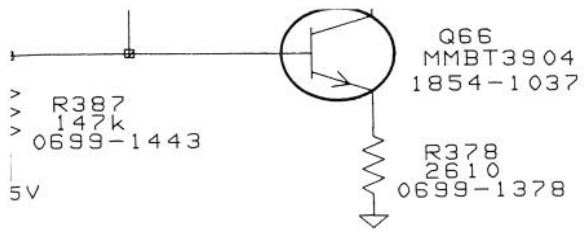

sheet 11 of 11
 page 2 lower

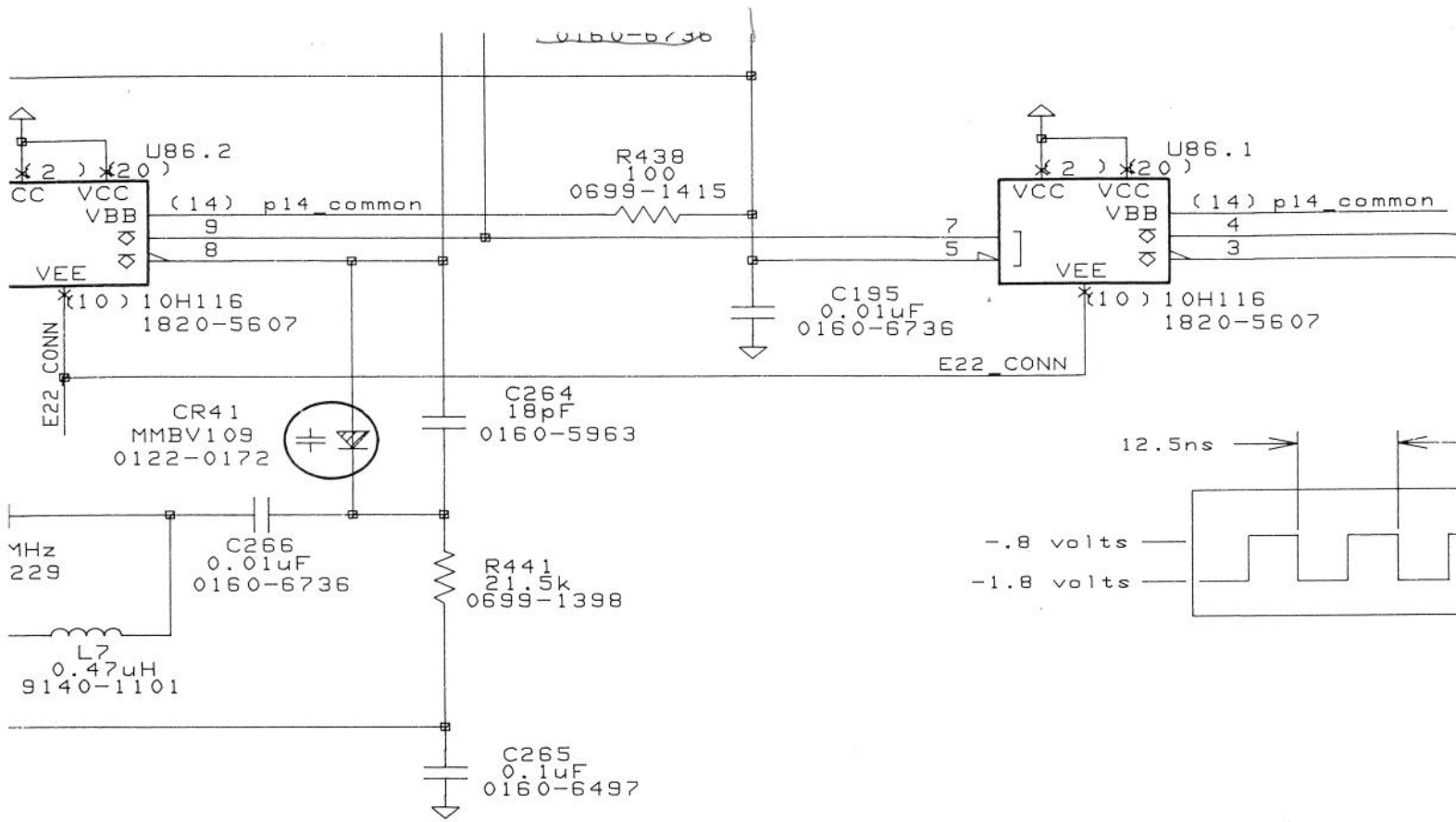

sheet 11 of 11
page 3 lower

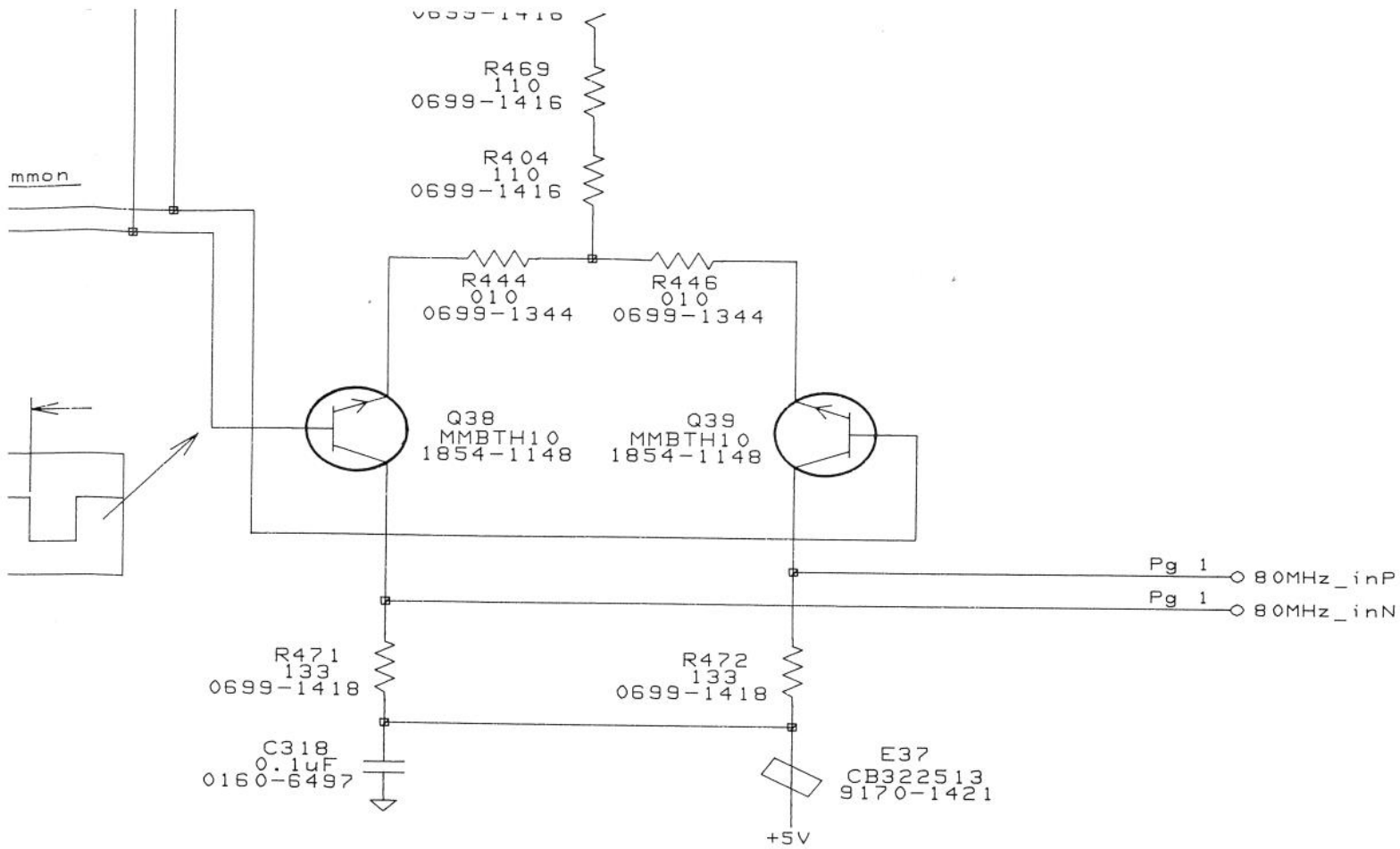

sheet 11 of 11
page 4 lower

DRAWN BY JIM STRINGER	DATE 6/27/91	80MHz CLOCK/ ARM CLOCK	 HEWLETT PACKARD
ENGINEER			
RELEASE TO PROD.		TITLE	PART NUMBER
SUPERSEDES DWG.		SCALE	P-54600-66501
		SHEET 11 OF 11	