

Keysight Technologies

Simplify Signal Creation with Signal Studio Software

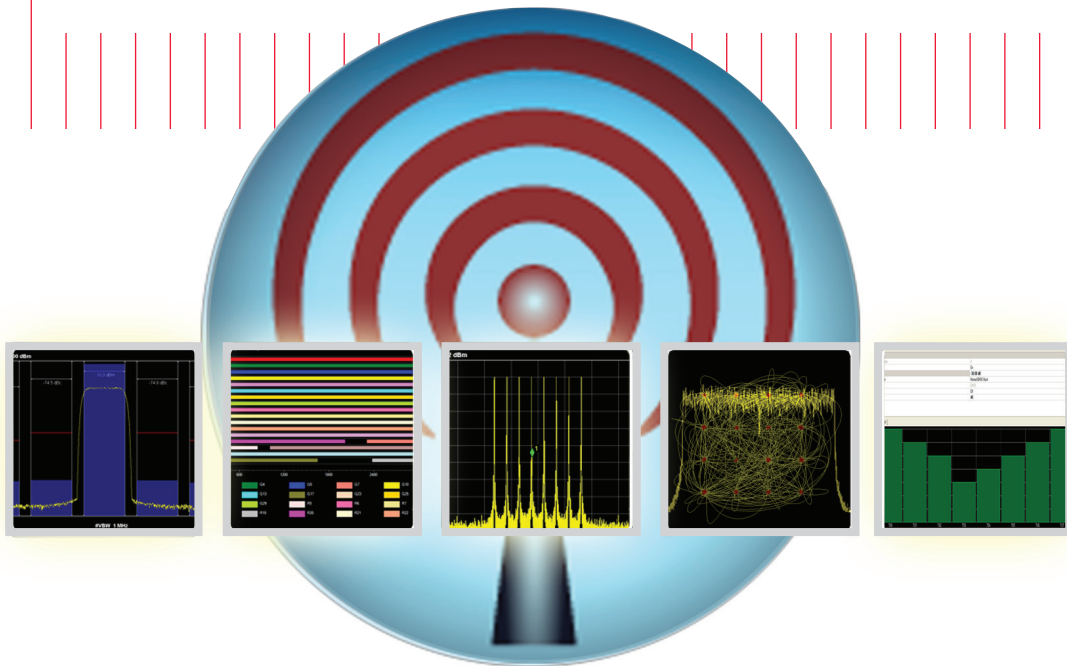

Simplify Signal Creation

Whether you're working on a single radio format or integrating multiple formats into a single device, easy access to the right test signals streamlines validation and helps ensure interoperability. Accelerate your work with Keysight Technologies, Inc. Signal Studio software.

Signal Studio is a flexible suite of signal-creation tools that reduces the time you spend on signal simulation. Its performance-optimized reference signals—validated by Keysight—enhance the characterization and verification of your devices. Connect your source to Signal Studio—and simplify signal creation.

Try Before You Buy!

Free 30-day trials of Signal Studio software are available to evaluate the user interface and generate signals. Redeem a trial license online at www.keysight.com/find/StudioStudio_trial

Reduce the time you spend on signal simulation

Signal Studio puts a wealth of capabilities at your fingertips, enabling the creation of application-specific test signals at baseband, RF and microwave frequencies. Choose from presets or quickly set up custom reference signals for testing devices used in cellular communications, wireless connectivity and digital broadcast standards. Define test patterns for advanced wireless systems used for detection, positioning, tracking and navigation. Enhance component testing with virtually distortion-free stimulus signals. Evaluate receiver tolerance by creating calibrated additive signal impairments. It's all fast and simple with a user interface featuring tree-style navigation and graphical, parameterized signal configuration.

The screenshot displays the Keysight Signal Studio interface for 3GPP LTE TDD - RF Output. The main window shows a configuration for a "Full filled QPSK 5MHz (25 RB) (Modified)" signal. A table lists various signal components:

#	Name	Type	State	Power (dB)	Data
2	CFI	CFI	On	0.000	N/A
3	HI	HI	On	0.000	N/A
4	DCI	DCI	On	0.000	N/A
5	DL-SCH1	DL-SCH	On	0.000	PNS
6	DL-SCH2	DL-SCH	On	0.000	PNS
7	DL-SCH3	DL-SCH	Off	0.000	PNS
8	DL-SCH4	DL-SCH	Off	0.000	PNS
9	DL-SCH5	DL-SCH	Off	0.000	PNS

A dialog box titled "DL-SCH Tx sequence" is open, showing a table of transmission parameters:

Sequence	Frame	Subframe	State	Retrans 0	MCS Index 0	Modulation 0	TB
1	0	0	<input checked="" type="checkbox"/>	<input type="checkbox"/>	18	64QAM	
2	0	1					
3	0	2					
4	0	3					
5	0	4					
6	0	5	<input checked="" type="checkbox"/>	<input checked="" type="checkbox"/>	18	64QAM	
7	0	6					
8	0	7					
9	0	8					

At the bottom of the main window, a visualization shows a time-frequency grid with colored bars representing signal transmission over 24 subcarriers and 19 time slots.

Three callout boxes highlight key features:

- Efficiently configure fully parameterized signal**: Points to the configuration table.
- Intuitively navigate signal structure using tree-style interface**: Points to the left-hand navigation pane.
- Visualize signal to validate setup**: Points to the time-frequency visualization at the bottom.

Apply your signals in real-world testing

When your signals are fully defined, you can download them to a variety of Keysight instruments and design software. Signal Studio complements these instruments by providing a cost-effective way to tailor them to your test needs in design, development and production. And, with our demonstrated first-to-market track record of support for new standards, Signal Studio will help you stay at the forefront as wireless systems continue to evolve.

Simulation software

- SystemVue software: Simulate systems, circuits, and modules for wireless and aerospace/defense communications.

Vector signal generators

- PSG: Create reference signals for aerospace, defense, radar, and broadband wireless applications up to 44 GHz.
- MXG X-Series: Design and verify receivers for cellular basestations, wireless connectivity, digital video and more
- EXG X-Series: Maintain tight tolerances in component and module manufacturing
- ESG and 1st-generation MXG: Repurpose existing test systems with the latest signal creation capabilities.

Verify the performance of components and modules for leading edge technologies like 802.11ac with 160-MHz bandwidth on the MXG X-Series signal generator.

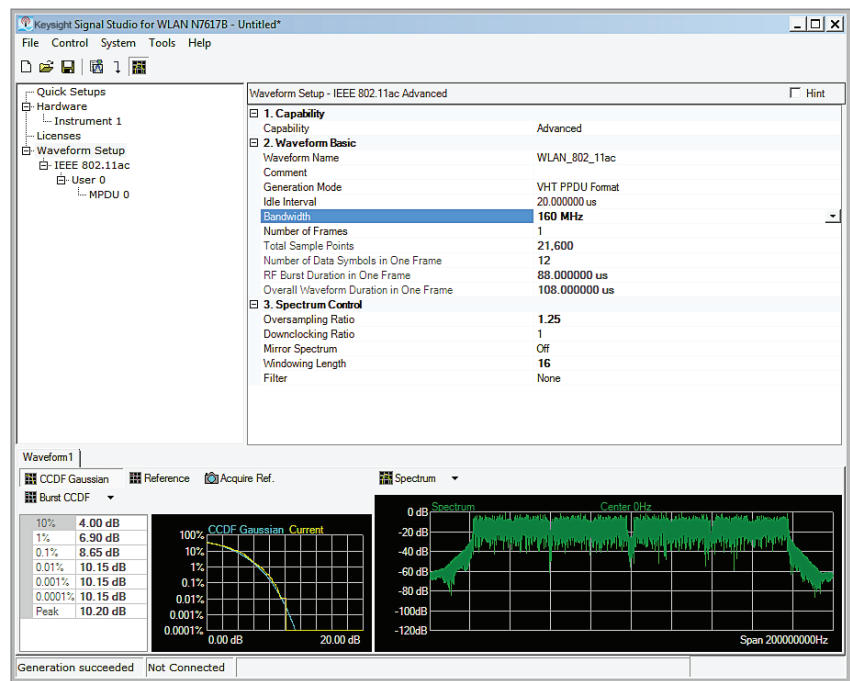

Baseband generator and channel emulator

- PXB baseband generator and channel emulator: Validate single- and multi-channel baseband designs under ideal, impaired, and real-world fading test conditions.

DigRF testers

- 16800 and 16900 Series logic analyzers: Characterize ICs that use the DigRF V3 digital serial bus.
- N534xA DigRF modules: Characterize ICs that use the DigRF V4 digital serial bus.

Wireless test set

- EXT wireless communications test set: Manufacture wireless devices using non-signaling test.

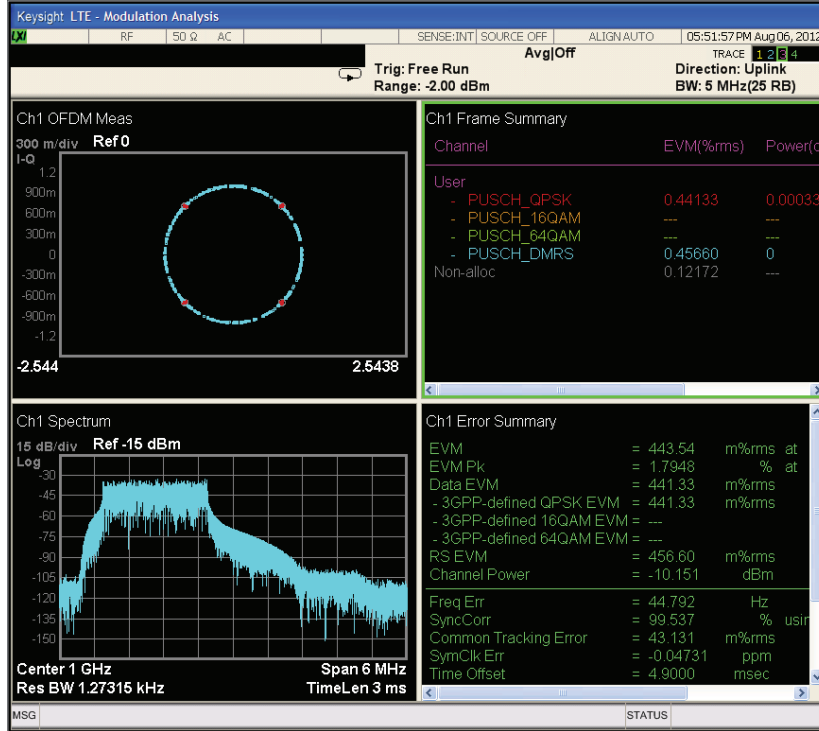

Use Signal Studio software with the E6607 EXT wireless communication test set to simplify signal creation in order to synchronize, control, and test your wireless device.

Modular Products

- N824xA/N603xA/M933xA arbitrary waveform generators: Use with the PSG signal generator to create waveforms with bandwidths up to 1 GHz
- M8190A arbitrary waveform generator: Generate wideband signals up to 2 GHz.
- PXIe M9381A vector signal generator: Accelerate throughput with new levels of speed in your modular test system with bandwidths up to 160 MHz.

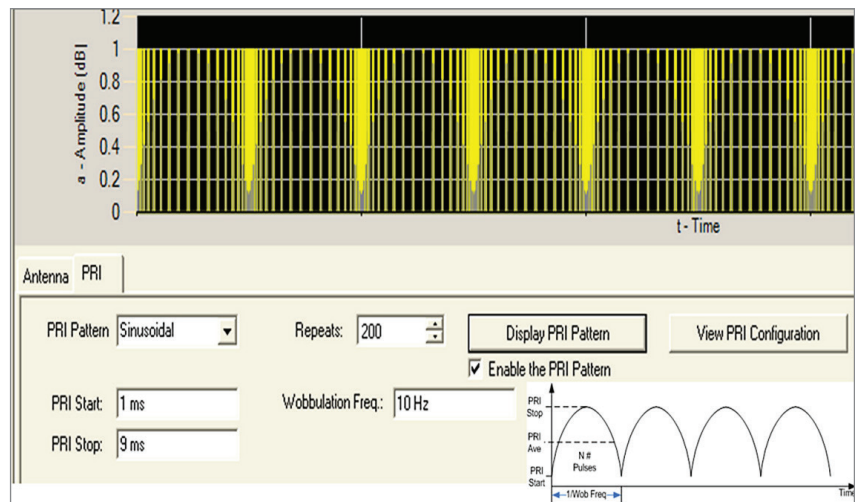

Create, store and play back custom radar test patterns such as pulse repetition intervals (PRI) with the PSG and arbitrary waveform generators.

Configure a Suite That Meets Your Needs

Signal Studio software is scalable to meet a wide range of requirements in component and receiver testing. It starts with a choice of two operating modes: waveform playback mode and real-time mode. Waveform playback mode supports two levels of functionality, basic and advanced. Real-time mode provides advanced capabilities such as closed-loop control during signal generation. This level of flexibility helps you optimize the cost and capability of the Signal Studio configuration that's right for you.

Enhance component and receiver testing with waveform playback

Use waveform playback mode to create and customize the waveform files needed to test components and receivers. Its user-friendly interface lets you configure signal parameters, calculate the resulting waveforms and download files for playback with a Keysight instrument.

Basic waveform-playback options allow you to create partially coded, statistically correct signals for stimulus/response measurements. For example, you can perform component-level parametric test of amplifiers, modulators, filters, and other components. You can also verify the performance of transmitter and receiver RF subsystems.

Advanced options enable you to create fully channel-coded signals for analysis of receiver BER, FER, BLER and PER so that you can verify baseband subsystem coding in ASICs, DSPs, and more. You can also check receiver performance and functionality during RF/baseband integration, system-level test, and beyond.

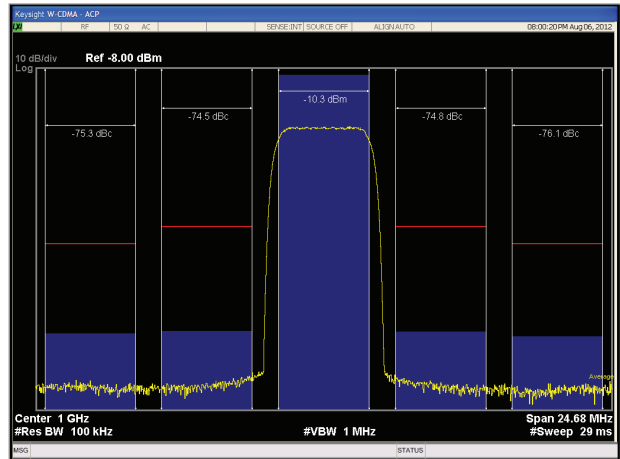

Combine Signal Studio's basic capabilities with the -73 dBc W-CDMA ACLR performance of the EXG X-Series signal generators to test components such as power amplifiers.

The built-in predistortion correction capability of the N7621B Signal Studio for multitone distortion software significantly improves test signal IMD suppression, RF flatness, image suppression and carrier feed-through characteristics of the test signal so that you measure the performance of your device, not your test system.

Uncorrected multitone distortion test signal generated with the N7621B Signal Studio software.

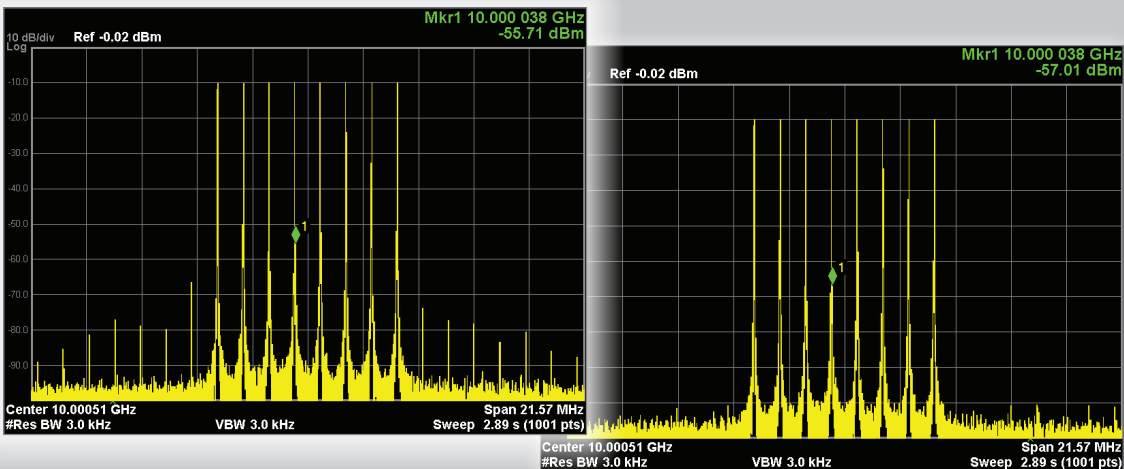

Corrected multitone signal.

Perform advanced receiver testing with real-time mode

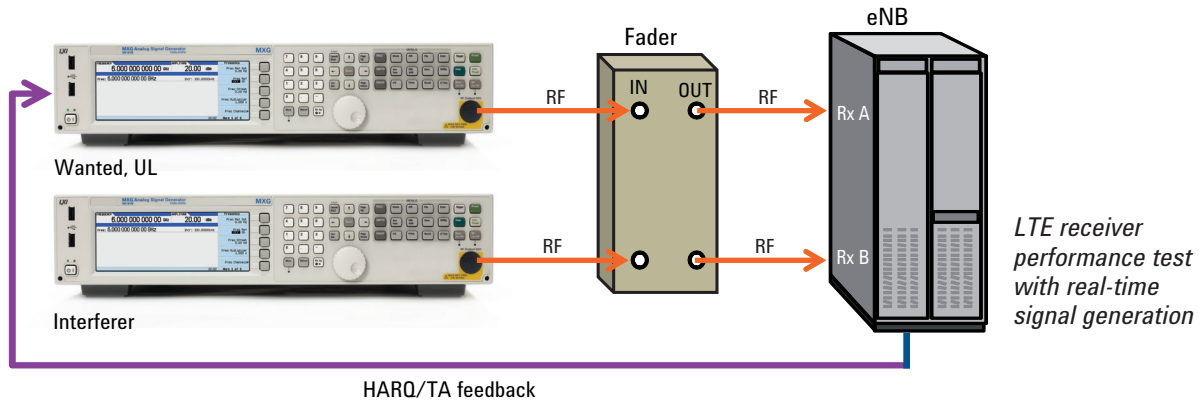

In Signal Studio, simulation of real-world signals in real-time mode enables the user to define the parameters of nonrepeating signals needed for receiver testing. Its graphical interface provides a direct instrument connection for parameter transfer and closed-loop or interactive control during signal generation.

Real-time capabilities are currently available in versions of Signal Studio that address the following standards.

- LTE FDD/TDD
- W-CDMA/HSPA+
- GSM/EDGE
- cdma2000®
- Global Navigation Satellite Systems (GNSS)
- Digital video

Real-time generation supports creation of complex signal scenarios of extremely long durations. In satellite navigation applications, an MXG or EXG can generate up to 56 line-of-sight satellite and multipath channels with greater than 24 hours duration. In DVB applications, this solution supports up to two hours of playback or continuous PN23 data sequences. Closed-loop testing is becoming increasingly important with the latest digital wireless standards, especially during throughput testing of realworld channels. In LTE applications, Signal Studio plus an X-Series signal generator supports full conformance testing with BTS loopback performance testing.

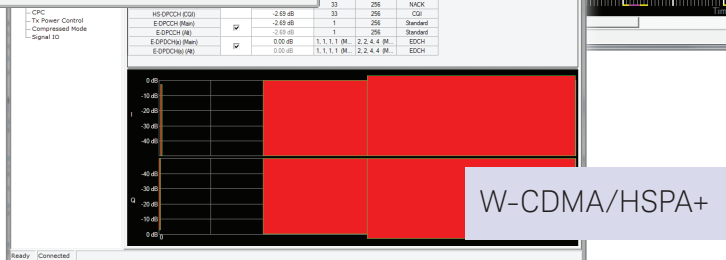
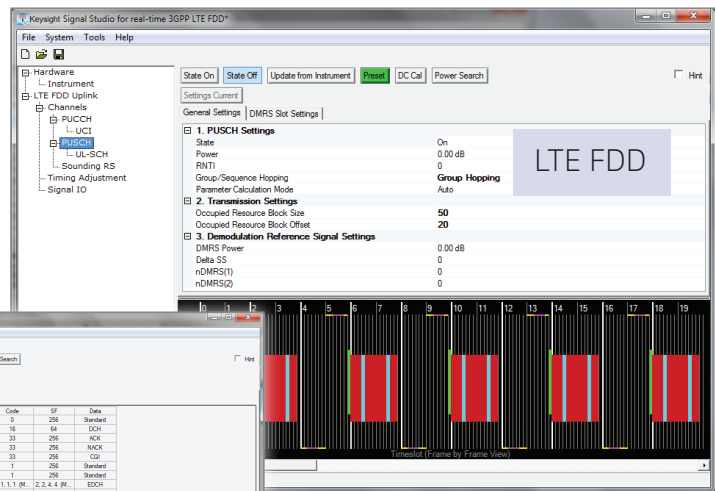
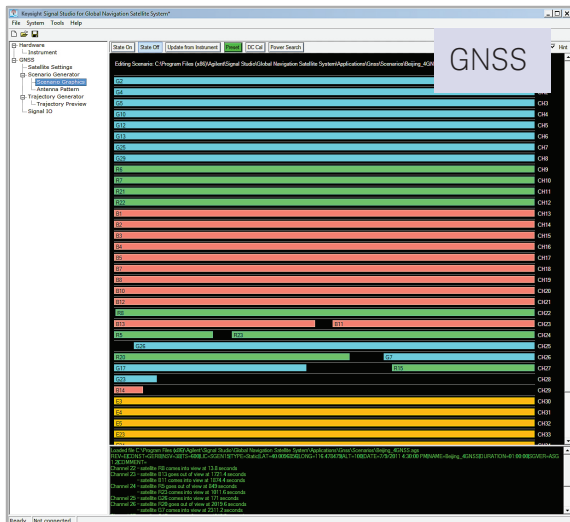

Easily Create Signals for Your Bench or Production Line

Whether you need test stimuli in R&D or manufacturing, Signal Studio simplifies creation of the signals you need for characterization, verification and pass/fail testing of components, devices, receivers, and more.

Simplify signal creation on the bench

Create your own signal-creation workstation in R&D by connecting Signal Studio to a Keysight instrument through the LAN or GPIB port of a PC. A built-in configuration tool makes it fast and simple, and the Signal Studio user interface includes a window that enables direct control of a connected instrument.

For advanced automation and control, the available application programming interface (API) exposes the signal creation and generation parameters of the software. This capability also enables creation of a custom user interface for signal creation.

Accelerate testing on the production line

To save time during automated testing, waveforms created in Signal Studio can be downloaded to an instrument and stored in memory. Recall and playback can be initiated programmatically with SCPI commands or through the front panel.

When you need to use custom signals with multiple test systems, flexible right-to-use licenses can meet your specific needs, schedules and budget requirements. For example, waveform licensing is ideal for cost-effective deployment of Signal Studio test signals in a manufacturing environment. Each of these licenses is fixed to a single instrument but is available in packs of 5 or 50 waveform licenses that can be used for different signal formats. Please see page 20 for more information about other licensing options.

Key features & attributes

Signal generation	<ul style="list-style-type: none"> – Custom, standard-based and presets for common test signals – Arbitrary I/Q waveform and real-time I/Q generation
Additive impairments	<ul style="list-style-type: none"> – I/Q impairments – AWGN – Real time fading with N5106A PXB
Graphs	<ul style="list-style-type: none"> – I(t), Q(t), I(t) + Q(t), P(t) – Spectrum, CCDF, CDP – Frame structure – Power envelope

Easy to use graphical display for signal visualization & verification.

I/Q polar vector display with added I/Q impairments.

Calibrated AWGN to simulation a noisy environment.

```







// Summary description for API TEST.
// NOTICE: DLL reference should be set to appropriate one.
// Agilent.SignalStudio.N7600.dll is defaultly located at
// C:\Program Files\Agilent\Signal Studio\TOPP_FDD\Agilent.SignalStudio.N7600.dll
// In Solution Explorer,
// Solution API TEST
// API TEST
// Agilent.SignalStudio.N7600
// If above reference does not exist or is marked with an exclamation point,
// delete the reference and add C:\Program Files\Agilent\Signal Studio\TOPP_FDD\Agilent.SignalStudio.N7600.dll
using System;
using Agilent.SignalStudio.N7600;

// The main entry point for the application.
// Summary
// [STAThread]
static void Main(string[] args)
{
    // Sets the culture to English (GB)
    Thread.CurrentThread.CurrentCulture = new CultureInfo("en-GB");
    // Sets the UI culture to English (GB)
    Thread.CurrentThread.CurrentUICulture = new CultureInfo("en-GB");

    Console.WriteLine("Start N7600A Simple API test program");
    var test = new N7600A.SimpleAPI();
}
    
```

Automate test with .NET API or SCPI (for real-time applications).

Signal Studio Software and Compatible Instruments

Signal Studio product		Real-time capability ¹	N5172B EXG	N5182B MXG	E8267D PSG	M9381A PXIe VSG	N5106A PXB	E6607 EXT	E6630A WiCon test set	DigRF testers	AWG (M8190A, E8241A)
											
Cellular communications											
N7600B	W-CDMA/HSPA+		•	•	•	•	•	•		•	
N7601B	cdma2000/1xEV-DO	 (cdma2000 only)	•	•	•	•	•	•		•	
N7602B	GSM/EDGE/Evo	 (GSM/EDGE only)	•	•	•	•	•	•		•	
N7612B	TD-SCDMA/HSDPA		•	•	•	•	•	•		•	
N7624B	LTE/LTE-Advanced FDD	 (LTE only)	•	•	•	•	•	• ²		•	
N7625B	LTE/LTE-Advanced TDD	 (LTE only)	•	•	•	•	•	• ²		•	
Wireless connectivity											
N7606B	Bluetooth®		•	•	•	•	•	•	•		
N7607B	DFS Radar Profiles		•	•	•						
N7613A	Fixed WiMAX™				•						
N7615B	Mobile WiMAX		•	•	•	•	•	•		•	
N7617B	WLAN 802.11a/b/g/n/ac		•	•	•	•	•		•		•
Audio/video broadcasting											
N7611B	Broadcast radio		•	•		•	•	•			
N7623B	Digital video		•	•	•	•	•	•			
Detection, positioning, tracking & navigation											
N7609B	Global Navigation Satellite Systems (GNSS)	 On EXG, MXG-B, and PXB only	•	•	•		•	•	•		
N7620B	Pulse building		•	•	•						•
General RF & microwave											
E8267D-SP1	Jitter injection				•						
N7621B	Multitone distortion (wideband/narrowband)		•	•	•						•
N7622B	Toolkit		•	•	•		•	•			

1. Not compatible with all instruments.

2. LTE-Advanced not supported on EXT wireless communications test set.

Cellular Communications

Signal Studio has earned its reputation as the benchmark for test stimuli in the cellular industry. One reason: Its comprehensive suite of 2G, 3G, and 4G compliant solutions addresses current and emerging standards with tools that reduce the time you spend on signal creation and simulation. As cellular technology continues to advance, Signal Studio will too, enabling you to streamline validation and ensure interoperability. Count on Signal Studio to help you tackle increasingly complex challenges in product development and manufacturing test.

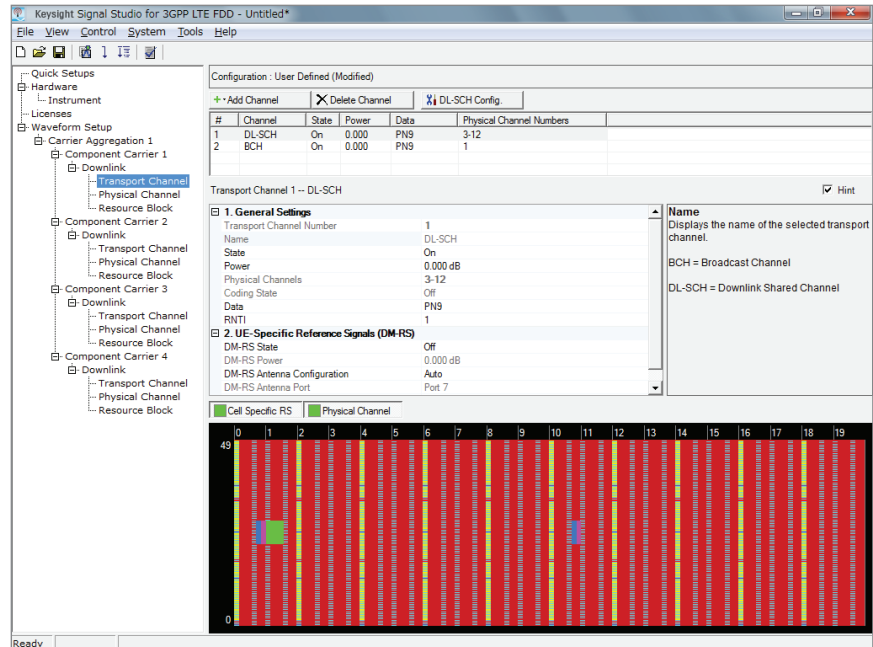

LTE/LTE-Advanced FDD

- Create single- and multi-carrier LTE/LTE-Advanced FDD signals
- Basic mode for BTS and UE component and Tx design and verification
- Advanced mode for BTS and UE Rx test with transport-channel coding
- Predefined configurations: E-UTRA test models, fixed reference channels (FRC)
- Up to 8x8 MIMO (TM9) combined with inter-band carrier aggregation and cross carrier scheduling
- Real-time LTE/LTE-Advanced UL signals for eNB Rx conformance tests with closed loop HARQ and timing adjustment feedback
- Downlink (DL): P-SS, S-SS, cell specific-RS, UE specific-RS, MBSFN-RS, PRS, CSI-RS, PDSCH, PDCCH, PBCH, PCFICH, PHICH, PMCH
- Uplink (UL): PUSCH, PUCCH, DMRS, SRS, PRACH
- Multi-Standard Radio (MSR) signal generation with LTE/LTE-Advanced FDD and TDD, W-CDMA/HSPA+, TD-SCDMA, GSM/EDGE/Evo, cdma2000/1xEV-DO
- Envelope signal generation and timing control for testing envelope tracking power amplifiers and power supplies

www.keysight.com/find/N7624B

Cellular Communications (continued)

LTE/LTE-Advanced TDD

- Create single- and multi-carrier LTE/LTE-Advanced TDD signals
- Basic mode for BTS and UE component and Tx design and verification
- Advanced mode for BTS and UE Rx test with transport-channel coding
- Predefined configurations: E-UTRA test models, fixed reference channels (FRC)
- Supports all uplink and downlink subframe configurations
- Up to 8x8 MIMO (TM9) combined with inter-band carrier aggregation and cross carrier scheduling
- Downlink (DL): P-SS, S-SS, cell specific-RS, UE specific-RS, MBSFN-RS, PRS, CSI-RS, PDSCH, PDCCH, PBCH, PCFICH, PHICH, PMCH
- Uplink (UL): PUSCH, PUCCH, DMRS, SRS, PRACH
- Multi-Standard Radio (MSR) signal generation with LTE/LTE-Advanced FDD and TDD, W-CDMA/HSPA+, TD-SCDMA, GSM/EDGE/Evo, cdma2000/1xEV-DO
- Envelope signal generation and timing control for testing envelope tracking power amplifiers and power supplies

www.keysight.com/find/N7625B

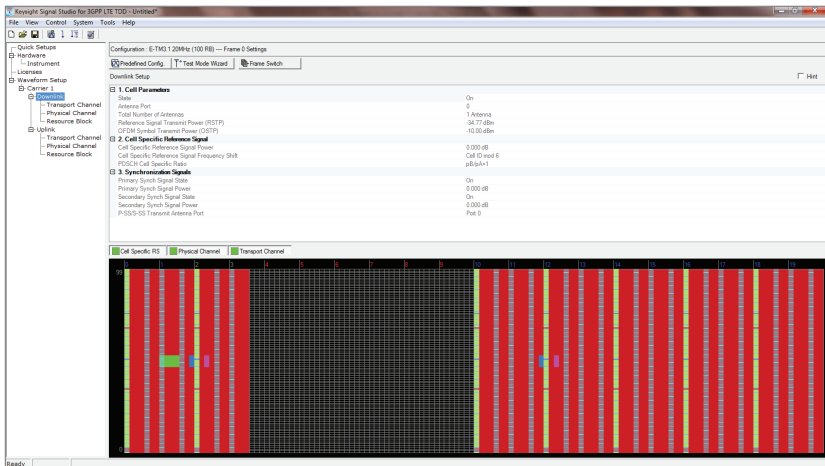

W-CDMA/HSPA+

- Create single- and multi-carrier W-CDMA, HSPA, and HSPA+ signals
- Basic mode for BTS and UE component and Tx design and verification
- Advanced mode for BTS and UE Rx test with transport-channel coding
- Signal presets: test models, FRC, RMC, H-Set, and sub-test signals
- UL signal generation to test CPC, and MIMO/multi-cell (includes dual-cell, 3-cell, and 4-cell) HARQ and CQI/PCI
- PRACH with transport channel coding for BER/BLER testing
- Complete UE receiver evaluation with DC, MIMO, DC+MIMO, CPC, compressed mode and more
- Real-time capabilities support the required UL HARQ ACK/NACK closed-loop feedback for TS25.141 conformance testing along with closed-loop control of the RF power level, compressed mode and E-TFCI switching for functional tests

www.keysight.com/find/N7600B

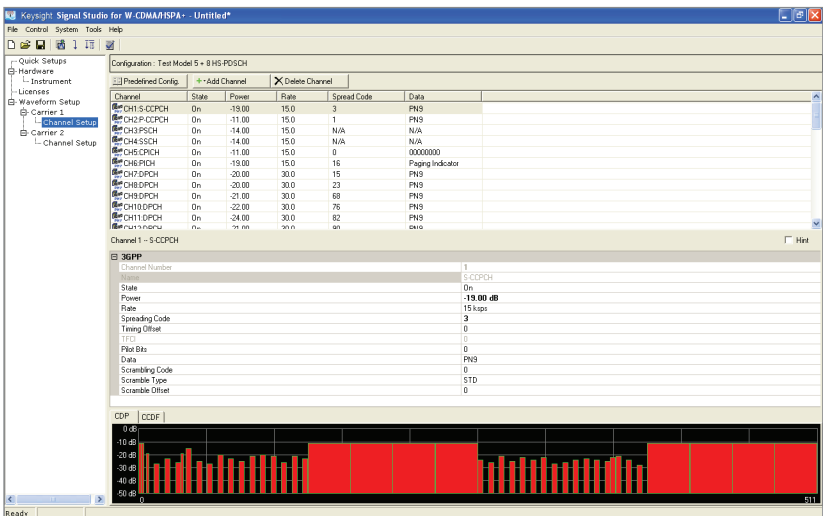

Cellular Communications (continued)

GSM/EDGE/Evo

- Create single- and multi-carrier GSM, EDGE and EDGE Evo signals
- Basic mode for BTS and UE component and Tx design and verification
- Easily save/recall preset and user-defined carrier configurations
- Mixed GSM, EDGE and EDGE Evo carriers and timeslots
- 15 burst types with GMSK, 8-PSK, 16QAM, 32QAM, HSR QPSK, HSR 16QAM, HSR 32QAM
- Adjustable timeslot parameters: power level, burst type, data offset, and multi-slot feature to maintain power
- Advanced mode with transport channel coding for UL and DL receiver test
- Support broadcast channel (BCH)
- Real-time capabilities also support alternate amplitude power control, real-time data input, and error insertion for BER and FER test

www.keysight.com/find/N7602B

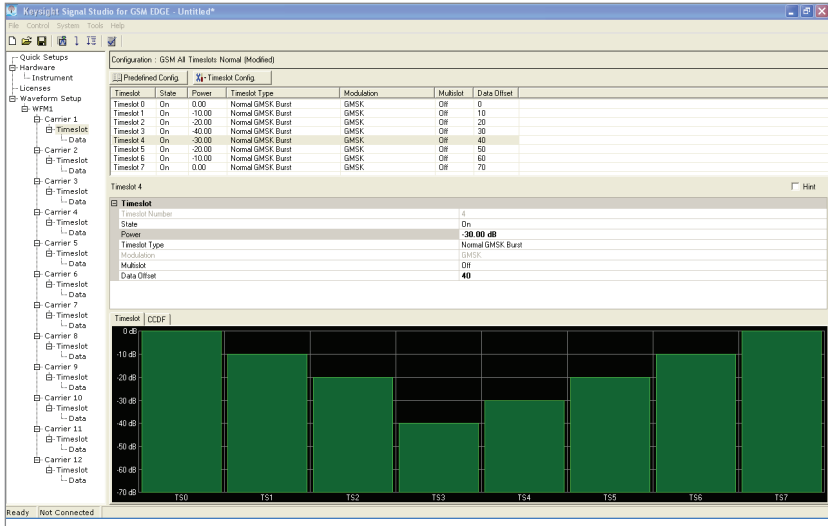

cdma2000/1xEV-DO

- Create single- and multi-carrier 3GPP2 cdma2000 and 1xEV-DO (Rev. 0 & A) signals
- Basic mode for BTS and UE component and Tx design and verification
- Advanced mode for BTS and UE 1xEV-DO Rx test
- Configure forward and reverse link channel parameters
- IS-95A and cdma2000 BTS Rx test in real-time mode
- Real-time capabilities also support closed loop power control and error insertion for BER and FER test

www.keysight.com/find/N7601B

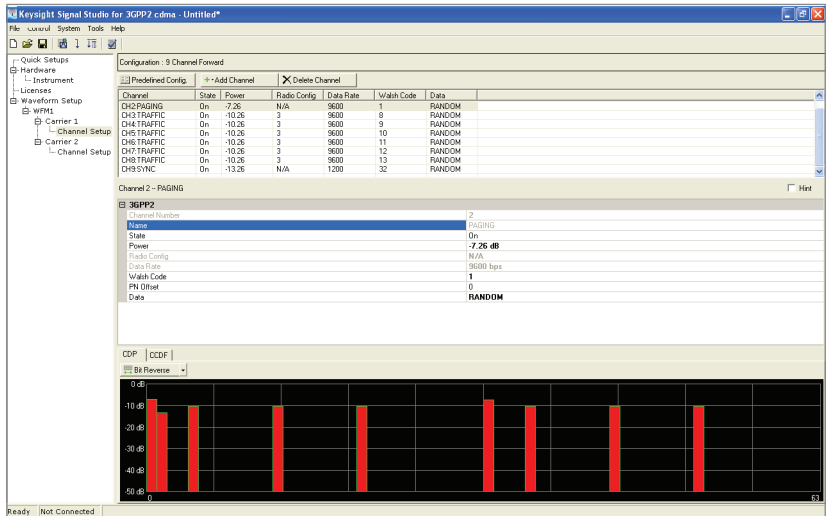

Cellular Communications (continued)

TD-SCDMA/HSDPA

- Create single- and multi-carrier 3GPP TD-SCDMA LCR with HSDPA signals
- Configure uplink and downlink transport and physical channels
- Basic mode for BTS and UE component and Tx design and verification
- Advanced mode for BTS and UE Rx test with transport-channel coding

www.keysight.com/find/N7612B

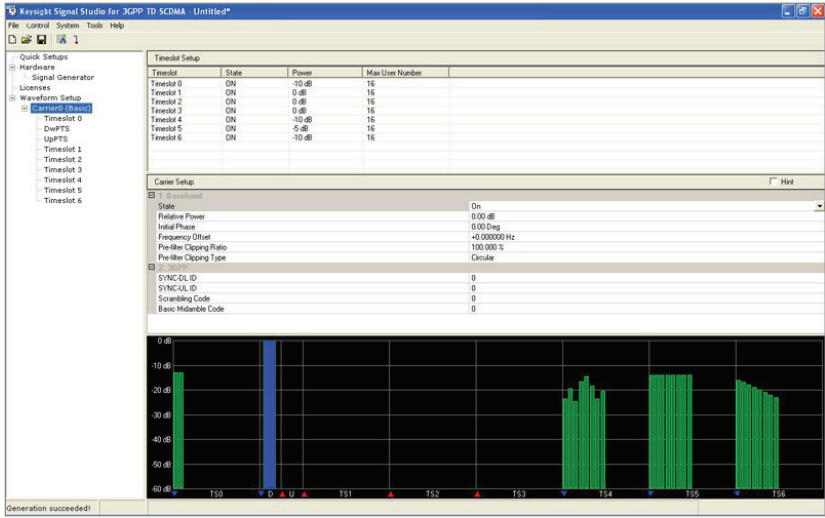

Test Case Manager

- Easily and quickly perform standard compliant conformance tests with confidence
- Generate wanted and interferer signals with single or multiple signal generators
- SCPI command list expedites test automation
- Supports LTE eNB receiver characteristic tests for FDD and TDD

www.keysight.com/find/TCM

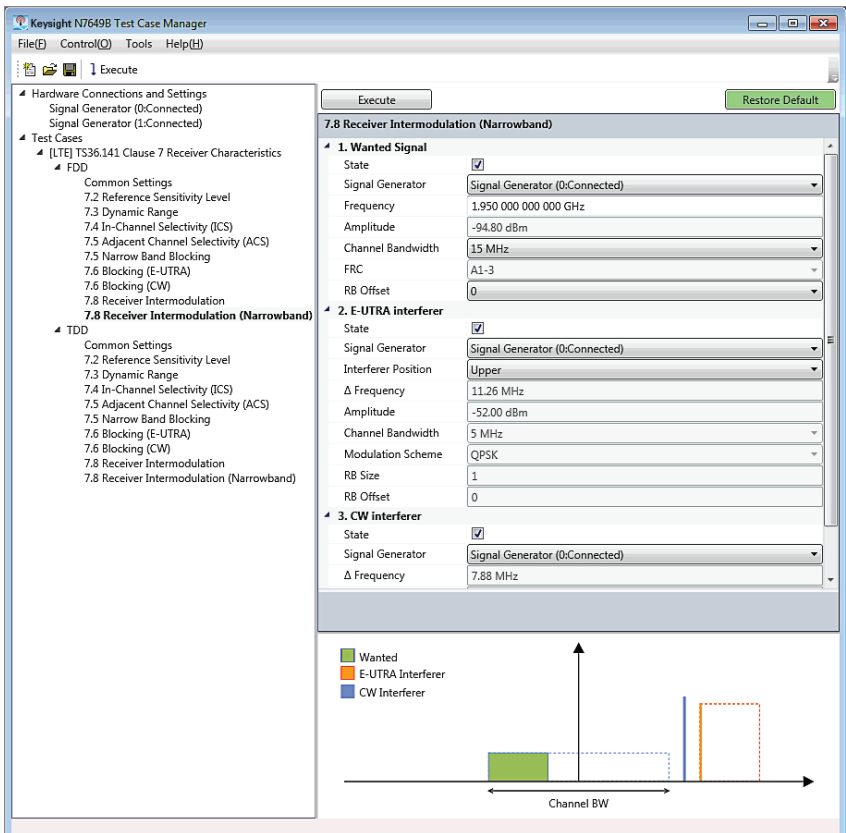

Wireless Connectivity

Wireless connectivity formats, such as WLAN and *Bluetooth*, are continuing to evolve to address the growing need for faster data services. Whether you're working on long- or short-range wireless connectivity, Keysight is striving to help you stay ahead of the pack by providing signal-creation solutions early in the lifecycle of new standards and technologies. As you continue to push for higher data rates, we'll keep pushing Signal Studio forward with the tools you need to streamline validation, ensure interoperability, and meet the challenges of product design and manufacturing test.

WLAN 802.11a/b/g/n/ac

- Create single- and multi-carrier 802.11 a/b/g/j/p WLAN signals
- 802.11n and 802.11ac MIMO system test with channel simulation: 2x2, 2x3, 2x4, 3x3, 3x4 and 4x4
- Basic mode for component and Tx design and verification
- Advanced mode for Rx test with full channel coding

www.keysight.com/find/N7617B

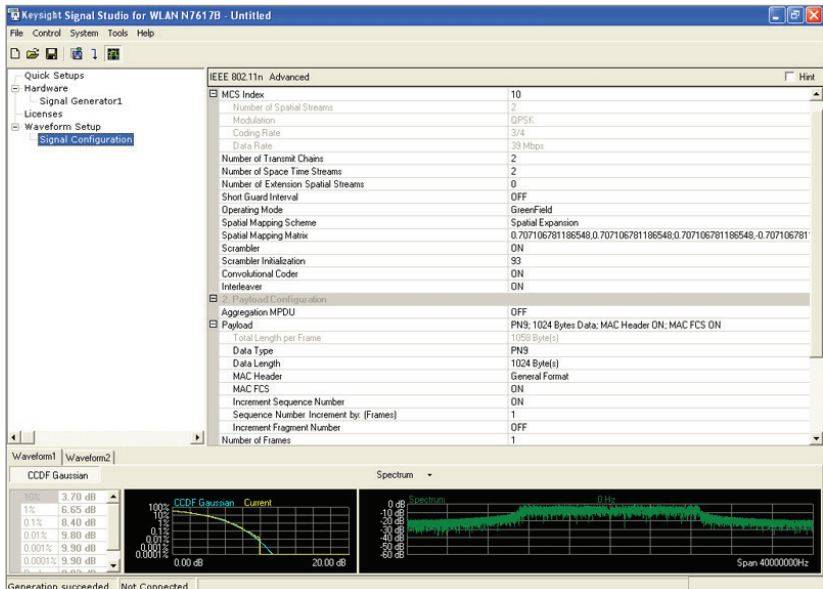

Dynamic Frequency Selection (DFS) radar profiles

- Create radar signals according to profiles defined by FCC, ETSI, and TELEC for DFS test
- Controllable number of trials and waveforms generated for each trial is unique
- Randomized sets of radar parameters can be regenerated

www.keysight.com/find/N7607B

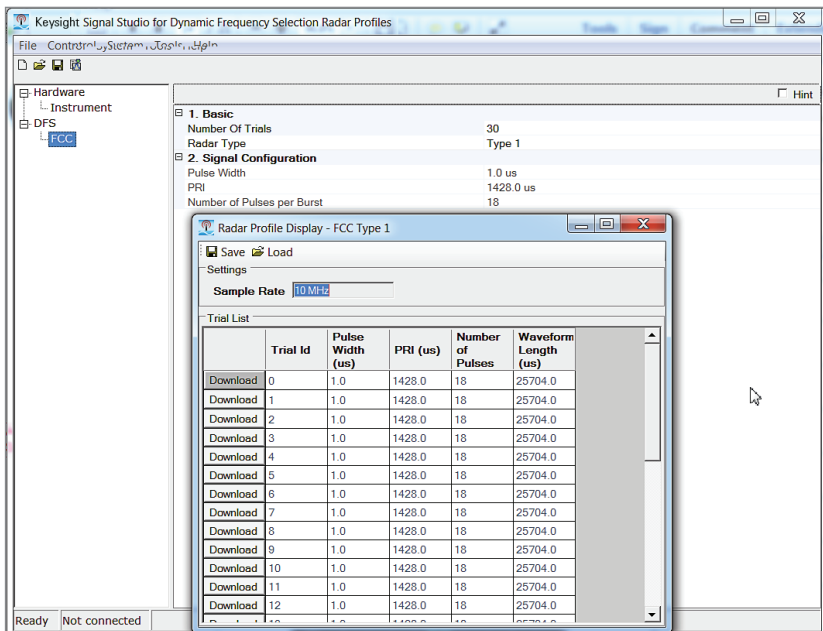

Wireless Connectivity (continued)

Bluetooth

- Create standard-based signals for *Bluetooth* v2.1+EDR and low energy technology (*Bluetooth* 4.0)
- Configure *Bluetooth* and EDR modulated data streams component and Tx test
- Configure fully-coded *Bluetooth* and EDR packets for Rx test
- Dirty transmitter test setup for Rx sensitivity tests using DHx, 2-DHx, 2-EVx, 3-DHx and 3-EVx packet types
- Simple BER test optimization using BER vs. payload gate delay plot feature

www.keysight.com/find/N7606B

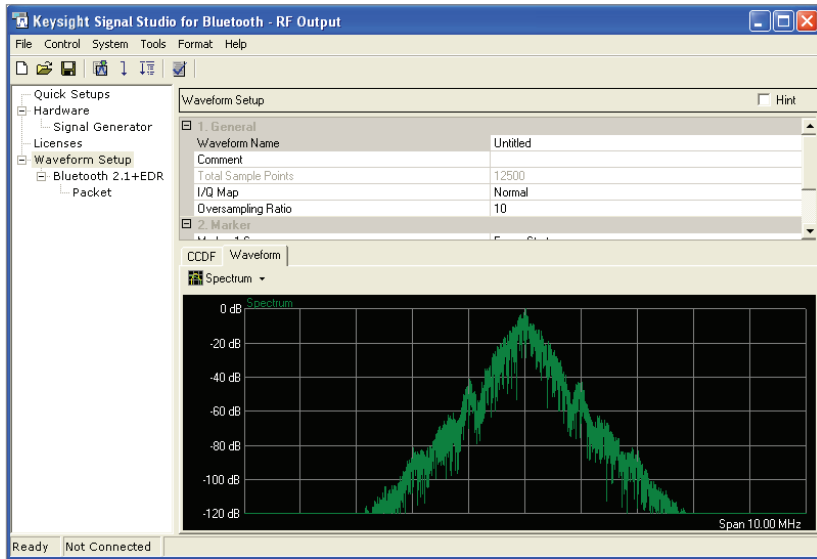

Wireless Connectivity (continued)

Mobile WiMAX

- Create single- and multi-carrier 802.16 Mobile WiMAX and WiBro signals
- Configure uplink and downlink channel parameters
- Test STC and MIMO features, and IEEE 802.16-2009 (formerly 802.16Rev2) features such as CDD and FDD/H-FDD frames
- Basic mode for component and Tx design and verification
- Advanced mode for Rx test with fully coded signals with flexible zone and burst configuration
- Add fading effects for Rx test

www.keysight.com/find/N7615B

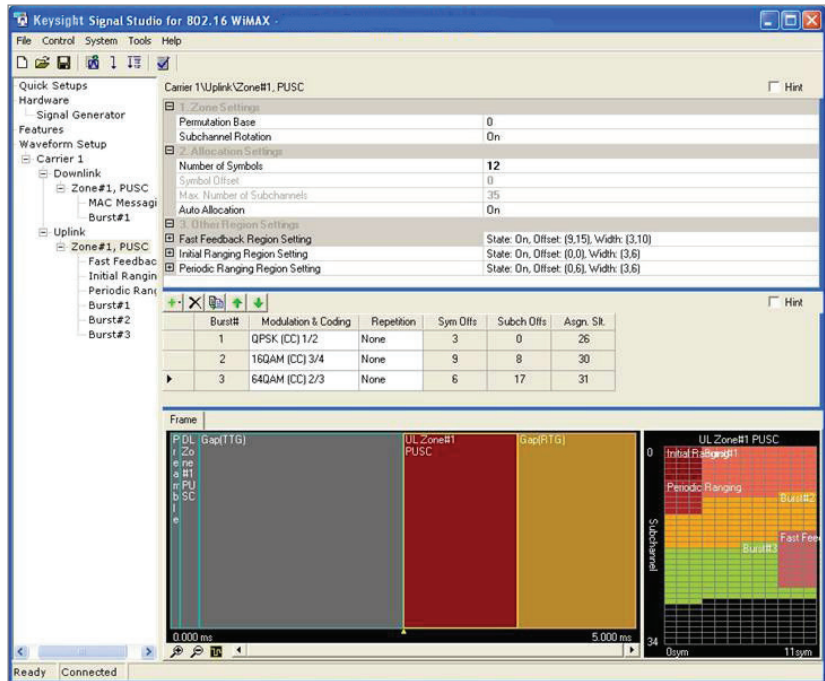

Fixed WiMAX

- Create single-carrier 802.16-2004 fixed WiMAX signals
- Configure uplink and downlink channel parameters for component, Tx, and Rx test
- Set bandwidth, cyclic prefix ratio (G), sampling factor (n), frame length, preamble, FCH and data bursts
- Choose raw or fully coded data (with randomization, Reed-Solomon convolutional coding, and interleaving) and create MAC PDUs including headers and CRC

www.keysight.com/find/N7613A

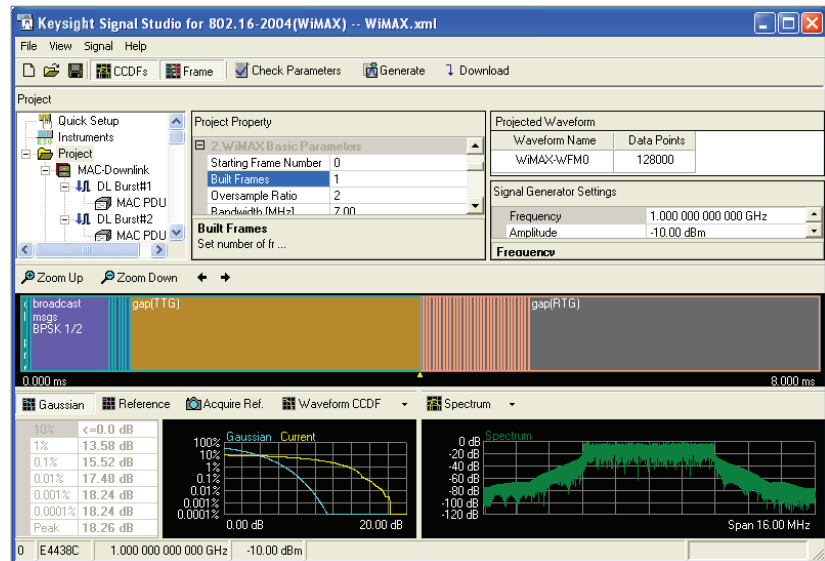

Audio and Video Broadcasting

The push for increased quality of mobile entertainment services is driving wider bandwidths and denser modulation schemes in communication systems and handheld devices. Whether you're working on satellite, terrestrial or mobile broadcast systems, count on Signal Studio to provide the tools to help you address the challenges of mobile device and set-to-box product design and manufacturing test.

Digital video

- Create standard-compliant single- or multi-carrier digital video waveforms for component or receiver test
 - DVB-T/H/T2/C/S/S2
 - ISDB-T/T_B/TS_B/Tmm
 - DTMB(CTTB)
 - CMMB
 - J.83 Annex A/B/C
 - DOCSIS DS
 - ATSC or ATSC-M/H
- Perform real-time signal generation for DVB-T/H/T2/C/S/S2 & ISDB-T
- Select from multiple payload types: MPEG2-TS file or ColorBar for subjective evaluation or data pattern for BER test
- Use with N5106A PXB for performance tests such as real-time fading, AWGN, interference tests and more

www.keysight.com/find/N7623B

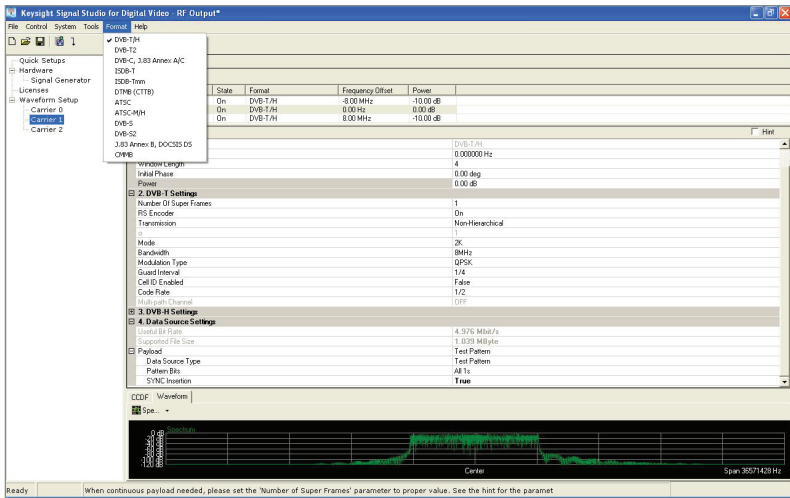

Broadcast radio

- Create standard-compliant waveforms for component or receiver test
 - FM Stereo/RDS/RBDS
 - DAB/DAB+, T-DMB and DMB-Audio
- Select from multiple payload types: WAV, MP2 or AAC+ audio file, ETI or STI stream file or data pattern
- Provide audio sample files and ETI demo stream file for subjective test
- Use with N5106A PXB for performance tests

www.keysight.com/find/N7611B

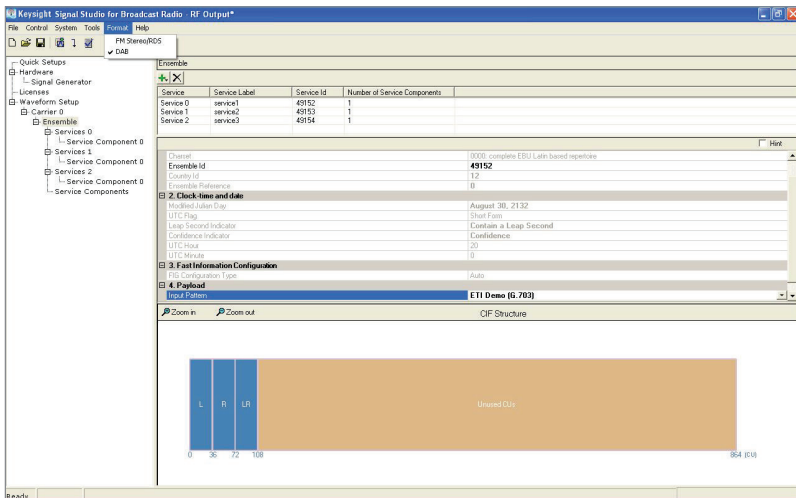

Detection, Positioning, Tracking and Navigation

During receiver verification, advanced signal-creation tools provide highly realistic simulations of the operating environment facing detection, positioning, tracking and navigation systems. What once required racks of test equipment can now be accomplished with cost-effective COTS instruments and Signal Studio.

Global navigation satellite systems (GNSS)

- Create real-time multi-satellite open service signals for the U.S. Global Positioning System (GPS), Russian Global Navigation Satellite System (GLONASS), European Galileo system, or Chinese Beidou Navigation Satellite System (BDS, also known as Compass)
- Simulate up to 15 line-of-sight satellites for each GNSS
- Up to 40 channels for line-of-sight and multipath signals for any combination of GPS or GLONASS L1 signals with C/A code or Beidou B1 signals, with 16 additional channels for Galileo E1 line-of-sight and multipath signals
- Support static scenarios for stationary receivers or dynamic scenarios for moving receivers
- Up to 24 hours simulation using saved scenario files, or longer simulations using continuous scenario generation mode
- Control satellite visibility, power, multipath, and pseudorange error in real time
- Create or edit custom scenarios
- Receiver antenna pattern modeling
- Trajectory generator utility for moving receiver scenarios
- Basic mode provides waveform files that simulate a single satellite for GPS, GLONASS, Galileo, Beidou (Compass), SBAS, or QZSS for manufacturing test

Channel	Group	SV ID	Enabled	Frequency	Relative Power Scale (dB)	Power (dBm)	Pseudorange (m)	Pseudorange Error (m)	Doppler Shift (Hz)	Multipath
1		G2	☑	L1	0.00	-100.00	20453603.50	0.00	966.851	0 Taps
2		G4	☑	L1	0.00	-100.00	21337666.70	0.00	-1873.584	0 Taps
3		G5	☑	L1	0.00	-100.00	21184639.67	0.00	1823.844	0 Taps
4		G10	☑	L1	0.00	-100.00	20277812.11	0.00	-1389.662	0 Taps
5		G12	☑	L1	0.00	-100.00	23291783.70	0.00	-1839.898	0 Taps
6		G13	☑	L1	0.00	-100.00	22780606.25	0.00	-1384.170	0 Taps
7		G17	☑	L1	0.00	-100.00	23818163.76	0.00	-3632.579	0 Taps
8		G23	☑	L1	0.00	-100.00	24951310.35	0.00	-2731.714	0 Taps
9		G25	☑	L1	0.00	-100.00	23874788.15	0.00	-42.485	0 Taps
10		G29	☑	L1	0.00	-100.00	24867856.77	0.00	3465.222	0 Taps
11		E3	☑	E1	0.00	-100.00	2592775.79	0.00	2746.034	0 Taps
12		E4	☑	E1	0.00	-100.00	23492539.88	0.00	763.329	0 Taps
13		E5	☑	E1	0.00	-100.00	24890656.46	0.00	-1719.694	0 Taps
14		E23	☑	E1	0.00	-100.00	25996676.37	0.00	2205.256	0 Taps
15		E24	☑	E1	0.00	-100.00	23334510.29	0.00	478.049	0 Taps
16		E25	☑	E1	0.00	-100.00	24657806.23	0.00	-1596.113	0 Taps
17		E30	☑	E1	0.00	-100.00	26435953.98	0.00	2230.316	0 Taps
18		R5	☑	1	0.00	-100.00	23528008.88	0.00	4006.813	0 Taps
19		R6	☑	-4	0.00	-100.00	19677237.47	0.00	-1929.492	0 Taps
20		R7	☑	5	0.00	-100.00	20386050.47	0.00	2361.586	0 Taps
21		R20	☑	2	0.00	-100.00	22624218.19	0.00	-3808.490	0 Taps
22		R21	☑	4	0.00	-100.00	19300064.98	0.00	-1065.010	0 Taps
23		R22	☑	-3	0.00	-100.00	20428732.86	0.00	2750.808	0 Taps
24		B1	☑	B1	0.00	-100.00	37725936.07	0.00	-145.001	0 Taps
25		B2	☑	B1	0.00	-100.00	38228906.33	0.00	-32.420	0 Taps
26		B3	☑	B1	0.00	-100.00	37203727.76	0.00	66.567	0 Taps
27		B4	☑	B1	0.00	-100.00	38886360.97	0.00	-142.962	0 Taps
28		B5	☑	B1	0.00	-100.00	39471870.12	0.00	53.703	0 Taps

Detection, Positioning, Tracking and Navigation (continued)

Pulse building

- Create complex single emitter pulse patterns and enhance signal quality using baseband predistortion
- Build a library of pulses, patterns, looks, dwells, and antenna scans
- Import/Export scenarios from .csv and ASCII files
- Apply intra-pulse modulation: linear and non-linear FM chirp, FM step, AM step, BPSK, QPSK, Barker codes
- Create, store, and recall custom pulse patterns with 80 dB on/off ratio and up to 80 MHz or 1 GHz BW
- Set repetition interval, number of repetitions, and frequency, phase, and power offsets on a pulse-by-pulse basis
- Use the COM-based API to access the pulse building engine from your own programming environment

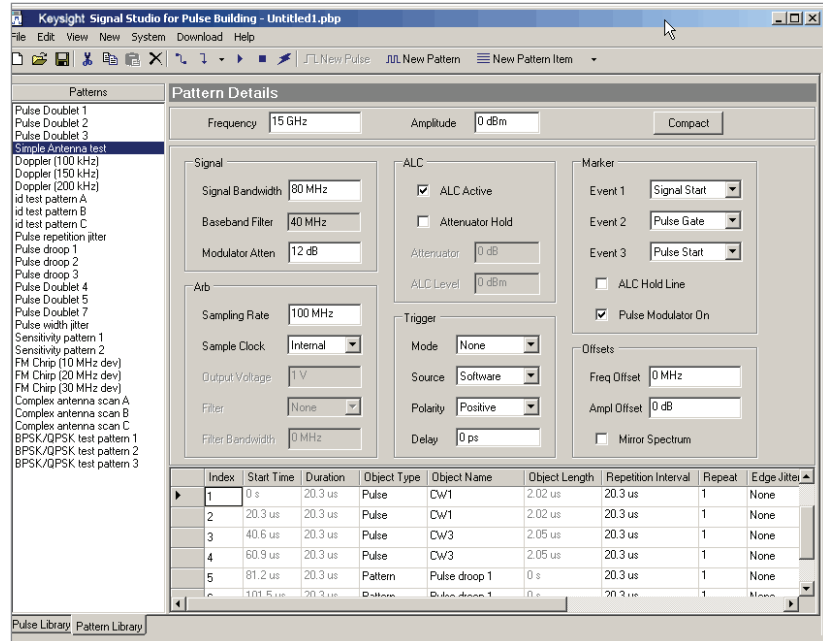

www.keysight.com/find/N7620B

General Purpose

Across a wide range of RF and microwave test applications, Signal Studio shortens development time by simplifying test setups and lowering the overall cost of test. Our innovative signal-creation and performance-optimization tools can accelerate your work in the development and manufacturing of transceivers and the components that comprise them. You can create multi-tone and NPR signals for distortion test, and reduce measurement uncertainty by applying signal corrections to minimize nonlinear distortion of the test stimulus.

Multitone distortion

Wideband

- Create fast-hopping LO signals across a 2 GHz bandwidth with good image- and carrier-suppression
- Create distortion-free 2-tone and multitone signals (up to 4097 tones) across 2 GHz bandwidth
- Create an NPR test stimulus with notch depth > 60 dBc and ± 0.5 dB noise flatness

Narrowband

- Create distortion-free 2-tone and multitone test signals, with up to 4097 tones (IMD suppression > 70 dBc)
- Create an NPR test stimulus with up to 100 MHz noise BW, notch depth > 60 dBc, and ± 0.5 dB noise flatness

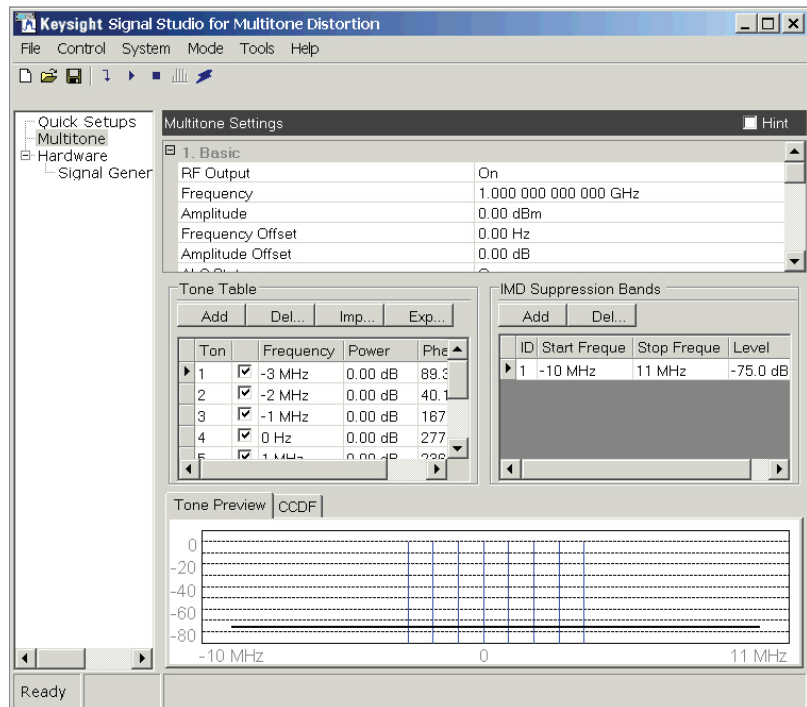

Common features

- Control magnitude and phase (random, parabolic, or constant) for individual tones with presets across tones to control CCDF characteristics
- Apply pre-distortion to enhance signal quality and minimize test uncertainty
- Reduce carrier feedthrough issues using tone/noise/notch offset capability
- Sequence waveforms with the API for smooth transition between signals
- Automate signal configuration and generation using the COM and .NET API

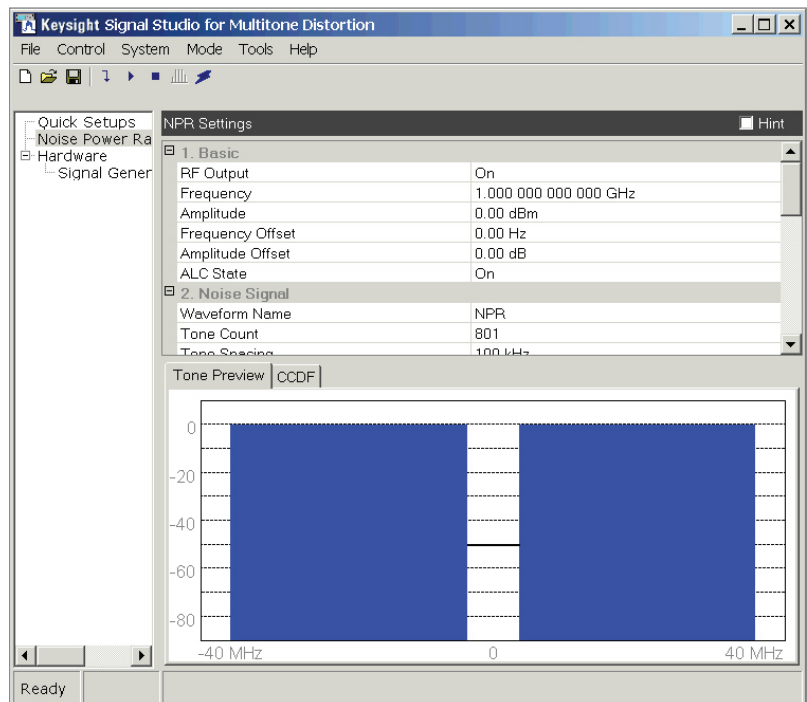

www.keysight.com/find/N7621B

General Purpose (continued)

Jitter injection

- Create calibrated jitter impairments with digital accuracy for tolerance measurements
- Predefined jitter types: ITU-T G.8251-OC-48, OC-192 and OC-768
- Periodic jitter types: sinusoidal, square, triangle, saw tooth, exponential, and custom
- Custom jitter rates and deviations: up to 20 MHz at 0.15 UI peak to peak
- Random jitter setup: customize the standard deviation and noise seed for randomness down to 1×10^6

www.keysight.com/find/E8267D-SP1

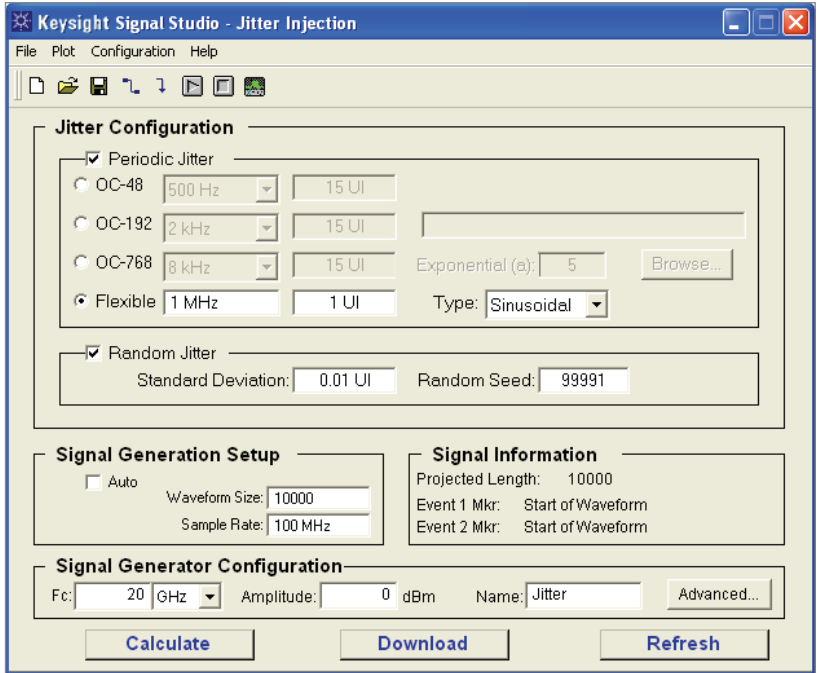

Signal Studio toolkit

- Free utility to download/playback your custom I/Q waveform files
- Hardware connection wizard simplifies instrument connectivity
- Supports six file formats: MATLAB "MAT File 5", ASCII, Keysight 16-bit and 14-bit, and more

www.keysight.com/find/N7622B

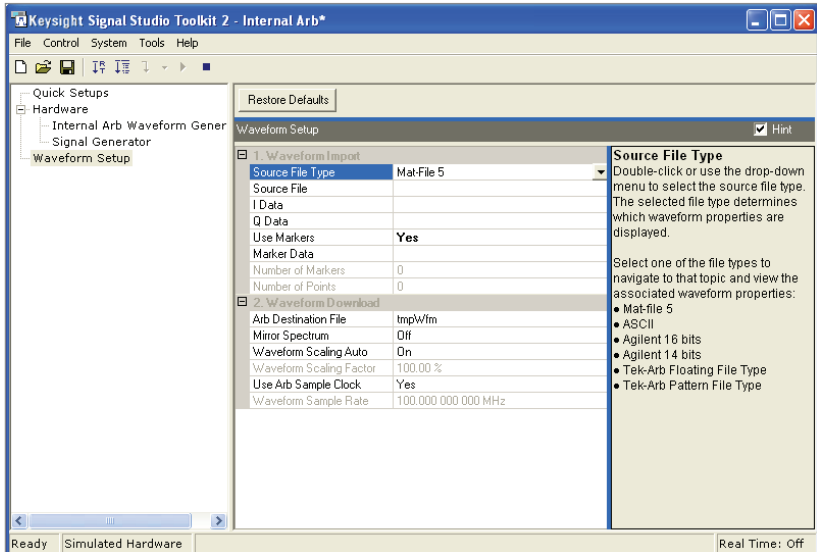

Flexible Licensing

Signal Studio software may be freely installed on any PC and used to create encrypted waveform files. Where those waveform files will play is governed by the licensing choices, as shown in this table.

License type	Application	Waveform playback ¹
Fixed	Primary: R&D Secondary: Manufacturing	Unlimited number of waveforms Playback on one host ID
Transportable²	Primary: R&D, rental Secondary: Manufacturing	Unlimited Playback on multiple host IDs (One at a time, transports limited to 10x per month)
Floating²	Primary: R&D simulation Used with SystemVue	Unlimited Based on number of seats
Waveform^{3,4} (5/50-pack)	Primary: Manufacturing Secondary: R&D	Quantity-limited Up to 545 waveforms (Each waveform individually licensed to a single host ID)
Trial, time-based (1 time, 30-day)	All	Time-limited Playback on one host ID

1. A host ID generally represents a single instrument or PC. For modular products, Signal Studio is licensed to a chassis controller, which is also referred to as a host ID.
2. Transportable and floating licenses carry a 30% price premium.
3. Not compatible with N7620B Signal Studio for pulse building or N7621B Signal Studio for multitone distortion.
4. Lowest cost option. You may purchase up to nine 5-packs and up to ten 50-packs.
(MXG/EXG/ESG/EXT Options 221-229; N7650B for modular products, Option 221-229)
(MXG/EXG/ESG/EXT Options 250-259; N7650B for modular products, Options 250-259).

www.Keysight.com/find/SignalStudio

Additional Resources

Signal Studio software

Access the comprehensive online documentation, which includes the complete software HELP
www.keysight.com/find/SignalStudio



myKeysight

www.keysight.com/find/mykeysight

A personalized view into the information most relevant to you.

www.keysight.com/go/quality

Keysight Technologies, Inc.

DEKRA Certified ISO 9001:2008

Quality Management System

Keysight Channel Partners

www.keysight.com/find/channelpartners

Get the best of both worlds: Keysight's measurement expertise and product breadth, combined with channel partner convenience.

cdma2000 is a registered certification mark of the Telecommunications Industry Association. Used under license.

WiMAX, Mobile WiMAX, WiMAX Forum, the WiMAX Forum logo, WiMAX Forum Certified, and the WiMAX Forum Certified logo are US trademarks of the WiMAX Forum.

Bluetooth and the Bluetooth logos are trademarks owned by Bluetooth SIG, Inc, U.S.A. and licensed to Keysight Technologies, Inc.

www.keysight.com/find/SignalStudio

For more information on Keysight Technologies' products, applications or services, please contact your local Keysight office. The complete list is available at: www.keysight.com/find/contactus

Americas

Canada	(877) 894 4414
Brazil	55 11 3351 7010
Mexico	001 800 254 2440
United States	(800) 829 4444

Asia Pacific

Australia	1 800 629 485
China	800 810 0189
Hong Kong	800 938 693
India	1 800 112 929
Japan	0120 (421) 345
Korea	080 769 0800
Malaysia	1 800 888 848
Singapore	1 800 375 8100
Taiwan	0800 047 866
Other AP Countries	(65) 6375 8100

Europe & Middle East

Austria	0800 001122
Belgium	0800 58580
Finland	0800 523252
France	0805 980333
Germany	0800 6270999
Ireland	1800 832700
Israel	1 809 343051
Italy	800 599100
Luxembourg	+32 800 58580
Netherlands	0800 0233200
Russia	8800 5009286
Spain	800 000154
Sweden	0200 882255
Switzerland	0800 805353
	Opt. 1 (DE)
	Opt. 2 (FR)
	Opt. 3 (IT)
United Kingdom	0800 0260637

For other unlisted countries:
www.keysight.com/find/contactus
 (BP-09-23-14)

