

Keysight Technologies

Millimeter-Wave Network Analyzers 10 MHz to 110 GHz, with Extensions to 1.1 THz

Technical Overview

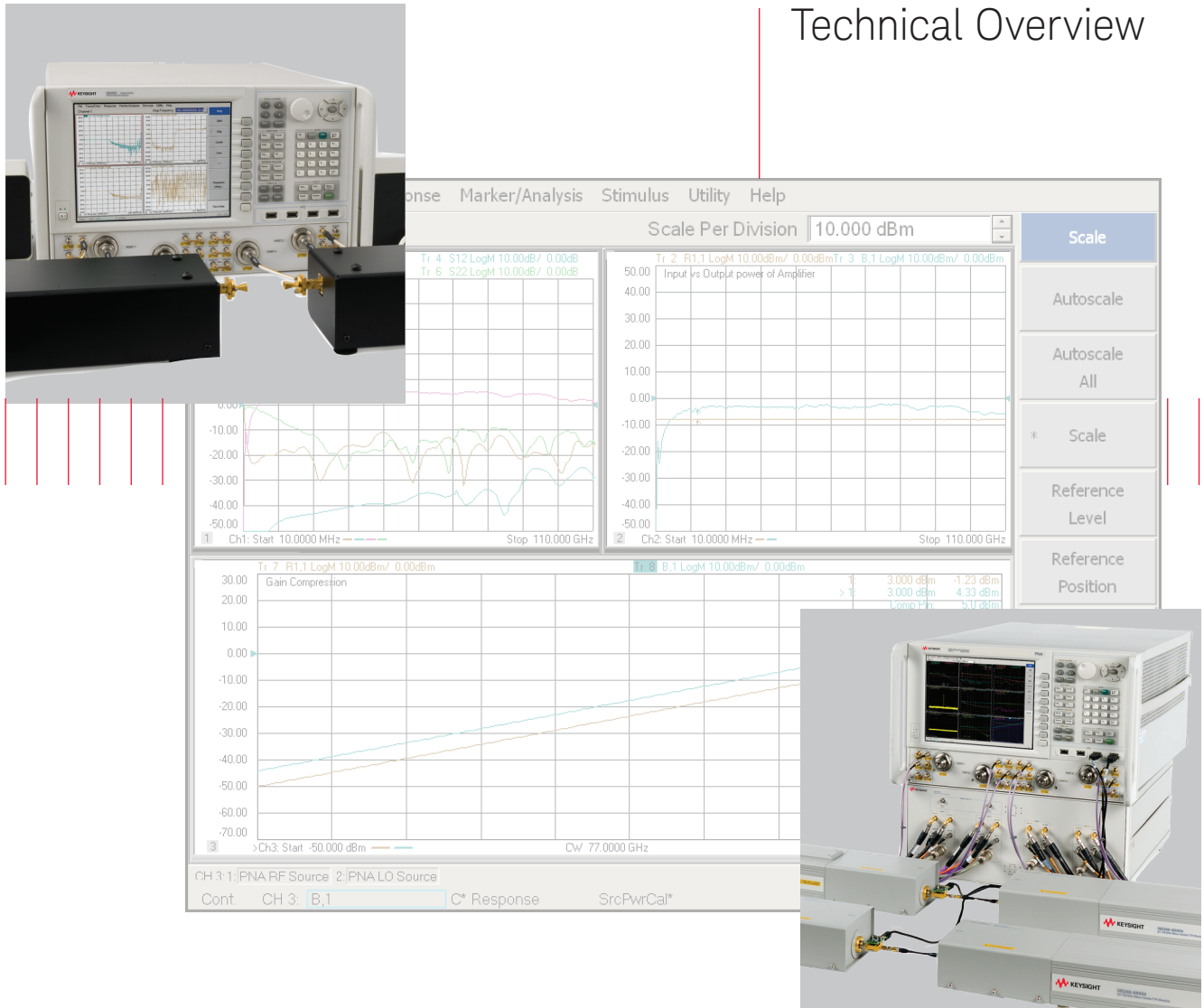

Single Sweep 10 MHz to 110 GHz Measurement Solution

Keysight Technologies, Inc. currently offers the N5251A single sweep 10 MHz to 110 GHz vector network analyzer solution.

The N5251A solution uses a millimeter-wave test controller and a combination of broadband frequency extenders that provide a male 1.0 mm test port output connector. Users can purchase the N5251A as a single product solution or configure using separate components. This allows for existing N5227A PNA users the capability to add the N5261A or N5262A test controller and broadband frequency extenders to make measurements from 10 MHz to 110 GHz.

For users that have or wish to purchase the N5247A 67 GHz PNA-X, you can also extend these to cover a single sweep 10 MHz to 110 GHz measurement by adding the N5261A / 62A test set controller and a set of broadband frequency extenders.

The Keysight 110 GHz solution is the only broadband solution with integrated tri-axial bias tees that provide accurate control of device bias through its force/sense ability. This solution is ideal for device characterization, modeling and parameter extraction in coaxial or on-wafer. The broad frequency coverage down to 10 MHz offers superb time domain resolution. With the introduction of the N5251A, accurate leveled power can be applied to the device being measured providing the ability to sweep the power at the 1.0 mm port.

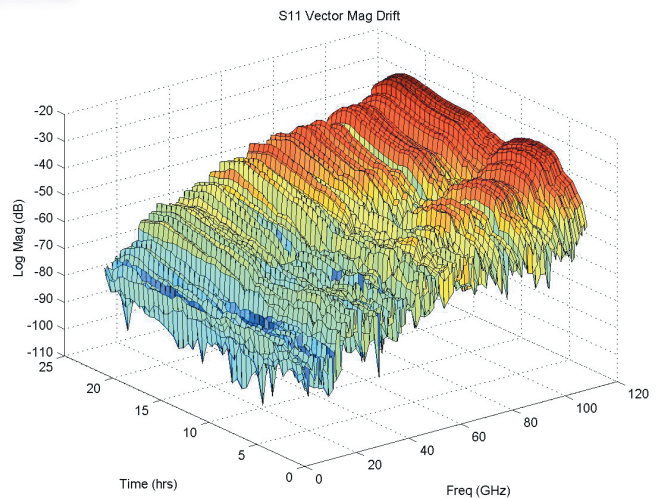

N5251A Single Sweep Solution (10 MHz to 110 GHz)

This configuration of the millimeter network analyzer is based on the N5227A PNA network analyzer. It allows both a single sweep measurement solution that starts at 10 MHz and goes to 110 GHz. This solution is intended as a replacement for the HP 8510XF solution and has improved performance capability. In particular it adds the capability to control and use receiver leveling to set the power accurately at the 1.0 mm test port. Architecturally very similar to the existing N5250C but allows for the configuration of either a 2 or 4 port 10 MHz to 110 GHz measurements. Refer to the configuration information at the end of this section.

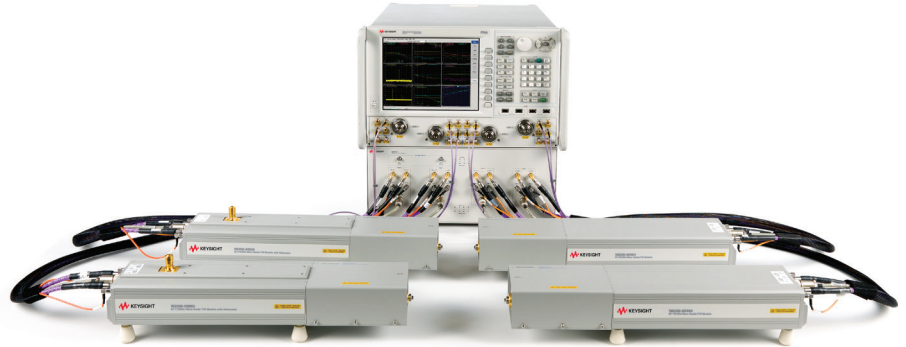

Key features

- Frequency range: 10 MHz to 110 GHz
- Built in Kelvin bias tee on combiners which brings the bias signal close to the device being measured
- Industry leading stability less the 1% drift over a 24-hour period
- Full source power control across the 10 MHz to 110 GHz with receiver leveling down to -50 dBm
- Existing Cascade hardware allows the broadband extenders to be easily integrated on a probe station
- Utilizes Keysight's patented weight least squares calibration method in 1.0 mm for industry leading accuracy at 110 GHz
- Provides 2- and 4-port S-Parameter measurements from 10 MHz to 110 GHz in a single sweep
- Broad power sweeps across the entire frequency range
- Supports true differential measurements across the frequency range
- Support for scalar mixer measurements for harmonic and fundamental mixers
- Integrated pulse measurement capability across the 10 MHz to 110 GHz
- Spectral power measurement capability

N5251A Single Sweep Solution Performance

Typical error residuals at 1.0 mm for 2-port N5251A solution

Frequency	Directivity	Transmission tracking	Source match	Load match	Reflection tracking	Isolation
10 MHz to 2 GHz	-50 dB	-0.09 dB	-40 dB	-40 dB	-0.04 dB	> 100 dB
2 GHz to 40 GHz	-44 dB	-0.065 dB	-44 dB	-44 dB	-0.05 dB	> 100 dB
40 GHz to 75 GHz	-37.5 dB	-0.1 dB	-37 dB	-37 dB	-0.1 dB	> 100 dB
75 GHz to 110 GHz	-36.8 dB	-0.1 dB	-33 dB	-36 dB	-0.08 dB	> 100 dB

Data applies over environment temperature of 23 °C ± 3 °C, with less than 1 °C deviation from the calibration temperature. Data present from 1.0 mm coaxial interface typical performance using 85059A 1.0 mm calibration kit with expanded math and offset short calibration. Note all data represented as upper limit typical performance and are interim performance data from the existing N5250C.

System dynamic range, port power, and noise floor performance

Frequency (GHz)	Maximum output test port power (dBm)		Noise floor (dBm)		System dynamic range (dB)	
	1.0 mm test port	PNA 1.85 mm test port	1.0 mm test port	PNA 1.85 mm test port	1.0 mm test port	PNA 1.85 mm test port
0.01 to 0.45	10	12	-77	-70	87	82
0.045 to 0.5	12	13	-95	-92	107	105
0.5 to 2	11	13	-117	-101	128	114
2 to 10	11	13	-116	-114	127	127
10 to 24	7	12	-116	-116	123	128
24 to 30	7	12	-108	-106	115	120
30 to 40	0	10	-104	-104	104	114
40 to 45	0	11	-100	-101	100	112
45 to 50	0	11	-100	-101	100	112
50 to 60	1	11	-98	-101	99	112
60 to 67	-2	11	-98	-101	96	112
67 to 70	-5	n/a	85	n/a	80	n/a
70 to 75	-4	n/a	-86	n/a	82	n/a
75 to 80	-3	n/a	-97	n/a	94	n/a
80 to 100	-2.5	n/a	-93	n/a	90.5	n/a
100 to 110	-4.5	n/a	-93	n/a	88.5	n/a

Notes

1. Typical performance is expected performance of an average unit which does not include guard bands. It is covered by the product warranty.
2. Assumes a 30-inch cable from PNA source out connector is used to provide the 10 MHz to 67 GHz source signal.
3. All data is based on broadband extenders that include a bias tee in the 1.0 mm head.
4. Measured at test port with a 10 Hz IFBW with 201 points and known averaging.
5. System dynamic range is computed as the difference between maximum power and noise floor.
6. Receiver dynamic range is typically 5.5 dB higher.

N5251A Single Sweep Solution Performance

N5251A 110 GHz typical uncertainty curves

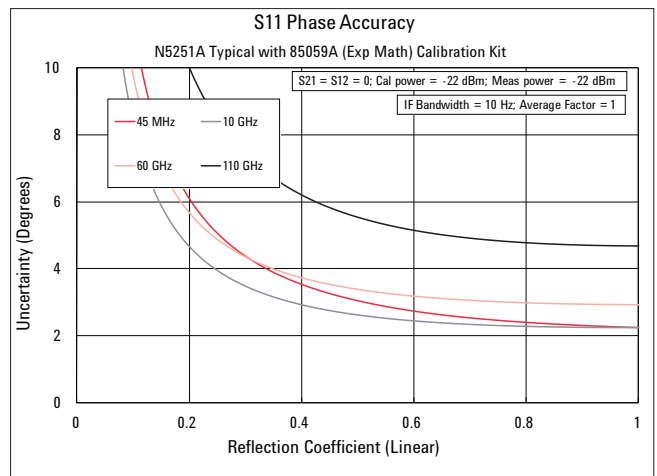
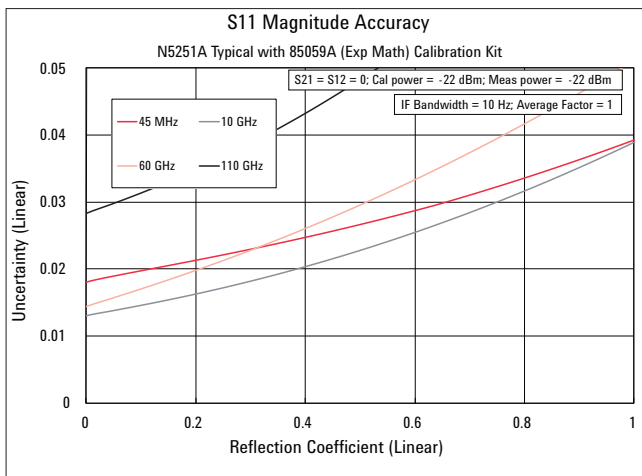
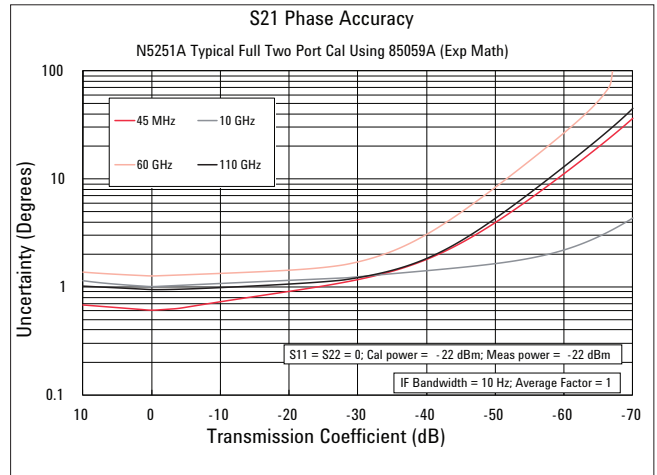
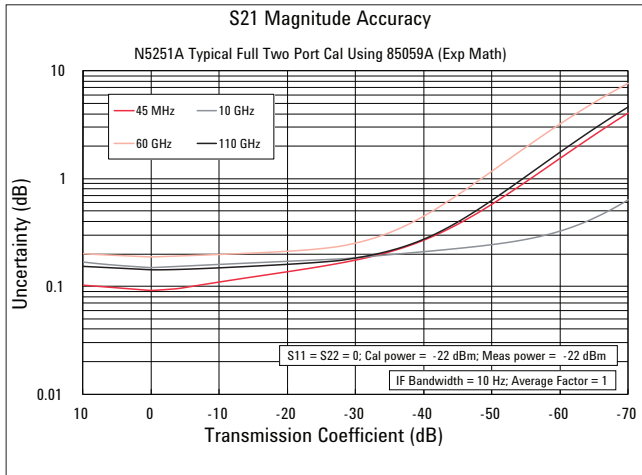

N5251A Single Sweep Solution Performance

N5251A source power accuracy

This solution provides the most complete and highest performance network analysis capability for frequencies from 10 MHz to 110 GHz. The figure below illustrates just one of the most significant features of this system, leveled port power to within less than 0.2 dB a factor of 5 times better than the HP 8510XF solution.

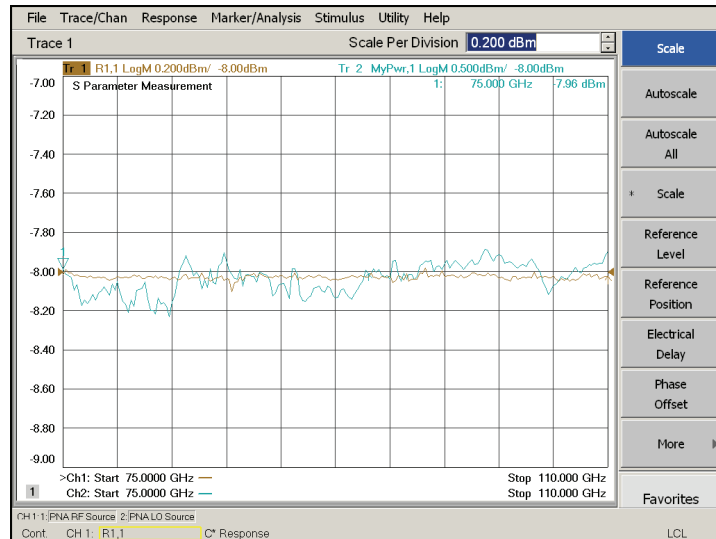

Figure 1. A demonstration of power accuracy; power sensor measurement vs. N5247A PNA-X R1 receiver < 0.1 dBm

Another key performance characteristic is the ability to produce very low level signals for 110 GHz device measurements. Figure 2 below shows the typical performance of the power output across the 10 MHz to 110 GHz frequency range.

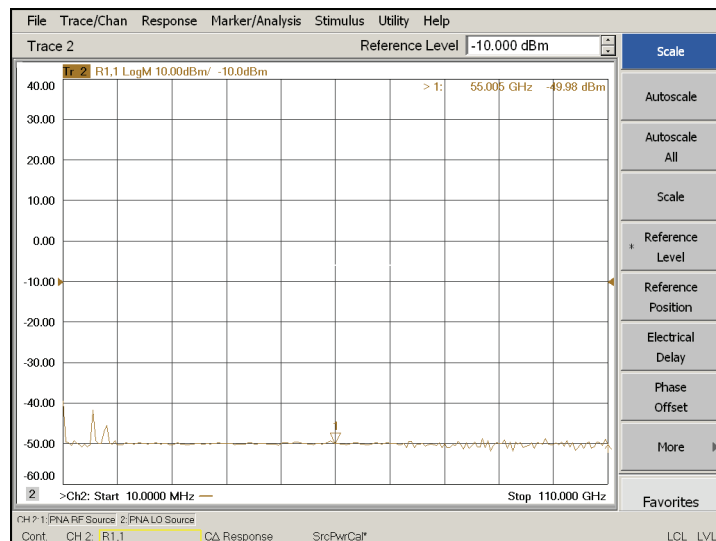

Figure 2. The lowest output power of -50 dBm from 10 MHz to 110 GHz

N5251A Single Sweep Solution Performance

N5251A stability

The following table shows the worst case stability data of two N5251A systems.

	System 1		System 2	
Worst Case (10 MHz to 110 GHz)	S11	S22	S11	S22
Mag Drift over Time	.02 dB	.04 dB	.04 dB	.03 dB
Mag Drift over Temp	2.0 dB	2.0 dB	1.4 dB	1.4 dB
Phase Drift over Time	.22 deg	.29 deg	.30 deg	.42 deg
Phase Drift over Temp	3.8 deg/C	4.8 deg/C	3.1 deg/C	3.9 deg/C
Vector Difference Mag over Time	.04 dB	.05 dB	.05 dB	.07 dB

Notes

1. For system 1, results above do not include an increase for 12 and 24 hours, believed to be due to a movement of a 1.85 mm cable.
2. For System 1, results do not include instability around 95 GHz which was attributed to a loose cable in the coupler/combiner.
3. All measurements were made in Thermotron 7800 ovens (ovens 78 and 80 in ETL lab).
4. Thermal measurements were made at oven settings of 18C and 32C and are relative to data at 25C.
5. Time measurements are made at 30,60,90,120, and 150 minutes, then at 12 and 24 hours.

N5251A application support

The N5251A architecture is based on the N5227A PNA platform, this allows for several new measurement applications such as, true differential measurements, pulsed measurements, and scalar mixer measurements. The flexibility of the system measurement capabilities enables a single touchdown for on-wafer components that will completely characterize the behavior of the device being measured.

The ability to accurately control power makes gain-compression measurements at millimeter-wave frequencies much simpler. Below is an application example of power sweep being used to do a 110 GHz buffer amplifier measurement while also doing a traditional S-parameter measurement.

Swept power

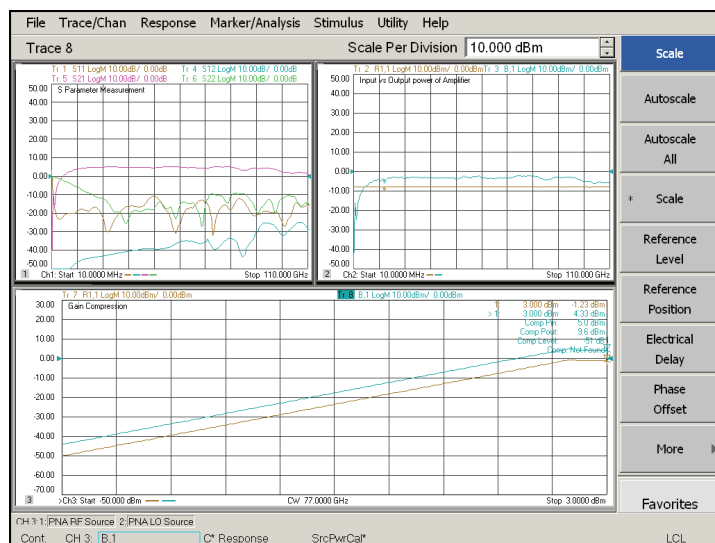

Figure 3. Application of power sweep gain compression measurement at 77 GHz

N5251A Single Sweep Solution Performance

Pulse measurements

With the integrated pulse modulators and receivers of the N5227A PNA, pulse measurements can be easily achieved. Below is an example of a pulse profile at a CW of 98 GHz.

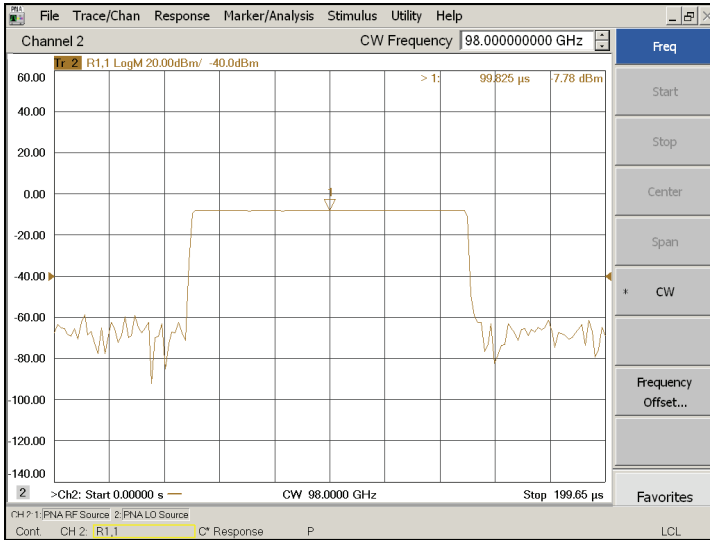

Figure 4. Pulse profile of the calibrated R1 receiver input to an amplifier at 98 GHz

True mode measurements

With the integrated true differential application, true mode signals can now be applied to devices all the way to 110 GHz. The following is an example of such a measurement; it shows the differential phase of a WR-10 Magic-Tee sum and difference port phase.

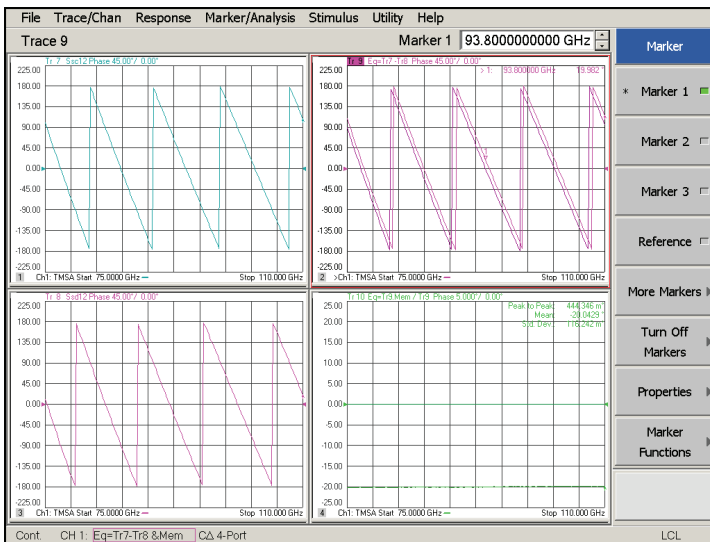

Figure 5. True differential measurements

N5251A Single Sweep Solution Performance

Mixer measurements

In addition to the above application measurements at millimeter-wave frequencies, this solution also offers the capability to easily make mixer measurements. Here is an example using the PNA performing a LO power sweep of a 75 to 110 GHz down converter mixer at a CW of 75 GHz. It shows the SC21 plot while sweeping the LO from -20 to +11 dBm.

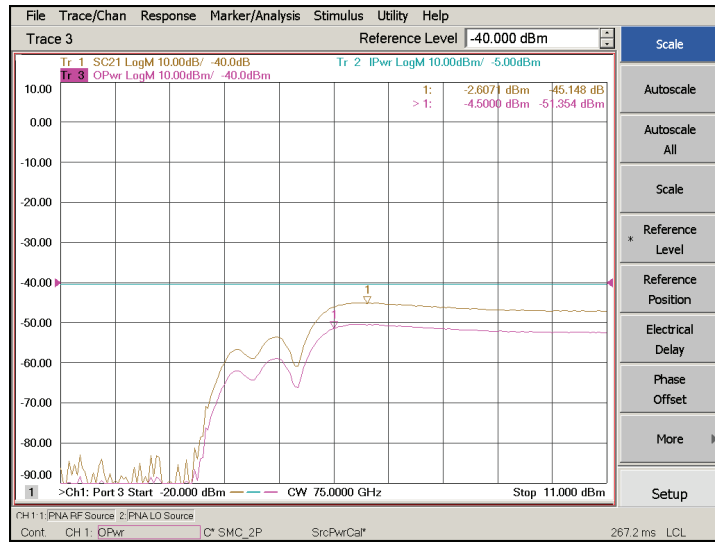

Figure 6. Swept LO at a millimeter wave frequency of 75 GHz

Power spectral measurements

Using the built-in IM spectrum option on the PNA or PNA-X, you can now measure the spectral power of components all across the frequency range from 10 MHz to 110 GHz. The example below is a measurement of an input and output spectrum of a 110 GHz buffer amplifier.

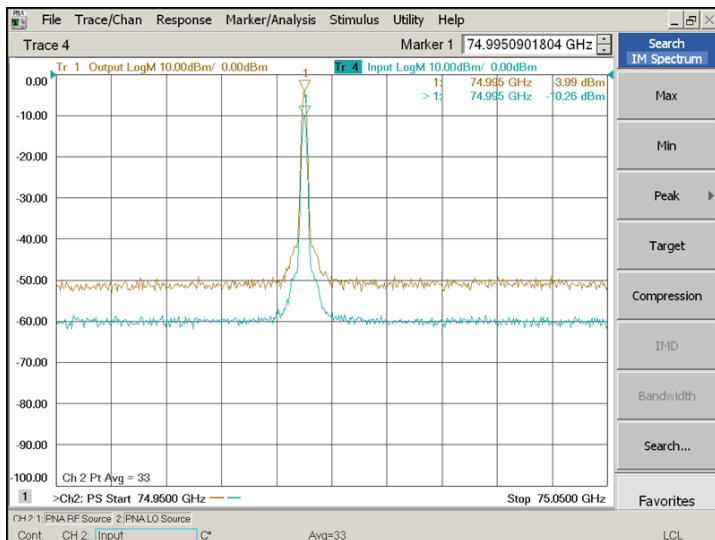

Figure 7. Input/output spectrum of an amplifier at 77 GHz

On-wafer measurements

The N5251A is currently the first system to have been fully integrated into a Cascade probe station and provide a single sweep 10 MHz to 110 GHz using the Cascade 1.0 mm Infinity probes. The broadband extenders have built-in bias-tees that are close to the DUT, greatly improving the stability for on-wafer and in-fixture measurements.

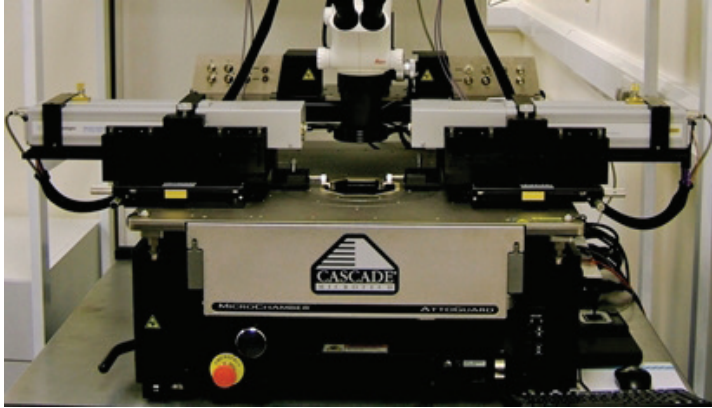
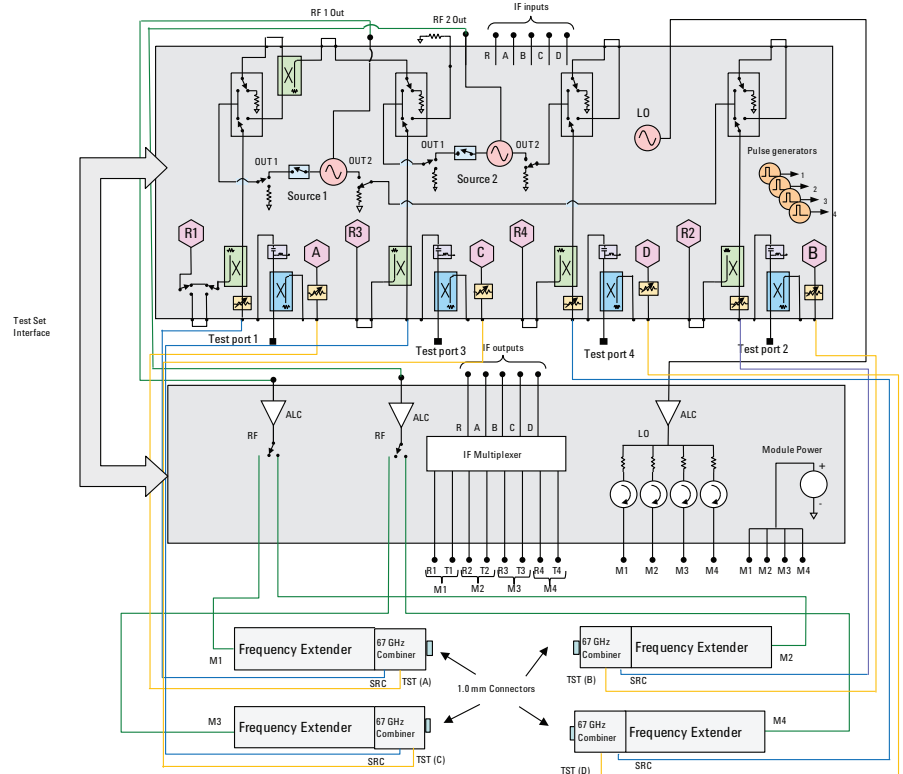

Figure 8. 110 GHz millimeter-wave system with Cascade Microtech probe station

N5251A Block diagram

The following block diagram is for the 4-port 110 GHz N5251A solution based on the new N5227A PNA.



Banded Measurement Solutions to 1.1 THz

Keysight offers a variety of banded millimeter-wave solutions that enable the PNA/PNA-X network analyzers to make S-parameter measurements up to 1.1 THz. These solutions are easily configurable and the frequency extenders used are from OML Inc and Virginia Diodes Inc. as well as Farran Microwave. The currently supported solutions through Keysight may be configured with or without a test set controller depending on the measurements required and the frequency extenders being used.

Supported measurement capability

The following table is a summary of some of the measurement capability that is available using the banded configurations.

Application type	Test set controller support	Direct control support
S-parameters	Yes	Yes
True-mode measurements	Yes	No
Time domain	Yes	Yes
Power measurements ³	Yes	Yes
Power sweep ³ (single frequency)	Yes	Yes
Power spectrum	Yes	No
Pulse ³	Yes	No
Mixers	Yes	No
Material measurements	Yes	Yes
Antenna measurements	Yes	Yes
On-wafer measurements	Yes	Yes
Inter-modulation distortion	No	No
Noise figure	No	No
Source phase control	No	No

Notes

1. The above is not a complete list of capabilities but is what has been verified to date using the banded solution.
2. Please work with your local Keysight Sales representative for measurements not listed above.
3. Note for PNA-X models that work below 67 GHz pulse and RF power leveling is available with the rear panel switched outputs and requires the combiner option. For the PNA models that work below 67 GHz it is required that the front panel connection be used for pulse and power level support.

Test Set Controller Solutions

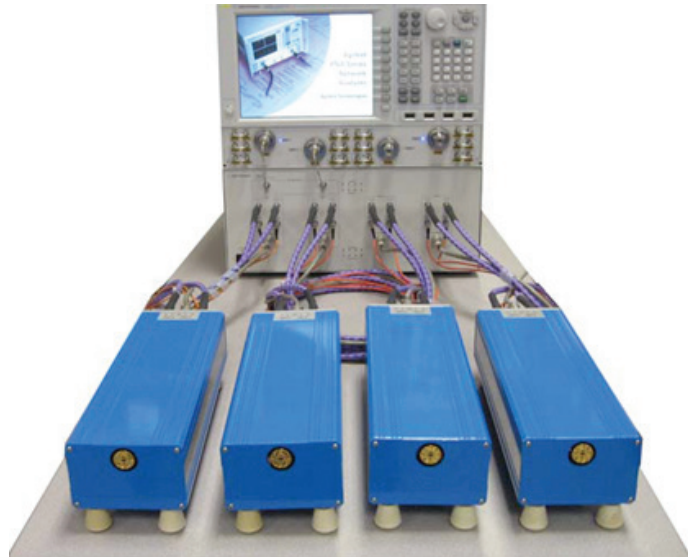

Key features

- The frequency extenders from OML Inc. cover a frequency range of 50 GHz to 500 GHz while the extenders from Virginia Diodes Inc. allow the solutions frequency range to extend to 950 GHz.
- These configurations allow for special modules to be configured that can extend the frequency of a particular waveguide band, in particular there is a 56 GHz to 94 GHz frequency to address the 60 GHz wireless HDMI applications.
- These solutions allow for 2- and 4-port configurations and have integrated power supplies and signal condition with the test set controller.
- Multiple waveguide bands can be configured and using the firmware interface it is easy to switch between frequencies for measurements.
- The 4-port configurations are ideally suited for mixer applications without the need for additional external LO for the device being tested.
- It takes advantage of the PNA/PNA-X features to enable, power level control, scalar mixer, spectral power, and pulse measurements.

Test Set Controller Solutions

Test set controller based solutions performance

The test set controller based solutions offer not only the highest frequency coverage up to 950 GHz but have also shown the best dynamic range in the industry. The following is an example of a WR2.2 frequency extender dynamic range using a PNA/PNA-X network analyzer, and a N5262A test set controller with a typical performance of 100 dB in a 10 Hz IFBW.

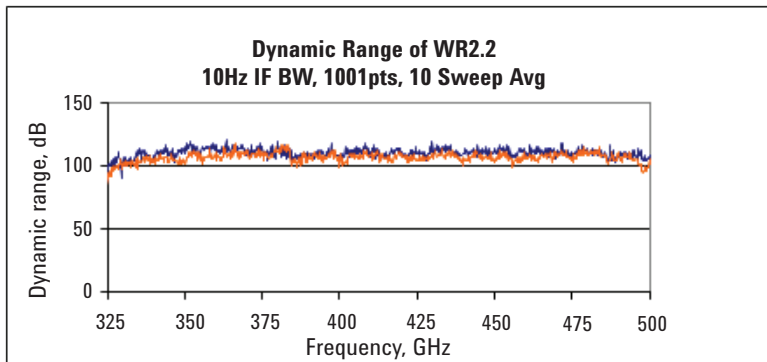

Figure 9. Dynamic range of a 325 to 500 GHz WR 2.20 VDI frequency extender

Ease-of-use

The banded millimeter-wave system uses built-in firmware, allowing you to leverage software between PNA and PNA-X Series network analyzers. Regardless of the frequency range of your measurements, you can manually control the instrument from the front panel or use a mouse to access the simple pull-down menus. In addition, you can utilize Cal Wizard to guide you step-by-step through the most complicated of calibrations.

The banded millimeter-wave system can easily be configured using the dialogue box shown in Figure 10. Multiple system configurations can be added to the list, but only one is active at a time. Creating a banded configuration is easy, simply enter the start and stop frequencies and the multipliers for RF and LO frequency ranges (the values are located on the test head modules). Once a configuration has been added to the list, simply highlight the setup of choice and then click Activate Selected Config to apply.

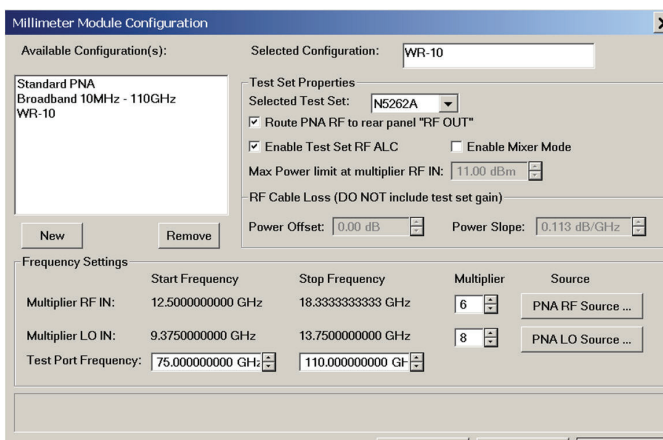

Figure 10. On-screen dialog to configure a banded millimeter-wave setup

Test Set Controller Solutions

A number of different configurations can be setup for different frequency bands. In addition, for the N5261A and N5262A there is the added capability to turn on and off the test set controller ALC for pulse measurements. Also available, is the ability to enable mixer sweep for scalar mixer measurements. This interface allows for ease of switching from one configuration to the next without restarting the PNA/PNA-X or reconfiguration of connections.

In addition, an extensive, context-sensitive Help system thoroughly explains all of the PNA and PNA-X features. In any dialog box, simply click **Help** to see a detailed explanation of the feature you are using. Programming examples in both SCPI and COM are also included.

Test set controller based solution block diagram

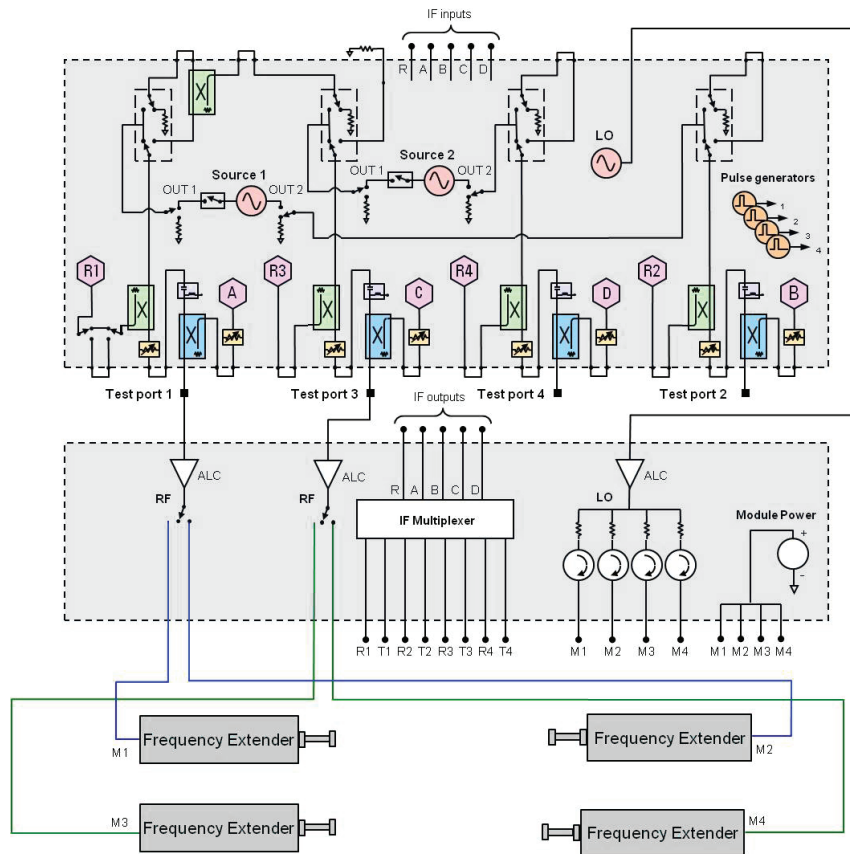

Direct Connect Solutions

These solutions do not require a millimeter-wave test set controller and connect directly to the front panel of a dual source PNA or PNA-X. Although both OML and VDI frequency extenders support this configuration it is typically configured with the VDI frequency extenders as shown below.



Key features

- Does not require a test set controller
- Supports full S-parameter measurements within a waveguide band with a dual source PNA/PNA-X network analyzer with either two or four test ports
- Uses external power supplies that come with the frequency extenders from Virginia Diodes Inc.
- The frequency offset mode of the PNA/PNA-X is utilized to drive the frequency extenders
- Currently supports a power calibration and power sweep with the OML frequency extenders
- Allows for the use of a higher IF frequency for test and reference signals and can be driven with either a 26.5, 43.5, 50, or 67 GHz PNA/PNA-X
- A downloadable macro is available from Keysight which simplifies the setup of the frequency offset mode

Direct Connect Solutions

Key performance

The direct connection configuration is currently supported using the frequency offset mode of the PNA/PNA-X and requires at least two sources to be able to do complete 2-port S-parameter measurements. The RF signal for the frequency extenders are supplied via the PNA/PNA-X port 1 and port 2 while the LO is supplied with the second source that drives the PNA/PNA-X ports 3 and 4. With this hardware configuration, the frequency offset mode can be used to set the RF source to sweep the frequency range of the waveguide band while the LO sweeps the mixers in the extenders to produce the IF signals required to make S-parameter measurements. The external power supply is required for allowing the frequency extenders to operate.

Calibration technology is built into the PNA/PNA-X that enables the most accurate measurements. The following is a few of the performance characteristics of the system. The first is a demonstration of the achievable stability of this system; it shows the vector magnitude stability of a 500 to 750 GHz solution over a period of 24 hours under typical laboratory conditions of 25 °C.

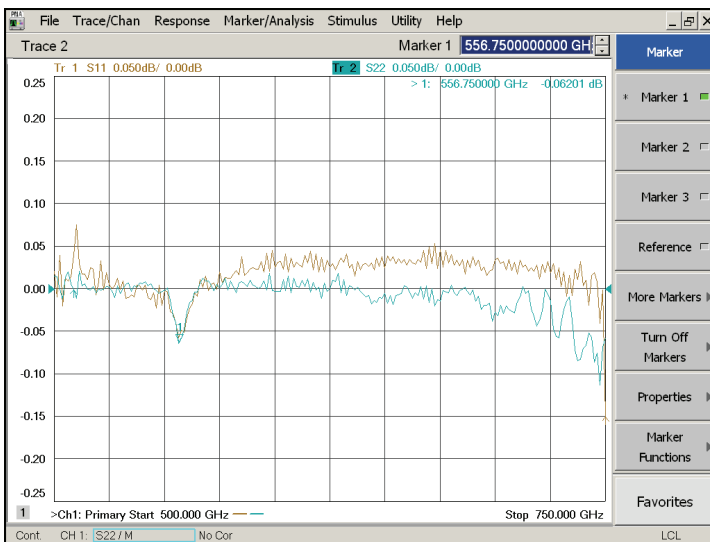

Figure 11. Typical drift performance of the PNA/PNA-X solution at 500 to 750 GHz with Virginia Diodes frequency extenders

Direct Connect Solutions

Notice the excellent performance of less than 0.15 dB of both the short terminated ports relative to memory over a period of 24 hours. The key performance characteristic is the excellent dynamic range as illustrated by the 500 to 750 GHz.

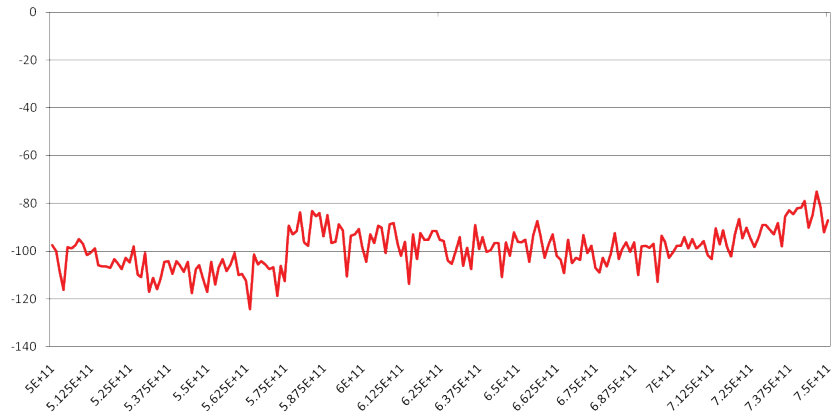

Figure 12. WR1.5 Dynamic range measurements VDI frequency extenders with a PNA-X

This solution provides unsurpassed dynamic range performance as shown in the Figure 12 plot of a 500 to 750 GHz dynamic range measurement using a direct connection of VDI extenders to a PNA/PNA-X. Note the typical performance is around 100 dB of dynamic range.

Direct Connect Solutions

Direct connect solution block diagram

This configuration of the PNA/PNA-X with Virginia Diodes Inc. frequency extenders offers the ability to directly connect frequency extenders to a 4-port PNA/PNA-X with dual sources enabling vector network analysis measurements up to 1.05 THz. A list of the available frequency extenders that are currently available are listed in the configuration table. For performance details for each of the different extenders please refer to the OML and VDI websites.

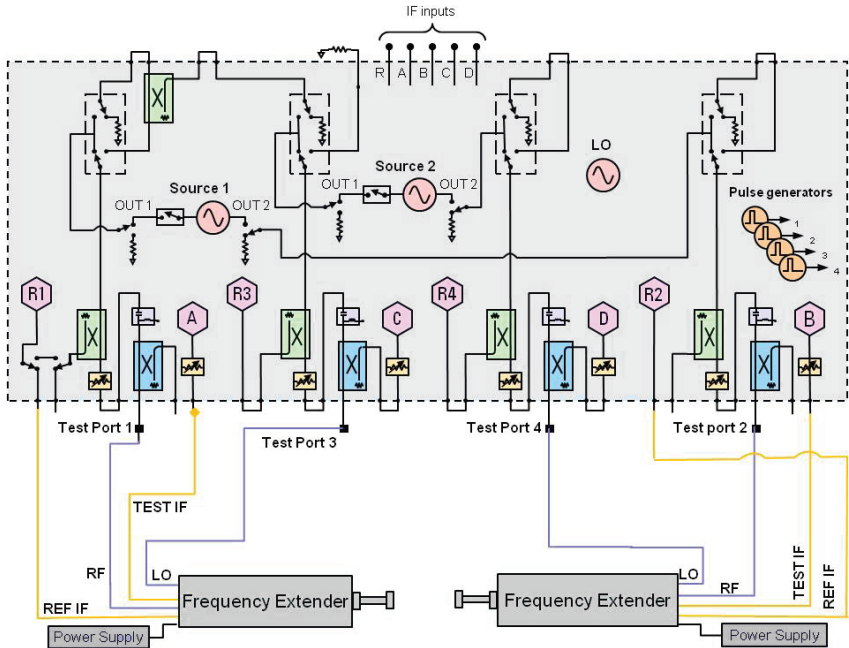

Broadband Solution Configuration

N5251A configurations

The following flow chart can be used to select the basic N5251A (10 MHz to 110 GHz) solution. All options include required cables for interconnection of the PNA and the test set controller as well as the lock link kits. In addition, each of the solutions will come with a standard set of 48-inch cables for connection of the frequency extenders to the millimeter-wave test set control.

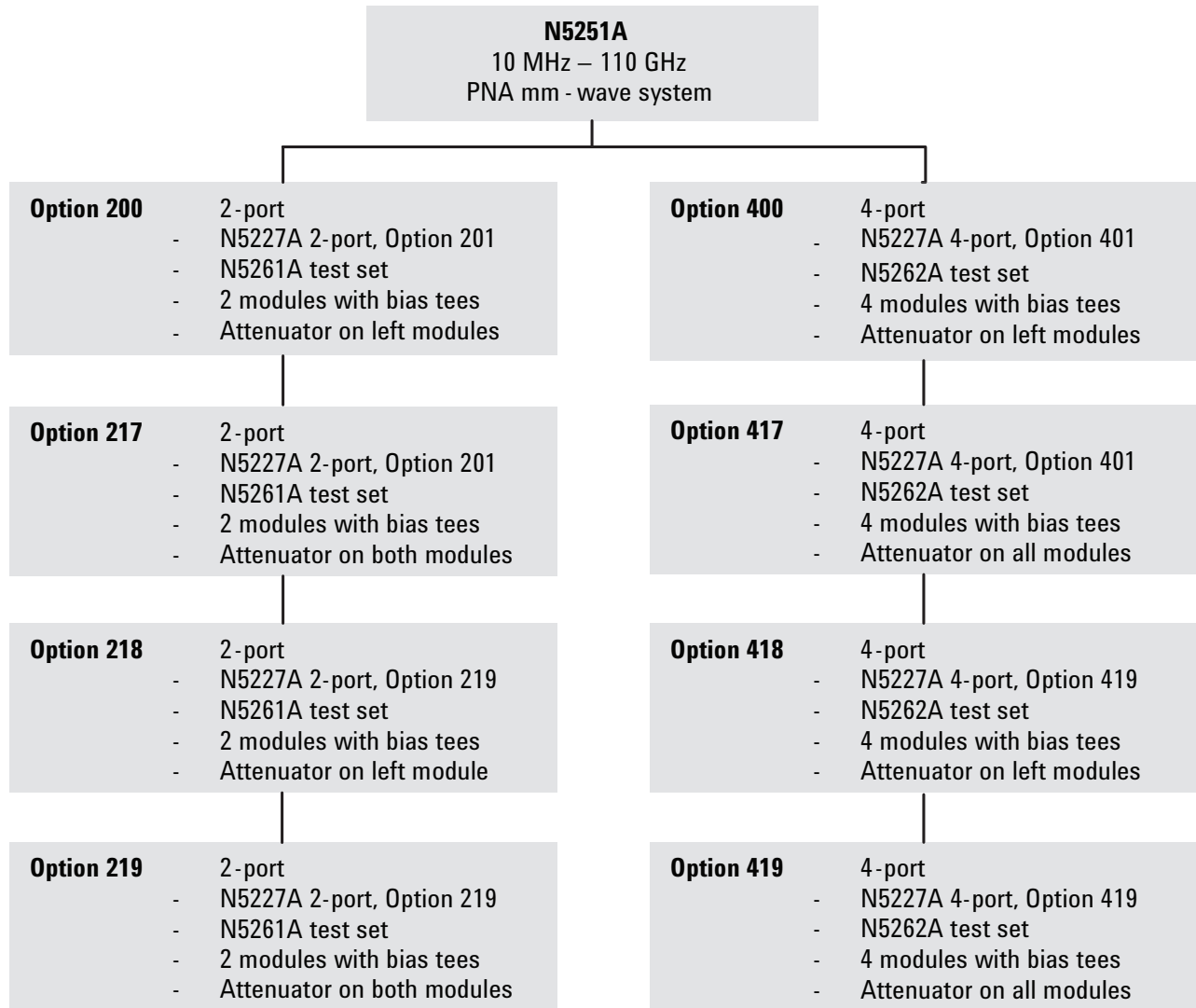

Note:

The Kelvin bias-tees have a voltage rating of 40 volts and a maximum of 0.5 amps.

Broadband Solution Configuration

Configuring a 10 MHz to 110 GHz solution using separate components

Configuration of the single sweep solution using individual system components is easily done by selecting one each of the following components

1. 67 GHz PNA with configurable test set or PNA-X network analyzer
2. Either a N5261A (2-port) or N5262A (4-port) millimeter-wave test set controller
3. A set of N5250CX10 67 GHz to 110 GHz frequency extenders

The following table provides a list of available system components that may be selected to create a 10 MHz to 110 GHz solution.

N5227A PNA or N5247A PNA-X based single sweep solution hardware configuration table

Product/ options	Description
67 GHz PNA-X/PNA network analyzer¹	
N5227A -201/ 219 or N5247A -200	2-ports, single source 10 MHz to 67 GHz PNA-X or PNA with configurable test set
N5227A-401/ 419 or N5247A-400	4-ports, dual source PNA-X or PNA with configurable test set
N5227A -020 N5247A -020 Required	Adds rear panel direct access IF Inputs for either N5227A or N5247A ²
2-port millimeter wave test set controller³	
N5261A	2-port millimeter-wave test set controller for PNA/ PNA-X based configuration
N5261A-112, required	A set of cables for 1.85 mm connection to a 2-port PNA/ PNA-X N5247A
Must choose one of the following connection cables. One per module.	
N5261A-501	A single set (1-port) of RF,LO,DC and IF cables for connection to a single T/R millimeter module, 48"
N5261A-502	A single set (1-port) of RF,LO,DC and IF cables for connection to a single T/R millimeter module, 2 meter
N5261A-503	A single set (1-port) of RF,LO,DC and IF cables for connection to a single T/R millimeter module, 3 meter
N5261A-505	A single set (1-port) of RF,LO,DC and IF cables for connection to a single T/R millimeter module, 5 meter ⁴
4-port millimeter wave test set controller³	
N5262A	4-port millimeter-wave test set controller for PNA/ PNA-X based configuration
N5262A-114, required	A set of cables for 1.85 mm connection to a 4-port PNA/ PNA-X N5247A
Must choose one of the following connection cables. One per module.	
N5262A-501	A single set of RF,LO,DC and IF cables for connection to a single T/R millimeter module, 48"
N5262A-502	A single set of RF,LO,DC and IF cables for connection to a single T/R millimeter module, 2 meter
N5262A-503	A single set of RF,LO,DC and IF cables for connection to a single T/R millimeter module, 3 meter
N5262A-505	A single set of RF,LO,DC and IF cables for connection to a single T/R millimeter module, 5 meter ⁴
Millimeter-wave frequency extenders	
N5250CX10-L05	67 to 110 GHz, left T/R module & 1.00 mm combiner assembly without adjustable attenuator, or bias tee
N5250CX10-L10	67 to 110 GHz, left T/R module & 1.00 mm combiner assembly with adjustable attenuator, and no bias tee
N5250CX10-L15	67 to 110 GHz, left T/R module & 1.00 mm combiner assembly with bias tee, and no adjustable attenuator
N5250CX10-L20	67 to 110 GHz, left T/R module & 1.00 mm combiner assembly with adjustable attenuator and bias tee
N5250CX10-R10	67 to 110 GHz, right T/R module & 1.00 mm combiner assembly without adjustable attenuator, or bias tee
N5250CX10-R15	67 to 110 GHz, right T/R module & 1.00 mm combiner assembly with adjustable attenuator, and no bias tee
N5250CX10-R20	67 to 110 GHz, right T/R module & 1.00 mm combiner assembly with bias tee and no adjustable attenuator
N5250CX10-R30	67 to 110 GHz, right T/R module & 1.00 mm combiner assembly with adjustable attenuator and bias tee

Notes

1. For PNA/PNA-X options select either a 2-port option for a 2-port 110 GHz configuration or a 4-port option for 4-port 110 GHz solutions.
2. Option 020 is a required option that allows for direct connection of the IF into the back of the PNA/PNA-X.
3. The millimeter-wave test set controller will include cables and the lock link kit to interface to the PNA/PNA-X when either Option 112 or 114 is selected.
4. When selecting Option 505, cable set external RF and LO amplifiers will be required because of cable loss around 6.6 dB.
5. The Kelvin bias-tees have a voltage rating of 40 volts and a maximum of 0.5 amps.

Broadband Solution Configuration

Measurement options

The following is a list of measurement options that are supported with the N5251A or the individually configured PNA/PNA-X solution. These measurement options are supported across the 10 MHz to 110 GHz frequency range and are required if using the N5227A PNA or N5247A PNA-X.

Options	Supported options
010	Time domain measurement
082	Scalar-calibrated converter measurements
083	Scalar-calibrated converter measurements with phase
460	Integrated true differential stimulus
087	Spectrum power measurements
008	Pulse application
080	Frequency offset mode
021	Add pulse modulator to internal 1st source
022	Add pulse modulator to internal 2nd source
025	Add internal 4 pulse generators
118	Fast CW mode

For additional measurement options that are currently only supported up to 67 GHz on the N5227A or N5247A, please refer to the Keysight Network Analyzer Configuration Guide, literature number 5990-7745EN.

Accessories

1.0 mm accessories

The following accessories are available for use with the N5250C system, but are not included in the system.

- 11500I 1.0 mm (f-f) test port cable (8.8 cm)
- 11500J 1.0 mm (m-f) test port cable (16.0 cm)¹
- 11500K 1.0 mm (m-f) test port cable (20.0 cm)¹
- 11500L 1.0 mm (m-f) test port cable (24.0 cm)¹
- 85059A DC to 110 GHz precision calibration/verification kit
- V281C 1.0 mm (f) to V-band waveguide adapter
- V281D 1.0 mm (m) to V-band waveguide adapter
- W281C 1.0 mm (f) to W-band waveguide adapter
- W281D 1.0 mm (m) to W-band waveguide adapter
- 11920A 1.0 mm (m) to 1.0 mm (m) adapter
- 11920B 1.0 mm (f) to 1.0 mm (f) adapter
- 11920C 1.0 mm (m) to 1.0 mm (f) adapter
- 11921E 1.0 mm (m) to 1.852 mm (m) adapter
- 11921F 1.0 mm (f) to 1.852 mm (f) adapter
- 11921G 1.0 mm (m) to 1.852 mm (f) adapter
- 11921H 1.0 mm (f) to 1.852 mm (m) adapter
- 11922A 1.0 mm (m) to 2.4 mm (m) adapter
- 11922B 1.0 mm (f) to 2.4 mm (f) adapter
- 11922C 1.0 mm (m) to 2.4 mm (f) adapter
- 11922D 1.0 mm (f) to 2.4 mm (m) adapter
- 11923A 1.0 mm (f) connector launch assembly

S-Parameter calibration accessories

Please refer to the sidebar for the details of available 1.0 mm test port cables. It is recommended for accurate S-parameter measurements at the 1.0 mm port that a 85059A calibration kit be used. In the case of on-wafer calibrations Cascade Microtech offers a full range of ISS calibration standards for full on-wafer S-parameter calibrations.

Source power calibration accessories

For calibration of source power at the calibration port, it is recommended that three power sensors be used to cover the entire 10 MHz to 110 GHz band. In addition to the recommended power sensors, a set of adapters are required to interface to the 1.0 mm calibration port for power calibration.

Product number	Description	Requirement
N8487A	50 GHz Thermocouple power sensor	Required to calibrate power over the 10 MHz to 50 GHz band
11921F	1.0 mm (f) to 1.85 mm (f), DC to 67 GHz	Required to connect the N8487A to 1.0 mm (M) test port
V8486A	50 GHz to 75 GHz V-band power sensor	Required to calibrate power over the 50 GHz to 75 GHz band
V281C	V-Band to 1.0mm (f) adapter	Required to connect the V8486A to 1.0 mm (M) test port
W8486A	75 GHz to 110 GHz W-band power sensor	Required to calibrate power over the 75 GHz to 110 GHz band
W281C	W-Band to 1.0mm (f) adapter	Required to connect the W8486A to 1.0 mm (M) test port
N1914A	Dual channel power meter	Require 2 power meters that allow for all 3 sensors to be configured for the measurement
11730A	Power sensor cable	Require 3 to connect each of the sensors to the two N1914A power meters
10833A	GPIB cable	Required to connect the 2 power meters to the PNA/PNA-X

Banded Solution Configuration

Configuration of a banded solution is similar to configuration of a single sweep solution using separate components. With the support of several frequency extenders and vector network analyzer options, the banded solutions offer industry leading flexibility and extensibility for measurements to 1.1 THz.

To configure basic hardware required for a particular solution select the following three components:

1. Performance network analyzer configured to support either a test set controller or direct connection of the frequency extenders
2. 2- or 4-port millimeter test set controller, not required for direct connection. See page 13 for Supported measurement capability.
3. Select the required frequency extenders for the frequency coverage required

Supported PNA and PNA-X configurations for banded waveguide

Product model	Description	Minimum option required for test set controller connection	Minimum option required for direct connection PNA	Minimum option required for direct connection PNA-X
N5222A or N5242A	2-port 26.5 GHz PNA or PNA-X network analyzer	Option 020	Unsupported	Option 200 or 200/219 and Option 080 with Option 224
N5222A or N5242A	4-port 26.5 GHz PNA or PNA-X network analyzer	Option 020	Requires Option 080 and Options 401, or 417, or 419 for N5222A	Option 400 or 400/419 and Option 080
N5224A or N5244A	2-port 43.5 GHz PNA or PNA-X network analyzer	Option 020	Unsupported	Option 200 or 200/219 and Option 080 with Option 224
N5224A or N5244A	4-port 43.5 GHz PNA or PNA-X network analyzer	Option 020	Requires Option 080 and Options 401, or 417, or 419 for N5224A	Option 400 or 400/419 and Option 080
N5225A or N5245A	2-port 50 GHz PNA or PNA-X network analyzer	Option 020	Unsupported	Option 200 or 200/219 and Option 080 with Option 224
N5225A or N5245A	4-port 50 GHz PNA or PNA-X network analyzer	Option 020	Requires Option 080 and Options 401, or 417, or 419 for N5225A	Option 400 or 400/419 and Option 080
N5227A or N5247A	2-port 67 GHz PNA or PNA-X network analyzer	Option 020	Unsupported	Option 200 or 200/219 and Option 080 with Option 224
N5227A or N5247A	4-port 67 GHz PNA or PNA-X network analyzer	Option 020	Requires Option 080 and Options 401, or 417, or 419 for N5227A	Option 400 or 400/419 and Option 080

Banded Solution Configuration

Millimeter-wave test set controllers for banded and single sweep

N5261A 2-port millimeter-wave test set controller for PNA/PNA-X based configuration	
N5261A-102	A set of cables for 3.5 mm connection to a 2-port N5222A or N5242A
N5261A-104	A set of cables for 3.5 mm connection to a 4-port N5222A or N5242A
N5261A-106	A set of cables for 2.4 mm connection to a 2-port N5224A/N5225A or N5244A/N5245A
N5261A-108	A set of cables for 2.4 mm connection to a 4-port N5224A/N5225A or N5244A/N5245A
N5261A-112	A set of cables for 1.85 mm connection to a 2-port N5227A or N5247A
N5262A 4-port millimeter wave test set controller for PNA/PNA-X based configuration	
N5262A-104	A set of cables for 3.5 mm connection to a 4-port N5222A or N5242A
N5262A-108	A set of cables for 2.4 mm connection to a 4-port N5224A/N5225A or N5244A/N5245A
N5262A-114	A set of cables for 1.85 mm connection to a 4-port N5227A or N5247A

Notes

- For the N5261A and N5262A several cable options exist for connecting OML Inc. T/R frequency extenders please refer to the option description section for details, page 25.
- A 2-Port PNA/PNA-X will only support 2-port banded measurements if used with a N5262A 4-port millimeter controller.

Millimeter-wave modules

Several modules are available and other special options may be configured on request. Select the appropriate quantity of modules required for the measurement set up. To request a specially configured test module contact your local Keysight sales engineer.

The single and dual channel receiver modules are used for antenna applications or for 1-port single path S-parameter measurements.

Transmission reflection modules (OML Inc.)

Waveguide flange	Frequency GHz	Standard transmission/reflection modules	Transmission/reflection modules with 25 dB mechanical attenuator	Transmission/reflection modules with 15 dB LO and RF amplifier ¹
WR15	50 - 75	N5256AW15 - STD	N5256AW15 - 001	N5256AW15 - 002
WR12	60 - 90	N5256AW12 - STD	N5256AW12 - 001	N5256AW12 - 002
WR10	75 - 110	N5256AW10 - STD	N5256AW10 - 001	N5256AW10 - 002
WR08	90 - 140	N5256AW08 - STD	N5256AW08 - 001	N5256AW08 - 002
WR06	110 - 170	N5256AW06 - STD	N5256AW06 - 001	N5256AW06 - 002
WR05	140 - 220	N5256AW05 - STD	N5256AW05 - 001	N5256AW05 - 002
WR03	220 - 325	N5256AW03 - STD	N5256AW03 - 001	N5256AW03 - 002
WR02.2	325 - 500	N5256AW02 - STD	Not available	N5256AW02 - 002 ²
Extended WR12	56 - 94	N5256AX12 - STD	N5256AX12 - 001	Available on request

- Note the modules with the RF/LO amplifiers are for antenna applications that include a cable loss of 15 dBm to the module from the port of the test set controller being used. Do not connect these directly to the test set controller port with the standard 48 inch cable, use a 15 dB pad if needed.
- These modules require an external DC power supply (e.g. U8001A) when using them with the N5260A.
- For transmission reflection modules with both the 25 dB mechanical attenuator and the 15 dB LO and RF amplifier order N5256AWxx-003. Not available for N5256AW02.

IMD transmission reflection modules (OML Inc.)

Waveguide flange	Frequency GHz	IMD module product number
WR12	60 - 90	N5256AW12 - IMD
Extended WR12	56 - 94	N5256AX12 - IMD
WR10	75 - 110	N5256AW10 - IMD

Notes

- Note the above modules maybe used to make as IMD measurements using Option 087 measurement class for the PNA-X
- It is currently in banded mode only.
- The above option requires the use of a 4-port controller N5262A.
- The access to the swept IMD application in millimeter-wave mode requires an upgrade to Windows 7.0.
- Requires N5260A-501 cable set and an additional 20 GHz 3.5 mm (male-male) RF cable for connecting the second source. The additional cable may be purchased as a separate part number 8121-1221.

Banded Solution Configuration

Single channel receive modules (OML Inc.)

Waveguide flange	Frequency GHz	Standard single channel receive modules	Single channel receive modules with 15 dB LO amplifier
WR15	50 - 75	N5257AR15 - STD	N5257AR15 - 001
WR12	60 - 90	N5257AR12 - STD	N5257AR12 - 001
WR10	75 - 110	N5257AR10 - STD	N5257AR10 - 001
WR08	90 - 140	N5257AR08 - STD	N5257AR08 - 001
WR06	110 - 170	N5257AR06 - STD	N5257AR06 - 001
WR05	140 - 220	N5257AR05 - STD	N5257AR05 - 001
WR03	220 - 325	N5257AR03 - STD	N5257AR03 - 001
WR02.2	325 - 500	N5257AR02 - STD	Available on request

Cables for OML Inc. banded millimeter-wave modules - direct connect only

Model number	Description
N5260AK48	4 ft cables (RF, LO, IF,Bias + adapters) for direct connect mm-head TxRx to N5224A, N5225A, N5227A, or N5244A, N5245A, N5247A
N5260AK50	4 ft cables (RF, LO, IF,Bias) to direct connect mm-head T/R to N5222A or N5242A
N5260AK51	4 ft cables (LO, IF, Bias) to direct connect mm-head Rec. only to N5222A or N5242A

Note

When configuring an OML Inc. frequency extender for direct connect please include a 12 V, 1.3 A power supply (e.g. Keysight U8001A). Requires one power supply per extender being used for direct connection.

Cables for test set controlled OML frequency extenders

Choose one of the following cable options per module to be connected to controller.

N5261A Based OML Solution

Cable option	Description
N5261A-501	A single set (1-port) of RF,LO,DC and IF cables for connection to a single T/R millimeter module, 48"
N5261A-502	A single set (1-port) of RF,LO,DC and IF cables for connection to a single T/R millimeter module, 2 meters
N5261A-503	A single set (1-port) of RF,LO,DC and IF cables for connection to a single T/R millimeter module, 3 meters
N5261A-505	A single set (1-port) of RF,LO,DC and IF cables for connection to a single T/R millimeter module, 5 meters

N5262A Based OML Solution

Cable option	Description
N5262A-501	A single set of RF,LO,DC and IF cables for connection to a single T/R millimeter module, 48"
N5262A-502	A single set of RF,LO,DC and IF cables for connection to a single T/R millimeter module, 2 meters
N5262A-503	A single set of RF,LO,DC and IF cables for connection to a single T/R millimeter module, 3 meters
N5262A-505	A single set of RF,LO,DC and IF cables for connection to a single T/R millimeter module, 5 meters

Note

Other special option cables are also available on request.

Dual channel receive modules (OML Inc.)

Waveguide flange	Frequency GHz	Standard dual channel receive module	Dual channel receive module with 15 dB LO amplifier
WR15	50 - 75	N5258AD15 - STD	N5258AD15 - 001
WR12	60 - 90	N5258AD12 - STD	N5258AD12 - 001
WR10	75 - 110	N5258AD10 - STD	N5258AD10 - 001
WR08	90 - 140	N5258AD08 - STD	N5258AD08 - 001
WR06	110 - 170	N5258AD06 - STD	N5258AD06 - 001
WR05	140 - 220	N5258AD05 - STD	N5258AD05 - 001
WR03	220 - 325	N5258AD03 - STD	N5258AD03 - 001

Banded Solution Configuration

Millimeter-wave calibration kits (OML Inc.)

Waveguide flange	Frequency GHz	Calibration kit
WR15	50 - 75	V11644A
WR12	60 - 90	N5260AC12
WR10	75 - 110	W11644A
WR08	90 - 140	N5260AC08
WR06	110 - 170	N5260AC06
WR05	140 - 220	N5260AC05
WR03	220 - 325	N5260AC03
WR02.2	325 - 500	N5260AC02
Extended WR12	56 - 94	N5260AC12

Banded waveguide transmission reflection modules (Virginia Diodes Inc.)

Waveguide flange	Frequency GHz	Modules compatible with 26.5 GHz PNA or PNA-X	Modules Compatible with PNA or PNA-X 43.5 GHz and above	Modules Compatible with PNA or PNA-X 43.5 GHz and above with 25 dB Mechanical attenuator	N5261A or N5262A test set controller compatible modules
WR15	50 to 75	N5262AW15-026	N5262AW15-STD	N5262AW15-001	N5262AW15-TST
WR12	60 to 90	N5262AW12-026	N5262AW12-STD	N5262AW12-001	N5262AW12-TST
WR10	75 to 110	N5262AW10-026	N5262AW10-STD	N5262AW10-001	N5262AW10-TST
WR8.0	90 to 140	N5262AW08-026	N5262AW08-STD	N5262AW08-001	N5262AW08-TST
WR6.5	110 to 170	N5262AW06-026	N5262AW06-STD	N5262AW06-001	N5262AW06-TST
WR5.1	140 to 220	N5262AW05-026	N5262AW05-STD	N5262AW05-001	N5262AW05-TST
WR3.4	220 to 325	N5262AW03-026	N5262AW03-STD	N5262AW03-001	N5262AW03-TST
WR2.2	325 to 500	N5262AW02-026	N5262AW02-STD	N5262AW02-001	N5262AW02-TST
WR1.5	500 to 750	N5256AW01-026	N5256AW01-STD	No Attenuator Option	Not supported
WR1.0	750 to 1.1 THz	N5262AW01-026	N5262AW01-STD	No Attenuator Option	Not supported

Notes

- Each product number includes a single frequency extender. Please add the required power supply and cable option.
- For full 2-Port S-parameter measurements order quantity 2 of the Tx/Rx modules listed above.
- The test set option modules TST require a power supply, please include these at the time of order as well as cable options.

Power supply option (Virginia Diodes Inc.)

Option number	Description
N5262VDI-175	VDI-175 power supply for VDI Modules

Notes

Must be ordered with N5262AWxx. See table above for product option numbers.

Cable options (Virginia Diodes Inc.)

Option number	Description
N5262AWCBL-201	1.2 m cable set for use with Tx/Rx modules designed for 26.5 GHz PNA / PNA-X direct connection. (Option 026 modules)
N5262AWCBL-501	1.2 m cable set for use with Tx/Rx modules designed for Test set controller (Option - TST modules)
N5262AWCBL-401	1.2 m cable set for use with Tx/Rx modules designed for >43 GHz PNA / PNA-X direct connection (Option -STD)
N5262AWCBL-505	5 m cable set for use with Tx/Rx modules designed for Test set controller (Option - TST modules)
N5262AWCBL-205	5 m cable set for use with Tx/Rx modules designed for 26.5 GHz PNA / PNA-X direct connection. (Option 026 modules)
N5262AWCBL-N05	Exclude cables for module designed for use with 5 m cable set.
N5262AWCBL-N01	Exclude cables for module designed for use with 1.2 m cable set.

Banded Solution Configuration

Banded waveguide receive only modules (Virginia Diodes Inc.)

Waveguide flange	Frequency GHz	Modules compatible with 26.5 GHz PNA or PNA-X	Modules Compatible with PNA or PNA-X 43.5 GHz and above	N5261A or N5262A test set controller compatible modules
WR15	50 to 75	N5262AR15-026	N5262AR15-STD	N5262AR15-TST
WR12	60 to 90	N5262AR12-026	N5262AR12-STD	N5262AR12-TST
WR10	75 to 110	N5262AR10-026	N5262AR10-STD	N5262AR10-TST
WR8.0	90 to 140	N5262AR08-026	N5262AR08-STD	N5262AR08-TST
WR6.5	110 to 170	N5262AR06-026	N5262AR06-STD	N5262AR06-TST
WR5.1	140 to 220	N5262AR05-026	N5262AR05-STD	N5262AR05-TST
WR3.4	220 to 325	N5262AR03-026	N5262AR03-STD	N5262AR03-TST
WR2.2	325 to 500	N5262AR02-026	N5262AR02-STD	N5262AR02-TST
WR1.5	500 to 750	N5256AR01-026	N5256AR01-STD	Not supported
WR1.0	750 to 1.1 THz	N5262AR01-026	N5262AR01-STD	Not supported

Notes

1. Each product number includes a single frequency extender only. Please add the required power supply and cable options at time of order.
2. The above are receiver only and require a Tx/Rx module for 1 path 2-port S-parameter measurement capability.
3. Test set option modules TST require a power supply, please include these at the time of order as well as cable options.

Millimeter-wave calibration kits (Virginia Diodes Inc.)

Waveguide flange	Frequency GHz	Calibration kit
WR15	50 to 75	N5262AC15
WR12	60 to 90	N5262AC12
WR10	75 to 110	N5262AC10
WR8.0	90 to 140	N5262AC08
WR6.5	110 to 170	N5262AC06
WR5.1	140 to 220	N5262AC05
WR3.4	220 to 325	N5262AC03
WR2.2	325 to 500	N5262AC02
WR1.5	500 to 750	N5260AC01
WR1.0	750 to 1.1 THz	N5262AC01

Banded waveguide transmission reflection mini-modules (Virginia Diodes Inc.)

Waveguide flange	Frequency GHz	Standard transmission reflection modules	Transmission reflection modules with variable 25 dB mechanical attenuator
WR15	50 to 75	N5262BW15 - STD	N5262BW15 - 001
WR12	60 to 90	N5262BW12 - STD	N5262BW12 - 001
WR10	75 to 110	N5262BW10 - STD	N5262BW10 - 001

Notes

1. Modules include a selectable option for use with a 1.2 m cable set (Option 120) or a 5m cable set (Option 500).
2. A power supply is included with each module ordered.
3. All modules are compatible with PNA/PNA-X or test set controller and have cable options for direct connection or test set connections.

Banded waveguide receiver mini-modules (Virginia Diodes Inc.)

Waveguide flange	Frequency GHz	Standard receiver only modules	High sensitivity receive only module with external fixed attenuator
WR15	50 to 75	N5262BR15 - STD	N5262BW15 - 001
WR12	60 to 90	N5262BR12 - STD	N5262BW12 - 001
WR10	75 to 110	N5262BR10 - STD	N5262BW10 - 001

Notes

1. The high sensitivity modules have the same dynamic range, with about 25 dB lower noise floor and lower saturation point.
2. Modules include a selectable option for use with a 1.2 m cable set (Option 120) or a 5m cable set (Option 500).
3. A power supply is included with each module ordered.
4. All modules are compatible with PNA/PNA-X or test set controller and have cable options for direct connection or test set connections.

Dimensions for waveguide transmission reflection modules (Virginia Diodes Inc.)

Module	Width	Length	Height
Standard	5.0 inches	15.275 inches including waveguide, WR1.5 to WR15. 10.25 inches including waveguide WR1.0	3.5 inches (feet adjust +1.25 inches)
Mini-modules	3.0 inches	10.8 inches including waveguide, WR10 to WR15	2.35 inches (feet adjust +0.75 inches)

Waveguide designation equivalent table

MIL-DTL-85/3C	IEEE Std 1785.1	Frequency range
WR-15	WM-3759	50 GHz – 75 GHz
WR-12	WM-3099	60 GHz – 90 GHz
WR-10	WM-2540	75 GHz – 110 GHz
WR-08	WM-2032	90 GHz – 140 GHz
WR-06	WM-1651	110 GHz – 170 GHz
WR-05	WM-1295	140 GHz – 220 GHz
WR-04	WM-1092	170 GHz – 260 GHz
WR-03	WM-864	220 GHz – 330 GHz
WR-02	WM-570	330 GHz – 500 GHz
WR-1.5	WM-380	500 GHz – 750 GHz
WR1.0	WM-250	750 GHz – 1.1 THz

Reference: IEEE Standard for Rectangular Metallic Waveguides and Their Interfaces for Frequencies of 110 GHz and Above – Part 1: Frequency Bands and Waveguide Dimensions

Key Web Resources

Engineering services for 8510 to PNA Series migration

Keysight’s network analyzer experts can save you time and money by working with you to migrate your 8510 instruments and transition your test code quickly and easily.

For more information visit: www.keysight.com/find/8510

For information about probing equipment and accessories, contact:

Cascade Microtech, Inc.

2430 NW 206th Avenue

Beaverton, Oregon 97006, USA

Toll-free telephone: (800) 550-3279

Telephone: (503) 601-1000

Fax: (503) 601-1002

Web site: www.cascademicrotech.com

E-mail: sales@cmicro.com

For more information on Keysight Technologies’ products, applications or services, please contact your local Keysight office. The complete list is available at: www.keysight.com/find/contactus

Americas

Canada	(877) 894 4414
Brazil	55 11 3351 7010
Mexico	001 800 254 2440
United States	(800) 829 4444

Asia Pacific

Australia	1 800 629 485
China	800 810 0189
Hong Kong	800 938 693
India	1 800 112 929
Japan	0120 (421) 345
Korea	080 769 0800
Malaysia	1 800 888 848
Singapore	1 800 375 8100
Taiwan	0800 047 866
Other AP Countries	(65) 6375 8100

Europe & Middle East

Austria	0800 001122
Belgium	0800 58580
Finland	0800 523252
France	0805 980333
Germany	0800 6270999
Ireland	1800 832700
Israel	1 809 343051
Italy	800 599100
Luxembourg	+32 800 58580
Netherlands	0800 0233200
Russia	8800 5009286
Spain	800 000154
Sweden	0200 882255
Switzerland	0800 805353
	Opt. 1 (DE)
	Opt. 2 (FR)
	Opt. 3 (IT)
United Kingdom	0800 0260637

For other unlisted countries:
www.keysight.com/find/contactus
 (BP-09-23-14)

myKeysight

myKeysight

www.keysight.com/find/mykeysight

A personalized view into the information most relevant to you.

Three-Year Warranty

www.keysight.com/find/ThreeYearWarranty

Keysight’s commitment to superior product quality and lower total cost of ownership. The only test and measurement company with three-year warranty standard on all instruments, worldwide.

Keysight Assurance Plans

www.keysight.com/find/AssurancePlans

Up to five years of protection and no budgetary surprises to ensure your instruments are operating to specification so you can rely on accurate measurements.

www.keysight.com/go/quality

Keysight Technologies, Inc.

DEKRA Certified ISO 9001:2008

Quality Management System

Keysight Channel Partners

www.keysight.com/find/channelpartners

Get the best of both worlds: Keysight’s measurement expertise and product breadth, combined with channel partner convenience.

www.keysight.com/find/pna

www.keysight.com/find/N5251A

www.keysight.com/find/mmwave

