

Keysight Technologies

7

Compelling Reasons to Migrate from the Keysight 856xE/EC Spectrum Analyzers to the Keysight X-Series Signal Analyzers

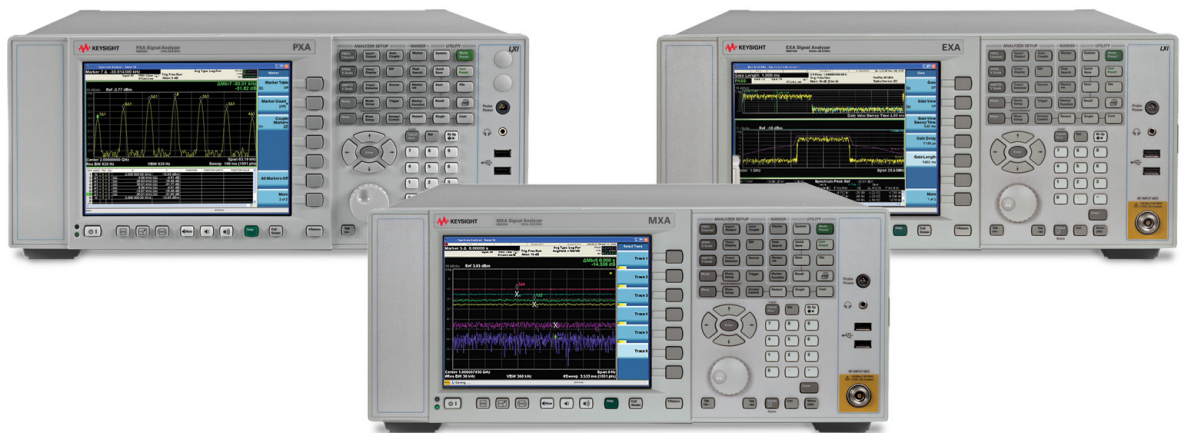



Building upon a tradition of excellence with leading-edge innovation

- Backward compatibility enables easy migration
- Industry-leading measurement speeds
- Superior amplitude accuracy
- Increased sensitivity and dynamic range
- Improved selectivity and accuracy with all-digital IF
- Enhanced usability with modern user interfaces
- Broader offering of measurement applications
- Simpler and more robust data sanitization for security

Save on a new X-Series signal analyzer by trading in your 856x spectrum analyzer

To learn more, visit: www.keysight.com/find/tradein

Overview

Keysight Technologies X-Series

The Keysight X-Series is an evolutionary approach to signal analysis that spans instrumentation, measurements and software. To learn more about the X-Series, visit:

www.keysight.com/find/x-series

If you are facing the need to replace out-of-support or legacy instruments, you may be concerned with the form (physical dimension compatibility), fit (comparability of specifications and applications), and function (backward programming language compatibility) of available replacement instruments.

The intent of this document is to explain how each of these concerns can be addressed and resolved by migrating from the 856xE/EC spectrum analyzers to the Keysight Technologies, Inc. X-Series signal analyzers.

Since their introduction more than a decade ago, the Keysight 856xE/EC spectrum analyzers have been widely adopted for a variety of signal analysis applications. Today, Keysight's X-Series signal analyzers (PXA, MXA, and EXA) are setting standards in signal analysis with leading-edge technology innovations.

Depending upon your specific application, the X-Series signal analyzers offer migration paths to fit your needs. While the MXA signal analyzer has generally been the leading choice by 856xE/EC customers as a replacement analyzer for automated test systems, the future-ready, leading performance, PXA may be the analyzer of choice for those engaged in R&D activities and the EXA may most accurately suit the needs of those who require the ability to speed up signal analysis within a tightening budget.

Migrate to the X-Series

The next generation of signal analysis

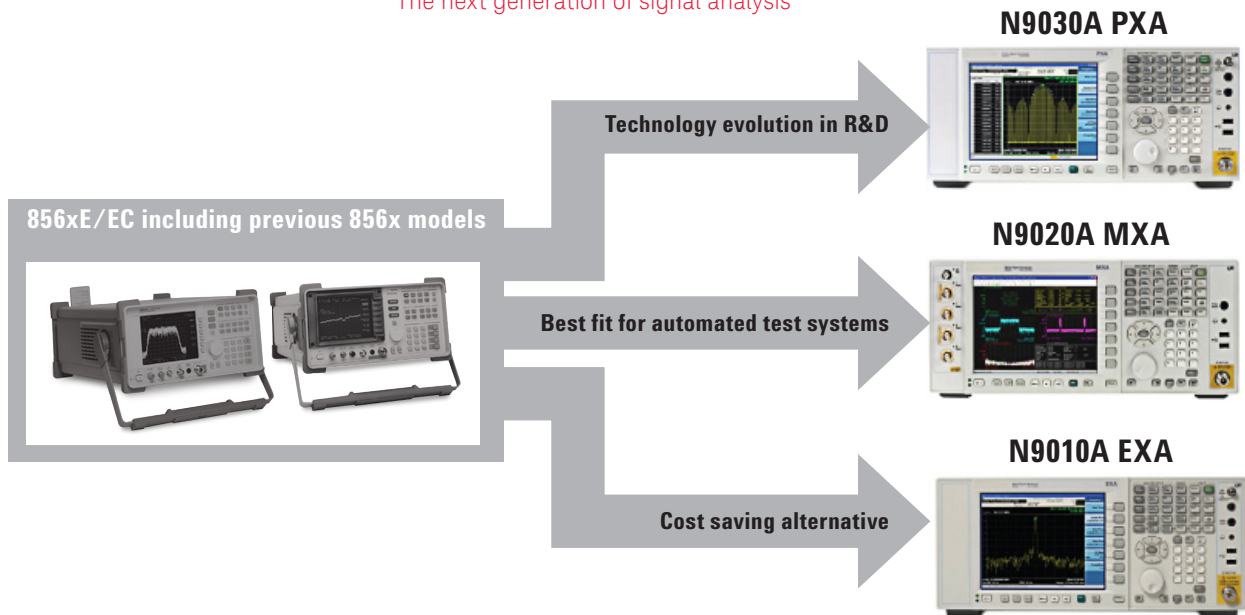

Stay ready, stay in sync and arrive ahead – with the Keysight X-Series

Table of Contents

1. Backward Compatibility For Easy Migration	4
2. Industry-Leading Measurement Speed	8
3. Superior Performance.....	9
4. Improved Selectivity and Accuracy with All-Digital IF.....	13
5. Modern User Interface Provides Enhanced Usability	15
6. Broader Offering of Measurement Applications.....	16
7. Greater Security with Simpler and More Robust Data Sanitization.....	18

1

Backward Compatibility For Easy Migration

Remote language compatibility

Remote language compatibility (RLC) becomes particularly critical when considering replacing an 856xE/EC analyzer in an automated test environment (ATE). A better RLC offering results in less effort spent on re-programming and a smaller reinvestment in the replacement of the instrument.

The 856xE/EC employed a very instrument-specific command set for remote programming, whereas the MXA/PXA/EXA X-Series signal analyzers use SCPI commands (standard commands for programming instruments, part of the IEEE-488-2 standard). RLC application software available for the X-Series signal analyzers (N9061A-2FP) provides a bridge between the legacy 856xE/EC remote programming and the SCPI programming. N9061A RLC application software for the X-Series signal analyzers provides a bridge between the legacy 856xE/EC instruments' remote programming and the SCPI programming used by the X-Series analyzers. The RLC application software supports the 856xE/EC programming commands that are most frequently so that the X-Series signal analyzers can emulate the behaviors of the 856xE/EC in your remote programming environment. With the N9061A software, legacy 856xE/EC remote programs can communicate seamlessly with the X-Series signal analyzers.

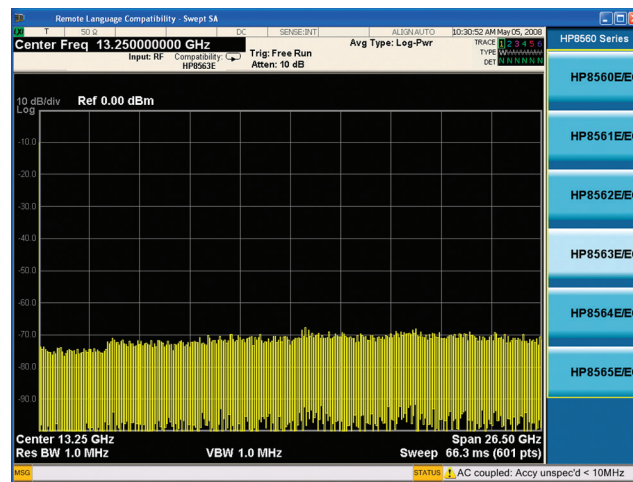

Figure 1. Activating the N9061A-2FP measurement application enables the MXA to emulate the 856xE/EC behaviors in a remote programming environment.

Physical dimensions and weight comparison

Physical parameters of an instrument, such as dimension or weight, may be a concern, particularly when the 856xE/EC to be replaced is in a rack-mounted cabinet or in a portable working environment. The following table compares the physical dimension and weight of the 856xE/EC, the MXA, EXA, and PXA.

Table 1. Dimension and weight comparison of the 856xE/EC, MXA, EXA, and PXA.

	856xE/EC	MXA/EXA	PXA
Dimension (WxHxD)	337 mm x 187 mm x 461 mm	426 mm x 177 mm x 368 mm	426 mm x 177 mm x 556 mm
Dimension with rack (Requires optional rack mount kit)	1 full 5-U in 19 inch chassis	1 full 4-U in 19 inch chassis	1 full 4-U in 19 inch chassis
Weight	16.5 kg (36 lb)	16 kg (35 lb)	22 kg (48 lb)

The following figures show the physical dimensions for the 856xE/EC, MXA, and EXA in their respective portable configurations.

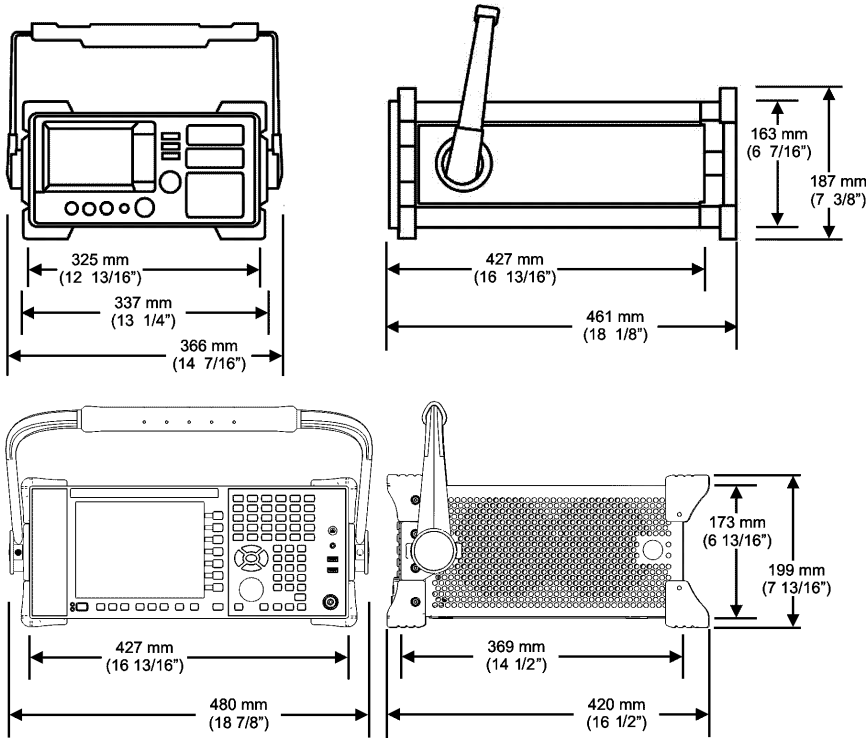

Figure 2. Physical dimensions of 856xE/EC (above) and the MXA /EXA with optional portable configuration (below).

When installed in an instrument rack, the 856xE/EC requires Option 908 (without handle and fringe) or 909 (with handle and fringe) as the rack mount mechanism. With Option 908 or 909, the 856xE/EC occupies a full 5-rack-unit (5-U) in a 19-inch rack system, which is one rack-unit higher than the MXA or EXA with its own rack mount kit, saving 1-U of your valuable rack space. The PXA has the same height and width as the MXA and EXA, but is about 187 mm longer in depth to accommodate 7 extra slots for upgrades.

The MXA and EXA weigh slightly less than the 856xE/EC. Order the portable configuration (Option PRC) to add a pivoting handle and protective rubber corners to an MXA or EXA, which makes it more suitable for a portable working environment (Figure 3).

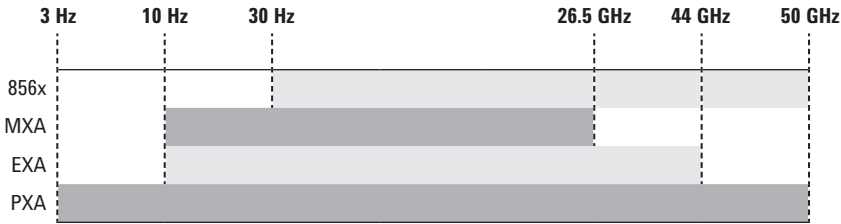

Figure 3. An MXA or EXA with the portable configuration option (Option PRC).

Comparison of RF and microwave frequency coverage

In the RF and microwave range, the X-Series in general has wider frequency coverage than the 856xE/EC (Table 2). The MXA and EXA feature a standard 10 Hz starting frequency, whereas the 856xE/EC starts at 30 Hz (the 8563E/EC, 8564E/EC, and 8565E/EC start at 9 kHz unless Option 006 is installed). The PXA starts at 3 Hz. The maximum frequency coverage for the MXA is 26.5 GHz. For the EXA it is 44 GHz and for the PXA it is 50 GHz.

Table 2. Comparison of RF/microwave frequency coverage.



Beyond 50 GHz, the 856xE/EC offers external mixing which works with the legacy Keysight 11970 or 11974 external mixers. The optional external mixing feature (Option EXM) on millimeter-wave EXA and PXA analyzers, when connected with the Keysight M1970 smart mixers which cover V-band, E-band or W-band, can achieve up to 20 dB better sensitivity than the 856x. For further information, please refer to *Why Migrate to the Keysight M1970 Series Smart Mixers?*

Comparison of hardware options and features

The following table (Table 3) provides a comparison of the hardware options and features in the 856xE/EC, MXA, PXA, and EXA. Unlike the 856xE/EC, which offers input attenuation at 10 dB/step, the MXA and PXA include a 2 dB/step mechanical attenuator standard (Optional for the EXA). Furthermore, an optional electronic attenuator (Option EA3), which steps at 1 dB, is also available for the MXA, PXA, and EXA. This enables MXA, PXA, and EXA users to optimize the input mixer level to achieve the best possible dynamic range. Additionally, the MXA and PXA offer optional built-in preamplifiers which cover the entire frequency range of the analyzer to achieve the best measurement sensitivity. In contrast, the 856xE/EC does not offer an internal preamplifier.

Table 3. Comparison of hardware options and features

Option	856x	MXA	EXA	PXA
Input attenuator	Standard mechanical	Standard mechanical		
	70 dB (10 dB/step) - RF/mW	70 dB (2 dB/step)	60 dB (10 dB/step) 60 dB (2 dB/step) w/ Option FSA	70 dB (2 dB/step)
	Electronic attenuator	Electronic attenuator, Option EA3		
	N/A	24 dB (1 dB/step), up to 3.6 GHz		
Preamplifier	Optional - External only	Internal preamp option to the max frequency of analyzer		
External mixing	Standard	N/A	Option EXM (for Opt 532/544 only)	Option EXM
PowerSuite	Two standard measurements	Up to 10 standard measurements		
Precision freq ref (Ext ref in range)	Standard	Option PFR	Option PFR	Standard
1 Hz RBW	Standard	Standard		
Time gating	Standard	Standard		
ACP DR extension	Option 8563E-E35	Standard		
Remote connectivity	GPIB - Standard	1,000 base-T LAN -standard		
		GPIB/USB 2.0 -standard; Remote Desktop and Embedded Web Server, standard		
Security option	Procedure available	Standard removable solid state drive		

Table 4. Provides an overview of some of the one-button power measurement capabilities. While some of these capabilities are available either as standard or optional on the 856x analyzers, they are standard on the X-Series analyzers.

Table 4. One-button power measurements

	856xE/EC	MXA/EXA	PXA
Channel power	Yes	Yes	Yes
Occupied bandwidth	Yes	Yes	Yes
Multicarrier, multi-offset ACP	Optional	Yes	Yes
Multicarrier power	Optional	Yes	Yes
CCDF		Yes	Yes
Harmonic distortion	Optional	Yes ¹	Yes
Burst power		Yes	Yes
Intermodulation (TOI)	Optional	Yes ¹	Yes
Intermodulation emissions		Yes	Yes
Spectrum emission mask		Yes	Yes

1. Requires FW rev. A.03.08 or later, and to upgrade the existing MXA or EXA which do not include these features, ordering Option N9020AK-R2C or N9010AK-R2C may be required.

2

Industry-Leading Measurement Speed

With increasing pressure to be first-to-market and reduce costs, legacy test equipment may face tougher measurement speed challenges than ever before. In a world of high-volume manufacturing, every millisecond counts. Replacing your 856xE/EC with the MXA, PXA, or EXA signal analyzers can help you make the productivity gains necessary to stay competitive. The MXA and PXA are equipped with a dual-core CPU as a standard feature (optional for EXA), making the MXA, PXA, and EXA stand out as the measurement speed benchmarks among in-class signal and spectrum analyzers. Some key characteristics of measurement speed for the MXA are listed as follows,

- < 1.5 ms marker peak search
- < 20 ms tune, measure, and transfer over GPIB
- < 39 ms measurement/mode switch
- < 14 ms W-CDMA ACLR fast mode measurement speed ($\sigma = 0.2$ dB)

The MXA is significantly faster than the 856xE/EC. Figures 4a and 4b compare the sweep time for a 13.2 GHz full span under the same measurement conditions with a wide RBW. Under these conditions, the 856xE/EC took more than 10 times longer than the MXA to complete a single sweep.

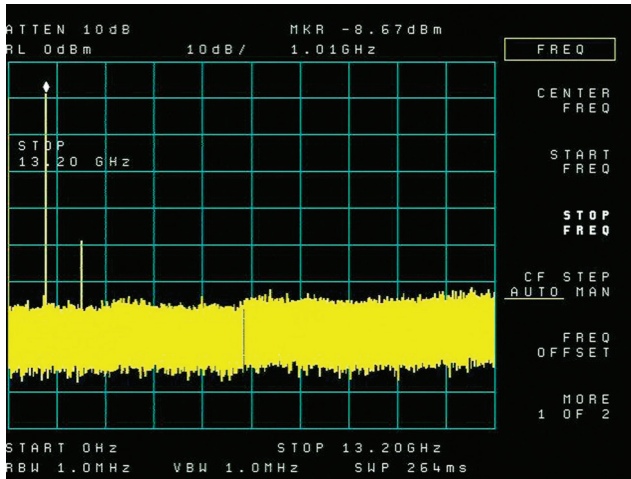

Figure 4a. The 8562 EC takes 260 ms for a full span of 13.2 GHz sweep (RBW=VBW=1 MHz).

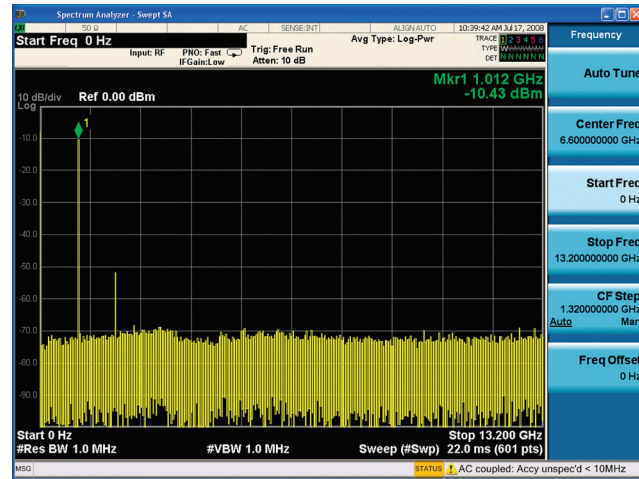

Figure 4b. The MXA only takes 22 ms for a full span of 13.2 GHz sweep (RBW=VBW=1 MHz).

In the real world, narrow RBWs are often required in order to achieve better sensitivity. The recently introduced fast sweep capability (now ship standard on all PXAs, and available on the MXA and EXA with Option B40, DP2 or MPB) further improves sweep speed across wide frequency spans, saving a tremendous amount of time at narrower RBW settings (from several kHz to dozens of kHz). For example, sweeping across 13.2 GHz spans with 30 kHz RBW takes 37 seconds for an 856x, whereas it takes only 0.37 seconds for an X-Series analyzer with fast sweep capability. This drastic savings in sweep time is especially beneficial for applications such as spur search, which demand narrower RBWs to detect very low level signals across a very wide frequency range.

3

Superior Performance

Improved measurement accuracy translates to enhanced productivity. In manufacturing settings, test equipment with better measurement accuracy means production lines and rework stations can have more stringent pass/fail criteria, reduce “false-positive” results, and yield more products which meet defined specifications. In R&D environments, higher accuracy test equipment provides greater design confidence and therefore maximized productivity.

The MXA and PXA signal analyzers offer significantly better amplitude accuracy than the 856xE/EC. Tables 5 and 6 compare frequency response specifications, which are the primary contributing factors to an instrument’s amplitude accuracy.

Table 5. Frequency response in \pm dB (relative/typical relative or 95th percentile)¹ for RF/uW analyzers

Frequency band	8560EC	8561EC	8562EC	8563EC	MXA	RF/ μ W EXA	RF/ μ W PXA
10 MHz to 2.9 GHz	1.0/0.8	1.0/0.7	1.25/0.8	1.25/0.8	0.45/0.17	0.6/0.21	0.35/0.16
2.9 to 6.46 GHz		1.5/1.1	1.5/1.1	1.5/1.0	1.5/0.48	2.0/0.69	1.5/0.39
6.46 to 13.2 GHz			2.2/1.5	2.2/1.5	2.0/0.47	2.5/NA	2.0/0.45
13.2 to 22 GHz				2.5/1.5	2.0/0.52	3.0/NA	2.0/0.62
22 to 26.5 GHz				3.3/2.2	2.5/0.71	3.2/NA	2.5/0.82

Table 6. Frequency response in \pm dB (relative/typical relative or 95th percentile)¹ for mmW analyzers

Frequency band	8564EC	8565EC	mmW EXA	mmW PXA
10 MHz to 2.9 GHz	1.0/0.8	1.0/0.8	0.45/0.20	0.35/0.15
2.9 to 6.46 GHz	1.7/1.4	1.7/1.4	1.7/0.91	1.7/0.7
6.46 to 13.2 GHz	2.6/2.2	2.6/2.2	2.0/0.61	2.0/0.54
13.2 to 22 GHz	2.5/2.5	2.5/2.5	2.0/0.78	2.0/0.72
22 to 26.5 GHz	3.3/2.2	3.3/2.2	2.5/0.72	2.5/0.71
26.5 to 31.15 GHz	3.1/2.9	3.1/2.9	2.5/1.11	2.5/0.93
31.15 to 40 GHz	2.6/2.4	3.2/3.0	3.2/1.42	3.2/1.24
40 to 50 GHz		3.2/3.0		3.2/1.24

The guaranteed specification of overall absolute amplitude accuracy at a reference of 50 MHz is \pm 0.40 dB for the EXA, \pm 0.33 dB for the MXA, and \pm 0.24 dB for the PXA. Furthermore, the typical performance level based on a 2 sigma value (95%) for the absolute amplitude accuracy below 3.6 GHz is \pm 0.27 dB for the EXA, \pm 0.23 dB for the MXA and \pm 0.19 dB for the PXA— this sets the X-Series apart from other signal analyzers. When calculating the overall amplitude accuracy of the 856xE/EC, additional terms, such as IF gain uncertainty and IF alignment uncertainty, will need to be considered for a complete error analysis. These terms of amplitude uncertainty are eliminated in the X-Series due to its “all-digital IF” architecture. Additionally, the logarithmic amplifier implemented in the 856xE/EC is eliminated from the signal path in the X-Series. This results in superior display linearity and completely removes the uncertainty contributed by the impaired “log fidelity” due to use of the logarithmic amplifier.

1. The EXA/MXA/PXA frequency bands are defined differently from the 856x when specifying the frequency responses; refer to the EXA/MXA/PXA data sheets for more details

Increased sensitivity

When searching for very low level signals, such as in signal monitoring use cases, the sensitivity of the signal analyzer becomes more critical. The displayed average noise level (DANL) is the indication of the analyzer's sensitivity. The X-Series signal analyzers offer excellent DANL performance because of its optional built-in low-noise, high-gain preamplifiers. Further, the Keysight-exclusive noise floor extension (NFE), along with the internal preamplifier, enables the high-performance PXA to offer extraordinarily low DANL, allowing users to detect extremely weak signals. The optional preamplifiers cover frequencies up to the maximum frequency of the X-Series signal analyzers.

The comparison tables below indicates that the DANL performance of the MXA with preamplifier is over 10 dB better than that of the 856xEC. Without the preamplifier, the MXA's DANL performance is comparable to or even slightly better than that of the 856xEC.

Table 7. DANL performance (RBW= 1 Hz) comparisons for RF/uW analyzers, in dBm¹

Frequency	8560EC	8561EC	8562EC	8563EC	MXA	RF/ μ W EXA	RF/ μ W PXA
10 MHz	-140	-140	-140	-140	-150 (-161)	-147 (-161)	-155 (-164)
2.9 GHz	-151	-145	-151	-149	-149 (-162)	-147 (-160)	-160 (-172)
6 GHz		-145	-148	-148	-149 (-162)	-147 (-160)	-156 (-172)
13 GHz			-145	-145	-148 (-162)	-143 (-160)	-157 (-169)
17 GHz				-140	-144 (-159)	-137 (-157)	-151 (-165)
20 GHz				-140	-143 (-157)	-137 (-155)	-145 (-160)
26.5 GHz				-139	-136 (-152)	-134 (-150)	-145 (-160)

Table 8. DANL performance (RBW= 1 Hz) comparisons for mmW analyzers, in dBm¹

Frequency	8564EC	8565EC	mmW EXA	mmW PXA
10 MHz	-140	-140	-152 (-164)	-155 (-164)
2.9 GHz	-145	-145	-149 (-162)	-160 (-172)
6 GHz	-147	-147	-145 (-160)	-154 (-165)
13 GHz	-143	-143	-147 (-160)	-154 (-167)
17 GHz	-140	-140	-145 (-160)	-155 (-167)
20 GHz	-140	-140	-142 (-160)	-152 (-165)
26.5 GHz	-136	-136	-140 (-158)	-152 (-165)
31 GHz	-139	-139	-140 (-156)	-147 (-162)
40 GHz	-130	-130	-135 (-153)	-142 (-156)
50 GHz	-127	-127		-142 (-156)

1. Refer to the 856x and EXA/MXA/PXA data sheets for more details; the 856xE/EC instruments do not offer the built-in preamplifier, whereas the EXA/MXA/PXA provides preamplifier options. The DANL values in parentheses are for conditions with preamp on. PXA DANL performance specs are "effective DANL" at the middle of corresponding frequency bands. Refer to the PXA datasheet for details.

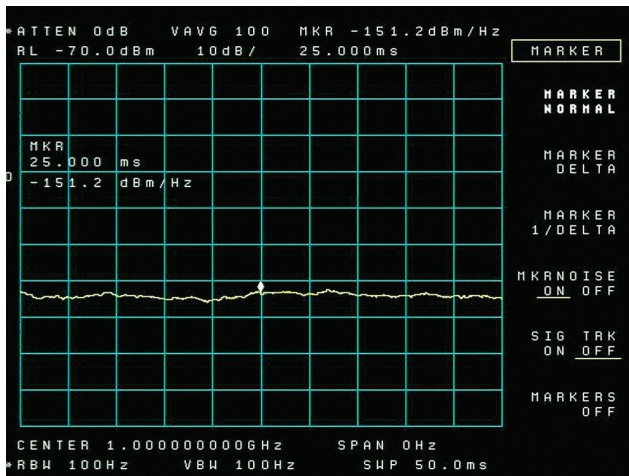

Figure 5a. In a DANL comparison at 1 GHz center frequency, an 8562EC shows -151.2 dBm DANL normalized to RBW of 1 Hz.



Figure 5b. At 1 GHz center frequency, an MXA shows -165.38 dBm DANL normalized to RBW of 1 Hz, with the preamplifier on.

Wider dynamic range

A signal analyzer's dynamic range determines its ability to measure lower level signals in the presence of higher power signals with negligible distortion. Dynamic range is the most important figure of merit for measurements like spur search. The best dynamic range is achieved with the lowest DANL, combined with the highest third-order intercept point (TOI). A comparison of third-order dynamic range for the 856xE, EXA, MXA, and PXA analyzers is shown in the following table.

Table 9. Third-order dynamic range comparisons for RF/uW analyzers¹

Frequency	8560EC	8561EC	8562EC	8563EC	MXA	RF/uW EXA	RF/uW PXA
10 MHz	108 dB	103 dB	108 dB	108 dB	108 dB		112 dB
2.9 GHz	108 dB	103 dB	108 dB	108 dB	110 dB	107.3 dB	115.3 dB
6 GHz		107 dB	108.5 dB	108.5 dB	109.3 dB	107.3 dB	110 dB
13 GHz			101.5 dB	101.5 dB	108.6 dB	104.6 dB	109.3 dB
17 GHz				98 dB	106 dB	99.3 dB	105.3 dB
20 GHz				98 dB	105.3 dB	99.3 dB	105.3 dB
26.5 GHz				97.5 dB	100.6 dB	97.3 dB	101.3 dB

Table 10. Third-order dynamic range comparisons for mmW analyzers¹

Frequency	8564EC	8565EC	mmW EXA	mmW PXA
10 MHz	104 dB	104 dB	109.3 dB	112 dB
2.9 GHz	108 dB	108 dB	109.3 dB	115 dB
6 GHz	108 dB	108 dB	106.6 dB	107.3 dB
13 GHz	100 dB	100 dB	108 dB	109.3 dB
17 GHz	98 dB	98 dB	104 dB	108 dB
20 GHz	98 dB	98 dB	103.3 dB	106.6 dB
26.5 GHz	95.5 dB	95.5 dB	101.3 dB	104.6 dB
31 GHz	101 dB (nom)	101 dB (nom)	102.0 dB (nom)	102.6 dB (nom)
40 GHz	95 dB (nom)	95 dB (nom)	98.6 dB (nom)	99.3 dB (nom)
50 GHz		93 dB (nom)		97.3 dB (nom)

1. The third-order dynamic range is calculated by $2/3 \cdot (TOI - DANL)$. The PXA values are calculated without NFE being enabled for DANL.

These tables reveal that the third-order dynamic range performance of the MXA and PXA exceeds that of the 856xE/EC. Even the less expensive EXA provides comparable dynamic range to the 856xE/EC. Additionally, the X-Series' 2 dB/step mechanical attenuator (standard on the MXA and PXA and optional on EXA) and the optional 1 dB/step electronic attenuator, as compared to the 10 dB/step attenuator used in the 856xE/EC, make it much easier to fine-tune the analyzer's mixer level setting to achieve the best usable dynamic range.

Superior phase noise

Phase noise is the most important metric for an oscillating device and can be a limiting factor in mission-critical applications in aerospace and defense, such as radar transceivers, as well as in communications. Stringent phase noise specifications are demanded of spectrum/signal analyzers for the most accurate characterization of a device or subsystem involving an oscillating component. The 856xE/EC family was previously known to be the spectrum analyzer with "best-in-class" phase noise performance. However, the newer MXA offers better overall phase noise performance than the 856xE/EC and can be the best choice to replace your existing 856x. If you are pursuing the most advanced phase noise, consider the high performance PXA. If your application allows for a trade-off between performance and price, the EXA can also be a good option as an 856x replacement. Refer to Figure 6 for phase noise comparisons.

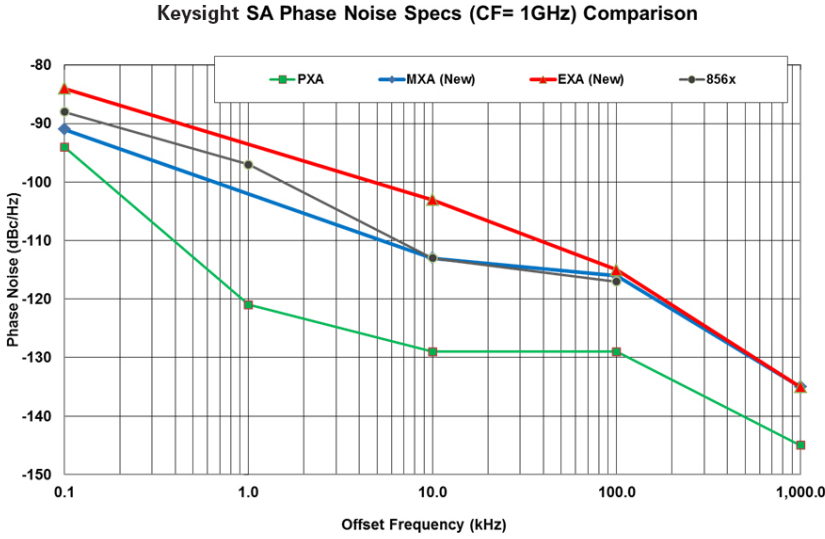

Figure 6. The phase noise of the MXA is better than the 856x overall, particularly at close-in and pedestal regions. The PXA excels in phase noise with a large margin.

4

Improved Selectivity and Accuracy with All-Digital IF

160 choices of RBW settings from 1 Hz to 8 MHz

The set of resolution bandwidth (RBW) filters determines the resolving power of the spectrum/signal analyzer for unequal signals that are close to each other in frequency domain (selectivity). The narrower the RBW setting, the higher the selectivity of a spectrum/signal analyzer. However, choosing a narrower RBW can significantly slow down the measurement speed in an analyzer's swept tuned mode.

Both the 856xE/EC and the X-Series offer resolution bandwidth (RBW) filters as narrow as 1 Hz to achieve the maximum frequency resolution. The 856xE/EC have RBW steps in per 1-3-10 sequence from 1 Hz to 1 MHz, whereas the X-Series has RBW increments at 10% a step from 1 Hz to 3 MHz. There is a total of 160 RBW settings in the X-Series, compared to 14 RBW settings in the 856xE/EC, allowing users to optimize the trade-off between selectivity and measurement speed.

Superb selectivity and RBW accuracy

Unlike the 856xE/EC, in which the digital RBW filters are only in the narrowest bandwidth (1 Hz through 100 Hz) and the remaining RBW filters are analog, all of the X-Series' 160 RBW filters (1 Hz through 8 MHz) are digitally implemented. With all-digital processing, the X-Series's IF specifications, including the RBW performance, improved significantly compared to the 856xE/EC (Table 11).

Table 11. RBW performance comparison

	856xE/EC	X-Series (MXA, EXA, PXA)
Selectivity (-60 dB/-3 dB)		
RBW \geq 300 Hz	< 15:1	4.1:1 for all RBW settings
RBW \leq 100 Hz	< 5:1	
Range (-3 dB)	1 Hz to 1 MHz in a 1, 3, 10 sequence, and 2 MHz (3 MHz at -6 dB), 14 choices	1 Hz to 3 MHz (10% steps), 4, 5, 6, 8 MHz, 160 choices
RBW Accuracy (-3 dB)		nominal
1 Hz to 300 kHz	\pm 10%	\pm 2%
1 MHz	\pm 25%	\pm 8%
2 MHz	+50%, -25%	\pm 20%

Consistent shape factor at 4.1:1 ratio

All of the RBW settings in the X-Series have an identical shape factor at a 4.1:1 ratio (-60 dB/-3 dB). In contrast, the RBW filters beyond 100 Hz used in the 856xE/EC, due to its analog nature, have a shape factor of a 15:1 ratio. The smaller the shape factor, the sharper the RBW filter frequency response curves (that is, the narrower the skirt at the bottom). The sharper RBW filter shape used in the X-Series effectively separates a small signal that is close to a larger signal in frequency domain (Figures 4a and 4b) without having to select narrower resolution bandwidth and sacrificing measurement speed.

Improved RBW accuracy

Because of the all-digital implementation, every RBW filter used in the X-Series has identical characteristics, ensuring that no additional errors contribute to the overall IF amplitude accuracy. The improvement of the RBW accuracy in the MXA and PXA can be seen in Table 11. Furthermore, the all-digital RBW filtering eliminates the RBW switching uncertainty—one of the contributing error factors in the 856xE/EC.

Improved speed

The digitally implemented RBW filters used in the X-Series, which are based on FFT analysis and digital circuitry offer significant speed advantages. They are 2.5 to 4 times faster than the analog RBW filters in the 856x/EC, which are LC-crystal-filter-based and take time to charge and discharge. Refer to Figures 7a and 7b to compare the implementation time between the MXA and the 856x/EC, as indicated in the lower right corner of the screens, under the same conditions.

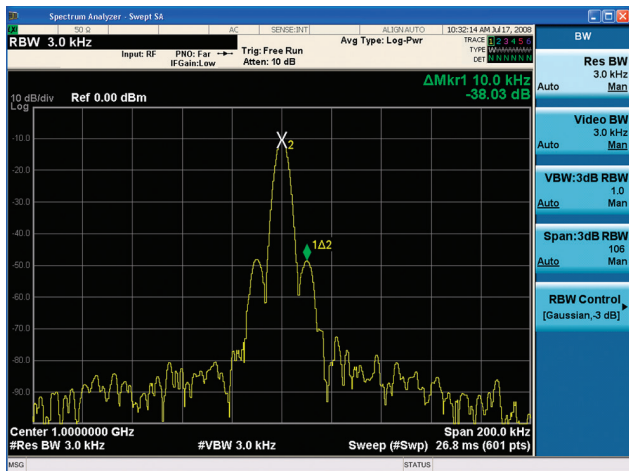

Figure 7a. Testing a 2.5% depth AM signal with an MXA (RBW=VBW=3 kHz), the AM sideband can be clearly seen (at Marker 1Δ2).

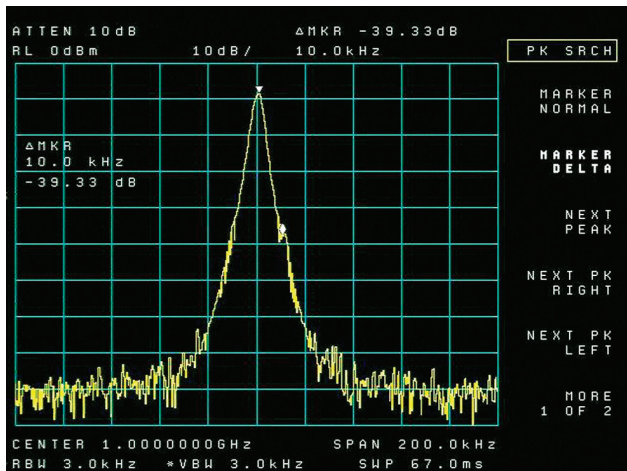

Figure 7b. Testing the same signal as in 7a with an 8562EC (RBW=VBW=3 kHz), the AM sideband is covered by the RBW skirt and cannot be detected.

5

Modern User Interface Provides Enhanced Usability

Open Windows operating system and embedded online help

The Keysight X-Series signal analyzers are built in the open Windows operating system (OS) environment which enables quick and easy file management with Windows Explorer. Also, the Windows environment allows the user to run MATLAB and the industry-leading 89600 VSA software inside the X-Series analyzer. Additionally, you can troubleshoot and control the X-Series analyzers via Windows Remote Desktop software or with the embedded Web server (LXI-C compliant).

The features offered by the Windows OS environment enable the X-Series analyzers to provide a comprehensive context-specific help system, accessible by simply pressing the HELP key on the instrument's front panel. The help system offers information on any key or menu at any time (see Figure 8). By contrast, with the 856xE/EC, one would have to search for information in the hard copy user's guide, which is much less efficient.

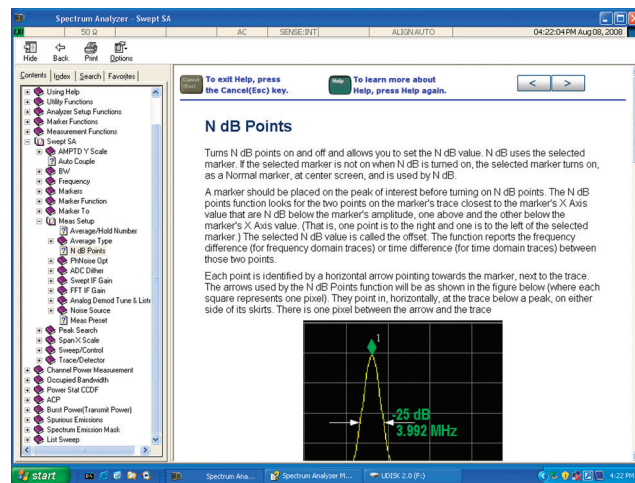

Figure 8. X-Series embedded online help provides a detailed user's guide for measurement concepts, front-panel key definitions and SCPI commands.

Modern connectivity

There are seven USB 2.0 ports installed in an X-Series analyzer (6 type-A, and 1 type-B). A user can connect the analyzer to external peripherals such as a DVD drive, keyboard, mouse, and USB flash drive via the A-type USB ports, or acquire IQ waveforms and control the analyzer remotely from an external PC over the B-type USB port. Using a USB flash drive, you can save the measurement data and easily transfer it from the analyzer to an external PC.

The 1000Base-T LAN connectivity, standard on MXA, PXA, and EXA analyzers, offers an easy and fast analyzer connection to your network environment. X-Series analyzers are also LXI-compliant, further enabling fast, efficient, and cost-effective creation and reconfiguration of your test system.

Like most signal/spectrum analyzers in their class, X-Series signal analyzers are also equipped with GPIB (IEEE-488 bus) ports for instrument remote control and data transfer. The GPIB port is the only data interface available for the 856xE/EC.

6

Broader Offering of Measurement Applications

The Keysight X-Series measurement applications allow users of the X-Series signal analyzers to maximize productivity by minimizing equipment setup time and operating errors.

While the 856xE/EC only offers a few measurement utilities, such as phase noise and spurious response, the X-Series signal analyzers support more than 25 measurement applications—and the number is growing. The measurement applications cover traditional measurements like phase noise and noise figure to 2G/3G/4G cellular standards and the latest wireless connectivity technologies such as WLAN and *Bluetooth*®. The scalability of the X-Series' measurement applications protect so that you are ready to meet the test challenges of today and tomorrow.

The X-Series measurement applications are also much more powerful than the measurement utilities offered in the 856xE/EC instruments. For example, while both the 856xE/EC and the X-Series offer phase noise measurement capabilities, the X-Series N9068A phase noise measurement application performs phase noise measurements much faster and provides a more user-friendly interface than the 85671A phase noise utility in the 856xE/EC family.

The X-Series measurement applications include Remote language compatibility (RLC), analog demodulation, phase noise, noise figure, GSM/EDGE, cdma2000®, W-CDMA/HSPA, 802.16 OFDMA, 1xEV-DO, TD-SCDMA/HSDPA/8PSK, LTE FDD/TDD, MATLAB, VXA vector signal analyzer, iDEN/WiDEN/MotoTalk, DVB/T/H, DTMB, pulse measurement, EMI-precompliance, and more.

In addition, with the industry-leading 89600 VSA software, the X-Series is capable of supporting deep analysis of over 50 different modulation formats. The VSA software can also be operated via a combination of front panel hard and soft key commands when used with the VXA software (N9064A). Similarly, the MATLAB software can also be installed into the X-Series, and the user can control the MATLAB functions via either the mouse/keyboard or front-panel keys.

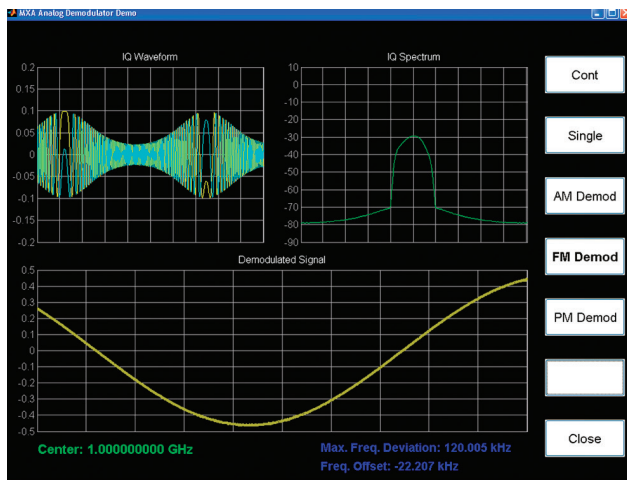

Figure 9. An MXA display for FM modulation analysis using the N6171A MATLAB interactive software.

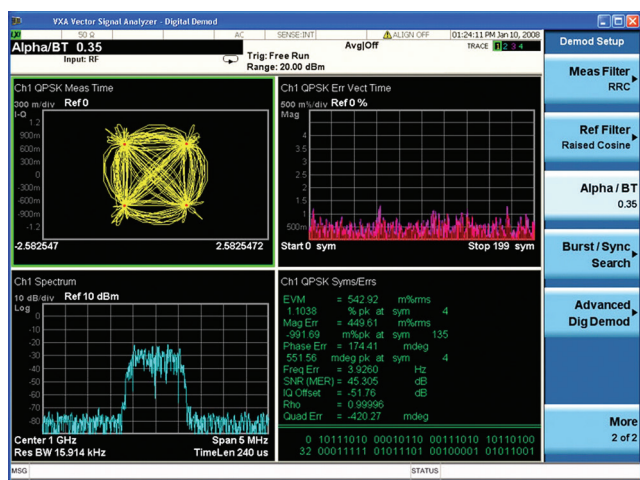

Figure 10. The N9064A VXA vector signal analyzer measurement application enables you to operate the vector signal analyzer via the front panel keys of the MXA.

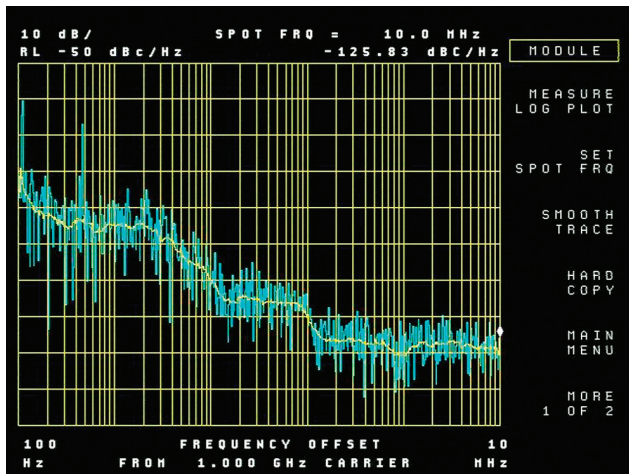

Figure 11a. Phase noise log plot obtained with 85671A phase noise utility installed in an 856xEC.

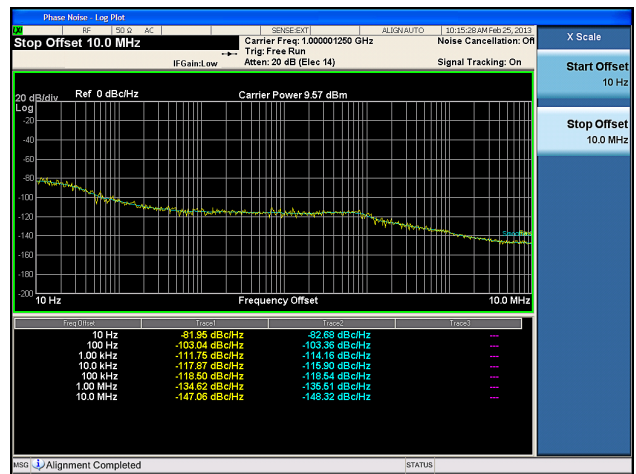

Figure 11b. Phase noise log plot obtained with N9068A phase noise measurement application in an MXA—much faster and easier to use than the 85671A.

7

Greater Security with Simpler and More Robust Data Sanitization

In many cases, particularly in the aerospace and defense industry, instrument security is a requirement. An instrument will not be allowed to leave a secured (or classified) area unless it can be proven that all devices capable of maintaining memory have been thoroughly erased or secured.

The removable solid state drive (SSD), standard on the X-Series analyzers, offers a simple but effective way to meet the most stringent data sanitization requirements. A classified SSD includes non-volatile user sensitive data and needs to be retained in the secured area. Physically removing the classified SSD allows the analyzer to be safely transported to non-secured areas, such as a calibration/repair facility, without fear of leaking sensitive user information. An additional removable SSD (Option SSD) is imaged with the operating system (OS) and instrument software but contains no sensitive user data. When in a non-secured area, the analyzer equipped with this non-classified SSD remains fully functional. Figure 12 depicts how this works.

On the other hand, the 856xE/EC instrument security procedure, which involves removal and replacement of the controller board inside the instrument is a more complex, time consuming, and costly procedure.



Returning PXA/MXA/EXA to a secured area

Back up the alignment files then remove the non-classified hard drive before returning your PXA/MXA/EXA to secured area.

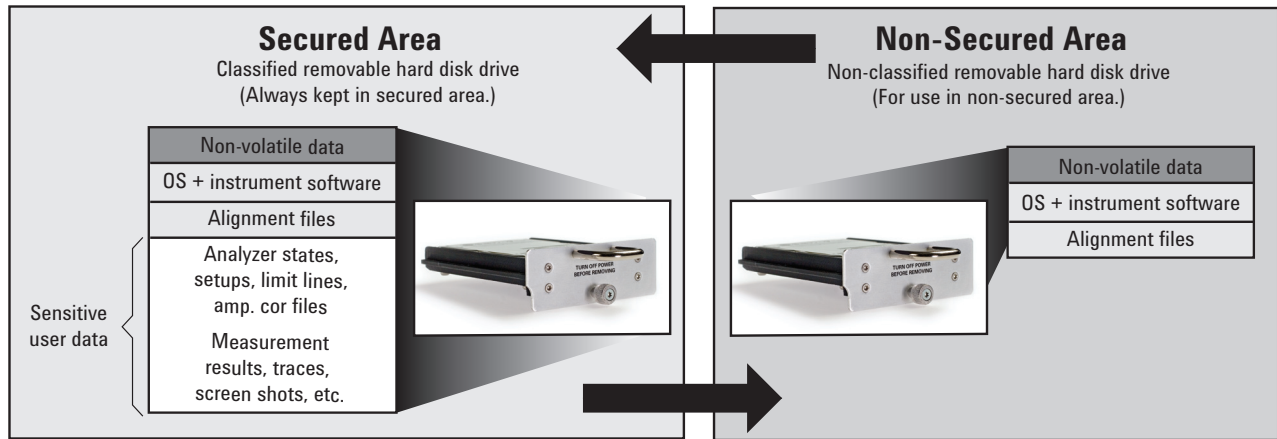

Removing PXA/MXA/EXA from secured area

Remove the classified hard drive before moving your PXA/MXA/EXA to a non-secured area.



Figure 12. Data sanitization with removable hard drives in the X-Series signal analyzers

Migrate from your 856xE/EC to a PXA, MXA, or EXA signal analyzer to minimize cost and instrument downtime, and to maximize instrument security!

myKeysight

myKeysight
www.keysight.com/find/mykeysight
 A personalized view into the information most relevant to you.



www.lxistandard.org
 LAN eXtensions for Instruments puts the power of Ethernet and the Web inside your test systems. Keysight is a founding member of the LXI consortium.



Three-Year Warranty
www.keysight.com/find/ThreeYearWarranty
 Keysight's commitment to superior product quality and lower total cost of ownership. The only test and measurement company with three-year warranty standard on all instruments, worldwide.



Keysight Assurance Plans
www.keysight.com/find/AssurancePlans
 Up to five years of protection and no budgetary surprises to ensure your instruments are operating to specification so you can rely on accurate measurements.



www.keysight.com/quality
 Keysight Electronic Measurement Group
 DEKRA Certified ISO 9001:2008
 Quality Management System

Keysight Channel Partners
www.keysight.com/find/channelpartners
 Get the best of both worlds: Keysight's measurement expertise and product breadth, combined with channel partner convenience.

cdma2000 is a US registered certification mark of the Telecommunications Industry Association.

Bluetooth® and **Bluetooth** Logo® are trademarks owned by **Bluetooth SIG, Inc.**, U.S.A. and licensed to Keysight Technologies.

www.keysight.com/find/xseries

For more information on Keysight Technologies' products, applications or services, please contact your local Keysight office. The complete list is available at: www.keysight.com/find/contactus

Americas

Canada	(877) 894 4414
Brazil	55 11 3351 7010
Mexico	001 800 254 2440
United States	(800) 829 4444

Asia Pacific

Australia	1 800 629 485
China	800 810 0189
Hong Kong	800 938 693
India	1 800 112 929
Japan	0120 (421) 345
Korea	080 769 0800
Malaysia	1 800 888 848
Singapore	1 800 375 8100
Taiwan	0800 047 866
Other AP Countries	(65) 6375 8100

Europe & Middle East

Austria	0800 001122
Belgium	0800 58580
Finland	0800 523252
France	0805 980333
Germany	0800 6270999
Ireland	1800 832700
Israel	1 809 343051
Italy	800 599100
Luxembourg	+32 800 58580
Netherlands	0800 0233200
Russia	8800 5009286
Spain	0800 000154
Sweden	0200 882255
Switzerland	0800 805353
	Opt. 1 (DE)
	Opt. 2 (FR)
	Opt. 3 (IT)
United Kingdom	0800 0260637

For other unlisted countries:
www.keysight.com/find/contactus
 (BP-05-19-14)

