

Keysight Technologies N9340B Handheld Spectrum Analyzer

Demo Guide



Introduction

This demo guide is a tool for the new user to gain familiarity with the basic functions and features of the Keysight Technologies, Inc. N9340B handheld spectrum analyzer.

Almost all exercises utilize a signal from an external signal generator with amplitude of -10 dBm and frequency of 100 MHz.

Key names surrounded by [] indicate hardkeys located on the front panel, while key names surrounded by { } indicate softkeys located on the right of the display.

Demos

1. Panel Tour
2. File Operation
3. Measurement Basics
4. Peak Search and Makers
5. Measuring Signal to Noise with Delta Markers
6. Improving Signal to Noise
7. Limit Lines and Pass/Fail Testing
8. Spectrogram
9. Tracking Generator
10. Power Meter Measurements
11. Field Strength Measurements
12. AM/FM, ASK/FSK Demodulation
13. Spectrum Emission Mask
14. Automation

Section 1

Panel Tour



Caption	Function
1	Power switch Toggles the analyzer between on and off
2	Function keys Includes hardkeys: SYS, FREQ, SPAN, AMPTD, BW/SWP, TRACE, MEAS, and MODE
3	Preset Returns the analyzer to a known state, also turns on/off power save feature (press for 1 sec.)
4	Enter Confirms a parameter selection or configuration
5	ESC/CLR Exits and closes the dialog box or clears the character input
6	MARKER Activates the marker functions
7	LIMIT Sets limit lines for quick pass/fail testing
8	Save Quickly saves the current trace
9	Arrow keys Increases or decreases a parameter step by step
10	Knob Selects an option item or edits a numerical parameter
11	Softkeys Indicate current menu functions
12	Built-in light sensor Adjusts the display brightness automatically
13	Speaker Active when in demodulation mode
14	Screen Displays measured traces and status

Section 1

Top Panel Overview

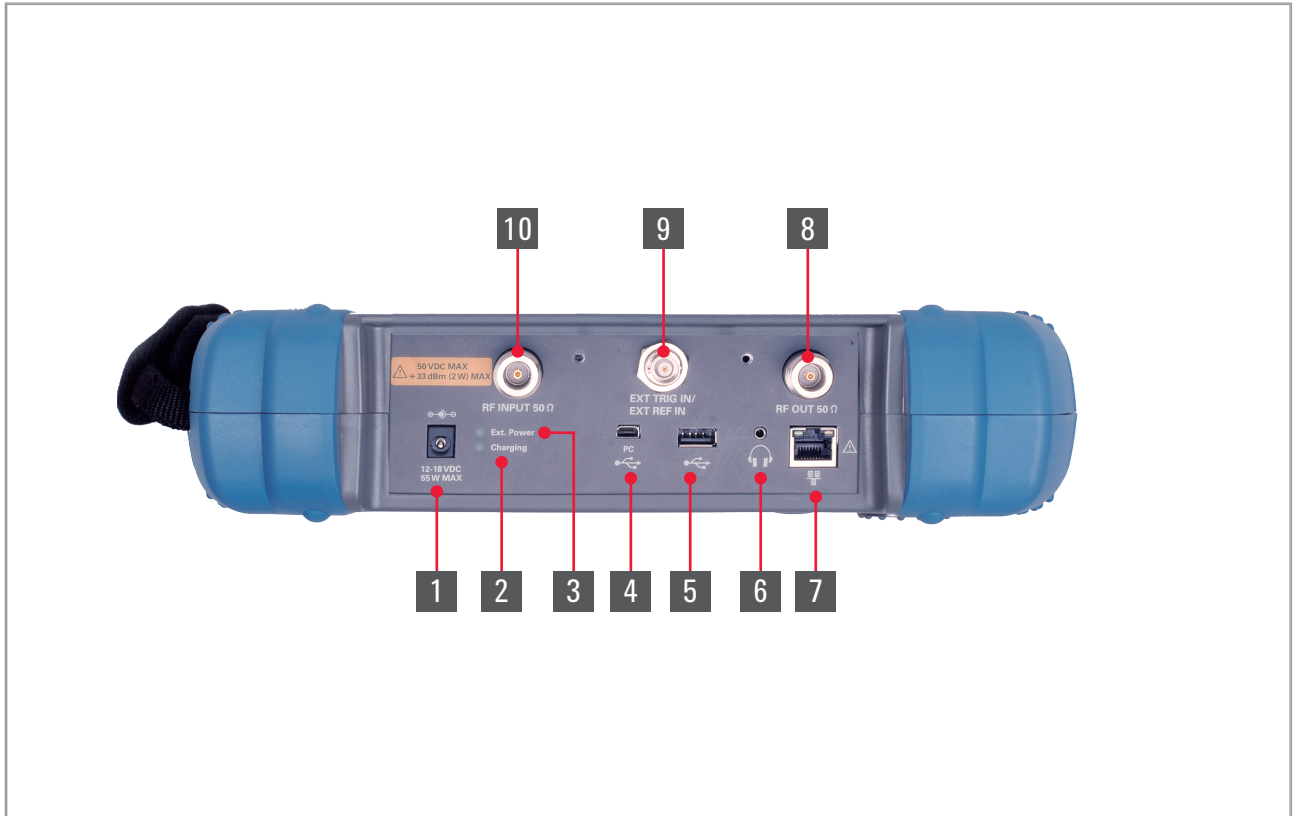

Caption	Function
1 External DC power connector	Provides input for the DC power source via an AC-DC adapter or automotive type DC adapter.
2 LED indicator (charging)	Light is {On} when the battery is charging
3 LED indicator	Light is {On} when external DC power is connected to the tester
4 USB interface (device)	Connects the analyzer to a PC
5 USB interface (host)	Connects the analyzer to a USB memory stick or disk
6 Headphone	Connects the analyzer to a headphone
7 LAN interface	Connects the analyzer to a PC for SCPI remote control
8 RF OUT connector	The output for the built-in tracking generator. Enabled with Option TG3.
9 EXT TRIG IN/REF IN (BNC, female)	Connects to an external TTL signal or a 10 MHz reference signal. The TTL signal is used to trigger the analyzer's internal sweep.
10 RF IN connector (50 Ω)	Accepts an external input with a frequency range from 100 kHz to 3 GHz, tunable to 9 kHz

Section 1

Auto-Brightness and Backlit Keys

Communication system maintenance and repair often requires a technician to troubleshoot in bright daylight or in the dark. There is a light sensor on the front panel of the N9340B that measures the ambient light and automatically adjusts the brightness of the display and its backlit keys.

You can also manually set the brightness of the display, and the backlit keys, so they can be seen clearly in any light. The duration of the key light can also be set to maximize battery life.

1. Adjust the display brightness

Instruction	Key strokes
Switch the screen brightness state from automatic to manual.	[SYS], {Brightness Man}
Rotate the knob to adjust the display brightness.	
Switch the screen brightness state back to automatic.	[SYS], {Brightness Auto}
Cover the light sensor with your finger and watch as the display brightness adjusts automatically.	

2. Backlit key demo

Instruction	Key strokes
Switch the backlit key state to auto.	[SYS], {KeyBackLight}
Cover the light sensor with your finger and watch as the back lights come on.	
Switch the backlit key state to manual, and adjust the backlit keys' brightness.	[SYS], {KeyBackLight}, {BackLight Man}, {Brightness}, {High} {Off} {Brightness}, {Med}
Set the automatic turn-off time interval so the backlit keys will shut off when not in operation.	[SYS], {KeyBackLight}, {AutoOffTimer}, {5 Sec}, {10 Sec}

Section 2

Save/Recall Setups and Results

A key feature of the Keysight N9340B Handheld spectrum analyzer is the easy-to-use file system.

In addition to the 16 MB internal memory, the Keysight N9340B also allows you to save files to an external USB memory device, such as a USB memory stick.

The analyzer has seven file types:

- CSV (*.CSV) Records the trace data as comma separated variables.
- Pattern (*.PTN) Records the limit-line settings.
- Screen (*.JPG) Records the current screen.
- Setup (*.SET) Records the current system setting information.
- Spectrum Mask (*.MSK) Records spectrum mask settings.
- State (*.STA) Records the current controls and settings of the analyzer.
- Trace (*.DAT) Records the data of the current trace and controls.

In this section, the state of the instrument is saved to a filename of your choice so that it can be recalled for use in later sections.

1. Save a state file to the local memory

Instruction	Key strokes
Call up the file save menu.	[SYS]
Select the internal memory.	[File], {File Setup}, {Save Path}, {Local}
Select the file type.	{File Setup}, {File Type}, {State}
Enter the file name using numeric keypad.	Enter a file name.
Save to the internal memory.	{Save}

Section 2

Save/Recall Setups and Results (continued)

2. Save the state file to an external USB memory stick.

Instruction	Key strokes
Insert a USB memory stick into the USB port on the top panel of the analyzer.	
Call up the file save menu.	[SYS]
Select the save path.	{File}, {File Setup} {Save Path}, {USB}
Select the file type.	{File Setup}, {File Type}, {State}
Enter the file name using the numeric keypad (using alphabet and/or number keys).	Enter a file name.
Save to the USB memory stick.	{Save}

Keep the USB stick connected for the following operation.

Recalling a file from either the local memory or an external USB memory stick is a simple task.

Here is an example:

3. Recall the state file you just saved in the USB memory stick.

Instruction	Key strokes
Call up the file save menu.	[SYS]
Select the load path.	{File}, {View}, {USB}
Select the file type.	{File Setup}, {File Type}, {State}
Rotate the knob to highlight the file.	
Load the file.	{Load now}

Section 3

Measurement Basics: Frequency, Span, Amplitude

The key measurement setup parameters of a spectrum analyzer are:

- Frequency: Adjusts the frequency.
- Span: Adjusts the difference between the start and stop frequencies of the displayed spectrum.
- Amplitude: Adjusts the view of the signal level.

A typical spectrum analyzer measurement procedure contains the following three steps:

1. First, the center frequency of the analyzer is tuned to the signal of interest.
2. Next, the span is adjusted to zoom in on the signal of interest.
3. Finally, the amplitude is adjusted to give the optimum view of the signal.

In this section, you will set an external signal generator to 100 MHz at -10 dBm and connect an RF cable from its output port to the input port of the N9340B.

Software

If you do not have a signal generator, you can connect an antenna to the input port of the N9340B and perform this demonstration using an ambient signal such as from a local radio station. In this case you may need to jump ahead to Section 6 to learn how to lower the noise floor by reducing the resolution bandwidth (RBW).

Instruction	Key strokes
Connect a Type-N RF cable from an external signal generator's RF output port to the RF input connector of the N9340B.	
Tune the center frequency to 100 MHz.	[FREQ], [100], {MHz}
Adjust the span to zoom in on the signal on the screen.	[Span], [10], {MHz}
Set the reference level so that the signal peak is at the top graticule line.	[AMPTD], then rotate the knob.

Section 4

Peak Searching and Markers

The peak auto search feature of the analyzer allows you to measure multiple peaks simultaneously. Not only does this save time, it also provides a clear printout of frequency and amplitude data.

If you do not have a signal generator or this signal generator only generates one peak, you can connect an antenna to the input port of the N9340B and perform this demonstration using ambient signals, such as from several local radio stations. In this case you may need to jump ahead to Section 6 to learn how to lower the noise.

Instruction	Key strokes
Connect the 100 MHz signal to the RF IN connector. Set start frequency and stop frequency.	[Preset], [FREQ] {Start Freq}, [90], {MHz}, {Stop Freq}, [320], {MHz}
Activate auto peak search.	[MARKER], {Peak Search}, {6 Peaks Search {On}}

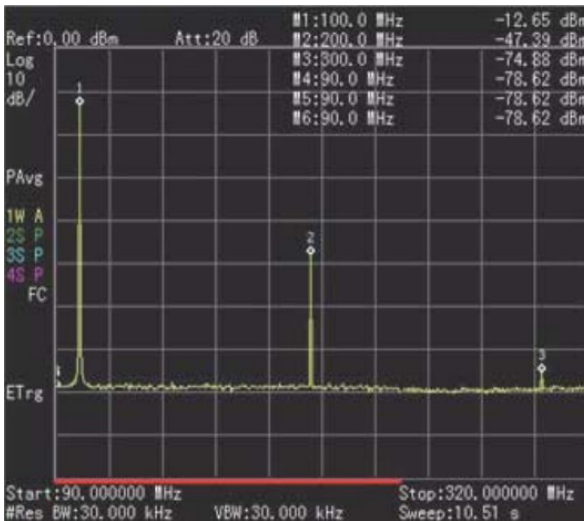

Figure 1. Marker peak search function

Section 5

Measuring Signal to Noise with Delta Markers

Harmonic distortion is present in any electronic system where a signal travels through an active device. Communication engineers are extremely concerned with harmonic distortion. For example, cellular radio systems must be checked for harmonics of the carrier signal that might interfere with other systems operating at the same frequencies as the harmonics.

In this section, the 100 MHz signal's harmonics will be located using marker delta. The marker delta function allows you to easily compare the frequency and amplitude differences between two signals.

Note: Besides harmonics, you can also measure the amplitude ratio of any two signals present in dBc using delta markers. The Marker Normal function lets you enter the exact frequency you want the marker to go. The Delta Marker function lets you enter the exact frequency difference desired and places the second marker at that point. The amplitude difference is shown in the upper right corner of the display.

Instruction	Key strokes
Set center frequency and span.	[FREQ], {Center Freq}, [290], {MHz}, [SPAN], [420], {MHz}
Place a marker at the highest peak on the display (100 MHz).	[MARKER], {Peak Search}, {Return}
Anchor the first marker and activate a second marker.	[MARKER], {Delta}
Move the second marker to another signal peak by rotating the knob or entering the frequency offset.	Rotate the knob, or press [100], {MHz}

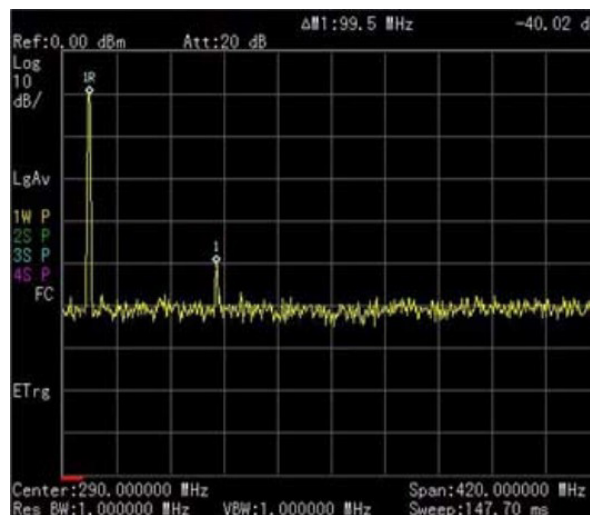

Figure 2. Delta markers

Section 6

Improving Signal to Noise: RBW, Input Attenuation, Preamplifier and Video Average

One of the primary uses of a spectrum analyzer is searching for and measuring low-level signals (such as the 3rd harmonic of an oscillator). Sensitivity optimization of the analyzer is absolutely crucial when trying to characterize signals of this nature. The input attenuator and bandwidth settings affect the level of signals that can be seen on the display. The attenuator affects the level of a signal passing through the instrument. Narrowing the resolution bandwidth (RBW) filter allows you to resolve two or more signals that are close together in frequency, and lowers the noise floor of the analyzer so you can detect very small signals.

The Keysight N9340B provides a 1-dB step attenuator to allow maximum flexibility when setting the analyzer's dynamic range.

If after adjusting the attenuation and RBW, a signal is still near the noise, visibility can be improved by using the video bandwidth (VBW) or averaging functions. VBW filter smoothes small signal variations. Averaging function simply averages the traces on screen as the sweep is made. Turning on the internal preamplifier also reduces the effective noise floor.

Instruction	Key strokes
Connect the 100 MHz signal to RF IN connector.	[Preset]
Zoom in on the 3rd harmonic “= (150 kHz span).	[Frequency] [300], {MHz}, [Span], [150], {kHz}
Turn preamp on.	[AMPTD], {preamp off on} {On}
Bring the peak of the harmonic to top graticule line.	[AMPTD], then rotate the knob.
Reduce the resolution bandwidth to 1 kHz.	[BW/SWP] {RBW} {Man} reduce to 100 Hz
Manually reduce the attenuation.	[AMPTD], {Attenuation} {Man}, [0] {dB}
Smooth out the noise using averaging function.	[TRACE], {More} {Average} {On}}

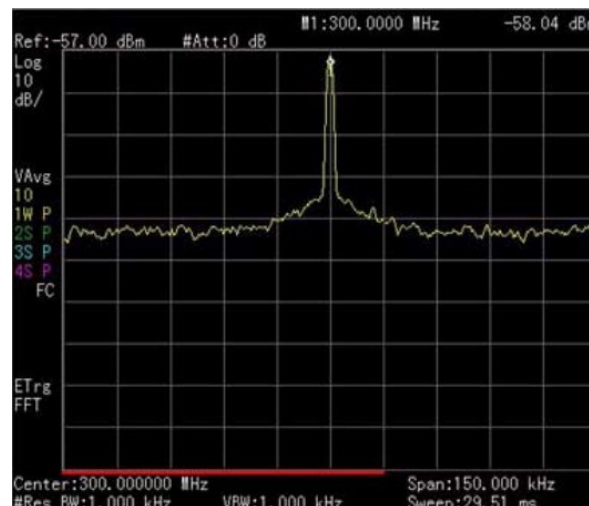

Figure 3. Improved signal to noise

Section 7

Limit Lines and Pass/Fail Testing: Creating a Mask with Limit Lines

In many onsite test situations, it is necessary to quickly test a signal to see whether or not it meets a specification for frequency and amplitude. For example, during radio transmitter service and maintenance, the technician would want to make sure that the center frequency of a carrier and its harmonic fall within a certain frequency and amplitude mask.

Limit lines make it easy to set up pass/fail testing. The analyzer compares trace data to a set of amplitude and frequency parameters while the analyzer is sweeping the measurement range.

Instruction	Key strokes
Connect the signal to the RF IN connector. Set center frequency and span.	[Preset], [FREQ], {Center Freq}, [100], {MHz}, [Span], [1], {MHz}
Quit digital edit state.	[ESC/CLR]
Open the limit menu.	[Limit]
Activate the limit lines.	{Limit {On}}
Open the limit lines edit menu.	{Edit Limits}
There are two ways to edit limit lines: limit points and limits table.	{Limits Table}
Edit the point 0.	{Frequency}, [99.5] {MHz}, {Amplitude}, [48], {-dBm}

Note: For other points, you only need to press {Add} and enter the frequency and amplitude. Firmware above A.01.02 will support 100 limit points.

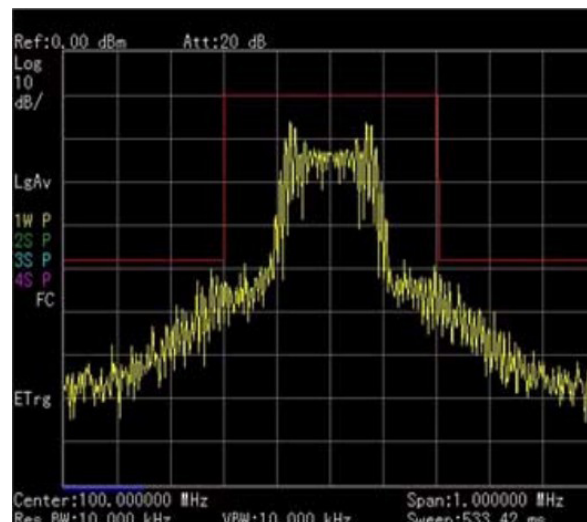

Figure 4. FM signal with limit lines

Section 8

Spectrogram

The Spectrogram shows a three-dimensional display of the spectrum with power over frequency and time. This allows you to locate intermittent interfering signals and identify spurious signals that cause dropped calls and poor service quality in communications systems.

The X-axis represents frequency as in a normal spectrum display, but amplitude is now represented by color, red for a strong signal and blue for noise floor. The Y-axis now represents time, with the trace from the newest sweep displayed at the bottom of the screen. Earlier traces move up toward the top with each new sweep. Two coupled markers allow you to place a marker on any trace in the spectrogram and view the normal spectrum for the time of that sweep. The time interval between sweeps can be adjusted, and up to 1500 traces can be displayed and saved.

In the following demo, an Omni Antenna with a frequency range from 1.8 GHz to 1.9 GHz is needed.

Instruction	Key strokes
Connect the omni antenna to the RF IN connector.	
Set HSA to high sensitivity mode.	[AMPTD], {HiSensitivity}, {On}
Set the center frequency and span. ¹	[FREQ], {Center Freq}, [1.8052], {GHz}, [SPAN], [5], {MHz}
Turn on the spectrogram function.	[MEAS], {Spectrogram}
Set the update interval time between two frames.	{Update Int. {On}}, rotate the knob or pres the numeric keypads to set the update interval time.
Turn on Marker 1 and Marker 2.	[MARKER], {State {On}}, {Marker (2)}, {State {On}}
Change the frequency of marker.	{Frequency}, rotate the knob to change the marker to the frequency you want.
View trace.	[MEAS], {Disp Mode} {Trace}
Save spectrogram data.	{Save&Load}, {Save RAM As}, type a name for the trace and press [ENTER]
Recall the saved spectrogram file.	{Load Spctrng}, select trace name with the knob, {Load Now}

1. The frequency selected for this demo depends on the cellular signals present. In the USA, use: [FREQ], {Center Freq}, [877.13], {MHz}, [SPAN], [10], {MHz}

Section 8

Spectrogram (continued)

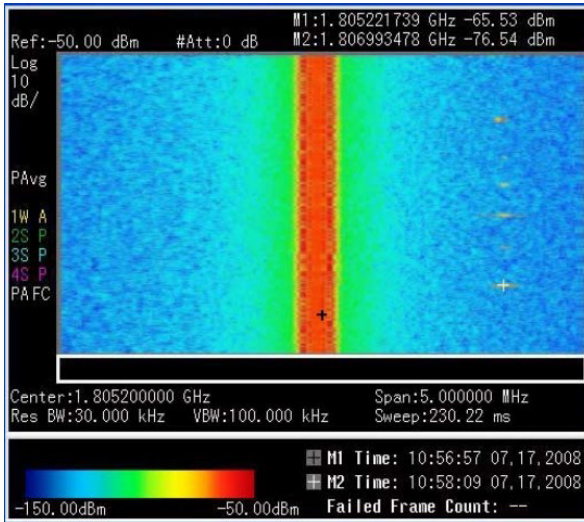

Figure 5. Spectrogram screenshot

Trace display shows the trace from the spectrogram for the time selected.

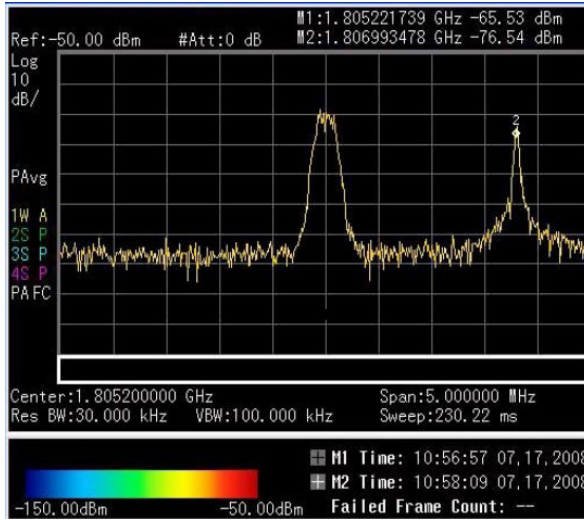

Figure 6. Spectrogram trace mode

Section 9

Tracking Generator: Transmission and Reflection Measurements

A spectrum analyzer with tracking generator can be used to perform component tests such as frequency response and gain and loss on components and subsystems. The tracking generator is a signal source whose RF output follows (tracks) the tuning of the spectrum analyzer. The N9340B spectrum analyzer has an optional high-performance, built-in tracking generator (Option TG3), operating from 5 MHz to 3 GHz. A tuned receiver architecture and narrow IF bandwidths provide high dynamic range for scalar component test.

The N9340B spectrum analyzer can be used to characterize measure transmission parameters, such as flatness and rejection, or reflection parameters, such as return loss on devices under test (DUTs). Return loss is an a reflection measurement requiring a directional coupler or bridge.

Transmission measurements

In the following demo, the rejection of a bandpass filter is measured.

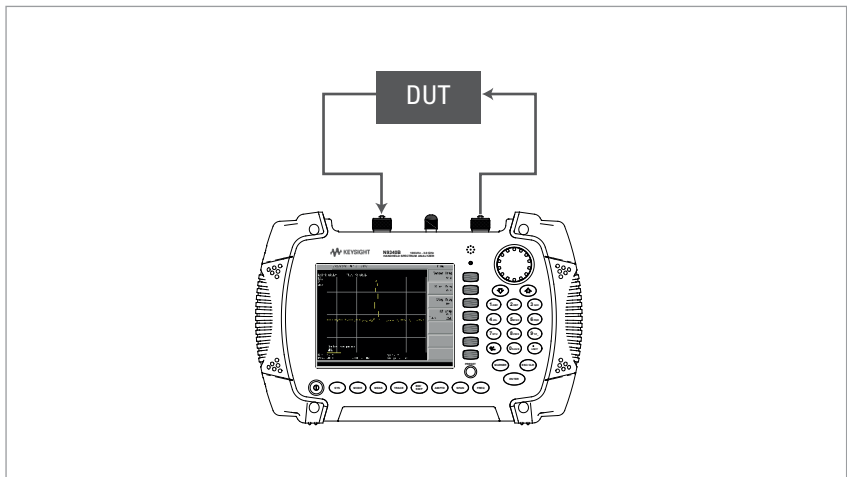

Figure 7. Transmission measurement setup

In the following demo, a 300 MHz bandpass filter is used as a DUT.

The marker readout displays the rejection of the filter at 90 MHz above the center frequency of the band pass.

Section 9

Tracking Generator: Transmission and Reflection Measurements (continued)

Instruction	Key strokes
Preset the analyzer.	[PRESET]
Set the start and stop frequencies and the resolution bandwidth.	[FREQ] {Start Freq}, [100] {MHz}, {Stop Freq}, [1] {GHz}, [BW/SWP], {RBW}, [1] {MHz}
Turn on tracking generator, and set its output level to -10 dBm.	[MODE], {Tracking Generator}, {Amplitude {On}}, [-10] {dBm}
Make sure the sweep time is auto coupled.	[BW/SWP], {Sweep Time {Auto}}
Increase measurement sensitivity and smooth the noise.	{RBW} [30] {kHz}, {VBW} [30] {kHz}
Disconnect the DUT, and directly connect the cable from the tracking generator output to the analyzer input.	
Store the frequency response of the cable in trace 4 by performing normalization.	[MEAS] {Normalize}, {Store Ref (1 → 4)}, {Normalize {On}}
Reconnect the DUT.	
Change the normalized reference position.	{Norm Ref Posn}, [8], [ENTER]
Measure the rejection of the low-pass filter.	[300] {MHz}, {Delta} [130] {MHz}

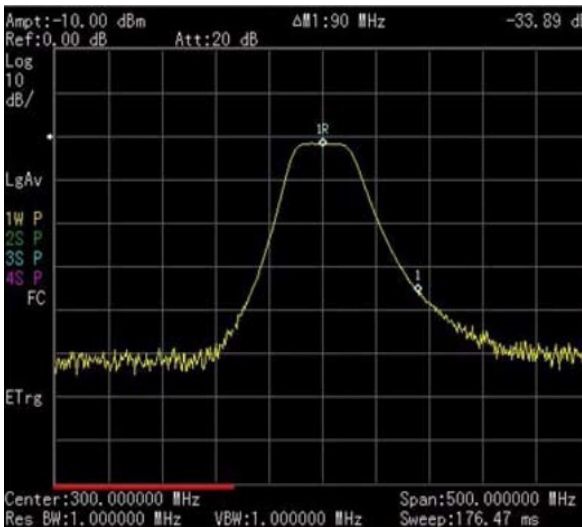

Figure 8. Transmission measurement

Section 9

Reflection measurements

This demo shows a return loss measurement on a 300 MHz bandpass filter. You will need a directional bridge such as the Keysight 86205A to perform this measurement. Before making the measurement, calibrate the test setup using a calibration standard with a known reflection coefficient.

The calibration standard for reflection measurements is usually a short circuit connected at the reference plane (the point at which the DUT is connected). A short circuit has a reflection coefficient of 1 (0 dB return loss); it reflects all incident power and provides a convenient 0 dB reference.

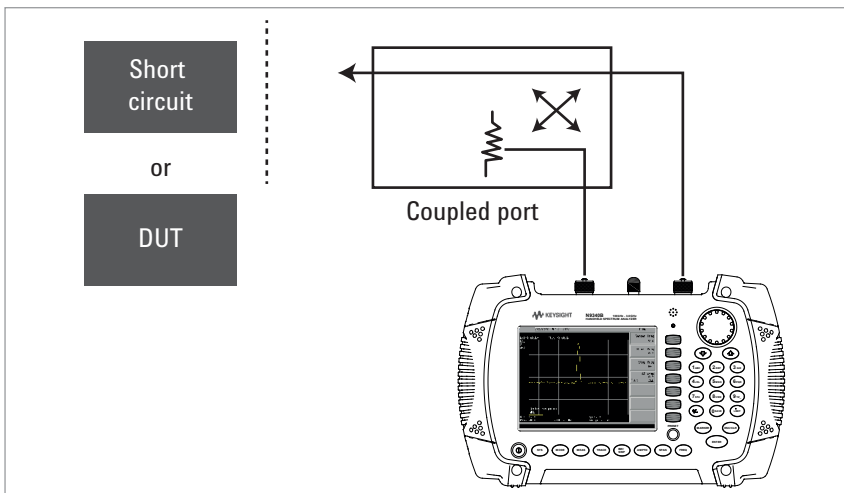

Figure 9. Reflection measurement setup

If possible, use a coupler or bridge with the correct test port connector for both calibrating and measuring. Any adapter between the test port and DUT degrades coupler/bridge directivity and system source match. Ideally, you should use the same adapter for the calibration and the measurement. Be sure to terminate the second port of a two port device.

Please refer to the following procedures when connecting the DUT to the instrument:

1. Connect the DUT to the directional bridge as shown in Figure 9 and terminate the unconnected port of the DUT.
2. Connect the RF OUT port of the analyzer to the directional bridge.
3. Connect the RF IN port to the coupled port of the directional bridge.

CAUTION:

Excessive signal input may damage the DUT. Do not exceed the maximum power that the DUT can tolerate.

Section 9

Reflection measurements (continued)

Instruction	Key strokes
Preset the analyzer.	[PRESET]
Turn on tracking generator, set the output level to -10 dBm.	[MODE], {Tracking Generator}, [ENTER], {Amplitude {On}}, -10, dBm
Set the start and stop frequencies for your DUT. (Frequencies shown here are for example only.)	[FREQ], {Start Freq}, [100], {MHz} {Stop Freq}, [500], {MHz}
Disconnect the DUT, and connect a cable from the input connector to the directional bridge output connector.	
Normalize to eliminate the test system response error.	[MEAS], {Normalize}, {Store Ref (1 to 4)}, {Normalize {On}}
Change the normalized reference position.	{Norm Ref Posn}, 8, [ENTER]
Reconnect the DUT without changing any analyzer settings and terminate the unconnected port of the DUT.	
Use a marker to read the return loss.	Position a marker and rotate the knob to find the highest peak; this is the maximum return loss.



Figure 10. Short circuit normalized

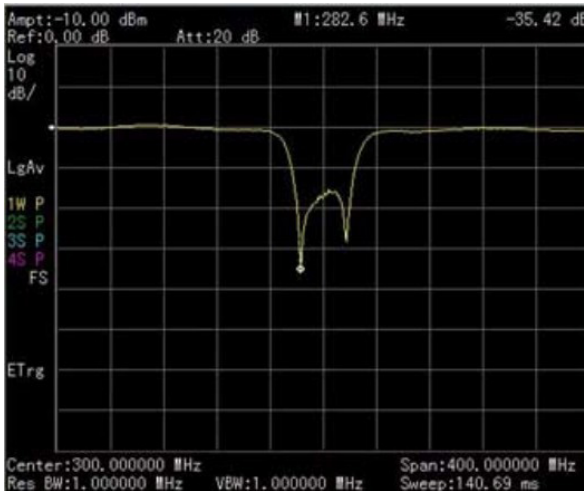

Figure 11. Return loss of the bandpass filter

Section 10

Power Meter

The N9340B spectrum analyzer can be used with the Keysight U2000 Series USB power sensor to make average power measurements. It can make true average power measurements for all types of signals with a frequency range of 9 kHz to 24 GHz, power levels from -60 dBm to +20 dBm, and with measurement speed of up to 1000 readings per second in buffered mode. The N9340B controls the power sensor, and retrieves measurement results over the USB port.

The N9340B displays measurement results and provides pass/fail testing with user-defined upper and lower limits. The results are displayed in dBm and W for absolute power measurements and in dB and percentage for relative measurements. Results can be displayed in power meter mode with fast display update rates or on a chart of power versus time.

In this demo, the N9340B is used with a U2000A USB power sensor to measure the output power of an external signal generator.

Instruction	Key strokes
Connect the U2000A power sensor to the USB interface of the N9340B.	[PRESET]
Turn on the power meter function.	[MODE], Rotate the knob to highlight PowerMeter, [ENTER]
Zero and the zero type is INT	{Zeroing}, {Zeroing}
Connect the USB power sensor's RF IN port to the signal generator's output and turn on the generator.	
Turn on the limit function. If sound warning when power is beyond limit value, {Limit Beep {On}}.	[MEAS], [Meas Setup], {Limits}, {Limits {On}}, {Return}
Change the display mode from meter to chart.	[MEAS], {Meas Disp}, {Chart View}
Save the chart (400 points)	[SYS], {File}, Enter the file name, {Save}

Section 10

Power Meter (continued)

The N9340B can display power measurement results in meter mode or chart mode.

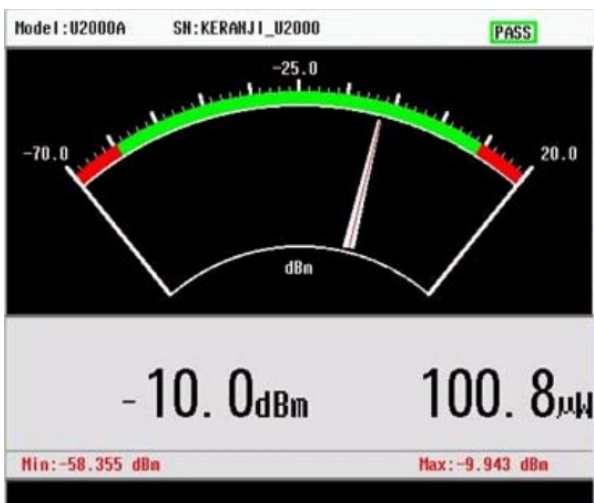

Figure 12. Power meter mode

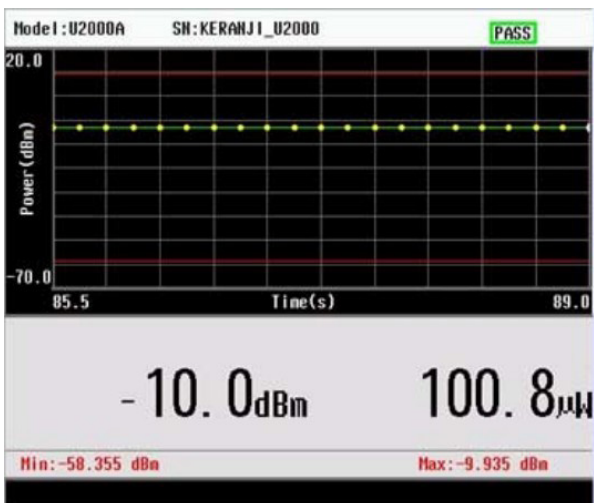

Figure 13. Chart mode

Section 11

Field Strength Measurements

Electromagnetic field strength measurements are frequently required for transmitter and antenna coverage testing in the field.

The N9340B includes field strength measurements as a standard function. Calibrated field strength measurements are easy to make once antenna factors have been loaded into the analyzer via the antenna template provided by the N9340 PC software.

The N9340B provides you with quick and convenient field strength measurements and analysis. Either field strength (in dBmV/m, dBmV/m, or V/m) or power flux density (in dBm/m or W/m) can be displayed. Use the amplitude offset function to correct gain or loss. You can also set limit lines for pass/fail testing.

In the following demo, an Omni antenna with a frequency range from 890 MHz to 960 MHz is needed.

1. Edit the antenna factor file and load it into the N9340B via USB cable.

Instruction	Key strokes
Connect the N9340B to a PC using a USB cable.	
Run the Keysight N9340 PC software on the PC.	Click the N9340 PC software shortcut key on the PC screen.
Open a new antenna file.	{File}, {New} select the antenna file.
Edit the antenna file.	{Insert}, fill out the antenna parameters in the antenna point dialog box, such as frequency, antenna factor and antenna gain.
Repeat the previous step until all points have been entered.	
Save the file.	{File}, {Save}, choose the directory, enter the file name and save it.
Click the save shortcut key on the toolbar.	
Open the File Manager menu.	Click the shortcut key for the File Manager.
	Highlight the corresponding USB address of the N9340B in the instrument list dialog box.
	Click {ENTER}, then the File Manager dialog box will appear.
Transfer the antenna file from the PC to the N9340B.	Click the Send button.
	Select the file you want to transfer in the open dialog box.
	Click Open and the file will be transferred from the PC to the N9340B.

Section 11

Field Strength Measurements (continued)

2. Load the antenna file into the N9340B via a USB memory stick.

Instruction	Key strokes
Create an N9340DATA folder in the root directory of the USB memory stick.	
Copy the antenna file from PC to the N9340DATA folder. Insert this USB memory stick into the N9340B USB port.	
Turn on the field strength measurement function.	[MEAS], {FiledStrength}, {More}, {Field Strength}
Load the antenna file into N9340B via USB.	[SYS], {File}, {View {Usb}}, {File Setup}, {File Type}, {Antenna}, rotate the knob to highlight the file, {Copy}

3. Run the field strength measurement function.

Instruction	Key strokes
Connect the antenna to the RF IN connector.	
Turn on the field strength function.	[MEAS], {More}, {FieldStrength}
Load the antenna file.	{AntennaTable}, highlight the file by rotating the knob, {Load}

You can set up limit lines using the N9340B limit function or the PC software.

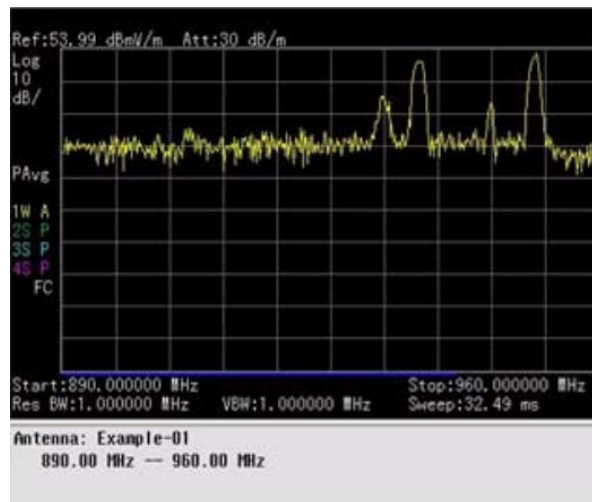

Figure 14. Field strength measurement

The N9340B field strength measurements are automatically adjusted using the antenna factors defined in the antenna table of the N9340B PC software.

Section 12

AM/FM, ASK/FSK Demodulation

AM/FM demodulation

The N9340B provides optional AM/FM demodulation analysis: Option AMA. This capability can be activated with a license key.

Optional AM/FM demodulation analysis provides modulation metrics, including carrier power, modulation rate, AM depth/FM deviation, signal to noise and distortion ratio (SINAD) and carrier frequency offset.

User-definable limits provide pass/fail indicators for four types of measurements:

- Maximum carrier power
- Maximum AM modulation index or FM deviation
- Minimum AM modulation index or FM deviation
- Minimum carrier frequency offset

You can save the waveforms with metrics for reporting and set up parameters for future measurements or analysis.

In the following demo, a source with AM/FM signal generation capability is needed.

Section 12

AM/FM, ASK/FSK Demodulation (continued)

AM demodulation analysis

Instruction	Key strokes
Connect the signal generator to the RF IN connector and turn on the signal generator's AM and RF output.	
Set the signal generator to 100 MHz, AM; AM depth, 50%; amplitude, -15 dBm; modulation rate, 1 kHz.	
Turn on the AM demodulation analysis function.	[MODE], rotate the knob to highlight Demodulation Analysis, [ENTER], {AM}
Set the carrier frequency of the source.	{Carrier Freq}, [100], {MHz}
Set the attenuation state to auto.	{More 1 of 3}, {More 2 of 3}, {Attenuation {Auto}}, {More 3 of 3}
Set the Y scale.	{Y Scale}, {Auto Scale}, {Return}
Set the AM depth limit and turn on the limit function.	{More 1 of 3}, {Limits}, {AM Depth UP}, [51], {%, {AM Depth Low}, [49], {%, {Limits on}}, {Return}
Save the result.	[SYS], {File}, enter the file using the numeric keypad, {Save}

Detailed metrics provide you with a complete understanding of the AM signal.

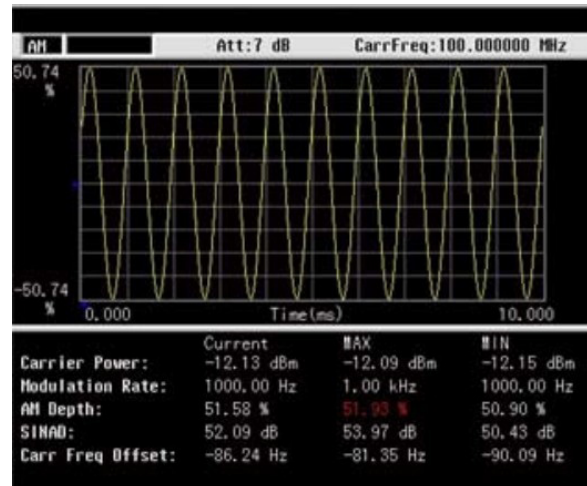

Figure 15. AM demodulation

Section 12

AM/FM, ASK/FSK Demodulation (continued)

FM demodulation

Instruction	Key strokes
Connect the signal generator to the RF IN connector and turn on the signal generator's FM and RF output.	
Set the signal generator to 100 MHz, FM; FM deviation, 100 kHz; FM rate, 1 kHz; amplitude -15 dBm.	
Turn on the FM demodulation analysis function.	[MODE], rotate the knob to highlight Demodulation Analysis, [ENTER], {FM}
Set the carrier frequency.	{Carrier Freq}, [100], {MHz}
Set the attenuation state to auto.	{More 1 of 3}, {More 2 of 3}, {Attenuation {Auto}}, {More 3 of 3}
Set the Y scale.	{Y Scale}, {Auto Scale}, {Return}
Set the FM deviation limit and turn on the limit function.	{More 1 of 3}, {Limits}, {FreqDev UP}, [11], {kHz}, {FreqDev Low}, {9.9}, {kHz}, {Limits on}}, {Return}

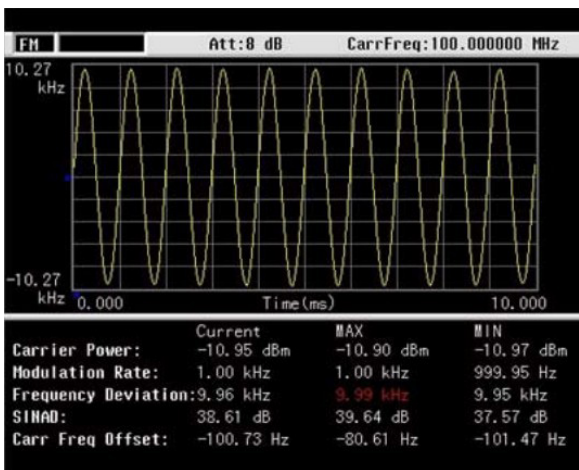

Figure 16. FM demodulation

Detailed metrics give you a complete understanding of the FM signal.

Section 12

ASK/FSK Demodulation Analysis (continued)

Amplitude Shift Keying (ASK) and Frequency Shift Keying (FSK) are used in many applications including cordless phones, paging systems, automotive electronics (TPMS, RKE and PKE) and RFID.

N9340B provides the ASK/FSK demodulation analysis Option DMA. This capability can be activated with a license key. It supports four display modes:

- Symbol
- Waveform
- ASK/FSK error
- Eye diagram

User-definable limits provide pass/fail indicators. Option AMA provides four types of measurements:

- Maximum carrier power
- Maximum ASK modulation depth/FSK frequency deviation
- Minimum ASK modulation depth/FSK frequency deviation
- Maximum carrier frequency offset

Metrics include carrier power, ASK/FSK error, ASK depth/FSK frequency deviation, ASK index, etc. You can save the waveform with metrics and setup parameters for reports and future measurements.

In the following demo, a source with ASK/FSK generation capability is needed.

For an ASK/FSK signal, use a Nyquist filter, Alpha is 0.35.

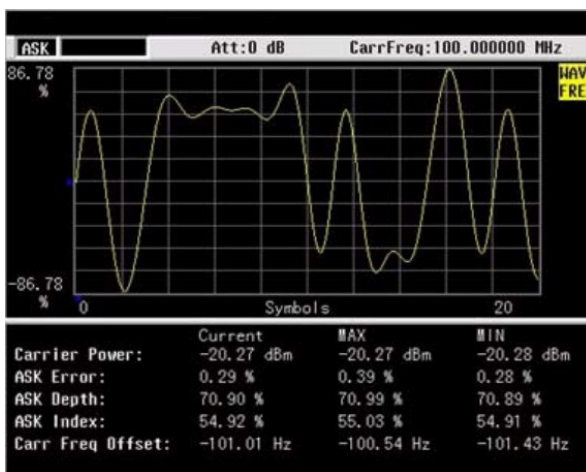

Figure 17. ASK demodulation

Section 12

ASK/FSK Demodulation Analysis (continued)

ASK demodulation analysis

Instruction	Key strokes
Connect the signal generator to the RF IN connector and turn on the signal generator's ASK and RF output.	
Turn on the ASK demodulation analysis function.	[MODE], rotate the knob to highlight Demodulation Analysis, [ENTER], {ASK}
Set the carrier frequency.	{Carrier Freq}, [100], {MHz}
Set the symbol rate.	{Symbol Rate}, [10], {ksps}
Set the filter type.	{Filter Setup}, {Ref Filter}, {Nyquist}, {Return}
Set the attenuation state to auto.	{More 1 of 3}, {More 2 of 3}, {Attenuation {Auto}}, {More 3 of 3}
Set the Y scale.	{Y Scale}, {Auto Scale}, {Return}
Set the ASK depth limit and turn on the limit function.	{More 1 of 3}, {Limits}, {ASK Depth UP}, [71], {%}, {ASK Depth Low}, [70], {%}, {Limits on}}, {Return}
View the eye diagram.	{More 2 of 3}, {More 3 of 3}, {View}, {Eye Diagram}

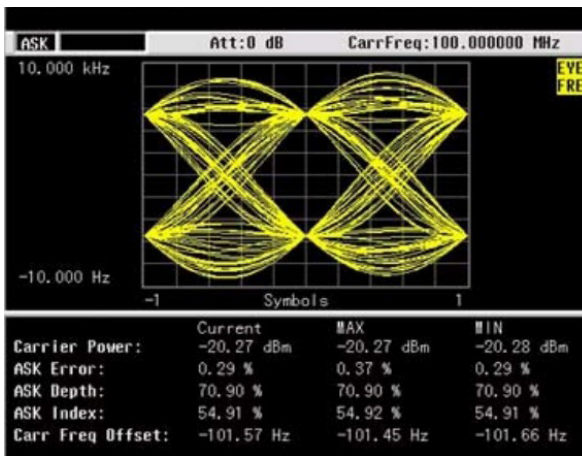

Figure 18. ASK eye diagram

Section 12

ASK/FSK Demodulation Analysis (continued)

FSK demodulation analysis

Instruction	Key strokes
Connect the signal generator to the RF IN connector and turn on the signal generator's FSK and RF output.	
Turn on the FSK demodulation analysis function.	[MODE], rotate the knob to highlight Demodulation Analysis, [ENTER], {FSK}
Set the carrier frequency.	{Carrier Freq}, [100], {MHz}
Set the symbol rate.	{Symbol Rate}, [10], {ksps}
Set the filter type.	{Filter Setup}, {Ref Filter}, {Nyquist}, {Return}
Set the attenuation state to auto	{More 1 of 3}, {More 2 of 3}, {Attenuation {Auto}}, {More 3 of 3}
Set the Y scale.	{Y Scale}, {Auto Scale}, {Return}
Set the FSK deviation limit and turn on the limit function.	{More 1 of 3}, {Limits}, {FreDev UP}, [41], {kHz}, {FreqDev Low}, [39], {kHz}, {Limits on}), {Return}
View the eye diagram.	{More 2 of 3}, {More 3 of 3}, {View}, {Eye Diagram}

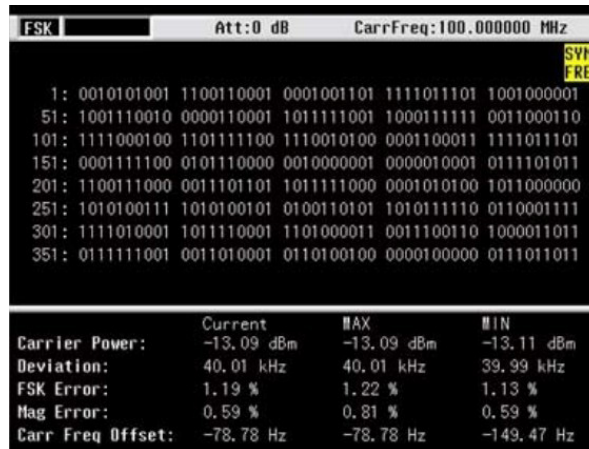

Figure 19. FSK demodulation

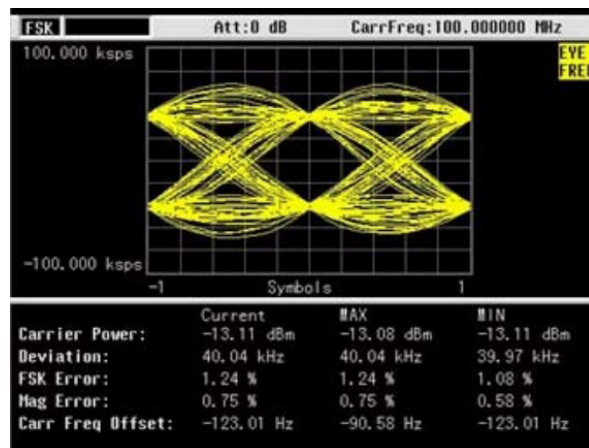

Figure 20. FSK eye diagram

Section 13

Spectrum Emission Mask (SEM)

SEM is a relative measurement of the out-of-channel emissions to the in-channel. The purpose for this test is to measure the excess emissions that would interfere with other channels or with other systems.

The N9340B includes spectrum emission mask (SEM) as a standard feature. The user can set the parameters of the main channel, out-of-channel frequency bands, and the limit lines. Moreover, it provides Pass/Fail testing for the overall spectrum emission mask and each individual out-of-channel frequency range. The N9340B will trigger the failure indicator once any measurement result violates the mask. It displays the main channel power and the power level vectors relative to in-channel power for each out-of-channel frequency range. The user can save the spectrum scan, the mask, the data or screen shot for later analysis and reporting.

As it applies to W-CDMA (3GPP), this is the power contained in a specified frequency bandwidth at certain offsets relative to the total carrier power. It may also be expressed as a ratio of power spectral densities between the carrier and the specified offset frequency band. For WLAN, the reference power is taken as the peak PSD in the signal, and all offset results are also the peak PSD in that offset as opposed to the integrated power. The N9340B's default setup for SEM is W-CDMA (3GPP).

In the following demo, you can use any source available as long as it has W-CDMA signal generation capability.

Instruction	Key strokes
Connect the signal generator's output to the RF IN port.	
Turn on the SEM function.	[MEAS], {SEM}
Enter the parameters depend required for your test.	

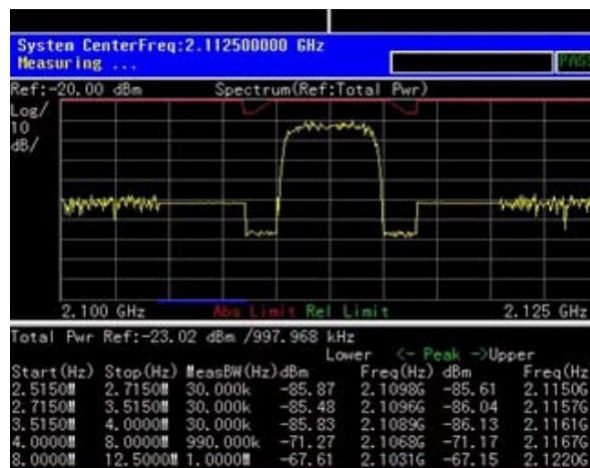

Figure 21. Spectrum emission mask

Section 14

Automation

Communications systems require routine spectrum monitoring to keep them working reliably long term. Routine spectrum monitoring is usually automated with software that controls the spectrum analyzer remotely. You can program and control the N9340B using SCPI programming over LAN or USB and monitor signal changes remotely.

The following two modes are used to set up the N9340B's LAN IP address:

- Static
- DHCP

For the following demos, the N9340B's PC software and the Keysight I/O library should be installed on your PC.

Remote control the N9340B via USB.

Instruction	Key strokes
Connect the N9340B and PC with a USB cable.	
Run the Keysight N9340 PC software on the PC.	Click the N9340 PC software shortcut key on the PC screen.
Monitor the signal on the PC.	Click the Monitor shortcut key. Highlight the corresponding USB address of the N9340B in the instrument list dialog box. Click ENTER.
You can set up the corresponding N9340B's parameters using a mouse.	Example: Changing the center frequency: Move the cursor to the center and double click. Input the center frequency; select the unit and click Set in the center frequency dialog box.

Section 14

Automation (continued)

In the following demo, an N9340B with firmware A.01.02 or later, an NI604+C... A1 router, a PC with Keysight IO Libraries Suite (version 15.0 or later), and N9340 PC software (version A.01.04) or later installed, and 3 LAN cables are needed. See Figure 22 for system connection.

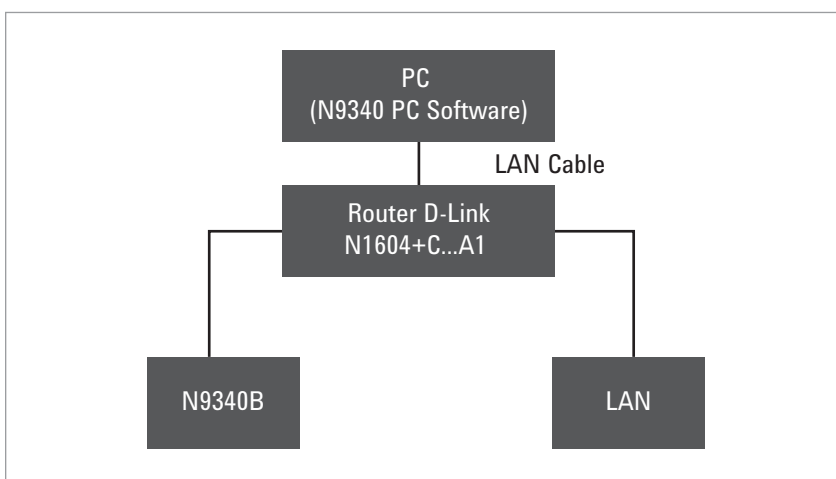

Figure 22. System connection

Section 14

Automation (continued)

Remote control the N9340B via LAN.

Instruction	Key strokes
Connect the equipment as shown in Figure 22. Next, power on the equipment.	
Set the N9340B IP address with DHCP mode.	[SYS], {Setting}, {IP Admin}, {IP Address {DHCP}}
You can also set the N9340B IP address with static mode such as a static IP address: 192.168.0.112.	[SYS], {Setting}, {IP Admin}, {IP Address {Static}}, [192.168.0.112], {ENTER}
Run the Keysight connection expert to automatically find the N9340B. Note: After clicking Add Instrument, if the Add Instrument dialog box comes up, click the interface Add LAN instrument on LAN (TCP/IP0).	Run the Keysight connection expert. The connection expert is a program in the Keysight IO libraries. Click Refresh All. Click the Add Instrument shortcut key on the toolbar. Click the Auto Find Discover Local Instruments shortcut key on the toolbar. Select the item corresponding to the IP address of the N9340B. Click Ok.
You can manually add the N9340B into the Keysight connection expert.	Click the Add Instrument shortcut key on the toolbar. Click the Add Address shortcut key or manually add a known IP address or hostname. Select Use IP Address item and input the IP address of the N9340B. Select *IDN query, click Test Connection, and the prompt "this instrument is present" message will appear. Click Ok.
Run the N9340 PC software on the PC. Note: Once the N9340B enters into remote control mode, you can set up the N9340B's parameters, and transfer files between the PC and the N9340B with the File Manager and monitor of the N9340 PC software.	Click the N9340B PC software shortcut key on the PC screen. Click the Monitor shortcut key in the toolbar. Highlight the corresponding IP address and click ENTER in the Instrument list dialog box. The monitor panel will open.

myKeysight

myKeysight

www.keysight.com/find/mykeysight

A personalized view into the information most relevant to you.



www.axiestandard.org

AdvancedTCA® Extensions for Instrumentation and Test (AXIe) is an open standard that extends the AdvancedTCA for general purpose and semiconductor test. Keysight is a founding member of the AXIe consortium. ATCA®, AdvancedTCA®, and the ATCA logo are registered US trademarks of the PCI Industrial Computer Manufacturers Group.



www.lxistandard.org

LAN eXtensions for Instruments puts the power of Ethernet and the Web inside your test systems. Keysight is a founding member of the LXI consortium.



www.pxisa.org

PCI eXtensions for Instrumentation (PXI) modular instrumentation delivers a rugged, PC-based high-performance measurement and automation system.



Three-Year Warranty

www.keysight.com/find/ThreeYearWarranty

Keysight's commitment to superior product quality and lower total cost of ownership. The only test and measurement company with three-year warranty standard on all instruments, worldwide.



Keysight Assurance Plans

www.keysight.com/find/AssurancePlans

Up to five years of protection and no budgetary surprises to ensure your instruments are operating to specification so you can rely on accurate measurements.



www.keysight.com/quality

Keysight Technologies, Inc.
DEKRA Certified ISO 9001:2008
Quality Management System

Keysight Channel Partners

www.keysight.com/find/channelpartners

Get the best of both worlds: Keysight's measurement expertise and product breadth, combined with channel partner convenience.

www.keysight.com/find/n9340b

For more information on Keysight Technologies' products, applications or services, please contact your local Keysight office. The complete list is available at: www.keysight.com/find/contactus

Americas

Canada	(877) 894 4414
Brazil	55 11 3351 7010
Mexico	001 800 254 2440
United States	(800) 829 4444

Asia Pacific

Australia	1 800 629 485
China	800 810 0189
Hong Kong	800 938 693
India	1 800 112 929
Japan	0120 (421) 345
Korea	080 769 0800
Malaysia	1 800 888 848
Singapore	1 800 375 8100
Taiwan	0800 047 866
Other AP Countries	(65) 6375 8100

Europe & Middle East

Austria	0800 001122
Belgium	0800 58580
Finland	0800 523252
France	0805 980333
Germany	0800 6270999
Ireland	1800 832700
Israel	1 809 343051
Italy	800 599100
Luxembourg	+32 800 58580
Netherlands	0800 0233200
Russia	8800 5009286
Spain	0800 000154
Sweden	0200 882255
Switzerland	0800 805353
	Opt. 1 (DE)
	Opt. 2 (FR)
	Opt. 3 (IT)
United Kingdom	0800 0260637

For other unlisted countries:
www.keysight.com/find/contactus
(BP-07-10-14)

