

# Agilent M9362A-D01-F26

PXIe Quad  
Downconverter  
10 MHz to 26.5 GHz

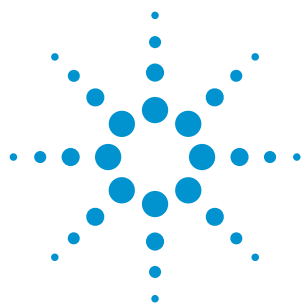

Data Sheet



*Challenge the Boundaries of Test  
Agilent Modular Products*

*Anticipate — Accelerate — Achieve*



**Agilent Technologies**

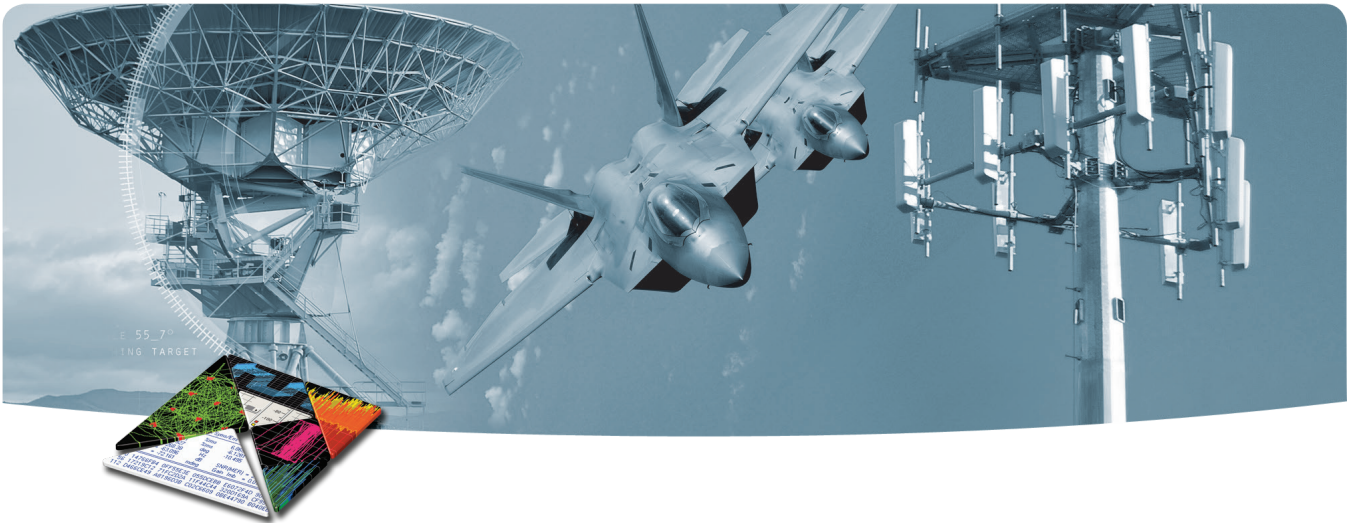

## OVERVIEW

### Introduction

The Agilent M9362A-D01-F26 is a PXIe 3-slot, 4-channel, coherent microwave downconverter with frequency coverage from 10 MHz to 26.5 GHz and 1.5 GHz of instantaneous bandwidth. The M9362A-D01-F26 is well suited for wideband signal capture where multiple channels are required for applications such as multi-channel coherent signal analysis, radar, SIGNIT, ELINT, MASINT, EW signal capture and analysis, and RF and microwave recording and analysis.

### Product description

When combined with an Agilent M9302A Local Oscillator and one or more Agilent M9210A 4GS/s Digitizers, the M9362A-D01-F26 Downconverter can be used to synchronously capture up to 4 signals in up to 1.4 GHz bandwidth, with 10-bit resolution.

### Applications

- Aerospace and defense
- Wireless communications
- Radar and wideband signal capture

### Features

- Frequency range: 10 MHz to 26.5 GHz
- 1.5 GHz bandwidth per channel
- Four-channel coherent downconversion
- Chassis slot compatibility: PXIe Hybrid, PXIe
- PXIe form factor

### Customer values

- Wide bandwidth, multi-channel downconversion in small form factor
- Synchronize multiple M9362A-D01-F26 downconverters for greater than 4 coherent channels
- Conforms to Modular Open Systems Approach (MOSA)

# EASY SETUP ... TEST ... AND MAINTENANCE

## Hardware platform

### Compliance

The M9362A-D01-F26 is PXI compliant using either a PXIe or PXIe Hybrid slot. Designed to benefit from fast data interfaces, the product can be integrated with other test and automation modules in PXIe or PXIe Hybrid chassis slots. The PXI format offers high performance in a small, rugged package. It is an ideal deployment platform for many automated test systems. A wide array of complementary PXI products are currently available. Products include multimeters, waveform generators, local oscillators, digitizers, and switch multiplexers.

## Software platform

### IO libraries

Agilent IO Libraries Suite offers FAST and EASY connection to instruments and the newest version extends that capability to include modular instruments.

The Agilent IO Libraries Suite helps you display ALL of the modules in your system, whether they are PXI, PXIe, or PCIe®. From here you can view information about the installed software or start the module's soft front panel. Launch the module's soft front panel directly from Agilent Connection Expert. Find the right driver from Agilent Connection Expert.

### Calibration intervals

A functional certificate is supplied with the M9362A-D01-F26. No annual calibration is required.

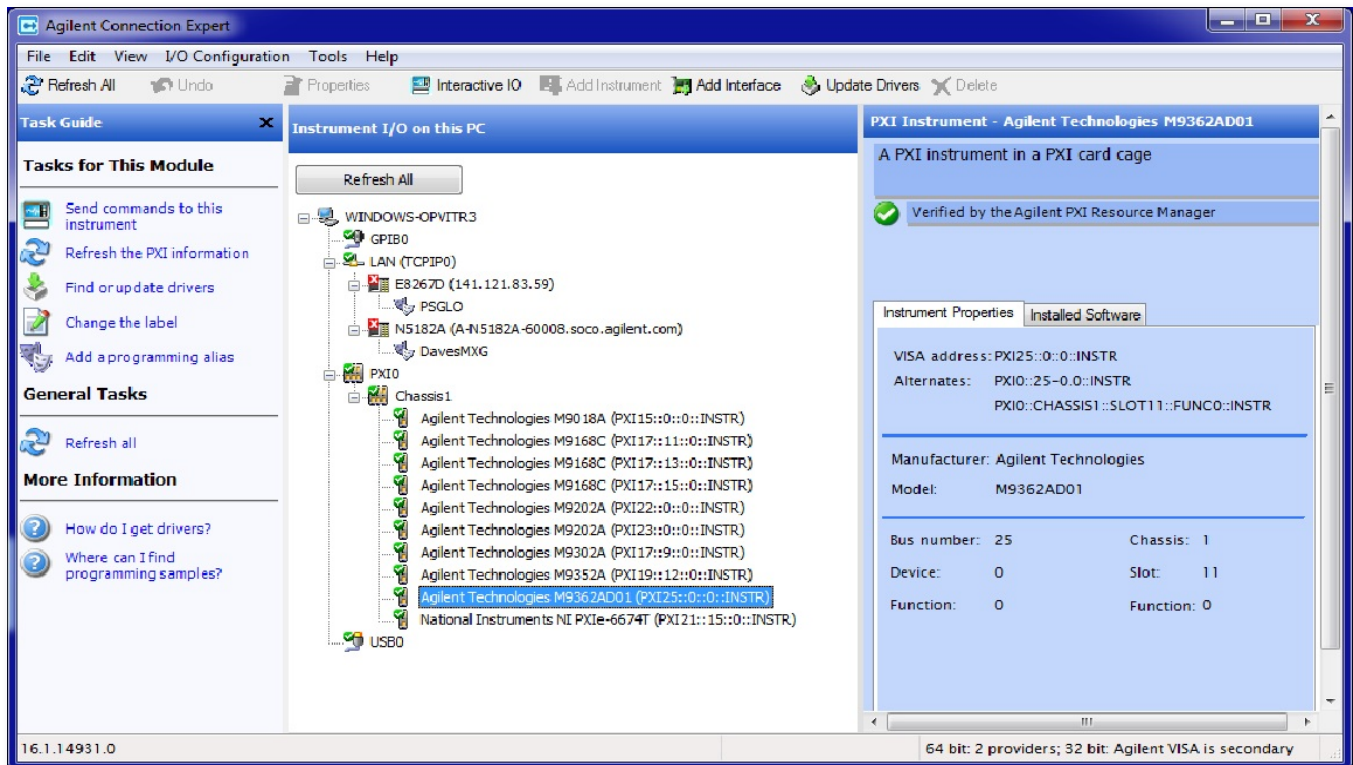

Figure 1. Agilent IO Libraries Suite 16.1

# TECHNICAL SPECIFICATIONS

All specifications are nominal unless otherwise noted.

Input and output ports		
Frequency range and connectors		
Port	Frequency range	Connectors
RF port	0.01 to 26.5 GHz	3.5 mm female
LO port	0.01 to 26.5 GHz	3.5 mm female
IF port	0.007 to 1.5 GHz	SMA female

Input and output power levels		
Input power damage levels		
RF port		+18 dBm
LO port		+5 dBm
Optimum power levels		
LO power		0 dBm ( $\pm 1$ dB)
RF power		-10 dBm
RF input @ 1 dB compression		
Ports A through D		> -10 dBm
IF output level <sup>1</sup>		

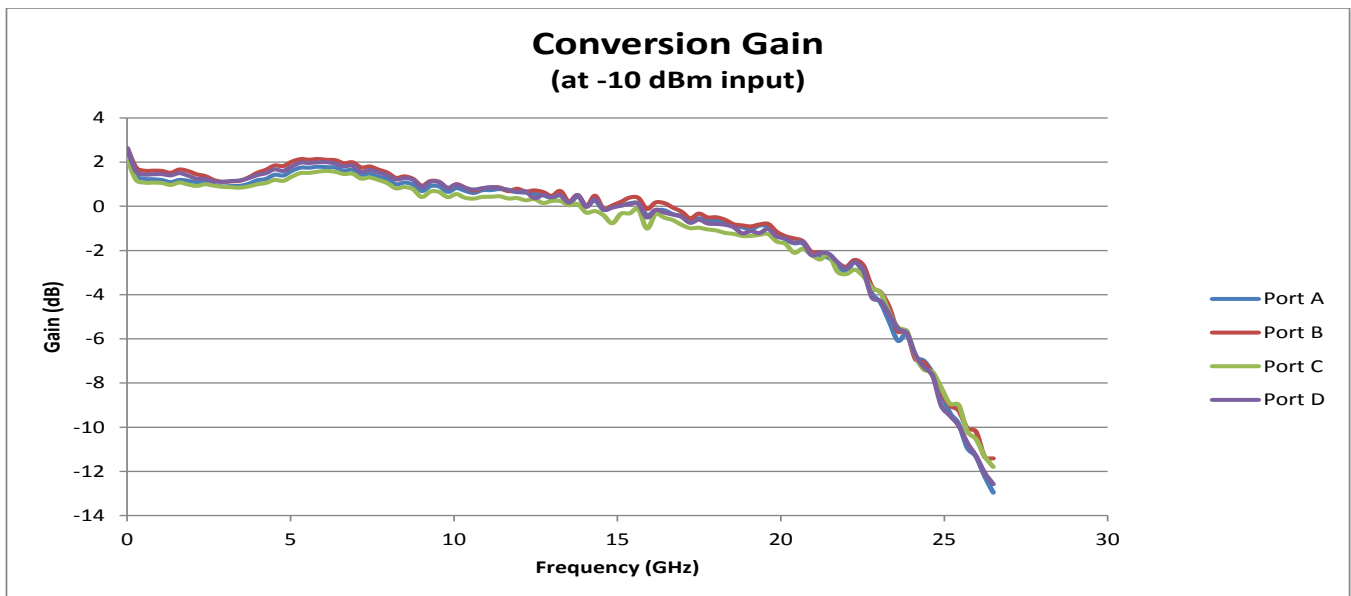

Figure 2. Conversion Gain

<sup>1</sup>IF output level is based on the RF input @ 1 dB compression

### Additional characteristics

Noise figure	24 dB
Channel to channel isolation	< -80 dB
LO to IF leakage	< -20 dB

### Port match

#### RF port input match

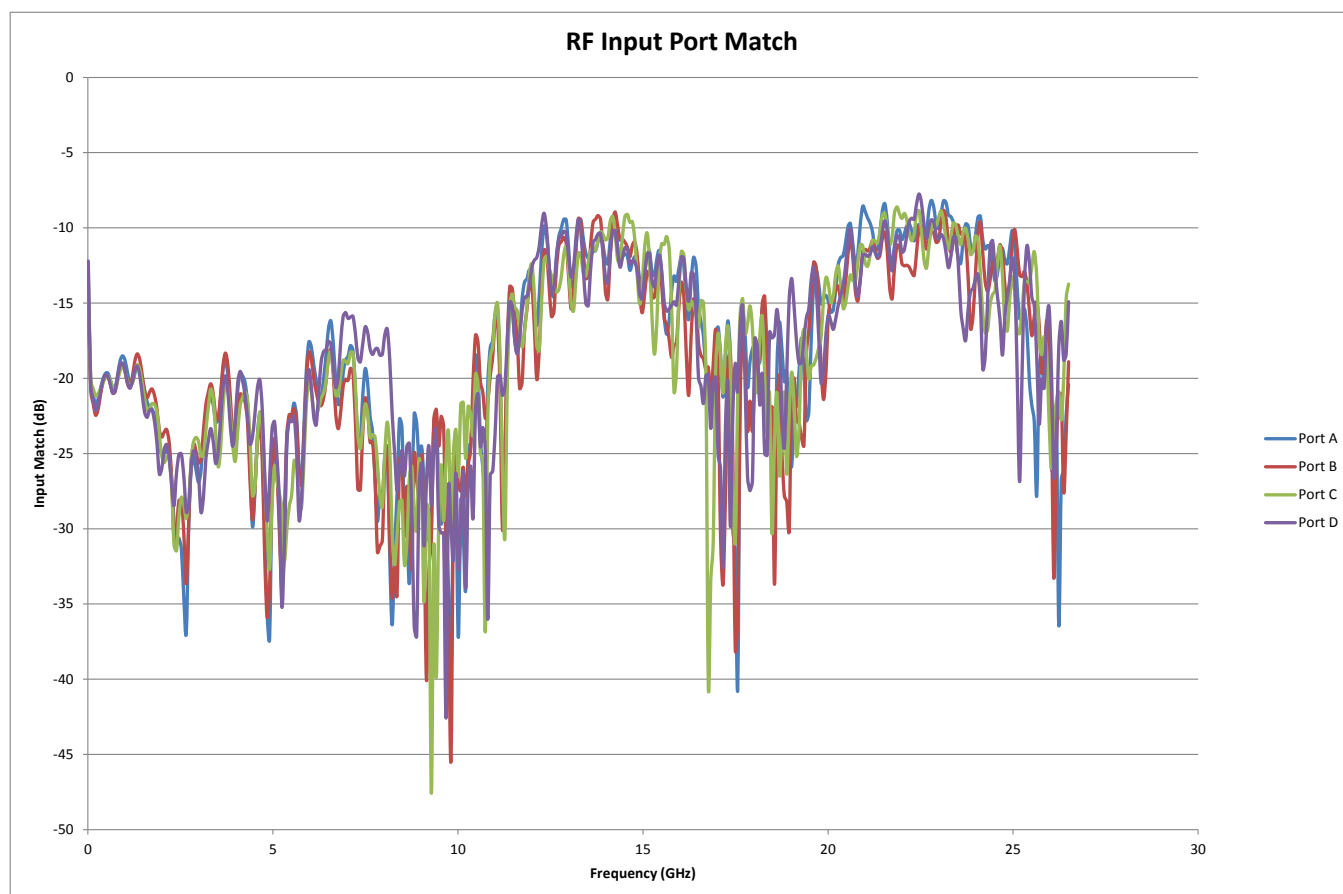

Figure 3. RF input port match



# TECHNICAL SPECIFICATIONS

All specifications are nominal unless otherwise noted.

System requirements		
Operating systems	Windows XP, Service Pack 3 or later (32-bit) <sup>1</sup>	Windows 7 (32-bit and 64-bit) Starter, Home Basic, Home Premium, Professional, Ultimate, Enterprise
Processor speed	600 MHz or higher required 800 MHz recommended	1 GHz 32-bit (x86), 1 GHz 64-bit (x64), no support for Itanium 64
Available memory	256 MB minimum (1 GB or greater recommended)	1 GB minimum <sup>2</sup>
Available disk space <sup>1</sup>	1.5 GB available hard disk space, includes: <ul style="list-style-type: none"><li>• 1 GB available for Microsoft .NET Framework 3.5 SP1 <sup>2</sup></li><li>• 100 MB for Agilent IO Libraries Suite</li></ul>	1.5 GB available hard disk space, includes: <ul style="list-style-type: none"><li>• 1 GB available for Microsoft .NET Framework 3.5 SP1 <sup>2</sup></li><li>• 100 MB for Agilent IO Libraries Suite</li></ul>
Video	Super VGA (800x600) 256 colors or more	Support for DirectX 9 graphics with 128 MB graphics memory recommended (Super VGA graphics is supported)
Browser	Microsoft Internet Explorer 6.0 or greater	Microsoft Internet Explorer 7 or greater

1. Because of the installation procedure, less memory may be required for operation than is required for installation.

2. .NET Framework Runtime Components are installed by default with Windows Vista and Windows 7. Therefore, you may not need this amount of available disk space

## Definitions for specifications

**Specifications** describe the warranted performance of calibrated instruments that have been stored for a minimum of 2 hours within the operating temperature range of 0 to 55°C, unless otherwise stated, and after a 45 minute warm-up period. Data represented in this document are specifications unless otherwise noted.

**Characteristics** describe product performance that is useful in the application of the product, but that is not covered by the product warranty. Characteristics are often referred to as *Typical* or *Nominal* values. Characteristics are represented in italics.

- **Typical** describes characteristic performance, which 80% of instruments are expected to meet when operated over a 20 to 30 °C temperature range. Typical performance is not warranted.
- **Nominal** describes representative performance that is useful in the application of the product when operated over a 20 to 30 °C temperature range. Nominal performance is not warranted.

Note: All graphs contain measured data from several units at room temperature unless otherwise noted

# RECOMMENDED CONFIGURATIONS

Quad DC M9362A-D01-F26	Channels	Digitizers M9210A <sup>1, 3</sup>	Sample rate	Analog bandwidth per channel	Local oscillator M9302A <sup>2</sup>
1	1	1	4 GS	1.4 GHz	1
1	2	1	2 GS	1.4 GHz	1



Quad DC M9362A-D01-F26	Channels	Digitizers M9210A <sup>1, 3</sup>	Sample rate	Analog bandwidth per channel	Local oscillator M9302A <sup>2</sup>
1	2	2	4 GS	1.4 GHz	1
1	4	2	2 GS	1.4 GHz	1



# RECOMMENDED CONFIGURATIONS

Quad DC M9362A-D01-F26	Channels	Digitizers M9210A <sup>1,3</sup>	Sample rate	Analog bandwidth per channel	Local oscillator M9302A <sup>2</sup>
1	3	3	4 GS	1.4 GHz	1



Quad DC M9362A-D01-F26	Channels	Digitizers M9210A <sup>1,3</sup>	Sample rate	Analog bandwidth per channel	Local oscillator M9302A <sup>2</sup>
2	6	3	2 GS	1.4 GHz	1



1. The module displayed is the Agilent M9210A PXI-H High-speed Digitizing Scope: 10-bit, 2-4 GS/s
2. The module displayed is the Agilent M9302A PXI Local Oscillator, VCO-based, with frequency range from 2.75 GHz to 10 GHz, optimized for fast settling time to allow for fast frequency down conversion applications.
3. Maximum number of digitizers on AS Bus2 is three.



# ORDERING

## Hardware

Model	Description
<input checked="" type="checkbox"/> M9362A-D01-F26 <sup>1</sup>	PXIe Quad Downconverter: 10 MHz to 26.5 GHz
M9362AD01-CA1	IF Jumper Cables For Use With 4-M9202A Single CH Digitizers
M9362AD01-CA2	IF Jumper Cables For Use With 2-M9202A Dual CH Digitizers
<input checked="" type="checkbox"/> M9362AD01-CA3	IF Jumper Cables For Use With The M9210A
<input checked="" type="checkbox"/> M9362AD01-CA4	LO Interconnect Kit For Use With The M9302A

*Recommended configuration*

Includes software and product information on CD

<sup>1</sup> For the M9362A-D01-F26 to work properly, at least one PXIe chassis and one PXIe controller type must be available.

## Related products

Model	Description
M9210A	PXI-H High-speed Digitizing Scope: 10-bit
M9302A	PXI Local Oscillator: 3 GHz to 10 GHz
M9018A	18-slot PXIe chassis
M9036A	PXIe Embedded Controller

## Software

Model	Description
Supported application development environments (ADE)	Agilent IO Libraries: Visual Studio (VB.NET, C#, C/C++), VEE, LabVIEW, LabWindows/CVI, MATLAB

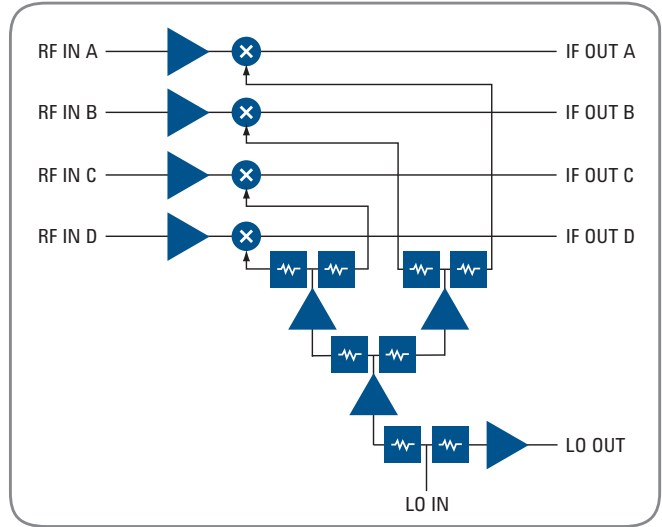

Figure 4. M9362A-D01-F26 PXIe Quad Downconverter block diagram

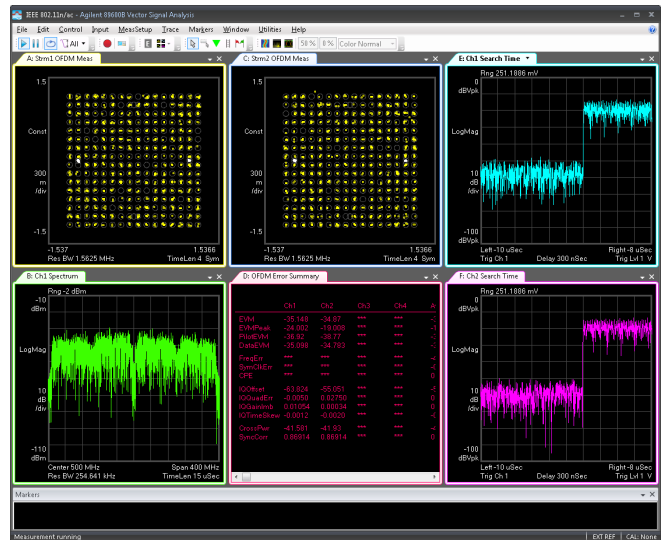

Figure 5. Example of a 2-channel, 400 MHz analysis

# WARRANTY AND CALIBRATION

## Advantage Services: Calibration and warranty

Agilent Advantage Services is committed to your success throughout your equipment's lifetime.

## Warranty

Standard warranty on the M9362A-D01 is 1 year.



## The modular tangram

The four-sided geometric symbol that appears in this document is called a tangram. The goal of this seven-piece puzzle is to create identifiable shapes—from simple to complex. As with a tangram, the possibilities may seem infinite as you begin to create a new test system. With a set of clearly defined elements—hardware, software—Agilent can help you create the system you need, from simple to complex.



## Challenge the Boundaries of Test Agilent Modular Products



**myAgilent**  
[www.agilent.com/find/myagilent](http://www.agilent.com/find/myagilent)



[www.pxisa.org](http://www.pxisa.org)

**Agilent SolutionPartners**  
[www.agilent.com/find/solutionpartners](http://www.agilent.com/find/solutionpartners)

[www.agilent.com](http://www.agilent.com)

[www.agilent.com/find/modular](http://www.agilent.com/find/modular)

[www.agilent.com/find/m9362a-d01](http://www.agilent.com/find/m9362a-d01)

For more information on Agilent Technologies' products, applications or services, please contact your local Agilent office. The complete list is available at: [www.agilent.com/find/contactus](http://www.agilent.com/find/contactus)

### Americas

Canada	(877) 894 4414
Brazil	(11) 4197 3600
Mexico	01800 5064 800
United States	(800) 829 4444

### Asia Pacific

Australia	1 800 629 485
China	800 810 0189
Hong Kong	800 938 693
India	1 800 112 929
Japan	0120 (421) 345
Korea	080 769 0800
Malaysia	1 800 888 848
Singapore	1 800 375 8100
Taiwan	0800 047 866
Other AP Countries	(65) 375 8100

### Europe & Middle East

Belgium	32 (0) 2 404 93 40
Denmark	45 45 80 12 15
Finland	358 (0) 10 855 2100
France	0825 010 700*
	*0.125 €/minute
Germany	49 (0) 7031 464 6333
Ireland	1890 924 204
Israel	972-3-9288-504/544
Italy	39 02 92 60 8484
Netherlands	31 (0) 20 547 2111
Spain	34 (91) 631 3300
Sweden	0200-88 22 55
United Kingdom	44 (0) 118 927 6201

For other unlisted countries: [www.agilent.com/find/contactus](http://www.agilent.com/find/contactus)

(BP-11-07-13)

Product specifications and descriptions in this document subject to change without notice.

PICMG and the PICMG logo, CompactPCI and the CompactPCI logo, AdvancedTCA and the AdvancedTCA logo are US registered trademarks of the PCI Industrial Computers Manufacturers Group. "PCIe" and "PCI EXPRESS" are registered trademarks and/or service marks of PCI-SIG.

© Agilent Technologies, Inc. 2013

Published in USA, November 20, 2013

5990-6624EN



**Agilent Technologies**