

U7238C and U7238D MIPI D-PHY Conformance Test Software for Infiniium Oscilloscopes

Data Sheet

Validate and Debug Your Embedded D-PHY Data Links Quickly and Easily

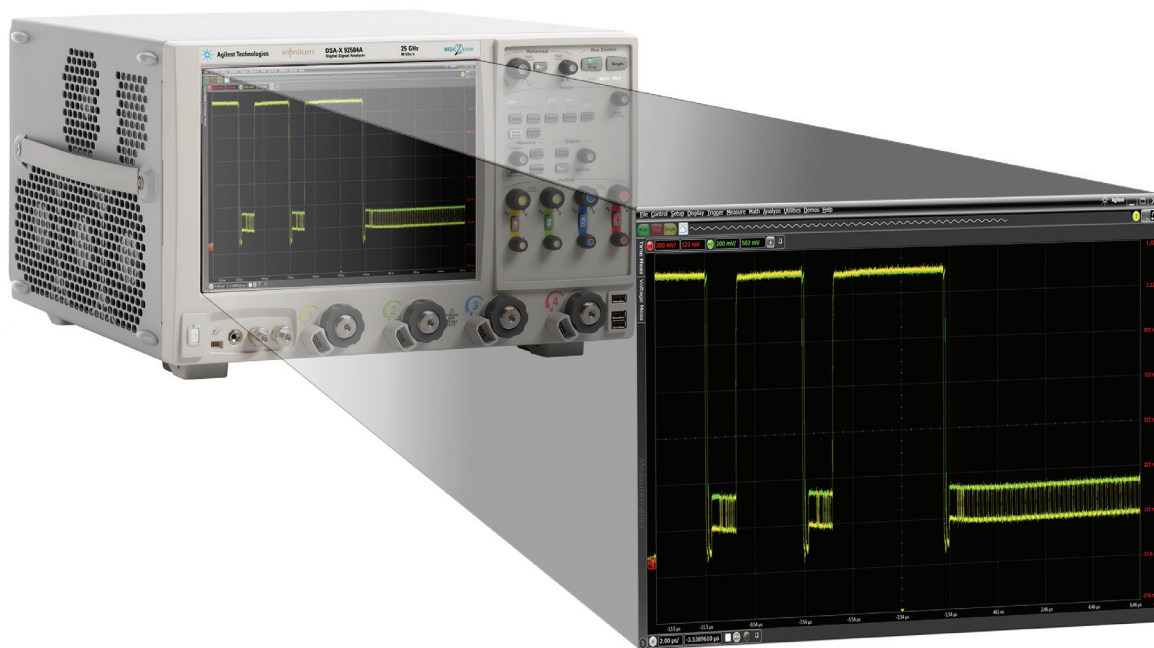

Agilent Technologies' MIPI D-PHY conformance test software for Infiniium oscilloscopes gives you a fast, easy way to validate and debug your embedded D-PHY data links. The D-PHY electrical test software allows you to automatically execute D-PHY electrical checklist tests for CSI-2 and DSI architectures, and displays the results in a flexible report format. In addition to the measurement data, the report provides margin analysis that shows how closely your product passed or failed each test.

The D-PHY conformance test software performs a wide range of tests required to meet the physical layer requirements per Section 9 of the MIPI Alliance Specification for D-PHY v1.1 and Section 1 of the D-PHY Conformance Test Suite (CTS) v1.1. The D-PHY conformance test software helps you execute the most difficult physical layer tests for transmitters (TX tests only) that can be measured with a 4-GHz or higher-bandwidth real-time oscilloscope. Although there are not currently any requirements for physical layer compliance verification, it is highly recommended that every MIPI D-PHY link be tested against the limits of the physical layer specification to ensure that it is compliant to the specification and to minimize concerns with protocol level interoperability.



Features

The D-PHY conformance test software offers several features to simplify design validation:

- Complete MIPI Alliance Specification for D-PHY v1.1, section 9 and D-PHY CTS v1.1, section 1
- User selection of tests and configuration of data rate
- Automated scope measurement setup and programming for increased accuracy, time-savings and repeatability
- Advanced debug modes for troubleshooting
- Automated margin analysis and pass/fail conformance reporting

With the D-PHY conformance test software, you can use the same oscilloscope you use for everyday debugging to perform automated testing and margin analysis based on the MIPI Alliance Specification for D-PHY v1.1, section 9 requirements and D-PHY CTS v1.1, section 1.

D-PHY App Saves You Time

The D-PHY conformance test software saves you time by setting the stage for automatic execution of required electrical tests. The primary difficulty of performing electrical tests for D-PHY is connecting the oscilloscope to the target device, correctly configuring the scope's measurement system for ultimate accuracy, issuing the proper commands to perform the tests and then analyzing the measured results by comparing them to limits published in the specification. The D-PHY conformance test software automates this work to provide rapid, accurate and repeatable test execution. In addition, if you discover a problem with your product, debug tools in the scope are available to aid in root-cause analysis.

See Table 1 for a complete list of the measurements you can make with the D-PHY conformance test software.

Easy Test Definition

The D-PHY conformance test software extends the ease-of-use advantages of Agilent's Infiniium oscilloscopes to testing D-PHY designs. The Agilent automated test engine walks you quickly through the steps required to define and configure the tests, execute the tests, and view the test results. You can select a category of tests all at once or specify individual tests. The user interface is oriented to minimize unnecessary reconnections, which saves time and ensures accuracy and repeatability of tests. You can save tests and configurations as project files and recall them later for quick re-testing or review of previous test. Straightforward menus let you perform tests with a minimum of mouse clicks.

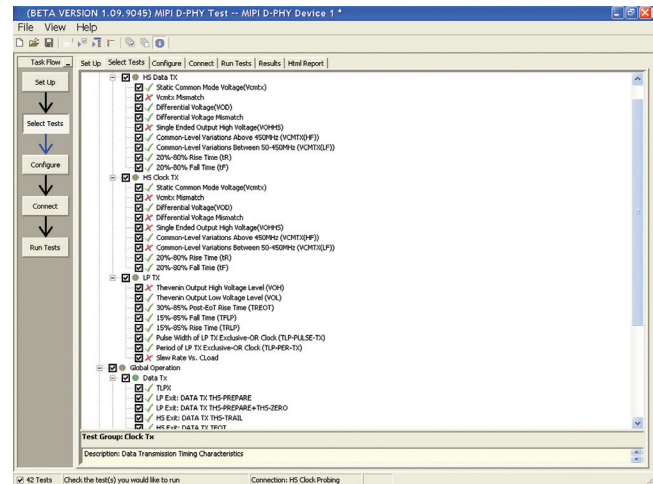

Figure 1. You can easily select individual tests or groups of test with a mouse-click and customize your output report based on the test results you want to see.

Configurability and Guided Connections

The D-PHY conformance test software provides flexibility in your test setup. The D-PHY conformance test software provides you with user-defined controls for critical test parameters such as channel probe configurations, number of measurement observations for tests and the low-power trigger threshold.

After you configure the tests to meet your needs, the D-PHY user interface will present you the connection screen that is specific to the configuration data you have selected. This includes the oscilloscope channels used for the test and the routing of any necessary probing needed to perform the tests. In some cases, a configuration change may be necessary to properly make a new set of measurements. Guided configuration diagrams will be presented when each change is needed to ensure proper configuration for the tests. The software is designed to minimize connection changes to increase the efficiency of test operation and save you time.

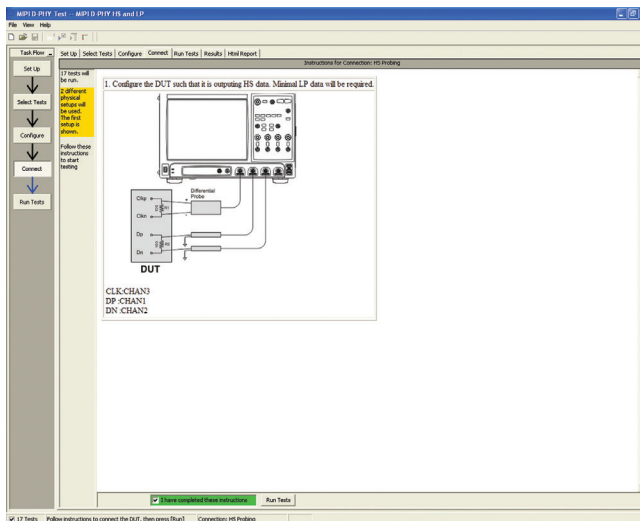

Figure 2. Guided configuration diagrams provide you with channel and probe configurations needed to properly connect to your product and accurately perform tests.

Results Reports with Margin Analysis

In addition to providing you with measurement results, the D-PHY test software provides a report format that shows you not only where your product passes or fails, but also reports how close you are to the limits specified for a particular test assertion. You select the margin test report parameter, which means you can specify the level at which warnings are issued to alert you to the electrical tests where your product is operating close to the official test limit defined by the specification for a given test assertion.

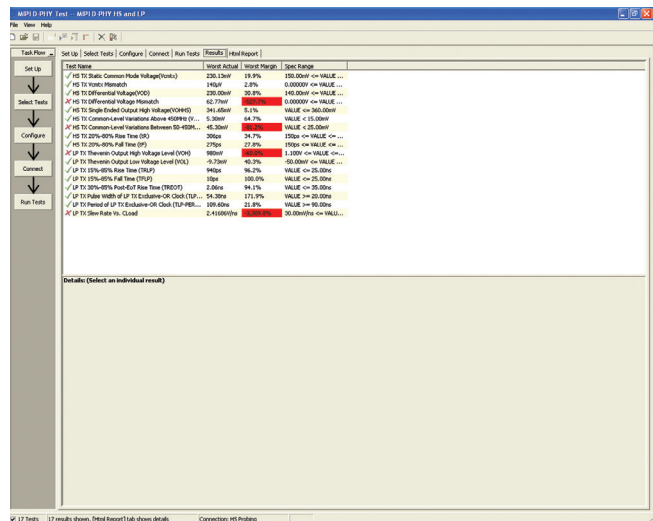

Figure 3. Results reports quickly highlight test margins versus specified limits and a summary of measurements that pass/fail or violate the margin warnings you have set.

Configurability and Guided Connections

The D-PHY conformance software generates thorough reports that not only capture the performance and status of the device under test, but capture the screen shots of your most significant measurements for your documentation and evaluation.

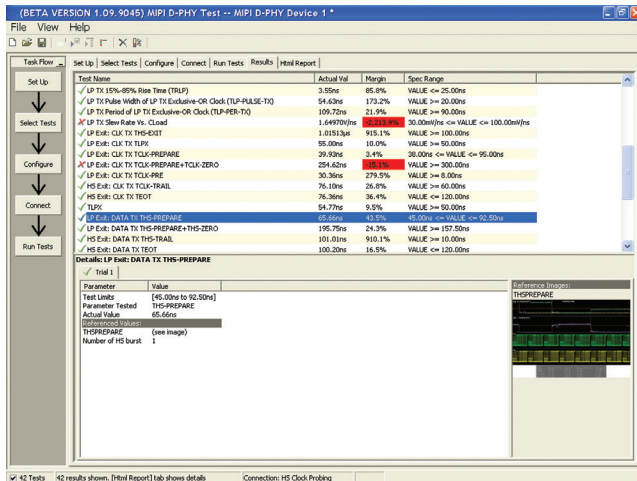

Figure 4. A complete HTML-formatted report provides a results summary for documentation and archiving with full detail on measurement definitions referenced to the specification and screen images from the oscilloscope during test.

Extensibility

You may add additional custom tests or steps to your application using the N5467B/N5467C User Defined Application (UDA) development tool (www.agilent.com/find/uda). Use UDA to develop functional “Add-Ins” that you can plug into your application.

Add-ins may be designed as:

- Complete custom tests (with configuration variables and connection prompts)
- Any custom steps such as pre or post processing scripts, external instrument control and your own device control

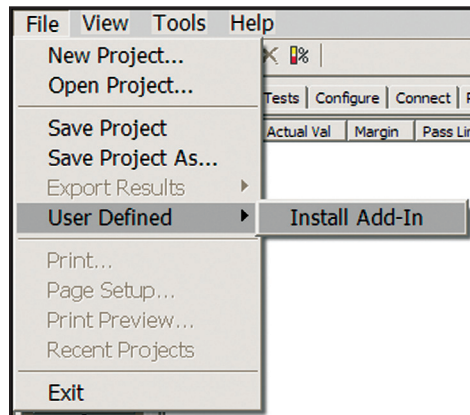

Figure 5. Importing a UDA Add-In into your test application.

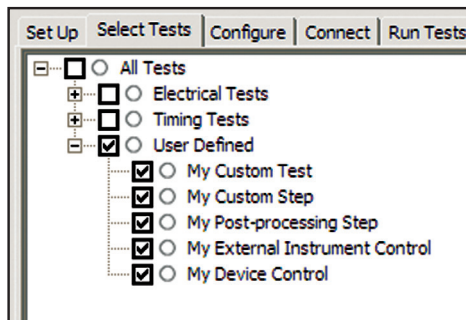

Figure 6. UDA Add-In tests and utilities in your test application.

Automation

You can completely automate execution of your application's tests and Add-Ins from a separate PC using the included N5452A Remote Interface feature (download free toolkit from www.agilent.com/find/scope-apps-sw). You can even create and execute automation scripts right inside the application using a convenient built-in client.

The commands required for each task may be created using a command wizard or from "remote hints" accessible throughout the user interface.

Using automation, you can accelerate complex testing scenarios and even automate manual tasks such as:

- Opening projects, executing tests and saving results
- Executing tests repeatedly while changing configurations
- Sending commands to external instruments
- Executing tests out of order

Combine the power of built-in automation and extensibility to transform your application into a complete test suite executive:

- Interact with your device controller to place it into desired states or test modes before test execution.
- Configure additional instruments used in your test suite such as a pattern generator and probe switch matrix.
- Export data generated by your tests and post-process it using your favorite environment, such as MATLAB, Python, LabVIEW, C, C++, Visual Basic etc.
- Sequence or repeat the tests and "Add-In" custom steps execution in any order for complete test coverage of the test plan.

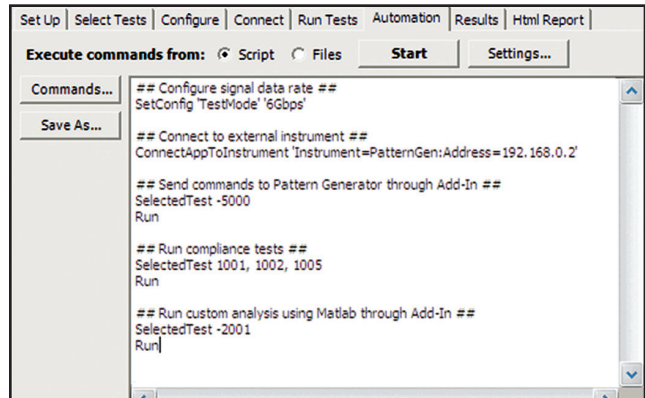

Figure 7. Remote Programming script in the Automation tab.

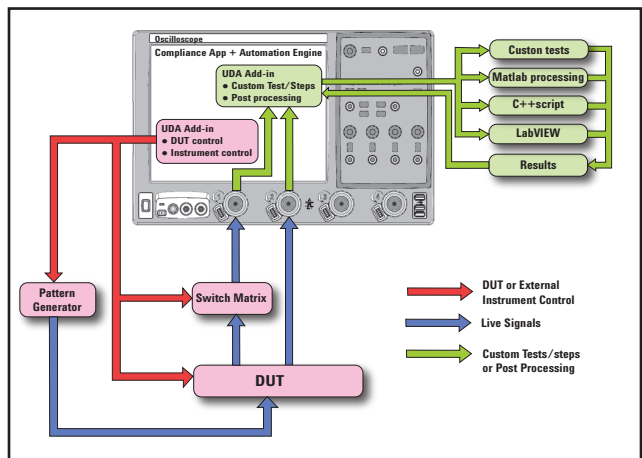

Figure 8. Combine the power of built-in automation and extensibility to transform your application into a complete test suite executive.

Switch Matrix

The Agilent switch matrix software option for the conformance application, used together with switch matrix hardware, enables fully automated testing for multi-lane digital bus interfaces. The benefits of this automated switching solution include:

- *Eliminate reconnections*, which saves time and reduces errors through automating test setup for each lane of a multi-lane bus.
- *Maintain accuracy* with the use of unique PrecisionProbe or InfiniiSim features to compensate for switch path losses and skew.
- *Customize testing* by using remote programming interface and the UDA tool for device control, instrument control and test customization.

More information of the switching solution and configuration, visit www.agilent.com/find/switching and the Agilent application note with the publication number 5991-2375EN.



Figure 9. Automated testing for multi-lane digital bus interface through switching solution

Measurement Requirements

To use the D-PHY conformance software you will need an Agilent Infiniium Series oscilloscope with at least 4 GHz of analog, real-time bandwidth. In order to use the D-PHY conformance test software, your product will need to be able to source the necessary low-power (LP) to high-speed (HS) data transitions needed to perform the testing.

Tests Performed

The D-PHY conformance software performs the following tests as per MIPI Alliance Specification for D-PHY v1.1, section 9 and D-PHY CTS v1.1, section 1.

Section 9, Electrical Characteristics

High-speed data and clock measurements

- HS data and clock TX static common-mode voltage (VCMTX)
- HS data and clock TX VCMTX mismatch ($\Delta VCMTX(1,0)$)
- HS data and clock TX differential voltage (VOD)
- HS data and clock TX differential voltage mismatch (ΔVOD)
- HS data and clock TX single-ended output high voltage (VOHHS)
- HS data and clock TX common-level variations above 450 MHz (VCMTX(HF))
- HS data and clock TX common-level variations between 50-450 MHz (VCMTX(LF))
- HS data and clock TX 20%-80% rise time (tR)
- HS data and clock TX 20%-80% fall time (tF)
- HS clock instantaneous (UI INST)

Low-power data measurements

- LP TX Thevenin output high voltage level (VOH)
- LP TX Thevenin output low voltage (VOL)
- LP TX 15%-85% rise time (tRLP)
- LP TX 15%-85% fall time (tFLP)
- LP TX 30%-85% post-EoT rise time (tREOT)
- LP TX pulse width of LP TX exclusive-OR clock (TLP-PULSE-TX)
- LP TX period of LP TX exclusive-OR clock (TLP-PER-TX)
- LP TX slew rate vs. CLOAD

Global operation data and clock TX measurements

- TLPX
- LP exit: data TX THS-prepare
- LP exit: data TX THS-prepare+THS-zero
- HS exit: data TX THS-trail
- HS exit data TX TEOT
- HS exit: data TX THS-exit
- LP exit: clock TX THS-exit
- LP exit: clock TX TLPX
- LP exit: clock TX TCLK-prepare
- LP exit: clock TX TCLK-prepare+TCLK-zero
- LP exit: clock TX TCLK-PRE
- LP exit: clock TX TCLK-trail
- LP exit: clock TC TX TEOT

HS data-clock timing

- HS clock instantaneous
- HS clock rising edge alignment to first payload bit
- Data-to-clock skew (TSKEW(TX))

Table 1. MIPI D-PHY electrical conformance tests performed by the software

Recommended Oscilloscopes

The D-PHY compliance software is compatible with Agilent Infiniium Series oscilloscopes with operating software revision 4.20 or higher. For oscilloscopes with earlier revisions, free upgrade software is available here: www.agilent.com/find/scope-apps-sw.

Data rate	Minimum bandwidth	Minimum channels	Compatible oscilloscopes
Up to 1 Gbps	4 GHz	3	Infiniium 9000, S-Series, 90000 and Z-Series
Up to 1.5 Gbps	6 GHz	3	Infiniium 90000 and Z-Series
Up to 2.5 Gbps	12 GHz	3	Infiniium 90000 and Z-Series

Ordering Information

To purchase the D-PHY software with a new or existing Infiniium Series oscilloscope, order the following options.

Software options

Application	License type		Infiniium Z-Series	Infiniium S-Series	Infiniium 90000 Series	Infiniium 9000 Series
D-PHY conformance software	Fixed	Factory-installed	U7238C-1FP	U7238D-1FP	Option 035	Option 035
		User-installed	U7238C-1FP	U7238D-1FP	U7238C-1NL	U7238D-1NL
	Floating	Transportable	U7238C-1TP	U7238D-1TP	U7238C-1TP ^{1,2}	U7238D-1TP ^{1,2}
		Server-based	N5435A-022	N5435A-022	N5435A-022	N5435A-022
D-PHY switch matrix support (optional) ³	Fixed	Factory-installed	U7238C-7FP	U7238D-7FP	Option 703	–
		User-installed	U7238C-7FP	U7238D-7FP	U7238C-7NL	U7238D-7NL
	Floating	Transportable	U7238C-7TP	U7238D-7TP	U7238C-7TP ^{1,2}	U7238D-7TP ^{1,2}
		Server-based	N5435A-703	N5435A-703	N5435A-703	N5435A-703
PrecisionProbe (optional)	Fixed	Factory-installed	N2809A-1FP	N2808A-1FP	Option 001	–
		User-installed	N2809A-1FP	N2808A-1FP	N2809A-1NL	N2808A-1NL
	Floating	Transportable	N2809A-1TP	N2808A-1TP	N2809A-1TP ^{1,2}	N2808A-1TP ^{1,2}
		Server-based	N5435A-003	N5435A-003	N5435A-003	N5435A-003

1 Requires software 5.00 and above.

2 Software 4.30 or above requires Windows 7. N2753A Infiniium Windows XP to 7 OS upgrade kit (oscilloscope already has M890 motherboard). N2754A Infiniium Windows XP to 7 OS and M890 motherboard upgrade kit (oscilloscope without M890 motherboard). Verify the M890 motherboard using the procedure found in the Windows 7 upgrade kit data sheet with the publication number 5990-8569EN.

3 For full switch configuration, refer to www.agilent.com/find/switching or the brochure Automated Switching Solution for Oscilloscopes with the publication number 5991-2413EN.

Other hardware, probes and accessories

Model number	Description	Quantity
1132A ⁴	InfiniiMax 5-GHz differential probe amplifier	4
E2669A	Differential probe connectivity kit (contains needed probe heads)	1
RTB	MIPI D-PHY Reference Termination Board from UNH-IOL https://www.iol.unh.edu/services/testing/mipi/fixtures.php	1

4 InfiniiMax I and II probes are suitable for D-PHY probing but not InfiniiMax III probes.

Related Literature

Publication title	Publication type	Publication number
<i>N5414B/N5415B InfiniiScan Event Identification</i>	Data sheet	5989-4605EN
<i>MIPI D-PHY Protocol Test Solutions</i>	Data sheet	5989-7921EN
<i>N5990A Test Automation Software Platform</i>	Data sheet	5989-5483EN
<i>PrecisionProbe for Bandwidths up to 33 GHz</i>	Data sheet	5990-7940EN
<i>Next-Generation Infiniium User Interface</i>	Brochure	5991-3864EN
<i>30 Things Only Infiniium Oscilloscopes Can Do</i>	Brochure	5991-3958EN



myAgilent

www.agilent.com/find/myagilent

A personalized view into the information most relevant to you.



www.axistandard.org

AdvancedTCA® Extensions for Instrumentation and Test (AXIe) is an open standard that extends the AdvancedTCA for general purpose and semiconductor test. Agilent is a founding member of the AXIe consortium.



www.lxistandard.org

LAN eXtensions for Instruments puts the power of Ethernet and the Web inside your test systems. Agilent is a founding member of the LXI consortium.



www.pxisa.org

PCI eXtensions for Instrumentation (PXI) modular instrumentation delivers a rugged, PC-based high-performance measurement and automation system.



Three-Year Warranty

www.agilent.com/find/ThreeYearWarranty

Beyond product specification, changing the ownership experience. Agilent is the only test and measurement company that offers three-year warranty on all instruments, worldwide.



Agilent Assurance Plans

www.agilent.com/find/AssurancePlans

Five years of protection and no budgetary surprises to ensure your instruments are operating to specifications and you can continually rely on accurate measurements.



www.agilent.com/quality

Agilent Electronic Measurement Group
DEKRA Certified ISO 9001:2008
Quality Management System

Agilent Channel Partners

www.agilent.com/find/channelpartners

Get the best of both worlds: Agilent's measurement expertise and product breadth, combined with channel partner convenience.

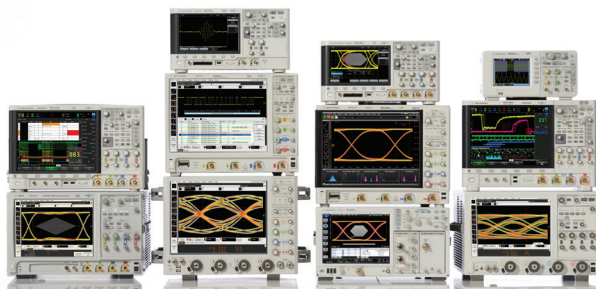

Agilent Technologies Oscilloscopes

Multiple form factors from 20 MHz to > 90 GHz | Industry leading specs | Powerful applications

www.agilent.com

For more information on Agilent Technologies' products, applications or services, please contact your local Agilent office. The complete list is available at: www.agilent.com/find/contactus

Americas

Canada	(877) 894 4414
Brazil	(11) 4197 3600
Mexico	01800 5064 800
United States	(800) 829 4444

Asia Pacific

Australia	1 800 629 485
China	800 810 0189
Hong Kong	800 938 693
India	1 800 112 929
Japan	0120 (421) 345
Korea	080 769 0800
Malaysia	1 800 888 848
Singapore	1 800 375 8100
Taiwan	0800 047 866
Other AP Countries	(65) 375 8100

Europe & Middle East

Belgium	32 (0) 2 404 93 40
Denmark	45 45 80 12 15
Finland	358 (0) 10 855 2100
France	0825 010 700*
	*0.125 €/minute
Germany	49 (0) 7031 464 6333
Ireland	1890 924 204
Israel	972-3-9288-504/544
Italy	39 02 92 60 8484
Netherlands	31 (0) 20 547 2111
Spain	34 (91) 631 3300
Sweden	0200-88 22 55
United Kingdom	44 (0) 118 927 6201

For other unlisted countries:

www.agilent.com/find/contactus

(BP-01-15-14)

Product specifications and descriptions in this document subject to change without notice.

© Agilent Technologies, Inc. 2013, 2014
Published in USA, June 2, 2014
5991-2400EN



Agilent Technologies