

Keysight Technologies Modular Products

M9703A AXIe High-Speed Digitizer with Real-Time Digital Downconversion Capability

Application Note



In an array of antennas with hundreds or thousands of elements, where it is necessary to characterize the phase and gain alignment between elements, the ability to accelerate test by using multiple coherent measurement channels is a significant benefit. Of equal importance, as technology evolves and antenna configurations continue to have higher and higher antenna element densities, is a scalable platform that can accommodate additional parallel channels.

This application note describes an innovative solution for accelerating calibration of multi-antenna arrays using a high-speed, multi-channel digitizer with real-time digital downconversion (DDC). The solution characterizes the element-to-element phase and magnitude errors of the various components in the array. The misalignment of the radiating elements can then be accurately identified and calibrated out to ensure efficient operation of the antenna system.

Introduction

This application note describes how to use the Keysight Technologies, Inc. M9703A AXIe high-speed digitizer with real-time digital downconversion (DDC) capability to perform ultra-fast relative phase and gain measurements and includes an example of how to use the M9703A to perform such high sensitivity measurements on wideband signals (e.g. LFM chirp, comms, etc.).

Abstract

The Keysight M9703A AXIe high-speed digitizer provides wide-bandwidth signal capture on 8 synchronous acquisition channels, with the best accuracy and flexibility, and optimized throughput. The 12-bit digitizer card can easily be scaled up to 40 channels in a 5-slot AXIe chassis. The M9703A is able to capture signals from DC up to 2 GHz bandwidth. It also provides very long signal acquisition depth and real-time data processing capability with four Virtex 6 FPGAs. The digitizer is also supported by a variety of software tools for advanced measurement analysis such as the industry standard Keysight 89600 VSA software.

The M9703A FPGAs feature an optional real-time DDC, allowing tuning and zooming on the analyzed signal. The use of the real-time DDC optimizes the dynamic range, reduces integrated noise in the decimated span, and extends the capture time for an accelerated measurement speed.

Your Benefits

- Accelerate test time by measuring relative phase and amplitude over a large number of parallel channels
- Isolate the signal of interest and reduce the amount of data to be transferred
- Improve the analog performance and dynamic range (SNR, ENOB) by reducing the amount of integrated noise
- Extend the amount of capture memory (in seconds) or reduce the amount of data that needs to be transferred for a given duration
- Reduce the workload on post-processing algorithms

Applications

- Multi-channel phase-coherent wideband measurements in active antenna calibration
- RADAR
- Beam-forming
- Electronic warfare (EW)
- MIMO and BBIQ advanced research

Table of Contents

Overview	4-6
How to use Keysight's M9703A AXIe high-speed digitizer with digital downconversion option to perform multi-antenna array measurements	
Methodology	6-12
Measuring relative phase and gain measurements	
Benefits of using a DDC	
Configuring a Test System	12-25
Requirements for the RF signal chain	
Digitizer requirements	
Measuring Digitizer Channel-to-Channel Phase Coherence	
System level calibration	
Measurement example	
Narrowband vs. Wideband	
The hardware	
The measurement	
Summary	26

How to use Keysight's M9703A AXIe high-speed digitizer with real-time DDC option to perform multi-antenna array measurements

Measurement Challenge

Measuring phase and magnitude relationships across radiating elements of an antenna array presents a number of challenges, including making accurate measurements while also making measurements representative of the anticipated real-world use of the antenna. Here we will discuss a few of the challenges that a digitizer-based measurement solution can help you address by providing more speed and flexibility for making high-resolution measurements across a broader range of bandwidths than ever before.

Historical phased array test challenges

The element-to-element phase and magnitude (gain) errors of the various components in the array are significant limitations to its overall performance. Since phase is used to steer the beam in a phased array, the errors introduced by the misalignment of the radiating elements must be calibrated out so that the antenna operates efficiently. This application note will focus on the static phase and gain errors across elements and describe how to produce a set of calibration measurement data to correct for these errors.

Phase and gain mismatches of antenna elements lead to increased sidelobe levels (Figure 1), non-centered lobes of the radiating pattern.

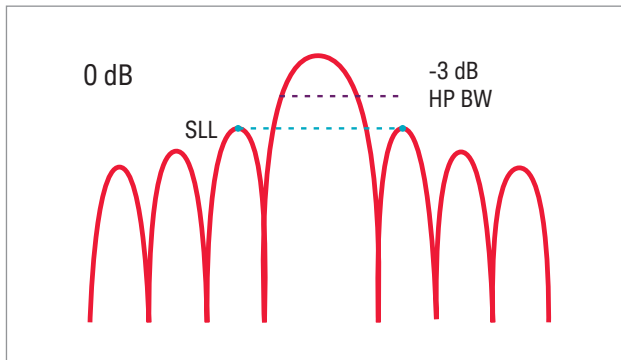

Figure 1. Sin(x)/x antenna radiation pattern.

In general, excess energy radiating off-angle from the main lobe makes a phased array antenna operate less efficiently. In a transmit antenna configuration for RADAR, the sidelobe levels (SLL) transmit energy into free space (i.e. not in the intended direction as the antenna) and it can be reflected back and cause interference with the signal that is returning off of the target. In addition to increased interference with the signal of interest, large sidelobes indicate a waste of beamforming power and create a large radiated signature making the antenna more easily detected by jamming systems. In receive mode, large sidelobes will pick up more interference and reduce the signal-to-noise (SNR) ratio in the receiver.

The average sidelobe level due to phase and amplitude errors (normalized to isotropic level and using $\lambda/2$ element spacing) can be determined by the following formula:

$$\overline{SLL}_0 = \pi(\overline{\phi}^2 + \overline{\delta}^2)$$

where ϕ is the phase error variance (radians) and δ is the fractional amplitude error variance.

Depending on the resolution with which one wishes to measure the relative phase and amplitude between elements in an array, care must be taken to identify a test platform with at least as low an amplitude and phase variance between measurement channels as is required for aligning the elements in the array to achieve desired sidelobe levels.

1. J. Ruze, "Pattern degradation of space fed phased arrays," MIT Lincoln Laboratory, Project Rept. SBR-1, Dec. 1979.

New or growing challenges

In addition to the historical phased array test challenges mentioned above, there are also new or growing challenges associated with advancements in antenna technology that necessitate measuring phase and gain to align elements in an array such as:

- Increased number of array elements requires faster speeds without a loss of accuracy
- Digital signals moving closer to the antenna (i.e. the stimulus may not be available in analog form)
- Broadband modulated signals, rather than simple pulsed signals, require that antennas must be able to generate and capture wideband signals
- Multi-function antennas such as for those used for search, synthetic aperture RADAR (SAR), or communications, require flexible measurement systems capable of performing other types of signal analysis such as modulation accuracy

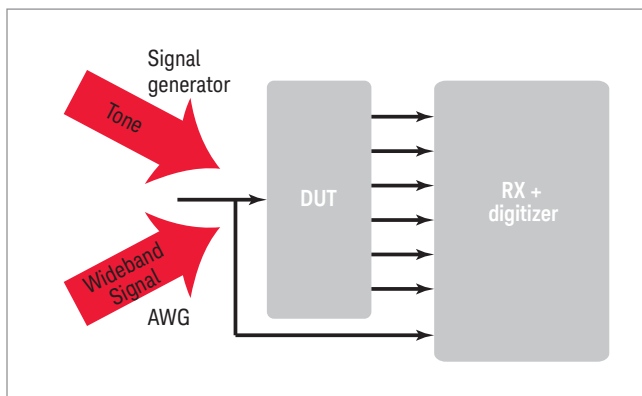

Figure 2. Measurement solution using digitizer with DDC.

The DDC algorithm, implemented in the on-board FPGAs, allows real-time tuning and zooming of the analyzed signal and improves the dynamic range, reduces the integrated noise, and extends the capture time for an accelerated measurement speed.

Using the M9703A digitizer (optionally including the real-time DDC), with the Keysight 89600 VSA software for advanced measurement analysis, provides a means for performing cross-channel baseband measurements including phase and amplitude. Keysight's latest 89600 VSA software provides seamless control of the M9703A digitizer including multi-channel support (up to 8 measurements) and automatic recognition of the hardware DDC supported spans.

Measurement solution overview

Depending on the signal, there are two possible methods for analyzing cross-channel response by measuring relative phase and gain.

The first method is a narrowband approach that uses a swept or stepped tone and a narrowband receiver to measure one frequency at a time and perform cross-channel computations in the time domain. However, this method is limited to narrowband measurements.

The second method uses a broadband stimulus and a wideband receiver to measure all frequencies simultaneously and compute the cross-channel spectrum. The ideal measurement solution has the flexibility to use both methods and is unique to a digitizer with DDC because of its adjustable bandwidth.

The Keysight M9703A AXIe 12-bit high-speed digitizer is able to capture signals from DC up to 2 GHz at 1.6 GS/s on each of its 8 phase coherent channels. The interleaving capability of this high-speed digitizer allows waveform acquisition at up to 3.2 GS/s with exceptional measurement accuracy. The Keysight M9703A also provides very long acquisition capability by implementing up to 4 GBytes internal memory and real-time data processing with four Virtex 6 FPGAs.



Figure 3. M9703A hardware extension for the 89600 VSA Software.

Methodology

Measuring relative phase and gain

Signal representation

Depending on the algorithms used (including what kind of sampled data those algorithms work on) and the resulting precision of the measurements given the spectral content of the signal, several approaches to measure relative phase and amplitude are needed.

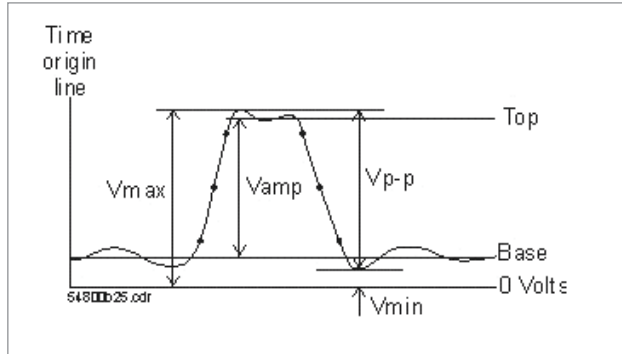

Figure 4. Amplitude in time domain.

Time domain samples

The time domain approach works well on real (voltage vs. time) samples where the signal-to-noise ratio is large (usually best to occupy the full dynamic range of the analog-to-digital converter (ADC) so that all quantization levels are used) and the signal was sampled at a sufficiently high sample rate ($>4 \cdot F_s$) to avoid large errors from interpolating between widely spaced samples. Specific parameters (i.e. top, base, middle level) of the signal need to be resolved in order to precisely position in voltage/time and provide high-resolution measurements (Figure 4).

The amplitude per channel is measured, and then the difference (i.e. $A_1 - A_2$) between the two channels is determined. Phase is always relative and is depicted with the standard time domain representation (Figure 5).

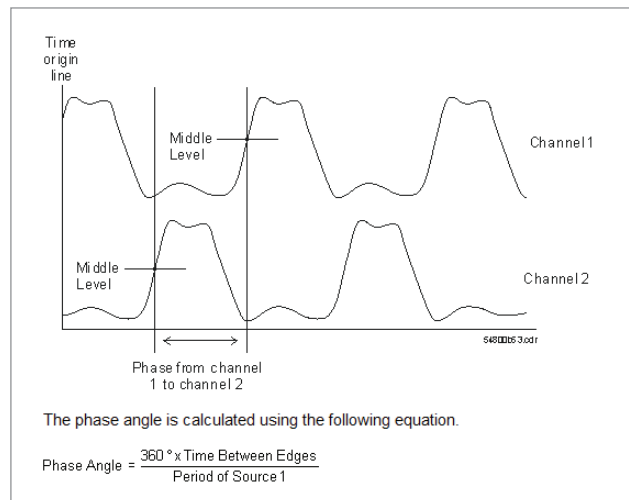

Figure 5. Phase in time domain.

Using complex samples

Converting real samples from the ADC to produce in-phase (I) and quadrature (Q) samples, which can then be digitally filtered to achieve optimal sensitivity on the measurements, is the most efficient and accurate method for measuring relative phase and amplitude over a reduced set of required samples.

I&Q sampling methods provide a simple way of calculating complex cross-channel ratios for measuring relative phase and amplitude. It is no longer necessary to create a histogram of the waveforms to try and identify specific instances in voltage or time to make the measurements (such as that of the time domain samples approach previously described).

The following equations demonstrate how relative phase and amplitude can be quickly determined from a polar representation of the complex cross-channel ratio (described as G1 later in the application note), I+jQ (Figure 6).

$$\text{Phase: } \theta = \tan^{-1} \frac{Q}{I}$$

$$\text{Mag (Gain): } |r| = \sqrt{I^2 + Q^2}$$

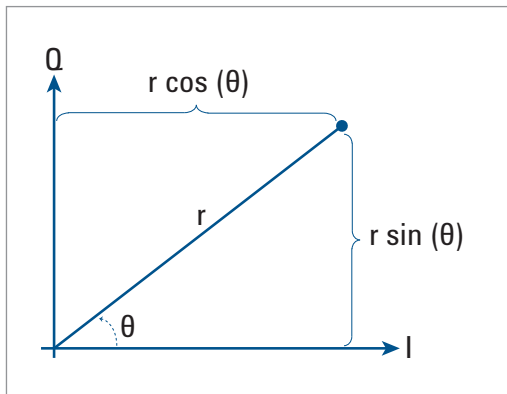

Figure 6. Vector representation of the complex number I+jQ in polar coordinates.

Generating complex samples (DDC)

An ADC digitizes the real signal at a minimum sampling rate defined by the Nyquist criteria to be 2x the highest frequency component (f_1) of the signal (Figure 7).

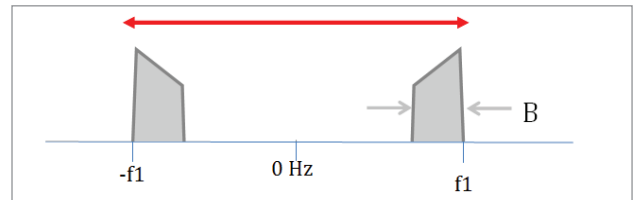

Figure 7. Real signal conjugate symmetry about DC.

Often, the positive frequency span of the signal covers only a small portion of the digitizer's Nyquist bandwidth.

What is a digital down-converter (DDC)?

A DDC enables the signal to be asymmetric about DC and reduces the required sampling rate to achieve the Nyquist criteria for perfect signal reconstruction to be equal to the analysis bandwidth (B) (Figure 8).

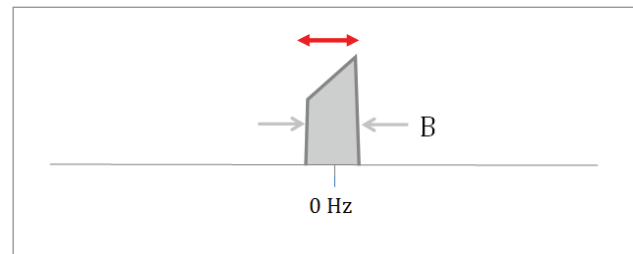

Figure 8. Complex signal asymmetric about DC.

Frequency translation (tune)

The frequency translation (tune) stage of the DDC (Figure 9) generates the complex samples by multiplying the digitized stream of samples from the ADC with a digitized cosine for the in-phase channel and a digitized sine for the quadrature channel.

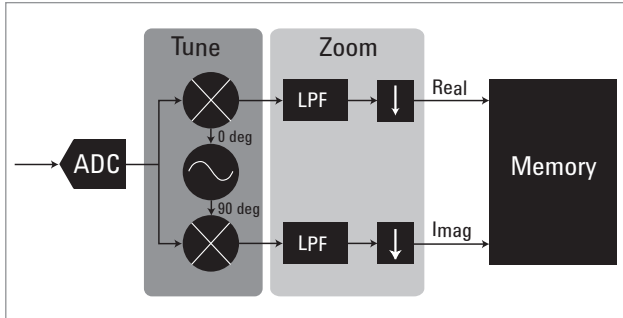

Figure 9. Digital downconverter block diagram.

In this case, the LO frequency was selected to move the signal frequency band down to baseband (Figure 10).

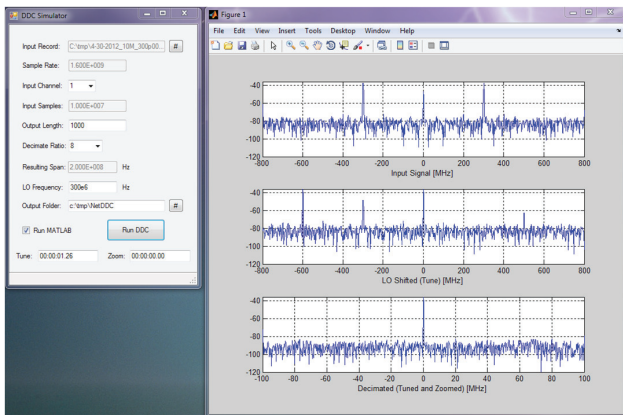

Figure 10. DDC simulator displaying tune results.

Filter and decimation (zoom)

The phase and quadrature signals can now be filtered to remove unwanted frequency components. When combined as a complex value, $I+jQ$, the components from the negative frequency signals can be cancelled, zooming in on the signal of interest (Figure 11) and reducing the required sampling rate (decimation).

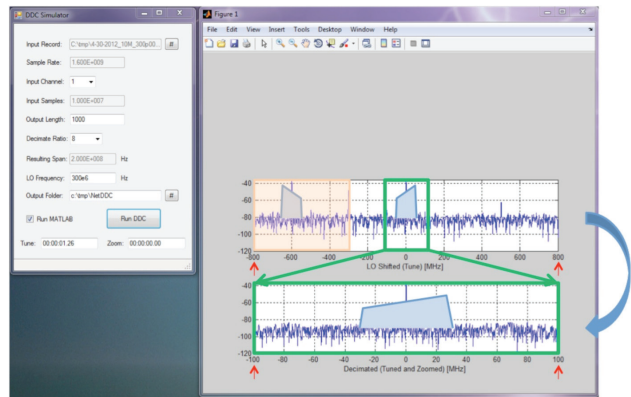

Figure 11. DDC simulator displaying zoom results.

DDC – process gain for measurements

The output from the DDC zooms in on the signal of interest and, as a consequence of the reduced bandwidth, there is less integrated noise, resulting in improved sensitivity for the amplitude and phase measurements. This is also referred to as process gain. As the SNR improves (sensitivity) in the resulting decimated span, there is also an increase in the effective number of bits (ENOB). In the absence of a shaped noise floor, it can be approximated that there is a 10 dB improvement in the SNR for every 10 dB reduction in span and that for every 6 dB improvement in SNR, there is one extra bit of resolution.

By reducing noise in the time domain, the DDC effectively improves the sensitivity for phase and amplitude (gain) measurements. Although the noise density remains the same, less noise is integrated into the measurement as the bandwidth span is reduced. By plotting relative phase variance vs. decimated DDC bandwidth and across multiple input power levels, it is possible to visualize the improvements in relative phase variance at narrower spans (Figure 12).

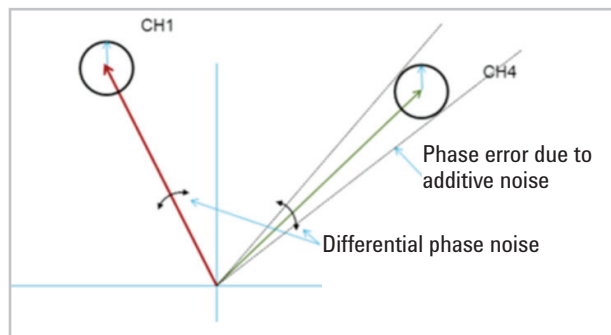
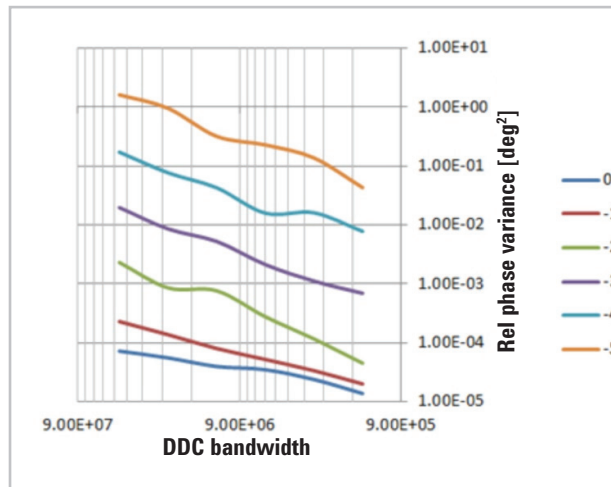
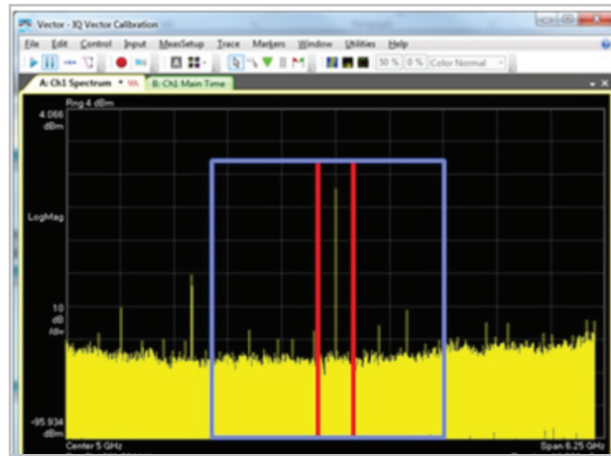

Figure 12. DDC process gain for measurements. With reduced bandwidth there is less noise power (and spurious) to interfere with amplitude and phase measurements.

DDC – noise reduction in time domain

In the time domain, it can be difficult to determine the actual time instance when a noisy waveform crosses through the threshold (i.e. at what exact time the waveform is at the $V(\text{threshold})$). However, by using the DDC to reduce the integrated noise, it is possible to more precisely determine where the waveform crosses the threshold in the time domain (Figure 13). As the decimation ratio increases (integrated noise is reduced at lower bandwidths), the signal is less noisy, and it would be easier to determine the precise intersection of a threshold through the middle of each waveform pictured at the right in the figure below.

Benefits of using a DDC

In summary, a DDC provides several benefits. A DDC can be used to:

- Isolate the signal of interest
- Improve the analog performance and dynamic range (SNR, ENOB) by reducing the amount of integrated noise
- Extend the amount of capture memory (in seconds) or reduce the amount of data that needs to be transferred for a given duration
- Reduce the workload on post-processing algorithms since there is less data to analyze

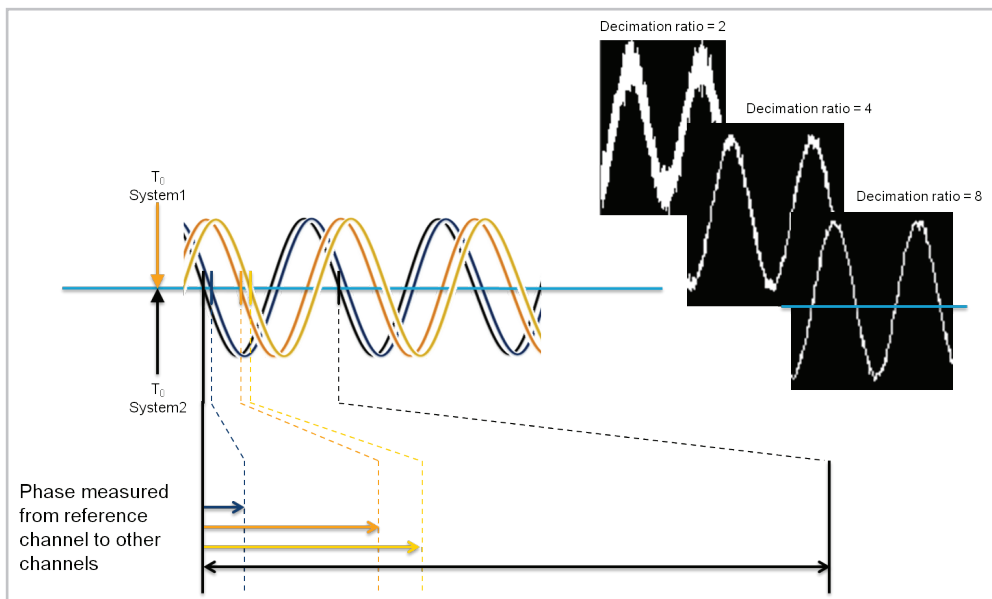

Figure 13. Measuring relative phase in the presence of noise.

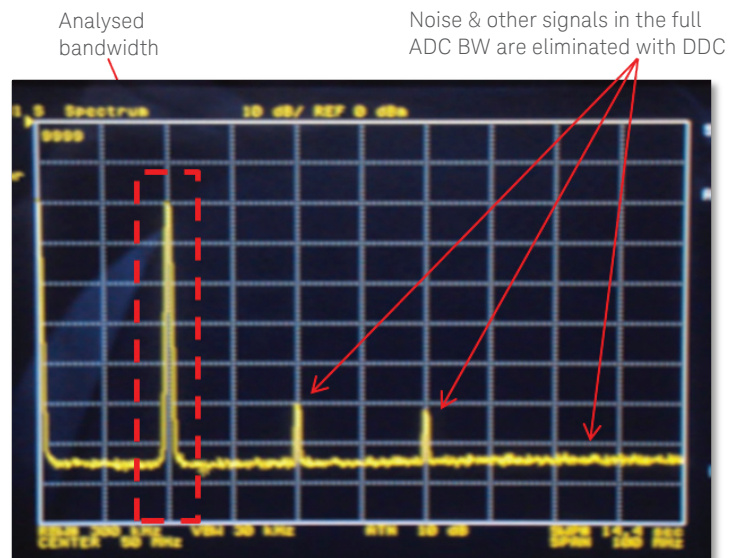

Figure 14. Bandwidth and noise reduction using a DDC.

Narrowband amplitude and phase calculation in time domain

There are some advantages to using the narrowband approach to perform cross-channel (i.e. coherent) processing. The following equation can be used to perform phase and magnitude calculations in the presence of spurious and noisy signals. Note that for phase-only measurements, the denominator does not need to be computed.

Let $r(t)$ be the reference channel and $x(t)$ be the signal on one of the receive channels, both functions of time (t). The test signal is positioned away from spurs and does not have to be at the center of the IF.

Let $X = [x_0 \ x_1 \ x_2 \ \dots \ x_{n-1}]$ be N complex samples of $x(t)$
 Let $R = [r_0 \ r_1 \ r_2 \ \dots \ r_{n-1}]$ be N complex samples of $r(t)$

In matrix form, the complex number that can be converted to amplitude and phase is:

$$G1 = \frac{XR'}{RR'}$$

where R' is the conjugate transpose of R . In summation form the computation is:

$$G1 = \frac{\sum_{n=0}^{N-1} x(nT) * r(nT)^*}{\sum_{n=0}^{N-1} r(nT) * r(nT)^*}$$

This calculation is unbiased, as the expected value of the noise and off-frequency spurious is zero.

Use $N=1$ when the DDC bandwidth provides sufficient isolation from system spurs and integrated noise power. Use $N > 1$, i.e. 10 or 100 samples, to reduce the phase variance due to noise and spurious.

Wideband amplitude and phase calculation in frequency domain

The following wideband method can be used to calculate a cross-channel frequency response based on DUT transfer function $H(f)$. Once the input and output spectrums are computed (S_x and S_y - i.e. channel 1 and 2), it is a matter then of finding the ratio of the cross-spectrum and auto-spectrum (G_{yx} and G_{xx} respectively) to determine the cross-channel frequency response. The cross-channel frequency response has magnitude and phase values across the range of spectrum common between the two channels (Figure 15).

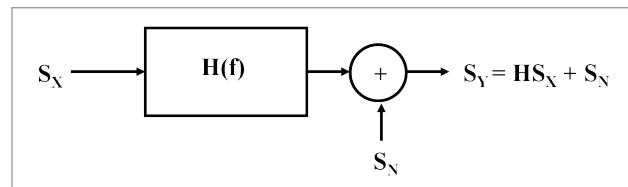

Figure 15. Measuring wideband amplitude and phase in frequency domain.

$$S_x(f) = \int_{-\infty}^{\infty} x(t) e^{-j \cdot 2 \cdot \pi \cdot f \cdot t} dt$$

~~$$H_{est} = \overline{S_y / S_x}$$~~

$$H_{est} = \overline{G_{yx}} / \overline{G_{xx}}$$

$$G_{yx} = S_y S_x^*$$

$$G_{xx} = S_x S_x^*$$

where,

- = average operation
- * = conjugate operation

$x(t)$ is a broadband signal with energy at all frequencies of interest (noise, chirp, etc.),

S_x is the vector input spectrum of $x(t)$ computed as the FFT of $x(t)$,

S_y is the vector output spectrum, and

S_n is noise.

Comparing wideband and narrowband response methods

The familiar narrowband approach is useful for traditional network analysis of classic RADAR narrow-band signals. The tones used in narrowband signals have a 0 dB peak/average, and all of the power source is focused at a single frequency. Therefore, the dynamic range is typically better than in the wideband approach, however, the reduced bandwidths may have long settling times that slow measurements and degrade accuracy.

Contrarily, wideband signals can be almost anything provided there is energy at the frequencies of interest and may even be generated by the DUT. Chirps can be used to achieve 0 dB peak/average with a lower spectral power density than a tone. Moreover, since wideband signals are closer to real DUT signals, they provide more realistic measurements in the presence of nonlinearities. For example, pulse shaping, if present, does not need to be gated. Narrow reduced bandwidth wideband measurements may be faster since all frequencies are captured in parallel. However, there are many other variables that also need to be considered such as data transfer time and the number of averages performed.

Configuring a Test System

A test system configuration to measure the relative phase and amplitude of radiating elements (or antennas) in a phased array includes various signal conditioning elements, a downconversion component, and a digitizer (Figure 16).

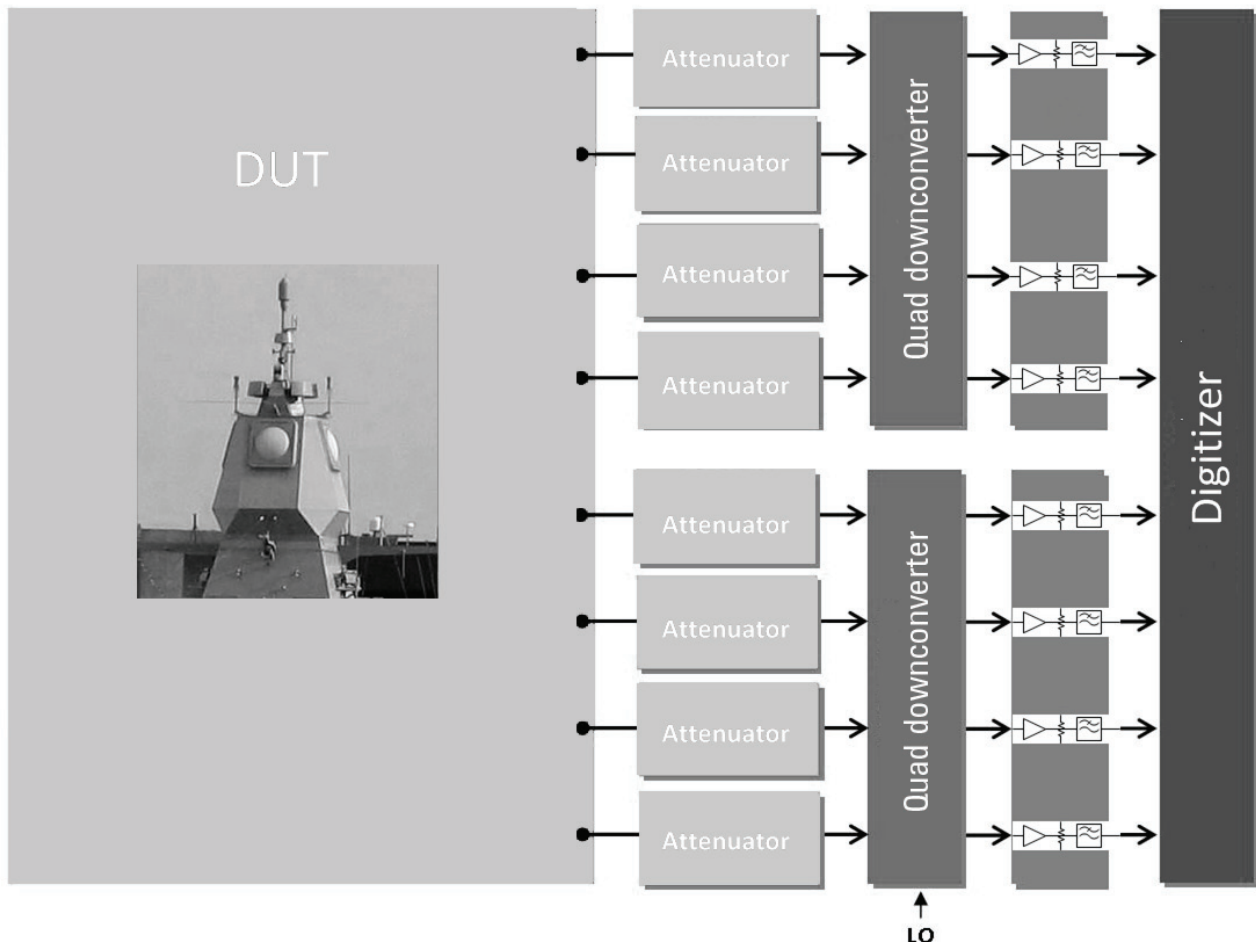

Figure 16. Test system configuration to perform multi-antenna array measurements.

Requirements for the RF signal chain

The signal path flows from left to right, originating with the DUT (antenna array) and then through several stages of signal conditioning and downconversion depending on the application (Figure 17). The goal is to translate the RF/ μ W signal from the antenna elements down to an intermediate frequency (IF) that is within the bandwidth range of the digitizer. Furthermore, to maximize the dynamic range of the digitizer, it is typical to amplify/attenuate the signal to a level that falls close to the full-scale range of the digitizer. In some cases a low-pass filter is also required for image protection.

Cable losses along the signal path vary depending upon the frequency. The overall cascaded noise figure can be determined by the following equation:

$$F_{\text{sys}} = F_1 + \frac{F_2 - 1}{G_1} + \frac{F_3 - 1}{G_1 G_2} + \dots + \frac{F_n - 1}{G_1 G_2 \dots G_{n-1}}$$

By calculating the system noise figure, it is possible to understand the SNR and absolute power level available at the digitizer input.

Digitizer requirements

The digitizer is the back-end of the signal measurement chain. When testing a phased array antenna configuration, it is often desirable to test multiple pairs of elements in parallel to accelerate test speeds. Therefore, a multi-channel digitizer with phase coherent inputs (< 1 degree phase difference) is required. In a phased array antenna with hundreds or thousands of elements, where it is necessary to characterize each element in a relative way to the others, the ability to accelerate the test by using multiple input channels is a significant benefit. As technology evolves and antenna configurations continue to have higher and higher densities, a scalable platform that can accommodate additional channels in the future becomes equally important.

In addition, a digitizer with sufficient 3 dB analog bandwidth is also necessary for characterizing signals across the different possible functions in the phased array. Modern active electronically scanned array (AESA) antennas do not only transmit and receive continuous wave (CW) tones, but also often have signals of bandwidth as in the case of communications or different types of modulation. For example, there are several radar configurations that use pulsed RF or Barker codes, or other forms of modulation, that increase the amount of bandwidth that is used. Therefore, a digitizer that has enough bandwidth to encompass a variety of high bandwidth test conditions is also required.

Furthermore, a digitizer with a built-in DDC is needed to maximize the sensitivity for the bandwidth that is actually required. A DDC implemented in a field programmable gate array (FPGA) is ideal, since it can be programmed on the fly to adjust for narrowband or wideband conditions using the same hardware. The FPGA-based DDC also performs on-board data processing, so that the only samples stored into the digitizer's acquisition memory are the decimated I&Q pairs that represent the reduced bandwidth complex signal. As a result, use of the digitizer's memory is much more efficient and the workload for post acquisition analysis in the software is reduced.

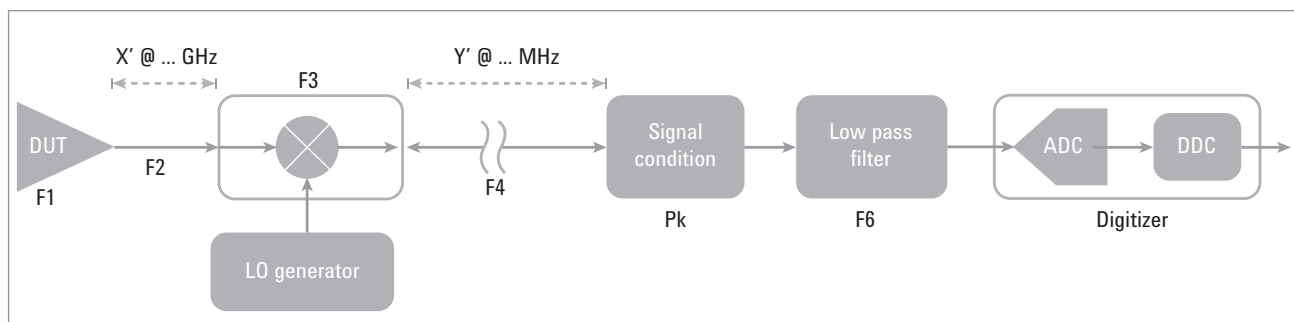

Figure 17. Signal path analysis.

Measuring digitizer channel-to-channel phase coherence

There are two possible methods of measuring digitizer channel-to-channel phase coherence and determining the actual phase performance of the digitizer. The methods are:

Sine-fit

This method is mathematically based on IEEE basic test methods and is only really relevant if the test signal coming from the signal generator is a CW tone. The Sine-fit method involves mathematically creating a sine wave that has a least error squared match by performing a match test as it goes through a loop to build a mathematical representation of the sine wave fit to the digitized points. Once the mathematically fit sine wave has been generated, the phase is known and the channel-to-channel phase can be measured using the mathematically created pure sine waves. However, this is relatively slow compared to DDC, since multiple point waveforms have to be created mathematically and then measurements in the time domain have to be performed.

DDC

This method involves a software DDC without decimation used to characterize the digitizing system. Complex samples are obtained and the complex conjugate ratio method is used to cancel common mode phase modulation. Therefore anything common in terms of phase relationship between two channels is cancelled out and phase measurements between channels can be performed.

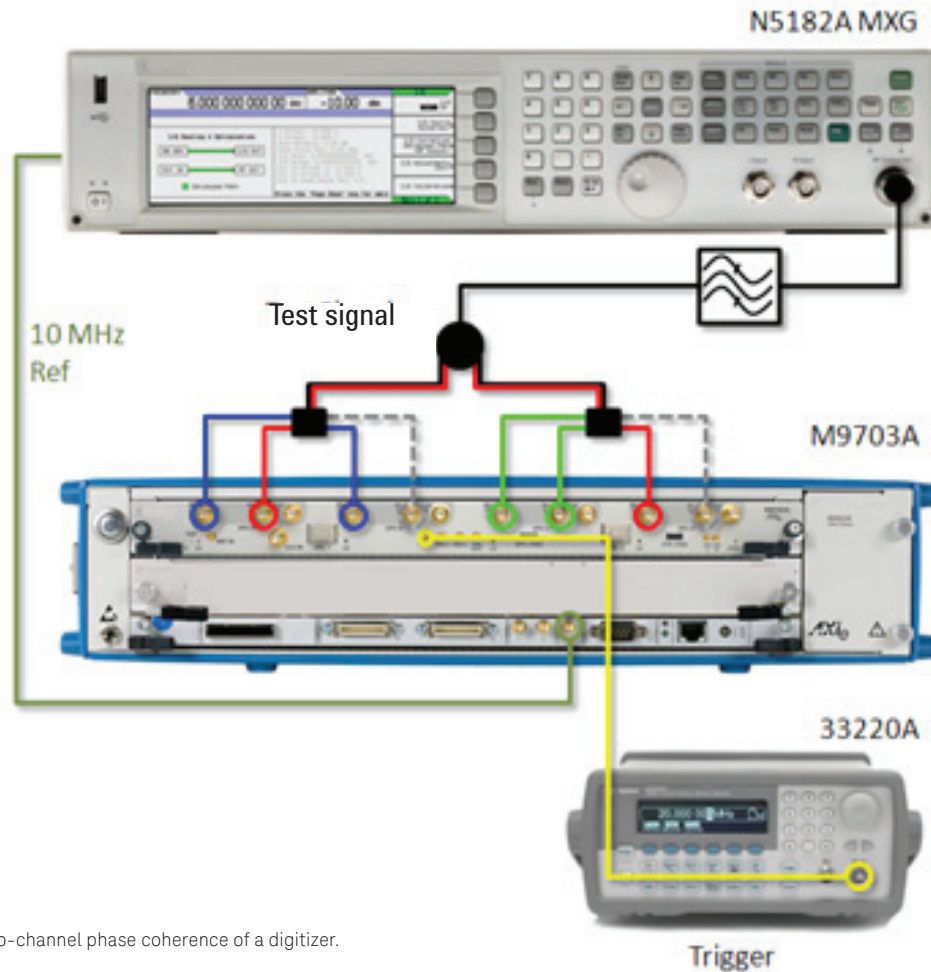

Figure 18. Verify channel-to-channel phase coherence of a digitizer.

Sample measurements

The following table summarizes sample measurements taken at various input power levels from a test setup (Figure 18) to verify the channel-to-channel phase coherence of Keysight's M9703A digitizer.

Input power (dBm)	Sinefit method skew variance (sec ²)			DDC method skew variance (sec ²)		
	Ch1Ch3	Ch2Ch7	Ch5Ch6	Ch1Ch3	Ch2Ch7	Ch5Ch6
6.5	4.81E-26	2.02E-24	2.10E-27	5.49E-26	1.97E-24	1.30E-27
-3.5	1.17E-27	9.54E-26	3.25E-26	7.07E-28	9.90E-26	2.53E-26
-13.5	4.15E-27	1.26E-25	3.31E-26	5.81E-27	8.64E-26	1.75E-24
-23.5	1.61E-26	1.09E-25	6.65E-26	7.21E-26	7.23E-26	5.51E-26
-33.5	3.41E-26	1.16E-25	1.07E-25	2.74E-24	6.38E-25	1.42E-24
-43.5	1.79E-25	1.05E-24	1.93E-24	2.67E-24	6.75E-24	6.46E-24
-53.5	1.30E-23	6.16E-24	6.80E-25	4.44E-23	5.43E-23	4.65E-23

Table 1: Sample measurements of sine-fit and DDC methods to verify channel-to-channel phase coherence.

The M9703A has 1V/2V fixed full-scale range, however 1V was used to perform the above measurements. As expected, the variance is not as good when less of the total dynamic range of the digitizer is used (Figure 19).

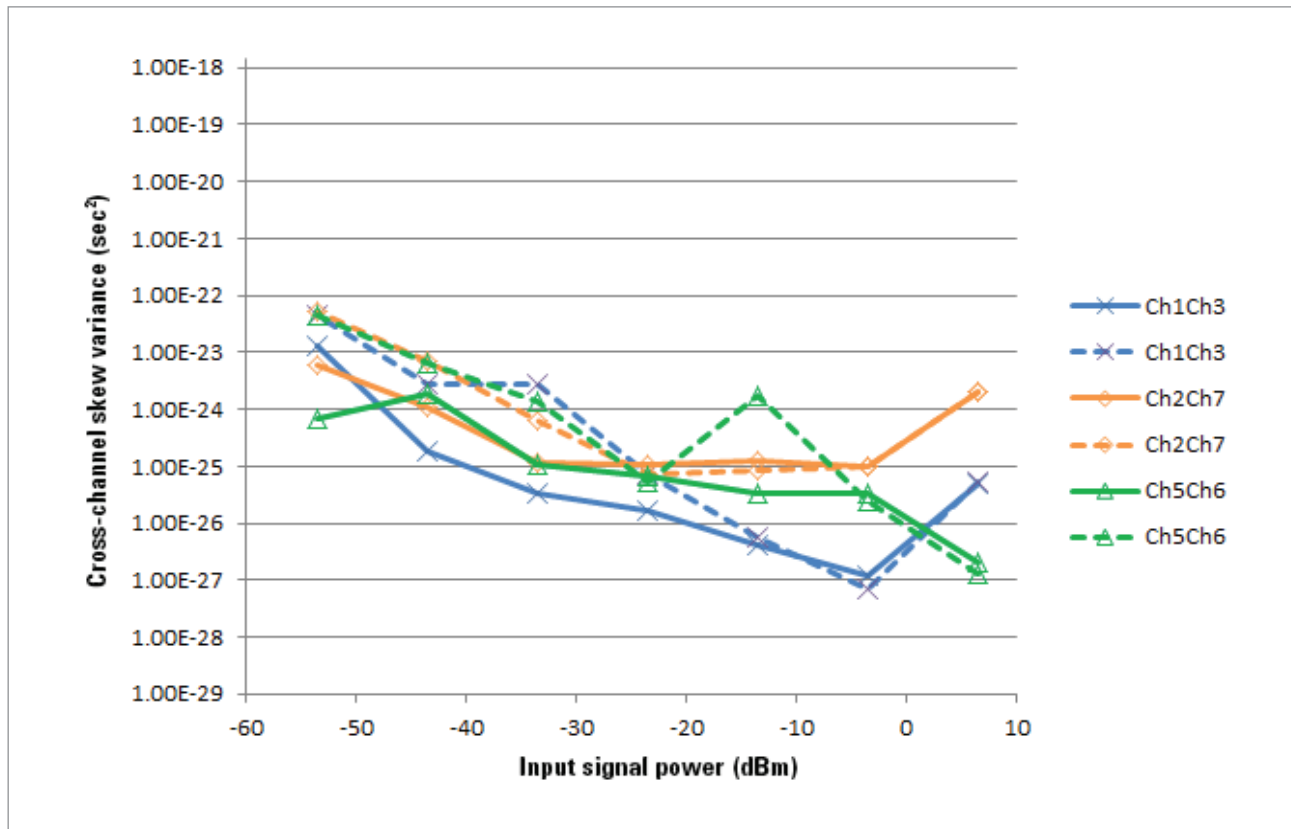

Figure 19. Plot of cross-channel skew variance vs. input signal power.

System level calibration

There is unfortunately no perfect ‘one size fits all’ solution for calibration. The following are some questions that should be considered when determining a system level calibration plan:

- What accuracy is required?
- What is the IF center frequency and IF bandwidth?
- Is a DDC being used?
- How many digitizers are being used?
- What is the software environment?
- Is there data on the complex frequency response for all signal path blocks out to the calibration reference plane?

It is also important to understand what facilities may already be included in the software you chose to use as far as calibration data. We’ll look at Keysight’s 89600 VSA software in a moment (although in some cases there are benefits of doing the raw complex ratio calculations inside other software routines that also are involved with stepping the DUT through the test plan for accelerating measurements).

IF magnitude and phase calibration with channel matching

An IF magnitude and phase calibration, with compensation for individual channel matching, is often required for applications where cross channel ratios include errors from mismatched channel responses. Ideally the calibration includes the complete measurement chain, including the full signal path to the DUT, as the calibration reference plane. This could be a challenge if the complete complex response for the signal path is unknown. In some cases, the measurement requirement involves less than one degree of phase coherence (i.e. approx. 1mm of coax cable at 500 MHz equates to 1 degree electrical length), so the impact to the overall accuracy of the frequency and magnitude response could be significant.

When using a wide-band source such as a step generator or comb generator, the entire response across the digitizer’s bandwidth can be characterized in a single acquisition (Figure 20). These sources are preferred to traditional swept-sine calibration methods since both phase and magnitude responses are measurable. When sweeping frequencies with the swept-sine method, the phase relationship is not maintained, and therefore an accurate phase calibration across frequencies cannot be achieved.

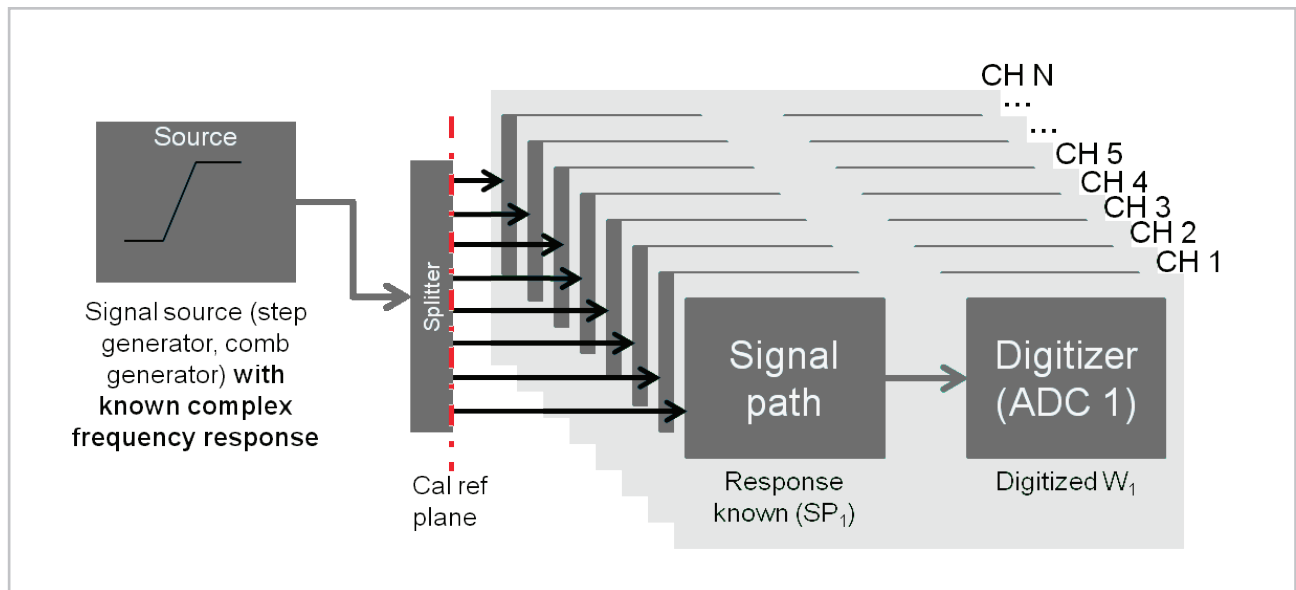

Figure 20. IF magnitude and phase calibration with channel matching block diagram.

The digitizer response can be determined by the following equation:

$$\text{Digitizer response}_1 = W_1 / (\text{Source} * SP_1)$$

It is also necessary to account for the impact of the splitter on the channel-to-channel phase. This can be done, for example, by using a differential 2-step calibration which involves creating a calibration signal, with approximately the same frequency as expected from the DUT, and splitting it using an RF splitter to drive two channels of the measurement system. By measuring the phase in both possible channel connection orientations to the measurement system (i.e. ch1-ch2 and ch2-ch1), it is possible to determine the fixed phase offset between channels in the measurement system. For instance, if the ch1-ch2 phase measurement produced a result of 6 degrees and the ch2-ch1 phase measurement resulted in 8 degrees, it is then reasonable to conclude that there is a 7 degree fixed offset in the measurement system and the other 1 degree error is generated from the calibration source or calibration fixturing (i.e. cables and/or splitter).

The following is an example of a system level calibration using both magnitude and phase response. The magnitude response was created using a tone swept across DC to 500 MHz and sampled by the digitizer. A FIR filter was designed to compensate for the non-flat response in MATLAB (Figure 21).

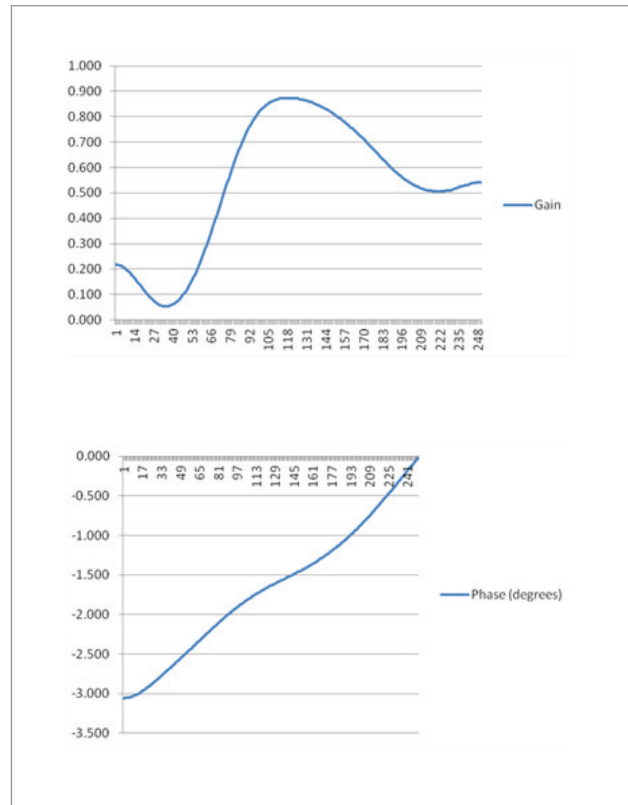

Figure 21. Magnitude and phase response for a single digitizer channel.

A calibration table, including a correction for both phase and magnitude was created in a file that is compatible with the IF filter user calibration in Keysight's 89600 VSA software (Figure 22).

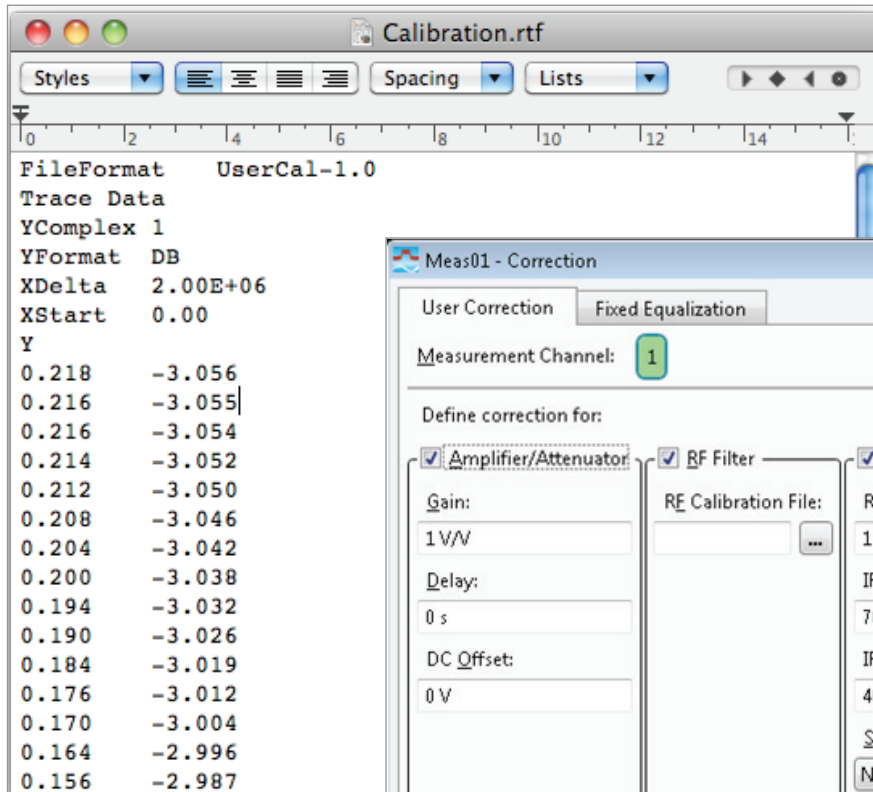

Figure 22. Phase and magnitude calibration table file.

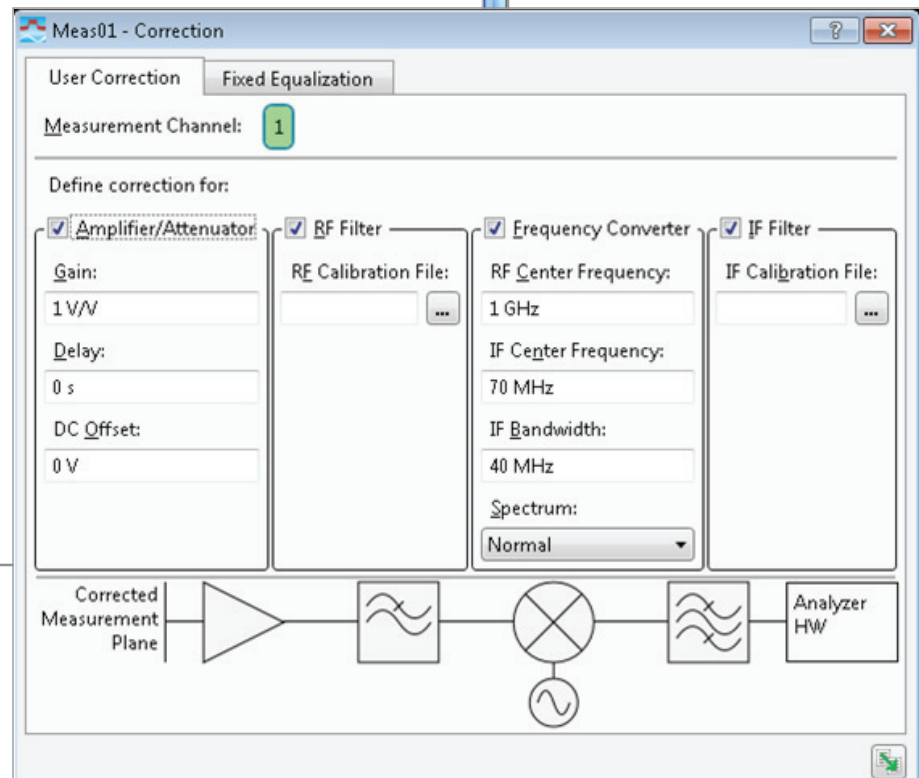

Figure 23. System level calibration example using Keysight's 89600 VSA software.

This file was then loaded into Keysight's 89600 VSA software to correct for the raw frequency response of the digitizer (Figure 23).

The 89600 VSA software provides flexible correction for most typical RF signal path topologies used with a digitizer. In addition to compensating for errors in the digitizer response, the 89600 VSA software also allows for the compensation of various errors due to signal conditioning and frequency translation of elements in front of the digitizer. However, the complex frequency response must already be known or measurable for the particular calibration method described above to be used.

Selecting the digitizer solution

As previously described, a digitizer with the unique combination of multiple phase coherent input channels, sufficient 3dB bandwidth, and a DDC is required to successfully perform relative phase and amplitude measurements in a multi-antenna array.

Keysight's M9703A digitizer (Figure 24) with DDC meets all of these requirements.



Figure 24. Keysight M9703A multi-channel digitizer.

The main features of the M9703A high-speed AXIe digitizer include:

- 12 bit resolution
- 8 channels @ 1.6 GS/s
- Interleaving option to have 4 channels @ 3.2 GS/s
- DC to 2 GHz analog 3 dB bandwidth
- Optional real-time digital downconversion (DDC) on 8 phase-coherent channels
- Up to 256 MS/channel memory and segmented acquisition
- 650 MB/s data transfer
- Scalable to 40 channels with the AXIe chassis (Figure 25)
- Keysight 89600 VSA software support



Figure 25. AXIe chassis with 5 Keysight M9703A multi-channel digitizers.

M9703A digitizer with DDC

The M9703A high-speed digitizer is the industry's first 12-bit digitizer that combines 8 synchronous acquisition channels for wider signal capture with the best accuracy to significantly reduce testing times.

ENOB	48 MHz	8.7 (typical)
	100 MHz	8.8 (typical)
	410 MHz	8.2 (8.8, typical)
SFDR	48 MHz	58 dBc (typical)
	100 MHz	60 dBc (typical)
	410 MHz	52 dBc (60 dBc, typical)
Time skew (proportional to phase offset)	Max ch-ch skew	± 50 ps (nominal)
	Ch-ch skew variance	± 100 fs (nominal)

Table 2: Key performance characteristics of the M9703A.

M9703A DDC

The M9703A DDC is very flexible and has the available analysis bandwidth and decimation options to create the required I&Q samples (Figure 26). The DDC allows the tuning and zooming of the analyzed signal, improves the dynamic range, reduces the noise floor, and extends the capture time for accelerated measurements.

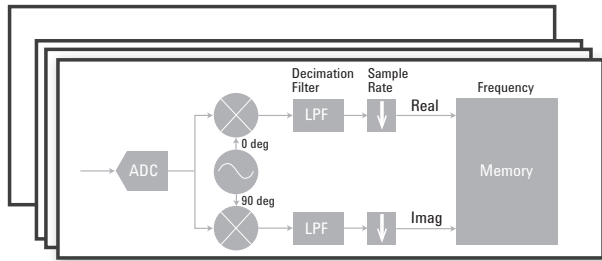

Sample rate	Analysis bandwidth
1.6 GS/s	1 GHz
400 Ms/s	300 MHz
200 Ms/s	160 MHz
100 Ms/s	80 MHz
50 Ms/s	40 MHz
50/2 ^N Ms/s	40/2 ^N MHz

Figure 26. Keysight M9703A DDC with decimation options.

There are two DDCs implemented in each of the 4 on-board FPGAs of the M9703A, for a total of 8 DDCs or 1 per channel (Figure 27).

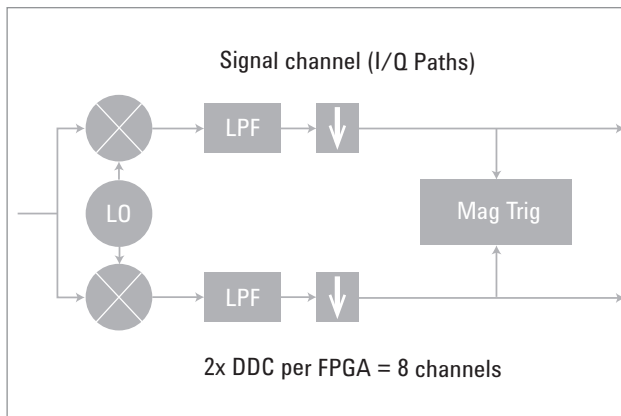
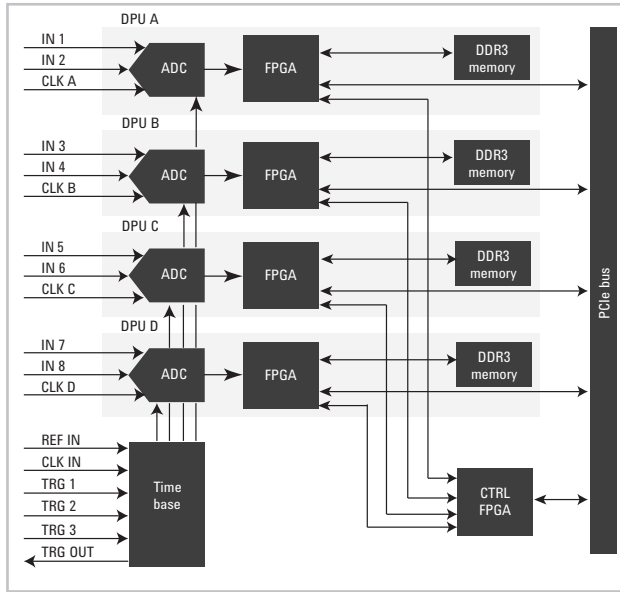

Figure 27. M9703A digital processing data flow.

M9703A segmented memory mode

Segmented memory optimizes capture time by dividing the digitizer's available acquisition memory into smaller segments (Figure 28). Samples are stored only during the segment time surrounding each trigger.

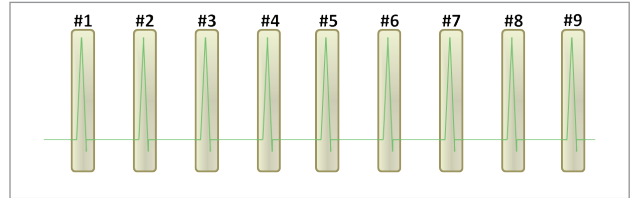

Figure 28. Segmented memory acquisition.

If there is a significant time between trigger events where there is no signal, as in the case of low pulse repetition frequency (PRF) or long pulse repetition interval (PRI) in radar, then segmented memory can provide significant savings as far as the memory required to digitize a pulse train by avoiding digitizing in the off-time when nothing is transmitted (Figure 29). Since there are fewer samples per duration of time, longer duration acquisitions are possible given a certain amount of limited digitizer acquisition memory. The post-processing of such waveform data is also faster.

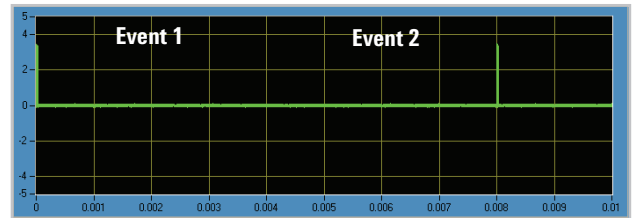

Figure 29. Low duty cycle digital signal.

For digitizers such as the M9703A that offer a segmented memory mode feature, it is typically more efficient for a digitizer to move the memory pointer to the next segment in memory rather than transfer the acquisition to the controller and then prepare to re-write over the previous acquisition (Figure 30).

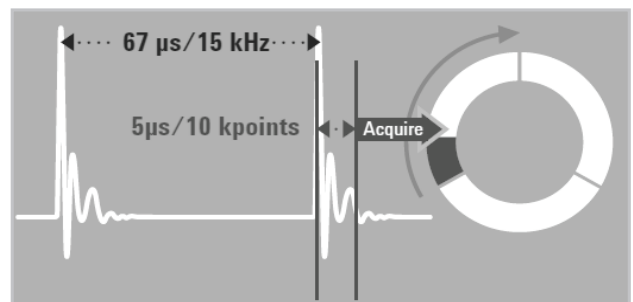

Figure 30. Circular acquisition buffer for segmented memory.

Measurement example

The following is a measurement example showing how to determine the phase and magnitude variance of a broadband test system.

Measurement setup

An arbitrary waveform generator (AWG) is used to mimic the LO output by creating a phased modulated (constant frequency) signal that passes through an 8-way splitter to drive the inputs to the digitizer. In this example, the digitizer is configured as a multi-channel broadband tuned receiver (Figure 31).

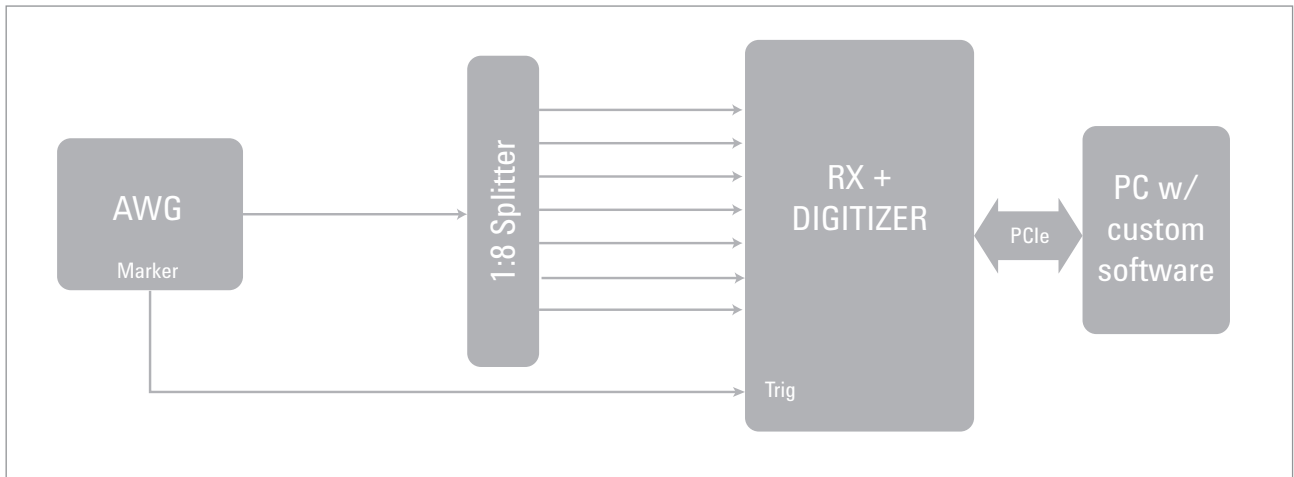

Figure 31. Broadband demo setup: These signals have bandwidth. Therefore, we can compute FRF at multiple frequencies.

Narrowband vs. wideband

It is easier in the broadband approach to determine single channel phase response since there are multiple frequencies at which the phase can be measured. The shift in phase which is linear relative to the frequency difference is due to delay. The remaining offset from DC is due to the phase response of the channel itself.

The digitizer solution with a flexible DDC is capable of providing both the narrowband and broadband/wideband measurement approaches with the same hardware. Only a few changes to settings are required and different analysis algorithms used.

The hardware

The following figure illustrates the hardware configuration of the broadband test system (Figure 32). The single-ended output from Keysight's M8190 dual-channel AWG is passed through an 8-way splitter to drive the M9703A digitizer. Also depicted is an embedded controller, as well as a system module that performs basic AXIe chassis functionality.

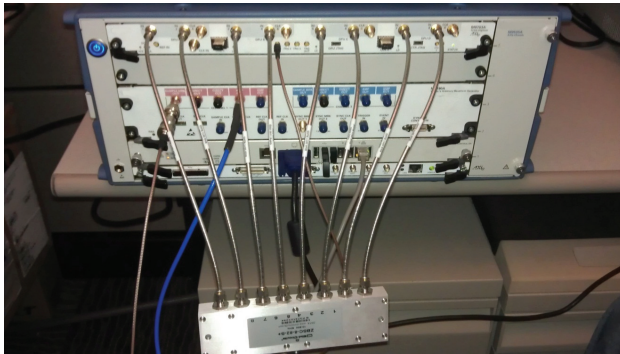

Figure 32. Broadband test system in lab.

The measurement

Using Keysight's 89600 VSA software, it is easy to compute multi-point magnitude and phase frequency response plots (Figure 33). The frequency response plots shown below were produced using an AWG (Keysight M8190A) to generate a wideband (100 MHz) chirp at 200 MHz center frequency with a pulse width of 4 μ sec that was then digitized by the M9703A. Since the 89600 VSA software (versions 15 and higher) has a hardware extension to control an M9703A (a M9703A which also has the optional DDC feature enabled), the 89600 VSA software actually programs and controls the M9703A directly.

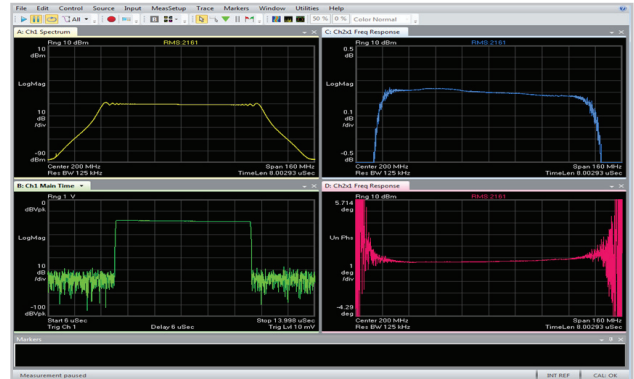

Figure 33. Multi-point phase and magnitude frequency response plots.

In this example, we are considering a broadband scenario. Instead of averaging multiple cross-channel ratio samples over periods of constant phase in order to reduce variance, in the broadband case the samples are averaged over multiple FFTs to reduce variance. Since the M9703A DDC decimates down to the minimum bandwidth required and directly creates I&Q samples, the averaging across FFTs in the 89600 VSA software is much faster than computing averages across multiple FFTs at the full digitizer sampling rate using real samples.

Also, it is worth noting, that while the measurements shown used the 89600 VSA software, the cross-channel algorithms which were presented earlier could be used to program custom software to perform the exact required measurements in an optimized manner for manufacturing test (or other scenarios requiring the fastest measurement cycle times).

Measurement results

It is possible to view multiple plot overlays in the 89600 VSA software (Figure 34). Using the cross-spectrum and coherence functions while enabling averaging, it is possible to achieve significantly higher sensitivity by computing the spectrum across two channels rather than on a single channel (>10 dB lower floor when noise is dominated on the outside edges of the modulation BW). The single-channel spectrums are shown in yellow and red, channels 1 and 2 respectively, while the cross-spectrum between channels 1 and 2 is shown in light blue.

The sensitivity of a resulting cross-spectrum based frequency response measurement improves across the computation of multiple averages since noise which is uncorrelated across channels continues to decrease while the common (correlated) signal in both channels remains constant.

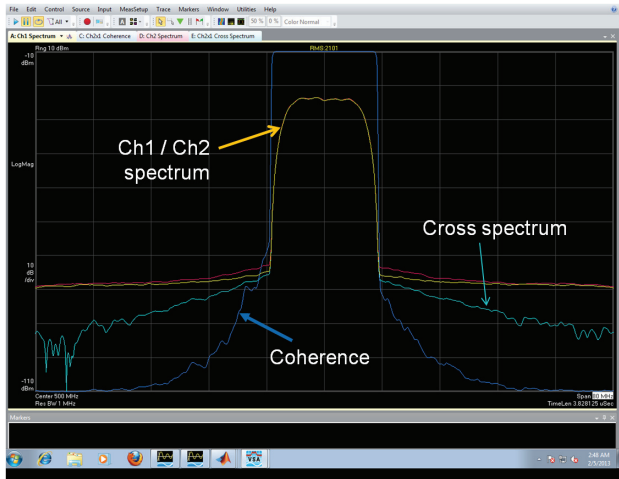

Figure 34. Multiple multi-point phase and magnitude frequency response plots.

The coherence function is also plotted in dark blue. The coherence function provides a visual indication of how well the cross-spectrum signals are correlated (0=no correlation, 1=perfectly correlated). As expected, where the coherence is high, the cross-spectrum and single-channel spectrum overlap.

The use of cross-spectrum techniques with a multi-channel coherent digitizer such as the M9703A is useful for more than producing low variance when measuring relative phase and gain. These measurements provide a valuable tool for investigating a variety of RF design issues with signal cross-coupling or leakage.

Two important elements of the M9703A make it the ideal solution for measuring the coherence of a DUT: measurement throughput (Figure 35) and its excellent channel-to-channel phase coherence. Without the strong coherence between channels, its own channel-to-channel phase and amplitude errors would overpower the small differences between measurements needed to characterize the DUT. Table 4 provides examples of the high-speed measurement throughput possible with the M9703A with DDC and fast backplane data transfers.

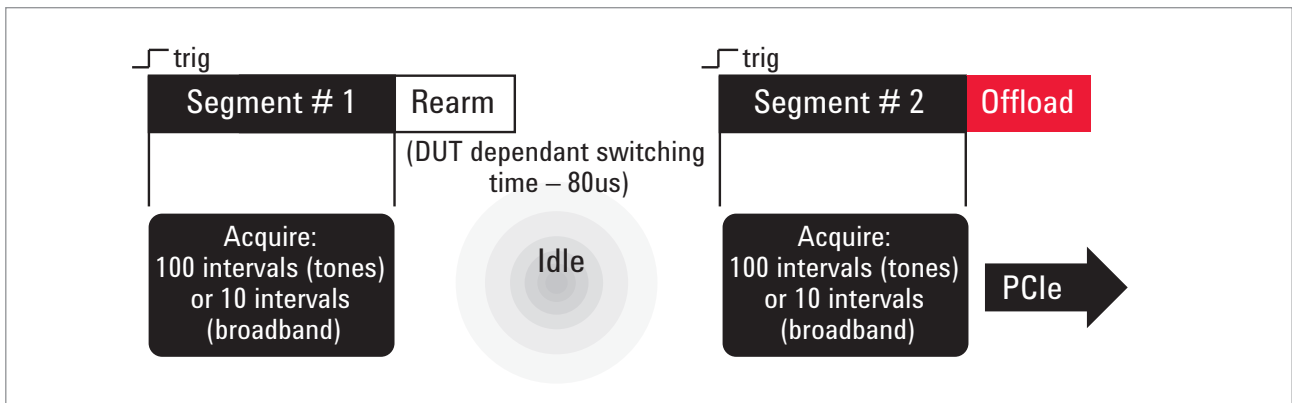

Figure 35. Measurement throughput example of M9703A

Segment	Intervals	Rearm time	DUT time	Acquisition cycle	Time/interval	Speed
500 μ s	100	160 μ s (1.56 MSa/s)	80 μ s	660 μ s	6.6 μ s	152k int/sec/ch or 1.2M meas/sec
500 μ s	100	80 μ s (3.125 Sa/s)	80 μ s	580 μ s	5.8 μ s	172k int/sec/ch or 1.4M meas/sec
500 μ s	10	40 μ sec (6.25 MSa/s)	80 μ s	580 μ s	58 μ s	17.2k int/sec/ch or 138k meas/sec

Table 3. DUT measurement throughput results using M9703A.

Quality of measurement results

Estimating cross channel phase variance

In simplistic terms, variance can be thought of as noise power, and standard deviation as voltage. As with any other signal, noise has a real component and an imaginary component:

$$\text{Complex noise: } N_R + jN_I$$

$$\text{Noise power: } N_R^2 + N_I^2$$

Variance and power are closely related. For small angles, $x \approx \sin(x)$. Some of the noise power goes to changing the angle, and some changes amplitude. For a single channel, the angle variance can be calculated with the following equation:

Single channel angle variance =

$$\left(\frac{180}{\pi}\right)^2 \times \left(\frac{10^{-\frac{SNR}{10}}}{2}\right)$$

For a nominal angle of zero degrees, only the imaginary element of the noise contributes to the angular variance, hence the angular variance in radians is half of the normalized noise variance (Figure 36).

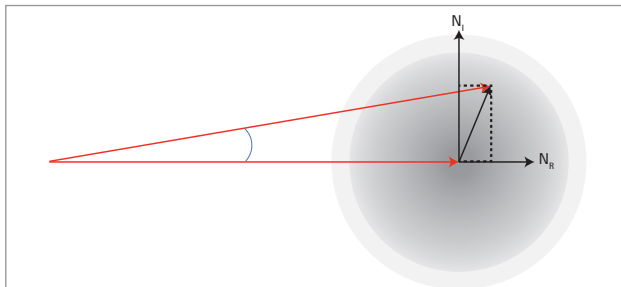

Figure 36. The real and imaginary components of noise vector.

Noise on each channel is uncorrelated so we can simply add the variances to get:

Cross channel angle variance =

$$\left(\frac{180}{\pi}\right)^2 \times \left(\frac{10^{-\frac{SNR_STIM}{10}}}{2} + \frac{10^{-\frac{SNR_RESPONSE}{10}}}{2}\right)$$

Estimating digitizer performance using SNR

Applying the above equation, it is possible to estimate the expected cross-channel variance of a measurement made using the M9703 digitizer (Figure 37).

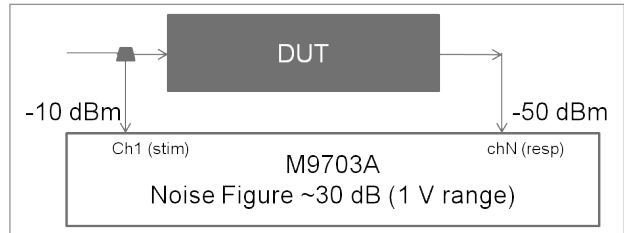

Figure 37. Estimating the digitizer performance of the M9703.

Estimating the M9703A digitizer observed SNR can be performed using the following equation:

$$\text{SNR} = \text{SigLevel} - (\text{Noise density} + 10 \log_{10}(\text{ENBW}))$$

where $\text{ENBW} \equiv 1/T$

Using only the digitizer noise and assuming $T = 100 \mu\text{sec}$,

$$\text{SNR_STIM} = -10 - (-174 + 30 + 10 \log_{10}(1.0/100 \mu\text{sec})) = 94 \text{ dB}$$

$$\text{SNR_RESP} = -50 - (-174 + 30 + 10 \log_{10}(1.0/100 \mu\text{sec})) = 54 \text{ dB}$$

Cross channel angle variance =

$$\left(\frac{180}{\pi}\right)^2 \times \left(\frac{10^{-\frac{SNR_STIM}{10}}}{2} + \frac{10^{-\frac{SNR_RESPONSE}{10}}}{2}\right)$$

Therefore, in the above example, the cross channel angle variance is 6.5 mDeg^2 or equivalently, a standard deviation of 0.08 degrees.

Summary

Using a high-speed digitizer with DDC, such as Keysight's M9703A digitizer, offers an ideal way to characterize the element-to-element phase and magnitude errors of various components in a multi-antenna array and to compensate for them through calibration to ensure optimal operational efficiency.

Keysight's M9703A digitizer with DDC provides the following benefits for multi-antenna array measurements:

1. Multi-channel coherent measurements with less than 1 degree of phase difference.
2. Provides fast, adjustable bandwidth measurements across multiple channels simultaneously, producing complex samples with just enough sampling rate to reduce variance between channels.
3. Sufficient 3 dB bandwidth allows for performance of both narrowband and broadband/wideband measurements with the same hardware.
4. An FPGA-based DDC to focus in on the signal of interest, perform on-board data processing to ensure efficient use of on-board memory, and reduce post acquisition analysis.
5. Integrated 89600 VSA software control with hardware DDC acceleration allows for execution of an abundance of existing, industry standardized, measurements.

For more information visit:

www.keysight.com/find/axie-antennatest

Configuration and Ordering Information

Model	Description
M9703A	AXIe 12-bit Digitizer
Base Configuration Options	
M9703A-SR1 ¹	1 GS/s sampling rate
M9703A-SR2	1.6 GS/s sampling rate
M9703A-INT	Interleaved channel sampling
M9703A-F05 ¹	650 MHz Maximum Analog Bandwidth
M9703A-F10	1 GHz Bandwidth Additional Path
M9703A-M10 ¹	1 GB (64 MS/ch) Acquisition Memory
M9703A-M20	2 GB (128 MS/ch) acquisition memory
M9703A-M40	4 GB (256 MS/ch) acquisition memory
M9703A-DDC	Digital down-converter firmware

myKeysight

myKeysight

www.keysight.com/find/mykeysight

A personalized view into the information most relevant to you.

www.pxisa.org



PCI eXtensions for Instrumentation (PXI) modular instrumentation delivers a rugged, PC-based high-performance measurement and automation system.

Three-Year Warranty

www.keysight.com/find/ThreeYearWarranty

Keysight's commitment to superior product quality and lower total cost of ownership. The only test and measurement company with three-year warranty standard on all instruments, worldwide.



www.keysight.com/go/quality

Keysight Technologies, Inc.

DEKRA Certified ISO 9001:2008

Quality Management System



Keysight Channel Partners

www.keysight.com/find/channelpartners

Get the best of both worlds: Keysight's measurement expertise and product breadth, combined with channel partner convenience.

PICMG and the PICMG logo, CompactPCI and the CompactPCI logo, AdvancedTCA and the AdvancedTCA logo are US registered trademarks of the PCI Industrial Computers Manufacturers Group. "PCIe" and "PCI EXPRESS" are registered trademarks and/or service marks of PCI-SIG.

www.keysight.com/find/axie-antennatest

For more information on Keysight Technologies' products, applications or services, please contact your local Keysight office. The complete list is available at: www.keysight.com/find/contactus

Americas

Canada	(877) 894 4414
Brazil	55 11 3351 7010
Mexico	001 800 254 2440
United States	(800) 829 4444

Asia Pacific

Australia	1 800 629 485
China	800 810 0189
Hong Kong	800 938 693
India	1 800 112 929
Japan	0120 (421) 345
Korea	080 769 0800
Malaysia	1 800 888 848
Singapore	1 800 375 8100
Taiwan	0800 047 866
Other AP Countries	(65) 6375 8100

Europe & Middle East

Austria	0800 001122
Belgium	0800 58580
Finland	0800 523252
France	0805 980333
Germany	0800 6270999
Ireland	1800 832700
Israel	1 809 343051
Italy	800 599100
Luxembourg	+32 800 58580
Netherlands	0800 0233200
Russia	8800 5009286
Spain	0800 000154
Sweden	0200 882255
Switzerland	0800 805353
	Opt. 1 (DE)
	Opt. 2 (FR)
	Opt. 3 (IT)
United Kingdom	0800 0260637

For other unlisted countries:
www.keysight.com/find/contactus
 (BP-07-10-14)