

Keysight Technologies

M9391A PXIe

Vector Signal Analyzer

1 MHz to 3 GHz or 6 GHz

Data Sheet

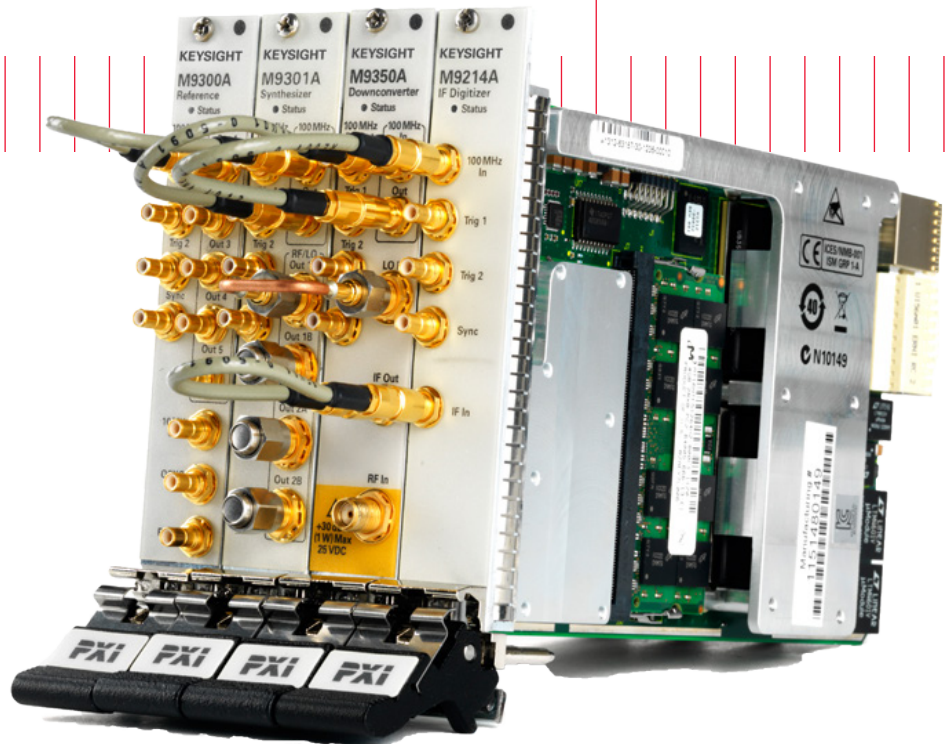

Overview

Be ready for tomorrow - today

RF requirements keep growing while timelines keep shrinking. To help ease the technical and business pressures, the right test solution provides continuity in measurements and longevity in capability. The Keysight Technologies, Inc. M9391A PXIe Vector Signal Analyzer is the next logical step in RF signal analysis.

The M9391A PXI VSA, combined with the M9381A PXIe Vector Signal Generator - the PXI VSA/G - provides a complete solution for fast, high quality measurements optimized for RF manufacturing test environments.

To help you get proven results even faster, Keysight's PXI VSA/G can be used with its X-Series measurement applications for modular instruments, 89600 VSA software, SystemVue, Waveform Creator, and Signal Studio. These software applications enable you to investigate, validate and test your RF communications designs.

From fully modular hardware to software leverage to world-wide support, the PXI VSA/G is the low-risk way to manage change and be ready for tomorrow—today.

Product description

The M9391A PXI VSA is a modular vector signal analyzer for frequencies from 1 MHz to 3 or 6 GHz. A typical PXI VSA configuration includes four individual PXI modules – M9300A frequency reference, M9301A synthesizer, M9350A down-converter and the M9214A digitizer – designed for fast data interfaces and high-speed automated test systems.

The M9391A PXI VSA was designed to work seamlessly with the M9381A PXI VSG, 89600 VSA software, SystemVue and X-Series measurement applications for modular instruments, supporting communications standards such as LTE, W-CDMA, 802.11 WLAN and more.

The PXI VSA can be used in a multi-channel configuration for LTE/LTE-A and WLAN design validation. MIMO transmitter testing is based on Keysight's industry-recognized 89600 VSA/WLA software with full support for PHY-layer measurements including MIMO EVM, cross-channel isolation and channel flatness.

For more information on product configurations for the M9391A PXI VSA, see the M9381A & M9391A Configuration Guide, literature number 5991-0897EN. For more information on the M9381A PXI VSG, see the M9381A Data Sheet, literature number 5991-0279EN.

Applications

- Power amplifier and front-end-module design validation and manufacturing
- Radio transceiver design validation and production test
- MIMO & multi-channel device test

Reference solutions

Application specific reference solutions, a combination of recommended hardware, software, and measurement expertise, provide the essential components of a test system. The following reference solutions include the M9391A PXI VSA as a hardware component.

- RF PA/FEM characterization and test, Reference Solution for the industry's fastest envelope tracking test, rapid waveform download, tight synchronization, automated calibration and digital pre-distortion. For more information, see www.keysight.com/find/solution-padvt
- LTE/LTE-A multi-channel test, Reference Solution for faster insight into carrier aggregation and spatial multiplexing designs. For more information, see www.keysight.com/find/solution-LTE

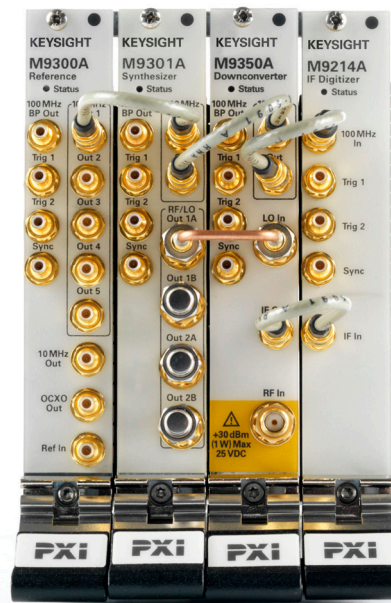

Figure 1. M9391A PXIe vector signal analyzer with four modules consisting of the M9300A frequency reference, M9301A synthesizer, the M9350A downconverter and the M9214A digitizer.

Overview

Accelerate RF test speed

The M9391A PXI VSA offers raw hardware speed and delivers proven results—faster through the following technology innovations.

- A unique embedded power measurement mode reduces test times by enabling power servos to converge faster with outstanding linearity.
- Rapid frequency and amplitude switching with fast baseband adjustments.
- Real-time hardware resampling pinpoints answers faster with extremely fast modulation analysis.
- X-Series measurement applications for modular instruments include a unique resource manager, which lets you quickly switch between raw commands and standard-based measurements.

Easily extend system capability

The M9391A PXI VSA was developed with system capability extensions in mind. Many of its options, such as memory, frequency range or analysis bandwidth can be easily upgraded through license keys.

The M9391A PXI VSA can also be configured with one or more PXI VSA's or M9381A PXI VSGs. A wide range of instrument drivers are available to support your development environment of choice. This enables you to programmatically extend the capability of your system.

Achieve confidence and continuity in measurements

The M9391A extends Keysight's expertise in metrology to the modular form factor. It provides the same quality results you have come to expect in our signal analyzers. Here are a few examples of ways that we continue to provide measurement quality and continuity.

- Better than ± 0.46 dB typical absolute amplitude accuracy.
- RF analysis bandwidth up to 160 MHz with ± 0.17 dB IF channel flatness.
- ISO 17025 traceable calibration and Z540.3 compliance is supported by 17 accredited RF parameters. Innovative eCalibration certificates reside inside each module.
- Achieve proven results with X-Series measurement applications for modular instruments and 89600 VSA/WLA software support.
- Reduce design cycle times by tightening the linkage between design simulation and test with SystemVue.

Worldwide support and services and standard 3 year warranty

Keysight performs its own calibrations at each of its 35 service centers worldwide. And we take pride in our product quality, as evidenced by our standard 3 year warranty.

The standard product repair time averages less than 14 days. You have the option to upgrade to our express warranty - the fastest repair service in the industry, with a 5 day typical turnaround time.



Figure 2. X-series measurement applications - the same applications developed for X-Series benchtop signal analyzers can be used with the M9391A PXIe Vector Signal Analyzer as well as the M9393A PXIe Performance Vector Signal Analyzer.

Technical Specifications and Characteristics

Definitions for specifications

Temperatures referred to in this document are defined as follows:

- Full temperature range = Individual module temperature of 25 to 75 °C, as reported by the module, and environment temperature of 0 to 55 °C.
- Controlled temperature range = Individual module temperature of 40 to 51 °C, as reported by the module, and environment temperature of 20 to 30 °C.

Specifications describe the warranted performance of calibrated instruments. Data represented in this document are specifications unless otherwise noted under the following conditions.

- Calibrated instruments have been stored for a minimum of 2 hours within the full temperature range
- 45 minute warm-up time
- Calibration cycle maintained
- When used with Keysight M9300A frequency reference and Keysight interconnect cables

Characteristics describe product performance that is useful in the application of the product, but that is not covered by the product warranty. Characteristics are often referred to as Typical or Nominal values and are italicized.

- ***Typical*** describes characteristic performance, which 80% of instruments will meet when operated within the controlled temperature range.
- ***Nominal*** describes representative performance that is useful in the application of the product when operated within the controlled temperature range.

Recommended best practices in use

- Use slot blockers and EMC filler panels in empty module slots to ensure proper operating temperatures. Keysight chassis and slot blockers optimize module temperature performance and reliability of test.
- At environment temperatures above 45 °C, chassis fan should be set to high.

Conversion type definitions

Conversion types	Frequency range
Auto	1 MHz to 3 or 6 GHz
Image protect	1 MHz to 3 or 6 GHz
Single high	400 MHz to 3 or 6 GHz
Single low	1.1 GHz to 3 or 6 GHz

Additional information

- Mixer level offset modifies the receiver gain prior to the first mixer of the receiver. A negative setting improves distortion (i.e., TOI) at the cost of noise performance (i.e., DANL). A positive setting improves noise performance at the cost of distortion.
- Total absolute amplitude accuracy is the total of all amplitude measurement errors. This specification includes the sum of the following individual specifications: linearity, expected input level switching uncertainty, IF bandwidth filter switching uncertainty, absolute amplitude accuracy. The wide range of settings used (i.e., expected input level, etc.) are tested independently. The individual error contributions are calculated as follows: a 99.8 % proportion and 95% confidence are computed for each parameter on a statistically significant number of instruments. The root-sum-square (RSS) of these four independent Gaussian parameters is then taken. To that RSS value, two environmental effects and measurement uncertainty are added. One environmental effect is that of temperature (full and controlled temperature range, as defined above) and the other is the temperature variation of ± 3 degrees around a field alignment.

Technical Specifications and Characteristics

Additional information (cont'd)

- All graphs contain measured data from one unit and is representative of product performance within the controlled temperature range unless otherwise noted.
- The specifications contained in this document are subject to change.

Block diagram

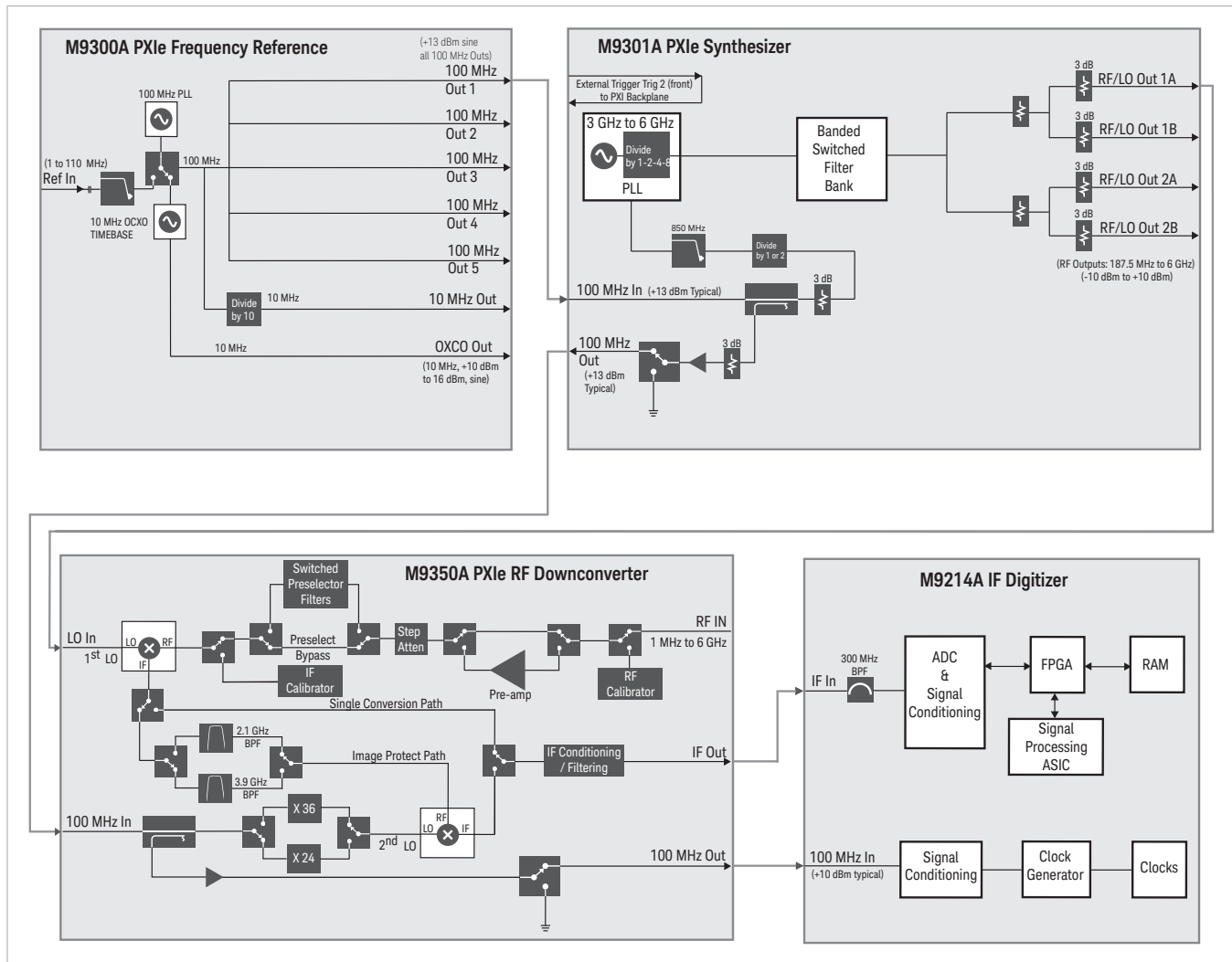

Figure 3. M9391A PXIe vector signal analyzer block diagram with four modules consisting of the M9301A synthesizer, M9350A downconverter, M9214A digitizer and the optional M9300A frequency reference.

Technical Specifications and Characteristics

Frequency

Frequency range and resolution					
Option F03	1 MHz to 3 GHz				
Option F06	1 MHz to 6 GHz				
Tuning resolution	0.001 Hz				
IF frequency	Nominal				
15 MHz filter	326 MHz				
40 MHz filter	240 MHz				
160 MHz filter	300 MHz				
Analysis bandwidth ¹					
Maximum bandwidth	Option B04 40 MHz				
	Option B10 100 MHz				
	Option B16 160 MHz				
Frequency switching speed ^{2,3}					
List mode switching speed ⁴	Conversion type	Sample rate	Acquisition bandwidth	Standard, nominal	Option UNZ, nominal
Baseband frequency offset change ⁵	All	≤ 100 MHz	≤ 80 MHz	5 ms	27 μs
		> 100 MHz to < 180 MHz	> 80 MHz to < 144 MHz	5 ms	102 μs
		≥ 180 MHz	≥ 144 MHz	5 ms	15 μs
Arbitrary frequency change	All			5 ms	320 μs
Non-list mode switching speed ⁶	Conversion type			Standard, nominal	Option UNZ, nominal
Baseband frequency offset change ⁵	All			5 ms	310 μs
Arbitrary frequency change	All			5 ms	2.3 ms

1. Instantaneous bandwidth (1 dB bandwidth) available around a center frequency over which the input signal can be digitized for further analysis or processing in the time, frequency or modulation domain.
2. When used with the M9018A PXIe chassis (2-link configuration: 1 x 8 [factory default]) and M9036A PXIe embedded controller.
3. Settled to within 1 kHz or 1 ppm, whichever is greater of final value. Does not include data acquisition or processing time. Amplitude settled to within 0.1 dB. Channel filter set to none.
4. Time from trigger input to frequency and amplitude settled. Minimum IQ sample rate ≥ 6 MHz. Minimum spectrum acquisition ≥ 4.8 MHz. Minimum power acquisition channel filter bandwidth ≥ 4.8 MHz. For lists with first point < 400 MHz or for frequency changes from > 400 MHz to < 400 MHz, add 40 ms.
5. Baseband offset can be adjusted ± from carrier frequency within limits determined by RF analysis bandwidth and IF filter bandwidth. Synthesizer frequency and amplitude are not changing. Baseband offset settled to within 1 kHz.
6. Mean time from IVI command to carrier frequency settled to within 1 kHz or 1 ppm, whichever is greater. Amplitude settled within 0.1 dB. Simultaneous carrier frequency and amplitude switching. For frequency changes from > 400 MHz to < 400 MHz, add 40 ms.

Technical Specifications and Characteristics

Frequency (cont'd)

Frequency reference (M9300A PXIe frequency reference module)		
Reference outputs		
100 MHz Out (Out 1 through Out 5)		
Amplitude	≥ 10 dBm	13 dBm, typical
Connectors	5 SMB snap-on	
Impedance	50 Ω , nominal	
10 MHz Out		
Amplitude	9.5 dBm, nominal	
Connectors	1 SMB snap-on	
Impedance	50 Ω , nominal	
OCXO Out		
Amplitude	11.5 dBm, nominal	
Connectors	1 SMB snap-on	
Impedance	50 Ω , nominal	
Frequency accuracy		
Same as accuracy of internal time base or external reference input		
Internal timebase		
Accuracy	\pm [(time since last adjustment x aging rate) \pm temperature effects \pm calibration accuracy]	
Frequency stability		
Aging rate		
Daily	$< \pm 0.5$ ppb/day, after 72 hours of warm-up	
Yearly	$< \pm 0.1$ ppm/year, after 72 hours of warm-up	
Total 10 years	$< \pm 0.6$ ppm/10yrs, after 72 hours of warm-up	
Achievable initial calibration accuracy (at time of shipment)	$\pm 5 \times 10^{-8}$	
Temperature effects		
20 to 30 °C	$< \pm 10$ ppb	
Full temperature range	$< \pm 50$ ppb	
Warm up		
5 minutes over +20 to +30 °C, with respect to 1 hour	$< \pm 0.1$ ppm	
15 minutes over +20 to +30 °C, with respect to 1 hour	$< \pm 0.01$ ppm	
External reference input		
Frequency	1 to 110 MHz, sine wave	
Lock range	± 1 ppm, nominal	
Amplitude	0 to 10 dBm, nominal	
Connector	1 SMB snap-on	
Impedance	50 Ω , nominal	

Technical Specifications and Characteristics

Amplitude

Input level						
Max safe average total power		+30 dBm (1 W)				
Max DC voltage		25 Vdc				
Max RF input (specified performance)		1 to 2 MHz		0 dBm		
		2 to 4 MHz		+4 dBm		
		4 to 100 MHz		+12 dBm		
		100 MHz to 6 GHz		+30 dBm		
Expected input level setting resolution		0.1 dB				
Expected input level setting range						
Pre-amp ON		-50 to 0 dBm				
Pre-amp OFF		-50 to +30 dBm				
Pre-amp AUTO ⁷		-50 to +30 dBm				
Absolute amplitude accuracy & total absolute amplitude accuracy						
40 MHz IF filter		Module temperature within ± 3 °C of field alignment				
Pre-Amp ON & OFF		Full temperature range		Controlled temperature range		@ 46 °C module temp ¹⁰ , typical
Conversion type	Frequency	Total absolute amplitude accuracy ⁸	Absolute amplitude accuracy ⁹	Total absolute amplitude accuracy ⁸	Absolute amplitude accuracy ⁹	Total absolute amplitude accuracy ⁸
Image protect	≤ 3 GHz	± 1.78 dB	± 1.72 dB	± 1.27 dB	± 1.21 dB	± 0.46 dB
	> 3 GHz	± 1.54 dB	± 1.48 dB	± 1.19 dB	± 1.13 dB	± 0.46 dB
Single	All	± 1.47 dB	± 1.41 dB	± 1.22 dB	± 1.17 dB	± 0.45 dB
160 MHz IF filter		Module temperature within ± 3 °C of field alignment				
Pre-amp OFF ¹¹						
Image protect	≤ 3 GHz	± 1.46 dB	± 1.34 dB	± 0.96 dB	± 0.85 dB	± 0.33 dB
	> 3 GHz	± 1.54 dB	± 1.48 dB	± 1.16 dB	± 1.09 dB	± 0.45 dB
Single	All	± 1.18 dB	± 1.08 dB	± 0.94 dB	± 0.86 dB	± 0.36 dB
Pre-amp ON ¹²						
Image protect	≤ 3 GHz	± 1.68 dB	± 1.60 dB	± 1.18 dB	± 1.10 dB	± 0.39 dB
	> 3 GHz	± 1.55 dB	± 1.49 dB	± 1.21 dB	± 1.15 dB	± 0.45 dB
Single	≤ 3 GHz	± 1.09 dB	± 0.96 dB	± 0.85 dB	± 0.72 dB	± 0.29 dB
	> 3 GHz	± 1.36 dB	± 1.28 dB	± 1.04 dB	± 0.96 dB	± 0.39 dB

7. At expected input level ≤ -37 dBm, pre-amp is switched on.

8. As described in more detail under Definitions of Specifications (page 4), total absolute amplitude accuracy is the total of all amplitude measurement errors, and applies over the following subset of settings and conditions: expected input level -50 dBm to +30 dBm; input signals within 60 dB below expected input level; 40 MHz and 160 MHz IF filters; input signal at center frequency over full frequency range.

9. The absolute amplitude accuracy is the amplitude measurement error when only changing frequency. The expected input level, conversion type and IF bandwidth settings remain the same and the error introduced by those parameters are not included. Pre-amp auto/OFF expected input level +10 dBm and -12 dBm. Pre-amp ON expected input level -30 dBm.

10. Typical specifications shown at M9350A downconverter reported module temperature of 46 °C and a corresponding environment temperature of 25 °C.

11. When using pre-amp auto mode, applies for signal level within expected input level > -37 dBm.

12. When using pre-amp auto mode, applies for signal level within expected input level ≤ -37 dBm.

Technical Specifications and Characteristics

Amplitude (cont'd)

Amplitude repeatability and linearity		
	Input signal relative to expected input level setting	Specification
Repeatability		<0.05 dB, nominal
Linearity ¹³	>-35 dB	± 0.12 dB ± 0.03 dB, nominal
	≤ -35 dB	± 0.21 dB ± 0.04 dB, nominal

IF flatness ^{14,15}		
Analysis bandwidth	IF filter	Nominal
40 MHz	40 MHz	± 0.08 dB
100 MHz	160 MHz	± 0.09 dB
160 MHz	160 MHz	± 0.10 dB

IF phase linearity ¹⁵		
Analysis bandwidth	Conversion type	Peak to peak, nominal
40 MHz	All	1.0°
100 MHz	Single	0.8°
	Image protect	1.7°
160 MHz	Single	1.4°
	Image protect	1.8°

13. Input level 20 dB above the noise floor and dither on, no change in hardware settings, below expected input level.

14. Amplitude deviation from the mean error of the entire bandwidth, all conversion types.

15. Expected input level 0 dBm. Center frequency ≥ 250 MHz.

Technical Specifications and Characteristics

Amplitude (cont'd)

IF bandwidth filter switching uncertainty ¹⁶	Specification	Typical	Nominal
	±0.4 dB	±0.15 dB	±0.09 dB

Expected input level switching uncertainty	Specification	Typical	Nominal
Pre-amp Auto/OFF			
Max input to +5 dBm	±0.45 dB	±0.14 dB	±0.10 dB
Crossing +5 dBm	±0.63 dB	±0.24 dB	±0.17 dB
Pre-amp OFF			
+5 to -50 dBm	±0.41 dB	±0.16 dB	±0.11 dB
Pre-amp ON			
+0 to -50 dBm	±0.64 dB	±0.27 dB	±0.21 dB
Pre-amp AUTO			
Crossing -37 dBm	±0.95 dB	±0.19 dB	±0.12 dB

Amplitude switching speed		
Arbitrary amplitude change	Standard, nominal	Option UNZ, nominal
List mode switching speed ¹⁷	≤ 5 ms	≤ 136 μs
Non-list mode switching speed ¹⁸	≤ 5 ms	≤ 1.5 ms

Input voltage standing wave ratio (VSWR)	Nominal
< 10 MHz	1.7:1
10 MHz to 2.5 GHz	1.4:1
> 2.5 GHz	1.7:1

16. Amplitude error relative to the reference IF bandwidth filter of 40 MHz.

17. Settled to within 0.1 dB of final value. Does not include data acquisition or processing time.
When used with the M9018A PXIe chassis (2-link configuration: 1 x 8 [factory default]) and the M9036A PXIe embedded controller.

18. Mean time from IVI command to amplitude settled.

Technical Specifications and Characteristics

Dynamic range specifications

Displayed average noise level (DANL) ¹⁹			
Conversion type	Frequency	Specification	Nominal
Pre-amp OFF			
Image protect	< 100 MHz		-145 dBm/Hz
	100 to < 700 MHz	-137 dBm/Hz	-147 dBm/Hz
	700 MHz to < 5.75 GHz	-140 dBm/Hz	-148 dBm/Hz
	5.75 to 6 GHz	-129 dBm/Hz	-146 dBm/Hz
Single	<1.2 GHz	-148 dBm/Hz	-154 dBm/Hz
	1.2 to 3.1 GHz	-143 dBm/Hz	-152 dBm/Hz
	> 3.1 to < 5.4 GHz	-138 dBm/Hz	-149 dBm/Hz
	5.4 to 6 GHz	-133 dBm/Hz	-148 dBm/Hz
Pre-amp ON			
Image protect	< 100 MHz		-162 dBm/Hz
	100 MHz to < 2.7 GHz	-156 dBm/Hz	-161 dBm/Hz
	2.7 to 4.4 GHz	-155 dBm/Hz	-160 dBm/Hz
	> 4.4 to < 5.6 GHz	-152 dBm/Hz	-157 dBm/Hz
	5.6 to 6 GHz	-141 dBm/Hz	-154 dBm/Hz
Single	<1.1 GHz	-157 dBm/Hz	-161 dBm/Hz
	1.1 to < 3.6 GHz	-154 dBm/Hz	-158 dBm/Hz
	3.6 to 5 GHz	-151 dBm/Hz	-156 dBm/Hz
	> 5 to 6 GHz	-146 dBm/Hz	-153 dBm/Hz

Third order intermodulation distortion (TOI) ²⁰		TOI ²³		Distortion ²⁴
Conversion type: auto	Frequency	Specification	Typical	Specification
Pre-amp OFF ²¹	≤ 400 MHz	+15 dBm	+20.5 dBm	-52 dBc
	> 400 MHz to 3 GHz	+18 dBm	+23 dBm	-52 dBc
	> 3 GHz	+20 dBm	+23.5 dBm	-52 dBc
Pre-amp ON ²²	≤ 100 MHz	-9.9 dBm	-2.5 dBm	-56 dBc
	> 100 to 850 MHz	-7.9 dBm	+2 dBm	-58 dBc
	> 850 MHz to 2 GHz	-4.3 dBm	+5 dBm	-47 dBc
	> 2 to 3 GHz	-0.9 dBm	+7 dBm	-41 dBc
	> 3 to 6 GHz	+1 dBm	+5 dBm	-32 dBc

19. Expected input level of -50 dBm. Mixer level offset +10 dB.

20. Two tone, 100 kHz tone spacing.

21. Expected input level -5 dBm. Mixer level offset +10 dB.

22. Expected input level -25 dBm. Mixer level offset +15 dB.

23. TOI = third order intercept. The TOI is given by the input tone level (in dBm) minus (distortion/2) where distortion is the relative level of the distortion tones in dBc.

24. Expected input level -10 dBm with preamp off and -30 dBm with preamp on.

Technical Specifications and Characteristics

Dynamic range specifications (cont'd)

Second harmonic distortion (SHI)			
Conversion type: image protect	Frequency	SHI, Nominal ²⁶	Distortion, Nominal ²⁷
Pre-amp OFF ²⁵	≤ 1.35 GHz	+35 dBm	-45 dBc
	> 1.35 GHz	+95 dBm	-105 dBc

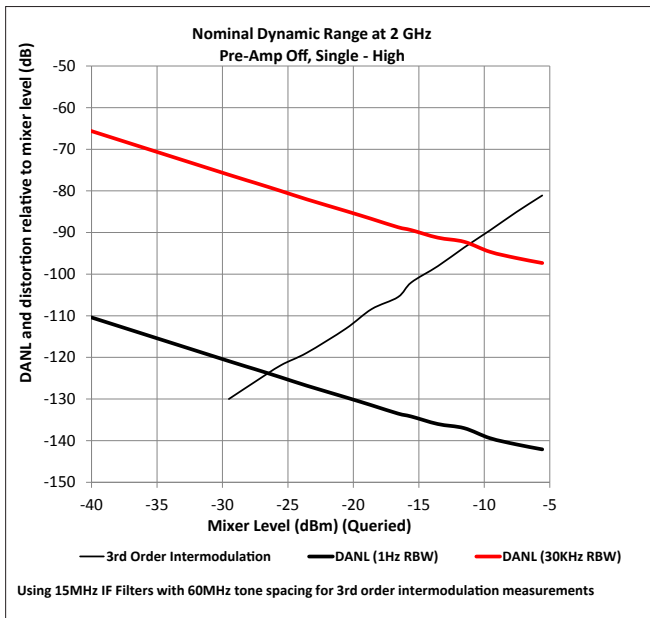

Figure 4. Dynamic range at 2 GHz, pre-amp OFF, single-high conversion type.

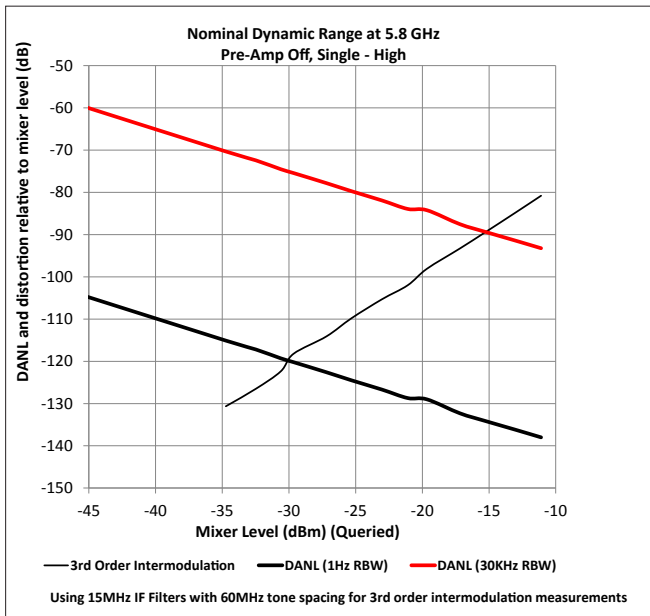

Figure 5. Dynamic range at 5.8 GHz, pre-amp OFF, single-high conversion type.

25. Expected input level -10 dBm. Mixer level offset +10 dB.

26. SHI = second harmonic intercept. The SHI is given by the input power in dBm minus the second harmonic distortion level relative to the input signal in dBc.

27. For 0 dBm input signal.

Technical Specifications and Characteristics

Dynamic range specifications (cont'd)

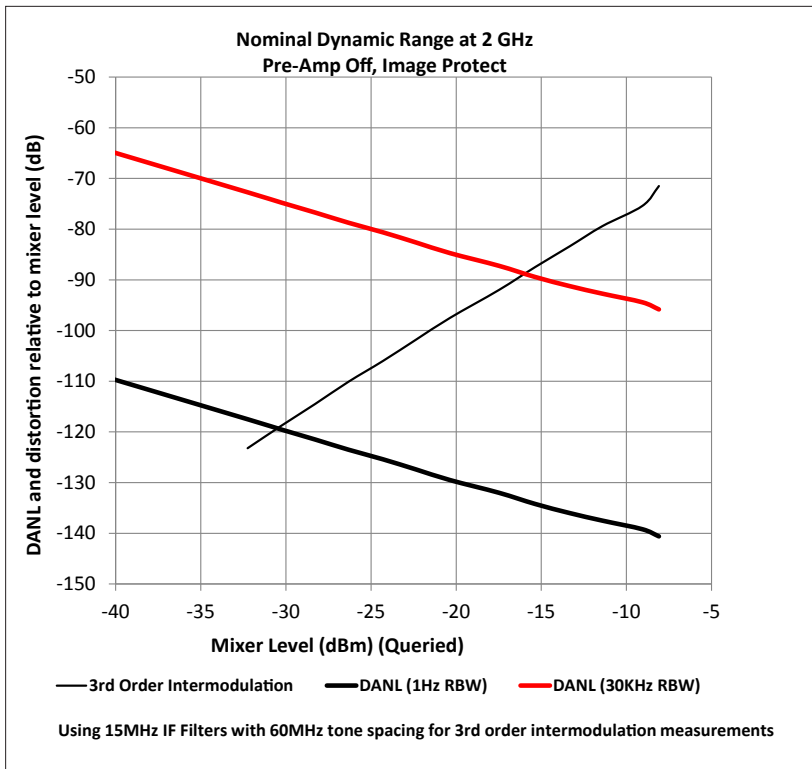

Figure 6. Dynamic range at 2 GHz, pre-amp OFF, image protect conversion type.

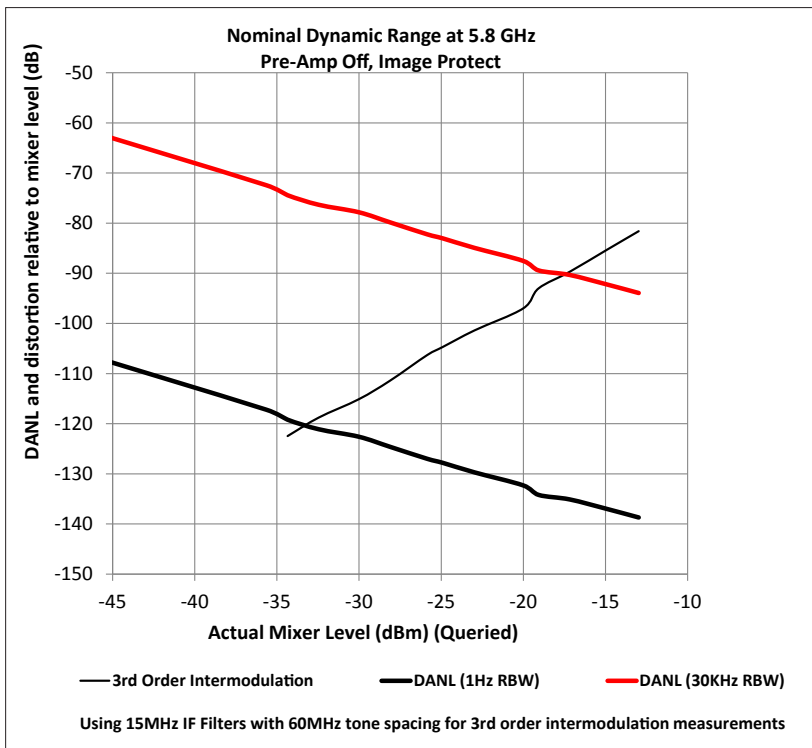

Figure 7. Dynamic range at 5.8 GHz, pre-amp OFF, image protect conversion type.

Technical Specifications and Characteristics

Spectral purity

Phase noise ²⁸			
	Offset	Conversion type	Nominal
Noise sidebands (CF = 1.1 GHz for single low) (CF = 1 GHz for single high)	10 kHz	Single - low	-120 dBc/Hz
		Single - high	-119 dBc/Hz

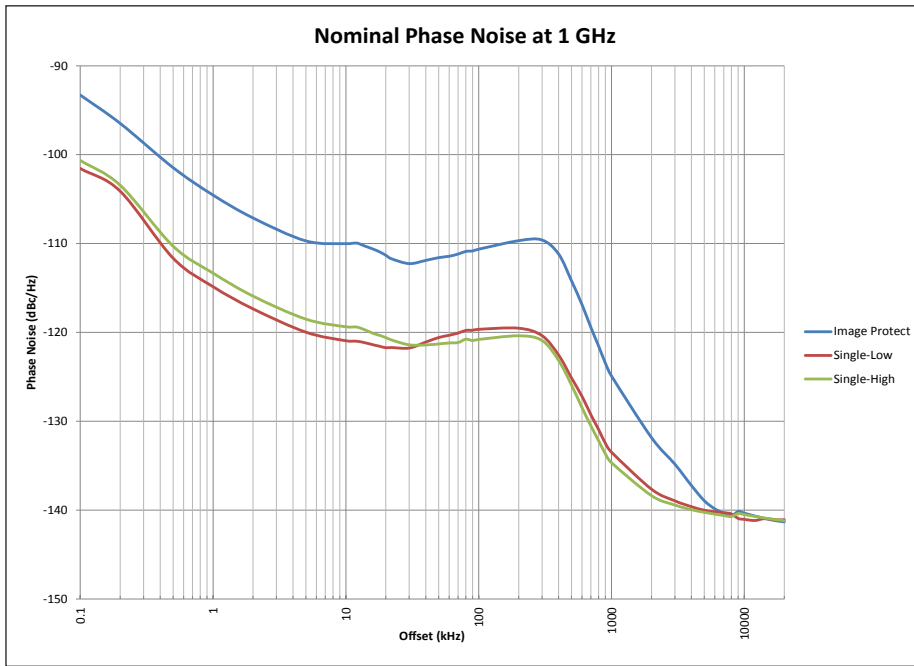

Figure 8. Phase noise at 1 GHz (1.1 GHz for single-low conversion type).

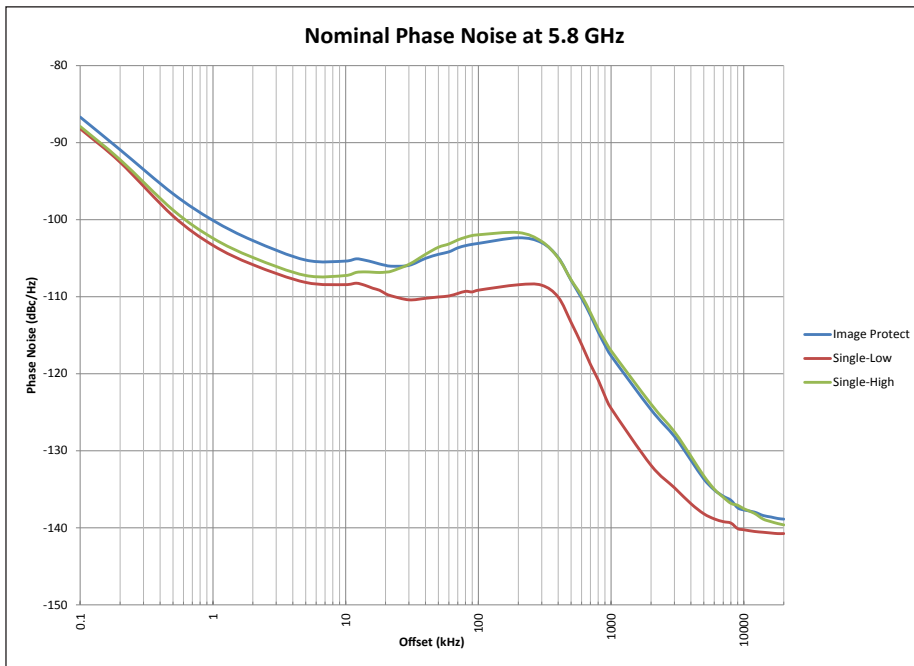

Figure 9. Phase noise at 5.8 GHz.

28. Mixer level offset +20 dB.

Technical Specifications and Characteristics

Spectral purity (cont'd)

Residuals, images & spurious responses			
Non-input related spurs ²⁹	Conversion type	Frequency	Nominal
Expected input level			
Pre-amp ON			
≤ 0 dBm (measured at -50 dBm)	Single	All	< -120 dBm
	Image protect	All ³⁰	< -120 dBm
Pre-amp OFF			
< +5 dBm (measured at -50 dBm)	Single	≤ 3 GHz	< -120 dBm
		> 3 GHz	< -116 dBm
	Image protect	All ³¹	< -105 dBm
≥ +5 dBm (measured at +6 dBm)	Single	All	< -98 dBm
	Image protect	All ³²	< -90 dBm
LO related spurs ³³			
	Offsets from carrier	Frequency	Nominal
	200 to 10 kHz	All	-82 dBc
	10 kHz to 10 MHz	All	-55 dBc
First order RF spurious responses ³⁴			
	Offsets from carrier	Frequency	Nominal
	≥ 10 MHz	≥ 200 MHz to 6 GHz	-60 dBc
Higher order RF spurious responses ³⁴			
	Offsets from carrier	Frequency	Nominal
	≥ 10 MHz	≥ 200 MHz to 6 GHz	-60 dBc
Image responses ³⁵			
	Conversion type	Frequency	Nominal
	Image protect	All	< -68 dBc
IF rejection ³⁶			
	IF bandwidth filter	Frequency	Nominal
15 MHz		≤ 400 MHz	< -57 dBc
		> 400 MHz	< -105 dBc
40 MHz		≤ 450 MHz	< -57 dBc
		> 450 MHz	< -98 dBc
160 MHz		All	< -85 dBc
LO emission ³⁷			
	Conversion type	Frequency	Nominal
Single		≤ 3 GHz	-72 dBm
		> 3 GHz	-62 dBm
Image protect		All	-88 dBm

29. Mixer level offset at 10 dB, input terminated, with 50Ω load.

30. From 4.72 to 4.88 GHz, specification at <-108 dBm, nominal.

31. From 4.72 to 4.88 GHz, specification at <-96 dBm, nominal.

32. From 4.72 to 4.88 GHz, specification at <-80 dBm, nominal.

33. Expected input level 0 dBm. Mixer offset level -10 dB.

34. Conversion type: image protect, pre-amp OFF, expected input level -20 dBm and mixer level offset 0 dB.

35. Excitation frequency: [F=2*Final IF] MHz, expected input level -20 dBm, mixer level offset -30 dB.

36. Suppression of signal at IF frequencies when tuned at least 2 x IF BW away.

All input paths, image protect, expected input level -30 dBm. Input signal at -30 dBm and mixer level offset 0 dB.

37. Expected input level -50 dBm. Mixer level offset +10 dB.

Technical Specifications and Characteristics

Data acquisition

Maximum capture memory		Non-list mode	List mode
Option M01		128 MSample (512 MB)	128 MSample (512 MB)
Option M05		512 MSample (2 GB)	512 MSample (2 GB)
Option M10		1 GSAMPLE (4 GB) ³⁸	512 MSample (2 GB) to ~ 1 GSAMPLE (3.999 GB) ³⁹
Segments			
Minimum length		1 sample ⁴⁰	
Maximum length		Full capture memory ³⁸	
Maximum sample rate		Specification	
Option B04 / 40 MHz		50 MS/s complex, 100 MS/s real	
Option B10 / 100 MHz		125 MS/s complex, 250 MS/s real	
Option B16 / 160 MHz		200 MS/s complex, 400 MS/s real	
List mode			
Maximum number of segments		3201	
Trigger sources		External, magnitude	
Trigger modes		Per acquisition, interval timer trigger	
Triggering			
Delay range ⁴¹		-500 ms to +500 ms, nominal	
Delay resolution		1 sample, nominal	
External trigger signal frequency range		10 to 30 MHz for pulse	
External trigger signal level		TTL	
External trigger signal duty cycle range		20% to 80%	
External trigger signal waveform		Sine, pulse/square, ramp (symmetry 0% to 100%)	
Timing⁴²			
Channel-to-channel synchronization		$\leq \pm 5$ ns, nominal	

38. The default mode for allocation of capture memory is AgM9391MemoryModeNormal, where the digitizer's memory is shared by both the default single acquisition (capture ID = 0) and all the other acquisitions with non-zero capture IDs. In particular, the memory for the default single acquisition is allocated from the area unused by the list acquisitions. If the available memory is not sufficient for the single acquisition, the user must release memory allocated for the non-zero capture ID acquisitions manually, thus increasing free space. Total memory usage is limited according to the memory option. Note that the maximum size of acquisition is 2 GB in this mode. To perform the default single acquisition with memory size larger than 2 GB, AgM9391MemoryModeLargeAcquisition must be selected. The non-zero capture ID acquisitions cannot be performed in this mode. All data acquired with AgM9391MemoryModeNormal will be invalidated.

39. The maximum size for a single list point capture is limited to 512 MSamples (2 GB). However, with option M10, total capture of up to 3.999 GB is available across all list mode captures.

40. 64-bit mode, 2 samples for 32-bit mode.

41. Negative trigger delay limited to capture size.

42. MIMO capability only supported when configured with a Keysight M9018A PXIe chassis. 89600 VSA software required for MIMO analysis.

Technical Specifications and Characteristics

Measurement speed⁴³

IQ data capture ⁴⁴	Nominal	
Large block (50 MSamples)	1.5 s	Transferred in 100 kSa or 1 MSa blocks
Small block (100 captures, 100 ksamples each)	292 ms	Transferred in 10 kSa blocks
Adjust level, freq (10 ksamples)	1.7 ms	Transferred in 10 kSa blocks

Power measurements ⁴⁵			
Channel power settings & filter bandwidth	Acquisition Time	Averages	Nominal
3.84 MHz	400 μ s	None	1.8 ms
		10	7.6 ms
	100 μ s	None	1.3 ms
		10	4.1 ms
	50 μ s	None	1.3 ms
		10	3.4 ms
30 kHz	100 μ s	None	3.9 ms
		10	30.4 ms

Format specific measurement data

GSM ^{46, 47}		
	Parameters	Nominal
Global phase error	0.9, 1.8, 1.9, 2.0, 2.1, 2.2 GHz	0.17 °
ORFS dynamic range	200 kHz offset	-36 dBc
	250 kHz offset	-41 dBc
	400 kHz offset	-69 dBc
	600 kHz offset	-73 dBc
	800 kHz offset	-77 dBc
	1200 kHz offset	-80 dBc
	1800 kHz offset	-78 dBc

EDGE ^{46, 47}		
	Parameters	Nominal
Residual EVM	0.9, 1.8, 1.9, 2.0, 2.1, 2.2 GHz	0.23% rms
ORFS dynamic range	200 kHz offset	-37 dBc
	250 kHz offset	-42 dBc
	400 kHz offset	-69 dBc
	600 kHz offset	-73 dBc
	800 kHz offset	-77 dBc
	1200 kHz offset	-80 dBc
	1800 kHz offset	-77 dBc

43. EVM, ACPR and servo loop test times for the RF power amplifier test, reference solution are included in the solution brochure 5991-4104EN.

44. Capture block, transfer to host memory, 160 MHz BW, excludes frequency transitions below 400 MHz, with M9037A embedded controller (2-link configuration: 1 x 8 [factory default]).

45. Transfer to host memory, 160 MHz IF bandwidth filter, excludes frequency transitions below 400 MHz, with M9037A embedded controller (2-link configuration: 1 x 8 [factory default]).

46. Synthesizer PLL mode set to PLL mode best wide offset.

47. Expected input level 0 dBm, input signal (total power) 0 dBm, mixer level offset +10 dB, conversion type: Auto, PeakToAverage set per signal peak to average.

Technical Specifications and Characteristics

Format Specific measurement (cont'd)

W-CDMA ^{48, 49}	Parameters	Typical		Nominal	
Residual EVM	2 GHz, 1 DPCH, 1 carrier			0.5%	
ACLR dynamic range	2 GHz, 1 DPCH, 1 carrier (power mode)	Adjacent	-68.1 dBc	-69.8 dBc	
		Alternate	-70.7 dBc	-71.7 dBc	
802.11g ^{48, 49, 53}	Parameters	Nominal			
EVM	2.4 GHz, 20 MHz BW	-52.8 dB			
802.11a ^{48, 49, 53}	Parameters	Nominal			
EVM	5.8 GHz, 20 MHz BW	-48.1 dB			
802.11n ^{48, 49, 53}	Parameters	Nominal			
EVM	2.4 GHz, 40 MHz BW	1-channel	2-channel ⁵¹	3-channel ⁵¹	4-channel ⁵¹
		-52.0 dB	-51.6 dB	-50.6 dB	-50.9 dB
EVM	5.8 GHz, 40 MHz BW	1-channel	2-channel ⁵¹	3-channel ⁵¹	4-channel ⁵¹
		-48.6 dB	-46.6 dB	-45.3 dB	-46.0 dB
802.11ac ^{48, 49}	Parameters	Nominal			
EVM ⁵²	5.8 GHz, 80 MHz BW	1-channel	2-channel ⁵¹	3-channel ⁵¹	4-channel ⁵¹
		-46.5 dB	-44.3 dB	-43.0 dB	-43.6 dB
EVM ⁵²	5.8 GHz, 160 MHz BW	1-channel	2-channel ⁵¹	3-channel ⁵¹	4-channel ⁵¹
		-44.7 dB	-43.4 dB	-41.7 dB	-43.3 dB
EVM ⁵²	5.8 GHz, 80 MHz BW	Preamble only			
		1-channel	2-channel ⁵¹	3-channel ⁵¹	4-channel ⁵¹
EVM ⁵²	5.8 GHz, 160 MHz BW	Preamble, pilots & data			
		1-channel	2-channel ⁵¹	3-channel ⁵¹	4-channel ⁵¹
SEM	5.8 GHz, 80 MHz BW	Preamble only			
		1-channel	2-channel ⁵¹	3-channel ⁵¹	4-channel ⁵¹
SEM	5.8 GHz, 160 MHz BW	Preamble, pilots & data			
		1-channel	2-channel ⁵¹	3-channel ⁵¹	4-channel ⁵¹
SEM	5.8 GHz, 80 MHz BW	see Figure 10			
802.11a/g ^{48, 49}	Parameters				
SEM	2.4 GHz	see Figure 11			
	5.5 GHz	see Figure 12			
802.11e ^{48, 49, 54}	Parameters				
OFDMA WiMAX™ EVM	2.5, 3.5, & 5.8 GHz	-48.3 dB, nominal			

48. Synthesizer PLL mode set to PLL mode best wide offset.

49. Expected input level 0 dBm, input signal (total power) 0 dBm, conversion type: Auto. PeakToAverage set per signal peak to average.

50. Synthesizer PLL mode set to PLL mode normal.

51. 2-channel, 3-channel and 4-channel configurations require M9391A instrument driver version 1.1 or greater.

52. Mixer level offset = +5 dB

53. Mixer level offset = +10 dB

54. Mixer level offset = +15 dB

Technical Specifications and Characteristics

Format specific measurement (cont'd)

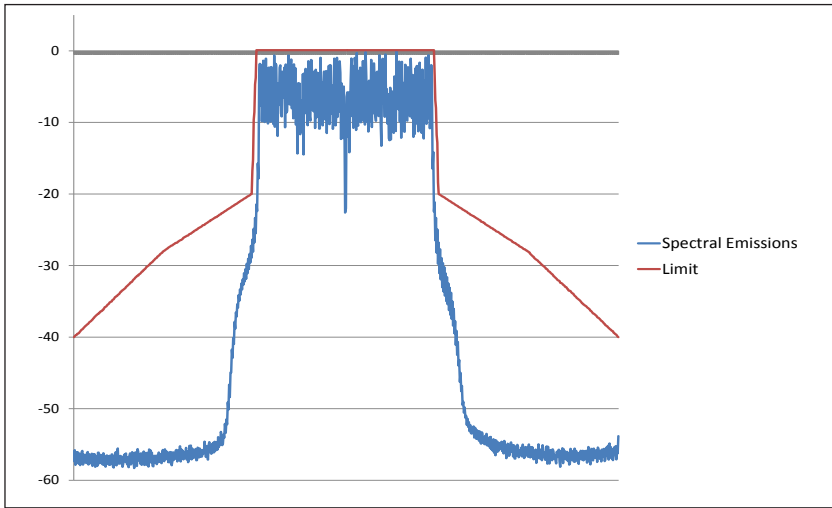

Figure 10. WLAN 802.11ac SEM at 5.8 GHz, 80 MHz bandwidth.

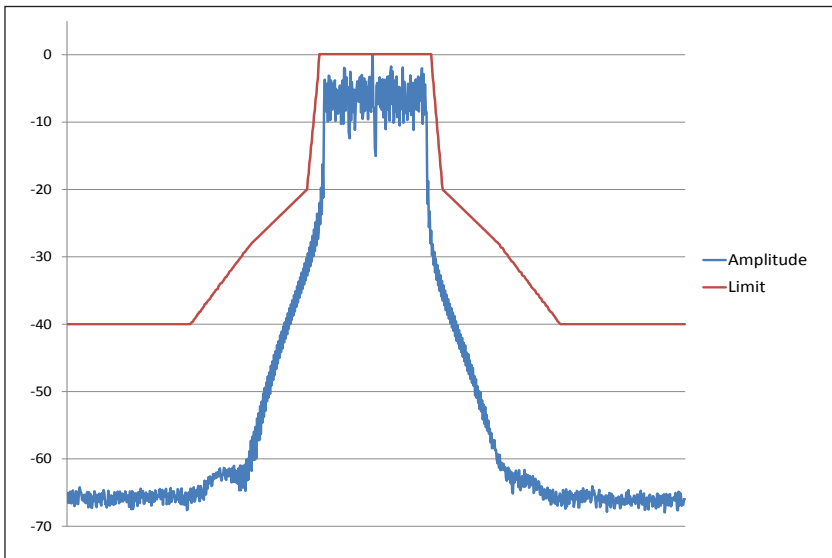

Figure 11. WLAN 802.11a/g SEM at 2.4 GHz, 20 MHz bandwidth.

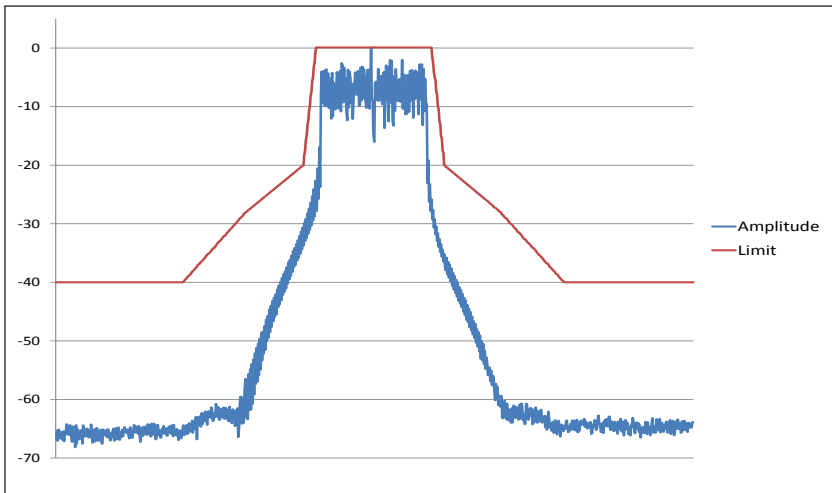

Figure 12. WLAN 802.11a/g SEM at 5.5 GHz, 20 MHz bandwidth.

Technical Specifications and Characteristics

Format specific measurement (cont'd)

LTE FDD - single channel ^{55, 56}	Parameters		1-channel, nominal
10 MHz BW EVM, E-TM 3.1 ^{58, 59}	0.7, 0.9 GHz		-52.2 dB (0.25%)
	1.8, 1.9, 2.0, 2.1, 2.2 GHz		-51.0 dB (0.28%)
10 MHz BW ACLR, E-TM 1.1 ⁶⁰	0.7, 0.9, 1.8, 1.9, 2.0, 2.1, 2.2 GHz (power mode)	Adjacent	-64.2 dBc
		Alternate	-65.5 dBc
LTE FDD - MIMO ^{55, 56, 57}	Parameters	2-channel, nominal	4-channel, nominal
10 MHz BW EVM, R9 downlink, 64 QAM, open loop spacial multiplexing	0.9 GHz	-49.8 dB (0.32%)	-50.1 dB (0.31%)
	2.0 GHz	-49.2 dB (0.35%)	-49.3 dB (0.34%)
LTE TDD - MIMO ^{55, 56, 57}	Parameters	2-channel, nominal	4-channel, nominal
10 MHz BW EVM, R9 downlink, 64 QAM, open loop spacial multiplexing	0.9 GHz	-50.7 dB (0.29%)	-50.3 dB (0.31%)
	2.0 GHz	-49.0 dB (0.36%)	-49.0 dB (0.36%)

55. Expected input level 0 dBm, input signal (total power) 0 dBm, conversion type: Auto. PeakToAverage set per signal peak to average.

56. Synthesizer PLL mode set to PLL mode normal.

57. MIMO configurations require M9391A instrument driver version 1.1 or greater.

58. PDCCCH power boost = 1.065 dB

59. Mixer level offset = +10 dB

60. Mixer level offset = +15 dB

Technical Specifications and Characteristics

Environmental and physical specifications				
Temperature	Operating		Individual module temp 25 to 75 °C as reported by the module and environment temp of 0 to 55 °C	
	Non-operating (storage)		Environment temp of -40 to +70 °C	
Humidity ⁶¹	Type tested at 95%, +40 °C (non-condensing)			
Shock/vibration ⁶¹	Operating random vibration		Type tested at 5 to 500 Hz, 0.21 g rms	
	Survival random vibration		Type tested at 5 to 500 Hz, 2.09 g rms	
	Functional shock		Type tested at half-sine, 30 g, 11 ms	
	Bench handling		Type tested per MIL-PRF-28800F	
Altitude	Up to 15,000 feet (4,572 meters) ⁶²			
Connectors	RF In		SMA female	
EMC	Complies with European EMC Directive 2004/108/EC			
	<ul style="list-style-type: none"> - IEC/EN 61326-2-1 - CISPR Pub 11 Group 1, class A - AS/NZS CISPR 11 - ICES/NMB-001 This ISM device complies with Canadian ICES-001. Cet appareil ISM est conforme a la norme NMB-001 du Canada.			
Warm-up time	45 minutes			
Size	M9300A		1 PXIe slot	
	M9301A		1 PXIe slot	
	M9350A		1 PXIe slot	
	M9214A		1 PXIe slot	
Dimensions	Module	Length	Width	Height
	M9300A	210 mm	22 mm	130 mm
	M9301A	210 mm	22 mm	130 mm
	M9350A	210 mm	22 mm	130 mm
	M9214A	210 mm	22 mm	130 mm
Weight	M9300A		0.55 kg (1.21 lbs)	
	M9301A		0.54 kg (1.19 lbs)	
	M9350A		0.56 kg (1.23 lbs)	
	M9214A		0.36 kg (0.79 lbs)	
Power drawn from chassis	M9300A		≤ 18 W	
	M9301A		≤ 25 W	
	M9350A		≤ 30 W	
	M9214A		≤ 35 W	

61. Samples of this product have been type tested in accordance with the Keysight Environmental Test Manual and verified to be robust against the environmental stresses of storage, transportation and end-use--those stresses include but are not limited to temperature, humidity, shock, vibration, altitude and power-line conditions. Test methods are aligned with IEC 60068-2 and levels are similar to MIL-PRF-28800F Class 3.

62. At 15,000 feet, the maximum environmental temperature is de-rated to 52 °C.





Technical Specifications and Characteristics

System requirements		
Topic	Windows 7 and Vista requirements	Windows XP requirements
Operating systems	Windows 7 (32-bit and 64-bit) Windows Vista, SP1 and SP2 (32-bit and 64-bit)	Windows XP, SP 3
Processor speed	1 GHz 32-bit (x86), 1 GHz 64-bit (x64) (no support for Itanium 64)	600 MHz or higher required 800 MHz recommended
Available memory	4 GB minimum 8 GB or greater recommended	3 GB minimum
Available disk space ⁶³	1.5 GB available hard disk space, includes: 1 GB available for Microsoft .NET Framework 3.5 SP1 ⁶⁴ 100 MB for Keysight IO Libraries Suite	
Video	Support for DirectX 9 graphics with 128 MB graphics memory recommended (Super VGA graphics is supported)	Super VGA (800 x 600) 256 colors or more
Browser	Microsoft Internet Explorer 7 or greater	Microsoft Internet Explorer 6 or greater
M9391A vector signal analyzer instrument drivers		
Keysight IO libraries	Version 16.3 or greater	
M9391A instrument driver	Version 1.1 or greater	

63. Because of the installation procedure, less disk space may be required for operation than is required for installation.

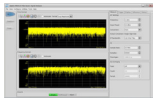
64. NET Framework Runtime Components are installed by default with Windows Vista and Windows 7. Therefore, you may not need this amount of available disk space.

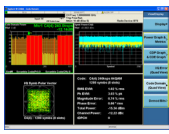
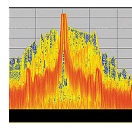
Software

Instrument connection software			
	Keysight IO library	The IO library suite offers a single entry point for connection to the most common instruments including AXIe, PXI, GPIB, USB, Ethernet/LAN, RS-232, and VXI test instruments from Keysight and other vendors. It automatically discovers interfaces, chassis, and instruments. The graphical user interface allows you to search for, verify, and update IVI instrument and soft front panel drivers for modular and traditional instruments. The IO suite safely installs in side-by-side mode with NI I/O software.	Free software download at www.keysight.com/find/iosuite
Module setup and usage			
	Keysight soft front panel	The PXI module includes a soft front panel (SFP), a software-based graphical user interface (GUI) which enables the instrument's capabilities from your PC.	Included on CD-ROM shipped with module or online
Module management			
	Keysight connection expert	Connection expert is the graphical user interface included in the IO libraries suite that allows you to search for, verify and update IVI instrument and soft front panel drivers for modular and traditional instruments	Free software download at www.keysight.com/find/iosuite
Programming			
Driver	Development environments		
IVI-COM, IVI-C LabVIEW, MATLAB	Visual Studio (VB.NET, C#, C/C++), VEE LabVIEW, LabWindows/CVI, MATLAB		Included on CD-ROM shipped with module.
Programming assistance			
	Command expert	Assists in finding the right instrument commands and setting correct parameters. A simple interface includes documentation, examples, syntax checking, command execution, and debug tools to build sequences for integration in Excel, MATLAB, Visual Studio, LabVIEW, VEE, and SystemVue.	Free software download at www.keysight.com/find/commandexpert
	Programming examples	Each module includes programming examples for Visual Studio.net, LabVIEW, MATLAB, LabWindows, and Keysight VEE Pro.	Included on CD-ROM shipped with module.
Signal analysis software			
	X-Series measurement applications for modular instruments	The X-Series measurement applications transform modular PXI VSAs into standards based RF transmitter testers. Provides conformance measurements for many communications standards including : LTE, WLAN 802.11ac and others.	Licensed software. For more information, visit www.keysight.com/find/pxi-x-series_apps
	89600 VSA	89600 VSA software sees through the complexity of emerging and existing industry standards, serving as your window into complex signal interactions. Quickly characterize spurs and harmonics with speed-optimized stepped spectrum measurement provided by 89601B-SSA option.	Licensed software. For more information, visit www.keysight.com/find/vsa
	SystemVue	SystemVue is a system-level EDA platform for designing communications and defense systems. Used with the M9391A, SystemVue enables you to create model-based design validation tests to ensure consistency from design to manufacturing.	Licensed software. For more information, visit www.keysight.com/find/systemvue

Setup and Calibration Services

Assistance

One day startup assistance	Gain access to a technical expert who will help you get started quickly with the M9391A PXI VSA and its powerful software tools. The flexible instruction format is designed to get you to your first measurements and familiarize you with ways to adapt the equipment to a specific application.	Included in base configuration
----------------------------	--	--------------------------------

Calibration and traceability

Factory calibration	The M9391A PXI VSA ships factory calibrated with an ISO-9002, NIST-traceable calibration certificate.	Included in base configuration
Calibration cycle	A one year calibration cycle is recommended.	
Calibration sites	<ul style="list-style-type: none"> - At Keysight worldwide service centers - On-site by Keysight - By self-maintainers 	For more information visit www.keysight.com/find/infoline
N7800A calibration and adjustment software	The M9391A PXI VSA is supported by Keysight's calibration and adjustment software. This is the same software used at Keysight service centers to automate calibration. The software offers compliance tests for ISO 17025:2005, ANSI/NCSL Z540.3-2006, and measurement uncertainty per ISO Guide to Expression of Measurement Uncertainty.	Licensed software. For more information, visit www.keysight.com/find/calibrationsoftware
Keysight calibration status utility	The Keysight calibration status utility helps ensure your M9391A is calibrated by managing the calibration interval and providing messages regarding instrument and module calibration status.	Included in base configuration

Support and Warranty

Warranty		
Global warranty	Keysight's warranty service provides standard coverage for the country where product is used. – All parts and labor necessary to return to full specified performance – Recalibration for products supplied originally with a calibration certificate – Return shipment	Included
Standard	Return to Keysight warranty—3 years 15 days typical turnaround repair service	Included
R-51B-001-5Z	Return to Keysight warranty—5 years 15 days typical turnaround repair service	Optional
R-51B-001-3X Express warranty 3 years	The express warranty upgrades the global warranty to provide, for 3 years, a 5 day typical turnaround repair service in the US, Japan, China and many EU countries.	Optional
R-51B-001-5X Express warranty 5 years	The express warranty upgrades the global warranty to provide, for 5 years, a 5 day typical turnaround repair service in the US, Japan, China and many EU countries.	Optional
Support		
Core exchange program	Keysight's replacement core exchange program allows fast and easy module repairs. A replacement core assembly is a fully functioning pre-calibrated module replacement that is updated with the defective module serial number, allowing the replacement module to retain the original serial number.	For qualified self-maintainers in US only
Self-test utility	A self-test utility runs a set of internal tests which verifies the health of the modules and reports their status.	Included in base configuration

Configuration and Ordering Information

Ordering information

Model	Description
M9391A	PXIe vector signal analyzer: 1 MHz to 3 or 6 GHz Includes: M9301A PXIe synthesizer M9350A PXIe downconverter M9214A PXIe IF digitizer One day startup assistance Module interconnect cables Software, example programs and product information on CD Return to Keysight warranty—3 Years

Base configuration	
M9391A-F03	Frequency range: 1 MHz to 3 GHz
M9391A-B04	Analysis bandwidth, 40 MHz
M9391A-M01	Memory, 128 MSa
M9391A-300	PXIe frequency reference: 10 and 100 MHz
Required for warranted specifications	Adds M9300A PXIe frequency reference: 10 and 100 MHz (M9300A module can support multiple M9391A modular instruments)

For configurations of the M9391A PXI VSA, including combinations with a single or multiple M9381A PXI VSGs, please consult the M9391A & M9381A configuration guide, literature number 5991-0897EN.

Configurable options	
Frequency	
M9391A-F03	1 MHz to 3 GHz
✓ M9391A-F06	1 MHz to 6 GHz
Switching speed	
✓ M9391A-UNZ	Fast switching
Analysis bandwidth	
M9391A-B04	40 MHz
M9391A-B10	100 MHz
✓ M9391A-B16	160 MHz
Memory	
M9391A-M01	128 MSa
M9391A-M05	512 MSa
✓ M9391A-M10	1024 MSa
Other	
M9391A-UK6	Commercial calibration certificate with test data for M9391A (M9301A, M9350A, M9214A)
M9300A-UK6	Commercial calibration certificate with test data for M9300A (module only)
Related products in recommended configuration	
✓ M9037A	PXIe embedded controller
✓ M9018A	18-slot PXIe chassis

✓ Indicates recommended configuration

Configuration and Ordering Information

Software information

Supported operating systems	Microsoft Windows XP (32-bit) Microsoft Windows 7 (32/64-bit) Windows Vista, SP1 and SP2 (32-bit and 64-bit)
Standard compliant drivers	IVI-COM, IVI-C, LabVIEW, MATLAB
Supported application development environments (ADE)	VisualStudio (VB.NET, C#, C/C++), VEE, LabVIEW, LabWindows/CVI, MATLAB
Keysight IO libraries (version 16.3 or newer)	Includes: VISA libraries, Keysight Connection Expert, IO monitor
Keysight Command Expert	Instrument control for SCPI or IVI-COM drivers
89600 VSA Software (version 17.21 or newer; Option SSA added in version 18.5)	89600B-200 Basic VSA software 89601B-300 Hardware connectivity 89601B-SSA Spectrum analysis 89601B-AYA GP analysis 89601B-B7T cdma2000®/1xEV-DO 89601B-B7U W-CDMA/HSPA+ 89601B-B7R WLAN 802.11a/b/g/j/p 89601B-B7X TD-SCDMA 89601B-BHD LTE FDD 89601B-BHG LTE FDD - Advanced 89601B-BHE LTE TDD 89601B-BHH LTE TDD - Advanced
X-Series Measurement Applications for Modular Instruments transportable perpetual license.	M9063A Analog demodulation M9064A Vector signal analysis M9071A GSM/EDGE/Evo M9072A cdma2000®/cdmaOne M9073A W-CDMA/HSPA+ M9076A 1xEV-DO M9077A WLAN 802.11a/b/g/n/ac M9079A TD-SCDMA/HSDPA M9080B LTE/LTE-A FDD M9081A Bluetooth® M9082B LTE/LTE-A TDD

Accessories

Model	Description
Y1212A	Slot blocker kit: 5 modules
Y1213A	PXI EMC filler panel kit: 5 slots
Y1214A	Air inlet kit: M9018A 18-slot chassis
Y1215A	Rack mount kit: M9018A 18-slot chassis
Y1299-001	PXI solutions startup kit - MIMO solution

Related products

Model	Description
M9381A	PXIe vector signal generator
M9380A	PXIe CW source
M9300A	PXIe frequency reference
M9021A	PCIe cable interface
M9018A	PXIe 18-slot chassis
M9037A	PXIe embedded controller
M9045B	PCIe express card adaptor for laptop connectivity
Y1200B	PCIe cable for laptop connectivity
M9048A	PCIe desktop adaptor for desktop connectivity
Y1202A	PCIe cable for desktop connectivity

Advantage services: Calibration and warranty

Keysight Advantage Services is committed to your success throughout your equipment's lifetime

R-51B-001-5Z	Return to Keysight warranty - 5 years
R-51B-001-3X	Express warranty - 3 years
R-51B-001-5X	Express warranty - 5 years
N7800A	Calibration & adjustment software

myKeysight

myKeysight

www.keysight.com/find/mykeysight

A personalized view into the information most relevant to you.



www.axiestandard.org

AdvancedTCA® Extensions for Instrumentation and Test (AXIe) is an open standard that extends the AdvancedTCA for general purpose and semiconductor test. Keysight is a founding member of the AXIe consortium. ATCA®, AdvancedTCA®, and the ATCA logo are registered US trademarks of the PCI Industrial Computer Manufacturers Group.



www.lxistandard.org

LAN eXtensions for Instruments puts the power of Ethernet and the Web inside your test systems. Keysight is a founding member of the LXI consortium.



www.pxisa.org

PCI eXtensions for Instrumentation (PXI) modular instrumentation delivers a rugged, PC-based high-performance measurement and automation system.



Three-Year Warranty

www.keysight.com/find/ThreeYearWarranty

Keysight's commitment to superior product quality and lower total cost of ownership. The only test and measurement company with three-year warranty standard on all instruments, worldwide.



Keysight Assurance Plans

www.keysight.com/find/AssurancePlans

Up to five years of protection and no budgetary surprises to ensure your instruments are operating to specification so you can rely on accurate measurements.



www.keysight.com/go/quality

Keysight Technologies, Inc.
DEKRA Certified ISO 9001:2008
Quality Management System

Keysight Channel Partners

www.keysight.com/find/channelpartners

Get the best of both worlds: Keysight's measurement expertise and product breadth, combined with channel partner convenience.

PICMG and the PICMG logo, CompactPCI and the CompactPCI logo are US registered trademarks of the PCI Industrial Computers Manufacturers Group. "PCIe" and "PCI EXPRESS" are registered trademarks and/or service marks of PCI-SIG. cdma2000 is a registered certification mark of the Telecommunications Industry Association.

www.keysight.com/find/modular

www.keysight.com/find/m9391a

For more information on Keysight Technologies' products, applications or services, please contact your local Keysight office. The complete list is available at: www.keysight.com/find/contactus

Americas

Canada	(877) 894 4414
Brazil	55 11 3351 7010
Mexico	001 800 254 2440
United States	(800) 829 4444

Asia Pacific

Australia	1 800 629 485
China	800 810 0189
Hong Kong	800 938 693
India	1 800 112 929
Japan	0120 (421) 345
Korea	080 769 0800
Malaysia	1 800 888 848
Singapore	1 800 375 8100
Taiwan	0800 047 866
Other AP Countries	(65) 6375 8100

Europe & Middle East

Austria	0800 001122
Belgium	0800 58580
Finland	0800 523252
France	0805 980333
Germany	0800 6270999
Ireland	1800 832700
Israel	1 809 343051
Italy	800 599100
Luxembourg	+32 800 58580
Netherlands	0800 0233200
Russia	8800 5009286
Spain	800 000154
Sweden	0200 882255
Switzerland	0800 805353
	Opt. 1 (DE)
	Opt. 2 (FR)
	Opt. 3 (IT)
United Kingdom	0800 0260637

For other unlisted countries:
www.keysight.com/find/contactus
(BP-09-23-14)

