



N6468A SFP+ Electrical Performance Validation and Conformance Software

For Infiniium Oscilloscopes

Data Sheet

Features

- The N6468A SFP+ Ethernet electrical test software has several features to simplify the validation of Ethernet designs:
- Setup wizard for quick and clear setup, configuration and test
- Wide range of SFP+ Ethernet electrical tests enabling standards conformance
- Accurate and repeatable results with Agilent Infiniium oscilloscopes
- Automated reporting in a comprehensive HTML format with margin analysis

With the SFP+ Ethernet electrical test software, you can use the same oscilloscope you use for everyday debugging to perform automated testing and margin analysis based on the SFF-8431 standard.

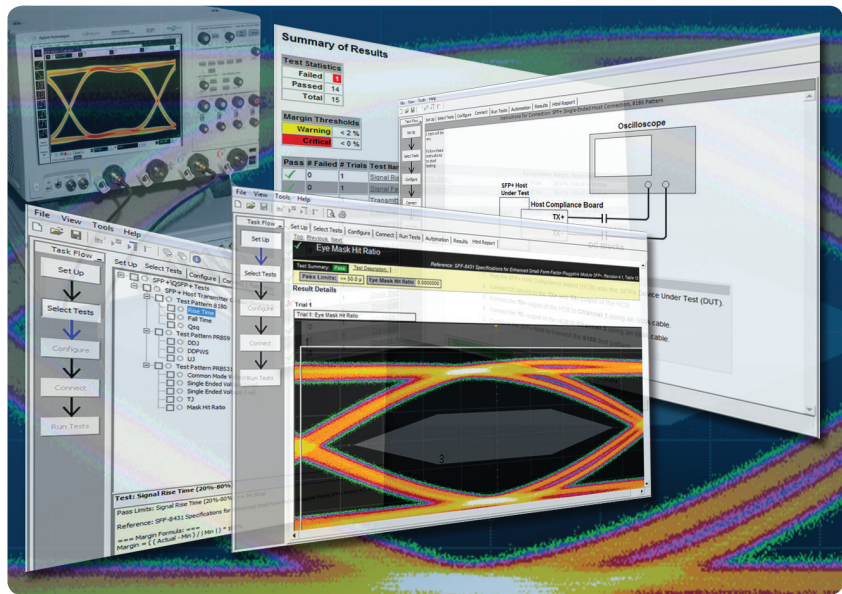

Easy and Accurate SFP+ Ethernet Transmitter Design Validation and Debug

The Agilent Technologies N6468A SFP+ Ethernet electrical performance validation and conformance software for Infiniium oscilloscopes gives you an easy and accurate way to verify and debug your SFP+ and QSFP+ Ethernet designs. The Ethernet electrical test software allows you to automatically execute Ethernet physical-layer (PHY) electrical tests, and displays the results in a flexible report format. In addition to the measurement data, the report provides a margin analysis that shows how closely your device passed or failed each test.

The N6468A software performs a wide range of electrical tests required to meet the SFP+ Ethernet electrical specifications as documented in the SFF-8431 standard. The N6468A SFP+ also covers module tests found in the IEEE 802.3ba Annex 86A standard. To meet signal quality requirements, your product must successfully pass conformance testing based on these specifications.

Performing these tests gives you confidence in your design. The N6468A SFP+ Ethernet Compliance software helps you execute a wide subset of the conformance tests that can be measured with an oscilloscope.



N6468A SFP+ Compliance Application Software Saves You Time

The SFP+ Ethernet electrical test software saves you time by setting the stage for automatic execution of SFP+ electrical tests. Part of the difficulty of performing electrical tests for Ethernet transmitters is properly connecting to the oscilloscope, loading the proper setup files, and then analyzing the measured results by comparing them to limits published in the specification. The Ethernet electrical test software does much of this work for you.

It automatically configures the oscilloscope for each test, and it provides an informative results report that includes margin analysis indicating how close your product is to passing or failing that specification. See Table 2 for a complete list of the measurements made by the SFP+ Ethernet electrical test software.

Easy test definition

The software extends the ease-of-use advantages of Agilent's Infiniium oscilloscopes to testing SFP+ designs. Agilent's automated test engine quickly walks you through the steps required to define the tests you want to make, set up the tests, perform the tests, and view the test results. A setup page lets you quickly make decisions from the outset regarding the choice of tests and perform functions that affect the testing task. The test selections available in the following steps are then filtered according to the choices made in the setup page. While selecting tests, you can select a category of tests all at once or specify individual tests. You can save tests and configurations as project files and recall them later for quick testing and review of previous test results. Straightforward menus let you perform tests with a minimum number of mouse clicks.

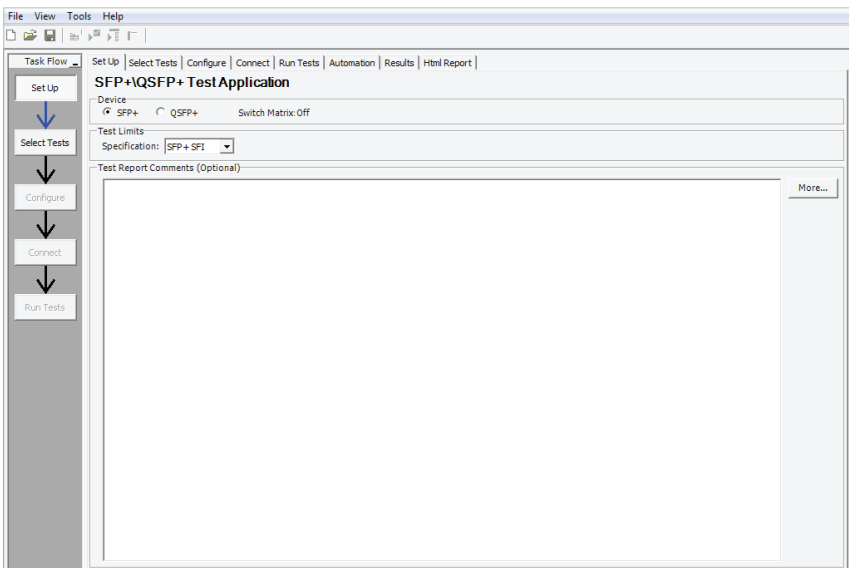

Figure 1. The clean interface lets you select SFP+ or QSFP+ as well as several test categories and test limits found in the SFF-8431 specification.

View All of the SFP+ Ethernet Electrical Tests in the GUI Under Selected Tests

- Setup wizard for quick and clear setup, configuration and test
- Clearly see all the SFP+ Ethernet electrical tests
- Run single or multiple tests based on your needs
- When a test is highlighted, it shows the description of the test along with pass limits
- Accurate and repeatable results with Agilent Infiniium oscilloscopes
- Automated reporting in a comprehensive HTML format with margin analysis

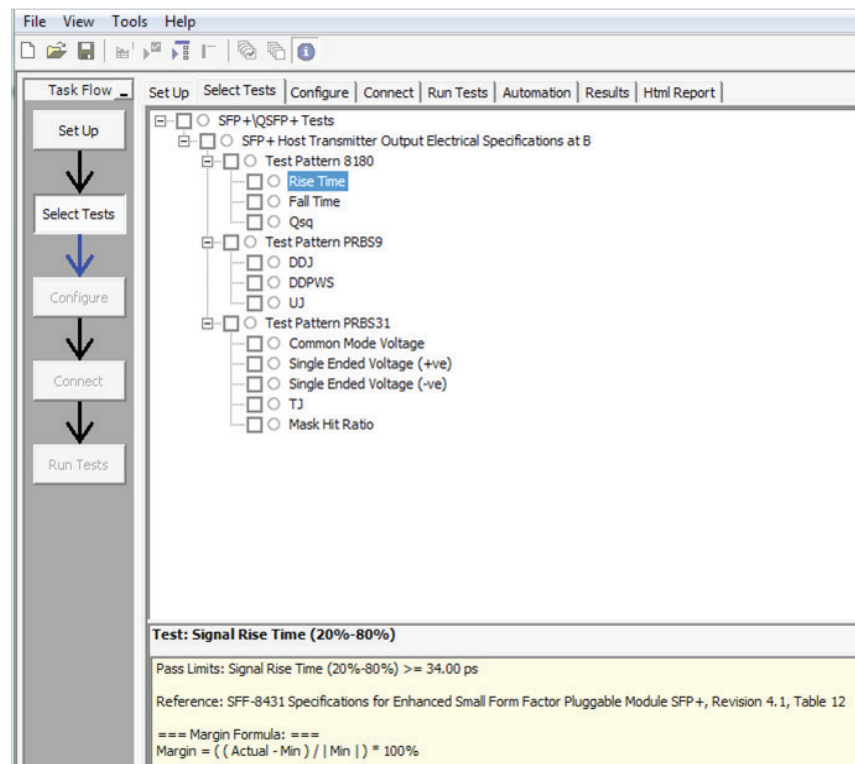

Figure 2. The Agilent automated test engine quickly guides you through selecting and configuring tests, setting up the connection, running the tests, and viewing the results. You can easily select individual tests or groups of tests with a mouse-click.

Configurability and Guided Connections

The N6468A SFP+ Ethernet electrical test software provides flexibility in your test setup. It guides you to make connection changes with hookup diagrams when the tests you select require it. You connect the oscilloscope to the device under test using the Wilder SFP+ or QSFP+ test fixture (www.wilder-tech.com). SMA cables may be required to attach the Wilder test fixtures to the Agilent Infiniium oscilloscope. See ordering information for more details.

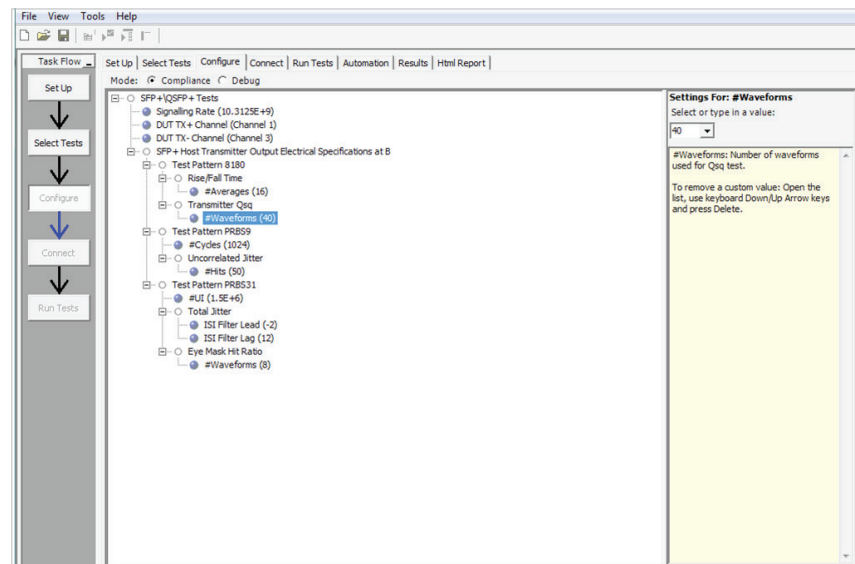

Figure 3. To set up tests, you define the device to test, its configuration, and how the oscilloscope is connected to it.

In addition to providing you with measurement results, the SFP+ Ethernet electrical test software provides a report format that shows you not only where your product passes or fails, but also how close you are to the limits specified for a particular test. You can select the margin test report parameter, which means you can specify the level at which warnings are issued to alert you to electrical tests where your product is operating close to the official test limit defined by the SFP+ specification.

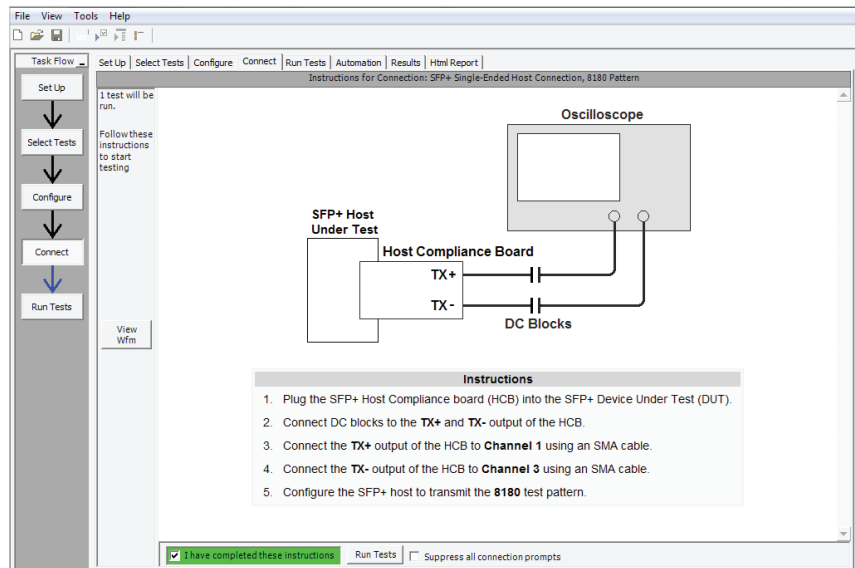

Figure 4. When you make multiple tests where the connections must be changed, the software prompts you with connection diagrams.

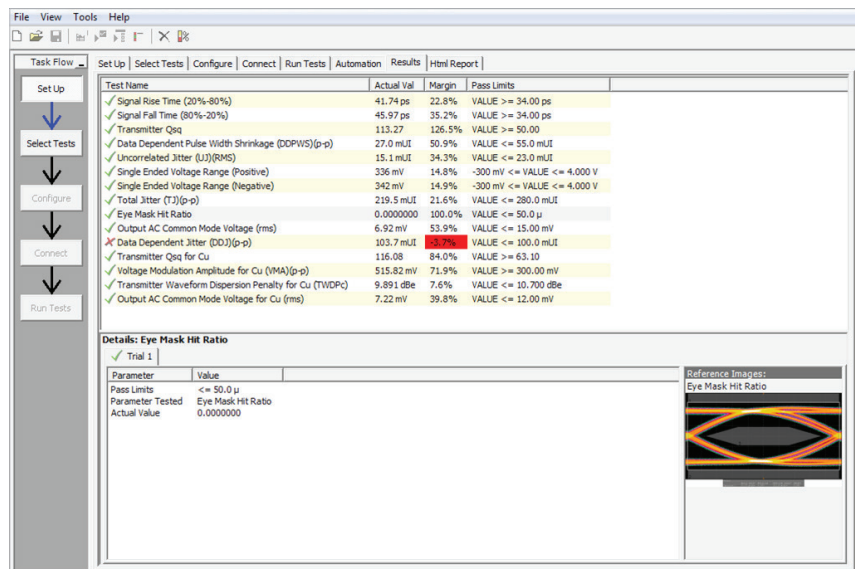

Figure 5. The SFP+ Ethernet electrical test software results screen shows a summary of the tests performed, pass/fail status, and margin. Clicking on a specific test also shows the test specification and a measurement waveform, if appropriate.

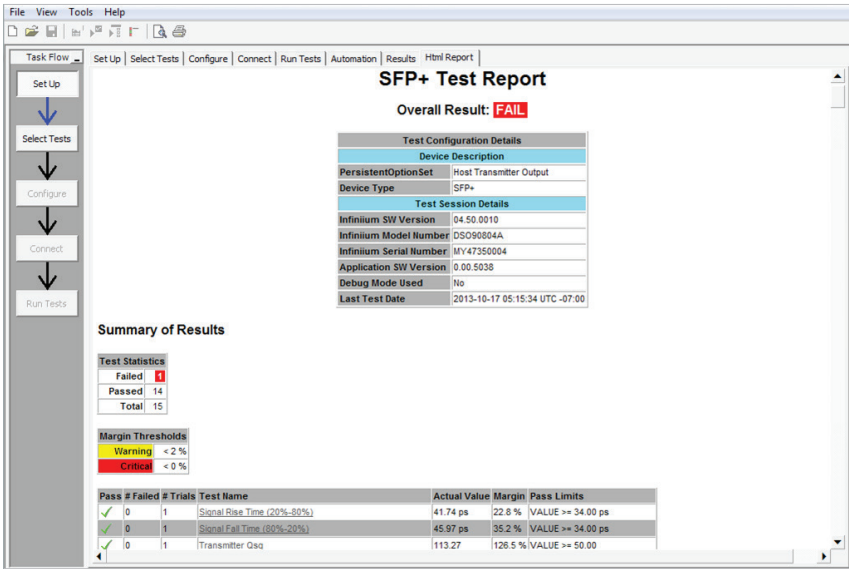

Figure 6. The SFP+ Ethernet electrical test software HTML report documents your test. It indicates the pass/fail status, test specification range, measured values, and margin.

Reports with Margin Analysis

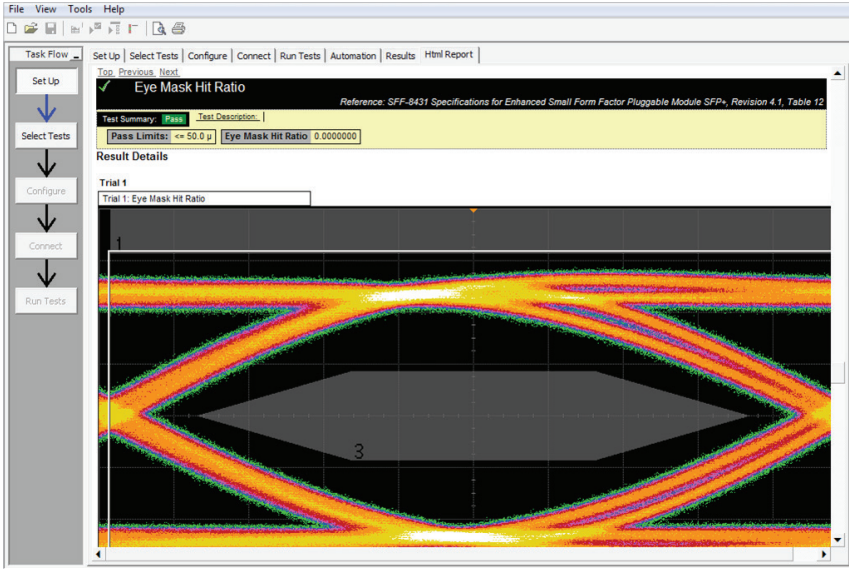

Figure 7. Additional details are available for each test, including the test limits, test description, and test results, including waveforms, if appropriate.

Reports with Margin Analysis (continued)

Summary of Results

Test Statistics	
Failed	1
Passed	14
Total	15

Margin Thresholds	
Warning	< 2 %
Critical	< 0 %

Pass	# Failed	# Trials	Test Name	Actual Value	Margin	Pass Limits
✓	0	1	Signal Rise Time (20%-80%)	41.74 ps	22.8 %	VALUE >= 34.00 ps
✓	0	1	Signal Fall Time (80%-20%)	45.97 ps	35.2 %	VALUE >= 34.00 ps
✓	0	1	Transmitter Osg	113.27	126.5 %	VALUE >= 55.00
✓	0	1	Data Dependent Pulse Width Shrinkage (DDPWS)(p-p)	27.0 mUI	50.9 %	VALUE <= 55.0 mUI
✓	0	1	Uncorrelated Jitter (UJ)(RMS)	15.1 mUI	34.3 %	VALUE <= 23.0 mUI
✓	0	1	Single Ended Voltage Range (Positive)	336 mV	14.8 %	-300 mV <= VALUE <= 4.000 V
✓	0	1	Single Ended Voltage Range (Negative)	342 mV	14.9 %	-300 mV <= VALUE <= 4.000 V
✓	0	1	Total Jitter (TJ)(p-p)	219.5 mUI	21.6 %	VALUE <= 280.0 mUI
✓	0	1	Eye Mask Hit Ratio	0.0000000	100.0 %	VALUE <= 50.0 μ
✓	0	1	Output AC Common Mode Voltage (rms)	6.92 mV	53.9 %	VALUE <= 15.00 mV
✗	1	1	Data Dependent Jitter (DDJ)(p-p)	103.7 mUI	3.7 %	VALUE <= 100.0 mUI
✓	0	1	Transmitter Osg for Cu	116.08	84.0 %	VALUE >= 63.10
✓	0	1	Voltage Modulation Amplitude for Cu (VMA)(p-p)	515.82 mV	71.9 %	VALUE >= 300.00 mV
✓	0	1	Transmitter Waveform Dispersion Penalty for Cu (TWDPe)	9.891 dBe	7.6 %	VALUE <= 10.700 dBe
✓	0	1	Output AC Common Mode Voltage for Cu (rms)	7.22 mV	39.8 %	VALUE <= 12.00 mV

Figure 8. How close your device comes to passing or failing a test is indicated as a percentage in the margin field. A result highlighted in yellow or red indicates that your device has tripped the margin threshold level for a warning or failure.

Extendibility

You may add additional custom tests or steps to your application using the N5467A User Defined Application (UDA) development tool (www.agilent.com/find/uda). Use UDA to develop functional “Add-Ins” that you can plug into your application.

Add-ins may be designed as:

- Complete custom tests (with configuration variables and connection prompts)
- Any custom steps such as pre or post processing scripts, external instrument control and your own device control

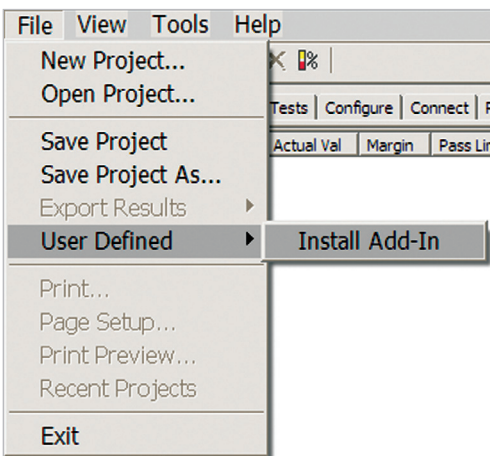

Figure 9. Importing a UDA Add-In into your test application.

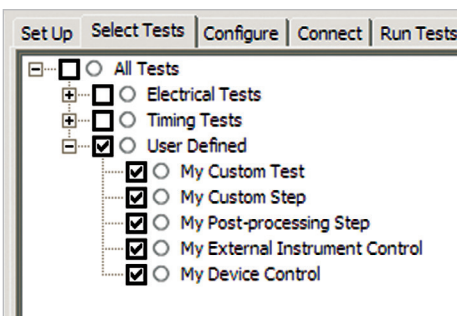

Figure 10. UDA Add-In tests and utilities in your test application.

Automation

You can completely automate execution of your application's tests and Add-Ins from a separate PC using the included N5452A Remote Interface feature (download free toolkit from www.agilent.com/find/scope-apps-sw). You can even create and execute automation scripts right inside the application using a convenient built-in client.

The commands required for each task may be created using a command wizard or from "remote hints" accessible throughout the user interface.

Using automation, you can accelerate complex testing scenarios and even automate manual tasks such as:

- Opening projects, executing tests and saving results
- Executing tests repeatedly while changing configurations
- Sending commands to external instruments
- Executing tests out of order

Combine the power of built-in automation and extensibility to transform your application into a complete test suite executive:

- Interact with your device controller to place it into desired states or test modes before test execution.
- Configure additional instruments used in your test suite such as a pattern generator and probe switch matrix.
- Export data generated by your tests and post process it using your favorite environment, such as MATLAB, Python, LabVIEW, C, C++, Visual Basic etc.
- Sequence or repeat the tests and "Add-In" custom steps execution in any order for complete test coverage of the test plan.

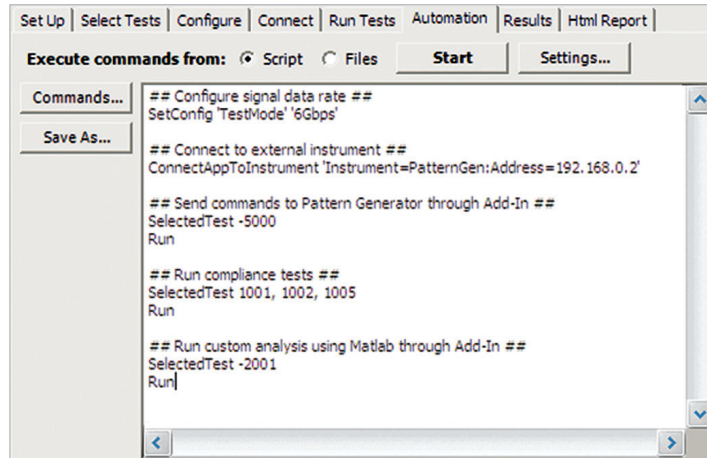

Figure 11. Remote Programming script in the Automation tab.

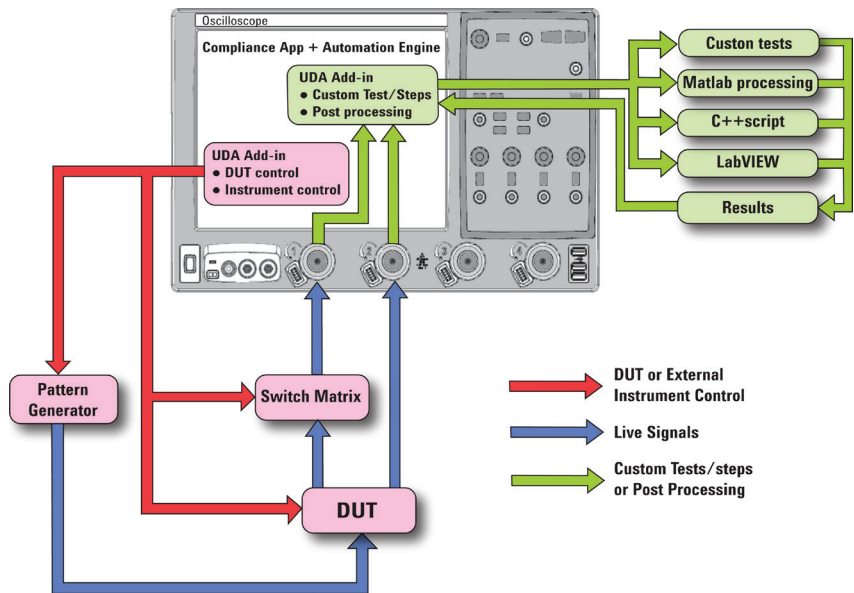

Figure 12. Combine the power of built-in automation and extensibility to transform your application into a complete test suite executive.

QSFP+ Switch Matrix Option

The Agilent switch matrix software option for the compliance application used together with switch matrix hardware, enables fully-automated testing for multi-lane digital bus interfaces.

The benefits of this automated switching solution include:

- *Eliminate reconnections*, which saves time and reduces errors through automating test setup for each lane of a multi-lane bus.
- *Maintain accuracy* with the use of the unique N2809A PrecisionProbe or N5465A InfiniiSim features to compensate for switch path losses and skew.
- *Customize testing* by using remote programming interface and the N5467A user-defined application tool for device control, instrument control and test customization.

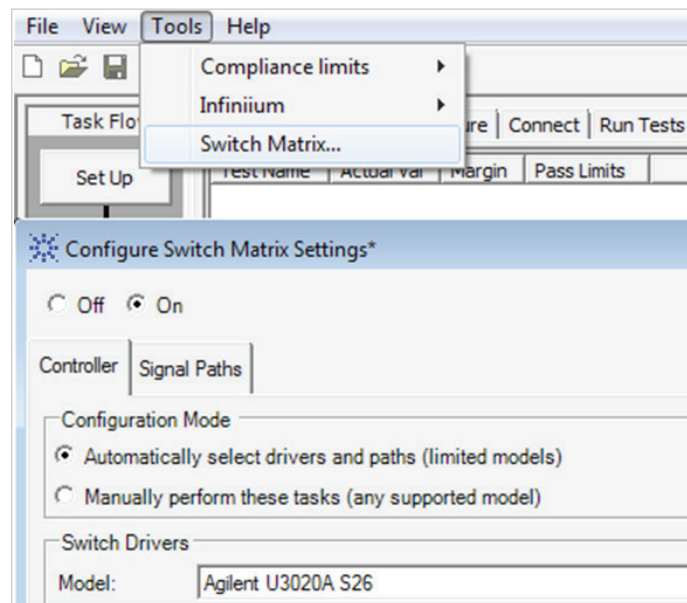

Figure 13. Switch matrix software feature enabled in the compliance application.

Switch matrix hardware

Agilent U3020A S26 or BitIfEye BIT2100

For more information about the switching solution and configuration, visit: www.agilent.com/find/switching and the Agilent application note with the publication number 5991-2375EN.



Figure 14. Automated testing for multi-lane digital bus interface through switching solution switch matrix.

Oscilloscope Compatibility

The N6468A Ethernet compliance software will run on:

- 90000A Series, version 4.60 or higher
- 90000 X-Series, version 4.60 or higher

These are shown in Table 1 below with minimum recommended bandwidth model and probes shown.

For oscilloscopes with earlier software revisions, upgrade software is available at http://www.agilent.com/find/infiniium_software.

Table 1. Recommended oscilloscopes and fixtures

Data rate	Standard	Recommended oscilloscope	Bandwidth of recommended oscilloscope	Recommended fixture	Bandwidth of recommended fixture
10 Gb/s	SFF-8431	DSO/DSAX92504A	25 GHz	SFP+ fixture	10 GHz
		DSO/DSAX92504A	25 GHz	SFP+ fixture	10 GHz
		DSO/DSAX92804A	28 GHz	SFP+ fixture	10 GHz
		DSO/DSAX93204A	32 GHz	SFP+ fixture	10 GHz
		DSO/DSAX92504Q	25 GHz	SFP+ fixture	10 GHz
		DSO/DSAX93304Q	33 GHz	SFP+ fixture	10 GHz
		DSO/DSAX95004Q	50 GHz	SFP+ fixture	10 GHz
		DSO/DSAX96204Q	62GHz	SFP+ fixture	10 GHz

Data rate	Standard	Recommended oscilloscope	Bandwidth of recommended oscilloscope	Recommended fixture	Bandwidth of recommended fixture
10 Gb/s	SFF-8431	DSO/DSAX92504A	25 GHz	QSFP+ fixture	10 GHz
	IEEE 802.3ba Annex 86A	DSO/DSAX92804A	28 GHz	QSFP+ fixture	10 GHz
		DSO/DSAX93204A	32 GHz	QSFP+ fixture	10 GHz
		DSO/DSAX92504Q	25 GHz	QSFP+ fixture	10 GHz
		DSO/DSAX93304Q	33 GHz	QSFP+ fixture	10 GHz
		DSO/DSAX95004Q	50 GHz	QSFP+ fixture	10 GHz
		DSO/DSAX96204Q	62 GHz	QSFP+ fixture	10 GHz

N6468A SFP+ Ethernet Compliance Tests

Table 2. N6468A SFP+ Ethernet compliance tests performed by the N6468A software.

Host transmitter tests

Specification	Test description
SFF-8431, Revision 4.1, Table 11, host transmitter output tests	Single-ended voltage range (+)
	Single-ended voltage range (-)
	Output AC common mode voltage
SFF-8431, Revision 4.1, Table 12, host transmitter output tests	Signal rise time (20%-80%)
	Signal fall time (80%-20%)
	Total jitter (TJ)
	Data dependent jitter (DDJ)
	Data dependent pulse width shrinkage (DDPWS)
	Uncorrelated jitter (UJ)
	Transmitter Qsq
	Eye mask hit ratio
	SFF-8431, Revision 4.1, Table 33, host transmitter output for Cu tests
Transmitter Qsq (for Cu)	
Output AC common mode voltage (for Cu)	
Host output TWDPc	

XLPPi tests

Specification	Test description
IEEE 802.3ba, Annex 86A, Table 86A-1, host to module output for XLPPi tests	Single-ended output voltage (+)
	Single-ended output voltage (-)
	AC common mode output voltage
	Output rise time (20%-80%)
	Output fall time (80%-20%)
	J2 jitter output
	J9 jitter output
	Data dependent pulse width shrinkage (DDPWS)
	Qsq
	Eye mask hit ratio

Test signal calibration tests

Specification	Test description
IEEE 802.3ba, Annex 86A, Table 86A-1, test signal calibration tests	Crosstalk source VMA
	Crosstalk source rise time (20% to 80%)
	Crosstalk source fall time (80% to 20%)

Measurement Requirements

To use the N6468A SFP+ Ethernet electrical performance validation and conformance software on your Infiniium oscilloscope, you will need oscilloscope probes, probe heads, and other test accessories depending on the Ethernet standard and test suites you want to perform.

Ordering Information

The following products are used in the total solution for the N6468A SFP+ Ethernet compliance test software.

To order the SFP+ compliance application for a new oscilloscope purchase, order oscilloscope option 078. To purchase a new license for the SFP+ compliance application software for an existing oscilloscope, order product number N6468A.

SFP+ option

Model number	Description
See oscilloscope compatibility Table 1	25 GHz oscilloscope (recommended minimum bandwidth) New oscilloscope purchase: SFP+ compliance application: DSO90000 Option 078 or DSOX-90000 Option 078 factory-installed license Existing oscilloscope: N6468A standalone license Server-based license: N5435A Option 074
N8806A	MATLAB basic software package for running TWDPc tests - TWDPc script is not provided by Agilent; user is responsible for obtaining the script from the SFF-8431 standard (Option 061 on new oscilloscopes)
SFP+-TPA-HCB-P	Wilder Technologies SFP+ plug adapter
N9399C (qty. 2)	DC block (N9398C/F/G or N9399C/F)
1810-0118 (qty. 2)	SMA (m) 50 Ω termination
1250-1158 (qty. 2)	Adapter, SMA (f) to SMA (f)
N2812A (qty. 2)	High performance input cable, 2.92 mm connectors, 1 m length

QSFP+ switch matrix option

Model number	Description
U3020AS26 Or BIT-4000-2198-0	Agilent switch matrix BitifEye BIT-2100 switch New oscilloscope purchase: QSFP+ compliance application: DSO90000 Option 707 or DSOX-90000 Option 707 factory-installed license Existing oscilloscope: N6468A standalone license Server-based license: N5435A Option 707
N8806A	MATLAB basic software package for running TWDPc tests - TWDPc script is not provided by Agilent; user is responsible for obtaining the script from the SFF-8431 standard (Option 061 on new oscilloscopes)
QSFP+-TPA-HCB-P	Wilder Technologies QSFP+ plug adapter
N9399C (Qty. 2)	DC Block (N9398C/F/G or N9399C/F)
1810-0118 (as needed)	SMA (m) 50 Ω termination
1250-1158 (Qty. 8)	Adapter, SMA (f) to SMA (f)
N2812A (Qty. 10)	High performance input cable, 2.92 mm connectors, 1 m length

Wilder Fixtures are based on either host and/or module testing. They can either be order together or separately depending on customer needs and application. www.wilder-tech.com

Related Literature

Publication title	Publication type	Publication number
Agilent Infiniium DSO/DSA90000A Series	Data Sheet	5989-7819EN
Infiniium Application Server License for Infiniium Oscilloscopes	Data Sheet	5989-6937EN
E2688A High-Speed Serial Data Analysis and Clock Recovery Software	Data Sheet	5989-0108EN
Agilent Infiniium 9000 Series Oscilloscopes	Data Sheet	5990-3746EN
Agilent Infiniium 90000 X-Series Oscilloscopes	Data Sheet	5990-5271EN



myAgilent

www.agilent.com/find/myagilent

A personalized view into the information most relevant to you.



AdvancedTCA® Extensions for Instrumentation and Test (AXIe) is an open standard that extends the AdvancedTCA for general purpose and semiconductor test. Agilent is a founding member of the AXIe consortium.

www.axistandard.org



LAN eXtensions for Instruments puts the power of Ethernet and the Web inside your test systems. Agilent is a founding member of the LXI consortium.

www.lxistandard.org



PCI eXtensions for Instrumentation (PXI) modular instrumentation delivers a rugged, PC-based high-performance measurement and automation system.

Three-Year Warranty



www.agilent.com/find/ThreeYearWarranty

Beyond product specification, changing the ownership experience. Agilent is the only test and measurement company that offers three-year warranty on all instruments, worldwide.



Agilent Assurance Plans

www.agilent.com/find/AssurancePlans

Five years of protection and no budgetary surprises to ensure your instruments are operating to specifications and you can continually rely on accurate measurements.



www.agilent.com/quality



Agilent Electronic Measurement Group
DEKRA Certified ISO 9001:2008
Quality Management System

Agilent Channel Partners

www.agilent.com/find/channelpartners

Get the best of both worlds: Agilent's measurement expertise and product breadth, combined with channel partner convenience.

For more information on Agilent Technologies' products, applications or services, please contact your local Agilent office. The complete list is available at: www.agilent.com/find/contactus

Americas

Canada	(877) 894 4414
Brazil	(11) 4197 3600
Mexico	01800 5064 800
United States	(800) 829 4444

Asia Pacific

Australia	1 800 629 485
China	800 810 0189
Hong Kong	800 938 693
India	1 800 112 929
Japan	0120 (421) 345
Korea	080 769 0800
Malaysia	1 800 888 848
Singapore	1 800 375 8100
Taiwan	0800 047 866
Other AP Countries	(65) 375 8100

Europe & Middle East

Belgium	32 (0) 2 404 93 40
Denmark	45 45 80 12 15
Finland	358 (0) 10 855 2100
France	0825 010 700*
	*0.125 €/minute
Germany	49 (0) 7031 464 6333
Ireland	1890 924 204
Israel	972-3-9288-504/544
Italy	39 02 92 60 8484
Netherlands	31 (0) 20 547 2111
Spain	34 (91) 631 3300
Sweden	0200-88 22 55
United Kingdom	44 (0) 118 927 6201

For other unlisted countries:

www.agilent.com/find/contactus

(BP-09-27-13)

Product specifications and descriptions in this document subject to change without notice.

© Agilent Technologies, Inc. 2013
Published in USA, November 27, 2013
5991-3587EN

