

# Keysight 87406Q Low PIM Coaxial Matrix Switch



Operating and  
Service Manual



NOTICE: This document contains references to Agilent Technologies. Agilent's former Test and Measurement business has become Keysight Technologies. For more information, go to [www.keysight.com](http://www.keysight.com).



## Notices

© Keysight Technologies 2014

No part of this manual may be reproduced in any form or by any means (including electronic storage and retrieval or translation into a foreign language) without prior agreement and written consent from Keysight Technologies as governed by United States and international copyright laws.

### Manual Part Number

87406-80005

### Edition

Edition 2, October 2014

Published by Keysight Technologies

Printed in Malaysia

Keysight Technologies Sdn. Bhd.  
Phase 3 Bayan Lepas Free Industrial Zone  
Bayan Lepas, Penang 11900 Malaysia

### Certification

Keysight Technologies certifies that this product met its published specifications at the time of shipment from the factory. Keysight Technologies further certifies that its calibration measurements are traceable to the United States National Institute of Standards and Technology (NIST, formerly NBS), to the extent allowed by the Institute's calibration facility, and to the calibration facilities of the other International Standards Organization members.

### Warranty

**The material contained in this document is provided "as is," and is subject to being changed, without notice, in future editions. Further, to the maximum extent permitted by applicable law, Keysight disclaims all warranties, either express or implied, with regard to this manual and any information contained herein, including but not limited to the implied warranties of merchantability and fitness for a particular purpose. Keysight shall not be liable for errors or for incidental or consequential damages in connection with the furnishing, use, or performance of this document or of any information contained herein. Should Keysight and the user have a separate written agreement with warranty terms covering the material in this document that conflict with these terms, the warranty terms in the separate agreement shall control.**

### Technology Licenses

The hardware and/or software described in this document are furnished under a license and may be used or copied only in accordance with the terms of such license.

### Restricted Rights Legend

U.S. Government Restricted Rights. Software and technical data rights granted to the federal government include only those rights customarily provided to end user customers. Keysight provides this customary commercial license in Software and technical data pursuant to FAR 12.211 (Technical Data) and 12.212 (Computer Software) and, for the Department of Defense, DFARS 252.227-7015 (Technical Data - Commercial Items) and DFARS 227.7202-3 (Rights in Commercial Computer Software or Computer Software Documentation).

### Safety Notices

#### CAUTION

A **CAUTION** notice denotes a hazard. It calls attention to an operating procedure, practice, or the like that, if not correctly performed or adhered to, could result in damage to the product or loss of important data. Do not proceed beyond a **CAUTION** notice until the indicated conditions are fully understood and met.

---

#### WARNING

A **WARNING** notice denotes a hazard. It calls attention to an operating procedure, practice, or the like that, if not correctly performed or adhered to, could result in personal injury or death. Do not proceed beyond a **WARNING** notice until the indicated conditions are fully understood and met.

---

## WEEE Compliance



This product complies with the WEEE Directive (2002/96/EC) marking requirements. The affixed label indicates that you must not discard this electrical/electronic product in domestic household waste.

Product Category: With reference to the equipment types in the WEEE Directive Annex I, this product is classed as a "Monitoring and Control Instrumentation" product.

Do not dispose in domestic household waste.

To return unwanted products, contact your local Keysight office, or see [www.keysight.com](http://www.keysight.com) for more information.

## Contacting Keysight

For more information, please contact your nearest Keysight office.

### Americas

Canada	(877) 894 4414
Brazil	55 11 3351 7010
Mexico	001 800 254 2440
United States	(800) 829 4444

### Asia Pacific

Australia	1 800 629 485
China	800 810 0189
Hong Kong	800 938 693
India	1 800 112 929
Japan	0120 (421) 345
Korea	080 769 0800
Malaysia	1 800 888 848
Singapore	1 800 375 8100
Taiwan	0800 047 866
Other AP Countries	(65) 6375 8100

### Europe & Middle East

Austria	0800 001122
Belgium	0800 58580
Finland	0800 523252
France	0805 980333
Germany	0800 6270999
Ireland	1800 832700
Israel	1 809 343051
Italy	800 599100
Luxembourg	+32 800 58580
Netherlands	0800 0233200
Russia	8800 5009286
Spain	0800 000154
Sweden	0200 882255
Switzerland	0800 805353
	Opt. 1 (DE)
	Opt. 2 (FR)
	Opt. 3 (IT)
United Kingdom	0800 0260637
For other unlisted countries:	<a href="http://www.keysight.com/find/contactus">www.keysight.com/find/contactus</a>

Or, go to [www.keysight.com/find/assist](http://www.keysight.com/find/assist) for more information.

# Contents

<b>1</b>	<b>Introduction</b>	<b>7</b>
	General Information	8
	Key Features	9
<b>2</b>	<b>Switch Configuration</b>	<b>11</b>
	General Operation	12
	Driving the Switch	14
	DC power connection	14
	RF path selection	15
	Open all RF ports	16
	Electronic Position Indicators	18
<b>3</b>	<b>Specifications</b>	<b>19</b>
	General Specifications	20
	Supplemental specifications (cold switching)	21
	Specifications	22
	Switch drive specifications	22
	RF specifications	23
	Environmental specifications	24
	Physical specifications	25
	Troubleshooting	27
<b>4</b>	<b>Installation and Verification</b>	<b>29</b>
	Installation	30
	Initial inspection	30

## Contents

<b>Operating and Service Instruction</b>	<b>31</b>
Operator's check	31
Performance test	32
Service instructions	32



# Keysight 87406Q Low PIM Coaxial Matrix Switch Operating and Service Manual

## 1 Introduction

General Information 8

Key Features 9

This chapter provides an overview of the Keysight 87406Q Low PIM Coaxial Matrix Switch.

## General Information

The Keysight 87406Q terminated switch provides the life and reliability required for automated test and measurement and signal monitoring and routing applications. The switch can be used in various applications as it is available in multiple frequency ranges, up to 20 GHz.



**Figure 1-1** Keysight 87406Q Low PIM Coaxial Matrix Switch

Innovative design and careful process control create switches that meet the requirements for highly repeatable switching elements in test instruments and switching interfaces. The exceptional 0.03 dB insertion loss repeatability is warranted for 3 million cycles at 25 °C. This reduces sources of random errors in the measurement path and improves measurement uncertainty. Switch life is a critical consideration in production test systems, satellite and antenna monitoring systems, and test instrumentation. The longevity of these switches increases system uptime and lowers the cost of ownership by reducing calibration cycles and switch maintenance.

## Key Features

- 3 x 3, 2 x 4, and 1 x 5 blocking matrix configurations
- Magnetic latching
- Guaranteed repeatability of 0.03 dB up to 3 million cycles, ensuring accurate system measurements and reducing calibration intervals
- Excellent isolation, typically > 100 dB at 20 GHz
- PIM level (typical) of -165 dBc
- Opto-electronic indicators and interrupts
- Terminated ports
- TTL/5 V CMOS compatibility (optional)

**This page is intentionally left blank.**

## **2 Switch Configuration**

**General Operation 12**

**Driving the Switch 14**

DC power connection 14

RF path selection 15

Open all RF ports 16

**Electronic Position Indicators 18**

This chapter provides you information on how to drive the switch using standard drive and TTL drive. Also included is the configuration to utilize the function of the position indicator.

# General Operation

The 87406Q matrix switch consists of six ports which can be individually connected via internal microwave switches to form an RF path (see [Figure 2-1](#)). When control inputs are sent to the switch, the internal diode logic and position sensing circuitry routes current to the appropriate solenoids to close or open the microwave switches based on the input state. The position sensing circuitry utilizes opto-electronic components to determine the position of the individual internal microwave switches. Each internal microwave switch has two solenoids: one to select or close the RF port, and one to unselect or open the RF port. Each solenoid requires 200 mA at 24 VDC nominal. The position sensing circuits serve three purposes: to enable solenoids that need to be switched, to interrupt the solenoid current once the individual internal microwave switch is closed or opened, and to power the position indicator circuits. The solenoid current is interrupted once the switching solenoids are magnetically latched. The drive current then returns to the standby level that is required by the opto-electronic components. When a control input is applied, all RF ports that have no enabling control input are automatically opened by the internal logic circuitry.

To configure a desired RF path, two ports must be engaged which requires a control input for each port to be maintained. If the input is removed from either port, that port will be automatically opened by the internal logic circuitry. All of the "open" solenoids are internally connected to pin 16 via diode logic circuitry (Option 161 and T24 only). If no input is present at any of the port select pins (3, 5, 7, 9, 11, 13), all of the RF ports will be opened if pin 16 is selected. Input applied to port select pins (3, 5, 7, 9, 11, 13) while pin 16 is selected will override the signal on pin 16 and close the respective ports. On standard switches, pin 16 can be permanently connected to ground to allow the switch to open all RF ports at power up (assuming no input is present at any of the port select pins). Not available with Options 100 or T24.

### CAUTION

If pin 15 is not grounded, the logic circuit will not operate as expected, and damage to the switch will occur.

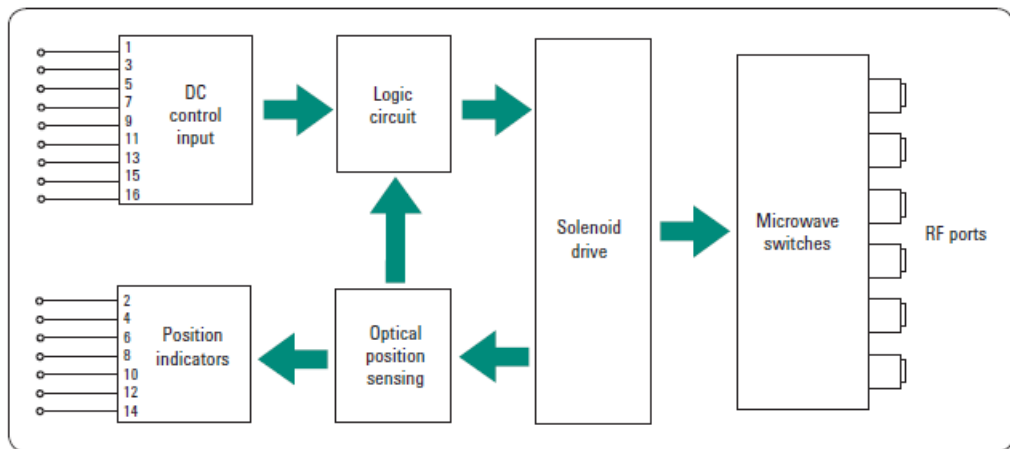

**Figure 2-1** Keysight 87406Q block diagram

## Driving the Switch

### DC power connection

- Connect pin 1 to supply (+20 VDC to +32 VDC)
- Connect pin 15 to chassis ground to enable the electronic position indicating circuitry and drive logic circuitry.

**NOTE**

Pin 15 must always be connected to ground to enable the electronic position-indicating circuitry and drive logic circuitry.

---

**CAUTION**

If pin 15 is not connected to power supply ground, catastrophic failure will occur.

---

**NOTE**

After the RF path is switched and latched, the drive current is interrupted by the electronic position-sensing circuitry. Pulsed control is not necessary, but if implemented, the pulse width must be 15 ms minimum to ensure the switch is fully latched.

---



## RF path selection

To connect any two RF ports, apply control signal to the corresponding drive pins as shown below.

**Table 2-1** Keysight 87406Q RF port drive pin control data (see [Figure 3-5](#) for drive connection diagrams)

RF port	6	5	4	3	2
1	3, 13	3, 11	3, 9	3, 7	3, 5
2	5, 13	5, 11	5, 9	5, 7	
3	7, 13	7, 11	7, 9		
4	9, 13	9, 11			
5	11, 13				

Using [Table 2-1](#), **select** (close) the desired RF path by connecting ground (Option 024 and Option 100) or applying TTL "High" (Option T24) to the corresponding "drive" pins.

**Clear** (open) RF paths by disconnecting ground (Option 024 and Option 100) or applying TTL "Low" (Option T24) to the corresponding "drive" pins.

### Example: Configure the RF path from port 2 to port 5

Using the data in [Table 2-1](#), select pins 5 and 11 while ensuring no other pins are selected.

RF port	1	2	3	4	5	6	Open all <sup>[1]</sup>
Drive pin	3	5	7	9	11	13	16
Option 024, Option 100	U	G	U	U	G	U	X <sup>[2]</sup>
Option T24, Option 100	L	H	L	L	H	L	X <sup>[2]</sup>

U = Ungrounded, G = Grounded, L = TTL "Low", H = TTL "High", X = Negligible

## 2 Switch Configuration

[1] "Open All Ports" is not available with Option 100 or Option T24.

[2] "Open all RF Ports" feature is overridden by port selection.

Selected ports will be closed and unselected ports will be automatically opened by the internal logic circuits when new port selections are made. After the RF port is switched and magnetically latched, the solenoid current is interrupted by the solid state position sensing circuitry. The drive voltage must be maintained to avoid RF path disconnection by the internal logic.

### Open all RF ports

Unselecting all RF ports and selecting Pin 16 on standard and Option T24 open all RF ports:

Drive pin	3	5	7	9	11	13	16
Option 024	U	U	U	U	U	U	G
Option T24	L	L	L	L	L	L	H

U = Ungrounded, G = Ground, L = TTL "Low", H = TTL "High"

Selecting an RF port will override the "open all RF ports" for each selected port. If desired, pin 16 can be wired directly to ground (Option 024) or TTL "High" (Option T24) to open all RF ports at power-up.

### Break-before-make

Remove the control inputs from the undesired port, and then select the desired port. The internal logic will unselect the old port automatically upon application of the new port selection.

**Make-before-break**

Select the new RF port while maintaining the control input on the original ports. Allow 15 ms for the switching action to be completed, and then unselect the original port; the original port will be automatically disconnected by the internal logic.

## Electronic Position Indicators

The electronic position indicators consist of optically isolated, solid state relays which are driven by photo-electric sensors coupled to the mechanical position of the RF path's moving elements (see [Figure 2-2](#)). The circuitry consists of a common which can be connected to an output corresponding to each RF path. If multiple RF paths are engaged, the position indicator corresponding to each closed RF path will be connected to common. The solid state relays are configured for AC and/or DC operation. See [“Environmental specifications” on page 24](#). The electronic position indicators require that the supply (20 to 32 VDC) be connected to pin 1 and ground connected to pin 15.

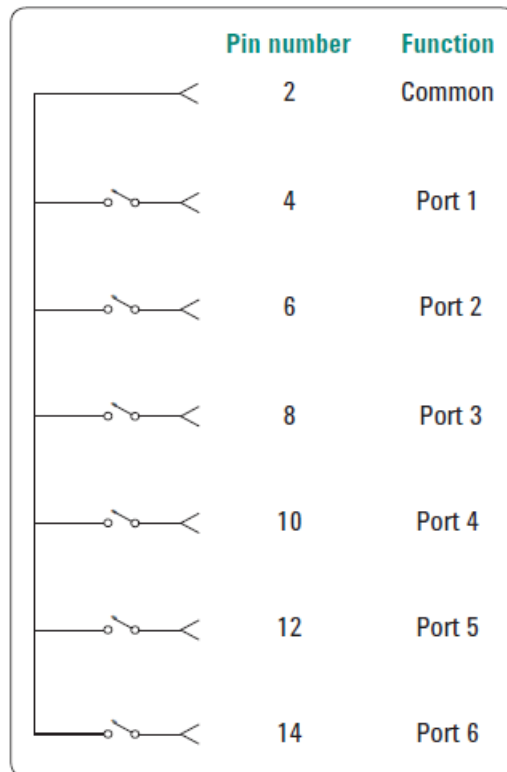

**Figure 2-2** Pin configuration for indicator function

# **3**

## **Specifications**

**General Specifications 20**

Supplemental specifications (cold switching) 21

**Specifications 22**

Switch drive specifications 22

Environmental specifications 24

Physical specifications 25

**Troubleshooting 27**

This chapter provides the specifications of the switch.

Specifications describe the warranted performance of the switch.

Supplemental and typical characteristics are intended to provide information useful in applying the switch by giving typical, but not warranted performance parameters.

## General Specifications

Specifications refer to the performance standards or limits against which the switch is tested.

*Typical characteristics are included for additional information only and they are not specifications. These are denoted as "typical", "nominal", or "approximate" and are printed in italics.*

---

Maximum power rating	
Into internal termination	1 W CW 50 W peak, 10 $\mu$ s max pulse width, not to exceed 1 W average
Into thru path	
Hot switching	2 W CW 100 W peak, 10 $\mu$ s max pulse width, not to exceed 2 W average
Cold switching	See <b>"Supplemental specifications (cold switching)"</b>
Switching time	15 ms maximum

---

## Supplemental specifications (cold switching)

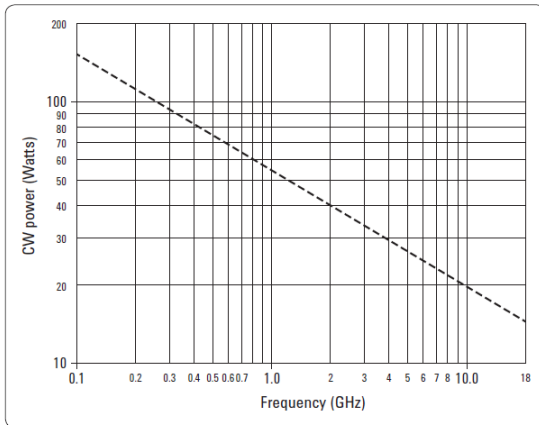

### Supplemental characteristics

Insertion loss repeatability (measured at 25 °C)	0.03 dB
Characteristic impedance	50 Ω
RF connectors	SMA (f)

### Reference conditions

- Cold switching only (NO hot switching)
- Ambient temperature of 75 °C or less
- Sea level (0.88 derating at 15,000 feet)
- Load VSWR < 1.2 (see [Figure 3-1](#) for derating above 1.2 VSWR)
- Power handling at 25 °C is 100 W at 4 GHz

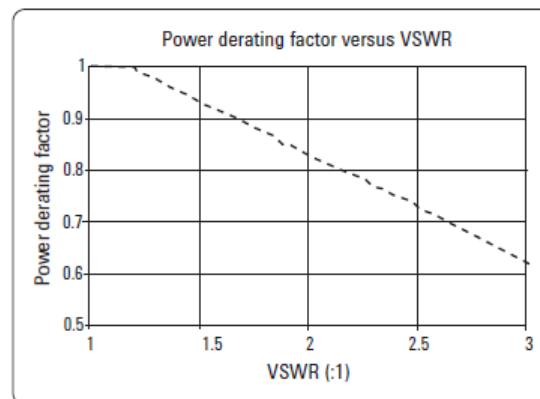

**Figure 3-1** Power derating factor vs. VSWR

# Specifications

## Switch drive specifications

Parameter	Condition	Minimum	Nominal	Maximum	Unit
Supply voltage, Vcc		20	24	32	V
Switching current	Vcc = 24 VDC		200 <sup>[1]</sup>		mA
Standby current (quiescent)		25		50	mA
<b>Option T24/100</b>					
High level input		3		7	V
Low level input				0.8	V
Maximum high input current	Vcc = Max; Vinput = 3.85 VDC		1	1.4	mA

[1] 200 mA is required for each RF port closed or opened. Using “open all ports” (pin 16) will require up to 1200 mA (six ports times 200 mA each). See “General Operation” on page 12.

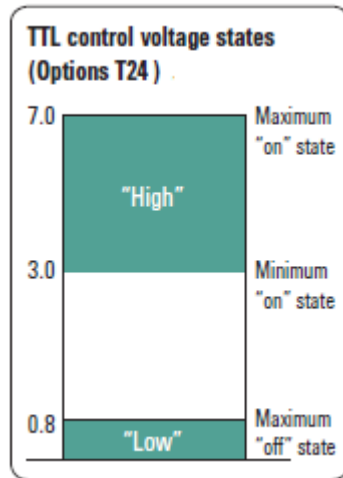

Figure 3-2 TTL control voltage states (Option T24)



## RF specifications

Parameter	Specification
Frequency range	DC to 20 GHz
Insertion loss	0.34 dB + 0.033 x frequency (GHz) maximum
Isolation	100 dB minimum to 12 GHz 80 dB minimum from 12 to 15 GHz 70 dB minimum from 15 to 20 GHz
SWR	1.21 maximum from DC to 4 GHz 1.35 maximum from 4 to 10 GHz 1.5 maximum from 10 to 15 GHz 1.7 maximum from 15 to 18 GHz 1.9 maximum from 18 to 20 GHz

### 3 Specifications

## Environmental specifications

The low PIM switches are designed to fully comply with Keysight's product operating environmental specifications.

Parameter	Specification
Temperature	
• Operating	–25 °C to 75 °C
• Storage	–55 °C to 85 °C
• Cycling	–50 °C to 150 °C, 10 cycles
Humidity	
• Operating	40 °C/95% RH, 5 days
• Storage	65 °C/90% RH, 24 hours
• Condensation	40 °C/95% RH
Shock	
• Non-operating:	
• Half-sine	500 G at 0.5 ms, 3 drops/direction
• Transportation	50 G Vibration: 8 m/s $\pm$ 10%
• Operating	50 G at 6 ms, 6 directions
Vibration	
• Operating	7 G rms, 5 to 2000 Hz at 0.25 in p-p
• Survival	20 G rms, 20 to 2000 Hz at 0.06 in p-p, 4 min/cycle, 4 cycles/axis
• Random	7 G rms, 50 to 2000 Hz, 15 min/axis
ESD immunity	
• Direct discharge	6 kV (to outer conductor)
• Air discharge	15 kV (to outer conductor)
RFI	Radiated emission per CISPR 11
Magnetic field	
• Operating emission	AC magnetic emission (1.88 G rms) DC magnetic emission (5 G)
• Operating immunity	30 A/M rms at 47 Hz, 50 Hz, 60 Hz, and 189 Hz 150 A/M rms at 47 Hz and 189 Hz

## Physical specifications

Parameter	Specification
Dimensions	Figure 3-3
Weight	229 gm (0.50 lb)

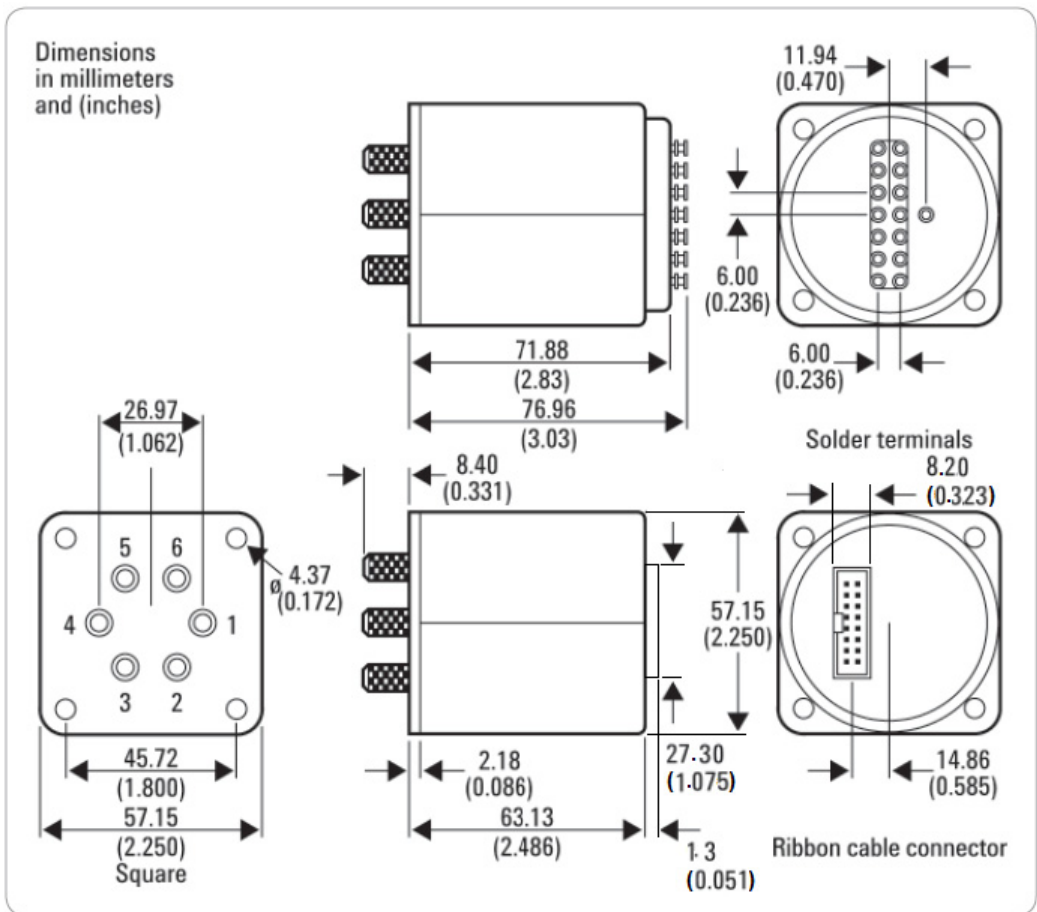
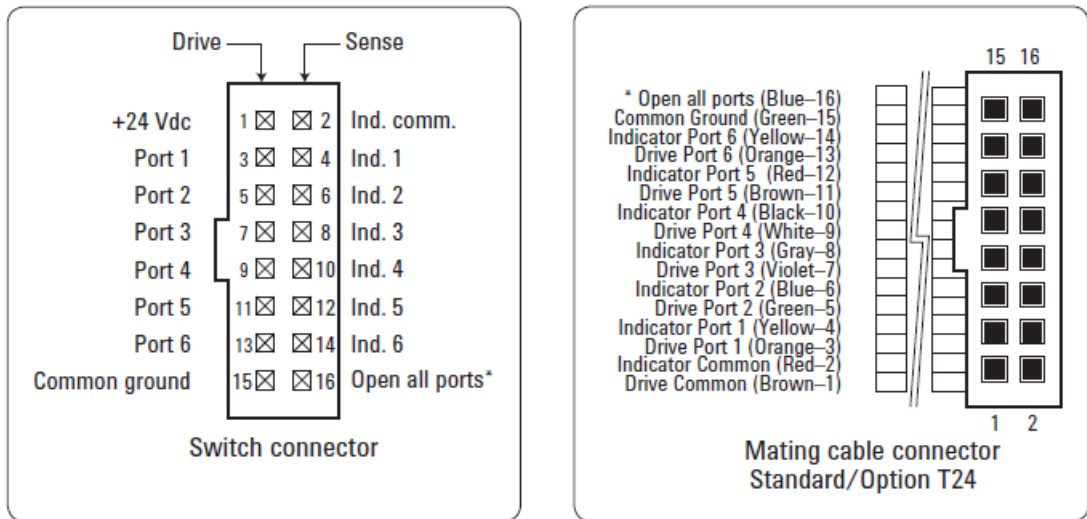

Figure 3-3 Product outline

### 3 Specifications



\* Open all ports pin is not available with Options 100/T24.1516Common

**Figure 3-4** Connector configuration

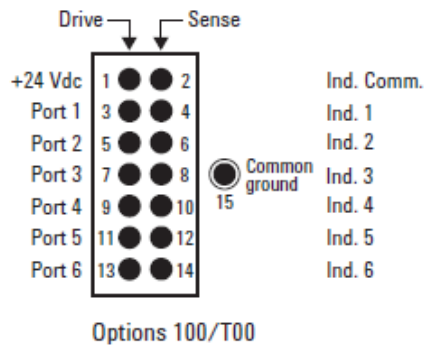

**Figure 3-5** Drive connection diagram

# Troubleshooting

Symptom	Probable cause
1. Will not switch	<ul style="list-style-type: none"><li>• Not connected to supply</li><li>• Supply &lt; 20 V</li><li>• Supply current too low</li><li>• Not connected to ground</li><li>• Select line not at ground (std)</li><li>• TTL "Low" voltage too high (Option T24)</li></ul>
2. Position indicators do not work	<ul style="list-style-type: none"><li>• Supply not connected</li><li>• Supply &lt; 20 VDC</li><li>• Pin 15 not connected to ground</li></ul>

### **3 Specifications**

**This page is intentionally left blank.**

## **4 Installation and Verification**

**Installation 30**

Initial inspection 30

**Operating and Service Instruction 31**

Operator's check 31

Performance test 32

Service instructions 32

This chapter provides you installation information and simple verification steps of the switch.

## Installation

### Initial inspection

- 1 Inspect the shipping container for damage. If the shipping container or cushioning material is damaged, it should be kept until the contents of the shipment have been checked for completeness and the instrument has been checked both mechanically and electrically.
  - Check for mechanical damage such as scratches or dents.
  - Procedures for checking electrical performance are given under “Operator’s check” on page 31 or “Performance test” on page 32.
- 2 If the contents are incomplete, there is mechanical damage or defect, or the instrument does not pass the electrical performance test, contact the nearest Keysight Sales and Service office (refer to “Contacting Keysight” on page 4). Keysight will arrange for repair or replacement of the damaged or defective equipment. Keep the shipping materials for the carrier’s inspection.
- 3 If you are returning the instrument under warranty or for service, repackaging the instrument requires original shipping containers and materials or their equivalents. Keysight can provide packaging materials identical to the original materials. Refer to “Contacting Keysight” on page 4 for the Keysight office nearest to you. Attach a tag indicating the type of service required, return address, model number, and serial number. Mark the container **FRAGILE** to insure careful handling. In any correspondence, refer to the instrument by its model number and serial number.



# Operating and Service Instruction

## Operator's check

The operator's check is supplied to allow the operator to make a quick check on the switch prior to use or if a failure is suspected.

### CAUTION

ESD exceeding the level specified in “**Environmental specifications**” or RF power applied is greater than the maximum specified as in “**General Specifications**” may cause permanent damage to the device.

### Description

The coaxial matrix switch is connected to a network analyzer configured for the S-parameter measurement. The network analyzer may be set to sweep over the whole or selected frequency range of the switch to be verified. The S-parameter measurement is the best way to determine if the switch is working properly.

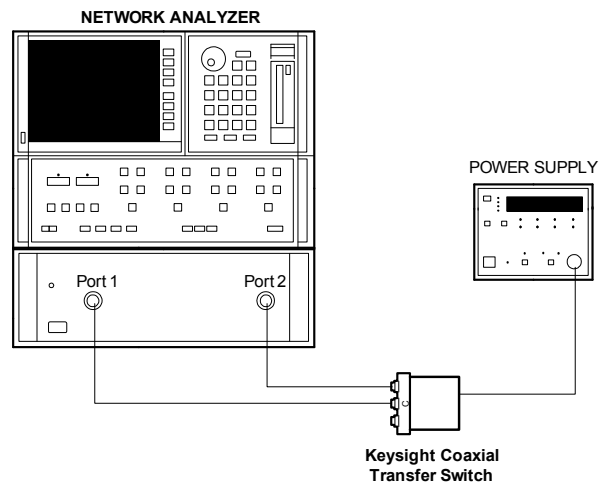

**Figure 4-1** Connection to perform quick check

### Quick check procedure

- 1 Connect one port of the switch to Port 1 of the network analyzer and one of the outer RF ports to another port of the network analyzer as illustrated in [Figure 4-1](#).
- 2 For standard drive, apply ground to the corresponding “drive” pin to close the selected path. Refer to [“Driving the Switch” on page 14](#).
- 3 For TTL drive (option T24), apply “High” to the corresponding “drive” pin to close the selected path. Refer to [“Driving the Switch” on page 14](#).
- 4 Perform the S-parameter measurement and verify against [“Supplemental specifications \(cold switching\)” on page 21](#).
- 5 Repeat steps 1 to 4 until all paths are measured and verified.

## Performance test

The coaxial matrix switch can be tested to the accuracy of the specifications with a network analyzer or equivalent equipment of suitable accuracy. If a network analyzer is available, test the instrument using the procedure in the analyzer’s operating manual.

## Service instructions

### Adjustment and repair

Keysight 87406Q low PIM coaxial matrix switch does not require internal adjustments and are not recommended for repair.

#### NOTE

If any of the low PIM coaxial matrix switches fails within the warranty period, a new unit will be replaced. Refer to [“Replacement units” on page 33](#) for more details.

## Maintenance

The connectors, particularly the connector faces, must be kept clean. For instructions on connecting and care of your connectors, refer to the Microwave Connector Care Quick Reference Card (08510-90360).

## Replacement units

Replacement unit	Part number
Low PIM switch, matrix, DC - 20 GHz, terminated, 24 VDC with Option 100, T24	87406-60009
Low PIM switch, matrix, DC - 20 GHz, terminated, 24 VDC with Option 161, 024	87406-60010
Low PIM switch, matrix, DC - 20 GHz, terminated, 24 VDC with Option 162, T24	87406-60011
Low PIM switch, matrix, DC - 20 GHz, terminated, 24 VDC with Option 100, T24	87406-60012

### NOTE

The above list of replacement units is not applicable as customer-orderable units. The list only applies for any low PIM coaxial matrix switch which fails within the warranty period.

**This page is intentionally left blank.**

This information is subject to change without notice.  
© Keysight Technologies 2014  
Edition 2, October 2014



87406-80005  
[www.keysight.com](http://www.keysight.com)