

Errata

Title & Document Type: 8753C Network Operating Manual (Apr89)

Manual Part Number: 08753-99000

Revision Date: April 1989

HP References in this Manual

This manual may contain references to HP or Hewlett-Packard. Please note that Hewlett-Packard's former test and measurement, semiconductor products and chemical analysis businesses are now part of Agilent Technologies. We have made no changes to this manual copy. The HP XXXX referred to in this document is now the Agilent XXXX. For example, model number HP8648A is now model number Agilent 8648A.

About this Manual

We've added this manual to the Agilent website in an effort to help you support your product. This manual provides the best information we could find. It may be incomplete or contain dated information, and the scan quality may not be ideal. If we find a better copy in the future, we will add it to the Agilent website.

Support for Your Product

Agilent no longer sells or supports this product. You will find any other available product information on the Agilent Test & Measurement website:

www.tm.agilent.com

Search for the model number of this product, and the resulting product page will guide you to any available information. Our service centers may be able to perform calibration if no repair parts are needed, but no other support from Agilent is available.

**HP 8753C
NETWORK ANALYZER**

OPERATING MANUAL

GENERAL INFORMATION AND SPECIFICATIONS

SAFETY CONSIDERATIONS

GENERAL

This product and related documentation must be reviewed for familiarization with safety markings and instructions before operation. This product has been designed and tested in accordance with international standards.

SAFETY SYMBOLS



Instruction manual symbol: the product will be marked with this symbol when it is necessary for the user to refer to the instruction manual (refer to Table of Contents).



Indicates hazardous voltages.



Indicates earth (ground) terminal.

WARNING

The WARNING sign denotes a hazard. It calls attention to a procedure, practice, or the like, which, if not correctly performed or adhered to, could result in personal injury. Do not proceed beyond a WARNING sign until the indicated conditions are fully understood and met.

CAUTION

The CAUTION sign denotes a hazard. It calls attention to an operating procedure, practice, or the like, which, if not correctly performed or adhered to, could result in damage to or destruction of part or all of the product. Do not proceed beyond a CAUTION sign until the indicated conditions are fully understood and met.

SAFETY EARTH GROUND

This is a Safety Class I product (provided with a protective earthing terminal). An uninterruptible safety earth ground must be provided from the main power source to the product input wiring terminals, power, cord, or supplied power cord set. Whenever it is likely that the protection has been impaired, the product must be made inoperative and secured against any unintended operation.

BEFORE APPLYING POWER

Verify that the product is configured to match the available main power source per the input power configuration instructions provided in this manual.

If this product is to be energized via an auto-transformer make sure the common terminal is connected to the neutral (grounded side of the mains supply).

SERVICING

WARNING

Any servicing, adjustment, maintenance, or repair of this product must be performed only by qualified personnel.

Adjustments described in this manual may be performed with power supplied to the product while protective covers are removed. Energy available at many points may, if contacted, result in personal injury.

Capacitors inside this product may still be charged even when disconnected from their power source.

To avoid a fire hazard, only fuses with the required current rating and of the specified type (normal blow, time delay, etc.) are to be used for replacement.

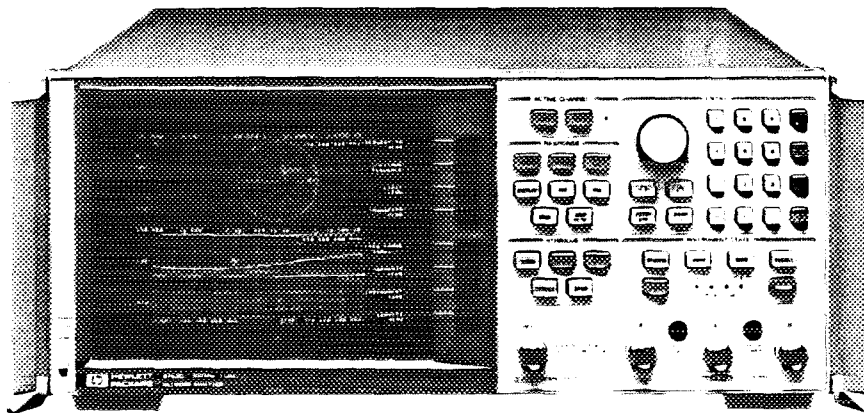

HP 8753C RF Network Analyzer

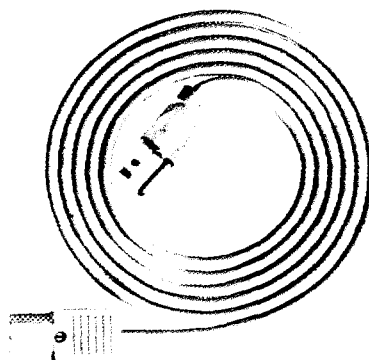

Power Cable*

* Power Cable/Plug Supplied Depends on Country of Destination

Figure 1. HP 8753C Network Analyzer with Power Cable Supplied

General Information (and Specifications)

CONTENTS

2	About This Manual Set	25	Comparison of Typical Error-Corrected Measurement Uncertainty
2	HP 8753C Manual Description	30	Types of Residual Measurement Errors
4	System Description	31	System Error Model
4	Hewlett-Packard Interface Bus	32	Reflection Uncertainty Equations
4	Options Available	33	Transmission Uncertainty Equations
6	Equipment Required	34	Dynamic Accuracy
6	Test Sets Available	38	Effects of Temperature Drift
7	Measurement Accessories Available	41	System Performance with Different Test Sets and Connector Types
9	System Accessories Available	49	Determining Expected System Performance
10	Recommended Test Equipment		
12	Instrument Specifications		
25	System Performance		

ABOUT THIS MANUAL SET

This *Hewlett-Packard 8753C Network Analyzer Operating Manual* is a complete guide to operating the analyzer alone or in a system. It is part of a two manual set; the *Service Manual* completes the set.

To explore the manuals further, inspect their title pages and the "Contents" and "Index" sections.

Instruments Covered by This Manual

The instrument you received with this manual is covered by this manual without change. Any other instrument with one of the serial number prefixes listed on the title page is also described by this manual. (The serial number plate, shown in figure 2, is attached to the rear panel of the analyzer.)

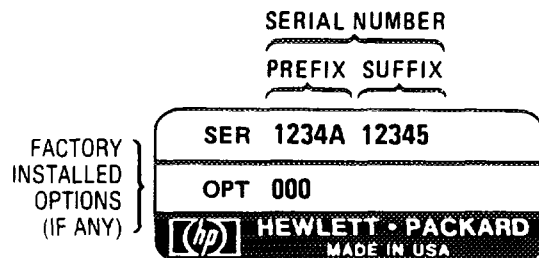

Figure 2. Typical Serial Number Plate

Other instruments differ from the instruments covered directly by this manual. Those differences are documented in the "Instrument History" section. See the "Instrument History" section if the serial number prefix of your instrument is not listed on the title page.

Microfiche Copies of the Manual

Use the microfiche part number on the title page to order a package of 10 x 15 centimeter (4 x 6 inch) microfilm transparencies of this manual and the *Service* manual.

HP 8753C DESCRIPTION



A properly grounded AC outlet is mandatory when operating the analyzer. Operating the instrument with an improperly grounded or floating ground prong WILL DAMAGE THE INSTRUMENT!

The HP 8753C is a high performance vector network analyzer for laboratory or production measurements of reflection and transmission parameters. It integrates a high resolution synthesized RF source and a dual channel three-input receiver to measure and display magnitude, phase, and group delay responses of active and passive RF networks. Option 002 provides swept harmonic measurements of RF amplifiers. Option 006 extends the frequency range of the three-input receiver to 6 GHz. Option 010 provides the capability of transforming measured data from the frequency domain to the time domain. For information on other options, refer to *Options Available* later in this section.

Two independent display channels and a large screen color CRT display the measured results of one or both channels, in rectangular or polar/Smith chart formats.

Digital signal processing and microprocessor controls combine to provide easy operation and measurement improvement. Measurement functions are selected with front panel keys and softkey menus. Displayed measurement results can be printed or plotted directly to a compatible peripheral without the use of an external computer. Instrument states can be saved in internal memory for at least three days. In addition, the instrument can control a compatible disc drive for external storage capability. Built-in service diagnostics are available to simplify troubleshooting procedures.

Trace math, data averaging, trace smoothing, electrical delay, and accuracy enhancement provide performance improvement and flexibility. Accuracy enhancement methods range from normalizing data to complete one or two port vector error correction. Vector error correction reduces the effects of system directivity, frequency response, source and load match, and crosstalk.

In combination with its compatible test sets and accessories, the analyzer has the ability to make complete reflection and transmission measurements in both 50 and 75 ohm impedance environments.

Additional Features

In addition to the above capabilities, this analyzer has several features not included in older instruments:

1601 Error Corrected Measurement Points. The analyzer allows full two-port error correction with 1601 measurement points.

Automatic Sweep Time. The analyzer can automatically shorten sweep time as much as possible for the given IF bandwidth, number of points, averaging mode, frequency range, number of points, and sweep type.

External Source Capability. External source mode allows you to phase lock the analyzer's receiver to an external source. Refer to the *Reference*, Chapter 14.

Independent Receiver Use. The tuned receiver mode allows you to use the receiver as a stand-alone device. CW measurements are possible with a synthesized external source. This mode is used in non-phase-locked applications which require great speed, or that require arbitrary measurements at certain frequencies. Refer to the *Reference*, Chapter 14.

Receiver/Source Frequency Offset. For mixer test applications, the analyzer's receiver and source may be programmed with a fixed frequency offset. The instrument will maintain phase-lock with a mixer placed between its RF output and R input port. An external source is required as a local oscillator. Refer to the *Reference*, Chapter 14.

Power Meter Calibration. The analyzer uses an HP-IB compatible power meter to monitor and correct its output power at each point. A power correction table stores the correction values. This feature may be used in either of two ways:

- The power meter measures and corrects every sweep (continuous correction). This method should be used in applications where greatest accuracy is a critical factor.
- The power meter measures and corrects power in a sample sweep. Subsequent sweeps are corrected by the values in the power correction table. This method is much faster than continuous correction.

Refer to the *Reference*, Chapter 5.

Interpolated Error Correction. This allows the operator to perform any type of calibration, and then display any subset of that frequency range or use a different number of points. If the operator changes only the frequency range, interpolated error correction uses the same number of points as the original calibration. New error coefficients are interpolated from the coefficients of the original calibration. Interpolated error correction provides a great improvement over uncorrected measurements, but is not specified. Refer to the *Reference*, Chapter 5.

Segmented Error Correction in Frequency List Mode. Frequency list mode now allows the operator to select any frequency segment from the list —and retain full specified calibration. Refer to the *Reference*, Chapter 3.

Automated Operation Without an External Computer Controller. The test sequence function allows the operator to save all keystrokes in a particular measurement task, and have the analyzer perform them automatically at a later time. This feature combines simple operation with many advanced features, such as sequence stacking, conditional jumps, user-defined prompts, and many others. Sequences may be stored to an optional external disk drive. Refer to the *Reference*, Chapter 13.

Harmonic Measurements (Option 002). This displays the second or third harmonic of the fundamental while sweeping either frequency or power. The fundamental may be displayed simultaneously. The minimum fundamental frequency is 16 MHz, and harmonics can not be measured if they exceed the upper frequency range of the instrument. Refer to the *Reference*, Chapter 14.

Plotter/Printer Buffer. The buffer allows a single plot or print-out to be made while the instrument continues to make measurements. During the plot (or print), measurement time may increase as the analyzer CPU controls both instrument and plotter functions. See chapter 9 of the *Reference*, for details.

SYSTEM DESCRIPTION

An HP 8753C system consists of the analyzer with one of the following test sets/accessories:

- HP 85046A/B or 85047A S-parameter test set
- HP 85044A/B transmission/reflection test set
- HP 11850C/D or 11667A power splitter

In addition to one of the above, a system requires a compatible Hewlett-Packard calibration kit and the necessary cables. The compatible test sets, power splitters, calibration kits, and cables are described under *Test Sets Available* and *Measurement Accessories Available* later in this section.

The system may also include other compatible peripherals such as a printer, plotter, or optional disc drive. The printer and plotter are described under *Other Accessories Available*. The optional disc drive is described under *Options Available*.

The system can be automated with the addition of an HP 9000 series 200 or 300 computer. This allows all of the analyzer's measurement capabilities to be programmed over the Hewlett-Packard Interface Bus (HP-IB).

HEWLETT-PACKARD INTERFACE BUS (HP-IB)

The analyzer is factory-equipped with a remote programming interface using the Hewlett-Packard Interface Bus (HP-IB). HP-IB is Hewlett-Packard's hardware, software, documentation, and support for IEEE-488.1 and IEC-625, worldwide standards for interfacing instruments. This provides a remote operator with the same control of the instrument available to the local operator, except for control of the power line switch and some internal tests. Remote control is maintained by a controlling computer that sends commands or instructions to and receives data from the analyzer using the HP-IB. Several output modes are available for outputting data. Through a subset of HP-GL (Hewlett-Packard Graphics Language), user graphics can be plotted on the CRT. A complete general description of HP-IB is available in *Condensed Description of the Hewlett-Packard Interface Bus* (HP part number 59401-90030), and in *Tutorial Description of the Hewlett-Packard Interface Bus* (HP literature number 5952-0156).

The analyzer itself can use HP-IB to output measurement results directly to a compatible printer or plotter, to store instrument states using an optional disc drive, without the use of an external computer. It can also control a power meter for power calibration.

OPTIONS AVAILABLE

Option 002, Harmonic Mode

The analyzer, when equipped with this option, can measure second or third harmonics of the DUT's fundamental output signal. Frequency and power sweep are supported in this mode. Harmonic frequencies may be measured up to the maximum frequency of the receiver. However, the fundamental frequency may not be lower than 16 MHz.

Option 006, 6 GHz Receiver Operation

This option extends the maximum receiver frequency of the analyzer to 6 GHz, although it does not extend the maximum frequency of the built-in RF source. When used with the HP 85047A S-parameter test set, option 006 provides high performance vector measurement capability to 6 GHz.

Option 010, Time Domain

This option displays the time domain response of a network by computing the inverse Fourier transform of the frequency domain response. It shows the response of a test device as a function of time or distance. Displaying the reflection coefficient of a network versus time determines the magnitude and location of each discontinuity, or displaying the transmission coefficient of a network versus time determines the characteristics of individual transmission paths. Time domain operation retains all accuracy inherent with the calibration that is active in the frequency domain. The time domain capability is useful for the design and characterization of such devices as SAW filters, SAW delay lines, RF cables, and RF antennas.

Option 802, External Disc Drive

This provides an HP 9122 dual 3.5 inch microfloppy disc drive. This double-sided drive provides a total of 1420 kbytes of formatted capacity. Ordering numbers for discs and disc holders are provided in *Other Accessories Available*, later in this section. The one-year on-site warranty provided with the analyzer (where available) also applies to this disc drive.

Option 908, Rack Mount Without Handles

Option 908 is a rack mount kit containing a pair of flanges and the necessary hardware to mount the instrument, with handles detached, in an equipment rack with 482.6 mm (19 inches) horizontal spacing.

Option 913, Rack Mount With Handles

Option 913 is a rack mount kit containing a pair of flanges and the necessary hardware to mount the instrument with handles attached in an equipment rack with 482.6 mm (19 inches) spacing.

Service and Support Options

The analyzer automatically includes a one-year on-site service warranty, where available. The following service and support products are available with an HP 8753C system at any time during or after the time of purchase. The "system" consists of an HP 8753C with either a 85044A, 85046A, or 85047A test set; either an HP 11851B or 11857D cable kit; and an HP 85031B 7 mm calibration kit. Some restrictions apply to 75 ohm systems, i.e. those with an HP 85044B or 85046B test set. Additional service and support options may be available at some sites. Consult your local HP customer engineer for details.

On-Site System Verification (+23G), performed by a Hewlett-Packard customer engineer, confirms the system's error-corrected uncertainty performance by measuring traceable 7 mm devices. It provides a hardcopy listing of both ideal and actual data, together with a certificate of traceability. Preventive maintenance is performed at the time of system verification. Travel through Zone 3 (up to 100 miles/160 km from Hewlett-Packard's nearest service-responsible office) is included.

Standard System Maintenance Service (+02A) provides four-hour on-site response through Travel Zone 3 on all service requests for the HP 8753C and a 50 ohm test set by a Hewlett-Packard customer engineer.

Basic System Maintenance Service (+02B) provides next day on-site response through Travel Zone 3 on all service requests for the HP 8753C and a 50 ohm test set by a Hewlett-Packard customer engineer.

Return to HP Full Service Agreement (+22A) is a one-year service contract that provides for any repair of the HP 8753C at a Hewlett-Packard repair facility. One complete calibration procedure is included.

Return to HP Repair Agreement (+22B) provides repair of the HP 8753C at a Hewlett-Packard repair facility for a period of one year. Following repair, the instrument is tested functionally but is not fully calibrated.

Return to HP Calibration Agreement (+22C) provides a once-a-year complete calibration procedure at a Hewlett-Packard facility.

Return to HP Calibration (+22G) is a one-time complete calibration procedure performed at a Hewlett-Packard facility. The procedure verifies that the HP 8753C is performing according to its published specifications.

Tool Kit: a dedicated tool kit is available for HP 8753C troubleshooting, consisting of extender boards, extender cables, and adapters. The contents of the tool kit are listed in the *Service Manual*.

Option 910, Extra Manual Set provides an additional *Operating Manual* and *Service Manual*. After initial shipment, order extra manuals by part number. The numbers are listed on the title page and rear cover of the manuals and in the *Replaceable Parts* section of the *Service Manual*.

EQUIPMENT REQUIRED

In order to make measurements, the analyzer requires a portion of the RF signal to be routed to the reference input for proper network analyzer phase-locked operation. Therefore, a test set or power splitter is required for signal separation. In addition, connecting cables and standard devices for calibration are required. The compatible Hewlett-Packard devices are described under *Test Sets Available* and *Measurement Accessories Available*.

For automatic operation, an HP 9000 series 200/300 computer is recommended. This computer is also required to run automated performance tests or adjustment procedures.

TEST SETS AVAILABLE

HP 85046A/B S-Parameter Test Sets

The HP 85046A/B S-parameter test sets provide the signal separation devices, RF path switching, and external connectors to enable the analyzer to measure all four S-parameters of a two-port 50 or 75 ohm device with a single connection. The HP 85046A measures the responses of 50 ohm devices from 300 kHz to 3.0 GHz, and the HP 85046B measures the responses of 75 ohm devices from 300 kHz to 2.0 GHz. The test sets are totally controlled by the analyzer and include a 0 to 70 dB step attenuator programmable in 10 dB steps. Each test set also contains two internal DC bias tees for biasing of active devices.

The test port connectors for the HP 85046A are precision 7 mm connectors, and the HP 85046B test port connectors are 75 ohm type-N (f). Both connectors can be adapted to other interfaces with the appropriate precision adapters. Four interconnect cables are included to connect the test set to the analyzer. In addition, test port return cables are required: HP 11857D cables with the HP 85046A, or HP 11857B 75 ohm cables with the HP 85046B.

HP 85047A 6 GHz S-Parameter Test Set

The HP 85047A is similar to the 50 Ω HP 85046A test set, but operates up to 6 GHz. This test set includes a frequency doubler that can be switched in to measure 3 MHz to 6 GHz in a single sweep or switched out to measure 300 kHz to 3 GHz in a single sweep. The HP 85047A is equipped with a 70 dB step attenuator and internal DC bias tees. The test port connectors are precision 7 mm. Four interconnect cables are included to connect the test set to the analyzer. HP 11857D test port return cables must be ordered separately.

Option 001 substitutes an electronic transfer switch for the standard mechanical one to allow two improvements:

- The instrument switches driven ports faster.
- Continuously switching between driven ports unrestricted.

HP 85044A/B Transmission/Reflection Test Sets

The HP 85044A/B transmission/reflection test sets provide the signal separation devices and external connectors that enable the analyzer to simultaneously measure the reflection and transmission characteristics of a 50 or 75 ohm device in one direction. The HP 85044A measures the responses of 50 ohm devices from 300 kHz to 3.0 GHz, and the HP 85044B measures the responses of 75 ohm devices from 300 kHz to 2.0 GHz. Both test sets include a 0 to 70 dB step attenuator manually controllable in 10 dB steps, and the circuitry necessary to allow biasing of active devices through the test set.

The test port connectors are precision 7 mm on the HP 85044A and 75 ohm type-N (f) on the HP 85044B, and they can be adapted to other interfaces with the appropriate precision adapters. A 7 mm to 50 ohm type-N (f) adapter is included with the HP 85044A. An HP 11852B 50 to 75 ohm minimum loss pad is included with the HP 85044B, to provide a low SWR impedance match between the output port of the device under test and the return cable to the network analyzer. The HP 11851B 50 ohm type-N RF cable set is required for use with either of these transmission/reflection test sets.

MEASUREMENT ACCESSORIES AVAILABLE

Power Splitters

HP 11850C/D Three-Way Power Splitters. These are four-port, three-way power splitters. One output arm is used as the reference for the network analyzer in making ratio measurements and the other two output arms are test channels. The HP 11850C has a frequency range of DC to 3 GHz and an impedance of 50 ohms; the HP 11850D has a frequency range of DC to 2 GHz and an impedance of 75 ohms. Three HP 11852A 50 to 75 ohm minimum loss pads are supplied with the HP 11850D power splitter, to provide a low SWR impedance match between the power splitter and the 50 ohm ports of the network analyzer.

HP 11667A Power Splitter. This is a two-way power splitter with one output arm used for reference and one for test. It has a frequency range of DC to 18 GHz and an impedance of 50 ohms.

Calibration Kits

The following calibration kits contain precision standards (and required adapters) of the indicated connector type. The standards (known devices) facilitate measurement calibration, also called vector error correction. Refer to the data sheet and ordering guide for additional information. Parts numbers for the standards are in their manuals.

- HP 85031B 7 mm Calibration Kit
- HP 85032B 50 Ohm Type-N Calibration Kit
- HP 85033C 3.5 mm Calibration Kit
- HP 85036B 75 Ohm Type-N Calibration Kit

Verification Kit

Accurate operation of the network analyzer system can be verified by measuring known devices other than the standards used in calibration, and comparing the results with recorded data.

HP 85029B 7 mm Verification Kit. This kit contains traceable precision 7 mm devices used to confirm the system's error-corrected measurement uncertainty performance. Also included is verification data on a 3.5 inch disc, together with a hard-copy listing. A system verification procedure is provided with this kit and also in the *Service Manual*.

Test Port Return Cables

The following RF cables are used to return the transmitted signal to the test set in measurements of two-port devices. These cables provide shielding for high dynamic range measurements.

HP 11857D 7 mm Test Port Return Cable Set. These are a pair of test port return cables for use with the HP 85046A or 85047A S-parameter test sets. The cables can be used in measurements of devices with connectors other than 7 mm by using the appropriate precision adapters.

HP 11857B 75 Ohm Type-N Test Port Return Cable Set. These are a pair of test port return cables for use with the HP 85046B S-parameter test set.

HP 11851B 50 Ohm Type-N RF Cable Set. This kit contains the three phase-matched 50 ohm type-N cables necessary to connect the HP 85044A/B transmission/reflection test set or a power splitter to the analyzer, as well as an RF cable to return the transmitted signal of a two-port device to the network analyzer. For use with the HP 85044B test set, the HP 11852B 50 to 75 ohm minimum loss pad supplied with the test set must be used for impedance matching with the RF return cable.

Adapter Kits

HP 11852B 50 to 75 Ohm Minimum Loss Pad. This device converts impedance from 50 ohms to 75 ohms or from 75 ohms to 50 ohms. It is used to provide a low SWR impedance match between a 75 ohm device under test and the HP 8753B network analyzer or a 50 ohm measurement accessory. An HP 11852B pad is included with the HP 85044B 75 ohm transmission/reflection test set. Three HP 11852B pads are included with the HP 11850D 75 ohm power splitter.

These adapter kits contain the connection hardware required for making measurements on devices of the indicated connector type.

- HP 11853A 50 Ohm Type-N Adapter Kit
- HP 11854A 50 Ohm BNC Adapter Kit
- HP 11855A 75 Ohm Type-N Adapter Kit
- HP 11856A 75 Ohm BNC Adapter Kit

Transistor Test Fixtures

HP 11600B and 11602B Transistor Fixtures. These fixtures are used to hold devices for S-parameter measurements in a 50 ohm coaxial circuit. They can be used to measure bipolar or field-effect transistors in several configurations, from DC to 2.0 GHz. The HP 11600B accepts transistors with TO-18 to TO-72 package dimensions, and the HP 11602B accepts transistors with TO-5 to TO-12 package dimensions. Both fixtures can also be used to measure other circuit elements such as diodes, resistors, or inductors, which have 0.016 to 0.019 inch diameter leads.

HP 11608A Option 003 Transistor Fixture. This fixture is designed to be user-milled to hold stripline transistors for S-parameter measurements. Option 003 is pre-milled for 0.205 inch diameter disc packages, such as the HP HPAC-200.

HP 11858A Transistor Fixture Adapter. This adapter provides a rigid RF cable interconnection between the HP 85046A or 85047A S-parameter test set and the HP 11600B, 11602B, or 11608A transistor fixture.

SYSTEM ACCESSORIES AVAILABLE

System Rack

The HP 85043B system rack is a 124 cm (49 inch) high metal cabinet designed to rack mount the analyzer in a system configuration. The rack is equipped with a large built-in work surface, a drawer for calibration kits and other hardware, a bookshelf for system manuals, and a locking rear door for secured access. Lightweight steel instrument support rails support the instruments along their entire depth. Heavy-duty casters make the cabinet easily movable even with the instruments in place. Screw-down lock feet permit leveling and semi-permanent installation: the cabinet is extremely stable when the lock feet are down. Power is supplied to the cabinet through a heavy-duty grounded primary power cable, and to the individual instruments through special power cables included with the cabinet.

Plotters and Printers

The analyzer is capable of plotting or printing displayed measurement results directly with a compatible peripheral (without the use of an external computer). An internal buffer allows one hardcopy print or plot to proceed while the instrument makes measurements.

These plotters are compatible:

- **HP 7440A Option 002 ColorPro Eight-Pen Color Graphics Plotter** plots on ISO A4 or 8 1/2 x 11 inch charts.
- **HP 7475A Option 002 Six-Pen Graphics Plotter** plots on ISO A4/A3 or 8 1/2 x 11 inch or 11 x 17 inch charts.
- **HP 7550A High-Speed Eight-Pen Graphics Plotter** plots on ISO A4/A3 or 8 1/2 x 11 inch or 11 x 17 inch plots.
- **HP 7090 Measurement Plotting System** is a high-performance six-pen programmable digital plotter. It plots on ISO A4/A3 or 8.5 x 11 inch or 11 x 17 inch paper or overhead transparency film.

These printers are compatible:

- HP 2225A ThinkJet printer
- HP 2227B QuietJet printer
- HP 3630A PaintJet color graphics printer
- HP 2673A thermal graphics printer (obsolete but compatible)
- HP 82906A option 002 graphics printer (obsolete but compatible)
- HP 9876A thermal graphics printer (obsolete but compatible)

Mass Storage

The analyzer has the capability of storing instrument states directly to an external mass storage device without the use of a computer. Any disk drive that uses CS80 protocol and HP 200/300 series (LIF) format is compatible. Disks can be formatted directly by the analyzer. An HP 9122 dual 3.5 inch floppy disk drive is supplied when the HP 8753C option 802 is ordered. Another recommended disk drive is the HP 9153C 20 Megabyte Winchester disk drive.

HP-IB Cables

An HP-IB cable is required for interfacing the analyzer with a plotter, printer, external disk drive, or computer. The cables available are HP 18033A (1 m), HP 10833B (2 m), and HP 10833D (0.5 m).

Computer

An external controller is not required for measurement calibration or time domain capability. However, the system can be automated with the addition of an HP 200/300 series computer. In addition, some performance test procedures are semi-automated and require the use of an external controller. (The system verification procedure does not require an external controller.) For more information about compatible computers, call your Hewlett-Packard customer engineer.

Sample Software

A sample measurement program is provided with the analyzer, on a 3.5 inch disk inserted at the back of this manual. The program includes typical measurements to be used as an introductory example for programming the analyzer over HP-IB. It is designed to be easily modified for use in developing programs for specific needs. The program is compatible with BASIC versions 2.0 and later and will run on an HP series 200/300 computer, using any HP 8753C compatible printer or plotter.

System Furniture

A table is required for the system controller and the plotter or printer. The recommended work station table is HP 92170G, which is 720 mm (28 in) high by 930 mm (36 in) wide by 712 mm (28 in) deep and mounted on casters.

Disks and Disk Accessories

Hewlett-Packard disks are warranted against defects in material and workmanship for a period of five years from date of delivery. Price information is available from the toll-free number shown below. If you wish, ask for the free *HP Personal Computer User's Catalog*.

To order: CALL TOLL FREE 1-800-538-8787. Orders ship within 24 hours.

HP Part Number	Description
92192A	Box of 10 3.5 inch microfloppy disks
92191R	Rosewood roll-top disk holder. Holds 50 disks.
92191Q	Acrylic lift-top disk holder. Holds 25 disks.
92191E	Set of five modular disk holders. Holds 10 disks per module.
92191T	Bookshelf-style folding plastic disk holder. Holds 10 disks.
92191M	Micro disk carry case. Holds 5 disks.
92191H	Disk library binder. Holds 20 disks initially.
92191L	20 additional pages for binder. Holds 40 additional disks.

External Monitors

The analyzer can drive both its internal CRT and an external monitor simultaneously. One recommended color monitor is the HP 35741A/B. A monochrome monitor, such as the HP 35731A/B, may also be used if the analyzer is operated in monochrome mode.

RECOMMENDED TEST EQUIPMENT

Equipment required to test, adjust, and service the system is listed in the beginning of the *Service Manual*. Other equipment may be substituted if it meets or exceeds the critical specifications listed.

Instrument Specifications

Table 1. HP 8753C Instrument Specifications (1 of 10)

The specifications listed in Table 1 range from those guaranteed by Hewlett-Packard to those typical of most HP 8753C instruments but not guaranteed. Codes in the far right column of Table 1 reference a specification definition listed below. These definitions are intended to clarify the extent to which Hewlett-Packard supports the specified performance of the HP 8753C.

S-1: This performance parameter is verifiable using performance tests documented in the service manual.

* Explicitly tested as part of an on-site verification performed by Hewlett-Packard.

S-2: Due to limitations on available industry standards, the guaranteed performance of the instrument cannot be verified outside the factory. Field procedures can verify performance with a confidence prescribed by available standards.

S-3: These specifications are generally digital functions or are mathematically derived from tested specifications, and can therefore be verified by functional pass/fail testing.

T: Typical but non-warranted performance characteristics intended to provide information useful in applying the instrument. Typical characteristics are representative of most instruments, though not necessarily tested in each unit. Not field tested.

SOURCE

FREQUENCY CHARACTERISTICS

		Code
Range	300 kHz to 3 GHz	S-1 *
Accuracy (at 25°C ± 5°C)	± 10 ppm	S-1 *
Stability		
0° to 55°C	± 7.5 ppm	T
per year	± 3 ppm	T
Resolution	1 Hz	S-3

OUTPUT POWER CHARACTERISTICS

Range	-5 to +20 dBm	S-1 *
Resolution	0.1 dB	S-3
Level Accuracy (at +10 dBm output level, 50 MHz)	± 0.5 dB	S-1 *
(at 25°C ± 5°C)		
Flatness (at 25°C ± 5°C)	± 1 dB	S-1 *
Linearity (at 25°C ± 5°C)		
-5 to +15 dBm	± 0.2 dB (relative to +10 dBm output level)	S-1
+15 to +20 dBm	± 0.5 dB (relative to +10 dBm output level)	S-1
Impedance	50 ohms; >16 dB return loss (<1.38 SWR)	T

Table 1. HP 8753C Instrument Specifications (2 of 10)

SOURCE (Cont'd)

SPECTRAL PURITY CHARACTERISTICS

(with 0 to -10 dBm into R input)

		Code
2nd Harmonic		
at +20 dBm output level	< -25 dBc	S-1*
at +10 dBm	< -40 dBc	T
at 0 dBm	< -50 dBc	T
3rd Harmonic		
at +20 dBm output level	< -25 dBc	S-1*
at +10 dBm	< -40 dBc	T
at 0 dBm	< -50 dBc	T
Non-Harmonic Spurious Signals		
Mixer Related		
at +20 dBm output level	< -32 dBc	S-1
at 0 dBm output level	< -55 dBc	T
Other Spurious Signals (see graph) (25°C ± 5°C)		
<i>(within 20 kHz)</i>		
f < 135 MHz	-60 dBc	S-1
f ≥ 135 MHz	$[-60 + 20 \log (f/135 \text{ MHz})]$ dBc	S-1

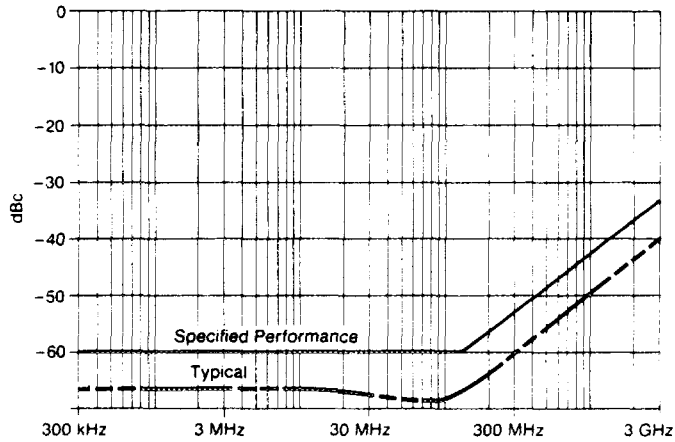

Other Spurious Signals

Phase Noise (10 kHz offset from fundamental in 1 Hz bandwidths)

f < 135 MHz	-90 dBc	S-1
f ≥ 135 MHz	$[-90 + 20 \log (f/135 \text{ MHz})]$ dBc	S-1

Table 1. HP 8753C Instrument Specifications (3 of 10)

RECEIVER

INPUT CHARACTERISTICS

	Code
Frequency Range	
Standard	300 kHz to 3 GHz S-1*
Option 006 ¹	300 kHz to 6 GHz S-1*
Impedance	50 ohms nominal
300 kHz to 2 MHz	> 20 dB return loss S-1
2 MHz to 2 GHz	> 23 dB return loss S-1
2 GHz to 3 GHz	> 20 dB return loss S-1
3 GHz to 6 GHz ¹	> 8 dB return loss T
Dynamic Range (10 Hz IF bandwidth)	
A, B	
300 kHz to 3 GHz	100 dB S-1
3 GHz to 6 GHz ¹	95 dB S-1
R	
300 kHz to 3 GHz	35 dB S-1
3 GHz to 6 GHz ¹	30 dB S-1
Maximum Input Level	0 dBm S-1
Damage Level	+ 20 dBm or > 25 volts DC T
Noise Level (A, B)	
300 kHz to 3 GHz	
3 kHz IF bandwidth	- 90 dBm S-1
10 Hz IF bandwidth	- 100 dBm S-1
	- 110 dBm T
3 GHz to 6 GHz ¹	
3 kHz IF bandwidth	- 85 dBm S-1
10 Hz IF bandwidth	- 95 dBm S-1
	- 105 T
Minimum R Level (required for source operation)	
300 kHz to 3 GHz	- 35 dBm S-1
3 GHz to 6 GHz ¹	- 30 dBm S-1

1. Operation from 3 GHz to 6 GHz requires option 006. Operation from 3 GHz to 6 GHz in the normal network analyzer mode requires option 006 and an HP 85047A S-parameter test set.

Table 1. HP 8753C Instrument Specifications (4 of 10)

RECEIVER (Cont'd)

INPUT CHARACTERISTICS (Cont'd)

Input Crosstalk (10 Hz IF bandwidth) (see graphs)

Frequency Range	Typical Crosstalk (dB)	Code
300 kHz to 1 GHz	-100 dB	S-1
1 GHz to 3 GHz	-90 dB	S-1
3 GHz to 4.5 GHz ¹	-82 dB	S-1
4.5 GHz to 6 GHz ¹	-75 dB	S-1

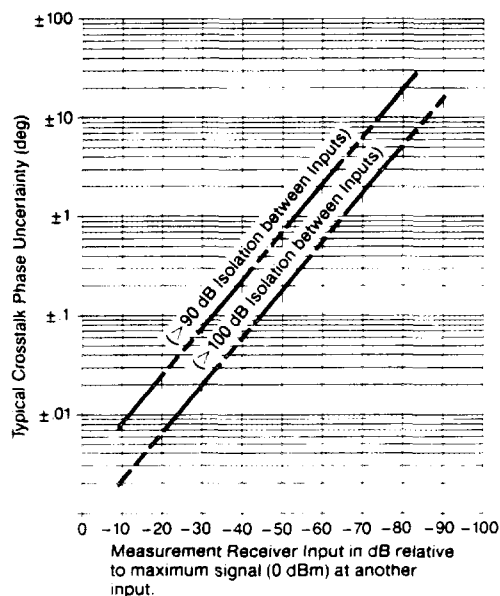
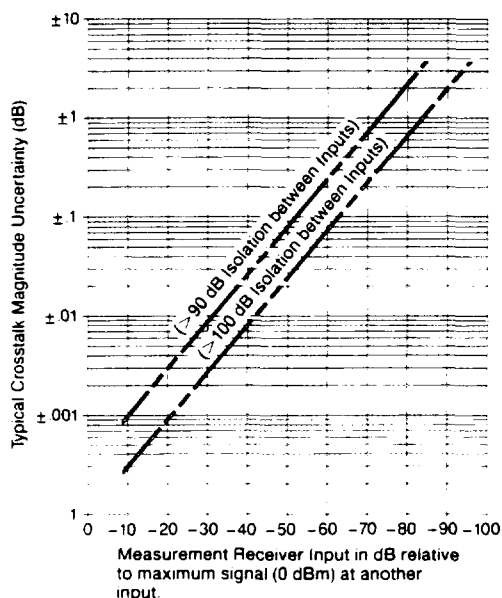

Input Crosstalk

Source Crosstalk (10 Hz IF bandwidth)	< -135 dB	T
---------------------------------------	-------------	---

Receiver Harmonics (option 002)

2nd Harmonic		
at 0 dBm input level	-15 dBc	S-1*
at -10 dBm	-35 dBc	T
at -30 dBm	-45 dBc	T

3rd Harmonic		
at 0 dBm input level	-30 dBc	S-1*
at -10 dBm	-50 dBc	T
at -30 dBm	-50 dBc	T

Harmonic Measurement Accuracy

16 MHz to 3 GHz	± 1 dB	S-1
3 GHz to 6 GHz ¹	± 3 dB	S-1

Harmonic Measurement Dynamic Range (with source at 0 dBm and receiver at < -30 dBm)	-40 dBc	T
--	---------	---

1. Operation from 3 GHz to 6 GHz requires option 006. Operation from 3 GHz to 6 GHz in the normal network analyzer mode requires option 006 and an HP 85047A S-parameter test set.

Table 1. HP 8753C Instrument Specifications (5 of 10)

RECEIVER (Cont'd)

INPUT CHARACTERISTICS (Cont'd)

Frequency Offset Operation^{1,2}

		Code
Frequency Range	16 MHz to 3 GHz	S-1

R Channel Input Requirements (required for phase-locked operation)

Power Level	0 to -35 dBm	S-1
LO Spectral Purity and Accuracy		
Maximum Spurious Input	< -25 dBc	T
Residual FM	< 20 kHz	T
Frequency Accuracy	-1 to +5 MHz of nominal frequency	T

Accuracy (see *Magnitude Characteristics and Phase Characteristics*)

External Source Mode^{2,3} (CW Time sweep only)

Frequency Range ⁴	300 kHz to 6 GHz	S-1
------------------------------------	------------------------	-----

R Input Requirements

Power Level	0 to -25 dBm	S-1
Spectral Purity		
Maximum Spurious Input	< -30 dBc	T
Residual FM	< 20 kHz	T

Settling Time

Auto	500 ms	T
Manual	50 ms	T

Frequency Readout Accuracy (auto)	0.1%	T
---	------------	---

Input Frequency Margin

Manual	-0.5 to 5 MHz	T
Auto		
≤ 50 MHz	± 5 MHz of nominal CW frequency	T
> 50 MHz	± 10% of nominal CW frequency	T

Accuracy (see *Magnitude Characteristics and Phase Characteristics*)³

1. The HP 8753C RF source characteristics in this mode are dependent on the stability of the external LO source. The RF source tracks the LO to maintain a stable IF signal at the R channel receiver input. Degradation in accuracy is negligible with an HP 8642A/B or HP 8656B RF signal generator as the LO source.
2. Refer to Chapter 14 of the *Reference* for a functional description.
3. Measurement accuracy is dependent on the stability of the input signal.
4. Operation from 3 GHz to 6 GHz requires option 006.

Table 1. HP 8753C Instrument Specifications (6 of 10)

RECEIVER (Cont'd)

MAGNITUDE CHARACTERISTICS

Absolute Amplitude Accuracy (A, B, R) (see graph)
 (with -10 dBm into input, $25^{\circ}\text{C} \pm 5^{\circ}\text{C}$)

			Code
300 kHz to 3 GHz	± 1.0 dB	S-1
3 GHz to 6 GHz ¹	± 3.0 dB	S-1

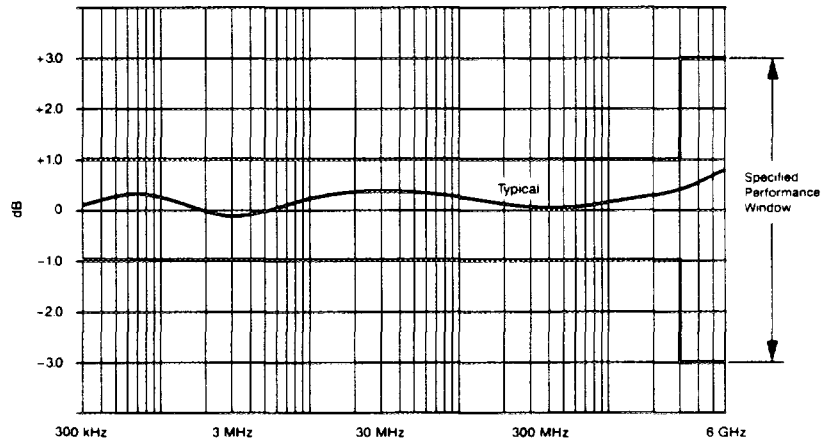

Absolute Amplitude Accuracy

Ratio Accuracy (A/R, B/R, A/B)²
 ($25^{\circ}\text{C} \pm 5^{\circ}\text{C}$, with -10 dBm on all inputs)

300 kHz to 3 GHz	± 0.5 dB	S-1
3 GHz to 6 GHz ¹	± 2.0 dB	S-1

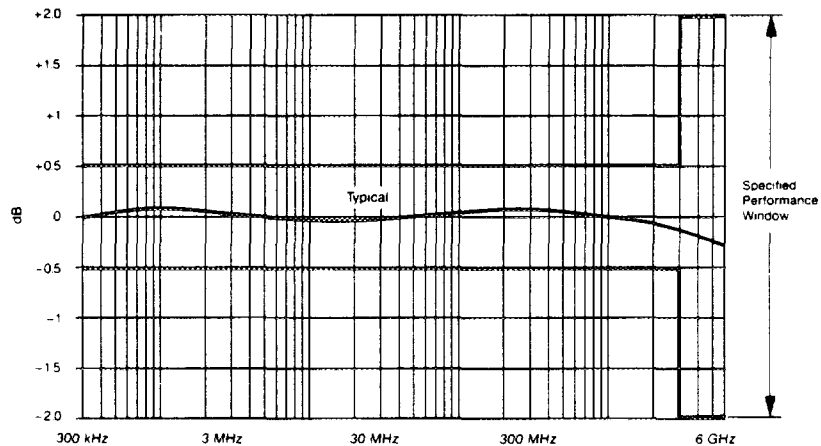

Ratio Accuracy

1. Operation from 3 GHz to 6 GHz requires option 006. Operation from 3 GHz to 6 GHz in the normal network analyzer mode requires option 006 and an HP 85047A S-parameter test set.
2. Unnormalized

Table 1. HP 8753C Instrument Specifications (7 of 10)

RECEIVER (Cont'd)

MAGNITUDE CHARACTERISTICS (Cont'd)

		Code
Display Resolution	0.01 dB/division	S-3
Marker Resolution ¹	0.001 dB	S-3
Dynamic Accuracy (see graph)		S-1
(10 Hz bandwidth, inputs A and B; R to -35 dBm)		

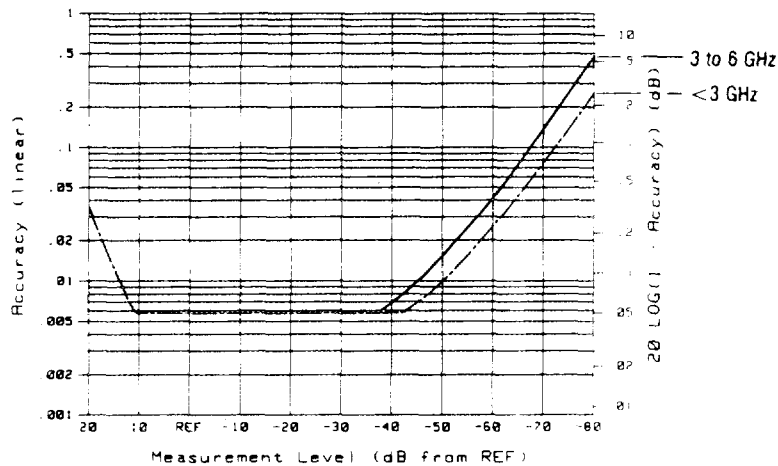

Assumption: Reference Power Level = -20 dBm

Dynamic Accuracy (Magnitude)

Trace Noise (CW sweep)	<0.006 dB rms	S-1
(A/R, B/R, A/B, at -10 dBm, 3 kHz bandwidth)		
Reference Level		
Range	±500 dB	S-3
Resolution	0.001 dB	S-3
Stability (300 kHz to 3 GHz)	0.01 dB/degree C	T
(3 to 6 GHz)	0.02 dB/degree C	T

PHASE CHARACTERISTICS

(A/R, B/R, A/B)

Range	±180°	S-3
Display Resolution	0.01°/division	S-3
Marker Resolution	0.01°	S-3

1. Marker resolution for magnitude, phase, and delay is dependent upon the value measured: resolution is limited to 5 digits.

Table 1. HP 8753C Instrument Specifications (8 of 10)

RECEIVER (Cont'd)

PHASE CHARACTERISTICS (Cont'd)

Frequency Response (deviation from linear) (see graph)
 (with -10 dBm into inputs, $25^{\circ}\text{C} \pm 5^{\circ}\text{C}$)

		Code
300 kHz to 3 GHz	$\pm 3^{\circ}$	S-1
3 GHz to 6 GHz ¹	$\pm 10^{\circ}$	S-1

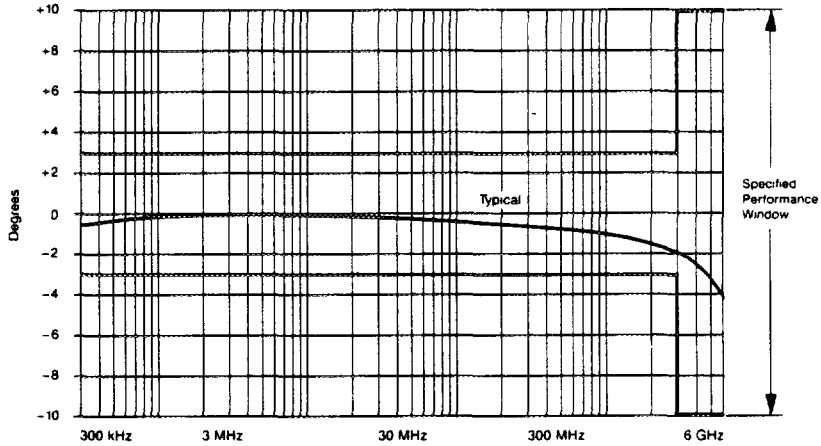

Frequency Response

Dynamic Accuracy (see graph)		S-1
(10 Hz bandwidth A/R, B/R, and A/B; R to -35 dBm)		

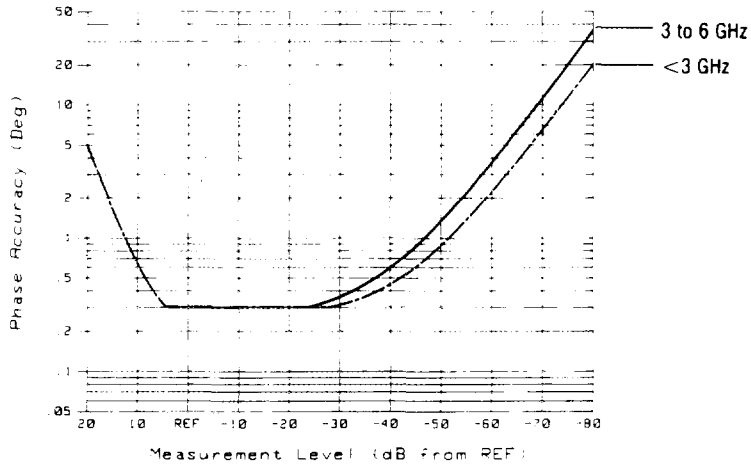

Assumption: Reference Power Level = -20 dBm

Dynamic Accuracy (Phase)

Trace Noise (A/R, B/R, A/B)

300 kHz to 3 GHz	$< 0.035^{\circ}$ rms	S-1
3 GHz to 6 GHz ¹	$< 0.06^{\circ}$ rms	S-1

1. Operation from 3 GHz to 6 GHz requires option 006. Operation from 3 GHz to 6 GHz in the normal network analyzer mode requires option 006 and an HP 85047A S-parameter test set.

Table 1. HP 8753C Instrument Specifications (9 of 10)

RECEIVER (Cont'd)

PHASE CHARACTERISTICS (Cont'd)

	Code
Reference Level	
Range	±500° S-3
Resolution	0.01° S-3
Stability	
300 kHz to 3 GHz	0.05°/degree C T
3 GHz to 6 GHz ¹	0.10°/degree C T

POLAR CHARACTERISTICS

(A/R, B/R, A/B)

Range	10 x 10 ⁻¹² up to 1000 units full scale	S-3
Reference	range of ±500 units	S-3

GROUP DELAY CHARACTERISTICS

Group delay is computed by measuring the phase change within a specified frequency step (determined by the frequency span and the number of points per sweep).

Aperture (selectable)	(frequency span)(number of points - 1)	S-3
Maximum aperture	20% of frequency span	S-3
Range	1/2 x (1/minimum aperture)	S-3
<i>(The maximum delay is limited to measuring no more than 180° of phase change within the minimum aperture.)</i>		
Accuracy		S-3

The following graph shows group delay accuracy at 3 GHz with an HP 85046A S-parameter test set with 7 mm full 2-port calibration and a 10 Hz IF bandwidth. Insertion loss is assumed to be <1 dB and electrical length to be 1 metre.

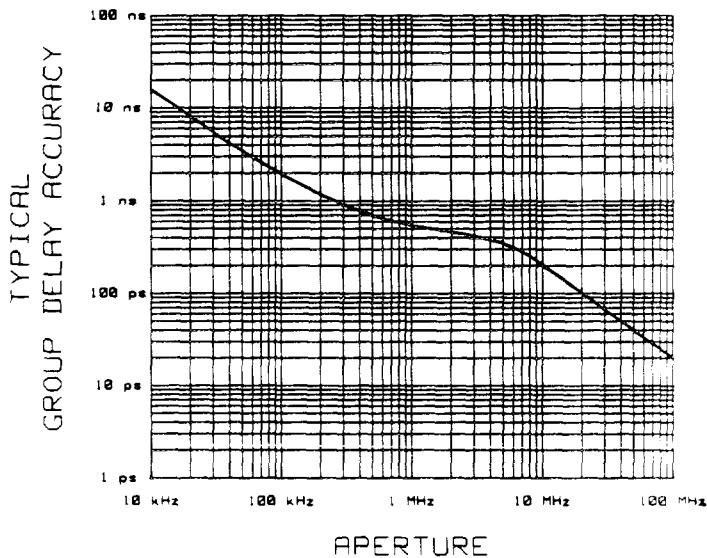

¹ Operation from 3 GHz to 6 GHz requires option 006. Operation from 3 GHz to 6 GHz in the normal network analyzer mode requires option 006 and an HP 85047A S-parameter test set.

Table 1. HP 8753C Instrument Specifications (10 of 10)

RECEIVER (Cont'd)

GROUP DELAY CHARACTERISTICS (Cont'd)

In general, the following formula can be used to determine the accuracy, in seconds, of a specific group delay measurement:

$$\pm (0.003 \times \text{Phase Accuracy (deg)}) / \text{Aperture (Hz)}$$

Depending on the aperture and device length, the phase accuracy used is either incremental phase accuracy or worst case phase accuracy. The graph on the previous page shows this transition.

Table 2. HP 8753C General Characteristics (1 of 3)

MEASUREMENT THROUGHPUT SUMMARY

The following table shows typical measurement times for the HP 8753C in milliseconds.

Typical Time for Completion (ms)

	Number of Points			
	51	201	401	1601
Measurement				
Uncorrected	120	190	290	890
1-port cal ¹	120	190	290	890
2-port cal ²	540	1030	1680	5610
Time Domain Conversion ³	125	540	1150	2840
HP-IB Data Transfer ⁴				
Binary (Internal)	30	90	170	660
IEEE 754 floating point format				
32 bit	60	190	380	1500
64 bit	85	310	600	2400
ASCII	540	2080	4100	16.000

REMOTE PROGRAMMING

Interface

HP-IB interface operates according to IEEE 488-1978 and IEC 625 standards and IEEE 728-1982 recommended practices.

Transfer Formats

Binary (internal 48-bit floating point complex format)

ASCII

32/64 bit IEEE 754 Floating Point Format

Interface Function Codes

SH1, AH1, T6, TE0, L4, LE0, SR1, RL1, PP0, DC1, DT1, C1, C2, C3, C10, E2

1. S11 1-port calibration, with a 3 kHz IF bandwidth. Includes system retrace time, but does not include bandswitch time. Time domain gating is assumed off.
2. S21 measurement with full 2-port calibration, using a 3 kHz IF bandwidth. Includes system retrace time and RF switching time, but does not include bandswitch time. Time domain gating is assumed off.
3. Option 010 only, gating off.
4. Measured with an HP 9000 series 300 computer.

Table 2. HP 8753C General Characteristics (2 of 3)

FRONT PANEL CONNECTORS

Connector Type type-N (female)
 Impedance 50 ohms (nominal)
 Connector Pin Protrusion 0.201 to 0.207 in

REAR PANEL CONNECTORS

External Reference Frequency Input (EXT REF INPUT)

Frequency 1, 2, 5, and 10 MHz (± 200 Hz @ 10 MHz)
 Level -10 dBm to +20 dBm, typical
 Impedance 50 ohms

External Auxiliary Input (AUX INPUT)

Input Voltage Limits -10V to +10V

External AM Input (EXT AM)

± 1 volt into a 5k ohm resistor, 1 kHz maximum, resulting in 8 dB/volt amplitude modulation.

External Trigger (EXT TRIGGER)

Triggers on a negative TTL transition or contact closure to ground.

External Trigger Circuit

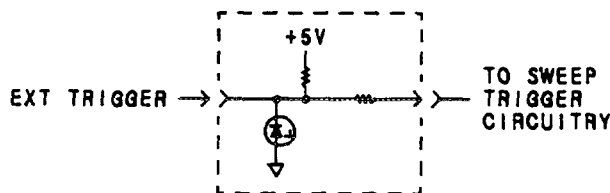

VIDEO OUTPUT

The R, G, and B connectors drive external monitors with these characteristics:

- R, G, B with synch on green.
- 75 ohm impedance.
- 1V p-p (0.7V = white; 0V = black; -0.3V = synch).

LINE POWER

48 to 66 Hz
 115V nominal (90V to 132V) or 230V nominal (198V to 264V). 280 VA max.

PROBE POWER

+15V $\pm 2\%$ 400 mA (combined load for both probe connections)
 -12.6V $\pm 5.5\%$ 300 mA (combined load for both probe connections)

Table 2. HP 8753C General Characteristics (3 of 3)

ENVIRONMENTAL CHARACTERISTICS

General Conditions

RFI and EMI susceptibility: defined by VDE 0730, CISPR Publication 11, and FCC Class B Standards.

ESD (electrostatic discharge): must be eliminated by use of static-safe work procedures and an antistatic bench mat (such as HP 92175T).

Dust: the environment should be as dust-free as possible.

Operating Conditions

Temperature (unless otherwise noted) 0° to 55°C
 Humidity 5% to 95% at 40°C (non-condensing)
 Altitude 0 to 4500 meters (15,000 feet)

Non-Operating Storage Conditions

Temperature -40°C to +70°C
 Humidity 0 to 90% relative at +65°C (non-condensing)
 Altitude 0 to 15,240 metres (50,000 feet)

WEIGHT

Net 22 kg (48 lb)
 Shipping 25 kg (55 lb)

CABINET DIMENSIONS

177 mm H x 425 mm W x 497.8 mm D
 (7.0 x 16.75 x 20.0 in)
 (These dimensions exclude front and rear panel protrusions.)

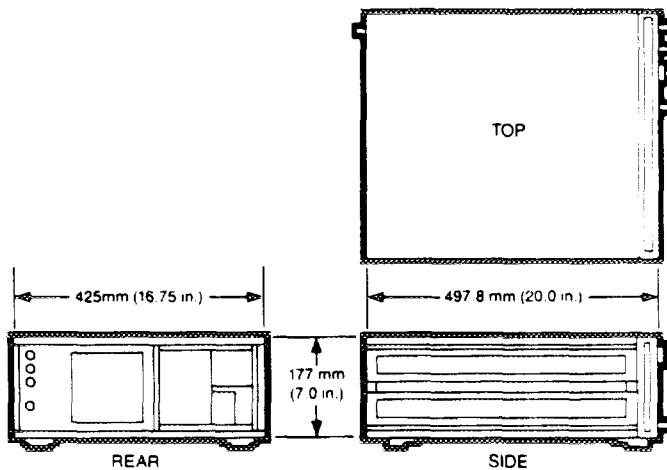

System Performance

INTRODUCTION

The performance of a network analyzer system depends not only on the performance of the individual instruments, but also on the system configuration, the user-selected operating conditions, and the measurement calibration.

This section explains the residual errors remaining in a measurement system after accuracy enhancement. It provides information to calculate the total measurement uncertainty of different systems. Graphs at the beginning of the section show examples of the performance that can be calculated using the methods explained in this section.

The sources of measurement errors are explained, with an error model flowgraph and uncertainty equations. Information is provided for conversion of the dynamic accuracy error (in dB) to a linear value for use in the uncertainty equations. The effects of temperature drift on measurement uncertainty are illustrated with graphs.

System specification tables are provided for an HP 8753C 7 mm system using an HP 85046A, 85044A, or 85047A test set. Typical system performance tables are given for 50 ohm type-N and 3.5 mm systems, and for 75 ohm type-N systems using the HP 85046B and 85044B test sets.

Procedures and blank worksheets are supplied to compute the total error-corrected measurement uncertainty of a system. These procedures combine the terms in the tables, the uncertainty equations, and the nominal S-parameter data of the device under test.

COMPARISON OF TYPICAL ERROR-CORRECTED MEASUREMENT UNCERTAINTY

Figures 3 through 10 are examples of the measurement uncertainty data that can be calculated using the information provided in this section. These figures compare the reflection and transmission measurement uncertainty of a 7 mm system using different levels of error correction. Each figure shows uncorrected values and residual uncertainty values after response calibration, response and isolation calibration, and full one or two port calibration. The data applies to a frequency range of 300 kHz to 3 GHz and 3 GHz to 6 GHz with a stable temperature (no temperature drift), and using compatible 7 mm calibration devices from the HP 85031B calibration kit.

The results graphed in figures 3 through 10 can be obtained using the HP 85046A, 85044A, or 85047A. Different measurement calibration procedures provide comparable measurement improvement for the following compatible connector types and test sets (using the compatible calibration kits):

- 50 ohm type-N connectors
- 3.5 mm connectors
- HP 85047A test set from 3 GHz to 6 GHz (with HP 8753C option 006)
- HP 85046B and 85044B with 75 ohm type-N connectors

Reflection Uncertainty of a One-Port Device

Assumptions: Reference Power Level = -20 dBm
 $S_{21} = S_{12} = 0$ (one-port device only)

Uncorrected ————
 Response
 Response and Isolation - - - -
 Full one or two port —————

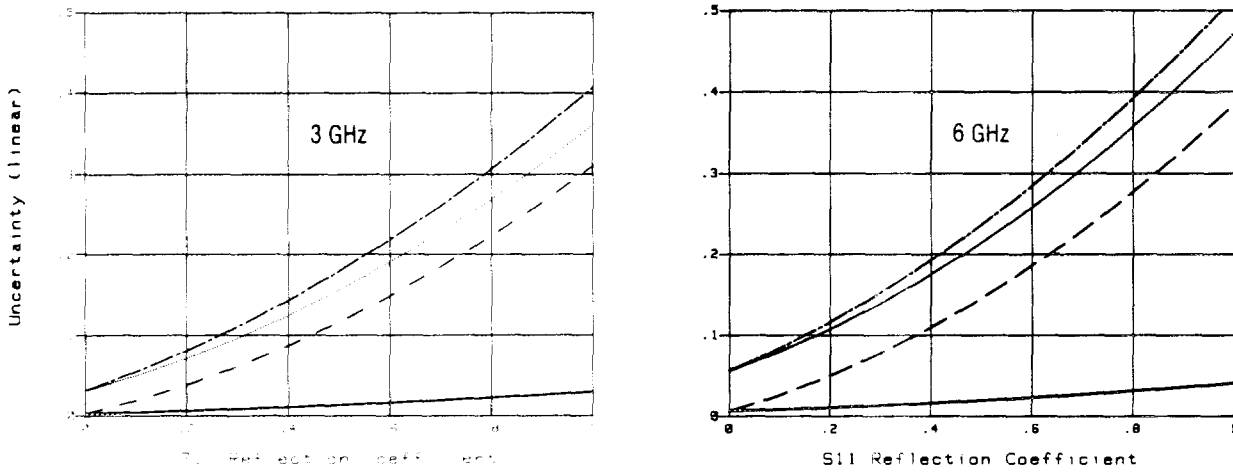

Figure 3. Total Reflection Magnitude Uncertainty

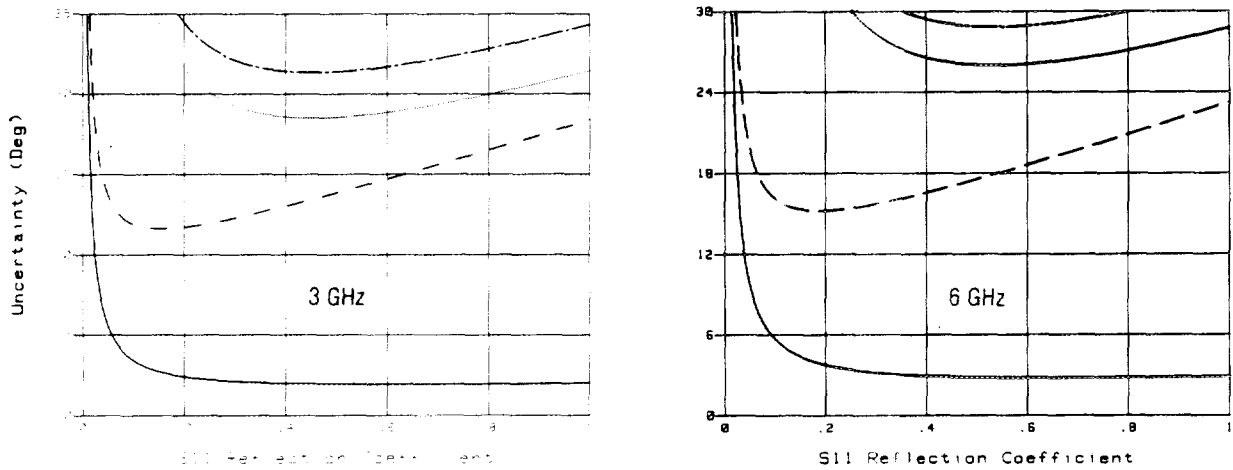

Figure 4. Total Reflection Phase Uncertainty

Reflection Uncertainty of a Two-Port Device

Assumptions: Reference Power Level = -20 dBm
 $S_{21} = S_{12} = 0.5$ (6 dB insertion loss device)

Uncorrected ————
 Response
 Response and Isolation - - - -
 Full one or two port —————

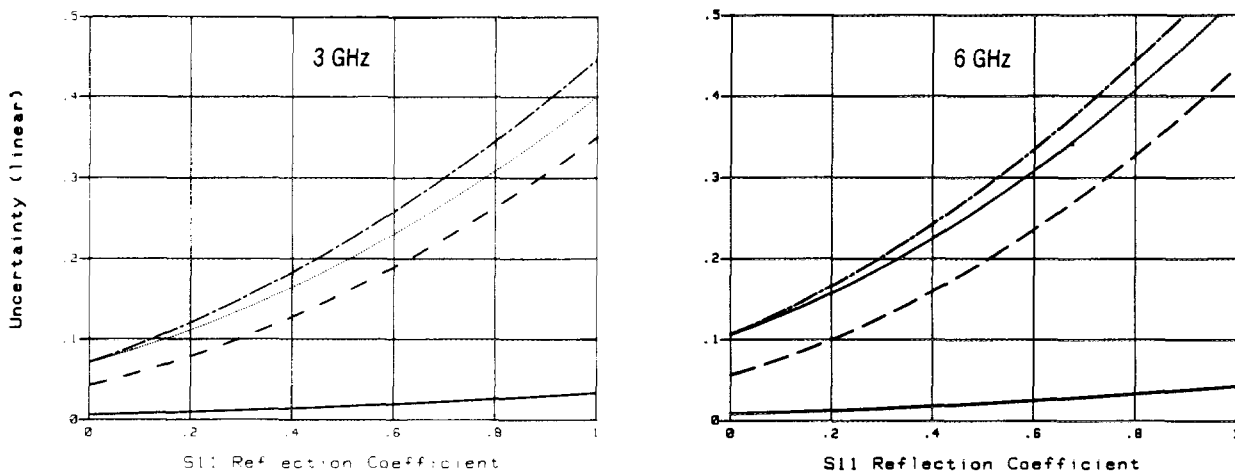

Figure 5. Total Reflection Magnitude Uncertainty

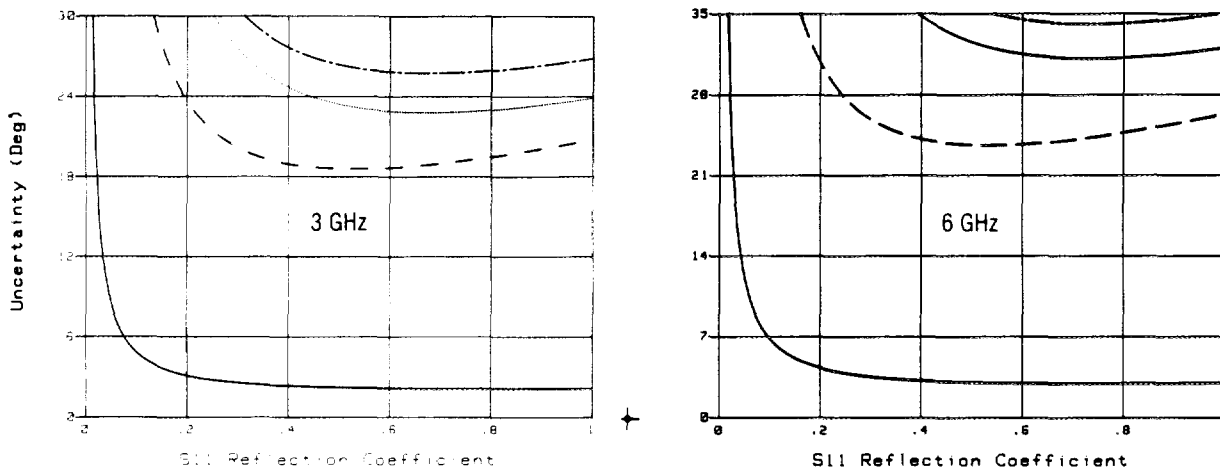

Figure 6. Total Reflection Phase Uncertainty

Transmission Uncertainty of a Low-Loss Device

Assumptions: Reference Power Level = -10 dBm
 $S_{11} = S_{22} = 0.1$

Uncorrected - - - - -
 Response
 Response and Isolation - - - - -
 Full one or two port - - - - -

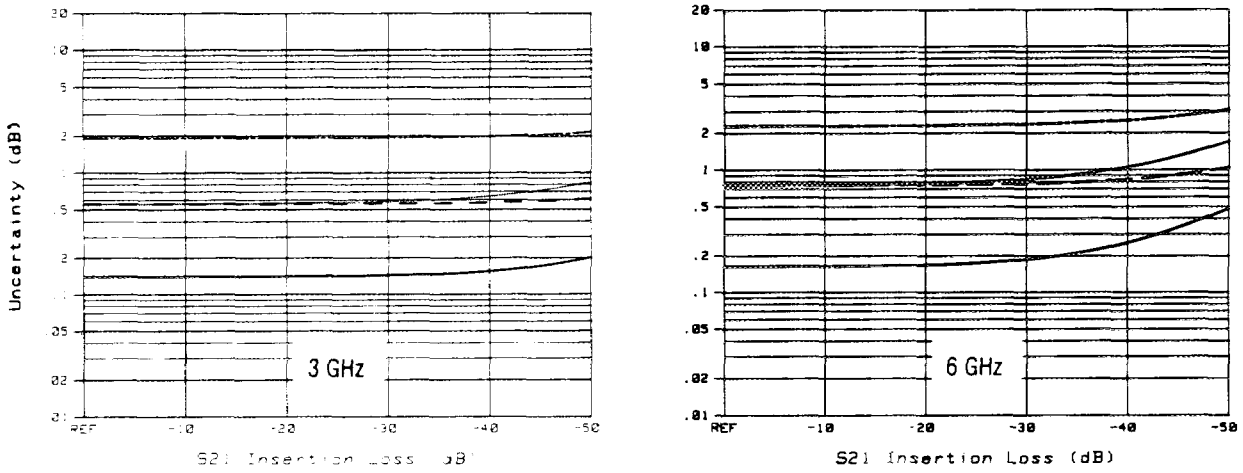

Figure 7. Total Transmission Magnitude Uncertainty

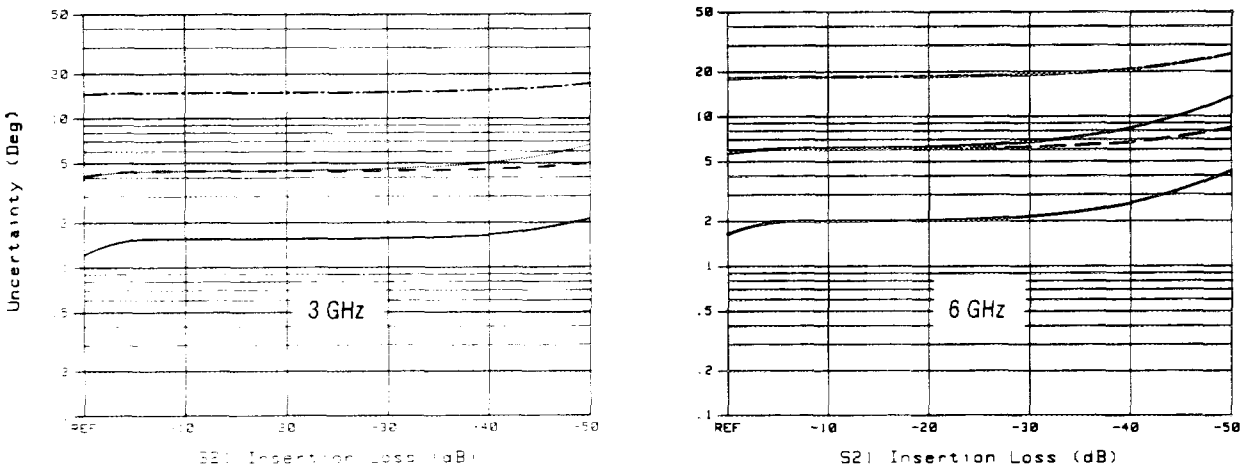

Figure 8. Total Transmission Phase Uncertainty

Transmission Uncertainty of a Wide Dynamic Range Device

Assumptions: Reference Power Level = 0 dBm
 $S_{11} = S_{22} = 0.1$

Uncorrected — — — — —
 Response ·······
 Response and Isolation — — — — —
 Full one or two port —————

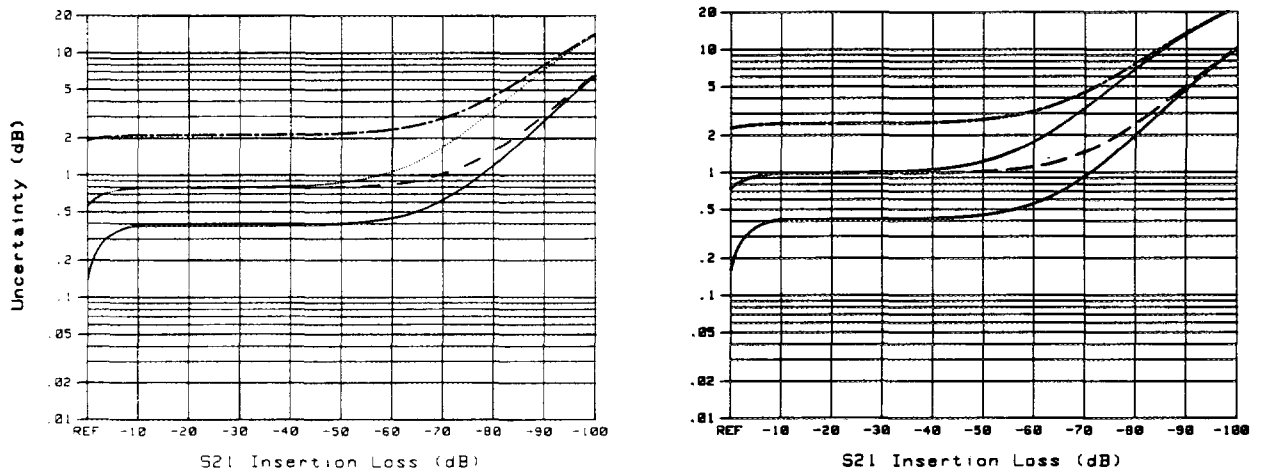

Figure 9. Total Transmission Magnitude Uncertainty

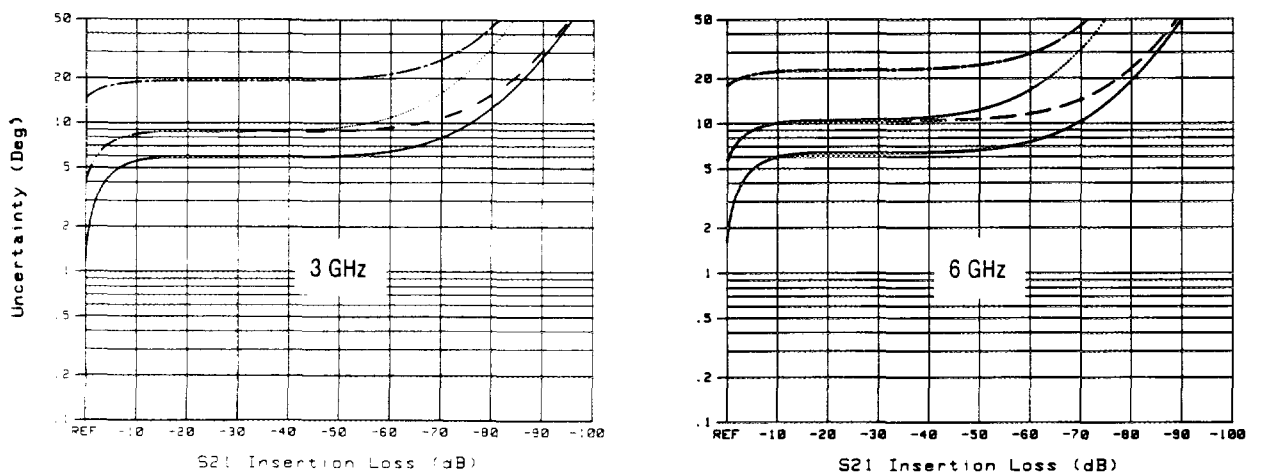

Figure 10. Total Transmission Phase Uncertainty

TYPES OF RESIDUAL MEASUREMENT ERRORS

Network analysis measurement errors can be separated into three types: systematic, random, and drift errors. Measurement errors that remain after measurement calibration are called residual measurement errors. See chapter 5, "Measurement Calibration", in the "Reference" section, for a detailed description of the systematic errors corrected by measurement calibration.

Residual Systematic Errors

These errors result from imperfections in the calibration standards, connector standards and interface, interconnecting cables, and instrumentation. These are the errors that affect transmission and reflection measurements:

Transmission Measurements	Reflection Measurements
Dynamic Accuracy Effective Switch port match Switch tracking Frequency error	
Effective crosstalk Effective load match Effective transmission tracking Cable stability	Effective directivity Effective source match Effective reflection tracking

Residual Random Errors

These non-repeatable errors are due to trace noise, noise floor, and connector repeatability. They affect both transmission and reflection measurements.

Residual Drift Errors

These errors stem from frequency drift and instrumentation drift. They affect both kinds of measurements. Instrumentation drift is primarily temperature-related.

SYSTEM ERROR MODEL

Any measurement result is the vector sum of the actual test device response plus all error terms. The precise effect of each error term depends upon its magnitude and phase relationship to the actual test device response. When the phase of an error response is not known, phase is assumed to be worst case (0 or 180 degrees). Random errors such as noise and connector repeatability are generally combined in a root-sum-of-the-squares (RSS) manner. The error term related to thermal drift is combined on a worst-case basis as shown in each uncertainty equation given in the following paragraphs.

Figure 11 illustrates the error model for the analyzer with the HP 85046A or 85047A S-parameter test set. This error model shows the relationship of the various error sources in the forward direction, and may be used to analyze overall measurement performance. The model for signal flow in the reverse direction is similar. Note the appearance of the dynamic accuracy, noise errors, switch errors, and connector repeatability terms in both the reflection and transmission portions of the model.

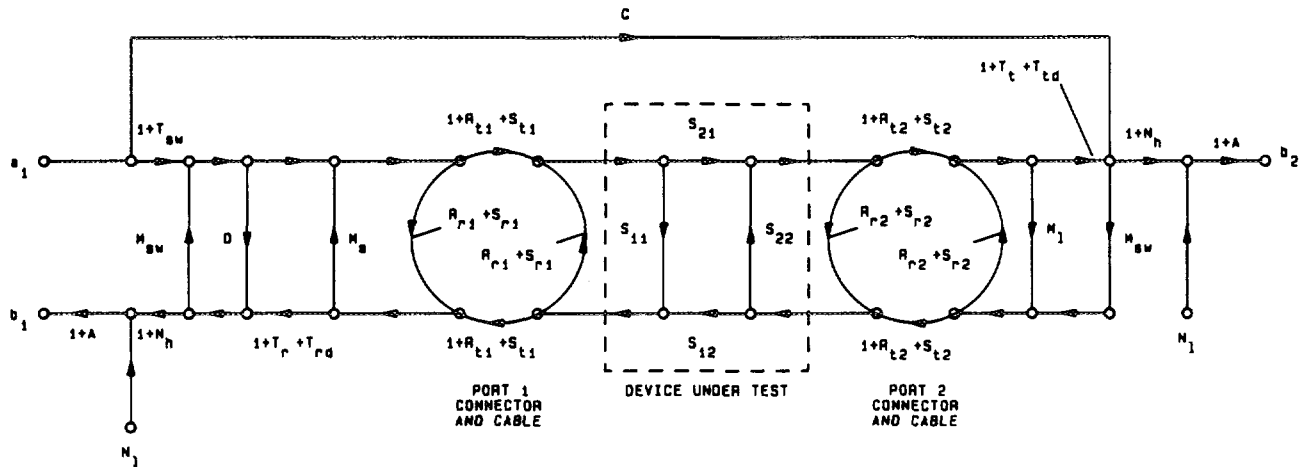

- | | | | |
|------------|--|-------|----------------------------------|
| A | = Dynamic Accuracy
(A_m = Magnitude Dynamic Accuracy)
(A_p = Phase Dynamic Accuracy) | D | = Residual Directivity |
| N_1 | = Noise Floor | M_s | = Residual Source Match |
| N_h | = High Level Noise | M_l | = Residual Load Match |
| T_{sw}^* | = Switch Repeatability (Transmission) | C | = Residual Crosstalk |
| M_{sw}^* | = Switch Repeatability (Reflection) | T_r | = Residual Reflection Tracking |
| R_r | = Reflection Repeatability | T_t | = Residual Transmission Tracking |
| R_t | = Transmission Repeatability | S_r | = Cable Reflection Stability |
| T_{rd} | = Reflection Tracking Drift | S_t | = Cable Transmission Stability |
| T_{td} | = Transmission Tracking Drift | | |

Figure 11. HP 8753C/85046A/85047A System Error Model

For measurement of one-port devices, set the crosstalk (C), load match (M_l), transmission tracking (T_t), port 2 connector repeatability (R_{r2} , R_{t2}), and port 2 cable stability (S_{r2} , S_{t2}) error terms to zero.

* In the tables of specifications and typical system performance, the effects of switch repeatability are included in the terms for source match, load match, reflection tracking, and transmission tracking.

REFLECTION UNCERTAINTY EQUATIONS

Total Reflection Magnitude Uncertainty (E_{rm})

An analysis of the error model yields an equation for the reflection magnitude uncertainty. The equation contains all of the first order terms and the significant second order terms. The error term related to thermal drift is combined on a worst case basis with the total of systematic and random errors. The four terms under the radical are random in character and are combined on an RSS basis. The terms in the systematic error group are combined on a worst case basis. In all cases, the error terms and the S-parameters are treated as linear absolute magnitudes.

$$E_{rm} \text{ (linear)} = V_r + S_{11} \times T_{rd} \text{ (magnitude); and}$$

$$E_{rm} \text{ (log)} = 20 \log (1 \pm E_{rm}/S_{11})$$

where

$$V_r = S_r + \sqrt{Y_r^2 + Z_r^2}$$

$$S_r = \text{systematic error} = D + S_{r1} + T_r \times S_{11} + (M_s + S_{r1}) \times S_{11}^2 + M_r \times S_{21} \times S_{12} + A_m \times S_{11}$$

$$Y_r = \text{random port 1 repeatability} = R_{r1} + 2 \times R_{r11} \times S_{11} + R_{r11} \times S_{11}^2$$

$$Z_r = \text{random port 2 repeatability} = R_{r2} \times S_{21} \times S_{12}$$

Total Reflection Phase Uncertainty (E_{rp})

Reflection phase uncertainty is determined from a comparison of the magnitude uncertainty with the test signal magnitude. The worst case phase angle is computed. This result is combined with the error terms related to thermal drift of the total system, port 1 cable stability, and phase dynamic accuracy.

$$E_{rp} = \arcsin ((V_r - A_m \times S_{11}) / S_{11}) + T_{rd} \text{ (phase)} + 2S_{r1} + A_p$$

TRANSMISSION UNCERTAINTY EQUATIONS

Total Transmission Magnitude Uncertainty (E_{tm})

An analysis of the error model in Figure 11 yields an equation for the transmission magnitude uncertainty. The equation contains all of the first order terms and some of the significant second order terms. The error term related to thermal drift is combined on a worst case basis with the total of systematic and random errors. The four terms under the radical are random in character and are combined on an RSS basis. The terms in the systematic error group are combined on a worst case basis. In all cases, the error terms are treated as linear absolute magnitudes.

$$E_{tm} \text{ (linear)} = V_t + S_{21} \times T_{td} \text{ (magnitude); and}$$

$$E_{tm} \text{ (log)} = 20 \log (1 \pm E_{tm} / S_{21})$$

where

$$V_t = S_t + \sqrt{Y_t^2 + Z_t^2}$$

$$S_t = \text{systematic error} = C + T_t \times S_{21} + (M_s + S_{r1}) \times S_{11} \times S_{21} + (M_i + S_{r2}) \times S_{21} \times S_{22} + A_m \times S_{21}$$

$$Y_t = \text{random port 1 repeatability} = R_{t1} \times S_{21} + R_{r1} \times S_{11} \times S_{21}$$

$$Z_t = \text{random port 2 repeatability} = R_{t2} \times S_{21} + R_{r2} \times S_{22} \times S_{21}$$

Total Transmission Phase Uncertainty (E_{tp})

Transmission phase uncertainty is calculated from a comparison of the magnitude uncertainty with the test signal magnitude. The worst case phase angle is computed. This result is combined with the error terms related to phase dynamic accuracy, cable phase stability, and thermal drift of the total system.

$$E_{tp} = \arcsin ((V_t - A_m \times S_{21}) / S_{21}) + T_{td} \text{ (phase)} + S_{t1} + S_{t2} + A_p$$

DYNAMIC ACCURACY

The dynamic accuracy value used in the system uncertainty equations is obtained from the analyzer's dynamic accuracy specifications. The specification for magnitude dynamic accuracy is in dB, and it must be converted to a linear value to be used in the uncertainty equations. In addition, the HP 8753B's dynamic accuracy specifications are given for an absolute input signal in dBm, and must be converted to a relative error (relative to the power at which the measurement calibration occurs) to be used in the system uncertainty equations.

$$\text{Dynamic Accuracy (linear)} = \frac{10^{(+\text{DynAcc(dB)}/20)} - 1}{10^{(-\text{DynAcc(dB)}/20)} + 1}$$

$$\text{Dynamic Accuracy (dB)} = 20 \cdot \log(1 \pm \text{Dynamic Accuracy (linear)})$$

Definitions

Pcal = the calibration (thus the reference) power level at the instrument input port (A or B) (i.e. when the short is measured in a reflection calibration OR when the thru is measured in a transmission calibration)

Pmeas = the measured input signal (dBm) when the DUT is measured

Residual dynamic accuracy = the residual error remaining when $P_{\text{meas}} = P_{\text{cal}}$

Linacc = relative dynamic accuracy (linear magnitude or phase) for the ratioed measurement used in the linear system performance calculation

Lincal = dynamic accuracy (linear magnitude or phase) term for single input at P_{cal}

Linmeas = dynamic accuracy (linear magnitude or phase) term for single input at P_{meas}

Determining Relative Dynamic Accuracy Error Contribution

The example given here shows how to determine the relative dynamic accuracy error contribution to a measurement in a ratio mode. Six example graphs are provided: figures 12 and 13 show the worst-case magnitude and phase dynamic accuracy error with a reference power level of 0 dBm, figures 14 and 15 with a reference power level of -20 dBm, and figures 16 and 17 with a reference power level of -60 dBm.

Assume R channel power level to be constant ($P_{\text{cal}} = P_{\text{meas}}$)

Example:

$0 \text{ dBm} \geq P_{\text{cal}} \geq -60 \text{ dBm}$ (magnitude)	
$0 \text{ dBm} \geq P_{\text{cal}} \geq -50 \text{ dBm}$ (phase)	
↙	↘
$0 \text{ dBm} \geq P_{\text{meas}} \geq -60 \text{ dBm}$ (magnitude)	$-60 \text{ dBm} \geq P_{\text{meas}} \geq -100 \text{ dBm}$ (magnitude)
$0 \text{ dBm} \geq P_{\text{meas}} \geq -50 \text{ dBm}$ (phase)	$-50 \text{ dBm} \geq P_{\text{meas}} \geq -100 \text{ dBm}$ (phase)

$$\text{Linacc} = \text{ABS}(\text{Lincal} - \text{Linmeas}) + \text{Residual} \qquad \text{Linacc} = \text{Lincal} + \text{Linmeas} - \text{Residual}$$

$$\begin{aligned} \text{Residual Magnitude Dynamic Accuracy (linear)} &= 0.00577 \\ \text{Residual Phase Dynamic Accuracy} &= 0.331 \text{ degrees} \end{aligned}$$

Dynamic Accuracy Error Contribution

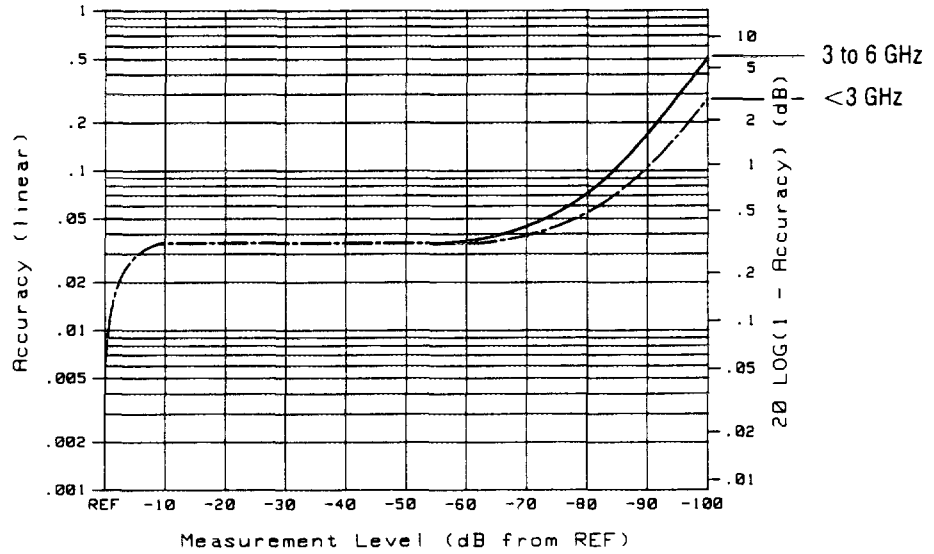

Assumption: Reference Power Level = 0 dBm

Figure 12. Worst-Case Magnitude Dynamic Accuracy Error

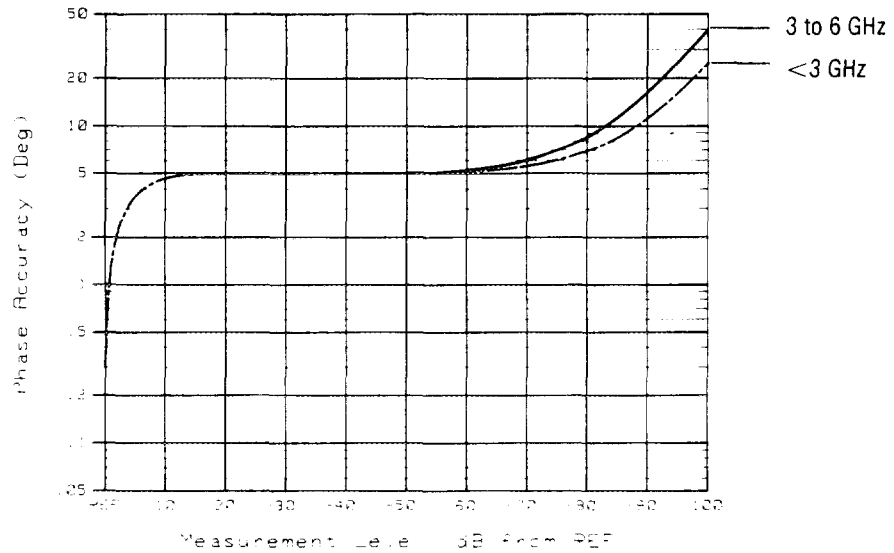

Assumption: Reference Power Level = 0 dBm

Figure 13. Worst-Case Phase Dynamic Accuracy Error

Dynamic Accuracy Error Contribution

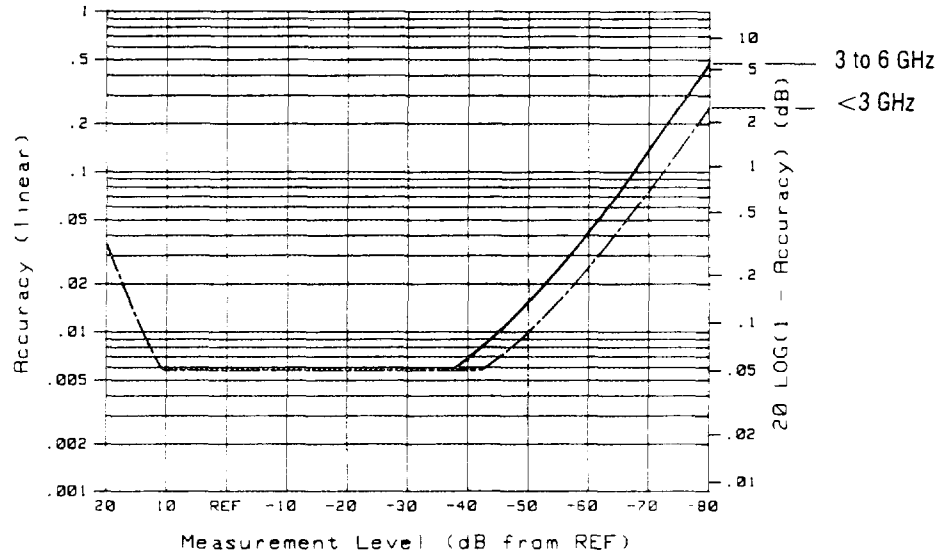

Assumption: Reference Power Level = -20 dBm

Figure 14. Worst-Case Magnitude Dynamic Accuracy Error

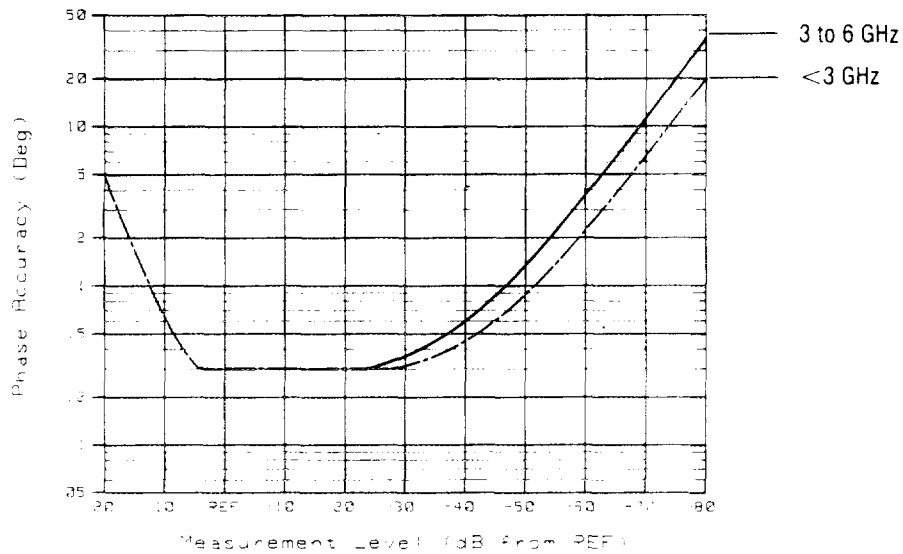

Assumption: Reference Power Level = -20 dBm

Figure 15. Worst-Case Phase Dynamic Accuracy Error

Dynamic Accuracy Error Contribution

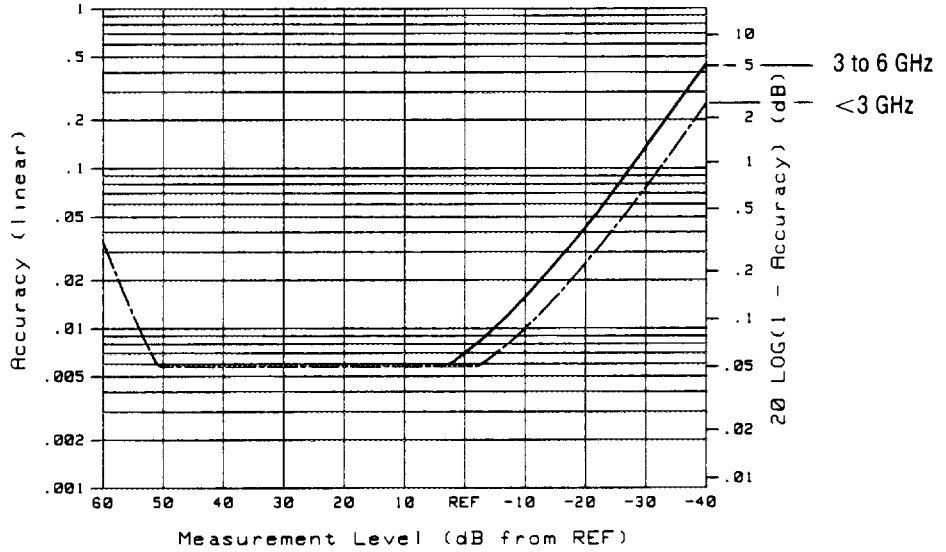

Assumption: Reference Power Level = -60 dBm

Figure 16. Worst-Case Magnitude Dynamic Accuracy Error

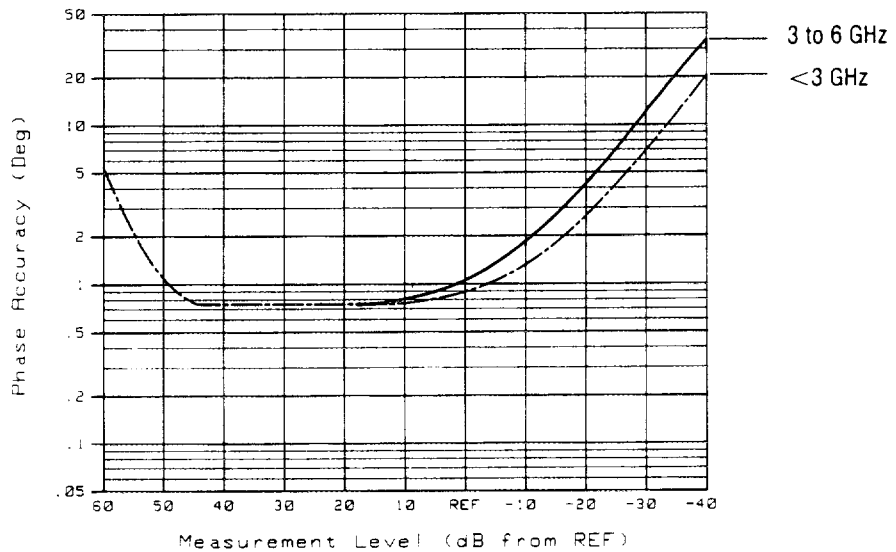

Assumption: Reference Power Level = -60 dBm

Figure 17. Worst-Case Phase Dynamic Accuracy Error

EFFECTS OF TEMPERATURE DRIFT

Figures 18 to 21 are graphs showing the effects of temperature drift on error-corrected measurement uncertainty values. Values are shown for changes of $\pm 3^{\circ}\text{C}$ and $\pm 5^{\circ}\text{C}$ from the ambient temperature. Figures 18 and 19 show total reflection magnitude and phase uncertainty with temperature drift following an S11 one-port calibration. Figures 20 and 21 show total transmission magnitude and phase uncertainty with temperature drift following a full two-port error correction. The graphs apply to measurements up to 6 GHz.

Temperature Drift with S11 One-Port Calibration

Assumptions: Reference Power Level = -20 dBm
 $S_{21} = S_{12} = 0$

$\Delta T = 0^\circ\text{C}$ —————
 $\Delta T = \pm 3^\circ\text{C}$
 $\Delta T = \pm 5^\circ\text{C}$ - - - - -

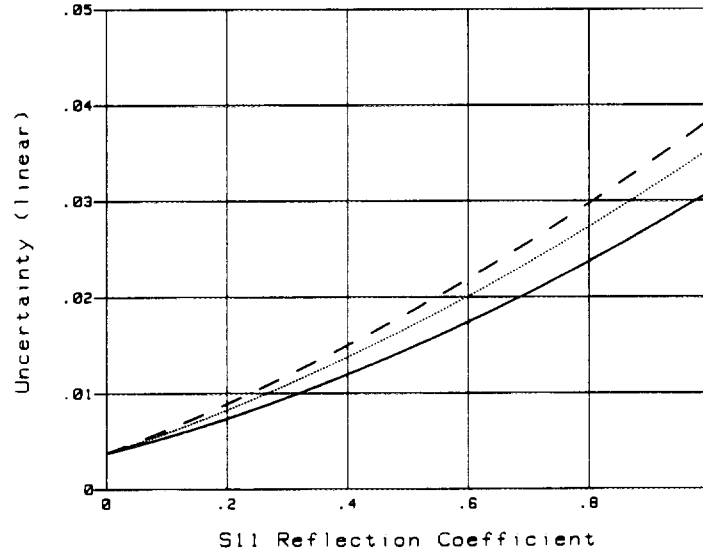

Figure 18. Total Reflection Magnitude Uncertainty

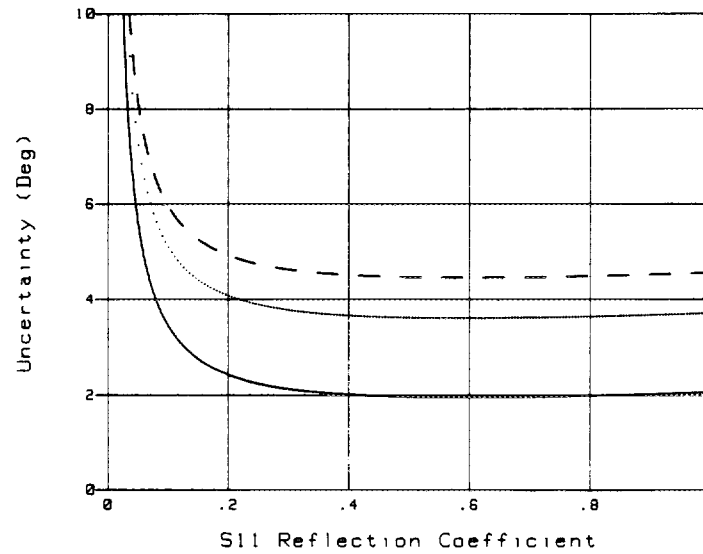

Figure 19. Total Reflection Phase Uncertainty

Temperature Drift with Full Two-Port Calibration

Assumptions: Reference Power Level = -10 dBm
 $S_{11} = S_{22} = 0$

$\Delta T = 0^\circ\text{C}$ —————
 $\Delta T = \pm 3^\circ\text{C}$
 $\Delta T = \pm 5^\circ\text{C}$ - - - - -

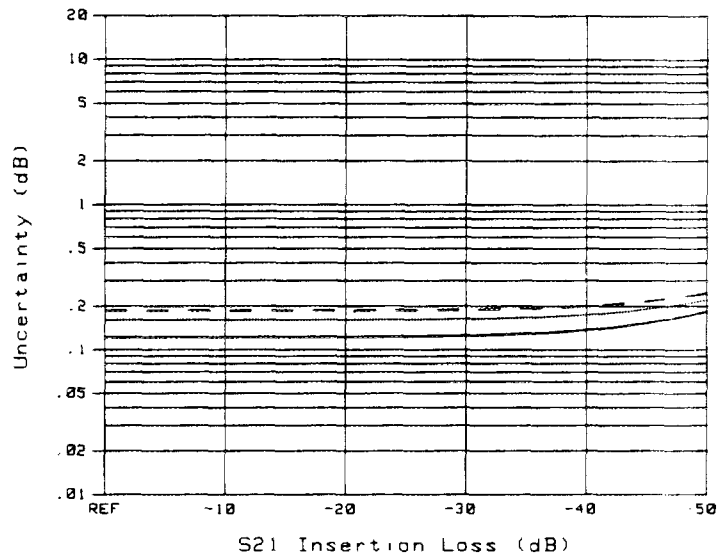

Figure 20. Total Transmission Magnitude Uncertainty

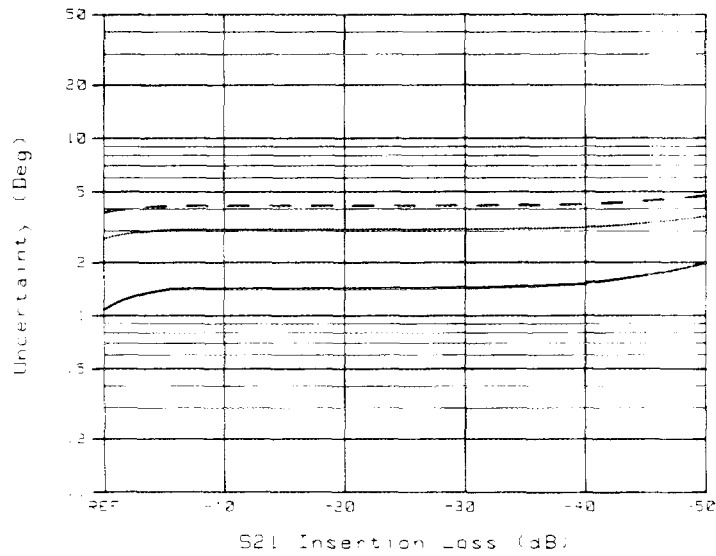

Figure 21. Total Transmission Phase Uncertainty

SYSTEM PERFORMANCE WITH DIFFERENT TEST SETS AND CONNECTOR TYPES

The tables in the following pages provide system specifications or typical system performance for HP 8753B systems using different test sets and different connector types. The values listed are for uncorrected measurements and for corrected measurements after measurement calibration.

Table	Connector	Test Set	Frequency Range
3	7 mm	HP 85046A, 85044A, 85047A	300 kHz to 3 GHz
4	7 mm	HP 85047A	3 GHz to 6 GHz
5	50 ohm type-N	HP 85046A, 85044A, 85047A	300 kHz to 3 GHz
6	50 ohm type-N	HP 85047A	3 GHz to 6 GHz
7	3.5 mm	HP 85046A, 85044A, 85047A	300 kHz to 3 GHz
8	3.5 mm	HP 85047A	3 GHz to 6 GHz
9	75 ohm type-N	HP 85046B, 85044B	300 kHz to 2 GHz

Tables 3 and 4 provide specifications for HP 8753C 7 mm systems. Error correction was performed using precision devices from the HP 85031B 7 mm calibration kit. Data listed in the columns headed *Residuals After Accuracy Enhancement* was measured accurately at the factory with standards traceable to the National Institute of Standards and Technology (formerly NBS). These residuals can be verified only at the factory (USA). Aggregate system performance after accuracy enhancement can be verified using the HP 85029B 7 mm verification kit and the *System Verification* procedure in the *Service Manual*.

Tables 5 through 9 provide typical performance figures for other systems. These are not specifications, but are intended to provide information useful in applying the instrument by giving typical but non-warranted performance parameters. Error correction for these systems is performed using the compatible calibration kits listed in *General Information*.

NOTE: Tables 3 through 9 are generated with the analyzer in chop A and B sweep mode. Refer to *Calibrate More Menu* in Chapter 5 for details.

Table 3. System Specifications for Devices with 7mm Connectors
HP 8753C with HP 85046A, 85044A, or 85047A Test Set, up to 3 GHz

Symbol	Error Terms	Uncorrected		Residual after Accuracy Enhancement ^{1, 2}							
				Response Only		Response and Isolation		One-Port		Full Two-Port ³	
		dB	Linear	dB	Linear	dB	Linear	dB	Linear	dB	Linear
D	Directivity	-30	0.032	-30	0.032	-50 ⁴	0.0032	-50	0.0032	-50	0.0032
M _s	Source Match ⁵	-16 ⁶	0.16	-16 ⁶	0.16	-16	0.16	-40	0.01	-40	0.01
M _l	Load Match ⁵	-16 ^{6, 7}	0.16 ⁷	-16 ^{6, 7}	0.16 ⁷	-16 ⁷	0.16 ⁷	—	—	-42	0.005
T _r	Reflection Tracking ⁵	±1.5 ⁷	+0.19 ⁷ -0.16 ⁷	+1.5 ⁷ -1.8 ⁷	0.19 ⁷	+1.3 ⁷ -1.5 ⁷	0.16 ⁷	±0.05	0.006	±0.05	0.006
T _t	Transmission Tracking ⁵	±1.5 ^{7, 8}	+0.19 ⁷ -0.16 ⁷	±0.20 ⁷	0.026 ⁷	±0.20 ⁷	0.026 ⁷	—	—	±0.03	0.0035
C	Crosstalk	-90 ⁷	0.000032 ⁷	-90 ⁷	0.000032	-100 ⁹	0.00001	—	—	-100 ⁹	0.00001
R _{r1}	Port 1 Reflection Connector Repeatability (Typical)	-70 dB or 0.00032 linear									
R _{t1}	Port 1 Transmission Connector Repeatability (Typical)	-70 dB or 0.00032 linear									
R _{r2}	Port 2 Reflection Connector Repeatability (Typical)	-70 dB or 0.00032 linear									
R _{t2}	Port 2 Transmission Connector Repeatability (Typical)	-70 dB or 0.00032 linear									
N _l	Low-Level Noise ² (Noise Floor)	-100 dBm									
N _h	High-Level Noise ^{2, 10}	Magnitude: 0.004 dB or 0.00046 linear									
A _m , A _p	HP 8753 Magnitude and Phase Dynamic Accuracy Error	Refer to "Dynamic Accuracy" in this section									
S _{t1}	Port 1 Cable Transmission Phase Stability ¹¹	0.05 x f(GHz), degrees									
S _{r1}	Port 1 Cable Reflection Stability ¹¹	-70 dB or 0.00032 linear									
S _{t2}	Port 2 Cable Transmission Phase Stability ¹¹	0.05 x f(GHz), degrees									
S _{r2}	Port 2 Cable Reflection Stability ¹¹	-70 dB or 0.00032 linear									
T _{td}	Transmission Tracking Drift (Typical)	Magnitude: 0.0015 x Δ°C, linear Phase: [0.1 + 0.15 x f(GHz)] x Δ°C, degrees									
T _{rd}	Reflection Tracking Drift (Typical)	Magnitude: 0.0015 x Δ°C, linear Phase: ¹² [0.1 + 0.15 x f(GHz)] x Δ°C, degrees									

1 Accuracy enhancement procedures are performed using HP 85031B 7 mm calibration kit. Environmental temperature is 25°C ± 5°C at calibration; ± 1°C from calibration temperature must be maintained for valid measurement calibration

2 With IF bandwidth of 10 Hz.

3 One-path 2-port calibration with HP 85044A

4 With impedance-matched load

5 Includes effects of switch repeatability

6 Applies over most of the frequency range. Refer to test set manual for detailed specifications

7 Typical

8 HP 85044A typically has a -6 dB offset

9 Typically, crosstalk after accuracy enhancement is -110 dB

10 High-level noise is the RMS of a continuous measurement of a short circuit or thru. Refer to the trace noise performance test

11 Arrived at by bending HP 11857D cables out perpendicular to front panel and reconnecting. Stability is much better with less flexing.

12 Arrived at using HP 11857D cables and full 2-port calibration. Drift is much better without cables and with 1-port calibration. For this case, drift typically is [0.1 + 0.05 x f(GHz)] x Δ°C, degrees.

Table 4. System Specifications for Devices with 7mm Connectors
HP 8753C with HP 85047A Test Set, 3 GHz to 6 GHz

Symbol	Error Terms	Uncorrected		Residual after Accuracy Enhancement ^{1, 2}							
				Response Only		Response and Isolation		One-Port		Full Two-Port	
		dB	Linear	dB	Linear	dB	Linear	dB	Linear	dB	Linear
D	Directivity	-25	0.06	-25	0.06	-44 ³	0.006	-44	0.0032	-44	0.006
M _s	Source Match ⁴	-14	0.20	-14	0.20	-14	0.20	-36	0.01	-36	0.016
M _l	Load Match ⁴	-14 ⁵	0.20 ⁵	-14 ⁵	0.20 ⁵	-14 ⁵	0.20 ⁵	—	—	-42	0.008
T _r	Reflection Tracking ⁴	+0.5 ⁵ -2.5 ⁵	+0.06 ⁵ -0.25 ⁵	+2.0 -2.6	0.26 ⁵	+1.6 -1.9	0.20 ⁵	±0.06	0.007	±0.06	0.007
T _t	Transmission Tracking ⁴	+0.5 ⁵ -2.5 ⁵	+0.06 ⁵ -0.25 ⁵	±0.35 ⁵	0.04 ⁵	±0.35 ⁵	0.04 ⁵	—	—	±0.05	0.006
C	Crosstalk	-80 ⁵	0.0001 ⁵	-80 ⁵	0.0001	-90 ⁶	0.000032	—	—	-90 ⁶	0.000032
R _{r1}	Port 1 Reflection Connector Repeatability (Typical)	-70 dB or 0.00032 linear									
R _{t1}	Port 1 Transmission Connector Repeatability (Typical)	-70 dB or 0.00032 linear									
R _{r2}	Port 2 Reflection Connector Repeatability (Typical)	-70 dB or 0.00032 linear									
R _{t2}	Port 2 Transmission Connector Repeatability (Typical)	-70 dB or 0.00032 linear									
N _l	Low-Level Noise ² (Noise Floor)	-95 dBm									
N _h	High-Level Noise ^{2,7}	Magnitude: 0.004 dB or 0.00046 linear									
A _m , A _φ	HP 8753 Magnitude and Phase Dynamic Accuracy Error	Refer to "Dynamic Accuracy" in this section									
S _{t1}	Port 1 Cable Transmission Phase Stability ⁸	0.05 x f(GHz), degrees									
S _{r1}	Port 1 Cable Reflection Stability ⁸	-70 dB or 0.00032 linear									
S _{t2}	Port 2 Cable Transmission Phase Stability ⁸	0.05 x f(GHz), degrees									
S _{r2}	Port 2 Cable Reflection Stability ⁸	-70 dB or 0.00032 linear									
T _{td}	Transmission Tracking Drift (Typical)	Magnitude: 0.0015 x Δ°C, linear Phase: [0.1 + 0.15 x f(GHz)] x Δ°C, degrees									
T _{rd}	Reflection Tracking Drift (Typical)	Magnitude: 0.0015 x Δ°C, linear Phase: ⁹ [0.1 + 0.15 x f(GHz)] x Δ°C, degrees									

1. Accuracy enhancement procedures are performed using HP 85031B 7 mm calibration kit. Environmental temperature is 25°C ± 5°C at calibration: ± 1°C from calibration temperature must be maintained for valid measurement calibration.

2. With IF bandwidth of 10 Hz.

3. With impedance-matched load.

4. Includes effects of switch repeatability.

5. Typical.

6. Typically, crosstalk after accuracy enhancement is -100 dB.

7. High-level noise is the RMS of a continuous measurement of a short circuit or thru. Refer to trace noise performance test.

8. Arrived at by bending HP 11857D cables out perpendicular to front panel and reconnecting. Stability is much better with less flexing.

9. Arrived at using HP 11857D cables and full 2-port calibration. Drift is much better without cables and with 1-port calibration. For this case, drift typically is [0.1 + 0.05 x f(GHz)] x Δ°C, degrees.

Table 5. Typical System Performance for Devices with 50 Ohm Type-N Connectors
HP 8753C with HP 85046A, 85044A, or 85047A Test Set up to 3 GHz

Symbol	Error Terms	Uncorrected		Typical Residual after Accuracy Enhancement ^{1, 2}							
				Response Only		Response and Isolation		One-Port		Full Two-Port ³	
		dB	Linear	dB	Linear	dB	Linear	dB	Linear	dB	Linear
D	Directivity	-30	0.032	-30	0.032	-44 ⁴	0.0063	-44	0.0063	-44	0.0063
M _s	Source Match ⁵	-16 ⁶	0.16	-16	0.16	-16	0.16	-35	0.018	-35	0.018
M _l	Load Match ⁵	-16 ⁶	0.16	-16 ⁶	0.16	-16	0.16	—	—	-42	0.008
T _r	Reflection Tracking ⁵	±1.5	+0.19 -0.16	+1.5 -1.8	0.19	+1.4 -1.6	0.17	±0.06	0.007	±0.06	0.007
T _t	Transmission Tracking ⁵	±1.5 ⁷	+0.19 -0.16	±0.20	0.026	±0.20	0.026	—	—	±0.05	0.006
C	Crosstalk	-90	0.000032	-90	0.000032	-100 ⁸	0.00001	—	—	-100 ⁸	0.00001
R _{r1}	Port 1 Reflection Connector Repeatability (Typical)	-65 dB or 0.00056 linear									
R _{t1}	Port 1 Transmission Connector Repeatability (Typical)	-65 dB or 0.00056 linear									
R _{r2}	Port 2 Reflection Connector Repeatability (Typical)	-65 dB or 0.00056 linear									
R _{t2}	Port 2 Transmission Connector Repeatability (Typical)	-65 dB or 0.00056 linear									
N _l	Low-Level Noise ² (Noise Floor)	-100 dBm									
N _h	High-Level Noise ^{2,9}	Magnitude: 0.004 dB or 0.00046 linear									
A _m , A _p	HP 8753 Magnitude and Phase Dynamic Accuracy Error	Refer to "Dynamic Accuracy" in this section									
S _{t1}	Port 1 Cable Transmission Phase Stability ¹⁰	0.05 x f(GHz), degrees									
S _{r1}	Port 1 Cable Reflection Stability ¹⁰	-70 dB or 0.00032 linear									
S _{t2}	Port 2 Cable Transmission Phase Stability ¹⁰	0.05 x f(GHz), degrees									
S _{r2}	Port 2 Cable Reflection Stability ¹⁰	-70 dB or 0.00032 linear									
T _{tc}	Transmission Tracking Drift (Typical)	Magnitude: 0.0015 x Δ°C linear Phase: [0.1 + 0.15 x f(GHz)] x Δ°C, degrees									
T _{rc}	Reflection Tracking Drift (Typical)	Magnitude: 0.0015 x Δ°C linear Phase: ¹¹ [0.1 + 0.15 x f(GHz)] x Δ°C, degrees									

1 Accuracy enhancement procedures are performed using HP 85032B 50Ω type-N calibration kit. Environmental temperature is 25°C ±5°C at calibration; ±1°C from calibration temperature must be maintained for valid measurement calibration.

2 With IF bandwidth of 10 Hz.

3 One-path 2-port calibration with HP 85044A.

4 With impedance-matched load.

5 Includes effects of switch repeatability.

6 Applies over most of the frequency range. Refer to test set manual for detailed specifications.

7 HP 85044A typically has a -6 dB offset.

8 Typically, crosstalk after accuracy enhancement is -110 dB.

9 High-level noise is the RMS of a continuous measurement of a short circuit or thru. Refer to the trace noise performance test.

10 Arrived at by bending HP 11857D cables out perpendicular to front panel and reconnecting. Stability is much better with less flexing.

11 Arrived at using HP 11857D cables and full 2-port calibration. Drift is much better without cables and with 1-port calibration. For this case, drift typically is [0.1 + 0.05 x f(GHz)] x Δ°C, degrees.

Table 6. Typical System Performance for Devices with 50 Ohm Type-N Connectors
HP 8753C with HP 85047A Test Set, 3 GHz to 6 GHz

Symbol	Error Terms	Uncorrected		Typical Residual after Accuracy Enhancement ^{1, 2}							
				Response Only		Response and Isolation		One-Port		Full Two-Port	
		dB	Linear	dB	Linear	dB	Linear	dB	Linear	dB	Linear
D	Directivity	-25	0.06	-25	0.06	-40 ³	0.01	-40	0.01	-40	0.01
M _s	Source Match ⁴	-14	0.20	-14	0.20	-14	0.20	-32	0.025	-32	0.025
M _l	Load Match ⁴	-14	0.20	-14	0.20	-14	0.20	—	—	-38	0.013
T _r	Reflection Tracking ⁴	+0.5 -2.5	+0.06 -0.25	+2.0 -2.6	0.26	+1.7 -2.0	0.21	±0.12	0.014	±0.12	0.014
T _t	Transmission Tracking ⁴	+0.5 -2.5	+0.06 -0.25	±0.35	0.04	±0.35	0.04	—	—	±0.06	0.007
C	Crosstalk	-80	0.0001	-80	0.0001	-90 ⁵	0.000032	—	—	-90 ⁵	0.000032
R _{r1}	Port 1 Reflection Connector Repeatability (Typical)	-65 dB or 0.00056 linear									
R _{t1}	Port 1 Transmission Connector Repeatability (Typical)	-65 dB or 0.00056 linear									
R _{r2}	Port 2 Reflection Connector Repeatability (Typical)	-65 dB or 0.00056 linear									
R _{t2}	Port 2 Transmission Connector Repeatability (Typical)	-65 dB or 0.00056 linear									
N _l	Low-Level Noise ² (Noise Floor)	-95 dBm									
N _h	High-Level Noise ^{2,6}	Magnitude: 0.004 dB or 0.00046 linear									
A _m , A _p	HP 8753 Magnitude and Phase Dynamic Accuracy Error	Refer to "Dynamic Accuracy" in this section									
S _{t1}	Port 1 Cable Transmission Phase Stability ⁷	0.05 x f(GHz), degrees									
S _{r1}	Port 1 Cable Reflection Stability ⁷	-70 dB or 0.00032 linear									
S _{t2}	Port 2 Cable Transmission Phase Stability ⁷	0.05 x f(GHz), degrees									
S _{r2}	Port 2 Cable Reflection Stability ⁷	-70 dB or 0.00032 linear									
T _{td}	Transmission Tracking Drift (Typical)	Magnitude: 0.0015 x Δ°C, linear Phase: [0.1 + 0.15 x f(GHz)] x Δ°C, degrees									
T _{rd}	Reflection Tracking Drift (Typical)	Magnitude: 0.0015 x Δ°C, linear Phase: ⁸ [0.1 + 0.15 x f(GHz)] x Δ°C, degrees									

1. Accuracy enhancement procedures are performed using HP 85032B 50Ω type-N calibration kit. Environmental temperature is 25°C ± 5°C at calibration: ± 1°C from calibration temperature must be maintained for valid measurement calibration.

2. With IF bandwidth of 10 Hz.

3. With impedance-matched load.

4. Includes effects of switch repeatability.

5. Typically, crosstalk after accuracy enhancement is -100 dB.

6. High-level noise is the RMS of a continuous measurement of a short circuit or thru. Refer to trace noise performance test.

7. Arrived at by bending HP 11857D cables out perpendicular to front panel and reconnecting. Stability is much better with less flexing.

8. Arrived at using HP 11857D cables and full 2-port calibration. Drift is much better without cables and with 1-port calibration. For this case, drift typically is {0.1 + 0.05 x f(GHz)} x Δ°C, degrees.

Table 7. Typical System Performance for Devices with 3.5 mm Connectors
HP 8753C with HP 85046A, 85044A, or 85047A Test Set up to 3 GHz

Symbol	Error Terms	Uncorrected		Typical Residual after Accuracy Enhancement ^{1, 2}							
				Response Only		Response and Isolation		One-Port		Full Two-Port ³	
		dB	Linear	dB	Linear	dB	Linear	dB	Linear	dB	Linear
D	Directivity	-30	0.032	-30	0.032	-40 ⁴	0.01	-40	0.01	-40	0.01
M _s	Source Match ⁵	-16 ⁶	0.16	-16 ⁶	0.16	-16	0.16	-36	0.015	-36	0.015
M _l	Load Match ⁵	-16 ⁶	0.16	-16 ⁶	0.16	-16	0.16	—	—	-38	0.012
T _r	Reflection Tracking ⁵	± 1.5	+0.19 -0.16	+1.51 -1.83	0.19	+1.3 -1.6	0.17	±0.14	0.016	±0.14	0.016
T _t	Transmission Tracking ⁵	± 1.5 ⁷	+0.19 -0.16	± 0.2	0.026	± 0.20	0.026	—	—	± 0.05	0.006
C	Crosstalk	-90	0.000032	-90	0.000032	-100 ⁸	0.00001	—	—	-100 ⁸	0.00001
R _{r1}	Port 1 Reflection Connector Repeatability (Typical)	-70 dB or 0.00032 linear									
R _{t1}	Port 1 Transmission Connector Repeatability (Typical)	-70 dB or 0.00032 linear									
R _{r2}	Port 2 Reflection Connector Repeatability (Typical)	-70 dB or 0.00032 linear									
R _{t2}	Port 2 Transmission Connector Repeatability (Typical)	-70 dB or 0.00032 linear									
N _l	Low-Level Noise ² (Noise Floor)	-100 dBm									
N _h	High-Level Noise ^{2,9}	Magnitude: 0.004 dB or 0.00046 linear									
A _m , A _p	HP 8753 Magnitude and Phase Dynamic Accuracy Error	Refer to "Dynamic Accuracy" in this section									
S _{r1}	Port 1 Cable Transmission Phase Stability ¹⁰	0.05 x f(GHz), degrees									
S _{r1}	Port 1 Cable Reflection Stability ¹⁰	-70 dB or 0.00032 linear									
S _{r2}	Port 2 Cable Transmission Phase Stability ¹⁰	0.05 x f(GHz), degrees									
S _{r2}	Port 2 Cable Reflection Stability ¹⁰	-70 dB or 0.00032 linear									
T _{td}	Transmission Tracking Drift (Typical)	Magnitude: 0.0015 x Δ°C linear Phase: [0.1 + 0.15 x f(GHz)] x Δ°C, degrees									
T _{rd}	Reflection Tracking Drift (Typical)	Magnitude: 0.0015 x Δ°C linear Phase: [0.1 + 0.15 x f(GHz)] x Δ°C, degrees									

1 Accuracy enhancement procedures are performed using HP 85033C 3.5 mm calibration kit. Environmental temperature is 25°C ± 5°C at calibration ± 1°C from calibration temperature must be maintained for valid measurement calibration

2 With IF bandwidth of 10 Hz

3 One-path 2-port calibration with HP 85044A

4 With impedance-matched load

5 Includes effects of switch repeatability

6 Applies over most of the frequency range. Refer to test set manual for detailed specifications

7 HP 85044A typically has a +6 dB offset.

8 Typically, crosstalk after accuracy enhancement is -110 dB

9 High-level noise is the RMS of a continuous measurement of a short circuit or thru. Refer to the trace noise performance test.

10 Arrived at by bending HP 11857D cables out perpendicular to front panel and reconnecting. Stability is much better with less flexing

11 Arrived at using HP 11857D cables and full 2-port calibration. Drift is much better without cables and with 1-port calibration. For this case, drift typically is [0.1 + 0.05 x f(GHz)] x Δ°C, degrees

Table 8. Typical System Performance for Devices with 3.5 mm Connectors
HP 8753C with HP 85047A Test Set, 3 GHz to 6 GHz

Symbol	Error Terms	Uncorrected		Typical Residual after Accuracy Enhancement ^{1, 2}							
				Response Only		Response and Isolation		One-Port		Full Two-Port	
		dB	Linear	dB	Linear	dB	Linear	dB	Linear	dB	Linear
D	Directivity	-25	0.06	-25	0.06	-35	0.018	-35	0.018	-35	0.018
M _s	Source Match ⁴	-14	0.20	-14	0.20	-14	0.20	-30	0.032	-30	0.032
M _l	Load Match ⁴	-14	0.20	-14	0.20	-14	0.20	—	—	-32	0.025
T _r	Reflection Tracking ⁴	+0.5 -2.5	+0.06 -0.25	+2.0 -2.6	0.26	+1.7 -2.0	0.21	±0.12	0.016	±0.12	0.014
T _t	Transmission Tracking ⁴	+0.5 -2.5	+0.06 -0.25	±0.35	0.04	±0.35	0.04	—	—	±0.1	0.012
C	Crosstalk	-80	0.0001	-80	0.0001	-90 ⁵	0.000032	—	—	-90 ⁵	0.000032
R _{r1}	Port 1 Reflection Connector Repeatability (Typical)	-70 dB or 0.00032 linear									
R _{t1}	Port 1 Transmission Connector Repeatability (Typical)	-70 dB or 0.00032 linear									
R _{r2}	Port 2 Reflection Connector Repeatability (Typical)	-70 dB or 0.00032 linear									
R _{t2}	Port 2 Transmission Connector Repeatability (Typical)	-70 dB or 0.00032 linear									
N _l	Low-Level Noise ² (Noise Floor)	-95 dBm									
N _h	High-Level Noise ^{2,6}	Magnitude: 0.004 dB or 0.00046 linear									
A _m , A _p	HP 8753 Magnitude and Phase Dynamic Accuracy Error	Refer to "Dynamic Accuracy" in this section									
S _{t1}	Port 1 Cable Transmission Phase Stability ⁷	0.05 x f(GHz), degrees									
S _{r1}	Port 1 Cable Reflection Stability ⁷	-70 dB or 0.00032 linear									
S _{t2}	Port 2 Cable Transmission Phase Stability ⁷	0.05 x f(GHz), degrees									
S _{r2}	Port 2 Cable Reflection Stability ⁷	-70 dB or 0.00032 linear									
T _{td}	Transmission Tracking Drift (Typical)	Magnitude: 0.0015 x Δ°C linear Phase: [0.1 + 0.15 x f(GHz)] x Δ°C, degrees									
T _{rd}	Reflection Tracking Drift (Typical)	Magnitude: 0.0015 x Δ°C linear Phase: ⁸ [0.1 + 0.15 x f(GHz)] x Δ°C, degrees									

1. Accuracy enhancement procedures are performed using HP 85033C 3.5 mm calibration kit. Environmental temperature is 25°C ± 5°C at calibration: ± 1°C from calibration temperature must be maintained for valid measurement calibration.

2. With IF bandwidth of 10 Hz.

3. With impedance-matched load.

4. Includes effects of switch repeatability.

5. Typically, crosstalk after accuracy enhancement is -100 dB.

6. High-level noise is the RMS of a continuous measurement of a short circuit or thru. Refer to trace noise performance test.

7. Arrived at by bending HP 11857D cables out perpendicular to front panel and reconnecting. Stability is much better with less flexing.

8. Arrived at using HP 11857D cables and full 2-port calibration. Drift is much better without cables and with 1-port calibration. For this case, drift typically is [0.1 + 0.05 x f(GHz)] x Δ°C, degrees

Table 9. Typical System Performance for Devices with 75 Ohm Type-N Connectors
HP 8753C with HP 85046B or 85044B Test Set

Symbol	Error Terms	Uncorrected		Typical Residual after Accuracy Enhancement ^{1, 2}							
				Response Only		Response and Isolation		One-Port		Full Two-Port ³	
		dB	Linear	dB	Linear	dB	Linear	dB	Linear	dB	Linear
D	Directivity	-30	0.032	-30	0.032	-44 ⁴	0.0063	-44	0.0063	-44	0.0063
M _s	Source Match ⁵	-16 ⁶	0.16	-16 ⁶	0.16	-16	0.16	-35	0.018	-35	0.018
M _l	Load Match ⁵	-16 ⁶	0.16	-16 ⁶	0.16	-16	0.16	—	—	-42	0.008
T _r	Reflection Tracking ⁵	± 1.5	+0.19 -0.16	+1.5 -1.8	0.19	+1.3 -1.6	0.17	± 0.06	0.007	± 0.06	0.007
T _t	Transmission Tracking ⁵	± 1.5 ⁷	+0.019 -0.16	± 0.21	0.025	± 0.20	0.026	—	—	± 0.05	0.006
C	Crosstalk	-85	0.000063	-85	0.000063	-94 ⁸	0.00002	—	—	-94 ⁸	0.00002
R _{r1}	Port 1 Reflection Connector Repeatability (Typical)	-65 dB or 0.00056 linear									
R _{t1}	Port 1 Transmission Connector Repeatability (Typical)	-65 dB or 0.00056 linear									
R _{r2}	Port 2 Reflection Connector Repeatability (Typical)	-65 dB or 0.00056 linear									
R _{t2}	Port 2 Transmission Connector Repeatability (Typical)	-65 dB or 0.00056 linear									
N _l	Low-Level Noise ² (Noise Floor)	-94 dBm									
N _h	High-Level Noise ^{2,9}	Magnitude: 0.004 dB or 0.00046 linear									
A _m , A _p	HP 8753 Magnitude and Phase Dynamic Accuracy Error	Refer to "Dynamic Accuracy" in this section									
S _{t1}	Port 1 Cable Transmission Phase Stability ¹⁰	0.05 x f(GHz), degrees									
S _{r1}	Port 1 Cable Reflection Stability ¹⁰	-70 dB or 0.00032 linear									
S _{t2}	Port 2 Cable Transmission Phase Stability ¹⁰	0.05 x f(GHz), degrees									
S _{r2}	Port 2 Cable Reflection Stability ¹⁰	-70 dB or 0.00032 linear									
T _{td}	Transmission Tracking Drift (Typical)	Magnitude: 0.0015 x Δ°C linear Phase: [0.1 + 0.15 x f(GHz)] x Δ°C, degrees									
T _{rd}	Reflection Tracking Drift (Typical)	Magnitude: 0.0015 x Δ°C linear Phase: ¹¹ [0.1 + 0.15 x f(GHz)] x Δ°C, degrees									

1 Accuracy enhancement procedures are performed using HP 85036B 75Ω type-N calibration kit. Environmental temperature is 25°C ± 5°C at calibration; ± 1°C from calibration temperature must be maintained for valid measurement calibration.

2 With IF bandwidth of 10 Hz.

3 One-path 2-port calibration with HP 85044B.

4 With impedance-matched load.

5 Includes effects of switch repeatability

6 Applies over most of the frequency range. Refer to test set manual for detailed specifications

7 HP 85044B typically has a > 6 dB offset.

8 Typically, crosstalk after accuracy enhancement is -104 dB.

9 High-level noise is the RMS of a continuous measurement of a short circuit or thru. Refer to the trace noise performance test.

10 Arrived at by bending HP 11857B cables out perpendicular to front panel and reconnecting. Stability is much better with less flexing.

11 Arrived at using HP 11857B cables and full 2-port calibration. Drift is much better without cables and with 1-port calibration. For this case, drift typically is [0.1 + 0.05 x f(GHz)] x Δ°C, degrees.

DETERMINING EXPECTED SYSTEM PERFORMANCE

The uncertainty equations, dynamic accuracy calculations, and tables of system performance values provided in the preceding pages can be used to calculate the expected system performance. The following pages explain how to determine the residual errors of a particular system and combine them to obtain total error-corrected residual uncertainty values, using worksheets provided. The uncertainty graphs at the beginning of this *System Performance* section are examples of the results that can be calculated using this information.

Procedures

Table 10 is a worksheet used to calculate the residual uncertainty in reflection measurements. Table 11 is a worksheet for residual uncertainty in transmission measurements. Determine the linear values of the residual error terms and the nominal linear S-parameter data of the device under test as described below and enter these values in the worksheets. Then use the instructions and equations in the worksheets to combine the residual errors for total system uncertainty performance. The resulting total measurement uncertainty values have a confidence factor of 99.9%.

S-Parameter Values. Convert the S-parameters of the test device to their absolute linear terms.

Noise Floor. Refer to the *Receiver Noise Level Performance Test* in the *Service Manual* to determine the actual noise floor performance of your measurement setup.

Crosstalk. Refer to the *Input Crosstalk Performance Test*. Connect an impedance-matched load to each of the test ports and measure S₂₁ or S₁₂ after calibration. Turn on the marker statistics function (see chapter 6, *Using Markers*), and measure the mean value of the trace. Use the mean value plus one standard deviation as the residual crosstalk value of your system.

Dynamic Accuracy. Determine the absolute linear magnitude dynamic accuracy as described under *Dynamic Accuracy* in this chapter.

Other Error Terms. Refer to tables 3 through 9, depending on the test set and connector type in your system. Find the absolute linear magnitude of the remaining error terms.

Combining Error Terms. Combine the above terms using the reflection or transmission uncertainty equations in the worksheets.

Table 10. Reflection Measurement Uncertainty Worksheet

In the columns below, enter the appropriate values for each term. Frequency: _____

Error Term	Symbol	dB Value	Linear Value
Directivity	D	_____	_____
Reflection tracking	T _r	_____	_____
Source match	M _s	_____	_____
Load match	M _l	_____	_____
Dynamic accuracy ¹			
Magnitude	A _m	_____	_____
Phase	A _p	_____	_____
S11	S11	_____	_____
S21	S21	_____	_____
S12	S12	_____	_____
Noise floor ²	N _l	_____	_____
High level noise ²	N _h	_____	_____
Connector reflection repeatability	R _{r1} , R _{r2}	_____	_____
Connector transmission repeatability	R _{t1} , R _{t2}	_____	_____
Magnitude drift due to temperature	T _{rd} (mag)	_____	_____
Phase drift due to temperature	T _{rd} (phase)	_____	_____
Cable reflection stability	S _r	_____	_____
Cable transmission stability	S _t	_____	_____

Magnitude

Combine Systematic Errors. In the space provided, enter the appropriate linear values from the list of errors. Then combine these errors to obtain the total sum of systematic errors.

D + S _{r1}	_____ + _____ = _____ [k]
(T _r × S11)	(_____ × _____) = _____ [l]
(S _{r1} + M _s) × (S11) × (S11)	(_____ + _____) × (_____ × _____) = _____ [m]
M _l × S21 × S12	(_____ × _____ × _____) = _____ [n]
(A _m) × (S11)	(_____ × _____) = _____ [o]
Subtotal: k + l + m + n + o	_____ + _____ + _____ + _____ + _____ = _____ [S]

Combine Random Errors. In the space provided, enter the appropriate linear values from the list of errors. Then combine these errors in an RSS fashion to obtain a total sum of the random errors.

R _{r1} + 2 × (R _{r1}) × (S11) + (R _{r1}) × (S11) × (S11)	_____ + 2 × (_____) × (_____) + (_____) × (_____) × (_____) = _____ [y]
(R _{r2}) × (S21) × (S12)	(_____ × _____) × (_____ × _____) = _____ [z]
√ y ² + z ²	√ _____ × _____ + _____ × _____ = _____ [R]
S + R	_____ + _____ = _____ [V _r]

Total Magnitude Errors:

E _{rm} (linear) = V _r + T _{rd} (mag) × S11	_____ + (_____ × _____) = _____
E _{rm} (log) = 20 Log (1 ± E _{rm} /S11)	20 Log (1 ± _____ / _____) = _____ dB

Phase

E _p = Arcsin((V _r - A _m × S11) / S11) + T _{rd} (phase) + 2 × S _{r1} + A _p	Arcsin((_____ - _____ × _____) / _____) + _____ + 2 × _____ + _____ = ± _____ degrees
---	---

1. With IF bandwidth of 10 Hz.
 2. Included in dynamic accuracy.

Table 11. Transmission Measurement Uncertainty Worksheet

In the columns below, enter the appropriate values for each term. Frequency: _____

Error Term	Symbol	dB Value	Linear Value
Crosstalk	C	_____	_____
Transmission tracking	T _t	_____	_____
Source match	M _s	_____	_____
Load match	M _l	_____	_____
Dynamic accuracy ¹		_____	_____
Magnitude	A _m	_____	_____
Phase	A _p	_____	_____
S11	S11	_____	_____
S21	S21	_____	_____
S12	S12	_____	_____
S22	S22	_____	_____
Noise floor ²	N _l	_____	_____
High level noise ²	N _h	_____	_____
Connector reflection repeatability	R _{r1} , R _{r2}	_____	_____
Connector transmission repeatability	R _{t1} , R _{t2}	_____	_____
Magnitude drift due to temperature	T _{td} (mag)	_____	_____
Phase drift due to temperature	T _{td} (phase)	_____	_____
Cable reflection stability	S _r	_____	_____
Cable transmission stability	S _t	_____	_____

Magnitude

Combine Systematic Errors. In the space provided, enter the appropriate linear values from the list of errors. Then combine these errors to obtain the total sum of systematic errors.

C = _____ [k]

(T_c × S21) (_____ × _____) = _____ [l]

(S_{r1} + M_s) × (S11) × (S21) (_____ + _____) × (_____ × _____) = _____ [m]

(S_{r2} + M_l) × (S21) × (S22) (_____ + _____) × (_____ × _____) = _____ [n]

(A_m) × (S21) (_____ × _____) = _____ [o]

Subtotal: k + l + m + n + o _____ + _____ + _____ + _____ + _____ = _____ [S]

Combine Random Errors. In the space provided, enter the appropriate linear values from the list of errors. Then combine these errors in an RSS fashion to obtain a total sum of the random errors.

(R_{t1}) × (S21) + (R_{r1}) × (S11) × (S21) (_____ × _____) + (_____ × _____) × (_____ × _____) = _____ [y]

(R_{t2}) × (S21) + (R_{r2}) × (S22) × (S21) (_____ × _____) + (_____ × _____) × (_____ × _____) = _____ [z]

$\sqrt{y^2 + z^2}$ $\sqrt{\text{_____} \times \text{_____} + \text{_____} \times \text{_____}}$ = _____ [R]

S + R _____ + _____ = _____ [V_i]

Total Magnitude Errors

E_{tm}(linear) = V_i + T_{td}(mag) × S21 _____ + (_____ × _____) = _____

E_{tm}(log) = 20 Log (1 ± E_{tm}/S21) 20 Log (1 ± _____ / _____) = _____ dB

Phase

E_{ip} = Arcsin[(V_i - A_m × S21)/S21] + T_{td}(phase) + S_{r1} + S_{r2} + A_p Arcsin[(_____ - _____ × _____) / _____] + _____ + _____ + _____ + _____ = ± _____ degrees

1. With IF bandwidth of 10 Hz.
2. Included in dynamic accuracy.

HP-IB Programming Guide



For the HP 8752A and HP 8753C Network Analyzers with the HP 9000 series 200/300 desktop computer (BASIC)

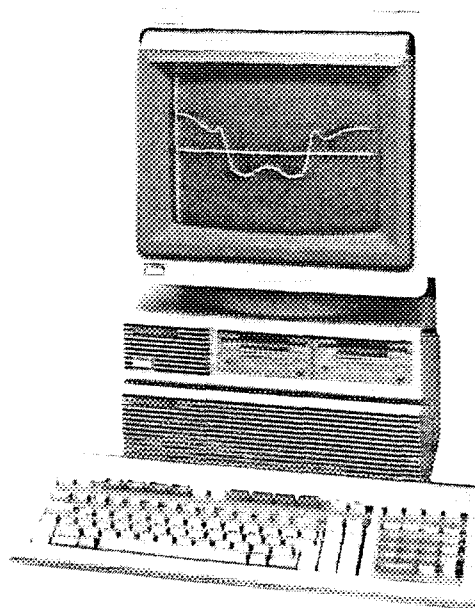
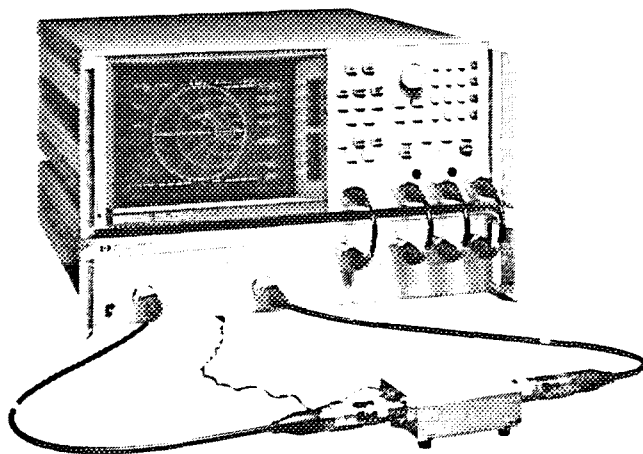

Introduction

This programming guide is an introduction to remote operation of the HP 8752A and 8753C Network Analyzers using an HP 9000 series 200 or 300 computer. It is a tutorial introduction, using BASIC programming examples. The examples are on the Example Programs disk (part numbers 08752-10001 and 08753-10014), included with the operating manual. This document is closely associated with the *HP-IB Quick Reference* for the HP 8700-series network analyzers. The *HP-IB Quick Reference* provides complete programming information in a concise format. Included in the *HP-IB Quick Reference* are both functional and alphabetical lists of HP-IB commands. The *Quick Reference* also lists HP-IB commands, along with its softkey menu explanations.

The Hewlett-Packard computers specifically addressed are the HP 9000 series 200 and 300 computers, operating with BASIC 2.0 with AP2—1, or BASIC 3.0 or higher. This includes the 216 (9816), 217 (9817), 220 (9920), 226 (9826), 236 (9836), 310 and 320 computers.

The reader should become familiar with the operation of the network analyzer before controlling it over HP-IB. This document is not intended to teach BASIC programming or to discuss HP-IB theory except at an introductory level: see page 2 for documents better suited to these tasks.

For more information

For more information concerning the operation of the network analyzer, refer to the following:

User's Guide
Quick Reference
Operating Manual

For more information concerning BASIC, see the manual set for the BASIC revision being used. For example:

BASIC 5.0 Programming Techniques 98613-90012
BASIC 5.0 Language Reference 98613-90052

For more information concerning HP-IB, see:

BASIC 5.0 Interfacing Techniques 98613-90022
Tutorial Description of the Hewlett-Packard Interface Bus 5952-0156
Condensed Description of the Hewlett-Packard Interface Bus 59401-90030

Table of contents

Basic Instrument Control	3
Measurement Programming	6
Basic Programming Examples:	
1. Setting up a basic measurement	8
Performing a measurement calibration:	
2A. S11 1-port calibration	10
2B. Full 2-port calibration (HP 8753C)	12
Data transfer from analyzer to computer:	
3A. Data transfer using ASCII transfer format	17
3B. Data transfer using IEEE 64 bit floating point format	20
3C. Data transfer using the network analyzer internal binary format	22
Advanced Programming Examples:	
Using list frequency mode:	
4A. Setting up a list frequency sweep	24
4B. Selecting a single segment from a table of segments	26
Using limit lines to perform limit testing:	
5A. Setting up limit lines	28
5B. Performing PASS/FAIL tests while tuning	30
Storing and recalling instrument states:	
6A. Using the learn string	32
6B. Coordinating disk storage	33
6C. Reading calibration data	34
Miscellaneous Programming Examples:	
Controlling peripherals:	
7. Operation using pass control mode	36
8. Creating a user interface	38
Transferring disk data files:	
9. Reading data files into a computer	41
Appendix A: Status Reporting	42
A1. Using the error queue	42
A2. Using the status registers	44
A3. Generating interrupts	45

Required equipment

To run the examples of this *Programming Guide*, the following equipment is required:

1. HP 8752A or 8753C Network Analyzer.
2. HP 9000 series 200 or 300 computer with enough memory to hold BASIC, needed binaries, and at least 64 kBytes of program space. In addition, 512 kBytes are needed for BASIC 3.0 or higher operating systems, with the binaries suggested in step 2 in the section *Powering up the system*. A disk drive (e.g. HP 9122) is required to load BASIC if no internal disk drive is available.
3. HP BASIC 2.0 with AP2—1, or BASIC 3.0 or higher operating system.
4. HP 10833A/B/C/D HP-IB cables to interconnect the computer, the network analyzer, and any peripherals.

Optional equipment

1. HP 85032B 50 ohm type-N calibration kit.
2. HP 11852D test port return cables.
3. A test device such as a filter to use in the example measurement programs.
4. HP 7440A ColorPro plotter, an HP 2225A Thinkjet printer, or an HP 9122 or HP 9153 CS80 disk drive. See the General Information section of the manual for a more complete list of compatible peripherals.

Using other computers

Although the examples in this guide apply only to the equipment listed above, other computers can control the network analyzer.

- HP VECTRA Personal Computer using an HP 82300 BASIC Language Processor.
- MS-DOS® compatible computer (PC) with HP 82990A "HP-IB Interface and Command Library". Microsoft® Quick BASIC 4.0 is fully compatible with the HP 82990A.

Powering up the system

1. **Set up the network analyzer as shown in Figure 1.** Connect the network analyzer to the computer with an HP-IB cable. The network analyzer has only one HP-IB interface, but it occupies two addresses: one for the instrument, one for the display. The display address is the instrument address with the least significant bit complemented. The default addresses are 16 for the instrument, 17 for the display. Devices on the HP-IB cannot occupy the same address as the network analyzer.
2. **Turn on the computer and load the BASIC operating system.** For BASIC 2.0, load AP2—1 if available. If BASIC 3.0 or higher is used, load the following BASIC binary extensions: HPIB, GRAPH, IO, KBD, and ERR. Depending on the disk drive, a binary such as CS80 may be also be required.
3. **Turn the network analyzer on.** To verify the network analyzer's address, press [LOCAL] [SET ADDRESSES] and [ADDRESS: 875x]. If the address has been changed from the default value (16), return it to 16 while performing the examples in this document by pressing [1] [6] [x1] and then presetting the instrument. Make sure the instrument is in either [USE PASS CONTROL] or [TALKER/LISTENER] mode, as indicated under the [LOCAL] key. These are the only modes in which the network analyzer will accept commands over HP-IB.
4. **On the computer type the following:** OUTPUT 716; "PRES ; " [EXECUTE] (or [RETURN]) This will preset the network analyzer. If Preset does not occur, there is a problem. First check all HP-IB addresses and connections: most HP-IB problems are caused by an incorrect address and bad or loose HP-IB cables.

Microsoft® is a U.S. registered trademark of Microsoft Corporation.
MS-DOS™ is a U.S. registered trademark of Microsoft Corporation.

NOTE: Only the 9826 and 9836 computers have an [EXECUTE] key. The HP 216 has an [EXEC] key with the same function. All other computers use the [RETURN] key as both execute and enter. The notation [EXECUTE] is used in this document.

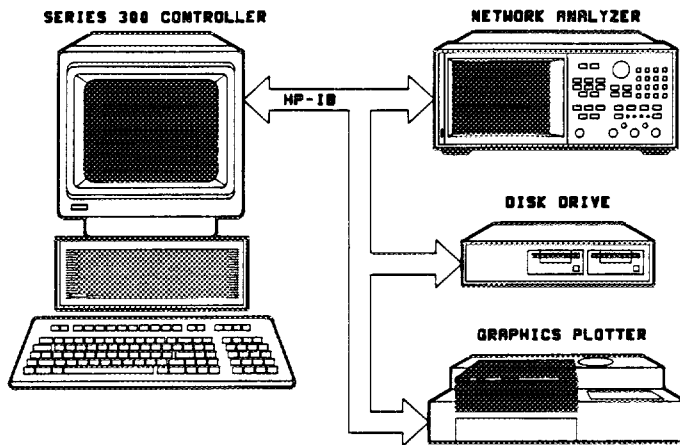

Figure 1. HP-IB connections in a typical setup.

Basic Instrument Control

A computer controls the network analyzer by sending it commands over HP-IB. The commands are specific to the network analyzer. Each command is executed automatically, taking precedence over manual control of the network analyzer. A command applies only to the active channel except where functions are coupled between channels, just as with front panel operation. Most commands are equivalent to front panel functions. For example, type:

```
OUTPUT 716; "STAR 10 MHZ; " and press [EXECUTE].
```

The network analyzer now has a start frequency of 10 MHz. The construction of the command is:

```
OUTPUT 716; "STAR 10 MHZ; "
```

The BASIC data output statement. The data is directed to interface 7 (HP-IB), and on out to the device at address 16 (the network analyzer).

The network analyzer mnemonic for setting the start frequency. The mnemonic, less the quotation marks, is sent literally by the OUTPUT statement, followed by a carriage return, line feed.

The STAR 10 MHZ; command performs the same function as pressing [START] and keying in 10 [M/u]. STAR is the root mnemonic for the start key, 10 is the data, and MHZ are the units. The network analyzer's root mnemonics are derived from the equivalent key label where possible, otherwise from the common name for the function. The HP-IB Quick Reference lists all the root mnemonics, and all the different units accepted.

The semicolon following MHZ terminates the command inside the network analyzer. It removes start frequency

from the active entry area, and prepares the network analyzer for the next command. If there is a syntax error in a command, the network analyzer will ignore the command and look for the next terminator. When it finds the next terminator, it starts processing incoming commands normally. Characters between the syntax error and the next terminator are lost. A line feed also acts as terminator. The BASIC OUTPUT statement transmits a carriage return, line feed following the data. This can be suppressed by putting a semicolon at the end of the statement.

The OUTPUT 716; statement will transmit all items listed, as long as they are separated by commas or semicolons. It will transmit literal information enclosed in quotes, numeric variables, string variables, and arrays. A carriage return, line feed is transmitted after each item. This can be stopped by separating items with semicolons instead of commas.

The front panel remote (R) and listen (L) HP-IB status indicators are on. The network analyzer automatically goes into remote mode when sent a command with the OUTPUT statement. In remote mode, the network analyzer ignores all front panel keys except the local key. Pressing the [LOCAL] key returns the network analyzer to manual operation, unless the universal HP-IB command LOCAL LOCKOUT 7 has been issued. The only way to get out of local lockout is to issue the LOCAL 7 command, or cycle power on the network analyzer.

Setting a parameter is one form of command the network analyzer will accept. It will also accept simple commands that require no operand. For example, execute:

```
OUTPUT 716; "AUTO; "
```

In response, the network analyzer autoscales the active channel. Autoscale only applies to the active channel, unlike start frequency, which applies to both channels as long as the channels are stimulus coupled.

The network analyzer will also accept commands that turn various functions on and off. Execute:

```
OUTPUT 716; "DUACON; "
```

This causes the network analyzer to display both channels. To go back to single channel display mode, execute:

```
OUTPUT 716; "DUACOFF; "
```

The construction of the command starts with the root mnemonic DUAC (dual channel display,) and ON or OFF appended to the root to form the entire command.

The network analyzer does not distinguish between upper and lower case letters. For example, execute:

```
OUTPUT 716; "auto; "
```

The network analyzer also has a debug mode to aid in trouble-shooting systems. When debug mode is on, the network analyzer scrolls incoming HP-IB commands across the display. To turn the mode on manually, press [LOCAL] [HP-IB DIAG ON]. To turn it on over HP-IB, execute:

```
OUTPUT 716; "DEBUON; "
```

Command interrogate

Suppose the operator has changed the power level from the front panel. The computer can find the new level by using the network analyzer's command interrogate function. If a question mark is appended to the root of a command, the network analyzer will output the value of that function. For instance, **POWE 5 DB**; sets the output power to 5 dB, and **POWE ?**; outputs the current RF output power at the test port. For example, type **SCRATCH** and press **[EXECUTE]** to clear old programs. Type **EDIT** and press **[EXECUTE]** to get into the edit mode. Then type in:

```
10 OUTPUT 716;"POWE?;"
20 ENTER 716;Reply
30 DISP Reply
40 END
```

Run the program. The computer will display the source power level in dBm. The preset level is 0 dBm. Change the power level by pressing **[LOCAL] [MENU] [POWER]** and then entering **[1] [x1]**. Run the program again.

When the network analyzer receives **POWE ?**, it prepares to transmit the current RF source power level. The BASIC statement **ENTER 716** allows the network analyzer to transmit information to the computer by addressing it to talk. This turns the network analyzer front panel talk light (T) on. The computer places the data transmitted by the network analyzer into the variables listed in the enter statement. In this case, the network analyzer transmits the output power, which gets placed in the variable **Reply**.

The **ENTER** statement takes the stream of binary data output by the network analyzer and reformats it back into numbers and ASCII strings. With the formatting in its default state, the enter statement will format the data into real variables, integers, or ASCII strings, depending on the variable being filled. The variable list must match the data the network analyzer has to transmit: if there are too few variables, data is lost, and if there are too many variables for the data available, a BASIC error is generated.

The formatting done by the enter statement can be changed. As discussed in *Data transfer from analyzer to computer*, the formatting can be turned off to allow binary transfers of data. Also, the **ENTER USING** statement can be used to selectively control the formatting.

On/off commands can be also be interrogated. The reply is a one if the function is on, a zero if it is off. Similarly, if a command controls a function that is underlined on the network analyzer display when active, interrogating that command yields a one if the command is underlined, a zero if it is not. For example, there are nine options on the format menu: only one is underlined at a time. The underlined option will return a one when interrogated.

For instance, rewrite line 10 as:

```
10 OUTPUT 716;"DUAC?;"
```

Run the program once, note the result, then press **[LOCAL] [DISPLAY] [DUAL CHAN]** to toggle the display mode, and run the program again.

Another example is to rewrite line 10 as:

```
10 OUTPUT 716;"PHAS?;"
```

In this case, the program will display a one if phase is currently being displayed. Since the command only applies to the active channel, the response to the **PHAS?** inquiry depends on which channel is active.

Held commands

When the network analyzer is executing a command that cannot be interrupted, it will hold off processing new HP-IB commands. It will fill the 16 character input buffer, and then halt HP-IB until the held command has completed execution. This action will be clear to a programmer unless HP-IB timeouts have been set with the **ON TIMEOUT** statement.

While a held command is executing, the network analyzer will still service the HP-IB interface commands, such as **SPOLL(716)**, **CLEAR 716**, and **ABORT 7**. Executing **CLEAR 716** or **CLEAR 7** will abort a command hold off, leaving the held command to complete execution as if it had been begun from the front panel. These commands also clear the input buffer, destroying any commands received after the held command. If the network analyzer has halted the bus because its input buffer was full, **ABORT 7** will release the bus.

Operation complete

Occasionally, there is a need to find out when certain operations have completed inside the network analyzer. For instance, a program should not have the operator connect the next calibration standard while the network analyzer is still measuring the current one.

To provide such information, the network analyzer has an Operation Complete reporting mechanism that will indicate when certain key commands have completed operation. The mechanism is activated by sending either **OPC** or **OPC?** immediately before an OPC'able command. When the command completes execution, bit 0 of the event status register will be set. If OPC was interrogated with **OPC?**, the network analyzer will output a 1 when the command completes execution.

As an example: type **SCRATCH**, press **[EXECUTE]**, type **EDIT**, press **[EXECUTE]**, and type in the following program:

10	OUTPUT 716;"SWET 3 S;OPC?;SING;"	Set the sweep time to 3 seconds, and OPC a single sweep.
20	DISP "SWEEPING"	
30	ENTER 716;Reply	The program will halt until the network analyzer completes the sweep and issues a one.
40	DISP "DONE"	
50	END	

Running this program causes the computer to display the sweeping message for about 3 seconds, as the instrument executes the sweep. The computer will display **DONE** just as the instrument goes into hold. When the **DONE** message appears, the program could then continue on, being assured that there is a valid data trace in the instrument. Without single sweep, we would have had to wait at least two sweep times to ensure good data.

Preparing for HP-IB control

At the beginning of a program, the network analyzer has to be taken from an unknown state and brought under computer control. One way to do this is with an abort/clear sequence. **ABORT 7** is used to halt bus activity and return control to the computer. **CLEAR 716** will then prepare the network analyzer to receive commands by clearing syntax errors, the input command buffer, and any messages waiting to be output.

The abort/clear sequence makes the network analyzer ready to receive HP-IB commands. The next step is to put the network analyzer into a known state. The most convenient way to do this is to send **PRES**, which returns the instrument to the preset state. If preset cannot be used and the status reporting mechanism is going to be used, **CLES** can be sent to clear all of the status reporting registers and their enables.

Type **SCRATCH**, press **[EXECUTE]**, type **EDIT**, press **[EXECUTE]**, and type in the following program:

10	ABORT 7	This halts all bus action and gives active control to the computer.
20	CLEAR 716	This clears all HP-IB errors, resets the HP-IB interface, clears syntax errors. It does not affect the status reporting system.
30	OUTPUT 716;"PRES;"	Preset the instrument. This clears the status reporting system, as well as resetting all the front panel settings, except the HP-IB mode and HP-IB addresses.
40	END	

This program brings the network analyzer to a known state, ready to respond to HP-IB control.

The network analyzer will not respond to HP-IB commands unless the remote line is asserted. When the remote line is asserted and the network analyzer is addressed to listen, it automatically goes into remote mode. Remote mode means that all the front panel keys are disabled except **[LOCAL]** and the line power switch. **ABORT 7** asserts the remote line, which remains asserted until a **LOCAL 7** statement is executed. Another way to assert the remote line is to execute:

REMOTE 716

This statement asserts remote and addresses the network analyzer to listen so it goes into remote mode. Press any front panel key except local. None will respond until you press **[LOCAL]**.

The local key can also be disabled with the sequence:

```
REMOTE 716  
LOCAL LOCKOUT 7
```

Now no front panel keys will respond. The HP 8753C can be returned to local mode temporarily with:

```
LOCAL 716
```

But as soon as the HP 8753C is next addressed to listen, it goes back into local lockout. The only way to clear local lockout, aside from cycling power, is to execute:

```
LOCAL 7
```

Which un-asserts the remote line on the interface. This puts the instrument into local mode and clears local lockout. Be sure to put the instrument back into remote mode.

Measurement Programming

The previous section of this document outlined how to get commands into the network analyzer. The next step is to organize the commands into a measurement sequence. A typical measurement sequence consists of the following steps:

1. Set up the instrument.
2. Calibrate.
3. Connect the device.
4. Take data.
5. Post process data.
6. Transfer data.

Set up the instrument

Define the measurement by setting all of the basic measurement parameters. These include all the stimulus parameters: sweep type, span, sweep time, number of points, and RF power level. They also include the parameter to be measured, and both IF averaging and IF bandwidth. These parameters define the way data is gathered and processed within the instrument, and to change one requires that a new sweep be taken.

There are other parameters that can be set within the instrument that do not affect data gathering directly, such as smoothing, trace scaling or trace math. These functions are classed as post processing functions: they can be changed with the instrument in hold mode, and the data will correctly reflect the current state.

The save/recall registers and the learn string are two rapid ways of setting up an entire instrument state. The learn string is a summary of the instrument state compacted into a string that can be read into the computer and retransmitted to the network analyzer. See Example 6A, *Using the learn string*, for a discussion of how to do this.

Calibrate

Measurement calibration is normally performed once the instrument state has been defined. Measurement calibration is not required to make a measurement, but it does improve the accuracy of the data.

There are several ways to calibrate the instrument. The simplest is to stop the program and have the operator perform the calibration from the front panel. Alternatively, the computer can be used to guide the operator through the calibration, as discussed in Example 2A and 2B, *1-port calibration* and *Full 2-port calibration* (HP 8753C only. Full 2-port calibration is not available in the HP 8752A). The last option is to transfer calibration data from a previous calibration back into the instrument, as discussed in Example 6C, *Reading calibration data*.

Connect device under test

Have the operator connect and adjust the device. The computer can be used to speed the adjustment process by setting up such functions as limit testing, bandwidth searches, and trace statistics. All adjustments take place at this stage so that there is no danger of taking data from the device while it is being adjusted.

Take data

With the device connected and adjusted, measure its frequency response, and hold the data within the instrument so that there is a valid trace to analyze.

The single sweep command **SING** is designed to ensure a valid sweep. All stimulus changes are completed before the sweep is started, and the HP-IB hold state is not released until the formatted trace is displayed. When the sweep is complete, the instrument is put into hold, freezing the data inside the instrument. Because single sweep is OPC'able, it is easy to determine when the sweep has been completed.

The number of groups command **NUMGn** is designed to work the same as single sweep, except that it triggers *n* sweeps. This is useful, for example, in making a measurement with an averaging factor *n*. (*n* can be 1 to 999). Both single sweep and number of groups restart averaging.

Post process

With valid data to operate on, the post-processing functions can be used. Referring ahead to Figure 2, any function that affects the data after the error correction stage can be used. The most useful functions are trace statistics, marker searches, electrical delay offset, time domain, and gating. If a 2-port calibration is active, then any of the four S-parameters can be viewed without taking a new sweep.

Transfer data

Lastly, read the results out of the instrument. All the data output commands are designed to ensure that the data transmitted reflects the current state of the instrument:

- **OUTPDATA**, **OUTPRAWn**, and **OUTPFORM** will not transmit data until all formatting functions have completed.
- **OUTPLIML**, **OUTPLIMM**, and **OUTPLIMF** will not transmit data until limit test has occurred, if on.
- **OUTPMARK** will activate a marker if one is not already selected, and it will make sure that any current marker searches have completed before transmitting data.
- **OUTPMSTA** makes sure that statistics have been calculated for the current trace before transmitting data. If statistics is not on, it will turn statistics on to update the current values, and then turn it off.
- **OUTPMWID** makes sure that a bandwidth search has been executed for the current trace before transmitting data. If bandwidth search is not on, it will turn the search on to update the current values, and then turn it off.

Data transfer is discussed further in Examples 3A through 3C, *Data transfer using ASCII transfer format*, etc.

Basic Programming Examples

Example 1: Setting up a basic measurement

In general, the procedure for setting up measurements on the network analyzer via HP-IB follows the same sequence as if the setup was performed manually. There is no required order, as long as the desired frequency range, number of points and power level are set prior to performing the calibration.

This example illustrates how a basic measurement can be set up on the network analyzer. The program will first select the desired parameter, the measurement format, and then the frequency range. Performing calibrations is described later.

By interrogating the analyzer to determine the actual values of the start and stop frequencies, the computer can keep track of the actual frequencies.

This example program is stored on the Example Programs disk as **IPG1**.

10	ABORT 7	
20	CLEAR 716	Prepare for HP-IB control.
30	OUTPUT 716;"PRES;"	Preset the network analyzer.
40	OUTPUT 716;"CHAN1; S11; LOGM;"	Make channel 1 the active channel, and measure the reflection parameter, S_{11} for the HP 8753C, or REFL for the HP 8752A, displaying its magnitude in dB.
50	OUTPUT 716;"CHAN2; S11; PHAS;"	Make channel 2 the active channel, and measure the phase of S_{11} on it.
60	OUTPUT 716;"DUACDN;"	Tell the analyzer to display both channels simultaneously.
70	INPUT "ENTER START FREQUENCY (MHz):", F_start	Input a start frequency.
80	INPUT "ENTER STOP FREQUENCY (MHz):", F_stop	Input a stop frequency.
90	OUTPUT 716;"STAR"; F_start;"MHZ;"	Set the start frequency to F_start.
100	OUTPUT 716;"STOP"; F_stop; "MHZ;"	Set the stop frequency to F_stop.
110	DISP F_start, F_Stop	Show the current start and stop frequencies.
120	END	

Running the program

The program sets up a measurement of reflection log magnitude on channel 1, reflection phase on channel 2, and turns on the dual channel display mode. When prompted for start and stop frequencies, enter any value in MHz from 0.3 (300 kHz) to 3 GHz (1.3 GHz for the HP 8752A). These will be entered into the network analyzer, and the frequencies will be displayed.

Performing a measurement calibration

This section will demonstrate how to coordinate a measurement calibration over HP-IB. The HP-IB program follows the keystrokes required to calibrate from the front panel: there is a command for every step.

The general key sequence is to select the calibration, measure the calibration standards, and then declare the calibration done. The actual sequence depends on the calibration kit and changes slightly for 2-port calibrations*, which are divided into three calibration sub-sequences.

Calibration kits

The calibration kit tells the network analyzer what standards to expect at each step of the calibration. The set of standards associated with a given calibration is termed a class. For example, measuring the short during a 1-port calibration is one calibration step. All of the shorts that can be used for this calibration step make up the class, which is called class $S_{11}B$. For the 7 mm* and the 3.5 mm cal kits, class $S_{11}B$ has only one standard in it. For type-N cal kits, class $S_{11}B$ has two standards in it: male and female shorts.

When doing a 1-port calibration in 7* or 3.5 mm, selecting *[SHORT]* automatically measures the short because there is only one standard in the class. When doing the same calibration in type-N, selecting *[SHORTS]* brings up a second menu, allowing the user to select which standard in the class is to be measured. The sex listed refers to the test port: if the test port is female, then the user selects the female short option.

Doing a 1-port calibration over HP-IB is very similar. In 7* or 3.5 mm, sending `CLASS11B` will automatically measure the short. In type-N, sending `CLASS11B` brings up the menu with the male and female short options. To select a standard, use `STANA` or `STANB`. The `STAN` command is appended with the letters A through G, corresponding to the standards listed under softkeys 1 through 7, softkey 1 being the topmost softkey.

The `STAN` command is OPC'able. A command that calls a class is only OPC'able if that class has only one standard in it. If there is more than one standard in a class, the command that calls the class only brings up another menu, and there is no need to OPC it.

Hence, both the manual and HP-IB calibration sequences depend heavily on which calibration kit is active.

Full 2-port calibrations (HP 8753C only)

Each full 2-port measurement calibration is divided into three sub-sequences: transmission, reflection, and isolation. Each subsequence is treated like a calibration in its own right: each must be opened, have all the standards measured, and then be declared done.

The opening and closing statements for the transmission sub-sequence are `TRAN` and `TRAD`. The opening and closing statements for the reflection sub-sequence are `REFL` and `REFD`. The opening and closing statements for isolation are `ISOL` and `ISOD`.

*HP 8753 only.

Example 2A: 1-port calibration

To demonstrate coordinating a calibration over HP-IB, the following program does a 1-port calibration, using the HP 85032B 50 ohm type-N calibration kit. This program simplifies the calibration for the operator by giving explicit directions on the network analyzer display, and allowing the user to continue the program from the network analyzer front panel.

This example program is stored on the Example Programs disk as **IPG2A**.

10	ABORT 7	
20	CLEAR 716	Prepare for HP-IB control.
30	OUTPUT 716;"CALKN50; MENUOFF;CLES;ESE 64;"	This is the minimum instrument set up: the 50 ohm type-N cal kit is selected, the softkey menu is turned off, and the status reporting system is set up so that bit 6, User Request, of the event status register, is summarized by bit 5 of the status byte. This allows us to detect a key press with a serial poll. Refer to Appendix A.
40	OUTPUT 716;"CALIS111;"	Open the calibration by calling the S ₁₁ 1-port calibration.
50	CALL Waitforkey("CONNECT LOAD AT PORT 1")	Now ask for the load, and wait for the operator. The Waitforkey subroutine will not return until the operator presses a key on the front panel of the network analyzer.
60	OUTPUT 716;"OPC? CLASS11C;"	There is only one choice in this class, so the CLASS command is OPC'able. Using the OPC? command causes the program to wait until the standard has been measured before continuing. This is very important, because the prompt to connect the next standard should only appear after the first standard is measured.
70	ENTER 716;Reply	Wait until the network analyzer is done with the standard.
80	CALL Waitforkey("CONNECT OPEN AT PORT 1")	Ask for an open, and wait for the operator to connect it.
90	OUTPUT 716;"CLASS11A; OPC?; STANB;"	Measure the open. There is more than one standard in this loads class, so we must identify the specific standard within that class. The female open is the second softkey selection from the top in the menu, so select a lowband load as the standard using the command STANB.
100	ENTER 716;Reply	Wait for the standard to be measured.
110	CALL Waitforkey("CONNECT SHORT LOAD AT PORT 1")	Have the operator connect the short and wait for a reply.
120	OUTPUT 716;"CLASS11B; OPC?; STANB;"	There is more than one standard in the short class, too. The specific standard is the female short, or STAN B. Measure the short.
130	ENTER 716;Reply	Wait for the standard to be measured.
140	OUTPUT 717;"PG;"	The PG command sent to the display clears the user graphics, removing the last prompt.
150	DISP "COMPUTING CALIBRATION COEFFICIENTS"	
160	OUTPUT 716;"DONE;OPC? SAV1;"	Affirm the completion of the calibration, and save the calibration

170 ENTER 716;Reply	Wait until the network analyzer is done calculating the calibration coefficients before allowing the program to go on.
180 DISP "1-PORT CAL COMPLETED. CONNECT TEST DEVICE."	
190 OUTPUT 716;"MENUON;"	The calibration is complete, so turn the softkey menu back on.
200 END	
210 SUB Waitforkey(Lab\$)	This subroutine displays the passed message on the network analyzer, and waits for the operator to press a key. It assumes that bit 6, User Request, of the event status register has been enabled.
220 DISP Lab\$	First, display a message on the computer in case the operator has returned to the computer keyboard.
230 OUTPUT 717;"PG;PU;PA390, 3600; PD;LB";Lab\$;"", PRESS ANY KEY WHEN READY;"	This statement writes on the network analyzer's display. PG (page) clears old user graphics. PU (pen up) prevents anything from being drawn. PA390,3600; moves the logical pen to just above the message area on the display. PD (pen down) enables drawing. LB (label) writes the message on the display. The label command is terminated with an ETX symbol, which is [CTRL] [C] (pressed simultaneously) on the keyboard.
240 CLEAR 716	Clear the message line on the network analyzer.
250 OUTPUT 716;"ESR?;"	Clear the latched User Request bit so that old key presses will not trigger a measurement.
260 ENTER 716;Estat	
270 Stat = SPOLL(716)	Now wait for a key press to be reported.
280 IF NOT BIT(Stat,5) THEN GOTO 340	
290 SUBEND	

Running the program

The program assumes that the port being calibrated is a 50 ohm, type-N female test port. The prompts appear just above the message line on the network analyzer display. Pressing any key on the front panel of the network analyzer continues the program and measures the standard. The program will display a message when the measurement calibration is complete.

Before running the program, set up the desired instrument state. This program does not modify the instrument state in any way. Run the program, and connect the standards as prompted. When the standard is connected, press any key on the network analyzer's front panel to measure it.

Example 2B: Full 2-port measurement calibration (HP 8753C only)

This example shows how to perform a full 2-port measurement calibration using the HP 85032B calibration kit. The main difference between this example and Example 2A is that in this case, the calibration process allows removal of both the forward and reverse error terms, so that all four S-parameters of the device under test can be measured. Port 1 is a female test port and Port 2 is a male test port.

This example program is stored on the Example Programs disk as **IPG2B**.

10	ABORT 7	
20	CLEAR 716	
30	OUTPUT 716;"CALKN50; MENUOFF;CLES;ESE 64;"	This is the minimum instrument set up: the 50 ohm type-N kit is selected, the softkey menu is turned off, and the status reporting system is set up so that bit 6, User Request, of the event status register, is summarized by bit 5 of the status byte. This allows us to detect a key press with a serial poll. Refer to Appendix A.
40	OUTPUT 716;"CALIFUL2;"	Open the calibration by calling for a full 2-port calibration.
50	OUTPUT 716;"REFL;"	Open the reflection calibration subsequence.
60	CALL Waitforkey("CONNECT OPEN AT PORT 1")	Ask for the open, and wait for the operator. The Waitforkey subroutine will not return until a key on the front panel of the HP 8753C is pressed.
70	OUTPUT 716;"CLASS11A; OPC?;STANB;"	There is more than one standard in the open class, so we must identify the specific standard within that class. The female open selection is the second softkey from the top in the menu, so we select a broadband load as the standard using the command STANB.
80	ENTER 716;Reply	Wait until the HP 8753C is done with the standard.
90	CALL Waitforkey("CONNECT SHORT AT PORT 1")	Ask for a short, and wait for the operator to connect it.
100	OUTPUT 716;"CLASS11B; OPC?;STANB;"	Measure the short.
110	ENTER 716;Reply	Wait for the standard to be measured.
120	CALL Waitforkey("CONNECT BROADBAND LOAD AT PORT 1")	Have the operator connect the broadband load, and wait for his reply.
130	OUTPUT 716;"OPC?; CLASS11C;"	There is only one choice in this class, so the CLASS command is OPC'able. Using the OPC? command causes the program to wait until the standard has been measured before continuing. This is important, because the prompt to connect the next standard should appear only after the first standard is measured.
140	ENTER 716;Reply	Wait for the standard to be measured.
150	CALL Waitforkey("CONNECT OPEN AT PORT 2")	Ask for the male open for port 2, and wait for the operator.
160	OUTPUT 716;"CLASS22A; OPC?;STANA;"	Measure the open.
170	ENTER 716;Reply	Wait until the HP 8753C is done with the standard.
180	CALL Waitforkey("CONNECT SHORT AT PORT 2")	Ask for a male short, and wait for the operator to connect it.

190	OUTPUT 716;"CLASS22B; OPC?;STANA;"	Measure the short.
200	ENTER 716;Reply	Wait for the standard to be measured.
210	CALL Waitforkey("CONNECT LOAD AT PORT 2")	Have the operator connect the load, and wait for a reply.
220	OUTPUT 716;"OPC?; CLASS22C;"	Measure the load.
230	ENTER 716;Reply	Wait for the standard to be measured.
240	OUTPUT 716;"REFD;"	Close the reflection calibration subsequence.
250	DISP "COMPUTING REFLECTION CALIBRATION COEFFICIENTS"	
260	OUTPUT 716;"TRAN;"	Open the transmission calibration subsequence.
270	CALL Waitforkey("CONNECT THRU [PORT 1 TO PORT 2]")	
280	DISP "MEASURING FORWARD TRANSMISSION")	
290	OUTPUT 716;"OPC?;FWDT;"	Measure forward transmission.
300	ENTER 716;Reply	
310	OUTPUT 716;"OPC?;FWDI;"	Measure forward load match.
320	ENTER 716;Reply	
330	DISP "MEASURING REVERSE TRANSMISSION")	
340	OUTPUT 716;"OPC?;REVT;"	Measure reverse transmission.
350	ENTER 716;Reply	
360	OUTPUT 716;"OPC?;REVM;"	Measure reverse load match.
370	ENTER 716;Reply	
380	OUTPUT 716;"TRAD;"	Close the transmission calibration sub-sequence.
390	INPUT "SKIP ISOLATION CAL? Y OR N.", An\$	Ask operator if the isolation cal should be skipped.
400	"IF An\$="Y" THEN	If the answer is yes, skip the isolation cal and branch to the computation of the calibration coefficients.
410	OUTPUT 716;"OMII;"	
420	GOTO 520	
430	END IF	
440	CALL Waitforkey("ISOLATE TEST PORTS")	Ask operator to isolate the test ports.
450	OUTPUT 716;"ISOL; AVERFACT10;AVERDOON;"	Open the isolation calibration subsequence. Turn on averaging with an averaging factor of 10 for the isolation cal.
460	DISP "MEASURING REVERSE ISOLATION"	
470	OUTPUT 716;"OPC?;REVI;"	Measure reverse isolation.
480	ENTER 716;Reply	
490	DISP "MEASURING FORWARD ISOLATION"	
500	OUTPUT 716;"OPC?;FWDI;"	Measure forward isolation.
510	ENTER 716;Reply	

520	OUTPUT 716;"ISOD; AVEROFF;"	Close the isolation calibration subsequence and turn off averaging.
530	OUTPUT 717;"PG;"	The PG command sent to the display clears the user graphics, removing the last prompt.
540	DISP "COMPUTING CALIBRATION COEFFICIENTS"	
550	OUTPUT 716;"OPC?;SAV2;"	
560	ENTER 716;Reply	Wait until the HP 8753C is done calculating the calibration coefficients before going on.
570	DISP "DONE FULL 2-PORT CAL. CONNECT TEST DEVICE."	
580	OUTPUT 716;"MENUON;"	The calibration is completed, so turn the soft key menu back on.
590	END	
600	SUB Waitforkey(Lab\$)	This subroutine displays the passed message on the HP 8753C, and waits for the operator to press a key. It assumes that bit 6, User Request, of the event status register has been enabled.
610	DISP Lab\$	First, display a message on the computer in case the operator has returned to the computer keyboard.
620	OUTPUT 717;"PG;PU;PA390, 3600;PD;LB";Lab\$;" PRESS ANY KEY*;"	This statement writes on the HP 8753C's display. PG (page) clears old user graphics. PU (pen up) prevents anything from being drawn. PA390, 3600; moves the logical pen to just above the message area on the display. PD (pen down) enables drawing. LB (label) writes the message on the display. The label command is terminated with an ETX symbol, which is [CTRL][C] on the keyboard.
630	CLEAR 716	Clear the message line on the HP 8753C.
640	OUTPUT 716;"ESR?;"	Clear the latched User Request bit so that old key presses will not trigger a measurement.
650	ENTER 716;Estat	Now wait for a key press to be reported.
660	Stat=SPOLL(716)	
670	IF NOT BIT(Stat,5) THEN GOTO 660	
680	OUTPUT 717;"PG;"	Clear the prompt from the display.
690	SUBEND	

Running the program

The program assumes that the test ports being calibrated are type-N, port 1 being a female test port and port 2 being a male test port. The HP 85032B 50 ohm type-N calibration kit is to be used. The prompts appear just above the message line on the HP 8753C display. Pressing any key on the front panel of the HP 8753C continues the program and measures the standard. The operator has the option of omitting the isolation cal. If the isolation cal is performed, averaging is automatically employed to ensure a good calibration. The program will display a message when the measurement calibration is complete.

Before running the program, set up the desired instrument state. This program does not modify the instrument state in any way. Run the program, and connect the standards as prompted. When the standard is connected, press any key on the HP 8753C's front panel to measure it.

Data transfer from analyzer to computer

Using markers to obtain trace data at specific points

Trace information can be read out of the network analyzer in several ways. Data can be read off the trace selectively using the markers, or the entire trace can be read out. If only specific information such as a single point off the trace or the result of a marker search is needed, the marker output command can be used to read the information. If all the trace data is needed, see Examples 3A thru 3C.

To get data off the trace using the marker, the marker first has to be put at the frequency desired. This is done with the marker commands. For example, execute:

```
OUTPUT 716;"MARK1 1.20 GHZ;"
```

This places marker one at 1.20 GHz. If the markers are in continuous mode, the marker value will be linearly interpolated from the two nearest points if 1.2000 GHz was not sampled. This interpolation can be prevented by putting the markers into discrete mode. The key sequence for this is [LOCAL] [MKR] [MARKER MODE MENU] [MARKERS:DISCRETE]. To do it over HP-IB, execute:

```
OUTPUT 716;"MARKDISC;"
```

After executing this, note that the marker is may no longer be precisely on 1.20 GHz. (This depends on the start and stop frequencies).

Another way of using the markers is to let the network analyzer pick the stimulus value on the basis of one of the marker searches: max, min, target value, or bandwidths search. For example, execute:

```
OUTPUT 716;"SEAMAX;"
```

This executes a one-time trace search for the trace maximum, and puts the marker at that maximum. In order to continually update the search, turn tracking on. The key sequence is [MKR FCTN] [MKR SEARCH] [TRACKING] [SEARCH:MAX]. To do it over HP-IB, execute:

```
OUTPUT 716;"TRACKON;SEAMAX;"
```

The trace maximum search will stay on this time, until search is turned off, tracking is turned off, or all markers are turned off. For example, execute:

```
OUTPUT 716;"MARKOFF;"
```

Marker data is read out with the command OUTPMARK. This command causes the network analyzer to transmit three numbers: marker value 1, marker value 2, and marker stimulus value. In this case we get the log magnitude at marker 1, zero, and the marker frequency. See Table 1 for all the different possibilities for values one and two. The third value is frequency in this case, but it could have been time as in time domain (option 010 only) or CW time.

Type **SCRATCH**, press [EXECUTE], type **EDIT**, press [EXECUTE], and then type in the following program:

10	OUTPUT 716;"SEAMIN; OUTPMARK;"	Have the network analyzer search out the trace minimum, and then output the marker values at that point.
20	ENTER 716;Val1,Val2,Stim	Read marker value 1, marker value 2, and the stimulus value.
30	DISP Val1,Val2,Stim	Display the values.
40	END	

Run the program. The values displayed by the computer should agree with the marker values displayed on the network analyzer, except that the second value displayed by the computer will be meaningless in phase and log mag formats. To see the possibilities for different values, run the program three times: once in log magnitude format, once in phase format, and once in Smith chart format. To change display format, press [LOCAL] [FORMAT] and then select the desired format.

Trace transfer

Getting trace data out of the network analyzer with a 200/300 series computer can be broken down into three steps:

1. Setting up the receive array.
2. Telling the network analyzer to transmit the data.
3. Accepting the transferred data.

Data inside the network analyzer is always stored in pairs, to accommodate real/imaginary pairs, for each data point. Hence, the receiving array has to be two elements wide, and as deep as the number of points. This memory space for this array must be declared before any data is to be transferred from the network analyzer to the computer.

The network analyzer can transmit data over HP-IB in five different formats. The type of format affects what kind of data array is declared (real or integer), since the format determines what type of data is transferred. Examples for data transfers using different formats are given below. The first, Example 3A, illustrates the basic transfer using form 4, an ASCII transfer. For more information on the various data formats, see the section entitled *Data Formats*. For information on the various types of data that can be obtained (raw data, corrected data and so on), see the section entitled *Data Levels*.

Note that Example 9, *Reading disk files into a computer*, allows the operator to access disk files from a computer.

Table 1. Units as a Function of Display Format

DISPLAY FORMAT	MARKER MODE	OUTPMARK value 1, value 2	OUTPFORM value 1, value 2	MARKET READOUT** value, aux value
LOG MAG		dB,*	dB,*	dB,*
PHASE		degrees,*	degrees,	degrees,*
DELAY		seconds,*	seconds,*	seconds,*
SMITH CHART	LIN MKR	lin mag, degrees	real, imag	lin mag, degrees
	LOG MKR	dB, degrees	"	dB, degrees
	Re/Im	real, imag	"	real, imag
	R + jX	real, imag ohms	"	real, imag ohms
	G + jB	real, imag Siemens	"	real, imag Siemens
POLAR	LIN MKR	lin mag, degrees	real, imag	lin mag, degrees
	LOG MKR	dB, degrees	"	dB, degrees
	Re/Im	real, imag	"	real, imag
LIN MAG		lin mag,*	lin mag,*	lin mag,*
REAL		real,*	real,*	real,*
SWR		SWR,*	SWR,*	SWR,*

* Value not significant in this format, but is included in data transfers.

** The marker readout values are the marker values displayed in the upper left hand corner of the display. They also correspond to the value and aux value associated with the fixed marker.

Example 3A: Data transfer using form 4 (ASCII transfer)

As detailed in the *HP-IB Quick Reference*, when form 4 is used, each number is sent as a 24 character string, each character being a digit, sign, or decimal point. Since there are two numbers per point, a 201 point transfer in form 4 takes 9,648 bytes. An example simple data transfer using form 4, an ASCII data transfer is shown in this program.

This example program is stored on the Example Programs disk as **IPG3A**.

```
10  ABORT 7
20  CLEAR 716                               Prepare for HP-IB control.
30  OUTPUT 716;"PRES;"                     Preset the analyzer.
40  DIM Dat(1:11,1:2)                       This line sets up an array to receive the data. The
                                           ENTER 716;Dat(*) statement in line 60 fills the
                                           array Dat automatically, changing the second
                                           subscript fastest. Since the network analyzer
                                           transmits the data as ordered pairs, we make the
                                           second dimension two so that the pairs will be
                                           properly grouped. The number of points will be
                                           set to 11, so we know to make the first dimension
                                           11.

50  OUTPUT 716;"POIN 11;                   Set the number of points, tell the network ana-
    SING; FORM4;OUTPFORM;"                 lyzer to use ASCII transfer format, and request the
                                           formatted trace data. Frequency information is not
                                           included in the transfer.

60  ENTER 716;Dat(*)                       The computer takes the data from the instrument
                                           and puts it in the receiving array. By specifying
                                           Dat(*), we have told the enter statement to fill
                                           every location in the array.

70  DISP DAT(1,1),DAT(1,2)                 This line checks the first data point received. The
                                           data is in the current network analyzer display
                                           format: see Table 1 for the contents of the array as
                                           a function of display format.

80  END
```

Running the program

The first number of the result is a trace value in dB, and the second is zero. Put a marker at 300 kHz, which was the first point transmitted, to see that the values displayed by the computer agree with the network analyzer. No matter how many digits are displayed, the network analyzer is specified to measure magnitude to a resolution of .001 dB, phase to a resolution of .01 degrees, and group delay to a resolution of .01 psec.

Changing the display format will change the data sent with the **OUTPFORM** transfer. See Table 1 for a list of what data is provided with what formats. The data from **OUTPFORM** reflects all the post processing such as time domain, gating, electrical delay, trace math, and smoothing. If time domain (option 010 only) is on, operation is limited to 201 points in the lowpass mode.

Relating the data from a linear frequency sweep to frequency can be done by interrogating the start frequency, the frequency span, and the number of points. The frequency of point N in a linear frequency sweep is just:

$$F = \text{Start_frequency} + (N-1) \times \text{Span}/(\text{Points}-1)$$

It is possible to read the frequencies directly out of the instrument with the **OUTPLIML** command. **OUTPLIML** reports the limit test results by transmitting the stimulus point tested, a number indicating the limit test results, and the upper and lower limits at that stimulus point, if available. The number indicating the limit results is a -1 for no test, 0 for fail, and 1 for pass. If there are no limits available, the network analyzer transmits zeros.

For this example, throw away the limit test information and keep the stimulus information. Edit line 40 to read:

```
40 DIM Dat(1:11,1:2), Stim(1:11)
```

And type in:

```
70 OUTPUT 716;"OUTPLIML; "      Request the limit test results.
80 FOR I=1 TO 11                Loop 11 times to read in all 11 data points.
90 ENTER 716;Stim(I),           Read the stimulus values in, throw the rest away.
   Reslt,Upr,Lwr                Because we are not loading the data into a single
                                array, it is necessary to loop and read every point.
100 PRINT Stim(I),Dat(I,1),     Print the data value and stimulus value.
    Dat(I,2)
110 NEXT I
120 DISP Reslt,Upr,Lwr         Show what the last limit test result was, just to see
                                what came out.
130 END
```

Running this program will print out all the trace data and the stimulus values. Put the instrument into a log frequency sweep by pressing **[LOCAL] [MENU] [SWEEP TYPE MENU] [LOG FREQ]**, and run the program again. If you define a list frequency table with 11 points, this program will still show the sampled frequencies. If you define a limit test table, **Reslt** will hold the limit test results.

Data levels

Different levels of data can be read out of the instrument (see Figure 2). There is available:

- Raw data. The basic measurement data, reflecting the stimulus parameters, IF averaging, and IF bandwidth. If a full 2-port measurement calibration is on, there are four raw arrays kept: one for each raw S -parameter. The data is read out with the commands **OUTPRAW1**, **OUTPRAW2**, **OUTPRAW3**, **OUTPRAW4**. Normally, only raw 1 is available, and it holds the current parameter. If a 2-port calibration is on, the four arrays refer to S_{11} , S_{21} , S_{12} , and S_{22} respectively. This data is in real/imaginary pairs.
- Error Corrected data. This is the raw data with error correction applied. The array is for the currently measured parameter, and is in real/imaginary pairs. The error corrected data is read out with **OUTPDATA**. **OUTPMEMO** reads the trace memory if available, which is also error corrected. Neither raw nor error corrected data reflect such post-processing functions as electrical delay offset, trace math, or time domain gating.
- Formatted data. This is the array of data being displayed. It reflects all post-processing functions such as electrical delay or time domain, and the units of the array read out depends on the current display format. See Table 1 for the various units as a function of display format.
- Calibration coefficients. The results of a calibration are arrays of calibration coefficients which are used in the error correction routines. Each array corresponds to a specific error term in the error model. The *HP-IB Quick Reference* details which error coefficients are used for specific calibration types, and which arrays those coefficients are to be found in. Not all calibration types use all 12 arrays. The data is stored as real/imaginary pairs.

Formatted data is generally the most useful, being the same information seen on the display. However, if the post processing is not necessary, as may be the case with smoothing, error corrected data is more desirable. Error corrected data also gives you the opportunity to put the data into the instrument and apply post-processing at a later time.

As an example of error corrected data, change line 50 to:

```
50 OUTPUT 716;"PDIN 11; SING; FORM4; OUTPDATA; "
```

Running the program now displays real and imaginary trace data, regardless of what display format is currently being used. Select the real display format to verify that the data is the real portion.

Data formats

The network analyzer can transmit data over HP-IB in four different formats. Until now, we have been using form 4, an ASCII data transfer. Another option is to use form 3, which is the IEEE 64 bit floating point format. In this mode, each number takes only 8 bytes instead of 24. This means that a 201 point transfer takes only 3,216 bytes. Data is stored internally in the 200/300 series computer with the IEEE 64 bit floating point format, eliminating the need for any reformatting by the computer.

MS-DOS® personal computer format

Use form 5 to transfer data to an MS-DOS® PC. This mode is a modification of IEEE 32 bit floating point format with the byte order reversed. Form 5 also has a four byte header which must be read in so that data order is maintained. In this mode, an MS-DOS® PC can store data internally without reformatting it.

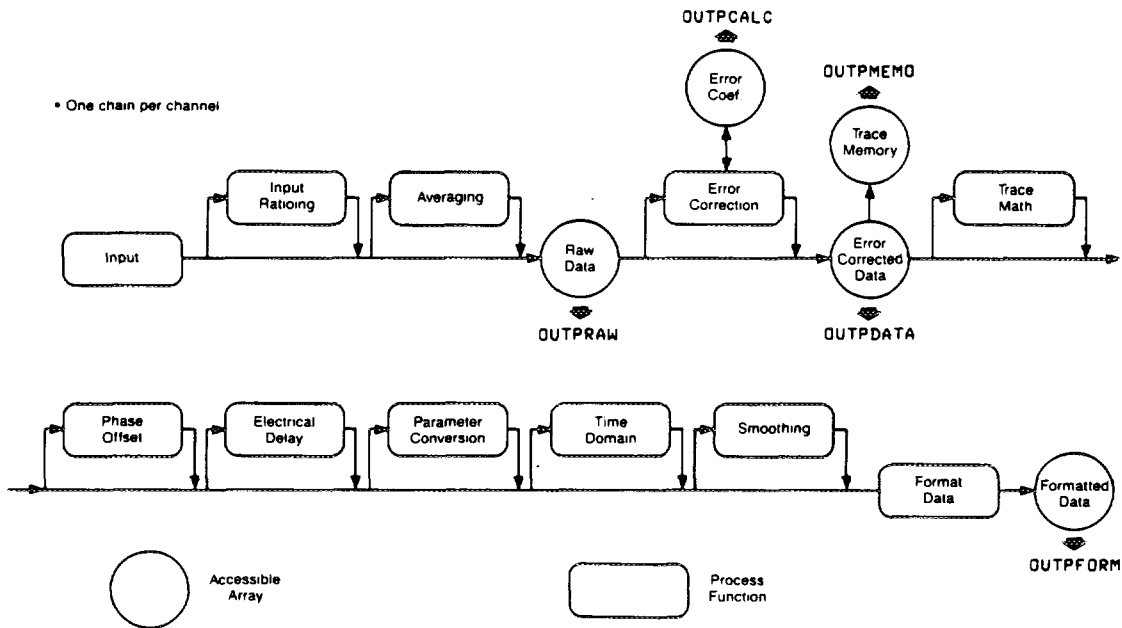

Figure 2. Data processing chain

Example 3B: Data transfer using form 3 (IEEE 64 bit floating point format)

This program illustrates data transfer using form 3, in which data is transmitted in the IEEE 64 bit floating point format.

To use form 3, the computer is told to stop formatting the incoming data with the **ENTER** statement. This is done by defining an I/O path with formatting off. Form 3 also has a four byte header to deal with. The first two bytes are the ASCII characters "#A" that indicate that a fixed length block transfer follows, and the next two bytes form an integer containing number of bytes in the block to follow. The header must read in so that data order is maintained.

This example program is stored on the Example Programs disk as **IPG3B**.

10	ABORT 7	
20	CLEAR 716	Prepare for HP-IB control.
30	DIM Dat(1:201,1:2)	As before, prepare the receiving array.
40	INTEGER Hdr,Lgth	Since an integer takes two bytes, Hdr and Lgth will take care of the four byte header. Lgth will hold the number of bytes in the data block.
50	ASSIGN @Dt TO 716;FORMAT OFF	This statement defines a data I/O path with ASCII formatting off. The I/O path points to the network analyzer, and can be used to read or write data to the instrument, as long as that data is in binary rather than ASCII format.
60	OUTPUT 716;"SING;FORM3;OUTPFORM;"	The analyzer is told to output formatted data using form 3.
70	ENTER @Dt;Hdr,Lgth,Dat(*)	The data is read in much as before, but the I/O path has format off to accept the binary data from form 3. The network analyzer and the computer must be in agreement as to the format of the data being transmitted.
80	DISP Lgth,Dat(1,1),Dat(1,2)	
90	END	

Running the program

Preset the instrument and run the program. The computer displays 3.216 and the trace values at 300 kHz. The number 3.216 comes from 201 points, 2 values per point, 8 bytes per value. This transfer is more than twice as fast as a form 4 transfer.

To illustrate a point, go to the instrument and press **[LOCAL] [MENU] [NUMBER of POINTS]**, and key in **101 [x1]**. Now run the program again: a **BASIC** error will be generated because the network analyzer ran out of data to transmit before the variable list was full.

Go to the instrument again, and this time change the number of points to 401. Running the program again does not generate an error, but not all of the data was read in. The network analyzer is still waiting to transmit data, but the program has not been designed to detect the situation.

As illustrated above, it is imperative that the receiving array be correctly dimensioned. There are two things that assure correct dimensions. First, the number of points is readily available through **POIN?** or through the header that precedes forms 1, 2 and 3. Second, **BASIC** allows dimensioning, redimensioning, allocating, and deallocating statements anywhere in a program. We can take advantage of this in simple programs to wait until we know how many points to expect before we dimension.

BASIC offers two options to those who want to dimension an array with a variable expression, such as the number of points in the sweep. One is the **REDIM** statement, available with AP2—1 or the MAT binary, which redimensions a given array to any size less than or equal to its originally dimensioned size. The other option is to **ALLOCATE** the array just before using it, and **DEALLOCATE** when it's no longer needed. **ALLOCATE** works exactly like **DIM**, except that when you deallocate, the memory space is returned to general use and you can re-use the variable name. All of the following examples use **ALLOCATE**.

For example, delete line 30 and type in the following lines over the last program:

```
70 ENTER @Dt;Hdr,Lgth
80 ALLOCATE                               This guarantees that the receiving array is the
    Dat(1:Lgth/16,1:2)                   correct size. In form 3, each number is 8 bytes,
                                           and there are two numbers per point, so we divide
                                           Lgth by 16 to get number of points.

90 ENTER @Dt;Dat(*)
100 DISP Dat(Lgth/16,1)                  Display the last number read in.
110 END
```

Set the number of points to 51 and run the program: this time no errors are generated. Set the number of points to 401, and run the program again. Move a marker to the last point on the trace, and check to see that the last point read in was the last point on the trace, as expected.

There are two other formats available. Form 2 is not used with 200/300 computers, and form 1 is a special high speed transfer. Form 1 is a condensed transfer format that is useful if data is being transferred out of the network analyzer for direct storage and later re-transmission to the network analyzer. Example 3C gives an example of a data transfer using form 1.

Example 3C: Data transfer using form 1 (network analyzer internal format)

In form 1, each data point is sent out as it is stored inside the network analyzer, in a six byte binary string. It is a very fast transfer, using only 1206 bytes to transfer 201 points, but it is difficult to decode. (Real/imaginary data uses the first two bytes for the imaginary fraction mantissa, the middle two bytes for the real fraction mantissa, the fifth byte is used for additional resolution when transferring raw data, and the last byte as the common power of two). The data could be recombined and displayed in the computer, but this requires reformatting time.

In this example, we use form 1 to get data to store on disk. Before running this program, be sure that the mass storage device is a disk drive with a formatted disk in it. We also introduce a method of loading data back into the network analyzer. For most `OUTPxxxx` commands, there is a corresponding `INPUxxxx` command, and here we take advantage of that to load error corrected data back into the instrument.

This example program is stored on the Example Programs disk as `IPG3C`.

```
10  ABORT 7
20  CLEAR 716                                Prepare for HP-IB control.
30  INTEGER Hdr,Lgth                          Set up to integers to take the header, the same as
                                           with form 3.
40  ASSIGN @Dt TO
     716;FORMAT OFF
50  OUTPUT 716;"SING;FORM1;
     OUTPDATA;"                               Have the network analyzer take a sweep, and
                                           prepare to transmit the trace data to the computer.
60  ENTER @Dt;Hdr,Lgth
70  CREATE BDAT "TESTDATA", 1,                This statement creates a disk file to store the form
     Lgth+4                                    1 data in. It creates a binary data file name
                                           TESTDATA. The file is 1 record long, using a record
                                           length of Lgth+4 bytes. The extra 4 bytes are for
                                           the header. This example will not run unless MASS
                                           STORAGE IS points to a disk drive with a
                                           formatted disk it, and that disk cannot have a file
                                           named TESTDATA on it.
80  ASSIGN @Disc TO "TESTDATA"               This statement creates a data I/O path pointing to
                                           the file TESTDATA.
90  ALLOCATE INTEGER Dat                      Create an integer receiving array. There are six
     (1:Lgth/6,1:3)                            bytes per point in form 1, so allocating 3 integers
                                           per point will hold the data correctly, since an
                                           integer is two bytes.
100 ENTER @Dt;Dat(*)                          The data is received much as before.
110 OUTPUT @Disc;Hdr,Lgth,                    Write the data to the disk drive.
     Dat(*)
120 INPUT "CHANGE TRACE AND                   Disconnect the test device, and take a sweep.
     HIT RETURN", Dum$                          Read the data off the disk, and put it back in the
                                           instrument.
130 OUTPUT 716;"SING;"                        Take one sweep and hold.
140 ASSIGN @Disc TO "TESTDATA"               Re-establish the data path. This is necessary to
                                           begin reading data from the start of the file, rather
                                           than the end of the file where the file pointer was
                                           left by line 110.
150 ENTER @Disc;Hdr,Lgth,                    Get the information.
     Dat(*)
160 OUTPUT 716;"INPUDATA"
```

170	OUTPUT @Dt;Hdr,Lgth,Dat(*)	And copy it out to the network analyzer.
180	ASSIGN @Disc TO *	Close the file.
190	DEALLOCATE Dat(*)	Release the memory for the data array.
200	PURGE "TESTDATA"	And purge the data file.
210	END	

Running the program

A data file is stored to disk during program execution. Either remove the write-protection from the Example Programs disk or install a blank, formatted data disk. Preset the network analyzer, and run the program. When the program pauses press **[LOCAL]**, change the trace, and press **[RETURN]**. When the data is reloaded into the network analyzer, it will be formatted and displayed as the current trace. This form of data transfer is faster than the transfer using form 3.

Advanced Programming Examples

Using list frequency mode

The network analyzer takes data points spaced at regular intervals across the overall frequency range of the measurement. For a 2 GHz frequency span using 201 points, data will be taken at intervals of 10 MHz. The list frequency mode lets you select the specific points or frequency spacing between points at which measurements are to be made. This allows flexibility in setting up tests to ensure efficient device performance. Sampling specific points reduces measurement time since additional time is not spent measuring device performance at frequencies not needed.

The following examples illustrate the use of the network analyzer's list frequency mode to perform arbitrary frequency testing. Example 4A lets you construct a table of list frequency segments which is then loaded into the network analyzer's list frequency table. Each segment stipulates a start and stop frequency, and the number of data points to be taken over that frequency range. Example 4B lets you select a specific segment to "zoom-in" on. A single instrument can be ready to measure several different devices, each with its own frequency range, using a single calibration performed with all of the segments active. When a specific device is connected, you select the appropriate segment for that device. The list frequency segments can be overlapped, but the number of points in all the segments must not exceed 1632 points.

Example 4A: Setting up a list frequency sweep

This example shows how to create a list frequency table and transmit it to the network analyzer.

The command sequence for entering a list frequency table imitates the key sequence followed when entering a table from the front panel: there is a command for every key press. Editing a segment is also the same as the key sequence, but the network analyzer automatically reorders each edited segment in order of increasing start frequency.

The list frequency table is also carried as part of the learn string. While it cannot be modified as part of the learn string, it can easily be stored and recalled.

This example takes advantage of the computer's capabilities to simplify creating, adding to, and editing the table. The table is entered and completely edited before being transmitted to the network analyzer. To simplify the programming task, options such as entering center/span or step size are not included. For information on reading list frequency data out of the network analyzer, see the section *Data transfer from analyzer to computer*.

This program is stored on the Example Programs disk as **IPG4A**.

```
10  ABORT 7
20  CLEAR 716           Prepare the network analyzer for HP-IB control.
30  OUTPUT 716;"EDITLIST;"  Activate the frequency list edit mode.
40  OUTPUT 716;"CLEL;"      Delete any existing segments.
50  INPUT "Number of      Find out how many segments to expect.
    segments?", Numb
60  ALLOCATE Table(1:Numb,1:3) Create a table to hold the segments. Keep start
    frequency, stop frequency, and number of points.
70  PRINTER IS 1         Make sure we print on the screen.
80  OUTPUT 2;CHR$(255)&"K"; Clear the screen.
90  PRINT USING "10A, 10A, 10A, Print the table header
    20A"; "SEGMENT",
    "START(MHZ)",
    "STOP(MHZ)", "NUMBER OF
    POINTS"
100 FOR I = 1 TO Numb    Read in each segment.
110 GOSUB Loadpoin      (line 300) reads in the start frequency, stop fre-
    quency, and number of points for segment I. Since
    Loadpoin is a subroutine, I is used as a global
    variable.
120 NEXT I
```

130 LOOP	Use the LOOP, EXIT IF, END LOOP structure to loop and edit the table until editing is no longer needed. This structure sets up a loop with the exit point in the middle of the loop rather than at the beginning (as with WHILE, END WHILE), or at the end (as with REPEAT, UNTIL).
140 INPUT "DO YOU WANT TO EDIT? Y OR N", An\$	Edit the table. Editing is re-entering the entire segment. The old segment values are left in place if return is pressed without typing anything.
150 EXIT IF An\$="N"	Exit the edit loop if editing is finished. Execution is continued at line 210.
160 INPUT "ENTRY NUMBER?", I	For editing, get the entry number.
170 GOSUB Loadpoin	Re-enter the values.
180 END LOOP	
190 OUTPUT 716;"EDITLIST"	To begin the table, open the list frequency table for editing. The table must be empty, or these segments will be added on top of the old ones.
200 FOR I=1 TO Numb	Loop for each segment.
210 OUTPUT 716;"SADD;STAR"; Table(I,1);"MHZ;"	
220 OUTPUT 716;"STOP"; Table(I,2);"MHZ;"	
230 OUTPUT 716;"POIN", Table(I,3),";"	Enter the segment values.
240 OUTPUT 716;"SDON;"	Declare the segment done.
250 NEXT I	
260 OUTPUT 716;"EDITDONE; LISFREQ;"	Close the table, and turn on list frequency mode.
270 STOP	
280 Loadpoin: !	Enter in a segment.
290 INPUT "START FREQUENCY? (MHZ)", Table(I,1)	
300 INPUT "STOP FREQUENCY? (MHZ)", Table(I,2)	
310 INPUT "NUMBER OF POINTS?", Table(I,3)	Enter the segment values.
320 IF Table(I,3)=1 THEN Table(I,2)=Table(I,1)	If only one point in the segment, make the stop frequency equal to the start frequency to avoid ambiguity.
330 PRINT TABXY(0,I+1);I; TAB(10);Table(I,1); TAB(20);Table(I,2); TAB(30);Table	Print the segment out. If a segment is being edited, TABXY, will print over old segments.
340 RETURN	
350 END	

Running the program

The program displays the frequency list table as it is entered. During editing, the displayed table is updated as each line is edited. The table is not re-ordered. At the completion of editing, the table is entered into the network analyzer, and list frequency mode turned on. During editing, pressing [RETURN] leaves an entry at the old value.

Any segments already in the list frequency table in the network analyzer will be deleted by the program. If not wanted, delete lines 40 thru 60. New segments will write over the old ones.

Example 4B: Selecting a single segment from a table of segments

This example program shows how a single segment can be chosen to be the operating frequency range of the network analyzer, out of a table of segments. The program assumes that a list frequency table has already been entered into the network analyzer, either manually, or using the program in Example 4A, *Setting up a list frequency sweep*.

The program first loads the list frequency table into the computer by reading the start and stop frequencies of each segment, and the number of points for each segment. The segments' parameters are then displayed on the computer screen, and the user can choose which segment is to be used by the analyzer. Note that only one segment can be chosen at a time.

This program is stored on the Example Programs disk as **IPG4B**.

10	ABORT 7	
20	CLEAR 716	Prepare for HP-IB control
30	PRINTER IS 1	Make sure we print on the screen.
40	OUTPUT 2;CHR\$(255)\$"K";	Clear the screen.
50	PRINT USING "10A, 15A, 15A, 20A"; "SEGMENT", "START(MHZ)", "STOP(MHZ)", "NUMBER OF POINTS"	Print out the table header.
60	OUTPUT 716; "EDITLIST; SEDI30; SEDI; "	Interrogate the number of the highest segment. This allows the program to determine the number of list frequency segments.
70	ENTER 716; Numsegs	Read the active parameter (segment number) into the variable Numsegs .
80	ALLOCATE Table(1:Numsegs, 1:3)	Create an array large enough to hold all the segment parameters.
90	FOR I=1 to Numsegs	This FOR NEXT loop calls the subroutine Readlist which reads in the segment parameters.
100	GOSUB Readlist	
110	NEXT I	
120	LOOP	Use the LOOP structure to allow continuous selection of the desired segment to be measured.
130	INPUT "SELECT SEGMENT NUMBER: (0 TO EXIT)", Segment	
140	EXIT IF Segment = 0	Allow the operator to exit the loop by entering 0 as the segment number
150	OUTPUT 716; "SSEG"; Segment; "; EDITDONE; "	The SSEG command causes the specific segment to become the new operating frequency range of the measurement.
160	END LOOP	
170	OUTPUT 716; "ASEG; "	When the loop is exited, resume operation using all list frequency segments. The ASEG command turns on all the segments.
180	DISP "PROGRAM ENDED"	
190	STOP	
200	Readlist: !	This subroutine reads out all the segment parameters.
210	OUTPUT 716; "EDITLIST; SEDI; ", I, "; "	Activate the Ith segment.

220	OUTPUT 716;"STAR; OUTPACTI;"	Make the start frequency active, and output its value using the OUTPACTI command.
230	ENTER 716;Table(I,1)	Read the start frequency into the list table.
240	OUTPUT 716;"STOP; OUTPACTI;"	Make the stop frequency active, and output its value.
250	ENTER 716;Table(I,2)	Read the stop frequency value.
260	OUTPUT 716;"POINT; OUTPACTI;"	Make the number of points active, and output its value.
270	ENTER 716;Table(I,3)	Read the number of points.
280	IF I=18 THEN INPUT "HIT RETURN FOR MORE",A\$	Stop printing when 17 segments have been listed on the display, this allows the operator to examine the first 17 segments before they are scrolled off the computer display by addition segments (remember, there are up to 30 segments).
290	IMAGE 4D,6X,4D.6D,3X, 4D.6D,3X,4D	Specify the print format and margins for the list frequency table.
300	PRINT USING 290;I;Table (I,1)/1.E+9;Table(I,2)/ 1.E+9;Table(I,3)	Print out the segment parameters for the Ith segment.
310	RETURN	
320	END	

Running the program

The program will read the parameters for each list frequency segment from the network analyzer, and build a table containing all the segments. The parameters of each segment will be printed on the computer screen. If there are more than 17 segments, the program will pause. Press **[RETURN]** to see more segments. The maximum number of segments that can be read is 30 (which is the maximum number of segments that the network analyzer can hold). Use the computer's **[Prev]** and **[Next]** keys to scroll the list of segments back and forth if there are more than 17 segments.

After all the segments are displayed, the program will prompt for a specific segment to be used. Type in the number of the segment, and the network analyzer will then "zoom-in" on that segment. The program will continue looping, allowing continuous selection of different segments. To exit the loop, type **0**. This will restore all the segments (with the command ASEG), allowing the network analyzer to sweep all of the segments, and the program will terminate.

Using limit lines to perform PASS/FAIL tests

There are two steps to performing limit testing on the network analyzer under HP-IB control. First, limit specifications must be specified and loaded into the analyzer. Second, the limits are activated, the device is measured, and its performance to the specified limits is signaled by a pass or fail message on the network analyzer's display.

Example 5A illustrates the first step, setting up limits, and Example 5B performs the limit testing.

Example 5A: Setting up limit lines

This example shows how to create a limit table and transmit it to the network analyzer.

The command sequence for entering a limit table imitates the key sequence followed when entering a table from the front panel: there is a command for every key press. Editing a limit is also the same as the key sequence, but remember that the network analyzer automatically re-orders the table in order of increasing start frequency.

The limit table is also carried as part of the learn string. While it cannot be modified as part of the learn string, it can be stored and recalled with very little effort.

This example takes advantage of the computer's capabilities to simplify creating and editing the table. The table is entered and completely edited before being transmitted to the network analyzer. To simplify the programming task, options such as entering offsets are not included.

This program is stored as **IPG5A** on the Example Programs disk.

```
10  ABORT 7
20  CLEAR 716           Prepare the network analyzer for HP-IB control.
30  OUTPUT 716;"EDIT LIML;
    CDEL;"             Delete any existing limits.
40  INPUT "Number of   Find out how many limits to expect.
    limits?",Numb
50  ALLOCATE Table(1:Numb,1:3) Create a table to hold the limits. It will contain
    stimulus value (frequency), upper limit value, and
    the lower limit value
60  ALLOCATE Limtype$(Numb)[2] Create a string array to indicate the limit types.
70  PRINTER IS 1       Make sure we print on the screen.
80  OUTPUT 2;CHR$(255)&"K"; Clear the screen.
90  PRINT USING "10A,20A, Print the table header
    15A,20A";"SEG",
    "STIMULUS(MHZ)", "UPPER
    (dB)", "LOWER
    (dB)", "TYPE"
100 FOR I = 1 TO Numb   Read in each segment.
110 GOSUB Loadlimit    Loadlimit (line 310) reads in the stimulus value
    (frequency), upper value, lower value, and the
    limit type for limit I. Since Loadlimit is a
    subroutine, I is used as a global variable.
120 NEXT I
130 LOOP              Use the LOOP, EXIT IF, END LOOP structure to
    loop and edit the table until the operator indicates
    that editing is no longer desired. This structure
    sets up a loop with the exit point in the middle of
    the loop rather than at the beginning (as with
    WHILE, END WHILE), or at the end (as with
    REPEAT, UNTIL).
140 INPUT "DO YOU WANT TO Edit the table. Editing is re-entering the entire
    EDIT? Y OR N",An$ limit. The old limit values are left in place if return
    is pressed without typing anything.
```

150 EXIT IF An\$="N"	Exit the edit loop if editing is finished. Execution is continued at line 190.
160 INPUT "ENTRY NUMBER?", I	For editing, get the entry number.
170 GOSUB Loadlimit	And have Loadlimit re-enter the values.
180 END LOOP	
190 OUTPUT 716;"EDITLIML;"	Begin the table entry by opening the limit table for editing. The limit table must be empty, or these limits will just be added on top of the old ones.
200 FOR I=1 TO Numb	Loop for each limit.
210 OUTPUT 716;"SADD;LIMS"; Table(I,1);"MHZ;"	Enter the stimulus value.
220 OUTPUT 716;"LIMU";Table (I,2);"DB;"	Enter the upper limit value.
230 OUTPUT 716;"LIML",Table (I,3),"DB;"	Enter the lower limit value.
240 IF Limtype\$(I)="FL" THEN OUTPUT 716;"LIMTFL;"	Set flat limit type.
250 IF Limtype\$(I)="SL" THEN OUTPUT 716;"LIMTSL;"	Set sloped limit type.
260 IF Limtype\$(I)="SP" THEN OUTPUT 716;"LIMTSP;"	Set point limit type.
270 OUTPUT 716;"SDON;"	Declare the limit done.
280 NEXT I	
290 OUTPUT 716;"EDITDONE; LIMILINEON;LIMITESTON;"	Close the table, display the limits, and activate limit testing.
300 STOP	
310 Loadlimit: !	Enter in a segment.
320 INPUT "STIMULUS VALUE? (MHZ)",Table(I,1)	
330 INPUT "UPPER LIMIT VALUE (DB)?",Table(I,2)	
340 INPUT "LOWER LIMIT VALUE (DB)?",Table(I,3)	Enter the limit values.
350 INPUT "LIMIT TYPE" (FL=FLAT, SL=SLOPED, SP=SINGLE POINT)",Limtype\$(I)	Enter the limit type.
360 PRINT TABXY(0,I+1);I; TAB(10);Table(I,1); TAB(30);Table(I,2); TAB(45);Table(I,3); TAB(67);Limtype\$(I)	Print the limit values out. Because of the TABXY, this will print over old limits if a limit is being edited.
370 RETURN	
380 END	

Running the program

The program displays the limit table as it is entered. During editing, the displayed table is updated as each line is edited. The table is not reordered. When editing is done, the table is entered into the network analyzer, and limit testing mode turned on. During editing, pressing [RETURN] leaves an entry at the old value.

This example program will delete any existing limit lines before entering the new limits. If this is not wanted, omit lines 30 through 50.

Example 5B: Performing PASS/FAIL tests while tuning

The purpose of this example is to demonstrate the use of the limit/search fail bits in event status register B, to determine whether a device passes the specified limits. Limits can be entered manually, or using the Example 5A.

The limit/search fail bits are set and latched when limit testing or a marker search fails. There are four bits, one for each channel for both limit testing and marker search. Their purpose is to allow the computer to determine whether the test/search just executed was successful. The sequence of their use is to clear event status register B, trigger the limit test or marker search, and then check the appropriate fail bit.

In the case of limit testing, the best way to trigger the limit test is to trigger a single sweep. By the time the **SING** command finishes, limit testing will have occurred. A second consideration when dealing with limit testing is that if the device is tuned during the sweep, it may be tuned into and then out of limit, causing a limit test pass when the device is not in fact within limits.

In the case of the marker searches (max, min, target, and widths), outputting marker or bandwidth values automatically triggers any related searches. Hence, all that is needed is to check the fail bit after reading the data.

In this example, the requirement that several sweeps in a row must pass is used in order to give confidence that the limit test pass was not extraneous due to the device settling or the operator tuning during the sweep. Upon running the program, the number of passed sweeps for qualification is entered. For very slow sweeps, a small number of sweeps such as two is appropriate. For very fast sweeps, where the device needs time to settle after tuning and the operator needs time to get away from the device, as many sweeps as six or more sweeps might be appropriate.

A limit test table can be entered over HP-IB: the sequence is very similar to that used in entering a list frequency table and is shown in Example 5A. The manual sequence is closely followed.

This program is stored under **IPG5B** on the Example Programs disk.

10	ABORT 7	
20	CLEAR 716	Prepare the network analyzer for remote control.
30	INPUT "Number of consecutive passed sweeps for qualification?",Qual	Find out how many sweeps must pass before the device is considered to have passed the limit test.
40	DISP "TUNE DEVICE"	Tell operator to begin tuning.
50	Reap=0	Reap is a counter holding how many sweeps have passed the limit test.
60	OUTPUT 716;"DPC?;SING;"	Take a sweep. When it is done, limit test will have occurred.
70	ENTER 716;Reply	Wait for the end of the sweep.
80	OUTPUT 716;"ESB?;"	Check to see if the fail bit is set.
90	ENTER 716;Estat	
100	IF BIT(Estat,4) THEN	If the fail bit for channel one is set, reset the number of sweeps passed counter.
110	IF Reap<>0 THEN BEEP 1200,.05	If sweeps had been passing, warn the operator that the device is now failing.
120	Reap=0	
130	GOTO 40	
140	END IF	If the fail bit was not set, tell the operator.
150	BEEP 2500,.01	
160	Reap=Reap+1	Increment the sweeps passed counter.
170	DISP "STOP TUNING"	Encourage the operator to stop tuning the device.

180	IF Reap < Qual THEN GOTO 60	If not enough sweeps have passed, loop.
190	DISP "DEVICE PASSED!"	The device has passed.
200	FOR I = 1 TO 10	Warble, telling the operator the device has passed, using an audible signal.
210	BEEP 1000, .05	
220	BEEP 2000, .01	
230	NEXT I	
240	INPUT "HIT RETURN FOR NEXT DEVICE", Dum\$	Wait for the next device.
250	GOTO 40	
260	END	

Running the program

Set up a limit table on channel 1 for a specific device either manually, or using the program in Example 5A. Run the program, and enter the number of passed sweeps desired for qualification. After entering the qualification number, connect the filter. When a sweep passes, the computer beeps. When enough sweeps in a row pass to qualify the device, the computer warbles and asks for a new device.

The program assumes a response calibration (thru calibration) or full 2-port calibration has been performed prior to running the program. Try causing the DUT to fail by loosening the cables connecting the DUT to the network analyzer, and then retightening them.

Storing and recalling instrument states

This example demonstrates ways of storing and recalling entire instrument states over HP-IB. The methods discussed are to use the learn string, and the computer to coordinate direct store/load of instrument states to disk.

Using the learn string is a quick way of saving the instrument state, but using direct disk access will automatically store calibrations, cal kits, and data along with the instrument state.

Example 6A: Using the learn string

The learn string is a fast and easy way to read an instrument state. The learn string includes all front panel settings, the limit table for each channel, and the list frequency table. The learn string is read out with `OUTPLEAS`, and put back into the instrument with `INPULEAS`. The string is in form 1, and is no longer than 3000 bytes long.

This example program is stored on the Example Programs disk as `IPG6A`.

```
10 DIM State$(3000)           Set up the receive string.
20 OUTPUT 716;"OUTPLEAS;"     Request the learn string.
30 ENTER 716 USING           Read in the learn string. Normally, the enter
   "-K";State$              statement will terminate if a line feed is received,
                           so USING "-K" is used, which allows termina-
                           tion only on End Or Identify.
40 LOCAL 716                 Put the analyzer in LOCAL mode.
50 INPUT "CHANGE STATE AND   Give the operator a chance to modify the state or
   HIT RETURN",Dum$         connect a new analyzer.
60 OUTPUT 716;"INPULEAS";    Transmit the state back to the HP 8753B.
   State$
70 DISP "INITIAL INSTRUMENT  STATE RESTORED"
80 END
```

Running the program

Run the program. When the program stops, change the instrument state and press `[RETURN]`. The network analyzer will return its original state.

When using a learn string from an HP 8753B, additional commands are needed because the "old" string is shorter. Therefore, you must tell the network analyzer when the transfer of the string has reached completion (sending EOI concurrently with the last byte of information).

The following program will output an HP 8753B learn string (previously obtained and put in `State$`) to an HP 8753C:

```
10 OTHER CODE WHICH HAS State$
   :
100 EOI$=":"                This syncs EOI (End or Identify) with a semicolon
                           as the last character in the string.
120 ASSIGN@Ana to 716; EOL EOI$
   END
130 OUTPUT@Ana;
   "INPULEAS";State$
140 DISP "8753B
   Learn String State"
150 END
```

Example 6B: Coordinating disk storage

To have the network analyzer store an instrument state on disk, specify the state name by titling a file using TITF n, then specify a STOR n of that file, where n is the file number, 1 to 5. On receipt of the store command, the network analyzer will request active control. When control is received, the network analyzer will store the instrument state on disk as defined under the [DEFINE STORE] menu.

To have the network analyzer load a file from disk, specify the state name, and then request a LOAD n of that file. The best way of learning what the register titles on the disk are, is to use the [READ FILE TITLES] under the [RECALL] key.

This example program is stored on the Example Programs disk as IPG6B.

```
10  ABORT 7
20  CLEAR 716                               Prepare the network analyzer for remote control.
30  INPUT "STATE TITLE? PRESS              Get the name of the file to create.
     RETURN", Nam$
40  OUTPUT 716;"USEPASC;"                  Tell the network analyzer to use pass control
                                         mode.
50  OUTPUT 716;"TITF1""";                  Title register 1, and store it. The title must be
     Nam$;"";STOR1;"                        preceded and followed by double quotation
                                         marks, and the only way to do that with an output
                                         statement is to use two sets of quotation
                                         marks:
                                         ""

60  DISP "SAVING ON DISC"
70  SEND 7;TALK 16 CMD 9                   Pass control to the network analyzer, assuming it
                                         has interpreted the STOR1 command and set the
                                         request control bit.

80  STATUS 7,6;Stat
90  IF NOT BIT(Stat,6) THEN                Wait for active control to return.
     GOTO 80
100 INPUT "STATE STORED. HIT
     RETURN TO RECALL", Dum$
110 INPUT "STATE TITLE?", Nam$            Get the name of the file to read.
120 OUTPUT 716;"TITF1""";                  Title register one, and request a load.
     Nam$;"";LOAD1;"
130 DISP "READING DISC"
140 SEND 7;TALK 16 CMD 9                   Pass control.
150 STATUS 7,6;Stat
160 IF NOT BIT(Stat,6) THEN                Wait for control to return.
     GOTO 150
170 DISP "DONE"                            The program is done, and the state has been
                                         loaded back into the instrument.

180 END
```

Running the program

Put a formatted disk in the disk drive, and point the network analyzer's disk address, unit number, and volume number toward that drive. Run the example, and when the program pauses, change the instrument state so that a change will be noticeable. Pressing return will recall the state just stored, or a completely different state can be recalled.

Example 6C: Reading calibration data

This example demonstrates how to read measurement calibration data out of the network analyzer, how to put it back into the instrument, and how to determine which calibration is active.

The data used to perform measurement error correction is stored inside the network analyzer in up to twelve calibration coefficient arrays. Each array is a specific error coefficient, and is stored and transmitted as an error corrected data array: each point is a real/imaginary pair, and the number of points in the array is the same as the number of points in the sweep. The four data formats also apply to the transfer of calibration coefficient arrays. Appendix C, *Calibration*, of the *HP-IB Quick Reference* specifies where the calibration coefficients are stored for different calibration types.

A computer can read out the error coefficients using the commands `OUTPCALC01`, `OUTPCALC02`, . . . `OUTPCALC12`. Each calibration type uses only as many arrays as needed, starting with array 1. Hence, it is necessary to know the type of calibration about to be read out: attempting to read an array not being used in the current calibration causes the "REQUESTED DATA NOT CURRENTLY AVAILABLE" warning.

A computer can also store calibration coefficients in the network analyzer. To do this, declare the type of calibration data about to be stored in the network analyzer just as if you were about to perform that calibration. Then, instead of calling up different classes, transfer the calibration coefficients using the `INPUCALCnn` commands. When all the coefficients are in the network analyzer, activate the calibration by issuing the mnemonic `SAVC`, and have the network analyzer take a sweep.

This example reads the calibration coefficients into a very large array, from which they can be examined, modified, stored, or put back into the instrument. If the data is to be directly stored onto disk, it is usually more efficient to use form 1 (network analyzer internal binary format), and to store each coefficient array as it is read in.

This program is stored on the Example Programs disk as `IPG6C`.

```
10  ABORT 7
20  CLEAR 716                                Prepare the network analyzer for HP-IB control.
30  DATA "CALIRESP", 1,
      "CALIRAI", 2,
      "CALIS111", 3
40  DATA "CALIS221", 3,
      "CALIFUL2", 12
50  DATA "NOOP", 0                          Set up the data base of possible calibrations, and
                                             the number of arrays associated with each
                                             calibration.
60  INTEGER Hdr, Lgth, I, J                  Define integers to hold the header, and to act as
                                             counters.
70  ASSIGN @Dt TO 716; FORMAT
      OFF
80  READ Calt$, Numb                          Get a calibration type and the number of
                                             associated arrays.
90  IF Numb = 0 THEN GOTO 360                If correction was not on, stop the program.
100 OUTPUT 716; Calt$; "?; "                Interrogate the network analyzer to see if this cali-
                                             bration is active.
110 ENTER 716; Active
120 IF NOT Active THEN GOTO 80              If the calibration was not active, loop.
130 DISP Calt$, Numb                        Show the operator that we have found the cali-
                                             bration and number of arrays.
140 OUTPUT 716; "FORM3; POIN?; "           Find out how many points to expect.
150 ENTER 716; Poin
```

160	ALLOCATE Cal(1:Numb, 1: Poin, 1:2)	Create a very large array to hold all the coefficients.
170	FOR I = 1 TO Numb	Loop once for each calibration coefficient.
180	OUTPUT 716 USING "K, ZZ"; "OUTPCALC", I	Request the calibration coefficient. The K transmits OUTPCALC literally, and ZZ transmits I as two digits, using a leading zero if needed.
190	ENTER @Dt;Hdr, Lgth	Read the header.
200	FOR J = 1 TO Poin	
210	ENTER @Dt; Cal(I, J, 1), Cal(I, J, 2)	Since we are not filling the entire array, we have to read each point individually.
220	NEXT J	
230	NEXT I	The calibration data is now all in the computer.
240	INPUT "HIT RETURN TO RE- TRANSMIT CALIBRATION", Dum\$	
250	OUTPUT 716; Calt\$, ""	Begin the calibration retransmission by declaring what calibration type is about to be loaded.
260	FOR I = 1 TO Numb	Now load each calibration coefficient.
270	DISP "TRANSMITTING ARRAY: ", I	
280	OUTPUT 716 USING "K, ZZ"; "FORM3; INPUCALC", I	
290	OUTPUT @Dt;Hdr, Lgth	
300	FOR J = 1 TO Poin	
310	OUTPUT @Dt; Cal(I, J, 1), Cal(I, J, 2)	
320	NEXT J	
330	NEXT I	All of the calibration data has been loaded.
340	OUTPUT 716; "SAVC; "	End the sequence by activating the calibration.
350	OUTPUT 716; "CONT; "	Trigger a sweep so the calibration becomes active.
360	DISP "DONE"	
370	END	

Running the program

Before executing the program, perform a calibration.

The program is able to detect what calibration is active, and with that information it predicts how many arrays to read out. When all the arrays are inside the computer, the program prompts the user. At this point, turn calibration off, or perform a completely different calibration on the network analyzer. Then press continue on the computer, and the computer will reload the old calibration.

Note that the retransmitted calibration is associated with the current instrument state: the instrument has no way of knowing the original state associated with the calibration data. For this reason, it is recommended that the learn string be used to store the instrument state whenever calibration data is stored. See Example 6A, *Using the learn string*.

Miscellaneous Programming Examples

Controlling peripherals

The purpose of this section is to demonstrate how to coordinate printers, plotters, power meters, and disk drives with the network analyzer.

The network analyzer has three operating modes with respect to HP-IB, as set under the **[LOCAL]** menu. System controller mode is used when no computer is present. The other two modes allow the computer to coordinate certain actions: in talker/listener mode the computer can control the network analyzer, as well as coordinate plotting and printing, and in pass control mode the computer can pass active control to the network analyzer so that the network analyzer can plot, print, control a power meter, or load/store to disk. Peripheral control is the major difference between the two modes.

Note that the network analyzer assumes that the address of the computer is correctly stored in its HP-IB addresses menu under the **[ADDRESS: CONTROLLER]** entry. If this address is incorrect, control will not return to the computer. If control is passed to the network analyzer while it is in talker/listener mode, control will not return to the computer.

Example 7: Operation using pass control mode

If the network analyzer is in pass control mode and receives a command telling it to plot, print, control a power meter, or store/load to disk, it sets bit 1 in the event status register to indicate that it needs control of the bus. If the computer then uses the HP-IB control command to pass control to the network analyzer, the network analyzer will take control of the bus, and access the peripheral. When the network analyzer no longer needs control, it will pass it back to the computer. When performing a power meter cal over HP-IB, the network analyzer requests control at each measurement point in a sweep which is typically $\cong 3 \times$ the number of readings.

Control should not be passed to the network analyzer before it has set event status register bit 1, Request Active Control. If the network analyzer receives control before the bit is set, control is passed immediately back.

While the network analyzer has control, it is free to address devices to talk and listen as needed. The only functions denied it are the ability to assert the interface clear line (IFC), and the remote line (REN). These are reserved for the system controller. As active controller, the network analyzer can send messages to and read replies back from printers, plotters, and disk drives.

This example prints the display. It is stored on the Example Programs disk as **IPG7B**. The program could request a plot with **PLDT**, or a disk access with a command such as **REFT** (read file titles.)

10	<code>OUTPUT 716; "CLES;ESE2;"</code>	Clear the status reporting system, and enable the Request Active Control bit in the event status register.
20	<code>OUTPUT 716; "USEPASC; PRINALL;"</code>	Put the network analyzer in pass control mode, and request a print
30	<code>Stat = SPOLL(716)</code>	Get the status byte of the network analyzer.
40	<code>IF NOT BIT(Stat,5) THEN GOTO 30</code>	If the network analyzer is not requesting control, loop and wait. If using color printer, use COLOP .

50	SEND 7;TALK 16 CMD 9	This is the bus command to pass active control to device 16. With BASIC 3.0 or higher, or 2.0 with extensions 2.1, the command <code>PASS CONTROL 7 16</code> can be used instead.
60	DISP "PRINTING"	
70	STATUS 7,6;Hp1b	To determine when the print is finished, watch for return of active control. The <code>STATUS</code> command loads the interface 7 (HP-IB) register 6, the computer's status with respect to HP-IB, into the variable <code>Hp1b</code> . Bit 6 tells if the computer is the active controller: it will be set when the network analyzer returns control.
80	IF NOT BIT(Hp1b,6) THEN GOTO 70	If control has not returned, loop and wait.
90	DISP "DONE"	Control has returned.
100	END	

Running the program

The network analyzer will briefly flash the message `WAITING FOR CONTROL`, before receiving control and making the print. The computer will display the `PRINTING` message.

When the print is complete, the network analyzer passes control back to the address stored as the controller address under the `[LOCAL] [SET ADDRESSES]` menu. The computer will detect the return of active control and exit the wait loop.

Because the program waits for the network analyzer's request for control, it can be used to respond to front panel requests as well. Delete `PRINALL;` from line 20, and run the program. Nothing will happen until you go to the front panel of the network analyzer and request a print, plot, or disk access. For example, press `[LOCAL] [COPY]` and `[PRINT]`.

Example 8: Creating a user interface

This example shows how to create a custom user interface involving only the front panel keys and display of the network analyzer.

User graphics

The network analyzer's display can be treated as an HP-GL plotter. The BASIC graphics commands can be used to create a custom display. Some of the more useful commands are as follows. **VIEWPORT** defines what area of the display is to be plotted on. **WINDOW** allows you to specify the plotting units (i.e. how many units per axis) in the **VIEWPORT** defined area. **DRAW** draws lines from point to point. **MOVE** moves the logical pen without drawing anything. **GCLEAR** clears the graphics display area. **PEN** selects the line color.

All of the BASIC graphics statements are accepted. The **LABEL** statement is not recommended because it fills the display memory up very rapidly as opposed to when the HP-GL **LB** command is used. See the **Waitforkey** subroutine of Example 2A for an example of the **LB** command.

HP-GL (Hewlett-Packard Graphics Language) commands, such as the **LB** command mentioned above, can be directly sent to the network analyzer display with the **OUTPUT statement**. See **Appendix D, Display Graphics**, of the *HP-IB Quick Reference* for a list of the HP-GL commands accepted, and their functions.

Front panel control

It is possible to take over the front panel keys. The user request bit in the event status register is set whenever a front panel key is pressed or the knob is turned, whether the instrument is in remote or local mode. Each key has a number associated with it, as shown in Figure E.4, *Front Panel Keycodes* of the *HP-IB Quick Reference*. The number of the key last pressed can be read with the **KOR?** and the **OUTPKEY?** commands. With **KOR?**, a knob turn is reported as a negative number encoded with the number of counts turned. With **OUTPKEY?**, a knob turn is always reported as a negative one.

The keycode encoding with **KOR?** is as follows. Clockwise rotations are reported as numbers from -1 to -64 , -1 being a very small rotation. Counter-clockwise rotations are reported as the numbers $-32,767$ to $-32,703$, $-32,767$ being a very small rotation. Hence, clockwise rotations don't need any decoding at all, and counter-clockwise rotations can be decoded by adding 32,768.

There are approximately 120 counts per knob rotation, and sign of the count depends on the direction the knob was turned.

This example uses the knob and the up and down keys on the network analyzer to position a grid on the display. Pressing **[ENTRY OFF]** on the network analyzer causes the computer to put a trace on the grid.

This example program is stored on the Example Programs disk as **IPG8**.

10	INTEGER Hdr, Lgth, Keyc	Declare variables to hold the header and the key code.
20	ASSIGN @Dt TO 716; FORMAT OFF	Define an IO path with formatting off, to receive the form 3 trace data for plotting.
30	OUTPUT 716; "HOLD; AUTO; CLES; ESE 64; POIN?; "	Prepare the instrument HOLD; AUTO; freezes and scales the trace for plotting. CLES; ESE 64; clears the status reporting system and enables the User Request bit in the event status register. Lastly, POIN?; requests the number of points.
40	ENTER 716; POIN	Read in the number of points.
50	GINIT	Initialize the graphics functions in the computer.
60	PLOTTER IS 717, "HPGL"	Specify the network analyzer display as the plotting device.
70	OUTPUT 717; "CS; SP3; "	Turn off the measurement display and set the rectangle color to that of channel 2 data.

80 Cx=55	Initialize the x position of the center of the
90 Cy=60	rectangle. Initialize the y position of the center of the
100 S=20	rectangle.
110 REPEAT	Set the size of the rectangle. The REPEAT, UNTIL structure sets up a loop that
120 GCLEAR	keeps repeating until the condition specified in
130 IF Cx>160 THEN Cx=160	the UNTIL statement is found to be true. The
140 IF Cx<-17 THEN Cx=-17	condition is checked at the end of the loop. In this
150 IF Cy>115 THEN Cy=115	case, loop and redraw the rectangle until [ENTRY
160 IF Cy<-15 THEN Cy=-15	OFF] has been pressed.
170 VIEWPORT Cx-S,Cx+S,Cy-	Clear the graphics area on the network analyzer.
180 WINDOW 0,Point-1,0,1	Prevent box from going off the screen. Note that these values are linked to the
190 FRAME	increments set in lines 270/310 and 320!
200 Stat=SPOLL(716)	Define the area of the rectangle, which will
210 IF NOT BIT(Stat,5) THEN	become the plotting area for the grid and trace.
220 OUTPUT 716;"ESR?;"	Define the units along the edges of the rectangle.
230 ENTER 716;Estat	In this case, the horizontal edge has as many units
240 OUTPUT 716;"KOR?;"	as points in the sweep, and the vertical edge is
250 ENTER 716;Keyc	simply unity.
260 IF Keyc=26 THEN Cy=Cy+5	Draw the rectangle around the plotting area.
270 IF Keyc=18 THEN Cy=Cy-5	Read the status byte.
280 IF Keyc<0 THEN	If bit 5 is not set, a key has not been pressed, so
290 Knb=Keyc	loop and wait.
300 IF Knb<-64 THEN	A key press has occurred, so read the event status
310 Cx=Cx-Knb*3	register in order to clear the latched bit.
320 END IF	Read in the register value, but do nothing with it.
330 UNTIL Keyc=34	Now read in the key or knob count.
	Key 26 is the up key, so shift the rectangle up.
	Key 18 is the down key, so shift the rectangle
	down.
	If the keycode was negative, then it is a knob
	count.
	Decode the knob count into the variable Knb.
	If the count is less than -64, add 32768 (2 ¹⁵) to
	recover the knob count. If the count is more than
	-64, then no decoding is needed.
	Shift the rectangle according the knob count,
	multiplying the knob count to make the rectangle
	move farther.
	This is the end of the REPEAT, UNTIL structure.
	Leave the loop only when key 34, [ENTRY OFF]
	has been pressed.

340 GRID (Poin-1)/10,.1	[ENTRY OFF] has been pressed, so draw the grid and the trace. This statement draws a grid with 10 divisions on each axis.
350 OUTPUT 717;"SP 1;"	Set the trace color to that of channel 1 data.
360 OUTPUT 716;"FORM3;OUTPFORM;"	Now get the trace data.
370 ENTER @Dt;Hdr,Lgth	Get the header information.
380 ALLOCATE Dat(1:Poin,1:2)	Define the receiving array.
390 ENTER @Dt;Dat(*)	And read in the data.
400 OUTPUT 716:"SCALE 2.0"	Instead of scaling the data in this program

Appendix A: Status Reporting

The network analyzer has a status reporting mechanism that gives information about specific functions and events inside the network analyzer. The status byte is an 8 bit register with each bit summarizing the state of one aspect of the instrument. For example, the error queue summary bit will always be set if there are any errors in the queue. The value of the status byte can be read with the `SPOLL(716)` statement. This command does not automatically put the instrument in remote mode, thus giving the operator access to the network analyzer front panel functions. The status byte can also be read by sending the command `OUTPSTAT`. Reading the status byte does not affect its value. The sequencing bit can be set by the operator during execution of a test sequence.

The status byte summarizes the error queue, as mentioned before. It also summarizes two event status registers that monitor specific conditions inside the instrument. The status byte also has a bit that is set when the instrument is issuing a service request over HP-IB, and a bit that is set when the network analyzer has data to send out over HP-IB. See Figure A.1 for a definition of the status registers.

Example A1: Using the error queue

The error queue holds up to 20 instrument errors and warnings in the order that they occurred. Each time the network analyzer detects an error condition and displays a message on the CRT, it also puts the error in the error queue. If there are any errors in the queue, bit 3 of the status byte will be set. The errors can be read from the queue with the `OUTPERRD` command, which causes the network analyzer to transmit the error number and the error message of the oldest error in the queue.

This example program is stored on the Example Programs disk as `IPGA1`.

10 DIM Err\$(50)	Prepare a string to hold the error message.
20 Stat=SPOLL(716)	Use the serial poll statement to read the status byte into the variable Stat. Serial poll is an HP-IB function dedicated specifically to getting the status byte of an instrument quickly, and does not cause the network analyzer to go into remote.
30 IF NOT BIT(Stat,3) THEN GOTO 20	If the error queue summary bit is not set, loop until it is set.
40 OUTPUT 716;"OUTPERRD;"	If the error queue has something in it, we instruct the network analyzer to output the error number and the error message. This communication with the network analyzer will put it in remote mode.
50 ENTER 716;Err,Err\$	Err holds the error number, Err\$ the error message.
60 PRINT Err,Err\$	
70 LOCAL 716	Return the network analyzer to local mode so that the front panel is available to the operator.
80 BEEP 600,.2	Give an audible signal that there is a problem.
90 GOTO 20	
100 END	

Running the program

Preset the network analyzer and run the program. Nothing should happen at first. To get something to happen, press a blank softkey. The message "CAUTION: INVALID KEY" will appear on the network analyzer, the computer will beep and print two lines. The first line will be the invalid key error, and the second message will be the "NO ERRORS" message. Hence, to clean the error queue, you can either loop until the no errors message is received, or until the bit in the status register is cleared. In this case, we wait until the status bit is clear. Note that all through this, the front panel of the network analyzer is in local mode.

Because the error queue will keep up to 20 errors until either all the errors are read out or the instrument is preset, it is important to clear out the error queue whenever errors are detected so that old errors are not associated with the current instrument state.

Not all messages displayed by the network analyzer are put in the error queue: operator prompts and cautions are not included.

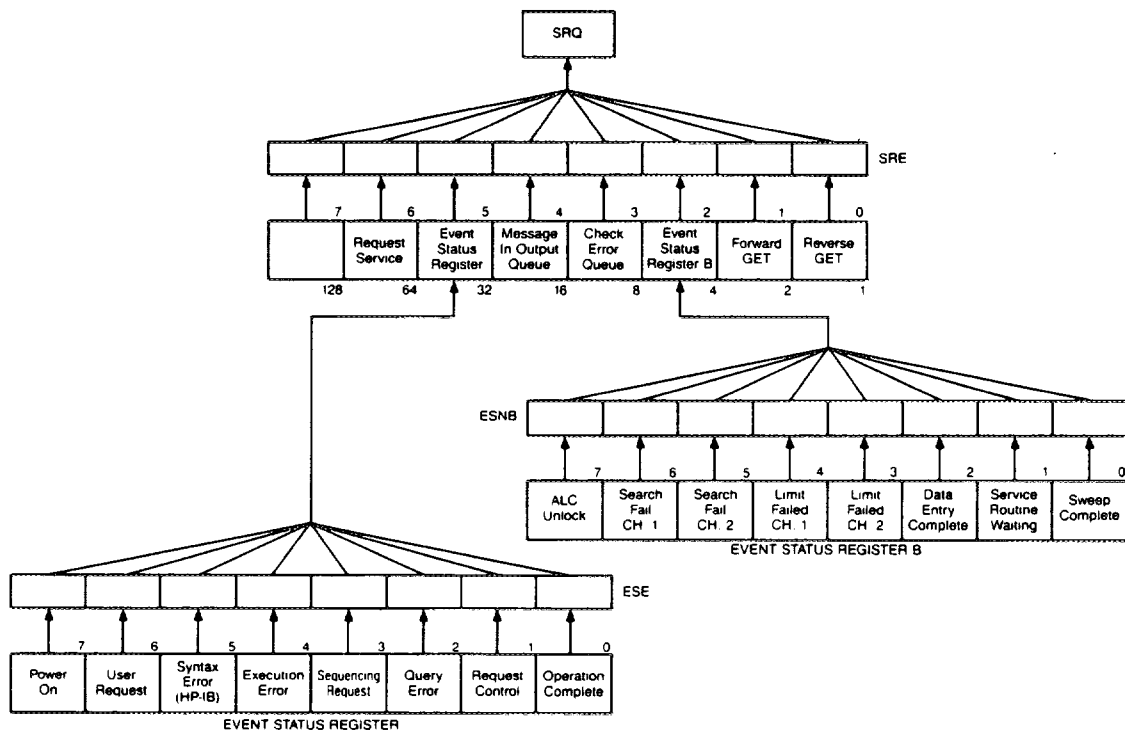

Figure A.1. Status reporting system

Example A2: Using the status registers

The other key components of the status reporting system are the event status register, and event status register B. These 8 bit registers consist of latched event bits. A latched bit is set at the onset of the monitored condition, and is cleared by a read of the register or by clearing the status registers with CLES.

This example program is stored on the Example Programs disk as **IPGA2**.

10	CLEAR 716	Clear out any old conditions.
20	OUTPUT 716;"ESR?;"	Read out the event status register.
30	ENTER 716;Estat	
40	IF NOT BIT(Estat,6) THEN GOTO 20	If the user request bit of the event status register is not set, loop back.
50	OUTPUT 716;"KOR?;"	If the user request bit has been set, there has been some front panel activity, and we read out the key code. The network analyzer's reply to KOR?; includes the knob count if the knob was turned. The information comes as a negative number, and has to be decoded.
60	ENTER 716;Keyc	
70	IF Keyc ≥ 0 then PRINT "KEY ";	If the code was positive, it was a key press rather than a knob turn, and print the leader KEY. Placing a semicolon after the statement, suppresses the carriage return, line feed, allowing the code to be printed on the same line.
80	IF Keyc < -400 THEN Keyc = Keyc + 32768	If the keycode is negative, it is a knob count. If it isn't less than -400, then the count is a clockwise rotation and needs no modification. If the count is less than -400, we have to add 32,768 (2 ¹⁵) to get the counter-clockwise count.
90	PRINT "CODE =", Keyc	Print the decoded key code.
100	GOTO 20	Wait for the next key press.
110	END	

Running the program

Run the program. Pressing a key on the network analyzer causes the computer to display the keycode associated with that key. Note that since the network analyzer is in remote mode, the normal function of the key is not executed. In effect, we have taken over the front panel and can now redefine the keys.

Example A3: Generating interrupts

It is also possible to generate interrupts using the status reporting mechanism. The status byte bits can be enabled to generate a service request (SRQ) when set. The 200/300 series computers can in turn be set up to generate an interrupt on the SRQ.

To be able to generate an SRQ, a bit in the status byte has to be enabled using **SREn**. A one in a bit position enables that bit in the status byte. Hence, **SRE 8** enables an SRQ on bit 3, check error queue, since 8 equals 00001000 in binary representation. That means that whenever an error is put into the error queue and bit 3 gets set, the SRQ line is asserted, and the (S) indicator on the front panel of the network analyzer comes on. The only way to clear the SRQ is to disable bit 3, re-enable bit 3, or read out all the errors from the queue.

A bit in the event status register can be enabled so that it is summarized by bit 5 of the status byte. If any enabled bit in the event status register is set, bit 5 of the status byte will also be set. For example **ESE 66** enables bits 1 and 6 of the event status register, since in binary, 66 equals 01000010. Hence, whenever active control is requested or a front panel key is pressed, bit five of the status byte will be set. Similarly, **ESNBn** enables bits in event status register B so that they will be summarized by bit 2 in the status byte.

To generate an SRQ from an event status register, enable the desired event status register bit. Then enable the status byte to generate an SRQ. For instance, **ESE 32;SRE 32;** enables the syntax error bit, so that when the syntax error bit is set, the summary bit in the status byte will be set, and it enables an SRQ on bit 5 of the status byte, the summary bit for the event status register.

The following example program is stored on the Example Programs disk as **IPGA3**.

10	OUTPUT 716;"CLES; ESE 32; SRE 32;"	Clear the status reporting system, and then enable bit 5 of the event status register, and bit 5 of the status byte so that an SRQ will be generated on a syntax error.
20	ON INTR 7 GOTO Err	Tell the computer where to branch it gets the interrupt.
30	ENABLE INTR 7;2	Tell the 200/300 series to enable an interrupt from interface 7 (HP-IB) when bit 1 (value 2, the SRQ bit) of the interrupt register is set. If there is more than one instrument on the bus capable of generating an SRQ, it is necessary to use serial poll to determine which device has issued the SRQ. In this case, we assume the network analyzer did it. A branch to Err will disable the interrupt, so the return from Err re-enables it.
40	GOTO 40	Do nothing loop.
50	Err:!	
70	OUTPUT 716;"ESR?;"	The interrupt has come in! Read the register to clear the bit.
80	ENTER 716;Estat	
90	PRINT "SYNTAX ERROR DETECTED"	
100	ENABLE INTR 7	
110	GOTO 30	
120	END	

Running the program

Preset the instrument, and run the program. The computer will do nothing. With the program still running, execute:

```
OUTPUT 716; "STIP 1 GHZ; "
```

The computer will display **SYNTAX ERROR DETECTED**, and the network analyzer will display **CAUTION: SYNTAX ERROR**, and display the incorrect command, pointing at the first character it did not understand.

The SRQ can be cleared by reading the event status register and hence clearing the latched bit, or by clearing the enable registers with **CLES**. The syntax error message on the network analyzer display can only be cleared by **CLEAR 7** or **CLEAR 716**. **CLEAR 7** is not commonly used because it clears every device on the bus.

Note that an impossible data condition does not generate a syntax error. For example, execute:

```
CLEAR 716  
OUTPUT 716; "STAR 10 HZ; "
```

The network analyzer simply sets the start frequency to 300 kHz, without generating a syntax error.

For more information, call your local HP sales office listed in your telephone directory or an HP regional office listed below for the location of your nearest sales office.

United States:

Hewlett-Packard Company
4 Choke Cherry Road
Rockville, MD 20850
(301) 670-4300

Hewlett-Packard Company
5201 Tollview Drive
Rolling Meadows, IL 60008
(312) 255-9800

Hewlett-Packard Company
5161 Lankershim Blvd.
No. Hollywood, CA 91601
(818) 505-5600

Hewlett-Packard Company
2015 South Park Place
Atlanta, GA 30339
(404) 955-1500

Canada:

Hewlett-Packard Ltd.
6877 Goreway Drive
Mississauga, Ontario L4V1M8
(416) 678-9430

Australia/New Zealand:

Hewlett-Packard Australia Ltd.
31-41 Joseph Street,
Blackburn, Victoria 3130
Melbourne, Australia
(03) 895-2895

Europe/Africa/Middle East:

Hewlett-Packard S.A.
Central Mailing Department,
P.O. Box 529
1180 AM Amstelveen,
The Netherlands
(31) 20/547 9999

Far East:

Hewlett-Packard Asia Ltd.
22/F Bond Centre
West Tower
89 Queensway
Central, Hong Kong
(5) 8487777

Japan:

Yokogawa-Hewlett-Packard Ltd.
29-21, Takaido-Higashi 3-chome
Suginami-ku, Tokyo 168
(03) 331-6111

Latin America:

Latin American Region Headquarters
Monte Pelvoux Nbr. 111
Lomas de Chapultepec
11000 Mexico, D.F. Mexico
(905) 596-79-33