

System Verification and Performance Test Guide

HP 8753E Network Analyzer



**HP Part No. 08753-90394 Supersedes October 1998
Printed in USA February 1999**

Notice.

The information contained in this document is subject to change without notice.

Hewlett-Packard makes no warranty of any kind with regard to this material, including but not limited to, the implied warranties of merchantability and fitness for a particular purpose. Hewlett-Packard shall not be liable for errors contained herein or for incidental or consequential damages in connection with the furnishing, performance, or use of this material.

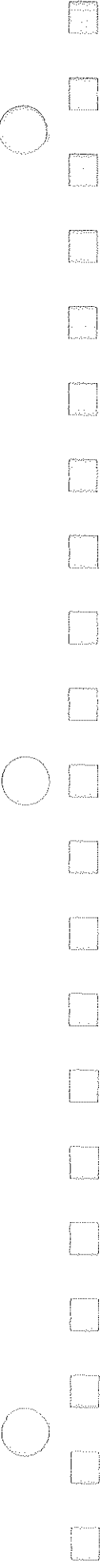

Certification

Hewlett-Packard Company certifies that this product met its published specifications at the time of shipment from the factory. Hewlett-Packard further certifies that its calibration measurements are traceable to the United States National Institute of Standards and Technology, to the extent allowed by the Institute's calibration facility, and to the calibration facilities of other International Standards Organization members.

Warranty

This Hewlett-Packard instrument product is warranted against defects in material and workmanship for a period of three years from date of shipment. During the warranty period, Hewlett-Packard Company will, at its option, either repair or replace products which prove to be defective.

For warranty service or repair, this product must be returned to a service facility designated by Hewlett-Packard. Buyer shall prepay shipping charges to Hewlett-Packard and Hewlett-Packard shall pay shipping charges to return the product to Buyer. However, Buyer shall pay all shipping charges, duties, and taxes for products returned to Hewlett-Packard from another country.

Hewlett-Packard warrants that its software and firmware designated by Hewlett-Packard for use with an instrument will execute its programming instructions when properly installed on that instrument. Hewlett-Packard does not warrant that the operation of the instrument, or software, or firmware will be uninterrupted or error-free.

LIMITATION OF WARRANTY

The foregoing warranty shall not apply to defects resulting from improper or inadequate maintenance by Buyer, Buyer-supplied software or interfacing, unauthorized modification or misuse, operation outside of the environmental specifications for the product, or improper site preparation or maintenance.

NO OTHER WARRANTY IS EXPRESSED OR IMPLIED. HEWLETT-PACKARD SPECIFICALLY DISCLAIMS THE IMPLIED WARRANTIES OF MERCHANTABILITY AND FITNESS FOR A PARTICULAR PURPOSE.

EXCLUSIVE REMEDIES

THE REMEDIES PROVIDED HEREIN ARE BUYER'S SOLE AND EXCLUSIVE REMEDIES. HEWLETT-PACKARD SHALL NOT BE LIABLE FOR ANY DIRECT, INDIRECT, SPECIAL, INCIDENTAL, OR CONSEQUENTIAL DAMAGES, WHETHER BASED ON CONTRACT, TORT, OR ANY OTHER LEGAL THEORY.

Assistance

Product maintenance agreements and other customer assistance agreements are available for Hewlett-Packard products. For any assistance, contact your nearest Hewlett-Packard Sales and Service Office.

Table 0-1. Hewlett-Packard Sales and Service Offices

UNITED STATES		
<p>Instrument Support Center Hewlett-Packard Company (800) 403-0801</p>		
EUROPEAN FIELD OPERATIONS		
<p>Headquarters Hewlett-Packard S.A. 150, Route du Nant-d'Avril 1217 Meyrin 2/Geneva Switzerland (41 22) 780.8111</p>	<p>France Hewlett-Packard France 1 Avenue Du Canada Zone D'Activite De Courtaboeuf F-91947 Les Ulis Cedex France (33 1) 69 82 60 60</p>	<p>Germany Hewlett-Packard GmbH Hewlett-Packard Strasse 61352 Bad Homburg v.d.H Germany (49 6172) 16-0</p>
<p>Great Britain Hewlett-Packard Ltd. Eskdale Road, Winnersh Triangle Wokingham, Berkshire RG41 5DZ England (44 734) 696622</p>		
INTERCON FIELD OPERATIONS		
<p>Headquarters Hewlett-Packard Company 3495 Deer Creek Road Palo Alto, California, USA 94304-1316 (415) 857-5027</p>	<p>Australia Hewlett-Packard Australia Ltd. 31-41 Joseph Street Blackburn, Victoria 3130 (61 3) 895-2895</p>	<p>Canada Hewlett-Packard (Canada) Ltd. 17500 South Service Road Trans-Canada Highway Kirkland, Quebec H9J 2X8 Canada (514) 697-4232</p>
<p>China China Hewlett-Packard Company 38 Bei San Huan X1 Road Shuang Yu Shu Hai Dian District Beijing, China (86 1) 256-6888</p>	<p>Japan Hewlett-Packard Japan, Ltd. 9-1 Takakura-Cho, Hachioji Tokyo 192, Japan (81 426) 80-2111</p>	<p>Singapore Hewlett-Packard Singapore (Pte.) Ltd. 150 Beach Road #29-00 Gateway West Singapore 0718 (65) 291-9088</p>
<p>Taiwan Hewlett-Packard Taiwan 8th Floor, H-P Building 337 Fu Hsing North Road Taipei, Taiwan (886 2) 712-0404</p>		

Safety Notes

The following safety notes are used throughout this manual. Familiarize yourself with each of the notes and its meaning before operating this instrument.

Caution Caution denotes a hazard. It calls attention to a procedure that, if not correctly performed or adhered to, would result in damage to or destruction of the instrument. Do not proceed beyond a caution sign until the indicated conditions are fully understood and met.

Caution Always use the three-prong ac power cord supplied with this instrument. Failure to ensure adequate earth grounding by not using this cord may cause instrument damage.

Warning Warning denotes a hazard. It calls attention to a procedure which, if not correctly performed or adhered to, could result in injury or loss of life. Do not proceed beyond a warning note until the indicated conditions are fully understood and met.

Warning No operator serviceable parts inside. Refer servicing to qualified personnel. To prevent electrical shock, do not remove covers.

Warning For continued protection against fire hazard replace line fuse only with same type and rating (F 3A/250V). The use of other fuses or material is prohibited.

Warning This is a Safety Class I product (provided with a protective earthing ground incorporated in the power cord). The mains plug shall only be inserted in a socket outlet provided with a protective earth contact. Any interruption of the protective conductor, inside or outside the instrument, is likely to make the instrument dangerous. Intentional interruption is prohibited.

Warning The power cord is connected to internal capacitors that may remain live for 10 seconds after disconnecting the plug from its power supply.

Warning The opening of covers or removal of parts is likely to expose dangerous voltages. Disconnect the instrument from all voltage sources while it is being opened.



The instruction documentation symbol. The product is marked with this symbol when it is necessary for the user to refer to the instructions in the documentation.

“CE” The CE mark is a registered trademark of the European Community. (If accompanied by a year, it is when the design was proven.)

“ISM1-A” This is a symbol of an Industrial Scientific and Medical Group 1 Class A product.

“CSA” The CSA mark is a registered trademark of the Canadian Standards Association.

HP 8753E Network Analyzer Documentation Set

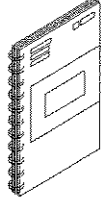

The **Installation and Quick Start Guide** familiarizes you with the HP 8753E network analyzer's front and rear panels, electrical and environmental operating requirements, as well as procedures for installing, configuring, and verifying the operation of the HP 8753E.

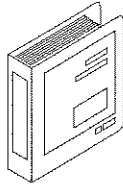

The **User's Guide** shows how to make measurements, explains commonly-used features, and tells you how to get the most performance from your analyzer.

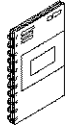

The **Quick Reference Guide** provides a summary of selected user features.



The **HP-IB Programming and Command Reference Guide** provides programming information for operation of the network analyzer under HP-IB control.

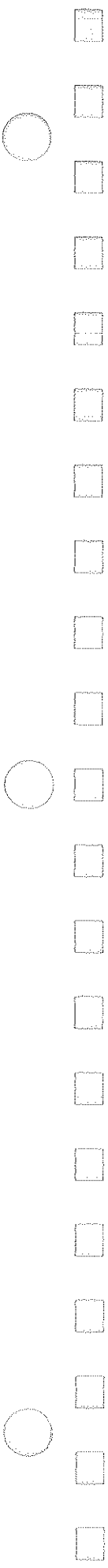

The **HP BASIC Programming Examples Guide** provides a tutorial introduction using BASIC programming examples to demonstrate the remote operation of the network analyzer.

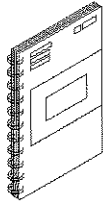

The **System Verification and Test Guide** provides the system verification and performance tests and the Performance Test Record for your analyzer.

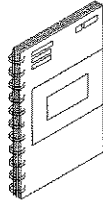

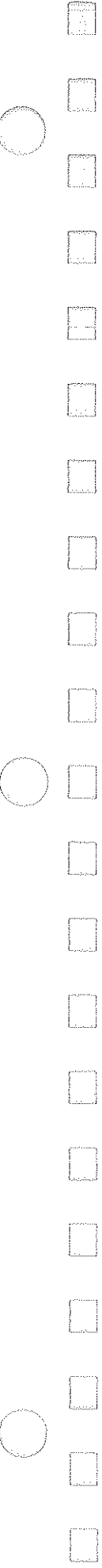

Contents

1. System Verification and Performance Tests

System Specifications	1
Instrument Specifications	1
System Verification Procedure	2
Performance Tests	2
How to Confirm Performance to System Specifications	2
How to Confirm Performance to Instrument Specifications	2
Certificate of Calibration	3
Sections in this Chapter	3
Performance Test Record	4
System Verification Cycle and Kit Re-certification	4
HP 8753E System Verification	5
Initialization	5
Measurement Calibration	7
Device Verification	9
In Case of Difficulty	11
1. Test Port Output Frequency Range and Accuracy	12
In Case of Difficulty	13
2. External Source Mode Frequency Range	14
In Case of Difficulty	15
3. Test Port Output Power Accuracy	16
In Case of Difficulty	18
4. Test Port Output Power Range and Linearity	19
In Case of Difficulty	21
5. Minimum R Channel Level	22
In Case of Difficulty	24
6. Test Port Input Noise Floor Level	27
Port 1 Noise Floor Level from 300 kHz to 3 GHz (IF BW = 3 kHz)	28
Port 1 Noise Floor Level from 300 kHz to 3 GHz (IF BW = 10 Hz)	29
Port 2 Noise Floor Level from 300 kHz to 3 GHz (IF BW = 10 Hz)	29
Port 2 Noise Floor Level from 300 kHz to 3 GHz (IF BW = 3 kHz)	29
Port 2 Noise Floor Level from 3 GHz to 6 GHz (IF BW = 3 kHz)	29
Port 2 Noise Floor Level from 3 GHz to 6 GHz (IF BW = 10 Hz)	30
Port 1 Noise Floor Level for 3 GHz to 6 GHz (IF BW = 10 Hz)	30
Port 1 Noise Floor Level from 3 GHz to 6 GHz (IF BW = 3 kHz)	30
In Case of Difficulty	30
7. Test Port Input Frequency Response	31
Power Meter Calibration for Test Port 1 from 300 kHz to 3 GHz	32
Test Port 2 Input Frequency Response from 300 kHz to 3 GHz	35
Power Meter Calibration on Port 2 from 300 kHz to 3 GHz	36
Test Port 1 Input Frequency Response from 300 kHz to 3 GHz	37
Power Meter Calibration for Test Port 2 from 3 GHz to 6 GHz	37
Test Port 1 Input Frequency Response from 3 GHz to 6 GHz	39
Power Meter Calibration on Test Port 1 from 3 GHz to 6 GHz	40
Test Port 2 Input Frequency Response from 3 GHz to 6 GHz	41
In Case of Difficulty	41

8. Test Port Crosstalk	42
Crosstalk to Test Port 2 from 300 kHz to 3 GHz	43
Crosstalk to Test Port 1 from 300 kHz to 3 GHz	43
Crosstalk to Test Port 1 from 3 GHz to 6 GHz	43
Crosstalk to Test Port 2 from 3 GHz to 6 GHz	44
In Case of Difficulty	44
9. Calibration Coefficients	46
First Full 2-Port Calibration	46
Directivity (Forward) Calibration Coefficient	48
Source Match (Forward) Calibration Coefficient	48
Transmission Tracking (Forward) Calibration Coefficient	48
Reflection Tracking (Forward) Calibration Coefficient	48
Load Match (Reverse) Calibration Coefficient	48
Transmission Tracking (Reverse) Calibration Coefficient	48
Second Full 2-Port Calibration	49
Load Match (Forward) Calibration Coefficient	50
Directivity (Reverse) Calibration Coefficient	50
Source Match (Reverse) Calibration Coefficient	50
Reflection Tracking (Reverse) Calibration Coefficient	50
10. System Trace Noise (Only for Analyzers without Option 006)	51
System Trace Noise for A/R Magnitude	52
System Trace Noise for A/R Phase	52
System Trace Noise for B/R Magnitude	52
System Trace Noise for B/R Phase	52
In Case of Difficulty	52
11. System Trace Noise (Only for Analyzers with Option 006)	53
System Trace Noise for A/R Magnitude from 30 kHz to 3 GHz	54
System Trace Noise for A/R Magnitude from 3 GHz to 6 GHz	54
System Trace Noise for A/R Phase from 3 GHz to 6 GHz	54
System Trace Noise for A/R Phase from 30 kHz to 3 GHz	54
System Trace Noise for B/R Magnitude from 30 kHz to 3 GHz	54
System Trace Noise for B/R Magnitude from 3 GHz to 6 GHz	55
System Trace Noise for B/R Phase from 3 GHz to 6 GHz	55
System Trace Noise for B/R Phase from 30 kHz to 3 GHz	55
In Case of Difficulty	55
12. Test Port Input Impedance	56
In Case of Difficulty	59
13. Test Port Receiver Magnitude Dynamic Accuracy	60
Initial Calculations	62
Port 1 Power Meter Calibration	63
Adapter Removal Calibration	65
Measure Test Port 2 Magnitude Dynamic Accuracy	67
Measure Test Port 1 Magnitude Dynamic Accuracy	69
In Case of Difficulty	69
14. Test Port Receiver Magnitude Compression	70
Test Port 2 Magnitude Compression	70
Test Port 1 Magnitude Compression	71
In Case of Difficulty	72
15. Test Port Receiver Phase Compression	73
Test Port 2 Phase Compression	73
Test Port 1 Phase Compression	74
In Case of Difficulty	74
16. Test Port Output/Input Harmonics (Option 002 Analyzers without Option 006 Only)	75
Test Port Output Worst Case 2nd Harmonic	75

Test Port Output Worst Case 3rd Harmonic	76
Port 1 Input Worst Case 2nd Harmonic	77
Port 1 Input Worst Case 3rd Harmonic	77
Port 2 Input Worst Case 2nd Harmonic	78
Port 2 Input Worst Case 3rd Harmonic	78
17. Test Port Output/Input Harmonics (Option 002 Analyzers with Option 006 Only)	79
Test Port Output Worst Case 2nd Harmonic	80
Test Port Output Worst Case 3rd Harmonic	81
Port 1 Input Worst Case 2nd Harmonic	82
Port 1 Input Worst Case 3rd Harmonic	83
Port 2 Input Worst Case 2nd Harmonic	83
Port 2 Input Worst Case 3rd Harmonic	83
18. Test Port Output Harmonics (Analyzers without Option 002)	84
Procedure	85
2. Performance Test Record	
For Analyzers with a Frequency Range of 30 kHz to 3 GHz	1
3. Performance Test Record	
For Analyzers with a Frequency Range of 30 kHz to 6 GHz	1
Index	

Figures

1-1. System Verification Test Setup	6
1-2. Connections for Measurement Calibration Standards	7
1-3. Transmission Calibration Setup	8
1-4. Connections for the 20 dB Verification Device	9
1-5. Connections for the 50 dB Verification Device	9
1-6. Mismatch Device Verification Setup	10
1-7. Mismatch Device Verification Setup	10
1-8. Test Port Output Frequency Range and Accuracy Test Setup	13
1-9. External Source Mode Frequency Range Test Setup	14
1-10. Source Output Power Accuracy Test Setup	17
1-11. Test Port Output Power Range and Accuracy Test Setup	20
1-12. Minimum R Channel Level Test Setup	22
1-13. Flexible RF Cable Location	24
1-14. Connections for Substituting the R Sampler (A4)	25
1-15. Setup for Checking the R Sampler (A4)	25
1-16. Source Input Noise Floor Test Setup	28
1-17. Setup for Power Meter Calibration on Test Port 1	32
1-18. Test Port 2 Input Frequency Response Test Setup	35
1-19. Setup for Power Meter Calibration on Test Port 2	36
1-20. Test Port 1 Input Frequency Response Test Setup	37
1-21. Setup for Power Meter Calibration on Test Port 2	38
1-22. Setup for Test Port 1 Input Frequency Response	39
1-23. Setup for Power Meter Calibration on Test Port 1	40
1-24. Test Port 2 Input Frequency Response Test Setup	41
1-25. Test Port Crosstalk Test Setup	42
1-26. HP 8753E Bottom View	45
1-27. First Full 2-Port Calibration Test Setup	46
1-28. Transmission Calibration Test Setup	47
1-29. Second Full 2-Port Calibration Test Setup	49
1-30. Transmission Calibration Test Setup	50
1-31. System Trace Noise Test Setup	51
1-32. System Trace Noise Test Setup	53
1-33. S11 1-Port Cal Test Setup	57
1-34. Test Port 2 Input Impedance Test Setup	58
1-35. S22 1-Port Cal Test Setup	58
1-36. Test Port 1 Input Impedance Test Setup	59
1-37. Power Meter Calibration for Magnitude Dynamic Accuracy	63
1-38. Full 2-Port Calibration with Adapter Removal	65
1-39. Magnitude Dynamic Accuracy Measurement	67
1-40. Test Port Magnitude Compression Test Setup	70
1-41. Test Port Phase Compression Test Setup	73
1-42. Test Port Output Harmonics Test Setup	76
1-43. Receiver Harmonics Test Setup	77
1-44. Test Port Output Harmonics Test Setup	80
1-45. Receiver Harmonics Test Setup	82
1-46. Test Port Output Harmonics Test Setup	85

Tables

0-1. Hewlett-Packard Sales and Service Offices	iv
1-1. Magnitude Dynamic Accuracy Calculations	62



System Verification and Performance Tests

The performance of the HP 8753E network analyzer is specified in two ways:

- **System Specifications:**
Specifies warranted performance of the *measurement system* when making error-corrected S-parameter measurements. The measurement system includes the analyzer, test cables, and calibration kit. The System Verification Procedure is used to confirm performance of the measurement system to the System Specifications.
- **Instrument Specifications:**
Specifies the network analyzer's output and input behavior and its uncorrected measurement port characteristics. Performance tests are used to confirm performance of the analyzer to the Instrument Specifications.

System Specifications

System Specifications, also called Measurement Port Specifications, are described in Chapter 7 of the *HP 8753E User's Guides*. They specify warranted performance of the entire *measurement system* when making error-corrected S-parameter measurements. The measurement system includes the analyzer, test cables, and calibration kit. System Specifications are expressed in two ways:

- graphs of measurement uncertainty versus reflection and transmission coefficients
- residual errors of the measurement system—the *corrected* Measurement Port Characteristics

System Specifications, confirmed by the System Verification Procedure, are applicable when the measurement system is used to make error-corrected S-parameter measurements.

Instrument Specifications

Instrument specifications comprise the following sections and tables in Chapter 7, "Specifications and Measurement Uncertainties," of the *HP 8753E User's Guide*:

- all specifications in the section "Instrument Specifications"
- Table 7-3 "Measurement Port Characteristics (uncorrected) for HP 8753E (50 Ω) with 7-mm Test Ports"
- Table 7-7 "Measurement Port Characteristics (uncorrected) for HP 8753E (75 Ω) with 7-mm Test Ports"

These specifications apply when the analyzer is used to make measurements *other than* error-corrected S-parameter measurements. An example would be the measurement of amplifier gain compression. In such cases, the analyzer's output and input behavior—such as source power, receiver accuracy, and receiver linearity—are important and are covered by Instrument Specifications.

System Verification Procedure

The System Verification Procedure tests the network analyzer measurement system, as defined above, against the System Specifications. If confirmation is successful, the measurement system is capable of making S-parameter measurements to the accuracy specified by the graphs of measurement uncertainty. An outline of the System Verification Procedure follows:

- The measurement system is calibrated with the calibration kit to be used for future measurements. The measurement system's systematic errors are determined by this procedure.
- The S-parameters of verification-kit test-devices are measured with error correction applied.
- These measurements are compared to measurement data stored on a unique, serial-numbered data disk included with the verification kit.
- The measurement system passes the System Verification Procedure if the measurements of the test devices differ from the measurement data on the data disk by less than specified test limits. The test limits account for the specified accuracy of the measurement system and the measurement uncertainties attributed to the stored data for the test devices.

Note Calibration kits are different from verification kits. *Calibration* kits are used to determine the systematic errors of a network analyzer measurement system. *Verification* kits are used to confirm system specifications and are not used to generate error-correction. For example, the HP 85031B is a 7-mm calibration kit, but the HP 85029B is a 7-mm verification kit.

Performance Tests

Performance tests are used to confirm analyzer performance against the Instrument Specifications. If confirmation is successful, the analyzer meets the Instrument Specifications as defined above. If the calibration kit to be used for measurements is also certified, successful completion of the Performance Tests also ensures that the network analyzer measurement system meets the System Specifications.

How to Confirm Performance to System Specifications

- Complete the System Verification Procedure in this chapter using a certified verification kit,
or
- Complete all of the performance tests and certify (or re-certify) the calibration kit to be used for future measurements. This alternative verifies both the System Specifications and the Instrument Specifications for the analyzer.

How to Confirm Performance to Instrument Specifications

- Complete the Performance Tests.

Certificate of Calibration

Hewlett-Packard will issue a Certificate of Calibration for the product upon successful completion of System Verification or completion of the Performance Tests. The Certificate of Calibration will include a *System Attachment* if the System Verification Procedure is used to confirm the System Specifications. If the Performance Tests are used to confirm Instrument Specifications, the Certificate of Calibration will not include a System Attachment. The equipment and measurement standards used for the tests must be certified and must be traceable to recognized standards.

Note If you have a measurement application that does not use all of the measurement capabilities of the analyzer, you may ask your local Hewlett-Packard Customer Service Center to verify only a subset of the specifications. However, this creates the possibility of making inaccurate measurements if you then use the analyzer in an application requiring additional capabilities.

Sections in this Chapter

■ System Verification

■ Performance Tests

1. Test Port Output Frequency Range and Accuracy
2. External Source Mode Frequency Range
3. Test Port Output Power Accuracy
4. Test Port Output Power Range and Linearity
5. Minimum R Channel Level
6. Test Port Input Noise Floor Level
7. Test Port Input Frequency Response
8. Test Port Crosstalk
9. Calibration Coefficients
10. System Trace Noise (Only for Analyzers *without* Option 006)
11. System Trace Noise (Only for Analyzers *with* Option 006)
12. Test Port Input Impedance
13. Test Port Receiver Magnitude Dynamic Accuracy
14. Test Port Receiver Magnitude Compression
15. Test Port Receiver Phase Compression
16. Test Port Output/Input Harmonics (Option 002 Analyzers *without* Option 006 only)
17. Test Port Output/Input Harmonics (Option 002 Analyzers *with* Option 006 only)

Performance Test Record

Find and use the appropriate "Performance Test Record" in the following subchapters:

- Performance Test Record for 30 kHz to 3 GHz
- Performance Test Record for 30 kHz to 6 GHz

System Verification Cycle and Kit Re-certification

Hewlett-Packard recommends that you verify your network analyzer measurement system every six months. Hewlett-Packard also suggests that you get your verification kit re-certified annually. Refer to *HP 85029B 7-mm Verification Kit Operating and Service Manual* for more information.

Note The system verification procedures can also apply to analyzers with Option 075 (75 ohm analyzers) if minimum loss pads and type-N (m) to APC-7 adapters are used.

Check to see how the verification kit floppy disk is labeled:

- If your verification disk is labeled HP 8753D Verification Data Disk, or HP 8753D & HP 8753E Verification Data Disk, you may proceed with the system verification.
- If your verification disk is not labeled as indicated above, you may send your HP 85029B 7-mm verification kit to the nearest service center for recertification, which includes a data disk that you can use with the HP 8753E.

HP 8753E System Verification

Equipment Required

Calibration Kit, 7-mm	HP 85031B
Verification Kit, 7-mm	HP 85029B
Test Port Extension Cable Set, 7-mm	HP 11857D
Printer	HP ThinkJet/DeskJet/LaserJet

Additional Equipment Required for Option 075 Analyzers

Minimum Loss Pad (2), 50 Ω to 75 Ω	HP 11852B
Adapter (2), APC-7 to Type-N (m)	HP 11525A

Analyzer warmup time: 1 hour

This system verification consists of three separate procedures:

1. Initialization
2. Measurement Calibration
3. Device Verification

Initialization

1. Clear all internal memory.

Caution This will erase all instrument states that may be stored in internal memory.

Perform the following steps to save any instrument states that are stored in internal memory to a floppy disk.

- a. Press **SAVE/RECALL** **SELECT DISK** **INTERNAL MEMORY** **RETURN**.
- b. Select an instrument state and press **RECALL STATE**.
- c. Press **SELECT DISK** **INTERNAL DISK** **RETURN** **SAVE STATE**.
- d. If the instrument state file was not saved to disk with the same name that it had while in internal memory, you may wish to rename the file.

Press **FILE UTILITIES** **RENAME FILE**, enter the desired name, and press **DONE**.
- e. Repeat steps a through d for each instrument state that you wish to save.

To clear all internal memory, press **SYSTEM** **SERVICE MENU** **PEEK/POKE** **RESET MEMORY** **PRESET**.

2. Connect the equipment as shown in Figure 1-1. Let the analyzer warm up for one hour.

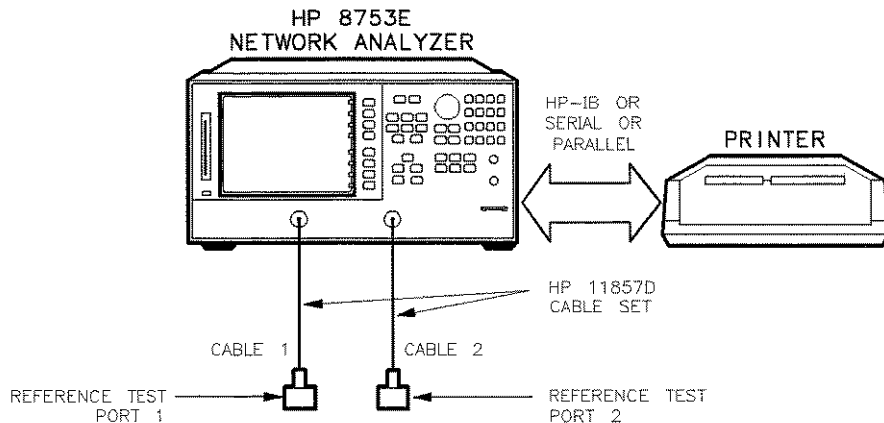

Figure 1-1. System Verification Test Setup

3. While the equipment is warming up, review the "Connector Care Quick Reference" information in the "Service Equipment and Analyzer Options" chapter. Good connections and clean, undamaged connectors are critical for accurate measurement results.
4. Insert the verification kit disk into the analyzer disk drive.
5. Press **Presets** **Save/Recall** **SELECT DISK** **INTERNAL DISK**.
6. If you want a printout of the verification data for all the devices, press **System** **SERVICE MENU** **TEST OPTIONS** **RECORD ON**.

Note If you switch on the record function, you *CANNOT* switch it off during the verification procedure.

7. Position the paper in the printer so that printing starts at the top of the page.
8. If you have difficulty with the printer:
 - If the interface on your printer is HP-IB, verify that the printer address is set to 1 (or change the setting in the analyzer to match the printer).
 - If the interface on your printer is serial or parallel, be sure that you selected the printer port and the printer type correctly (refer to the *HP 8753E Network Analyzer User's Guide* for more information on how to perform these tasks).
9. Press **System** **SERVICE MENU** **TESTS** **SYS VER TESTS** **EXECUTE TEST**.
10. The analyzer displays Sys Ver Init DONE, the initialization procedure is complete.

Caution *DO NOT* press **Presets** or recall another instrument state. You must use the instrument state that you loaded during the initialization procedure.

Measurement Calibration

11. Press **Cal** **CAL KIT** **SELECT CAL KIT** **CAL KIT:7mm** **RETURN** **RETURN** **CALIBRATE MENU** **FULL 2-PORT**.
12. Press **ISOLATION** **OMIT ISOLATION**.
13. Press **REFLECTION**.
14. Connect the "open" end of the open/short combination (supplied in the calibration kit) to reference test port 1, as shown in Figure 1-2.

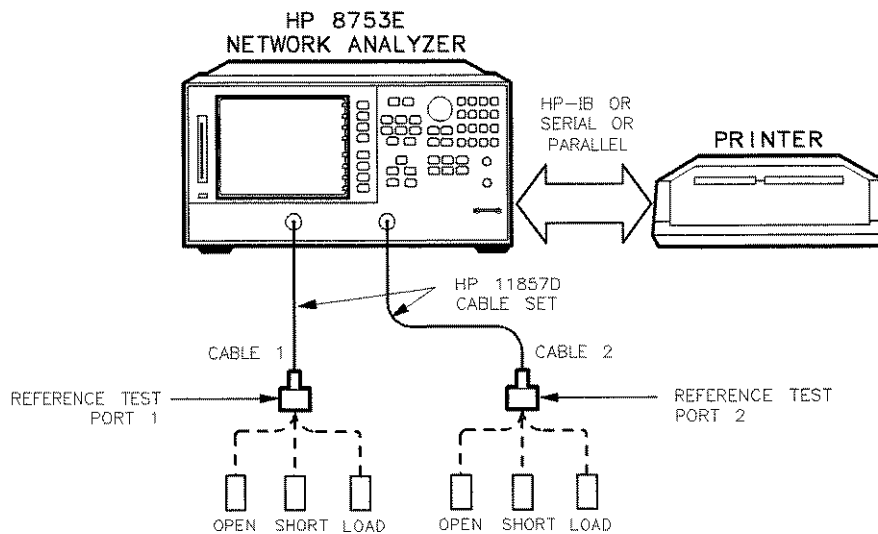

sg62e

Figure 1-2. Connections for Measurement Calibration Standards

15. Press **FORWARD:OPEN**.
16. When the analyzer finishes measuring the standard, connect the "short" end of the open/short combination to reference test port 1.
17. Press **FORWARD:SHORT**.
18. When the analyzer finishes measuring the standard, connect the 50 ohm termination (supplied in the calibration kit) to reference test port 1.
19. Press **FORWARD:LOAD**.
20. When the analyzer finishes measuring the standard, connect the "open" end of the open/short combination to reference test port 2.
21. Press **REVERSE:OPEN**.
22. When the analyzer finishes measuring the standard, connect the "short" end of the open/short combination to reference test port 2.
23. Press **REVERSE:SHORT**.
24. When the analyzer finishes measuring the standard, connect the 50 ohm termination to reference test port 2.

25. Press **REVERSE:LOAD**.
26. When the analyzer finishes measuring the standard, press **STANDARDS DONE**.
The analyzer briefly displays **COMPUTING CAL COEFFICIENTS**.
27. Connect the test port cables as shown Figure 1-3.

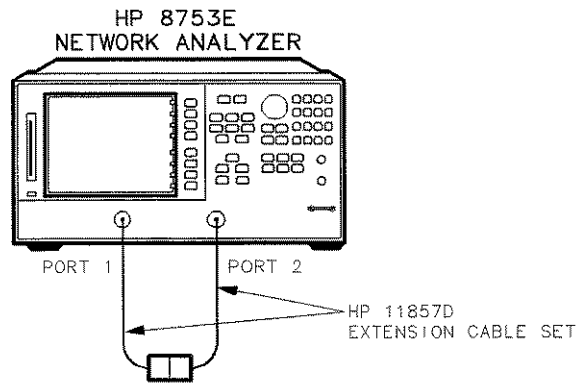

sg63e

Figure 1-3. Transmission Calibration Setup

28. Press **TRANSMISSION DO BOTH FWD + REV**.
29. Press **DONE 2-PORT CAL**.
30. Press **Save/Recall SELECT DISK INTERNAL MEMORY RETURN SAVE STATE** to save the calibration into the analyzer internal memory.
31. When the analyzer finishes saving the instrument state, press **SELECT DISK INTERNAL DISK**.

Device Verification

32. Press **(System) SERVICE MENU TESTS 28 x1 EXECUTE TEST**.
33. At the prompt, connect the 20 dB attenuator (supplied in the verification kit) as shown in Figure 1-4.
34. Press **CONTINUE** to run the test:
 - If you switched OFF the record function, you have to press **CONTINUE** after each S-parameter measurement.
 - If you switched ON the record function, the analyzer measures all S-parameters (magnitude and phase) without pausing. Also, the analyzer only displays and prints the PASS/FAIL information for the S-parameter measurements that are valid for system verification.

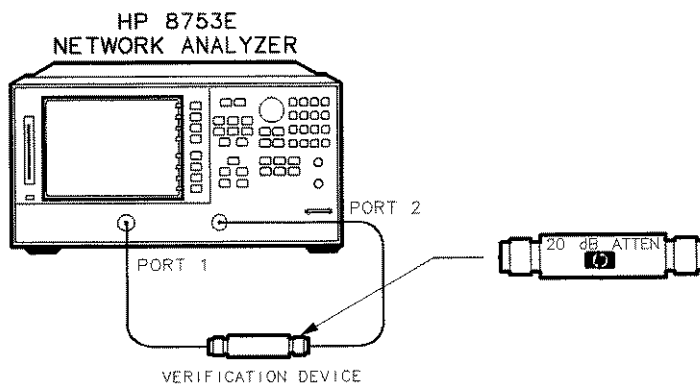

sg64e

Figure 1-4. Connections for the 20 dB Verification Device

35. When the analyzer finishes all the measurements, connect the 50 dB attenuator (supplied in the verification kit), as shown in Figure 1-5.

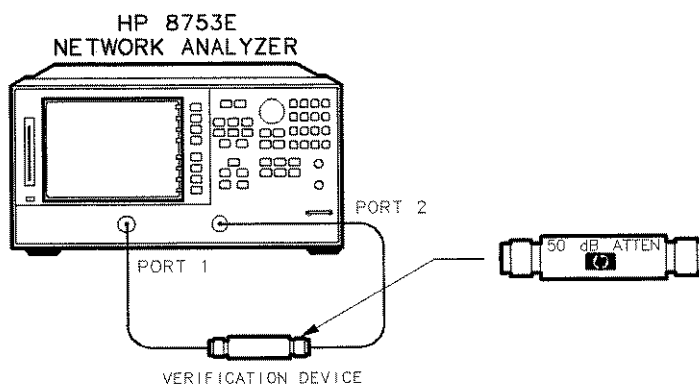

sg65e

Figure 1-5. Connections for the 50 dB Verification Device

36. Press **(↑) 29 x1 EXECUTE TEST CONTINUE**.

37. When all measurements are complete, replace the verification device with the verification mismatch, as shown in Figure 1-6. Be sure that you connect Port A of the verification mismatch to reference test port 1.

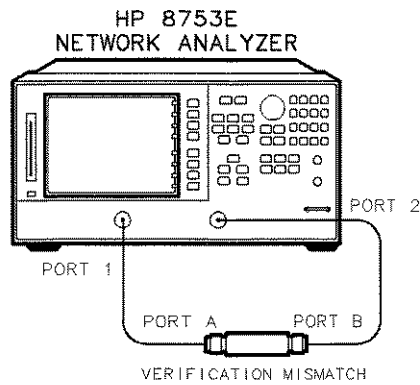

sg66e

Figure 1-6. Mismatch Device Verification Setup

38. Press **RETURN TESTS** **30** **x1** **EXECUTE TEST** **CONTINUE**.
39. When the analyzer finishes all the measurements, connect the mismatch verification device, as shown in Figure 1-7. Notice that Port B is now connected to reference test port 1.

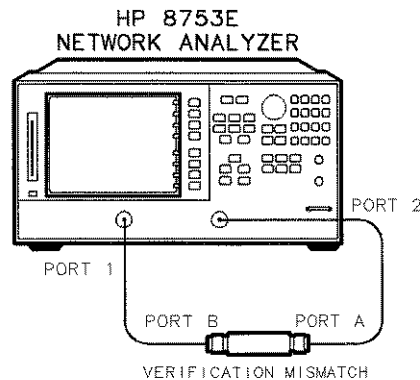

sg67e

Figure 1-7. Mismatch Device Verification Setup

40. Press **RETURN TESTS** **31** **x1** **EXECUTE TEST** **CONTINUE**.
41. You have completed the system verification procedure when the analyzer displays Ver Def 4 DONE.

In Case of Difficulty

1. Inspect all connections. *DO NOT* disconnect the cables from the analyzer test ports. Doing so *WILL INVALIDATE* the calibration that you have done earlier.
2. Press **Preset** **Save/Recall** **SELECT DISK** **INTERNAL MEMORY** **RETURN**. Using the front panel knob, highlight the title of the full 2-Port calibration that you have done earlier, then press **RECALL STATE**.
3. Repeat the "Device Verification" procedure.
4. If the analyzer still fails the test, check the measurement calibration as follows:
 - a. Press **Preset**.
 - b. Recall the calibration by pressing **Save/Recall** **SELECT DISK** **INTERNAL MEMORY** **RETURN**.
 - c. Use the front panel knob to highlight the calibration you want to recall and press **RECALL STATE**.
 - d. Connect the short to reference test port 1.
 - e. Press **Meas** **Ref1: FWD S11 (A/R)** **Menu** **TRIGGER MENU** **CONTINUOUS**.
 - f. Press **Scale Ref** **SCALE/DIV** **.05** **x1**.
 - g. Check that the trace response is 0.00 ± 0.05 dB.
 - h. Disconnect the short and connect it to reference test port 2.
 - i. Press **Meas** **Ref1: REV S22(B/R)**.
 - j. Check that the trace response is 0.00 ± 0.05 dB.
 - k. If any of the trace responses are out of the specified limits, repeat the "Measurement Calibration" and "Device Verification" procedures.
5. Refer to the "Start Troubleshooting Here" chapter of the *HP 8753E Service Guide* for more troubleshooting information.

1. Test Port Output Frequency Range and Accuracy

Specifications

Frequency Range	Frequency Accuracy ¹
30 kHz to 3 GHz	±10 ppm
3 GHz to 6 GHz ²	±10 ppm

1 At 25° C ±5° C.

2 Only for analyzers with Option 006 – 30 kHz to 6 GHz range.

Required Equipment

- Frequency Counter (30 kHz to 500 Mhz) HP 5350B/51B/52B
- Frequency Counter (500 MHz to 6 GHz) HP 5350B/51B/52B
- Cable, 50Ω Type-N, 24-inch HP P/N 8120-4781
- Adapter, APC-3.5 (f) to Type-N (f) HP P/N 1250-1745
- Adapter, APC-7 to Type-N (f) HP P/N 11524A
- Adapter, Type-N (f) to BNC (m) HP P/N 1250-1477

Additional equipment needed for an HP 8753E with Option 075

- Minimum Loss Pad, 50Ω to 75Ω HP 11852B

Analyzer warmup time: 30 minutes

Perform this test to verify the frequency accuracy of the HP 8753E over its entire operating frequency range.

1. Connect the equipment as shown in Figure 1-8.

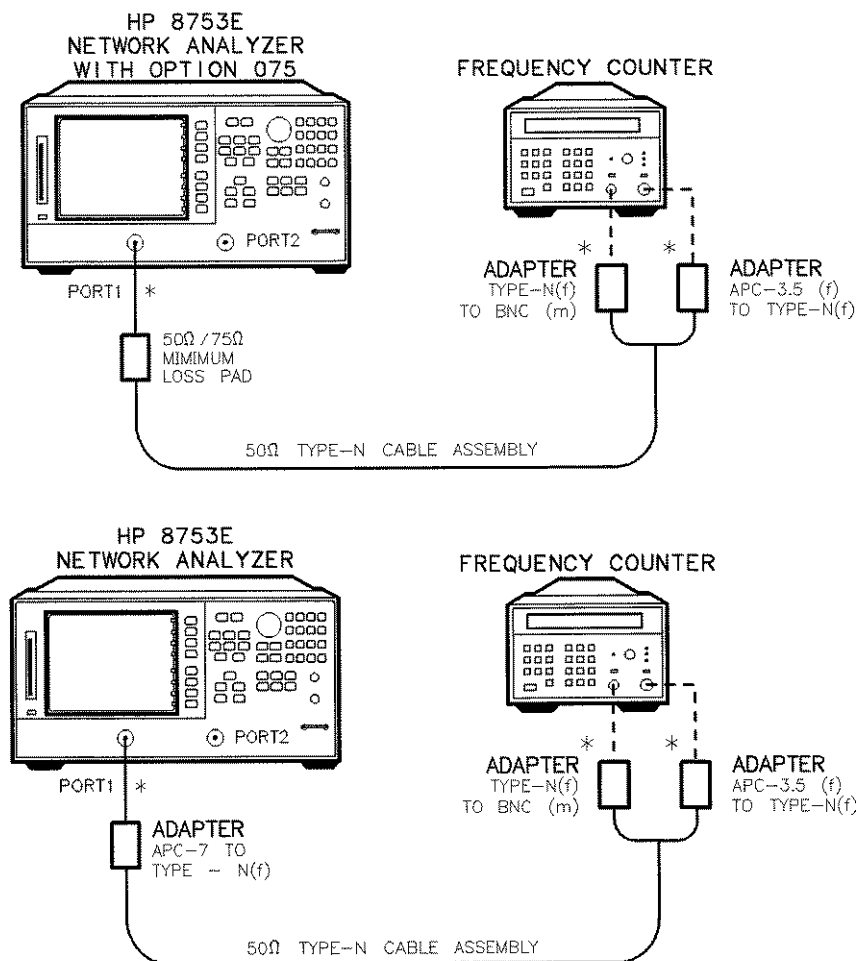

* DIRECT CONNECTION

sg68e

Figure 1-8. Test Port Output Frequency Range and Accuracy Test Setup

2. Press **Preset** **Menu** **CW FREQ**.
3. Press **30** **(k/m)** and write the frequency counter reading on the "Performance Test Record."
4. Repeat step 3 for each instrument frequency listed in the "Performance Test Record."

In Case of Difficulty

1. If any measured frequency is close to the specification limits, check the time base accuracy of the counter used.
2. If the analyzer fails by a significant margin at *all* frequencies (especially if the deviation increases with frequency), the master time base probably needs adjustment. In this case, refer to the "Frequency Accuracy Adjustment" procedure, located in the "Adjustments and Correction Constants" chapter of the *HP 8753E Service Guide*. The "Fractional-N Frequency Range Adjustment" also affects frequency accuracy.
3. Refer to the "Source Troubleshooting" chapter of the *HP 8753E Service Guide* for related troubleshooting information.

2. External Source Mode Frequency Range

Specifications

Frequency Range
300 kHz to 3 GHz
300 kHz to 6 GHz ¹

300 kHz to 3 GHz

300 kHz to 6 GHz¹

¹ Only for analyzers with
Option 006 – 30 kHz to
6 GHz range.

Equipment Required

External Source	HP 83620A
Cable, APC-7, 24-inch	HP P/N 8120-4779
Adapter, APC-3.5 (f) to APC-7	HP P/N 1250-1747
Adapter, APC-3.5 (m) to APC-7	HP P/N 1250-1746

Analyzer warmup time: 30 minutes

Perform this test to verify that the analyzer's reference channel, input R, is capable of phase locking to an external CW signal.

1. On the external source, press **Preset** **CW** **10** **MHz/μsec** **POWER LEVEL** **-/←** **20** **GHz/dB(m)**.
2. Connect the equipment as shown in Figure 1-9.

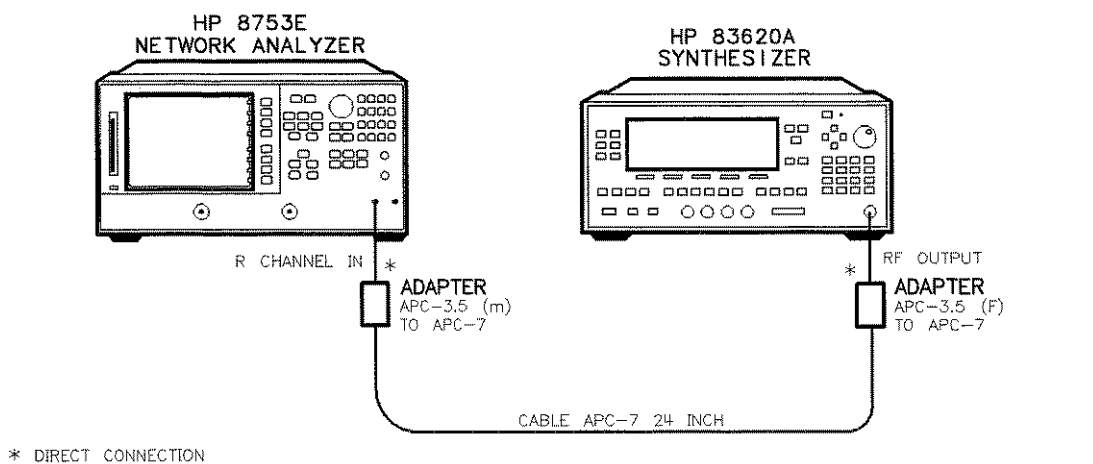

Figure 1-9. External Source Mode Frequency Range Test Setup

3. On the network analyzer, press **Preset** **Meas** **INPUT PORTS** **R**.
4. Press **System** **INSTRUMENT MODE** **EXT SOURCE AUTO** **Menu** **CW FREQ** **10** **M/μ**.
5. Check to see if the analyzer is phase locking to the external CW signal:
 - If the analyzer displays any phase lock error messages, write "unlock" in the "Performance Test Record" for the set CW signal.

- If the analyzer does not display any phase lock error messages, write “lock” in the “Performance Test Record” for the set CW signal.
6. On the external source, press **CW** **20** **MHz/μ**.
 7. On the analyzer, press **20** **M/μ**.
 8. Repeat step 5 through 7 for the other external source CW frequencies listed in the “Performance Test Record.”

In Case of Difficulty

1. Be sure the external source power is set within 0 to -25 dBm.
2. Make sure the analyzer’s “Ext Source Auto” feature is selected. In addition, verify that the analyzer is set to measure its input channel R.
3. Verify that all connections are tight.

3. Test Port Output Power Accuracy

Specifications

Frequency Range	Test Port Output Power Accuracy ¹
300 kHz to 3 GHz	±1.0 dB
3 GHz to 6 GHz ²	±1.0 dB

1 At 0 dBm and 25° C ±5° C

2 Only for analyzers with Option 006 – 30 kHz to 6 GHz range.

Equipment Required for 50Ω Analyzers

Power MeterHP 436A/437B/438A
Power SensorHP 8482A
Adapter, APC-7 to Type-N (f)HP 11524A

Additional Equipment Required for Analyzers with Option 006

Power SensorHP 8481A

Equipment Required for 75Ω Analyzers

Power MeterHP 436A/437B/438A
Power SensorHP 8483A Option H03

Analyzer warmup time: 30 minutes

Perform this test to confirm the accuracy of the HP 8753E source output power.

1. Zero and calibrate the power meter. For more information of how to perform this task, refer to the power meter operating manual.
2. Connect the equipment as shown in Figure 1-10.

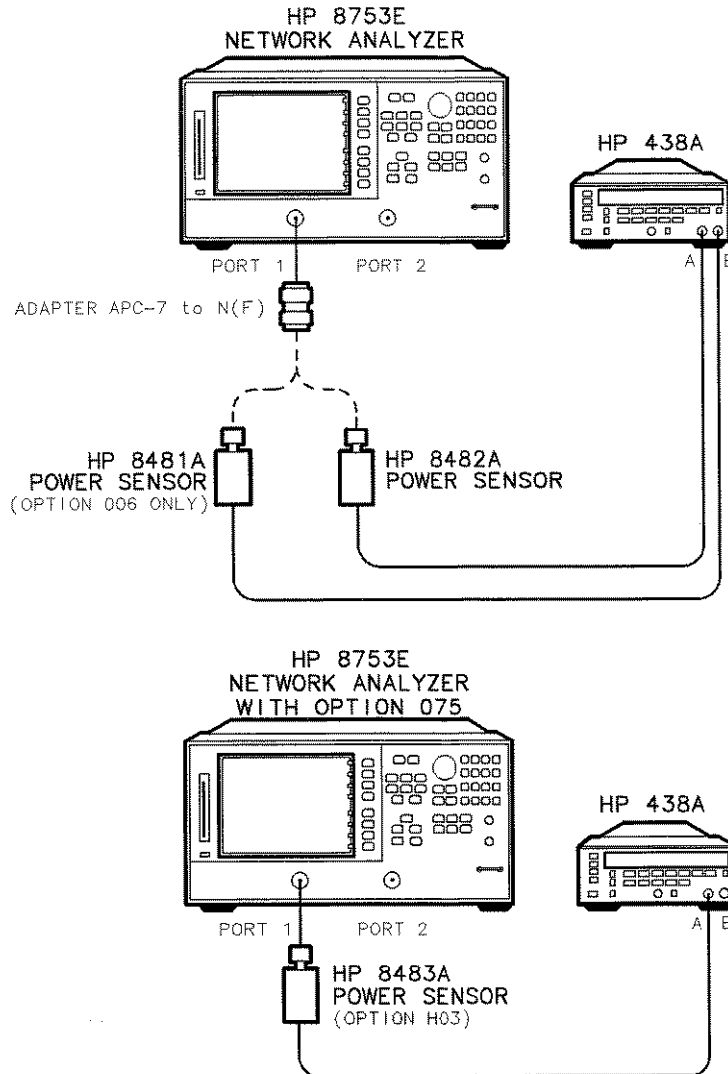

sg610e

Figure 1-10. Source Output Power Accuracy Test Setup

3. Press **Preset**.

Note The factory preset test port power is 0 dBm.

4. Press **Menu** **CW FREQ** **300** **(k/m)**. Set the calibration factor on the power meter for this CW frequency.
5. Write the power meter reading on the "Performance Test Record."
6. Repeat steps 4 and 5 for each CW frequency listed in the "Performance Test Record." For analyzers with Option 006, use the HP 8481A power sensor for all frequencies above 3 GHz.

In Case of Difficulty

1. Be sure the source power is switched on. Press **Menu** **POWER**. Check the **SOURCE PWR** softkey; "on" *should* be highlighted. Otherwise, press **SOURCE PWR** to switch on the source power.
2. Refer to the "Source Troubleshooting" chapter of the *HP 8753E Service Guide* for more troubleshooting information.

4. Test Port Output Power Range and Linearity

Specifications

Power Range	Power Level Linearity ¹
-15 to +5 dBm	±0.2 dB
+5 to +10 dBm ²	±0.5 dB
+5 to +8 dBm ³	±0.5 dB

1 Relative to 0 dBm output level.

2 Applies to instruments not using Option 075.

3 For Option 075 only.

Required Equipment

Power Meter HP 437B/438A
Power Sensor HP 8482A
Adapter, APC-7 to Type-N (f) HP 11524A

Additional Required Equipment for Analyzers with Option 006

Power Sensor HP 8481A

Additional Required Equipment for Analyzers with Option 075

Power Sensor HP 8483A Option H03

Analyzer warmup time: 1 hour

Perform this test to verify the analyzer's test port output power range and power level linearity at selected CW frequencies.

1. Zero and calibrate the power meter. Refer to the power meter operating and service manual for more information on how to do this task.
2. On the network analyzer, press **[Preset]** **[Menu]** **CW FREQ** **[300]** **[k/m]**. Set the power meter calibration factor for this CW frequency.
3. Connect the equipment as shown in Figure 1-11.

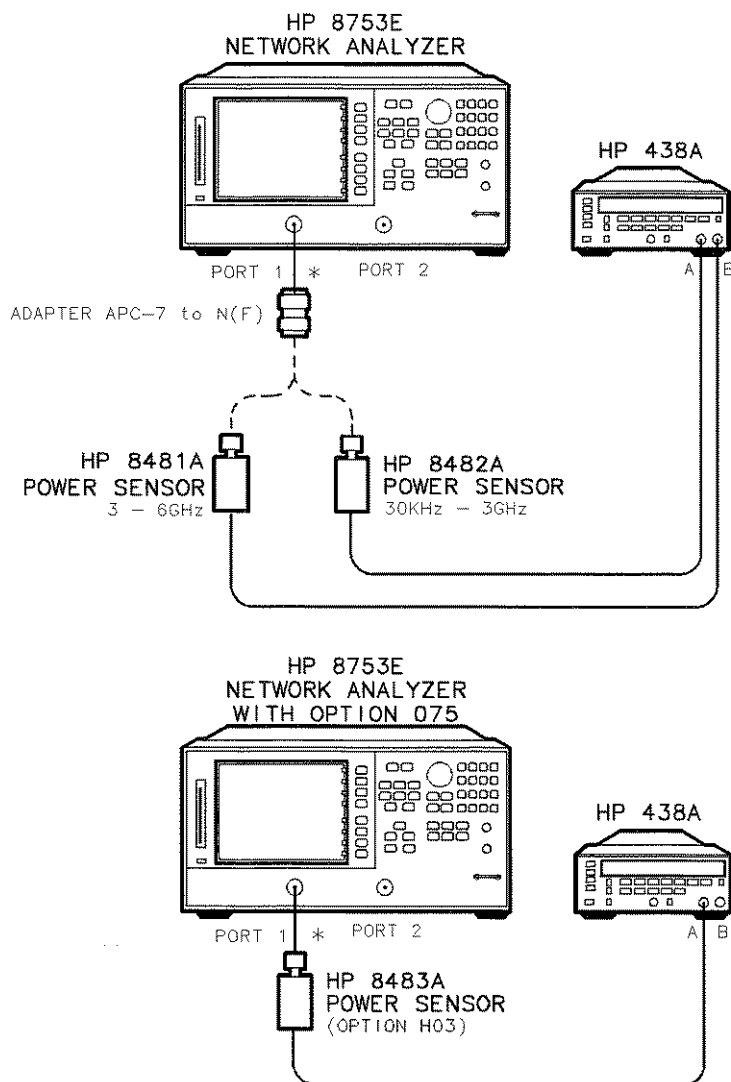

sg611e

Figure 1-11. Test Port Output Power Range and Accuracy Test Setup

4. On the HP 438A, press **[REL]**. This sets the current power level for relative power measurement.
5. On the network analyzer, press **[Menu]** **POWER PWR RANGE MAN** **[-15]** **[x1]**.
6. Write the power meter reading in the "Results Measured" column on the "Performance Test Record."
7. Calculate the difference between the analyzer test port power (which appears on the analyzer's display) and the power meter reading. Write the result in the "Power Level Linearity" column on the "Performance Test Record."

8. Repeat steps 5 through 7 for the other power levels listed in the "Performance Test Record."
9. After all required power levels have been measured, press **0** **x1** to reset power to 0 dBm.
10. Press **Menu** **CW FREQ** **3** **G/n**.
11. Set the power meter calibration factor for this CW frequency and press **REL** to set the reference at this new frequency.
12. Press **Menu** **POWER** **-15** **x1**.
13. Write the power meter reading in the "Results Measured" column on the "Performance Test Record."
14. Calculate the difference between the analyzer test port power and the power meter reading. Write the result in the "Power Level Linearity" column of the "Performance Test Record."
15. Repeat steps 11 through 13 for the other power levels listed in the "Performance Test Record."
16. Repeat steps 9 through 13 for 6 GHz using 8481A sensor.

In Case of Difficulty

1. Ensure that the power meter and power sensor(s) are operating to specifications. Be sure you set the power meter calibration factor for the CW frequency that you are testing.
2. Verify that there is power coming out of the analyzer's test port 1. Be sure you did not accidentally switch off the analyzer's internal source. If you did so, press **Menu** **POWER** **SOURCE PWR ON**.
3. Repeat this performance test.

5. Minimum R Channel Level

Specifications

Frequency Range	Minimum R Channel Level
300 kHz to 3 GHz	< -35 dBm
3 GHz to 6 GHz ¹	< -30 dBm

¹ Only for analyzers with Option 006 – 30 kHz to 6 GHz range.

Required Equipment for 50Ω Analyzers

Adapter, APC-3.5 (m) to APC-7 HP P/N 1250-1746
 Cable, APC-7 24-inch HP P/N 8120-4779

Required Equipment for 75Ω Analyzers (Option 075)

Minimum Loss Pad, 50Ω to 75Ω HP 11852B
 Cable, 50Ω Type-N, 24-inch HP P/N 8120-4781
 Adapter, APC-3.5 (m) to Type-N (f) HP P/N 1250-1750

Analyzer warmup time: 1 hour

Perform this test to determine the minimum R channel input power level at which phase lock can be accomplished.

1. Connect the equipment as shown in Figure 1-12.

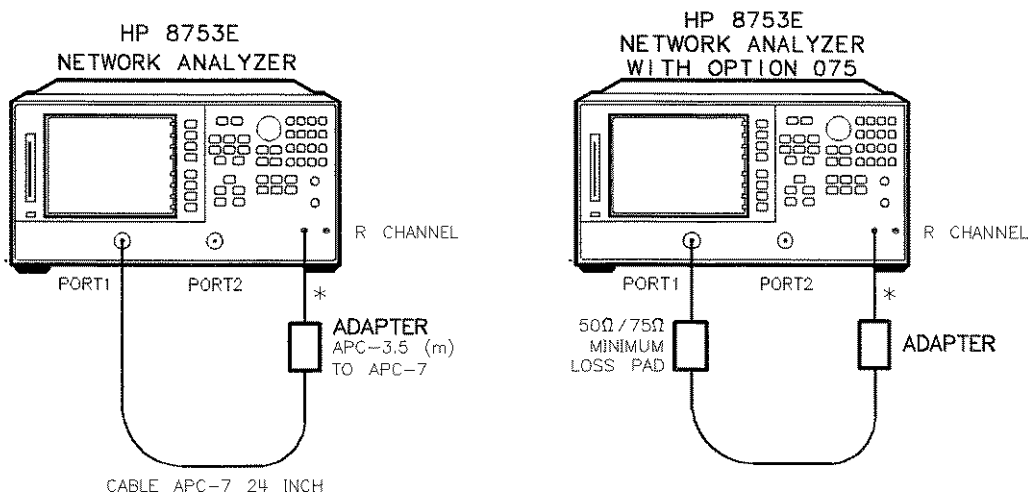

* DIRECT CONNECTION

sg612e

Figure 1-12. Minimum R Channel Level Test Setup

2. Press **[Preset]** **[Meas]** **INPUT PORTS** **R**.
3. Press **[Menu]** **POWER** **PWR RANGE MAN** **POWER RANGES** **RANGE 4** **-55 to -30**.
4. Press **[Scale Ref]** **REFERENCE VALUE** **[-70]** **[x1]**.

5. Press (Menu) CW FREQ (300) (k/m).

6. Press (Menu) POWER (-65) (x1).

The analyzer displays the message CAUTION: NO IF FOUND: CHECK R INPUT LEVEL.

7. Press (↑) to increase the test port power by 1 dBm.

8. If the analyzer displays a phase lock error message, continue increasing the test port power until phase lock is achieved.

9. Write the test port power, that is displayed on the analyzer, on the "Performance Test Record."

10. Repeat steps 5 through 9 for the other CW frequencies listed in the "Performance Test Record."

In Case of Difficulty

1. Check the flexible RF cable (W8, as shown in Figure 1-13) between the R sampler assembly (A4) and the A11 phase lock assembly. Make sure it is connected between A11J1 (PL IF IN) and 1st IF Out.

Caution *Do not push cable W8 down next to the A11 phase lock assembly.*

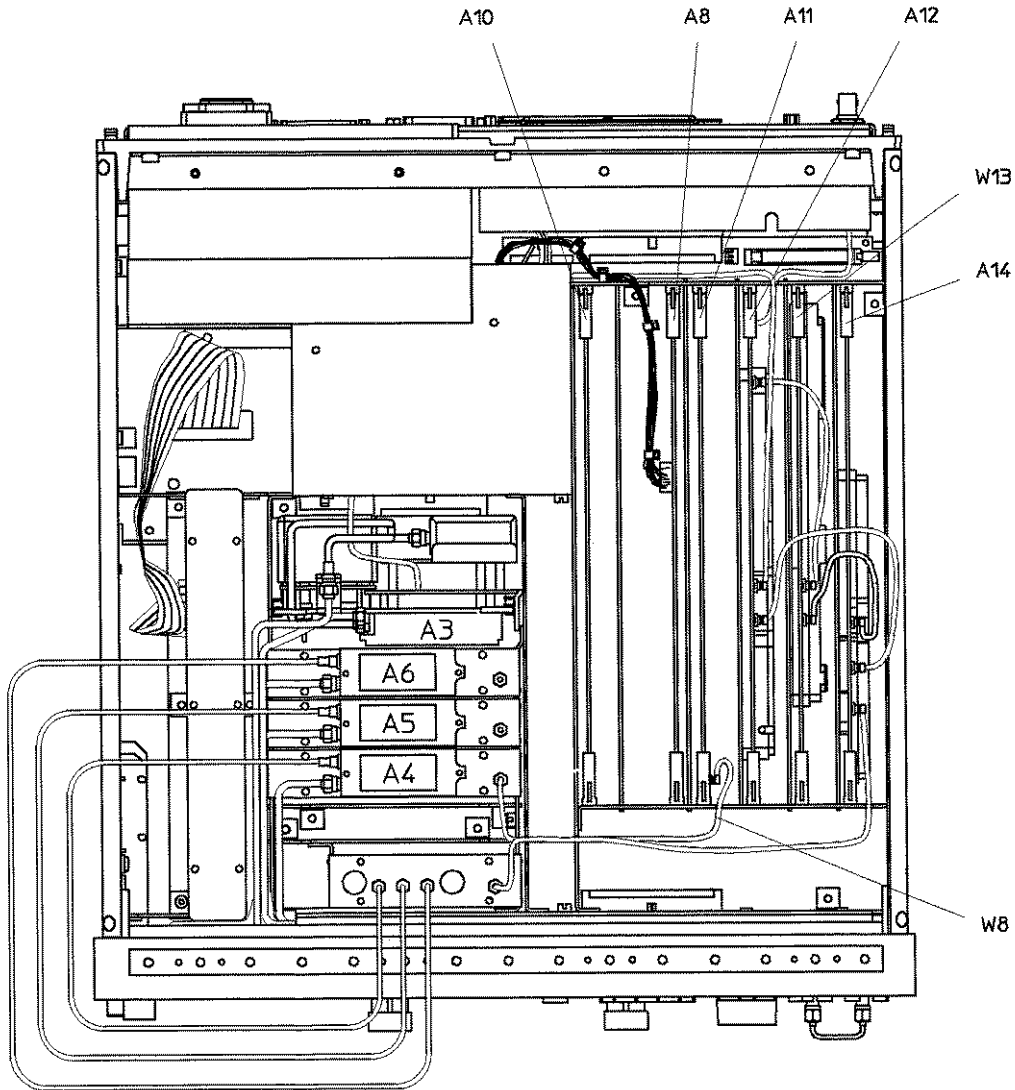

sg686e

Figure 1-13. Flexible RF Cable Location

2. Using an ohmmeter, verify that the RF cable is not open. In addition, examine both the cable connectors – measure the resistance between the cable center pin and the cable connector and make sure it is *not* close to zero.
3. Check the R sampler by substituting it with the B sampler (A6).
 - a. Move cable W8 to the B sampler (A6), as shown in Figure 1-14.

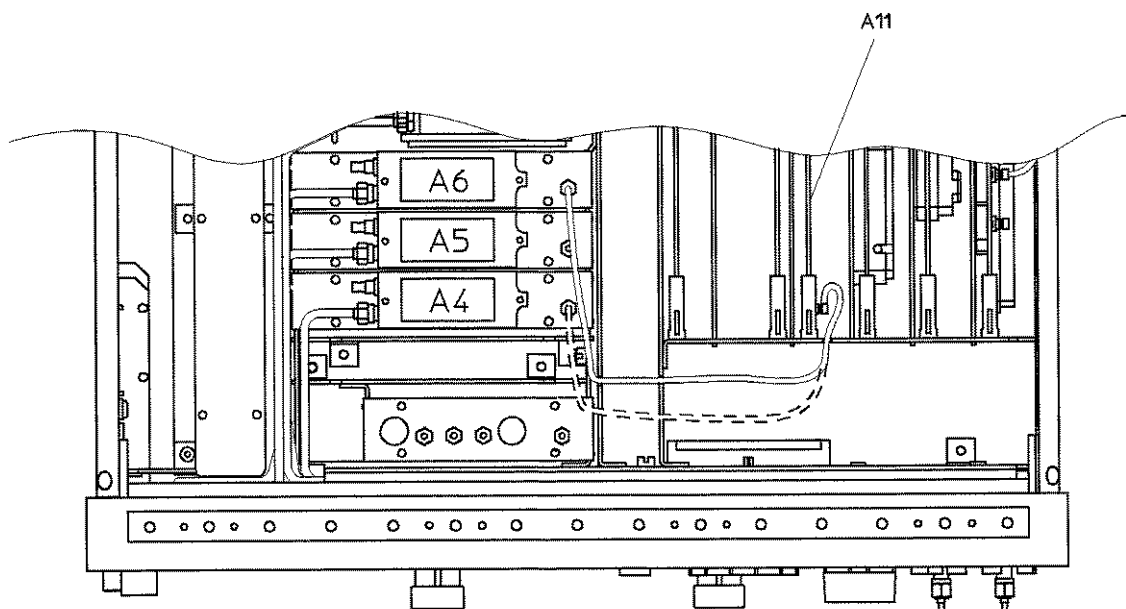

sg6115e

Figure 1-14. Connections for Substituting the R Sampler (A4)

4. Connect the equipment as shown in Figure 1-15.

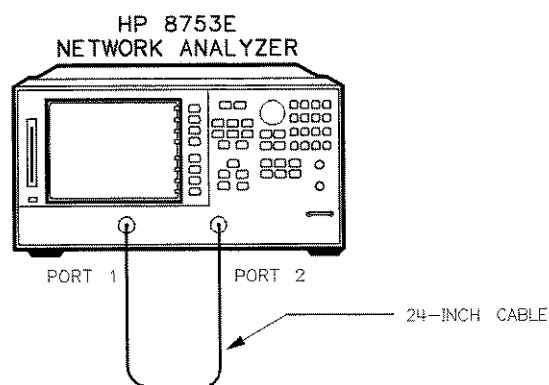

sg613e

Figure 1-15. Setup for Checking the R Sampler (A4)

5. Repeat the test, but select the B sampler (A6) by pressing **Meas** **INPUT PORTS** **B** in step 2. Use the following specifications:

300 kHz to 3 GHz < -27 dBm
 3 GHz to 6 GHz < -22 dBm

6. If the analyzer fails the test, replace the A11 assembly.
7. Verify that the high/low band adjustments are still within specifications. For more information on how to perform this task, refer to the “High/Low Band Transition Adjustment” located in the “Adjustments and Correction Constants” chapter of the *HP 8753E Service Guide*.
8. Refer to the “Source Troubleshooting” chapter of the *HP 8753E Service Guide* for more troubleshooting information.

6. Test Port Input Noise Floor Level

Specifications

Frequency Range	Test Port	IF Bandwidth	Average Noise Level
300 kHz to 3.0 GHz	Port 1	3 kHz	-82 dBm
300 kHz to 3.0 GHz	Port 1	10 Hz	-102 dBm
300 kHz to 3.0 GHz	Port 2	3 kHz	-82 dBm
300 kHz to 3.0 GHz	Port 2	10 Hz	-102 dBm
3.0 GHz to 6.0 GHz ¹	Port 1	3 kHz	-77 dBm
3.0 GHz to 6.0 GHz ¹	Port 1	10 Hz	-97 dBm
3.0 GHz to 6.0 GHz ¹	Port 2	3 kHz	-77 dBm
3.0 GHz to 6.0 GHz ¹	Port 2	10 Hz	-97 dBm

¹ Only for analyzer with Option 006 – 30 kHz to 6 GHz range.

Equipment Required for 50 Ω Analyzers

Calibration Kit, 7-mm HP 85031B

Equipment Required for 75 Ω Analyzers

Calibration Kit, Type-N HP 85036B

Analyzer warmup time: 1 hour

Perform this test to determine the HP 8753E port 1 and port 2 noise floor levels at the input test ports.

Port 1 Noise Floor Level from 300 kHz to 3 GHz (IF BW = 3 kHz)

1. Connect the equipment as shown in Figure 1-16.

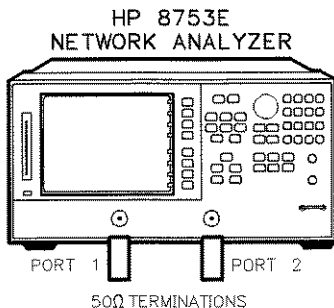

sg614e

Figure 1-16. Source Input Noise Floor Test Setup

2. Press **Preset** **Avg** **IFBW** **3000** **x1** **Menu** **POWER** **-85** **x1** **Start** **300 kHz** **Stop** **3** **G/n**.
3. Press **Meas** **INPUT PORTS** **A** **TESTPORT 2** **Format** **LIN MAG** **Scale Ref** **AUTO SCALE**.
4. Press **Marker Fctn** **MARKER MODE MENU** **STATS ON** **Menu** **TRIGGER MENU** **SINGLE**.
5. When the analyzer finishes the sweep, notice the mean value (which appears on the analyzer display).
6. Convert the measured linear magnitude mean value to log magnitude, using this equation.

$$Power (dBm) = 20 * [\log_{10}(\text{linear magnitude mean value})]$$

Note Notice that the mean value that is displayed on the analyzer is in μ Units. So, for example, if the displayed value is 62 μ U, the value that you would put in the equation is (62×10^{-6}) .

7. Write this calculated value on the "Performance Test Record."

Port 1 Noise Floor Level from 300 kHz to 3 GHz (IF BW = 10 Hz)

8. Press **(Avg)** **IF BW** **(10)** **(x1)** to change the IF bandwidth to 10 Hz.
9. Press **(Menu)** **TRIGGER MENU** **SINGLE**.
10. When the analyzer finishes the sweep, notice the mean value.
11. Convert the measured linear magnitude mean value to log magnitude, using this equation.

$$Power (dBm) = 20 * [\log_{10}(\text{linear magnitude mean value})]$$

12. Write this calculated value on the "Performance Test Record."

Port 2 Noise Floor Level from 300 kHz to 3 GHz (IF BW = 10 Hz)

13. Press **(Meas)** **INPUT PORTS** **B** **TESTPORT 1** **(Format)** **LIN MAG**.
14. Press **(Menu)** **TRIGGER MENU** **SINGLE**.
15. When the analyzer finishes the sweep, notice the mean value.
16. Convert the measured linear magnitude mean value to log magnitude, using this equation.

$$Power (dBm) = 20 * [\log_{10}(\text{linear magnitude mean value})]$$

17. Write this calculated value on the "Performance Test Record."

Port 2 Noise Floor Level from 300 kHz to 3 GHz (IF BW = 3 kHz)

18. Press **(Avg)** **IF BW** **(3)** **(k/m)** to change the IF bandwidth to 3 kHz.
19. Press **(Menu)** **TRIGGER MENU** **SINGLE**.
20. When the analyzer finishes the sweep, notice the mean value.
21. Convert the measured linear magnitude mean value to log magnitude, using this equation.

$$Power (dBm) = 20 * [\log_{10}(\text{linear magnitude mean value})]$$

22. Write this calculated value on the "Performance Test Record."
23. This completes the "Test Port Input Noise Floor Level" procedure if your analyzer does not have Option 006. Otherwise continue with the next section.

Port 2 Noise Floor Level from 3 GHz to 6 GHz (IF BW = 3 kHz)

24. Press **(Start)** **(3)** **(G/n)** **(Stop)** **(6)** **(G/n)**.
25. Press **(Menu)** **TRIGGER MENU** **SINGLE**.
26. When the analyzer finishes the sweep, notice the mean value.
27. Convert the measured linear magnitude mean value to log magnitude, using this equation.

$$Power (dBm) = 20 * [\log_{10}(\text{linear magnitude mean value})]$$

28. Write this calculated value on the "Performance Test Record."

Port 2 Noise Floor Level from 3 GHz to 6 GHz (IF BW = 10 Hz)

29. Press **[Avg]** **IF BW** **[10]** **[x1]** to change the IF bandwidth to 10 Hz.
30. Press **[Menu]** **TRIGGER MENU** **SINGLE**.
31. When the analyzer finishes the sweep, notice the mean value.
32. Convert the measured linear magnitude mean value to log magnitude, using this equation.
$$Power (dBm) = 20 * [\log_{10}(linear\ magnitude\ mean\ value)]$$
33. Write this calculated value on the "Performance Test Record."

Port 1 Noise Floor Level for 3 GHz to 6 GHz (IF BW = 10 Hz)

34. Press **[Meas]** **INPUT PORTS** **A** **TESTPORT 2**.
35. Press **[Menu]** **TRIGGER MENU** **SINGLE**.
36. When the analyzer finishes the sweep, notice the mean value.
37. Convert the measured linear magnitude mean value to log magnitude, using this equation.
$$Power (dBm) = 20 * [\log_{10}(linear\ magnitude\ mean\ value)]$$
38. Write this calculated value on the "Performance Test Record."

Port 1 Noise Floor Level from 3 GHz to 6 GHz (IF BW = 3 kHz)

39. Press **[Avg]** **IF BW** **[3]** **[k/m]**.
40. Press **[Menu]** **TRIGGER MENU** **SINGLE**.
41. When the analyzer finishes the sweep, notice the mean value.
42. Convert the measured linear magnitude mean value to log magnitude, using this equation.
$$Power (dBm) = 20 * [\log_{10}(linear\ magnitude\ mean\ value)]$$
43. Write this calculated value on the "Performance Test Record."

In Case of Difficulty

1. Perform the "ADC Linearity Correction Constants (Test 52)," located in the "Adjustments and Correction Constants" chapter of the *HP 8753E Service Guide*.
2. Repeat the "Test Port Input Noise Floor Level" procedure.
3. Suspect the A10 Digital IF assembly if the analyzer fails both test port input noise floor tests.
4. Refer to the "Receiver Troubleshooting" chapter of the *HP 8753E Service Guide* for more troubleshooting information.

7. Test Port Input Frequency Response

Specifications

Frequency Range	Test Port	Input Frequency Response
300 kHz to 3 GHz	Port 1	± 1 dB
300 kHz to 3 GHz	Port 2	± 1 dB
3 GHz to 6 GHz ¹	Port 1	± 2 dB
3 GHz to 6 GHz ¹	Port 2	± 2 dB

¹ Only for analyzers with Option 006 – 30 kHz to 6 GHz range.

Equipment Required for 50 Ω Analyzers

Power Meter HP 436A/437B/438A
Power Sensor HP 8482A
Cable, APC-7 24-inch HP P/N 8120-4779
Adapter, APC-7 to Type-N (f) HP 11524A

Additional Equipment Required for Analyzers with Option 006

Power Sensor HP 8481A

Equipment Required for 75 Ω Analyzers

Power Meter HP 436A/437B/438A
Power Sensor HP 8483A Option H03
Cable, Type-N HP P/N 8120-2408

Analyzer warmup time: 1 hour

Perform this test to examine the vector sum of all test setup error vectors in both magnitude and phase change as a function of frequency.

Power Meter Calibration for Test Port 1 from 300 kHz to 3 GHz

1. Zero and calibrate the power meter.
2. Connect the equipment as shown in Figure 1-17.

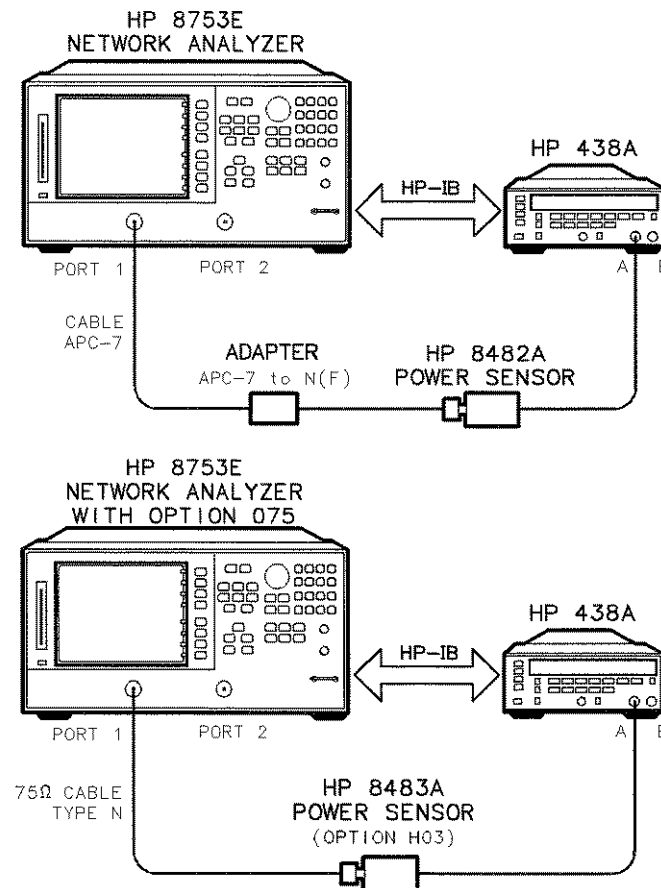

sg615e

Figure 1-17. Setup for Power Meter Calibration on Test Port 1

3. Press **Preset** **Start** **300** **(k/m)**.
4. **Only for Analyzers with Option 006:** Press **Stop** **3** **(G/n)**.
5. Press **Local** **SYSTEM CONTROLLER**.
6. Press **SET ADDRESSES** and **POWER MTR** until the analyzer shows the correct power meter model.

7. Press **ADDRESS: P MTR/HP-IB**. The default power meter HP-IB address is 13. Make sure it is the same as your power meter HP-IB address. Otherwise, use the analyzer front panel keypad to enter the correct HP-IB address for your power meter.
8. Press **Menu** **NUMBER of POINTS** **51** **(x1)**.
9. Press **POWER** **PWR RANGE MAN** to turn the auto power range off.

Note The analyzer displays the PRm annotation, indicating that the analyzer power range is set to MANUAL.

10. Press **PORT POWER** to uncouple the test port output power.
11. Press **Cal** **PWRMTR CAL**.
12. Press **LOSS/SENSR LISTS** **CAL FACTOR SENSOR A**. Refer to the back of the power sensor to locate the different calibration factor values along with their corresponding frequencies.

Note The analyzer's calibration factor sensor table can hold a MAXIMUM of 12 calibration factor data points.

The following softkeys are included in the sensor calibration factor entries menu:

SEGMENT	press to select a point where you can use the front panel knob or entry keys to enter a value.
EDIT	press to edit or change a previously entered value.
DELETE	press to delete a point from the sensor calibration factor table.
ADD	select this key to add a point into the sensor calibration factor table.
CLEAR LIST	select this key to erase the entire sensor calibration factor table.
DONE	select this key when done entering points to the sensor calibration factor table.

As an example, the following are the keystrokes for entering the first two calibration factor data points for the HP 8482A power sensor (assuming CF% = 96.4 at 100 kHz and CF% = 98.4 at 300 kHz):

- a. From the sensor calibration factor entries menu, press **ADD**.
 - b. Press **FREQUENCY** **100** **(k/m)**. If you make an entry error, press **(←)** and re-enter the correct value again.
 - c. Press **CAL FACTOR** **96.4** **(x1)**.
 - d. Press **DONE** to terminate the first calibration factor data point entry.
 - e. To enter the second cal factor data point, press **ADD**.
 - f. Press **FREQUENCY** **300** **(k/m)**.
 - g. Press **CAL FACTOR** **98.4** **(x1)**.
 - h. To terminate the second calibration factor data point entry, press **DONE**.
 - i. Press **SEGMENT** and use the front panel knob to scroll through the sensor calibration factors table. Check to be sure all values are entered correctly. If you spot an error, use the front panel knob to point to the data point you want to modify and press **EDIT**.
13. Press the appropriate softkeys to create a power sensor calibration factors table.
 14. Press **DONE** to exit the sensor calibration factor entries menu.
 15. Press **RETURN** **ONE SWEEP** **TAKE CAL SWEEP** to start the power meter calibration.

Wait until the analyzer finishes the sweep, then continue with this procedure.

Note The analyzer displays the PC annotation, indicating the power meter calibration is done and the error correction is active.

Test Port 2 Input Frequency Response from 300 kHz to 3 GHz

16. Connect the equipment as shown in Figure 1-18.

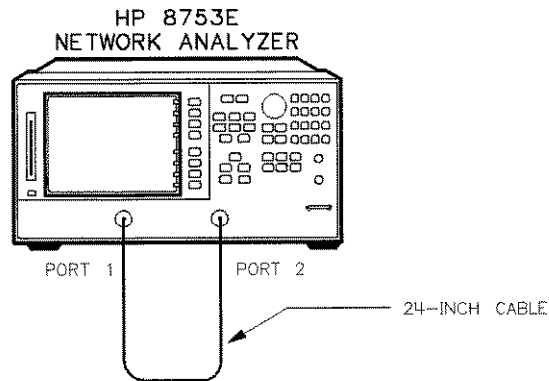

sg613e

Figure 1-18. Test Port 2 Input Frequency Response Test Setup

17. Press **Meas** **INPUT PORTS** **B**.
18. Press **Scale Ref** **SCALE/DIV** **1** **x1**.
19. Press **Marker** **MARKER 1** **Marker Fctn** **MKB SEARCH** **SEARCH:MIN** to put marker 1 at the minimum magnitude location of the trace.
20. Press **Marker** **MARKER 2** **Marker Fctn** **MKB SEARCH** **SEARCH:MAX** to position marker 2 at the maximum magnitude location of the trace.
21. Write the marker 1 or marker 2 value (which appears on the analyzer display), whichever has the larger absolute magnitude, in the "Performance Test Record."

Power Meter Calibration on Port 2 from 300 kHz to 3 GHz

22. Connect the equipment as shown Figure 1-19.

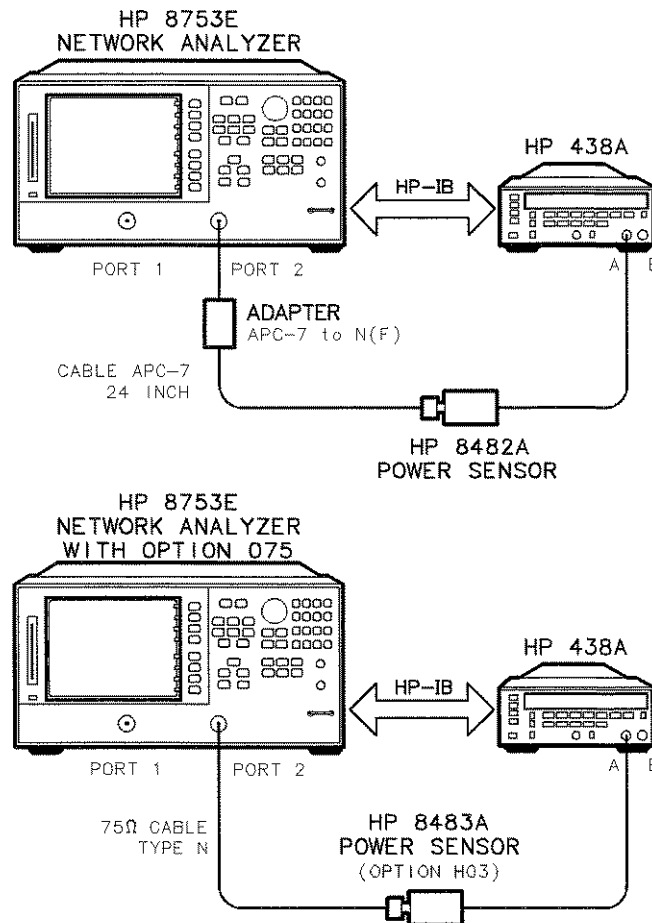

sg616e

Figure 1-19. Setup for Power Meter Calibration on Test Port 2

23. Press **Meas** **INPUT PORTS** **TESTPORT 2**.
24. Press **Cal** **PWRMTR** **ONE SWEEP** **TAKE CAL SWEEP** to start the power meter calibration for test port 2.
25. When the analyzer displays the message **POWER METER CALIBRATION SWEEP DONE**, connect the equipment as shown as in Figure 1-20.

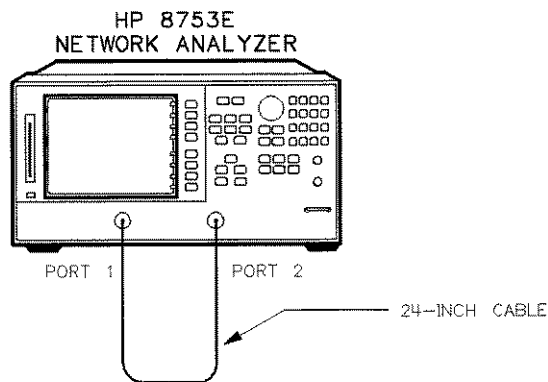

sg613e

Figure 1-20. Test Port 1 Input Frequency Response Test Setup

Test Port 1 Input Frequency Response from 300 kHz to 3 GHz

26. Press **Meas** **INPUT PORTS** **A**.
27. Press **Marker** **MARKER 1** **Marker Fctn** **MKR SEARCH** **SEARCH:MIN**.
28. Press **Marker** **MARKER 2** **Marker Fctn** **MKR SEARCH** **SEARCH:MAX**.
29. Write the marker 1 or marker 2 reading, whichever has the larger absolute magnitude, in the "Performance Test Record."
30. This completes the "Test Port Input Frequency Response" procedure if your analyzer does not have Option 006. Otherwise continue with the next sections.

Power Meter Calibration for Test Port 2 from 3 GHz to 6 GHz

31. Replace the power sensor with the HP 8481A, and then setup the power meter:
 - If the power meter is an HP 438A, press **LCL**.
 - If the power meter is an HP 437B, press **PRESET/LOCAL**.
 - If the power meter is an HP 436A, cycle the line power.
32. Connect the equipment as shown in Figure 1-21.

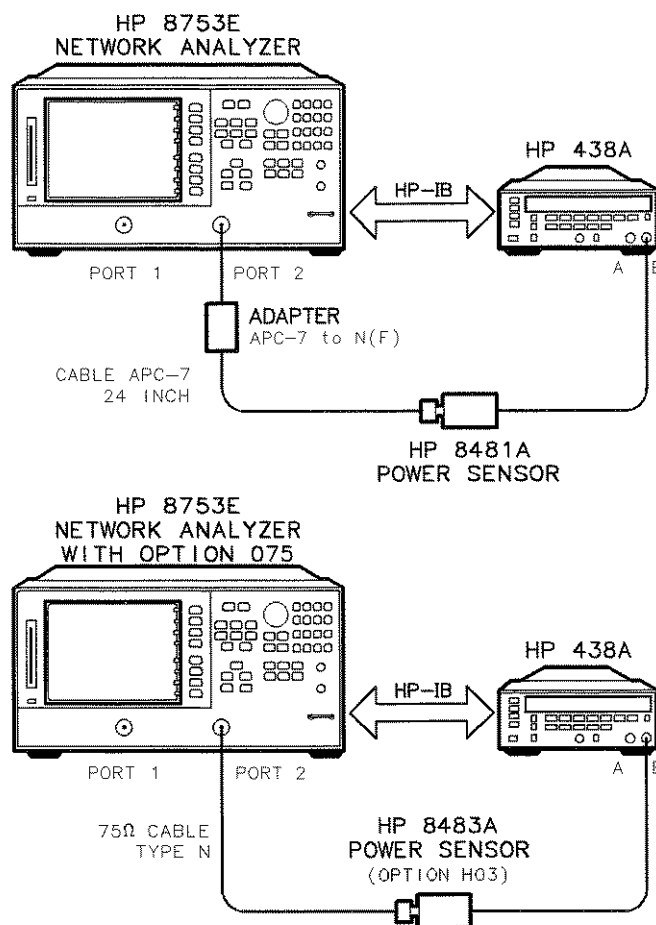

sg617e

Figure 1-21. Setup for Power Meter Calibration on Test Port 2

33. Press **Start** **3** **G/n** **Stop** **6** **G/n**.
34. Press **Cal** **PWRMTR CAL**.
35. Press **LOSS/SENSE LISTS** **CAL FACTOR SENSOR B**. Repeat step 10 to build a calibration factor sensor table for the HP 8481A power sensor.
36. Press **DONE** to exit the sensor calibration factor entries menu.
37. To select the HP 8481A power sensor, press **USE SENSOR B**.
38. Press **RETURN** **TAKE CAL SWEEP** to start the power meter calibration.

Test Port 1 Input Frequency Response from 3 GHz to 6 GHz

39. When the analyzer finishes the calibration sweep, connect the equipment as shown in Figure 1-22.

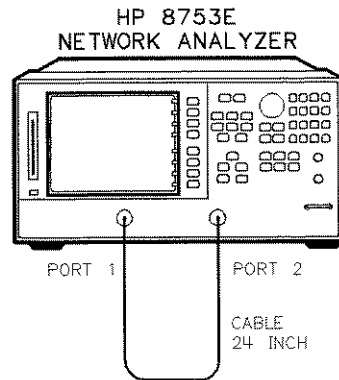

sg618e

Figure 1-22. Setup for Test Port 1 Input Frequency Response

40. Press **Meas** **INPUT PORTS** **A**.
41. Press **Marker** **MARKER 1** **Marker Fctn** **MKR SEARCH** **SEARCH:MIN** to put marker 1 at the minimum magnitude location of the trace.
42. Press **Marker** **MARKER 2** **Marker Fctn** **MKR SEARCH** **SEARCH:MAX** to position marker 2 at the maximum magnitude location of the trace.
43. Write the marker 1 or marker 2 reading, whichever has the largest absolute magnitude, in the "Performance Test Record."

Power Meter Calibration on Test Port 1 from 3 GHz to 6 GHz

44. Connect the equipment as shown in Figure 1-23.

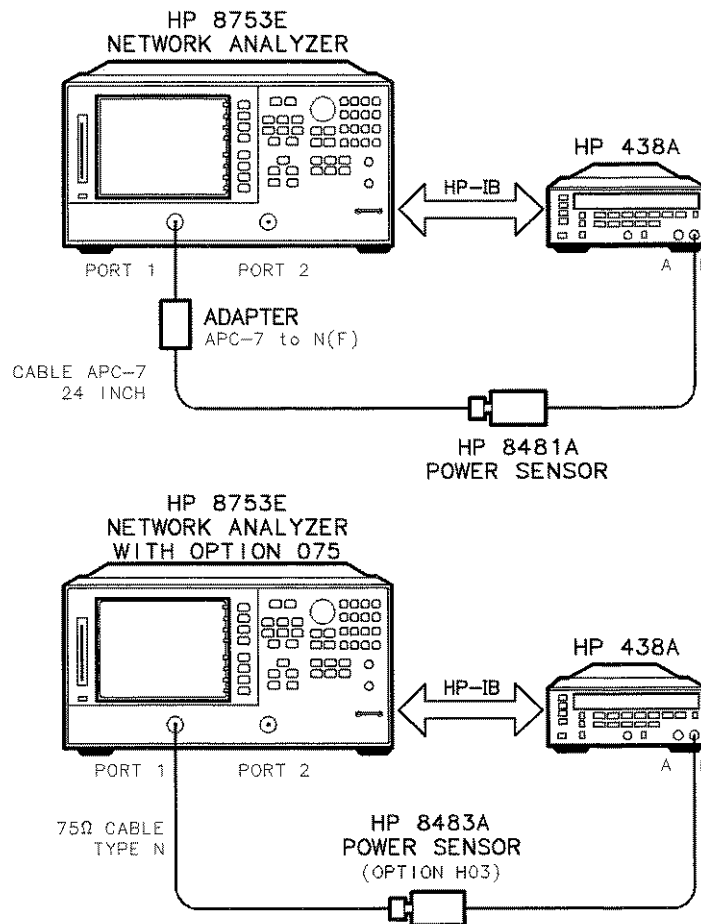

sg619e

Figure 1-23. Setup for Power Meter Calibration on Test Port 1

45. Press **(Meas) INPUT PORTS TESTPORT 1**.
46. Press **(Cal) PWRMTR ONE SWEEP TAKE CAL SWEEP** to start the power meter calibration for output test port 1.

Test Port 2 Input Frequency Response from 3 GHz to 6 GHz

47. When the analyzer displays the message POWER METER CALIBRATION SWEEP DONE, connect the equipment as shown as in Figure 1-24.

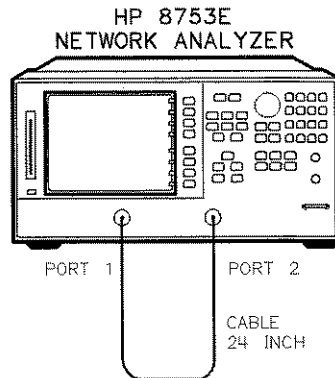

sg618e

Figure 1-24. Test Port 2 Input Frequency Response Test Setup

48. Press **Meas** **INPUT PORTS** **B**.
49. Press **Marker** **MARKER 1** **Marker Fctn** **MKR SEARCH** **SEARCH:MIN**.
50. Press **Marker** **MARKER 2** **Marker Fctn** **MKR SEARCH** **SEARCH:MAX**.
51. Write the marker 1 or marker 2 reading, whichever has the largest magnitude, in the "Performance Test Record."

In Case of Difficulty

1. Be sure you have used the correct power sensor for the frequency range.
2. Verify that the calibration factors that you have entered for the power sensors are correct.
3. Repeat this test with a "known good" thru cable.

8. Test Port Crosstalk

Specifications

Frequency Range	Crosstalk ¹
300 kHz to 3 GHz	100 dB
3 GHz to 6 GHz ²	90 dB

¹ At 25° C ±5° C.

² Only for analyzers with Option 006 –
30 kHz to 6 GHz range.

Required Equipment for 50Ω Analyzers

Calibration Kit, 7-mm HP 85031B
Cable, APC-7 24-inch HP P/N 8120-4779

Required Equipment for 75Ω Analyzers

Calibration Kit, 75Ω, Type-N HP 85036B

Analyzer warmup time: 1 hour

Perform this test to verify the signal leakage between the analyzer's test ports.

1. Connect the equipment as shown in Figure 1-25.

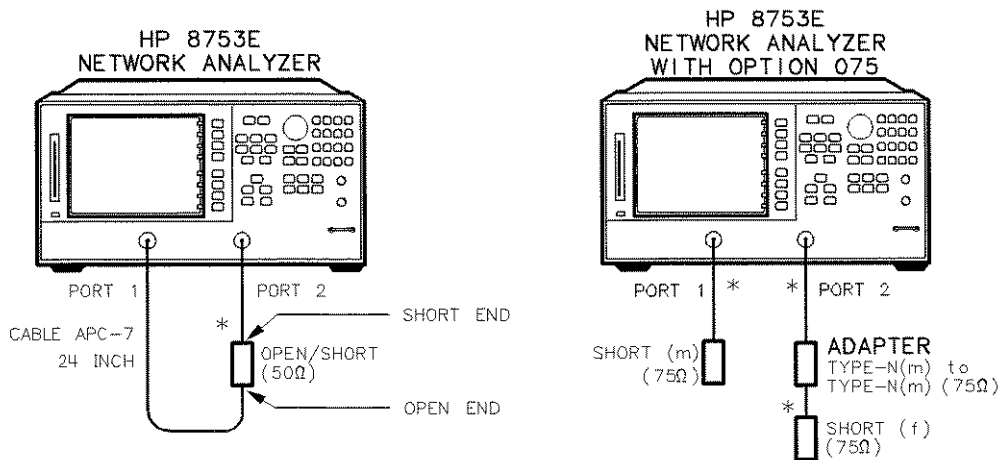

* DIRECT CONNECTION

sg620e

Figure 1-25. Test Port Crosstalk Test Setup

2. Press **Preset** **Menu** **POWER** **10** **x1**.
3. Press **Avg** **IF BW** **10** **x1**.

Crosstalk to Test Port 2 from 300 kHz to 3 GHz

4. Press **Start** **300** **k/m** **Stop** **3** **G/n**.
5. Press **Meas** **Trans: FWD S21 (B/R)**.
6. Press **Scale Ref** **REFERENCE VALUE** **-100** **x1**.
7. Press **Menu** **TRIGGER MENU** **SINGLE**.
8. Press **Marker Fctn** **MKR SEARCH** **SEARCH: MAX**.
9. Write the marker value (which appears on the analyzer display) in the "Performance Test Record."

Crosstalk to Test Port 1 from 300 kHz to 3 GHz

10. Press **Meas** **Trans: REV S12 (A/R)**.
11. Press **Menu** **TRIGGER MENU** **SINGLE**.
12. Press **Marker Fctn** **MKR SEARCH** **SEARCH: MAX**.
13. Write the marker value (which appears on the analyzer display) in the "Performance Test Record."
14. This completes the "Test Port Crosstalk" performance test if your analyzer does not have Option 006. Otherwise, proceed to the next section.

Crosstalk to Test Port 1 from 3 GHz to 6 GHz

15. Press **Start** **3** **G/n** **Stop** **6** **G/n**.
16. Press **Menu** **TRIGGER MENU** **SINGLE**.
17. Press **Marker Fctn** **MKR SEARCH** **SEARCH: MAX**.
18. Write the marker value (which appears on the analyzer display) in the "Performance Test Record."

Crosstalk to Test Port 2 from 3 GHz to 6 GHz

1. Press **Meas** **Trans: FWD S21 (B/R)**.
2. Press **Menu** **TRIGGER MENU** **SINGLE**.
3. Press **Marker Fctn** **MKR SEARCH** **SEARCH: MAX**.
4. Write the marker value (which appears on the analyzer display) in the "Performance Test Record."

In Case of Difficulty

1. Remove the instrument top cover. Using an 8 lb-inch torque wrench, verify that ALL semirigid cables connected to the sampler/mixer assemblies are tight. In addition, tighten any loose screws on the sampler/mixer assemblies (A4/5/6) and the pulse generator assembly (A7).
2. Remove the instrument bottom cover. Refer to Figure 1-26. Verify that cables W1, W31 and W32 are tight.
3. Repeat this test.

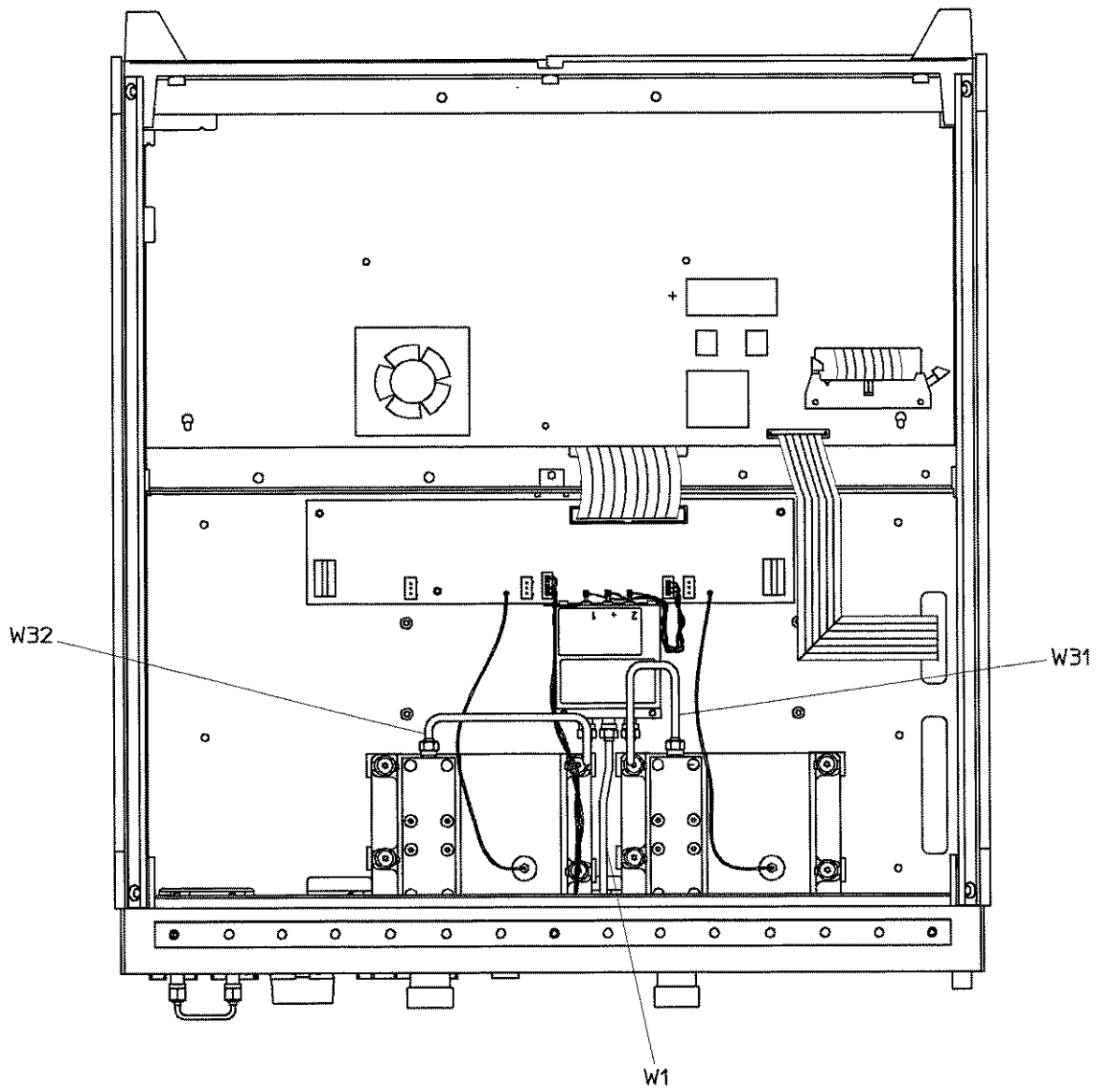

sg6102e

Figure 1-26. HP 8753E Bottom View

9. Calibration Coefficients

Specifications

Uncorrected ¹ Error Terms	Frequency Range		
	300 kHz to 1.3 GHz	1.3 GHz to 3 GHz	3 GHz to 6 GHz ²
Directivity	35 dB	30 dB	25 dB
Source Match	16 dB	16 dB	14 dB
Load Match	18 dB	16 dB	14 dB
Transmission Tracking	±1.5 dB	±1.5 dB	±2.5 dB
Reflection Tracking	±1.5 dB	±1.5 dB	±2.5 dB

1 At 25° ±5° C, with less than 1° C deviation from the measurement calibration temperature.

2 Only for analyzers with Option 006 – 30 kHz to 6 GHz range.

Equipment Required for 50Ω Analyzers

Calibration Kit, 7-mm HP 85031B
 Cable, APC-7, 24-inch HP P/N 8120-4779

Equipment Required for 75Ω Analyzers

Calibration Kit, Type-N HP 85036B
 Cable, Type-N, 24-inch HP P/N 8120-4781

Analyzer warmup time: 30 minutes

Perform this procedure to verify the analyzer uncorrected test port characteristics.

Note The crosstalk calibration coefficients are omitted in this procedure. They are covered in the “Test Port Crosstalk” performance test.

First Full 2-Port Calibration

1. Connect the equipment as shown in Figure 1-27.

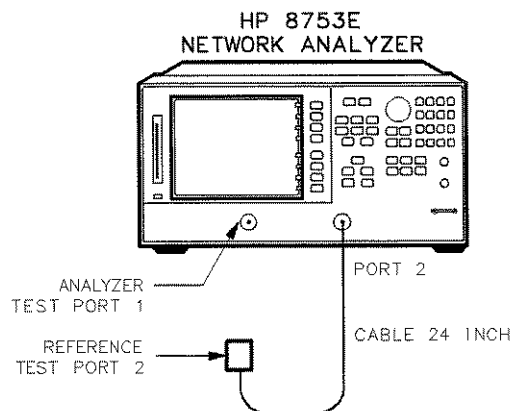

sg621e

Figure 1-27. First Full 2-Port Calibration Test Setup

2. Press **Preset Start 300 k/m**.
3. Press **Cal CAL KIT SELECT CAL KIT CAL KIT:7mm RETURN RETURN CALIBRATE MENU FULL 2-PORT**.
4. Press **ISOLATION OMIT ISOLATION**.
5. Connect the "open" end of the open/short combination (supplied in the calibration kit) to analyzer test port 1.
6. Press **REFLECTION FORWARD:OPEN**.
7. Connect the "short" end of the open/short combination to analyzer test port 1.
8. Press **FORWARD:SHORT**.
9. Replace the open/short combination with the 50 ohm termination (supplied in the calibration kit).
10. Press **FORWARD:LOAD**.
11. Connect the "open" end of the open/short combination to the reference test port 2.
12. Press **REVERSE:OPEN**.
13. Connect the "short" end of the open/short combination to the reference test port 2.
14. Press **REVERSE:SHORT**.
15. Connect the 50 ohm termination to the reference test port 2.
16. Press **REVERSE:LOAD**.
17. When the analyzer displays **PRESS 'DONE' IF FINISHED WITH STD(s)**, press **STANDARDS DONE**.
 Wait for the message **COMPUTING CAL COEFFICIENTS** to disappear from the analyzer display before proceeding to the next step.
18. Connect the equipment as shown in Figure 1-28.

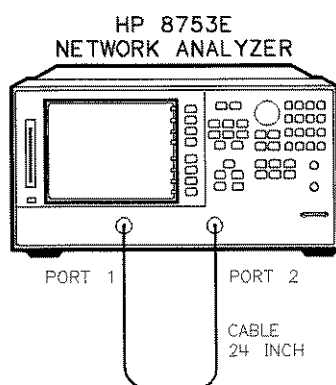

sg618e

Figure 1-28. Transmission Calibration Test Setup

19. Press **TRANSMISSION DO BOTH FWD + REV**.

20. Press **DONE 2-PORT CAL**.

Directivity (Forward) Calibration Coefficient

21. Press **(System) SERVICE MENU TESTS (32) (x1) EXECUTE TEST**.
22. When the analyzer finishes the test, press **(Marker)**.
23. Using the front panel knob, locate the maximum value of the data trace for the 300 kHz to 1.3 GHz frequency range.
24. Write the maximum value in the "Performance Test Record."
25. Repeat the previous two steps for the other frequency range(s) listed on the "Performance Test Record."

Source Match (Forward) Calibration Coefficient

26. Press **(System) SERVICE MENU TESTS (33) (x1) EXECUTE TEST**.
27. When the analyzer finishes the test, repeat steps 22 through 25.

Transmission Tracking (Forward) Calibration Coefficient

28. Press **(System) SERVICE MENU TESTS (37) (x1) EXECUTE TEST**.
29. When the analyzer finishes the test, repeat steps 22 through 25.

Reflection Tracking (Forward) Calibration Coefficient

30. Press **(System) SERVICE MENU TESTS (34) (x1) EXECUTE TEST**.
31. When the analyzer finishes the test, repeat steps 22 through 25.

Load Match (Reverse) Calibration Coefficient

32. Press **(System) SERVICE MENU TESTS (42) (x1) EXECUTE TEST**.
33. When the analyzer finishes the test, repeat steps 22 through 25.

Transmission Tracking (Reverse) Calibration Coefficient

34. Press **(System) SERVICE MENU TESTS (43) (x1) EXECUTE TEST**.
35. When the analyzer finishes the test, repeat steps 22 through 25.

Second Full 2-Port Calibration

36. Connect the equipment as shown in Figure 1-29.

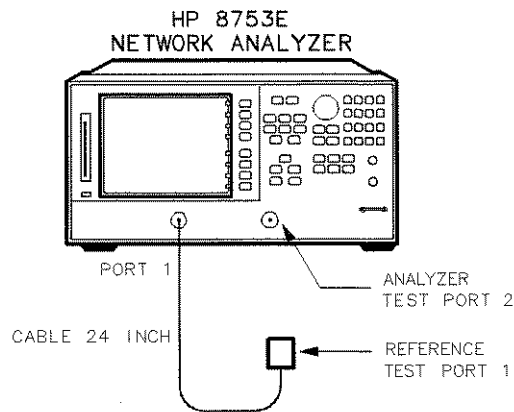

sg622e

Figure 1-29. Second Full 2-Port Calibration Test Setup

37. Press **Preset** **Start** **300** **(k/m)**.
38. Press **Cal** **CAL KIT** **SELECT CAL KIT** **CAL KIT: 7mm** **RETURN** **RETURN** **CALIBRATE MENU** **FULL 2-PORT**.
39. Press **ISOLATION** **OMIT ISOLATION**.
40. Connect the "open" end of the open/short combination (supplied in the calibration kit) to reference test port 1.
41. Press **REFLECTION** **FORWARD: OPEN**.
42. Connect the "short" end of the open/short combination to reference test port 1.
43. Press **FORWARD: SHORT**.
44. Replace the open/short combination with the 50 ohm termination (supplied in the calibration kit).
45. Press **FORWARD: LOAD**.
46. Connect the "open" end of the open/short combination to the analyzer test port 2.
47. Press **REVERSE: OPEN**.
48. Connect the "short" end of the open/short combination to the analyzer test port 2.
49. Press **REVERSE: SHORT**.
50. Connect the 50 ohm termination to the analyzer test port 2.
51. Press **REVERSE: LOAD**.
52. When the analyzer displays **PRESS 'DONE' IF FINISHED WITH STD(s)**, press **STANDARDS DONE**.
Wait for the message **COMPUTING CAL COEFFICIENTS** to disappear from the analyzer display before proceeding to the next step.

53. Connect the equipment as shown in Figure 1-30.

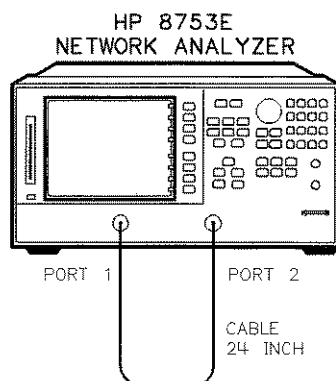

sg618e

Figure 1-30. Transmission Calibration Test Setup

54. Press **TRANSMISSION DO BOTH FWD + REV**.

55. Press **DONE 2-PORT CAL**.

Load Match (Forward) Calibration Coefficient

56. Press **(System) SERVICE MENU TESTS (36) (x1) EXECUTE TEST**.

57. When the test is done, press **(Marker) MARKER 1**.

58. Using the front panel knob, locate the maximum value of the data trace for the 300 kHz to 1.3 GHz frequency range.

59. Write the maximum value on the "Performance Test Record."

60. Repeat the previous three steps for the other frequency range(s) listed on the "Performance Test Record."

Directivity (Reverse) Calibration Coefficient

61. Press **(System) SERVICE MENU TESTS (38) (x1) EXECUTE TEST**.

62. When the analyzer finishes the test, repeat steps 57 through 60.

Source Match (Reverse) Calibration Coefficient

63. Press **(System) SERVICE MENU TESTS (39) (x1)**. At the prompt, press **EXECUTE TEST**.

64. When the analyzer finishes the test, repeat steps 57 through 60.

Reflection Tracking (Reverse) Calibration Coefficient

65. Press **(System) SERVICE MENU TESTS (40) (x1) EXECUTE TEST**.

66. When the analyzer finishes the test, repeat steps 57 through 60.

10. System Trace Noise (Only for Analyzers without Option 006)

Frequency Range	Ratio	System Trace Noise (Magnitude ¹)	System Trace Noise (Phase ¹)
30 kHz to 3 GHz	A/R	<0.006 dB rms	<0.038° rms
30 kHz to 3 GHz	B/R	<0.006 dB rms	<0.038° rms

¹ At +5 dBm into test port, 3 kHz IF bandwidth, and CW sweep.

Required Equipment for 50Ω Analyzers

Cable, APC-7, 24-inch HP P/N 8120-4779

Required Equipment for 75Ω Analyzers

Cable, 75Ω, Type-N 24-inch HP P/N 8120-2408

Analyzer warmup time: 1 hour

Perform this test to measure the system trace noise at a designated frequency in both the A/R and B/R ratioed measurements.

1. Connect the equipment as shown in Figure 1-31.

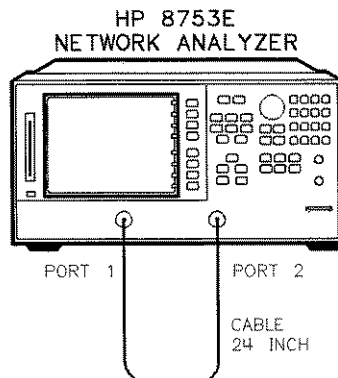

sg618e

Figure 1-31. System Trace Noise Test Setup

2. Press **Preset** **Menu** **POWER** **5** **x1**.
3. Press **RETURN** **CW FREQ** **3** **G/n** **NUMBER of POINTS** **1601** **x1**.
4. Press **Marker Fctn** **MARKER MODE MENU** **STATS ON** to activate the instrument's statistic feature.

System Trace Noise for A/R Magnitude

5. Press **[Meas]** **Trans: REV S12 (A/R)**.
6. Press **[Menu]** **TRIGGER MENU** **NUMBER of GROUPS** **[5]** **[x1]**.
7. When the analyzer displays the "Hld" annotation, press **[Scale Ref]** **AUTO SCALE**.
8. Write the s.dev (standard deviation) value, which appears on the analyzer display, on the "Performance Test Record."

System Trace Noise for A/R Phase

9. Press **[Format]** **PHASE**.
10. Press **[Menu]** **TRIGGER MENU** **NUMBER of GROUPS** **[5]** **[x1]**.
11. When the analyzer finishes the number of sweeps, press **[Scale Ref]** **AUTO SCALE**.
12. Write the s.dev value on the "Performance Test Record."

System Trace Noise for B/R Magnitude

13. Press **[Meas]** **Trans: FWD S21 (B/R)**.
14. Press **[Menu]** **TRIGGER MENU** **NUMBER of GROUPS** **[5]** **[x1]**.
15. When the analyzer finishes the number of sweeps, press **[Scale Ref]** **AUTO SCALE**.
16. Write the s.dev value on the "Performance Test Record."

System Trace Noise for B/R Phase

17. Press **[Format]** **PHASE**.
18. Press **[Menu]** **TRIGGER MENU** **NUMBER of GROUPS** **[5]** **[x1]**.
19. When the analyzer finishes the number of sweeps, press **[Scale Ref]** **AUTO SCALE**.
20. Write the s.dev value on the "Performance Test Record."

In Case of Difficulty

1. Perform the "ADC Offset Correction Constants" procedure, located in the "Adjustments and Correction Constants" chapter.
2. Repeat this performance test.
3. Suspect the A10 Digital IF board assembly if the analyzer still fails the test.

11. System Trace Noise (Only for Analyzers with Option 006)

Specifications

Frequency Range	Ratio	System Trace Noise (Magnitude ¹)	System Trace Noise (Phase ¹)
30 kHz to 3 GHz	A/R	<0.006 dB rms	<0.038° rms
30 kHz to 3 GHz	B/R	<0.006 dB rms	<0.038° rms
3 GHz to 6 GHz	A/R	<0.010 dB rms	<0.070° rms
3 GHz to 6 GHz	B/R	<0.010 dB rms	<0.070° rms

¹ At +5 dBm into test port, 3 kHz IF bandwidth, and CW sweep.

Required Equipment

Cable, APC-7, 24-inch HP P/N 8120-4779

Analyzer warmup time: 1 hour

Perform this test to measure the system trace noise at designated CW frequencies in both the A/R and B/R ratioed measurements.

1. Connect the equipment as shown in Figure 1-32.

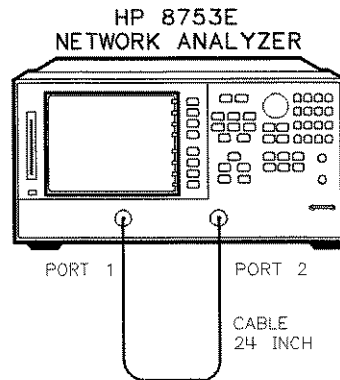

sg618e

Figure 1-32. System Trace Noise Test Setup

2. Press **Preset** **Menu** **POWER** **5** **x1** **RETURN** **NUMBER of POINTS** **1601** **x1**.
3. Press **Marker Fctn** **MARKER MODE MENU** **STATS ON** to activate the instrument's statistic feature.

System Trace Noise for A/R Magnitude from 30 kHz to 3 GHz

4. Press **[Meas]** **Trans: REV S12 (A/R)**.
5. Press **[Menu]** **CW FREQ** **[3]** **[G/n]** **TRIGGER MENU** **NUMBER of GROUPS** **[5]** **[x1]**.
6. When the analyzer finishes the number of sweeps, press **[Scale Ref]** **AUTO SCALE**.
7. Write the s.dev value shown, which appears on the analyzer display, on the "Performance Test Record."

System Trace Noise for A/R Magnitude from 3 GHz to 6 GHz

8. Press **[Menu]** **CW FREQ** **[6]** **[G/n]** **TRIGGER MENU** **NUMBER of GROUPS** **[5]** **[x1]**.
9. When the analyzer finishes the number of sweeps, press **[Scale Ref]** **AUTO SCALE**.
10. Write the s.dev value, which appears on the analyzer display, on the "Performance Test Record."

System Trace Noise for A/R Phase from 3 GHz to 6 GHz

11. Press **[Format]** **PHASE**.
12. Press **[Menu]** **TRIGGER MENU** **NUMBER of GROUPS** **[5]** **[x1]**.
13. When the analyzer finishes the number of sweeps, press **[Scale Ref]** **AUTO SCALE**.
14. Write the s.dev value, which appears on the analyzer display, on the "Performance Test Record."

System Trace Noise for A/R Phase from 30 kHz to 3 GHz

15. Press **[Menu]** **CW FREQ** **[3]** **[G/n]** **TRIGGER MENU** **NUMBER of GROUPS** **[5]** **[x1]**.
16. When the analyzer finishes the number of sweeps, press **[Scale Ref]** **AUTO SCALE**.
17. Write the s.dev value, which appears on the analyzer display, on the "Performance Test Record."

System Trace Noise for B/R Magnitude from 30 kHz to 3 GHz

18. Press **[Meas]** **Trans: FWD S21 (B/R)** **[Menu]** **TRIGGER MENU** **NUMBER of GROUPS** **[5]** **[x1]**.
19. When the analyzer finishes the number of sweeps, press **[Scale Ref]** **AUTO SCALE**.
20. Write the s.dev value, which appears on the analyzer display, on the "Performance Test Record."

System Trace Noise for B/R Magnitude from 3 GHz to 6 GHz

21. Press **Menu** **CW FREQ** **6** **G/n** **TRIGGER MENU** **NUMBER of GROUPS** **5** **x1**.
22. When the analyzer finishes the number of sweeps, press **Scale Ref** **AUTO SCALE**.
23. Write the s.dev value, which appears on the analyzer display, on the "Performance Test Record."

System Trace Noise for B/R Phase from 3 GHz to 6 GHz

24. Press **Format** **PHASE** **Menu** **TRIGGER MENU** **NUMBER of GROUPS** **5** **x1**.
25. When the analyzer finishes the number of sweeps, press **Scale Ref** **AUTO SCALE**.
26. Write the s.dev value, which appears on the analyzer display, on the "Performance Test Record."

System Trace Noise for B/R Phase from 30 kHz to 3 GHz

27. Press **Menu** **CW FREQ** **3** **G/n** **TRIGGER MENU** **NUMBER of GROUPS** **5** **x1**.
28. When the analyzer finishes the number of sweeps, press **Scale Ref** **AUTO SCALE**.
29. Write the s.dev value, which appears on the analyzer display, on the "Performance Test Record."

In Case of Difficulty

1. Perform the "ADC Offset Correction Constants" procedure, located in the "Adjustments and Correction Constants" chapter.
2. Repeat this performance test.
3. Suspect the A10 Digital IF board assembly if the analyzer still fails the test.

12. Test Port Input Impedance

Specifications

Frequency Range	Test Port Input	Return Loss
300 kHz to 1.3 GHz	Port 1	≥ 18 dB
1.3 GHz to 3 GHz	Port 1	≥ 16 dB
3 GHz to 6 GHz	Port 1	≥ 14 dB
300 kHz to 1.3 GHz	Port 2	≥ 18 dB
1.3 GHz to 3 GHz	Port 2	≥ 16 dB
3 GHz to 6 GHz	Port 2	≥ 14 dB

Required Equipment for 50 Ω Analyzers

Cable, APC-7, 24-inch HP P/N 8120-4779
Calibration Kit, 7-mm HP 85031B

Required Equipment for 75 Ω Analyzers

Cable, 75 Ω , Type-N, 24-inch HP P/N 8120-2408
Calibration Kit, 75 Ω , Type-N HP 85036B

Analyzer warmup time: 1 hour

Perform this test to measure the return loss of each input test port.

1. Connect the equipment as shown in Figure 1-33.

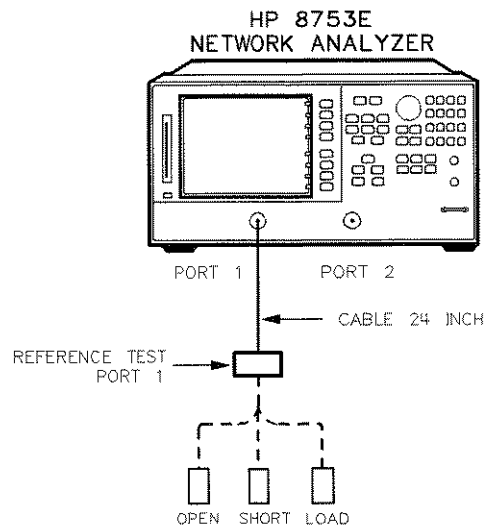

sg623e

Figure 1-33. S11 1-Port Cal Test Setup

2. Press **Preset** **AVE** **IF BW** **3000** **x1** **Menu** **NUMBER of POINTS** **1601** **x1**.
3. Press **Start** **300** **k/m**.
4. Press **Cal** **CAL KIT** **SELECT CAL KIT** and select the appropriate calibration kit:
 - If your analyzer is 50Ω, press **CAL KIT: 7mm**.
 - If your analyzer is 75Ω, press **CAL KIT: N 75Ω**.
5. Press **RETURN** **RETURN** **CALIBRATE MENU** **S11 1-PORT**.
6. Connect an open to reference test port 1, as shown in Figure 1-33.
7. Press **FORWARD: OPEN**.
8. When the analyzer displays the prompt **CONNECT STD THEN PRESS KEY TO MEASURE**, connect a short to reference test port 1.
9. Press **FORWARD: SHORT**.
10. At the prompt, connect a load to reference test port 1.
11. Press **FORWARD: LOAD**.
12. When the analyzer displays 'DONE' IF FINISHED WITH CAL, press **DONE 1-PORT CAL**.
13. Press **Save/Recall** **SAVE STATE**.
14. Connect the equipment as shown in Figure 1-34.

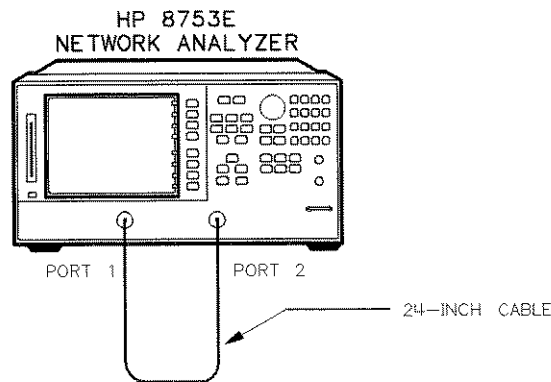

sg613e

Figure 1-34. Test Port 2 Input Impedance Test Setup

15. Press **Marker** to turn the analyzer's marker 1 on. Use the front panel knob to locate the maximum value of the data trace for each of the frequency ranges listed in the "Performance Test Record."
16. Write these maximum values on the "Performance Test Record."
17. Connect the equipment as shown in Figure 1-35.

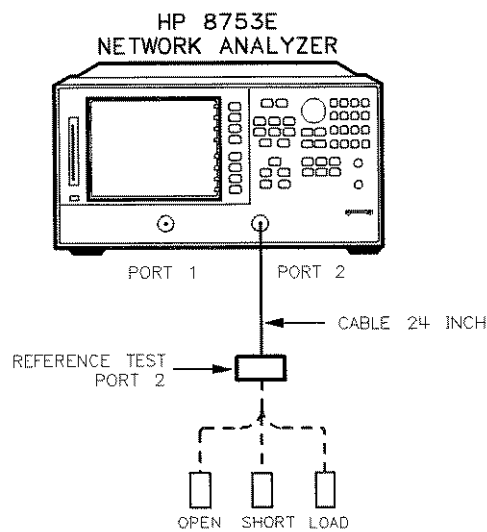

sg624e

Figure 1-35. S22 1-Port Cal Test Setup

18. Press **Cal** **CALIBRATE MENU** **S22 1-PORT**.
19. At the prompt, connect an open to reference test port 2, as shown in Figure 1-35.
20. Press **REVERSE: OPEN**.
21. When the analyzer displays the prompt **CONNECT STD THEN PRESS KEY TO MEASURE**, connect a short to reference test port 2.
22. Press **REVERSE: SHORT**.

23. At the prompt, connect a load to reference test port 2.
24. Press **REVERSE LOAD**.
25. When the analyzer displays 'DONE' IF FINISHED WITH CAL, press **DONE 1-PORT CAL**.
26. Press **Save/Recall SAVE STATE** to save the 1-Port calibration.
27. Connect the equipment as shown in Figure 1-36.

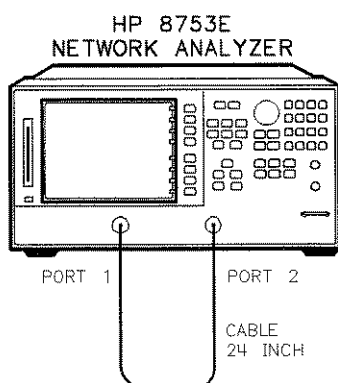

sg618e

Figure 1-36. Test Port 1 Input Impedance Test Setup

28. Press **Marker** to activate the analyzer's marker 1. Use the front panel knob to locate the maximum value of the data trace for each of the frequency ranges listed in the "Performance Test Record."
29. Write the maximum values on the "Performance Test Record."

In Case of Difficulty

1. Suspect the A10 digital IF board assembly if the analyzer fails BOTH test port tests.
2. Refer to the "Receiver Troubleshooting" chapter of the *HP 8753E Service Guide* for more troubleshooting information.

13. Test Port Receiver Magnitude Dynamic Accuracy

Specifications

HP8753E Magnitude Dynamic Accuracy 0.3 to 3000 MHz

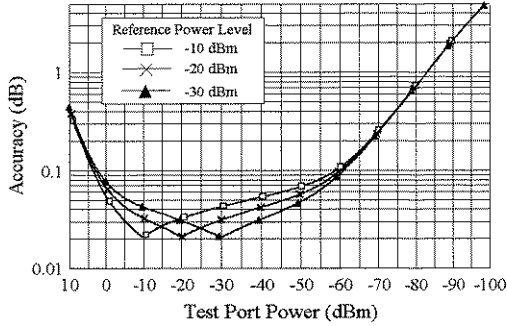

HP8753E Magnitude Dynamic Accuracy 3-6 GHz

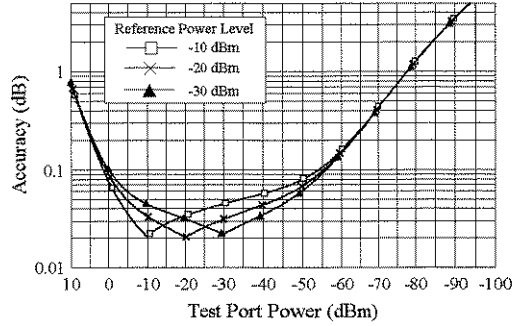

Required Equipment

Power Meter	HP 436A/437B/438A
Power Sensor	HP 8482A
Step Attenuator, 110 dB	HP 8496A Option 001, H18
(See notes on the following page.)	
Adapter (2), APC-7 to Type-N (f)	HP 11524A
Adapter, Type-N (f) to Type-N (f)	HP P/N 1250-0777
Cable (3), 50Ω, Type-N, 24-inch	8120-4781
Cable, HP-IB	HP 10833A
Diskette, 3.5 inch	any
Calibration Kit, Type-N, 50 Ω	HP 85032B

Additional Required Equipment for 75Ω Analyzers

Minimum Loss Pad (2), 50Ω to 75Ω	HP 11852B
--	-----------

Analyzer warmup time: 1 hour

Note

The HP 8496A step attenuator (Option 001, H18) comes with a special calibration that supports the measurement uncertainties expressed in the test record for this performance test.

The special calibration consists of two measurements. The first is a measurement of the attenuation at each step. The data reported for this measurement have the following uncertainties:

- ± 0.006 dB from 0 to 40 dB
- ± 0.015 dB from >40 to 80 dB
- ± 0.025 dB from >80 to 90 dB
- ± 0.05 dB >90 dB

The second calibration measurement characterizes match stability between attenuator settings for each attenuator port. The vector difference of S_{11} or (S_{22}) between the reference attenuation step and all the other steps is measured. The magnitude of this difference is certified to be <0.0316 (>30 dB).

Note

The HP 8496A used for this test will have known attenuator errors for attenuations up to 100 dB using a test frequency of 30 MHz. The attenuation used as a reference is 0 dB. If the available calibration data is not expressed as attenuation errors, it can be converted to such a form by the following equation:

$$(\text{actual attenuation}) - (\text{expected attenuation}) = \text{attenuator error}$$

Actual attenuation values that are greater than the expected attenuation values will result in positive errors. Actual attenuation values that are less than the expected attenuation values will result in negative errors.

Initial Calculations

1. Fill in the attenuator error values (referenced to 0 dB attenuation) in Table 1-1 by referring to the calibration data for the HP 8496A step-attenuator. Refer to the note on the previous page.
 - a. Find the column in the HP 8496A attenuation error table that pertains to the attenuation errors for 30 MHz.
 - b. Starting with the "10 dB" step in this column, write down the value in the corresponding space in Table 1-1 for column "B." This value should be placed in the row for the 10 dB HP 8496A setting.
 - c. Continue transferring the remaining values of the HP 8496A attenuation errors to column "B" in Table 1-1.
2. In Table 1-1, transfer the 10 dB error value located within the parenthesis in column "B" to each space in column "C."

Table 1-1. Magnitude Dynamic Accuracy Calculations

A	B	C	D (B - C)	E	F (E - D)
8496A Attn. (dB)	Attn. Error (ref 0 dB)	10 dB Error Value	Attn. Error (ref 10 dB)	Expected Measurement (dB)	Expected Measurement (corrected) (dB)
0	0 dB	_____	_____	10	_____
10	(_____)	_____	0 dB	0	_____
20	_____	_____	_____	- 10	_____
30	_____	_____	_____	- 20	_____
40	_____	_____	_____	- 30	_____
50	_____	_____	_____	- 40	_____
60	_____	_____	_____	- 50	_____
70	_____	_____	_____	- 60	_____
80	_____	_____	_____	- 70	_____
90	_____	_____	_____	- 80	_____

3. The values in column "D" result from changing the reference attenuation of the calibration data of the HP 8496A to 10 dB.
 Calculate the attenuation error values for this column by subtracting the values in column "C" from the values in column "B" ($B - C = D$).
4. The values in column "F" result from correcting the expected measurement value by the amount of attenuator error.
 Calculate the values in this column by subtracting the values in column "D" from the values in column "E" ($E - D = F$).
5. Transfer the values from column "F" in Table 1-1 to column "F" in the "Performance Test Record" for both test ports.

Port 1 Power Meter Calibration

6. Zero and calibrate the power meter. (Refer to the power meter manual for details on this procedure.)
7. Connect the equipment as shown in Figure 1-37.

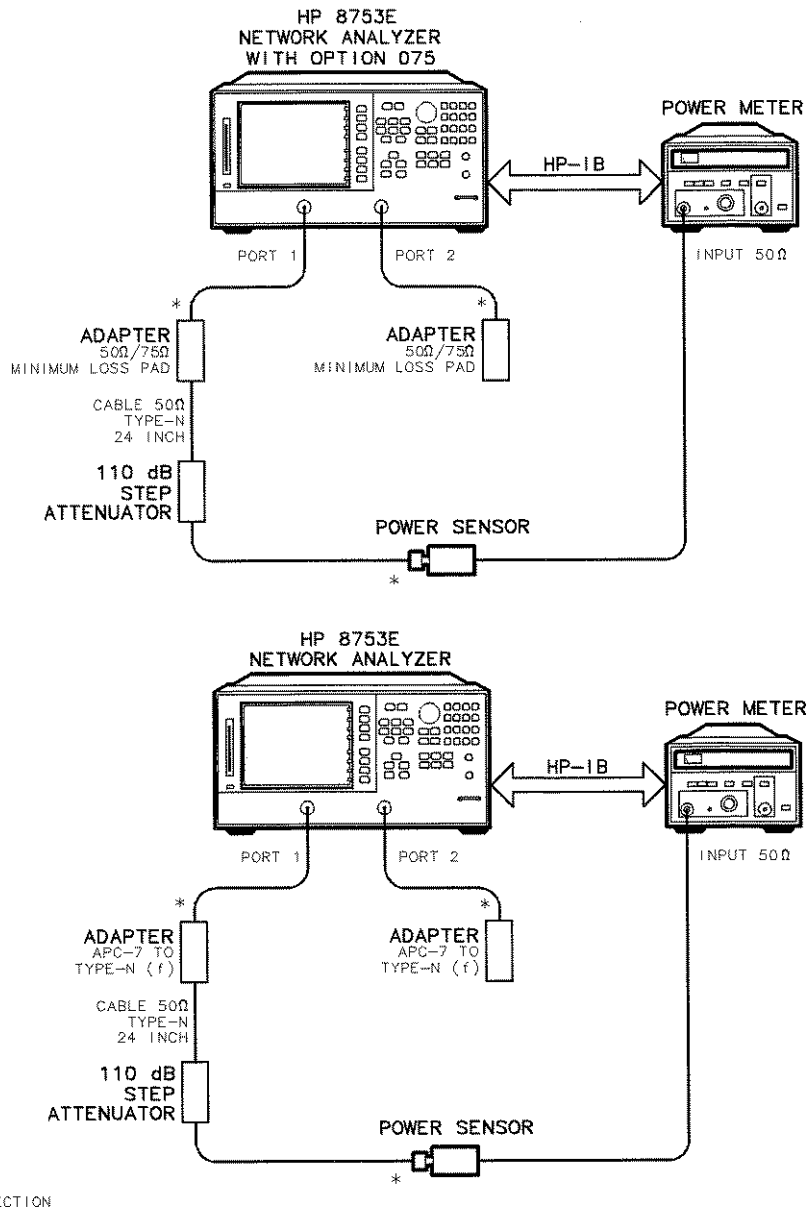

Figure 1-37. Power Meter Calibration for Magnitude Dynamic Accuracy

8. Set the HP 8496A to 10 dB.
9. Set the following analyzer parameters:

10. Set up the HP 8753E for power meter calibration:

- a. Select the HP 8753E as the system controller:

- b. Set the power meter's address:

- c. Select the appropriate power meter by pressing until the correct model number is displayed (HP 436A or HP 438A/437).

- d. Select the cal kit and enter the power sensor calibration data.

(enter the power sensor calibration data for 30 MHz)

11. Take a power meter calibration sweep.

12. Verify that the power meter reads approximately -20 dBm.

Adapter Removal Calibration

13. Connect the equipment as shown in the Figure 1-38:

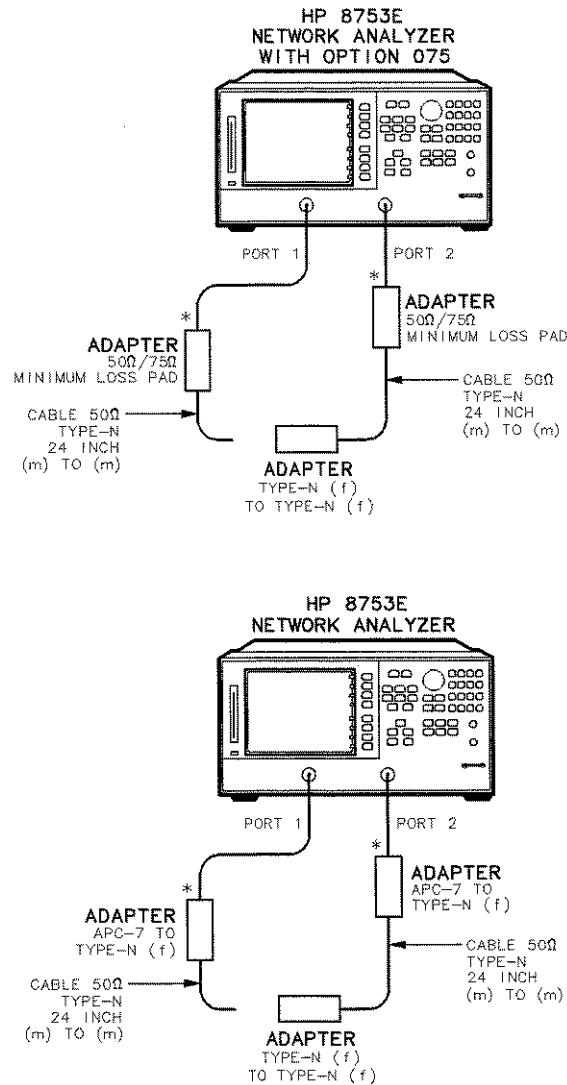

sg6118e

Figure 1-38. Full 2-Port Calibration with Adapter Removal

14. Perform a full 2-port error correction with isolation.

Note

When you are performing error-correction for a system that has type-N test port connectors, the softkey menus label the sex of the test port connector – *not* the calibration standard connector. For example, the label **SHORT (F)** refers to the short that will be connected to the female *test port*.

15. Save the results to disk. Name the file "PORT1."

16. Move the adapter to reference test port 1 and perform another full 2-port error correction.

17. Save the results to disk. Name the file "PORT2."

18. Press **[Cal]** **MORE** **ADAPTER REMOVAL** **RECALL CAL SETS**.
19. From the disk directory, choose the file "PORT1" and press **RECALL CAL PORT 1**.
20. When this is complete, choose the file "PORT2" and press **RECALL CAL PORT 2**.
21. When complete, press **RETURN**.
22. To enter the adapter delay, press **ADAPTER DELAY** **[.110]** **[G/n]** (default for Type-N adapter 1250-1777). The analyzer display will read 110 ps.
23. Press **ADAPTER COAX** **REMOVE ADAPTER**.
24. Save the results of the new cal set.

Measure Test Port 2 Magnitude Dynamic Accuracy

25. Remove the Type-N (f) to (f) adapter and connect the equipment as shown in Figure 1-39. Confirm that the step attenuator is set to 10 dB.

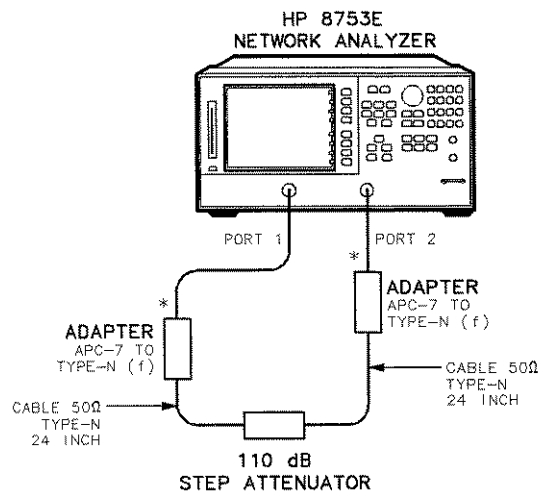
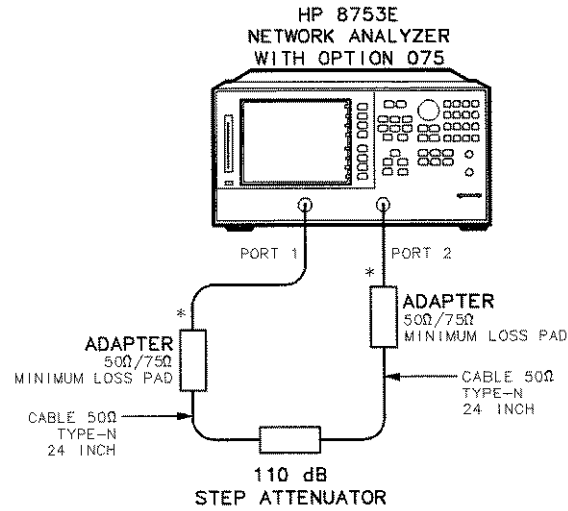

* DIRECT CONNECTION

sq661e

Figure 1-39. Magnitude Dynamic Accuracy Measurement

26. To set up the dynamic accuracy measurement, press the following:

Meas **Trans:FWD S21 (B/R)**
Marker Fctn **MKR MODE MENU** **STATS ON**
Menu **TRIGGER MENU** **SINGLE**

27. Wait for the sweep to finish, then press **Display** **DATA → MEM** **DATA/MEM**.

28. Set the step attenuator to 0 dB.

29. Press **Menu** **TRIGGER MENU** **SINGLE**.

30. Write the mean value (which appears on the analyzer's display) in the "Test Port Measurement" column of the "Performance Test Record." This column is also labeled "G."

31. Repeat steps 28 through 30 for each setting of the step attenuator.

32. Calculate dynamic accuracy for each step by using the formula $|G - F|$. Place these values in the appropriate column of the "Performance Test Record."

Measure Test Port 1 Magnitude Dynamic Accuracy

33. Set the step attenuator to 10 dB.
34. To set up the dynamic accuracy measurement, press the following:
 - Meas** **Trans:REV S12 (A/R)**
 - Display** **DATA**
 - Menu** **TRIGGER MENU SINGLE**
35. Wait for the sweep to finish, then press **Display** **DATA → MEM DATA/MEM**.
36. Set the step attenuator to 0 dB.
37. Press **Menu** **TRIGGER MENU SINGLE**.
38. Write the mean value (which appears on the analyzer's display) in the "Test Port Measurement" column of the "Performance Test Record." This column is also labeled "G."
39. Repeat steps 36 through 38 for each setting of the step attenuator.
40. Calculate dynamic accuracy for each step by using the formula $|G - F|$. Place these values in the appropriate column of the "Performance Test Record."

In Case of Difficulty

1. If the analyzer fails the test at ALL power levels, be sure you followed the recommended attenuator settings as listed in the "Performance Test Record." Repeat this performance test.
2. If both test port measured values are out of specifications:
 - a. Recalibrate the power meter.
 - b. Repeat this performance test.
3. If the analyzer fails either test port 2 or test port 1 dynamic accuracy at lower power levels:
 - a. Perform the "IF Amplifier Correction Constants" and "ADC Offset Correction Constants" procedures (located in the "Adjustments and Correction Constants" chapter).
 - b. Repeat this performance test.
 - c. If it still fails, replace the A10 Digital IF assembly.
 - d. Repeat the two adjustment procedures mentioned in this step and then repeat this performance test.

14. Test Port Receiver Magnitude Compression

Specifications

Frequency Range	Test Port	Magnitude ¹
300 kHz to 3 GHz	Port 1	≤0.45 dB
3 GHz to 6 GHz ²	Port 1	≤0.80 dB
300 kHz to 3 GHz	Port 2	≤0.45 dB
3 GHz to 6 GHz ²	Port 2	≤0.80 dB

1 With a 10 Hz IF bandwidth.

2 Only for analyzers with Option 006 – 30 kHz to 6 GHz range.

Required Equipment for 50Ω Analyzers

Cable, APC-7, 24-inch HP P/N 8120-4779

Required Equipment for 75Ω Analyzers

Cable, 75Ω, Type-N, 24-inch HP P/N 8120-2408

Analyzer warmup time: 1 hour

Perform this test to verify the compression/expansion magnitude levels of the analyzer’s test port receiver samplers.

Test Port 2 Magnitude Compression

1. Connect the equipment as shown in Figure 1-40.

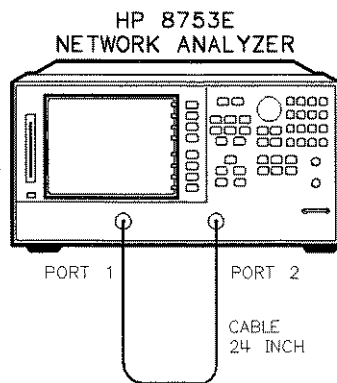

sg618e

Figure 1-40. Test Port Magnitude Compression Test Setup

2. Press **Preset** **Meas** **Trans: FWD S21 (B/R)**.
3. Press **Avg** **IF BW** **10** **x1**.
4. Press **Menu** **CW FREQ** **50** **(M/μ)**.
5. Press **SWEEP TYPE MENU** **POWER SWEEP** **START** **-10** **x1**.

6. Press **[Menu]** **TRIGGER MENU** **SINGLE**.
7. At the end of the sweep, press **[Scale Ref]** **AUTO SCALE**.
8. Press **[Marker Fctn]** **MKR SEARCH** **SEARCH: MAX**.
9. Press **[Marker]** **MARKER 2** **[Marker Fctn]** **MKR SEARCH** **SEARCH: MIN**.
10. Press **[Marker]** **ΔMODE MENU** **ΔREF = 1**.
11. Write the absolute value of the marker 2 reading in the "Performance Test Record."
12. Press **[Menu]** **CW FREQ** **[1]** **[G/n]**.
13. Press **TRIGGER MENU** **SINGLE**.
14. At the end of the sweep, press **[Scale Ref]** **AUTO SCALE**.
15. Press **[Marker]** **MARKER ΔREF=1** **[Marker Fctn]** **MKR SEARCH** **SEARCH: MAX**.
16. Press **[Marker]** **MARKER 2** **[Marker Fctn]** **MKR SEARCH** **SEARCH: MIN**.
17. Write the absolute value of marker 2 in the "Performance Test Record."
18. Repeat steps 12 through 17 for the other frequencies listed for Port 2 on the "Performance Test Record."

Test Port 1 Magnitude Compression

19. Press **[Meas]** **Trans: REV S12 (A/R)**.
20. Press **[Menu]** **CW FREQ** **[50]** **[M/μ]**.
21. Press **TRIGGER MENU** **SINGLE**.
22. At the end of the sweep, press **[Scale Ref]** **AUTO SCALE**.
23. Press **[Marker]** **MARKER ΔREF = 1** **[Marker Fctn]** **MKR SEARCH** **SEARCH: MAX**.
24. Press **[Marker]** **MARKER 2** **[Marker Fctn]** **MKR SEARCH** **SEARCH: MIN**.
25. Write the absolute value of the marker 2 reading in the "Measured Value" column of the "Performance Test Record."
26. Repeat steps 19 through 25 for the other CW frequencies listed for Port 1 in the "Performance Test Record."

In Case of Difficulty

1. If the analyzer fails "Test Port 2 Magnitude Compression":
 - a. Repeat this test.
 - b. Replace the A6 B sampler assembly if the analyzer still fails the test.
2. If the analyzer fails "Test Port 1 Magnitude Compression":
 - a. Repeat this test.
 - b. Replace the A5 A sampler assembly if the analyzer still fails the test.

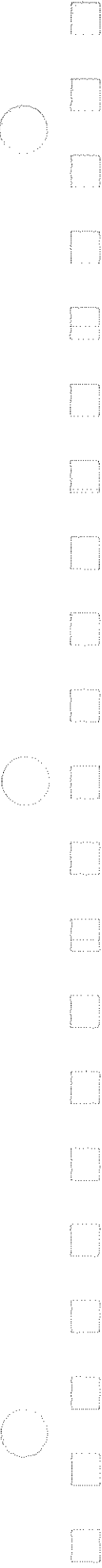

15. Test Port Receiver Phase Compression

Specifications

CW Frequency	Test Port	Phase ¹
300 kHz to 3 GHz	Port 1	$\leq 6^\circ$
3 GHz to 6 GHz ²	Port 1	$\leq 7.5^\circ$
300 kHz to 3 GHz	Port 2	$\leq 6^\circ$
3 GHz to 6 GHz ²	Port 2	$\leq 7.5^\circ$

1 With 10 Hz IF bandwidth.

2 Only for analyzer with Option 006 – 30 kHz to 6 GHz range.

Required Equipment for 50Ω Analyzers

Cable, APC-7, 24-inch HP P/N 8120-4779

Required Equipment for 75Ω Analyzers

Cable, 75Ω, Type-N, 24-inch HP P/N 8120-2408

Analyzer warmup time: 1 hour

Perform this test to verify the compression/expansion phase relationships of the analyzer's test port receiver samplers.

Test Port 2 Phase Compression

1. Connect the equipment as shown in Figure 1-41.

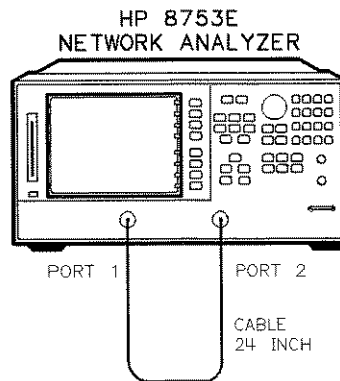

sg618e

Figure 1-41. Test Port Phase Compression Test Setup

2. Press **Preset** **Meas** **Trans: FWD S21 (B/R)** **Format** **PHASE**.
3. Press **Avg** **IF BW** **10** **x1**.
4. Press **Menu** **SWEEP TYPE MENU** **POWER SWEEP** **START** **-10** **x1**.
5. Press **Menu** **CW FREQ** **50** **M/μ**.

6. Press **Menu** **TRIGGER MENU** **SINGLE**.
7. At the end of the sweep, press **Scale Ref** **AUTO SCALE**.
8. Press **Marker Fctn** **MKR SEARCH** **SEARCH: MAX**.
9. Press **Marker** **MARKER 2** **Marker Fctn** **MKR SEARCH** **SEARCH: MIN**.
10. Press **Marker** **ΔMODE MENU** **ΔREF = 1**.
11. Write the absolute value of the marker 2 reading in the "Measured Value" column of the "Performance Test Record."
12. Repeat steps 5 to 11 for the other CW frequencies listed for Port 2 in the "Performance Test Record."

Test Port 1 Phase Compression

13. Press **Meas** **Trans: REV S12 (A/R)** **Format** **PHASE**.
14. Press **Menu** **CW FREQ** **50** **(M/μ)**.
15. Press **Menu** **TRIGGER MENU** **SINGLE**.
16. At the end of the sweep, press **Scale Ref** **AUTO SCALE**.
17. Press **Marker** **MARKER ΔREF = 1** **Marker Fctn** **MKR SEARCH** **SEARCH: MAX**.
18. Press **Marker** **MARKER 2** **Marker Fctn** **MKR SEARCH** **SEARCH: MIN**.
19. Write the absolute value of the marker 2 reading in the "Measured Value" column of the "Performance Test Record."
20. Repeat steps 14 to 19 for the other CW frequencies listed for Port 1 in the "Performance Test Record."

In Case of Difficulty

1. If the analyzer fails the "Test Port 2 Phase Compression" test:
 - a. Repeat this test.
 - b. Replace the A6 B sampler assembly if analyzer still fails the test.
2. If the analyzer fails the "Test Port 1 Phase Compression" test:
 - a. Repeat this test.
 - b. Replace the A5 A sampler assembly if analyzer still fails the test.

16. Test Port Output/Input Harmonics (Option 002 Analyzers without Option 006 Only)

Specifications

Test Port	Harmonic	Limit
Output	2nd	< -25 dBc @ +10 dBm
Output	3rd	< -25 dBc @ +10 dBm
Input Port 1	2nd	< -15 dBc @ +8 dBm
Input Port 1	3rd	< -30 dBc @ +8 dBm
Input Port 2	2nd	< -15 dBc @ +8 dBm
Input Port 2	3rd	< -30 dBc @ +8 dBm

Equipment Required for 50Ω Analyzers

Cable, APC-7, 24-inch HP P/N 8120-4779
Attenuator (2), 20 dB, APC-7 HP 8492A Option 020

Equipment Required for 75Ω Analyzers

Minimum Loss Pad (2) HP 11852B
Cable, Type-N HP P/N 8120-2408
Attenuator (2), 20 dB, Type-N HP 8491A Option 020

Analyzer warmup time: 30 minutes

Perform this test to determine the spectral purity of the HP 8753E input and output test ports.

Note The test port input 3rd harmonic specifications are *better* than the test port output 3rd harmonic specifications.

Test Port Output Worst Case 2nd Harmonic

1. Press **Pre** **Menu** **POWER** **10** **x1**.
2. Press **Start** **16** **M/μ** **Stop** **1.5** **G/n** to set the frequency range.
3. Press **Avg** **IF BW** **10** **x1** to set the IF bandwidth to 10 Hz.
4. Connect the equipment as shown in Figure 1-42.

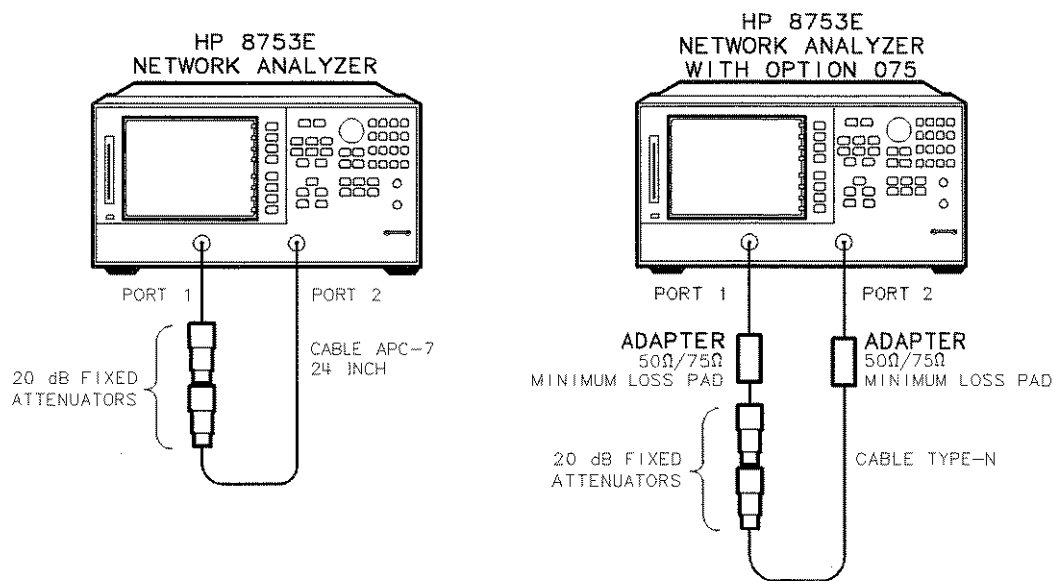

sg627e

Figure 1-42. Test Port Output Harmonics Test Setup

5. Press **Meas** **Trans:REV S12 (A/R)** **INPUT PORTS A**.
6. After one sweep, press **Display** **DATA—MEMORY** **DATA/MEM** to normalize the trace.
7. Press **System** **HARMONIC MEAS** **HARMONIC SECOND**.
8. After one sweep, press **Scale Ref** **AUTO SCALE** to get a better viewing of the trace.
9. Press **Marker Fctn** **MKR SEARCH** **SEARCH MAX**.
10. Write the marker 1 value (which appears on the analyzer display) on the “Performance Test Record.” This is the worst case test port output 2nd harmonic.

Test Port Output Worst Case 3rd Harmonic

11. Press **Stop** **1** **G/n** to change the stop frequency to 1 GHz.
12. Press **System** **HARMONIC MEAS** **HARMONIC OFF**.
13. After one sweep, press **Display** **DATA—MEMORY** **DATA/MEM** to normalize the trace.
14. Press **Scale Ref** **AUTO SCALE** **SCALE/DIV** **1** **x1** to get a better viewing of the trace.
15. Press **System** **HARMONIC MEAS** **HARMONIC THIRD**.
16. After one sweep, press **Scale Ref** **AUTO SCALE**.
17. Press **Marker Fctn** **MKR SEARCH** **SEARCH MAX**.
18. Write the marker 1 value on the “Performance Test Record.”

Port 1 Input Worst Case 2nd Harmonic

19. Connect the equipment as shown in Figure 1-43.

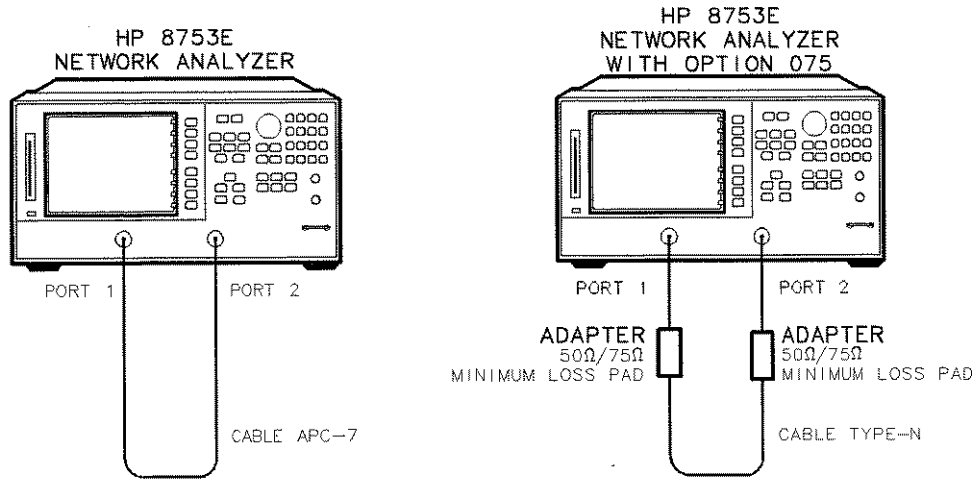

sg628e

Figure 1-43. Receiver Harmonics Test Setup

20. Press **Preset** **Menu** **POWER** **8** **x1**.
21. Press **Avg** **IF BW** **1** **0** **x1**.
22. Press **Start** **16** **M/μ** **Stop** **1.5** **G/n** to set the frequency range.
23. Press **Meas** **Trans:REV S12 (A/R)** **INPUT PORTS** **A**.
24. After one sweep, press **Display** **DATA-MEMORY** **DATA/MEM** to normalize the trace.
25. Press **System** **HARMONIC MEAS** **HARMONIC SECOND**.
26. After one sweep, press **Scale Ref** **AUTO SCALE** to get a better viewing of the trace.
27. Press **Marker Fctn** **MKR SEARCH** **SEARCH MAX**.
28. Write the marker 1 value (which appears on the analyzer display) on the "Performance Test Record." This is the worst case port 1 input (receiver channel A) 2nd harmonic.

Port 1 Input Worst Case 3rd Harmonic

29. Press **Stop** **1** **G/n** to change the stop frequency for measuring the receiver 3rd harmonic.
30. Press **System** **HARMONIC MEAS** **HARMONIC OFF**.
31. After one sweep, press **Display** **DATA-MEMORY** **DATA/MEM** to normalize the trace.
32. Press **Scale Ref** **AUTO SCALE** **SCALE/DIV** **1** **x1** to get a better viewing of the trace.
33. Press **System** **HARMONIC MEAS** **HARMONIC THIRD**.
34. After one sweep, press **Scale Ref** **AUTO SCALE**.

35. Press **Marker Fctn** **MKR SEARCH** **SEARCH MAX**.
36. Write the marker 1 value on the "Performance Test Record."
37. Press **System** **HARMONIC MEAS** **HARMONIC OFF**.

Port 2 Input Worst Case 2nd Harmonic

38. Press **Stop** **1.5** **G/n** to set the stop frequency for measuring the 2nd harmonic.
39. Press **Meas** **Trans:FWD S21 (B/R)** **INPUT PORTS B**.
40. After one sweep, press **Display** **DATA→MEMORY** **DATA/MEM** to normalize the trace.
41. Press **System** **HARMONIC MEAS** **HARMONIC SECOND**.
42. After one sweep, press **Scale Ref** **AUTO SCALE** to get a better viewing of the trace.
43. Press **Marker Fctn** **MKR SEARCH** **SEARCH MAX**.
44. Write the marker 1 value (which appears on the analyzer display) on the "Performance Test Record." This is the worst case port 2 input (receiver channel B) 2nd harmonic.

Port 2 Input Worst Case 3rd Harmonic

45. Press **Stop** **1** **G/n** to change the stop frequency for measuring the receiver 3rd harmonic.
46. Press **System** **HARMONIC MEAS** **HARMONIC OFF**.
47. After one sweep, press **Display** **DATA→MEMORY** **DATA/MEM** to normalize the trace.
48. Press **Scale Ref** **AUTO SCALE** **SCALE/DIV** **1** **x1** to get a better viewing of the trace.
49. Press **System** **HARMONIC MEAS** **HARMONIC THIRD**.
50. After one sweep, press **Scale Ref** **AUTO SCALE**.
51. Press **Marker Fctn** **MKR SEARCH** **SEARCH MAX**.
52. Write the marker 1 value on the "Performance Test Record."

17. Test Port Output/Input Harmonics (Option 002 Analyzers with Option 006 Only)

Specifications

Test Port	Harmonic	Limit
Output	2nd	< -25 dBc @ +10 dBm
Output	3rd	< -25 dBc @ +10 dBm
Input Port 1	2nd	< -15 dBc @ +8 dBm
Input Port 1	3rd	< -30 dBc @ +8 dBm
Input Port 2	2nd	< -15 dBc @ +8 dBm
Input Port 2	3rd	< -30 dBc @ +8 dBm

Equipment Required

Cable, APC-7, 24-inch HP P/N 8120-4779
Attenuator (2), 20 dB HP 8492A Opt 020

Analyzer warmup time: 30 minutes

Perform this test to determine the spectral purity of the HP 8753E input and output test ports.

Note The test port input 3rd harmonic specifications are *better* than the test port output 3rd harmonic specifications.

Test Port Output Worst Case 2nd Harmonic

1. Press **[Preset]** **[Menu]** **POWER** **[10]** **[x1]** to set the test port power to +10 dBm.
2. Press **[Start]** **[16]** **[M/μ]** **[Stop]** **[3]** **[G/n]** to set the frequency range.
3. Press **[Avg]** **IF BW** **[10]** **[x1]** to set the IF bandwidth to 10 Hz.
4. Connect the equipment as shown in Figure 1-44.

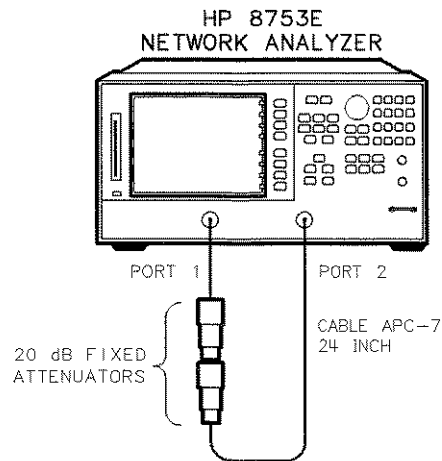

sg629e

Figure 1-44. Test Port Output Harmonics Test Setup

5. Press **[Meas]** **Trans:REV S12 (A/R)** **INPUT PORTS A**.
6. After one sweep, press **[Display]** **DATA→MEMORY** **DATA/MEM** to normalize the trace.
7. Press **[System]** **HARMONIC MEAS** **HARMONIC SECOND**.
8. After one sweep, press **[Scale Ref]** **AUTO SCALE** to get a better viewing of the trace.
9. Press **[Marker Fctn]** **MKR SEARCH** **SEARCH MAX**.
10. Write the marker 1 value (which appears on the analyzer display) on the "Performance Test Record." This is the worst case test port output 2nd harmonic.

Test Port Output Worst Case 3rd Harmonic

11. Press **Stop** **2** **G/n** to change the stop frequency to 2 GHz.
12. Press **System** **HARMONIC MEAS** **HARMONIC OFF**.
13. After one sweep, press **Display** **DATA→MEMORY** **DATA/MEM** to normalize the trace.
14. Press **Scale Ref** **AUTO SCALE** **SCALE/DIV** **1** **x1** to get a better viewing of the trace.
15. Press **System** **HARMONIC MEAS** **HARMONIC THIRD**.
16. After one sweep, press **Scale Ref** **AUTO SCALE**.
17. Press **Marker Fctn** **MKR SEARCH** **SEARCH MAX**.
18. Write the marker 1 value on the "Performance Test Record."

Port 1 Input Worst Case 2nd Harmonic

19. Connect the equipment as shown in Figure 1-45.

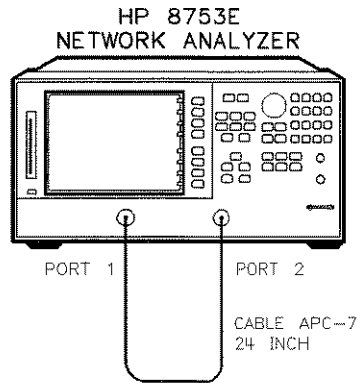

sg630e

Figure 1-45. Receiver Harmonics Test Setup

20. Press **Preset** **Menu** **POWER** **8** **x1**.
21. Press **Avg** **IF BW** **10** **x1**.
22. Press **Start** **16** **M/μ** **Stop** **3** **G/n** to set the frequency range.
23. Press **Meas** **Trans-REV S12 (A/R)** **INPUT PORTS** **A**.
24. After one sweep, press **Display** **DATA-MEMORY** **DATA/MEM** to normalize the trace.
25. Press **System** **HARMONIC MEAS** **HARMONIC SECOND**.
26. After one sweep, press **Scale Ref** **AUTO SCALE** to get a better viewing of the trace.
27. Press **Marker Fctn** **MKR SEARCH** **SEARCH: MAX**.
28. Write the marker 1 value (which appears on the analyzer display) on the "Performance Test Record." This is the worst case port 1 input (receiver channel A) 2nd harmonic.

Port 1 Input Worst Case 3rd Harmonic

29. Press **(Stop)** **(2)** **(G/n)** to change the stop frequency for measuring the receiver 3rd harmonic.
30. Press **(System)** **HARMONIC MEAS** **HARMONIC OFF**.
31. After one sweep, press **(Display)** **DATA→MEMORY** **DATA/MEM** to normalize the trace.
32. Press **(Scale Ref)** **AUTO SCALE** **SCALE/DIV** **(1)** **(x1)** to get a better viewing of the trace.
33. Press **(System)** **HARMONIC MEAS** **HARMONIC THIRD**.
34. After one sweep, press **(Scale Ref)** **AUTO SCALE**.
35. Press **(Marker Fctn)** **MKR SEARCH** **SEARCH: MAX**.
36. Write the marker 1 value on the "Performance Test Record."
37. Press **(System)** **HARMONIC MEAS** **HARMONIC OFF**.

Port 2 Input Worst Case 2nd Harmonic

38. Press **(Stop)** **(3)** **(G/n)** to set the stop frequency for measuring the 2nd harmonic.
39. Press **(Meas)** **Trans:FWD S21 (B/R)** **INPUT PORTS** **B**.
40. After one sweep, press **(Display)** **DATA→MEMORY** **DATA/MEM** to normalize the trace.
41. Press **(System)** **HARMONIC MEAS** **HARMONIC SECOND**.
42. After one sweep, press **(Scale Ref)** **AUTO SCALE** to get a better viewing of the trace.
43. Press **(Marker Fctn)** **MKR SEARCH** **SEARCH MAX**.
44. Write the marker 1 value (which appears on the analyzer display) on the "Performance Test Record." This is the worst case port 2 input (receiver channel B) 2nd harmonic.

Port 2 Input Worst Case 3rd Harmonic

45. Press **(Stop)** **(2)** **(G/n)** to change the stop frequency for measuring the receiver 3rd harmonic.
46. Press **(System)** **HARMONIC MEAS** **HARMONIC OFF**.
47. After one sweep, press **(Display)** **DATA→MEMORY** **DATA/MEM** to normalize the trace.
48. Press **(Scale Ref)** **AUTO SCALE** **SCALE/DIV** **(1)** **(x1)** to get a better viewing of the trace.
49. Press **(System)** **HARMONIC MEAS** **HARMONIC THIRD**.
50. After one sweep, press **(Scale Ref)** **AUTO SCALE**.
51. Press **(Marker Fctn)** **MKR SEARCH** **SEARCH: MAX**.
52. Write the marker 1 value on the "Performance Test Record."

18. Test Port Output Harmonics (Analyzers without Option 002)

Specifications

Harmonic	Limit, +10dBm source output ¹
2nd	<-25 dBc
3rd	<-25 dBc

¹ For HP 8753E Option 075: +8 dBm source output;
limits valid for frequencies below 2 GHz

Equipment Required for 50Ω Analyzers

Spectrum analyzer	HP 8595E
Cable, 50Ω, type-N (m) to type-N (m), 24-inch	HP P/N 8120-4781
Adapter, APC-7 to type-N (f)	HP 11524A
Adapter, type-N (m) to BNC (f)	HP P/N 1250-1476
Cable, 50Ω, BNC (m)	HP P/N 8120-1840

Additional Equipment Required for 75Ω Analyzers

Minimum-loss pad	HP 11852B
------------------------	-----------

Equipment warmup time: 30 minutes (network analyzer and spectrum analyzer)

Perform this test to determine the spectral purity of the network analyzer RF source. Use this procedure with HP 8753E network analyzers without Option 002 (harmonic measurement capability).

Procedure

1. Calibrate the *spectrum analyzer*:
 - a. Connect the BNC cable between the spectrum analyzer CAL OUT connector and the 50 Ω input. Use the type-N (m) to BNC (f) adapter at the 50 Ω input.
 - b. Press **CAL**.
 - c. Press **CAL YTF** and wait for calibration to complete.
 - d. Press **CAL FREQ & AMPTD** and wait for calibration to complete.
 - e. Press **STORE CAL**.
 - f. Remove the BNC cable and adapter.
2. Connect the equipment as shown in Figure 1-46.

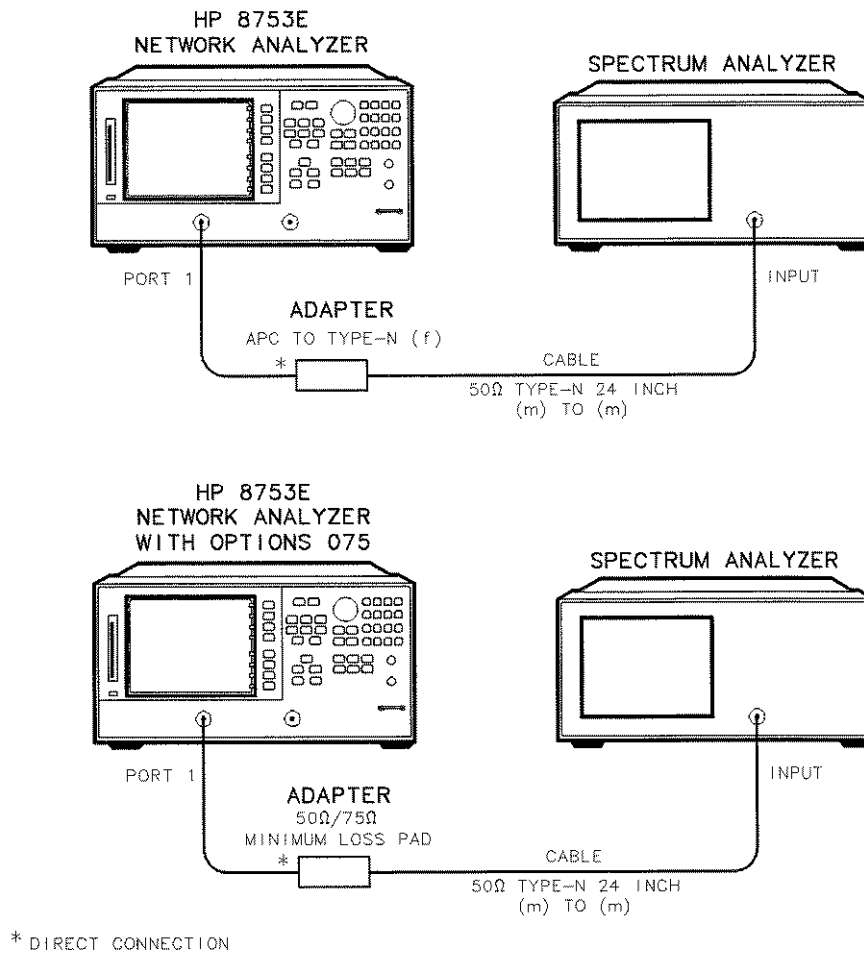

sg6123e

Figure 1-46. Test Port Output Harmonics Test Setup

3. Set the *network analyzer* source power to +10 dBm:

- a. Press **PRESET**.
- b. Press **MENU**.
- c. Press **Power**.
- d. Press **10** **x 1**. (For 75Ω analyzers, press **8** **x1**.)
- e. Press **RETURN**.

4. Set up the *spectrum analyzer* display:

- a. Press **SPAN**.
- b. Press **20** **MHz**.
- c. Press **BW**.
- d. Press **300** **kHz**.
- e. Press **VBW/RBW RATIO**.
- f. Press **.03** **ENTER**.
- g. Press **AMPLITUDE**.
- h. Press **REF LVL**.
- i. Press **10** **+dBm**.

5. Set the *network analyzer* and *spectrum analyzer* to the harmonic frequency. Use the appropriate test record to choose the proper harmonic frequency. Refer to the test record in Section 2a for 3 GHz network analyzers, or the test record in Section 2b for 6 GHz network analyzers.

■ *Network Analyzer*

- a. Press **CW FREQ**.
- b. Enter the harmonic frequency from the test record. For example, press **100** **M/μ** to set the network analyzer to the second harmonic of the first fundamental frequency in the 3 GHz test record.

■ *Spectrum Analyzer*

- c. Press **FREQUENCY**.
- d. Enter the harmonic frequency from the test record. For example, press **100** **MHz** to set the spectrum analyzer to the second harmonic of the first fundamental frequency in the 3 GHz or 6 GHz test record.
- e. Press **MKR →**.
- f. Press **MKR → CF**.
- g. Press **SGL SWP**.
- h. Press **MKR**.
- i. Press **MKR Δ**.

6. Set up the *network analyzer* to output the fundamental frequency:
 - a. Press **CW FREQ**.
 - b. Enter the fundamental frequency. For example, press **50** **(M/μ)** to enter the first fundamental frequency in the 3 GHz test record.
7. Measure and record the power in the second or third harmonic by taking a single sweep with the *spectrum analyzer*:
 - a. Press **(SGL SWEEP)**.
 - b. Read the **MARKER Δ** measurement, and record it in the appropriate row of the test record under **Measurement Value (dBc)**.
8. Reset the *spectrum analyzer* marker:
 - a. Press **(MKR)**.
 - b. Press **MARKER NORMAL**.
9. Repeat steps 5 through 8 for the remaining second and third harmonic frequencies, and the fundamental frequencies listed in the test record.

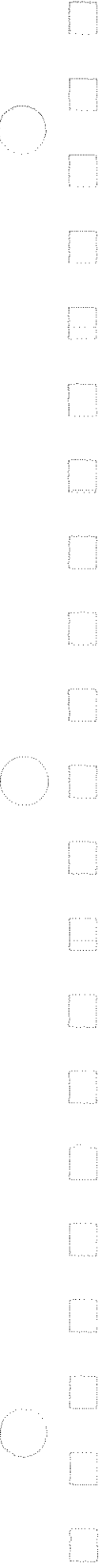

Performance Test Record

**For Analyzers with a Frequency Range of
30 kHz to 3 GHz**

Note See the next "Performance Test Record" section if your analyzer frequency range is from 30 kHz to 6 GHz (Option 006).

HP 8753E Performance Test Record (1 of 13)

Calibration Lab Address: _____ _____ _____	Report Number _____ Date _____ Last Calibration Date _____ Customer's Name _____ Performed by _____																								
Model HP 8753E Serial No. _____ Option(s) _____ Firmware Revision _____ Ambient Temperature _____ ° C Relative Humidity _____ %																									
Test Equipment Used: <table border="1" style="width: 100%; border-collapse: collapse; margin-top: 5px;"> <thead> <tr> <th style="text-align: left;">Description</th> <th style="text-align: left;">Model Number</th> <th style="text-align: left;">Trace Number</th> <th style="text-align: left;">Cal Due Date</th> </tr> </thead> <tbody> <tr> <td>Frequency Counter</td> <td>_____</td> <td>_____</td> <td>_____</td> </tr> <tr> <td>Power Meter</td> <td>_____</td> <td>_____</td> <td>_____</td> </tr> <tr> <td>Power Sensor</td> <td>_____</td> <td>_____</td> <td>_____</td> </tr> <tr> <td>Calibration Kit</td> <td>_____</td> <td>_____</td> <td>_____</td> </tr> <tr> <td>Verification Kit</td> <td>_____</td> <td>_____</td> <td>_____</td> </tr> </tbody> </table>		Description	Model Number	Trace Number	Cal Due Date	Frequency Counter	_____	_____	_____	Power Meter	_____	_____	_____	Power Sensor	_____	_____	_____	Calibration Kit	_____	_____	_____	Verification Kit	_____	_____	_____
Description	Model Number	Trace Number	Cal Due Date																						
Frequency Counter	_____	_____	_____																						
Power Meter	_____	_____	_____																						
Power Sensor	_____	_____	_____																						
Calibration Kit	_____	_____	_____																						
Verification Kit	_____	_____	_____																						
Notes/Comments: _____ _____ _____																									

**HP 8753E Performance Test Record (2 of 13)
For 30 kHz—3 GHz Analyzers**

Hewlett-Packard Company Model HP 8753E Serial Number _____	Report Number _____ Date _____
--	---------------------------------------

▶▶ 1. Test Port Output Frequency Range and Accuracy

CW Frequencies (MHz)	Min. (MHz)	Results Measured (MHz)	Max. (MHz)	Measurement Uncertainty (MHz)
0.03	0.029 999 7	_____	0.030 000 3	± 0.000 000 050
0.3	0.299 997	_____	0.300 003	± 0.000 000 520
5.0	4.999 950	_____	5.000 050	± 0.000 009
16.0	15.999 840	_____	16.000 160	± 0.000 028
31.0	30.999 690	_____	31.000 310	± 0.000 054
60.999 999	60.999 390	_____	61.000 610	± 0.000 105
121.0	120.998 790	_____	121.001 210	± 0.000 207
180.0	179.998 200	_____	180.001 800	± 0.000 307
310.0	309.995 900	_____	310.003 100	± 0.000 528
700.0	699.930 000	_____	700.007 000	± 0.001 192
1 300.0	1 299.987	_____	1 300.013	± 0.002 212
2 000.0	1 999.980	_____	2 000.020	± 0.003 403
3 000.0	2 999.970	_____	3 000.030	± 0.005 104

▶▶ 2. External Source Mode Frequency Range

Test Frequencies (GHz)	Results
0.010	_____
0.020	_____
0.100	_____
1.000	_____
2.000	_____
3.000	_____

**HP 8753E Performance Test Record (3 of 13)
For 30 kHz—3 GHz Analyzers**

Hewlett-Packard Company Model HP 8753E Serial Number _____		Report Number _____ Date _____		
▶▶ 3. Test Port Output Power Accuracy				
Test Frequencies	Test Port Output Power (dBm)	Specification (dB)	Measured Value (dB)	Measurement Uncertainty (dB)
Center Frequency				
300 kHz	0	± 1	_____	± 0.465
20 MHz	0	± 1	_____	± 0.10
50 MHz	0	± 1	_____	± 0.10
100 MHz	0	± 1	_____	± 0.10
200 MHz	0	± 1	_____	± 0.10
500 MHz	0	± 1	_____	± 0.10
1 GHz	0	± 1	_____	± 0.13
2 GHz	0	± 1	_____	± 0.13
3 GHz	0	± 1	_____	± 0.27
▶▶ 4. Test Port Output Power Range and Linearity				
Test Settings	Results Measured (dB)	Power Level Linearity (dB)	Specification (dB)	Measurement Uncertainty (dB)
CW Frequency = 300 kHz				
- 15	_____	_____	± 0.2	± 0.03
- 13	_____	_____	± 0.2	± 0.03
- 11	_____	_____	± 0.2	± 0.03
- 9	_____	_____	± 0.2	± 0.02
- 7	_____	_____	± 0.2	± 0.02
- 5	_____	_____	± 0.2	± 0.02
- 3	_____	_____	± 0.2	± 0.02
- 1	_____	_____	± 0.2	± 0.02
+ 1	_____	_____	± 0.2	± 0.03
+ 3	_____	_____	± 0.2	± 0.03
+ 5	_____	_____	± 0.5	± 0.03

**HP 8753E Performance Test Record (4 of 13)
For 30 kHz—3 GHz Analyzers**

Hewlett-Packard Company Model HP 8753E Serial Number _____	Report Number _____ Date _____
--	-----------------------------------

▶▶ 4. Test Port Output Power Range and Linearity (continued)

Test Settings	Results Measured (dB)	Power Level Linearity (dB)	Specification (dB)	Measurement Uncertainty (dB)
+ 7	_____	_____	± 0.5	± 0.03
+ 8	_____	_____	± 0.5	± 0.03
+ 9	_____	_____	± 0.5	± 0.03
+ 10	_____	_____	± 0.5	± 0.03
CW Frequency = 3 GHz				
- 15	_____	_____	± 0.2	± 0.03
- 13	_____	_____	± 0.2	± 0.03
- 11	_____	_____	± 0.2	± 0.03
- 9	_____	_____	± 0.2	± 0.02
- 7	_____	_____	± 0.2	± 0.02
- 5	_____	_____	± 0.2	± 0.02
- 3	_____	_____	± 0.2	± 0.02
- 1	_____	_____	± 0.2	± 0.02
+ 1	_____	_____	± 0.2	± 0.03
+ 3	_____	_____	± 0.2	± 0.03
+ 5	_____	_____	± 0.5	± 0.03
+ 7	_____	_____	± 0.5	± 0.03
+ 8	_____	_____	± 0.5	± 0.03
+ 9	_____	_____	± 0.5	± 0.03
+ 10	_____	_____	± 0.5	± 0.03

**HP 8753E Performance Test Record (5 of 13)
For 30 kHz—3 GHz Analyzers**

Hewlett-Packard Company Model HP 8753E Serial Number _____	Report Number _____ Date _____
--	---------------------------------------

▶▶ 5. Minimum R Channel Level

CW Frequency	Specification (dB)	Test Port Power	Measurement Uncertainty (dB)
300 kHz	< -35	_____	± 1.0
3.29 MHz	< -35	_____	± 1.0
3.31 MHz	< -35	_____	± 1.0
15.90 MHz	< -35	_____	± 1.0
16.10 MHz	< -35	_____	± 1.0
30.90 MHz	< -35	_____	± 1.0
31.10 MHz	< -35	_____	± 1.0
1.6069 GHz	< -35	_____	± 1.0
1.6071 GHz	< -35	_____	± 1.0
3.000 GHz	< -35	_____	± 1.0

▶▶ 6. Test Port Input Noise Floor Level

Frequency Range	Test Port	IF Bandwidth	Specification (dBm)	Calculated Value	Measurement Uncertainty
300 kHz - 3 GHz	Port 1	3 kHz	- 82	_____	N/A
300 kHz - 3 GHz	Port 1	10 Hz	- 102	_____	N/A
300 kHz - 3 GHz	Port 2	10 Hz	- 102	_____	N/A
300 kHz - 3 GHz	Port 2	3 kHz	- 82	_____	N/A

**HP 8753E Performance Test Record (6 of 13)
For 30 kHz—3 GHz Analyzers**

Hewlett-Packard Company Model HP 8753E		Report Number _____		
Serial Number _____		Date _____		
▶▶ 7. Test Port Input Frequency Response				
Frequency Range	Test Port	Specification (dB)	Measured Value (dB)	Measurement Uncertainty (dB)
300 kHz—3 GHz	Port 2	± 1	_____	0.47
300 kHz—3 GHz	Port 1	± 1	_____	0.47
▶▶ 8. Test Port Crosstalk				
Test Settings	Specification (dB)	Measured Value (dB)	Measurement Uncertainty	
Crosstalk to Test Port 2 300 kHz—3 GHz	< -100	_____	N/A	
Crosstalk to Test Port 1 300 kHz—3 GHz	< -100	_____	N/A	

**HP 8753E Performance Test Record (7 of 13)
For 30 kHz—3 GHz Analyzers**

Hewlett-Packard Company Model HP 8753E		Report Number _____		
Serial Number _____		Date _____		
▶▶ 9. Calibration Coefficients				
Test Description	Frequency Range	Spec. (dB)	Measured Value (dB)	Measurement Uncertainty (dB)
Forward Direction				
Directivity	300 kHz - 1.3 GHz	≥ 35	_____	± 0.9
Directivity	1.3 GHz - 3 GHz	≥ 30	_____	± 0.8
Forward Direction				
Source Match	300 kHz - 1.3 GHz	≥ 16	_____	± 0.2
Source Match	1.3 GHz - 3 GHz	≥ 16	_____	± 0.2
Forward Direction				
Trans. Tracking	300 kHz - 1.3 GHz	± 1.5	_____	± 0.006
Trans. Tracking	1.3 GHz - 3 GHz	± 1.5	_____	± 0.009
Forward Direction				
Refl. Tracking	300 kHz - 1.3 GHz	± 1.5	_____	± 0.001
Refl. Tracking	1.3 GHz - 3 GHz	± 1.5	_____	± 0.005
Reverse Direction				
Load Match	300 kHz - 1.3 GHz	≥ 18	_____	± 0.1
Load Match	1.3 GHz - 3 GHz	≥ 16	_____	± 0.2

**HP 8753E Performance Test Record (8 of 13)
For 30 kHz—3 GHz Analyzers**

Hewlett-Packard Company Model HP 8753E		Report Number _____		
Serial Number _____		Date _____		
▶▶ 9. Calibration Coefficients (continued)				
Test Description	Frequency Range	Spec. (dB)	Measured Value (dB)	Measurement Uncertainty (dB)
Reverse Direction Trans. Tracking	300 kHz - 1.3 GHz	± 1.5	_____	± 0.006
Trans. Tracking	1.3 GHz - 3 GHz	± 1.5	_____	± 0.009
Forward Direction Load Match	300 kHz - 1.3 GHz	≥ 18	_____	± 0.1
Load Match	1.3 GHz - 3 GHz	≥ 16	_____	± 0.2
Reverse Direction Directivity	300 kHz - 1.3 GHz	≥ 35	_____	± 0.9
Directivity	1.3 GHz - 3 GHz	≥ 30	_____	± 0.8
Reverse Direction Source Match	300 kHz - 1.3 GHz	≥ 16	_____	± 0.2
Source Match	1.3 GHz - 3 GHz	≥ 16	_____	± 0.2
Reverse Direction Ref. Tracking	300 kHz - 1.3 GHz	± 1.5	_____	± 0.001
Ref. Tracking	1.3 GHz - 3 GHz	± 1.5	_____	± 0.005

**HP 8753E Performance Test Record (9 of 13)
For 30 kHz—3 GHz Analyzers**

Hewlett-Packard Company Model HP 8753E		Report Number _____		
Serial Number _____		Date _____		
▶▶ 10. System Trace Noise				
CW Frequency (GHz)	Ratio	Specification	Measured Value	Measurement Uncertainty
3	A/R	< 0.006 dB rms	_____	±0.001 dB
3	A/R	< 0.038° rms	_____	±0.01°
3	B/R	< 0.006 dB rms	_____	±0.001 dB
3	B/R	< 0.038° rms	_____	±0.01°
▶▶ 12. Test Port Input Impedance				
Frequency Range	Test Port	Return Loss (dB)	Specification (dB)	Measurement Uncertainty (dB)
300 kHz—1.3 GHz	Port 2	_____	≥ 18	± 1.5
1.3 GHz—3 GHz	Port 2	_____	≥ 16	± 1.5
300 kHz—1.3 GHz	Port 1	_____	≥ 18	± 1.5
1.3 GHz—3 GHz	Port 1	_____	≥ 16	± 1.5

**HP 8753E Performance Test Record (10 of 13)
For 30 kHz—3 GHz Analyzers**

Hewlett-Packard Company Model HP 8753E				Report Number _____		
Serial Number _____				Date _____		
▶▶ 13. Test Port Receiver Magnitude Dynamic Accuracy						
		G	F	 G - F 		
Test Port Input Power (dBm)	S496A Attn. (dB)	Test Port Measurement (dB)	Expected Measurement (corrected) (dB)	Dynamic Accuracy (Calculated)	Spec. (dB)	Meas. Uncer. (dB)
Test Port 2						
- 10	0	_____	_____	_____	≤ 0.033	± 0.008
- 20 (Ref)	10	_____	0.000	_____	≤ 0.020	± 0.008
- 30	20	_____	_____	_____	≤ 0.031	± 0.008
- 40	30	_____	_____	_____	≤ 0.042	± 0.008
- 50	40	_____	_____	_____	≤ 0.057	± 0.008
- 60	50	_____	_____	_____	≤ 0.098	± 0.017
- 70	60	_____	_____	_____	≤ 0.247	± 0.017
- 80	70	_____	_____	_____	≤ 0.725	± 0.017
- 90	80	_____	_____	_____	≤ 2.097	± 0.017
- 100	90	_____	_____	_____	≤ 5.399	± 0.027
Test Port 1						
- 10	0	_____	_____	_____	≤ 0.033	± 0.008
- 20 (Ref)	10	_____	0.000	_____	≤ 0.020	± 0.008
- 30	20	_____	_____	_____	≤ 0.031	± 0.008
- 40	30	_____	_____	_____	≤ 0.042	± 0.008
- 50	40	_____	_____	_____	≤ 0.057	± 0.008
- 60	50	_____	_____	_____	≤ 0.098	± 0.017
- 70	60	_____	_____	_____	≤ 0.247	± 0.017
- 80	70	_____	_____	_____	≤ 0.725	± 0.017
- 90	80	_____	_____	_____	≤ 2.097	± 0.017
- 100	90	_____	_____	_____	≤ 5.399	± 0.027

**HP 8753E Performance Test Record (11 of 13)
For 30 kHz—3 GHz Analyzers**

Hewlett-Packard Company Model HP 8753E		Report Number _____		
Serial Number _____		Date _____		
▶▶ 14. Test Port Receiver Magnitude Compression				
CW Frequency	Test Port	Measured Value (dB)	Specification (dB)	Measurement Uncertainty
50 MHz	Port 2	_____	≤ 0.45	N/A
1 GHz	Port 2	_____	≤ 0.45	N/A
2 GHz	Port 2	_____	≤ 0.45	N/A
3 GHz	Port 2	_____	≤ 0.45	N/A
50 MHz	Port 1	_____	≤ 0.45	N/A
1 GHz	Port 1	_____	≤ 0.45	N/A
2 GHz	Port 1	_____	≤ 0.45	N/A
3 GHz	Port 1	_____	≤ 0.45	N/A
▶▶ 15. Test Port Receiver Phase Compression				
CW Frequency	Test Port	Measured Value (degrees)	Specification (degrees)	Measurement Uncertainty
50 MHz	Port 2	_____	≤ 6°	N/A
1 GHz	Port 2	_____	≤ 6°	N/A
2 GHz	Port 2	_____	≤ 6°	N/A
3 GHz	Port 2	_____	≤ 6°	N/A
50 MHz	Port 1	_____	≤ 6°	N/A
1 GHz	Port 1	_____	≤ 6°	N/A
2 GHz	Port 1	_____	≤ 6°	N/A
3 GHz	Port 1	_____	≤ 6°	N/A

**HP 8753E Performance Test Record (12 of 13)
For 30 kHz—3 GHz Analyzers**

Hewlett-Packard Company Model HP 8753E Serial Number _____		Report Number _____ Date _____	
▶▶ 16. Test Port Output/Input Harmonics (Option 002 without Option 006)			
Test Description	Specification (dBc)	Measurement Value (dBc)	Measurement Uncertainty (dB)
Test Port Output Harmonics			
2nd	≤ 25	_____	± 1.5
3rd	≤ 25	_____	± 1.5
Port 1 Input Harmonics			
2nd	≤ 15	_____	± 1.5
3rd	≤ 30	_____	± 1.5
Port 2 Input Harmonics			
2nd	≤ 15	_____	± 1.5
3rd	≤ 30	_____	± 1.5

**HP 8753E Option 011 Performance Test Record (13 of 13)
For 30 kHz—3 GHz Analyzers**

Hewlett-Packard Company Model HP 8753E		Report Number _____		
Serial Number _____		Date _____		
▶▶ 18. Test Port Output Harmonics (Analyzers without Option 002)				
Second Harmonic Frequency	Fundamental Frequency	Specification (dBc)	Measurement Value (dBc)	Measurement Uncertainty (dB)
100 MHz	50 MHz	≤ 25	_____	± 1.6
1.0 GHz	500 MHz	≤ 25	_____	± 1.6
2.4 GHz	1.2 GHz	≤ 25	_____	± 1.6
3.0 GHz	1.5 GHz	≤ 25	_____	± 1.6
Third Harmonic Frequency				
300 MHz	100 MHz	≤ 25	_____	± 1.6
1.2 GHz	400 MHz	≤ 25	_____	± 1.6
2.7 GHz	900 MHz	≤ 25	_____	± 1.6
3.0 GHz	1 GHz	≤ 25	_____	± 1.6

Performance Test Record

**For Analyzers with a Frequency Range of
30 kHz to 6 GHz**

Note See the previous "Performance Test Record" section if your analyzer frequency range is from 30 kHz to 3 GHz.

HP 8753E Performance Test Record (1 of 15)

Calibration Lab Address: _____	Report Number _____		
_____	Date _____		
_____	Last Calibration Date _____		
_____	Customer's Name _____		
_____	Performed by _____		
Model HP 8753E Option 006			
Serial No. _____	Option(s) _____		
Firmware Revision _____			
Ambient Temperature _____ ° C	Relative Humidity _____ %		
Test Equipment Used:			
Description	Model Number	Trace Number	Cal Due Date
Frequency Counter _____	_____	_____	_____
Power Meter _____	_____	_____	_____
Power Sensor _____	_____	_____	_____
Calibration Kit _____	_____	_____	_____
Verification Kit _____	_____	_____	_____
Notes/Comments: _____			

**HP 8753E Performance Test Record (2 of 15)
For 30 kHz—6 GHz Analyzers**

Hewlett-Packard Company Model HP 8753E Option 006		Report Number _____		
Serial Number _____		Date _____		
▶▶ 1. Test Port Output Frequency Range and Accuracy				
Test Frequencies (MHz)	Min. (MHz)	Results Measured (MHz)	Max. (MHz)	Measurement Uncertainty (MHz)
0.03	0.029 999 7	_____	0.030 000 3	± 0.000 000 050
0.3	0.299 997	_____	0.300 003	± 0.000 000 520
5.0	4.999 950	_____	5.000 050	± 0.000 009
16.0	15.999 840	_____	16.000 160	± 0.000 028
31.0	30.999 690	_____	31.000 310	± 0.000 054
60.999 999	60.999 390	_____	61.000 610	± 0.000 105
121.0	120.998 790	_____	121.001 210	± 0.000 207
180.0	179.998 200	_____	180.001 800	± 0.000 307
310.0	309.995 900	_____	310.003 100	± 0.000 528
700.0	699.930 000	_____	700.007 000	± 0.001 192
1 300.0	1 299.987	_____	1 300.013	± 0.002 212
2 000.0	1 999.980	_____	2 000.020	± 0.003 403
3 000.0	2 999.970	_____	3 000.030	± 0.005 104
4.0	3.999 960	_____	4.000 040	± 0.006 805
5.0	4.999 950	_____	5.000 050	± 0.008 506
6.0	5.999 940	_____	6.000 060	± 0.010 207

**HP 8753E Performance Test Record (3 of 15)
For 30 kHz—6 GHz Analyzers**

Hewlett-Packard Company Model HP 8753E Option 006		Report Number _____		
Serial Number _____		Date _____		
▶▶ 2. External Source Mode Frequency Range				
Test Frequencies (GHz)		Result		
0.010		_____		
0.020		_____		
0.100		_____		
1.000		_____		
2.000		_____		
3.000		_____		
4.000		_____		
5.000		_____		
6.000		_____		
▶▶ 3. Test Port Output Power Accuracy				
Test Frequency	Test Port Output Power (dBm)	Specification (dB)	Measured Value (dB)	Measurement Uncertainty (dB)
300 kHz	0	± 1	_____	± 0.47
20 MHz	0	± 1	_____	± 0.25
50 MHz	0	± 1	_____	± 0.12
100 MHz	0	± 1	_____	± 0.12
200 MHz	0	± 1	_____	± 0.12
500 MHz	0	± 1	_____	± 0.12
1 GHz	0	± 1	_____	± 0.12
2 GHz	0	± 1	_____	± 0.15
3 GHz	0	± 1	_____	± 0.15
4 GHz	0	± 1	_____	± 0.17
5 GHz	0	± 1	_____	± 0.17
6 GHz	0	± 1	_____	± 0.17

**HP 8753E Performance Test Record (4 of 15)
For 30 kHz—6 GHz Analyzers**

Hewlett-Packard Company Model HP 8753E Option 006		Report Number _____		
Serial Number _____		Date _____		
▶▶ 4. Test Port Output Power Range and Linearity				
Test Settings	Results Measured (dB)	Power Level Linearity (dB)	Specification (dB)	Meas. Uncert. (dB)
CW Frequency = 300 kHz				
- 15	_____	_____	± 0.2	± 0.03
- 13	_____	_____	± 0.2	± 0.03
- 11	_____	_____	± 0.2	± 0.03
- 9	_____	_____	± 0.2	± 0.02
- 7	_____	_____	± 0.2	± 0.02
- 5	_____	_____	± 0.2	± 0.02
- 3	_____	_____	± 0.2	± 0.02
- 1	_____	_____	± 0.2	± 0.02
+ 1	_____	_____	± 0.2	± 0.03
+ 3	_____	_____	± 0.2	± 0.03
+ 5	_____	_____	± 0.5	± 0.03
+ 7	_____	_____	± 0.5	± 0.03
+ 8	_____	_____	± 0.5	± 0.03
+ 9	_____	_____	± 0.5	± 0.03
+ 10	_____	_____	± 0.5	± 0.03
CW Frequency = 3 GHz				
- 15	_____	_____	± 0.2	± 0.03
- 13	_____	_____	± 0.2	± 0.03
- 11	_____	_____	± 0.2	± 0.03
- 9	_____	_____	± 0.2	± 0.02
- 7	_____	_____	± 0.2	± 0.02
- 5	_____	_____	± 0.2	± 0.02
- 3	_____	_____	± 0.2	± 0.02
- 1	_____	_____	± 0.2	± 0.02
+ 1	_____	_____	± 0.2	± 0.03
+ 3	_____	_____	± 0.2	± 0.03
+ 5	_____	_____	± 0.5	± 0.03

**HP 8753E Performance Test Record (5 of 15)
For 30 kHz—6 GHz Analyzers**

Hewlett-Packard Company Model HP 8753E Option 006		Report Number _____		
Serial Number _____		Date _____		
▶▶ 4. Test Port Output Power Range and Linearity (continued)				
Test Settings	Results Measured (dB)	Power Level Linearity (dB)	Specification (dB)	Meas. Uncert. (dB)
+ 7	_____	_____	± 0.5	± 0.03
+ 8	_____	_____	± 0.5	± 0.03
+ 9	_____	_____	± 0.5	± 0.03
+ 10	_____	_____	± 0.5	± 0.03
CW Frequency = 6 GHz				
- 15	_____	_____	± 0.2	± 0.03
- 13	_____	_____	± 0.2	± 0.03
- 11	_____	_____	± 0.2	± 0.03
- 9	_____	_____	± 0.2	± 0.03
- 7	_____	_____	± 0.2	± 0.02
- 5	_____	_____	± 0.2	± 0.02
- 3	_____	_____	± 0.2	± 0.02
- 1	_____	_____	± 0.2	± 0.02
+ 1	_____	_____	± 0.2	± 0.02
+ 3	_____	_____	± 0.2	± 0.03
+ 5	_____	_____	± 0.5	± 0.03
+ 7	_____	_____	± 0.5	± 0.03
+ 8	_____	_____	± 0.5	± 0.03
+ 9	_____	_____	± 0.5	± 0.03
+ 10	_____	_____	± 0.5	± 0.03

**HP 8753E Performance Test Record (6 of 15)
For 30 kHz—6 GHz Analyzers**

Hewlett-Packard Company Model HP 8753E Option 006 Serial Number _____	Report Number _____ Date _____
---	---------------------------------------

▶▶ 5. Minimum R Channel Level

CW Frequency	Specification (dB)	Test Port Power	Measurement Uncertainty (dB)
300 kHz	< -35	_____	± 1.0
3.29 MHz	< -35	_____	± 1.0
3.31 MHz	< -35	_____	± 1.0
15.90 MHz	< -35	_____	± 1.0
16.10 MHz	< -35	_____	± 1.0
30.90 MHz	< -35	_____	± 1.0
31.10 MHz	< -35	_____	± 1.0
1.6069 GHz	< -35	_____	± 1.0
1.6071 GHz	< -35	_____	± 1.0
3.000 GHz	< -35	_____	± 2.0
4.000 GHz	< -30	_____	± 2.0
5.000 GHz	< -30	_____	± 2.0
6.000 GHz	< -30	_____	± 2.0

▶▶ 6. Test Port Input Noise Floor Level

Frequency Range	Test Port	IF Bandwidth	Specification (dBm)	Calculated Value	Measurement Uncertainty
300 kHz—3 GHz	Port 1	3 kHz	- 82	_____	N/A
300 kHz—3 GHz	Port 1	10 Hz	- 102	_____	N/A
300 kHz—3 GHz	Port 2	10 Hz	- 102	_____	N/A
300 kHz—3 GHz	Port 2	3 kHz	- 82	_____	N/A
3 GHz—6 GHz	Port 2	3 kHz	- 77	_____	N/A
3 GHz—6 GHz	Port 2	10 Hz	- 97	_____	N/A
3 GHz—6 GHz	Port 1	10 Hz	- 97	_____	N/A
3 GHz—6 GHz	Port 1	3 kHz	- 77	_____	N/A

**HP 8753E Performance Test Record (7 of 15)
For 30 kHz—6 GHz Analyzers**

Hewlett-Packard Company Model HP 8753E Option 006		Report Number _____		
Serial Number _____		Date _____		
▶▶ 7. Test Port Input Frequency Response				
Frequency Range	Test Port	Specification (dB)	Measured Value (dB)	Measurement Uncertainty (dB)
300 kHz—3 GHz	Port 2	± 1	_____	0.47
300 kHz—3 GHz	Port 1	± 1	_____	0.47
3 GHz—6 GHz	Port 1	± 2	_____	0.17
3 GHz—6 GHz	Port 2	± 2	_____	0.17
▶▶ 8. Test Port Crosstalk				
Test Settings	Specification (dB)	Measured Value (dB)	Measurement Uncertainty	
Crosstalk to Test Port 2 300 kHz—3 GHz	< -100	_____	N/A	
Crosstalk to Test Port 1 300 kHz—3 GHz	< -100	_____	N/A	
Crosstalk to Test Port 1 3 GHz—6 GHz	< -90	_____	N/A	
Crosstalk to Test Port 2 3 GHz—6 GHz	< -90	_____	N/A	

**HP 8753E Performance Test Record (8 of 15)
For 30 kHz—6 GHz Analyzers**

Hewlett-Packard Company Model HP 8753E Option 006		Report Number _____		
Serial Number _____		Date _____		
▶▶ 9. Calibration Coefficients				
Test Description	Frequency Range	Spec. (dB)	Measured Value (dB)	Measurement Uncertainty (dB)
Forward Direction				
Directivity	300 kHz—1.3 GHz	≥ 35	_____	± 0.9
Directivity	1.3 GHz—3 GHz	≥ 30	_____	± 0.8
Directivity	3 GHz—6 GHz	≥ 25	_____	± 0.8
Forward Direction				
Source Match	300 kHz—1.3 GHz	≥ 16	_____	± 0.2
Source Match	1.3 GHz—3 GHz	≥ 16	_____	± 0.2
Source Match	3 GHz—6 GHz	≥ 14	_____	± 0.3
Forward Direction				
Trans. Tracking	300 kHz—1.3 GHz	± 1.5	_____	± 0.006
Trans. Tracking	1.3 GHz—3 GHz	± 1.5	_____	± 0.009
Trans. Tracking	3 GHz—6 GHz	± 2.5	_____	± 0.021
Forward Direction				
Ref. Tracking	300 kHz—1.3 GHz	± 1.5	_____	± 0.001
Ref. Tracking	1.3 GHz—3 GHz	± 1.5	_____	± 0.005
Ref. Tracking	3 GHz—6 GHz	± 2.5	_____	± 0.020
Reverse Direction				
Load Match	300 kHz—1.3 GHz	≥ 18	_____	± 0.1
Load Match	1.3 GHz—3 GHz	≥ 16	_____	± 0.2
Load Match	3 GHz—6 GHz	≥ 14	_____	± 0.2

**HP 8753E Performance Test Record (9 of 15)
For 30 kHz—6 GHz Analyzers**

Hewlett-Packard Company Model HP 8753E Option 006		Report Number _____		
Serial Number _____		Date _____		
▶▶ 9. Calibration Coefficients (continued)				
Test Description	Frequency Range	Spec. (dB)	Measured Value (dB)	Measurement Uncertainty (dB)
Reverse Direction				
Trans. Tracking	300 kHz—1.3 GHz	± 1.5	_____	± 0.006
Trans. Tracking	1.3 GHz—3 GHz	± 1.5	_____	± 0.009
Trans. Tracking	3 GHz—6 GHz	± 2.5	_____	± 0.021
Forward Direction				
Load Match	300 kHz—1.3 GHz	≥ 18	_____	± 0.1
Load Match	1.3 GHz—3 GHz	≥ 16	_____	± 0.2
Load Match	3 GHz—6 GHz	≥ 14	_____	± 0.2
Reverse Direction				
Directivity	300 kHz—1.3 GHz	≥ 35	_____	± 0.9
Directivity	1.3 GHz—3 GHz	≥ 30	_____	± 0.8
Directivity	3 GHz—6 GHz	≥ 25	_____	± 0.8
Reverse Direction				
Source Match	300 kHz - 1.3 GHz	≥ 16	_____	± 0.2
Source Match	1.3 GHz - 3 GHz	≥ 16	_____	± 0.2
Source Match	3 GHz - 6 GHz	≥ 14	_____	± 0.3
Reverse Direction				
Ref. Tracking	300 kHz - 1.3 GHz	± 1.5	_____	± 0.001
Ref. Tracking	1.3 GHz - 3 GHz	± 1.5	_____	± 0.005
Ref. Tracking	3 GHz - 6 GHz	± 2.5	_____	± 0.020

**HP 8753E Performance Test Record (10 of 15)
For 30 kHz—6 GHz Analyzers**

Hewlett-Packard Company Model HP 8753E Option 006		Report Number _____		
Serial Number _____		Date _____		
▶▶ 11. System Trace Noise				
Frequency (GHz)	Ratio	Measured Value	Specification	Measurement Uncertainty
3	A/R (Magnitude)	_____	≤ 0.006 dB rms	± 0.001 dB
6	A/R (Magnitude)	_____	≤ 0.010 dB rms	± 0.001 dB
6	A/R (Phase)	_____	$\leq 0.070^\circ$ rms	$\pm 0.01^\circ$
3	A/R (Phase)	_____	$\leq 0.038^\circ$ rms	$\pm 0.01^\circ$
3	B/R (Magnitude)	_____	≤ 0.006 dB rms	± 0.001 dB
6	B/R (Magnitude)	_____	≤ 0.010 dB rms	± 0.001 dB
6	B/R (Phase)	_____	$\leq 0.070^\circ$ rms	$\pm 0.01^\circ$
3	B/R (Phase)	_____	$\leq 0.038^\circ$ rms	$\pm 0.01^\circ$
▶▶ 12. Test Port Input Impedance				
Test Description	Test Port	Return Loss (dB)	Specification (dB)	Measurement Uncertainty (dB)
300 kHz—1.3 GHz	Port 2	_____	≥ 18	± 1.5
1.3 GHz—3 GHz	Port 2	_____	≥ 16	± 1.5
3 GHz—6 GHz	Port 2	_____	≥ 14	± 1.0
300 kHz—1.3 GHz	Port 1	_____	≥ 18	± 1.5
1.3 GHz—3 GHz	Port 1	_____	≥ 16	± 1.5
3 GHz—6 GHz	Port 1	_____	≥ 14	± 1.0

**HP 8753E Performance Test Record (11 of 15)
For 30 kHz—6 GHz Analyzers**

Hewlett-Packard Company Model HP 8753E Option 006				Report Number _____		
Serial Number _____				Date _____		
▶▶ 13. Test Port Receiver Magnitude Dynamic Accuracy						
		G	F	 G - F 		
Test Port Input Power (dBm)	8496A Attn. (dB)	Test Port Measurement (dB)	Expected Measurement (corrected) (dB)	Dynamic Accuracy (Calculated)	Spec. (dB)	Meas. Uncer. (dB)
Test Port 2						
- 10	0	_____	_____	_____	≤ 0.033	± 0.008
- 20 (Ref)	10	_____	0.000	_____	≤ 0.020	± 0.008
- 30	20	_____	_____	_____	≤ 0.031	± 0.008
- 40	30	_____	_____	_____	≤ 0.042	± 0.008
- 50	40	_____	_____	_____	≤ 0.057	± 0.008
- 60	50	_____	_____	_____	≤ 0.098	± 0.017
- 70	60	_____	_____	_____	≤ 0.247	± 0.017
- 80	70	_____	_____	_____	≤ 0.725	± 0.017
- 90	80	_____	_____	_____	≤ 2.097	± 0.017
- 100	90	_____	_____	_____	≤ 5.399	± 0.027
Test Port 1						
- 10	0	_____	_____	_____	≤ 0.033	± 0.008
- 20 (Ref)	10	_____	0.000	_____	≤ 0.020	± 0.008
- 30	20	_____	_____	_____	≤ 0.031	± 0.008
- 40	30	_____	_____	_____	≤ 0.042	± 0.008
- 50	40	_____	_____	_____	≤ 0.057	± 0.008
- 60	50	_____	_____	_____	≤ 0.098	± 0.017
- 70	60	_____	_____	_____	≤ 0.247	± 0.017
- 80	70	_____	_____	_____	≤ 0.725	± 0.017
- 90	80	_____	_____	_____	≤ 2.097	± 0.017
- 100	90	_____	_____	_____	≤ 5.399	± 0.027

**HP 8753E Performance Test Record (12 of 15)
For 30 kHz—6 GHz Analyzers**

Hewlett-Packard Company Model HP 8753E Option 006		Report Number _____		
Serial Number _____		Date _____		
▶▶ 14. Test Port Receiver Magnitude Compression				
CW Frequency	Test Port	Measured Value (dB)	Specification (dB)	Measurement Uncertainty
50 MHz	Port 2	_____	≤ 0.45	N/A
1 GHz	Port 2	_____	≤ 0.45	N/A
2 GHz	Port 2	_____	≤ 0.45	N/A
3 GHz	Port 2	_____	≤ 0.45	N/A
4 GHz	Port 2	_____	≤ 0.80	N/A
5 GHz	Port 2	_____	≤ 0.80	N/A
6 GHz	Port 2	_____	≤ 0.80	N/A
50 MHz	Port 1	_____	≤ 0.45	N/A
1 GHz	Port 1	_____	≤ 0.45	N/A
2 GHz	Port 1	_____	≤ 0.45	N/A
3 GHz	Port 1	_____	≤ 0.45	N/A
4 GHz	Port 1	_____	≤ 0.80	N/A
5 GHz	Port 1	_____	≤ 0.80	N/A
6 GHz	Port 1	_____	≤ 0.80	N/A

**HP 8753E Performance Test Record (13 of 15)
For 30 kHz—6 GHz Analyzers**

Hewlett-Packard Company Model HP 8753E Option 006		Report Number _____		
Serial Number _____		Date _____		
▶▶ 15. Test Port Receiver Phase Compression				
CW Frequency	Test Port	Measured Value (degrees)	Specification (degrees)	Measurement Uncertainty
50 MHz	Port 2	_____	$\leq 6^\circ$	N/A
1 GHz	Port 2	_____	$\leq 6^\circ$	N/A
2 GHz	Port 2	_____	$\leq 6^\circ$	N/A
3 GHz	Port 2	_____	$\leq 6^\circ$	N/A
4 GHz	Port 2	_____	$\leq 7.5^\circ$	N/A
5 GHz	Port 2	_____	$\leq 7.5^\circ$	N/A
6 GHz	Port 2	_____	$\leq 7.5^\circ$	N/A
50 MHz	Port 1	_____	$\leq 6^\circ$	N/A
1 GHz	Port 1	_____	$\leq 6^\circ$	N/A
2 GHz	Port 1	_____	$\leq 6^\circ$	N/A
3 GHz	Port 1	_____	$\leq 6^\circ$	N/A
4 GHz	Port 1	_____	$\leq 7.5^\circ$	N/A
5 GHz	Port 1	_____	$\leq 7.5^\circ$	N/A
6 GHz	Port 1	_____	$\leq 7.5^\circ$	N/A

**HP 8753E Performance Test Record (14 of 15)
For 30 kHz—6 GHz Analyzers**

Hewlett-Packard Company Model HP 8753E Option 006 Serial Number _____		Report Number _____ Date _____	
▶▶ 17. Output/Input Test Port Harmonics (Option 002 only)			
Test Description	Specification (dBc)	Measurement Value (dBc)	Measurement Uncertainty (dB)
Test Port Output Harmonics			
2nd	≤ 25	_____	± 1.5
3rd	≤ 25	_____	± 1.5
Port 1 Input Harmonics			
2nd	≤ 15	_____	± 1.5
3rd	≤ 30	_____	± 1.5
Port 2 Input Harmonics			
2nd	≤ 15	_____	± 1.5
3rd	≤ 30	_____	± 1.5

**HP 8753E Performance Test Record (15 of 15)
For 30 kHz—6 GHz Analyzers**

Hewlett-Packard Company Model HP 8753E Option 006		Report Number _____		
Serial Number _____		Date _____		
▶▶ 18. Test Port Output Harmonics (Analyzers without Option 002)				
Second Harmonic Frequency	Fundamental Frequency	Specification (dBc)	Measurement Value (dBc)	Measurement Uncertainty (dB)
100 MHz	50 MHz	≤ 25	_____	± 1.6
1.0 GHz	500 MHz	≤ 25	_____	± 1.6
2.4 GHz	1.2 GHz	≤ 25	_____	± 1.6
3.2 GHz	1.6 GHz	≤ 25	_____	± 1.6
4.0 GHz	2.0 GHz	≤ 25	_____	± 1.6
5.0 GHz	2.5 GHz	≤ 25	_____	± 1.6
6.0 GHz	3.0 GHz	≤ 25	_____	± 1.6
Third Harmonic Frequency				
300 MHz	100 MHz	≤ 25	_____	± 1.6
1.2 GHz	400 MHz	≤ 25	_____	± 1.6
2.7 GHz	900 MHz	≤ 25	_____	± 1.6
3.3 GHz	1.1 GHz	≤ 25	_____	± 1.6
4.8 GHz	1.6 GHz	≤ 25	_____	± 1.6
6.0 GHz	2.0 GHz	≤ 25	_____	± 1.6

Index

A

accuracy and range of frequency, 1-12
accuracy of power test, 1-16
analyzer verification, 1-1

C

certification of kit, 1-4

E

equipment

automated system verification, 1-5
external source mode frequency range,
1-14
minimum R channel level, 1-22
test port frequency range and accuracy
test, 1-12
test port input noise floor level, 1-27
test port output power accuracy, 1-16
test port output power range and linearity,
1-19

external source mode frequency range, 1-14

F

floor level test, 1-27
frequency range and accuracy test, 1-12
frequency range for external source mode,
1-14

H

how to

test external source mode frequency range,
1-14
test frequency range and accuracy, 1-12
test minimum R channel level, 1-22
test port input noise floor level, 1-27
test port output frequency range and
accuracy, 1-12
test port output power accuracy, 1-16
test port output power range and linearity,
1-19
verify an analyzer system automatically,
1-5

I

input noise floor level test, 1-27

K

kit re-certification, 1-4

L

linearity and range of power test, 1-19

M

minimum R channel level, 1-22

N

noise floor level test, 1-27

O

operation verification, 1-1

P

performance test record types, 1-4

performance tests

1. Test Port Output Frequency Range and Accuracy, 1-12
2. External Source Mode Frequency Range, 1-14
3. Test Port Output Power Accuracy, 1-16
4. Test Port Output Power Range and Linearity, 1-19
5. Minimum R Channel Level, 1-22
6. Test Port Input Noise Floor Level, 1-27

chapter, 1-1

description of, 1-1

port input noise floor level test, 1-27

port output power accuracy test, 1-16

power accuracy test, 1-16

power range and linearity test, 1-19

procedures

external source mode frequency range,
1-14

minimum R channel level, 1-22

Test Port Input Noise Floor Level, 1-27

test port output frequency range and
accuracy, 1-12

test port output power accuracy, 1-16

test port output power range and linearity,
1-19

verify an analyzer system (automated),
1-5

R

range and accuracy of frequency, 1-12
R channel level, 1-22

S

setup

external source mode frequency range,
1-14
minimum R channel level, 1-22
mismatch device verification, 1-10
test port frequency range and accuracy
test, 1-13
test port input noise floor level, 1-28
test port output power accuracy, 1-17
test port output power range and linearity,
1-20
transmission calibration, 1-8

source mode frequency range, 1-14

specifications

external source mode frequency range,
1-14
minimum R channel level, 1-22
test port input noise floor level, 1-27
test port output frequency range and
accuracy, 1-12
test port output power accuracy, 1-16

test port output power range and linearity,
1-19

system verification

description of, 1-1

system verification (automated), 1-5

system verification cycle, 1-4

T

test port input noise floor level, 1-27

test port output frequency range and accuracy
test, 1-12

test port output power accuracy, 1-16

test port output power range and linearity,
1-19

test record types, 1-4

tests

1. Test Port Output Frequency Range and
Accuracy, 1-12

2. External Source Mode Frequency Range,
1-14

chapter, 1-1

minimum R channel level, 1-22

Test Port Input Noise Floor Level, 1-27

Test Port Output Power Accuracy, 1-16

Test Port Output Power Range and Linearity,
1-19

V

verification cycle, kit re-certification, 1-4