

## Errata

**Title & Document Type:** 8903A Audio Analyzer Operating and Service Manual

**Manual Part Number:** 08903-90024

**Revision Date:** January 1, 1981

---

### HP References in this Manual

This manual may contain references to HP or Hewlett-Packard. Please note that Hewlett-Packard's former test and measurement, semiconductor products and chemical analysis businesses are now part of Agilent Technologies. We have made no changes to this manual copy. The HP XXXX referred to in this document is now the Agilent XXXX. For example, model number HP8648A is now model number Agilent 8648A.

### About this Manual

We've added this manual to the Agilent website in an effort to help you support your product. This manual provides the best information we could find. It may be incomplete or contain dated information, and the scan quality may not be ideal. If we find a better copy in the future, we will add it to the Agilent website.

### Support for Your Product

Agilent no longer sells or supports this product. You will find any other available product information on the Agilent Test & Measurement website:

[www.tm.agilent.com](http://www.tm.agilent.com)

Search for the model number of this product, and the resulting product page will guide you to any available information. Our service centers may be able to perform calibration if no repair parts are needed, but no other support from Agilent is available.

# 8903A AUDIO ANALYZER

(Including Option 001)

## SERIAL NUMBERS

This manual applies directly to instruments with serial numbers prefixed 2016A.

With changes described in Section VII, this manual also applies to instruments with serial numbers prefixed 1942A and 2006A.

For additional important information about serial numbers, see INSTRUMENTS COVERED BY MANUAL in Section I.



© Copyright HEWLETT-PACKARD COMPANY 1980, 1981  
E. 24001 MISSION AVE., TAF C-34, SPOKANE, WASHINGTON, U.S.A. 99220

OPERATING AND SERVICE MANUAL PART NO. 08903-90023  
Operating Manual Part No. 08903-90024  
Microfiche Operating and Service Manual Part No. 08903-90025

Printed: JANUARY 1981

# CONTENTS

	Page		Page
<b>Section I</b>			
<b>GENERAL INFORMATION</b>			
Introduction .....	1-1	HP-IB Address Selection .....	2-2
Specifications .....	1-1	Interconnections .....	2-3
Safety Considerations .....	1-1	Mating Connectors .....	2-3
Instruments Covered by Manual .....	1-1	Operating Environment .....	2-3
Manual Changes Supplement .....	1-2	Bench Operation .....	2-5
Description .....	1-2	Rack Mounting .....	2-5
General .....	1-2	Storage and Shipment .....	2-5
Audio Testing .....	1-2	Environment .....	2-5
Transceiver Testing .....	1-3	Packaging .....	2-5
Systems .....	1-3	<b>Section III</b>	
Options .....	1-4	<b>OPERATION</b>	
Electrical Option 001 .....	1-4	Introduction .....	3-1
Mechanical Options .....	1-4	General .....	3-1
Hewlett-Packard Interace Bus (HP-IB) .....	1-4	Operating Characteristics .....	3-1
Compatibility .....	1-4	Turn-On Procedure .....	3-1
Selecting the HP-IB Address .....	1-4	Local Operation .....	3-1
Accessories Supplied .....	1-5	Remote Operation .....	3-1
Electrical Equipment Available .....	1-5	Operator's Checks .....	3-1
HP-IB Controllers .....	1-5	Operator's Maintenance .....	3-1
Front-to-Rear-Panel Connectors Retrofit Kit .....	1-5	Operator's Checks .....	3-10
Rear-to-Front-Panel Connectors Retrofit Kit .....	1-5	Basic Functional Checks .....	3-10
Mechanical Equipment Available .....	1-5	HP-IB Functional Checks .....	3-13
Chassis Slide Mount Kit .....	1-5	Remote Operation, Hewlett-Packard .....	
Chassis Tilt Slide Mount Kit .....	1-5	Interface Bus .....	3-21
Recommended Test Equipment .....	1-5	HP-IB Compatibility .....	3-21
Principles of Operation for Simplified Block .....		Remote Mode .....	3-21
Diagram .....	1-5	Local Mode .....	3-21
Voltmeter and Notch Filter .....	1-6	Addressing .....	3-21
Counter .....	1-7	Data Messages .....	3-23
Source .....	1-8	Receiving The Data Message .....	3-24
Controller .....	1-8	Sending The Data Message .....	3-27
Basics of Audio Measurements .....	1-8	Receiving the Clear Message .....	3-28
AC Level .....	1-8	Receiving the Trigger Message .....	3-28
Frequency .....	1-9	Receiving the Remote Message .....	3-28
DC Level .....	1-9	Receiving The Local Message .....	3-28
Signal Impurities .....	1-9	Receiving the Local Lockout Message .....	3-29
Distortion .....	1-9	Receiving the Clear Lockout/Set Local .....	
SINAD .....	1-11	Message .....	3-29
Signal-to-Noise Ratio .....	1-11	Receiving the Pass Control Message .....	3-29
Internal Source .....	1-11	Sending the Require Service Message .....	3-30
Plotting .....	1-12	Selecting the Service Request Condition .....	3-30
<b>Section II</b>			
<b>INSTALLATION</b>			
Introduction .....	2-1	Sending the Status Byte Message .....	3-30
Initial Inspection .....	2-1	Sending the Status Bit Message .....	3-31
Preparation for use .....	2-1	Receiving the Abort Message .....	3-31
Power Requirements .....	2-1	Detailed Operating Instructions .....	3-38
Line Voltage and Fuse Selection .....	2-1	AC Level .....	3-38
Power Cables .....	2-1	Amplitude .....	3-40
		Automatic Operation .....	3-41
		DC Level .....	3-42
		Default Conditions and Power-up Sequence .....	3-43



## CONTENTS (Cont'd)

	Page
Display Level in Watts .....	3-44
Display Source Settings .....	3-46
Distortion .....	3-47
Distortion Level .....	3-49
Error Disable .....	3-51
Error Message Summary .....	3-53
Filters .....	3-57
Float .....	3-59
Frequency .....	3-61
Hold Decimal Point .....	3-62
Hold Settings .....	3-63
HP-IB Address .....	3-64
Increment .....	3-67
Input Level Range (DC Level) .....	3-69
Input Level Range (Except DC Level) .....	3-70
Monitor .....	3-72
Notch Tune .....	3-75
Plot Limit .....	3-76
Post-Notch Detector Response (Except SINAD) .....	3-78
Post-Notch Gain .....	3-79
Rapid Frequency Count .....	3-80
Rapid Source .....	3-82
RATIO and LOG/LIN .....	3-86
Read Display to HP-IB .....	3-89
Service Request Condition .....	3-91
Signal-to-Noise .....	3-93
SINAD .....	3-95
Special Functions .....	3-97
Sweep .....	3-104
Sweep Resolution .....	3-106
Time Between Measurements .....	3-109
X-Y Recording .....	3-110

### Section IV PERFORMANCE TESTS

Introduction .....	4-1
Equipment Required .....	4-1
Test Record .....	4-1
Calibration Cycle .....	4-1
Abbreviated Performance Testing .....	4-1
AC Level Accuracy and Output Level Accuracy and Flatness Performance Test .....	4-2
DC Level Accuracy Performance Test .....	4-7
Distortion and Noise Performance Test .....	4-8
Distortion, SINAD and Signal-to-Noise Accuracy Performance Test .....	4-10
Frequency Accuracy and Sensitivity Performance Test .....	4-13
Audio Filters Performance Test .....	4-15

Input and Output Impedance Performance Test ..	4-17
Common-Mode Rejection Ratio Performance Test .....	4-18

### Section V ADJUSTMENTS

Introduction .....	5-1
Safety Considerations .....	5-1
Equipment Required .....	5-1
Factory-Selected Components .....	5-1
Post-Repair Tests, Adjustments and Checks .....	5-1
Related Adjustments .....	5-1
Internal Reference Frequency Adjustment .....	5-4
Input Flatness Adjustment .....	5-5
Common-Mode Rejection Adjustment .....	5-7
Input DC Offset Adjustment .....	5-8
400 Hz High-Pass and Psophometric Filter Adjustment .....	5-9
Notch Filter Tune and Balance Adjustment .....	5-10
Voltmeter Adjustment .....	5-11
SINAD Meter Adjustment .....	5-13
Oscillator and Output Attenuator Adjustment .....	5-14

### Section VI REPLACEABLE PARTS

Introduction .....	6-1
Abbreviations .....	6-1
Replaceable Parts List .....	6-1
Factory Selected Parts (*) .....	6-1
Part List Backdating (†) .....	6-1
Parts List Updating (Manual Changes Supplement) .....	6-1
Ordering Information .....	6-1
Recommended Spares List .....	6-2
Spare Parts Kit .....	6-2

### Section VII MANUAL CHANGES

Introduction .....	7-1
Manual Changes .....	7-1
Manual Change Instruction .....	7-1

### Section VIII SERVICE

Introduction .....	8-1
Service Sheets .....	8-1
Block Diagrams .....	8-1



## ILLUSTRATIONS

Figure	Page	Figure	Page
1-1. HP Model 8903A Accessories Supplied, and Options 907, 908, and 909 .....	1-0	6-3. Chassis and Mechanical Parts Identification — Front Panel .....	6-39
1-2. Typical Combined Source and AC Level Flatness .....	1-3	6-4. Chassis and Mechanical Parts Identification — Rear Panel .....	6-39
1-3. Typical Combined Source and Analyzer Residual Distortion .....	1-3	6-5. Chassis and Mechanical Parts Identification — Rear Panel, Including Option 001 .....	6-40
1-4. Three-Tone Burst Sequence (15 ms Duration) .....	1-4	8-1. Assemblies A7 and A8 Shown on Extender Boards .....	8-3
1-5. Simplified HP 8903A Audio Analyzer Block Diagram .....	1-6	8-2. Heat Staking Tip .....	8-3
1-6. Several Waveforms each with 5% THD and the Signal Components Which Produced Them .....	1-10	8-3. Assembly Locations .....	8-5
2-1. Line Voltage and Fuse Selection .....	2-2	8-4. Example Showing Programmable Gain Amplifier Switching .....	8-8
2-2. Power Cable and Mains Plug Part Numbers .....	2-3	8-5. Example Showing Input Overload Detector Readback .....	8-9
2-3. The HP-IB Address Switch Shown as Set by the Factory .....	2-3	8-6. Key Codes for Key Scan (Service Special Function 60.0) .....	8-13
2-4. Hewlett-Packard Interface Bus Connection .....	2-4	8-7. Basic Logic Symbols and Qualifiers .....	8-20
3-1. Front-Panel Features .....	3-2	8-8. Indicator Symbols .....	8-21
3-2. Readout Panel Features .....	3-4	8-9. Contiguous Blocks .....	8-22
3-3. Source and Output Features .....	3-5	8-10. AND Dependency Notation .....	8-22
3-4. Measurement and Input Features .....	3-8	8-11. Address Dependency Notation: Coder Example Using Alpha Characters (Letters) .....	8-22
3-5. Rear Panel Features .....	3-9	8-12. OR and Free Dependency Notation .....	8-23
3-6. Basic Functional Checks Setup .....	3-10	8-13. Common Control Block .....	8-23
3-7. Example Flow Chart for Driving the Audio Analyzer Using the Require Service Message (SRQ) .....	3-31	8-14. Quad D-Type Latch (Individual) .....	8-23
4-1. Low-Level AC Level Accuracy Test Setup .....	4-5	8-15. Quad D-Type Latch (Combined) .....	8-23
4-2. Distortion, SINAD, and Signal-to-Noise Accuracy Test Setup .....	4-10	8-16. Shift Register .....	8-24
4-3. Frequency Accuracy and Sensitivity Test Setup .....	4-13	8-17. AND-OR Selector .....	8-24
4-4. Common-Mode Rejection Ratio Test Setup .....	4-18	8-18. Up/Down Counter .....	8-24
5-1. Internal Reference Frequency Adjustment Test Setup .....	5-4	8-19. Quad D-Type Latch .....	8-25
5-2. Input Flatness Adjustment Test Setup .....	5-5	8-20. Schmitt Trigger .....	8-25
5-3. Common-Mode Rejection Adjustment Test Setup .....	5-7	8-21. ECL-to-TTL Translator .....	8-25
5-4. Notch Filter Tune and Balance Adjustment Test Setup .....	5-10	8-22. One-Shot Multivibrator .....	8-25
5-5. Voltmeter Adjustment Test Setup .....	5-11	8-23. D-Type Flip-Flop (Edge-Triggered) .....	8-26
5-6. SINAD Meter Adjustment Test Setup .....	5-13	8-24. Presettable Counter .....	8-26
6-1. Cabinet Parts .....	6-37	8-25. Three-Bit Binary One-of-Eight Decoder .....	8-26
6-2. Top Chassis Parts, Mechanical Parts, and Cable Identifications .....	6-38	8-26. Analog Multiplexer .....	8-27
		8-27. Digital-to-Analog Converter .....	8-27
		8-28. Eight-Bit Addressable Latch .....	8-27
		8-29. BCD-to-Decimal Converter .....	8-28
		8-30. Analog Switch .....	8-28
		8-31. Read Only Memory (ROM) .....	8-28
		8-32. Static Random Access Memory (RAM) .....	8-28
		8-33. Non-Inverting Amplifier (Gain=1) .....	8-28
		8-34. Non-Inverting Amplifier (Gain=1+R <sub>1</sub> /R <sub>2</sub> ) .....	8-28
		8-35. Inverting Amplifier (Gain=-R <sub>1</sub> /R <sub>2</sub> ) .....	8-28
		8-36. Non-Inverting Comparator .....	8-38
		8-37. Inverting Comparator .....	8-38
		8-38. Four-Quadrant Multiplier .....	8-38

## ILLUSTRATIONS (Cont'd)

Figure	Page	Figure	Page
8-95. P/O A12 Connector/Filter Assembly Component Locations (DAC and Counter Trigger Circuits) .....	8-90	8-110. Simplified HP-IB Handshake .....	8-104
8-96. P/O A7 Latch Assembly Component Locations (DAC and Counter Trigger Circuits) .....	8-91	8-111. Address Recognition Check Trouble- shooting Flowchart .....	8-106
8-97. Latch—DAC and Counter-Trigger Circuits Schematic .....	8-91	8-112. Remote and Local Messages and the LCL Key Check Troubleshooting Flowchart .....	8-106
8-98. Controller/Counter Assembly Trouble- shooting Setup .....	8-92	8-113. Sending the Data Message Trouble- shooting Flowchart .....	8-106
8-99. P/O A8 Controller/Counter Assembly Component Locations (Counter Circuits) .....	8-93	8-114. Abort Message Check Troubleshooting Flowchart .....	8-106
8-100. Controller/Counter—Counter Circuits Schematic .....	8-93	8-115. A9 Remote Interface Assembly Component Locations .....	8-107
8-101. P/O A8 Controller/Counter Assembly Component Locations (Controller) .....	8-95	8-116. A10 Remote Interface Connector Assembly Component Locations .....	8-107
8-102. Controller/Counter—Controller Schematic .....	8-95	8-117. Remote Interface Schematic .....	8-107
8-103. P/O A8 Controller/Counter Assembly Component Locations (Read-Only Memory) .....	8-97	8-118. A11 Series Regulator Socket Assembly Component Locations .....	8-108
8-104. Controller/Counter—Read-Only Memory Schematic .....	8-97	8-119. P/O A13 Power Supply and Mother Board Assembly Component Locations .....	8-109
8-105. Signatures for the Front-Panel Keys and Scanners Check .....	8-98	8-120. Power Supply and Mother Board — Power Supply Schematic .....	8-109
8-106. P/O A1 Keyboard and Display Assembly Component Locations (Keyboard Circuits) .....	8-99	8-121. Power Supply and Mother Board — Mother Board Schematic .....	8-111
8-107. Keyboard and Display—Keyboard Circuits Schematic .....	8-99	8-122. Front-Panel Pushbutton Switch Assembly .....	8-112
8-108. P/O A1 Keyboard and Display Assembly Component Locations (Display Circuits) .....	8-101	8-123. Heat Staking Tip and Assembly Anvil .....	8-112
8-109. Keyboard and Display — Display Circuits Schematic .....	8-101	8-124. Typical Assembly for Heat Staking Operation .....	8-112
		8-125. Front-Panel Illustrated Parts Breakdown .....	8-113
		8-126. Rear-Panel Illustrated Parts Breakdown .....	8-115
		8-127. Key Scan Codes .....	8-117

## TABLES

Table	Page	Table	Page
1-1. Specifications .....	1-12	3-3. Message Reference Table .....	3-22
1-2. Supplemental Information .....	1-15	3-4. Audio Analyzer Response to Unused ASCII Codes .....	3-25
1-3. Recommended Test Equipment .....	1-17	3-5. Response to a Clear Message .....	3-29
1-4. Recommended Alternate Test Equipment ..	1-18	3-6. Audio Analyzer Parameter to HP-IB Code Summary .....	3-33
1-5. Service Accessories .....	1-18	3-7. Audio Analyzer HP-IB Code to Parameter Summary .....	3-34
2-1. Allowable HP-IB Address Codes .....	2-5	3-8. Audio Analyzer Special Function to HP-IB Code Summary .....	3-35
3-1. Operating Characteristics Summary .....	3-1	3-9. Commonly Used Code Conversion .....	3-37
3-2. Detailed Operating Instructions Table of Contents (Functional Listing) .....	3-3		

## SAFETY CONSIDERATIONS

### GENERAL

This product and related documentation must be reviewed for familiarization with safety markings and instructions before operation.

This product is a Safety Class I instrument (provided with a protective earth terminal).

### BEFORE APPLYING POWER

Verify that the product is set to match the available line voltage and the correct fuse is installed.

### SAFETY EARTH GROUND

An uninterruptible safety earth ground must be provided from the main power source to the product input wiring terminals, power cord, or supplied power cord set.

### SAFETY SYMBOLS



Instruction manual symbol: the product will be marked with this symbol when it is necessary for the user to refer to the instruction manual (refer to Table of Contents).



Indicates hazardous voltages.



Indicates earth (ground) terminal.

#### WARNING

The WARNING sign denotes a hazard. It calls attention to a procedure, practice, or the like, which if not correctly performed or adhered to, could result in personal injury. Do not proceed beyond a WARNING sign until the indicated conditions are fully understood and met.

#### CAUTION

The CAUTION sign denotes a hazard. It calls attention to an operating procedure, practice, or the like, which, if not correctly performed or adhered to, could result in damage to or destruction of part or all of the product.

Do not proceed beyond a CAUTION sign until the indicated conditions are fully understood and met.

#### WARNINGS

Any interruption of the protective (grounding) conductor (inside or outside the instrument) or disconnecting the protective earth terminal will cause a potential shock hazard that could result in personal injury. (Grounding one conductor of a two conductor outlet is not sufficient protection). In addition, verify that a common ground exists between the unit under test and this instrument prior to energizing either unit.

Whenever it is likely that the protection has been impaired, the instrument must be made inoperative and be secured against any unintended operation.

If this instrument is to be energized via an auto-transformer (for voltage reduction), make sure the common terminal is connected to the earth terminal of the power source.

Servicing instructions are for use by service-trained personnel only. To avoid dangerous electric shock, do not perform any servicing unless qualified to do so.

Adjustments described in the manual are performed with power supplied to the instrument while protective covers are removed. Energy available at many points may, if contacted, result in personal injury.

Capacitors inside the instrument may still be charged even if the instrument has been disconnected from its source of supply.

For continued protection against fire hazard, replace the line fuse(s) only with 250V fuse(s) of the same current rating and type (for example, normal blow, time delay, etc.). Do not use repaired fuses or short circuited fuseholders.

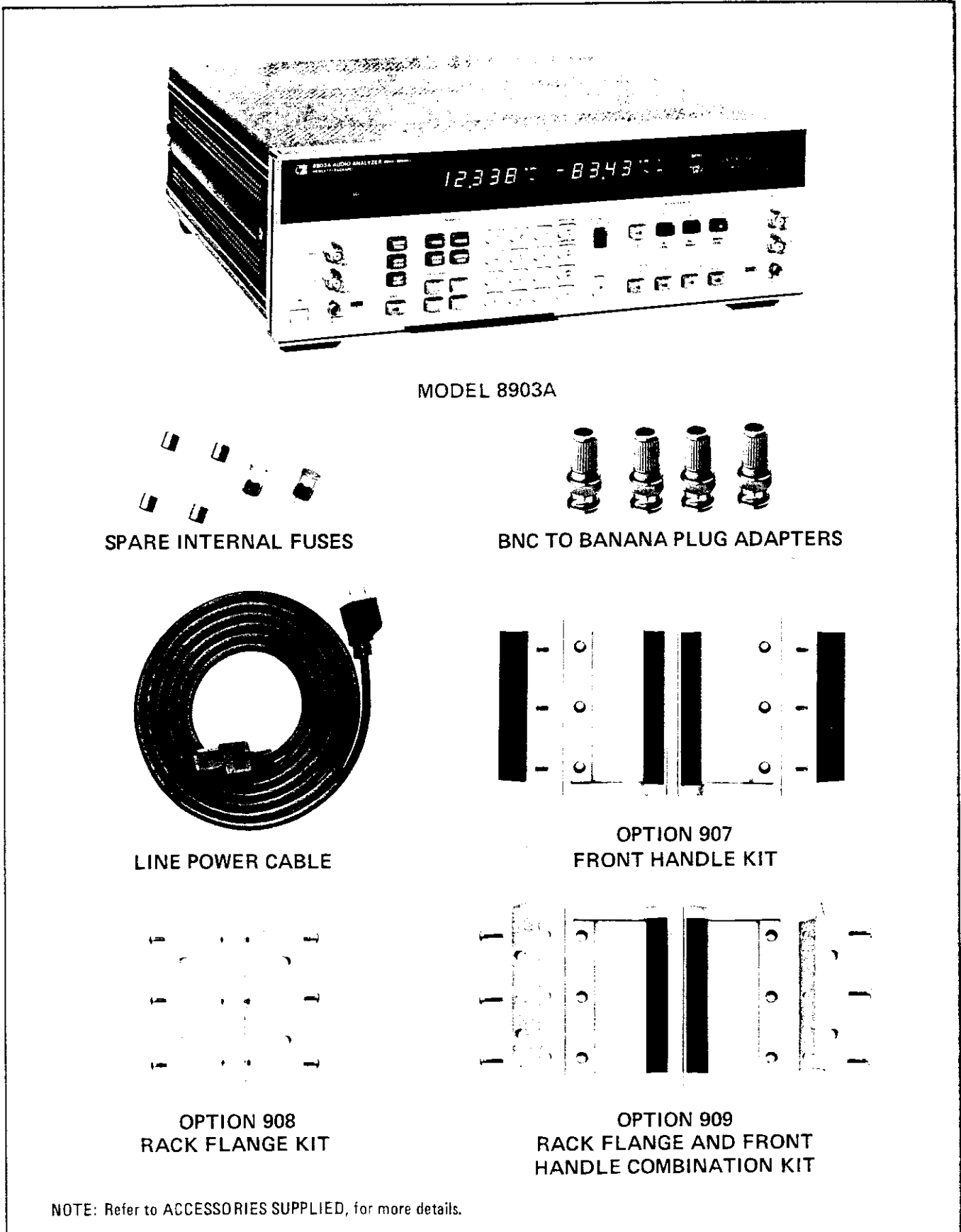

Figure 1-1. HP Model 8903A Accessories Supplied, and Options 907, 908, and 909

## SECTION I GENERAL INFORMATION

### 1-1. INTRODUCTION

This manual contains information required to install, operate, test, adjust, and service the Hewlett-Packard Model 8903A Audio Analyzer. The Audio Analyzer is shown in Figure 1-1 with all of its externally supplied accessories. This manual also documents Audio Analyzers supplied with Option 001.

This section of the manual describes the instruments documented by the manual and covers instrument description, options, accessories, specifications, and other basic information. This section also contains principles of operation on a simplified block diagram level and basic information on audio measurements. The other sections contain the following information:

**Section II, Installation:** provides information about initial inspection, preparation for use (including address selection for remote operation), and storage and shipment.

**Section III, Operation:** provides information about panel features, and includes operating checks, operating instructions for both local and remote operation, and maintenance information.

**Section IV, Performance Tests:** provides the information required to check performance of the instrument against the critical specifications in Table 1-1.

**Section V, Adjustments:** provides the information required to properly adjust the instrument.

**Section VI, Replaceable Parts:** provides ordering information for all replaceable parts and assemblies.

**Section VII, Manual Changes:** provides manual change information necessary to document all serial prefixes listed on the Service Manual title page.

**Section VIII, Service:** provides the information required to repair the instrument.

Two copies of operating information are supplied with the Audio Analyzer. One copy is in the form

of an Operating Manual. The Operating Manual is simply a copy of the first three sections of the Operating and Service Manual and should stay with the Audio Analyzer for use by the operator. Additional copies of the Operating Manual can be ordered separately through your nearest Hewlett-Packard office. The part number is listed on the title page of this manual.

Also on the title pages of each of these manuals, below the manual part number, is a microfiche part number. This number may be used to order 100 x 150 mm (4 x 6 inch) microfilm transparencies of the Operating and Service Manual. Each microfiche contains up to 96 photo-duplicates of the manual pages. The microfiche package also includes the latest Manual Changes supplements.

### 1-2. SPECIFICATIONS

Instrument specifications are listed in Table 1-1. These are the performance standards, or limits against which the instrument may be tested. Characteristics listed under Supplemental Information, Table 1-2, are not warranted specifications but are typical characteristics included as additional information for the user.

### 1-3. SAFETY CONSIDERATIONS

This product is a Safety Class I instrument (i.e., provided with a protective earth terminal). The Audio Analyzer and all related documentation must be reviewed for familiarization with safety markings and instructions before operation. Refer to the Safety Considerations page found at the beginning of this manual for a summary of the safety information. Safety information pertinent to the task at hand (installation, performance testing, adjustment, or service) is found throughout the manual.

### 1-4. INSTRUMENTS COVERED BY MANUAL

**Options.** Electrical Option 001 and various mechanical options are documented in this manual. The differences are noted under the appropriate paragraph such as Options in Section I, the Replaceable Parts List, and the schematic diagrams.

## INSTRUMENTS COVERED BY MANUAL (Cont'd)

**Serial Numbers.** Attached to the instrument is a serial number plate. The serial number is in the form 1234A00123. The first four digits and the letter are the serial prefix. The last five digits form the sequential suffix that is unique to each instrument. The contents of these manuals apply directly to instruments having the same serial number prefix(es) as listed under SERIAL NUMBERS on the title page. For information concerning a serial number prefix not listed on the title page or in the Manual Changes supplement, contact your nearest Hewlett-Packard office.

### 1-5. MANUAL CHANGES SUPPLEMENT

An instrument manufactured after the printing of this manual may have a serial number prefix that is not listed on the title page. This unlisted serial number prefix indicates the instrument is different from those described in this manual. The manual for this instrument is supplied with a Manual Changes supplement that contains "change information" that documents the difference.

In addition to change information, the supplement may contain information for correcting errors in the manual. To keep this manual as current and accurate as possible, Hewlett-Packard recommends that you periodically request the latest Manual Changes supplement. The supplement is identified with the print date and part number that appears on the title page. Complimentary copies of the supplement are available from Hewlett-Packard.

### 1-6. DESCRIPTION

#### 1-7. General

The HP Model 8903A Audio Analyzer is a complete audio measurement system covering the frequency range of 20 Hz to 100 kHz. It combines a low-distortion signal source with a signal analyzer. The analyzer can perform distortion analysis, frequency count, and ac level, dc level, SINAD, and signal-to-noise measurements. The Audio Analyzer reduces the number of instruments required in many applications involving audio signal characterization.

The Audio Analyzer is easy to use. All measurements are selected by one or two keystrokes. For distortion measurements, the Audio Analyzer automatically tunes to and levels the input signal. Measurement and output ranges are automati-

cally selected for maximum resolution and accuracy. Furthermore, tuning is independent of the source. Thus, the source can be set to one frequency while the analyzer is measuring the distortion on a signal at another frequency (i.e., there is no need to tune the analyzer to the source).

The combined capabilities of the instrument are enhanced by microprocessor control, resulting in more capability than would be available from separate instruments. For example, when making signal-to-noise measurements, the Audio Analyzer monitors the ac input level while turning the source on and off. The microprocessor then computes and displays the ratio of the on and off levels. The ratio can be displayed in either % or dB. In addition, the source can be swept. This makes measurements such as frequency response or complete distortion characterization simple to perform. Microprocessor control allows flexible entry of source parameters and versatile display formats. For example, ac level can be displayed in V, mV, dBV, watts, or as a ratio (in % or dB) referenced to an entered or measured value.

Virtually all functions are remotely programmable through the Hewlett-Packard Interface Bus (HP-IB<sup>1</sup>). Programming is easy and straightforward, and all measurements are made through a single input connector. This eliminates the need to switch between multiple inputs under remote control and reduces software development time and hardware costs.

The Audio Analyzer measures the true rms level on all measurements. True rms measurements assure greater accuracy when measuring complex waveforms and noise. Accurate distortion measurements typically can be made to less than 0.003% (-90 dB) between 20 Hz and 20 kHz at a 1V level.

#### 1-8. Audio Testing

The Audio Analyzer has numerous features which make audio testing simple and convenient. These include flexible data entry and display formats, convenient source control, and swept measurement capability. For example, distortion results can be displayed in % or dB. AC level measurements can be displayed in volts, dBV, or watts. Measurement results can be displayed in % or dB relative to a measured or entered value. Finding the 3 dB points of filters and amplifiers is simpli-

<sup>1</sup>HP-IB. Not just IEEE-488, but the hardware, documentation and support that delivers the shortest path to a measurement system

**Audio Testing (Cont'd)**

fied by using the source increment and decrement keys together with the relative display feature. A major contribution of the Audio Analyzer is its ability to make swept measurements. When sweeping, the Audio Analyzer steps its tuning in logarithmic increments. With an x-y recorder, hard-copy measurement results can be obtained. X-axis scaling is determined by the entered start and stop frequencies. Y-axis scaling is determined by the measurement units selected and the plot limits entered through the keyboard. Any valid display units (except mV) are allowed when plotting. To change the scaling from frequency response to swept distortion plots, simply key in new values for the plot limits. No adjustment of the x-y recorder is necessary. The Audio Analyzer also features high accuracy. The instrument can typically measure flatness to 0.5% (0.05 dB) over the range of 20 Hz to 20 kHz and swept distortion over the same range to 0.003% (-90 dB). See Figures 1-2 and 1-3.

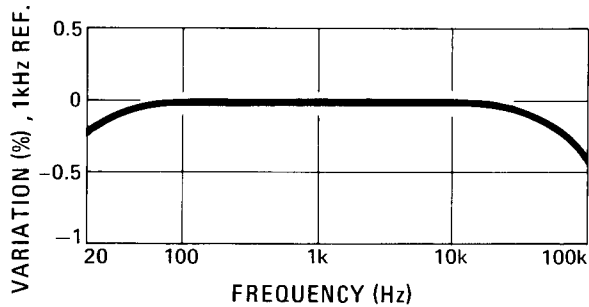

Figure 1-2. Typical Combined Source and AC Level Flatness

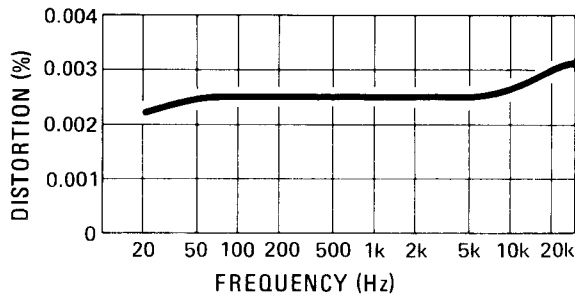

Figure 1-3. Typical Combined Source and Analyzer Residual Distortion

**1-9. Transceiver Testing**

The Audio Analyzer has several measurements and features specifically designed for transceiver testing. It has SINAD and signal-to-noise measurements for receiver testing, a psophometric filter for testing to CEPT recommendations, a reciprocal counter for measuring squelch tones, and a 400 Hz high-pass filter for eliminating squelch

tones when measuring transceiver audio distortion.

SINAD is one of the most basic receiver measurements. It must be made repeatedly when performing sensitivity or adjacent channel sensitivity tests. In the Audio Analyzer, the SINAD measurement is more heavily filtered than the distortion measurement in order to smooth the noisy signals encountered in receiver testing. The filtering is optimized for excellent repeatability and speed (2 readings/second typical). Some automatic distortion analyzers have a tendency to become unlocked when measuring SINAD on noisy signals. The Audio Analyzer overcomes this problem by fixing the notch filter to the source frequency when measuring SINAD. SINAD measurement results are indicated both by the digital display and a front-panel analog meter. The meter is specifically marked for EIA and CEPT sensitivity and selectivity. For SINAD ratios less than 25 dB, the digital display is automatically rounded to the nearest 0.5 dB to reduce digit flicker.

AM receiver test signal-to-noise measurements are also filtered for improved repeatability and speed (1 reading/second typical), and automatic display rounding is provided. For accurate noise measurements, the Audio Analyzer uses true rms detection for both SINAD and signal-to-noise measurements. Most older instruments employ average detection which reads low for noise. The discrepancy can be 1.5 dB or greater and varies with the ratio being measured. If it is necessary to correlate results with past test data, the Audio Analyzer's detector can be converted to average responding.

For transceivers, the Audio Analyzer has a seven-pole 400 Hz high-pass filter for rejecting squelch tones. Rejection of squelch tones up to 250 Hz is greater than 40 dB. Therefore, audio distortion measurements to 1% accuracy can be made without disabling the transmitter squelch tones.

Under remote control, the Audio Analyzer can generate or count burst tone sequences. Typically the maximum count rate is 8 ms/reading and the minimum tone duration is 12 ms. This is fast enough for applications such as unsquelching pagers (see Figure 1-4).

**1-10. Systems**

The Audio Analyzer features capabilities for general systems applications. The audio source is

**Systems (Cont'd)**

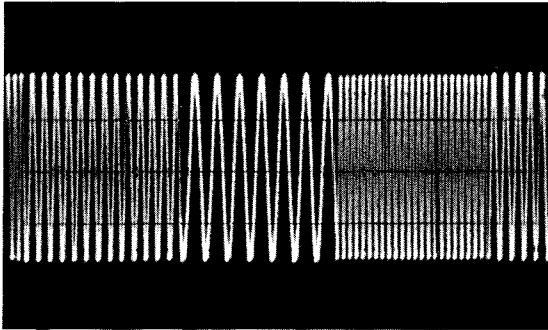

**Figure 1-4. Three-Tone Burst Sequence (15 ms Duration)**

programmable in both frequency and level and has very low distortion. The distortion measurements are fully automatic, programmable, and fast. The typical time to tune and return the first distortion measurement is 1.5 seconds with a measurement rate of 2 readings/second thereafter. The combined distortion of the internal source together with the measurement section is typically 0.003% (-90 dB) between 20 Hz and 20 kHz at a 1 V level.

Often systems applications involve measuring low level ac signals. The Audio Analyzer features a full range ac level display of 0.3000 mV with an accuracy of 4% of reading (2% of reading for levels >50 mV and from 20 Hz to 20 kHz). The ac detector is true rms for correct noise measurements, and the 3 dB measurement bandwidth is greater than 500 kHz.

Since many systems have noise problems, the Audio Analyzer has both 30 and 80 kHz low-pass filters to reject high frequency noise. In addition, the 400 Hz high-pass filter attenuates line-related hum and noise by more than 68 dB.

Two special binary programming modes are available in remote operation. A rapid frequency count mode provides a packed, four-byte output for fast counting. Also, a rapid source binary programming mode is available which allows the internal oscillator tuning to be programmed directly with five bytes of data.

**1-11. OPTIONS**

**1-12. Electrical Option 001**

This option provides rear-panel (instead of front-panel) connections for both the INPUT and OUTPUT HIGH and LOW jacks (fuse protected).

**1-13. Mechanical Options**

The following options may have been ordered and received with the Audio Analyzer. If they were not ordered with the original shipment and are now desired, they can be ordered from the nearest Hewlett-Packard office using the part number included in each of the following paragraphs.

**Front Handle Kit (Option 907).** Ease of handling is increased with the front-panel handles. Order HP part number 5061-0089.

**Rack Flange Kit (Option 908).** The Audio Analyzer can be solidly mounted to the instrument rack using the flange kit. Order HP part number 5061-0077.

**Rack Flange and Front Handle Combination Kit (Option 909).** This is not a front handle kit and a rack flange kit packaged together; it is composed of a unique part which combines both functions. Order HP part number 5061-0083.

**1-14. HEWLETT-PACKARD INTERFACE BUS (HP-IB)**

**1-15. Compatibility**

The Audio Analyzer is compatible with HP-IB to the extent indicated by the following code: SH1, AH1, T5, TE0, L3, LE0, SR1, RL1, PP0, DC1, DT1, C0. The Audio Analyzer interfaces with the bus via open collector TTL circuitry. An explanation of the compatibility code can be found in IEEE Standard 488, "IEEE Standard Digital Interface for Programmable Instrumentation" or the identical ANSI Standard MC1.1. For more detailed information relating to programmable control of the Audio Analyzer, refer to Remote Operation, Hewlett-Packard Interface Bus in Section III of this manual.

**1-16. Selecting the HP-IB Address**

The HP-IB address switches are located within the Audio Analyzer. The switches represent a five-bit binary number. This number represents the talk and listen address characters which an HP-IB controller is capable of generating. In addition, two more switches allow the Audio Analyzer to be set to talk only or listen only. A table in Section II shows all HP-IB talk and listen addresses. Refer to HP-IB Address Selection in Section II of this manual.



## 1-17. ACCESSORIES SUPPLIED

The accessories supplied with the Audio Analyzer are shown in Figure 1-1.

a. The line power cable may be supplied in several configurations, depending on the destination of the original shipment. Refer to Power Cables in Section II of this manual.

b. Time delay fuses with a 1.25A rating for 100/120 Vac operation (HP 2110-0305) and a 0.5A rating for 220/240 Vac operation (HP 2100-0202) are supplied. One fuse is factory installed according to the voltage available in the country of original destination. Refer to Line Voltage and Fuse Selection in Section II of this manual.

c. Four additional fuses are supplied as replacements for those in series with the Audio Analyzer INPUT and OUTPUT HIGH and LOW connectors. For the INPUT HIGH line, a spare 0.032A fuse is supplied (HP 2110-0337). For the INPUT LOW line, a spare 0.062A fuse is supplied (HP 2110-0011). For the OUTPUT HIGH and LOW lines, spare 0.125A fuses are supplied (HP 2110-0513).

d. Four type BNC-to-banana-plug adapters (HP 5021-0844) are also supplied for use when double-ended inputs or outputs are desired. The conductor of the banana jack is connected to the center conductor of the BNC connector adapted to. These adapters are used when the front-panel INPUT or OUTPUT FLOAT switches are set to FLOAT.

## 1-18. ELECTRICAL EQUIPMENT AVAILABLE

(Also refer to Service Accessories, Table 1-5.)

### 1-19. HP-IB Controllers

The Audio Analyzer has an HP-IB interface and can be used with any HP-IB compatible computing controller or computer for automatic systems applications.

### 1-20. Front-to-Rear-Panel Connectors Retrofit Kit

This kit contains all the necessary components and full instructions for converting instruments with front-panel connections for INPUT and OUTPUT HIGH and LOW to rear-panel connections. Order HP part number 08903-60100. After installation and calibration, performance will be identical to the 8903A Option 001.

### 1-21. Rear-to-Front-Panel Connectors Retrofit Kit

This kit contains all the necessary components and full instructions for converting instruments with rear-panel connections for INPUT and OUTPUT HIGH and LOW to front-panel connections. Order HP part number 08903-60101. After installation and calibration, performance will be identical to the standard 8903A.

## 1-22. MECHANICAL EQUIPMENT AVAILABLE

### 1-23. Chassis Slide Mount Kit

This kit is extremely useful when the Audio Analyzer is rack mounted. Access to internal circuits and components or the rear-panel is possible without removing the instrument from the rack. Order HP part number 1494-0018 for 431.8 mm (17 in.) fixed slides and part number 1490-0023 for the correct adapters for non-HP rack enclosures.

### 1-24. Chassis Tilt Slide Mount Kit

This kit is the same as the Chassis Slide Mount Kit above except it also allows the tilting of the instrument up or down 90°. Order HP part number 1494-0025 for 431.8 mm (17 in.) tilting slides and part number 1490-0023 for the correct adapters for non-HP rack enclosures.

## 1-25. RECOMMENDED TEST EQUIPMENT

Table 1-3 lists the test equipment recommended for use in testing, adjusting, and servicing the Audio Analyzer. If any of the recommended equipment is unavailable, instruments with equivalent minimum specifications may be substituted. Table 1-3 also includes some alternate equipment listings. These alternate instruments are highlighted in Table 1-4 which also indicates the possible advantages of using them as substitutes.

## 1-26. PRINCIPLES OF OPERATION FOR SIMPLIFIED BLOCK DIAGRAM

The HP Model 8903A Audio Analyzer combines three instruments into one: a low-distortion audio source, a general-purpose voltmeter with a tuneable notch filter at the input, and a frequency counter. Measurements are managed by a microprocessor-based Controller. This combination forms an instrument that can make most common measurements on audio circuits automatically. To add to its versatility, the Audio Analyzer also has selectable input filters, logarithmic frequency sweep, x and y outputs for plotting measurement result vs. frequency, and HP-IB programmability.

**PRINCIPLES OF OPERATION (Cont'd)**

The operation of the instrument is described in the following order: Voltmeter and Notch Filter, Counter, Source, and Controller. Refer to Figure 1-5.

**1-27. Voltmeter and Notch Filter**

The amplitude measurement path flows from the INPUT jacks (HIGH and LOW) to the MONITOR output (on the rear panel) and includes the Input and Output RMS Detectors, dc voltmeter (the Voltage-to-Time Converter and Counter), and SINAD meter circuitry. Measurements are made on the difference between the signals at the HIGH jack and the LOW jack (or ground). Differential levels can be as high as 300V. Signals that are common to both the HIGH and LOW jacks are balanced out. Common-mode levels must not exceed 4V peak.

The input signal is ac coupled for all measurement modes except dc level. The signal is scaled by the Input Attenuator to a level of 3V or less. To protect the active circuits that follow, the Over-Voltage Protection circuit opens whenever its input exceeds 15V. The differential signal is converted to a single-ended signal (i.e., a signal referenced to ground) and amplified. In the dc level mode, the dc voltage is measured at this point by the dc voltmeter. The signal is further amplified by a Programmable Gain Amplifier which is ac coupled. The gain of this amplifier and the Differential-to-

Single-Ended Amplifier are programmed to keep the signal level into the Input RMS Detector and Notch Filter between 1.7 and 3 Vrms to optimize their effectiveness and accuracy, particularly in the distortion and SINAD modes.

The output from the first Programmable Gain Amplifier is converted to dc by the Input RMS Detector and measured by the dc voltmeter. The output of the detector is used to set the gain of the input circuits and becomes the numerator of the SINAD measurement and the denominator of the distortion measurement (refer to Basics of Audio Measurements). The Input RMS Detector is not used to make the ac level measurement, the Output RMS (Avg) Detector is used for this measurement. For dc level measurements, the Input RMS Detector also monitors the ac component (if there is one) and lowers the gain of the input path if the signal will overload the input amplifiers; otherwise, the gain of the input path is determined by measuring the dc level. At this point, either a 400 Hz high-pass filter or a psophometric filter can be inserted into the signal path. The 400 Hz high-pass filter is usually used to suppress line hum or the low-frequency squelch tone used on some mobile transceivers. The psophometric filter has a bandpass frequency response that simulates the "average" response of human hearing. In the SINAD, distortion, and distortion level modes, the frequency of the input signal is counted at the output of the HP/BP Filters.

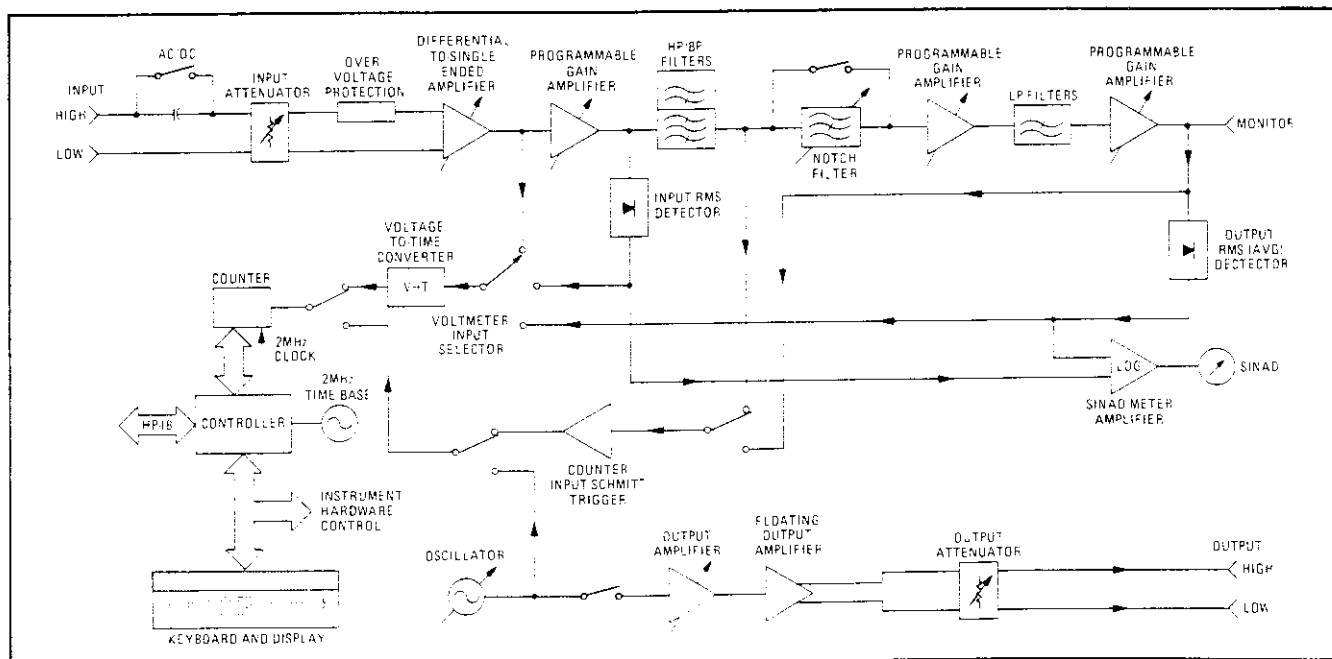

Figure 1-5. Simplified HP 8903A Audio Analyzer Block Diagram

### Voltmeter and Notch Filter (Cont'd)

When measuring SINAD, distortion, or distortion level, the fundamental of the signal is removed by the Notch Filter. The output from the filter is the distortion and noise of the signal. In the ac level and signal-to-noise modes the Notch Filter is bypassed. After amplifying and low-pass filtering, the output from the Notch Filter is converted to dc by the Output RMS (Avg) Detector and measured by the dc voltmeter.

When measuring distortion or distortion level, the Notch Filter is automatically tuned to the frequency counted at the input to the filter. Coarse tuning is via the Controller. Fine tuning and balance are via circuitry internal to the Notch Filter. When measuring SINAD, the Notch Filter is coarse tuned by the Controller to the same frequency as the internal source. Thus, a SINAD measurement is normally only made with the internal source as the stimulus and permits measurements in the presence of large amounts of noise (where the Controller would be unable to determine the input frequency). If an external source is used in the SINAD measurement mode, the source frequency must be within 5% of the frequency of the internal source. The two Programmable Gain Amplifiers, following the Notch Filter, amplify the low-level noise and distortion signals from the Notch Filter. The overall gain of the two amplifiers is normally set to maintain a signal level of 0.3 to 3V at the MONTIOR output.

The 30 kHz and 80 kHz LP Filters are selected from the Keyboard. With no low-pass filtering, the bandwidth of the measurement system is approximately 750 kHz. The filters are most often used to remove the high-frequency noise components in low-frequency SINAD and distortion measurements. The output from the second Programmable Gain Amplifier drives the rear-panel MONITOR output jack. The frequency of this signal is also measured by the Counter in the ac level and signal-to-noise measurement modes because of the increased sensitivity at this point.

The Output RMS (Avg) Detector is read by the dc voltmeter in the ac level, SINAD (the denominator), distortion (the numerator), distortion level, and signal-to-noise measurement modes. It is also used to set the gain of the two Programmable Gain Amplifiers. The detector can be configured internally to respond to the absolute average of the signal instead of the true rms value.

In the SINAD mode the outputs from the Input and Output RMS Detectors are converted to a current representing the log of the ratio of the two signals by the SINAD Meter Amplifier to drive the SINAD panel meter. Since SINAD measurements are often made under very noisy conditions, the panel meter makes it easier to average the reading and to discern trends. The Voltage-to-Time Converter converts the dc inputs into a time interval which is measured by the Counter.

### 1-28. Counter

The Counter is a reciprocal counter. To measure frequency, it counts the period of one or more cycles of the signal at its input, then the Controller divides the number of periods by the accumulated count. The reference for the Counter is the 2 MHz Time Base which also is the clock for the Controller. The Counter has four inputs and three modes of operation:

1. **Voltage Measurement.** The time interval from the Voltage-to-Time Converter is counted. The accumulated count is proportional to the dc voltage. For direct measurements (ac level, dc level, and distortion level), the count is processed directly by the Controller and displayed on the right display. For ratio measurements (SINAD, distortion, and signal-to-noise), the counts of two successive measurements are processed and displayed. For SINAD and distortion, the ratio of the outputs of the Input and Output RMS Detectors is computed. For signal-to-noise, the ratio of two consecutive outputs from the Output RMS Detector is computed. One output is with the Oscillator on and the other is with the Oscillator off.
2. **Input Frequency Measurement.** The signal from the last Programmable Gain Amplifier or the HP/BP Filters is conditioned by the Counter Input Schmitt Trigger to make it compatible with the Counter's input. The period of the signal is then counted, the count is processed by the Controller, and the frequency is displayed on the left display.
3. **Source Frequency Measurement.** The Counter measures the frequency of the internal source only when the Oscillator is being tuned. The frequency is normally not displayed. To make a measurement of the source frequency, the output of the Oscillator is fed into the Counter,

**Counter (Cont'd)**

the period measured, and the result processed by the Controller.

**1-29. Source**

The source covers the frequency range of 20 Hz to 100 kHz. It is tuned to the frequency entered from keyboard by the Controller using a tune-and-count routine. (Note that the frequency is not obtained by frequency synthesis.) The switch following the Oscillator is normally closed except in the signal-to-noise measurement mode or when an amplitude of 0V is entered from the keyboard. The output from the Oscillator is approximately 3V.

The Output Amplifier sets the source output level in fine steps. The Floating Output Amplifier converts the single-ended input into a balanced signal (either output can be grounded or floated up to 10V peak). The Output attenuator sets the output level in coarse steps. The maximum signal to the OUTPUT jacks is 6V into an open circuit or 3V into 600 ohms.

**1-30. Controller**

The entire operation of the instrument is under control of a microprocessor-based Controller. The Controller sets up the instrument at turn-on, interprets Keyboard entries, executes changes in mode of operation, continually monitors instrument operation, sends measurement results and errors to the front-panel displays, and interfaces with HP-IB. In addition, its computing capability is used to simplify circuit operation. For example, it forms the last stage of the Counter, converts measurement results into ratios (in % or dB), etc. It also contains routines useful for servicing the instrument.

**1-31. BASICS OF AUDIO MEASUREMENTS**

The "audio" frequency range is usually taken to be from 20 Hz to 20 kHz. Few people have hearing that good, but the term is a convenient one to describe sub-RF frequencies encountered in electronics. The frequency range of the Audio Analyzer extends beyond the audio range to include fundamentals of up to 100 kHz.

Electronic instrumentation provides most of the tools for quantitative analysis of audio signals. Thus, if the signal is non-electrical (e.g., mechanical or acoustic), it must be converted to an electrical

signal by a transducer of some sort (e.g., a strain gauge or microphone) before it can be analyzed. Apart from attentive listening to a hi-fi system, the most intuitive way of analyzing an electrical signal in the audio range is visually with an oscilloscope. Here you get a feeling for the signal's size (loudness), frequency (pitch), and shape (timbre). You can also determine if these parameters change with time or are stable, and you can even make some quantitative measurements on it (e.g., peak level, dc offset, period, risetime, etc). Many times, however, the parameter sought does not lend itself to easy visual analysis. Therefore, the Audio Analyzer was designed. It combines into one instrument a series of general and specialized instruments, under microprocessor control, that make it easy for the user to obtain accurate, quantitative measurements on audio signals of any general waveshape.

**1-32. AC Level**

Consider the very common measurement of a signal's ac rms level. To make this measurement with an oscilloscope, you must first decide the nature of the signal, because from it, the relationship of the peak level to the rms level can be mathematically determined. If it is sinusoidal, for example, the rms value is the peak amplitude divided by  $\sqrt{2}$ .

This measurement is greatly simplified with an rms voltmeter which electronically measures the rms level and displays the result. However, no other information about the signal is provided. The Audio Analyzer contains an rms voltmeter. The rms level of the signal is displayed whenever the AC LEVEL mode is selected. A special function is also provided which converts the measurement result into watts into a specified (external) load resistance.

Another important ac signal characteristics is the variation in level vs. frequency (flatness). Of course you can easily set a reference level (such as 1V) at a particular frequency (such as 1 kHz) and monitor the change in level as the input frequency is changed. (The source's level is assumed to be flat; otherwise, it too must be checked.) The Audio Analyzer makes this measurement easier in three ways. First, it contains a flat, wide-range oscillator that can be used as the stimulus. Second, the reference can be set to 100% or 0 dB by the press of a button (the RATIO key). Third, the measurement can be automatically swept and the results can be plotted by connecting an x-y recorder to the (rear-panel) X AXIS and Y AXIS outputs.

### AC Level (Cont'd)

An additional parameter related to ac level is gain, and more often gain vs. frequency. To make a gain measurement, measure the input to the device, then the output, and take the ratio. This measurement is made easier by the Audio Analyzer when used with its internal oscillator. You first key in the desired input level, then either measure it and set it as a reference (press RATIO) or key in the level as the ratio reference. Then measure the output. The result can be expressed in either % or dB. If desired, the input can be swept and the gain plotted as a function of frequency (since the frequency plots logarithmically, the result is a Bode plot if dB is used).

### 1-33. Frequency

Another common and basic measurement is frequency. With an oscilloscope, you simply determine the time interval between like points on the repetitive waveform and take the reciprocal. With a frequency counter, frequency is measured electronically and displayed. The measurement is easier and usually much more accurate than could be made visually with an oscilloscope.

The Audio Analyzer contains a counter which displays the frequency of the input signal for all ac measurements. It should be noted that the counter is a reciprocal type; it measures the period of the signal (as you do with an oscilloscope) and computes the reciprocal to obtain the frequency. The advantage of this technique is that for low (audio) frequencies, higher resolution is obtained in a shorter measurement time.

### 1-34. DC Level

Although not part of an audio signal, dc level is a quantity often encountered in audio equipment (e.g., bias voltages and outputs from ac-to-dc converters). Sometimes plots of dc level vs. frequency are desired (as in the case of an ac-to-dc converter). The Audio Analyzer has dc level as one of its measurement modes.

### 1-35. Signal Impurities

Distortion, SINAD, and signal-to-noise ratio are used to describe the impurity content of a signal. These terms are somewhat related and can often be confused. A pure signal is defined as a perfect sinusoid, i.e., one whose frequency spectrum contains only a single spectral component.

Impurities are not always undesirable. Impurities, for example, are what add character to the sound of musical instruments. Pure signals in music sound monotonous. However, when testing a linear audio system, if a pure signal is applied to the input, anything but a pure signal at the output indicates that the system is degrading the signal. There are several common classifications of impurities: harmonic distortion (harmonics of the fundamental); intermodulation distortion (beat signals of two or more non-related signals); noise (random signals); and spurious signals (e.g., line hum and interference). All but intermodulation distortion are easily measured by the Audio Analyzer.

### 1-36. Distortion

Harmonic distortion on a spectrally pure signal is created by non-linearities in the circuit through which it passes. The non-linearities can arise in the transfer characteristics of the active devices or by running the active device into saturation or cutoff. Often, distortion can be reduced by reducing the signal level, filtering, or adding negative feedback. According to Fourier mathematics, the non-linear terms in the circuit's transfer function give rise to harmonics of the signal. Total harmonic distortion (THD) is usually defined as the ratio of the rms sum of the harmonics to the rms level of the fundamental. The ratio is usually converted to % or dB. An oscilloscope gives only a rough indication of the amount of distortion present on a signal. A general rule of thumb is that if the non-linearity causing the distortion is "gentle" (e.g., not clipped), a trained eye can discern distortion as low as 5% on an oscilloscope display. Figure 1-6 shows several examples of waveforms with 5% THD and the components that combined to produce them. (5% distortion would be considered quite high in a quality hi-fi amplifier.) An audio spectrum analyzer, which allows the user to see the magnitude of all harmonics, is perhaps the best instrument to measure harmonic distortion. The audio spectrum analyzer method, however, requires a fairly expensive instrument and some mathematical manipulation. The traditional method of measuring distortion (accepted by the Institute of High Fidelity<sup>2</sup> and others) is with a distortion analyzer. The method is simple and adequate for most situa-

<sup>2</sup>The Institute of High Fidelity, Inc., *Standard Methods of Measurement for Audio Amplifiers*. The Institute of High Fidelity, Inc., New York (1978), p. 9.

**Distortion (Cont'd)**

tions. With a distortion analyzer, you simply measure the signal level and set it up as a reference, then you insert a notch filter, tuned to the frequency of the fundamental, and measure the output of the filter relative to the input. This is the method used by the Audio Analyzer in the DISTN mode where the tuning and measuring are done automatically. When using the distortion analyzer method, it is important to understand that the measurement result is not "total

harmonic distortion" as defined above except under the condition that the distortion is not too excessive but that it does predominate over any other signal impurities. Some examples will illustrate these restrictions.

Consider the case of excessive harmonic distortion. Let us use the example of a signal with 10% actual total harmonic distortion in which all the distortion comes from the second harmonic. The second harmonic is then 20 dB below the funda-

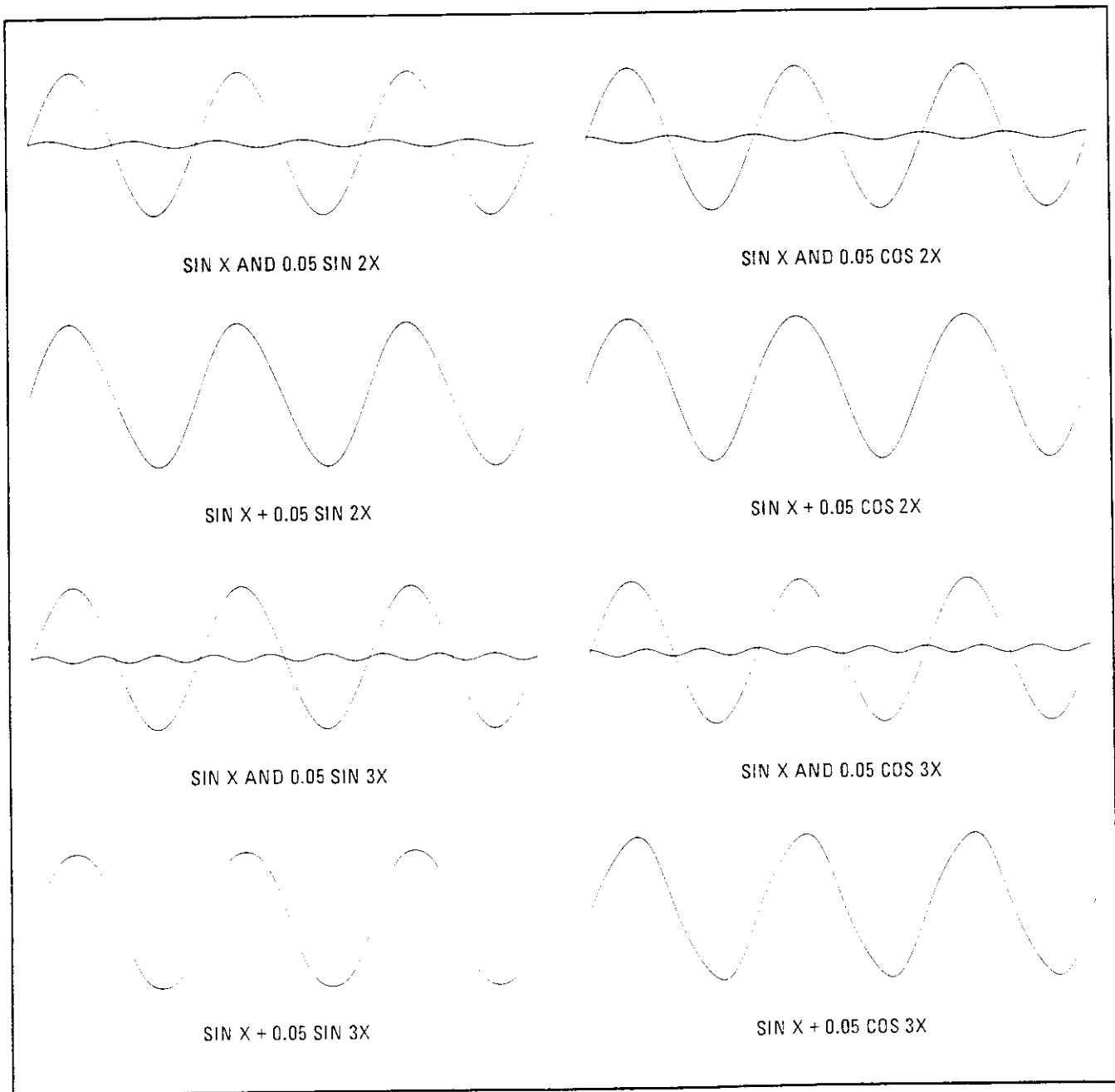

Figure 1-6. Several Waveforms each with 5% THD and the Signal Components Which Produced Them

**Distortion (Cont'd)**

mental as viewed on a spectrum analyzer. When this signal is measured by a distortion analyzer, an error results from the first part of the measurement (measuring the input level) because the input level is not quite the same as the level of the fundamental. If the fundamental level were 1 Vrms, the second harmonic level would be 0.1 Vrms (one-tenth of the fundamental). The total input level (measured with a true rms voltmeter) is the rms sum of the two components, namely,

$$\text{Input} = \sqrt{(1)^2 + (0.1)^2} = 1.005 \text{ V}$$

or 0.5% high. Thus, the measurement result would be 9.95% distortion instead of the true 10%. Actually you can see that the distortion must really be excessive to affect the measurement significantly.

Now consider the case where other types of impurities are significant. Suppose the actual total harmonic distortion is 1% but that there is a hum component that has a level that is 1% of the fundamental level. The distortion measured by a distortion analyzer will be 1.4% (i.e., 40% or 3 dB high). How, then, can you be sure that the result is a valid measurement of distortion? One way is to observe the (rear-panel) MONITOR output with an oscilloscope. If the waveform is clean and harmonically related to the fundamental, the measurement is actual total harmonic distortion. If it is not, selectable filters are provided to remove unwanted signals. Use the 400 Hz HIGH PASS FILTER to remove line hum. Use the 30 kHz or 80 kHz LOW PASS FILTER to remove out-of-band noise. However, select only filters that do not affect the fundamental and the harmonics of interest. Sometimes it is desired to include hum and noise as part of the "distortion" measurement. For this reason, the measurement is often referred to as a THD+N (total harmonic distortion plus noise) measurement.

**1-37. SINAD**

For most practical purposes the SINAD measurement, as made by the Audio Analyzer, is equal to the reciprocal of the distortion measurement. It is usually expressed in dB. The one subtle distinction is that the notch filter is coarsely programmed to the frequency of the internal source (but fine tuned to the signal at its input). This permits measurements in the presence of large amounts of impurities and assures that the fundamental is tuned out. If an external source is used, it must be

within 5% of the frequency setting of the internal source.

SINAD is an acronym for Signal, Noise, And Distortion. The ratio (normally expressed in dB) computed in the SINAD measurement is

$$\text{SINAD} = 20 \log \left( \frac{\text{rms value of signal, noise, and distortion}}{\text{rms value of noise and distortion}} \right)$$

The equation eliminates the two restrictions discussed in connection with the distortion measurement.

SINAD is used most often in determining the sensitivity of a receiver. Receiver sensitivity is defined as the RF level that, when modulated in a specified manner with a pure audio tone, creates a certain SINAD (usually 10 or 12 dB) at the receiver's audio output. (The tone can just be discerned in the noise.) Sometimes a psophometric (i.e., noise measuring) filter is required in the receiver sensitivity measurement. The psophometric filter weights the frequency response of the Audio Analyzer with a bandpass characteristic that approximates the response of human hearing and gives predominance to 1 kHz (where human hearing is best). The filter in the Audio Analyzer is specified by the C.C.I.T.T.<sup>3</sup>

**1-38. Signal-to-Noise Ratio**

Measurement of the signal-to-noise ratio requires the use of the Audio Analyzer's internal source. The Audio Analyzer simply turns the source (set to a specified level) on and off and measures the ac level for both conditions. This is similar to the experience you have when listening to a recording at a comfortable volume, then lifting the tone arm and listening to the level of the residual hiss and hum.

**1-39. Internal Source**

The internal source is used when a low-distortion stimulus for the device under test is desired. Its distortion is about the same as that of the Audio Analyzer's measurement system. The combination permits measurements of distortion as low as 0.01% (-80 dB).

<sup>3</sup>The International Telegraph and Telephone Consultative Committee (C.C.I.T.T.), Fifth Plenary Assembly, 1972. *Telephone Transmission Quality*, The International Telecommunication Union (1973), pp. 87-91.

**1-40. Plotting**

When used in conjunction with the sweep mode, any of the measurements vs. frequency can be plotted using the rear-panel X and Y AXIS outputs and an x-y recorder. The internal source is used as

the stimulus. This simplifies traditionally time consuming measurements such as flatness, gain, distortion, and SINAD vs. frequency, and does not require the use of an external controller (although this too can be used via HP-IB).

**Table 1-1. Specifications (1 of 4)**

All parameters describe performance in automatic operation or with properly set manual controls.		
SOURCE		
Characteristic	Performance Limits	Conditions
<b>FREQUENCY</b> Range Resolution Accuracy	20 Hz to 100 kHz 0.3% increments 0.3% of setting	
<b>OUTPUT LEVEL</b> Range Resolution Accuracy	0.6 mV to 6V Better than 0.3% ±2% of setting ±3% of setting ±5% of setting	Open circuit  60 mV to 6V; open circuit; 20 Hz to 50 kHz 6 mV to 60 mV; open circuit; 20 Hz to 100 kHz 0.6 mV to 6 mV; open circuit; 20 Hz to 100 kHz
Flatness	±0.7% ±2.5%	20 Hz to 20 kHz; 1 kHz reference 20 Hz to 100 kHz; 1 kHz reference
Distortion and Noise (the higher of)	-80 dB or 30 μV -70 dB or 95 μV -65 dB or 169 μV	20 Hz to 20 kHz; 80 kHz BW 20 Hz to 50 kHz; 500 kHz BW 50 kHz to 100 kHz; 500 kHz BW
Impedance	600Ω ±1%	
MEASUREMENT		
<b>SINAD</b> Fundamental Frequency Range Display Range Accuracy	20 Hz to 100 kHz 0 to 99.99 dB ±1 dB ±2 dB	Residual noise and distortion same as for distortion 20 Hz to 20 kHz 20 kHz to 100 kHz
Input Voltage Range	50 mV to 300V	
<b>SIG/NOISE</b> Frequency Range Display Range Accuracy	50 Hz to 100 kHz 0 to 99.99 dB ±1 dB	
Input Voltage Range Residual Noise (the higher of)	50 mV to 300V -80 dB or 30 μV -70 dB or 95 μV	80 kHz BW 500 kHz BW



Table 1-1. Specifications (2 of 4)

MEASUREMENT (Cont'd)		
Characteristic	Performance Limits	Conditions
<b>DISTORTION</b>		
Fundamental		
Frequency Range	20 Hz to 100 kHz	
Display Range	0.001% to 100% :-99.99 to 0 dB	
Accuracy	±1 dB ±2 dB	20 Hz to 20 kHz 20 kHz to 100 kHz
Input Voltage Range	50 mV to 300V	
Residual Noise and Distortion (the higher of:	0.01% (-80 dB) or 30 μV 0.032% (-70 dB) or 95 μV 0.056% (-65 dB) or 169 μV	20 Hz to 20 kHz; 80 kHz BW 20 kHz to 50 kHz; 500 kHz BW 50 kHz to 100 kHz; 500 kHz BW
<b>AC LEVEL</b>		
Full Range Display	300.0V, 30.00V, 3.00V, .3000V, 30.00mV, 3.00mV, .3000 mV	
Overrange Accuracy	33% ±2% ±2% ±4%	Except on the 300.0V range 30V to 300V; 20 Hz to 1 kHz 50 mV to 30V; 20 Hz to 20 kHz 0.3 mV to 30V; 20 Hz to 100 kHz
<b>DC LEVEL</b>		
Full Range Display	300.0V, 48.00V, 16.00V, 4.00V	
Overrange Accuracy	33% ±0.75% of reading ±3 mV	Except on the 300.0V range 400 mV to 300V <400 mV
<b>FREQUENCY</b>		
Measurement Range	20 Hz to 150 kHz 20 Hz to 100 kHz	In ac level mode In distortion, SINAD, and signal-to-noise modes
Resolution	5 digits 0.01 Hz	Frequencies >100 Hz Frequencies <100 Hz
Accuracy	±0.004% ±1 digit	
Sensitivity	50 mV 5.0 mV	Distortion and SINAD modes only In ac level and signal-to-noise modes only

Table 1-1. Specifications (3 of 4)

MEASUREMENT (Cont'd)		
Characteristic	Performance Limits	Conditions
<b>AUDIO FILTERS</b> 400 Hz High-pass Filter 3 dB Cutoff Frequency Rolloff Psophometric Filter Deviation from Ideal Response  30 kHz Low-pass Filter 3 dB Cutoff Frequency Rolloff 80 kHz Low-pass Filter 3 dB Cutoff Frequency Rolloff	400 ±40 Hz 140 dB/decade  ±0.2 dB ±1 dB ±2 dB ±3 dB  30 ±2 kHz 60 dB/decade  80 ±4 kHz 60 dB/decade	CCITT Recommendation P53  At 800 Hz 300 Hz to 3 kHz 50 Hz to 3.5 kHz 3.5 kHz to 5 kHz
GENERAL		
<b>TEMPERATURE</b> Operating Storage  <b>INPUT IMPEDANCE</b> Resistance  Shunt Capacitance  <b>COMMON MODE REJECTION RATIO</b> (at 60 Hz)  <b>REMOTE OPERATION</b>	0° to 55°C -55° to 75°C  100 kΩ ±1% 101 kΩ ±1% <300 pF <330 pF  60 dB 36 dB 30 dB  IEEE STD 488-1978 Compatibility Code: SH1, AH1, T5, TE0, L3, LE0, SR1, RL1, PP0, DC1, DT1, C0	Except in dc level mode In dc level mode only Low terminal grounded; except Option 001 Low terminal grounded; Option 001 only  <2V differential input voltage <48V differential input voltage >48V differential input voltage  The Hewlett-Packard Interface Bus (HP-IB) is Hewlett-Packard Company's implementation of IEEE Std. 488-1978, "Digital Interface for Programmable Instrumentation". All functions except the line switch, the ×10 and ÷10 keys, and the low terminal float ground switches are remotely controllable.

Table 1-1. Specifications (4 of 4)

GENERAL (Cont'd)		
Characteristic	Performance Limits	Conditions
<b>POWER REQUIREMENTS</b> Line Voltage 100, 120, 220, 240 Vac 100, 120 Vac	+5%, -10% +5%, -10%	48 to 66 Hz 48 to 440 Hz
<b>POWER DISSIPATION</b>	100 V·A maximum	
<b>CONDUCTED AND RADIATED INTERFERENCE (EMI)</b>	MIL STD 461A, VDE 0871, and CISPR publication 11	Conducted and radiated interference is within the requirements of methods CE03 and RE02 of MIL STD 461A, VDE 0871, and CISPR publication 11.
<b>CONDUCTED AND RADIATED SUSCEPTIBILITY</b>	MIL STD 461A-1968	Conducted and radiated susceptibility meets the requirements of methods CS01, CS02, and RS03 (1 volt/metre) of MIL STD 461A dated 1968.
<b>NET WEIGHT</b>	12.3 kg (27 lb)	
<b>DIMENSIONS (Full Envelope)</b> Height Width Depth	146 mm (5.75 in.) 425 mm (16.8 in.) 462 mm (18.2 in.)	Note: For ordering cabinet accessories, the module sizes are 5¼H, 1MW, and 17D.

Table 1-2. Supplemental Information (1 of 2)

All parameters describe performance in automatic operation or with properly set manual controls.	
<b>SOURCE</b>	
Frequency Switching Speed: <3 ms (does not include HP-IB programming time). Output Level Switching Speed: 20 ms (does not include HP-IB programming time).	Sweep Mode: Logarithmic sweep with up to 500 points/decade or 255 points total between entered start and stop frequencies.
<b>MEASUREMENT</b>	
<b>SINAD</b> Detection: true rms (average detection selectable by internal modification). Resolution: 0.01 dB for ratios >25 dB. For ratios	<25 dB, the display is rounded to the nearest half dB to reduce digit flickering with noisy signals. (Full resolution is available by defeating this feature using Special Function 16.1.)

Table 1-2. Supplemental Information (2 of 2)

MEASUREMENT (Cont'd)	
<p><b>SINAD</b>  <b>Analog Meter:</b> active in SINAD only and for SINAD ratios &lt;18 dB (or 24 dB using Special Function 7.1).                      Accuracy: 1 dB typical.  <b>Tuning:</b> notch filter is tuned to analyzer source frequency.  <b>Time to Return First Measurement:</b> 1.5s typical.  <b>Measurement Rate:</b> 2.0 readings/s typical.</p> <p><b>SIG/NOISE</b>  <b>Resolution:</b> same as SINAD.  <b>Detection:</b> true rms (average detection selectable by internal modification).  <b>Time to Return First Measurement:</b> &lt;2.5s typical.  <b>Measurement Rate:</b> 1 reading/s typical.  <b>Operation:</b> The Audio Analyzer displays the ratio of the input voltages as the internal source is switched on and off.</p> <p><b>DISTORTION</b>  <b>Measurement Bandwidth:</b> 10 Hz to 500 kHz.  <b>Detection:</b> true rms (average detection selectable by internal modification).  <b>Displayed Resolution:</b>                      0.0001% (&lt;0.1% distortion)                      0.001% (0.1% to 3% distortion)                      0.01% (3% to 30% distortion)                      0.1% (&gt;30% distortion)  <b>Time to Return First Measurement:</b> 1.5s typical.  <b>Measurement Rate:</b> 2 readings/s typical.</p> <p><b>AC LEVEL</b>  <b>High Level Accuracy:</b> ±2%; 30 to 300V; 20 Hz to 20 kHz.  <b>AC Converter:</b> true rms responding for signals with crest factor of &lt;3 and harmonics up to 80 kHz.</p>	<p><b>3 dB Measurement Bandwidth:</b> &gt;500 kHz.  <b>Time to Return First Measurement:</b> &lt;1.5s typical.  <b>Measurement Rate:</b> 2.5 readings/s.</p> <p><b>DC LEVEL:</b>  <b>Time to Return First Measurement:</b> &lt;1.5s typical.  <b>Measurement Rate:</b> 3 reading/s.</p> <p><b>FREQUENCY MEASUREMENT</b>  <b>Measurement Rate:</b> same as measurement mode selected.  <b>Counting Technique:</b> reciprocal with 2 MHz time base.</p> <p><b>AUDIO FILTERS</b>  <b>400 Hz High-Pass Filter Rejection:</b> &gt;40 dB at 240 Hz; &gt;65 dB at 60 Hz.</p> <p><b>REAR-PANEL INPUTS AND OUTPUTS</b>  <b>Recorder Outputs:</b>                      X Axis: 0 to 10 Vdc corresponding to the log of the oscillator frequency.                      Output Resistance: 1 kΩ.                      Y Axis: 0 to 10 Vdc corresponding to the displayed value and entered plot limits.                      Output Resistance: 1 kΩ.                      Pen Lift: TTL output.</p> <p><b>Monitor Output</b>                      Output Impedance: 600Ω.                      In ac level mode, provides scaled output of measured input signal.                      In SINAD, distortion, and distortion level modes, provides scaled output of input signal with the fundamental removed.</p>

Table 1-3. Recommended Test Equipment (1 of 2)

Instrument Type	Critical Specifications	Suggested Model	Use*
AC Calibrator and High Voltage Amplifier	Accuracy: 0.1%, 30 to 300V, 20 Hz to 1 kHz; 0.25%, 30 mV to 300V, 20 Hz to 100 kHz Flatness: $\pm 0.1\%$ , 20 Hz to 100 kHz, <6V Output Current: 50 mA Frequency Accuracy: $\pm 5\%$	HP 745A and HP 746A	P, A
Audio Oscillator	Frequency Range: 20 Hz to 500 kHz Frequency Accuracy: $\pm 5\%$ Output Range: 3V into 600 $\Omega$ Output Attenuation Accuracy: $\pm 0.075$ dB, to 0.3 mV range	HP 651B	P, A
Attenuator	Attenuation Range: 0 to 40 dB Frequency Range: 20 Hz to 100 kHz Accuracy: $\pm 1$ dB Impedance: 600 $\Omega$ Maximum Power Dissipation: 100 mW	HP 4437A	P
Computing Controller	HP-IB compatibility as defined by IEEE Std. 488 and the identical ANSI Std. MC1.1: SH1, AH1, T2, TE0, L2, LE0, SR0, PP0, DC0, DT0, and C1, 2, 3, 4, 5.	HP 9825A/ 98034A/98213A or HP 9835A/ 98034A/98332A (see Table 1-4)	C, T
Counter	Frequency Range: 20 Hz to 100 kHz Level Sensitivity: 25 mV Input Impedance: >1 M $\Omega$ Maximum Resolution: 0.001 Hz	HP 5300B/ 5307A	P
DC Standard	Output Range: 3 mV to 300V Accuracy: $\pm 0.1\% \pm 0.3$ mV	HP 740B or Fluke 893AR (see Table 1-4)	P
Digital Voltmeter	AC Accuracy: $\pm 0.2\%$ at 6 Vrms and 1 kHz DC Accuracy: $+0.2\%$ at 1V	HP 3455A	A, T
Feedthrough Termination	Impedance: 600 $\Omega$ Impedance Accuracy: $\pm 1\%$ Maximum Dissipation: 100 mW	HP 11095A	P, A
Frequency Standard	Frequency: 0.1, 1, 2, 5, or 10 MHz Accuracy: $\pm 1$ ppm	House Standard	A
Oscilloscope	Bandwidth: less than 3 dB down 0 to 10 MHz Sensitivity: 5 mV per division minimum Input Impedance: 1 M $\Omega$ Triggering: Internal and External	HP 1740A	C,A,T
Resistor 100 $\Omega$	Accuracy. $\pm 0.1\%$	HP 0698-7497	P
*C = Operator's Checks; P = Performance Tests; A = Adjustments; T = Troubleshooting			

Table 1-3. Recommended Test Equipment (2 of 2)

Instrument Type	Critical Specifications	Suggested Model	Use*
Signature Analyzer	Because the signatures documented are unique to a given signature analyzer, no substitution is recommended.	HP 5004A	T
Test Oscillator	Frequency: 1 kHz Output: 30 Vpp	HP 3310A	T
True RMS Voltmeter	Type: true rms responding Level Range: 100 mV to 10V Frequency Range: 20 Hz to 500 kHz Accuracy: $\pm 0.2\%$ of range $\pm 0.2\%$ of reading Coupling: ac	HP 3403C	P
* = Operator's Checks; P = Performance Tests; A = Adjustments; T = Troubleshooting			

Table 1-4. Recommended Alternate Test Equipment

Instrument Type	Suggested Alternate	Instrument Replaced	Advantages of Alternate
Computing Controller	HP 9835A/98034A/ 98332A	HP 9825A/98034A/ 98213A	CRT Display ANSI BASIC Larger Memory
DC Standard	Fluke 893AR	HP 740B	Availability

Table 1-5. Service Accessories\*

Accessory*	Specifications	Suggested Model
Digital Test/ Extender Board	No substitution recommended	HP 08903-60018
Extender Board	44 contacts (2 × 22)	HP 08901-60084
Extender Board	30 contacts (2 × 15)	HP 08901-60085
Foam Pad	Conductive polyurethane foam, 12 × 12 × 0.25 inches (nonmagnetic)	HP 4208-0094
*Refer to Section VIII, paragraph 8-11, of this manual for application.		

**NOTE**

*The performance tests, adjustments, and troubleshooting procedures are based on the assumption that the recommended test equipment is used. Substituting alternate test equipment may require modification of some procedures.*

## SECTION II INSTALLATION

### 2-1. INTRODUCTION

This section provides the information needed to install the Audio Analyzer. Included is information pertinent to initial inspection, power requirements, line voltage selection, power cables, interconnection, environment, instrument mounting, storage, and shipment. In addition, this section also contains the procedure for setting the internal HP-IB talk and listen address switches.

### 2-2. INITIAL INSPECTION

#### WARNING

*To avoid hazardous electrical shock, do not perform electrical tests when there are signs of shipping damage to any portion of the outer enclosure (covers, panels, meters).*

Inspect the shipping container for damage. If the shipping container or cushioning material is damaged, it should be kept until the contents of the shipment have been checked for completeness and the instrument has been checked mechanically and electrically. The contents of the shipment should be as shown in Figure 1-1. Procedures for checking electrical performance are given in Section IV. If the contents are incomplete, if there is mechanical damage or defect, or if the instrument does not pass the electrical performance test, notify the nearest Hewlett-Packard office. If the shipping container is damaged, or the cushioning material shows signs of stress, notify the carrier as well as the Hewlett-Packard office. Keep the shipping materials for the carrier's inspection.

### 2-3. PREPARATION FOR USE

#### 2-4. Power Requirements.

#### WARNING

*To avoid the possibility of hazardous electrical shock, do not operate this instrument at line voltages greater than 126.5 Vac with line frequencies greater than 66 Hz. Leakage currents at these line settings may exceed 3.5 mA.*

The Audio Analyzer requires a power source of 100, 120, 220, or 240 Vac, +5% to -10%, 48 to 66 Hz single phase or 100, 120 Vac, -5% to -10%, 48 to 440 Hz single phase. Power consumption is 100 V·A maximum.

#### WARNINGS

*This is a Safety Class I product (i.e., provided with a protective earth terminal). An uninterruptible safety earth ground must be provided from the main power source to the product input wiring terminals, power cord, or supplied power cord set. Whenever it is likely that the protection has been impaired, the product must be made inoperative and be secured against any unintended operation.*

*If this instrument is to be energized via an external autotransformer, make sure the autotransformer's common terminal is connected to the earthed pole of the power source.*

#### 2-5. Line Voltage and Fuse Selection

#### CAUTION

*BEFORE PLUGGING THIS INSTRUMENT into the Mains (line) voltage, be sure the correct voltage and fuse have been selected.*

Verify that the line voltage selection card and the fuse are matched to the power source. Refer to Figure 2-1. Line Voltage and Fuse Selection.

Fuses may be ordered under HP part numbers 2110-0305, 1.25A (250V, time delay) for 100/120 Vac operation and 2110-0202, 0.5A (250V, time delay) for 220/240 Vac operation.

#### 2-6. Power Cables

#### WARNING

*BEFORE CONNECTING THIS INSTRUMENT, the protective earth terminals of*  
*(continued)*

## Power Cables (Cont'd)

**WARNING** (Cont'd)

*this instrument must be connected to the protective conductor of the (Mains) power cord. The Mains plug shall only be inserted in a socket outlet provided with a protective earth contact. The protective action must not be negated by the use of an extension cord (power cable) without a protective conductor (grounding).*

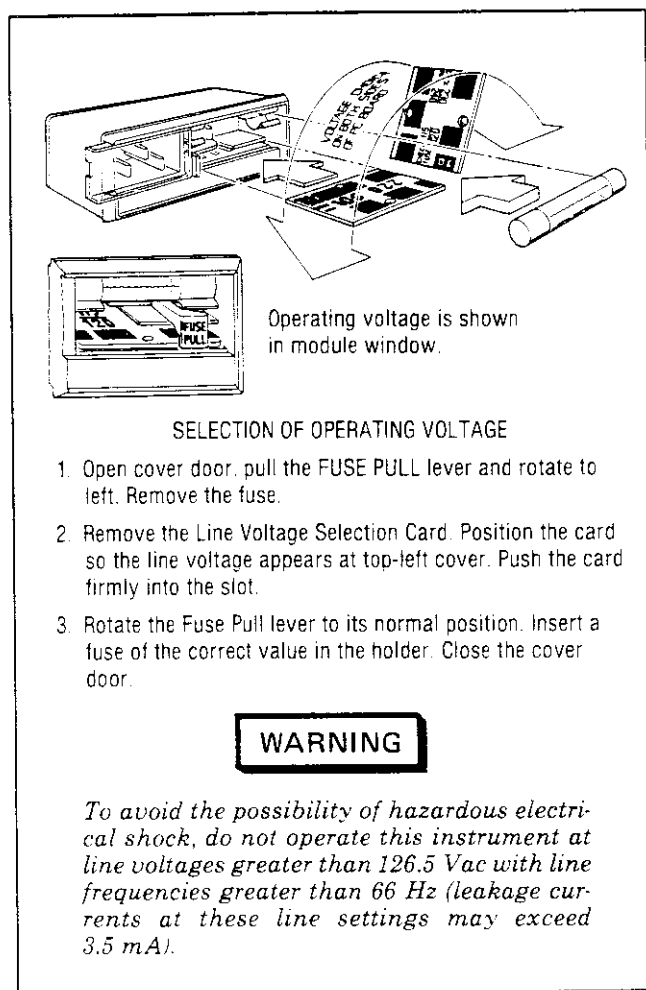

Figure 2-1. Line Voltage and Fuse Selection

This instrument is equipped with a three-wire power cable. When connected to an appropriate ac power receptacle, this cable grounds the instrument cabinet. The type of power cable plug shipped with each instrument depends on the country of destination. Refer to Figure 2-2 for the part numbers of the power cables available.

2-7. HP-IB Address Selection **HP-IB****WARNINGS**

*This task should be performed only by service trained persons who are aware of the potential shock hazard of working on an instrument with protective covers removed.*

*To avoid hazardous electrical shock, the line (Mains) power cable should be disconnected before attempting to change the HP-IB address.*

In the Audio Analyzer, the HP-IB talk and listen addresses are selectable by an internal switch. The following procedure explains how the switches are to be set. Refer to Table 2-1 for a listing of the talk and listen addresses. The address is factory set for a Talk address of "\ " and a listen address of "<" (in binary, this is 11100; in decimal it is 28.) To change the HP-IB address, the top cover of the Audio Analyzer must be removed.

- a. Disconnect the line (Mains) power cable.
- b. Remove any HP-IB cables or connectors from the HP-IB connector.
- c. Remove the Audio Analyzer top cover.
  1. Remove the two plastic feet from the rear of the top cover by removing the pan-head Pozidriv screw within each foot.
  2. Unscrew the Pozidriv screw at the center of the rear edge of the top cover. This is a captive screw and will cause the top cover to pull away from the front frame.
  3. Lift off the top cover.
- d. Locate the HP-IB address switch accessible through a hole near the center rear of the internal shield cover.
- e. Use a pencil to set the switches to the desired HP-IB address and Talk Only (TON) or Listen Only (LON) condition. The switch is illustrated in Figure 2-3. Facing the board, the left hand switch (marked with a "5") is the most significant address





<p>220/240V OPERATION</p>  <p>PLUG*: SEV 1011.1959-24507 TYPE 12 CABLE*: HP 8120-2104</p>	<p>220/240V OPERATION</p>  <p>PLUG*: NZSS 198/AS C112 CABLE*: HP 8120-1369</p>	<p>100/120V OPERATION</p>  <p>PLUG*: NEMA 5-15P CABLE*: 8120-1378</p>	<p>220/240V OPERATION</p>  <p>PLUG*: NEMA 6-15P CABLE*: HP 8120-0698</p>
<p>220/240V OPERATION</p>  <p>PLUG*: CEE7-VII CABLE*: HP 8120-1689</p>	<p>220/240V OPERATION</p>  <p>PLUG*: CEE22-V1 CABLE*: HP 8120-1860</p>	<p>220/240V OPERATION</p>  <p>PLUG*: BS 1363A CABLE: HP 8120-1351</p>	
<p>*The number shown for the plug is the industry identifier for the plug only. The number shown for the cable is an HP part number for a complete cable including the plug.</p>			

Figure 2-2. Power Cable and Mains Plug Part Numbers

**HP-IB Address Selection (Cont'd)** 

bit (A5 in Table 2-1). Setting a switch toward the printed circuit board places it in its "1" position. If the TON and LON switches are both set to "1", the Talk Only setting will override. If the address switches and the TON switch are all set to "1", the Audio Analyzer will output one byte (the status byte) each measurement cycle. (Setting all switches to "1" defeats HP-IB operation.)

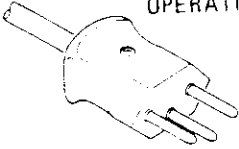
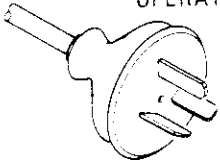
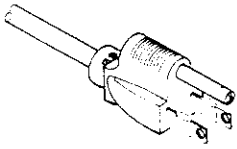
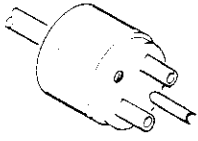
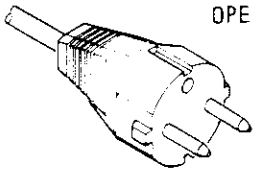
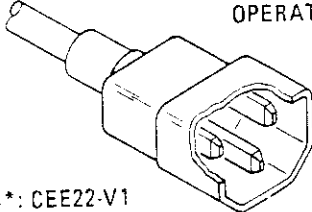
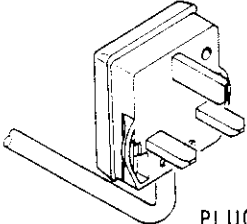
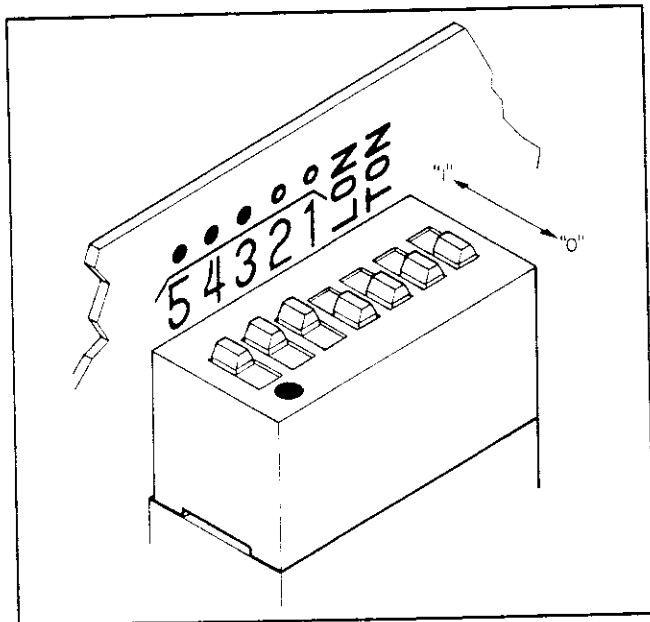

Figure 2-3. The HP-IB Address Switch Shown as Set by the Factory. The Address Shown is 11100 in Binary with Both Talk Only and Listen Only Off.

f. Reinstall the top cover by reversing the procedure in step c above.

g. Connect the line (Mains) power cable to the Line Power Module and reconnect the HP-IB cable to the HP-IB connector.

h. To confirm the setting, refer to HP-IB Address in the Detailed Operating Instructions in Section III of this manual.

**2-8. Interconnections**

Interconnection data for the Hewlett-Packard Interface Bus is provided in Figure 2-4.

**2-9. Mating Connectors**

**Interface Connector.** The HP-IB mating connector is shown in Figure 2-4. Note that two securing screws are metric.

**Coaxial Connectors.** Coaxial mating connectors used with the Audio Analyzer should be the 50-ohm BNC male connectors.

**2-10. Operating Environment**

The operating environment should be within the following limitations:

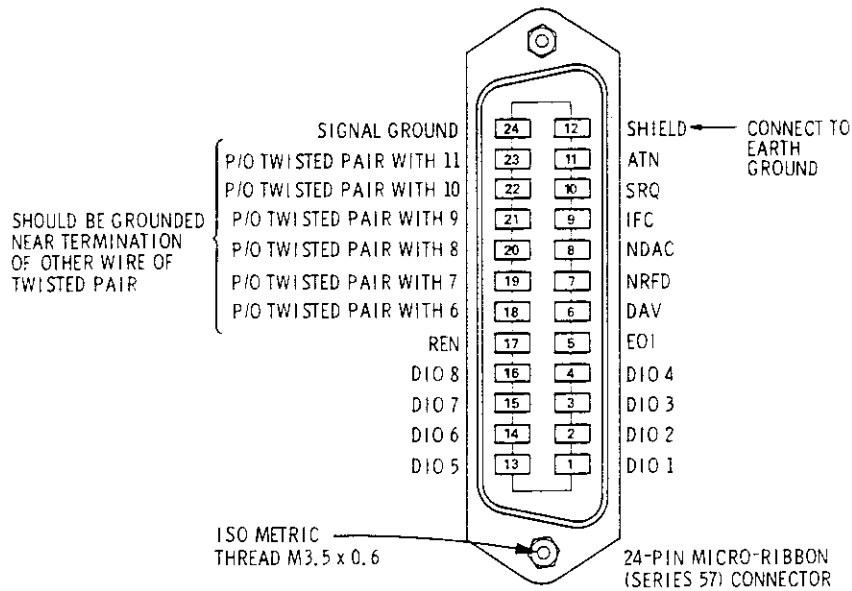

**Logic Levels**

The Hewlett-Packard Interface Bus Logic Levels are TTL compatible, i.e., the true (1) state is 0.0 Vdc to +0.4 Vdc and the false (0) state is -2.5 Vdc to +5.0 Vdc.

**Programming and Output Data Format**

Refer to Section III, Operation.

**Mating Connector**

HP 1251-0293; Amphenol 57-30240.

**Mating Cables Available**

HP 10833A, 1 metre (3.3 ft); HP 10833B, 2 metres (6.6 ft)  
 HP 10833C 4 metres (13.2 ft); HP 10833D, 0.5 metres (1.6 ft)

**Cabling Restrictions**

1. A Hewlett-Packard Interface Bus system may contain no more than 2 metres (6.6 ft) of connecting cable per instrument.
2. The maximum accumulative length of connecting cable for any Hewlett-Packard Interface Bus system is 20.0 metres (65.6 ft).

Figure 2-4. Hewlett-Packard Interface Bus Connection

**Operating Environment (Cont'd)**

Temperature ..... 0°C to -55°C  
 Humidity ..... <95% relative  
 Altitude ..... <4570 metres (15 000 feet)

**HP-IB** Table 2-1. Allowable HP-IB Address Codes

Address Switches					Talk Address Character	Listen Address Character	Decimal Equivalent
A5	A4	A3	A2	A1			
0	0	0	0	0	@	SP	0
0	0	0	0	1	A	!	1
0	0	0	1	0	B	"	2
0	0	0	1	1	C	=	3
0	0	1	0	0	D	\$	4
0	0	1	0	1	E	%	5
0	0	1	1	0	F	&	6
0	0	1	1	1	G	'	7
0	1	0	0	0	H	(	8
0	1	0	0	1	I	)	9
0	1	0	1	0	J	*	10
0	1	0	1	1	K	+	11
0	1	1	0	0	L	,	12
0	1	1	0	1	M	-	13
0	1	1	1	0	N		14
0	1	1	1	1	O	/	15
1	0	0	0	0	P	0	16
1	0	0	0	1	Q	1	17
1	0	0	1	0	R	2	18
1	0	0	1	1	S	3	19
1	0	1	0	0	T	4	20
1	0	1	0	1	U	5	21
1	0	1	1	0	V	6	22
1	0	1	1	1	W	7	23
1	1	0	0	0	X	8	24
1	1	0	0	1	Y	9	25
1	1	0	1	0	Z	:	26
1	1	0	1	1	{	;	27
1	1	1	0	0	\	<	28
1	1	1	0	1	}	=	29
1	1	1	1	0	~	>	30

**2-11. Bench Operation**

The instrument cabinet has plastic feet and fold-away tilt stands for convenience in bench operation. The plastic feet are shaped to ensure self-aligning of the instruments when stacked. The

tilt stands raise the front of the instrument for easier viewing of the front panel.

**2-12. Rack Mounting**

**WARNING**

*The Audio Analyzer is heavy for its size (12.3 kg, 27 lb). Care must be exercised when lifting to avoid personal injury. Use equipment slides when rack mounting.*

Rack mounting information is provided with the rack mounting kits. If the kits were not ordered with the instrument as options, they may be ordered through the nearest Hewlett-Packard office. Refer to paragraph 1-13, Mechanical Options, in Section I.

**2-13. STORAGE AND SHIPMENT**

**2-14. Environment**

The instrument should be stored in a clean, dry environment. The following environmental limitations apply to both storage and shipment:

Temperature ..... -55°C to +75°C  
 Humidity ..... <95% relative  
 Altitude ..... <15 300 metres (50 000 feet)

**2-15. Packaging**

**Tagging for Service.** If the instrument is being returned to Hewlett-Packard for service, please complete one of the blue repair tags located at the end of this manual and attach it to the instrument.

**Original Packaging.** Containers and materials identical to those used in factory packaging are available through Hewlett-Packard offices. Mark the container "FRAGILE" to assure careful handling. In any correspondence refer to the instrument by model number and full serial number.

**Other Packaging.** The following general instructions should be used for re-packaging with commercially available materials:

- a. Wrap the instrument in heavy paper or plastic. (If shipping to a Hewlett-Packard office or service center, complete one of the blue tags mentioned above and attach it to the instrument.)
- b. Use a strong shipping container. A double-wall carton made of 2.4 MPa (350 psi) test material is adequate.

**Packaging (Cont'd)**

c. Use enough shock-absorbing material (75 to 100 mm layer; 3 to 4 inches) around all sides of instrument to provide firm cushion and prevent movement in the container. Protect the front panel with cardboard.

d. Seal the shipping container securely.

e. Mark the shipping container "FRAGILE" to assure careful handling.

## SECTION III OPERATION

### 3-1. INTRODUCTION

#### 3-2. General

This section provides complete operating information for the Audio Analyzer. Included in this section are descriptions of all front- and rear-panel controls, connectors, and indicators, remote and local operator's checks, operating instructions, and operator's maintenance.

#### 3-3. Operating Characteristics

Table 3-1 briefly summarizes the major operating characteristics of the Audio Analyzer. The table is not intended to be an in-depth listing of all operations and ranges but gives an idea of the instrument's capabilities. For more information on the Audio Analyzer capabilities, refer to the description in Section 1; Table 1-1, Specifications; and Table 1-2, Supplemental Information. For information on HP-IB capabilities, refer to the summary contained in Table 3-3, Message Reference Table.



#### 3-4. Turn-On Procedure

##### WARNINGS

*Before the Audio Analyzer is switched on, all protective earth terminals, extension cords, auto-transformers, and devices connected to it should be connected to a protective earth socket. Any interruption of the protective earth grounding will cause a potential shock hazard that could result in personal injury. In addition, verify that a common ground exists between the unit under test and the Audio Analyzer prior to energizing either unit.*

*For continued protection against fire hazard, replace the line fuse with a 250V time delay fuse of the same rating. Do not use repaired fuses or short circuited fuseholders.*

##### CAUTIONS

*Before the Audio Analyzer is switched on, it must be set to the voltage of the*

*power source, or damage to the instrument may result.*

*Do not apply greater than +15V or less than -15V (ac + dc) to the INPUT LOW terminal or damage to the instrument may result. Do not allow the voltage at the SOURCE OUTPUT LOW terminal to be greater than +10V or less than -10V (ac + dc) or damage to the instrument may result.*

If the Audio Analyzer is already plugged in, set the LINE switch to ON. If the power cable is not plugged in, follow these instructions.

1. Check that the line voltage setting matches the power source (see Figure 2-1).
2. Check that the fuse rating is appropriate for the line voltage used (see Figure 2-1). Fuse ratings are given under Operator's Maintenance on this foldout.
3. Plug in the power cable.
4. Set the LINE switch to ON.

##### NOTE

*When the LINE switch is set to ON, all front-panel indicators will light for approximately 4 seconds after which the instrument is ready to be operated.*

#### 3-5. Local Operation

Information covering front-panel operation of the Audio Analyzer is given in the sections described below. To rapidly learn the operation of the instrument, begin with Simplified Operation and Operator's Checks. Once familiar with the general operation of the instrument, use the Detailed Operating Instructions for in-depth and complete information on operating the Audio Analyzer.

**Simplified Operation.** Located on the inside of this fold, Simplified Operation provides a quick introduction to front-panel operation of the Audio Analyzer. It is designed to rapidly orient the novice

#### Local Operation (Cont'd)

user with basic operating procedures and therefore is not an exhaustive listing of all Audio Analyzer functions. However, an index to the Detailed Operating Instructions appears opposite the fold to guide the operator to the more complete discussion of the topic of interest.

**Panel Features.** Front-panel controls, indicators, and connectors are illustrated and described in Figures 3-2 to 3-4. These figures describe the functions of the various key groups and summarize briefly how to use them. Rear-panel features are shown in Figure 3-5. The figure provides a good quick reference for rear-panel signal levels and also includes the impedance at the rear-panel connections.

**Detailed Operating Instructions.** The Detailed Operating Instructions provide the complete operating reference for the Audio Analyzer user. The instructions are organized alphabetically by subtitle. Not only do the instructions contain information on the various measurements that can be made (listed under titles such as AC Level, Distortion, etc.) but there are also individual discussions of nearly all controls, inputs, and outputs (e.g., Amplitude, Monitor, etc.). Also included are instructions for using the many User Special Functions (e.g., Hold Settings, Error Disable, Special Functions, etc.). The Detailed Operating Instructions are indexed by function in Table 3-2.

Each section contains a general description which covers signal levels, ranges, and other general information. Following the description are related procedures, an operating example, the relevant HP-IB codes, front-panel indications, and, where pertinent, a description of the technique the Audio Analyzer uses to make the measurement. At the end of each discussion are comments intended to guide the user away from measurement pitfalls and to help him get the most out of the Audio Analyzer. Also included are references to other sections which contain related information. The Detailed Operating Instructions are designed so that both casual and sophisticated users can rapidly find at one location all the information needed to apply the instrument to the task at hand.

**Operating Information Pull-Out Cards.** The Operating Information pull-out cards are flexible plastic reference sheets attached to the Audio Analyzer by a tray located below the front-panel. They contain a complete listing of HP-IB codes and data and error output formats, Error codes, and User Special Functions. The cards are intended to be a reference for the user who already has a basic understanding of front-panel operation.

**Supplemental Information.** In addition to the information described above several other discussions pertinent to operating the Audio Analyzer to its fullest capabilities are contained in Section I of this manual. Principles of Operation for a Simplified Block Diagram is a fundamental description of what the Audio Analyzer is and how it works. This information supplements the block diagrams given in the Detailed Operating Instructions and provides a basis for applying the Audio Analyzer to various measurement situations. Basics of Audio Measurements is a general discussion of audio measurements. It is intended to provide an intuitive understanding of audio measurements rather than an in-depth mathematical analysis.

**FRONT-PANEL FEATURES  
AND SIMPLIFIED OPERATION** 

### 3-6. Remote Operation

The Audio Analyzer is capable of remote operation via the Hewlett-Packard Interface Bus (HP-IB). Instructions pertinent to HP-IB operation cover all considerations and instructions specific to remote operation including capabilities, addressing, input and output formats, the status byte, and service requests. At the end of the discussion is a complete summary of all codes and formats.

In addition to the section described above, information concerning remote operation appears in several other locations. Address setting is discussed on page 2-2. A summary of HP-IB codes and output formats appear on one of the Operating Information pull-out cards, and numerous examples of program strings appear throughout the Detailed Operating Instructions described under Local Operation above.

### 3-7. Operator's Checks

Operator's Checks are procedures designed to verify the proper operation of the Audio Analyzer's main functions. Two procedures are provided as described below.

**Basic Functional Checks.** This procedure requires an oscilloscope and interconnecting cables. It assures that most front-panel controlled functions are being properly executed by the Audio Analyzer.

**HP-IB Functional Checks.** This series of procedures require an HP-IB compatible computing controller and an HP-IB interface and connecting cable. The HP-IB Functional Checks assume that front-panel operation has been verified (e.g., by performing the Basic Functional Checks). The procedures check all of the applicable bus messages summarized in Table 3-3.

### 3-8. Operator's Maintenance

#### WARNING

*For continued protection against fire hazard, replace the line fuse with a 250V time delay fuse of the same rating only. Do not use repaired fuses or short circuited fuseholders.*

The only maintenance the operator should normally perform is the replacement of the primary power fuse located within the Line Power Module (A14). For instructions on how to change the fuse, refer to Figure 2-1, steps 1 and 3.

Fuses may be ordered under HP Part Numbers 2110-0305, 1.25A (250V, time delay) for 100/120 Vac operation and 2110-0202, 0.5A (250V, time delay) for 220/240 Vac operation.

#### NOTE

*If the instrument does not operate properly and is being returned to Hewlett-Packard for service, please complete one of the blue repair tags located at the end of this manual and attach it to the instrument. Refer to Paragraph 2-15 for packaging instructions.*

Table 3-1. Operating Characteristics Summary

Operating Parameter	Capabilities
Output Limits	Frequency: 20 Hz to 100 kHz. Level: 0.6 mV to 6V (open circuit). Impedance: 600Ω; floating output can be selected.
Input Limits	Frequency: 20 Hz to 100 kHz (150 kHz, ac level) Level: ≈0 to 300V ac or dc. Impedance: 100 kΩ (except dc level); 101 kΩ (dc level); floating input can be selected.
Measurements (including counter frequency measurements except in DC Level)	AC LEVEL: ≈0 to 300 Vac; 20 Hz to 150 kHz. Full range display from .3000 mV to 300.0V in seven ranges. DC LEVEL: 0 to 300 Vdc. Full range display from 4.000V to 300.0V in four ranges. SINAD: 50 mV to 300V; 20 Hz to 100 kHz. Display range 0 to 99.99 dB. SINAD meter marked for EIA and CEPT readings. SIG/NOISE: 50 mV to 300V; 50 Hz to 100 kHz. Display range 0 to 99.99 dB. DISTN: 50 mV to 300V; 20 Hz to 100 kHz. Display range -99.99 to 0 dB. DISTN LEVEL: Similar to ac level except that the notch filter is used in the measurement.
Detection	True rms (average detection selectable by internal modification).
Swept Measurements	All measurements can be swept and frequency vs. measurement result can be plotted using an external X-Y recorder.
Audio Filters	HP/BP FILTER HIGH PASS 400 Hz: 400 ±40 Hz (3 dB cutoff). PSOPH: approximates CCITT Recommendation P53.  LP FILTER LOW PASS 30 kHz: 30 ±2 kHz (3 dB cutoff). 80 kHz: 80 ±4 kHz (3 dB cutoff).
Manual Operation	Output level and frequency, input attenuation, ratio, log/linear, display resolution, measurement selection, and many other operations can be manually controlled.
Remote Operation	All Audio Analyzer operations except the LINE switch, the two FLOAT switches, and the ÷10 and ×10 FREQ/AMPT ADJUST keys can be controlled via the Hewlett-Packard Interface Bus.

## FRONT-PANEL FEATURES

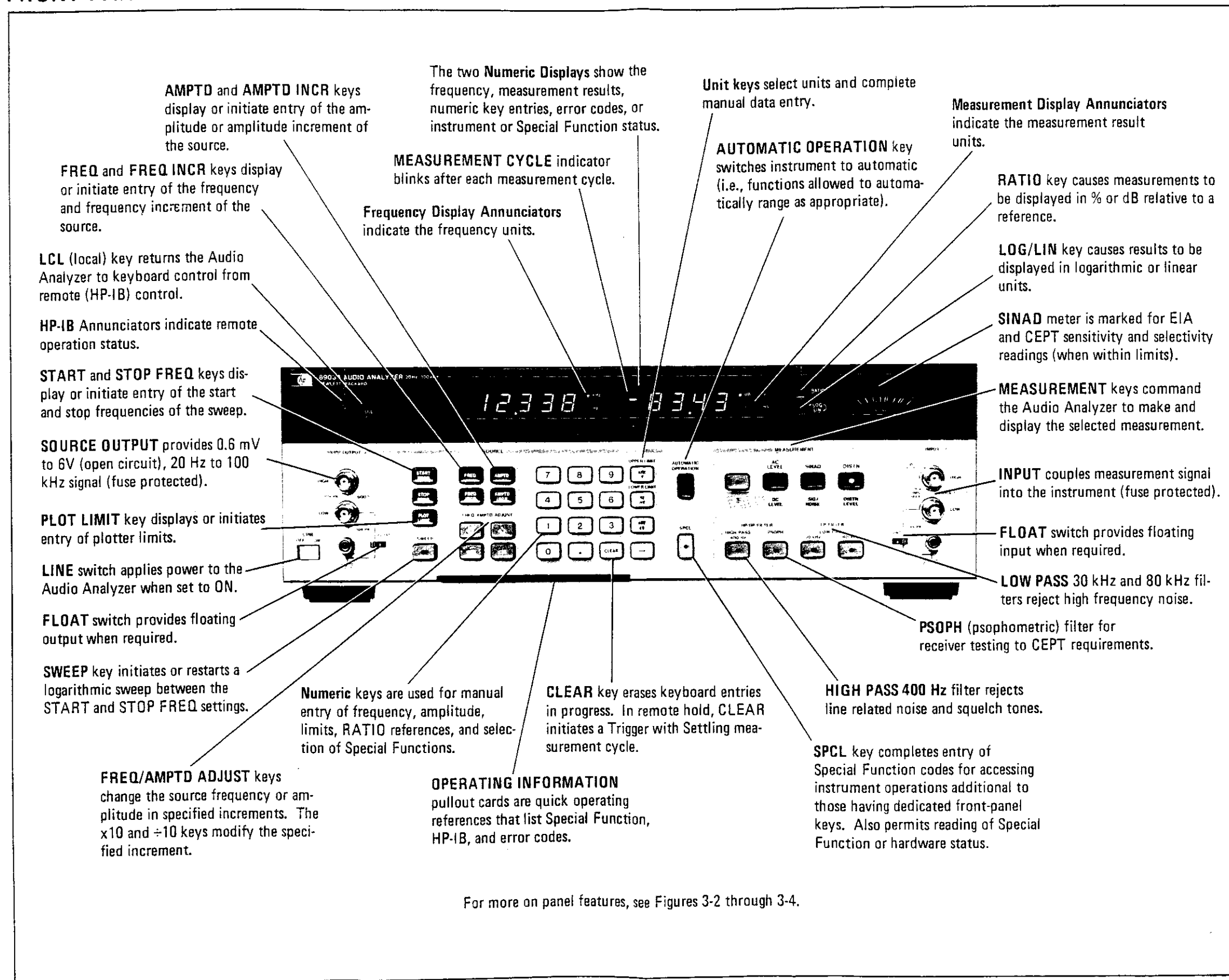

For more on panel features, see Figures 3-2 through 3-4.

Figure 3-1. Front-Panel Features

# SIMPLIFIED OPERATION

## SOURCE FREQUENCY AND AMPLITUDE

**Frequency**  
To set source frequency to 500 Hz,  
press:

**Amplitude:**  
To set source amplitude to 3V,  
press:

**Frequency Increment**  
To set frequency increment step to 10 Hz,  
press:

**Amplitude Increment**  
To set amplitude increment step to 200 mV,  
press:

**Stepping Increments**  
To step frequency up 10 Hz (as set above),  
press:   (holding  down causes frequency to move up slowly in 10 Hz steps).

## MEASUREMENT

For ac level, SINAD, or distortion measurements,  
press:  or  or

For dc level, signal-to-noise, or distortion level measurements,  
press:  or  or

## FILTERS

**HP/BP Filter**  
To activate the PSOPH (psophometric) filter, press:

**LP Filter**  
To activate the LOW PASS 30 kHz filter, press:

## SWEEP

**Start Frequency**  
To set the start frequency of the sweep to 100 Hz,  
press:

**Stop Frequency**  
To set the stop frequency of the sweep to 10 kHz, press:

**Starting the Sweep**  
To start the frequency sweep, press:

## RATIO and LOG/LIN

**RATIO**  
To set the displayed measurement as the ratio reference, press:

**LOG/LIN**  
To convert from linear to logarithmic (or from logarithmic to linear) measurement units,  
press:

Measurement Mode	RATIO on		RATIO off	
	LIN	LOG	LIN	LOG
AC LEVEL	%	dB	V or mV	dBV
DC LEVEL	%	dB	V or mV	dBV
SINAD	%	dB	%	dB
SIG/NOISE	%	dB	%	dB
DISTN	%	dB	%	dB
DISTN LEVEL	%	dB	V or mV	dBV

### NOTE

*During power up, the Audio Analyzer is initialized and set to AUTOMATIC OPERATION.*

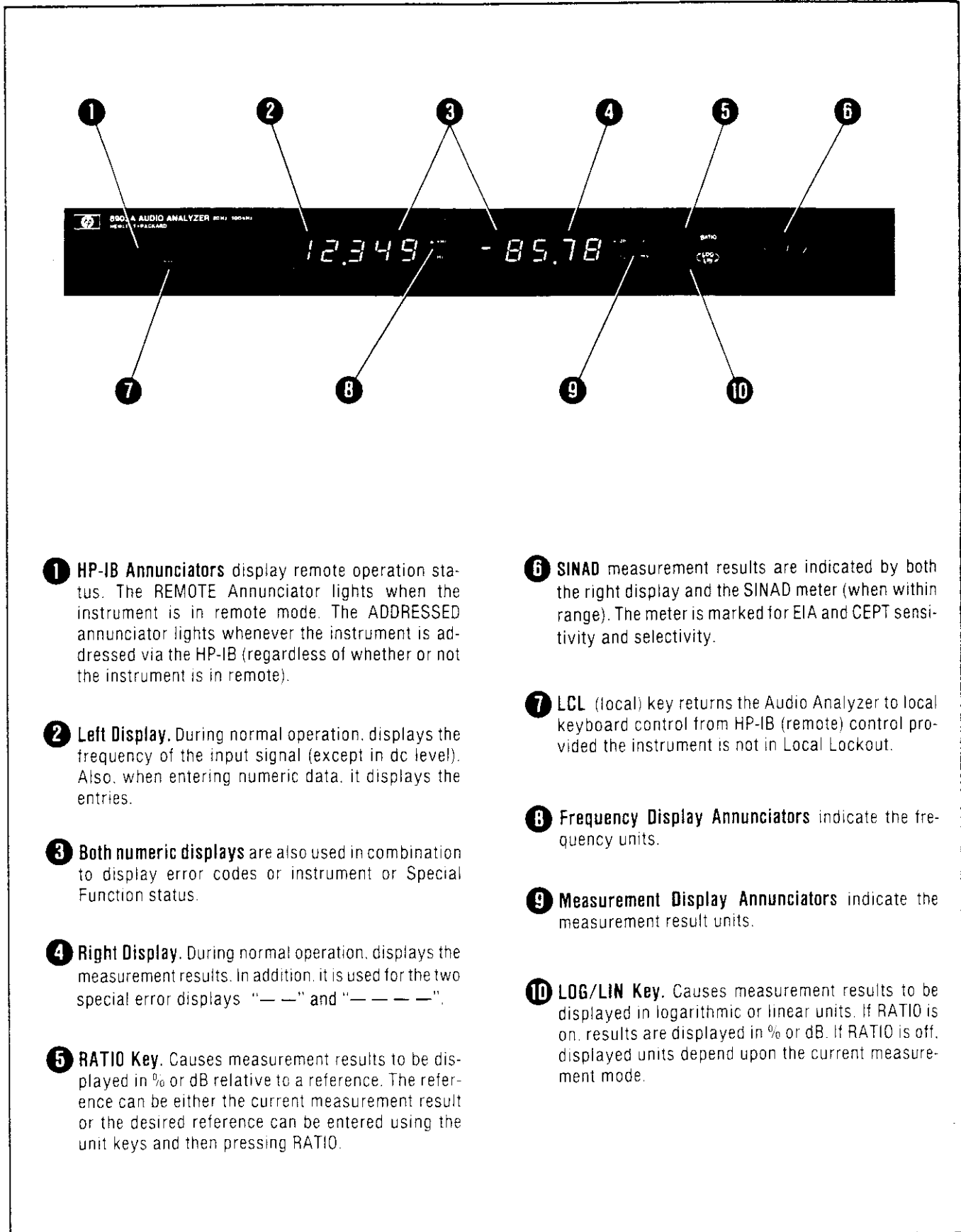

Table 3-2. Detailed Operating Instructions Table of Contents (Functional Listing)<sup>1</sup>

Section	Page	Section	Page
Source		Inputs and Outputs  <sup>2</sup>	
Amplitude .....	3-40	Float .....	3-59
Display Source Settings .....	3-46	Monitor .....	3-72
Frequency .....	3-61	X-Y Recording .....	3-110
Increment .....	3-67		
Measurements		Special Functions	
AC Level .....	3-38	Display Level in Watts .....	3-44
DC Level .....	3-42	Display Source Settings .....	3-46
Distortion .....	3-47	Error Disable .....	3-51
Distortion Level .....	3-49	Hold Decimal Point .....	3-62
Signal-to-Noise .....	3-93	Hold Settings .....	3-63
SINAD .....	3-95	HP-IB Address .....	3-64
Filters		Input Level Range (DC Level) .....	3-69
Filters .....	3-57	Input Level Range (Except DC Level) .....	3-70
Notch Tune .....	3-75	Notch Tune .....	3-75
Post-Notch Detector Response .....	3-78	Post-Notch Detector Response .....	3-78
Sweep and X-Y Recording		Post-Notch Gain .....	3-79
Plot Limit .....	3-76	Read Display to HP-IB .....	3-89
Sweep .....	3-104	Service Request Condition .....	3-91
Sweep Resolution .....	3-106	Special Functions .....	3-97
Time Between Measurements .....	3-109	Sweep Resolution .....	3-106
X-Y Recording .....	3-110	Time Between Measurements .....	3-109
Data Manipulation		HP-IB	
Display Level in Watts .....	3-44	HP-IB Address .....	3-64
Hold Decimal Point .....	3-62	Rapid Frequency Count .....	3-80
Ratio and Log/Linear .....	3-86	Service Request Condition .....	3-91
Errors		Rapid Source .....	3-82
Error Disable .....	3-51	Read Display to HP-IB .....	3-89
Error Message Summary .....	3-53	Miscellaneous	
		Automatic Operation .....	3-41
		Default Conditions and Power-Up	
		Sequence .....	3-43
		Float .....	3-59

<sup>1</sup>The detailed operating instructions are arranged in alphabetical order at the end of the Operation section.

<sup>2</sup>  Do not apply more than 300 Vrms to the INPUT.



**1 HP-IB Annunciators** display remote operation status. The REMOTE Annunciator lights when the instrument is in remote mode. The ADDRESSED annunciator lights whenever the instrument is addressed via the HP-IB (regardless of whether or not the instrument is in remote).

**2 Left Display.** During normal operation, displays the frequency of the input signal (except in dc level). Also, when entering numeric data, it displays the entries.

**3 Both numeric displays** are also used in combination to display error codes or instrument or Special Function status.

**4 Right Display.** During normal operation, displays the measurement results. In addition, it is used for the two special error displays "—" and "———".

**5 RATIO Key.** Causes measurement results to be displayed in % or dB relative to a reference. The reference can be either the current measurement result or the desired reference can be entered using the unit keys and then pressing RATIO.

**6 SINAD** measurement results are indicated by both the right display and the SINAD meter (when within range). The meter is marked for EIA and CEPT sensitivity and selectivity.

**7 LCL** (local) key returns the Audio Analyzer to local keyboard control from HP-IB (remote) control provided the instrument is not in Local Lockout.

**8 Frequency Display Annunciators** indicate the frequency units.

**9 Measurement Display Annunciators** indicate the measurement result units.

**10 LOG/LIN Key.** Causes measurement results to be displayed in logarithmic or linear units. If RATIO is on, results are displayed in % or dB. If RATIO is off, displayed units depend upon the current measurement mode.

Figure 3-2. Readout Panel Features

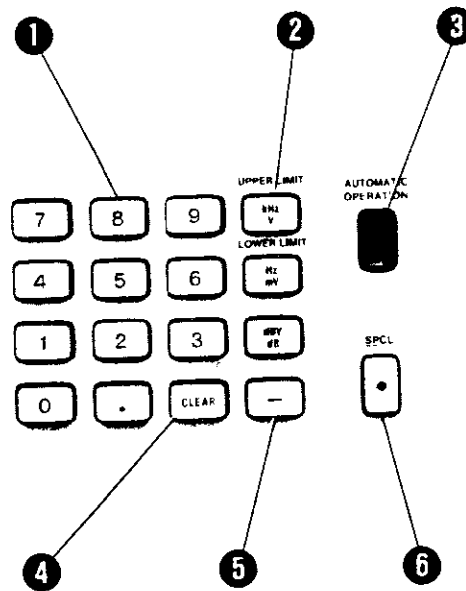

**1 Numeric Keys.** Used to enter source frequency and amplitude, incremental values, ratio references, sweep start and stop frequencies, plot limits, and to select Special Functions. Numeric entries are completed by the **RATIO**, **kHz/V** (**UPPER LIMIT**), **Hz/mV** (**LOWER LIMIT**), **dBV/dB**, or **SPCL** keys. Numeric entries in progress are cleared by the **CLEAR** key.

**2 Suffix Keys.** Terminate the keyboard entries (if properly sequenced) by entering the programmed value in memory. Instrument operation is modified as appropriate.

**AUTOMATIC OPERATION Key.** Switches the instrument functions to automatic (i.e., each function is allowed to automatically range to the appropriate setting). It also cancels all of the Special Functions and lights the **SPCL** key.

**4 CLEAR Key.** Removes any keyboard entry in progress. If no entry is in progress, **CLEAR** turns off some Special Functions. In remote hold only (HP-IB code T1), the **CLEAR** key remains active and acts as a manual trigger with settling (HP-IB code T3).

**5 - (Minus) Key.** Used as a prefix for **RATIO** or **dBV/dB** entries. If the **Minus** key is pressed while entry is in progress, the **minus** is inserted into the leftmost digit. However, if it is pressed after five digits have been entered, it is ignored. If the **minus** is not allowed for the selected entry, **Error 21** is displayed.

**6 SPCL Key.** Completes the keyboard entry of a Special Function code. Special Functions are instrument operations in addition to those accessible from dedicated front-panel keys. If pressed alone once, the **SPCL** key causes the requested modes of Special Functions 1 through 8 to be displayed. If pressed again while the requested modes are being displayed, the **SPCL** key causes the actual instrument settings to be displayed.

Figure 3-3. Source and Output Features (1 of 3)

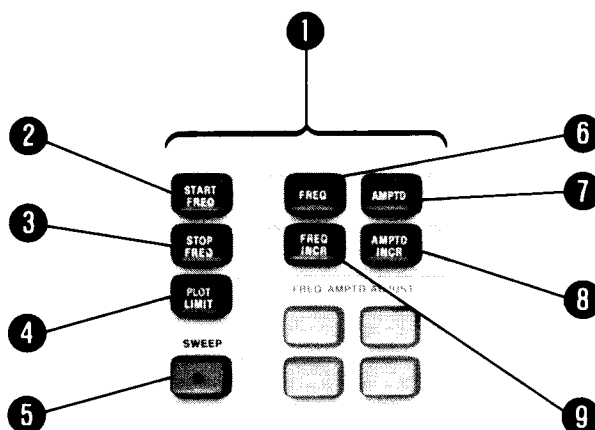

- 1 Source Prefix Keys.** In addition to the functions described, the following keys are used to prefix numeric entries for the specified functions: START FREQ, STOP FREQ, PLOT LIMIT, FREQ, FREQ INCR, AMPTD, AMPTD INCR. The same specified function can be changed repeatedly without repressing the same prefix key as long as no other prefix key is pressed.
- 2 START FREQ Key.** Holding key down causes the programmed starting frequency of the sweep to appear in the left display. Note that the source is tuned to this frequency whenever the key is pressed. (Also see prefix keys.)
- 3 STOP FREQ Key.** Holding key down causes the programmed stopping frequency of the sweep to appear in the left display. Note that the source is tuned to this frequency whenever the key is pressed. (Also see prefix keys.)
- 4 PLOT LIMIT Key.** Holding key down causes the programmed plot limits to appear in the displays. The lower limit is in the left display and the upper limit is in the right display. (Also see prefix keys.)

- 5 SWEEP Key.** Initiates or restarts the sweep function. If the sweep is off, it initiates one sweep cycle and turns on the SWEEP LED. When cycle is completed, the LED is turned off. The source frequency remains at the last sweep point initiated before termination. If the sweep is on, pressing this key restarts the sweep. Use the CLEAR key to stop the sweep.
- 6 FREQ Key.** Holding key down causes the programmed frequency of the source to appear in the left display. (Also see prefix keys.)
- 7 AMPTD Key.** Holding key down causes the programmed amplitude of the source to appear in the right display. (Also see prefix keys.)
- 8 AMPTD INCR Key.** Holding key down causes the programmed amplitude increment to appear in the right display. (Also see prefix keys.)
- 9 FREQ INCR Key.** Holding key down causes the programmed frequency increment to appear in the left display. (Also see prefix keys.)

**NOTE**

*Some delays may be noted when pressing keys during sweeps with an x-y recoder enabled. These delays allow the pen to lift before moving. However, the keys are recognized and it is unnecessary to hold them down while waiting for the Audio Analyzer to respond.*

**Figure 3-3. Source and Output Features (2 of 3)**

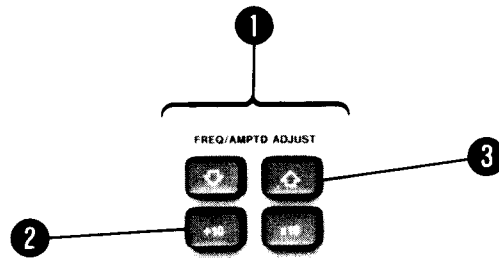

**1 FREQ/AMPTD ADJUST Keys.** These keys are used to manually adjust the frequency and amplitude of the source.

**2 ÷10 ( or × 10) Keys.** Divides (or multiplies) the programmed frequency or amplitude increment value by a factor of 10 (the parameter changed depends upon whether FREQ INCR or AMPTD INCR was pressed last). If the source limits are exceeded, Error 21 is displayed.

**3 ↑ (or ↓) Keys.** Increments (or decrements) the programmed frequency or amplitude of the source by the current frequency or amplitude increment (the parameter changed depends upon whether FREQ INCR or AMPTD INCR was pressed last). Holding the ↑ or the ↓ key down causes the increment (or decrement) to be repeated once each measurement cycle. If the source limits are exceeded, Error 21 is displayed.

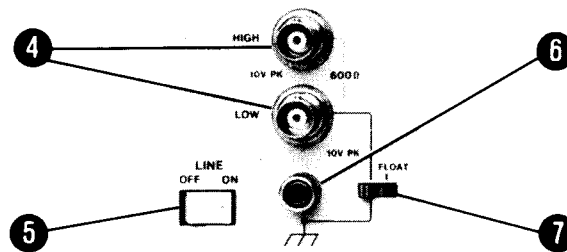

**4 OUTPUT HIGH and LOW Connectors.** Used to connect the source to the device under test. When the FLOAT switch is in the FLOAT position, both connectors are used. If the switch is in the grounded position, a single BNC-connector can be connected to the HIGH output. Output at the connectors is 0.60 mV to 6V (open circuit), 20 Hz to 100 kHz, with 600 Ω impedance.

**5 LINE Switch.** Applies power to the Audio Analyzer when set to the ON position.

**6 Ground Connector.** Convenient grounding point for source output cables.

**7 FLOAT Switch.** Used to select a floating or grounded LOW OUTPUT when required. Refer to FLOAT detailed operating instruction for additional information.

Figure 3-3. Source and Output Features (3 of 3)

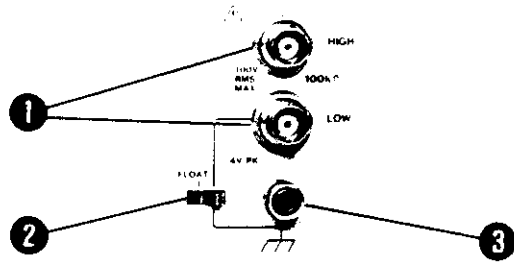

**1 INPUT HIGH and LOW Connectors.** Used to connect the device under test to the analyzer. When the FLOAT switch is in the FLOAT position, both connectors are used. If the switch is in the grounded position a single BNC-connector can be connected to the HIGH input. Input impedance is 100 kΩ (101 kΩ, dc level only).

**2 FLOAT Switch.** Used to select a floating or grounded HIGH INPUT when required. Refer to FLOAT detailed operating instruction for additional information.

**3 Ground Connector.** Convenient grounding point for input cables.

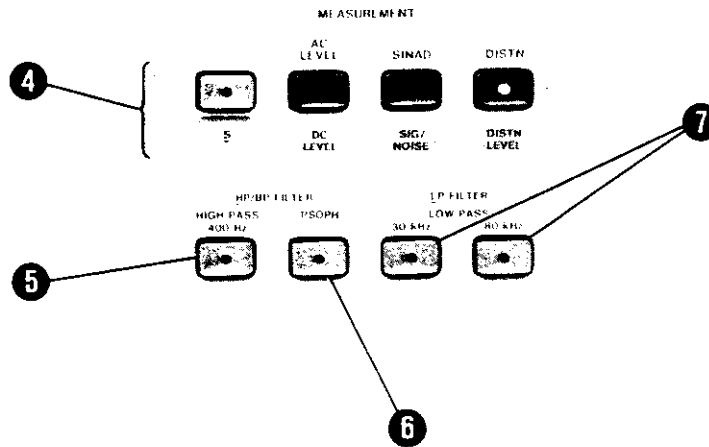

**4 MEASUREMENT Keys.** Automatically configure the Audio Analyzer to make and display the measurement selected. To select a measurement labeled above a key, press the key. To select a measurement labeled below a key, press the S (Shift) key, then the MEASUREMENT key.

**5 HIGH PASS 400 Hz filter** rejects line related noise and squelch tones.

**6 PSOPH (psophometric) filter** for receiver testing to CEPT requirements.

**7 LOW PASS 30 kHz and 80 kHz filters** reject high frequency noise.

Figure 3-4. Measurement and Input Features

### REAR-PANEL FEATURES

**HP-IB Connector** connects the Audio Analyzer to the Hewlett-Packard Interface Bus for remote operations. When in remote mode, the front-panel REMOTE annunciator lights.

**X AXIS.** A scaled voltage output representing the log of the oscillator frequency range from the start to the stop frequencies. The start frequency equals 0V and the stop frequency equals 10V. Output impedance is 1 k $\Omega$ .

**Y AXIS.** A scaled voltage output representing the amplitude range from the lower to the upper limit of the plot. The lower limit equals 0V. The upper limit equals 10V. Output impedance is 1 k $\Omega$ .

**Fuse.** 1.25A (250V, time delay) for 100/120 Vac. 0.5A (250V, time delay) for 220/240 Vac.

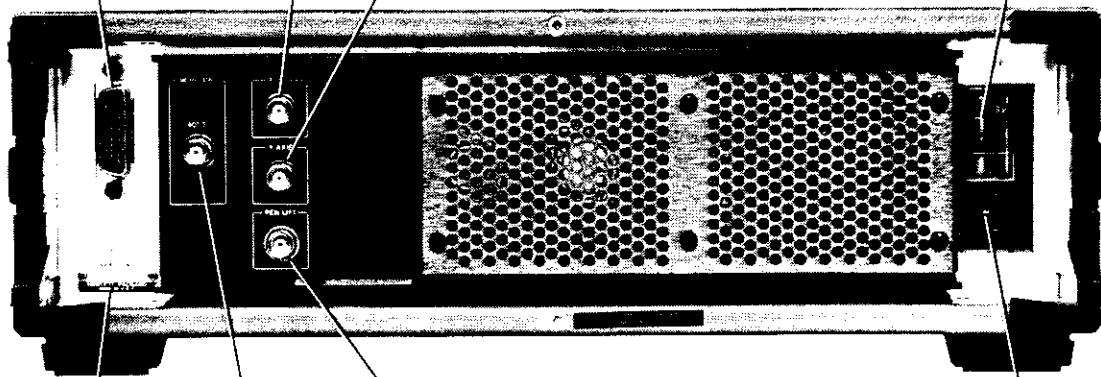

**Line Power Module** permits operation from 100, 120, 220, or 240 Vac. The number visible in window indicates nominal line voltage to which instrument must be connected (see Figure 2-1). Center conductor is safety earth ground.

**PEN LIFT.** TTL compatible output that is used for pen control. TTL high signal is used to lift pen.

**MONITOR.** In ac level mode, provides a scaled voltage output representing the input signal. In SINAD, distortion, and distortion level modes, provides a scaled voltage output of the input signal with the fundamental removed. Output impedance is 600 $\Omega$ .

**Serial Number Plate.** First four numbers and letter comprise the prefix that denotes the instrument configuration. The last five digits form the suffix that is unique to each instrument.

Figure 3-5. Rear Panel Features

**OPERATOR'S CHECKS**

---

**3-9. OPERATOR'S CHECKS**

**3-10. Basic Functional Checks**

DESCRIPTION: Using only an oscilloscope, the overall operation of the Audio Analyzer is verified.

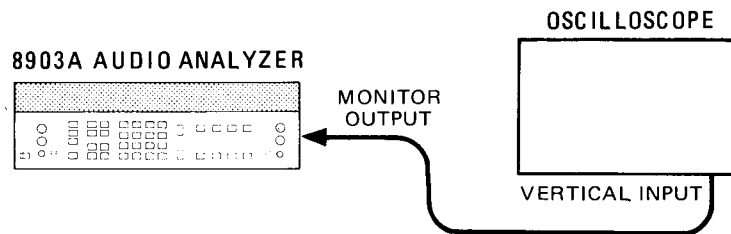

**Figure 3-6. Basic Functional Checks Setup**

EQUIPMENT: Oscilloscope .....HP 1740A

**NOTE**

*The following checks are made using the rms responding voltmeter. If the Audio Analyzer has been changed to an average responding voltmeter configuration, the readings will differ slightly from those shown in these procedures.*

**PROCEDURE: Preliminary Check**

1. Remove any cables from the Audio Analyzer's INPUT or OUTPUT. Set LINE switch to OFF, and then back to ON and note that the front-panel LED annunciators, display segments and decimal points, and key lights turn on. All LEDs should light for approximately four seconds.
2. After the turn-on sequence, the left display should show 0.000 kHz and the right display should show a low flickering value in mV. In addition, the measurement cycle annunciator in the upper left-hand corner of the right display should be blinking and the AC LEVEL and LOW PASS 80 kHz keys should light.
3. Connect a BNC-to-BNC cable between the OUTPUT HIGH jack and the INPUT HIGH jack and set both FLOAT switches to the grounded position.
4. Connect the oscilloscope to the MONITOR output on the rear-panel (see Figure 3-6).

**AC LEVEL Check**

5. Press the AMPTD key and note that the source is set to 0.00 mV as shown in the right display. Next, press the 1 and the V keys to set the amplitude to 1V. The left display will now show between 960 and 1040 Hz (the frequency that the source is set to during power up). The right display will show between 960 and 1040 mV. The oscilloscope should show a 1kHz (1 ms period) sine wave of approximately 7 Vp-p.



**OPERATOR'S CHECKS**

---

6. Press the **RATIO** key. The right display will show 100%.
7. Set **OUTPUT FLOAT** switch to **FLOAT**. The right display will show approximately 90%.
8. Set **INPUT FLOAT** switch to **FLOAT**. The right display will show approximately 50%.
9. Set both **FLOAT** switches to the grounded position.
10. Press the **STOP FREQ** key. The left display will show 20.000 kHz (the stop frequency that the source was set to during power up). Next, press the **1 0 0 kHz** keys. The left display will show between 99.70 and 100.30 kHz.
11. Press the **LOW PASS 80 kHz** key and verify that the key's LED goes off.
12. Press the **SWEEP** key. Verify that the key's LED lights and that the source's frequency starts sweeping from 20 Hz to 100 kHz. During this sweep observe the right display and verify that it continues to show between 96 and 104% throughout the entire sweep. (Press **SWEEP** again if required to reinitiate the sweep.)

**Filter Checks**

13. Press the **LOG/LIN** key and verify that the right display annunciators switch to **dB**.
14. Press the **LOW PASS 80 kHz** key.
15. Use the **FREQ**, numeric data, and units keys to set the source to 80 kHz. Verify that the right display shows between -2 and -4 dB.
16. Press the **LOW PASS 30 kHz** key.
17. Set the source frequency to 30 kHz and verify that the right display shows between -2 and -4 dB.
18. Press the **HIGH PASS 400 Hz** key.
19. Set the source frequency to 400 Hz and verify that the right display shows between -2 and -6 dB.
20. Press the **PSOPH** key and set the source frequency as shown below. Verify that the right display is within the limits shown for each frequency.

Source Frequency (Hz)	RATIO Limits (dB)
300	-12.1 to -9.1
800	-0.4 to +0.4
3000	-7.1 to -4.1
3500	-11.5 to -5.5
5000	-40.0 to -32.0

---

**OPERATOR'S CHECKS**

---

**SINAD Meter Check**

21. Press the SINAD key and verify that the LED in the SINAD key lights.
22. Set the source frequency to 1 kHz.
23. Set the source frequency increment to 100 Hz.
24. Key in 6.1 then press the SPCL key.
25. Press the FREQ/AMPTD ADJUST ↓ key. The left display should show 900 Hz and the right display should show approximately 14 dB. The SINAD meter should read within  $\pm 1$  dB of the right display.

**DISTN, SINAD, and SIG/NOISE Check**

26. Press AUTOMATIC OPERATION and PSOPH keys. Right display should show 80 dB or more.
27. Press DISTN key. Right display should show 0.01% or less.
28. Press S (Shift) and SIG/NOISE keys. Right display should show 80 dB or more.

**SWEEP, X AXIS, Y AXIS, and PEN LIFT Check**

29. Disconnect the cable from the OUTPUT, and reconnect it to the X AXIS connector on the rear panel.
30. Press the S (Shift) and DC LEVEL keys.
31. Press the SWEEP key. The right display will show an evenly spaced rising voltage from approximately 0V to 10V.
32. Disconnect the cable and reconnect it to the Y AXIS connector.
33. Press the START FREQ key. The right display will show between -0.01 and +0.01 V.
34. Press the STOP FREQ key. The right display will show between 9.6 and 10.4V.
35. Disconnect the cable and reconnect it to the PEN LIFT connector.
36. Press the SWEEP key. The right display will momentarily show a TTL high level (greater than 2.4V), then drop to a TTL low level (less than 0.4V), and remain there until the sweep is complete. The display then shows a TTL high level.



## OPERATOR'S CHECKS

---

### 3-11. HP-IB Functional Checks

**DESCRIPTION:** The following ten procedures check the Audio Analyzer's ability to process or send all of the applicable HP-IB messages described in Table 3-3. In addition, the Audio Analyzer's ability to recognize its HP-IB address is checked and all of the bus data, handshake, and control lines except DIO8 (the most significant data line which is not used by the Audio Analyzer) are set to both their true and false states. These procedures do not check whether or not all Audio Analyzer program codes are being properly interpreted and executed by the instrument, however, if the front-panel operation is good, the program codes, in all likelihood will be correctly implemented.

The validity of these checks is based on the following assumptions:

- The Audio Analyzer performs properly when operated via the front-panel keys (that is, in local mode). This can be verified with the Basic Functional Checks.
- The bus controller properly executes HP-IB operations.
- The bus controller's HP-IB interface properly executes the HP-IB operations.

If the Audio Analyzer appears to fail any of these HP-IB checks, the validity of the above assumptions should be confirmed before attempting to service the instrument.

The select code of the controller's HP-IB interface is assumed to be 7. The address of the Audio Analyzer is assumed to be 28 (its address as set at the factory). This select code-address combination (that is, 728) is not necessary for these checks to be valid. However, the program lines presented here would have to be modified for any other combination.

These checks are intended to be as independent of each other as possible. Nevertheless, the first four checks should be performed in order before other checks are selected. Any special initialization or requirements for a check are described at its beginning.

**INITIAL SETUP:** The test setup is the same for all of the checks. Connect the Audio Analyzer to the bus controller via the HP-IB interface. Do not connect any equipment to the Audio Analyzer's INPUT.

**EQUIPMENT:** HP-IB Controller . . . . . HP 9825A/98213A (General and Extended I/O ROM)  
 —or— HP 9835A/98332A (I/O ROM)  
 —or— HP 9845A (with HP-IB I/O capability)  
 HP-IB Interface . . . . . HP 98034A (use "revised" version with 9835A and 9845A)

### Address Recognition

**NOTE** This check determines whether or not the Audio Analyzer recognizes when it is being addressed and when it is not. This check assumes only that the Audio Analyzer can properly handshake on the bus. Before beginning this check, set the Audio Analyzer's LINE switch to OFF, then to ON.



**OPERATOR'S CHECKS**

**3-11. HP-IB Functional Checks (Cont'd)**

Description	HP 9825A (HPL)	HP 9835A and 9845A (BASIC)
Set the Remote Enable (REN) bus control line false.	lcl 7	LOCAL 7
Send the Audio Analyzer's listen address.	wrt 728	OUTPUT 728

**OPERATOR'S RESPONSE** Check that the Audio Analyzer's REMOTE annunciator is off and that its ADDRESSED annunciator is on.

Unaddress the Audio Analyzer by sending a different address.	wrt 715	OUTPUT 715
--	---------	------------

**OPERATOR'S RESPONSE** Check that both the Audio Analyzer's REMOTE and ADDRESSED annunciators are off.

**Remote and Local Messages and the LCL Key**

**NOTE** This check determines whether the Audio Analyzer properly switches from local to remote control, from remote to local control, and whether the LCL key returns the instrument to local control. This check assumes that the Audio Analyzer is able to both handshake and recognize its own address. Before beginning this check, set the Audio Analyzer's LINE switch to OFF, then to ON.

Description	HP 9825A (HPL)	HP 9835A and 9845A (BASIC)
Send the Remote message (by setting Remote Enable, REN, true and addressing the Audio Analyzer to listen).	rem 728	REMOTE 728

**OPERATOR'S RESPONSE** Check that both the Audio Analyzer's REMOTE and ADDRESSED annunciators are on.

Send the Local message to the Audio Analyzer.	lcl 728	LOCAL 728
---	---------	-----------

**OPERATOR'S RESPONSE** Check that the Audio Analyzer's REMOTE annunciator is off but its ADDRESSED annunciator is on.

Send the Remote message to the Audio Analyzer.	rem 728	REMOTE 728
--	---------	------------

**OPERATOR'S RESPONSE** Check that both the Audio Analyzer's REMOTE and ADDRESSED annunciators are on. Press the LCL key on the Audio Analyzer. Check that the Audio Analyzer's REMOTE annunciator is now off, but that its ADDRESSED annunciator remains on.



**OPERATOR'S CHECKS**

**3-11. HP-IB Functional Checks (Cont'd)**

**Sending the Data Message**

**NOTE** This check determines whether or not the Audio Analyzer properly issues Data messages when addressed to talk. This check assumes that the Audio Analyzer is able to handshake and recognize its own address. Before beginning this check, set the Audio Analyzer's LINE switch to OFF, then to ON, then after the power-up sequence is complete, press the DISTN key.

Description	HP 9825A (HPL)	HP 9835A and 9845A (BASIC)
Address the Audio Analyzer to talk and store its output data in variable V. (The output is E96 since there is no signal at its INPUT.)	red 728,V	ENTER 728;V
Display the value of V.	dsp V	PRINT V

**OPERATOR'S RESPONSE** Check that the Audio Analyzer's REMOTE annunciator is off but that its ADDRESSED annunciator is on. The controller's display should read 9009600000.00 (HP 9825A) or 9009600000 (HP 9835A and 9845A).

**Receiving the Data Message**

**NOTE** This check determines whether or not the Audio Analyzer properly receives Data messages. The Data messages sent also cause the 7 least significant HP-IB data lines to be placed in both their true and false states. This check assumes the Audio Analyzer is able to handshake, recognize its own address and properly make the remote/local transitions. Before beginning this check, set the Audio Analyzer's LINE switch to OFF, then to ON.

Description	HP 9825A (HPL)	HP 9835A and 9845A (BASIC)
Send the first part of the Remote message (enabling the Audio Analyzer to remote).	rem 7	REMOTE 7
Address the Audio Analyzer to listen (completing the Remote message), then send a Data message (selecting the SINAD measurement).	wrt 728,"M2"	OUTPUT 728;"M2"

**OPERATOR'S RESPONSE** Check that both the Audio Analyzer's REMOTE and ADDRESSED annunciators are on. Check also that its SINAD key light is on.

**Local Lockout and Clear Lockout/Set Local Messages**

**NOTE** This check determines whether or not the Audio Analyzer properly receives the Local Lockout message, disabling all front-panel keys. The check also determines whether or not the Clear Lockout/Set Local message is properly received and executed by the Audio Analyzer. This check assumes that the Audio Analyzer is able to handshake, recognize its own address, and properly make the remote/local transitions. Before beginning this check, set the Audio Analyzer's LINE switch to OFF, then to ON.



**OPERATOR'S CHECKS**

**3-11. HP-IB Functional Checks (Cont'd)**

**Local Lockout and Clear Lockout/Set Local (Cont'd)**

Description	HP 9825A (HPL)	HP 9835A and 9845A (BASIC)
Send the first part of the Remote message (enabling the Audio Analyzer to remote).	rem 7	REMOTE 7
Send the Local Lockout message.	llo 7	LOCAL LOCKOUT 7
Address the Audio Analyzer to listen (completing the Remote message).	wrt 728	OUTPUT 728

**OPERATOR'S RESPONSE** Check that both the Audio Analyzer's REMOTE and ADDRESSED annunciators are on. Press the Audio Analyzer's LCL key. Both its REMOTE and ADDRESSED annunciators should remain on.

Send the Clear Lockout/Set Local message	lcl 7	LOCAL 7
--	-------	---------

**OPERATOR'S RESPONSE** Check that the Audio Analyzer's REMOTE annunciator is off but its ADDRESSED annunciator is on.

**Clear Message**

**NOTE** This check determines whether or not the Audio Analyzer properly responds to the Clear message. This check assumes that the Audio Analyzer is able to handshake, recognize its own address, make the remote/local changes and receive Data messages. Before beginning this check set the Audio Analyzer's LINE switch to OFF, then to ON.

Description	HP 9825A (HPL)	HP 9835A and 9845A (BASIC)
Send the first part of the Remote message (enabling the Audio Analyzer to remote).	rem 7	REMOTE 7
Address the Audio Analyzer to listen (completing the Remote message), then send a Data message that selects the SINAD measurement.	wrt 728,"M2"	OUTPUT 728;"M2"

**OPERATOR'S RESPONSE** Check that both the Audio Analyzer's REMOTE and ADDRESSED annunciators are on and that the SINAD key light is also on.



**OPERATOR'S CHECKS**

**3-11. HP-IB Functional Checks (Cont'd)**

**Clear Message (Cont'd)**

Send the Clear message (setting the Audio Analyzer's measurement to AC LEVEL).	clr 728	RESET 728
--	---------	-----------

OPERATOR'S RESPONSE Check that both the Audio Analyzer's REMOTE and ADDRESSED annunciators are on and that the AC LEVEL key light is on.

**Abort Message**

NOTE This check determines whether or not the Audio Analyzer becomes unaddressed when it receives the Abort message. This check assumes that the Audio Analyzer is able to handshake, recognize its own address, make the remote/local changes, and enter serial-poll mode. Before beginning this check, set the Audio Analyzer's LINE switch to OFF, then to ON.

Description	HP 9825A (HPL)	HP 9835A and 9845A (BASIC)
Send the Remote message to the Audio Analyzer.	rem 728	REMOTE 728

OPERATOR'S RESPONSE Check that both the Audio Analyzer's REMOTE and ADDRESSED annunciators are on.

Send the Abort message, unaddressing the Audio Analyzer to listen.	cli 7	ABORTIO 7
--	-------	-----------

OPERATOR'S RESPONSE Check that the Audio Analyzer's ADDRESSED annunciator is off. Note that the HP 9835A and 9845A ABORTIO statement sends both the Abort message *and the Local message*. Thus if the HP 9825A is being used, the Audio Analyzer's REMOTE annunciator should remain on. If the HP 9835A or 9845A is being used, the Audio Analyzer's REMOTE annunciator should turn off.

Send the Local message (HP 9825A only).	lcl 7	(The Local message was already sent with the ABORTIO 7 statement above.) ENTER 728;V
Address the Audio Analyzer to talk and store its output data in variable V.	red 728,V	

OPERATOR'S RESPONSE Check that the Audio Analyzer's REMOTE annunciator is off but that its ADDRESSED annunciator is on.

Send the Abort message, unaddressing the Audio Analyzer to talk.	cli 7	ABORTIO 7
--	-------	-----------



**OPERATOR'S CHECKS**

**3-11. HP-IB Functional Checks (Cont'd)**

**Abort Message (Cont'd)**

**OPERATOR'S RESPONSE** Check that both the Audio Analyzer's REMOTE and ADDRESSED annunciators are off.

Send the serial-poll-enable bus command (SPE) through the interface to place the Audio Analyzer in serial-poll mode.	wti 0, 7; wti 6, 24	SENBUS 728; 1, 24
--	------------------------	-------------------

**OPERATOR'S RESPONSE** On the Audio Analyzer, key in 61.3 SPCL. The right display should show 1.0. This indicates the Audio Analyzer is in serial-poll mode (indicated by the "1").

Send the Abort message, removing the Audio Analyzer from serial-poll mode.	cli 7	ABORTIO 7
--	-------	-----------

**OPERATOR'S RESPONSE** Check that the Audio Analyzer's right display shows 0.0. This indicates the Audio Analyzer properly left serial-poll mode upon receiving the Abort message.

**Status Byte Message**

**NOTE** This check determines whether or not the Audio Analyzer sends the Status Byte message in both the local and remote modes. This check assumes that the Audio Analyzer is able to handshake, recognize its own address, and make the remote/local changes. Before beginning this check, set the Audio Analyzer's LINE switch to OFF, then to ON.

Description	HP 9825A (HPL)	HP 9835A and 9845A (BASIC)
Place the Audio Analyzer in serial-poll mode and address it to talk (causing it to send the Status Byte message).	rds (728)- V	STATUS 728;V
Display the value of V.	dsp V	PRINT V

**OPERATOR'S RESPONSE** Check that Audio Analyzer's REMOTE annunciator is off. Depending upon the vintage of the HP-IB interface (HP 98034A) used, the Audio Analyzer's ADDRESSED annunciator may be either on or off. The controller's display should read 0.00 (HP 9825A) or 0 (HP 9835A and HP 9845A).

Send the Remote message.	rem 728	REMOTE 728
Place the Audio Analyzer in serial-poll mode and address it to talk (causing it to send the Status Byte message).	rds (728) -- V	STATUS 728;V
Display the value of V.	dsp V	PRINT V





**OPERATOR'S CHECKS**

**3-11. HP-IB Functional Checks (Cont'd)**

**Status Byte Message (Cont'd)**

**OPERATOR'S RESPONSE** Check that the Audio Analyzer's REMOTE annunciator is on. Depending upon the vintage of the HP-IB interface (HP 98034A) used, the Audio Analyzer's ADDRESSED annunciator may be either on or off. The controller's display should read 0.00 (HP 9825A) or 0 (HP 9835A and HP 9845A).

**Require Service Message**

**NOTE** This check determines whether or not the Audio Analyzer can issue the Require Service message (set the SRQ bus control line true). This check assumes that the Audio Analyzer is able to handshake, recognize its own address, make the remote/local changes, and receive Data messages. Before beginning this check, set the Audio Analyzer's LINE switch to OFF, then to ON, then after the power-up sequence is complete, press the DISTN key.

Description	HP 9825A (HPL)	HP 9835A and 9845A (BASIC)
Send the first part of the Remote message (enabling the Audio Analyzer to remote).	rem 7	REMOTE 7
Address the Audio Analyzer to listen (completing the Remote message) then send a Data message (enabling a Require Service message to be sent upon Instrument Error).	wrt 728,"22.4SP"	OUTPUT 728;"22.4SP"
Make the controller wait 2 seconds to allow time for the Audio Analyzer to send the Require Service message. (This step is not necessary if sufficient time is allowed.)	wait 2000	WAIT 2000
Read the binary status of the controller's HP-IB interface and store the data in variable V (in this step, 7 is the interface's select code).	rds (7) - V	STATUS 7; V
Display the value of the SRQ bit (in this step, 7 is the SRQ bit, numbered from 0).	dsp "SRQ=",bit (7,V)	PRINT "SRQ=";BIT (V,7)

**OPERATOR'S RESPONSE** Check that the SRQ value is 1, indicating the Audio Analyzer issued the Require Service message.



**OPERATOR'S CHECKS**

**3-11. HP-IB Functional Checks (Cont'd)**

**Trigger Message and Clear Key Triggering**

**NOTE** This check determines whether or not the Audio Analyzer responds to the Trigger message and whether the CLEAR key serves as a manual trigger in remote. This check assumes that the Audio Analyzer is able to handshake, recognize its own address, make the remote/local changes, and send and receive Data messages. Before beginning this check, set the Audio Analyzer's LINE switch to OFF, then to ON, then, when the power-up sequence is complete, press the DISTN key.

Description	HP 9825A (HPL)	HP 9835A and 9845A (BASIC)
Send the first part of the Remote message (enabling the Audio Analyzer to remote).	rem 7	REMOTE 7
Address the Audio Analyzer to listen (completing the Remote message), then send a Data message (placing the Audio Analyzer in Hold mode).	wrt 728, "T1"	OUTPUT 728; "T1"
Send the Trigger message.	trg 7	TRIGGER 7
Address the Audio Analyzer to talk and store the data in variable V.	red 728, V	ENTER 728; V
Display the value of V.	dsp V	PRINT V

**OPERATOR'S RESPONSE** Check that both the Audio Analyzer's REMOTE and ADDRESSED annunciators are on. The controller's display should read 9009600000.00 (HP 9825A) or 9009600000 (HP 9835A and HP 9845A).

Address the Audio Analyzer to talk and store the data in variable V.	red 728, V	ENTER 728;V
--	------------	-------------

**OPERATOR'S RESPONSE** Check that the controller's "run" indicator is still on indicating that it has not received data from the Audio Analyzer. Press the Audio Analyzer's CLEAR key. The controller's "run" indicator should turn off.



### 3-12. REMOTE OPERATION, HEWLETT-PACKARD INTERFACE BUS

The Audio Analyzer can be operated through the Hewlett-Packard Interface Bus (HP-IB). Bus compatibility, programming, and data formats are described in the following paragraphs.

Except for the LINE switch, the  $\div 10$  and  $\times 10$  keys, the low terminal ground/FLOAT switches, and the Controller Reset Service Special Function, all Audio Analyzer operations (including service related functions) are fully programmable via HP-IB. In addition, rapid source tuning and rapid frequency count capabilities (not available from the front-panel) are provided in remote operation.

A quick test of the HP-IB I/O is described under HP-IB Functional Checks. These checks verify that the Audio Analyzer can respond to or send each of the applicable bus messages described in Table 3-3.

For more information about HP-IB, refer to IEEE Standard 488, ANSI Standard MC1.1, the Hewlett-Packard Electronic Systems and Instruments catalog, and the booklet, "Improving Measurements in Engineering and Manufacturing" (HP part number 5952-0058).

#### 3-13. HP-IB Compatibility

The Audio Analyzer's complete bus compatibility (as defined by IEEE Standard 488, and the identical ANSI Standard MC1.1) is described at the end of Table 3-3. Table 3-3 also summarizes the Audio Analyzer's HP-IB capabilities in terms of the twelve bus messages in the left-hand column.

#### 3-14. Remote Mode

**Remote Capability.** In remote, most of the Audio Analyzer's front-panel controls are disabled (exceptions are the LCL and CLEAR keys). However, front-panel displays and the signal at various outputs remain active and valid. In remote, the Audio Analyzer may be addressed to talk or listen. When addressed to listen, the Audio Analyzer will respond to the Data, Trigger, Clear (SDC), and Local messages. When addressed to talk, the Audio Analyzer can issue the Data and Status Byte messages. Whether addressed or not, the Audio Analyzer will respond to the Clear (DCL), Local Lockout, Clear Lockout/Set Local, and Abort messages, and in addition, the Audio Analyzer may issue the Require Service message.

**Local-to-Remote Mode Changes.** The Audio Analyzer switches to remote operation upon receipt of the Remote message. The Remote message has two parts. They are:

- Remote enable bus control line (REN) set true
- Device listen address received once (while REN is true)

When the Audio Analyzer switches to remote, both the REMOTE and ADDRESSED annunciators on its front panel will turn on.

#### 3-15. Local Mode

**Local Capability.** In local, the Audio Analyzer's front-panel controls are fully operational and the instrument will respond to the Remote message. Whether addressed or not, it will also respond to the Clear, Local Lockout, Clear Lockout/Set Local, and the Abort messages. When addressed to talk, the instrument can issue Data messages and the Status Byte message, and whether addressed or not, it can issue the Require Service message.

**Remote-to-Local Mode Changes.** The Audio Analyzer always switches to local from remote whenever it receives the Local message (GTL) or the Clear Lockout/Set Local message. (The Clear Lockout/Set Local message sets the Remote Enable control line [REN] false.) If it is not in Local Lockout mode, the Audio Analyzer switches to local from remote whenever its front panel LCL key is pressed.

#### 3-16. Addressing

The Audio Analyzer interprets the byte on the bus' eight data lines as an address or a bus command if the bus is in the command mode: attention control line (ATN) true and interface clear control line (IFC) false. Whenever the Audio Analyzer is being addressed (whether in local or remote), the ADDRESSED annunciator on the front-panel will turn on.

The Audio Analyzer talk and listen addresses are switch selectable as described in paragraph 2-7. Refer to Table 2-1 for a comprehensive listing of all valid HP-IB address codes. To determine the present address setting, refer to the discussion titled HP-IB Address in the Detailed Operating Instructions near the end of this section.

**Local Lockout.** When a data transmission is interrupted, which can happen by returning the Audio



Table 3-3. Message Reference Table (1 of 2)

HP-IB Message	Applicable	Response	Related Commands and Controls	Interface Functions*
Data	Yes	All Audio Analyzer operations except the LINE switch and FLOAT switches and the +10 and ×10 functions are bus-programmable. All measurement results, special displays, and error outputs except the " — — — —" display are available to the bus.		AH1 SH1 T5, TE0 L3, LEO
Trigger	Yes	If in remote and addressed to listen, the Audio Analyzer makes a settled measurement according to previously programmed set-up. It responds equally to bus command GET and program code T3, Trigger With Settling (a Data message).	GET	DT1
Clear	Yes	Sets SOURCE to 1 kHz at 0 mV, MEASUREMENT to AC LEVEL with the 80 kHz LP FILTER on, and sets the trigger mode to free run. Resets many additional parameters as shown in Table 3-5. Clears Status Byte, RQS bit, Require Service message (if issued) and Local Lockout. Sets the Service Request Condition to the 22.2 state. Responds equally to Device Clear (DCL) and Selected Device Clear (SDC) bus commands.	DCL SDC	DC1
Remote	Yes	Remote mode is enabled when the REN bus control line is true. However, remote mode is not entered until the first time the Audio Analyzer is addressed to listen. The front-panel REMOTE annunciator lights when the instrument is actually in the remote mode. When entering remote mode, no instrument settings or functions are changed, but all front-panel keys except LCL and CLEAR are disabled, and entries in progress are cleared.	REN	RL1
Local	Yes	The Audio Analyzer returns to local mode (front-panel control). Responds equally to the GTL bus command and the front-panel LCL key. When entering local mode, no instrument settings or functions are changed but entries in progress are cleared. In local, triggering is free run only.	GTL	RL1
Local Lockout	Yes	Disables all front-panel keys including LCL and CLEAR. Only the controller can return the Audio Analyzer to local (front-panel control).	LLO	RL1
Clear Lockout/Set Local	Yes	The Audio Analyzer returns to local (front-panel control) and local lockout is cleared when the REN bus control line goes false. When entering local mode, no instrument settings or functions are changed, but entries in progress are cleared. In local, triggering is free run only.	REN	RL1
Pass Control/ Take Control	No	The Audio Analyzer has no control capability.		C0

\*Commands, Control lines, and Interface Functions are defined in IEEE Std. 488. Knowledge of these might not be necessary if your controller's manual describes programming in terms of the twelve HP-IB Messages shown in the left column.



Table 3-3. Message Reference Table (2 of 2)

HP-IB Message	Applicable	Response	Related Commands and Controls	Interface Functions*
Require Service	Yes	The Audio Analyzer sets the SRQ bus control line true if an invalid program code is received. The Audio Analyzer will also set SRQ true, if enabled by the operator to do so, when measurement data is ready or when an instrument error occurs.	SRQ	SR1
Status Byte	Yes	The Audio Analyzer responds to a Serial Poll Enable (SPE) bus command by sending an 8-bit byte when addressed to talk. If the instrument is holding the SRQ control line true (issuing the Require Service message) bit 7 (RQS bit) in the Status Byte and the bit representing the condition causing the Require Service message to be issued will both be true. The bits in the Status Byte are latched but can be cleared by: 1) removing the causing condition, and 2) reading the Status Byte.	SPE SPD	T5, TE0
Status Bit	No	The Audio Analyzer does not respond to a parallel poll.		PP0
Abort	Yes	The Audio Analyzer stops talking and listening.	IFC	T5, TE0 L3, LE0
*Commands, Control lines, and Interface Functions are defined in IEEE Std. 488. Knowledge of these might not be necessary if your controller's manual describes programming in terms of the twelve HP-IB Messages shown in the left column.				

Complete HP-IB capability as defined in IEEE Std.488 and ANSI Std.MC1.1 is: SH1, AH1, T5, TE0, L3, LE0, SR1, RL1, PP0, DC1, DT1, C0.

**Addressing (Cont'd)**

Analyzer to local mode by pressing the LCL key, the data could be lost. This would leave the Audio Analyzer in an unknown state. To prevent this, a local lockout is recommended. Local lockout disables the LCL key (and the CLEAR key) and allows return-to-local only under program control.

**NOTE**

*Return-to-local can also be accomplished by turning the Audio Analyzer's LINE switch to OFF, then back to ON. However, this technique has several disadvantages.*

- It defeats the purpose and advantages of local lockout (that is, the system controller will lose control of a system element).
- There are several HP-IB conditions that reset to default states at turn-on.

**3-17. Data Messages**

The Audio Analyzer communicates on the interface bus primarily with data messages. Data messages consist of one or more bytes sent over the 8 data bus lines, when the bus is in the data mode (attention control line [ATN] false). Unless it is set to Talk Only, the Audio Analyzer receives data messages when addressed to listen. Unless it is set to Listen Only, the Audio Analyzer sends data messages or the Status Byte message (if enabled) when addressed to talk. Virtually all instrument operations available in local mode may be performed in remote mode via data messages. The only exceptions are changing the LINE switch or FLOAT switch settings, using the ÷10 or ×10 functions, or the Controller Reset Service Special Function. In addition, the Audio Analyzer may be triggered via data messages to make measurements at a particular time.



### 3-18. Receiving the Data Message

Depending on how the internal address switches are set, the Audio Analyzer can either talk only, talk status only, listen only, or talk and listen both (normal operation). The instrument responds to Data messages when it is enabled to remote (REN control line true) and it is addressed to listen or set to Listen Only. If not set to Listen Only, the instrument remains addressed to listen until it receives an Abort message or until its talk address or a universal unlisten command is sent by the controller.

**Listen Only.** If the internal LON (Listen Only) switch is set to "1", the Audio Analyzer is placed in the Listen Only mode when the remote enable bus control line (REN) is set true. The instrument then responds to all Data messages, and the Trigger, Clear, and Local Lockout messages. However, it is inhibited from responding to the Local or Abort messages and from responding to a serial poll with the Status Byte message.

Listen Only mode is provided to allow the Audio Analyzer to accept programming from devices other than controllers (e.g., card readers).

**Data Input Format.** The Data message string, or program string, consists of a series of ASCII codes. With the exception of the Rapid Source mode, each code is typically equivalent to a front-panel keystroke in local mode. Thus, for a given

operation, the program string syntax in remote mode is the same as the keystroke sequence in local mode. (For information about RS, Rapid Source, refer to Rapid Source in the Detailed Operating Instructions.) Example 1 shows the general case programming order for selecting Audio Analyzer functions. Specific program order considerations are discussed on page 3-27. All functions can be programmed together as a continuous string as typified in Example 2. The string in Example 2 clears most Special Functions (with Automatic Operation), programs the source to 440 Hz at 1V, selects a distortion measurement with 30 kHz low-pass filtering and log units, then triggers a settled measurement.

**Program Codes.** All of the valid HP-IB codes for controlling Audio Analyzer functions are summarized in Table 3-6. All front-panel keys except the LCL key and the ÷10 and ×10 keys have corresponding program codes.

Table 3-4 shows the Audio Analyzer's response to various ASCII characters not used in its code set. The characters in the left-hand column will be ignored unless they appear between two characters of a program code. The characters in the right-hand columns, if received by the Audio Analyzer, will always cause Error 24 (invalid HP-IB code) to be displayed and a Require Service message to be generated. The controller recognizes the invalid code entry and clears the Require Service condi-

#### EXAMPLE 1: General Program Syntax and Protocol\*

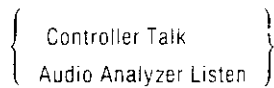

[Automatic Operation] [Source Frequency] [Source Amplitude] [Measurement] [Filters] [Special Functions] [Log/Lin] [Ratio] [Start Frequency] ... [Stop Frequency] [Plo: Limit] [Sweep] [Trigger]

\*Excluding Rapid Source or Rapid Frequency Count Modes.

#### EXAMPLE 2: Typical Program String

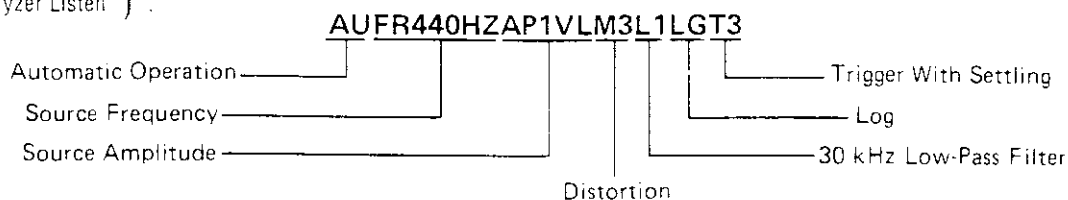
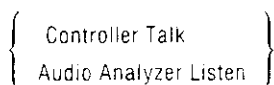



**Receiving The Data Message (Cont'd)**

**Table 3-4. Audio Analyzer Response to Unused ASCII Codes**

Ignored †	Generate Error 24
!	@
"	B
"	E
#	G
%	I
&	J
'	N
:	Q
*	Y
,	Z
/	DEL

†Except when inserted between two characters of a program code.

tion. Thereafter, the invalid code entry is ignored, and subsequent valid entries are processed in normal fashion. As a convenience, all lower case alpha characters are treated as upper case.

**Turning Off Functions.** When operating in local mode, the High-Pass, Bandpass, and Low-Pass Filters, and Ratio functions toggle on and off with successive keystrokes. In remote mode, these functions do not toggle on and off. Instead, each of the above groups has a specific code which turns off all the keys in the group. The HP-IB codes for turning off these functions are given in the table below.

Function	HP-IB Code
HP/BP FILTERS all off	H0
LP FILTERS all off	L0
RATIO off	R0
SWEEP off	W0

**Programming Numeric Data.** When programming source amplitude or frequency, entering ratio references, plot limits, or issuing any numeric data (other than specific HP-IB codes) to the Audio Analyzer, certain precautions should be observed. Numeric data may be entered in fixed, floating point, or exponential formats. Usually, numeric data consists of a signed mantissa of up to five digits (including leading zeros), one decimal point, and one- or two-digit signed exponent. The decimal point may fall between any two digits of the mantissa but should not appear ahead of the first digit.

If it does, a leading zero will be automatically inserted by the Audio Analyzer. Any digit beyond the five allowed for the mantissa will be received as zero. The general format for numeric data entry is given below, followed by several examples illustrating various entries and the resulting data as received by the Audio Analyzer.

**General Numeric Data Input Format:**

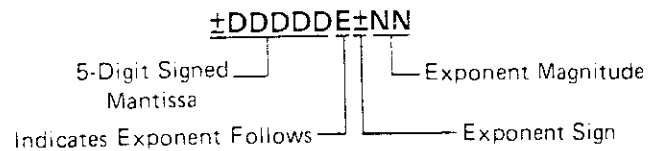

Example: +.12345E+01 issued  
0.12340E+01 received by  
Audio Analyzer

Example: +123456E+01 issued  
123450E+01 received by  
Audio Analyzer

Example: +00012345 issued  
12000 received by  
Audio Analyzer

In general, do not issue numeric data with more significant digits than can be displayed on the Audio Analyzer's five-digit left display.

**NOTE**

*The above numeric data input format information does not apply to the Rapid Source mode. Refer to Rapid Source in the Detailed Operating Instructions.*

**Triggering Measurements with the Data Message.** A feature that is only available via remote programming is the selection of free run, standby, or triggered operation of the Audio Analyzer. During local operation the Audio Analyzer is allowed to free run, outputting data to the display as each measurement is completed. In remote (except in sweep), three additional operating modes are allowed: Hold, Trigger Immediate, and Trigger with Settling. In addition, the CLEAR key can act as a manual trigger while the instrument is in remote. The trigger modes and use of the CLEAR key are described below.

**Free Run (T0).** This mode is identical to local operation and is the mode of operation in effect when no other trigger mode has been selected. The measurement result data available to the bus are constantly being updated as rapidly as the Audio



### Receiving the Data Message (Cont'd)

Analyzer can make measurements. A Device Clear message or entry into remote from local sets the Audio Analyzer to the Free Run mode.

#### NOTE

*Free Run triggering (code T0) is the only trigger mode allowed when using the sweep function (code W1). Any other triggering (codes T1, T2, or T3) or use of CLEAR key triggering will cause only the start frequency point to be displayed, plotted, and read to the HP-IB. Both the rear-panel X AXIS and Y AXIS outputs will be inhibited from continuing beyond the start frequency point.*

**Hold (T1).** This mode is used to set up triggered measurements (initiated by program codes T2 or T3, the Trigger message, or the CLEAR key). In Hold mode, internal settings can be altered by the instrument itself or by the user via the bus. Thus, the signal at the MONITOR output can change. However, the instrument is inhibited from outputting any data to the front-panel key lights and display, to the rear-panel X AXIS or Y AXIS outputs, or to the HP-IB except as follows. The instrument will issue the Require Service message if an HP-IB code error occurs. The instrument will issue the Status Byte message if serial polled. (A serial poll, however, will trigger a new measurement, update displays and return the instrument to Hold.)

Upon leaving Hold, the front-panel indications are updated as the new measurement cycle begins. The Status Byte will be affected (and the Require Service message issued) by the events that occur during the new measurement cycle. The Audio Analyzer leaves Hold when it receives either the Free Run, Trigger Immediate, Trigger with Settling codes, or the Trigger Message, when the CLEAR key is pressed (if not in Local Lockout), or when it returns to local operation.

**Trigger Immediate (T2).** When the Audio Analyzer receives the Trigger Immediate code, it makes one measurement in the shortest possible time. The instrument then waits for the measurement results to be read. While waiting, the instrument can process most bus commands without losing the measurement results. However, if the instrument receives GTL (Go To Local), GET (Group Execute Trigger), or its listen address or if it is triggered by the CLEAR key, a new measurement cycle will be executed. Once the data (mea-

surement results) are read onto the bus, the Audio Analyzer reverts to the Hold mode. Measurement results obtained via Trigger Immediate are normally valid only when the instrument is in a steady, settled state.

**Trigger with Settling (T3).** Trigger with Settling is identical to Trigger Immediate except the Audio Analyzer inserts a settling-time delay before taking the requested measurement. This settling time is sufficient to produce valid, accurate measurement results. Trigger with Settling is the trigger type executed when a Trigger message is received via the bus.

**Triggering Measurements with the CLEAR Key.** When the Audio Analyzer is in remote Hold mode and not in Local Lockout, the front-panel CLEAR key may be used to issue a Trigger with Settling instruction. First place the instrument in Hold mode (code T1). Each time the CLEAR key is pressed, the Audio Analyzer performs one Trigger with Settling measurement cycle, then waits for the data to be read. Once the data is read out to the bus, the instrument returns to Hold mode. If data is not read between trigger cycles, it will be replaced with data acquired from subsequent measurements.

**Special Considerations for Triggered Operation.** When in free-run mode, the Audio Analyzer must pay attention to all universal bus commands, for example, serial poll enable (SPE), local lockout (LLO), etc. In addition, if it is addressed to listen, it must pay attention to all addressed bus commands, for example, go to local (GTL), group execute trigger (GET), etc. As a consequence of this, the Audio Analyzer must interrupt the current measurement cycle to determine whether any action in response to these commands is necessary. Since many elements of the measurements are transitory, the measurement must be reinitiated following each interruption. Thus, if much bus activity occurs while the Audio Analyzer is trying to take a measurement, that measurement may never be completed.

Trigger Immediate and Trigger with Settling provide a way to avoid this problem. When the Trigger Immediate (T2) and Trigger with Settling (T3) codes are received, the Audio Analyzer will not allow its measurement to be interrupted. (Indeed, handshake of bus commands is inhibited until the measurement is complete.) Once the measurement is complete, bus commands will be



**Receiving the Data Message (Cont'd)**

processed, as discussed under Trigger Immediate above, with no loss of data. Thus, in an HP-IB environment where many bus commands are present, Trigger Immediate or Trigger with Settling should be used for failsafe operation.

**NOTE**

*Free Run triggering (code T0) is the only trigger mode allowed when using the sweep function (code W1). Any other triggering (codes T1, T2, or T3) or use of CLEAR key triggering will cause only the start frequency point to be displayed, plotted, and read to the HP-IB. Both the rear-panel X AXIS and Y AXIS outputs will be inhibited from continuing beyond the start frequency point.*

**Reading Data from the Right or Left Display.** The Audio Analyzer can only read data to the HP-IB once for each measurement made. Only the information on one display can be read each time. Use the codes RR (read right display) or RL (read left display) to control which information is read. The selected display will remain enabled until the opposing display is specified (or until a clear message is received or power-up occurs). Errors (which occupy two displays) are output as described above, and DC LEVEL measurement results (always occupying the right display only) are placed on the bus (when requested) regardless of which display is enabled.

**Program Order Considerations.** Although program string syntax is virtually identical to keystroke order some program order considerations need highlighting.

**AUTOMATIC OPERATION (AU).** As in local mode, when AUTOMATIC OPERATION is executed in remote it sets all Special Functions prefixed 1 through 8 to their zero-suffix mode and also affects many other Special Functions. Thus when AUTOMATIC OPERATION is used, it should appear at the beginning of a program string.

**Frequency or Amplitude Increment Step Up or Steep Down (UP or DN).** When a Step Up (UP) or Step Down (DN) is executed, the frequency or the amplitude is modified as determined by the established increment. The parameter changed is dependent upon which increment command was executed last. To insure the correct modification, program either Frequency Increment (FN) or

Amplitude Increment (AN) immediately before the UP or DN command.

**Trigger Immediate and Trigger with Settling (T2 and T3).** When either of the trigger codes T2 or T3 is received by the Audio Analyzer, a measurement is immediately initiated. Once the measurement is complete, some bus commands can be processed without losing the measurement results. However, any HP-IB program code sent to the Audio Analyzer before the triggered measurement results have been output will initiate a new measurement. Thus, trigger codes should always appear at the end of a program string, and the triggered measurement results must be read before any additional program codes are sent.

**3-19. Sending the Data Message**

Depending on how the internal address switches are set, the Audio Analyzer can either talk only, talk status only, listen only, or talk and listen both (normal operation). If set to both talk and listen, the instrument sends Data messages when addressed to talk. The instrument then remains configured to talk until it is unaddressed to talk by the controller. To unaddress the Audio Analyzer, the controller must send either an Abort message, a new talk address, or a universal untalk command.

**Talk Only Mode.** If the internal address switches are set to a valid Talk address and the TON (Talk Only) switch is set to "1", the Audio Analyzer is placed in the Talk Only mode. In this mode instrument is configured to send Data messages whenever the bus is in the data mode. Each time the measurement is completed, the measurement result will be output to the bus unless the listening device is not ready for data. If the listener is not ready and the Audio Analyzer is not in a trigger mode, another measurement cycle is executed.

**Talk Status Only Mode.** If all the internal address switches and the TON (Talk Only) switch are set to "1", but the LON (Listen Only) switch is set to "0", the Audio Analyzer is placed in the Talk Status Only mode. In this mode the instrument is configured to send a one-byte data message whenever the bus is in the data mode. The byte sent is an exact copy of the Status Byte. Each time this byte is successfully sent on the bus, the internal Status Byte is cleared. The Data Valid (DAV) handshake line is pulsed each time the one-byte Data message is sent.

**HP-IB**

**Sending the Data Message (Cont'd)**

**Data Output Format.** As shown below, the output data is usually formatted as a real constant in exponential form: first the sign, then five digits (leading zeros not suppressed) followed by the letter E and a signed power-of-ten multiplier. (Refer to Rapid Frequency Count in the Detailed Operation Instructions for the only exceptions to this format.) The string is terminated by a carriage return (CR) and a line feed (LF), string positions 11 and 12. Data is always output in fundamental units (e.g., Hz, volts, dB, %, etc.), and the decimal point (not sent) is assumed to be to the right of the fifth digit of the mantissa. Data values never exceed 4 000 000 000.

**Data Output Format:**

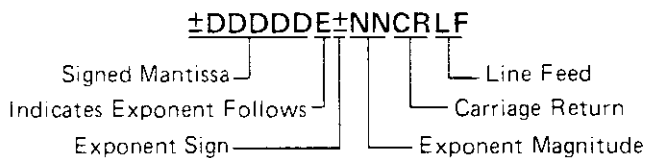

**NOTE**

*For the only exception to the above format, refer to Rapid Frequency Count in the Detailed Operating-Instructions.*

When an error is output to the bus, it follows the same twelve-byte format described above except most of the numeric digits have predetermined values as shown below. Error outputs always exceed 9 000 000 000. The two-digit error code is represented by the last two digits of the five-digit mantissa. The error code can be derived from the string by subtracting  $9 \times 10^9$ , then dividing the results by 100 000.

**Error Output Format:**

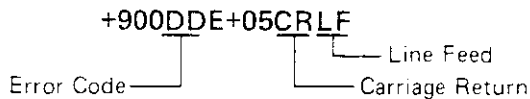

**3-20. Receiving the Clear Message**

The Audio Analyzer responds to the Clear message by assuming the settings detailed in Table 3-5. The Audio Analyzer responds equally to the Selected Device Clear (SDC) bus command when addressed to listen, and the Device Clear (DCL) bus command whether addressed or not. The Clear message clears any pending Require Service message and resets the Service Request Condition (Special Function 22) such that the Require Ser-

vice message will be issued on HP-IB code errors only (22.2 SPCL).

**3-21. Receiving the Trigger Message**

When in remote and addressed to listen, the Audio Analyzer responds to a Trigger message by executing one settled-measurement cycle. The Audio Analyzer responds equally to a Trigger message (the Group Execute Trigger bus command [GET]) and a Data message, program code T3 (Trigger with Settling). Refer to Triggering Measurements with the Data Message, page 3-25.

**3-22. Receiving the Remote Message**

The Remote message has two parts. First, the remote enable bus control line (REN) is held true, then the device listen address is sent by the controller. These two actions combine to place the Audio Analyzer in remote mode. Thus, the Audio Analyzer is enabled to go into remote when the controller begins the Remote message, but it does not actually switch to remote until addressed to listen the first time. No instrument settings are changed by the transition from local to remote, but the Trigger mode is set to Free Run (code T0). When actually in remote, the Audio Analyzer lights its front-panel REMOTE annunciator. When the Audio Analyzer is being addressed (whether in remote or local), its front-panel ADDRESSED annunciator turns on.

**3-23. Receiving the Local Message**

The Local message is the means by which the controller sends the Go To Local (GTL) bus command. If addressed to listen, the Audio Analyzer returns to front-panel control when it receives the Local message. If the instrument was in local lockout when the Local message was received, front-panel control is returned, but lockout is not cleared. Unless it receives the Clear Lockout/Set Local message, the Audio Analyzer will return to local lockout the next time it goes to remote. No instrument settings are changed by the transition from remote to local, but all measurements are made in a free run mode.

When the Audio Analyzer goes to local mode, the front-panel REMOTE annunciator turns off. However, when the Audio Analyzer is being addressed (whether in remote or local), its front-panel ADDRESSED annunciator lights.

If the Audio Analyzer is not in local lockout mode, pressing the front-panel LCL (local) key might



Table 3-5. Response to a Clear Message

Parameter	Setting
Start Frequency	20 Hz
Stop Frequency	20 kHz
Plot Limits	
Lower	-100.0
Upper	+100.0
X-Y Recorder	Enabled
Frequency	1000.0 Hz
Frequency Increment	1000.0 Hz
Amplitude	0.00 mV
Amplitude Increment	0.100V
Measurement	AC Level
Low-Pass (LP) Filter	80 kHz Low-Pass On
High-Pass (HP)/ Bandpass (BP) Filter	All off
SPCL	All Special Functions off or set to their zero-suffix mode except Service Request Condition set to 22.2 (HP-IB code error).
Ratio	Off
Log/Lin	Linear (refer to RATIO and LOG/LIN Detailed Operating Instructions.)
Right Display Read	Enabled
Service Request Condition	HP-IB Code Error Only
Status Byte	Cleared
Trigger Mode	Free Run (Code T0)
Local Lockout	Cleared

**Receiving the Local Message (Cont'd)**

interrupt a Data message being sent to the instrument, leaving the instrument in a state unknown to the controller. This can be prevented by disabling the Audio Analyzer's front-panel keys entirely using the Local Lockout message.

**3-24. Receiving the Local Lockout Message**

The Local Lockout message is the means by which the controller sends the Local Lockout (LLO) bus command. If in remote, the Audio Analyzer responds to the Local Lockout Message by disabling the front-panel LCL (local) and CLEAR keys. (In remote, CLEAR initiates a Trigger with Settling cycle.) The local lockout mode prevents loss of data or system control due to someone accidentally pressing front-panel keys. If, while in local, the Audio Analyzer is enabled to remote (i.e., REN is set true) and it receives the Local Lockout message, it will switch to remote mode with local lockout the first time it is addressed to listen. When in local lockout, the Audio Analyzer can be returned

to local only by the controller (using the Local or Clear Lockout/Set Local messages) or by setting the LINE switch to OFF and back to ON or by removing the bus cable.

**3-25. Receiving the Clear Lockout/Set Local Message**

The Clear Lockout/Set Local message is the means by which the controller sets the Remote Enable (REN) bus control line false. The Audio Analyzer returns to local mode (full front-panel control) when it receives the Clear Lockout/Set Local message. No instrument settings are changed by the transition from remote with local lockout to local. When the Audio Analyzer goes to local mode, the front-panel REMOTE annunciator turns off.

**3-26. Receiving the Pass Control Message**

The Audio Analyzer does not respond to the Pass Control message because it cannot act as a controller.



### 3-27. Sending the Require Service Message

The Audio Analyzer sends the Require Service message by setting the Service Request (SRQ) bus control line true. The instrument can send the Require Service message in either local or remote mode. The Require Service message is cleared when a serial poll is executed by the controller or if a Clear message is received by the Audio Analyzer. (During serial poll, the Require Service message is cleared immediately before the Audio Analyzer places the Status Byte message on the bus.) An HP-IB code error will always cause a Require Service message to be issued. In addition, there are two other conditions which can be enabled to cause the Require Service message to be sent when they occur. All three conditions are described below.

- Data Ready: When the Audio Analyzer is ready to send any information except error codes or the Status Byte.
- HP-IB Code Error: When the Audio Analyzer receives an invalid Data message. (This condition always causes a Require Service message to be sent.)

#### NOTE

*The "----" display indicates a transient condition. After 128 attempts to make a measurement, it is replaced by Error 31 which causes the Require Service message to be sent.*

- Instrument Error: When any Error is being displayed by the Audio Analyzer including HP-IB Code error, E24.

### 3-28. Selecting the Service Request Condition

Use Special Function 22, Service Request Condition, to enable the Audio Analyzer to issue the Require Service message on any of the conditions above (except HP-IB code errors which always cause the Require Service message to be sent). The Service Request Condition Special Function is entered from either the front panel or via the HP-IB. The conditions enabled by Special Function 22 are always disabled by the Clear message. A description of the Service Request Condition Special Function and the procedure for enabling the various conditions are given under Service Request Condition in the Detailed Operation Instructions.

Normally, device subroutines for the Audio Analyzer can be implemented simply by triggering measurements then reading the output data. In certain applications, the controller must perform other tasks while controlling the Audio Analyzer. Figure 3-7 illustrates a flow chart for developing device subroutines using the instrument's ability to issue the Require Service message when data is ready. This subroutine structure frees the controller to process other routines until the Audio Analyzer is ready with data.

### 3-29. Sending the Status Byte Message

The Status Byte message consists of one 8-bit byte in which 3 of the bits are set according to the enabled conditions described above under Sending the Require Service Message.

If one or more of the three conditions described above are both enabled and present, all the bits corresponding to the conditions and also bit 7, the RQS bit, will be set true (and the Require Service message is sent). If one of the above conditions occurs but has not been enabled by Special Function 22, neither the bit corresponding to the condition nor the RQS bit will be set (and the Require Service message will not be sent). The bit pattern of the Status Byte is shown on page 3-32.

Once the Audio Analyzer receives the serial poll enable bus command (SPE), it is no longer allowed to alter the Status Byte. When addressed to talk (following SPE), the Audio Analyzer sends the Status Byte message.

#### NOTE

*Since the Audio Analyzer cannot alter the Status Byte while in serial poll mode, it is not possible to continually request the Status Byte while waiting for a condition to cause a bit to be set.*

After the Status Byte message has been sent it will be cleared if the Serial Poll Disable (SPD) bus command is received, if the Abort message is received, or if the Audio Analyzer is unaddressed to talk. Regardless of whether or not the Status Byte message has been sent, the Status Byte and any Require Service message pending will be cleared if a Clear message is received. If the instrument is set to Talk Only, the Status Byte is cleared each time the one-byte Data message is issued to the bus.

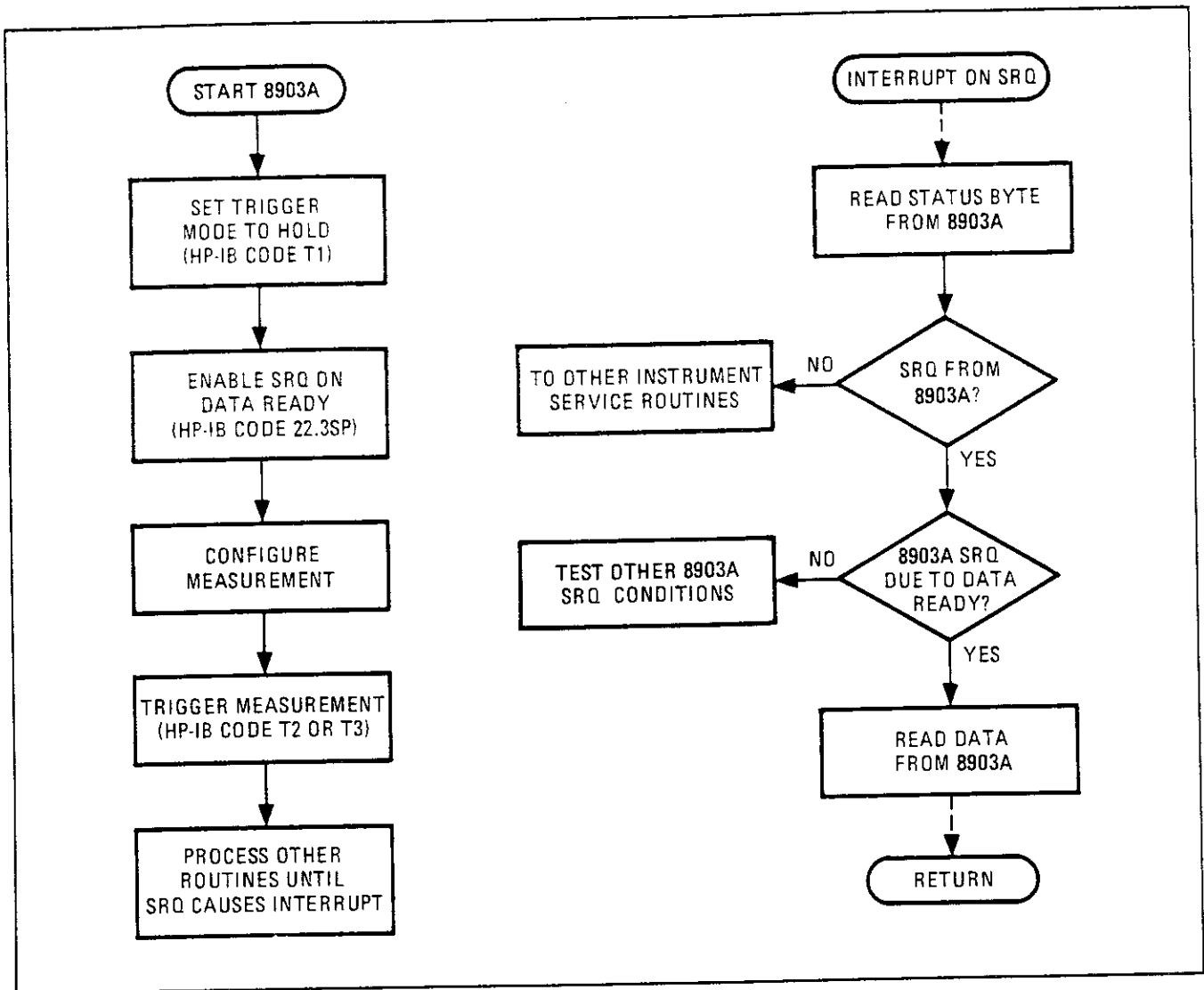

Figure 3-7. Example Flow Chart for Driving the Audio Analyzer Using the Require Service Message (SRQ)

**3-30. Sending the Status Bit Message**

The Audio Analyzer does not respond to a Parallel Poll Enable (PPE) bus command and thus cannot send the Status Bit message.

**3-31. Receiving the Abort Message**

The Abort message is the means by which the controller sets the Interface Clear (IFC) bus control line true. When the Abort message is received, the Audio Analyzer becomes unaddressed and stops talking or listening.



**HP-IB SYNTAX AND CHARACTERISTICS SUMMARY**

**Address:**

Set in binary by internal switches — may be displayed on front panel using Special Function 21, HP-IB Address. Factory set to 28 decimal; 11100 binary.

**General Operating Syntax:** (Excluding Rapid Frequency Count and Rapid Source modes.)\*

[Automatic Operation] [Source Frequency] [Source Amplitude] [Measurement] [Filters] [Special Functions] [Log/Lin] [Ratio] . . .  
 . . . [Start Frequency] [Stop Frequency] [Plot Limit] [Sweep] [Trigger]

**Numeric Data Input Format:** (Except in Rapid Source mode.)\*

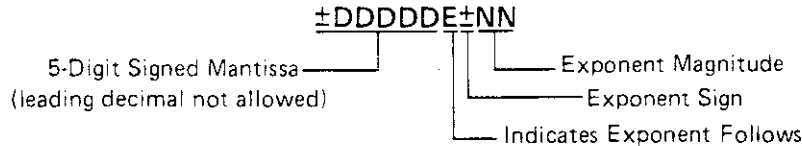

**Output Formats:** (Except in Rapid Frequency Count mode.)\*

Data (valid data output value always  $<4 \times 10^9$  and in fundamental units):

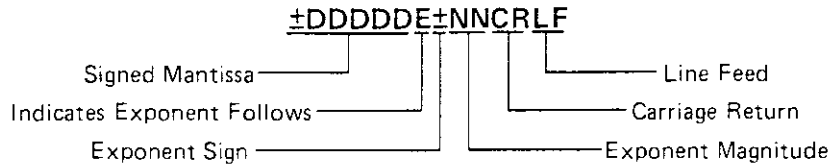

**Errors:**

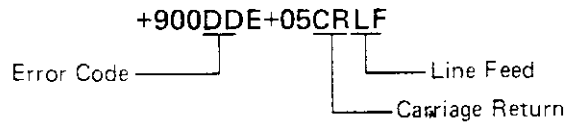

**Return to Local:**

Front panel LCL key if not locked out.

**Manual Trigger:**

Front panel CLEAR key initiates Trigger with Settling measurement.

**Status Byte:**

Bit	8	7	6	5	4	3	2	1
Weight	128	64	32	16	8	4	2	1
Service Request Condition	0 (always)	RQS Bit Require Service	0 (always)	0 (always)	0 (always)	Instru-ment Error	HP-IB Code Error	Data Ready

- Notes:
1. The condition indicated in bits 1 and 3 must be enabled to cause a Service Request by Special Function 22, Service Request Condition.
  2. The RQS bit (bit 7) is set true whenever an HP-IB code error occurs or when any of the conditions of bits 1 and 3 are enabled and occur.
  3. Bits set remain set until the Status Byte is cleared.

**Complete HP-IB Capability** (as described in IEEE Std 488, and ANSI Std MC1.1):

SH1, AH1, T5, TE0, L3, LE0, SR1, RL1, PP0, DC1, DT1, C0.

\*For information on Rapid Frequency Count or Rapid Source modes refer to them by name in the Detailed Operating Instructions.

Table 3-6. Audio Analyzer Parameter to HP-IB Code Summary

Parameter	Program Code	Parameter	Program Code
Source		Measurements	
Function		AC Level	M1
Start Frequency	FA	SINAD	M2
Stop Frequency	FB	Distortion	M3
Plot Limit	PL	DC Level	S1
Frequency	FR	Signal-to-Noise	S2
Frequency Increment	FN	Distortion Level	S3
Amplitude	AP	HP/BP Filters	
Amplitude Increment	AN	400 Hz HP Filter on	H1
Data		Psophometric BP Filter on	H2
- (minus)	-	All HP/BP Filters off	H0
*Clear	CL	LP Filters	
0-9	0-9	30 kHz LP Filter on	L1
. (decimal point)	.	80 kHz LP Filter on	L2
Units		All LP Filters off	L0
kHz	KZ	Ratio	
V	VL	On	R1
Upper Limit	UL	Off	R0
Hz	HZ	Log/Lin	
mV	MV	Log	LG
Lower Limit	LL	Lin	LN
dB	DB	Trigger Modes	
dBV	DV	Free Run	T0
Sweep on	W1	Hold	T1
Sweep off	W0	Trigger Immediate	T2
↑ (step up)	UP	Trigger with Settling	T3
↓ (step down)	DN	Miscellaneous	
Automatic Operation	AU	Read Left Display	RL
SPCL	SP	Read Right Display	RR
SPCL SPCL	SS	Rapid Frequency Count	RF
		Rapid Source	RS

\*Not to be confused with Clear message which is defined in Table 3-3.



Table 3-7. Audio Analyzer HP-IB Code to Parameter Summary

Program Code	Parameter	Program Code	Parameter
AN	Amplitude Increment	PL	Plot Limit
AP	Amplitude	RF	Rapid Frequency Count
AU	Automatic Operation	RL	Read Left Display
*CL	Clear	RR	Read Right Display
DV	dBV	RS	Rapid Source
DB	dB	R0	Ratio on
DN	↓ (step down)	R1	Ratio off
FA	Start Frequency	SP	SPCL
FB	Stop Frequency	SS	SPCL SPCL
FN	Frequency Increment	S1	DC Level
FR	Frequency	S2	Signal-to-Noise
		S3	Distortion Level
HZ	Hz	T0	Free Run
H0	All HP/BP Filters off	T1	Hold
H1	400 Hz Filter on	T2	Trigger Immediate
H2	Psophometric BP Filter on	T3	Trigger with Settling
KZ	kHz	UP	↑ (step up)
LG	Log	UL	Upper Limit
LN	Linear	VL	V
LL	Lower Limit	W0	Sweep off
L0	All LP Filters off	W1	Sweep on
L1	30 kHz LP Filter on	-	- (minus)
L2	80 kHz LP Filter on	0-9	0-9
MV	mV	.	.(decimal point)
M1	AC Level		
M2	SINAD		
M3	Distortion		

\*Not to be confused with Clear message which is defined in Table 3-3.





Table 3-8. Audio Analyzer Special Function to HP-IB Code Summary (1 of 2)

Special Function	Program Code	Special Function	Program Code
Input Level Range (except DC Level)		Post Notch Detector Response (except in SINAD)	
Automatic Selection	1.0SP	Fast Detector	5.0SP
300V range	1.1SP	Slow Detector	5.1SP
189V range	1.2SP		
119V range	1.3SP	Notch Tune	
75.4V range	1.4SP	Automatic notch tuning.	6.0SP
47.6V range	1.5SP	Hold notch tuning.	6.1SP
30.0V range	1.6SP		
18.9V range	1.7SP	SINAD Meter	
11.9V range	1.8SP	Range	
7.54V range	1.9SP	0 to $\approx$ 18 dB range	7.0SP
4.76V range	1.10SP	0 to $\approx$ 24 dB range	7.1SP
3.00V range	1.11SP		
1.89V range	1.12SP	Error Disable	
1.19V range	1.13SP	All errors enabled	8.0SP
0.754V range	1.14SP	Disable Analyzer errors (Errors 12-17, 31, and 96)	8.1SP
0.476V range	1.15SP	Disable Source errors (Error 18 and 19)	8.2SP
0.300V range	1.16SP	Disable both Analyzer and Source errors	8.3SP
0.189V range	1.17SP		
0.119V range	1.18SP		
0.0754V range	1.19SP		
Input Level Range (DC Level only)		Hold Settings	
Automatic Selection	2.0SP	Hold input level ranges, post- notch gain, decimal point and notch tuning at present settings.	9.0SP
300V range	2.1SP		
64V range	2.2SP	Display Source Settings	
16V range	2.3SP	Display source settings as en- tered. Frequency in left display; amplitude in right display.	10.0SP
4V range	2.4SP		
Post Notch Gain		Re-enter Ratio Mode	
Automatic Selection	3.0SP	Restore last RATIO reference and enter RATIO mode if allowed.	11.0SP
0 dB gain	3.1SP	Display RATIO reference.	11.1SP
20 dB gain	3.2SP		
40 dB gain	3.3SP		
60 dB gain	3.4SP		
Hold Decimal Point		Signal-to-Noise Measurements	
Automatic Selection	4.0SP	Delay	
DDDD. range	4.1SP	Automatic Selection	12.0SP
DDD.D range	4.2SP	200 ms delay	12.1SP
DD.DD range	4.3SP	400 ms delay	12.2SP
D.DDD range	4.4SP	600 ms delay	12.3SP
0.DDDD range	4.5SP	800 ms delay	12.4SP
DD.DD mV range	4.6SP	1.0s delay	12.5SP
D.DDD mV range	4.7SP	1.2s delay	12.6SP
0.DDDD mV range	4.8SP		



Table 3-8. Audio Analyzer Special Function to HP-IB Code Summary (2 of 2)

Special Function	Program Code	Special Function	Program Code
Signal-to-Noise Measurements		200 points/decade	17.8SP
Delay (Cont'd)		500 points/decade	17.9SP
1.4s delay	12.7SP	Display Level in Watts	
1.6s delay	12.8SP	Display level as watts into	19.0SP
1.8s delay	12.9SP	8 ohms.	
X-Y Recorder		Display level as watts into	19.NNNSP
Enable plot.	13.0SP	NNN ohms.	
Disable plot.	13.1SP	Read Display to HP-IB	
Time Between Measurements		Read right display.	20.0SP
Minimum time between	14.0SP	Read left display.	20.1SP
measurements.		HP-IB Address	
Add 1 s between measurements.	14.1SP	Displays HP-IB address (in	21.0SP
SINAD and Signal-to-Noise		binary) in left display; right	
Display Resolution		display in form TLS where T=1	
0.01 dB above 25 dB;	16.0SP	means talk only; L=1 means	
0.5 dB below 25 dB		listen only; S=1 means SRQ.	21.1SP
0.01 dB all ranges	16.1SP	Displays HP-IB address in	
Sweep Resolution (maximum		decimal.	
255 points/sweep)		HP-IB Service Request Condition	
10 points/decade	17.0SP	Enable a Condition to cause a	22.NSP
1 points/decade	17.1SP	service request, N is the sum of	
2 points/decade	17.2SP	any combination of the weighted	
5 points/decade	17.3SP	conditions below:	
10 points/decade	17.4SP	1—Data Ready	
20 points/decade	17.5SP	2—HP-IB error	
50 points/decade	17.6SP	4—Instrument error	
100 points/decade	17.7SP	The instrument powers up in the	
		22.2 state (HP-IB) error.	

Table 3-9. Commonly Used Code Conversions

ASCII	Binary	Octal	Decimal	Hexa- decimal	ASCII	Binary	Octal	Decimal	Hexa- decimal
NUL	00 000 000	000	0	00	@	01 000 000	100	64	40
SOH	00 000 001	001	1	01	A	01 000 001	101	65	41
STX	00 000 010	002	2	02	B	01 000 010	102	66	42
ETX	00 000 011	003	3	03	C	01 000 011	103	67	43
EOT	00 000 100	004	4	04	D	01 000 100	104	68	44
ENO	00 000 101	005	5	05	E	01 000 101	105	69	45
ACK	00 000 110	006	6	06	F	01 000 110	106	70	46
BEL	00 000 111	007	7	07	G	01 000 111	107	71	47
BS	00 001 000	010	8	08	H	01 001 000	110	72	48
HT	00 001 001	011	9	09	I	01 001 001	111	73	49
LF	00 001 010	012	10	0A	J	01 001 010	112	74	4A
VT	00 001 011	013	11	0B	K	01 001 011	113	75	4B
FF	00 001 100	014	12	0C	L	01 001 100	114	76	4C
CR	00 001 101	015	13	0D	M	01 001 101	115	77	4D
SO	00 001 110	016	14	0E	N	01 001 110	116	78	4E
SI	00 001 111	017	15	0F	O	01 001 111	117	79	4F
DLE	00 010 000	020	16	10	P	01 010 000	120	80	50
DC1	00 010 001	021	17	11	Q	01 010 001	121	81	51
DC2	00 010 010	022	18	12	R	01 010 010	122	82	52
DC3	00 010 011	023	19	13	S	01 010 011	123	83	53
DC4	00 010 100	024	20	14	T	01 010 100	124	84	54
NAK	00 010 101	025	21	15	U	01 010 101	125	85	55
SYN	00 010 110	026	22	16	V	01 010 110	126	86	56
ETB	00 010 111	027	23	17	W	01 010 111	127	87	57
CAN	00 011 000	030	24	18	X	01 011 000	130	88	58
EM	00 011 001	031	25	19	Y	01 011 001	131	89	59
SUB	00 011 010	032	26	1A	Z	01 011 010	132	90	5A
ESC	00 011 011	033	27	1B	[	01 011 011	133	91	5B
FS	00 011 100	034	28	1C	\	01 011 100	134	92	5C
GS	00 011 101	035	29	1D	^	01 011 101	135	93	5D
RS	00 011 110	036	30	1E	_	01 011 110	136	94	5E
US	00 011 111	037	31	1F	`	01 011 111	137	95	5F
SP	00 100 000	040	32	20	a	01 100 000	140	96	60
!	00 100 001	041	33	21	b	01 100 001	141	97	61
"	00 100 010	042	34	22	c	01 100 010	142	98	62
#	00 100 011	043	35	23	d	01 100 011	143	99	63
\$	00 100 100	044	36	24	e	01 100 100	144	100	64
%	00 100 101	045	37	25	f	01 100 101	145	101	65
&	00 100 110	046	38	26	g	01 100 110	146	102	66
'	00 100 111	047	39	27	h	01 100 111	147	103	67
(	00 101 000	050	40	28	i	01 101 000	150	104	68
)	00 101 001	051	41	29	j	01 101 001	151	105	69
*	00 101 010	052	42	2A	k	01 101 010	152	106	6A
+	00 101 011	053	43	2B	l	01 101 011	153	107	6B
,	00 101 100	054	44	2C	m	01 101 100	154	108	6C
-	00 101 101	055	45	2D	n	01 101 101	155	109	6D
.	00 101 110	056	46	2E	o	01 101 110	156	110	6E
/	00 101 111	057	47	2F	p	01 101 111	157	111	6F
0	00 110 000	060	48	30	q	01 110 000	160	112	70
1	00 110 001	061	49	31	r	01 110 001	161	113	71
2	00 110 010	062	50	32	s	01 110 010	162	114	72
3	00 110 011	063	51	33	t	01 110 011	163	115	73
4	00 110 100	064	52	34	u	01 110 100	164	116	74
5	00 110 101	065	53	35	v	01 110 101	165	117	75
6	00 110 110	066	54	36	w	01 110 110	166	118	76
7	00 110 111	067	55	37	x	01 110 111	167	119	77
8	00 111 000	070	56	38	y	01 111 000	170	120	78
9	00 111 001	071	57	39	z	01 111 001	171	121	79
:	00 111 010	072	58	3A	[	01 111 010	172	122	7A
;	00 111 011	073	59	3B	]	01 111 011	173	123	7B
<	00 111 100	074	60	3C	^	01 111 100	174	124	7C
=	00 111 101	075	61	3D	_	01 111 101	175	125	7D
>	00 111 110	076	62	3E	`	01 111 110	176	126	7E
?	00 111 111	077	63	3F	DEL	01 111 111	177	127	7F

# AC Level

**Description** The Audio Analyzer contains a wideband, true rms voltmeter with high accuracy and sensitivity. The AC LEVEL key causes the Audio Analyzer to measure the differential ac voltage between its HIGH and LOW INPUT jacks. Signals that are common to both the HIGH and LOW jacks are rejected.

**Procedure** To make an ac level measurement, press the AC LEVEL key. AC level results can be displayed in V, mV, dBV, watts, or as the ratio to an entered or measured value. The Audio Analyzer powers up displaying ac level in linear units (mV or V). To obtain a display in dBV (that is, dB relative to 1 volt), press the LOG/LIN key. To return to linear, simply press the LOG/LIN key again. If the ac level is to be displayed relative to a reference, refer to RATIO and LOG/LIN.

**Example** To measure the ac level of a signal at the INPUT jacks:

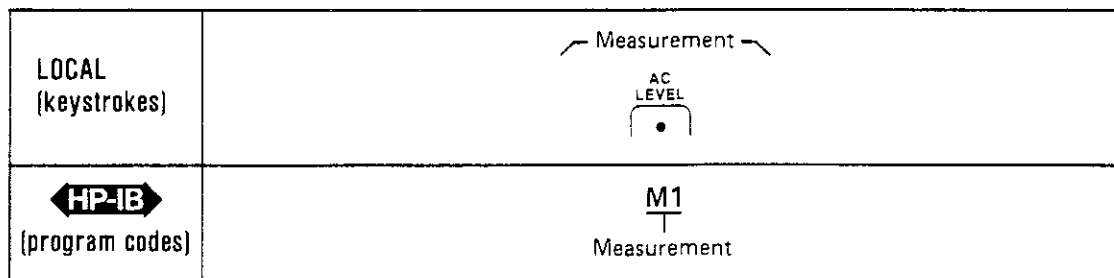

**Program Code** M1 is the program code for AC LEVEL.



**Indications** When ac level is selected, the LED within the AC LEVEL key will light. The right display shows the ac level with the appropriate units. The Audio Analyzer automatically ranges for maximum resolution and accuracy. The left display shows the input signal frequency. If the input level to the frequency counter is too small, the left display will show 0.000 kHz. (This will often occur when the signal is in the stop band of the high-pass or psophometric filters, but not usually with the low-pass filters.)

**Measurement Technique** In ac level the Audio Analyzer acts as an ac voltmeter. The Audio Analyzer automatically sets the input attenuation and the gain settings of the various amplifiers so that the input signal amplitude lies within the range of the output rms detector. The output rms detector converts the ac level to a dc voltage which is then measured by the dc voltmeter and after correction for input gain and attenuation, displayed in appropriate units. The frequency of the input signal is also measured and displayed.

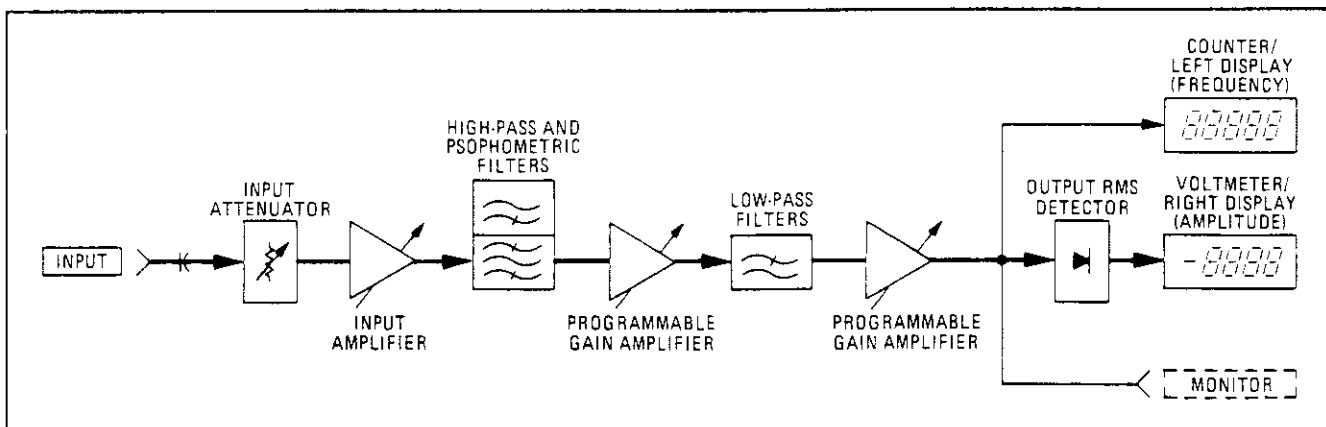

AC Level Measurement Block Diagram

## AC Level (Cont'd)

### Comments

The Audio Analyzer powers up in the ac level measurement mode with the 80 kHz low-pass filter activated. The 80 kHz low-pass filter reduces the measurement bandwidth from 500 kHz to 80 kHz.

### NOTE

*Common mode levels must not exceed 4V peak. Higher common mode levels may cause inaccurate measurements.*

The Audio Analyzer employs a true rms detector. When measuring complex waveforms or noise, a true rms detector will provide a more accurate rms measurement than an average-responding detector which has been calibrated to indicate the rms value of a sine wave. For a sine wave, both the true rms and the average-responding detectors give correct rms readings. However, when the signal is a complex waveform, or when significant noise is present, the average-responding detector reading can be in error. The amount of error depends upon the particular signal being measured. For noise, an average-responding detector reads low.

Many ac voltmeters employ an average-responding detector. For those applications requiring the use of an average-responding detector the Audio Analyzer can be converted by altering internal jumpers. The jumpers are installed at the factory for true rms detection. (See Service Sheet 6 in Section VIII.)

### Related Sections

Display Level in Watts  
Filters  
Monitor  
RATIO and LOG/LIN  
Special Functions

# Amplitude

**Description** The Audio Analyzer contains a low-distortion audio source. The AMPTD key, the numeric data and the unit keys are used to program the output level of the source. The source level can be entered in V, mV, or dBV (that is, dB relative to 1 volt). The amplitude entered is the open-circuit value. The output impedance is 600 ohms. The AMPTD key is also used to display the currently programmed output level. The amplitude range is 0.6 mV to 6V. The maximum resolution is better than 0.3 percent.

**Procedure** To set the source output level, press the AMPTD key and then the appropriate numeric data and unit keys. Once the AMPTD key has been pressed, new data and unit entries can be made to select different amplitudes until another source function key (for example, the FREQ key) is pressed. To display the currently programmed amplitude, press and hold the AMPTD key.

**Example** To set source output level to 1.5V:

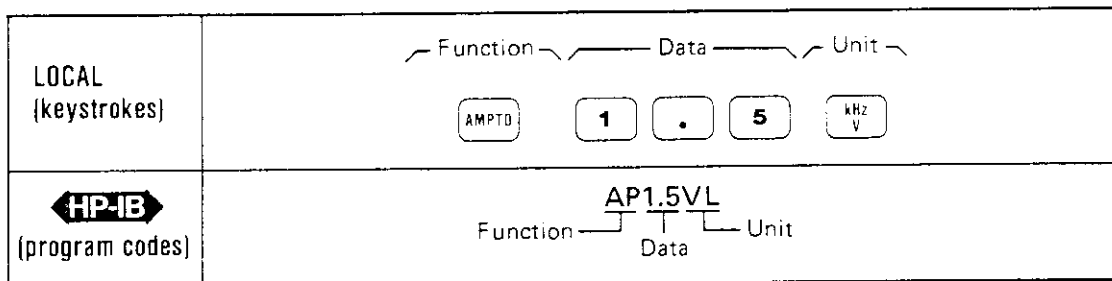

**Program Code** AP is the program code for the AMPTD key.



**Indications** When the AMPTD key is pressed, the right display shows the currently programmed output level. As the new output level data is entered, it will appear on the left display. When the units key is pressed, the left display returns to show the input signal frequency. When the amplitude is set to 0V, the output is opened up but the oscillator remains on.

**Comments** The Audio Analyzer powers up with the source amplitude set at 0 volts. When the amplitude is set to 0V, the output is opened up but the oscillator remains on.

When the AMPTD key is pressed and held the right display shows the currently programmed amplitude. It is important to realize the value shown in the right display is the programmed value which can differ from the actual value at the OUTPUT. For example, since the source output impedance is 600 ohms, the voltage developed across an external 600-ohm load will be half the programmed value.



**Related Sections** Display Source Settings  
Frequency  
Increment

## Automatic Operation

**Description** The AUTOMATIC OPERATION key sets the instrument functions to automatic (i.e., each function is allowed to automatically range to the appropriate setting). It also cancels all of the functions that light the SPCL key light.

**Procedure** To set the Audio Analyzer to automatic operation, press the AUTOMATIC OPERATION key.

**Example** To set the Audio Analyzer to automatic operation:

LOCAL (keystrokes)	
 (program codes)	AU   Function

**Program Code** AU is the HP-IB code for AUTOMATIC OPERATION.



**Indications** When the key is pressed, the right display blanks and then shows four dashes. When the key is released, the display is dependent upon the current measurement mode and input.

**Comments** If the Audio Analyzer is in the 10.0 Special Function (Display Source Settings), the instrument returns to the ac level measurement mode.

The converse of the automatic operation mode is the Hold Settings Special Function (prefixed 9). Refer to Hold Settings.

For information on which specific Special Functions are turned off by the AUTOMATIC OPERATION key refer to Special Functions. Since AUTOMATIC OPERATION affects Special Functions, it is a good practice to place the AU code at the beginning of a program string when used in programming.

**Related Sections**



- Display Source Settings
- Hold Settings
- Special Functions

## DC Level

**Description** The DC LEVEL key causes the Audio Analyzer to measure the differential dc voltage between its HIGH and LOW INPUT jacks. Signals that are common to both the HIGH and LOW jacks are rejected.

**Procedure** To make a dc level measurement, press the S (Shift) key, then the DC LEVEL key. The voltage can be expressed in either volts, or, if the voltage is positive, in dBV (that is, dB relative to 1 volt). To obtain a display in dBV, press the LOG/LIN key. To return to linear, simply press the LOG/LIN key again. If the dc level is to be displayed relative to a reference level, refer to RATIO and LOG/LIN.

**Example** To measure the dc level at the INPUT jacks:

LOCAL (keystrokes)	
 (program codes)	S1 Measurement

**Program Code** S1 is the HP-IB code for DC LEVEL.



**Indications** When dc level is selected, the LEDs within the DC LEVEL key and the S (Shift) key will light. The right display shows the dc level with the appropriate units. The Audio Analyzer automatically ranges for maximum resolution and accuracy. In the dc level measurement mode the left display is blanked even though an ac signal may be present.

**Measurement Technique** In the dc level measurement mode the Audio Analyzer automatically sets the input attenuation and the gain of the input amplifier so that the signal amplitude lies within the proper range of the dc voltmeter. The signal is then measured by the dc voltmeter and after correction for input gain and attenuation, displayed in appropriate units.

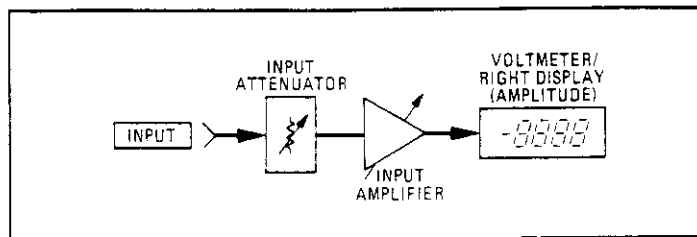

**DC Level Measurement Block Diagram**

**Comments** Common-mode levels must not exceed 4V peak.

In the dc level measurement mode only the ac component of the input signal is coupled to the MONITOR output. The ac component also affects the input gain.

**Related Sections** RATIO and LOG/LIN  
Special Functions



## Default Conditions and Power-up Sequence

**Description** When first turned on, the Audio Analyzer performs a sequence of internal checks after which the instrument is ready to make measurements. During the power-up sequence, all front-panel indicators light to allow the operator to determine if any are defective. After approximately four seconds, this sequence is completed and the Audio Analyzer is preset as follows:

START FREQ .....	20 Hz
STOP FREQ .....	20 kHz
PLOT LIMIT	
LOWER LIMIT .....	-100.0
UPPER LIMIT .....	100.0
FREQ .....	1000.0 Hz
FREQ INCR .....	1000.0 Hz
AMPTD .....	0.00 mV
AMPTD INCR .....	0.100V
MEASUREMENT .....	AC LEVEL
LP FILTER .....	LOW PASS 80 kHz
HP/BP FILTER .....	Off
RATIO .....	Off
Ratio Reference .....	0
LOG/LIN .....	LIN (see RATIO and LOG/LIN Detailed Operating Instruction)
Left Display .....	Input Frequency
Right Display .....	Input AC Level
Service Request	
Condition .....	HP-IB Code Error Only
Status Byte .....	Cleared
Trigger Mode .....	Free Run (Code T0)
SPCL .....	All Special Functions off or in their zero suffix, except Service Request Condition which is set to 22.2 (HP-IB Code Error).
Plotter .....	Enabled
X AXIS, Y AXIS .....	0V
PEN LIFT .....	TTL high

**Related Sections**

RATIO and LOG/LIN  
Service Request Condition

## Display Level in Watts (Special Function 19)

**Description** The measurement mode can be set to read the ac input power level in watts into a specified external load resistance by using Special Function 19. The range of the selectable load resistance is an integer value from 1 to 999 ohms.

**Procedure** To set the measurement to display the ac level in watts into a specified resistance, key in the corresponding Special Function code; and then press the SPCL key.

Resistance (ohms)	Special Function Code	Program Code <b>HP-IB</b>
8 1-999	19.0 SPCL 19.NNN SPCL (where NNN corresponds to the load resistance)	19.0SP 19.NNNSP

**Example** To set the right display to read INPUT signal level in watts into an external 16 ohm speaker:

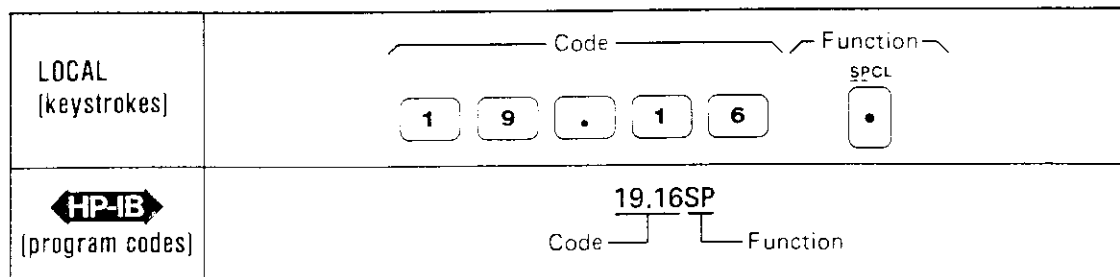

**Program Codes** For HP-IB codes, refer to Procedure above.



**Indications** As the numeric code is entered, both displays will blank and the entered code will appear in the left display. When the SPCL key is pressed, the SPCL key will light if it is not already on. If it is on, it will remain on. The right display shows a four-digit readout of the ac power in watts but no units are indicated. All measurement LEDs go off.

**Comments** The load resistance in ohms must be entered in integers (e.g., a resistance of 5.8 ohms cannot be entered). The decimal point has already been used when entering the Special Function. An attempt to enter a second decimal point is ignored.

Remember that the instrument assumes that the input voltage is being developed across the specified external load resistance. If an incorrect resistance is entered, the readout in watts is shown for the resistance entered.

Zeros immediately following the decimal point are optional. For example, when setting the load resistance to 1 ohm, 19.1 is equivalent to 19.01 and 19.001. However, 19.1 is not equivalent to 19.10 or 19.100. Note that 19.0 and 19.8 are equivalent (i.e., they both specify an 8 ohm load resistance).

## Display Level in Watts (Cont'd)

(Special Function 19)

**Comments  
(Cont'd)**

The displayed power level is accurate regardless of distortion unless the Audio Analyzer's audio detector is configured as average responding.

Neither the RATIO nor the LOG function can be used with this Special Function.

**Related  
Section**

AC Level

## Display Source Settings (Special Function 10)

**Description** The currently programmed frequency and amplitude of the source can be simultaneously displayed by using Special Function 10. The programmed frequency is displayed in the left display and the programmed amplitude (open-circuit) is displayed in the right display.

**Procedure** To display the currently programmed frequency and amplitude of the source, press 10.0 and then the SPCL key.

**Example** To display the source settings:

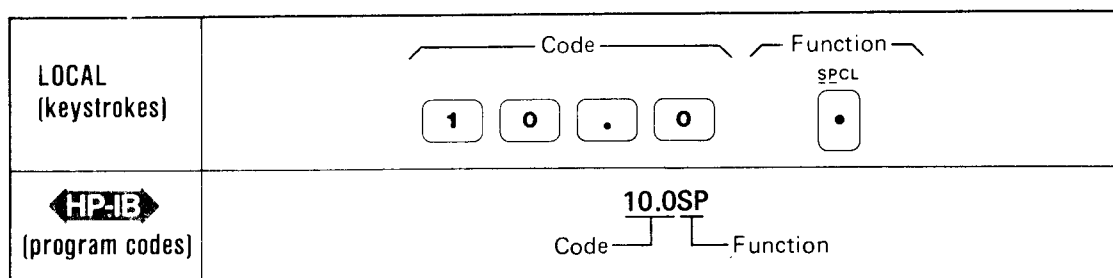

**Program Code** 10.0SP is the HP-IB code for Special Function 10.



**Indications** As the numeric code is entered, both displays will blank, and the entered code will appear in the left display. When the SPCL key is pressed, the SPCL key LED will light if it is not already on. If it is already on, it will remain on. The displays then show the source's currently programmed frequency in the left display and its currently programmed amplitude in the right display.

**Comments** It is important to realize that neither display is a measurement of the source output. Therefore, the actual values at the OUTPUT jack may differ from the programmed values. In the case of frequency, there is usually only a very slight difference. In the case of amplitude, the difference is dependent upon the load impedance. For example, since the output impedance is 600 ohms, a load impedance of 600 ohms causes the amplitude at the OUTPUT jack to be half of the programmed value.

**Related Sections**  
 Amplitude  
 Automatic Operation  
 Frequency  
 Special Functions

# Distortion

**Description** The Audio Analyzer measures distortion by first determining the following value:

$$D = \frac{\text{noise} + \text{distortion}}{\text{signal} + \text{noise} + \text{distortion}}$$

It then converts D into the appropriate measurement units as follows:

$$\% \text{ units} = D \times 100\%$$

$$\text{dB units} = 20\log D$$

The **RATIO** key can be used to compare the measured results to a predetermined ratio reference value (refer to **RATIO** and **LOG/LIN**).

A distortion measurement can be made on signals from 20 Hz to 100 kHz and from 50 mV to 300V.

**Procedure** To make a distortion measurement, press the **DISTN** key. If the internal source is to be used as the stimulus signal, key in the desired frequency and amplitude. Use the filters to limit noise, hum, spurious signals, etc. The Audio Analyzer powers up with the **LOW PASS 80 kHz** filter activated.

**Example** To measure the distortion of an external source in a 30 kHz bandwidth:

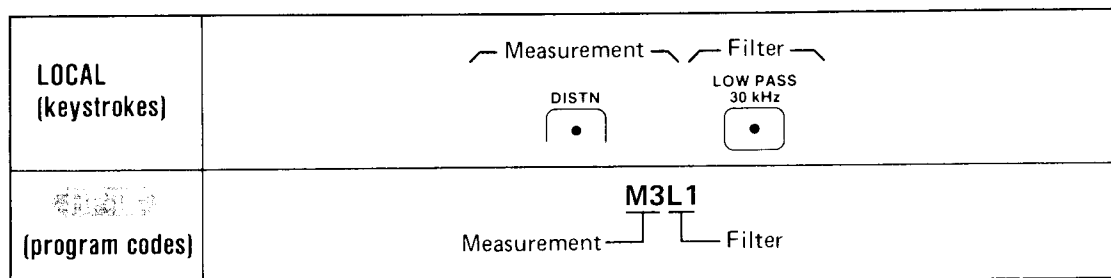

**Program Code** M3 is the HP-IB code for the distortion measurement.



**Indications** When distortion is selected, the LED within the **DISTN** key will light. The frequency and distortion of the input signal are displayed and the appropriate annunciators are lighted (see Description above).

**Measurement Technique** In the distortion measurement mode, the controller automatically sets the input attenuation and the gain settings of various amplifiers. This control ensures that the signal amplitude is within the proper range for the input and output rms detectors. The input rms detector converts the ac level of the combined signal + noise + distortion to dc. The notch filter removes the fundamental signal. The notch filter automatically tunes to the component whose frequency is measured by the counter (usually the fundamental of the input signal). The output rms detector converts the residual noise + distortion to dc. The dc voltmeter measures both dc signals. The controller then corrects for the programmed gain and attenuation, computes the ratio of the two signals, and displays the results in appropriate units. The frequency of the input signal is also measured and displayed.

## Distortion (Cont'd)

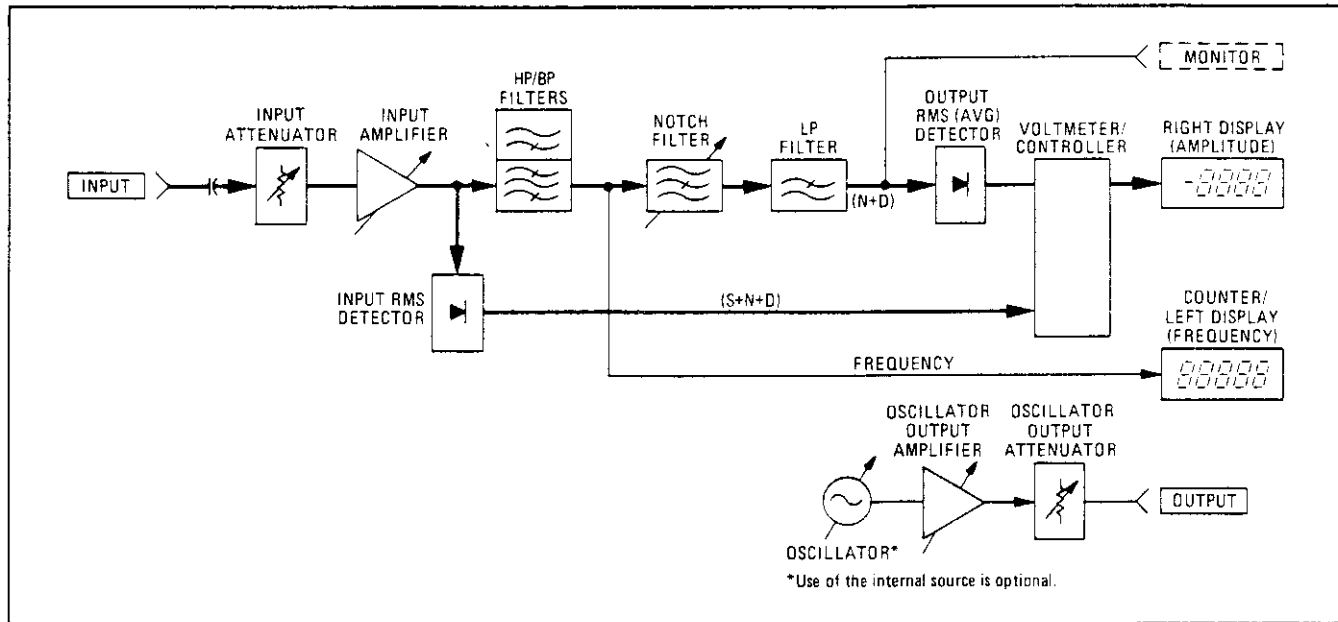

**Distortion Measurement Block Diagram**

**Related Sections**

- Distortion Level
- Filters
- Notch Tune
- RATIO and LOG/LIN

# Distortion Level

**Description** The Audio Analyzer measures the distortion level by removing the fundamental of the input signal and then measuring the ac level of the remaining noise and distortion. The mV and V units are displayed in the linear mode or the values are converted to dBV (i.e., dB relative to 1V). The **RATIO** key can be used to compare the measured results to a predetermined ratio reference (refer to **RATIO** and **LOG/LIN**).

**Procedure** To make a distortion level measurement, press the **S** (**Shift**) and **DISTN LEVEL** keys. If the internal source is to be used as a stimulus signal, key in the desired frequency and amplitude. The filters are used to limit the bandwidth. The Audio Analyzer powers up with the **LOW PASS 80 kHz** filter activated.

**Example** To measure distortion level on an external source signal in a 30 kHz bandwidth:

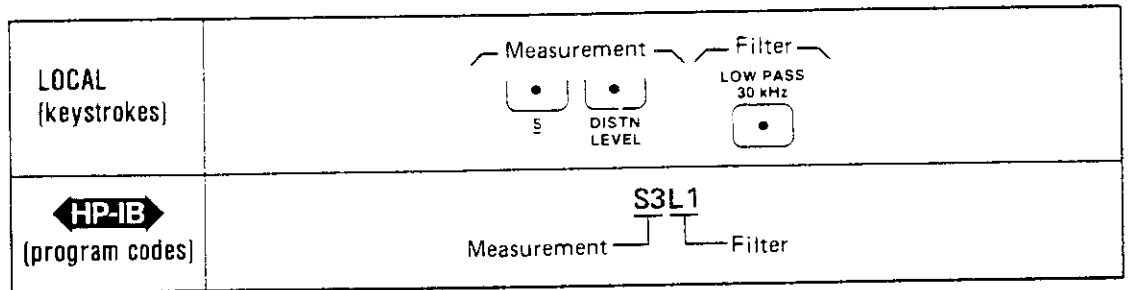

**Program Code** S3 is the HP-IB code for distortion level.



**Indications** When distortion level is selected, the LEDs in the **S** (**Shift**) key and the **DISTN LEVEL** key will light. The frequency and amplitude of the input signal are displayed and the appropriate annunciators will light (see **Description** above).

**Measurement Technique** In the distortion level measurement mode, the controller automatically sets the input attenuation and the gain settings of various amplifiers. This control ensures that the signal amplitude is within the proper range for the output rms detector. The notch filter removes the fundamental from the input signal. The notch filter automatically tunes to the component whose frequency is measured by the counter (usually the fundamental of the input signal). The output rms detector converts the residual noise + distortion to dc. The dc voltmeter measures the signal and the controller corrects for the programmed gain and attenuation. The results are then displayed in the appropriate units. The frequency of the input is also measured and displayed.

*(Distortion Level Block Diagram on next page)*

## Distortion Level (Cont'd)

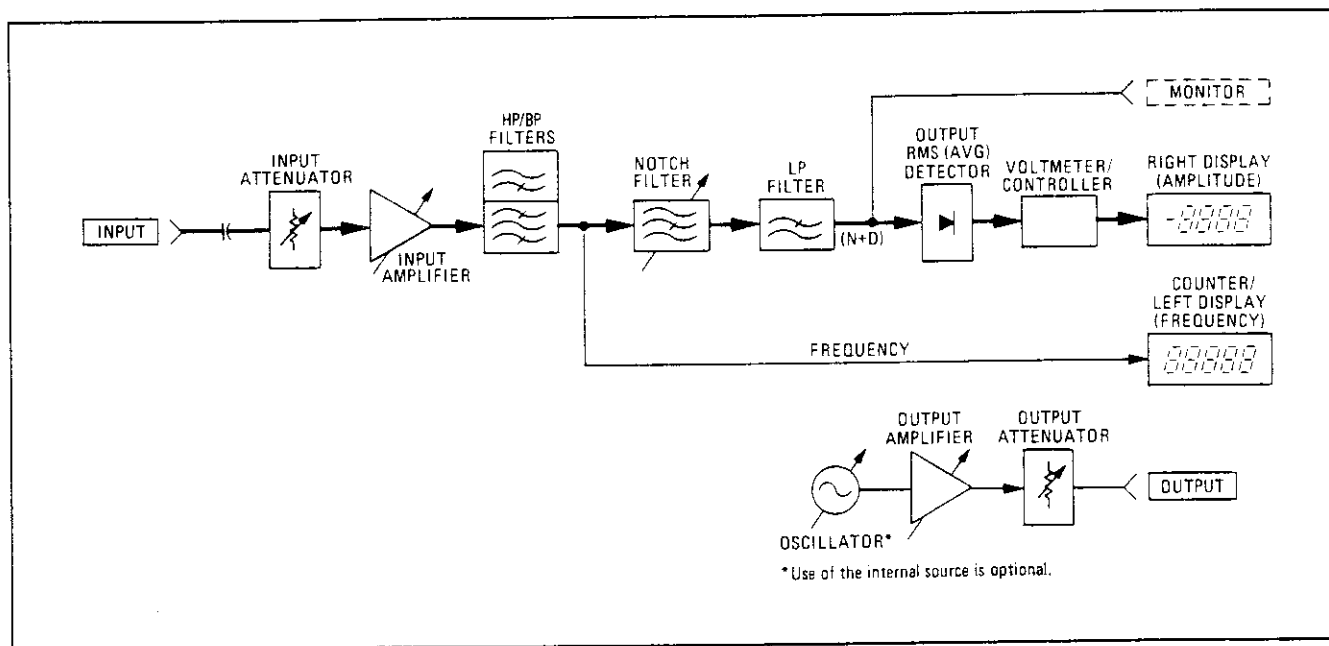

Distortion Level Measurement Block Diagram

**Related Sections**

- Distortion
- Filters
- Monitor
- Notch Tune
- RATIO and LOG/LIN



## Error Disable (Special Function 8)

**Description** The Error Disable Function is used to selectively disable operating error messages. Using the 8.N Special Function allows the user to enable all operator error messages, disable analyzer errors (measurement related errors), disable source errors (output related errors), or disable both analyzer and source errors.

**Procedure** To selectively disable (or enable) operator error messages, key in the corresponding Special Function code; and then press the SPCL key.

Error Message Status	Special Function Code	Program Code 
All error messages enabled.	8.0 SPCL	8.0SP
Disable analyzer error messages (Errors 12-17, 31, and 96).	8.1 SPCL	8.1SP
Disable source error messages (Errors 18 and 19).	8.2 SPCL	8.2SP
Disable both analyzer and source error messages.	8.3 SPCL	8.3SP

**Example** To disable the source error messages:

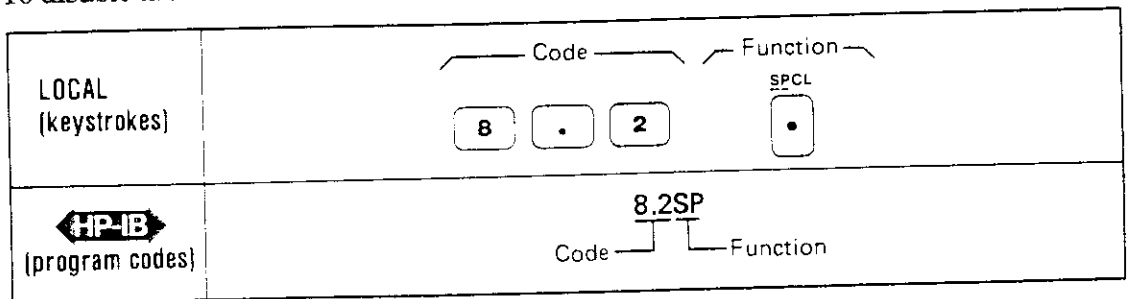

**Program Codes** For HP-IB codes refer to Procedure above.



**Indications**

As the numeric code is entered, both displays will blank, and the entered code will appear in the left display. When the SPCL key is pressed, the SPCL key will light (except for Special Function 8.0) if it is not already on. If it is already on, it will remain on (except for Special Function 8.0). Both displays then return to the display that is appropriate for the currently selected measurement mode.

**Comments**

The error messages can be selectively disabled to prevent the analyzer error messages from halting the operation of the source section of the Audio Analyzer and vice-versa.

## **Error Disable (Cont'd)**

**(Special Function 8)**

### **Comments (Cont'd)**

The error messages can also be selectively disabled to prevent unwanted error interrupts to the HP-IB bus controller.

Error messages are one means by which the instrument safeguards accurate measurements. When these safeguards are disabled, erroneous measurements can result under certain conditions. This should be kept in mind when operating the instrument with error messages disabled.

### **Related Sections**

Automatic Operation  
Error Message Summary  
Special Functions

# Error Message Summary

**Description** The instrument generates error messages to indicate operating problems, incorrect keyboard entries, or service related problems. The error message is generally cleared when the error condition is removed. (Error 31 is an exception.) The Error Messages are grouped by error code as follows:

**Error 10 through Error 39 and Error 90 through Error 99.** These are Operating and Entry Errors which indicate that not all conditions have been met to assure a calibrated measurement or that an invalid key sequence or keyboard entry has been made. Operating Errors can usually be cleared by using the front-panel controls. The Error Disable Special Function (8.N) can be used to selectively disable certain operating error messages. Entry Errors require that a new keyboard entry or function selection be made.

**Error 65 through Error 89.** These are Service Errors which provide additional service related information. Service Errors must be enabled to appear and do not necessarily represent failures within the instrument. Service Errors are discussed in the Service Section (VIII) of this manual.

**HP-IB Output Format** The HP-IB output format for errors is shown below:

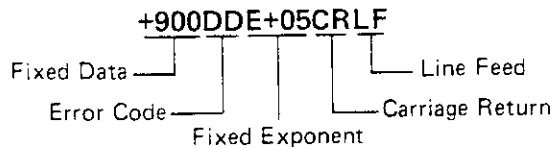

For example, Error 10 is output to the HP-IB as +90010E+05CRLF. This format differs from normal data outputs since normal data outputs will never exceed  $4 \times 10^9$ . Once an error has been input to the computing controller, the error code is simply derived by subtracting  $9 \times 10^9$  from the input number, then dividing the result by 100 000.

**Error Displays**

Shown below and on the next page are three types of error displays. The first is typical of most error displays and is shown as a general case. The second and third have specific meaning and occur often.

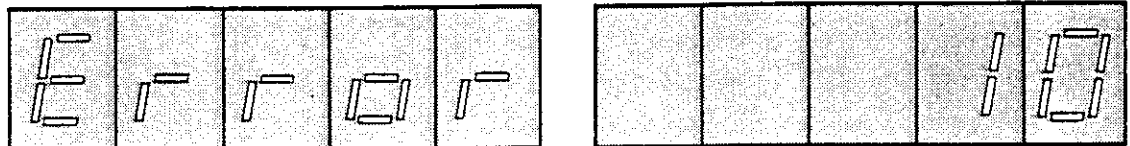

This display shows the general error display format. These errors are output to the HP-IB as shown under the HP-IB format above.

## Error Message Summary (Cont'd)

### Error Displays (Cont'd)

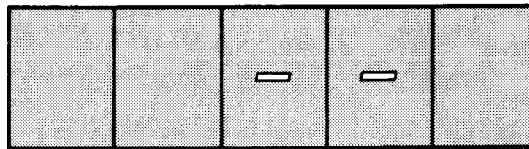

This display means that no signal has been sensed at the input. This display is output to the HP-IB as Error 96 using the HP-IB format shown above.

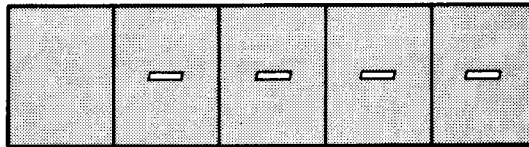

This display means that a signal has been detected but for various reasons a measurement result is not yet available. This display is never output to the HP-IB and typically indicates a transitory state in instrument operation. After 128 successive occurrences, the display changes to Error 31. Error 31 is output to the HP-IB using the HP-IB format shown above.

### Error Messages

The table below describes all Operating and Entry errors. The error code, message, and the action typically required to remove the error-causing condition are given. Additional information pertaining to particular errors is also given.

Error Code	Message	Action Required/Comments
<b>Operating Errors</b>		
10	Reading too large for display.	This error code indicates that although the required calculation is within the capability of the instrument, the result of the calculation exceeds the display capabilities.
11	Calculated value out of range.	Enter new RATIO reference. Refer to RATIO and LOG/LIN.
13	Notch cannot tune to input.	Adjust input frequency to within specified limits. Refer to Table 1-1.
14	Input level exceeds instrument specifications.	This error code indicates that the input overload detector has tripped (not in range hold). This could be caused by too large an ac signal, or too much ac on a dc signal.

## Error Message Summary (Cont'd)

**Error Messages (Cont')**

Error Code	Message	Action Required/Comments
<b>Operating Errors (Cont'd)</b>		
<b>NOTE</b>		
<i>Although error codes 17, 18 and 19 are officially listed here under Operating Errors, they should be considered rather as diagnostic indications.</i>		
17	Internal voltmeter cannot make measurement.	This error code indicates that the counter (A8) has failed to return a value. This can only be caused by a malfunction in the counter. Refer to Service Sheet 14.
18	Source cannot tune as requested.	This error code indicates a malfunction in the counter (A8) and/or the oscillator (A5). Refer to Service Sheets 8, 9 and 14.
19	Cannot confirm source frequency.	This error indicates that in notch routine, the frequency could not be measured, and thus the notch could not be adjusted. This usually indicates a counter (A8) problem. Refer to Service Sheet 14.
25	Top and bottom plotter limits are identical.	This error code indicates that the user has entered the same upper and lower limits to scale the sweep of the X-Y plotter output. This would cause a division by zero. The user should enter some realistic plot limits. Refer to X-Y Recording, and, more particularly, to Plot Limit.
26	RATIO not allowed in present mode.	This error code indicates that use of the RATIO key does not make sense in the current mode. Refer to RATIO and LOG/LIN.
30	Input overload detector tripped in range hold.	This error code indicates that the input signal is too high for the selected range. Press CLEAR key and then enter a more realistic range setting, or press AUTOMATIC OPERATION key to allow the Audio Analyzer to seek the correct input range. Refer to Automatic Operation.
31	Cannot make measurement.	This error code indication occurs when the input signal is changing too quickly for the Audio Analyzer to make consistent measurements. The "— — —" display indicates that the instrument is trying to make a measurement. After 128 unsuccessful tries, Error 31 is displayed.
32	More than 255 points total in a sweep.	Although sweep resolution can be changed with Special Function 17, care should be taken to ensure that it will not result in more than 255 points in the total sweep. Refer to Sweep Resolution.
96	(HP-IB only) No signal sensed at input.	This error is sent on the HP-IB when the "— —" display is shown.

## Error Message Summary (Cont'd)

**Error Messages (Cont')**

Error Code	Message	Action Required/Comments
<b>Entry Errors</b>		
20	Entered value out of range.	Re-enter new value.
21	Invalid key sequence.	Check for compatibility of functions selected.
22	Invalid Special Function prefix.	Check, then re-enter correct Special Function code. Refer to Special Functions.
23	Invalid Special Function prefix.	Check, then re-enter correct Special Function code. Refer to Special Functions.
24 	Invalid HP-IB code.	Check, then re-enter correct HP-IB code. This error causes a Require Service message to be sent on the HP-IB. Refer to Table 3-4 and accompanying text.
<b>Service Errors</b>		
65—89	Service related errors.	Refer to Paragraph 8-12, Service Errors.

**Related Sections**

Automatic Operation  
 Plot Limit  
 RATIO and LOG/LIN  
 Sweep Resolution  
 X-Y Recording

# Filters

**Description** The HP/BP (high-pass/bandpass) and LP (low-pass) FILTER keys cause the respective filters to be inserted into the audio signal path. The filters limit the measurement bandwidth. The HP/BP filters are inserted before the notch filter (control of the notch filter is covered in the Notch Tune discussion). The LP filters are inserted after the notch filter. When in use, the HP/BP and LP FILTERs always affect the signal at the rear-panel MONITOR output.

**Procedure** Select the desired signal filters by pressing the appropriate keys. Only one HP/BP and one LP filter can be in at a time. To turn a filter off, press the key again or select another filter in the same group. HP-IB codes for the different filter keys (shown below) turn on the selected filter (defeating others in the group if on). To turn an HP/BP or LP filter off via HP-IB, use code H0 or L0 respectively or select the alternate filter in the pair.

**Example** To select the 400 Hz HP filter and the 30 kHz LP filter:

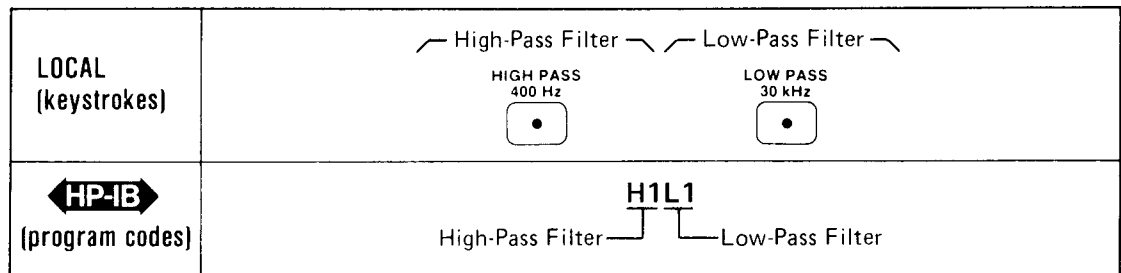

**Program Codes**



HP/BP Filter	Program Code 	LP Filter	Program Code 
Both off	H0	Both off	L0
HIGH PASS 400 Hz	H1	LOW PASS 30 kHz	L1
PSOPH	H2	LOW PASS 80 kHz	L2

**Indications** When a filter is activated (by either automatic or manual selection), the LED within that filter's key will light.

**Comments** The selected filters are always in the path of the audio signal.

With all filters off, the 3 dB measurement bandwidth is approximately 10 Hz to 750 kHz.

The HP/BP filters affect the signal being counted; however, the LP filters usually do not. Repeating the HP-IB command to turn on a specific filter has no effect (i.e., the filters cannot be toggled on and off using the same HP-IB command).

The individual filter characteristics are given in Table 1-1, Specifications and in Table 1-2, Supplemental Information.

## Filters (Cont'd)

**Comments  
(Cont'd)**

The bandpass, or psophometric (PSOPH), filter weights the frequency response of the Audio Analyzer as shown in the following curve. The psophometric bandpass characteristic approximates the response of human hearing and is a standard of the C.C.I.T.T.\*.

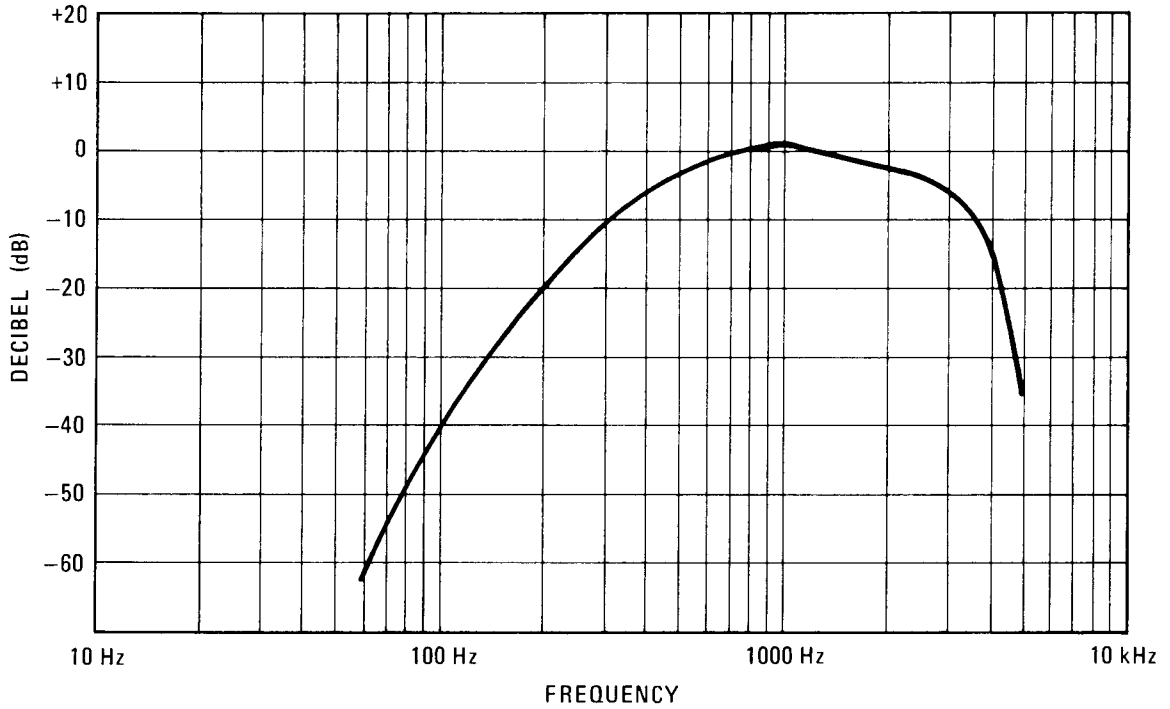

**Characteristic Curve of Psophometric Filter**

**Related  
Sections**

- AC Level
- Distortion
- Distortion Level
- Signal-to-Noise
- SINAD

\*The International Telegraph and Telephone Consultative Committee



# Float

**Description** To minimize measurement errors caused by ground loops, both the source output and the analyzer input can be floated. Floating the analyzer input improves rejection of low-frequency, common mode signals (e.g., line-related hum and noise). The two front-panel FLOAT switches determine whether the input and output circuitry are floating or single-ended. Note that the FLOAT switches are not HP-IB programmable.

**Procedure** To float either the analyzer input or the source output, set the corresponding FLOAT switch to the FLOAT position. In the float mode the LOW center conductor is isolated from chassis ground. In the single-ended mode (the FLOAT switch in the grounded position) the LOW center conductor is connected directly to chassis ground.

**Comments** The INPUT and OUTPUT BNC connectors allow the attachment of shielded cables, which minimize electromagnetic interference (EMI). This is important if the Audio Analyzer is operated near a transmitter or in the presence of large RF signals.

The outer conductor of each BNC connector is connected directly to chassis ground. When the FLOAT switch is in the grounded position the center conductor of the LOW connector is also connected to chassis ground. Thus, no connection to the LOW connector is required if a BNC coaxial cable is connected to the HIGH connector. In this configuration, the BNC cable shield serves as a return path. When the FLOAT switch is in the FLOAT position, both the LOW and HIGH connectors must be connected.

**NOTE**

*Since the input attenuators are on the HIGH side, care must be taken to avoid inserting the signal at the LOW connector. No damage will be done to the instrument, but incorrect readings will be provided which could be mistaken for valid data, particularly at higher frequencies.*

If EMI shielding is not critical, banana-type connectors can be used. Four BNC-to-banana adapters are supplied with the instrument to convert the BNC input and output to dual banana with standard 3/4 inch spacing. The adapters connect the conductor of the banana jack to the center conductor of the BNC connector. These adapters are normally used when the FLOAT switches are set in the FLOAT position.

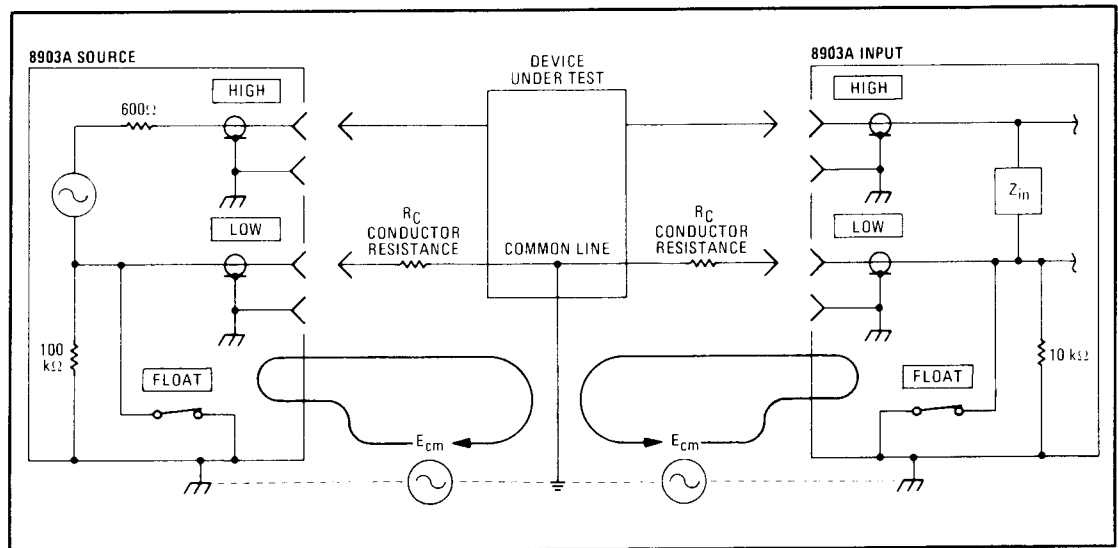

Effect of Multipoint Ground System (FLOAT Switch Closed)

One major source of error which must be considered when measuring low level ac signals or when making low distortion measurements is error introduced by ground

## Float (Cont'd)

### Comments (Cont'd)

loops. The figure above illustrates a typical measurement setup using the Audio Analyzer. In the figure the system common line is connected to chassis or earth ground at two separate points: the chassis of the Audio Analyzer and the common point of the device under test. Since two physically separate ground points are seldom at the same ground potential, current will flow in the system common line. Due to conductor resistance ( $RC$ ) in the system common line, the current causes a voltage drop. This voltage drop (a common mode voltage) sums with the signal under measurement and can cause erroneous readings. Grounding the system common line at a single point minimizes the effect of common mode voltages caused by ground loops. Floating the Audio Analyzer input and output circuitry isolates the LOW center conductor of the Audio Analyzer from chassis ground. Thus the Audio Analyzer input and output circuits are grounded only through the device under test. Note that the system common line is now grounded at a single point.

In the FLOAT mode the INPUT LOW connector can be floated up to 4V peak.

#### CAUTION

*To prevent damage to the Audio Analyzer input circuitry, do not apply greater than +15V or less than -15V (ac + dc) to the INPUT LOW terminal.*

A simplified diagram of the source output circuit is shown below. Note that in the float mode, there is no ground present at the output (actually, the center conductor of the LOW terminal is connected to chassis ground through a 10 k $\Omega$  resistor).

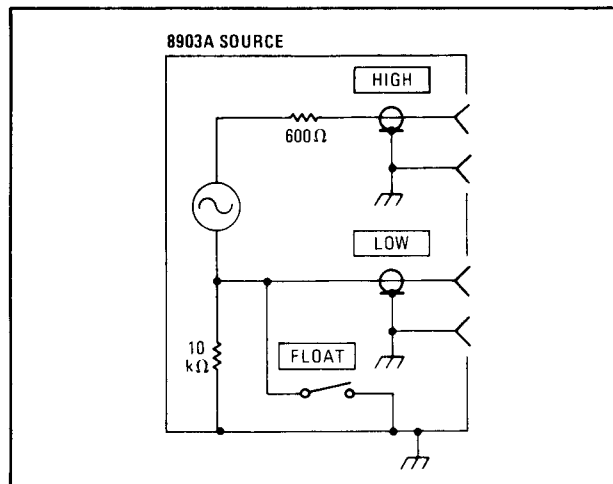

Simplified Schematic of the Audio Analyzer Source Output

In the float mode the output can be used as a summing circuit. An external source (either ac or dc) can be applied to either the HIGH or LOW connectors. The output signal is the sum of the internal source plus the external source. The OUTPUT LOW and HIGH connectors can be floated up to 10V peak.

#### CAUTION

*Do not allow the voltage at the OUTPUT LOW or OUTPUT HIGH connector to be greater than +10V or less than -10V(ac + dc).*

# Frequency

**Description** The Audio Analyzer provides a low distortion sine wave output from 20 Hz to 100 kHz. The **FREQ** key along with numeric data and unit keys are used to program the frequency of the source. The **FREQ** key is also used to display the currently programmed frequency.

**Procedure** To program a source frequency, press the **FREQ** key and then the appropriate numeric data and unit keys. Once the **FREQ** key has been pressed, new data and unit entries can be made to select different frequencies until another source function key (for example, the **AMPTD** key) is pressed. To display the currently programmed source frequency press and hold the **FREQ** key.

**Example** To set the source frequency to 500 Hz:

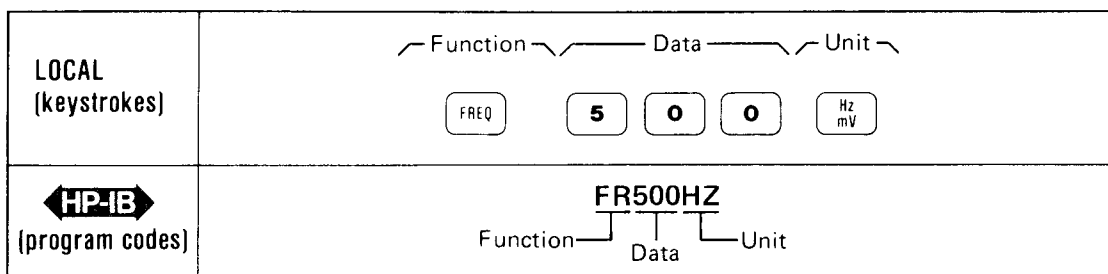

**Program Codes**



Keys	Program Code 
FREQ	FR
Hz	HZ
kHz	KZ

**Indications** When the **FREQ** key is pressed, the left display shows the currently programmed frequency setting. As the new frequency data is entered, it will appear on the left display. When the unit key is pressed, the left display returns to show the input signal frequency.

**Comments** When the **FREQ** key is pressed and held the left display shows the currently programmed frequency. It is important to realize the value shown in the left display is the programmed value which can differ from the actual frequency at the **OUTPUT**. This difference is caused by the fact that the source is a programmable oscillator and not a synthesizer. However, the source frequency is within  $\pm 0.3\%$  of the entered value. Also realize that the displayed count is the frequency of the input signal and is the same as the source frequency only if the source is the stimulus for the input.

For an alternate method of programming frequency with high rapidity (3 ms typical), see **Rapid Source**. For a method which permits a more rapid reading of the frequency, see **Rapid Frequency Count**.

**Related Sections**

- Amplitude
- Increment
- Rapid Frequency Count
- Rapid Source

# Hold Decimal Point

(Special Function 4)

**Description** The position of the decimal point in the right display can be held in a specific location by using Special Function 4.

**Procedure** To hold the decimal point in the right display to a specific position, key in the corresponding Special Function code; and then press the SPCL key.

Decimal Point Hold Position	Special Function Code	Program Code <b>HP-IB</b>
Automatic Selection	4.0 SPCL	4.0SP
DDDD. V Range*	4.1 SPCL	4.1SP
DDD.D V Range	4.2 SPCL	4.2SP
DD.DD V Range	4.3 SPCL	4.3SP
D.DDD V Range	4.4 SPCL	4.4SP
0.DDDD V Range**	4.5 SPCL	4.5SP
DD.DD mV Range	4.6 SPCL	4.6SP
D.DDD mV Range	4.7 SPCL	4.7SP
0.DDDD mV Range**	4.8 SPCL	4.8SP

\* The decimal point does not appear on the display. It is shown to establish the position it would appear in the numeric value of the readout.

\*\* The zero does not appear on the display. It is shown to clarify the position of the decimal point.

**Example** To hold the decimal point after the first digit of a mV Range (D.DDD mV):

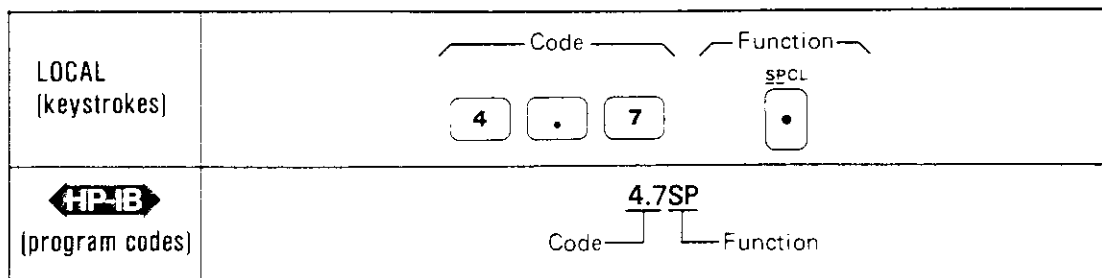

**Program Codes** For HP-IB codes refer to Procedure above.



**Indications** As the numeric code is entered, both displays will blank, and the entered code will appear in the left display. When the SPCL key is pressed, the SPCL key LED will light if it is not already on. If it is already on, it will remain on. The right display will show the amplitude with the decimal held in the position requested. The left display provides the normal information associated with the selected measurement mode.

**Comments** It is possible to use the Hold Decimal Point Special Function to set the display for a readout that exceeds the resolution of the instrument. For example, in the dc level measurement mode, 4.7 SPCL will set the display to a mV range. In this case, the three digits following the decimal point will always be zeros and are not significant digits in the amplitude readout.

**Related Sections** Automatic Operation  
Special Functions

## Hold Settings (Special Function 9)

**Description** The Hold Settings Special Function is used to freeze the instrument in the presently selected settings for the input level ranges, the post-notch gain, the decimal point position, and the notch tuning.

**Procedure** To hold the presently selected settings for the functions above, press 9.0 and then the SPCL key.

**Example** To hold the present settings of the specified functions:

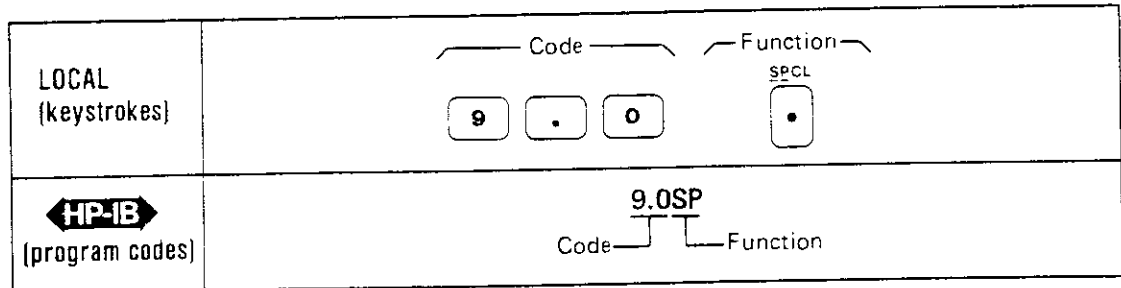

**Program Code** For HP-IB code, refer to Example above.



**Indications** As the numeric code is entered, both displays will blank, and the entered code will appear in the left display. When the SPCL key is pressed, the SPCL key LED will light if it is not already on. If it is already on, it will remain on. The displays will then show the normal readings for the currently selected measurement mode.

**Comments** Using Special Function 9 is equivalent to entering the following Special Functions from the keyboard:

- 1.N Input Level Range (Except DC Level)
- 2.N Input Level Range (DC Level Only)
- 3.N Post-Notch Gain
- 4.N Hold Decimal Point (Right Display Only)
- 6.1 Hold Notch Tuning

For Special Functions 1 through 4, N is set equal to the currently selected value that the instrument is using for that function. These values can be read by using the Special Special Display (refer to Special Functions).

Note that using the Hold Settings Special Function can cause inaccurate measurements under some circumstances.

Once settings have been held by the Hold Settings Special Function, one or more of them can be reset to their automatic modes by issuing the 0 suffix code of the corresponding Special Function code. As an example, Hold Settings places the instrument in hold notch tuning mode. Use 6.0 SPCL to re-enter the automatic notch tuning mode.

**Related Sections** Automatic Operation  
Special Functions



# HP-IB Address

(Special Function 21)

**Description** The Audio Analyzer's present HP-IB address can be displayed by using Special Function 21. This display is in binary or decimal. When in binary (Special Function 21.0), the right display shows whether the instrument is set to talk only or listen only, and whether it is at present issuing a service request. The left display shows the address in binary. When in decimal (Special Function 21.1), the display is shown as "Addr= NN" (where NN is the HP-IB decimal address). The address set at the factory is 28 (11100 in binary).

**Procedure** To display the HP-IB address, key in the appropriate Special Function code on the numeric keys, then press the SPCL key. To clear the display, press the CLEAR key. The instrument then reverts to the previous measurement mode. A list of the Special Function codes is given below:

Display Format	Special Function Code	Program Code 
Binary	21.0 SPCL	21.0SP
Decimal	21.1 SPCL	21.1SP

A list of the allowable addresses for the Audio Analyzer is given below:

**Allowable HP-IB Address Codes**

Address Switches					Talk Address Character	Listen Address Character	Decimal Equivalent
A5	A4	A3	A2	A1			
0	0	0	0	0	@	SP	0
0	0	0	0	1	A	!	1
0	0	0	1	0	B	"	2
0	0	0	1	1	C	#	3
0	0	1	0	0	D	\$	4
0	0	1	0	1	E	%	5
0	0	1	1	0	F	&	6
0	0	1	1	1	G	'	7
0	1	0	0	0	H	(	8
0	1	0	0	1	I	)	9
0	1	0	1	0	J	*	10
0	1	0	1	1	K	+	11
0	1	1	0	0	L	,	12
0	1	1	0	1	M	-	13
0	1	1	1	0	N	.	14
0	1	1	1	1	O	/	15

Address Switches					Talk Address Character	Listen Address Character	Decimal Equivalent
A5	A4	A3	A2	A1			
1	0	0	0	0	P	0	16
1	0	0	0	1	Q	1	17
1	0	0	1	0	R	2	18
1	0	0	1	1	S	3	19
1	0	1	0	0	T	4	20
1	0	1	0	1	U	5	21
1	0	1	1	0	V	6	22
1	0	1	1	1	W	7	23
1	1	0	0	0	X	8	24
1	1	0	0	1	Y	9	25
1	1	0	1	0	Z	:	26
1	1	0	1	1	[	;	27
1	1	1	0	0	\	<	28
1	1	1	0	1	]	=	29
1	1	1	1	0	(	>	30

**Indications** As the numeric code is entered, it will appear on left display. When the SPCL key is pressed, the light within the key will turn on and all measurement key lights and annunciators will turn off. If the 21.0 Special Function was entered, the left display will show a binary number of the form AAAAA where AAAAA is the HP-IB address in binary. The right display will show a binary number of the form TLS where the T, L, and S have the meaning indicated in the table below:



## HP-IB Address (Cont'd)

(Special Function 21)

**Indications  
(Cont'd)**

	T	L	S
<b>0</b>	NOT TALK ONLY	NOT LISTEN ONLY	NOT REQUESTING SERVICE
<b>1</b>	TALK ONLY	LISTEN ONLY	REQUESTING SERVICE

If T and L are both 1, the instrument is set to talk only (talk overrides listen). If all the A digits are set to 1 and T is 1, the instrument will be in talk status only (i.e., output the status byte only). (If all digits AAAAA.TL are 1 but S is 0, the Remote Interface board is not installed.) If the 21.1 Special Function was entered, the left display will show the statement "Addr=" and the right display will show the decimal value of the instrument's HP-IB address (28 if it has not been changed).

**Examples**

To display the HP-IB address in binary and the status of the T, L, and S bits:

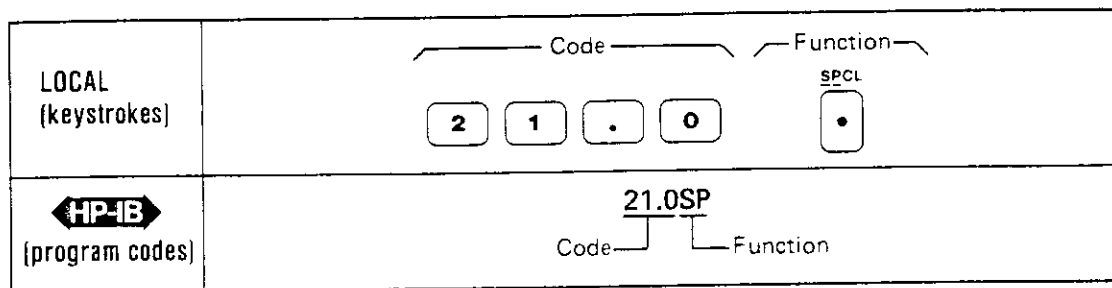

If the following is displayed:

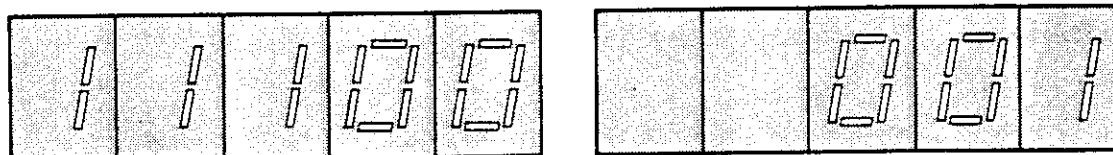

then the HP-IB address is 11100 in binary (28 in decimal). In ASCII, the talk address is \, and the listen address is <. The instrument is not set to talk or listen only, but it is issuing a service request (setting the SRQ control line true).

To display the HP-IB address in decimal:

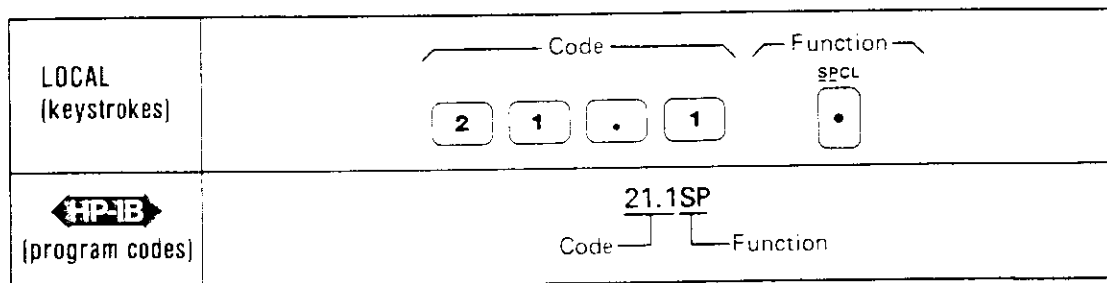



## HP-IB Address (Cont'd)

(Special Function 21)

### Examples (Cont'd)

Assuming the same address, the following will be displayed:

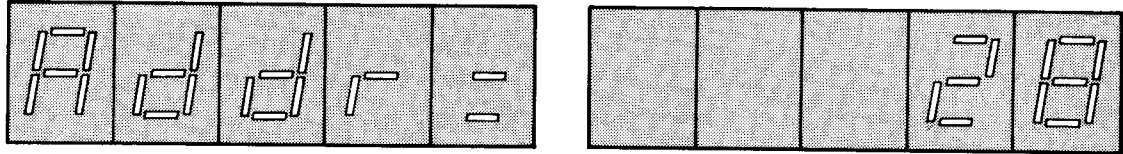

**Program Codes** For HP-IB codes refer to Procedure.



### Comments

The HP-IB address display is continuously updated. This makes setting the address easy since the result of changing a switch setting is immediately visible on the display. For information on setting the HP-IB address of the Audio Analyzer, refer to Section II of this manual. The factory-set address is, as shown in the examples, decimal 28. The T and L bits are set to 0. The S bit powers up at 0.

### Related Sections

Special Functions  
Remote Operation, Hewlett-Packard Interface Bus



# Increment

**Description** The frequency and amplitude of the source can be incremented (or decremented) using the proper combination of the **FREQ**, **FREQ INCR**, **AMPTD**, **AMPTD INCR**,  $\div 10$ ,  $\times 10$ , and **FREQ/AMPTD ADJUST** keys. These keys provide a convenient method of controlling the source when it is used in applications such as locating the 3 dB point of filters and amplifiers.

**Procedure** The general procedure to change the source parameters is to use either the **FREQ INCR** or **AMPTD INCR** key to establish which parameter is to be changed and the initial increment size. The **FREQ/AMPTD ADJUST** keys are then used to modify the source output.

**Examples** To set the amplitude increment to 1.5V:

LOCAL (keystrokes)	
(program codes)	

To increment the currently programmed source amplitude value +1.5V:

LOCAL (keystrokes)	
(program codes)	

To divide the currently programmed amplitude increment by 10 (i.e., to set the amplitude increment to 0.15V):

LOCAL (keystrokes)	
(program codes)	This function is not programmable.

**NOTE**

*In the last two examples above, either the programmed amplitude or amplitude increment would be changed only if either the **AMPTD** or **AMPTD INCR** key was pressed last. If either the **FREQ** or **FREQ INCR** key had been pressed last, the programmed frequency or frequency increment would be changed. Note that when using **HP-IB** program codes, the **UP** or **DN** commands increment or decrement the parameter that was last implemented; for example, **FN** (or **FR**) or **AN** (or **AP**).*

## Increment (Cont'd)

**Program Codes**



Parameter	Program Code 
Frequency Increment	FN
Amplitude Increment	AN
↑ (step up)	UP
↓ (step down)	DN
Frequency Units (Hz, kHz)	HZ, KZ
Amplitude Units (V, mV, dB)	VL, MV, DB

**Indications**

The specific indications depend on the manner in which the keys are pressed. For example, momentarily pressing the **FREQ INCR** key will cause the currently programmed frequency increment to appear in the left display for approximately two seconds. Pressing and holding the **FREQ INCR** key down will cause the currently programmed frequency increment to remain displayed until the key is released. The **AMPTD INCR** key can be used in a similar manner to display the currently programmed value of the amplitude increment. When using the ↑ (step up) or ↓ (step down) keys, the parameter that is incremented depends upon which of the source parameter keys (i.e., **FREQ**, **FREQ INCR**, **AMPTD**, or **AMPTD INCR**) was pressed last. Momentarily pressing ↑ causes the parameter to be incremented one step. The new value of the source parameter can be observed by pressing **FREQ** or **AMPTD** as appropriate. Remember that the programmed values for the source can differ from the displayed measurement values. Pressing and holding the ↑ or ↓ keys down causes the parameter to be stepped continuously. The effect of the change on the measurement results can be seen on the displays.

Pressing the ÷10 or ×10 keys modifies the currently programmed parameter that is active as indicated. Note that to repeat the division or multiplication of the parameter the key must be pressed again. Holding these keys down do not cause additional multiplication or division of the source parameter.

**Comments**

Neither the ÷10 or the ×10 keys are HP-IB programmable.

Remember that all **FREQ/AMPTD ADJUST** key operations depend upon source parameter information previously input to the Audio Analyzer (e.g., **FREQ**, **AMPTD**, etc.).

The amplitude can be incremented in either linear units ( V or mV) or logarithmic units (dB) regardless of the units used to program the amplitude originally.

**Related Sections**

Amplitude  
Frequency

# Input Level Range (DC Level)

## (Special Function 2)

**Description** In all measurement modes the input level range can be manually set by keyboard entry using the SPCL key. The following discussion describes this function for dc level mode only. Refer to Input Level Range (Except DC Level) for additional information. In the automatic operation mode, the input level range is determined by both the dc and ac (if there is one) level of the input signal.

**Procedure** To set the input level range to a selected range or to re-enter the automatic selection mode, key in the corresponding Special Function code, then press the SPCL key.

Input Level Range (Full Scale)	Input Attenuation	Special Function Code	Program Code 
Automatic Selection	—	2.0 SPCL	2.0SP
300V range	40 dB	2.1 SPCL	2.1SP
64V range	24 dB	2.2 SPCL	2.2SP
16V range	12 dB	2.3 SPCL	2.3SP
4V range	0 dB	2.4 SPCL	2.4SP

**Example** To set the input level range to the 16V range:

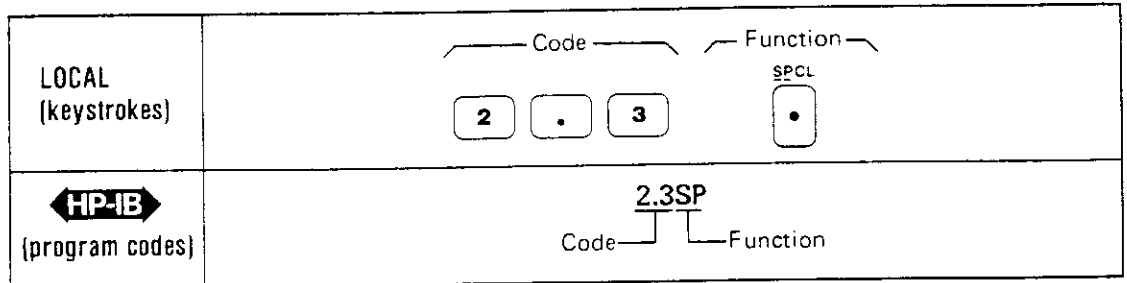

**Program Codes** For HP-IB codes, refer to Procedure above.



**Indications** As the numeric code is entered, it will appear on the left display. When the SPCL key is pressed, the left display blanks out. Note that for all measurement modes except dc level, the left display will return to show the input signal frequency after the SPCL key is pressed. Unless Special Function code 2.0 was entered, the light within the SPCL key will turn on if not already on. If the light is already on, it will remain on.

**Comments** When the Audio Analyzer powers up or when AUTOMATIC OPERATION is selected, the input level range is placed in the automatic selection mode.

If the input level range is set such that the input signal level causes the input overload detector to trip, Error 30 will be displayed.

Manually selecting the gain of the input level circuitry can cause measurement error. Measurement accuracy is not specified whenever the gain of the input level circuitry is manually selected because the selected gain setting may be less than optimum. It is important to note that error messages indicating invalid measurements due to incorrect gain settings are not generated unless overload conditions occur. Automatic operation ensures accurate measurements for all combinations of input signals and measurement modes.

**Related Sections** Automatic Operation DC Level    Input Level Range (Except DC Level) Monitor    Special Functions

## Input Level Range (Except DC Level) (Special Function 1)

**Description** In all measurement modes the input level range can be manually set by keyboard entry using the SPCL key. The following discussion describes this function for all measurement modes except DC Level mode. Refer to Input Level Range( DC Level) for additional information. The input circuitry consists of a programmable attenuator and two programmable amplifiers. In automatic operation mode, the gain of the attenuator-amplifier section of the input is automatically set according to the level of the input signal.

**Procedure** To set the input level range to a selected range or to re-enter the automatic selection mode, key in the corresponding Special Function Code, then press the SPCL key.

Input Level Range (Full Scale)	Special Function Code	Program Code <b>HP-IB</b>
Automatic Selection	1.0 SPCL	1.0SP
300V	1.1 SPCL	1.1SP
189V	1.2 SPCL	1.2SP
119V	1.3 SPCL	1.3SP
75.4V	1.4 SPCL	1.4SP
47.6V	1.5 SPCL	1.5SP
30.0V	1.6 SPCL	1.6SP
18.9V	1.7 SPCL	1.7SP
11.9V	1.8 SPCL	1.8SP
7.54V	1.9 SPCL	1.9SP
4.76V	1.10 SPCL	1.10SP
3.00V	1.11 SPCL	1.11SP
1.89V	1.12 SPCL	1.12SP
1.19V	1.13 SPCL	1.13SP
0.754V	1.14 SPCL	1.14SP
0.476V	1.15 SPCL	1.15SP
0.300V	1.16 SPCL	1.16SP
0.189V	1.17 SPCL	1.17SP
0.119V	1.18 SPCL	1.18SP
0.0754V	1.19 SPCL	1.19SP

**Example** To set the input level range to the 30.0V range:

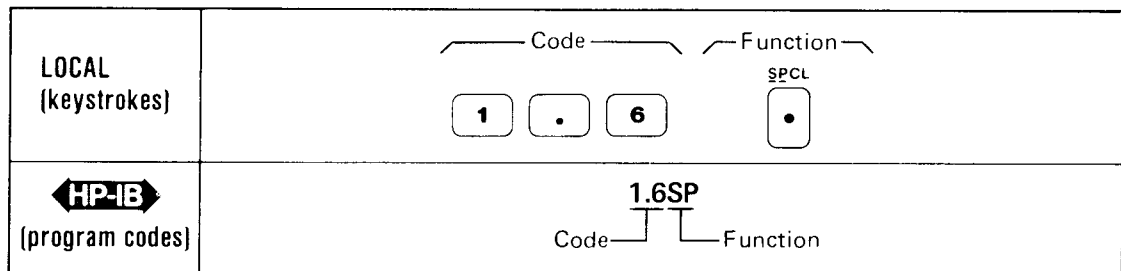

**Program Codes** For HB-IB codes, refer to Procedure above.



# Input Level Range (Except DC Level) (Cont'd) (Special Function 1)

<b>Indications</b>	As the numeric code is entered, it will appear on the left display. When the SPCL key is pressed, the display returns to show the input signal frequency. Unless Special Function code 1.0 was entered, the light within the SPCL key will turn on if not already on. If the light is already on, it will remain on.
<b>Comments</b>	<p>When the Audio Analyzer is first powered up or when AUTOMATIC OPERATION is selected, the input level range is placed in the automatic selection mode. If the input level range is set such that the input signal level creates an overrange condition, an error message will be displayed. The error message generated depends on instrument settings and the input signal level. For example, if the input level range is set such that the input signal level causes the input overload detector to trip, Error 30 will be displayed. For a complete listing of the error messages, refer to Error Message Summary.</p> <p>Manually selecting the gain of the input level circuitry can cause measurement error. Measurement accuracy is not specified whenever the gain of the input level circuitry is manually selected because the selected gain setting may be less than optimum. It is important to note that error messages indicating invalid measurements due to incorrect gain settings are not generated unless overload conditions occur. Automatic operation ensures accurate measurements for all combination of input signals and measurement modes.</p>
<b>Related Sections</b>	AC Level Automatic Operation Input Level Range (DC Level) Monitor Special Functions

# Monitor

**Description** The rear-panel MONITOR output provides a means of monitoring the ac signal into the output rms detector. The auto-ranging MONITOR output level is normally a 0.3 to 3 V<sub>rms</sub> signal which is proportional to the input signal. In ac level and dc level the MONITOR output provides a scaled representation of the ac component of the input signal. In SINAD, distortion, and distortion level the MONITOR output provides a scaled representation of the input signal with the fundamental removed. The output is dc coupled with a 600 ohm output impedance and a BNC female connector. The MONITOR output can be used to drive other test instruments, such as an oscilloscope, wave analyzer, or spectrum analyzer for further analysis.

**Block Diagram** A simplified block diagram of the Audio Analyzer measurement circuits illustrating the relationships between the MONITOR output and the other circuit blocks is shown below. The MONITOR output block diagram illustrates the signal path from the INPUT to the MONITOR output. The diagram is that of a programmable gain amplifier with a tunable notch filter. In ac level, dc level, and signal-to-noise, the notch filter is bypassed. In SINAD, distortion, and distortion level the notch filter is switched into the signal path, removing the fundamental frequency.

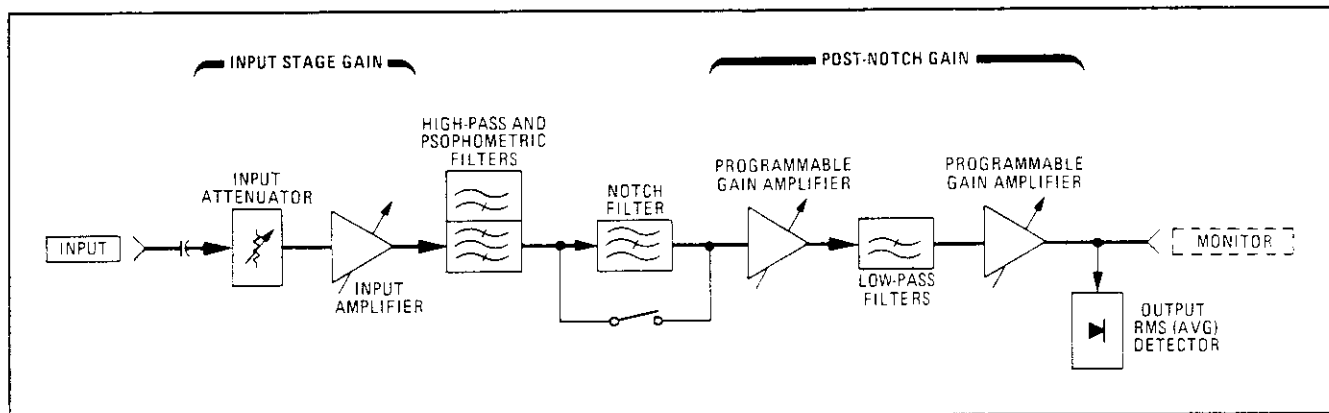

Monitor Output Block Diagram

**Comments** The MONITOR output gain and sensitivity (that is, the net signal gain from the INPUT to the MONITOR output) are dependent on the input stage gain and the post-notch gain. Both the input stage gain and the post-notch gain can be determined by viewing the Special Special Display (refer to Special Functions).

The input stage gain and post-notch gain for various instrument settings are listed in the tables below.

# Monitor (Cont'd)

Comments  
(Cont'd)

INPUT STAGE GAIN (except dc)			
Special Special Display 1.NN	Input Level Range	Gain	
		Log (dB)	Linear
1.1	300V	-40	0.0100
1.2	189V	-36	0.0158
1.3	119V	-32	0.0251
1.4	75.4V	-28	0.0398
1.5	47.6V	-24	0.0631
1.6	30.0V	-20	0.1000
1.7	18.9V	-16	0.1585
1.8	11.9V	-12	0.2512
1.9	7.54V	-8	0.3981
1.10	4.76V	-4	0.6310
1.11	3.00V	0	1.00
1.12	1.89V	+4	1.58
1.13	1.19V	+8	2.51
1.14	0.754V	+12	3.98
1.15	0.476V	+16	6.31
1.16	0.300V	+20	10.00
1.17	0.189V	+24	15.85
1.18	0.119V	+28	25.12
1.19	0.0754V	+32	39.81

POST-NOTCH GAIN		
Special Special Display 3.N	Gain	
	Log (dB)	Linear
3.1	0	1
3.2	+20	10
3.3	+40	100
3.4	+60	1000

The measurement system net gain equals the combined gain of the two stages. To calculate the net gain use the following formulas:

$$\text{Net Gain (LOG)} = \text{Input Stage Gain (LOG)} + \text{Post-Notch Gain (LOG)}$$

or

$$\text{Net Gain (LIN)} = \text{Input Stage Gain (LIN)} \times \text{Post-Notch Gain (LIN)}$$

In ac level the MONITOR output is a scaled replica of the input signal. The MONITOR output level is calculated as:

$$V_{out} = V_{in} \times \text{Net Gain}$$

where  $V_{in}$  is the input signal level and the linear net gain is used.

In SINAD, distortion, and distortion level, the fundamental frequency is removed (suppressed by more than 80 dB). The output after the notch filter includes all harmonics of the fundamental plus any noise, hum, and other spurious signals that may be present. These signal impurities are amplified and are available at the MONITOR for further analysis.

## Monitor (Cont'd)

### Comments (Cont'd)

The following equations express the MONITOR output level as a function of the parameter being measured (the displayed reading). (Use linear Net Gain.)

For distortion:

$$V_{\text{out}} = \frac{\text{Displayed Reading (in \%)} \times V_{\text{in}} \times \text{Net Gain}}{100}$$

or

$$V_{\text{out}} = 10^{\text{Displayed Reading (in dB)}/20} \times V_{\text{in}} \times \text{Net Gain}$$

For distortion level:

$$V_{\text{out}} = \text{Displayed Reading (in volts)} \times \text{Net Gain}$$

or

$$V_{\text{out}} = 10^{\text{Displayed Reading (in dB)}/20} \times \text{Net Gain}$$

For SINAD:

$$V_{\text{out}} = \frac{100}{\text{Displayed Reading (in \%)}} \times V_{\text{in}} \times \text{Net Gain}$$

or

$$V_{\text{out}} = 10^{-|\text{Displayed Reading (in dB)}|/20} \times V_{\text{in}} \times \text{Net Gain}$$

In the above equations  $V_{\text{out}}$  is the MONITOR output level as measured with a true rms voltmeter and  $V_{\text{in}}$  is the input signal level.

In the SIG/NOISE measurement mode the source is turned on and off. Therefore the signal level at the MONITOR output is constantly alternating.

The MONITOR output does not respond to dc signals presented at the INPUT. In the dc level measurement mode only the ac components of the input signal are presented at the MONITOR output.

### Related Sections

- AC Level
- DC Level
- Distortion
- Distortion Level
- Input Level Range (DC Level)
- Input Level Range (Except DC Level)
- Signal-to-Noise
- SINAD
- Special Functions



# Notch Tune

## (Special Function 6)

**Description** In distortion and distortion level modes, the Audio Analyzer automatically tunes the notch filter to the input frequency. In the SINAD mode, the notch filter is tuned to the frequency of the internal source. However, by means of keyboard entry using the SPCL key, the notch filter can be held to the current notch filter frequency setting.

**Procedure** To freeze the notch filter enter Special Function code 6.1, then press the SPCL key. To return to the automatic tuning mode press the AUTOMATIC OPERATION key or key in the Special Function code 6.0, then press the SPCL key.

Notch Tune	Special Function Code	Program Code <b>HP-IB</b>
Automatic Notch Tuning	6.0 SPCL	6.0SP
Hold Notch Tuning	6.1 SPCL	6.1SP

**Example** To freeze the notch filter:

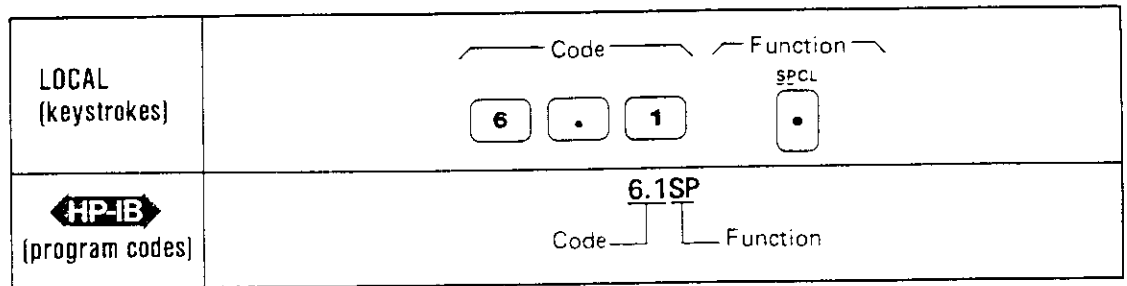

**Program Codes** For HP-IB codes, refer to the Procedure above.



**Indications** As the numeric code is entered, it will appear on the left display. When the SPCL key is pressed, the display returns to show the input signal frequency. When Special Function code 6.1 is entered and the SPCL key is pressed, the LED within the SPCL key will turn on. The LED will not turn on for Special Function code 6.0.

**Comments** When the Audio Analyzer first powers up or when AUTOMATIC OPERATION is selected, the Audio Analyzer is placed in the automatic notch tuning mode.

In the automatic tuning mode the Audio Analyzer counts the frequency of the input signal, then coarsely tunes the notch filter to that frequency. The notch filter is then fine tuned via circuitry internal to the notch filter. In the hold tune mode, the notch filter is no longer coarsely tuned, however the fine tune circuitry still remains operational. Thus the notch filter still automatically tunes, but now over a limited range. In the hold tuning mode the tuning or nulling range of the notch filter is approximately 5% of the frequency of the original notch filter setting.

**Related Sections**

- Automatic Operation
- Distortion
- Distortion Level
- SINAD
- Special Functions

# Plot Limit

**Description** The PLOT LIMIT, UPPER LIMIT, LOWER LIMIT, and the numeric data keys are used to program the upper and lower plot limits. The upper and lower plot limits correspond to the respective upper and lower scaling points of an X-Y plot. For more information on X-Y plots, refer to X-Y Recording. The Y-axis scaling is determined by the displayed measurement unit in the right display and the programmed upper and lower plot limit. The PLOT LIMIT key can be also used to display the currently programmed upper and lower plot limits.

**Procedure** To enter new plot limits, first press the PLOT LIMIT key to initiate entries. To enter an upper plot limit, press the appropriate numeric data keys, then the UPPER LIMIT key. Similarly, to enter a lower plot limit, press the appropriate numeric data keys, then the LOWER LIMIT key. Once the PLOT LIMIT key has been pressed, new plot limits can be successively entered until another source function key (for example, **FREQ** key) is pressed. To display the currently programmed plot limits press and hold the PLOT LIMIT key.

**Example** To enter an upper plot limit of 20 and a lower plot limit of -10:

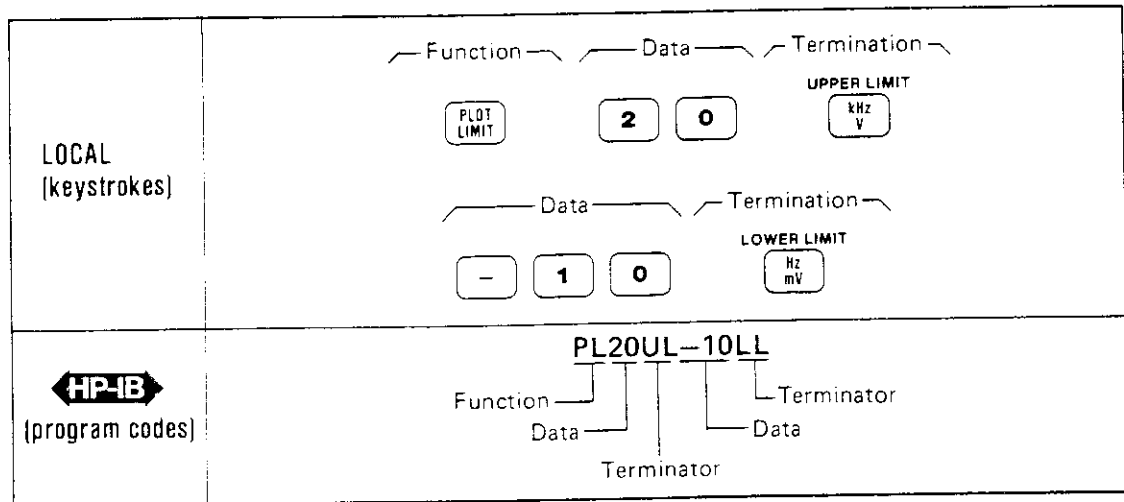

**Program Codes**

Key	Program Code
PLOT LIMIT	PL
UPPER LIMIT	UL
LOWER LIMIT	LL

**Indications** When the PLOT LIMIT key is pressed, both displays will show the currently programmed plot limits. The upper limit appears on the right display and the lower limit appears on the left display. As a new upper or lower plot limit is entered, it will appear on the left display. When the UPPER LIMIT or LOWER LIMIT key is pressed, the left display returns to show the input signal frequency and the right display returns to show the measurement previously selected.

**Comments** The Audio Analyzer powers up with an upper and lower plot limit of 100 and -100 respectively.

The plot limit values can range from -1099 to 1099 in steps of 0.001. The values entered for the upper and lower plot limits are dimensionless. The plot limit units are

## Plot Limit (Cont'd)

### Comments (Cont'd)

the same as the right display measurement unit. For example, if an upper plot limit of 20 and a lower plot limit of -10 are entered and the measurement result is displayed in dB, the upper plot limit would correspond to 20 dB and the lower plot limit would correspond to -10 dB. If the measurement result had been displayed in % instead of dB, the upper plot limit would have corresponded to 20% while the lower plot limit would have corresponded to -10%. The plot limit units can be any of the following fundamental units: V, dB, dBV, and %. Note that, mV cannot be used as a plot limit unit.

If the upper and lower plot limits are identical and the SWEEP key is pressed, Error 25 will be displayed. If plot limits are entered whereby the lower limit is greater than the upper limit, no error code is displayed. In this case, the Y-axis output ranges from approximately 10 Vdc for the lower plot limit value to 0 Vdc for the upper plot limit value, and the X-Y plot obtained is simply inverted. For example, if an upper plot limit of -10 and a lower plot limit of 20 are entered, and the measurement result is displayed in dB, the upper plot limit would correspond to -10 dB, and the lower plot limit would correspond to 20 dB.

### Related Sections

X-Y Recording  
RATIO and LOG/LIN

## Post-Notch Detector Response (Except SINAD)

(Special Function 5)

**Description** The Audio Analyzer normally makes audio measurements using a fast-responding detector. By means of keyboard entry using the SPCL key, additional low-pass filtering can be added after the post-notch detector. The additional low-pass filtering (slow detector) is useful in stabilizing measurements on unstable or noisy signals or whenever display jitter is considered excessive.

**Procedure** To change the Audio Analyzer post-notch detector response from fast to slow or vice versa, enter the corresponding Special Function code, then press the SPCL key.

Post-Notch Detector Response	Special Function Code	Program Code <b>HP-IB</b>
Fast Detector	5.0 SPCL	5.0SP
Slow Detector	5.1 SPCL	5.1SP

**Example** To enter a slow detector response mode:

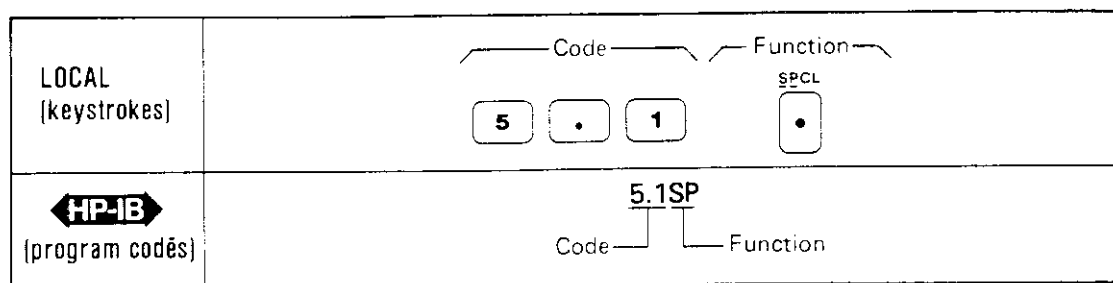

**Program Codes** For HP-IB codes, refer to the Procedure above.



**Indications** As the numeric code is entered, it will appear on the left display. When the SPCL key is pressed, the display returns to show the input signal frequency. When Special Function code 5.1 is entered and the SPCL key is pressed, the LED within the SPCL key will turn on if not already on. If the light is already on, it will remain on. The LED will not turn on if Special Function code 5.0 is entered.

**Comments** When the Audio Analyzer is first turned on or when AUTOMATIC OPERATION is selected, the fast detector is selected.

In SINAD the slow detector response is always used. The fast detector cannot be selected by means of keyboard entry using the SPCL key when in SINAD.

**Related Sections** Automatic Operation  
Special Functions

# Post-Notch Gain

## (Special Function 3)

**Description** The overall stage gain of the post-notch circuit can be manually set by keyboard entry using the SPCL key. The gain is selectable from 0 dB to 60 dB in 20 dB steps. In automatic operation mode, the instrument will automatically select the optimum post-notch gain.

**Proceasure** To manually set the gain of the post-notch circuit or to re-enter the automatic selection mode, key in the corresponding Special Function code, then press the SPCL key.

Post-Notch Gain	Special Function Code	Program Code ◀HP-IB▶
Automatic Selection	3.0 SPCL	3.0SP
0 dB gain	3.1 SPCL	3.1SP
20 dB gain	3.2 SPCL	3.2SP
40 dB gain	3.3 SPCL	3.3SP
60 dB gain	3.4 SPCL	3.4SP

**Example** To set the post-notch gain to 40 dB:

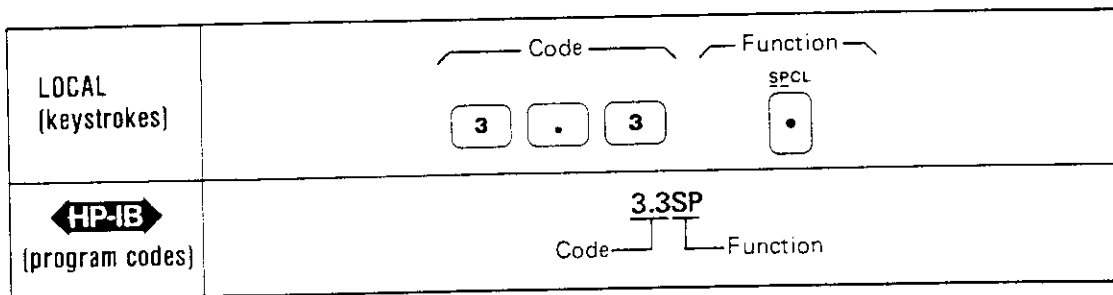

**Program Codes** For HP-IB codes, refer to Procedure above.



**Indications** As the numeric code is entered, it will appear on the left display. When the SPCL key is pressed, the display returns to show the input signal frequency. Unless Special Function code 3.0 was entered, the light within the SPCL key will turn on if not already on. If the light is already on, it will remain on.

**Comments** When the Audio Analyzer is first powered up or when AUTOMATIC OPERATION is selected, the Audio Analyzer is placed in the automatic selection mode. If the post-notch gain is set such that the input signal level causes the post-notch circuitry to be overdriven, four dashes will be displayed on the right display. If this overload condition is not corrected within 128 measurement cycles, Error 31 will be displayed. Manually selecting the gain of the post-notch circuit can cause measurement error. Measurement accuracy is not specified whenever the gain of the post-notch circuitry is manually selected because the selected gain setting may be less than optimum. It is important to note that error messages indicating invalid measurements due to incorrect gain settings are not generated unless overload conditions occur. Automatic operation ensures accurate measurements for all combination of input signals and measurement modes.

**Related Sections**

Automatic Operation  
Monitor

Special Functions

# Rapid Frequency Count

**Description** Rapid Frequency Count mode allows a remote controller to partially bypass the Audio Analyzer's own internal controller. The advantage is that frequency count measurements can be obtained from the Audio Analyzer much more quickly. The data obtained, however, is in a packed binary form, and thus requires additional processing to produce the final results in hertz. Once the Rapid Frequency Count mode is entered, data will be placed on the bus in four-byte sequences until the mode is terminated. Rapid Frequency Count mode is terminated whenever the Audio Analyzer receives a bus command or whenever it is sent new programming data.

**Procedure** To use the Rapid Frequency Count mode, the remote controller must be able to read the four-byte compacted frequency data using a binary specifier. First, place the Audio Analyzer into the ac level measurement mode, set it to measure the input signal (i.e., the signal before the notch filter), and to trigger with settling. The HP-IB codes for this configuration are M146.1SPT3. Next, issue the HP-IB code for Rapid Frequency Count (RF) and then read the frequency data from the Audio Analyzer. The Audio Analyzer does not send carriage return, line feed, or any other characters as delimiters.

The frequency data will be in the form shown below:

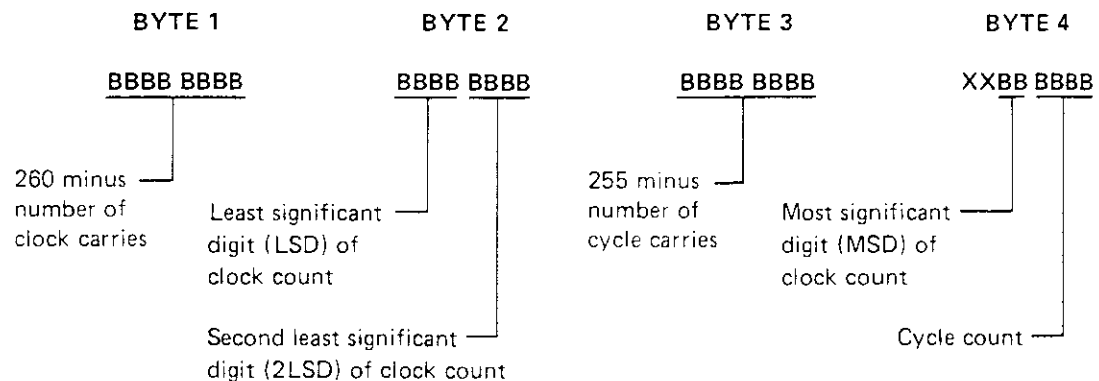

To obtain the frequency, compute:

$$\text{Total clock counts} = \text{LSD} + 16(2\text{LSD}) + 256(\text{MSD}) + 1024(260 - \text{BYTE 1})$$

$$\text{Total cycle counts} = \text{Cycle count} + 16(255 - \text{BYTE 3})$$

$$\text{Frequency} = \frac{\text{Total cycle counts}}{\text{Total clock counts}} \times (2 \cdot 10^6)$$

Where:

LSD = Least significant digit of clock count

2LSD = Second least significant digit of clock count

MSD = Most significant digit of clock count.

Using a Hewlett-Packard Model 9825A Desktop Computer, the computation is set up in five steps as shown below.

- 0: wrt 728, "RF"
- 1: fmt , z, 4b; red 728, r1, r2, r3, r4
- 2: shf (r2, 4) +16 (band (r2, 15) + band (r4, 48) ) +1024 (260-r1) → r5
- 3: band (r4, 15) +16 (255-r3) → r6
- 4: 2e6r6/r5→B; dsp B

## Rapid Frequency Count (Cont'd)

### Procedure (Cont'd)

- 0: Place the Audio Analyzer in the Rapid Frequency Count mode (RF).
- 1: Establish a format suitable for reading four binary bytes from the Audio Analyzer. Take the readings and store the value in four "r" variables. The value stored is the decimal equivalent of the binary word.
- 2: Shift various bytes around and weight their value by the proper amount (in accordance with the routine given) to obtain the number of Audio Analyzer clock counts. Assign that value to variable "r5".
- 3: Position bits correctly and weight appropriately to determine the number of cycle counts. Assign that value to variable "r6".
- 4: Since the Audio Analyzer uses a reciprocal counter the frequency of the input signal equals the number of input cycles (r6) divided by total time elapsed during these input cycles. The denominator is determined by counting the number of 2 MHz clock counts that occur during these input cycles and multiplying by the frequency of the clock (2 MHz). Total time equals number of clock counts divided by  $2 \cdot 10^6$ .

$$\text{Total time (seconds)} = \frac{r5}{2 \cdot 10^6}$$

$$\text{Thus:} \\ \text{Input frequency (Hz)} = \frac{r6}{r5/2 \cdot 10^6} = \left( \frac{r6}{r5} \right) \times 2 \cdot 10^6$$

**Program Code** Program Code RF is the HP-IB code that initiates the Rapid Frequency Count mode.



### Indications

When in Rapid Frequency Count mode, the Audio Analyzer's left display will show "— — — — —" (five dashes).

### Comments

The major advantage of Rapid Frequency Count mode is that data can be taken in rapid sequence and stored in an array in the computing controller. Then, at a later time when operations do not require immediate controller attention, the packed binary data can be converted into decimal frequency data. This way the time required for the Audio Analyzer to process the data into decimal frequency is eliminated. This greatly increases its measurement speed for measuring tone burst sequences.

### Related Section

Rapid Source



## Rapid Source

**Description** Rapid Source mode allows a remote controller to partially bypass the Audio Analyzer's internal controller and tune the source portion of the instrument directly. The main advantage of this function is that by directly controlling the source with binary data, the time the Audio Analyzer's controller needs to convert decimal frequency information to the binary control data is eliminated. Typically, in this mode, the source can be programmed in less than three milliseconds. This makes generation of tone burst sequences practical.

**Procedure** To use the Rapid Source mode, two procedures must be performed. First, the packed binary tuning data must be obtained from the Audio Analyzer. Second the instrument is placed into the Rapid Source mode and the five-byte binary tuning data is sent.

### NOTE

*When using the 55, 56, and 57 Special Functions, entering 55. SPCL, 56. SPCL, and 57. SPCL will give a readback of the present instrument settings. Entering 55.0 SPCL, 56.0 SPCL, and 57.0 SPCL will actually set the instrument settings to 0. This is a different default condition than is used with most Special Functions. Normally, omitting the 0 following the decimal has the same result as entering it. However, in the case of 55, 56, and 57 Special Functions, two different functions are performed. For additional information refer to the Service Special Functions in Section VIII.*

**Acquiring the Tuning Data.** Three values must be acquired from the Audio Analyzer: coarse tune data, fine tune data, and range data. To do this, first tune the Audio Analyzer to the desired frequency either manually or via the HP-IB. Then use the 55., 56., and 57. Special Functions to determine the range, coarse tune, and fine tune values respectively. Then build the five-byte sequence as follows:

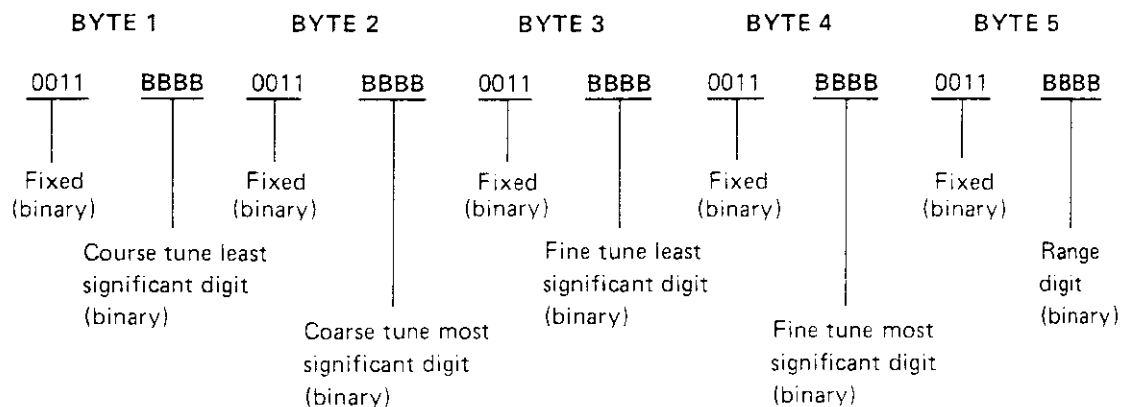

As shown above, the upper four bits of each byte sent to the Audio Analyzer are always 0011. This places the resulting codes in the ASCII range of "0" (decimal 48) to "?" (decimal 63). (Refer to Table 3-9, Commonly Used Code Conversions.) To build the five-byte sequence, convert the decimal data obtained via the Special Functions into binary. In the case of the coarse and fine tune data, split the eight bits into two groups of four (representing the most and least significant digits). Insert each four-bit packet into its respective byte.





# Rapid Source (Cont'd)

## Procedure (Cont'd)

### NOTE

*The binary data obtained to tune the Audio Analyzer to a particular frequency may vary both with warm up and between instruments. Therefore, when maximum accuracy is desired, it is recommended that this data be reacquired approximately each hour or each time a different Audio Analyzer is used.*

**Entering and Terminating Rapid Source Mode.** Rapid Source mode is entered immediately when the Audio Analyzer receives the HP-IB code RS. Rapid Source mode is terminated whenever any Audio Analyzer front-panel key is pressed or whenever the Attention bus control line is set true (i.e., whenever any bus command or talk or listen address is placed onto the bus).

### NOTE

*Once the Rapid Source code has been issued to the Audio Analyzer, no bus activity should occur until the tuning is completed. Bus activity will cause the Rapid Source mode to be prematurely terminated.*

## Example

To obtain the tuning data to tune the Audio Analyzer to 1000 Hz, first tune the Audio Analyzer by conventional techniques:

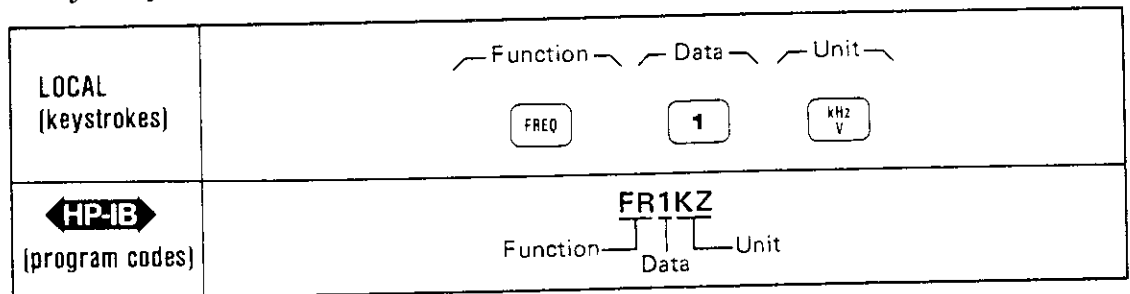

Now use the Special Functions to obtain the tuning data. First get the range data:

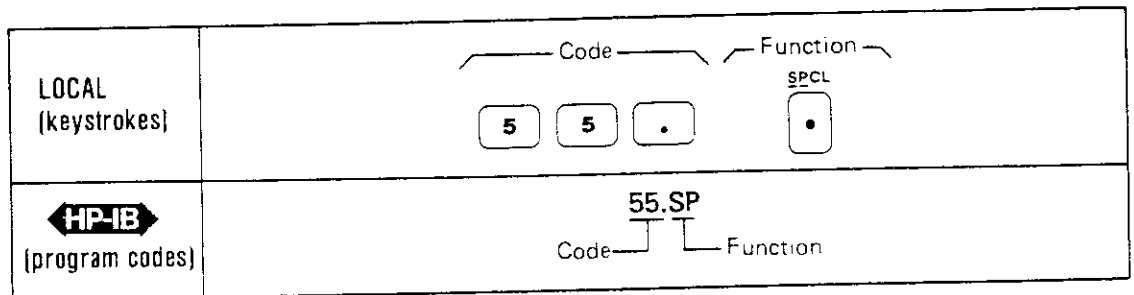

For example, the right display on the Audio Analyzer shows a 1 (decimal) which equals 0001 in binary.



## Rapid Source (Cont'd)

**Example  
(Cont'd)**

Now obtain the coarse tune data:

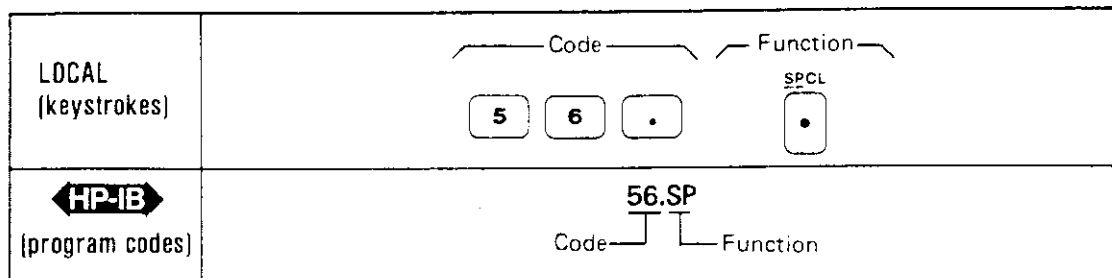

For example, the right display reads 147 (decimal) which equals 1001 0011 in binary.

Now, obtain the fine tune data:

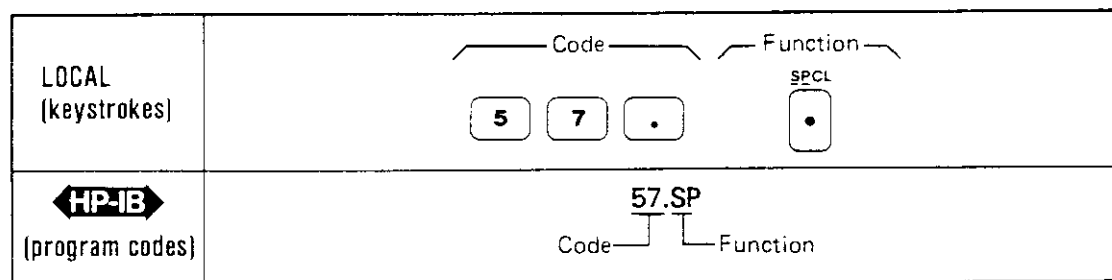

For example, the right display reads 128 (decimal) which equals 1000 0000 in binary.

Now combine the data into the required five-byte sequence:

Range (55. SPCL) = 1 (decimal) =	0001
Coarse Tune (56. SPCL) = 147 (decimal) =	1001 0011
	(MSD) (LSD)
Fine Tune (57. SPCL) = 128 (decimal) =	1000 0000
	(MSD) (LSD)

## Rapid Source (Cont'd)

**Example (Cont'd)**

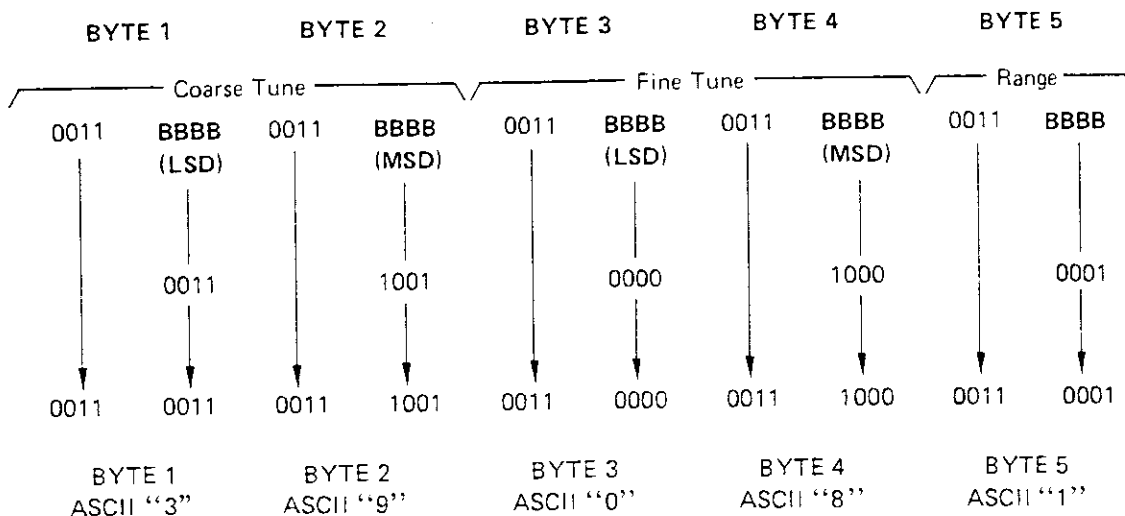

To select the Audio Analyzer's Rapid Source mode, issue the HP-IB code "RS". To tune the Audio Analyzer to 1 kHz in the Rapid Source mode, issue the ASCII string "39081".

Using a Hewlett-Packard Model 9825A Desktop Computer, issue the command:  
*wrt 728, "RS39081"*

When using a series of Rapid Source mode commands to create a tone burst, issue delays between commands. For example, when using an HP 9825A, to obtain an approximate delay of 200 ms, issue the command:  
*wait 200*

**Program Codes** RS is the program code for initiating the Rapid Source tuning mode. The table below summarizes the Special Functions needed to acquire the tuning data.

**HP-IB**

Function	Program Code <b>HP-IB</b>
Range	55.SP
Coarse Tune	56.SP
Fine Tune	57.SP

**Indications** When in Rapid Source mode, the Audio Analyzer's left display shows "-----" (five dashes).

**Comments** Within a single frequency range, frequency switching is phase-continuous. In the Rapid Source mode, the Audio Analyzer's leveling circuitry is disabled. For frequencies between 200 Hz and 5 kHz, the level errors are typically less than 5% (0.5 dB).

**Related Section** Rapid Frequency Count



## RATIO and LOG/LIN

### (Special Function 11)

#### Description

The RATIO key can be used to compare any measurement (except frequency) to a reference value. The reference value can be the result of a previous measurement or a keyboard entry. The LOG/LIN (logarithmic/ linear) key can be used to express the results in logarithmic or linear units. The following table shows which units are applicable to the individual measurement modes:

Measurement Mode	RATIO On		RATIO Off*	
	LIN	LOG	LIN	LOG
AC LEVEL	%	dB	V or mV*	dBV
DC LEVEL	%	dB	V or mV	dBV
SINAD	%	dB	%	dB*
SIG/NOISE	%	dB	%	dB
DISTN	%	dB	%*	dB
DISTN LEVEL	%	dB	V or mV*	dBV

\*After initial power on, switching measurement mode results in the configuration indicated by the asterisks. In subsequent operations, the last setting of the LOG/LIN key is remembered for each measurement mode and applied to the new measurement.

When the RATIO LED is on, the measurement result is compared to a reference value. The reference value can be the result of a previous measurement or a keyboard entry. The LOG/LIN key allows any measurement result to be viewed in linear or logarithmic format.

The Audio Analyzer stores only one ratio reference at a time. When in ratio, if a new measurement is selected, ratio is disabled.

When returning to the previous measurement, it is possible to re-enter the ratio mode with the same factor as before using Special Function 11.0. Additionally, the ratio reference can be displayed using Special Function 11.1.

#### Procedure

To use the RATIO key, set the display to the desired reference value. This can be done by adjusting the signal parameter being measured to a reference setting or by entering the reference on the numeric keys and then pressing RATIO. If the numeric keys are used to enter the ratio reference, the entry must be made in fundamental units (e.g., for a ratio reference of 60 mV enter .06 regardless of the displayed value). The display will show the measurement result relative to the reference value. The units used with the right display depend upon the setting of the LOG/LIN key (see table above). Pressing the LOG/LIN key alternates the display between the LOG and the LIN functions. When the measurement modes is changed, the last setting of the LOG/LIN key for that mode is remembered and applied to the new measurement.

To re-enter ratio with the previous ratio reference or to read the reference, key in the corresponding Special Function code, and press the SPCL key. The Special Function codes are listed as follows:



# RATIO and LOG/LIN (Cont'd)

## (Special Function 11)

Ratio Operation	Special Function Code	Program Code
Re-enter ratio with the previous reference.	11.0 SPCL	11.0SP
Read ratio reference.	11.1 SPCL	11.1SP

**Examples**

If the display shows 100 mV, to enter this value as the RATIO reference for future measurements:

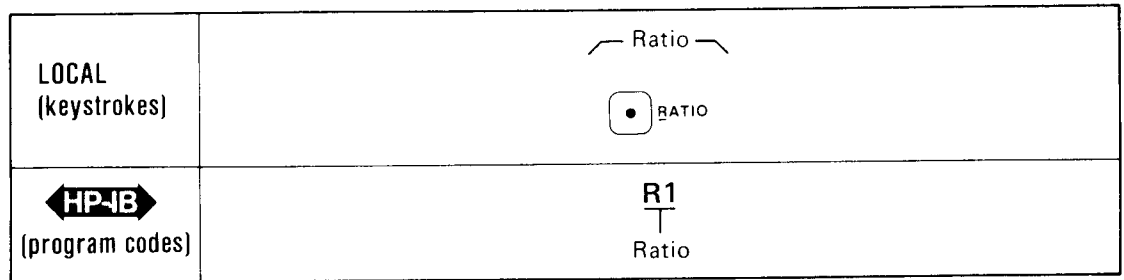

If the display shows 0.100V, to compare this to a value of 2V:

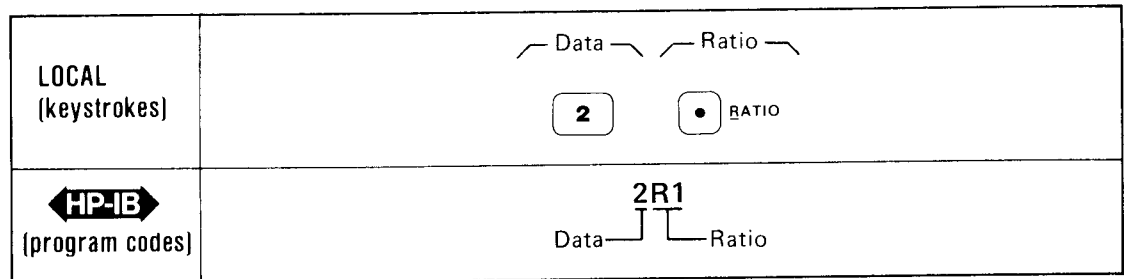

**Program Codes** The HP-IB codes for re-entering ratio or for reading the reference are given above. The HP-IB codes for the RATIO and LOG/LIN keys are given below:



Function	Program Code
LOG	LG
LIN	LN
RATIO Off	R0
RATIO On	R1

**Indications**

When the instrument is displaying a ratio measurement, the RATIO key lights. The status of the LOG/LIN key can be determined by observing the the current measurement mode, the measurement unit lights, and the table above.

**Comments**

The ratio mode can also be used to view an extra digit of resolution when the right display is only showing three digits. Depending upon the current value displayed, pressing either 100 RATIO or 1 RATIO will cause an unscaled right display readout (i.e., the numbers are correct but the decimal point may not be in the correct position). However, an extra digit of resolution is displayed (e.g., if 1.58 was originally dis-



## RATIO and LOG/LIN (Cont'd)

(Special Function 11)

### Comments (Cont'd)

played, the new display might indicate 1.576). Note that the units annunciator will change to % and should be interpreted properly.

Ratio cannot be used with a frequency measurement. Also, if a negative reference is entered, the ratio indication will be displayed in absolute (unsigned) value.

The LOG function cannot be used with a reference that is zero or negative. If the reference is zero, Error 20 (entered value out of range) is displayed. If the reference is negative, Error 11 (calculated value out of range) is displayed.

### Related Sections

AC Level

DC Level

Distortion

Distortion Level

Error Message Summary

Signal-to-Noise

SINAD

Special Functions



## Read Display to HP-IB (Cont'd)

(Special Function 20)

### HP-IB Output (Cont'd)

Data is always output in fundamental units (i.e., Hz, %, dB, or V).

Error messages and the voltage value in dc level mode are always read out regardless of the status of the Read Display to HP-IB commands.

**Related Section** Special Functions



# Service Request Condition

## (Special Function 22)

**Description**

The Audio Analyzer will issue a Require Service message under various circumstances. For example, a Require Service message will always be issued if an HP-IB code error occurs. Using the keyboard and the SPCL key, the operator may enable one or more conditions to cause the Require Service message to be issued. Whenever the enabled condition occurs, it sets both the bit corresponding to the condition and bit 7 (RQS bit) in the Status Byte. The bits set in the status byte and the Require Service message are not cleared unless the status byte is read (by serial polling), a Clear message is received and executed by the Audio Analyzer, or a Controller Reset or Controller Clear Service Special Function is performed. The enabled Service Request conditions are always disabled again whenever a Clear message is received and executed by the Audio Analyzer or whenever a Controller Reset or Controller Clear Service Special Function is performed. Automatic operation does not clear a Require Service message.

**Procedure**

To enable one or more conditions to cause the Audio Analyzer to issue a Require Service message, sum the weights of the conditions to be enabled (from the table below). This sum becomes the code suffix of Special Function 22. Enter the Special Function code (prefix, decimal, and suffix) via the numeric keyboard, then press the SPCL key. An HP-IB code error (weight 2) will always cause a Require Service message. This condition cannot be disabled, and if the weight is not summed in, it will be assumed by the instrument.

Condition	Weight
Data ready	1
HP-IB code error	2
Instrument error	4

**Example**

To set the Audio Analyzer to send a Require Service message when an instrument error occurs (or when an HP-IB code error occurs) first compute the Special Function suffix by summing the weights corresponding to those conditions:

$$(2)+4 = 6$$

Then enter the code:

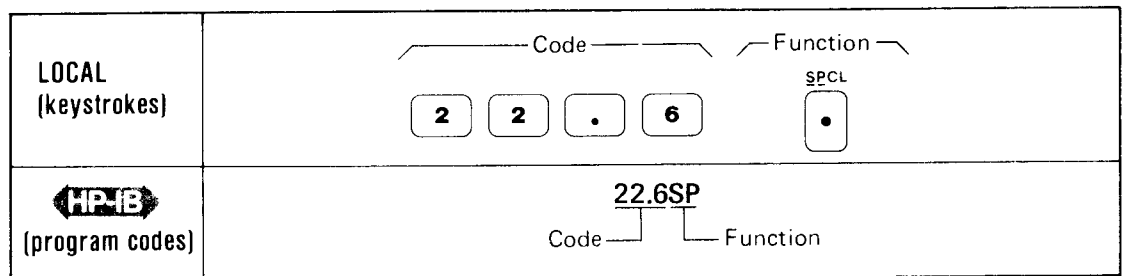

**Program Codes** Compute the Special Function code as described under Procedure above. SP is the HP-IB code for the SPCL key.







## Service Request Condition (Cont'd)

### (Special Function 22)

#### Indications

As the numeric code is entered, it will appear on the front-panel display. When the SPCL key is pressed, the display returns to show the measurement previously selected. Special Function 22 has no effect on the SPCL key light. When any enabled condition occurs, both the RQS bit and the bit corresponding to the enabled condition are set in the status byte, and the SRQ control line on the HP-IB will be set true. The Audio Analyzer's status byte is shown below for reference.

Audio Analyzer's Status Byte

Bit	8	7	6	5	4	3	2	1
Weight	128	64	32	16	8	4	2	1
Condition	0 (always)	RQS	0 (always)	0 (always)	0 (always)	Instru- ment Error	HP-IB Code Error	Data Ready

#### Comments

For more information on HP-IB operation, serial polling, and the Status Byte message, refer to the HP-IB discussion titled HP-IB Operation appearing earlier in Section III of this manual.

The HP-IB Address Special Function provides a convenient means to determine at any time whether a Require Service message is being issued by the Audio Analyzer.

#### Related Sections

HP-IB Address  
HP-IB Operation (appears earlier in Section III)

# Signal-to-Noise

**Description** The instrument uses its internal source to make signal-to-noise measurements. The source is set to a specified value and alternately turned on and off. The measurement is made by first determining the following value:

$$D = \frac{\text{signal} + \text{noise}}{\text{noise}}$$

D is then converted into the appropriate measurement units as follows:

$$\% \text{ units} = D \times 100\%$$

$$\text{dB units} = 20\log D$$

The **RATIO** key can be used to compare these values to a predetermined ratio reference (refer to **RATIO** and **LOG/LIN**).

The signal-to-noise measurement can be made on source signals from 50 Hz to 100 kHz and from 50 mV to 300V.

**Procedure** Set the internal source to the desired frequency and amplitude. Press the **S** (Shift) key and then the **SIG/NOISE** key.

**Example** To make a signal-to-noise measurement at 1V and 1 kHz:

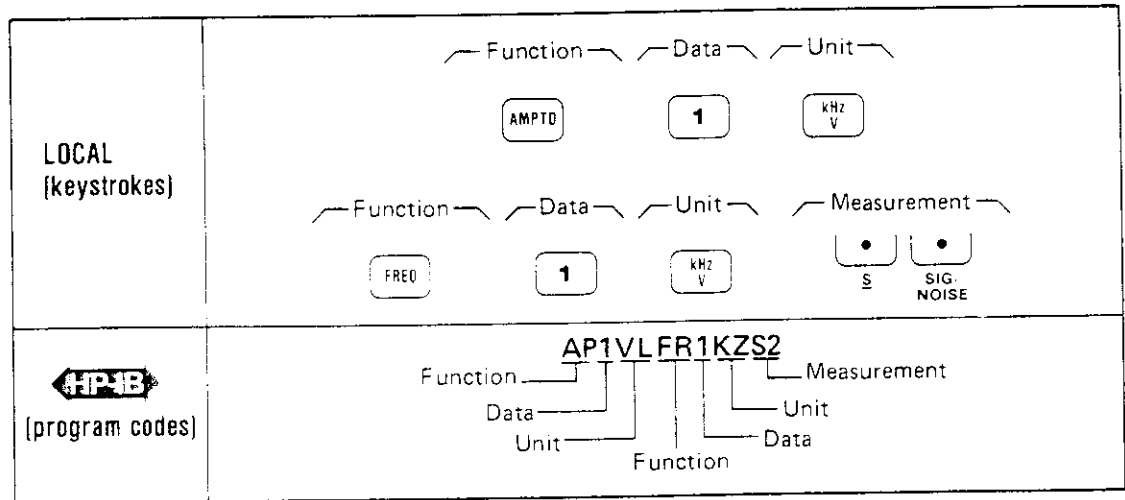

**Program Code** S2 is the HP-IB code for the signal-to-noise measurement.



**Indications** When signal-to-noise is selected, the LEDs in the **S** (Shift) and the **SIG/NOISE** keys will light. The appropriate signal-to-noise information is displayed.

**Measurement Technique** In the signal-to-noise measurement mode, the controller automatically sets the input attenuation and the gain settings of various amplifiers. This control ensures that the signal amplitude is within the proper range for the output rms detector. In addition, the controller alternately turns the oscillator on and off for each measurement. The

## Signal-to-Noise (Cont'd)

**Measurement Techniques (Cont'd)** output rms detector converts the two ac signals (signal + noise and noise) to dc. The dc voltmeter measures the dc. The controller then corrects for the gain and attenuation, computes the ratio, and displays the results in the appropriate units. The frequency of the input signal is also measured and displayed.

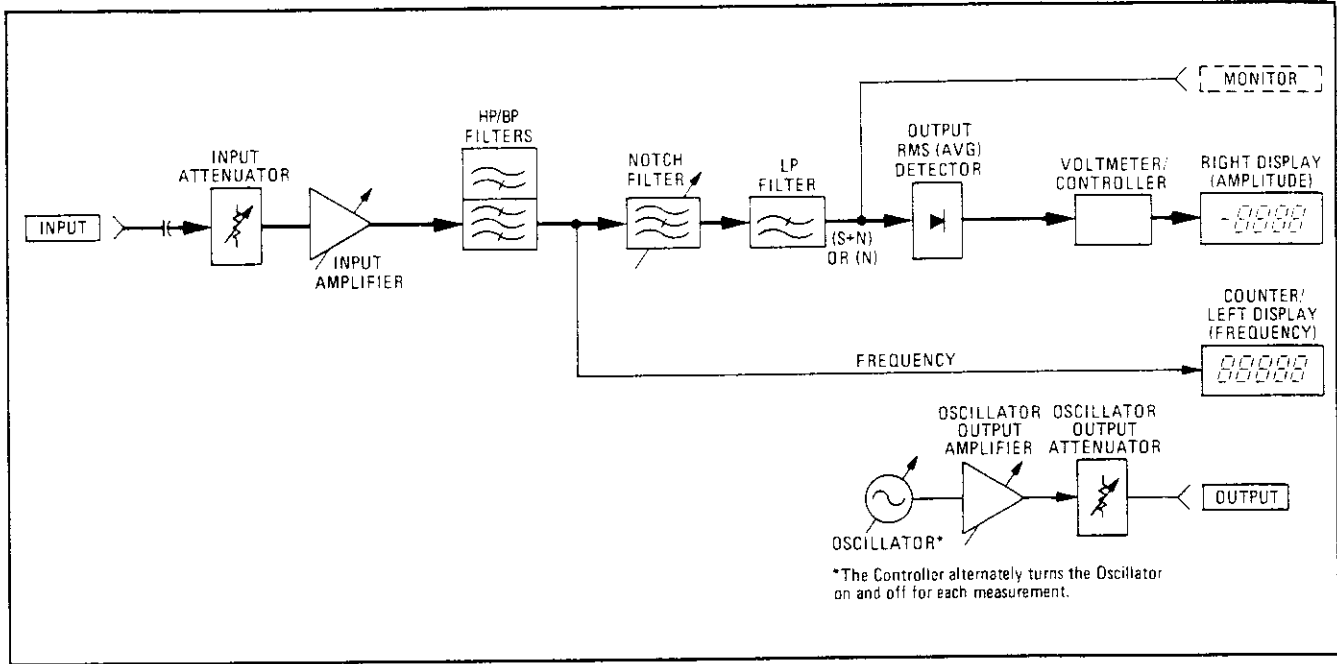

Signal-To-Noise Measurement Block Diagram

**Comments** The Audio Analyzer's internal source must be used as the signal stimulus when making signal-to-noise measurements.

**Related Sections** Amplitude  
Frequency  
RATIO and LOG/LIN

# SINAD

**Description** The Audio Analyzer measures SINAD (Signal to Noise And Distortion) by first determining the following value:

$$S = \frac{\text{signal, noise, and distortion}}{\text{noise and distortion}}$$

S is then converted into the appropriate measurement units as follows:

$$\% \text{ units} = S \times 100\%$$

$$\text{dB units} = 20\log S$$

A SINAD measurement can be made on signals from 20 Hz to 100 kHz and from 50 mV to 300V. SINAD measurements are generally made to determine the sensitivity of a receiver. The Audio Analyzer internal notch filter is automatically coarse-tuned to the frequency of the internal oscillator to permit measurements in the presence of large amounts of impurities and to assure that the fundamental frequency is tuned out. The notch filter then fine tunes itself to the signal at the instrument's input. If an external oscillator is used, it must be tuned to within 5% of the internal oscillator frequency. If it is not, the notch filter will not tune to the fundamental frequency of the input signal.

**Procedure** First, manually set the internal oscillator to the frequency desired. To do this, press **FREQ**, enter the numeric value for the desired frequency, and then press the appropriate unit key (e.g., kHz). Next press **SINAD**. If the internal source is being used as a stimulus, also key in the desired amplitude. The SINAD ratio can then be read on the right display or the SINAD meter (if within range). Special Function 7 can be used to change the SINAD meter range.

**Example** To set the internal source to 1 kHz and select SINAD:

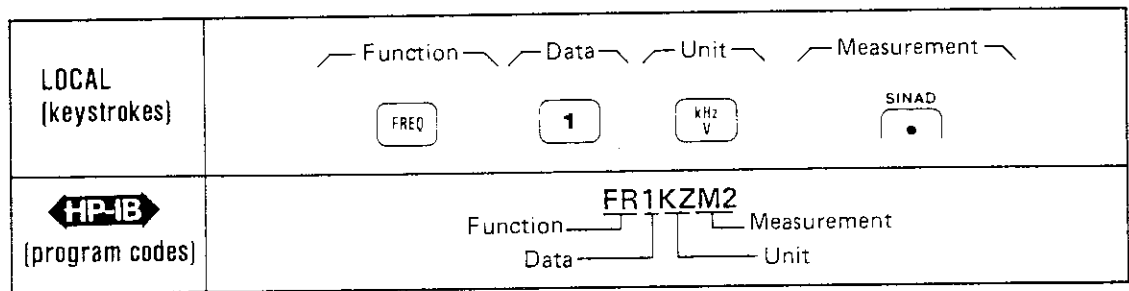

**Program Code** M2 is the HP-IB code for the SINAD measurement.



**Indications** When either the **FREQ** or **AMPTD** key is pressed, the currently programmed values are displayed in the left and right displays respectively. When the numeric data is entered, the numbers appear in the left display. When the unit keys are pressed, both displays blank and four dashes are momentarily displayed in the left display. The displays then return to the normally displayed information for the currently selected measurement mode. When **SINAD** is pressed, the LED in the **SINAD** key lights and the appropriate SINAD information for the input signal is displayed.

# SINAD (Cont'd)

## Measurement Techniques

In the SINAD measurement mode, the controller automatically sets the input attenuation and the gain of various amplifiers. This control ensures that the signal amplitude is within the proper range of the input and output rms detectors. In addition, the controller coarse tunes the notch filter to the programmed frequency of the oscillator to ensure that the Audio Analyzer will not be mistuned. The oscillator is normally used as the source of the test signal. If an external signal source is used, it must be tuned within 5% of the oscillator's programmed frequency. The input rms detector converts the combined signal + noise + distortion ac signal to dc. The notch filter then removes the fundamental signal and the output rms detector converts the noise + distortion ac signal to dc. The dc voltmeter measures both signals. The controller then corrects for the programmed gain and attenuation, computes the ratio, and displays the results in the appropriate units. The frequency of the input signal is also measured and displayed. As a convenience, the SINAD meter displays the SINAD measurement results if within its range. The meter is specially marked for EIA and CEPT sensitivity and selectivity.

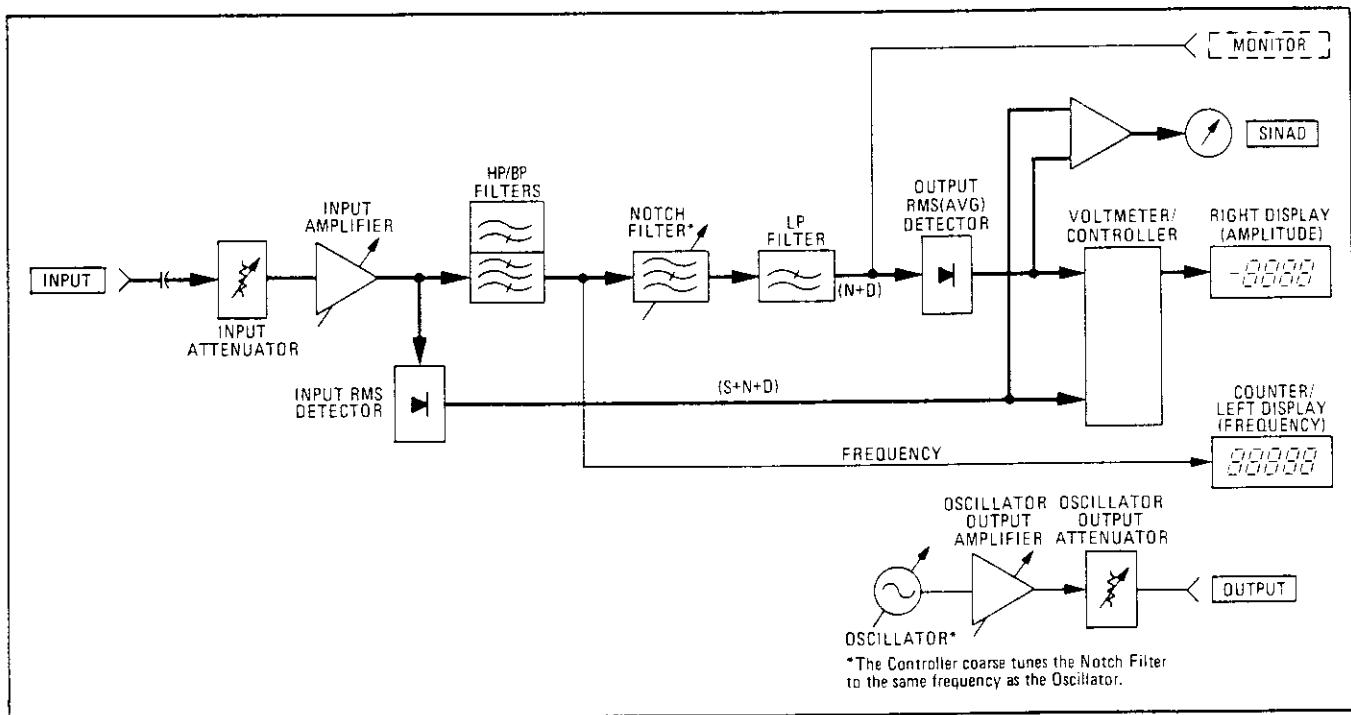

SINAD Measurement Block Diagram

## Comments

If an external oscillator is used, it must be tuned to within 5% of the internal oscillator frequency.

During a SINAD measurement, the output rms detector uses increased filtering to obtain more consistent readings in the presence of noise.

Special Function 7 can be used to change the SINAD meter range (refer to Special Functions).

For SINAD ratios less than 25 dB, the digital display is automatically rounded to the nearest 0.5 dB to reduce digit flicker.

## Related Sections

Amplitude  
Frequency  
Special Functions

## Special Functions

**Description** **General Information.** Special Functions extend user control of the instrument beyond that normally available from dedicated front-panel keys. They are intended for the user who has an understanding of the instrument and the service technician who needs arbitrary control of the instrument functions. Special Functions are accessed via keyboard or HP-IB entry of the appropriate numeric code and terminated by the SPCL key or HP-IB code (refer to Procedures below). The codes comprise a prefix, decimal, and suffix. Special Functions are disabled by a variety of means, depending upon the function. Refer to the comprehensive listings below for actions which clear or disable any Special Function. Special Functions are grouped by their prefixes into three categories as follows:

### Prefix 0

This is the Direct Control Special Function and is intended for use in servicing the Audio Analyzer. All instrument error messages and safeguards are inactive. This is discussed in detail in Section VIII. If the Direct Control is entered inadvertently press AUTOMATIC OPERATION.

### Prefixes 1 to 39

These are the User Special Functions which are used during normal instrument operation when a special configuration, a special measurement, or special information is required. All error messages and some safeguards remain in effect unless the operator disables them. These Special Functions are described below.

### Prefixes 40 to 99

These are the Service Special Functions used to assist in troubleshooting an instrument fault. The functions available are quite diverse — special internal measurements, software control, and special service tests and configurations. Most instrument safeguards are relinquished. These Special Functions are discussed in detail in Section VIII. If a Service Special Function is entered inadvertently, press AUTOMATIC OPERATION.

**Viewing Special Function States.** In addition to completing the entry of Special Function codes, the SPCL key allows viewing of some Special Function settings. The operator-requested settings of Special Functions prefixed 1 through 8 may be viewed by pressing the SPCL key once (following no numeric entry). This display is called the Special Display. If some of these Special Functions are in automatic modes (generally the 0-suffix setting), the actual instrument settings of these functions may be displayed by pressing the SPCL key a second time while the Special Display is active. This display is called the Special Special Display. If desired, these displays can be cleared by pressing any key except the LCL, numeric, or S (Shift) keys. (While either display is active, pressing the SPCL key will switch to the other display.) A summary of User Special Functions is given on the following pages. Following the summary are procedures for using Special Display. These displays are also illustrated and explained.

Special Function Summary (1 of 4)

Special Function		HP-IB Code 	Description	Lights SPCL key	Disable				References and Comments
					AUTO. OP. key	Any Meas. key	CLEAR key	All keys*	
Name	Code								
Input Level Range (except DC level)	1.0	1.0SP	Automatic selection	N	—	—	—	—	Input Level Range (except DC Level)
	1.1	1.1SP	300V range	Y	Y	N	N	N	
	1.2	1.2SP	189V range	Y	Y	N	N	N	
	1.3	1.3SP	119V range	Y	Y	N	N	N	
	1.4	1.4SP	75.4V range	Y	Y	N	N	N	
	1.5	1.5SP	47.6V range	Y	Y	N	N	N	
	1.6	1.6SP	30.0V range	Y	Y	N	N	N	
	1.7	1.7SP	18.9V range	Y	Y	N	N	N	
	1.8	1.8SP	11.9V range	Y	Y	N	N	N	
	1.9	1.9SP	7.54V range	Y	Y	N	N	N	
	1.10	1.10SP	4.76V range	Y	Y	N	N	N	
	1.11	1.11SP	3.00V range	Y	Y	N	N	N	
	1.12	1.12SP	1.89V range	Y	Y	N	N	N	
	1.13	1.13SP	1.19V range	Y	Y	N	N	N	
	1.14	1.14SP	0.754V range	Y	Y	N	N	N	
	1.15	1.15SP	0.476V range	Y	Y	N	N	N	
	1.16	1.16SP	0.300V range	Y	Y	N	N	N	
	1.17	1.17SP	0.189V range	Y	Y	N	N	N	
	1.18	1.18SP	0.119V range	Y	Y	N	N	N	
1.19	1.19SP	0.0754V range	Y	Y	N	N	N		
Input Level Range (DC Level only)	2.0	2.0SP	Automatic Selection	N	—	—	—	—	Input Level Range (DC Level only)
	2.1	2.1SP	300V range	Y	Y	N	N	N	
	2.2	2.2SP	64V range	Y	Y	N	N	N	
	2.3	2.3SP	16V range	Y	Y	N	N	N	
	2.4	2.4SP	4V range	Y	Y	N	N	N	
Post-Notch Gain	3.0	3.0SP	Automatic selection	N	—	—	—	—	Post-Notch Gain
	3.1	3.1SP	0 dB gain	Y	Y	N	N	N	
	3.2	3.2SP	20 dB gain	Y	Y	N	N	N	
	3.3	3.3SP	40 dB gain	Y	Y	N	N	N	
	3.4	3.4SP	60 dB gain	Y	Y	N	N	N	
Hold Decimal Point (right display only)	4.0	4.0SP	Automatic Selection	N	—	—	—	—	Hold Decimal Point  <sup>1</sup> Decimal Point not displayed  <sup>2</sup> Leading zero not displayed. Shown to clarify decimal point position.
	4.1	4.1SP	DDDD. range <sup>1</sup>	Y	Y	N	N	N	
	4.2	4.2SP	DDD.D range	Y	Y	N	N	N	
	4.3	4.3SP	DD.DD range	Y	Y	N	N	N	
	4.4	4.4SP	D.DDD range	Y	Y	N	N	N	
	4.5	4.5SP	0.DDDD range <sup>2</sup>	Y	Y	N	N	N	
	4.6	4.6SP	DD.DD mV range	Y	Y	N	N	N	
	4.7	4.7SP	D.DDD mV range	Y	Y	N	N	N	
	4.8	4.8SP	0.DDDD mV range <sup>2</sup>	Y	Y	N	N	N	

N = No; — = Not Applicable; Y = Yes; \*Except the LCL, S (Shift), and Numeric Keys.

Special Function Summary (2 of 4)

Special Function		HP-IB Code ◀HP-IB▶	Description	Lights SPCL key	Disable					References and Comments
Name	Code				AUTO. OP. key	Any Meas. key	CLEAR key	All keys*		
Post-Notch Detector Response (except in SINAD)	5.0	5.0SP	Fast Detector	N	—	—	—	—	Post-Notch Detector Response	
	5.1	5.1SP	Slow Detector	Y	Y	N	N	N		
Notch Tune	6.0	6.0SP	Automatic notch tuning	N	—	—	—	—	Notch Tune	
	6.1	6.1SP	Hold notch tuning	Y	Y	N	N	N		
SINAD Meter Range	7.0	7.0SP	0 to ~18 dB range	N	—	—	—	—	SINAD	
	7.1	7.1SP	0 to ~24 dB range	Y	Y	N	N	N		
Error Disable	8.0	8.0SP	All errors enabled	N	—	—	—	—	Error Disable	
	8.1	8.1SP	Disable Analyzer errors (Errors 12-17, 31, and 96)	Y	Y	N	N	N		
	8.2	8.2SP	Disable Source errors (Error 18 and 19)	Y	Y	N	N	N		
	8.3	8.3SP	Disable both Analyzer and Source errors	Y	Y	N	N	N		
Hold Settings	9.0	9.0SP	Hold input level ranges, post-notch gain, decimal point and notch tuning at present settings.	Y	Y	N	N	N	Hold Settings	
Display Source Settings	10.0	10.0SP	Display source settings as entered. Frequency in left display/ amplitude in right display.	Y	Y	Y	N	N	Display Source Settings	
Re-enter Ratio Mode	11.0	11.0SP	Restore last RATIO reference and enter RATIO mode if allowed.	N	N	Y	N	N	RATIO and LOG/LIN	
	11.1	11.1SP	Display RATIO reference	Y	Y	Y	Y	N		
Signal-to-Noise Measurements Delay (Continued on next page)	12.0	12.0SP	Automatic Selection	N	—	—	—	—	Signal-to-Noise	
	12.1	1.21SP	200 ms delay	Y	Y	Y	N	N		
	12.2	12.2SP	400 ms delay	Y	Y	Y	N	N		
	12.3	12.3SP	600 ms delay	Y	Y	Y	N	N		
	12.4	12.4SP	800 ms delay	Y	Y	Y	N	N		
12.5	12.5SP	1.0s delay	Y	Y	Y	N	N			

N = No; — = Not applicable; Y = Yes; \*Except the LCL, S (Shift), and Numeric Keys.



Special Function Summary (3 of 4)

Special Function		HP-IB Code <b>HP-IB</b>	Description	Lights SPCL key	Disable					References and Comments
Name	Code				AUTO. OP. key	Any Meas. key	CLEAR key	All keys*		
Signal-to-Noise (Cont'd)	12.6	12.6SP	1.2s delay	Y	Y	Y	N	N		
	12.7	12.7SP	1.4s delay	Y	Y	Y	N	N		
	12.8	12.8SP	1.6s delay	Y	Y	Y	N	N		
	12.9	12.9SP	1.8s delay	Y	Y	Y	N	N		
X-Y Recorder	13.0	13.0SP	Enable plot	N	N	Y	Y	N	X-Y Recording	
	13.1	13.1SP	Disable plot	Y	Y	N	N	N		
Time Between Measurements	14.0	14.0SP	Minimum time between measurements	N	—	—	—	—	Time Between Measurement	
	14.1	14.1SP	Add 1s between measurements	Y	Y	N	N	N		
SINAD and Signal-to-Noise Display Resolution	16.0	16.0SP	0.01 dB above 25 dB; 0.5 dB below 25 dB	N	—	—	—	—	SINAD and Signal-to-Noise	
	16.1	16.1SP	0.01 dB all ranges	Y	Y	N	N	N		
Sweep Resolution (Maximum 255 points/sweep)	17.0	17.0SP	10 points/decade	N	—	—	—	—	Sweep Resolution	
	17.1	17.1SP	1 points/decade	Y	Y	N	N	N		
	17.2	17.2SP	2 points/decade	Y	Y	N	N	N		
	17.3	17.3SP	5 points/decade	Y	Y	N	N	N		
	17.4	17.4SP	10 points/decade	Y	Y	N	N	N		
	17.5	17.5SP	20 points/decade	Y	Y	N	N	N		
	17.6	17.6SP	50 points/decade	Y	Y	N	N	N		
	17.7	17.7SP	100 points/decade	Y	Y	N	N	N		
	17.8	17.8SP	200 points/decade	Y	Y	N	N	N		
	17.9	17.9SP	500 points/decade	Y	Y	N	N	N		
Display Level in Watts	19.0	19.0SP	Display level as watts into 8 ohms	Y	Y	Y	Y	Y	Display Level in Watts	
	19.NNN	19.NNNSP	Display level as watts into NNN ohms	Y	Y	Y	Y	Y		
Read Display to HP-IB <b>HP-IB</b>	20.0	20.0SP	Read right display	N	N	N	N	N	Read Display to HP-IB	
	20.1	20.1SP	Read left display	N	N	N	N	N		

N = No; — = Not Applicable; Y = Yes; \*Except the LCL, S (Shift), and Numeric Keys.

Special Function Summary (4 of 4)

Special Function		HP-IB Code <b>HP-IB</b>	Description	Lights SPCL key	Disable				References and Comments
Name	Code				AUTO. OP. key	Any Meas. key	CLEAR key	All keys*	
HP-IB Address <b>HP-IB</b>	21.0	21.0SP	Displays HP-IB address (in binary) in left display; right display in form TLS where T=1 means talk only; L=1 means listen only; S=1 means SRQ.	Y	Y	Y	Y	Y	HP-IB Address
	21.1	21.1SP	Displays HP-IB address in decimal.						
Service Request <b>HP-IB</b>	22.N	22.NSP	Enable a condition to cause a service request, N is the sum of any combination of the weighted conditions below: 1—Data Ready 2—HP-IB error 4—Instrument error The instrument powers up in the 22.2 state (HP-IB error).	N	N	N	N	N	HP-IB Service Request Condition

N = No; — = Not Applicable; Y = Yes; \*Except the LCL, S (Shift), and Numeric Keys.

## Special Functions (Cont'd)

**Procedure** **Entering Special Functions.** To use a Special Function, key in the corresponding code, then press the SPCL key.

**Special Display.** To display the user-requested modes of Special Functions 1 through 8, press the SPCL key alone one time. The digit position (noted beneath the displays) corresponds to the Special Function prefix, and the number displayed in that position corresponds to the Special Function suffix.

**Special Special Display.** To determine the actual instrument settings of functions prefixed 1 through 8, press the SPCL key alone once while Special Display is active. (If the Special Display described above is not in effect, press the SPCL key twice to get this display.) The digit position corresponds to the function prefix, and the number displayed in that digit corresponds to the function suffix.

**Examples** **Entering Special Functions.** To display the frequency and the amplitude settings entered for the source (Special Function 10):

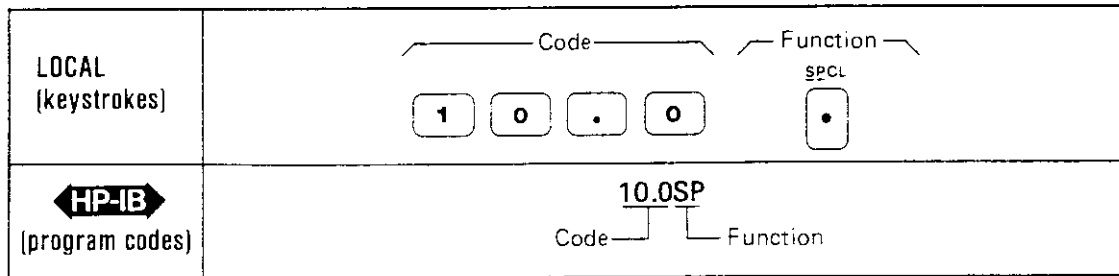

**Special Display.** When SPCL is pressed alone once and the following display results,

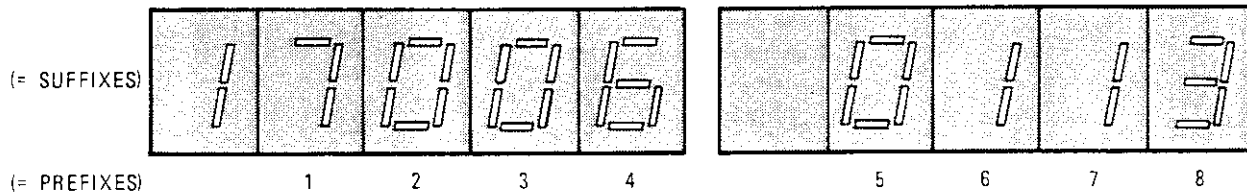

This display indicates that the following Special Functions were selected by the operator:

Special Function		User-Requested Setting
Code	Name	
1.17	Input Level Range (Except DC Level)	0.189V range
2.0	Input Level Range (DC Level only)	
3.0	Post-Notch Gain	Automatic Selection
4.6	Hold Decimal Point (right display only)	Automatic Selection
5.0	Post-Notch Detector Response (Except in SINAD)	DD.DD mV range
6.1	Notch Tune	Fast Detector
7.1	SINAD Meter Range	Hold notch tuning
8.3	Error Disable	0 to 24 dB range
		Disable both analyzer and source errors

## Special Functions (Cont'd)

**Examples (Cont'd)**

**Special Special Display.** When SPCL is pressed again while the Special Display is active and the following display results, the actual instrument settings are tabulated below.

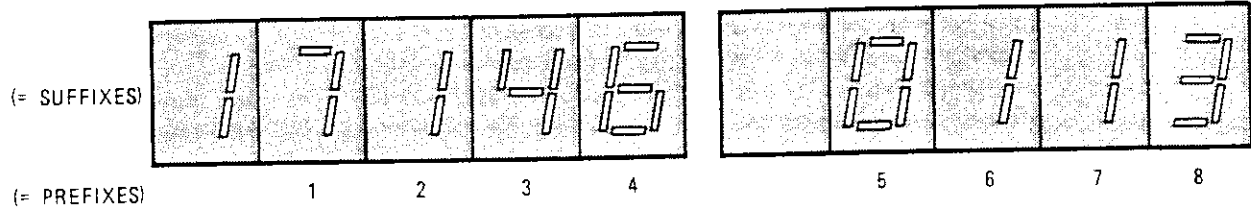

Special Function		Actual Instrument Setting
Code	Name	
1.17	Input Level Range (Except DC Level)	0.189V range 300V range
2.1	Input Level Range (DC Level only)	
3.4	Post-Notch Gain	60 dB Range
4.6	Hold Decimal Point	DD.DD mV range Fast Detector
5.0	Post-Notch Detector Response (Except in SINAD)	
6.1	Notch Tune	Hold notch tuning
7.1	SINAD Meter Range	0 to 24 dB range
8.3	Error Disable	Disable both analyzer and source errors

**Program Codes** HP-IB Codes for the Special Functions are summarized in the Special Function Summary above.



**Indications**

**Entering Special Functions.** As the numeric code is entered, both displays will blank, and the entered code will appear in the left display. When the SPCL key is pressed, both displays will again blank and four dashes will momentarily appear in the right display. These dashes are replaced with the appropriate reading for the selected measurement mode.

**Comments**

If a User Special Function (prefixes 1 to 39) has a suffix of zero, the zero need not be entered. For example, 10.0 SPCL equals 10. SPCL. (However, 1.1 SPCL does not equal 1.10 SPCL.) If when entering a Special Function code, Error 21 (invalid key sequence) is displayed, the Special Function requested has not been executed. Entry of invalid special function suffixes results in display of Error 23. For additional information on Direct Control Special Functions (prefix 0) or Service Special Functions (prefixes 40 to 99) refer to Section VIII.

**Related Sections**

Automatic Operation  
Default Conditions and Power-up Sequence  
Special Function Summary table (under Description above)

# Sweep

**Description** The Audio Analyzer source frequency can be logarithmically swept. The sweep range can be set between any two frequencies in the range of 20 Hz and 100 kHz. The source frequency changes in discrete steps rather than in a continuous analog manner. The number of frequency points in a sweep is determined by the sweep width (the ratio of the entered stop and start frequencies) and the sweep resolution selected. The maximum number of points allowable in one sweep is 255. For more information about the number of points in a sweep and sweep resolution refer to Sweep Resolution. Using the sweep feature in conjunction with one of the Audio Analyzer measurement modes provides swept measurement capability. Swept response measurement can be plotted by connecting an X-Y recorder to the Audio Analyzer recorder outputs which are located on the rear panel. Any of the measurement results can be plotted as the source is swept in frequency.

**Procedure** **Sweep Range Selection.** The START FREQ and the STOP FREQ keys are used to set the starting and stopping points of the frequency sweep. To select a start frequency, press the START FREQ key, then the appropriate numeric data and unit keys. To select a stop frequency, press the STOP FREQ key, then the appropriate numeric data and unit keys. To display the currently programmed start or stop frequency, press and hold the respective START FREQ or STOP FREQ key.

**Sweep Mode Selection.** The SWEEP key puts the instrument in the sweep mode. The source does not start sweeping until a signal is sensed at the INPUT. At the end of the sweep, the sweep circuitry is turned off (no longer in sweep mode). To stop in midsweep, press the CLEAR key. Pressing the SWEEP key again will reset and restart the sweep.

**Example** To sweep the source frequency from 100 Hz to 25 kHz:

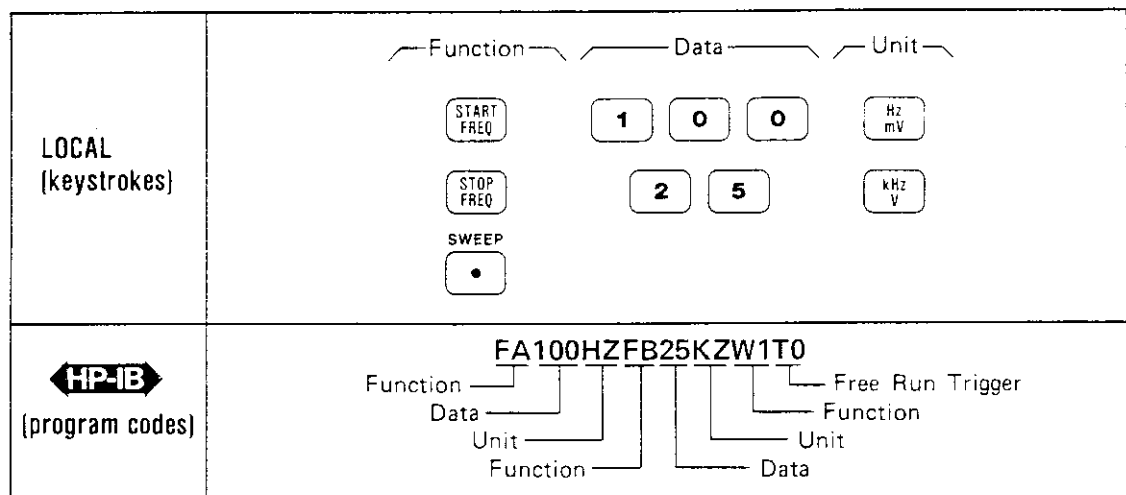

**Program Codes**



Key	Program Codes
START FREQ	FA
STOP FREQ	FB
SWEEP OFF	W0
SWEEP ON	W1
kHz	KZ
Hz	HZ

**NOTE**

*Free Run triggering (code T0) is the only trigger mode allowed when using the sweep function (code W1). Any other triggering (codes T1, T2, or T3) or use of CLEAR key triggering will cause only the start frequency point to be displayed, plotted, and read to the HP-IB. Both the rear-panel X AXIS and Y AXIS outputs will be inhibited from continuing beyond the start frequency point.*

## Sweep (Cont'd)

### Indications

When the START FREQ or STOP FREQ key is pressed, the left display shows the currently programmed start or stop frequency and the source goes to that frequency. As the new start or stop frequency is entered, it will appear on the left display. When the unit key is pressed, the left display returns to show the input signal frequency. (The source remains at the start or stop frequency.)

When the SWEEP key is pressed, the LED within the SWEEP key will light. The light indicates that the instrument is in the sweep mode. Note, the light does not necessarily mean that the source is sweeping. When the sweep is completed, the light will turn off.

### Comments

The Audio Analyzer powers up with start and stop frequencies of 20 Hz and 20 kHz respectively.

Reverse sweep (that is, sweeping from a higher frequency to a lower frequency) is obtained by simply entering a start frequency which is higher than the stop frequency.

During the sweep mode, all the front-panel keys remain active, hence they affect the sweep function. Pressing certain front-panel keys while the instrument is in the sweep mode can cause an undefined state or an error condition. Therefore, it is recommended that only the following keys be pressed during a sweep: CLEAR, STOP FREQ, START FREQ, AUTOMATIC OPERATION, and SWEEP. The function of these keys during sweep mode is described below.

**CLEAR and AUTOMATIC OPERATION:** When pressed the keys stop the sweep. The source remains tuned to the frequency point where the sweep was stopped. However, the sweep cannot be restarted from that point.

**START FREQ and STOP FREQ:** These keys when pressed, stop the current sweep and tune the source to either the currently programmed start or stop frequency. Which frequency the source is tuned to, depends upon which key was pressed.

**SWEEP:** The sweep key stops the current sweep, retunes the source frequency back to the start frequency, and restarts the sweep from that point.

Errors which are signified by the two dashes or four dashes on the right display, stop the sweep but do not take the instrument out of sweep mode. As soon as the error-causing condition is removed, the sweep starts again from where it left off.

Nonrecoverable errors, such as Error 10, Error 11, etc., require that the error-causing condition be removed and the error message be cleared before another sweep can be initiated. Note, the sweep cannot continue from the frequency point at which the error first occurred.

The time required to complete a sweep depends on factors such as measurement mode, sweep width, sweep resolution, and input signal level.

### Related Sections

Plot Limit  
Sweep Resolution  
X-Y Recording

## Sweep Resolution (Special Function 17)

**Description** The Audio Analyzer powers up with a sweep resolution of 10 points/decade. However, the sweep resolution can be manually selected from 1 to 500 points/decade by keyboard entry using the SPCL key.

**Procedure** To select a different sweep resolution, key in the corresponding Special Function code, then press the SPCL key.

Sweep Resolution	Special Function Code	Program Code <b>HP-IB</b>
10 points/decade	17.0 SPCL	17.0SP
1 point/decade	17.1 SPCL	17.1SP
2 points/decade	17.2 SPCL	17.2SP
5 points/decade	17.3 SPCL	17.3SP
10 points/decade	17.4 SPCL	17.4SP
20 points/decade	17.5 SPCL	17.5SP
50 points/decade	17.6 SPCL	17.6SP
100 points/decade	17.7 SPCL	17.7SP
200 points/decade	17.8 SPCL	17.8SP
500 points/decade	17.9 SPCL	17.9SP

**Example** To set the sweep resolution to 100 points/decade:

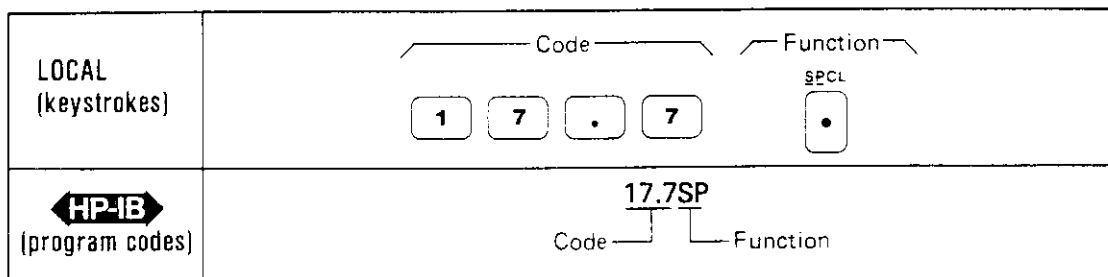

**Program Codes** For HB-IB codes, refer to Procedure above.

**HP-IB**

**Indications** As the numeric code is entered, it will appear on the left display. When the SPCL key is pressed, the left display returns to show the input signal frequency. Unless Special Function code 17.0 was entered, the light within the SPCL key will turn on if not already on. If the light is already on, it will remain on.

**Comments** The maximum number of points in a sweep is restricted to 255 points. Therefore, if a sweep resolution of 500 points/decade is required the sweep span has to be limited to approximately half a decade.

The frequency points in a sweep can be computed by using the following formulas:

$$\text{Frequency} = \text{START FREQ} \times 10^{n/k}$$

Where: n = the frequency point number and n = 0 is for the start frequency

k = number of points per decade.

## Sweep Resolution (Cont'd)

### (Special Function 17)

#### Comments (Cont'd)

For reverse sweep the frequency point formula becomes:

$$\text{Frequency} = \text{START FREQ} \times 10^{-n/k}$$

The following example illustrates how to compute the frequency points for a 50 Hz to 30 kHz sweep with a sweep resolution of 5 points/decade (Special Function code 17.3).

1. Compute the sweep range in decades using the formula:

$$\text{sweep range (in decades)} = \log \frac{\text{STOP FREQ}}{\text{START FREQ}}$$

$$\text{For this example; sweep range} = \log \frac{30\,000}{50}$$

$$\text{sweep range} = 2.78 \text{ decades}$$

2. Compute the total number of points in a sweep using the formula:

$$\text{total number of points} = \text{points/decade} \times \text{sweep range}$$

Since the number of points in a sweep is always an integer, round off the result from the above equation to the nearest integer.

For this example:

$$\text{total number of points} = 5 \text{ points/decade} \times 2.78 \text{ decades}$$

$$\text{total number of points} = 13.89 \text{ points}$$

Therefore, the total number of points equals 14 points.

3. Compute the frequency points using the frequency point formula. Use the result from step 2 to calculate the point numbers. Start from  $n=0$  (start frequency) and continue to  $n = \text{last point (stop frequency)}$ . Note that the stop frequency always equals the programmed stop frequency which can differ from the computed value.

*(Continued on next page)*



## Sweep Resolution (Cont'd)

(Special Function 17)

### Comments (Cont'd)

For this example, the frequency points are computed and listed in the table below.

Point Number [n]	Computed Frequency $f = 50 \text{ Hz} \times 10^{n/5}$
0	50.000 Hz
1	79.245 Hz
2	125.59 Hz
3	199.05 Hz
4	315.48 Hz
5	500.00 Hz
6	792.45 Hz
7	1255.9 Hz
8	1990.5 Hz
9	3154.8 Hz
10	5000.0 Hz
11	7924.5 Hz
12	12.559 kHz
13	19.905 kHz
14	31.548 kHz*

\*For the last point in the sweep the instrument tunes to the programmed stop frequency (30 kHz) and not the computed value (31.548 kHz).

### Related Sections

Special Functions  
Sweep  
X-Y Recording

## Time Between Measurements (Special Function 14)

**Description** A one-second delay between measurements can be added using Special Function 14. This one second delay is normally used when making plots with a relatively slow X-Y recorder. It can also be used to allow the device under test to settle before making the measurement.

**Procedure** To add or delete the one second time delay between measurements, key in the corresponding Special Function code; and then press the SPCL key.

Time Delay Between Measurements	Special Function Code	Program Code ◀HP-IB▶
Minimum	14.0 SPCL	14.0SP
Add 1 second	14.1 SPCL	14.1SP

**Example** To set a one second time delay between measurements:

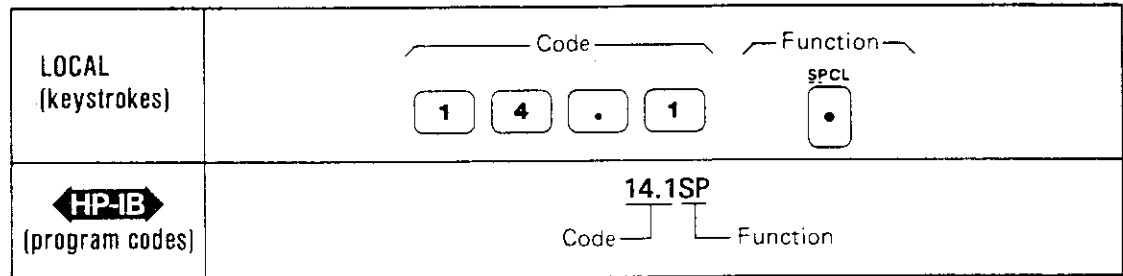

**Program Codes** For HP-IB codes, refer to Procedure above.



**Indications** As the numeric code is entered, both displays will blank and the entered code will appear in the left display. When the SPCL key is pressed, the SPCL key lights if it is not already on. If it is already on, it will remain on. Both displays then return to the display that is appropriate for the currently selected measurement mode.

**Related Sections**  
 Automatic Operation  
 Special Functions  
 X-Y Recording

## X-Y Recording

### Description

When used in conjunction with the sweep mode, any of the measurement results can be plotted as a function of frequency by connecting an X-Y recorder to the Audio Analyzer recorder outputs. The recorder outputs are X AXIS, Y AXIS, and PEN LIFT. These outputs are located on the rear panel of the instrument.

The X AXIS and Y AXIS outputs provide a voltage staircase scaled between 0 and 10 Vdc. The output impedance for both outputs is 1000 ohms. X-axis scaling is determined by the programmed start and stop frequencies. The output voltage is proportional to the logarithmic sweep of the source. The output voltage ranges from 0 Vdc for the start frequency to approximately 10 Vdc for the stop frequency. Y-axis scaling is determined by the measurement unit selected and the programmed upper and lower plot limits. The output voltage is proportional to the displayed reading. The output voltage ranges from 0 Vdc for the lower plot limit value to approximately 10 Vdc for the upper plot limit value.

The PEN LIFT output is a TTL high level for a pen-up condition and a TTL low level for a pen-down condition. During a sweep the PEN LIFT output goes low (pen-down condition) after reaching the first point, then goes high again after plotting the last point.

### Procedure

The following procedure describes how to use the Audio Analyzer with an X-Y recorder:

1. The figure below illustrates a typical set-up for X-Y recording. Connect the equipment as shown in the figure and select a measurement.

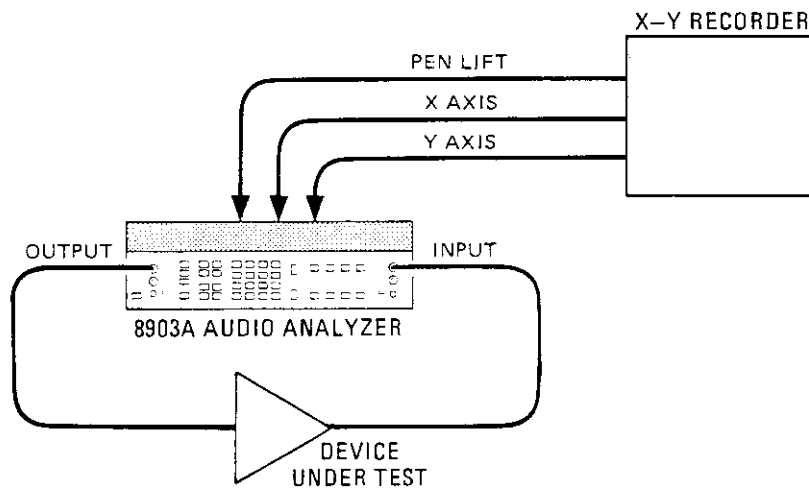

X-Y Recording Setup

2. The START FREQ and STOP FREQ keys are used to establish the two reference points needed for adjusting the X-Y recorder X and Y axes. These two references determine the plotting area or plot dimension. The START FREQ key sets both the X AXIS and Y AXIS outputs to 0 volts. This reference point corresponds to the lower left corner of the graph. To set the lower left corner point, press the START FREQ key and adjust the zero controls on the X-Y recorder to position the pen to the lower left corner of the graph. The STOP FREQ key sets both the X AXIS and Y AXIS outputs to 10 volts. This reference point corresponds to the upper right

## X-Y Recording (Cont'd)

**Procedure  
(Cont'd)**

corner of the graph. To set the upper right corner point, press the STOP FREQ key and adjust the vernier controls on the X-Y recorder to position the pen to the upper right corner of the graph.

3. The Y-axis scaling unit is determined by the displayed measurement unit in the right display. Any displayed measurement unit except mV can be used when plotting. To scale the Y axis, key in the desired upper and lower plot limit.
4. The X axis corresponds to the frequency span of the Audio Analyzer source. The frequency scaling of the X axis is in logarithmic units. To scale the X axis, key in the desired start and stop frequencies. The left-most point on the X axis corresponds to the start frequency.

**NOTE**

*No readjustment of the X-Y recorder is required if the X and Y scale factors are changed. The Audio Analyzer automatically scales both the X- and Y-axis outputs to fit in the established plot dimension.*

5. To execute the plot, press the SWEEP key. The number of frequency points plotted is determined by the sweep size (the ratio of the entered start and frequencies) and the sweep resolution selected. The sweep resolution can be selected from 1 to 500 points per decade using Special Function 17. The maximum number of points allowable in one sweep is 255.

**Example**

The following example describes how to plot the frequency response (gain vs. frequency) of a RIAA (Record Industry Association of America) phonograph preamplifier. The figure below is a plot of a theoretical RIAA curve. By plotting the frequency response of the amplifier on a copy of this figure, the response of the amplifier can be directly compared with the theoretical response. A table of RIAA response values is also included. (This standard is normally specified over a range 50 Hz to 15 kHz.)

RIAA Standard Response			
Frequency (Hz)	Relative Gain (dB)	Frequency (Hz)	Relative Gain (dB)
20	+19.27	800	+0.75
30	+18.59	1 000*	0.00
40	+17.79	1 500	-1.40
50	+16.95	2 000	-2.59
60	+16.10	3 000	-4.74
80	+14.51	4 000	-6.61
100	+13.09	5 000	-8.21
150	+10.27	6 000	-9.60
200	+8.22	8 000	-11.90
300	+5.48	10 000	-13.74
400	+3.78	15 000	-17.16
500	+2.65	20 000	-19.62

\* Reference frequency

1. Connect the equipment as shown in the figure on the previous page.
2. Place a graph paper or a copy of the RIAA curve on the X-Y recorder. (This procedure assumes that the measurement result is plotted on a copy of the RIAA

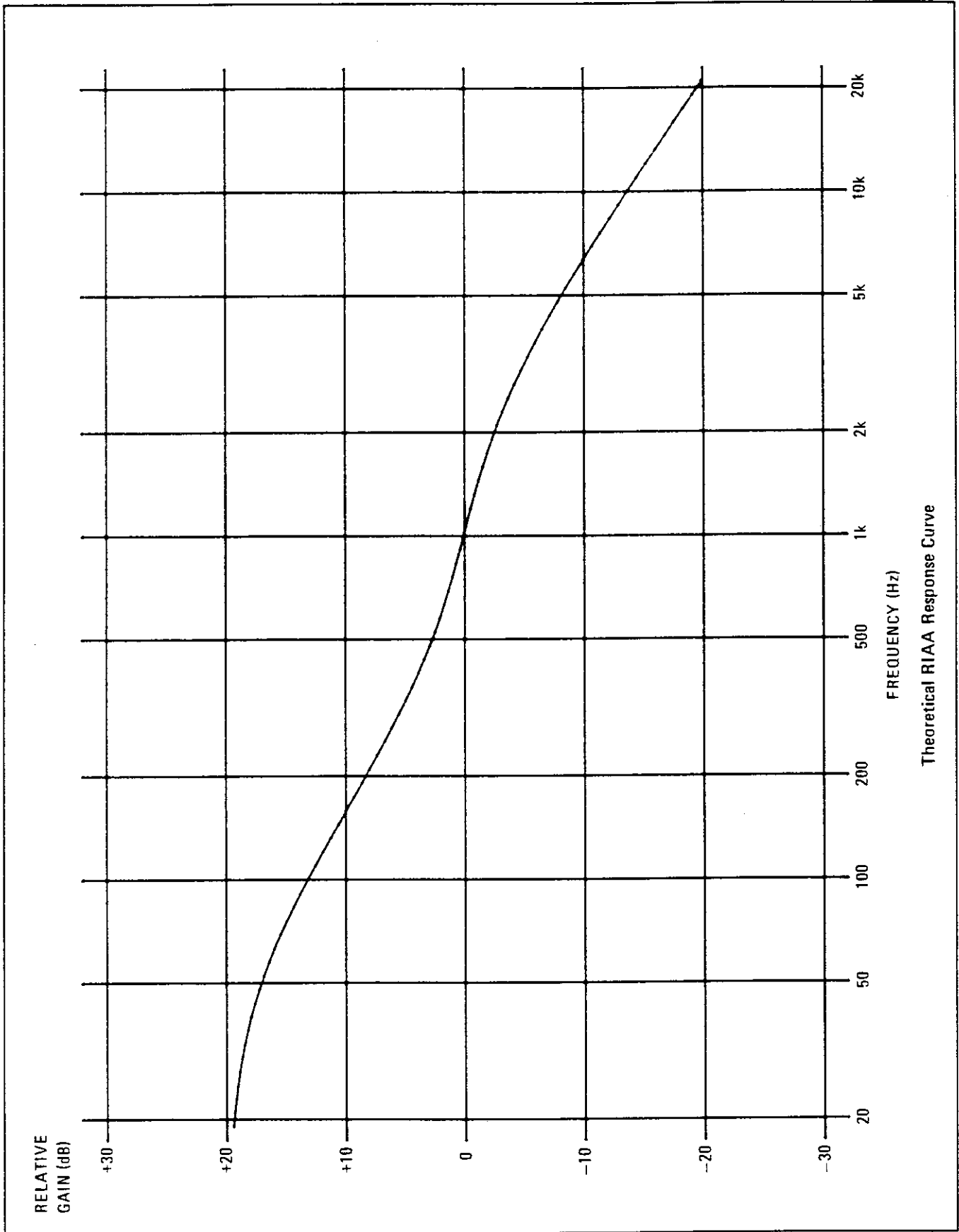

Theoretical RIAA Response Curve

## X-Y Recording (Cont'd)

**Example  
(Cont'd)**

curve.) Press the START FREQ key and use the zero controls on the X-Y recorder to move the pen to the lower left corner of the graph. The point where the 20 Hz and -30 dB grid lines cross corresponds to the lower left corner. Next, press the STOP FREQ key and use the vernier controls on the X-Y recorder to move the pen to the upper right corner of the graph (the intersection of the +30 dB and 20 kHz grid lines). Press the START FREQ key again to check the lower left corner point and readjust if necessary.



3. Set the Audio Analyzer to measure ac level.



4. Set the Audio Analyzer source to sweep from 20 Hz to 20 kHz. (The Audio Analyzer powers up with start and stop frequencies of 20 Hz and 20 kHz respectively.)

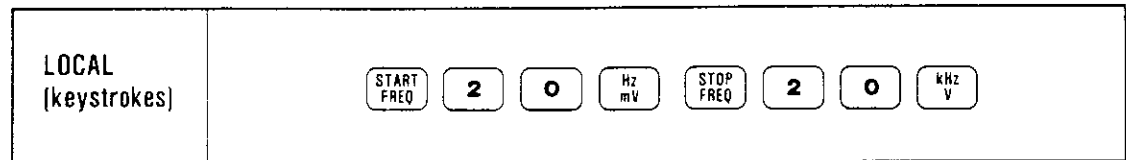

5. Set the Audio Analyzer upper and lower plot limit to +30 and -30, respectively.

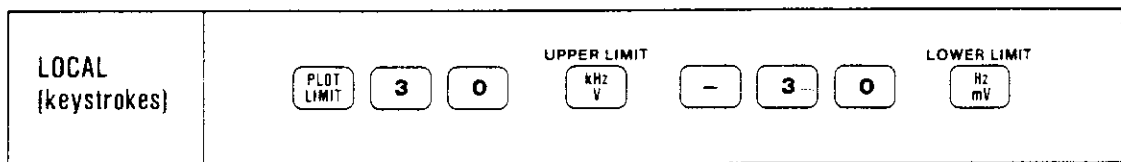

6. Select the desired sweep resolution using Special Function 17. (The Audio Analyzer powers up with the sweep resolution set at 10 points per decade.) In this example there are three decades ( $\log 20000/20 = 3$ ) so the maximum sweep resolution allowed is 50 points per decade.
7. Set the Audio Analyzer source frequency to 1 kHz and establish a ratio reference in dB to the displayed value. If the ac level is displayed in volts, press the LOG/LIN key to obtain a display in dB.

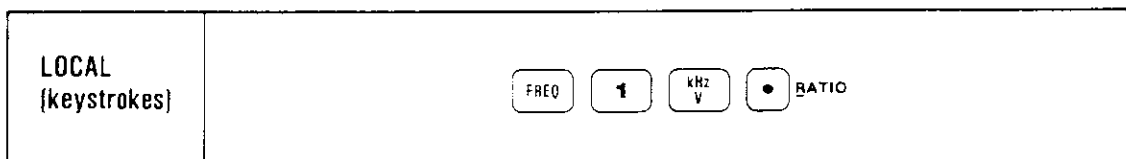

## X-Y Recording (Cont'd)

**Example (Cont'd)**

NOTE. Since the RIAA amplifier gain is much higher at 20 Hz, it is recommended that the signal source first be set to 20 Hz and the level be set for less than rated output from the preamplifier.

8. The graph paper is now scaled to measure ac level in dB from 20 Hz to 20 kHz. The upper plot limit is equal to +30 dB and the lower plot limit is equal to -30 dB. The level at 1 kHz is referenced to 0 dB. Press the SWEEP key to start the plot. When the plot is completed the LED within the sweep key will turn off and the PEN LIFT output will go high. (If the plot has been disabled by Special Function 13.1, enable plot by keying in 13.0 SPCL.)

**Program Codes** The HP-IB codes for the above example are given below:



Key	Program Code 
START FREQ	FA
STOP FREQ	FB
AC LEVEL	M1
Hz	HZ
kHz	KZ
PLOT LIMIT	PL
UPPER LIMIT	UL
LOWER LIMIT	LL
RATIO Off	R0
RATIO On	R1
LOG	LG
SWEEP	W1

**Comments**

The X- and Y-axis outputs and the PEN LIFT output can be selectively enabled or disabled by using Special Function 13. This feature allows the user to disable the X-Y recorder during a sweep.

Some delay may be noted when pressing keys during sweep with an X-Y recorder enabled. This delay allows the pen to lift before moving on. Keys pressed during the sweep are recognized, and it is not necessary to hold them down while waiting for the Audio Analyzer to respond.

If the sweep is too fast for the X-Y Recorder, a delay of 1 second can be added between points by using Special Function 14.1.

**Related Sections**

- AC Level
- DC Level
- SINAD
- Signal-to-Noise
- Distortion
- Distortion Level
- Plot Limit
- Special Functions
- Sweep
- Sweep Resolution
- Time Between Measurements