

# Keysight Technologies

## PNA-X Series Microwave Network Analyzers

Active-Device Characterization in Pulsed Operation Using the PNA-X

### Application Note

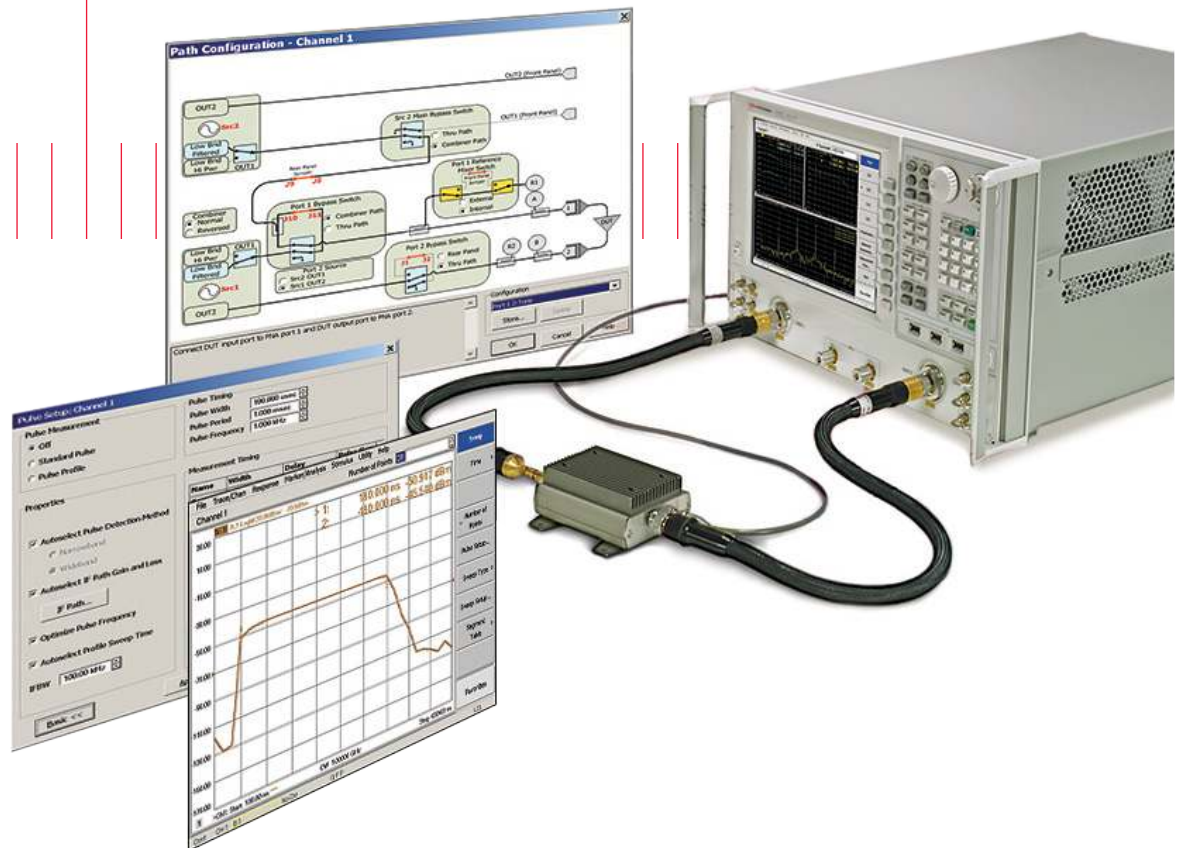



## Introduction

Vector network analyzers (VNA) are the common tool for characterizing RF and microwave components in both continuous-wave (CW) and pulsed operations. Some external equipment may be used in conjunction with a VNA to modulate the stimulus or DC bias, and to perform accurate S-parameter measurements in pulsed operation. However, components that need to be characterized in pulsed operation mode are often active devices such as amplifiers or converters, and many active parameters are characterized in addition to S-parameters. For amplifiers as an example, 1 dB compression (P1 dB), intermodulation distortion (IMD), and third-order intercept point (IP3) are commonly measured, and many parameters such as noise figure, higher-order distortion products, harmonics, etc. are characterized depending on their intended application needs. These active parameters are power-dependent, so additional factors must be considered for precise characterization.

To respond to such needs, Keysight Technologies, Inc.'s PNA-X Series, the most flexible VNA that employs many capabilities designed for active-device characterization, enables S-parameter and active parameter measurements with a single set of connections. The PNA-X's four internal pulse generators and pulse modulators, two internal sources with a combining network, and active-application options provide fully integrated pulsed active-device characterization. This application note discusses pulsed S-parameter measurements using the PNA-X Series and measurement techniques that enable power-dependent active-device characterization including compression and distortion. It also provides a brief summary of pulsed-RF measurement types, and two detection techniques (wideband and narrowband detection) are explained specifically using PNA-X architecture and methodologies. Refer to application note 1408-12 Pulsed-RF S-Parameter Measurements Using Wideband and Narrowband Detection part number 5989-4839EN for further details of measurement types and detection techniques.

# Table of Contents

Introduction .....	2
Device Types .....	4
Pulsed-RF Measurement Types .....	5
Pulsed-RF Detection Techniques .....	6
Wideband detection .....	7
Narrowband detection .....	8
Pulsed-RF S-parameter Measurements Using PNA-X .....	9
PNA-X pulse system .....	9
PNA-X hardware overview .....	9
PNA-X IF paths .....	10
Internal pulse generators .....	10
Internal pulse modulators .....	11
Pulse I/O .....	11
Pulse system delays .....	12
Setting up measurements using Pulsed-RF measurement application .....	14
PNA-X wideband pulse measurements .....	16
Wideband pulse data acquisition .....	16
Synchronizing pulsed-RF stimulus and measurements .....	19
Wideband pulse system dynamic range .....	23
PNA-X narrowband pulse measurements .....	24
Narrowband filter path with crystal filter .....	24
Software gating .....	26
Digital filter nulling .....	28
Active-Device Measurements with Calibrated Stimulus .....	29
Power leveling modes .....	29
Accurate pulsed stimulus using receiver leveling .....	30
Pulsed stimulus power calibration .....	30
Receiver leveling with wideband detection .....	31
Receiver leveling with narrowband detection .....	33
Swept-power measurement examples .....	35
Improving stimulus power level accuracy in pulse profile measurements .....	36
Compression vs. Frequency Measurements in Pulse Mode .....	37
Two-tone IMD measurements in Pulse Mode .....	39
Additional Resources .....	42
Application note .....	42
Web .....	42

## Device Types

Figure 1 shows two types of pulse operation modes, pulsed-RF and pulsed-bias. Pulsed-RF operation drives the device with a pulse-modulated RF signal while the DC bias is always on. Amplifiers in receivers used in pulse-modulated applications are typically tested under pulsed-RF operation. Testing devices in pulsed-RF operation requires RF pulse modulators for the stimulus as well as pulse generators to drive the RF modulator and to synchronize or gate the VNA receivers to capture the modulated RF signals. The pulsed-bias operation is when the DC bias is switched on and off to generate a pulse-modulated signal while the input is mostly a CW signal and is always on. Traveling-wave-tube (TWT) amplifiers are one example of this type and are commonly used in radar transmitters. The RF pulse modulator is not required for the stimulus in this mode, but pulse generators are needed to turn on and off the DC bias and synchronize the VNA receivers to measure the output signal when the device is on.

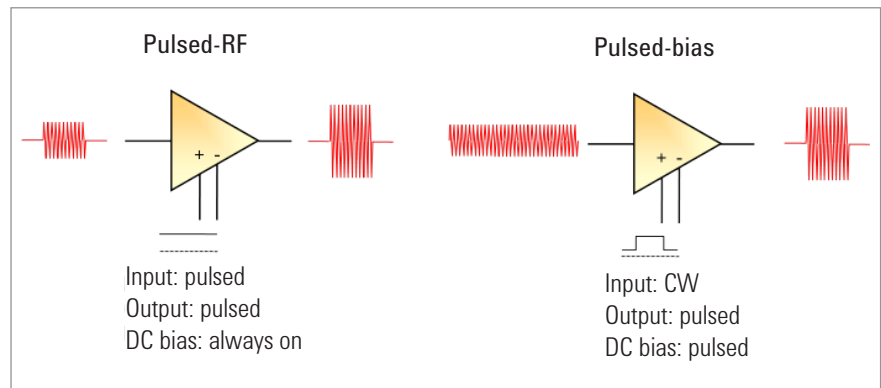

Figure 1. Pulsed-RF and pulsed-bias operation modes

## Pulsed-RF Measurement Types

Figure 2 shows three major types of pulsed-RF measurements. The first two are pulsed S-parameter measurements, where a single data point is acquired for each carrier frequency. The data is displayed in the frequency domain with magnitude and/or phase of transmission and/or reflection. Average pulse measurements make no attempt to position the data point at a specific position within the pulse. For each carrier frequency, the displayed S-parameter represents the average value of the pulse. Point-in-pulse measurements result from acquiring data only during a specified gate width and position (delay) within the pulse. There are different ways to do this in hardware, depending on the type of detection used, which will be covered later. Pulse profile measurements display the magnitude and/or phase of the pulse versus time, instead of frequency. The data is acquired at uniformly spaced time positions across the pulse while the carrier frequency is fixed at some desired frequency.

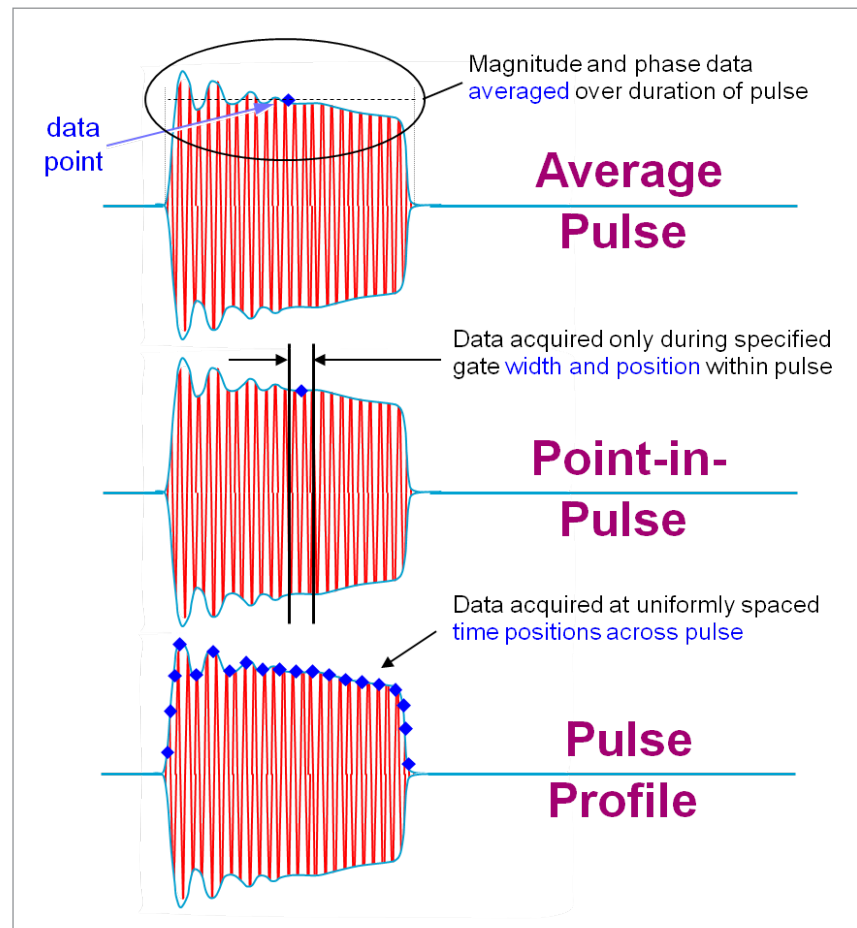

Figure 2. Average, point-in-pulse and pulse profile measurements

## Pulsed-RF Detection Techniques

Figure 3 shows an important measure of a pulsed RF signal and its relationship between the time and frequency domain. When a signal is switched on and off in the time domain (pulsed), the signal's spectrum in the frequency domain has a  $\sin(x)/x$  response. The width of the lobes is inversely related to the pulse width (PW). This means that as the pulses get shorter in duration, the spectral energy is spread across a wider bandwidth. The spacing between the various spectral components is equal to the pulse repetition frequency (PRF). If the PRF is 10 kHz, then the spacing of the spectral components is 10 kHz. In the time domain, the repetition of pulses is expressed as pulse repetition interval (PRI) or pulse repetition period (PRP), which are two terms with the same meaning.

Another important measure of a pulsed RF signal is its duty cycle. This is the amount of time the pulse is on, compared to the period of the pulses. A duty cycle of 1 (100%) would be a CW signal. A duty cycle of 0.1 (10%) means that the pulse is on for one-tenth of the overall pulse period. For a fixed pulse width, increasing the PRF will increase the duty cycle. For a fixed PRF, increasing the pulse width increases the duty cycle. Duty cycle will become an important pulse parameter when we look at narrowband detection.

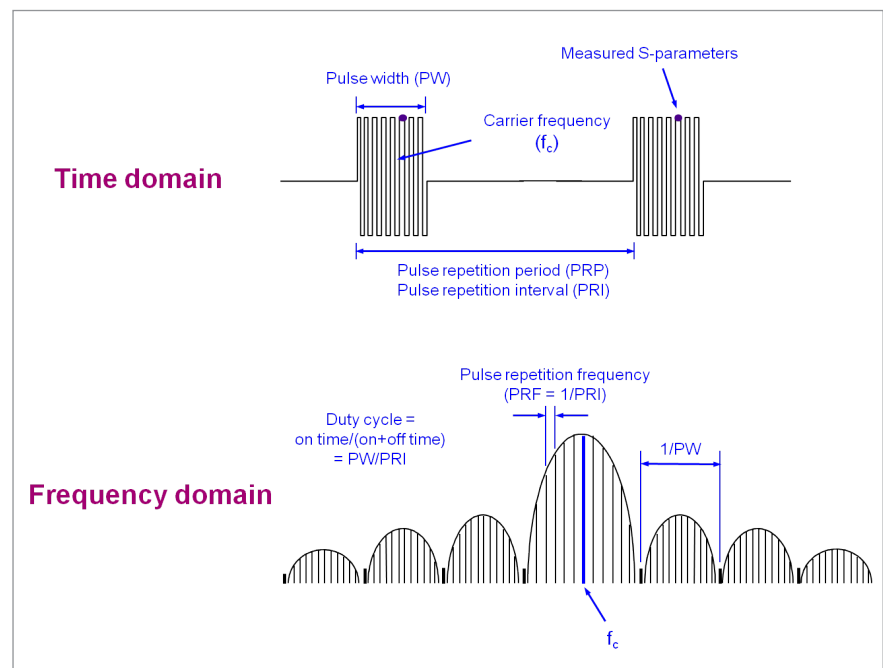

Figure 3. Pulsed-RF network analysis terminologies

## Wideband detection

Wideband detection can be used when the majority of the pulsed-RF spectrum is within the bandwidth of the receiver. In this case, the pulsed-RF signal will be demodulated in the instrument, producing baseband pulses. With wideband detection, the analyzer is synchronized with the pulse stream, and data acquisition only occurs when the pulse is in the “on” state. This means that a pulse trigger that is synchronized to the PRF must be present; for this reason, this technique is also called synchronous acquisition mode. The advantage of the wideband mode is that there is no loss in dynamic range when the pulses have a low duty cycle (long time between pulses). The measurement might take longer, but since the analyzer is always sampling when the pulse is on, the signal-to-noise ratio is essentially constant versus duty cycle. The disadvantage of this technique is that there is a lower limit to measurable pulse widths. As shown in Figure 4, as the pulse width becomes narrower, the spectral energy spreads out—once enough of the energy is outside the bandwidth of the receiver, the instrument cannot detect the pulses properly.

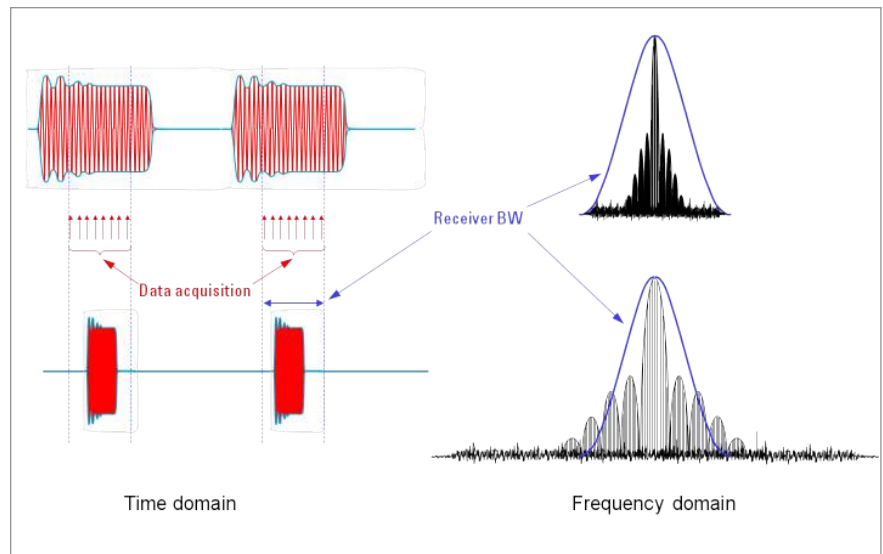

Figure 4. Pulse width and receiver bandwidth with wideband detection in time and frequency domain

## Narrowband detection

Narrowband detection is used when most of the pulsed-RF spectrum is outside the bandwidth of the receiver. In other words, the pulse width is narrower than the minimum data acquisition period with the widest available receiver bandwidth. With this technique, the entire pulse spectrum is removed by filtering except the central frequency component, which represents the frequency of the RF carrier. After filtering, the pulsed-RF signal appears as a sinusoid or CW signal. With narrowband detection, the analyzer samples are not synchronized with the incoming pulses (therefore no pulse trigger is required), so the technique is also called asynchronous acquisition mode. Usually, the PRF is high compared to the IF bandwidth of the receiver, so the technique is also sometimes called the "high PRF" mode.

Keysight has developed a novel way of achieving narrowband detection using wider IF bandwidths than normal, by using a unique "spectral nulling" and "software gating" techniques that will be explained later. These techniques let the user trade dynamic range for speed, with the result almost always yielding faster measurements than those obtained by conventional filtering.

The advantage to narrowband detection is that there is no lower pulse-width limit, regardless of how broad the pulse spectrum is, most of it is filtered away, leaving only the central spectral component. The disadvantage to narrowband detection is that measurement dynamic range is a function of duty cycle. As the duty cycle of the pulses becomes smaller (longer time between pulses), the power of the central spectral component becomes smaller, resulting in less signal-to-noise ratio as shown in Figure 5. Using this method, measurement dynamic range decreases as duty cycle decreases. This phenomenon is often called "pulse desensitization" and can be expressed as  $20 \cdot \log(\text{duty cycle})$  in dB. The PNA-X employs a number of unique features to minimize this effect, resulting in considerably less degradation in dynamic range. More details about these features will be discussed later.

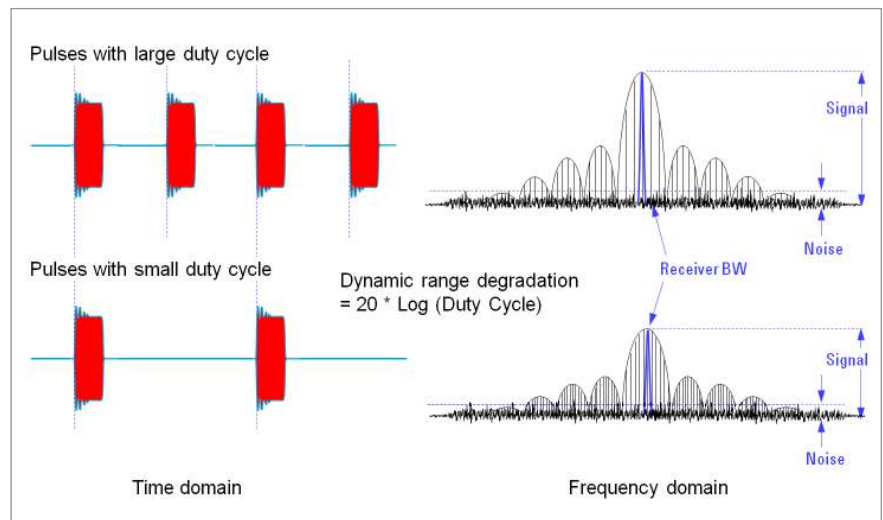

Figure 5. Duty cycle (time domain) versus signal-to-noise ratio of center spectrum (frequency domain)



# Pulsed-RF S-parameter Measurements Using PNA-X

## PNA-X pulse system

This section discusses pulsed-RF S-parameter measurements using the PNA-X with wideband detection and narrowband detection techniques.

## PNA-X hardware overview

Figure 6 shows the PNA-X block diagram with two test ports, two internal sources, source/receiver attenuators, internal combining network, and rear access loops with mechanical path switches. Each source has two outputs; Output 1 and 2 of Source 1 are routed to test port 1 and test port 2 and used for basic S-parameter measurements. Output 1 and 2 of Source 2 are routed to two front-panel source output ports on a 2-port configuration, and are routed to test port 3 and test port 4 on a 4-port configuration (not shown). Output 1 (OUT 1) of each source is filtered to reduce harmonics, and can be switched to the combining network for two-tone IMD measurements. Both outputs of each source can be routed through the rear access loop for additional signal conditioning or switched to the thru path to the test port. All source paths and test-receiver paths have optional step attenuators to lower the source power for high gain devices or to reduce the signal level to avoid receiver compression. The source attenuators are sometimes used to improve the source match for active measurements. All of these features make the PNA-X the most flexible network analyzer, enabling accurate S-parameters and active-device measurements with the best possible configuration. The PNA-X also integrates internal pulse generators, and a pulse modulator on OUT 1 of each internal source. Pulsed-RF measurements with pulsed stimulus in the forward direction only requires one internal source with a pulse modulator. Adding the second internal source and a pulse modulator enables bi-directional pulsed-RF measurements. In this configuration, pulsed stimulus from the second internal source is routed from J8 through J1 connectors of the rear panel to the port 2.

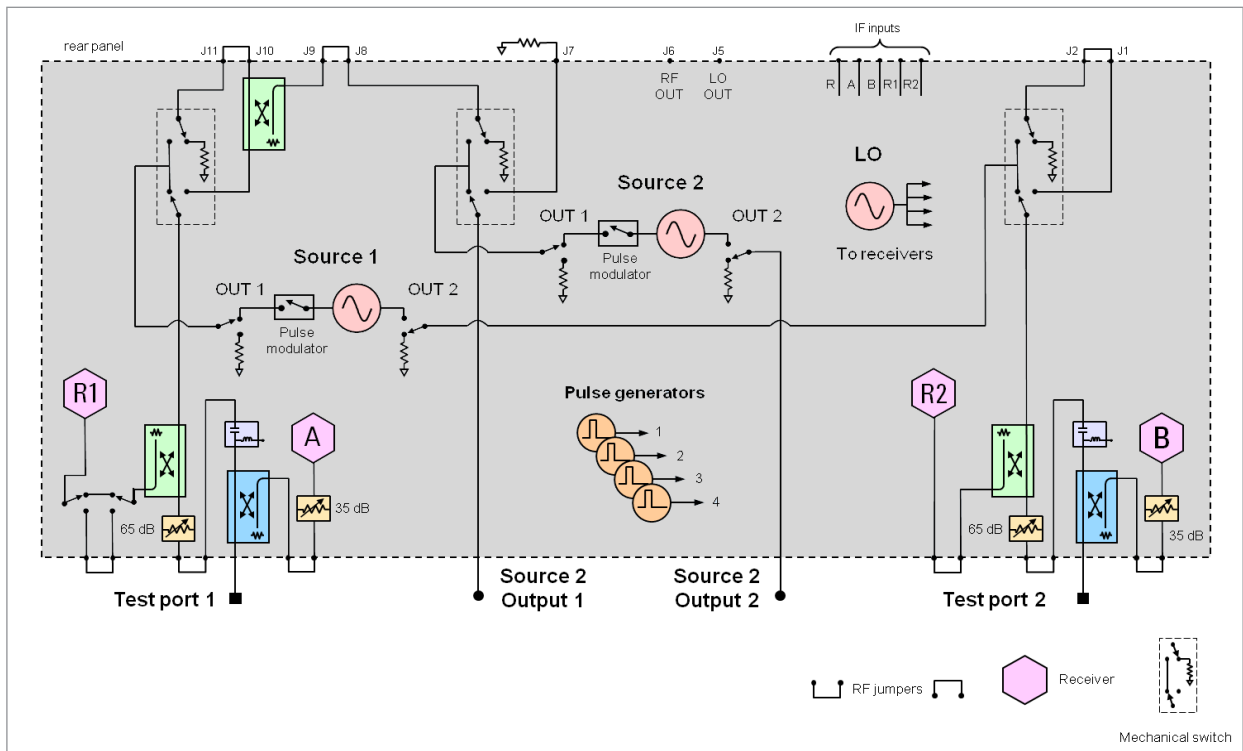

Figure 6. 13.5/26.5 GHz PNA-X block diagram with options 200, 219, 224, 020, 021, 022 and 025

## PNA-X IF paths

Figure 7 shows the PNA-X receiver/IF path block diagram with internal pulse generators and modulators. The narrowband filter path employs a crystal filter with 30 kHz bandwidth centered at 10.7 MHz for better signal selectivity, and also adds receiver gating capability for narrowband pulse measurements. Earlier PNA-X models had 60 MSa/s analog-to-digital converters (ADC) with 60 MHz system clock (DSP version 4), later versions have been upgraded to 100 MSa/s ADC with 100 MHz system clock (DSP version 5).

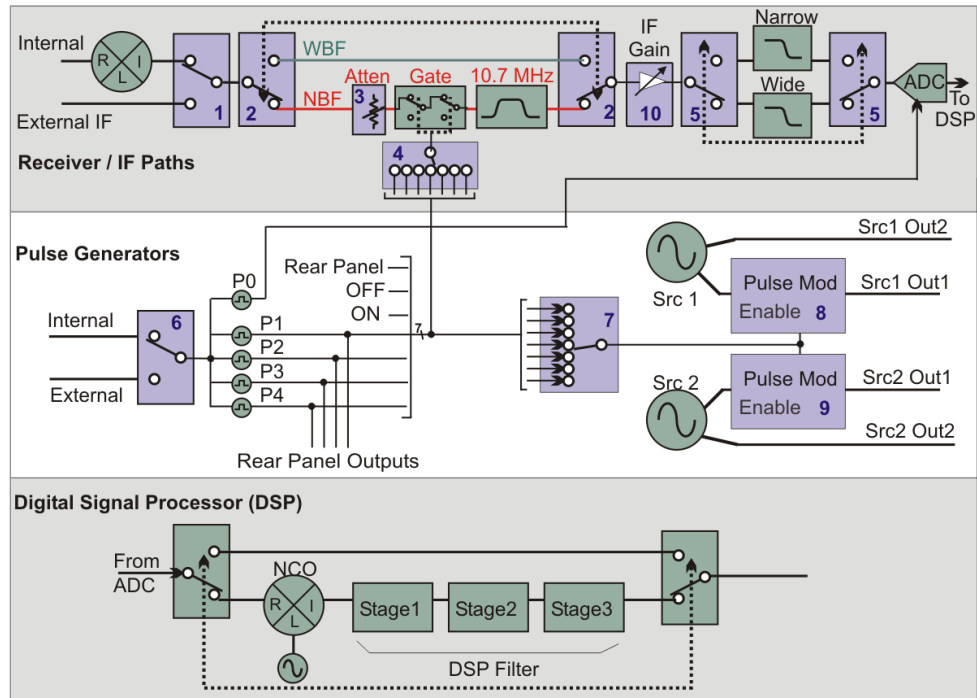

Figure 7. PNA-X IF path block diagram

## Internal pulse generators

The PNA-X with internal pulse generators (Option 025) adds four pulse generators (P1, P2, P3, and P4) and an additional pulse generator (P0) that is used for synchronizing the data acquisition. These internal pulse generators can be triggered internally or externally—all at the same time. They can have an individual delay up to 35 s, and pulse width up to 10 s. When triggered internally, the pulse generators output a continuous pulse train with specified periods up to 35 s. The minimum timing resolution of all pulse generators is based on the clock, 16.7 ns with DSP version 4 and 10 ns with DSP version 5. P1 through P4 pulse generators are used to drive internal pulse modulators, IF gates and/or external devices, such as pulsed-bias switches. P0 pulse generator is used to trigger the DSP for data acquisition. When P0 outputs a pulse, the DSP starts data acquisition and continues until it completes the required number of samples per specified IF bandwidth. If P0 outputs the next pulse before the DSP completes the data acquisition, the P0 pulse is ignored. Approximate data acquisition time is  $1/(\text{IF bandwidth})$ .

## Internal pulse modulators

The PNA-X with the internal pulse modulator options adds a pulse modulator to the “OUT 1” of each internal source (Option 021 for Source 1 and Option 022 for Source 2). Both modulators are driven by a common pulse, which can be selected from P1 through P4 internal pulse generators, or external pulse inputs with minimum pulse width of system clock timing resolution.

## Pulse I/O

The pulse input/output (I/O) port on the PNA-X rear panel adds accessibility to internal pulse generators and modulators, and enables synchronous pulse measurements with external pulse generators or a device under test (DUT). The N1966A pulse I/O adapter converts the 15-pin D-sub connector to SMB connectors for five PULSE IN (inputs for A, B, C/R1, D/R2, and R receiver gates), PULSE SYNC IN (to trigger internal pulse generators for pulse modulation and data acquisition), RF PULSE MOD IN (to modulate RF sources), and four PULSE OUT (P1 through P4). The four PULSE OUT ports are hard-wired to the internal pulse generators without switches. Figure 8 shows how the pulse I/O connectors map to the IF block diagram.

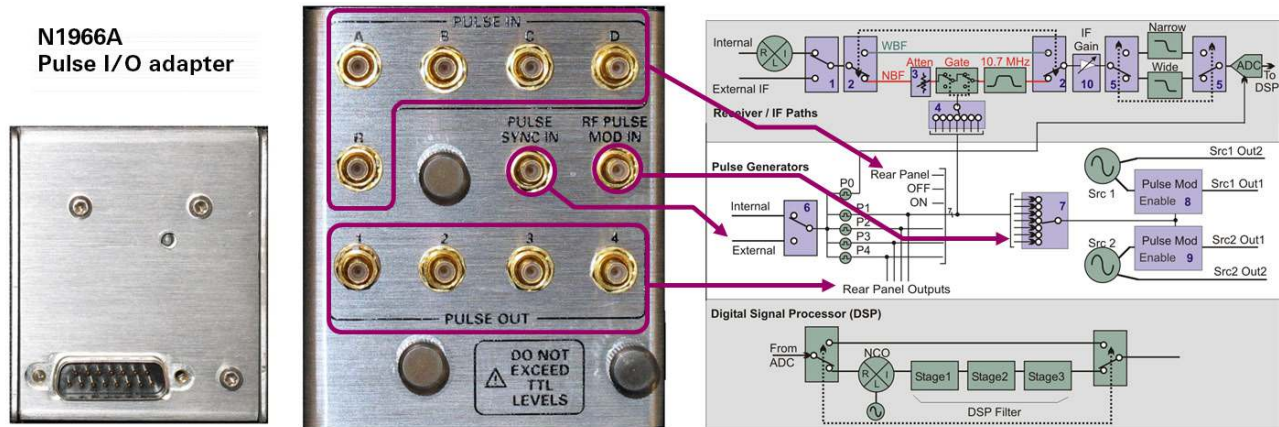

## Pulse system delays

From pulse trigger to internal pulse generators, to pulse modulators, and then to ADC for data acquisition, there are some delays in the pulse system that need to be taken into account. Figure 9 shows the timing diagram from the pulse trigger at PULSE SYNC IN through the data acquisition with wideband detection technique.

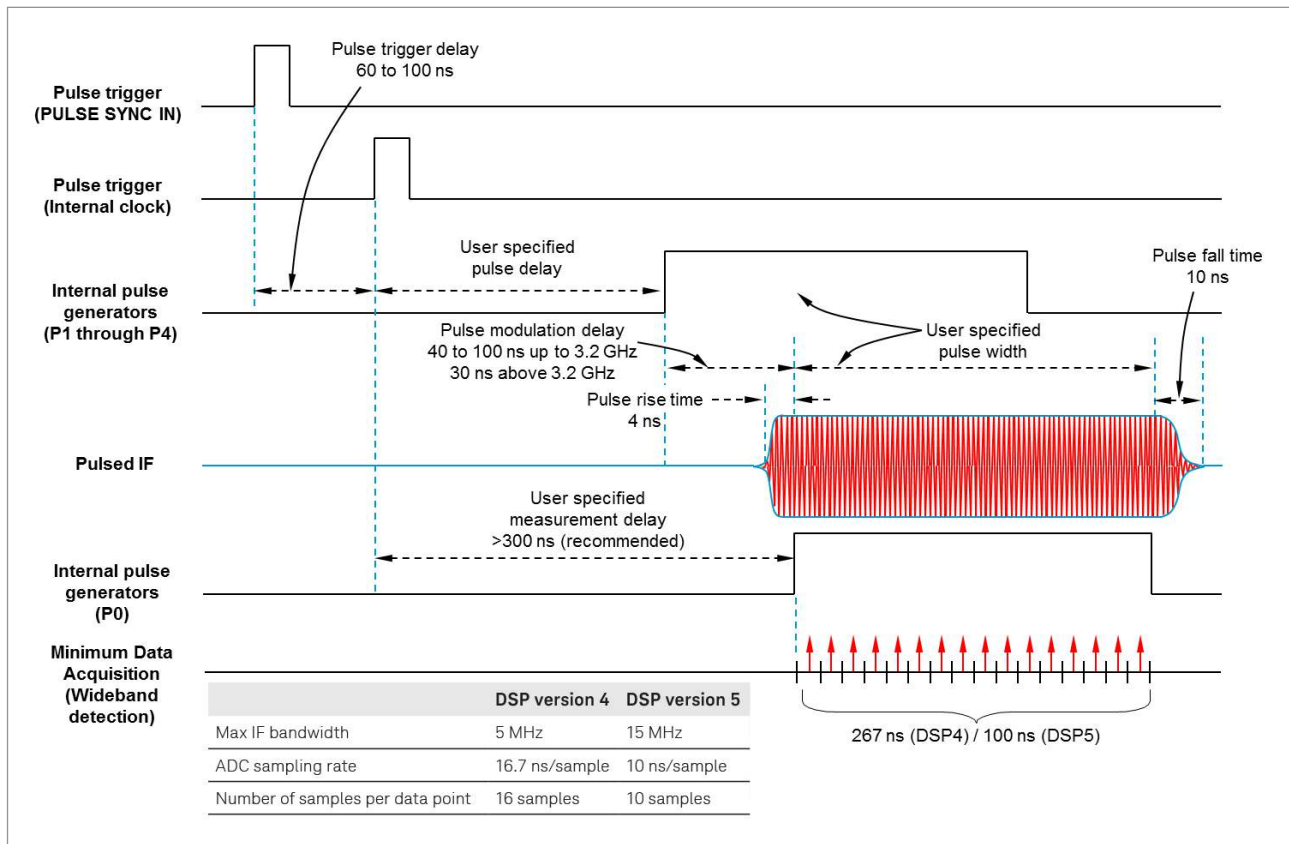

Figure 9. PNA-X pulse system delays with wideband data acquisition

Internal pulse generators start generating the pulses approximately 60 to 100 ns after the pulse trigger inputs at the PULSE SYNC IN—(denoted as pulse trigger delay). The jitter of this delay is the minimum time resolution of the system. The exact pulse trigger delay can be measured with an oscilloscope between PULSE SYNC IN and one of the PULSE OUT (P1 through P4). If the internal clock is used to trigger the pulse generators, this pulse trigger delay is very small and therefore it can be neglected. One of the P1 through P4 internal pulse generators drives the internal pulse modulators to generate pulsed-RF signals. The actual pulsed-RF signals have a delay of approximately 30 ns from the P1 through P4 modulation pulse at the test port with a 48 inch RF test port cable—(denoted as pulse modulation delay). The pulse modulation delay with RF carrier frequencies of 3.2 GHz and below is about 40 ns or larger (nearly 100 ns delay at the low-end frequency of the analyzer). The combiner path on port 1 adds an additional 5 ns delay compared to the thru path. The pulse modulators switch the RF sources on and off with approximately 4 ns rise time and 10 ns fall time.

P0 pulse generator is also triggered by PULSE SYNC IN (or internal trigger) and generates a data acquisition pulse with the same amount of pulse trigger delay as other internal pulse generators (or zero if triggered internally). Although the data acquisition process starts immediately with the P0 pulse, there is approximately 250 ns data-processing delay, the time it takes for sampled data with pulse on to become available in the buffer. The user-specified measurement delay (the delay for P0) must take into account these data-acquisition and pulse-modulation delays to align the pulsed stimulus and data-acquisition window. Approximately 300 ns for the measurement delay accounts for pulse-modulation delay and data-acquisition delay, as well as pulse-settling time. Additional delay may be necessary depending on the frequency, the PNA-X's internal path switches, and external cables and devices.

## Setting up pulsed-RF measurements

The basis of pulsed-RF point-in-pulse measurements with wideband detection method is to synchronize pulsed stimulus and data acquisition so that all receivers measure responses only within the RF pulses. The following three steps must be completed for successful measurements.

### Step 1 Setup pulse generators and modulators

Specify pulse width, delay and period for internal pulse generators with Pulse Generator Setup dialog (Figure 10a). Note that Pulse0 width is determined by the IF bandwidth chosen (in step 3) thus it is not editable on the pulse generator dialog. When internal pulse modulators are used, specify the drive source (typically one of internal pulse generators). It is also required to disable automatic level control (ALC) on the source port with pulse modulation enabled. Change the leveling mode from "Internal" to "Open loop" on Power and attenuator dialog. Otherwise the ALC will try to level the source with the detected power level with pulse on and off, causing a source unlevelled error.

## Step 2 Synchronize data acquisition and pulses

With internal pulse generator option, pulse trigger feature is added to the PNA-X trigger system (Figure 10b Pulse Trigger tab on Trigger dialog). Specify trigger source—either internal or external (incoming pulses to PULSE SYNC IN) and check “Synchronize receiver to pulse generator Pulse0”. Note that measurement trigger (MEAS TRIG IN port on PNA-X rear panel) is not used in typical setup.

## Step 3 Adjust data acquisition time

Set IF bandwidth to be wider than at least  $1/(\text{pulse width})$ , in order to complete the data acquisition while pulse is on. For example, 10  $\mu\text{s}$  pulse width requires at least 100 kHz IF bandwidth or wider. It is recommended checking Pulse0 width is smaller than the pulse width of modulation drive on Pulse Generator Setup dialog. Recommended setting is to a step wider IF bandwidth than the narrowest possible bandwidth for the given pulse width so that numerous system delays do not cause a problem. The PNA-X, to account for the test port coupler roll-off at low frequencies, adjusts IF bandwidth automatically and maintains the measurement accuracy. This causes a problem in pulse measurements using wideband detection method. Turn off “Reduce IF Bandwidth at Low Frequency” on IF Bandwidth dialog.

For pulse profile measurements, the basic steps stay the same as point-in-pulse measurements, but add slightly more complexity. The sweep type must be CW Time sweep. The IF bandwidth needs to be much wider than the one for point-in-pulse at the same pulse width. This is because pulse profile often requires minimum 10 or more measurement points in a pulse compared to only one point in a pulse with point-in-pulse. Define the IF bandwidth to achieve desired timing resolution. In order to display the whole pulse profile, adjust number of points and the delay for the modulation drive.

## Setting up with pulsed-RF measurement application

Option 008 pulsed-RF application optimizes the setup through Pulse Setup dialog, and adds narrowband pulse measurements. The basic pulsed-RF measurements can be done by simply choosing measurement type (Standard or Pulse Profile), specifying the pulse width and period on Pulse Setup dialog (Figure 11a). All other necessary settings explained earlier are done automatically. It also adds pulse measurements with narrowband detection method to extend lower limit of measurable pulse width.

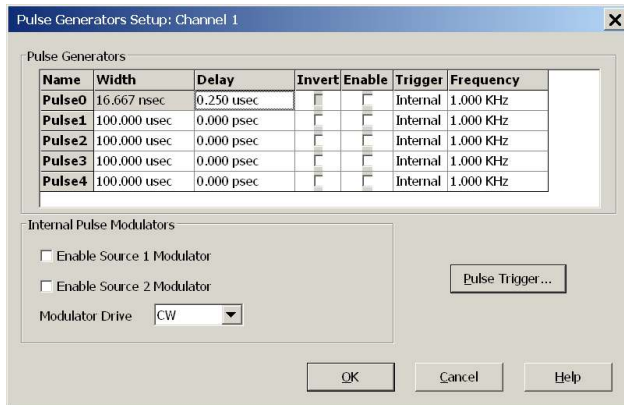

Figure 10a. Pulse Generators Setup dialog box

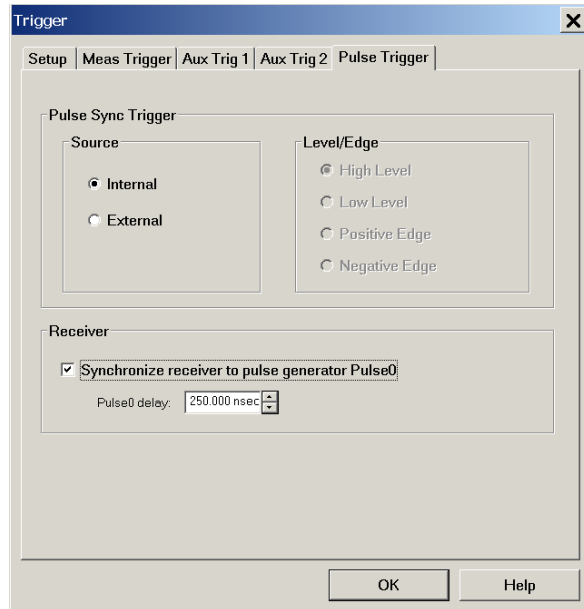

Figure 10b. Pulse Trigger tab or Trigger dialog box

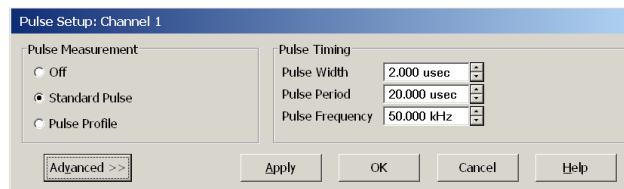

Figure 11a. Basic Pulse Setup dialog box

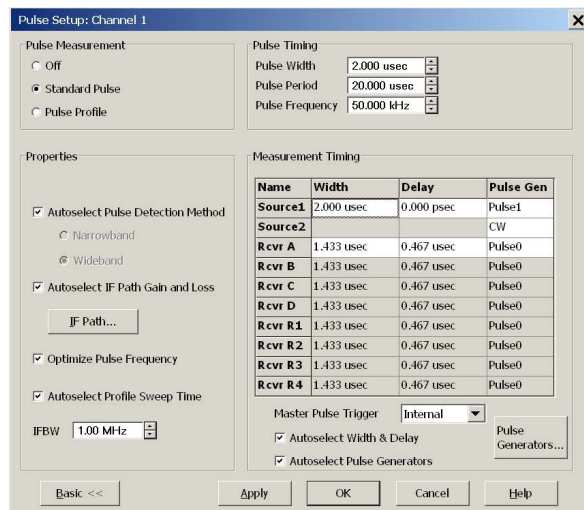

Figure 11b. Advanced Pulse Setup dialog box

The Advanced setup shown in Figure 11b allows you to adjust the analyzer settings for a particular case. The following are references for adjusting the pulse measurement settings available in the Advanced setup dialog.

### Autoselect pulse detection method

If selected, wideband detection method is used for pulse widths of 267 ns or wider for point-in-pulse measurements, and 1.6  $\mu$ s or wider pulse width for pulse profile measurements. Otherwise, narrowband detection method is used.

### Autoselect IF path gain and loss

Autoselect is used in most cases, but it may need to be adjusted for high-power configurations with user-supplied high-power couplers and attenuators instead of internal test port couplers. De-select to adjust the IF settings for non-standard setups. Refer to PNA Help for more details.

### Optimize pulse frequency

If selected, it adjusts the pulse frequency to maximize the spectral nulling effect when using the narrowband detection method. It is ignored for the wideband detection method.

### Autoselect profile sweep time

If selected, the time span in pulse profile measurements is set to double of the pulse width, and a delay of half of the pulse width is added to the pulse generator that drives the modulators. In the case of 10  $\mu$ s pulse width, the hardware sets 20  $\mu$ s span and 5  $\mu$ s delay of the pulse generator, and displays the pulse in the middle of the screen. If de-selected, it sets the time span based on the current number of measurement points and IF bandwidth. The start and stop time can be adjusted in the Sweep, Time menu.

### IFBW

In wideband detection, the IF bandwidth is set automatically based on the specified pulse width in order to make the data acquisition window (approximately 1/IFBW) narrower than the pulse width. In narrowband detection, it is also set automatically, but with a custom IF filter for spectral nulling. The display shows the closest standard IF bandwidth.

### Master pulse trigger

It is used to define the trigger source between internal or external (incoming pulse on PULSE SYNC IN).

### Autoselect width & delay

If selected, the data acquisition or receiver gate widths and delays are set to acquire data within the pulses. They are adjusted to display the pulse in the middle of the screen in pulse profile. They can be customized in the Measurement Timing table or in the Pulse Generators Setup dialog box.

### Autoselect pulse generators

If selected, PNA firmware assigns Pulse1 to modulators in wideband and narrowband mode, and Pulse2 to all receiver gates in narrowband mode. If de-selected, any internal pulse generator and "external" (Pulse Sync In) can be selected in the Measurement Timing table. The pulse generators must be enabled in the Pulse Generators Setup dialog box (Figure 10) to be activated.



## PNA-X wideband pulse measurements

Wideband pulse measurements are accomplished by modulating the RF source, setting the IF bandwidth wide enough to capture all pulse spectrum, and synchronizing the modulation and measurements with appropriate triggering and delay settings. The internal pulse generators and modulators can be controlled either by SCPI/COM commands or the Pulse Setup dialog added with Option 008 pulsed-RF measurements.

### Wideband pulse data acquisition

The PNA-X with DSP version 4 requires 16 samples with its widest IF bandwidth of 5 MHz to get a single data point, which takes 267 ns (16.7 ns per sample) with its 60 MSa/s ADC. The PNA-X with DSP version 5 enables widest IF bandwidth of 15 MHz and requires only 10 samples, which takes 100 ns (10 ns per sample) with its 100 MSa/s ADC. Figure 12 shows how the data acquisition progressed in point-in-pulse and pulse-to-pulse measurements with wideband detection technique. The RF carrier frequency of point-in-pulse is increased at every data point, thus each data point needs to be calculated with the required number of samples for specified IF bandwidth within the same pulse. The minimum pulse width for wideband point-in-pulse measurements at widest IF bandwidth is 267 ns with DSP version 4 and 100 ns with DSP version 5 (refer to Table 1 for a list of bandwidths and the associated minimum pulse width).

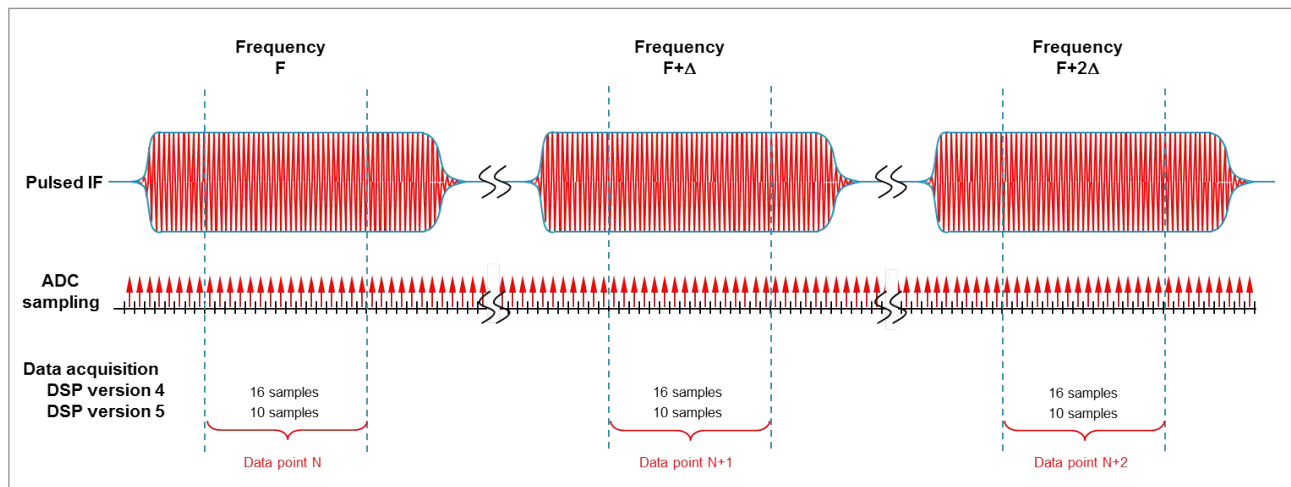

Figure 12. Wideband point-in-pulse and pulse-to-pulse data acquisition with widest IF bandwidth

In wideband pulse profile measurements, all the data is acquired with a single pulse, thus the pulse width needs to be relatively wide (Figure 13). For each data point with 1 MHz and wider IF bandwidth on DSP version 4 or 10 kHz and wider IF bandwidth on DSP version 5, the latter half of samples from the previous data point are used for the first half of samples of the next data point. This means that the data acquisition timing resolution is one-half of the data acquisition time. With DSP version 4 widest IF bandwidth of 5 MHz, the last 8 samples of previous data points and 8 new samples are used to calculate a new data point, which makes 133 ns minimum time resolution measurements. It becomes 50 ns minimum time resolution with DSP version 5 widest IF bandwidth of 15 MHz.

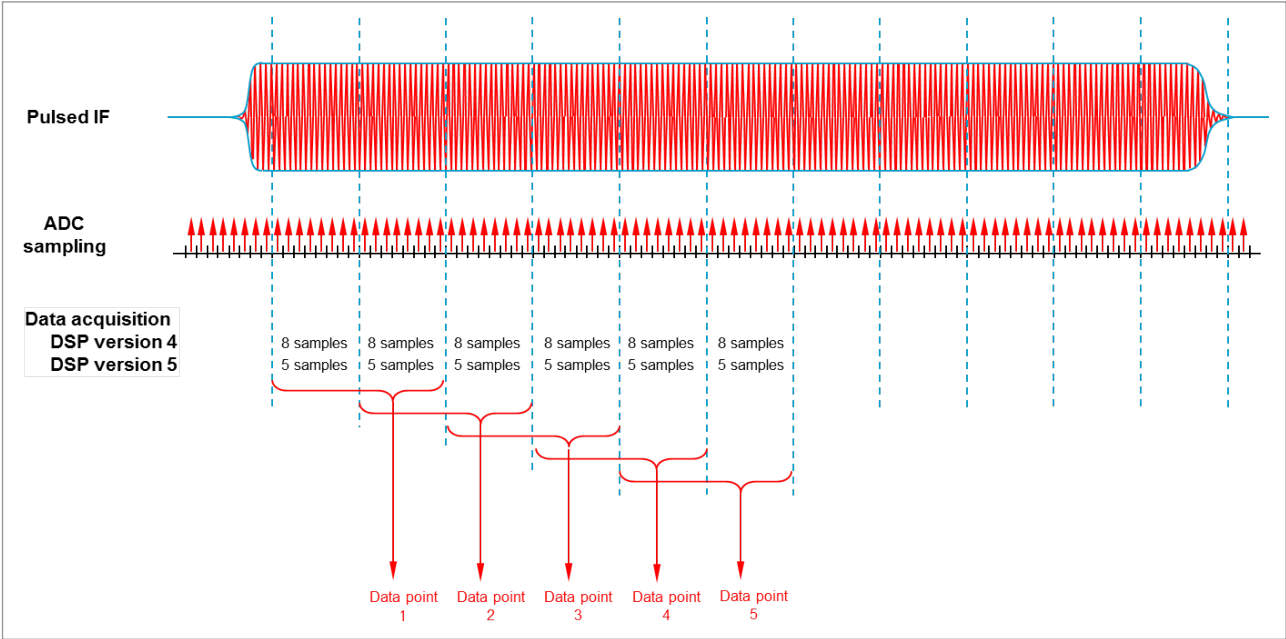

Figure 13. Wideband pulse profile data acquisition using widest IF bandwidth

Table 1 shows theoretical values of the data-acquisition time-per-point and timing resolution for each IF bandwidth. These represent the minimum pulse width for wideband point-in-pulse and timing resolution for wideband pulse profile respectively. The minimum timing resolution can also be found on the PNA-X display by setting CW time sweep and dividing sweep time by the number of points. In other words, the length of pulse profile can be set by number of points, up to 32001 points in PNA-X standard operation mode. Note that the maximum number of points with DSP version 4 is limited by 1001 points with 1 MHz or wider IF bandwidth. Thus the maximum length of pulse profile is (timing resolution) \* (1001 points) in this case, instead of (timing resolution) \* (32001 points).

In practice, the minimum pulse width for wideband point-in-pulse is affected by pulse rise and fall time, the alignment of pulses and data acquisition window, and is determined based on measurement accuracy requirements. When one of the few sampled data points falls outside of the pulse, the error becomes considerably large. However, the number of samples increases with narrower IF bandwidth and missing one of many samples causes a relatively small error, which may be acceptable.

Table 1. Minimum pulse width (point-in-pulse) and timing resolution (pulse profile) in wideband pulse measurements

IF bandwidth (kHz)	Wideband point-in-pulse minimum pulse width (ns)		Wideband pulse profile minimum timing resolution (ns)	
	DSP version 4	DSP version 5	DSP version 4	DSP version 5
100	10650	14520	10650	7260
150	7100	9680	7100	4840
200	4733	7260	4733	3630
280	3550	5160	3550	2580
360	2367	4420	2367	2410
600	1183	3620	2367	2410
1000	1433	1440	717	720
1500	933	960	467	480
2000	700	720	350	360
3000	467	500	233	250
5000	267	300	133	150
7000	n/a	200	n/a	100
10000	n/a	140	n/a	70
15000	n/a	100	n/a	50

## Synchronizing pulsed-RF stimulus and measurements

In wideband pulse measurements, the appropriate IF bandwidth and the pulse generators' width/delay are set in order to acquire the data within pulses. The following measurements demonstrate the results with inappropriate IF bandwidth and delay settings, which should be avoided when customizing pulse measurement setups. The following point-in-pulse measurements are made using a PNA-X with DSP version 4, 4 to 6 GHz frequency range,  $-5$  dBm input power, and 2  $\mu$ s pulse width and 20  $\mu$ s PRI (10% duty cycle). With "Autoselect" mode, 1 MHz IF bandwidth (which takes 1.433  $\mu$ s for the data acquisition) and 467 ns measurement delay are selected. A narrower IF bandwidth may be used to reduce noise. If the IF bandwidth becomes too narrow such as 100 kHz, the data acquisition takes 10.65  $\mu$ s and the majority of the measurements occur outside of the pulses, resulting in significant errors in the absolute power measurements (B receiver trace) and noisy ratio measurements (S21 trace) as shown in Figure 14a. Note that the examples show S21 measurements with 1 dB/div and the B receiver measurements with 10 dB/div in both Figure 14a and 14b.

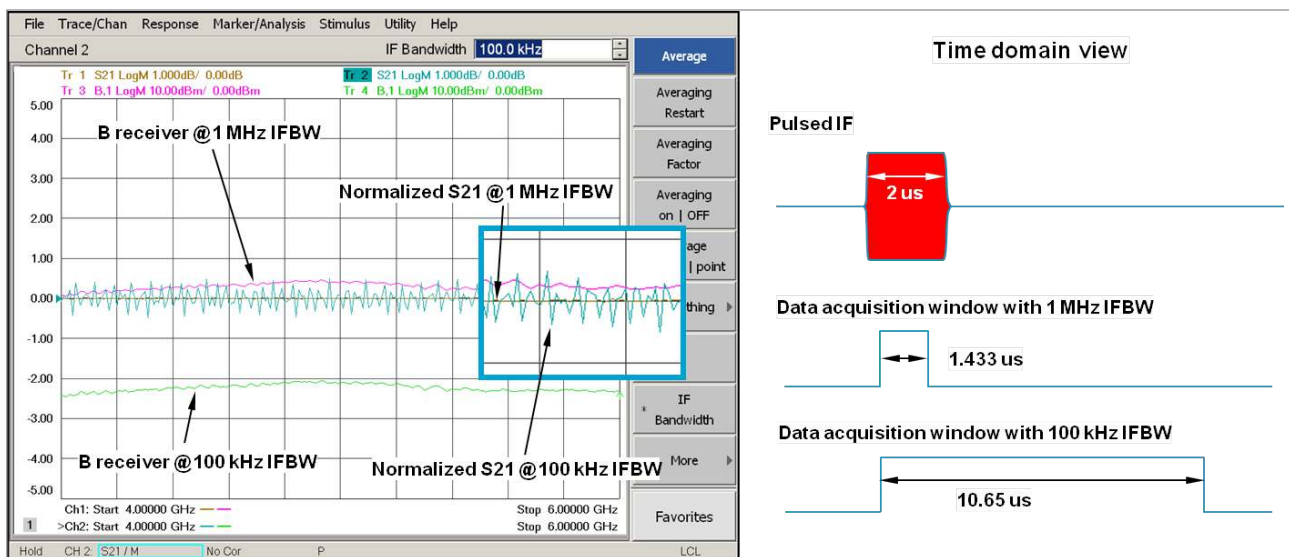

Figure 14a. Measurement errors caused by improper IF bandwidth

When the measurement delay (or pulse delay) is adjusted, it is crucial to keep the data acquisition window within the pulses. Unlike previous examples, the measurement errors may not be obvious due to a few ADC samples outside of the pulses. Figure 14b shows the measurement errors caused by improper measurement delay. It is recommended to have enough timing margin when adjusting IF bandwidth and/or the delays. Approximately 300 ns or greater measurement delay is recommended to account for data processing and pulse modulation delays as shown earlier in Figure 9. The chosen IF bandwidth should leave a margin of more than a few internal clock cycles (50 ns or more) within the pulses.

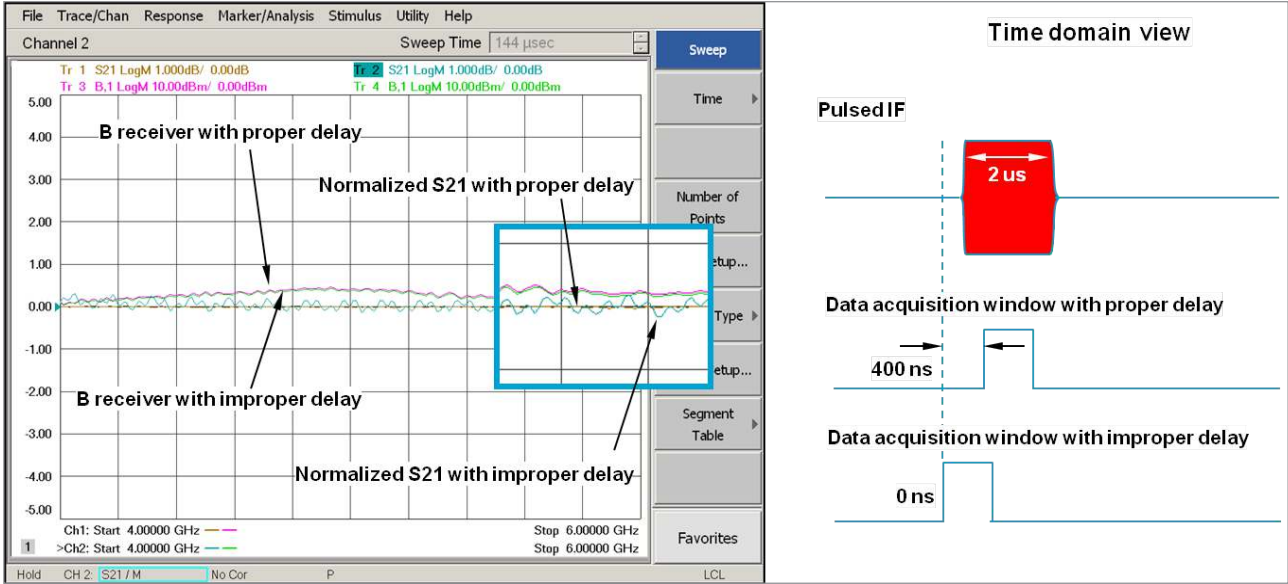

Figure 14b. Measurement errors caused by improper measurement delay

In pulse-to-pulse measurements, PRI has to be wide enough for the PNA-X to keep up with the data acquisition from one pulse to the next. The minimum PRI becomes slightly longer with narrower IF bandwidth as the data acquisition time becomes longer. Table 2 is the minimum PRI by IF bandwidth for 26.5 GHz PNA-X with DSP version 4 and 1.5 GHz CPU board as a reference. The minimum PRI could be improved as the data processing time becomes shorter with a faster CPU and/or DSP.

Table 2. Minimum PRI in wideband pulse-to-pulse measurement

IF bandwidth (kHz)	Minimum PRI in wideband pulse-to-pulse measurements (us)
100	47
150	43
200	41
280	40
360	39
600	37
1000	36
1500	34
2000	34
3000	33
5000	32

If the data acquisition process is not ready when the second pulse comes, it waits for the next pulse to take data for the second data point. Thus the missing pulses cannot be easily seen in pulse-to-pulse measurements. To verify every single pulse is measured in a particular setup, an oscilloscope may be used to compare the PNA-X's AUX trigger output to the pulse trigger. Figure 15 shows the setup and the screen shots from the oscilloscope for every pulse and missing pulses.

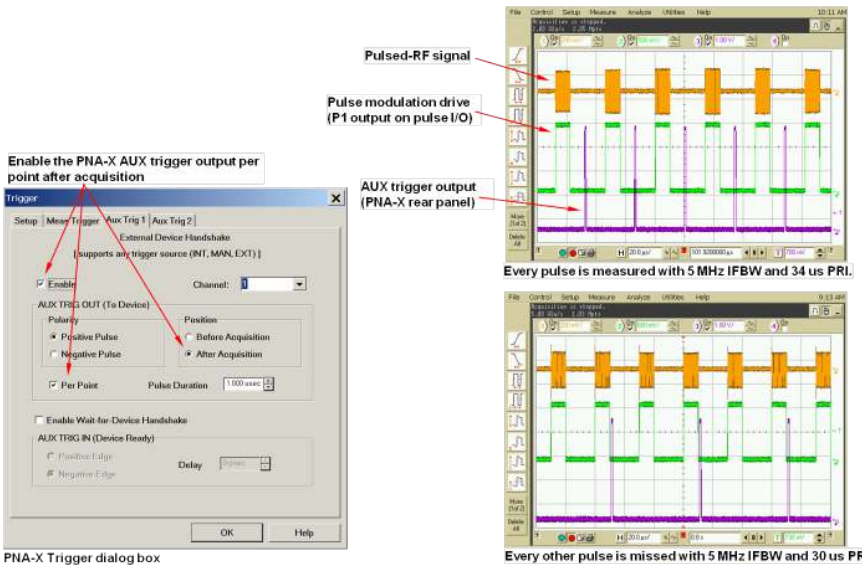

Figure 15. Wideband pulse-to-pulse measurement verification

### Wideband pulse system dynamic range

The wideband detection with PNA-X can be used for relatively fast pulsed-RF operation (with shorter PRI or high PRF) compared to legacy VNA's due to a wide IF bandwidth up to 15 MHz. However, the recommended IF bandwidth should be wide enough to capture most of the pulse spectrum, while the dynamic range and trace noise performance meets the measurement requirements. Figure 16 compares the PNA-X wideband pulse dynamic ranges at 5 MHz and 200 kHz IF bandwidth as a reference.

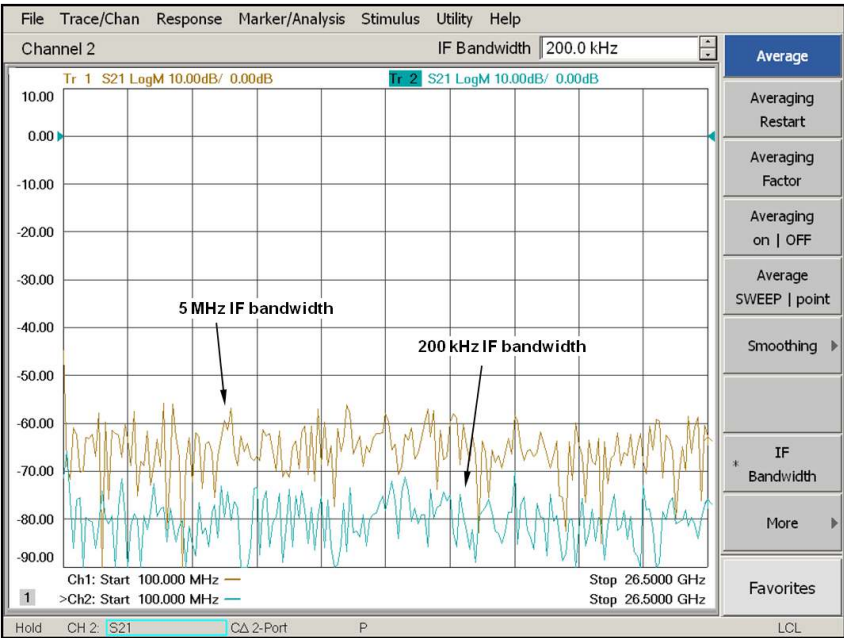

Figure 16. PNA-X wideband pulse measurement dynamic range

## PNA-X narrowband pulse measurements

The Option 008 pulsed-RF measurement uses narrowband detection method for a pulse width narrower than 267 ns in standard pulse (point-in-pulse) measurements and 1.6  $\mu$ s pulse width or narrower in pulse profile measurements. When narrowband detection is selected, each receiver gate width and delay can be controlled independently. The PNA-X narrowband pulse implementation employs unique hardware and software techniques—narrowband filter path, software gating, and digital filter nulling, all of which improve the receiver sensitivity and the measurement throughput.

### Narrowband filter path with crystal filter

The narrowband filter path consists of three major elements; an amplifier, receiver gate switches, and a 30 kHz crystal filter centered at 10.7 MHz as shown in Figure 17. The basic idea is to amplify the signal as much as possible from the upstream receiver path before the IF gate. The levels are such that the IF gate does not compress and the peak pulse envelop energy passes relatively unchanged, the IF gate is then used for time discrimination. The crystal filter removes the undesirable portion of the pulse spectrum before reaching the downstream amplifiers and digitizer. As a result, it reduces the overall energy of the pulsed spectrum avoiding the center spectral component to be compressed by the ADC. The larger the duty cycle and smaller the pulse width (as the pulse spectrum spreads out) the crystal filter contributes more to the sensitivity improvement.

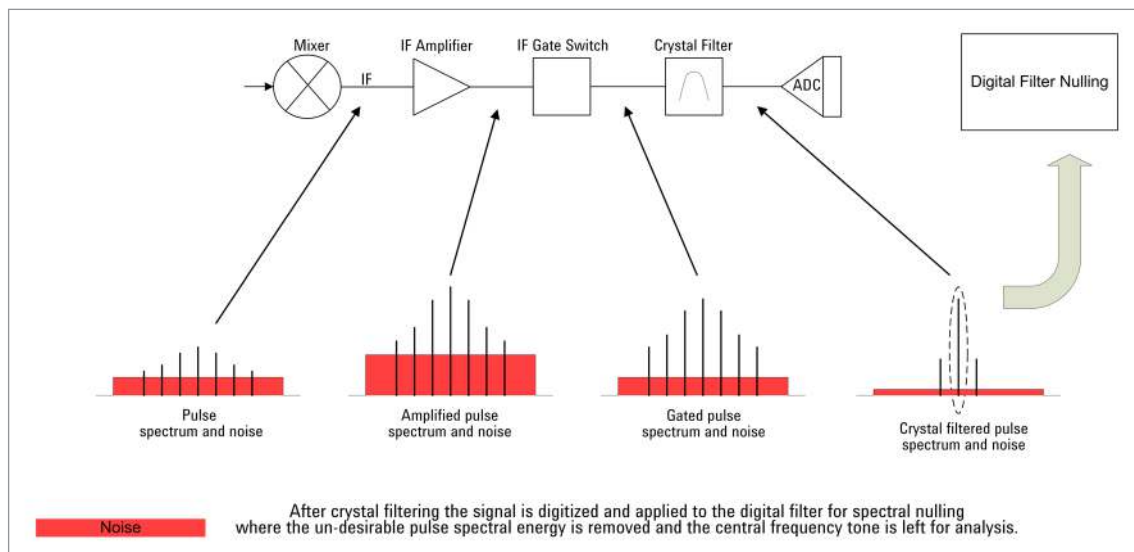

Figure 17. Narrowband filter path



Figure 18 shows how the narrowband filter path affects pulsed-RF signals by looking at the central frequency tone of the pulsed-RF signals with 200 ns pulse width and 2 us PRI. In Figure 18, the top window shows the PNA-X's 500 Hz IF filter response with the wideband IF path. The bottom window shows the narrowband filter path, which removes some of the undesired spectrum of the pulse-RF signals with 30 kHz crystal filter.

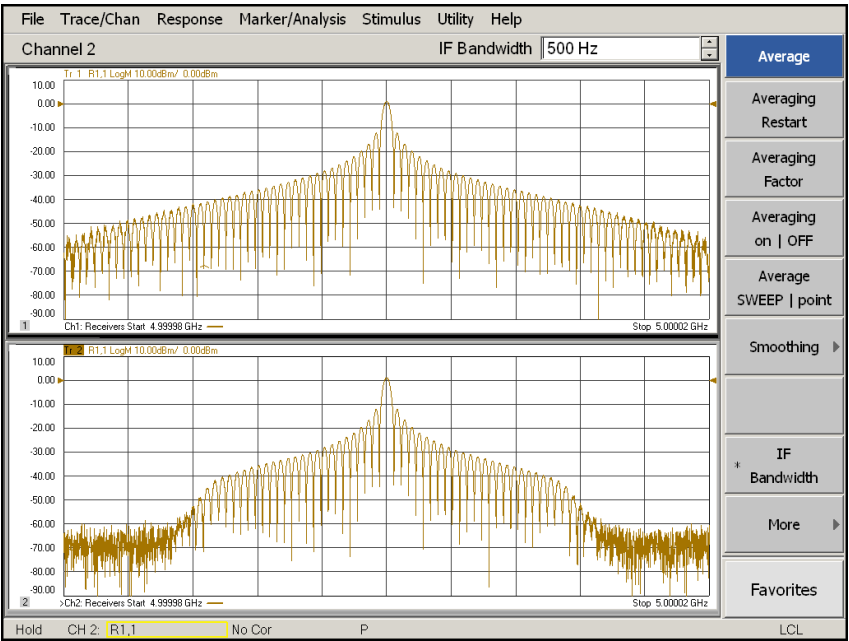

Figure 18. Pulsed-RF signal filtered in wideband IF path and narrowband filter

### Software gating

The IF gating in the narrowband filter path uses hardware switches driven by a pulse generator, which leaves residual noise at the gate off time caused by internally generated noise and the switch isolation. When hardware IF gating and an internal pulse generator are used, the on and off times of the gated signal can be determined precisely. Since the off times of the gate contain undesirable noise and residual gate isolation, the algorithm can replace the off times with an ideal off state (i.e. zeros), thereby improving the receiver sensitivity. Figure 19 shows how the software gating improves measurement sensitivity.

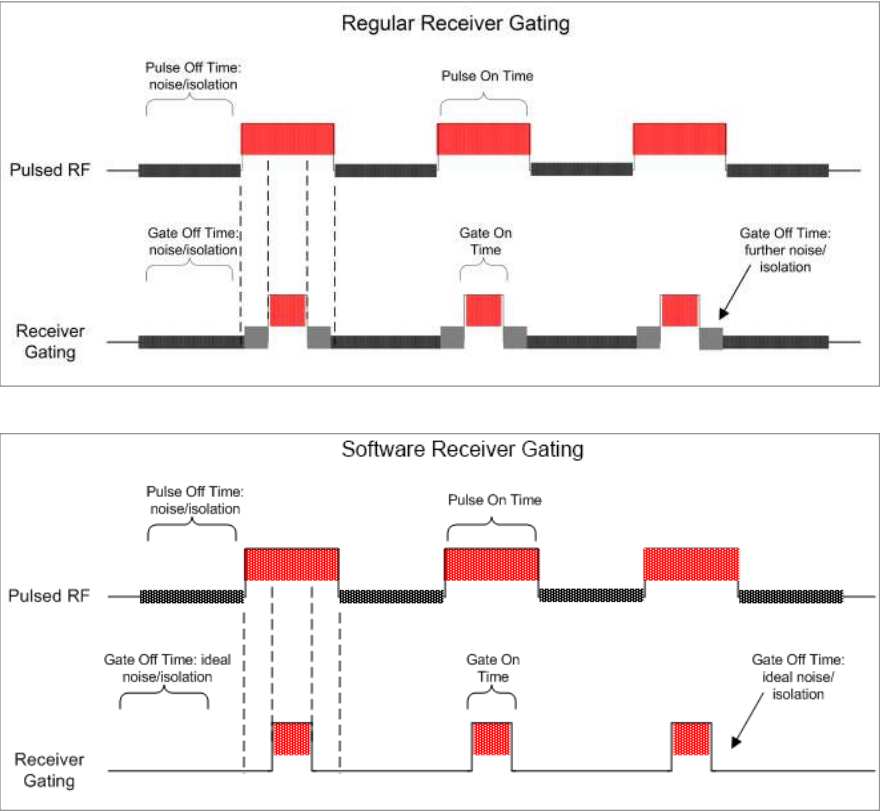

Figure 19. Software gating replaces the residual noise with ideal zeros and increases the receiver sensitivity

Figure 20 shows an example of the dynamic range improvement that the PNA-X has over the E836x PNA models due to the narrowband filter path and the software gating technique. In this example of 0.001% duty cycle, the measurement in the PNA is very noisy, and many averages are needed to get a usable measurement. At this duty cycle, the PNA-X's hardware gives about 20 dB of improvement and the software gating provides another 20 dB, for a total of 40 dB improvement. This gives a very usable dynamic range; in fact, the 60 dB dynamic range is about the same as that afforded by an 8510-based pulsed solution, but with much shorter pulses (50 ns versus 1 us).

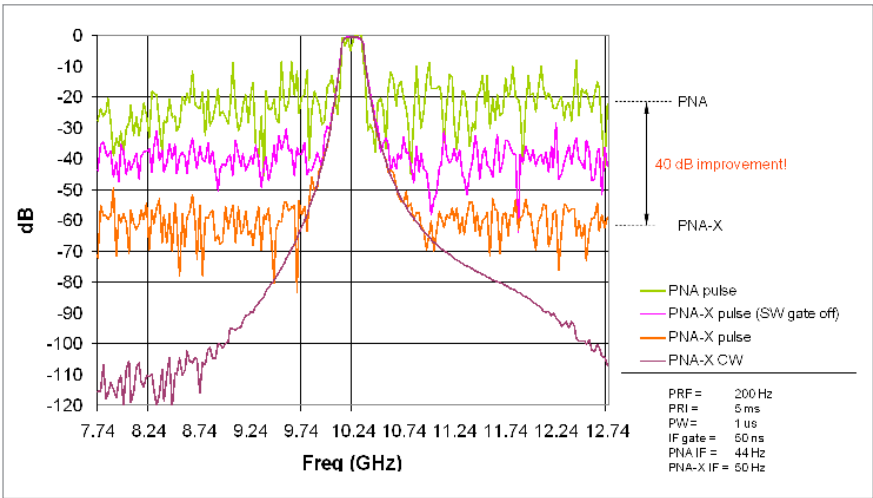

Figure 20. System dynamic range comparisons, 40 dB improvement with PNA-X and software gating

## Digital filter nulling

The gated and filtered pulsed IF signal is digitized and sent to DSP for IF filtering. The remaining pulse spectrum is filtered using custom IF filter nulls leaving only the center spectral component to analyze. The spacing between the nulls depends on the IF filter bandwidth, which is adjusted to align with the PRF. Figure 21 illustrates the effects of digital filter nulling. In this example, the PRI is adjusted to 1.767 ms to align with the standard 500 Hz IF filter nulls to demonstrate the nulling effects. In actual narrowband pulse applications the custom IF filter is created to align an arbitrary PRF. The center spectrum is  $-75.15$  dBm at 5 GHz as indicated with marker 1 in the top window. Other pulse spectral components are at the same power level as the center spectrum (marker 2 through 5 in the top window). After the pulsed IF signal goes through the digital filter, the undesired spectral components decrease by about 60 to 70 dB (marker 2 through 5 in the bottom window), while the signal level of the center spectrum is nearly unchanged.

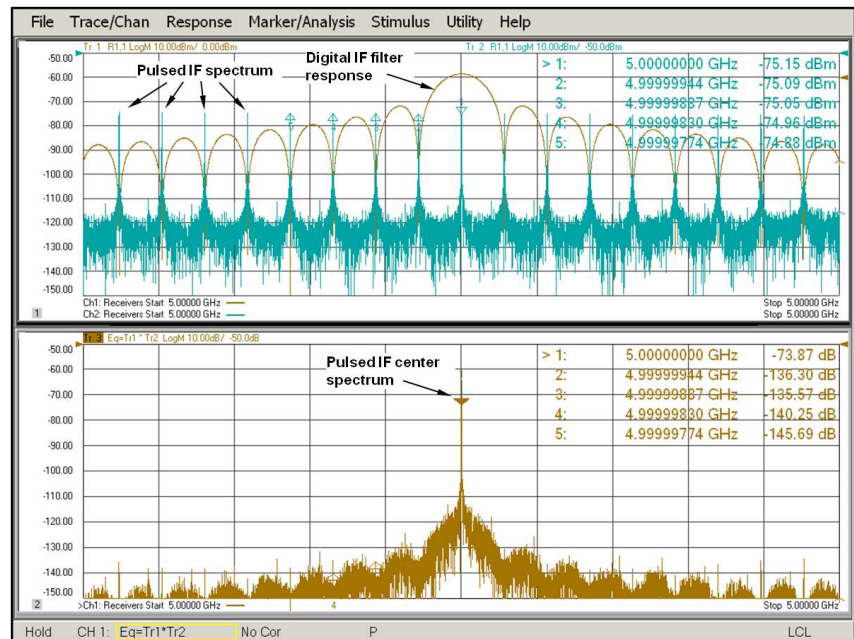

Figure 21. Filter nulling is used to reject undesired pulse spectrum

# Active-Device Measurements with Calibrated Stimulus

Devices that operate under pulsed conditions are often discrete active devices or modules that consist of amplifiers and/or mixers. The performance of these devices is typically power-dependent. Therefore, they are characterized in linear and nonlinear operating conditions. Inaccurate stimulus power may introduce considerable measurement errors. In this section we will discuss source leveling techniques in pulsed measurements that minimize errors caused by inaccurate pulsed-RF stimulus.

## Power leveling modes

The stimulus power of every PNA-X has been calibrated at the factory with continuous-wave (CW) with a default setting to cover the entire frequency range of the analyzer. This allows reasonably accurate stimulus power level at the test ports even without source power calibration. The PNA-X monitors and adjusts the source's automatic level control (ALC) internally to maintain the specified power level. This is called "internal" leveling mode and is used in most measurement setups. However, the internal detectors do not measure correct peak power of the pulsed stimulus resulting in ALC-unleveled errors. For pulsed-RF measurements the internal leveling has to be turned off by changing the leveling mode to "open loop." This prevents the ALC errors but at a cost of source level accuracy. There are three accuracy errors with open loop leveling mode: level offset, sweep-to-sweep, and band-crossing level inconsistency. The level offset and band-crossing level inconsistency are typically within a few dB and they are repeatable. This means that the source power calibration can correct these errors. The power-sensor-loss feature must be used to calibrate the pulsed-RF power, because the average pulse power is lower than the peak pulse power by  $10 \cdot \log(\text{duty cycle})$ ; refer to the next section for how to calibrate pulsed stimulus power. The sweep-to-sweep error is typically very small (typically less than 0.1 dB but it could be larger), appears as a short-term drift which the source power calibration cannot correct. All of these open loop errors can be minimized by using the "receiver" leveling mode, which uses a VNA receiver to monitor the pulsed-RF power and correct the source power level on every measurement sweep. Once receiver leveling is selected, the source level is adjusted with the receiver readings, thus the source power correction coefficients are ignored (source power calibration is not used even if it is turned on). The leveling mode can be setup in Power and Attenuators, and Receiver Leveling Setup dialog boxes as shown in Figure 22.

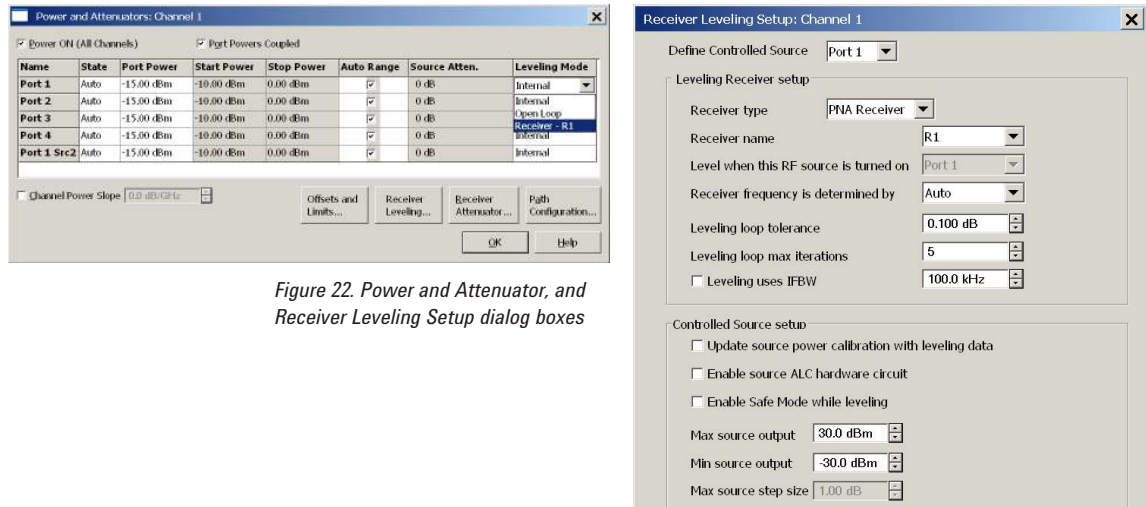

Figure 22. Power and Attenuator, and Receiver Leveling Setup dialog boxes

## Accurate pulsed stimulus using receiver leveling

Reference receivers are typically used for the receiver leveling, although any receiver or a power sensor (if added as a receiver to the PNA-X) can be used. The source level accuracy in receiver leveling mode depends on the receiver's absolute power measurement accuracy, therefore receiver calibration is strongly recommended. There are three ways to calibrate the reference receivers—perform a receiver calibration independently, as a part of a source power calibration, or as a part of a guided S-parameter calibration. When performed independently, the receiver readings are compared to the calibrated source settings (note that an independent receiver calibration requires a calibrated source). Source accuracy and drift introduce additional errors to the receiver calibration. Thus performing receiver calibration either as a part of a source power or S-parameter calibration is recommended. This way the reference receiver readings are compared to the power sensor readings regardless of the source accuracy when the correction coefficients are computed. As a result it transfers the power sensor accuracy to the receiver with minimal errors. The open loop leveling mode must be used during calibration in order to keep the source settings the same between calibration and measurements. The pulse modulation can remain on if sensor loss compensation is used during the calibration. However, a calibration with the pulse modulation off is recommended, because the sensor loss value may add some errors (refer to the next section for more details). Also the receiver setting such as attenuators, IF bandwidth, and gate widths must be the same between the receiver calibration and the pulsed measurements, otherwise, the receiver calibration is turned off and then the source level becomes inaccurate. Once the receiver is successfully calibrated, it accurately measures the peak pulse power in wideband detection, and it adjusts the source power until it's within the specified tolerance or reaches the maximum number of iterations before the measurement sweep.

## Pulsed stimulus power calibration

Although turning off the pulse modulation is recommended during calibration, it may not be possible in some cases such as using a booster amplifier that has a different response between pulsed and non-pulsed signals. In this case, the pulse modulator needs to stay on during calibration. The PNA-X uses power meters only in average power measurement mode, regardless of an average or peak-power sensor. Therefore, under pulsed-RF stimulus, the power meter will read a value that is lower than the peak pulse power (defined as the power during the time the pulse is on) by  $10 \cdot \log(\text{duty cycle})$ . This difference is specified as a sensor loss to avoid the PNA-X's source to go unlevelled as it tries to bring the test port power to the desired level. For example, if the pulse duty cycle is 5%, then the power sensor reading is  $10 \cdot \log(0.05) = -13$  dB lower than the peak pulse power.

Note that the pulse desensitization (power sensor loss value) calculated from pulse duty cycle introduces errors due to the pulse rise and fall time. If the pulse rise and fall time are relatively large compared to the pulse width, the power sensor loss value may need to be adjusted. The PNA-X's internal pulse modulators provide approximately 4 ns pulse rise time and 10 ns fall time. When the pulse width is 1  $\mu$ s and the duty cycle is 1% (100  $\mu$ s PRI), the average power is calculated as 20 dB lower than the pulse peak power. The actual pulsed stimulus adds some RF energy for 14 ns to the ideal pulsed stimulus, which makes the actual duty cycle 1.01% approximately, and the average pulse power is 19.96 dB lower instead of the typical 20 dB. However, if the pulse width is 300 ns and the duty cycle is 1% (30  $\mu$ s PRI), then the duty cycle is approximately 1.033% and the average pulse power is 19.85 dB lower than the peak pulse power.

The following examples show calibration with pulse modulation off.

### Receiver leveling with wideband detection

This section explains the basic steps to setup a leveled pulsed-RF stimulus, make calibrated swept-frequency point-in-pulse S-parameter, and absolute power measurements using wideband detection technique.

### Setting up wideband pulse measurements

First, set up the wideband pulse measurements with the following conditions. It is essential to set up the pulsed stimulus and measurements before performing calibrations so that the calibrations are kept valid in the measurements. In this example, we use a 5 GHz amplifier as a sample DUT.

Frequency range:	2 GHz to 8 GHz	
Source power:	-10 dBm	
Traces:	Tr1 S11, Tr2 S21, Tr3 R1,1, Tr4 B,1	

Setting up wideband pulse measurements

Sweep—Pulse Setup... then enter the following

Pulse Measurement:	Standard Pulse	
Pulse Timing:	Pulse Width:	
Pulse Period:	1 us	100 us
Measurement Timing:	Rcvr A Delay:	300 ns

This modulates the stimulus with 1 us pulse width and 1% duty cycle. Rcvr A delay is set to 300 ns to account for measurement delay (data processing delay, refer to Figure 9 for detailed pulse system timing). Once the setup is completed, the uncorrected input match, gain, input power, and output power are measured using wideband detection in open loop leveling mode as shown in Figure 23. Note that the pulse measurement application selects optimum IF bandwidth and other settings from the specified pulse timing information, and sets the leveling mode to open loop when the pulse modulation is turned on.

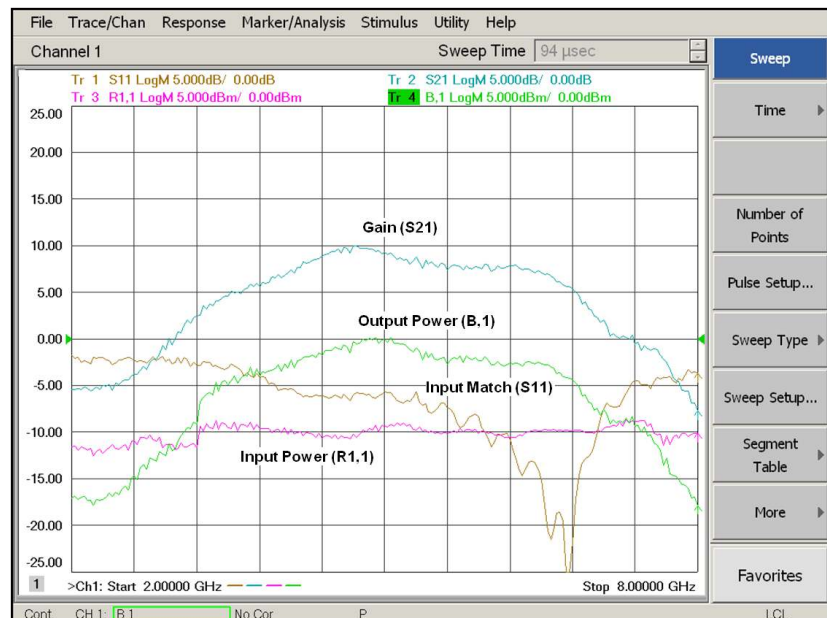

Figure 23. Uncorrected pulsed-RF S-parameters and absolute power measurements using wideband detection

## Performing receiver and S-parameter calibrations

A calibrated receiver enables accurate and leveled pulsed-RF stimulus using receiver leveling mode. In the calibration process, use a power sensor to create source power and receiver calibration coefficients. In order for the power sensor to read correct power levels, the pulse modulation must be turned off. Source power calibration should be part of the calibration process. However, the source power correction is not actually used to level the pulsed-RF stimulus; instead, calibrated R1 receiver readings are used to level the pulsed-RF stimulus. The example below shows measuring the amplifier output powers with the B receiver on port 2. B receiver calibration coefficients are computed from the source power calibration, and transmission tracking and port match coefficients of the S-parameter error correction. Therefore corrected output power measurements can be done without performing B receiver calibration independently.

```

Turn off pulse modulation
  Sweep – Pulse Setup...
  Pulse Gen for Source1: CW – OK
Perform S-parameter, source and receiver calibration
  Cal – Start Cal – Cal Wizard... then follow the wizard
Check “Calibrate source and receiver power” when selecting a calibration type and ports
Switch to receiver leveling
  Power – Power and attenuators... – Port 1 Leveling Mode: Receiver – R1
Turn on pulse modulation
  Sweep – Pulse Setup...
  Pulse Gen for Source1: Pulse – OK
    
```

If a different receiver is shown in the leveling mode pull down menu (Receiver – B, for example), select R1 receiver for port 1 in the Receiver Leveling setup dialog box. The calibration procedure is exactly the same as the CW stimulus procedure. Figure 24 shows the calibrated S-parameter and input/output power measurements under the pulsed-RF stimulus condition. Note that the calibration type annotation shown at the bottom of the screen adds a “Δ” (delta) when you turn on the pulse modulation after the calibration. This indicates that a non-critical stimulus setting was changed after the S-parameter calibration. Turning on pulse modulation causes this indication, which does not affect the S-parameter calibration accuracy.

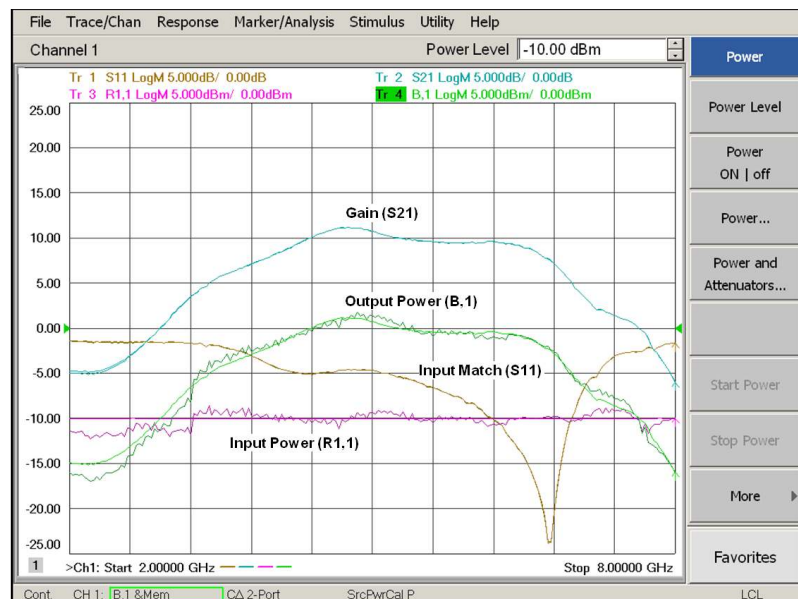

Figure 24. Calibrated wideband pulsed S-parameters and absolute power measurements with a comparison between open loop and receiver leveling modes



## Comparing the results

Figure 24 also shows memory traces comparing the input match, gain, input power, and output power under pulsed conditions with open loop and receiver leveling. The difference is very small in the input match and gain measurements, but it is quite large in the absolute power measurements. If you perform only S-parameter measurements and the DUT is in the linear operation, the open loop leveling is probably acceptable. However, if you measure absolute power and/or power dependent performance such as compression and distortion, the pulsed stimulus power needs to be accurately leveled. With wideband detection, the receivers always measure during the pulses, thus receiver leveling is recommended.

## Receiver leveling with narrowband detection

The PNA-X with DSP version 4 or version 5 must use narrowband detection method for a pulse width narrower than 267 ns or 100 ns respectively. Fortunately, the procedure to level the stimulus with narrowband pulse is exactly the same as the one with wideband pulse—set up pulse measurements, turn off the pulse modulator for calibration, then turn back on the modulator and use a receiver to level the pulsed stimulus. In narrowband pulse, the receiver gates must be placed inside the pulse, otherwise the receivers do not measure pulsed-RF signals. PNA-X firmware sets the receiver gate width one half of the pulse width by default. Receiver gates have internal delay from the pulses that drive the pulse modulator. This may cause the receiver gates to be off the pulse, resulting in noisy measurements. The delay varies by frequency band and frequency model of the PNA-X. It is recommended increasing receiver gate delay by the pulse system timing resolution, 16.7 ns increments with DSP version 4 and 10 ns increments with DSP version 5, to find an optimum delay at a particular measurement setup. This example uses a 50 GHz PNA-X with DSP version 4, with a minimum receiver gate delay of 16.7 ns. Figure 25a through Figure 25c show the S11, S21, input and output powers of the same amplifier used in the previous example at each step. The setup is 100 ns pulse width, 50 ns receiver gate width, 10 us pulse period, 16.7 ns receiver gate delay, and -10 dBm source power.

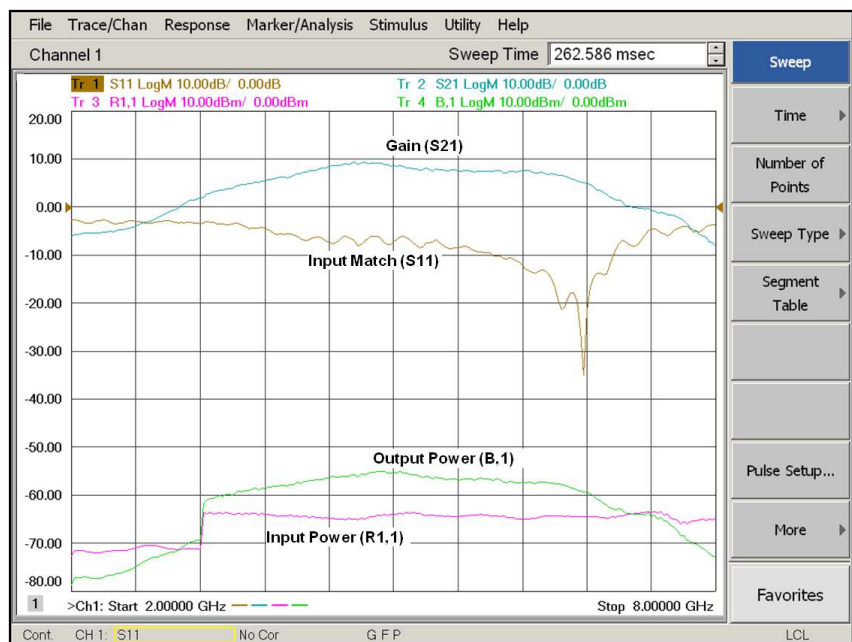

Figure 25a. Uncorrected narrowband pulse measurements

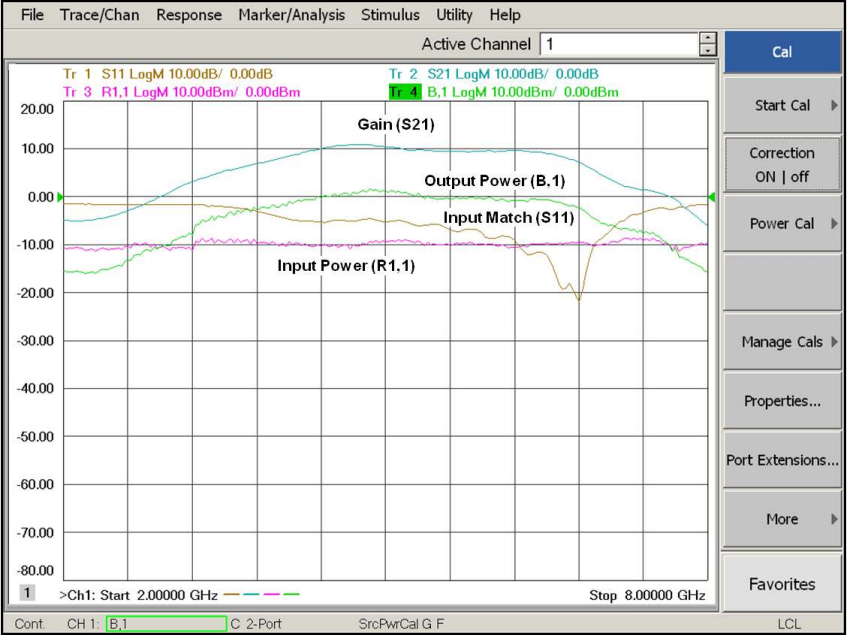

Figure 25b. Measurements after calibration with pulse modulator off

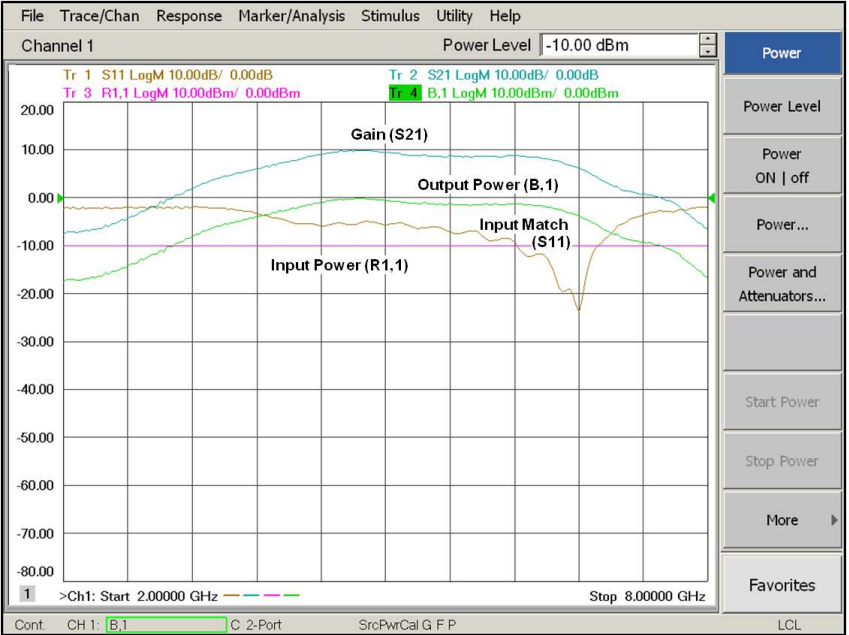

Figure 25c. Corrected pulsed-RF S-parameters and absolute power measurements using narrowband detection

Note that the reference receiver measures the pulsed stimulus power at the set power minus  $20 \cdot \log(\text{receiver gate duty cycle})$  with some additional path loss (Figure 25a). Once the reference receiver is calibrated it reads close to set power at  $-10 \text{ dBm}$  (Figure 25b). Then the pulsed stimulus level is well maintained after turning on the pulse modulation and receiver leveling (Figure 25c).

## Swept-power measurement examples

The setup and calibration processes described in the previous sections can be used for swept-power with either wideband or narrowband pulse measurements. Figure 26 compares the results between open loop and receiver leveling modes in swept-power measurements with the same sample 5 GHz amplifier using wideband detection technique. The following setup is used in this example.

CW Frequency:	5 GHz
Power sweep range:	-25 to +5 dBm
Number of points:	201
IF bandwidth:	5 MHz
PRI:	100 us
Pulse width:	5 us
Pulse delay:	0 s
Measurement delay:	400 ns
Pulse trigger:	Internal
Traces:	Tr1 S11, Tr2 S21, Tr3 R1,1, Tr4 B,1

The input and output power measurements show the differences between the open loop and receiver leveling modes, which are similar to the swept-frequency measurements. However, the gain traces are close with both modes while the amplifier is in linear operation and exhibit differences as the amplifier compresses. This is because the input powers are slightly different between two leveling modes with the same stimulus power settings, resulting in a different gain compression point.

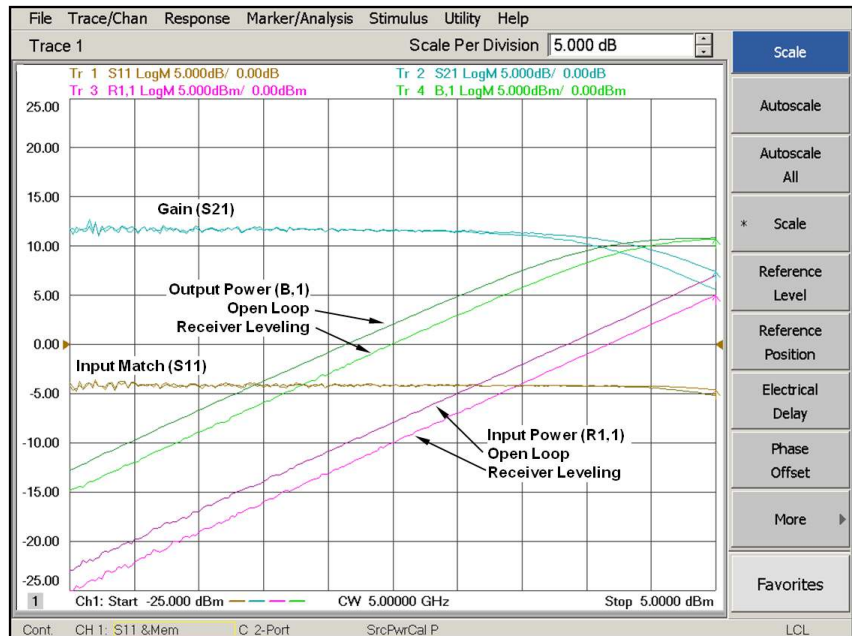

Figure 26. Wideband pulse swept-power measurement comparisons between open loop and receiver leveling modes (calibrated)

## Improving stimulus power level accuracy in pulse profile measurements

In pulse profile measurements, regardless of wideband or narrowband detection techniques, receivers measure signals inside of pulses as well as noise outside of pulses. If receiver leveling is used while the receivers measure noise, the source tries to adjust the source power by referencing the noise measurements causing source unlevelled errors. Alternatively, the analyzer can remember the previous receiver leveling during the stimulus on condition, and use it as source power correction coefficients to improve the level accuracy. Receiver leveling must be turned on once with the pulse modulators turned off. Follow this procedure: turn off the pulse modulator, perform a calibration, switch to the receiver leveling, select "Update source power calibration with leveling data," switch to the Open Loop leveling mode, then turn on the pulse modulator. Once the receiver leveling result is used for source power cal ("Update source power calibration with leveling data" can be found in the "Receiver Leveling" dialog box shown in Figure 22), the pulsed stimulus level becomes reasonably accurate in pulse profile measurements, as shown in Figure 27.

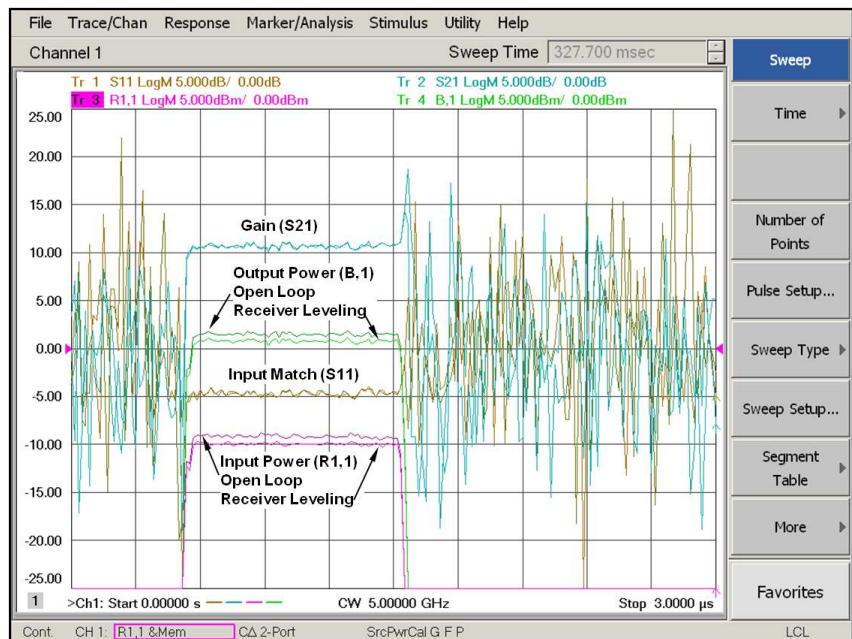

Figure 27. Narrowband pulse profile with "last receiver leveling result" used for source power calibration

## Compression vs. Frequency Measurements in Pulse Mode

Gain Compression (commonly specified as input/output power at 1 dB compression point: IP1dB/OP1dB) is a very popular amplifier characteristic. It is measured and calculated from either swept-power gain (S21) or amplifier output power at a single frequency point. Often this is repeated at many frequency points to characterize the amplifier compression point over its operating frequency range (Figure 28). The PNA-X offers a gain compression application (GCA) option that provides fast and accurate compression measurements versus frequency with a very simple setup. It is important in this measurement that the compression points are calculated from accurate input power with gain or output power measurements. The GCA corrects power/receiver and mismatch errors, providing the highest level of accuracy for compression measurements. When the amplifiers are in pulse mode, these error corrections need to be kept valid in order to take advantage of the accurate measurements with GCA. In this section, we will discuss amplifier's compression versus frequency measurements under pulse operation using the GCA option and wideband detection technique (narrowband pulse is not available in PNA-X application measurement classes). But this technique for setting up a pulsed-RF measurement is also applied to setting up a pulsed-RF mixer/converter compression measurement in a Gain Compression Converters (GCX) measurement class.

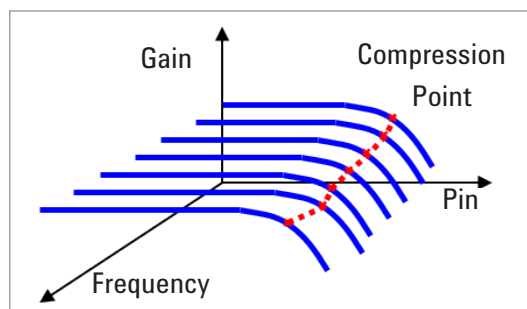

Figure 28. Compression measurements vs. frequency

The measurement setup and calibration procedure is similar to the pulsed S-parameter measurement setup. Measuring stimulus level correctly is crucial for accurate compression measurements, which requires GCA calibration remains enabled with pulsed stimulus. Use receiver leveling to level the pulsed stimulus, then GCA calibration for accurate compression versus frequency measurements. Fortunately, R1 receiver used for the source leveling is calibrated during the GCA calibration (B receiver is calibrated as well); therefore no additional calibration for the receiver leveling is needed. Note, measurements with such wide IF bandwidth become noisy thus adding averaging is recommended. A wider IF bandwidth may cause misalignment between the data acquisition and pulses resulting in a noisy trace. Adding 300 ns or more delay to the Pulse 0 (the pulse for data acquisition) solves this problem as explained earlier in the PNA-X pulse system delay section. Once the GCA and pulse setup is completed, turn off the pulse modulation for calibration. The GCA calibration wizard guides you through the steps based on the measurement setup. Then the pulse modulation drive can be switched back to the pulse generator and the R1 receiver is ready for leveling pulsed stimulus.

In the swept power measurement example shown earlier (Figure 26), found were different input powers at compression points by the leveling mode due to the errors of the input powers. In GCA, the input and output powers at compression point versus frequency also show some difference between the leveling modes. Shown in Figure 29, the maximum difference is about 1 dB.

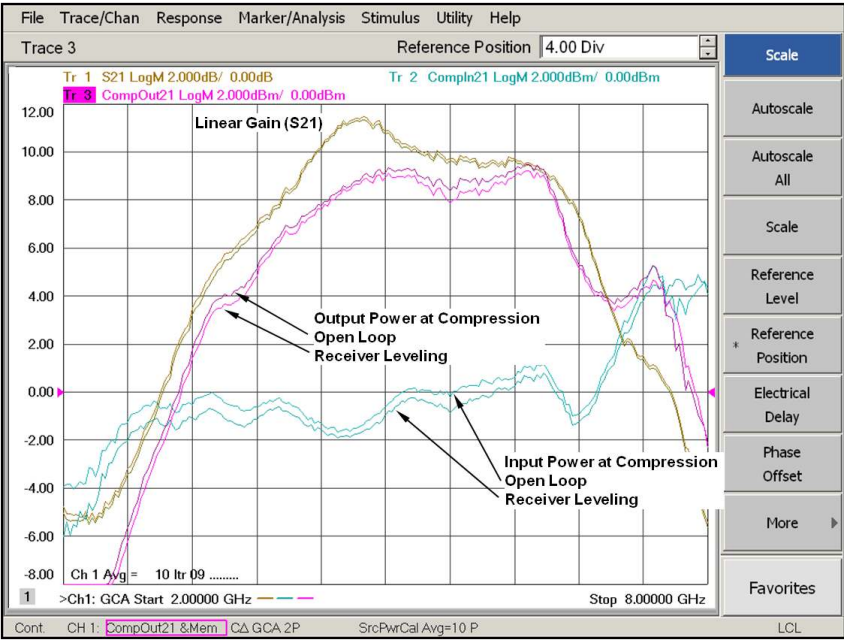

Figure 29. Wideband pulse GCA measurement comparisons between open loop and receiver leveling

## Two-tone IMD measurements in Pulse Mode

The PNA-X employs clean internal sources with high output power, internal combining network, and an optional IMD measurement application that makes two-tone IMD measurements over the frequencies easier and faster. Unlike traditional signal generators and a spectrum analyzer method, the IMD measurements using PNA-X provides single point of setup dialog, guided calibration, and several-tens to one-hundred times improved measurement speed in swept-frequency or swept-power IMD measurements. In this swept IMD measurement, the PNA-X uses its unique narrowband filter path for better signal selectivity. In this section, we will discuss IMD measurements under pulse condition with measurement setup considerations and techniques to overcome measurement problems (narrowband pulse is not available in PNA-X application measurement classes).

There is a fundamental setup conflict between typical IMD measurements and wideband pulse measurements, when made together. The wideband pulse measurements use relatively wide IF bandwidth (to narrow the data acquisition window), while IMD measurements in general use narrow IF bandwidth to accurately measure low level distortion products. The following are some considerations in IMD measurement setups under pulse operation.

### Tone spacing versus IF bandwidth

The spacing between two main tones should be approximately more than 10 times wider than the IF bandwidth. If narrower tone spacing is required, the IF bandwidth must be reduced to avoid signal interference (seen as ripples on the traces) thus requires wider pulse width.

### Use standard IF filter path

The IMD application automatically switches to the narrowband IF filter path, where the IF signal is filtered with the high-Q crystal filter with 30 kHz bandwidth. This filter prevents capturing the whole spectrum of pulsed-RF signal. It must be switched to standard IF path when IF bandwidths greater than 30 kHz are used.

### Disable “Reduce IFBW at Low Frequencies”

The PNA-X uses narrow IF bandwidth to reduce trace noise at low frequencies by default. The frequency and the IF bandwidth reduction ratio depend on the frequency models. It is recommended that this capability is always turned off when making IMD measurements under pulsed operation.

### Use sweep averaging to reduce noise

IMD measurements become noisier with wide IF bandwidths, so sweep averaging is recommended to reduce the noise.



The IMD calibration includes R1 receiver calibration, source 1 and source 2 power calibration, and B receiver calibration when port 1 for the DUT input and port 2 for the DUT output are selected. If 2-port error correction is used during an IMD calibration, the power sensor mismatch during R1 receiver calibration is corrected and the transmission response term is used to transfer the R1 receiver calibration to the B receiver. IMD calibration without 2-port calibration ignores the power sensor mismatches during R1 receiver calibration and uses a response calibration to transfer to the B receiver. Calibrating at all receiver frequencies is recommended for wide tone spacing; otherwise it can be at only the center frequency of each stimulus setup. Often recommended in wideband pulse measurements, is to calibrate all frequencies due to the fact that wider IF bandwidth requires wider tone spacing, easily wider than 1 MHz or often several megahertz. The frequency responses of the receivers at each tone frequency can be different from the center frequency with wide tone spacing. The pulse modulation must switch to CW before the swept IMD calibration. Note that both f1 (port 1) and f2 (port 1 source 2) source leveling mode must be changed to receiver leveling in Swept IMD Measurement class.

Figure 30a and 30b show the measurement example of wideband pulse swept-frequency IMD with open loop and receiver leveling respectively. The 12 us pulse width is selected based on the minimum pulse width for 100 kHz IF bandwidth shown in Table 1. With open loop leveling mode the input powers are inconsistent across the frequency range and a few dB off from the set power level, which can be corrected with receiver leveling mode.

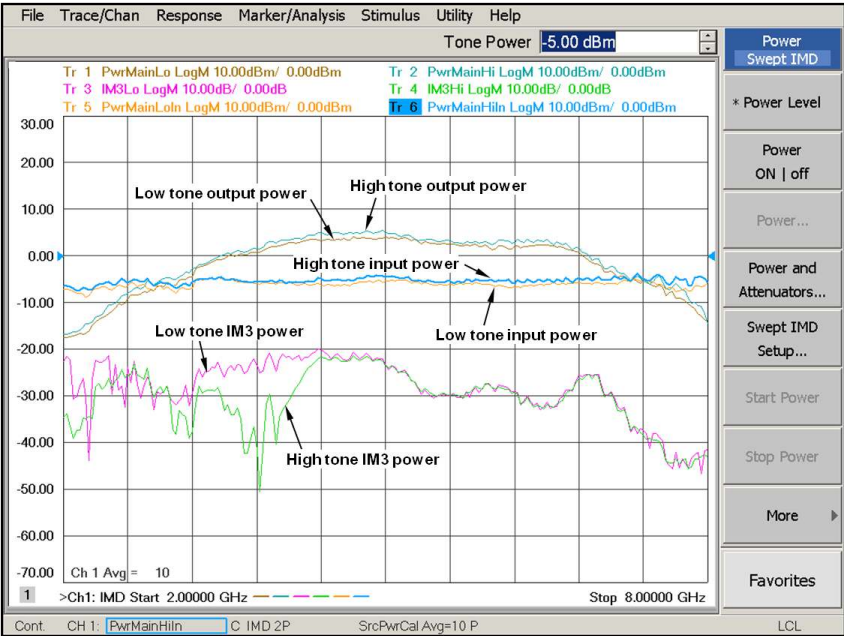

Figure 30a. Wideband pulse swept-frequency IMD measurements with open loop leveling



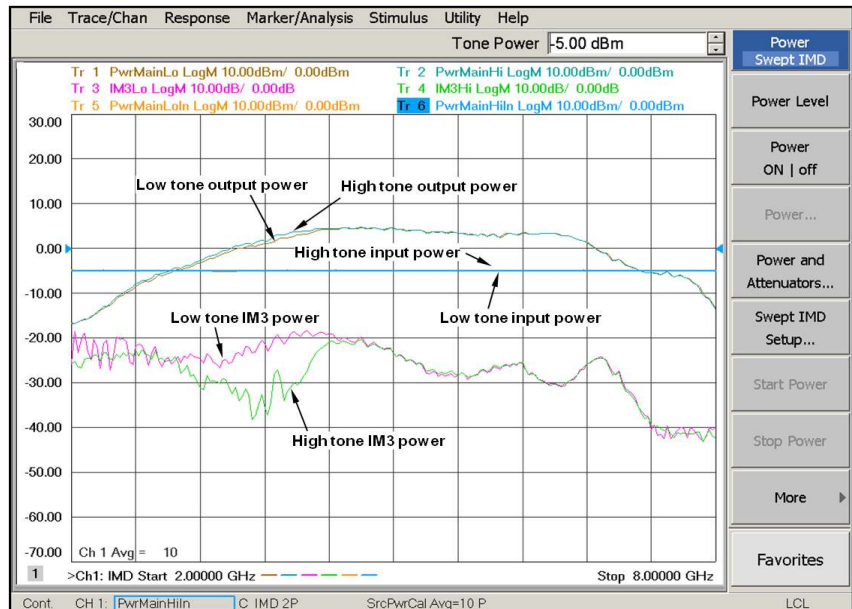

Figure 30b. Wideband pulse swept-frequency IMD measurements with receiver leveling

Figure 30c shows swept-power IMD measurements with the same pulse setup as above and compares open loop and receiver leveling modes. Although IM3 traces show a few dB difference, both input and output referred IP3 are very close to each other. This is because the difference of IM products is translated to smaller changes of IP3 from the following IP3 formula.

$$IP3 = \frac{1}{2}(3 \cdot P_{\text{main}} - P_{\text{im3}})$$

where,  $P_{\text{main}}$  is main tone power and  $P_{\text{im3}}$  is IM3 power

If IP3 is a main interest or stimulus power and IM levels are not as important as IP3, open loop leveling mode may be acceptable.

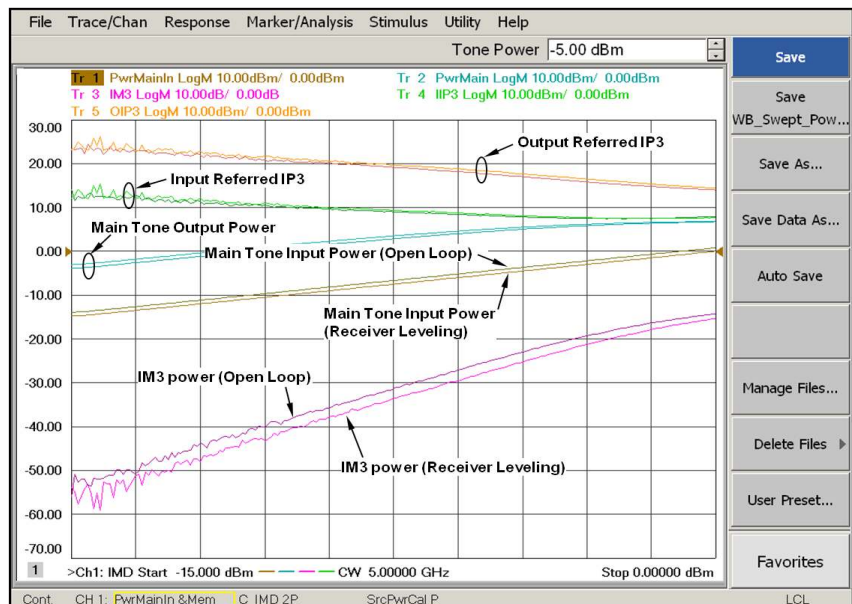

Figure 30c. Wideband pulse swept-power IMD measurement comparisons between open loop and receiver leveling

**myKeysight**

myKeysight

[www.keysight.com/find/mykeysight](http://www.keysight.com/find/mykeysight)

A personalized view into the information most relevant to you.



[www.lxistandard.org](http://www.lxistandard.org)

LAN eXtensions for Instruments puts the power of Ethernet and the Web inside your test systems. Keysight is a founding member of the LXI consortium.



**Three-Year Warranty**

[www.keysight.com/find/ThreeYearWarranty](http://www.keysight.com/find/ThreeYearWarranty)

Keysight's commitment to superior product quality and lower total cost of ownership. The only test and measurement company with three-year warranty standard on all instruments, worldwide.



**Keysight Assurance Plans**

[www.keysight.com/find/AssurancePlans](http://www.keysight.com/find/AssurancePlans)

Up to five years of protection and no budgetary surprises to ensure your instruments are operating to specification so you can rely on accurate measurements.



[www.keysight.com/go/quality](http://www.keysight.com/go/quality)

Keysight Technologies, Inc.  
DEKRA Certified ISO 9001:2008  
Quality Management System

**Keysight Channel Partners**

[www.keysight.com/find/channelpartners](http://www.keysight.com/find/channelpartners)

Get the best of both worlds: Keysight's measurement expertise and product breadth, combined with channel partner convenience.

[www.keysight.com/find/pna](http://www.keysight.com/find/pna)

## Additional Resources

### Application note

*Pulsed-RF S-Parameter Measurements Using Wideband and Narrowband Detection* AN 1408-12, literature number 5989-4839EN

### Web

More information about the PNA-X, including pulsed-RF measurement option can be found at: [www.keysight.com/find/pnax](http://www.keysight.com/find/pnax)

Keysight pulsed-RF signal generation, power/spectrum/network measurements can be found at: [www.keysight.com/find/pulsedrf](http://www.keysight.com/find/pulsedrf)

For more information on Keysight Technologies' products, applications or services, please contact your local Keysight office. The complete list is available at: [www.keysight.com/find/contactus](http://www.keysight.com/find/contactus)

### Americas

Canada	(877) 894 4414
Brazil	55 11 3351 7010
Mexico	001 800 254 2440
United States	(800) 829 4444

### Asia Pacific

Australia	1 800 629 485
China	800 810 0189
Hong Kong	800 938 693
India	1 800 112 929
Japan	0120 (421) 345
Korea	080 769 0800
Malaysia	1 800 888 848
Singapore	1 800 375 8100
Taiwan	0800 047 866
Other AP Countries	(65) 6375 8100

### Europe & Middle East

Austria	0800 001122
Belgium	0800 58580
Finland	0800 523252
France	0805 980333
Germany	0800 6270999
Ireland	1800 832700
Israel	1 809 343051
Italy	800 599100
Luxembourg	+32 800 58580
Netherlands	0800 0233200
Russia	8800 5009286
Spain	800 000154
Sweden	0200 882255
Switzerland	0800 805353
	Opt. 1 (DE)
	Opt. 2 (FR)
	Opt. 3 (IT)
United Kingdom	0800 0260637

For other unlisted countries:  
[www.keysight.com/find/contactus](http://www.keysight.com/find/contactus)  
(BP-09-23-14)

Formerly known as Application Note 1408-21